

BEFORE THE  
FEDERAL ENERGY REGULATORY COMMISSION  
APPLICATION FOR LICENSE FOR MAJOR PROJECT  
**SUSITNA HYDROELECTRIC PROJECT**

VOLUME 2

EXHIBIT B

FEBRUARY 1983

Prepared by:



ALASKA POWER AUTHORITY

SUSITNA HYDROELECTRIC PROJECT  
FERC LICENSE APPLICATION  
PROJECT NO. 7114-000  
As accepted by FERC, July, 27, 1983

343

TK  
1425  
.58  
F471  
no. 124

BEFORE THE  
FEDERAL ENERGY REGULATORY COMMISSION  
APPLICATION FOR LICENSE FOR MAJOR PROJECT  
SUSITNA HYDROELECTRIC PROJECT

**VOLUME 2**

**ARLIS**  
Alaska Resources  
Library & Information Services  
Anchorage, Alaska

**EXHIBIT B**  
CHAPTER 1-4  
**JULY 1983**

**ALASKA POWER AUTHORITY**

SUSITNA HYDROELECTRIC PROJECT

VOLUME 2

EXHIBIT B

STATEMENT OF PROJECT OPERATION  
AND RESOURCE UTILIZATION

SUSITNA HYDROELECTRIC PROJECT

VOLUME 2

EXHIBIT B

STATEMENT OF PROJECT OPERATION AND RESOURCE UTILIZATION

TABLE OF CONTENTS

	<u>Page</u>
1 - DAMSITE SELECTION .....	B-1-1
1.1 - Previous Studies .....	B-1-1
(a) Early Studies of Hydroelectric Potential .....	B-1-1
(b) U.S. Bureau of Reclamation - 1953 Study .....	B-1-2
(c) U.S. Bureau of Reclamation - 1961 Study .....	B-1-2
(d) Alaska Power Administration - 1974 Study .....	B-1-3
(e) Kaiser Proposal for Development .....	B-1-3
(f) U.S. Army Corps Engineers - 1975 and 1979 Studies .....	B-1-3
1.2 - Plan Formulation and Selection Methodology .....	B-1-4
1.3 - Damsite Selection .....	B-1-5
(a) Site Screening .....	B-1-6
(b) Engineering Layouts .....	B-1-7
(c) Capital Costs .....	B-1-11
1.4 - Formulation of Susitna Basin Development Plans .....	B-1-11
(a) Tunnel Alternatives .....	B-1-13
(b) Additional Basin Development Plan .....	B-1-14
(c) Selected Basin Development Plans .....	B-1-14
1.5 - Evaluation of Basin Development Plans .....	B-1-16
(a) Evaluation Methodology .....	B-1-16
(b) Evaluation Criteria .....	B-1-21
(c) Results of Evaluation Process .....	B-1-22
1.6 - Preferred Susitna Basin Development Plan .....	B-1-26
2 - ALTERNATIVE FACILITY DESIGN, PROCESSES AND OPERATIONS .....	B-2-1
2.1 - Susitna Hydroelectric Development .....	B-2-1
2.2 - Watana Project Formulation .....	B-2-1
(a) Selection of Reservoir Level .....	B-2-2
(b) Selection of Installed Capacity .....	B-2-6
(c) Selection of Spillway Design Flood .....	B-2-8
(d) Main Dam Alternatives .....	B-2-10
(e) Diversion Scheme Alternatives .....	B-2-14
(f) Spillway Facilities Alternatives .....	B-2-18
(g) Power Facilities Alternatives .....	B-2-19
2.3 - Selection of Watana General Arrangement .....	B-2-23
(a) Selection Methodology .....	B-2-23
(b) Design Data and Criteria .....	B-2-25
(c) Evaluation Criteria .....	B-2-25
(d) Preliminary Review .....	B-2-25
(e) Intermediate Review .....	B-2-31
(f) Final Review .....	B-2-36



TABLE OF CONTENTS (Continued)

	<u>Page</u>
2.4 - Devil Canyon Project Formulation .....	B-2-42
(a) Selection of Reservoir Level .....	B-2-43
(b) Selection of Installed Capacity .....	B-2-43
(c) Selection of Spillway Capacity .....	B-2-44
(d) Main Dam Alternatives .....	B-2-45
(e) Diversion Scheme Alternatives .....	B-2-49
(f) Spillway Alternatives .....	B-2-51
(g) Power Facilities Alternatives .....	B-2-52
2.5 - Selection of Devil Canyon General Arrangement .....	B-2-54
(a) Selection Methodology .....	B-2-54
(b) Design Data Criteria .....	B-2-54
(c) Preliminary Review .....	B-2-54
(d) Final Review .....	B-2-59
2.6 - Selection of Access Road Corridor .....	B-2-60
(a) Previous Studies .....	B-2-60
(b) Selection Process Constraints .....	B-2-61
(c) Corridor Identification and Selection .....	B-2-61
(d) Development of Plans .....	B-2-62
(e) Evaluation of Plans .....	B-2-62
(f) Comparison of the Selected Alternative Plans .....	B-2-65
(g) Summary .....	B-2-73
(h) Final Selection of Plan .....	B-2-73
2.7 - Selection of Transmission Facilities .....	B-2-76
(a) Electric System Studies .....	B-2-76
(b) Corridor Selection .....	B-2-83
(c) Corridor Screening .....	B-2-94
(d) Selected Corridor .....	B-2-103
(e) Route Selection .....	B-2-110
(f) Towers, Foundations and Conductors .....	B-2-116
2.8 - Selection of Project Operation .....	B-2-121
(a) Pre-Project Flows .....	B-2-125
(b) Range of Post-Project Flows .....	B-2-125
(c) Timing of Flow Releases .....	B-2-125
(d) Maximum Drawdown .....	B-2-126
(e) Energy Production .....	B-2-126
(f) Net Benefits .....	B-2-127
(g) Operational Flow Scenario Selection .....	B-2-127
(h) Instream Flow and Fishery Impact on Flow Selection .....	B-2-128
3 - DESCRIPTION OF PROJECT OPERATION .....	B-3-1
3.1 - Operation within Railbelt Power System .....	B-3-1
3.2 - Plant and System Operation Requirements .....	B-3-2
3.3 - General Power Plant and System Railbelt Criteria .....	B-3-2
(a) Installed Generating Capacity .....	B-3-2
(b) Transmission System Capability .....	B-3-3
(c) Summary .....	B-3-6

TABLE OF CONTENTS (Continued)

	<u>Page</u>
3.4 - Economic Dispatch of Units .....	B-3-6
(a) Merit-Order Schedule .....	B-3-7
(b) Optimum Load Dispatching .....	B-3-7
(c) Operating Limits of Units .....	B-3-8
(d) Optimum Maintenance Program .....	B-3-8
3.5 - Unit Operation Reliability Criteria .....	B-3-9
(a) Power System Analyses .....	B-3-9
(b) System Response and Load-Frequency Control .....	B-3-9
(c) Protective Relaying System and Devices .....	B-3-9
3.6 - Dispatch Control Centers .....	B-3-10
3.7 - Susitna Project Operation .....	B-3-11
4 - DEPENDABLE CAPACITY AND ENERGY PRODUCTION .....	B-4-1
4.1 - Hydrology .....	B-4-1
(a) Historical Streamflow Records .....	B-4-1
(b) Water Resources .....	B-4-1
(c) Streamflow Extension .....	B-4-2
(d) Floods .....	B-4-2
(e) Flow Adjustments .....	B-4-3
4.2 - Reservoir Data .....	B-4-4
(a) Reservoir Storage .....	B-4-4
(b) Rule Curves .....	B-4-4
Operating Capabilities of Susitna Units .....	B-4-5
4.3 - (a) Watana .....	B-4-5
(b) Devil Canyon .....	B-4-6
(c) Dependable Capacity and Energy Production.....	B-4-7
4.4 - Tailwater Rating Curve .....	B-4-8

## LIST OF TABLES

<u>Number</u>	<u>Title</u>
B.0	Alaska Power Authority, Resource Agency Consultation Correspondence and Meeting Log Concerning Aquatic and Fisheries Resources, 1980 Through 1983.
B.1	Potential Hydroelectric Development
B.2	Cost Comparisons
B.3	Dam Crest and Full Supply Levels
B.4	Capital Cost Estimate Summaries - Susitna Basin Dam Schemes - Cost in \$ Million 1980
B.5	Results of Screening Model
B.6	Information on the Devil Canyon Dam and Tunnel Schemes
B.7	Devil Canyon Tunnel Schemes - Costs, Power Output and Average Annual Energy
B.8	Capital Cost Estimate Summaries - Tunnel Schemes - Costs in \$ Million 1980
B.9	Susitna Development Plans
B.10	Susitna Environmental Development Plans
B.11	Results of Economic Analyses of Susitna Plans - Medium Load Forecast
B.12	Results of Economic Analyses of Susitna Plans - Low and High Load Forecast
B.13	Annual Fixed Carrying Charges
B.14	Summary of Thermal Generating Resource Plant Parameters
B.15	Economic Backup Data for Evaluation of Plans
B.16	Economic Evaluation of Devil Canyon Dam and Tunnel Schemes and Watana/Devil Canyon and High Devil Canyon/Vee Plans
B.17	Environmental Evaluation of Devil Canyon Dam and Tunnel Schemes
B.18	Social Evaluation of Susitna Basin Development Schemes/Plans

LIST OF TABLES (Continued)

<u>Number</u>	<u>Title</u>
B.19	Energy Contribution Evaluation of the Devil Canyon Dam and Tunnel Schemes
B.20	Overall Evaluation of Tunnel Scheme and Devil Canyon Dam Scheme
B.21	Environmental Evaluation of Watana/Devil Canyon and High Devil Canyon/Vee Development Plans
B.22	Energy Contribution Evaluation of the Watana/Devil Canyon and High Devil Canyon/Vee Plans
B.23	Overall Evaluation of the High Devil Canyon/Vee and Watana/Devil Canyon Dam Plans
B.24	Combined Watana and Devil Canyon Operation
B.25	Present Worth of Production Costs
B.26	Design Parameters for Dependable Capacity and Energy Production
B.27	Watana - Maximum Capacity Required (MW) - Option 1 - Thermal as Base
B.28	Watana - Maximum Capacity Required (MW) - Option 2 - Thermal as Peak
B.29	Summary Comparison of Powerhouses at Watana
B.30	Design Data and Design Criteria for Final Review of Layouts
B.31	Evaluation Criteria
B.32	Summary of Comparative Cost Estimates
B.33	Devil Canyon - Maximum Capacity Required (MW)

LIST OF TABLES (Continued)

<u>Number</u>	<u>Title</u>
B.34	Design Data and Design Criteria for Review of Alternative Layouts
B.35	Summary of Comparative Cost Estimates
B.36	Power Transfer Requirements (MW)
B.37	Summary of Life Cycle Costs
B.38	Technical, Economic, and Environmental Criteria Used in Corridor Selection
B.39	Environmental Inventory - Southern Study Area
B.40	Environmental Inventory - Central Study Area
B.41	Environmental Inventory - Northern Study Area
B.42	Soil Associations Within the Proposed Transmission Corridors - General Description, Offroad Trafficability, Limitations (ORTL), and Common Crop Suitability (CCS)
B.43	Definitions for Offroad Trafficability Limitations and Common Crop Suitability of Soil Associations
B.44	Economical and Technical Screening - Southern Study Area
B.45	Economical and Technical Screening - Central Study Area
B.46	Economical and Technical Screening - Northern Study Area
B.47	Summary of Screening Results
B.48	Environmental Constraints - Southern Study Area
B.49	Environmental Constraints - Central Study Area
B.50	Environmental Constraints - Northern Study Area
B.51	Technical, Economic and Environmental Criteria Used in Corridor Screening
B.52	Pre-project Flow at Watana
B.53	Pre-project Flow at Devil Canyon

LIST OF TABLES (Continued)

<u>Number</u>	<u>Title</u>
B.54	Monthly Flow Requirements at Gold Creek
B.55	Energy Potential of the Watana Development for Different Downstream Flow Requirements
B.56	Energy Potential of Watana - Devil Canyon Developments for Different Downstream Flow Requirements
B.57	Net Benefits for Susitna Hydroelectric Project Operating Scenarios
B.58	System Generation Reserve
B.59	Transmission System Performance Under Double Contingency
B.60	Average Annual and Monthly Flow at Gage in the Susitna Basin
B.61	Peak Flows of Record
B.62	Estimated Flood Peaks in Susitna River
B.63	Watana Flood Routing-Maximum Flows (cfs)
B.64	Estimated Evaporation Losses - Watana and Devil Canyon Reservoirs
B.65	Flow Release at Watana for Watana Only
B.66	Flow Release at Devil Canyon for Watana/Devil Canyon
B.67	Water Appropriations Within One Mile of the Susitna River
B.68	Turbine Operating Conditions
B.69	Total 1981 Alaska Energy Consumption
B.70	Railbelt 1981 Energy Consumption By Fuel Type For Each Sector
B.71	Installed Capacity of the Anchorage-Cook Inlet Area

LIST OF TABLES (Continued)

<u>Number</u>	<u>Title</u>
B.72	Installed Capacity of the Fairbanks-Tanana Valley Area
B.73	Generating Plants of the Railbelt Region
B.74	Monthly Distribution of Peak and Energy Demand
B.75	Projected Monthly Distribution of Peak and Energy Demand
B.76	Typical Daily Load Duration
B.77	Load Diversity in the Railbelt
B.78	Residential and Commercial Electric Rates - Anchorage-Cook Inlet Area, March 1983
B.79	Residential and Commercial Electric Rates - Fairbanks-Tanana Area, March 1983
B.80	Anchorage Municipal Light and Power, Cumulative Energy Conservation Projections
B.81	Programmatic Versus Market Driven Energy Conservation Projections in AMLP's Service Area
B.82	Average Annual Electricity Consumption Per Household On the GVEA System 1972-1982
B.83	Historic Economic and Electric Power Data 1960-1982
B.84	Monthly Load Data from Electric Utilities of the Anchorage-Cook Inlet Area 1976-1982
B.85	Monthly Load Data from Electric Utilities of the Fairbanks-Tanana Valley Area 1976-1982
B.86	Net Electric Power Generation By Electric Utilities 1976-1982
B.87	Simulation of Historical Economic Conditions
B.88	Comparison of Actual and Predicted Electricity Consumption
B.89	Alternative Petroleum Price Projections 1983-2010
B.90	Level of Analysis Employed with World Oil Forecasts
B.91	Variables and Assumptions (PETREV Model)

LIST OF TABLES (Continued)

<u>Number</u>	<u>Title</u>
B.92	Variableness and Assumptions - MAP Model
B.93	Summary of Exogenous Economic Assumptions
B.94	Variables and Assumptions - RED Model
B.95	Fuel Price Forecasts Used by RED
B.96	Housing Demand Coefficients
B.97	Example of Market Saturations of Appliances in Single Family Homes for Anchorage-Cook Inlet Area
B.98	Parameter Values in RED Price Adjustment Mechanism
B.99	Percentage of Appliances Using Electricity and Averaged Annual Electricity Consumption, Railbelt Load Centers
B.100	Growth Rates in Electric Appliance Capacity and Initial Annual Average Consumption for New Appliances
B.101	Percent of Appliances Remaining in Service Years after Purchase
B.102	Variables and Assumptions - OGP Model
B.103	Reference Case Forecast - Summary of Input and Output Data
B.104	Reference Case Forecast - State Petroleum Revenues
B.105	Reference Case Forecast - State Government Fiscal Conditions
B.106	Reference Case Forecast - Population
B.107	Reference Case Forecast - Employment
B.108	Reference Case Forecast - Households
B.109	Reference Case Forecast - Number of Households
B.110	Reference Case Forecast - Number of Vacant Households
B.111	Reference Case Forecast - Residential Use Per Household
B.112	Reference Case Forecast - Business Use Per Employee



LIST OF TABLES (Continued )

<u>Number</u>	<u>Title</u>
B.113	Reference Case Forecast - Summary of Price Effects and Programmatic Conservation - Anchorage-Cook Inlet Area
B.114	Breakdown of Electricity Requirements - Anchorage-Cook Inlet Area.
B.115	Reference Case Forecast - Summary of Price Effects and Programmatic Conservation - Fairbanks-Tanana Valley Area
B.116	Reference Case Forecast - Breakdown of Electricity Requirements - Fairbanks-Tanana Valley Area
B.117	Reference Case Forecast - Projected Peak and Energy Demand
B.118	Department of Revenue, Mean -Summary of Input and Output Data
B.119	Department of Revenue, 50% -Summary of Input and Output Data
B.120	Department of Revenue, 30% -Summary of Input and Output Data
B.121	Data Resources Inc. -Summary of Input and Output Data
B.122	FERC +2% -Summary of Input and Output Data
B.123	FERC 0% -Summary of Input and Output Data
B.124	FERC -1% -Summary of Input and Output Data
B.125	FERC -2% -Summary of Input and Output Data

LIST OF TABLES (Continued )

<u>Number</u>	<u>Title</u>
B.126	Results of MAP Model Sensitivity Tests
B.127	Results of RED Model Sensitivity Tests
B.128	Results of RED Model Sensitivity Tests
B.129	Results of RED Model Sensitivity Tests
B.130	Results of RED Model Sensitivity Tests
B.131	Results of RED Model Sensitivity Tests
B.132	List of Previous Forecasts

## LIST OF FIGURES

<u>Number</u>	<u>Title</u>
B.1	Location Map
B.2	Damsites Proposed by Others
B.3	Susitna Basin Plan Formulation and Selection Process
B.4	Profile Through Alternative Sites
B.5	Mutually Exclusive Development Alternatives
B.6	Devil Canyon Hydro Development Fill Dam
B.7	Watana Hydro Development Fill Dam
B.8	Watana Staged Fill Dam
B.9	High Devil Canyon Hydro Development
B.10	Susitna III Hydro Development
B.11	Vee Hydro Development
B.12	Denali and MacLaren Hydro Developments
B.13	Schematic Representation of Conceptual Tunnel Schemes
B.14	Preferred Tunnel Scheme 3 Plan View
B.15	Preferred Tunnel Scheme 3 Sections
B.16	Generation Scenario with Susitna Plan E1.3
B.17	Generation Scenario with Susitna Plan E2.3
B.18	Generation Scenario with Susitna Plan E3.1
B.19	Watana Reservoir - Dam Crest Elevation/Present Worth of Production Costs
B.20	Watana - Arch Dam Alternative
B.21	Watana - Alternative Dam Axes
B.22	Watana Diversion - Headwater Elevation/Tunnel Diameter
B.23	Watana Diversion - Upstream Cofferdam Costs

LIST OF FIGURES (continued)

<u>Number</u>	<u>Title</u>
B.24	Watana Diversion - Tunnel Cost/Tunnel Diameter
B.25	Watana Diversion - Total Cost/Tunnel Diameter
B.26	Watana - Preliminary Schemes
B.27	Watana - Scheme WP1 Plan
B.28	Watana - Scheme WP3 Sections
B.29	Watana - Scheme WP2 and WP 3
B.30	Watana - Scheme WP2 Sections
B.31	Watana - Scheme WP4 Plan
B.32	Watana - Scheme WP4 Sections
B.33	Watana - Scheme WP3A
B.34	Watana - Scheme WP4A
B.35	Devil Canyon Diversion - Headwater Elevation/Tunnel Diameter
B.36	Devil Canyon Diversion - Total Cost/Tunnel Diameter
B.37	Devil Canyon - Scheme DC1
B.38	Devil Canyon - Scheme DC2
B.39	Devil Canyon - Scheme DC3
B.40	Devil Canyon - Scheme DC4
B.41	Devil Canyon - Selected Scheme
B.42	Alternative Access Corridors
B.43	Access Plan 13 (North)
B.44	Access Plan 16 (South)
B.45	Access Plan 18 (Proposed)
B.46	Schedule for Access and Diversion

LIST OF FIGURES (Continued)

<u>Number</u>	<u>Title</u>
B.47	Alternative Transmission Line Corridors - Southern Study Area
B.48	Alternative Transmission Line Corridors - Central Study Area
B.49	Alternative Transmission Line Corridors - Northern Study Area
B.50	Recommended Transmission Line Corridor - Southern Study Area
B.51	Recommended Transmission Line Corridor - Southern Study Area
B.52	Recommended Transmission Line Corridor - Central Study Area
B.53	Recommended Transmission Line Corridor - Central Study Area
B.54	Recommended Transmission Line Corridor - Northern Study Area
B.55	Recommended Transmission Line Corridor - Northern Study Area
B.56	Recommended Transmission Line Corridor - Northern Study Area
B.57	Recommended Transmission Line Corridor - Northern Study Area
B.57A	Transmission Reliability Studies
B.58	Typical Load Variation in Alaska Railbelt System
B.59	Data Collection Stations
B.60	Average Annual Flow Distribution Within the Susitna River Basin
B.61	Monthly Average Flows in the Susitna River at Gold Gulch
B.62	Flow Duration Curve Mean Monthly Inflow at Watana Pre-Project

LIST OF FIGURES (continued)

<u>Number</u>	<u>Title</u>
B.63	Flow Duration Curve Mean Monthly Inflow at Devil Canyon Pre-Project
B.64	Frequency Analysis of Average Annual Energy for Susitna Development
B.65	Watana Hydrological Data - Sheet 1
B.66	Devil Canyon Hydrological Data - Sheet 1
B.67	Watana Hydrological Data - Sheet 2
B.68	Devil Canyon Hydrological Data - Sheet 2
B.69	Monthly Target Minimum Reservoir Levels
B.70	Watana - Unit Output
B.71	Watana - Turbine Performance (at Rated Head)
B.72	Watana - Unit Efficiency (at Rated Head)
B.73	Devil Canyon - Unit Output
B.74	Devil Canyon - Turbine Performance (at Rated Head)
B.75	Devil Canyon - Unit Efficiency (at Rated Head)
B.76	Dependable Capacity
B.77	Railbelt Area of Alaska Showing Electrical Load Centers
B.78	Location Map Showing Transmission Systems
B.79	Monthly Load Variation for Railbelt Area
B.80	Daily Load Curves - 1982
B.81	Historical Population Growth 1960-1980
B.82	Historical Growth in Net Generation 1960-1980
B.83	Relationship of Planning Models and Input Data
B.84	MAP Model System Flow Chart

LIST OF FIGURES (Continued)

<u>Number</u>	<u>Title</u>
B.85	MAP Economic Sub-Model Flow Chart
B.86	MAP Regionalization Sub-Model Flowchart
B.87	RED Information Flow
B.88	RED Uncertainty Module
B.89	RED Housing Module
B.90	RED Residential Consumption Module
B.91	RED Business Consumption Module
B.92	RED Program Induced Conservaton Module
B.93	RED Miscellaneous Consumption Module
B.94	RED Peak Demand Module
B.95	Optimization Generation Planning (OGP) Model Information Flows
B.96	OGP - Example of Conventional Hydro Operations
B.97	Data Resources Inc. - U.S. Oil Outlook, Crude Oil Prices and Production
B.98	Free World Petroleum - and Broad Sources of Supply -SHCA
B.99	Alternative Oil Price Projections
B.100	Alternative State General Fund Expenditure Forecasts
B.101	Alternative Railbelt Population Forecasts
B.102	Alternative Railbelt Households Forecasts
B.103	Alternative Electric Energy Demand Forecasts
B.104	Alternative Electric Peak Demand Forecasts

Note: Figures B.76-B.80 in the February 1983 License Application are replaced by new Figures B.77 through B.104 contained in Volume 2A.

1 - DAMSITE SELECTION



## EXHIBIT B - PROJECT OPERATION AND RESOURCE UTILIZATION

### 1 - DAMSITE SELECTION

This section summarizes the previous site selection studies and the studies done during the Alaska Power Authority Susitna Hydroelectric Project Feasibility Study (Acres 1982c, Vol. 1).

#### 1.1 - Previous Studies

Prior to the undertaking of the Susitna Hydroelectric Project Feasibility Study by the applicant, the hydroelectric development potential of the Alaskan Railbelt had been studied by several entities.

##### (a) Early Studies of Hydroelectric Potential

Shortly after World War II ended, the United States Bureau of Reclamation (USBR) conducted an initial investigation of hydroelectric potential in Alaska and issued a report of the results in 1948. Responding to a recommendation made in 1949 by the nineteenth Alaska territorial legislature that Alaska be included in the Bureau of Reclamation program, the Secretary of the Interior provided funds to update the 1948 work. The resulting report, issued in 1952, recognized the vast hydroelectric potential within the territory and placed particular emphasis on the strategic location of the Susitna River between Anchorage and Fairbanks as well as its proximity to the connecting Railbelt (Figure B.1).

A series of studies was commissioned over the years to identify damsites and conduct geotechnical investigations. By 1961, the Department of the Interior proposed authorization of a two-dam power system on the Susitna River involving the Devil Canyon and the Denali sites (Figure B.2). The definitive 1961 report was subsequently updated by the Alaska Power Administration (an agency of the USBR) in 1974, at which time the desirability of proceeding with hydroelectric development was reaffirmed.

The Corps of Engineers (COE) was also active in hydropower investigations in Alaska during the 1950s and 1960s, but focused its attention on a more ambitious development at Rampart on the Yukon River. This project was capable of generating five times as much annual electric energy as the prior Susitna proposal. The sheer size and the technological challenges associated with Rampart captured the imagination of supporters and effectively diverted attention from the Susitna basin for more than a decade. The Rampart report was finally shelved in the early 1970s because of strong environmental concerns and the uncertainty of marketing prospects for so much energy, particularly in light of abundant

natural gas which had been discovered and developed in Cook Inlet.

The energy crisis precipitated by the OPEC oil boycott in 1973 provided some further impetus for seeking development of renewable resources. Federal funding was made available both to complete the Alaska Power Administration's update report on Susitna in 1974 and to launch a prefeasibility investigation by the COE. The State of Alaska itself commissioned a reassessment of the Susitna project by the Henry J. Kaiser Company in 1974.

Salient features of the various reports to date are outlined in the following sections.

(b) U.S. Bureau of Reclamation - 1953 Study

The USBR 1952 report to the Congress on Alaska's overall hydro-electric potential was followed shortly by the first major study of the Susitna basin in 1953. Ten damsites were identified above the railroad crossing at Gold Creek. These sites are identified on Figure B.2, and are listed below:

- Gold Creek
- Olson
- Devil Canyon
- Devil Creek
- Watana
- Vee
- Maclaren
- Denali
- Butte Creek
- Tyone (on the Tyone River).

Fifteen more sites were considered below Gold Creek. However, more attention has been focused over the years on the upper Susitna basin where the topography is better suited to dam construction and where less impact on anadromous fisheries is expected. Field reconnaissance eliminated half the original upper basin list, and further USBR consideration centered on Olson, Devil Canyon, Watana, Vee, and Denali. All of the USBR studies since 1953 have regarded these sites as the most appropriate for further investigation.

(c) U.S. Bureau of Reclamation - 1961 Study

In 1961 a more detailed feasibility study resulted in a recommended five-stage development plan to match the load growth curve as it was then projected. Devil Canyon was to be the first development--a 635-foot high arch dam with an installed capacity of about 220 MW. The reservoir formed by the Devil Canyon Dam

alone would not store enough water to permit higher capacities to be economically installed, since long periods of relatively low flow occur in the winter months. The second stage would have increased storage capacity by adding an earthfill dam at Denali in the upper reaches of the basin. Subsequent stages involved adding generating capacity to the Devil Canyon Dam. Geotechnical investigations at Devil Canyon were more thorough than at Denali. At Denali, test pits were dug, but no drilling occurred.

(d) Alaska Power Administration - 1974 Study

Little change from the basic USBR 1961, five-stage concept appeared in the 1974 report by the Alaska Power Administration. This later effort offered a more sophisticated design, provided new cost and schedule estimates, and addressed marketing, economics, and environmental considerations.

(e) Kaiser Proposal for Development

The Kaiser study, commissioned by the Office of the Governor in 1974, proposed that the initial Susitna development consist of a single dam known as High Devil Canyon located on Figure B.2. No field investigations were made to confirm the technical feasibility of the High Devil Canyon location because the funding level was insufficient for such efforts. Visual observations suggested the site was probably favorable. The USBR had always been uneasy about foundation conditions at Denali, but had to rely upon the Denali reservoir to provide storage during long periods of low flow. Kaiser chose to avoid the perceived uncertainty at Denali by proposing to build a rockfill dam at High Devil Canyon which, at a height of 810 feet, would create a large enough reservoir to overcome the storage problem. Although the selected sites were different, the COE reached a similar conclusion when it later chose the high dam at Watana as the first to be constructed.

Subsequent developments suggested by Kaiser included a downstream dam at the Olson site and an upstream dam at a site known as Susitna III (Figure B.2). The information developed for these additional dams was confined to estimating energy potential. As in the COE study, future development of Denali remained a possibility if foundation conditions were found to be adequate and if the value of additional firm energy provided economic justification at some later date.

(f) U.S. Army Corps of Engineers - 1975 and 1979 Studies

The most comprehensive study of the upper Susitna basin prior to the current study was completed in 1975 by the COE. A total of 23 alternative developments were analyzed, including those proposed by the USBR, as well as consideration of coal as the primary

energy source for Railbelt electrical needs. The COE agreed that an arch dam at Devil Canyon was appropriate, but found that a high dam at the Watana site would form a large enough reservoir for seasonal storage and would permit continued generation during low flow periods.

The COE recommended an earthfill dam at Watana with a height of 810 feet. In the longer term, development of the Denali site remained a possibility which, if constructed, would increase the amount of firm energy available in dry years.

An ad hoc task force was created by Governor Jay Hammond upon completion of the 1975 COE study. This task force recommended endorsement of the COE request for Congressional authorization, but pointed out that extensive further studies, particularly those dealing with environmental and socioeconomic questions, were necessary before any construction decision could be made.

At the federal level, concern was expressed at the Office of Management and Budget regarding the adequacy of geotechnical data at the Watana site as well as the validity of the economics. The apparent ambitiousness of the schedule and the feasibility of a thin arch dam at Devil Canyon were also questioned. Further investigations were funded and the COE produced an updated report in 1979. Devil Canyon and Watana were reaffirmed as appropriate sites, but alternative dam types were investigated. A concrete gravity dam was analyzed as an alternative for the thin arch dam at Devil Canyon and the Watana Dam was changed from earthfill to rockfill. Subsequent cost and schedule estimates still indicated economic justification for the project.

## 1.2 - Plan Formulation and Selection Methodology

The proposed plan which is the subject of this license application was selected after a review and reassessment of all previously considered sites (Acres 1982c, Vol. 1).

This section of the report outlines the engineering and planning studies carried out as a basis for formulation of Susitna basin development plans and selection of the preferred plan.

In the description of the planning process, certain plan components and processes are frequently discussed. It is appropriate that three particular terms be clearly defined:

Damsite - An individual potential damsite in the Susitna basin, referred to in the generic process as "candidate."

Basin Development Plan

- A plan for developing energy within the upper Susitna basin involving one or more dams, each of specified height, and corresponding power plants of specified capacity. Each plan is identified by a plan number and subnumber indicating the staging sequence to be followed in developing the full potential of the plan over a period of time.

Generation Scenario

- A specified sequence of implementation of power generation sources capable of providing sufficient power and energy to satisfy an electric load growth forecast for the 1980-2010 period in the Railbelt area. This sequence may include different types of generation sources such as hydroelectric and coal-, gas- or oil-fired thermal. These generation scenarios were developed for the comparative evaluations of Susitna basin generation versus alternative methods of generation.

In applying the generic plan formulation and selection methodology, five basic steps are required: defining the objectives, selecting candidates, screening, formulation of development plans, and, finally, a detailed evaluation of the plans (Figure B.3). The objective is to determine the optimum Susitna basin development plan. The various steps required are outlined in subsections of this section.

Throughout the planning process, engineering layout studies were made to refine the cost estimates for power generation facilities or water storage development at several damsites within the basin. These data were fed into the screening and plan formulation and evaluation studies.

The second objective, the detailed evaluation of the various plans, is satisfied by comparing generation scenarios that include the selected Susitna basin development plan with alternative generation scenarios, including all-thermal and a mix of thermal plus alternative hydropower developments.

1.3 - Damsite Selection

In previous Susitna basin studies, twelve damsites were identified in the upper portion of the basin, i.e., upstream from Gold Creek. These sites are listed in Table B.1 with relevant data concerning facilities, cost, capacity, and energy.

The longitudinal profile of the Susitna River and typical reservoir levels associated with these sites are shown in Figure B.4. Figure B.5 illustrates which sites are mutually exclusive, i.e., those which cannot be developed jointly, since the downstream site would inundate the upstream site.

It can be readily seen that there are several mutually exclusive schemes for power development of the basin. The development of the Watana site precludes development of High Devil Canyon, Devils Creek, Susitna III and Vee but fits well with Devil Canyon. Conversely, the High Devil Canyon site would preclude Watana and Devil Canyon but fits well with Olson and Vee or Susitna III. These downstream sites do not preclude development of the upstream storage sites, Denali or Butler Creek and Maclaren.

All relevant data concerning dam type, capital cost, power, and energy output were assembled and are summarized in Table B.1. For the Devil Canyon, High Devil Canyon, Watana, Susitna III, Vee, Maclaren, and Denali sites, conceptual engineering layouts were produced and capital costs were estimated based on calculated quantities and unit rates. Detailed analyses were also undertaken to assess the power capability and energy yields. At the Gold Creek, Devil Creek, Maclaren, Butte Creek, and Tyone sites, no detailed engineering or energy studies were undertaken; data from previous studies were used with capital cost estimates updated in 1980 levels. Approximate estimates of the potential average energy yield at the Butte Creek and Tyone sites were undertaken to assess the relative importance of these sites as energy producers.

The data presented in Table B.1 show that Devil Canyon, High Devil Canyon, and Watana are the most economic large energy producers in the basin. Sites such as Vee and Susitna III have only medium energy production, and are slightly more costly than the previously mentioned damsites. Other sites such as Olson and Gold Creek are competitive provided they have additional upstream regulation. Sites such as Denali and Maclaren produce substantially higher cost energy than the other sites but can also be used to increase regulation of flow for downstream use.

(a) Site Screening

The objective of this screening process was to eliminate sites which would obviously not be included in the initial stages of the Susitna basin development plan and which, therefore, did not deserve further study at this stage. Three basic screening criteria were used: environmental, alternative sites, and energy contribution.

The screening process involved eliminating all sites falling in the unacceptable environmental impact and alternative site categories. Those failing to meet the energy contribution criteria were also eliminated unless they had some potential for upstream regulation. The results of this process were as follows:

- The "unacceptable site" environmental category eliminated the Gold Creek, Olson, and Tyone sites.
- The alternative sites category eliminated the Devil Creek and Butte Creek sites.
- No additional sites were eliminated for failing to meet the energy contribution criteria. The remaining sites upstream from Vee, i.e., Maclaren and Denali, were retained to insure that further study be directed toward determining the need and viability of providing flow regulation in the headwaters of the Susitna.

(b) Engineering Layouts

In order to obtain a uniform and reliable data base for studying the seven sites remaining, it was necessary to develop engineering layouts and reevaluate the costs. In addition, staged developments at several of the larger dams were studied.

The basic objective of these layout studies was to establish a uniform and consistent development cost for each site. These layouts are consequently conceptual in nature and do not necessarily represent optimum project arrangements at the sites. Also, because of the lack of geotechnical information at several of the sites, judgmental decisions had to be made on the appropriate foundation and abutment treatment. The relative accuracy of cost estimates made in these studies is on the order of plus or minus 30 percent.

(i) Design Assumptions

In order to maximize standardization of the layouts, a set of basic design assumptions was developed. These assumptions covered geotechnical, hydrologic, hydraulic, civil, mechanical, and electrical considerations and were used as guidelines to determine the type and size of the various components within the overall project layouts. As stated previously, other than at Watana, Devil Canyon, and Denali, little information regarding site conditions was available. Broad assumptions were made on the basis of the limited data, and those assumptions and the interpretation of data have been conservative.

It was assumed that the relative cost differences between rockfill and concrete dams at the site would either be marginal or greatly in favor of the rockfill. The more detailed studies carried out subsequently for the Watana and Devil Canyon sites support this assumption. Therefore, a rockfill dam has been assumed at all developments in order to eliminate cost discrepancies that might result from a consideration of dam-fill unit costs compared to concrete unit costs at alternative sites.

(ii) General Arrangements

Brief descriptions of the general arrangements developed for the various sites are given below. Descriptions of Watana and Devil Canyon in this section are of the preliminary layouts and should not be confused with the proposed layouts in Exhibit A and Exhibit F. Figures B.6 to B.12 illustrate the layout details. Table B.3 summarizes the crest levels and dam heights considered.

In laying out the developments, conservative arrangements have been adopted, and whenever possible there has been a general standardization of the component structures.

- Devil Canyon (Figure B.6)

The development at Devil Canyon, located at the upper end of the canyon at its narrowest point, consists of a rock-fill dam, single spillway, power facilities incorporating an underground powerhouse, and a tunnel diversion.

The rockfill dam would rise above the valley on the south abutment and terminate in an adjoining saddle dam of similar construction. The dam would be 675 feet above the lowest foundation level with a crest elevation of 1470 and a volume of 20 million cubic yards.

The spillway would be located on the north bank and would consist of a gated overflow structure and a concrete-lined chute linking the overflow structure with intermediate and terminal stilling basins. Sufficient spillway capacity would be provided to pass the Probable Maximum Flood safely.

The power facilities would be located on the north abutment. The massive intake structure would be founded within the rock at the end of a deep approach channel and would consist of four integrated units, each serving individual tunnel penstocks. The powerhouse would house four 150-MW vertically mounted Francis type turbines driving overhead 165 MVA umbrella type generators.

As an alternative to the full power development in the first phase of construction, a staged powerhouse alternative was also investigated. The dam would be completed to its full height but with a initial plant installed capacity in the 300-MW range. The complete powerhouse would be constructed together with penstocks and a tailrace tunnel for the initial two 150-MW units, together with concrete foundations for future units.



- Watana (Figure B.7 and B.8)

For initial comparative study purposes, the dam at Watana is assumed to be a rockfill structure located on a similar alignment to that proposed in the previous COE studies. It would be similar in construction to the dam at Devil Canyon with an impervious core founded on sound bedrock and an outer shell composed of blasted rock excavated from a single quarry located on the south abutment. The dam would rise 880 feet from the lowest point on the foundation and have an overall volume of approximately 63 million cubic yards for a crest elevation of 2225.

The spillway would be located on the north bank and would be similar in concept to that at Devil Canyon with an intermediate and terminal stilling basin.

The power facilities located within the south abutment with similar intake, underground powerhouse, and water passage concepts to those at Devil Canyon would incorporate four 200-MW turbine/generator units giving a total output of 800 MW.

As an alternative to the initial full development at Watana, staging alternatives were investigated. These included staging of both dam and powerhouse construction. Staging of the powerhouse would be similar to that at Devil Canyon, with a Stage I installation of 400 MW and a further 400 MW in Stage II.

In order to study the alternative dam staging concept, it was assumed that the dam would be constructed for a maximum operating water surface elevation some 200 feet lower than that in the final stage (Figure B.8).

The powerhouse would be completely excavated to its final size during the first stage. Three oversized 135-MW units would be installed together with base concrete for an additional unit. A low-level control structure and twin concrete-lined tunnels leading into a downstream stilling basin would form the first stage spillway.

For the second stage, the dam would be completed to its full height, the impervious core would be appropriately raised, and additional rockfill would be placed on the downstream face. It was assumed that, before construction commenced, the top 40 feet of the first stage dam would be removed to ensure the complete integrity of the impervious core for the raised dam. A second spillway control structure would be constructed at a higher level and would

incorporate a downstream chute leading to the Stage I spillway structure. The original spillway tunnels would be closed with concrete plugs. A new intake structure would be constructed utilizing existing gates and hoists, and new penstocks would be driven to connect with the existing ones. The existing intake would be sealed off. One additional 200-MW unit would be installed and the required additional penstock and tailrace tunnel constructed. The existing 135-MW units would be upgraded to 200 MW.

- High Devil Canyon (Figure B.9)

The development would be located between Devil Canyon and Watana. The 855-foot high rockfill dam would be similar in design to Devil Canyon, containing an estimated 48 million cubic yards of rockfill with a crest elevation of 1775. The south bank spillway and the north bank powerhouse facilities would also be similar in concept to Devil Canyon, with an installed capacity of 800 MW.

Two stages of 400 MW were envisaged in each which would be undertaken in the same manner as at Devil Canyon, with the dam initially constructed to its full height.

- Susitna III (Figure B.10)

The development would involve a rockfill dam with an impervious core approximately 670 feet high, a crest elevation of 2360, and a volume of approximately 55 million cubic yards. A concrete-lined spillway chute and a single stilling basin would be located underground, with the two diversion tunnels on the south bank.

- Vee (Figure B.11)

A 610-foot high rockfill dam founded on bedrock with a crest elevation of 2350 and total volume of 10 million cubic yards was considered.

Since Vee is located farther upstream than the other major sites, the flood flows are correspondingly lower, thus allowing for a reduction in size of the spillway facilities. A spillway utilizing a gated overflow structure, chute, and flip bucket was adopted.

The power facilities would consist of a 400-MW underground powerhouse located in the south bank with a tailrace outlet well downstream of the main dam. A secondary rockfill dam would also be required in this vicinity to seal off a low point. Two diversion tunnels would be provided on the north bank.

- Maclaren (Figure B.12)

The development would consist of a 185-foot high earthfill dam founded on pervious riverbed materials. The crest elevation of the dam would be 2405. This reservoir would essentially be used for regulating purposes. Diversion would occur through three conduits located in an open cut on the south bank, and floods would be discharged via a side chute spillway and stilling basin on the north bank.

- Denali (Figure B.12)

Denali is similar in concept to Maclaren. The dam would be 230 feet high, of earthfill construction, and would have a crest elevation of 2555. As for Maclaren, no generating capacity would be included. A combined diversion and spillway facility would be provided by twin concrete conduits founded in open cut excavation in the north bank and discharging into a common stilling basin.

(c) Capital Costs

For purposes of initial comparisons of alternatives, construction quantities were determined for items comprising the major works and structures at the site. Where detail or data were not sufficient for certain work, quantity estimates were made on the basis of previous development of similar sites and general knowledge of site conditions reported in the literature. In order to determine total capital costs for various structures, unit costs have been developed for the items measured. These have been estimated on the basis of review of rates used in previous studies, and of rates used on similar works in Alaska and elsewhere. Where applicable, adjustment factors based on geography, climate, manpower and accessibility were used. Technical publications have also been reviewed for basic rates and escalation factors.

The total capital costs developed are shown in Tables B.1 and B.2. It should be noted that the capital costs for Maclaren and Denali shown in Table B.1 have been adjusted to incorporate the costs of generation plants with capacities of 55 MW and 60 MW, respectively. Additional data on the projects are summarized in Table B.3.

1.4 - Formulation of Susitna Basin Development Plans

The results of the site screening process described above indicate that the Susitna basin development plan should incorporate a combination of several major dams and powerhouses located at one or more of the following sites:

- Devil Canyon
- High Devil Canyon
- Watana
- Susitna III
- Vee.

Supplementary upstream flow regulation could be provided by structures at Maclaren and Denali.

Cost estimates of these projects are itemized on Table B.4.

A computer-assisted screening process identified the plans of Devil Canyon/Watana or High Devil Canyon/Vee as most economic. In addition to these two basic development plans, a tunnel scheme which provides potential environmental advantages by replacing the Devil Canyon Dam with a long power tunnel and a development plan involving Watana Dam was also introduced.

The criteria used at this stage of the process for selection of preferred Susitna basin development plans were mainly economic (Figure B.3). Environmental considerations were incorporated into the further assessment of the plans finally selected.

The results of the screening process are shown in Table B.5. Because of the simplifying assumptions that were made in the screening model, the three best solutions from an economic point of view are included in the table.

The most important conclusions that can be drawn are as follows:

- For energy requirements of up to 1750 GWh, the High Devil Canyon, Devil Canyon or the Watana sites individually provided the most economic energy. The difference between the costs shown on Table B.5 is around 10 percent, which is similar to the accuracy that can be expected from the screening model.
- For energy requirements of between 1750 and 3500 GWh, the High Devil Canyon site is the most economic.
- For energy requirements of between 3500 and 5250 GWh, the combinations of either Watana and Devil Canyon or High Devil Canyon and Vee are most economic.
- The total energy production capability of the Watana/Devil Canyon development is considerably larger than that of the High Devil Canyon/Vee alternative and is the only plan capable of meeting energy demands in the 6000 GWh range.

(a) Tunnel Alternatives

A scheme involving a long power tunnel could conceivably be used to replace the Devil Canyon Dam in the Watana/Devil Canyon development plan. It could develop similar head for power generation and may provide some environmental advantages by avoiding inundation of Devil Canyon. Obviously, because of the low winter flows in the river, a tunnel alternative could be considered only as a second stage to the Watana development.

Conceptually, the tunnel alternatives would comprise the following major components in some combination, in addition to the Watana Dam, reservoir and associated powerhouse:

- Power tunnel intake works;
- One or two power tunnels up to 40 feet in diameter and up to 30 miles in length;
- A surface or underground powerhouse with a capacity of up to 1200 MW;
- A re-regulation dam if the intake works are located downstream from Watana; and
- Arrangements for compensation flow in the bypassed river reach.

Four basic alternative schemes were developed and studied. Figure B.13 is a schematic illustration of these schemes. All schemes assumed an initial Watana development with full reservoir supply level at Elevation 2200 and the associated powerhouse with an installed capacity of 800 MW. Table B.6 lists all the pertinent technical information. Table B.7 lists the power and energy yields for the four schemes. Table B.8 itemizes the capital cost estimate.

Based on the foregoing economic information, Scheme 3 (Figures B.14 and B.15) produces the lowest cost energy by a factor of nearly 2.

A review of the environmental impacts associated with the four tunnel schemes indicates that Scheme 3 would have the least impact, primarily because it offers the best opportunities for regulating daily flows downstream from the project. Based on this assessment and because of its almost 2 to 1 economic advantage, Scheme 3 was selected as the only scheme worth further study. (See Development Selection Report for detailed analysis.) The capital cost estimate for Scheme 3 appears in Table B.8. The estimates also incorporate single and double tunnel options. For purposes of these studies, the double tunnel option has been selected

because of its superior reliability. It should also be recognized that the cost estimates associated with the tunnels are probably subject to more variation than those associated with the dam schemes due to geotechnical uncertainties. In an attempt to compensate for these uncertainties, economic sensitivity analyses using both higher and lower tunnel costs have been conducted.

(b) Additional Basin Development Plan

As noted, the Watana and High Devil Canyon damsites appear to be individually superior in economic terms to all others. An additional plan was therefore developed to assess the potential for developing these two sites together. For this scheme, the Watana Dam would be developed to its full potential. The High Devil Canyon Dam would be constructed to a crest elevation of 1470 to fully utilize the head downstream from Watana.

(c) Selected Basin Development Plans

The essential objective of this step in the development selection process was defined as the identification of those plans which appear to warrant further, more detailed evaluation. The results of the final screening process indicate that the Watana/Devil Canyon and the High Devil Canyon/Vee plans are clearly superior to all other dam combinations. In addition, it was decided to study Tunnel Scheme 3 further as an alternative to the High Devil Canyon Dam and a plan combining Watana and High Devil Canyon.

Associated with each of these plans are several options for staged development. For this more detailed analysis of these basic plans, a range of different approaches to staging the developments was considered. In order to keep the total options to a reasonable number and also to maintain reasonably large staging steps consistent with the total development size, staging of only the two larger developments (i.e., Watana and High Devil Canyon) was considered. The basic staging concepts adopted for these developments involved staging both dam and powerhouse construction or, alternatively, just staging powerhouse construction. Powerhouse stages were considered in 400-MW increments.

Four basic plans and associated subplans are briefly described below. Plan 1 involves the Watana/Devil Canyon sites, Plan 2 the High Devil Canyon/Vee sites, Plan 3 the Watana-tunnel concept, and Plan 4 the Watana/High Devil Canyon sites. Under each plan several alternative subplans were identified, each involving a different staging concept. Summaries of these plans are given in Table B.9.

(i) Plan 1

- Subplan 1.1: The first stage involves constructing Watana Dam to its full height and installing 800 MW. Stage 2 involves constructing Devil Canyon Dam and installing 600 MW.
- Subplan 1.2: For this subplan, construction of the Watana Dam is staged from a crest elevation of 2060 to 2225. The powerhouse is also staged from 400 MW to 800 MW. As for Subplan 1.1, the final stage involves Devil Canyon with an installed capacity of 600 MW.
- Subplan 1.3: This subplan is similar to subplan 1.2 except that only the powerhouse and not the dam at Watana is staged.

(ii) Plan 2

- Subplan 2.1: This subplan involves constructing the High Devil Canyon Dam first with an installed capacity of 800 MW. The second stage involves constructing the Vee Dam with an installed capacity of 400 MW.
- Subplan 2.2: For this subplan, the construction of High Devil Canyon is staged from a crest elevation of 1630 to 1775. The installed capacity is also staged from 400 to 800 MW. As for subplan 2.1, Vee follows with 400 MW of installed capacity.
- Subplan 2.3: This subplan is similar to subplan 2.2 except that only the powerhouse and not the dam at High Devil Canyon is staged.

(iii) Plan 3

- Subplan 3.1: This subplan involves initial construction of Watana and installation of 800-MW capacity. The next stage involves the construction of the downstream re-regulation dam to a crest elevation of 1500 and a 15-mile long tunnel. A total of 300 MW would be installed at the end of the tunnel and a further 30 MW at the reregulation dam. An additional 50 MW of capacity would be installed at the Watana powerhouse to facilitate peaking operations.
- Subplan 3.2: This subplan is essentially the same as subplan 3.1 except that construction of the initial 800-MW powerhouse at Watana is staged.

(iv) Plan 4

This single plan was developed to jointly evaluate the development of the two most economic damsites, Watana and High Devil Canyon. Stage 1 involves constructing Watana to its full height with an installed capacity of 400 MW. Stage 2 involves increasing the capacity at Watana to 800 MW. Stage 3 involves constructing High Devil Canyon to a crest elevation of 1470 so that the reservoir extends to just downstream of Watana. In order to develop the full head between Watana and Portage Creek, an additional smaller dam is added downstream of High Devil Canyon. This dam would be located just upstream from Portage Creek so as not to interfere with the anadromous fisheries, and would have a crest elevation of 1030 and an installed capacity of 150 MW. For purposes of these studies, this site is referred to as the Portage Creek site.

1.5 - Evaluation of Basin Development Plans

The overall objective of this step in the evaluation process was to select the preferred basin development plan. A preliminary evaluation of plans was initially undertaken to determine broad comparisons of the available alternatives. This was followed by appropriate adjustments to the plans and a more detailed evaluation and comparison.

In the process of initially evaluating the final four schemes, it became apparent that there would be environmental problems associated with allowing daily peaking operations from the most downstream reservoir in each of the plans described above. In order to avoid these potential problems while still maintaining operational flexibility to peak on a daily basis, re-regulation facilities were incorporated in the four basic plans. These facilities incorporate both structural measures such as re-regulation dams and modified operational procedures. Details of these modified plans, referred to as E1 to E4, are listed in Table B.10.

The plans listed in Table B.10 were subjected to a more detailed analysis as described in the following section.

(a) Evaluation Methodology

The approach to evaluating the various basin development plans described above is twofold:

- For determining the optimum staging concept associated with each basic plan (i.e., the optimum subplan), only economic criteria are used and the least-cost staging concept is adopted.



- For assessing which plan is the most appropriate, a more detailed evaluation process incorporating economic, environmental, social and energy contribution aspects is taken into account.

Economic evaluation of any Susitna basin development plan requires that the impact of the plan on the cost of energy to the Railbelt area consumer be assessed on a systemwide basis. Since the consumer is supplied by a large number of different generating sources, it is necessary to determine the total Railbelt system cost in each case to compare the various Susitna basin development options.

The primary tool used for system costs was the mathematical model developed by the Electricity Utility Systems Engineering Department of General Electric Company. The model is commonly known as OGP5 or Optimized Generation Planning Model, Version 5. The following information is paraphrased from GE literature on the program (General Electric 1979).

The OGP5 program was developed over ten years to combine the three main elements of generation expansion planning (system reliability, operating and investment costs) and automate generation addition decision analysis. OGP5 will automatically develop optimum generation expansion patterns in terms of economics, reliability and operation. Many utilities use OGP5 to study load management, unit size, capital and fuel costs, energy storage, forced outage rates, and forecast uncertainty.

The OGP5 program requires an extensive system of specific data to perform its planning function. In developing an optimal plan, the program considers the existing and committed units (planned and under construction) available to the system and the characteristics of these units including age, heat rate, size and outage rates as the base generation plan. The program then considers the given load forecast and operation criteria to determine the need for additional system capacity based on given reliability criteria. This determines "how much" capacity to add and "when" it should be installed. If a need exists during any monthly iteration, the program will consider additions from a list of alternatives and select the available unit best fitting the system needs. Unit selection is made by computing production costs for the system for each alternative included and comparing the results.

The unit resulting in the lowest system production cost is selected and added to the system. Finally, an investment cost analysis of the capital costs is completed to answer the question of "what kind" of generation to add to the system.

The model is then further used to compare alternative plans for meeting variable electrical demands, based on system reliability and production costs for the study period.

A minor limitation inherent in the use of the OGP5 model is that the number of years of simulation is limited to 20. To overcome this, the study period of 1980 to 2040 has been broken into three separate segments for study purposes. These segments are common to all system generation plans.

The first segment has been assumed to be from 1980 to 1990. The model of this time period included all committed generation units and is assumed to be common to all generation scenarios.

The end point of this model becomes the beginning of each 1990-2010 model.

The model of the first two time periods considered (1980 to 1990, and 1990 to 2010) provides the total production costs on a year-to-year basis. These total costs include, for the period of modeling, all costs of fuel and operation and maintenance of all generating units included as part of the system. In addition, the completed production costs include the annualized investment costs of any production plans added during the period of study. A number of factors which contribute to the ultimate cost of power to the consumer are not included in this model. These are common to all scenarios and include:

- All investment costs to plants in service prior to 1981;
- Costs of transmission systems in service both at the transmission and distribution level; and
- Administrative costs of utilities for providing electric service to the public.

Thus, it should be recognized that the production costs modeled represent only a portion of ultimate consumer costs and in effect are only a portion, albeit major, of total costs.

The third period, 2010 to 2040, was modeled by assuming that production costs of 2010 would recur for the additional 30 years to 2040. This assumption is believed to be reasonable given the limitations on forecasting energy and load requirements for this period. The additional period to 2040 is required to at least take into account the benefit derived or value of the addition of a hydroelectric power plant which has a useful life of 50 years or more.

The selection of the preferred generation plan is based on numerous factors. One of these is the cost of the generation plan. To provide a consistent means of assessing the production cost of a given generation scenario, each production cost total has been converted to a 1980 present worth basis. The present worth cost

of any generation scenario is made up of three cost amounts. The first is present worth cost (PWC) of the first ten years of study (1981 to 1990), the second is the PWC of the scenario assumed during 1990 to 2010, and the third is the PWC of the scenario in 2010 assumed to recur for the period 2010 to 2040. In this way the long-term (60 years) PWC of each generation scenario in 1980 dollars can be compared.

A summary of the input data to the model and a discussion of the results follow.

(i) Initial Economic Analyses

Table B.11 lists the results of the first series of economic analyses undertaken for the basic Susitna basin development plans listed in Table B.10. The information provided includes the specified on-line dates for the various stages of the plans, the OGP5 run index number, the total installed capacity at year 2010 by category, and the total system present worth cost in 1980 for the period 1980 to 2040. Matching of the Susitna development to the load growth for Plans E1, E2, and E3 is shown in Figures B.16, B.17 and B.18, respectively. After 2010, steady state conditions are assumed and the then-existing generation mix and annual costs for 2010 are applied to the years 2011 to 2040. This extended period of time is necessary to ensure that the hydroelectric options being studied, many of which only come on line around 2000, are simulated as operating for periods approaching their economic lives and that their full impact on the cost of the generation system is taken into account.

- Plan E1 - Watana/Devil Canyon

- . Staging the dam at Watana (Plan E1.2) is not as economic as constructing it to its full height (Plan E1.1 and E1.3). The present worth advantage of not staging the dam amounts to \$180 million in 1980 dollars.

The results indicate that, with the level of analysis performed, there is no discernible benefit in staging construction of the Watana powerhouse (Plan E1.1 and E1.3). However, Plan E1.4 results indicate that, should the powerhouse size at Watana be restricted to 400 MW, the overall system present worth costs would increase.

Additional runs performed for variations of Plan E1.3 indicate that system present worth would increase by \$1,110 million if the Devil Canyon Dam were not constructed. A five-year delay in construction of the Watana Dam would increase system present worth by \$220 million.

- Plan E2 - High Devil Canyon/Vee

. The results for Plan E2.3 indicate that the system present worth is \$520 million more than Plan E1.3. Present worth increases also occur if the Vee Dam stage is not constructed. A reduction in present worth of approximately \$160 million is possible if the Chakachamna hydroelectric project is constructed instead of the Vee Dam.

. The results of Plan E2.1 indicate that total system present worth would increase by \$250 million if the total capacity at High Devil Canyon were limited to 400 MW.

- Plan E3 - Watana-Tunnel

The results for Plan E3.1 illustrate that the tunnel scheme versus the Devil Canyon Dam scheme (E1.3) adds approximately \$680 million to the total system present worth cost. The availability of reliable geotechnical data would undoubtedly have improved the accuracy of the cost estimates for the tunnel alternative. For this reason, a sensitivity analysis was made as a check to determine the effect of halving the tunnel costs. This analysis indicates that the tunnel scheme is still more costly than constructing the Devil Canyon Dam.

- Plan E4 - Watana/High Devil Canyon/Portage Creek

The results indicate that system present worth associated with Plan E4.1, excluding the Portage Creek site development, is \$200 million more than the equivalent E1.3 plan. If the Portage Creek development is included, the present worth difference would be even greater.

(ii) Load Forecast Sensitivity Analyses

The plans with the lowest present worth cost were subjected to further sensitivity analysis. The objective of the analysis was to determine the impact on the development decision of a variance in forecast. The load forecasts used for this analysis were made by ISER and are presented in Section 5.1 of this Exhibit. These results are summarized in Table B.12.

At the low load forecast, full capacity development of Watana/Devil Canyon Scheme 1.3 is not warranted. Under Scheme 1.4, the most economic development includes a 400-MW development at each site, as compared to Watana only.

Similarly, it is more economic to develop High Devil Canyon and Vee, as compared to High Devil Canyon only, but at a total capacity of only 800 MW.

At this level of projected demand, the Watana/Devil Canyon plan is more economic than the High Devil Canyon/Vee plan or any singular development (\$210 million, present worth basis). As individual developments, however, the High Devil Canyon only plan is slightly superior economically to the Watana project (\$90 million, present worth basis).

At the high load forecast, the larger capacities are clearly needed. In addition, both the High Devil Canyon/Vee and Watana/Devil Canyon plans are improved economically by the addition of the Chackachamna project. This illustrates the superiority of the Chackachamna project to the addition of alternative coal and gas projects using the study price projections. Similar to the low load forecast, the Watana/Devil Canyon project is superior to the High Devil Canyon/Vee alternative but the margin of difference on a present worth basis is much greater (\$1.0 billion, present worth basis).

(b) Evaluation Criteria

The following criteria were used to evaluate the short-listed basin development plans. These criteria generally contain the requirements of the generic process with the exception that an additional criterion, energy contribution, is added in order to ensure that full consideration is given to the total basin energy potential developed by the various plans.

(i) Economic

Plans were compared using long-term present worth costs, calculated using the OGP5 generation planning model. The parameters used in calculating the total present worth cost of the total Railbelt generating system for the period 1980 to 2040 are listed in Tables B.13 and B.14. Load forecasts used in the analysis are presented in Section 5.1(b).

(ii) Environmental

A qualitative assessment of the environmental impact on the ecological, cultural, and aesthetic resources is undertaken for each plan. Emphasis is placed on identifying major concerns so that these can be combined with the other evaluation attributes in an overall assessment of the plan.

(iii) Social

This attribute includes determination of the potential non-renewable resource displacement, the impact on the state and local economy, and the risks and consequences of major structural failures due to seismic events. Impacts on the economy refer to the effects of an investment plan on economic variables.

(iv) Energy Contribution

The parameter used is the total amount of energy produced from the specific development plan. An assessment of the energy development foregone is also undertaken. The energy loss that is inherent to the plan and cannot easily be recovered by subsequent staged developments is of greatest concern.

(c) Results of Evaluation Process

The various attributes outlined above have been determined for each plan and are summarized in Tables B.15 through B.23. Some of the attributes are quantitative while others are qualitative. Overall evaluation is based on a comparison of similar types of attributes for each plan. In cases where the attributes associated with one plan all indicate equality or superiority with respect to another plan, the decision as to the best plan is clear cut. In other cases where some attributes indicate superiority and others inferiority, differences are highlighted and trade-off decisions are made to determine the preferred development plan. In cases where these trade-offs have had to be made, they were relatively straightforward, and the decision-making process can therefore be regarded as effective and consistent. In addition, these trade-offs are clearly identified so that independent assessment can be made.

The overall evaluation process is conducted in a series of steps. At each step, only two plans are compared. The superior plan is then taken to the next step for evaluation against a third plan.

(i) Devil Canyon Dam Versus Tunnel

The first step in the process involves the comparison of the Watana/Devil Canyon Dam plan (E1.3) and the Watana-tunnel plan (E3.1). Since Watana is common to both plans, the evaluation is based on a comparison of the Devil Canyon Dam and the Scheme 3 tunnel alternative.

In order to assist in the evaluation in terms of economic criteria, additional information obtained by analyzing the results of the OGP5 computer runs is shown in Table B.15. This information illustrates the breakdown of the total system present worth cost in terms of capital investment, fuel, and operation and maintenance costs.

- Economic Comparison

From an economic point of view, the Watana/Devil Canyon Dam scheme is superior. As summarized in Tables B.15 and B.16, on a present worth basis the tunnel scheme is \$680 million more expensive than the dam scheme. For a low demand growth rate, this cost difference would be reduced slightly to \$650 million. Even if the tunnel scheme costs are halved, the total cost difference would still amount to \$380 million. As highlighted in Table B.16, consideration of the sensitivity of the basic economic evaluation to potential changes in capital cost estimates, the period of economic analysis, the discount rate, fuel costs, fuel cost escalation, and economic plant life do not change the basic economic superiority of the dam scheme over the tunnel scheme.

- Environmental Comparison

The environmental comparison of the two schemes is summarized in Table B.17. Overall, the tunnel scheme is judged to be superior because:

- . It offers the potential for enhancing anadromous fish populations downstream of the re-regulation dam due to the more uniform flow distribution that will be achieved in this reach;
- . It would inundate 13 miles less of resident fisheries habitat in the river and major tributaries;
- . It has a lower potential for inundating archaeological sites due to the smaller reservoir involved; and
- . It would preserve much of the characteristics of the Devil Canyon gorge which is considered to be an aesthetic and recreational resource.

- Social Comparison

Table B.18 summarizes the evaluation of the two schemes in terms of the social criteria. In terms of impact on state and local economics and risks because of seismic exposure,

the two schemes are rated equal. However, due to its higher energy yield, the dam scheme has more potential for displacing nonrenewable energy resources and therefore has a slight overall advantage in terms of the social evaluation criteria.

- Energy Comparison

Table B.19 summarizes the evaluation in terms of the energy contribution criteria. The results show that the dam scheme has a greater potential for energy production and develops a larger portion of the basin's potential. The dam scheme is therefore judged to be superior from the energy contribution standpoint.

- Overall Comparison

The overall evaluation of the two schemes is summarized in Table B.20. The estimated cost saving of \$680 million in favor of the dam scheme plus the additional energy produced are considered to outweigh the reduction in the overall environmental impact of the tunnel scheme. The dam scheme is therefore judged to be superior overall.

(ii) Watana/Devil Canyon Versus High Devil Canyon/Vee

The second step in the development selection process involves an evaluation of the Watana/Devil Canyon (E1.3) and the High Devil Canyon/Vee (E2.3) development plans.

- Economic Comparison

In terms of the economic criteria (see Table B.15 and B.16) the Watana/Devil Canyon plan is less costly by \$520 million. Consideration of the sensitivity of this decision to potential changes in the various parameters considered (i.e., load forecast, discounted rates, etc.) does not change the basic superiority of the Watana/Devil Canyon plan.

Under the low load-growth forecast, the Watana/Devil Canyon plan is favored by only \$210 million, while under the high load-growth forecast the advantage is \$1,040 million.

- Environmental Comparison

The evaluation in terms of the environmental criteria is summarized in Table B.21. In assessing these plans, a reach-by-reach comparison was made for the section of the



Susitna River between Portage Creek and the Tyone River. The Watana/Devil Canyon scheme would create more potential environmental impacts in the Watana Creek area. However, it is judged that the potential environmental impacts which would occur above the Vee Canyon Dam with a High Devil Canyon/Vee development are more severe in overall comparison.

Of the seven environmental factors considered in Table B.21, except for the increased loss of river valley, bird and black bear habitat, the Watana/Devil Canyon development plan is judged to be more environmentally acceptable than the High Canyon/Vee plan.

The other six areas in which Watana/Devil Canyon was judged to be superior are fisheries, moose, caribou, furbearers, cultural resources, aesthetics, and land use.

- Energy Comparison

The evaluation of the two plans in terms of energy contribution criteria is summarized in Table B.22. The Watana/Devil Canyon scheme is assessed to be superior because of its higher energy potential and the fact that it develops a higher proportion of the basin's energy potential.

The Watana/Devil Canyon plan annually develops 1160 GWh and 1650 GWh more average and firm energy, respectively, than the High Devil Canyon/Vee plans.

- Social Comparison

Table B.18 summarizes the evaluation in terms of the social criteria. As in the case of the dam versus tunnel comparison, the Watana/Devil Canyon plan is judged to have a slight advantage over the High Devil Canyon/Vee plan. This is because of its greater potential for displacing nonrenewable resources. In other social impact areas there are minimal differences between plans.

- Overall Comparison

The overall evaluation of the two schemes is summarized in Table B.23. The \$520 million estimated cost saving coupled with the lower environmental impacts and a marginal social advantage make the Watana/Devil Canyon plan superior to High Devil Canyon/Vee.

## 1.6 - Preferred Susitna Basin Development Plan

One-on-one comparisons of the Watana/Devil Canyon plan with the Watana-tunnel plan and the High Devil Canyon/Vee plan are judged to favor the Watana/Devil Canyon plan in each case.

The Watana/Devil Canyon plan was therefore selected as the preferred Susitna basin development plan, and the basis for continuation of more detailed design optimization and environmental studies.

2 - ALTERNATIVE FACILITY DESIGN, PROCESSES  
AND OPERATIONS

## 2 - ALTERNATIVE FACILITY DESIGN, PROCESSES AND OPERATIONS

### 2.1 - Susitna Hydroelectric Development

As originally conceived, the Watana project initially comprised an earthfill dam with a crest elevation of 2225 and 400 MW of generating capacity scheduled to commence operation in 1993. An additional 400 MW would be brought on line in 1996. At Devil Canyon, an additional 400 MW would be installed to commence operation in the year 2000. Detailed studies of each project have led to refinement and optimization of designs in terms of a number of key factors, including updated load forecasts and economics. Geotechnical and environmental constraints identified as a result of continuing field work have also greatly influenced the currently recommended design concepts.

Plan formulation and alternative facility designs considered for the Watana and Devil Canyon developments are discussed in this section. Background information on the site characteristics as well as additional detail on the plan formulation process are included in the Supporting Design Report of Exhibit F and the referenced reports.

### 2.2 - Watana Project Formulation

This section describes the evolution of the general arrangement of the Watana project which, together with the Devil Canyon project, comprises the development plan proposed. The process by which reservoir operating levels and the installed generating capacity of the power facilities were established is presented, together with the means of handling floods expected during construction and subsequent project operation.

The main components of the Watana development are as follows:

- Main dam
- Diversion facilities
- Spillway facilities
- Outlet facilities
- Emergency release facilities
- Power facilities.

A number of alternatives are available for each of these components and they can be combined in a number of ways. The following paragraphs describe the various components and methodology for the preliminary, intermediate, and final screening and review of alternative general arrangement of the components, together with a brief description of the selected scheme. This section presents the alternative arrangements studied for the Watana project.

(a) Selection of Reservoir Level

The selected elevation of the Watana Dam crest is based on considerations of the value of the hydroelectric energy produced from the associated reservoir, geotechnical constraints on reservoir levels, and freeboard requirements. Firm energy, average annual energy, construction costs, and operation and maintenance costs were determined for the Watana development with dam crest elevations of 2240, 2190, and 2140. The relative value of energy produced in terms of the present worth of the long-term production costs (LTPWC) for each of these three dam elevations was determined by means of the OGP5 generation planning model described in Section 1 of this Exhibit. The physical constraints imposed on dam height and reservoir elevation by geotechnical considerations were reviewed and incorporated into the crest elevation selection process. Finally, freeboard requirements for the Probable Maximum Flood (PMF) and settlement of the dam after construction or as a result of seismic activity were taken into account.

(i) Methodology

Firm and average annual energy produced by the Susitna development is based on 32 years of hydrological records. The energy produced was determined by using a multi-reservoir simulation of the operation of the Watana and Devil Canyon reservoirs. A variety of reservoir drawdowns was examined, and drawdowns producing the maximum firm energy consistent with engineering feasibility and cost of the intake structure were selected. Minimum flow requirements were established at both project sites based on downstream fisheries considerations.

To meet system demand, the required maximum generating capability at Watana in the period between 1994 and 2010 ranges from 665 MW to 908 MW. For the reservoir level determinations, energy estimates were made on the basis of assumed average annual capacity requirements of 680 MW at Watana in 1994, increasing to 1020 MW at Watana in 2007, with an additional 600 MW at Devil Canyon coming on line in the year 2002. The long term present worth costs of the generation system required to meet the Railbelt energy demand were then determined for each of the three crest elevations of the Watana Dam using the OGP5 model.

The construction cost estimates used in the OGP5 modeling process for the Watana and Devil Canyon projects were based on preliminary conceptual layouts and construction schedules. Further refinement of these layouts has taken place during the optimization process. These refinements have no significant impact on the reservoir level selection.

(ii) Economic Optimization

Economic optimization of the Watana reservoir level was based on an evaluation of three dam crest elevations of 2240, 2190, and 2140. These crest elevations applied to the central portion of the embankment with appropriate allowances for freeboard and seismic settlement, and correspond to maximum operating levels of the reservoir of 2215, 2165, and 2115 feet, respectively. Average annual energy calculated for each case using the reservoir simulation model are given in Table B.24, together with corresponding project construction costs.

In the determination of LTPWC, the Susitna capital costs were adjusted to include an allowance for interest during construction and then used as input to the OGP5 model. Simulated annual energy yields were distributed on a monthly basis by the reservoir operation model to match as closely as possible the projected monthly energy demand of the Railbelt and then input to the OGP5 model. The LTPWC of meeting the Railbelt energy demand using the Susitna development as the primary source of energy was then determined for each of the three reservoir levels.

The results of these evaluations are shown in Table B.25, and a plot showing the variation of the LTPWC with dam crest elevation is shown in Figure B.19. This figure indicates that, on the basis of the assumptions used, the minimum LTPWC occurs at a Watana crest elevation ranging from approximately 2160 to 2200 (reservoir levels 2140 to 2180 feet). A higher dam crest will still result in a development which has an overall net economic benefit relative to thermal energy sources. However, it is also clear that, as the height of the Watana Dam is increased, the unit cost of additional energy produced at Watana is somewhat greater than for the displaced thermal energy source. Hence, the LTPWC of the overall system would increase. Conversely, as the height of the dam is lowered, and thus Watana produces less energy, the unit cost of the energy produced by a thermal generation source to replace the lost Susitna energy is more expensive than Susitna energy. In this case also, the LTPWC increases.

(iii) Geotechnical Considerations

On the north side of the reservoir created by the Watana Dam, a relict channel reaching 400 feet deep connects the reservoir to Tsusena Creek. The potential problems caused by the relict channel are:

- breaching of the reservoir rim resulting in catastrophic drawdown of the reservoir; and
- subsurface seepage resulting in potential downstream piping and/or loss of energy.

Breaching of the reservoir rim could be caused by saturation of the unconsolidated sediments within the channel resulting in surface settlement or by liquefaction during an earthquake.

Excessive subsurface seepage could be caused by a highly permeable unit(s) within the channel that could provide a continuous flow path between the reservoir and Tsusena Creek.

Details of the geology and potential impacts of the relict channel are addressed in Acres 1982a and 1982e reports.

As a result of these potential problems, extensive consideration was given to defining the reservoir level with respect to the relict channel.

Raising the water surface up to and beyond Elevation 2200 would require the construction of a costly retaining dike in a low area of the relict channel. Due to the uncertainty of foundation conditions in this area (to include material properties, groundwater, and permafrost) it was determined that the normal reservoir level of 2185 would provide the best energy development without incurring excessive costs in construction of additional water retaining structures in the relict channel. This reservoir level would require the construction of a small freeboard dike in this area. The following conditions would exist for a reservoir level of 2185:

- For flood magnitudes up to the 1:10,000-year event, there would be no danger of overtopping the lowest point in the relict channel.
- For the PMF, a 10-foot freeboard dike in the low area would provide adequate protection. This dike would be wetted only a few days during the PMF event.
- If seismic settlement or settlement due to permafrost melting did occur, the combination of the 10-foot freeboard dike constructed on a suitable foundation plus normal reservoir level of 2185 feet would ensure that breaching of the relict channel would not occur.

Lowering the reservoir to Elevation 2185 does not, however, lessen the possibility of subsurface seepage that could result in loss of energy and/or downstream piping. Preliminary analyses performed during the study (Acres 1982e) showed that an average permeability of  $10^{-2}$  cm/sec would be required in the relict channel to significantly affect project power economics. No such continuous horizons of low permeable materials have been found in the relict channel to date. However, if future geotechnical explorations find such a permeable unit(s), conventional remedial work to include grouting and cutoffs can be implemented to contain leakage. To facilitate the potential for piping, a contingency of more than \$100,000,000 has been provided in the cost estimate for the construction of a downstream filter blanket.

In summary, no further consideration was given to lowering the reservoir below the inlet to the relict channel because:

- This would require lowering the reservoir by more than 300 feet which would severely impact the energy provided by the basin development plans.
- Costs for remedial work in the relict channel were considered small with respect to the economics of the project.

(iv) Conclusions

It is important to establish clearly the overall objective used as a basis for setting the Watana reservoir level. An objective which would minimize the LTPW energy cost would lead to selection of a slightly lower reservoir level than an objective which would maximize the amount of energy which could be obtained from the available resource, while doing so with a technically sound project.

The three values of LTPWC developed by the OGP5 computer runs defined a relationship between LTPWC and Watana Dam height which is relatively insensitive to dam height. This is highlighted by the curve of LTPWC versus dam height in Figure B.19. This figure shows that there is only a slight variation in the LTPWC for the range of dam heights included in the analysis. Thus, from an economic standpoint, the optimum crest elevation could be considered as varying over a range of elevations from 2140 to 2220 with little effect on project economics. The main factors in



establishing the upper limit of dam height were consequently the geotechnical considerations discussed in (iii) above.

The normal maximum operating level of the reservoir was therefore set at Elevation 2185, allowing the objective of maximizing the economic use of the Susitna resource still to be satisfied.

(b) Selection of Installed Capacity

The generating capacity to be installed at both Watana and Devil Canyon was determined on the basis of generation planning studies together with appropriate consideration of the following (Acres 1982c, Vol. 1):

- Available firm and average energy from Watana and Devil Canyon;
- The forecast energy demand and peak load demand of the system;
- Available firm and average energy from other existing and committed plant;
- Capital cost and annual operating costs for Watana and Devil Canyon;
- Capital cost and annual operating costs for alternative sources of energy and capacity;
- Environmental constraints on reservoir operation; and
- Turbine and generator operating characteristics.

Table B.26 lists the design parameters used in establishing the dependable capacity at Watana.

(i) Installed Capacity

A computer simulation of reservoir operation over 32 years of hydrological record was used to predict firm (dependable) and average energy available from Watana and Devil Canyon reservoirs on a monthly basis. Seven alternative reservoir operating rules were assumed, varying from a maximum power generation scenario which would result in significant impact to downstream fisheries (Case A), through to a scenario that provides guaranteed minimum summer releases which minimize the impact on downstream fisheries (Case D). For the preliminary design, Case C predicted energies have been used to assess the required plant capacity.

The computer simulation gives an estimate of the monthly energy available from each reservoir, but the sizing of the plant capacity must take into account the variation of demand load throughout each month on an hourly basis. Load forecast studies have been undertaken to predict the hourly variation of load through each month of the year and also

the growth in peak load (MW) and annual energy demand (GWh) through the end of the planning horizon (2010).

The economic analysis for the proposed development assumes that the average energy from each reservoir is available every year. The hydrological record, however, is such that this average energy is available only from a series of wetter and drier years. In order to utilize the average energy, capacity must be available to generate the energy available in the wet years up to the maximum requirement dictated by the system energy demand, less any energy available from other committed hydroplant.

Watana has been designed to operate as a peaking station, if required. Tables B.27 and B.28 show the estimated maximum capacity required in the peak demand month (December) at Watana to fully utilize the energy available from the flows of record. If no thermal energy is needed (i.e., in wetter years), the maximum requirement is controlled only by the shape of the demand curve. If thermal energy is required (in average to dry years), the maximum capacity required at Watana will depend on whether the thermal energy is provided by high merit order plant at base load (Option 1, Table B.27), or by low merit order peaking plant (Option 2, Table B.28).

On the basis of this evaluation, the ultimate power generation capability at Watana was selected as 1020 MW for design purposes to allow a margin for hydro spinning reserve and standby for forced outage. This installation also provides a margin in the event that the load growth exceeds the medium load forecast.

(ii) Unit Capacity

Selection of the unit size for a given total capacity is a compromise between the initial least-cost solution, generally involving a scheme with a smaller number of large capacity units, and the improved plant efficiency and security of operation provided by a larger number of smaller capacity units. Other factors include the size of each unit as a proportion of the total system load and the minimum anticipated load on the station. Any requirement for a minimum downstream flow would also affect the selection. Growth of the actual load demand is also a significant factor, since the installation of units may be phased to match the actual load growth. The number of units and their individual ratings were determined by the need to deliver the required peak capacity in the peak demand month of December at the

minimum December reservoir level with the turbine wicket gates fully open.

An examination was made of the economic impact on power plant production costs of various combinations of a number of units and rated capacity which would provide the selected total capacity of 1020 MW. For any given installed capacity, plant efficiency increases as the number of units increases. The assumed capitalized value used in this evaluation was \$1.00 per average annual kWh over project life, based on the economic analysis completed for the thermal generation system. Variations in the number of units and capacity will affect the cost of the power intakes, penstocks, powerhouse, and tailrace. The differences in these capital costs were estimated and included in the evaluation. The results of this analysis are presented below.

<u>Number of Units</u>	<u>Rated Capacity of Unit (MW)</u>	<u>Capitalized Value of Additional Energy (\$ Millions)</u>	<u>Additional Capital Cost (\$ Millions)</u>	<u>Net Benefit (\$ Millions)</u>
4	250	-	-	-
6	170	40	31	9
8	125	50	58	-8

It is apparent from this analysis that a six-unit scheme with a net benefit of approximately \$9 million is the most economic alternative. This scheme also offers a higher degree of flexibility and security of operation compared to the four-unit alternative, as well as advantages if unit installation is phased to match actual load growth. The net economic benefit of the six-unit scheme is \$17 million greater than that of the eight-unit scheme, while at the same time no significant operational or scheduling advantages are associated with the eight-unit scheme.

A scheme incorporating six units each with a rated capacity of 170 MW, for a total of 1020 MW, has been adopted for all Watana alternatives.

(c) Selection of the Spillway Design Flood

Normal design practice for projects of this magnitude, together with applicable design regulations, require that the project be capable of passing the PMF routed through the reservoir without endangering the dam.

In addition to this requirement, the project should have sufficient spillway capacity to safely pass a major flood of lesser magnitude than the PMF without damaging the main dam or ancillary structures. The frequency of occurrence of this flood, known as the spillway design flood or Standard Project Flood (SPF), is generally selected on the basis of an evaluation of the risks to the project if the spillway design flood is exceeded, compared to the costs of the structures required to safely discharge the flood. For this study, a spillway design flood with a return frequency of 1:10,000 years was selected for Watana. A list of spillway design flood frequencies and magnitudes for several major projects is presented below.

Project	Spillway Design Flood		Basin PMF (cfs)	Spillway Capacity After Routing (cfs)*
	Frequency	Peak Inflow (cfs)		
Mica, Canada	PMF	250,000	250,000	150,000
Churchill Falls, Canada	1:10,000	600,000	1,000,000	230,000
New Bullards, USA	PMF	226,000	226,000	170,000
Oroville, USA	1:10,000	440,500	711,400	440,500
Guri, Venezuela (final stage)	PMF	1,000,000	1,000,000	1,000,000
Itaipu, Brazil	PMF	2,195,000	2,195,000	2,105,000
Sayano, USSR	1:10,000	480,000	N/A	680,000

\*All spillways except Sayano have capacity to pass PMF with surcharge.

The flood frequency analysis produced the following values:

<u>Flood</u>	<u>Frequency</u>	<u>Inflow Peak</u>
Probable Maximum Spillway Design	-- 1:10,000 years	326,000 cfs 156,000 cfs

Additional capacity required to pass the PMF will be provided by an emergency spillway consisting of a fuse plug and rock channel on the right bank.

(d) Main Dam Alternatives

This section describes the alternative types of dams considered at the Watana site and the basis for the selected alternative.

(i) Comparison of Embankment and Concrete Type Dams

The selection between an embankment type or a concrete type dam is usually based on the configuration of the valley, the condition of the foundation rock, depth of the overburden, and the relative availability of construction materials. Previous studies by the COE envisaged an embankment dam at Watana. Initial studies completed as part of this current evaluation included comparison of an earthfill dam with a concrete arch dam at the Watana site. An arrangement for a concrete arch dam alternative at Watana is presented in Figure B.20. The results of this analysis indicated that the cost of the embankment dam was somewhat lower than the arch dam, even though the concrete cost rates used were significantly lower than those used for the Devil Canyon Dam. This preliminary evaluation did not indicate any overall cost savings in the project in spite of some savings in the earthworks and concrete structures for the concrete dam layout. A review of the overall construction schedule indicated a minimal savings in time for the concrete dam project.

Based on the above and the likelihood that the cost of the arch dam would increase relative to that of the embankment dam, the arch dam alternative was eliminated from further consideration.

(ii) Concrete Face Rockfill Type Dam

The selection of a concrete face rockfill dam at Watana would appear to offer economic and schedule advantages when compared to a conventional impervious-core rockfill dam. For example, one of the primary areas of concern with the earth-core rockfill dam is the control of water content for the core material and the available construction period during each summer. The core material will have to be protected against frost penetration at the end of each season and the area cleared and prepared to receive new material after each winter. On the other hand, rockfill materials can be worked almost year-round and the quarrying and placing/compacting operations are not affected by rain and only marginally by winter weather.

The concrete face rockfill dam would also require less foundation preparation, since the critical foundation contact area is much less than that for the impervious-core/rock foundation contact. The side slopes for faced

rockfill could probably be on the order of 1.5H:1V or steeper as compared to the 2.5 and 2.0H:1V for the earth-core rockfill. This would allow greater flexibility for layout of the other facilities, in particular the upstream and downstream portals of the diversion tunnels and the tailrace tunnel portals. The diversion tunnels could be shorter, giving further savings in cost and schedule.

However, the height of the Watana Dam as currently proposed is 885 feet, some 70 percent higher than the highest concrete face rockfill dam built to date (the 525-foot high Areia Dam in Brazil completed in 1980). A review of concrete face rockfill dams indicates that increases in height have been typically in the range of 20 percent; for example, Paradela - 370 feet completed in 1955; Alto Anchicaya - 460 feet completed in 1974; Areia - 525 feet completed in 1980. Although recent compacted rockfill dams have generally performed well and a rockfill dam is inherently stable even with severe leakage through the face, a one-step increase in height of 70 percent over existing structures is well beyond precedent.

In addition to the height of the dam, other factors which are beyond precedent include the seismic and climatic conditions at Susitna. It has been stated that concrete face rockfill dams are well able to resist earthquake forces and it is admitted that they are very stable structures in themselves. However, movement of rock leading to failure of the face slab near the base of the dam could result in excessive leakage through the dam. To correct such an occurrence would require lowering the water level in the reservoir which would take many years and involve severe economic penalties from loss of generating capacity.

No concrete face rockfill dam has yet been built in an arctic environment. The drawdown at Watana is in excess of 100 feet and the upper section of the face slab will be subjected to severe freeze/thaw cycles.

Although the faced rockfill dam appears to offer schedule advantages, the overall gain in impoundment schedule would not be so significant. With the earth-core rockfill dam, impoundment can be allowed as the dam is constructed. This is not the case for a concrete face rockfill since the concrete face slab is normally not constructed until all rockfill has been placed and construction settlement taken place. The slab is then poured in continuous strips from the foundation to the crest. Most recent high faced rockfill dams also incorporate an impervious earth fill cover

over the lower section to minimize the risk of excessive leakage through zones which, because of their depth below normal water level, are difficult to repair. Such a zone at Watana might cover the lower 200 to 300 feet of the slab and require considerable volumes of impervious fill, none of which could be placed until all other construction work had been completed. This work would be on the critical path with respect to impoundment and, at the same time, be subject to interference by wet weather.

The two types of dam were not costed in detail because cost was not considered to be a controlling factor. It is of interest to note, however, that similar alternatives were estimated for the LG 2 project in northern Quebec and the concrete face alternative was estimated to be about 5 percent cheaper. However, the managers, on the recommendation of their consultants, decided against the use of a concrete face rockfill dam for the required height of 500 feet in that environment.

In summary, a concrete face rockfill dam at Watana is not considered appropriate as a firm recommendation for the feasibility stage of development of the Susitna project because of:

- . the 70 percent increase in height over precedent; and
- . the possible impacts of high seismicity and climatic conditions.

(iii) Selection of Dam Type

Selection of the configuration of the embankment dam cross section was undertaken within the context of the following basic considerations:

- The availability of suitable construction materials within economic haul distance, particularly core material;
- The requirement that the dam be capable of withstanding the effects of a significant earthquake shock as well as the static loads imposed by the reservoir and its own weight;
- The relatively limited construction season available for placement of compacted fill materials.

The main dam would consist of a compacted core protected by fine and coarse filter zones on both the upstream and down-

stream slopes of the core. The upstream and downstream outer supporting fill zones would contain relatively free draining compacted gravel or rockfill, providing stability to the overall embankment structure. The location and inclination of the core is fundamental to the design of the embankment. Two basic alternatives exist in this regard:

- A vertical core located centrally within the dam; and
- An inclined core with both faces sloping upstream.

A central vertical core was chosen for the embankment based on a review of precedent design and the nature of the available impervious material.

The exploration program undertaken during 1980-81 indicated that adequate quantities of materials suitable for dam construction were located within reasonable haul distance from the site. The well-graded silty sand material is considered the most promising source of impervious fill. Compaction tests indicate a natural moisture content slightly on the wet side of optimum moisture content, so that control of moisture content will be critical in achieving a dense core with high shear strength.

Potential sources for the upstream and downstream shells include either river gravel from borrow areas along the Susitna River or compacted rockfill from quarries or excavations for spillways.

During the intermediate review process, the upstream slope of the dam was flattened from 2.5H:1V used during the initial review to 2.75H:1V. This slope was based on a conservative estimate of the effective shear strength parameters of the available construction materials, as well as a conservative allowance in the design for the effects of earthquake loadings on the dam.

During the final review stage, the exterior upstream slope of the dam was steepened from 2.75H:1V to 2.4H:1V, reflecting the results of the preliminary static and dynamic design analyses being undertaken at the same time as the general arrangement studies. As part of the final review, the volume of the dam with an upstream slope of 2.4H:1V was computed for four alternative dam axes. The locations of these alternative axes are shown on Figure B.21. The dam volume associated with each of the four alternative axes is listed below:



<u>Alternative Axis Number</u>	<u>Total Volume (million yd<sup>3</sup>)</u>
1	69.2
2	71.7
3	69.3
4	71.9

A section with a 2.4H:1V upstream slope and a 2H:1V downstream slope located on alternative axis number 3 was used for the final review of alternative schemes.

(e) Diversion Scheme Alternatives

The topography of the site generally dictates that diversion of the river during construction be accomplished using diversion tunnels with upstream and downstream cofferdams protecting the main construction area.

The configuration of the river in the vicinity of the site favors location of the diversion tunnels on the north bank, since the tunnel length for a tunnel on the south bank would be approximately 2000 feet greater. In addition, rock conditions on the north bank are more favorable for tunneling and excavation of intake and outlet portals.

(i) Design Flood for Diversion

The recurrence interval of the design flood for diversion is generally established based on the characteristics of the flow regime of the river, the length of the construction period for which diversion is required and the probable consequences of overtopping of the cofferdams. Design criteria and experience from other projects similar in scope and nature have been used in selecting the diversion design flood.

At Watana, damage to the partially completed dam could be significant or, more importantly, would probably result in at least a one-year delay in the completion schedule. A preliminary evaluation of the construction schedule indicates that the diversion scheme would be required for four or five years until the dam is of sufficient height to permit initial filling of the reservoir. A design flood with a return frequency of 1:50 years was selected based on experience and practice with other major hydroelectric projects. This approximates a 90 percent probability that the cofferdam will not be overtopped during the five-year construction period. The diversion design flood together with average flow characteristics of the river significant to diversion are presented below:

Average annual flow	7,990 cfs
Maximum average monthly flow	42,800 cfs (June)
Minimum average monthly flow	570 cfs (March)
Design flood inflow (1:50 years)	87,000 cfs

(ii) Cofferdams

For the purposes of establishing the overall general arrangement of the project and for subsequent diversion optimization studies, the upstream cofferdam section adopted comprises an initial closure dam structure approximately 30 feet high placed in the wet.

(iii) Diversion Tunnels

Concrete-lined tunnels and unlined rock tunnels were compared. Preliminary hydraulic studies indicated that the design flood routed through the diversion scheme would result in a design discharge of approximately 80,500 cfs. For concrete-lined tunnels, design velocities on the order of 50 ft/sec have been used in several projects. For unlined tunnels, maximum design velocities ranging from 10 ft/sec in good quality rock to 4 ft/sec in less competent material are typical. Thus, the volume of material to be excavated using an unlined tunnel would be at least 5 times that for a lined tunnel. The reliability of an unlined tunnel is more dependent on rock conditions than is a lined tunnel, particularly given the extended period during which the diversion scheme is required to operate. Based on these considerations, given a considerably higher cost, together with the somewhat questionable feasibility of four unlined tunnels with diameters approaching 50 feet in this type of rock, the unlined tunnels have been eliminated.

The following alternative lined tunnel schemes were examined as part of this analysis:

- Pressure tunnel with a free outlet
- Pressure tunnel with a submerged outlet
- Free flow tunnel.

(iv) Emergency Release Facilities

The emergency release facilities influenced the number, type, and arrangement of the diversion tunnels selected for the final scheme.

At an early stage of the study, it was established that some form of low-level release facility was required to

meet instream flow requirements during filling of the reservoir, and to permit lowering of the reservoir in the event of an extreme emergency. The most economical alternative available would involve converting one of the diversion tunnels to permanent use as a low-level outlet facility. Since it would be necessary to maintain the diversion scheme in service during construction of the emergency facilities outlet works, two or more diversion tunnels would be required. The use of two diversion tunnels also provides an additional measure of security to the diversion scheme in case of the loss of service of one tunnel.

The low-level release facilities will be operated for approximately three years during filling of the reservoir. Discharge at high heads usually requires some form of energy dissipation prior to returning the flow to the river. Given the space restrictions imposed by the size of the diversion tunnel, it was decided to utilize a double expansion system constructed within the upper tunnel.

(v) Optimization of Diversion Scheme

Given the considerations described above relative to design flows, cofferdam configuration, and alternative types of tunnels, an economic study was undertaken to determine the optimum combination of upstream cofferdam height and tunnel diameter.

Capital costs were developed for three heights of upstream cofferdam embankment with a 30-foot wide crest and exterior slopes of 2H:1V. A freeboard allowance of 5 feet for settlement and wave runup and 10 feet for the effects of downstream ice jamming on tailwater elevations was adopted.

Capital costs for the 4700-foot long tunnel alternatives included allowances for excavation, concrete liner, rock bolts, and steel supports. Costs were also developed for the upstream and downstream portals, including excavation and support. The cost of intake gate structures and associated gates was determined not to vary significantly with tunnel diameter and was excluded from the analysis.

Curves of headwater elevation versus tunnel diameter for the various tunnel alternatives with submerged and free outlets are presented in Figure B.22. The relationship between capital cost and crest elevation for the upstream cofferdam is shown in Figure B.23. The capital cost for various tunnel diameters with free and submerged outlets is given in Figure B.24.

The results of the optimization study are presented in Figure B.25 and indicate the following optimum solutions for each alternative.

<u>Type of Tunnel</u>	<u>Diameter (feet)</u>	<u>Cofferdam Crest Elevation (ft)</u>	<u>Total Cost (\$)</u>
Two pressure tunnels	30	1595	66,000,000
Two free flow tunnels	32.5	1580	68,000,000
Two free flow tunnels	35	1555	69,000,000

The cost studies indicate that a relatively small cost differential (4 to 5 percent) separates the various alternatives for tunnel diameter from 30 to 35 feet.

(vi) Selected Diversion Scheme

An important consideration at this point is ease of cofferdam closure. For the pressure tunnel scheme, the invert of the tunnel entrance is below riverbed elevation, and once the tunnel is complete diversion can be accomplished with a closure dam section approximately 10 feet high. The free flow tunnel scheme, however, requires a tunnel invert approximately 30 feet above the riverbed level, and diversion would involve an end-dumped closure section 50 feet high. The velocities of flows which would overtop the cofferdam before the water levels were raised to reach the tunnel invert level would be prohibitively higher, resulting in complete erosion of the cofferdam, and hence the dual free flow tunnel scheme was dropped from consideration.

Based on the preceding considerations, a combination of one pressure tunnel and one free flow tunnel (or pressure tunnel with free outlet) was adopted. This will permit initial diversion to be made using the lower pressure tunnel, thereby simplifying the critical closure operation and avoiding potentially serious delays in the schedule. Two alternatives were re-evaluated as follows:

<u>Tunnel Diameter (feet)</u>	<u>Upstream Cofferdam</u>	
	<u>Crest Elevation (feet)</u>	<u>Approximate Height (feet)</u>
30	1595	150
35	1555	110

More detailed layout studies indicated that the higher cofferdam associated with the 30-foot diameter tunnel alternative would require locating the inlet portal further upstream into "The Fins" shear zone. Since good rock conditions for portal construction are essential and the 35-foot diameter tunnel alternative would permit a portal location downstream of "The Fins", this latter alternative was adopted. As noted in (v), the overall cost difference was not significant in the range of tunnel diameters considered, and the scheme incorporating two 35-foot diameter tunnels with an upstream cofferdam crest elevation of 1555 was incorporated as part of the selected general arrangement.

(f) Spillway Facilities Alternatives

As discussed in subsection (c) above, the project has been designed to safely pass floods with the following return frequencies:

<u>Flood</u>	<u>Frequency</u>	<u>Inflow Peak (cfs)</u>	<u>Total Spillway Discharge (cfs)</u>
Spillway Design	1:10,000 years	156,000	120,000
Probable Maximum	--	326,000	150,000

Discharge of the spillway design flood will require a gated service spillway on either the left or right bank. Three basic alternative spillway types were examined:

- Chute spillway with flip bucket
- Chute spillway with stilling basin
- Cascade spillway.

Consideration was also given to combinations of these alternatives with or without supplemental facilities such as valved tunnels and an emergency spillway fuse plug for handling the PMF discharge.

Clearly, the selected spillway alternatives will greatly influence and be influenced by the project general arrangement.

(i) Energy Dissipation

The two chute spillway alternatives considered achieve effective energy dissipation either by means of a flip bucket which would direct the spillway discharge in the form of a free-fall jet into a plunge pool well downstream from the dam or a stilling basin at the end of the chute which would dissipate energy in a hydraulic jump. The cascade type spillway would limit the free-fall height of the discharge by utilizing a series of 20- to 50-foot steps down to river level, with energy dissipation at each step.

All spillway alternatives were assumed to incorporate a concrete ogee type control section controlled by fixed-roller vertical lift gates. Chute spillway sections were assumed to be concrete-lined, with ample provision for air entrainment in the chute to prevent cavitation erosion, and with pressure relief drains and rock anchors in the foundation.

(ii) Environmental Mitigation

During development of the general arrangements for both the Watana and Devil Canyon Dams, a restriction was imposed on the amount of excess dissolved nitrogen permitted in the spillway discharges. Supersaturation occurs when aerated flows are subjected to pressures greater than 30 to 40 feet of head which forces excess nitrogen into solution. This occurs when water is subjected to the high pressures that occur in deep plunge pools or at large hydraulic jumps. The excess nitrogen would not be dissipated within the downstream Devil Canyon reservoir and a buildup of nitrogen concentration could occur throughout the body of water. It would eventually be discharged downstream from Devil Canyon with harmful effects on the fish population. On the basis of an evaluation of the related impacts and discussions with interested federal and state agencies, spillway facilities were designed to limit discharges of water from either Watana or Devil Canyon that may become supersaturated with nitrogen to a recurrence period of not less than 1:50 years.

(g) Power Facilities Alternatives

Selection of the optimum power plant development involved consideration of the following:

- Location, type and size of the power plant
- Geotechnical considerations
- Number, type, size and setting of generating units
- Arrangement of intake and water passages
- Environmental constraints.

(i) Comparison of Surface and Underground Powerhouse

Studies were carried out to compare the construction costs of a surface powerhouse and of an underground powerhouse at Watana. These studies were undertaken on the basis of preliminary conceptual layouts assuming four or six units and a total installed capacity of 840 MW. The comparative cost estimates for powerhouse civil works and electrical and mechanical equipment (excluding common items) indicated an

advantage in favor of the underground powerhouse of \$16,300,000. A summary comparison of the cost estimates for the two types of powerhouses is in Table B.29. The additional cost for the surface powerhouse arrangement is primarily associated with the longer penstocks and the steel linings required.

The underground powerhouse arrangement is also better suited to the severe winter conditions in Alaska, is less affected by river flood flows in summer, and is aesthetically less obtrusive. This arrangement has therefore been adopted for further development.

(ii) Comparison of Alternative Locations

Preliminary studies were undertaken during the development of conceptual project layouts at Watana to investigate both right and left bank locations for power facilities. The configuration of the site is such that south bank locations required longer penstock and/or tailrace tunnels and were therefore more expensive.

The location on the south bank was further rejected because of indications that the underground facilities would be located in relatively poor quality rock. The underground powerhouse was therefore located on the north bank such that the major openings lay between the two major shear features ("The Fins" and the "Fingerbuster").

(iii) Underground Openings

Because no construction adits or extensive drilling in the powerhouse and tunnel locations have been completed, it has been assumed that full concrete-lining of the penstocks and tailrace tunnels would be required. This assumption is conservative and is for preliminary design only; in practice, a large proportion of the tailrace tunnels would probably be unlined, depending on the actual rock quality encountered.

The minimum center-to-center spacing of rock tunnels and caverns has been assumed for layout studies to be 2.5 times the width or diameter of the larger excavation.

(iv) Selection of Turbines

The selection of turbine type is governed by the available head and flow. For the design head and specific speed, Francis type turbines have been selected. Francis turbines

have a reasonably flat load-efficiency curve over a range from about 50 percent to 115 percent of rated output with peak efficiency of about 92 percent.

The number and rating of individual units is discussed in detail in subsection (b) above. The final selected arrangement comprises six units producing 170 MW each, rated at minimum reservoir level (from reservoir simulation studies) in the peak demand month (December) at full gate. The unit output at best efficiency and a rated head of 680 feet is 181 MW.

(v) Transformers

The selection of transformer type, size, location and step-up rating is summarized below:

- Single-phase transformers are required because of transport limitations on Alaskan roads and railways;
- Direct transformation from 15 kV to 345 kV is preferred for overall system transient stability;
- An underground transformer gallery has been selected for minimum total cost of transformers, cables, bus, and transformer losses; and
- A grouped arrangement of three sets of three single-phase transformers for each set of two units has been selected (a total of nine transformers) to reduce the physical size of the transformer gallery and to provide a transformer spacing comparable with the unit spacing.

(vi) Power Intake and Water Passages

The power intake and approach channel are significant items in the cost of the overall power facilities arrangement. The size of the intake is controlled by the number and minimum spacing between the penstocks, which in turn is dictated by geotechnical considerations.

The preferred penstock arrangement comprises six individual penstocks, one for each turbine. With this arrangement, no inlet valve is required in the powerhouse since turbine dewatering can be performed by closing the control gate at the intake and draining the penstocks and scroll case through a valved bypass to the tailrace. An alternative arrangement with three penstocks was considered in detail to assess any possible advantages. This scheme would require a bifurcation and two inlet valves on each penstock



and extra space in the powerhouse to accommodate the inlet valves. Estimates of relative cost differences are summarized below:

<u>Item</u>	<u>Cost Difference (\$ x 10<sup>6</sup>)</u>	
	<u>6 Penstocks</u>	<u>3 Penstocks</u>
Intake	Base Case	-20.0
Penstocks	0	- 3.0
Bifurcations	0	+ 3.0
Valves	0	+ 4.0
Powerhouse	0	+ 8.0
Capitalized Value of Extra Head Loss	<u>0</u>	<u>+ 6.0</u>
Total	0	- 2.0

Despite a marginal saving of \$2 million (or less than 2 percent in a total estimated cost of \$120 million) in favor of three penstocks, the arrangement of six individual penstocks has been retained. This arrangement provides improved flexibility and security of operation.

The preliminary design of the power facilities involves two tailrace tunnels leading from a common surge chamber. An alternative arrangement with a single tailrace tunnel was also considered, but no significant cost saving was apparent.

Optimization studies on all water passages were carried out to determine the minimum total cost of initial construction plus the capitalized value of anticipated energy losses caused by conduit friction, bends and changes of section. For the penstock optimization, the construction costs of the intake and approach channel were included as a function of the penstock diameter and spacing. Similarly, in the optimization studies for the tailrace tunnels the costs of the surge chamber were included as a function of tailrace tunnel diameter.

(vii) Environmental Constraints

Apart from the potential nitrogen supersaturation problem discussed, the major environmental constraints on the design of the power facilities are:

- Control of downstream river temperatures
- Control of downstream flows.

The intake design has been modified to enable power plant flows to be drawn from the reservoir at four different levels throughout the anticipated range of reservoir

drawdown for energy production in order to control the downstream river temperatures within acceptable limits.

Minimum flows at Gold Creek during the critical summer months have been studied to mitigate the project impacts on salmon spawning downstream of Devil Canyon. These minimum flows represent a constraint on the reservoir operation and influence the computation of average and firm energy produced by the Susitna development.

The Watana development will be operated as a daily peaking plant for load following. The actual extent of daily peaking will be dictated by unit availability, unit size, system demand, system stability, generating costs, etc.

### 2.3 - Selection of Watana General Arrangement

Preliminary alternative arrangements of the Watana project were developed and subjected to a series of review and screening processes. The layouts selected from each screening process were developed in greater detail prior to the next review and, where necessary, additional layouts were prepared combining the features of two or more of the alternatives. Assumptions and criteria were evaluated at each stage and additional data incorporated as necessary. The selection process followed the general selection methodology established for the Susitna project and is outlined below.

#### (a) Selection Methodology

The determination of the project general arrangement at Watana was undertaken in three distinct review stages: preliminary, intermediate, and final.

##### (i) Preliminary Review (completed early in 1981)

This comprised four steps:

- Step 1: Assemble available data, determine design criteria, and establish evaluation criteria.
- Step 2: Develop preliminary layouts and design criteria based on the above data including all plausible alternatives for the constituent facilities and structures.
- Step 3: Review all layouts on the basis of technical feasibility, readily apparent cost differences, safety, and environmental impact.

- Step 4: Select those layouts that can be identified as most favorable, based on the evaluation criteria established in Step 1, and taking into account the preliminary nature of the work at this stage.

(ii) Intermediate Review (completed by mid-1981)

This involved a series of 5 steps:

- Step 1: Review all data, incorporating additional data from other work tasks.

Review and expand design criteria to a greater level of detail.

Review evaluation criteria and modify, if necessary.

- Step 2: Revise selected layouts on basis of the revised criteria and additional data. Prepare plans and principal sections of layouts.

- Step 3: Prepare quantity estimates for major structures based on drawings prepared under Step 2.

Develop a preliminary construction schedule to evaluate whether or not the selected layout will allow completion of the project within the required time frame.

Prepare a preliminary contractor's type estimate to determine the overall cost of each scheme.

- Step 4: Review all layouts on the basis of technical feasibility, cost impact of possible unknown conditions and uncertainty of assumptions, safety, and environmental impact.

- Step 5: Select the two most favorable layouts based on the evaluation criteria determined under Step 1.

(iii) Final Review (completed early in 1982)

- Step 1: Assemble and review any additional data from other work tasks.

Revise design criteria in accordance with additional available data.

Finalize overall evaluation criteria.

- Step 2: Revise or further develop the two layouts on the basis of input from Step 1 and determine overall dimensions of structures, water passages, gates, and other key items.
- Step 3: Prepare quantity take-offs for all major structures.

Review cost components within a preliminary contractor's type estimate using the most recent data and criteria, and develop a construction schedule.

Determine overall direct cost of schemes.

- Step 4: Review all layouts on the basis of practicability, technical feasibility, cost, impact of possible unknown conditions, safety, and environmental impact.
- Step 5: Select the final layout on the basis of the evaluation criteria developed under Step 1.

(b) Design Data and Criteria

As discussed above, the review process included assembling relevant design data, establishing preliminary design criteria, and expanding and refining these data during the intermediate and final reviews of the project arrangement. The design data and design criteria which evolved through the final review are presented in Table B.30.

(c) Evaluation Criteria

The various layouts were evaluated at each stage of the review process on the basis of the criteria summarized in Table B.31. These criteria illustrate the progressively more detailed evaluation process leading to the final selected arrangement.

(d) Preliminary Review

The development selection studies (Acres 1982c, Vol. 1; Acres 1981) involved comparisons of hydroelectric schemes at a number of sites on the Susitna River. As part of these comparisons a preliminary conceptual design was developed for Watana incorporating a double stilling basin type spillway.

Eight further layouts were subsequently prepared and examined for the Watana project during this preliminary review process in

addition to the scheme shown on Figure B.7. These eight layouts are shown in schematic form on Figure B.26. Alternative 1 of these layouts was the scheme recommended for further study.

This section describes the preliminary review undertaken of alternative Watana layouts.

(i) Basis of Comparison of Alternatives

Although it was recognized that provision would have to be made for downstream releases of water during filling of the reservoir and for emergency reservoir drawdown, these features were not incorporated in these preliminary layouts. These facilities would either be interconnected with the diversion tunnels or be provided for separately. Since the system selected would be similar for all layouts with minimal cost differences and little impact on other structures, it was decided to exclude these facilities from overall assessment at this early stage.

Ongoing geotechnical explorations had identified the two major shear zones crossing the Susitna River and running roughly parallel in the northwest direction. These zones enclose a stretch of watercourse approximately 4500 feet in length. Preliminary evaluation of the existing geological data indicated highly fractured and altered materials within the actual shear zones which would pose serious problems for conventional tunneling methods and would be unsuitable for founding of massive concrete structures. The originally proposed dam axis was located between these shear zones; since no apparent major advantage appeared to be gained from large changes in the dam location, layouts generally were kept within the confines of these bounding zones.

An earth and rockfill dam was used as the basis for all layouts. The downstream slope of the dam was assumed as 2H:1V in all alternatives, and upstream slopes varying between 2.5H:1V and 2.25H:1V were examined in order to determine the influence of variance in the dam slope on the congestion of the layout. In all preliminary arrangements except the one shown on Figure B.7, cofferdams were incorporated within the body of the main dam.

Floods greater than the routed 1:10,000-year spillway design flood and up to the probable maximum flood were assumed to be passed by surcharging the spillways, except in cases where an unlined cascade or stilling basin type spillway served as the sole discharge facility. In such

instances, under large surcharges, these spillways would not act as efficient energy dissipators but would be drowned out, acting as steep open channels with the possibility of their total destruction. In order to avoid such an occurrence, the design flood for these latter spillways was considered as the routed probable maximum flood.

On the basis of information existing at the time of the preliminary review, it appeared that an underground powerhouse could be located on either side of the river. A surface powerhouse on the north bank appeared feasible but was precluded from the south bank by the close proximity of the downstream toe of the dam and the adjacent broad shear zone. Locating the powerhouse further downstream would require tunneling across the shear zone, which would be expensive and would require excavating a talus slope. Furthermore, it was found that a south bank surface powerhouse would either interfere with a south bank spillway or would be directly impacted by discharges from a north bank spillway.

(ii) Description of Alternatives

- Double Stilling Basin Scheme

The scheme as shown on Figure B.7 has a dam axis location similar to that originally proposed by the COE, and a north bank double stilling basin spillway. The spillway follows the shortest line to the river, avoiding interference with the dam and discharging downstream almost parallel to the flow into the center of the river. A substantial amount of excavation is required for the chute and stilling basins, although most of this material could probably be used in the dam. A large volume of concrete is also required for this type of spillway, resulting in a spillway system that would be very costly. The maximum head dissipated within each stilling basin is approximately 450 feet. Within world experience, cavitation and erosion of the chute and basins should not be a problem if the structures are properly designed. Extensive erosion downstream would not be expected.

The diversion follows the shortest route, cutting the bend of the river on the north bank, and has inlet portals as far upstream as possible without having to tunnel through "The Fins." It is possible that the underground powerhouse is in the area of "The Fingerbuster," but the powerhouse could be located upstream almost as far as

the system of drain holes and galleries just downstream of the main dam grout curtain.

- Alternative 1

This alternative (Figure B.26) is recommended for further study and is similar to the layout described above except that the north side of the dam has been rotated clockwise, the axis relocated upstream, and the spillway changed to a chute and flip bucket. The revised dam alignment resulted in a slight reduction in total dam volume compared to the above alternative. A localized downstream curve was introduced in the dam close to the north abutment in order to reduce the length of the spillway. The alignment of the spillway is almost parallel to the downstream section of the river and it discharges into a pre-excavated plunge pool in the river approximately 800 feet downstream from the flip bucket. This type of spillway should be considerably less costly than one incorporating a stilling basin, provided that excessive pre-excavation of bedrock within the plunge pool area is not required. Careful design of the bucket will be required, however, to prevent excessive erosion downstream causing undermining of the valley sides and/or buildup of material downstream which could cause elevation of the tailwater levels.

- Alternatives 2 through 2D

Alternative 2 consists of a south bank cascade spillway with the main dam axis curving downstream at the abutments. The cascade spillway would require an extremely large volume of rock excavation, but it is probable that most of this material, with careful scheduling, could be used in the dam. The excavation would cross "The Fing-erbuster" and extensive dental concrete would be required in that area. In the upstream portion of the spillway, velocities would be relatively high because of the narrow configuration of the channel, and erosion could take place in this area in proximity to the dam. The discharge from the spillway enters the river perpendicular to the general flow, but velocities would be relatively low and should not cause substantial erosion problems. The powerhouse is in the most suitable location for a surface alternative where the bedrock is close to the surface and the overall rock slope is approximately 2H:1V.

Alternative 2A is similar to Alternative 2 except that the upper end of the channel is divided and separate control structures are provided. This division would allow the use of one structure on upstream channel while maintenance or remedial work is being performed on the other.

Alternative 2B is similar to Alternative 2 except that the cascade spillway is replaced by a double stilling basin type structure. This spillway is somewhat longer than the similar type of structure on the north bank in the alternative described above. However, the slope of the ground is less than the rather steep north bank and may be easier to construct, a factor which may partly mitigate the cost of the longer structure. The discharge is at a sharp angle to the river and more concentrated than the cascade, which could cause erosion of the opposite bank.

Alternative 2C is a derivative of 2B with a similar arrangement, except that the double stilling basin spillway is reduced in size and augmented by an additional emergency spillway in the form of an inclined, unlined rock channel. Under this arrangement the concrete spillway acts as the main spillway, passing the 1:10,000-year design flood with greater flows passed down the unlined channel which is closed at its upstream end by an erodible fuse plug. The problems of erosion of the opposite bank still remain, although these could be overcome by excavation and/or slope protection. Erosion of the chute would be extreme for significant flows, although it is highly unlikely that this emergency spillway would ever be used.

Alternative 2D replaces the cascade of Alternative 2 with a lined chute and flip bucket. The comments relative to the flip bucket are the same as for Alternative 1 except that the south bank location in this instance requires a longer chute, partly offset by lower construction costs because of the flatter slope. The flip bucket discharges into the river at an angle which may cause erosion of the opposite bank. The underground powerhouse is located on the north bank, an arrangement which provides an overall reduction of the length of the water passages.

- Alternative 3

This arrangement has a dam axis location slightly upstream from Alternative 2, but retains the downstream



curve at the abutments. The main spillway is an unlined rock cascade on the south bank which passes the design flood. Discharges beyond the 1:10,000-year flood would be discharged through the auxiliary concrete-lined chute and flip bucket spillway on the north bank. A gated control structure is provided for this auxiliary spillway which gives it the flexibility to be used as a back-up if maintenance should be required on the main spillway. Erosion of the cascade may be a problem, as mentioned previously, but erosion downstream should be a less important consideration because of the low unit discharge and the infrequent operation of the spillway. The diversion tunnels are situated in the north abutment, as with previous arrangements, and are of similar cost for all these alternatives.

- Alternative 4

This alternative involves rotating the axis of the main dam so that the south abutment is relocated approximately 1000 feet downstream from its Alternative 2 location. The relocation results in a reduction in the overall dam quantities but would require siting the impervious core of the dam directly over "The Fingerbuster" shear zone at maximum dam height. The south bank spillway, consisting of chute and flip bucket, is reduced in length compared to other south bank locations, as are the power facility water passages. The diversion tunnels are situated on the south bank; there is no advantage to a north bank location, since the tunnels are of similar length owing to the overall downstream relocation of the dam. Spillways and power facilities would also be lengthened by a north bank location with this dam configuration.

- Selection of Schemes for Further Study

A basic consideration during design development was that the main dam core should not cross the major shear zones because of the obvious problems with treatment of the foundation. Accordingly, there is very little scope for realigning the main dam apart from a slight rotation to place it more at right angles to the river.

Location of the spillway on the north bank results in a shorter distance to the river and allows discharges almost parallel to the general direction of river flow. The double stilling basin arrangement would be extremely expensive, particularly if it must be designed to pass the probable maximum flood. An alternative such as 2C

would reduce the magnitude of design flood to be passed by the spillway but would only be acceptable if an emergency spillway with a high degree of operational predictability could be constructed. A flip bucket spillway on the north bank, discharging directly down the river, would appear to be an economic arrangement, although some scour might occur in the plunge pool area. A cascade spillway on the south bank could be an acceptable solution provided that most of the excavated material could be used in the dam, and adequate rock conditions exist.

The length of diversion tunnels can be decreased if they are located on the north bank. In addition, the tunnels would be accessible by a preliminary access road from the north, which is the most likely route. This location would also avoid the area of "The Fingerbuster" and the steep cliffs which would be encountered on the south side close to the downstream dam toe.

The underground configuration assumed for the powerhouse in these preliminary studies allows for location on either side of the river with a minimum of interference with the surface structures.

Four of the preceding layouts, or variations of them, were selected for further study:

- . A variation of the double stilling basin scheme, but with a single stilling basin main spillway on the north bank, a rock channel and fuse plug emergency spillway, a south bank underground powerhouse and a north bank diversion scheme;
- . Alternative 1 with a north bank flip bucket spillway, an underground powerhouse on the south bank, and north bank diversion;
- . A variation of Alternative 2 with a reduced capacity main spillway and a north bank rock channel with a fuse plug serving as an emergency spillway; and
- . Alternative 4 with a south bank rock cascade spillway, a north bank underground powerhouse, and a north bank diversion.

(e) Intermediate Review

For the intermediate review process, the four schemes selected as a result of the preliminary review were examined in more detail

and modified. A description of each of the schemes is given below and shown on Figures B.27 through B.32. The general locations of the upstream and downstream shear zones shown on these plates are approximate and have been refined on the basis of subsequent field investigations for the proposed project.

(i) Description of Alternative Schemes

The four schemes are shown on Figures B.27 through B.32.

- Scheme WP1 (Figure B.27)

This scheme is a refinement of Alternative 1. The upstream slope of the dam is flattened from 2.5:1 to 2.75:1. This conservative approach was adopted to provide an assessment of the possible impacts on project layout of conceivable measures which may prove necessary in dealing with severe earthquake design conditions. Uncertainty with regard to the nature of river alluvium also led to the location of the cofferdams outside the limits of the main dam embankment. As a result of these conditions, the intake portals of the diversion tunnels on the north bank are also moved upstream from "The Fins". A chute spillway with a flip bucket is located on the north bank. The underground powerhouse is located on the south bank.

- Scheme WP2 (Figures B.29 and B.30)

This scheme is derived from the double stilling basin layout. The main dam and diversion facilities are similar to Scheme WP1 except that the downstream cofferdam is relocated further downstream from the spillway outlet and the diversion tunnels are correspondingly extended. The main spillway is located on the north bank, but the two stilling basins of the preliminary scheme (Acres 1981) are combined into a single stilling basin at the river level. An emergency spillway is also located on the north bank and consists of a channel excavated in rock, discharging downstream from the area of the relict channel. The channel is closed at its upstream end by a compacted earthfill fuse plug and is capable of discharging the flow differential between the probable maximum flood and the surcharged capacity of the main spillway. The underground powerhouse is located on the south bank.

- Scheme WP3 (Figures B.28 and B.29)

This scheme is similar to Scheme WP1 in all respects except that an emergency spillway is added consisting of north bank rock channel and fuse plug.

- Scheme WP4 (Figures B.31 and B.32)

The dam location and geometry for Scheme WP4 are similar to that for the other schemes. The diversion is on the north bank and discharges downstream from the powerhouse tailrace outlet. A rock cascade spillway is located on the south bank and is served by two separate control structures with downstream stilling basins. The underground powerhouse is located on the north bank.

(ii) Comparison of Schemes

The main dam is in the same location and has the same configuration for each of the four layouts considered. The cofferdams have been located outside the limits of the main dam in order to allow more extensive excavation of the alluvial material and to ensure a sound rock foundation beneath the complete area of the dam. The overall design of the dam is conservative, and it was recognized during the evaluation that savings in both fill and excavation costs can probably be made after more detailed study.

The diversion tunnels are located on the north bank. The upstream flattening of the dam slope necessitates the location of the diversion inlets upstream from "The Fins" shear zone which would require extensive excavation and support where the tunnels pass through this extremely poor rock zone and could cause delays in the construction schedule.

A low-lying area exists on the north bank in the area of the relict channel and requires approximately a 50-foot high saddle dam for closure, given the reservoir operating level assumed for the comparison study. However, the finally selected reservoir operating level will require only a nominal freeboard structure at this location.

A summary of capital cost estimates for the four alternative schemes is given in Table B.32.

The results of this intermediate analysis indicate that the chute spillway with flip bucket (Scheme WP1) is the least costly spillway alternative.

The scheme has the additional advantage of relatively simple operating characteristics. The control structure

has provision for surcharging to pass the design flood. The probable maximum flood can be passed by additional surcharging up to the crest level of the dam. In Scheme WP3 a similar spillway is provided, except that the control structure is reduced in size and discharges above the routed design flood are passed through the rock channel emergency spillway. The arrangement in Scheme WP1 does not provide a backup facility to the main spillway, so that if repairs caused by excessive plunge pool erosion or damage to the structure itself require removal of the spillway from service for any length of time, no alternative discharge facility would be available. The additional spillway of Scheme WP3 would permit emergency discharge if it were required under extreme circumstances.

The stilling basin spillway (Scheme WP2) would reduce the potential for extensive erosion downstream, but high velocities in the lower part of the chute could cause cavitation even with the provision for aeration of the discharge. This type of spillway would be very costly, as can be seen from Table B.32.

The feasibility of the rock cascade spillway is entirely dependent on the quality of the rock, which dictates the amount of treatment required for the rock surface and also the proportion of the excavated material which can be used in the dam. For determining the capital cost of Scheme WP4, conservative assumptions were made regarding surface treatment and the portion of material that would have to be wasted.

The diversion tunnels are located on the north bank for all alternatives examined in the intermediate review. For Scheme WP2, the downstream portals must be located downstream from the stilling basin, resulting in an increase of approximately 800 feet in the length of the tunnels. The south bank location of the powerhouse requires its placement close to a suspected shear zone, with the tailrace tunnels passing through this shear zone to reach the river. A longer access tunnel is also required, together with an additional 1000 feet in the length of the tailrace. The south-side location is remote from the main access road, which will probably be on the north side of the river, as will the transmission corridor.

(iii) Selection of Schemes for Further Study

Examination of the technical and economic aspects of Schemes WP1 through WP4 indicates there is little scope for adjustment of the dam axis owing to the confinement imposed

by the upstream and downstream shear zones. In addition, passage of the diversion tunnels through the upstream shear zone could result in significant delays in construction and additional cost.

From a comparison of costs in Table B.32, it can be seen that the flip bucket type spillway is the most economical, but because of the potential for erosion under extensive operation it is undesirable to use it as the only discharge facility. A mid-level release will be required for emergency drawdown of the reservoir, and use of this release as the first-stage service spillway with the flip bucket as a backup facility would combine flexibility and safety of operation with reasonable cost. The emergency rock channel spillway would be retained for discharge of PMF flows.

The stilling basin spillway is very costly and the operating head of 800 feet is beyond precedent experience. Erosion downstream should not be a problem but cavitation on the chute could occur. Scheme WP2 was therefore eliminated from further consideration.

The cascade spillway was also not favored for technical and economic reasons. However, this arrangement does have an advantage in that it provides a means of preventing nitrogen supersaturation in the downstream discharges from the project which could be harmful to the fish population. A cascade configuration would reduce the dissolved nitrogen content; hence, this alternative was retained for further evaluation. The capacity of the cascade was reduced and the emergency rock channel spillway was included to pass the extreme floods.

The results of the intermediate review indicated that the following components should be incorporated into any scheme carried forward for final review:

- Two diversion tunnels located on the north bank of the river;
- An underground powerhouse also located on the north bank;
- An emergency spillway, comprising a rock channel excavated on the north bank and discharging well downstream from the north abutment. The channel is sealed by an erodible fuse plug of impervious material designed to fail if overtopped by the reservoir; and

- A compacted earthfill and rockfill dam situated between the two major shear zones which traverse the project site.

As discussed above, two specific alternative methods exist with respect to routing of the spillway design flood and minimizing the adverse effects of nitrogen supersaturation on the downstream fish population. These alternatives are:

- A chute spillway with flip bucket on the north bank to pass the spillway design flood, with a mid-level release system designed to operate for floods with a frequency of up to about 1:50 years; or
- A cascade spillway on the south bank.

Accordingly, two schemes were developed for further evaluation as part of the final review process. These schemes are described separately in the paragraphs below.

#### (f) Final Review

The two schemes considered in the final review process were essentially derivations of Schemes WP3 and WP4.

##### (i) Scheme WP3A (Figure B.33)

This scheme is a modified version of Scheme WP3 described above. Because of scheduling and cost considerations, it is extremely important to maintain the diversion tunnels downstream from "The Fins." It is also important to keep the dam axis as far upstream as possible to avoid congestion of the downstream structures. For these reasons, the inlet portals to the diversion tunnels were located in the sound bedrock forming the downstream boundary of "The Fins." The upstream cofferdam and main dam are maintained in the upstream locations as shown on Figure B.33. As mentioned previously, additional criteria have necessitated modifications in the spillway configuration, and low-level and emergency drawdown outlets have been introduced.

The main modifications to the scheme are as follows:

##### - Main Dam

Continuing preliminary design studies and review of world practice suggest that an upstream slope of 2.4H:1V would be acceptable for the rock shell. Adoption of this slope

results not only in a reduction in dam fill volume but also a reduction in the base width of the dam which permits the main project components to be located between the major shear zones.

The downstream slope of the dam is retained as 2H:1V. The cofferdams remain outside the limits of the dam in order to allow complete excavation of the riverbed alluvium.

- Diversion

In the intermediate review arrangements, diversion tunnels passed through the broad structure of "The Fins," an intensely sheared area of breccia, gouge, and infills. Tunneling of this material would be difficult, and might even require excavation in open cut from the surface. High cost would be involved, but more important would be the time taken for construction in this area and the possibility of unexpected delays. For this reason, the inlet portals have been relocated downstream from this zone with the tunnels located closer to the river and crossing the main system of jointing at approximately 45°. This arrangement allows for shorter tunnels with a more favorable orientation of the inlet and outlet portals with respect to the river flow directions.

A separate low-level inlet and concrete-lined tunnel is provided, leading from the reservoir at approximate Elevation 1550 to downstream of the diversion plug where it merges with the diversion tunnel closest to the river. This low-level tunnel is designed to pass flows up to 12,000 cfs during reservoir filling. It would also pass up to 30,000 cfs under 500-foot head to allow emergency draining of the reservoir.

Initial closure is made by lowering the gates to the tunnel located closest to the river and constructing a concrete closure plug in the tunnel at the location of the grout curtain underlying the core of the main dam. On completion of the plug, the low-level release is opened and controlled discharges are passed downstream. The closure gates within the second diversion tunnel portal are then closed and a concrete closure plug constructed in line with the grout curtain. After closure of the gates, filling of the reservoir would commence.

- Outlet Facilities

As a provision for drawing down the reservoir in case of emergency, a mid-level release is provided. The intake



to these facilities is located at depth adjacent to the power facilities intake structures. Flows would then be passed downstream through a concrete-lined tunnel, discharging beneath the downstream end of the main spillway flip bucket. In order to overcome potential nitrogen supersaturation problems, Scheme WP3A also incorporates a system of fixed-cone valves at the downstream end of the outlet facilities. The valves were sized to discharge in conjunction with the powerhouse operating at 7000 cfs capacity (flows up to the equivalent routed 50-year flood). Eight feet of reservoir storage is utilized to reduce valve capacity. Six cone valves are required, located on branches from a steel manifold and protected by individual upstream closure gates. The valves are partly incorporated into the mass concrete block forming the flip bucket of the main spillway. The rock downstream is protected from erosion by a concrete facing slab anchored back to the spund bedrock.

#### - Spillways

As discussed above, the designed operation of the main spillway facilities was arranged to limit discharges of potentially nitrogen-supersaturated water from Watana to flows having an equivalent return period greater than 1:50 years.

The main chute spillway and flip bucket discharge into an excavated plunge pool in the downstream river bed. Releases are controlled by a three-gated ogee structure located adjacent to the outlet facilities and power intake structure just upstream from the dam centerline. The design discharge is approximately 120,000 cfs, corresponding to the routed 1:10,000-year flood (150,000 cfs) reduced by the 31,000 cfs flows attributable to outlet and power facilities discharges. Maximum reservoir level is 2194 feet. The plunge pool is formed by excavating the alluvial river deposits to bedrock. Since the excavated plunge pool approaches the limits of the calculated maximum scour hole, it is not anticipated that, given the infrequent discharges, significant downstream erosion will occur.

An emergency spillway is provided by means of a channel excavated in rock on the north bank, discharging well downstream from the north abutment in the direction of Tsusena Creek. The channel is sealed by an erodible fuse plug of impervious material designed to fail if overtopped by the reservoir, although some preliminary excavation may be necessary. The crest level of the plug will be set at Elevation 2230, well below that of the main dam. The channel will be capable of passing, in conjunction with the main spillway and outlet facilities, the probably maximum flood of 326,000 cfs.

## Power Facilities

The power intake is set slightly upstream from the dam axis deep within sound bedrock at the downstream end of the approach channel. The intake consists of six units with provision in each unit for drawing flows from a variety of depths covering the complete drawdown range of the reservoir. This facility also provides for drawing water from the different temperature strata within the upper part of the reservoir and thus regulating the temperature of the downstream discharges close to the natural temperatures of the river or temperatures advantageous to fishery enhancement. For this preliminary conceptual arrangement, flow withdrawals from different levels are achieved by a series of upstream vertical shutters moving in a single set of guides and operated to form openings at the required level. Downstream from these shutters each unit has a pair of wheel-mounted closure gates which will isolate the individual penstocks.

The six penstocks are 18-foot diameter, concrete-lined tunnels inclined at 55° immediately downstream from the intake to a nearly horizontal portion leading to the powerhouse. This horizontal portion is steel-lined for 150 feet upstream from the turbine units to extend the seepage path to the powerhouse and reduce the flow within the fractured rock area caused by blasting in the adjacent powerhouse cavern.

The six 170-MW turbine/generator units are housed within the major powerhouse cavern and are serviced by an overhead crane which runs the length of the powerhouse and into the service area adjacent to the units. Switchgear, maintenance room and offices are located within the main cavern, with the transformers situated downstream in a separate gallery excavated above the tail-race tunnels. Six inclined tunnels carry the connecting bus ducts from the main power hall to the transformer gallery. A vertical elevator and vent shaft run from the power cavern to the main office building and control room located at the surface. Vertical cable shafts, one for each pair of transformers, connect the transformer gallery to the switchyard directly overhead. Downstream from the transformer gallery the underlying draft tube tunnels merge into two surge chambers (one chamber for

three draft tubes) which also house the draft tube gates for isolating the units from the tailrace. The gates are operated by an overhead traveling gantry located in the upper part of each of the surge chambers. Emerging from the ends of the chambers, two concrete-lined, low-pressure tailrace tunnels carry the discharges to the river. Because of space restrictions at the river, one of these tunnels has been merged with the downstream end of the diversion tunnel. The other tunnel emerges in a separate portal with provision for the installation of bulkhead gates.

The orientation of water passages and underground caverns is such as to avoid, as far as possible, alignment of the main excavations with the major joint sets.

- Access

Access is assumed to be from the north side of the river. Permanent access to structures close to the river is by a road along the north downstream river bank and then via a tunnel passing through the concrete forming the flip bucket. A tunnel from this point to the power cavern provides for vehicular access. A secondary access road across the crest of the dam passes down the south bank of the valley and across the lower part of the dam.

(ii) Scheme WP4A (Figure B.34)

This scheme is similar in most respects to Scheme WP3A previously discussed, except for the spillway arrangements.

- Main Dam

The main dam axis is similar to that of Scheme WP3A, except for a slight downstream rotation at the south abutment at the spillway control structures.

- Diversion

The diversion and low-level releases are the same for the two schemes.

- Outlet Facilities

The outlet facilities used for emergency drawdown are separate from the main spillway for this scheme. The

Outlet facilities consist of a low-level gated inlet structure discharging up to 30,000 cfs into the river through a concrete-lined, free-flow tunnel with a ski jump flip bucket. This facility may also be operated as an auxiliary outlet to augment the main south bank spillway.

- Spillways

The main south bank spillway is capable of passing a design flow equivalent to the 1:10,000-year flood through a series of 50-foot drops into shallow pre-excavated plunge pools. The emergency spillway is designed to operate during floods of greater magnitude up to and including the PMF.

Main spillway discharges are controlled by a broad multi-gated control structure discharging into a shallow stilling basin. The feasibility of this arrangement is governed by the quality of the rock in the area, requiring both durability to withstand erosion caused by spillway flows and a high percentage of sound rockfill material that can be used from the excavation directly in the main dam.

On the basis of the site information developed concurrently with the general arrangement studies, it became apparent that the major shear zone known to exist in the south bank area extended further downstream than initial studies had indicated. The cascade spillway channel was therefore lengthened to avoid the shear area at the lower end of the cascade. The arrangement shown on Figure B.34 for Scheme WP4A does not reflect this relocation, which would increase the overall cost of the scheme.

The emergency spillway consisting of rock channel and fuse plug is similar to that of the north bank spillway scheme.

- Power Facilities

The power facilities are similar to those in Scheme WP3A.

iii) Evaluation of Final Alternative Schemes

An evaluation of the dissimilar features for each arrangement (the main spillways and the discharge arrangements at

the downstream end of the outlets) indicates a saving in capital cost of \$197,000,000, excluding contingencies and indirect cost, in favor of Scheme WP3A. If this difference is adjusted for the savings associated with using an appropriate proportion of excavated material from the cascade spillway as rockfill in the main dam, this represents a net overall cost difference of approximately \$110,000,000 including contingencies, engineering, and administration costs.

As discussed above, although limited information exists regarding the quality of the rock in the downstream area on the south bank, it is known that a major shear zone runs through and is adjacent to the area presently allocated to the spillway in Scheme WP4. This would require relocating the south bank cascade spillway several hundred feet farther downstream into an area where the rock quality is unknown and the topography less suited to the gentle overall slope of the cascade. The cost of the excavation would substantially increase compared to previous assumptions, irrespective of the rock quality. In addition, the resistance of the rock to erosion and the suitability for use as excavated material in the main dam would become less certain. The economic feasibility of this scheme is largely predicated on this last factor, since the ability to use the material as a source of rockfill for the main dam represents a major cost saving.

In conjunction with the main chute spillway, the problem of the occurrence of nitrogen supersaturation can be overcome by the use of a regularly operated dispersion-type valve outlet facility in conjunction with the main chute spillway. Since this scheme presents a more economic solution with fewer potential problems concerning the geotechnical aspects of its design, the north bank chute arrangement (Scheme WP3A) has been adopted as the final selected scheme.

Subsequent to adoption of this final scheme, minor changes to the design criteria have been made and are presented in Exhibit F.

#### 2.4 - Devil Canyon Project Formulation

This section describes the development of the general arrangement of the Devil Canyon project. The method of handling floods during construction and subsequent project operation is also outlined in this section.

The reservoir level fluctuations and inflow for Devil Canyon will essentially be controlled by operation of the upstream Watana project. This aspect is also briefly discussed in this section.

(a) Selection of Reservoir Level

The selected normal maximum operating level at Devil Canyon Dam is Elevation 1455. Studies by the USBR and COE on the Devil Canyon project were essentially based on a similar reservoir level which corresponds to the average tailwater level at the Watana site. Although the narrow configuration of the Devil Canyon site and the relatively low costs involved in increasing the dam height suggest that it might be economic to do so, it is clear that the upper economic limit of reservoir level at Devil Canyon is the Watana tailrace level.

Although significantly lower reservoir levels at Devil Canyon would lead to lower dam costs, the location of adequate spillway facilities in the narrow gorge would become extremely difficult and lead to offsetting increases in cost. In the extreme case, a spillway discharging over the dam would raise concerns regarding safety from scouring at the toe of the dam which have already led to rejection of such schemes.

(b) Selection of Installed Capacity

The methodology used for the preliminary selection of installed capacity at Devil Canyon is similar to the Watana methodology described in Section 2.2(b).

The decision to operate Devil Canyon primarily as a base-loaded plant was governed by the following main considerations:

- Daily peaking is more effectively performed at Watana than at Devil Canyon; and
- Excessive fluctuations in discharge from the Devil Canyon Dam may have an undesirable impact on mitigation measures incorporated in the final design to protect the downstream fisheries.

Given this mode of operation, the required installed capacity at Devil Canyon has been determined as the maximum capacity needed to utilize the available energy from the hydrological flows of record, as modified by the reservoir operation rule curves. In years where the energy from Watana and Devil Canyon exceeds the system demand, the usable energy has been reduced at both stations in proportion to the average net head available, assuming that flows used to generate energy at Watana will also be used to generate energy at Devil Canyon.

Table B.33 shows an assessment of maximum plant capacity required at Devil Canyon in the peak demand month (December). The Devil Canyon capacity is the same whether thermal energy is used for

base load or for peaking since Devil Canyon is designed for peaking only.

The selected total installed capacity at Devil Canyon has been established as 600 MW for design purposes. This will provide some margin for standby during forced outage and possible accelerated growth in demand.

The major factors governing the selection of the unit size at Devil Canyon are the rate of growth of system demand, the minimum station output, and the requirement of standby capacity under forced outage conditions.

The power facilities at Devil Canyon have been developed using four units at 150 MW each. This arrangement will provide for efficient station operation during low load periods as well as during peak December loads. During final design, consideration of phasing of installed capacity to match the system demand may be desirable. However, the uncertainty of load forecasts and the additional contractual costs of mobilization for equipment installation are such that for this study it has been assumed that all units will be commissioned by 2002.

The Devil Canyon reservoir will usually be full in December; hence, any forced outage could result in spilling and a loss of available energy. The units have been rated to deliver 150 MW at maximum December drawdown occurring during an extremely dry year; this means that, in an average year, with higher reservoir levels the full station output can be maintained even with one unit on forced outage.

(c) Selection of Spillway Capacity

A flood frequency of 1:10,000 years was selected for the spillway design on the same basis as described for Watana. An emergency spillway with an erodible fuse plug will also be provided to safely discharge the probable maximum flood. The development plan envisages completion of the Watana project prior to construction at Devil Canyon. Accordingly, the inflow flood peaks at Devil Canyon will be less than pre-project flood peaks because of routing through the Watana reservoir. Spillway design floods are:

<u>Flood</u>	<u>Inflow Peak (cfs)</u>
1:10,000 years	165,000
Probable Maximum	345,000

The avoidance of nitrogen supersaturation in the downstream flow for Watana also will apply to Devil Canyon. Thus, the discharge of water possibly supersaturated with nitrogen from Devil Canyon will be limited to a recurrence period of not less than 1:50 years by the use of fixed-cone valves similar to Watana.

(d) Main Dam Alternatives

The location of the Devil Canyon damsite was examined during previous studies by the USBR and COE. These studies focused on the narrow entrance to the canyon and led to the recommendation of a concrete arch dam. Notwithstanding this initial appraisal, a comparative analysis was undertaken as part of this feasibility study to evaluate the relative merits of the following types of structures at the same location:

- Thick concrete arch
- Thin concrete arch
- Fill embankment.

(i) Comparison of Embankment and Concrete Type Dams

The geometry was developed for both the thin concrete arch and the thick concrete arch dams, and the dams were analyzed and their behavior compared under static, hydrostatic, and seismic loading conditions. The project layouts for these arch dams were compared to a layout for a rockfill dam with its associated structures.

Consideration of the central core rockfill dam layout indicated relatively small cost differences from an arch dam cost estimate, based on a cross section significantly thicker than the finally selected design. Furthermore, no information was available to indicate that impervious core material in the necessary quantities could be found within a reasonable distance of the damsite. The rockfill dam was accordingly dropped from further consideration. It is further noted that, since this alternative dam study, seismic analysis of the rockfill dam at Watana has resulted in an upstream slope of 1:2.4, thus indicating the requirement to flatten the 1:2.5 slope adopted for the rockfill dam alternative at Devil Canyon.

Neither of the concrete arch dam layouts was intended as the final site arrangement, but were sufficiently representative of the most suitable arrangement associated with each dam type to provide an adequate basis for comparison. Each type of dam was located just downstream from where the river enters Devil Canyon and close to the canyon's



narrowest point, which is the optimum location for all types of dams. A brief description of each dam type and configuration is given below.

- Rockfill Dam

For this arrangement the dam axis would be some 625 feet downstream of the crown section of the concrete dams. The assumed embankment slopes would be 2.25H:1V on the upstream face and 2H:1V on the downstream face. The main dam would be continuous with the south bank saddle dam, and therefore no thrust blocks would be required. The crest length would be 2200 feet at Elevation 1470; the crest width would be 50 feet.

The dam would be constructed with a central impervious core, inclined upstream, supported on the downstream side by a semi-pervious zone. These two zones would be protected upstream and downstream by filter and transition materials. The shell sections would be constructed of rockfill obtained from blasted bedrock. For preliminary design all dam sections would be assumed to be founded on rock; external cofferdams would be founded on the river alluvium, and would not be incorporated into the main dam. The approximate volume of material in the main dam would be 20 million cubic yards.

A single spillway would be provided on the north abutment to control all flood flows. It would consist of a gate control structure and a double stilling basin excavated into rock; the chute sections and stilling basins would be concrete-lined, with mass concrete gravity retaining walls. The design capacity would be sufficient to pass the 1:10,000-year flood without damage; excess capacity would be provided to pass the PMF without damage to the main dam by surcharging the reservoir and spillway.

The powerhouse would be located underground in the north abutment. The multi-level power intake would be constructed in a rock cut in the north abutment on the dam centerline, with four independent penstocks to the 150-MW Francis turbines. Twin concrete-lined tailrace tunnels would connect the powerhouse to the river via an intermediate draft tube manifold.

- Thick Arch Dam

The main concrete dam would be a single-center arch structure, acting partly as a gravity dam, with a verti-

cal cylindrical upstream face and a sloping downstream face inclined at 1V:0.4H. The maximum height of the dam would be 635 feet with a uniform crest width of 30 feet, a crest length of approximately 1400 feet, and a maximum foundation width of 225 feet. The crest elevation would be 1460. The center portion of the dam would be founded on a massive mass concrete pad constructed in the excavated riverbed. This central section would incorporate the main spillway with sidewalls anchored into solid bedrock and gated orifice spillways discharging down the steeply inclined downstream face of the dam into a single large stilling basin set below river level and spanning the valley.

The main dam would terminate in thrust blocks high on the abutments. The south abutment thrust block would incorporate an emergency gated control spillway structure which would discharge into a rock channel running well downstream and terminating at a level high above the river valley.

Beyond the control structure and thrust block, a low-lying saddle on the south abutment would be closed by means of a rockfill dike founded on bedrock. The powerhouse would house four 150-MW units and would be located underground within the north abutment. The intake would be constructed integrally with the dam and connected to the powerhouse by vertical steel-lined penstocks.

The main spillway would be designed to pass the 1:10,000-year routed flood. The probable maximum flood is passed by combined discharges through the main spillway, outlet facility, and emergency spillway.

- Thin Arch Dam

The main dam would be a two-center, double-curved arch structure of similar height to the thick arch dam, but with a 20-foot uniform crest and a maximum base width of 90 feet. The crest elevation would be 1460. The center section would be founded on a concrete pad, and the extreme upper portion of the dam would terminate in concrete thrust blocks located on the abutments.

The main spillway would be located on the north abutment and would consist of a conventional gated control structure discharging down a concrete-lined chute terminating in a flip bucket. The bucket would discharge into an unlined plunge pool excavated in the riverbed alluvium and located sufficiently downstream to prevent undermining of the dam and associated structures.

The main spillway would be supplemented by orifice type spillways located in the center portion of the dam which would discharge into a concrete-lined plunge pool immediately downstream from the dam. An emergency spillway consisting of a fuse plug discharging into an unlined rock channel terminating well downstream would be located beyond the saddle dam on the south abutment.

The concrete dam would terminate in a massive thrust block on each abutment which, on the south abutment, would adjoin a rockfill saddle dam.

The main and auxiliary spillways would be designed to discharge the 1:10,000-year flood. The probable maximum flood would be discharged through the emergency south abutment spillway, main spillway and auxiliary spillway.

#### - Comparison of Arch Dam Types

Sand and gravel for concrete aggregates are believed to be available in sufficient quantities within economic distance from the damsite. The gravel and sands are formed from the granitic and metamorphic rocks of the area; at this time it is anticipated that they will be suitable for the production of aggregates after screening and washing.

The bedrock geology of the site is discussed in the 1980-81 Geotechnical Report (Acres 1982a). At this time it appears that there are no geological or geotechnical concerns that would preclude either of the dam types from consideration.

Under hydrostatic and temperature loadings, stresses within the thick arch dam would be generally lower than for the thin arch alternative. However, finite element analysis has shown that the additional mass of the dam under seismic loading would produce stresses of a greater magnitude in the thick arch dam than in the thin arch dam. If the surface stresses approach the maximum allowable at a particular section, the remaining understressed area of concrete will be greater for the thick arch, and the factor of safety for the dam would be correspondingly higher. The thin arch is, however, a more efficient design and better utilizes the inherent properties of the concrete. It is designed around acceptable predetermined factors of safety and requires a much smaller volume of concrete for the actual dam structure.

The thick arch arrangement did not appear to have a distinct technical advantage compared to a thin arch dam

and would be more expensive because of the larger volume of concrete needed. Studies therefore continued on refining the feasibility of the thin arch alternative.

(e) Diversion Scheme Alternatives

In this section the selection of general arrangement and the basis for sizing of the diversion scheme are presented.

(i) General Arrangements

The steep-walled valley at the site essentially dictated that diversion of the river during construction be accomplished using one or two diversion tunnels, with upstream and downstream cofferdams protecting the main construction area.

The selection process for establishing the final general arrangement included examination of tunnel locations on both banks of the river. Rock conditions for tunneling did not favor one bank over the other. Access and ease of construction strongly favored the south bank or abutment, the obvious approach being via the alluvial fan. The total length of tunnel required for the south bank is approximately 300 feet greater; however, access to the north bank could not be achieved without great difficulty.

(ii) Design Flood for Diversion

The recurrence interval of the design flood for diversion was established in the same manner as for Watana Dam. Accordingly, at Devil Canyon a risk of exceedence of 10 percent per annum has been adopted, equivalent to a design flood with a 1:10-year return period for each year of critical construction exposure. The critical construction time is estimated at 2.5 years. The main dam could be subjected to overtopping during construction without causing serious damage, and the existence of the Watana facility upstream would offer considerable assistance in flow regulation in case of an emergency. These considerations led to the selection of the design flood with a return frequency of 1:25 years.

The equivalent inflow, together with average flow characteristics of the river significant to diversion, are presented below:

- |   |            |
|---|------------|
| - Average annual flow:  | 9,080 cfs  |
| - Design flood inflow (1:25 years routed through Watana reservoir): | 37,800 cfs |

(iii) Cofferdams

As at Watana, the considerable depth of riverbed alluvium at both cofferdam sites indicates that embankment-type cofferdam structures would be the only technically and economically feasible alternative at Devil Canyon. For the purposes of establishing the overall general arrangement of the project and for subsequent diversion optimization studies, the upstream cofferdam section adopted will comprise an initial closure section approximately 20 feet high constructed in the wet, with a zoned embankment constructed in the dry. The downstream cofferdam will comprise a closure dam structure approximately 30 feet high placed in the wet. Control of underseepage through the alluvium material may be required and could be achieved by means of a grouted zone. The coarse nature of the alluvium at Devil Canyon led to the selection of a grouted zone rather than a slurry wall.

(iv) Diversion Tunnels

Although studies for the Watana project indicated that concrete-lined tunnels are the most economically and technically feasible solution, this aspect was reexamined at Devil Canyon. Preliminary hydraulic studies indicated that the design flood routed through the diversion scheme would result in a design discharge of approximately 37,800 cfs. For concrete-lined tunnels, design velocities of approximately 50 ft/sec would permit the use of one concrete-lined tunnel with an equivalent diameter of 30 feet. Alternatively, for unlined tunnels a maximum design velocity of 10 ft/sec in good quality rock would require four unlined tunnels, each with an equivalent diameter of 35 feet, to pass the design flow. As was the case for the Watana diversion scheme, considerations of reliability and cost were considered sufficient to eliminate consideration of unlined tunnels for the diversion scheme.

For the purposes of optimization studies, only a pressure tunnel was considered, since previous studies indicated that cofferdam closure problems associated with free flow tunnels would more than offset their other advantages.

(v) Optimization of Diversion Scheme

Given the considerations described above relative to design flows, cofferdam configuration, and alternative types of tunnels, an economic study was undertaken to determine the optimum combination of upstream cofferdam elevation (height) and tunnel diameter.

Capital costs were developed for a range of pressure tunnel diameters and corresponding upstream cofferdam embankment crest elevations with a 30-foot wide crest and exterior slopes of 2H:1V. A freeboard allowance of 5 feet was included for settlement and wave runup.

Capital costs for the tunnel alternatives included allowances for excavation, concrete liner, rock bolts, and steel supports. Costs were also developed for the upstream and downstream portals, including excavation and support. The cost of an intake gate structure and associated gates was determined not to vary significantly with tunnel diameter and was excluded from the analysis.

The centerline tunnel length in all cases was estimated to be 2000 feet.

Rating curves for the single-pressure tunnel alternatives are presented in Figure B.35. The relationship between capital costs for the upstream cofferdam and various tunnel diameters is given in Figure B.36.

The results of the optimization study indicated that a single 30-foot diameter pressure tunnel results in the overall least cost (Figure B.36). An upstream cofferdam 60 feet high, with a crest elevation of 945, was carried forward as part of the selected general arrangement.

(f) Spillway Alternatives

The project spillways have been designed to safely pass floods with the following return frequencies:

<u>Inflow Peak Flood</u>	<u>Discharge Frequency</u>	<u>Inflow (cfs)</u>
Spillway Design	1:10,000 years	165,000
Probable Maximum	--	345,000

A number of alternatives were considered singly and in combination for Devil Canyon spillway facilities. These included gated orifices in the main dam discharging into a plunge pool, chute or tunnel spillways with either a flip bucket or stilling basin for energy dissipation, and open channel spillways. As described for Watana, the selection of the type of spillway was influenced by the general arrangement of the major structures. The main spillway facilities would discharge the spillway design flood through a gated spillway control structure with energy dissipation by a flip bucket which directs the spillway discharge in a free-fall jet into a plunge pool in the river. As noted above, restrictions with respect to limiting nitrogen supersaturation in selecting

acceptable spillway discharge structures have been applied. The various spillway arrangements developed in accordance with these considerations are discussed in Section 2.5.

(g) Power Facilities Alternatives

The selection of the optimum arrangements for the power facilities involved consideration of the same factors as described for Watana.

(i) Comparison of Surface and Underground Powerhouses

A surface powerhouse at Devil Canyon would be located either at the downstream toe of the dam or along the side of the canyon wall. As determined for Watana, costs favored an underground arrangement. In addition to cost, the underground powerhouse layout has been selected based on the following:

- Insufficient space is available in the steep-sided canyon for a surface powerhouse at the base of the dam;
- The provision of an extensive intake at the crest of the arch dam would be detrimental to stress conditions in the arch dam, particularly under earthquake loading, and would require significant changes in the arch dam geometry; and
- The outlet facilities located in the arch dam are designed to discharge directly into the river valley; these would cause significant winter icing and spray problems to any surface structure below the dam.

(ii) Comparison of Alternative Locations

The underground powerhouse and related facilities have been located on the north bank for the following reasons:

- Generally superior rock quality at depth;
- The south bank area behind the main dam thrust block is unsuitable for the construction of the power intake; and
- The river turns north downstream from the dam, and hence the north bank power development is more suitable for extending the tailrace tunnel to develop extra head.

(iii) Selection of Units

The turbine type selected for the Devil Canyon development is governed by the design head and specific speed and by

economic considerations. Francis turbines have been adopted for reasons similar to those discussed for Watana in Section 2.2(g).

The selection of the number and rating of individual units is discussed in detail in Section 2.4(b). The four units will be rated to deliver 150 MW each at full gate opening and minimum reservoir level in December (the peak demand month).

(iv) Transformers

Transformer selection is similar to Watana (Section 2.2(g)(v)).

(v) Power Intake and Water Passages

For flexibility of operation, individual penstocks are provided to each of the four units. Detailed cost studies showed that there is no significant cost advantage in using two larger diameter penstocks with bifurcation at the powerhouse compared to four separate penstocks.

A single tailrace tunnel with a length of 6800 feet to develop 30 feet of additional head downstream from the dam has been incorporated in the design. Detailed design may indicate that two smaller tailrace tunnels for improved reliability may be superior to one large tunnel since the extra cost involved is relatively small. The surge chamber design would be essentially the same with one or two tunnels.

The overall dimensions of the intake structure are governed by the selected diameter and number of the penstocks and the minimum penstock spacing. Detailed studies comparing construction cost to the value of energy lost or gained were carried out to determine the optimum diameter of the penstocks and the tailrace tunnel.

(vi) Environmental Constraints

In addition to potential nitrogen-supersaturation problems caused by spillway operation, the major impacts of the Devil Canyon power facilities development are:

- Changes in the temperature regime of the river; and
- Fluctuations in downstream river flows and levels.

Temperature modeling has indicated that a multiple-level intake design at Devil Canyon would aid in controlling downstream water temperatures.



Consequently, the intake design at Devil Canyon incorporates two levels of draw-off.

The Devil Canyon station will normally be operated as a base-loaded plant throughout the year to satisfy the requirement of no significant daily variation in power flow.

## 2.5 Selection of Devil Canyon General Arrangement

The approach to selection of a general arrangement for Devil Canyon was a similar but simplified version of that used for Watana.

### (a) Selection Methodology

Preliminary alternative arrangements of the Devil Canyon project were developed and selected using two rather than three review stages. Topographic conditions at this site limited the development of reasonably feasible layouts, and four schemes were initially developed and evaluated. During the final review, the selected layout was refined based on technical, operational and environmental considerations identified during the preliminary review.

### (b) Design Data and Criteria

The design data and design criteria on which the alternative layouts were based are presented in Table B.34. Subsequent to selection of the preferred Devil Canyon scheme, the information was refined and updated as part of the ongoing study program.

### (c) Preliminary Review

Consideration of the options available for types and locations of various structures led to the development of four primary layouts for examination at Devil Canyon in the preliminary review phase. Previous studies had led to the selection of a thin concrete arch structure for the main dam and indicated that the most acceptable technical and economic location was at the upstream entrance to the canyon. The dam axis has been fixed in this location for all alternatives.

#### (i) Description of Alternative Schemes

The schemes evaluated during the preliminary review are described below. In each of the alternatives evaluated, the dam is founded on the sound bedrock underlying the riverbed. The structure is 635 feet high, has a crest width of 20 feet, and a maximum base width of 90 feet. Mass concrete thrust blocks are founded high on the abutments, the south block extending approximately 100 feet

above the existing bedrock surface and supporting the upper arches of the dam. The thrust block on the north abutment makes the cross-river profile of the dam more symmetrical and contributes to a more uniform stress distribution.

- Scheme DC1 (Figure B.37)

In this scheme, diversion facilities comprise upstream and downstream earthfill and rockfill cofferdams and two 24-foot diameter tunnels beneath the south abutment.

A rockfill saddle dam occupies the lower-lying area beyond the south abutment running from the thrust block to the higher ground beyond. The impervious fill cut-off for the saddle dam is founded on bedrock approximately 80 feet beneath the existing ground surface. The maximum height of this dam above the foundation is approximately 200 feet.

The routed 1:10,000-year design flood of 165,000 cfs is passed by two spillways. The main spillway is located on the north abutment. It has a design discharge of 120,000 cfs, and flows are controlled by a three-gated ogee control structure. This discharges down a concrete-lined chute and over a flip bucket which ejects the water in a diverging jet into a pre-excavated plunge pool in the riverbed. The flip bucket is set at Elevation 925, approximately 35 feet above the river level. An auxiliary spillway discharging a total of 35,000 cfs is located in the center of the dam, 100 feet below the dam crest, and is controlled by three wheel-mounted gates. The orifices are designed to direct the flow into a concrete-lined plunge pool just downstream from the dam.

An emergency spillway is located in the sound rock south of the saddle dam. This is designed to pass, in conjunction with the main spillway and auxiliary spillway, a probable maximum flood of 345,000 cfs, if such an event should ever occur. The spillway is an unlined rock channel which discharges into a valley downstream from the dam leading into the Susitna River.

The upstream end of the channel is closed by an earth-fill fuse plug. The plug is designed to be eroded if overtopped by the reservoir. Since the crest is lower than either the main or saddle dams, the plug would be washed out prior to overtopping of either of these structures.

The underground power facilities are located on the north bank of the river, within the bedrock forming the

dam abutment. The rock within this abutment is of better quality with fewer shear zones and a lesser degree of jointing than the rock on the south side of the canyon, and hence more suitable for underground excavation.

The power intake is located just upstream from the bend in the valley before it turns sharply to the right into Devil Canyon. The intake structure is set deep into the rock at the downstream end of the approach channel. Separate penstocks for each unit lead to the powerhouse.

The powerhouse contains four 150-MW turbine/generator units. The turbines are Francis type units coupled to overhead umbrella type generators. The units are serviced by an overhead crane running the length of the powerhouse and into the end service bay. Offices, the control room, switchgear room, maintenance room, etc., are located beyond the service bay. The transformers are housed in a separate upstream gallery located above the lower horizontal section of the penstocks. Two vertical cable shafts connect the gallery to the surface. The draft tube gates are housed above the draft tubes in separate annexes off the main powerhall. The draft tubes converge in two bifurcations at the tailrace tunnels which discharge under free flow conditions to the river. Access to the powerhouse is by means of an unlined tunnel leading from an access portal on the north side of the canyon.

The switchyard is located on the south bank of the river just downstream from the saddle dam, and the power cables from the transformers are carried to it across the top of the dam.

#### Scheme DC2 (Figure B.38)

The layout is generally similar to Scheme DC1 except that the chute spillway is located on the south side of the canyon. The concrete-lined chute terminates in a flip bucket high on the south side of the canyon which drops the discharges into the river below. The design flow is 120,000 cfs, and discharges are controlled by a three-gated ogee-crested control structure similar to that for Scheme DC1 which abuts the south side thrust block.

The saddle dam axis is straight, following the shortest route between the control structure at one end and the rising ground beyond the low-lying area at the other.

- Scheme DC3 (See Figure B.39)

The layout is similar to Scheme DC1 except that the north-side main spillway takes the form of a single tunnel rather than an open chute. A two-gated ogee-control structure is located at the head of the tunnel and discharges into an inclined shaft 45 feet in diameter at its upper end. The structure will discharge up to a maximum of 120,000 cfs.

The concrete-lined tunnel narrows to 35 feet in diameter and discharges into a flip bucket which directs the flows in a jet into the river below as in Scheme DC1.

An auxiliary spillway is located in the center of the dam and an emergency spillway is excavated on the south abutment.

The layout of dams and power facilities are the same as for Scheme DC1.

- Scheme DC4 (See Figure B.40)

The dam, power facilities, and saddle dam for this scheme are the same as those for Scheme DC1. The major difference is the substitution of a stilling basin type spillway on the north bank for the chute and flip bucket. A 3-gated ogee control structure is located at the end of the dam thrust block and controls the discharges up to a maximum of 120,000 cfs.

The concrete-lined chute is built into the face of the canyon and discharges into a 500-foot long by 115-foot wide by 100-foot high concrete stilling basin formed below river level and deep within the north side of the canyon. Central orifices in the dam and the south bank rock channel and fuse plug form the auxiliary and emergency spillways, respectively, as in the other alternative schemes.

The downstream cofferdam is located beyond the stilling basin and the diversion tunnel outlets are located farther downstream to enable construction of the stilling basin.

(ii) Comparison of Alternatives

The arch dam, saddle dam, power facilities, and diversion vary only in a minor degree among the four alternatives. Thus, the comparison of the schemes rests solely on a comparison of the spillway facilities.

As can be seen from a comparison of the costs in Table B.35, the flip bucket spillways are substantially less costly to construct than the stilling basin type of Scheme DC4. The south-side spillway of Scheme DC2 runs at a sharp angle to the river and ejects the discharge jet from high on the canyon face toward the opposite side of the canyon. Over a longer period of operation, scour of the heavily jointed rock could cause undermining of the canyon sides and their subsequent instability. The possibility also exists of deposition of material in the downstream riverbed with a corresponding elevation of the tailrace. Construction of a spillway on the steep south side of the river could be more difficult than on the north side because of the presence of deep fissures and large unstable blocks of rock which are present on the south side close to the top of the canyon.

The two north-side flip bucket spillway schemes, based on either an open chute or a tunnel, take advantage of a downstream bend in the river to discharge parallel to the course of the river. This will reduce the effects of erosion but could still present a problem if the estimated maximum possible scour hole would occur.

The tunnel type spillway could prove difficult to construct because of the large diameter inclined shaft and tunnel paralleling the bedding planes. The high velocities encountered in the tunnel spillway could cause problems with the possibility of spiraling flows and severe cavitation both occurring.

The stilling basin type spillway of Scheme DC4 reduces downstream erosion problems within the canyon. However, cavitation could be a problem under the high flow velocities experienced at the base of the chute. This would be somewhat alleviated by aeration of the flows. There is, however, little precedent for stilling basin operation at heads of over 500 feet; even where floods of much less than the design capacity have been discharged, severe damage has occurred.

(iii) Selection of Final Scheme

The chute and flip bucket spillway of Scheme DC2 could generate downstream erosion problems which could require considerable maintenance costs and cause reduced efficiency in operation of the project at a future date. Hydraulic design problems exist with Scheme DC3 which may also have

severe cavitation problems. Also, there is no cost advantage in Scheme DC3 over the open chute Scheme DC1. In Scheme DC4, the operating characteristics of a high head stilling basin are little known, and there are few examples of successful operation. Scheme DC4 also costs considerably more than any other scheme (Table B.35).

All spillways operating at the required heads and discharges will eventually cause some erosion. For all schemes, the use of solid-cone valve outlet facilities in the lower portion of the dam to handle floods up to 1:50-year frequency is considered a more reasonable approach to reduce erosion and eliminate nitrogen supersaturation problems than the gated high-level orifice outlets in the dam. Since the cost of the flip bucket type spillway in the scheme is considerably less than that of the stilling basin in Scheme DC4, and since the latter offers no relative operational advantage, Scheme DC1 has been selected for further study as the selected scheme.

Subsequent to the adoption of this scheme, minor modifications to the design criteria were made as presented in Exhibit F.

(d) Final Review

The layout selected in the previous section was further developed in accordance with updated engineering studies and criteria. The major change compared to Scheme DC1 is the elimination of the high-level gated orifices and introduction of low-level fixed-cone valves, but other modifications that were introduced are described below.

The revised layout is shown on Figure B.41. A description of the structures is as follows.

(i) Main Dam

The maximum operating level of the reservoir was raised to Elevation 1455 in accordance with updated information relative to the Watana tailwater level. This requires raising the dam crest to Elevation 1463 with the concrete parapet wall crest at Elevation 1466. The saddle dam was raised to Elevation 1472.

(ii) Spillways and Outlet Facilities

To eliminate the potential for nitrogen supersaturation problems, the outlet facilities were designed to restrict supersaturated flow to an average recurrence interval of greater than 50 years. This led to the replacement of the high-level gated orifice spillway by outlet facilities incorporating seven fixed-cone valves, three with a diameter

of 90 inches and four with a diameter of 102 inches, capable of passing a design flow of 38,500 cfs.

The chute spillway and flip bucket are located on the north bank, as in Scheme DC1; however, the chute length was decreased and the elevation of the flip bucket raised compared to Scheme DC1.

More recent site surveys indicated that the ground surface in the vicinity of the saddle dam was lower than originally estimated. The emergency spillway channel was relocated slightly to the south to accommodate the larger dam.

(iii) Diversion

The previous twin diversion tunnels were replaced by a single tunnel scheme. This was determined to provide all necessary security and will cost approximately one-half as much as the two tunnel alternative.

(iv) Power Facilities

The drawdown range of the reservoir was reduced, allowing a reduction in height of the power intake. In order to locate the intake within solid rock, it has been moved into the side of the valley, requiring a slight rotation of the water passages, powerhouse, and caverns comprising the power facilities.

2.6 - Selection of Access Road Corridor

(a) Previous Studies

The potential for hydroelectric power generation within the Susitna basin has been the subject of considerable investigation over the years as described in Section 1.1 of this exhibit. These studies produced much information on alternative development plans but little on the question of access.

The first report to incorporate an access plan was that of the Corps of Engineers in 1975. The proposed plan consisted of a 24-foot wide road with a design speed of 30 miles per hour that connected with the Parks Highway near Chulitna Station, paralleled the Alaska Railroad south and east to a crossing of the Susitna River, then proceeded up the south side of the river to Devil Canyon. The road continued on the south side of the Susitna River to Watana, passing by the north end of Stephan Lake and the west end of the Fog Lakes. In addition, a railhead facility was to be constructed at Gold Creek. This plan is similar to one of the selected alternative plans, Plan 16 (South), discussed later in this section.

Other studies concerning the Susitna Hydroelectric Project mentioned access only in passing and did not involve the development of an access plan.

(b) Selection Process Constraints

Throughout the development, evaluation and selection of the access plans, the foremost objective has been to provide a transportation system that would support construction activities and allow for the orderly development and maintenance of site facilities.

Meeting this fundamental objective involved the consideration not only of economics and technical ease of development, but also many other diverse factors. Of prime importance was the potential for impacts to the environment, namely impacts to the local fish and game populations. In addition, since the Native villages and the Cook Inlet Region will eventually acquire surface and subsurface rights, their interests were recognized and taken into account as were those of the local communities and general public.

With so many different factors influencing the choice of an access plan, it is evident that no one plan will satisfy all interests. The aim during the selection process has been to consider all factors in their proper perspective and produce a plan that represents the most favorable solution to meeting both project-related goals and minimizing impacts to the environment and surrounding communities.

(c) Corridor Identification and Selection

Three general corridors were identified leading from the existing transportation network to the damsites. This network consists of the Parks Highway and the Alaska Railroad to the west of the damsites and the Denali Highway to the north. The three general corridors are identified in Figure B.42.

Corridor 1 - From the Parks Highway to the Watana damsite via the north side of the Susitna River.

Corridor 2 - From the Parks Highway to the Watana damsite via the south side of the Susitna River.

Corridor 3 - From the Denali Highway to the Watana damsite.

The access road studies identified a total of eighteen alternative plans within the three corridors. The alternatives were developed by laying out routes on topographical maps in accordance with accepted road and rail design criteria. Subsequent field investigations resulted in minor modifications to reduce environmental impacts and improve alignment.



(d) Development of Plans

At the beginning of the study a plan formulation and initial selection process was developed. The criteria that most significantly affected the selection process were identified as:

- Minimizing impacts to the environment;
- Minimizing total project costs;
- Providing transportation flexibility to minimize construction risks;
- Providing ease of operation and maintenance; and
- Pre-construction of a pioneer road.

During evaluation of the access plans, input from the public agencies and Native organizations was sought and their response resulted in an expansion of the original list of eight alternative plans to eleven. These studies culminated in the production of the Access Route Selection Report (Acres 1982b) which recommended Plan 5 as the route which most closely satisfied the selection criteria. Plan 5 starts from the Parks Highway near Hurricane and traverses southeast along the Indian River to Gold Creek. From Gold Creek the road continues east on the south side of the Susitna River to the Devil Canyon damsite, crosses a low-level bridge and continues east on the north side of the Susitna River to the Watana damsite. For the project to remain on schedule it would have been necessary to construct a pioneer road along this route prior to the FERC license being issued.

In March of 1982 the Alaska Power Authority (APA) presented the results of the Susitna Hydroelectric Feasibility Report (Acres 1982c), of which access Plan 5 was a part, to the public, agencies and organizations. During April, comment was obtained from these groups relative to the feasibility study. As a result of these comments, the pioneer road concept was eliminated, the evaluation criteria were refined, and six additional access alternatives were developed.

During the evaluation process the APA formulated an additional plan, thus increasing the total number of plans under evaluation to eighteen. This subsequently became the plan recommended by APA staff to the APA Board of Directors, and was formally adopted as the Proposed Access Plan in September 1982.

(e) Evaluation of Plans

The refined criteria used to evaluate the eighteen alternative access plans were:

- No pre-license construction
- Minimize environmental impacts
- Minimize construction duration
- Provide access between sites during project operation phase

- Provide access flexibility to ensure project is brought on line within budget and schedule
- Minimize total cost of access
- Minimize initial investment required to provide access to the Watana damsite
- Minimize risks to project schedule
- Accommodate current land uses and plans
- Accommodate agency preferences
- Accommodate preferences of Native organizations
- Accommodate preferences of local communities
- Accommodate public concerns

All eighteen plans were evaluated using these refined criteria to determine the most responsive access plan in each of the three basic corridors.

To meet the overall project schedule requirements for the Watana development, it is necessary to secure initial access to the Watana damsite within one year of the FERC license being issued. The constraint of no pre-license construction resulted in the elimination of any plan in which initial access could not be completed within one year. This constraint eliminated six plans (plans 2, 5, 8, 9, 10, 12) from further consideration.

On completion of both the Watana and Devil Canyon Dams it is planned to operate and maintain both sites from one central location, Watana. To facilitate these operation and maintenance activities, access plans with a road connection between the sites were considered superior to those plans without a road connection. Plans 3 and 4 do not have access between the sites and were discarded.

The ability to make full use of both rail and road systems from southcentral ports of entry to the railhead facility provides the project management with far greater flexibility to meet contingencies, and control costs and schedule. Limited access plans utilizing an all-rail or rail-link system with no road connection to an existing highway have less flexibility and would impose a restraint on project operation that could result in delays and significant increases in cost. Four plans with limited access (plans 8, 9, 10 and 15) were eliminated because of this constraint.

Residents of the Indian River and Gold Creek communities are generally not in favor of a road access near their communities. Plan 1 was discarded because plans 13 and 14 achieve the same objectives without impacting the Indian River and Gold Creek areas.

Plan 7 was eliminated because it includes a circuit route connecting to both the George Parks and Denali Highways. This circuit route was considered unacceptable by the resource agencies since it aggravated the control of public access.

The seven remaining plans found to meet the selection criteria were plans 6, 11, 13, 14, 16, 17 and 18. Of these plans, plans 13, 16 and 18 in the North, South, and Denali corridors, respectively, were selected as being the most responsive plan in each corridor. The three plans are described below and the route locations shown in Figures B.43 through B.45.

(i) Plan 13 'North' (see Figure B.43)

This plan utilizes a roadway from a railhead facility adjacent to the George Parks Highway at Hurricane to the Watana damsite following the north side of the Susitna River. A spur road, seven miles in length, would be constructed at a later date to service the Devil Canyon development. This route is mountainous and includes terrain at high elevations. In addition, extensive sidehill cutting in the region of Portage Creek will be necessary; however, construction of the road would not be as difficult as plan 16.

(ii) Plan 16 'South' (see Figure B.44)

This route generally parallels the Susitna River, traveling west to east from a railhead at Gold Creek to the Devil Canyon damsite, and continues following a southerly loop to the Watana damsite. Twelve miles downstream of the Watana damsite a temporary low-level crossing across the Susitna River will be used until completion of a permanent bridge. A connecting road from the George Parks Highway to Devil Canyon with a major high-level bridge across the Susitna River is necessary to provide full road access to either site. The topography from Devil Canyon to Watana is mountainous and the route involves the most difficult construction of the three plans, requiring a number of sidehill cuts and the construction of two major bridges. To provide initial access to the Watana damsite this route presents the most difficult construction problems of the three routes and has the highest potential for schedule delays and related cost increases.

(iii) Plan 18 'Denali-North' (see Figure B.45)

This route originates at a railhead in Cantwell, utilizing the existing Denali Highway to a point 21 miles east of the junction of the George Parks and Denali Highways. A new road will be constructed from this point due south to the Watana damsite. The majority of the new road will traverse

relatively flat terrain which will allow construction using side borrow techniques, resulting in a minimum of disturbance to areas away from the alignment. This is the most easily constructed route for initial access to the Watana site. Access to the Devil Canyon development will consist primarily of a railroad extension from the existing Alaska Railroad at Gold Creek to a railhead facility adjacent to the Devil Canyon camp area. To provide access to the Watana damsite and the existing highway system, a connecting road will be constructed from the Devil Canyon railhead following a northerly loop to the Watana damsite. Access to the north side of the Susitna River will be attained via a high-level suspension bridge constructed approximately one mile downstream of the Devil Canyon Dam. In general the alignment crosses terrain with gentle to moderate slopes which will allow roadbed construction without deep cuts.

(f) Comparison of the Selected Alternative Plans

To determine which access plan best accommodates both project-related goals and the concerns of the resource agencies, Native organizations and affected communities, the three selected alternative plans were subjected to a multi-disciplinary evaluation and comparison. The key issues addressed in this evaluation and comparison were:

(i) Costs

For the development of access to the Watana site, the Denali-North Plan has the least cost and the lowest probability of increased costs resulting from unforeseen conditions. The North Plan is ranked second. The North Plan has the lowest overall cost while the Denali-North has the highest. However, a large portion of the cost of the Denali-North Plan would be incurred more than a decade in the future. When converting costs to equivalent present value, the overall costs of the Denali-North and the South Plans are approximately equal. The costs of the three alternative plans can be summarized as follows:

<u>Plan</u>	<u>Estimated Total Cost (\$ x 10<sup>6</sup>)</u>			
	<u>Watana</u>	<u>Devil Canyon</u>	<u>Total</u>	<u>Discounted Total</u>
North (13)	241	127	368	287
South (16)	312	104	416	335
Denali-North (18)	224	213	437	326

The costs are in terms of 1982 dollars and include all costs associated with design, construction, maintenance and logistics.

(ii) Schedule

The schedule for providing initial access to the Watana site was given prime consideration since the cost ramifications of a schedule delay are highly significant. The elimination of pre-license construction of a pioneer access road has resulted in the compression of on-site construction activities in the 1985-86 period. With the present overall project scheduling, should diversion not be completed prior to spring runoff in 1987, dam foundation preparation work will be delayed one year, and hence cause a delay to the overall project of one year. It has been estimated that the resultant increase in cost would likely be in the range of 100-200 million dollars. The access route that assures the quickest completion and hence the earliest delivery of equipment and material to the site has a distinct advantage. The forecasted construction period, including mobilization, for the three plans is:

Denali-North	6 months
North	9 months
South	12 months

It is evident that, with the Denali-North Plan, site activities can be supported at an earlier date than by either of the other routes. Consequently the Denali-North Plan offers the highest probability of meeting schedule and hence the least risk of project delay and increase in cost. The schedule for access in relation to diversion is shown for the three plans in Figure B.46.

(iii) Environmental Issues

Outlined below are the key environmental impacts which have been identified for the three routes. The specific mitigation measures necessary to avoid, minimize or compensate for these impacts are discussed in Exhibit E.

- Wildlife and Habitat

The three selected alternative access routes are made up of five distinct wildlife and habitat segments:

1. Hurricane to Devil Canyon: This segment is composed almost entirely of productive mixed forest, riparian, and wetlands habitats important to moose, fur-bearers, and birds. It includes three areas where slopes of over 30 percent will require side hill cuts, all above wetland zones vulnerable to erosion-related impacts.

2. Gold Creek to Devil Canyon: This segment is composed of mixed forest and wetland habitats, but includes less wetland habitat and fewer wetland habitat types than the Hurricane to Devil Canyon segment. Although this segment contains habitat suitable for moose, black bears, furbearers and birds, it has the least potential for adverse impacts to wildlife of the five segments considered.
3. Devil Canyon to Watana (North Side): The following comments apply to both the Denali-North and North routes. This segment traverses a varied mixture of forest, shrub, and tundra habitat types, generally of medium-to-low productivity as wildlife habitat. It crosses the Devils and Tsusena Creek drainages and passes by Swimming Bear Lake which contains habitat suitable for furbearers.
4. Devil Canyon to Watana (South Side): This segment is highly varied with respect to habitat types, containing complex mixtures of forest, shrub, tundra, wetlands, and riparian vegetation. The western portion is mostly tundra and shrub, with forest and wetlands occurring along the eastern portion in the vicinity of Prairie Creek, Stephan Lake, and Tsusena and Deadman Creeks. Prairie Creek supports a high concentration of brown bears and the lower Tsusena and Deadman Creek areas support lightly hunted concentrations of moose and black bears. The Stephan Lake area supports high densities of moose and bears. Access development in this segment would probably result in habitat loss or alteration, increased hunting and human-bear conflicts.
5. Denali Highway to Watana: This segment is primarily composed of shrub and tundra vegetation types, with little productive forest habitat present. Although habitat diversity is relatively low along this segment, the southern portion along Deadman Creek contains an important brown bear concentration and browse for moose. This segment crosses a peripheral portion of the range of the Nelchina caribou herd and there is evidence that, as herd size increases, caribou are likely to migrate across the route and calve in the vicinity. Although it is not possible to predict with any certainty how the physical presence of the road itself or traffic will affect caribou movements, population size or productivity, it is likely that a variety of site-specific mitigation measures will be necessary to protect the herd.

The three access plans are made up of the following combinations of route segments:

North	Segments 1 and 3
South	Segments 1, 2, and 4
Denali-North	Segments 2, 3, and 5

The North route has the least potential for creating adverse impacts to wildlife and habitat, for it traverses or approaches the fewest areas of productive habitat and zones of species concentration or movement. The wildlife impacts of the South Plan can be expected to be greater than those of the North Plan due to the proximity of the route to Prairie Creek, Stephan Lake and the Fog Lakes, which currently support high densities of moose and black and brown bears. In particular, Prairie Creek supports what may be the highest concentration of brown bears in the Susitna basin. Although the Denali-North Plan has the potential for disturbances of caribou, brown bear and black bear concentrations and movement zones, it is considered that the potential for adverse impacts with the South Plan is greater.

#### - Fisheries

All three alternative routes would have direct and indirect impacts on the fisheries. Direct impacts include the effects on water quality and aquatic habitat whereas increased angling pressure is an indirect impact. A qualitative comparison of the fishery impacts related to the alternative plans was undertaken. The parameters used to assess impacts along each route included: the number of streams crossed, the number and length of lateral transits (i.e., where the roadway parallels the streams and runoff from the roadway can run directly into the stream), the number of watersheds affected, and the presence of resident and anadromous fish.

The three access plan alternatives incorporate combinations of seven distinct fishery segments:

1. Hurricane to Devil Canyon: Seven stream crossings will be required along this route, including Indian River which is an important salmon spawning river. Both the Chulitna River watershed and the Susitna River watershed are affected by this route. The increased access to Indian River will be an important indirect impact to the segment. Approximately 1.8 miles of cuts into banks greater than 30 degrees occur along this route requiring erosion control measures to preserve the water quality and aquatic habitat.

2. Gold Creek to Devil Canyon: This segment crosses six streams and is expected to have minimal direct and indirect impacts. Anadromous fish spawning is likely in some streams but impacts are expected to be minimal. Approximately 2.5 miles of cuts into banks greater than 30 degrees occur in this section. In the Denali-North Plan, this segment would be railroad whereas in the South Plan it would be road.
3. Devil Canyon to Watana (North Side, North Plan): This segment crosses twenty streams and laterally transits four rivers for a total distance of approximately 12 miles. Seven miles of this lateral transit parallels Portage Creek which is an important salmon spawning area.
4. Devil Canyon to Watana (North Side, Denali-North Plan): The difference between this segment and segment 3 described above is that it avoids Portage Creek by traversing through a pass 4 miles to the east. The number of streams crossed is consequently reduced to twelve, and the number of lateral transits is reduced to two with a total distance of 4 miles.
5. Devil Canyon to Watana (South Side): The portion between the Susitna River crossing and Devil Canyon requires nine stream crossings, but it is unlikely that these contain significant fish populations. The portion of this segment from Watana to the Susitna River is not expected to have any major direct impacts; however, increased angling pressure in the vicinity of Stephan Lake may result due to the proximity of the access road. The segment crosses both the Susitna and the Talkeetna watershed. Seven miles of cuts into banks of greater than 30 degrees occur in this segment.
6. Denali Highway to Watana: The segment from the Denali Highway to the Watana damsite has twenty-two stream crossings and passes from the Nenana into the Susitna watershed. Much of the route crosses or is in proximity to seasonal grayling habitat and runs parallel to Deadman Creek for nearly 10 miles. If recruitment and growth rates are low along this segment, it is unlikely that resident populations could sustain heavy fishing pressure. Hence, this segment has a high potential for impacting the local grayling population.



7. Denali Highway: The Denali Highway from Cantwell to the Watana access turnoff will require upgrading. The upgrading will involve only minor realignment and negligible alteration to present stream crossings. The segment crosses eleven streams and laterally transits two rivers for a total distance of 5 miles. There is no anadromous fish spawning in this segment and little direct or indirect impact is expected.

The three alternative access routes are comprised of the following segments:

North	Segments 1 and 3
South	Segments 1, 2, and 5
Denali-North	Segments 2, 4, 6 and 7

The Denali-North Plan is likely to have a significant direct and indirect impact on grayling fisheries given the number of stream crossings, lateral transits, and watershed affected. Anadromous fisheries impact will be minimal and will only be significant along the railroad spur between Gold Creek and Devil Canyon.

The South Plan is likely to create significant direct and indirect impacts at Indian River, which is an important salmon spawning river. Anadromous fisheries impacts will also occur in the Gold Creek to Devil Canyon segment as for the Denali-North Plan. In addition, indirect impacts may occur in the Stephan Lake area.

The North Plan, like the South Plan, may impact salmon spawning activity in Indian River. Significant impacts are likely along Portage Creek due to water quality impacts through increased erosion and due to indirect impacts such as increased angling pressure.

With any of the selected plans, direct and indirect effects can be minimized through proper engineering design and prudent management. Criteria for the development of borrow areas and the design of bridges and culverts for the proposed access plan together with mitigation recommendations are discussed in Exhibit E.

(iv) Cultural Resources

A level-one cultural resources survey was conducted over a large portion of the three access plans. The segment of

the Denali-North Plan between the Watana damsite and the Denali Highway traverses an area of high potential for cultural resource sites. Treeless areas along this segment lack appreciable soil deposition, making cultural resources visible and more vulnerable to secondary impacts. Common to both the Denali-North and the North Plans is the segment on the north side of the Susitna River from the Watana damsite to where the road parallels Devils Creek. This segment is also largely treeless making it highly vulnerable to secondary impacts. The South Plan traverses less terrain of archaeological importance than either of the other two routes. Several sites exist along the southerly Devil Canyon to Watana segment; however, since much of the route is forested, these sites are less vulnerable to secondary impacts.

The ranking from the least to the highest with regard to cultural resources impacts is South, North, Denali-North. However, impacts to cultural resources can be fully mitigated by avoidance, protection or salvage; consequently, this issue was not critical to the selection process.

(v) Socioeconomics

Socioeconomic impacts on the Mat-Su Borough as a whole would be similar in magnitude for all three plans. However, each of the three plans affects future socioeconomic conditions in differing degrees in certain areas and communities. The important differences affecting specific communities are outlined below.

- Cantwell: The Denali-North Plan would create significant increases in population, local employment, business activity, housing and traffic. These impacts result because a railhead facility would be located at Cantwell and because Cantwell would be the nearest community to the Watana damsite. Both the North and South Plans would impact Cantwell to a far lesser extent.
- Hurricane: The North Plan would significantly impact the Hurricane area since currently there is little population, employment, business activity or housing. Changes in socioeconomic indicators for Hurricane would be less under the South Plan and considerably less under the Denali-North Plan.

- Trapper Creek and Talkeetna: Trapper Creek would experience slightly larger changes in economic indicators with the North Plan than under the South or Denali-North Plans. The South Plan would impact the Talkeetna area slightly more than the other two plans.
- Gold Creek: With the South Plan, a railhead facility would be developed at Gold Creek creating a significant increase in socioeconomic indicators in this area. The Denali-North Plan includes construction of a railhead facility at the Devil Canyon site, which would create impacts at Gold Creek, but not to the same extent as the South Plan. Minimal impacts would result in Gold Creek under the North Plan.

The affected public's responses to these potential changes are mixed. The people of Cantwell are generally in favor of some economic stimulus and development in their community. Residents of Trapper Creek and Talkeetna have indicated that rapid, uncontrolled change is not desired. This and other feedback to date indicates that the Denali-North Plan will come closest to creating socioeconomic changes that are acceptable to or desired by landholders and residents in the potentially impacted areas and communities.

(vi) Preferences of Native Organizations

The Tyonek Native Corporation, Cook Inlet Region Inc. (CIRI) and the CIRI Village residents all prefer the South Plan since it provides full road access to their lands south of the Susitna River. The Ahtna Native Region Corporation and the Cantwell Village Corporation support the Denali-North Plan. None of the Native organizations supports the North Plan.

(vii) Relationship to Current Land Stewardships, Uses and Plans

Much of the land required for project development has been or may be conveyed to Native organizations. The remaining lands are generally under state and federal control. The South Plan traverses more Native-selected lands than either of the other two routes; and, although present land use is low, the Native organizations have expressed an interest in potentially developing their lands for mining, recreation, forestry or residential use.

The other land management plans that have a large bearing on access development are the Bureau of Land Management's (BLM) recent decision to open the Denali Planning Block to mineral exploration, and the Denali Scenic Highway Study being initiated by the Alaska Land Use Council. The Denali Highway to Deadman Mountain segment of the Denali-North Plan would be compatible with BLM's plans. During the construction phase of the project the Denali-North Plan could create conflicts with the development of a Denali Scenic Highway; however, after construction, the access road and project facilities could be incorporated into the overall Scenic Highway planning.

By providing public access to a now relatively inaccessible, semi-wilderness area, conflict may be imposed with wildlife habitats necessitating an increased level of wildlife and people management by the various resource agencies.

In general, however, none of the plans will be in major conflict with any present federal, borough or Native management plans.

(g) Summary

In reaching the decision as to which of the three alternative access plans would be recommended, it was necessary to evaluate the highly complex interplay that exists between the many issues involved. Analysis of the key issues indicates that no one plan satisfied all the selection criteria nor accommodated all the concerns of the resource agencies, Native organizations and the public. Therefore, it was necessary to make a rational assessment of trade-offs between the sometimes conflicting environmental concerns of impacts on fisheries, wildlife, socioeconomics, land use and recreational opportunities on the one hand, with project cost, schedule, construction risk and management needs on the other. With all these factors in mind, it should be emphasized that the primary purpose of access is to provide and maintain an uninterrupted flow of materials and personnel to the damsite throughout the life of the project. Should this fundamental objective not be achieved, significant schedule and budget overruns will occur.

(h) Final Selection of Plan

(i) Elimination of 'South Plan'

The South route, Plan 16, was eliminated primarily because of the construction difficulties associated with building a major low-level crossing 12 miles downstream of the Watana damsite. This crossing would consist of a floating or

fixed temporary bridge which would need to be removed prior to spring breakup during the first three years of the project (the time estimated for completion of the permanent bridge). This would result in a serious interruption in the flow of materials to the site. Another drawback is that floating bridges require continual maintenance and are generally subject to more weight and dimensional limitations than permanent structures.

A further limitation of this route is that for the first three years of the project all construction work must be supported solely from the railhead facility at Gold Creek. This problem arises because it will take an estimated three years to complete construction of the connecting road across the Susitna River at Devil Canyon to Hurricane on the George Parks Highway. Limited access such as this does not provide the flexibility needed by the project management to meet contingencies and control costs and schedule.

Delays in the supply of materials to the damsite, caused by either an interruption of service of the railway system or the Susitna River not being passable during spring breakup, could result in significant cost impacts. These factors, together with the realization that the South Plan offers no specific advantages over the other two plans in any of the areas of environmental or social concern, led to the South Plan being eliminated from further consideration.

(ii) Schedule Constraints

The choice of an access plan thus narrowed down to the North and Denali-North plans. Of the many issues addressed during the evaluation process, the issue of "schedule" and "schedule risk" was determined to be the most important in the final selection of the recommended plan.

Schedule plays an extremely important role in the evaluation process because of the special set of conditions that exist in a sub-arctic environment. Building roads in these regions involves the consideration of many factors not found in other environments. Specifically, the chief concern is one of weather, and the consequent short duration of the construction season. The roads for both the North and Denali-North Plans will, for the most part, be constructed at elevations in excess of 3000 feet. At these elevations the likely time available for uninterrupted construction in a typical year is 5 months, and at most 6 months.

The forecasted construction period including mobilization is 6 months for the Denali-North Plan and 9 months for the North. At first glance a difference in schedule of 3 months does not seem great; however, when considering that only 6 months of the year are available for construction, the additional 3 months become highly significant.

If diversion is not achieved prior to spring runoff in 1987, dam foundation preparation work will be delayed one year, and hence cause a delay to the overall project of one year.

(iii) Cost Impacts

The increase in costs resulting from a one-year delay have been estimated to be in the range of 100-200 million dollars. This increase includes the financial cost of investment by spring of 1987, the financial costs of rescheduling work for a one-year delay, and replacement power costs.

(iv) Summary

The Denali-North Plan has the highest probability of meeting schedule and least risk of increase in project cost for two reasons. First it has the shortest construction schedule (six months). Second, a passable route could be constructed even under winter conditions due to the relatively flat terrain along its length. In contrast the North route is mountainous and involves extensive sidehill cutting, especially in the Portage Creek area. Winter construction along sections such as this would present major problems and increase the probability of schedule delay.

(v) Plan Recommendation

It is recommended that the Denali-North route be selected so as to ensure completion of initial access to the Watana damsite by the end of the first quarter of 1986, for it is considered that the risk of significant cost overruns is too high with any other route.

(vi) Environmental Concerns - Recommended Plan

The main disadvantage of the Denali-North route is that it has a higher potential for adverse environmental impacts than the North route alternative. These impacts have been identified and, following close consultation with environmental subconsultants, many of the impacted areas have been avoided both by careful alignment of the road and the

development of design criteria which do not detract from the semi-wilderness character of the area. Some environmental impacts and conflicts are unavoidable, however, and where these impacts occur, specific mitigation measures have been developed to reduce them to a minimum. These measures are outlined in detail within the relevant sections of Exhibit E.

## 2.7 - Selection of Transmission Facilities

The objective of this section is to describe the studies performed to select a power delivery system from the Susitna River basin generating plants to the major load centers in Anchorage and Fairbanks. This system will be comprised of transmission lines, substations, a dispatch center, and means of communications.

The major topics of the transmission studies include:

- Electric system studies
- Transmission corridor selection
- Transmission route selection
- Transmission towers, hardware and conductors
- Substations
- Dispatch center and communications.

### (a) Electric System Studies

Transmission planning criteria were developed to ensure the design of a reliable and economic electrical power system, with components rated to allow a smooth transition through early project stages to the ultimate developed potential.

Strict application of optimum, long-term criteria would require the installation of equipment with ratings larger than necessary at excessive cost. In the interest of economy and long-term system performance, these criteria were temporarily relaxed during the early development stages of the project. Although allowing for satisfactory operation during early system development, final system parameters must be based on the ultimate Susitna potential.

The criteria are intended to ensure maintenance of rated power flow to Anchorage and Fairbanks during the outage of any single line or transformer element. The essential features of the criteria are:

- Total power output of Susitna to be delivered to one or two stations at Anchorage and one at Fairbanks;
- "Breaker-and-a-half" switching station arrangements;

- Overvoltages during line energizing not to exceed specified limits;
- System voltages to be within established limits during normal operation;
- Power delivered to the loads to be maintained and system voltages to be kept within established limits for system operation under emergency conditions;
- Transient stability during a 3-phase line fault cleared by breaker action with no reclosing; and
- Where performance limits are exceeded, the most cost-effective corrective measures are to be taken.

(i) Existing System Data

Data compiled in a report by Commonwealth Associates Inc. (1980) have been used for preliminary transmission system analysis. Other system data were obtained in the form of single line diagrams from the various utilities.

(ii) Power Transfer Requirements

The Susitna transmission system must be designed to ensure the reliable transmission of power and energy generated by the Susitna Hydroelectric Project to the load centers in the Railbelt area. The power transfer requirements of this transmission system are determined by the following factors:

- System demand at the various load centers;
- Generating capabilities at the Susitna project; and
- Other generation available in the Railbelt area system.

Most of the electric load demand in the Railbelt area is located in and around two main centers: Anchorage and Fairbanks. The largest load center is Anchorage, with most of its load concentrated in the Anchorage urban area. The second largest load center is Fairbanks. Two small load centers (Willow and Healy) are located along the Susitna transmission route. The only other significant load centers in the Railbelt region are Glennallen and Valdez; however, their combined demand is expected to be less than 2 percent of the total Railbelt demand in the foreseeable future. A survey of past and present load demand levels as well as various forecasts of future trends indicates these approximate load levels at the various centers:



<u>Load Area</u>	<u>Percent of Total Railbelt Load</u>
Anchorage - Cook Inlet	78
Fairbanks - Tanana Valley	20
Glennallen - Valdez	2

Considering the geographic location and the currently projected magnitude of the total load in the area, transmission to Glennallen-Valdez is not likely to be economical in the foreseeable future. If it is ever to be economical, it would likely be a direct radial extension, either from Susitna or from Anchorage. In either case, its relative magnitude is too small to have significant influence on either the viability or development characteristics of the Susitna project or the transmission from Susitna to the Anchorage and Fairbanks areas.

Accordingly, it has been assumed for study purposes that approximately 80 percent of the generation at Susitna will be transmitted to the Anchorage area and 20 percent to Fairbanks. To account for the uncertainties in future local load growth and local generation development, the Susitna transmission system was designed to be able to transmit a maximum of 85 percent of Susitna generation to Anchorage and a maximum of 25 percent to Fairbanks.

The potential of the Susitna Hydroelectric Project is expected to be developed in three or four stages as the system load grows over the next two decades. The transmission system must be designed to serve the ultimate Susitna development, but staged to provide reliable transmission at every intermediate stage. Present plans call for three stages of Susitna development: 680 MW at Watana in January 1994, followed by an additional 340 MW in July 1994 and 600 MW at Devil Canyon in 2002.

Development of other generation resources could alter the geographic load and generation sharing in the Railbelt, depending on the location of this development. However, current studies indicate that no other very large projects are likely to be developed until the full potential of the Susitna project is utilized. The proposed transmission configuration and design should, therefore, be able to satisfy the bulk transmission requirements for at least the next two decades. The next major generation development after Susitna will then require a transmission system determined by its own magnitude and location.

The resulting power transfer requirements for the Susitna transmission system are indicated in Table B.36.

(iii) Transmission Alternatives

Because of the geographic location of the various centers, transmission from Susitna to Anchorage and Fairbanks will result in a radial system configuration. This allows significant freedom in the choice of transmission voltages, conductors, and other parameters for the two line sections, with only limited dependence between them. Transmission alternatives were developed for each of the two system areas, including voltage levels, number of circuits required, and other parameters, to satisfy the necessary transmission requirements of each area.

To maintain a consistency with standard ANSI voltages used in other parts of the United States, the following voltages were considered for Susitna transmission:

- o Watana to Devil Canyon and  
on to Anchorage: 500 kV or 345 kV
- o Devil Canyon to Fairbanks: 345 kV or 230 kV

- Susitna to Anchorage

Transmission at either of two different voltage levels (345 kV or 500 kV) could reasonably provide the necessary power transfer capability over the distance of approximately 140 miles between Devil Canyon and Anchorage. The required transfer capability of 1377 MW is 85 percent of the ultimate generating capacity of 1620 MW. At 500 kV, two circuits would provide more than adequate capacity. At 345 kV, either three circuits uncompensated or two circuits with series compensation are required to provide the necessary reliability for the single contingency outage criterion. At lower voltages, an excessive number of parallel circuits are required, while above 500 kV, two circuits are still needed to provide service in the event of a line outage.

- Susitna to Fairbanks

Applying the same reasoning used in choosing the transmission alternatives to Anchorage, two circuits of either 230 kV or 345 kV were chosen for the section from Devil Canyon to Fairbanks. The 230 kV alternative requires series compensation to satisfy the planning criteria in case of a line outage.

- Total System Alternatives

The transmission section alternatives mentioned above were combined into five realistic total system alternatives. Three of the five alternatives have different voltages for the two sections. The principal parameters of the five transmission system alternatives analyzed in detail are as follows:

<u>Alternative</u>	<u>Susitna to Anchorage</u>		<u>Susitna to Fairbanks</u>	
	<u>Number of Circuits</u>	<u>Voltage (kV)</u>	<u>Number of Circuits</u>	<u>Voltage (kV)</u>
1	2	345	2	345
2	3	345	2	345
3	2	345	2	230
4	3	345	2	230
5	2	500	2	230

Electric system analyses, including simulations of line energizing, load flows of normal and emergency operating conditions, and transient stability performance, were carried out to determine the technical feasibility of the various alternatives. An economic comparison of transmission system life cycle costs was carried out to evaluate the relative economic merits of each alternative. All five transmission alternatives were found to have acceptable performance characteristics. The most significant difference was that single-voltage systems (345 kV, Alternatives 1 and 2) and systems without series compensation (Alternative 2) offered reduced complexity of design and operation and therefore were likely to be marginally more reliable. The present worth life cycle costs of Alternatives 1 through 4 were all within 1 percent of each other. Only the cost of the 500/230 kV scheme (Alternative 5) was 14 percent above the others. A summary of the life cycle cost analyses for the various alternatives is shown in Table B.37.

A technical and economic comparison was also carried out to determine possible advantages and disadvantages of HVDC transmission, as compared to an ac system, for transmitting Susitna power to Anchorage and Fairbanks. HVDC transmission was found to be technically and operationally more complex as well as having higher life cycle costs.

(iv) Configuration at Generation and Load Centers

Interconnections between generation and load centers and the transmission system were developed after reviewing the existing system configurations at both Anchorage and Fairbanks as well as the possibilities and current development plans in the Susitna, Anchorage, Fairbanks, Willow, and Healy areas.

- Susitna Configuration

Preliminary development plans indicated that the first project to be constructed would be Watana with an initial installed capacity of 680 MW, to be increased to 1020 MW in the second development stage. The next project, and the last to be considered in this study, would be Devil Canyon, with an installed capacity of 600 MW.

- Switching at Willow

Transmission from Susitna to Anchorage is facilitated by the introduction of an intermediate switching station. This has the effect of reducing line energizing overvoltages and reducing the impact of line outages on system stability. Willow is a suitable location for this intermediate switching station; in addition, it would make it possible to supply local load when this is justified by development in the area. This local load is expected to be less than 10 percent of the total Railbelt area system load, but the availability of an EHV line tap would definitely facilitate future power supply.

- Switching at Healy

A switching station at Healy was considered early in the analysis but was found to be unnecessary to satisfy the planning criteria. The predicted load at Healy is small enough to be supplied by local generation and the existing 138 kV transmission from Fairbanks.

- Anchorage Configuration

Analysis of system configuration, distribution of loads, and development in the Anchorage area led to the conclusion that a transformer station near Palmer would be of little benefit. Most of the major loads are concentrated in and around the urban Anchorage area at

the mouth of Knik Arm. In order to reduce the length of subtransmission feeders, the transformer stations should be located as close to Anchorage as possible.

The routing of transmission into Anchorage was chosen from the following three possible alternatives:

o Submarine Cable Crossing From Point MacKenzie to Point Woronzof

This would require transmission through a very heavily developed area. It would also expose the cables to damage by ships' anchors, which has been the experience with existing cables, resulting in questionable transmission reliability.

o Overland Route North of Knik Arm via Palmer

This may be most economical in terms of capital cost in spite of the long distance involved. However, approval for this route is unlikely since overhead transmission through this developed area is considered environmentally unacceptable. A longer overland route around the developed area is considered unacceptable because of the mountainous terrain.

o Submarine Cable Crossing of Knik Arm, In the Area of Lake Lorraine and Six Mile Creek

This option, approximately parallel to the new 230 kV cable under construction for Chugach Electric Association (CEA), includes some 3 to 4 miles of submarine cable and requires a high capital cost. Since the area is upstream from the shipping lanes to the port of Anchorage, it will result in a reliable transmission link, and one that does not have to cross environmentally sensitive conservation areas.

The third alternative is clearly the best of the three options.

With this configuration a different option is possible for the submarine cable crossing. To reduce cable costs the crossing could be constructed with two cable circuits plus one spare phase. This option requires a switching station at the west terminal of Knik Arm. A switching station at the west terminal would clearly require increased costs and complications for construction and operation as a result of poor access.

- Fairbanks Configuration

Susitna power for the Fairbanks area is recommended to be delivered to a single EHV/138 kV transformer station located at Ester. No alternatives were given detailed consideration.

(b) Corridor Selection

(i) Methodology

Development of the proposed Susitna project will require a transmission system to deliver electric power to the Rail-belt area. The building of the Anchorage to Fairbanks Intertie system will result in a defined corridor and route for the Susitna transmission lines between Willow and Healy. Therefore, three areas require study for corridor selection: the northern area to connect Healy with Fairbanks, the central area to connect the Watana and Devil Canyon damsites with the Intertie, and the southern area to connect Willow with Anchorage.

Using the selection criteria discussed below, corridors three to five miles wide were selected in each of the three study areas. These corridors were then evaluated to determine which ones meet the more specific screening criteria. This screening process resulted in one corridor in each area being designated as the recommended corridor for the transmission line.

(ii) Selection Criteria

Since the corridors studied range in width from three to five miles, the base criteria had to be applied in broad terms. The study also indicated that the criteria listed for technical purposes could reappear in the economic or environmental classification. The technical criteria were defined as requirements for the normal and safe performance of the transmission system and its reliability.

The selection criteria were in three categories: technical, economic and environmental. The criteria are listed in Table B.38.

(iii) Identification of Corridors

As discussed previously, the Susitna transmission line corridors studied are located in three geographical areas, namely:

- The southern study area between Willow and Anchorage
- The central study area between Watana, Devil Canyon, and the Intertie
- The northern study area between Healy and Fairbanks.

(iv) Description of Corridors

Figures B.47 through B.49 portray the corridors evaluated in the southern, central, and northern study areas, respectively. For purposes of simplification, only the center-line of the three-to-five-mile wide corridors are shown in the figures.

In each of the three figures, each corridor under consideration has been identified by the use of letter symbols. The various segment intersections and the various segments, where appropriate, have been designated. Thus, segments in each of the three study areas can be separately referenced. Furthermore, the segments are joined together to form corridors. For example, in the northern study area Corridor ABC is composed of Segments AB and BC.

The alternative corridors selected for each study area are described in detail in the following paragraphs. In addition, Tables B.39, B.40 and B.41 contain detailed environmental data for each corridor segment.

- Southern Study Area

o Corridor One - Willow to Anchorage via Palmer

Corridor ABC', consisting of Segments AB and BC', begins at the intersection with the Intertie in the vicinity of Willow. From here, the corridor travels in a southeasterly direction, crossing wetlands, Willow Creek, and Willow Creek Road before turning slightly to the southeast following the drainage of Deception Creek. The topography in the vicinity of this segment of the corridor is relatively flat to gently rolling with standing water and tall-growing vegetation in the vicinity of the creek drainages.

At a point northwest of Bench Lake, the corridor turns in an easterly direction crossing the southern foothills of the Talkeetna Mountains. The topography here is gently to moderately rolling with shrub- to tree-sized vegetation occurring throughout. As the corridor approaches the crossing of the Little Susitna River, it turns and heads southeast again, crossing the Little Susitna River and Wasilla Fishhook Road.

Passing near Wolf Lake and Gooding Lake, the corridor then crosses a secondary road, some agricultural lands, State Route 3, and the Glenn Highway, before intersecting existing transmission lines south of Palmer. In the vicinity of the Little Susitna River, the topography is gently rolling. As the corridor travels toward Palmer, the land flattens, more lakes are present, and some agricultural development is occurring. After crossing the Glenn Highway, the corridor passes through a residential area before crossing the broad floodplain of the Matanuska River.

Just west of Bodenbug Butte, the corridor turns due south through more agricultural land before crossing the Knik River and eventually connecting with the Eklutna Power Station. All of the land south of Palmer is very flat with some agricultural development. Just south of Palmer, the proposed corridor intersects existing transmission facilities and parallels or replaces them from a point just south of Palmer, across the river and into the vicinity of the Eklutna Power House. From here into Anchorage, the corridor as proposed would parallel existing facilities, crossing near or through the communities of Eklutna, Peters Creek, Birchwood, and Eagle River by using one of the two existing transmission line rights-of-way in this area. The land here is flat to gently rolling with a great deal of residential development. This corridor segment is the most easterly of the three considered in the southern study area and avoids an underwater crossing of Knik Arm.

o Corridor Two - Willow to Point MacKenzie via Red Shirt Lake

Corridor ADFC, consisting of Segments ADF and FC, commences again at the point of intersection with the In-tertie in the vicinity of Willow but immediately turns to the southwest, first crossing the railroad, then the Parks Highway, then Willow Creek just west of Willow. The land in the vicinity of this part of the segment is very flat, with wetlands dominating the terrain.

Southwest of Florence Lake, the proposed corridor turns, crosses Rolly Creek, and heads nearly due south, passing through extensive wetlands west and south of Red Shirt Lake. The corridor in this area parallels existing tractor trails crossing very flat lands with significant amounts of tall-growing vegetation in the better drained locations.



Northwest of Yohn Lake, the corridor segment turns to the southeast, passing Yohn Lake and My Lake before crossing the Little Susitna River. Just south of My Lake, the corridor turns in a generally southerly direction, passing Middle Lake, and east of Horseshoe Lake before finally intersecting the existing Beluga 230 kV transmission line at a spot just north of MacKenzie Point. From here, the corridor parallels MacKenzie Point's existing transmission facilities before crossing under Knik Arm to emerge on the easterly shore of Knik Arm in the vicinity of Anchorage. The land in the vicinity of this segment is extremely flat and very wet, supporting dense stands of tall-growing vegetation on any of the higher or better drained areas.

o Corridor Three - Willow to Point MacKenzie via Lynx Lake

Corridor AEFC is very similar to and is a derivation of Corridor ADFC; it consists of Segments AEF and FC. This corridor also extends to the southwest of Willow. West of the Parks Highway, however, just north of Willow Lake, this corridor turns and travels southwest of Willow and east of Long Lake, passing between Honeybee Lake and Crystal Lake. The corridor then turns southeastward to pass through wetlands east of Lynx Lake and Butterfly Lake before crossing the Little Susitna River. The land is well developed in this area. It is very flat and, while it is wet, also supports dense stands of tall-growing vegetation on the better drained sites. Corridor Three rejoins Corridor Two at a point south of My Lake.

- Central Study Area

The central study area encompasses a broad area in the vicinity of the damsites. From Watana, the study area extends to the north as far as the Denali Highway and to the south as far as Stephan Lake. From this point westward, the study area encompasses the foothills of the Alaska Range and, to the south, the foothills of the Talkeetna Mountains. Included in this study area are lands under consideration by the Intertie Project investigators. The alternative corridors would connect both Devil Canyon and Watana Dams with the Intertie at

one of four locations, which are identified in Figure B.48.

As for the southern study area, individual corridor segments are listed in the text. This is to aid the reader both in determining corridor locations in the figures and in examining the environmental inventory data listed for each segment in Tables B.39, B.40, and B.41.

o Corridor One - Watana to Intertie via South Shore, Susitna River

Corridor ABCD consists of three segments: AB, BC, and CD. This corridor originates at the Watana damsite and follows the southern boundary of the river at an elevation of approximately 2000 feet from Watana to Devil Canyon. From Devil Canyon, the corridor continues along the southern shore of the Susitna River at an elevation of about 1400 feet to the point at which it connects with the Intertie, assuming the Intertie follows the railroad corridor. The land surface in this area is relatively flat, though incised at a number of locations by tributaries to the Susitna River. The relatively flat hills are covered by discontinuous stands of dense, tall-growing vegetation.

o Corridor Two - Watana to Intertie via Stephan Lake

ABECD, the second potential corridor, is essentially a derivation of Corridor One and is formed by replacing Segments BC with BEC. Originating at Point B, Corridor Segment BEC leaves the river and generally parallels one of the proposed Watana Dam access road corridors. This corridor extends southwest from the river, passing near Stephan Lake to a point northwest of Daneka Lake. Here the route turns back to the northwest and intersects Corridor One at the Devil Canyon damsite. The terrain in this area, again, is gently rolling hills with relatively flat benches. Vegetation cover ranges from sparse at the higher elevations to dense along the river bottom and along gentler slopes of the Susitna River and its tributaries.

o Corridor Three - Watana to Intertie via North Shore, Susitna River

Corridor Three (AJCF), located on the north side of the river, consists of Segments AJ and CF. Starting at the Watana damsite, the corridor crosses Tsusena Creek and heads westerly, following a small drainage

tributary to the Susitna River. Once crossing Devil Creek, the corridor passes north and west of High Lake.

The corridor stays below an elevation of 3700 feet as it crosses north of the High Lake area, east of Devil Creek, on its approach to Devil Canyon. From Devil Canyon, the corridor again extends to the west, crossing Portage Creek and intersecting the Intertie in the vicinity of Indian River. In the drainages, to elevations of about 2000 feet, tree heights range to 60 feet. Between Devil Creek and Tsusena Creek, however, at the higher elevations, very little vegetation grows taller than 3 feet. Once west of Devil Creek, discontinuous areas of tall-growing vegetation exist.

o Corridor Four - Watana to Intertie via Devil Creek Pass/East Fork Chulitna River

Another means of connecting the two dam schemes with the Intertie is to follow Corridor One from Watana to Devil Canyon and then exit the Devil Canyon project to the north (ABCJHI). This involves connecting Corridor Segments AB, BC, CJ, HJ, and HI. With this alternative, the corridor extends northeast at Devil Canyon past High Lake to Devil Creek drainage. From there, it moves northward to a point north of the south boundary of the Fairbanks Meridian. The corridor then follows the Portage Creek drainage beyond its point of origin to a site within the Tsusena Creek drainage. Likewise, it follows the Tsusena Creek drainage to a point near Jack River, at which point it parallels this drainage into Caribou Pass. From Caribou Pass, the corridor turns to the west, following the Middle Fork Chulitna River until meeting the Intertie in the vicinity of Summit Lake.

While along much of this corridor the route follows river valleys, the plan also requires crossing high mountain passes in rugged terrain. This is especially true in the crossing between Portage Creek and Tsusena Creek drainages, where elevations of over 4600 feet are involved. Tall-growing vegetation is restricted to the lower elevations along the river drainages with little other than low-growing forbs and shrubs present at higher elevations.

o Corridor Five - Watana to Intertie via Stephan Lake and the East Fork Chulitna River

A variation of Corridor Four, Corridor Five (ABECJHI) replaces Segment BC with Corridor Segment BEC (of Corridor Two). This results in a corridor that extends from the Watana damsite southwesterly to the vicinity of Stephan Lake, and from Stephan Lake into the Devil Canyon damsite. From Devil Canyon to the Intertie, the corridor follows the Devil Creek, Portage Creek, and Middle Fork Chulitna drainages previously mentioned. As before, the corridor crosses rolling terrain throughout the length of the paralleled drainages, with some confined, higher elevation passes encountered between Portage Creek and Tsusena Creek.

o Corridor Six - Devil Canyon to the Intertie via Tsusena Creek/Chulitna River

Another option (CBAHI) for connecting the dam projects to the Intertie involves connecting Devil Canyon and Watana along the south shore of the Susitna River via Corridor Segment CBA, then exiting Watana to the north on Segments AH and HI along Tsusena Creek to follow this drainage to Caribou Pass. The corridor then contains the previously-described route along the Jack River and Middle Fork Chulitna until connecting with the Intertie near Summit Lake. The terrain in this corridor proposal would be of moderate elevation with some confined, higher elevation passes between the drainages of Tsusena Creek and the Jack River.

o Corridor Seven - Devil Canyon to Intertie via Stephan Lake and Chulitna River

This alternative uses Corridor Six but replaces Segment BC with Segment BEC from Corridor Two. This route would thus be designated CEBAHI. Terrain features are as described in Corridors Two and Six.

o Corridor Eight - Devil Canyon to Intertie via Deadman/Brushkana Creeks and Denali Highway

Yet another option to the previously-described corridors is the interconnection of Devil Canyon with Watana via Corridor One (Segment CBA), with a segment then extending from Watana northeasterly along the Deadman Creek drainage (Segment AG). The segment pro-

ceeds north of Deadman Lake and Deadman Mountain, then turns to the west and intersects the Brushkana Creek drainage. It then follows Brushkana Creek north to a point east of the Kana Bench Mark. This segment of the corridor would parallel one of the proposed access roads. From there, the corridor turns west, generally parallel to the Denali Highway, to the point of interconnection with the Intertie in the vicinity of Cantwell. The area encompasses rolling hills with modest elevation changes and some forest cover, especially at the lower elevations.

o Corridor Nine - Devil Canyon to Intertie via Stephan Lake and Denali Highway

Corridor Nine (CEBAG) is exactly the same as Corridor Eight with the exception of Corridor Segment BEC, utilized to replace Segment BC. Each combination of segments has been previously described.

o Corridor Ten - Devil Canyon to Intertie via North Shore, Susitna River, and Denali Highway

Corridor Ten connects Devil Canyon-Watana with the Intertie in the vicinity of Cantwell by means of Corridor Segments CJAG. Segment CJA is part of Corridor Three and, as such, has been previously described. Segment AG has also been described above as part of Corridor Eight. As noted earlier, the Corridor Ten terrain consists of mountainous stretches with accompanying gently-rolling to moderately-rolling hills and flat plains covered in places with tall-growing vegetation.

o Corridor Eleven - Devil Canyon to the Intertie via Tsusena Creek/Chulitna River

Another northern route connecting Devil Canyon with Watana is that created by connecting Corridor Segment CJA (part of Corridor Three) with Segment AHI of Corridor Six.

o Corridor Twelve - Devil Canyon-Watana to the Intertie via Devil Creek/Chulitna River

Another route under consideration is Corridor JA-CJHI. From north to south, this involves a corridor extending from the Intertie near Summit Lake, heading

easterly along the Middle Fork Chulitna drainage into Caribou Pass. From here, it parallels the Jack River and connects with the Portage Creek-Devil Creek route, Segment HJ. At point J, located in the Devil Creek drainage east of High Lake, the corridor splits, with one segment extending westerly to Devil Canyon and the other extending east to the Watana damsite along previously-described Corridor Segments JC and JA, respectively. Terrain features of this route have been previously described.

o Corridor Thirteen - Watana to Devil Canyon via South Shore, Devil Canyon to Intertie via North Shore, Susitna River

Corridor Segments AB, BC, and CF are combined to form this corridor. Descriptions of the terrain crossed by these segments appear in discussions of Corridor One (ABCD) and Corridor Three (AJCF).

o Corridor Fourteen - Watana to Devil Canyon via North Shore, Devil Canyon to Intertie via South Shore, Susitna River

This corridor would connect the damsites in the directionally opposite order of the previous corridor, and include Corridor Segment AJCD. Again, as parts of Corridors One and Three, the terrain features of this corridor have been previously described.

o Corridor Fifteen - Watana to Devil Canyon via Stephan Lake, Devil Canyon to Intertie via North Shore, Susitna River

Corridor Two (ABEC) and Corridor Three (CF) form to create this study-area corridor. Terrain features have been presented under the discussions of each of these two corridors.

- Northern Study Area

In the northern study area, four transmission line corridor options exist for connecting Healy and Fairbanks (Figure B.49).

o Corridor One - Healy to Fairbanks via Parks Highway

Corridor One (ABC), consisting of Segments AB and BC, starts in the vicinity of the Healy Power Plant. From here, the corridor heads northwest, crossing the

existing Golden Valley Electric Association Transmission Line, the railroad, and the Parks Highway before turning to the north and paralleling this road to a point due west of Browne. Here, as a result of terrain features, the corridor turns northeast, crossing the Parks Highway once again as well as the existing transmission line, the Nenana River, and the railroad, and continues northeasterly to a point northeast of the Clear Missile Early Warning Station (MEWS).

Continuing northward, the corridor eventually crosses the Tanana River east of Nenana, then heads northeast, first crossing Little Goldstream Creek, then the Parks Highway just north of the Bonanza Creek Experimental Forest. Before reaching the drainage of Ohio Creek, this corridor turns back to the northeast, crossing the old Parks Highway and heading into the Ester substation west of Fairbanks.

Terrain along this entire corridor segment is relatively flat, with the exception of the foothills north of the Tanana River. Much of the route, especially that portion between the Nenana and the Tanana River crossings, is very broad and flat, has standing water during the summer months and, in some places, is overgrown by dense stands of tall-growing vegetation. This corridor segment crosses the foothills northeast of Nenana, also a heavily-wooded area.

An option to the above (and not shown in the figures), that of closely paralleling and sharing rights-of-way with the existing Healy-Fairbanks transmission line, has been considered. While it is usually attractive to parallel existing corridors wherever possible, this option necessitates a great number of road crossings and an extended length of the corridor paralleling the Parks Highway. A potentially significant amount of highway-abutting land would be usurped for containment of the right-of-way. These features, in combination, eliminated this corridor from further evaluation.

o Corridor Two - Healy to Fairbanks via Crossing Wood River

The second corridor (ABDC) is a variation of Corridor One and consists of Segments AB and BDC. At point B, east of the Clear MEWS, instead of turning north, the corridor continues to the northeast, crossing Fish

Creek, the Totatlanika River, Tatlanika Creek, the Wood River, and Crooked Creek before turning to the north. At a point equidistant from Crooked and Willow Creeks, the corridor turns north, crosses the Tanana River east of Hadley Slough, and extends to the Ester substation. North of the Tanana River, this corridor segment also crosses Rose Creek and the Parks Highway.

Where it diverges from the original corridor, this corridor traverses extensive areas of flat ground, with standing water very prevalent throughout the summer months. Heavily-wooded areas occur in the broad floodplain of the Tanana River, in the vicinity of the river crossing, and in the foothills around Rose Creek.

o Corridor Three - Healy to Fairbanks via Healy Creek and Japan Hills

Corridor Three (AEDC), consisting of Segments AE and EDC, exits the Healy Power Plant in an easterly direction. Instead of proceeding northwest, this corridor, following its interconnection with the Intertie Project, heads east up Healy Creek, passing the Usibelli Coal Mine. Near the headwaters of Healy Creek, the corridor cuts to the east, crossing a high pass of approximately 4700 feet elevation and descending into the Cody Creek drainage. From Healy to the Cody Creek drainage, the terrain is relatively gentle but bounded by very rugged mountain peaks. The elevation gain from the Healy Power Plant to the pass between the Healy Creek-Cody Creek drainages is approximately 3300 feet. From here, the segment turns to the northeast, following the lowlands accompanying the Wood River. The corridor next parallels the Wood River from the Anderson Mountain area, past Mystic Mountain, and out into the broad floodplain of the Tanana River east of Japan Hills. Near the confluence of Fish Creek and the Wood River, the corridor turns north and intersects the north-south portion of Corridor Two (Segment DC), after first passing through Wood River Buttes. Much of the area north of Japan Hills is flat and very wet with stands of dense, tall-growing vegetation.



o Corridor Four - Healy to Fairbanks via Wood River and Fort Wainwright

Corridor Four (AEF) is a derivation of Corridor Three and is composed of Segments AE and EF. Point E is located just north of Japan Hills along the Wood River. From here, the corridor deviates from Corridor Three by running north across the Blair Lake Air Force Range, Fort Wainwright, and several tributaries of the Tanana River, before reaching the crossing of Salchaket Slough. Corridor Four passes Clear Creek Butte on the east. A new substation would be located on the Fairbanks side of the Tanana River just north of Goose Island. From Point E to Point F, the terrain of the corridor is flat and very wet, and again, dense stands of tall-growing vegetation exist both in the better drained portions of the flat lands and in the vicinity of the river crossing.

(c) Corridor Screening

The objectives of the screening process were to focus on the previously-selected corridors and select those best meeting technical, economic, and environmental criteria.

(i) Reliability

Reliability is an uncompromising factor in screening alternative transmission line corridors. Many of the criteria utilized for economic, environmental, and technical reasons also relate to the selection of a corridor within which a line can be operated with minimum power interruption. Six basic factors were considered in relation to reliability:

- Elevation: Lines located at elevations below 4000 feet will be less exposed to severe wind and ice conditions, which can interrupt service.
- Aircraft: Avoidance of areas near aircraft landing and takeoff operations will minimize risks from collisions.
- Stability: Avoidance of areas susceptible to land, ice, and snow slides will reduce chance of power failures.
- Existing Power Lines: Avoidance of crossing existing transmission lines will reduce the possibility of lines touching during failures and will facilitate repairs.

- Topography: Lines located in areas with gentle relief will be easier to construct and repair.
- Access: Lines located in reasonable proximity to transportation corridors will be more quickly accessible and therefore more quickly repaired if any failures occur.

(ii) Technical Screening Criteria

Four primary and two secondary technical factors were considered in the screening of alternative corridors.

- Primary Aspects:

o Topography

o Climate and Elevation

Low temperatures, snow depth, icing, and severe winds are very important parameters in transmission design, operation, and reliability.

Climatic factors become more severe in the mountains, where extreme winds are expected for exposed areas and passes. The Alaska Power Administration believes that elevations above 4000 feet in the Alaska Range and Talkeetna Mountains are completely unsuitable for locating major transmission facilities. Significant advantages of reliability and cost are expected if the lines are routed below 3000 feet in elevation. This elevation figure was used in the screening process.

o Soils

Although transmission lines are less affected by soils and foundation limitations than railroads and pipelines, it is more reliable to build a transmission line on soil that does not appear to be underlain by seismically-induced ground failures or on a swampy area where maintenance and inspection may create problems. These factors were utilized in the screening process. Because of the vast areas of wetlands in the study area, particularly in the southern portion, it was not possible to locate a corridor that would avoid all wetland areas.

o Length of Corridors

- Secondary Aspects:

o Vegetation and Clearing

Heavily-forested areas must be cleared prior to construction of the transmission line. Clearing the vegetation will cause some disruption of the soil. If not properly stabilized through restoration and vegetation, increased erosion will result. If the vegetation is cleared up to river banks on stream crossings, additional sedimentation may result. During the corridor screening, those corridors crossing through large expanses of heavily-timbered areas were eliminated.

o Other

Highway and river crossings were avoided where possible.

(iii) Economic Screening Criteria

Three primary and one secondary aspect of the economic criteria were considered.

- Primary Aspects:

o Length

o Right-of-Way

Whenever possible, existing rights-of-ways were shared or paralleled to avoid problems associated with pioneering a corridor in previously inaccessible areas.

o Access Roads

- Secondary Aspects:

In addition to the major considerations concerning economic screening of corridors, some other aspects were also considered. These include topography (since it is more economical to build a line on a flat corridor than on a rugged or a mountainous one) and limiting the number of stream, river, highway, road, and railroad crossings in order to minimize costs.

(iv) Environmental Screening Criteria

Because of the potential adverse environmental impacts from transmission line construction and operation, environmental criteria were carefully scrutinized in the screening process. Past experience has shown the primary environmental considerations to be:

- Aesthetic and Visual (including impacts to recreation)
- Land Use (including ownership and presence of existing rights-of-way)

Also of significance in the evaluation process are:

- Length
- Topography
- Soils
- Cultural Resources
- Vegetation
- Fishery Resources
- Wildlife Resources

A description and rationale for use of these criteria are presented below:

- Primary Aspects:

o Aesthetic and Visual

The presence of large transmission line structures in undeveloped areas has the potential for adverse aesthetic impacts. Furthermore, the presence of these lines can conflict with recreational use, particularly those nonconsumptive recreational activities such as hiking and bird watching where great emphasis is placed on scenic values. The number of road crossings encountered by transmission line corridors is also a factor that needs to be inventoried because of the potential for visual impacts. The number of roads crossed, the manner in which they are crossed, the nature of existing vegetation at the crossing site (i.e., potential visual screening), and the number and

type of motorists using the highway all influence the desirability of one corridor versus another. Therefore, when screening the previously-selected corridors, consideration was focused on the presence of recreational areas, hiking trails, heavily utilized lakes, vistas, and highways where views of transmission line facilities would be undesirable.

o Land Use

The three primary components of land use considerations are: 1) land status/ownership, 2) existing rights-of-way, and 3) existing and proposed development.

. Land Status/Ownership

The ownership of land to be crossed by a transmission line is important because certain types of ownership present more restrictions than others. For example, some recreation areas such as state and federal parks and areas such as game refuges and military lands, among others, present possible constraints to corridor routing. Private landowners generally do not want transmission lines on their lands. This information, when known in advance, permits corridor routing to avoid such restrictive areas and to occur in areas where land use conflicts can be minimized.

. Existing Rights-of-Way

Paralleling existing rights-of-way tends to result in less environmental impact than that which is associated with a new right-of-way because the creation of a new right-of-way may provide a means of access to areas normally accessible only on foot. This can be a critical factor if it opens sensitive, ecological areas to all-terrain vehicles.

Impact on soils, vegetation, stream crossings, and other inventory categories can also be lessened through the paralleling of existing access roads and cleared rights-of-way. Some impact is still felt, however, even though a right-of-way may exist in the area. For example, cultural resources may not have been identified in the original routing effort.

Wetlands present under existing transmission lines may likewise be negatively influenced if ground access to the vicinity of the tower locations is required.

There are common occasions where paralleling an existing facility is not desirable. This is particularly true in the case of highways that offer the potential for visual impacts and in situations where paralleling a poorly sited transmission facility would only compound an existing problem.

#### . Existing and Proposed Developments

This inventory identifies such items as agricultural use, planned urban developments (such as the proposed capital site), existing residential and cabin developments, the location of airports and lakes used for float planes, and similar types of information. Such information is essential for locating transmission line corridors appropriately, as it presents conflicts with these land use activities.

#### - Secondary Aspects:

##### o Length

The length of a transmission line is an environmental factor and, as such, was considered in the screening process. A longer line will require more construction activity than a shorter line, will disturb more land area, and will have a greater inherent probability of encountering environmental constraints.

##### o Topography

The natural features of the terrain are significant from the standpoint that they offer both positive and negative aspects to transmission line routing. Steep slopes, for example, present both difficult construction and soil stabilization problems with potentially long-term, negative environmental consequences. Also, ridge crossings have the potential for visual impacts. At the same time, slopes and elevation changes present opportunities for routing transmission lines so as to screen them from both travel routes and existing communities. Hence, when planning corridors the identification of changes in relief is an important factor.

o Soils

Soils are important from several standpoints. First of all, scarification of the land often occurs during the construction of transmission lines. As a result, vegetation regeneration is affected, as are the related features of soil stability and erosion potential. In addition, the development and installation of access roads, where necessary, are very dependent upon soil types. Tower designs and locations are dictated by the types of soils encountered in any particular corridor segment. Consequently, the review of existing soils information is very significant. This inventory was conducted by means of a Soil Associations Table, Table B.42. Table B.43 presents the related definitions as they apply to the terms used in Table B.42.

o Cultural Resources

The avoidance of known or potential sites of cultural resources is an important component in the routing of transmission lines. A level-one cultural resources survey has been conducted along a large portion of the transmission corridors. In those areas where no information has been collected to date an appropriate program for identifying and mitigating impacts will be undertaken. This program is discussed in more detail in Section 4 of Exhibit E.

o Vegetation

The consideration of the presence and location of various plant communities is essential in transmission line siting. The inventory of plant communities, such as those of a tall-growing nature or wetlands, is significant from the standpoint of construction, clearing, and access road development requirements. In addition, identification of locations of endangered and threatened plant species is also critical. While several Alaskan plant species are currently under review by the U.S. Fish and Wildlife Service, no plant species are presently listed under the Endangered Species Act of 1973 as occurring in Alaska. No corridor currently under consideration has been identified as traversing any location known to support these identified plant species.

#### o Fishery Resources

The presence or absence of resident or anadromous fish in a stream is a significant factor in evaluating suitable transmission line corridors. The corridor's effects on a stream's resources must be viewed from the standpoint of possible disturbance to fish species, potential loss of habitat, and possible destruction of spawning beds. In addition, certain species of fish are more sensitive than others to disturbance.

Closely related to this consideration is the number of stream crossings. The nature of the soils and vegetation in the vicinity of the streams and the manner in which the streams are to be crossed are also important environmental considerations when routing transmission lines. Potential stream degradation, impact on fish habitat through disturbance, and long-term negative consequences resulting from siltation of spawning beds are all concerns that need evaluation in corridor routing. Therefore, the number of stream crossings and the presence of fish species and habitat value were considered when data were available.

#### o Wildlife Resources

The three major groups of wildlife which must be considered in transmission corridor screening are big game, birds, and furbearers. Of all the wildlife species to be considered in the course of routing studies for transmission lines, big game species (together with endangered species) are most significant. Many of the big game species, including grizzly bear, caribou, and sheep, are particularly sensitive to human intrusion into relatively undisturbed areas. Calving grounds, denning areas, and other important or unique habitat areas as identified by the Alaska Department of Fish and Game were identified and incorporated into the screening process.

Many species of birds such as raptors and swans are sensitive to human disturbance. Identifying the presence and location of nesting raptors and swans permits avoidance of traditional nesting areas. Moreover, if this category is investigated, the presence of endangered species (viz, peregrine falcons) can be determined.



Important habitat for furbearers exists along many potential transmission line corridors in the Railbelt area, and its loss or disruption would have a direct effect on these animal populations. Investigating habitat preferences, noting existing habitat, and identifying populations through available information are important steps in addressing the selection of environmentally acceptable alternatives.

(v) Screening Methodology

- Technical and Economic Screening Methodology

The parameters required for the technical and economic analyses were extracted from the environmental inventory tables (Tables B.39 through B.41). These tables, and Tables B.44 through B.50 are derived from studies carried out prior to the issuance of the Feasibility Report in March 1982; at that time the routing of the proposed access route was undecided. Subsequent to the publication of the Feasibility Report the decision was made to select the Denali-North Plan as the proposed access route. Since the location of the access route is of major importance in relation to the transmission line within the central study area, the tables have been modified to reflect this decision and the ratings assigned to each corridor adjusted accordingly. The reasons for changing these ratings are discussed in more detail in subsection 2.7(d).

The tables, together with the topographic maps, aerial photos, and existing published materials, were used to compare the alternative corridors from a technical and economic point of view. The parameters used in the analysis were: length of corridors, approximate number of highway/road crossings, approximate number of river/creek crossings, land ownership, topography, soils, and existing rights-of-way. The main factors contributing to the economic and technical analyses are combined and listed in Tables B.44, B.45, and B.46. It should be noted that most of the parameters are in miles of line length, except the tower construction. In this analysis, it was decided to assign 4.5 towers for each mile of 345 kV line.

In order to screen the most qualified corridor, it was decided to rate the corridors as follows:

- Corridor rated A - recommended
- Corridor rated C - acceptable but not preferred
- Corridor rated F - unacceptable

From a technical point of view, reliability is the main objective. An environmentally and economically sound transmission line was rejected if the line was not reliable. Thus, any line which received an F technical rating, was assigned an overall rating of F and eliminated from further consideration.

The ratings appear in each of the economic and technical screening tables (Tables B.44, B.45, and B.46) and are summarized in Table B.47.

- Environmental Screening Methodology

In order to compare the alternative corridors (Figures B.47, B.48, and B.49) from an environmental standpoint, the environmental criteria discussed above were combined into environmental constraint tables (Tables B.48, B.49, and B.50). These tables combine information for each corridor segment into the proper corridors under study. This permits the assignment of an environmental rating, which identifies the relative rating of each corridor within each of the three study areas. The assignment of environmental ratings is a subjective, qualitative technique intended as an aid to corridor screening. Those corridors that are recommended are identified with an "A," while those corridors that are acceptable but not preferred are identified with a "C." Finally, those corridors that are considered unacceptable are identified with an "F."

(d) Selected Corridor

The selected corridor consists of the following segments:

- Southern Study Area: Corridor ADFC (Figures B.50 and B.51)
- Central Study Area: Corridor AJCD (Figures B.52 and B.53)
- Northern Study Area: Corridor ABC (Figures B.54 through B.57)

Specifics of these corridors and reasons for rejection of others are discussed below. More detail on the screening process and the specific technical ratings of each alternative are in Chapter 10 of Exhibit E.

(i) Southern Study Area

In the southern study area, Corridor Segment AEF and, hence, Corridor Three (AEFC) were determined unacceptable. This results primarily from the routing of the segment through the relatively well-developed and heavily-utilized Nancy Lake state recreation area. Adjustments to this route to make it more acceptable were attempted but no alterations proved successful. Consequently, it was recom-

mended that this corridor be dropped from further consideration.

Corridor One (ABC'), identified as acceptable but not preferred, was thus given the C rating. Its great length, its traversing of residential and other developed lands, and the numerous creek crossings and extensive forest clearing involved relegate this corridor to this environmental rating. Economically and technically, this corridor has more difficulties than the other two considered. This is a longer line and crosses areas which may require easements in the area north of Anchorage.

Corridor Two (ADFC) was identified as the candidate which would satisfy most of the screening criteria. This corridor is shown in Figures B.50 and B.51 and stretches from an area north of Willow Creek to Point MacKenzie in the south. The corridor is located east of the lower Susitna River and crosses the Little Susitna River. The corridor also crosses an existing 138 kV line owned and operated by Chugach Electric Association (CEA), which starts at Point MacKenzie and extends to Teeland Substation.

Up to this point in the corridor selection study, Point MacKenzie has been considered a terminal point for Susitna power. It was assumed that an underwater cable crossing would be provided at this location. Upon further study and data gathering it has become known that the existing crossing at Point MacKenzie has experienced power interruptions caused by ship's anchors snagging the submarine cables. CEA, which owns the submarine cables, required additional transmission capacity to Anchorage. After thoroughly studying the matter, it has opted for a combined submarine/overhead cable transmission across Knik Arm and on to Anchorage. This was the most desirable option to CEA from both the environmental and technical point of view.

The CEA crossing will be located approximately 8 miles northeast of Point MacKenzie on the west shore of the Knik Arm and across from Elmendorf Air Force Base in the vicinity of Six Mile Creek. This crossing is located northeast of Anchorage Harbor, away from heavy ship traffic, thereby reducing the risk of anchor damage to the cable.

It is intended to terminate Corridor ADFC at this new crossing point and extend the transmission corridor to Elmendorf Air Force Base and beyond to Anchorage.

Although the crossing is approximately 8 miles northeast of Point MacKenzie, it does not influence the results of this corridor selection and screening process. The best corridor has been selected and screened. During routing studies

minor deviations outside the corridor will have to occur in order to terminate at the revised crossing point. However, preliminary investigations indicate it will be possible to select a technically, economically, and environmentally acceptable route, particularly since an existing transmission line can likely be paralleled from the selected corridor to the revised crossing point. Furthermore, CEA has received the necessary permits and is constructing an underwater crossing at Knik Arm, indicating acceptable levels of environmental impact.

(ii) Central Study Area

In the central study area, several corridor segments and their associated corridors were determined to be unacceptable. The first of these, Corridor Segment BEC, appears as part of Corridors Two (ABECD), Five (ABECJHI), Seven (CEJAH I), Nine (CEBAG), and Fifteen (ABECF). The primary reason for rejecting this segment is that the developed recreation area around Stephan Lake would be needlessly harmed because viable options exist to avoid intruding into this area. An acceptable modification could not be found and, consequently, it is recommended that these five corridors be dropped from further consideration.

Corridor Segment AG was also determined not to warrant further consideration because of its approximate 65-mile length, two-thirds of which would possibly require a pioneer access road. Also, extensive areas of clearing would be required, opening the corridor to view in some scenic locations. Finally, the impacts on fish and wildlife habitats are potentially severe. These preliminary findings, coupled with the fact that more viable options to Segment AG exist, suggest that consideration of this corridor segment and therefore Corridors Eight (CBAG) and Ten (CJAG) should be terminated.

Corridors Eleven (CJAH I) and Twelve (JA-CJHI) were identified as not acceptable. This rating arose from the fact that, as shown in Environmental Constraint Table B.49, numerous constraints affect this routing. Information from recently completed field investigations suggest that these constraints cannot be overcome and the routes should be rejected. Furthermore, the technical and economical ratings preclude these corridors from further consideration.

Corridor Segment HJ has been moved so that it no longer parallels the Devil Creek drainage; the new location HC is selected to avoid both High Lake and the Devil Creek drainage. It then follows the Portage Creek drainage to the point of intersection with Corridor Segment JH, near the creek's headwaters. Subsequent investigations have con-

firmed that this corridor segment is not viable and, consequently, Corridors Four and Five are eliminated from further consideration.

Corridor Six (CBAHI) intrudes on valuable wildlife habitat and would cross numerous creeks, none of which are currently crossed by existing access roads. In addition, a high mountain pass and its associated shallow soils, steep slopes, and surficial bedrock constrain this routing. Finally, its crossing of areas over 4000 feet in elevation makes it technically unacceptable, so this corridor is dropped from further consideration.

The four remaining corridors (Corridors One, Three, Thirteen and Fourteen) were each identified as being acceptable in terms of the technical, economic and environmental criteria described in subsection 2.7(c).

The Denali-North Plan was selected as the proposed access route for the Susitna development (subsection 2.6(h)). The location of existing and proposed access is of prime importance both from an economic and environmental standpoint. Therefore, subsequent to the access decision, each of the four corridors was subjected to a more detailed evaluation and comparison. In order to more directly compare the four corridors a preliminary route was selected in each of the segments. The final route selection process leading to the preferred route in the corridor, which was subsequently recommended, is discussed in more detail in subsection 2.7(e). The four corridors are comprised of the following segments:

- Corridor One            ABCD
- Corridor Three        AJCF
- Corridor Thirteen    ABCF
- Corridor Fourteen    AJCD

Segments ABC and AJC link Watana with Devil Canyon and, similarly, segments CD and CF link Devil Canyon with the Intertie. On closer examination of the possible routes between Devil Canyon and the Intertie, segment CD was found to be superior to segment CF for the following reasons.

- Economic

A four-wheel drive trail is already in existence on the south side of the Susitna River between Gold Creek and the proposed location of the railhead facility at Devil Canyon. Therefore, the need for new roads along segment CD, both for construction and operation and maintenance, is significantly less than for segment CF, which requires the construction of a pioneer road. In addition, the proposed Gold Creek to Devil Canyon railroad extension

will also run parallel to segment CD. The lengths of Segments CD and CF are 8.8 miles and 8.7 miles, respectively--not a significant factor. Among the secondary economic considerations is that of topography. Segment CF crosses more rugged terrain at a higher elevation than segment CD and would therefore prove more difficult and costly to construct and maintain. Hence, segment CD was considered to have a higher overall economic rating.

- Technical

Although both segments are routed below 3000 feet elevation, segment CF crosses more rugged, exposed terrain with a maximum elevation of 2600 feet. Segment CD, on the other hand, traverses generally flatter terrain and has a maximum elevation of 1800 feet. The disadvantages of segment CF are somewhat offset, however, by the Susitna River crossing that will be needed at river mile 150 for segment CD. Overall, the technical difficulties associated with the two segments may be regarded as being similar.

- Environmental

One of the main concerns of the various environmental groups and agencies is to keep any form of access away from sensitive ecological areas previously inaccessible other than by foot. Creating a pioneer road to construct and maintain a transmission line along segment CF would open that area to all-terrain vehicles and public use, and thereby increase the potential for adverse impacts to the environment. The potential for environmental impacts along segment CD would be present regardless of where the transmission line was built since there is an existing four-wheel drive trail together with the proposed railroad extension in that area. It is clearly desirable to restrict environmental impacts to a single common corridor; for that reason, segment CD is preferable to segment CF.

Because of potential environmental impacts and economic ratings, segment CF was dropped in favor of segment CD. Consequently, corridors Three (AJCF) and Thirteen (ABCF) were eliminated from further consideration.

The two corridors remaining are therefore corridors One (ABCD) and Fourteen (AJCD). This reduces to a comparison of segment ABC on the south side of the Susitna River and segment AJC on the north side. The two segments were then screened in accordance with the criteria set out in subsection 2.7(c). The key points of this evaluation are outlined below:

- Economic

For the Watana development, two 345 kV transmission lines will be constructed from Watana through to the Intertie. When comparing the relative lengths of transmission line, it was found that segment ABC was 33.6 miles in total length compared to 36.4 miles for the northern route using segment AJC. Although at first glance a difference in length of 2.8 miles (equivalent to 12 towers at a spacing of 1200 feet) seems significant, other factors were taken into account. Segment ABC contains mostly woodland, black spruce in segment AB. Segment BC contains open and woodland spruce forests, low shrub, and open and closed mixed forest in about equal amounts. Segment AJC, on the other hand, contains significantly less vegetation and is composed predominantly of low shrub and tundra in segment AJ and tall shrub, low shrub and open mixed forest in segment JC. Consequently, the amount of clearing associated with segment AJC is considerably less than with segment ABC, resulting in savings not only during construction but also during periodic recutting. Additional costs would also be incurred with segment ABC due to the increased spans needed to cross the Susitna River (at river mile 165.3) and two other major creek crossings. In summary, the cost differential between the two segments would probably be marginal.

- Technical

Segment AJC traverses generally moderately-sloping terrain ranging in height from 2000 feet to 3500 feet with 9 miles of the segment being at an elevation in excess of 3000 feet. Segment ABC traverses more rugged terrain, crossing several deep ravines and ranges in elevation from 1800 feet to 2800 feet. In general there are advantages of reliability and cost associated with transmission lines routed under 3000 feet. The 9 miles of segment AJC at elevations in excess of 3000 feet will be subject to more severe wind and ice loadings than segment ABC, and the towers will have to be designed accordingly. However, these additional costs will be offset by the construction and maintenance problems with the more rugged topography and major river and creek crossings of segment ABC. The technical difficulties associated with the two segments are therefore considered similar.

- Environmental

From the previous analysis, it is evident that there are no significant differences between the two segments in terms of technical difficulty and economics. The deciding factor therefore reduces to the environmental impacts. The access road routing between Watana and Devil Canyon was selected because it has the least potential for creating adverse impacts to wildlife, wildlife habitat and fisheries. Similarly, Segment AJC, within which the access road is located, is environmentally less sensitive than Segment ABC, for it traverses or approaches fewer areas of productive habitat and zones of species concentration or movement. The most important consideration, however, is that for ground access during operation and maintenance, it will be necessary to have some form of trail along the transmission line route. This trail would permit human entry into an area which is relatively inaccessible at present, causing both direct and indirect impacts. By placing the transmission line and access road within the same general corridor as in Segment AJC, impacts will be confined to that one corridor. If access and transmission are placed in separate corridors, as in Segment ABC, environmental impacts would be far greater.

Segment AJC is thus considered superior to Segment ABC. Consequently, Corridor One (ABCD) was eliminated and Corridor Fourteen (AJCD) selected as the proposed route.

(iii) Northern Study Area

Corridors Three (AEDC) and Four (AEF) were determined unacceptable because of many constraints, and thus rated F. They include: the lack of an existing access road; problems in dealing with tower erection in shallow bedrock zones; the need for extensive wetland crossings and forest clearing; the 75 river or creek crossings involved; and the fact that prime habitat for waterfowl, peregrine falcons, caribou, bighorn sheep, golden eagle, and brown bear would be crossed. In addition, Corridor Four crosses areas of significant land use constraints and elevations of over 4000 feet.

Corridor Two (ABDC) was identified as acceptable but not preferred, and thus rated C. Certain constraints identified for this corridor suggest that an alternative is preferable. Compared with Corridor One, Corridor Two crosses additional wetlands and requires the development of more access roads and the clearing of additional forest lands.



Corridor One (ABC), shown in Figures B.54 to B.57, was the only recommended corridor in the northern study area. While many constraints were identified under the various categories, it appears possible to select a route within this corridor to minimize constraint influences. This corridor is attractive economically, because it is close to access roads and the Parks Highway. The visual impact can be lessened by strategic placement of the line. This line also best meets technical and economical requirements.

(e) Route Selection

(i) Methodology

After identification of the preferred transmission line corridors, the next step in the route selection process involved the analysis of the data as gathered and presented on the base map. Overlays were compiled so that various constraints affecting construction or maintenance of a transmission facility could be viewed on a single map. The map was used to select possible routes within each of the three selected corridors. By placing all major constraints (e.g., areas of high visual exposure, private lands, endangered species, etc.) on one map, a route of least impact was selected. Existing facilities, such as transmission lines and tractor trails within the study area, were also considered during the selection of a minimum impact route. Whenever possible, the routes were selected near existing or proposed access roads, sharing wherever possible existing rights-of-way.

The data base used in this analysis was obtained from the following sources:

- An up-to-date land status study
- Existing aerial photos
- New aerial photos conducted for selected sections of the previously-recommended transmission line corridors
- Environmental studies including aesthetic considerations
- Climatological studies
- Geotechnical exploration
- Additional field studies
- Public opinions.

(ii) Selection Criteria

The purpose of this section is to identify three selected routes: one from Healy to Fairbanks, the second from the

Watana and Devil Canyon damsites to the intertie, and the third from Willow to Anchorage.

The previously-chosen corridors were subject to a process of refinement and evaluation based on the same technical, economic, and environmental criteria used in corridor selection. In addition, special emphasis was placed on the following points:

- Satisfying the regulatory and permit requirements
- Selection of routing that provides for minimum visibility from highways and homes
- Avoidance of developed agricultural lands and dwellings.

(iii) Environmental Analysis

The corridors selected were analyzed to arrive at the route which is most compatible with the environment and also meets engineering and economic objectives. The environmental analysis was conducted by the process described below:

- Literature Review

Data from various literature sources, agency communications, and site visits were reviewed to inventory existing environmental variables. From such an inventory, it was possible to identify environmental constraints in the recommended corridor locations. Data sources were cataloged and filed for later retrieval.

- Avoidance Routing by Constraint Analysis

To establish the most appropriate location for a transmission line route, it was necessary to identify those environmental constraints that could be impediments to the development of such a route. Many specific constraints were identified during the preliminary screening; others were determined during the 1981 field investigations.

By utilizing information on topography, existing and proposed land use, aesthetics, ecological features, and cultural resources as they exist within the corridors, and by careful placement of the route with these considerations in mind, impact on these various constraints was minimized.

- Base Maps and Overlays

Constraint analysis information was placed on base maps. Constraints were identified and presented on overlays to the base maps. This mapping process involved using both existing information and that acquired through Susitna project studies. This information was first categorized as to its potential for constraining the development of a transmission line route within the preferred corridor and then placed on maps of the corridors. Environmental constraints were identified and recorded directly onto the base maps. Overlays to the base maps were prepared indicating the type and extent of the encountered constraints.

Three overlays were prepared for each map: one for visual constraints, one for man-made, and one for biological constraints. These maps are presented as a separate document (Acres, TES 1982).

(iv) Technical and Economic Analysis

Route location objectives are to obtain an optimum combination of reliability and cost with the fewest environmental problems. In many cases, these objectives are mutually compatible.

Throughout the evaluation, much emphasis was placed on locating the route relatively close to existing surface transportation facilities whenever possible.

The factors that contributed heavily in the technical and economic analysis were: topography, climate and elevation, soils, length, and access roads. Other factors of less importance were vegetation and river and highway crossings. These factors are detailed in Tables B.38 and B.51.

- Selection of Alternative Routes

The next step in the route selection process involved analysis of the data presented on the base maps. The data were used to select possible routes within each corridor. By placing all major constraints on one map, routes of smallest impacts were selected. Existing facilities, such as transmission lines and tractor trails within the study area, were also taken into consideration during the selection of a least impact route.

- Evaluation of a Primary Route

The evaluation and selection of alternative routes to arrive at a primary route involved a closer examination of each of the possible routes using mapping processes and data previously described. Preliminary routes were compared to determine the route of least impact within the primary corridors of each study area. For example, such variables as number of stream and road crossings required were noted. Then, following the field studies and through a comparison of routing data, including the route's total length and its use of existing facilities, one route was designated the primary route. Land use, land ownership, and visual impacts were key factors in the selection process.

(v) Route Soil Conditions

- Description

Baseline geological and geotechnical information was compiled through photo interpretation and terrain unit mapping. The general objective was to document the conditions that would significantly affect the design and construction of the transmission line towers. More specifically, these conditions included the origins of various land forms, noting the occurrence and distribution of significant geologic features such as permafrost, potentially unstable slopes, potentially erodible soils, possible active fault traces, potential construction materials, active floodplains, organic materials, etc.

Work on the air photo interpretation consisted of several activities culminating in a set of terrain unit maps showing surface materials, geologic features and conditions in the project area.

The first activity consisted of a review of the literature concerning the geology of the intertie corridors and transfer of the information gained to high-level photographs at a scale of 1:63,000. Interpretation of the high-level photos created a regional terrain framework which assisted in interpretation of the low-level 1:30,000 project photos. Major terrain divisions identified on the high-level photos were then used as an aerial guide for delineation of more detailed terrain units on the low-level photos. The primary effort of the work was the interpretation of over 140 photos covering about 300 square miles of varied terrain. The land area covered in the mapping exercise is shown on map sheets and displayed in detail on photo mosaics (R&M Consultants 1981a).

As part of the terrain analysis, the various bedrock units and dominant lithologies were identified using published U.S. Geological Survey reports. The extent of these units was shown on the photographs, and, using exposure patterns, shade, texture, and other features of the rock unit as they appeared on the photographs, unit boundaries were drawn.

Physical characteristics and typical engineering properties of each terrain unit were considered and a chart for each corridor was developed. These charts identify the terrain units as they have been mapped and characterize their properties in numerous categories. This allows an assessment of each unit's influence on various project features.

- Terrain Unit Analysis

The terrain unit is a special purpose term comprising the land forms expected to occur from the ground surface to a depth of about 25 feet.

The terrain unit maps for the proposed Anchorage-to-Fairbanks transmission line show the aerial extent of the specific terrain units which were identified during the air photo investigation and were corroborated in part by a limited on-site surface investigation. The units document the general geology and geotechnical characteristics of the area.

The north and south corridors are separated by several hundred miles and not surprisingly encounter different geomorphic provinces and climatic conditions. Hence, while there are many landforms (or individual terrain units) that are common to both corridors, there are also some landforms mapped in just one corridor. The landforms or individual terrain units mapped in both corridors were briefly described.

Several of the landforms have not been mapped independently but rather as compound or complex terrain units. Compound terrain units result when one landform overlies a second recognized unit at a shallow depth (less than 25 feet), such as a thin deposit of glacial till overlying bedrock or a mantle of lacustrine sediments overlying till. Complex terrain units have been mapped where the surficial exposure pattern of two landforms are so intricately related that they must be mapped as a terrain unit complex, such as some areas of

bedrock and colluvium. The compound and complex terrain units were described as a composite of individual landforms comprising them. The stratigraphy, topographic position, and aerial extent of all units, as they appear in each corridor, were summarized on the terrain unit properties and engineering interpretations chart (R&M Consultants 1981a).

(vi) Results and Conclusions

A study of existing information and aerial overflights, together with additional aerial coverage, was used to locate the recommended route in each of the southern, central, and northern study areas.

Terrain unit maps describing the general material expected in the area were prepared specifically for transmission line studies and were used to locate the routes away from unfavorable soil conditions wherever possible. Similarly, environmental constraint analysis information was placed on base maps and overlays (Acres, TES 1982) and the route modified accordingly.

Subsequent to the submission of the Feasibility Study (Acres 1982c), additional environmental and land status studies made it possible to further refine the alignments to the extent that most environmentally sensitive areas and areas where land acquisition may present a problem have been avoided. In the Fairbanks-to-Healy and the Willow-to-Anchorage line sections, these refinements have resulted in an improved alignment which is generally in close proximity to the earlier proposal.

Also subsequent to the Feasibility Study, the proposals for access to the power development were reassessed. As mentioned earlier, this resulted in a decision to provide access to Watana from the Denali Highway and build a connecting road between the dams on the north side of the Susitna River. The earlier line routing proposals were accordingly reviewed to establish the optimum alignment. The desire to limit environmental impacts to a single corridor led to the routing of the transmission line more or less parallel to the access road. Hence, between the dams, the line shares the same general corridor as the access road to the north of the Susitna River. From Devil Canyon to the intersection with the Intertie (at a switching station approximately four miles northeast of Gold Creek), the line is located south of the Susitna River paralleling the proposed railroad extension, and an existing four-wheel drive trail.

The original corridors which were three to five miles in width were narrowed to a half mile and, after final adjustment, to a finalized route with a defined right-of-way. The selected transmission line route for the three study areas is presented in Exhibit G. Preliminary studies have indicated that, for a hinged-guyed X-configuration tower having horizontal phase spacing of 33 feet, the following right-of-way widths should be sufficient:

- 1 tower                    190 feet
- 2 towers                   300 feet
- 3 towers                   400 feet
- 4 towers                   510 feet

These right-of-way widths will be subject to minor local variation where the need for special tower structures dictates or where difficult terrain is encountered and will be addressed fully in the final design phase of the project.

(f) Towers, Foundations and Conductors

The Anchorage and Fairbanks Intertie will consist of existing lines and a new section between Willow and Healy. The new section will be built to 345 kV standards but will be temporarily operated at 138 kV and will be fully compatible with Susitna requirements.

(i) Transmission Line Towers

- Selection of Tower Type

Because of the unique soil conditions in Alaska which are characterized by extensive regions of muskeg and permafrost, conventional self-supporting or rigid towers will not provide a satisfactory solution for the proposed transmission line.

Permafrost and seasonal changes in the soil are known to cause large earth movements at some locations, requiring towers with a high degree of flexibility and capability to sustain appreciable loss of structural integrity.

A guyed tower is well suited to these conditions; these include the guyed-V, guyed-Y, guyed delta, and guyed portal type structures. The type of structure selected for the construction of the Intertie is the hinged-guyed steel X-tower, a refinement of the guyed structure concept. This type of tower is therefore a prime candidate

for use on the Watana transmission system. Guyed pole-type structures will be used on larger angle and dead end structures; a similar arrangement will be used in especially heavy loading zones.

The design features of the X-tower include hinged connections between the legs and the foundation and four longitudinal guys attached in pairs to two guy anchors, providing a high degree of flexibility with excellent structural strength. The wide leg spacing results in relatively low foundation forces which are carried on pile type footings in soil and steel grillage or rock anchor footings where rock is close to the surface.

In narrow right-of-way situations, cantilever steel pole structures are anticipated with foundations consisting of cast-in-place concrete augered piles.

In the final design process, experience gained in the construction and operation of the Intertie will be used in the final selection of the structure type to be used for the Watana transmission.

All tower structures will be of "weathering" type steel which matures to a dark brown color over a period of a few years and is considered to have a more aesthetically pleasing appearance than either galvanized steel or aluminum.

- Climatic Studies and Loadings

Climatic studies for transmission lines were performed to determine probable maximum wind and ice loads based on historical data. A more detailed study incorporating additional climatic data was carried out for the Intertie final design. These studies have resulted in the selection of preliminary loading for the line design (Acres 1982c, Vol. 4).

Preliminary loadings selected for line design should be confirmed by a detailed study, similar to that performed for the Intertie, that will examine conditions for the Healy-to-Fairbanks, Willow-to-Anchorage and Gold Creek-to-Watana sections of the route together with an update of the Healy-to-Willow study incorporating any data from field measurement stations collected in the interim period.



Based on data currently available, it appears that the line can be divided up into zones as far as climatic loading is concerned as follows:

- Normal Loading Zone
- Heavy Ice Loading Zone
- Heavy Wind Loading Zone

The heavy ice and heavy wind zones will have an additional critical loading case included to reflect the special nature of the zone.

- Tower Family

A family of tower designs will be developed as follows:

- . Suspension towers will be provided for both standard span plus angle (up to 3°) application and for long span or light angle (0° to 8°) application.
- . Tension towers will be provided for light angle and dead end (0° to 8°), for large angle and dead end (8° to 50°), and for minimum angle and dead end (50° to 90°).

The maximum wind span and weight span ratios to be utilized will be set in final design to reflect the rugged nature of the terrain along the line route. Some trial spotting of towers in representative terrains will be used to guide this selection. Minimum weight span to wind span ratio limits will be set during tower spotting and a "low temperature template" used to check that unexpected uplift will not develop at low weight span towers for very low temperatures.

The span to be used in design will be the subject of an economic optimization study. A span of not less than 1200 feet is expected with spans in the field varying to greater and lesser values in specific cases depending upon span ratio and loading zone.

(ii) Tower Foundations

- Geotechnical Conditions

The generalized terrain analysis (R&M Consultants 1981a) was conducted to collect geologic and geotechnical data for the transmission line corridors, a relatively large area. The engineering characteristics of the terrain units have been generalized and described qualitatively.

When evaluating the suitability of a terrain unit for a specific use, the actual properties of that unit must be verified by on-site subsurface investigation, sampling, and laboratory testing.

The three main types of foundation materials along the transmission line are:

- . Good material, which is defined as overburden which permits augered excavation and allows installation of concrete without special form work;
- . Wetland and permafrost material which requires special design details; and
- . Rock material defined as material in which drilled-in anchors and concrete footings can be used.

Based on aerial, topographic, and terrain unit maps, the following was noted:

- . For the southern study area: Wetland and permafrost materials constitute the major part of this area. Some rock and good foundation materials are present in this area in a very small proportion.
- . For the central study area: Rock foundation and good materials were observed in most of this study area.
- . For the northern study area: The major part of this area is wetland and permafrost materials. Some parts have rock materials.

- Types of Foundation

The types of tangent tower envisaged for these lines will require foundations to support the leg or mast capable of carrying a predominantly vertical load with some lateral shear, and a guy anchor foundation.

The cantilever pole structure foundation is required to resist the high overturning moment inherent in the cantilever arrangement.

The greater part of the combined maximum reactions on a transmission tower footing is usually from short duration loads such as broken wire, wind, and ice. With the exception of heavy-angle, dead end or terminal structures, only a part of the total reaction is of a permanent nature. As a consequence, the permissible soil

pressure, as used in the design of building foundations, may be considerably increased for footings for transmission structures.

The permissible values of soil pressure used in the footing design will depend on the structure and the supporting soil. The basic criterion is that displacement of the footing not be restricted because of the flexibility of the selected X-frame tower and its hinged connection to the footing. The shape and configuration of the selected tower are important factors in foundation considerations.

Loads on the tower consist of vertical and horizontal loads and are transmitted down to the foundation and then distributed to the soil. In a tower placed at an angle or used as dead end in the line, the horizontal loads are responsible for a large portion of the loads on the foundation. In addition to the horizontal shear, a moment is also present at the top of the foundation, creating vertical download and uplift forces on the footing.

To enable the selection of a safe and economical tower foundation design for each tower site, it is necessary to select a footing which takes account of the actual soil conditions at the site. This is done by matching the soil conditions to a series of ranges in soil types and groundwater conditions which have been predetermined during the design phase to cover the full range of soils expected to be encountered along the line length. Preconstruction drilling, soil sampling, and laboratory testing at representative locations along the line enable the design of a family of footings to be prepared for each tower type from which a selection of the appropriate footing for the specific site can be made during construction.

The foundation types for structure legs and masts will be grouted anchor where rock is very shallow or at surface and steel grillage with granular backfill where soil is competent and not unduly frost-sensitive. In areas where soils are weak and where permafrost or particularly frost-heave prone material is encountered, driven steel piles will be used.

Guy anchors will use grouted anchors in rock. Grouted earth or helical plate screw-in anchors with driven piles will be used in permafrost or very weak soils.

Proof load testing of piles and drilled-in anchors will be required both for design and to check on the as-built capacity of these foundation elements during construction.

(iii) Voltage Level and Conductor Size

Economic studies were carried out of transmission utilizing 500 kV, 345 kV, and 230 kV ac. At each voltage level an optimum conductor capacity was developed. Schemes involving use of 500 kV or 345 kV on the route to Anchorage and 345 kV or 230 kV to Fairbanks were investigated. The study recommended the adoption of two 345 kV units to Fairbanks and three 345 kV units to Anchorage. Comparative studies were carried out on the possible use of HVDC. However, these studies indicated no economic advantage of such a scheme.

The 345 kV system studies indicated that a conductor capacity of 1950 MCM per phase was economical with due account for the value of losses. A phase bundle consisting of twin 754 MCM Rail (45/7) ACSR was proposed as meeting the required capacity and also having acceptable corona and radio interference performance. Detailed design studies as part of the final design will compare the economics of this conductor configuration with the use of alternatives such as twin 954 MCM Cardinal (54/7) ACSR and single 215.6 MCM Bluebird (84/19) ACSR which could give comparable electrical performance with better structural performance. Cardinal, because of a 15 percent superior strength-to-weight ratio, can be sagged tighter than Rail, thereby resulting in savings in tower height and/or increased spans. Bluebird, because of a smaller circumference and projected area compared with a twin conductor bundle, attracts some 15 percent less load from ice or wind. Together with its greater strength, this leads to less sag under heavy loadings and lighter loads for the structures to carry. Conductor swing angles will also be reduced, thus reducing tower head size requirements and edge of right-of-way clearing.

2.8 - Selection of Project Operation

A reservoir simulation model was used to evaluate the optimum method of operating the Susitna Hydroelectric Project for a range of post-project flows at the Gold Creek gaging station 15 miles downstream of the Devil Canyon damsite. The model is essentially a monthly simulation of reservoir operation under historical streamflow conditions given the physical parameters associated with the dams, powerhouses, and reservoirs. The model is driven by four criteria which are listed below in the order of their application:

- Minimum Downstream Flow Requirements

The simulation model checks downstream flow requirements against the sum of the total powerhouse flow and spillage from the most downstream damsite. For the operations considered, generally the outflow exceeds the downstream flow requirement in the winter months of October through April. In the summer months, the energy generation outflow is at the lowest level because of low energy demand and the retention of river runoff in storage for release during the following winter. The exception to this is in late summer, usually September, when reservoirs can be full and spills could occur. When the required downstream flow is greater than the power flow simulated, additional discharge is made through the powerhouse to meet the downstream requirement. Consideration is made of the contribution flow between the damsite and Gold Creek.

Environmental considerations require the release of suitable flows during critical fish spawning, incubation, and rearing periods. Consultations through numerous meetings, correspondence, and workshops have been conducted with state and federal resource agency personnel to discuss recommended release schedules as part of the mitigation options for the Susitna Project. Table B.0 presents a summary of the correspondence with resource agencies which are appended to Exhibit E, Chapter 11.

In 1980 and 1981, prior to publication of the Feasibility Report, these meetings consisted of discussions to establish acceptable release schedules as part of project mitigation. On three occasions, specific recommendations and comments on the environmental sections of the proposed Susitna Project have been requested from state and federal resource agencies prior to formal submittal of the License Application. These included a request for comment on the Feasibility Report (September 2, 1982) and a request for comment on the draft Exhibit E of the License Application (November 15, 1982). In addition, agency representatives attended a workshop on the Draft Exhibit E held November 29 to December 3, 1982. The Feasibility Report, the workshop and Exhibits B and E of the Draft License Application included discussion of pre- and

post-project flows. Agency comments resulting from review of these reports and a synopsis of the workshop are also contained in Exhibit E, Chapter 11.

Another specific request for recommendations of suitable flow regimes was made to the key federal and state resource agencies in May of 1983. This request was sent to the National Marine Fisheries Service, U.S. Fish and Wildlife Service, and the Alaska Departments of Fish and Game, Natural Resources, and Environmental Conservation. In response to this request, as in previous discussions of flow regimes, the resource agencies which responded, declined to recommend specific flow regimes until additional information is available. Data concerning incremental flows will be available in the fall of 1983 to provide additional information for the consultation process. Additional detailed information for all riverine habitats and all seasons will be available by the summer of 1984. Agencies will continue to be asked for recommendations on flow preferences and consultation will continue until appropriate flow releases, considering agency requests and power generation requirements, are finalized.

Since specific agency recommendations on flow are lacking, several alternative flow regimes have been considered in order to provide a complete analyses of the range of potential flow regimes for both power generation and protection of downstream fisheries resources. The seven flow regimes set forth in the license application filed February 28, 1983 have been supplemented by three additional flow regimes (E, F, & G). These flow regimes (see Table B.54) range from those which optimized project economics (Case A) to those which approximate pre-project flows (Case G). These regimes are believed to encompass all possible flow regimes which could be proposed by resource agencies, especially since the regimes presented include one which reflects average pre-project or run-of-river conditions (Case G).

- Minimum Energy Demand

The energy patent used in the model is based on monthly load forecasts discussed in Section 5 of this Exhibit. This pattern is imposed as demand on the Susitna hydroelectric system and reservoir operation is simulated to yield this energy at all times. Downstream flow requirements may cause exceedence of this minimum energy requirement. Likewise, this minimum energy requirement may cause exceedence of minimum downstream flow needs.

- Reservoir Operating Rule Curve

The minimum energy demand controls the reservoir operation and energy production during critical low inflow periods. During other periods, it is apparent that additional energy could be produced

because of larger runoff volumes and consequent higher reservoir levels.

Essentially, with a reservoir rule curve which establishes minimum reservoir levels at different times during the years, particularly in winter, than by following a set energy patent. At the same time, the rule curve ensures that low flow sequences do not materially reduce the energy potential below a set minimum or firm annual energy. The rule curve also reduces the occurrence of spillage during summer months by creating additional flood storage potential.

- Maximum Usable Energy Level

Maximum energy is established by the load growth for the Railbelt system for a given year in the planning horizon, for example, year 2010. If maximum usable energy is exceeded due to high downstream flow requirements, flow is shifted from the powerhouse to the outlet facilities in sufficient quantities to reduce energy production while maintaining downstream flows.

The physical characteristics of the two reservoirs, the operational characteristics of the powerhouses, and either the monthly or weekly average flow at each damsite and Gold Creek for the number of years to be simulated are input to the simulation program. The program then uses the hierachy listed above to satisfy the minimum flow requirement at Gold Creek and the minimum energy requirement. The reservoir operating rule curve is checked and if "extra water" is in storage, the "extra water" is used to produce additional energy up to the maximum usable energy level. A further consideration is that the reservoir cannot be drawn below the maximum allowable drawdown limit. The energy produced, the flow at the damsites and at Gold Creek, and the reservoir levels are determined for the period of record input to the model.

The model algorithm which relates energy produced to powerhouse flows and reservoir heads is:

$$TP = K_1 (H_1 Q_1 + H_2 Q_2) E$$

where: TP = Total power output (kW)

H<sub>1</sub>, H<sub>2</sub> = Average monthly head in upper and lower reservoir, respectively

Q<sub>1</sub> = Mean monthly powerhouse flow (cfs); upper reservoir

Q<sub>2</sub> = Mean monthly powerhouse flow (cfs); lower reservoir

K<sub>1</sub> = Unit Conversion Constant = 0.084773

E = Efficiency = 0.85

For power computations using the above equations, monthly head is used and is determined from the average water surface elevation at the beginning and end of each month less tailwater elevation. A constant tailwater elevation of 1455 and 850 has been assumed for Watana and Devil Canyon, respectively. This is considered acceptable since the variation in tailwater elevation for the range of flows expected is +5 feet from the assumed values and is within the reasonable limit of accuracy of the tailwater elevation discharge curves.

Storage is depleted or replenished depending upon the magnitude of monthly inflow and outflow. Generally, storage is depleted during the months of October through May and replenished from June to September. The conversion from storage to flow is:

$$Q = SD_m / K_2$$

Where: Q = Discharge (cfs)

S = Change in storage (acre-feet)

K<sub>2</sub> = Constant (cfs days to acre-feet) = 1.984

D<sub>M</sub> = Number of days in month M.

The water surface elevation is determined by linear interpolation of the storage-elevation curves input to the model. The power potential determined is effectively the average power during the month. Multiplying this power by the number of hours in each month results in monthly energy in kilowatt-hours.

When outflow is below downstream flow requirements, either further powerhouse flows are released or spillage occurs depending on demand



for additional energy or powerhouse capacity. This will deplete storage or replenish it more slowly depending upon inflow.

The rule curve followed has been derived from several iterations of the reservoir operation and is believed to be close to the best fit for the energy produced up to the year 2010 and with the forecast developed by Battelle. In practice, with increase in system demand, the rule curve could be modified to yield energy that would fit into the system demand in a more economical manner.

The model procedure allows the reservoir to be drawn down each month to the rule curve levels when the water surface elevation at the start of the month is above these levels. Starting elevations below the target suggests that a dry sequence is experienced.

When the reservoir is being refilled during high streamflows, a further condition specifies the amount of surplus water that should be placed into storage. This is to ensure that during the early months of the filling sequence (May and June) the reservoir does not end up full too early in the summer. If filling occurred quickly, it is possible that spillage would be high in August and September. Preventing such spillage results in the production of more energy in May, June and July and a reduction in spillage amounts later on.

The process that led to the selection of the flow scenario used in this license application includes the following steps:

- Determination of pre-project flows at Gold Creek, Watana and Devil Canyon for 32 years of record
- Selection of range of flows to be included in the analysis
- Selection of timing of flow releases to match fishery requirements
- Selection of maximum drawdown at Watana
- Determination of energy produced for the ten flow release scenarios being studied
- Determination of net benefits for each flow scenario
- Selection of range of flows acceptable based on economic factors
- Influence of instream flow and fishery considerations on selection of project operational flows.

A summary discussion of the detailed analysis is presented in the following paragraphs.

(a) Pre-Project Flows

The USGS has operated a gaging station (Station 15292000) at Gold Creek on the Susitna River continuously since 1950. They have also operated the Cantwell gage near Vee Canyon on the upper end of the proposed Watana reservoir since 1961. These two gaging stations combined with a regional analysis were used to develop a 32-year record for the Cantwell gage. The flow at Watana and Devil Canyon was then calculated using the Cantwell flow as the base and adding an incremental flow proportional to the additional drainage area between the Cantwell gage and the damsites. The resulting flows at Watana and Devil Canyon are presented in Tables B.52 and B.53.

(b) Range of Post-Project Flows

During investigation of the full range of flows appropriate for use as operational target flows at Gold Creek, two factors were considered: that operational flow which would produce the maximum amount of winter energy from the project, neglecting all other considerations (Case A), and that operational summer flow thought to have minimum impact on downstream fishery and instream flow uses (Case G). Between these two end points, eight additional flow scenarios were established. The minimum target flows for all ten flow scenarios are presented in Table B.54.

(c) Timing of Flow Releases

In the reach of the river between Talkeetna and Devil Canyon, it is presently perceived that an important aspect of successful salmon spawning is providing access to the side channel and slough areas connected to the mainstem of the river. Access to these areas is primarily a function of water level (flow) in the main channel of the river during the period when the salmon must gain access to the spawning areas. Field studies during 1981 and 1982 have indicated that access should be provided in late July, August, and early September. Thus, the project operational flow has been scheduled to satisfy this requirement; i.e., the flow will be increased the last week of July, held constant during August and the first two weeks of September, and then decreased to a level specified by energy demands in mid- to late September.

This release of water for access to spawning areas is in competition with the timing of releases for optimal energy generation. For energy generation, releases would be less in the summer when demand for energy is less. Flows would be stored in the reservoir for use during other seasons when energy demand is higher and inflow to the reservoir is less. Case A (Table B.54) distributes the release of flows in the optimal fashion throughout the year for winter energy generation, given reservoir storage

constraints. Case D on the other hand, sets flow releases in the summer at those which have minimal impact on the access to spawning areas (19,000 cfs, Trihey 1982), and distributes the flows throughout the rest of the year in a pattern consistent with best energy production given the extent of summer releases.

Cases E and F provide not only for immigration of adults in August, but also provide a greater margin of safety for outmigration of juveniles during early summer. For example, flows of 10,290 and 16,000cfs for May and June, respectively, for Case E, are provided to facilitate outmigration. For Case F, flows of 10,480 and 18,000 cfs for May and June, respectively, are provided (See Table B.54 for specifics on these proposed release schedules) to ensure that adequate flows are available for outmigration of juvenile salmonids. Case G consists of essentially run-of-river conditions based on average flows for the previous 32 years. Case G flows should avoid all impacts to the fisheries other than those encountered naturally under pre-project conditions.

Results of ongoing instream flow and fisheries habitat investigations may allow the Power Authority and the resource agencies to agree upon flow regimes which could enhance fisheries over pre-project levels and provide suitable power for the Railbelt area. Results of the economic analysis of these cases in terms of annual average energy and average firm energy are presented in Table B.55 and B.56 for the Watana only and the Watana/Devil Canyon stages of the project, respectively. Dependable capacity for both project stages is presented in Figure B.76. Net benefits to the project of all flow regimes considered are presented in Table B.57.

(d) Maximum Drawdown

The maximum drawdown was selected as 140 feet for Watana and 50 feet for Devil Canyon (Acres 1982c, Vol. 1). Because the Devil Canyon maximum drawdown would be controlled by technical considerations, the 50-foot drawdown was not reconsidered and has been retained as the upper limit for Devil Canyon. On the other hand, the Watana maximum drawdown is governed by intake structure cost, energy production, and downstream flow considerations; thus, it was refined during the 1982 studies. This refinement process resulted in the selection of 1120 feet as the maximum drawdown for the Watana development.

(e) Energy Production

Using the pre-project flows, the ten flow release scenarios and the maximum drawdowns established in subsection (a)-(d) above

were input to the reservoir simulation model. The amount of energy produced, the flow at Gold Creek and the reservoir levels were determined for the 32 years of record. A summary of the energy produced using the ten flow scenarios is presented in Table B.56, and B.57 respectively for Watana operating alone and for Watana and Devil Canyon operating together.

It can be seen in Tables B.56 and B.57 that there are significant differences in total potential energy produced. Case G produces about 29 percent less energy than Case A for Watana and Devil Canyon operating together. However, these potentials must be analyzed in light of the energy usable by the system. Under Case G, a great deal of energy is produced in June through September, corresponding to a time when demand is also lowest. Additionally, the Case G firm energy, which reflects the dependable capacity of the project (See Section 4.3), is much less in December in comparison to Case A. This discounts the value of the project capacity and requires the system to need other power generation projects to meet reliability criteria.

(f) Net Benefits

To measure the economic impacts of the decreased and rescheduled energy from Case A to Case G, the ten flow cases were tested in the reservoir operation model using a regression equation based on the results of previous OGP analysis for the load forecast presented in the February 1983 license application. The long-term present worth of net benefits for each of the ten operational flow cases were calculated and tabulated in Table B.57. The regression equation was used to determine the present worth value (1982 dollars) of the long-term production costs (LTPWC) of supplying the Railbelt energy needs with each of the ten Susitna cases plus other needed generation. The LTPWC of each of the flow cases was then compared to the best non-Susitna scenario (developed in Exhibit D). Table B.57 presents the LPTWC of each of the ten cases. The February 1983 license application load forecast used to develop Table B.57 corresponds to the Reference Case forecast in approximately year 2018.

The net benefit presented in Table B.57 is the difference between the LTPWC for the "best thermal option" and the LTPWC for the various Susitna options. In Table B.57, Case A represents the maximum usable energy option and results in a benefit of \$1,359 million. As flow is transferred from the net winter to the August-September time period the usable energy decreases. This decrease is not significant until the flow provided at Gold Creek during August reaches the 12,000 to 14,000 cfs range. For a summer flow of 20,000 cfs at Gold Creek, the Susitna project becomes less attractive than the thermal alternative. A summer

flow of 20,000 cfs corresponds to the Case G flow scenario which represents minimum downstream fishery impact.

(g) Operational Flow Scenario Selection

Based on the economic analysis discussed above, it was judged that, while Case A flows produced the maximum net benefit, the loss in net benefits (compared to Case A) for Cases A<sub>1</sub>, A<sub>2</sub> and C were of an acceptable magnitude. The loss associated with Case C<sub>1</sub> is on the borderline between acceptable and unacceptable.

As fishery and instream flow impact (and hence mitigation costs associated with the various flow scenarios) are further quantified, the decrease in mitigation costs associated with high flows may warrant selecting a higher flow case such as C<sub>1</sub>. However, the loss in net benefits associated with Case C<sub>2</sub> through G was not considered acceptable and it is doubtful that the mitigation cost reduction associated with these higher flows will bring them into the acceptable range.

(h) Instream Flow and Fishery Impact on Flow Selection

As noted earlier, the primary function controlled by the late summer flow is the ability of the salmon to gain access to their traditional spawning grounds. Instream flow assessment conducted during 1981 (the wettest July-August on record) and 1982 (one of the driest July-August on record) has indicated that, for flows of the Case A magnitude, severe impacts would occur which cannot be mitigated except by compensating through hatchery construction.

For flows in the 12,000 cfs range (flows similar to those that occurred in August 1982) the salmon can, with difficulty, obtain access to their spawning grounds. To help salmon obtain access to spawning areas during flows of 12,000 cfs, physical mitigation measures were incorporated into the mitigation plan presented in Chapter 3 of Exhibit E.

Based on this assessment, the Case A<sub>1</sub> and A<sub>2</sub> flow scenarios are considered unacceptable, thus establishing a lower limit for the acceptable flow range as approximately 12,000 cfs (Case C) at Gold Creek during August.

As a result, by combining the economic analysis and the instream flow considerations, the Case C scenario, providing a flow of 12,000 cfs at Gold Creek during August (see Table B.54), has been selected as the project operational flow. As a more refined assessment of fishery impact, mitigation costs and projected project net benefits becomes available, the project operational flow will be adjusted.

### 3 - DESCRIPTION OF PROJECT OPERATION

### 3 - DESCRIPTION OF PROJECT OPERATION

#### 3.1 - Operation Within Railbelt Power System

A staged development is planned for implementation of Susitna power generation. The following schedule for unit start-up is proposed:

<u>Start-up Date</u>	<u>Damsite</u>	<u>No. and Size of Units (MW) Brought on Line</u>	<u>Total Susitna On-line Capacity* (MW)</u>
1994 (Jan.)	Watana	4 x 170	680
1994 (July)	Watana	2 x 170	1020
2002	Devil Canyon	4 x 150	1620

As shown above, the first four units are scheduled to be on line at Watana in early 1994, followed by the remaining two Watana units in mid 1994. Start-up of all four units at Devil Canyon is planned for 2002.

This section describes the operation of the Watana and Devil Canyon power plants in the Railbelt electrical system. Under current conditions in the Railbelt, a total of nine utilities share responsibility for generation and distribution of electric power, with limited interconnections. The proposed arrangement for optimization and control of the dispatch of Susitna power to Railbelt load centers is based on the expectation that single entity will eventually be set up for this purpose.

It is important to note that the Susitna project will be the single most significant power source in the system. The dispatch and distribution of power from all sources by the most economical and reliable means is therefore essential. The general principles of reliability of plant and system operation, reservoir regulation, stationary and spinning reserve requirements, and maintenance programming are discussed in this section. Estimates of dependable capacity and annual energy production for both Watana and Devil Canyon are presented. Operating and maintenance procedures are described, and the proposed performance monitoring system for the two projects is also outlined.

---

\*Installed generating capacity.

### 3.2 - Plant and System Operation Requirements

The main function of system planning and operation control is the allocation of generating plant on a short-term operational basis so that the total system demand is met by the available generation at minimum cost consistent with the security of supply. The objectives are generally the same for long-term planning or short-term operation load dispatching, but with important differences in the latter case. In the short-term case, the actual state of the system dictates system reliability requirements, overriding economic considerations in load dispatching. An important factor arising from economic and reliability considerations in the system planning and operation is the provision of stationary reserve and spinning reserve capacity. Figure B.58 shows the daily variation in demand for the Railbelt system during typical winter and summer weekdays and the seasonal variation in monthly peak demands for estimated loads in a typical year (the year 2000).

### 3.3 - General Power Plant and System Reliability Criteria.

Reliability criteria for electric power system operation can be divided into those criteria which apply to generation capacity requirements and those which apply to transmission adequacy assessment.

The following basic reliability standards and criteria have been adopted for planning the Susitna project.

#### (a) Installed Generating Capacity

Sufficient generating capacity is installed in the system to insure that the probability of occurrence of load exceeding the available generating capacity shall not be greater than one day in ten years (Loss-of-load probability (LOLP) of 0.1). The evaluation of generation reserve by probability techniques has been used for many years by utilities and the traditionally adopted value of LOLP has been about one day in ten years.<sup>1 2</sup> Many utilities and reliability councils in the lower-48 states continue to employ such a criterial.<sup>3</sup> Although there has been

---

<sup>1</sup>"Lowering Reliability Offers Little Benefit," Sebesta, D, Electrical World July 1, 1978 pp. 70-1,

<sup>2</sup>"Power System Reliability Evaluation," IEEE Tutorial Course, 1982 p. 54, 56.

<sup>3</sup>"Symposium on Reliability Criteria for System Dynamic Performance" IEEE Power Engineering Society 1977 Winter Meeting pp. 15, 34,36.



no economic evaluation of reliability criteria in the Railbelt, at least one major utility has expressed the aim of achieving a LOLP of one day in ten years.<sup>4</sup> Therefore for the present level of study a LOLP of one day in ten years has been adopted.

The above generation reliability criteria was used as an input to the generation planning model described in Section 1.5 of this Exhibit. This generation planning model was used to evaluate the generation expansion with the Susitna project and an all thermal expansion program as presented in Exhibit D.

The system generation reserve under each expansion program for each year from 1993 to 2010 is shown on Table B.58. As can be seen from Table B.58 the average percent reserve for the Susitna program is about 12 percentage points higher than the thermal program. However, this difference is due to the entrance of large blocks of hydro units in 1993 and 2002 rather than the reliability criteria. The average percent reserve for both programs are about equal if the years of large block hydro influence are excluded from the Susitna program average. Thus, from a generation standpoint the Susitna project provides the same level of reliability as a thermal alternative with about the same average reserve margin.

(b) Transmission System Capability

The high-voltage transmission system should be operable at all load levels to meet the following unscheduled single or double contingencies without instability, cascading or interruption of load.

- The single contingency situation is the loss of any single generating unit, transmission line, transformer, or bus (in addition to normal scheduled or maintenance outages) without exceeding the applicable emergency rating of any facility; and
- The double contingency situation is the subsequent outage of any remaining equipment, except for line, without exceeding the short time emergency rating of any facility.

In the single contingency situation, the power system must be capable of readjustment so that all equipment would be loaded

---

<sup>4</sup>Letter of June 22, 1983 from Thomas R. Stahr, General Manager, Anchorage Municipal Light and Power.

within normal ratings and, in the double contingency situation, within emergency ratings for the probable duration of the outage.

During any contingency:

- Sufficient reactive power (MVAR) capacity with adequate controls is installed to maintain acceptable transmission voltage profiles.
- The stability of the power system is maintained without loss of load or generation during and after a three-phase fault, cleared in normal time, at the most critical location.

Having the transmission lines in parallel, instead of one line only, improves greatly the reliability of the transmission system. Besides removing the necessity of hot lines maintenance, the frequency of failure of the transmission system will be lowered by a factor of about 15.

The transmission system performance was examined by performing load flow and transient stability studies. Load flow studies examined the system under normal operating conditions with all elements in service, then by removal of first one line segment critical circuit breaker verified adequate system performance under single contingency. Double contingency operating was verified by further removal of a second element (not including a second line).<sup>5</sup>

The following criteria were used for the load flow studies:

1. Energization while system in normal status:
  - a. Voltage at the sending end should not be reduced below 0.90 per unit.
  - b. Initial voltage at the receiving end should not exceed 1.10 per unit.
  - c. Following the switching of transformers and VAR control devices onto the system, the voltage at the receiving end should not exceed 1.05 per unit.
2. In case of normal status or single contingency and peak load:
  - a. The voltages at all buses tapped for loading shall stay between 0.95 and 1.05 per unit.

---

<sup>5</sup>The loss of two parallel line circuits would result in loss of the load center served and was not considered in double contingency studies.

- b. The voltage/load angle between the Susitna generators and any point of the system should not exceed 45°.
3. In case of double contingency and peak load:
- a. The voltages at all buses tapped for loading shall stay between 0.90 and 1.10.
  - b. The voltage/load angle between the Susitna generators and any point of the system should not exceed 55°.

Both the 1993 and 2002 system configurations were tested for energization (no load), and for peak load flows (1020 and 1971 MW, respectively) under normal conditions and under selected contingency conditions.

Figure B.57A is a one-line diagram showing 1993 system performance under a critical double contingency condition, in this case with one of the Devil Canyon-Willow lines out of service and with the additional loss of one of the Willow-Knik Arm lines.

The critical parameters of the above case are shown in Table B.59. As can be seen from Table B.59, the system performs within the criteria established above.

Figure B.57A shows the 2002 system configuration and the double contingency case which is the same 1993 double contingency case.

Table B.59 shows the critical parameters for the 2002 case. From Table B.59, it can be seen that the transmission system is capable of satisfactory operation under the double contingency conditions shown.

In addition to the load flow studies, the dynamic stability studies also indicated that the system remains stable following the clearing of the severest disturbance that could occur, namely a three phase fault at Devil Canyon.

The loss of two circuits on the same right-of-way has a low level of probability if the spacing between the two circuits are set far apart to minimize this potential problem. Part of the reserve capacity shown on Table B.58 will be in the form of spinning reserve. As determined in the generation planning studies this spinning reserve will be from the next most economical increment of capacity over those units required to meet load considering the system as a whole. In addition to spinning reserve, standby reserve can be maintained by the utilities in individual load centers using less economical units. The cost of this spinning and standby reserve have been included in the economic analyses presented in Exhibit D.

(d) Summary

Operational reliability criteria thus fall into four main categories:

- LOLP of 0.1, or one day in ten years, is maintained for the recommended plan of operation;
- The single and double contingency requirements are maintained for any of the more probable outages in the plant or transmission system;
- System stability and voltage regulation are assured from the electrical system studies. Detailed studies for load frequency control have not been performed, but it is expected that the stipulated criteria will be met with the more than adequate spinning reserve capacity with six units at Watana and four units at Devil Canyon; and
- The loss of all Susitna transmissions lines on a single right-of-way has a low level of probability. In the event of the loss of all lines serving a load center, standby reserve in the affected load center can be brought on line to meet critical loads.

The Railbelt utilities have no specific reliability criteria at the present time. Statistical data are not readily available. However, the foregoing criteria would represent significant improvements over the present system reliability and bring the quality of service closer in line with other major utility systems in the country.

3.4 - Economical Dispatch of Units

A Susitna Area Control Center will be located at Watana to control both the Watana and the Devil Canyon power plants. The control center will be linked through the supervisory system to the Central Dispatch Control Center at Willow.

Operation will be semi-automatic with generation instructions input from the Central Dispatch Center at Willow, but with direct control of the Susitna system at the control center at Watana and Devil Canyon power plants for testing/commissioning or during emergencies. The control system will be designed to perform the following functions at both power plants:

- Start/stop and loading of units by operator
- Load-frequency control of units
- Reservoir/water flow control
- Continuous monitoring and data logging
- Alarm annunciation
- Man-machine communication through visual display units (VDU) and console.

In addition, the computer system will be capable of retrieval of technical data, design criteria, equipment characteristics and operating limitations, schematic diagrams, and operating/maintenance records of the units.

The Susitna Area Control Center will be capable of completely independent control of the Central Dispatch Center in case of system emergencies. Similarly, it will be possible to operate the Susitna units in an emergency situation from the Central Dispatch Center, although this should be an unlikely operation considering the size, complexity, and impact of the Susitna generating plants on the system.

The Central Dispatch Control Engineer decides which generating units should be operated at any given time. Decisions are made on the basis of known information, including an "order-of-merit" schedule, short-term demand forecasts, limits of operation of units, and unit maintenance schedules.

(a) Merit-Order Schedule

In order to decide which generating unit should run to meet the system demand in the most economic manner, the Control Engineer is provided with information of the running cost of each unit in the form of an "order-of-merit" schedule. The schedule gives the capacity and fuel costs for thermal units and reservoir regulation limits for hydro plants.

(b) Optimum Load Dispatching

One of the most important functions of the Control Center is the accurate forecasting of the load demands in the various areas of the system.

Based on the anticipated demand, basic power transfers between areas, and an allowance for reserve, the planned generating capacity to be used is determined by taking into consideration the reservoir regulation plans of the hydro plants. The type and size of the units should also be taken into consideration for effective load dispatching.

In a hydro-dominated power system (such as the Railbelt system would be if Susitna is developed), the hydro unit will take up a much greater part of base load operation than in a thermal-dominated power system. The planned hydro units at Watana typically are well suited to load following and frequency regulation of the system and providing spinning reserve. Greater flexibility of operation was a significant factor in the selection of six units of 170 MW capacity at Watana, rather than fewer larger-size units.

(c) Operating Limits of Units

There are strict constraints on the minimum load and the loading rates of machines; to dispatch load to these machines requires a systemwide dispatch program taking these constraints into consideration. In general, hydro units have excellent start-up and load following characteristics; thermal units have good part-loading characteristics.

Typical plant loading limitations are given below:

(i) Hydro Units

- Reservoir regulation constraints resulting in not-to-exceed maximum and minimum reservoir levels, daily or seasonally.
- Part loading of units is impossible in the zone of rough turbine operation (typically from above no-load-speed to 50 percent load) due to vibrations arising from hydraulic surges.

(ii) Steam Units

- Loading rates are slow (10 percent per minute).
- The units may not be able to meet a sudden steep rate of rise of load demand.
- The units have a minimum economic shutdown period (about three hours).
- The total cost of using conventional units includes banking, raising pressure and part-load operations prior to maximum economic operation.

(iii) Gas Turbines

- Cannot be used a spinning reserve because of very poor efficiency and reduced service life.
- Require eight to ten minutes for normal start up from cold. Emergency start-up times are of the order of five to seven minutes.

(d) Optimum Maintenance Program

An important part of operational planning which can have a significant effect on operating costs is maintenance programming. The program specifies the times in the year and the sequence in which plant is released for maintenance.

### 3.5 - Unit Operation Reliability Criteria

During the operational load dispatching conditions of the power system, the reliability criteria often override economic considerations in scheduling of various units in the system. Also important in considering operational reliability are system response, load-frequency control, and spinning reserve capabilities.

#### (a) Power System Analyses

Load-frequency response studies determine the dynamic stability of the system due to the sudden forced outage of the largest unit (or generation block) in the system. The generation and load are not balanced, and, if the pick-up rate of new generation is not adequate, loss of load will eventually result from under-voltage and under frequency relay operation, or load-shedding. The aim of a well designed high security system is to avoid load-shedding by maintaining frequency and voltage within the specified statutory limits.

#### (b) System Response and Load-Frequency Control

To meet the frequency requirements, it is necessary that the effective capacity of generating plant supplying the system at any given instant should be in excess of the load demand. In the absence of detailed studies, an empirical factor of 1.67 times the capacity of the largest unit in the system is normally taken as a design criterion to maintain system frequency within acceptable limits in the event of the instantaneous loss of the largest unit. It is recommended that a factor of 1.5 times the largest unit size be considered as a minimum for the Alaska Railbelt system, with 2 times the largest unit size as a fairly conservative value (i.e., 300 to 340 MW).

The quickest response in system generation will come from the hydro units. The large hydro units at Watana and Devil Canyon on spinning reserve can respond in the turbining mode within 30 seconds. This is one of the particularly important advantages of the Susitna hydro units. Gas turbines can only respond in a second-stage operation within five to ten minutes and would not strictly qualify as spinning reserve. If thermal units are run part-loaded (e.g., 75 percent), this would be another source of spinning reserve. Ideally, it would be advantageous to provide spinning reserve in the thermal generation as well, in order to spread spinning reserves evenly in the system, with a compromise to economic loading resulting from such an operation.

#### (c) Protective Relaying System and Devices

The primary protective relaying systems provided for the generators and transmission system of the Susitna project are designed to disconnect the faulty equipment from the system in the

fastest possible time. Independent protective systems are installed to the extent necessary to provide a fast-clearing backup for the primary protective system so as to limit equipment damage, to limit the shock to the system and to speed restoration of service. The relaying systems are designed so as not to restrict the normal or necessary network transfer capabilities of the power system.

### 3.6 - Dispatch Control Centers

The operation of the Watana and Devil Canyon power plant in relation to the Central Dispatch Center can be considered to be the second tier of a three-tier control structure as follows:

- Central Dispatch Control Center (345 kV network) at Willow: manages the main system energy transfers, advises system configuration and checks overall security.
- Area Control Center (Generation connected to 345 kV system; for example, Watana and Devil Canyon): deals with the loading of generators connected directly to the 345 kV network, switching and safety precautions of local systems, checks security of interconnections to main system.
- District or Load Centers (138 kV and lower voltage networks): generation and distribution at lower voltage levels.

For the Anchorage and Fairbanks areas, the district center functions are incorporated in the respective area control centers.

Each generating unit at Watana and Devil Canyon is started up, loaded and operated, and shut down from the Area Control Center at Watana according to the loading demands from the Central Dispatch Control Center with due consideration to:

- Watana reservoir regulation criteria
- Devil Canyon reservoir regulation criteria
- Turbine loading and de-loading rates
- Part-loading and maximum loading characteristics of turbines and generators
- Hydraulic transient characteristics of waterways and turbines
- Load-frequency control of demands of the system
- Voltage regulation requirements of the system

The Watana Area Control Center is equipped with a computer-aided control system to efficiently carry out these functions. The



computer-aided control system allows a minimum of highly trained and skilled operators to perform the control and supervision of Watana and Devil Canyon plants from a single control room. The data information and retrieval system will enable the performance and alarm monitoring of each unit individually as well as the plant/reservoir and project operation as a whole.

### 3.7 - Susitna Project Operation

The Watana development will operate as a base load project until the Devil Canyon development enters operation at which time the Devil Canyon development will operate on base and the Watana development will operate on peak and reserve. The operation simulation of the reservoirs and the power facilities at the two developments was carried out on a monthly basis to assess the energy potential of the schemes, river flows downstream and flood control possibilities with the reservoirs. An optimum reservoir operation pattern was established by an iterative process to minimize net system operating costs while maximizing firm and average annual energy production. This process is discussed in Section 2 and resulted in the selection of flow regime C as that selected for operation of the two developments. Referring to flow regime C and the energy production given in Tables B.55 and B.56, the annual plant factors for the developments, based on installed capacity, are as follows:

<u>Development</u>	<u>Watana Only<sup>6</sup></u>	<u>Watana Plus Devil Canyon</u>	<u>Devil Canyon Increment</u>
Installed Capacity, MW	1020	1620	600
Annual Energy GWh/yr			
Average	3499	6934	3435
Firm	2618	5451	2833
Annual Plant Factor, %			
Average	39	49	65
Firm	29	38	54

The energy generated by the project under flow regime C during dry and mean water years is shown on Tables B.55 and B.56. The year of lowest energy generations after reservoir regulation during the 32 years of record is 1971. For the combined Watana plus Devil Canyon development the lowest energy generation, which is defined as firm energy

---

<sup>6</sup>Although Watana has an installed capacity on 1020 MW, its base load dependable capacity in the month of December is 520 MW as discussed in Section 4.3 of this Exhibit. When related to the dependable capacity, Watana operating alone would have average and firm annual plant factors of 77 and 57 percent, respectively.

generation, has a recurrence frequency approximately equal to 1 in 32 years as shown on Figure B.64. Under a high flow year, say the wettest year of the 32 years of record, energy generation for Watana only will reach 3837 GWh per year and for Watana plus Devil Canyon, 8036 GWh per year.

The determination of the dependable capacity and sensitivity to various flow regimes is discussed in Section 4.

4 - DEPENDABLE CAPACITY AND ENERGY PRODUCTION

## 4 - DEPENDABLE CAPACITY AND ENERGY PRODUCTION

Table B.26 summarizes design parameters for dependable capacity and energy production levels.

### 4.1 - Hydrology

#### (a) Historical Streamflow Records

Historical streamflow data are available for several gaging stations on the Susitna River and its main tributaries. Continuous gaging records were available for the following eight stations on the river and its tributaries: Maclaren River near Paxson, Denali, Cantwell, Gold Creek and Susitna Stations on the Susitna River, Chulitna Station on the Chulitna River, Talkeetna on the Talkeetna River, and Skwentna on the Skwentna River. The longest period of record available is for the station at Gold Creek (32 years from 1949 to 1981). At other stations, record length varies from 6 to 23 years. Gaging was continued at all these stations as part of the project study program. A gaging station was established at the Watana damsite in 1980, and streamflow records are available for the study period. Partial streamflow records are available at several other stations on the river for varying periods; the station locations are shown in Figure B.59. It should be noted that gaging will continue as the project progresses in order to improve the streamflow record, as well as after project completion at selected sites required for project operation.

#### (b) Water Resources

Above its confluence with the Chulitna River, the Susitna contributes approximately 20 percent of the mean annual flow measured at Susitna Station near Cook Inlet. Figure B.60 shows how the mean annual flow of the Susitna increases towards the mouth of the river at Cook Inlet.

Seasonal variation of flow in the river is extreme and ranges from very low values in winter (October to April) to high summer values (May to September). For the Susitna River at Gold Creek, the average winter and summer flows are 2210 and 20,200 cfs, respectively; i.e., a one to ten ratio. This large seasonal difference is mainly due to effects of glacial and snow melt in the summer.

The monthly average flows in the Susitna River at Gold Creek are given in Figure B.61. Some 40 percent of the streamflow at Gold Creek originates above the Denali and Maclaren gages. This catchment generally comprises the glaciers and associated high mountains. On the average, approximately 87 percent of the streamflow recorded at Gold Creek Station occurs during the summer months.

At higher elevations in the basin the distribution of flows is concentrated even more in the summer months. For the Maclaren River near Paxson (Elevation 4520), the average winter and summer flows are 144 and 2100 cfs, respectively; i.e., a 1 to 15 ratio. The monthly percent of annual discharge and mean monthly discharges for the Susitna river and tributaries at the gaging stations above the Chulitna confluence are given in Table B.60.

(c) Streamflow Extension

Synthesized flows at the Watana and Devil Canyon damsites are presented in Tables B.52 and B.53. Flow duration curves based on these monthly estimates are presented for the Watana and Devil Canyon damsites in Figures B.62 and B.63.

The FILLIN computer program developed by the Texas Water Development Board was used to fill in gaps in historical streamflow records at the eight continuous gaging stations. The 32-year record (up to 1981) at Gold Creek was used as the base record. The procedure adopted for filling in the data gaps uses a multisite regression technique which analyzes monthly time-series data. Flow sequences for the 32-year period were generated at the remaining seven stations. Using these flows at Cantwell Station and observed Gold Creek flows, 32-year monthly flow sequences at the Watana and Devil Canyon damsites were generated on the basis of prorated drainage areas. Recorded streamflows at Watana and Devil Canyon were included in the historical record where available.

(d) Floods

The most common causes of flood peaks in the Susitna River basin are snowmelt or a combination of snowmelt and rainfall over a large area. Annual maximum peak discharges generally occur between May and October with the majority (approximately 60 percent) occurring in June. Some of the annual maximum flood peaks have also occurred in August or later and are the result of heavy rains over large areas augmented by significant snowmelt from higher elevations and glacial runoff. Table B.61 presents selected flood peaks recorded at different gaging stations.

A regional flood peak and volume frequency analysis was carried out using the recorded floods in the Susitna River and its principal tributaries. These analyses were conducted for two different time periods. The first period, after the ice breakup and before freezeup (May through October), contains the largest floods which must be accommodated by the project. The second period represents that portion of time during which ice conditions occur in the river (October through May). These floods, although smaller, can be accompanied by ice jamming and must be considered during the construction phase of the project in planning the design of cofferdams for river diversion.

A set of multiple linear regression equations was developed using physiographic basin parameters such as catchment area, stream length, precipitation, snowfall amounts, etc., to estimate flood peaks at ungaged sites in the basin. In conjunction with the analysis of shapes and volumes of recorded large floods at Gold Creek, a set of project design flood hydrographs of different recurrence intervals was developed (see Figures B.65 and B.66).

The results of the above analysis were used for estimating flood hydrographs at the damsites and ungaged streams and rivers along the access road alignments for design of spillways, culverts, etc. Table B.62 lists mean annual, 50-, 100-, and 10,000-year floods at the Watana and Devil Canyon damsites and at the Gold Creek gage. The proposed reservoirs at Watana and Devil Canyon would be classified as "large" and with "high hazard potential" according to the guidelines for safety inspection of dams laid out by the Corps of Engineers. This would indicate the need for the probable maximum flood (PMF) to be considered in the evaluation of the proposed projects. Estimated peak discharges during the PMF at selected locations are included in Table B.62, and the PMF hydrograph is presented in Figure B.66.

Table B.63 lists the maximum flows through the various dam facilities for the 50, 10,000 and PMF events.

(e) Flow Adjustments

Evaporation from the proposed Watana and Devil Canyon reservoirs has been evaluated to determine its significance. Evaporation is influenced by air and water temperatures, wind, atmospheric pressure, and dissolved solids within the water. However, the evaluation of these factors' effects on evaporation is difficult because of their interdependence on each other. Consequently, more simplified methods were preferred and have been utilized to estimate evaporation losses from the two reservoirs.

The monthly evaporation estimates for the reservoirs are presented in Table B.64. The estimates indicate that evaporation losses will be less than or equal to additions due to precipitation on the reservoir surface. Therefore, a conservative approach was taken, with evaporation losses and precipitation gains neglected in the energy calculations.

Leakage is not expected to result in significant flow losses. Seepage through the relict channel is estimated as less than one-half of one percent of the average flow and therefore has been neglected in the energy calculations to date. This approach will be reviewed when further investigations of the relict channel are completed.

Minimum flow releases are required throughout the year to maintain downstream river stages. The most significant factor in determining the minimum flow value is the maintenance of downstream

fisheries. The monthly flow requirements that were used in determination of project energy potential are given in Table B.54.

The numbers shown in Table B.54 represent the minimum streamflow required at Gold Creek. These requirements would remain constant for all phases of project development. The actual flows released from the project at Watana (when Watana is operating alone) and at Devil Canyon (for combined operation of both dams) will be less than the required Gold Creek flows prorated on the basis of streamflow contributions from the intervening basin area. Table B.65 and B.66 give the typical minimum required flow releases at Watana and Devil Canyon for a 32-year period of record.

After completion of Devil Canyon, flow releases from Watana will be regulated by system operation requirements. Because the tail-water of the Devil Canyon reservoir will extend upstream to the Watana tailrace, there will be no release requirements for streamflow maintenance of Watana for the Watana/Devil Canyon combined operating configuration.

Existing water rights in the Susitna basin were investigated to determine impacts on downstream flow requirements. Based on inventory information provided by the Alaska Department of Natural Resources, it was determined that existing water users will not be affected by the project. A listing of all water appropriations located within 1 mile of the Susitna River is provided in Table B.67.

#### 4.2 - Reservoir Data

##### (a) Reservoir Storage

Gross storage volume of the Watana reservoir at its normal maximum operating level of 2185 feet is 9.5 million acre-feet, which is about 1.6 times the mean annual flow (MAF) at the damsite. Live storage in the reservoir is 3.7 million acre-feet. Devil Canyon reservoir has a gross storage of 1.1 million acre-feet and live storage of 0.35 million acre-feet.

The area-capacity curves for the Watana and Devil Canyon reservoirs are provided in Figures B.67 and Figure B.68, respectively.

##### (b) Rule Curves

Operation of the reservoirs for energy production is based on target water surface levels set for the end of each month. The target level represents that level below which no energy beyond firm energy can be produced. In other words, if the reservoir level drops below the target, only firm energy will be produced. In wetter years when the reservoir level surpasses the target level, energies greater than firm energy can be produced, but only as great as the system energy demand allows.

With a reservoir rule curve which establishes minimum reservoir levels at different times during the year, it will be possible to produce more energy in wetter years during winter than by following a set energy pattern. At the same time, the rule curve ensures that low flow sequences do not materially reduce the energy potential below a set minimum or firm annual energy.

The rule curves for Watana and Devil Canyon under combined operation are shown in Figure B.68.

#### 4.3 - Operating Capabilities of Susitna Units

The operating conditions of both the Watana and Devil Canyon turbines are summarized in Table B.65.

##### (a) Watana

The Watana powerhouse will have six generating units with a nominal capacity of 170 MW corresponding to the minimum December reservoir level (Elevation 2114).

The gross head on the plant will vary from 610 feet to approximately 735 feet. The maximum unit output will change with head, as shown on Figure B.70.

The rated head for the turbine has been established at 680 feet, which is the weighted average operating head on the station. Allowing for generator losses, the rated turbine output is 250,000 hp (186.5 MW) at full gate, and at 680 feet rated net head. Maximum and minimum heads on the units will be 725 feet and 600 feet, respectively. The full-gate output of the turbines will be about 275,000 hp at 725 feet net head and 209,000 hp at 600 feet net head. Overgating of the turbines may be possible, providing approximately five percent additional power; however, at high heads the turbine output will be restricted to avoid overloading the generators. The best-efficiency point of the turbines will be established at the time of preparation of bid documents for the generating equipment and will be based on a detailed analysis of the anticipated operating range of the turbines. For preliminary design purposes, the best-efficiency (best-gate) output of the units has been assumed as 85 percent of the full-gate turbine output. This percentage may vary from about 80 percent to 90 percent; in general, a lower percentage reduces turbine cost.

The full gate and best gate efficiencies of the turbines will be about 91 percent and 94 percent, respectively, at rated head. The efficiency will be about 0.5 percent lower at maximum head and one percent lower at minimum head. The preliminary performance curve for the turbine is shown on Figure B.71.

The Watana plant output may vary from zero, with the units at standstill or at spinning reserve, to approximately 1200 when all six units are operating under maximum output at maximum head. A



graph of plant efficiency versus output and the number of on-line units is shown in Figure B.72. The load following requirements of the plant result in widely varying loading, but because of the multiple unit installation the total plant efficiency varies only slightly.

(b) Devil Canyon

The Devil Canyon powerhouse will have four generating units with a nominal capacity of 150 MW based on the minimum reservoir level (Elevation 1405) and as corresponding gross head of 555 feet in the station.

The gross head on the plant will vary from 555 feet to 605 feet. The maximum unit output will change with head as shown in Figure B.73.

The rated average operating net head for the turbine has been established at 590 feet. Allowing for generator losses, this results in a rated turbine output of 225,000 hp (168 MW) at full gate.

The generator rating has been selected as 167 MVA with a 90 percent power factor. The generators will be capable of continuous operation at 115 percent rated power. Because of the high capacity factor for the Devil Canyon station, the generators will be sized on the basis of maximum turbine output at maximum head, allowing for a possible 5 percent addition in power from the turbine. This maximum turbine output (250,000 hp) is within the continuous overload rating of the generator.

Maximum and minimum net heads on the units will be 596 feet and 547 feet, respectively. The full-gate output of the turbines will be about 235,000 hp at maximum net head and 201,000 hp at minimum net head. Overgating of the turbines may be possible, providing approximately five percent additional power. For preliminary design purposes, the best-efficiency (best-gate) output of the units has been assumed at 85 percent of the full-gate turbine output.

The full-gate and best-gate efficiency of the turbines will be about 91 percent and 94 percent, respectively, at rated head. The efficiency will be about 0.2 percent lower at maximum head and 0.5 percent lower at minimum head. The preliminary performance curve for the turbine is shown in Figure B.74.

The Devil Canyon plant output may vary from zero to 700 MW with all four units operating at maximum output. The combined plant efficiency varies with output and number of units operating, as shown in Figure B.75. As with Watana, the plant efficiency varies only slightly with loading due to the load following capabilities of multiple units.

(c) Dependable Capacity and Energy Production

The dependable capacity of a hydroelectric project is defined as the capacity, which for specified time interval and period, can be relied upon to carry system load, provide assured reserve and meet firm power obligations, taking into account unit operating variables, hydrologic conditions, and seasonal or other characteristics of the load to be supplied.

Sections (a) and (b) above describe the operating variables of the units to be installed at Watana and Devil Canyon based on the hydrologic conditions discussed in Section 4.1 and the reservoir operation studies presented in Section 2.8. Based on those operation studies, the average and firm annual energy production from Watana operating alone and Watana and Devil Canyon operating together were determined for 10 flow regime cases shown on Table B.54. Average annual energy and firm energy production using the 10 flow-cases are presented on Tables B.56 and B.57 for Watana alone, and for Watana and Devil Canyon together, respectively. As discussed in Section 2.8, Case C was selected for Project operation. Case A was evaluated to maximize energy production. The other cases which were evaluated were derived to encompass possible Agency recommendations for avoiding impacts to the fisheries resources (as discussed in Section 2.8). The firm and average annual energy production for some of these cases are as follows:

<u>Flow Regime</u>	<u>Firm Annual<sup>1</sup></u>		<u>Average Annual</u>	
	<u>Energy Production GWh</u>		<u>Energy Generating GWh</u>	
	<u>Watana</u>	<u>Watana Plus</u>	<u>Watana</u>	<u>Watana Plus</u>
	<u>Only</u>	<u>Devil Canyon</u>	<u>Only</u>	<u>Devil Canyon</u>
A	2665	5509	3495	6962
C	2618	5451	3499	6934
D	2553	4765	3303	6355
G	2282	4064	2911	4927

A comparison of the monthly peak loads as shown on Figure B.58 to the capacity available from Watana alone and Watana and Devil Canyon operating together shows that the maximum exceedance of plant capability by peak load in both cases occurs in the month of December. The Susitna units were dispatched under the typical winter weekday load curve shown on Figure B.58 to determine the dependable capacity of Watana alone and Watana and Devil Canyon operating together.

As stated in Section 3.7, the Watana development will operate as a base load project until the Devil Canyon development begins opera-

---

<sup>1</sup> Minimum annual energy based on 32 years of streamflow.

tion at which time the Devil Canyon development will operate on base and the Watana development will operate on peak and reserve. Figure B.76 shows the dependable capacity of Watana and Devil Canyon in relation to the peak load forecast for each of the four flow regimes mentioned above. As can be seen from Figure B.76, the dependable capacity of the developments increases as the peak load increases until such time as the capacity limit of the units, based in operating variables and hydrologic conditons, is reached. That dependable capacity in 2020 achieved under each flow regime is as follows:

Flow Regime	Dependable Capacity in 2020, MW		
	<u>Watana</u>	<u>Devil Canyon</u>	<u>Total</u>
A	947	425	1372
C	893	379	1272
D	850	347	1197
G	697	225	922

#### 4.4 - Tailwater Rating Curve

The tailwater rating curve for the Watana development is shown on Figure B.67 and for the Devil Canyon development on Figure B.68.

TABLES

TABLE B.0

## ALASKA POWER AUTHORITY, RESOURCE AGENCY CONSULTATION CORRESPONDENCE AND MEETING LOG CONCERNING AQUATIC AND FISHERIES RESOURCES, 1980 THROUGH 1983

DATE	TOPIC	REFERENCE
July 1980	Establishment of Susitna Hydro Steering Committee	Exhibit E Pg. E-11-3 & Table E.11.8
Aug. 21, 1981	ADF&G letter relative to the impact of the Transmission Route on fisheries	Exhibit E Chapter 11 Appendix E11C
Dec. 31, 1981	NMFS review of the 1980 Fish Ecology Annual Report	Exhibit E Chapter 11 Appendix E11C
April 1981	Fishery reports (1980) provided to DNR, ADF&G, NMFS, USFWS, EPA, BLM to keep those agencies up to date on the progress of the fishery program	Exhibit E Chapter 11 Appendix E11c
Fall 1981	Establishment of the Susitna Fisheries mitigation Review Committee - letter from NMFS, COE, EPA, ADF&G, DNR	Exhibit E Chapter 11 Appendix E11E
Dec. 30, 1981	Letter to Acres from ADF&G regarding the development of the Fish and Wildlife Mitigation Policy	Exhibit E Chapter 11 Appendix E11E
Feb. 23, 1982	Acres response to ADF&G letter	Exhibit E Chapter 11 Appendix E11E
Dec. 30, 1982	Letter to APA from USFWS regarding the development of the Fish and Wildlife Mitigation Policy	Exhibit E Chapter 11 Appendix E11E
Feb. 24, 1982	Acres response to USFWS letter	Exhibit E Chapter 11 Appendix E11E
Dec. 31, 1981	Letter to APA from NMFS regarding the development of the Fish and Wildlife Mitigation Policy	Exhibit E Chapter 11 Appendix E11E
Feb. 23, 1982	Acres response to NMFS letter	Exhibit E Chapter 11 Appendix E11E

## B.O (continued)

## FISHERY COORDINATION CORRESPONDENCE

DATE	TOPIC	REFERENCE
Jan.20, 1982	Meetings of Fisheries Mitigation Review Group to discuss Fish and Wildlife Mitigation Policy and fisheries mitigation options (ADF&G, EPA, NMFS, DNR, BLM, USFWS)	Exhibit E Chapter 11 Appendix E11E
April 1, 1982	Fish and Wildlife Mitigation Policy distributed for final review (EPA DEC, DNR, NMFS, USFWS, ADF&G, BLM)	Exhibit E Chapter 11 Appendix E11E
May 13, 1982	Minutes meeting of Fisheries Mitigation Review Group	Exhibit E Chapter 11 Appendix E11E
July 27, 1982	Letter from ADF&G to APA regarding Fisheries Impact Assessment	Exhibit E Chapter 11 Appendix E11E
Sept. 1982	APA Response to ADF&G letters	Exhibit E Chapter 11 Appendix E11E
Sept. 1982	Letter from APA requesting review of the Feasibility Report and Agency responses	Exhibit E Chapter 11 Appendix E11E
Oct. 1982	Letter from NMFS regarding fisheries flow release, with APA response	Exhibit E Chapter 11 Appendix E11E
Oct. 1982	Letter from USFWS regarding aquatic studies, with APA response	Exhibit B Chapter 11 Appendix E11E

## B.0 (continued)

## FISHERY COORDINATION CORRESPONDENCE

DATE	TOPIC	REFERENCE
Nov. 29-Dec. 3, 1982	Workshop with APA, all environmental subcontractors, Acres, and EPA, ADF&G NMFS, DNR, DEC, BLM, and USFWS	Exhibit E Chapter 11 Appendix E11E
Jan. 1983	Letter from USFWS setting forth USFWS Resource Categories, with APA response	Exhibit E Chapter 11 Appendix E11E
Jan. 1983	Agency comments on Draft License Application	Exhibit E Chapter 11 Appendix E11J

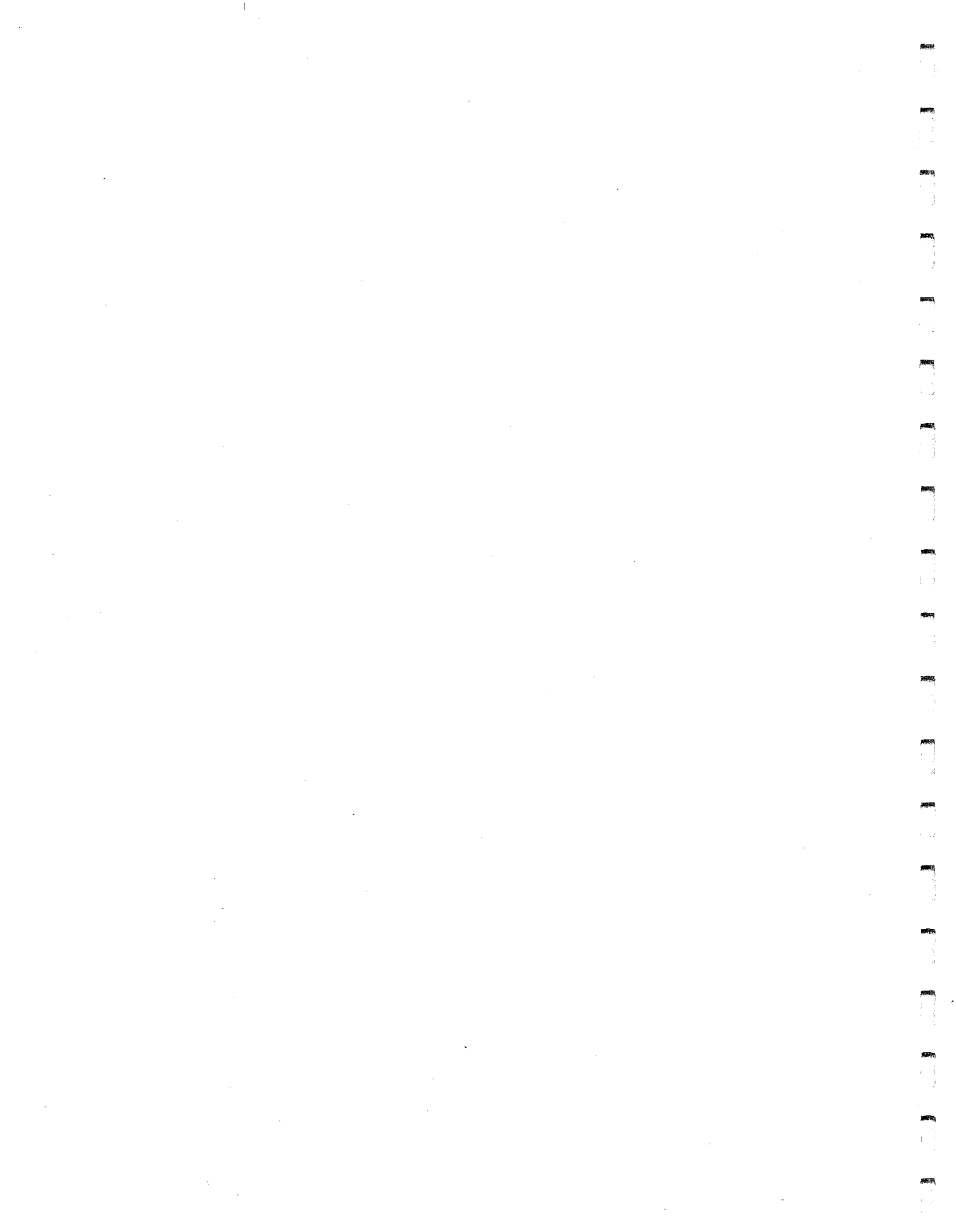



**TABLE B.1: POTENTIAL HYDROELECTRIC DEVELOPMENT**

Site	Dam		Upstream Regulation	Capital Cost \$ million (1980)	Installed Capacity (MW)	Average Annual Energy GWh	Economic <sup>1</sup> Cost of Energy \$/1000 kWh	Source of Data
	Proposed Type	Height Ft.						
Gold Creek <sup>2</sup>	Fill	190	Yes	900	260	1,140	37	USBR 1953
Olson (Susitna II)	Concrete	160	Yes	600	200	915	31	USBR 1953 KAISER 1974 COE 1975
Devil Canyon	Concrete	675	No	830	250	1,420	27	This Study "
			Yes	1,000	600	2,980	17	
High Devil Canyon (Susitna I)	Fill	855	No	1,500	800	3,540	21	"
Devil Creek <sup>2</sup>	Fill	Approx 850	No	-	-	-	-	-
Watana	Fill	880	No	1,860	800	3,250	28	"
Susitna III	Fill	670	No	1,390	350	1,580	41	"
Vee	Fill	610	No	1,060	400	1,370	37	"
Maclaren <sup>2</sup>	Fill	185	No	530 <sup>4</sup>	55	180	124	"
Denali	Fill	230	No	480 <sup>4</sup>	60	245	81	"
Butte Creek <sup>2</sup>	Fill	Approx 150	No	-	40	130 <sup>3</sup>	-	USBR 1953
Tyone <sup>2</sup>	Fill	Approx 60	No	-	6	22 <sup>3</sup>	-	USBR 1953

**Notes:**

- (1) Includes AFDC, Insurance, Amortization, and Operation and Maintenance Costs.
- (2) No detailed engineering or energy studies undertaken as part of this study.
- (3) These are approximate estimates and serve only to represent the potential of these two damsites in perspective.
- (4) Include estimated costs of power generation facility.

TABLE B.2 - COST COMPARISONS

D A M		Capital Cost Estimate <sup>2</sup> (1980 \$)				
		A C R E S 1980		O T H E R S		Source and Date of Data
Site	Type	Installed Capacity - MW	Capital Cost \$ million	Installed Capacity - MW	Capital Cost \$ million	
Gold Creek	Fill	-	-	260 <sup>1</sup>	890	USRB 1968
Olson (Susitna II)	Concrete	-	-	190 <sup>1</sup>	550	COE 1975
Devil Canyon	Fill	600	1,000	-	-	-
	Concrete Arch	-	-	776	630	COE 1975
	Concrete Gravity	-	-	776	910	COE 1978
High Devil Canyon (Susitna I)	Fill	800	1,500	700	1,480	COE 1975
Devil Creek	Fill	-	-	-	-	-
Watana	Fill	800	1,860	792	1,630	COE 1978
Susitna III	Fill	350	1,390	445	-	KAISER 1974
Vee	Fill	400	1,060	-	770	COE 1975
MacLaren	Fill	55	530	-	-	-
Denali	Fill	60	480	None	500	COE 1975

Notes:

(1) Dependable Capacity

(2) Excluding Anchorage/Fairbanks transmission intertie, but including local access and transmission.

TABLE B.3: DAM CREST AND FULL SUPPLY LEVELS

Site	Staged Dam Construction	Full Supply Level - Ft.	Dam Crest Level - Ft.	Average Tailwater Level - ft.	Dam Height <sup>1</sup> ft.
Gold Creek	No	870	880	680	290
Olson	No	1,020	1,030	810	310
Portage Creek	No	1,020	1,030	870	250
Devil Canyon - intermediate height	No	1,250	1,270	890	465
Devil Canyon - full height	No	1,450	1,470	890	675
High Devil Canyon	No	1,610	1,630	1,030	710
	No	1,750	1,775	1,030	855
Watana	Yes	2,000	2,060	1,465	680
	Stage 2	2,200	2,225	1,465	880
Susitna III	No	2,340	2,360	1,810	670
Yee	No	2,330	2,350	1,925	610
Maclaren	No	2,395	2,405	2,300	185
Denali	No	2,540	2,555	2,405	230

Notes:

(1) To foundation level.

TABLE B.4 - CAPITAL COST ESTIMATE SUMMARIES  
 SUSITNA BASIN DAM SCHEMES  
 COST IN \$MILLION 1980

Item	Devil Canyon 1470 ft Crest 600 MW	High Devil Canyon 1775 ft Crest 800 MW	Watana 2225 ft Crest 800 MW	Susitna III 2360 ft Crest 330 MW	Vee 2350 ft Crest 400 MW	MacLaren 2405 ft Crest No power	Denali 2250 ft Crest No power
1) Lands, Damages & Reservoirs	26	11	46	13	22	25	38
2) Diversion Works	50	48	71	88	37	118	112
3) Main Dam	166	432	536	398	183	106	100
4) Auxiliary Dam	0	0	0	0	40	0	0
5) Power System	195	232	244	140	175	0	0
6) Spillway System	130	141	165	121	74	0	0
7) Roads and Bridges	45	68	96	70	80	57	14
8) Transmission Line	10	10	26	40	49	0	0
9) Camp Facilities and Support	97	140	160	130	100	53	50
10) Miscellaneous <sup>1</sup>	8	8	8	8	8	5	5
11) Mobilization and Preparation	30	47	57	45	35	15	14
Subtotal	757	1137	1409	1053	803	379	333
Contingency (20%)	152	227	282	211	161	76	67
Engineering and Owner's Administration (12%)	91	136	169	126	96	45	40
TOTAL	1000	1500	1860	1390	1060	500	440

Notes:

(1) Includes recreational facilities, buildings and grounds and permanent operating equipment.



TABLE B.6: INFORMATION ON THE DEVIL CANYON DAM AND TUNNEL SCHEMES

Item	Devil Canyon Dam	Tunnel Scheme			
		1	2	3	4
Reservoir Area (Acres)	7,500	320	0	3,900	0
River Miles Flooded	31.6	2.0	0	15.8	0
Tunnel Length (Miles)	0	27	29	13.5	29
Tunnel Volume (1000 Yd <sup>3</sup> )	0	11,976	12,863	3,732	5,131
Compensating Flow Release (cfs)	0	1,000	1,000	1,000	1,000
Reservoir Volume (1000 Acre-feet)	1,100	9.5	--	350	--
Dam Height (feet)	625	75	--	245	--
Typical Daily Range of Discharge From Devil Canyon Powerhouse (cfs)	6,000 to 13,000	4,000 to 14,000	4,000 to 14,000	8,300 to 8,900	3,900 to 4,200
Approximate Maximum Daily Fluctuations in Reservoir (feet)	2	15	--	4	--

TABLE B.7 - DEVIL CANYON TUNNEL SCHEMES  
COSTS, POWER OUTPUT AND AVERAGE ANNUAL ENERGY

Stage	Installed Capacity (MW)		Increase <sup>1</sup> In Installed Capacity (MW)	Devil Canyon Average Annual Energy (GWh)	Increase <sup>1</sup> In Average Annual Energy (GWh)	Tunnel Scheme Total Project Costs \$ Million	Cost <sup>3</sup> of Additional Energy (mills/kWh)
	Watana	Devil Canyon Tunnel					
<u>STAGE 1:</u>							
Watana Dam	800	---	---	---	---	---	---
<u>STAGE 2:</u>							
Tunnel:							
- Scheme 1	800	550	550	2,050	2,050	1980	42.6
- Scheme 2 <sup>2</sup>	70	1,150	420	4,750	1,900	2320	52.9
- Scheme 3 <sup>2</sup>	850	330	380	2,240	2,180	1220	24.9
- Scheme 4	800	365	365	2,490	890	1490	73.6

Notes:

- (1) Increase over single Watana, 800 MW development 3250 GWh/yr
- (2) Includes power and energy produced at re-regulation dam
- (3) Energy cost is based on an economic analysis (i.e. using 3 percent interest rate)

TABLE B.8 - CAPITAL COST ESTIMATE SUMMARIES  
TUNNEL SCHEMES  
COSTS IN \$MILLION 1980

Item	Two 30 ft dia tunnels	One 40 ft dia tunnel
Land and damages, reservoir clearing	14	14
Diversion works	35	35
Re-regulation dam	102	102
Power system	680	576
(a) Main tunnels	557	453
(b) Intake, powerhouse, tailrace and switchyard	123	123
Secondary power station	21	21
Spillway system	42	42
Roads and bridges	42	42
Transmission lines	15	15
Camp facilities and support	131	117
Miscellaneous	8	8
Mobilization and preparation	47	47
<b>TOTAL CONSTRUCTION COST</b>	<b>1,137</b>	<b>1,015</b>
Contingencies (20%)	227	203
Engineering, and Owner's Administration	136	122
<b>TOTAL PROJECT COST</b>	<b>1,500</b>	<b>1,340</b>



TABLE B.9. SUSITNA DEVELOPMENT PLANS

Plan	Stage	Construction	Stage/Incremental Data				Cumulative System Data		
			Capital Cost \$ Millions (1980 values)	Earliest On-line Date <sup>1</sup>	Reservoir Full Supply Level - ft.	Maximum Seasonal Draw- down-ft	Annual Energy Production Firm Avg. GWh GWh	Plant Factor %	
1.1	1	Watana 2225 ft 800MW	1860	1993	2200	150	2670	3250	46
	2	Devil Canyon 1470 ft 600 MW	1000	1996	1450	100	5500	6230	51
		TOTAL SYSTEM 1400 MW	2860						
1.2	1	Watana 2060 ft 400 MW	1570	1992	2000	100	1710	2110	60
	2	Watana raise to 2225 ft	360	1995	2200	150	2670	2990	85
	3	Watana add 400 MW capacity	130 <sup>2</sup>	1995	2200	150	2670	3250	46
	4	Devil Canyon 1470 ft 600 MW	1000	1996	1450	100	5500	6230	51
		TOTAL SYSTEM 1400 MW	3060						
1.3	1	Watana 2225 ft 400 MW	1740	1993	2200	150	2670	2990	85
	2	Watana add 400 MW capacity	150	1993	2200	150	2670	3250	46
	3	Devil Canyon 1470 ft 600 MW	1000	1996	1450	100	5500	6230	51
		TOTAL SYSTEM 1400 MW	2890						

TABLE B.9 (Continued)

Plan	Stage	Construction	Stage/Incremental Data				Cumulative System Data		
			Capital Cost \$ Millions (1980 values)	Earliest Reservoir On-line Date <sup>1</sup>	Full Supply Level - ft.	Maximum Seasonal Draw- down-ft.	Annual Energy Production Firm Avg. GWh GWh	Plant Factor %	
2.1	1	High Devil Canyon							
		1775 ft 800 MW	1500	1994 <sup>3</sup>	1750	150	2460	3400	49
	2	Vee 2350 ft 400 MW TOTAL SYSTEM 1200 MW	<u>1060</u> 2560	1997	2330	150	3870	4910	47
2.2	1	High Devil Canyon							
		1630 ft 400 MW	1140	1993 <sup>3</sup>	1610	100	1770	2020	58
	2	High Devil Canyon add 400 MW capacity raise dam to 1775 ft	500	1996	1750	150	2460	3400	49
	3	Vee 2350 ft 400 MW TOTAL SYSTEM 1200 MW	<u>1060</u> 2700	1997	2330	150	3870	4910	47
2.3	1	High Devil Canyon							
		1775 ft 400 MW	1390	1994 <sup>3</sup>	1750	150	2400	2760	79
	2	High Devil Canyon add 400 MW capacity	140	1994	1750	150	2460	3400	49
	3	Vee 2350 ft 400 MW TOTAL SYSTEM 1200 MW	<u>1060</u> 2590	1997	2330	150	3870	4910	47
3.1	1	Watana 2225 ft 800 MW	1860	1993	2200	150	2670	3250	46
	2	Watana add 50 MW tunnel 330 MW TOTAL SYSTEM 1180 MW	<u>1500</u> 3360	1995	1475	4	4890	5430	53

TABLE B.9 (Continued)

Plan	Stage	Construction	Stage/Incremental Data				Cumulative System Data		
			Capital Cost \$ Millions (1980 values)	Earliest On-line Date <sup>1</sup>	Reservoir Full Supply Level - ft.	Maximum Seasonal Draw-down-ft.	Annual Energy Production Firm Avg. GWh GWh	Plant Factor %	
3.2	1	Watana 2225 ft 400 MW	1740	1993	2200	150	2670	2990	85
	2	Watana add 400 MW capacity	150	1994	2200	150	2670	3250	46
	3	Tunnel 330 MW add 50 MW to Watana	<u>1500</u> 3390	1995	1475	4	4890	5430	53
4.1	1	Watana 2225 ft 400 MW	1740	1995 <sup>3</sup>	2200	150	2670	2990	85
	2	Watana add 400 MW capacity	150	1996	2200	150	2670	3250	46
	3	High Devil Canyon 1470 ft 400 MW	860	1998	1450	100	4520	5280	50
	4	Portage Creek 1030 ft 150 MW	<u>650</u>	2000	1020	50	5110	6000	51
		TOTAL SYSTEM 1350 MW	<u>3400</u>						

NOTES:

- (1) Allowing for a 3 year overlap construction period between major dams.
- (2) Plan 1.2 Stage 3 is less expensive than Plan 1.3 Stage 2 due to lower mobilization costs.
- (3) Assumes FERC license can be filed by June 1984, ie. 2 years later than for the Watana/Devil Canyon Plan 1.

TABLE B.10. SUSITNA ENVIRONMENTAL DEVELOPMENT PLANS

Plan	Stage	Construction	Stage/Incremental Data				Cumulative System Data		
			Capital Cost \$ Millions (1980 values)	Earliest On-line Date	Reservoir Full Supply Level - ft.	Maximum Seasonal Draw-down-ft	Annual Energy Production Firm GWh	Avg. GWh	Plant Factor %
E1.1	1	Watana 2225 ft 800MW and Re-Regulation Dam	1960	1993	2200	150	2670	3250	46
	2	Devil Canyon 1470 ft 400MW	900	1996	1450	100	5520	6070	58
		TOTAL SYSTEM 1200MW	<u>2860</u>						
E1.2	1	Watana 2060 ft 400MW	1570	1992	2000	100	1710	2110	60
	2	Watana raise to 2225 ft	360	1995	2200	150	2670	2990	85
	3	Watana add 400MW capacity and Re-Regulation Dam	230 <sup>2</sup>	1995	2200	150	2670	3250	46
	4	Devil Canyon 1470 ft 400MW	900	1996	1450	100	5520	6070	58
	TOTAL SYSTEM 1200MW	<u>3060</u>							
E1.3	1	Watana 2225 ft 400MW	1740	1993	2200	150	2670	2990	85
	2	Watana add 400MW capacity and Re-Regulation Dam	250	1993	2200	150	2670	3250	46
	3	Devil Canyon 1470 ft 400 MW	900	1996	1450	100	5520	6070	58
	TOTAL SYSTEM 1200MW	<u>2890</u>							

TABLE B.10 (Continued)

Plan	Stage	Construction	Stage/Incremental Data				Cumulative System Data		
			Capital Cost \$ Millions (1980 values)	Earliest Reservoir On-line Date	Reservoir Full Supply Level - ft.	Maximum Seasonal Draw-down-ft.	Annual Energy Production Firm Avg. GWh GWh	Plant Factor %	
E1.4	1	Watana 2225 ft 400MW	1740	1993	2200	150	2670	2990	85
	2	Devil Canyon 1470 ft 400MW TOTAL SYSTEM 800MW	<u>900</u> 2640	1996	1450	100	5190	5670	81
E2.1	1	High Devil Canyon 1775 ft 800MW and Re-Regulation Dam	1600	1994 <sup>3</sup>	1750	150	2460	3400	49
	2	Vee 2350ft 400MW TOTAL SYSTEM 1200MW	<u>1060</u> 2660	1997	2330	150	3870	4910	47
E2.2	1	High Devil Canyon 1630 ft 400MW	1140	1993 <sup>3</sup>	1610	100	1770	2020	58
	2	High Devil Canyon raise dam to 1775 ft add 400MW and Re-Regulation Dam	600	1996	1750	150	2460	3400	49
	3	Vee 2350 ft 400 MW TOTAL SYSTEM 1200MW	<u>1060</u> 2800	1997	2330	150	3870	4910	47
E2.3	1	High Devil Canyon 1775 ft 400MW	1390	1994 <sup>3</sup>	1750	150	2400	2760	79
	2	High Devil Canyon add 400MW capacity and Re-Regulation Dam	240	1995	1750	150	2460	3400	49
	3	Vee 2350 ft 400MW TOTAL SYSTEM 1200	<u>1060</u> 2690	1997	2330	150	3870	4910	47

TABLE B.10 (Continued)

Plan	Stage	Construction	Stage/Incremental Data				Cumulative System Data		
			Capital Cost \$ Millions (1980 values)	Earliest On-line Date	Reservoir Full Supply Level - ft.	Maximum Seasonal Draw-down-ft.	Annual Energy Production Firm Avg. GWh	Plant Factor %	
E2.4	1	High Devil Canyon 1755 ft 400MW	1390	1994 <sup>3</sup>	1750	150	2400	2760	79
	2	High Devil Canyon add 400MW capacity and Portage Creek Dam 150 ft	790	1995	1750	150	3170	4080	49
	3	Vee 2350 ft 400MW	1060	1997	2330	150	4430	5540	47
		TOTAL SYSTEM	<u>3240</u>						
E3.2	1	Watana 2225 ft 400MW	1740	1993	2200	150	2670	2990	85
	2	Watana add 400 MW capacity and Re-Regulation Dam	250	1994	2200	150	2670	3250	46
	3	Watana add 50MW Tunnel Scheme 330MW	1500	1995	1475	4	4890	5430	53
		TOTAL SYSTEM 1180MW	<u>3490</u>						
E4.1	1	Watana 2225 ft 400MW	1740	1995 <sup>3</sup>	2200	150	2670	2990	85
	2	Watana add 400MW capacity and Re-Regulation Dam	250	1996	2200	150	2670	3250	46
	3	High Devil Canyon 1470 ft 400MW	860	1998	1450	100	4520	5280	50
	4	Portage Creek 1030 ft 150MW	650	2000	1020	50	5110	6000	51
		TOTAL SYSTEM 1350 MW	<u>3500</u>						

NOTES:

(1) Allowing for a 3 year overlap construction period between major dams.

(2) Plan 1.2 Stage 3 is less expensive than Plan 1.3 Stage 2 due to lower mobilization costs.

(3) Assumes FERC license can be filed by June 1984, i.e. 2 years later than for the Watana/Devil Canyon Plan 1.

TABLE 8.11 - RESULTS OF ECONOMIC ANALYSES OF SUSITNA PLANS - MEDIUM LOAD FORECAST

Susitna Development Plan Inc.					OGP5 Run Id. No.	Installed Capacity (MW) by Category in 2010					Total System Installed Capacity In 2010-MW	Total System Present Worth Cost \$ Million	Remarks Pertaining to the Susitna Basin Development Plan
Plan No.	On-line Dates Stages					Thermal		Hydro					
	1	2	3	4		Coal	Gas	Oil	Other	Susitna			
E1.1	1993	2000	--	--	LXE7	300	426	0	144	1200	2070	5850	
E1.2	1992	1995	1997	2002	L5Y9	200	501	0	144	1200	2045	6030	
E1.3	1993	1996	2000	--	L8J9	300	426	0	144	1200	2070	5850	Stage 3, Devil Canyon Dam not constructed
	1993	1996	--	--	L7W7	500	651	0	144	800	2095	6960	
	1998	2001	2005	--	LAD7	400	276	30	144	1200	2050	6070	
E1.4	1993	2000	--	--	LCK5	200	726	50	144	800	1920	5890	Total development limited to 800 MW
Modified E2.1	1994	2000	--	--	LB25	400	651	60	144	800	2055	6620	High Devil Canyon limited to 400 MW
E2.3 <sup>1</sup>	1993	1996	2000	--	L601	300	651	20	144	1200	2315	6370	Stage 3, Vee Dam, not constructed
	1993	1996	--	--	LE07	500	651	30	144	800	2125	6720	
Modified E2.3	1993	1996	2000		LEB3	300	726	220	144	1300	2690	6210	Vee Dam replaced by Chakachamma Dam
3.1	1993	1996	2000	--	L607	200	651	30	144	1180	2205	6530	
Special 3.1	1993	1996	2000	--	L615	200	651	30	144	1180	2205	6230	Capital cost of tunnel reduced by 50 percent
E4.1	1995	1996	1998	--	LTZ5	200	576	30	144	1200	2150	6050	Stage 4 not constructed

NOTES:

(1) Adjusted to incorporate cost of re-regulation dam

TABLE B.12 - RESULTS OF ECONOMIC ANALYSES OF SUSITNA PLANS - LOW AND HIGH LOAD FORECAST

Susitna Development Plan Inc. On-Line Dates					OGP5 Run Id. No.	Installed Capacity (MW) by Category in 2010					Total System Installed Capacity In 2010-MW	Total System Present Worth Cost \$ Million	Remarks Pertaining to the Susitna Basin Development Plan
Plan No.	Stages					Thermal			Hydro				
	1	2	3	4		Coal	Gas	Oil	Other	Susitna			
<u>VERY LOW FORECAST</u> <sup>1</sup>													
E1.4	1997	2005	--	--	L7B7	0	651	50	144	800	1645	3650	
<u>LOW LOAD FORECAST</u>													
E1.3	1993	1996	2000	--	--	--	--	--	--	--	--	--	Low energy demand does not warrant plan capacities
E1.4	1993	2002	--	--	LC07	0	351	40	144	800	1335	4350	Stage 2, Devil Canyon Dam, not constructed
	1993	--	--	--	LBK7	200	501	80	144	400	1325	4940	
E2.1	1993	2002	--	--	LG09	100	426	30	144	800	1500	4560	High Devil Canyon limited to 400 MW Stage 2, Vee Dam, not constructed
	1993	--	--	--	LBU1	400	501	0	144	400	1445	4850	
E2.3	1993	1996	2000	--	--	--	--	--	--	--	--	--	Low energy demand does not warrant plan capacities
Special 3.1	1993	1996	2000	--	L613	0	576	20	144	780	1520	4730	Capital cost of tunnel reduced by 50 percent
3.2	1993	2002	--	--	L609	0	576	20	144	780	1520	5000	Stage 2, 400 MW addition to Watana, not constructed
<u>HIGH LOAD FORECAST</u>													
E1.3	1993	1996	2000	--	LA73	1000	951	0	144	1200	3295	10680	
Modified E1.3	1993	1996	2000	2005	LBV7	800	651	60	144	1700	3355	10050	Chakachamna hydroelectric generating station (480 MW) brought on line as a fourth stage
E2.3	1993	1996	2000	--	LBV3	1300	951	90	144	1200	3685	11720	
Modified E2.3	1993	1996	2000	2003	LBV1	1000	876	10	144	1700	3730	11040	Chakachamna hydroelectric generating station (480 MW) brought on line as a fourth stage

NOTE:

(1) Incorporating load management and conservation



TABLE B.13 - ANNUAL FIXED CARRYING CHARGES

Project Type	Economic Parameters			
	Economic Life - Years	Cost of Money %	Amortization %	Insurance %
Thermal - Gas Turbine (Oil Fired)	20	3.00	3.72	0.25
- Diesel, Gas Turbine (Gas Fired) and Large Steam Turbine	30	3.00	2.10	0.25
- Small Steam Turbine	35	3.00	1.65	0.25
Hydropower	50	3.00	0.89	0.10

FUEL COSTS AND ESCALATION RATES

	Natural Gas	Coal	Distillate
<u>Base Period (January 1980)</u>			
- Prices (\$/million Btu)			
Market Prices	\$1.05	\$1.15	\$4.00
Shadow (Opportunity) Values	2.00	1.15	4.00
<u>Real Escalation Rates (Percentage)</u>			
- Change Compounded (Annually)			
1980 - 1985	1.79%	9.56%	3.38%
1986 - 1990	6.20	2.39	3.09
1991 - 1995	3.99	-2.87	4.27
Composite (average) 1980-1995	3.98	2.93	3.58
1996 - 2005	3.98	2.93	3.58
2006 - 2010	0	0	0

TABLE B.14 - SUMMARY OF THERMAL GENERATING RESOURCE PLANT PARAMETERS

Parameter	P L A N T T Y P E					
	COAL-FIRED STEAM			COMBINED	GAS	DIESEL
	500 MW	250 MW	100 MW	CYCLE 250 MW	TURBINE 75 MW	10 MW
Heat Rate (Btu/kWh)	10,500	10,500	10,500	8,500	12,000	11,500
<u>O&amp;M Costs</u>						
Fixed O&M (\$/yr/kW)	0.50	1.05	1.30	2.75	2.75	0.50
Variable O&M (\$/MWh)	1.40	1.80	2.20	0.30	0.30	5.00
<u>Outages</u>						
Planned Outages (%)	11	11	11	14	11	1
Forced Outages (%)	5	5	5	6	3.8	5
Construction Period (yrs)	6	6	5	3	2	1
Start-up Time (yrs)	6	6	6	4	4	1
<u>Total Capital Cost</u> (\$ million)						
Railbelt:	-	-	-	175	26	7.7
Beluga:	1,130	630	290	-	-	-
<u>Unit Capital Cost (\$/kW)<sup>1</sup></u>						
Railbelt:	-	-	-	728	250	778
Beluga:	2473	2744	3102	-	-	-

Notes:

(1) Including AFDC at 0 percent escalation and 3 percent interest.

TABLE B.15 - ECONOMIC BACKUP DATA FOR EVALUATION OF PLANS

Parameter	Total Present Worth Cost for 1981 - 2040 Period \$ Million (% Total)			All Thermal Generation Plans
	Generation Plan With High Devil Canyon - Vee	Generation Plan With Watana - Devil Canyon Dam	Generation Plan With Watana - Tunnel	
Capital Investment	2800 (44)	2740 (47)	3170 (49)	2520 (31)
Fuel	3220 (50)	2780 (47)	3020 (46)	5240 (64)
Operation and Maintenance	350 (6)	330 (6)	340 (5)	370 (5)
<b>TOTAL:</b>	<b>6370 (100)</b>	<b>5850 (100)</b>	<b>6530 (100)</b>	<b>8130 (100)</b>

TABLE B.16 - ECONOMIC EVALUATION OF DEVIL CANYON DAM AND TUNNEL SCHEMES AND WATANA/DEVIL CANYON AND HIGH DEVIL CANYON/VEE PLANS

		Present Worth of Net Benefit (\$ million) of Total Generation System Costs for the:		Remarks
		Devil Canyon Dam over the Tunnel Scheme	Watana/Devil Canyon Dams over the High Devil Canyon/Vee Dams	
<b>ECONOMIC EVALUATION:</b>				
- Base Case		680	520	Economic ranking: Devil Canyon Dam scheme is superior to tunnel scheme. Watana/Devil Canyon Dam plan is superior to the High Devil Canyon Dam/Vee Dam plan.
<b>SENSITIVITY ANALYSES:</b>				
- Load Growth	Low High	650 N.A.	210 1040	The net benefit of the Watana/Devil Canyon plan remains positive for the range of load forecasts considered. No change in ranking.
- Capital Cost Estimate		Higher uncertainty associated with tunnel scheme.	Higher uncertainty associated with H.D.C./Vee plan.	Higher cost uncertainties associated with higher cost schemes/plans. Cost uncertainty therefore does not affect economic ranking.
- Period of Economic Analysis	Period shortened to (1980 - 2010)	230	160	Shorter period of evaluation decreases economic differences. Ranking remains unchanged.
- Discount Rate	5% 8% (interpolated) 9%			
- Fuel Cost	80% basic fuel cost	As both the capital and fuel costs associated with the tunnel scheme and H.D.C./Vee Plan are higher than for Watana/Devil Canyon plan any changes to these parameters cannot reduce the Devil Canyon or Watana/Devil Canyon net benefit to below zero.		Ranking remains unchanged.
- Fuel Cost Escalation	0% fuel escalation 0% coal escalation			
- Economic Thermal Plant Life	50% extension 0% extension			

TABLE B.17 - ENVIRONMENTAL EVALUATION OF DEVIL CANYON DAM AND TUNNEL SCHEME

Environmental Attribute	Concerns	Appraisal (Differences in impact of two schemes)	Identification of difference	Appraisal Judgment	Scheme judged to have the least potential impact	
					Tunnel	DC
<b>Ecological:</b>						
- Downstream Fisheries and Wildlife	Effects resulting from changes in water quantity and quality.	No significant difference between schemes regarding effects downstream of Devil Canyon.	---	Not a factor in evaluation of scheme.		
		Difference in reach between Devil Canyon dam and tunnel re-regulation dam.	With the tunnel scheme controlled flows between regulation dam and downstream powerhouse offers potential for anadromous fisheries enhancement in this 11 mile reach of the river.	If fisheries enhancement opportunity can be realized the tunnel scheme offers a positive mitigation measure not available with the Devil Canyon Dam scheme. This opportunity is considered moderate and favors the tunnel scheme. However, there are no current plans for such enhancement and feasibility is uncertain. Potential value is therefore not significant relative to additional cost of tunnel.	X	
<b>Resident Fisheries:</b>	Loss of resident fisheries habitat.	Minimal differences between schemes.	Devil Canyon Dam would inundate 27 miles of the Susitna River and approximately 2 miles of Devil Creek. The tunnel scheme would inundate 16 miles of the Susitna River.	Loss of habitat with dam scheme is less than 5% of total for Susitna main stem. This reach of river is therefore not considered to be highly significant for resident fisheries and thus the difference between the schemes is minor and favors the tunnel scheme.	X	
<b>Wildlife:</b>	Loss of wildlife habitat.	Minimal differences between schemes.	The most sensitive wildlife habitat in this reach is upstream of the tunnel re-regulation dam where there is no significant difference between the schemes. The Devil Canyon Dam scheme in addition inundates the river valley between the two dam-sites resulting in a moderate increase in impacts to wildlife.	Moderate wildlife populations of moose, black bear, weasel, fox, wolverine, other small mammals and songbirds and some riparian cliff habitat for ravens and raptors, in 11 miles of river, would be lost with the dam scheme. Thus, the difference in loss of wildlife habitat is considered moderate and favors the tunnel scheme.	X	

TABLE B.17 (Continued)

Environmental Attribute	Concerns	Appraisal (Differences in Impact of two schemes)	Identification of difference	Appraisal Judgment	Scheme judged to have the least potential impact	
					Tunnel	DC
<u>Cultural:</u>	Inundation of archeological sites.	Potential differences between schemes.	Due to the larger area inundated the probability of inundating archeological sites is increased.	Significant archeological sites, if identified, can probably be excavated. Additional costs could range from several hundreds to hundreds of thousands of dollars, but are still considerably less than the additional cost of the tunnel scheme. This concern is not considered a factor in scheme evaluation.	-	-
<u>Land Use:</u>	Inundation of Devil Canyon.	Significant difference between schemes.	The Devil Canyon is considered a unique resource, 80 percent of which would be inundated by the Devil Canyon Dam scheme. This would result in a loss of both an aesthetic value plus the potential for white water recreation.	The aesthetic and to some extent the recreational losses associated with the development of the Devil Canyon Dam is the main aspect favoring the tunnel scheme. However, current recreational uses of Devil Canyon are low due to limited access. Future possibilities include major recreational development with construction of restaurants, marinas, etc. Under such conditions, neither scheme would be more favorable.	X	

OVERALL EVALUATION: The tunnel scheme has overall a lower impact on the environment.

TABLE B.18 - SOCIAL EVALUATION OF SUSITNA BASIN DEVELOPMENT SCHEMES/PLANS

Social Aspect	Parameter	Tunnel Scheme	Devil Canyon Dam Scheme	High Devil Canyon/Vee Plan	Watana/Devil Canyon Plan	Remarks
Potential non-renewable resource displacement	Million tons Beluga coal over 50 years	80	110	170	210	Devil Canyon Dam scheme potential higher than tunnel scheme. Watana/Devil Canyon plan higher than High Devil Canyon/Vee plan.
Impact on state economy	--	All projects would have similar impacts on the state and local economy.				Essentially no difference between plans/schemes.
Impact on local economy	--					
Seismic exposure	Risk of major structural failure	All projects designed to similar levels of safety.				
	Potential impact of failure on human life.	Any dam failures would effect the same downstream population.				
Overall Evaluation	<ol style="list-style-type: none"> <li>1. Devil Canyon Dam superior to tunnel.</li> <li>2. Watana/Devil Canyon superior to High Devil Canyon/Vee plan.</li> </ol>					

TABLE B.19 - ENERGY CONTRIBUTION EVALUATION OF THE DEVIL CANYON DAM AND TUNNEL SCHEMES

Parameter	Dam	Tunnel	Remarks
<u>Total Energy Production Capability</u>			
Annual Average Energy GWh	2850	2240	Devil Canyon dam annually develops 610 GWh and 540 GWh more average and firm energy respectively than the tunnel scheme.
Firm Annual Energy GWh	2590	2050	
<u>% Basin Potential Developed</u>			
	43	32	Devil Canyon scheme develops more of the basin potential.
<u>Energy Potential Not Developed GWh</u>			
	60	380	As currently envisaged, the Devil Canyon Dam does not develop 15 ft gross head between the Watana site and the Devil Canyon reservoir. The tunnel scheme incorporates additional friction losses in tunnels. Also the compensation flow released from re-regulation dam is not used in conjunction with head between re-regulation dam and Devil Canyon.

Notes:

- (1) Based on annual average energy. Full potential based on USBR four dam scheme.



TABLE B.20 - OVERALL EVALUATION OF TUNNEL SCHEME AND DEVIL CANYON DAM SCHEME

<u>ATTRIBUTE</u>	<u>SUPERIOR PLAN</u>
Economic	Devil Canyon Dam
Energy Contribution	Devil Canyon Dam
Environmental	Tunnel
Social	Devil Canyon Dam (Marginal)
Overall Evaluation	Devil Canyon Dam scheme is superior <u>Tradeoffs made:</u> Economic advantage of dam scheme is judged to outweigh the reduced environmental impact associated with the tunnel scheme.

TABLE B.21 - ENVIRONMENTAL EVALUATION OF WATANA/DEVIL CANYON AND HIGH DEVIL CANYON/VEE DEVELOPMENT PLANS

Environmental Attribute	Plan Comparison	Appraisal Judgment	Plan judged to have the least potential impact	
			HDC/V	W/DC
<u>Ecological:</u>				
1) Fisheries	<p>No significant difference in effects on downstream anadromous fisheries.</p> <p>HDC/V would inundate approximately 95 miles of the Susitna River and 28 miles of tributary streams, including the Tyone River.</p> <p>W/DC would inundate approximately 84 miles of the Susitna River and 24 miles of tributary streams, including Watana Creek.</p>	<p>Due to the avoidance of the Tyone River, lesser inundation of resident fisheries habitat and no significant difference in the effects on anadromous fisheries, the W/DC plan is judged to have less impact.</p>		X
2) Wildlife				
a) Moose	<p>HDC/V would inundate 123 miles of critical winter river bottom habitat.</p> <p>W/DC would inundate 108 miles of this river bottom habitat.</p> <p>HDC/V would inundate a large area upstream of Vee utilized by three sub-populations of moose that range in the northeast section of the basin.</p> <p>W/DC would inundate the Watana Creek area utilized by moose. The condition of this sub-population of moose and the quality of the habitat they are using appears to be decreasing.</p>	<p>Due to the lower potential for direct impact on moose populations within the Susitna, the W/DC plan is judged superior.</p>		X
b) Caribou	<p>The increased length of river flooded, especially upstream from the Vee damsite, would result in the HDC/V plan creating a greater potential division of the Nelchina herd's range. In addition, an increase in range would be directly inundated by the Vee reservoir.</p>	<p>Due to the potential for a greater impact on the Nelchina caribou herd, the HDC/V scheme is considered inferior.</p>		X
c) Furbearers	<p>The area flooded by the Vee reservoir is considered important to some key furbearers, particularly red fox. This area is judged to be more important than the Watana Creek area that would be inundated by the W/DC plan.</p>	<p>Due to the lesser potential for impact on furbearers the W/DC is judged to be superior.</p>		X
d) Birds and Bears	<p>Forest habitat, important for birds and black bears, exist along the valley slopes. The loss of this habitat would be greater with the W/DC plan.</p>	<p>The HDC/V plan is judged superior.</p>	X	
<u>Cultural:</u>	<p>There is a high potential for discovery of archeological sites in the easterly region of the upper Susitna basin. The HDC/V plan has a greater potential of affecting these sites. For other reaches of the river the difference between plans is considered minimal.</p>	<p>The W/DC plan is judged to have a lower potential effect on archeological sites.</p>		X

TABLE B.21 (Continued)

Environmental Attribute	Plan Comparison	Appraisal Judgment	Plan judged to have the least potential impact	
			HDC/V	W/DC
<u>Aesthetic/ Land Use</u>	With either scheme, the aesthetic quality of both Devil Canyon and Vee Canyon would be impaired. The HDC/V plan would also inundate Tsusena Falls.	Both plans impact the valley aesthetics. The difference is considered minimal.	-	-
	Due to construction at Vee damsite and the size of the Vee reservoir, the HDC/V plan would inherently create access to more wilderness area than would the W/DC plan.	As it is easier to extend access than to limit it, inherent access requirements were considered detrimental and the W/DC plan is judged superior. The ecological sensitivity of the area opened by the HDC/V plan reinforces this judgment.		X
<p>OVERALL EVALUATION: The W/DC plan is judged to be superior to the HDC/V plan.                      (The lower impact on birds and bears associated with HDC/V plan is considered to be outweighed by all the other impacts which favor the W/DC plan.)</p>				

NOTES:

W = Watana Dam  
 DC = Devil Canyon Dam  
 HDC = High Devil Canyon Dam  
 V = Vee Dam

TABLE B.22 - ENERGY CONTRIBUTION EVALUATION OF THE WATANA/DEVIL CANYON AND HIGH DEVIL CANYON/VEE PLANS

Parameter	Watana/ Devil Canyon	High Devil Canyon/Vee	Remarks
<u>Total Energy Production Capability</u>			
Annual Average Energy GWh	6070	4910	Watana/Devil Canyon plan annually develops 1160 GWh and 1650 GWh more average and firm energy, respectively, than the High Devil Canyon/Vee Plan.
Firm Annual Energy GWh	5520	3870	
<u>% Basin Potential Developed (1)</u>			
	91	81	Watana/Devil Canyon plan develops more of the basin potential
<u>Energy Potential Not Developed GWh (2)</u>			
	60	650	As currently conceived, the Watana/-Devil Canyon plan does not develop 15 ft of gross head between the Watana site and the Devil Canyon reservoir. The High Devil Canyon/Vee Plan does not develop 175 ft gross head between Vee site and High Devil reservoir.

Notes:

- (1) Based on annual average energy. Full potential based on USBR four dam schemes.
- (2) Includes losses due to unutilized head.

TABLE B.23 - OVERALL EVALUATION OF THE HIGH DEVIL CANYON/VEE AND  
WATANA/DEVIL CANYON DAM PLANS

ATTRIBUTE	SUPERIOR PLAN
Economic	Watana/Devil Canyon
Energy Contribution	Watana/Devil Canyon
Environmental	Watana/Devil Canyon
Social	Watana/Devil Canyon (Marginal)
Overall Evaluation	Plan with Watana/Devil Canyon is superior <u>Tradeoffs made:</u> None

TABLE B.24: COMBINED WATANA AND DEVIL CANYON OPERATION

Watana Dam Crest Elevation (ft MSL)	Watana <sup>1</sup> Cost (\$ x 10 <sup>6</sup> )	Devil Canyon <sup>1</sup> Cost (\$ x 10 <sup>6</sup> )	Total Cost (\$ x 10 <sup>6</sup> )	Average Annual Energy (Gwh)	
				Watana <sup>2</sup> Alone	Watana/Devil Canyon
2240 (2215 reservoir elevation)	4,076	1,711	5,787	3,542	6,809
2190 (2165 reservoir elevation)	3,785	1,711	5,496	3,322	6,586
2140 (2115 reservoir elevation)	3,516	1,711	5,227	3,071	6,264

Notes:

- (1) Estimated costs in January 1982 dollars, based on preliminary conceptual designs, including relict channel drainage blanket and 20 percent contingencies.
- (2) Prior to year 2002

TABLE B.25: PRESENT WORTH OF PRODUCTION COSTS

Watana Dam Crest Elevation (ft MSL)	Present Worth of Production Costs <sup>1</sup> (\$ x 10 <sup>6</sup> )
2240 (reservoir elevation 2215)	7,123
2190 (reservoir elevation 2165)	7,052
2140 (reservoir elevation 2115)	7,084

Notes:

- (1) LTPW in January 1982 dollars.

TABLE B.26: DESIGN PARAMETERS FOR DEPENDABLE CAPACITY AND ENERGY PRODUCTION

	<u>Watana</u>	<u>Devil Canyon</u>
Minimum stream flow (monthly average, cfs)	570 (March 1950)	664 (March 1964)
Mean streamflow	7,990	9,080
Maximum streamflow	42,840 (June 1964)	47,816 (June 1964)
Evaporation	Approximately cancels precipitation and is neglected. Section 4.1(f)	
Leakage	Negligible	Negligible
Minimum flow release	Table B.54	Table B.54
Flow duration curve	Figure B.62	Figure B.63
Critical streamflow for dependable capacity curve (Watana and Devil Canyon combined)	5,450 GWh annual potential recurrence frequency 1 in 32 years	
Area capacity curve	Figure B.67	Figure B.68
Rule curve	Figure B.69	Figure B.69
Hydraulic Capacity		
Flow (cfs) 1/2	1,775	1,895
full	3,550	3,790
best	2,900	3,100
Efficiency 1/2	87	87
full	91	91
best	94	94
Generator output (kW) 1/2	91,000	82,000
full	183,000	164,000
best	156,000	139,000
Tailwater rating curves	Figure B.67	Figure B.68
Powerplant capability vs head	Figure B.70	Figure B.73

TABLE B.27: WATANA - MAXIMUM CAPACITY REQUIRED (MW)  
 OPTION 1 - THERMAL AS BASE

Hydrological Year	CAPACITY (MW)		
	1995	2000	2010***
1	743	762	838*
2	550	569	680
3	760	779	836*
4	749	768	836*
5	744	763	868*
6	763	782	832*
7	737	756	838*
8	771	790	836**
9	799**	818**	825*
10	563	582	683*
11	769	788	832*
12	784*	803	829*
13	773	792	832*
14	771	790	838*
15	745	764	844*
16	550	569	840*
17	745	764	836*
18	554	573	684*
19	771	790	832*
20	550	569	685*
21	550	569	678
22	550	569	672
23	784*	803	834*
24	747	766	838*
25	550	569	684
26	550	569	678
27	728	747	839*
28	550	569	675
29	785*	804	833*
30	550	569	678
31	787*	806	837*
32	754	773	839*

\*Restricted by peak demand

\*\*Maximum value

\*\*\*Including Devil Canyon



TABLE B. 28: WATANA - MAXIMUM CAPACITY REQUIRED (MW)  
 OPTION 2 - THERMAL AS PEAK

Hydrological Year	CAPACITY (MW)		
	1995	2000	2010*
1	575	575	838
2	382	382	389
3	592	592	839
4	581	581	836
5	576	576	868
6	595	595	832
7	569	569	838
8	603	603	836
9	631	631	825
10	395	365	391
11	601	601	832
12	616	616	829
13	605	605	832
14	603	603	838
15	577	577	844
16	382	382	840
17	577	577	836
18	386	386	392
19	603	603	832
20	382	382	393
21	382	382	386
22	382	382	380
23	616	626	834
24	579	579	838
25	382	382	392
26	382	382	386
27	560	560	839
28	382	382	383
29	617	617	833
30	382	382	387
31	619	619	837
32	586	586	839

\*Including Devil Canyon

TABLE B29: SUMMARY COMPARISON OF POWERHOUSES AT WATANA

Item	SURFACE		UNDERGROUND	
	(\$000)		(\$000)	
	4 x 210 MW	4 x 210 MW	4 x 210 MW	6 x 140 MW
Civil Works:				
Intakes	54,000	54,000	54,000	70,400
Penstocks	72,000	22,700	22,700	28,600
Powerhouse/Draft Tube	29,600	26,300	26,300	28,100
Surge Chamber	NA	4,300	4,300	4,800
Transformer Gallery	NA	2,700	2,700	3,400
Tailrace Tunnel	NA	11,000	11,000	11,000
Tailrace Portal	NA	1,600	1,600	1,600
Main Access Tunnels	NA	8,100	8,100	8,100
Secondary Access Tunnels	NA	300	300	300
Main Access Shaft	NA	4,200	4,200	4,200
Access Tunnel Portal	NA	100	100	100
Cable Shaft	NA	1,500	1,500	1,500
Bus Tunnel/Shafts	NA	1,000	1,000	1,200
Fire Protection Head Tank	NA	400	400	400
Mechanical - For Above Items	54,600	55,500	55,500	57,200
Electrical - For Above Items	37,400	37,600	37,600	41,200
Switchyard - All Work	14,900	14,900	14,900	14,900
TOTAL	262,500	246,200	246,200	277,000

TABLE B.30: DESIGN DATA AND DESIGN CRITERIA FOR FINAL REVIEW OF LAYOUTS

River Flows

Average flow (over 30 years of record):	7,860 cfs
Probable maximum flood (routed):	326,000 cfs
Maximum inflow with return period of 1:10,000 years:	156,000 cfs
Maximum 1:10,000-year routed discharge:	115,000 cfs
Maximum flood with return period of 1:500 years:	116,000 cfs
Maximum flood with return period of 1:50 years:	87,000 cfs
Reservoir normal maximum operating level:	2215 ft
Reservoir minimum operating level:	2030 ft

Dam

Type:	Rockfill
Crest elevation at point of maximum super elevation:	2240 ft
Height:	890 ft above foundation
Cutoff and foundation treatment:	Core founded on rock; grout curtain and downstream drains
Upstream slope:	2.4H:1V
Downstream slope:	2H:1V
Crest width:	50 ft

Diversion

Cofferdam type:	Rockfill
Cutoff and foundation:	Slurry trench to bedrock
Upstream cofferdam crest elevation:	1585 ft
Downstream cofferdam crest elevation:	1475 ft
Maximum pool level during construction:	1580 ft
Tunnels:	Concrete-lined,
Final closure:	Mass concrete plugs
Releases during Impounding:	6,000 cfs maximum via bypass to outlet structure

Spillway

Design floods:	Passes PMF, preserving integrity of dam with no loss of life
	Passes routed 1:10,000-year flood with no damage to structures
Main spillway - Capacity:	Routed 1:10,000-year flood with 5 ft surcharge
- Control structure:	Gated ogee crests
Emergency spillway - Capacity:	PMF minus 1:10,000 year flood
- Type:	Fuse plug

Power Intake

Type:	Reinforced concrete
Number of Intakes:	6
Draw-off requirements:	Multi-level corresponding to temperature strata
Drawdown:	185 feet

TABLE B. 30: (Cont'd)

Penstocks

Type: Concrete-lined tunnels with downstream steel liners  
Number of penstocks: 6

Powerhouse

Type: Underground  
Transformer area: Separate gallery  
Control room and administration: Surface  
Access - Vehicle: Rock tunnel  
- Personnel: Elevator from surface

Power Plant

Type of turbines: Francis  
Number and rating: 6 x 170 MW  
Rated net head: 690 ft  
Design flow: 3,500 cfs per unit  
Normal maximum gross head: 745 ft  
Type of generator: Vertical synchronous  
Rated output: 190 MVA  
Power factor: 0.9  
Frequency: 60 HZ  
Transformers: 13.8-345 kV, 3-phase

Tailrace

Water passages: 2 concrete-lined tunnels  
Surge: Separate surge chambers  
Average tailwater elevation (full generation): 1458 ft

Note:

Certain design data and criteria have been revised since date of layout review.  
For current project parameters refer to Exhibit F, Preliminary Design Report.

TABLE B.31: EVALUATION CRITERIA

<u>PRELIMINARY REVIEW</u>	<u>INTERMEDIATE REVIEW</u>	<u>FINAL REVIEW</u>
Technical feasibility	Technical feasibility	Technical feasibility
Compatibility of layout with known geological and topographical site features	Compatibility of layout with known geological and topographical site features	Compatibility of layout with known geological and topographical site features
Ease of construction	Ease of construction	Ease of construction
Physical dimensions of component structures in certain locations	--	--
Obvious cost differences of comparable structures	Overall cost	Overall cost
Environmental acceptability	Environmental acceptability	Environmental impact

TABLE B.32: SUMMARY OF COMPARATIVE COST ESTIMATES

INTERMEDIATE REVIEW OF ALTERNATIVE ARRANGEMENTS  
(January 1982 \$ x 10<sup>6</sup>)

	<u>WP1</u>	<u>WP2</u>	<u>WP3</u>	<u>WP4</u>
Diversion	101.4	112.6	101.4	103.1
Service Spillway	128.2	208.3	122.4	267.2
Emergency Spillway	-	46.9	46.9	-
Tailrace Tunnel	13.1	13.1	13.1	8.0
Credit for Use of Rock in Dam	<u>(11.7)</u>	<u>(31.2)</u>	<u>(18.8)</u>	<u>(72.4)</u>
Total Non-Common Items	231.0	349.7	265.0	305.9
Common Items	<u>1643.0</u>	<u>1643.0</u>	<u>1643.0</u>	<u>1643.0</u>
Subtotal	1874.0	1992.7	1908.0	1948.9
Camp & Support Costs (16%)	<u>299.8</u>	<u>318.8</u>	<u>305.3</u>	<u>311.8</u>
Subtotal	2173.8	2311.5	2213.3	2260.7
Contingency (20%)	<u>434.8</u>	<u>462.3</u>	<u>442.7</u>	<u>452.1</u>
Subtotal	2608.6	2773.8	2656.0	2712.8
Engineering and Administration (12.5%)	<u>326.1</u>	<u>346.7</u>	<u>332.0</u>	<u>339.1</u>
TOTAL	2934.7	3120.5	2988.0	3051.9

TABLE B.33: DEVIL CANYON - MAXIMUM CAPACITY REQUIRED (MW)

Hydrological Year	Capacity (MW)
	2010 (Option 1 and 2)
1	544**
2	353
3	546
4	546
5	514
6	548
7	544
8	546
9	557
10	351
11	548
12	551
13	548
14	544
15	538
16	542
17	546
18	350
19	550
20	349
21	355
22	361
23	548
24	544
25	349
26	355
27	543
28	359
29	549
30	355
31	545
32	543

\*\*Maximum Value

TABLE B.34: DESIGN DATA AND DESIGN CRITERIA FOR  
REVIEW OF ALTERNATIVE LAYOUTS

River Flows

Average flow (over 30 years of record):	8,960 cfs
Probable maximum flood:	346,000 cfs
Max. flood with return period of 1:10,000 years:	165,000 cfs (after routing through Watana)
Maximum flood with return period of 1:500 years:	-
Maximum flood with return period of 1:50 years:	42,000 cfs (after routing through Watana)

Reservoir

Normal maximum operating level:	1455 feet
Reservoir minimum operating level:	1430 feet
Area of reservoir at maximum operating level:	21,000 acres
Reservoir live storage:	180,000 acre-feet
Reservoir full storage:	1,100,000 acre-feet

Dam

Type:	Concrete arch
Crest elevation:	1455 feet
Crest length:	-
Maximum height above foundation:	635 feet
Crest width:	20 feet

Diversion

Cofferdam types:	Rockfill
Upstream cofferdam crest elevation:	960 feet
Downstream cofferdam crest elevation:	900 feet
Maximum pool level during construction:	955 feet
Tunnels:	Concrete-lined
Outlet structures:	Low-level structure with slide closure gate
Final closure:	Mass concrete plugs in line with dam grout curtain
Releases during impounding:	2,000 cfs min. via fixed-cone valves

Spillway

Design floods:	Passes PMF, preserving integrity of dam with no loss of life
	Passes routed 1:10,000-year flood with no damage to structures
Service spillway - capacity:	45,000 cfs
- control structure:	Fixed-cone valves
- energy dissipation:	Five 108-inch diameter fixed-cone valves
Secondary spillway - capacity:	90,000 cfs
- control structure:	Gated, ogee crests
- energy dissipation:	Stilling basin
Emergency spillway - capacity:	pmf minus routed 1:10,000-year flood
- type:	Fuse plug



TABLE B. 34: (Cont'd)

Power Intake

Type:	Underground
Transformer area:	Separate gallery
Access:	Rock Tunnel
Type of turbines:	Francis
Number and rating:	4 x 140 MW
Rated net head:	550 feet
Maximum gross head:	565 feet approx.
Type of generator:	Vertical synchronous
Rated output:	155 MVA
Power factor:	0.9

Note:

Certain design data and criteria have been revised since date of layout review.  
For current project parameters refer to Exhibit F, Preliminary Design Report.

TABLE B.35: SUMMARY OF COMPARATIVE COST ESTIMATES

PRELIMINARY REVIEW OF ALTERNATIVE ARRANGEMENTS  
(January 1982 \$ X 10<sup>6</sup>)

<u>Item</u>	<u>DC1</u>	<u>DC2</u>	<u>DC3</u>	<u>DC4</u>
Land Acquisition	22.1	22.1	22.1	22.1
Reservoir	10.5	10.5	10.5	10.5
Main Dam	468.7	468.7	468.7	468.7
Emergency Spillway	25.2	25.2	25.2	25.2
Power Facilities	211.7	211.7	211.7	211.7
Switchyard	7.1	7.1	7.1	7.1
Miscellaneous Structures	9.5	9.5	9.5	9.5
Access Roads & Site Facilities	28.4	28.4	28.4	28.4
Common Items - Subtotal	<u>783.2</u>	<u>783.2</u>	<u>783.2</u>	<u>783.2</u>
Diversion	32.1	32.1	32.1	34.9
Service Spillway	46.8	53.3	50.1	85.2
Saddle Dam	19.9	18.6	18.6	19.9
Non-Common/Items Subtotal	<u>98.8</u>	<u>104.0</u>	<u>100.8</u>	<u>140.0</u>
Total	882.0	887.2	884.0	923.2
Camp & Support Costs (16%)	141.1	141.9	141.4	147.7
Subtotal	<u>1023.1</u>	<u>1029.1</u>	<u>1025.4</u>	<u>1070.9</u>
Contingency (20%)	204.6	205.8	205.1	214.2
Subtotal	<u>1227.7</u>	<u>1234.9</u>	<u>1230.5</u>	<u>1285.1</u>
Engineering & Administration (12.5%)	153.5	154.3	153.8	160.6
Total	<u>1381.2</u>	<u>1389.2</u>	<u>1384.3</u>	<u>1445.7</u>

TABLE B.36: POWER TRANSFER REQUIREMENTS (MW)

Year	INSTALLED CAPACITY			TRANSFER REQUIREMENT	
	Watana	Devil Canyon	Total Susitna	Susitna to Anchorage	Susitna to Fairbanks
1993	680	--	680	578	170
1994	1020	--	1020	867	255
2002	1020	600	1620	1377	405

TABLE B.37: SUMMARY OF LIFE CYCLE COSTS

TRANSMISSION ALTERNATIVE	1	2	3	4	5
Transmission Lines	1981 \$ x 10 <sup>6</sup>				
Capital	\$156.70	\$159.51	\$133.96	\$140.94	\$159.27
Land Acquisition	18.73	20.79	18.07	20.13	18.65
Capitalized Annual Charges	127.34	130.14	107.43	112.83	126.91
Capitalized Line Losses	<u>53.07</u>	<u>54.50</u>	<u>64.51</u>	<u>65.82</u>	<u>42.82</u>
Total Transmission Line Cost	\$355.84	\$364.94	\$323.97	\$339.72	\$347.65
Switching Stations					
Capital	\$114.09	\$106.40	\$128.32	\$120.64	\$154.75
Capitalized Annual Charges	<u>121.02</u>	<u>113.30</u>	<u>135.94</u>	<u>128.22</u>	<u>165.02</u>
Total Switching Station Cost	<u>235.11</u>	<u>219.70</u>	<u>264.26</u>	<u>248.86</u>	<u>319.77</u>
TOTAL	<u>\$590.95</u>	<u>\$584.64</u>	<u>\$588.23</u>	<u>\$588.58</u>	<u>\$667.42</u>

TABLE B.38: TECHNICAL, ECONOMIC, AND ENVIRONMENTAL CRITERIA  
USED IN CORRIDOR SELECTION

Type	Criteria	Selection
1. Technical - Primary	General Location	Connect with Intertie near Gold Creek, Willow, and Healy. Connect Healy to Fairbanks. Connect Willow to Anchorage.
	Elevation	Avoid mountainous areas.
	Relief	Select gentle relief.
	Access	Locate in proximity to existing transportation corridors to facilitate maintenance and repairs.
- Secondary	River Crossings	Minimize wide crossings.
2. Economical - Primary	Elevation	Avoid mountainous areas.
	Access	Locate in proximity to existing transportation corridors to reduce construction costs.
- Secondary	River Crossings	Minimize wide crossings.
	Timbered Areas	Minimize such areas to reduce clearing costs.
	Wetlands	Minimize crossings which require special designs.
3. Environmental		
- Primary	Development	Avoid existing or proposed developed areas.
	Existing Transmission Right-of-Way	Parallel.
	Land Status	Avoid private lands, wildlife refuges, parks.
	Topography	Select gentle relief.
- Secondary	Vegetation	Avoid heavily timbered areas.

TABLE B.39: ENVIRONMENTAL INVENTORY - SOUTHERN STUDY AREA  
(WILLOW TO ANCHORAGE/POINT MACKENZIE)

	AB	BC	Corridor Segment ADF	AEF	FC
Length (miles)	38	35	26	27	12
Number of Road Crossings	2 hwy (Rt. 3, Glenn), 6 light duty roads, 1 unimproved road, 2 trails, 1 railroad	4 hwy (Glenn, 4x), 3+ light duty roads, 7 unimproved roads, 1 trail, several railroads	1 hwy (Rt. 3), 3 tractor trails	1 hwy (Parks), 1 tractor trail	2 tractor trails
Number of River/Creek Crossings	1 river, 17 creeks	4 rivers, 11 creeks	1 river, 6 creeks	1 river, 6 creeks	2 creeks
Topography	Willow (100'), crosses Willow Ck., follows Deception Ck. (1000') along ridge of Talkeetna Mts., s.e. into Palmer (200')	Palmer (200'), crosses Knik River to base at Chugach Mts. (500'), along Knik Arm (200'-300'), to Anchorage (200')	Willow (100'), s. along Susitna River plains (flat, wet area, with drier, raised levees, 200'-400'), to F at 150'	Willow (100'), s. along flat wet area (200'-400'), to F at about 150'	F at 150' along flats to C near sea level
Soils <sup>1</sup>	Willow to near Palmer-S04, Palmer-E01	Palmer-E01, Knik Arm-EF1, s. of Eklutna to n. of Anchorage-S05, Anchorage - S04	Willow-S04, s. of Willow to F-S01	Near L. Susitna River - S05, Remainder-S04	Near F - S04, Near C - S01
Land Ownership/ <sup>2</sup> Status	A to s. of Willow Ck. Rd. crossing-mostly P, with some BAP and some SP;... to due n. of Wasilla-mainly SPTA;... to B-mostly P, with some BAP and SP	B to Knik R. - P; ... to Birchwood-mainly VS with some SPTA, P and BAP; Birchwood area-P; s.w. of Birchwood to near C'-U.S. Army Military Wdl.; C'-DATA VOID	Near A-P; route fairly even mix of BAP and SPTA; some P near Fish Ck; area surrounding L Susitna R - Susitna Flats Game Refuge; near F-SPTA	A, s. to Rainbow L. - mostly P, small parcels BAP; State selected Fed. parcel w. of Willow L.; s. to L. Susitna R. - Nancy Lake State Rec. Area; to F - mix of SPTA and BAP	F to 1 mi. s.-SPTA;... s. to Horseshoe L.-Pt. MacKenzie Agr. Sale;... s. to C-mainly SPTA, some BAP
Existing/Proposed Developments	Ag. uses n. & w. of Palmer; ag/res. use near L. Susitna; proposed capital site; mixed res. area at Willow Ck.; Willow air strip; cabin near A	Urban uses in Anch.; passes through/near several communities: Eagle R, Birchwood, Eklutna, Chugiak, Peters Ck.	Red Shirt Lake-mixed residential use; near residential & recr. areas s.w. of Willow; Susitna Flats State Game Refuge	Mixed res. areas; lakes used to land float planes	Scattered residential/cabins on Horseshoe Lake; proposed ag. uses in area
Existing Rights-of-Way	Follows no known right-of-way for appreciable distance	Parallels trans. line Knik R. to Anch.; parallels Glenn Hwy. from Knik R. to Birchwood; parallels RR-Eagle to C'	Generally parallels a tractor trail	No known	Generally follows a tractor trail
Scenic Quality/ Recreation	Gooding L. - bird-watching; rec. trails e. of Willow-hunting, hiking, x-c skiing, dog sledding, snowmobiling, snowshoeing; rec. trail by Decep. Ck. - snowmobiling, dog sledding, fishing	Passes near 2 camping grounds; parallels Iditarod racing trail (x-c skiing, sledding, snowmobiling); birdwatching at Eklutna Flats and Matunuska River	X-c ski & snowmobile trails; recreation area s.w. of Willow	Mixed rec. areas; Nancy Lake State Rec. area; trails and multiple uses; may cross Goose Bay St. Game Refuge	May cross Susitna Flats State Wildlife Refuge
Cultural Resources <sup>3</sup>	DATA VOID	DATA VOID	DATA VOID	DATA VOID	DATA VOID

TABLE B.39 (Cont'd)

	AB	BC	Corridor Segment ADF	AEF	FC
Vegetation <sup>4</sup>	Upland, mixed deciduous-conifer forests (birch-spruce) - open and closed mostly. Tall shrub (alder); some woodland black spruce; bogs along Deception Ck.	Deciduous forest (balsam poplar) along river, probably birch/spruce forests on uplands in most of area. DATA VOID	Higher grounds: Spruce-birch-poplar forests. Wet sedge grass bogs and black spruce forests prevalent in lower half	Upper half; mostly upland birch, spruce & aspen. Lower half: wet sedge-grass bogs and black spruce; some birch, spruce; aspen on higher ground	Spruce forests, spruce-birch forests, sedge-grass bogs and black spruce bogs
Fish Resources <sup>5</sup>	Willow Ck. - chinook salmon, grayling, burbot, longnose sucker, round whitefish, Dolly Varden, slimy sculpin, lake trout & rainbow trout in lakes; L. Susitna R. - king salmon; Decep. Ck. - king, pink salmon	Sockeye, chinook, pink, shum, coho salmon in large rivers; grayling burbot, longnose sucker, round whitefish, Dolly Varden, slimy sculpin, lake and rainbow trout in lakes & stream; salmon of particular significance in the Matanuska and Knik Rivers	Willow Ck. - chinook salmon; lake and rainbow trout possible in some lakes; also, in streams are grayling, burbot, longnose sucker, round whitefish, Dolly Varden, slimy sculpin; Red Skirt L. - lake trout, sockeye salmon	Lakes may contain rainbow and lake trout; possibly grayling in the region	Lake may contain rainbow and lake trout; possibly grayling in the region
Birds <sup>6</sup>	DATA VOID	Waterfowl and shore bird nesting areas around Knik Arm and Eagle River Flats	Waterfowl and shore bird nesting in Willow Creek/Delta Islands	Same as ADF	Waterfowl and shore bird migration route, feeding and nesting area
Furbearers <sup>6</sup>	DATA VOID	DATA VOID	DATA VOID	Same as ADF	Furbearer and small mammal summer/winter range
Big Game <sup>6</sup>	Except near Palmer-black bear summer range, moose winter/summer range, migrating corridors and calving area; near A also brown bear summer range and feeding area	DATA VOID	Brown and black bear feeding moose winter/summer range and calving area	Same as ADF	Black bear summer range and feeding area; moose winter/summer range, feeding and calving area

## NOTES:

- (1) Source: United States Department of Agriculture, Soil Conservation Service 1979. See Table B.43 for explanation of soil units.
- (2) Source: CIRI/Holmes and Narver. 1980. P=Private, SPTA=State Patented or Tentatively Approved, SP=State Patented, BAP=Borough Approved or Patented.
- (3) Coastal area probably has many sites, available literature not yet reviewed.
- (4) Tall shrub=alder; low shrub=dwarf birch, and/or willow; open spruce=black (wet) cover, mixed forest=spruce-birch.
- (5) Little data available. Source of information in this table: Alaska Department of Fish and Game 1978a.
- (6) Little data available. Source of information in this table: Alaska Department of Fish and Game 1978b.

TABLE B.40: ENVIRONMENTAL INVENTORY - CENTRAL STUDY AREA  
(DAMSITES TO INTERTIE)

Corridor Segment	Approx. Length (Miles)	Approx. # Road Crossings	Approx. # River/Creek Crossings	Topography	Soils <sup>a</sup>	Land Ownership/Status <sup>b</sup>
AB	7	0	5 creeks	Moderate sloping s. rim of Susitna R. Valley; crosses deep ravine at Fog Ck. at about 2000' contour	S015	VS
BC	18	0	8 creeks	2000' contour along s. rim of Susitna River; crosses 3 steep gorges	B, westward- S015; near C - S010	VS
CD	15	1+	1 river 4 creeks	Moderately sloping terrain; crosses Susitna R. near Gold Creek (800')	OS10	C to 1 1/2 mi. e. of Susitna R. - VS; Susitna R. to 1 1/2 mi. e. - SPTA; ... to D-P
BEC	23	0	8 creeks	Crosses moderate slopes around Stephan Lake; w., then n. to avoid deep ravine at Cheechako Ck., then follows s. rim of Susitna at about 2000'	8, westward - OS15; IU3; near C - S010	VS except where corridor skirts Cheechako Ck. ravine, which is classified SS Suspended
AJ	18	0	11 creeks	A (about 2000') to 3500'; crosses deep ravine at Devil Ck. (2000'); goes by several ponds	A, westward - OS15; remainder, except J - OS16; near J - S010	SS except at J and at A westward across Tsusena Ck., which are VS
JC	8	0	1 creek	J (2000'), s.w. through gently sloping High Lake area, to C at Devil Canyon (2000')	OS10	SS except at J and C which are VS
CF	15	0	2 creeks	Devil Canyon (<2000') west across 600' deep Portage Creek gorge, w. across gentle terrain to F (1200')	S010	C to 1 1/2 mi. e. of Miami L. mainly VS with small parcel of SS; ... to F-P
AG	65	0	1 river 35 creeks	A (2000'), n. along Deadman Ck. to 3200'; crosses Brushkana drainage (at 3200'); drops to Nenana River (2400') and fairly flat terrain to G (2200')	Near A and along Denali Hwy. - OS15; through mts. - S016	A - VS; n. of A to s.w. of Big L. - SS; ... to s. of Deadman L. - SPTA ... to Denali Hwy - Fed. D-1 Land; data void for 8 mi.; around G - Small Fed. Parcel
AH	22	0	9 creeks	A (2000'), along Tsusena Ck. past Tsusena Butte; through mt. pass at 3600'	Near A - S015; mt. base - S016; mts. - RM1	A - VS, ... to n. of Tsusena Butte SS; data void beyond here
HI	21	0	15 creeks	H (3400') through mts.; along Jack R. drainage and Caribou Pass; to I at 2400'	Mts. - RM1; along hwy - S015	I - VS; data void to east
HJ	23	0	13 creeks	H (3400') through mts. along Portage Ck. drainage, through pass at 3600' into Devil Creek drainage; to J at 2000'	Near J - S016 mid elevations- S017; mts. - RM1	J - VS; Devil Ck drainage - SS; data void beyond here

a. Source: United States Department of Agriculture, Soil Conservation Service 1979. See Table B.42 for explanation of soil units.

b. Source: CIRI/Holmes and Narver, 1980. P=Private, SPTA=State Patented or Tentatively Approved, SS=State Selection, VS=Village Selection.

TABLE B.40 (Cont'd)

Corridor Segment	Fish Resources <sup>a</sup>	Birds	Furbearers	Big Game
AB	Fog Lakes - Dolly Varden, sculpin; Stephan Lake contains lake and rainbow trout, sockeye & coho salmon, whitefish, longnose sucker, grayling; burbot	Potential raptor nesting habitat in Fog Creek area	Excellent fox and marten habitat; Fog Lakes support numerous beavers and muskrat, otters common	Supports large pop. of moose; wolves, wolverine and bear, (especially brown) common; caribou regularly use area
BC	Several small tributaries crossed, perhaps used by grayling	Potential raptor nesting habitat along Devil Canyon	Excellent fox and marten habitat	Area around Stephan Lake & Prairie Ck. supports large pop. of moose; wolves, wolverines, and some bear (especially brown) common; caribou regular users
CD	Same as BC	Potential raptor nesting habitat along Devil Canyon	Area around Devil Canyon has excellent fox and marten habitat	Moose, caribou, and bear habitat
BEC	Several small tributaries crossed, perhaps used by grayling, burbot	Potential raptor nesting habitat along Devil Canyon and along drainages upstream; Stephan Lake area important to waterfowl and migrating swans	Excellent fox and marten habitat, particularly around Stephan Lake	Same as AB
AJ	Dolly Verden; grayling in Tsusena Creek	Data void	Red fox denning sites, numerous beaver, muskrat and mink, especially around High Lake	Mouth of Tsusena Ck. important moose habitat; heavily used by black and brown bear
JC	Burbot; no data for High Lake	Potential raptor hab. by Devil Canyon; golden eagle nest along Devil Ck. s. of confluence of ck. from High Lake	Same as AJ	Important moose and bear habitat; data void
CF	Portage Creek has king, chinook, chum and pink salmon, grayling, burbot	Potential raptor habitat along lower Portage Ck. and from Portage Ck. mouth through Devil Canyon	Area between Parks Hwy and Devil Canyon supports numerous beaver, muskrat, and mink	Probably important moose wintering area and black bear habitat; at least one wolf pack
AG	Dolly Varden; lakes - lake trout, grayling, whitefish; tributaries to Nenana River and Brushkana Creek n. of Deadman Mt., and Jack R. near Denali Hwy considered fish habitat	Waterfowl numerous at Deadman Lake; important bald eagle habitat by Denali Hwy and Nenana R. just w. of Monahan Flat; unchecked bald eagle nest along Deadman Ck., s.e. of Tsusena Butte	Population relatively low, although beaver, mink, fox present; Deadman Mt. to Denali Hwy - moderate pop. red fox	Probably important area for caribou, especially in the north
AH	Dolly Varden; grayling	Known active bald eagle nest s.e. of Tsusena Butte	Population along Tsusena Ck. probably relatively low; with beaver, mink, and fox probably present	Data void
HI	Lake trout, Caribou Pass area; Jack River s. of Caribou Pass considered important fish habitat; data void	Data void	Data void	Data void
HJ	Portage Creek - king, chinook, chum, and pink salmon, grayling, burbot	Data void	Numerous beaver, muskrat, and mink around High Lake	Data void

a. Little data available. Sources of information in this table: Alaska Department of Fish and Game 1978a, Friese 1975, and Morrow 1980.



TABLE B.41: ENVIRONMENTAL INVENTORY - NORTHERN STUDY AREA  
(HEALY TO FAIRBANKS)

	Corridor Segment					
	AB	BC	BDC	AE	EDC	EF
Length (miles)	40	50	46	65	50	40
Number of Road Crossings	2 hwy (Park), 3 trails (1 winter), 2 unimproved rds., 1 rail-road	Parks Highway, 1 winter trail	1 winter trail	1 hwy. (Parks), 1 trail	7 trails	Several roads in Fairbanks depending upon exact route; 3 trails
Number of River/Creek Crossings	3 rivers, 15 creeks	1 river, 25 creeks	2 rivers, 29 creeks	1 river 50 creeks <sup>1</sup>	2 rivers, 22 creeks	2 rivers, 10 creeks, Salchaket Slough
Topography	Follows Nenana River north at 1000' to Browne-crosses River; n.w. to Clear MEWS at 500'	Clear MEWS (500') north across plain (400'), n.e. across Tanana River Valley to Ester (600')	Clear MEWS (500'), n.e. across plain to a point about 24 mi. due s. of Ester; n. across plain to Tanana R. (400') and n. to Ester	Up Healy Ck. to pass at 4500'; down Wood R. drainage to Japan Hills (1100'); steep mts.; valleys	Japan Hills (1100') n.w. on plain along Wood R.; through Wood R. Buttes area, n. across Tanana R.; n. to Ester	Japan Hills (1100') n. across plain to Tanana R. (500'); n. to Fairbanks
Soils <sup>2</sup>	IR10	Near B-IR10; flats s. of Tanana River-IQ2; Tanana River-IQ3; Tanana R. to Ester-IR14	Near B-IR10, Remainder -IQ2	Near A-IR10; mt. base-IQ25; mt. area-RM1; near E-IR1	Near E-IR1; between E and open flats-IR10; open flats IQ2; Tanana R.-IQ3; Ester-IR14	Near E-IR1; s. section of flats-IR10; flats-IQ2; Fairbanks-IQ3
Land Ownership/ <sup>3</sup> Status	A to e. of Dry Ck. - small Fed. Parcel; ... to s. of Clear MEWS and at B-mostly SPTA, small parcels of P, small Fed. Nat. Allot. along Nenana R.; Clear MEWS area-parcel CIRI Selection, and U.S. Army Wdl. Land	B to 1-1/2 mi n. - SPTA; ... to s. to Tanana R. -SS; ... to Tanana R. -P; ... to crossing L. Goldstream Ck. -mostly SPTA; ... to Bonanza Ck. Crossing - SS; ... to near C-SP; remainder-DATA VOID	B area - SPTA; Fish Ck. to Tanana R. -data void remainder-SPTA, BAP with P at C and just n. of Tanana R.	A to Nenana R. -small Fed. Parcel; ... to e. of Gold Run-SPTA ... remainder-DATA VOID	Same as BDC north of the Tanana River	DATA VOID
Existing/Proposed Developments	Scattered residential and other uses along Parks Hwy; cabin near Browne; air strip at Healy	Scattered residential and other uses along Parks Hwy; cabin at Tanana R. crossing	Ft. Wainwright Mil. Reservation	Air strips-Healy and Cripple/Healy Cks. confluence; cabins-Cody Ck/Wood R., Snow Mt. Gulch	Ft. Wainwright Mil. Res.; Wood R. Butte VABM	Ft. Wainwright Mil. Res.; cabin-Wood R. crossing s. of Clear Butte
Existing Rights-of-Way	Generally parallels Parks Hwy, RR and trans. line-Healy to Browne	Follows w/in several mi. Parks Hwy, RR, and trans. line; more closely follows Parks Hwy. and trans. line and sled rd. n. of of Tanana R.	No known	Parallels small rd. - near Healy to Coal Ck.; small RR-Healy to Suntrana; trail at pass between Healy and Cody Cks.	No known	Parallels Bonnifield Trail -Clear Ck. Butte to Fairbanks; trans. line just s. of Fairbanks
Scenic Quality/Recreation	Parks Hwy-scenic area; rafting, kayaking on Nenana R.	Parks Hwy-scenic area; hunting, fishing	Wide open flat-high visibility; snow-mobiling in flats s. of Fairbanks	Scenic quality data void; Healy Ck. -rafting area	Wide open flats-high visibility; snow-mobiling in flats s. of Fairbanks	Wide open flats-high visibility
Cultural Resources	Dry Ck. arch. site near Healy; good possibility for other sites; DATA VOID	Good possibility for arch. sites; DATA VOID	Good possibility for arch. sites; DATA VOID	Dry Ck. arch. site near Healy; few arch. sites in mountains; maybe near Japan Hills; DATA VOID	High possibility for arch. sites; DATA VOID	Arch. sites have been identified for the Ft. Wainwright and Blair Lakes areas

TABLE B.41 (Cont'd)

	Corridor Segment					
	AB	BC	BDC	AE	EDC	EF
Vegetation <sup>4</sup>	Southern end-data void Northern end-low shrub, sedge-grass tundra	S. of Tanana River-wet old river floodplain, low shrub and sedge-grass bogs; Tanana R. crossing-willow and alder shrub types, white spruce, balsam poplar forests along river; n. of Tanana R. -open and closed deciduous (birch and aspen) forests on slopes, w/woodland spruce and bogs, low shrub, and wet sedge-grass on valley bottoms	Probably wet, low shrub, and sedge-grass, alder shrub, lowland spruce; n. of Tanana-upland deciduous forests	DATA VOID	Probably similar to BDC	Probably similar to EDC; wet
Fish Resources <sup>5</sup>	Grayling, burbot, long-nose sucker, Dolly Varden, round white-fish, slimy sculpin	Grayling, burbot, long-nose sucker, Dolly Varden, round white-fish, slimy sculpin, salmon (coho, king, chum), sheefish; lake chub possible	Same as BC	Same as AB	Same as AB, lake chub possible	Same as BC with the exception of coho salmon, which is not recorded
Birds <sup>6</sup>	Important golden eagle habitat near A	Prime peregrine habitat at Tanana R.; prime waterfowl habitat along Tanana R. s. of corridor	Near Totatlanika Ck. to Tanana R.-prime waterfowl habitat; near Wood R.-important raptor habitat; between D&C by Tanana R.-prime peregrine habitat	Important golden eagle habitat at A & along Healy Ck. s. of Usibelli Pk; prime peregrine habitat on Keevy Pk.	From Wood R. Buttes to n. of Tanana R.-prime waterfowl habitat; between D&C along the Tanana R.-prime peregrine habitat	N. of Blair Lake Air Force Range to the Tanana R.-prime waterfowl habitat; s. of Fairbanks along Tanana R.-prime bald eagle habitat
Furbearers <sup>6</sup>	Prime habitat-15 mi. from Nenana to B	Prime habitat-from Clear MEWS across the Tanana	Prime habitat from B to across Tanana Rive	Prime habitat from E to the s. about 15 mi.	Prime habitat from E to just n. of Tanana River	Prime habitat from E to Tanana River
Big Game <sup>6</sup>	From Nenana R. to B-prime moose and important black bear habitat; from A northward about 10 mi.-prime moose habitat	Clear MEWS to across Tanana R.-prime moose and important black bear habitat; n. of Bonanza Ck. Exp. Forest-prime black bear habitat	B to across Tanana R.-prime moose, important black bear habitat; Wood R. to just s. of the Tanana R.-prime black bear habitat	Usibelli to Japan Hills-prime moose & caribou habitat; between A & Mystic Mt.-prime sheep habitat; E to the s.-import. black bear habitat	E to just n. of Tanana R.-prime moose, important black bear habitat; Wood R. to just s. of Tanana R.-prime black bear	E to tanana R.-prime moose and important black bear habitat; Clear MEWS to Tanana R.-prime black bear habitat

## NOTES:

- (1) Assumes corridor is located on n. side of Healy Ck. for most of its length, n. side of Cody Ck., and n.w. side of Wood R.
- (2) Source: United States Dept. of Agriculture, Soil Conservation Service 1979. See Table B.42 for explanation of soil units.
- (3) Source: CIRI/Holmes and Narver. 1980. P=Private, SPTA=State Patented or Tentatively Approved; SP=State Patented; SS=State Selection, BAP=Borough Approved or Patented.
- (4) Tall shrub=alder; low shrub=dwarf birch, and/or willow; open spruce=black (wet) or white spruce, 25%-60% cover; woodland spruce=white or black spruce, 10%-25% ccover; mixed forest=spruce-birch.
- (5) Little data available. Sources of information in this table: Alaska Dept. of Fish and Game 1978a and Morrow 1980.
- (6) Source: VanBallenberghe personal communication. Prime habitat=minimum amount of land necessary to provide sustained yield for that species; based upon knowledge of that species' needs from experience of ADF&G personnel. Important habitat=land which the ADF&G considers not as critical to a species as is Prime habitat but is valuable.

TABLE B.42

SOIL ASSOCIATIONS WITHIN THE PROPOSED TRANSMISSION CORRIDORS -  
GENERAL DESCRIPTION, OFFROAD TRAFFICABILITY LIMITATIONS (ORTL), AND  
COMMON CROP SUITABILITY (CCS)<sup>a</sup>

- EF1 - Typic Gyofluvents - Typic Cryaquepts, loamy, nearly level
- Dominant soils of this association consist of well-drained, stratified, waterlaid sediment of variable thickness over a substratum of gravel, sand, and cobblestones. Water table is high in other soils, including the scattered muskegs. ORTL: Slight - Severe (wet; subject to flooding); CCS: Good - Poor (low soil temperature throughout growing season).
- E01 - Typic Cryorthents, loamy, nearly level to rolling
- This association occupies broad terraces and moraines; most of the bedrock is under thick deposits of very gravelly and sandy glacial drift, capped with loess blown from barren areas of nearby floodplains. Well-drained, these soils are the most highly developed agricultural lands in Alaska. ORTL: Slight; CCS: Good - Poor.
- IQ2 - Histic Pergelic Cryaquepts - loamy, nearly level to rolling
- The dominant soils in this association are poorly drained, developed in silty material of variable thickness over very gravelly glacial drift. Most soils have a shallow permafrost table, but in some of the very gravelly, well-drained soils, permafrost is deep or absent. ORTL: Severe - Wet; CCS: Poor
- IQ3 - Histic Pergelic Cryaquepts - Typic Cryofluvents, loamy, nearly level
- Soils of this association located in low areas and meander scars of floodplains are poorly drained silt loam or sandy loam; these are usually saturated above a shallow permafrost table. Soils on the natural levees along existing and former channels are well-drained, stratified silt loam and fine sand; permafrost may occur. ORTL: Severe (wet); CCS: Unsuitable (low temperature during growing season; wet) - Good (but subject to flooding).
- IQ25 - Pergelic Cryaquepts - Pergelic Cryochrepts, very gravelly, hilly to steep
- Soils of this association occupying broad ridgetops, hillsides, and valley bottoms at high elevation are poorly drained, consisting of a few inches of organic matter, a thin layer of silt loam, under which is very gravelly silt loam; permafrost table is at a depth greater than 2 feet. In locations of hills and ridges above tree line these soils are well-drained. ORTL: Severe (wet, steep slopes); CCS: Unsuitable (wet; low soil temperature; short, frost-free period).

a. Source: U.S. Department of Agriculture, Soil Conservation Service 1979. See Table B.43 for definitions for Offroad Trafficability Limitations and Common Crop Suitability.

TABLE B.42 (Cont'd)

- Soils of nearly level to undulating outwash plains are well-drained to excessively well-drained, formed in a mantle of silty loess over very gravelly glacial till. Soils of the association located in depressions are very poorly drained, organic soils. ORTL: Slight - Very Severe; CCS: Good - Unsuitable (wet, organic).
- S05 - Typic Cryorthods, very gravelly, hilly to steep - Sphagnum Borofibrists, nearly level
  - On the hills and plains, these soils, formed in a thin mantle of silty loess over very gravelly and stony glacial drift, are well drained and strongly acid. In muskegs, most of these soils consist of fibrous peat. ORTL: Severe (steep slope); CCS: Unsuitable (steep slopes; stones and boulders; short, frost-free season).
- S010 - Humic Cryorthods, very gravelly, hilly to steep
  - Generally, these are well-drained soils of foothills and deep mountain valleys, formed in very gravelly drift with a thin mantle of silty loess or mixture of loess and volcanic ash. These soils are characteristically free of permafrost except in the highest elevation. ORTL: Severe (steep slope); CCS: Poor - Unsuitable (low soil temperature throughout growing season; steep slopes).
- S015 - Pergelic Cryorthods - Histic Pergelic Cryaquepts, very gravelly, nearly level to rolling
  - On low moraine hills, these soils are well drained, formed in 10 to 20 inches of loamy material over very gravelly glacial drifts. On foot slopes and valleys, these soils tend to be poorly drained, with shallow permafrost table. ORTL: Slight - Severe (wet); CCS: Unsuitable (short, frost-free period; wet; stones and boulders).
- S016 - Pergelic Cryorthods very gravelly, hilly to steep - Histic Pergelic Cryaquepts, loamy, nearly level
  - On hilly moraines these soils are well-drained; beneath a thin surface of partially decomposed organic matter, the soils have spodic horizons developed in shallow silt loam over very gravelly or sandy loam. In valleys and long foot slopes, these are poorly drained soils, with a thick, peaty layer over a frost-churned loam or silt loam. Here, depth of permafrost is usually less than 20 inches below surface mat. ORTL: Severe (steep slope; wet); CCS: Unsuitable (short, frost-free period) - Poor (wet; low soil temperature).

TABLE B.43 (Cont'd)

- Fair

Soils or climate limitations need to be recognized but can be overcome. Common crops can be grown, but careful management and special practices may be required. On soils of this group --

- (a) Loamy texture extends to a depth of at least 10 inches (25 cm).
- (b) Periods of excessive soil moisture, which can impede crop growth during the growing season, do not exceed a total of 2 weeks.
- (c) Damage by flooding occurs no more frequently than 2 years in 10.
- (d) Slopes are dominantly less than 12 percent.
- (e) Periods of soil moisture deficiency are infrequent.
- (f) Damage to crops as a result of early frost can be expected no more frequently than 3 years in 10.
- (g) There is no more than a moderate hazard of wind erosion.

- Poor

Soils or climate limitations are difficult to overcome and are severe enough to make the use questionable. The choice of crops is narrow, and special treatment or management practices are required. In some places, overcoming the limitations may not be feasible. On soils of this group --

- (a) Loamy texture extends to a depth of at least 5 inches (12 cm).
- (b) Periods of excessive soil moisture during the growing season do not exceed a total of 3 weeks.
- (c) Damage by flooding occurs no more frequently than 3 years in 10.
- (d) Slopes are dominantly less than 20 percent.
- (e) Periods of soil moisture deficiency are frequent enough to severely damage crops.
- (f) Climatic conditions permit at least one of the common crops, usually grasses, to be grown successfully in most years.

TABLE B.45: ECONOMICAL AND TECHNICAL SCREENING  
CENTRAL STUDY AREA (DAM SITES TO INTERTIE)

	(1) ABCD	(2) ABECD	(3) AJCF	(4) ABCJHI	(5) ABECJHI	(6) CBAHI	(7) CEBAHI	(8) CBAG	(9) CEBAG	(10) CJAG	(11) CJAHJ	(12) JACJHI	(13) ABCF	(14)* AJCD	(15) ABECF
- Length	40	45	41	77	82	68	75	90	95	91	69	70	41	41	45
- Max. Elevation, ft.	2500	3600	3500	4300	4300	4300	3500	3300	3600	3500	3800	3900	2500	3500	3600
- Clearing Medium & Light	38	30	26	18	30	20	27	45	37	40	55	17	39	26	35
None	2	15	15	59	50	48	46	45	60	51	14	53	2	15	10
- Access New Roads	28	31	12	58	49	44	53	44	49	13	27	44	41	5	45
4-Wheel	12	12	29	8	8	3	3	46	46	78	23	26	0	36	0
- Tower Construction*	180	203	185	347	369	306	338	405	428	410	311	315	185	185	203
- Rating: Economic	C	C	C	F	F	C	F	F	F	F	C	F	C	A	C
Technical	A	C	C	F	F	F	C	C	C	C	C	C	C	A	C

A = recommended

C = acceptable but not preferred

F = unacceptable

\* Approximate number of towers required for this corridor,  
assuming single-circuit line.

TABLE B.47: SUMMARY OF SCREENING RESULTS

Corridor	R A T I N G S			Summary
	Env.	Econ.	Tech.	
- Southern Study Area				
(1) ABCI	C	C	C	C
(2) ADFC	A	A	A	A
(3) AEFC	F	C	A	F
- Central Study Area				
(1) ABCD	C	C	A	C
(2) ABECD	F	C	C	F
(3) AJCF	C	C	C	C
(4) ABCJHI	F	F	F	F
(5) ABECJHI	F	F	F	F
(6) CBAHI	F	C	F	F
(7) CEBAHI	F	F	C	F
(8) CBAG	F	F	C	F
(9) CEBAG	F	F	C	F
(10) CJAG	F	F	C	F
(11) CJAHI	F	C	C	F
(12) JACJHI	F	F	C	F
(13) ABCF	C	C	C	C
(14) AJCD	A	A	A	A
(15) ABECF	F	C	C	F
- Northern Study Area				
(1) ABC	A	A	A	A
(2) ABDC	C	A	C	C
(3) AEDC	F	C	F	F
(4) AEF	F	C	F	F

A = recommended  
 C = acceptable but not preferred  
 F = unacceptable

TABLE B.49: ENVIRONMENTAL CONSTRAINTS  
CENTRAL STUDY AREA (DAM SITES TO INTERTIE)

	1 (ABCD)	2 (ABECD)	Corridor Segment 3 (AJCF)	4 (ABCJHI)	5 (ABECJHI)
Length (miles)	40	45	41	77	82
Topography/Soils	Crosses several deep ravines; about 1000' change in elevation; some wet soils	Crosses several deep ravines; about 2000' change in elevation; some steep slopes; some wet soils	Crosses several deep ravines; about 2000' change in elevation; some steep slopes; some wet soils	Crosses several deep ravines; >2000' change in elevation; routing above 4000'; steep slopes; some wet soils; shallow bedrock in mts.	Crosses several deep ravines; changes in elevation >2000'; routing above 4000'; steep slopes; some wet soils; shallow bedrock in mts.
Land Use	Little existing ROW except Corps Rd.; mostly Village Selection and Private Lands	Little existing ROW except Corps Rd. and at D; rec. and resid. areas; float plane areas; mostly Village Selection and Private Lands	No existing ROW except at F; rec. areas; float plane areas; mostly Village Selection and Private Land; resid. & rec. development in area of Otter L. and old sled road	No existing ROW; rec. areas isolated cabins; lakes used by float planes; much Village Selection Land	Same as corridor 4
Aesthetics	Fog Lakes; Stephan Lake	Fog Lakes; Stephan Lake; proposed railroad extension; high country (Prairie & Chulitna Ck. drainages) and viewshed of Alaska Range	Viewshed of Alaska Range & High Lake; proposed access road	Fog Lakes; Stephan Lake; proposed access road; viewshed of Alaska Range	Fog Lakes; Stephan Lake; High Lake; proposed access road; viewshed of Alaska Range
Cultural Resources	Archeologic sites near Watana dam site, Stephan Lake and Fog Lakes; DATA VOID from Gold Ck. to Devil Canyon; historic sites near the communities of Gold Creek and Canyon	Same as Corridor 1	Archeologic sites by Watana dam site, & near Portage Ck./Susitna R. Confluence; possible sites along Susitna R.; historic sites near communities of Gold Ck. and Canyon	Archeologic sites near Watana dam site, Stephan L. and Fog Lakes; possible sites along pass between drainages, DATA VOID between H and I	Same as Corridor 4
Vegetation	Wetlands in eastern third of corridor; extensive forest-clearing needed	Wetlands in eastern half of corridor; extensive forest-clearing needed	Forest-clearing needed in western half	Small wetland areas in JA area; extensive forest-clearing needed; DATA VOID	Wetlands in JA and Stephan Lake areas; extensive forest-clearing needed
Fish Resources	1 river and 17 creek crossings; valuable spawning areas, especially grayling; DATA VOID	1 river and 17 creek crossings; valuable spawning areas, especially grayling; DATA VOID	14 creek crossing; valuable spawning areas, especially grayling and salmon; Indian River, Portage Creek, DATA VOID	1 river and 42 creek crossings; valuable spawning areas, especially grayling	42 creek crossings; valuable spawning areas, especially grayling and salmon; DATA VOID
Wildlife Resources	unidentified raptor nest located on trib. to Susitna; passes through, habitat for: raptors, furbearers, wolves, wolverine, brown bear, caribou	Passes through habitat for: raptors, waterfowl, migrating swans, furbearers, caribou, wolves, wolverine, brown bear	Golden eagle nest along Devil Ck. near High L.; active raven nest on Devil Ck.; passes through habitat for: raptors, furbearers, wolves, brown bear	Golden eagle nest along Devil Ck. near High L.; caribou movement area; passes through habitat for: raptors, waterfowl, furbearers, wolves, wolverine, brown bear	Same as Corridor 4 with important waterfowl and migrating swan habitat at Stephan Lake
Environmental Rating <sup>1</sup>	C	F	C	F	F

NOTES:

(1) A = recommended, C = acceptable but not recommended, F = unacceptable



TABLE B.49: ENVIRONMENTAL CONSTRAINTS  
CENTRAL STUDY AREA (DAM SITES TO INTERTIE)

	1 (ABCD)	2 (ABECD)	Corridor Segment 3 (AJCF)	4 (ABCJHI)	5 (ABECJHI)
Length (miles)	40	45	41	77	82
Topography/Soils	Crosses several deep ravines; about 1000' change in elevation; some wet soils	Crosses several deep ravines; about 2000' change in elevation; some steep slopes; some wet soils	Crosses several deep ravines; about 2000' change in elevation; some steep slopes; some wet soils	Crosses several deep ravines; >2000' change in elevation; routing above 4000'; steep slopes; some wet soils; shallow bedrock in mts.	Crosses several deep ravines; changes in elevation >2000'; routing above 4000'; steep slopes; some wet soils; shallow bedrock in mts.
Land Use	Little existing ROW except Corps Rd.; mostly Village Selection and Private Lands	Little existing ROW except Corps Rd. and at D; rec. and resid. areas; float plane areas; mostly Village Selection and Private Lands	No existing ROW except at F; rec. areas; float plane areas; mostly Village Selection and Private Land; resid. & rec. development in area of Otter L. and old sled road	No existing ROW; rec. areas isolated cabins; lakes used by float planes; much Village Selection Land	Same as corridor 4
Aesthetics	Fog Lakes; Stephan Lake	Fog Lakes; Stephan Lake; proposed railroad extension; high country (Prairie & Chulitna Ck. drainages) and viewshed of Alaska Range	Viewshed of Alaska Range & High Lake; proposed access road	Fog Lakes; Stephan Lake; proposed access road; viewshed of Alaska Range	Fog Lakes; Stephan Lake; High Lake; proposed access road; viewshed of Alaska Range
Cultural Resources	Archeologic sites near Watana dam site, Stephan Lake and Fog Lakes; DATA VOID from Gold Ck. to Devil Canyon; historic sites near the communities of Gold Creek and Canyon	Same as Corridor 1	Archeologic sites by Watana dam site, & near Portage Ck./Susitna R. Confluence; possible sites along Susitna R.; historic sites near communities of Gold Ck. and Canyon	Archeologic sites near Watana dam site, Stephan L. and Fog Lakes; possible sites along pass between drainages, DATA VOID between H and I	Same as Corridor 4
Vegetation	Wetlands in eastern third of corridor; extensive forest-clearing needed	Wetlands in eastern half of corridor; extensive forest-clearing needed	Forest-clearing needed in western half	Small wetland areas in JA area; extensive forest-clearing needed; DATA VOID	Wetlands in JA and Stephan Lake areas; extensive forest-clearing needed
Fish Resources	1 river and 17 creek crossings; valuable spawning areas, especially grayling; DATA VOID	1 river and 17 creek crossings; valuable spawning areas, especially grayling; DATA VOID	14 creek crossing; valuable spawning areas, especially grayling and salmon; Indian River, Portage Creek, DATA VOID	1 river and 42 creek crossings; valuable spawning areas, especially grayling	42 creek crossings; valuable spawning areas, especially grayling and salmon; DATA VOID
Wildlife Resources	unidentified raptor nest located on trib. to Susitna; passes through, habitat for: raptors, furbearers, wolves, wolverine, brown bear, caribou	Passes through habitat for: raptors, waterfowl, migrating swans, furbearers, caribou, wolves, wolverine, brown bear	Golden eagle nest along Devil Ck. near High L.; active raven nest on Devil Ck.; passes through habitat for: raptors, furbearers, wolves, brown bear	Golden eagle nest along Devil Ck. near High L.; caribou movement area; passes through habitat for: raptors, waterfowl, furbearers, wolves, wolverine, brown bear	Same as Corridor 4 with important waterfowl and migrating swan habitat at Stephan Lake
Environmental Rating <sup>1</sup>	C	F	C	F	F

NOTES:

(1) A = recommended, C = acceptable but not recommended, F = unacceptable

TABLE B, 49 (Cont'd)

	6 (CBAH1)	7 (CEBAH1)	Corridor Segment 8 (CBAG)	9 (CEBAG)	10 (CJAG)
Length (miles)	68	73	90	95	91
Topography/Soils	Crosses several deep ravines; changes in elevation of about 1600'; routing above 4000'; steep slopes; some wet soils; shallow bedrock in mts.	Crosses several deep ravines; change in elevation of about 1600'; routing above 3000'; steep slopes; some wet soils; shallow bedrock in mts.	Crosses several deep ravines; change in elevation of about 1600'; routing above 3000'; steep slopes; some wet soils; shallow bedrock in mts.	Crosses several deep ravines; changes in elevation of about 1600'; routing above 3000'; steep slopes; some wet soils; shallow bedrock in mts.	Same as Corridor 8
Land Use	No known existing ROW; rec. areas and isolated cabins; float plane area; Susitna area and near I are Village Selection Lands	Same as Corridor 6	No existing ROW; rec. areas and isolated cabins; float plane areas; air strip and airport; much Village Selection and Federal Land	Same as Corridor 8	No existing ROW; rec. areas and isolated cabins; float plane areas; air strip and airport; mostly Village Selection and Federal Land
Aesthetics	Fog Lakes and Stephan Lake; Tsusena Butte; viewshed of Alaska Range	For Fog Lakes and Stephan Lake; high country (Prairie-Chunilina Cks.); Tsusena Butte; viewshed of Alaska Range	Fog Lakes; Stephan Lake; access road; scenic area of Deadman Ck.; viewshed of Alaska Range	Fog Lakes; Stephan Lake; proposed access road; high country (Prairie and Chunilina Cks.); Deadman Ck.; viewshed of Alaska Range	High Lakes area; proposed access road; Deadman Ck. drainage; viewshed at Alaska Range
Cultural Resources	Archeologic sites near Watana dam site, Fog Lakes & Stephan Lake; DATA VOID between H and I	Same as Corridor 6	Archeologic sites by near Watana dam site, Fog Lakes, Stephan Lake and along Deadman Ck.	Same as Corridor 8	Archeologic sites near Watana dam site and along Deadman Ck.
Vegetation	Extensive wetlands from B to near Tsusena Butte; extensive forest-clearing needed	Extensive wetlands in Stephan L., Fog Lakes Tsusena Butte areas; extensive forest-clearing needed	Wetlands between B and mountains; extensive forest-clearing needed	Wetlands in Stephan L./Fog Lakes areas; extensive forest-clearing needed	Small wetlands in JA area; extensive forest-clearing needed
Fish Resources	32 creek crossings; valuable spawning areas, especially grayling; DATA VOID	45 creek crossings; valuable spawning areas, especially grayling; DATA VOID	1 river and 43 creek crossings; valuable spawning areas, especially grayling; DATA VOID	1 river and 48 creek crossings; valuable spawning areas, especially grayling; DATA VOID	1 river and 47 creek crossings; valuable spawning areas, especially grayling; DATA VOID
Wildlife Resources	Bald eagle nest s. e. of Tsusena Butte; area of caribou movement; passes through habitat for: raptors, waterfowl, furbearers, wolves, wolverine, brown bear	Same as Corridor 6, with important waterfowl and migrating swan habitat at Stephan Lake	Important bald eagle habitat by Denali Hwy. & Deadman L.; unchecked bald eagle nest near Tsusena Butte; passes through habitat for: raptors, furbearers, wolves, wolverine, brown bear	Same as Corridor 8, with important waterfowl and migrating swan habitat at Stepahn Lake	Golden eagle nest along Devil Ck. near High Lake; unchecked bald eagle nest near Tsusena Butte; area of caribou movement; passes through habitat for: raptors, waterfowl, furbearers, brown bear
Environmental Rating	F	F	F	F	F

TABLE B.49 (Cont'd)

	11 (CJAH1)	12 (JA-CJH1)	Corridor Segment 13 (ABCF)	14 (AJCD)	15 (ABECF)
Length (miles)	69	70	41	41	45
Topography/Soils	Crosses several deep ravines; changes in elevation of about 1000'; routing above 3000'; steep slopes; some wet soils; shallow bedrock in mts.	Same as Corridor 11	Crosses several deep ravines; about 1000' change in elevation; some wet soils	Crosses deep ravine at Devil Ck.; about 2000' change in elevation; routing above 3000'; some steep slopes; some wet soils	Crosses several deep ravines; about 2000' change in elevation; some wet soils
Land Use	No existing ROW; rec. areas & isolated cabins; float plane areas; mostly Village Selection and Private Land	No existing ROW; rec. areas and isolated cabins; float plane area; mostly Village Selection and Private Land	No known existing ROW; except at F; rec. areas; float plane areas; resid. and rec. use near Otter L. and old sled rd.; isolated cabins; mostly Village Selection Land; some Private Land	Little existing ROW except Old Corps Rd. and at D; rec. areas; isolated cabins; much Village Selection land; some Private Land	No known existing ROW except at F; rec. areas; float plane areas; resid. and rec. use near Otter L. & old sled rd.; isolated cabins; mostly Village Selection land with some Private Land
Aesthetics	High Lakes area; proposed access road; viewshed of Alaska Range	High Lakes area; proposed access road; Tsusena Butte; viewshed of Alaska Range	Fog Lakes, Stephan L.	Viewshed of Alaska Range and High Lake; proposed access road	Fog Lakes; Stephan Lake; high country (Prairie and Chulina Cks. drainages); viewshed of Alaska Range
Cultural Resources	Archeologic sites near Watana dam site	Archeologic site near Watana dam site; possible sites along pass between drainages	Archeologic sites near Watana dam site, Portage Ck./Susitna R. confluence; Stephan L. and Fog Lakes; historic sites near communities of Canyon and Gold Ck.	Archeologic sites by Watana dam site, possible sites along Susitna R.; historic sites near communities of Canyon and Gold Ck.	Same as Corridor 13
Vegetation	Small wetland areas in JA area; some forest-clearing needed	Small wetland areas in JA area; fairly extensive forest-clearing needed	Wetlands in eastern third of corridor; extensive forest-clearing needed	Forest-clearing needed in western half	Wetlands in eastern half of corridor; extensive forest-clearing needed
Fish Resources	36 creek crossings; valuable spawning areas, especially grayling and salmon: DATA VOID	40 creek crossings; valuable spawning areas, especially grayling and salmon: DATA VOID	15 creek crossings; valuable spawning areas, especially grayling and salmon: Indian River, Portage Ck., DATA VOID	1 river and 16 creek crossings; valuable spawning areas, especially grayling: DATA VOID	15 creek crossings; valuable spawning areas, especially grayling and salmon: Indian River, Portage Ck., DATA VOID
Wildlife Resources	Golden eagle nest along Devil Ck. near High Lake; bald eagle nest s. e. of Tsusena Butte; passes through habitat for: raptors, furbearers, brown bear	Golden eagle nest along Devil Ck. near High Lake; passes through habitat for: raptors, furbearers, wolves, brown bear	Unidentified raptor nest on tributary to Susitna; passes through habitat for: raptors, furbearers, wolves, wolverine, brown bear, caribou	Golden eagle nest in Devil Ck./High Lake area; active raven nest on Devil Ck.; passes through habitat for: raptors, furbearers, wolves, brown bear, caribou	Important waterfowl and migrating swan habitat at Stephan L.; passes through habitat for: raptors, waterfowl, furbearers, wolves, wolverine, brown bear, caribou
Environmental Rating	F	F	C	A	F

TABLE B. 50: ENVIRONMENTAL CONSTRAINTS  
NORTHERN STUDY AREA (HEALY TO FAIRBANKS)

	Corridor Segment			
	1 (ABC)	2 (ABDC)	3 (AEDC)	4 (AEF)
Length (miles)	90	86	115	105
Topography/Soils	Some wet soils with severe limitations to off-road traffic	Severe limitations to off-road traffic in wet soils of the flats	Change in elevation of about 2500'; steep slopes; shallow bedrock in mts.; severe limitations to off-road traffic in the flats	Same as Corridor 3
Land Use	Air strip; residential areas and isolated cabins; some U. S. Military Withdrawal and Native land	No existing ROW n. of Brōwne; scattered residential and isolated cabins; airstrip; Fort Wainwright Military Reservation	No existing ROW beyond Healy/Cody Ck. confluence; isolated cabins; airstrips; Fort Wainwright Military Reservation	Airstrips; isolated cabins; Fort Wainwright Military Reservation
Aesthetics	3 crossings of Parks Hwy; Nenana R. - scenic area	3 crossings of Parks Hwy; high visibility in open flats	1 crossing of Parks Hwy.; high visibility in open flats	High visibility in open flats
Cultural Resources	Archeologic sites probable since there is a known site nearby; DATA VOID	Dry Creek archeologic site near Healy; possible sites along river crossings; DATA VOID	Dry Creek archeologic site near Healy; possible sites near Japan Hills and in the mts.; DATA VOID	Archeologic sites near Dry Creek and Fort Wainwright; possible sites near Tanana River; DATA VOID
Vegetation	Extensive wetlands; forest-clearing needed mainly north of the Tanana River	Probably extensive wetlands between Wood and Tanana Rivers; extensive forest-clearing needed n. of Tanana River	Probably extensive wetlands between Wood and Tanana Rivers; extensive forest-clearing needed n. of Tanana River; data lacking for southern part	Probably extensive wetlands between Wood and Tanana Rivers
Fish Resources	4 river and 40 creek crossings; valuable spawning sites: Tanana River, DATA VOID	5 river and 44 creek crossings; valuable spawning sites: Wood River, DATA VOID	3 river and 72 creek crossings; valuable spawning sites: Wood River, DATA VOID	3 river and 60 creek crossings; valuable spawning sites: Wood River, DATA VOID
Wildlife Resources <sup>1</sup>	Passes through or near prime habitat for: peregrines, waterfowl, furbearers, moose; passes through or near important habitat for: peregrines, golden eagles	Passes through or near prime habitat for: peregrines, waterfowl, furbearers; passes through or near important habitat for: golden eagles, other raptors	Passes through or near prime habitat for: peregrines, waterfowl, furbearers, caribou, sheep; passes through or near important habitat for: golden eagles, brown bear	Passes through or near prime habitat for: peregrines, bald eagles, waterfowl, furbearers, caribou, sheep; passes through or near important habitat for: golden eagles, brown bear
Environmental Rating <sup>2</sup>	A	C	F	F

NOTE:

(1) Source: VanBallenberghe personal communication. Prime habitat = minimum amount of land necessary to provide a sustained yield for a species; based upon knowledge of that species' needs from experience of ADF&G personnel. Important habitat = land which ADF&G considers not as critical to a species as is Prime habitat, but is valuable.

(2) A = recommended, B = acceptable but not preferred, C = unacceptable

TABLE B.51: TECHNICAL, ECONOMIC AND ENVIRONMENTAL CRITERIA  
USED IN CORRIDOR SCREENING

---

Technical

Primary

Topography  
Climate and Elevation  
Soils  
Length

Secondary

Vegetation and Clearing  
Highway and River Crossings

Economic

Primary

Length  
Presence of Right-of-Way  
Presence of Access Roads

Secondary

Topography  
Stream Crossings  
Highway and Railroad Crossings

Environmental

Primary

Aesthetic and Visual  
Land Use  
Presence of Existing Right-of-Way  
Existing and Proposed Development

Secondary

Length  
Topography  
Soils  
Cultural Reservoir  
Vegetation  
Fishery Resources  
Wildlife Resources

TABLE B. 52: PRE-PROJECT FLOW AT WATANA (CFS)

YEAR	OCT	NOV	DEC	JAN	FEB	MAR	APR	MAY	JUN	JUL	AUG	SEP	ANNUAL
1	4719.9	2083.6	1168.9	815.1	641.7	569.1	680.1	8655.9	16432.1	19193.4	16913.6	7320.4	6648.1
2	3299.1	1107.3	906.2	808.0	673.0	619.8	1302.2	11649.8	18517.9	19786.6	16478.0	17205.5	7733.7
3	4592.9	2170.1	1501.0	1274.5	841.0	735.0	803.9	4216.5	25773.4	22110.9	17356.3	11571.0	7776.1
4	6285.7	2756.8	1281.2	818.9	611.7	670.7	1382.0	15037.2	21469.8	17355.3	16681.6	11513.5	8035.2
5	4218.9	1599.6	1183.8	1087.8	803.1	638.2	942.6	11696.8	19476.7	16983.6	20420.6	9165.5	7400.4
6	3859.2	2051.1	1549.5	1388.3	1050.5	886.1	940.8	6718.1	24881.4	23787.9	23537.0	13447.8	8719.3
7	4102.3	1588.1	1038.6	816.9	754.8	694.4	718.3	12953.3	27171.8	25831.3	19153.4	13194.4	9051.0
8	4208.0	2276.6	07.0	1373.0	1189.0	935.0	945.1	10176.2	25275.0	19948.9	17317.7	14841.1	8381.0
9	6034.9	2935.9	2258.5	1480.6	1041.7	973.5	1265.4	9957.8	22087.8	19752.7	18843.1	5978.7	7769.4
10	3668.0	1729.5	1115.1	1081.0	949.0	694.0	885.7	10140.6	18329.6	20493.1	23940.4	12466.9	8011.0
11	5165.5	2213.5	1672.3	1400.4	1138.9	961.1	1069.9	13044.2	13233.4	19506.1	19323.1	16085.6	7954.0
12	6049.3	2327.8	1973.2	1779.9	1304.8	1331.0	1965.0	13637.9	22784.1	19839.8	19480.2	10146.2	8602.9
13	4637.6	2263.4	1760.4	1608.9	1257.4	1176.8	1457.4	11333.5	36017.1	23443.7	19887.1	12746.2	9832.9
14	5560.1	2508.9	1708.9	1308.9	1184.7	883.6	776.6	15299.2	20663.4	28767.4	21011.4	10800.0	9277.7
15	5187.1	1789.1	1194.7	852.0	781.6	575.2	609.2	3578.8	42841.9	20082.8	14048.2	7524.2	8262.7
16	4759.4	2368.2	1070.3	863.0	772.7	807.3	1232.4	10966.0	21213.0	23235.9	17394.1	16225.6	8451.5
17	5221.2	1565.3	1203.6	1060.4	984.7	984.7	1338.4	7094.1	25939.6	16153.5	17390.9	9214.1	7374.4
18	3269.8	1202.2	1121.6	1102.2	1031.3	889.5	849.7	12555.5	24711.9	21987.3	26104.5	13672.9	9095.7
19	4019.0	1934.3	1704.2	1617.6	1560.4	1560.4	1576.7	12826.7	25704.0	22082.8	14147.5	7163.6	8032.2
20	3135.0	1354.9	753.9	619.2	607.5	686.0	1261.6	9313.7	13962.1	14843.5	7771.9	60.0	4912.3
21	2403.1	1020.9	709.3	636.2	602.1	624.1	986.4	9536.4	14399.0	18410.1	16263.8	7224.1	6114.6
22	3768.0	2496.4	1687.4	1097.1	777.4	717.1	813.7	2857.2	27612.8	21126.4	27446.6	12188.9	8588.5
23	4979.1	2587.0	1957.4	1570.9	1491.4	1366.0	1305.4	15973.1	27429.3	19820.3	17509.5	10955.7	8963.4
24	4301.2	1977.9	1246.5	1031.5	1000.2	873.9	914.1	7287.0	23859.3	16351.1	18016.1	8099.7	7112.0
25	3056.5	1354.7	931.6	786.4	689.9	627.3	871.9	12889.0	14780.6	15971.9	13523.7	9786.2	6313.7
26	3088.8	1474.4	1276.7	1215.8	1110.3	1041.4	1211.2	11672.2	26689.2	23430.4	15126.6	13075.3	8402.7
27	5679.1	1601.1	876.2	757.8	743.2	690.7	1059.8	8938.8	19994.0	17015.3	18393.5	5711.5	6834.8
28	2973.5	1926.7	1687.5	1348.7	1202.9	1110.8	1203.4	8569.4	31352.8	19707.3	16807.3	10613.1	8232.6
29	5793.9	2645.3	1979.7	1577.9	1267.7	1256.7	1408.4	11231.5	17277.2	18385.2	13412.1	7132.6	6992.2
30	3773.9	1944.9	1312.6	1136.8	1055.4	1101.2	1317.9	12369.3	22904.8	24911.7	16670.7	9096.7	8183.7
31	6150.0	3525.0	2032.0	1470.0	1233.0	1177.0	404.0	10140.0	00.0	26740.0	18000.0	11000.0	8907.9
32	6458.0	3297.0	1385.0	1147.0	971.0	889.0	1103.0	10406.0	17017.0	27840.0	31435.0	12026.0	9580.4
MAX	6458.0	3525.0	2258.5	1779.9	1560.4	1560.4	1965.0	15973.1	42841.9	28767.4	31435.0	17205.5	9832.9
MIN	2403.1	1020.9	709.3	619.2	602.1	569.1	609.2	2857.2	13233.4	14843.5	7771.9	4260.0	4912.3
MEAN	4513.1	2052.4	1404.8	1157.3	978.9	898.3	1112.6	10397.6	22912.9	20778.0	18431.4	10670.4	7985.9

TABLE B.53: PRE-PROJECT FLOW AT DEVIL CANYON (CFS)

YEAR	OCT	NOV	DEC	JAN	FEB	MAR	APR	MAY	JUN	JUL	AUG	SEP	ANNUAL
1	5758.2	2404.7	1342.5	951.3	735.7	670.0	802.2	10490	18468.6	21383.4	18820.6	7950.8	7537.8
2	3652.0	1231.2	1030.8	905.7	767.5	697.1	1504.6	13218.5	19978.5	21575.9	18530.0	19799.1	8615.9
3	5221.7	2539.0	1757.5	1483.7	943.2	828.2	878.5	4989.5	30014.2	24861.7	19647.2	13441.1	8918.0
4	7517.6	3232.6	1550.4	999.6	745.6	766.7	1531.8	17758.3	25230.7	19184.0	19207.0	13928.4	9356.4
5	5109.3	1921.3	1387.1	1224.2	929.7	729.4	1130.6	15286.0	188.1	19154.1	24061.6	11579.1	866.9
6	4830.4	2506.8	1868.0	1649.1	1275.2	1023.6	1107.4	8390.1	28081.9	26212.8	24959.6	13989.2	9707.4
7	1647.9	1788.6	1206.6	921.7	893.1	852.3	867.3	15979.0	31137.1	29212.0	2609.8	16495.8	10608.2
8	5235.3	2773.8	1986.6	1583.2	1388.9	1105.4	1109.0	12473.6	28415.4	22109.6	19389.2	18029.0	9668.7
9	7434.5	3590.4	2904.9	1792.0	1212.2	1085.7	1437.4	11849.2	24413.5	21763.1	21219.8	6988.8	8866.8
10	4402.8	1999.8	1370.9	1316.9	1179.1	877.9	1119.9	13900.9	21537.7	23390.4	28594.4	15329.6	9649.6
11	6060.7	2622.7	2011.5	1686.2	1340.2	1112.8	1217.8	14802.9	14709.8	21739.3	22066.1	18929.9	9084.4
12	7170.9	2759.9	2436.6	2212.0	1593.6	1638.9	2405.4	16030.7	27069.3	22880.6	21164.4	12218.6	10021.3
13	5459.4	2544.1	1978.7	1796.0	1413.4	1320.3	1613.4	12141.2	40679.7	24990.6	22241.8	14767.2	10946.5
14	6307.7	2696.0	1896.0	1496.0	1387.4	958.4	810.9	17697.6	24094.1	32388.4	22720.5	11777.2	10431.8
15	5998.3	2085.4	1387.1	978.0	900.2	663.8	696.5	4046.9	47816.4	21926.0	15585.8	8840.0	9250.7
16	5744.0	2645.1	1160.8	925.3	828.8	866.9	1214.4	12267.1	24110.3	26195.7	19789.3	18234.2	9555.5
17	6496.5	1907.8	1478.8	1478.4	1278.7	1187.4	1619.1	8734.0	30446.3	18536.2	20244.6	10844.3	8697.0
18	3844.0	1457.9	1364.9	1357.9	1268.3	1089.1	1053.7	14435.5	27796.4	25081.2	30293.0	15728.2	10460.4
19	4885.3	2203.5	1929.7	1851.2	1778.7	1778.7	1791.0	14982.4	29462.1	24871.0	16090.5	8225.9	9175.4
20	3576.7	1531.8	836.3	686.6	681.8	769.6	1421.3	10429.9	14950.7	15651.2	8483.6	4795.5	5352.1
21	2866.5	1145.7	810.0	756.9	708.7	721.8	1046.6	10721.6	17118.9	21142.2	18652.8	8443.5	7063.9
22	4745.2	3081.8	2074.8	1318.8	943.6	866.8	986.2	3427.9	31031.0	22941.6	30315.9	13636.0	9657.2
23	5537.0	2912.3	2312.6	2036.1	1836.4	159.8	1565.5	19776.8	31929.8	21716.5	18654.1	11884.2	10199.0
24	4638.6	2154.8	1387.0	1139.8	1128.6	955.0	986.7	7896.4	26392.6	17571.8	19478.1	8726.0	7738.3
25	3491.4	1462.9	997.4	842.7	745.9	689.5	949.1	15004.6	16766.7	17790.0	15257.0	11370.1	7160.5
26	3506.8	1619.4	1486.5	1408.8	1342.2	1271.9	1456.7	14036.5	30302.6	26188.0	17031.6	15154.7	9609.6
27	7003.3	1853.0	1007.9	896.8	876.2	825.2	1261.2	11305.3	22813.6	18252.6	19297.7	6463.3	7705.5
28	3552.4	2391.7	2147.5	1657.4	1469.7	1361.0	1509.8	11211.9	35606.7	21740.5	18371.2	11916.1	9438.8
29	6936.3	3210.8	2371.4	1867.9	1525.0	1480.6	1597.1	11693.4	18416.8	20079.0	15326.5	8080.4	7765.1
30	4502.3	2324.3	1549.4	1304.1	1203.6	1164.7	1402.8	13334.0	24052.4	27462.8	19106.7	10172.4	9023.0
31	6900.0	3955.0	2279.0	1649.0	1383.0	1321.0	1575.0	11377.0	26255.0	30002.0	20196.0	12342.0	9994.5
32	7246.0	3699.0	1544.0	1287.0	1089.0	997.0	1238.0	11676.0	17741.0	31236.0	35270.0	12762.0	10577.9
MAX	7517.6	3955.0	2904.9	2212.0	1836.4	1778.7	2405.4	19776.8	47816.4	32388.4	35270.0	19799.1	10946.5
MIN	2866.5	1145.7	810.0	686.6	681.8	663.8	696.5	3427.9	14709.8	15651.2	8483.6	4795.5	5352.1
MEAN	5311.8	2382.9	1652.0	1351.9	1146.9	1041.8	1281.5	12230.2	25938.4	23100.9	20709.0	12276.3	9084.4

TABLE B.54: MONTHLY FLOW REQUIREMENTS AT GOLD CREEK

MONTH	A	A1	A2	C	C1	C2	D	E	F	G
OCT	5000	5000	5000	5000	5000	5000	5000	5000	5000	3500
NOV	5000	5000	5000	5000	5000	5000	5000	5000	2000	3000
DEC	5000	5000	5000	5000	5000	5000	5000	5000	2000	2000
JAN	5000	5000	5000	5000	5000	5000	5000	5000	2000	2000
FEB	5000	5000	5000	5000	5000	5000	5000	5000	2000	2000
MAR	5000	5000	5000	5000	5000	5000	5000	5000	2000	2000
APR	5000	5000	5000	5000	5000	5000	5000	5000	2000	2000
MAY	4000	5000	5000	6000	6000	6000	6000	10290	10480	11730
JUN	4000	5000	5000	6000	6000	6000	6000	16000	18000	20000
JUL	4000	5100	5320	6480	6530	6920	7260	9160	10970	20000
AUG	6000	8000	10000	12000	14000	16000	19000	16000	18000	20000
SEP	5000	6500	7670	9300	10450	11620	13170	10300	10480	11730

Notes:

Derivation of transitional flows.

DATE		CASE						
JUL	SEP	A	A1	A2	C	C1	C2	D
25	21	4000	5000	5000	6000	6000	6000	6000
26	20	4000	5000	5000	6000	7000	7000	7500
27	19	4000	5000	5000	7000	8000	8500	9000
28	18	4000	5000	6000	8000	9000	10000	10500
29	17	4000	5000	7000	9000	10000	11500	12000
30	16	4000	6000	8000	10000	11000	13000	14000
31	15	5000	7000	9000	11000	12500	14500	16000

MAY	JUN	JUL	SEPT	E MAY/SEPT	E JUL	F	G
26	6	26	6	10000	8000	10000	11000
27	5	27	5	10000	9000	10000	12500
28	4	28	4	10000	10000	11500	14500
29	3	29	3	11500	11500	13000	15500
30	2	30	2	13000	13000	14500	17000
31	1	31	1	14500	14500	16000	18500



TABLE 55: Energy Potential of the Watana Development For Different Downstream Flow Requirements. (GWh)

MO.	A		A <sub>1</sub>		A <sub>2</sub>		C		C <sub>1</sub>		C <sub>2</sub>		D		E		F		G	
	FIRM	AVERAGE	FIRM	AVERAGE	FIRM	AVERAGE	FIRM	AVERAGE	FIRM	AVERAGE	FIRM	AVERAGE	FIRM	AVERAGE	FIRM	AVERAGE	FIRM	AVERAGE	FIRM	AVERAGE
JAN	277	361	276	359	265	355	248	351	240	334	230	318	211	301	169	279	155	273	111	173
FEB	216	306	214	305	206	302	193	297	185	280	177	264	164	248	149	234	120	197	86	144
MAR	241	292	240	291	230	288	216	288	209	274	199	264	185	262	163	247	135	199	97	140
APR	202	266	201	266	191	265	179	266	173	250	165	237	161	226	154	233	113	196	81	125
MAY	195	240	194	240	186	237	175	184	171	194	162	192	150	182	119	261	115	267	96	317
JUN	176	211	175	210	168	205	158	197	153	180	146	174	135	155	356	363	332	331	332	332
JUL	180	222	179	221	172	219	161	201	156	166	149	161	138	156	230	211	293	276	376	376
AUG	189	238	188	245	233	287	307	350	370	385	394	393	344	394	394	394	394	394	394	394
SEP	193	210	192	211	211	223	269	271	316	318	350	356	403	395	303	313	305	316	338	351
OCT	235	334	234	333	224	314	210	305	204	326	196	314	181	291	145	228	159	233	95	158
NOV	257	405	256	405	245	395	230	392	223	392	213	369	198	336	158	218	145	233	104	154
DEC	304	410	302	409	290	404	272	397	260	376	251	376	233	357	185	348	170	296	122	197
TOTAL	2665	3495	2651	3495	2621	3494	2618	3499	2660	3476	2631	3418	2553	3303	2525	3392	2436	3272	2282	2911

TABLE 56: Energy Potential of the Watana - Devil Canyon Development For Different Downstream Flow Requirements. (GWh)

MO.	A		A <sub>1</sub>		A <sub>2</sub>		C		C <sub>1</sub>		C <sub>2</sub>		D		E		F		G	
	FIRM	AVERAGE	FIRM	AVERAGE	FIRM	AVERAGE	FIRM	AVERAGE	FIRM	AVERAGE	FIRM	AVERAGE	FIRM	AVERAGE	FIRM	AVERAGE	FIRM	AVERAGE	FIRM	AVERAGE
JAN	533	743	522	739	527	731	495	725	468	709	437	676	336	645	309	615	256	545	239	332
FEB	433	637	429	635	410	625	385	614	364	602	339	591	300	573	273	508	199	458	185	273
MAR	485	631	480	630	458	623	431	621	407	611	380	568	336	551	320	527	222	479	207	266
APR	407	565	403	565	394	562	361	528	341	519	318	538	281	530	217	442	186	412	174	240
MAY	454	496	465	496	450	490	434	479	329	457	306	458	384	450	214	411	205	403	213	498
JUN	390	438	394	437	379	429	362	419	388	412	343	402	306	394	526	526	526	526	526	526
JUL	399	452	403	451	388	443	371	434	402	429	379	426	333	425	477	456	517	514	517	517
AUG	385	455	381	460	433	489	481	518	543	541	543	543	543	543	543	543	543	543	543	543
SEP	389	435	386	433	394	437	482	500	569	556	569	568	569	569	569	551	569	553	569	569
OCT	477	600	492	603	535	615	535	622	510	586	482	546	438	485	362	456	370	437	306	406
NOV	522	700	536	704	576	706	572	698	547	664	516	615	467	547	338	544	398	495	324	382
DEC	610	810	604	809	576	799	542	776	513	757	479	724	422	643	329	663	280	546	261	375
TOTAL	5509	6962	5525	6962	5510	6949	5451	6934	5381	6843	5091	6655	4765	6355	4527	6242	4271	5911	4064	4927

TABLE B.57: NET BENEFITS FOR SUSITNA HYDROELECTRIC PROJECT OPERATING SCENARIOS

	LTPWC <sup>1</sup>	NET BENEFITS	PERCENT CHANGE RELATIVE TO CASE A
	<u>1982 dollars x 10<sup>6</sup></u>	<u>1982 dollars x 10<sup>6</sup></u>	
Thermal Option	8238		
Case A	6879	1359	
Case A <sub>1</sub>	6885	1353	-.5
Case A <sub>2</sub>	6904	1334	-.2
Case C	6923	1315	-3
Case C <sub>1</sub>	7017	1221	-10
Case C <sub>2</sub>	7200	1038	-24
Case D	7494	744	-45
Case E	7584	654	-52
Case F	7896	342	-75
Case G	8731	-493	-136

Note:

<sup>1</sup>Long-Term Present Worth Costs

TABLE B.58

## SYSTEM GENERATION RESERVE

YEAR		Estimated Peak Demand MW	Generation Reserve in Percent of Peak Load System Configuration	
			With Susitna	All Thermal
1993	Watana On-Line	947	95.7*	45.0
1994		965	88.8*	59.8
1995		983	80.5*	52.0
1996		1003	69.9*	61.9
1997		1023	59.4	58.4
1998		1044	50.8	56.6
1999		1064	48.0	53.6
2000		1084	41.2	46.8
2001		1121	36.6	48.2
2002	Devil Canyon On-Line	1158	79.5*	38.9
2003		1196	69.4*	35.9
2004		1233	64.4*	37.5
2005		1270	52.7	37.6
2006		1323	44.9	35.6
2007		1377	44.3	44.8
2008		1430	42.1	37.6
2009		1484	36.9	37.3
2010		1537	36.8	32.5
Average			57.9	45.6
Average excluding years (*) influenced by installation of large hydro project			44.9	---

TABLE B.59

## TRANSMISSION SYSTEM PERFORMANCE UNDER DOUBLE CONTINGENCY

	Acceptable Performance Criteria	System Configuration	
		1993	2002
Highest Line Loading as % of Rating	114 <sup>1</sup> / <sub>1</sub>	105 <sup>2</sup> / <sub>1</sub>	95 <sup>2</sup> / <sub>1</sub>
Highest P.U. Voltage	1.10	1.05	1.05
Lowest P.U. Voltage			
On 345 kV	0.90	0.95	0.95
On 115 or 138 kV	0.90	0.95	0.93
Max. Differential Phase Angle	55°	49.8°	49.8°

---

<sup>1</sup>/Based on an estimated 14% overload capability over rating in case of a 75% daily load factor.

<sup>2</sup>/Based on an underwater cable design presently under testing.

TABLE B.60: AVERAGE ANNUAL AND MONTHLY FLOW AT GAGES  
IN THE SUSITNA BASIN\*

MONTH	STATION (USGS Reference Number)							
	Susitna River at Gold Creek (2920)		Susitna River Near Cantwell (2915)		Susitna River Near Denali (2910)		Maclaren River Near Paxson (2912)	
	Drainage Area (sq. mi.)							
	6160		4140		950		280	
	%	Mean(cfs)	%	Mean(cfs)	%	Mean(cfs)	%	Mean(cfs)
JANUARY	1	1,463	1	824	1	244	1	96
FEBRUARY	1	1,243	1	722	1	206	1	84
MARCH	1	1,123	1	692	1	188	1	76
APRIL	1	1,377	1	853	1	233	1	87
MAY	12	13,277	10	7,701	6	2,036	7	803
JUNE	24	27,658	26	19,326	22	7,285	25	2,920
JULY	21	24,383	23	16,892	28	9,350	27	3,181
AUGUST	19	21,996	20	14,658	24	8,050	22	2,573
SEPTEMBER	12	13,175	10	7,800	10	3,350	10	1,149
OCTOBER	5	5,757	4	3,033	3	1,122	3	409
NOVEMBER	2	2,568	2	1,449	2	490	1	177
DECEMBER	2	1,793	1	998	1	314	1	118
ANNUAL - cfs	100	9,703	100	6,246	100	2,739	100	973

Period of Record - Gold Creek - 1950-81  
Cantwell - 1961-72  
Denali - 1957-79  
Maclaren - 1957-79

\* Ref. USGS Streamflow Data

TABLE B.61: PEAK FLOWS OF RECORD

Gold Creek		Cartwell		Denali		Maclaren	
Date	Peak cfs	Date	Peak cfs	Date	Peak cfs	Date	Peak cfs
8/25/59	62,300	6/23/61	30,500	8/18/63	17,000	9/13/60	8,900
6/15/62	80,600	6/15/62	47,000	6/07/64	16,000	6/14/62	6,650
6/07/64	90,700	6/07/64	50,500	9/09/65	15,800	7/18/65	7,350
6/06/66	63,600	8/11/70	20,500	8/14/67	28,200	8/14/67	7,600
8/15/67	80,200	8/10/71	60,000	7/27/68	19,000	8/10/71	9,300
8/10/71	87,400	6/22/72	45,000	8/08/71	38,200	6/17/72	7,100

TABLE B.62: ESTIMATED FLOOD PEAKS IN SUSITNA RIVER

Location	Peak Inflow in Cfs for Recurrence Interval in Years				
	1:2	1:50	1:100	1:10,000	PMF
Gold Creek	49,500	106,000	118,000	190,000	408,000
Watana Damsite	40,800	87,000	97,000	156,000	326,000
Devil Canyon Damsite (Routed Peak Inflow with Watana )	12,600	39,000	61,000	165,000	345,000

TABLE B.63: WATANA FLOOD ROUTING - MAXIMUM FLOWS (cfs)

WATANA FLOOD ROUTING						
Maximum Flows During Flood (cfs)						
Flood	Powerhouse	Outlet	Spillway		Total	Maximum Reservoir Level (ft)
			Main	Emergency		
1:50	7000	24,000	0	0	31,000	2193
1:10,000	7000	24,000	120,000	0	151,000	2193.5
PMF	7000 <sup>1</sup>	24,000	150,000	120,000	294,000	2201.0

DEVIL CANYON FLOOD ROUTING <sup>2</sup>						
Maximum Flow During Flood (cfs)						
Flood	Powerhouse	Outlet	Spillway		Total	Maximum Reservoir Level (ft)
			Main	Emergency		
1:50	3500	35,500	0	0	39,000	1455
1:10,000	3500	38,500	123,000	0	165,000	1455
PMF	3500 <sup>3</sup>	38,500	156,000	150,000	345,000	1466

Notes:

- (1) Powerhouse closes when reservoir level exceeds 2193 ft MSL
- (2) Assumes Watana Reservoir upstream
- (3) Powerhouse closes when reservoir level exceeds 1456 MSL



TABLE B.64: ESTIMATED EVAPORATION LOSSES - WATANA AND DEVIL CANYON RESERVOIRS

Month	WATANA		DEVIL CANYON		Average Monthly Air Temperature (°C)		
	Pan Evaporation (inches)	Reservoir Evaporation (inches)	Pan Evaporation (inches)	Reservoir Evaporation (inches)	Watana <sup>1</sup>	Devil Canyon <sup>2</sup>	Talkeetna <sup>3</sup>
January	0.0	0.0	0.0	0.0	- 2.5	- 4.5	-13.0
February	0.0	0.0	0.0	0.0	- 7.3	- 5.0	- 9.3
March	0.0	0.0	0.0	0.0	- 1.8	- 4.3	- 6.7
April	0.0	0.0	0.0	0.0	- 1.8	- 2.5	0.7
May	3.6	2.5	3.9	2.7	8.7	6.1	7.0
June	3.4	2.4	3.8	2.7	10.0	9.2	12.6
July	3.3	2.3	3.7	2.6	13.7	11.9	14.4
August	2.5	1.8	2.7	1.9	12.5	N/A	12.7
September	1.5	1.0	1.7	1.2	N/A	4.8	7.8
October	0.0	0.0	0.0	0.0	0.2	- 1.8	0.2
November	0.0	0.0	0.0	0.0	- 5.1	- 7.2	- 7.8
December	0.0	0.0	0.0	0.0	-17.9	-21.1	-12.7
Annual Evap.	14.3	10.0	15.8	11.1			

<sup>1</sup> Based on data - April 1980-June 1981  
<sup>2</sup> Based on data - July 1980-June 1981  
<sup>3</sup> Based on data - January 1941-December 1980

TABLE B.65: FLOW RELEASE (CFS) AT WATANA FOR WATANA ONLY - CASE C

	OCT	NOV	DEC	JAN	FEB	MAR	APR	MAY	JUN	JUL	AUG	SEP
1	5664.6	9716.3	11285.3	9705.6	8958.2	8080.8	7383.7	5632.5	4853.9	4617.4	9033.6	8301.0
2	5340.9	6640.7	7716.0	7189.9	6290.0	6468.3	5674.3	7874.1	4835.5	4778.1	8808.0	5265.5
3	7082.9	10164.1	11617.4	10165.0	9157.5	8246.7	7507.5	5326.8	5002.3	4797.2	8436.3	5391.0
4	8269.3	10750.7	11397.6	9709.4	8928.2	8182.4	8085.6	11375.6	4959.6	4560.9	8071.6	5543.5
5	5691.2	6591.6	11300.2	9978.3	9119.6	8149.9	7646.2	8369.3	4962.2	4590.8	6320.6	5545.5
6	5684.0	7246.1	11665.9	10278.8	9367.0	8397.8	7644.4	5258.9	5174.6	6849.6	14063.1	8457.8
7	7620.0	9582.1	11155.0	9707.4	9071.3	8206.1	7421.9	9500.1	9088.6	8818.7	10055.4	8275.0
8	7778.5	10270.5	11823.4	10263.5	9505.5	8446.7	7648.7	7000.7	7123.4	4748.4	8777.7	7254.1
9	9605.4	10929.9	12374.9	10371.1	9358.2	8485.2	7969.0	5804.2	4963.6	4755.7	8303.4	7550.0
10	5731.9	6512.7	7772.5	9971.5	9265.5	8205.7	7589.3	6968.7	4838.2	4780.9	8969.2	7390.3
11	8736.0	10207.4	11788.7	10290.9	9455.4	8472.8	7773.5	9581.9	4870.4	4812.9	7733.1	4875.6
12	6482.7	10321.7	12089.6	10670.4	9621.3	8842.7	8668.6	10116.3	5203.3	4747.4	9380.2	6076.2
13	6050.3	10257.3	11876.8	10499.4	9573.9	8688.5	8161.0	8042.3	16898.9	7579.4	11004.0	7286.0
14	9130.6	10502.9	11825.3	10199.4	9501.2	8395.3	7480.2	11611.4	4959.4	9515.9	12488.0	7780.0
15	6516.0	9783.1	11311.1	9742.5	9098.1	8086.9	7312.8	5333.1	18353.5	5020.1	9608.2	7253.2
16	5759.3	6535.8	7538.2	9560.5	9089.2	8319.0	7936.0	7711.6	4962.8	5167.4	8274.1	10381.7
17	8791.7	9559.3	11320.0	9950.9	9301.2	8496.4	8042.0	5258.9	6476.3	4555.1	7560.9	6764.1
18	5722.3	6504.8	7606.3	9992.7	9347.8	8401.2	7553.3	9142.1	6837.7	5550.2	16188.9	8753.5
19	7589.5	9928.2	11820.6	10508.1	9876.9	9072.1	8280.3	9336.2	7755.8	5705.5	8977.5	7647.6
20	5756.8	6543.1	7573.0	7636.5	9064.5	8197.7	7553.6	5258.9	4851.7	4629.7	9756.0	7674.0
21	5907.9	6809.4	7856.2	7330.4	6420.2	6619.0	5826.2	5428.1	4982.6	4747.2	8283.8	7403.1
22	5971.4	6790.2	7879.0	7336.3	6419.8	6614.8	5823.1	5501.8	5166.8	4938.7	8685.6	7048.9
23	7860.2	10580.9	12073.8	10561.4	9807.9	8877.7	8009.0	12218.0	9601.0	4742.3	10219.5	7855.7
24	5697.0	6589.5	11362.9	9922.0	9316.7	8385.6	7617.7	5258.9	4973.6	4585.1	9726.7	8325.7
25	5780.5	6573.2	7622.2	7091.7	6638.2	8139.0	7575.5	9442.3	4859.5	4654.8	9303.7	6836.2
26	5901.1	6782.7	7811.4	7274.2	6358.6	6537.0	5739.0	5346.7	7869.7	6791.1	9036.6	6065.3
27	7756.1	9595.1	10992.6	9648.3	9059.7	8202.4	7763.4	5887.1	4964.3	4587.9	10593.5	6881.0
28	5827.7	6628.1	7677.0	7135.9	6231.4	7593.1	7907.0	5554.6	12444.1	4745.4	9567.3	7273.1
29	5692.1	9188.0	12096.1	10468.4	9584.2	8768.4	8112.0	7950.5	4844.1	4608.4	9022.1	7825.6
30	5881.8	6683.9	7750.7	7215.6	6306.8	6477.9	5679.0	8309.9	5122.8	7742.0	8210.7	7626.7
31	5681.2	11305.1	12148.4	10360.5	9549.5	8688.7	8107.6	6968.2	5432.6	9231.9	9070.3	7020.0
32	9053.3	11290.9	11501.4	10037.5	9287.5	8400.7	7806.6	7207.6	4874.0	5632.0	19391.0	9316.0
AVE	6766.1	8667.7	10300.9	9399.2	8685.4	8098.3	7478.1	7519.6	6628.3	5549.6	9778.8	7310.7

TABLE B.66: FLOW RELEASE (CFS) AT DEVIL CANYON FOR WATANA/DEVIL CANYON - CASE C

	OCT	NOV	DEC	JAN	FEB	MAR	APR	MAY	JUN	JUL	AUG	SEP
1	6602.4	10756.1	12481.7	11574.6	10887.0	8809.3	7405.0	6305.0	6047.5	5989.5	10940.6	8949.8
2	6552.5	7072.3	8065.7	7443.3	6471.5	6589.0	7026.2	7913.0	5743.6	5714.3	10960.0	7859.1
3	6489.8	10226.1	12526.3	11610.6	11123.8	9807.8	7481.3	5765.5	7439.4	6373.2	10727.2	8261.1
4	6623.0	11385.9	12518.4	11589.2	11137.2	9929.7	8134.6	9743.6	9980.3	5760.1	10597.0	7958.4
5	6757.0	7069.0	11783.4	11239.8	10909.5	8868.7	7733.4	9876.4	7023.5	5950.5	9971.6	7959.1
6	6746.9	7139.0	12562.4	11637.5	11186.2	10459.6	7710.2	6222.3	8382.9	7547.1	11209.6	10143.6
7	7629.8	11012.4	12478.7	11566.9	10872.9	8991.6	7470.1	9900.5	10079.3	9210.5	11699.7	16495.8
8	8217.2	11397.6	12527.7	11605.1	11167.2	10364.0	8742.8	7279.6	9670.7	5931.7	10849.2	8401.8
9	10205.5	11485.2	12775.0	11624.3	11113.1	10320.3	9369.8	7957.4	7940.7	5865.2	10679.8	8738.8
10	6708.1	7079.9	8039.7	9862.0	11158.9	9017.2	7722.7	8638.5	6640.4	6339.8	10197.7	13012.6
11	9042.6	11349.7	12561.2	11646.1	11168.3	10355.1	8774.0	9253.8	5756.3	6024.0	10476.1	7719.9
12	6580.5	10507.2	12629.3	11805.8	11292.4	10433.1	9514.8	9570.9	10254.5	7147.3	11064.4	8148.6
13	6617.2	9907.0	12559.6	11597.4	11147.6	10353.0	9108.4	6904.7	10407.7	8172.5	16223.3	14767.2
14	9289.6	11228.8	12476.8	11592.5	11168.9	10314.7	8313.6	9578.7	9808.2	9378.0	11050.5	11008.1
15	8980.2	11309.2	12491.8	11568.8	11125.5	8803.1	7299.3	5739.9	10541.6	8342.2	11145.8	8569.0
16	6758.8	9041.7	12437.0	11566.4	10808.6	9006.2	7917.2	7043.1	7634.2	7540.4	10669.3	9528.7
17	9478.4	11131.6	12536.1	11617.6	11180.8	9835.1	8221.9	6206.0	10395.8	6056.7	10414.6	8394.3
18	6612.1	7070.6	8036.4	9555.7	11248.1	9228.4	7656.5	9024.1	9640.5	8122.5	12864.8	15728.2
19	7567.2	11273.5	12611.8	11621.8	11179.6	10388.7	9399.6	9454.5	9988.1	8922.8	10920.5	8709.9
20	6593.6	7055.6	7998.0	8703.6	10838.8	8919.3	7561.8	5988.5	5991.7	5682.0	11178.0	8712.0
21	6663.6	7143.0	8140.1	7540.0	6554.6	6689.2	6544.4	6087.6	6448.9	6324.6	10672.8	8622.5
22	6972.3	7399.5	8285.0	7573.9	6563.5	6686.7	5854.6	6244.8	6796.2	5742.0	10405.9	9248.8
23	8518.9	11304.0	12564.7	11665.0	11214.5	10417.7	9414.3	10266.8	10319.6	8408.5	11364.1	8784.2
24	6265.8	10931.9	12463.9	11559.3	11142.7	9484.3	7589.5	5682.3	6871.3	5805.8	11188.1	8952.0
25	6578.8	7043.8	8003.9	7392.6	6426.2	8067.3	7551.9	9436.1	6017.8	5796.9	11037.0	8420.1
26	6617.7	7119.5	8152.2	7527.7	6568.9	6690.3	5853.2	8173.9	9915.0	8905.6	10941.6	8144.7
27	7791.9	11076.8	12459.1	11362.8	10856.0	8964.5	7864.0	6575.2	6444.8	5796.6	11497.7	8882.3
28	6679.8	7257.3	8235.9	7536.0	6538.8	9075.6	8112.6	6715.4	10228.7	8499.0	11131.2	8576.1
29	6722.0	10985.1	12590.6	11649.5	11197.4	10391.1	9338.6	6729.8	5579.5	5721.3	10936.5	8773.4
30	6785.9	7228.4	8140.7	7489.2	6504.2	6582.8	7318.3	7986.2	7605.9	8585.9	10646.7	8702.4
31	6685.2	3891.8	12512.5	11590.6	11142.6	10351.8	9262.5	6238.7	9481.9	9188.2	11236.0	8362.0
32	7855.0	11345.7	12458.0	11592.9	11121.6	10331.1	8864.9	6509.5	5598.0	8176.9	17878.2	12762.0
AVE	7318.4	944.5	11128.2	10484.6	10094.3	9204.0	8005.7	7656.6	8146.1	7094.4	11333.6	9603.0

TABLE 8.67: WATER APPROPRIATIONS WITHIN ONE MILE OF THE SUSITNA RIVER

LOCATION*	ADDITIONAL NUMBER	TYPE	SOURCE (DEPTH)	AMOUNT	DAYS OF USE
<u>CERTIFICATE</u>					
T19N R5W	45156	Single-family dwelling general crops	well (?) same source	650 gpd 0.5 ac-ft/yr	365 91
T25N R5W	43981	Single-family dwelling	well (90 ft)	500 gpd	365
T26N R5W	78895 200540 209233	Single-family dwelling Grade school Fire station	well (20 ft) well (27 ft) well (34 ft)	500 gpd 910 gpd 500 gpd	365 334 365
T27N R5W	200180  200515 206633 206930 206931	Single-family dwelling Lawn & garden irrigation Single-family dwelling Single-family dwelling Single-family dwelling Single-family dwelling	unnamed stream same source unnamed lake unnamed lake unnamed lake unnamed lake	200 gpd 100 gpd 500 gpd 75 gpd 250 gpd 250 gpd	365 153 365 365 365 365
<u>PERMIT</u>					
	206929	General crops	unnamed creek	1 ac-ft/yr	153
T30N R3W	206735	Single-family dwelling	unnamed stream	250 gpd	365
<u>PENDING</u>					
	209866	Single-family dwelling Lawn & garden irrigation	Sherman Creek same source	75 gpd 50 gpd	365 183

\*All locations are within the Seward Meridian.

TABLE B.68: TURBINE OPERATING CONDITIONS

	<u>Watana</u>	<u>Devil Canyon</u>
Maximum net head	725 feet	603 feet
Minimum net head	600 feet	541 feet
Design head	680 feet	590 feet
Rated head	680 feet	590 feet
Turbine flow at rated head, cfs	3550 cfs	3800 cfs
Turbine efficiency at design head	91%	91%
Turbine-generating rating at rated head	186,500 kW	168,000 kW

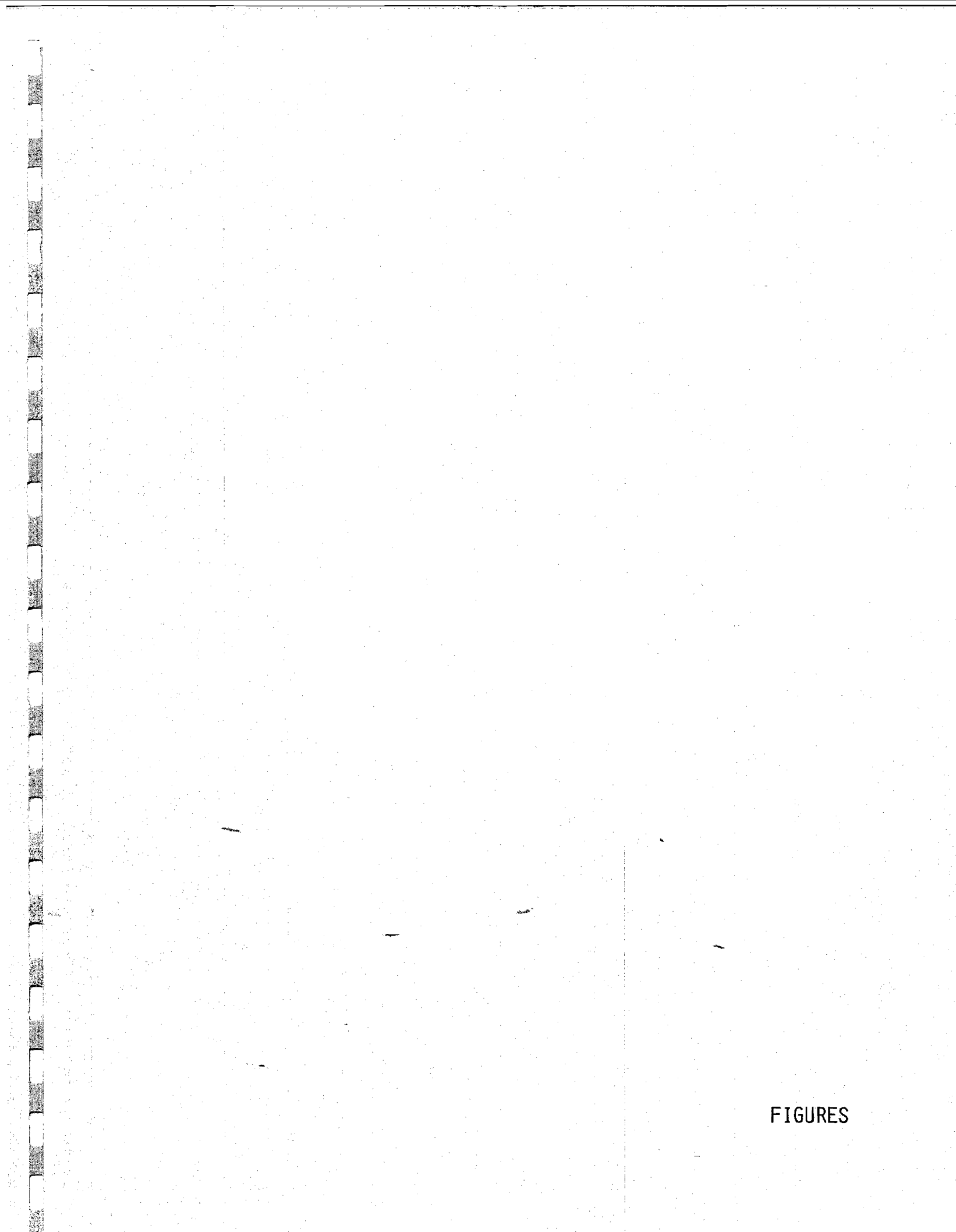

FIGURES

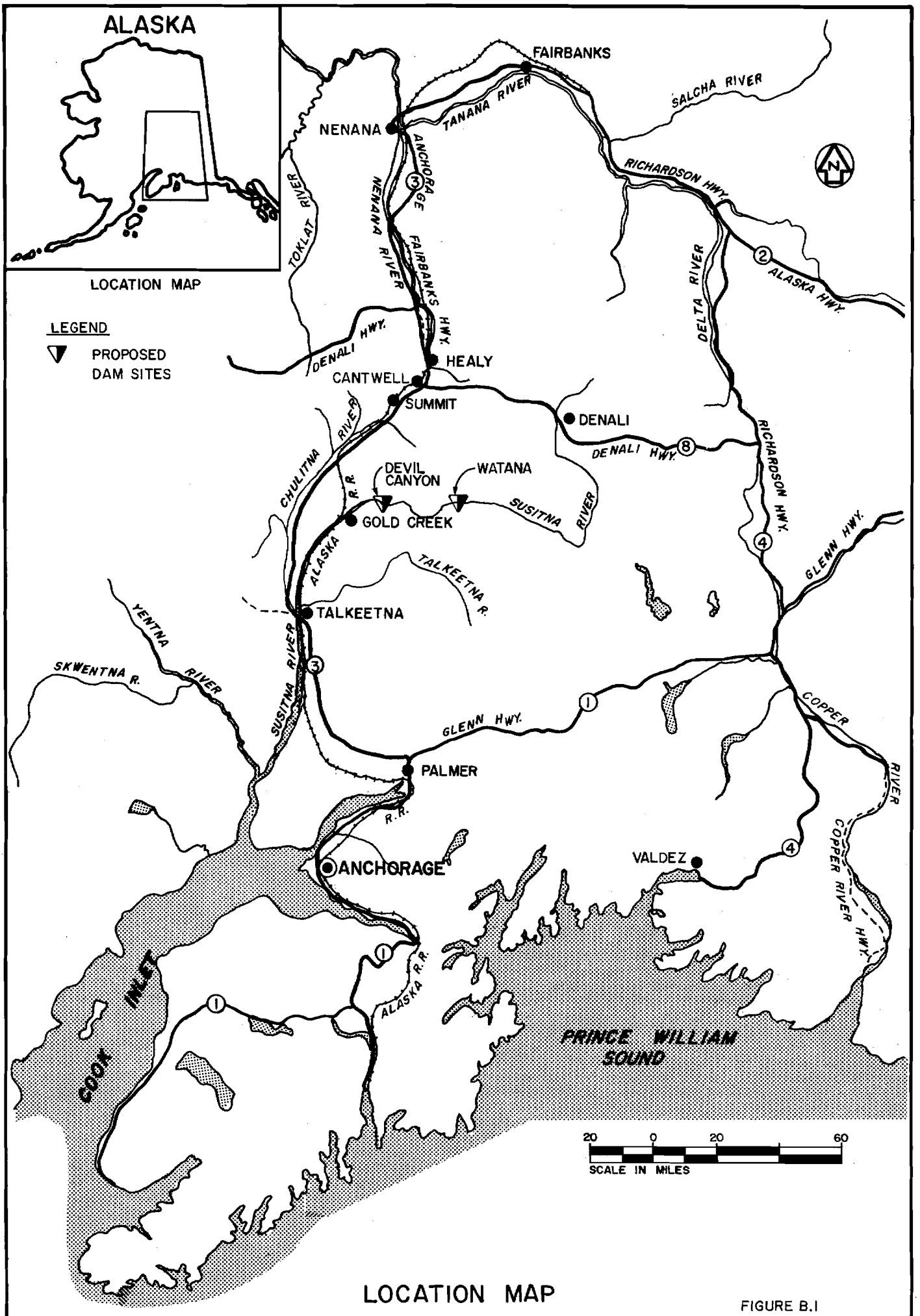

ALASKA

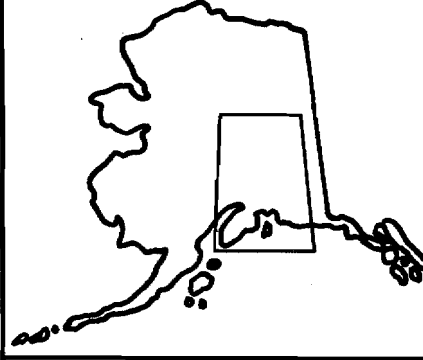

LOCATION MAP

LEGEND

- ▼ PROPOSED DAM SITES

LOCATION MAP

FIGURE B.1

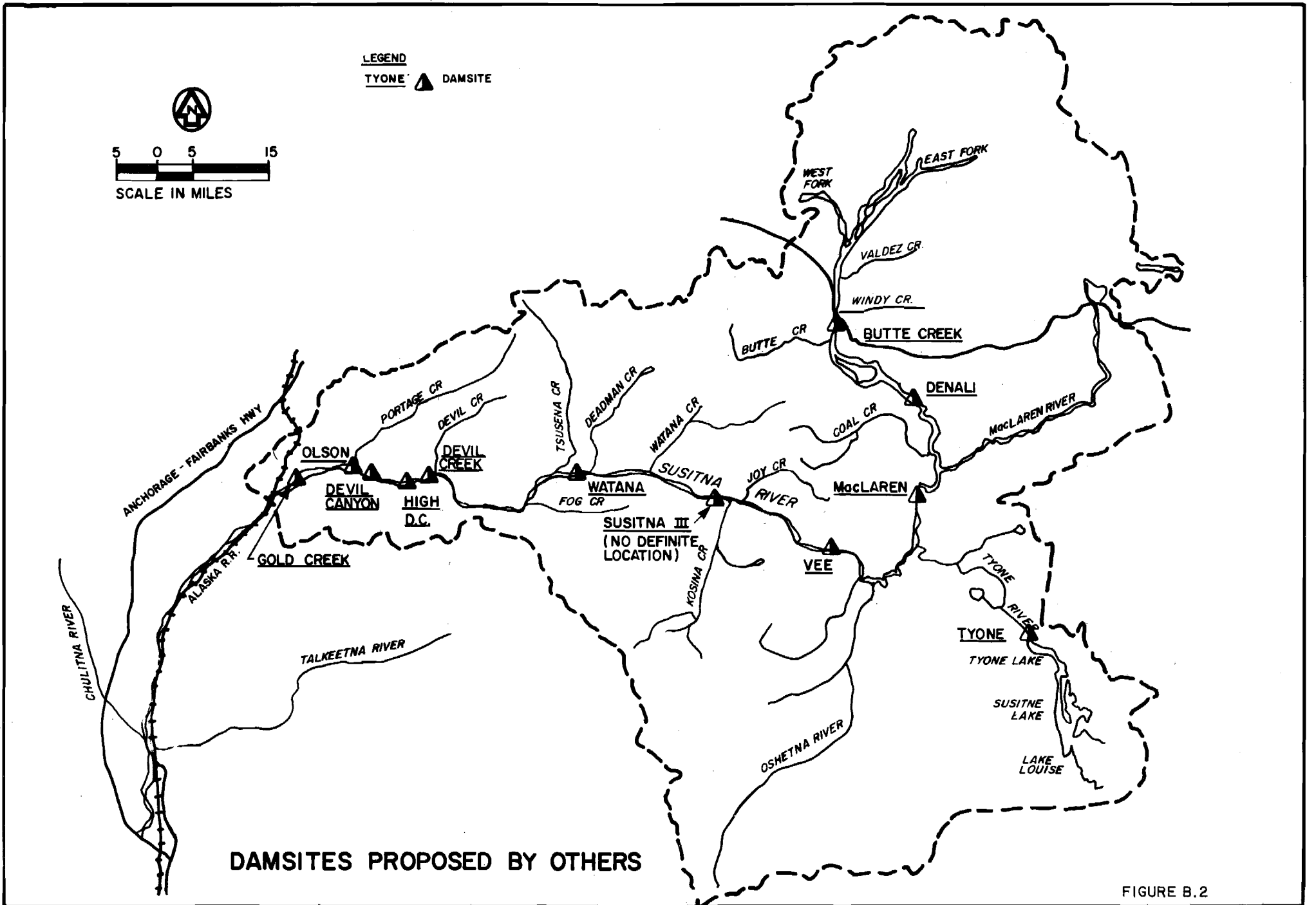
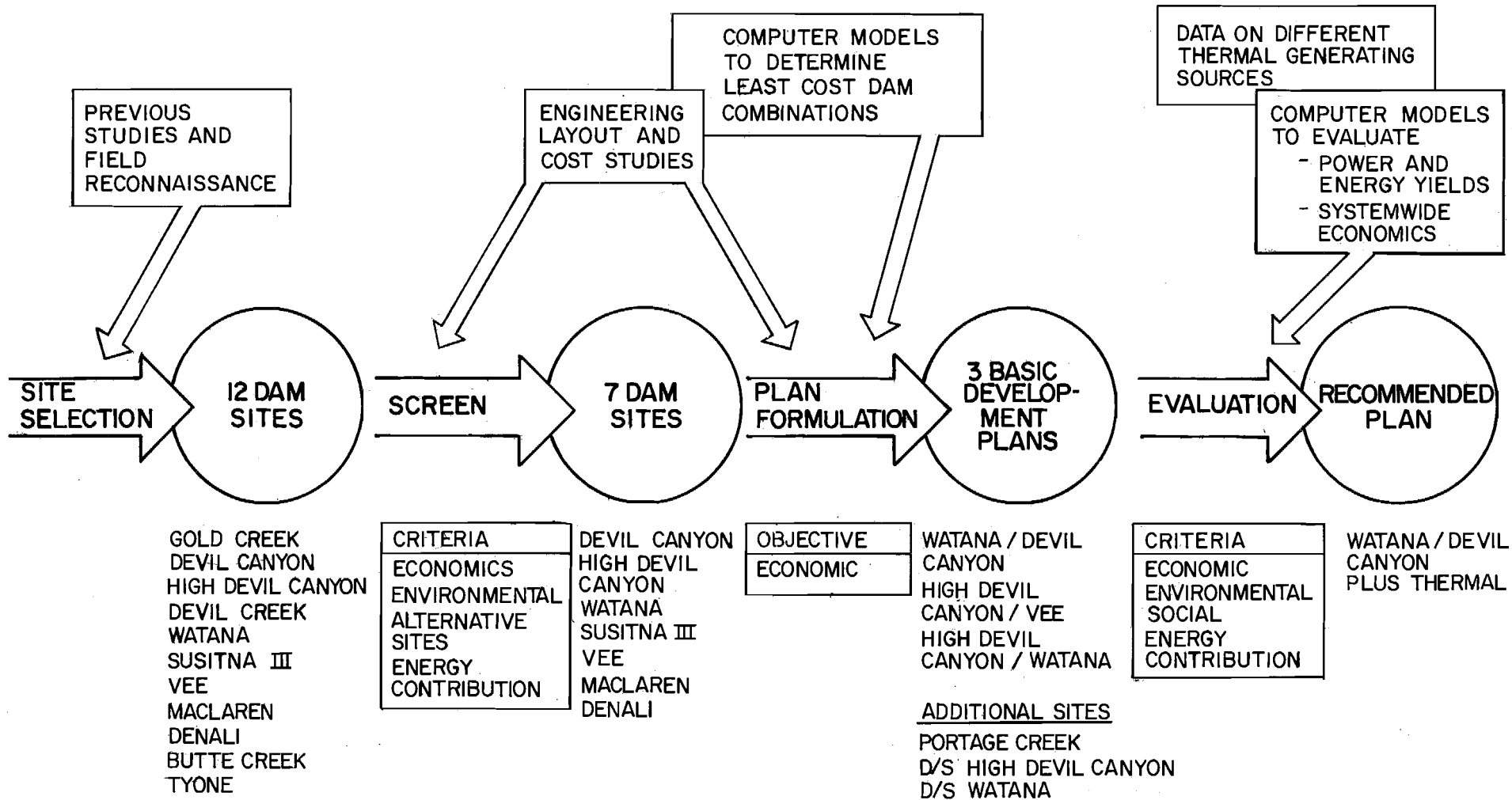

FIGURE B.2





SUSITNA BASIN PLAN FORMULATION AND SELECTION PROCESS

FIGURE B.3

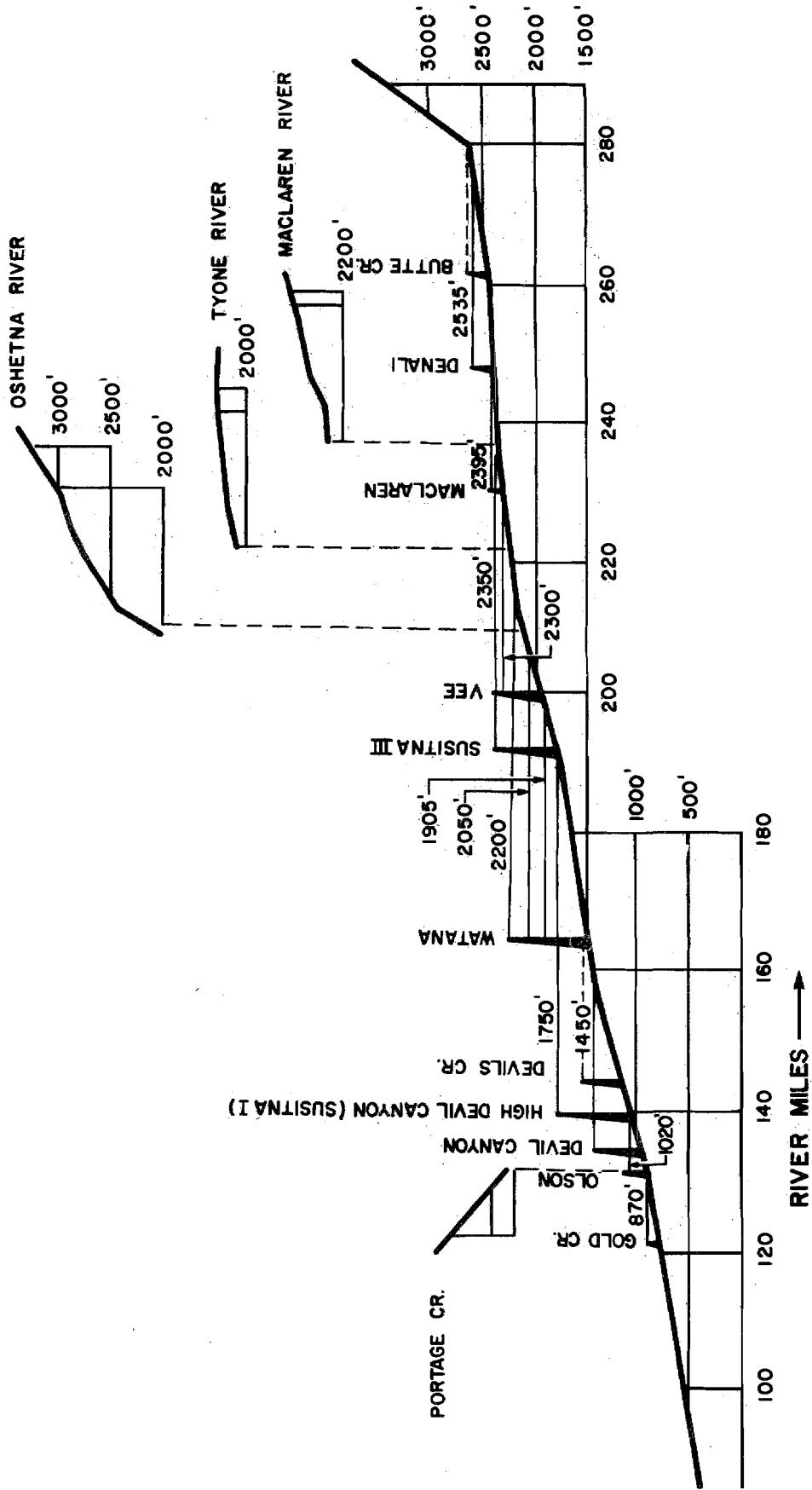

PROFILE THROUGH ALTERNATIVE SITES

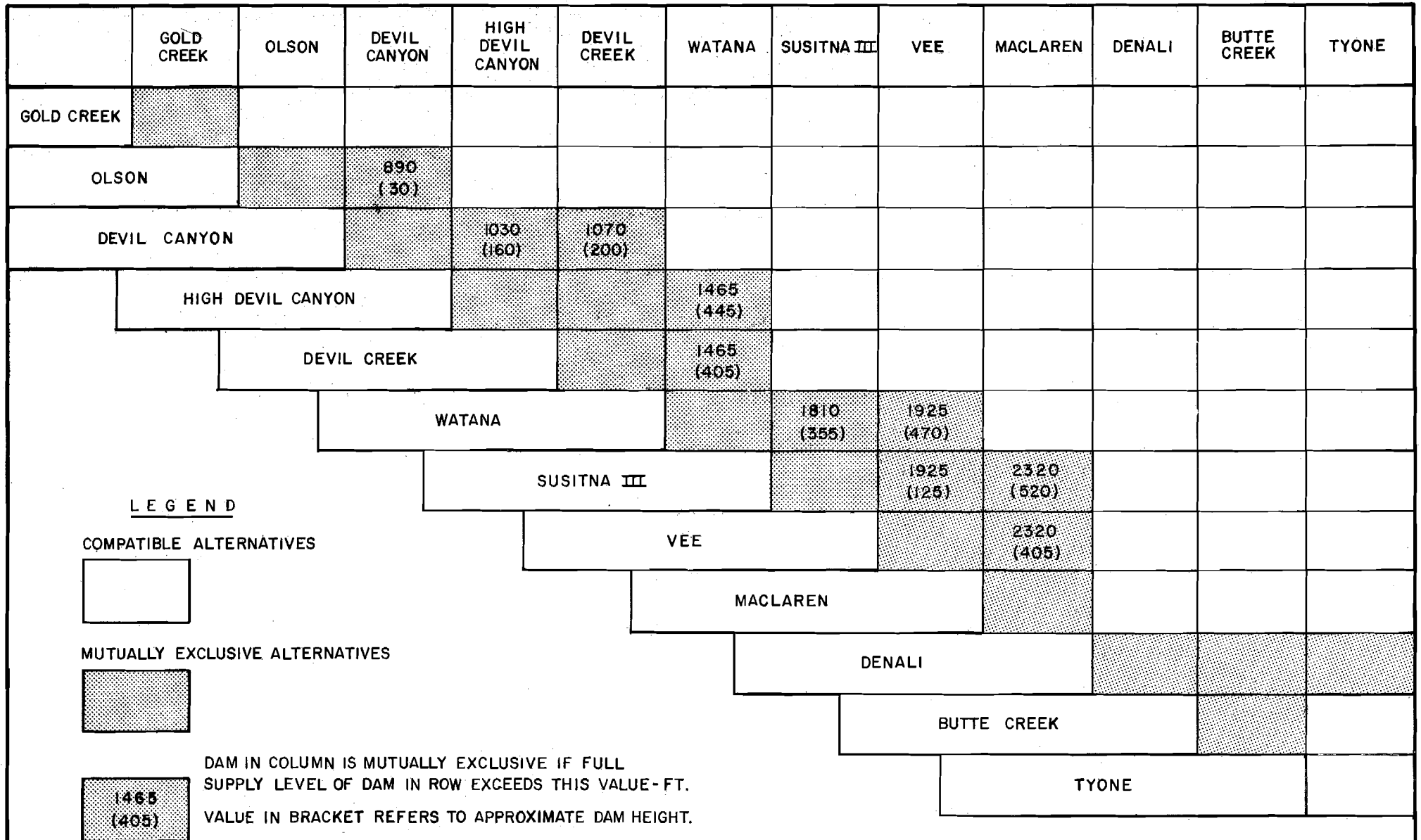

MUTUALLY EXCLUSIVE DEVELOPMENT ALTERNATIVES

FIGURE B.5

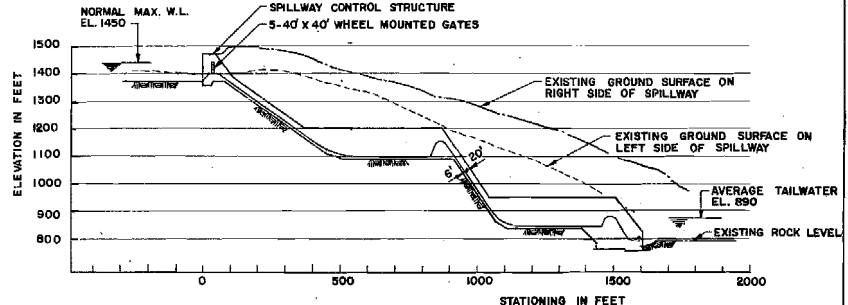
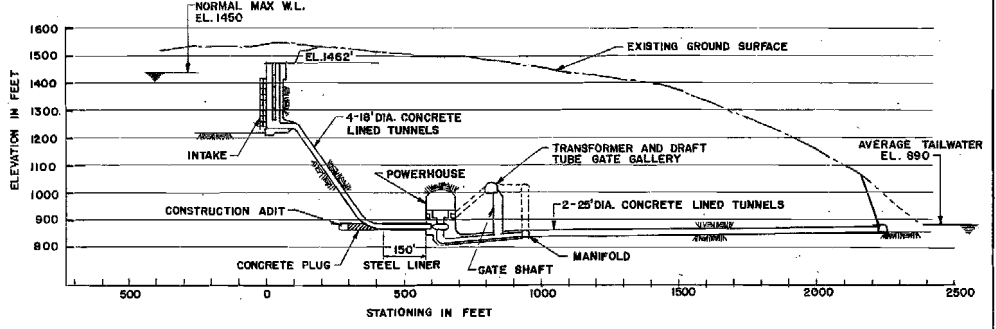
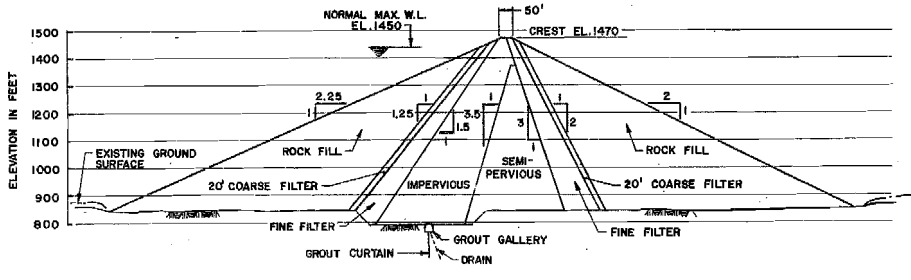
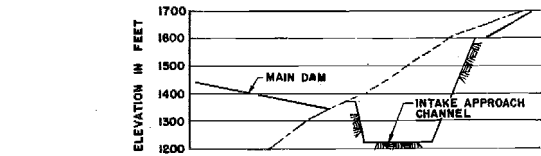
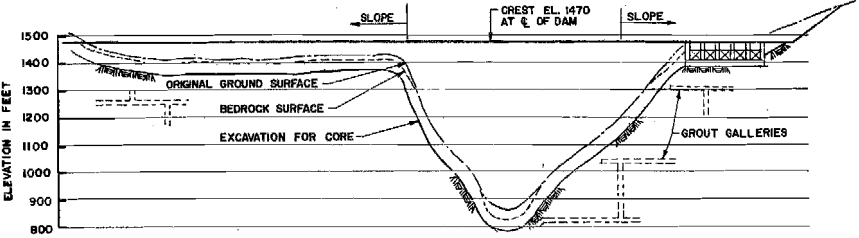
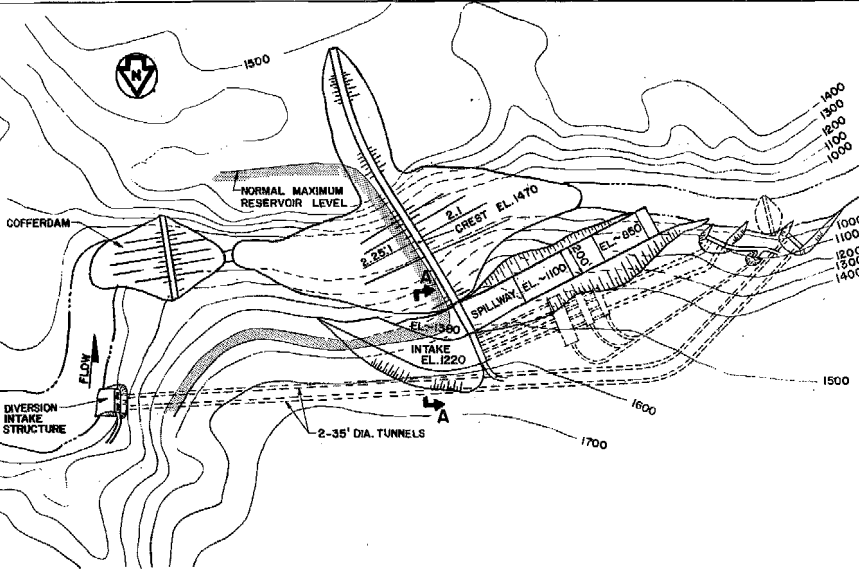

NOTE  
THIS DRAWING ILLUSTRATES A PRELIMINARY CONCEPTUAL PROJECT LAYOUT PREPARED FOR COMPARISON OF ALTERNATIVE SITE DEVELOPMENTS ONLY

DEVIL CANYON HYDRO DEVELOPMENT FILL DAM

FIGURE B.6

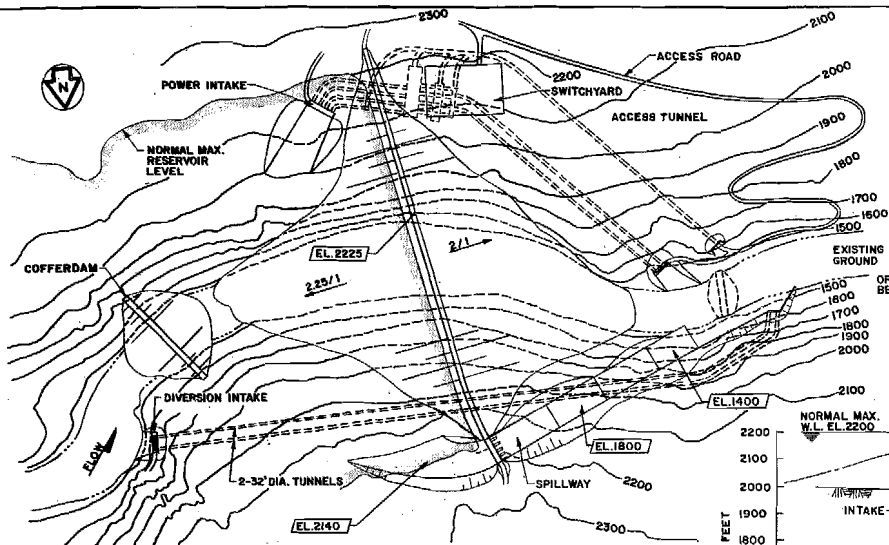

**GENERAL ARRANGEMENT**  
SCALE A

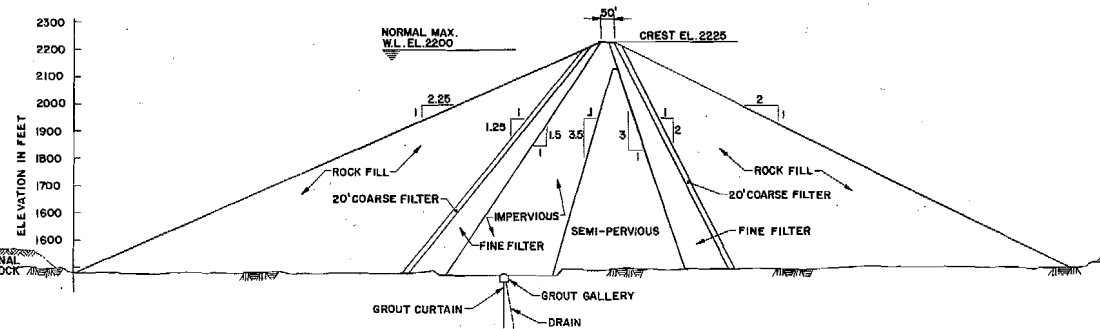

**SECTION THRU DAM**  
SCALE B

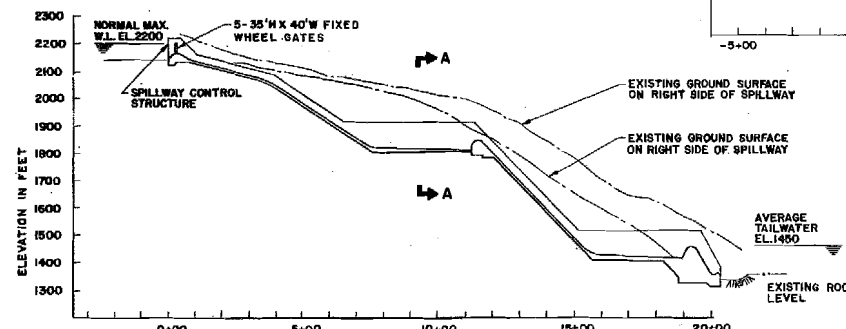

**SPILLWAY PROFILE**  
SCALE B

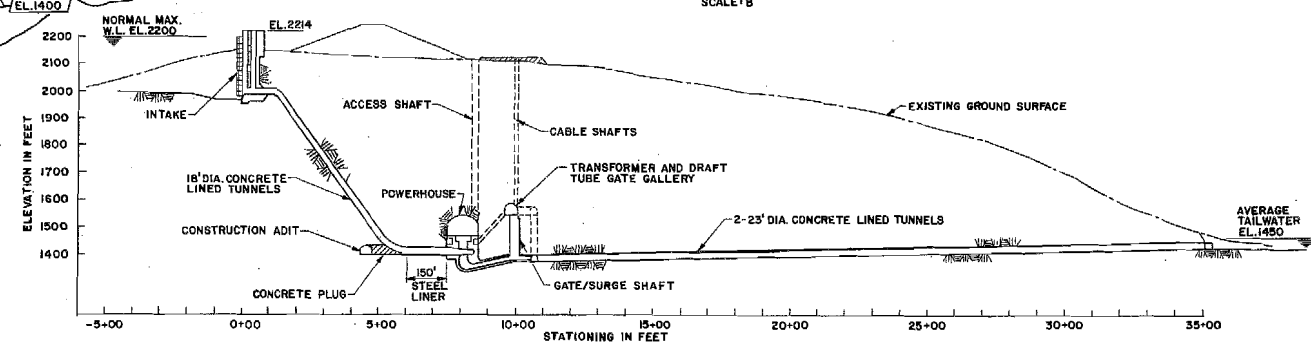

**POWER FACILITIES PROFILE**  
SCALE B

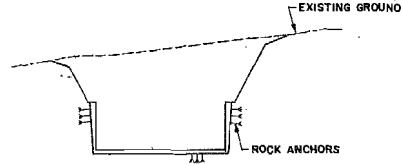

**SECTION A-A**  
SCALE C

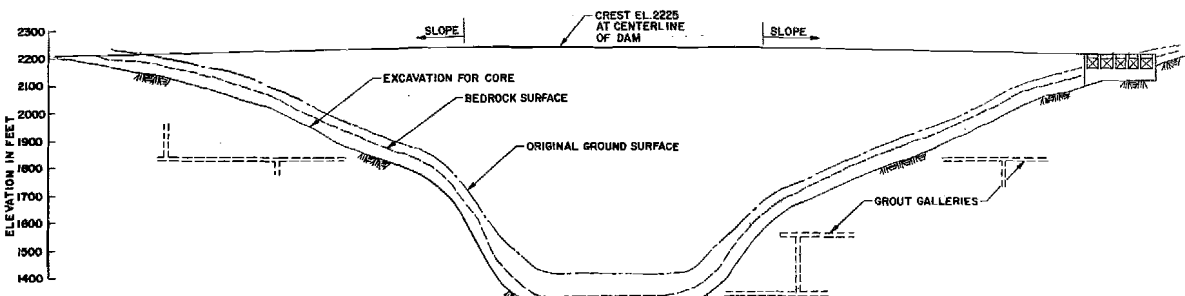

**LONGITUDINAL SECTION THRU CENTERLINE OF DAM**  
SCALE B

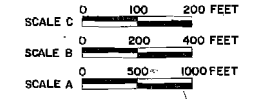

**NOTE**  
THIS DRAWING ILLUSTRATES A PRELIMINARY CONCEPTUAL PROJECT LAYOUT PREPARED FOR COMPARISON OF ALTERNATIVE SITE DEVELOPMENTS ONLY

**WATANA HYDRO DEVELOPMENT FILL DAM**

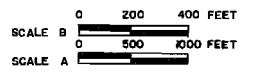
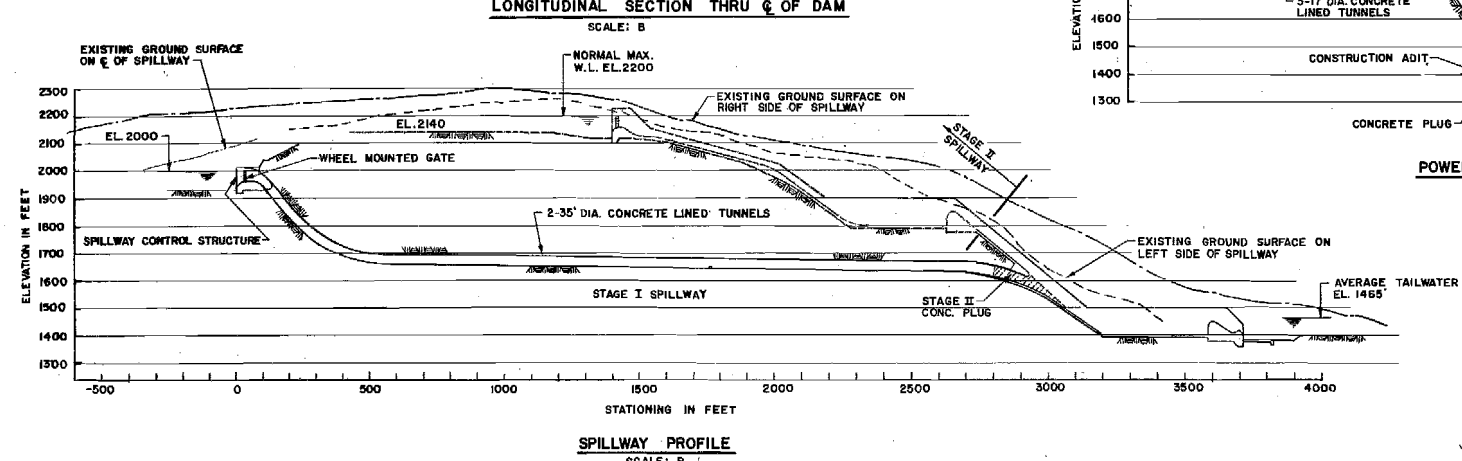
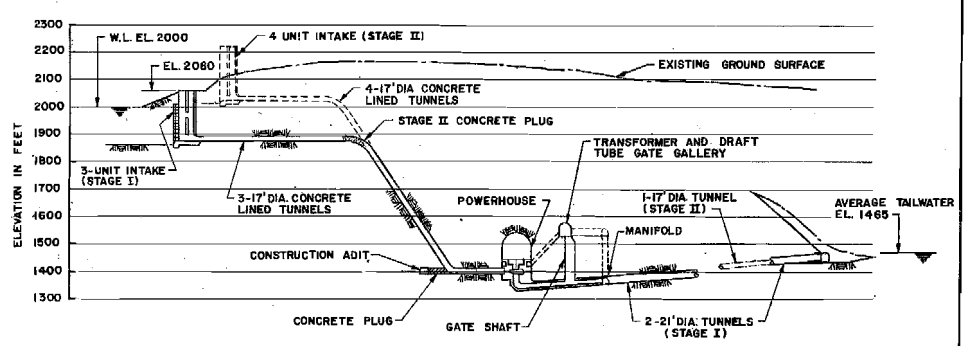
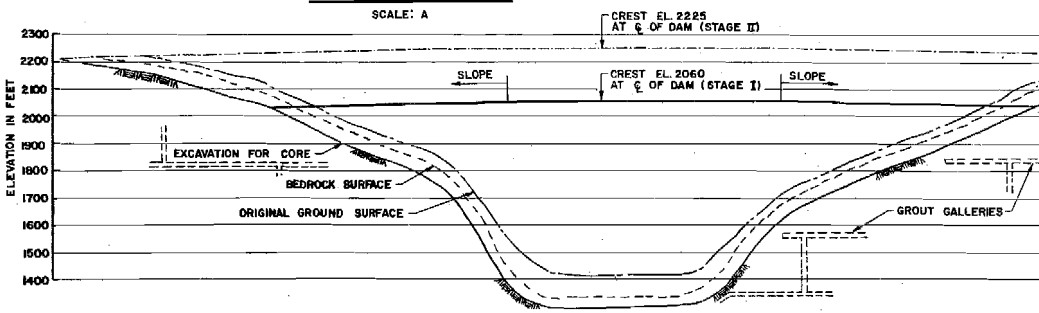
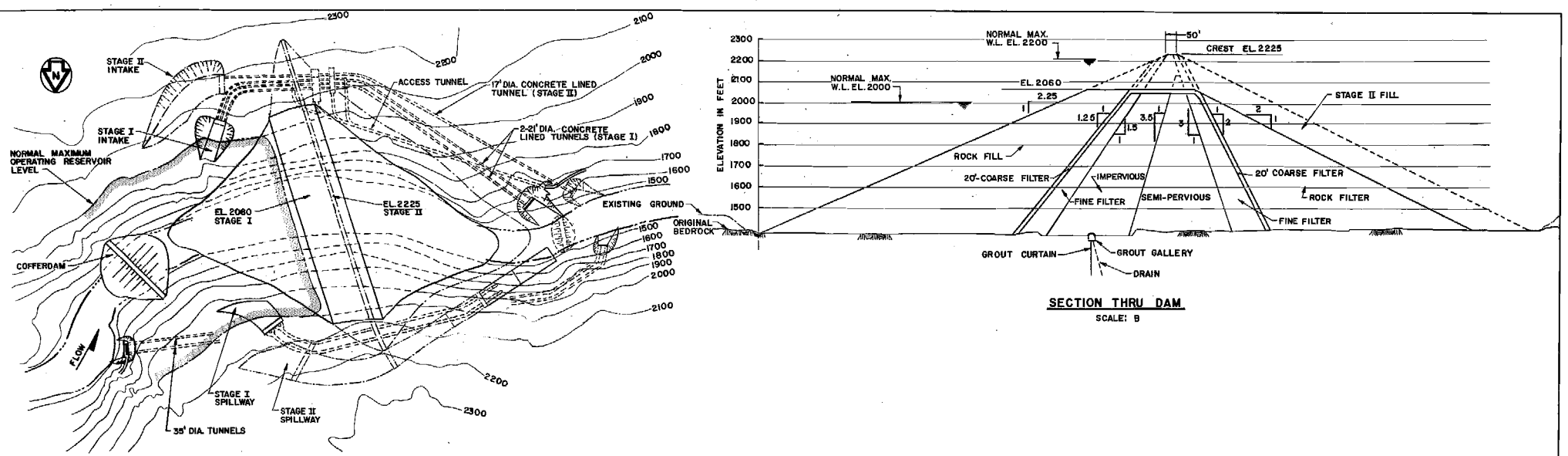

**NOTE**  
THIS DRAWING ILLUSTRATES A PRELIMINARY CONCEPTUAL PROJECT LAYOUT PREPARED FOR COMPARISON OF ALTERNATIVE SITE DEVELOPMENTS ONLY

**WATANA STAGED FILL DAM**

**FIGURE B.8**

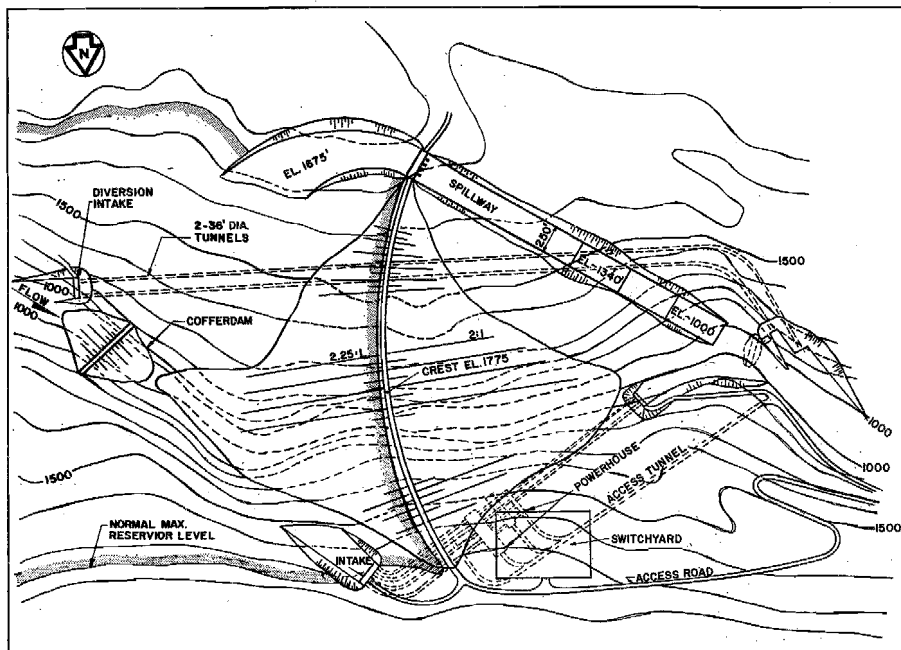

**GENERAL ARRANGEMENT**  
SCALE: A

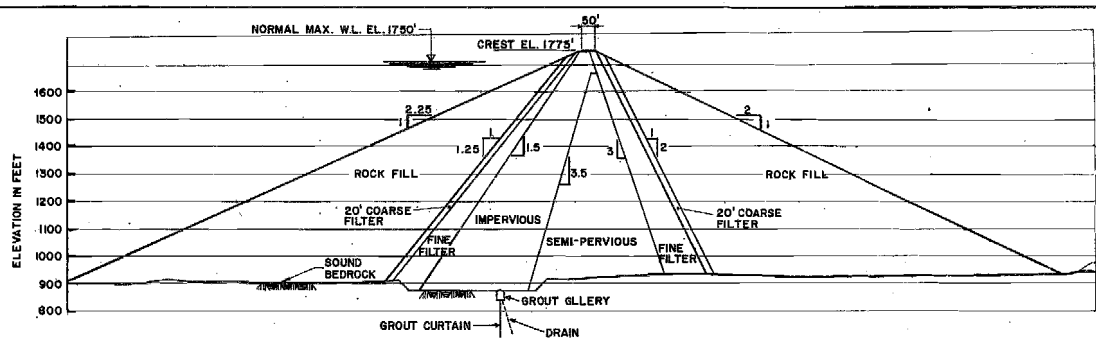

**SECTION THRU DAM**  
SCALE: B

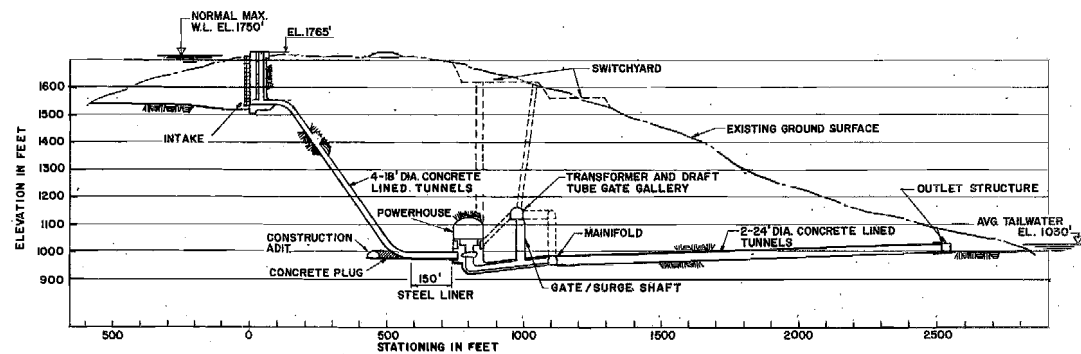

**POWER FACILITIES PROFILE**  
SCALE: B

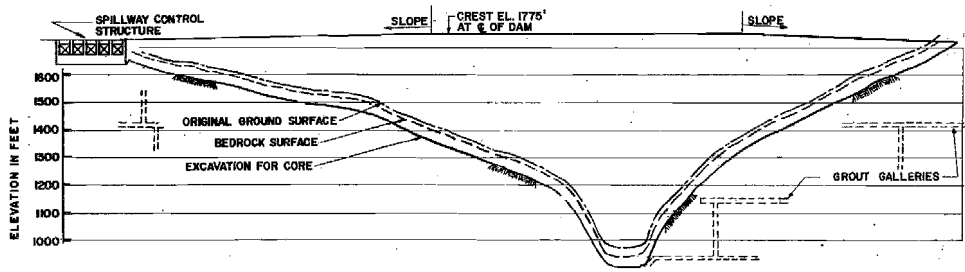

**LONGITUDINAL SECTION THRU & OF DAM**  
SCALE: B

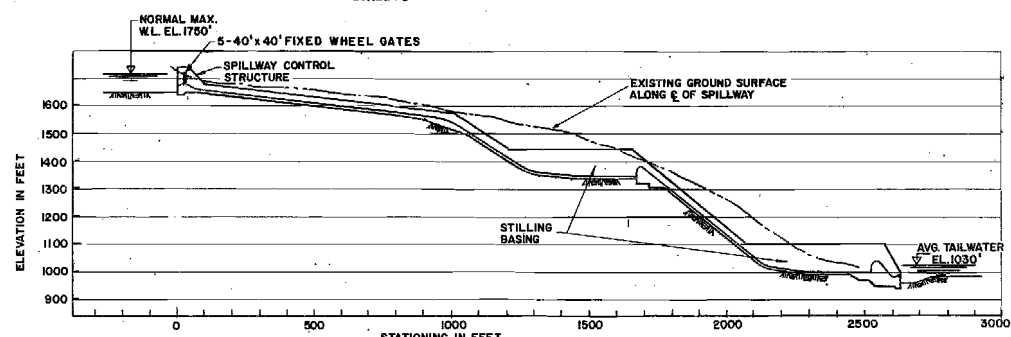

**SPILLWAY PROFILES**  
SCALE: B

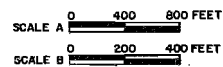

**NOTE**  
THIS DRAWING ILLUSTRATES A PRELIMINARY CONCEPTUAL PROJECT LAYOUT PREPARED FOR COMPARISON OF ALTERNATIVE SITE DEVELOPMENTS ONLY

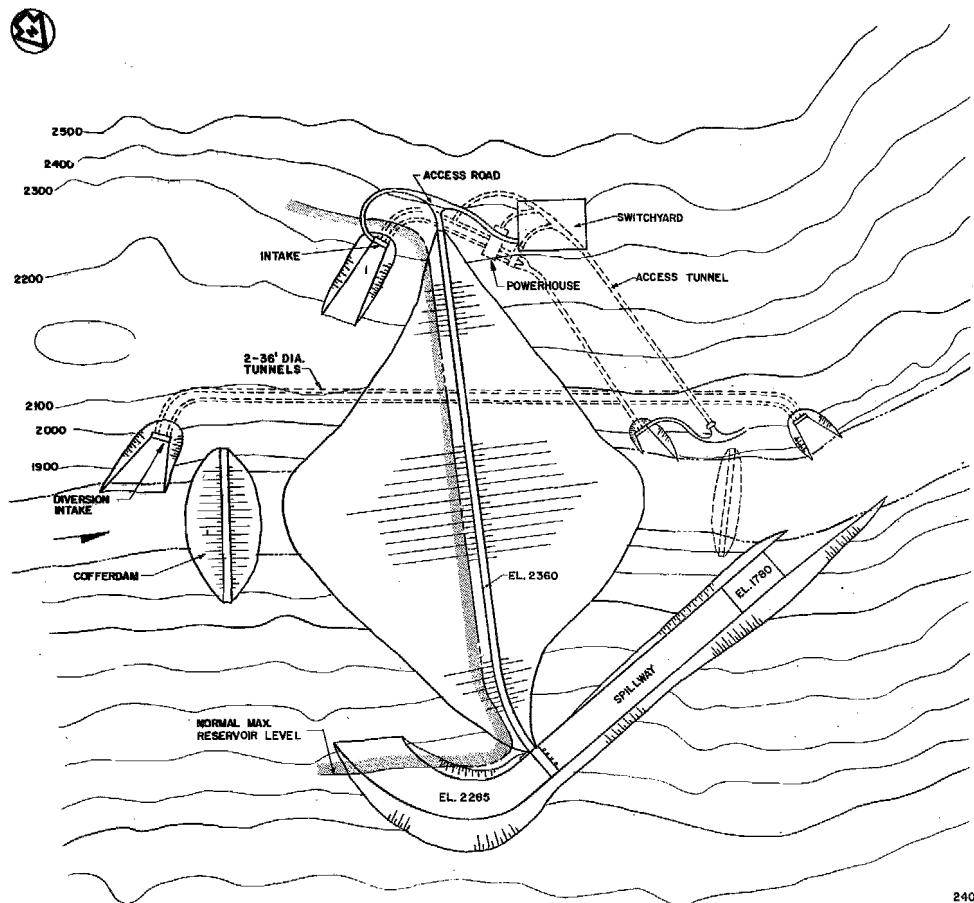

**GENERAL ARRANGEMENT**  
SCALE: A

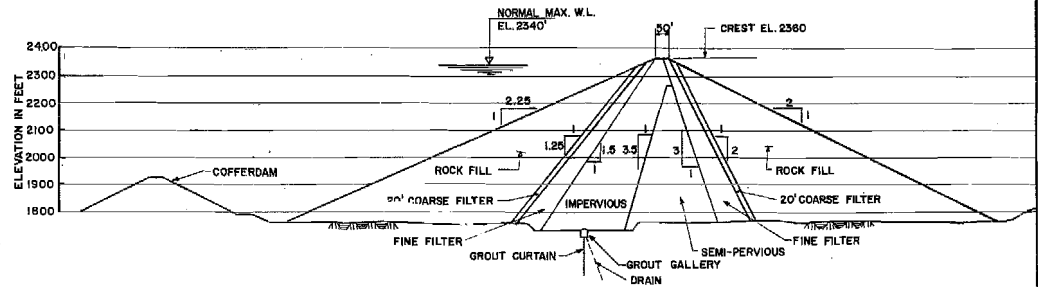

**SECTION THRU DAM**  
SCALE: B

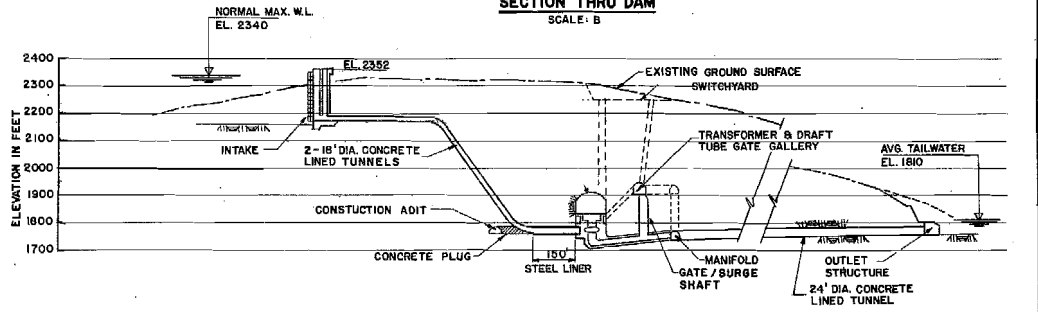

**POWER FACILITIES PROFILE**  
SCALE: B

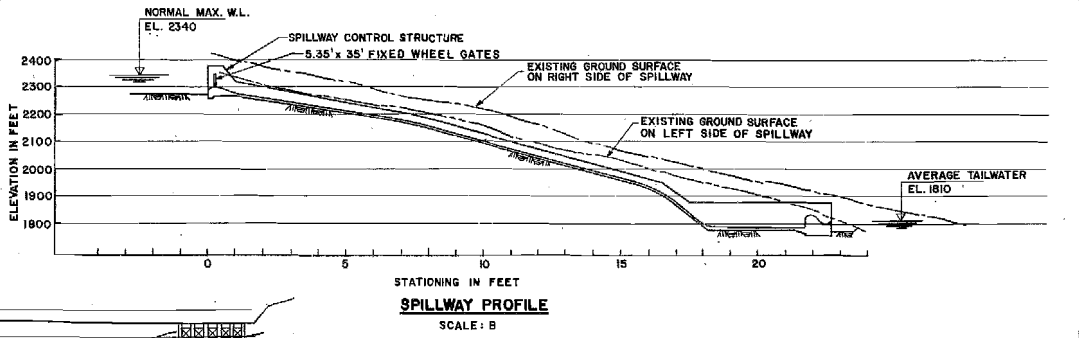

**SPILLWAY PROFILE**  
SCALE: B

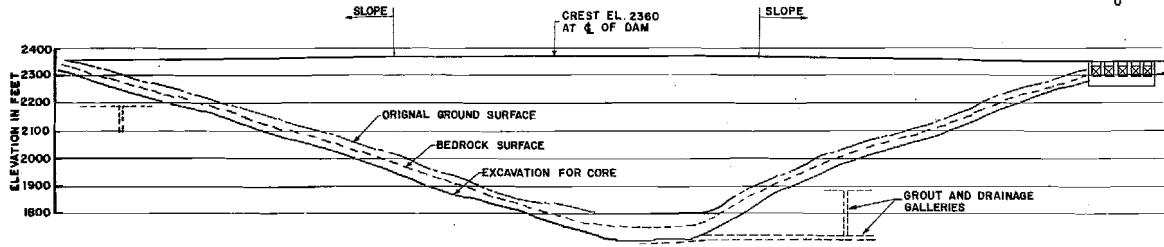

**LONGITUDINAL SECTION THRU C. OF DAM**  
SCALE: B

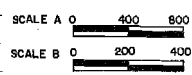

**NOTE**  
THIS DRAWING ILLUSTRATES A PRELIMINARY CONCEPTUAL PROJECT LAYOUT PREPARED FOR COMPARISON OF ALTERNATIVE SITE DEVELOPMENTS ONLY

**SUSITNA III HYDRO DEVELOPMENT**



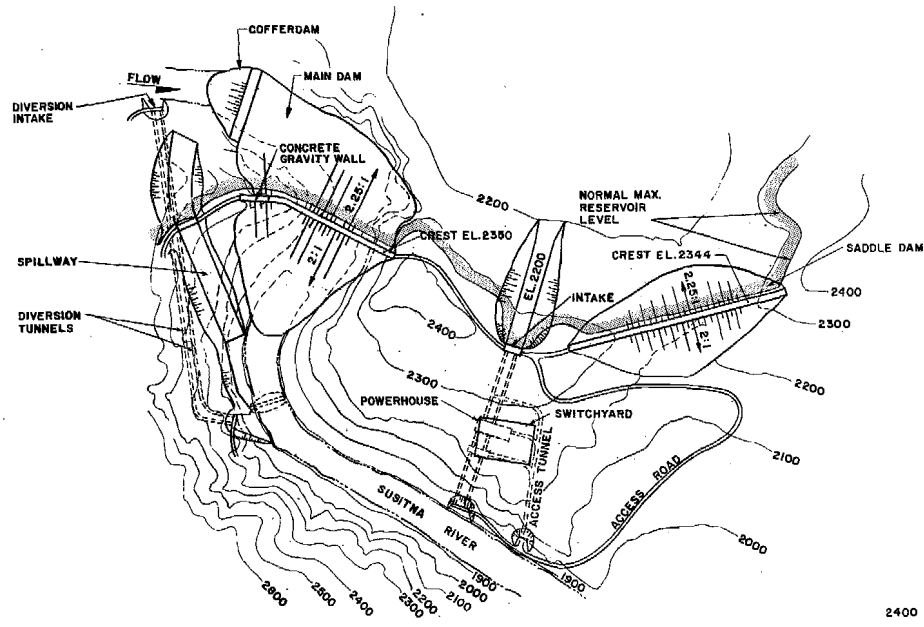

**GENERAL ARRANGEMENT**  
SCALE A

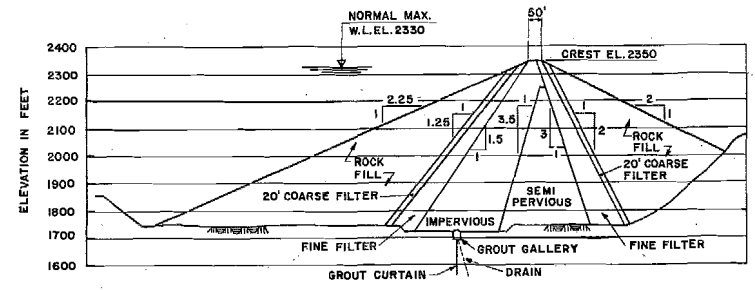

**SECTION THRU DAM**  
SCALE B

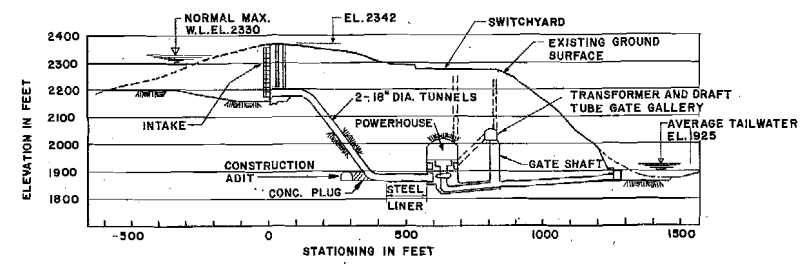

**POWER FACILITIES PROFILE**  
SCALE B

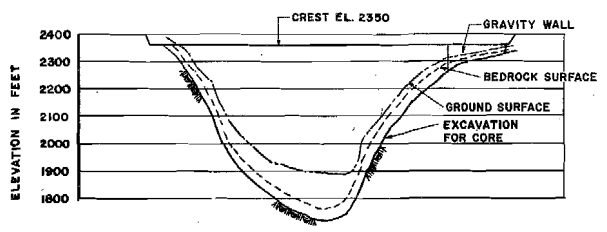

**LONGITUDINAL SECTION THRU C OF MAIN DAM**  
SCALE B

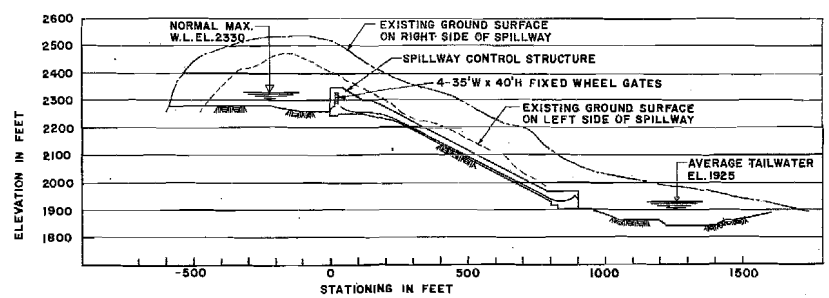

**SPILLWAY PROFILE**  
SCALE B

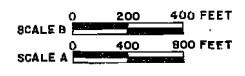

**NOTE**  
THIS DRAWING ILLUSTRATES A PRELIMINARY CONCEPTUAL PROJECT LAYOUT PREPARED FOR COMPARISON OF ALTERNATIVE SITE DEVELOPMENTS ONLY

**VEE HYDRO DEVELOPMENT**

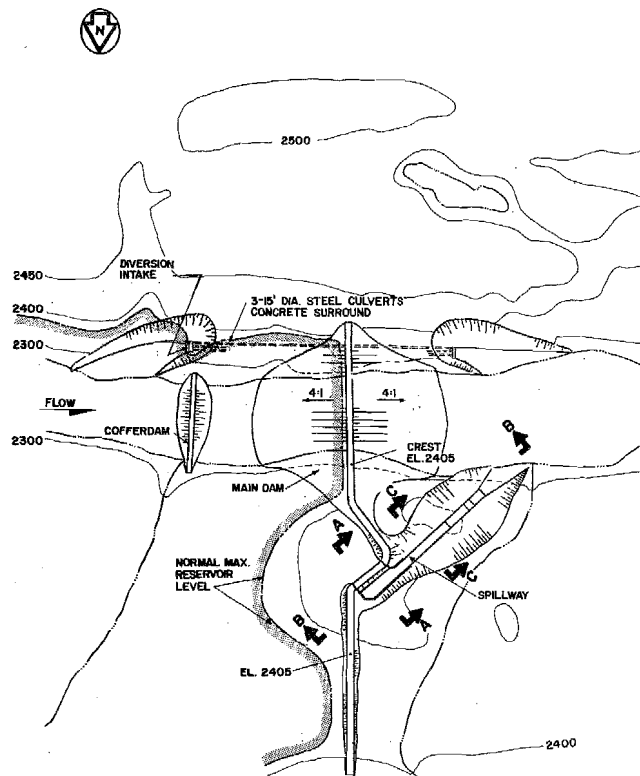

**MACLAREN  
GENERAL ARRANGEMENT**  
SCALE: A

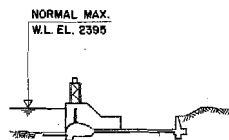

**SECTION A-A**

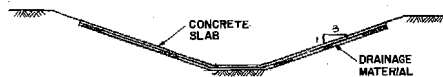

**SECTION C-C**

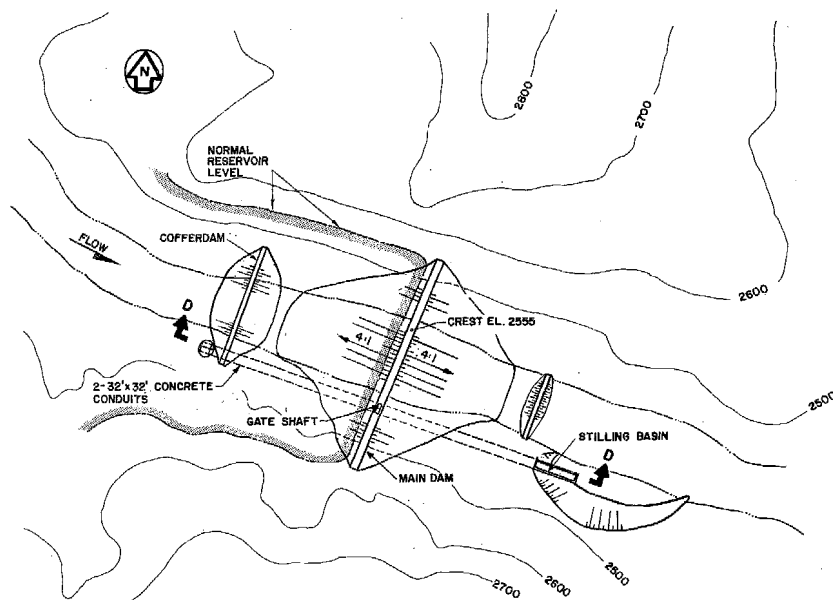

**DENALI  
GENERAL ARRANGEMENT**  
SCALE: A

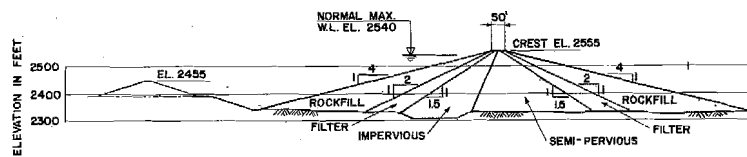

**DAM CROSS SECTION**

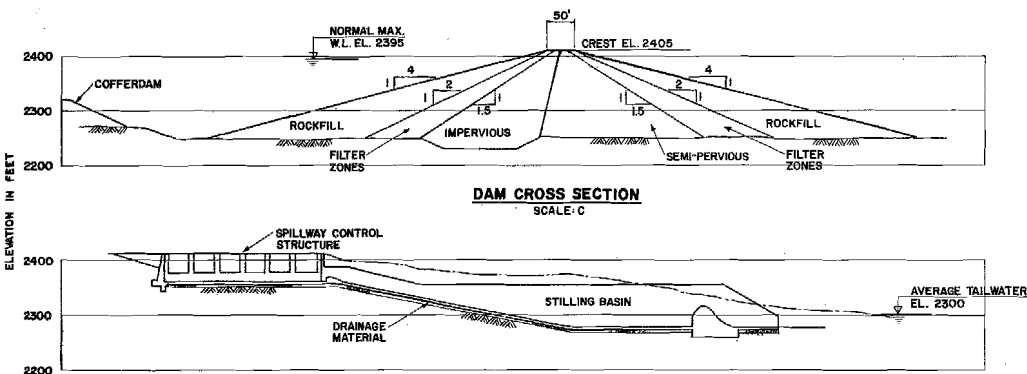

**SECTION B-B**  
SCALE: C

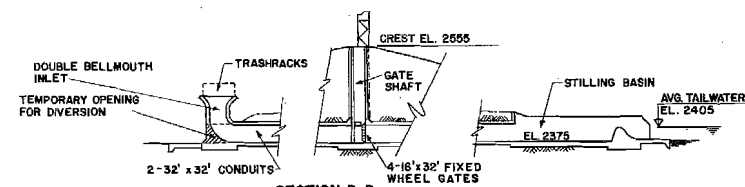

**SECTION D-D**  
SCALE: C

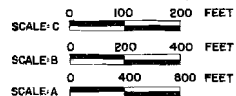

**NOTE**  
THIS DRAWING ILLUSTRATES A PRELIMINARY CONCEPTUAL PROJECT LAYOUT PREPARED FOR COMPARISON OF ALTERNATIVE SITE DEVELOPMENTS ONLY

**DENALI & MACLAREN HYDRO DEVELOPMENTS**

TUNNEL  
SCHEME  
#

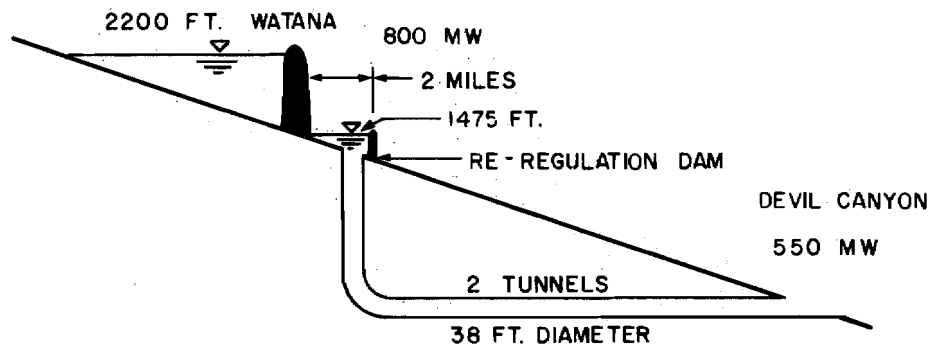

1.

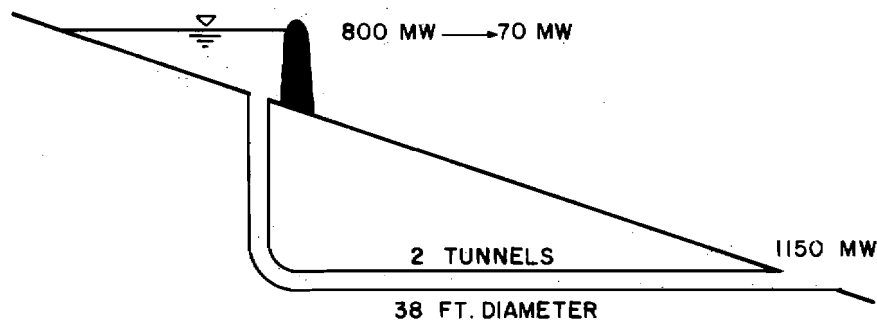

2.

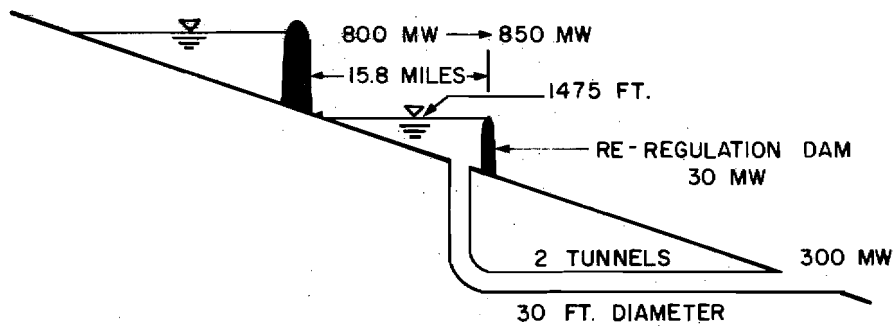

3.

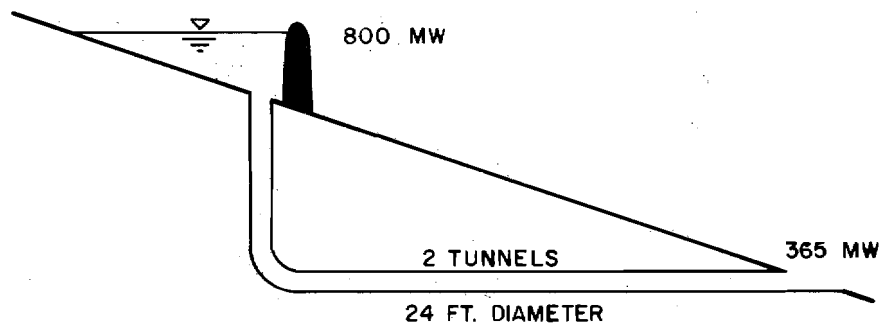

4.

SCHEMATIC REPRESENTATION  
OF CONCEPTUAL TUNNEL SCHEMES

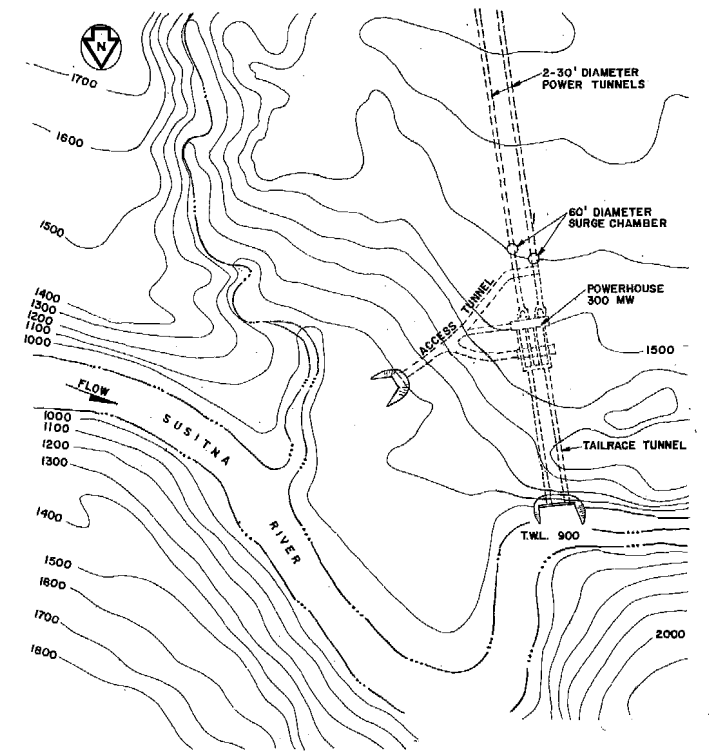
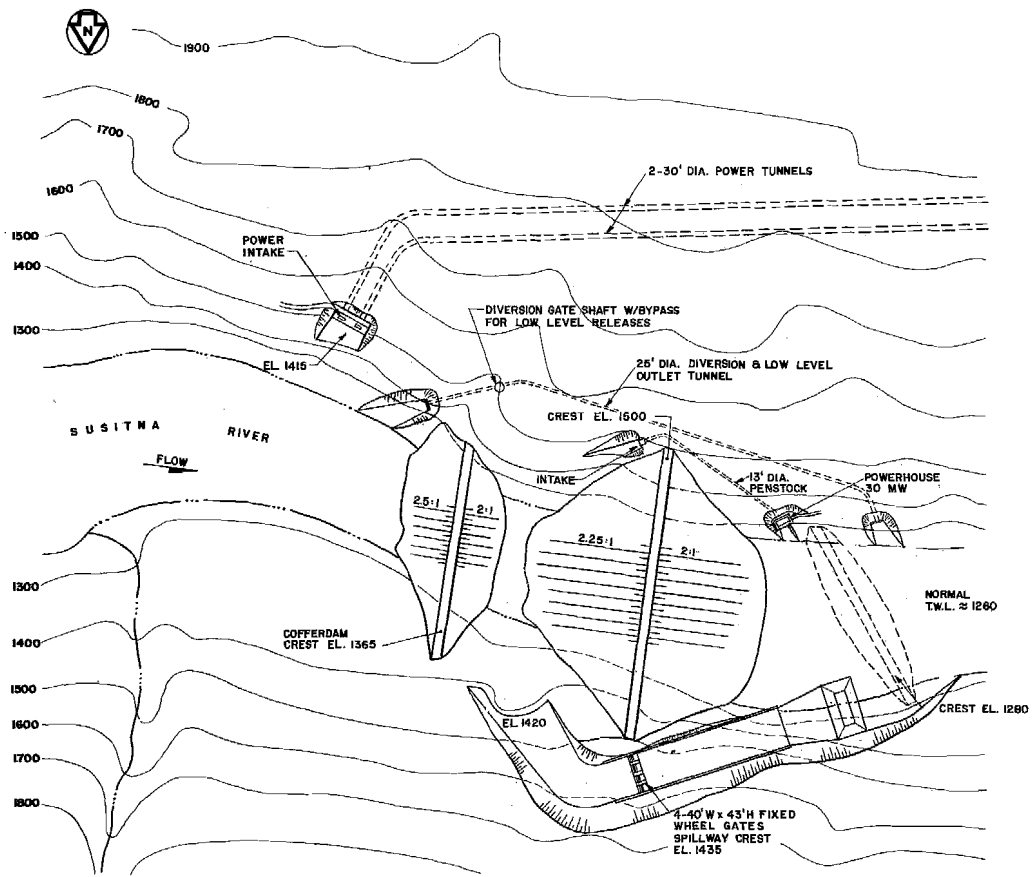
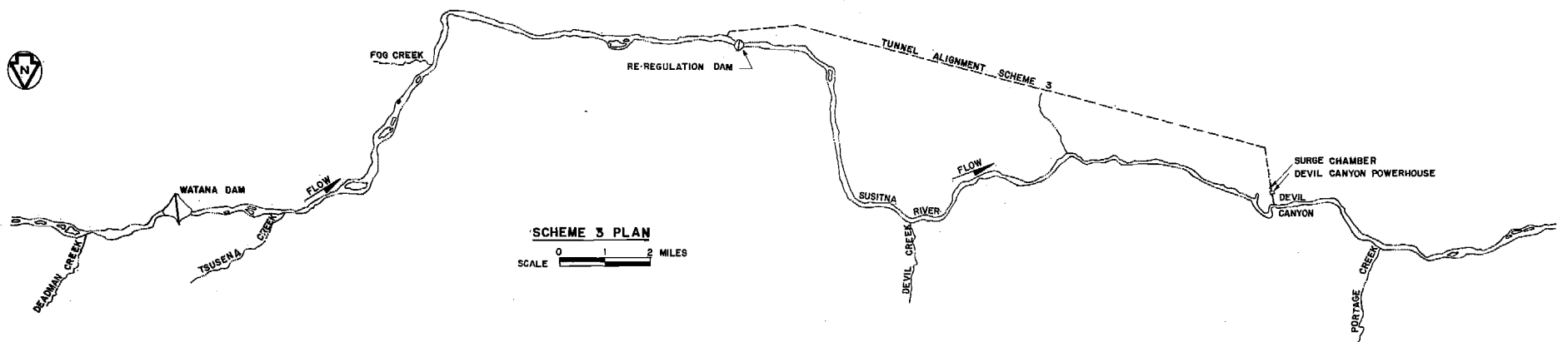

**NOTE**  
THIS DRAWING ILLUSTRATES A PRELIMINARY CONCEPTUAL PROJECT LAYOUT PREPARED FOR COMPARISON OF ALTERNATIVE SITE DEVELOPMENTS ONLY

**PREFERRED TUNNEL SCHEME 3 PLAN VIEW**

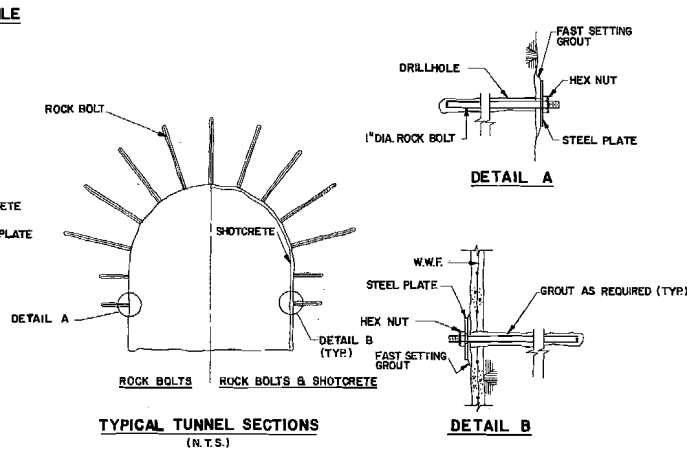
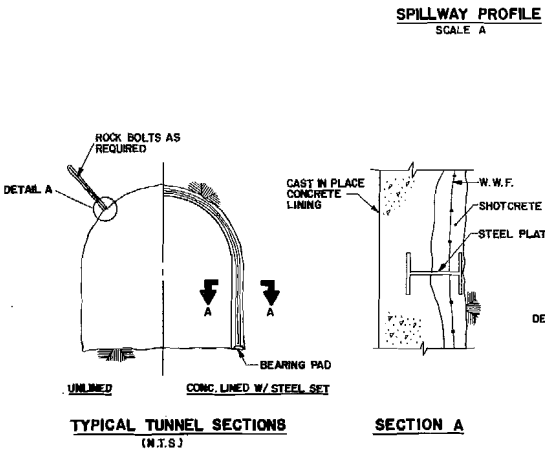
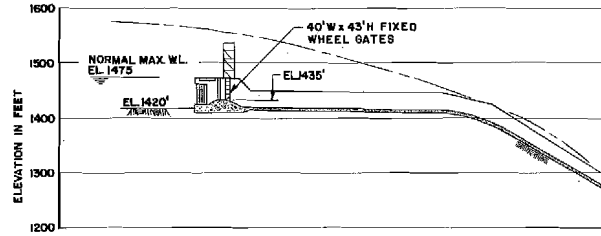
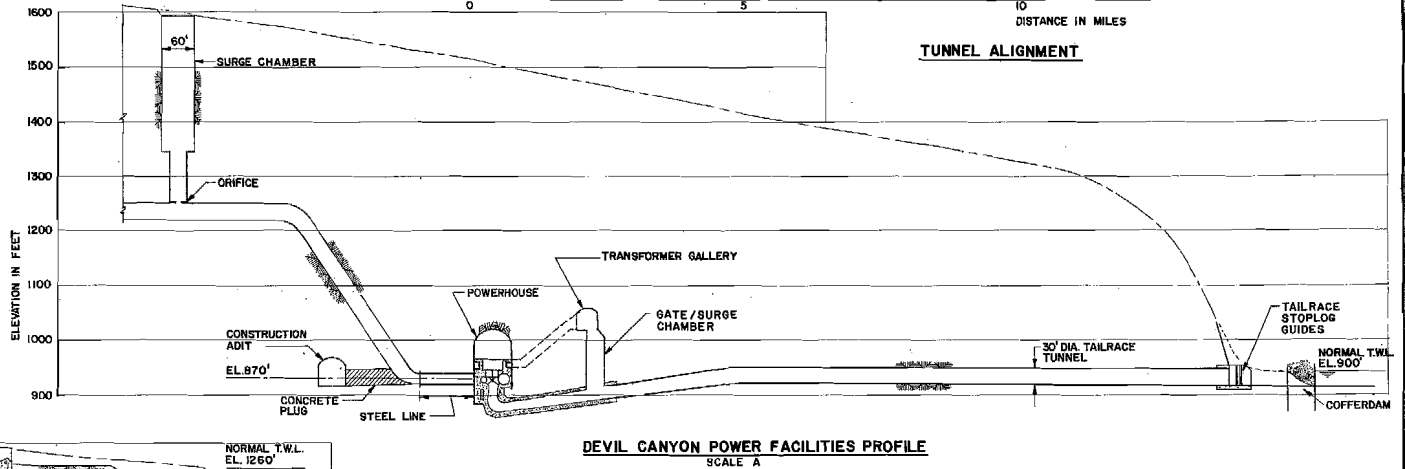
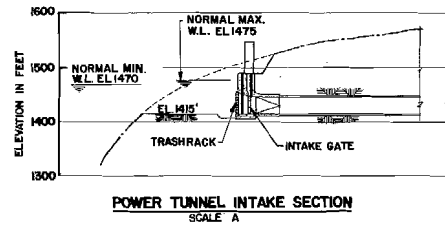
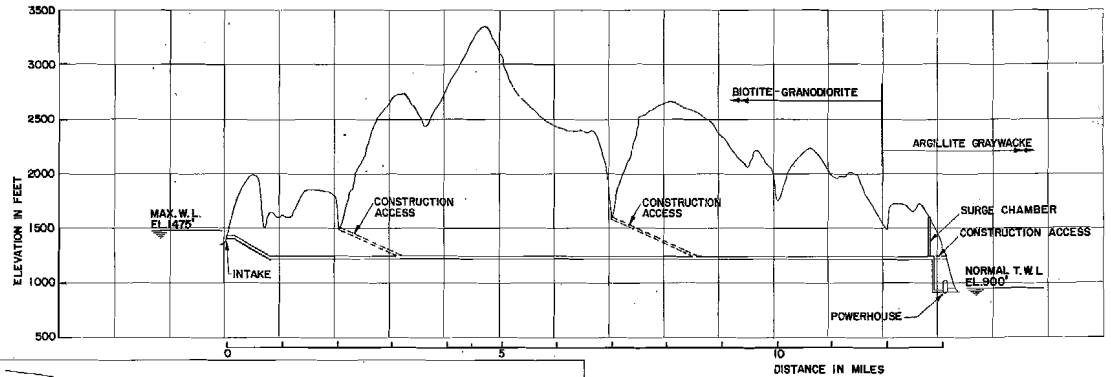
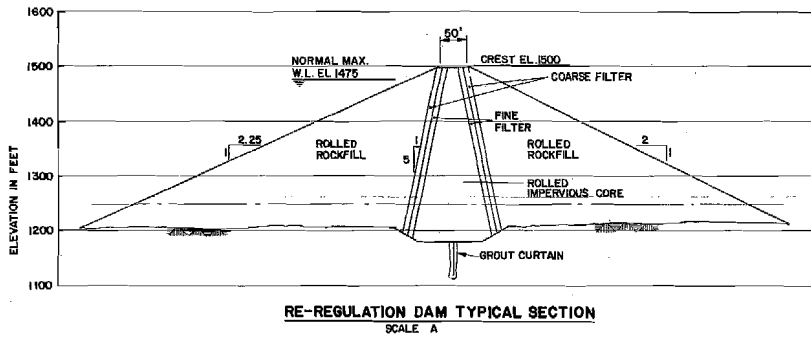

SCALE A 0 100 200 FEET

**NOTE**  
THIS DRAWING ILLUSTRATES A PRELIMINARY CONCEPTUAL PROJECT LAYOUT PREPARED FOR COMPARISON OF ALTERNATIVE SITE DEVELOPMENTS ONLY

**PREFERRED TUNNEL SCHEME 3 SECTIONS**

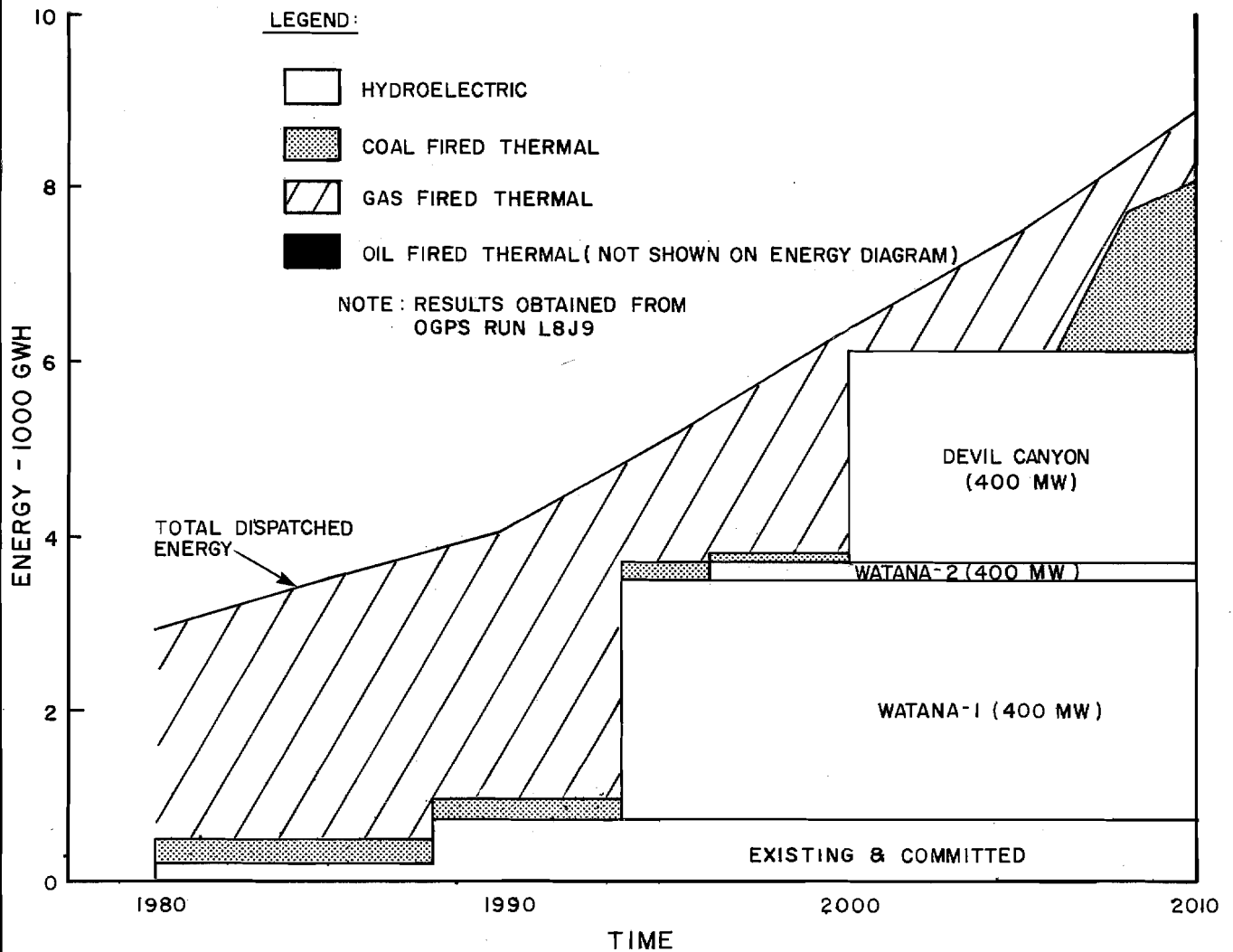
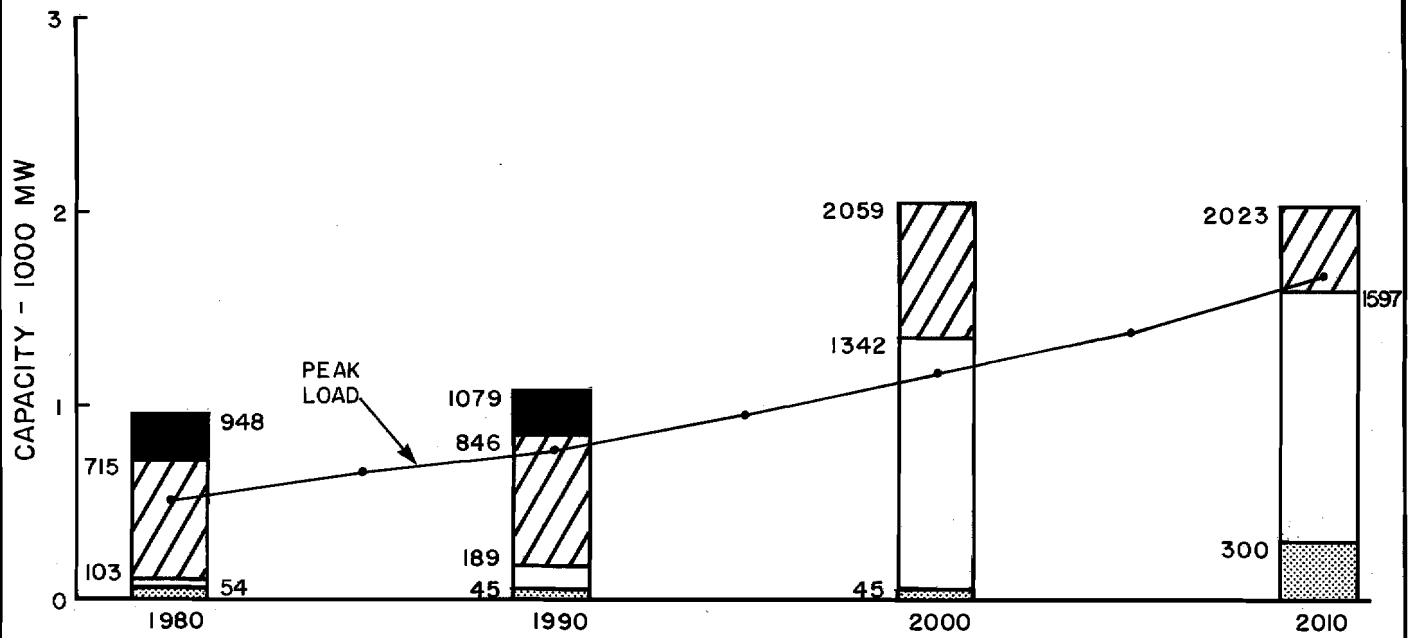

**GENERATION SCENARIO WITH SUSITNA PLAN E1.3  
- MEDIUM LOAD FORECAST -**

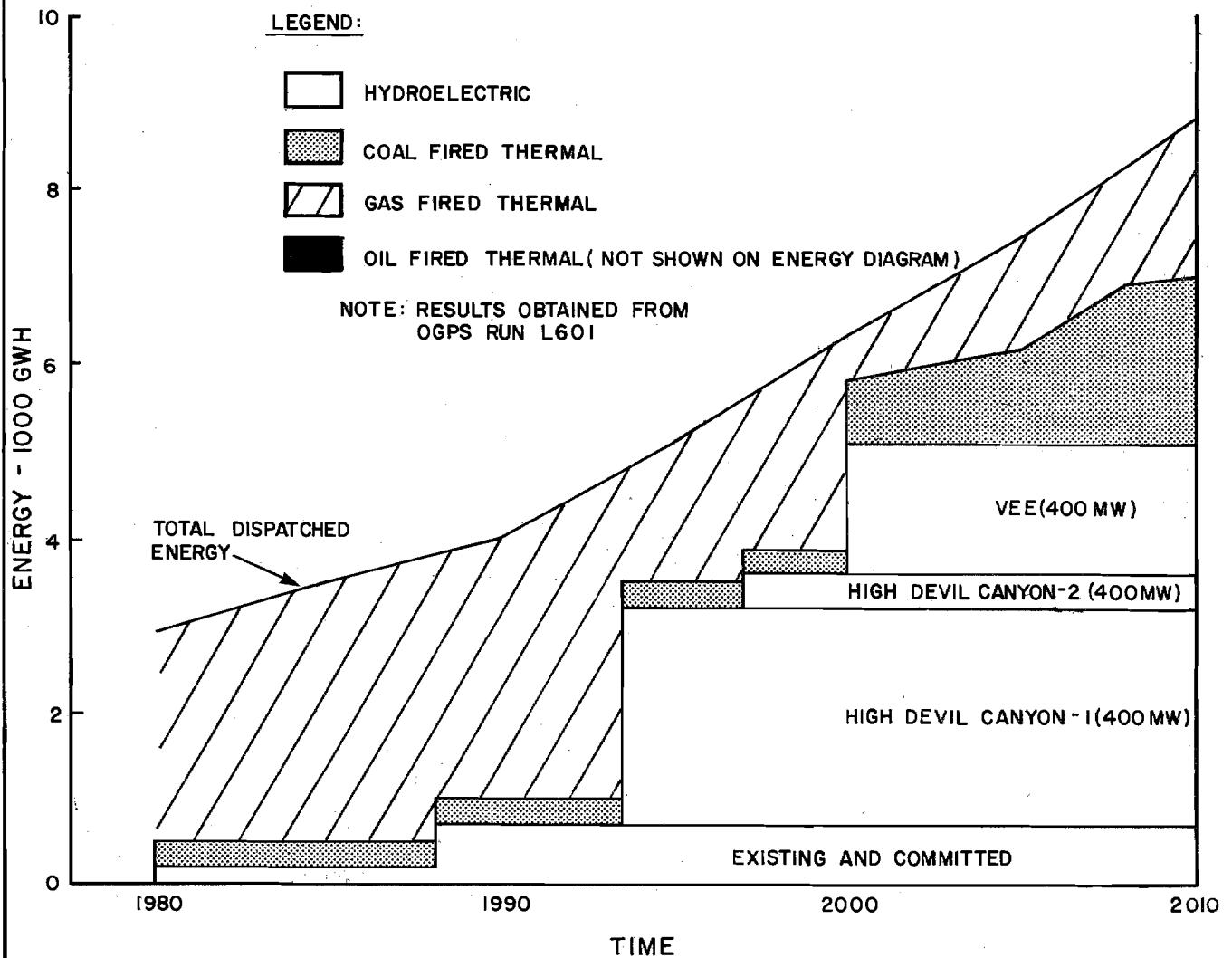
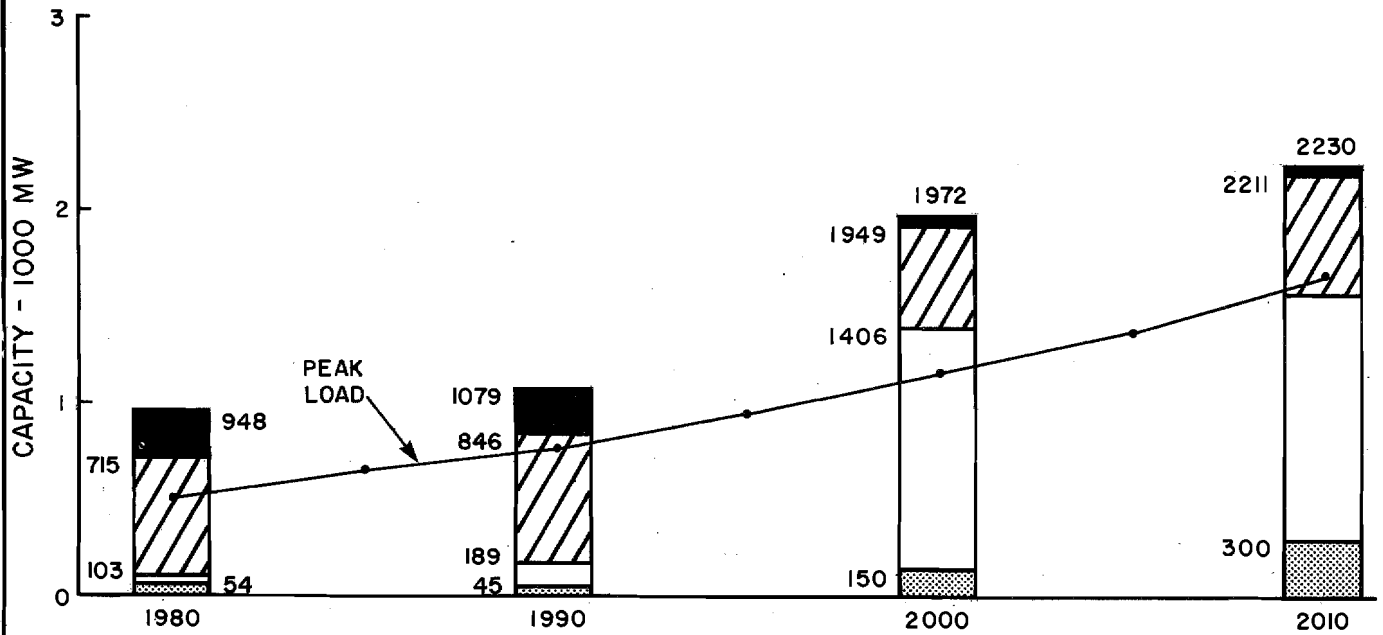

**GENERATION SCENARIO WITH SUSITNA PLAN E 2.3  
- MEDIUM LOAD FORECAST -**

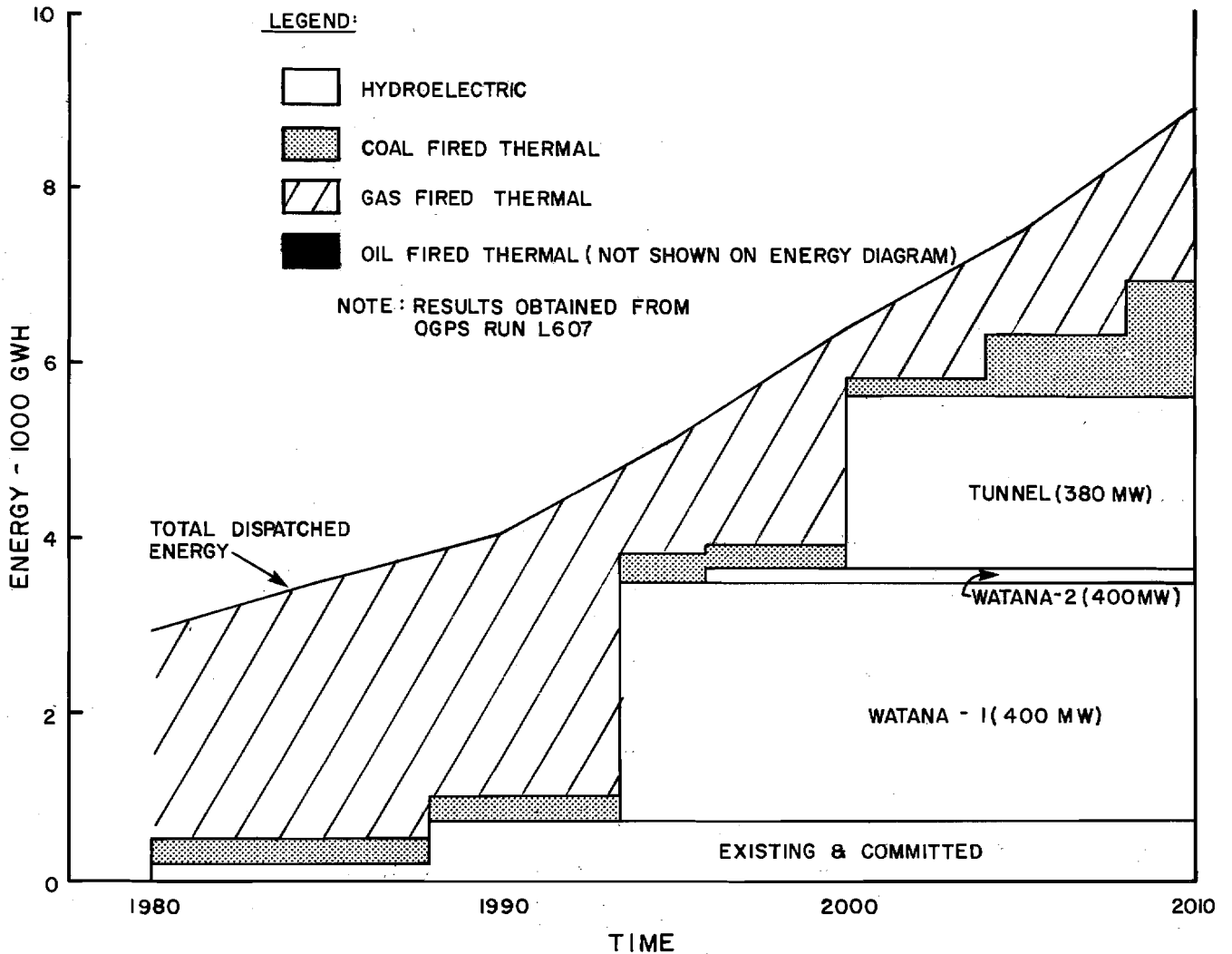
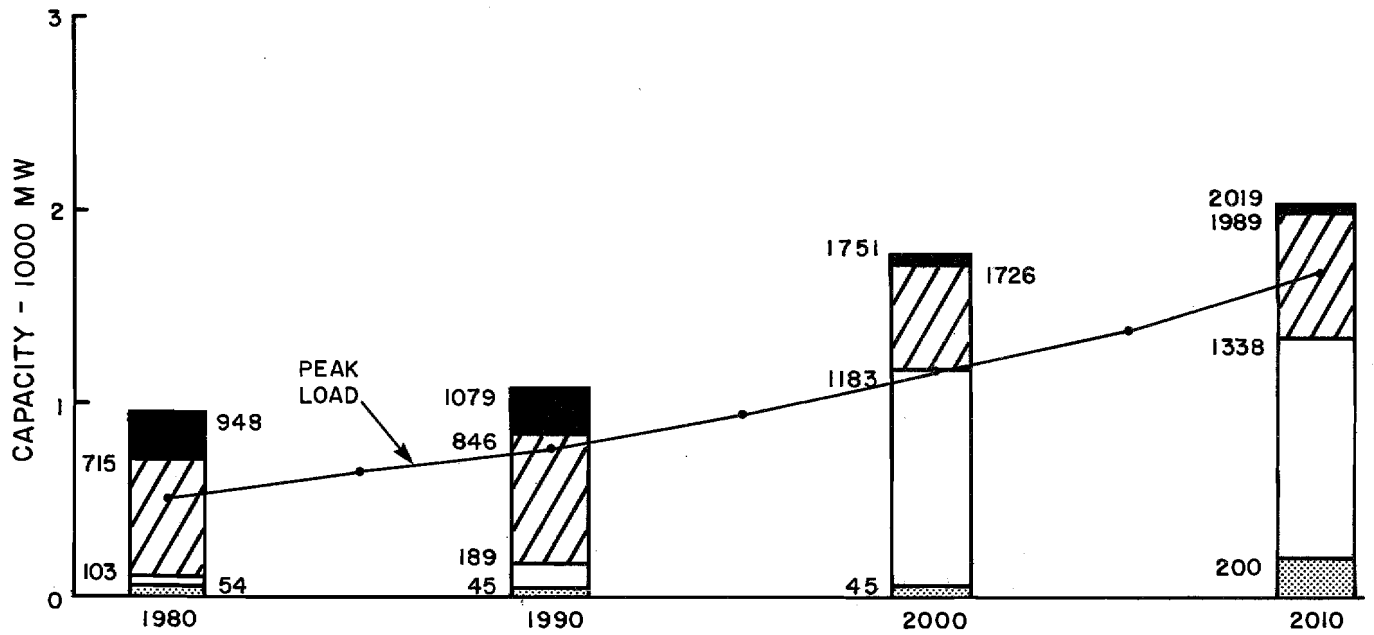

GENERATION SCENARIO WITH SUSITNA PLAN E3.1  
- MEDIUM LOAD FORECAST -



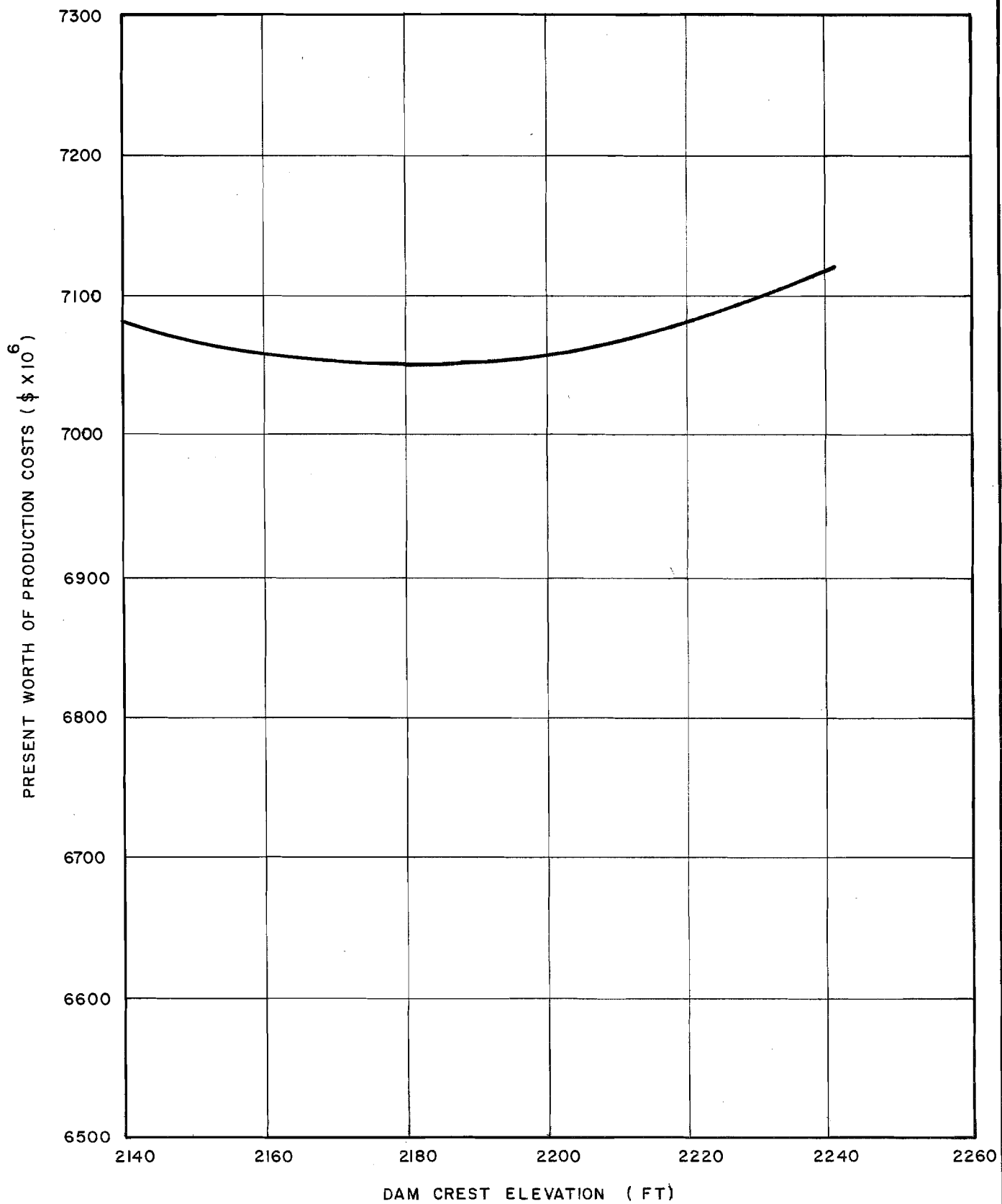

**WATANA RESERVOIR**  
**DAM CREST ELEVATION/ PRESENT WORTH OF PRODUCTION COSTS**

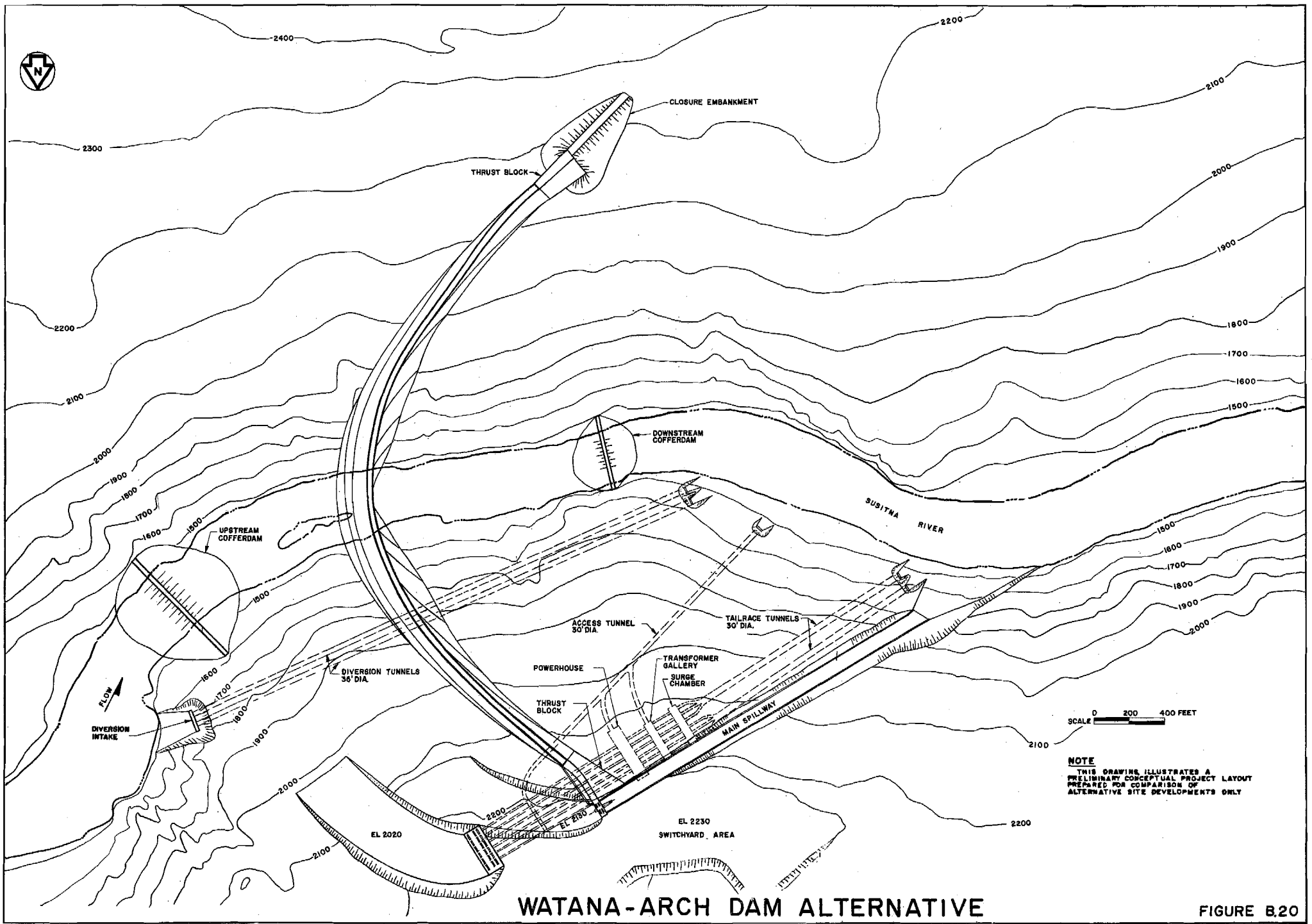

**WATANA-ARCH DAM ALTERNATIVE**

**FIGURE B.20**

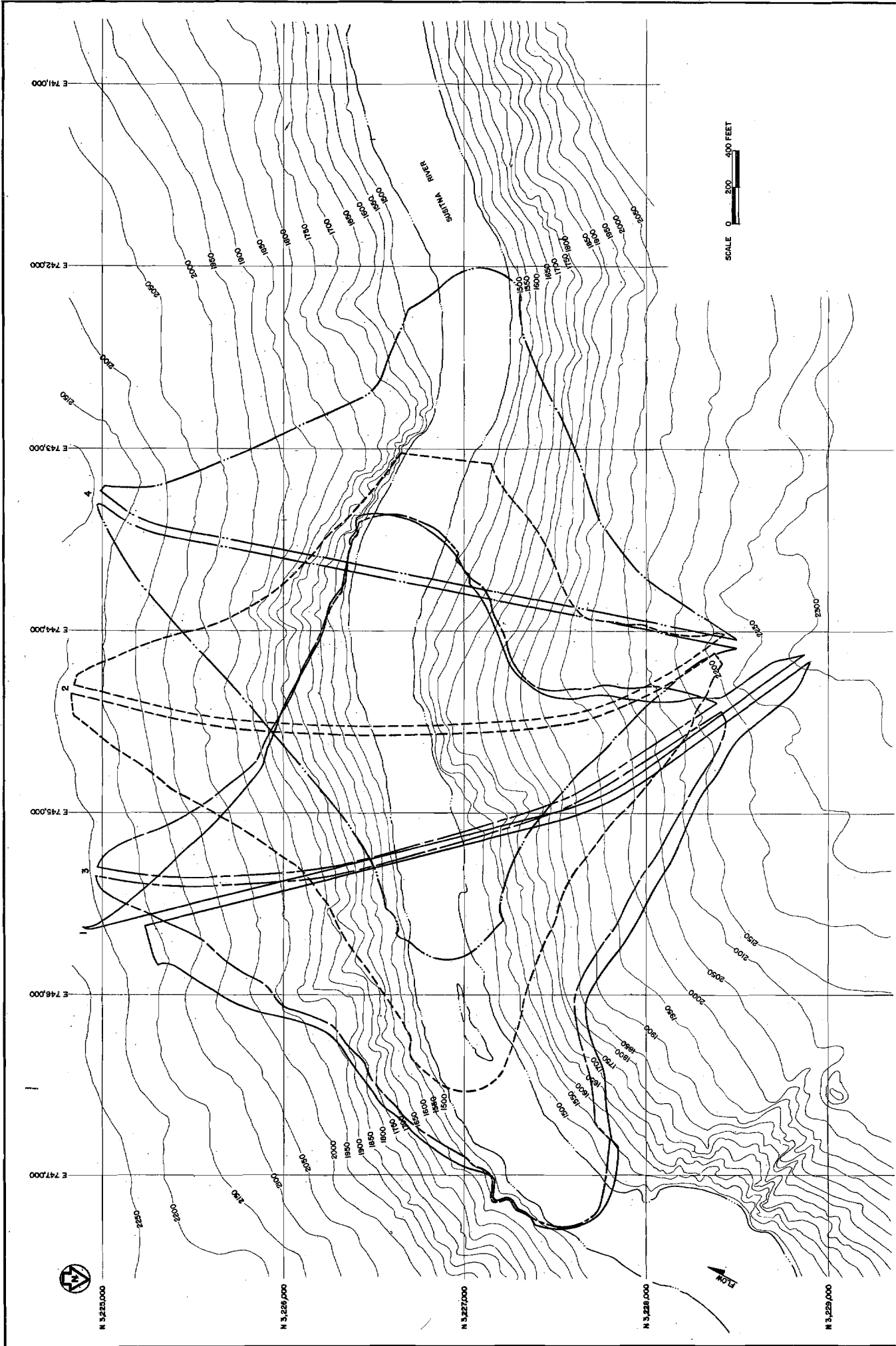

WATANA ALTERNATIVE DAM AXES

FIGURE B.21

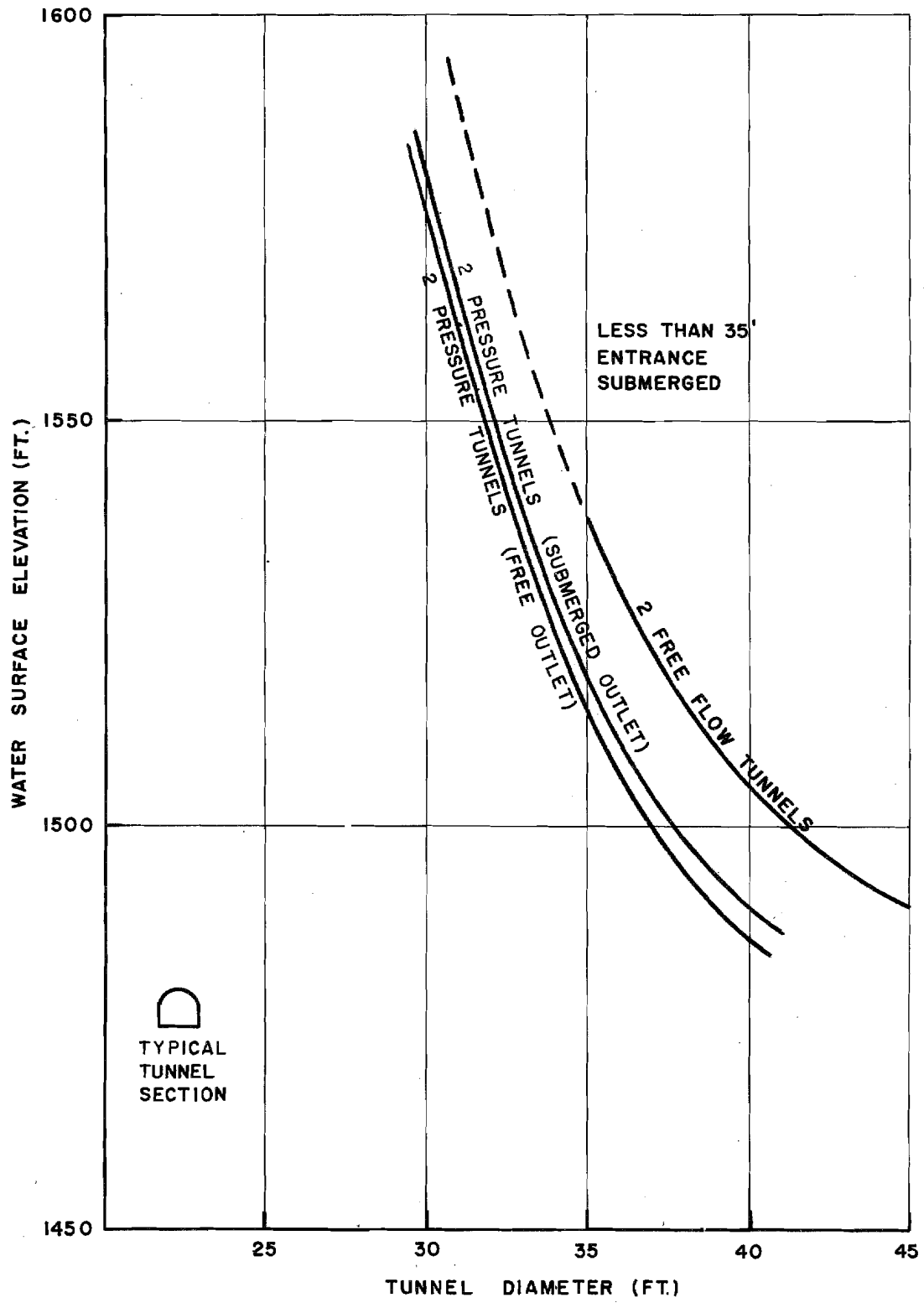

**NOTE**  
FOR 80,000 CFS

**WATANA DIVERSION  
HEADWATER ELEVATION/TUNNEL DIAMETER**

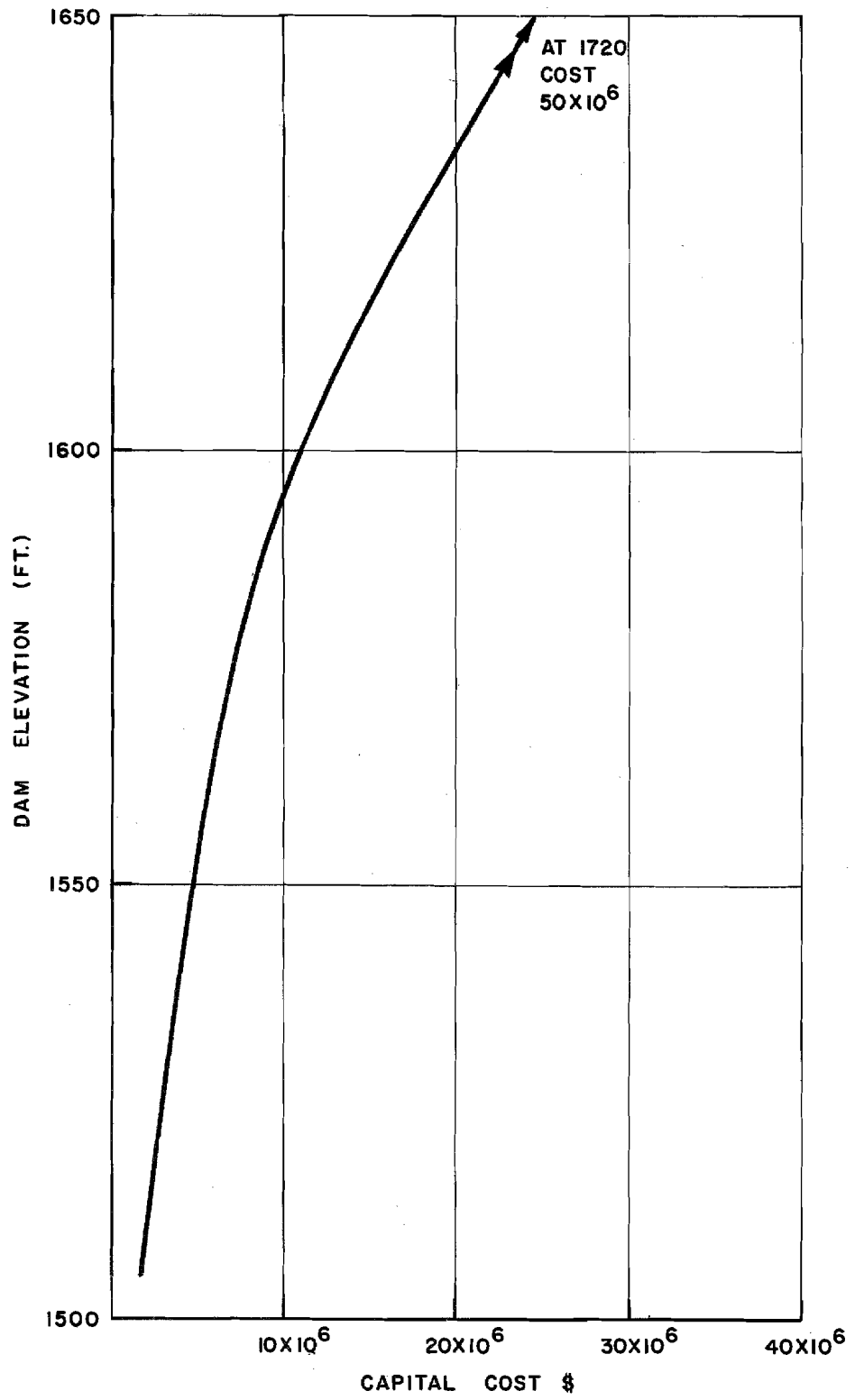

WATANA DIVERSION  
UPSTREAM COFFERDAM COSTS

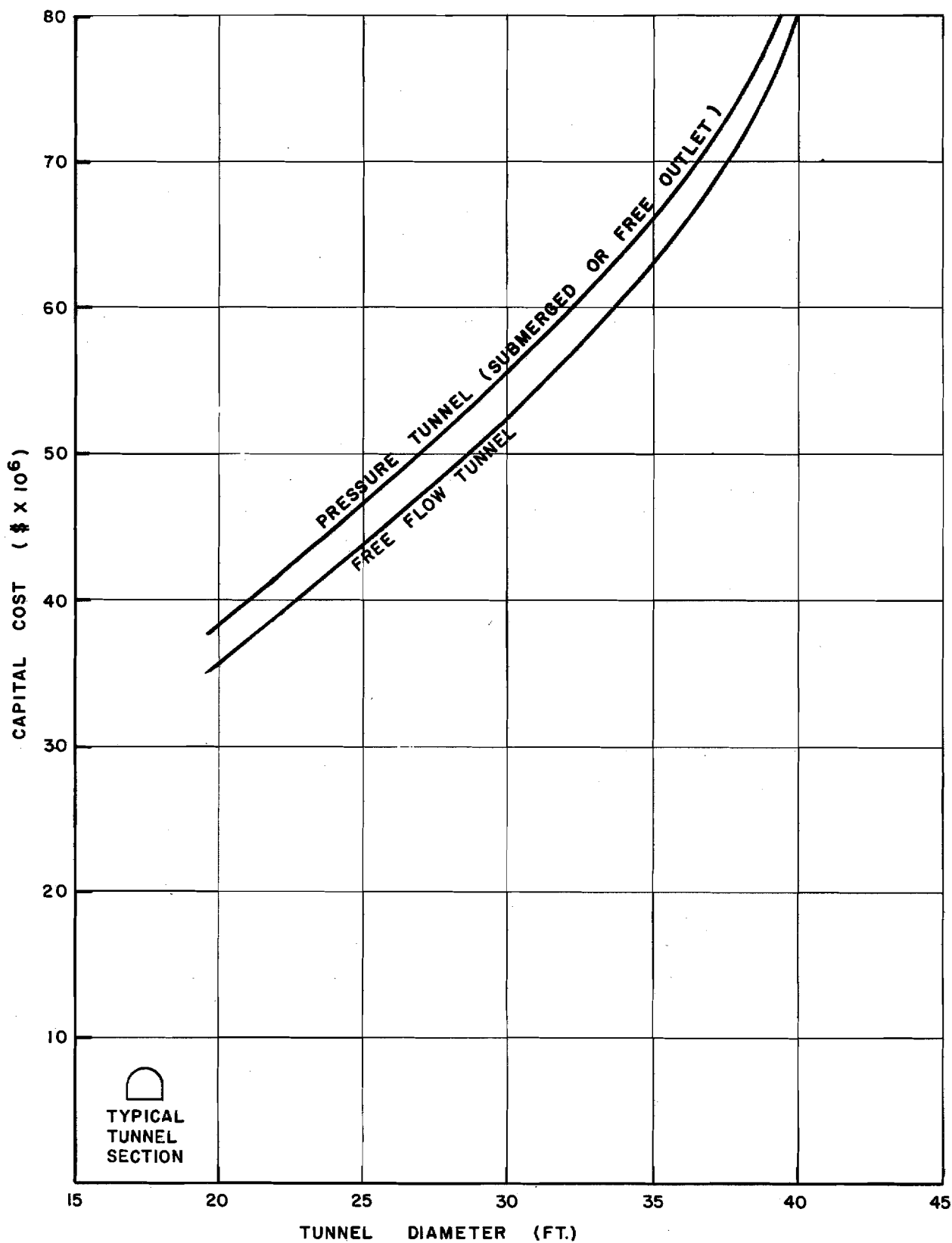

WATANA DIVERSION  
TUNNEL COST/TUNNEL DIAMETER

FIGURE B.24

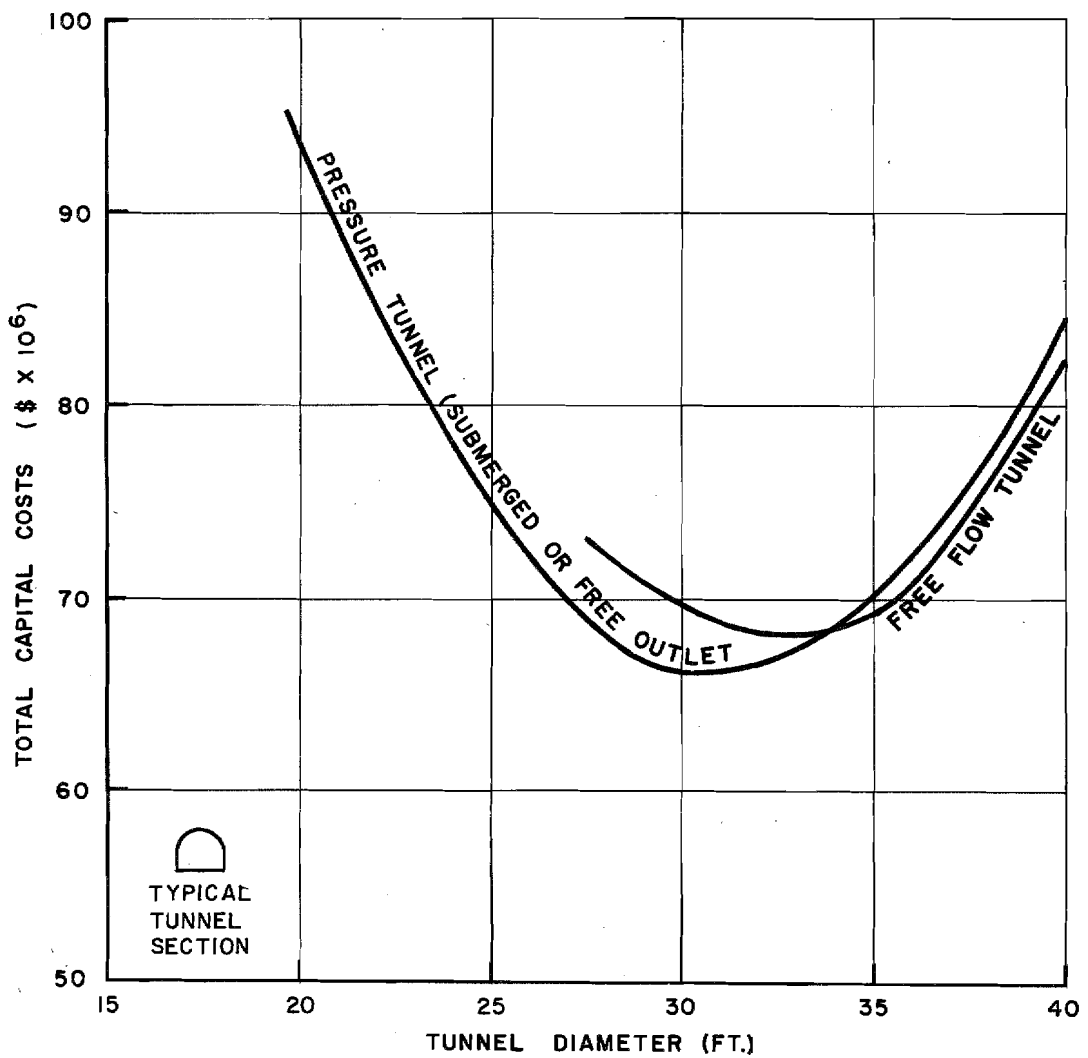

WATANA DIVERSION  
 TOTAL COST/TUNNEL DIAMETER

FIGURE B.25

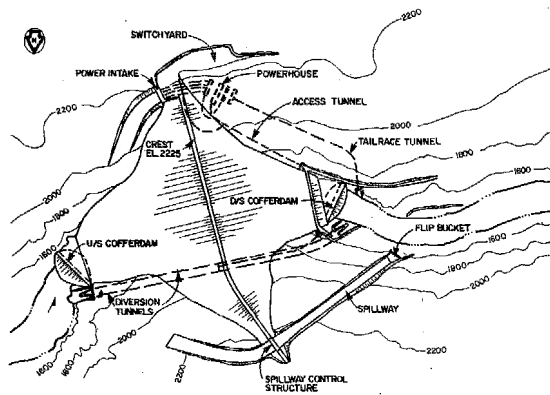

ALTERNATIVE 1

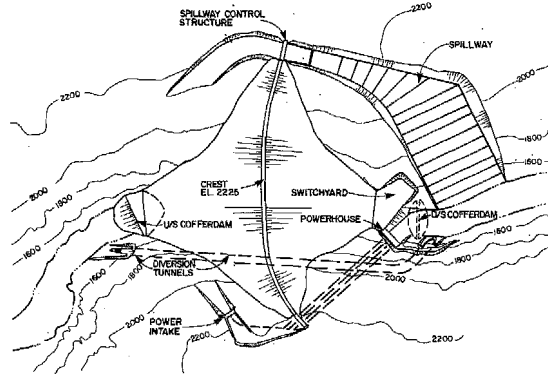

ALTERNATIVE 2

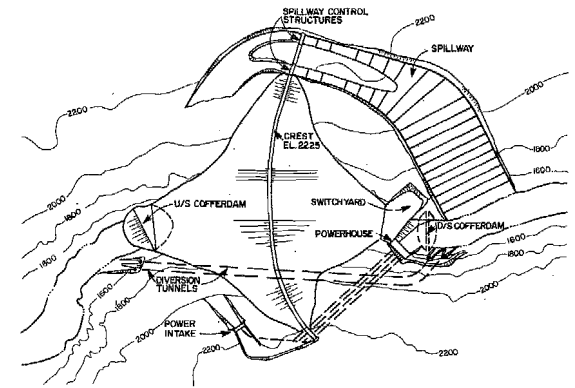

ALTERNATIVE 2A

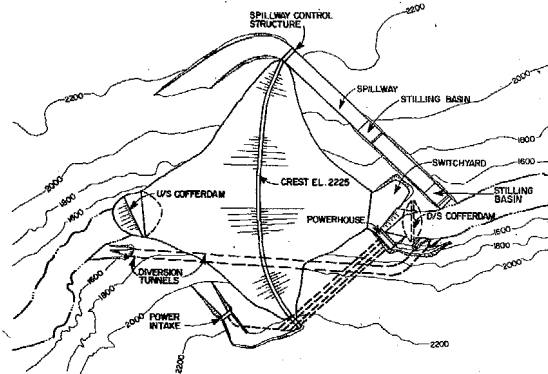

ALTERNATIVE 2B

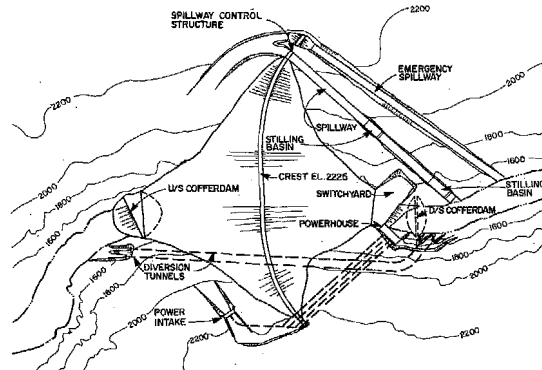

ALTERNATIVE 2C

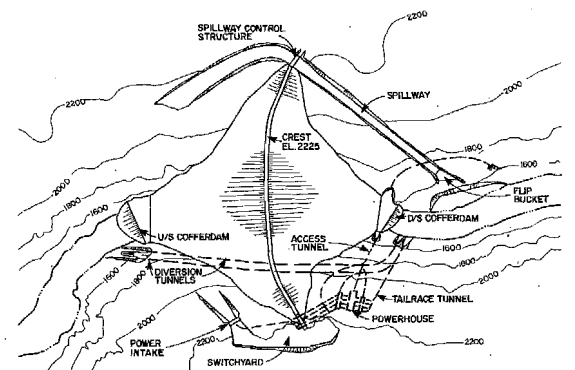

ALTERNATIVE 2D

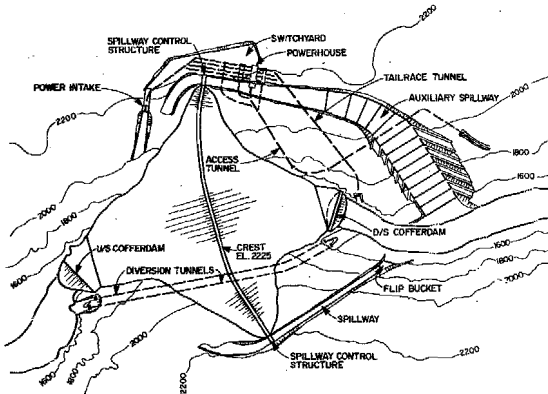

ALTERNATIVE 3

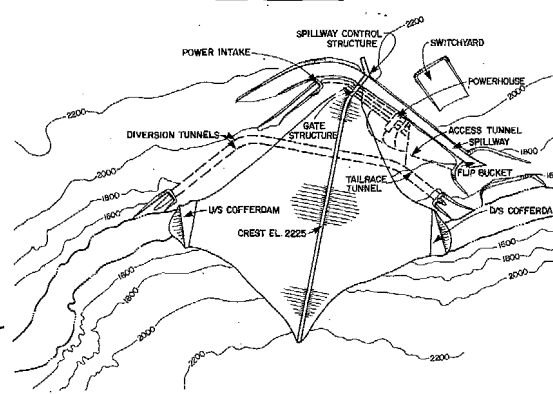

ALTERNATIVE 4

WATANA PRELIMINARY SCHEMES



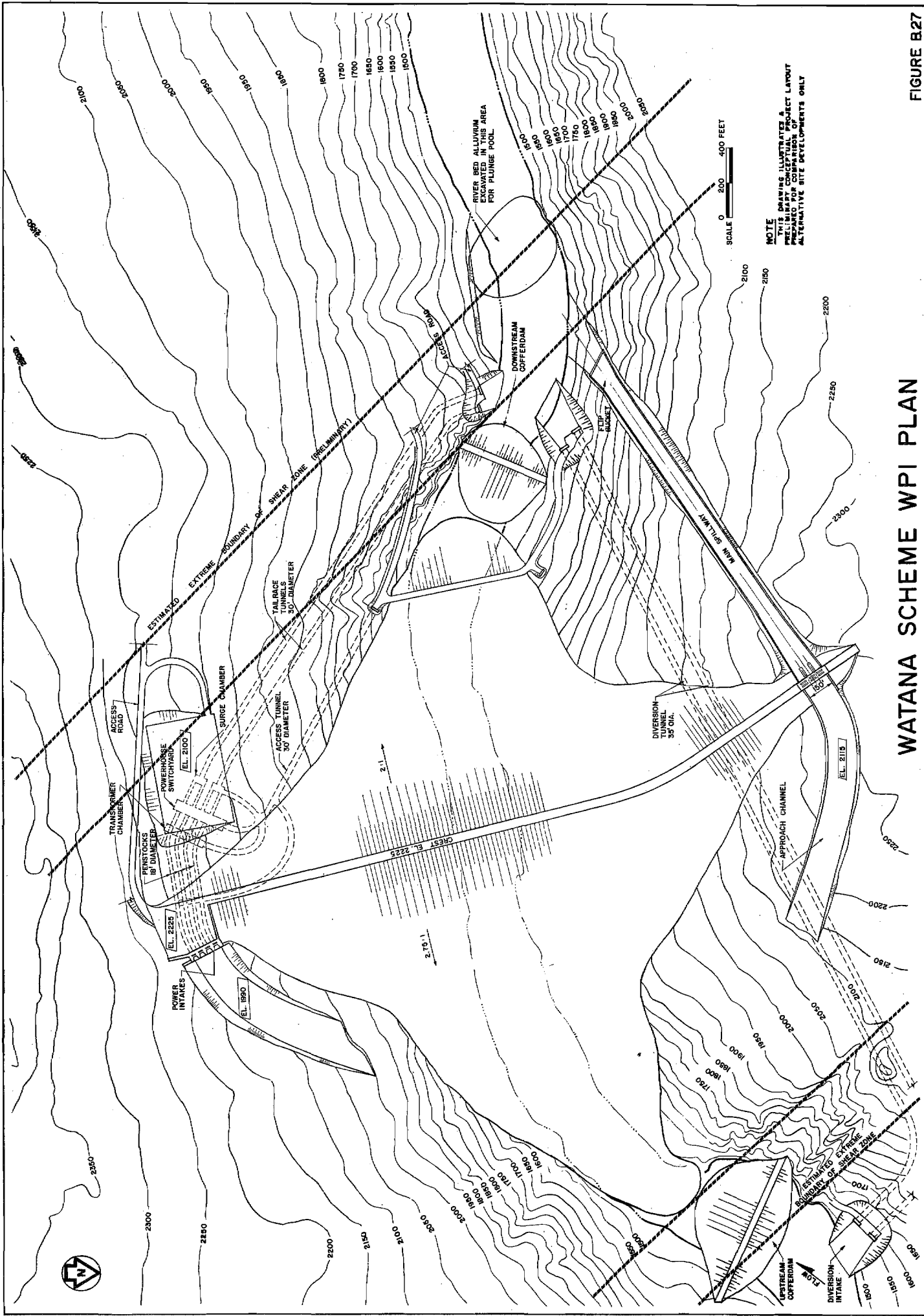

WATANAN SCHEME WPI PLAN

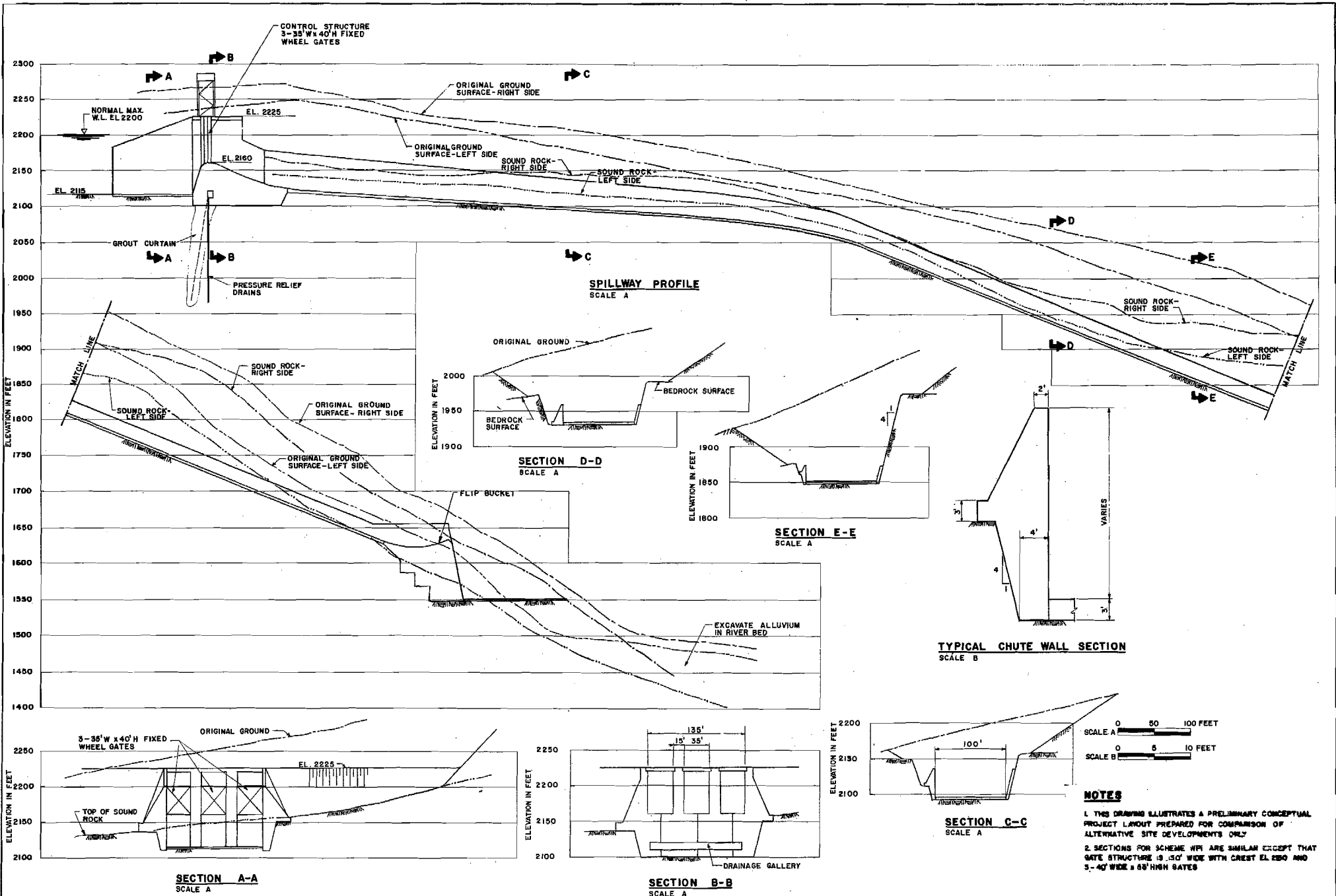

WATANA SCHEME WP3 SECTIONS

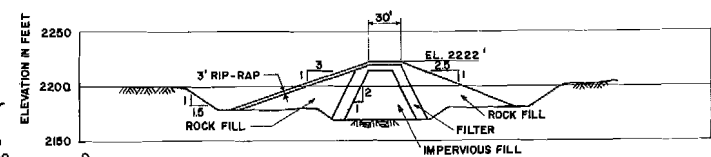
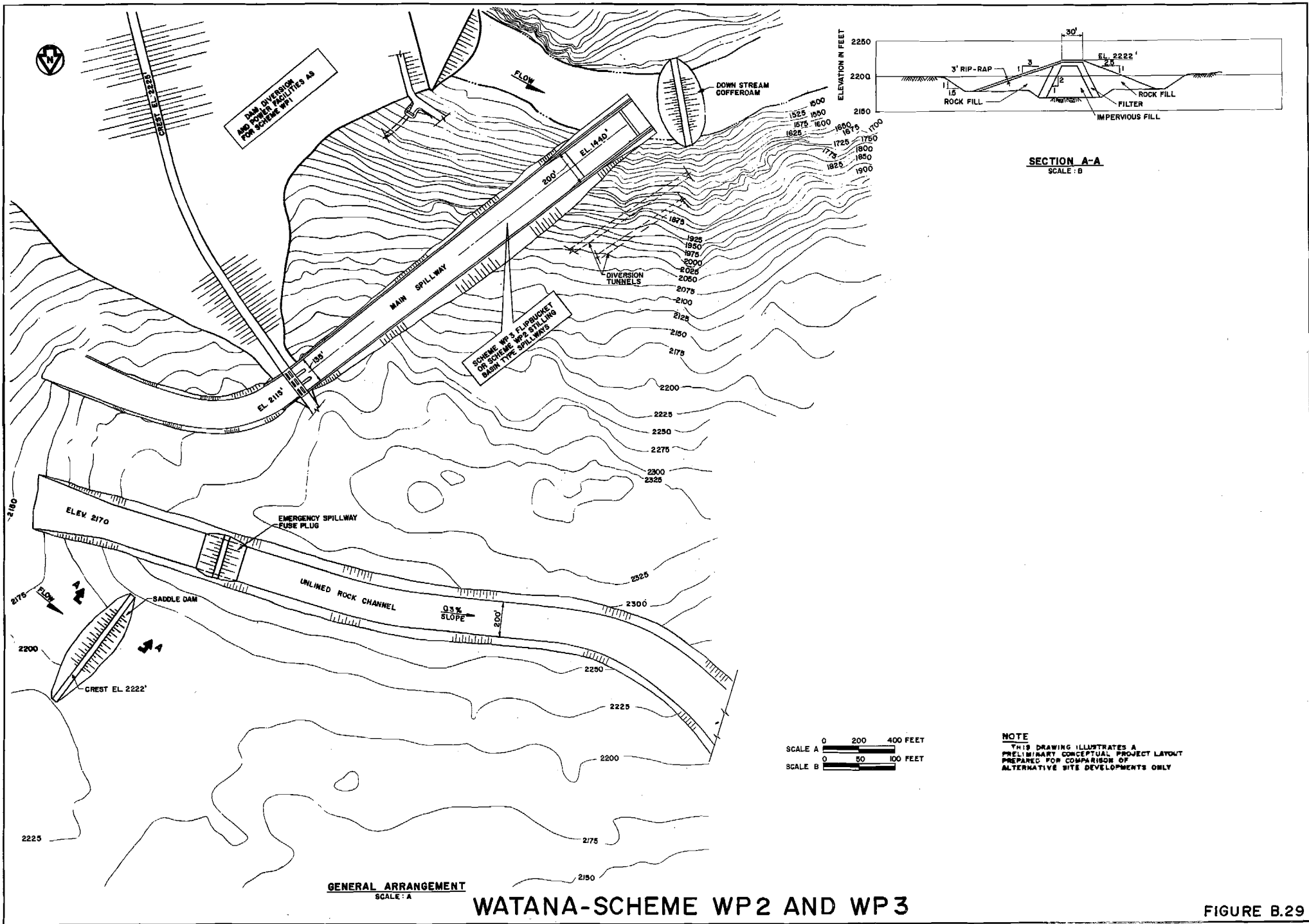

**NOTE**  
THIS DRAWING ILLUSTRATES A PRELIMINARY CONCEPTUAL LAYOUT PREPARED FOR COMPARISON OF ALTERNATIVE SITE DEVELOPMENTS ONLY

**GENERAL ARRANGEMENT**  
SCALE: A

**WATANA-SCHEME WP2 AND WP3**

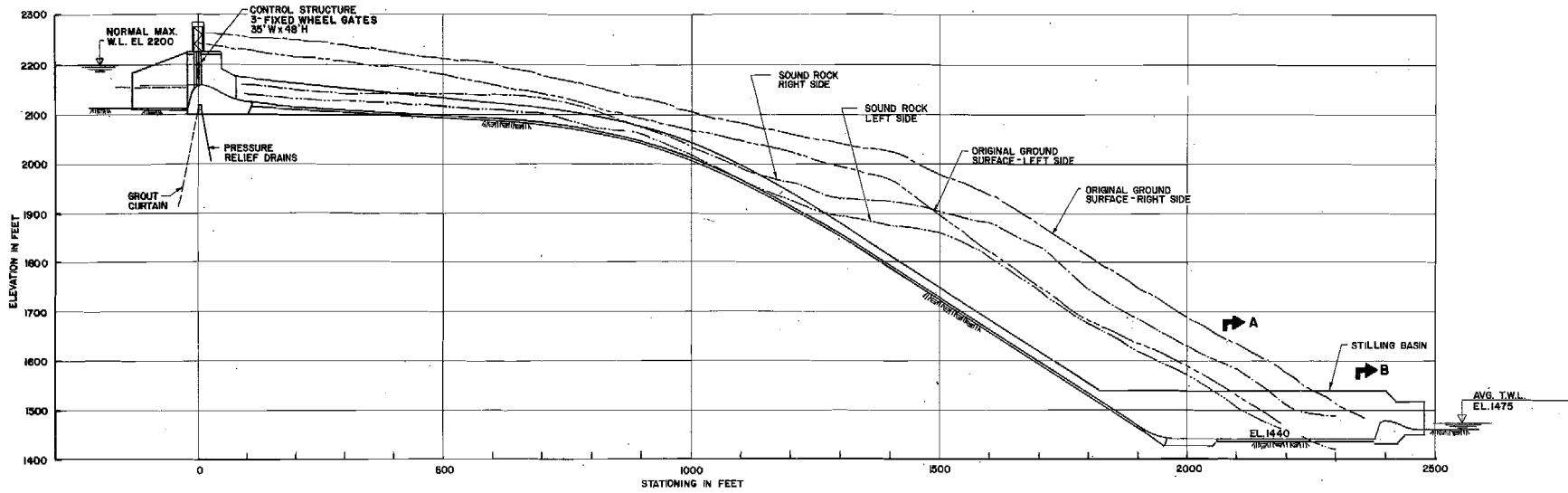

**SPILLWAY PROFILE**

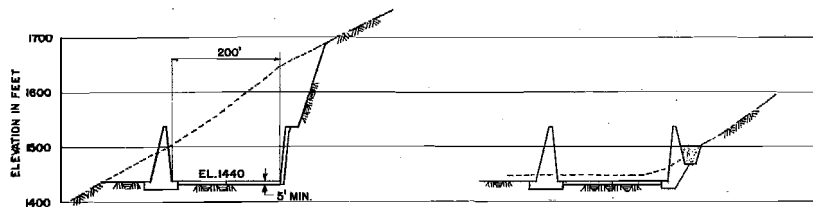

**SECTION A-A**

**SECTION B-B**

**NOTE**  
 THIS DRAWING ILLUSTRATES A  
 PRELIMINARY CONCEPTUAL PROJECT LAYOUT  
 PREPARED FOR COMPARISON OF  
 ALTERNATIVE SITE DEVELOPMENTS ONLY

SCALE 0 100 200 FEET

**WATANA SCHEME WP2 SECTIONS**

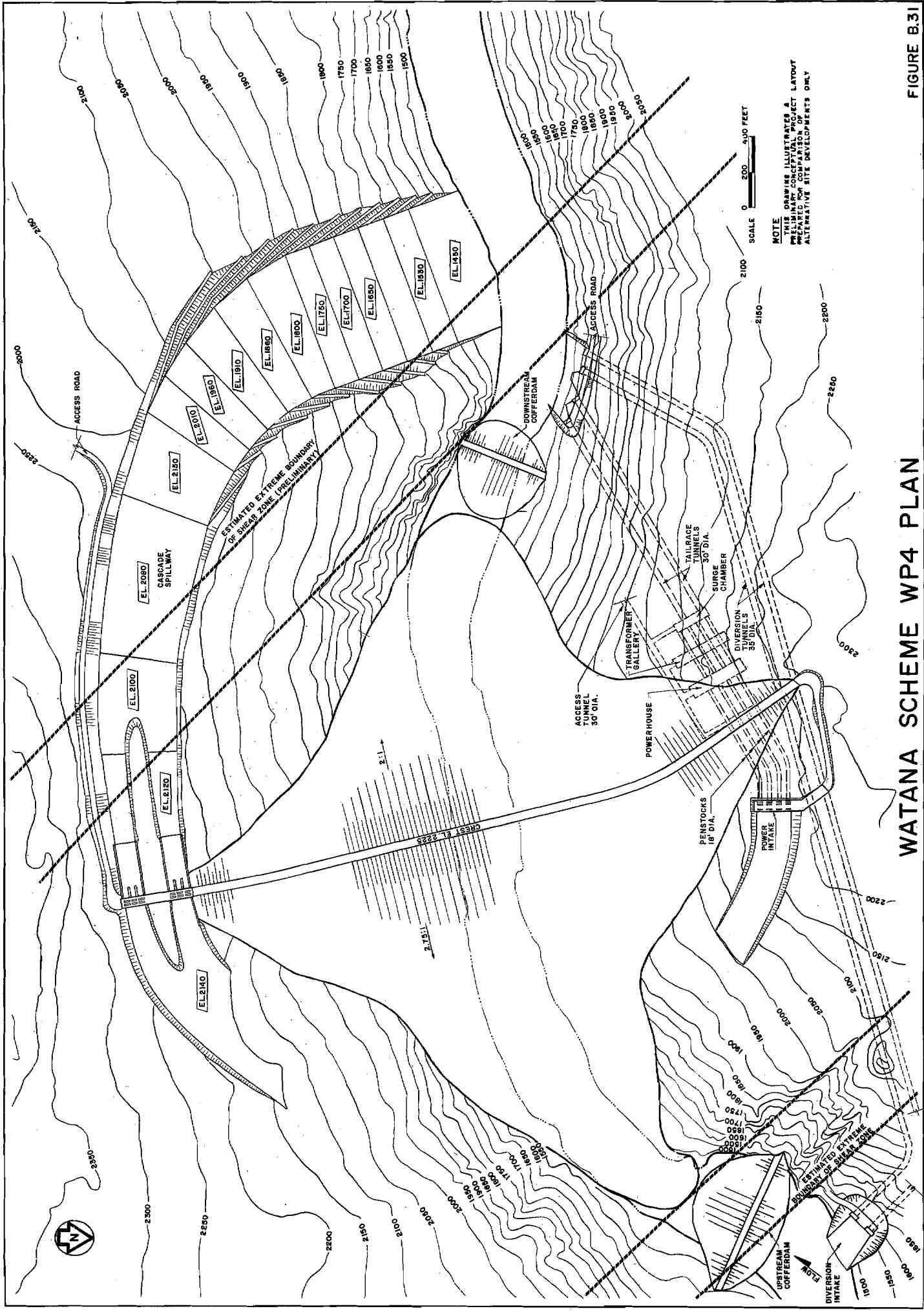

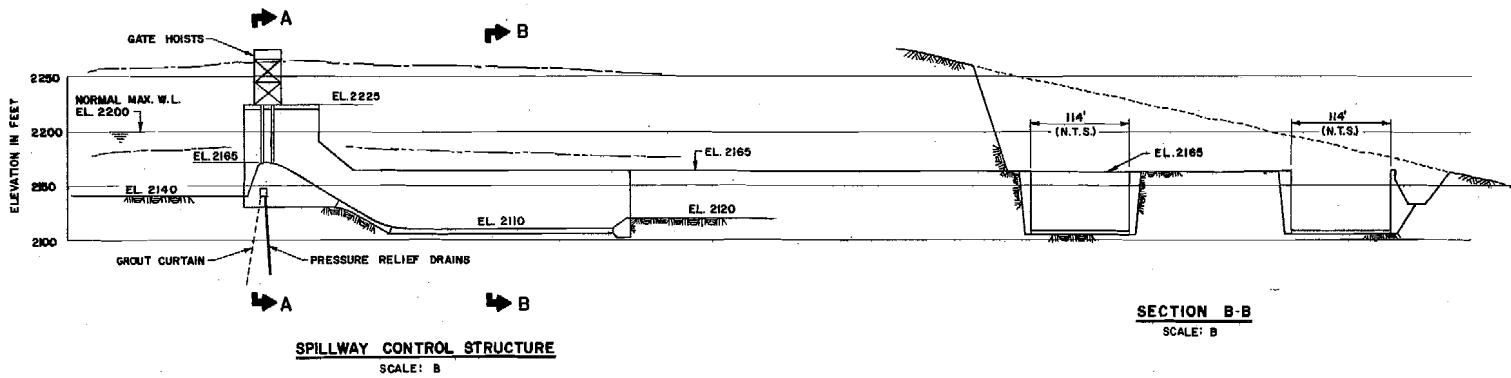
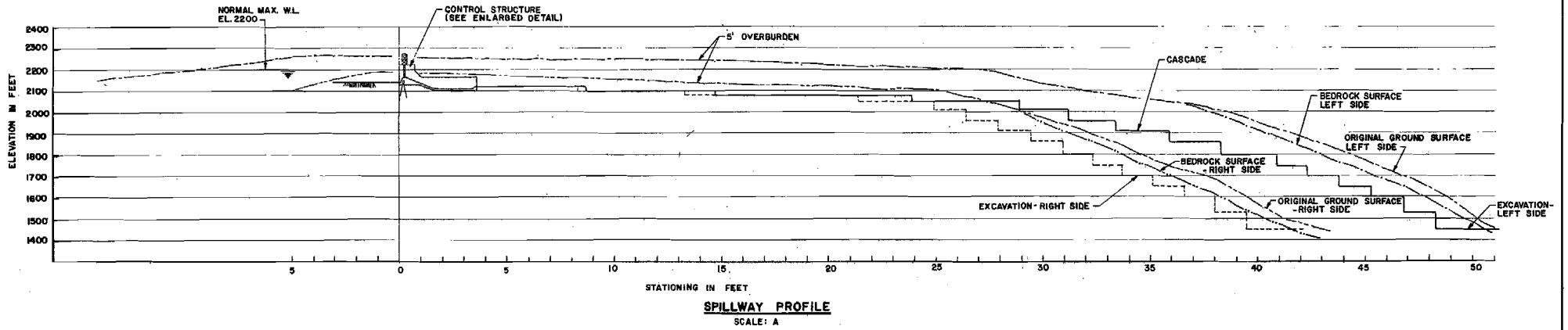

**SECTION B-B**  
SCALE: B

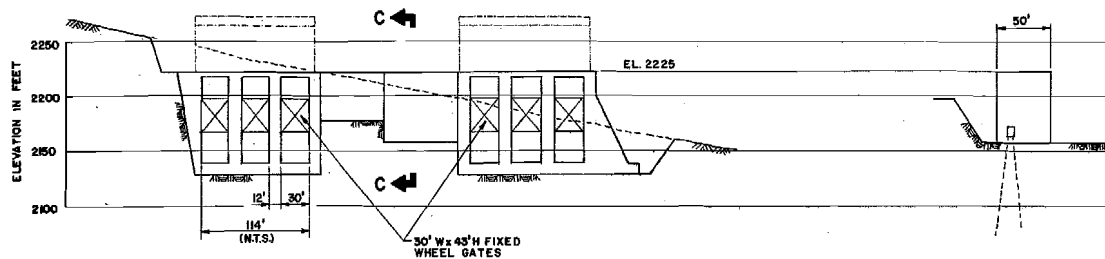

**SECTION C-C**  
SCALE: B

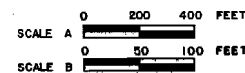

**NOTE**  
THIS DRAWING ILLUSTRATES A PRELIMINARY CONCEPTUAL PROJECT LAYOUT PREPARED FOR COMPARISON OF ALTERNATIVE SITE DEVELOPMENTS ONLY

**WATANA SCHEME WP4 SECTIONS**

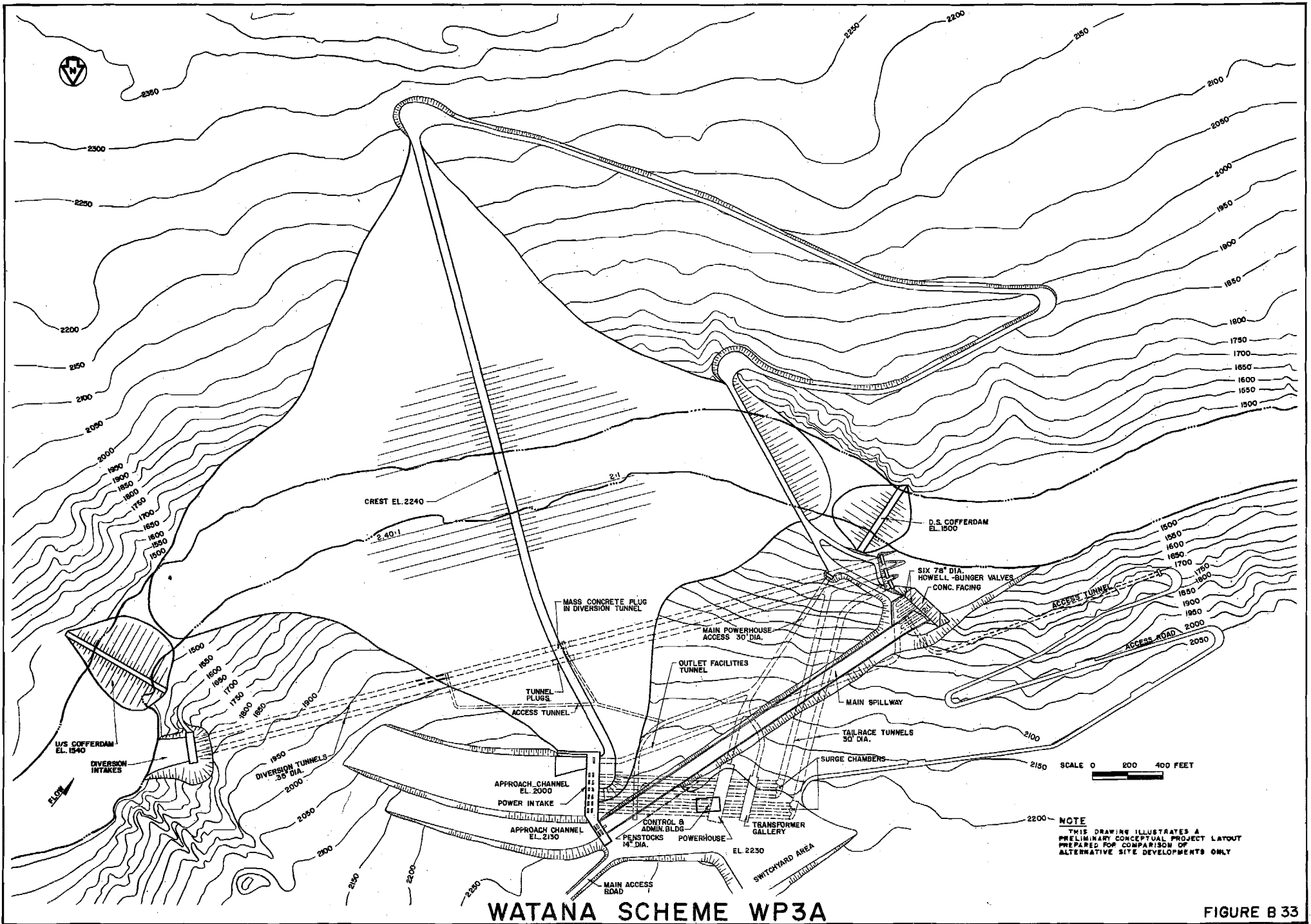
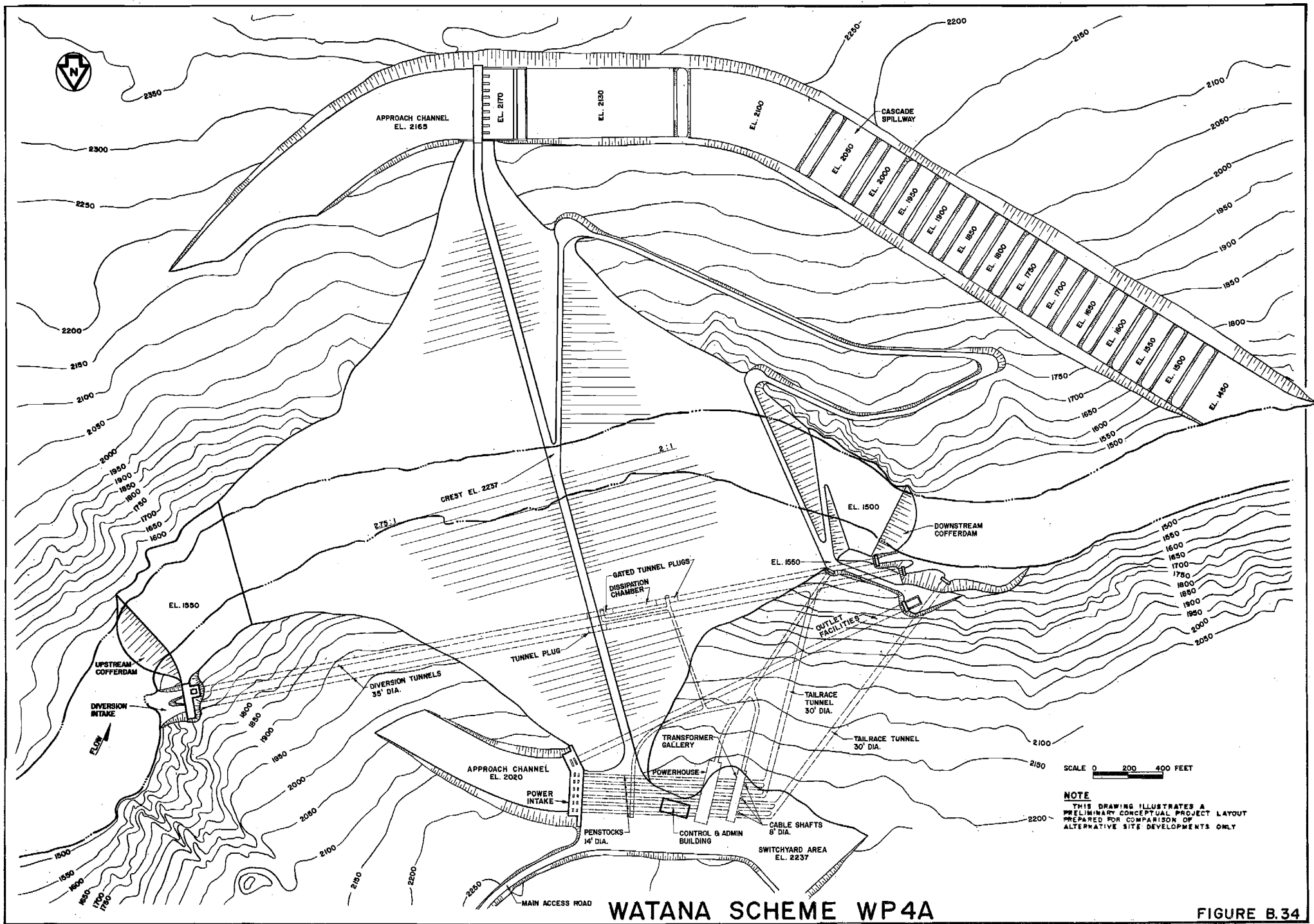

FIGURE B 33



**WATANA SCHEME WP4A**

**FIGURE B.34**



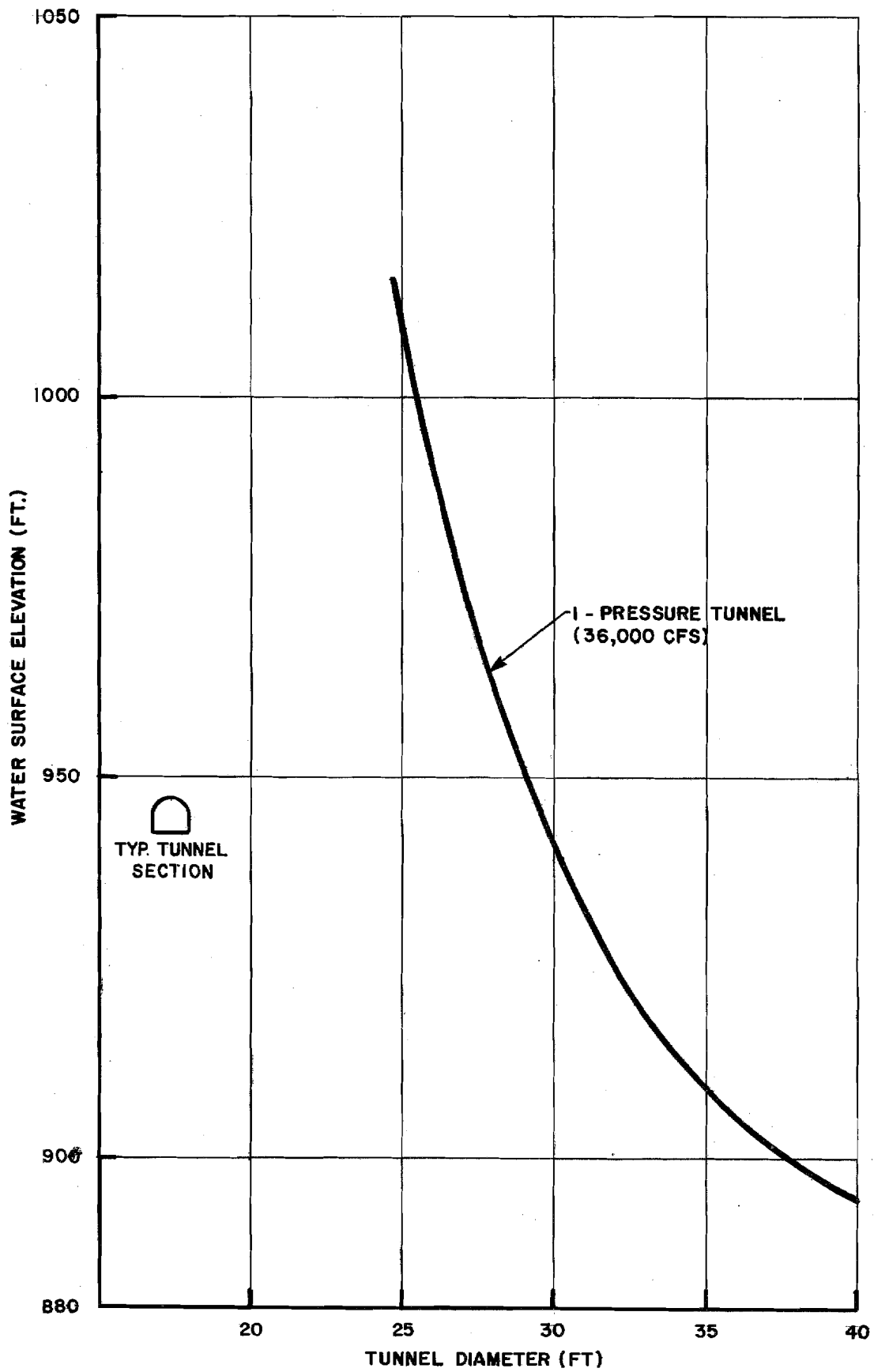

DEVIL CANYON DIVERSION  
HEADWATER ELEVATION/TUNNEL DIAMETER

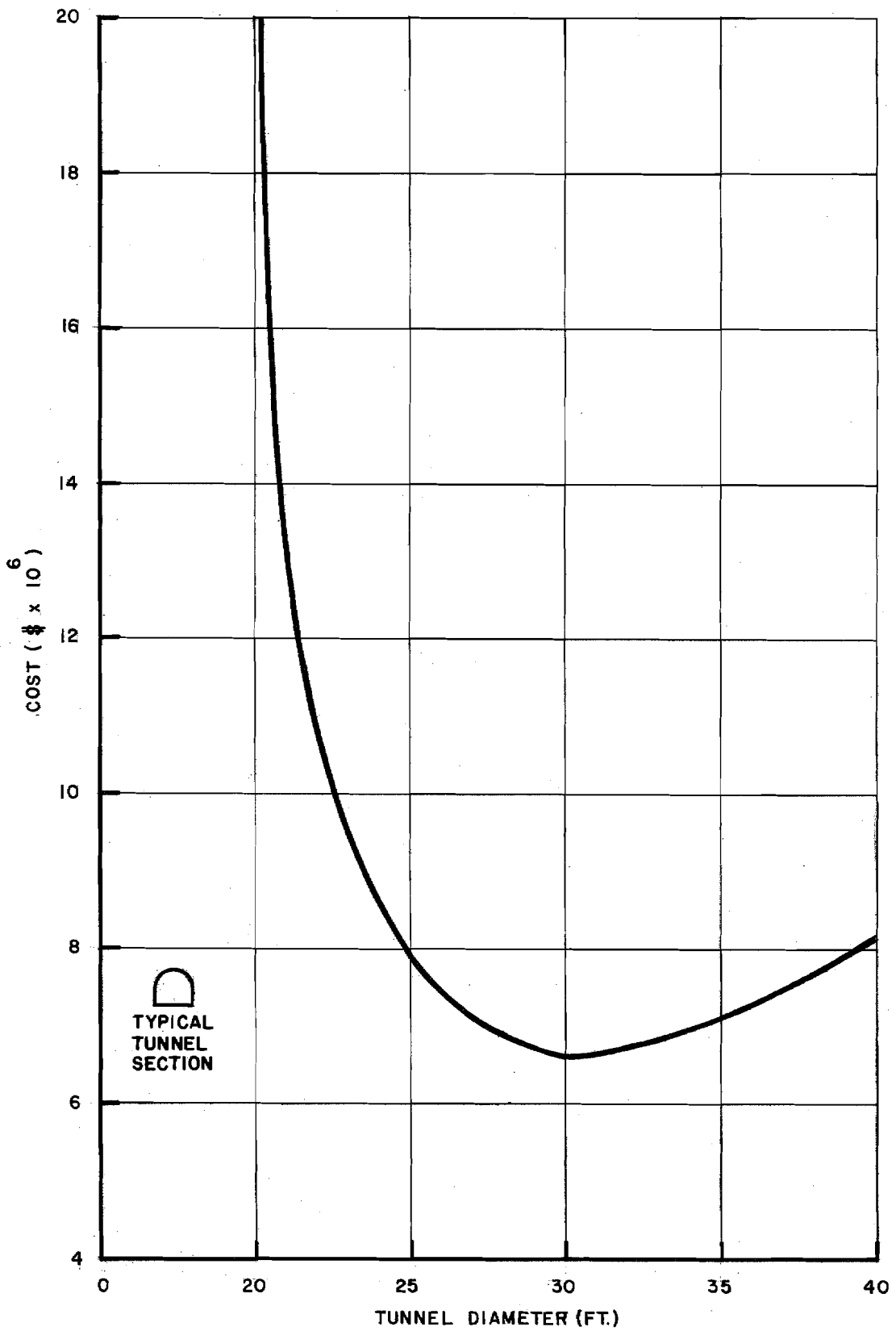

DEVIL CANYON DIVERSION  
TOTAL COST/TUNNEL DIAMETER

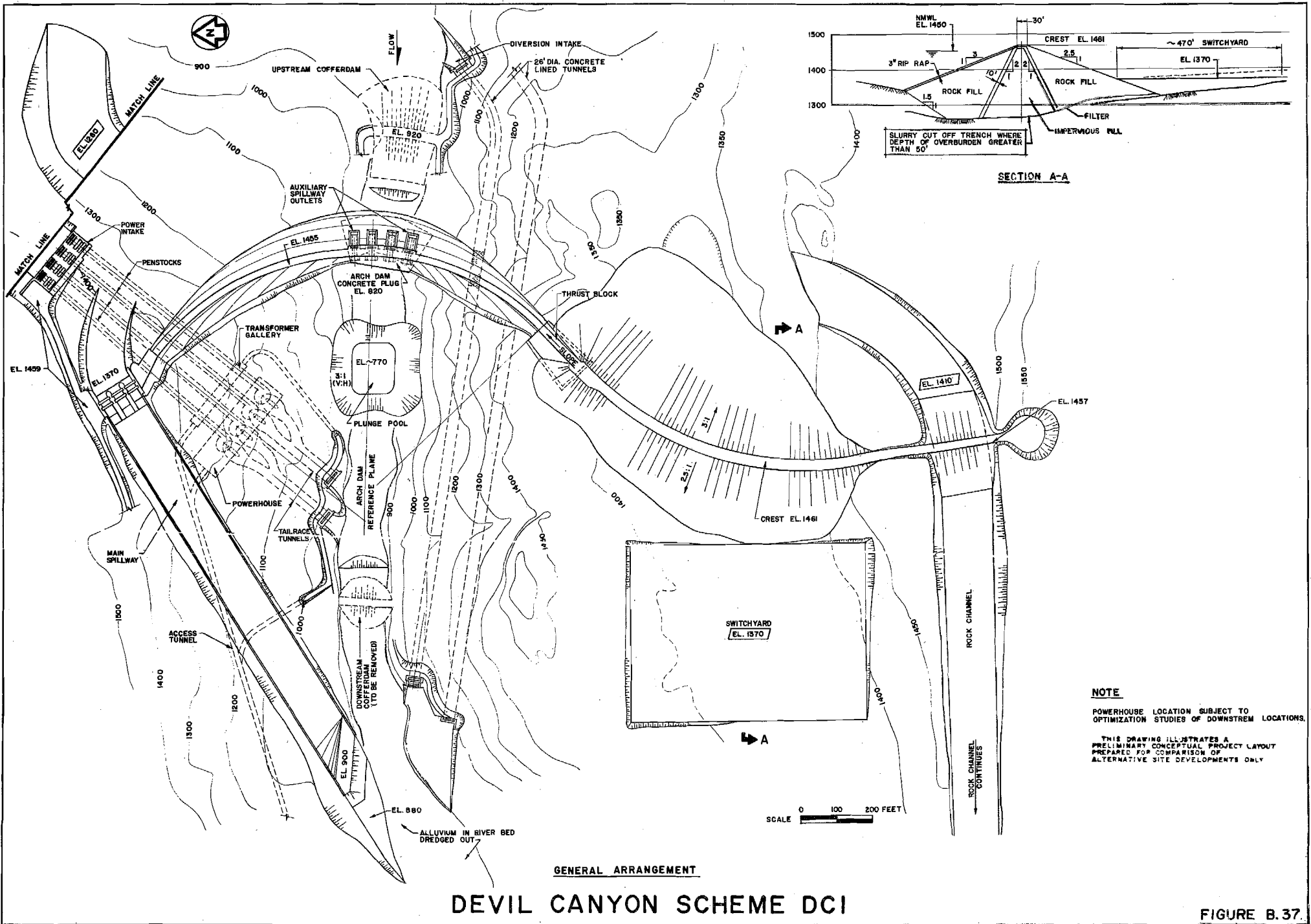
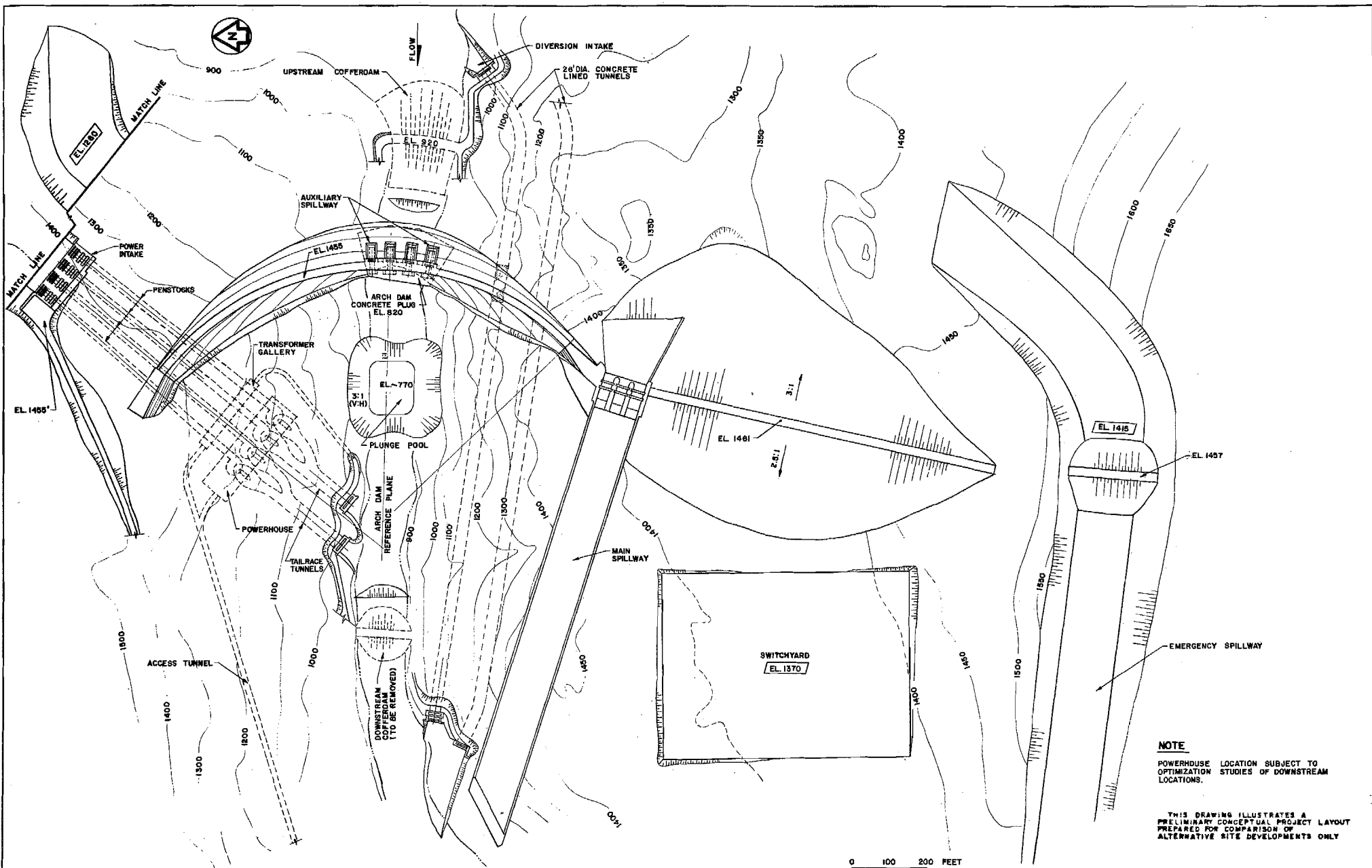

FIGURE B.37.



GENERAL ARRANGEMENT

DEVIL CANYON SCHEME DC2

**NOTE**  
 POWERHOUSE LOCATION SUBJECT TO  
 OPTIMIZATION STUDIES OF DOWNSTREAM  
 LOCATIONS.

THIS DRAWING ILLUSTRATES A  
 PRELIMINARY CONCEPTUAL PROJECT LAYOUT  
 PREPARED FOR COMPARISON OF  
 ALTERNATIVE SITE DEVELOPMENTS ONLY

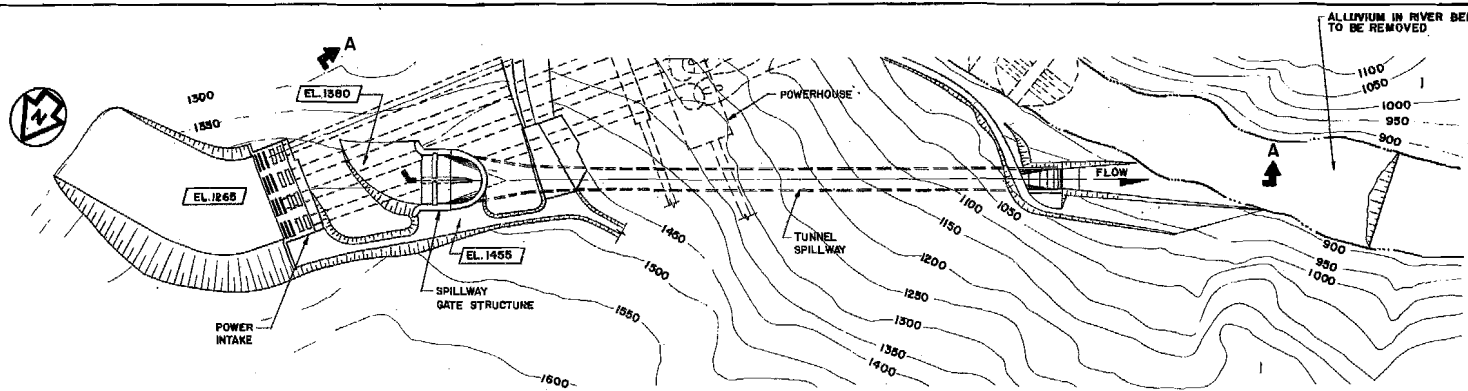

**GENERAL ARRANGEMENT**  
SCALE: A

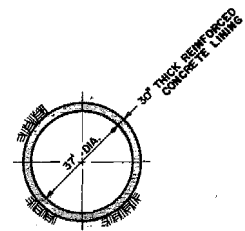

**SECTION E-E**  
SCALE: B

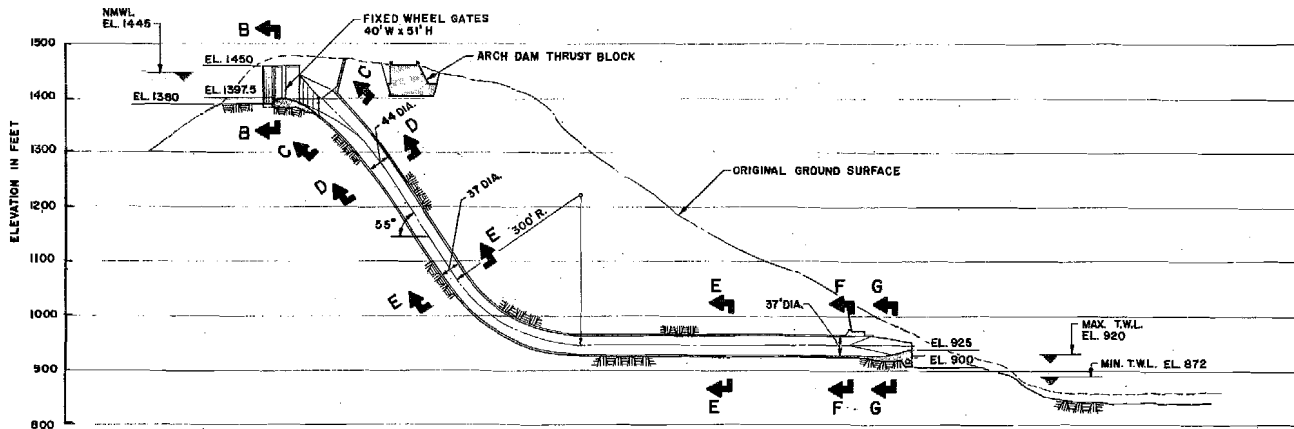

**SECTION A-A**  
SCALE: A

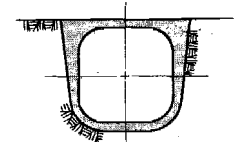

**SECTION F-F**  
SCALE: B

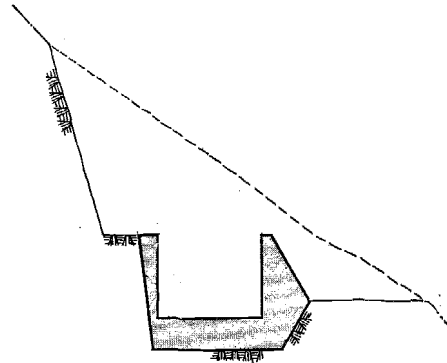

**SECTION G-G**  
SCALE: B

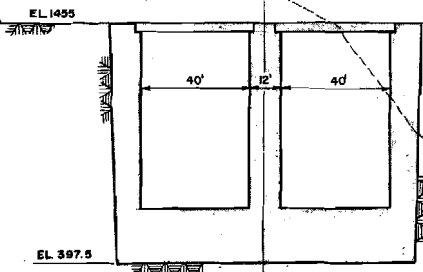

**SECTION B-B**  
SCALE: B

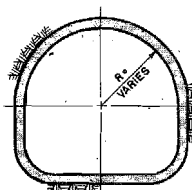

**SECTION C-C**  
SCALE: B

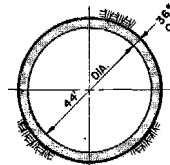

**SECTION D-D**  
SCALE: B

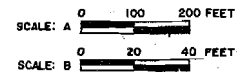

**NOTE**  
THIS DRAWING ILLUSTRATES A PRELIMINARY CONCEPTUAL PROJECT LAYOUT PREPARED FOR COMPARISON OF ALTERNATIVE SITE DEVELOPMENTS ONLY

**DEVIL CANYON SCHEME DC3**

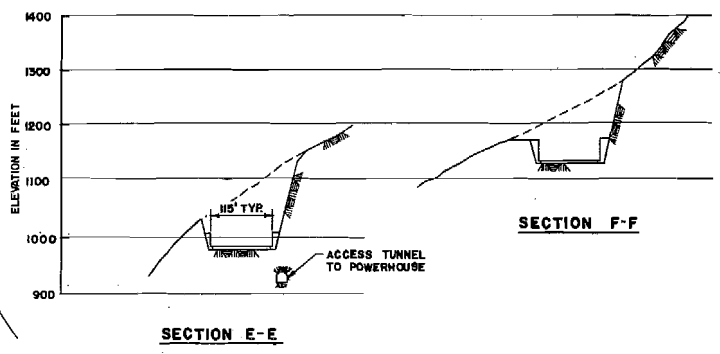
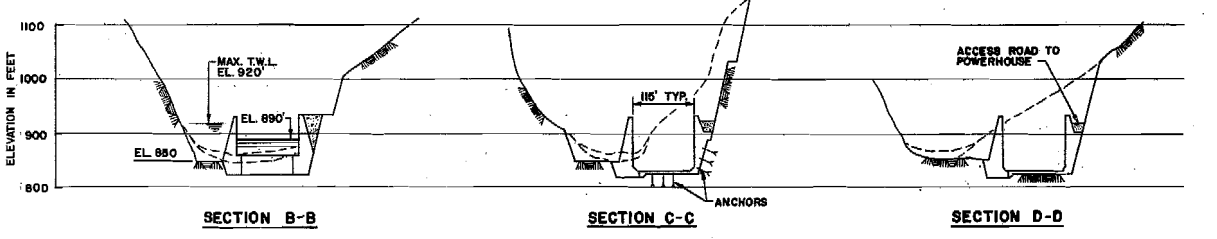
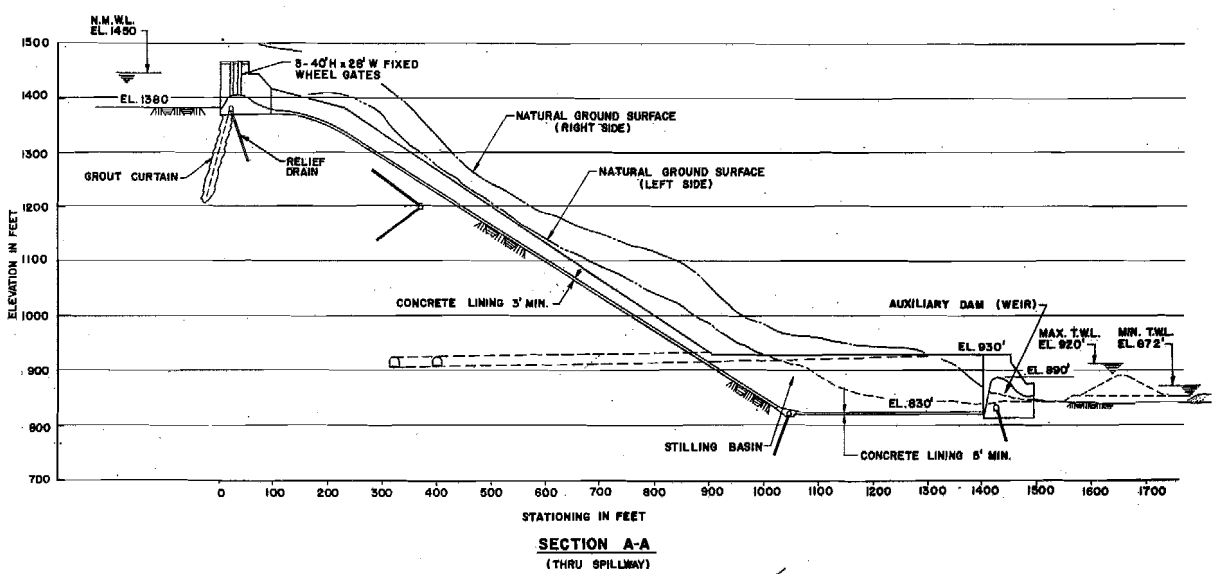
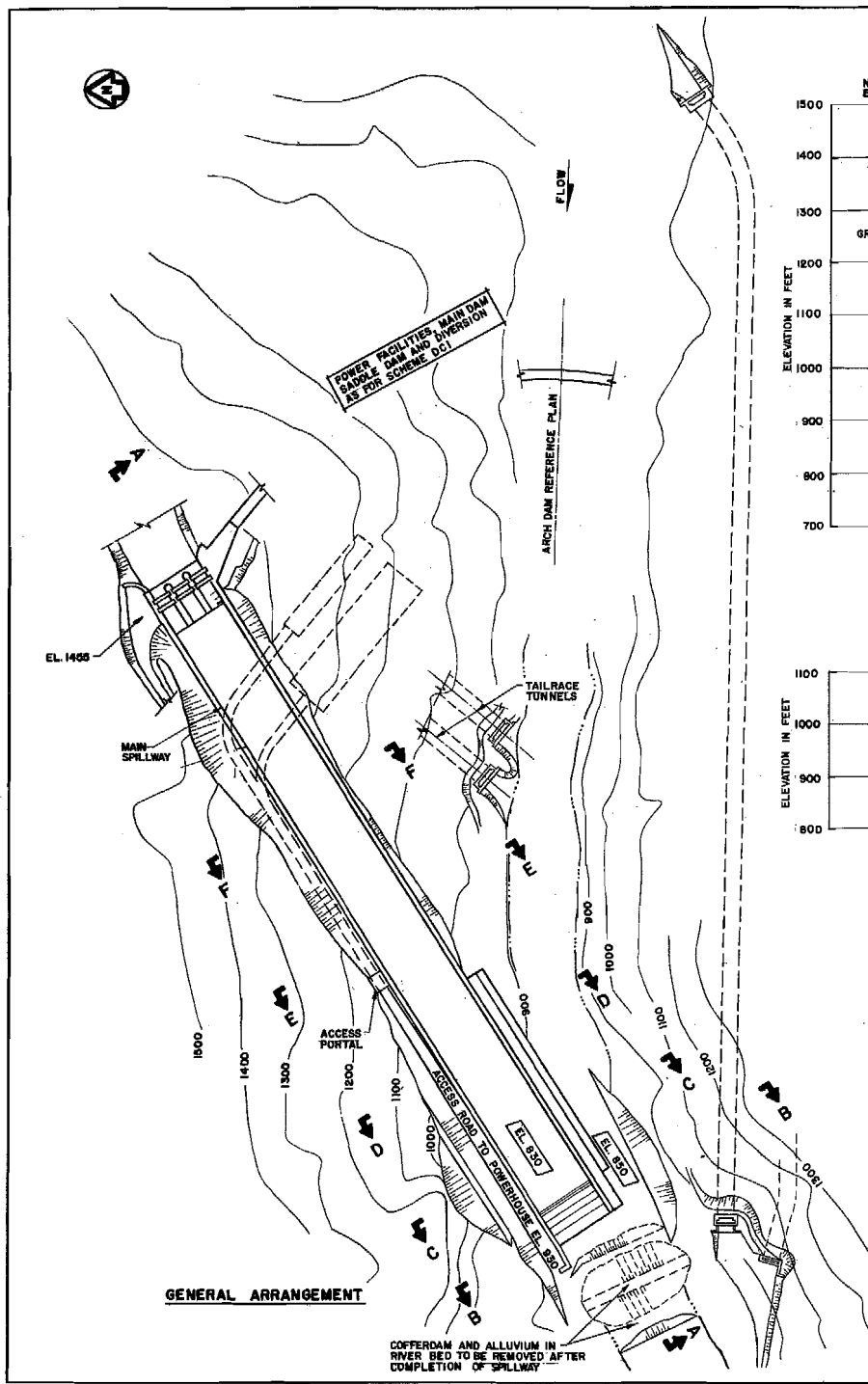

SCALE 0 100 200 FEET

**NOTE**  
 THIS DRAWING ILLUSTRATES A PRELIMINARY CONCEPTUAL PROJECT LAYOUT PREPARED FOR COMPARISON OF ALTERNATIVE SITE DEVELOPMENTS ONLY

**DEVIL CANYON SCHEME DC4**

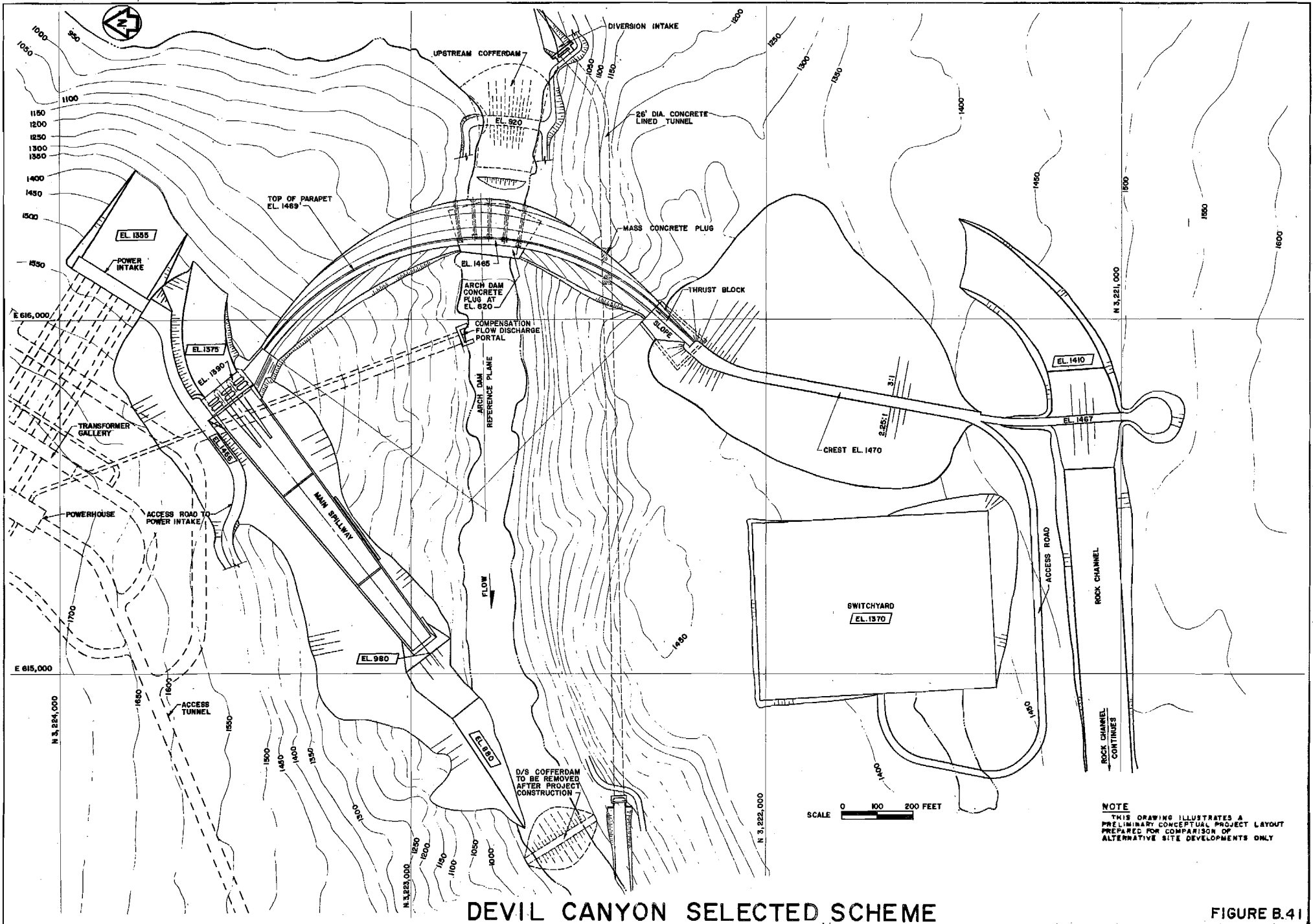

DEVIL CANYON SELECTED SCHEME

FIGURE B.41

NOTE  
 THIS DRAWING ILLUSTRATES A  
 PRELIMINARY CONCEPTUAL PROJECT LAYOUT  
 PREPARED FOR COMPARISON OF  
 ALTERNATIVE SITE DEVELOPMENTS ONLY

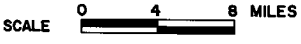
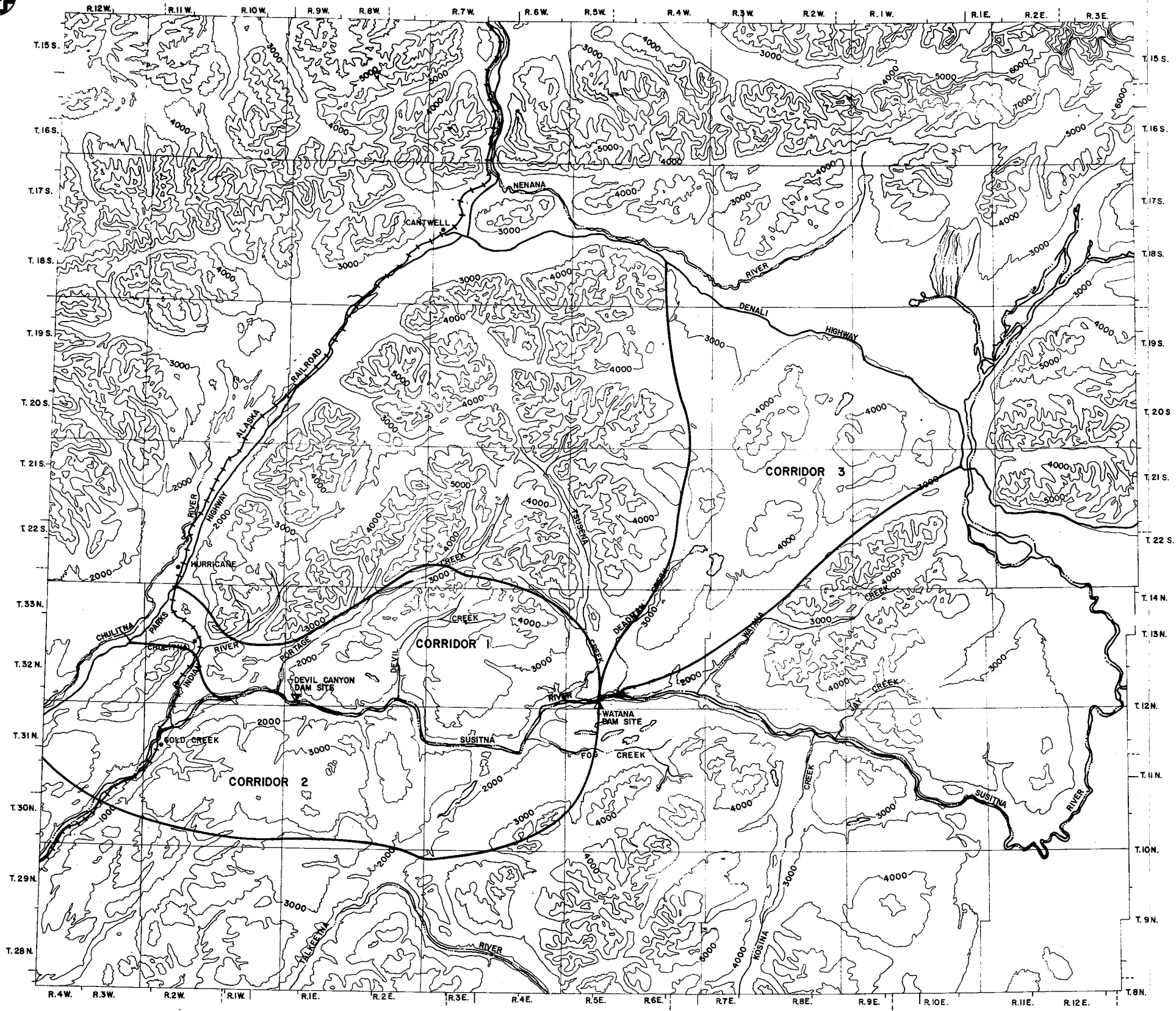

REFERENCE: BASE MAP FROM USGS, 1:250,000  
HEALY, ALASKA  
TALKEETNA MOUNTAINS, ALASKA

### ALTERNATIVE ACCESS CORRIDORS



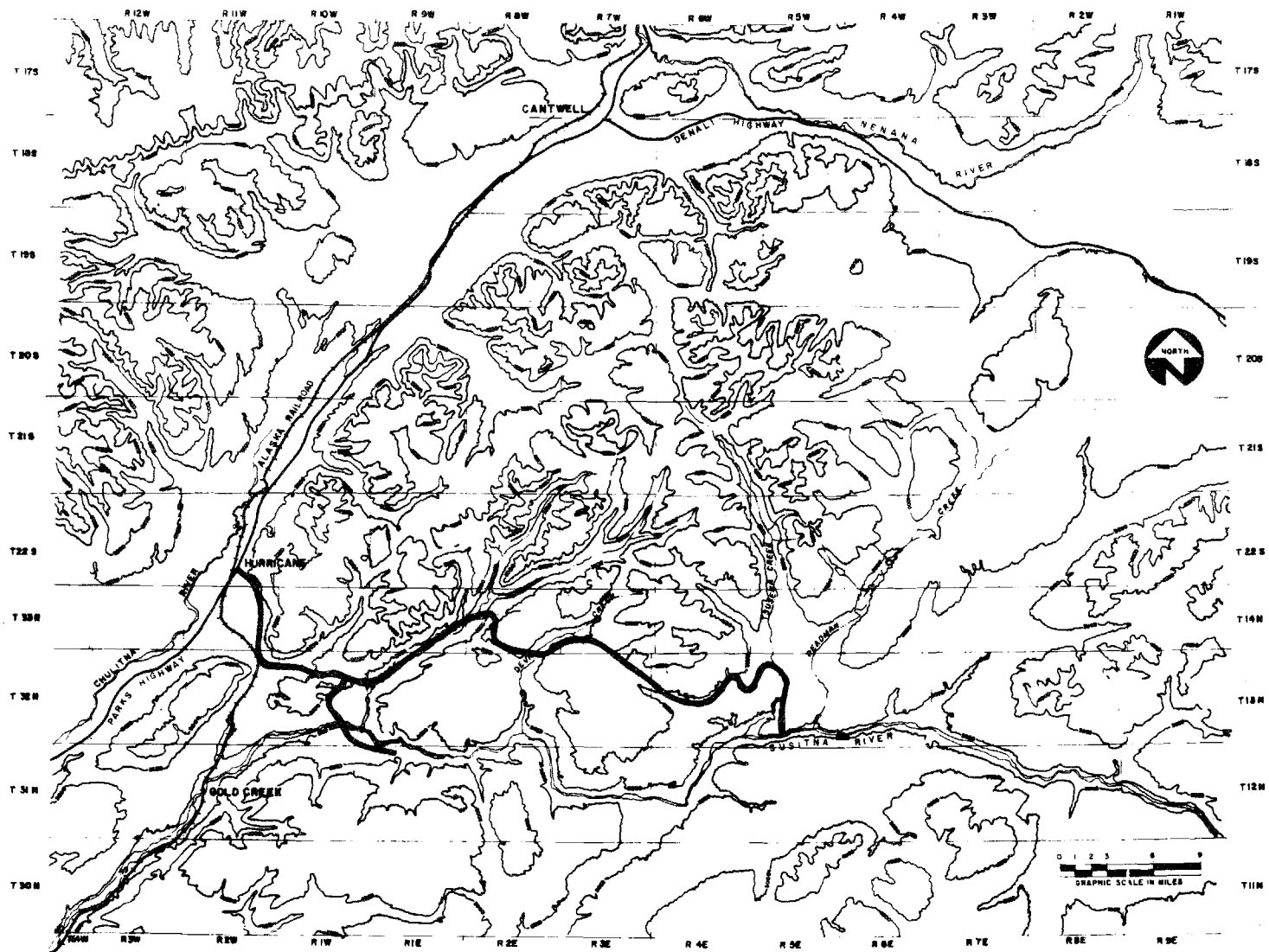

ACCESS PLAN 13 (NORTH)  
 SUSITNA HYDROELECTRIC PROJECT  
 ALTERNATIVE ACCESS PLAN

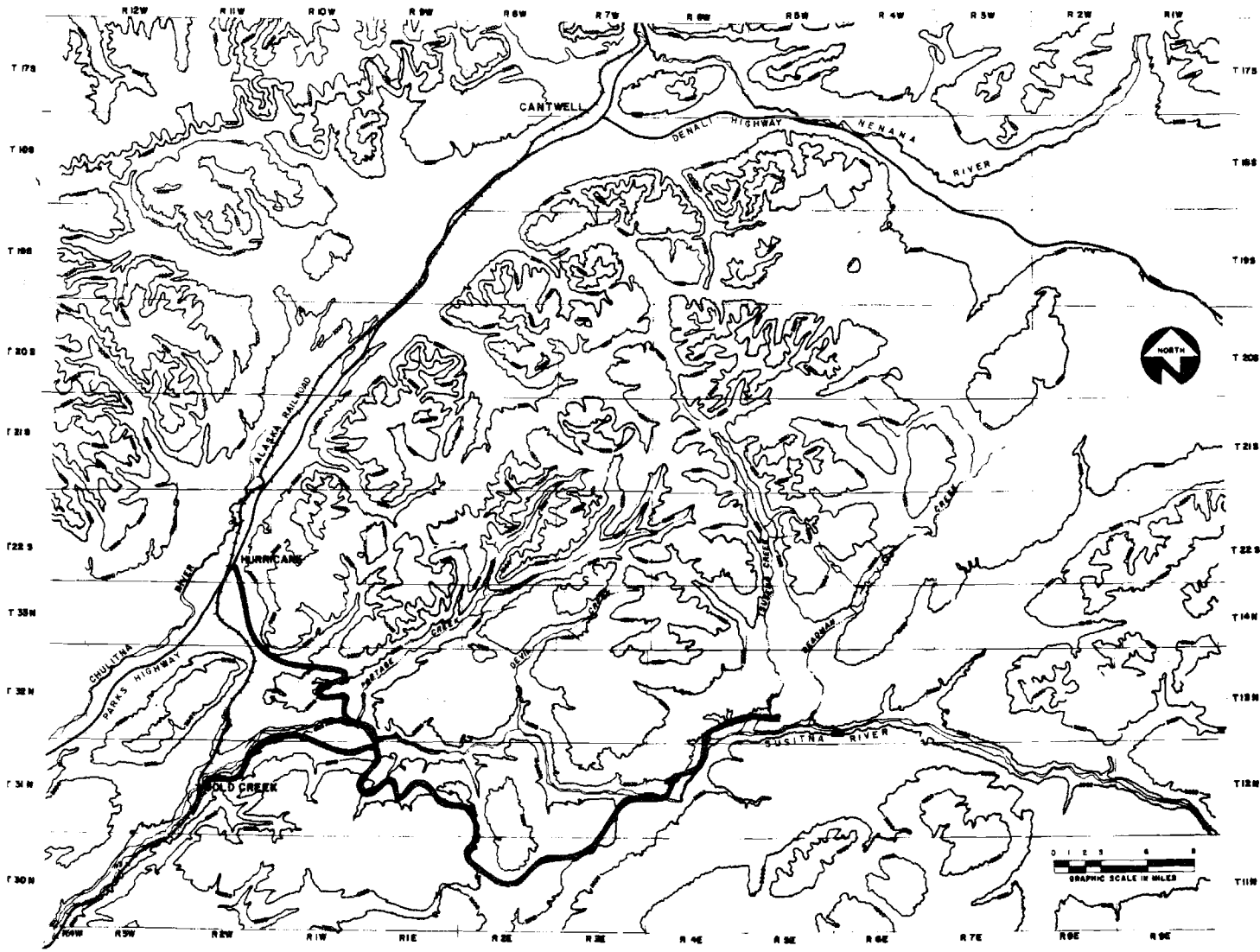

ACCESS PLAN 16 (SOUTH)  
 SUSITNA HYDROELECTRIC PROJECT  
 ALTERNATIVE ACCESS PLAN

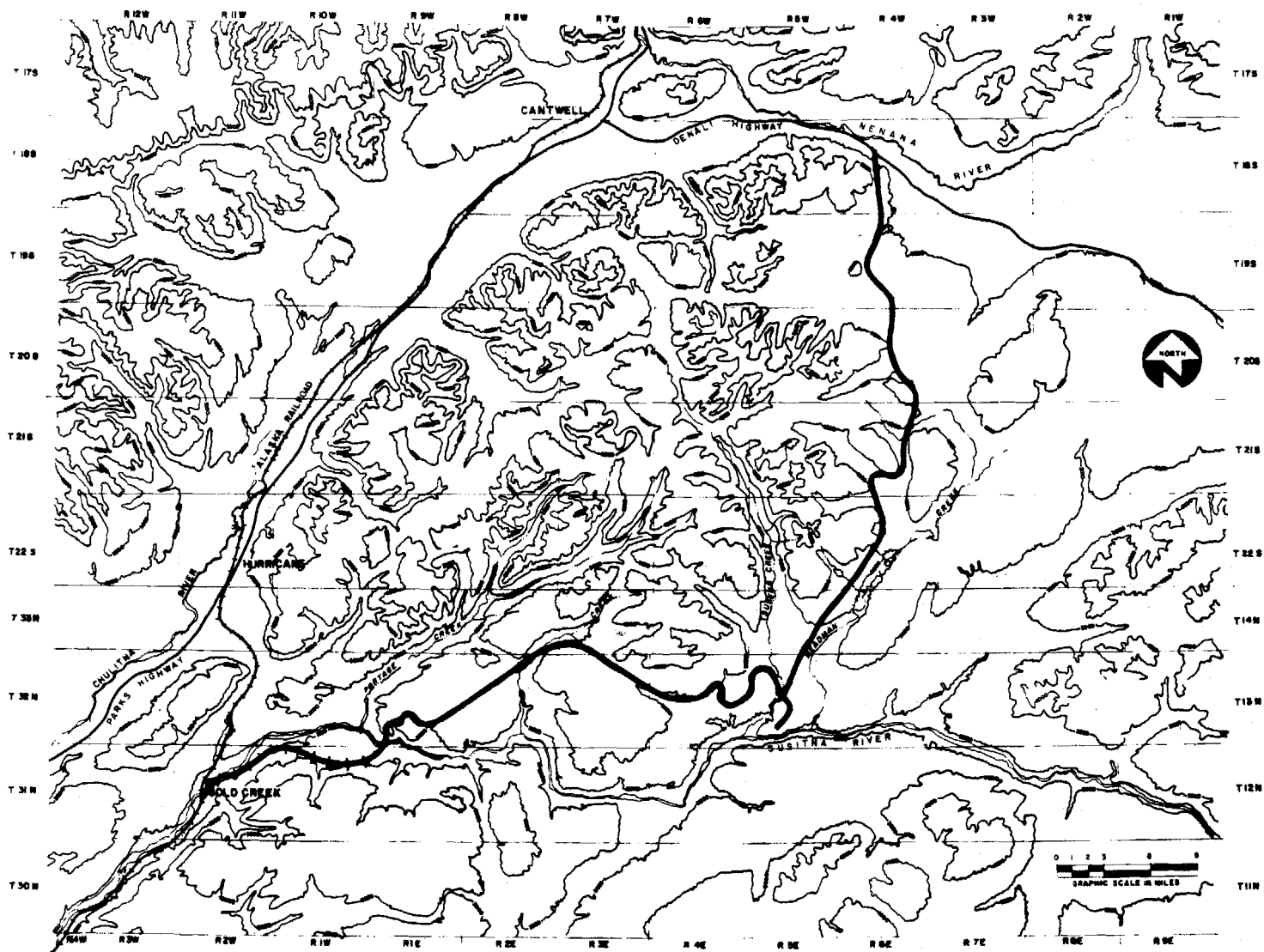

ACCESS PLAN 18 (PROPOSED)  
 SUSITNA HYDROELECTRIC PROJECT  
 ALTERNATIVE ACCESS PLAN

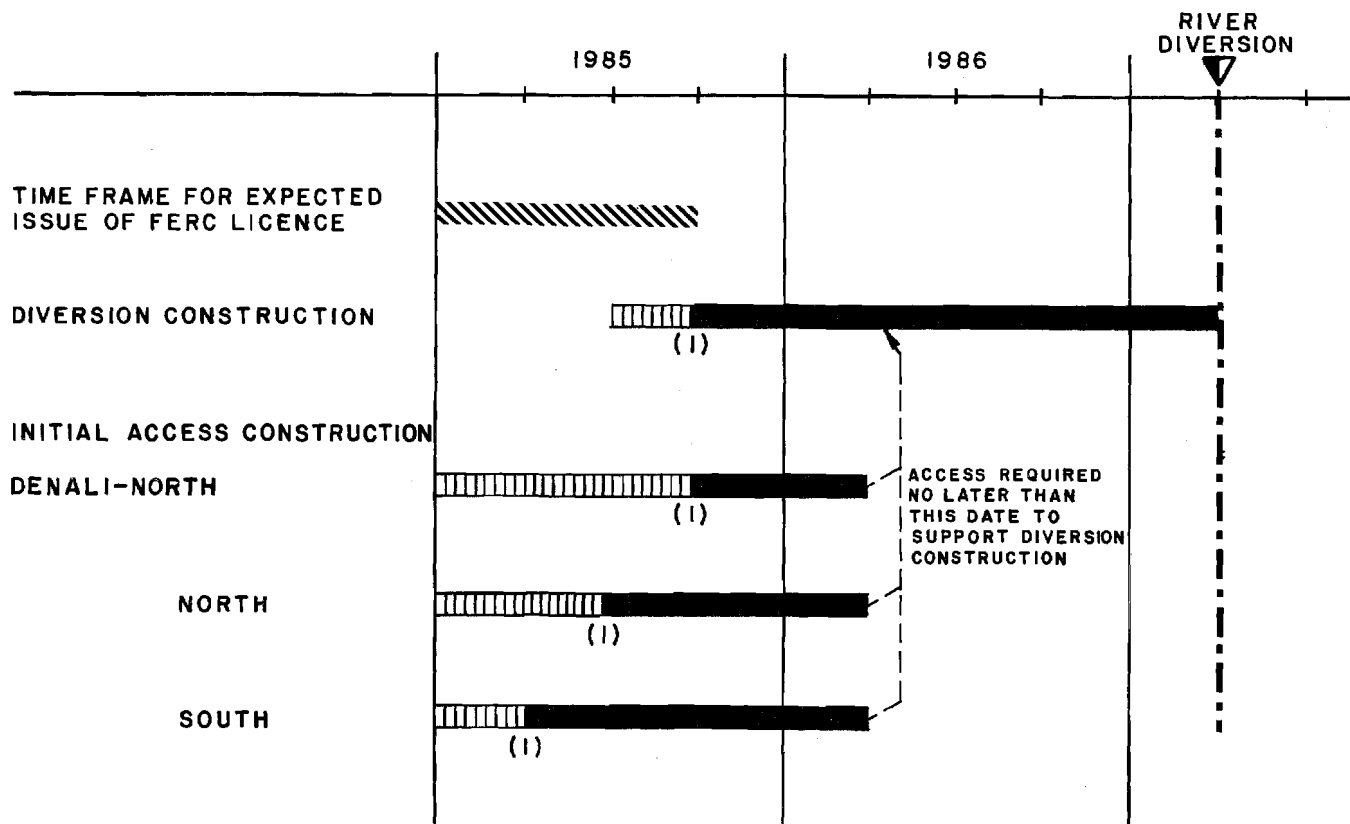

**NOTES:**

▨ ACTIVITY START COULD BE DELAYED AND DIVERSION STILL MET.

(1) LATEST START DATE OF CONSTRUCTION ACTIVITY.

**SCHEDULE FOR ACCESS AND DIVERSION**

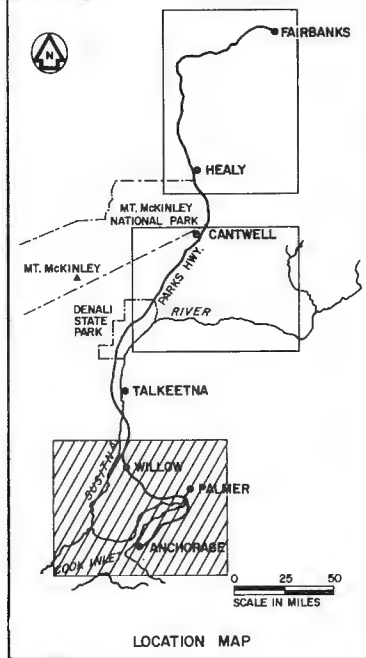
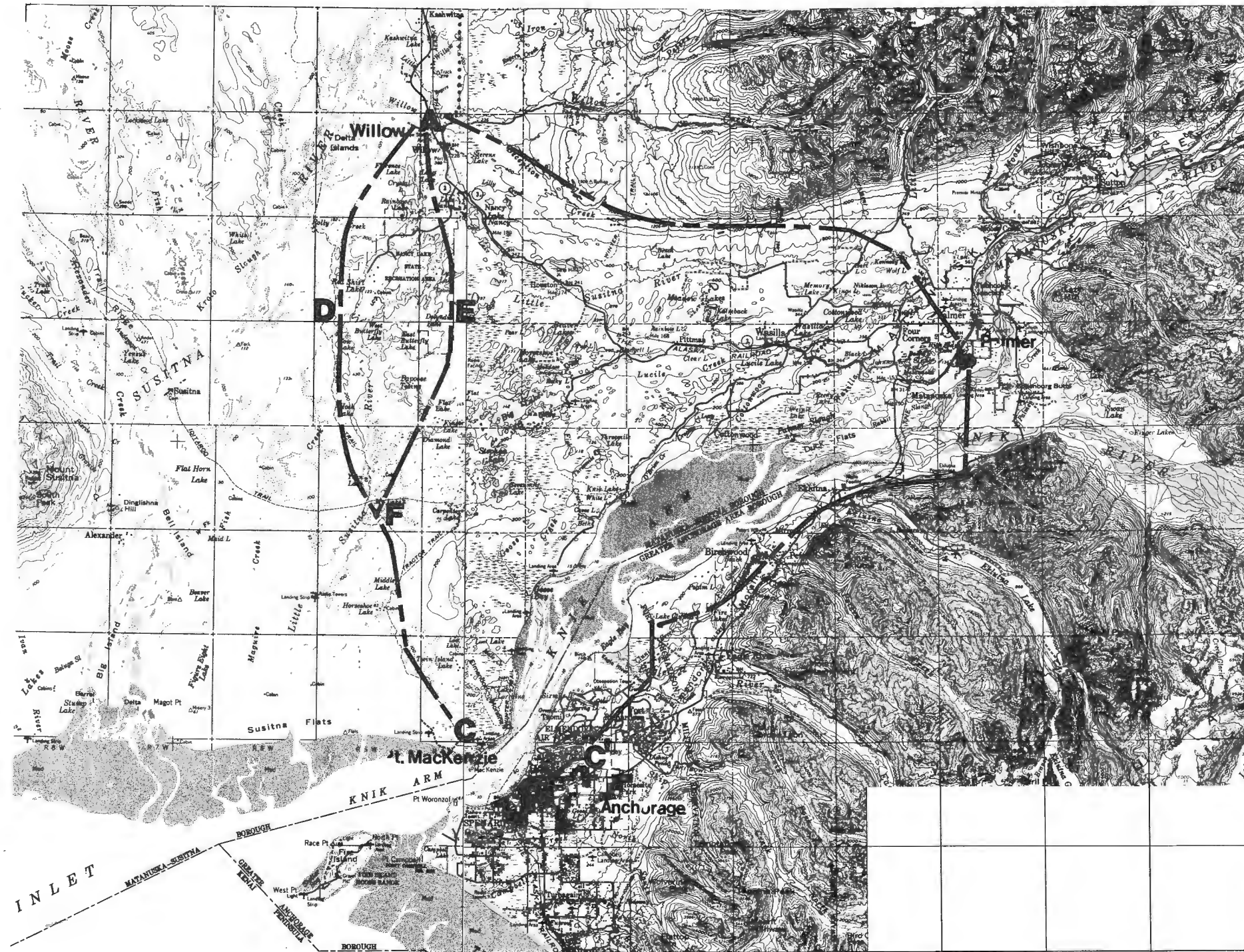

LEGEND  
——— STUDY CORRIDOR  
..... INTERTIE  
( APPROXIMATE )

0 5 10  
SCALE IN MILES

ALTERNATIVE TRANSMISSION LINE CORRIDORS  
SOUTHERN STUDY AREA



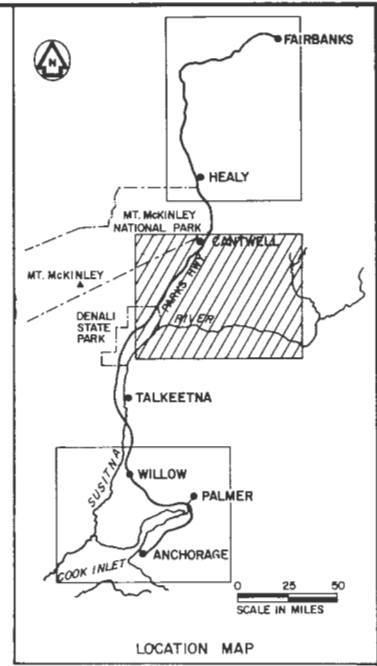
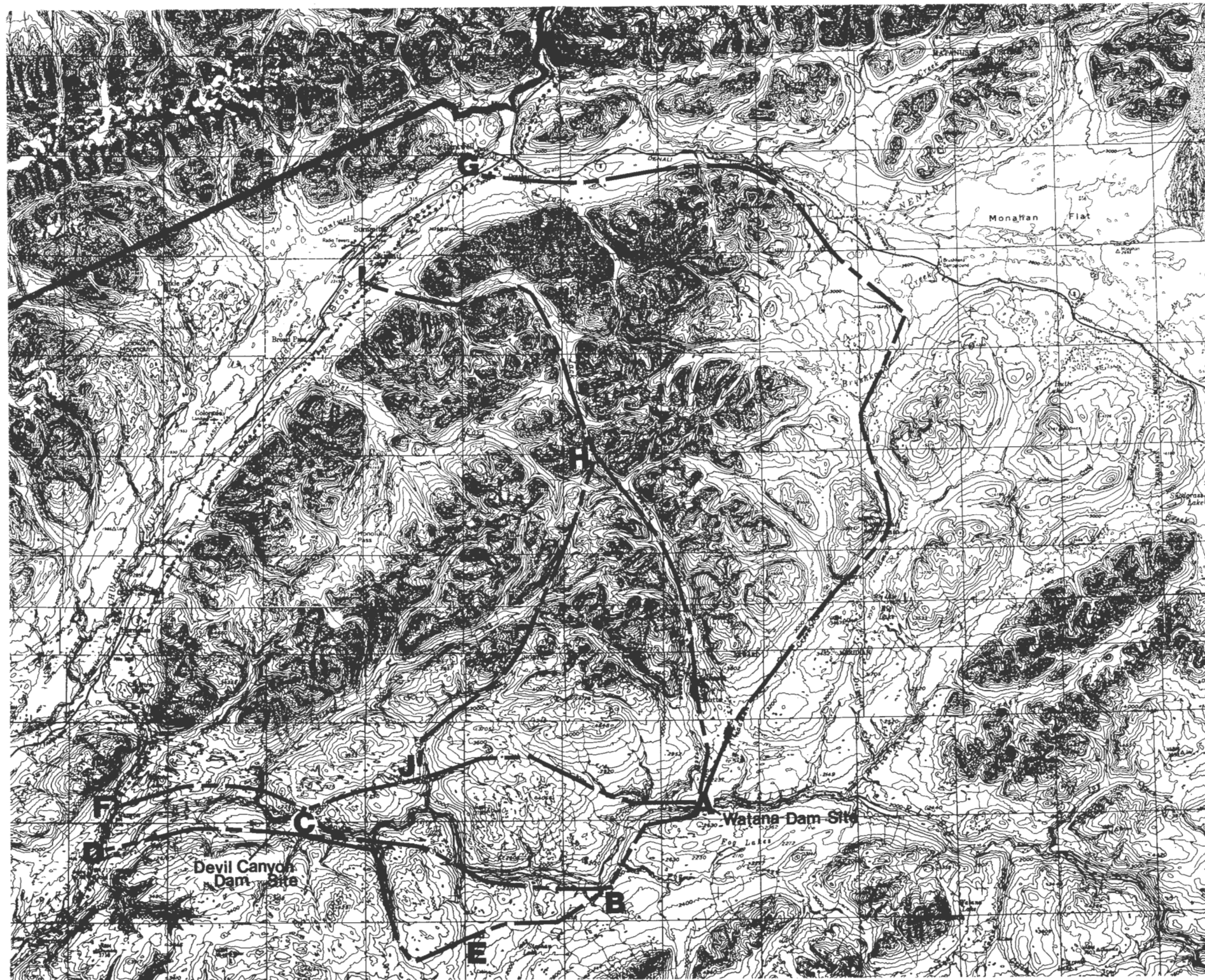

**LEGEND**  
—— STUDY CORRIDOR  
..... INTERTIE (APPROXIMATE)



ALTERNATIVE TRANSMISSION LINE CORRIDORS  
CENTRAL STUDY AREA

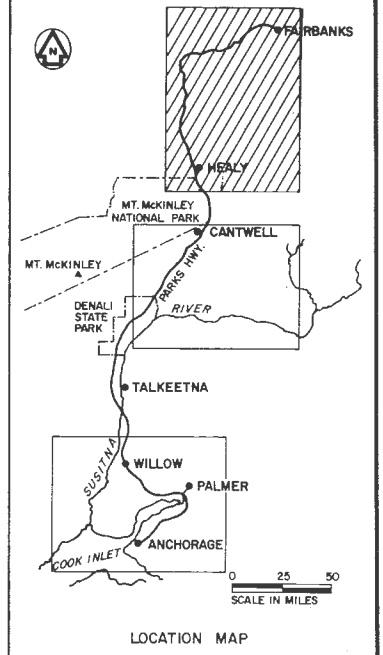
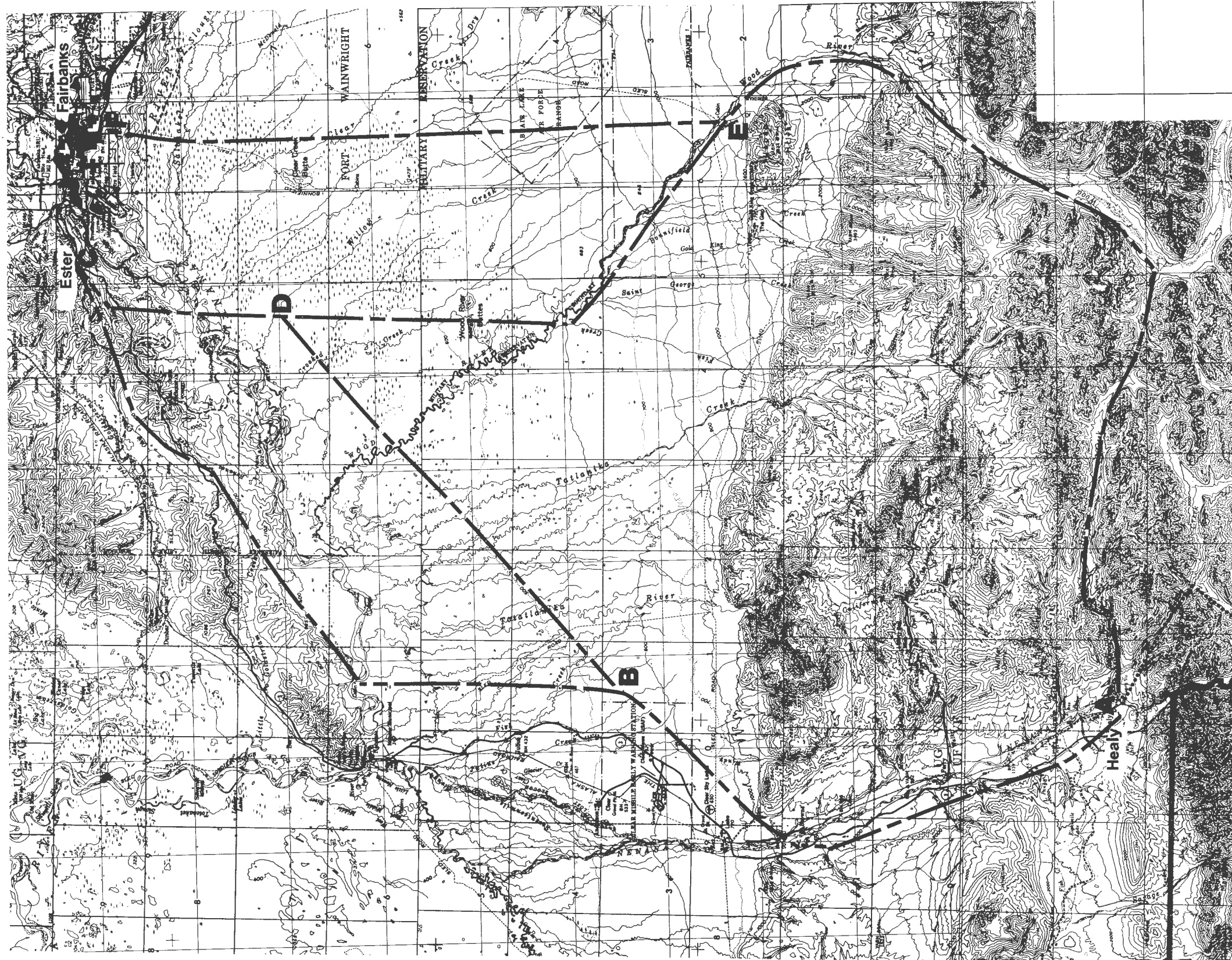

**LEGEND**  
 - - - - - STUDY CORRIDOR  
 ..... INTERTIE  
 (APPROXIMATE)

0 5 10  
 SCALE IN MILES

ALTERNATIVE TRANSMISSION LINE CORRIDORS  
 NORTHERN STUDY AREA



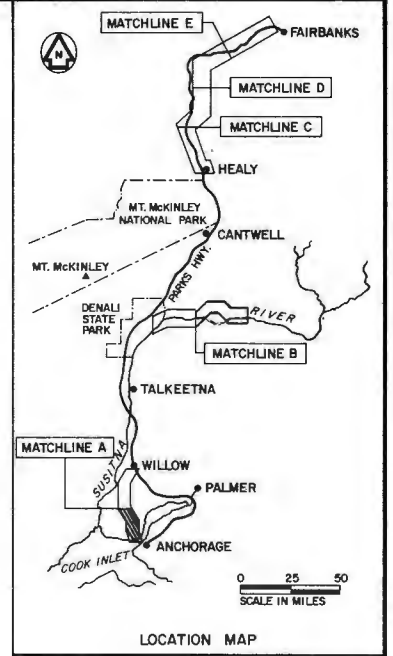
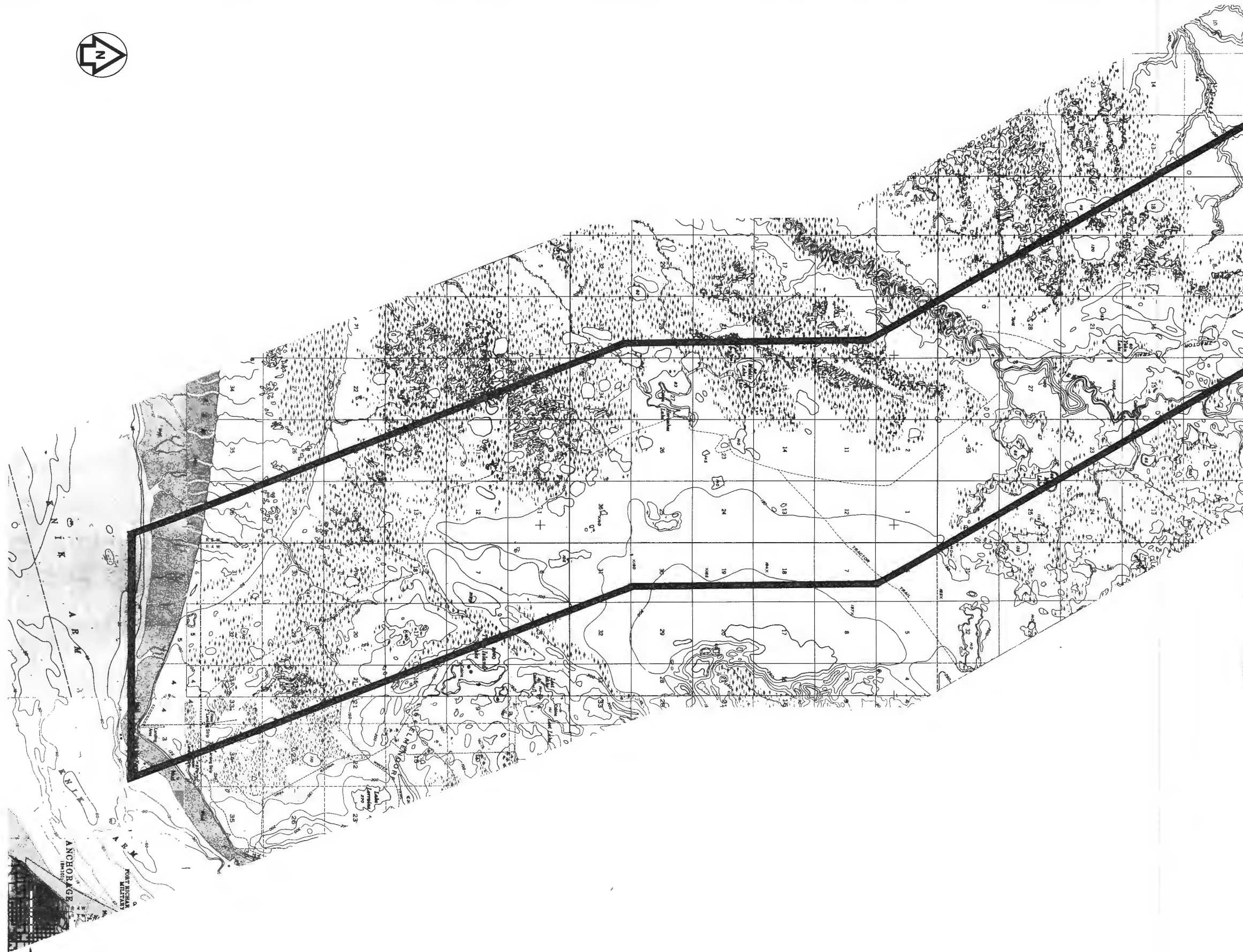

MATCHLINE A



RECOMMENDED TRANSMISSION CORRIDOR  
SOUTHERN STUDY AREA



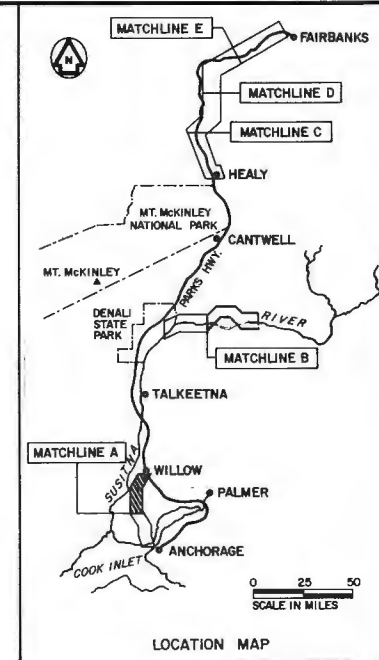
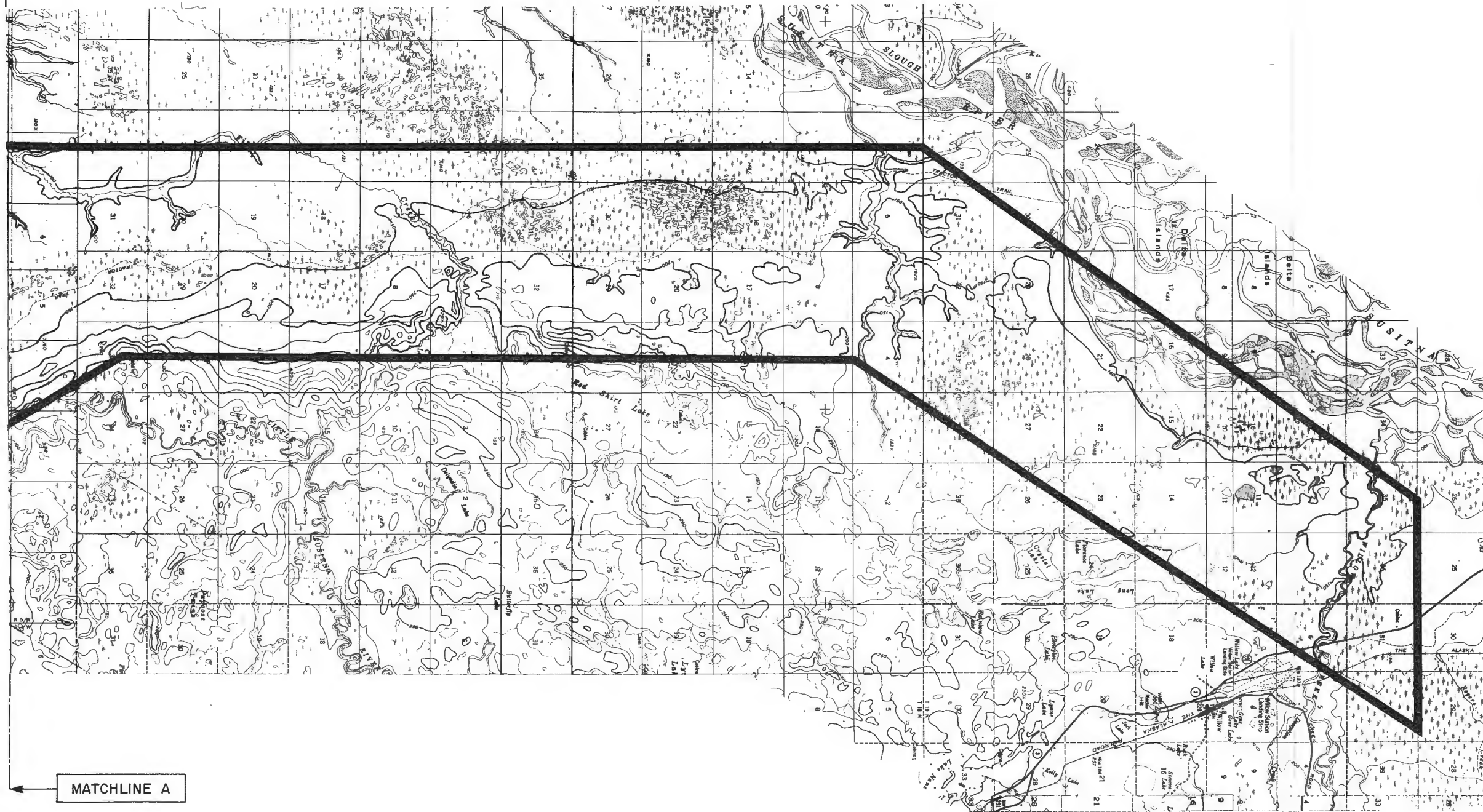

MATCHLINE A



RECOMMENDED TRANSMISSION CORRIDOR  
SOUTHERN STUDY AREA

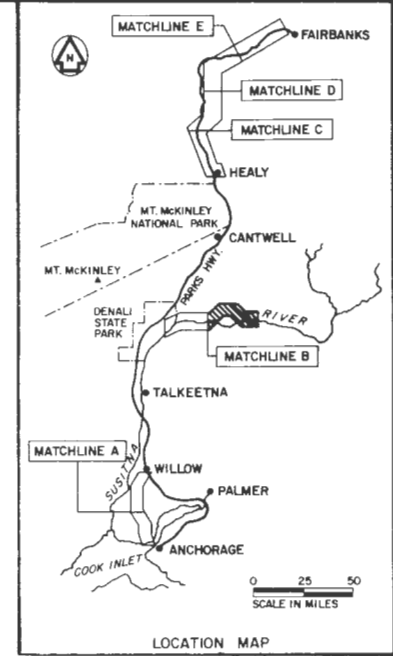
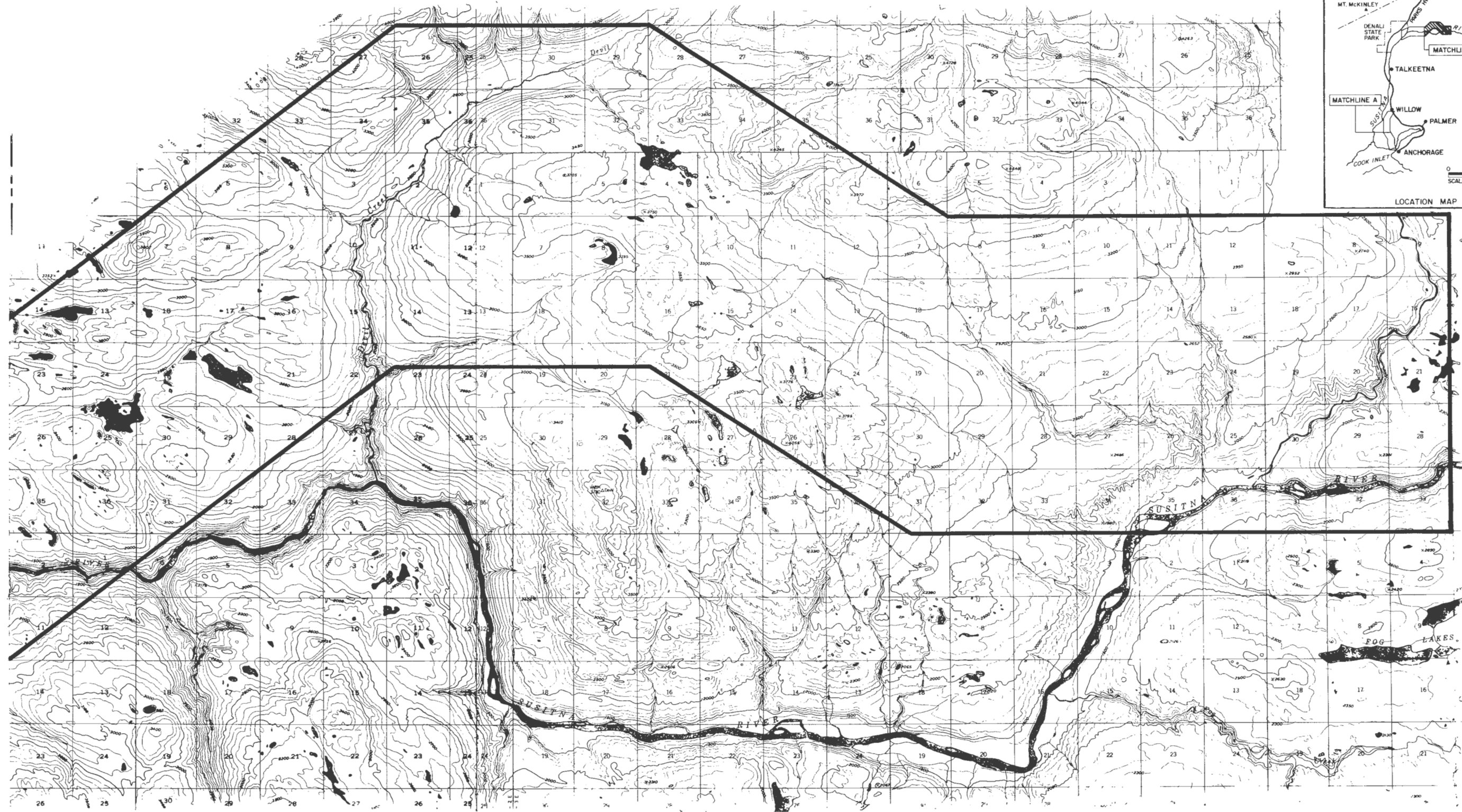

MATCHLINE B

RECOMMENDED TRANSMISSION CORRIDOR  
CENTRAL STUDY AREA



FIGURE B.52



MATCHLINE B

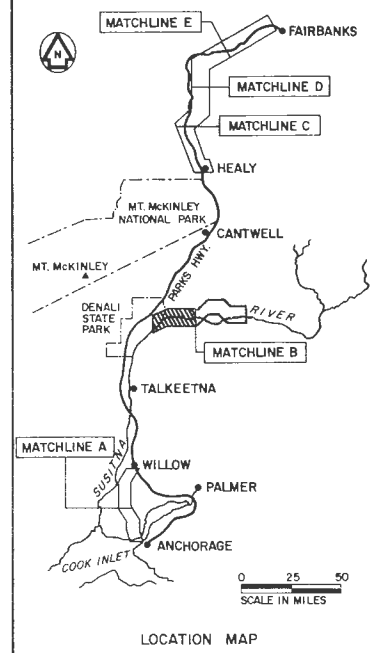

RECOMMENDED TRANSMISSION CORRIDOR  
CENTRAL STUDY AREA



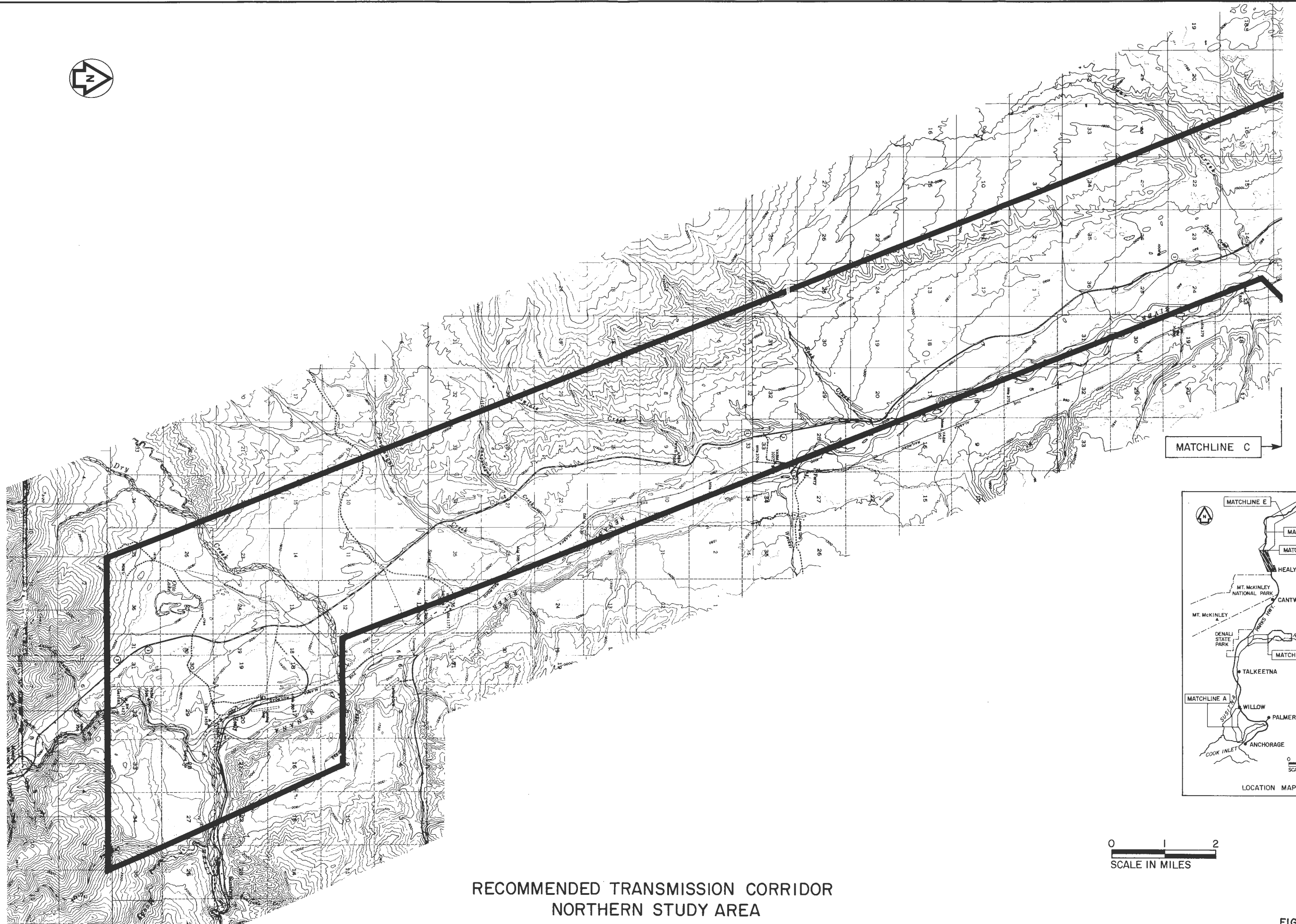

MATCHLINE C

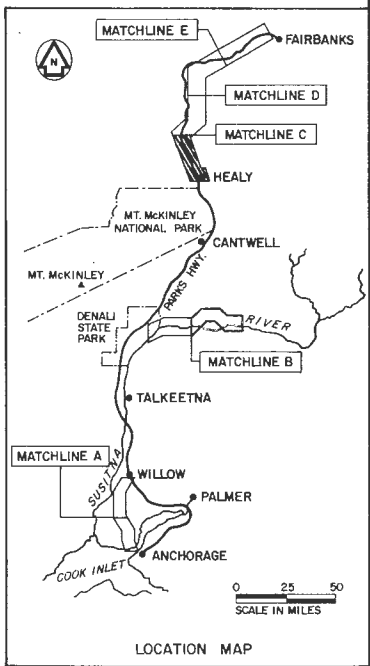

0 1 2  
SCALE IN MILES

RECOMMENDED TRANSMISSION CORRIDOR  
NORTHERN STUDY AREA

FIGURE B.54

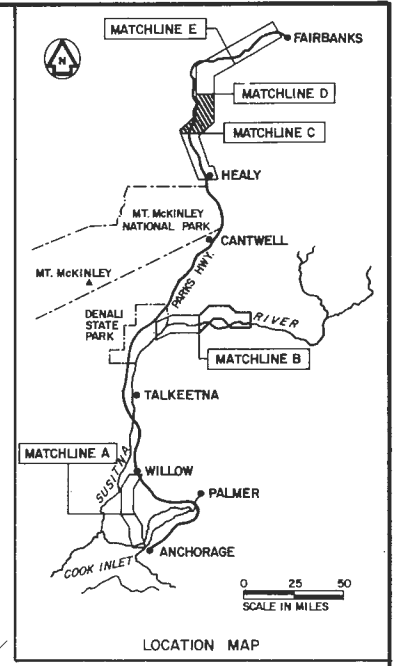
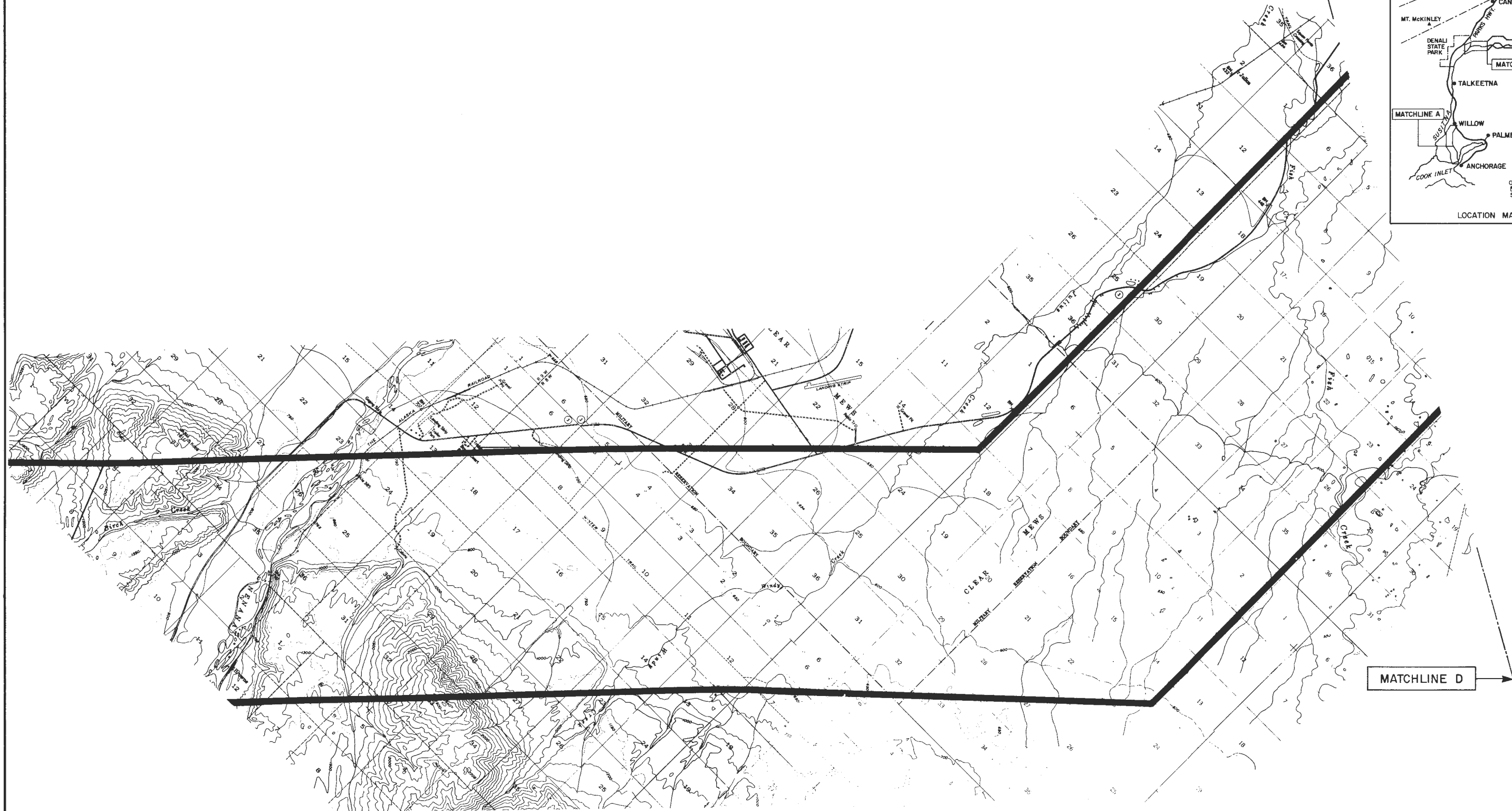

MATCHLINE C

MATCHLINE D



RECOMMENDED TRANSMISSION CORRIDOR  
NORTHERN STUDY AREA

FIGURE B.55



MATCHLINE D

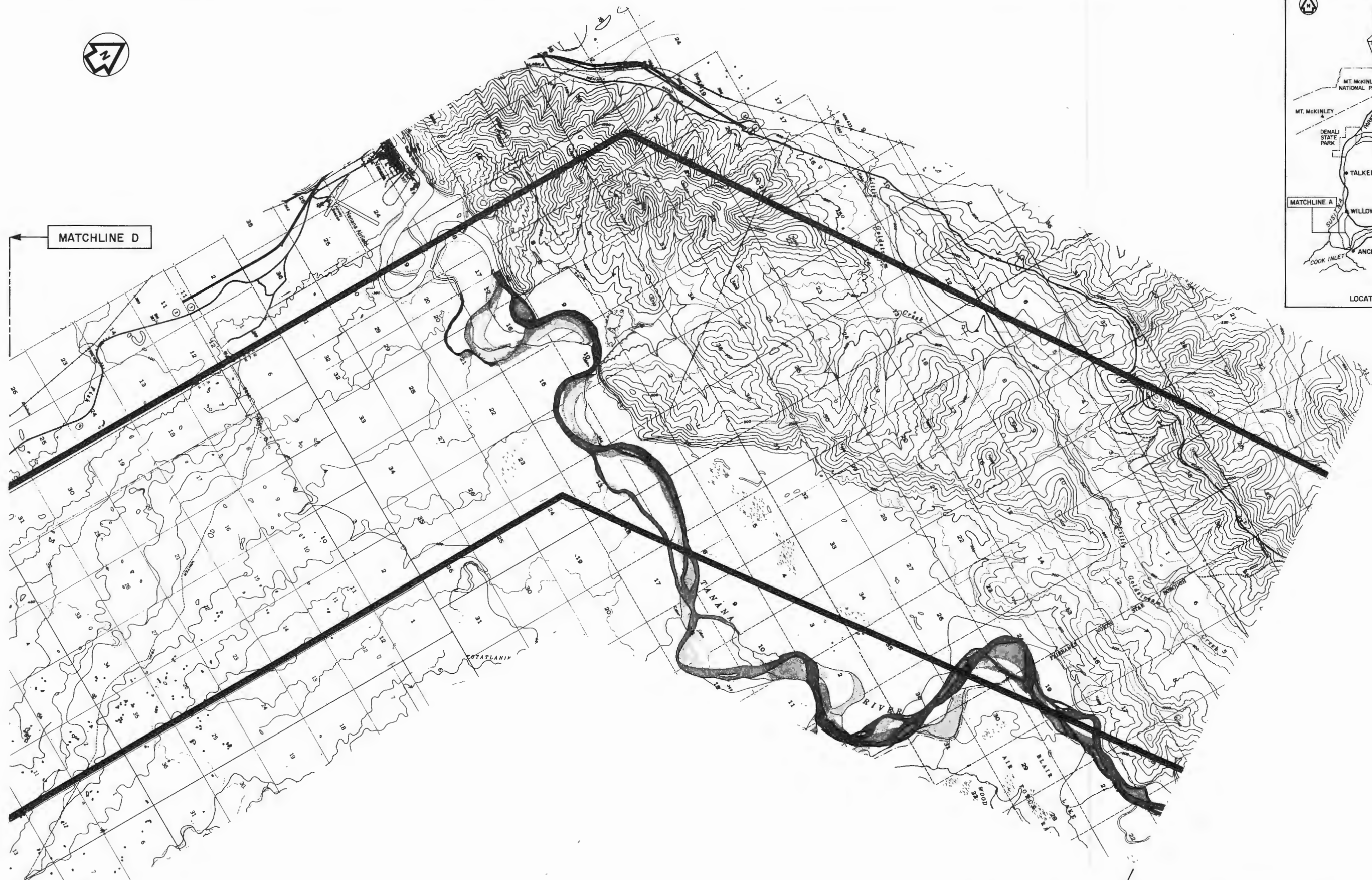

MATCHLINE E

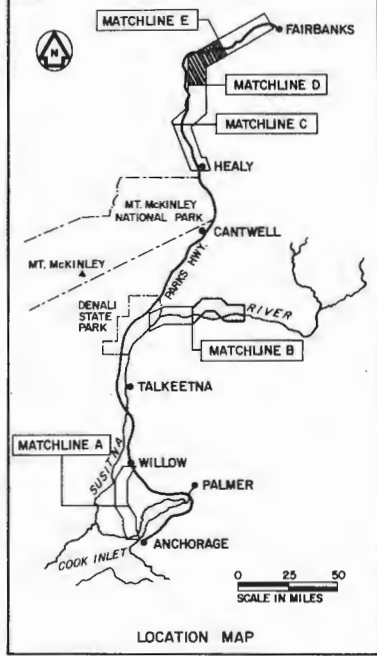

RECOMMENDED TRANSMISSION CORRIDOR  
NORTHERN STUDY AREA

FIGURE B.56





MATCHLINE E

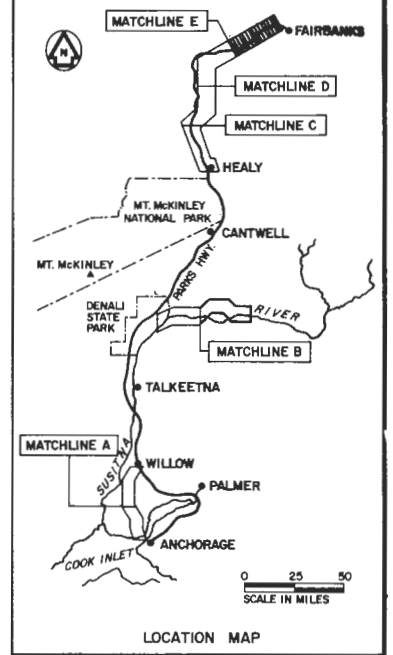
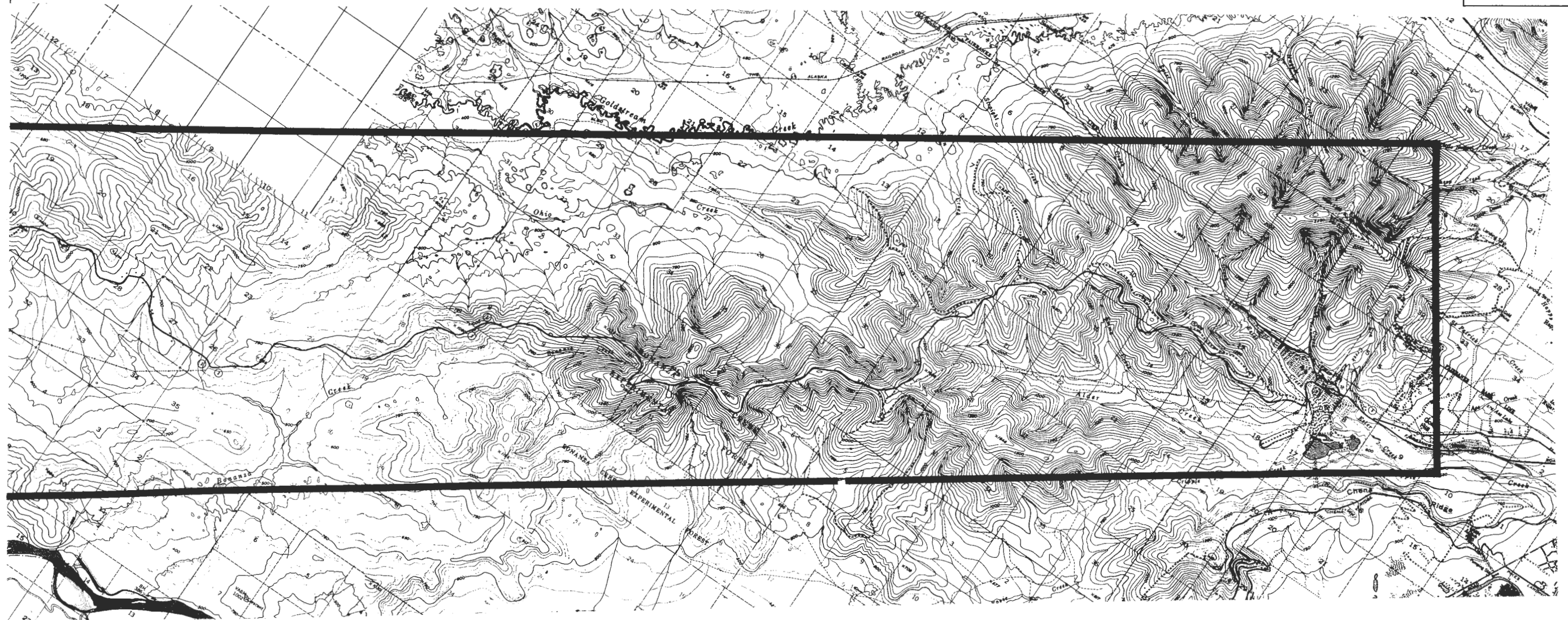

RECOMMENDED TRANSMISSION CORRIDOR  
NORTHERN STUDY AREA

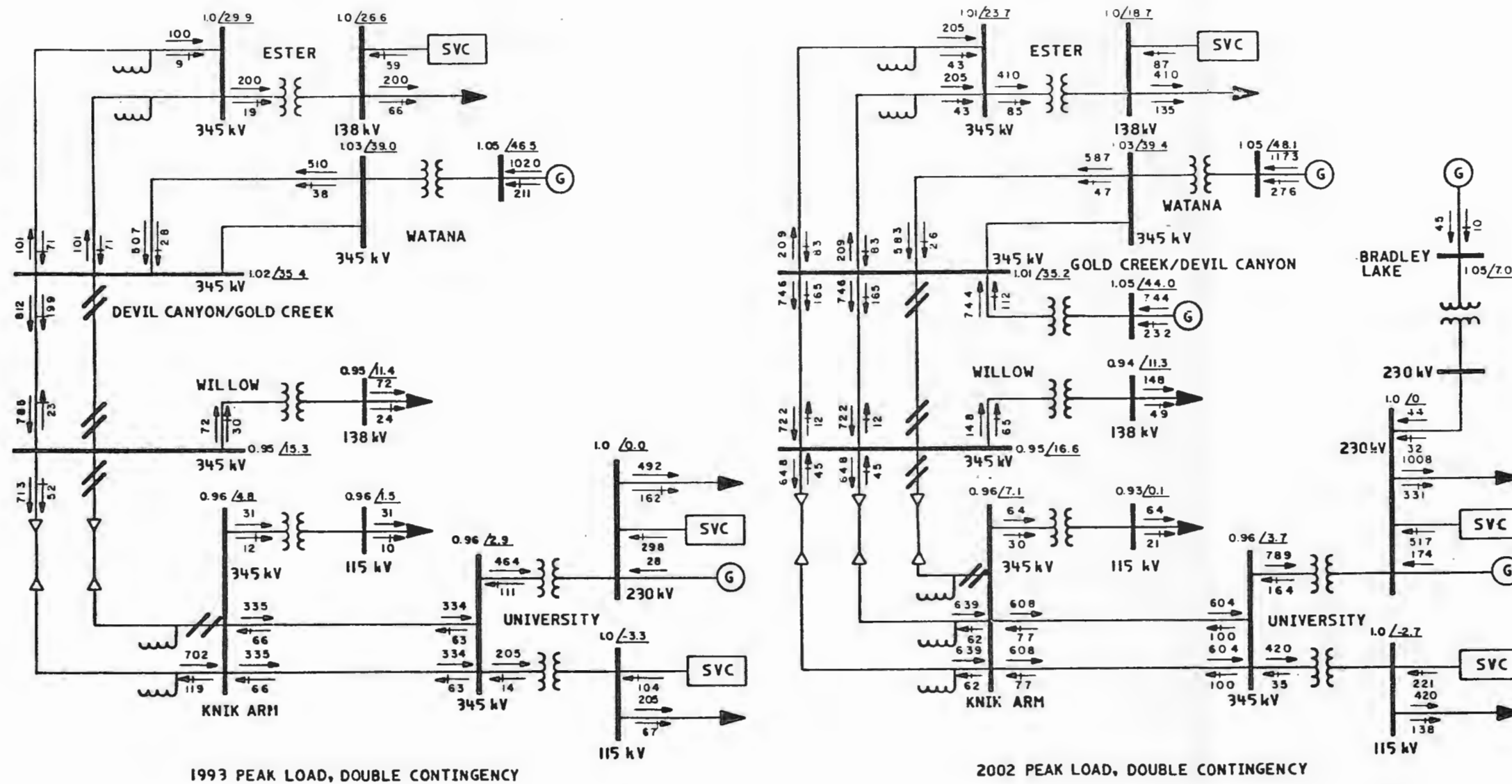

**LEGEND**

- REAL POWER (MW)
- REACTIVE POWER (MVAR)
- $\frac{1.00}{0.00}$  VOLTAGE IN PER UNIT & ANGLE IN DEGREES
- ▶ LOCAL LOAD
- (G) GENERATOR
- SVC STATIC VAR COMPENSATOR
- ⤴ O/H TL TO U/W CABLE

**ANCHORAGE - FAIRBANKS TRANSMISSION**  
**1993/2002 INTERCONNECTED SYSTEM**  
**SYSTEM PERFORMANCE EVALUATION**  
**ONE LINE DIAGRAM**



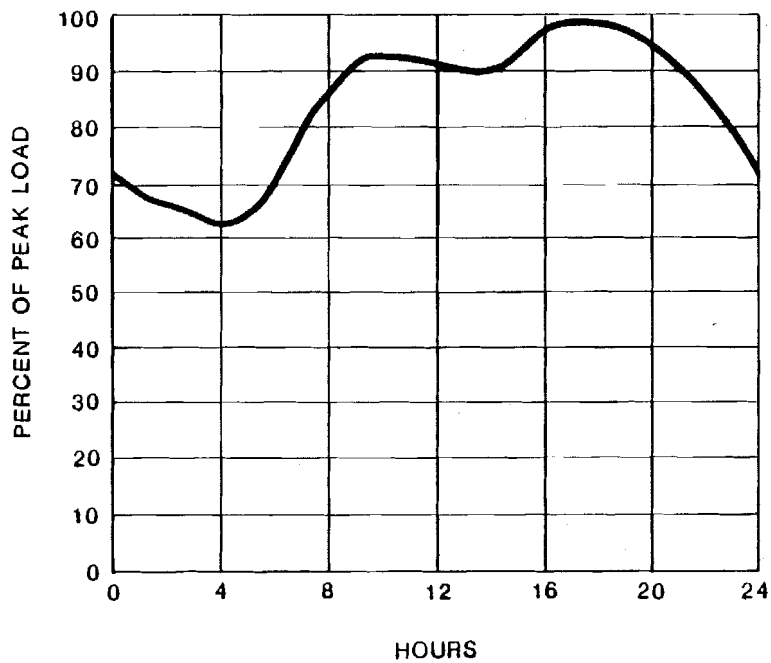

WINTER WEEKDAY  
HOURLY LOAD VARIATION

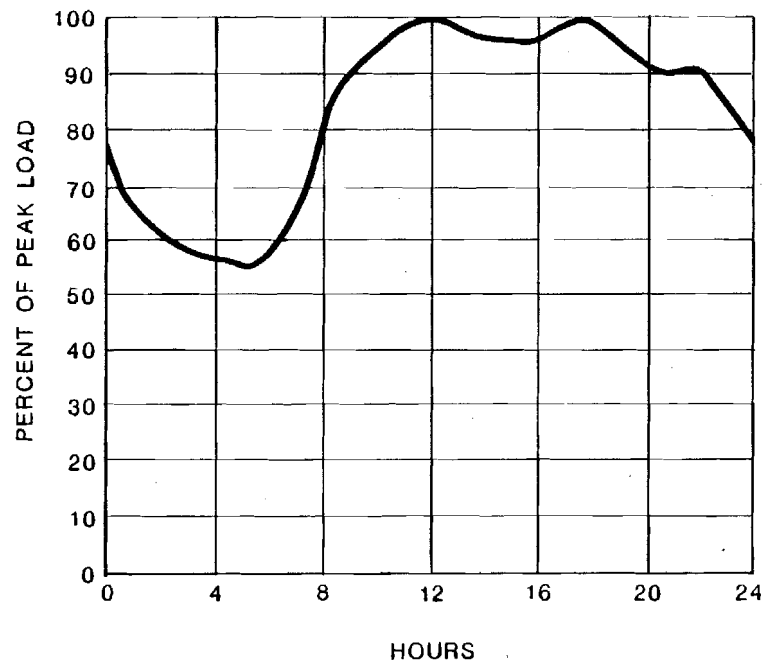

SUMMER WEEKDAY  
HOURLY LOAD VARIATION

TYPICAL LOAD VARIATION IN  
ALASKA RAILBELT SYSTEM

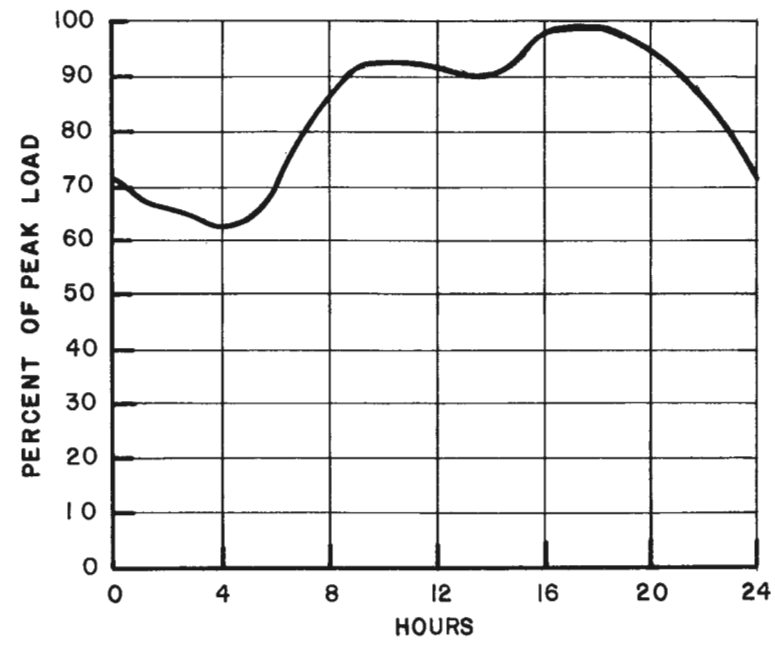

WINTER WEEKDAY  
HOURLY LOAD VARIATION

NOTE: PEAK MW DECEMBER 2000 AD = 1084 MW

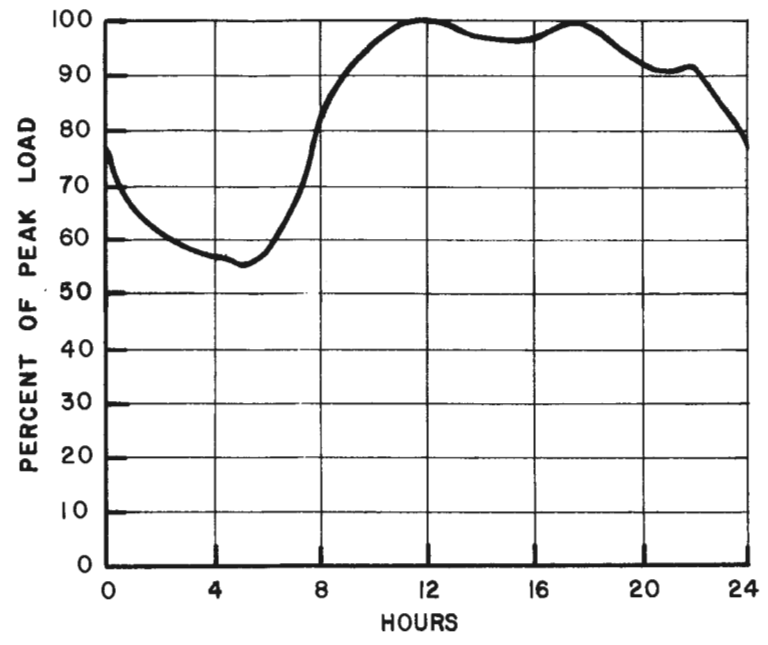

SUMMER WEEKDAY  
HOURLY LOAD VARIATION

NOTE: PEAK MW JULY 2000 AD = 658 MW

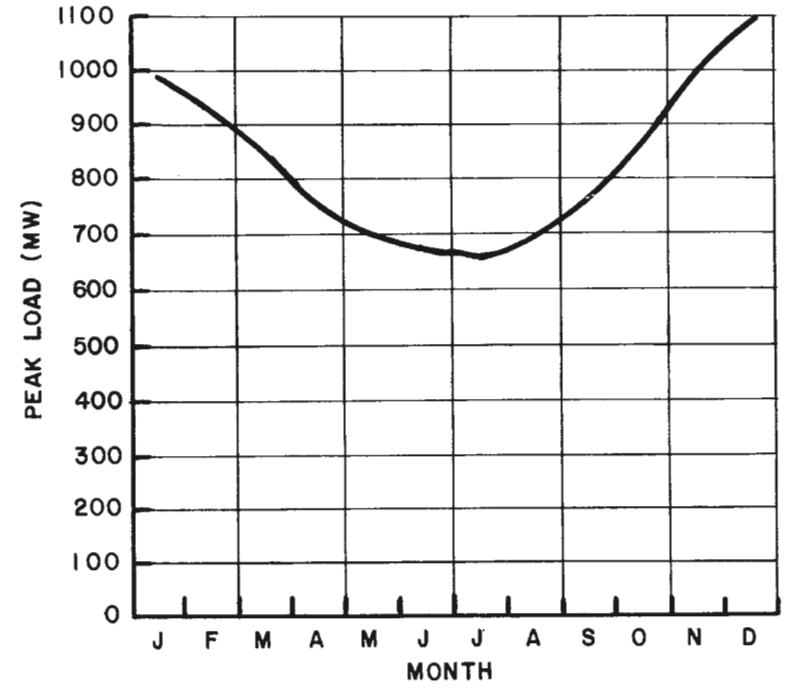

LOAD VARIATION  
IN YEAR 2000

TYPICAL LOAD VARIATION  
IN ALASKA RAILBELT SYSTEM

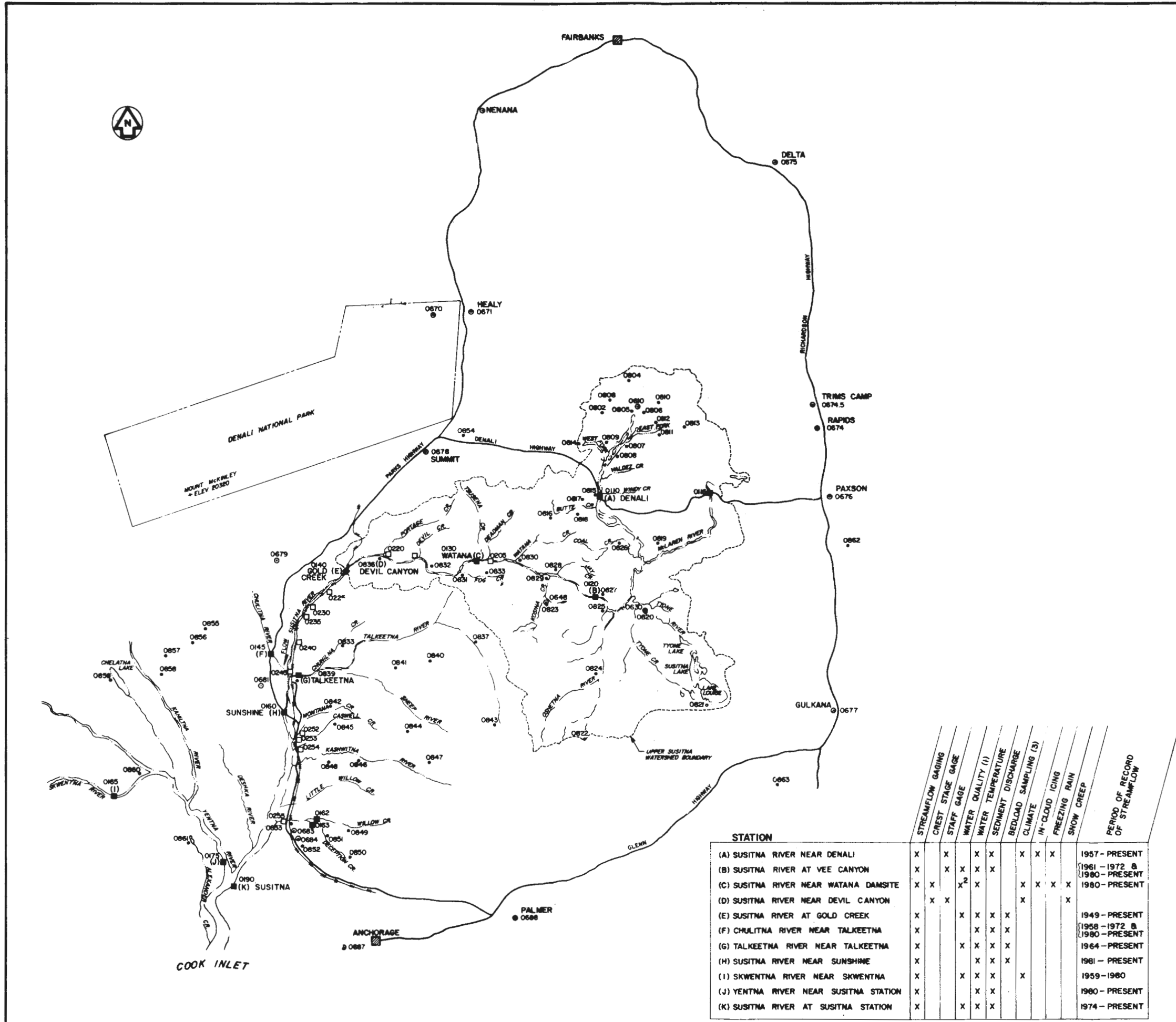

**DATA COLLECTED**

Symbol	Parameter	Index Number
■	STREAMFLOW - CONTINUOUS RECORD	0100
□	STREAMFLOW - PARTIAL RECORD	0200
●	WATER QUALITY	0300
T	WATER TEMPERATURE	0400
*	SEDIMENT DISCHARGE	0500
⊙	CLIMATE	0600
—	FREEZING RAIN AND IN-CLOUD ICING	0700
•	SNOW COURSE	0800
^	SNOW CREEP	0900

- NOTES**
- PARAMETERS MEASURED LISTED IN APPENDIX B1
  - CONTINUOUS WATER QUALITY MONITOR INSTALLED
  - DATA COLLECTION 1981 SEASON
  - THE LETTER BEFORE EACH STATION NAME IN THE TABLE IS USED ON THE MAP TO MARK THE APPROXIMATE LOCATION OF THE STATIONS.

STATION	STREAMFLOW GAGING	CREST STAGE GAGE	STAFF GAGE	WATER QUALITY (1)	WATER TEMPERATURE	SEDIMENT DISCHARGE	BEDLOAD SAMPLING (3)	CLIMATE	IN-CLOUD ICING	FREEZING RAIN	SNOW CREEP	PERIOD OF RECORD OF STREAMFLOW
(A) SUSITNA RIVER NEAR DENALI	X	X		X	X			X	X	X		1957 - PRESENT
(B) SUSITNA RIVER AT VEE CANYON	X		X	X	X							1961 - 1972 & 1980 - PRESENT
(C) SUSITNA RIVER NEAR WATANA DAMSITE	X	X		X <sup>2</sup>	X			X	X	X		1980 - PRESENT
(D) SUSITNA RIVER NEAR DEVIL CANYON		X	X					X			X	
(E) SUSITNA RIVER AT GOLD CREEK	X			X	X	X						1949 - PRESENT
(F) CHULITNA RIVER NEAR TALLEETNA	X			X	X	X						1958 - 1972 & 1980 - PRESENT
(G) TALLEETNA RIVER NEAR TALLEETNA	X			X	X	X						1964 - PRESENT
(H) SUSITNA RIVER NEAR SUNSHINE	X			X	X	X						1961 - PRESENT
(I) SKWENTNA RIVER NEAR SKWENTNA	X			X	X	X	X					1959 - 1980
(J) YENTNA RIVER NEAR SUSITNA STATION	X			X	X	X						1980 - PRESENT
(K) SUSITNA RIVER AT SUSITNA STATION	X			X	X	X						1974 - PRESENT

DATA COLLECTION STATIONS



FIGURE B.59

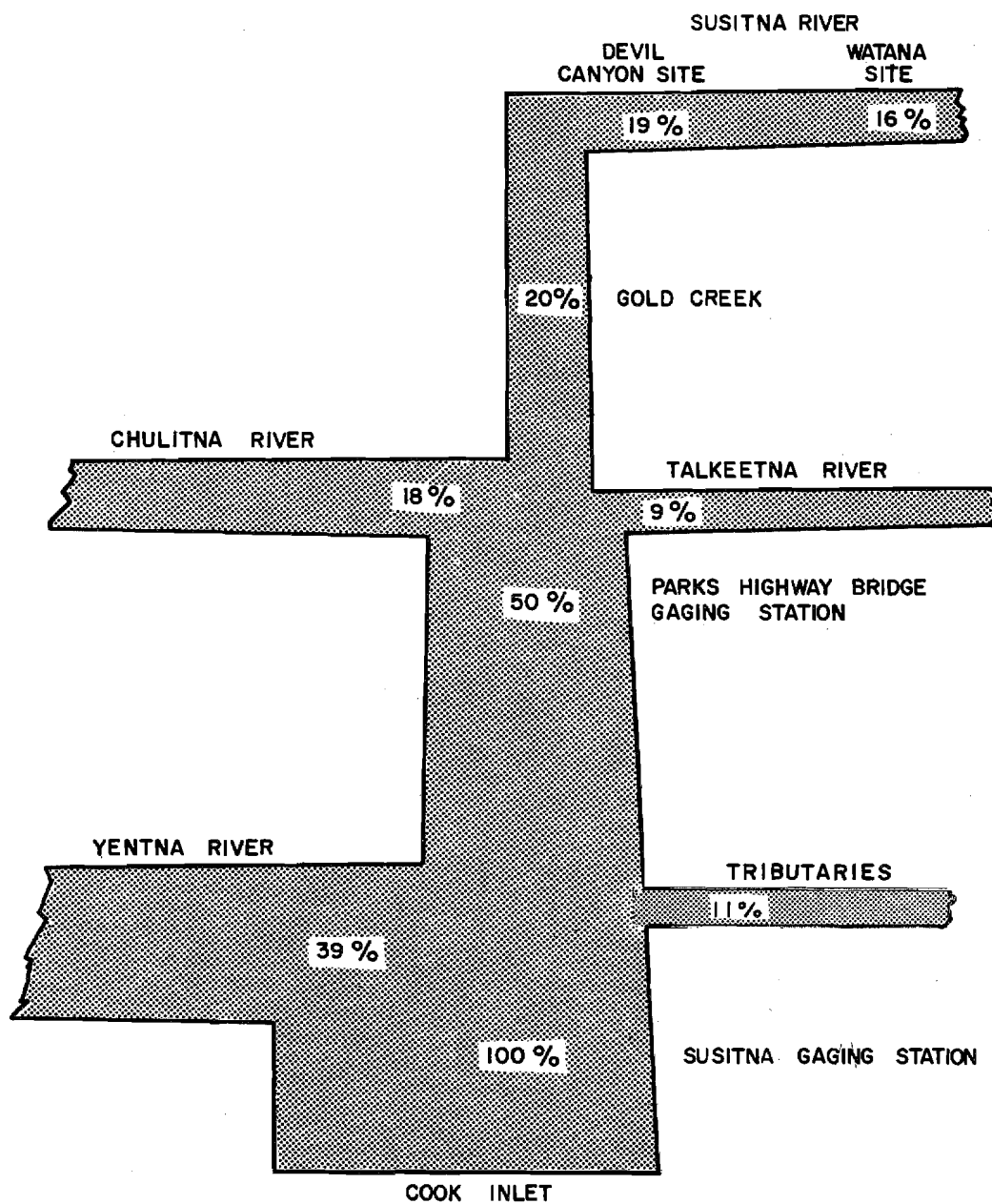

AVERAGE ANNUAL FLOW DISTRIBUTION  
WITHIN THE SUSITNA RIVER BASIN

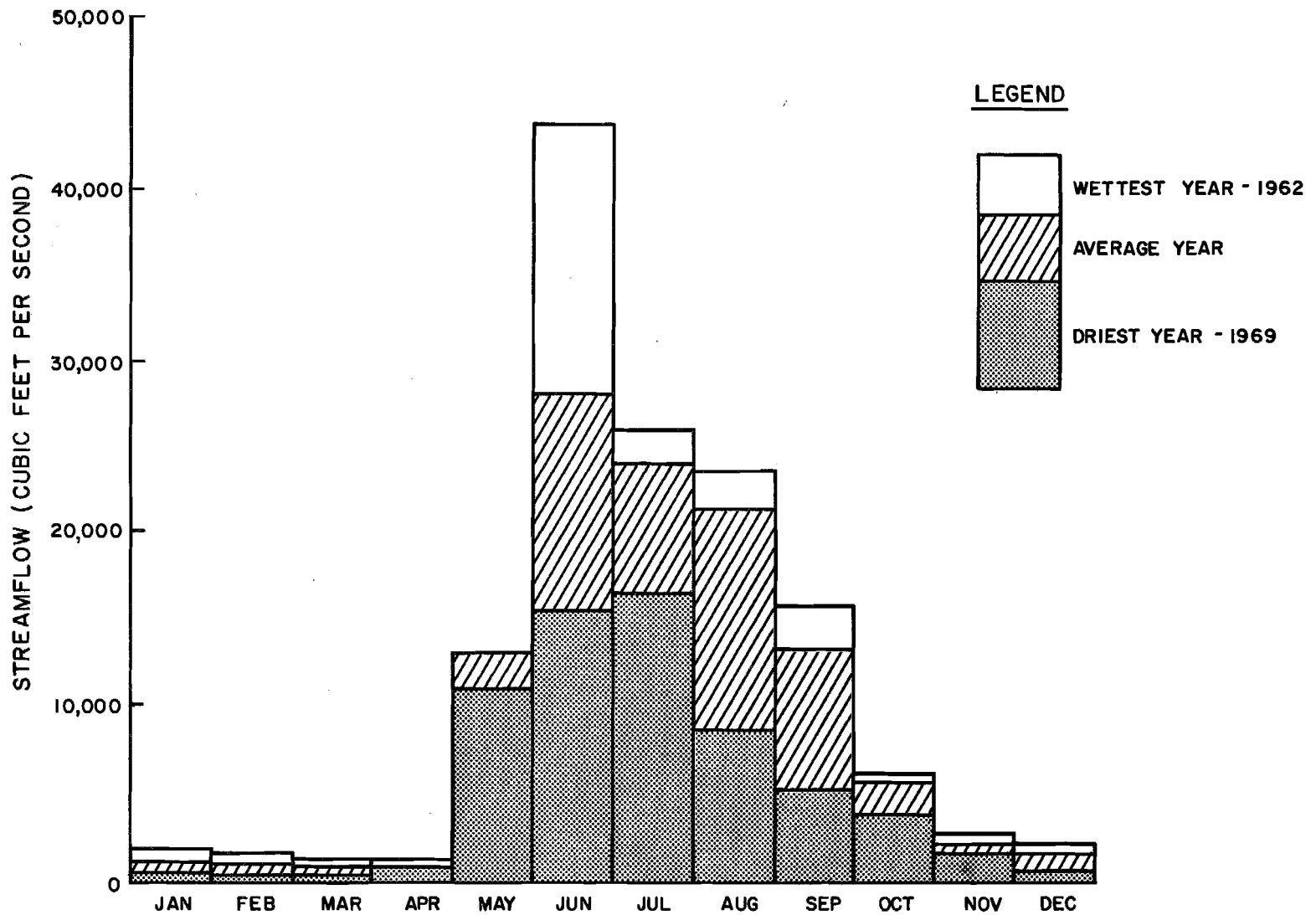

MONTHLY AVERAGE FLOWS  
SUSITNA RIVER AT GOLD CREEK

FIGURE B.61

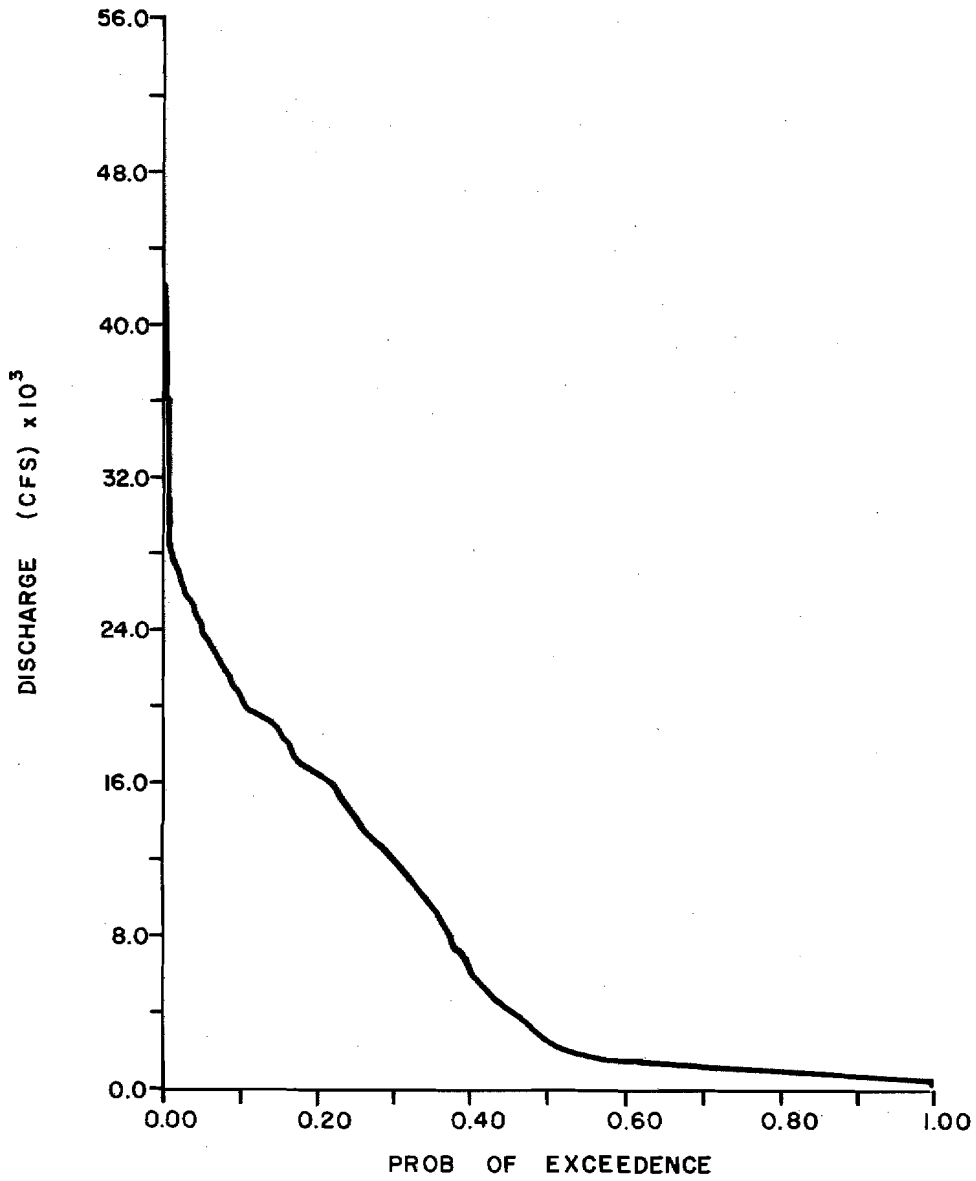

FLOW DURATION CURVE MEAN MONTHLY INFLOW  
AT WATANA PRE-PROJECT

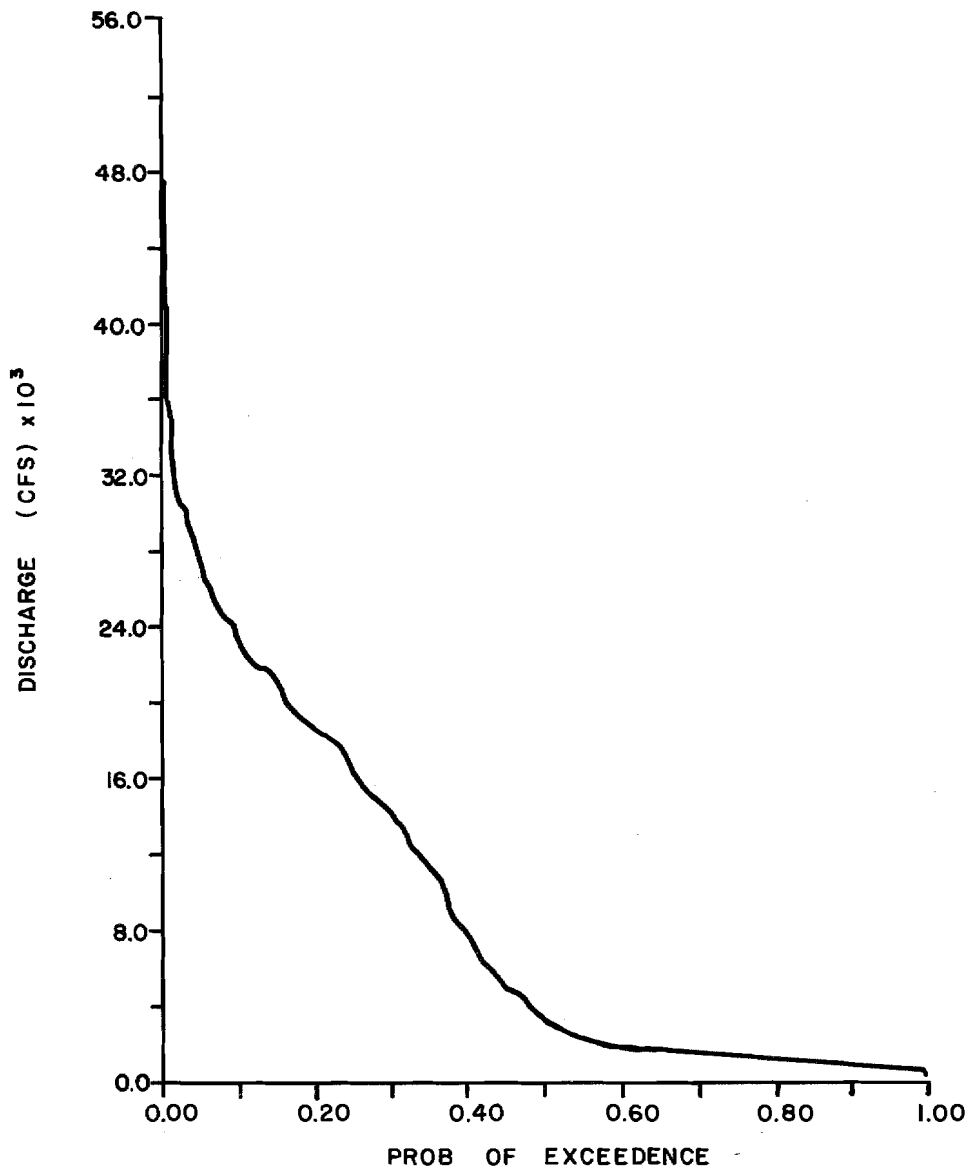

FLOW DURATION CURVE MEAN MONTHLY INFLOW  
AT DEVIL CANYON PRE-PROJECT

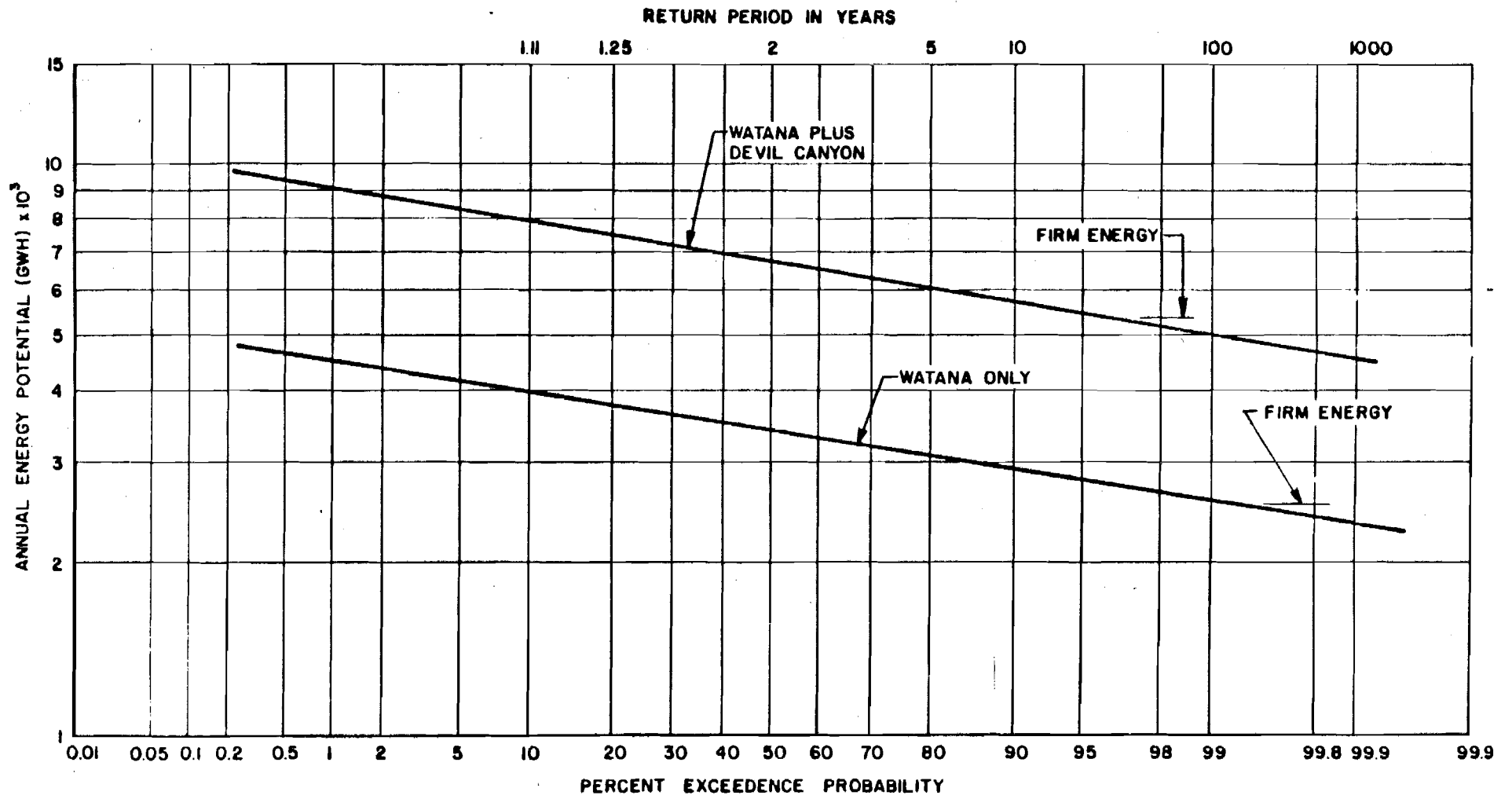

FREQUENCY ANALYSIS OF ANNUAL ENERGY FOR SUSITNA DEVELOPMENTS

FIGURE B.64



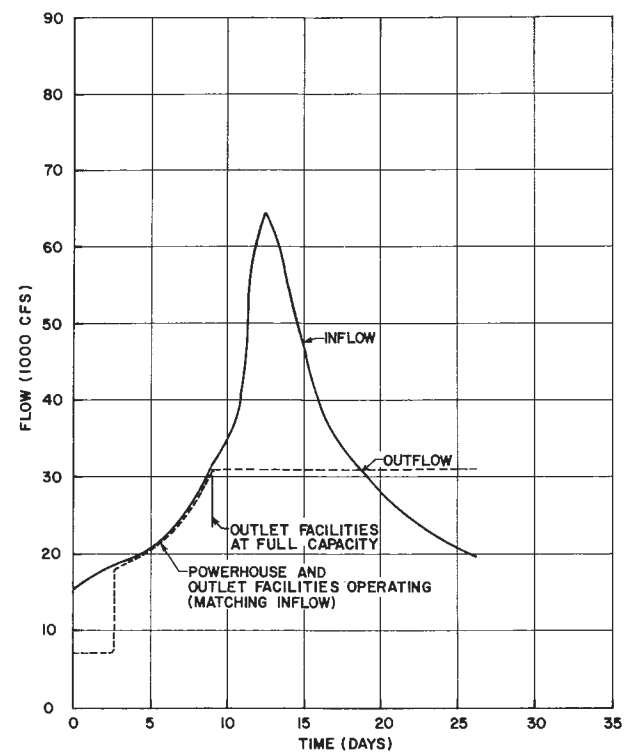

**1:50 YEAR FLOOD**  
(SUMMER)

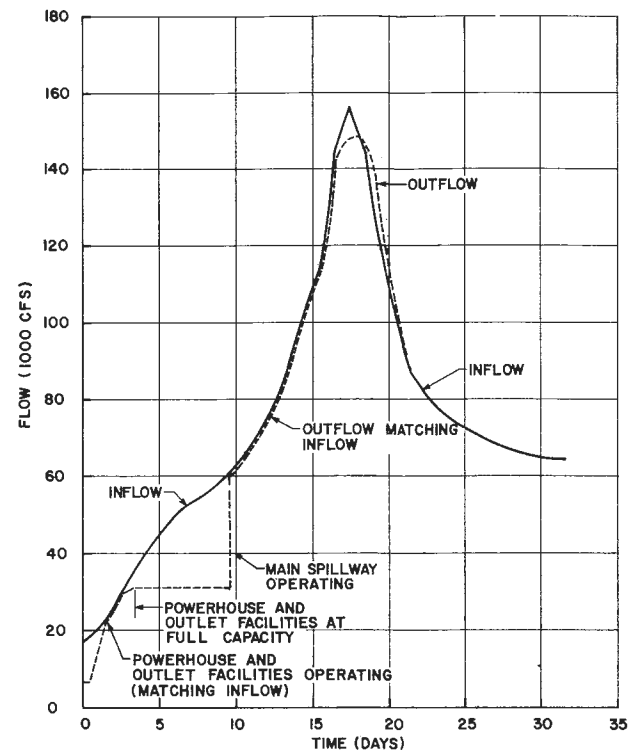

**1:10,000 YEAR FLOOD**

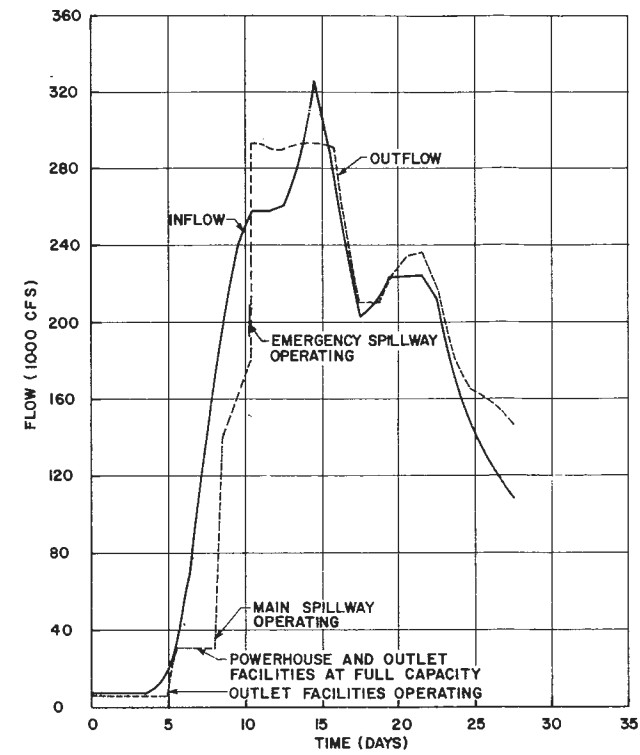

**PROBABLE MAXIMUM FLOOD**

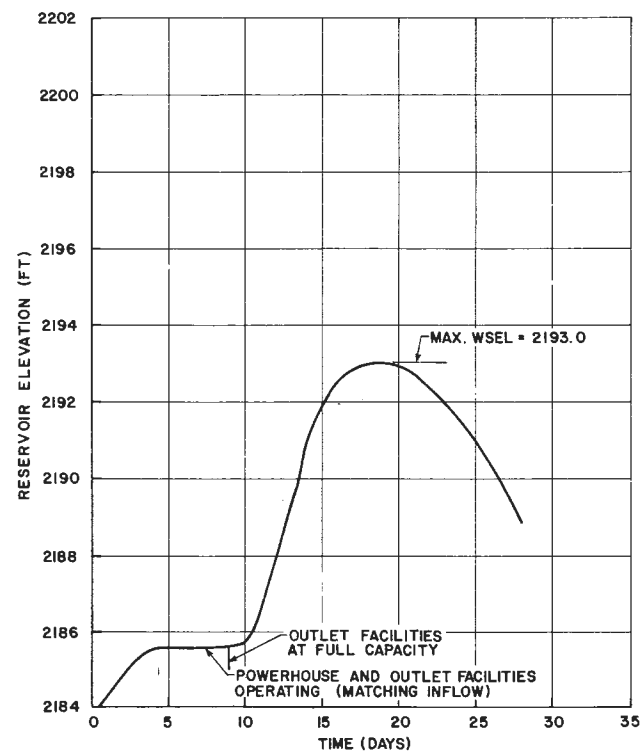

**1:50 YEAR FLOOD**  
(SUMMER)

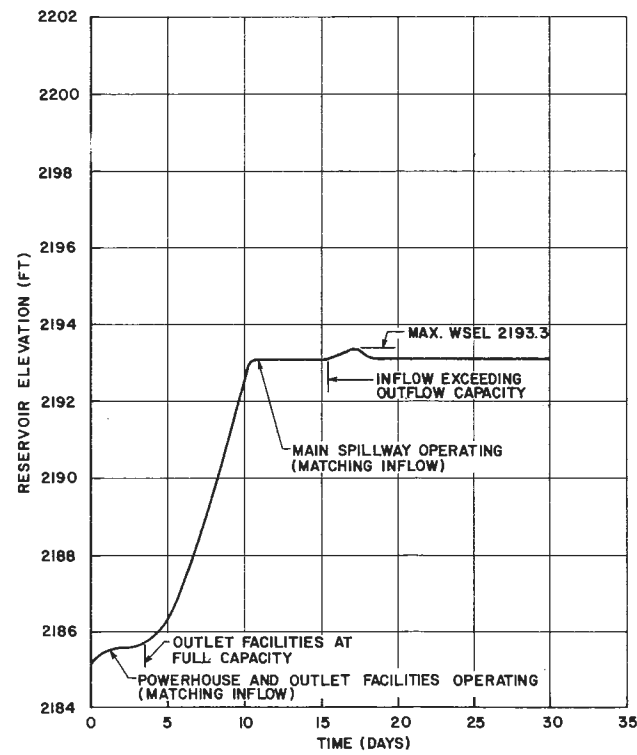

**1:10,000 YEAR FLOOD**

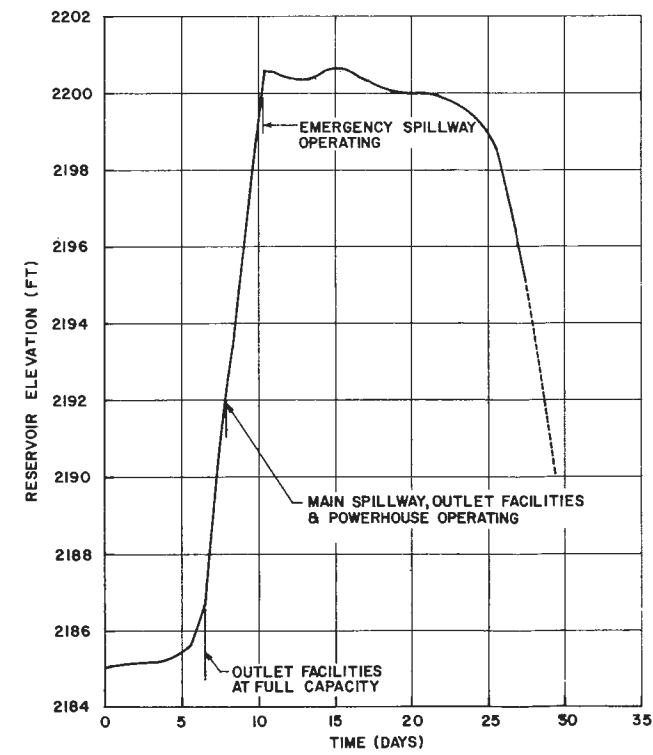

**PROBABLE MAXIMUM FLOOD**

**WATANA**  
**HYDROLOGICAL DATA - SHEET I**

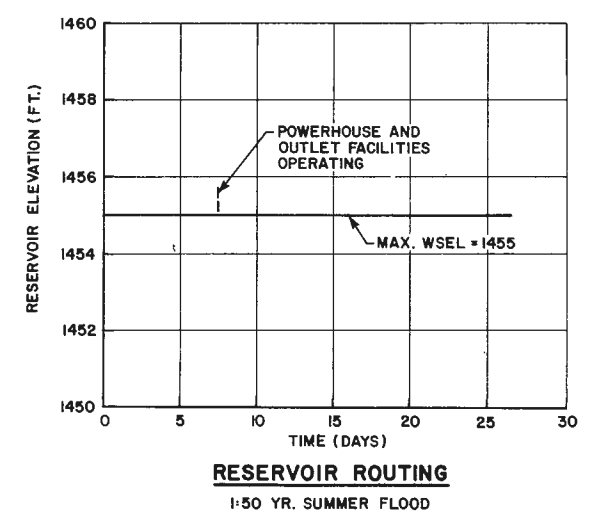
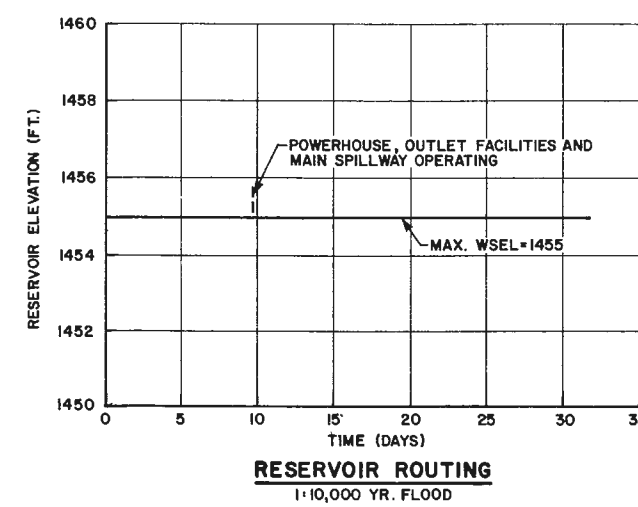
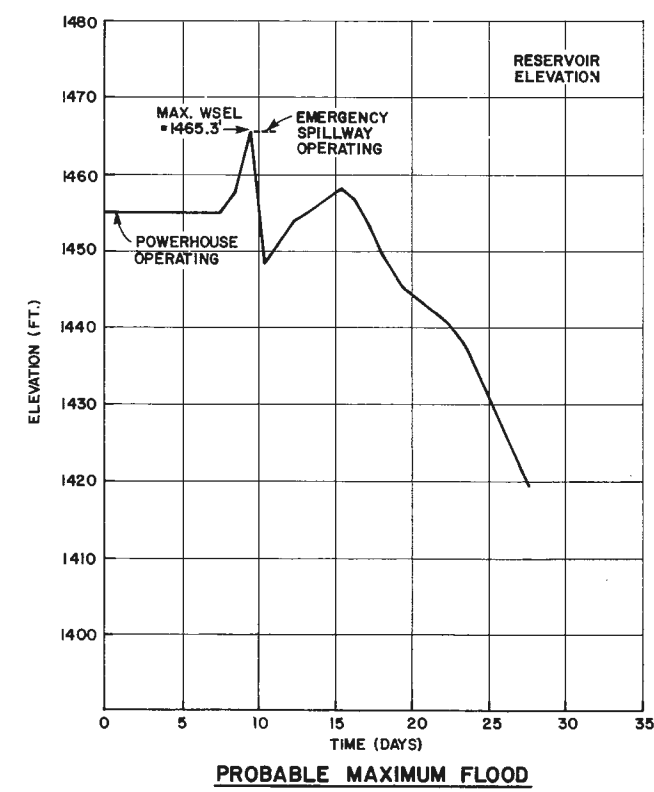
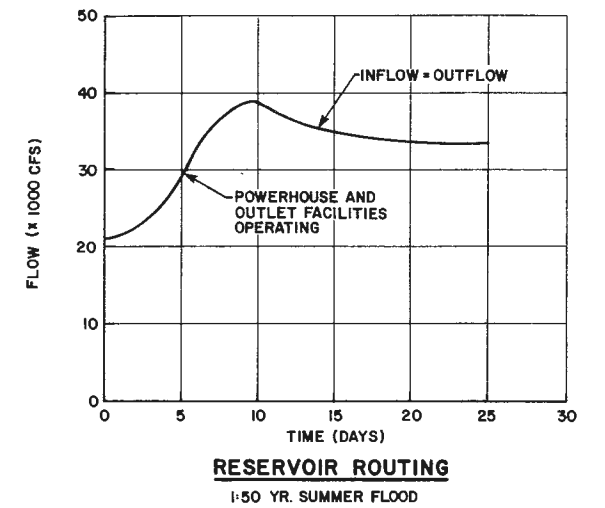
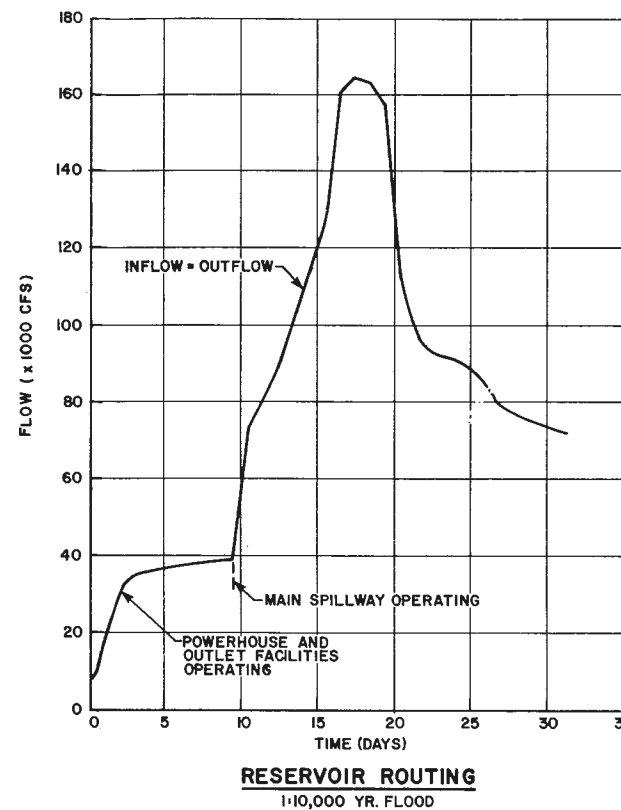
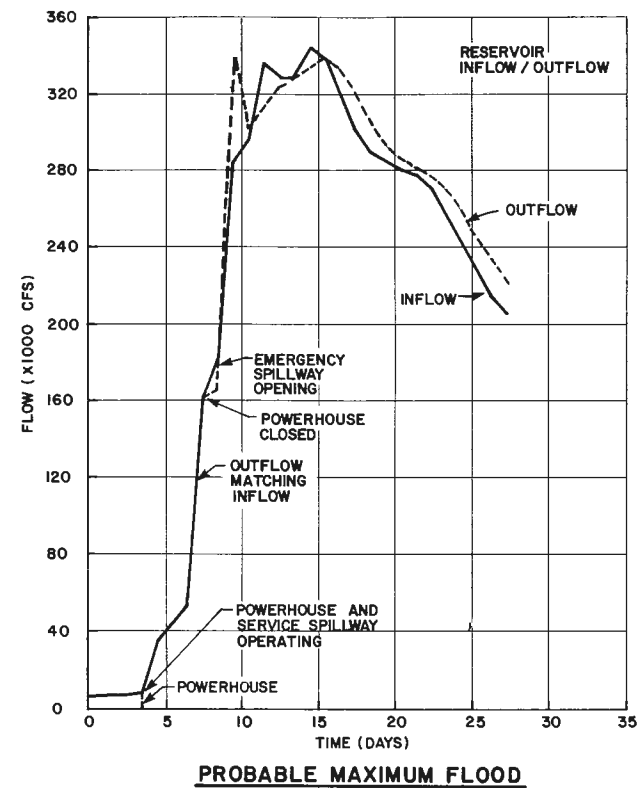

**DEVIL CANYON  
HYDROLOGICAL DATA - SHEET I**

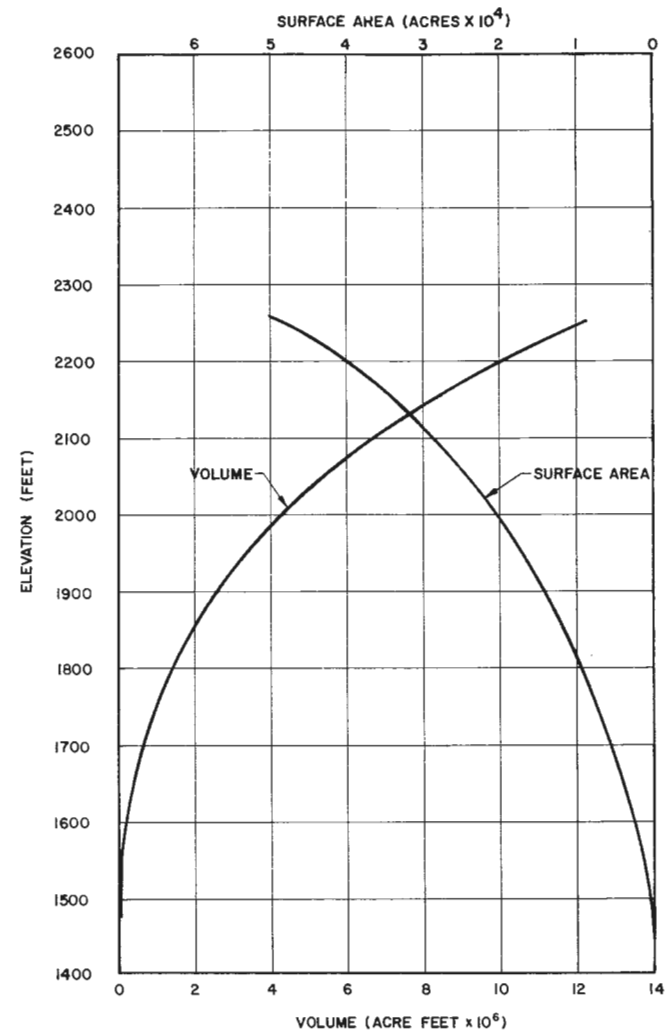

**RESERVOIR VOLUME AND SURFACE AREA**

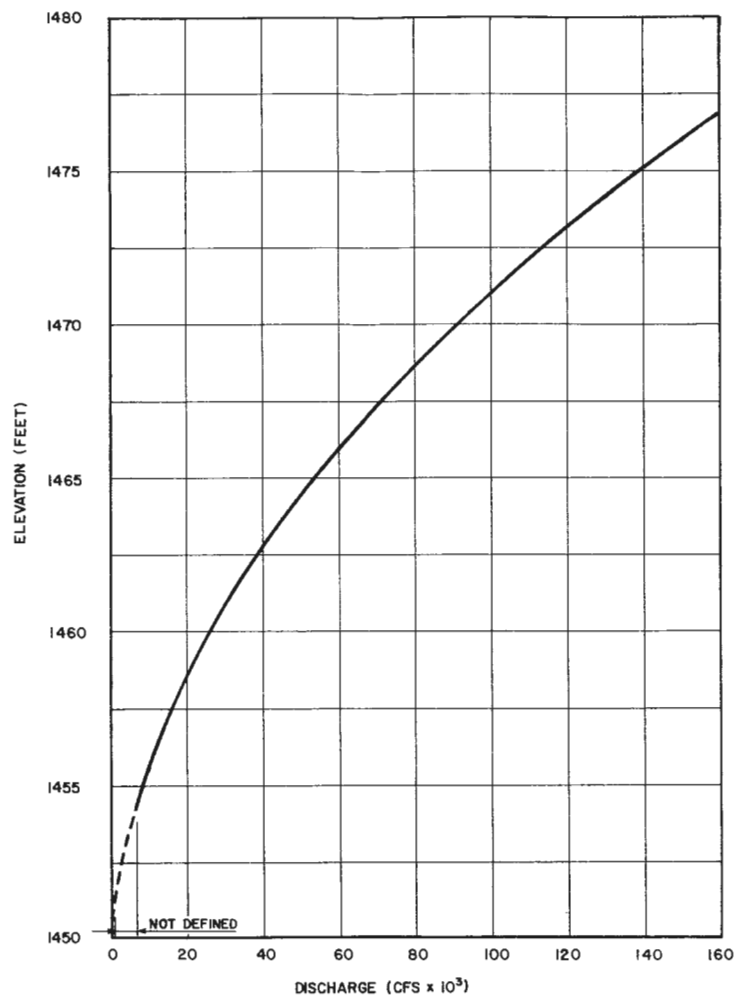

**TAILWATER RATING**

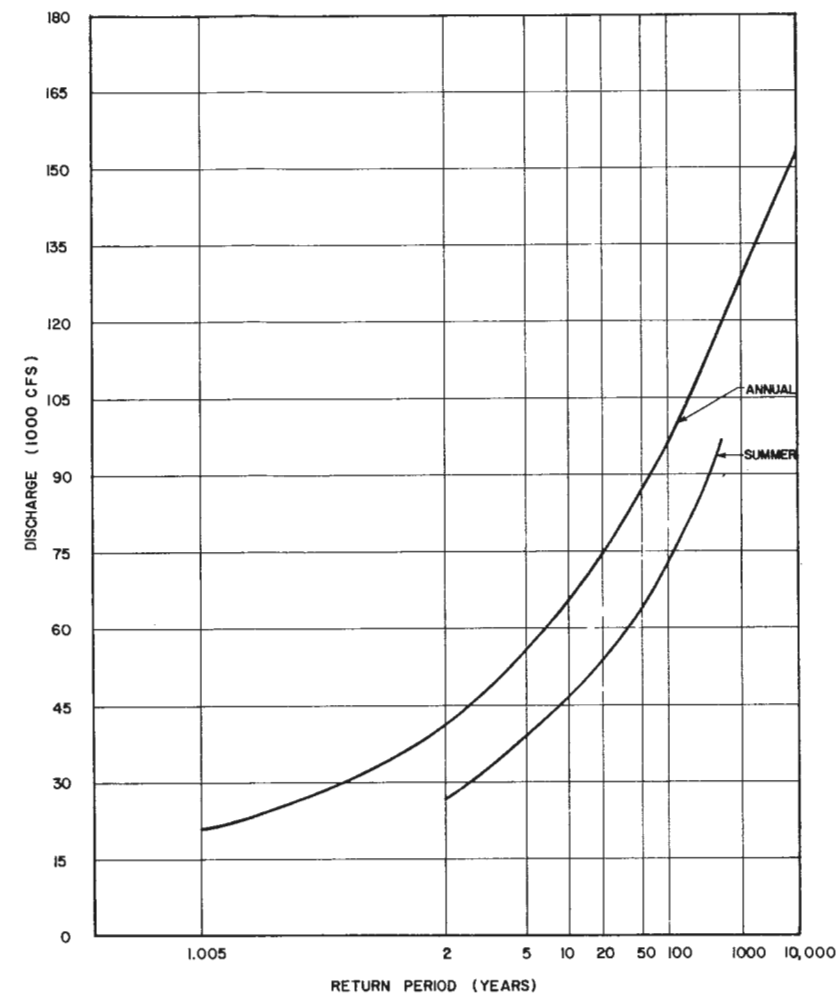

**INFLOW FLOOD FREQUENCY**

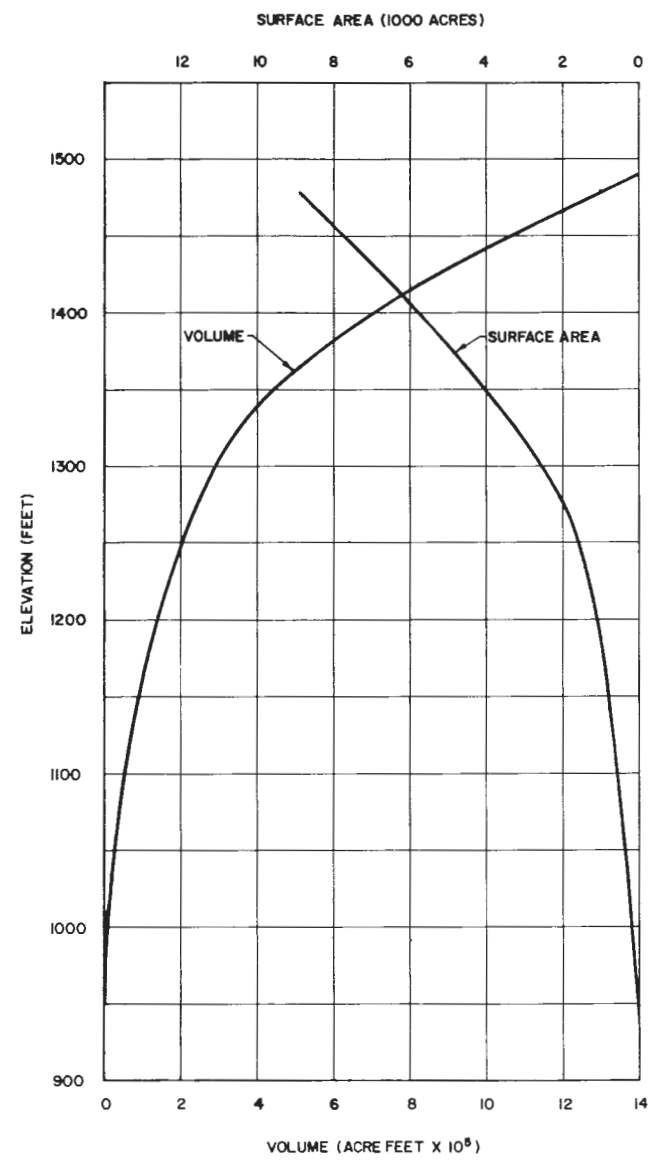

**RESERVOIR VOLUME AND SURFACE AREA**

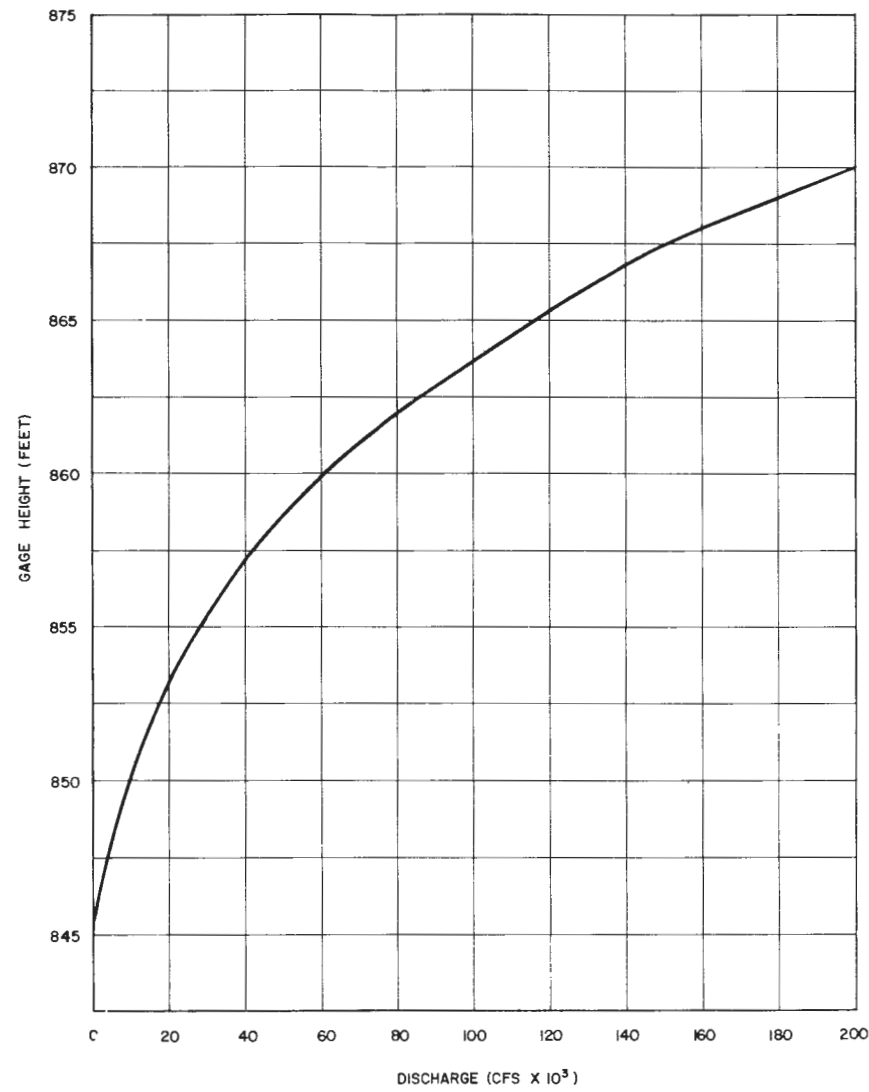

**TAILWATER RATING CURVE**

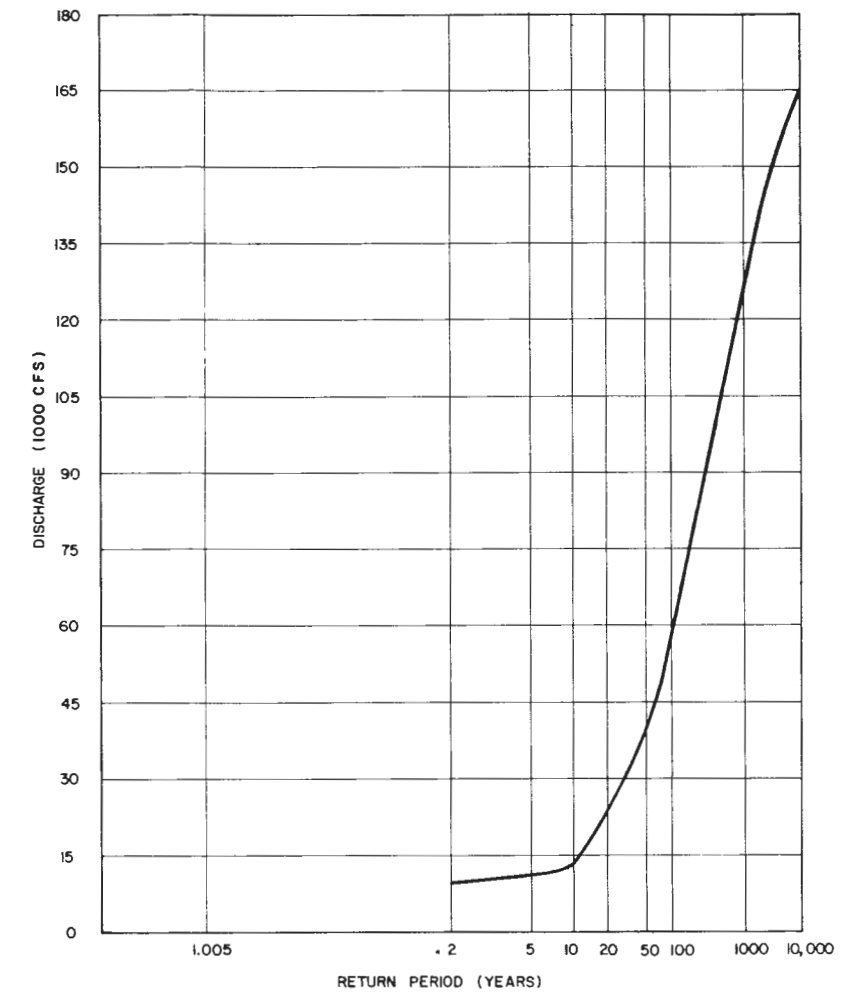

**FLOOD FREQUENCY CURVE**  
(INFLOW AFTER ROUTING THROUGH WATANA)

**DEVIL CANYON  
HYDROLOGICAL DATA - SHEET 2**

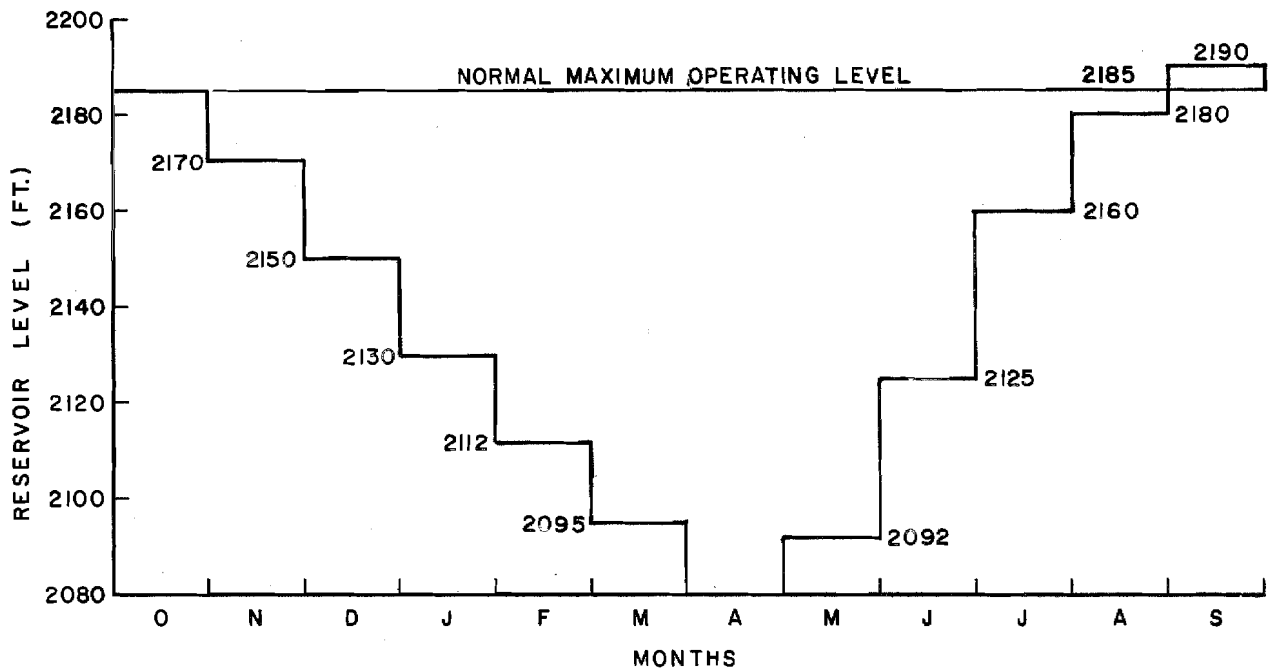

WATANA RESERVOIR

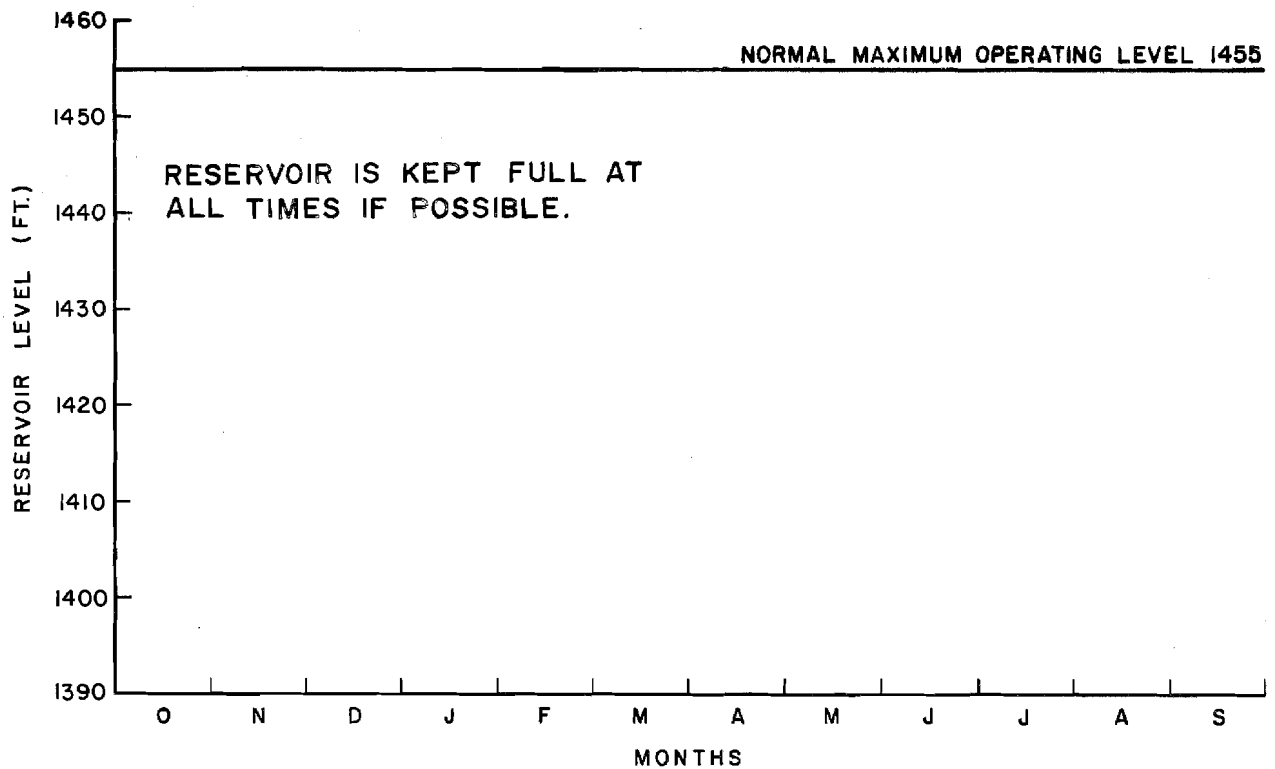

DEVIL CANYON RESERVOIR

MONTHLY TARGET MINIMUM RESERVOIR LEVELS

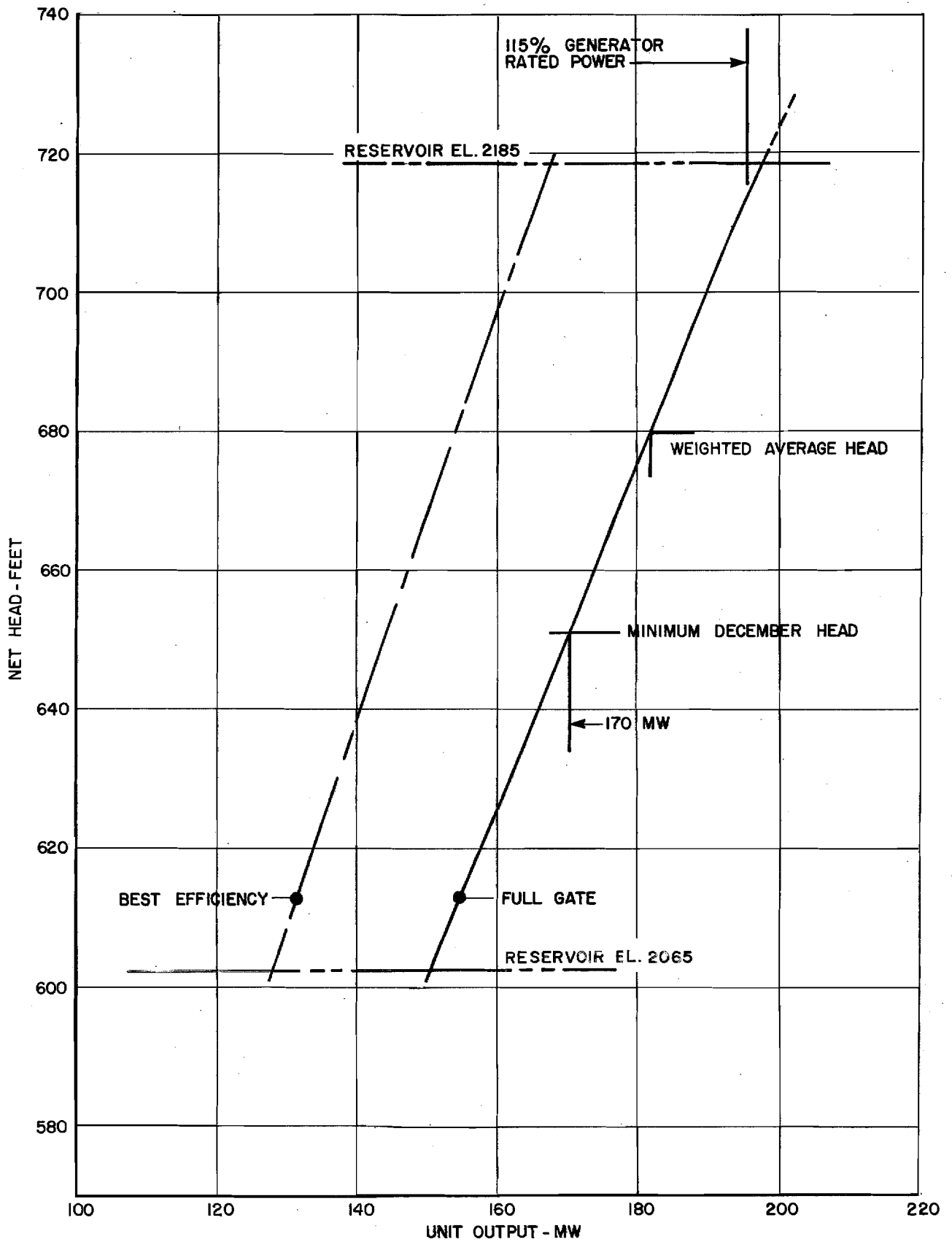

**WATANA - UNIT OUTPUT**

FIGURE B.70

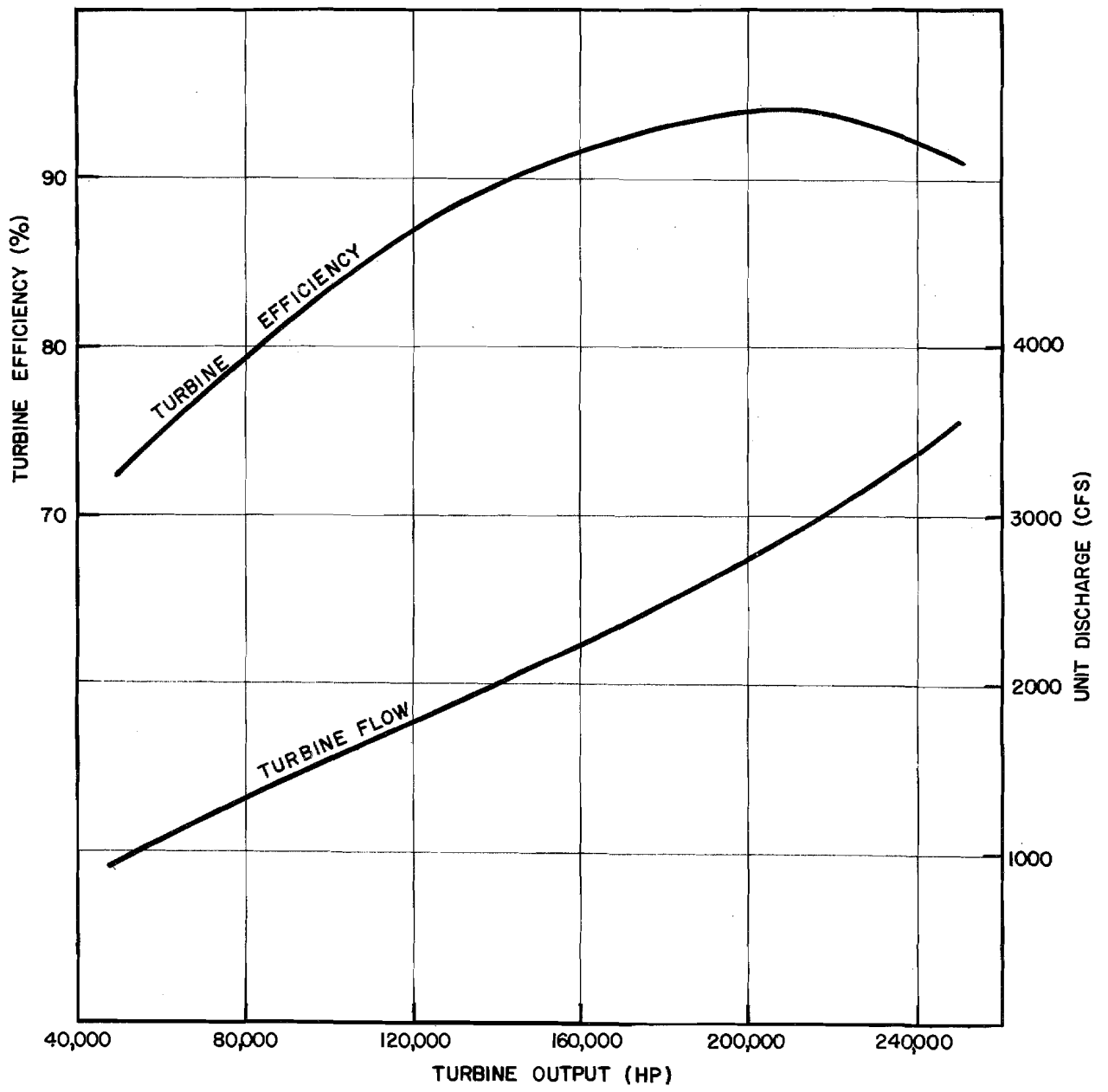

**WATANA-TURBINE PERFORMANCE  
(AT RATED HEAD)**

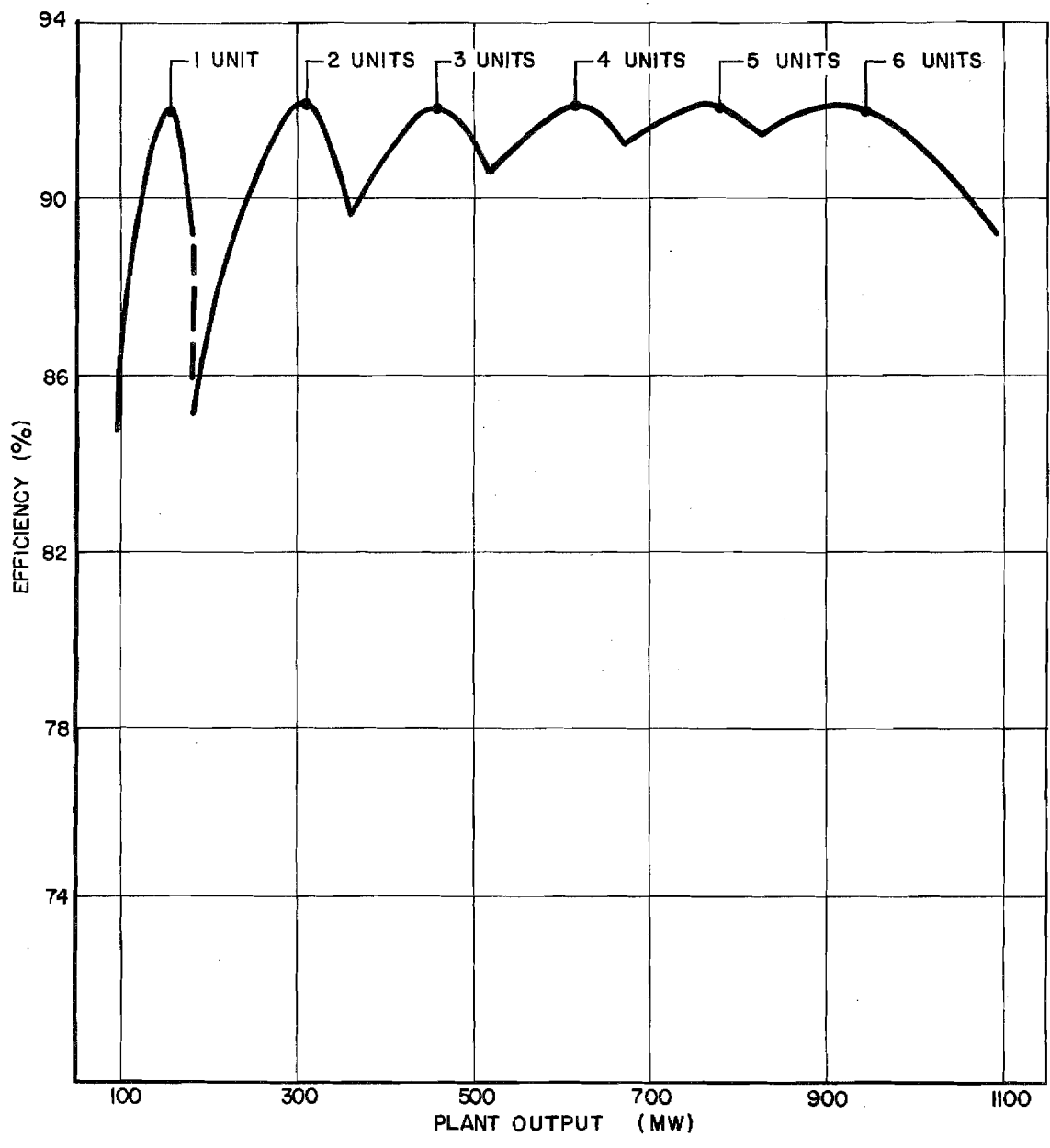

WATANA-UNIT EFFICIENCY  
(AT RATED HEAD)



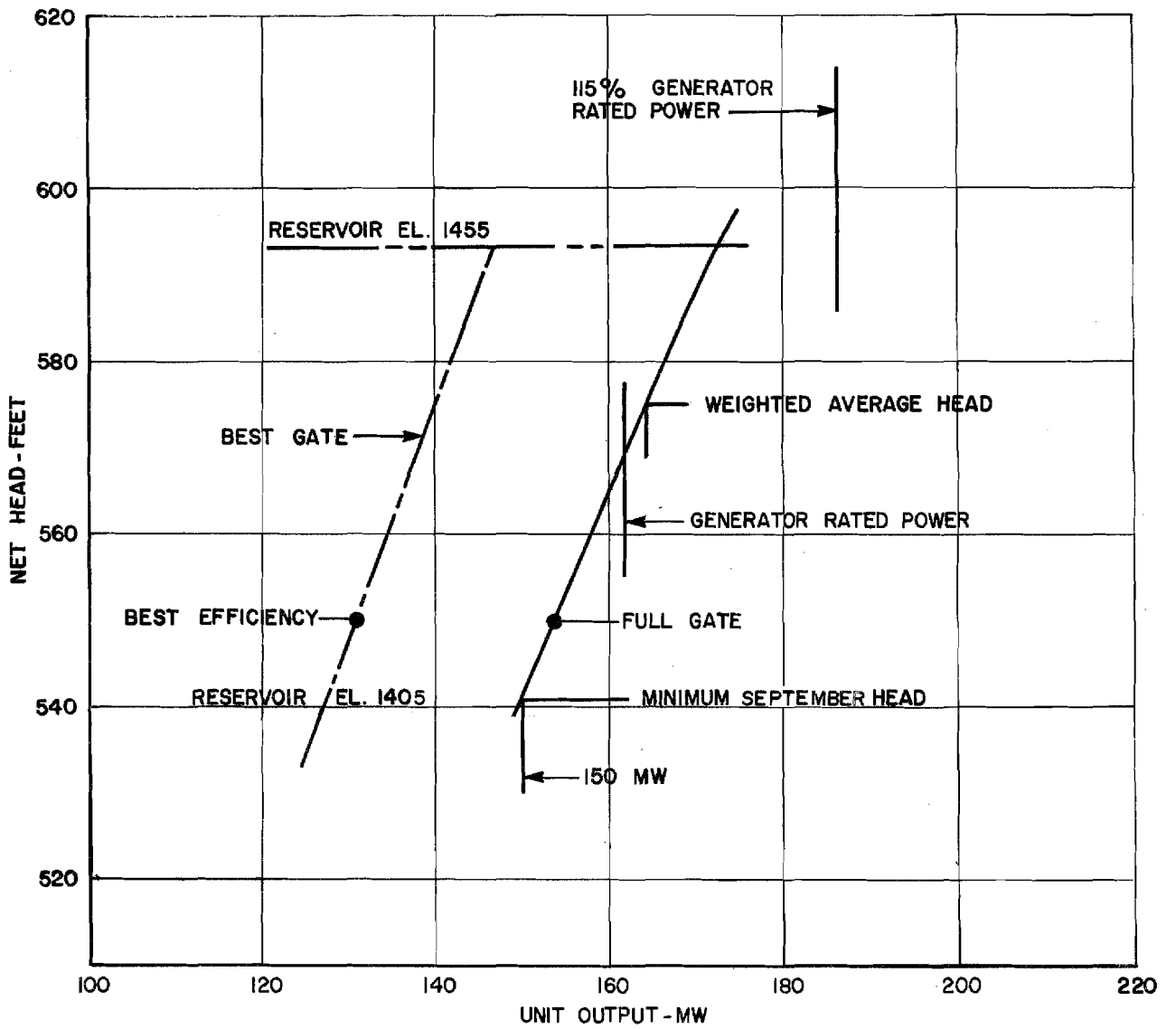

DEVIL CANYON-UNIT OUTPUT

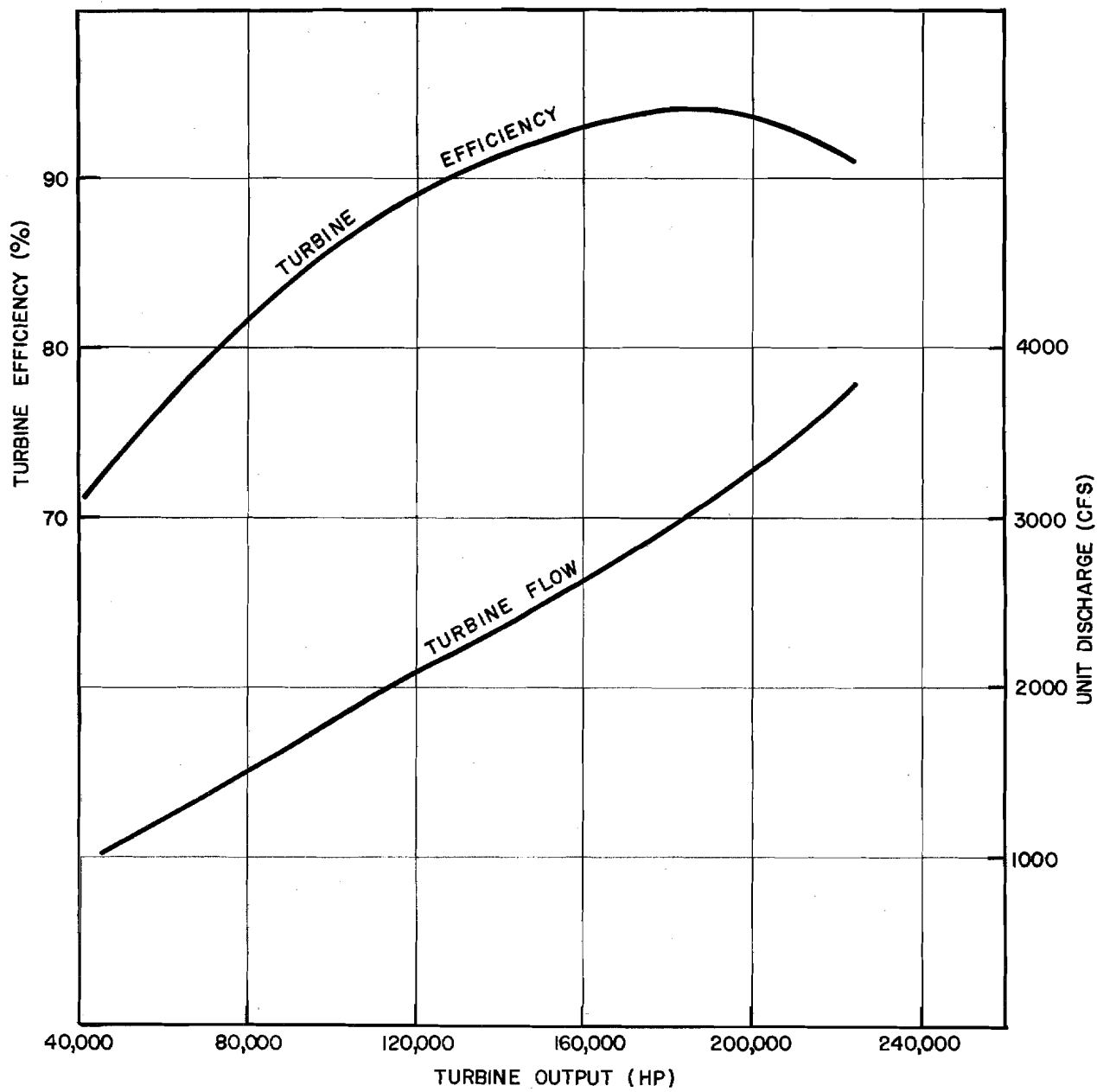

DEVIL CANYON-TURBINE PERFORMANCE  
(AT RATED HEAD)

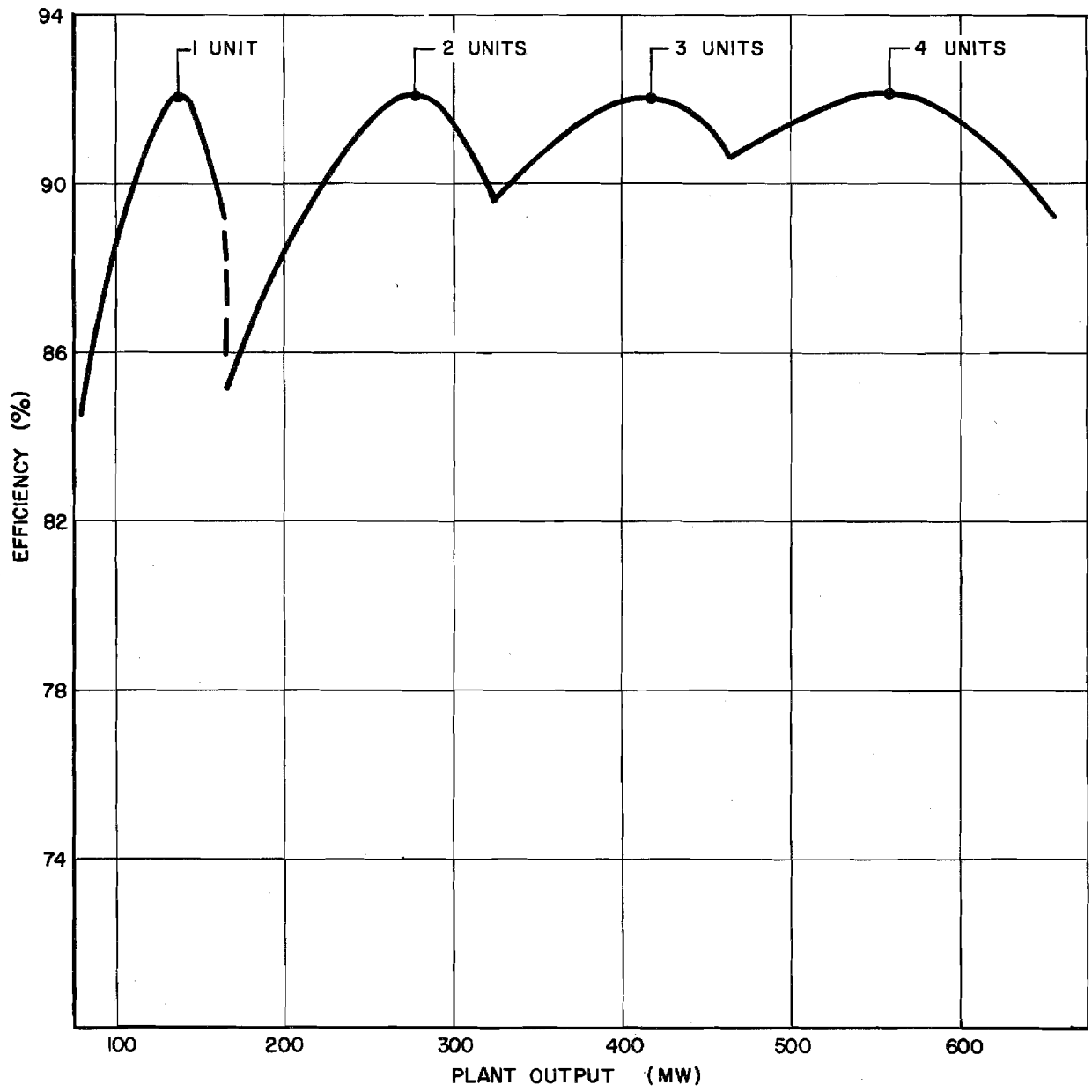

DEVIL CANYON-UNIT EFFICIENCY  
(AT RATED HEAD)

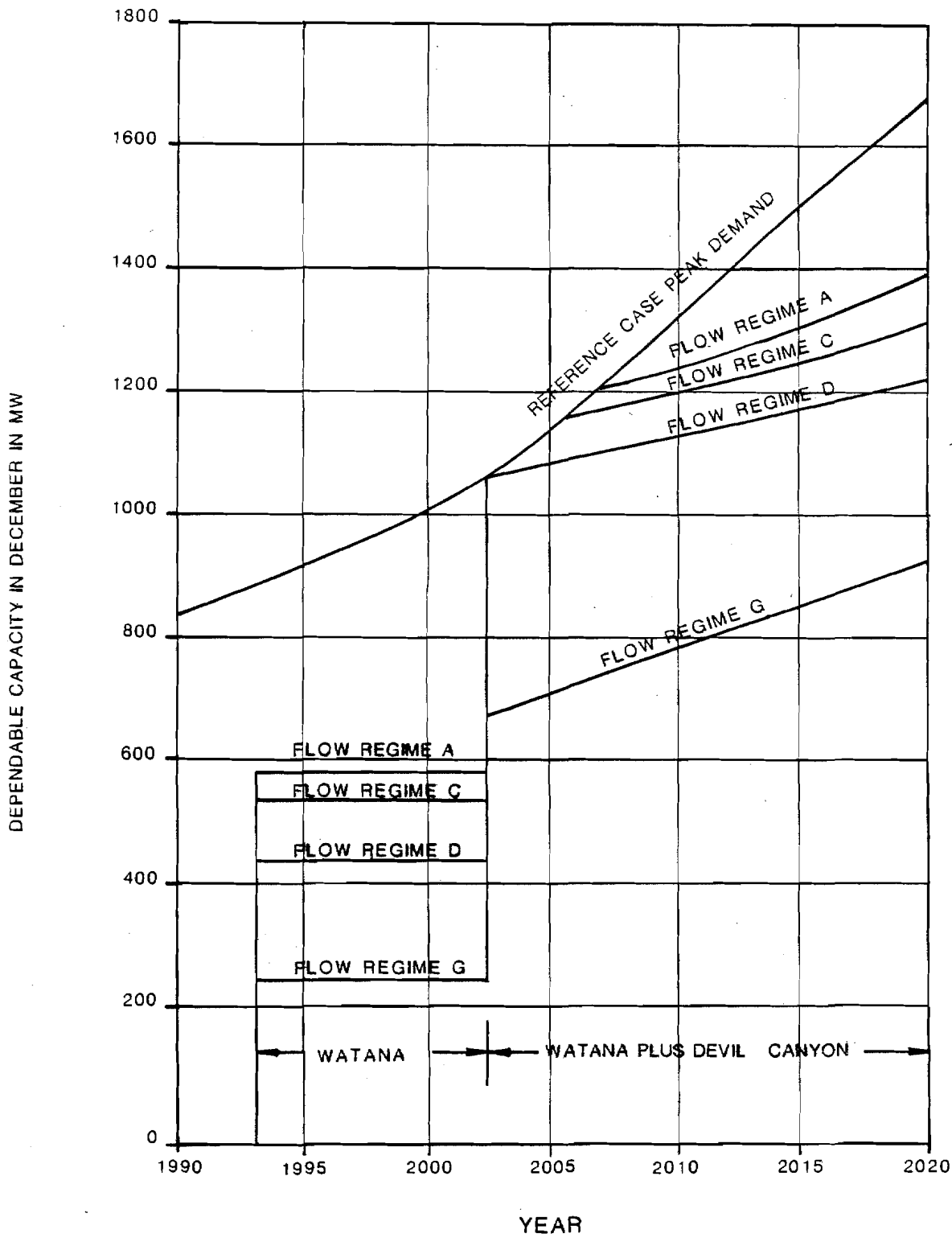

DEPENDABLE CAPACITY

FIGURE B.76