

TARIFA DE PRECIOS

IMPRESORAS DE INYECCIÓN DE TINTA

Business WorkForce Pro
Empresa
WorkForce monocromo profesional
Consumidor
EcoTank
Fotografía

PROYECTORES

Home cinema
Instalación
Portátil
Corta distancia
Proyector de ultracorta distancia
Ultraportátil

ROTULADORAS

IMPRESORAS LÁSER

Monocromo
Color

ESCÁNERES

Alimentación de hojas profesional
Plano profesional
Consumidor

COMERCIO MINORISTA

Impresoras de etiquetas en color
Impresoras para puntos de venta
Visores de cliente
Escáneres de cheques

VISORES

GRAN FORMATO

Fotografía profesional
Señalización
Sector textil
Fotografía y pruebas
Sector empresarial







IMPRESORAS MATRICIALES

PRODUCTOR DE DISCOS

PAPEL

Impresoras de inyección de tinta - Business WorkForce Pro

TARIFA DE PRECIOS

| Grupo de precios | WorkForce Pro WF-5110DW B2 | | WorkForce Pro WF-5190DW BQ | | WorkForce Pro WF-5620DWF B2 | | WorkForce Pro WF-5690DWF BQ | | WorkForce Pro WF-6090DW BQ | | WorkForce Pro WF-6590DWF BQ | | WorkForce Pro WF-8010DW B2 | |
|---|---|----------------------|---|----------------------|---|----------------------|---|----------------------|--|----------------------|---|----------------------|---|----------------------|
| |  | |  | |  | |  | |  | |  | |  | |
| Multifunción | Impresora | | Impresora | | Impresora multifunción 4 en 1 | | Impresora multifunción 4 en 1 | | Impresora | | Impresora multifunción 4 en 1 | | Impresora | |
| Formatos papel | A4 | | A4 | | A4 | | A4 | | A4 | | A4 | | A3+ | |
| Velocidad de impresión | 34 páginas/min en monocromo, 30 páginas/min en color | | 34 páginas/min en monocromo, 30 páginas/min en color | | 34 páginas/min en monocromo, 30 páginas/min en color | | 34 páginas/min en monocromo, 30 páginas/min en color | | 34 páginas/min en monocromo, 34 páginas/min en color | | 34 páginas/min en monocromo, 34 páginas/min en color | | 34 páginas/min en monocromo, 34 páginas/min en color | |
| Dúplex | Sí | | Sí | | Sí | | Sí | | Sí | | Sí | | Sí | |
| Entrada de papel estándar | 330 Hojas Estándar, 80 Hojas Bandeja MF, 250 Hojas Bandeja de papel | | 330 Hojas Estándar, 80 Hojas Bandeja MF, 250 Hojas Bandeja de papel | | 330 Hojas Estándar, 80 Hojas Bandeja MF, 250 Hojas Bandeja de papel | | 330 Hojas Estándar, 80 Hojas Bandeja MF, 250 Hojas Bandeja de papel | | 581 Hojas Estándar, 80 Hojas Bandeja MF, 500 Hojas Bandeja de papel | | 581 Hojas Estándar, 80 Hojas Bandeja MF, 500 Hojas Bandeja de papel | | 330 Hojas Estándar, 80 Hojas Bandeja MF, 250 Hojas Bandeja de papel | |
| Resolución de impresión | 4.800 x 1.200 ppp | | 4.800 x 1.200 ppp | | 4.800 x 1.200 ppp | | 4.800 x 1.200 ppp | | 4.800 x 1.200 ppp | | 4.800 x 1.200 ppp | | 4.800 x 1.200 ppp | |
| Emulaciones | ESC/P-R, GDI | | PCL6, PCL5c, PCL5e, ESC/P-R, Adobe® Postscript 3®, PDF 1.7 | | ESC/P-R, GDI | | PCL6, PCL5c, PCL5e, ESC/P-R, Adobe® Postscript 3®, PDF 1.7 | | PCL6, PCL5c, PCL5e, ESC/P-R, PDF 1.7, PostScript 3 | | PCL6, PCL5c, PCL5e, ESC/P-R, PDF 1.7, PostScript 3 | | GDI, ESC/P-R | |
| PVPR neto | C11CD12301 | 183,50 € | C11CD15301 | 233,50 € | C11CD08301 | 294,25 € | C11CD14301 | 314,25 € | C11CD47301 | 454,50 € | C11CD49301 | 500,25 € | C11CD42301 | 723,50 € |
| | | | | | | | | | DTWC C11CD47301BR D2TWC C11CD47301BZ | 691,50 € | DTWFC C11CD49301BR D2TWC C11CD49301BZ | 786,25 € | 901 € | |
| Opciones | B2 | | B2 | | B2 | | B2 | | B2 | | B2 | | B2 | |
| 500 Sheet Paper Cassette for WF-6000 Series | | | | | | | | | C12C932011 | 175 € | C12C932011 | 175 € | | |
| Bandeja de papel de 250 hojas | C12C817011 | 79 € | C12C817011 | 79 € | C12C817011 | 79 € | C12C817011 | 79 € | | | | | C12C817061 | 300 € |
| Bandeja de papel de 500 hojas | | | | | | | | | | | | | | |
| High Cabinet | | | | | | | | | C12C932671 | 169 € | C12C932671 | 169 € | C12C933561 | 209 € |
| Low Cabinet | | | | | | | | | C12C932681 | 149 € | C12C932681 | 149 € | C12C932891 | |
| Consumibles | S9, S3 | | S9, S3 | | S9, S3 | | S9, S3 | | S3, S9 | | S3, S9 | | S3 | |
| Cian | C13T79124010 | 800p 17,49 € | C13T79124010 | 800p 17,49 € | C13T79124010 | 800p 17,49 € | C13T79124010 | 800p 17,49 € | C13T908240 | 4000p 59,99 € | C13T908240 | 4000p 59,99 € | C13T756240 | 1500p 32,49 € |
| | C13T79024010 | 2000p 30,57 € | C13T79024010 | 2000p 30,57 € | C13T79024010 | 2000p 30,57 € | C13T79024010 | 2000p 30,57 € | C13T907240 | 7000p 81,77 € | C13T907240 | 7000p 81,77 € | C13T755240 | 4000p 59,99 € |
| | C13T789240 | 4000p 50,50 € | C13T789240 | 4000p 50,50 € | C13T789240 | 4000p 50,50 € | C13T789240 | 4000p 50,50 € | | | | | | |
| Magenta | C13T79134010 | 800p 17,49 € | C13T79134010 | 800p 17,49 € | C13T79134010 | 800p 17,49 € | C13T79134010 | 800p 17,49 € | C13T908340 | 4000p 59,99 € | C13T908340 | 4000p 59,99 € | C13T756340 | 1500p 32,49 € |
| | C13T79034010 | 2000p 30,57 € | C13T79034010 | 2000p 30,57 € | C13T79034010 | 2000p 30,57 € | C13T79034010 | 2000p 30,57 € | C13T907340 | 7000p 81,77 € | C13T907340 | 7000p 81,77 € | C13T755340 | 4000p 59,99 € |

Toda la información está sujeta a cambios sin notificación previa. Para las notas, por favor vea apéndice.

| | WorkForce Pro WF-5110DW | WorkForce Pro WF-5190DW | WorkForce Pro WF-5620DWF | WorkForce Pro WF-5690DWF | WorkForce Pro WF-6090DW | WorkForce Pro WF-6590DWF | WorkForce Pro WF-8010DW |
|--|--|--|--|--|--|--|---|
| | C13T789340 4000p 50,50 € | C13T789340 4000p 50,50 € | C13T789340 4000p 50,50 € | C13T789340 4000p 50,50 € | | | |
| Amarillo | C13T79144010 800p 17,49 € C13T79044010 2000p 30,57 € C13T789440 4000p 50,50 € | C13T79144010 800p 17,49 € C13T79044010 2000p 30,57 € C13T789440 4000p 50,50 € | C13T79144010 800p 17,49 € C13T79044010 2000p 30,57 € C13T789440 4000p 50,50 € | C13T79144010 800p 17,49 € C13T79044010 2000p 30,57 € C13T789440 4000p 50,50 € | C13T908440 4000p 59,99 € C13T907440 7000p 81,77 € | C13T908440 4000p 59,99 € C13T907440 7000p 81,77 € | C13T756440 1500p 32,49 € C13T755440 4000p 59,99 € |
| Negro | C13T79114010 900p 19 € C13T79014010 2600p 34,99 € C13T789140 4000p 44,80 € | C13T79114010 900p 19 € C13T79014010 2600p 34,99 € C13T789140 4000p 44,80 € | C13T79114010 900p 19 € C13T79014010 2600p 34,99 € C13T789140 4000p 44,80 € | C13T79114010 900p 19 € C13T79014010 2600p 34,99 € C13T789140 4000p 44,80 € | C13T908140 5000p 63,33 € C13T907140 10000p 72 € | C13T908140 5000p 63,33 € C13T907140 10000p 72 € | C13T756140 2500p 47,49 € C13T755140 5000p 63,33 € |
| Caja de mantenimiento | C13T671000 20,63 € | C13T671000 20,63 € | C13T671000 20,63 € | C13T671000 20,63 € | | C13T671200 26,74 € | C13T671200 26,74 € C13S210047 38,35 € C13S210046 38,35 € |
| Rodillo de mantenimiento S210047 | | | | | | | C13S990011 38,35 € |
| Rodillo de mantenimiento S210046 | | | | | | | C13S990021 38,35 € |
| Rodillo de mantenimiento S990011 | | | | | | | C13S990011 38,35 € |
| Rodillo de mantenimiento S990021 | | | | | | | C13S990021 38,35 € |
| CoverPlus | BP, BA | BR | BP | BR | BR | BR | BP |
| 03 años de servicio CoverPlus en laboratorio para WF-6090DW | | | | | | CP03RTBSCD47 80 € | |
| 03 años de servicio CoverPlus en laboratorio para WF-6590DWF | | | | | | | CP03RTBSCD49 80 € |
| 03 años de servicio CoverPlus en laboratorio para WorkForce Pro WF-4630DWF | | CP03RTBSCD15 80 € | | | | | |
| 03 años de servicio CoverPlus en laboratorio para WorkForce Pro WF-5110 | CP03RTBSCD12 80 € | | | | | | |
| 03 años de servicio CoverPlus en laboratorio para WorkForce Pro WF-5620 | | | CP03RTBSCD08 80 € | | | | |
| 03 años de servicio CoverPlus en laboratorio para WorkForce Pro WF-5690 | | | | CP03RTBSCD14 80 € | | | |
| 03 años de servicio CoverPlus in situ para WF-6090DW | | | | | CP03OSSWCD47 135 € | | |
| 03 años de servicio CoverPlus in situ para WF-6590DWF | | | | | | CP03OSSWCD49 135 € | |
| 03 años de servicio CoverPlus in situ para WF-8010DW | | | | | | | CP03OSSECD42 228 € |
| 03 años de servicio CoverPlus in situ para WorkForce Pro WF-5110 | CP03OSSECD12 135 € | | | | | | |
| 03 años de servicio CoverPlus | | | CP03OSSECD08 135 € | | | | |

Impresoras de inyección de tinta - Business WorkForce Pro



TARIFA DE PRECIOS

| | WorkForce Pro WF-5110DW | WorkForce Pro WF-5190DW | WorkForce Pro WF-5620DWF | WorkForce Pro WF-5690DWF | WorkForce Pro WF-6090DW | WorkForce Pro WF-6590DWF | WorkForce Pro WF-8010DW |
|---|----------------------------|----------------------------|-----------------------------|-----------------------------|----------------------------|------------------------------|----------------------------|
| in situ para WorkForce Pro WF-5620 | | | | | | | |
| 03 años de servicio CoverPlus in situ para WorkForce Pro WF-5690 | | | | CP03OSSECD14 | 135 € | | |
| 04 años de servicio CoverPlus en laboratorio para WF-6090DW | | | | | | CP04RTBSCD47 | 128 € |
| 04 años de servicio CoverPlus en laboratorio para WF-6590DWF | | | | | | CP04RTBSCD49 | 128 € |
| 04 años de servicio CoverPlus in situ para WF-6090DW | | | | | CP04OSSWCD47 | 216 € | |
| 04 años de servicio CoverPlus in situ para WF-6590DWF | | | | | | CP04OSSWCD49 CP04OSSECD49 | 216 € 216 € |
| 04 años de servicio CoverPlus in situ para WF-8010DW | | | | | | | CP04OSSECD42 468 € |
| 04 años de servicio CoverPlus in situ para WorkForce Pro WF-4630DWF | | CP04OSSECD15 | 240 € | | | | |
| 04 años de servicio CoverPlus in situ para WorkForce Pro WF-5110 | CP04OSSECD12 | 240 € | | | | | |
| 04 años de servicio CoverPlus in situ para WorkForce Pro WF-5620 | | | CP04OSSECD08 | 240 € | | | |
| 04 años de servicio CoverPlus in situ para WorkForce Pro WF-5690 | | | | CP04OSSECD14 | 240 € | | |
| 05 años de servicio CoverPlus en laboratorio para WF-6090DW | | | | | | CP05RTBSCD47 | 208 € |
| 05 años de servicio CoverPlus en laboratorio para WF-6590DWF | | | | | | CP05RTBSCD49 | 208 € |
| 05 años de servicio CoverPlus en laboratorio para WorkForce Pro WF-5620 | | | CP05RTBSCD08 | 192 € | | | |
| 05 años de servicio CoverPlus in situ para WF-6090DW | | | | | CP05OSSWCD47 | 351 € | |
| 05 años de servicio CoverPlus in situ para WF-6590DWF | | | | | | CP05OSSWCD49 CP05OSSECD49 | 351 € 351 € |
| 05 años de servicio CoverPlus in situ para WorkForce Pro WF-4630DWF | | CP05OSSECD15 | 300 € | | | | |
| 05 años de servicio CoverPlus | CP05OSSECD12 | 300 € | | | | | |



Impresoras de inyección de tinta - Business WorkForce Pro

TARIFA DE PRECIOS















| | WorkForce Pro WF-5110DW | WorkForce Pro WF-5190DW | WorkForce Pro WF-5620DWF | WorkForce Pro WF-5690DWF | WorkForce Pro WF-6090DW | WorkForce Pro WF-6590DWF | WorkForce Pro WF-8010DW |
|--|----------------------------|----------------------------|-----------------------------|-----------------------------|----------------------------|-----------------------------|----------------------------|
| in situ para WorkForce Pro WF-5110 | | | | | | | |
| 05 años de servicio CoverPlus in situ para WorkForce Pro WF-5620 | | | CP05OSSECD08 | 300 € | | | |
| 05 años de servicio CoverPlus in situ para WorkForce Pro WF-5690 | | | | CP05OSSECD14 | 300 € | | |
| 4E años de ampliación de servicio CoverPlus in situ para WF-6090 | | | | | CP4EOSSECD47 | 140,40 € | |
| 4E años de ampliación de servicio CoverPlus in situ para WF-8010DW | | | | | | | CP4EOSSECD42 304,20 € |
| 4E años de ampliación de servicio CoverPlus in situ para WFP-5110 | CP4EOSSECD12 | 156 € | | | | | |
| 5E años de ampliación de servicio CoverPlus in situ para WF-6090 | | | | | CP5EOSSECD47 | 316 € | |
| 5E años de ampliación de servicio CoverPlus in situ para WF-8010DW | | | | | | | CP5EOSSECD42 382,20 € |
| 5E años de ampliación de servicio CoverPlus in situ para WFP-5110 | CP5EOSSECD12 | 162,50 € | | | | | |

| | WorkForce Pro WF-8090 DW | WorkForce Pro WF-8510DWF | WorkForce Pro WF-8590DTWF |
|-------------------------------|---|---|--|
| Grupo de precios | BQ | B2 | BQ |
| |  |  |  |
| Multifunción | Impresora | Impresora multifunción 4 en 1 | Impresora multifunción 4 en 1 |
| Formatos papel | A3+ | A3+ | A3+ |
| Velocidad de impresión | 34 páginas/min en monocromo, 34 páginas/min en color | 34 páginas/min en monocromo, 34 páginas/min en color | 34 páginas/min en monocromo, 34 páginas/min en color |
| Dúplex | Sí | Sí | Sí |
| Entrada de papel estándar | 330 Hojas Estándar, 80 Hojas Bandeja MF, 250 Hojas Bandeja de papel | 330 Hojas Estándar, 80 Hojas Bandeja MF, 250 Hojas Bandeja de papel | 831 Hojas Estándar, 81 Hojas Bandeja MF, 750 Hojas Bandeja de papel |
| Resolución de impresión | 4.800 x 1.200 ppp | 4.800 x 1.200 ppp | 4.800 x 1.200 ppp |
| Emulaciones | PCL6, PCL5c, PCL5e, ESC/P-R, Adobe® Postscript 3®, PDF 1.7 | ESC/P-R, GDI | PCL6, PCL5c, PCL5e, ESC/P-R, Adobe® Postscript 3®, PDF 1.7 |
| PVPR neto | | C11CD44301 995,25 € | C11CD45301BT 1.684,25 € |
| | WorkForce Pro WF-8090DW C11CD43301 983,50 € WorkForce Pro WF-8090 DTW C11CD43301BT 1.233,50 € WorkForce Pro WF-8090 DTWC C11CD43301BR 1.403,50 € WorkForce Pro WF-8090 D3TWC C11CD43301BP 2.003,50 € | | DWF C11CD45301 1.424,25 € DTWFC C11CD45301BR 1.874,25 € D3TWFC C11CD45301BP 2.444,25 € |
| Opciones | B2 | B2 | B2 |
| Bandeja de papel de 500 hojas | C12C817061 300 € | C12C817061 300 € | C12C817061 300 € |
| High Cabinet | C12C933561 209 € | C12C933561 209 € | C12C933561 209 € |
| Low Cabinet | C12C932891 | C12C932891 | C12C932891 |
| Consumibles | S9, S3 | S3 | S9, S3 |
| Cian | C13T756240 1500p 32,49 € C13T755240 4000p 59,99 € C13T754240 7000p 81,77 € | C13T756240 1500p 32,49 € C13T755240 4000p 59,99 € | C13T756240 1500p 32,49 € C13T755240 4000p 59,99 € C13T754240 7000p 81,77 € |
| Magenta | C13T756340 1500p 32,49 € C13T755340 4000p 59,99 € | C13T756340 1500p 32,49 € C13T755340 4000p 59,99 € | C13T756340 1500p 32,49 € C13T755340 4000p 59,99 € |

| | WorkForce Pro WF-8090 DW | | WorkForce Pro WF-8510DWF | | WorkForce Pro WF-8590DTWF | |
|---|--------------------------|--------------|--------------------------|--------------|---------------------------|----------------------|
| | C13T754340 | 7000p | 81,77 € | | C13T754340 | 7000p 81,77 € |
| Amarillo | C13T756440 | 1500p | 32,49 € | C13T756440 | 1500p | 32,49 € |
| | C13T755440 | 4000p | 59,99 € | C13T755440 | 4000p | 59,99 € |
| | C13T754440 | 7000p | 81,77 € | C13T754440 | 7000p | 81,77 € |
| Negro | C13T756140 | 2500p | 47,49 € | C13T756140 | 2500p | 47,49 € |
| | C13T755140 | 5000p | 63,33 € | C13T755140 | 5000p | 63,33 € |
| | C13T754140 | 10000p | 72 € | C13T754140 | 10000p | 72 € |
| Caja de mantenimiento | C13T671200 | | 26,74 € | C13T671200 | | 26,74 € |
| Rodillo de mantenimiento S990011 | C13S990011 | | 38,35 € | C13S990011 | | 38,35 € |
| Rodillo de mantenimiento S990021 | C13S990021 | | 38,35 € | C13S990021 | | 38,35 € |
| CoverPlus | BR | | | BP | | BR |
| 03 años de servicio CoverPlus en laboratorio para WF-8090DW | CP03RTBSCD43 | | 182,40 € | | | |
| 03 años de servicio CoverPlus in situ para WF-8090DW | CP03OSSECD43 | | 228 € | | | |
| 03 años de servicio CoverPlus in situ para WF-8510DW | | CP03OSSECD44 | | 266 € | | |
| 03 años de servicio CoverPlus in situ para WF-8590DW | | | | CP03OSSECD45 | | 266 € |
| 04 años de servicio CoverPlus in situ para WF-8090DW | CP04OSSECD43 | | 468 € | | | |
| 04 años de servicio CoverPlus in situ para WF-8590DW | | | | CP04OSSECD45 | | 533 € |
| 05 años de servicio CoverPlus in situ para WF-8090DW | CP05OSSECD43 | | 588 € | | | |
| 05 años de servicio CoverPlus in situ para WF-8590DW | | | | CP05OSSECD45 | | 666 € |

| | WorkForce Pro WF-M5190DW | | WorkForce Pro WF-M5690DWF | |
|---|---|---|---|-----------------|
| Grupo de precios | BQ | | BQ | |
| |  | |  | |
| Multifunción | Impresora | | Impresora multifunción 4 en 1 | |
| Formatos papel | A4 | | A4 | |
| Velocidad de impresión | 34 páginas/min en monocromo | | 34 páginas/min en monocromo | |
| Dúplex | Sí | | Sí | |
| Entrada de papel estándar | 330 Hojas Estándar, 80 Hojas Bandeja MF, 250 Hojas Bandeja de papel | | 330 Hojas Estándar, 80 Hojas Bandeja MF, 250 Hojas Bandeja de papel | |
| Resolución de impresión | 1.200 x 2.400 ppp | | 1.200 x 2.400 ppp | |
| Emulaciones | PCL6, PCL5c, PCL5e, ESC/P-R, Adobe® Postscript 3®, PDF 1.7 | | PCL6, PCL5c, PCL5e, ESC/P-R, Adobe® Postscript 3®, PDF 1.7 | |
| VPVR neto | C11CE38401 | 353,50 € | C11CE37401 | 454,25 € |
| Opciones | B2 | | B2 | |
| Bandeja de papel de 250 hojas | C12C817011 | 79 € | C12C817011 | 79 € |
| Consumibles | S3, S9 | | S3, S9 | |
| Negro |  | C13T866140 2500p 54,38 € C13T865140 10000p 109 € | C13T866140 2500p 54,38 € C13T865140 10000p 109 € | |
| Caja de mantenimiento | C13T671000 | 20,63 € | C13T671000 | 20,63 € |
| CoverPlus | BR | | BR | |
| 03 años de servicio CoverPlus en laboratorio para WF-5690DWF | | | CP03RTBSCE37 | 86,40 € |
| 03 años de servicio CoverPlus in situ para WF-M5190DW | CP03OSSECE38 | 108 € | | |
| 03 años de servicio CoverPlus in situ para WF-M5690DWF | | | CP03OSSECE37 | 108 € |
| 04 años de servicio CoverPlus en laboratorio para WF-M5190DW | CP04RTBSCE38 | 138,24 € | | |
| 04 años de servicio CoverPlus en laboratorio para WF-M5690DWF | | | CP04RTBSCE37 | 130 € |
| 04 años de servicio CoverPlus in situ para WF-M5190DW | CP04OSSECE38 | 172 € | | |
| 04 años de servicio CoverPlus in situ para WF-M5690DWF | | | CP04OSSECE37 | 172 € |

| | WorkForce Pro WF-M5190DW | WorkForce Pro WF-M5690DWF |
|--|--------------------------|---------------------------|
| 05 años de servicio CoverPlus en laboratorio para WF-5190DW | CP05RTBSCE38 | 207,36 € |
| 05 años de servicio CoverPlus en laboratorio para WF-5690DWF | CP05RTBSCE37 | 207,36 € |
| 05 años de servicio CoverPlus in situ para WF-M5190DW | CP05OSSECE38 | 259 € |
| 05 años de servicio CoverPlus in situ para WF-M5690DWF | CP05OSSECE37 | 259 € |







| | WorkForce WF-100W | WorkForce WF-2010W | WorkForce WF-2510WF | WorkForce WF-2630WF | WorkForce WF-2750DWF | WorkForce WF-2760DWF | WorkForce Pro WF-3720DWF |
|-----------------------------------|--|--|--|---|--|---|--|
| Grupo de precios | C2 | | C2 | | C2 | | C2 |
| |  |  |  |  |  |  |  |
| Multifunción | Impresora | Impresora | Impresora multifunción 4 en 1 | Impresora multifunción 4 en 1 | Impresora multifunción 4 en 1 | Impresora multifunción 4 en 1 | Impresora multifunción 4 en 1 |
| Formatos papel | A4 | A4 | A4 | A4 | A4 | A4 | A4 |
| Velocidad de impresión | 14 páginas/min en monocromo, 11 páginas/min en color | 34 páginas/min en monocromo, 18 páginas/min en color, 38 Segundos por foto de 10 x 15 cm | 34 páginas/min en monocromo, 18 páginas/min en color, 38 Segundos por foto de 10 x 15 cm | 34 páginas/min en monocromo, 18 páginas/min en color | 33 páginas/min en monocromo, 20 páginas/min en color | 33 páginas/min en monocromo, 20 páginas/min en color | 33 páginas/min en monocromo, 20 páginas/min en color |
| Dúplex | NO | Manual | Manual | Manual | Sí (papel normal A4) | Sí (papel normal A4) | |
| Capacidad de la bandeja de salida | | | | 30 Hojas | 30 Hojas | 30 Hojas | 80 Hojas |
| Capacidad bandeja papel | 20 Hojas Estándar, 20 Hojas máximo, 5 Hojas fotográficas | 100 Hojas Estándar, 100 Hojas máximo, 20 Hojas fotográficas | 100 Hojas Estándar, 100 Hojas máximo, 20 Hojas fotográficas | 100 Hojas Estándar | 150 Hojas Estándar | 150 Hojas Estándar | 250 Hojas máximo |
| Resolución de impresión | 5.760 x 1.440 ppp | 5.760 x 1.440 ppp | 5.760 x 1.440 ppp | 5.760 x 1.440 ppp | 4.800 x 1.200 ppp | 4.800 x 1.200 ppp | 4.800 x 2.400 ppp |
| Emulaciones | ESC/P-R | | | | ESC/P-R | | ESC/P-R |
| VPVR neto | C11CE05402 239,78 € | C11CC40302 79,49 € | C11CC58302 80,24 € | C11CE36402 96,91 € | C11CF76402 113,58 € | C11CF77402 146,91 € | C11CF24402 138,58 € |
| Consumibles | S1 | SY, S1 | SY, S1 | SY, S1 | SY, S1 | SY, S1 | SX |
| Cian |  | C13T16224012 165p 7,90 € C13T16324012 450p 14,15 € | C13T16224012 165p 7,90 € C13T16324012 450p 14,15 € | C13T16224012 165p 7,90 € C13T16324012 450p 14,15 € | C13T16224012 165p 7,90 € C13T16324012 450p 14,15 € | C13T16224012 165p 7,90 € C13T16324012 450p 14,15 € | C13T34624010 300p 8,74 € C13T34724010 950p 19,15 € |
| Magenta |  | C13T16234012 165p 7,90 € C13T16334012 450p 14,15 € | C13T16234012 165p 7,90 € C13T16334012 450p 14,15 € | C13T16234012 165p 7,90 € C13T16334012 450p 14,15 € | C13T16234012 165p 7,90 € C13T16334012 450p 14,15 € | C13T16234012 165p 7,90 € C13T16334012 450p 14,15 € | C13T34634010 300p 8,74 € C13T34734010 950p 19,15 € |
| Amarillo |  | C13T16244012 165p 7,90 € C13T16344012 450p 14,15 € | C13T16244012 165p 7,90 € C13T16344012 450p 14,15 € | C13T16244012 165p 7,90 € C13T16344012 450p 14,15 € | C13T16244012 165p 7,90 € C13T16344012 450p 14,15 € | C13T16244012 165p 7,90 € C13T16344012 450p 14,15 € | C13T34644010 300p 8,74 € C13T34744010 950p 19,15 € |
| Negro |  C13T26614010 250p 17,90 € | C13T16214012 175p 9,99 € C13T16314012 500p 18,32 € | C13T16214012 175p 9,99 € C13T16314012 500p 18,32 € | C13T16214012 175p 9,99 € C13T16314012 500p 18,32 € | C13T16214012 175p 9,99 € C13T16314012 500p 18,32 € | C13T16214012 175p 9,99 € C13T16314012 500p 18,32 € | C13T34614010 350p 16,65 € C13T34714010 1100p 36,24 € C13T16814012 1000p 29,15 € |
| Color |  C13T26704010 200p 14,20 € | | | | | | |
| Multipack |  | C13T16264012standard 33,32 € C13T16364012 XL 60,77 € | C13T16264012standard 33,32 € C13T16364012 XL 60,77 € | C13T16264012standard 33,32 € C13T16364012 XL 60,77 € | C13T16264012standard 33,32 € C13T16364012 XL 60,77 € | C13T16264012standard 33,32 € C13T16364012 XL 60,77 € | C13T34664010standard 42,87 € C13T34764010 XL 93,69 € |
| Multipack EasyMail |  | C13T16264511 L 33,32 € C13T16364510 XL 60,77 € | C13T16264511 L 33,32 € C13T16364510 XL 60,77 € | C13T16264511 L 33,32 € C13T16364510 XL 60,77 € | C13T16264511 L 33,32 € C13T16364510 XL 60,77 € | C13T16264511 L 33,32 € C13T16364510 XL 60,77 € | C13T16264511 L 33,32 € C13T16364510 XL 60,77 € |







Impresoras de inyección de tinta - Empresa





TARIFA DE PRECIOS

| | WorkForce WF-100W | WorkForce WF-2010W | WorkForce WF-2510WF | WorkForce WF-2630WF | WorkForce WF-2750DWF | WorkForce WF-2760DWF | WorkForce Pro WF-3720DWF |
|--|-------------------|--------------------|---------------------|---------------------|----------------------|----------------------|--------------------------|
| Caja de mantenimiento | C13T295000 | 4,16 € | | | | | |
| CoverPlus | BA | BA | BA | BA | BA | BA | BA |
| 03 años de servicio CoverPlus en laboratorio para WF-2010W | | CP03RTBSCC40 | 60 € | | | | |
| 03 años de servicio CoverPlus en laboratorio para WorkForce 2630WF | | | | CP03RTBSCE36 | 49,90 € | | |
| 03 años de servicio CoverPlus en laboratorio para WorkForce 2750DWF | | | | | CP03RTBSCF76 | 30,10 € | |
| 03 años de servicio CoverPlus en laboratorio para WorkForce 2760DWF | | | | | | CP03RTBSCF77 | 30,10 € |
| 03 años de servicio CoverPlus en laboratorio para WorkForce Pro WF-37xx/47xx | | | | | | | CP03RTBSCF24 |
| | | | | | | | 50 € |
| 03 años de servicio CoverPlus en laboratorio para WorkForce WF-100W | CP03RTBSCE05 | 30 € | | | | | |
| 03 años de servicio CoverPlus en laboratorio para WorkForce WF-2510WF | | | CP03RTBSCC58 | 50 € | | | |
| 03 años de servicio CoverPlus in situ para WF-2660 | | | | | | CP03OSSWCE33 | 35 € |
| 04 años de servicio CoverPlus en laboratorio para WF-2010W | | CP04RTBSCC40 | 96 € | | | | |
| 04 años de servicio CoverPlus en laboratorio para WorkForce 2750DWF | | | | | CP04RTBSCF76 | 50 € | |
| 04 años de servicio CoverPlus en laboratorio para WorkForce 2760DWF | | | | | | CP04RTBSCF77 | 64,90 € |
| 04 años de servicio CoverPlus en laboratorio para WorkForce Pro WF-37xx/47xx | | | | | | | CP04RTBSCF24 |
| | | | | | | | 80 € |
| 04 años de servicio CoverPlus in situ para WorkForce WF-2750DWF | | | | | CP04OSSECF76 | 120 € | |
| 04 años de servicio CoverPlus in situ para WorkForce WF-2760DWF | | | | | | CP04OSSECF77 | 120 € |
| 05 años de servicio CoverPlus en laboratorio para WF-2010W | | CP05RTBSCC40 | 144 € | | | | |
| 05 años de servicio CoverPlus en laboratorio para WorkForce 2750DWF | | | | | CP05RTBSCF76 | 70 € | |

| | WorkForce WF-100W | WorkForce WF-2010W | WorkForce WF-2510WF | WorkForce WF-2630WF | WorkForce WF-2750DWF | WorkForce WF-2760DWF | WorkForce Pro WF-3720DWF |
|--|-------------------|--------------------|---------------------|---------------------|----------------------|----------------------|--------------------------|
| 05 años de servicio CoverPlus en laboratorio para WorkForce 2760DWF | | | | | | CP05RTBSCF77 | 70 € |
| 05 años de servicio CoverPlus en laboratorio para WorkForce Pro WF-37xx/47xx | | | | | | | CP05RTBSCF24 100 € |
| 05 años de servicio CoverPlus in situ para WorkForce Pro WF-37xx/47xx | | | | | | | CP05OSSECF24 120 € |
| 05 años de servicio CoverPlus in situ para WorkForce WF-2750DWF | | | | | CP05OSSECF76 | 230 € | |
| 05 años de servicio CoverPlus in situ para WorkForce WF-2760DWF | | | | | | CP05OSSECF77 | 230 € |

| | WorkForce Pro WF-4630DWF | WorkForce Pro WF-4720DWF | WorkForce Pro WF-4730DTWF | WorkForce Pro WF-4740DTWF | WorkForce WF-7110DTW | WorkForce WF-7210DTW | WorkForce WF-7610DWF |
|-----------------------------------|---|---|---|---|--|---|---|
| Grupo de precios | C2 | C2 | C2 | C2 | C2 | C2 | C2 |
| |  |  |  |  |  |  |  |
| Multifunción | Impresora multifunción 4 en 1 | Impresora multifunción 4 en 1 | Impresora multifunción 4 en 1 | Impresora multifunción 4 en 1 | Impresora | Impresora | Impresora multifunción 4 en 1 |
| Formatos papel | A4 | A4 | A4 | A4 | A3+ | A3+ | A3+ |
| Velocidad de impresión | 34 páginas/min en monocromo, 30 páginas/min en color | 34 páginas/min en monocromo, 30 páginas/min en color | 34 páginas/min en monocromo, 30 páginas/min en color | 34 páginas/min en monocromo, 30 páginas/min en color | 32 páginas/min en monocromo, 20 páginas/min en color | 32 páginas/min en monocromo, 20 páginas/min en color | 32 páginas/min en monocromo, 20 páginas/min en color |
| Dúplex | Sí (papel normal A4) | | | Sí (papel normal A4) | Sí (papel normal A4/A3) | Sí (papel normal A4/A3) | Sí (papel normal A4/A3) |
| Capacidad de la bandeja de salida | 150 Hojas | 80 Hojas | 80 Hojas | 80 Hojas | 125 Hojas | 125 Hojas | 125 Hojas |
| Capacidad bandeja papel | | 250 Hojas máximo | 500 Hojas máximo | 500 Hojas máximo | 500 Hojas Estándar, 500 Hojas máximo | 500 Hojas Estándar, 500 Hojas máximo | 250 Hojas Estándar, 250 Hojas máximo |
| Resolución de impresión | 4.800 x 1.200 ppp | 4.800 x 1.200 ppp | 4.800 x 1.200 ppp | 4.800 x 1.200 ppp | 4.800 x 2.400 ppp | 4.800 x 2.400 ppp | 4.800 x 2.400 ppp |
| Emulaciones | ESC/P-R | ESC/P-R | ESC/P-R | ESC/P-R | ESC/P-R | ESC/P-R | ESC/P-R |
| PVPR neto | C11CD10301 240,53 € | C11CF74402 188,58 € | C11CG01402 205,24 € | C11CF75402 255,24 € | C11CC99302 161,36 € | C11CG38402 179,49 € | C11CC98302 201,33 € |

































































| Consumibles | WorkForce Pro WF-4630DWF | | WorkForce Pro WF-4720DWF | | WorkForce Pro WF-4730DTWF | | WorkForce Pro WF-4740DTWF | | WorkForce WF-7110DTW | | WorkForce WF-7210DTW | | WorkForce WF-7610DWF | | |
|--|---|---|---|---|---|---|---|--|--|--|--|--|--|--|--|
| | S3 | SX | SX | SX | SX | SX | S1 | S1 | S1 | S1 | S1 | S1 | S1 | S1 | |
| Cian |  C13T79124010 800p 17,49 € C13T79024010 2000p 30,57 € | C13T35824010 650p 18,32 € C13T35924010 1900p 29,15 € | C13T35824010 650p 18,32 € C13T35924010 1900p 29,15 € | C13T35824010 650p 18,32 € C13T35924010 1900p 29,15 € | C13T35824010 650p 18,32 € C13T35924010 1900p 29,15 € | C13T35824010 650p 18,32 € C13T35924010 1900p 29,15 € | C13T27024012 300p 9,15 € C13T27124012 1100p 23,74 € | C13T27024012 300p 9,15 € C13T27124012 1100p 23,74 € | C13T27024012 300p 9,15 € C13T27124012 1100p 23,74 € | C13T27024012 300p 9,15 € C13T27124012 1100p 23,74 € | C13T27024012 300p 9,15 € C13T27124012 1100p 23,74 € | C13T27024012 300p 9,15 € C13T27124012 1100p 23,74 € | C13T27024012 300p 9,15 € C13T27124012 1100p 23,74 € | C13T27024012 300p 9,15 € C13T27124012 1100p 23,74 € | |
| Magenta |  C13T79134010 800p 17,49 € C13T79034010 2000p 30,57 € | C13T35834010 650p 18,32 € C13T35934010 1900p 29,15 € | C13T35834010 650p 18,32 € C13T35934010 1900p 29,15 € | C13T35834010 650p 18,32 € C13T35934010 1900p 29,15 € | C13T35834010 650p 18,32 € C13T35934010 1900p 29,15 € | C13T35834010 650p 18,32 € C13T35934010 1900p 29,15 € | C13T27034012 300p 9,15 € C13T27134012 1100p 23,74 € | C13T27034012 300p 9,15 € C13T27134012 1100p 23,74 € | C13T27034012 300p 9,15 € C13T27134012 1100p 23,74 € | C13T27034012 300p 9,15 € C13T27134012 1100p 23,74 € | C13T27034012 300p 9,15 € C13T27134012 1100p 23,74 € | C13T27034012 300p 9,15 € C13T27134012 1100p 23,74 € | C13T27034012 300p 9,15 € C13T27134012 1100p 23,74 € | C13T27034012 300p 9,15 € C13T27134012 1100p 23,74 € | |
| Amarillo |  C13T79144010 800p 17,49 € C13T79044010 2000p 30,57 € | C13T35844010 650p 18,32 € C13T35944010 1900p 29,15 € | C13T35844010 650p 18,32 € C13T35944010 1900p 29,15 € | C13T35844010 650p 18,32 € C13T35944010 1900p 29,15 € | C13T35844010 650p 18,32 € C13T35944010 1900p 29,15 € | C13T35844010 650p 18,32 € C13T35944010 1900p 29,15 € | C13T35844010 650p 18,32 € C13T35944010 1900p 29,15 € | C13T27044012 300p 9,15 € C13T27144012 1100p 23,74 € | C13T27044012 300p 9,15 € C13T27144012 1100p 23,74 € | C13T27044012 300p 9,15 € C13T27144012 1100p 23,74 € | C13T27044012 300p 9,15 € C13T27144012 1100p 23,74 € | C13T27044012 300p 9,15 € C13T27144012 1100p 23,74 € | C13T27044012 300p 9,15 € C13T27144012 1100p 23,74 € | C13T27044012 300p 9,15 € C13T27144012 1100p 23,74 € | |
| Negro |  C13T79114010 900p 19 € C13T79014010 2600p 34,99 € | C13T35814010 900p 26,24 € C13T35914010 2600p 47,49 € | C13T35814010 900p 26,24 € C13T35914010 2600p 47,49 € | C13T35814010 900p 26,24 € C13T35914010 2600p 47,49 € | C13T35814010 900p 26,24 € C13T35914010 2600p 47,49 € | C13T35814010 900p 26,24 € C13T35914010 2600p 47,49 € | C13T35814010 900p 26,24 € C13T35914010 2600p 47,49 € | C13T27014012 350p 14,57 € C13T27114012 1100p 29,99 € C13T27914012 2200p 39,99 € | C13T27014012 350p 14,57 € C13T27114012 1100p 29,99 € C13T27914012 2200p 39,99 € | C13T27014012 350p 14,57 € C13T27114012 1100p 29,99 € C13T27914012 2200p 39,99 € | C13T27014012 350p 14,57 € C13T27114012 1100p 29,99 € C13T27914012 2200p 39,99 € | C13T27014012 350p 14,57 € C13T27114012 1100p 29,99 € C13T27914012 2200p 39,99 € | C13T27014012 350p 14,57 € C13T27114012 1100p 29,99 € C13T27914012 2200p 39,99 € | C13T27014012 350p 14,57 € C13T27114012 1100p 29,99 € C13T27914012 2200p 39,99 € | |
| Multipack |  | | | | | | C13T27054012standard 27,45 € C13T27154012 XL 70,82 € | C13T27054012standard 27,45 € C13T27154012 XL 70,82 € | C13T27054012standard 27,45 € C13T27154012 XL 70,82 € | C13T27054012standard 27,45 € C13T27154012 XL 70,82 € | C13T27054012standard 27,45 € C13T27154012 XL 70,82 € | C13T27054012standard 27,45 € C13T27154012 XL 70,82 € | C13T27054012standard 27,45 € C13T27154012 XL 70,82 € | C13T27054012standard 27,45 € C13T27154012 XL 70,82 € | |
| Multipack |  | C13T35864010standard 81,20 € C13T35964010 XL134,94 € | C13T35864010standard 81,20 € C13T35964010 XL134,94 € | C13T35864010standard 81,20 € C13T35964010 XL134,94 € | C13T35864010standard 81,20 € C13T35964010 XL134,94 € | C13T35864010standard 81,20 € C13T35964010 XL134,94 € | | | | | | | | | |
| Caja de mantenimiento | C13T671000 20,63 € | C13T671500 20,40 € | C13T671500 20,40 € | C13T671500 20,40 € | C13T671500 20,40 € | C13T671500 20,40 € | C13T671100 19,16 € | C13T671100 19,16 € | C13T671100 19,16 € | C13T671100 19,16 € | C13T671100 19,16 € | C13T671100 19,16 € | C13T671100 19,16 € | C13T671100 19,16 € | |
| CoverPlus | BA | BA | BA | BA | BA | BA | BA | BA | BA | BA | BA | BA | BA | BA | |
| 03 años de servicio CoverPlus en laboratorio para WorkForce Pro WF-37xx/47xx | | CP03RTBSCF24 50 € | CP03RTBSCF24 50 € | CP03RTBSCF24 50 € | CP03RTBSCF24 50 € | CP03RTBSCF24 50 € | | | | | | | | | |
| 03 años de servicio CoverPlus en laboratorio para WorkForce Pro WF-4630DWF | CP03RTBSCD10 63 € | | | | | | | | | | | | | | |
| 03 años de servicio CoverPlus en laboratorio para WorkForce WF-7110DTW/7210 | | | | | | | CP03RTBSCC99 80 € | CP03RTBSCC99 80 € | CP03RTBSCC99 80 € | CP03RTBSCC99 80 € | CP03RTBSCC99 80 € | CP03RTBSCC99 80 € | CP03RTBSCC99 80 € | CP03RTBSCC99 80 € | |
| 03 años de servicio CoverPlus en laboratorio para WorkForce WF-7610DWF | | | | | | | | | | | | | | CP03RTBSCC98 80 € | |
| 04 años de servicio CoverPlus en laboratorio para WorkForce Pro WF-37xx/47xx | | CP04RTBSCF24 80 € | CP04RTBSCF24 80 € | CP04RTBSCF24 80 € | CP04RTBSCF24 80 € | CP04RTBSCF24 80 € | | | | | | | | | |
| 05 años de servicio CoverPlus en laboratorio para WorkForce Pro WF-37xx/47xx | | CP05RTBSCF24 100 € | CP05RTBSCF24 100 € | CP05RTBSCF24 100 € | CP05RTBSCF24 100 € | CP05RTBSCF24 100 € | | | | | | | | | |
| 05 años de servicio CoverPlus in situ para WorkForce Pro WF-37xx/47xx | | CP05OSSECF24 120 € | CP05OSSECF24 120 € | CP05OSSECF24 120 € | CP05OSSECF24 120 € | CP05OSSECF24 120 € | | | | | | | | | |

| Grupo de precios | WorkForce WF-7620DTWF | WorkForce WF-7710DWF | WorkForce WF-7715DWF | WorkForce WF-7720DTWF |
|---|--|--|--|--|
| | C2 | C2 | C2 | C2 |
| |  |  |  |  |
| Multifunción | Impresora multifunción 4 en 1 | Impresora multifunción 4 en 1 | Impresora multifunción 4 en 1 | Impresora multifunción 4 en 1 |
| Formatos papel | A3+ | A3+ | A3+ | A3+ |
| Velocidad de impresión | 32 páginas/min en monocromo, 20 páginas/min en color | 32 páginas/min en monocromo, 20 páginas/min en color | 32 páginas/min en monocromo, 20 páginas/min en color | 32 páginas/min en monocromo, 20 páginas/min en color |
| Dúplex | Sí (papel normal A4/A3) | Sí (papel normal A4/A3) | Sí (papel normal A4/A3) | Sí (papel normal A4/A3) |
| Capacidad de la bandeja de salida | 125 Hojas | 125 Hojas | 125 Hojas | 125 Hojas |
| Capacidad bandeja papel | 500 Hojas Estándar, 500 Hojas máximo | 250 Hojas Estándar, 250 Hojas máximo | 250 Hojas Estándar, 250 Hojas máximo | 500 Hojas máximo |
| Resolución de impresión | 4.800 x 2.400 ppp | 4.800 x 2.400 ppp | 4.800 x 2.400 ppp | 4.800 x 2.400 ppp |
| Emulaciones | ESC/P-R | ESC/P-R | ESC/P-R | ESC/P-R |
| PVPR neto | C11CC97302 240,53 € | C11CG36413 205,24 € | C11CG36414 205,24 € | C11CG37412 255,24 € |
| Consumibles | S1 | S1 | S1 | S1 |
| Cian | C13T27024012 300p 9,15 € C13T27124012 1100p 23,74 € | C13T27024012 300p 9,15 € C13T27124012 1100p 23,74 € | C13T27024012 300p 9,15 € C13T27124012 1100p 23,74 € | C13T27024012 300p 9,15 € C13T27124012 1100p 23,74 € |
| Magenta | C13T27034012 300p 9,15 € C13T27134012 1100p 23,74 € | C13T27034012 300p 9,15 € C13T27134012 1100p 23,74 € | C13T27034012 300p 9,15 € C13T27134012 1100p 23,74 € | C13T27034012 300p 9,15 € C13T27134012 1100p 23,74 € |
| Amarillo | C13T27044012 300p 9,15 € C13T27144012 1100p 23,74 € | C13T27044012 300p 9,15 € C13T27144012 1100p 23,74 € | C13T27044012 300p 9,15 € C13T27144012 1100p 23,74 € | C13T27044012 300p 9,15 € C13T27144012 1100p 23,74 € |
| Negro | C13T27014012 350p 14,57 € C13T27114012 1100p 29,99 € C13T27914012 2200p 39,99 € | C13T27014012 350p 14,57 € C13T27114012 1100p 29,99 € C13T27914012 2200p 39,99 € | C13T27014012 350p 14,57 € C13T27114012 1100p 29,99 € C13T27914012 2200p 39,99 € | C13T27014012 350p 14,57 € C13T27114012 1100p 29,99 € C13T27914012 2200p 39,99 € |
| Multipack | C13T27054012 standard 27,45 € C13T27154012 XL 70,82 € | C13T27054012 standard 27,45 € C13T27154012 XL 70,82 € | C13T27054012 standard 27,45 € C13T27154012 XL 70,82 € | C13T27054012 standard 27,45 € C13T27154012 XL 70,82 € |
| Caja de mantenimiento | C13T671100 19,16 € | | | |
| CoverPlus | BA | BA | BA | BA |
| 03 años de servicio CoverPlus en laboratorio para WorkForce WF-7620DTWF | CP03RTBSCC97 80 € | | | |
| 03 años de servicio CoverPlus en laboratorio para WorkForce WF-77xx | | CP03RTBSCG37 80 € | CP03RTBSCG37 80 € | CP03RTBSCG37 80 € |

| | WorkForce WF-7620DTWF | WorkForce WF-7710DWF | WorkForce WF-7715DWF | WorkForce WF-7720DTWF | | |
|---|-----------------------|----------------------|----------------------|-----------------------|--------------|-------|
| 04 años de servicio CoverPlus en laboratorio para WorkForce WF-77xx | CP04RTBSCG37 | 180 € | CP04RTBSCG37 | 180 € | CP04RTBSCG37 | 180 € |
| 05 años de servicio CoverPlus en laboratorio para WorkForce WF-77xx | CP05RTBSCG37 | 220 € | CP05RTBSCG37 | 220 € | CP05RTBSCG37 | 220 € |

Impresoras de inyección de tinta - Consumidor

TARIFA DE PRECIOS

| | Expression Home XP-345 | Expression Home XP-445 | Expression Home XP-247 | Expression Home XP-245 | Expression Home XP-342 | Expression Home XP-442 | Expression Premium XP-540 | | | | |
|---|---|---|---|---|---|---|---|---|--|--|-----------------|
| Grupo de precios | C1 | | C1 | | C1 | | C1 | | | | |
| |  |  |  |  |  |  |  | | | | |
| Multifunción | Impresora multifunción 3 en 1 | Impresora multifunción 3 en 1 | Impresora multifunción 3 en 1 | Impresora multifunción 3 en 1 | Impresora multifunción 3 en 1 | Impresora multifunción 3 en 1 | Impresora multifunción 3 en 1 | | | | |
| Formatos papel | A4 | A4 | A4 | A4 | A4 | A4 | A4 | | | | |
| Colores | 4 Colores | 4 Colores | 4 Colores | 4 Colores | 4 Colores | 4 Colores | 5 Colores | | | | |
| Velocidad de impresión ISO/IEC 24734 | 10 páginas/minuto Monocromo, 4,5 páginas/minuto Color | 10 páginas/minuto Monocromo, 4,5 páginas/minuto Color | 8 páginas/minuto Monocromo, 4 páginas/minuto Color | 8 páginas/minuto Monocromo, 4 páginas/minuto Color | 10 páginas/minuto Monocromo, 4,5 páginas/minuto Color | 10 páginas/minuto Monocromo, 4,5 páginas/minuto Color | 9,5 páginas/minuto Monocromo, 9 páginas/minuto Color | | | | |
| Dúplex | Manual | Manual | Manual | Manual | Manual | Manual | Sí (papel normal A4) | | | | |
| Alimentador automático de documentos | NO | NO | NO | NO | NO | NO | NO | | | | |
| Capacidad bandeja papel | 100 Hojas Estándar, 20 Hojas fotográficas | 100 Hojas Estándar, 20 Hojas fotográficas | 50 Hojas Estándar, 10 Hojas fotográficas | 50 Hojas Estándar, 10 Hojas fotográficas | 100 Hojas Estándar, 20 Hojas fotográficas | 100 Hojas Estándar, 20 Hojas fotográficas | 100 Hojas Estándar, 20 Hojas fotográficas | | | | |
| Pantalla LCD | Tipo: Color, Diagonal: 3,7 cm | Tipo: Color, Panel táctil, Diagonal: 6,8 cm | | | Tipo: Color, Diagonal: 3,7 cm | Tipo: Color, Panel táctil, Diagonal: 6,8 cm | Tipo: Color, Diagonal: 3,7 cm | | | | |
| Servicios de impresión móvil y en la nube | Epson Connect (iPrint, Email Print, Remote Print Driver), Apple AirPrint, Google Cloud Print | Epson Connect (iPrint, Email Print, Remote Print Driver, Scan-to-Cloud), Apple AirPrint, Google Cloud Print | Epson Connect (iPrint, Email Print, Remote Print Driver) | Epson Connect (iPrint, Email Print, Remote Print Driver) | Epson Connect (iPrint, Email Print, Remote Print Driver), Apple AirPrint, Google Cloud Print | Epson Connect (iPrint, Email Print, Remote Print Driver, Scan-to-Cloud), Apple AirPrint, Google Cloud Print | Epson Connect (iPrint, Email Print, Remote Print Driver), Apple AirPrint, Google Cloud Print | | | | |
| PVPR neto | C11CF31404 | C11CF30404 | C11CF32405 | C11CF32402 | 63,58 € | C11CF31403 | 76,08 € | C11CF30403 | 88,58 € | C11CF51402 | 115,05 € |
| Consumibles | SX | | SX | | SX | | SX | | SX | | |
| Cian |  C13T29824012 180p 7,49 € C13T29924012 450p 14,15 € |  C13T29824012 180p 7,49 € C13T29924012 450p 14,15 € |  C13T29824012 180p 7,49 € C13T29924012 450p 14,15 € |  C13T29824012 180p 7,49 € C13T29924012 450p 14,15 € |  C13T29824012 180p 7,49 € C13T29924012 450p 14,15 € |  C13T29824012 180p 7,49 € C13T29924012 450p 14,15 € |  C13T29824012 180p 7,49 € C13T29924012 450p 14,15 € |  C13T29824012 180p 7,49 € C13T29924012 450p 14,15 € |  C13T33424012 300p 9,99 € C13T33624012 650p 16,65 € |  C13T33424012 300p 9,99 € C13T33624012 650p 16,65 € | |
| Magenta |  C13T29834012 180p 7,49 € C13T29934012 450p 14,15 € |  C13T29834012 180p 7,49 € C13T29934012 450p 14,15 € |  C13T29834012 180p 7,49 € C13T29934012 450p 14,15 € |  C13T29834012 180p 7,49 € C13T29934012 450p 14,15 € |  C13T29834012 180p 7,49 € C13T29934012 450p 14,15 € |  C13T29834012 180p 7,49 € C13T29934012 450p 14,15 € |  C13T29834012 180p 7,49 € C13T29934012 450p 14,15 € |  C13T29834012 180p 7,49 € C13T29934012 450p 14,15 € |  C13T33434012 300p 9,99 € C13T33634012 650p 16,65 € |  C13T33434012 300p 9,99 € C13T33634012 650p 16,65 € | |
| Amarillo |  C13T29844012 180p 7,49 € C13T29944012 450p 14,15 € |  C13T29844012 180p 7,49 € C13T29944012 450p 14,15 € |  C13T29844012 180p 7,49 € C13T29944012 450p 14,15 € |  C13T29844012 180p 7,49 € C13T29944012 450p 14,15 € |  C13T29844012 180p 7,49 € C13T29944012 450p 14,15 € |  C13T29844012 180p 7,49 € C13T29944012 450p 14,15 € |  C13T29844012 180p 7,49 € C13T29944012 450p 14,15 € |  C13T29844012 180p 7,49 € C13T29944012 450p 14,15 € |  C13T33444012 300p 9,99 € C13T33644012 650p 16,65 € |  C13T33444012 300p 9,99 € C13T33644012 650p 16,65 € | |
| Negro |  C13T29814012 175p 10,82 € C13T29914012 470p 19,15 € |  C13T29814012 175p 10,82 € C13T29914012 470p 19,15 € |  C13T29814012 175p 10,82 € C13T29914012 470p 19,15 € |  C13T29814012 175p 10,82 € C13T29914012 470p 19,15 € |  C13T29814012 175p 10,82 € C13T29914012 470p 19,15 € |  C13T29814012 175p 10,82 € C13T29914012 470p 19,15 € |  C13T29814012 175p 10,82 € C13T29914012 470p 19,15 € |  C13T29814012 175p 10,82 € C13T29914012 470p 19,15 € |  C13T33314012 250p 13,32 € C13T33514012 530p 19,99 € |  C13T33314012 250p 13,32 € C13T33514012 530p 19,99 € | |
| Negro foto | | | | | | | |  C13T33414012 200p 9,99 € C13T33614012 400p 18,32 € |  C13T33414012 200p 9,99 € C13T33614012 400p 18,32 € | | |
| Multipack |  C13T29864012standard 33,29 € C13T29964012 XL 61,60 € |  C13T29864012standard 33,29 € C13T29964012 XL 61,60 € |  C13T29864012standard 33,29 € C13T29964012 XL 61,60 € |  C13T29864012standard 33,29 € C13T29964012 XL 61,60 € |  C13T29864012standard 33,29 € C13T29964012 XL 61,60 € |  C13T29864012standard 33,29 € C13T29964012 XL 61,60 € |  C13T29864012standard 33,29 € C13T29964012 XL 61,60 € |  C13T29864012standard 33,29 € C13T29964012 XL 61,60 € | | | |
| Multipack |  | | | | | | | C13T33374011 L 53,28 € C13T33574011 XL 88,26 € | | | |
| Multipack EasyMail |  C13T29864511standard 33,29 € C13T29964510 XL 61,60 € |  C13T29864511standard 33,29 € C13T29964510 XL 61,60 € |  C13T29864511standard 33,29 € C13T29964510 XL 61,60 € |  C13T29864511standard 33,29 € C13T29964510 XL 61,60 € |  C13T29864511standard 33,29 € C13T29964510 XL 61,60 € |  C13T29864511standard 33,29 € C13T29964510 XL 61,60 € |  C13T29864511standard 33,29 € C13T29964510 XL 61,60 € |  C13T29864511standard 33,29 € C13T29964510 XL 61,60 € | | | |

Impresoras de inyección de tinta - Consumidor



TARIFA DE PRECIOS

| | Expression Home XP-345 | Expression Home XP-445 | Expression Home XP-247 | Expression Home XP-245 | Expression Home XP-342 | Expression Home XP-442 | Expression Premium XP-540 |
|--|------------------------|------------------------|------------------------|------------------------|------------------------|------------------------|---|
| Multipack EasyMail  | | | | | | | C13T33374510standard 53,28 € C13T33574510 XL 88,26 € |
| CoverPlus | BA | BA | BA | BA | BA | BA | BA |
| 03 años de servicio CoverPlus en laboratorio para Expression Home XP-235 | | | CP03RTBSCE64 | 40 € | CP03RTBSCE64 | 40 € | |
| 03 años de servicio CoverPlus en laboratorio para Expression Home XP-332/5 | CP03RTBSCE63 | 40 € | | | | CP03RTBSCE63 | 40 € |
| 03 años de servicio CoverPlus en laboratorio para Expression Home XP-432 | | CP03RTBSCE62 | 40 € | | | CP03RTBSCE62 | 40 € |
| 03 años de servicio CoverPlus en laboratorio para Expression Home XP-442 | | | | | | CP03RTBSCE62 | 40 € |
| 03 años de servicio CoverPlus en laboratorio para Expression Home XP-530 | | | | | | CP03RTBSCE62 | 47 € |
| 03 años de servicio CoverPlus en laboratorio para Expression Home XP-530 | | | | | | CP03RTBSCE81 | 40 € |
| 04 años de servicio CoverPlus en laboratorio para Expression Home XP-235 | | | CP04RTBSCE64 | 64 € | CP04RTBSCE64 | 64 € | |
| 04 años de servicio CoverPlus en laboratorio para Expression Home XP-432 | | CP04RTBSCE62 | 64 € | | | CP04RTBSCE62 | 64 € |
| 04 años de servicio CoverPlus en laboratorio para Expression Home XP-442 | | | | | | CP04RTBSCE62 | 64 € |
| 04 años de servicio CoverPlus en laboratorio para Expression Home XP-530 | | | | | | CP04RTBSCE62 | 71 € |
| 04 años de servicio CoverPlus en laboratorio para Expression Home XP-530 | | | | | | CP04RTBSCE81 | 64 € |
| 05 años de servicio CoverPlus en laboratorio para Expression Home XP-235 | | | CP05RTBSCE64 | 96 € | CP05RTBSCE64 | 96 € | |
| 05 años de servicio CoverPlus en laboratorio para Expression Home XP-332/5 | CP05RTBSCE63 | 96 € | | | | CP05RTBSCE63 | 96 € |
| 05 años de servicio CoverPlus en laboratorio para Expression Home XP-432 | | CP05RTBSCE62 | 96 € | | | CP05RTBSCE62 | 96 € |
| 05 años de servicio CoverPlus en laboratorio para Expression Home XP-442 | | | | | | CP05RTBSCE62 | 96 € |
| 05 años de servicio CoverPlus en laboratorio para Expression Home XP-442 | | | | | | CP05RTBSCE62 | 96 € |
| 05 años de servicio CoverPlus en laboratorio para Expression Home XP-442 | | | | | | CP05RTBSCE62 | 95 € |
| 05 años de servicio CoverPlus en laboratorio para Expression Home XP-442 | | | | | | CP05RTBSCE62 | 95 € |
| 05 años de servicio CoverPlus en laboratorio para Expression Home XP-442 | | | | | | CP05RTBSCE81 | 119,05 € |

Expression Home XP-345 Expression Home XP-445 Expression Home XP-247 Expression Home XP-245 Expression Home XP-342 Expression Home XP-442 Expression Premium XP-540











Home XP-530

| Grupo de precios | Expression Premium XP-6000 | Expression Premium XP-640 | Expression Premium XP-645 | Expression Premium XP-900 | Expression Premium XP-830 |
|---|--|---|---|---|---|
| | C1 | C1 | C1 | C1 | C1 |
| |  |  |  |  |  |
| Multifunción | Impresora multifunción 3 en 1 | Impresora multifunción 3 en 1 | Impresora multifunción 3 en 1 | Impresora multifunción 3 en 1 | Impresora multifunción 4 en 1 |
| Formatos papel | A4 | A4 | A4 | A3 | A4 |
| Colores | 5 Colores | 5 Colores | 5 Colores | 5 Colores | 5 Colores |
| Velocidad de impresión ISO/IEC 24734 | 15,8 páginas/minuto Monocromo, 11,3 páginas/minuto Color | 13 páginas/minuto Monocromo, 10 páginas/minuto Color | 13 páginas/minuto Monocromo, 10 páginas/minuto Color | 14 páginas/minuto Monocromo, 11 páginas/minuto Color | 14 páginas/minuto Monocromo, 11 páginas/minuto Color |
| Dúplex | Sí (papel normal A4) | Sí (papel normal A4) | Sí (papel normal A4) | Sí (papel normal A4) | Sí (papel normal A4) |
| Alimentador automático de documentos | NO | NO | NO | NO | 30 páginas |
| Capacidad bandeja papel | 100 Hojas Estándar, 20 Hojas fotográficas | 100 Hojas Estándar, 20 Hojas fotográficas | 100 Hojas Estándar, 20 Hojas fotográficas | 100 Hojas Estándar, 20 Hojas fotográficas | 100 Hojas Estándar, 20 Hojas fotográficas |
| Pantalla LCD | Tipo: Color, Diagonal: 6,1 cm | Tipo: Color, Panel táctil, Diagonal: 6,8 cm | Tipo: Color, Panel táctil, Diagonal: 6,8 cm | Tipo: Color, Diagonal: 6,8 cm | Tipo: Color, Pantalla táctil, Diagonal: 10,9 cm |
| Servicios de impresión móvil y en la nube | Apple AirPrint, Google Cloud Print, Epson Connect (iPrint, Email Print, Remote Print Driver, Scan-to-Cloud), Apple Driver, Facebook print | Epson Connect (iPrint, Email Print, Remote Print Driver, Scan-to-Cloud), Apple AirPrint, Google Cloud Print | Epson Connect (iPrint, Email Print, Remote Print Driver, Scan-to-Cloud), Apple AirPrint, Google Cloud Print | Epson Connect (iPrint, Email Print, Remote Print Driver, Scan-to-Cloud), Apple AirPrint, Google Cloud Print | Epson Connect (iPrint, Email Print, Remote Print Driver, Scan-to-Cloud), Apple AirPrint, Google Cloud Print |
| VPVR neto | C11CG18403 122,89 € | C11CF50403 122,89 € | C11CF50404 122,89 € | C11CF54402 146,42 € | C11CE78402 185,64 € |
| Consumibles | SX | SX | SX | SX | SX |
| Cian |  C13T02F24010 300p 9,99 € C13T02H24010 650p 16,66 € | C13T33424012 300p 9,99 € C13T33624012 650p 16,65 € | C13T33424012 300p 9,99 € C13T33624012 650p 16,65 € | C13T33424012 300p 9,99 € C13T33624012 650p 16,65 € | C13T33424012 300p 9,99 € C13T33624012 650p 16,65 € |
| Magenta |  C13T02F34010 300p 9,99 € C13T02H34010 650p 16,66 € | C13T33434012 300p 9,99 € C13T33634012 650p 16,65 € | C13T33434012 300p 9,99 € C13T33634012 650p 16,65 € | C13T33434012 300p 9,99 € C13T33634012 650p 16,65 € | C13T33434012 300p 9,99 € C13T33634012 650p 16,65 € |
| Amarillo |  C13T02F44010 300p 9,99 € C13T02H44010 650p 16,66 € | C13T33444012 300p 9,99 € C13T33644012 650p 16,65 € | C13T33444012 300p 9,99 € C13T33644012 650p 16,65 € | C13T33444012 300p 9,99 € C13T33644012 650p 16,65 € | C13T33444012 300p 9,99 € C13T33644012 650p 16,65 € |
| Negro |  C13T02E14010 250p 13,32 € C13T02G14010 550p 21,66 € | C13T33314012 250p 13,32 € C13T33514012 530p 19,99 € | C13T33314012 250p 13,32 € C13T33514012 530p 19,99 € | C13T33314012 250p 13,32 € C13T33514012 530p 19,99 € | C13T33314012 250p 13,32 € C13T33514012 530p 19,99 € |

| | Expression Premium XP-6000 | Expression Premium XP-640 | Expression Premium XP-645 | Expression Premium XP-900 | Expression Premium XP-830 |
|--|---|---|---|---|---|
| Negro foto |  C13T02F14010 400p 9,99 € C13T02H14010 800p 18,32 € | C13T33414012 200p 9,99 € C13T33614012 400p 18,32 € | C13T33414012 200p 9,99 € C13T33614012 400p 18,32 € | C13T33414012 200p 9,99 € C13T33614012 400p 18,32 € | C13T33414012 200p 9,99 € C13T33614012 400p 18,32 € |
| Multipack |  C13T02E74010standard 53,28 € C13T02G74010 XL 89,96 € | C13T33374011 L 53,28 € C13T33574011 XL 88,26 € | C13T33374011 L 53,28 € C13T33574011 XL 88,26 € | C13T33374011 L 53,28 € C13T33574011 XL 88,26 € | C13T33374011 L 53,28 € C13T33574011 XL 88,26 € |
| Multipack EasyMail |  | C13T33374510standard 53,28 € C13T33574510 XL 88,26 € | C13T33374510standard 53,28 € C13T33574510 XL 88,26 € | C13T33374510standard 53,28 € C13T33574510 XL 88,26 € | C13T33374510standard 53,28 € C13T33574510 XL 88,26 € |
| Caja de mantenimiento | C13T366100 8,32 € | | | | |
| CoverPlus | BA | BA | BA | BA | BA |
| 03 años de servicio CoverPlus en laboratorio para Expression Home XP-630/635/640/645/6000/6005 | CP03RTBSCE79 50 € | CP03RTBSCE79 50 € | CP03RTBSCE79 50 € | | |
| 03 años de servicio CoverPlus en laboratorio para Expression Home XP-830 | | | | CP03RTBSCE78 50 € | |
| 03 años de servicio CoverPlus en laboratorio para Expression Home XP-960 | | | | CP03RTBSCE82 70 € | |
| 04 años de servicio CoverPlus en laboratorio para Expression Home XP-630/635/640/645/6000/6005 | CP04RTBSCE79 80 € | CP04RTBSCE79 80 € | CP04RTBSCE79 80 € | | |
| 04 años de servicio CoverPlus en laboratorio para Expression Home XP-830 | | | | CP04RTBSCE78 80 € | |
| 04 años de servicio CoverPlus en laboratorio para Expression Home XP-960 | | | | CP04RTBSCE82 112 € | |
| 05 años de servicio CoverPlus en laboratorio para Expression Home XP-630/635/640/645/6000 | CP05RTBSCE79 120 € | CP05RTBSCE79 120 € | CP05RTBSCE79 120 € | | |
| 05 años de servicio CoverPlus en laboratorio para Expression Home XP-830 | | | | CP05RTBSCE78 120 € | |
| 05 años de servicio CoverPlus en laboratorio para Expression Home XP-960 | | | | CP05RTBSCE82 168 € | |

Impresoras de inyección de tinta - EcoTank

TARIFA DE PRECIOS

| Grupo de precios | EcoTank ET-2500 | EcoTank L355 | EcoTank ET-2550 | EcoTank ET-2600 | EcoTank ET-2700 | EcoTank ET-2650 | EcoTank L555 | |
|--|--|---|---|---|--|---|---|------------------------------------|
| | F7 | F7 | F7 | F7 | F7 | F7 | F7 | |
| |  |  |  |  |  |  |  | |
| Multifunción | Impresora multifunción 3 en 1 | Impresora multifunción 3 en 1 | Impresora multifunción 3 en 1 | Impresora multifunción 3 en 1 | Impresora multifunción 3 en 1 | Impresora multifunción 3 en 1 | Impresora multifunción 4 en 1 | |
| Formatos papel | A4 | A4 | A4 | A4 | A4 | A4 | A4 | |
| Colores | 4 Colores | 4 Colores | 4 Colores | 4 Colores | 4 Colores | 4 Colores | 4 Colores | |
| Velocidad de impresión ISO/ IEC 24734 | 9,2 páginas/minuto Monocromo, 4,5 páginas/minuto Color | 9 páginas/minuto Monocromo, 4,5 páginas/minuto Color | 9,2 páginas/minuto Monocromo, 4,5 páginas/minuto Color | 10 páginas/minuto Monocromo, 5 páginas/minuto Color, 69 segundos por foto de 10 x 15 cm | 10,5 páginas/minuto Monocromo, 5 páginas/minuto Color | 10 páginas/minuto Monocromo, 5 páginas/minuto Color | 9 páginas/minuto Monocromo, 4,5 páginas/minuto Color | |
| Dúplex | Manual | Manual | Manual | Manual | Manual | Manual | Manual | |
| Alimentador automático de documentos | NO | NO | NO | NO | NO | NO | 30 páginas | |
| Capacidad bandeja papel | 100 Hojas Estándar | 100 Hojas Estándar, 100 Hojas máximo, 20 Hojas fotográficas | 100 Hojas Estándar, 20 Hojas fotográficas | 100 Hojas Estándar, 20 Hojas fotográficas | 100 Hojas Estándar, 20 Hojas fotográficas | 100 Hojas Estándar, 20 Hojas fotográficas | 100 Hojas Estándar, 100 Hojas máximo, 20 Hojas fotográficas | |
| Pantalla LCD | | | Tipo: Color, Diagonal: 3,7 cm | | | | Tipo: Color, Diagonal: 3,7 cm | Tipo: Monocromo, Texto de 2 líneas |
| Servicios de impresión móvil y en la nube | Epson Connect (iPrint, Email Print) | Epson Connect (iPrint) | Epson Connect (iPrint, Email Print), Apple AirPrint, Google Cloud Print | Epson Connect (iPrint, Email Print) | Epson Connect (iPrint, Email Print, Remote Print Driver), Google Cloud Print | Epson Connect (iPrint, Email Print), Apple AirPrint, Google Cloud Print | Epson Connect (iPrint) | |
| PVPR neto | C11CE92402 188,58 € | C11CC86409 213,58 € | C11CE91402 213,58 € | C11CF46402 230,24 € | C11CG24402 230,24 € | C11CF47402 255,24 € | C11CC96404 296,91 € | |
| Consumibles | S7 | S7 | S7 | S7 | S7 | S7 | S7 | |
| Ink Bottle Cian |  C13T664240 7500p 8,33 € | C13T664240 6500p 8,33 € | C13T664240 7500p 8,33 € | C13T664240 7500p 8,33 € | C13T03R240 6000p 7,84 € | C13T664240 7500p 8,33 € | C13T664240 6500p 8,33 € | |
| Ink Bottle Magenta |  C13T664340 7500p 8,33 € | C13T664340 6500p 8,33 € | C13T664340 7500p 8,33 € | C13T664340 7500p 8,33 € | C13T03R340 6000p 7,84 € | C13T664340 7500p 8,33 € | C13T664340 6500p 8,33 € | |
| Ink Bottle Amarillo |  C13T664440 7500p 8,33 € | C13T664440 6500p 8,33 € | C13T664440 7500p 8,33 € | C13T664440 7500p 8,33 € | C13T03R440 6000p 7,84 € | C13T664440 7500p 8,33 € | C13T664440 6500p 8,33 € | |
| Ink Bottle Negro |  C13T664140 4500p 8,33 € | C13T664140 4000p 8,33 € | C13T664140 4500p 8,33 € | C13T664140 4500p 8,33 € | C13T03R140 7500p 12,49 € | C13T664140 4500p 8,33 € | C13T664140 4000p 8,33 € | |
| Caja de mantenimiento | | | | | C13T04D100 8,32 € | | | |
| CoverPlus | BA | BA | BA | BA | BA | BA | BA | |
| 03 años de servicio CoverPlus en laboratorio para ET-2500 | CP03RTBSCE92 90 € | | | | | | | |
| 03 años de servicio CoverPlus en laboratorio para ET-2550 | | | CP03RTBSCE91 80 € | | | | | |
| 03 años de servicio CoverPlus en laboratorio para ET-2600/2650 | | | | CP03RTBSCF46 90 € | | CP03RTBSCF46 90 € | | |

Toda la información está sujeta a cambios sin notificación previa. Para as notas, por favor veja apéndice.

Impresoras de inyección de tinta - EcoTank

TARIFA DE PRECIOS

| | EcoTank ET-2500 | EcoTank L355 | EcoTank ET-2550 | EcoTank ET-2600 | EcoTank ET-2700 | EcoTank ET-2650 | EcoTank L555 |
|--|-----------------|--------------|-----------------|-----------------|-----------------|-----------------|-----------------------|
| 03 años de servicio CoverPlus en laboratorio para ET-2700/2750 | | | | | CP03RTBSCG24 | 90 € | |
| 03 años de servicio CoverPlus en laboratorio para L355/65 | | CP03RTBSCC86 | 120 € | | | | |
| 03 años de servicio CoverPlus en laboratorio para L550 | | | | | | | CP03RTBSCC95 119,70 € |
| 04 años de servicio CoverPlus en laboratorio para ET-2500 | CP04RTBSCE92 | 128 € | | | | | |
| 04 años de servicio CoverPlus en laboratorio para ET-2550 | | | CP04RTBSCE91 | 128 € | | | |
| 04 años de servicio CoverPlus en laboratorio para ET-2600/2650 | | | | CP04RTBSCF46 | 128 € | CP04RTBSCF46 | 128 € |
| 04 años de servicio CoverPlus en laboratorio para ET-2700/2750 | | | | | CP04RTBSCG24 | 128 € | |
| 05 años de servicio CoverPlus en laboratorio para ET-2500 | CP05RTBSCE92 | 192 € | | | | | |
| 05 años de servicio CoverPlus en laboratorio para ET-2550 | | | CP05RTBSCE91 | 192 € | | | |
| 05 años de servicio CoverPlus en laboratorio para ET-2600/2650 | | | | CP05RTBSCF46 | 192 € | CP05RTBSCF46 | 192 € |
| 05 años de servicio CoverPlus en laboratorio para ET-2700/2750 | | | | | CP05RTBSCG24 | 192 € | |

| Grupo de precios | EcoTank ET-2750 | EcoTank ET-4500 | EcoTank ET-3700 | EcoTank ET-3750 | EcoTank ET-3600 | EcoTank ET-4550 | EcoTank ET-4750 |
|--------------------------------------|---|---|---|---|--|---|---|
| | F7 | F7 | FE | FE | F7 | FE | FE |
| |  |  |  |  |  |  |  |
| Multifunción | Impresora multifunción 3 en 1 | Impresora multifunción 4 en 1 | Impresora multifunción 3 en 1 | Impresora multifunción 3 en 1 | Impresora multifunción 3 en 1 | Impresora multifunción 4 en 1 | Impresora multifunción 4 en 1 |
| Formatos papel | A4 | A4 | A4 | A4 | A4 | A4 | A4 |
| Colores | 4 Colores | 4 Colores | 4 Colores | 4 Colores | 4 Colores | 4 Colores | 4 Colores |
| Velocidad de impresión ISO/IEC 24734 | 10,5 páginas/minuto Monocromo, 5 páginas/ | 9,2 páginas/minuto Monocromo, 4,5 páginas/ | 15 páginas/minuto Monocromo, 8 páginas/ | 15 páginas/minuto Monocromo, 8 páginas/ | 13,7 páginas/minuto Monocromo, 7,3 páginas/ | 13,7 páginas/minuto Monocromo, 7,3 páginas/ | 15 páginas/minuto Monocromo, 8 páginas/ |

Impresoras de inyección de tinta - EcoTank

TARIFA DE PRECIOS





| | EcoTank ET-2750 | EcoTank ET-4500 | EcoTank ET-3700 | EcoTank ET-3750 | EcoTank ET-3600 | EcoTank ET-4550 | EcoTank ET-4750 |
|--|--|---|---|---|---|---|---|
| | minuto Color | minuto Color | minuto Color | minuto Color | minuto Color | minuto Color | minuto Color |
| Dúplex | Sí (papel normal A4) | Manual | Sí (papel normal A4) | Sí (papel normal A4) | Sí (papel normal A4) | Sí (papel normal A4) | Sí (papel normal A4) |
| Alimentador automático de documentos | NO | 30 páginas | NO | 30 páginas | NO | 30 páginas | 30 páginas |
| Capacidad bandeja papel | 100 Hojas Estándar, 20 Hojas fotográficas | 100 Hojas Estándar | 150 Hojas Estándar, 20 Hojas fotográficas | 150 Hojas Estándar, 20 Hojas fotográficas | 150 Hojas Estándar, 20 Hojas fotográficas | 150 Hojas Estándar | 250 Hojas Estándar, 20 Hojas fotográficas |
| Pantalla LCD | Tipo: Color, Diagonal: 3,7 cm | Tipo: Monocromo, Diagonal: 5,6 cm | Tipo: Color, Diagonal: 6,1 cm | Tipo: Color, Diagonal: 6,1 cm | Tipo: Monocromo, Diagonal: 5,6 cm | Tipo: Monocromo, Diagonal: 5,6 cm | Tipo: Color, Pantalla táctil, Diagonal: 6,1 cm |
| Servicios de impresión móvil y en la nube | Epson Connect (iPrint, Email Print, Remote Print Driver), Apple AirPrint, Google Cloud Print | Epson Connect (iPrint, Email Print), Apple AirPrint, Google Cloud Print | Epson Connect (iPrint, Email Print, Remote Print Driver, Scan-to-Cloud), Apple AirPrint, Google Cloud Print | Epson Connect (iPrint, Email Print, Remote Print Driver, Scan-to-Cloud), Apple AirPrint, Google Cloud Print | Epson Connect (iPrint, Email Print), Apple AirPrint, Google Cloud Print | Epson Connect (iPrint, Email Print), Apple AirPrint, Google Cloud Print | Epson Connect (iPrint, Email Print, Remote Print Driver, Scan-to-Cloud), Apple AirPrint, Google Cloud Print |
| PVPR neto | C11CG22402 296,91 € | C11CE90402 338,58 € | C11CG21401 338,58 € | C11CG20401 380,24 € | C11CF73401 380,25 € | C11CE71404 421,91 € | C11CG19401 421,91 € |
| Consumibles | S7 | S7 | S7 | S7 | S7 | S7 | S7 |
| Ink Bottle Cian | C13T03R240 6000p 7,84 € | C13T664240 7500p 8,33 € | C13T03R240 6000p 7,84 € | C13T03R240 6000p 7,84 € | C13T664240 6500p 8,33 € | C13T664240 6500p 8,33 € | C13T03R240 6000p 7,84 € |
| Ink Bottle Magenta | C13T03R340 6000p 7,84 € | C13T664340 7500p 8,33 € | C13T03R340 6000p 7,84 € | C13T03R340 6000p 7,84 € | C13T664340 6500p 8,33 € | C13T664340 6500p 8,33 € | C13T03R340 6000p 7,84 € |
| Ink Bottle Amarillo | C13T03R440 6000p 7,84 € | C13T664440 7500p 8,33 € | C13T03R440 6000p 7,84 € | C13T03R440 6000p 7,84 € | C13T664440 6500p 8,33 € | C13T664440 6500p 8,33 € | C13T03R440 6000p 7,84 € |
| Ink Bottle Negro | C13T03R140 7500p 12,49 € | C13T664140 4500p 8,33 € | C13T03R140 7500p 12,49 € | C13T03R140 7500p 12,49 € | C13T774140 6000p 12,49 € | C13T774140 6000p 12,49 € | C13T03R140 7500p 12,49 € |
| Caja de mantenimiento | C13T04D100 8,32 € | | C13T04D100 8,32 € | C13T04D100 8,32 € | | | C13T04D100 8,32 € |
| CoverPlus | BA | BA | BA | BA | BA | BA | BA |
| 03 años de servicio CoverPlus en laboratorio para ET-2700/2750 | CP03RTBSCG24 90 € | | | | | | |
| 03 años de servicio CoverPlus en laboratorio para ET-3600 | | | | | CP03RTBSCF73 90 € | | |
| 03 años de servicio CoverPlus en laboratorio para ET-3700/3750 | | | CP03RTBSCG20 90 € | CP03RTBSCG20 90 € | | | |
| 03 años de servicio CoverPlus en laboratorio para ET-4500 | | CP03RTBSCE93 95 € | | | | | |
| 03 años de servicio CoverPlus en laboratorio para ET-4550 | | | | | | CP03RTBSCE71 95 € | |
| 03 años de servicio CoverPlus en laboratorio para ET-4750 | | | | | | | CP03RTBSCG19 95 € |
| 04 años de servicio CoverPlus en laboratorio para ET-2700/2750 | CP04RTBSCG24 128 € | | | | | | |
| 04 años de servicio CoverPlus en laboratorio para ET-3600 | | | | | CP04RTBSCF73 128 € | | |
| 04 años de servicio CoverPlus en laboratorio para ET-3700/3750 | | | CP04RTBSCG20 128 € | CP04RTBSCG20 128 € | | | |







Impresoras de inyección de tinta - EcoTank

TARIFA DE PRECIOS

| | EcoTank ET-2750 | EcoTank ET-4500 | EcoTank ET-3700 | EcoTank ET-3750 | EcoTank ET-3600 | EcoTank ET-4550 | EcoTank ET-4750 |
|--|-----------------|-----------------|-----------------|-----------------|-----------------|-----------------|--------------------|
| 04 años de servicio CoverPlus en laboratorio para ET-4500 | | CP04RTBSCE93 | 152 € | | | | |
| 04 años de servicio CoverPlus en laboratorio para ET-4550 | | | | | | CP04RTBSCE71 | 152 € |
| 04 años de servicio CoverPlus en laboratorio para ET-4750 | | | | | | | CP04RTBSCE93 152 € |
| 05 años de servicio CoverPlus en laboratorio para ET-2700/2750 | CP05RTBSCE24 | 192 € | | | | | |
| 05 años de servicio CoverPlus en laboratorio para ET-3600 | | | | | CP05RTBSCE73 | 192 € | |
| 05 años de servicio CoverPlus en laboratorio para ET-3700/3750 | | | CP05RTBSCE20 | 192 € | CP05RTBSCE20 | 192 € | |
| 05 años de servicio CoverPlus en laboratorio para ET-4500 | | CP05RTBSCE93 | 228 € | | | | |
| 05 años de servicio CoverPlus en laboratorio para ET-4550 | | | | | | CP05RTBSCE71 | 228 € |
| 05 años de servicio CoverPlus en laboratorio para ET-4750 | | | | | | | CP05RTBSCE93 228 € |

| Grupo de precios | EcoTank ET-7700 | EcoTank ET-14000 | EcoTank ET-7750 | EcoTank ET-16500 |
|--------------------------------------|---|---|---|---|
| | F7 | FE | F7 | FE |
| |  |  |  |  |
| Multifunción | Impresora multifunción 3 en 1 | Impresora | Impresora multifunción 3 en 1 | Impresora multifunción 4 en 1 |
| Formatos papel | A4 | A3+ | A3 | A3+ |
| Colores | 5 Colores | 4 Colores | 5 Colores | 4 Colores |
| Velocidad de impresión ISO/IEC 24734 | 13 páginas/minuto Monocromo, 10 páginas/minuto Color | 15 páginas/minuto Monocromo, 5,5 páginas/minuto Color | 13 páginas/minuto Monocromo, 10 páginas/minuto Color | 18 páginas/minuto Monocromo, 10 páginas/minuto Color |
| Dúplex | Sí (papel normal A4) | Manual | Sí (papel normal A4) | Sí |
| Alimentador automático de documentos | NO | NO | NO | 35 páginas |
| Capacidad bandeja papel | 100 Hojas Estándar, 20 Hojas fotográficas | 100 Hojas Estándar, 20 Hojas fotográficas | 100 Hojas Estándar, 20 Hojas fotográficas | 500 Hojas máximo, 20 Hojas fotográficas |







| | EcoTank ET-7700 | EcoTank ET-14000 | EcoTank ET-7750 | EcoTank ET-16500 |
|--|---|--------------------------------|---|---|
| Pantalla LCD | Tipo: Color, Diagonal: 6,8 cm | | Tipo: Color, Diagonal: 6,8 cm | Tipo: Color, Panel táctil, Diagonal: 10,9 cm |
| Servicios de impresión móvil y en la nube | Epson Connect (iPrint, Email Print, Remote Print Driver, Scan-to-Cloud), Apple AirPrint, Google Cloud Print | | Epson Connect (iPrint, Email Print, Remote Print Driver, Scan-to-Cloud), Apple AirPrint, Google Cloud Print | Epson Connect (iPrint, Email Print, Remote Print Driver, Scan-to-Cloud), Google Cloud Print |
| PVPR neto | C11CG15401 505,24 € | C11CD81404 546,16 € | C11CG16401 588,58 € | C11CF49404 1.004,49 € |
| Consumibles | S7 | S7 | S7 | S7 |
| Ink Bottle Cian |  C13T00R240 1900p 11,24 € | C13T664240 6500p 8,33 € | C13T00R240 1900p 11,24 € | C13T664240 6500p 8,33 € |
| Ink Bottle Magenta |  C13T00R340 1900p 11,24 € | C13T664340 6500p 8,33 € | C13T00R340 1900p 11,24 € | C13T664340 6500p 8,33 € |
| Ink Bottle Amarillo |  C13T00R440 1900p 11,24 € | C13T664440 6500p 8,33 € | C13T00R440 1900p 11,24 € | C13T664440 6500p 8,33 € |
| Ink Bottle Negro |  C13T00Q140 1900p 16,65 € | C13T664140 7500p 8,33 € | C13T00Q140 1900p 16,65 € | C13T774140 6000p 12,49 € |
| Ink Bottle Negro foto |  C13T00R140 1900p 11,24 € | | C13T00R140 1900p 11,24 € | |
| Caja de mantenimiento | C13T04D000 8,32 € | | C13T04D000 8,32 € | |
| CoverPlus | BA | BA | BA | BA |
| 03 años de servicio CoverPlus en laboratorio para ET-7700/7750 | CP03RTBSCG16 100 € | | CP03RTBSCG16 100 € | |
| 03 años de servicio CoverPlus en laboratorio para L1455/ET-16500 | | | | CP03RTBSCF49 130 € |
| 04 años de servicio CoverPlus en laboratorio para ET-14000 | | CP04RTBSCD81 192 € | | |
| 04 años de servicio CoverPlus en laboratorio para ET-7700/7750 | CP04RTBSCG16 160 € | | CP04RTBSCG16 160 € | |
| 04 años de servicio CoverPlus en laboratorio para L1455/ET-16500 | | | | CP04RTBSCF49 195 € |
| 05 años de servicio CoverPlus en laboratorio para ET-14000 | | CP05RTBSCD81 288 € | | |
| 05 años de servicio CoverPlus en laboratorio para ET-7700/7750 | CP05RTBSCG16 240 € | | CP05RTBSCG16 240 € | |
| 05 años de servicio CoverPlus en laboratorio para L1455/ET-16500 | | | | CP05RTBSCF49 280 € |

| Grupo de precios | Expression Photo XP-55 | | Expression Photo XP-8500 | | Expression Photo XP-760 | | Expression Photo XP-860 | | Expression Photo XP-960 | | Epson Stylus Photo 1500W | |
|--|--|---|--|--|--|--|--|--|--|--|--|--|
| | C1 | | C1 | | C1 | | C1 | | C1 | | C1 | |
| |  | |  | |  | |  | |  | |  | |
| Multifunción | Impresora | | Impresora multifunción 3 en 1 | | Impresora multifunción 3 en 1 | | Impresora multifunción 4 en 1 | | Impresora multifunción 3 en 1 | | Impresora | |
| Formatos papel | A4 | | A4 | | A4 | | A4 | | A3 | | A3+ | |
| Velocidad de impresión | 32 páginas/min en monocromo, 32 páginas/min en color, 10 Segundos por foto de 10 x 15 cm | | 32 páginas/min en monocromo, 32 páginas/min en color, 10 Segundos por foto de 10 x 15 cm | | 32 páginas/min en monocromo, 32 páginas/min en color, 10 Segundos por foto de 10 x 15 cm | | 32 páginas/min en monocromo, 32 páginas/min en color, 10 Segundos por foto de 10 x 15 cm | | 28 páginas/min en monocromo, 28 páginas/min en color, 11 Segundos por foto de 10 x 15 cm | | 16 páginas/min en monocromo, 16 páginas/min en color, 45 Segundos por foto de 10 x 15 cm | |
| Dúplex | Sí (papel normal A4) | | Sí (papel normal A4) | | Sí (papel normal A4) | | Sí (papel normal A4) | | Sí (papel normal A4) | | NO | |
| Resolución de impresión | 5.760 x 1.400 ppp | | 5.760 x 1.400 ppp | | 5.760 x 1.400 ppp | | 5.760 x 1.400 ppp | | 5.760 x 1.400 ppp | | 5.760 x 1.440 ppp | |
| PVPR neto | C11CD36402 129,99 € | | C11CG17402 155,24 € | | C11CD96402 177,80 € | | C11CD95402 224,85 € | | C11CE82402 240,53 € | | C11CB53302 279 € | |
| Consumibles | SY, S1 | | SX | | SY, S1 | | SY, S1 | | SY, S1 | | S1 | |
| Cian claro |  C13T24254012 360p 9,57 € C13T24354012 740p 15,82 € | C13T37854010 360p 9,57 € C13T37954010 830p 17,91 € | C13T24254012 360p 9,57 € C13T24354012 740p 15,82 € | C13T24254012 360p 9,57 € C13T24354012 740p 15,82 € | C13T24254012 360p 9,57 € C13T24354012 740p 15,82 € | C13T24254012 360p 9,57 € C13T24354012 740p 15,82 € | C13T24254012 360p 9,57 € C13T24354012 740p 15,82 € | C13T24254012 360p 9,57 € C13T24354012 740p 15,82 € | C13T24254012 360p 9,57 € C13T24354012 740p 15,82 € | C13T07954010 660p 16,65 € | | |
| Cian |  C13T24224012 360p 9,57 € C13T24324012 740p 15,82 € | C13T37824010 360p 9,57 € C13T37924010 830p 17,91 € | C13T24224012 360p 9,57 € C13T24324012 740p 15,82 € | C13T24224012 360p 9,57 € C13T24324012 740p 15,82 € | C13T24224012 360p 9,57 € C13T24324012 740p 15,82 € | C13T24224012 360p 9,57 € C13T24324012 740p 15,82 € | C13T24224012 360p 9,57 € C13T24324012 740p 15,82 € | C13T24224012 360p 9,57 € C13T24324012 740p 15,82 € | C13T24224012 360p 9,57 € C13T24324012 740p 15,82 € | C13T07924010 1000p 16,65 € | | |
| Magenta claro |  C13T24264012 360p 9,57 € C13T24364012 740p 15,82 € | C13T37864010 360p 9,57 € C13T37964010 830p 17,91 € | C13T24264012 360p 9,57 € C13T24364012 740p 15,82 € | C13T24264012 360p 9,57 € C13T24364012 740p 15,82 € | C13T24264012 360p 9,57 € C13T24364012 740p 15,82 € | C13T24264012 360p 9,57 € C13T24364012 740p 15,82 € | C13T24264012 360p 9,57 € C13T24364012 740p 15,82 € | C13T24264012 360p 9,57 € C13T24364012 740p 15,82 € | C13T24264012 360p 9,57 € C13T24364012 740p 15,82 € | C13T07964010 930p 16,65 € | | |
| Magenta |  C13T24234012 360p 9,57 € C13T24334012 740p 15,82 € | C13T37834010 360p 9,57 € C13T37934010 830p 17,91 € | C13T24234012 360p 9,57 € C13T24334012 740p 15,82 € | C13T24234012 360p 9,57 € C13T24334012 740p 15,82 € | C13T24234012 360p 9,57 € C13T24334012 740p 15,82 € | C13T24234012 360p 9,57 € C13T24334012 740p 15,82 € | C13T24234012 360p 9,57 € C13T24334012 740p 15,82 € | C13T24234012 360p 9,57 € C13T24334012 740p 15,82 € | C13T24234012 360p 9,57 € C13T24334012 740p 15,82 € | C13T07934010 685p 16,65 € | | |
| Amarillo |  C13T24244012 360p 9,57 € C13T24344012 740p 15,82 € | C13T37844010 360p 9,57 € C13T37944010 830p 17,91 € | C13T24244012 360p 9,57 € C13T24344012 740p 15,82 € | C13T24244012 360p 9,57 € C13T24344012 740p 15,82 € | C13T24244012 360p 9,57 € C13T24344012 740p 15,82 € | C13T24244012 360p 9,57 € C13T24344012 740p 15,82 € | C13T24244012 360p 9,57 € C13T24344012 740p 15,82 € | C13T24244012 360p 9,57 € C13T24344012 740p 15,82 € | C13T24244012 360p 9,57 € C13T24344012 740p 15,82 € | C13T07944010 715p 16,65 € | | |
| Negro |  C13T24214012 240p 9,57 € C13T24314012 500p 15,82 € | C13T37814010 240p 9,57 € C13T37914010 500p 16,66 € | C13T24214012 240p 9,57 € C13T24314012 500p 15,82 € | C13T24214012 240p 9,57 € C13T24314012 500p 15,82 € | C13T24214012 240p 9,57 € C13T24314012 500p 15,82 € | C13T24214012 240p 9,57 € C13T24314012 500p 15,82 € | C13T24214012 240p 9,57 € C13T24314012 500p 15,82 € | C13T24214012 240p 9,57 € C13T24314012 500p 15,82 € | C13T24214012 240p 9,57 € C13T24314012 500p 15,82 € | C13T07914010 470p 16,65 € | | |
| Multipack EasyMail |  C13T24284510 L 57,42 € C13T24384510 XL 94,92 € | | | C13T24284510 L 57,42 € C13T24384510 XL 94,92 € | C13T24284510 L 57,42 € C13T24384510 XL 94,92 € | C13T24284510 L 57,42 € C13T24384510 XL 94,92 € | C13T24284510 L 57,42 € C13T24384510 XL 94,92 € | C13T24284510 L 57,42 € C13T24384510 XL 94,92 € | C13T24284510 L 57,42 € C13T24384510 XL 94,92 € | C13T24284510 L 57,42 € C13T24384510 XL 94,92 € | | |
| Multipack |  C13T24284011 standard 57,42 € C13T24384011 XL 94,92 € | C13T37884010 standard 57,42 € C13T37984010 XL 106,21 € | C13T24284011 standard 57,42 € C13T24384011 XL 94,92 € | C13T24284011 standard 57,42 € C13T24384011 XL 94,92 € | C13T24284011 standard 57,42 € C13T24384011 XL 94,92 € | C13T24284011 standard 57,42 € C13T24384011 XL 94,92 € | C13T24284011 standard 57,42 € C13T24384011 XL 94,92 € | C13T24284011 standard 57,42 € C13T24384011 XL 94,92 € | C13T24284011 standard 57,42 € C13T24384011 XL 94,92 € | C13T24284011 standard 57,42 € C13T24384011 XL 94,92 € | | |
| Caja de mantenimiento | C13T366100 8,32 € | | | | | | | | | | | |
| CoverPlus | BA | | BA | | BA | | BA | | BA | | BA | |
| 03 años de servicio CoverPlus en laboratorio para Expression Home XP-960 | | | | | | | | | CP03RTBSCE82 | | 70 € | |
| 03 años de servicio CoverPlus en laboratorio para Expression Photo XP-55 | CP03RTBSCD36 50 € | | | | | | | | | | | |

Impresoras de inyección de tinta - Fotografía

TARIFA DE PRECIOS

| | Expression Photo XP-55 | Expression Photo XP-8500 | Expression Photo XP-760 | Expression Photo XP-860 | Expression Photo XP-960 | Epson Stylus Photo 1500W |
|---|------------------------|--------------------------|-------------------------|-------------------------|-------------------------|--------------------------|
| 03 años de servicio CoverPlus en laboratorio para Expression Photo XP-760 | | | CP03RTBSCD96 | 30 € | | |
| 03 años de servicio CoverPlus en laboratorio para Expression Photo XP-8500/8505 | | CP03RTBSCG17 | 30 € | | | |
| 03 años de servicio CoverPlus en laboratorio para Expression Photo XP-860 | | | | CP03RTBSCD95 | 70 € | |
| 03 años de servicio CoverPlus en laboratorio para Stylus Photo 1500W | | | | | | CP03RTBSCB53 70 € |
| 03 años de servicio CoverPlus in situ para Stylus Photo 1500W | | | | | | CP03OSSECB53 90 € |
| 04 años de servicio CoverPlus en laboratorio para Expression Home XP-960 | | | | | CP04RTBSCE82 | 112 € |
| 04 años de servicio CoverPlus en laboratorio para Expression Photo XP-55 | CP04RTBSCD36 | 80 € | | | | |
| 04 años de servicio CoverPlus en laboratorio para Expression Photo XP-760 | | | CP04RTBSCD96 | 40 € | | |
| 04 años de servicio CoverPlus en laboratorio para Expression Photo XP-8500/8505 | | CP04RTBSCG17 | 40 € | | | |
| 04 años de servicio CoverPlus en laboratorio para Expression Photo XP-860 | | | | CP04RTBSCD95 | 84 € | |
| 05 años de servicio CoverPlus en laboratorio para Expression Home XP-960 | | | | | CP05RTBSCE82 | 168 € |
| 05 años de servicio CoverPlus en laboratorio para Expression Photo XP-55 | CP05RTBSCD36 | 120 € | | | | |
| 05 años de servicio CoverPlus en laboratorio para Expression Photo XP-760 | | | CP05RTBSCD96 | 60 € | | |
| 05 años de servicio CoverPlus en laboratorio para Expression Photo XP-8500/8505 | | CP05RTBSCG17 | 60 € | | | |
| 05 años de servicio CoverPlus en laboratorio para Expression Photo XP-860 | | | | CP05RTBSCD95 | 168 € | |

| Grupo de precios | WorkForce AL-M200DW B1 | WorkForce AL-M300DN B1 | WorkForce AL-MX300DN B1 | WorkForce AL-MX300DNF B1 | WorkForce AL-M310DN B1 | WorkForce AL-M320DN B1 | WorkForce AL-M400DN B1 |
|------------------------------------|---|---|---|---|---|---|---|
| |  |  |  |  |  |  |  |
| Formatos papel | A4 | A4 | A4 | A4 | A4 | A4 | A4 |
| Velocidad de impresión | 30 páginas/min. en monocromo a una sola cara | 35 páginas/min. en monocromo a una sola cara, 21 páginas/min. en monocromo a doble cara | 35 páginas/min. en monocromo a una sola cara, 21 páginas/min. en monocromo a doble cara | 35 páginas/min. en monocromo a una sola cara, 21 páginas/min. en monocromo a doble cara | 35 páginas/min. en monocromo a una sola cara, 18 páginas/min. en monocromo a doble cara | 40 páginas/min. en monocromo a una sola cara, 20 páginas/min. en monocromo a doble cara | 45 páginas/min. en monocromo a una sola cara, 27 páginas/min. en monocromo a doble cara |
| Tiempo de salida de primera página | Monocromo 7 segundos | Monocromo 6 segundos | Monocromo 6 segundos | Monocromo 6 segundos | Monocromo 7 segundos | Monocromo 6 segundos | Monocromo 6 segundos |
| Dúplex | Sí | Si | Sí | Sí | Sí | Sí | Sí |
| Capacidad bandeja papel | 250 Hojas Estándar, 260 Hojas máximo | | 250 Hojas Estándar, 550 Hojas máximo (WorkForce AL-MX300DN) 300 Hojas Estándar, 550 Hojas máximo (WorkForce AL-MX300DTN) | 250 Hojas Estándar, 550 Hojas máximo | 500 Hojas Estándar, 850 Hojas máximo | 500 Hojas Estándar, 850 Hojas máximo | 700 Hojas Estándar, 2.350 Hojas máximo (WorkForce AL-M400DN) 1.250 Hojas Estándar, 2.350 Hojas máximo (WorkForce AL-M400DTN) |
| Memoria | 128 MB incluido, 128 MB máximo | 128 MB incluido, 1152 MB máximo | 1 GB incluido | 1 GB incluido | 512 MB incluido | 1024 MB incluido | 128 MB incluido, 1152 MB máximo |
| Resolución de impresión | 1.200 x 1.200 ppp | 1.200 x 1.200 ppp | 1.200 x 1.200 ppp | 1.200 x 1.200 ppp | 1.200 x 1.200 ppp | 1.200 x 1.200 ppp | 1.200 x 1.200 ppp |
| Emulaciones | PCL6, PostScript 3 | PCL5c, PCL6, ESC/P, ESC/P2, ESC/Página, PostScript 3, PDF 1.6, FX, I239X | PCL5c, PCL6, ESC/Página, PostScript 3, PDF, FX, I239X | PCL5c, PCL6, ESC/Página, PostScript 3, PDF, FX, I239X | PCL5c, PCL6, ESC/P2, ESC/Página, FX, I239X | PCL5c, PCL6, PDF 1.7, ESC/P2, ESC/Página, FX, I239X, PostScript 3 | PCL5c, PCL6, ESC/P, ESC/P2, ESC/Página, PostScript 3, PDF 1.6, FX, I239X |
| VPVR neto | C11CC71011 | 183,50 € | | | C11CF22401 | C11CF21401 | |
| | | WorkForce AL-M300DN C11CC64011 349,50 € WorkForce AL-M300DTN C11CC64011BW 429,50 € | WorkForce AL-MX300DN C11CD74001 424,25 € WorkForce AL-MX300DTN C11CD74001BW 544,25 € | WorkForce AL-MX300DNF C11CD73001 494,25 € WorkForce AL-MX300DTNF C11CD73001BW 604,25 € | DTN C11CF22401BW | DTN C11CF21401BW | WorkForce AL-M400DN C11CC65011 855 € WorkForce AL-M400DTN C11CC65011BW 995 € |
| Opciones | | B1 | B1 | B1 | B1 | B1 | B1 |
| Ampliación de memoria de 1 GB | | 7106922 | 300 € | | | | 7106922 300 € |
| Ampliación de memoria de 128 MB | | 7106919 | 90 € | | | | 7106919 90 € |
| Ampliación de memoria de 256 MB | | 7106920 | 140 € | | | | 7106920 140 € |
| Ampliación de memoria de 512 MB | | 7106921 | 200 € | | | | 7106921 200 € |

| | WorkForce AL-M200DW | WorkForce AL-M300DN | WorkForce AL-MX300DN | WorkForce AL-MX300DNF | WorkForce AL-M310DN | WorkForce AL-M320DN | WorkForce AL-M400DN | | | | |
|---|---------------------|---------------------|----------------------|-----------------------|---------------------|---------------------|---------------------|--------------|----------------|----------------|---------------|
| Bandeja de papel de 250 hojas | C12C802761 | 129 € | C12C802791 | 155 € | C12C802791 | 155 € | C12C932811 | 129 € | C12C932811 | 129 € | |
| Bandeja de papel de 550 hojas | | | | | | | | | C12C802771 | 225 € | |
| Consumibles | S4 | S4 | S4 | S4 | S4 | S4 | S4 | S4 | S4 | S4 | |
| Estándar Capacidad Tóner Negro x 2 | C13S050710 | 5k 162,02 € | | | | | | | | | |
| Estándar Capacidad Tóner retornable x 2 | C13S050711 | 5k 140,56 € | | | | | | | | | |
| Estándar Capacidad Tóner Negro | C13S050709 | 2.5k 94,32 € | C13S050690 | 2.7k 94,50 € | C13S050690 | 2.7k 94,50 € | C13S050690 | 2.7k 94,50 € | C13S050698 | 12k 219,13 € | |
| Unidad de fijación | | C13S053049 | 100k 193,91 € | C13S053049 | 100k 193,91 € | C13S053049 | 100k 193,91 € | | | | |
| Alta Capacidad Tóner Negro | | C13S050689 | 10k 220,23 € | C13S050689 | 10k 220,23 € | C13S050689 | 10k 220,23 € | | C13S050697 | 23.7k 313,22 € | |
| Fotoconductor | | C13S051228 | 100k 63,26 € | C13S051228 | 100k 63,26 € | C13S051228 | 100k 63,26 € | | C13S051230 | 100k 63,26 € | |
| Alta Capacidad Tóner retornable | | C13S050691 | 10k 179,78 € | C13S050691 | 10k 179,78 € | C13S050691 | 10k 179,78 € | | C13S050699 | 23.7k 256,33 € | |
| Tóner Negro | | | | | | C13S110080 | 2.7k 94,35 € | C13S110080 | 2.7k 94,35 € | | |
| | | | | | | C13S110079 | 6.1k 133,03 € | C13S110079 | 6.1k 133,03 € | | |
| | | | | | | | | C13S110078 | 13.3k 239,11 € | | |
| Unidad de mantenimiento | | | | | | C13S110082 | 104,94 € | C13S110082 | 104,94 € | C13S053057 | 200k 182,92 € |
| CoverPlus | BA | BA | BA | BA | BA | BA | BA | BA | BA | BA | |
| 01 años de servicio CoverPlus in situ para AL-MX300 | | | CP010SSECD73 | 75 € | CP010SSECD73 | 75 € | | | | | |
| 03 años de servicio CoverPlus en laboratorio para WorkForce AL-M300/M310/M320 | | CP03RTBSCC64 | 50 € | | CP03RTBSCC64 | 50 € | CP03RTBSCC64 | 50 € | | | |
| 03 años de servicio CoverPlus en laboratorio para WorkForce AL-M400 | | | | | | | | | CP03RTBSCC65 | 81 € | |
| 03 años de servicio CoverPlus en laboratorio para WorkForce AL-MX300 | | | CP03RTBSCD73 | 108 € | CP03RTBSCD73 | 108 € | | | | | |
| 03 años de servicio CoverPlus en laboratorio para WorkForce M200 | CP03RTBSCC83 | 119,70 € | | | | | | | | | |
| 03 años de servicio CoverPlus in situ para AcuLaser M200DN | CP03OSSECC70 | 120 € | | | | | | | | | |
| 03 años de servicio CoverPlus in situ para WorkForce AL-M300/M310/M320 | | CP03OSSECC64 | 120 € | | CP03OSSECC64 | 120 € | CP03OSSECC64 | 120 € | | | |
| 03 años de servicio CoverPlus in situ para WorkForce AL-M400 | | | | | | | | | CP03OSSECC65 | 250 € | |
| 03 años de servicio CoverPlus in situ para WorkForce AL-MX300 | | | CP03OSSECD73 | 150 € | CP03OSSECD73 | 150 € | | | | | |

| | WorkForce AL-M200DW | WorkForce AL-M300DN | WorkForce AL-MX300DN | WorkForce AL-MX300DNF | WorkForce AL-M310DN | WorkForce AL-M320DN | WorkForce AL-M400DN |
|--|---------------------|---------------------|----------------------|-----------------------|---------------------|---------------------|-----------------------------|
| 04 años de servicio CoverPlus in situ para AcuLaser M200DN | CP04OSSECC70 | 192 € | | | | | |
| 04 años de servicio CoverPlus in situ para WorkForce AL-M300/M310/M320 | | CP04OSSECC64 | 150 € | | CP04OSSECC64 | 150 € | CP04OSSECC64 150 € |
| 04 años de servicio CoverPlus in situ para WorkForce AL-MX300 | | | CP04OSSECC73 | 250 € | CP04OSSECC73 | 250 € | |
| 05 años de servicio CoverPlus in situ para AcuLaser M200DN | CP05OSSECC70 | 288 € | | | | | |
| 05 años de servicio CoverPlus in situ para WorkForce AL-M300/M310/M320 | | CP05OSSECC64 | 200 € | | CP05OSSECC64 | 200 € | CP05OSSECC64 200 € |
| 05 años de servicio CoverPlus in situ para WorkForce AL-MX300 | | | CP05OSSECC73 | 330 € | CP05OSSECC73 | 330 € | |
| 4E años de ampliación de servicio CoverPlus in situ para AL-M300/M310/M320 | | CPE4OSSECC64 | 97,50 € | | CPE4OSSECC64 | 97,50 € | CPE4OSSECC64 97,50 € |
| 5E años de ampliación de servicio CoverPlus in situ para AL-M300/M310/M320 | | CP5EOSSECC64 | 130 € | | CP5EOSSECC64 | 130 € | CP5EOSSECC64 130 € |

WorkForce AL-M8100DN





Grupo de precios

B1



| | |
|------------------------------------|--|
| Formatos papel | A3 |
| Velocidad de impresión | 40 páginas/min. en monocromo a una sola cara, 28 páginas/min. en monocromo a doble cara |
| Tiempo de salida de primera página | Monocromo 9 segundos |
| Dúplex | Sí |
| Capacidad bandeja papel | 500 Hojas Estándar, 2.600 Hojas máximo, 750 Hojas fotográficas (WorkForce AL-M8100DN) 1.100 Hojas Estándar, 2.600 Hojas máximo |

| | | |
|--|-----------------------------|----------------|
| | WorkForce AL-M8100DN | |
| | (WorkForce AL-M8100DTN) | |
| Memoria | 1 GB incluido, 1 GB máximo | |
| Resolución de impresión | 1.200 x 1.200 ppp | |
| Emulaciones | PCL3, PCL5c, PCL6, PDF 1.7 | |
| | WorkForce AL-M8100DN | |
| | C11CE13401 | 1.479 € |
| | WorkForce AL-M8100DTN | |
| | C11CE13401BT | 1.859 € |
| Opciones | B1 | |
| Bandeja de papel de 500 hojas | C12C802811 | 410 € |
| Base de impresora | C12C932091 | 200 € |
| Face Up Tray | C12C817071 | 250 € |
| Consumibles | S4 | |
| Alta Capacidad Tóner Negro | C13S050762 | 21.7k 343,74 € |
| CoverPlus | BA | |
| 03 años de servicio CoverPlus en laboratorio para WorkForce AL-M8100DN | CP03RTBSCE13 | 297 € |
| 04 años de servicio CoverPlus in situ para WorkForce AL-M8100DN | CP04OSSECE13 | 660 € |







| Grupo de precios | WorkForce AL-C300N B1 | WorkForce AL-C300DN B1 | AcuLaser CX37DN B1 | WorkForce AL-C500DN B1 | AcuLaser C9300N B1 |
|------------------------------------|---|--|---|---|--|
| |  |  |  |  |  |
| Formatos papel | A4 | A4 | A4 | A4 | A3 |
| Velocidad de impresión | 31 páginas/min. en monocromo a una sola cara, 31 páginas/min. en color a una sola cara | 31 páginas/min. en monocromo a una sola cara, 15 páginas/min. en monocromo a doble cara, 31 páginas/min. en color a una sola cara, 15 páginas/min. en color a doble cara | 24 páginas/min. en monocromo a una sola cara, 24 páginas/min. en color a una sola cara | 45 páginas/min. en monocromo a una sola cara, 45 páginas/min. en monocromo a doble cara | 30 páginas/min. en monocromo a una sola cara, 30 páginas/min. en color a una sola cara |
| Tiempo de salida de primera página | Monocromo 12 segundos | Monocromo 12 segundos | Monocromo 16 segundos, Color 16 segundos | Monocromo 7 segundos, Color 8 segundos | Monocromo 8 segundos, Color 10 segundos |
| Dúplex | NO | Sí | Sí | Sí | opcional |
| Capacidad bandeja papel | 250 Hojas Estándar, 850 Hojas máximo (WorkForce AL-C300N) 850 Hojas Estándar, 850 Hojas máximo (WorkForce AL-C300TN) | 250 Hojas Estándar, 850 Hojas máximo (WorkForce AL-C300DN) 850 Hojas Estándar, 850 Hojas máximo (WorkForce AL-C300DTN) | 200 Hojas Estándar, 850 Hojas máximo (AcuLaser CX37DN) 750 Hojas Estándar, 750 Hojas máximo (AcuLaser CX37DTN) | 550 Hojas Estándar, 2.900 Hojas máximo (WorkForce AL-C500DN) 1.250 Hojas Estándar, 2.900 Hojas máximo (WorkForce AL-C500DTN) 1.650 Hojas Estándar, 2.750 Hojas máximo (WorkForce AL-C500DHN) 2.750 Hojas Estándar, 2.750 Hojas máximo (WorkForce AL-C500DXN) | 250 Hojas Estándar, 2.055 Hojas máximo |
| Memoria | 1 GB incluido, 1 GB máximo | 1 GB incluido, 1 GB máximo | 256 MB incluido, 768 MB máximo | 512 MB incluido, 1 GB máximo | 256 MB incluido, 1 GB máximo |
| Resolución de impresión | 1.200 x 1.200 ppp | 1.200 x 1.200 ppp | 600 x 600 ppp | 4.800 RIT (mejorado 1.200 x 1.200 ppp) | 4.800 RIT (mejorado 1.200 x 1.200 ppp) |
| Emulaciones | PCL5c, PCL5e, PCL6, PostScript 3, PDF 1.7 | PCL5c, PCL5e, PCL6, PostScript 3, PDF 1.7 | PCL5c, PCL6, PDF 1.7 (opcional), Genuine Postscript 3™, XPS (opcional) | PCL5c, PCL6, ESC/P2, ESC/Página, ESC/Página-Color, PostScript 3, PDF 1.6, FX, I239X | PCL5c, PCL6, ESC/P2, ESC/Página, ESC/Página-Color, PostScript 3, PDF 1.6, FX, I239X |
| | WorkForce AL-C300N C11CE09401 563,50 € | WorkForce AL-C300DN C11CE10401 693,50 € | AcuLaser CX37DN C11CB82011 864,25 € | WorkForce AL-C500DN C11CC12001 1.570 € | AcuLaser C9300N C11CB52011 1.877,50 € |
| | WorkForce AL-C300TN C11CE09401BW 753,50 € | WorkForce AL-C300DTN C11CE10401BW 883,50 € | AcuLaser CX37DTN C11CB82011BZ 1.045 € | WorkForce AL-C500DTN C11CC12001BZ 1.950 € | AcuLaser C9300DN C11CB52011BZ 2.129,50 € |
| | | | | WorkForce AL-C500DHN C11CC12001BV 2.320 € | AcuLaser C9300TN C11CB52011BV 2.254,50 € |

| | | | | |
|---------------------------|----------------------------|------------------------|-----------------------------|--------------------------------|
| WorkForce AL-C300N | WorkForce AL-C300DN | AcuLaser CX37DN | WorkForce AL-C500DN | AcuLaser C9300N |
| | | | WorkForce AL-C500DXN | AcuLaser C9300DTN |
| | | | C11CC12001BT 4.585 € | C11CB52011BT 2.504,50 € |
| | | | | AcuLaser C9300D2TN |
| | | | | C11CB52011BR 2.883,50 € |
| | | | | AcuLaser C9300D3TNC |
| | | | | C11CB52011BP 3.459,50 € |

| Opciones | B1 | | B1 | | B1 | | B1 | | B1 | |
|--------------------------------------|------------|----------------|------------|----------------|------------|---------------|------------|----------------|------------|---------------|
| Ampliación de memoria de 1 GB | | | | | | | 7106922 | | | 300 € |
| Ampliación de memoria de 128 MB | | | | | | | 7106919 | | | 90 € |
| Ampliación de memoria de 256 MB | | | | | | | 7106920 | | | 140 € |
| Ampliación de memoria de 512 MB | | | | | | | 7106921 | | | 200 € |
| Bandeja de papel de 1100 hojas | | | | | | | C12C802731 | | | 799,67 € |
| Bandeja de papel de 500 hojas | C12C802651 | 250,86 € | C12C802651 | 250,86 € | C12C802651 | 250,86 € | | | | |
| Bandeja de papel de 550 hojas | | | | | | | C12C802721 | 390,08 € | C12C802601 | 408,55 € |
| Base de impresora | | | | | | | | | C12C847181 | 201,71 € |
| Disco duro de 40 GB | | | | | C12C824511 | 496,61 € | | | | |
| Grapadora/apiladora de 1000 hojas | | | | | | | C12C802741 | 1.716,36 € | | |
| RAM de 512 MB | | | | | 7106195 | 276,47 € | | | | |
| Tarjeta de interfaz paralelo | | | | | | | C12C824521 | 151,54 € | C12C824521 | 151,54 € |
| Unidad dúplex | | | | | | | | | C12C802812 | 314,35 € |
| Consumibles | S4 | | S4 | | S4 | | S4 | | S4 | |
| Compartimento para el tóner residual | C13S050595 | 22,19 € | C13S050595 | 22,19 € | C13S050595 | 22,19 € | C13S050664 | 25k 23,21 € | C13S050610 | 24k 20,85 € |
| Fotoconductor Negro | C13S051204 | 30k 137,14 € | C13S051204 | 30k 137,14 € | C13S051204 | 30k 137,14 € | C13S051227 | 50k 87,12 € | C13S051210 | 24k 111,16 € |
| Fotoconductor Cian | C13S051203 | 30k 137,14 € | C13S051203 | 30k 137,14 € | C13S051203 | 30k 137,14 € | C13S051226 | 50k 87,12 € | | |
| Fotoconductor Magenta | C13S051202 | 30k 137,14 € | C13S051202 | 30k 137,14 € | C13S051202 | 30k 137,14 € | C13S051225 | 50k 87,12 € | | |
| Fotoconductor Amarillo | C13S051201 | 30k 137,14 € | C13S051201 | 30k 137,14 € | C13S051201 | 30k 137,14 € | C13S051224 | 50k 87,12 € | | |
| Estándar Capacidad Tóner Negro x 2 | C13S050751 | 14.6k 234,44 € | C13S050751 | 14.6k 234,44 € | | | | | | |
| Estándar Capacidad Tóner Negro | C13S050750 | 7.3k 164,12 € | C13S050750 | 7.3k 164,12 € | C13S050593 | 6k 134,91 € | C13S050663 | 10.5k 195,25 € | C13S050605 | 6.5k 121,58 € |
| Estándar Capacidad Tóner Cian | C13S050749 | 8.8k 293,85 € | C13S050749 | 8.8k 293,85 € | C13S050592 | 6k 200,31 € | C13S050662 | 7.5k 261,34 € | C13S050604 | 7.5k 244,12 € |
| Estándar Capacidad Tóner Magenta | C13S050748 | 8.8k 293,85 € | C13S050748 | 8.8k 293,85 € | C13S050591 | 6k 200,31 € | C13S050661 | 7.5k 261,34 € | C13S050603 | 7.5k 244,12 € |
| Estándar Capacidad Tóner Amarillo | C13S050747 | 8.8k 293,85 € | C13S050747 | 8.8k 293,85 € | C13S050590 | 6k 200,31 € | C13S050660 | 7.5k 261,34 € | C13S050602 | 7.5k 244,12 € |
| Unidad de fijación | C13S053061 | 100k 180,45 € | C13S053061 | 100k 180,45 € | C13S053041 | 100k 180,45 € | C13S053046 | 100k 144,08 € | | |

| | WorkForce AL-C300N | WorkForce AL-C300DN | AcuLaser CX37DN | WorkForce AL-C500DN | AcuLaser C9300N |
|---|---------------------------|---------------------------|--------------------------------|----------------------------------|--------------------------------|
| Alta Capacidad Tóner Negro x 2 | | | C13S050594 12k 192,73 € | | C13S050609 13k 179,47 € |
| Alta Capacidad Tóner Negro | | | | C13S050659 18.3k 242,95 € | |
| Alta Capacidad Tóner Cian | | | | C13S050658 13.7k 340,99 € | |
| Alta Capacidad Tóner Magenta | | | | C13S050657 13.7k 340,99 € | |
| Alta Capacidad Tóner Amarillo | | | | C13S050656 13.7k 340,99 € | |
| Banda de transferencia | | | | C13S053048 150k 235,14 € | |
| Cartucho de grapas 3x5K | | | | C13S904002 15k 149,46 € | |
| Alta Capacidad Tóner Cian x 2 | | | | | C13S050608 15k 358,76 € |
| Alta Capacidad Tóner Magenta x 2 | | | | | C13S050607 15k 358,76 € |
| Alta Capacidad Tóner Amarillo x 2 | | | | | C13S050606 15k 358,76 € |
| Fotoconductor | | | | | C13S051209 24k 111,16 € |
| CoverPlus | BA | BA | BA | BA | BA |
| 03 años de servicio CoverPlus en laboratorio para AcuLaser C2900/CX37 | | | CP03RTBSCB82 225 € | | |
| 03 años de servicio CoverPlus en laboratorio para WorkForce AL-C300 | CP03RTBSCE10 60 € | CP03RTBSCE10 60 € | | | |
| 03 años de servicio CoverPlus en laboratorio para WorkForce AL-C500 | | | | CP03RTBSCE10 126 € | |
| 03 años de servicio CoverPlus in situ para AcuLaser C2900/CX37 | | | CP03OSSECB82 330 € | | |
| 03 años de servicio CoverPlus in situ para AcuLaser C9300 | | | | | CP03OSSECB52 1.280 € |
| 03 años de servicio CoverPlus in situ para WorkForce AL-C300N | CP03OSSECE09 250 € | CP03OSSECE09 250 € | | | |
| 03 años de servicio CoverPlus in situ para WorkForce AL-C500 | | | | CP03OSSECC12 410 € | |
| 04 años de servicio CoverPlus in situ para AcuLaser C2900/CX37 | | | CP04OSSECB82 410 € | | |
| 04 años de servicio CoverPlus in situ para WorkForce AL-C300N | CP04OSSECE09 410 € | CP04OSSECE09 410 € | | | |
| 05 años de servicio CoverPlus in situ para AcuLaser C2900/CX37 | | | CP05OSSECB82 600 € | | |
| 05 años de servicio CoverPlus in situ para WorkForce AL- | CP05OSSECE09 600 € | CP05OSSECE09 600 € | | | |

| | WorkForce AL-C300N | WorkForce AL-C300DN | AcuLaser CX37DN | WorkForce AL-C500DN | AcuLaser C9300N |
|--|--------------------|---------------------|-----------------|---------------------|-----------------|
| C300N | | | | | |
| 4E años de ampliación de servicio CoverPlus in situ para AL-C500 | | | | CP4EOSSECC12 | 600 € |
| 5E años de ampliación de servicio CoverPlus in situ para AL-C500 | | | | CP5EOSSECC12 | 770 € |

| Grupo de precios | WorkForce DS-30 | WorkForce DS-310 | WorkForce DS-360W | WorkForce DS-410 | WorkForce DS-530 | WorkForce DS-570W | WorkForce DS-770 |
|--------------------------------------|---|--|--|---|--|--|--|
| | B4 | B4 | B4 | B4 | BM | BM | BM |
| |  |  |  |  |  |  |  |
| Formatos papel | A4 | A4 | A4 | A4 | A4 | A4 | A4 |
| Fuente luminosa | Tecnología ReadyScan LED | RGB LED | RGB LED | Tecnología ReadyScan LED | Tecnología ReadyScan LED | Tecnología ReadyScan LED | Tecnología ReadyScan LED |
| Tipo de escáner | Escáner portátil, Escáner con alimentación automática | Escáner portátil | Escáner portátil | Escáner con alimentación automática | Escáner con alimentación automática | Escáner con alimentación automática | Escáner con alimentación automática |
| Velocidad de escaneado | Monocromo: 13 s/página - Color: 13 s/página medido con tamaño: A4 , resolución: 200 / 300 ppp | Monocromo: 25 páginas/minuto - Color: 25 páginas/minuto medido con tamaño: A4 , resolución: 200 / 300 ppp | Monocromo: 25 páginas/minuto - Color: 25 páginas/minuto medido con tamaño: A4 , resolución: 200 / 300 ppp | Monocromo: 26 páginas/minuto - Color: 26 páginas/minuto medido con tamaño: A4 , resolución: 200 / 300 ppp | Monocromo: 35 páginas/minuto - Color: 35 páginas/minuto medido con tamaño: A4 , resolución: 200 / 300 ppp | Monocromo: 35 páginas/minuto - Color: 35 páginas/minuto medido con tamaño: A4 , resolución: 200 / 300 ppp | Monocromo: 45 páginas/minuto - Color: 45 páginas/minuto medido con tamaño: A4 , resolución: 200 / 300 ppp |
| Alimentador automático de documentos | NO | 20 páginas | 20 páginas | 50 páginas | 50 páginas | 50 páginas | 100 páginas |
| Peso del papel ADF | Carga automática: 35 - 270 g/m ² | Carga automática: 52 - 230 g/m ² | Carga automática: 52 - 230 g/m ² , Carga manual: 52 - 230 g/m ² | Carga automática: 50 - 209 g/m ² , Carga manual: 50 - 209 g/m ² | Carga automática: 27 - 413 g/m ² | Carga automática: 27 - 413 g/m ² | Carga automática: 27 - 413 g/m ² |
| Resolución de escaneado | 600 ppp (horizontal x vertical) | 1.200 ppp x 1.200 ppp (horizontal x vertical) | 1.200 ppp x 1.200 ppp (horizontal x vertical) | 50 ppp x 1.200 ppp (horizontal x vertical) | 600 ppp x 600 ppp (horizontal x vertical) | 600 ppp x 600 ppp (horizontal x vertical) | 600 ppp x 600 ppp (horizontal x vertical) |
| Interfaces | USB | USB | USB, Wi-Fi, Wi-Fi Direct | USB | USB | Wi-Fi, Wi-Fi Direct | USB |
| Software incluido | ABBYY FineReader® Sprint 9.0 (Windows), Epson Document Capture Pro (sólo Windows), Presto! BizCard 5 SE | Epson Document Capture (sólo Mac), Epson Document Capture Pro (sólo Windows), Epson Scan 2, Newsoft Presto BizCard 6.6 | Epson Document Capture (sólo Mac), Epson Document Capture Pro (sólo Windows), Epson Scan 2, Newsoft Presto BizCard 6.6 | Document Capture Pro 2.0, Epson Scan 2 | Epson Document Capture (sólo Mac), Epson Document Capture Pro (sólo Windows), Epson Document Capture Pro Server (en descarga gratuita), Epson Scan 2, Newsoft Presto BizCard 5.6 | Epson Document Capture (sólo Mac), Epson Document Capture Pro (sólo Windows), Epson Document Capture Pro Server (en descarga gratuita), Epson Scan 2, Newsoft Presto BizCard 5.6 | Epson Document Capture (sólo Mac), Epson Document Capture Pro (sólo Windows), Epson Document Capture Pro Server (en descarga gratuita), Epson Scan 2 |
| Pantalla LCD | NO | NO | NO | NO | NO | NO | NO |
| PVPR neto | B11B206301 | 123,50 € B11B241401 | 229 € B11B242401 | 299 € B11B249401 | 379 € B11B226401 | 499 € B11B228401 | 549 € B11B248401 |
| | | | | | | | 579 € |
| | | | | | | | 649 € |

NOVEDAD

Escáneres - Alimentación de hojas profesional

TARIFA DE PRECIOS

| | WorkForce DS-30 | WorkForce DS-310 | WorkForce DS-360W | WorkForce DS-410 | WorkForce DS-530 | WorkForce DS-570W | WorkForce DS-770 |
|---|-----------------|--------------------|--------------------|--------------------|------------------|-------------------|-----------------------------------|
| Opciones | B4 | B4 | B4 | B4 | B4 | B4 | B4 |
| Carrier Sheet 5 sheets | | | | | B12B819051 | 45 € | B12B819051 45 € B12B819051 45 € |
| Cleaning Kit | B12B819291 | 35 € | | | B12B819291 | 35 € | B12B819291 35 € B12B819291 35 € |
| Flatbed Scanner Conversion Kit | | | | | B12B819011FC | 169 € | B12B819011FC 169 € |
| Hoja guía x 5 | | | | B12B813431 | 30 € | | |
| Interfaz de red | | | | | B12B808451 | 299 € | B12B808451 299 € B12B808451 299 € |
| Kit de accesorios para Workforce DS-30 | B12B818291 | 9,99 € | | | | | |
| Kit de conjunto del rodillo | | | | | B12B819031 | 49 € | B12B819031 49 € B12B819031 49 € |
| Pick Up Roller | | B12B819251 19,99 € | B12B819251 19,99 € | | | | |
| Roller Assembly Kit | | | | B12B819381 | 25 € | | |
| Separation Pad | | B12B819271 14,99 € | B12B819271 14,99 € | | | | |
| CoverPlus | BA | BA | BA | BA | BA | BA | BA |
| 01 años de servicio CoverPlus in situ para DS-310 | | CP01OSSEB241 | 69 € | | | | |
| 01 años de servicio CoverPlus in situ para DS-360W | | | CP01OSSEB242 | 69 € | | | |
| 03 años de servicio CoverPlus en laboratorio para DS-530 | | | | | CP03RTBSB226 | 90 € | |
| 03 años de servicio CoverPlus en laboratorio para DS-570W | | | | | | CP03RTBSB228 | 90 € |
| 03 años de servicio CoverPlus en laboratorio para WorkForce DS-30 | CP03RTBSB206 | 63 € | | | | | |
| 03 años de servicio CoverPlus en laboratorio para WorkForce DS-310 | | CP03RTBSB241 | 81 € | | | | |
| 03 años de servicio CoverPlus en laboratorio para WorkForce DS-360W | | | CP03RTBSB242 | 81 € | | | |
| 03 años de servicio CoverPlus en laboratorio para WorkForce DS-410 | | | | CP03RTBSB249 | 81 € | | |
| 03 años de servicio CoverPlus en laboratorio para WorkForce DS-770 | | | | | | | CP03RTBSB248 81 € |
| 03 años de servicio CoverPlus in situ para DS-310 | | CP03OSSEB241 138 € | CP03OSSWB241 138 € | | | | |
| 03 años de servicio CoverPlus in situ para DS-360W | | | CP03OSSEB242 138 € | CP03OSSWB242 138 € | | | |
| 03 años de servicio CoverPlus in situ para DS-410 | | | | CP03OSSWB249 | 138 € | | |
| 03 años de servicio CoverPlus | | | | | CP03OSSWB226 | 138 € | |

Escáneres - Alimentación de hojas profesional

TARIFA DE PRECIOS

| | WorkForce DS-30 | WorkForce DS-310 | WorkForce DS-360W | WorkForce DS-410 | WorkForce DS-530 | WorkForce DS-570W | WorkForce DS-770 |
|---|-----------------|--|-------------------|------------------|------------------|-------------------|--|
| in situ para WorkForce DS-530 | | | | | | | |
| 03 años de servicio CoverPlus in situ para WorkForce DS-570W | | | | | | CP03OSSWB228 | 138 € |
| 03 años de servicio CoverPlus in situ para WorkForce DS-770 | | | | | | | CP03OSSEB248 138 € CP03OSSWB248 138 € |
| 04 años de servicio CoverPlus en laboratorio para DS-530 | | | | | CP04RTBSB226 | | 144 € |
| 04 años de servicio CoverPlus en laboratorio para DS-570W | | | | | | CP04RTBSB228 | 144 € |
| 04 años de servicio CoverPlus en laboratorio para WorkForce DS-310 | | CP04RTBSB241 | 125 € | | | | |
| 04 años de servicio CoverPlus en laboratorio para WorkForce DS-360W | | | | CP04RTBSB242 | 125 € | | |
| 04 años de servicio CoverPlus en laboratorio para WorkForce DS-410 | | | | | CP04RTBSB249 | 125 € | |
| 04 años de servicio CoverPlus en laboratorio para WorkForce DS-770 | | | | | | | CP04RTBSB248 125 € |
| 04 años de servicio CoverPlus in situ para DS-310 | | CP04OSSEB241 180 € CP04OSSWB241 180 € | 180 € | | | | |
| 04 años de servicio CoverPlus in situ para DS-360W | | | | CP04OSSEB242 | 180 € | | |
| 04 años de servicio CoverPlus in situ para DS-410 | | | | | CP04OSSWB249 | 180 € | |
| 04 años de servicio CoverPlus in situ para WorkForce DS-530 | | | | | CP04OSSWB226 | 180 € | |
| 04 años de servicio CoverPlus in situ para WorkForce DS-570W | | | | | | CP04OSSWB228 | 180 € |
| 04 años de servicio CoverPlus in situ para WorkForce DS-770 | | | | | | | CP04OSSEB248 180 € CP04OSSWB248 180 € |
| 05 años de servicio CoverPlus en laboratorio para DS-530 | | | | | CP05RTBSB226 | 216 € | |
| 05 años de servicio CoverPlus en laboratorio para DS-570W | | | | | | CP05RTBSB228 | 216 € |
| 05 años de servicio CoverPlus en laboratorio para WorkForce DS-310 | | CP05RTBSB241 | 170 € | | | | |
| 05 años de servicio CoverPlus en laboratorio para WorkForce DS-360W | | | | CP05RTBSB242 | 170 € | | |
| 05 años de servicio CoverPlus | | | | | CP05RTBSB249 | 170 € | |

| | WorkForce DS-30 | WorkForce DS-310 | WorkForce DS-360W | WorkForce DS-410 | WorkForce DS-530 | WorkForce DS-570W | WorkForce DS-770 |
|--|-----------------|------------------------------|------------------------------|------------------------------|------------------|-------------------|---------------------------|
| en laboratorio para WorkForce DS-410 | | | | | | | |
| 05 años de servicio CoverPlus en laboratorio para WorkForce DS-770 | | | | | | | CP05RTBSB248 170 € |
| 05 años de servicio CoverPlus in situ para DS-310 | | CP05OSSEB241 CP05OSSWB241 | 225 € 225 € | | | | |
| 05 años de servicio CoverPlus in situ para DS-360W | | | CP05OSSEB242 CP05OSSWB242 | 225 € 225 € | | | |
| 05 años de servicio CoverPlus in situ para DS-410 | | | | CP05OSSWB249 | 225 € | | |
| 05 años de servicio CoverPlus in situ para WorkForce DS-530 | | | | | CP05OSSWB226 | 225 € | |
| 05 años de servicio CoverPlus in situ para WorkForce DS-570W | | | | | | CP05OSSWB228 | 225 € |
| 05 años de servicio CoverPlus in situ para WorkForce DS-770 | | | | | | | CP05OSSEB248 225 € |







| Grupo de precios | WorkForce DS-780N | WorkForce DS-860 |
|------------------|-------------------|------------------|
| | BM | BM |



| | | |
|--------------------------------------|---|---|
| Formatos papel | A4 | A4 |
| Fuente luminosa | Tecnología ReadyScan LED | Tecnología ReadyScan LED |
| Tipo de escáner | Escáner con alimentación automática | Escáner con alimentación automática |
| Velocidad de escaneado | Monocromo: 45 páginas/ minuto - Color: 45 páginas/ minuto medido con tamaño: A4 , resolución: 200 / 300 ppp | Monocromo: 65 páginas/ minuto - Color: 65 páginas/ minuto , resolución: 200 / 300 ppp |
| Alimentador automático de documentos | 100 páginas | NO |
| Peso del papel ADF | Carga automática: 27 - 413 g/ | Carga automática: 40 - 210 g/ |



| | WorkForce DS-780N | WorkForce DS-860 | |
|---|---|---|---------------------------|
| | m² | m², Carga manual:40 - 210 g/ m² | |
| Resolución de escaneado | 600 ppp x 600 ppp (horizontal x vertical) | 600 ppp x 600 ppp (horizontal x vertical) | |
| Interfaces | USB, Ethernet | USB, Ethernet (Opcional) | |
| Software incluido | Document Capture Pro 2.0, Document Capture Pro Server 2.0, Document Capture Pro Server 2.0 Authentication Edition, Epson Scan 2 | Epson Document Capture Pro (sólo Windows), Epson Document Capture Pro Server (en descarga gratuita), Epson Scan | |
| Pantalla LCD | Panel de interfaz de red Epson | Unidad de interfaz de red opcional Epson | |
| PVPR neto | B11B227401 | 729 € | B11B222401 649 € |
| | | N | |
| | | B11B222401BT | 799 € |
| Opciones | B4 | B4 | |
| Carrier Sheet 5 sheets | B12B819051 | 45 € | |
| Cleaning Kit | B12B819291 | 35 € | B12B819291 35 € |
| Hoja guía x 5 | | | B12B813431 30 € |
| Interfaz de red | | | B12B808451 299 € |
| Kit de conjunto del rodillo | B12B819031 | 49 € | B12B813581 40 € |
| CoverPlus | BA | BA | |
| 03 años de servicio CoverPlus en laboratorio para WorkForce DS-780N | CP03RTBSB227 | 81 € | |
| 03 años de servicio CoverPlus en laboratorio para WorkForce DS-860 | | | CP03RTBSB222 108 € |
| 03 años de servicio CoverPlus in situ para DS-780N | CP03OSSEB227 CP03OSSWB227 | 138 € 138 € | |
| 03 años de servicio CoverPlus in situ para WorkForce DS-860 | | | CP03OSSEB222 183 € |
| 04 años de servicio CoverPlus en laboratorio para WorkForce DS-780N | CP04RTBSB227 | 125 € | |
| 04 años de servicio CoverPlus in situ para DS-780N | CP04OSSEB227 CP04OSSWB227 | 180 € 180 € | |
| 04 años de servicio CoverPlus in situ para WorkForce DS-860 | | | CP04OSSWB222 240 € |
| 05 años de servicio CoverPlus en laboratorio para WorkForce DS-780N | CP05RTBSB227 | 170 € | |

| | WorkForce DS-780N | WorkForce DS-860 |
|---|------------------------------|--------------------|
| 05 años de servicio CoverPlus in situ para DS-780N | CP05OSSER227 CP05OSSWB227 | 225 € 225 € |
| 05 años de servicio CoverPlus in situ para WorkForce DS-860 | | CP05OSSWB222 300 € |







| Grupo de precios | WorkForce DS-1630 | WorkForce DS-1660W | WorkForce DS-5500 | WorkForce DS-6500 | WorkForce DS-7500 | Expression 12000XL | WorkForce DS-5000 |
|--------------------------------------|--|--|--|---|---|---|---|
| | B4 | B4 | BM | BM | BM | BM | BM |
| |  |  |  |  |  |  |  |
| Formatos papel | A4 | A4 | A4 | A4 | A4 | A3 | A3 |
| Fuente luminosa | Tecnología ReadyScan LED | RGB LED | Tecnología ReadyScan LED | Tecnología ReadyScan LED | Tecnología ReadyScan LED | Tecnología ReadyScan LED | Tecnología ReadyScan LED |
| Tipo de escáner | Escáner plano | Escáner plano | Escáner plano | Escáner plano, Escáner con alimentación automática | Escáner plano, Escáner con alimentación automática | Escáner gráfico | Escáner plano |
| Velocidad de escaneado | Monocromo: 25 páginas/minuto medido con tamaño: A4 , resolución: 200 / 300 ppp | Monocromo: 25 páginas/minuto medido con tamaño: A4 , resolución: 200 / 300 ppp | Monocromo: 8 s/página - Color: 8 s/página medido con tamaño: A4 , resolución: 200 / 300 ppp | Monocromo: 25 páginas/minuto medido con tamaño: A4 , resolución: 200 / 300 ppp | Monocromo: 40 páginas/minuto medido con tamaño: A4 , resolución: 200 / 300 ppp | Monocromo: 12 s/página - Color: 12 s/página medido con tamaño: A4 , resolución: 300 ppp | Monocromo: 4 s/página - Color: 4 s/página medido con tamaño: A3 , resolución: 200 / 300 ppp |
| Alimentador automático de documentos | NO | NO | NO | 100 páginas | 100 páginas | NO | NO |
| Peso del papel ADF | Carga automática: 50 - 120 g/m² | Carga automática: 50 - 120 g/m² | | Carga automática: 50 - 128 g/m² | Carga automática: 50 - 128 g/m² | | |
| Resolución de escaneado | 1.200 ppp x 1.200 ppp (horizontal x vertical) | 1.200 ppp x 1.200 ppp (horizontal x vertical) | 1.200 ppp x 1.200 ppp (horizontal x vertical) | 1.200 ppp x 1.200 ppp (horizontal x vertical) | 1.200 ppp x 1.200 ppp (horizontal x vertical) | 2.400 ppp x 4.800 ppp (horizontal x vertical) | 600 ppp x 600 ppp (horizontal x vertical) |
| Interfaces | USB | USB, Wi-Fi, Wi-Fi Direct | USB | USB | USB | USB | USB |
| Software incluido | Epson Document Capture (sólo Mac), Epson Document Capture Pro (sólo Windows), Epson Document Capture Pro Server (en descarga gratuita), Epson Scan 2 | Epson Document Capture (sólo Mac), Epson Document Capture Pro (sólo Windows), Epson Document Capture Pro Server (en descarga gratuita), Epson Scan 2 | ABBYY FineReader® Sprint 8.0 (MacOS), ABBYY FineReader® Sprint 9.0 (Windows), Epson Document Capture Pro (sólo Windows), Epson Document Capture Pro Server (en descarga gratuita), Epson Event Manager (solo Mac), Epson Scan, EpsonNet Config | ABBYY FineReader® Sprint 8.0 (MacOS), ABBYY FineReader® Sprint 9.0 (Windows), Epson Document Capture Pro (sólo Windows), Epson Document Capture Pro Server (en descarga gratuita), Epson Scan | ABBYY FineReader® Sprint 8.0 (MacOS), ABBYY FineReader® Sprint 9.0 (Windows), Epson Document Capture Pro (sólo Windows), Epson Document Capture Pro Server (en descarga gratuita), Epson Scan | Epson Scan 2, SilverFast Ai ver.8.8 | ABBYY FineReader® Sprint 8.0 (MacOS), ABBYY FineReader® Sprint 9.0 (Windows), Epson Document Capture Pro (sólo Windows), Epson Document Capture Pro Server (en descarga gratuita), Epson Event Manager (solo Mac), Epson Scan |
| Pantalla LCD | NO | NO | Panel de interfaz de red opcional | Panel de interfaz de red opcional | Panel de interfaz de red opcional | NO | Panel de interfaz de red opcional |
| PVPR neto | B11B239401 273,50 € | B11B244401 303,50 € | B11B205131 503,50 € | B11B205231 899 € | B11B205331 1.149 € | B11B240401 3.403,50 € | B11B204131 1.499 € |
| | | | N B11B205131BT 753,50 € | N B11B205231BT 1.049 € | N B11B205331BT 1.349 € | Pro B11B240401BT 4.003,50 € | N B11B204131BT 1.749 € |
| Opciones | B4 | B4 | B4 | B4 | B4 | B4 | B4 |
| Cleaning Kit | | | B12B819291 35 € | B12B819291 35 € | B12B819291 35 € | | B12B819291 35 € |
| Interfaz de red | B12B80451 299 € | B12B80451 299 € | | | | | |
| Kit de conjunto del rodillo | | | | B12B813481 49 € | B12B813481 49 € | | |
| Panel de interfaz de red | | | B12B808411 299 € | B12B808411 299 € | B12B808411 299 € | | B12B808411 299 € |

| | WorkForce DS-1630 | WorkForce DS-1660W | WorkForce DS-5500 | WorkForce DS-6500 | WorkForce DS-7500 | Expression 12000XL | WorkForce DS-5000 |
|---|-------------------|--------------------|-------------------|-------------------|-------------------|------------------------------|-----------------------|
| Transparency unit | | | | | | B12B819221 | 900 € |
| CoverPlus | BA | BA | BA | BA | BA | BA | BA |
| 03 años de servicio CoverPlus en laboratorio para DS-1630 | CP03RTBSB239 | 63 € | | | | | |
| 03 años de servicio CoverPlus en laboratorio para DS-1660W | | CP03RTBSB244 | 63 € | | | | |
| 03 años de servicio CoverPlus en laboratorio para Expression 12000XL | | | | | | CP03RTBSB240 | 325 € |
| 03 años de servicio CoverPlus en laboratorio para WorkForce DS-5000/6000/7000 | | | | | | | CP03RTBSB204 133 € |
| 03 años de servicio CoverPlus en laboratorio para WorkForce DS-5500/6500/7500 | | | CP03RTBSB205 | 63 € | CP03RTBSB205 | 63 € | CP03RTBSB205 63 € |
| 03 años de servicio CoverPlus in situ para Expression 12000XL | | | | | | CP03OSSEB240 CP03OSSWB240 | 540 € 540 € |
| 03 años de servicio CoverPlus in situ para WF DS-1630 | CP03OSSWB239 | 96,60 € | | | | | |
| | CP03OSSEB239 | 96,60 € | | | | | |
| 03 años de servicio CoverPlus in situ para WorkForce DS-1660W | | CP03OSSWB244 | 96,60 € | | | | |
| 03 años de servicio CoverPlus in situ para WorkForce DS-5000/6000/7000 | | | | | | | CP03OSSEB204 225 € |
| 03 años de servicio CoverPlus in situ para WorkForce DS-5500/6500/7500 | | | CP03OSSEB205 | 106 € | CP03OSSEB205 | 106 € | CP03OSSEB205 106 € |
| 04 años de servicio CoverPlus en laboratorio para DS-1630 | CP04RTBSB239 | 100,80 € | | | | | |
| 04 años de servicio CoverPlus en laboratorio para DS-1660W | CP04RTBSB244 | 100,80 € | | | | | |
| 04 años de servicio CoverPlus in situ para Expression 12000XL | | | | | | CP04OSSWB240 | 1.200 € |
| 04 años de servicio CoverPlus in situ para WF DS-1630 | CP04OSSEB239 | 126 € | | | | | |
| 04 años de servicio CoverPlus in situ para WorkForce DS-1630 | CP04OSSWB239 | 126 € | | | | | |
| 04 años de servicio CoverPlus in situ para WorkForce DS-1660W | | CP04OSSWB244 | 126 € | | | | |
| 04 años de servicio CoverPlus in situ para WorkForce DS-5500/6500/7500 | | | CP04OSSWB205 | 109,20 € | CP04OSSWB205 | 109,20 € | CP04OSSWB205 109,20 € |







| | WorkForce DS-1630 | WorkForce DS-1660W | WorkForce DS-5500 | WorkForce DS-6500 | WorkForce DS-7500 | Expression 12000XL | WorkForce DS-50000 |
|--|-------------------|--------------------|-------------------|-------------------|-------------------|--------------------|------------------------------|
| 05 años de servicio CoverPlus en laboratorio para DS-1630 | CP05RTBSB239 | 151,20 € | | | | | |
| 05 años de servicio CoverPlus en laboratorio para DS-1660W | | CP05RTBSB244 | 151,20 € | | | | |
| 05 años de servicio CoverPlus in situ para Expression 12000XL | | | | | | CP05OSSWB240 | 1.500 € |
| 05 años de servicio CoverPlus in situ para WF DS-1630 | CP05OSSEB239 | 157,50 € | | | | | |
| 05 años de servicio CoverPlus in situ para WF DS-50000/60000/70000 | | | | | | | CP05OSSEB204 480 € |
| 05 años de servicio CoverPlus in situ para WorkForce DS-1630 | CP05OSSWB239 | 157,50 € | | | | | |
| 05 años de servicio CoverPlus in situ para WorkForce DS-1660W | | CP05OSSWB244 | 157,50 € | | | | |
| 05 años de servicio CoverPlus in situ para WorkForce DS-5500/6500/7500 | | | CP05OSSWB205 | 148,20 € | CP05OSSWB205 | 148,20 € | CP05OSSWB205 148,20 € |

| Grupo de precios | WorkForce DS-60000 | WorkForce DS-70000 |
|--------------------------------------|---|---|
| | BM | BM |
| |  |  |
| Formatos papel | A3 | A3 |
| Fuente luminosa | Tecnología ReadyScan LED | Tecnología ReadyScan LED |
| Tipo de escáner | Escáner plano, Escáner con alimentación automática | Escáner plano, Escáner con alimentación automática |
| Velocidad de escaneado | Monocromo: 40 páginas/ minuto - Color: 40 páginas/ minuto medido con tamaño: A4 , resolución: 200 / 300 ppp | Monocromo: 70 páginas/ minuto - Color: 70 páginas/ minuto medido con tamaño: A4 , resolución: 200 / 300 ppp |
| Alimentador automático de documentos | 200 páginas | 200 páginas |
| Peso del papel ADF | Carga automática: 35 - 128 g/ m² | Carga automática: 35 - 128 g/ m² |
| Resolución de escaneado | 600 ppp x 600 ppp (horizontal x vertical) | 600 ppp x 600 ppp (horizontal x vertical) |
| Interfaces | USB | USB, Ethernet (Opcional) |

| | WorkForce DS-60000 | | WorkForce DS-70000 | |
|--|--|----------------|--|----------------|
| Software incluido | ABBYY FineReader® Sprint 8.0 (MacOS), ABBYY FineReader® Sprint 9.0 (Windows), Epson Document Capture Pro (sólo Windows), Epson Document Capture Pro Server (en descarga gratuita), Epson Event Manager (solo Mac), Epson Scan, EpsonNet Config | | ABBYY FineReader® Sprint 8.0 (MacOS), ABBYY FineReader® Sprint 9.0 (Windows), Epson Document Capture Pro (sólo Windows), Epson Document Capture Pro Server (en descarga gratuita), Epson Event Manager (solo Mac), Epson Scan, EpsonNet Config | |
| Pantalla LCD | Panel de interfaz de red opcional | | Panel de interfaz de red opcional | |
| PVPR neto | B11B204231 | 2.899 € | B11B204331 | 3.699 € |
| | N | | N | |
| | B11B204231BT | 3.149 € | B11B204331BT | 3.949 € |
| Opciones | B4 | | B4 | |
| Cleaning Kit | B12B819291 | 35 € | B12B819291 | 35 € |
| Kit de conjunto del rodillo | B12B813501 | 49 € | B12B813501 | 49 € |
| Panel de interfaz de red | B12B808411 | 299 € | B12B808411 | 299 € |
| CoverPlus | BA | | BA | |
| 03 años de servicio CoverPlus en laboratorio para WorkForce DS-50000/60000/70000 | CP03RTBSB204 | 133 € | CP03RTBSB204 | 133 € |
| 03 años de servicio CoverPlus in situ para WorkForce DS-50000/60000/70000 | CP03OSSEB204 | 225 € | CP03OSSEB204 | 225 € |
| 05 años de servicio CoverPlus in situ para WF DS-50000/60000/70000 | CP05OSSEB204 | 480 € | CP05OSSEB204 | 480 € |

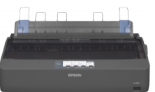





| Grupo de precios | Perfection V39 | Perfection V370 Photo | Perfection V550 Photo | Perfection V600 Photo | Perfection V800 Photo | Perfection V850 Pro |
|---|---|---|---|---|--|---|
| | C3 | C3 | C3 | C3 | C3 | C3 |
| |  |  |  |  |  |  |
| Formatos papel | A4 | A4 | A4 | A4 | A4 | A4 |
| Fuente luminosa | LED blanco | Tecnología ReadyScan LED | LED blanco, LED IR con tecnología ReadyScan LED | LED blanco, LED IR con tecnología ReadyScan LED | LED blanco, LED IR con tecnología ReadyScan LED | LED blanco, LED IR con tecnología ReadyScan LED |
| Tipo de escáner | Escáner plano | Escáner plano | Escáner plano | Escáner plano | Escáner plano | Escáner plano |
| Sensor óptico | CIS (sensor de imagen de contacto) | Matrix CCD | Matrix CCD | Matrix CCD | Matrix CCD con microlente | Matrix CCD con microlente y óptica de precisión |
| Interfaces | USB | USB | USB | USB | USB | USB |
| Resolución de escaneado | 4.800 ppp x 4.800 ppp (horizontal x vertical) | 4.800 ppp (horizontal x vertical) | 6.400 ppp (horizontal x vertical) | 6.400 ppp (horizontal x vertical) | 6.400 ppp (horizontal x vertical) | 6.400 ppp (horizontal x vertical) |
| Densidad óptica | | 3,2 Dmax | 3,4 Dmax | 3,4 Dmax | 4 Dmax | 4 Dmax |
| VPJR neto | B11B232401 | 79,49 € B11B207312 | 129,49 € B11B210302 | 204,49 € B11B198032 | 239,01 € B11B223401 | 522,14 € B11B224401 |
| Opciones | | | | | C3 | C3 |
| Accesorio para fluidos Epson | | | | | B12B818272 | 117,74 € B12B818272 |
| CoverPlus | BA | BA | BA | BA | BA | BA |
| 01 años de servicio CoverPlus in situ para Perfection V39 | CP01OSSEB232 | 18 € | | | | |
| 03 años de servicio CoverPlus en laboratorio para Perfection V37 | | CP03RTBSB207 | 18 € | | | |
| 03 años de servicio CoverPlus en laboratorio para Perfection V39 | CP03RTBSB232 | 19,80 € | | | | |
| 03 años de servicio CoverPlus en laboratorio para Perfection V800 Photo | | | | | CP03RTBSB223 | 63 € |
| 03 años de servicio CoverPlus en laboratorio para Perfection V800 Pro | | | | | | CP03RTBSB224 |
| | | | | | | 63 € |
| 03 años de servicio CoverPlus en laboratorio para V550 Photo | | | CP03RTBSB210 | 45 € | | |
| 03 años de servicio CoverPlus en laboratorio para V600 Photo | | | | CP03RTBSB198 | 45 € | |
| 03 años de servicio CoverPlus in situ para Perfection V800 | | | | | CP03OSSEB223 | 106 € |

| | Perfection V39 | Perfection V370 Photo | Perfection V550 Photo | Perfection V600 Photo | Perfection V800 Photo | Perfection V850 Pro |
|--|----------------|-----------------------|-----------------------|-----------------------|-----------------------|---------------------|
| Photo | | | | | | |
| 03 años de servicio CoverPlus in situ para Perfection V800 Pro | | | | | | CP03OSSEB224 106 € |
| 05 años de servicio CoverPlus en laboratorio para V600 Photo | | | | CP05RTBSB198 108 € | | |

| Grupo de precios | LX-350 | | LQ-350 | | LQ-50 | | LX-1350 | | LQ-630 | | PLQ-20 | | PLQ-22 | | |
|--|---|-----------------|---|-----------------|--|-----------------|---|--------------|---|-----------------|---|--|--|--|-------------|
| | B3 | | B3 | | B3 | | B3 | | B3 | | B3 | | B3 | | |
| |  | |  | |  | |  | |  | |  | |  | | |
| Agujas | 9 agujas | | 24 agujas | | 24 agujas | | 9 agujas | | 24 agujas | | 24 agujas | | 24 agujas | | |
| Número de columnas | 80 columnas | | 80 columnas | | 50 columnas | | 136 columnas | | 80 columnas | | 94 columnas | | 94 columnas | | |
| Velocidad de impresión | Borrador de alta velocidad: 10 ipc: 347 caracteres/s, 12 ipc: 357 caracteres/s, 15 ipc: 390 caracteres/s, Borrador: 10 ipc: 260 caracteres/s, 12 ipc: 312 caracteres/s, NLQ: 10 ipc: 65 caracteres/s, 12 ipc: 78 caracteres/s | | Borrador de alta velocidad: 10 ipc: 347 caracteres/s, LQ: 10 ipc: 86 caracteres/s, Borrador: 10 ipc: 260 caracteres/s | | Borrador de alta velocidad: 12 ipc: 360 caracteres/s, 10 ipc: 300 caracteres/s, Borrador: 10 ipc: 225 caracteres/s, 12 ipc: 270 caracteres/s, LQ: 10 ipc: 75 caracteres/s, 12 ipc: 90 caracteres/s | | Borrador de alta velocidad: 10 ipc: 347 caracteres/s, 12 ipc: 357 caracteres/s, Borrador: 10 ipc: 260 caracteres/s, 12 ipc: 312 caracteres/s, NLQ: 10 ipc: 65 caracteres/s, 12 ipc: 78 caracteres/s | | Borrador de alta velocidad: 10 ipc: 300 caracteres/s, 12 ipc: 360 caracteres/s, Borrador: 10 ipc: 225 caracteres/s, LQ: 10 ipc: 79 caracteres/s | | Borrador de alta velocidad: 10 ipc: 480 caracteres/s, 12 ipc: 576 caracteres/s, Borrador: 10 ipc: 360 caracteres/s, 12 ipc: 432 caracteres/s, LQ: 10 ipc: 120 caracteres/s, 12 ipc: 144 caracteres/s, NLQ: 10 ipc: 180 caracteres/s | | Borrador de alta velocidad: 10 ipc: 480 caracteres/s, Borrador: 10 ipc: 360 caracteres/s, LQ: 10 ipc: 120 caracteres/s | | |
| Copias carbón | 4 más un original | | 3 más un original | | 2 más un original | | 4 más un original | | 4 más un original | | 6 más un original | | 6 más un original | | |
| Resolución de impresión | 240 x 144 ppp | | 360 x 180 ppp | | 360 x 180 ppp | | 240 x 144 ppp | | 360 x 180 ppp | | 64 kB incluido | | 360 x 360 ppp | | |
| Memoria | 128 kB incluido | | 128 kB incluido | | 64 kB incluido | | 128 kB incluido | | 32 kB incluido | | 64 kB incluido | | 128 kB incluido | | |
| Tiempo entre fallos | 10.000 Horas | | 10.000 Horas | | 10.000 Horas | | 10.000 Horas | | 10.000 Horas | | 10.000 Horas | | 10.000 Horas | | |
| Emulaciones | ESC/P, IBM PPDS | | IBM 2390 Plus, ESC/P2 | | ESC/P2, IBM 2390 Plus | | ESC/P, IBM PPDS | | ESC/P2, IBM PPDS | | ESC/P2, IBM PPDS, PR2 | | ESC/P2, IBM PPDS, PR2 | | |
| Método de impresión | Impresora matricial de impacto | | Impresora matricial de impacto | | Impresora matricial de impacto | | Impresora matricial de impacto | | Impresora matricial de impacto | | Impresora matricial de impacto | | Impresora matricial de impacto | | |
| PVPR neto | C11CC24031 | 255,15 € | C11CC25001 | 275,45 € | C11CB12031 | 282,45 € | C11CD24301 | 527 € | C11C480141 | 581,70 € | C11C560171 | 599 € | C11CB01301 | 599 € | |
| | | | | | | | | | | | D C11C560361 M C11C560181 M (BA14816) C11C560031BX M EIB CUSTOM (FW: LC008628) C11C560031A2 | 599 € 699 € 699 € 699 € | M C11CB01401 M (FW R0616326) C11CB01401A1 BES (new) C11CB01301A2 CS w/o USB HUB C11CB01001 CSM w USB HUB C11CB01201 CSM w/USB Hub (BP015230) C11CB01201A4 | 699 € 699 € 699 € 1.500 € 1.700 € 1.700 € | |
| Opciones | B3 | | B3 | | B3 | | B3 | | B3 | | B3 | | B3 | | |
| Kit de ahorro de espacio Epson SIDM para las series PLQ-20/ 22 | | | | | | | | | | | | C12C802202 | 14 € | C12C802202 | 14 € |
| Soporte para rollo de papel Epson SIDM para las series LX-300+II/1170II, FX-890/A, | C12C811141 | 126 € | C12C811141 | 126 € | | | C12C811141 | 126 € | | | | C12C811141 | 126 € | | |

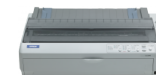

| | LX-350 | LQ-350 | LQ-50 | LX-1350 | LQ-630 | PLQ-20 | PLQ-22 |
|---|--------------|--------------|------------|--------------|--------------|--------------|----------------------|
| Soporte para rollo de papel y cubierta Epson SIDM para LQ-50 | | | | | | | |
| | | | C12C811262 | 33,16 € | | | |
| Consumibles | S5 | S5 | S5 | S5 | S5 | S5 | S5 |
| SIDM Black Ribbon Cartridge for LX-350/LX-300/+/II (C13S015637) | C13S015637 | x100 | 5 € | | | | |
| SIDM Black Ribbon Cartridge for LX-350/300+/300+II, Dualpack (C13S015647) | C13S015647 | | 9 € | | | | |
| SIDM Black Ribbon Cartridge for LQ-350/300/+/II (C13S015633) | C13S015633 | x100 | 6 € | | | | |
| Cartucho negro Epson SIDM para LQ-50 (C13S015624) | | | C13S015624 | x10 | 6 € | | |
| SIDM Black Ribbon Cartridge for LX-1350, LX-1170II, LX-1170 (C13S015642) | | | | C13S015642 | x50 | 6 € | |
| Cartucho negro Epson SIDM para LQ-630 (C13S015307) | | | | | C13S015307 | x60 | 6 € |
| Cartucho negro Epson SIDM para PLQ-20/22, pack de 3 (C13S015339) | | | | | | C13S015339 | 24 € C13S015339 24 € |
| CoverPlus | BA | BA | BA | BA | BA | BA | BA |
| 03 años de servicio CoverPlus en laboratorio para LQ-350 | | CP03RTBSCC25 | 30 € | | | | |
| 03 años de servicio CoverPlus en laboratorio para LQ-50 | | | | CP03RTBSCB12 | 30 € | | |
| 03 años de servicio CoverPlus en laboratorio para LQ-630 | | | | | CP03RTBSC480 | 50 € | |
| 03 años de servicio CoverPlus en laboratorio para LX-1350 | | | | CP03RTBSCD24 | 40 € | | |
| 03 años de servicio CoverPlus en laboratorio para LX-350 | CP03RTBSCC24 | 30 € | | | | | |
| 03 años de servicio CoverPlus en laboratorio para PLQ-20/30 | | | | | | CP03RTBSC560 | 150 € |
| 03 años de servicio CoverPlus en laboratorio para PLQ-22 | | | | | | | CP03RTBSCB01 185 € |
| 03 años de servicio CoverPlus in situ para LQ-350 | | CP03OSSECC25 | 50 € | | | | |
| 03 años de servicio CoverPlus in situ para LQ-630 | | | | | CP03OSSEC480 | 90 € | |
| 03 años de servicio CoverPlus in situ para LX-1350 | | | | CP03OSSECD24 | 90 € | | |

| | | | | | | | |
|--|--------------|--------|-------|---------|--------|---------------|---------------------|
| 03 años de servicio CoverPlus in situ para LX-350 | LX-350 | LQ-350 | LQ-50 | LX-1350 | LQ-630 | PLQ-20 | PLQ-22 |
| | CP03OSSECC24 | 50 € | | | | | |
| 03 años de servicio CoverPlus in situ para PLQ-20/30 | | | | | | CP03OSSECC560 | 250 € |
| 03 años de servicio CoverPlus in situ para PLQ-22 | | | | | | | CP03OSSECCB01 335 € |

| Grupo de precios | PLQ-30 | LQ-590 | LQ-690 | FX-890 | LQ-680 Pro | FX-2190 | LQ-2090 |
|---------------------------|---|--|--|---|--|---|--|
| | B3 | B3 | B3 | B3 | B3 | B3 | B3 |
| |  |  |  |  |  |  |  |
| Agujas | 24 agujas (2 x 12) | 24 agujas | 24 agujas | 18 agujas (2 x 9) | 24 agujas | 18 agujas (2 x 9) | 24 agujas |
| Número de columnas | 94 columnas | 80 columnas | 106 columnas | 80 columnas | 106 columnas | 18 columnas | 136 columnas |
| Velocidad de impresión | Borrador de alta velocidad: 585 ipc: 10 caracteres/s, 520 ipc: 10 caracteres/s, Borrador: 390 ipc: 10 caracteres/s, NLQ: 195 ipc: 10 caracteres/s, LQ: 130 ipc: 10 caracteres/s | Borrador de alta velocidad: 10 ipc: 440 caracteres/s, 12 ipc: 529 caracteres/s, Borrador: 10 ipc: 330 caracteres/s, LQ: 10 ipc: 110 caracteres/s | Borrador de alta velocidad: 10 ipc: 440 caracteres/s, 12 ipc: 529 caracteres/s, Borrador: 10 ipc: 330 caracteres/s, LQ: 10 ipc: 110 caracteres/s, 12 ipc: 132 caracteres/s | Borrador de alta velocidad: 10 ipc: 566 caracteres/s, 12 ipc: 680 caracteres/s, Borrador: 10 ipc: 419 caracteres/s, NLQ: 10 ipc: 104 caracteres/s, 12 ipc: 125 caracteres/s | Borrador de alta velocidad: 10 ipc: 413 caracteres/s, Borrador: 10 ipc: 310 caracteres/s, LQ: 10 ipc: 103 caracteres/s | Borrador de alta velocidad: 10 ipc: 566 caracteres/s, 12 ipc: 680 caracteres/s, Borrador: 10 ipc: 419 caracteres/s, NLQ: 10 ipc: 104 caracteres/s | Borrador de alta velocidad: 10 ipc: 440 caracteres/s, 12 ipc: 529 caracteres/s, Borrador: 10 ipc: 330 caracteres/s, LQ: 10 ipc: 110 caracteres/s |
| Copias carbón | 6 más un original | 4 más un original | 6 más un original | 6 más un original | 5 más un original | 6 más un original | 4 más un original |
| Resolución de impresión | | 360 x 180 ppp | 360 x 180 ppp | 240 x 144 ppp | 360 x 180 ppp | 240 x 144 ppp | 360 x 180 ppp |
| Memoria | | 128 kB incluido | 128 kB incluido | 128 kB incluido | 64 kB incluido | 128 kB incluido | 128 kB incluido |
| Tiempo entre fallos | 12.000 Horas | 20.000 Horas | 20.000 Horas | 20.000 Horas | 10.000 Horas | 20.000 Horas | 20.000 Horas |
| Emulaciones | ESC/P, IBM PPDS, PR2 | ESC/P2, IBM PPDS | ESC/P2, IBM PPDS | IBM PPDS, ESC/P | ESC/P2, IBM 2390/2391 Plus | ESC/P, IBM PPDS, IBM PPDS/ML | ESC/P2, IBM PPDS |
| Método de impresión | Impresora matricial de impacto | Impresora matricial de impacto | Impresora matricial de impacto | Impresora matricial de impacto | Impresora matricial de impacto | Impresora matricial de impacto | Impresora matricial de impacto |
| PVPR neto | C11CB64021 599 € | C11C558022 599,55 € | C11CA13041 658,35 € | C11C524025 726,60 € | C11C376125 811,65 € | C11C526022 872,55 € | C11C559012 929,25 € |
| M | C11CB64501 699 € | | | II C11CF37401 726,60 € A C11C524301 795,90 € IIN C11CF37403A0 983,60 € | | 110V C11C526001 N C11C526022A0 1.000,65 € | |
| Opciones | B3 | B3 | B3 | B3 | B3 | B3 | B3 |
| Alimentador extra para 50 | | | | | C12C806792 | 78 € | |

| | PLQ-30 | LQ-590 | LQ-690 | FX-890 | LQ-680 Pro | FX-2190 | LQ-2090 |
|---|------------|------------|-----------|------------------|------------------|------------------|---|
| hojas sueltas Epson SIDM para LQ-670/680/Pro | | | | | | | |
| Alimentador para 150 hojas sueltas Epson SIDM para LQ-590, FX-890/A | | C12C806382 | 199 € | | C12C806382 | 199 € | |
| Alimentador para 150 hojas sueltas Epson SIDM para LQ-680/Pro | | | | | C12C806872 | 226 € | |
| Alimentador para 50 hojas sueltas Epson SIDM para FX-890/A, LX/LQ-300+II, LQ-590 | | C12C806372 | 64 € | | C12C806372 | 64 € | |
| Guía frontal de hojas Epson SIDM para FX-890, LQ-590 | | C12C814022 | 33 € | | C12C814022 | 33 € | |
| Kit de ahorro de espacio Epson SIDM para las series PLQ-20/22 | C12C802202 | 14 € | | | | | |
| Placa serie I/F Epson SIDM, sin memoria intermedia de tipo B enchufable RS232D/20mA | | C12C824432 | 67 € | | C12C824432 | 67 € | C12C824432 67 € C12C824432 67 € |
| Servidor de impresión interno 5e EpsonNet 10/100 Base Tx de tipo B Epson SIDM | | C12C824352 | 360,83 € | | C12C824352 | 360,83 € | C12C824352 360,83 € C12C824352 360,83 € |
| Soporte para rollo de papel Epson SIDM para las series LX-300+II/1170II, FX-890/A, FX-2190, LQ-690/300+II | | C12C811141 | 126 € | C12C811141 126 € | C12C811141 126 € | C12C811141 126 € | C12C811141 126 € C12C811141 126 € |
| Tractor de arrastre/empuje Epson SIDM para FX-2190, LQ-2090 | | | | | | C12C800212 | 83 € C12C800212 83 € |
| Tractor de arrastre/empuje Epson SIDM para LQ-590/870, FX-890/A | | C12C800202 | 63 € | | C12C800202 | 63 € | |
| Consumibles | S5 | S5 | S5 | S5 | S5 | S5 | S5 |
| Cartucho negro Epson SIDM para PLQ-20/22, pack de 3 (C13S015339) | C13S015339 | 24 € | | | | | |
| Cartucho negro Epson SIDM para LQ-590 (C13S015337) | C13S015337 | x100 | 13 € | | | | |
| Cartucho negro Epson SIDM para LQ-690 (C13S015610) | | C13S015610 | x50 | 26 € | | | |
| Cartucho negro Epson SIDM para FX-890, FX-890A (C13S015329) | | | | C13S015329 | x100 | 6 € | |
| Cartucho negro Epson SIDM para LQ-670/680/pro/860/1060/25xx (C13S015262) | | | | | C13S015262 | x80 | 10 € |

| | PLQ-30 | LQ-590 | LQ-690 | FX-890 | LQ-680 Pro | FX-2190 | LQ-2090 |
|--|--------------|--------------|--------------|--------------|--------------|--------------|---------------------|
| Cartucho negro Epson SIDM para FX-2190 (C13S015327) | | | | | | C13S015327 | x50 13 € |
| Cartucho negro Epson SIDM para LQ-2090 (C13S015336) | | | | | | | C13S015336 x50 24 € |
| CoverPlus | BA | BA | BA | BA | BA | BA | BA |
| 03 años de servicio CoverPlus en laboratorio para FX-2190 | | | | | | CP03RTBSC526 | 90 € |
| 03 años de servicio CoverPlus en laboratorio para FX-890/A/AII/II/IIIN | | | | CP03RTBSC524 | 50 € | | |
| 03 años de servicio CoverPlus en laboratorio para LQ-2090 | | | | | | | CP03RTBSC559 90 € |
| 03 años de servicio CoverPlus en laboratorio para LQ-590 | | CP03RTBSC558 | 50 € | | | | |
| 03 años de servicio CoverPlus en laboratorio para LQ-680 Pro | | | | | CP03RTBSC376 | 50 € | |
| 03 años de servicio CoverPlus en laboratorio para LQ-690 | | | CP03RTBSCA13 | 50 € | | | |
| 03 años de servicio CoverPlus en laboratorio para PLQ-20/30 | CP03RTBSC560 | 150 € | | | | | |
| 03 años de servicio CoverPlus in situ para FX-2190 | | | | | | CP03OSSEC526 | 150 € |
| 03 años de servicio CoverPlus in situ para FX-890/A/AII/II/IIIN | | | | CP03OSSEC524 | 90 € | | |
| 03 años de servicio CoverPlus in situ para LQ-2090 | | | | | | | CP03OSSEC559 150 € |
| 03 años de servicio CoverPlus in situ para LQ-590 | | CP03OSSEC558 | 90 € | | | | |
| 03 años de servicio CoverPlus in situ para LQ-680 Pro | | | | | CP03OSSWC376 | 90 € | |
| 03 años de servicio CoverPlus in situ para LQ-690 | | | CP03OSSECA13 | 90 € | | | |
| 03 años de servicio CoverPlus in situ para PLQ-20/30 | CP03OSSEC560 | 250 € | | | | | |
| 04 años de servicio CoverPlus in situ para FX-2190 | | | | | | CP04OSSEC526 | 225 € |

| Grupo de precios | LQ-2190 | DLQ-3500 | DFX-9000 |
|---|--|--|--|
| | B3 | B3 | B3 |
| |  |  |  |
| Agujas | 24 agujas | 24 agujas | 36 agujas (4 x 9) |
| Número de columnas | 136 columnas | 136 columnas | 136 columnas |
| Velocidad de impresión | LQ: 10 ipc: 120 caracteres/s, 12 ipc: 144 caracteres/s, Borrador de alta velocidad: 10 ipc: 480 caracteres/s, 12 ipc: 576 caracteres/s, Borrador: 10 ipc: 360 caracteres/s, 12 ipc: 432 caracteres/s | Borrador de alta velocidad: 10 ipc: 550 caracteres/s, Borrador: 10 ipc: 495 caracteres/s, 12 ipc: 594 caracteres/s, LQ: 10 ipc: 165 caracteres/s | Borrador de alta velocidad: 10 ipc: 1550 caracteres/s, 12 ipc: 1450 caracteres/s, Borrador: 10 ipc: 1320 caracteres/s, NLQ: 10 ipc: 330 caracteres/s |
| Copias carbón | 5 más un original | 7 más un original | 9 más un original |
| Resolución de impresión | 360 x 180 ppp | 360 x 180 ppp | 240 x 144 ppp |
| Memoria | 128 kB incluido | 128 kB incluido | 128 kB incluido |
| Tiempo entre fallos | 20.000 Horas | 10.000 Horas | 20.000 Horas |
| Emulaciones | ESC/P2, IBM PPDS | IBM PPDS, ESC/P2, IBM 2390/2391 Plus | IBM PPDS, ESC/P |
| Método de impresión | Impresora matricial de impacto | Impresora matricial de impacto | Impresora matricial de impacto |
| PVPR neto | C11CA92001 1.256,85 € | C11C396085 2.182,95 € | C11C605011BZ 4.534,95 € |
| | N C11CA92001A1 1.422,75 € | | 120V C11C605011A1 4.534,95 € N C11C605011A3 4.792,20 € |
| Opciones | B3 | B3 | B3 |
| Placa serie I/F Epson SIDM, sin memoria intermedia de tipo B enchufable RS232D/20mA | C12C824432 67 € | C12C824432 67 € | C12C824432 67 € |
| Servidor de impresión interno 5e EpsonNet 10/100 Base Tx de tipo B Epson SIDM | C12C824352 360,83 € | C12C824352 360,83 € | C12C824352 360,83 € |
| Soporte para rollo de papel Epson SIDM para las series LX-300+II/1170II, FX-890/A, FX-2190, LQ-690/300+II | C12C811141 126 € | | |
| Tractor de arrastre/empuje Epson SIDM para FX/LQ-2170 | C12C800322 92 € | | |

| | LQ-2190 | DLQ-3500 | DFX-9000 |
|---|-----------------------|--------------|--|
| Consumibles | S5 | S5 | S5 |
| Cartucho negro Epson SIDM para LQ-2x70/2x80/FX-2170/2180 (C13S015086) | C13S015086 x20 | 25 € | |
| Cartucho de color Epson SIDM para DLQ-3000/+3500 (C13S015067) | | C13S015067 | 39 € |
| Cartucho negro Epson SIDM para DLQ-3000/+3500 (C13S015066) | | C13S015066 | 27 € |
| Cartucho negro Epson SIDM para DFX-9000 (C13S015384) | | | C13S015384 x20 24 € |
| CoverPlus | BA | BA | BA |
| 03 años de servicio CoverPlus en laboratorio para DLQ-3500 | | CP03RTBSC396 | 150 € |
| 03 años de servicio CoverPlus en laboratorio para LQ-2190 | CP03RTBSCA92 | 90 € | |
| 03 años de servicio CoverPlus in situ para DFX-9000 | | | CP03OSSEC605 770 € CP03RTBSC605 425 € |
| 03 años de servicio CoverPlus in situ para DLQ-3500 | | CP03OSSEC396 | 250 € |
| 03 años de servicio CoverPlus in situ para LQ-2190N | CP03OSSECA92 | 150 € | |

Grupo de precios

| LabelWorks LW-300 | LabelWorks LW-400 | LabelWorks LW-600P | LabelWorks LW-700 | LabelWorks LW-900P | LabelWorks LW-1000P |
|-------------------|-------------------|--------------------|-------------------|--------------------|---------------------|
| P9 | P9 | P9 | P9 | P9 | P9 |



| | | | | | | |
|--|--|--|--|--|--|---|
| Tecnología de impresión | Transferencia térmica | Transferencia térmica | Transferencia térmica | Transferencia térmica | Transferencia térmica | Transferencia térmica |
| Ancho cinta | 6 mm, 9 mm, 12 mm | 6 mm, 9 mm, 12 mm, 18 mm | 6 mm, 9 mm, 12 mm, 18 mm, 24 mm | 6 mm, 9 mm, 12 mm, 18 mm, 24 mm | 6 mm, 9 mm, 12 mm, 18 mm, 24 mm, 36 mm | 6 mm, 9 mm, 12 mm, 18 mm, 24 mm, 36 mm |
| Conexión con PC | | | Sí | Sí | Sí | Sí |
| Códigos de barras | | Código de barras (NW-7), Código 128, Código 39, EAN-13, EAN-8, ITF, UPC-A, UPC-E | | Código de barras (NW-7), Código 128, Código 39, EAN-13, EAN-8, ITF, Código QR, UPC-A, UPC-E | | |
| Símbolos | 457 | 457 | | 626 | | |
| Marco | 87 Marcos | 87 Marcos | | 87 Marcos | | |
| Archivo de memoria (etiquetas guardadas) | 30 | 50 | | 100 | | |
| Cortador | Manual | Manual | Automático | Automático | Automático, Medio, Recortar | Automático, Medio, Recortar |
| Incluye | Cintas de 2 x 4 m, Adaptador CA, Equipo, Guía rápida, Catálogo de consumibles, Manual de usuario, Documentos de garantía | Cintas de 2 x 4 m, Adaptador CA, Equipo, Guía rápida, Catálogo de consumibles, Manual de usuario, Documentos de garantía | Cinta de 1 x 9 m, Adaptador CA, Controladores y utilidades (CD), Epson Label Editor (CD-ROM), Instalación / Manual de seguridad, Equipo, Cable de alimentación, Catálogo de consumibles, Cable USB, Manual de usuario (CD), Documentos de garantía | Cinta de 1 x 9 m, Adaptador CA, Controladores y utilidades (CD), Epson Label Editor (CD-ROM), Equipo, Cable de alimentación, Guía rápida, Instrucciones de instalación, Cable USB, Manual de usuario, Documentos de garantía | Cintas de 2 x 4 m, Adaptador CA, Equipo, Cable de alimentación, Instrucciones de instalación, Software (CD), Catálogo de consumibles, Cable USB, Manual de usuario, Documentos de garantía | Cinta de 1 x 9 m, Manual en CD, Controladores y utilidades (CD), Epson Label Editor (CD-ROM), Instalación / Manual de seguridad, Equipo, Cable de alimentación, Catálogo de consumibles, Cable USB, Manual de usuario (CD), Documentos de garantía, |

| | | LabelWorks LW-300 | | LabelWorks LW-400 | | LabelWorks LW-600P | | LabelWorks LW-700 | | LabelWorks LW-900P | | LabelWorks LW-1000P | |
|---------------------|-----------------|-------------------|-------------------|-------------------|------------|--------------------|---------|-------------------|---------|--------------------|------------|---------------------|----------|
| PVPR neto | | C51CB69020 | 40,86 € | C51CB70020 | 56,46 € | C51CD69020 | 89,99 € | C51CA63050 | 99,17 € | C51C540080 | 194,94 € | C51CD06010 | 399,99 € |
| | | VP C51CB70100 | | 79 € | | | | | | | | | |
| Consumibles | | S6 | | S6 | | S6 | | S6 | | S6 | | S6 | |
| Código del producto | Tipo de cinta | Color de texto | Color de la cinta | Ancho/Longitud | | | | | | | | | |
| LK-2RBP | Color pastel | Negro | Rojo | 6mm x 9m | C53S652001 | x5 | 8,99 € | C53S652001 | x5 | 8,99 € | C53S652001 | x5 | 8,99 € |
| LK-2YBP | Color pastel | Negro | Amarillo | 6mm x 9m | C53S652002 | x5 | 8,99 € | C53S652002 | x5 | 8,99 € | C53S652002 | x5 | 8,99 € |
| LK-2WBN | Estándar | Negro | Blanco | 6mm x 9m | C53S652003 | x5 | 8,99 € | C53S652003 | x5 | 8,99 € | C53S652003 | x5 | 8,99 € |
| LK-2TBN | Transparente | Negro | Transparente | 6mm x 9m | C53S652004 | x5 | 8,99 € | C53S652004 | x5 | 8,99 € | C53S652004 | x5 | 8,99 € |
| LK-3RBP | Color pastel | Negro | Rojo | 9mm x 9m | C53S653001 | x5 | 9,99 € | C53S653001 | x5 | 9,99 € | C53S653001 | x5 | 9,99 € |
| LK-3YBP | Color pastel | Negro | Amarillo | 9mm x 9m | C53S653002 | x5 | 9,99 € | C53S653002 | x5 | 9,99 € | C53S653002 | x5 | 9,99 € |
| LK-3WBN | Estándar | Negro | Blanco | 9mm x 9m | C53S653003 | x5 | 9,99 € | C53S653003 | x5 | 9,99 € | C53S653003 | x5 | 9,99 € |
| LK-3TBN | Transparente | Negro | Transparente | 9mm x 9m | C53S653004 | x5 | 9,99 € | C53S653004 | x5 | 9,99 € | C53S653004 | x5 | 9,99 € |
| LK-3YBW | Adhesivo fuerte | Negro | Amarillo | 9mm x 9m | C53S653005 | x5 | 9,99 € | C53S653005 | x5 | 9,99 € | C53S653005 | x5 | 9,99 € |
| LK-3TBW | Adhesivo fuerte | Negro | Transparente | 9mm x 9m | C53S653006 | x5 | 9,99 € | C53S653006 | x5 | 9,99 € | C53S653006 | x5 | 9,99 € |
| LK-3WBW | Adhesivo fuerte | Negro | Blanco | 9mm x 9m | C53S653007 | x5 | 9,99 € | C53S653007 | x5 | 9,99 € | C53S653007 | x5 | 9,99 € |
| LK-3WRN | Estándar | Rojo | Blanco | 9mm x 9m | C53S653008 | x5 | 9,99 € | C53S653008 | x5 | 9,99 € | C53S653008 | x5 | 9,99 € |
| LK-4RBP | Color pastel | Negro | Rojo | 12mm x 9m | C53S654007 | x5 | 11,99 € | C53S654007 | x5 | 11,99 € | C53S654007 | x5 | 11,99 € |
| LK-4YBP | Color pastel | Negro | Amarillo | 12mm x 9m | C53S654008 | x5 | 11,99 € | C53S654008 | x5 | 11,99 € | C53S654008 | x5 | 11,99 € |
| LK-4BWV | Intenso | Blanco | Negro | 12mm x 9m | C53S654009 | x5 | 11,99 € | C53S654009 | x5 | 11,99 € | C53S654009 | x5 | 11,99 € |
| LK-4YBF | Fluorescente | Negro | Amarillo | 12mm x 9m | C53S654010 | x5 | 16,99 € | C53S654010 | x5 | 16,99 € | C53S654010 | x5 | 16,99 € |
| LK-4WRN | Estándar | Rojo | Blanco | 12mm x 9m | C53S654011 | x5 | 11,99 € | C53S654011 | x5 | 11,99 € | C53S654011 | x5 | 11,99 € |
| LK-4TBN | Transparente | Negro | Transparente | 12mm x 9m | C53S654012 | x5 | 11,99 € | C53S654012 | x5 | 11,99 € | C53S654012 | x5 | 11,99 € |
| LK-4TWN | Transparente | Blanco | Transparente | 12mm x 9m | C53S654013 | x5 | 11,99 € | C53S654013 | x5 | 11,99 € | C53S654013 | x5 | 11,99 € |
| LK-4YBW | Adhesivo fuerte | Negro | Amarillo | 12mm x 9m | C53S654014 | x5 | 11,99 € | C53S654014 | x5 | 11,99 € | C53S654014 | x5 | 11,99 € |
| LK-4TBW | Adhesivo | Negro | Transparente | 12mm x 9m | C53S654015 | x5 | 11,99 € | C53S654015 | x5 | 11,99 € | C53S654015 | x5 | 11,99 € |

| fuerte | | | | LabelWorks LW-300 | LabelWorks LW-400 | LabelWorks LW-600P | LabelWorks LW-700 | LabelWorks LW-900P | LabelWorks LW-1000P |
|----------|----------------------------|-------|------------|------------------------|-------------------|-----------------------|-----------------------|-----------------------|-----------------------|
| LK-4WBW | Adhesivo fuerte | Negro | Blanco | 12mm x 9m C53S654016 | x5 11,99 € | C53S654016 x5 11,99 € | C53S654016 x5 11,99 € | C53S654016 x5 11,99 € | C53S654016 x5 11,99 € |
| LK-4SBE | Mate | Negro | Plata mate | 12mm x 9m C53S654017 | x5 13,99 € | C53S654017 x5 13,99 € | C53S654017 x5 13,99 € | C53S654017 x5 13,99 € | C53S654017 x5 13,99 € |
| LK-4GBF | Fluorescente | Negro | Verde | 12mm x 9m C53S654018 | x5 16,99 € | C53S654018 x5 16,99 € | C53S654018 x5 16,99 € | C53S654018 x5 16,99 € | C53S654018 x5 16,99 € |
| LK-4SBM | Color metalizado | Negro | Plata | 12mm x 9m C53S654019 | x5 11,99 € | C53S654019 x5 11,99 € | C53S654019 x5 11,99 € | C53S654019 x5 11,99 € | C53S654019 x5 11,99 € |
| LK-4KBM | Color metalizado | Negro | Dorado | 12mm x 9m C53S654020 | x5 11,99 € | C53S654020 x5 11,99 € | C53S654020 x5 11,99 € | C53S654020 x5 11,99 € | C53S654020 x5 11,99 € |
| LK-4WBN | Estándar | Negro | Blanco | 12mm x 9m C53S654021 | x5 11,99 € | C53S654021 x5 11,99 € | C53S654021 x5 11,99 € | C53S654021 x5 11,99 € | C53S654021 x5 11,99 € |
| LK-4WLN | Estándar | Azul | Blanco | 12mm x 9m C53S654022 | x5 11,99 € | C53S654022 x5 11,99 € | C53S654022 x5 11,99 € | C53S654022 x5 11,99 € | C53S654022 x5 11,99 € |
| LK-4WBB | Papel mate | Negro | Blanco | 12mm x 9m C53S654023 | x5 11,99 € | C53S654023 x5 11,99 € | C53S654023 x5 11,99 € | C53S654023 x5 11,99 € | C53S654023 x5 11,99 € |
| LK-4WBQ | Transferencia térmica | Negro | Blanco | 12mm x 5m C53S654024 | x5 16,99 € | C53S654024 x5 16,99 € | C53S654024 x5 16,99 € | C53S654024 x5 16,99 € | C53S654024 x5 16,99 € |
| LK-4WBH | Resistente al calor | Negro | Blanco | 12mm x 2m C53S654025 | x5 16,99 € | C53S654025 x5 16,99 € | C53S654025 x5 16,99 € | C53S654025 x5 16,99 € | C53S654025 x5 16,99 € |
| LK-4WBA3 | Tubo termorretráctil (HST) | Negro | Blanco | 4mm x 2.5m C53S654903 | x5 37,99 € | C53S654903 x5 37,99 € | C53S654903 x5 37,99 € | C53S654903 x5 37,99 € | C53S654903 x5 37,99 € |
| LK-4WBA5 | Tubo termorretráctil (HST) | Negro | Blanco | 12mm x 2.5m C53S654904 | x5 39,99 € | C53S654904 x5 39,99 € | C53S654904 x5 39,99 € | C53S654904 x5 39,99 € | C53S654904 x5 39,99 € |
| LK-4YBA3 | Tubo termorretráctil (HST) | Negro | Amarillo | 4mm x 2.5m C53S654905 | x5 37,99 € | C53S654905 x5 37,99 € | C53S654905 x5 37,99 € | C53S654905 x5 37,99 € | C53S654905 x5 37,99 € |
| LK-4YBA5 | Tubo termorretráctil (HST) | Negro | Amarillo | 12mm x 2.5m C53S654906 | x5 39,99 € | C53S654906 x5 39,99 € | C53S654906 x5 39,99 € | C53S654906 x5 39,99 € | C53S654906 x5 39,99 € |
| LK-4KBK | Cinta satinada | Negro | Dorado | 12mm x 5m C53S654001 | x5 16,99 € | C53S654001 x5 16,99 € | C53S654001 x5 16,99 € | C53S654001 x5 16,99 € | C53S654001 x5 16,99 € |
| LK-4HKK | Cinta satinada | Gold | Navy Blue | 12mm x 5m C53S654002 | x5 16,99 € | C53S654002 x5 16,99 € | C53S654002 x5 16,99 € | C53S654002 x5 16,99 € | C53S654002 x5 16,99 € |
| LK-4PBK | Cinta satinada | Negro | Pink | 12mm x 5m C53S654031 | x5 16,99 € | C53S654031 x5 16,99 € | C53S654031 x5 16,99 € | C53S654031 x5 16,99 € | C53S654031 x5 16,99 € |
| LK-4RKK | Cinta satinada | Gold | Rojo | 12mm x 5m C53S654033 | x5 16,99 € | C53S654033 x5 16,99 € | C53S654033 x5 16,99 € | C53S654033 x5 16,99 € | C53S654033 x5 16,99 € |
| LK-5RBP | Color pastel | Negro | Rojo | 18mm x 9m C53S655002 | x5 13,99 € | C53S655002 x5 13,99 € | C53S655002 x5 13,99 € | C53S655002 x5 13,99 € | C53S655002 x5 13,99 € |
| LK-5YBP | Color pastel | Negro | Amarillo | 18mm x 9m C53S655003 | x5 13,99 € | C53S655003 x5 13,99 € | C53S655003 x5 13,99 € | C53S655003 x5 13,99 € | C53S655003 x5 13,99 € |
| LK-5YBF | Fluorescente | Negro | Amarillo | 18mm x 9m C53S655004 | x5 19,99 € | C53S655004 x5 19,99 € | C53S655004 x5 19,99 € | C53S655004 x5 19,99 € | C53S655004 x5 19,99 € |
| LK-5GBF | Fluorescente | Negro | Verde | 18mm x 9m C53S655005 | x5 19,99 € | C53S655005 x5 19,99 € | C53S655005 x5 19,99 € | C53S655005 x5 19,99 € | C53S655005 x5 19,99 € |

Rotuladoras

TARIFA DE PRECIOS

| | | | | | LabelWorks LW-300 | LabelWorks LW-400 | LabelWorks LW-600P | LabelWorks LW-700 | LabelWorks LW-900P | LabelWorks LW-1000P | | | | |
|-----------|----------------------------|--------|--------------|-------------|-------------------|-------------------|--------------------|-------------------|--------------------|---------------------|------------|------------|------------|------------|
| LK-5WBN | Estándar | Negro | Blanco | 18mm x 9m | C53S655006 | x5 13,99 € | C53S655006 | x5 13,99 € | C53S655006 | x5 13,99 € | C53S655006 | x5 13,99 € | C53S655006 | x5 13,99 € |
| LK-5WRN | Estándar | Rojo | Blanco | 18mm x 9m | C53S655007 | x5 13,99 € | C53S655007 | x5 13,99 € | C53S655007 | x5 13,99 € | C53S655007 | x5 13,99 € | C53S655007 | x5 13,99 € |
| LK-5TBN | Transparente | Negro | Transparente | 18mm x 9m | C53S655008 | x5 13,99 € | C53S655008 | x5 13,99 € | C53S655008 | x5 13,99 € | C53S655008 | x5 13,99 € | C53S655008 | x5 13,99 € |
| LK-5TWN | Transparente | Blanco | Transparente | 18mm x 9m | C53S655009 | x5 13,99 € | C53S655009 | x5 13,99 € | C53S655009 | x5 13,99 € | C53S655009 | x5 13,99 € | C53S655009 | x5 13,99 € |
| LK-5YBW | Adhesivo fuerte | Negro | Amarillo | 18mm x 9m | C53S655010 | x5 13,99 € | C53S655010 | x5 13,99 € | C53S655010 | x5 13,99 € | C53S655010 | x5 13,99 € | C53S655010 | x5 13,99 € |
| LK-5TBW | Adhesivo fuerte | Negro | Transparente | 18mm x 9m | C53S655011 | x5 13,99 € | C53S655011 | x5 13,99 € | C53S655011 | x5 13,99 € | C53S655011 | x5 13,99 € | C53S655011 | x5 13,99 € |
| LK-5WBW | Adhesivo fuerte | Negro | Blanco | 18mm x 9m | C53S655012 | x5 13,99 € | C53S655012 | x5 13,99 € | C53S655012 | x5 13,99 € | C53S655012 | x5 13,99 € | C53S655012 | x5 13,99 € |
| LK-5SBE | Mate | Negro | Plata mate | 18mm x 9m | C53S655013 | x5 15,99 € | C53S655013 | x5 15,99 € | C53S655013 | x5 15,99 € | C53S655013 | x5 15,99 € | C53S655013 | x5 15,99 € |
| LK-5BWW | Intenso | Blanco | Negro | 18mm x 9m | C53S655014 | x5 13,99 € | C53S655014 | x5 13,99 € | C53S655014 | x5 13,99 € | C53S655014 | x5 13,99 € | C53S655014 | x5 13,99 € |
| LK-5ZBU | Fosforescente | Negro | | 18mm x 2m | C53S655015 | x5 33,99 € | C53S655015 | x5 33,99 € | C53S655015 | x5 33,99 € | C53S655015 | x5 33,99 € | C53S655015 | x5 33,99 € |
| LK-5SBR | Reflectante | Negro | Plata | 18mm x 2m | C53S655016 | x5 19,99 € | C53S655016 | x5 19,99 € | C53S655016 | x5 19,99 € | C53S655016 | x5 19,99 € | C53S655016 | x5 19,99 € |
| LK-5WB2 | Magnéticas | Negro | Blanco | 18mm x 1.5m | C53S655001 | x5 29,99 € | C53S655001 | x5 29,99 € | C53S655001 | x5 29,99 € | C53S655001 | x5 29,99 € | C53S655001 | x5 29,99 € |
| LK-6RBP | Color pastel | Negro | Rojo | 24mm x 9m | | | C53S656004 | x5 15,99 € | C53S656004 | x5 15,99 € | C53S656004 | x5 15,99 € | C53S656004 | x5 15,99 € |
| LK-6YBP | Color pastel | Negro | Amarillo | 24mm x 9m | | | C53S656005 | x5 15,99 € | C53S656005 | x5 15,99 € | C53S656005 | x5 15,99 € | C53S656005 | x5 15,99 € |
| LK-6WBN | Estándar | Negro | Blanco | 24mm x 9m | | | C53S656006 | x5 15,99 € | C53S656006 | x5 15,99 € | C53S656006 | x5 15,99 € | C53S656006 | x5 15,99 € |
| LK-6TBN | Transparente | Negro | Transparente | 24mm x 9m | | | C53S656007 | x5 15,99 € | C53S656007 | x5 15,99 € | C53S656007 | x5 15,99 € | C53S656007 | x5 15,99 € |
| LK-6WBC | Etiqueta para cables | Negro | Blanco | 24mm x 9m | | | C53S656901 | x5 29,99 € | C53S656901 | x5 29,99 € | C53S656901 | x5 29,99 € | C53S656901 | x5 29,99 € |
| LK-6SBE | Mate | Negro | Plata mate | 24mm x 9m | | | C53S656009 | x5 17,99 € | C53S656009 | x5 17,99 € | C53S656009 | x5 17,99 € | C53S656009 | x5 17,99 € |
| LK-6WB2 | Magnéticas | Negro | Blanco | 24mm x 1.5m | | | C53S656003 | x5 32,99 € | C53S656003 | x5 32,99 € | C53S656003 | x5 32,99 € | C53S656003 | x5 32,99 € |
| LK-6WBA11 | Tubo termorretráctil (HST) | Negro | Blanco | 24mm x 2.5m | | | C53S656902 | x5 42,99 € | C53S656902 | x5 42,99 € | C53S656902 | x5 42,99 € | C53S656902 | x5 42,99 € |
| LK-6WBA14 | Tubo termorretráctil (HST) | Negro | Blanco | 24mm x 2.5m | | | C53S656903 | x5 44,99 € | C53S656903 | x5 44,99 € | | | C53S656903 | x5 44,99 € |
| LK-6YBA11 | Tubo termorretráctil (HST) | Negro | Amarillo | 24mm x 2.5m | | | C53S656904 | x5 42,99 € | C53S656904 | x5 42,99 € | C53S656904 | x5 42,99 € | C53S656904 | x5 42,99 € |
| LK-6YBA14 | Tubo termorretráctil (HST) | Negro | Amarillo | 24mm x 2.5m | | | C53S656905 | x5 44,99 € | C53S656905 | x5 44,99 € | C53S656905 | x5 44,99 € | C53S656905 | x5 44,99 € |
| LK-4LBK | Cinta satinada | Negro | Sky Blue | 12mm x 5m | | | C53S654032 | x5 16,99 € | C53S654032 | x5 16,99 € | | | C53S654032 | x5 16,99 € |

Rotuladoras

TARIFA DE PRECIOS

| | | LabelWorks LW-300 | | | LabelWorks LW-400 | | | LabelWorks LW-600P | | | LabelWorks LW-700 | | | LabelWorks LW-900P | | | LabelWorks LW-1000P | | |
|-----------|----------------------------|-------------------|--------------|-------------|-------------------|--|--|--------------------|--|--|-------------------|--|------------|--------------------|---------|------------|---------------------|---------|--|
| LK-7RBP | Color pastel | Negro | Rojo | 36mm x 9m | | | | | | | | | C53S657004 | x5 | 24,99 € | C53S657004 | x5 | 24,99 € | |
| LK-7YBP | Color pastel | Negro | Amarillo | 36mm x 9m | | | | | | | | | C53S657005 | x5 | 24,99 € | C53S657005 | x5 | 24,99 € | |
| LK-7WBN | Estándar | Negro | Blanco | 36mm x 9m | | | | | | | | | C53S657006 | x5 | 24,99 € | C53S657006 | x5 | 24,99 € | |
| LK-7TBN | Transparente | Negro | Transparente | 36mm x 9m | | | | | | | | | C53S657007 | x5 | 24,99 € | C53S657007 | x5 | 24,99 € | |
| LK-7WBC | Etiqueta para cables | Negro | Blanco | 36mm x 9m | | | | | | | | | C53S657902 | x5 | 39,99 € | C53S657902 | x5 | 39,99 € | |
| LK-7WB2 | Magnéticas | Negro | Blanco | 36mm x 1.5m | | | | | | | | | C53S657002 | x5 | 37,99 € | C53S657002 | x5 | 37,99 € | |
| LK-7WBA21 | Tubo termorretráctil (HST) | Negro | Blanco | 36mm x 2.5m | | | | | | | | | | | | C53S657903 | x5 | 59,99 € | |
| LK-7YBA21 | Tubo termorretráctil (HST) | Negro | Amarillo | 36mm x 2.5m | | | | | | | | | | | | C53S657904 | x5 | 59,99 € | |

CoverPlus

| | BA | BA | BA | BA | BA | BA |
|--|--------------|------|--------------|--------------|--------------|-------------------------------------|
| 01 años de ampliación de servicio CoverPlus en laboratorio para LW-300/400/K400 | CP1ERTBSCB70 | 15 € | CP1ERTBSCB70 | 15 € | | |
| 01 años de ampliación de servicio CoverPlus en laboratorio para LW-600/700 | | | | CP1ERTBSCD69 | 15 € | CP1ERTBSCD69 15 € |
| 01 años de ampliación de servicio CoverPlus en laboratorio para LW-900/1000/Pro100 | | | | | | CP1ERTBSCB11 15 € CP1ERTBSCB11 15 € |
| 04 años de servicio CoverPlus en laboratorio para LW-700 | | | | | | CP04RTBSCA63 30 € |
| 04 años de servicio CoverPlus en laboratorio para LabelWorks LW-300 | CP04RTBSCB69 | 20 € | | | | |
| 04 años de servicio CoverPlus en laboratorio para LabelWorks LW-400/K400 | | | CP04RTBSCB70 | 15 € | | |
| 04 años de servicio CoverPlus en laboratorio para LabelWorks LW-900P | | | | | | CP04RTBSC540 20 € |
| 05 años de servicio CoverPlus en laboratorio para LW-700 | | | | | CP05RTBSCA63 | 40 € |
| 05 años de servicio CoverPlus en laboratorio para LabelWorks LW-300 | CP05RTBSCB69 | 25 € | | | | |
| 05 años de servicio CoverPlus en laboratorio para LabelWorks LW-400/K400 | | | CP05RTBSCB70 | 79,90 € | | |
| 05 años de servicio CoverPlus en laboratorio para LabelWorks LW-900P | | | | | | CP05RTBSC540 25 € |
| 05 años de servicio CoverPlus in situ para LabelWorks LW-300 | CP05OSSWCB69 | 25 € | | | | |

Grupo de precios

**LabelWorks Pro100
(Continental AC Adapter)**

P9



| | |
|-------------------------|--|
| Tecnología de impresión | Transferencia térmica e impresión térmica directa |
| Ancho cinta | 50 mm, 100 mm |
| Conexión con PC | Sí |
| Cortador | Automático |
| Incluye | Adaptador CA, Herramienta para pegar etiquetas (con nivel de burbuja integrado), Equipo, Cable de alimentación, Software (CD), Catálogo de consumibles, Cable USB, Manual de usuario |

PVPR neto C51CB11020 **486,63 €**













S6

Consumibles



| Código del producto | Tipo de cinta | Color de texto | Color de la cinta | Ancho/Longitud | | |
|---------------------|---------------|----------------|-------------------|----------------|------------|----------------|
| RC-T1BNA | | | Negro | 100mm x 15m | C53S633007 | 58,51 € |
| RC-T1GNA | | | Verde | 100mm x 15m | C53S633006 | 58,51 € |
| RC-T1LNA | | | Azul | 100mm x 15m | C53S633005 | 58,51 € |
| RC-T1RNA | | | Rojo | 100mm x 15m | C53S633004 | 58,51 € |
| RC-T1TNA | | | Transparente | 100mm x 15m | C53S633002 | 58,51 € |
| RC-T1WNA | | | Blanco | 100mm x 15m | C53S633001 | 58,51 € |
| RC-T1YNA | | | Amarillo | 100mm x 15m | C53S633003 | 58,51 € |
| RC-T5BNA | | | Negro | 50mm x 15m | C53S634007 | 39,01 € |
| RC-T5GNA | | | Verde | 50mm x 15m | C53S634006 | 39,01 € |
| RC-T5LNA | | | Azul | 50mm x 15m | C53S634005 | 39,01 € |
| RC-T5RNA | | | Rojo | 50mm x 15m | C53S634004 | 39,01 € |
| RC-T5TNA | | | Transparente | 50mm x 15m | C53S634002 | 39,01 € |
| RC-T5WNA | | | Blanco | 50mm x 15m | C53S634001 | 39,01 € |

LabelWorks Pro100
(Continental AC Adapter)

| | | | | | | | | |
|--|-----------------------|------------|------------|-------------|------------|-----|--------------|------|
| RC-T5YNA | Amarillo | 50mm x 15m | C53S634003 | 39,01 € | | | | |
| RC-L1WAR | Etiquetas precortadas | Negro | Blanco | 90mm x 45mm | C53S633008 | 510 | 43,88 € | |
| RC-R1BNA | Cinta LabelWorks Pro | Negro | | | C53S635001 | | 43,88 € | |
| RC-R1GNA | Cinta LabelWorks Pro | Verde | | | C53S635005 | | 43,88 € | |
| RC-R1RNA | Cinta LabelWorks Pro | Rojo | | | C53S635004 | | 43,88 € | |
| RC-R1LNA | Cinta LabelWorks Pro | Azul | | | C53S635003 | | 43,88 € | |
| RC-R1WNA | Cinta LabelWorks Pro | Blanco | | | C53S635002 | | 43,88 € | |
| CoverPlus | BA | | | | | | | |
| 01 años de ampliación de servicio CoverPlus en laboratorio para LW-900/1000/Pro100 | | | | | | | CP1ERTBSCB11 | 15 € |
| 03 años de servicio CoverPlus en laboratorio para LabelWorks Pro100 | | | | | | | CP03RTBSCB11 | 80 € |

| Grupo de precios | SureColor SC-P400 | | SureColor SC-P600 | | SureColor SC-P800 | |
|-------------------------------------|---|----------------------------------|---|----------------------|---|-----------------------|
| | L2 | | L2 | | L2 | |
| |  | |  | |  | |
| Formatos papel | A3+ | | A3+ | | 17" (43,2 cm) | |
| Colores | 8 Colores | | 9 Colores | | 9 Colores | |
| Tecnología de tinta | Epson Ultrachrome® Hi-Gloss2 | | Ultrachrome® HD | | Ultrachrome® HD | |
| Capacidad de los depósitos de tinta | | | | | 80 ml | |
| Resolución de impresión | 5.760 x 1.440 ppp | | 5.760 x 1.440 ppp | | 2.880 x 1.440 ppp | |
| Grosor del papel adecuado | 0,08 mm - 1,3 mm | | 0,08 mm - 1,3 mm | | 0,29 mm - 1,5 mm | |
| Gestión de soportes | Alimentador automático de documentos. Impresión sin márgenes. Impresión en CD/DVD. Recorrido para Fine Art Paper, Rollo de papel, Bandeja para soportes gruesos | | Alimentador automático de documentos. Impresión sin márgenes. Impresión en CD/DVD. Recorrido para Fine Art Paper, Rollo de papel, Bandeja para soportes gruesos | | Alimentador automático de documentos. Impresión sin márgenes. Recorrido para Fine Art Paper, Dúplex manual, Rollo de papel, Bandeja para soportes gruesos | |
| PVPR neto | C11CE85301 | 462 € | C11CE21301 | | 587 € | C11CE22301BX 999,50 € |
| | | | 0 STD | | | |
| | | | C11CE41301A0 | | 2.495 € | |
| | | | 0 STD Spectro | | | |
| | | | C11CE41301A2 | | 3.795 € | |
| Opciones | | | | | | L2 |
| SC-P800 Roll Paper Unit | | | | | | C12C811431 207,50 € |
| Consumibles | S1 | | S2 | | S2 | |
| Cian claro |  | | C13T76054010 | 2400p 24,50 € | C13T850500 | 49,61 € |
| Cian |  | C13T32424010 980p 13,90 € | C13T76024010 | 2200p 24,50 € | C13T850200 | 49,61 € |
| Magenta claro |  | | | | C13T850600 | 49,61 € |
| Magenta vivo claro |  | | C13T76064010 | 2800p 24,50 € | | |
| Magenta vivo |  | | C13T76034010 | 1400p 24,50 € | C13T850300 | 49,61 € |
| Magenta |  | C13T32434010 980p 13,90 € | | | | |
| Amarillo |  | C13T32444010 980p 13,90 € | C13T76044010 | 2100p 24,50 € | C13T850400 | 49,61 € |
| Rojo |  | C13T32474010 980p 13,90 € | | | | |
| Naranja |  | C13T32494010 980p 13,90 € | | | | |

| | SureColor SC-P400 | SureColor SC-P600 | SureColor SC-P800 |
|---|-------------------|------------------------------------|-----------------------------------|
| Gris claro | | C13T76094010 12000p 24,50 € | C13T850900 49,61 € |
| Gris | | C13T76074010 10000p 24,50 € | C13T850700 49,61 € |
| Negro | | C13T32414010 4200p 13,90 € | C13T850100 49,61 € |
| Negro foto | | C13T76014010 24,50 € | |
| Negro mate | | C13T32484010 650p 13,90 € | C13T76084010 1100p 24,50 € |
| Optimizador del brillo | | C13T32404010 3350p 5,75 € | |
| Caja de mantenimiento | | | C13T582000 19,30 € |
| CoverPlus | BA | BA | BA |
| 03 años de servicio CoverPlus en laboratorio para SureColor SC-P400 | CP03RTBSCE85 | 110 € | |
| 03 años de servicio CoverPlus en laboratorio para SureColor SC-P600 | | CP03RTBSCE21 | 150 € |
| 03 años de servicio CoverPlus in situ para SC-P800 | | | CP03OSSECE22 360 € |
| 03 años de servicio CoverPlus in situ para SureColor SC-P400 | CP03OSSECE85 | 130 € | |
| 03 años de servicio CoverPlus in situ para SureColor SC-P600 | | CP03OSSECE21 | 150 € |
| 04 años de servicio CoverPlus en laboratorio para SureColor SC-P400 | CP04RTBSCE85 | 176 € | |
| 04 años de servicio CoverPlus en laboratorio para SureColor SC-P600 | | CP04RTBSCE21 | 300 € |
| 04 años de servicio CoverPlus in situ para SC-P800 | | | CP04OSSECE22 576 € |
| 04 años de servicio CoverPlus in situ para SureColor SC-P400 | CP04OSSECE85 | 208 € | |
| 05 años de servicio CoverPlus en laboratorio para SureColor SC-P400 | CP05RTBSCE85 | 264 € | |
| 05 años de servicio CoverPlus en laboratorio para SureColor SC-P600 | | CP05RTBSCE21 | 375 € |
| 05 años de servicio CoverPlus in situ para SC-P800 | | | CP05OSSECE22 864 € |
| 05 años de servicio CoverPlus in situ para SureColor SC-P400 | CP05OSSECE85 | 312 € | |













| Grupo de precios | SureColor SC-S40600 | | SureColor SC-S60600 | | SureColor SC-S80600 | | |
|---|---|-----------------|---|-----------------|---|-----------------|--------------|
| | B6 | | B6 | | B6 | | |
| |  | |  | |  | | |
| Formatos papel | 64 " (162,6 cm) | | 64 " (162,6 cm) | | 64 " (162,6 cm) | | |
| Colores | 4 Colores | | 4 Colores | | 12 Colores | | |
| Tecnología de tinta | UltraChrome® GS3 | | UltraChrome® GS3 | | UltraChrome® GS3 with Red | | |
| Capacidad de los depósitos de tinta | 700 ml | | 700 ml | | | | |
| Resolución de impresión | 1.440 x 1.440 ppp | | 1.440 x 1.440 ppp | | 1.440 x 1.440 ppp | | |
| Grosor del papel adecuado | 0,1 mm - 1 mm | | 0,1 mm - 1 mm | | 0,1 mm - 1.000 mm | | |
| Gestión de soportes | Rodillo de recogida automático | | | | | | |
| Emulaciones | ESC/P-R | | ESC/P-R | | | | |
| PVPR neto | C11CE44301A0 | 11.995 € | C11CE46301A0 | 18.995 € | C11CE45301A0 | 20.295 € | |
| Opciones | B8 | | B8 | | | | |
| Advanced Additional Print Drying System | C12C932381 | 1.995 € | | | C12C932381 | 1.995 € | |
| Consumibles | T2, B8 | | T2, B8 | | T2, B8 | | |
| Cian claro |  | | | | C13T890500 | 100 € | |
| Cian |  | C13T890200 | 100 € | C13T890200 | 100 € | C13T890200 | 100 € |
| Magenta claro |  | | | | C13T890600 | 100 € | |
| Magenta |  | C13T890300 | 100 € | C13T890300 | 100 € | C13T890300 | 100 € |
| Amarillo |  | C13T890400 | 100 € | C13T890400 | 100 € | C13T890400 | 100 € |
| Rojo |  | | | | C13T890900 | 100 € | |
| Naranja |  | | | | C13T890800 | 100 € | |
| Gris |  | | | | C13T890700 | 100 € | |
| Negro |  | C13T890100 | 100 € | C13T890100 | 100 € | C13T890100 | 100 € |
| Blanco |  | | | | C13T890A00 | 220 € | |
| Plata metálico |  | | | | C13T890B00 | 245 € | |
| Maintenance Parts Kit S210044 | C13S210044 | 85 € | C13S210044 | 85 € | C13S210044 | 85 € | |
| Cartucho limpieza | C13T696000 | 48 € | C13T696000 | 48 € | C13T696000 | 48 € | |
| Caja de mantenimiento | C13T724000 | 23 € | C13T724000 | 23 € | C13T724000 | 23 € | |
| Cleaning Stick S090013 (50 pcs) | C13S090013 | 21 € | C13S090013 | 21 € | C13S090013 | 21 € | |
| Rod Kit | C13S210036 | 44,10 € | C13S210036 | 44,10 € | C13S210036 | 44,10 € | |

| CoverPlus | SureColor SC-S40600 | SureColor SC-S60600 | SureColor SC-S80600 |
|--|---------------------|---------------------|----------------------|
| | BA | BA | BA |
| 03 años de servicio CoverPlus in situ excluidos cabezales de impresión para SureColor SC-S40600/10 | CP03OSWHCE44 | 1.800 € | |
| 03 años de servicio CoverPlus in situ excluidos cabezales de impresión para SureColor SC-S60600/10 | | CP03OSWHCE46 | 2.000 € |
| 03 años de servicio CoverPlus in situ excluidos cabezales de impresión para SureColor SC-S80600/10 | | | CP03OSWHCE45 2.100 € |
| 03 años de servicio CoverPlus in situ para SureColor SC-S40600/10 | CP03OSSECE44 | 2.300 € | |
| 03 años de servicio CoverPlus in situ para SureColor SC-S60600/10 | | CP03OSSECE46 | 3.000 € |
| 03 años de servicio CoverPlus in situ para SureColor SC-S80600/10 | | | CP03OSSECE45 3.200 € |
| 04 años de servicio CoverPlus in situ excluidos cabezales de impresión para SureColor SC-S40600/10 | CP04OSWHCE44 | 2.880 € | |
| 04 años de servicio CoverPlus in situ excluidos cabezales de impresión para SureColor SC-S60600/10 | | CP04OSWHCE46 | 3.900 € |
| 04 años de servicio CoverPlus in situ excluidos cabezales de impresión para SureColor SC-S80600/10 | | | CP04OSWHCE45 4.000 € |
| 04 años de servicio CoverPlus in situ para SureColor SC-S40600/10 | CP04OSSECE44 | 4.320 € | |
| 04 años de servicio CoverPlus in situ para SureColor SC-S60600/10 | | CP04OSSECE46 | 5.950 € |
| 04 años de servicio CoverPlus in situ para SureColor SC-S80600/10 | | | CP04OSSECE45 6.100 € |
| 05 años de servicio CoverPlus in situ excluidos cabezales de impresión para SureColor SC-S40600/10 | CP05OSWHCE44 | 4.320 € | |
| 05 años de servicio CoverPlus in situ excluidos cabezales de | | CP05OSWHCE46 | 4.875 € |

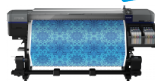
| | SureColor SC-S40600 | SureColor SC-S60600 | SureColor SC-S80600 | |
|--|---------------------|---------------------|---------------------|---------|
| impresión para SureColor SC-S60600/10 | | | | |
| 05 años de servicio CoverPlus in situ excluidos cabezales de impresión para SureColor SC-S80600/10 | | | CP05OSWHCE45 | 4.975 € |
| 05 años de servicio CoverPlus in situ para SureColor SC-S40600/10 | CP05OSSECE44 | 6.480 € | | |
| 05 años de servicio CoverPlus in situ para SureColor SC-S60600/10 | | CP05OSSECE46 | 7.400 € | |
| 05 años de servicio CoverPlus in situ para SureColor SC-S80600/10 | | | CP05OSSECE45 | 7.550 € |
| 1E años de ampliación de servicio CoverPlus in situ excluidos cabezales de impresión para SureColor SC-S40600/10 | CP1EOSWHCE44 | 1.900 € | | |
| 1E años de ampliación de servicio CoverPlus in situ excluidos cabezales de impresión para SureColor SC-S60600/10 | | CP1EOSWHCE46 | 2.200 € | |
| 1E años de ampliación de servicio CoverPlus in situ excluidos cabezales de impresión para SureColor SC-S80600/10 | | | CP1EOSWHCE45 | 2.300 € |
| 1E años de ampliación de servicio CoverPlus in situ para SureColor SC-S40600/10 | CP1EOSSECE44 | 2.400 € | | |
| 1E años de ampliación de servicio CoverPlus in situ para SureColor SC-S60600/10 | | CP1EOSSECE46 | 3.800 € | |
| 1E años de ampliación de servicio CoverPlus in situ para SureColor SC-S80600/10 | | | CP1EOSSECE45 | 3.900 € |

Gran formato - Sector textil

TARIFA DE PRECIOS

| Grupo de precios | SureColor SC-F2000 (5C) | | SureColor SC-F2000 (4C) | | SureColor SC-F6200 (hdK) | | SureColor SC-F6200 (nK) | | SureColor SC-F7200 (hdK) | | SureColor SC-F7200 (nK) | | SureColor SC-F9300 | |
|---|---|-----------------|---|-----------------|---|-----------------|---|-----------------|--|-----------------|---|-----------------|---|-----------------|
| | BD | | BD | | BB | | BB | | BB | | BB | | BB | |
| |  | |  | |  | |  | |  | |  | |  | |
| Formatos papel | | | | | 44 " (111,8 cm) | | 44 " (111,8 cm) | | 64 " (162,6 cm) | | 64 " (162,6 cm) | | 24 " (61,0 cm) | |
| Colores | 5 Colores | | 4 Colores | | 4 Colores | | 4 Colores | | 4 Colores | | 4 Colores | | 4 Colores | |
| Tecnología de tinta | Epson Ultrachrome® DG | | Epson Ultrachrome® DG | | Epson Ultrachrome® DS | | Epson Ultrachrome® DS | | Epson Ultrachrome® DS | | Epson Ultrachrome® DS | | Epson Ultrachrome® DS | |
| Capacidad de los depósitos de tinta | 250 ml | | 250 ml | | 1.500 ml | | 1.500 ml | | 1.500 ml | | 1.500 ml | | 1.500 ml | |
| Resolución de impresión | 1.440 x 1.440 ppp | | 1.440 x 1.440 ppp | | 720 x 1.440 ppp | | 720 x 1.440 ppp | | 720 x 1.440 ppp | | 720 x 1.440 ppp | | 720 x 1.440 ppp | |
| Grosor del soporte compatible | hasta 25 mm | | hasta 25 mm | | | | | | | | | | | |
| Gestión de soportes | | | | | Rollo de papel | | Rollo de papel | | Rodillo de recogida automático, Rollo de papel | | Rodillo de recogida automático, Rollo de papel | | Rodillo de recogida automático, Rollo de papel | |
| Emulaciones | | | | | ESC/P, ESC/P2 | | ESC/P, ESC/P2 | | ESC/P | | ESC/P | | | |
| PVPR neto | C11CC62001A0 | 12.995 € | C11CC62001A1 | 12.995 € | C11CF07002A0 | 5.495 € | C11CF07002A1 | 5.495 € | C11CF06002A0 | 12.995 € | C11CF06002A1 | 12.995 € | C11CG44301A0 | 19.995 € |
| Opciones | B8 | | B8 | | B8 | | B8 | | | | | | | |
| Epson SureColor SCF2000 Extra Small Platen | C12C932131 | 270 € | C12C932131 | 270 € | | | | | | | | | | |
| Epson SureColor SCF2000 Large Platen | C12C890911 | 380 € | C12C890911 | 380 € | | | | | | | | | | |
| Epson SureColor SCF2000 Medium Grooved Platen | C12C932151 | 380 € | C12C932151 | 380 € | | | | | | | | | | |
| Epson SureColor SCF2000 Medium Platen | C12C890912 | 310 € | C12C890912 | 310 € | | | | | | | | | | |
| Epson SureColor SCF2000 Sleeve Platen | C12C891191 | 270 € | C12C891191 | 270 € | | | | | | | | | | |
| Epson SureColor SCF2000 Small Platen | C12C890913 | 270 € | C12C890913 | 270 € | | | | | | | | | | |
| Roll Media Adapter F series | | | | | C12C811391 | 120,03 € | C12C811391 | 120,03 € | | | | | | |
| Consumibles | B8, T4 | | B8, T4 | | T3, B8 | | B8, T3 | | T3, B8 | | B8, T3 | | B8, T3 | |
| Cian |  | C13T725200 | 170 € | C13T725200 | 170 € | | | | | | | | | |
| Magenta |  | C13T725300 | 170 € | C13T725300 | 170 € | | | | | | | | | |
| Amarillo |  | C13T725400 | 170 € | C13T725400 | 170 € | | | | | | | | | |
| Negro |  | C13T725100 | 170 € | C13T725100 | 170 € | | | | | | | C13S210051 | 73 € | |
| Bianco |  | C13T725A00 | 170 € | | | | | | | | | | | |
| Multipack Negro de alta densidad 11 x6 |  | | | | | C13T741X00 | L 330 € | C13T741X00 | L 330 € | C13T741X00 | L 330 € | C13T741X00 | L 330 € | |

| | SureColor SC-F2000 (5C) | SureColor SC-F2000 (4C) | SureColor SC-F6200 (hdK) | SureColor SC-F6200 (nK) | SureColor SC-F7200 (hdK) | SureColor SC-F7200 (nK) | SureColor SC-F9300 |
|--|-----------------------------|-----------------------------|-----------------------------|-----------------------------|-----------------------------|-----------------------------|-----------------------------|
| Multipack Amarillo 1l x6 | | | C13T741400 L 330 € | C13T741400 L 330 € | C13T741400 L 330 € | C13T741400 L 330 € | C13T741400 L 330 € |
| Multipack Magenta 1l x6 | | | C13T741300 L 330 € | C13T741300 L 330 € | C13T741300 L 330 € | C13T741300 L 330 € | C13T741300 L 330 € |
| Multipack Cian 1l x6 | | | C13T741200 L 330 € | C13T741200 L 330 € | C13T741200 L 330 € | C13T741200 L 330 € | C13T741200 L 330 € |
| Multipack Negro 1l x6 | | | | C13T741100 L 330 € | | C13T741100 L 330 € | |
| Caja de mantenimiento | C13T724000 23 € | C13T724000 23 € | | C13T724000 23 € | C13T724000 23 € | C13T724000 23 € | C13T724000 23 € |
| Líquido de pretratamiento (20 l) | C13T736100 510 € | C13T736100 510 € | | | | | |
| Kit de mantenimiento T7362 | C13T736200 21,60 € | C13T736200 21,60 € | | | | | |
| Cartucho limpieza | C13T736000 15 € | C13T736000 15 € | | | | | |
| Epson Head Cleaning Set S092001 | C13S092001 73 € | C13S092001 73 € | | | | | |
| Filtro de aire | C13S092021 23 € | C13S092021 23 € | | | | | |
| Tube Cleaning Kit | C13T736300 18,40 € | C13T736300 18,40 € | | | | | |
| Cleaning Stick S090013 (50 pcs) | C13S090013 21 € | C13S090013 21 € | | | | | |
| Cuchilla de recambio del cortador automático S902006 | | | C13S902006 114,17 € | C13S902006 114,17 € | | | |
| Kit de mantenimiento | | | C13S210038 48 € | | C13S210053 56 € | C13S210053 56 € | C13S210063 48 € |
| Kit de mantenimiento del cabezal | | | C13S210042 20 € | C13S210042 20 € | | | |
| CoverPlus | BA | BA | BA | BA | BA | BA | BA |
| 03 años de servicio CoverPlus in situ excluidos cabezales de impresión para SureColor SC-F2000 | CP03OSWHCC62 1.950 € | CP03OSWHCC62 1.950 € | | | | | |
| 03 años de servicio CoverPlus in situ excluidos cabezales de impresión para SureColor SC-F6200 | | | CP03OSWHCF07 734 € | CP03OSWHCF07 734 € | | | |
| 03 años de servicio CoverPlus in situ excluidos cabezales de impresión para SureColor SC-F7200 | | | | | CP03OSWHCF06 918 € | CP03OSWHCF06 918 € | |
| 03 años de servicio CoverPlus in situ excluidos cabezales de impresión para SureColor SC-F9300 | | | | | | | CP03OSWHCG44 2.340 € |
| 03 años de servicio CoverPlus in situ para SC-F6200 | | | CP03OSSECF07 2.136 € | CP03OSSECF07 2.136 € | | | |
| 03 años de servicio CoverPlus in situ para SureColor SC-F2000 | CP03OSSECC62 2.250 € | CP03OSSECC62 2.250 € | | | | | |
| 03 años de servicio CoverPlus in situ para SureColor SC- | | | | | CP03OSSECF06 2.670 € | CP03OSSECF06 2.670 € | |

| | SureColor SC-F2000 (5C) | SureColor SC-F2000 (4C) | SureColor SC-F6200 (hdK) | SureColor SC-F6200 (nK) | SureColor SC-F7200 (hdK) | SureColor SC-F7200 (nK) | SureColor SC-F9300 |
|--|-------------------------|-------------------------|--------------------------|-------------------------|--------------------------|-------------------------|-----------------------------|
| F7200 | | | | | | | |
| 03 años de servicio CoverPlus in situ para SureColor SC-F9300 | | | | | | | CP03OSSECG44 3.570 € |
| 04 años de servicio CoverPlus in situ excluidos cabezales de impresión para SureColor SC-F6200 | | | CP04OSWHCF07 | CP04OSWHCF07 | | | |
| 04 años de servicio CoverPlus in situ excluidos cabezales de impresión para SureColor SC-F7200 | | | | | CP04OSWHCF06 | CP04OSWHCF06 | |
| 04 años de servicio CoverPlus in situ para SureColor SC-F2000 | CP04OSSECC62 | CP04OSSECC62 | | | | | |
| 04 años de servicio CoverPlus in situ para SureColor SC-F6200 | | | CP04OSSECF07 | CP04OSSECF07 | | | |
| 04 años de servicio CoverPlus in situ para SureColor SC-F7200 | | | | | CP04OSSECF06 | CP04OSSECF06 | |
| 05 años de servicio CoverPlus in situ excluidos cabezales de impresión para SureColor SC-F6200 | | | CP05OSWHCF07 | CP05OSWHCF07 | | | |
| 05 años de servicio CoverPlus in situ excluidos cabezales de impresión para SureColor SC-F7200 | | | CP05OSWHCF06 | CP05OSWHCF06 | CP05OSWHCF06 | CP05OSWHCF06 | |
| 05 años de servicio CoverPlus in situ para SureColor SC-F2000 | CP05OSSECC62 | CP05OSSECC62 | | | | | |
| 05 años de servicio CoverPlus in situ para SureColor SC-F6200 | | | CP05OSSECF07 | 5.340 € | CP05OSSECF07 | 5.340 € | |
| 05 años de servicio CoverPlus in situ para SureColor SC-F7200 | | | | | CP05OSSECF06 | CP05OSSECF06 | |
| 1 años de ampliación de servicio CoverPlus in situ para SC-F2000 | CP1E0SSECC62 | 1.363 € | CP1E0SSECC62 | 1.363 € | | | |
| 1E años de ampliación de servicio CoverPlus in situ excluidos cabezales de impresión para SureColor SC-F9300 | | | | | | | CP1E0SWHCG44 1.600 € |
| 1E años de ampliación de servicio CoverPlus in situ para SureColor SC-F7200 | | | | | CP1E0SSECF06 | 1.800 € | CP1E0SSECF06 1.800 € |

Gran formato - Sector textil

TARIFA DE PRECIOS













| | SureColor SC-F2000 (5C) | SureColor SC-F2000 (4C) | SureColor SC-F6200 (hdK) | SureColor SC-F6200 (nK) | SureColor SC-F7200 (hdK) | SureColor SC-F7200 (nK) | SureColor SC-F9300 | |
|---|-------------------------|-------------------------|--------------------------|-------------------------|--------------------------|-------------------------|--------------------|---------|
| 1E años de ampliación de servicio CoverPlus in situ para SureColor SC-F9300 | | | | | | | CP1EOSSECG44 | 2.300 € |
| Servicio CoverPlus de sustitución de cabezal de impresión para SureColor SC-F9300 | | | | | | | CPOTOSCHCG44 | 2.100 € |

SureColor SC-P5000 STD SureColor SC-P5000 Violet SureColor SC-P7000 STD SureColor SC-P7000V SureColor SC-P5000 STD Spectro SureColor SC-P5000 Violet Spectro SureColor SC-P8000 STD

Grupo de precios B5 B5 B5 B5 B5 B5 B5









| | | | | | | | |
|---|--|--|--|--|--|--|---|
| Formatos papel | 17 " (43,2 cm) | 17 " (43,2 cm) | 24 " (61,0 cm) | 24 " (61,0 cm) | 17 " (43,2 cm) | 17 " (43,2 cm) | 44 " (111,8 cm) |
| Colores | 11 Colores | 11 Colores | 11 Colores | 11 Colores | 11 Colores | 11 Colores | 9 Colores |
| Tecnología de tinta | UltraChrome® HDX | UltraChrome® HDX | UltraChrome® HDX | UltraChrome® HDX | UltraChrome® HDX | UltraChrome® HDX | Ultrachrome® HD |
| Capacidad de los depósitos de tinta | 200 ml | 200 ml | 700 ml | 700 ml | 200 ml | 200 ml | 700 ml |
| Resolución de impresión | 2.880 x 1.440 ppp | 2.880 x 1.440 ppp | 2.880 x 1.440 ppp | 2.880 x 1.440 ppp | 2.880 x 1.440 ppp | 2.880 x 1.440 ppp | 2.880 x 1.440 ppp |
| Grosor del papel adecuado | 0,08 mm - 1,5 mm | 0,08 mm - 1,5 mm | 0,08 mm - 1,5 mm | 0,08 mm - 1,5 mm | 0,08 mm - 1,5 mm | 0,08 mm - 1,5 mm | 0,08 mm - 1,5 mm |
| Impresión sin márgenes activada | | | 254 mm, 300 mm, 329 mm, 406 mm, 432 mm, 515 mm, 594 mm, 610 mm | 254 mm, 300 mm, 329 mm, 406 mm, 432 mm, 515 mm, 594 mm, 610 mm | | | 254 mm, 300 mm, 329 mm, 406 mm, 432 mm, 515 mm, 594 mm, 610 mm, 728 mm, 914 mm, 1118 mm |
| Gestión de soportes | Alimentador automático de documentos, Cortador automático, Impresión sin márgenes, Recorrido para Fine Art Paper, Dúplex manual, Rollo de papel, Bandeja para soportes gruesos | Alimentador automático de documentos, Cortador automático, Impresión sin márgenes, Recorrido para Fine Art Paper, Dúplex manual, Rollo de papel, Bandeja para soportes gruesos | Recorrido para Fine Art Paper, Rollo de papel, Bandeja para soportes gruesos | Recorrido para Fine Art Paper, Rollo de papel, Bandeja para soportes gruesos | Alimentador automático de documentos, Cortador automático, Impresión sin márgenes, Recorrido para Fine Art Paper, Dúplex manual, Rollo de papel, Bandeja para soportes gruesos | Alimentador automático de documentos, Cortador automático, Impresión sin márgenes, Recorrido para Fine Art Paper, Dúplex manual, Rollo de papel, Bandeja para soportes gruesos | Recorrido para Fine Art Paper, Rollo de papel, Bandeja para soportes gruesos |
| Emulaciones | ESC/P2 | ESC/P2 | ESC/P-R | ESC/P-R | ESC/P2 | ESC/P2 | |
| VPVR neto | C11CF66001A0 1.995 € | C11CF66001A1 1.995 € | C11CE39301A0 2.995 € | C11CE39301A1 2.995 € | C11CF66001A2 3.195 € | C11CF66001A3 3.195 € | C11CE42301A0 3.995 € |
| Opciones | B8, B5 | B8, B5 | B8, B5 | B8, B5 | B8, B5 | B8, B5 | B8, B5 |
| Adaptador de rollo C12C811241 | | | C12C811241 146,28 € | C12C811241 146,28 € | | | C12C811241 146,28 € |
| Armario | 7106492 433,97 € | 7106492 433,97 € | | | 7106492 433,97 € | 7106492 433,97 € | |
| Correa del rollo de papel | C12C890121 20,48 € | C12C890121 20,48 € | C12C890121 20,48 € | C12C890121 20,48 € | C12C890121 20,48 € | C12C890121 20,48 € | C12C890121 20,48 € |
| Cortador automático C12C815331 | | | C12C815331 146,28 € | C12C815331 146,28 € | | | C12C815331 146,28 € |
| Cortador automático para Epson Stylus Pro 4900 | C12C815351 150 € | C12C815351 150 € | | | C12C815351 150 € | C12C815351 150 € | |
| Eje de tensión doble de 2-3 pulgadas para Epson Stylus Pro 4900 | C12C811251 87,77 € | C12C811251 87,77 € | | | C12C811251 87,77 € | C12C811251 87,77 € | |
| Hard Disk Unit T & P series | | | C12C848031 299,32 € | C12C848031 299,32 € | | | C12C848031 299,32 € |

| | SureColor SC-P5000 STD | SureColor SC-P5000 Violet | SureColor SC-P7000 STD | SureColor SC-P7000V | SureColor SC-P5000 STD Spectro | SureColor SC-P5000 Violet Spectro | SureColor SC-P8000 STD |
|---|--|---------------------------|-----------------------------------|-----------------------------------|--------------------------------|-----------------------------------|-----------------------------------|
| Rodillo de recogida automática C12C815321 | | | | | | | C12C815321 1.433,55 € |
| SpectroProofer M1 17* | 7109100 1.400 € | 7109100 1.400 € | | | 7109100 1.400 € | 7109100 1.400 € | |
| SpectroProofer M1 24* | | | 7109101 1.500 € | 7109101 1.500 € | | | |
| SpectroProofer M1 44* | | | | | | 7109102 1.700 € | |
| Spectrophotometer ILS30EP | C12C932021 1.125 € | C12C932021 1.125 € | C12C932021 1.125 € | C12C932021 1.125 € | C12C932021 1.125 € | C12C932021 1.125 € | C12C932021 1.125 € |
| Consumibles | T1, S3 | T1, S3 | T1 | T1 | T1, S3 | T1, S3 | T1 |
| Cian claro |  C13T913500 81,26 € | C13T913500 81,26 € | C13T824500 C13T804500 130 € 235 € | C13T824500 C13T804500 130 € 235 € | C13T913500 81,26 € | C13T913500 81,26 € | C13T824500 C13T804500 130 € 235 € |
| Cian |  C13T913200 81,26 € | C13T913200 81,26 € | C13T824200 C13T804200 130 € 235 € | C13T824200 C13T804200 130 € 235 € | C13T913200 81,26 € | C13T913200 81,26 € | C13T824200 C13T804200 130 € 235 € |
| Magenta vivo claro |  C13T913600 81,26 € | C13T913600 81,26 € | C13T824600 C13T804600 130 € 235 € | C13T824600 C13T804600 130 € 235 € | C13T913600 81,26 € | C13T913600 81,26 € | C13T824600 C13T804600 130 € 235 € |
| Magenta vivo |  C13T913300 81,26 € | C13T913300 81,26 € | C13T824300 C13T804300 130 € 235 € | C13T824300 C13T804300 130 € 235 € | C13T913300 81,26 € | C13T913300 81,26 € | C13T824300 C13T804300 130 € 235 € |
| Amarillo |  C13T913400 81,26 € | C13T913400 81,26 € | C13T824400 C13T804400 130 € 235 € | C13T824400 C13T804400 130 € 235 € | C13T913400 81,26 € | C13T913400 81,26 € | C13T824400 C13T804400 130 € 235 € |
| Naranja |  C13T913A00 81,26 € | C13T913A00 81,26 € | C13T824A00 C13T804A00 130 € 235 € | C13T824A00 C13T804A00 130 € 235 € | C13T913A00 81,26 € | C13T913A00 81,26 € | |
| Verde |  C13T913B00 81,26 € | C13T913B00 81,26 € | C13T824B00 C13T804B00 130 € 235 € | C13T824B00 C13T804B00 130 € 235 € | C13T913B00 81,26 € | C13T913B00 81,26 € | |
| Violet |  | C13T913D00 81,26 € | | C13T824D00 C13T804D00 130 € 235 € | | C13T913D00 81,26 € | |
| Gris claro |  C13T913900 81,26 € | | C13T824900 C13T804900 130 € 235 € | | C13T913900 81,26 € | | C13T824900 C13T804900 130 € 235 € |
| Gris |  C13T913700 81,26 € | C13T913700 81,26 € | C13T824700 C13T804700 130 € 235 € | C13T824700 C13T804700 130 € 235 € | C13T913700 81,26 € | C13T913700 81,26 € | C13T824700 C13T804700 130 € 235 € |
| Negro |  | | C13T804100 235 € | C13T804100 235 € | | | C13T804100 235 € |
| Negro foto |  C13T913100 81,26 € | C13T913100 81,26 € | C13T824100 130 € | C13T824100 130 € | C13T913100 81,26 € | C13T913100 81,26 € | C13T824100 130 € |
| Negro mate |  C13T913800 81,26 € | C13T913800 81,26 € | C13T824800 C13T804800 130 € 235 € | C13T824800 C13T804800 130 € 235 € | C13T913800 81,26 € | C13T913800 81,26 € | C13T824800 C13T804800 130 € 235 € |
| Caja de mantenimiento | C13T619100 14,21 € | C13T619100 14,21 € | C13T699700 29 € | C13T699700 29 € | C13T619100 14,21 € | C13T619100 14,21 € | C13T699700 29 € |
| Kit de mantenimiento T619000 | C13T619000 18,12 € | C13T619000 18,12 € | | | C13T619000 18,12 € | C13T619000 18,12 € | |
| CoverPlus | BA | BA | BA | BA | BA | BA | BA |
| 03 años de servicio CoverPlus in situ para SC-P7000 | | | CP03OSSECE39 650 € | CP03OSSECE39 650 € | | | |
| 03 años de servicio CoverPlus in situ para SC-P8000 | | | | | | CP03OSSECE42 1.500 € | |
| 03 años de servicio CoverPlus in situ para SureColor SC-P5000 | CP03OSSECF66 550 € | CP03OSSECF66 550 € | | | CP03OSSECF66 550 € | CP03OSSECF66 550 € | |

Gran formato - Fotografía y pruebas

TARIFA DE PRECIOS









| | SureColor SC-P5000 STD | SureColor SC-P5000 Violet | SureColor SC-P7000 STD | SureColor SC-P7000V | SureColor SC-P5000 STD Spectro | SureColor SC-P5000 Violet Spectro | SureColor SC-P8000 STD |
|---|------------------------|---------------------------|------------------------|---------------------|--------------------------------|-----------------------------------|------------------------|
| 04 años de servicio CoverPlus in situ para SC-P7000 | | | CP04OSSECE39 | 973,50 € | CP04OSSECE39 | 973,50 € | |
| 04 años de servicio CoverPlus in situ para SC-P8000 | | | | | | | CP04OSSECE42 2.250 € |
| 04 años de servicio CoverPlus in situ para SureColor SC-P5000 | CP04OSSECF66 825 € | CP04OSSECF66 825 € | | | CP04OSSECF66 825 € | CP04OSSECF66 825 € | |
| 05 años de servicio CoverPlus in situ para SC-P7000 | | | CP05OSSECE39 | 1.299 € | CP05OSSECE39 | 1.299 € | |
| 05 años de servicio CoverPlus in situ para SC-P8000 | | | | | | | CP05OSSECE42 2.795 € |
| 05 años de servicio CoverPlus in situ para SureColor SC-P5000 | CP05OSSECF66 1.050 € | CP05OSSECF66 1.050 € | | | CP05OSSECF66 1.050 € | CP05OSSECF66 1.050 € | |
| 1E años de ampliación de servicio CoverPlus in situ para SC-P7000 | | | CP1EOSSECE39 | 450 € | CP1EOSSECE39 | 450 € | |
| 1E años de ampliación de servicio CoverPlus in situ para SC-P8000 | | | | | | | CP1EOSSECE42 1.200 € |
| 1E años de ampliación de servicio CoverPlus in situ para SureColor SC-P5000 | CP1EOSSECF66 390 € | CP1EOSSECF66 390 € | | | CP1EOSSECF66 390 € | CP1EOSSECF66 390 € | |

| Grupo de precios | SureColor SC-P7000 STD Spectro | SureColor SC-P7000 Violet Spectro | Epson Stylus Pro WT7900 | SureColor SC-P9000 STD | SureColor SC-P9000V | SureColor SC-P8000 STD Spectro | SureColor SC-P9000 STD Spectro |
|-------------------------------------|---|---|---|---|--|---|---|
| | B5 | B5 | B5 | B5 | B5 | B5 | B5 |
| |  |  |  |  |  |  |  |
| Formatos papel | 24 " (61,0 cm) | 17 " (43,2 cm) | 24 " (61,0 cm) | 44 " (111,8 cm) | 44 " (111,8 cm) | 44 " (111,8 cm) | 44 " (111,8 cm) |
| Colores | 11 Colores | 11 Colores | 9 Colores | 11 Colores | 11 Colores | 9 Colores | 11 Colores |
| Tecnología de tinta | UltraChrome® HDX | UltraChrome® HDX | Tecnología Epson Ultrachrome® HDR con tinta blanca | UltraChrome® HDX | UltraChrome® HDX | Ultrachrome® HD | UltraChrome® HDX |
| Capacidad de los depósitos de tinta | 700 ml | 700 ml | | 700 ml | 700 ml | 700 ml | 700 ml |
| Resolución de impresión | 2.880 x 1.440 ppp | 2.880 x 1.440 ppp | 1.440 x 1.440 ppp | 2.880 x 1.440 ppp | 2.880 x 1.440 ppp | 2.880 x 1.440 ppp | 2.880 x 1.440 ppp |

| | SureColor SC-P7000 STD Spectro | SureColor SC-P7000 Violet Spectro | Epson Stylus Pro WT7900 | SureColor SC-P9000 STD | SureColor SC-P9000V | SureColor SC-P8000 STD Spectro | SureColor SC-P9000 STD Spectro |
|---|--|--|---|---|---|---|---|
| Grosor del papel adecuado | 0,08 mm - 1,5 mm | 0,08 mm - 1,5 mm | 0,08 mm - 1,5 mm | 0,08 mm - 1,5 mm | 0,08 mm - 1,5 mm | 0,08 mm - 1,5 mm | 0,08 mm - 1,5 mm |
| Impresión sin márgenes activada | 254 mm, 300 mm, 329 mm, 406 mm, 432 mm, 515 mm, 594 mm, 610 mm | 254 mm, 300 mm, 329 mm, 406 mm, 432 mm, 515 mm, 594 mm, 610 mm | | 254 mm, 300 mm, 329 mm, 406 mm, 432 mm, 515 mm, 594 mm, 610 mm, 914 mm, 1118 mm | 254 mm, 300 mm, 329 mm, 406 mm, 432 mm, 515 mm, 594 mm, 610 mm, 914 mm, 1118 mm | 254 mm, 300 mm, 329 mm, 406 mm, 432 mm, 515 mm, 594 mm, 610 mm, 728 mm, 914 mm, 1118 mm | 254 mm, 300 mm, 329 mm, 406 mm, 432 mm, 515 mm, 594 mm, 610 mm, 914 mm, 1118 mm |
| Gestión de soportes | Recorrido para Fine Art Paper, Rollo de papel, Bandeja para soportes gruesos | Recorrido para Fine Art Paper, Rollo de papel, Bandeja para soportes gruesos | Recorrido para Fine Art Paper, Rollo de papel, Bandeja para soportes gruesos | Recorrido para Fine Art Paper, Rollo de papel, Bandeja para soportes gruesos | Recorrido para Fine Art Paper, Rollo de papel, Bandeja para soportes gruesos | Recorrido para Fine Art Paper, Rollo de papel, Bandeja para soportes gruesos | Recorrido para Fine Art Paper, Rollo de papel, Bandeja para soportes gruesos |
| Emulaciones | ESC/P-R | ESC/P-R | | | | | |
| PVPR neto | C11CE39301A2 4.295 € | C11CE39301A3 4.295 € | C11CA68001A0 4.995 € | C11CE40301A0 4.995 € | C11CE40301A1 4.995 € | C11CE42301A2 5.495 € | C11CE40301A2 6.495 € |
| Opciones | B8, B5 | B8, B5 | B8 | B8, B5 | B8, B5 | B8, B5 | B8, B5 |
| Adaptador de rollo C12C811241 | C12C811241 146,28 € | C12C811241 146,28 € | C12C811241 146,28 € | C12C811241 146,28 € | C12C811241 146,28 € | C12C811241 146,28 € | C12C811241 146,28 € |
| Correa del rollo de papel | C12C890121 20,48 € | C12C890121 20,48 € | C12C890121 20,48 € | C12C890121 20,48 € | C12C890121 20,48 € | C12C890121 20,48 € | C12C890121 20,48 € |
| Cortador automático C12C815331 | C12C815331 146,28 € | C12C815331 146,28 € | C12C815331 146,28 € | C12C815331 146,28 € | C12C815331 146,28 € | C12C815331 146,28 € | C12C815331 146,28 € |
| Depósito de mantenimiento | | | C12C890191 28,28 € | | | | |
| Hard Disk Unit T & P series | C12C848031 299,32 € | C12C848031 299,32 € | | C12C848031 299,32 € | C12C848031 299,32 € | C12C848031 299,32 € | C12C848031 299,32 € |
| Rodillo de recogida automática C12C815321 | | | | C12C815321 1.433,55 € | C12C815321 1.433,55 € | C12C815321 1.433,55 € | C12C815321 1.433,55 € |
| SpectroProofer M1 24* | 7109101 1.500 € | 7109101 1.500 € | | | | | |
| SpectroProofer M1 44* | | | | 7109102 1.700 € | 7109102 1.700 € | 7109102 1.700 € | 7109102 1.700 € |
| Spectrophotometer ILS30EP | C12C932021 1.125 € | C12C932021 1.125 € | | C12C932021 1.125 € | C12C932021 1.125 € | C12C932021 1.125 € | C12C932021 1.125 € |
| Consumibles | T1 | T1 | T1 | T1 | T1 | T1 | T1 |
| Cian claro | C13T824500 130 € C13T804500 235 € | C13T824500 130 € C13T804500 235 € | C13T642500 66,15 € C13T596500 136,50 € C13T636500 246,75 € | C13T824500 130 € C13T804500 235 € | C13T824500 130 € C13T804500 235 € | C13T824500 130 € C13T804500 235 € | C13T824500 130 € C13T804500 235 € |
| Cian | C13T824200 130 € C13T804200 235 € | C13T824200 130 € C13T804200 235 € | C13T642200 66,15 € C13T596200 136,50 € C13T636200 246,75 € | C13T824200 130 € C13T804200 235 € | C13T824200 130 € C13T804200 235 € | C13T824200 130 € C13T804200 235 € | C13T824200 130 € C13T804200 235 € |
| Magenta vivo claro | C13T824600 130 € C13T804600 235 € | C13T824600 130 € C13T804600 235 € | C13T642600 66,15 € C13T596600 136,50 € C13T636600 246,75 € | C13T824600 130 € C13T804600 235 € | C13T824600 130 € C13T804600 235 € | C13T824600 130 € C13T804600 235 € | C13T824600 130 € C13T804600 235 € |
| Magenta vivo | C13T824300 130 € C13T804300 235 € | C13T824300 130 € C13T804300 235 € | C13T642300 66,15 € C13T596300 136,50 € C13T636300 246,75 € | C13T824300 130 € C13T804300 235 € | C13T824300 130 € C13T804300 235 € | C13T824300 130 € C13T804300 235 € | C13T824300 130 € C13T804300 235 € |
| Amarillo | C13T824400 130 € C13T804400 235 € | C13T824400 130 € C13T804400 235 € | C13T642400 66,15 € C13T596400 136,50 € C13T636400 246,75 € | C13T824400 130 € C13T804400 235 € | C13T824400 130 € C13T804400 235 € | C13T824400 130 € C13T804400 235 € | C13T824400 130 € C13T804400 235 € |
| Naranja | C13T824A00 130 € C13T804A00 235 € | C13T824A00 130 € C13T804A00 235 € | C13T596A00 136,50 € C13T636A00 246,75 € | C13T824A00 130 € C13T804A00 235 € | C13T824A00 130 € C13T804A00 235 € | | C13T824A00 130 € C13T804A00 235 € |

Gran formato - Fotografía y pruebas



TARIFA DE PRECIOS















| | SureColor SC-P7000 STD Spectro | SureColor SC-P7000 Violet Spectro | Epson Stylus Pro WT7900 | SureColor SC-P9000 STD | SureColor SC-P9000V | SureColor SC-P8000 STD Spectro | SureColor SC-P9000 STD Spectro | | | | | | |
|---|--|-----------------------------------|--------------------------|------------------------|--|---------------------------------|--------------------------------|--------------------------|--------------------------|--------------------------|--------------------------|----------------|---------|
| Verde |  C13T824B00 C13T804B00 | 130 € 235 € | C13T824B00 C13T804B00 | 130 € 235 € | C13T596B00 C13T636B00 | 136,50 € 246,75 € | C13T824B00 C13T804B00 | 130 € 235 € | C13T824B00 C13T804B00 | 130 € 235 € | | | |
| Violet |  | | C13T824D00 C13T804D00 | 130 € 235 € | | | C13T824D00 C13T804D00 | 130 € 235 € | | | | | |
| Gris claro |  C13T824900 C13T804900 | 130 € 235 € | | | C13T824900 C13T804900 | 130 € 235 € | | C13T824900 C13T804900 | 130 € 235 € | C13T824900 C13T804900 | 130 € 235 € | | |
| Gris |  C13T824700 C13T804700 | 130 € 235 € | C13T824700 C13T804700 | 130 € 235 € | | C13T824700 C13T804700 | 130 € 235 € | C13T824700 C13T804700 | 130 € 235 € | C13T824700 C13T804700 | 130 € 235 € | | |
| Negro |  C13T804100 | 235 € | C13T804100 | 235 € | | C13T804100 | 235 € | C13T804100 | 235 € | C13T804100 | 235 € | | |
| Negro foto |  C13T824100 | 130 € | C13T824100 | 130 € | C13T642100 C13T596100 C13T636100 | 66,15 € 136,50 € 246,75 € | C13T824100 | 130 € | C13T824100 | 130 € | C13T824100 | 130 € | |
| Negro mate |  C13T824800 C13T804800 | 130 € 235 € | C13T824800 C13T804800 | 130 € 235 € | | | C13T824800 C13T804800 | 130 € 235 € | C13T824800 C13T804800 | 130 € 235 € | C13T824800 C13T804800 | 130 € 235 € | |
| Blanco |  | | | | C13T596C00 | 241,50 € | | | | | | | |
| Caja de mantenimiento | C13T699700 | 29 € | C13T699700 | 29 € | | | C13T699700 | 29 € | C13T699700 | 29 € | C13T699700 | 29 € | |
| Cartucho limpieza | | | | | C13T642000 | 39,69 € | | | | | | | |
| CoverPlus | | | | | | | | | | | | | |
| 03 años de servicio CoverPlus in situ para SC-P7000 | CP03OSSECE39 | 650 € | CP03OSSECE39 | 650 € | | | | | | | | | |
| 03 años de servicio CoverPlus in situ para SC-P8000 | | | | | | | CP03OSSECE42 | 1.500 € | | | | | |
| 03 años de servicio CoverPlus in situ para SC-P9000 | | | | | | | CP03OSSECE40 | 1.500 € | CP03OSSECE40 | 1.500 € | | CP03OSSECE40 | 1.500 € |
| 03 años de servicio CoverPlus in situ para Stylus Pro WT 7900 | | | | | CP03OSSECA68 | 990 € | | | | | | | |
| 04 años de servicio CoverPlus in situ para SC-P7000 | CP04OSSECE39 | 973,50 € | CP04OSSECE39 | 973,50 € | | | | | | | | | |
| 04 años de servicio CoverPlus in situ para SC-P8000 | | | | | | | CP04OSSECE42 | 2.250 € | | | | | |
| 04 años de servicio CoverPlus in situ para SC-P9000 | | | | | | | CP04OSSECE40 | 2.250 € | CP04OSSECE40 | 2.250 € | | CP04OSSECE40 | 2.250 € |
| 04 años de servicio CoverPlus in situ para Stylus Pro WT 7900 | | | | | CP04OSSECA68 | 1.485 € | | | | | | | |
| 05 años de servicio CoverPlus in situ para SC-P7000 | CP05OSSECE39 | 1.299 € | CP05OSSECE39 | 1.299 € | | | | | | | | | |
| 05 años de servicio CoverPlus in situ para SC-P8000 | | | | | | | CP05OSSECE42 | 2.795 € | | | | | |
| 05 años de servicio CoverPlus in situ para SC-P9000 | | | | | | | CP05OSSECE40 | 2.795 € | CP05OSSECE40 | 2.795 € | | CP05OSSECE40 | 2.795 € |
| 05 años de servicio CoverPlus in situ para Stylus Pro WT 7900 | | | | | CP05OSSECA68 | 1.980 € | | | | | | | |

Gran formato - Fotografía y pruebas







TARIFA DE PRECIOS

| | SureColor SC-P7000 STD Spectro | SureColor SC-P7000 Violet Spectro | Epson Stylus Pro WT7900 | SureColor SC-P9000 STD | SureColor SC-P9000V | SureColor SC-P8000 STD Spectro | SureColor SC-P9000 STD Spectro |
|---|--------------------------------|-----------------------------------|-------------------------|------------------------|---------------------|--------------------------------|--------------------------------|
| 1E años de ampliación de servicio CoverPlus in situ para SC-P7000 | CP1EOSSECE39 | 450 € | CP1EOSSECE39 | 450 € | | | |
| 1E años de ampliación de servicio CoverPlus in situ para SC-P8000 | | | | | | CP1EOSSECE42 | 1.200 € |
| 1E años de ampliación de servicio CoverPlus in situ para SC-P9000 | | | | CP1EOSSECE40 | 1.200 € | CP1EOSSECE40 | 1.200 € |
| 1E años de ampliación de servicio CoverPlus in situ para SP-7900 | | | CP1EOSSECA12 | 650 € | | | |

| Grupo de precios | SureColor SC-P9000 Violet Spectro | SureColor SC-P10000 | SureColor SC-P20000 |
|-------------------------------------|---|---|--|
| | B5 | BT | BT |
| |  |  |  |
| Formatos papel | 17 " (43,2 cm) | 36 " (91,4 cm) | 64 " (162,6 cm) |
| Colores | 11 Colores | 10 Colores | 10 Colores |
| Tecnología de tinta | UltraChrome® HDX | Ultrachrome® PRO | Ultrachrome® PRO |
| Capacidad de los depósitos de tinta | 700 ml | 700 ml | 700 ml |
| Resolución de impresión | 2.880 x 1.440 ppp | 2.400 x 1.200 ppp | 2.400 x 1.200 ppp |
| Grosor del papel adecuado | 0,08 mm - 1,5 mm | 0,08 mm - 1,5 mm | 0,08 mm - 1,5 mm |
| Impresión sin márgenes activada | 254 mm, 300 mm, 329 mm, 406 mm, 432 mm, 515 mm, 594 mm, 610 mm, 914 mm, 1118 mm | 254 mm, 297 mm, 300 mm, 329 mm, 406 mm, 432 mm, 515 mm, 594 mm, 610 mm, 728 mm, 841 mm, 914 mm, 1118 mm | 254 mm, 300 mm, 329 mm, 406 mm, 432 mm, 515 mm, 594 mm, 610 mm, 728 mm, 841 mm, 914 mm, 1030 mm, 1118 mm, 1270 mm, 1372 mm |
| Gestión de soportes | Recorrido para Fine Art Paper, Rollo de papel, Bandeja para soportes gruesos | Impresión sin márgenes, Rollo de papel, Bandeja para soportes gruesos | Impresión sin márgenes, Rollo de papel, Bandeja para soportes gruesos |
| PVPR neto | C11CE40301A3 6.495 € | C11CE17001A0 7.295 € | C11CE20001A0 10.995 € |
| Opciones | B5, B8 | B8, BT | B8, BT |
| Adaptador de rollo C12C811241 | C12C811241 146,28 € | | |
| Adobe Postscript 3 Expansion | | C12C891131 1.200 € | C12C891131 1.200 € |







| | SureColor SC-P9000 Violet Spectro | SureColor SC-P10000 | SureColor SC-P20000 |
|--|--|---------------------|---|
| Unit | | | |
| Auto Take up Reel Unit | | C12C932201A0 | 1.265 € C12C932201A0 1.265 € |
| Correa del rollo de papel | C12C890121 | 20,48 € | |
| Cortador automático C12C815331 | C12C815331 | 146,28 € | |
| Hard Disk Unit T & P series | C12C848031 | 299,32 € | C12C848031 299,32 € C12C848031 299,32 € |
| Rodillo de recogida automática C12C815321 | C12C815321 | 1.433,55 € | |
| Roll Adapter SC-P20000 | | C12C932231 | 148 € C12C932231 148 € |
| SpectroProofer M1 44" | 7109102 | 1.700 € | |
| Spectrophotometer ILS30EP | C12C932021 | 1.125 € | |
| Consumibles | T1 | BV, B8 | BV, B8 |
| Cian claro |  C13T824500 C13T804500 | 130 € 235 € | C13T800500 235 € C13T800500 235 € |
| Cian |  C13T824200 C13T804200 | 130 € 235 € | C13T800200 235 € C13T800200 235 € |
| Magenta vivo claro |  C13T824600 C13T804600 | 130 € 235 € | C13T800600 235 € C13T800600 235 € |
| Magenta vivo |  C13T824300 C13T804300 | 130 € 235 € | C13T800300 235 € C13T800300 235 € |
| Amarillo |  C13T824400 C13T804400 | 130 € 235 € | C13T800400 235 € C13T800400 235 € |
| Naranja |  C13T824A00 C13T804A00 | 130 € 235 € | |
| Verde |  C13T824B00 C13T804B00 | 130 € 235 € | |
| Violet |  C13T824D00 C13T804D00 | 130 € 235 € | |
| Gris claro |  | | C13T800000 235 € C13T800000 235 € |
| Gris oscuro |  | | C13T800700 235 € C13T800700 235 € |
| Gris |  C13T824700 C13T804700 | 130 € 235 € | C13T800900 235 € C13T800900 235 € |
| Negro |  C13T804100 | 235 € | |
| Negro foto |  C13T824100 | 130 € | C13T800100 235 € C13T800100 235 € |
| Negro mate |  C13T824800 C13T804800 | 130 € 235 € | C13T800800 235 € C13T800800 235 € |
| Caja de mantenimiento | C13T699700 | 29 € | C13T619300 57,10 € C13T619300 57,10 € |
| Cuchilla de recambio del cortador automático | | C13S210040 | 138 € C13S210040 138 € |
| Cleaning Stick S090013 (50 pcs) | | C13S090013 | 21 € C13S090013 21 € |

| | SureColor SC-P9000 Violet Spectro | SureColor SC-P10000 | SureColor SC-P20000 |
|--|-----------------------------------|----------------------|----------------------|
| CoverPlus | BA | BA | BA |
| 03 años de servicio CoverPlus in situ para SC-P9000 | CP03OSSECE40 | 1.500 € | |
| 03 años de servicio CoverPlus in situ para Sure Colour 20000 | | | CP03OSSECE20 2.180 € |
| 03 años de servicio CoverPlus in situ para SureColor P10000 | | CP03OSSECE17 1.800 € | |
| 04 años de servicio CoverPlus in situ para SC-P9000 | CP04OSSECE40 | 2.250 € | |
| 04 años de servicio CoverPlus in situ para Sure Colour 20000 | | | CP04OSSECE20 4.360 € |
| 04 años de servicio CoverPlus in situ para SureColor P10000 | | CP04OSSECE17 3.500 € | |
| 05 años de servicio CoverPlus in situ para SC-P9000 | CP05OSSECE40 | 2.795 € | |
| 05 años de servicio CoverPlus in situ para Sure Colour 20000 | | | CP05OSSECE20 5.450 € |
| 05 años de servicio CoverPlus in situ para SureColor P10000 | | CP05OSSECE17 4.360 € | |
| 1E años de ampliación de servicio CoverPlus in situ para SC-P10000 | | CP1EOSSECE17 1.000 € | |
| 1E años de ampliación de servicio CoverPlus in situ para SC-P9000 | CP1EOSSECE40 | 1.200 € | |
| 1E años de ampliación de servicio CoverPlus in situ para SureColor SC-P20000 | | | CP1EOSSECE20 1.400 € |

| | SureColor SC-T3200 w/o stand | SureColor SC-T3200 | SureColor SC-T5200 | SureColor SC-T3200-PS | SureColor SC-T7200 | SureColor SC-T5200-PS | SureColor SC-T7200-PS |
|--|--|--|--|--|--|--|--|
| Grupo de precios | P5 | P5 | P5 | P5 | P5 | P5 | P5 |
| |  |  |  |  |  |  |  |
| Formatos papel | 17 " (43,2 cm) | 17 " (43,2 cm) | 36 " (91,4 cm) | 17 " (43,2 cm) | 44 " (111,8 cm) | 36 " (91,4 cm) | 44 " (111,8 cm) |
| Colores | 5 Colores | 5 Colores | 5 Colores | 5 Colores | 5 Colores | 5 Colores | 5 Colores |
| Tecnología de tinta | Ultrachrome® XD | Ultrachrome® XD | Ultrachrome® XD | Ultrachrome® XD | Ultrachrome® XD | Ultrachrome® XD | Ultrachrome® XD |
| Resolución de impresión | 2.880 x 1.440 ppp | 2.880 x 1.440 ppp | 2.880 x 1.440 ppp | 2.880 x 1.440 ppp | 2.880 x 1.440 ppp | 2.880 x 1.440 ppp | 2.880 x 1.440 ppp |
| Grosor del papel adecuado | 0,08 mm - 1,5 mm | 0,08 mm - 1,5 mm | 0,08 mm - 1,5 mm | 0,08 mm - 1,5 mm | 0,08 mm - 1,5 mm | 0,08 mm - 1,5 mm | 0,08 mm - 1,5 mm |
| Impresión sin márgenes activada | 254 mm, 300 mm, 329 mm, 406 mm, 432 mm, 515 mm, 594 mm, 610 mm | 254 mm, 300 mm, 329 mm, 406 mm, 432 mm, 515 mm, 594 mm, 610 mm | 254 mm, 300 mm, 329 mm, 406 mm, 432 mm, 515 mm, 594 mm, 610 mm, 728 mm, 841 mm, 914 mm | 254 mm, 300 mm, 329 mm, 406 mm, 432 mm, 515 mm, 594 mm, 610 mm | 254 mm, 300 mm, 329 mm, 406 mm, 432 mm, 515 mm, 594 mm, 610 mm, 728 mm, 841 mm, 914 mm, 1030 mm, 1118 mm | 254 mm, 300 mm, 329 mm, 406 mm, 432 mm, 515 mm, 594 mm, 610 mm, 728 mm, 841 mm, 914 mm | 254 mm, 300 mm, 329 mm, 406 mm, 432 mm, 515 mm, 594 mm, 610 mm, 728 mm, 841 mm, 914 mm, 1030 mm, 1118 mm |
| Gestión de soportes | Cortador automático, Impresión sin márgenes, Rollo de papel, Bandeja para soportes gruesos | Cortador automático, Impresión sin márgenes, Rollo de papel, Bandeja para soportes gruesos | Cortador automático, Impresión sin márgenes, Rollo de papel, Bandeja para soportes gruesos | Cortador automático, Impresión sin márgenes, Rollo de papel, Bandeja para soportes gruesos | Cortador automático, Impresión sin márgenes, Rollo de papel, Bandeja para soportes gruesos | Cortador automático, Impresión sin márgenes, Rollo de papel, Bandeja para soportes gruesos | Cortador automático, Impresión sin márgenes, Rollo de papel, Bandeja para soportes gruesos |
| Emulaciones | ESC/P-R, HP-GL2, RTL, Adobe® Postscript 3® (opcional) | ESC/P-R, HP-GL2, RTL, Adobe® Postscript 3® (opcional) | HP-GL2, RTL, Adobe® Postscript 3® (opcional), ESC/P-R | ESC/P-R, HP-GL2, RTL, Adobe® Postscript 3® | HP-GL2, RTL, Adobe® Postscript 3® (opcional), ESC/P-R | HP-GL2, RTL, Adobe® Postscript 3®, ESC/P-R | HP-GL2, RTL, Adobe® Postscript 3®, ESC/P-R |
| PVPR neto | C11CD66301A1 1.995 € | C11CD66301A0 2.295 € | C11CD67301A0 2.995 € | C11CD66301EB 3.295 € | C11CD68301A0 3.495 € | C11CD67301EB 3.995 € | C11CD68301EB 4.495 € |
| Opciones | B8 | B8 | B8, PC | B8 | B8, PC | B8, PC | B8, PC |
| Accesorio del rodillo de recogida automática para SC-T7000 | | | | | C12C815411 | 243,86 € | C12C815411 243,86 € |
| Adobe Postscript 3 Expansion Unit | C12C891131 1.200 € | C12C891131 1.200 € | C12C891131 1.200 € | C12C891131 1.200 € | C12C891131 1.200 € | C12C891131 1.200 € | C12C891131 1.200 € |
| Hard Disk Unit T & P series | C12C848031 299,32 € | C12C848031 299,32 € | C12C848031 299,32 € | C12C848031 299,32 € | C12C848031 299,32 € | C12C848031 299,32 € | C12C848031 299,32 € |
| MFP Scanner | | C12C891071 2.295 € | | C12C891071 2.295 € | | C12C891071 2.295 € | C12C891071 2.295 € |
| MFP Scanner stand 36" | | | C12C844151 780 € | | | C12C844151 780 € | |
| MFP Scanner stand 44" | | | | | C12C844161 780 € | | C12C844161 780 € |
| Rodillo de recogida automática C12C815321 | | | | | C12C815321 1.433,55 € | | C12C815321 1.433,55 € |
| Roll Adapter new T series | C12C811401 120,03 € | C12C811401 120,03 € | C12C811401 120,03 € | C12C811401 120,03 € | C12C811401 120,03 € | C12C811401 120,03 € | C12C811401 120,03 € |
| Stand (24inch) SC-T3200 | C12C844171 300 € | C12C844171 300 € | | C12C844171 300 € | | | |





| | SureColor SC-T3200 w/o stand | SureColor SC-T3200 | SureColor SC-T5200 | SureColor SC-T3200-PS | SureColor SC-T7200 | SureColor SC-T5200-PS | SureColor SC-T7200-PS | | | | | |
|---|------------------------------|--------------------|--------------------|-----------------------|--------------------|-----------------------|-----------------------|-----------|--------------|-----------|--------------|-----------|
| Consumibles | B8, T1 | T1, B8 | T1, B8 | T1, B8 | T1, B8 | T1, B8 | T1, B8 | | | | | |
| Cian | C13T692200 | 55 € | C13T692200 | 55 € | C13T692200 | 55 € | C13T692200 | 55 € | C13T692200 | 55 € | C13T692200 | 55 € |
| | C13T693200 | 130 € | C13T693200 | 130 € | C13T693200 | 130 € | C13T693200 | 130 € | C13T693200 | 130 € | C13T693200 | 130 € |
| | C13T694200 | 235 € | C13T694200 | 235 € | C13T694200 | 235 € | C13T694200 | 235 € | C13T694200 | 235 € | C13T694200 | 235 € |
| Magenta | C13T692300 | 55 € | C13T692300 | 55 € | C13T692300 | 55 € | C13T692300 | 55 € | C13T692300 | 55 € | C13T692300 | 55 € |
| | C13T693300 | 130 € | C13T693300 | 130 € | C13T693300 | 130 € | C13T693300 | 130 € | C13T693300 | 130 € | C13T693300 | 130 € |
| | C13T694300 | 235 € | C13T694300 | 235 € | C13T694300 | 235 € | C13T694300 | 235 € | C13T694300 | 235 € | C13T694300 | 235 € |
| Amarillo | C13T692400 | 55 € | C13T692400 | 55 € | C13T692400 | 55 € | C13T692400 | 55 € | C13T692400 | 55 € | C13T692400 | 55 € |
| | C13T693400 | 130 € | C13T693400 | 130 € | C13T693400 | 130 € | C13T693400 | 130 € | C13T693400 | 130 € | C13T693400 | 130 € |
| | C13T694400 | 235 € | C13T694400 | 235 € | C13T694400 | 235 € | C13T694400 | 235 € | C13T694400 | 235 € | C13T694400 | 235 € |
| Negro foto | C13T692100 | 55 € | C13T692100 | 55 € | C13T692100 | 55 € | C13T692100 | 55 € | C13T692100 | 55 € | C13T692100 | 55 € |
| | C13T693100 | 130 € | C13T693100 | 130 € | C13T693100 | 130 € | C13T693100 | 130 € | C13T693100 | 130 € | C13T693100 | 130 € |
| | C13T694100 | 235 € | C13T694100 | 235 € | C13T694100 | 235 € | C13T694100 | 235 € | C13T694100 | 235 € | C13T694100 | 235 € |
| Negro mate | C13T692500 | 55 € | C13T692500 | 55 € | C13T692500 | 55 € | C13T692500 | 55 € | C13T692500 | 55 € | C13T692500 | 55 € |
| | C13T693500 | 130 € | C13T693500 | 130 € | C13T693500 | 130 € | C13T693500 | 130 € | C13T693500 | 130 € | C13T693500 | 130 € |
| | C13T694500 | 235 € | C13T694500 | 235 € | C13T694500 | 235 € | C13T694500 | 235 € | C13T694500 | 235 € | C13T694500 | 235 € |
| Caja de mantenimiento | C13T619300 | 57,10 € | C13T619300 | 57,10 € | C13T619300 | 57,10 € | C13T619300 | 57,10 € | C13T619300 | 57,10 € | C13T619300 | 57,10 € |
| Cuchilla de recambio del cortador automático | C13S902007 | 114,17 € | C13S902007 | 114,17 € | C13S902007 | 114,17 € | C13S902007 | 114,17 € | C13S902007 | 114,17 € | C13S902007 | 114,17 € |
| CoverPlus | BA | BA | BA | BA | BA | BA | BA | BA | BA | BA | BA | BA |
| 03 años de servicio CoverPlus in situ para SureColor SC-T Scanner | CP03OSSESCTS | 300 € | CP03OSSESCTS | 300 € | CP03OSSESCTS | 300 € | CP03OSSESCTS | 300 € | CP03OSSESCTS | 300 € | CP03OSSESCTS | 300 € |
| 03 años de servicio CoverPlus in situ para SureColor SC-T5200 | | | CP03OSSECD67 | 870 € | | | CP03OSSECD67 | 870 € | | | | |
| 03 años de servicio CoverPlus in situ para SureColor SC-T7200 | | | | | | CP03OSSECD68 | 1.100 € | | CP03OSSECD68 | 1.100 € | | |
| 03 años de servicio CoverPlus in situ para SureColour SC-T3200 | CP03OSSECD66 | 650 € | CP03OSSECD66 | 650 € | | CP03OSSECD66 | 650 € | | | | | |
| 04 años de servicio CoverPlus in situ para SureColor SC-T Scanner | CP04OSSESCTS | 400 € | CP04OSSESCTS | 400 € | CP04OSSESCTS | 400 € | CP04OSSESCTS | 400 € | CP04OSSESCTS | 400 € | CP04OSSESCTS | 400 € |
| 04 años de servicio CoverPlus in situ para SureColor SC-T5200 | | | CP04OSSECD67 | 1.300 € | | | CP04OSSECD67 | 1.300 € | | | | |
| 04 años de servicio CoverPlus in situ para SureColor SC-T7200 | | | | | | CP04OSSECD68 | 1.632 € | | CP04OSSECD68 | 1.632 € | | |
| 04 años de servicio CoverPlus in situ para SureColour SC-T3200 | CP04OSSECD66 | 978 € | CP04OSSECD66 | 978 € | | CP04OSSECD66 | 978 € | | | | | |
| 05 años de servicio CoverPlus in situ para SureColor SC-T Scanner | CP05OSSESCTS | 500 € | CP05OSSESCTS | 500 € | CP05OSSESCTS | 500 € | CP05OSSESCTS | 500 € | CP05OSSESCTS | 500 € | CP05OSSESCTS | 500 € |

| | SureColor SC-T3200 w/o stand | SureColor SC-T3200 | SureColor SC-T5200 | SureColor SC-T3200-PS | SureColor SC-T7200 | SureColor SC-T5200-PS | SureColor SC-T7200-PS | |
|--|------------------------------|--------------------|--------------------|-----------------------|--------------------|-----------------------|-----------------------|---------|
| 05 años de servicio CoverPlus in situ para SureColor SC-T5200 | | | CP050SSECD67 | 1.734 € | | CP050SSECD67 | 1.734 € | |
| 05 años de servicio CoverPlus in situ para SureColor SC-T7200 | | | | | CP050SSECD68 | 2.176 € | CP050SSECD68 | 2.176 € |
| 05 años de servicio CoverPlus in situ para SureColour SC-T3200 | CP050SSECD66 | 1.402 € | CP050SSECD66 | 1.402 € | CP050SSECD66 | 1.402 € | | |
| 1E años de servicio CoverPlus in situ para SureColor SC-T5200 | | | CP010SSECD67 | 455 € | | CP010SSECD67 | 455 € | |

| Grupo de precios | SureColor SC-T5200D | SureColor SC-T7200D | SureColor SC-T5200D-PS | SureColor SC-T5200 MFP HDD | SureColor SC-T7200D-PS | SureColor SC-T5200 PS MFP | SureColor SC-T5200D MFP PS | | | | | | | |
|---------------------------------|--|--|--|--|--|--|--|---------|--------------|---------|--------------|---------|--------------|---------|
| | PC | PC | PC | PC | PC | PC | PC | | | | | | | |
| |  |  |  |  |  |  |  | | | | | | | |
| Formatos papel | 36 " (91.4 cm) | 44 " (111.8 cm) | 17 " (43.2 cm) | 17 " (43.2 cm) | 44 " (111.8 cm) | 36 " (91.4 cm) | 36 " (91.4 cm) | | | | | | | |
| Colores | 5 Colores | 5 Colores | 5 Colores | 5 Colores | 5 Colores | 5 Colores | 5 Colores | | | | | | | |
| Tecnología de tinta | Ultrachrome® XD | Ultrachrome® XD | Ultrachrome® XD | Ultrachrome® XD | Ultrachrome® XD | Ultrachrome® XD | Ultrachrome® XD | | | | | | | |
| Resolución de impresión | 2.880 x 1.440 ppp | 2.880 x 1.440 ppp | 2.880 x 1.440 ppp | 2.880 x 1.440 ppp | 2.880 x 1.440 ppp | 2.880 x 1.440 ppp | 2.880 x 1.440 ppp | | | | | | | |
| Grosor del papel adecuado | 0,08 mm - 1,5 mm | 0,08 mm - 1,5 mm | 0,08 mm - 1,5 mm | 0,08 mm - 1,5 mm | 0,08 mm - 1,5 mm | 0,08 mm - 1,5 mm | 0,08 mm - 1,5 mm | | | | | | | |
| Impresión sin márgenes activada | 254 mm, 300 mm, 329 mm, 406 mm, 432 mm, 515 mm, 594 mm, 610 mm, 728 mm, 841 mm, 914 mm | 254 mm, 300 mm, 329 mm, 406 mm, 432 mm, 515 mm, 594 mm, 610 mm, 728 mm, 841 mm, 914 mm, 1030 mm, 1118 mm | 254 mm, 300 mm, 329 mm, 406 mm, 432 mm, 515 mm, 594 mm, 610 mm, 728 mm, 841 mm, 914 mm | 254 mm, 300 mm, 329 mm, 406 mm, 432 mm, 515 mm, 594 mm, 610 mm, 728 mm, 841 mm, 914 mm | 254 mm, 300 mm, 329 mm, 406 mm, 432 mm, 515 mm, 594 mm, 610 mm, 728 mm, 841 mm, 914 mm, 1030 mm, 1118 mm | 254 mm, 300 mm, 329 mm, 406 mm, 432 mm, 515 mm, 594 mm, 610 mm, 728 mm, 841 mm, 914 mm | 254 mm, 300 mm, 329 mm, 406 mm, 432 mm, 515 mm, 594 mm, 610 mm, 728 mm, 841 mm, 914 mm | | | | | | | |
| Gestión de soportes | Cortador automático, Impresión sin márgenes, Rollo de papel, Bandeja para soportes gruesos | Cortador automático, Impresión sin márgenes, Rollo de papel, Bandeja para soportes gruesos | Cortador automático, Impresión sin márgenes, Rollo de papel, Bandeja para soportes gruesos | Cortador automático, Impresión sin márgenes, Rollo de papel, Bandeja para soportes gruesos | Cortador automático, Impresión sin márgenes, Rollo de papel, Bandeja para soportes gruesos | Cortador automático, Impresión sin márgenes, Rollo de papel, Bandeja para soportes gruesos | Cortador automático, Impresión sin márgenes, Rollo de papel, Bandeja para soportes gruesos | | | | | | | |
| Emulaciones | ESC/P-R, HP-GL2, RTL, Adobe® Postscript 3® (opcional) | HP-GL2, RTL, Adobe® Postscript 3® (opcional), ESC/P-R | Adobe® Postscript 3®, RTL, HP-GL2, ESC/P-R | RTL, HP-GL2, ESC/P-R, Adobe® Postscript 3® | HP-GL2, RTL, Adobe® Postscript 3®, ESC/P-R | HP-GL2, RTL, Adobe® Postscript 3®, ESC/P-R | Adobe® Postscript 3®, HP-GL2, RTL, ESC/P-R | | | | | | | |
| VPVR neto | C11CD40301A0 | 4.995 € | C11CD41301A0 | 5.695 € | C11CD40301EB | 5.995 € | C11CD67301A2 | 6.270 € | C11CD41301EB | 6.695 € | C11CD67301A1 | 7.070 € | C11CD40301A1 | 9.070 € |

Gran formato - Sector empresarial







TARIFA DE PRECIOS

| | SureColor SC-T5200D | SureColor SC-T7200D | SureColor SC-T5200D-PS | SureColor SC-T5200 MFP HDD | SureColor SC-T7200D-PS | SureColor SC-T5200 PS MFP | SureColor SC-T5200 MFP PS |
|---|---|---|---|---|---|---|---|
| Opciones | B8, PC | B8, PC | B8, PC | B8, PC | B8, PC | B8, PC | |
| Adobe Postscript 3 Expansion Unit | C12C891131 1.200 € | C12C891131 1.200 € | C12C891131 1.200 € | C12C891131 1.200 € | C12C891131 1.200 € | C12C891131 1.200 € | |
| Hard Disk Unit T & P series | C12C848031 299,32 € | C12C848031 299,32 € | C12C848031 299,32 € | C12C848031 299,32 € | C12C848031 299,32 € | C12C848031 299,32 € | |
| MFP Scanner | C12C891071 2.295 € | C12C891071 2.295 € | C12C891071 2.295 € | C12C891071 2.295 € | C12C891071 2.295 € | C12C891071 2.295 € | |
| MFP Scanner stand 36" | C12C844151 780 € | | C12C844151 780 € | C12C844151 780 € | | | |
| MFP Scanner stand 44" | | C12C844161 780 € | | | | C12C844161 780 € | |
| Roll Adapter new T series | C12C811401 120,03 € | C12C811401 120,03 € | C12C811401 120,03 € | C12C811401 120,03 € | C12C811401 120,03 € | C12C811401 120,03 € | |
| Consumibles | T1, B8 | B8, T1 | T1, B8 | T1, B8 | T1, B8 | T1, B8 | T1, B8 |
| Cian |  | C13T692200 55 € C13T693200 130 € C13T694200 235 € | C13T692200 55 € C13T693200 130 € C13T694200 235 € | C13T692200 55 € C13T693200 130 € C13T694200 235 € | C13T692200 55 € C13T693200 130 € C13T694200 235 € | C13T692200 55 € C13T693200 130 € C13T694200 235 € | C13T692200 55 € C13T693200 130 € C13T694200 235 € |
| Magenta |  | C13T692300 55 € C13T693300 130 € C13T694300 235 € | C13T692300 55 € C13T693300 130 € C13T694300 235 € | C13T692300 55 € C13T693300 130 € C13T694300 235 € | C13T692300 55 € C13T693300 130 € C13T694300 235 € | C13T692300 55 € C13T693300 130 € C13T694300 235 € | C13T692300 55 € C13T693300 130 € C13T694300 235 € |
| Amarillo |  | C13T692400 55 € C13T693400 130 € C13T694400 235 € | C13T692400 55 € C13T693400 130 € C13T694400 235 € | C13T692400 55 € C13T693400 130 € C13T694400 235 € | C13T692400 55 € C13T693400 130 € C13T694400 235 € | C13T692400 55 € C13T693400 130 € C13T694400 235 € | C13T692400 55 € C13T693400 130 € C13T694400 235 € |
| Negro foto |  | C13T692100 55 € C13T693100 130 € C13T694100 235 € | C13T692100 55 € C13T693100 130 € C13T694100 235 € | C13T692100 55 € C13T693100 130 € C13T694100 235 € | C13T692100 55 € C13T693100 130 € C13T694100 235 € | C13T692100 55 € C13T693100 130 € C13T694100 235 € | C13T692100 55 € C13T693100 130 € C13T694100 235 € |
| Negro mate |  | C13T692500 55 € C13T693500 130 € C13T694500 235 € | C13T692500 55 € C13T693500 130 € C13T694500 235 € | C13T692500 55 € C13T693500 130 € C13T694500 235 € | C13T692500 55 € C13T693500 130 € C13T694500 235 € | C13T692500 55 € C13T693500 130 € C13T694500 235 € | C13T692500 55 € C13T693500 130 € C13T694500 235 € |
| Cuchilla de intercambio del cortador automático | | C13S902007 114,17 € | C13S902007 114,17 € | C13S902007 114,17 € | C13S902007 114,17 € | C13S902007 114,17 € | C13S902007 114,17 € |
| Caja de mantenimiento | | C13T619300 57,10 € | C13T619300 57,10 € | C13T619300 57,10 € | C13T619300 57,10 € | C13T619300 57,10 € | C13T619300 57,10 € |
| CoverPlus | BA | BA | BA | BA | BA | BA | BA |
| 03 años de servicio CoverPlus in situ para SureColor SC-T Scanner | CP03OSSESCTS 300 € | CP03OSSESCTS 300 € | CP03OSSESCTS 300 € | CP03OSSESCTS 300 € | CP03OSSESCTS 300 € | CP03OSSESCTS 300 € | CP03OSSESCTS 300 € |
| 03 años de servicio CoverPlus in situ para SureColor SC-T5200 | CP03OSSECD67 870 € | | CP03OSSECD67 870 € | CP03OSSECD67 870 € | | CP03OSSECD67 870 € | CP03OSSECD67 870 € |
| 03 años de servicio CoverPlus in situ para SureColor SC-T7200 | | CP03OSSECD68 1.100 € | | | CP03OSSECD68 1.100 € | | |
| 04 años de servicio CoverPlus in situ para SureColor SC-T Scanner | CP04OSSESCTS 400 € | CP04OSSESCTS 400 € | CP04OSSESCTS 400 € | CP04OSSESCTS 400 € | CP04OSSESCTS 400 € | CP04OSSESCTS 400 € | CP04OSSESCTS 400 € |
| 04 años de servicio CoverPlus in situ para SureColor SC-T5200 | CP04OSSECD67 1.300 € | | CP04OSSECD67 1.300 € | CP04OSSECD67 1.300 € | | CP04OSSECD67 1.300 € | CP04OSSECD67 1.300 € |
| 04 años de servicio CoverPlus | | CP04OSSECD68 1.632 € | | | CP04OSSECD68 1.632 € | | |

Gran formato - Sector empresarial

TARIFA DE PRECIOS







| | SureColor SC-T5200D | SureColor SC-T7200D | SureColor SC-T5200D-PS | SureColor SC-T5200 MFP HDD | SureColor SC-T7200D-PS | SureColor SC-T5200 PS MFP | SureColor SC-T5200D MFP PS |
|---|----------------------|----------------------|------------------------|----------------------------|------------------------|---------------------------|----------------------------|
| in situ para SureColor SC-T7200 | | | | | | | |
| 05 años de servicio CoverPlus in situ para SureColor SC-T Scanner | CP05OSSESCTS 500 € | CP05OSSESCTS 500 € | CP05OSSESCTS 500 € | CP05OSSESCTS 500 € | CP05OSSESCTS 500 € | CP05OSSESCTS 500 € | CP05OSSESCTS 500 € |
| 05 años de servicio CoverPlus in situ para SureColor SC-T5200 | CP05OSSECD67 1.734 € | | CP05OSSECD67 1.734 € | CP05OSSECD67 1.734 € | | CP05OSSECD67 1.734 € | CP05OSSECD67 1.734 € |
| 05 años de servicio CoverPlus in situ para SureColor SC-T7200 | | CP05OSSECD68 2.176 € | | | CP05OSSECD68 2.176 € | | |
| 1E años de servicio CoverPlus in situ para SureColor SC-T5200 | | | CP01OSSECD67 455 € | CP01OSSECD67 455 € | | CP01OSSECD67 455 € | CP01OSSECD67 455 € |

| Grupo de precios | EH-TW7300 | | EH-TW5350 | | EH-TW5300 | | EH-TW5210 | | EH-TW9300W | | EH-TW9300 | | EH-TW6700 | |
|---|---|--|---|--|---|--|---|--|--|--|---|--|---|--|
| | P6 | | L1 | | L1 | | W1 | | P6 | | P6 | | L1 | |
| |  | |  | |  | |  | |  | |  | |  | |
| Resolución | Full HD 1080p, 1920 x 1080, 16:9 | | Full HD 1080p, 1920 x 1080, 16:9 | | Full HD 1080p, 1920 x 1080, 16:9 | | Full HD 1080p, 1920 x 1080, 16:9 | | Full HD 1080p, 1920 x 1080, 16:9 | | Full HD 1080p, 1920 x 1080, 16:9 | | Full HD 1080p, 1920 x 1080, 16:9 | |
| Relación proyección | 1,35 - 2,84:1 | | 1,22 - 1,47:1 | | 1,22 - 1,47:1 | | 1,22 - 1,47:1 | | 1,35 - 2,84:1 | | 1,35 - 2,84:1 | | 1,32 - 2,15:1 | |
| Emisión de luz en color | 2.300 Lumen | | 2.200 Lumen- 1.500 Lumen (económico) de conformidad con IDMS15.4 | | 2.200 Lumen- 1.500 Lumen (económico) de conformidad con IDMS15.4 | | 2.200 Lumen- 1.500 Lumen (económico) de conformidad con IDMS15.4 | | 2.500 Lumen | | 2.500 Lumen | | 3.000 Lumen | |
| Relación de contraste | 160.000 : 1 | | 35.000 : 1 | | 35.000 : 1 | | 30.000 : 1 | | 1.000.000 : 1 | | 1.000.000 : 1 | | 70.000 : 1 | |
| 3D | Activo | | Activo | | Activo | | Activo | | Activo | | Activo | | Activo | |
| Interfaces | HDMI, VGA, USB, Ethernet, Wi-Fi (Opcional) | | HDMI, VGA, Miracast, USB, Wi-Fi | | HDMI, VGA, USB | | HDMI, VGA, USB | | HDMI, VGA, USB, Ethernet, Wi-Fi (Opcional) | | HDMI, VGA, USB, Ethernet, Wi-Fi (Opcional) | | HDMI, VGA, USB, Wi-Fi (Opcional) | |
| Altavoces | | | 5 vatio | | 5 vatio | | 5 vatio | | | | | | 20 vatio, Equipo estéreo: Equipo estéreo | |
| nivel de ruido | Normal: 24 dB (A) - Ahorro: 20 dB (A) | | Normal: 37 dB (A) - Ahorro: 27 dB (A) | | Normal: 37 dB (A) - Ahorro: 27 dB (A) | | Normal: 37 dB (A) - Ahorro: 27 dB (A) | | Normal: 24 dB (A) - Ahorro: 20 dB (A) | | Normal: 24 dB (A) - Ahorro: 20 dB (A) | | Normal: 32 dB (A) - Ahorro: 24 dB (A) | |
| Peso | 11 kg | | 3,1 kg | | 2,9 kg | | 2,9 kg | | 11,2 kg | | 11 kg | | 6,9 kg | |
| Garantía | 36 meses Reparación en taller, lámpara: 36 meses o 3.000 h | | 36 meses Reparación en taller, lámpara: 36 meses o 3.000 h | | 36 meses Reparación en taller, lámpara: 36 meses o 3.000 h | | 36 meses Reparación en taller, lámpara: 36 meses o 3.000 h | | 36 meses Reparación en taller, lámpara: 36 meses o 3.000 h | | 36 meses Reparación en taller, lámpara: 36 meses o 3.000 h | | 36 meses Reparación en taller, lámpara: 36 meses o 3.000 h | |
| VPVR neto | V11H715040 | | V11H709040 | | V11H707040 | | V11H708040 | | V11H711040 | | V11H710040 | | V11H799040 | |
| Opciones | J4, J3, J1 | | J1, J3 | | J1, J3 | | J1, J3 | | J1, J4, J3 | | J1, J4, J3 | | J1, J4, J3 | |
| Cargador USB para gafas 3D | V12H564C17 10,93 € | | | | | | | | V12H564C17 10,93 € | | V12H564C17 10,93 € | | V12H564C17 10,93 € | |
| Filtro de Aire- ELPAF32 | | | V13H134A32 18,72 € | | V13H134A32 18,72 € | | V13H134A32 18,72 € | | | | | | | |
| Tubo de montaje en techo (668-918 mm) - ELPPFP13 | V12H003P13 51,02 € | | V12H003P13 51,02 € | | V12H003P13 51,02 € | | V12H003P13 51,02 € | | V12H003P13 51,02 € | | V12H003P13 51,02 € | | V12H003P13 51,02 € | |
| Gafas Epson 3D (RF) - ELPGS03 | V12H548001 61,66 € | | V12H548001 61,66 € | | V12H548001 61,66 € | | V12H548001 61,66 € | | V12H548001 61,66 € | | V12H548001 61,66 € | | V12H548001 61,66 € | |
| Tubo de montaje en techo (918-1168 mm) - ELPPFP14 | V12H003P14 85,04 € | | V12H003P14 85,04 € | | V12H003P14 85,04 € | | V12H003P14 85,04 € | | V12H003P14 85,04 € | | V12H003P14 85,04 € | | V12H003P14 85,04 € | |
| Lámpara - ELPLP85 | | | | | | | | | | | | | V13H010L85 89,34 € | |
| ELPLP89 | V13H010L89 110,25 € | | | | | | | | V13H010L89 110,25 € | | V13H010L89 110,25 € | | | |
| Soporte para techo (Blanco) - ELPMB23 | | | V12H003B23 137,60 € | | V12H003B23 137,60 € | | V12H003B23 137,60 € | | | | | | | |
| Soporte para techo (Blanco) - ELPMB22 | V12H003B22 153,07 € | | | | | | | | V12H003B22 153,07 € | | V12H003B22 153,07 € | | V12H003B22 153,07 € | |
| Filtro de Aire- ELPAF39 | V13H134A39 13,47 € | | | | | | | | V13H134A39 13,47 € | | V13H134A39 13,47 € | | V13H134A39 13,47 € | |
| Soporte para techo (Perfil Bajo) - ELPMB30 | V12H526040 104,35 € | | | | | | | | V12H526040 104,35 € | | V12H526040 104,35 € | | V12H526040 104,35 € | |

Proyectores - Home cinema

TARIFA DE PRECIOS

| | EH-TW7300 | EH-TW5300 | EH-TW5300 | EH-TW5210 | EH-TW9300W | EH-TW9300 | EH-TW6700 |
|--|------------|--------------|-----------|--------------|--------------|--------------|---------------------------------------|
| Wireless LAN Adapter - ELPAP10 | V12H731P01 | 93,22 € | | | V12H731P01 | 93,22 € | V12H731P01 93,22 € V12H731P01 93,22 € |
| ELPLP88 | | V13H010L88 | 73,28 € | V13H010L88 | 73,28 € | V13H010L88 | 73,28 € |
| CoverPlus | | BA | BA | BA | BA | BA | BA |
| 03 años de servicio CoverPlus en laboratorio para EH-TW5210 | | | | CP03RTBSH708 | 150 € | | |
| 03 años de servicio CoverPlus en laboratorio para EH-TW5300/50 | | CP03RTBSH707 | 150 € | CP03RTBSH707 | 150 € | | |
| 03 años de servicio CoverPlus en laboratorio para EH-TW6700/W | | | | | | CP03RTBSH799 | 150 € |
| 03 años de servicio CoverPlus in situ para EH-TW6700/W | | | | | | CP03OSSWH799 | 250 € |
| 03 años de servicio CoverPlus in situ para EH-TW9200/W/9300W | | | | | CP03OSSWH588 | 250 € | CP03OSSWH588 250 € |
| 04 años de servicio CoverPlus en laboratorio para EH-TW5210 | | | | CP04RTBSH708 | 240 € | | |
| 04 años de servicio CoverPlus en laboratorio para EH-TW5300/50 | | CP04RTBSH707 | 240 € | CP04RTBSH707 | 240 € | | |
| 04 años de servicio CoverPlus en laboratorio para EH-TW6700/W | | | | | | CP04RTBSH799 | 240 € |
| 04 años de servicio CoverPlus in situ para EH-TW6700/W | | | | | | CP04OSSWH799 | 300 € |
| 05 años de servicio CoverPlus en laboratorio para EH-TW5210 | | | | CP05RTBSH708 | 360 € | | |
| 05 años de servicio CoverPlus en laboratorio para EH-TW5300/50 | | CP05RTBSH707 | 360 € | CP05RTBSH707 | 360 € | | |
| 05 años de servicio CoverPlus en laboratorio para EH-TW6700/W | | | | | | CP05RTBSH799 | 360 € |
| 05 años de servicio CoverPlus in situ para EH-TW6700/W | | | | | | CP05OSSWH799 | 375 € |







| Grupo de precios | EH-TW6700W | | EH-TW6800 | | EH-LS10500 | | EH-TW650 | | EH-TW5650 | | EH-LS100 | | EH-TW570 | |
|---|---|--|---|--|---|--|---|--|--|--|---|--|---|--|
| | L1 | | P6 | | PT | | L1 | | L1 | | C4 | | L1 | |
| |  | |  | |  | |  | |  | |  | |  | |
| Resolución | Full HD 1080p, 1920 x 1080, 16:9 | | Full HD 1080p, 1920 x 1080, 16:9 | | Full HD 1080p, 1920 x 1080, 16:9 | | Full HD 1080p, 1920 x 1080, 16:9 | | Full HD 1080p, 1920 x 1080, 16:9 | | Full HD, 1920 x 1200, 16:10 | | WXGA, 1280 x 800, 16:10 | |
| Relación proyección | 1,32 - 2,15:1 | | 1,32 - 2,15:1 | | 1,28 - 2,73:1 | | 1,02 - 1,23:1 | | 1,33 - 2,16:1 | | 0,27 - 0,37:1 | | 1,30 - 1,56:1 | |
| Emisión de luz en color | 3.000 Lumen | | 2.700 Lumen | | 1.500 Lumen de conformidad con IDMS15.4 | | 3.100 Lumen- 1.925 Lumen (económico) de conformidad con IDMS15.4 | | 2.500 Lumen- 1.650 Lumen (económico) de conformidad con IDMS15.4 | | 4.000 Lumen- 2.800 Lumen (económico) | | 3.000 Lumen- 2.100 Lumen (económico) | |
| Relación de contraste | 70.000 : 1 | | 120.000 : 1 | | Absolute black | | 15.000 : 1 | | 60.000 : 1 | | 2.500.000 : 1 | | 15.000 : 1 | |
| 3D | Activo | | Activo | | Activo | | NO | | Activo | | Activo | | Activo | |
| Interfaces | HDMI, VGA, USB, Wi-Fi (Opcional) | | HDMI, VGA, USB, Ethernet, Wi-Fi (Opcional) | | HDMI, VGA, USB, Ethernet | | HDMI, VGA, USB, Wi-Fi | | HDMI, VGA, Miracast, USB, Wi-Fi | | HDMI, VGA, USB, Ethernet, Wi-Fi (Opcional) | | HDMI, VGA, USB | |
| Altavoces | 20 vatio, Equipo estéreo: Equipo estéreo | | | | | | 2 vatio | | 10 vatio | | 16 vatio | | 2 vatio | |
| nivel de ruido | Normal: 32 dB (A) - Ahorro: 24 dB (A) | | Normal: 32 dB (A) - Ahorro: 24 dB (A) | | Ahorro: 19 dB (A) (4K enhancement OFF) | | Normal: 37 dB (A) - Ahorro: 28 dB (A) | | Normal: 37 dB (A) - Ahorro: 27 dB (A) | | Normal: 39 dB (A) - Ahorro: 30 dB (A) | | Normal: 37 dB (A) - Ahorro: 29 dB (A) | |
| Peso | 7 kg | | 6,6 kg | | 18 kg | | 2,7 kg | | 3,5 kg | | 11 kg | | 2,4 kg | |
| Garantía | 36 meses Reparación en taller, lámpara: 36 meses o 3.000 h | | 36 meses Reparación en taller, lámpara: 36 meses o 3.000 h | | 36 meses Reparación en taller | | 36 meses Reparación en taller, lámpara: 36 meses o 3.000 h | | 36 meses Reparación en taller, lámpara: 36 meses o 3.000 h | | 60 meses Reparación en taller o 12.000 h | | 36 meses Reparación en taller, lámpara: 36 meses o 3.000 h | |
| VPVR neto | V11H829040 | | V11H798040 | | V11H873040 | | V11H849040 | | V11H852040 | | V11H879540 | | V11H664040 582,50 € | |
| Opciones | J1, J4, J3 | | J1, J4, J3 | | J1, J4 | | J1, J3 | | J1, J3 | | P8, J1 | | J1, J3 | |
| Cargador USB para gafas 3D | V12H564C17 10,93 € | | V12H564C17 10,93 € | | | | | | V12H564C17 10,93 € | | | | | |
| Soft Carry Case - ELPKS69 - EB-x05/x41/x42, EH-TW6 series | | | | | | | V12H001K69 13,29 € | | | | | | | |
| Maleta de transporte acolchada - ELPKS63 | | | | | | | | | | | | | V12H001K63 13,42 € | |
| Filtro de Aire - ELPAF32 | | | | | | | V13H134A32 18,72 € | | | | | | V13H134A32 18,72 € | |
| Tubo de montaje en techo (668-918 mm) - ELPPP13 | V12H003P13 51,02 € | | V12H003P13 51,02 € | | | | V12H003P13 51,02 € | | V12H003P13 51,02 € | | | | V12H003P13 51,02 € | |
| ELPLP96 | | | | | | | V13H010L96 61,24 € | | V13H010L96 61,24 € | | | | | |
| Gafas Epson 3D (RF) - ELPGS03 | V12H548001 61,66 € | | V12H548001 61,66 € | | V12H548001 61,66 € | | | | V12H548001 61,66 € | | | | V12H548001 61,66 € | |
| Tubo de montaje en techo (918-1168 mm) - ELPPP14 | V12H003P14 85,04 € | | V12H003P14 85,04 € | | | | V12H003P14 85,04 € | | V12H003P14 85,04 € | | | | V12H003P14 85,04 € | |
| Lámpara - ELPLP85 | V13H010L85 89,34 € | | V13H010L85 89,34 € | | | | | | | | | | | |
| Soporte para techo (Blanco) - | | | | | | | V12H003B23 137,60 € | | V12H003B23 137,60 € | | | | V12H003B23 137,60 € | |

| | EH-TW6700W | EH-TW6800 | EH-LS10500 | EH-TW650 | EH-TW5650 | EH-LS100 | EH-TW570 |
|--|--------------|-----------|--------------|--------------|--------------|--------------|-----------|
| ELPMB23 | | | | | | | |
| Soporte para techo (Blanco) - ELPMB22 | V12H003B22 | 153,07 € | V12H003B22 | 153,07 € | | | |
| Filtro de Aire- ELPAF39 | V13H134A39 | 13,47 € | V13H134A39 | 13,47 € | V13H134A39 | 13,47 € | |
| Soporte para techo (Perfil Bajo) - ELPMB30 | V12H526040 | 104,35 € | V12H526040 | 104,35 € | | | |
| Memoria USB de conexión inalámbrica rápida - ELPAP09 | | | | | | V12H005M09 | 71,71 € |
| Wireless LAN Adapter - ELPAP10 | V12H731P01 | 93,22 € | V12H731P01 | 93,22 € | | V12H731P01 | 93,22 € |
| Filtro de Aire- ELPAF43 | | | | | | V13H134A43 | 79,54 € |
| Lámpara - ELPLP78 | | | | | | V13H010L78 | 91,78 € |
| Pantalla de 80" pantógrafo 16:10 - ELPSC24 | | | | V12H002S24 | 456,10 € | | |
| CoverPlus | BA | BA | BA | BA | BA | BA | BA |
| 03 años de servicio CoverPlus en laboratorio para EH-TW54xx/56xx | | | | | CP03RTBSH852 | 150 € | |
| 03 años de servicio CoverPlus en laboratorio para EH-TW570 | | | | | | CP03RTBSH664 | 50 € |
| 03 años de servicio CoverPlus en laboratorio para EH-TW6700/W | CP03RTBSH799 | 150 € | | | | | |
| 03 años de servicio CoverPlus en laboratorio para EH-TW6800 | | | CP03RTBSH798 | 150 € | | | |
| 03 años de servicio CoverPlus en laboratorio para EH-TW6xx | | | | CP03RTBSH849 | 50 € | | |
| 03 años de servicio CoverPlus in situ para EH-TW6700/W | CP03OSSWH799 | 250 € | | | | | |
| 03 años de servicio CoverPlus in situ para EH-TW6800 | | | CP03OSSWH798 | 250 € | | | |
| 04 años de servicio CoverPlus en laboratorio para EH-LS10000 | | | CP04RTBSH488 | 480 € | | | |
| 04 años de servicio CoverPlus en laboratorio para EH-TW54xx/56xx | | | | | CP04RTBSH852 | 240 € | |
| 04 años de servicio CoverPlus en laboratorio para EH-TW6700/W | CP04RTBSH799 | 240 € | | | | | |
| 04 años de servicio CoverPlus en laboratorio para EH-TW6800 | | | CP04RTBSH798 | 240 € | | | |
| 04 años de servicio CoverPlus | | | | CP04RTBSH849 | 80 € | | |

Proyectores - Home cinema

TARIFA DE PRECIOS

| | EH-TW6700W | EH-TW6800 | EH-LS10500 | EH-TW650 | EH-TW5650 | EH-LS100 | EH-TW570 |
|--|--------------|--------------|--------------|--------------|--------------|----------|----------|
| en laboratorio para EH-TW6xx | | | | | | | |
| 04 años de servicio CoverPlus in situ para EH-TW6700/W | CP04OSSWH799 | 300 € | | | | | |
| 04 años de servicio CoverPlus in situ para EH-TW6800 | | CP04OSSWH798 | 300 € | | | | |
| 05 años de servicio CoverPlus en laboratorio para EH-LS10000 | | | CP05RTBSH488 | 600 € | | | |
| 05 años de servicio CoverPlus en laboratorio para EH-TW54xx/56xx | | | | | CP05RTBSH852 | 360 € | |
| 05 años de servicio CoverPlus en laboratorio para EH-TW6700/W | CP05RTBSH799 | 360 € | | | | | |
| 05 años de servicio CoverPlus en laboratorio para EH-TW6800 | | CP05RTBSH798 | 360 € | | | | |
| 05 años de servicio CoverPlus en laboratorio para EH-TW6xx | | | | CP05RTBSH849 | 120 € | | |
| 05 años de servicio CoverPlus in situ para EH-TW6700/W | CP05OSSWH799 | 375 € | | | | | |
| 05 años de servicio CoverPlus in situ para EH-TW6800 | | CP05OSSWH798 | 375 € | | | | |

| Grupo de precios | EB-2040 | | EB-2055 | | EB-2065 | | EB-2140W | | EB-2155W | | EB-2165W | | EB-2245U | |
|---|---|---|---|---|--|---|---|-----------------|--|-------------------|--|-------------------|--|-------------------|
| | C5 | | C5 | | C5 | | C5 | | C5 | | B9 | | C5 | |
| |  |  |  |  |  |  |  | | | | | | | |
| Resolución | XGA, 1024 x 768, 4:3 | | XGA, 1024 x 768, 4:3 | | XGA, 1024 x 768, 4:3 | | WXGA, 1280 x 800, 16:10 | | WXGA, 1280 x 800, 16:10 | | WXGA, 1280 x 800, 16:10 | | WUXGA, 1920 x 1200, 16:10 | |
| Relación proyección | 1,38 - 2,24:1 | | 1,38 - 2,24:1 | | 1,38 - 2,24:1 | | 1,38 - 2,24:1 | | 1,38 - 2,24:1 | | 1,38 - 2,28:1 | | 1,57 - 2,58:1 | |
| Emisión de luz en color | 4.200 Lumen- 2.700 Lumen (económico) de conformidad con IDMS15.4 | | 5.000 Lumen- 3.800 Lumen (económico) de conformidad con IDMS15.4 | | 5.500 Lumen- 3.800 Lumen (económico) de conformidad con IDMS15.4 | | 4.200 Lumen- 2.700 Lumen (económico) de conformidad con IDMS15.4 | | 5.000 Lumen- 3.600 Lumen (económico) de conformidad con IDMS15.4 | | 5.500 Lumen- 3.800 Lumen (económico) de conformidad con IDMS15.4 | | 4.200 Lumen- 3.100 Lumen (económico) de conformidad con IDMS15.4 | |
| Relación de contraste | 15.000 : 1 | | 15.000 : 1 | | 15.000 : 1 | | 15.000 : 1 | | 15.000 : 1 | | 15.000 : 1 | | 15.000 : 1 | |
| Interfaces | HDMI, VGA, USB, Ethernet, Wi-Fi (Opcional) | | HDMI, VGA, USB, Ethernet, Wi-Fi | | HDMI, VGA, USB, Ethernet, Wi-Fi | | HDMI, VGA, USB, Ethernet, Wi-Fi (Opcional) | | HDMI, VGA, USB, Ethernet, Wi-Fi | | HDMI, VGA, Miracast, HD-BaseT, USB, Ethernet, Wi-Fi | | HDMI, VGA, USB, Ethernet, Wi-Fi | |
| Garantía | 36 meses Reparación en taller o 8.000 h, lámpara: 12 meses o 1.000 h | | 36 meses Reparación en taller o 8.000 h, lámpara: 12 meses o 1.000 h | | 36 meses Reparación en taller o 8.000 h, lámpara: 12 meses o 1.000 h | | 36 meses Reparación en taller o 8.000 h, lámpara: 12 meses o 1.000 h | | 36 meses Reparación en taller o 8.000 h, lámpara: 12 meses o 1.000 h | | 36 meses Reparación en taller o 8.000 h, lámpara: 12 meses o 1.000 h | | 36 meses Reparación en taller o 8.000 h, lámpara: 12 meses o 1.000 h | |
| PVPR neto | V11H822040 | 808,29 € | V11H821040 | 1.059,03 € | V11H820040 | 1.225,67 € | V11H819040 | 996,73 € | V11H818040 | 1.246,69 € | V11H817040 | 1.829,04 € | V11H816040 | 1.229,03 € |
| Opciones | J1, J3 | | J1, J3 | | J1, J3 | | J1, J3 | | J1, J3 | | J1, J3 | | J1, J3 | |
| Filtro de Aire- ELPAF41 | V13H134A41 | 18,72 € | V13H134A41 | 18,72 € | V13H134A41 | 18,72 € | V13H134A41 | 18,72 € | V13H134A41 | 18,72 € | V13H134A41 | 18,72 € | V13H134A41 | 18,72 € |
| Maleta de transporte acolchada - ELPKS68 | V12H001K68 | 23,62 € | V12H001K68 | 23,62 € | V12H001K68 | 23,62 € | V12H001K68 | 23,62 € | V12H001K68 | 23,62 € | V12H001K68 | 23,62 € | V12H001K68 | 23,62 € |
| Tubo de montaje en techo (668-918 mm) - ELPPF13 | V12H003P13 | 51,02 € | V12H003P13 | 51,02 € | V12H003P13 | 51,02 € | V12H003P13 | 51,02 € | V12H003P13 | 51,02 € | V12H003P13 | 51,02 € | V12H003P13 | 51,02 € |
| Tubo de montaje en techo (918-1168 mm) - ELPPF14 | V12H003P14 | 85,04 € | V12H003P14 | 85,04 € | V12H003P14 | 85,04 € | V12H003P14 | 85,04 € | V12H003P14 | 85,04 € | V12H003P14 | 85,04 € | V12H003P14 | 85,04 € |
| ELPLP95 | | | V13H010L95 | 92,39 € | V13H010L95 | 92,39 € | V13H010L95 | 92,39 € | V13H010L95 | 92,39 € | V13H010L95 | 92,39 € | V13H010L95 | 92,39 € |
| Soporte para techo (Blanco) - ELPMB23 | V12H003B23 | 137,60 € | V12H003B23 | 137,60 € | V12H003B23 | 137,60 € | V12H003B23 | 137,60 € | V12H003B23 | 137,60 € | V12H003B23 | 137,60 € | V12H003B23 | 137,60 € |
| Wireless LAN Adapter - ELPA10 | V12H731P01 | 93,22 € | V12H731P01 | 93,22 € | V12H731P01 | 93,22 € | V12H731P01 | 93,22 € | V12H731P01 | 93,22 € | V12H731P01 | 93,22 € | V12H731P01 | 93,22 € |
| Caja de control y conexiones Epson - ELPCB02 | V12H614040 | 207,50 € | V12H614040 | 207,50 € | V12H614040 | 207,50 € | V12H614040 | 207,50 € | V12H614040 | 207,50 € | V12H614040 | 207,50 € | V12H614040 | 207,50 € |
| HDBaseT Transmitter - ELPHD01 | | | | | | | | | | | V12H547040 | 489,04 € | | |
| Lámpara - ELPLP87 | V13H010L87 | 59,36 € | | | | | | | | | | | | |
| CoverPlus | BA | | BA | | BA | | BA | | BA | | BA | | BA | |
| 03 años de servicio CoverPlus in situ para EB-20xx | CP03OSSEH821 | 150 € | CP03OSSEH821 | 150 € | CP03OSSEH821 | 150 € | CP03OSSEH821 | 150 € | CP03OSSEH821 | 150 € | CP03OSSEH821 | 150 € | CP03OSSEH821 | 150 € |
| | CP03OSSWH821 | 150 € | CP03OSSWH821 | 150 € | CP03OSSWH821 | 150 € | CP03OSSWH821 | 150 € | CP03OSSWH821 | 150 € | CP03OSSWH821 | 150 € | CP03OSSWH821 | 150 € |
| | CP03OSSLH821 | 170 € | CP03OSSLH821 | 170 € | CP03OSSLH821 | 170 € | CP03OSSLH821 | 170 € | CP03OSSLH821 | 170 € | CP03OSSLH821 | 170 € | CP03OSSLH821 | 170 € |
| 03 años de servicio CoverPlus in situ para EB-21xxW | | | | | | | CP03OSSLH818 | 170 € | CP03OSSLH818 | 170 € | CP03OSSLH818 | 170 € | CP03OSSLH818 | 170 € |
| | | | | | | | CP03OSSEH818 | 150 € | CP03OSSEH818 | 150 € | CP03OSSEH818 | 150 € | CP03OSSEH818 | 150 € |
| | | | | | | | CP03OSSWH818 | 150 € | CP03OSSWH818 | 150 € | CP03OSSWH818 | 150 € | CP03OSSWH818 | 150 € |

Proyectores - Instalación

TARIFA DE PRECIOS

| | EB-2040 | EB-2055 | EB-2065 | EB-2140W | EB-2155W | EB-2165W | EB-2245U |
|--|--|--|--|--|--|--|--|
| 03 años de servicio CoverPlus in situ para EB-22xxU | | | | | | | CP03OSSEH815 150 € CP03OSSWH815 150 € CP03OSSLH815 170 € |
| 04 años de servicio CoverPlus en laboratorio para EB-20xx | CP04RTBSSH821 144 € | CP04RTBSSH821 144 € | CP04RTBSSH821 144 € | CP04RTBSSH818 144 € | CP04RTBSSH818 144 € | CP04RTBSSH818 144 € | CP04RTBSSH815 144 € |
| 04 años de servicio CoverPlus en laboratorio para EB-21xxW | | | | CP04RTBSSH818 144 € | CP04RTBSSH818 144 € | CP04RTBSSH818 144 € | CP04RTBSSH815 144 € |
| 04 años de servicio CoverPlus en laboratorio para EB-22xxU | | | | | | | CP04RTBSSH815 144 € |
| 04 años de servicio CoverPlus in situ para EB-20xx | CP04OSSEH821 250 € CP04OSSWH821 250 € CP04OSSLH821 280 € | CP04OSSEH821 250 € CP04OSSWH821 250 € CP04OSSLH821 280 € | CP04OSSEH821 250 € CP04OSSWH821 250 € CP04OSSLH821 280 € | CP04OSSEH818 250 € CP04OSSWH818 250 € CP04OSSEH818 250 € | CP04OSSEH818 250 € CP04OSSWH818 250 € CP04OSSEH818 250 € | CP04OSSEH818 250 € CP04OSSWH818 250 € CP04OSSEH818 250 € | CP04OSSEH815 250 € CP04OSSWH815 250 € CP04OSSLH815 280 € |
| 04 años de servicio CoverPlus in situ para EB-21xxW | | | | CP04OSSLH818 280 € CP04OSSWH818 250 € CP04OSSEH818 250 € | CP04OSSLH818 280 € CP04OSSWH818 250 € CP04OSSEH818 250 € | CP04OSSLH818 280 € CP04OSSWH818 250 € CP04OSSEH818 250 € | CP04OSSLH815 280 € CP04OSSWH815 250 € CP04OSSLH815 280 € |
| 04 años de servicio CoverPlus in situ para EB-22xxU | | | | | | | CP04OSSEH815 250 € CP04OSSWH815 250 € CP04OSSLH815 280 € |
| 05 años de servicio CoverPlus en laboratorio para EB-20xx | CP05RTBSSH821 216 € | CP05RTBSSH821 216 € | CP05RTBSSH821 216 € | CP05RTBSSH818 216 € | CP05RTBSSH818 216 € | CP05RTBSSH818 216 € | CP05RTBSSH815 216 € |
| 05 años de servicio CoverPlus en laboratorio para EB-21xxW | | | | CP05RTBSSH818 216 € | CP05RTBSSH818 216 € | CP05RTBSSH818 216 € | CP05RTBSSH815 216 € |
| 05 años de servicio CoverPlus en laboratorio para EB-22xxU | | | | | | | CP05RTBSSH815 216 € |
| 05 años de servicio CoverPlus in situ para EB-20xx | CP05OSSEH821 330 € CP05OSSWH821 330 € CP05OSSLH821 370 € | CP05OSSEH821 330 € CP05OSSWH821 330 € CP05OSSLH821 370 € | CP05OSSEH821 330 € CP05OSSWH821 330 € CP05OSSLH821 370 € | CP05OSSEH818 330 € CP05OSSWH818 330 € CP05OSSEH818 330 € | CP05OSSEH818 330 € CP05OSSWH818 330 € CP05OSSEH818 330 € | CP05OSSEH818 330 € CP05OSSWH818 330 € CP05OSSEH818 330 € | CP05OSSEH815 330 € CP05OSSWH815 330 € CP05OSSLH815 370 € |
| 05 años de servicio CoverPlus in situ para EB-21xxW | | | | CP05OSSLH818 370 € CP05OSSWH818 330 € CP05OSSEH818 330 € | CP05OSSLH818 370 € CP05OSSWH818 330 € CP05OSSEH818 330 € | CP05OSSLH818 370 € CP05OSSWH818 330 € CP05OSSEH818 330 € | CP05OSSLH815 370 € CP05OSSWH815 330 € CP05OSSLH815 370 € |
| 05 años de servicio CoverPlus in situ para EB-22xxU | | | | | | | CP05OSSEH815 330 € CP05OSSWH815 330 € CP05OSSLH815 370 € |

| | EB-2255U | EB-2265U | EB-5520W | EB-5530U | EB-5530U with 3 replacement lamps | EB-700U | EB-G7000W |
|------------------|---|---|---|---|--|---|---|
| Grupo de precios | B9 | B9 | PR | PR | PR | P7 | PR |
| |  |  |  |  |  |  |  |

EB-2255U

EB-2265U

EB-5520W

EB-5530U

EB-5530U with 3 replacement lamps

EB-700U

EB-G7000W



| | | | | | | | |
|--|--|--|--|--|--|--|---|
| Resolución | WUXGA, 1920 x 1200, 16:10 | WUXGA, 1920 x 1200, 16:10 | WXGA, 1280 x 800, 16:10 | WUXGA, 1920 x 1200, 16:10 | WUXGA, 1920 x 1200, 16:10 | WUXGA, 1920 x 1200, 16:10 | WXGA, 1280 x 800, 16:10 |
| Relación proyección | 1,38 - 2,28:1 | 1,38 - 2,28:1 | 1,26 - 2,30:1 | 1,26 - 2,30:1 | 1,26 - 2,30:1 | 0,27 - 0,37:1 | 1,44 - 2,33:1 |
| Emisión de luz en color | 5.000 Lumen- 3.800 Lumen (económico) de conformidad con IDMS15.4 | 5.500 Lumen- 3.800 Lumen (económico) de conformidad con IDMS15.4 | 5.500 Lumen- 3.700 Lumen (económico) de conformidad con IDMS15.4 | 5.500 Lumen- 3.700 Lumen (económico) de conformidad con IDMS15.4 | 5.500 Lumen- 3.700 Lumen (económico) de conformidad con IDMS15.4 | 4.000 Lumen- 2.800 Lumen (económico) de conformidad con IDMS15.4 | 6.500 Lumen- 5.915 Lumen (económico) de conformidad con IDMS15.4 |
| Relación de contraste | 15.000 : 1 | 15.000 : 1 | 15.000 : 1 | 15.000 : 1 | 15.000 : 1 | 2.500.000 : 1 | 50.000 : 1 |
| Interfaces | HDMI, VGA, Miracast, USB, Ethernet, Wi-Fi | HDMI, VGA, Miracast, HD-BaseT, USB, Ethernet, Wi-Fi | HDMI, VGA, Miracast, HD-BaseT, USB, Wi-Fi (Opcional) | HDMI, VGA, Miracast, HD-BaseT, USB, Wi-Fi (Opcional) | HDMI, VGA, Miracast, HD-BaseT, USB, Wi-Fi (Opcional) | HDMI, VGA, USB, Ethernet, Wi-Fi (Opcional) | VGA, HD-BaseT, USB, Ethernet, Wi-Fi (Opcional) |
| Garantía | 36 meses Reparación en taller o 8.000 h, lámpara: 12 meses o 1.000 h | 36 meses Reparación en taller o 8.000 h, lámpara: 12 meses o 1.000 h | 36 meses Reparación en taller o 8.000 h, lámpara: 12 meses o 1.000 h | 36 meses Reparación en taller o 8.000 h, lámpara: 12 meses o 1.000 h | 36 meses Reparación en taller o 8.000 h, lámpara: 12 meses o 1.000 h | 60 meses Reparación en taller o 20.000 h | 36 meses Reparación en taller o 20.000 h, lámpara: 12 meses o 1.000 h |
| VPVR neto | V11H815040 1.854,33 € | V11H814040 2.088 € | V11H826040 1.860 € | V11H824040 2.040 € | V11H824040LP 2.188,88 € | V11H878540 2.801,53 € | V11H752040 2.946,83 € |
| Opciones | J1, J3 | J1, J3 | J1, J3 | J1, J3 | J3, J1 | P8, J3, J1 | P8, J1, J3 |
| Filtro de Aire - ELPAF30 | | | | | | | V13H134A30 18,72 € |
| Filtro de Aire - ELPAF41 | V13H134A41 18,72 € | V13H134A41 18,72 € | | | | | |
| Maleta de transporte acolchada - ELPKS68 | V12H001K68 23,62 € | V12H001K68 23,62 € | | | | | |
| Gafas 3D pasivas (para adulto, x5) - ELPGS02A | | | | | | | V12H541A10 26,80 € |
| Gafas 3D pasivas (para niño, x5) - ELPGS02B | | | | | | | V12H541B10 26,80 € |
| Tubo de montaje en techo (668-918 mm) - ELPPF13 | V12H003P13 51,02 € | V12H003P13 51,02 € | | | | V12H003P13 51,02 € | V12H003P13 51,02 € |
| Tubo de montaje en techo (918-1168 mm) - ELPPF14 | V12H003P14 85,04 € | V12H003P14 85,04 € | | | | V12H003P14 85,04 € | V12H003P14 85,04 € |
| ELPLP95 | V13H010L95 92,39 € | V13H010L95 92,39 € | V13H010L95 92,39 € | V13H010L95 92,39 € | V13H010L95 92,39 € | V13H010L95 92,39 € | |
| Soporte para techo (Blanco) - ELPMB23 | V12H003B23 137,60 € | V12H003B23 137,60 € | | | | | |
| Soporte para techo (Blanco) - ELPMB22 | | | V12H003B22 153,07 € | V12H003B22 153,07 € | V12H003B22 153,07 € | V12H003B22 153,07 € | V12H003B22 153,07 € |
| Wall Mount - ELPMB53 - EB700U | | | | | | V12H902040 191,67 € | |
| Ceiling Mount - ELPMB47 Low EB-G7000/L1000 | | | | | | | V12H802010 249,36 € |

Proyectors - Instalación







TARIFA DE PRECIOS

| | EB-2255U | EB-2265U | EB-5520W | EB-5530U | EB-5530U with 3 replacement lamps | EB-700U | EB-G7000W |
|--|---|---|--|--|--|--|------------------------------|
| ELPLP93 | | | | | | | V13H010L93 252,08 € |
| Ceiling Mount - ELPMB48 High EB-G7000/L1000 | | | | | | | V12H803010 330,22 € |
| 3D Polarizer - ELPLL01 | | | | | | | V12H618A01 395,88 € |
| Soporte para techo (Perfil Bajo) - ELPMB30 | | | V12H526040 104,35 € | V12H526040 104,35 € | V12H526040 104,35 € | V12H526040 104,35 € | |
| Memoria USB de conexión inalámbrica rápida - ELPAP09 | | | | | | | V12H005M09 71,71 € |
| Wireless LAN Adapter - ELPAP10 | V12H731P01 93,22 € | V12H731P01 93,22 € | V12H731P01 93,22 € | V12H731P01 93,22 € | V12H731P01 93,22 € | V12H731P01 93,22 € | V12H731P01 93,22 € |
| Caja de control y conexiones Epson - ELPCEB02 | V12H614040 207,50 € | V12H614040 207,50 € | | | | | |
| HDBaseT Transmitter - ELPHD01 | | V12H547040 489,04 € | V12H547040 489,04 € | V12H547040 489,04 € | V12H547040 489,04 € | V12H547040 489,04 € | V12H547040 489,04 € |
| Filtro de Aire - ELPAF45 | | | V13H134A45 60,32 € | V13H134A45 60,32 € | V13H134A45 60,32 € | V13H134A45 60,32 € | |
| Filtro de Aire - ELPAF43 | | | | | | V13H134A43 79,54 € | |
| Lens - ELPLM08 - Mid throw 1 - G7000/L1000 series | | | | | | | V12H004M08 812,50 € |
| Lens - ELPLM15 - Mid Throw L1500/L1700 Series | | | | | | | V12H004M0F 1.149,98 € |
| Lens - ELPLM09 - Mid throw 2 - G7000/L1000 series | | | | | | | V12H004M09 1.150 € |
| Lens - ELPLM10 - Mid throw 3 - G7000/L1000 series | | | | | | | V12H004M0A 1.375 € |
| Lens - ELPLM11 - Mid throw 4 - G7000/L1000 series | | | | | | | V12H004M0B 1.375 € |
| Lens - ELPLW05 - G7000 & L1000 Series wide zoom 1 | | | | | | | V12H004W05 1.375 € |
| Lens - ELPLL08 - Long throw - G7000/L1000 series | | | | | | | V12H004L08 2.200 € |
| Lens - ELPLU03 - G7000 & L1000 Series ST off axis 1 | | | | | | | V12H004U03 3.018,75 € |
| Lens - ELPLU04 - G7000 & L1000 Series ST off axis 2 | | | | | | | V12H004U04 3.018,75 € |
| Lens - ELPLX01 - UST lens G7000 series & L1100,1200,1300,1400/5U | | | | | | | V12H004X01 7.249,87 € |
| CoverPlus | BA | BA | BA | BA | BA | BA | BA |
| 03 años de servicio CoverPlus in situ para EB-22xxU | CP03OSSEH815 150 € CP03OSSWH815 150 € CP03OSSLH815 170 € | CP03OSSEH815 150 € CP03OSSWH815 150 € CP03OSSLH815 170 € | | | | | |
| 03 años de servicio CoverPlus in situ para EB-5510/20W/30U | | | CP03OSSEH826 410 € CP03OSSWH826 410 € | CP03OSSEH826 410 € CP03OSSWH826 410 € | CP03OSSEH826 410 € CP03OSSWH826 410 € | CP03OSSEH826 410 € CP03OSSWH826 410 € | |

Proyectores - Instalación

TARIFA DE PRECIOS

| | EB-2255U | EB-2265U | EB-5520W | EB-5530U | EB-5530U with 3 replacement lamps | EB-700U | EB-G7000W |
|---|---|---|--|--|--|--|---|
| 03 años de servicio CoverPlus in situ para EB-G7XX/W/U | | | | | | | CP03OSSWH752 410 € CP03OSSEH752 410 € |
| 04 años de servicio CoverPlus en laboratorio para EB-22xxU | CP04RTBSH815 144 € | CP04RTBSH815 144 € | | | | | |
| 04 años de servicio CoverPlus en laboratorio para EB-5510/20W/30U | | | CP04RTBSH826 144 € | CP04RTBSH826 144 € | CP04RTBSH826 144 € | CP04RTBSH826 144 € | |
| 04 años de servicio CoverPlus in situ para EB-22xxU | CP04OSSEH815 250 € CP04OSSWH815 250 € CP04OSSLH815 280 € | CP04OSSEH815 250 € CP04OSSWH815 250 € CP04OSSLH815 280 € | | | | | |
| 04 años de servicio CoverPlus in situ para EB-5510/20W/30U | | | CP04OSSEH826 652 € CP04OSSWH826 652 € | CP04OSSEH826 652 € CP04OSSWH826 652 € | CP04OSSEH826 652 € CP04OSSWH826 652 € | CP04OSSEH826 652 € CP04OSSWH826 652 € | |
| 04 años de servicio CoverPlus in situ para EB-G7XX/W/U | | | | | | | CP04OSSWH752 708,48 € CP04OSSEH752 656 € |
| 05 años de servicio CoverPlus en laboratorio para EB-22xxU | CP05RTBSH815 216 € | CP05RTBSH815 216 € | | | | | |
| 05 años de servicio CoverPlus en laboratorio para EB-5510/20W/30U | | | CP05RTBSH826 216 € | CP05RTBSH826 216 € | CP05RTBSH826 216 € | CP05RTBSH826 216 € | |
| 05 años de servicio CoverPlus in situ para EB-22xxU | CP05OSSEH815 330 € CP05OSSWH815 330 € CP05OSSLH815 370 € | CP05OSSEH815 330 € CP05OSSWH815 330 € CP05OSSLH815 370 € | | | | | |
| 05 años de servicio CoverPlus in situ para EB-5510/20W/30U | | | CP05OSSEH826 984 € CP05OSSWH826 984 € | CP05OSSEH826 984 € CP05OSSWH826 984 € | CP05OSSEH826 984 € CP05OSSWH826 984 € | CP05OSSEH826 984 € CP05OSSWH826 984 € | |
| 05 años de servicio CoverPlus in situ para EB-700U | | | | | | CP05OSSEH878 900 € CP05OSSWH878 900 € | |
| 05 años de servicio CoverPlus in situ para EB-G7XX/W/U | | | | | | | CP05OSSWH752 984 € CP05OSSEH752 984 € |

| Grupo de precios | EB-G7200W | EB-G7400U | EB-G7800 | EB-G7900U | EB-G7905U | EB-L1000U | EB-L1100U |
|-------------------------|---|---|---|---|--|---|---|
| | P7 | PR | P7 | P7 | P7 | P7 | PZ |
| |  |  |  |  |  |  |  |
| Resolución | WXGA, 1280 x 800, 16:10 | WUXGA, 1920 x 1200, 16:10 | XGA, 1024 x 768, 4:3 | WUXGA, 1920 x 1200, 16:10 | WUXGA, 1920 x 1200, 16:10 | WUXGA, 1920 x 1200, 16:10 | WUXGA, 1920 x 1200, 16:10 |
| Relación proyección | 1,44 - 2,33:1 | 1,44 - 2,33:1 | 1,47 - 2,38:1 | 1,44 - 2,33:1 | 1,44 - 2,33:1 | 1,44 - 2,32:1 | 1,44 - 2,32:1 |
| Emisión de luz en color | 7.500 Lumen- 6.000 Lumen (económico) de conformidad con IDMS15.4 | 5.500 Lumen de conformidad con IDMS15.4 | 8.000 Lumen- 6.400 Lumen (económico) de conformidad con IDMS15.4 | 7.000 Lumen- 5.600 Lumen (económico) de conformidad con IDMS15.4 | 7.000 Lumen- 5.600 Lumen (económico) de conformidad con IDMS15.4 | 5.000 Lumen- 3.500 Lumen (económico) de conformidad con IDMS15.4 | 6.000 Lumen- 4.200 Lumen (económico) de conformidad con IDMS15.4 |
| Relación de contraste | 50.000 : 1 | 50.000 : 1 | 50.000 : 1 | 50.000 : 1 | 50.000 : 1 | 2.500.000 : 1 | 2.500.000 : 1 |

Proyectors - Instalación







TARIFA DE PRECIOS

| | EB-G7200W | EB-G7400U | EB-G7800 | EB-G7900U | EB-G7905U | EB-L1000U | EB-L1000U |
|--|---|---|---|---|---|--|--|
| Interfaces | VGA, HD-BaseT, USB, Ethernet, Wi-Fi (Opcional) | VGA, HD-BaseT, USB, Ethernet, Wi-Fi (Opcional) | VGA, HD-BaseT, USB, Ethernet, Wi-Fi (Opcional) | VGA, HD-BaseT, USB, Ethernet, Wi-Fi (Opcional) | VGA, HD-BaseT, USB, Ethernet, Wi-Fi (Opcional) | HDMI, VGA, HD-BaseT, USB, Ethernet, Wi-Fi (Opcional) | HDMI, VGA, HD-BaseT, USB, Ethernet, Wi-Fi (Opcional) |
| Garantía | 36 meses Reparación en taller o 20.000 h, lámpara: 12 meses o 1.000 h | 36 meses Reparación en taller o 20.000 h, lámpara: 12 meses o 1.000 h | 36 meses Reparación en taller o 20.000 h, lámpara: 12 meses o 1.000 h | 36 meses Reparación en taller o 20.000 h, lámpara: 12 meses o 1.000 h | 36 meses Reparación en taller o 20.000 h, lámpara: 12 meses o 1.000 h | 60 meses Reparación en taller o 20.000 h | 60 meses Reparación en taller o 20.000 h |
| PVPR neto | V11H751040 3.472 € | V11H762040 3.173,56 € | V11H753040 3.214 € | V11H749040 4.628,63 € | V11H749140 4.628,63 € | V11H934040 5.593 € | V11H735040 7.071,61 € |
| Opciones | P8, J1, J3 | P8, J1, J3 | P8, J1, J3 | P8, J1, J3 | P8, J1, J3 | P8, J1, J3 | P8, J1, J3 |
| Filtro de Aire - ELPAF30 | V13H134A30 18,72 € | V13H134A30 18,72 € | V13H134A30 18,72 € | V13H134A30 18,72 € | V13H134A30 18,72 € | V13H134A30 18,72 € | |
| Gafas 3D pasivas (para adulto, x5) - ELPGS02A | V12H541A10 26,80 € | V12H541A10 26,80 € | V12H541A10 26,80 € | V12H541A10 26,80 € | V12H541A10 26,80 € | V12H541A10 26,80 € | |
| Gafas 3D pasivas (para niño, x5) - ELPGS02B | V12H541B10 26,80 € | V12H541B10 26,80 € | V12H541B10 26,80 € | V12H541B10 26,80 € | V12H541B10 26,80 € | V12H541B10 26,80 € | |
| Tubo de montaje en techo (668-918 mm) - ELPPF13 | V12H003P13 51,02 € | V12H003P13 51,02 € | V12H003P13 51,02 € | V12H003P13 51,02 € | V12H003P13 51,02 € | V12H003P13 51,02 € | |
| Air Filter - ELPAF51 | | | | | | V13H134A51 81,32 € | V13H134A51 81,32 € |
| Tubo de montaje en techo (918-1168 mm) - ELPPF14 | V12H003P14 85,04 € | V12H003P14 85,04 € | V12H003P14 85,04 € | V12H003P14 85,04 € | V12H003P14 85,04 € | V12H003P14 85,04 € | |
| Soporte para techo (Blanco) - ELPMB22 | V12H003B22 153,07 € | V12H003B22 153,07 € | V12H003B22 153,07 € | V12H003B22 153,07 € | V12H003B22 153,07 € | V12H003B22 153,07 € | |
| Ceiling Mount - ELPMB47 Low EB-G7000/L1000 | V12H802010 249,36 € | V12H802010 249,36 € | V12H802010 249,36 € | V12H802010 249,36 € | V12H802010 249,36 € | V12H802010 249,36 € | V12H802010 249,36 € |
| ELPLP93 | V13H010L93 252,08 € | V13H010L93 252,08 € | V13H010L93 252,08 € | V13H010L93 252,08 € | V13H010L93 252,08 € | V13H010L93 252,08 € | |
| Ceiling Mount - ELPMB48 High EB-G7000/L1000 | V12H803010 330,22 € | V12H803010 330,22 € | V12H803010 330,22 € | V12H803010 330,22 € | V12H803010 330,22 € | V12H803010 330,22 € | V12H803010 330,22 € |
| 3D Polarizer - ELPLP01 | V12H618A01 395,88 € | V12H618A01 395,88 € | V12H618A01 395,88 € | V12H618A01 395,88 € | V12H618A01 395,88 € | V12H618A01 395,88 € | V12H618A01 395,88 € |
| Stacking Frame - ELPMB50 - L1000 Series (Premium) | | | | | | V12H003B50 3.309,51 € | V12H003B50 3.309,51 € |
| Memoria USB de conexión inalámbrica rápida - ELPAP09 | V12H005M09 71,71 € | V12H005M09 71,71 € | V12H005M09 71,71 € | V12H005M09 71,71 € | V12H005M09 71,71 € | V12H005M09 71,71 € | V12H005M09 71,71 € |
| Wireless LAN Adapter - ELPAP10 | V12H731P01 93,22 € | V12H731P01 93,22 € | V12H731P01 93,22 € | V12H731P01 93,22 € | V12H731P01 93,22 € | V12H731P01 93,22 € | V12H731P01 93,22 € |
| HDBaseT Transmitter - ELPHD01 | V12H547040 489,04 € | V12H547040 489,04 € | V12H547040 489,04 € | V12H547040 489,04 € | V12H547040 489,04 € | V12H547040 489,04 € | V12H547040 489,04 € |
| Lens - ELPLM08 - Mid throw 1 - G7000/L1000 series | V12H004M08 812,50 € | V12H004M08 812,50 € | V12H004M08 812,50 € | V12H004M08 812,50 € | V12H004M08 812,50 € | V12H004M08 812,50 € | V12H004M08 812,50 € |
| Lens - ELPLM15 - Mid Throw L1500/L1700 Series | V12H004M0F 1.149,98 € | V12H004M0F 1.149,98 € | V12H004M0F 1.149,98 € | V12H004M0F 1.149,98 € | V12H004M0F 1.149,98 € | V12H004M0F 1.149,98 € | V12H004M0F 1.149,98 € |
| Lens - ELPLM09 - Mid throw 2 - G7000/L1000 series | V12H004M09 1.150 € | V12H004M09 1.150 € | V12H004M09 1.150 € | V12H004M09 1.150 € | V12H004M09 1.150 € | V12H004M09 1.150 € | V12H004M09 1.150 € |
| Lens - ELPLM10 - Mid throw 3 - G7000/L1000 series | V12H004M0A 1.375 € | V12H004M0A 1.375 € | V12H004M0A 1.375 € | V12H004M0A 1.375 € | V12H004M0A 1.375 € | V12H004M0A 1.375 € | V12H004M0A 1.375 € |
| Lens - ELPLM11 - Mid throw 4 - V12H004M0B | V12H004M0B 1.375 € | V12H004M0B 1.375 € | V12H004M0B 1.375 € | V12H004M0B 1.375 € | V12H004M0B 1.375 € | V12H004M0B 1.375 € | V12H004M0B 1.375 € |

Proyectors - Instalación

TARIFA DE PRECIOS

| | EB-G7200W | EB-G7400U | EB-G7800 | EB-G7900U | EB-G7905U | EB-L1000U | EB-L1100U |
|--|---|---|---|---|---|---|---|
| G7000/L1000 series | | | | | | | |
| Lens - ELPLW05 - G7000 & L1000 Series wide zoom 1 | V12H004W05 1.375 € | V12H004W05 1.375 € | V12H004W05 1.375 € | V12H004W05 1.375 € | V12H004W05 1.375 € | V12H004W05 1.375 € | V12H004W05 1.375 € |
| Lens - ELPLL08 - Long throw - G7000/L1000 series | V12H004L08 2.200 € | V12H004L08 2.200 € | V12H004L08 2.200 € | V12H004L08 2.200 € | V12H004L08 2.200 € | V12H004L08 2.200 € | V12H004L08 2.200 € |
| Lens - ELPLU03 - G7000 & L1000 Series ST off axis 1 | V12H004U03 3.018,75 € | V12H004U03 3.018,75 € | V12H004U03 3.018,75 € | V12H004U03 3.018,75 € | V12H004U03 3.018,75 € | V12H004U03 3.018,75 € | V12H004U03 3.018,75 € |
| Lens - ELPLU04 - G7000 & L1000 Series ST off axis 2 | V12H004U04 3.018,75 € | V12H004U04 3.018,75 € | V12H004U04 3.018,75 € | V12H004U04 3.018,75 € | V12H004U04 3.018,75 € | V12H004U04 3.018,75 € | V12H004U04 3.018,75 € |
| Lens - ELPLX01 - UST lens G7000 series & L1100, L1200, L1300, L1400/5U | V12H004X01 7.249,87 € | V12H004X01 7.249,87 € | V12H004X01 7.249,87 € | V12H004X01 7.249,87 € | V12H004X01 7.249,87 € | V12H004X01 7.249,87 € | V12H004X01 7.249,87 € |
| CoverPlus | BA | BA | BA | BA | BA | BA | BA |
| 03 años de servicio CoverPlus in situ para EB-G7XX/W/U | CP03OSSWH752 410 € CP03OSSEH752 410 € | CP03OSSWH752 410 € CP03OSSEH752 410 € | CP03OSSWH752 410 € CP03OSSEH752 410 € | CP03OSSWH752 410 € CP03OSSEH752 410 € | CP03OSSWH752 410 € CP03OSSEH752 410 € | CP03OSSWH752 410 € CP03OSSEH752 410 € | CP03OSSWH752 410 € CP03OSSEH752 410 € |
| 04 años de servicio CoverPlus in situ para EB-G7XX/W/U | CP04OSSWH752 708,48 € CP04OSSEH752 656 € | CP04OSSWH752 708,48 € CP04OSSEH752 656 € | CP04OSSWH752 708,48 € CP04OSSEH752 656 € | CP04OSSWH752 708,48 € CP04OSSEH752 656 € | CP04OSSWH752 708,48 € CP04OSSEH752 656 € | CP04OSSWH752 708,48 € CP04OSSEH752 656 € | CP04OSSWH752 708,48 € CP04OSSEH752 656 € |
| 04 años de servicio CoverPlus in situ para EB-L1100U/1105U | | | | | | CP04OSSEH735 800 € | CP04OSSEH735 800 € |
| 05 años de servicio CoverPlus in situ para EB-G7XX/W/U | CP05OSSWH752 984 € CP05OSSEH752 984 € | CP05OSSWH752 984 € CP05OSSEH752 984 € | CP05OSSWH752 984 € CP05OSSEH752 984 € | CP05OSSWH752 984 € CP05OSSEH752 984 € | CP05OSSWH752 984 € CP05OSSEH752 984 € | CP05OSSWH752 984 € CP05OSSEH752 984 € | CP05OSSWH752 984 € CP05OSSEH752 984 € |
| 05 años de servicio CoverPlus in situ para EB-L1100U/1105U | | | | | | CP05OSSEH735 1.200 € | CP05OSSEH735 1.200 € |

| Grupo de precios | EB-L1105U | EB-L1300U | EB-L1405U | EB-L1500U | EB-L1505U | EB-L1715S | EB-L1750U |
|-------------------------|---|---|---|---|--|---|---|
| | PZ | PZ | PQ | PQ | PQ | PQ | PQ |
| |  |  |  |  |  |  |  |
| Resolución | WUXGA, 1920 x 1200, 16:10 | WUXGA, 1920 x 1200, 16:10 | WUXGA, 1920 x 1200, 16:10 | WUXGA, 1920 x 1200, 16:10 | WUXGA, 1920 x 1200, 16:10 | SXGA+ (1400 x 1050), 4:3 | WUXGA, 1920 x 1200, 16:10 |
| Relación proyección | 1,44 - 2,32:1 | 1,44 - 2,32:1 | 1,44 - 2,32:1 | 1,57 - 2,56:1 | 1,57 - 2,56:1 | 1,62 - 2,65:1 | 1,57 - 2,56:1 |
| Emisión de luz en color | 6.000 Lumen- 4.200 Lumen (económico) de conformidad con IDMS15.4 | 8.000 Lumen- 5.600 Lumen (económico) de conformidad con IDMS15.4 | 8.000 Lumen- 5.600 Lumen (económico) de conformidad con IDMS15.4 | 12.000 Lumen- 8.400 Lumen (económico) de conformidad con IDMS15.4 | 12.000 Lumen- 8.400 Lumen (económico) de conformidad con IDMS15.4 | 15.000 Lumen- 10.500 Lumen (económico) de conformidad con IDMS15.4 | 15.000 Lumen- 10.500 Lumen (económico) de conformidad con IDMS15.4 |
| Relación de contraste | 2.500.000 : 1 | 2.500.000 : 1 | 2.500.000 : 1 | 2.500.000 : 1 | 2.500.000 : 1 | 2.500.000 : 1 | 2.500.000 : 1 |
| Interfaces | HDMI, VGA, HD-BaseT, USB, Ethernet, Wi-Fi (Opcional) | HDMI, VGA, HD-BaseT, USB, Ethernet, Wi-Fi (Opcional) | HDMI, HDSDI, VGA, HD-BaseT, USB, Ethernet, Wi-Fi (Opcional) | HDMI, HDSDI, VGA, HD-BaseT, USB, Ethernet, Wi-Fi (Opcional) | HDMI, HDSDI, VGA, HD-BaseT, USB, Ethernet, Wi-Fi (Opcional) | HDMI, VGA, HD-BaseT, USB, Ethernet, Wi-Fi (Opcional) | HDMI, HDSDI, VGA, HD-BaseT, USB, Ethernet, Wi-Fi (Opcional) |
| Garantía | 60 meses Reparación en | 60 meses Reparación en | 60 meses Reparación en | 60 meses Reparación en | 60 meses Reparación en | | |

Toda la información está sujeta a cambios sin notificación previa. Para as notas, por favor veja apéndice.

Proyectors - Instalación







TARIFA DE PRECIOS

| | EB-L1105U | EB-L1300U | EB-L1405U | EB-L1500U | EB-L1505U | EB-L1715S | EB-L1750U | | | |
|--|-------------------|-------------------|-------------------|--------------------|-------------------|--------------------|-------------------|-------------------|-------------------|-------------------|
| | taller o 20.000 h | taller o 20.000 h | taller o 20.000 h | taller o 20.000 h | taller o 20.000 h | taller o 20.000 h | taller o 20.000 h | | | |
| VPVR neto | V11H735140 | 7.071,61 € | V11H733040 | 11.571,33 € | V11H739140 | 13.946,67 € | V11H792040 | V11H792140 | V11H890140 | V11H892040 |
| Opciones | P8, J1, J3 | P8, J1, J3 | P8, J1, J3 | P8, J1, J3 | P8, J1, J3 | P8, J1, J3 | P8, J1, J3 | P8, J3, J1 | J1, P8, J3 | |
| Air Filter - ELPAF51 | V13H134A51 | 81,32 € | V13H134A51 | 81,32 € | V13H134A51 | 81,32 € | V13H134A51 | 81,32 € | V13H134A51 | 81,32 € |
| Ceiling Mount - ELPMB47 Low EB-G7000/L1000 | V12H802010 | 249,36 € | V12H802010 | 249,36 € | V12H802010 | 249,36 € | V12H802010 | 249,36 € | V12H802010 | 249,36 € |
| Ceiling Mount - ELPMB48 High EB-G7000/L1000 | V12H803010 | 330,22 € | V12H803010 | 330,22 € | V12H803010 | 330,22 € | V12H803010 | 330,22 € | V12H803010 | 330,22 € |
| 3D Polarizer - ELPPLO1 | V12H618A01 | 395,88 € | V12H618A01 | 395,88 € | V12H618A01 | 395,88 € | V12H618A01 | 395,88 € | V12H618A01 | 395,88 € |
| Stacking Frame - ELPMB50 - L1000 Series (Premium) | V12H003B50 | 3.309,51 € | V12H003B50 | 3.309,51 € | V12H003B50 | 3.309,51 € | V12H003B50 | 3.309,51 € | V12H003B50 | 3.309,51 € |
| Memoria USB de conexión inalámbrica rápida - ELPAP09 | V12H005M09 | 71,71 € | V12H005M09 | 71,71 € | V12H005M09 | 71,71 € | V12H005M09 | 71,71 € | V12H005M09 | 71,71 € |
| Wireless LAN Adapter - ELPAP10 | V12H731P01 | 93,22 € | V12H731P01 | 93,22 € | V12H731P01 | 93,22 € | V12H731P01 | 93,22 € | V12H731P01 | 93,22 € |
| HDBaseT Transmitter - ELPHD01 | V12H547040 | 489,04 € | V12H547040 | 489,04 € | V12H547040 | 489,04 € | V12H547040 | 489,04 € | V12H547040 | 489,04 € |
| Lens - ELPLM08 - Mid throw 1 - G7000/L1000 series | V12H004M08 | 812,50 € | V12H004M08 | 812,50 € | V12H004M08 | 812,50 € | V12H004M08 | 812,50 € | V12H004M08 | 812,50 € |
| Lens - ELPLM15 - Mid Throw L1500/L1700 Series | V12H004M0F | 1.149,98 € | V12H004M0F | 1.149,98 € | V12H004M0F | 1.149,98 € | V12H004M0F | 1.149,98 € | V12H004M0F | 1.149,98 € |
| Lens - ELPLM09 - Mid throw 2 - G7000/L1000 series | V12H004M09 | 1.150 € | V12H004M09 | 1.150 € | V12H004M09 | 1.150 € | V12H004M09 | 1.150 € | V12H004M09 | 1.150 € |
| Lens - ELPLM10 - Mid throw 3 - G7000/L1000 series | V12H004M0A | 1.375 € | V12H004M0A | 1.375 € | V12H004M0A | 1.375 € | V12H004M0A | 1.375 € | V12H004M0A | 1.375 € |
| Lens - ELPLM11 - Mid throw 4 - G7000/L1000 series | V12H004M0B | 1.375 € | V12H004M0B | 1.375 € | V12H004M0B | 1.375 € | V12H004M0B | 1.375 € | V12H004M0B | 1.375 € |
| Lens - ELPLW05 - G7000 & L1000 Series wide zoom 1 | V12H004W05 | 1.375 € | V12H004W05 | 1.375 € | V12H004W05 | 1.375 € | V12H004W05 | 1.375 € | V12H004W05 | 1.375 € |
| Lens - ELPLL08 - Long throw - G7000/L1000 series | V12H004L08 | 2.200 € | V12H004L08 | 2.200 € | V12H004L08 | 2.200 € | V12H004L08 | 2.200 € | V12H004L08 | 2.200 € |
| Lens - ELPLW06 - L1500U/1505U wide zoom 2 | V12H004W06 | 2.200 € | V12H004W06 | 2.200 € | V12H004W06 | 2.200 € | V12H004W06 | 2.200 € | V12H004W06 | 2.200 € |
| Lens - ELPLU03 - G7000 & L1000 Series ST off axis 1 | V12H004U03 | 3.018,75 € | V12H004U03 | 3.018,75 € | V12H004U03 | 3.018,75 € | V12H004U03 | 3.018,75 € | V12H004U03 | 3.018,75 € |
| Lens - ELPLU04 - G7000 & L1000 Series ST off axis 2 | V12H004U04 | 3.018,75 € | V12H004U04 | 3.018,75 € | V12H004U04 | 3.018,75 € | V12H004U04 | 3.018,75 € | V12H004U04 | 3.018,75 € |
| Lens - ELPLX01 - UST lens G7000 series & L1100,1200,1300,1400/5U | V12H004X01 | 7.249,87 € | V12H004X01 | 7.249,87 € | V12H004X01 | 7.249,87 € | V12H004X01 | 7.249,87 € | V12H004X01 | 7.249,87 € |
| CoverPlus | BA | BA | BA | BA | BA | BA | BA | BA | BA | |
| 03 años de servicio CoverPlus in situ para EB-L1300U | CP03OSSWH733 | 560 € | CP03OSSHE733 | 560 € | | | | | | |

Proyectores - Instalación

TARIFA DE PRECIOS

| | EB-L1105U | EB-L1300U | EB-L1405U | EB-L1500U | EB-L1505U | EB-L1715S | EB-L1750U |
|--|--------------|------------------------------|------------------------------|------------------|-----------|------------------------------|--------------------|
| 03 años de servicio CoverPlus in situ para EB-L1405U | | | CP03OSSWH739 CP03OSSEH739 | 510 € 510 € | | | |
| 03 años de servicio CoverPlus in situ para EB-L15xx | | | | CP03OSSEH792 | 810 € | CP03OSSEH792 | 810 € |
| 03 años de servicio CoverPlus in situ para EB-L17xx | | | | | | CP03OSSEH892 CP03OSSWH892 | 900 € 900 € |
| 04 años de servicio CoverPlus in situ para EB-L1100U/1105U | CP04OSSEH735 | 800 € | | | | | |
| 04 años de servicio CoverPlus in situ para EB-L1300U | | CP04OSSEH733 CP04OSSWH733 | 800 € 800 € | | | | |
| 04 años de servicio CoverPlus in situ para EB-L1405U | | | CP04OSSEH739 CP04OSSWH739 | 700 € 700 € | | | |
| 04 años de servicio CoverPlus in situ para EB-L15xx | | | | CP04OSSEH792 | 1.100 € | CP04OSSEH792 | 1.100 € |
| 04 años de servicio CoverPlus in situ para EB-L17xx | | | | | | CP04OSSEH892 CP04OSSWH892 | 1.440 € 1.440 € |
| 05 años de servicio CoverPlus in situ para EB-L1100U/1105U | CP05OSSEH735 | 1.200 € | | | | | |
| 05 años de servicio CoverPlus in situ para EB-L1300U | | CP05OSSWH733 CP05OSSEH733 | 1.200 € 1.200 € | | | | |
| 05 años de servicio CoverPlus in situ para EB-L1405U | | | CP05OSSWH739 CP05OSSEH739 | 990 € 1.200 € | | | |
| 05 años de servicio CoverPlus in situ para EB-L15xx | | | | CP05OSSEH792 | 1.480 € | CP05OSSEH792 | 1.480 € |
| 05 años de servicio CoverPlus in situ para EB-L17xx | | | | | | CP05OSSEH892 CP05OSSWH892 | 2.160 € 2.160 € |

| Grupo de precios | EB-L1755U | EB-L25000U | EB-Z10000U | EB-Z10005U | EB-Z11000 | EB-Z11000W | EB-Z11005 |
|-------------------------|---|---|---|---|--|---|---|
| | PQ | PQ | PP | PP | PP | PP | PP |
| |  |  |  |  |  |  |  |
| Resolución | WUXGA, 1920 x 1200, 16:10 | WUXGA, 1920 x 1200, 16:10 | WUXGA, 1920 x 1200, 16:10 | WUXGA, 1920 x 1200, 16:10 | XGA, 1024 x 768, 4:3 | WXGA, 1280 x 800, 16:10 | XGA, 1024 x 768, 4:3 |
| Relación proyección | 1,57 - 2,56:1 | | 1,57 - 2,56:1 | 1,57 - 2,56:1 | 1,65 - 2,65:1 | 1,57 - 2,56:1 | 1,65 - 2,65:1 |
| Emisión de luz en color | 15.000 Lumen- 10.500 Lumen (económico) de conformidad con IDMS15.4 | 25.000 Lumen- 17.500 Lumen (económico) de conformidad con IDMS15.4 | 10.000 Lumen- 6.600 Lumen (económico) | 10.000 Lumen- 6.600 Lumen (económico) | 11.000 Lumen- 7.300 Lumen (económico) | 11.000 Lumen- 7.100 Lumen (económico) | 11.000 Lumen- 7.300 Lumen (económico) |
| Relación de contraste | 2.500.000 : 1 | 2.500.000 : 1 | 15.000 : 1 | 15.000 : 1 | 15.000 : 1 | 15.000 : 1 | 15.000 : 1 |
| Interfaces | HDMI, HDSIDI, VGA, HD- | HDSIDI, VGA, HD-BaseT, | HDMI, HDSIDI, VGA, HD- | HDMI, HDSIDI, VGA, HD- | HDMI, VGA, HD-BaseT, | HDMI, VGA, HD-BaseT, | HDMI, VGA, HD-BaseT, |

Proyectors - Instalación

TARIFA DE PRECIOS

| | EB-L1755U | EB-L25000U | EB-Z10000U | EB-Z10005U | EB-Z11000 | EB-Z11000W | EB-Z11005 |
|---|--|---------------------------------|---|---|---|---|---|
| | BaseT, USB, Ethernet, Wi-Fi (Opcional) | USB, Ethernet, Wi-Fi (Opcional) | BaseT, USB | BaseT, USB | USB | USB | USB |
| Garantía | | | 36 meses Reparación en taller o 20.000 h, lámpara: 12 meses o 1.000 h | 36 meses Reparación en taller o 20.000 h, lámpara: 12 meses o 1.000 h | 36 meses Reparación en taller o 20.000 h, lámpara: 12 meses o 1.000 h | 36 meses Reparación en taller o 20.000 h, lámpara: 12 meses o 1.000 h | 36 meses Reparación en taller o 20.000 h, lámpara: 12 meses o 1.000 h |
| VPR neto | V11H892140 | V11H679840 | V11H610040 | V11H610140 | V11H606040 | V11H608040 | V11H606140 |
| Opciones | P8, J1, J3 | J6, J1, J3 | P8, J3 | P8, J3 | P8, J3 | P8, J3 | P8, J3 |
| Gafas 3D pasivas (para niño, x5) - ELPGS02B | | | V12H541B10 | V12H541B10 | V12H541B10 | V12H541B10 | V12H541B10 |
| Air Filter - ELPAF51 | V13H134A51 | | | | | | |
| Ceiling Mount - ELPMB47 Low EB-G7000/L1000 | V12H802010 | | | | | | |
| Air Filter - ELPAF52 | | V13H134A52 | | | | | |
| Ceiling Mount - ELPMB48 High EB-G7000/L1000 | V12H803010 | | | | | | |
| 3D Polarizer - ELPLP01 | V12H618A01 | | V12H618A01 | V12H618A01 | V12H618A01 | V12H618A01 | V12H618A01 |
| Carry Handle - ELPMB49 - EB-L25000U | | V12H830010 | | | | | |
| Stacking Frame - ELPMB50 - L1000 Series (Premium) | V12H003B50 | | | | | | |
| Lens - ELPLM12 - EB-L25000U Zoom Lens | | V12H004M0C | | | | | |
| Lens - ELPLM13 - EB-L25000U Zoom Lens | | V12H004M0D | | | | | |
| Lens - ELPLM14 - EB-L25000U Zoom Lens | | V12H004M0E | | | | | |
| Stacking Frame - ELPMB52 - L25000U | | V12H003B52 | | | | | |
| Lens - ELPLL09 - EB-L25000U Zoom Lens | | V12H004L09 | | | | | |
| Lens - ELPLW07 - EB-L25000U Zoom Lens | | V12H004W07 | | | | | |
| Lens - ELPLL10 - EB-L25000U Zoom Lens | | V12H004L0A | | | | | |
| Lens - ELPLR05 - EB-L25000U Rear Pro | | V12H004R05 | | | | | |
| Lens - ELPLU05 - EB-L25000U Zoom Lens | | V12H004U05 | | | | | |
| Filtro de Aire - ELPAF46 | | | V13H134A46 | V13H134A46 | V13H134A46 | V13H134A46 | V13H134A46 |
| Soporte para techo (Bajo) - ELPMB25 | | | V12H003B25 | V12H003B25 | V12H003B25 | V12H003B25 | V12H003B25 |
| Soporte para techo - ELPMB26 | | | V12H003B26 | V12H003B26 | V12H003B26 | V12H003B26 | V12H003B26 |
| Stacking Frame - ELPMB44 | | | V12H681010 | V12H681010 | V12H681010 | V12H681010 | V12H681010 |

Proyectors - Instalación

TARIFA DE PRECIOS

| | EB-L1755U | EB-L25000U | EB-Z10000U | EB-Z10005U | EB-Z11000 | EB-Z11000W | EB-Z11005 | | | | | |
|--|--------------|-------------------|--------------|-------------------|------------|-------------------|------------|-------------------|------------|-------------------|------------|-------------------|
| Memoria USB de conexión inalámbrica rápida - ELPAP09 | V12H005M09 | 71,71 € | | | | | | | | | | |
| Wireless LAN Adapter - ELPAP10 | V12H731P01 | 93,22 € | V12H731P01 | 93,22 € | | | | | | | | |
| HDBaseT Transmitter - ELPHD01 | V12H547040 | 489,04 € | V12H547040 | 489,04 € | V12H547040 | 489,04 € | V12H547040 | 489,04 € | V12H547040 | 489,04 € | V12H547040 | 489,04 € |
| Lámpara (Portrait, x1) - ELPLP83 | | | V13H010L83 | 634,83 € | V13H010L83 | 634,83 € | V13H010L83 | 634,83 € | V13H010L83 | 634,83 € | V13H010L83 | 634,83 € |
| Lámpara - ELPLP81 | | | V13H010L81 | 634,83 € | V13H010L81 | 634,83 € | V13H010L81 | 634,83 € | V13H010L81 | 634,83 € | V13H010L81 | 634,83 € |
| Lámpara (Portrait, x2) - ELPLP84 | | | V13H010L84 | 1.075,08 € | V13H010L84 | 1.075,08 € | V13H010L84 | 1.075,08 € | V13H010L84 | 1.075,08 € | V13H010L84 | 1.075,08 € |
| Lámpara (x2) - ELPLP82 | | | V13H010L82 | 1.075,08 € | V13H010L82 | 1.075,08 € | V13H010L82 | 1.075,08 € | V13H010L82 | 1.075,08 € | V13H010L82 | 1.075,08 € |
| Lens - ELPLM15 - Mid Throw L1500/L1700 Series | V12H004M0F | 1.149,98 € | | | | | | | | | | |
| Lens - ELPLM09 - Mid throw 2 - G7000/L1000 series | V12H004M09 | 1.150 € | | | | | | | | | | |
| Lens - ELPLM10 - Mid throw 3 - G7000/L1000 series | V12H004M0A | 1.375 € | | | | | | | | | | |
| Lens - ELPLM11 - Mid throw 4 - G7000/L1000 series | V12H004M0B | 1.375 € | | | | | | | | | | |
| Lens - ELPLW05 - G7000 & L1000 Series wide zoom 1 | V12H004W05 | 1.375 € | | | | | | | | | | |
| Lens - ELPLL08 - Long throw - G7000/L1000 series | V12H004L08 | 2.200 € | | | | | | | | | | |
| Lens - ELPLW06 - L1500U/1505U wide zoom 2 | V12H004W06 | 2.200 € | | | | | | | | | | |
| Lente (de media distancia 2) - ELPLM07 | | | V12H004M07 | 2.200 € | V12H004M07 | 2.200 € | V12H004M07 | 2.200 € | V12H004M07 | 2.200 € | V12H004M07 | 2.200 € |
| Lente (de larga distancia) - ELPLL07 | | | V12H004L07 | 2.200 € | V12H004L07 | 2.200 € | V12H004L07 | 2.200 € | V12H004L07 | 2.200 € | V12H004L07 | 2.200 € |
| Lente (de media distancia 1) - ELPLM06 | | | V12H004M06 | 2.200 € | V12H004M06 | 2.200 € | V12H004M06 | 2.200 € | V12H004M06 | 2.200 € | V12H004M06 | 2.200 € |
| Lente (gran angular) - ELPLW04 | | | V12H004W04 | 2.200 € | V12H004W04 | 2.200 € | V12H004W04 | 2.200 € | V12H004W04 | 2.200 € | V12H004W04 | 2.200 € |
| Lente (gran angular posterior) - ELPLR04 | | | V12H004R04 | 2.700 € | V12H004R04 | 2.700 € | V12H004R04 | 2.700 € | V12H004R04 | 2.700 € | V12H004R04 | 2.700 € |
| Lens - ELPLU03 - G7000 & L1000 Series ST off axis 1 | V12H004U03 | 3.018,75 € | | | | | | | | | | |
| Lens - ELPLU04 - G7000 & L1000 Series ST off axis 2 | V12H004U04 | 3.018,75 € | | | | | | | | | | |
| Lente (ST Off Axis) - ELPLU02 | | | V12H004U02 | 3.725 € | V12H004U02 | 3.725 € | V12H004U02 | 3.725 € | V12H004U02 | 3.725 € | V12H004U02 | 3.725 € |
| CoverPlus | BA | | BA | | BA | | | | | | | |
| 03 años de servicio CoverPlus in situ para EB-L17xx | CP03OSSEH892 | 900 € | CP03OSSWH892 | 900 € | | | | | | | | |

| | EB-L1755U | EB-L25000U | EB-Z10000U | EB-Z10005U | EB-Z11000 | EB-Z11000W | EB-Z11005 |
|--|------------------------------|--------------------|--------------|------------|--------------|------------|-----------|
| 04 años de servicio CoverPlus en laboratorio para EB-Z10000/5U | | | CP04RTBSH458 | 979,20 € | CP04RTBSH458 | 979,20 € | |
| 04 años de servicio CoverPlus in situ para EB-L17xx | CP04OSSEH892 CP04OSSWH892 | 1.440 € 1.440 € | | | | | |
| 05 años de servicio CoverPlus en laboratorio para EB-Z10000/5U | | | CP05RTBSH458 | 1.468,80 € | CP05RTBSH458 | 1.468,80 € | |
| 05 años de servicio CoverPlus in situ para EB-L17xx | CP05OSSEH892 CP05OSSWH892 | 2.160 € 2.160 € | | | | | |

Grupo de precios **EB-Z9800W** PP



| | |
|-------------------------|---|
| Resolución | WXGA, 1280 x 800, 16:10 |
| Relación proyección | 1,57 - 2,56:1 |
| Emisión de luz en color | 8.300 Lumen- 7.100 Lumen (económico) |
| Relación de contraste | 15.000 : 1 |
| Interfaces | HDMI, VGA, HD-BaseT, USB |
| Garantía | 36 meses Reparación en taller o 20.000 h, lámpara: 12 meses o 1.000 h |

| | | |
|------------------|------------|---------|
| PVPR neto | V11H615040 | 6.120 € |
|------------------|------------|---------|

Opciones P8, J3







| | | |
|---|------------|----------|
| Gafas 3D pasivas (para niño, x5) - ELPGS02B | V12H541B10 | 26,80 € |
| 3D Polarizer - ELPLP01 | V12H618A01 | 395,88 € |
| Filtro de Aire - ELPAF46 | V13H134A46 | 81 € |
| SopORTE para techo (Bajo) - ELPMB25 | V12H003B25 | 246,79 € |
| SopORTE para techo - ELPMB26 | V12H003B26 | 329,05 € |
| Stacking Frame - ELPMB44 | V12H681010 | 1.800 € |
| HDBaseT Transmitter - ELPHD01 | V12H547040 | 489,04 € |
| Lámpara (Portrait, x1) - ELPLP83 | V13H010L83 | 634,83 € |
| Lámpara - ELPLP81 | V13H010L81 | 634,83 € |

Proyectores - Instalación

TARIFA DE PRECIOS

EB-Z9800W

| | | |
|---|--------------|------------|
| Lámpara (Portrait, x2) - ELPLP84 | V13H010L84 | 1.075,08 € |
| Lámpara (x2) - ELPLP82 | V13H010L82 | 1.075,08 € |
| Lente (de media distancia 2) - ELPLM07 | V12H004M07 | 2.200 € |
| Lente (de larga distancia) - ELPLLO7 | V12H004L07 | 2.200 € |
| Lente (de media distancia 1) - ELPLM06 | V12H004M06 | 2.200 € |
| Lente (gran angular) - ELPLW04 | V12H004W04 | 2.200 € |
| Lente (gran angular posterior) - ELPLR04 | V12H004R04 | 2.700 € |
| Lente (ST Off Axis) - ELPLU02 | V12H004U02 | 3.725 € |
| CoverPlus | BA | |
| 04 años de servicio CoverPlus en laboratorio para EB-Z9800W | CP04RTBSH615 | 766,94 € |
| 04 años de servicio CoverPlus in situ para EB-Z9800 | CP04OSSEH615 | 1.530 € |
| 05 años de servicio CoverPlus en laboratorio para EB-Z9800W | CP05RTBSH615 | 1.533,88 € |

| Grupo de precios | EB-108 | | EB-945H | | EB-965H | | EB-970 | | EB-980W | | EB-98H | | EB-990U | |
|---|---|-----------------|---|-----------------|---|-----------------|---|-----------------|--|-----------------|---|-----------------|---|-----------------|
| | E9 | E9 | E9 | E9 | E9 | E9 | E9 | E9 | E9 | E9 | E9 | E9 | E9 | E9 |
| |  | |  | |  | |  | |  | |  | |  | |
| Resolución | XGA, 1024 x 768, 4:3 | | XGA, 1024 x 768, 4:3 | | XGA, 1024 x 768, 4:3 | | XGA, 1024 x 768, 4:3 | | WXGA, 1280 x 800, 16:10 | | XGA, 1024 x 768, 4:3 | | WUXGA, 1920 x 1200, 16:10 | |
| Relación proyección | 1,48 - 1,77:1 | | 1,38 - 2,24:1 | | 1,38 - 2,24:1 | | 1,38 - 2,24:1 | | 1,38 - 2,24:1 | | 1,48 - 1,77:1 | | 1,39 - 2,23:1 | |
| Emisión de luz en color (económico) | 3.700 Lumen- 2.340 Lumen | | 3.000 Lumen- 2.100 Lumen | | 3.500 Lumen- 2.450 Lumen | | 4.000 Lumen- 2.500 Lumen | | 3.800 Lumen- 2.410 Lumen | | 3.000 Lumen- 2.100 Lumen | | 3.800 Lumen- 2.440 Lumen | |
| Relación de contraste | 15.000 : 1 | | 10.000 : 1 | | 10.000 : 1 | | 15.000 : 1 | | 15.000 : 1 | | 15.000 : 1 | | 15.000 : 1 | |
| Interfaces | HDMI, VGA, USB, Ethernet, Wi-Fi (Opcional) | | HDMI, VGA, USB, Ethernet, Wi-Fi (Opcional) | | HDMI, VGA, USB, Ethernet, Wi-Fi (Opcional) | | HDMI, VGA, USB, Ethernet, Wi-Fi (Opcional) | | HDMI, VGA, USB, Ethernet, Wi-Fi (Opcional) | | HDMI, VGA, USB, Ethernet, Wi-Fi (Opcional) | | HDMI, VGA, USB, Ethernet, Wi-Fi (Opcional) | |
| Altavoces | 16 vatio | | 16 vatio | | 16 vatio | | 16 vatio | | 16 vatio | | 16 vatio | | 16 vatio | |
| nivel de ruido | Normal: 37 dB (A) - Ahorro: 28 dB (A) | | Normal: 37 dB (A) - Ahorro: 29 dB (A) | | Normal: 37 dB (A) - Ahorro: 29 dB (A) | | Normal: 37 dB (A) - Ahorro: 28 dB (A) | | Normal: 37 dB (A) - Ahorro: 28 dB (A) | | Normal: 37 dB (A) - Ahorro: 29 dB (A) | | Normal: 37 dB (A) - Ahorro: 28 dB (A) | |
| Peso | 2,8 kg | | 2,9 kg | | 2,9 kg | | 3 kg | | 3,1 kg | | 2,7 kg | | 3,2 kg | |
| Garantía | 24 meses Reparación en taller, lámpara: 12 meses o 1.000 h | | 36 meses Reparación en taller, lámpara: 12 meses o 1.000 h | | 36 meses Reparación en taller, lámpara: 12 meses o 1.000 h | | 24 meses Reparación en taller, lámpara: 12 meses o 1.000 h | | 24 meses Reparación en taller, lámpara: 12 meses o 1.000 h | | 36 meses Reparación en taller, lámpara: 12 meses o 1.000 h | | 24 meses Reparación en taller, lámpara: 12 meses o 1.000 h | |
| PVPR neto | V11H860040 | 601,94 € | V11H684040 | 643,43 € | V11H682040 | 756,66 € | V11H865040 | 685,24 € | V11H866040 | 749,10 € | V11H687040 | 608,03 € | V11H867040 | 908,74 € |
| Opciones | J3, J1 | | J3, J1 | | J3, J1 | | J1, J3 | | J3, J1 | | J3, J1 | | J1, J3 | |
| Filtro de Aire- ELPAF32 | V13H134A32 | 18,72 € | V13H134A32 | 18,72 € | V13H134A32 | 18,72 € | | | | | V13H134A32 | 18,72 € | | |
| Soft Carry Case - ELPKS70 | V12H001K70 | 23,38 € | | | | | V12H001K70 | 23,38 € | V12H001K70 | 23,38 € | | | V12H001K70 | 23,38 € |
| Tubo de montaje en techo (668-918 mm) - ELPFP13 | V12H003P13 | 51,02 € | | | | | V12H003P13 | 51,02 € | V12H003P13 | 51,02 € | | | V12H003P13 | 51,02 € |
| ELPLP96 | V13H010L96 | 61,24 € | | | | | V13H010L96 | 61,24 € | V13H010L96 | 61,24 € | | | V13H010L96 | 61,24 € |
| Tubo de montaje en techo (918-1168 mm) - ELPFP14 | V12H003P14 | 85,04 € | | | | | V12H003P14 | 85,04 € | V12H003P14 | 85,04 € | | | V12H003P14 | 85,04 € |
| Altavoces - ELPSP02 | V12H467040 | 115,21 € | V12H467040 | 115,21 € | V12H467040 | 115,21 € | V12H467040 | 115,21 € | V12H467040 | 115,21 € | V12H467040 | 115,21 € | V12H467040 | 115,21 € |
| SopORTE para techo (Blanco) - ELPMB23 | V12H003B23 | 137,60 € | V12H003B23 | 137,60 € | V12H003B23 | 137,60 € | V12H003B23 | 137,60 € | V12H003B23 | 137,60 € | V12H003B23 | 137,60 € | V12H003B23 | 137,60 € |
| Memoria USB de conexión inalámbrica rápida - ELPA09 | | | V12H005M09 | 71,71 € | V12H005M09 | 71,71 € | | | | | V12H005M09 | 71,71 € | | |
| Wireless LAN Adapter - ELPAP10 | V12H731P01 | 93,22 € | V12H731P01 | 93,22 € | V12H731P01 | 93,22 € | V12H731P01 | 93,22 € | V12H731P01 | 93,22 € | V12H731P01 | 93,22 € | V12H731P01 | 93,22 € |
| Caja de control y conexiones Epson - ELPB02 | | | V12H614040 | 207,50 € | V12H614040 | 207,50 € | | | | | V12H614040 | 207,50 € | | |
| ELPLP88 | | | V13H010L88 | 73,28 € | V13H010L88 | 73,28 € | | | | | V13H010L88 | 73,28 € | | |
| Pantalla de 50" tipo escritorio - | | | V12H002S32 | 87,21 € | V12H002S32 | 87,21 € | | | | | V12H002S32 | 87,21 € | | |

| | EB-108 | EB-945H | EB-965H | EB-970 | EB-980W | EB-98H | EB-990U |
|--|--------------------|----------------------|----------------------|--------------------|--------------------|----------------------|--------------------|
| ELPSC32 | | | | | | | |
| Pantalla de 80" multiaspecto - ELPSC26 | | V12H002S26 134,66 € | V12H002S26 134,66 € | | | V12H002S26 134,66 € | |
| CoverPlus | BA | BA | BA | BA | BA | BA | BA |
| 03 años de servicio CoverPlus en laboratorio para EB-945/H | | CP03RTBSH581 49,90 € | | | | | |
| 03 años de servicio CoverPlus en laboratorio para EB-965/H | | | CP03RTBSH583 49,90 € | | | | |
| 03 años de servicio CoverPlus en laboratorio para EB-970/980/990/108 | CP03RTBSH866 55 € | | | CP03RTBSH866 55 € | CP03RTBSH866 55 € | | CP03RTBSH866 55 € |
| 03 años de servicio CoverPlus en laboratorio para EB-98/H | | | | | | CP03RTBSH577 49,90 € | |
| 04 años de servicio CoverPlus en laboratorio para EB-970/980/990/108 | CP04RTBSH866 88 € | | | CP04RTBSH866 88 € | CP04RTBSH866 88 € | | CP04RTBSH866 88 € |
| 05 años de servicio CoverPlus en laboratorio para EB-970/980/990/108 | CP05RTBSH866 132 € | | | CP05RTBSH866 132 € | CP05RTBSH866 132 € | | CP05RTBSH866 132 € |

| Grupo de precios | EB-S05 | EB-S27 | EB-S39 | EB-S41 | EB-U05 | EB-U32 | EB-U42 |
|------------------|--------|--------|--------|--------|--------|--------|--------|
| | W1 | C5 | C5 | L1 | W1 | C5 | C5 |



| | | | | | | | |
|-------------------------|--|---------------------------------------|---------------------------------------|--|--|--|--|
| Resolución | SVGA, 800 x 600, 4:3 | SVGA, 800 x 600, 4:3 | SVGA, 800 x 600, 4:3 | SVGA, 800 x 600, 4:3 | Full HD, 1920 x 1200, 16:10 | WUXGA, 1920 x 1200, 16:10 | WUXGA, 1920 x 1200, 16:10 |
| Relación proyección | 1,45 - 1,96:1 | 1,45 - 1,96:1 | 1,45 - 1,96:1 | 1,45 - 1,96:1 | 1,38 - 1,68:1 | 1,38 - 1,68:1 | 1,38 - 1,68:1 |
| Emisión de luz en color | 3.200 Lumen- 1.985 Lumen (económico) de conformidad con IDMS15.4 | 2.700 Lumen- 1.890 Lumen (económico) | 3.300 Lumen- 2.050 Lumen (económico) | 3.300 Lumen- 2.050 Lumen (económico) de conformidad con IDMS15.4 | 3.400 Lumen- 2.110 Lumen (económico) de conformidad con IDMS15.4 | 3.200 Lumen- 2.240 Lumen (económico) de conformidad con IDMS15.4 | 3.600 Lumen- 2.235 Lumen (económico) de conformidad con IDMS15.4 |
| Relación de contraste | 15.000 : 1 | 10.000 : 1 | 15.000 : 1 | 15.000 : 1 | 15.000 : 1 | 15.000 : 1 | 15.000 : 1 |
| 3D | NO | | | NO | NO | | |
| Interfaces | HDMI, VGA, USB, Wi-Fi (Opcional) | HDMI, VGA, USB, Wi-Fi (Opcional) | HDMI, VGA, USB, Wi-Fi (Opcional) | HDMI, VGA, USB, Wi-Fi (Opcional) | HDMI, VGA, USB, Wi-Fi (Opcional) | HDMI, VGA, USB, Wi-Fi (Opcional) | HDMI, VGA, Miracast, USB, Wi-Fi |
| Altavoces | 2 vatio | 5 vatio | 5 vatio | 2 vatio | 2 vatio | 2 vatio | 2 vatio |
| nivel de ruido | Normal: 37 dB (A) - Ahorro: 28 dB (A) | Normal: 37 dB (A) - Ahorro: 29 dB (A) | Normal: 37 dB (A) - Ahorro: 28 dB (A) | Normal: 37 dB (A) - Ahorro: 28 dB (A) | Normal: 37 dB (A) - Ahorro: 28 dB (A) | Normal: 37 dB (A) - Ahorro: 28 dB (A) | Normal: 37 dB (A) - Ahorro: 28 dB (A) |
| Peso | 2,4 kg | 2,5 kg | 2,7 kg | 2,5 kg | 2,8 kg | 2,8 kg | 2,8 kg |
| Garantía | 36 meses Reparación en | 36 meses Reparación en | 24 meses Reparación en | 36 meses Reparación en | 36 meses Reparación en | 36 meses Reparación en | 24 meses Reparación en |

Proyectors - Portátil

TARIFA DE PRECIOS

| | EB-S05 | EB-S27 | EB-S39 | EB-S41 | EB-U05 | EB-U32 | EB-U42 |
|--|-------------------------------------|-------------------------------------|-------------------------------------|-------------------------------------|-------------------------------------|-------------------------------------|-------------------------------------|
| | taller, lámpara: 12 meses o 1.000 h | taller, lámpara: 12 meses o 1.000 h | taller, lámpara: 12 meses o 1.000 h | taller, lámpara: 12 meses o 1.000 h | taller, lámpara: 12 meses o 1.000 h | taller, lámpara: 12 meses o 1.000 h | taller, lámpara: 12 meses o 1.000 h |
| VPVR neto | V11H838040 | V11H694040 402,33 € | V11H854040 386,35 € | V11H842040 | V11H841040 | V11H722040 699,08 € | V11H846040 761,62 € |
| Opciones | J1, J3 | J3, J1 | J1, J3 | J1, J3 | J1, J3 | J1, J3 | J1, J3 |
| Soft Carry Case - ELPKS69 - EB-x05/x41/x42, EH-TW6 series | V12H001K69 13,29 € | | | V12H001K69 13,29 € | V12H001K69 13,29 € | | V12H001K69 13,29 € |
| Filtro de Aire - ELPAP32 | V13H134A32 18,72 € | V13H134A32 18,72 € | V13H134A32 18,72 € | V13H134A32 18,72 € | V13H134A32 18,72 € | V13H134A32 18,72 € | V13H134A32 18,72 € |
| Soft Carry Case - ELPKS70 | | | V12H001K70 23,38 € | | | | |
| Tubo de montaje en techo (668-918 mm) - ELPFP13 | V12H003P13 51,02 € | | V12H003P13 51,02 € | V12H003P13 51,02 € | V12H003P13 51,02 € | V12H003P13 51,02 € | V12H003P13 51,02 € |
| ELPLP96 | V13H010L96 61,24 € | | V13H010L96 61,24 € | V13H010L96 61,24 € | V13H010L96 61,24 € | | V13H010L96 61,24 € |
| Tubo de montaje en techo (918-1168 mm) - ELPFP14 | V12H003P14 85,04 € | | V12H003P14 85,04 € | V12H003P14 85,04 € | V12H003P14 85,04 € | V12H003P14 85,04 € | V12H003P14 85,04 € |
| Altavoces - ELPS02 | | V12H467040 115,21 € | V12H467040 115,21 € | | | | V12H467040 115,21 € |
| SopORTE para techo (Blanco) - ELPMB23 | V12H003B23 137,60 € | V12H003B23 137,60 € | V12H003B23 137,60 € | V12H003B23 137,60 € | V12H003B23 137,60 € | V12H003B23 137,60 € | V12H003B23 137,60 € |
| Memoria USB de conexión inalámbrica rápida - ELPAP09 | | V12H005M09 71,71 € | | | | V12H005M09 71,71 € | |
| Wireless LAN Adapter - ELPAP10 | V12H731P01 93,22 € | V12H731P01 93,22 € | V12H731P01 93,22 € | V12H731P01 93,22 € | V12H731P01 93,22 € | | |
| Caja de control y conexiones Epson - ELPB02 | | V12H614040 207,50 € | | | | | |
| ELPLP88 | | V13H010L88 73,28 € | | | | V13H010L88 73,28 € | |
| Pantalla de 50" tipo escritorio - ELPSC32 | | V12H002S32 87,21 € | | | | V12H002S32 87,21 € | |
| Pantalla de 80" multiaspecto - ELPSC26 | | V12H002S26 134,66 € | | | | V12H002S26 134,66 € | |
| Pantalla de 80" pantógrafo 16:10 - ELPSC24 | V12H002S24 456,10 € | | | V12H002S24 456,10 € | V12H002S24 456,10 € | V12H002S24 456,10 € | V12H002S24 456,10 € |
| CoverPlus | BA | BA | BA | BA | BA | BA | BA |
| 03 años de servicio CoverPlus en laboratorio para EB-S//X39 | | | CP03RTBSH856 49,90 € | | | | |
| 03 años de servicio CoverPlus en laboratorio para EB-S27 | | CP03RTBSH694 49,90 € | | | | | |
| 03 años de servicio CoverPlus en laboratorio para EB-S31/S41 | | | | CP03RTBSH719 49,90 € | | | |
| 03 años de servicio CoverPlus en laboratorio para EB-U04/U05 | | | | | CP03RTBSH763 49,90 € | | |
| 03 años de servicio CoverPlus en laboratorio para EB-U32 | | | | | | CP03RTBSH722 50 € | |

| | EB-S05 | EB-S27 | EB-S39 | EB-S41 | EB-U05 | EB-U32 | EB-U42 |
|--|--------------|--------------|--------------|--------------|--------------|--------------|--|
| 03 años de servicio CoverPlus en laboratorio para EB-U42/W42 | | | | | | | CP03RTBSH845 50 € |
| 03 años de servicio CoverPlus in situ para EB-S/W/X39 | | | CP03OSSWH856 | 120 € | | | |
| 03 años de servicio CoverPlus in situ para EB-S05/X05 | CP03RTBSH839 | 50 € | | | | | |
| 03 años de servicio CoverPlus in situ para EB-U42/W42 | | | | | | | CP03OSSEH845 120 € CP03OSSWH845 120 € |
| 04 años de servicio CoverPlus en laboratorio para EB-S/W/X39 | | | CP04RTBSH856 | 75 € | | | |
| 04 años de servicio CoverPlus en laboratorio para EB-S27 | | CP04RTBSH694 | 75 € | | | | |
| 04 años de servicio CoverPlus en laboratorio para EB-U04/U05 | | | | | CP04RTBSH763 | 80 € | |
| 04 años de servicio CoverPlus en laboratorio para EB-U32 | | | | | | CP04RTBSH722 | 80 € |
| 04 años de servicio CoverPlus en laboratorio para EB-U42/W42 | | | | | | | CP04RTBSH845 80 € |
| 04 años de servicio CoverPlus in situ para EB-S/W/X39 | | | CP04OSSWH856 | 192 € | | | |
| 04 años de servicio CoverPlus in situ para EB-S05/X05 | CP04RTBSH839 | 80 € | | | | | |
| 04 años de servicio CoverPlus in situ para EB-U42/W42 | | | | | | | CP04OSSEH845 192 € CP04OSSWH845 192 € |
| 05 años de servicio CoverPlus en laboratorio para EB-S/W/X39 | | | CP05RTBSH856 | 100 € | | | |
| 05 años de servicio CoverPlus en laboratorio para EB-S27 | | CP05RTBSH694 | 100 € | | | | |
| 05 años de servicio CoverPlus en laboratorio para EB-S31/S41 | | | | CP05RTBSH719 | 119,76 € | | |
| 05 años de servicio CoverPlus en laboratorio para EB-U04/U05 | | | | | CP05RTBSH763 | 144 € | |
| 05 años de servicio CoverPlus en laboratorio para EB-U32 | | | | | | CP05RTBSH722 | 120 € |
| 05 años de servicio CoverPlus en laboratorio para EB-U42/W42 | | | | | | CP05RTBSH845 | 120 € CP05RTBSH845 120 € |
| 05 años de servicio CoverPlus in situ para EB-S/W/X39 | | | CP05OSSWH856 | 288 € | | | |

| | EB-S05 | EB-S27 | EB-S39 | EB-S41 | EB-U05 | EB-U32 | EB-U42 |
|---|--------------|--------|--------|--------|--------|--------|--------|
| 05 años de servicio CoverPlus in situ para EB-S05/X05 | CP05RTBSH839 | 120 € | | | | | |

| | | | | | | | | |
|---|--|--|--|--|--|--|------------------------------|----------------|
| 05 años de servicio CoverPlus in situ para EB-U42/W42 | | | | | | | CP05OSSEH845 CP05OSSWH845 | 288 € 280 € |
|---|--|--|--|--|--|--|------------------------------|----------------|

| Grupo de precios | EB-W04 | EB-W05 | EB-W16 | EB-W16SK ES | EB-W32 | EB-W39 | EB-W41 |
|------------------|--------|--------|--------|-------------|--------|--------|--------|
| | W1 | W1 | C5 | C5 | C5 | C5 | L1 |



| | | | | | | | |
|-------------------------|---|--|--|--|--|--|--|
| Resolución | WXGA, 1280 x 800, 16:10 | WXGA, 1280 x 800, 16:10 | WXGA, 1280 x 800, 16:10 | WXGA, 1280 x 800, 16:10 | WXGA, 1280 x 800, 16:10 | WXGA, 1280 x 800, 16:10 | WXGA, 1280 x 800, 16:10 |
| Relación proyección | 1,30 - 1,56:1 | 1,30 - 1,56:1 | 1,30 - 1,56:1 | 1,42 - 1,56:1 | 1,30 - 1,56:1 | 1,30 - 1,56:1 | 1,30 - 1,56:1 |
| Emisión de luz en color | 3.000 Lumen-2.100 Lumen (económico) de conformidad con IDMS15.4 | 3.300 Lumen- 2.050 Lumen (económico) de conformidad con IDMS15.4 | 3.000 Lumen- 2.400 Lumen (económico) | 3.000 Lumen- 2.400 Lumen (económico) | 3.200 Lumen- 2.240 Lumen (económico) de conformidad con IDMS15.4 | 3.500 Lumen- 2.280 Lumen (económico) | 3.600 Lumen- 2.235 Lumen (económico) de conformidad con IDMS15.4 |
| Relación de contraste | 15.000 : 1 | 15.000 : 1 | 5.000 : 1 | 5.000 : 1 | 15.000 : 1 | 15.000 : 1 | 15.000 : 1 |
| 3D | NO | NO | Activo | Pasivo | | | NO |
| Interfaces | HDMI, VGA, USB, Wi-Fi (Opcional) | HDMI, VGA, USB, Wi-Fi (Opcional) | HDMI, VGA, USB | HDMI, VGA, USB | HDMI, VGA, USB, Wi-Fi | HDMI, VGA, USB, Ethernet, Wi-Fi (Opcional) | HDMI, VGA, USB, Wi-Fi (Opcional) |
| Altavoces | 1 vatio | 2 vatio | 2 vatio | 2 vatio | 2 vatio | 5 vatio | 2 vatio |
| nivel de ruido | Normal: 37 dB (A) - Ahorro: 28 dB (A) | Normal: 37 dB (A) - Ahorro: 28 dB (A) | Normal: 36 dB (A) - Ahorro: 29 dB (A) | Normal: 39 dB (A) - Ahorro: 32 dB (A) | Normal: 37 dB (A) - Ahorro: 28 dB (A) | Normal: 37 dB (A) - Ahorro: 28 dB (A) | Normal: 37 dB (A) - Ahorro: 28 dB (A) |
| Peso | 2,4 kg | 2,5 kg | 2,7 kg | 7,9 kg | 2,4 kg | 2,4 kg | 2,5 kg |
| Garantía | 36 meses Reparación en taller, lámpara: 12 meses o 1.000 h | 36 meses Reparación en taller, lámpara: 12 meses o 1.000 h | 36 meses Reparación en taller, lámpara: 12 meses o 1.000 h | 36 meses Reparación en taller, lámpara: 12 meses o 1.000 h | 36 meses Reparación en taller, lámpara: 12 meses o 1.000 h | 24 meses Reparación en taller, lámpara: 12 meses o 1.000 h | 36 meses Reparación en taller, lámpara: 12 meses o 1.000 h |

| | | | | | | | |
|------------------|------------|------------|--------------|--------------------|--------------------|---------------------|---------------------|
| PVPR neto | V11H718040 | V11H840040 | V11H493040LA | 708 € V11H494040LA | 1.582 € V11H721040 | 567,82 € V11H856040 | 583,28 € V11H844040 |
|------------------|------------|------------|--------------|--------------------|--------------------|---------------------|---------------------|

| Opciones | J1, J3 | J1, J3 | J3, J1 | J3, J1 | J1, J3 | J1, J3 | J1, J3 |
|----------|--------|--------|--------|--------|--------|--------|--------|
|----------|--------|--------|--------|--------|--------|--------|--------|

| | | | | | | | |
|----------------------------|--|--|------------|---------|--|--|--|
| Cargador USB para gafas 3D | | | V12H564C17 | 10,93 € | | | |
|----------------------------|--|--|------------|---------|--|--|--|

| | | | | | | | | |
|---|--|------------|---------|--|--|--|------------|---------|
| Soft Carry Case - ELPKS69 - EB-x05/x41/x42, EH-TW6 series | | V12H001K69 | 13,29 € | | | | V12H001K69 | 13,29 € |
|---|--|------------|---------|--|--|--|------------|---------|

| | | | | | | | |
|--|------------|---------|--|--|--|--|--|
| Maleta de transporte acolchada - ELPKS63 | V12H001K63 | 13,42 € | | | | | |
|--|------------|---------|--|--|--|--|--|

| | | | | | | | |
|-------------------------|--|--|------------|---------|------------|---------|--|
| Filtro de Aire- ELPAF42 | | | V13H134A42 | 18,40 € | V13H134A42 | 18,40 € | |
|-------------------------|--|--|------------|---------|------------|---------|--|





| | | | | | | | | |
|-------------------------|------------|---------|------------|---------|------------|---------|------------|---------|
| Filtro de Aire- ELPAF32 | V13H134A32 | 18,72 € | V13H134A32 | 18,72 € | V13H134A32 | 18,72 € | V13H134A32 | 18,72 € |
|-------------------------|------------|---------|------------|---------|------------|---------|------------|---------|

Proyectors - Portátil

TARIFA DE PRECIOS





| | EB-W04 | EB-W05 | EB-W16 | EB-W16SK ES | EB-W32 | EB-W39 | EB-W41 | |
|---|--------------|--------------|--------------|-------------|--------------|--------------|------------|----------|
| Soft Carry Case - ELPKS70 | | | | | | V12H001K70 | 23,38 € | |
| Gafas 3D pasivas (para adulto, x5) - ELPGS02A | | | | V12H541A10 | 26,80 € | | | |
| Gafas 3D pasivas (para niño, x5) - ELPGS02B | | | | V12H541B10 | 26,80 € | | | |
| Tubo de montaje en techo (668-918 mm) - ELPFP13 | V12H003P13 | 51,02 € | V12H003P13 | 51,02 € | V12H003P13 | 51,02 € | V12H003P13 | 51,02 € |
| ELPLP96 | | V13H010L96 | 61,24 € | | | V13H010L96 | 61,24 € | |
| Gafas Epson 3D (RF) - ELPGS03 | | | V12H548001 | 61,66 € | | | | |
| Tubo de montaje en techo (918-1168 mm) - ELPFP14 | V12H003P14 | 85,04 € | V12H003P14 | 85,04 € | V12H003P14 | 85,04 € | V12H003P14 | 85,04 € |
| Altavoces - ELPSP02 | | | | | | V12H467040 | 115,21 € | |
| Soporte para techo (Blanco) - ELPMB23 | V12H003B23 | 137,60 € | V12H003B23 | 137,60 € | V12H003B23 | 137,60 € | V12H003B23 | 137,60 € |
| Lámpara - ELPLP67 | | | V13H010L67 | 184,57 € | V13H010L67 | 184,57 € | | |
| Memoria USB de conexión inalámbrica rápida - ELPAP09 | V12H005M09 | 71,71 € | | | V12H005M09 | 71,71 € | | |
| Wireless LAN Adapter - ELPAP10 | V12H731P01 | 93,22 € | V12H731P01 | 93,22 € | | V12H731P01 | 93,22 € | |
| ELPLP88 | V13H010L88 | 73,28 € | | | V13H010L88 | 73,28 € | | |
| Pantalla de 50" tipo escritorio - ELPSC32 | V12H002S32 | 87,21 € | V12H002S32 | 87,21 € | V12H002S32 | 87,21 € | V12H002S32 | 87,21 € |
| Pantalla de 80" multiaspecto - ELPSC26 | V12H002S26 | 134,66 € | V12H002S26 | 134,66 € | V12H002S26 | 134,66 € | V12H002S26 | 134,66 € |
| Pantalla de 80" pantógrafo 16:10 - ELPSC24 | V12H002S24 | 456,10 € | V12H002S24 | 456,10 € | V12H002S24 | 456,10 € | V12H002S24 | 456,10 € |
| CoverPlus | BA | BA | BA | BA | BA | BA | BA | |
| 03 años de servicio CoverPlus en laboratorio para EB-S/W/ X39 | | | | | | CP03RTBSH856 | 49,90 € | |
| 03 años de servicio CoverPlus en laboratorio para EB-W03/ W05 | | CP03RTBSH554 | 49,90 € | | | | | |
| 03 años de servicio CoverPlus en laboratorio para EB-W04 | CP03RTBSH718 | 49,90 € | | | | | | |
| 03 años de servicio CoverPlus en laboratorio para EB-W16/SK | | | CP03RTBSH493 | 90 € | CP03RTBSH493 | 90 € | | |
| 03 años de servicio CoverPlus en laboratorio para EB-W32 | | | | | CP03RTBSH721 | 49,90 € | | |
| 03 años de servicio CoverPlus en laboratorio para EB-W41/ X41 | | | | | | CP03RTBSH844 | 49,90 € | |
| 03 años de servicio CoverPlus | | | | | | CP03OSSWH856 | 120 € | |

| | EB-W04 | EB-W05 | EB-W16 | EB-W16SK ES | EB-W32 | EB-W39 | EB-W41 |
|--|--------------|----------|--------|-------------|--------------|--------------|-----------------------|
| in situ para EB-S/W/X39 | | | | | | | |
| 04 años de servicio CoverPlus en laboratorio para EB-S/W/X39 | | | | | | CP04RTBSH856 | 75 € |
| 04 años de servicio CoverPlus en laboratorio para EB-W04 | CP04RTBSH718 | 63,80 € | | | | | |
| 04 años de servicio CoverPlus en laboratorio para EB-W32 | | | | | CP04RTBSH721 | 80 € | |
| 04 años de servicio CoverPlus en laboratorio para EB-W41/X41 | | | | | | | CP04RTBSH844 79,84 € |
| 04 años de servicio CoverPlus in situ para EB-S/W/X39 | | | | | | CP04OSSWH856 | 192 € |
| 05 años de servicio CoverPlus en laboratorio para EB-S/W/X39 | | | | | | CP05RTBSH856 | 100 € |
| 05 años de servicio CoverPlus en laboratorio para EB-W04 | CP05RTBSH718 | 119,76 € | | | | | |
| 05 años de servicio CoverPlus en laboratorio para EB-W32 | | | | | CP05RTBSH721 | 119,76 € | |
| 05 años de servicio CoverPlus en laboratorio para EB-X41 | | | | | | | CP05RTBSH844 119,76 € |
| 05 años de servicio CoverPlus in situ para EB-S/W/X39 | | | | | | CP05OSSWH856 | 288 € |

| Grupo de precios | EB-W42 | EB-X05 | EB-X27 | EB-X41 |
|-------------------------|---|---|---|---|
| | C5 | W1 | C5 | L1 |
| |  |  |  |  |
| | | NOVEDAD | | NOVEDAD |
| Resolución | WXGA, 1280 x 800, 16:10 | XGA, 1024 x 768, 4:3 | XGA, 1024 x 768, 4:3 | XGA, 1024 x 768, 4:3 |
| Relación proyección | 1,30 - 1,56:1 | 1,48 - 1,77:1 | 1,48 - 1,77:1 | 1,48 - 1,77:1 |
| Emisión de luz en color | 3.600 Lumen- 2.235 Lumen (económico) de conformidad con IDMS15.4 | 3.300 Lumen- 2.050 Lumen (económico) de conformidad con IDMS15.4 | 2.700 Lumen- 1.890 Lumen (económico) | 3.600 Lumen- 2.235 Lumen (económico) de conformidad con IDMS15.4 |
| Relación de contraste | 15.000 : 1 | 15.000 : 1 | 10.000 : 1 | 15.000 : 1 |
| 3D | | NO | | NO |
| Interfaces | HDMI, VGA, USB, Wi-Fi | HDMI, VGA, USB, Wi-Fi (Opcional) | HDMI, VGA, USB, Ethernet, Wi-Fi (Opcional) | HDMI, VGA, USB, Wi-Fi (Opcional) |
| Altavoces | 2 vatio | 2 vatio | 5 vatio | 2 vatio |

| | EB-W42 | EB-X05 | EB-X27 | EB-X41 |
|--|--|--|--|--|
| nivel de ruido | Normal: 37 dB (A) - Ahorro: 28 dB (A) | Normal: 37 dB (A) - Ahorro: 28 dB (A) | Normal: 37 dB (A) - Ahorro: 29 dB (A) | Normal: 37 dB (A) - Ahorro: 28 dB (A) |
| Peso | 2,5 kg | 2,5 kg | 2,6 kg | 2,5 kg |
| Garantía | 24 meses Reparación en taller, lámpara: 12 meses o 1.000 h | 36 meses Reparación en taller, lámpara: 12 meses o 1.000 h | 36 meses Reparación en taller, lámpara: 12 meses o 1.000 h | 36 meses Reparación en taller, lámpara: 12 meses o 1.000 h |
| VPVR neto | V11H845040 567,79 € | V11H839040 | V11H692040 458,23 € | V11H843040 |
| Opciones | J3, J1 | J1, J3 | J3, J1 | J1, J3 |
| Soft Carry Case - ELPKS69 - EB-X05/x41/x42, EH-TW6 series | V12H001K69 13,29 € | V12H001K69 13,29 € | | V12H001K69 13,29 € |
| Filtro de Aire- ELPAF32 | V13H134A32 18,72 € | V13H134A32 18,72 € | V13H134A32 18,72 € | V13H134A32 18,72 € |
| Tubo de montaje en techo (668-918 mm) - ELPFP13 | V12H003P13 51,02 € | V12H003P13 51,02 € | V12H003P13 51,02 € | V12H003P13 51,02 € |
| ELPLP96 | V13H010L96 61,24 € | V13H010L96 61,24 € | | V13H010L96 61,24 € |
| Tubo de montaje en techo (918-1168 mm) - ELPFP14 | V12H003P14 85,04 € | V12H003P14 85,04 € | V12H003P14 85,04 € | V12H003P14 85,04 € |
| Altavoces - ELPSP02 | V12H467040 115,21 € | | V12H467040 115,21 € | |
| Soporte para techo (Blanco) - ELPMB23 | V12H003B23 137,60 € | V12H003B23 137,60 € | V12H003B23 137,60 € | V12H003B23 137,60 € |
| Memoria USB de conexión inalámbrica rápida - ELPAP09 | | | V12H005M09 71,71 € | |
| Wireless LAN Adapter - ELPAP10 | | V12H731P01 93,22 € | V12H731P01 93,22 € | V12H731P01 93,22 € |
| Caja de control y conexiones Epson - ELPCB02 | | | V12H614040 207,50 € | |
| ELPLP88 | | | V13H010L88 73,28 € | |
| Pantalla de 50" tipo escritorio - ELPSC32 | | | V12H002S32 87,21 € | |
| Pantalla de 80" multiaspecto - ELPSC26 | | | V12H002S26 134,66 € | |
| Pantalla de 80" pantógrafo 16:10 - ELPSC24 | | V12H002S24 456,10 € | V12H002S24 456,10 € | V12H002S24 456,10 € |
| CoverPlus | BA | BA | BA | BA |
| 03 años de servicio CoverPlus en laboratorio para EB-U42/W42 | CP03RTBSH845 50 € | | | |
| 03 años de servicio CoverPlus en laboratorio para EB-W41/X41 | | | CP03RTBSH844 49,90 € | |
| 03 años de servicio CoverPlus en laboratorio para EB-X27 | | | CP03RTBSH692 49,99 € | |
| 03 años de servicio CoverPlus in situ para EB-S05/X05 | | CP03RTBSH839 50 € | | |
| 03 años de servicio CoverPlus in situ para EB-U42/W42 | CP03OSSEH845 120 € CP03OSSWH845 120 € | | | |

| | EB-W42 | EB-X05 | EB-X27 | EB-X41 | |
|--|--------------|--------------|--------------|--------------|----------|
| 04 años de servicio CoverPlus en laboratorio para EB-U42/W42CP04RTBSH845 | | 80 € | | | |
| 04 años de servicio CoverPlus en laboratorio para EB-W41/X41 | | | | CP04RTBSH844 | 79,84 € |
| 04 años de servicio CoverPlus in situ para EB-S05/X05 | | CP04RTBSH839 | 80 € | | |
| 04 años de servicio CoverPlus in situ para EB-U42/W42 | CP04OSSEH845 | 192 € | | | |
| | CP04OSSWH845 | 192 € | | | |
| 04 años de servicio CoverPlus in situ para EB-X27 | | | CP04OSSEH692 | 192 € | |
| 05 años de servicio CoverPlus en laboratorio para EB-X41 | | | | CP05RTBSH844 | 119,76 € |
| 05 años de servicio CoverPlus in situ para EB-S05/X05 | | CP05RTBSH839 | 120 € | | |
| 05 años de servicio CoverPlus in situ para EB-U42/W42 | CP05OSSEH845 | 288 € | | | |
| | CP05OSSWH845 | 280 € | | | |

| Grupo de precios | EB-520 | | EB-525W | | EB-530 | | EB-535W | | EB-536Wi | |
|--|---|-----------------|---|-----------------|---|-----------------|---|-------------------|--|-------------------|
| | E9 | | E9 | | E9 | | E9 | | E9 | |
| |  | |  | |  | |  | |  | |
| Resolución | XGA, 1024 x 768, 4:3 | | WXGA, 1280 x 800, 16:10 | | XGA, 1024 x 768, 4:3 | | WXGA, 1280 x 800, 16:10 | | WXGA, 1280 x 800, 16:10 | |
| Relación proyección | 0,55:1 | | 0,48:1 | | 0,55:1 | | 0,48:1 | | 0,48:1 | |
| Emisión de luz en color | 2.700 Lumen- 1.600 Lumen (económico) | | 2.800 Lumen- 1.700 Lumen (económico) | | 3.200 Lumen- 1.800 Lumen (económico) | | 3.400 Lumen- 1.900 Lumen (económico) | | 3.400 Lumen- 1.900 Lumen (económico) | |
| Relación de contraste | 16.000 : 1 | | 16.000 : 1 | | 16.000 : 1 | | 16.000 : 1 | | 16.000 : 1 | |
| Interactivos | NO | | NO | | NO | | NO | | Sí: lápiz | |
| Interfaces | HDMI, VGA, USB, Ethernet, Wi-Fi (Opcional) | | HDMI, VGA, USB, Ethernet, Wi-Fi (Opcional) | | HDMI, VGA, USB, Ethernet, Wi-Fi (Opcional) | | HDMI, VGA, USB, Ethernet, Wi-Fi (Opcional) | | HDMI, VGA, USB, Ethernet, Wi-Fi (Opcional) | |
| Altavoces | 16 vatio | | 16 vatio | | 16 vatio | | 16 vatio | | 16 vatio | |
| nivel de ruido | Normal: 35 dB (A) - Ahorro: 28 dB (A) | | Normal: 35 dB (A) - Ahorro: 28 dB (A) | | Normal: 37 dB (A) - Ahorro: 29 dB (A) | | Normal: 37 dB (A) - Ahorro: 29 dB (A) | | Normal: 37 dB (A) - Ahorro: 29 dB (A) | |
| Peso | 3,7 kg | | 3,7 kg | | 3,7 kg | | 3,7 kg | | 3,9 kg | |
| Garantía | 36 meses Reparación en taller, lámpara: 36 meses o 3.000 h | | 36 meses Reparación en taller, lámpara: 36 meses o 3.000 h | | 36 meses Reparación en taller, lámpara: 36 meses o 3.000 h | | 36 meses Reparación en taller, lámpara: 36 meses o 3.000 h | | 36 meses Reparación en taller, lámpara: 36 meses o 3.000 h | |
| PVPR neto | V11H674040 | 874,09 € | V11H672040 | 961,15 € | V11H673040 | 961,15 € | V11H671040 | 1.049,95 € | V11H670040 | 1.303,06 € |
| Opciones | J1, J3 | | J3, J1 | | J3, J1 | | J3, J1 | | J3, J1 | |
| Soft Carry Case - ELPKS66 - EB-52x/53x series | V12H001K66 | 11,16 € | V12H001K66 | 11,16 € | V12H001K66 | 11,16 € | V12H001K66 | 11,16 € | V12H001K66 | 11,16 € |
| Filtro de Aire- ELPFA47 | V13H134A47 | 18,33 € | V13H134A47 | 18,33 € | V13H134A47 | 18,33 € | V13H134A47 | 18,33 € | V13H134A47 | 18,33 € |
| Tubo de montaje en techo (688-918 mm) - ELPPF13 | | | V12H003P13 | 51,02 € | V12H003P13 | 51,02 € | V12H003P13 | 51,02 € | V12H003P13 | 51,02 € |
| Tubo de montaje en techo (918-1168 mm) - ELPPF14 | | | V12H003P14 | 85,04 € | V12H003P14 | 85,04 € | V12H003P14 | 85,04 € | V12H003P14 | 85,04 € |
| Altavoces - ELPSP02 | V12H467040 | 115,21 € | V12H467040 | 115,21 € | V12H467040 | 115,21 € | V12H467040 | 115,21 € | V12H467040 | 115,21 € |
| Soporte para techo (Blanco) - ELPMB23 | | | V12H003B23 | 137,60 € | V12H003B23 | 137,60 € | V12H003B23 | 137,60 € | V12H003B23 | 137,60 € |
| Soporte para pared - ELPMB45 | V12H706040 | 151,06 € | V12H706040 | 151,06 € | V12H706040 | 151,06 € | V12H706040 | 151,06 € | V12H706040 | 151,06 € |
| Memoria USB de conexión inalámbrica rápida - ELPAP09 | V12H005M09 | 71,71 € | V12H005M09 | 71,71 € | V12H005M09 | 71,71 € | V12H005M09 | 71,71 € | V12H005M09 | 71,71 € |
| Wireless LAN Adapter - ELPAP10 | V12H731P01 | 93,22 € | V12H731P01 | 93,22 € | V12H731P01 | 93,22 € | V12H731P01 | 93,22 € | V12H731P01 | 93,22 € |
| Caja de control y conexiones Epson - ELPCB02 | V12H614040 | 207,50 € | V12H614040 | 207,50 € | V12H614040 | 207,50 € | V12H614040 | 207,50 € | V12H614040 | 207,50 € |
| Lápiz interactivo - ELPPN04A | | | | | | | | | V12H666010 | 40,72 € |
| Lápiz interactivo - ELPPN04B | | | | | | | | | V12H667010 | 40,72 € |







Proyectors - Corta distancia

TARIFA DE PRECIOS

| Lámpara - ELP87 | EB-520 | | EB-525W | | EB-530 | | EB-535W | | EB-536Wi | |
|--|--------------|---------|--------------|---------|--------------|---------|--------------|---------|--------------|---------|
| | V13H010L87 | 59,36 € | V13H010L87 | 59,36 € | V13H010L87 | 59,36 € | V13H010L87 | 59,36 € | V13H010L87 | 59,36 € |
| CoverPlus | BA | | BA | | BA | | BA | | BA | |
| 03 años de servicio CoverPlus en laboratorio para EB-520 | CP03RTBSH674 | 90 € | | | | | | | | |
| 03 años de servicio CoverPlus en laboratorio para EB-525W | | | CP03RTBSH672 | 90 € | | | | | | |
| 03 años de servicio CoverPlus en laboratorio para EB-530 | | | | | CP03RTBSH673 | 90 € | | | | |
| 03 años de servicio CoverPlus en laboratorio para EB-535W | | | | | | | CP03RTBSH671 | 90 € | | |
| 03 años de servicio CoverPlus en laboratorio para EB-536Wi | | | | | | | | | CP03RTBSH670 | 90 € |
| 03 años de servicio CoverPlus in situ para EB-535W | | | | | | | CP03OSSWH671 | 150 € | | |
| 04 años de servicio CoverPlus en laboratorio para EB-525W | | | CP04RTBSH672 | 135 € | | | | | | |
| 04 años de servicio CoverPlus en laboratorio para EB-535W | | | | | | | CP04RTBSH671 | 135 € | | |
| 04 años de servicio CoverPlus en laboratorio para EB-536Wi | | | | | | | | | CP04RTBSH670 | 135 € |
| 05 años de servicio CoverPlus en laboratorio para EB-525W | | | CP05RTBSH672 | 225 € | | | | | | |
| 05 años de servicio CoverPlus en laboratorio para EB-535W | | | | | | | CP05RTBSH671 | 225 € | | |
| 05 años de servicio CoverPlus en laboratorio para EB-536Wi | | | | | | | | | CP05RTBSH670 | 225 € |

Proyectores - Proyector de ultracorta distancia







TARIFA DE PRECIOS

| Grupo de precios | EB-670 | | EB-675Wi | | EB-675W | | EB-680Wi | | EB-680 | | EB-685Wi | | EB-685W | | |
|--|---|-------------------|---|-------------------|---|-------------------|---|-------------------|--|-------------------|---|-------------------|---|-------------------|----------------|
| | E9 | | E9 | | E9 | | E9 | | E9 | | E9 | | E9 | | |
| |  | |  | |  | |  | |  | |  | |  | | |
| Resolución | XGA, 1024 x 768, 4:3 | | WXGA, 1280 x 800, 16:10 | | WXGA, 1280 x 800, 16:10 | | WXGA, 1280 x 800, 16:10 | | XGA, 1024 x 768, 4:3 | | WXGA, 1280 x 800, 16:10 | | WXGA, 1280 x 800, 16:10 | | |
| Relación proyección | 0,32 - 0,43:1 | | 0,28 - 0,37:1 | | 0,28 - 0,37:1 | | 0,28 - 0,37:1 | | 0,32 - 0,43:1 | | 0,28 - 0,37:1 | | 0,28 - 0,37:1 | | |
| Emisión de luz en color | 3.100 Lumen- 1.800 Lumen (económico) de conformidad con IDMS15.4 | | 3.200 Lumen- 1.800 Lumen (económico) de conformidad con IDMS15.4 | | 3.200 Lumen- 1.800 Lumen (económico) de conformidad con IDMS15.4 | | 3.200 Lumen- 1.800 Lumen (económico) de conformidad con IDMS15.4 | | 3.500 Lumen- 2.900 Lumen (económico) de conformidad con IDMS15.4 | | 3.500 Lumen- 2.900 Lumen (económico) | | 3.500 Lumen- 2.900 Lumen (económico) de conformidad con IDMS15.4 | | |
| Relación de contraste | 14.000 : 1 | | 14.000 : 1 | | 14.000 : 1 | | 14.000 : 1 | | 14.000 : 1 | | 14.000 : 1 | | 14.000 : 1 | | |
| Interactivos | NO | | Sí: lápiz | | NO | | Sí: lápiz y táctil | | NO | | Sí: lápiz | | NO | | |
| Interfaces | HDMI, VGA, USB, Ethernet, Wi-Fi (Opcional) | | HDMI, VGA, USB, Ethernet, Wi-Fi (Opcional) | | HDMI, VGA, USB, Ethernet, Wi-Fi (Opcional) | | HDMI, VGA, USB, Ethernet, Wi-Fi (Opcional) | | HDMI, VGA, USB, Ethernet, Wi-Fi (Opcional) | | HDMI, VGA, USB, Ethernet, Wi-Fi (Opcional) | | HDMI, VGA, USB, Ethernet, Wi-Fi (Opcional) | | |
| Altavoces | 16 vatio | | 16 vatio | | 16 vatio | | 16 vatio | | 16 vatio | | 16 vatio | | 16 vatio | | |
| nivel de ruido | Normal: 35 dB (A) - Ahorro: 28 dB (A) | | Normal: 35 dB (A) - Ahorro: 28 dB (A) | | Normal: 35 dB (A) - Ahorro: 28 dB (A) | | Normal: 35 dB (A) - Ahorro: 28 dB (A) | | Normal: 35 dB (A) - Ahorro: 28 dB (A) - Eco2: 29 dB (A) | | Normal: 35 dB (A) - Ahorro: 30 dB (A) - Eco2: 29 dB (A) | | Normal: 35 dB (A) - Ahorro: 30 dB (A) - Eco2: 29 dB (A) | | |
| Peso | 5,7 kg | | 5,8 kg | | 5,7 kg | | 5,8 kg | | 5,7 kg | | 5,9 kg | | 5,7 kg | | |
| Garantía | 36 meses Reparación en taller o 8.000 h, lámpara: 12 meses o 1.000 h | | 36 meses Reparación en taller o 8.000 h, lámpara: 12 meses o 1.000 h | | 36 meses Reparación en taller o 8.000 h, lámpara: 12 meses o 1.000 h | | 36 meses Reparación en taller o 8.000 h, lámpara: 12 meses o 1.000 h | | 36 meses Reparación en taller o 8.000 h, lámpara: 12 meses o 1.000 h | | 36 meses Reparación en taller o 8.000 h, lámpara: 12 meses o 1.000 h | | 36 meses Reparación en taller o 8.000 h, lámpara: 12 meses o 1.000 h | | |
| PVPR neto | V11H747040 | 1.410,56 € | V11H743040 | 2.016,52 € | V11H745040 | 1.521,04 € | V11H742040 | 2.328,10 € | V11H746040 | 1.521,04 € | V11H741040 | 2.118,24 € | V11H744040 | 1.613,25 € | |
| Opciones | J3, J1 | | J3, J1 | | J3, J1 | | J3, J1 | | J3, J1 | | J3, J1 | | J3, J1 | | |
| Replacement Pen Tip - ELPPS03 (Teflon) x 2 piezas | | | V12H775010 | 10,43 € | | | V12H775010 | 10,43 € | | | V12H775010 | 10,43 € | | | |
| Replacement Pen Tip - ELPPS04 (Felt) x 4 piezas | | | V12H776010 | 10,43 € | | | V12H776010 | 10,43 € | | | V12H776010 | 10,43 € | | | |
| Air Filter - ELPAF49 | V13H134A49 | 19,36 € | V13H134A49 | 19,36 € | V13H134A49 | 19,36 € | V13H134A49 | 19,36 € | V13H134A49 | 19,36 € | V13H134A49 | 19,36 € | V13H134A49 | 19,36 € | |
| Interactive Pen - ELPPN05A - Orange - EB-6xxWi/Ui / 14xxUi | | | V12H773010 | 38,59 € | | | V12H773010 | 38,59 € | | | V12H773010 | 38,59 € | | | |
| Interactive Pen - ELPPN05B - Blue - EB-6xxWi/Ui / 14xxUi | | | V12H774010 | 38,59 € | | | V12H774010 | 38,59 € | | | V12H774010 | 38,59 € | | | |
| ELPLP90 | V13H010L90 | 58,79 € | V13H010L90 | 58,79 € | V13H010L90 | 58,79 € | V13H010L90 | 58,79 € | | | V13H010L90 | 58,79 € | V13H010L90 | 58,79 € | |
| ELPLP91 | | | | | | | | V13H010L91 | 58,79 € | V13H010L91 | 58,79 € | V13H010L91 | 58,79 € | V13H010L91 | 58,79 € |
| Altavoces - ELPSP02 | V12H467040 | 115,21 € | V12H467040 | 115,21 € | V12H467040 | 115,21 € | V12H467040 | 115,21 € | V12H467040 | 115,21 € | V12H467040 | 115,21 € | V12H467040 | 115,21 € | |
| Soporte para mesa para la serie de distancia ultra corta - ELPMB29 | V12H516040 | 133,07 € | V12H516040 | 133,07 € | V12H516040 | 133,07 € | V12H516040 | 133,07 € | V12H516040 | 133,07 € | V12H516040 | 133,07 € | V12H516040 | 133,07 € | |
| Wireless LAN Adapter - ELPAP10 | V12H731P01 | 93,22 € | V12H731P01 | 93,22 € | V12H731P01 | 93,22 € | V12H731P01 | 93,22 € | V12H731P01 | 93,22 € | V12H731P01 | 93,22 € | V12H731P01 | 93,22 € | |

Proyectors - Proyector de ultracorta distancia

TARIFA DE PRECIOS

| | EB-670 | | EB-675Wi | | EB-675W | | EB-680Wi | | EB-680 | | EB-685Wi | | EB-685W | |
|---|--------------|----------|--------------|----------|--------------|----------|--------------|----------|--------------|----------|--------------|----------|--------------|----------|
| Caja de control y conexiones Epson - ELPCB02 | V12H614040 | 207,50 € | V12H614040 | 207,50 € | V12H614040 | 207,50 € | V12H614040 | 207,50 € | V12H614040 | 207,50 € | V12H614040 | 207,50 € | V12H614040 | 207,50 € |
| CoverPlus | BA | | BA | | BA | | BA | | BA | | BA | | BA | |
| 03 años de servicio CoverPlus in situ para EB-6xx | CP03OSSEH745 | 150 € | | | CP03OSSEH745 | 150 € | | | CP03OSSEH745 | 150 € | | | CP03OSSEH745 | 150 € |
| | CP03OSSLH745 | 170 € | | | CP03OSSLH745 | 170 € | | | CP03OSSLH745 | 170 € | | | CP03OSSLH745 | 170 € |
| 03 años de servicio CoverPlus in situ para EB-6xxWi/Ui | | | CP03OSSWH740 | 150 € | | | CP03OSSWH740 | 150 € | | | CP03OSSWH740 | 150 € | | |
| | | | CP03OSSEH740 | 150 € | | | CP03OSSEH740 | 150 € | | | CP03OSSEH740 | 150 € | | |
| | | | CP03OSSLH740 | 170 € | | | CP03OSSLH740 | 170 € | | | CP03OSSLH740 | 170 € | | |
| 04 años de servicio CoverPlus en laboratorio para EB-6xx | CP04RTBSH745 | 144 € | | | CP04RTBSH745 | 144 € | | | CP04RTBSH745 | 144 € | | | CP04RTBSH745 | 144 € |
| 04 años de servicio CoverPlus en laboratorio para EB-6xxWi/Ui | | | CP04RTBSH740 | 144 € | | | CP04RTBSH740 | 144 € | | | CP04RTBSH740 | 144 € | | |
| 04 años de servicio CoverPlus in situ para EB-6xx | CP04OSSEH745 | 250 € | | | CP04OSSEH745 | 250 € | | | CP04OSSEH745 | 250 € | | | CP04OSSEH745 | 250 € |
| | CP04OSSWH745 | 250 € | | | CP04OSSWH745 | 250 € | | | CP04OSSWH745 | 250 € | | | CP04OSSWH745 | 250 € |
| | CP04OSSLH745 | 280 € | | | CP04OSSLH745 | 280 € | | | CP04OSSLH745 | 280 € | | | CP04OSSLH745 | 280 € |
| 04 años de servicio CoverPlus in situ para EB-6xxWi/Ui | | | CP04OSSWH740 | 250 € | | | CP04OSSWH740 | 250 € | | | CP04OSSWH740 | 250 € | | |
| | | | CP04OSSEH740 | 250 € | | | CP04OSSEH740 | 250 € | | | CP04OSSEH740 | 250 € | | |
| | | | CP04OSSLH740 | 280 € | | | CP04OSSLH740 | 280 € | | | CP04OSSLH740 | 280 € | | |
| 05 años de servicio CoverPlus en laboratorio para EB-6xx | CP05RTBSH745 | 216 € | | | CP05RTBSH745 | 216 € | | | CP05RTBSH745 | 216 € | | | CP05RTBSH745 | 216 € |
| 05 años de servicio CoverPlus en laboratorio para EB-6xxWi/Ui | | | CP05RTBSH740 | 150 € | | | CP05RTBSH740 | 150 € | | | CP05RTBSH740 | 150 € | | |
| 05 años de servicio CoverPlus in situ para EB-6xx | CP05OSSEH745 | 330 € | | | CP05OSSEH745 | 330 € | | | CP05OSSEH745 | 330 € | | | CP05OSSEH745 | 330 € |
| | CP05OSSWH745 | 330 € | | | CP05OSSWH745 | 330 € | | | CP05OSSWH745 | 330 € | | | CP05OSSWH745 | 330 € |
| | CP05OSSLH745 | 370 € | | | CP05OSSLH745 | 370 € | | | CP05OSSLH745 | 370 € | | | CP05OSSLH745 | 370 € |
| 05 años de servicio CoverPlus in situ para EB-6xxWi/Ui | | | CP05OSSWH740 | 330 € | | | CP05OSSWH740 | 330 € | | | CP05OSSWH740 | 330 € | | |
| | | | CP05OSSEH740 | 330 € | | | CP05OSSEH740 | 330 € | | | CP05OSSEH740 | 330 € | | |
| | | | CP05OSSLH740 | 370 € | | | CP05OSSLH740 | 370 € | | | CP05OSSLH740 | 370 € | | |

| Grupo de precios | EB-695Wi | | EB-696Ui | | EB-710Ui | | EB-1440Ui | | EB-1450Ui | | EB-1460Ui | | EB-1470Ui | |
|--|---|---|---|---|--|---|---|--|--|--|--|--|--|---|
| | E9 | | E9 | | E9 | | B9 | | B9 | | B9 | | B9 | |
| |  |  |  |  |  |  |  | | | | | | | |
| Resolución | WXGA, 1280 x 800, 16:10 | WUXGA, 1920 x 1200, 16:10 | WUXGA, 1920 x 1200, 16:10 | WUXGA, 1920 x 1200, 16:10 | WUXGA, 1920 x 1200, 16:10 | WUXGA, 1920 x 1200, 16:10 | WUXGA, 1920 x 1200, 16:10 | WUXGA, 1920 x 1200, 16:10 | WUXGA, 1920 x 1200, 16:10 | WUXGA, 1920 x 1200, 16:10 | WUXGA, 1920 x 1200, 16:10 | WUXGA, 1920 x 1200, 16:10 | WUXGA, 1920 x 1200, 16:10 | WUXGA, 1920 x 1200, 16:10 |
| Relación proyección | 0,28 - 0,37:1 | 0,27 - 0,37:1 | 0,27 - 0,37:1 | 0,27 - 0,37:1 | 0,27 - 0,37:1 | 0,27 - 0,37:1 | 0,27 - 0,37:1 | 0,27 - 0,37:1 | 0,27 - 0,37:1 | 0,27 - 0,37:1 | 0,27 - 0,37:1 | 0,27 - 0,37:1 | 0,27 - 0,37:1 | 0,27 - 0,37:1 |
| Emisión de luz en color | 3.500 Lumen- 2.900 Lumen (económico) de conformidad con IDMS15.4 | 3.800 Lumen- 2.900 Lumen (económico) de conformidad con IDMS15.4 | 4.000 Lumen- 2.800 Lumen (económico) de conformidad con IDMS15.4 | 3.800 Lumen- 2.900 Lumen (económico) de conformidad con IDMS15.4 | 3.800 Lumen- 2.900 Lumen (económico) de conformidad con IDMS15.4 | 4.400 Lumen- 2.900 Lumen (económico) de conformidad con IDMS15.4 | 4.000 Lumen- 2.800 Lumen (económico) de conformidad con IDMS15.4 | | | | | | | |
| Relación de contraste | 14.000 : 1 | 16.000 : 1 | 2.500.000 : 1 | 16.000 : 1 | 16.000 : 1 | 16.000 : 1 | 16.000 : 1 | 16.000 : 1 | 16.000 : 1 | 16.000 : 1 | 16.000 : 1 | 16.000 : 1 | 16.000 : 1 | 2.500.000 : 1 |
| Interactivos | Sí: lápiz y táctil | Sí: lápiz y táctil | Sí: lápiz y táctil | Sí: lápiz y táctil | Sí: lápiz y táctil | Sí: lápiz y táctil | Sí: lápiz y táctil | Sí: lápiz y táctil | Sí: lápiz y táctil | Sí: lápiz y táctil | Sí: lápiz y táctil | Sí: lápiz y táctil | Sí: lápiz y táctil | Sí: lápiz y táctil |
| Interfaces | HDMI, VGA, USB, Ethernet, Wi-Fi (Opcional) | HDMI, VGA, USB, Ethernet, Wi-Fi (Opcional) | HDMI, VGA, USB, Ethernet, Wi-Fi (Opcional) | HDMI, VGA, USB, Ethernet, Wi-Fi | HDMI, VGA, USB, Ethernet, Wi-Fi | HDMI, VGA, USB, Ethernet, Wi-Fi | HDMI, VGA, USB, Ethernet, Wi-Fi | HDMI, VGA, USB, Ethernet, Wi-Fi | HDMI, VGA, Miracast, USB, Ethernet, Wi-Fi | HDMI, VGA, Miracast, USB, Ethernet, Wi-Fi | HDMI, VGA, Miracast, USB, Ethernet, Wi-Fi | HDMI, VGA, Miracast, USB, Ethernet, Wi-Fi | HDMI, VGA, Miracast, USB, Ethernet, Wi-Fi | HDMI, VGA, Miracast, USB, Ethernet, Wi-Fi |
| Altavoces | 16 vatio | 16 vatio | 16 vatio | 16 vatio | 16 vatio | 16 vatio | 16 vatio | 16 vatio | 16 vatio | 16 vatio | 16 vatio | 16 vatio | 16 vatio | 16 vatio |
| nivel de ruido | Normal: 35 dB (A) - Ahorro: 30 dB (A) - Eco2: 29 dB (A) | Normal: 35 dB (A) - Ahorro: 30 dB (A) | Normal: 39 dB (A) - Ahorro: 30 dB (A) | Normal: 37 dB (A) - Ahorro: 30 dB (A) | Normal: 37 dB (A) - Ahorro: 30 dB (A) | Normal: 37 dB (A) - Ahorro: 30 dB (A) | Normal: 37 dB (A) - Ahorro: 30 dB (A) | Normal: 37 dB (A) - Ahorro: 30 dB (A) | Normal: 37 dB (A) - Ahorro: 30 dB (A) | Normal: 38 dB (A) - Ahorro: 30 dB (A) | Normal: 38 dB (A) - Ahorro: 30 dB (A) | Normal: 38 dB (A) - Ahorro: 30 dB (A) | Normal: 38 dB (A) - Ahorro: 30 dB (A) | Normal: 38 dB (A) - Ahorro: 27 dB (A) |
| Peso | 5,8 kg | 8,3 kg | 11,2 kg | 8,4 kg | 8,4 kg | 8,4 kg | 8,4 kg | 8,4 kg | 8,4 kg | 8,5 kg | 8,5 kg | 8,5 kg | 8,5 kg | 11,4 kg |
| Garantía | 36 meses Reparación en taller o 8.000 h, lámpara: 12 meses o 1.000 h | 36 meses Reparación en taller o 8.000 h, lámpara: 12 meses o 1.000 h | 60 meses Reparación en taller o 12.000 h | 36 meses Reparación en taller o 8.000 h, lámpara: 12 meses o 1.000 h | 36 meses Reparación en taller o 8.000 h, lámpara: 12 meses o 1.000 h | 36 meses Reparación en taller o 8.000 h, lámpara: 12 meses o 1.000 h | 36 meses Reparación en taller o 8.000 h, lámpara: 12 meses o 1.000 h | 36 meses Reparación en taller o 8.000 h, lámpara: 12 meses o 1.000 h | 36 meses Reparación en taller o 8.000 h, lámpara: 12 meses o 1.000 h | 36 meses Reparación en taller o 8.000 h, lámpara: 12 meses o 1.000 h | 36 meses Reparación en taller o 8.000 h, lámpara: 12 meses o 1.000 h | 36 meses Reparación en taller o 8.000 h, lámpara: 12 meses o 1.000 h | 36 meses Reparación en taller o 8.000 h, lámpara: 12 meses o 1.000 h | 60 meses Reparación en taller o 12.000 h |
| PVPR neto | V11H740040 | 2.418,84 € | V11H728040 | 2.851,70 € | V11H877040 | V11H771040 | 3.595,87 € | 2.691,70 € | V11H727040 | 2.942,39 € | V11H726040 | 3.108,48 € | V11H726040 | 3.770,41 € |
| Opciones | J3, J1 | | J3, J1 | | J1, J3, P8 | J3, J1 | | J3, J1 | J3, J1 | | J3, J1 | | J3, J1, P8 | |
| Replacement Pen Tip - ELPPS03 (Teflon) x 2 piezas | V12H775010 | 10,43 € | V12H775010 | 10,43 € | V12H775010 | 10,43 € | V12H775010 | 10,43 € | V12H775010 | 10,43 € | V12H775010 | 10,43 € | V12H775010 | 10,43 € |
| Replacement Pen Tip - ELPPS04 (Felt) x 4 piezas | V12H776010 | 10,43 € | V12H776010 | 10,43 € | V12H776010 | 10,43 € | V12H776010 | 10,43 € | V12H776010 | 10,43 € | V12H776010 | 10,43 € | V12H776010 | 10,43 € |
| Air Filter - ELPAF49 | V13H134A49 | 19,36 € | | | | | | | | | | | | |
| Interactive Pen - ELPPN05A - Orange - EB-6xxWi/Ui / 14xxUi | V12H773010 | 38,59 € | V12H773010 | 38,59 € | V12H773010 | 38,59 € | V12H773010 | 38,59 € | V12H773010 | 38,59 € | V12H773010 | 38,59 € | V12H773010 | 38,59 € |
| Interactive Pen - ELPPN05B - Blue - EB-6xxWi/Ui / 14xxUi | V12H774010 | 38,59 € | V12H774010 | 38,59 € | V12H774010 | 38,59 € | V12H774010 | 38,59 € | V12H774010 | 38,59 € | V12H774010 | 38,59 € | V12H774010 | 38,59 € |
| Tubo de montaje en techo (668-918 mm) - ELPPP13 | | | | | | V12H003P13 | 51,02 € | V12H003P13 | 51,02 € | V12H003P13 | 51,02 € | V12H003P13 | 51,02 € | V12H003P13 |
| ELPLP91 | V13H010L91 | 58,79 € | | | | | | | | | | | | |

Proyectors - Proyector de ultracorta distancia







TARIFA DE PRECIOS

| | EB-695Ui | EB-696Ui | EB-710Ui | EB-1440Ui | EB-1450Ui | EB-1460Ui | EB-1470Ui | | |
|--|--------------|------------|--------------|--------------|------------|--------------|--------------|--------------|----------|
| ELPLP92 | | V13H010L92 | 58,79 € | | V13H010L92 | 58,79 € | V13H010L92 | 58,79 € | |
| Tubo de montaje en techo (918-1168 mm) - ELPFP14 | | | | V12H003P14 | 85,04 € | V12H003P14 | 85,04 € | V12H003P14 | 85,04 € |
| Altavoces - ELPSP02 | V12H467040 | 115,21 € | V12H467040 | 115,21 € | V12H467040 | 115,21 € | V12H467040 | 115,21 € | |
| Soporte para mesa para la serie de distancia ultra corta - ELPMB29 | V12H516040 | 133,07 € | | V12H516040 | 133,07 € | V12H516040 | 133,07 € | V12H516040 | 133,07 € |
| Soporte para techo (Blanco) - ELPMB23 | | | | V12H003B23 | 137,60 € | V12H003B23 | 137,60 € | | |
| Soporte para techo (Blanco) - ELPMB22 | | | | | | | V12H003B22 | 153,07 € | |
| Wireless LAN Adapter - ELPAP10 | V12H731P01 | 93,22 € | V12H731P01 | 93,22 € | V12H731P01 | 93,22 € | | V12H731P01 | 93,22 € |
| Caja de control y conexiones Epson - ELPCE02 | V12H614040 | 207,50 € | V12H614040 | 207,50 € | V12H614040 | 207,50 € | | | |
| Filtro de Aire- ELPAF45 | | V13H134A45 | 60,32 € | | V13H134A45 | 60,32 € | V13H134A45 | 60,32 € | |
| Filtro de Aire- ELPAF43 | | | V13H134A43 | 79,54 € | | | V13H134A43 | 79,54 € | |
| CoverPlus | BA | BA | BA | BA | BA | BA | BA | BA | |
| 03 años de servicio CoverPlus in situ para EB-14xxUi | | | | CP03OSSWH726 | 150 € | CP03OSSWH726 | 150 € | CP03OSSWH726 | 150 € |
| | | | | CP03OSSEH726 | 150 € | CP03OSSEH726 | 150 € | CP03OSSEH726 | 150 € |
| | | | | CP03OSSLH726 | 170 € | CP03OSSLH726 | 170 € | CP03OSSLH726 | 170 € |
| 03 años de servicio CoverPlus in situ para EB-6xxWi/Ui | CP03OSSWH740 | 150 € | CP03OSSWH740 | 150 € | | | | | |
| | CP03OSSEH740 | 150 € | CP03OSSEH740 | 150 € | | | | | |
| | CP03OSSLH740 | 170 € | CP03OSSLH740 | 170 € | | | | | |
| 04 años de servicio CoverPlus en laboratorio para EB-14xxUi | | | | CP04RTBSH726 | 144 € | CP04RTBSH726 | 144 € | CP04RTBSH726 | 144 € |
| 04 años de servicio CoverPlus en laboratorio para EB-6xxWi/Ui | CP04RTBSH740 | 144 € | CP04RTBSH740 | 144 € | | | | | |
| 04 años de servicio CoverPlus in situ para EB-14xxUi | | | | CP04OSSWH726 | 250 € | CP04OSSWH726 | 250 € | CP04OSSWH726 | 250 € |
| | | | | CP04OSSEH726 | 250 € | CP04OSSEH726 | 250 € | CP04OSSEH726 | 250 € |
| | | | | CP04OSSLH726 | 280 € | CP04OSSLH726 | 280 € | CP04OSSLH726 | 280 € |
| 04 años de servicio CoverPlus in situ para EB-6xxWi/Ui | CP04OSSWH740 | 250 € | CP04OSSWH740 | 250 € | | | | | |
| | CP04OSSEH740 | 250 € | CP04OSSEH740 | 250 € | | | | | |
| | CP04OSSLH740 | 280 € | CP04OSSLH740 | 280 € | | | | | |
| 05 años de servicio CoverPlus en laboratorio para EB-14xxUi | | | | CP05RTBSH726 | 216 € | CP05RTBSH726 | 216 € | CP05RTBSH726 | 216 € |
| 05 años de servicio CoverPlus en laboratorio para EB-6xxWi/Ui | CP05RTBSH740 | 150 € | CP05RTBSH740 | 150 € | | | | | |
| 05 años de servicio CoverPlus in situ para EB-1470Ui | | | | | | | CP05OSSWH876 | 900 € | |
| | | | | | | | CP05OSSEH876 | 900 € | |
| 05 años de servicio CoverPlus in situ para EB-14xxUi | | | | CP05OSSWH726 | 330 € | CP05OSSWH726 | 330 € | CP05OSSWH726 | 330 € |
| | | | | CP05OSSEH726 | 330 € | CP05OSSEH726 | 330 € | CP05OSSEH726 | 330 € |
| | | | | CP05OSSLH726 | 370 € | CP05OSSLH726 | 370 € | CP05OSSLH726 | 370 € |

Proyectores - Proyector de ultracorta distancia

TARIFA DE PRECIOS

| | EB-695Wi | EB-696Ui | EB-710Ui | EB-1440Ui | EB-1450Ui | EB-1460Ui | EB-1470Ui |
|-------------------------------|--------------|----------|--------------|-----------|-----------|-----------|-----------|
| 05 años de servicio CoverPlus | CP05OSSWH740 | 330 € | CP05OSSWH740 | 330 € | | | |
| in situ para EB-6xxWi/Ui | CP05OSSEH740 | 330 € | CP05OSSEH740 | 330 € | | | |
| | CP05OSSLH740 | 370 € | CP05OSSLH740 | 370 € | | | |
| 05 años de servicio CoverPlus | | | CP05OSSEH877 | 900 € | | | |
| in situ para EB-710Ui | | | CP05OSSWH877 | 900 € | | | |

| | EB-1751 with ES Warranty Card | EB-1761W | EB-1780W | EB-1771W | EB-1776W | EB-1785W | EB-1795F |
|--|---|---|---|---|--|---|---|
| Grupo de precios | C5 | C5 | C5 | B9 | B9 | B9 | B9 |
| |  |  |  |  |  |  |  |
| Resolución | XGA, 1024 x 768, 4:3 | WXGA, 1280 x 800, 16:10 | WXGA, 1280 x 800, 16:10 | WXGA, 1280 x 800, 16:10 | WXGA, 1280 x 800, 16:10 | WXGA, 1280 x 800, 16:10 | Full HD 1080p, 1920 x 1080, 16:9 |
| Relación proyección | 1,19 - 1,43:1 | 1,04 - 1,26:1 | 1,04 - 1,26:1 | 1,04 - 1,26:1 | 1,04 - 1,26:1 | 1,04 - 1,26:1 | 1,04 - 1,26:1 |
| Emisión de luz en color (económico) | 2.600 Lumen- 1.400 Lumen | 2.600 Lumen- 1.700 Lumen | 3.000 Lumen- 1.900 Lumen | 3.000 Lumen- 1.700 Lumen | 3.000 Lumen- 1.700 Lumen | 3.200 Lumen- 1.900 Lumen | 3.200 Lumen- 1.900 Lumen |
| Relación de contraste | 2.000 : 1 | 2.000 : 1 | 10.000 : 1 | 2.000 : 1 | 2.000 : 1 | 10.000 : 1 | 10.000 : 1 |
| 3D | | | NO | | | NO | NO |
| Interfaces | HDMI, VGA, USB | HDMI, VGA, USB, Wi-Fi (Opcional) | HDMI, VGA, USB, Wi-Fi | HDMI, VGA, USB, Wi-Fi (Opcional) | HDMI, VGA, USB, Wi-Fi (Opcional) | HDMI, VGA, Miracast, USB, Wi-Fi | HDMI, VGA, Miracast, USB, Wi-Fi |
| Altavoces | 1 vatio | 1 vatio | 1 vatio | 1 vatio | 1 vatio | 1 vatio | 1 vatio |
| nivel de ruido | Normal: 40 dB (A) - Ahorro: 30 dB (A) | Normal: 37 dB (A) - Ahorro: 30 dB (A) | Normal: 39 dB (A) - Ahorro: 30 dB (A) | Normal: 40 dB (A) - Ahorro: 30 dB (A) | Normal: 40 dB (A) - Ahorro: 30 dB (A) | Normal: 39 dB (A) - Ahorro: 30 dB (A) | Normal: 39 dB (A) - Ahorro: 30 dB (A) |
| Peso | 1,66 kg | 1,68 kg | 1,8 kg | 1,68 kg | 1,71 kg | 1,8 kg | 1,8 kg |
| Garantía | 36 meses Reparación en taller, lámpara: 12 meses o 1.000 h | 36 meses Reparación en taller, lámpara: 12 meses o 1.000 h | 24 meses Reparación en taller, lámpara: 12 meses o 1.000 h | 36 meses Reparación en taller, lámpara: 12 meses o 1.000 h | 36 meses Reparación en taller, lámpara: 12 meses o 1.000 h | 24 meses Reparación en taller, lámpara: 12 meses o 1.000 h | 24 meses Reparación en taller, lámpara: 12 meses o 1.000 h |
| PVPR neto | V11H479040LA 611,72 € | V11H478040LA 742,95 € | V11H795040 817,18 € | V11H477040LA 1.052,90 € | V11H476040LA 1.228,66 € | V11H793040 1.351,45 € | V11H796040 1.516,58 € |
| Opciones | J1, J3 | J1, J3 | J3, J1 | J1, J3 | J1, J3 | J3, J1 | J3, J1 |
| Filtro de Aire - ELPAP31 | V13H134A31 18,72 € | V13H134A31 18,72 € | | V13H134A31 18,72 € | V13H134A31 18,72 € | | |
| Air Filter - ELPAP53 | | | V13H134A53 18,72 € | | | V13H134A53 18,72 € | V13H134A53 18,72 € |
| Tubo de montaje en techo (668-918 mm) - ELPPFP13 | V12H003P13 51,02 € | V12H003P13 51,02 € | | V12H003P13 51,02 € | V12H003P13 51,02 € | | |
| Tubo de montaje en techo (918-1168 mm) - ELPPFP14 | V12H003P14 85,04 € | V12H003P14 85,04 € | | V12H003P14 85,04 € | V12H003P14 85,04 € | | |
| ELPLP94 | | | V13H010L94 91,78 € | | | V13H010L94 91,78 € | V13H010L94 91,78 € |
| Lámpara - ELPLP65 | V13H010L65 91,78 € | V13H010L65 91,78 € | | V13H010L65 91,78 € | V13H010L65 91,78 € | | |
| Soporte para techo (Blanco) - ELPMB23 | V12H003B23 137,60 € | V12H003B23 137,60 € | V12H003B23 137,60 € | V12H003B23 137,60 € | V12H003B23 137,60 € | V12H003B23 137,60 € | V12H003B23 137,60 € |
| Placa de instalación - ELPPT01 | V12H003D01 40,87 € | V12H003D01 40,87 € | V12H003D01 40,87 € | V12H003D01 40,87 € | V12H003D01 40,87 € | V12H003D01 40,87 € | V12H003D01 40,87 € |
| Memoria USB de conexión inalámbrica rápida - ELPAP09 | | V12H005M09 71,71 € | | V12H005M09 71,71 € | V12H005M09 71,71 € | | |
| Wireless LAN Adapter - ELPAP10 | | V12H731P01 93,22 € | | V12H731P01 93,22 € | V12H731P01 93,22 € | | |
| Pantalla de 50" tipo escritorio - ELPSC32 | V12H002S32 87,21 € | V12H002S32 87,21 € | | V12H002S32 87,21 € | V12H002S32 87,21 € | | |
| Pantalla de 80" multiaspecto - ELPSC26 | V12H002S26 134,66 € | V12H002S26 134,66 € | | V12H002S26 134,66 € | V12H002S26 134,66 € | | |







Proyectores - Ultrapotátiles



TARIFA DE PRECIOS







| | EB-1751 with ES Warranty Card | EB-1761W | EB-1780W | EB-1771W | EB-1776W | EB-1785W | EB-1795F |
|--|-------------------------------|--------------|--------------|--------------|--------------|--------------|----------|
| Pantalla de 80" móvil tipo X 16:9 - ELPSC21 | | | | V12H002S21 | 166,98 € | V12H002S21 | 166,98 € |
| Pantalla de 80" pantógrafo 16:10 - ELPSC24 | | V12H002S24 | 456,10 € | V12H002S24 | 456,10 € | V12H002S24 | 456,10 € |
| CoverPlus | BA | BA | BA | BA | BA | BA | BA |
| 03 años de servicio CoverPlus RTB para EB-1780W/81W/85W/95F | | | CP03RTBSH795 | 90 € | | CP03RTBSH795 | 90 € |
| 03 años de servicio CoverPlus en laboratorio para EB-1751 | CP03RTBSH479 | 90 € | | | | | |
| 03 años de servicio CoverPlus en laboratorio para EB-1761W | | CP03RTBSH478 | 90 € | | | | |
| 03 años de servicio CoverPlus en laboratorio para EB-1771W | | | | CP03RTBSH477 | 90 € | | |
| 03 años de servicio CoverPlus en laboratorio para EB-1776W | | | | | CP03RTBSH476 | 90 € | |
| 03 años de servicio CoverPlus in situ para EB-1780W/81W/85W/95F | | | CP03OSSEH795 | 150 € | | CP03OSSEH795 | 150 € |
| | | | CP03OSSWH795 | 150 € | | CP03OSSWH795 | 150 € |
| 04 años de servicio CoverPlus en laboratorio para EB-1751 | CP04RTBSH479 | 144 € | | | | | |
| 04 años de servicio CoverPlus en laboratorio para EB-1761W | | CP04RTBSH478 | 144 € | | | | |
| 04 años de servicio CoverPlus en laboratorio para EB-1780W/81W/85W/95F | | | CP04RTBSH795 | 144 € | | CP04RTBSH795 | 144 € |
| 04 años de servicio CoverPlus in situ para EB-1780W/81W/85W/95F | | | CP04OSSEH795 | 250 € | | CP04OSSEH795 | 250 € |
| | | | CP04OSSWH795 | 250 € | | CP04OSSWH795 | 250 € |
| 05 años de servicio CoverPlus en laboratorio para EB-1751 | CP05RTBSH479 | 216 € | | | | | |
| 05 años de servicio CoverPlus en laboratorio para EB-1761W | | CP05RTBSH478 | 216 € | | | | |
| 05 años de servicio CoverPlus en laboratorio para EB-1771W | | | | CP05RTBSH477 | 216 € | | |
| 05 años de servicio CoverPlus en laboratorio para EB-1780W/81W/85W/95F | | | CP05RTBSH795 | 216 € | | CP05RTBSH795 | 216 € |
| 05 años de servicio CoverPlus in situ para EB-1780W/81W/85W/95F | | | CP05OSSEH795 | 330 € | | CP05OSSEH795 | 330 € |
| | | | CP05OSSWH795 | 330 € | | CP05OSSWH795 | 330 € |

Grupo de precios

| | ELPDC07 | ELPDC13 | ELPDC21 |
|-----------------|---|--|---|
| | J3 | J3 | J3 |
| |  |  |  |
| Resolución | | SXGA(1280*1024)/XGA(1024*768)/WXGA(1280*800)/WXGA 16:10 (1280*800)/WXGA 16:9 (1360*768)/1080p (1920*1080), 480p/ 720p/ 1080p | SXGA(1280*1024)/XGA(1024*768)/WXGA 16:10 (1280*800)/WXGA 16:9 (1360*768)/1080p (1920*1080), 480p/ 720p/ 1080p |
| Zona de disparo | Tamaño A3 297 x 420 mm | Tamaño A3 297 x 420 mm | Tamaño A3 297 x 420 mm |
| Zoom | digital 8 | digital 16 | Óptico 12, digital 10 |
| Características | Enfoque automático, Congelar imagen | Enfoque automático, Congelar imagen, Parallel video output, SD card viewer, Pantalla dividida, Zoom | Enfoque automático, Congelar imagen, Parallel video output, SD card viewer, Pantalla dividida, Zoom |
| VVPR neto | V12H759040 227,26 € | V12H757040 462,10 € | V12H758040 601,87 € |







| | ColorWorks C3400 | ColorWorks C3500 (012CD) (incl. NiceLabel CD) | ColorWorks C831 | ColorWorks C7500 |
|---|---|---|---|--|
| Grupo de precios | PL | PL | PL | PL |
| |  |  |  |  |
| Velocidad de impresión | Máx. 92 mm/s en 360 x 180 ppp (ancho de impresión 56 mm) | Máx. 103 mm/s en 360 x 360 ppp (ancho de impresión 56 mm) | Máx. 92 mm/s en 360 x 360 ppp | Máx. 300 mm/s en 600 x 1.200 ppp (ancho de impresión 108 mm) |
| Ancho de impresión | máx. 104 mm | máx. 104 mm | máx. 203 mm | máx. 108 mm |
| Incluye | Cartucho de tinta, Etiqueta rollo papel, Equipo, PS-180, Bandeja de papel, Tapa del botón de conexión, Instrucciones de instalación, Software (CD), Cable USB, Manual de usuario | Adaptador CA, Controladores y utilidades (CD), Cartuchos de tinta independientes, Equipo, Caja de mantenimiento, Rollo de papel, Cable USB, Manual de usuario | Adaptador CA, Controladores y utilidades (CD), Cartuchos de tinta independientes, Equipo, Instrucciones de instalación, Manual de usuario | Cartuchos de tinta independientes, Equipo, Caja de mantenimiento, Rollo de papel, Software (CD), Cable USB |
| VPVR neto | | C31CD54012CD 1.305,15 € | C11CC68132 1.795 € | |
| | ColorWorks C3400 - USB C31CA26012 974,50 € ColorWorks C3400 (012LG) USB C31CA26012LG 979 € ColorWorks C3400 - USB (incl. NiceLabel CD) C31CA26012CD 1.023 € ColorWorks C3400 - LAN C31CA26032 1.092 € ColorWorks C3400 (032LG) LAN C31CA26032LG 1.096,50 € ColorWorks C3400 - LAN (incl. NiceLabel CD) C31CA26032CD 1.146,50 € | | | ColorWorks C7500 C31CD84012 6.695 € ColorWorks C7500G C31CD84312 6.695 € |
| Opciones | | | | PL |
| TU-RC7508 Rewinder for ColorWorks C7500 | | | | C32C815471 595 € |
| Consumibles | U4 | U4 | U4 | U4 |
| Cian |  | C33S020602 19,73 € | C13S020564 18,79 € | C33S020640 125 € |
| Magenta |  | C33S020603 19,73 € | C13S020565 18,79 € | C33S020641 125 € |

| | ColorWorks C3400 | ColorWorks C3500 (012CD) (incl. NiceLabel CD) | ColorWorks C831 | ColorWorks C7500 |
|---|---|--|---------------------------|-----------------------------|
| Amarillo |  | C33S020604 19,73 € | C13S020566 18,79 € | C33S020642 125 € |
| Negro |  | C33S020601 19,73 € | C13S020563 47,75 € | C33S020639 125 € |
| Color |  C33S020464 52,50 € | | | |
| Caja de mantenimiento | | C33S020580 28,23 € | | C33S020596 25 € |
| CoverPlus | BL, BA | BL, BA | BL, BA | BL |
| 03 años de servicio CoverPlus en laboratorio para ColorWorks C7500 | | | | CP03RTBSCD84 1.045 € |
| 03 años de servicio CoverPlus en laboratorio para ColorWorks TM-C3400 | CP03RTBSCA26 158 € | | | |
| 03 años de servicio CoverPlus en laboratorio para GP-C831 | | | CP03RTBSCC88 194 € | |
| 03 años de servicio CoverPlus en laboratorio para TM-C3500 | CP03RTBSCD54 159 € | | | |
| 03 años de servicio CoverPlus in situ para ColorWorks C7500 | | | | CP03OSSECD84 2.095 € |
| 03 años de servicio CoverPlus in situ para ColorWorks TM-C3400 | CP03OSSECA26 263 € | | | |
| 03 años de servicio CoverPlus in situ para ColorWorks-C831 | | | CP03OSSECC88 352 € | |
| 03 años de servicio CoverPlus in situ para TM-C3500 | CP03OSSECD54 263 € | | | |
| 04 años de servicio CoverPlus in situ para C3400 | CP04OSSECA26 315 € | | | |
| 04 años de servicio CoverPlus in situ para C3500 | CP04OSSECD54 299 € | | | |
| 04 años de servicio CoverPlus in situ para GP-C831 | | | CP04OSSECC89 536 € | |
| 05 años de servicio CoverPlus in situ para C3500 | CP05OSSECD54 631 € | | | |
| 1E años de ampliación de servicio CoverPlus in situ para ColorWorks C7500 | | | | CP01OSSECD84 730 € |

| Grupo de precios | TM-T20II P3 | TM-T70II P3 | TM-m30 PJ | TM-U220D Serie P3 | TM-U220B P3 | TM-T88V Serie P3 | TM-U220A Serie P3 |
|--------------------------------|--|---|---|--|---|---|--|
| |  |  |  |  |  |  |  |
| Método de impresión | Impresión térmica de líneas | Impresión térmica de líneas | Impresión térmica de líneas | Impresora matricial de impacto en serie de 9 agujas | Impresora matricial de impacto en serie de 9 agujas | Impresión térmica de líneas | Impresora matricial de impacto en serie de 9 agujas |
| Velocidad de impresión | 200 mm/s | 250 mm/s | 200 mm/s | 4,70 lps (40 columnas, 16,00 cpp) | 4,70 lps (40 columnas, 16,00 cpp) | 300 mm/s | 4,70 lps (40 columnas, 16,00 cpp) |
| Capacidad de la columna recibo | Ancho de papel 80 mm, 48 / 64 | Ancho de papel 80 mm, 56 / 42 | Ancho de papel 80 mm, 48 / 57 | Ancho de papel 76 mm, 33 / 40 | Ancho de papel 76 mm, 33 / 40 | Ancho de papel 80 mm, 56 / 42 | Ancho de papel 76 mm, 33 / 40 |
| Capacidad de copia recibo | uno copias más un original | | | | | | |
| Instalación | Horizontal, Vertical, Vertical con soporte para pared | | Horizontal, Vertical, Soporte para pared | Horizontal, Vertical con soporte para pared | Horizontal, Vertical con soporte para pared | Horizontal, Vertical, Soporte para pared | Horizontal |
| Incluye | Adaptador de CA, C1, Manual en CD, Cable de CA de Europa, Equipo, Espaciador de rollo de papel, Tapa del botón de conexión, Rollo de papel, Pies de goma, Instrucciones de instalación, Cable USB, Manual de usuario, Soporte para montaje en pared, Certificado de garantía | Manual en CD, Equipo, PS-180 y cable CA, Tapa del botón de conexión, Rollo de papel, Instrucciones de instalación, Documentos de garantía | Adaptador de CA, C1, Cable de CA, Soporte para fijación de cables, Equipo, Espaciador de papel, Tapa del botón de conexión, Rollo de papel, Instrucciones de instalación, Certificado de garantía | Adaptador de CA, C, Equipo, Cable de alimentación, Cinta entintada, Rollo de papel, Manual de usuario, Certificado de garantía | Adaptador de CA, C, Equipo, Cable de alimentación, Cinta entintada, Rollo de papel, Manual de usuario | Papel de 58 mm de ancho, placa guía, Cubierta de conector, Equipo, PS-180 y cable CA, Tapa del botón de conexión, Rollo de papel térmico, Manual de usuario | Adaptador de CA, C, Equipo, Cable de alimentación, Cinta entintada, Rollo de papel, Manual de usuario, Certificado de garantía |
| | TM-T20II (002): Built-in USB + Serial, PS, EDG, EU C31CD52002 | TM-T70II (032): Serial + Built-in USB, PS, EDG, EU C31CD38032 | TM-m30 (121): Ethernet, White, PS, EU C31CE95121 | TM-U220D (002LG): Serial, PS, ECW, EU C31C515002LG | TM-U220B (007A0): USB, PS, ECW C31C514007A0 | TM-T88V (031): Serial, w/o PS, ECW C31CA85031 | TM-U220PA (007LG): Parallel, PS, ECW, EU C31C516007LG |
| | 149,25 € | 209 € | 225 € | 236 € | 279 € | 297,50 € | 312 € |
| | TM-T20II (007): Built-in USB + Ethernet, PS, EDG, EU C31CD52007 | TM-T70II (023A0): Serial + Built-in USB, PS, ECW, EU C31CD38023A0 | TM-m30 (122): Ethernet, Black, PS, EU C31CE95122 | TM-U220D (052LG): Serial, PS, EDG, EU C31C515052LG | TM-U220B (057A0): USB, PS, EDG C31C514057A0 | TM-T88V (034): Serial, w/o PS, ECW C31CA85034 | TM-U220PA (057LG): Parallel, PS, EDG, EU C31C516057LG |
| | 177,50 € | 209 € | 225 € | 236 € | 279 € | 298,26 € | 312 € |
| | | TM-T70II (025A0): Serial + Built-in USB, PS, Black, EU C31CD38025A0 | TM-m30 (111): Ethernet + BT, White, PS, EU C31CE95111 | TM-U220PD (002LG): Parallel, PS, ECW, EU C31C518002LG | TM-U220B (007LG): Serial, PS, ECW, EU C31C514007LG | TM-T88V (012): Serial, PS, ECW, EU C31CA85012 | |
| | | 209 € | 280 € | 236 € | 282,50 € | 306 € | |
| | | TM-T70II (026A0): Serial + Built-in USB, PS, White, EU C31CD38026A0 | TM-m30 (112): Ethernet + BT, Black, PS, EU C31CE95112 | TM-U220PD (052LG): Parallel, PS, EDG, EU C31C518052LG | TM-U220B (057LG): Serial, PS, EDG, EU C31C514057LG | TM-T88V (042): Serial, PS, EDG, EU C31CA85042 | |
| | | 209 € | 280 € | 236 € | 282,50 € | 306 € | |
| | | | TM-m30 (121B0): Ethernet + Wifi, White, PS, EU C31CE95121B0 | TM-U220D (052B0): USB, PS, EDG C31C515052B0 | TM-U220PB (007LG): Parallel, PS, ECW, EU C31C517007LG | TM-T88V (813): Parallel, PS, ECW, EU C31CA85813 | |
| | | | 290 € | 288 € | 282,50 € | 306 € | |

| | TM-T20II | TM-T70II | TM-m30 | TM-U220D Serie | TM-U220B | TM-T88V Serie | TM-U220A Serie |
|---|------------|--|---|----------------|--|--|----------------|
| | | TM-T70II (024B0): Powered USB + Built-in USB, no PS, EDG C31CD38024B0 216,50 € TM-T70II (023B2): UB-E04 + Built-in USB, PS, ECW, EU C31CD38023B2 229 € TM-T70II (024C0): UB-E04 + Built-in USB, PS, EDG, EU C31CD38024C0 229 € TM-T70II (025C0): UB-E04 + Built-in USB, PS, Black, EU C31CD38025C0 229 € TM-T70II (026C0): UB-E04 + Built-in USB, PS, White, EU C31CD38026C0 229 € TM-T70II (971): Bluetooth + Built-in USB, PS, White, EU C31CD38971 279 € TM-T70II (972): Bluetooth + Built-in USB, PS, Black, EU C31CD38972 279 € TM-T70II (023A2): Wifi + Built-in USB, PS, ECW, EU C31CD38023A2 302 € TM-T70II (024A2): Wifi + Built-in USB, PS, EDG, EU C31CD38024A2 302 € TM-T70II (025B2): Wifi + Built-in USB, PS, Black, EU C31CD38025B2 302 € TM-T70II (026B2): Wifi + Built-in USB, PS, White, EU C31CD38026B2 302 € | TM-m30 (122B0): Ethernet + Wifi, Black, PS, EU C31CE95122B0 290 € | | TM-U220PB (057LG): Parallel, PS, EDG, EU C31C517057LG 282,50 € | TM-T88V (833): Parallel, PS, EDG, EU C31CA85833 306 € TM-T88V (044A0): Serial, PS, White, EU C31CA85044A0 306 € TM-T88V (033A0): Serial, PS, Black, EU C31CA85033A0 306 € TM-T88V (653): Ethernet UB-E04, PS, ECW, Buzzer, EU C31CA85653 383,50 € TM-T88V (654): Ethernet UB-E04, PS, EDG, Buzzer, EU C31CA85654 383,50 € TM-T88V (953): Bluetooth + Built-in USB, PS, EDG, EU C31CA85953 396 € TM-T88V (044B0): Wifi, PS, White, EU C31CA85044B0 439 € TM-T88V (031B0): Wifi, PS, ECW, EU C31CA85031B0 439 € TM-T88V (321B0): Wifi, PS, EDG, EU C31CA85321B0 439 € TM-T88V (033B0): Wifi, PS, Black, EU C31CA85033B0 439 € | |
| Opciones | P3 | P3 | P3, PJ | P3 | P3 | P3 | P3 |
| Cable PUSB Epson: 010857A CYBERDATA P-USB 12 pies (EDG) | | 2126741 | | | | | |
| | | | | | | | 53 € |
| Epson Connector Cover for TM-T70II only ECW | | C32C814605 | | | | | |
| | | | | | | | 19,50 € |
| Epson Connector Cover for TM-T70II only EDG | | C32C814606 | | | | | |
| | | | | | | | 19,50 € |
| Epson OT-BX88V-595: PS COVER FOR T88V excl. PS-180 ECW | | | | | | C32C814595 | |
| | | | | | | | 10,50 € |
| Epson OT-BX88V-596: PS COVER FOR T88V excl. PS-180 EDG | | | | | | C32C814596 | |
| | | | | | | | 10,50 € |
| Epson OT-BZ20-634: ZUMBADOR EXTERNO OPCIONAL para T88 y T20 | C32C890634 | | | | | | |
| | | 38,50 € | C32C890634 | | | C32C890634 | |
| | | | | 38,50 € | | | 38,50 € |
| Epson TM-m30 Back Plate Cover, Black | | | | C32C881021 | | | |
| | | | | | | | 19,50 € |

| | TM-T20II | TM-T70II | TM-m30 | TM-U220D Serie | TM-U220B | TM-T88V Serie | TM-U220A Serie | | |
|--|--------------|--------------|--------------|----------------|-------------|---------------|----------------|--------------|-------------|
| Epson TM-m30 Back Plate Cover, White | | | C32C881020 | 19,50 € | | | | | |
| Epson UB-E04:10/100BASE T ETHERNET I/F BOARD | | | | C32C881008 | 60 € | C32C881008 | 60 € | C32C881008 | 60 € |
| Epson UB-P02II | | | | C32C823891 | 35,50 € | C32C823891 | 35,50 € | C32C823891 | 35,50 € |
| Epson UB-R04 (613): IEEE802.11a/b/g/n WIRELESS LAN I/F BOARD | | | | C32C824613 | 133 € | C32C824613 | 133 € | C32C824613 | 133 € |
| Epson UB-S01 | | | | C32C823361 | 35,50 € | C32C823361 | 35,50 € | C32C823361 | 35,50 € |
| Epson UB-S09 | | | | C32C823861 | 35,50 € | C32C823861 | 35,50 € | C32C823861 | 35,50 € |
| Epson UB-U01III | | | | C32C824111 | 106 € | C32C824111 | 106 € | C32C824111 | 106 € |
| Epson UB-U02III | | | | C32C824121 | 88,50 € | C32C824121 | 88,50 € | C32C824121 | 88,50 € |
| Epson UB-U03II | | | | C32C824131 | 88,50 € | C32C824131 | 88,50 € | C32C824131 | 88,50 € |
| Epson UB-U04 | | | | C32C823950 | 88,50 € | C32C823950 | 88,50 € | C32C823950 | 88,50 € |
| Epson UB-U05 | | | | | | C32C823991 | 53 € | | |
| Epson UB-U06 | | | | | | C32C824071 | 88,50 € | | |
| Epson UB-U09 | | | | C32C823893 | 88,50 € | C32C823893 | 88,50 € | C32C823893 | 88,50 € |
| Epson UB-U19 | | | | | | C32C824092 | 88,50 € | | |
| Epson WH-10: Soporte para montaje en pared para TM-T88I?, ?M-T88V | | | | C32C845040 | 47 € | C32C845040 | 47 € | C32C845040 | 47 € |
| Epson Wall Hanging Bracket for TM-m30 | | | C32C881017 | 47 € | | | | | |
| Tablet Stand, Black | | | 7110080 | 60 € | | | | | |
| Consumibles | | | | U2 | | U2 | | U2 | |
| Cartucho Epson ERC38BR para TM-300/U300/U210D/ U220/U230, negro/rojo | | | | C43S015376 | x120 2,16 € | C43S015376 | x120 2,16 € | C43S015376 | x120 2,16 € |
| Cartucho Epson ERC38B para TM-U200/U210/U220/U230/ U300/U375, negro | | | | C43S015374 | x120 2,16 € | C43S015374 | x120 2,16 € | C43S015374 | x120 2,16 € |
| CoverPlus | BA | BA | BA | BA | BA | BA | BA | BA | BA |
| 03 años de servicio CoverPlus en laboratorio para TM-M30/ M10 | | | CP03RTBSCE74 | 50 € | | | | | |
| 03 años de servicio CoverPlus en laboratorio para TM-T20 | CP03RTBSCB10 | 70 € | | | | | | | |
| 03 años de servicio CoverPlus en laboratorio para TM-T70II | | CP03RTBSCD38 | 70 € | | | | | | |
| 03 años de servicio CoverPlus en laboratorio para TM-U220A | | | | CP03RTBSC513 | 90 € | CP03RTBSC513 | 90 € | CP03RTBSC513 | 90 € |
| 04 años de servicio CoverPlus en laboratorio para TM-M30/ | | | CP04RTBSCE74 | 80 € | | | | | |







| | TM-T20II | TM-T70II | TM-m30 | TM-U220D Serie | TM-U220B | TM-T88V Serie | TM-U220A Serie | |
|---|---|---|--|---|--|---|--|-------|
| M10 | | | | | | | | |
| 04 años de servicio CoverPlus in situ para TM-T20 | CP04OSSECB10 | 192 € | | | | | | |
| 05 años de servicio CoverPlus en laboratorio para TM-M30/ M10 | | | CP05RTBSCE74 | 120 € | | | | |
| 05 años de servicio CoverPlus en laboratorio para TM-T88V | | | | | | CP05RTBSCA85 | 190 € | |
| 05 años de servicio CoverPlus in situ para TM-T20 | CP05OSSECB10 | 288 € | | | | | | |
| | TM-T88VI | TM-U295 Serie | TM-T88IV ReStick (366): Serial, PS, EDG, Buzzer, EU | Impresora de tickets portátil TM-P20 | TM-P80 | TM-P60II | TM-T70-iHub Intelligent Printer, Black, EU | |
| Grupo de precios | P3 | P3 | P3 | PM | PM | PM | PG | |
| |  |  |  |  |  |  |  | |
| Método de impresión | Impresión térmica de líneas | Impresora matricial de impacto de enlace de 7 agujas | Impresión térmica de líneas | Impresión térmica de líneas | Impresión térmica de líneas | Impresión térmica de líneas | | |
| Almacenamiento | | | | | | | 256MB NAND Flash | |
| Velocidad de impresión | 350 mm/s | 1,90 ~ 2,30 lps | 150 mm/s | 100 mm/s | 100 mm/s | 100 mm/s | 170 mm/s | |
| Capacidad de la columna de recibo | Ancho de papel 80 mm, 58 / 80 | | Ancho de papel 80 mm, 64 / 48 | Ancho de papel 58 mm | Ancho de papel 79,5 mm | | Ancho de papel 80 mm, 42 / 56 | |
| Instalación | Horizontal, Soporte para pared | Horizontal | Horizontal, Vertical con soporte para pared | Horizontal, Vertical | Horizontal, Vertical | Horizontal, Vertical | Horizontal | |
| Incluye | Cubierta de conector, Equipo, PS-180 y cable CA, Espaciador de papel, Tapa del botón de conexión, Rollo de papel, Instrucciones de instalación, Certificado de garantía | Equipo, Cinta entintada, Manual de usuario, Certificado de garantía | Cubierta de conector, Equipo, PS-180 y cable CA, Tapa del botón de conexión, Rollo de papel térmico, Manual de usuario | Adaptador de CA, C, Batería (OT-BY20), Pinza de correa, Soporte, Cable de CA de Europa, Equipo, Rollo de papel, Cable USB, Manual del usuario (CD-ROM), Certificado de garantía | Batería (OY-BY60II), Pinza de correa, Cable de CA de Europa, Equipo, PS-11, Rollo de papel, Instrucciones de instalación, Cable USB, Manual del usuario (CD-ROM) | Cable de CA, Batería (OY-BY60II), Pinza de correa, Soporte para fijación de cables, Equipo, Rollo de papel, Cable USB | Adaptador de CA RA, Cable de CA, Espaciador de papel, Tapa del botón de conexión, Rollo de papel, Instrucciones de instalación, Manual de usuario (CD), Documentos de garantía | |
| PVPR neto | | | C31C636366 | 368 € | | | C31C637761 | 442 € |

| TM-T88VI | TM-U295 Serie | TM-T88IV ReStick (366): Serial, PS, EDG, Buzzer, EU | Impresora de tickets portátil TM-P20 | TM-P80 | TM-P60II | TM-T70-iHub Intelligent Printer, Black, EU |
|---|---|---|---|---|---|---|
| TM-T88VI (101): Serial, USB, Ethernet, PS, White, EU C31CE94101 | TM-U295 (272LG): Serial, w/o PS, ECW C31C163272LG | | | TM-P20 (552): Receipt, NFC, BT, Cradle, EU C31CE14552 | TM-P80 (652): Receipt, NFC, BT, PS, EU C31CD70652 | TM-P60II (652): Receipt, NFC, BT, PS, EU C31CC796652 |
| 326 € | 339 € | | | 385 € | 405 € | 430 € |
| TM-T88VI (102): Serial, USB, Ethernet, Buzzer, PS, White, EU C31CE94102 | TM-U295 (292LG): Serial, w/o PS, EDG C31C163292LG | | | TM-P20 (021): Receipt, NFC, Wifi, Cradle, EU C31CE14021 | TM-P80 (121): Receipt, NFC, Wifi, PS, EU C31CD70121 | TM-P60II (121): Receipt, NFC, Wifi, PS, EU C31CC79121 |
| 326 € | 339 € | | | 395 € | 415 € | 440 € |
| TM-T88VI (111): Serial, USB, Ethernet, PS, Black, EU C31CE94111 | | | | | TM-P80 (752): Receipt, Autocutter, NFC, BT, PS, EU C31CD70752 | |
| 326 € | | | | | 480 € | |
| TM-T88VI (112): Serial, USB, Ethernet, Buzzer, PS, Black, EU C31CE94112 | | | | | TM-P80 (321): Receipt, Autocutter, NFC, Wifi, PS, EU C31CD70321 | |
| 326 € | | | | | 490 € | |
| TM-T88VI (121): Serial, USB, Ethernet, PS, EDG, EU C31CE94121 | | | | | | |
| 326 € | | | | | | |
| TM-T88VI (111P0): PDN, Serial, USB, Ethernet, PS, Black, EU C31CE94111P0 | | | | | | |
| 376 € | | | | | | |
| TM-T88VI (551): USB, Ethernet, Bluetooth, PS, Black, EU C31CE94551 | | | | | | |
| 396 € | | | | | | |

| Opciones | P3, PJ | P3 | PM, P3 | PM | PM | P3 |
|---|------------|---------|------------|---------|------------|------|
| Epson OT-BS20 (001): Battery Spacer for OT-BY20 | | | C32C881001 | 13 € | | |
| Epson OT-BY20 (093): Li-Ion Battery for TM-P20 | | | C32C831093 | 68 € | | |
| Epson OT-BZ20-634: ZUMBADOR EXTERNO OPCIONAL para T88 y T20 | C32C890634 | 38,50 € | | | | |
| Epson OT-MC20 (005): Multi Printer Charger for TM-P20 | | | C32C881005 | 211 € | | |
| Epson OT-SC20 (002): Single Printer Charger for TM-P20 | | | C32C881002 | 68 € | | |
| Epson OT-WL01 (732): Juego para LAN inalámbrica para Epson TM-i | | | | | C32C890732 | 72 € |
| Epson OT-WL02 (739): Wireless LAN Dongle, 2.4 GHz | C32C890739 | 72 € | | | | |
| Epson OT-WL05 (737): Wireless LAN dongle, 2.4 and 5 GHz | C32C890737 | 105 € | | | | |
| Epson UB-E04:10/100BASE T ETHERNET I/F BOARD | | | C32C881008 | 60 € | | |
| Epson UB-P02II | | | C32C823891 | 35,50 € | | |

| TM-T88VI | TM-U295 Serie | TM-T88IV ReStick (366): Serial, PS, EDG, Buzzer, EU | Impresora de tickets portátil TM-P20 | TM-P80 | TM-P60II | TM-T70-iHub Intelligent Printer, Black, EU |
|---|---------------|---|---|--------------|-----------|---|
| Epson UB-R04 (613): IEEEE802.11a/b/g/n WIRELESS LAN I/F BOARD | | | | | | |
| | | C32C824613 | 133 € | | | |
| Epson UB-S01 | | | | | | |
| | | C32C823361 | 35,50 € | | | |
| Epson UB-S09 | | | | | | |
| | | C32C823861 | 35,50 € | | | |
| Epson UB-U01III | | | | | | |
| | | C32C824111 | 106 € | | | |
| Epson UB-U02III | | | | | | |
| | | C32C824121 | 88,50 € | | | |
| Epson UB-U03II | | | | | | |
| | | C32C824131 | 88,50 € | | | |
| Epson UB-U04 | | | | | | |
| | | C32C823950 | 88,50 € | | | |
| Epson UB-U05 | | | | | | |
| | | C32C823991 | 53 € | | | |
| Epson UB-U06 | | | | | | |
| | | C32C824071 | 88,50 € | | | |
| Epson UB-U09 | | | | | | |
| | | C32C823893 | 88,50 € | | | |
| Epson UB-U19 | | | | | | |
| | | C32C824092 | 88,50 € | | | |
| Epson WH-10: Soporte para montaje en pared para TM- T88I?, ?M-T88V | | | | | | |
| C32C845040 | 47 € | C32C845040 | 47 € | | | |
| OT-BY60II: Lithium-ion battery for TM-P60II/P80 | | | | | | |
| | | | | C32C831091 | 68 € | C32C831091 68 € |
| OT-CC70-607: Connector Cover for TM-T70-i EBCK | | | | | | |
| | | | | | | C32C814607 18,50 € |
| OT-CH60II: Multi battery charger for TM-P60II/P80 | | | | | | |
| | | | | C32C825374 | 198 € | C32C825374 198 € |
| OT-PC20 (000): Padded Case for TM-P20 | | | | | | |
| | | | C32C881000 | 42 € | | |
| OT-SB60II: Single battery charger for TM-P60II/P80 | | | | | | |
| | | | | C32C881007 | 81,50 € | C32C881007 81,50 € |
| PS-11: Power supply for TM- P60II/P80 | | | | | | |
| | | | | C32C825375 | 21 € | C32C825375 21 € |
| Consumibles | U2 | | | | | |
| Cartucho Epson ERC27B para TM-U290/II, -U295, M-290, negro | C43S015366 | x240 | 2,16 € | | | |
| CoverPlus | BA | BA | BA | BA | BA | BA |
| 03 años de servicio CoverPlus en laboratorio para TM-P20 | | | | CP03RTBSCE14 | 50 € | |
| 03 años de servicio CoverPlus en laboratorio para TM-P60II | | | | | | CP03RTBSCC79 90 € |
| 03 años de servicio CoverPlus en laboratorio para TM-P80 with Wi-Fi | | | | CP03RTBSCD70 | 90 € | |
| 03 años de servicio CoverPlus | | | | | | CP03RTBSC637 90 € |

| | TM-T88VI | TM-U295 Serie | TM-T88IV ReStick (366): Serial, PS, EDG, Buzzer, EU | Impresora de tickets portátil TM-P20 | TM-P80 | TM-P60II | TM-T70-iHub Intelligent Printer, Black, EU |
|---|------------------------------|----------------|---|---|--------|--------------|---|
| en laboratorio para TM-T70-i | | | | | | | |
| 03 años de servicio CoverPlus en laboratorio para TM-T88IV | | | CP03RTBSC636 | 90 € | | | |
| 03 años de servicio CoverPlus en laboratorio para TM-U295 | | CP03RTBSC178 | 70 € | | | | |
| 03 años de servicio CoverPlus in situ para TM-T88VI | CP03OSSECE94 CP03OSSWCE94 | 150 € 150 € | | | | | |
| 04 años de servicio CoverPlus en laboratorio para TM-P60II | | | | | | CP04RTBSCC79 | 233,80 € |
| 04 años de servicio CoverPlus in situ para TM-T88VI | CP04OSSECE94 CP04OSSWCE94 | 225 € 270 € | | | | | |
| 05 años de servicio CoverPlus en laboratorio para TM-P60II | | | | | | CP05RTBSCC79 | 317,30 € |
| 05 años de servicio CoverPlus en laboratorio para TM-T88VI | CP05RTBSC94 | 190 € | | | | | |
| 05 años de servicio CoverPlus in situ para TM-T88VI | CP05OSSECE94 CP05OSSWCE94 | 300 € 325 € | | | | | |

| Grupo de precios | TM-T88V-iHub | TM-T88VI-iHub | TM-L90 Liner-Free | TM-P60II Peeler | TM-L90 | TM-L90Peeler (393): USB + UB-E04, PS, EDG, | TM-H6000IV Serie |
|-----------------------------------|---|---|---|---|--|---|---|
| | PG | PG | P3 | PM | P3 | P3 | P3 |
| |  |  |  |  |  |  |  |
| Método de impresión | | Impresión térmica de líneas | Impresión térmica de líneas | Impresión térmica de líneas | Impresión térmica de líneas | Impresión térmica de líneas | |
| Almacenamiento | 256MB NAND Flash | 512MB NAND Flash | | | | | |
| Velocidad de impresión | 300 mm/s | 350 mm/s | 90 mm/s | | 150 mm/s | 150 mm/s | |
| Capacidad de la columna recibo | Ancho de papel 80 mm, 42 / 56 | Ancho de papel 80 mm, 58 / 80 | 48 / 64 | Ancho de papel 60 mm | Ancho de papel 80 mm, 38 / 70 | Ancho de papel 80 mm, 48 / 64 | Ancho de papel 80 mm, 42 / 56 |
| Instalación | Horizontal | Horizontal, Vertical con soporte para pared | Horizontal, Vertical, Vertical con soporte para pared | | Horizontal, Vertical con soporte para pared | Vertical, Vertical con soporte para pared | Horizontal |
| Opciones de fábrica | | | | | | | Impresora de endoso de cheques (E/P), Dispositivo |

| | TM-T88V-iHub | TM-T88VI-iHub | TM-L90 Liner-Free | TM-P60II Peeler | TM-L90 | TM-L90Peeler (393): USB + UB-E04, PS, EDG, | TM-H6000IV Serie |
|---|--|--|---|--|--|--|---|
| Incluye | Adaptador de CA RA, Cable de CA, Espaciador de papel, Tapa del botón de conexión, Rollo de papel, Instrucciones de instalación, Manual de usuario (CD), Documentos de garantía | Adaptador de CA, Cubierta de conector, Cable de CA de Europa, Equipo, Guía de papel, Tapa del botón de conexión, Rollo de papel, Instrucciones de instalación, Certificado de garantía | Equipo, PS-180 y cable CA, Manual de usuario | Batería (OY-BY60II), Pinza de correa, Soporte para fijación de cables, Equipo, Rollo de papel, Cable USB | Etiqueta rollo papel, Equipo, PS-180, Etiqueta de panel para instalación horizontal, Bandeja de salida de papel, guía, Espaciador de rollo de papel, Tapa del botón de conexión, Manual de usuario | Etiqueta rollo papel, Equipo, PS-180, Bandeja de salida de papel, guía, Espaciador de rollo de papel, Tapa del botón de conexión, Manual de usuario | MICR, Validación Cubierta de conector, Equipo, PS-180 y cable CA, Tapa del botón de conexión, Cartucho de cinta de color (slip), Rollo de papel térmico, Manual de usuario |
| VPVR neto | | | C31C412607 494 € | | | C31C412393 572,50 € | |
| | TM-T88V-iHub Intelligent Printer, Black, EU C31CA85792 442 € TM-T88V-iHub Intelligent Printer, White, EU C31CA85793 442 € | TM-T88VI-iHub (751): PS, Black, EU C31CE94751 442 € TM-T88VI-iHub (751P0): PDN, PS, Black, EU C31CE94751P0 492 € | (662): w/o IF, built-in USB, PS, EDG, Liner-free NCR C31C412662 399 € (662A0): Serial, built-in USB, PS, EDG, Liner-free NCR C31C412662A0 399 € TM-L90 Liner-Free C31C412651A0 419 € TM-L90 Liner-Free C31C412652A0 419 € (668): UB-E04, built-in USB, PS, EDG, Liner-free NCR C31C412668 541 € | TM-P60II (852): Peeler, NFC, BT, PS, EU C31CC79852 510 € TM-P60II (421): Peeler, NFC, Wifi, PS, EU C31CC79421 520 € | TM-L90 (402): Serial+Built-in USB, PS, ECW C31C412402 529,50 € TM-L90 (412): Serial+Built-in USB, PS, EDG C31C412412 529,50 € TM-L90 (402LG): Serial+Built-in USB, PS, ECW, EU C31C412402LG 533 € TM-L90 (412LG): Serial+Built-in USB, PS, EDG, EU C31C412412LG 533 € TM-L90 (465): Ethernet E04+Built-in USB, PS, EDG C31C412465 560 € TM-L90 (465LG): Ethernet E04+Built-in USB, PS, EDG C31C412465LG 560 € | TM-H6000IV (015): Serial, w/o PS, EDG C31CB25015 607,55 € TM-H6000IV (905): Serial, PS, ECW, EU C31CB25905 630,50 € TM-H6000IV (906): Serial, PS, EDG, EU C31CB25906 630,50 € TM-H6000IV (036): Powered USB, w/o PS, EDG, MICR C31CB25036 727 € | |
| Opciones | P3 | P3, PJ | P3 | PM | P3 | P3 | |
| Cable PUBS Epson: 010857A CYBERDATA P-USB 12 pies (EDG) | | | | | | | 2126741 53 € |
| Epson OT-BZ20-634: ZUMBADOR EXTERNO OPCIONAL para T88 y T20 | | C32C890634 38,50 € | | | | | |
| Epson OT-WL01 (732): Juego para LAN inalámbrica para Epson TM-i | C32C890732 72 € | | | | | | |
| Epson OT-WL02 (739): Wireless LAN Dongle, 2.4 GHz | | C32C890739 72 € | | | | | |
| Epson OT-WL05 (737): Wireless LAN dongle, 2.4 and 5 GHz | | C32C890737 105 € | | | | | |
| Epson UB-E04:10/100BASE T ETHERNET I/F BOARD | | | C32C881008 60 € | | | | |
| Epson UB-P02II | | | C32C823891 35,50 € | | | C32C823891 35,50 € | |
| Epson UB-R04 (613): IEEE802.11a/b/g/n WIRELESS | | | C32C824613 133 € | | | C32C824613 133 € | |

| | TM-T88V-iHub | TM-T88VI-iHub | TM-L90 Liner-Free | TM-P60II Peeler | TM-L90 | TM-L90Peeler (393): USB + UB-E04, PS, EDG, | TM-H6000IV Serie |
|---|--------------|---------------|-------------------|-----------------|--------------|--|------------------------|
| LAN I/F BOARD | | | | | | | |
| Epson UB-S01 | | | C32C823361 | 35,50 € | | | C32C823361 35,50 € |
| Epson UB-S09 | | | C32C823861 | 35,50 € | | | C32C823861 35,50 € |
| Epson UB-U01III | | | C32C824111 | 106 € | | | C32C824111 106 € |
| Epson UB-U02III | | | C32C824121 | 88,50 € | | | C32C824121 88,50 € |
| Epson UB-U03II | | | C32C824131 | 88,50 € | | | C32C824131 88,50 € |
| Epson UB-U04 | | | C32C823950 | 88,50 € | | | C32C823950 88,50 € |
| Epson UB-U05 | | | | | | | C32C823991 53 € |
| Epson UB-U06 | | | | | | | C32C824071 88,50 € |
| Epson UB-U09 | | | C32C823893 | 88,50 € | | | C32C823893 88,50 € |
| Epson UB-U19 | | | | | | | C32C824092 88,50 € |
| Epson WH-10: Soporte para montaje en pared para TM-T88I?, ?M-T88V | C32C845040 | 47 € | C32C845040 | 47 € | | C32C845040 | 47 € |
| OT-BY60II: Lithium-ion battery for TM-P60II/P80 | | | | | C32C831091 | 68 € | |
| OT-CH60II: Multi battery charger for TM-P60II/P80 | | | | | C32C825374 | 198 € | |
| OT-SB60II: Single battery charger for TM-P60II/P80 | | | | | C32C881007 | 81,50 € | |
| PS-11: Power supply for TM-P60II/P80 | | | | | C32C825375 | 21 € | |
| Consumibles | | | | | | | U2 |
| Cartucho Epson ERC32B para las series TM-U675/-H6000, M-U420/820/825, negro | | | | | | | C43S015371 x80 3,15 € |
| CoverPlus | BA | BA | BA | BA | BA | BA | BA |
| 03 años de servicio CoverPlus en laboratorio para TM-H6000IV | | | | | | | CP03RTBSCB25 90 € |
| 03 años de servicio CoverPlus en laboratorio para TM-L90 | | | CP03RTBSC412 | 70 € | | CP03RTBSC412 | 70 € CP03RTBSC412 70 € |
| 03 años de servicio CoverPlus en laboratorio para TM-P60II | | | | | CP03RTBSCC79 | 90 € | |
| 03 años de servicio CoverPlus in situ para TM-T88VI | CP03OSSECE94 | 150 € | CP03OSSWCE94 | 150 € | | | |
| 04 años de servicio CoverPlus en laboratorio para TM-H6000IV | | | | | | | CP04RTBSCB25 310,80 € |
| 04 años de servicio CoverPlus en laboratorio para TM-P60II | | | | | CP04RTBSCC79 | 233,80 € | |

| TM-T88V-iHub | TM-T88VI-iHub | TM-L90 Liner-Free | TM-P60II Peeler | TM-L90 | TM-L90Peeler (393): USB + UB-E04, PS, EDG, | TM-H6000IV Serie |
|--|------------------------------|-------------------|-----------------|----------|--|------------------|
| 04 años de servicio CoverPlus in situ para TM-T88VI | CP04OSSECE94 CP04OSSWCE94 | 225 € 270 € | | | | |
| 05 años de servicio CoverPlus en laboratorio para TM-P60II | | | CP05RTBSCC79 | 317,30 € | | |
| 05 años de servicio CoverPlus en laboratorio para TM-T88V | CP05RTBSCA85 | 190 € | | | | |
| 05 años de servicio CoverPlus en laboratorio para TM-T88VI | CP05RTBSCCE94 | 190 € | | | | |
| 05 años de servicio CoverPlus in situ para TM-T88VI | CP05OSSECE94 CP05OSSWCE94 | 300 € 325 € | | | | |

| Grupo de precios | TM-U950 Serie | TM-H5000II (012LG): Serial, w/o PS, ECW | TM-J7200 | TM-T88V-DT | TM-T70II-DT | TM-J7700 | TM-L500A TICKET |
|------------------|---------------|---|----------|------------|-------------|----------|-----------------|
| | P3 | P3 | P4 | PG | PG | P4 | P4 |



NOVEDAD



NOVEDAD





| | | | | | | | |
|--------------------------------|--|---|---|--|---|---|--|
| Método de impresión | Impresora matricial de impacto en serie de 9 agujas | | Inyector de tinta en línea con cabezal de inyección | Impresión térmica de líneas | Impresión térmica de líneas | Inyector de tinta en línea con cabezal de inyección | Impresión térmica de líneas |
| Almacenamiento | | | | SSD 32 GB | SSD 16GB | | |
| Velocidad de impresión | 311 / 233 cps | 120 mm/s | 98 mm/s | 300 mm/s | 250 mm/s | 98 mm/s | 250 mm/s |
| Capacidad de la columna recibo | Ancho de papel 69,5 mm, 30 / 40 | Ancho de papel 80 mm, 42 / 56 | | Ancho de papel 80 mm, 56 / 42 | Ancho de papel 80 mm, 42 / 56 | | Ancho de papel 82 mm |
| Instalación | Horizontal | Horizontal | | Horizontal | Horizontal | | Horizontal |
| Opciones de fábrica | Dispositivo MICR | Dispositivo MICR | | Cortador automático, Sensor de fin próximo | | | |
| Incluye | Equipo, Bobina tensora de rollo de papel, Tapa del botón de conexión, Cinta entintada, Rollo de papel, Manual de usuario | Equipo, Tapa del botón de conexión, Cartucho de cinta de color (slip), Rollo de papel térmico, Manual de usuario, Certificado de garantía | Manual en CD, Cartucho de tinta, PS-180, Cable de alimentación, Tapa del botón de conexión, Rollo de papel, Instrucciones de instalación, Cable USB, Manual de usuario (CD) | Adaptador CA, Cubierta de cable, Equipo, Espaciador de rollo de papel, Rollo de papel térmico, Manual de usuario | Adaptador CA, Equipo, Rollo de papel, Manual de usuario | Manual en CD, Cartucho de tinta, PS-180, Cable de alimentación, Tapa del botón de conexión, Rollo de papel, Instrucciones de instalación, Cable USB, Manual de usuario (CD) | Equipo, PS-180 y cable CA, Manual de usuario |
| PVPR neto | | C31C246012LG | 709,50 € | | | | |

| TM-U950 Serie | TM-H5000II (012LG): Serial, w/o PS, ECV | TM-J7200 | TM-T88V-DT | TM-T70II-DT | TM-J7700 | TM-L500A TICKET |
|---|--|---|---|--|--|--|
| TM-U950 (283LG): Serial, w/o PS, ECV | TM-H5000II (012LG): Serial, w/o PS, ECV | TM-J7200 (301) W/O MIC?, ?LAC?, ?NC PS?, ?U | TM-T88V-DT Intelligent Terminal, 16GB SSD, LE, Linux, Black, EU | TM-T70II-DT C31CD51222 | TM-J7700(301) W/O MICR, BLACK, INC PSU, EU | TM-L500A Ticket C31CB49300 |
| C31C151283LG 674 € | | C31CF69301 748 € | C31CC74522 790 € | TM-T70II-DT C31CD51122 919 € | C31CF70301 800 € | 889,50 € |
| TM-U950P (252LG): Parallel, w/o PS, ECV | TM-J7200(321) W/O MIC?, ?HITE, INC PSU, EU | C31CF69321 748 € | TM-T88V-DT Intelligent Terminal, 16GB SSD, LE, Linux, White, EU | TM-T70II-DT Intelligent Terminal, 16GB SSD, LE, WPR7, Black, EU | TM-J7700(321) W/O MIC?, ?HITE, INC PSU, EU | TM-L500A (300LG) TICKET Non-LCD, Combo, PS, EU |
| C31C176252LG 674 € | | | C31CC74525A0 790 € | C31CD51226A0 931 € | C31CF70321 800 € | C31CB49300LG 893 € |
| | | | TM-T88V-DT Intelligent Terminal, 16GB SSD, LE, WPR2009, White, EU | TM-T70II-DT Intelligent Terminal, 16GB SSD, HE, WPR2009, Black, EU | | |
| | | | C31CC74421 919 € | C31CD51426A0 966 € | | |
| | | | TM-T88V-DT Intelligent Terminal, 16GB SSD, LE, WPR2009, Black, EU | TM-T70II-DT C31CD51322 | | |
| | | | C31CC74422 919 € | | | |
| | | | TM-T88V-DT Intelligent Terminal, 16GB SSD, LE, WPR7, White, EU | | | |
| | | | C31CC74525A2 931 € | | | |
| | | | TM-T88V-DT Intelligent Terminal, 16GB SSD, LE, WPR7, Black, EU | | | |
| | | | C31CC74526A0 931 € | | | |
| | | | TM-T88V-DT Intelligent Terminal, 16GB SSD, HE, WPR2009, White, EU | | | |
| | | | C31CC74825A0 966 € | | | |
| | | | TM-T88V-DT Intelligent Terminal, 16GB SSD, HE, WPR2009, Black, EU | | | |
| | | | C31CC74826A0 966 € | | | |
| | | | TM-T88V-DT Intelligent Terminal, 16GB SSD, HE, WPR7, White, EU | | | |
| | | | C31CC74721 979 € | | | |
| | | | TM-T88V-DT Intelligent Terminal, 16GB SSD, HE, WPR7, Black, EU | | | |
| | | | C31CC74722 979 € | | | |
| | | | TM-T88V-DT Intelligent Terminal, 32GB SSD, HE, WPR2009, Black, EU | | | |
| | | | C31CC74828A2 1.005 € | | | |
| | | | TM-T88V-DT Intelligent Terminal, 32GB SSD, HE, WPR7, Black, EU | | | |
| | | | C31CC74828A0 1.018 € | | | |

| Opciones | P3 | P3, PJ | P3, PJ | P4 |
|--|----|--------|------------------|----|
| Epson DM-D110 (103): Customer Display for TM-T88V-D?, ?S?, ?hite | | | A61B133103 200 € | |
| Epson DM-D110 (113): Customer Display for TM-T88V- | | | A61B133113 200 € | |

| TM-U950 Serie | TM-H5000II (012LG): Serial, w/o PS, ECW | TM-J7200 | TM-T88V-DT | TM-T70II-DT | TM-J7700 | TM-L500A TICKET |
|--|---|-----------------------|-------------------|-------------------|-------------------|--------------------|
| D?, ?S?, ?lack | | | | | | |
| Epson DM-D110 (123): Cust Dsp for TM-T88V-D?, ?tr Pol?, ?S?, ?hite | | | | | | |
| | | | A61B133123 | 200 € | | |
| Epson DM-D110 (133): Cust Dsp for TM-T88V-D?, ?tr Pol?, ?S?, ?lack | | | | | | |
| | | | A61B133133 | 200 € | | |
| Epson OT-WL01 (732): Juego para LAN inalámbrica para Epson TM-i | | | | | | |
| | | | C32C890732 | 72 € | C32C890732 | 72 € |
| Epson OT-WL02 (739): Wireless LAN Dongle, 2.4 GHz | | | | | | |
| | | | C32C890739 | 72 € | C32C890739 | 72 € |
| Epson OT-WL05 (737): Wireless LAN dongle, 2.4 and 5 GHz | | | | | | |
| | | | C32C890737 | 105 € | C32C890737 | 105 € |
| Epson SU-RPL500B | | | | | | |
| | | | | | | C32C811311 204 € |
| Epson UB-P02II | | | | | | |
| | C32C823891 | 35,50 € | | | | |
| Epson UB-S01 | | | | | | |
| | C32C823361 | 35,50 € | | | | |
| Epson UB-S09 | | | | | | |
| | C32C823861 | 35,50 € | | | | |
| Epson UB-U01III | | | | | | |
| | C32C824111 | 106 € | | | | |
| Epson UB-U02III | | | | | | |
| | C32C824121 | 88,50 € | | | | |
| Epson UB-U03II | | | | | | |
| | C32C824131 | 88,50 € | | | | |
| Epson UB-U04 | | | | | | |
| | C32C823950 | 88,50 € | | | | |
| Epson UB-U09 | | | | | | |
| | C32C823893 | 88,50 € | | | | |
| ML-500-901: Unidad mecánica para TM-L500A | | | | | | |
| | | | | | | C31CB49901 140 € |
| Consumibles | U2 | U2 | U3 | U3 | | |
| Cartucho Epson ERC31B para TM-H5000II, -U930/II, -U950/925, -U590, negro | C43S015369 x80 2,59 € | C43S015369 x80 2,59 € | | | | |
| SJIC33P(K) TM-J7200/7700 Ink Cartridge | | | | | | |
| | | | C33S020655 40 € | | C33S020655 40 € | |
| CoverPlus | BA | BA | BA | BA | BA | BA |
| 03 años de servicio CoverPlus en laboratorio para TM-H5000II | CP03RTBSC246 | 90 € | | | | |
| 03 años de servicio CoverPlus en laboratorio para TM-J7000/J7200/J7700 | | | CP03RTBSC487 90 € | | CP03RTBSC487 90 € | |
| 03 años de servicio CoverPlus en laboratorio para TM-L500A | | | | | | CP03RTBSCB49 200 € |
| 03 años de servicio CoverPlus en laboratorio para TM-T70II | | | | CP03RTBSCD38 70 € | | |

| TM-U950 Serie | TM-H5000II (012LG): Serial, w/o PS, ECW | TM-J7200 | TM-T88V-DT | TM-T70II-DT | TM-J7700 | TM-L500A TICKET |
|---|---|------------------------------|----------------|-------------|------------------------------|-----------------|
| 03 años de servicio CoverPlus en laboratorio para TM-T88V-DT | | | CP03RTBSCC74 | 150,30 € | | |
| 03 años de servicio CoverPlus en laboratorio para TM-U950 | | CP03RTBSC176 | 90 € | | | |
| 03 años de servicio CoverPlus in situ para TM-L500A | | | | | CP03OSSWCB49 | 350 € |
| 04 años de servicio CoverPlus in situ para TM-J7000/J7200/J7700 | | CP04OSSEC487 CP04OSSWC487 | 240 € 240 € | | CP04OSSEC487 CP04OSSWC487 | 240 € 240 € |
| 05 años de servicio CoverPlus en laboratorio para TM-T88V-DT | | | CP05RTBSC74 | 317,30 € | | |
| 05 años de servicio CoverPlus in situ para TM-J7000/J7200/J7700 | | CP05OSSEC487 CP05OSSWC487 | 360 € 216 € | | CP05OSSEC487 CP05OSSWC487 | 360 € 216 € |

| Grupo de precios | TM-L500A | TM-C710 | TM-L500A (115A2): W/O LCD, PS Shor?, 7OMBO IF - ARINC FW |
|------------------------|---|---|---|
| | P4 | P4 | P4 |
| |  |  |  |
| Método de impresión | Impresión térmica de líneas | Matricial de inyección de tinta en serie (máx. 720 ppp x 360 ppp) | Impresión térmica de líneas |
| Velocidad de impresión | 250 mm/s | 130 mm/s | 250 mm/s |
| Instalación | Horizontal | Horizontal | Horizontal |
| Incluye | Equipo, PS-180, Manual de usuario | Cartucho de tinta, Equipo, PS-180 y cable CA, Rollo de papel, Manual de usuario | Equipo, PS-180, Manual de usuario |
| PVPR neto | | C31CA91021 1.265 € | C31CB49115A2 1.300 € |

| TM-L500A | TM-C710 | TM-L500A (115A2): W/O LCD, PS Shor?, ?OMBO IF - ARINC F/W |
|--|---------|---|
| TM-L500A (114): W/O LC?, ?ra?, ?S Shor?, ?OMBO IF | | Ticket |
| C31CB49114 1.000 € | | C31CB49300 889,50 € |
| TM-L500A (115): W/O LCD, PS Shor?, ?OMBO IF | | (300LG) TICKET Non-LCD, Combo, PS, EU |
| C31CB49115 1.000 € | | C31CB49300LG 893 € |
| TM-L500A (106): Combo, PS short, EDG, LCD | | (114): W/O LC?, ?ra?, ?S Shor?, ?OMBO IF |
| C31CB49106 1.100 € | | C31CB49114 1.000 € |
| TM-L500A (107): Combo, PS short, EDG, LCD, Tray | | (115): W/O LCD, PS Shor?, ?OMBO IF |
| C31CB49107 1.100 € | | C31CB49115 1.000 € |
| TM-L500A (112): Combo, PS, EDG, LCD, Tray | | (119) W/O LCD, Combo, PS short, ACS |
| C31CB49112 1.100 € | | C31CB49119 1.000 € |
| TM-L500A (118): LCD, Combo, PS short, ACS | | (106): Combo, PS short, EDG, LCD |
| C31CB49118 1.100 € | | C31CB49106 1.100 € |
| TM-L500A (115A1): W/O LCD, PS Shor?, ?OMBO IF - SITA F/W | | (107): Combo, PS short, EDG, LCD, Tray |
| C31CB49115A1 1.300 € | | C31CB49107 1.100 € |
| TM-L500A (106A1): Combo, PS short, EDG, LCD - SITA F/W | | (112): Combo, PS, EDG, LCD, Tray |
| C31CB49106A1 1.400 € | | C31CB49112 1.100 € |
| TM-L500A (107A1): Combo, PS short, EDG, LCD, Tray - SITA F/W | | (118): LCD, Combo, PS short, ACS |
| C31CB49107A1 1.400 € | | C31CB49118 1.100 € |
| TM-L500A (112A1): Combo, PS, EDG, LCD, Tray - SITA F/W | | (112PR): Combo, PS, EDG, LCD, Tray, PR Firmware |
| C31CB49112A1 1.400 € | | C31CB49112PR 1.100 € |
| TM-L500A (118A1): LCD, Combo, PS short, ACS, SFW | | (115A1): W/O LCD, PS Shor?, ?OMBO IF - SITA F/W |
| C31CB49118A1 1.400 € | | C31CB49115A1 1.300 € |
| | | (114A1): W/O LC?, ?ra?, ?S Shor?, ?OMBO IF, SITA F/W |
| | | C31CB49114A1 1.300 € |
| | | (114A2): W/O LC?, ?ra?, ?S Shor?, ?OMBO IF, ARINC F/W |
| | | C31CB49114A2 1.300 € |
| | | (119A1) W/O LCD, Combo, PS short, ACS, SFW |
| | | C31CB49119A1 1.300 € |
| | | (119A2) W/O LCD, Combo, PS short, ACS, AFW |
| | | C31CB49119A2 1.300 € |
| | | (106A1): Combo, PS short, EDG, LCD - SITA F/W |
| | | C31CB49106A1 1.400 € |
| | | (107A1): Combo, PS short, EDG, LCD, Tray - SITA F/W |
| | | C31CB49107A1 1.400 € |
| | | (112A1): Combo, PS, EDG, LCD, Tray - SITA F/W |
| | | C31CB49112A1 1.400 € |

TM-L500A TM-C710

TM-L500A (115A2): W/O
 LCD, PS Shor?, 7OMBO IF -
 ARINC F/W
 (107A2): Combo, PS short, EDG,
 LCD, Tray - ARINC F/W 1.400 €
 C31CB49107A2
 (112A2): Combo, PS, EDG,
 LCD, Tray - ARINC F/W 1.400 €
 C31CB49112A2
 (118A1): LCD, Combo, PS short,
 ACS, SFW 1.400 €
 C31CB49118A1
 (118A2): LCD, Combo, PS short,
 ACS, AFW 1.400 €
 C31CB49118A2

| Opciones | P4 | | P4 | |
|---|---------------|---------|---------------|-------|
| Epson SU-RPL500B | C32C811311 | 204 € | C32C811311 | 204 € |
| ML-500-901: Unidad mecánica para TM-L500A | C31CB49901 | 140 € | C31CB49901 | 140 € |
| ML-500-902: Unidad mecánica para TM-L500A | C31CB49902 | 140 € | | |
| ML-500-904: Mech Unit for TM-L500A for ACS type | C31CB49904 | 140 € | | |
| Consumibles | U3 | | | |
| Epson SJIC25P cartridge for TM-C710 | C33S020591 | 70,24 € | | |
| Rollo de papel para cupones Epson para TM-C610, 58 mm x 70 m | C33S045267 | 1,31 € | | |
| CoverPlus | BA | | BA | |
| 03 años de servicio CoverPlus en laboratorio para Epson TM-C710 | CP03RTBSCA91 | 150 € | | |
| 03 años de servicio CoverPlus en laboratorio para TM-L500A | CP03RTBSCB49 | 200 € | CP03RTBSCB49 | 200 € |
| 03 años de servicio CoverPlus in situ para TM-L500A | CP03OSS ECB49 | 350 € | CP03OSS WCB49 | 350 € |



| | | | |
|------------------|---------|--------|---------|
| Grupo de precios | DM-D110 | DM-D30 | DM-D210 |
| | P3 | P3 | P3 |



| | | | |
|------------------------|---|--|---|
| tecnología de pantalla | Pantalla fluorescente al vacío | LCD | Pantalla fluorescente al vacío |
| Número de caracteres | máx. 40 (20 columnas x 2 líneas) | máx. 40 (20 columnas x 2 líneas) | máx. 40 (20 columnas x 2 líneas) |
| Luminosidad | 690 cd/m² | 100 cd/m² | 700 cd/m² |
| Panel de dimensiones | 165 mm (ancho) x 50,5 mm (D) x 69 mm (alto) | 130 mm (ancho) x 100 mm (D) x 68 mm (alto) | 260 mm (ancho) x 60 mm (D) x 83 mm (alto) |

| | | |
|---|--|---|
| DM-D110 (712): Customer display head only (EDG) A61B133712 141,50 € | DM-D30 (101): Customer Display for TM-m30 White A61CF26101LG 170 € | DM-D210 (701): Customer display head only (ECW) A61B134701 235 € |
| DM-D110 (704): Customer display head only (white) A61B133704 142 € | DM-D30 (111): Customer Display for TM-m30 Black A61CF26111LG 170 € | DM-D210 (711): Customer display head only (EDG) A61B134711 235 € |
| DM-D110 (714): Customer display head only (black) A61B133714 142 € | | DM-D210BB: TM attachment type with DP-502 for TM-U950/U925/U375/U675/H6000 (EDG) A61B134711A1 275 € |
| DM-D110BB: TM attachment type 1 for TM-U950/U925/U375/U675/H6000 A61B133EBW 178 € | | DM-D210BC: TM attachment type with DP-503 for TM-H5000III/J8000 (ECW) A61B134701A1 289 € |
| DM-D110BA: Stand-alone type A61B133EAWILG 230,50 € | | DM-D210BA: Stand-alone type with DP-210 (ECW) A61B134701A0 336,50 € |
| DM-D110BA: Stand-alone type USB-connection A61B133EAWULG 230,50 € | | DM-D210BA: Stand-alone type with DP-210 (EDG) A61B134711A0 336,50 € |
| DM-D110BA: Stand-alone type with DP-110 with IF (EDG) A61B133712B0 230,50 € | | DM-D210BA: Stand-alone type with DP-210 (ECW) A61B134701B0 336,50 € |
| DM-D110BA: Stand-alone type with DP-110 w/o IF (EDG) A61B133712B1 230,50 € | | |

| | DM-D110 | DM-D30 | DM-D210 |
|--|--------------|---------|--------------------|
| Opciones | P3 | | P3 |
| Epson DP-105 (112): DM-D110 Stand Unit, Black | A62B098112 | 14 € | A62B098112 14 € |
| Epson DP-105-101 ECW | A62B098101 | 14,50 € | A62B098101 14,50 € |
| Epson DP-105-111 EDG | A62B098111 | 14,50 € | A62B098111 14,50 € |
| Epson DP-110 (113): Base plate for DM-D110 Black | A62B131113 | 41,50 € | |
| Epson DP-210-101 ECW | | | A62B132101 101 € |
| Epson DP-505-111 EDG | A62B139111 | 35,50 € | |
| CoverPlus | BA | | |
| 03 años de servicio CoverPlus en laboratorio para TM-M30/M10 | CP03RTBSCE74 | | 50 € |

| | TM-S1000 (031LG): USB, PS, EDG, EU, Frank stamp, 60DPM, CD | TM-S2000MJ | TM-S9000MJ |
|----------------------|--|--|--|
| Grupo de precios | P3 | P3 | P3 |
| |  |  |  |
| Tamaño del documento | 120 mm - 235 mm (L) x 68 mm - 120 mm (alto) | 120 mm - 235 mm (L) x 60 mm - 120 mm (alto) | 120 mm - 235 mm (L) x 60 mm - 120 mm (alto) |
| Simbología MICR | E13B, CMC7 | E13B, CMC7 | E13B, CMC7 |
| Incluye | Controladores y utilidades (CD), Equipo, PS-180, Tapa del botón de conexión, Cable USB, Manual de usuario, Certificado de garantía | Cartucho de tinta x 2, Adaptador de CA, J, Cable de alimentación, Cable USB, Manual de usuario | Cartucho de tinta x 2, Adaptador de CA, J, Cable de alimentación, Rollo de papel térmico, Cable USB, Manual de usuario |
| PVPR neto | A41A266031LG 1.153 € | | |

| | |
|---|---|
| TM-S2000MJ (032): 110DPM, 1Pocket, USB, w/o MSR | TM-S9000MJ (032): 110DPM, 1Pocket, USB, w/o MSR |
| A41A268032 1.670 € | A41A267032 1.970 € |
| TM-S2000MJ (022): 110DPM, 1Pocket, USB HUB, MSR | TM-S9000MJ (332): V2, 130DPM, 1Pocket, USB, w/o MSR |
| A41A268022 1.770 € | A41A267022 2.070 € |
| TM-S2000MJ (012): 110DPM, 2Pocket, USB, w/o MSR | TM-S9000MJ (022): 110DPM, 1Pocket, USB HUB, MSR |
| A41A268012 1.800 € | A41A267012 2.100 € |
| TM-S2000MJ (002): 110DPM, 2Pocket, USB HUB, MSR | TM-S9000MJ (012): 110DPM, 2Pocket, USB, w/o MSR |
| A41A268002 1.900 € | A41A267011 2.100 € |
| TM-S2000MJ (132): 200DPM, 1Pocket, USB, w/o MSR | TM-S9000MJ (132): 200DPM, 1Pocket, USB, w/o MSR |
| A41A268132 1.970 € | A41A267002 2.200 € |
| TM-S2000MJ (122): 200DPM, 1Pocket, USB HUB, MSR | TM-S9000MJ (122): 200DPM, 1Pocket, USB, w/o MSR |
| A41A268122 2.070 € | A41A267132 2.270 € |
| TM-S2000MJ (112): 200DPM, 2Pocket, USB, w/o MSR | TM-S9000MJ (112): 200DPM, 1Pocket, USB HUB, MSR |
| A41A268112 2.100 € | A41A267122 2.370 € |
| TM-S2000MJ (102): 200DPM, 2Pocket, USB HUB, MSR | TM-S9000MJ (102): 200DPM, 2Pocket, USB, w/o MSR |
| A41A268102 2.200 € | A41A267112 2.400 € |
| | TM-S9000MJ (102): 200DPM, 2Pocket, USB HUB, MSR |
| | A41A267102 2.500 € |
| | TM-S9000MJ (402): V2, 200DPM, 2Pocket, USB Hub, MSR |
| | A41A267402 2.500 € |

TM-S1000 (031LG): USB, PS, EDG, EU, Frank stamp, 60DPM, CD TM-S2000MJ TM-S9000MJ

Consumibles

Cartucho de sellado Epson EFC-01 para TM-S1000

A43S020461  12,34 €

| | | |
|----|----|----|
| U2 | U2 | U2 |
|----|----|----|

Cartucho Epson SJIC18(K)

C33S020484 21 € C33S020484 21 €

CoverPlus

03 años de servicio CoverPlus en laboratorio para TM-S1000

CP03RTBSA266 150 €





| | | |
|----|----|----|
| BA | BA | BA |
|----|----|----|

03 años de servicio CoverPlus en laboratorio para TM-S2000MJ

CP03RTBSA268 250 €

03 años de servicio CoverPlus en laboratorio para TM-S9000MJ

CP03RTBSA267 410 €

| | Discproducer™ PP-100AP | | Discproducer™ PP-50 | | Discproducer™ PP-100II | | Discproducer™ PP-100N (SATA) | |
|---|---|----------------------------|---|----------------------------|---|----------------------------|---|----------------------------|
| Grupo de precios | P1 | | P1 | | P1 | | P1 | |
| |  | |  | |  | |  | |
| Velocidad de escritura | | | CD-R 40 x, DVD-R 12 x | | CD-R 40 x, DVD-R 12 x | | CD-R 40 x, DVD-R 12 x | |
| Velocidad de impresión | 95 Soportes/h (modo rápido) | | 60 Soportes/h (modo rápido), 40 Soportes/h (modo calidad) | | 65 Soportes/h (modo rápido), 45 Soportes/h (modo calidad) | | 60 Soportes/h (modo rápido), 42 Soportes/h (modo calidad) | |
| Número de unidades de disco | | | 1 | | 2 | | 2 | |
| Software incluido | Epson Total Disc Maker | | Epson Total Disc Maker | | Epson Total Disc Maker | | Epson Total Disc Maker | |
| Cabezal de impresión | Micro Piezo | | Micro Piezo | | Micro Piezo | | Micro Piezo | |
| Modo por lotes | 100 Soportes/h | | 50 Soportes/h | | 100 Soportes/h | | 100 Soportes/h | |
| VPNR neto | C11CA93021 | 1.950 € | C11CB72121 | 2.101,86 € | C11CD37021 | 2.903,72 € | C11CA31121 | 3.903,72 € |
| | | | BD C11CB72321 | 2.801,86 € | BD C11CD37121 | 5.003,72 € | | |
| Opciones | P1 | | | | | | | |
| Epson Discproducer™ DVD drive (1) for PP-100II (Pioneer PR1 W series) | | | | | C32C891008 | 320 € | | |
| Consumibles | U1 | | U1 | | U1 | | U1 | |
| Negro | C13S020447 C13S020452 | 33 € 33 € | C13S020451 C13S020452 | 33 € 33 € | C13S020447 C13S020452 | 33 € 33 € | C13S020447 C13S020452 | 33 € 33 € |
| Soportes CD y set de tintas | 5115078 | 841 € | 5115078 | 841 € | 5115078 | 841 € | 5115078 | 841 € |
| Caja de mantenimiento | C13S020476 | 23 € | | | C13S020476 | 23 € | | |
| Soportes CD | 5115076 | 223 € | 5115076 | 223 € | 5115076 | 223 € | 5115076 | 223 € |
| Soportes BD-R | 5129568 | 720 € | | | | | | |
| Soportes DVD y set de tintas | 5145246 | 1.365 € | 5145246 | 1.365 € | 5145246 | 1.365 € | 5145246 | 1.365 € |
| CoverPlus | BA | | BA | | BA | | BA | |
| 01 años de servicio CoverPlus en laboratorio para PP-100/II/50 | CP1ERTBSCA43 | 500 € | | | CP1ERTBSCA43 | 500 € | CP1ERTBSCA43 | 500 € |
| 03 años de servicio CoverPlus en laboratorio para PP-100 | CP03RTBSCA31 | | | | | | CP03RTBSCA31 | |
| 03 años de servicio CoverPlus in situ para PP-100II | | | | | CP03OSSECD37 | | | |

| | Discproducer™ PP-100AP | Discproducer™ PP-50 | Discproducer™ PP-100II | Discproducer™ PP-100N (SATA) | |
|---|------------------------|---------------------|------------------------|------------------------------|---------|
| 03 años de servicio CoverPlus in situ para PP-100N | | | | CP03OSSPCA31 | 900 € |
| 03 años de servicio CoverPlus in situ para PP-50 | | CP03OSSECB72 | | | |
| 04 años de servicio CoverPlus in situ para PP-100II | | | CP04OSSECD37 | | 1.155 € |
| 04 años de servicio CoverPlus in situ para PP-50 | | CP04OSSECB72 | | | |
| 05 años de servicio CoverPlus in situ para PP-100II | | | CP05OSSECD37 | | 1.540 € |
| 05 años de servicio CoverPlus in situ para PP-50 | | CP05OSSECB72 | | | 1.540 € |

Papel en rollo Epson ReStick: MS2141150: rollo ReStick de 58 mm x 45,7 m
 Epson ReStick Roll paper: MS3181602GO: 80mm x 48.7m Restick roll
 Epson ReStick Roll paper: MS2142402GO: 58mm x 73m Restick roll
 Hoja de limpieza
 DS Transfer Multi-Purpose 111,8 cm x 91,4 m
 DS Transfer Multi-Purpose 162 cm x 91,4 m
 DS Transfer Multi-Purpose 61 cm x 91,4 m
 DS Transfer Production 108cm x 152m
 DS Transfer Production 162cm x 175m
 Papel láser color A4 - 10 x 250 hojas

Artes gráficas - Papel de acabado artístico

Somerset Velvet Fine Art Paper, 24" x 30", 505 g/m²
 Rollo de Somerset Velvet Fine Art Paper, 24" x 15 m, 255 g/m²
 Rollo de Somerset Velvet Fine Art Paper, 44" x 15 m, 255 g/m²
 Rollo de Premium Canvas Satin, 13" x 6,1 m, 350g/m²
 Rollo de Premium Canvas Satin, 17" x 12,2m, 350g/m[s2]
 Rollo de Premium Canvas Satin, 24" x 12,2 m, 350 g/m²
 Rollo de Premium Canvas Satin, 44" x 12,2 m, 350 g/m²
 Rollo de Premium Canvas Satin, 17" x 3 m, 350 g/m²
 Rollo de Premium Canvas Satin, 60" x 12,2 m, 350 g/m²
 Cold Press Bright, A3+, 25 hojas
 Cold Press Bright, DIN A2, 25 hojas
 Cold Press Bright 17" x 15 m
 Cold Press Bright 24" x 15 m
 Cold Press Bright 44" x 15 m
 Cold Press Bright 60" x 15 m
 Cold Press Natural, A3+, 25 hojas
 Cold Press Natural, DIN A2, 25 hojas
 Cold Press Natural 17" x 15 m
 Cold Press Natural 24"x 15 m
 Cold Press Natural 44"x 15 m
 Cold Press Natural 60"x 15 m
 Enhanced Matte Poster Board, 24" x 30", 1130 g/m²
 Enhanced Matte Poster Board, 30" x 40", 1130 g/m², 5 hojas
 Rollo de Ultra Smooth Fine Art Paper, 24" x 15,2 m, 250 g/m²
 Rollo de Ultra Smooth Fine Art Paper, 44" x 15,2 m, 250 g/m²
 Rollo de Ultra Smooth Fine Art Paper, 17" x 15,2 m, 250 g/m²
 Ultra Smooth Fine Art Paper, 60" x 15,2 m, 250 g/m²
 Rollo de papel acuarela blanco, 24" x 18 m, 190 g/m²
 Rollo de papel acuarela blanco, 44" x 18 m, 190 g/m²
 Hot Press Bright, A3+, 25 hojas
 Hot Press Bright, DIN A2, 25 hojas
 Hot Press Bright 17" x 15 m
 Hot Press Bright 24" x 15 m
 Hot Press Bright 44" x 15 m
 Hot Press Bright 60" x 15 m
 Hot Press Natural, A3+, 25 hojas
 Hot Press Natural, DIN A2, 25 hojas
 Hot Press Natural 17" x 15 m
 Hot Press Natural 24" x 15 m
 Hot Press Natural 44" x 15 m
 Hot Press Natural 60"x 15 m
 Japanese Kozo Paper Thin 17" x 10m
 Japanese Kozo Paper Thin 13" x 10m
 Ultra Smooth Fine Art Paper, A3+, 325 g/m², 25 hojas
 Ultra Smooth Fine Art Paper, DIN A2, 325 g/m², 25 hojas
 Velvet Fine Art Paper, A3+, 260 g/m², 20 hojas

| Tipo papel | Tamaño de papel | Número de hojas | Código SKU | Precio |
|----------------------------------|-------------------|-----------------|------------|----------|
| | | | 1520527 | 8,73 € |
| | | | 7107935 | 9,34 € |
| | | | 7107936 | 10,08 € |
| | | | C13S400045 | 8,30 € |
| DS Transfer Multipurpose | 1.118 mm x 91,4 m | | C13S045451 | 92 € |
| DS Transfer Multipurpose | 1.620 mm x 91,4 m | | C13S045452 | 133,80 € |
| DS Transfer Multipurpose | 610 mm x 91,4 m | | C13S045480 | 50,20 € |
| DS Transfer Production Textile | 1.080 mm x 152 m | | C13S045520 | 114 € |
| DS Transfer Production Textile | 1.620 mm x 175 m | | C13S045521 | 199 € |
| Epson Color Laser Paper Uncoated | 210 " x 297 " | 2.500 Hojas | C13S041163 | 69,15 € |

| Tipo papel | Tamaño de papel | Número de hojas | Código SKU | Precio |
|--|-------------------|-----------------|------------|----------|
| | 610 mm x 762 mm | 20 Hojas | C13S041699 | 278,50 € |
| | 610 mm x 15 m | | C13S041702 | 173,50 € |
| | 1.118 mm x 15 m | | C13S041703 | 310,10 € |
| | 330 mm x 6,1 m | | C13S041845 | 43,50 € |
| | 432 mm x 12,2 m | | C13S041846 | 108,10 € |
| | 610 mm x 12,2 m | | C13S041847 | 147,50 € |
| | 1.118 mm x 12,2 m | | C13S041848 | 269,50 € |
| | 432 mm x 3 m | | C13S041858 | 29,95 € |
| | 1.524 mm x 12,2 m | | C13S045065 | 367,50 € |
| Cold Press Bright | 329 mm x 483 mm | 25 Hojas | C13S042310 | 99 € |
| Cold Press Bright | 420 mm x 594 mm | 25 Hojas | C13S042312 | 159 € |
| Cold Press Bright | 432 mm x 15 m | | C13S042313 | 119 € |
| Cold Press Bright | 610 mm x 15 m | | C13S042314 | 159 € |
| Cold Press Bright | 1.118 mm x 15 m | | C13S042315 | 299 € |
| Cold Press Bright | 1.524 mm x 15 m | | C13S042316 | 349 € |
| Cold Press Natural | 329 mm x 483 mm | 25 Hojas | C13S042300 | 99 € |
| Cold Press Natural | 420 mm x 594 mm | 25 Hojas | C13S042302 | 159 € |
| Cold Press Natural | 432 mm x 15 m | | C13S042303 | 119 € |
| Cold Press Natural | 610 mm x 15 m | | C13S042304 | 159 € |
| Cold Press Natural | 1.118 mm x 15 m | | C13S042305 | 299 € |
| Cold Press Natural | 1.524 mm x 15 m | | C13S042306 | 349 € |
| Enhanced Matte Posterboard | 610 mm x 762 mm | 10 Hojas | C13S041598 | 94,10 € |
| Enhanced Matte Posterboard | 762 mm x 1.016 mm | 5 Hojas | C13S041599 | 89,90 € |
| Epson Ultrasmooth Fine Art Paper Roll | 610 mm x 15,2 m | | C13S041782 | 174,50 € |
| Epson Ultrasmooth Fine Art Paper Roll | 1.118 mm x 15,2 m | | C13S041783 | 320,50 € |
| Epson Ultrasmooth Fine Art Paper Roll | 432 mm x 15,2 m | | C13S042074 | 123,50 € |
| Epson Ultrasmooth Fine Art Paper Roll | 1.524 mm x 15,2 m | | C13S042141 | 460 € |
| Epson Water Color Paper Radiant White Roll | 610 mm x 18 m | | C13S041396 | 99 € |
| Epson Water Color Paper Radiant White Roll | 1.118 mm x 18 m | | C13S041398 | 174 € |
| Hot Press Bright | 329 mm x 483 mm | 25 Hojas | C13S042330 | 99 € |
| Hot Press Bright | 420 mm x 594 mm | 25 Hojas | C13S042332 | 159 € |
| Hot Press Bright | 432 mm x 15 m | | C13S042333 | 119 € |
| Hot Press Bright | 610 mm x 15 m | | C13S042334 | 159 € |
| Hot Press Bright | 1.118 mm x 15 m | | C13S042335 | 299 € |
| Hot Press Bright | 1.524 mm x 15 m | | C13S042336 | 349 € |
| Hot Press Natural | 329 mm x 483 mm | 25 Hojas | C13S042320 | 99 € |
| Hot Press Natural | 420 mm x 594 mm | 25 Hojas | C13S042322 | 159 € |
| Hot Press Natural | 432 mm x 15 m | | C13S042323 | 119 € |
| Hot Press Natural | 610 mm x 15 m | | C13S042324 | 159 € |
| Hot Press Natural | 1.118 mm x 15 m | | C13S042325 | 299 € |
| Hot Press Natural | 1.524 mm x 15 m | | C13S042326 | 349 € |
| Japanese Kozo Paper | 432 mm x 10 m | | C13S045599 | 65 € |
| Japanese Kozo Paper | 330 mm x 10 m | | C13S450153 | 50 € |
| Ultrasmooth Fine Art Paper | 329 mm x 483 mm | 25 Hojas | C13S041896 | 101,25 € |
| Ultrasmooth Fine Art Paper | 420 mm x 594 mm | 25 Hojas | C13S042105 | 157 € |
| Velvet Fine Art Paper | 329 mm x 483 mm | 20 Hojas | C13S041637 | 63,25 € |

Soportes

TARIFA DE PRECIOS

| |
|---|
| Velvet Fine Art Paper, DIN A2, 260 g/m ² , 25 hojas |
| Rollo de WaterResistant Matte Canvas, 17" x 2,1 m, 375 g/m ² |
| Rollo de WaterResistant Matte Canvas, 13" x 6,1 m, 375 g/m ² |
| Rollo de WaterResistant Matte Canvas, 17" x 12,2 m, 375 g/m ² |
| Rollo de WaterResistant Matte Canvas, 24" x 12,2 m, 375 g/m ² |
| Rollo de WaterResistant Matte Canvas, 44" x 12,2 m, 375 g/m ² |
| Rollo de WaterResistant Matte Canvas, 60" x 12,2 m |
| Papel acurela blanco, DIN A3+, 190 g/m ² , 20 hojas |
| Artes gráficas - Papel fotográfico |
| Archival Matte Paper, DIN A3+, 189 g/m ² , 50 hojas |
| Archival Matte Paper, DIN A3, 189 g/m ² , 50 hojas |
| Photo Paper Gloss, 17" x 30,5 m, 250 g/m ² |
| Photo Paper Gloss, 24" x 30,5 m, 250 g/m ² |
| Photo Paper Gloss, 44" x 30,5 m, 250 g/m ² |
| Rollo de Premium Glossy Photo Paper, 329 mm x 10 m, 255g/m ² (s2) |
| Rollo de Premium Glossy Photo Paper, 24" x 30,5 m, 166 g/m ² |
| Rollo de Premium Glossy Photo Paper, 44" x 30,5 m, 166 g/m ² |
| Rollo de Premium Glossy Photo Paper, 24" x 30,5 m, 260 g/m ² |
| Rollo de Premium Glossy Photo Paper, 44" x 30,5 m, 260 g/m ² |
| Rollo de Premium Glossy Photo Paper, 16" x 30,5 m, 260 g/m ² |
| Premium Glossy Photo Paper, 16" x 30,5 m, 170 g/m ² |
| Rollo de Premium Glossy Photo Paper, 60" x 30,5 m, 260 g/m ² |
| Rollo de Premium Glossy Photo Paper, 60" x 30,5 m, 166 g/m ² |
| Rollo de Premium Semigloss Photo Paper, rollo de papel (w: 329), 250 g/m ² |
| Rollo de Premium Semigloss Photo Paper, 24" x 30,5 m, 160 g/m ² |
| Rollo de Premium Semigloss Photo Paper, 44" x 30,5 m, 160 g/m ² |
| Rollo de Premium Semigloss Photo Paper, 24" x 30,5 m, 250 g/m ² |
| Rollo de Premium Semigloss Photo Paper, 44" x 30,5 m, 250 g/m ² |
| Rollo de Premium Semigloss Photo Paper, 16" x 30,5 m, 250 g/m ² |
| Premium Semigloss Photo Paper, 16,5" x 30,5 m, 160 g/m ² |
| Premium Semigloss Photo Paper, 60" x 30,5 m, 250 g/m ² |
| Rollo de Premium Semigloss Photo Paper, 60" x 30,5 m, 170 g/m ² |
| Photo Paper Gloss, 36" x 30,5 m, 250g/m ² (s2) |
| Premium Glossy Photo Paper, DIN A3, 255 g/m ² , 20 hojas |
| Premium Glossy Photo Paper, DIN A3+, 250 g/m ² , 20 hojas |
| Premium Glossy Photo Paper, DIN A2, 255 g/m ² , 25 hojas |
| Premium Luster Photo Paper, DIN A4, 250 g/m ² |
| Premium Luster Photo Paper, DIN A3+, 250 g/m ² |
| Premium Luster Photo Paper, DIN A2, 250 g/m ² , 25 hojas |
| Premium Semigloss Photo Paper, DIN A3+, 250 g/m ² , 20 hojas |
| Premium Semigloss Photo Paper, DIN A3, 251 g/m ² , 20 hojas |
| Premium Semigloss Photo Paper, DIN A2, 250 g/m ² , 25 hojas |
| Rollo de Premium Semimatte Photo Paper, 16" x 30,5 m, 260 g/m ² |
| Rollo de Premium Semimatte Photo Paper, 24" x 30,5 m, 260 g/m ² |
| Rollo de Premium Semimatte Photo Paper, 44" x 30,5 m, 260 g/m ² |
| Premium Luster Photo Paper, 30 cm x 30,5 m, 260 g/m ² |
| Premium Luster Photo Paper, 16" x 30,5 m, 260 g/m ² |
| Premium Luster Photo Paper, 20" x 30,5 m, 260 g/m ² |
| Premium Luster Photo Paper, 24" x 30,5 m, 260 g/m ² |
| Premium Luster Photo Paper, 44" x 30,5 m, 260 g/m ² |
| Premium Luster Photo Paper, 60" x 30,5 m, 260 g/m ² |
| Traditional Photo Paper, DIN A4, 330 g/m ² , 25 hojas |
| Traditional Photo Paper, DIN A3+, 330 g/m ² , 25 hojas |
| Traditional Photo Paper, DIN A2, 330 g/m ² , 25 hojas |
| Traditional Photo Paper, 24" x 36", 330 g/m ² , 25 hojas |
| Traditional Photo Paper, 17" x 15 m |
| Traditional Photo Paper, 24" x 15 m |
| Traditional Photo Paper, 44" x 15 m |
| Traditional Photo Paper, 64" x 15 m |

| Velvet Fine Art Paper | 420 mm x 594 mm | 25 Hojas | C13S042096 | 124 € |
|--|-------------------|-----------------|------------|----------|
| Water Resistant Matte Canvas Roll | 432 mm x 2,1 m | | C13S042011 | 27,50 € |
| Water Resistant Matte Canvas Roll | 330 mm x 6,1 m | | C13S042012 | 41,70 € |
| Water Resistant Matte Canvas Roll | 432 mm x 12,2 m | | C13S042013 | 104 € |
| Water Resistant Matte Canvas Roll | 610 mm x 12,2 m | | C13S042014 | 136 € |
| Water Resistant Matte Canvas Roll | 1.118 mm x 12,2 m | | C13S042016 | 248 € |
| Water Resistant Matte Canvas Roll | 1.524 mm x 12,2 m | | C13S045062 | 338,18 € |
| WaterColor Paper Radiant White | 329 mm x 483 mm | 20 Hojas | C13S041352 | 31 € |
| Tipo papel | Tamaño de papel | Número de hojas | Código SKU | Precio |
| Archival Matte Paper | 329 mm x 483 mm | 50 Hojas | C13S041340 | 44,13 € |
| Archival Matte Paper | 297 mm x 420 mm | 50 Hojas | C13S041344 | 35,46 € |
| Epson Photo Paper Gloss | 432 mm x 30,5 m | | C13S041892 | 62 € |
| Epson Photo Paper Gloss | 610 mm x 30,5 m | | C13S041893 | 85 € |
| Epson Photo Paper Gloss | 1.118 mm x 30,5 m | | C13S041895 | 155 € |
| Epson Premium Glossy Photo Paper Roll | 329 mm x 10 m | | C13S041379 | 40 € |
| Epson Premium Glossy Photo Paper Roll | 610 mm x 30,5 m | | C13S041390 | 117 € |
| Epson Premium Glossy Photo Paper Roll | 1.118 mm x 30,5 m | | C13S041392 | 213,50 € |
| Epson Premium Glossy Photo Paper Roll | 610 mm x 30,5 m | | C13S041638 | 139,40 € |
| Epson Premium Glossy Photo Paper Roll | 1.118 mm x 30,5 m | | C13S041640 | 254,80 € |
| Epson Premium Glossy Photo Paper Roll | 406 mm x 30,5 m | | C13S041742 | 93 € |
| Epson Premium Glossy Photo Paper Roll | 406 mm x 30,5 m | | C13S042076 | 90 € |
| Epson Premium Glossy Photo Paper Roll | 1.524 mm x 30,5 m | | C13S042132 | 279,99 € |
| Epson Premium Glossy Photo Paper Roll | 1.524 mm x 30,5 m | | C13S042136 | 250 € |
| Epson Premium Semigloss Photo Paper Roll | 329 mm x 10 m | | C13S041338 | 40 € |
| Epson Premium Semigloss Photo Paper Roll | 610 mm x 30,5 m | | C13S041393 | 117 € |
| Epson Premium Semigloss Photo Paper Roll | 1.118 mm x 30,5 m | | C13S041395 | 213,50 € |
| Epson Premium Semigloss Photo Paper Roll | 610 mm x 30,5 m | | C13S041641 | 139,40 € |
| Epson Premium Semigloss Photo Paper Roll | 1.118 mm x 30,5 m | | C13S041643 | 254,80 € |
| Epson Premium Semigloss Photo Paper Roll | 406 mm x 30,5 m | | C13S041743 | 93 € |
| Epson Premium Semigloss Photo Paper Roll | 419 mm x 30,5 m | | C13S042075 | 90 € |
| Epson Premium Semigloss Photo Paper Roll | 1.524 mm x 30,5 m | | C13S042137 | 279,99 € |
| Epson Premium Semigloss Photo Paper Roll | 1.524 mm x 30,5 m | | C13S042137 | 250 € |
| Photo Paper | 914 mm x 30,5 m | | C13S041894 | 126,72 € |
| Premium Glossy Photo Paper | 297 mm x 420 mm | 20 Hojas | C13S041315 | 37,71 € |
| Premium Glossy Photo Paper | 328 mm x 483 mm | 20 Hojas | C13S041316 | 25 € |
| Premium Glossy Photo Paper | 420 mm x 594 mm | 25 Hojas | C13S042091 | 39,25 € |
| Premium Luster Photo Paper | 210 mm x 297 mm | 250 Hojas | C13S041784 | 124,50 € |
| Premium Luster Photo Paper | 329 mm x 483 mm | 100 Hojas | C13S041785 | 125 € |
| Premium Luster Photo Paper | 420 mm x 594 mm | 25 Hojas | C13S042123 | 41 € |
| Premium Semigloss Photo Paper | 328 mm x 483 mm | 20 Hojas | C13S041328 | 25 € |
| Premium Semigloss Photo Paper | 297 mm x 420 mm | 20 Hojas | C13S041334 | 38,77 € |
| Premium Semigloss Photo Paper | 420 mm x 594 mm | 25 Hojas | C13S042093 | 39,25 € |
| Premium Semimatte Photo Paper Roll | 406 mm x 30,5 m | | C13S042149 | 93 € |
| Premium Semimatte Photo Paper Roll | 610 mm x 30,5 m | | C13S042150 | 139 € |
| Premium Semimatte Photo Paper Roll | 1.118 mm x 30,5 m | | C13S042152 | 254 € |
| Rollo de Premium Luster Photo Paper | 300 mm x 30,5 m | | C13S042078 | 68 € |
| Rollo de Premium Luster Photo Paper | 406 mm x 30,5 m | | C13S042079 | 92,35 € |
| Rollo de Premium Luster Photo Paper | 508 mm x 30,5 m | | C13S042080 | 115,75 € |
| Rollo de Premium Luster Photo Paper | 610 mm x 30,5 m | | C13S042081 | 139,25 € |
| Rollo de Premium Luster Photo Paper | 1.118 mm x 30,5 m | | C13S042083 | 256 € |
| Rollo de Premium Luster Photo Paper | 1.524 mm x 30,5 m | | C13S042134 | 360 € |
| Traditional Photo Paper | 210 mm x 297 mm | | C13S045050 | 35 € |
| Traditional Photo Paper | 329 mm x 483 mm | 25 Hojas | C13S045051 | 87 € |
| Traditional Photo Paper | 420 mm x 594 mm | 25 Hojas | C13S045052 | 136 € |
| Traditional Photo Paper | 610 mm x 914 mm | 25 Hojas | C13S045053 | 300 € |
| Traditional Photo Paper | 432 mm x 15 m | | C13S045054 | 116,20 € |
| Traditional Photo Paper | 610 mm x 15 m | | C13S045055 | 164 € |
| Traditional Photo Paper | 1.118 mm x 15 m | | C13S045056 | 300,70 € |
| Traditional Photo Paper | 1.626 mm x 15 m | | C13S045107 | 437,30 € |

Artes gráficas - Papel fotográfico, Hogar - Soportes especiales

Archival Matte Paper - A4 - 50 hojas

Artes gráficas - Papel para gráficos y cartelería

Matte Backlit Film, 24" x 30,5 m, 280 g/m²
 Matte Backlit Film, 44" x 30,5 m, 280 g/m²
 Matte Backlit Film, 60" x 30,5 m, 280 g/m²
 Rollo de Doubleweight Matte Paper, 24" x 25 m, 180 g/m²
 Rollo de Doubleweight Matte Paper, 44" x 25 m, 180 g/m²
 Rollo de Doubleweight Matte Paper, 64" x 25 m, 180 g/m²
 Rollo de Enhanced Adhesive Synthetic Paper, 24" x 30,5 m, 135 g/m²
 Rollo de Enhanced Adhesive Synthetic Paper, 44" x 30,5 m, 135 g/m²
 Enhanced Matte Paper, DIN A4, 192 g/m², 250 hojas
 Enhanced Matte Paper, DIN A3+, 192 g/m², 100 hojas
 Enhanced Matte Paper, DIN A2, 192 g/m², 50 hojas
 Enhanced Matte Poster Board, DIN A3+, 800 g/m², 20 hojas
 Enhanced Matte Poster Board, DIN A2, 800 g/m², 20 hojas
 Rollo de Enhanced Synthetic Paper, 24" x 40 m, 84 g/m²
 Rollo de Enhanced Synthetic Paper, 44" x 40 m, 84 g/m²
 Enhanced Matte Paper, 24" x 30,5 m, 189 g/m²
 Enhanced Matte Paper, 44" x 30,5 m, 189 g/m²
 Rollo de Enhanced Matte Paper, 17" x 30,5 m, 189 g/m²
 Enhanced Matte Paper, 64" x 30,5 m, 189 g/m²
 Rollo de Singleweight Matte Paper, 17" x 40 m, 120 g/m²
 Rollo de Singleweight Matte Paper, 24" x 40 m, 120 g/m²
 Rollo de Singleweight Matte Paper, 44" x 40 m, 120 g/m²
 Matte Paper Heavy Weight, DIN A3, 167 g/m², 50 hojas
 Matte Paper Heavy Weight, DIN A3+, 167 g/m², 50 hojas
 Photo Quality Ink Jet Paper, DIN A3, 102 g/m², 100 hojas
 Photo Quality Ink Jet Paper, DIN A3+, 102 g/m², 100 hojas
 Photo Quality Ink Jet Paper, DIN A2, 102 g/m², 30 hojas
 Rollo de Presentation Matte Paper, 44" x 25 m, 172 g/m²
 Rollo de Presentation Matte Paper, 24" x 25 m, 172 g/m²

Artes gráficas - Papel para pruebas

Rollo de Commercial Proofing Paper, 13" x 30,5 m, 250 g/m²
 Rollo de Commercial Proofing Paper, 17" x 30,5 m, 250 g/m²
 Rollo de Commercial Proofing Paper, 24" x 30,5 m, 250 g/m²
 Rollo de Commercial Proofing Paper, 44" x 30,5 m, 250 g/m²
 Película Epson MetallicProof® de 24" x 30,5 m (para SP WT7900)
 Película Epson ClearProof® de 24" x 30,5 m (para SP WT7900)
 Película Epson ClearProof® delgada de 24" x 30,5 m (para SP WT7900)
 Película CrystalClear para Epson de 17" x 30,5 m (para SP WT7900)
 Película CrystalClear para Epson de 24" x 30,5 m (para SP WT7900)
 Standard Proofing Paper 240, 17" x 30,5 m
 Standard Proofing Paper 240, 24" x 30,5 m
 Standard Proofing Paper 240, 44" x 30,5 m
 Standard Proofing Paper, DIN A3+, 100 hojas
 Epson Standard Proofing Paper 240, A3+ (100 hojas)
 Proofing Paper White Semimatte, 13" x 30,5 m, 250 g/m²
 Proofing Paper White Semimatte, 17" x 30,5 m, 250 g/m²
 Proofing Paper White Semimatte, 24" x 30,5 m, 250 g/m²
 Proofing Paper White Semimatte, 44" x 30,5 m, 250 g/m²
 Proofing Paper White Semimatte, DIN A3+, 100 hojas
 Proofing Paper White Semimatte, 60" x 30,5 m, 250 g/m²
 Standard Proofing Paper, DIN A3+, 205 g/m², 100 hojas
 Standard Proofing Paper, DIN A2, 205 g/m², 50 hojas
 Standard Proofing Paper, 17" x 50 m, 205 g/m²
 Standard Proofing Paper, 24" x 50 m, 205 g/m²
 Standard Proofing Paper, 44" x 50 m, 205 g/m²

| Tipo papel | Tamaño de papel | Número de hojas | Código SKU | Precio |
|--|-------------------|-----------------|------------|----------|
| Archival Matte Paper | 210 mm x 297 mm | 50 Hojas | C13S041342 | 16,93 € |
| Tipo papel | Tamaño de papel | Número de hojas | Código SKU | Precio |
| | 610 mm x 30,5 m | | C13S045083 | 132,50 € |
| | 1,118 mm x 30,5 m | | C13S045084 | 242,90 € |
| | 1,524 mm x 30,5 m | | C13S045085 | 331,10 € |
| Doubleweight Matte Paper Roll | 610 mm x 25 m | | C13S041385 | 57,77 € |
| Doubleweight Matte Paper Roll | 1,118 mm x 25 m | | C13S041387 | 95,33 € |
| Doubleweight Matte Paper Roll | 1,626 mm x 25 m | | C13S042138 | 147,01 € |
| Enhanced Adhesive Synthetic Paper Roll | 610 mm x 30,5 m | | C13S041617 | 236,25 € |
| Enhanced Adhesive Synthetic Paper Roll | 1,118 mm x 30,5 m | | C13S041619 | 418,95 € |
| Enhanced Matte Paper | 210 mm x 297 mm | 250 Hojas | C13S041718 | 69,50 € |
| Enhanced Matte Paper | 329 mm x 483 mm | 100 Hojas | C13S041719 | 73,95 € |
| Enhanced Matte Paper | 420 mm x 594 mm | 50 Hojas | C13S042095 | 58,95 € |
| Enhanced Matte Posterboard | 329 mm x 483 mm | 20 Hojas | C13S042110 | 58 € |
| Enhanced Matte Posterboard | 420 mm x 594 mm | 20 Hojas | C13S042111 | 89 € |
| Enhanced Synthetic Paper Roll | 610 mm x 40 m | | C13S041614 | 132,30 € |
| Enhanced Synthetic Paper Roll | 1,118 mm x 40 m | | C13S041616 | 236,25 € |
| Epson Enhanced Matte Paper Roll | 610 mm x 30,5 m | | C13S041595 | 83,50 € |
| Epson Enhanced Matte Paper Roll | 1,118 mm x 30,5 m | | C13S041597 | 152,50 € |
| Epson Enhanced Matte Paper Roll | 432 mm x 30,5 m | | C13S041725 | 60,65 € |
| Epson Enhanced Matte Paper Roll | 1,626 mm x 30,5 m | | C13S042135 | 240 € |
| Epson Singleweight Matte Paper Roll | 432 mm x 40 m | | C13S041746 | 48 € |
| Epson Singleweight Matte Paper Roll | 610 mm x 40 m | | C13S041853 | 67,75 € |
| Epson Singleweight Matte Paper Roll | 1,118 mm x 40 m | | C13S041855 | 124,30 € |
| Matte Paper Heavy Weight | 297 mm x 420 mm | 50 Hojas | C13S041261 | 31,87 € |
| Matte Paper Heavy Weight | 329 mm x 483 mm | 50 Hojas | C13S041264 | 39,67 € |
| Photo Quality Ink Jet Paper | 297 mm x 420 mm | 100 Hojas | C13S041068 | 41,25 € |
| Photo Quality Ink Jet Paper | 329 mm x 483 mm | 100 Hojas | C13S041069 | 47,93 € |
| Photo Quality Ink Jet Paper | 420 mm x 594 mm | 30 Hojas | C13S041079 | 28,88 € |
| Presentation Matte Paper Roll | 1,118 mm x 25 m | | C13S041220 | 83,10 € |
| Presentation Matte Paper Roll | 610 mm x 25 m | | C13S041295 | 45,30 € |
| Tipo papel | Tamaño de papel | Número de hojas | Código SKU | Precio |
| | 330 mm x 30,5 m | | C13S042144 | 81,99 € |
| | 432 mm x 30,5 m | | C13S042145 | 100 € |
| | 610 mm x 30,5 m | | C13S042146 | 130 € |
| | 1,118 mm x 30,5 m | | C13S042148 | 225,01 € |
| | 610 mm x 30,5 m | | C13S042377 | 660 € |
| | 610 mm x 30,5 m | | C13S042372 | 632,50 € |
| ClearProof® Film | 610 mm x 30,5 m | | C13S042408 | 632,50 € |
| Crystal Clear Film for Epson | 432 mm x 30,5 m | | C13S045151 | 134,23 € |
| Crystal Clear Film for Epson | 610 mm x 30,5 m | | C13S045152 | 189,50 € |
| Epson Standard Proofing Paper 240 | 432 mm x 30,5 m | | C13S045111 | 109,11 € |
| Epson Standard Proofing Paper 240 | 610 mm x 30,5 m | | C13S045112 | 154,42 € |
| Epson Standard Proofing Paper 240 | 1,118 mm x 30,5 m | | C13S045114 | 283,02 € |
| Epson Standard Proofing Paper 240 | 329 mm x 483 mm | 100 Hojas | C13S045115 | 131,89 € |
| Epson Standard Proofing Paper 240 | 329 mm x 559 mm | 100 Hojas | C13S045193 | 131,89 € |
| Proofing Paper White Semimatte | 330 mm x 30,5 m | | C13S042002 | 80 € |
| Proofing Paper White Semimatte | 432 mm x 30,5 m | | C13S042003 | 95 € |
| Proofing Paper White Semimatte | 610 mm x 30,5 m | | C13S042004 | 120 € |
| Proofing Paper White Semimatte | 1,118 mm x 30,5 m | | C13S042006 | 210 € |
| Proofing Paper White Semimatte | 329 mm x 483 mm | 100 Hojas | C13S042118 | 126 € |
| Proofing Paper White Semimatte | 1,524 mm x 30,5 m | | C13S042140 | 299 € |
| Standard Proofing Paper | 329 mm x 483 mm | 100 Hojas | C13S045005 | 111,25 € |
| Standard Proofing Paper | 420 mm x 594 mm | 50 Hojas | C13S045006 | 87 € |
| Standard Proofing Paper | 432 mm x 50 m | | C13S045007 | 150,75 € |
| Standard Proofing Paper | 610 mm x 50 m | | C13S045008 | 212 € |
| Standard Proofing Paper | 1,118 mm x 50 m | | C13S045009 | 387,55 € |

Sportes

TARIFA DE PRECIOS

Epson Standard Proofing Paper 205, A3++ (100 hojas)
 Standard Proofing Paper OBA 17" x 30.5 m
 Standard Proofing Paper OBA 24" x 30.5 m
 Standard Proofing Paper OBA 44" x 30.5 m
 Standard Proofing Paper OBA DIN A3+ 100 Sh

| | | | | |
|-----------------------------|-------------------|-----------|------------|----------|
| Standard Proofing Paper | 329 mm x 559 mm | 100 Hojas | C13S045192 | 111,25 € |
| Standard Proofing Paper OBA | 432 mm x 30,15 m | | C13S450187 | 109,11 € |
| Standard Proofing Paper OBA | 610 mm x 30,5 m | | C13S450188 | 154,42 € |
| Standard Proofing Paper OBA | 1.118 mm x 30,5 m | | C13S450189 | 283,02 € |
| Standard Proofing Paper OBA | 329 mm x 483 mm | 100 Hojas | C13S450190 | 131,89 € |

Artes gráficas - Soportes para inyección de tinta

Bond Paper Bright 90, 594mm x 50m
 Bond Paper Bright 90, 610mm x 50m
 Bond Paper Bright 90, 841mm x 50m
 Bond Paper Bright 90, 914mm x 50m
 Bond Paper Bright 90, 1067mm x 50m
 Bond Paper Satin 90, 610mm x 50m
 Bond Paper Satin 90, 914mm x 50m
 Bond Paper White 80, 594mm x 50m
 Bond Paper White 80, 610mm x 50m
 Bond Paper White 80, 841mm x 50m
 Bond Paper White 80, 914mm x 50m
 Bond Paper White 80, 1067mm x 50m
 Coated Paper 95, 610 mm x 45 m
 Coated Paper 95, 914 mm x 45 m
 Coated Paper 95, 1067 mm x 45 m
 Presentation Paper HiRes 120, 610 mm x 30 m
 Presentation Paper HiRes 120, 914 mm x 30 m
 Presentation Paper HiRes 120, 1067 mm x 30 m
 Presentation Paper HiRes 180, 610 mm x 30 m
 Presentation Paper HiRes 180, 914 mm x 30 m
 Presentation Paper HiRes 180, 1067 mm x 30 m
 Production Canvas Matte, 610 mm x 12,2 m
 Production Canvas Matte, 1118 mm x 12,2 m
 Production Canvas Matte, 914mm x 12,2m
 Production PP Film Matte
 Production PP Film Matte
 Production Poly Textile B1 Light (180), 1067 mm x 50 m
 Production Poly Textile B1 (290), 1067 mm x 30 m
 Production Poly Textile B1 Light (180), 914mm x 50m
 Production Poly Textile B1 (290), 914mm x 30m
 Production SA Vinyl Matte, 1118 mm x 20 m
 Production SA Vinyl Matte, 914mm x 20m
 Production Scrim Banner B1, 1067 mm x 12,2 m
 Production Scrim Banner B1, 914mm x 12,2m

| Tipo papel | Tamaño de papel | Número de hojas | Código SKU | Precio |
|----------------------------------|-------------------|-----------------|------------|----------|
| Bond Paper Bright 90 | 594 mm x 50 m | | C13S045277 | 10,52 € |
| Bond Paper Bright 90 | 610 mm x 50 m | | C13S045278 | 10,15 € |
| Bond Paper Bright 90 | 841 mm x 50 m | | C13S045279 | 13,82 € |
| Bond Paper Bright 90 | 914 mm x 50 m | | C13S045280 | 14,27 € |
| Bond Paper Bright 90 | 1.067 mm x 50 m | | C13S045281 | 18,33 € |
| Bond Paper Satin 90 | 610 mm x 50 m | | C13S045282 | 15,01 € |
| Bond Paper Satin 90 | 914 mm x 50 m | | C13S045283 | 21,03 € |
| Bond Paper White 80 | 594 mm x 50 m | | C13S045272 | 8,30 € |
| Bond Paper White 80 | 610 mm x 50 m | | C13S045273 | 8,01 € |
| Bond Paper White 80 | 841 mm x 50 m | | C13S045274 | 11,42 € |
| Bond Paper White 80 | 914 mm x 50 m | | C13S045275 | 11,70 € |
| Bond Paper White 80 | 1.067 mm x 50 m | | C13S045276 | 16,73 € |
| Coated Paper 95 | 610 mm x 45 m | | C13S045284 | 17,71 € |
| Coated Paper 95 | 914 mm x 45 m | | C13S045285 | 23,32 € |
| Coated Paper 95 | 1.067 mm x 45 m | | C13S045286 | 27,17 € |
| Presentation Paper HiRes 120/180 | 610 mm x 30 m | | C13S045287 | 17,85 € |
| Presentation Paper HiRes 120/180 | 914 mm x 30 m | | C13S045288 | 26,78 € |
| Presentation Paper HiRes 120/180 | 1.067 mm x 30 m | | C13S045289 | 31,19 € |
| Presentation Paper HiRes 120/180 | 610 mm x 30 m | | C13S045291 | 22,70 € |
| Presentation Paper HiRes 120/180 | 914 mm x 30 m | | C13S045292 | 34,05 € |
| Presentation Paper HiRes 120/180 | 1.067 mm x 30 m | | C13S045293 | 39,70 € |
| Production Canvas Matte | 610 mm x 12,2 m | | C13S045295 | 77,25 € |
| Production Canvas Matte | 1.118 mm x 12,2 m | | C13S045296 | 141,44 € |
| Production Canvas Matte | 914 mm x 12,2 m | | C13S045527 | 113,74 € |
| Production PP Film Matte | 1.118 mm x 30,5 m | | C13S045298 | 175,16 € |
| Production PP Film Matte | 914 mm x 30,5 m | | C13S045522 | 143,79 € |
| Production Poly Textile 180/290 | 1.067 mm x 50 m | | C13S045302 | 283 € |
| Production Poly Textile 180/290 | 1.067 mm x 30 m | | C13S045304 | 280 € |
| Production Poly Textile 180/290 | 914 mm x 50 m | | C13S045524 | 242,42 € |
| Production Poly Textile 180/290 | 914 mm x 30 m | | C13S045525 | 239,85 € |
| Production SA Vinyl Matte | 1.118 mm x 20 m | | C13S045300 | 164,85 € |
| Production SA Vinyl Matte | 914 mm x 20 m | | C13S045523 | 134,77 € |
| Production Scrim Banner B1 | 1.067 mm x 12,2 m | | C13S045306 | 136,40 € |
| Production Scrim Banner B1 | 914 mm x 12,2 m | | C13S045526 | 116,84 € |

Hogar - Papel fotográfico

Value Glossy Photo Paper - A4 - 20 Hojas
 Value Glossy Photo Paper - A4 - 50 Hojas
 Value Glossy Photo Paper - 10x15cm - 20 Hojas
 Value Glossy Photo Paper - 10x15cm - 50 Hojas
 Value Glossy Photo Paper - 10x15cm - 100 Hojas
 Value Glossy Photo Paper - 10x15cm - 2x 20 Hojas
 Matte Paper Heavy Weight - A4 - 50 hojas
 Premium Glossy Photo Paper - 10x15cm - 20 Hojas
 Premium Glossy Photo Paper - 10x15cm - 100 Hojas
 Premium Glossy Photo Paper - 10x15cm - 40 Hojas
 Premium Glossy Photo Paper - 13x18cm - 30 Hojas
 Premium Semi-Gloss Photo Paper - A4 - 20 hojas

| Tipo papel | Tamaño de papel | Número de hojas | Código SKU | Precio |
|-------------------------------|-----------------|-----------------|------------|---------|
| Glossy Photo Paper económico | 210 mm x 297 mm | 20 Hojas | C13S400035 | 5,83 € |
| Glossy Photo Paper económico | 210 mm x 297 mm | 50 Hojas | C13S400036 | 11,66 € |
| Glossy Photo Paper económico | 100 mm x 150 mm | 20 Hojas | C13S400037 | 4,16 € |
| Glossy Photo Paper económico | 100 mm x 150 mm | 50 Hojas | C13S400038 | 5,83 € |
| Glossy Photo Paper económico | 100 mm x 150 mm | 100 Hojas | C13S400039 | 8,33 € |
| Glossy Photo Paper económico | 100 mm x 150 mm | 40 Hojas | C13S400044 | 4,12 € |
| Matte Paper Heavy Weight | 210 mm x 297 mm | 50 Hojas | C13S041256 | 13,63 € |
| Premium Glossy Photo Paper | 100 mm x 150 mm | 20 Hojas | C13S041706 | 5,69 € |
| Premium Glossy Photo Paper | 100 mm x 150 mm | 100 Hojas | C13S041822 | 13,21 € |
| Premium Glossy Photo Paper | 100 mm x 150 mm | 40 Hojas | C13S042153 | 10,32 € |
| Premium Glossy Photo Paper | 130 mm x 180 mm | 30 Hojas | C13S042154 | 11,15 € |
| Premium Semigloss Photo Paper | 210 mm x 297 mm | 20 Hojas | C13S041332 | 16,93 € |

Hogar - Soportes especiales

Double-Sided Matte Paper - A4 - 50 hojas
 Iron-on-Transfer Paper - A4 - 10x hojas
 Photo Quality Inkjet Paper - A4 - 100 hojas

| Tipo papel | Tamaño de papel | Número de hojas | Código SKU | Precio |
|------------------------------|-----------------|-----------------|------------|---------|
| Double-Sided Matte Paper | 210 mm x 297 mm | 50 Hojas | C13S041569 | 18,59 € |
| Epson Iron-on-transfer Paper | 210 mm x 297 mm | 10 Hojas | C13S041154 | 17,76 € |
| Photo Quality Ink Jet Paper | 210 mm x 297 mm | 100 Hojas | C13S041061 | 13,63 € |

Soportes

TARIFA DE PRECIOS

Self-Adhesive Photo Paper - A4 - 10 hojas

Impresora de etiquetas de inyección de tinta de sobremesa - Papel para etiquetas

| |
|--|
| BOPP High Gloss Label - Coil 220mm x 750m |
| BOPP High Gloss Label - Die-cut Roll: 102mm x 51mm, 2770 labels |
| BOPP High Gloss Label - Die-cut Roll: 102mm x 76mm, 1890 labels |
| BOPP High Gloss Label - Die-cut Roll: 102mm x 152mm, 960 labels |
| BOPP High Gloss Label - Die-cut Roll: 76mm x 51mm, 2770 labels |
| BOPP High Gloss Label - Die-cut Roll: 76mm x 127mm, 1150 labels |
| BOPP Satin Gloss Label - Coil 220mm x 750m |
| BOPP Satin Gloss Label - Die-cut Roll: 102mm x 51mm, 2770 labels |
| BOPP Satin Gloss Label - Die-cut Roll: 102mm x 76mm, 1890 labels |
| BOPP Satin Gloss Label - Die-cut Roll: 102mm x 152mm, 960 labels |
| BOPP Satin Gloss Label - Die-cut Roll: 76mm x 51mm, 2770 labels |
| BOPP Satin Gloss Label - Die-cut Roll: 76mm x 127mm, 1150 labels |
| PE Matte Label - Coil: 220mm x 750m |
| PE Matte Label - Continuous Roll: 51mm x 29m |
| PE Matte Label - Continuous Roll: 76mm x 29m |
| PE Matte Label - Continuous Roll: 102mm x 29m |
| PE Matte Label - Die-cut Roll: 102mm x 51mm, 535 labels |
| PE Matte Label - Die-cut Roll: 102mm x 76mm, 365 labels |
| PE Matte Label - Die-cut Roll: 102mm x 152mm, 185 labels |
| PE Matte Label - Die-cut Roll: 76mm x 51mm, 535 labels |
| PE Matte Label - Die-cut Roll: 76mm x 127mm, 220 labels |
| PE Matte Label - Die-cut Fanfold sheets with sprockets: 203mm x 305mm, 500 labels |
| PE Matte Label - Die-cut Fanfold sheets with sprockets: 203mm x 152mm, 1000 labels |
| PE Matte Label - Die-cut Roll: 102mm x 51mm, 2310 labels |
| PE Matte Label - Die-cut Roll: 102mm x 76mm, 1570 labels |
| PE Matte Label - Die-cut Roll: 102mm x 152mm, 800 labels |
| PE Matte Label - Die-cut Roll: 76mm x 51mm, 2310 labels |
| PE Matte Label - Die-cut Roll: 76mm x 127mm, 960 labels |
| High Gloss Label - Coil: 220mm x 750m |
| High Gloss Label - Continuous Roll: 51mm x 33m |
| High Gloss Label - Continuous Roll: 76mm x 33m |
| High Gloss Label - Continuous Roll: 102mm x 33m |
| High Gloss Label - Die-cut Roll: 102mm x 51mm, 610 labels |
| High Gloss Label - Die-cut Roll: 102mm x 76mm, 415 labels |
| High Gloss Label - Die-cut Roll: 102mm x 152mm, 210 labels |
| High Gloss Label - Die-cut Roll: 76mm x 51mm, 610 labels |
| High Gloss Label - Die-cut Roll: 76mm x 127mm, 250 labels |
| High Gloss Label - Die-cut Roll: 102mm x 51mm, 2310 labels |
| High Gloss Label - Die-cut Roll: 102mm x 76mm, 1570 labels |
| High Gloss Label - Die-cut Roll: 102mm x 152mm, 800 labels |
| High Gloss Label - Die-cut Roll: 76mm x 51mm, 2310 labels |
| High Gloss Label - Die-cut Roll: 76mm x 127mm, 960 labels |
| Premium Matte Label - Die-cut Roll: 76mm x 127mm, 960 labels |
| Rollo continuo de Premium Matte Label, 51 mm x 35 m |
| Rollo continuo de Premium Matte Label, 76 mm x 35 m |
| Rollo continuo de Premium Matte Label, 102 mm x 35 m |
| Premium Matte Label - Coil: 220mm x 750m |
| Premium Matte Label - Die-cut Roll: 102mm x 51mm, 650 labels |
| Premium Matte Label - Die-cut Roll: 102mm x 76mm, 440 labels |
| Premium Matte Label - Die-cut Roll: 102mm x 152mm, 225 labels |
| Premium Matte Label - Die-cut Roll: 76mm x 51mm, 650 labels |
| Premium Matte Label - Die-cut Roll: 76mm x 127mm, 265 labels |
| Premium Matte Label - Die-cut Roll: 102mm x 51mm, 2310 labels |
| Premium Matte Label - Die-cut Roll: 102mm x 76mm, 1570 labels |
| Premium Matte Label - Die-cut Roll: 102mm x 152mm, 800 labels |
| Premium Matte Label - Die-cut Roll: 76mm x 51mm, 2310 labels |
| Premium Matte Label Cont.R, 105mm x 35m |

| Photo Quality Ink Jet Paper self-adhesive | 210 mm x 297 mm | 10 Hojas | C13S041106 | 12,80 € |
|---|-----------------|-----------------|------------|----------|
| Tipo papel | Tamaño de papel | Número de hojas | Código SKU | Precio |
| BOPP High Gloss Label | | | C33S045700 | 786,75 € |
| BOPP High Gloss Label | | | C33S045702 | 74,93 € |
| BOPP High Gloss Label | | | C33S045703 | 74,93 € |
| BOPP High Gloss Label | | | C33S045704 | 74,93 € |
| BOPP High Gloss Label | | | C33S045705 | 56,93 € |
| BOPP High Gloss Label | | | C33S045706 | 56,93 € |
| Etiqueta de brillo satinado | | | C33S045701 | 786,75 € |
| Etiqueta de brillo satinado | | | C33S045707 | 74,93 € |
| Etiqueta de brillo satinado | | | C33S045708 | 74,93 € |
| Etiqueta de brillo satinado | | | C33S045709 | 74,93 € |
| Etiqueta de brillo satinado | | | C33S045710 | 56,93 € |
| Etiqueta de brillo satinado | | | C33S045711 | 56,93 € |
| Etiqueta mate PE | | | C33S045530 | 680,64 € |
| Etiqueta mate PE | | | C33S045544 | 9,90 € |
| Etiqueta mate PE | | | C33S045545 | 14 € |
| Etiqueta mate PE | | | C33S045546 | 19 € |
| Etiqueta mate PE | | | C33S045547 | 19,20 € |
| Etiqueta mate PE | | | C33S045548 | 19,20 € |
| Etiqueta mate PE | | | C33S045549 | 19,20 € |
| Etiqueta mate PE | | | C33S045550 | 14,20 € |
| Etiqueta mate PE | | | C33S045551 | 14,20 € |
| Etiqueta mate PE | | 500 Hojas | C33S045552 | 335 € |
| Etiqueta mate PE | | 1.000 Hojas | C33S045553 | 325 € |
| Etiqueta mate PE | | | C33S045712 | 60,90 € |
| Etiqueta mate PE | | | C33S045713 | 60,90 € |
| Etiqueta mate PE | | | C33S045714 | 60,90 € |
| Etiqueta mate PE | | | C33S045715 | 45,08 € |
| Etiqueta mate PE | | | C33S045716 | 45,08 € |
| Etiqueta muy brillante | | | C33S045529 | 580,79 € |
| Etiqueta muy brillante | | | C33S045536 | 8,50 € |
| Etiqueta muy brillante | | | C33S045537 | 12,50 € |
| Etiqueta muy brillante | | | C33S045538 | 16,80 € |
| Etiqueta muy brillante | | | C33S045539 | 17 € |
| Etiqueta muy brillante | | | C33S045540 | 17 € |
| Etiqueta muy brillante | | | C33S045541 | 17 € |
| Etiqueta muy brillante | | | C33S045542 | 12,70 € |
| Etiqueta muy brillante | | | C33S045543 | 12,70 € |
| Etiqueta muy brillante | | | C33S045717 | 47,18 € |
| Etiqueta muy brillante | | | C33S045718 | 47,18 € |
| Etiqueta muy brillante | | | C33S045719 | 47,18 € |
| Etiqueta muy brillante | | | C33S045720 | 35,33 € |
| Etiqueta muy brillante | | | C33S045721 | 35,33 € |
| Etiqueta muy brillante | | | C33S045726 | 15 € |
| Premium Matte Label | | | C33S045417 | 4 € |
| Premium Matte Label | | | C33S045418 | 5,50 € |
| Premium Matte Label | | | C33S045419 | 7 € |
| Premium Matte Label | | | C33S045528 | 280,61 € |
| Premium Matte Label | | | C33S045531 | 7,20 € |
| Premium Matte Label | | | C33S045532 | 7,20 € |
| Premium Matte Label | | | C33S045533 | 7,20 € |
| Premium Matte Label | | | C33S045534 | 5,70 € |
| Premium Matte Label | | | C33S045535 | 5,70 € |
| Premium Matte Label | | | C33S045722 | 18,90 € |
| Premium Matte Label | | | C33S045723 | 18,90 € |
| Premium Matte Label | | | C33S045724 | 18,90 € |
| Premium Matte Label | | | C33S045725 | 15 € |
| Premium Matte Label | | | C33S045727 | 7 € |

Impresora de inyección de tinta de sobremesa para etiquetas - Papel para tickets

Rollo de Premium Matte Ticket, 80 mm x 50m
 Rollo de Premium Matte Ticket, 102 mm x 50 m

| Tipo papel | Tamaño de papel | Número de hojas | Código SKU | Precio |
|----------------------|-----------------|-----------------|------------|--------|
| Premium Matte Ticket | | | C33S045389 | 5,50 € |
| Premium Matte Ticket | | | C33S045390 | 7 € |

Oficina - Papel fotográfico, Hogar - Papel fotográfico

Photo Paper Glossy - A3+ - 20 Hojas
 Photo Paper Glossy - A3 - 20 Hojas
 Photo Paper Glossy - A3 - 50 Hojas
 Photo Paper Glossy - A4 - 20 Hojas
 Photo Paper Glossy - A4 - 50 Hojas
 Photo Paper Glossy - A4 - 100 Hojas
 Photo Paper Glossy - 13x18cm - 50 Hojas
 Photo Paper Glossy - 10x15cm - 20 Hojas
 Photo Paper Glossy - 10x15cm - 50 Hojas
 Photo Paper Glossy - 10x15cm - 100 Hojas
 Photo Paper Glossy - 10x15cm - 500 Hojas
 Premium Glossy Photo Paper - A4 - 20 Hojas
 Premium Glossy Photo Paper - A4 - 50 Hojas
 Premium Glossy Photo Paper - A4 - 15 Hojas
 Premium Glossy Photo Paper - 10x15cm - 2x 40 Hojas
 Premium Glossy Photo Paper - A4 - 2x 15 Hojas
 Premium Semi-Gloss Photo Paper - 10x15cm - 50 hojas
 Ultra Glossy Photo Paper - 10x15cm - 20 Hojas
 Ultra Glossy Photo Paper - A4 - 15 Hojas
 Ultra Glossy Photo Paper - 10x15cm - 50 Hojas
 Ultra Glossy Photo Paper - 13x18cm - 50 Hojas

| Tipo papel | Tamaño de papel | Número de hojas | Código SKU | Precio |
|-------------------------------|-----------------|-----------------|------------|---------|
| Photo Paper Glossy | 329 mm x 483 mm | 20 Hojas | C13S042535 | 23,96 € |
| Photo Paper Glossy | 297 mm x 420 mm | 20 Hojas | C13S042536 | 20,65 € |
| Photo Paper Glossy | 297 mm x 420 mm | 50 Hojas | C13S042537 | 41,73 € |
| Photo Paper Glossy | 210 mm x 297 mm | 20 Hojas | C13S042538 | 11,15 € |
| Photo Paper Glossy | 210 mm x 297 mm | 50 Hojas | C13S042539 | 22,31 € |
| Photo Paper Glossy | 210 mm x 297 mm | 100 Hojas | C13S042540 | 36,36 € |
| Photo Paper Glossy | 130 mm x 180 mm | 50 Hojas | C13S042545 | 9,50 € |
| Photo Paper Glossy | 100 mm x 150 mm | 20 Hojas | C13S042546 | 4,95 € |
| Photo Paper Glossy | 100 mm x 150 mm | 50 Hojas | C13S042547 | 8,26 € |
| Photo Paper Glossy | 100 mm x 150 mm | 100 Hojas | C13S042548 | 10,74 € |
| Photo Paper Glossy | 100 mm x 150 mm | 500 Hojas | C13S042549 | 37,60 € |
| Premium Glossy Photo Paper | 210 mm x 297 mm | 20 Hojas | C13S041287 | 22,72 € |
| Premium Glossy Photo Paper | 210 mm x 297 mm | 50 Hojas | C13S041624 | 33,05 € |
| Premium Glossy Photo Paper | 210 mm x 297 mm | 15 Hojas | C13S042155 | 14,45 € |
| Premium Glossy Photo Paper | 100 mm x 150 mm | 80 Hojas | C13S042167 | 10,74 € |
| Premium Glossy Photo Paper | 210 mm x 297 mm | 30 Hojas | C13S042169 | 14,45 € |
| Premium Semigloss Photo Paper | 100 mm x 150 mm | 50 Hojas | C13S041765 | 8,67 € |
| Ultra Glossy Photo Paper | 100 mm x 150 mm | 20 Hojas | C13S041926 | 8,67 € |
| Ultra Glossy Photo Paper | 210 mm x 297 mm | 15 Hojas | C13S041927 | 17,76 € |
| Ultra Glossy Photo Paper | 100 mm x 150 mm | 50 Hojas | C13S041943 | 15,28 € |
| Ultra Glossy Photo Paper | 130 mm x 180 mm | 50 Hojas | C13S041944 | 16,11 € |

Oficina - Papel normal brillante para oficinas, Hogar - Papel normal brillante para el hogar

Bright White Inkjet Paper - A4 - 500 hojas
 Business Paper - A4 - 500 hojas

| Tipo papel | Tamaño de papel | Número de hojas | Código SKU | Precio |
|----------------------------------|-----------------|-----------------|------------|--------|
| Epson Bright White Ink Jet Paper | 210 mm x 297 mm | 500 Hojas | C13S041749 | 8,26 € |
| Epson Bright White Ink Jet Paper | 210 mm x 297 mm | 500 Hojas | C13S450075 | 6,65 € |

OFICINAS CENTRALES:

Epson Ibérica, S.A.U.
Cami de ca n'Armetler, 22, Edificio 2
08195 Sant Cugat del Vallès
Barcelona

Tel: 93 582 15 00

Tel: 902 49 59 69 (Preventa)
Fax: 93 582 15 55
www.epson.es

Las marcas comerciales o marcas registradas son propiedad de Seiko Epson Corporation o de sus respectivos propietarios. La información sobre los productos puede estar sujeta a modificación en función de las actualizaciones en sus especificaciones.