

## Product Information PEM-UC

## CONTROLS

# Universal digital indicator 4½-digit

## Application/specified usage

- Machine and switch cabinet construction
- Indicating and transforming of process values  
Input settable for current, voltage or temperature

## Application examples

- Realizing a small process controlling
- In-situ indication of process parameters
- Pt100 temperature transmitter with integrated display

## Features

- Universal power supply 24 V...230 V AC/DC ±10 %
- Protection class IP 65 front side
- Completely programmable via key pad
- Integrated sensor supply
- Unit symbol changeable
- Alarm modul, 2 changeover contacts
- Pre selectable operation mode (e.g. 3-step controller)

## Options

- Analog output: (0/4...20 mA, 0...10 V DC)

## Digital indicator PEM-UC



Specification		
<b>Housing</b>	control board mounting	96 mm x 48 mm x 130 mm, 2 side mounting clips
<b>Panel cutout</b>	(W x H)	92.5 mm x 45 mm, tolerance +0.5 mm
<b>Protection class</b>	front/rear	IP 65/IP 20
<b>Ambient</b>	operation temperature storage temperature humidity	0...+50 °C -20...+70 °C 0...95 % no condensation
<b>Input</b>	Pt100 current voltage	-100.0...+600.0 °C 0/4...20 mA (R <sub>i</sub> = 50 Ω), measurement range -22...22 mA 0...10 V (R <sub>i</sub> = 50 kΩ), measurement range -11...11 V
<b>Accuracy</b>		0.1 % ±1 digit, 15 bit + prefix
<b>Display</b>	7-segment	-19999...+19999; height: 13 mm
<b>Sensor supply</b>	short-circuit proof	ca. 20 V DC, maximum 25 mA
<b>Supply voltage</b>	universal current	24 V...230 V AC/DC, ±10 %, max. 7 VA
<b>Alarm outputs</b>	2 outputs	250 V/3 A AC changeover contacts, gold-bonded function mode and hysteresis freely adjustable
<b>Analog output</b>	Option SA	current 0/4...20 mA, 12 bit resolution, max. 500 Ω burden
<b>Weight</b>		maximum 500 g

Legend



**Details:** Non observance of this warning notice may cause troubles.



**Danger:** Non observance of this warning notice may cause serious injury of persons and/or damages or destruct the unit.



**Information/Tip:** This symbol indicates useful additional informations.

Global safety instructions



- Mounting, electrical connection, set up and maintenance of the unit must be done by trained and skilled personnel. They must have read and understood these installation and operating instructions. They must follow them carefully.
- Do not use the product where flammable or combustion gases are present.
- The product has been designed for industrial areas and must be used in an installed condition. (See assembly instructions)
- This product is not a safety device. Product failure may prevent operation of outputs. Take safety measures, such as installing a separate monitoring system, to ensure safety and to prevent serious accidents caused by such failure, thus ensuring safety.
- Do not open the housing, there are no serviceable parts inside. Inside are high voltage circuits.

Electrical connection

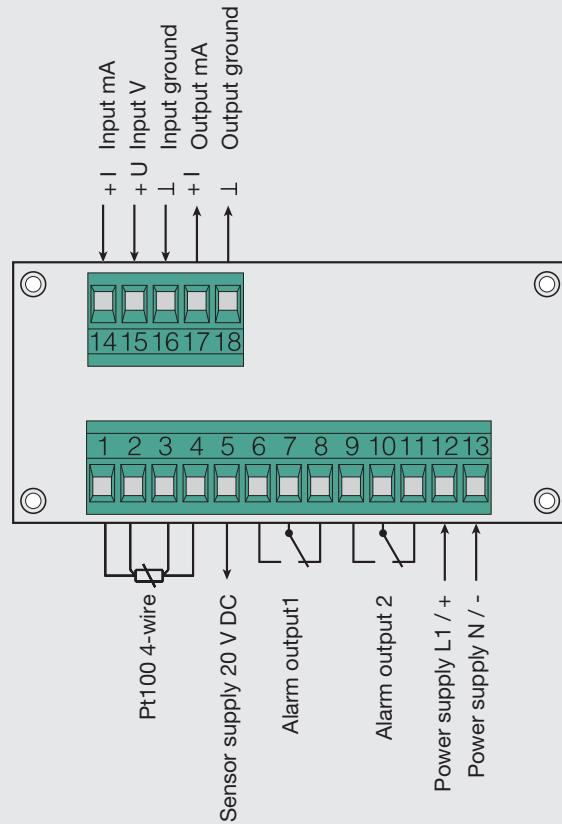

Information



Digital Indicator PEM-UC is equipped with an universal power supply, to be connected to any supply voltage in the range of 24 V...230 V AC/DC  $\pm 10\%$ . Special settings in hardware or menu are not necessary.

Assembly instructions



The PEM-UC is designed for mounting into a front panel.

- 1: Make a cutout with the dimensions of W x H 92,5 mm x 45 mm, tolerance +0,5 mm.
- 2: Place the PEM-UC into the cutout.
- 3: Clip on mounting clips on both sides.
- 4: Screw both clips against the front panel and control the correct mounting.

Conformity declaration



- Applicable directives:
  - Electromagnetic Compatibility Equipment Directive 2004/108/EC
  - Low Voltage Directive 2006/95/EC
- The operator is responsible for ensuring compliance with the directives that are applicable to the overall system.



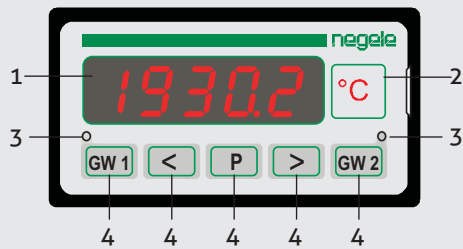



## Control elements









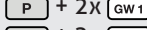
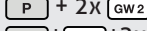
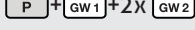

- 1: Display
- 2: Unit (inserted at the side of panel, changeable)
- 3: Status LEDs for alarm outputs
- 4: Operating keys (see tables "Key Functions")

## Key functions - Run mode

Holding grey background keys  pressed. In display mode the keys produce the following function:





	display alarm output 1
	display alarm output 2
	display unit version
	display MIN value
	display MAX value
	delete MIN value
	delete MAX value
	edit mode alarm output 1
	edit mode alarm output 2
	edit mode base settings

## Setting procedure



- 1: Press  +  + 2x  to start edit mode of base settings.
- 2: With the keys  or  select the menu point.
- 3: With the keys  or  change the value.
- 4: To store the settings push  button.

## Key functions - Edit mode

If no entry within 2 minutes, the display returns to the display mode!

	scroll forward to next setting
	scroll back to previous setting
	select digit (flashing) to be changed
	counts flashing digits UP
	store settings, END edit mode

## Example: Changing base settings

 +  + 2x  1. Start edit mode base settings

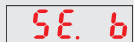

2. First menu item is displayed

2 seconds

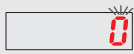

3. After 2 seconds the set value is displayed (flashing)

 ↓

4. Scroll to desired menu item



5. Menu item is displayed

2 seconds

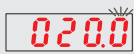

6. After 2 seconds the set value is displayed

 ↓

7. Select digit (flashing)



 ↓

8. Change value



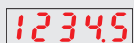

 ↓

9. Store and return to run mode, if needed go on with point 4. or 7.



10. Run mode

## Example: Changing alarm settings

 + 2x  1. Start edit mode alarm settings

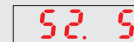

2. First menu item is displayed

2 seconds

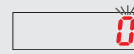

3. After 2 seconds the set value is displayed (flashing)

 ↓

4. Scroll to desired menu item

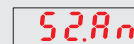

5. Menu item is displayed

2 seconds



6. After 2 seconds the set value is displayed

 ↓

7. Select digit (flashing)



 ↓

8. Change value







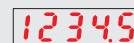



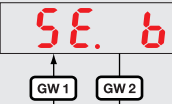

 ↓

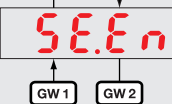
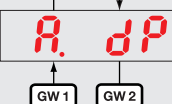
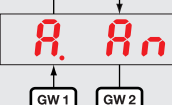
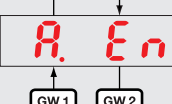
9. Store and return to run mode, if needed go on with point 4. or 7.

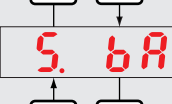

10. Run mode

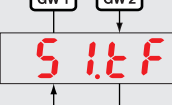
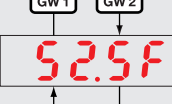
Parameter list base settings



	<p><b>Signal input</b>                  0 = Pt100, 4-wire                  1 = Current (mA)                  2 = Voltage (V)</p>
	<p><b>Signal low (*1)</b>                  Current: -22.00...+22.00 mA                  Voltage: -11.00...+11.00 V</p>
	<p><b>Signal high (*1)</b>                  Current: -22.00...+22.00 mA                  Voltage: -11.00...+11.00 V</p>
	<p><b>Decimal point (*1)</b>                  Select position with &gt; -key</p>
	<p><b>Display low (*2)</b>                  -19999...19999                  Scaling display start with input signal low</p>
	<p><b>Display high (*2)</b>                  -19999...19999                  Scaling display end with input signal high</p>
	<p><b>Correction factor -100.0...100.0</b>                  Zero offset</p>
	<p><b>Current output low(*3)</b>                  0...22 mA                  Scaling display start with output current low</p>
	<p><b>Current output high (*3)</b>                  0...22 mA                  Scaling display end with output current high</p>
	<p><b>Alarm output mode (*4)</b>                  0 = independent alarm outputs                  1 = window function                  2 = 3-step controller</p>
	<p><b>Switch mode alarm output 1 (*4)</b>                  0 = Min                    2 = Min inverted                  1 = Max                    3 = Max inverted</p>
	<p><b>Time function alarm output 1 (*4)</b>                  0 = switch                  1 = push button</p>
	<p><b>Switch mode alarm output 2 (*4)</b>                  0 = Min                    2 = Min inverted                  1 = Max                    3 = Max inverted</p>
	<p><b>Time function alarm output 2 (*4)</b>                  0 = switch                  1 = push button</p>

\*1: Not available if signal input Pt100 4-wire  
 \*2: If signal input is Pt100 with option SA  
 \*3: Only available with option SA  
 \*4: Detailed explanation see page 5

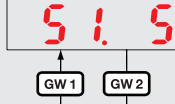
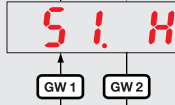
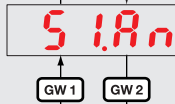
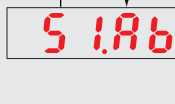
Parameter list alarm output 1

	<p><b>Switch-point alarm output 1</b>                  -19999...19999                  (see explanation page 5)</p>
	<p><b>Switching hysteresis</b>                  1...19999                  (see explanation page 5)</p>
	<p><b>On-delay in seconds</b>                  0...999.9</p>
	<p><b>Off-delay in seconds</b>                  0...999.9</p>

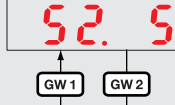
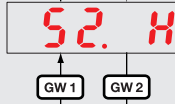
Parameter list alarm output 2

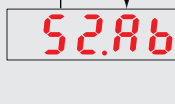
	<p><b>Switch-point alarm output 2</b>                  -19999...19999                  (see explanation page 5)</p>
	<p><b>Switching hysteresis</b>                  1...19999                  (see explanation page 5)</p>
	<p><b>On-delay in seconds</b>                  0...999.9</p>
	<p><b>Off-delay in seconds</b>                  0...999.9</p>

Error codes

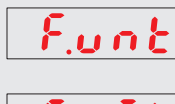
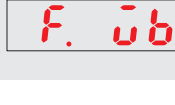
	<p><b>Range low underflow</b></p>
	<p><b>Range high overflow</b></p>



**Alarm output modes**

Basic function of integrated alarm outputs is pre selectable in the base settings (parameter S.bA). Function and mode of action of switching points S1.S and S2.S depends on selected mode. For further details of alarm outputs see below.

**Independent outputs | S.bA = 0**

Alarm outputs are not interacting. Switching point, hysteresis and on/off-delay may be set for each output separately. Selectable switching modes (S1.SF, S2.SF) are described in the diagram below.

Switch: (e.g. S1.tF = 0)

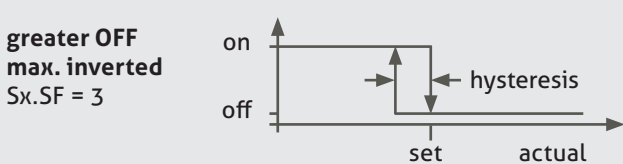
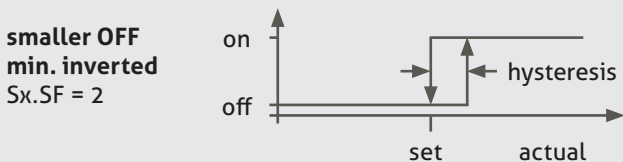
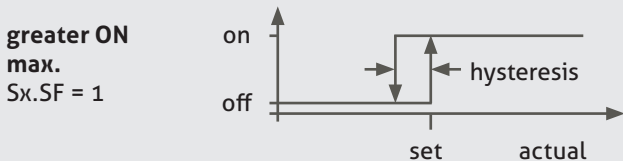
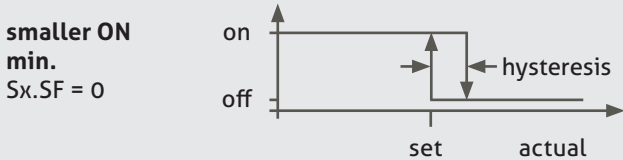

Push button: (e.g. S2.tF = 1), pulse time ca. 0.5 sec.

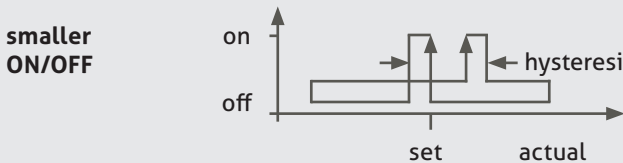
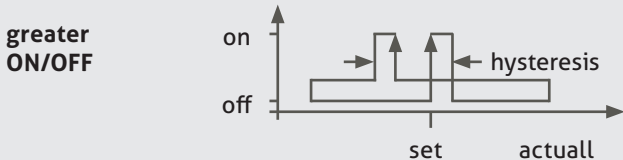

**Window function | S.bA = 1**

Alarm outputs are interacting in a window function. Switching mode and time function are fixed and not editable in the base settings.

- switching points 1 and 2 defines the switching range
- hysteresis is not editable
- on/off-delay is editable

Mode of action is described in the diagram below. Example: S1.S = 50, S2.S = 55

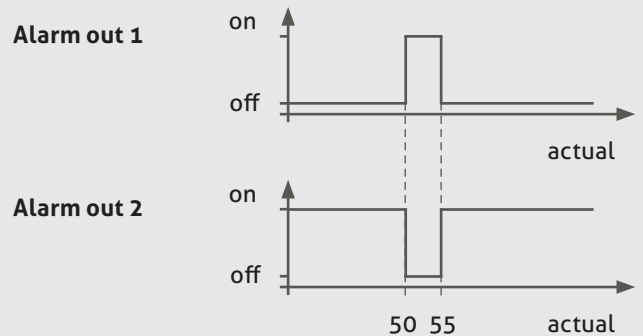

**3-step controller | S.bA = 2**

Alarm outputs are interacting like a 3-step controller (e.g. cooling and heating). Switching mode and time function are fixed and not editable in the base settings.

- switching point 1 defines set point
- switching point 2 defines control limits (range between cooling and heating)
- hysteresis is not editable
- on/off-delay is editable

Mode of action is described in the diagram below. Example: S1.S = 50, S2.S = 10

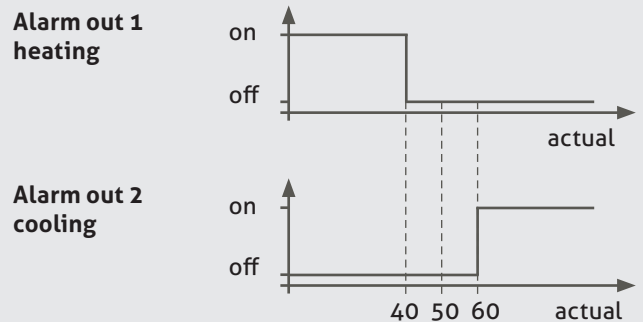

**Fig. 1:**  
Electrical connection | 2-wire transducer

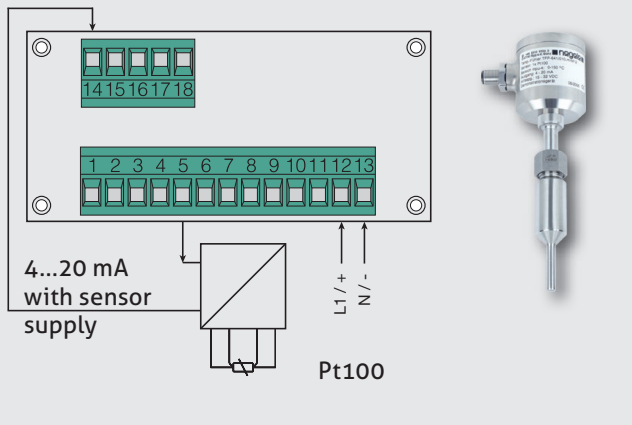

**Example 1: Temperature measurement with 2-wire transducer, e.g. TFP-58P with MPU-4**

Sensor will be supplied by the indicator, terminal clamp 5 (+20 V DC).

Adjustment for current input 4...20 mA = 0...100.0 °C

Menu	Adjustment	Explanation
SE. b	1	Signal input current
SE.An	4.00	Signal input low 4.00 mA
SE.En	20.00	Signal input high 20.00 mA
A. dP	1111.1	Decimal point
A. An	0.0	Display low 0.0 °C
A. En	100.0	Display high 100.0 °C

**Fig. 2:**  
Electrical connection | Pt100 4-wire

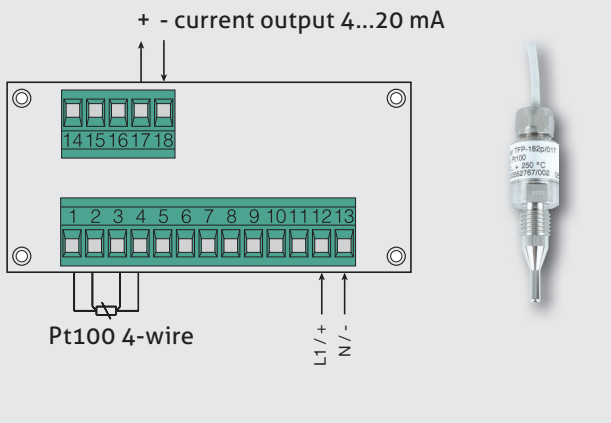

**Example 2: Temperature measurement with Pt100, e.g. TFP-182P**

Adjustment for input Pt100 and current output 4...20 mA = 0...100.0 °C

Menu	Adjustment	Explanation
SE. b	0	Signal input Pt100
A. An	0.0	Display low 0.0 °C
A. En	100.0	Display high 100.0 °C
SA.An	4.00	Current output low 4.00 mA
SA.En	20.00	Current output high 20.00 mA

**Fig. 3: Electrical connection | 0/4...20 mA**

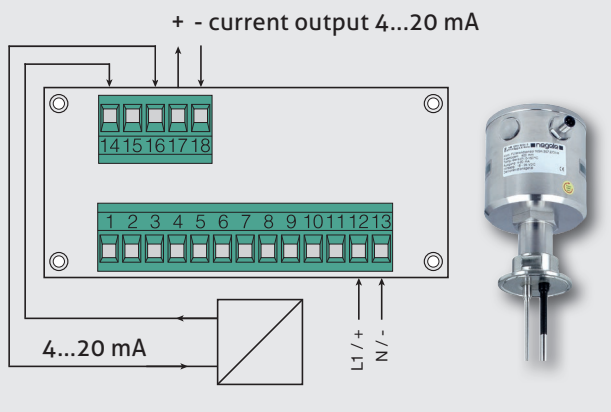

**Example 3: Level measurement in linear vessels, e.g. NSK-357.2**

Adjustment for current input 4...20 mA = 0...550.0 l

Menu	Adjustment	Explanation
SE. b	1	Signal input current
SE.An	4.00	Signal input low 4.00 mA
SE.En	20.00	Signal input high 20.00 mA
A. dP	1111.1	Decimal point
A. An	0.0	Display low 0.0 l
A. En	550.0	Display high 550.0 l
SA.An	4.00	Current output low 4.00 mA
SA.En	20.00	Current output high 20.00 mA

**Reference note regarding power supply/sensor supply**

Sensor supply (terminal 5) is designed for powering 2-wire transducers, e.g. TFP with MPU or pressure transmitters. If device requires 24 V DC, e.g. NSK, ILM or ITM, a separate power supply is needed.



**Specified usage**

- Indicating and transforming of process values like: current, voltage, temperature- or potentiometer signals

**Features**

- Completely programmable via key pad
- Free scalable display range
- Integrated sensor supply (GS version)
- Unit symbol changeable (illuminated)
- Housing also available as 96 mm x 96 mm
- Alarm modul: 2 or 4 alarm relays available (option)
- Analog output: (0/4...20 mA, 0...10 V DC) (option)

**DPM | Universal indicator 4-digit****Specified usage**

- Selectable input types: pulse counter, frequency counter, revolution counter, timer or distance meter with rotation encoder

**Features**

- Completely programmable via key pad
- Display range and counter settings free programmable
- Sum or difference counting by means of two inputs
- Hold and reset function, min and max drag indicator
- Two alarm relays
- Unit symbol changeable
- Analog output 0/4...20 mA (option)

**PEZ | Universal counter****Specified usage**

- Accurate vessel content measurement, also for pressurized vessels by means of difference pressure measurement.

**Features**

- Completely programmable via key pad
- 2 inputs 0/4...20 mA e.g.. for pressure transmitter
- Linearization for 6 standard vessels preprogrammed
- Linearization of special vessel dimensions by means of up to 25
- Basic values (volume or high percent)
- Input for additional level sensor for zero correction
- Unit symbol changeable
- Analog output 0/4...20 mA (option)

**PEM-DD | Vessel level indicator****Specified usage**

- On-site indicating of process value

**Features**

- No power supply needed, operating in 4...20 mA current loop
- Less wiring
- Sturdy and industrial proofed stainless steel housing, IP 69 K
- Display range and decimal point free programmable
- Ambient temperature up to 70 °C
- Version with 2-wire transducer for Pt100 available

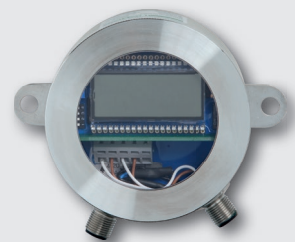
**DOH-VA | Indicator without supply**

Order code			
PEM-UC	(W x H: 96 x 48 mm)		
	<b>Analog output</b>		
	X	(without analog output)	
	SA	(with analog output 0/4...20 mA)	
		<b>Display range</b>	
	X	(free adjustable between -1999...9999)	
	xxx...yyy	(factory-made adjustment according to specification)	
		<b>Units</b>	
		°C, °F, %, m <sup>3</sup> , l/min, mA, bar, others on request	
PEM-UC /	SA /	10...30 /	bar

**Transport/storage**



- Use suitable transport packaging only to avoid damage of the equipment!
- No outdoor storage
- Store dry and dust free
- Not exposed to corrosive media
- Protect against solar radiation
- Avoiding mechanical shock and vibration
- Storage temperature -20...70 °C
- Relative humidity maximum 95 %

**Disposal**



- This instrument is not subject to the WEEE directive 2002/96/ EG and the respective national laws.
- Pass the device directly on to a specialised recycling company and do not use the municipal collecting points.