

MAX98361

Tiny, Cost-Effective, Plug-and-Play Digital Class-D Amplifier

General Description

The MAX98361A/B/C/D is an easy-to-use, low-cost, digital pulse-code modulation (PCM) input Class-D amplifier that provides industry-leading, Class-AB audio performance with Class-D efficiency. The digital audio interface automatically recognizes different PCM and TDM clocking schemes which eliminates the need for I²C programming. Simply supply power, LRCLK, BCLK, and digital audio to generate audio. Furthermore, a novel pinout allows customers to use the cost-effective WLP package with no need for expensive vias.

The digital audio interface is highly flexible. The devices support I²S, left-justified, and 8-channel time division multiplexed (TDM) data formats. The digital audio interface accepts 8kHz, 16kHz, 32kHz, 44.1kHz, 48kHz, 88.2kHz, and 96kHz sample rates. Data words can be 16-bit, 24-bit, or 32-bit in I²S and left-justified modes and 16-bit or 32-bit in TDM mode.

Digital audio interface input thresholds are ideal for interfacing to 1.2V and 1.8V logic. The devices can tolerate logic input voltages up to 5.5V.

The MAX98361A and MAX98361B have fast 1ms turn-on times while the MAX98361C and MAX98361D ramp the volume over 13ms during turn-on and turn-off.

The devices eliminate the need for the external MCLK signal that is typically used for PCM communication. This reduces EMI and possible board coupling issues in addition to reducing the size and pin count. The devices also feature a very high wideband jitter tolerance (12ns, typ) on BCLK and LRCLK to provide robust operation.

Active emissions-limiting, edge-rate limiting, and overshoot control circuitry greatly reduce EMI. A filterless spread-spectrum modulation scheme eliminates the need for output filtering found in traditional Class-D devices and reduces the component count of the solution.

The devices are specified over the -40°C to +85°C temperature range.

Applications

- Single Li-ion Cell/5V Devices
- Smart Speakers
- Notebook Computers
- IoT Devices
- Gaming Devices (Audio and Haptics)
- Smartphones
- Tablets
- Cameras

Benefits and Features

- Simple Plug-and-Play Design
- Single-Supply Operation (2.5V to 5.5V)
- 3.2W Output Power into 4Ω at 5V
- 2.2mA Quiescent Current
- 1ms Turn-On Time (for MAX98361A and MAX98361B)
- 92% Efficiency ($R_L = 8\Omega$, THD+N = 10%)
- 10μV_{RMS} Output Noise
- 110dB Dynamic Range
- Low 0.009% THD+N at 1kHz
- No MCLK Required
- Sample Rates of 8kHz to 96kHz
- Supports Left, Right, or (Left/2 + Right/2) Output in I²S and Left-Justified Modes
- Sophisticated Edge Rate Control Enables Filterless Class-D Outputs
- 81dB PSRR at 217Hz
- 1.5μA Standby Current Allows Elimination of GPIO for EN Pin
- Low RF Susceptibility Rejects TDMA Noise from GSM Radios
- Class-D Switching Frequency Trimmed to 5% for Better EMI Planning
- Extensive Click-and-Pop Reduction Circuitry
- Robust Short-Circuit and Thermal Protection
- Available in Space-Saving Package: 9-Pin WLP (0.4mm Pitch)
- 3.69mm² Solution Size for WLP With A Single Bypass Capacitor

Simplified Block Diagram

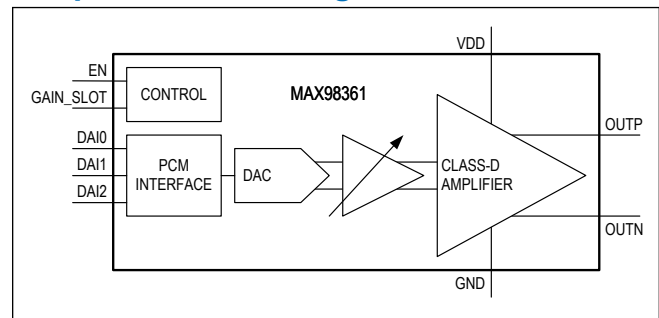

TABLE OF CONTENTS

| | |
|--|----|
| General Description | 1 |
| Applications | 1 |
| Benefits and Features | 1 |
| Simplified Block Diagram | 1 |
| Absolute Maximum Ratings | 6 |
| Package Information | 6 |
| WLP | 6 |
| Electrical Characteristics | 7 |
| Typical Operating Characteristics | 12 |
| Pin Configuration | 19 |
| 9 WLP | 19 |
| Pin Description | 19 |
| Functional Diagram | 20 |
| Detailed Description | 21 |
| EN and Shutdown Mode | 21 |
| Standby Mode | 21 |
| GAIN_SLOT Pin | 22 |
| Digital Audio Interface (DAI) Configuration (Patent Pending) | 23 |
| Valid Clock Frequencies | 24 |
| MCLK Elimination | 24 |
| BCLK Jitter Tolerance | 24 |
| BCLK Polarity | 25 |
| LRCLK Polarity in I ² S/Left-Justified Mode | 25 |
| I ² S and Left-Justified Mode | 25 |
| TDM Mode | 28 |
| Gain Selection | 31 |
| DC Blocking Filter | 31 |
| DAC Digital Filters | 31 |
| Class-D Amplifier | 31 |
| Class-D Output Short-Circuit Protection | 31 |
| Turn-On and Turn-Off Volume Ramping | 32 |
| Click-and-Pop Suppression | 32 |
| Ultra-Low EMI Filterless Output Stage | 32 |
| Applications Information | 33 |
| Filterless Class-D Operation | 33 |
| Power Supply Input | 33 |
| Layout and Grounding | 33 |
| WLP GAIN_SLOT Routing | 35 |
| Typical Application Circuits | 37 |

TABLE OF CONTENTS (CONTINUED)

| | |
|--|----|
| I ² S/Left-Justified Left-Channel Operation with 6dB Gain | 37 |
| I ² S/Left-Justified Left-Channel Operation with 12dB Gain | 37 |
| I ² S/Left-Justified Left-Channel Operation with 3dB Gain | 38 |
| I ² S/Left-Justified Right-Channel Operation with 6dB Gain | 38 |
| I ² S/Left-Justified Left/2 + Right/2 Operation with 6dB Gain | 39 |
| I ² S/Left-Justified Stereo Operation with 6dB Gain | 40 |
| TDM Operation (Gain Fixed at 12dB). | 41 |
| Ordering Information | 42 |
| Revision History | 43 |

LIST OF FIGURES

| | |
|--|----|
| Figure 1. GAIN_SLOT Internal Resistors | 22 |
| Figure 2. DAI Connections | 23 |
| Figure 3. MAX98361A and MAX98361C I ² S Protocol, 16-Bit Resolution. | 26 |
| Figure 4. MAX98361A and MAX98361C I ² S Protocol, 32-Bit Resolution. | 26 |
| Figure 5. MAX98361B and MAX98361D Left-Justified Protocol, 16-Bit Resolution | 27 |
| Figure 6. MAX98361B and MAX98361D Left-Justified Protocol, 32-Bit Resolution | 27 |
| Figure 7. I ² S Timing Diagram (MAX98361A and MAX98361C) | 28 |
| Figure 8. Left-Justified Timing Diagram (MAX98361B and MAX98361D) | 28 |
| Figure 9. MAX98361A and MAX98361C TDM Protocol, 16-Bit Resolution | 29 |
| Figure 10. MAX98361A and MAX98361C TDM Protocol, 32-Bit Resolution | 29 |
| Figure 11. MAX98361B and MAX98361D TDM Protocol, 16-Bit Resolution | 30 |
| Figure 12. MAX98361B and MAX98361D TDM Protocol, 32-Bit Resolution | 30 |
| Figure 13. TDM Timing Diagrams—BCLK Rising Edge (MAX98361A/C) and BCLK Falling Edge (MAX98361B/D) . . . | 31 |
| Figure 14. Solution Size | 34 |
| Figure 15. GAIN_SLOT Tied to V _{DD} (Gain is 6dB in I ² S and Left-Justified Modes). | 35 |
| Figure 16. GAIN_SLOT Unconnected (Gain is 9dB in I ² S and Left-Justified Modes). | 35 |
| Figure 17. GAIN_SLOT Tied to GND (Gain is 12dB in I ² S and Left-Justified Modes) | 36 |

LIST OF TABLES

| | |
|---|----|
| Table 1. MAX98361 Versions | 21 |
| Table 2. DAI Configurations | 23 |
| Table 3. Valid Resolutions and Frame Widths | 24 |
| Table 4. Valid BCLK Frequencies (kHz) | 24 |
| Table 5. BCLK Polarity | 25 |
| Table 6. LRCLK Polarity in I ² S/Left-Justified Mode | 25 |
| Table 7. Channel Selection in I ² S and Left-Justified Modes | 25 |
| Table 8. TDM Mode Channel Selection | 28 |
| Table 9. Gain Selection | 31 |

Absolute Maximum Ratings

| | | | |
|--|---------------------------------|--|-----------------|
| V _{DD} , DAI0, DAI1, and DAI2 to GND..... | -0.3V to +6V | Continuous power dissipation (T _A = +70°C) WLP (derate 13.7mW/°C above +70°C) | 1096mW |
| All other pins to GND | -0.3V to V _{DD} + 0.3V | Junction temperature | +150°C |
| Duration of OUTP or OUTN short circuit to GND or V _{DD} | Continuous | Operating temperature range..... | -40°C to +85°C |
| Duration of OUTP short to OUTN..... | Continuous | Storage temperature range..... | -65°C to +150°C |
| | | Soldering temperature (reflow) | +260°C |

Stresses beyond those listed under "Absolute Maximum Ratings" may cause permanent damage to the device. These are stress ratings only, and functional operation of the device at these or any other conditions beyond those indicated in the operational sections of the specifications is not implied. Exposure to absolute maximum rating conditions for extended periods may affect device reliability.

Package Information

WLP

| | |
|--|--|
| Package Code | W91F1+2 |
| Outline Number | 21-100634 |
| Land Pattern Number | Refer to Application Note 1891 |
| Thermal Resistance, Four-Layer Board: | |
| Junction to Ambient (θ _{JA}) | 73°C/W |
| Junction to Case (θ _{JC}) | N/A |

For the latest package outline information and land patterns (footprints), go to www.maximintegrated.com/packages. Note that a "+", "#", or "." in the package code indicates RoHS status only. Package drawings may show a different suffix character, but the drawing pertains to the package regardless of RoHS status.

Package thermal resistances were obtained using the method described in JEDEC specification JESD51-7, using a four-layer board. For detailed information on package thermal considerations, refer to www.maximintegrated.com/thermal-tutorial.

Electrical Characteristics

($V_{DD} = 5V$, $V_{GND} = 0V$, gain = 12dB, $f_{BCLK} = 3.072MHz$, $f_{LRCLK} = 48kHz$, $Z_{SPK} = \infty$ between OUTP and OUTN, AC Measurement Bandwidth = 20Hz to 20kHz, $T_A = T_{MIN}$ to T_{MAX} , typical values are at $T_A = +25^\circ C$) (Note 1)

| PARAMETER | SYMBOL | CONDITIONS | MIN | TYP | MAX | UNITS |
|--------------------------------------|--------------|---|------|-----------|------|------------|
| SYSTEM | | | | | | |
| Supply Voltage Range | V_{DD} | Guaranteed by PSRR test | 2.5 | | 5.5 | V |
| Undervoltage Lockout | V_{UVLO} | | 1.5 | 1.8 | 2.3 | V |
| Quiescent Current | I_{VDD} | $T_A = +25^\circ C$ | | 2.4 | 3.35 | mA |
| | | $T_A = +25^\circ C$, $V_{DD} = 3.7V$ | | 2.2 | 2.85 | |
| Shutdown Current | I_{SHDN} | EN = 0V, $T_A = +25^\circ C$ | | 0.014 | 0.5 | μA |
| Standby Current | I_{STNDBY} | EN = 1.8V, $T_A = +25^\circ C$, all DAI _n pins at 0V | | 1.5 | 3 | μA |
| | | EN = 1.8V, $T_A = +25^\circ C$, no toggling on DAI _n pins | | | 49 | |
| Turn-On Time | t_{ON} | Time from shutdown or standby to full gain audio out, MAX98361A and MAX98361B | | 1 | 1.2 | ms |
| | | Time from shutdown or standby to full gain audio out, MAX98361A and MAX98361B, $f_S = 8kHz$ | | 1.8 | | |
| | | Time from shutdown or standby to full gain audio out, MAX98361C and MAX98361D | | | | |
| Thermal Shutdown Temperature | | | | 150 | | $^\circ C$ |
| Thermal Shutdown Recovery Hysteresis | | | | 18 | | $^\circ C$ |
| CLASS-D AMPLIFIER | | | | | | |
| Output Offset Voltage | V_{OS} | $T_A = +25^\circ C$ | -2.5 | ± 0.3 | +2.5 | mV |
| Click-and-Pop Level | K_{CP} | Peak voltage, A-weighted, 32 samples per second, digital silence used for input signal, $Z_{SPK} = 8\Omega + 33\mu H$ or $4\Omega + 33\mu H$, into Standby or Shutdown | | -72 | | dBV |
| | | Peak voltage, A-weighted, 32 samples per second, digital silence used for input signal, $Z_{SPK} = 8\Omega + 33\mu H$ or $4\Omega + 33\mu H$, out of Standby or Shutdown | | -66 | | |
| Power-Supply Rejection Ratio | PSRR | $T_A = +25^\circ C$, digital silence used for input signal, $Z_{SPK} = \infty$, DC, $V_{DD} = 2.5V$ to 5.5V | 66 | 81 | | dB |
| | | $T_A = +25^\circ C$, digital silence used for input signal, $Z_{SPK} = 8\Omega + 33\mu H$ or $4\Omega + 33\mu H$, $f = 217Hz$, 200mV _{PP} ripple | | 81 | | |
| | | $T_A = +25^\circ C$, digital silence used for input signal, $Z_{SPK} = 8\Omega + 33\mu H$ or $4\Omega + 33\mu H$, $f = 1kHz$, 200mV _{PP} ripple | | 81 | | |
| | | $T_A = +25^\circ C$, digital silence used for input signal, $Z_{SPK} = 8\Omega + 33\mu H$ or $4\Omega + 33\mu H$, $f = 10kHz$, 200mV _{PP} ripple | | 73 | | |

Electrical Characteristics (continued)

($V_{DD} = 5V$, $V_{GND} = 0V$, gain = 12dB, $f_{BCLK} = 3.072MHz$, $f_{LRCLK} = 48kHz$, $Z_{SPK} = \infty$ between OUTP and OUTN, AC Measurement Bandwidth = 20Hz to 20kHz, $T_A = T_{MIN}$ to T_{MAX} , typical values are at $T_A = +25^\circ C$) (Note 1)

| PARAMETER | SYMBOL | CONDITIONS | MIN | TYP | MAX | UNITS |
|---|-----------|---|------|----------|------|---------------|
| Output Power | P_{OUT} | THD+N \leq 10%, $Z_{SPK} = 4\Omega + 33\mu H$ | | 3.2 | | W |
| | | THD+N \leq 10%, $Z_{SPK} = 8\Omega + 33\mu H$ | | 1.8 | | |
| | | THD+N \leq 10%, $Z_{SPK} = 8\Omega + 33\mu H$, $V_{DD} = 3.7V$ | | 0.93 | | |
| | | THD+N \leq 1%, $Z_{SPK} = 4\Omega + 33\mu H$ | | 2.5 | | |
| | | THD+N \leq 1%, $Z_{SPK} = 8\Omega + 33\mu H$ | | 1.4 | | |
| | | THD+N \leq 1%, $Z_{SPK} = 8\Omega + 33\mu H$, $V_{DD} = 3.7V$ | | 0.77 | | |
| Total Harmonic Distortion + Noise | THD+N | f = 1kHz, $P_{OUT} = 1W$, $T_A = +25^\circ C$, $Z_{SPK} = 4\Omega + 33\mu H$ | | 0.01 | | % |
| | | f = 1kHz, $P_{OUT} = 0.7W$, $T_A = +25^\circ C$, $Z_{SPK} = 8\Omega + 33\mu H$ (Note 3) | | 0.009 | 0.02 | |
| Dynamic Range | DR | A-weighted, $Z_{SPK} = 8\Omega + 33\mu H$, -60dB 1kHz output signal, normalized to full scale (THD+N = 1%), 24- or 32-bit data | | 110 | | dB |
| Output Noise | e_{Nd} | A-weighted, 24-bit or 32-bit data | | 10 | | μV_{RMS} |
| Gain (Relative to a 2.3dBV Reference Level) | A_V | I ² S or left-justified mode with GAIN_SLOT = GND, or TDM mode | 11.4 | 12 | 12.6 | dB |
| | | I ² S or left-justified mode, GAIN_SLOT = unconnected | 8.4 | 9 | 9.6 | |
| | | I ² S or left-justified mode, GAIN_SLOT = V_{DD} | 5.4 | 6 | 6.6 | |
| | | I ² S or left-justified mode, GAIN_SLOT = V_{DD} through 100k Ω | 2.4 | 3 | 3.6 | |
| | | I ² S or left-justified mode, GAIN_SLOT = GND through 100k Ω | -3.6 | -3 | -2.4 | |
| Output Current Limit | I_{LIM} | | | 2.6 | | A |
| Output Current Limit Autorestart Time | | | | 100 | | μs |
| Efficiency | η | $Z_{SPK} = 8\Omega + 33\mu H$, THD+N = 10%, f = 1kHz | | 92 | | % |
| Frequency Response | | | -0.2 | | +0.3 | dB |
| Class-D Switching Frequency | f_{SW} | $V_{DD} = 3.0V$ to $5.5V$ | 285 | 300 | 315 | kHz |
| Spread-Spectrum Bandwidth | f_{SSM} | $V_{DD} = 2.5V$ to $5.5V$ | | ± 14 | | kHz |
| Output Stage On-Resistance | R_{ON} | PMOS + NMOS (Full H-Bridge), $T_A = +25^\circ C$ | | 285 | | m Ω |
| Maximum Device to Device Phase Error | | Output phase shift between multiple devices from 20Hz to 20kHz across all sample rates and DAI operating modes | | 1 | | deg |

Electrical Characteristics (continued)

($V_{DD} = 5V$, $V_{GND} = 0V$, gain = 12dB, $f_{BCLK} = 3.072MHz$, $f_{LRCLK} = 48kHz$, $Z_{SPK} = \infty$ between OOUTP and OOUTN, AC Measurement Bandwidth = 20Hz to 20kHz, $T_A = T_{MIN}$ to T_{MAX} , typical values are at $T_A = +25^\circ C$) (Note 1)

| PARAMETER | SYMBOL | CONDITIONS | MIN | TYP | MAX | UNITS |
|--|-------------|---|---------------|-----|---------------|-------|
| DAC DIGITAL FILTERS/VOICE MODE IIR LOWPASS FILTER (LRCLK < 30kHz) | | | | | | |
| Passband | f_{PLP} | Ripple < δ_P | 0.443 x f_S | | | Hz |
| | | Droop < 3dB | 0.446 x f_S | | | |
| Passband Ripple | δ_P | $f < f_{PLP}$, referenced to signal level at 1kHz | -0.1 | | +0.1 | dB |
| Stopband | f_{SLP} | Attenuation > δ_S | | | 0.464 x f_S | Hz |
| Stopband Attenuation | δ_S | $f > f_{SLP}$ | 75 | | | dB |
| DAC DIGITAL FILTERS/AUDIO MODE FIR LOWPASS FILTER (30kHz < LRCLK < 50kHz) | | | | | | |
| Passband | f_{PLP} | Ripple < δ_P | 0.43 x f_S | | | Hz |
| | | Droop < 3dB | 0.47 x f_S | | | |
| | | Droop < 6.02dB | 0.5 x f_S | | | |
| Passband Ripple | δ_P | $f < f_{PLP}$, referenced to signal level at 1kHz | -0.1 | | +0.1 | dB |
| Stopband | f_{SLP} | Attenuation > δ_S | | | 0.58 x f_S | Hz |
| Stopband Attenuation | δ_S | $f > f_{SLP}$ | 60 | | | dB |
| DAC DIGITAL FILTERS/AUDIO MODE FIR LOWPASS FILTER (LRCLK > 50kHz) | | | | | | |
| Passband | f_{PLP} | Ripple < δ_P | 0.24 x f_S | | | Hz |
| | | Droop < 3dB | 0.31 x f_S | | | |
| Passband Ripple | δ_P | $f < f_{PLP}$, referenced to signal level at 1kHz | -0.1 | | +0.1 | dB |
| Stopband | f_{SLP} | Attenuation > δ_S | | | 0.477 x f_S | Hz |
| Stopband Attenuation | δ_S | $f < f_{SLP}$ | 60 | | | dB |
| DAC DIGITAL FILTERS/DIGITAL DC BLOCKING FILTER | | | | | | |
| DC Blocking Filter -3dB Cutoff Frequency | f_C | $f_S = 96kHz$ | 3.75 | | | Hz |
| | | $f_S = 48kHz$ | 3.75 | | | |
| | | $f_S = 44.1kHz$ | 3.47 | | | |
| | | $f_S = 8kHz$ | 0.65 | | | |
| DIGITAL I/O | | | | | | |
| Minimum LRCLK Frequency | f_{LRMIN} | Minimum LRCLK frequency for DAI Configuration and unmuting (Note 2) | 6.44 | 6.8 | 7.12 | kHz |
| Maximum LRCLK Frequency | f_{LRMAX} | Maximum LRCLK frequency for DAI Configuration and unmuting (Note 2) | 110 | 116 | 125 | kHz |
| LRCLK Range 1 | f_{S1} | (Note 2) | 7.6 | 8 | 8.4 | kHz |
| LRCLK Range 2 | f_{S2} | (Note 2) | 15.2 | 16 | 16.8 | kHz |
| LRCLK Range 3 | f_{S3} | (Note 2) | 30.4 | 48 | 50.4 | kHz |
| LRCLK Range 4 | f_{S4} | (Note 2) | 83.8 | 96 | 100.8 | kHz |

Electrical Characteristics (continued)

($V_{DD} = 5V$, $V_{GND} = 0V$, gain = 12dB, $f_{BCLK} = 3.072MHz$, $f_{LRCLK} = 48kHz$, $Z_{SPK} = \infty$ between OOUTP and OOUTN, AC Measurement Bandwidth = 20Hz to 20kHz, $T_A = T_{MIN}$ to T_{MAX} , typical values are at $T_A = +25^\circ C$) (Note 1)

| PARAMETER | SYMBOL | CONDITIONS | MIN | TYP | MAX | UNITS |
|--|------------------|--|------------------|-----|--------|---------|
| BCLK Periods per LRCLK Period Range 1 | BL_CLK1 | (Note 2) | 29 | 32 | 36 | none |
| BCLK Periods per LRCLK Period Range 2 | BL_CLK2 | (Note 2) | 41 | 48 | 56 | none |
| BCLK Periods per LRCLK Period Range 3 | BL_CLK3 | (Note 2) | 57 | 64 | 72 | none |
| BCLK Periods per LRCLK Period Range 4 | BL_CLK4 | (Note 2) | 113 | 128 | 144 | none |
| BCLK Periods per LRCLK Period Range 5 | BL_CLK5 | (Note 2) | 225 | 256 | 288 | none |
| Resolution | | I ² S/left-justified mode | 16/24/32 | | | Bits |
| | | TDM mode | 16/32 | | | |
| BCLK Frequency Range | f_{BCLK} | BCLK frequency required for DAI Configuration and unmuting (Note 2) | 0.2432 | | 25.804 | MHz |
| BCLK High Time | t_{BCLKH} | | 15 | | | ns |
| BCLK Low Time | t_{BCLKL} | | 15 | | | ns |
| Maximum Low Frequency BCLK and LRCLK Jitter | | Maximum allowable jitter before a -20dBFS, 20kHz input has a 1dB reduction in THD+N, RMS jitter \leq 40kHz | | 0.5 | | ns |
| Maximum High Frequency BCLK and LRCLK Jitter | | Maximum allowable jitter before the dynamic range has a 1dB reduction, RMS jitter > 40kHz | | 12 | | ns |
| Input High Voltage | V_{IH} | DAI0, DAI1, DAI2 | 0.84 | | | V |
| | | EN | 1.0 | | | |
| Input Low Voltage | V_{IL} | DAI0, DAI1, DAI2 | 0.54 | | | V |
| | | EN | 0.24 | | | |
| Input Hysteresis | V_{HYS} | DAI0, DAI1, DAI2 (Note 3) | 75 | | | mV |
| | | EN | 25 | | | |
| Input Leakage Current | I_{IH}, I_{IL} | $V_{IN} = 0V, V_{DD} = 5.5V, T_A = +25^\circ C$ | DAI0, DAI1, DAI2 | -1 | +4 | μA |
| | | | EN | -1 | +1 | |
| Input Capacitance | C_{IN} | | | 3 | | pF |
| DIN to BCLK Setup Time | t_{SETUP} | | 10 | | | ns |
| LRCLK to BCLK Setup Time | $t_{SYNCSET}$ | | 10 | | | ns |
| DIN to BCLK Hold Time | t_{HOLD} | | 10 | | | ns |
| LRCLK to BCLK Hold Time | $t_{SYNHOLD}$ | | 10 | | | ns |

Electrical Characteristics (continued)

($V_{DD} = 5V$, $V_{GND} = 0V$, gain = 12dB, $f_{BCLK} = 3.072MHz$, $f_{LRCLK} = 48kHz$, $Z_{SPK} = \infty$ between OOUTP and OOUTN, AC Measurement Bandwidth = 20Hz to 20kHz, $T_A = T_{MIN}$ to T_{MAX} , typical values are at $T_A = +25^\circ C$) (Note 1)

| PARAMETER | SYMBOL | CONDITIONS | MIN | TYP | MAX | UNITS |
|---|-------------------|--|----------------------|-----|----------------------|-------|
| GAIN_SLOT COMPARATOR TRIP POINTS | | | | | | |
| GAIN_SLOT Comparator Trip Points | V_{GAIN_SLOT4} | $A_V = 6dB$ gain in I ² S and left-justified modes, channel 1, 3, or 7 in TDM mode | $0.9 \times V_{DD}$ | | V_{DD} | V |
| | V_{GAIN_SLOT3} | $A_V = 3dB$ gain in I ² S and left-justified modes | $0.65 \times V_{DD}$ | | $0.85 \times V_{DD}$ | |
| | V_{GAIN_SLOT2} | $A_V = 9dB$ gain in I ² S and left-justified modes, channel 2 or 6 in TDM mode | $0.4 \times V_{DD}$ | | $0.6 \times V_{DD}$ | |
| | V_{GAIN_SLOT1} | $A_V = -3dB$ gain in I ² S and left-justified modes | $0.15 \times V_{DD}$ | | $0.35 \times V_{DD}$ | |
| | V_{GAIN_SLOT0} | $A_V = 12dB$ gain in I ² S and left-justified modes, channel 0, 4, or 5 in TDM mode | 0 | | $0.1 \times V_{DD}$ | |

Note 1: Limits are 100% tested at $T_A = +25^\circ C$. Limits over the operating temperature range and relevant supply voltage range are guaranteed by design and characterization.

Note 2: See the Digital Audio Interface Configuration and [Valid Clock Frequencies](#) sections for more information.

Note 3: Minimum and/or maximum limit is guaranteed by design and by statistical analysis of device characterization data. The specification is not guaranteed by production testing.

Typical Operating Characteristics

($V_{DD} = 5V$, $V_{GND} = 0V$, Gain = 12dB, $f_{BCLK} = 3.072MHz$, $f_{LRCLK} = 48kHz$, $Z_{SPK} = \infty$ between OUTP and OUTN, AC Measurement Bandwidth = 20Hz to 20kHz, $T_A = +25^\circ C$.)

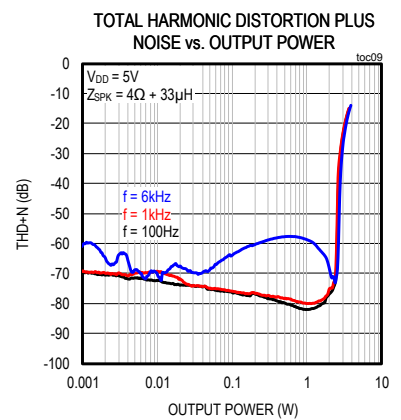
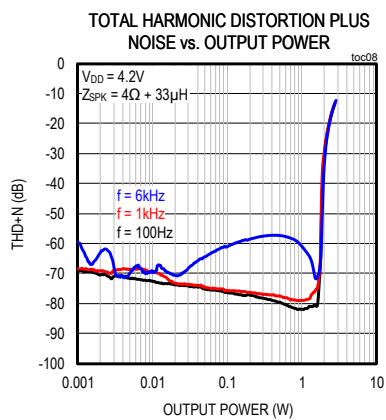
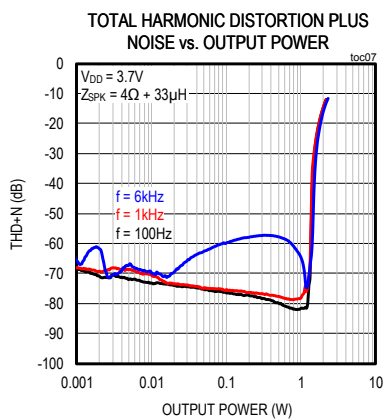
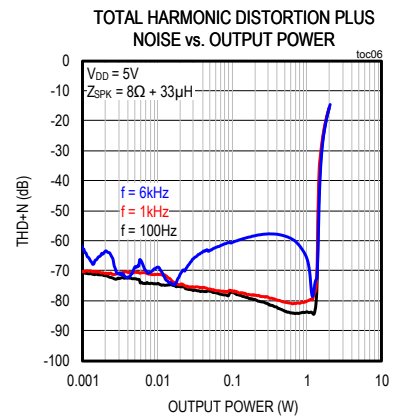
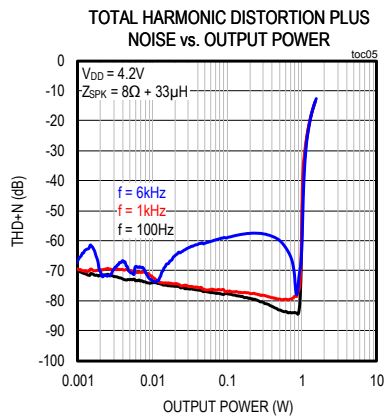
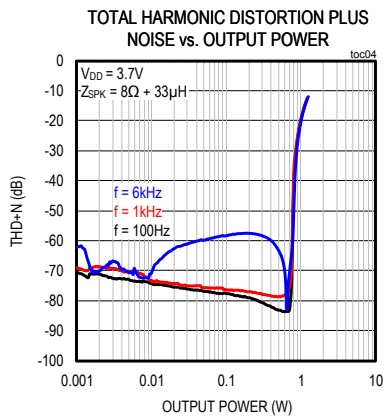
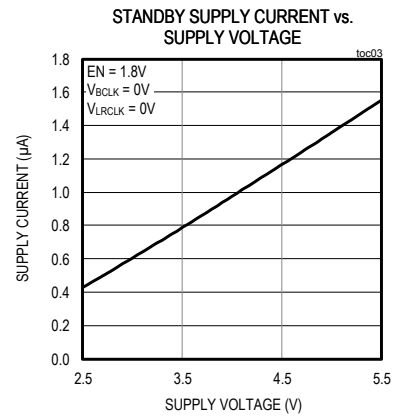
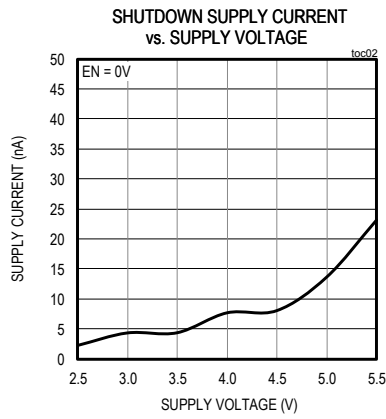
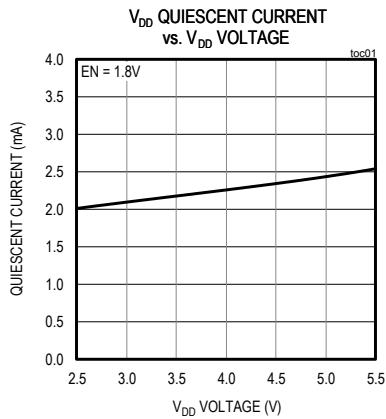

Typical Operating Characteristics (continued)

($V_{DD} = 5V$, $V_{GND} = 0V$, Gain = 12dB, $f_{BCLK} = 3.072MHz$, $f_{LRCLK} = 48kHz$, $Z_{SPK} = \infty$ between OUTP and OUTN, AC Measurement Bandwidth = 20Hz to 20kHz, $T_A = +25^{\circ}C$.)

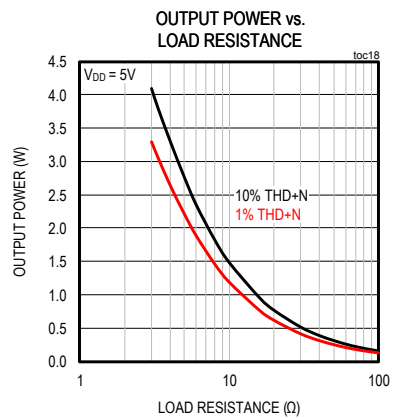
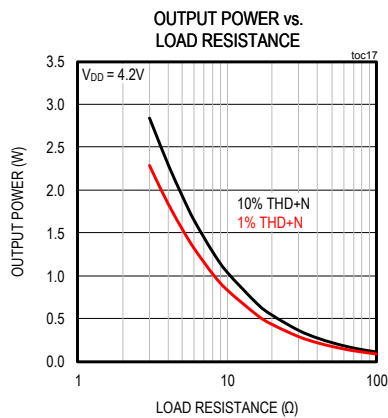
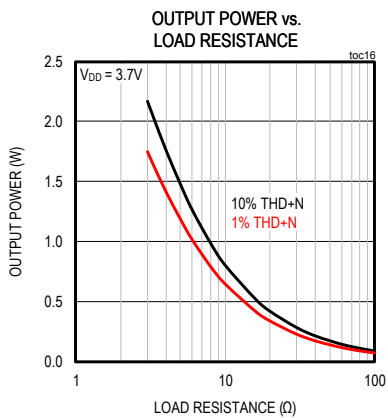
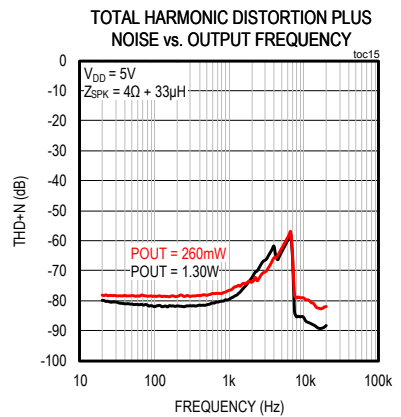
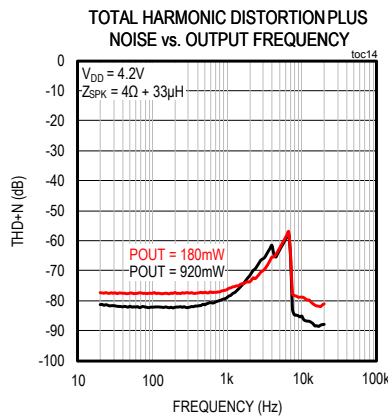
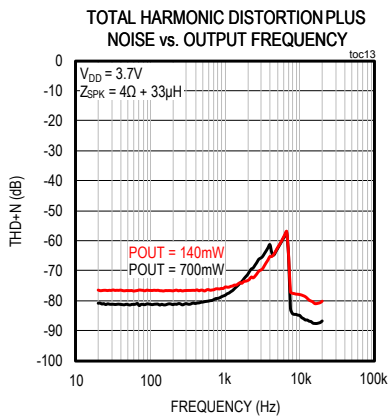
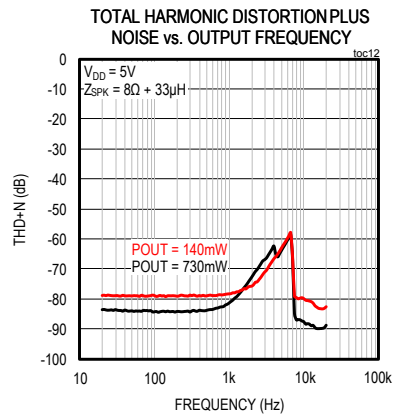
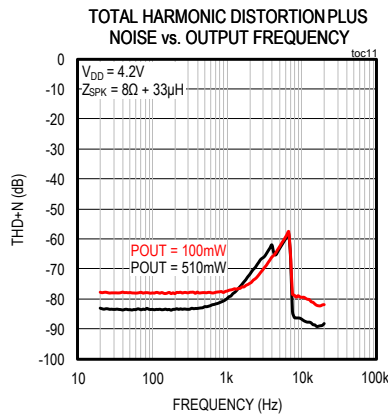
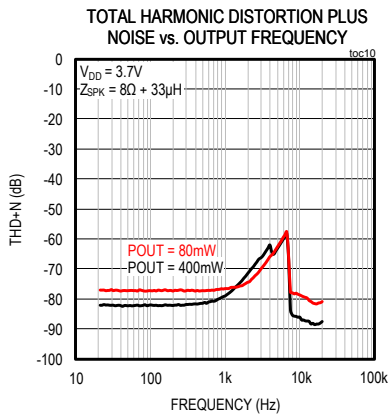

Typical Operating Characteristics (continued)

($V_{DD} = 5V$, $V_{GND} = 0V$, Gain = 12dB, $f_{BCLK} = 3.072MHz$, $f_{LRCLK} = 48kHz$, $Z_{SPK} = \infty$ between OUTP and OUTN, AC Measurement Bandwidth = 20Hz to 20kHz, $T_A = +25^\circ C$.)

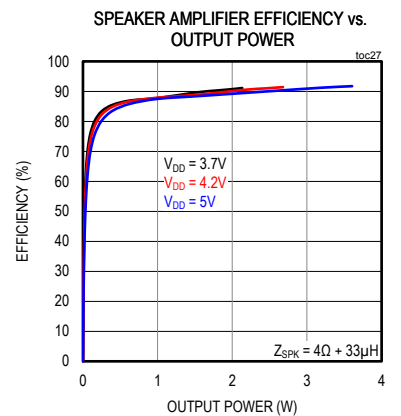
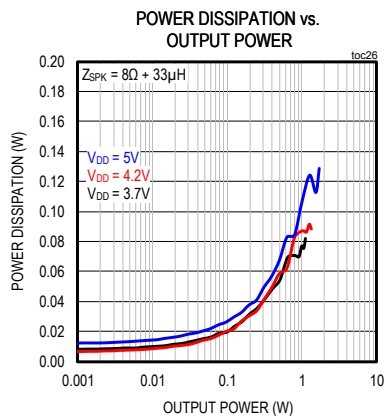
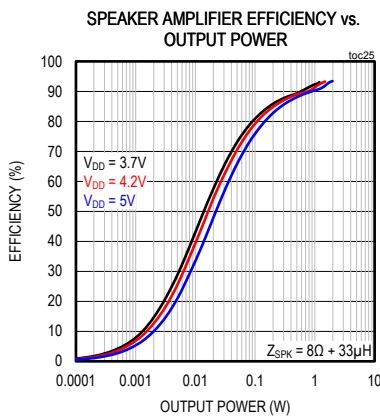
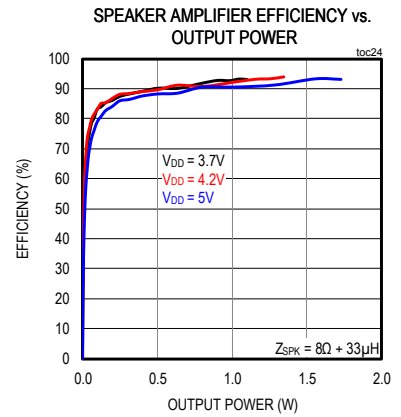
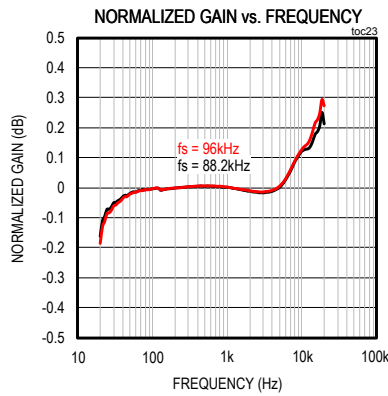
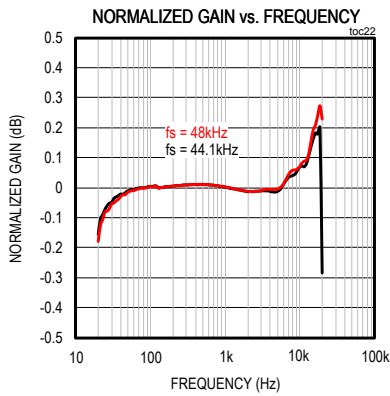
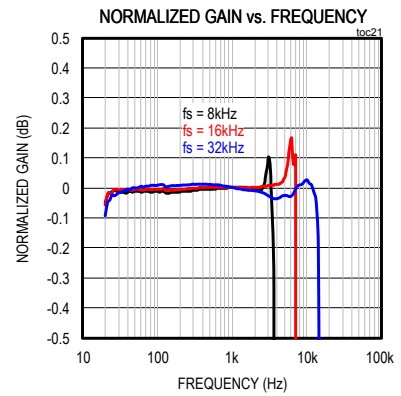
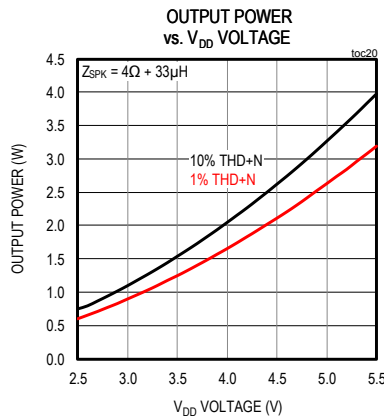
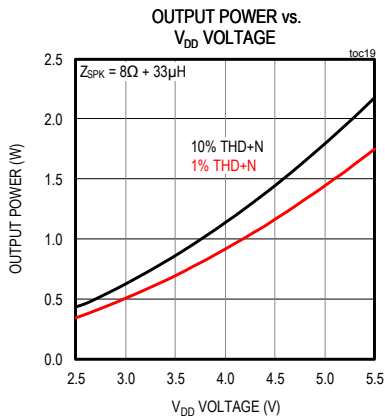

Typical Operating Characteristics (continued)

($V_{DD} = 5V$, $V_{GND} = 0V$, Gain = 12dB, $f_{BCLK} = 3.072MHz$, $f_{LRCLK} = 48kHz$, $Z_{SPK} = \infty$ between OUTP and OUTN, AC Measurement Bandwidth = 20Hz to 20kHz, $T_A = +25^{\circ}C$.)

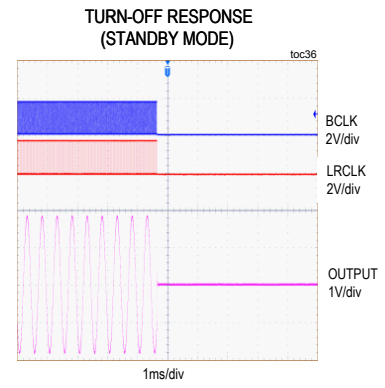
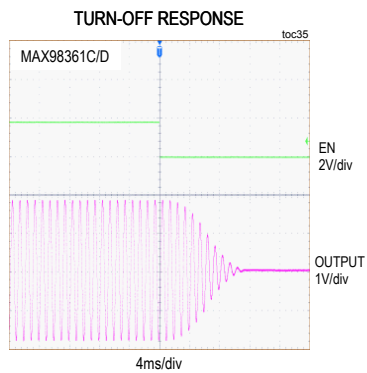
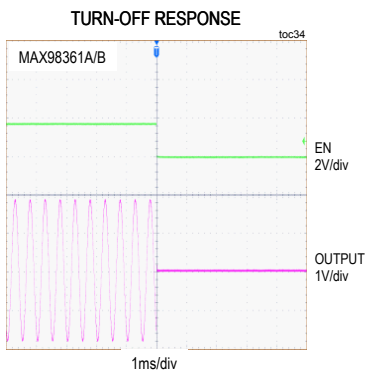
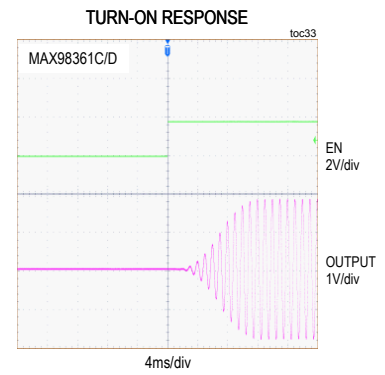
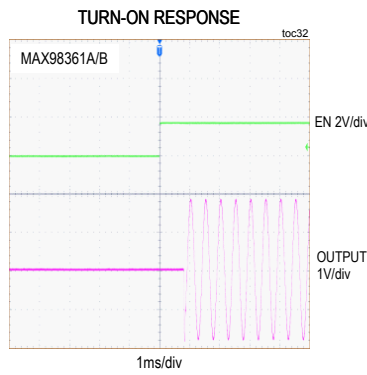
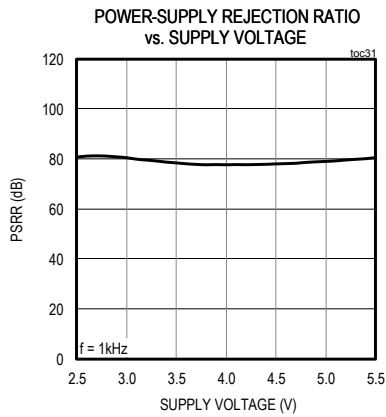
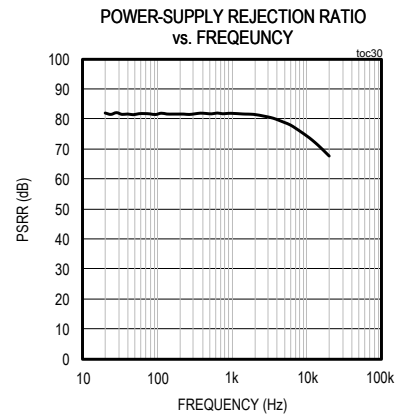
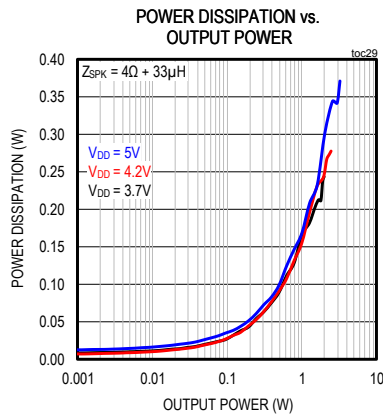
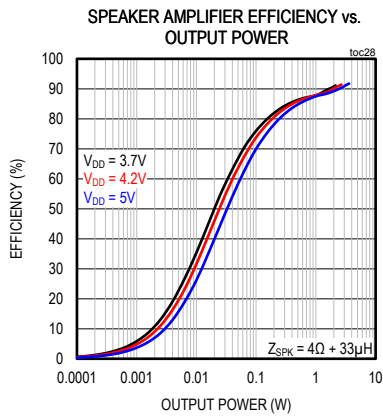

Typical Operating Characteristics (continued)

($V_{DD} = 5V$, $V_{GND} = 0V$, Gain = 12dB, $f_{BCLK} = 3.072MHz$, $f_{LRCLK} = 48kHz$, $Z_{SPK} = \infty$ between OUTP and OUTN, AC Measurement Bandwidth = 20Hz to 20kHz, $T_A = +25^\circ C$.)

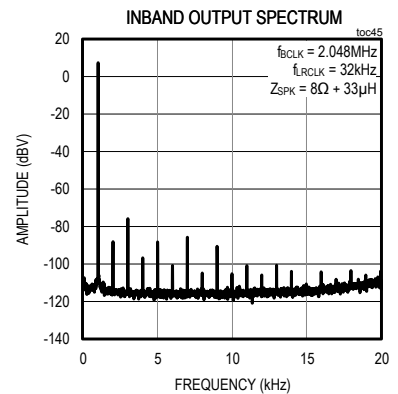
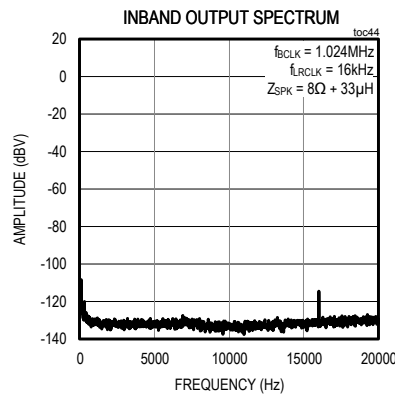
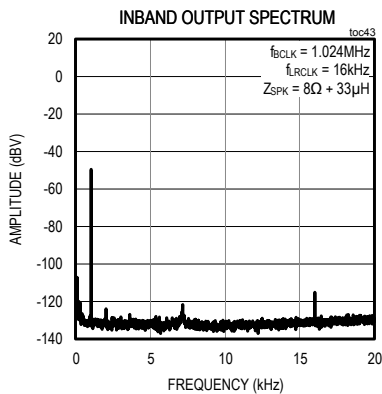
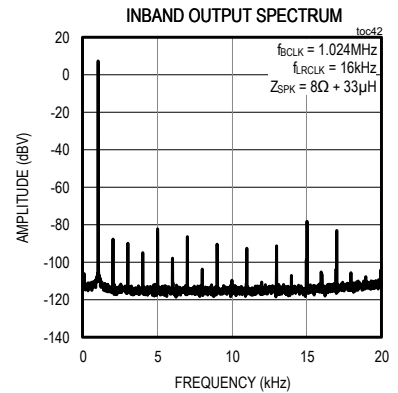
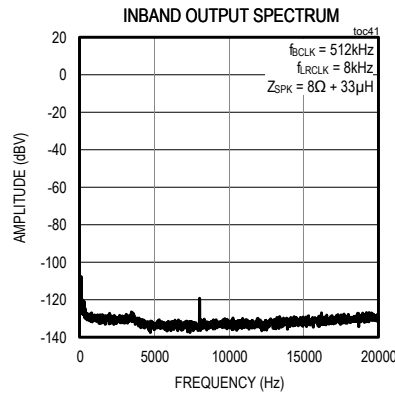
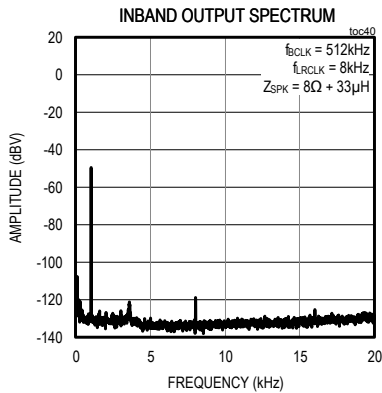
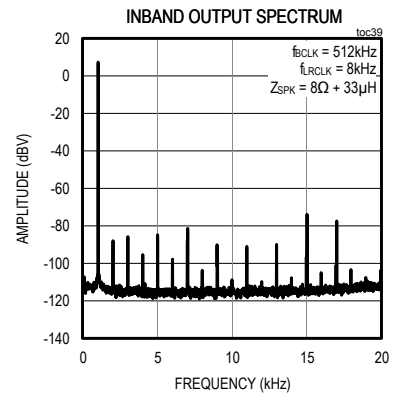
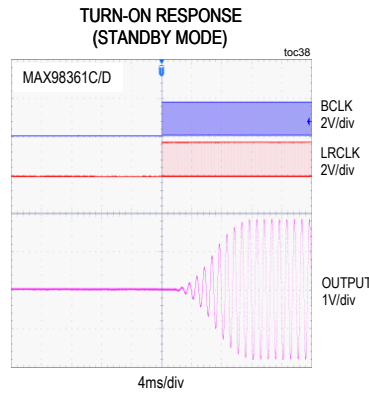
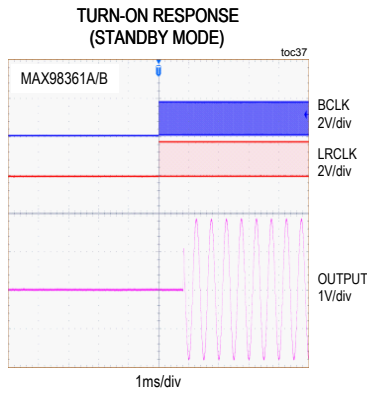

Typical Operating Characteristics (continued)

($V_{DD} = 5V$, $V_{GND} = 0V$, Gain = 12dB, $f_{BCLK} = 3.072MHz$, $f_{LRCLK} = 48kHz$, $Z_{SPK} = \infty$ between OUTP and OUTN, AC Measurement Bandwidth = 20Hz to 20kHz, $T_A = +25^{\circ}C$.)

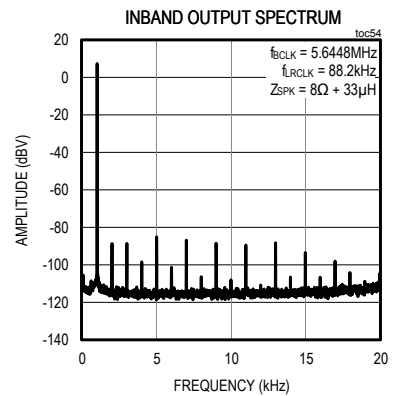
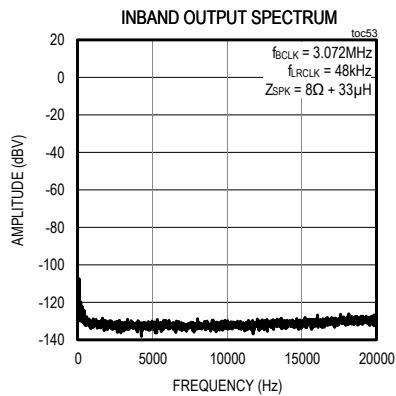
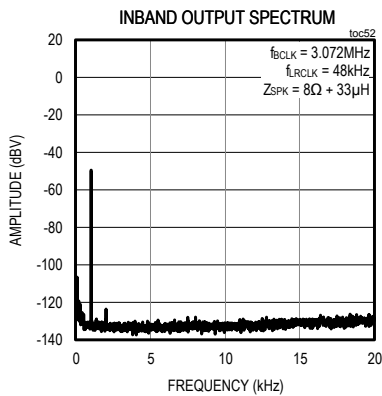
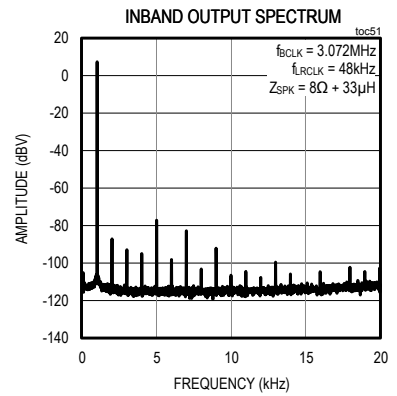
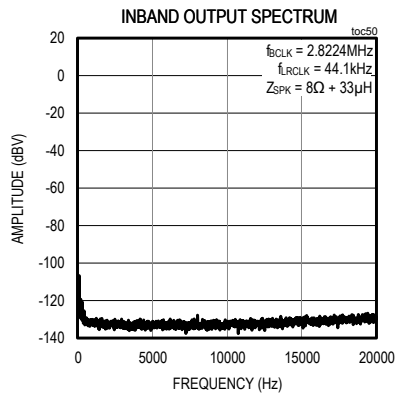
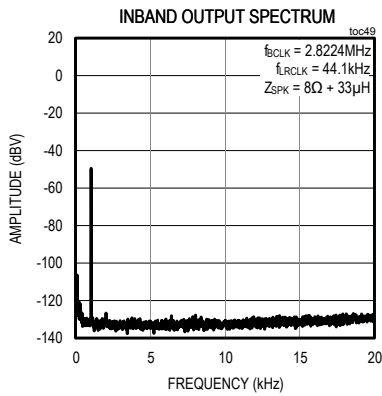
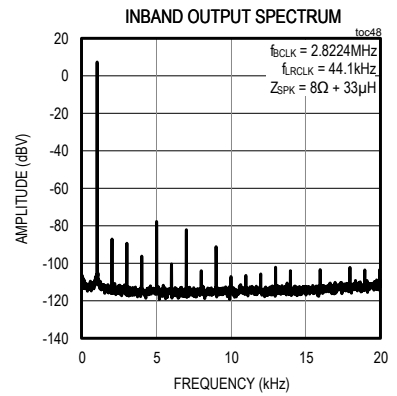
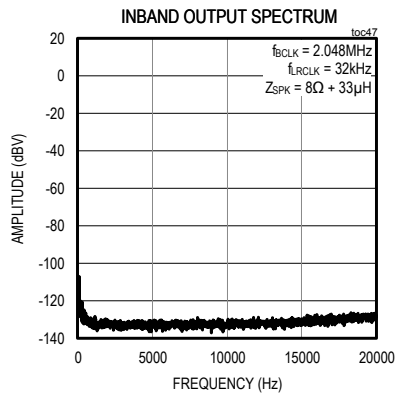
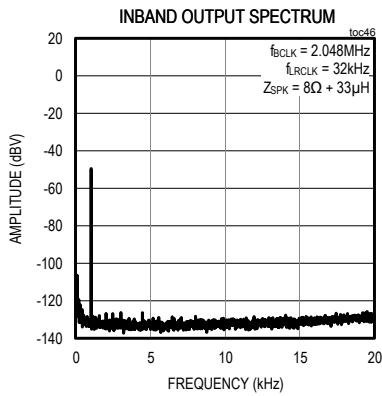

Typical Operating Characteristics (continued)

($V_{DD} = 5V$, $V_{GND} = 0V$, Gain = 12dB, $f_{BCLK} = 3.072MHz$, $f_{LRCLK} = 48kHz$, $Z_{SPK} = \infty$ between OUTP and OUTN, AC Measurement Bandwidth = 20Hz to 20kHz, $T_A = +25^{\circ}C$.)

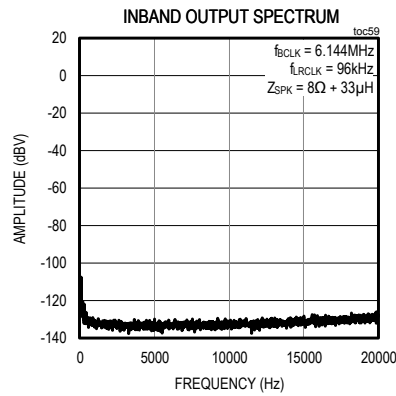
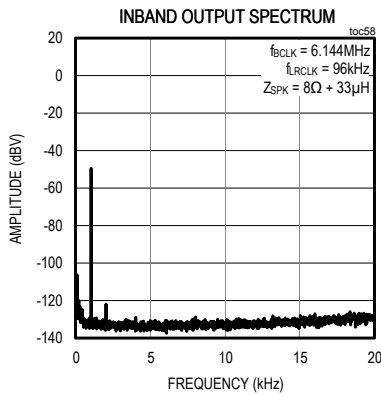
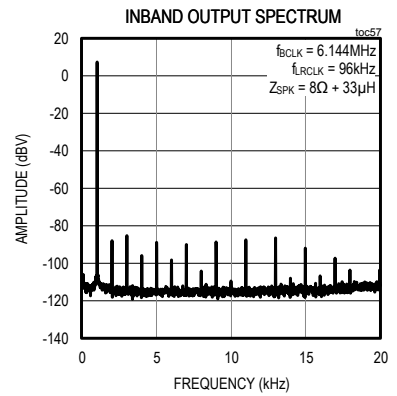
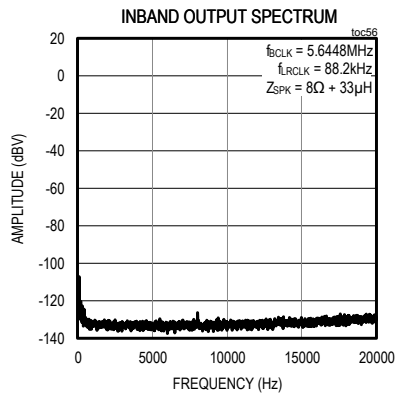
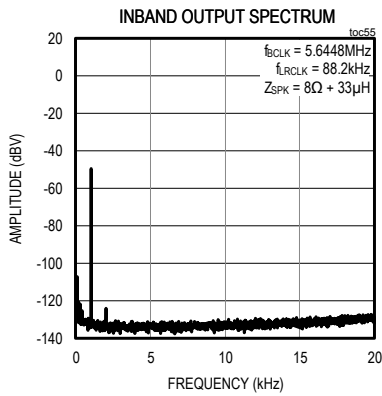

Pin Configuration

9 WLP

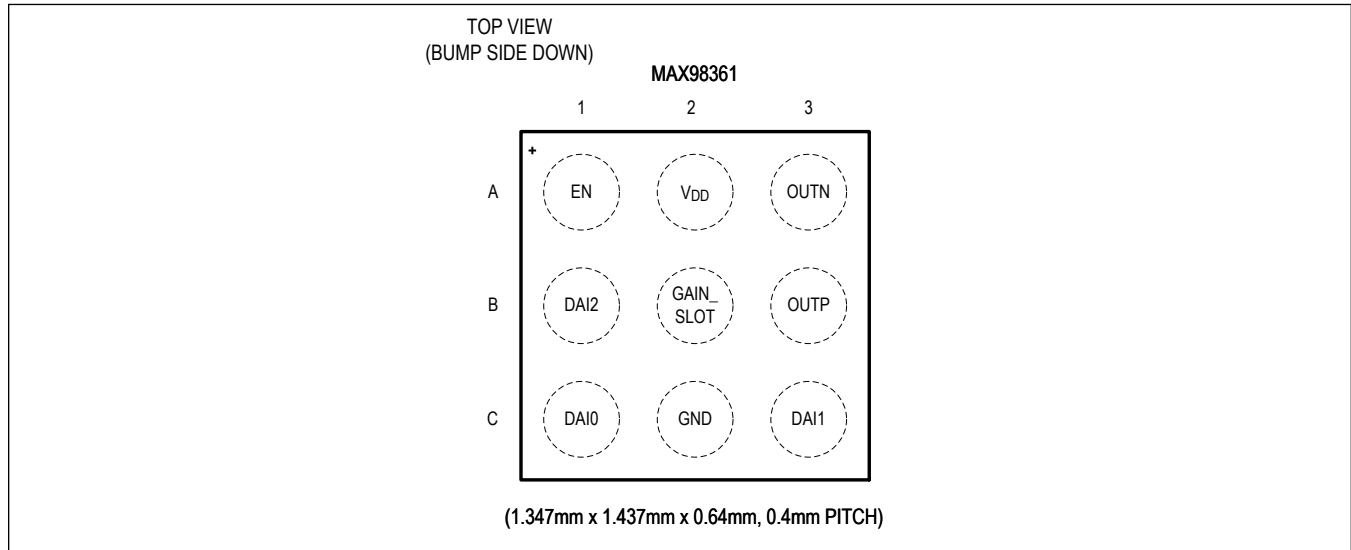

Pin Description

| PIN | NAME | FUNCTION | REF SUPPLY | TYPE |
|-----|-----------------|--|-----------------|---------------|
| A1 | EN | When EN is low, the device is in Shutdown mode. | V _{DD} | Digital Input |
| A2 | V _{DD} | Power Supply Input | — | Supply |
| A3 | OUTN | Negative Class-D Amplifier Output | V _{DD} | Analog Output |
| B1 | DAI2 | Digital Audio Interface Pin 2. Internally pulled down to GND through a 3MΩ resistor. | — | Digital Input |
| B2 | GAIN_SLOT | Gain and Channel Selection. Determines amplifier gain in I ² S and left-justified modes (Table 9). Used for channel selection along with DAI Configuration in TDM mode (Table 8). In TDM mode, gain is fixed at 12dB. | V _{DD} | Digital Input |
| B3 | OUTP | Positive Class-D Amplifier Output | V _{DD} | Analog Output |
| C1 | DAI0 | Digital Audio Interface Pin 0. Internally pulled down to GND through a 3MΩ resistor. | — | Digital Input |
| C2 | GND | Ground | — | Supply |
| C3 | DAI1 | Digital Audio Interface Pin 1. Internally pulled down to GND through a 3MΩ resistor. | — | Digital Input |

Functional Diagram

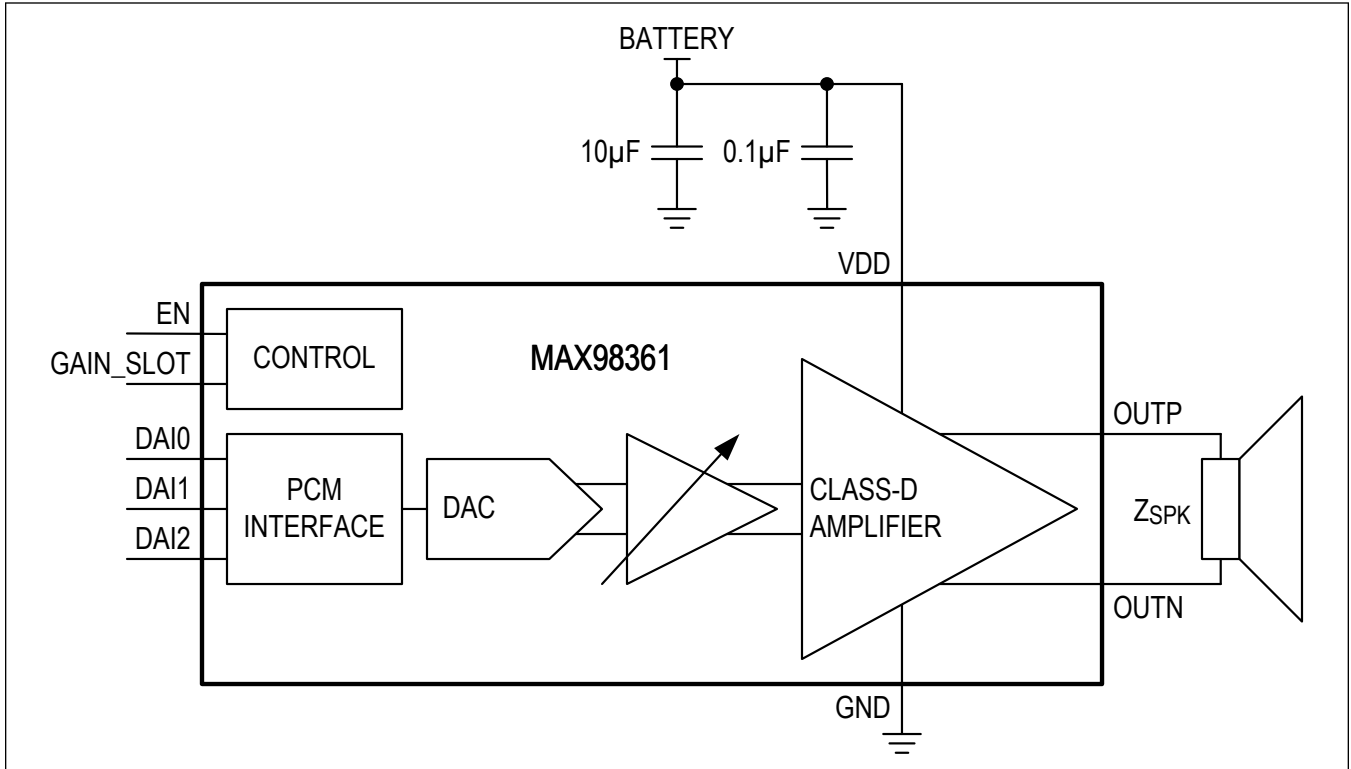

Detailed Description

The MAX98361A/B/C/D are digital PCM input Class-D power amplifiers. When LRCLK duty cycle is 50%, the MAX98361A and MAX98361C accept standard I²S data, while the MAX98361B and MAX98361D accept left-justified data. When LRCLK is a frame sync pulse (LRCLK is high for 4 BCLK periods or less), the device accepts 16-bit or 32-bit TDM data with eight channels. The digital audio interface eliminates the need for an external MCLK signal that is typically required for I²S data transmission.

The MAX98361A and MAX98361B have a fast 1ms turn-on time. The MAX98361C and MAX98361D ramp the audio volume over 13ms upon EN going high or low.

Table 1. MAX98361 Versions

| | TURN-ON AND TURN-OFF RAMP | TURN-ON TIME (ms) | DATA FORMAT WHEN LRCLK DUTY CYCLE IS 50% | DATA FORMAT WHEN LRCLK IS A SYNC PULSE |
|------------------|------------------------------|----------------------|---|---|
| MAX98361A | Ramp Disabled | 1 | I ² S data valid on BCLK rising edge | TDM data valid on BCLK rising edge |
| MAX98361B | Ramp Disabled | 1 | Left-justified data valid on BCLK rising edge | TDM data valid on BCLK falling edge |
| MAX98361C | Ramp Enabled | 13 | I ² S data valid on BCLK rising edge | TDM data valid on BCLK rising edge |
| MAX98361D | Ramp Enabled | 13 | Left-justified data valid on BCLK rising edge | TDM data valid on BCLK falling edge |

Gain and channel selection are configured by a combination of GAIN_SLOT pin settings and connecting digital audio source signals to different DAI_n pins.

The MAX98361A/B/C/D features low quiescent current, comprehensive click-and-pop suppression, and excellent RF immunity. The amplifier offers Class-AB audio performance with Class-D efficiency in a minimal board-space solution. The Class-D amplifier features spread-spectrum modulation with edge-rate and overshoot control circuitry that offers significant improvements in switch-mode amplifier radiated emissions. The amplifier features click-and-pop suppression that reduces audible transients during turn-on and turn-off. The amplifier includes thermal-overload and short-circuit protection.

EN and Shutdown Mode

The device features a low-power shutdown mode, drawing I_{SHDN} current. During shutdown, all internal blocks are turned off, including setting the output stage to a Hi-Z state. Drive EN low to put the device into shutdown.

Take care to avoid violating the Absolute Maximum Ratings limits for the EN pin. Ensuring that V_{DD} is always greater than EN is one way to prevent EN from violating the Absolute Maximum Ratings limits. If this is not possible in the application (e.g., if V_{DD} < 3.0V and EN = 3.3V), then it is necessary to add a small resistance (~2kΩ) in series with EN to limit the current into the EN pin.

Standby Mode

When the EN pin is high and there is no toggling on the DAI_n pins, the device automatically enters Standby mode. In Standby mode, the Class-D amplifier is off and the outputs are in a Hi-Z state. Standby mode has reduced current consumption from normal operation (I_{STNDBY}), but not as low as full shutdown when the EN pin is low (I_{SHDN}). Standby mode can be used to reduce power consumption when no host GPIO is available to control the EN pin.

Note that volume is not ramped down when entering standby. For optimal click-and-pop performance on MAX98361A and MAX98361B, ramp down the digital audio amplitude on data presented to DIN before removing clocks. For optimal click-and-pop performance on MAX98361C and MAX98361D, either ramp down the digital audio amplitude on data presented to DIN before removing clocks or keep clocks valid for at least 13ms after pulling EN low to allow time for turn-off volume ramping.

While in standby, any toggling of the DAI_n pins causes the part to exit Standby mode and enter DAI Configuration.

GAIN_SLOT Pin

The voltage on the GAIN_SLOT pin selects the gain setting while in I²S and left-justified modes and selects (in conjunction with DAI Configuration) which channel is sent to the amplifier while in TDM mode.

When the EN pin is high and the device emerges from Standby mode because of toggling on the DAI_n pins, 200kΩ pullup and pulldown resistors are internally connected to GAIN_SLOT. The voltage on GAIN_SLOT can be selected by connecting the pin to GND, connecting the pin to V_{DD}, connecting the pin to GND through a 100kΩ 5% resistor, connecting the pin to V_{DD} through a 100kΩ 5% resistor, or leaving the pin unconnected.

See the [Gain Selection](#) section for more information on setting the gain in I²S and left-justified modes or see the [TDM Mode](#) section for more information on selecting the channel in TDM mode.

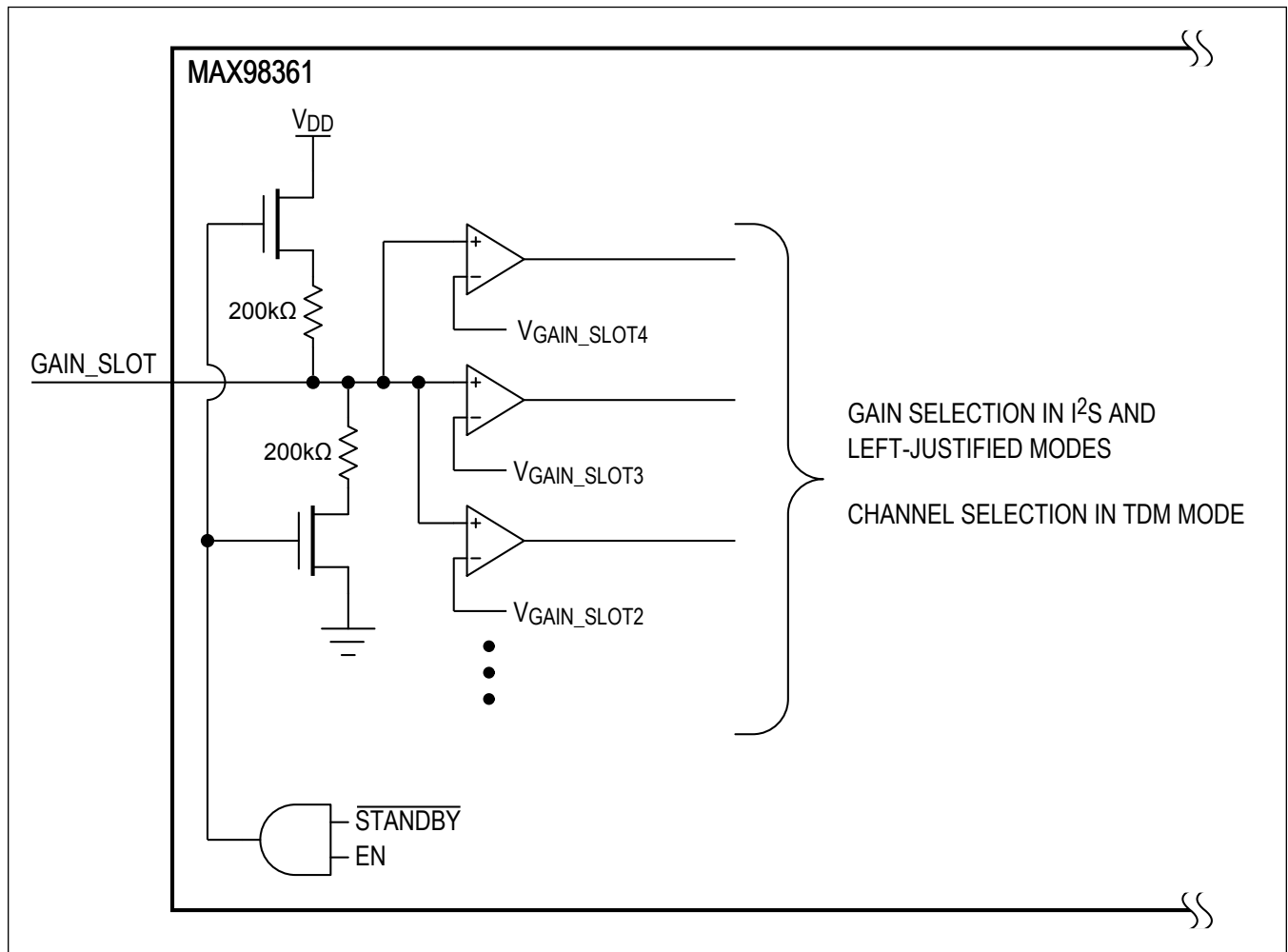

Figure 1. GAIN_SLOT Internal Resistors

Digital Audio Interface (DAI) Configuration (Patent Pending)

Different operating modes can be selected by connecting the digital audio bit clock (BCLK), the digital audio frame clock (LRCLK), and the digital audio data (DIN) to different DAI pins.

The DAI detects BCLK by monitoring the switching frequencies at the DAI pins. Detection starts when EN is toggled from low to high, when V_{DD} rises from UVLO to operating range while EN is held high, and when exiting Standby mode by applying clocks. The DAI pin with the highest frequency is selected as the BCLK input. Once the BCLK input pin is identified, the LRCLK and DIN pin locations are assumed, as shown in [Table 2](#).

If the clocks are valid for four consecutive LRCLK periods, the DAI Configuration is latched and the amplifier is allowed to turn on. Otherwise, if there is still toggling on the DAI pins, the detection routine is restarted; if there is no toggling on the DAI pins, the device enters Standby mode.

Once a DAI Configuration has been latched, it does not change unless EN is toggled, V_{DD} falls below V_{UVLO} , DAI Configuration restarts due to invalid clocks, or the DAI pins stop toggling and the part goes into Standby mode. Shutdowns due to thermal protection or Class-D Current Limit do not trigger a new round of BCLK detection.

While the amplifier is on, clock validity is continually checked. If clocks become invalid, the Class-D amplifier is immediately turned off (no volume ramping) and the outputs go into a Hi-Z state. If there is still toggling on the DAI pins, the detection routine is restarted; if there is no toggling on the DAI pins, the device enters Standby mode.

DAI Configurations other than those shown in [Table 2](#) are not valid.

Table 2. DAI Configurations

| BCLK LOCATION | LRCLK LOCATION | DIN LOCATION | DAI CONFIGURATION |
|---------------|----------------|--------------|-------------------|
| DAI0 | DAI1 | DAI2 | A |
| DAI1 | DAI2 | DAI0 | B |
| DAI2 | DAI0 | DAI1 | C |

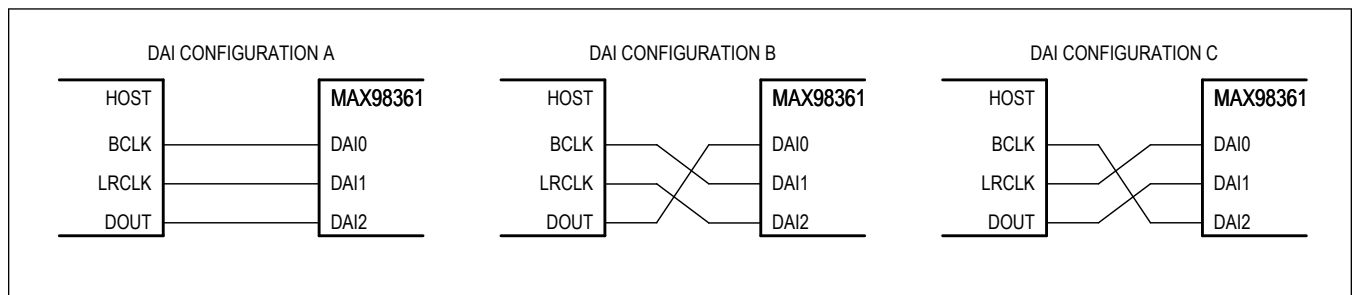

Figure 2. DAI Connections

Valid Clock Frequencies

When LRCLK has a 50% duty cycle, MAX98361A and MAX98361C are automatically configured for I²S mode, while MAX98361B and MAX98361D are automatically configured for left-justified mode. When a frame sync pulse is used for LRCLK (LRCLK is high for 4 BCLK periods or less), the device is automatically configured for TDM mode.

Valid sample rates are 8kHz, 16kHz, 32kHz, 44.1kHz, 48kHz, 88.2kHz, and 96kHz. (LRCLK clocks at 11.025kHz, 12kHz, 22.05kHz, and 24kHz are **NOT** supported.) f_{S1} , f_{S2} , f_{S3} , and f_{S4} define LRCLK frequency regions where the device is guaranteed to perform within specifications (assuming that all other inputs are in valid ranges). The output waveform is unpredictable if LRCLK frequency is not within f_{S1} , f_{S2} , f_{S3} , or f_{S4} .

In I²S/left-justified mode, valid resolutions are 16 bits per channel, 24 bits per channel, and 32 bits per channel. There are 2 channels per LRCLK period. Therefore, the valid numbers of BCLK periods per LRCLK period in I²S/left-justified mode are exactly 32 BCLK periods per LRCLK period, 48 BCLK periods per LRCLK period, and 64 BCLK periods per LRCLK period.

In TDM mode, valid resolutions are 16 bits per channel and 32 bits per channel. There are 8 channels per LRCLK period. Therefore, the valid numbers of BCLK periods per LRCLK period in TDM mode are exactly 128 BCLK periods per LRCLK period and exactly 256 BCLK periods per LRCLK period.

An invalid number of BCLKs per LRCLK results in an unpredictable output waveform.

Table 3. Valid Resolutions and Frame Widths

| SAMPLE RESOLUTION (BITS) | BCLK PERIODS PER LRCLK IN I ² S/LEFT-JUSTIFIED MODE | BCLK PERIODS PER LRCLK IN TDM MODE |
|--------------------------|--|------------------------------------|
| 16 | 32 | 128 |
| 24 | 48 | NOT VALID |
| 32 | 64 | 256 |

Table 4. Valid BCLK Frequencies (kHz)

| | I ² S/LEFT-JUSTIFIED MODE | | | TDM MODE | |
|-----------------|--------------------------------------|--------------------|--------------------|---------------------|---------------------|
| | 32 BCLKs PER LRCLK | 48 BCLKs PER LRCLK | 64 BCLKs PER LRCLK | 128 BCLKs PER LRCLK | 256 BCLKs PER LRCLK |
| LRCLK = 8kHz | 256 | 384 | 512 | 1024 | 2048 |
| LRCLK = 16kHz | 512 | 768 | 1024 | 2048 | 4096 |
| LRCLK = 32kHz | 1024 | 1536 | 2048 | 4096 | 8192 |
| LRCLK = 44.1kHz | 1411.2 | 2116.8 | 2822.4 | 5644.8 | 11289.6 |
| LRCLK = 48kHz | 1536 | 2304 | 3072 | 6144 | 12288 |
| LRCLK = 88.2kHz | 2822.4 | 4233.6 | 5644.8 | 11289.6 | 22579.2 |
| LRCLK = 96kHz | 3072 | 4608 | 6144 | 12288 | 24576 |

MCLK Elimination

The MAX98361 eliminates the need for the external MCLK signal that is typically used for PCM communication. This reduces EMI and possible board coupling issues in addition to reducing the size and pin-count.

BCLK Jitter Tolerance

The MAX98361 features a high BCLK jitter tolerance while maintaining a high dynamic range (see the [Electrical Characteristics](#) table).

BCLK Polarity

In I²S and left-justified mode, incoming serial data is always clocked-in on the rising-edge of BCLK. In TDM mode, the MAX98361A and MAX98361C clock-in serial data on the rising-edge of BCLK, while the MAX98361B and MAX98361D clock in serial data on the falling-edge of BCLK ([Table 5](#)).

Table 5. BCLK Polarity

| MODE | PART NUMBERS | BCLK POLARITY |
|------------------|--------------|---------------|
| I ² S | MAX98361A/C | Rising edge |
| Left-justified | MAX98361B/D | Rising edge |
| TDM | MAX98361A/C | Rising edge |
| TDM | MAX98361B/D | Falling edge |

LRCLK Polarity in I²S/Left-Justified Mode

In I²S and left-justified mode, LRCLK specifies whether left-channel data or right-channel data is currently being read by the digital audio interface. The MAX98361A and MAX98361C indicate the left channel word when LRCLK is low, and the MAX98361B and MAX98361D indicate the left channel word when LRCLK is high ([Table 6](#)).

Table 6. LRCLK Polarity in I²S/Left-Justified Mode

| PART NUMBER | LRCLK POLARITY (LEFT CHANNEL) |
|-------------|-------------------------------|
| MAX98361A/C | Low |
| MAX98361B/D | High |

I²S and Left-Justified Mode

When LRCLK duty cycle is 50%, the MAX98361A and MAX98361C follow standard I²S timing by allowing a delay of one BCLK cycle after the LRCLK transition before the beginning of a new data word ([Figure 3](#) and [Figure 4](#)). The MAX98361B and MAX98361D follow the left-justified timing specification by aligning the LRCLK transitions with the beginning of a new data word ([Figure 5](#) and [Figure 6](#)).

In I²S and left-justified modes, the audio channel that is sent to the amplifier output is chosen by the DAI Configuration (see [Table 2](#)). Use DAI Configuration A to select the left word of the stereo input data. Use DAI Configuration B to select the right word of the stereo input data. Use DAI Configuration C to select both the left and right words of the stereo input data (left/2 + right/2).

Table 7. Channel Selection in I²S and Left-Justified Modes

| DAI CONFIGURATION | CHANNEL |
|-------------------|------------------|
| A | Left |
| B | Right |
| C | Left/2 + Right/2 |

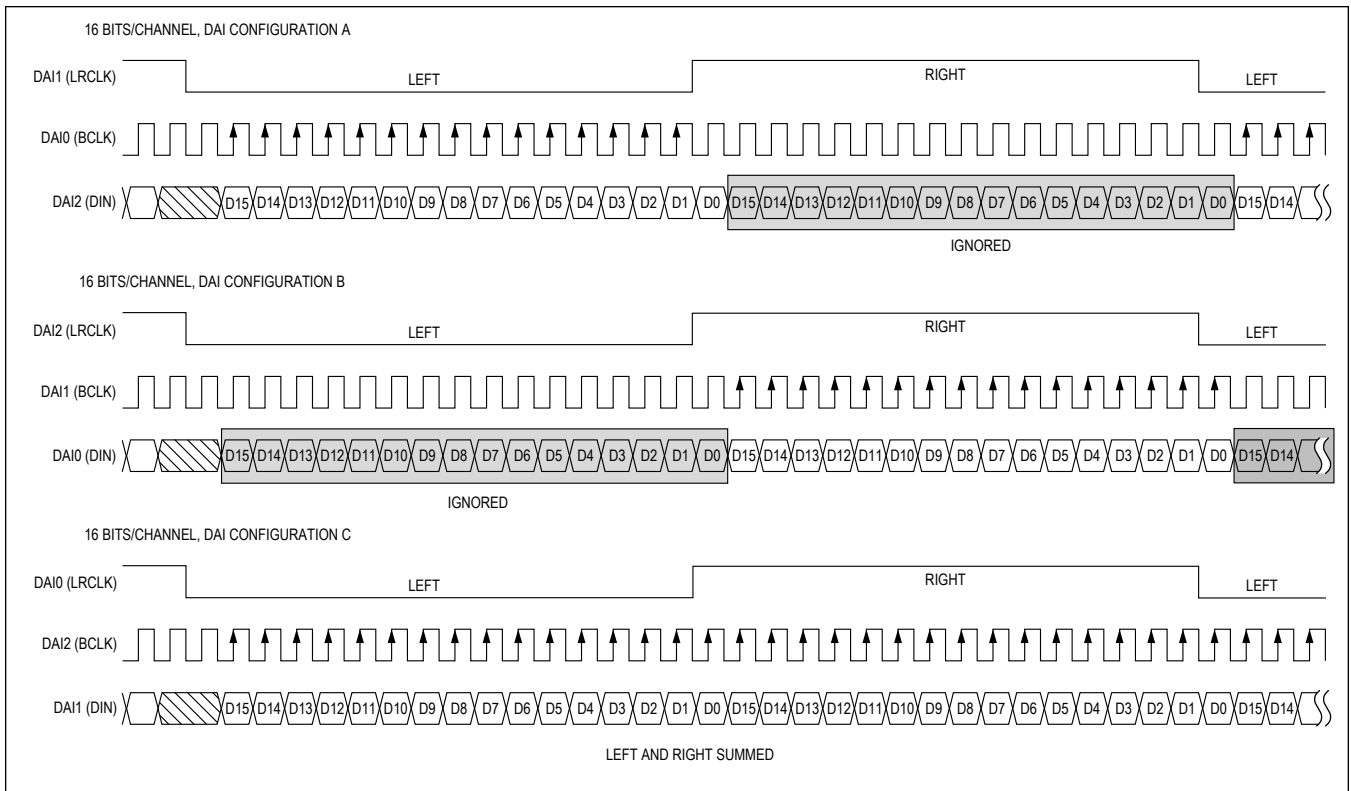

Figure 3. MAX98361A and MAX98361C I²S Protocol, 16-Bit Resolution

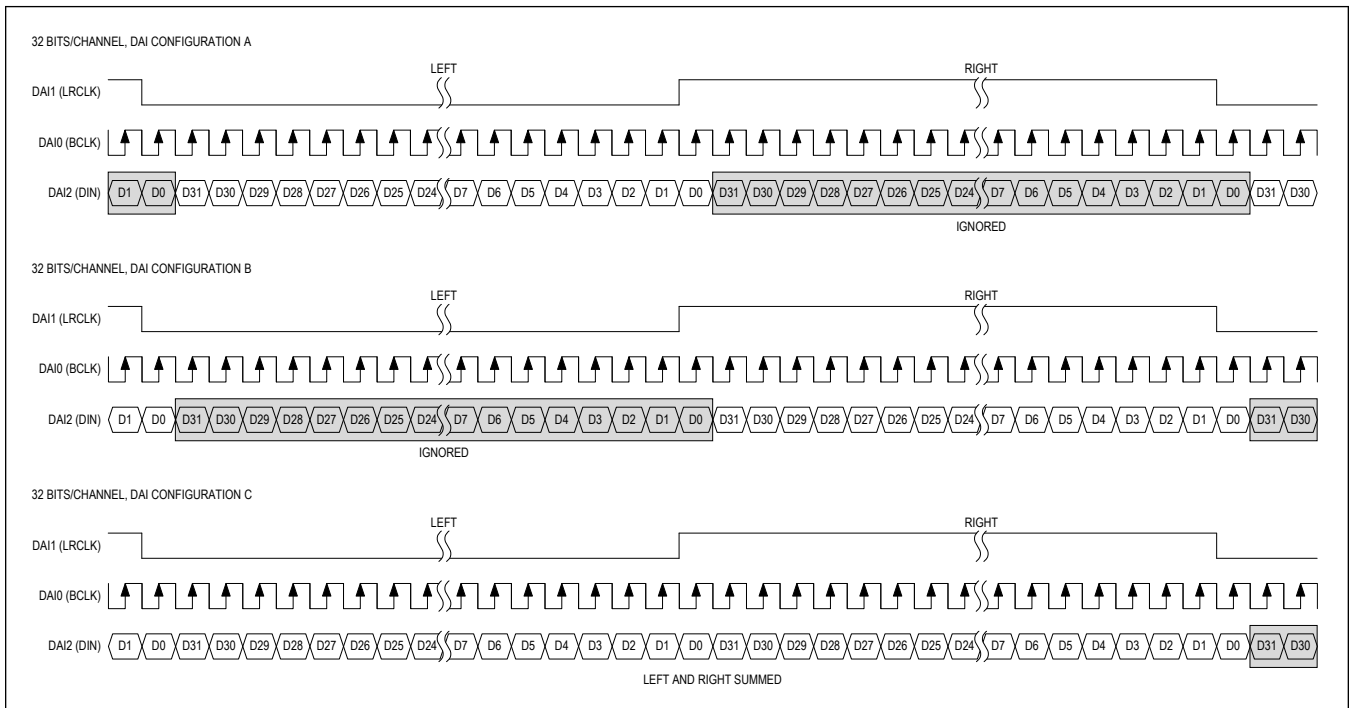

Figure 4. MAX98361A and MAX98361C I²S Protocol, 32-Bit Resolution

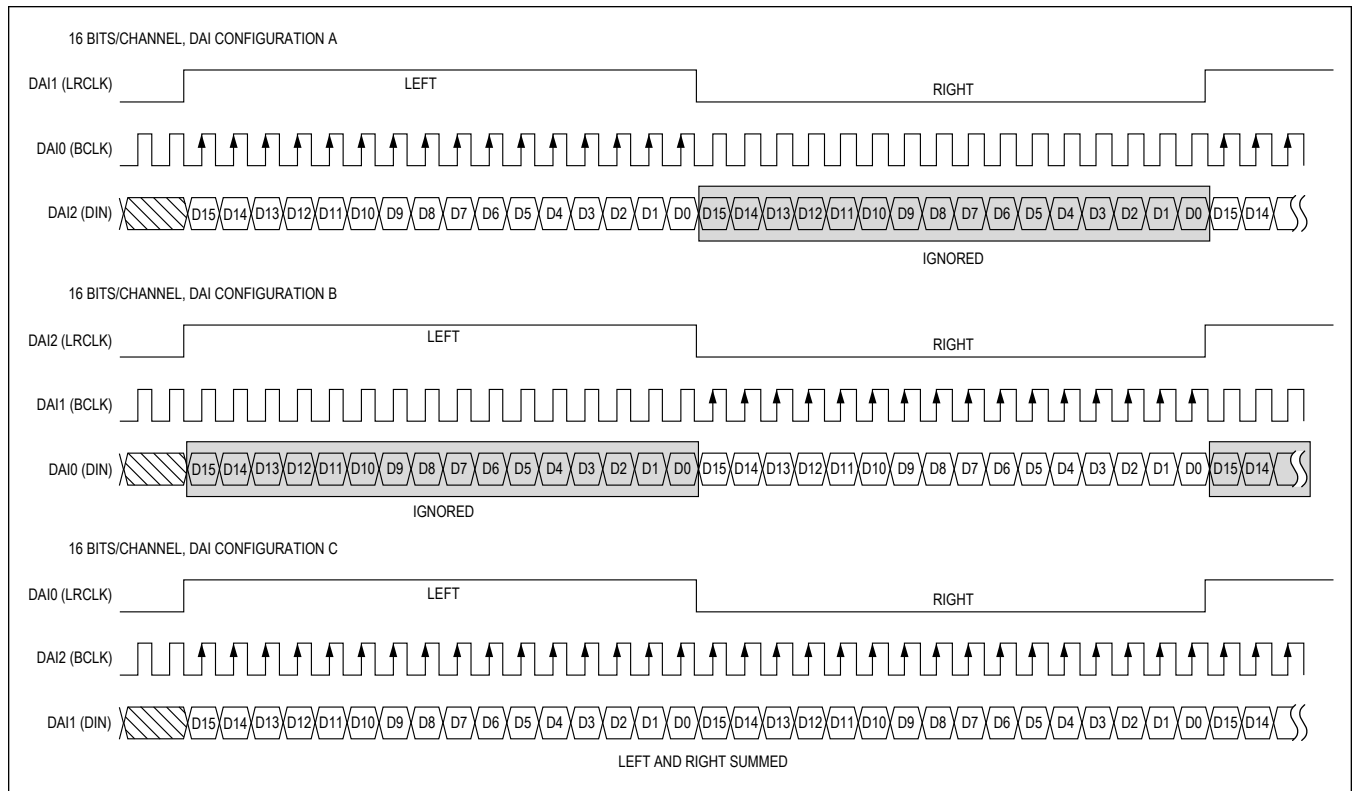

Figure 5. MAX98361B and MAX98361D Left-Justified Protocol, 16-Bit Resolution

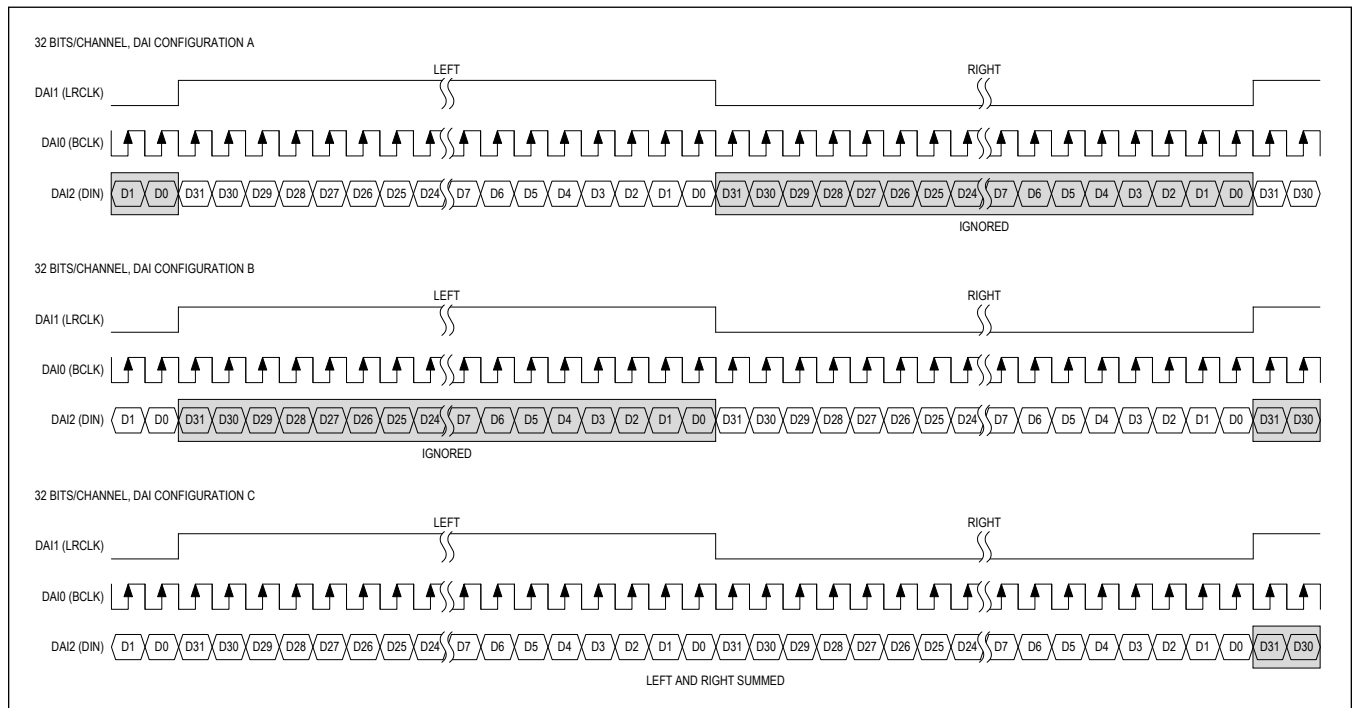

Figure 6. MAX98361B and MAX98361D Left-Justified Protocol, 32-Bit Resolution

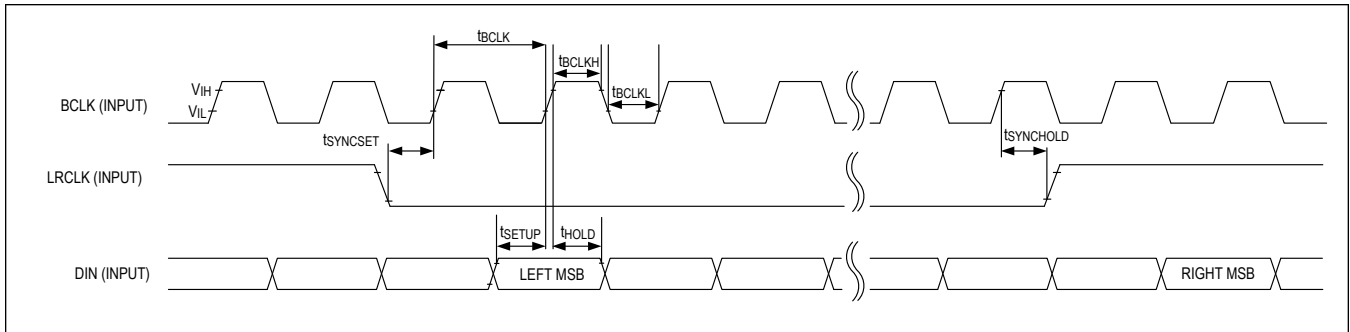

Figure 7. I²S Timing Diagram (MAX98361A and MAX98361C)

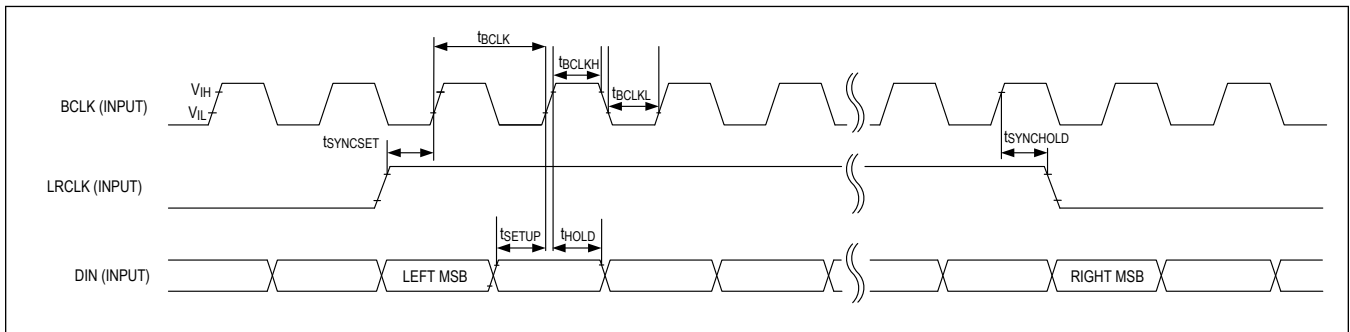

Figure 8. Left-Justified Timing Diagram (MAX98361B and MAX98361D)

TDM Mode

When a frame sync pulse is used for LRCLK (LRCLK is high for 4 BCLK periods or less), the device is automatically configured for TDM mode.

In TDM mode, the device only accepts 8 channels of 16-bit or 32-bit formatted data. Therefore, there must be 128 (16-bit mode) or 256 (32-bit mode) BCLK cycles per frame.

DAI Configuration and GAIN_SLOT are used to select which channel is sent to the amplifier (see [Table 8](#)).

On the MAX98361A and MAX98361C, data is valid on the BCLK rising edge (see [Figure 9](#) and [Figure 10](#)). On the MAX98361B and MAX98361D, data is valid on the BCLK falling edge (see [Figure 11](#) and [Figure 12](#)).

Table 8. TDM Mode Channel Selection

| DAI CONFIGURATION | GAIN_SLOT | CHANNEL |
|-------------------|-----------------|---------|
| A | GND | 0 |
| A | V _{DD} | 1 |
| A | Unconnected | 2 |
| B | V _{DD} | 3 |
| B | GND | 4 |
| C | GND | 5 |
| C | Unconnected | 6 |
| C | V _{DD} | 7 |

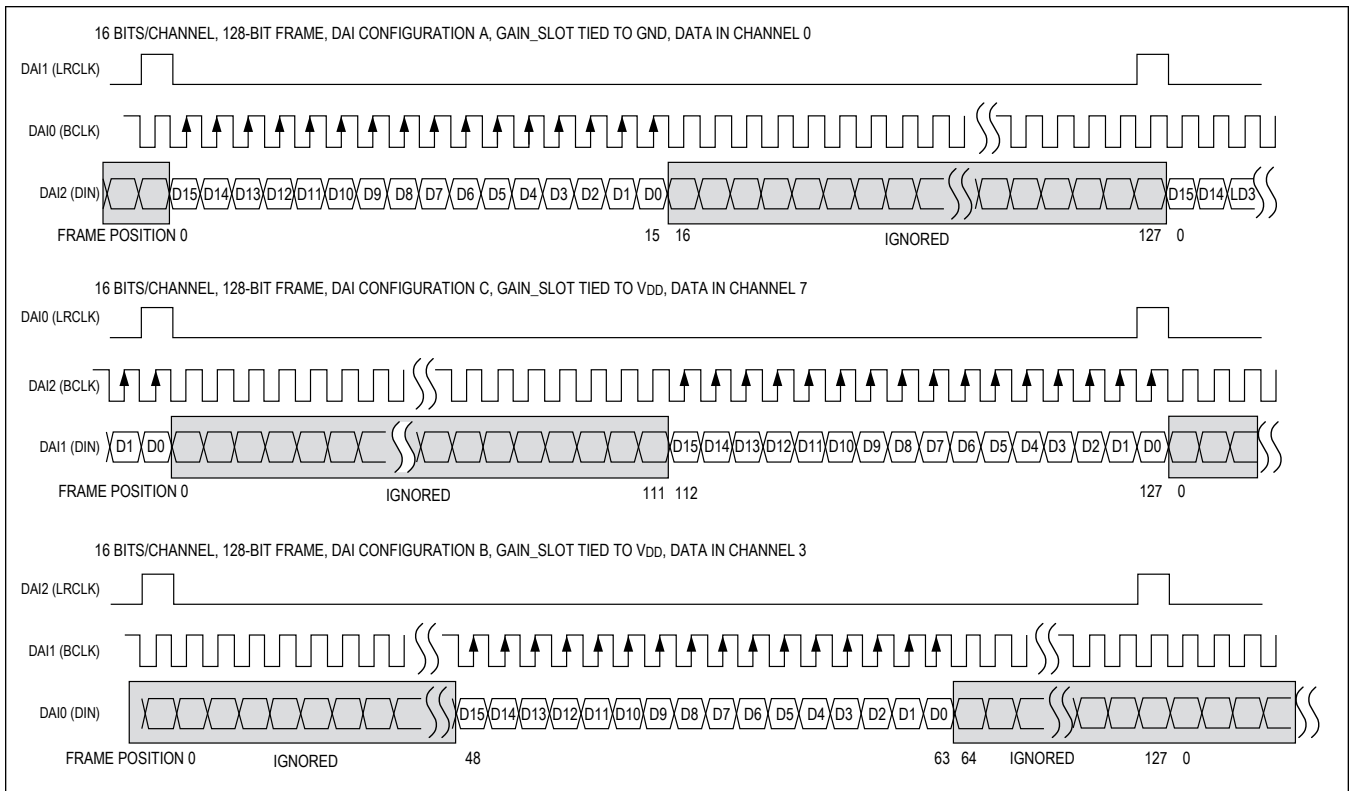

Figure 9. MAX98361A and MAX98361C TDM Protocol, 16-Bit Resolution

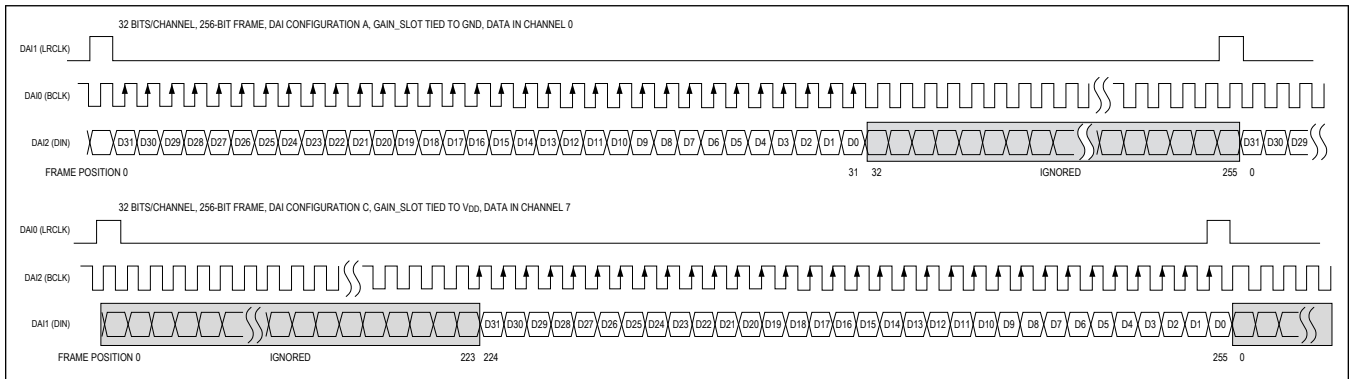

Figure 10. MAX98361A and MAX98361C TDM Protocol, 32-Bit Resolution

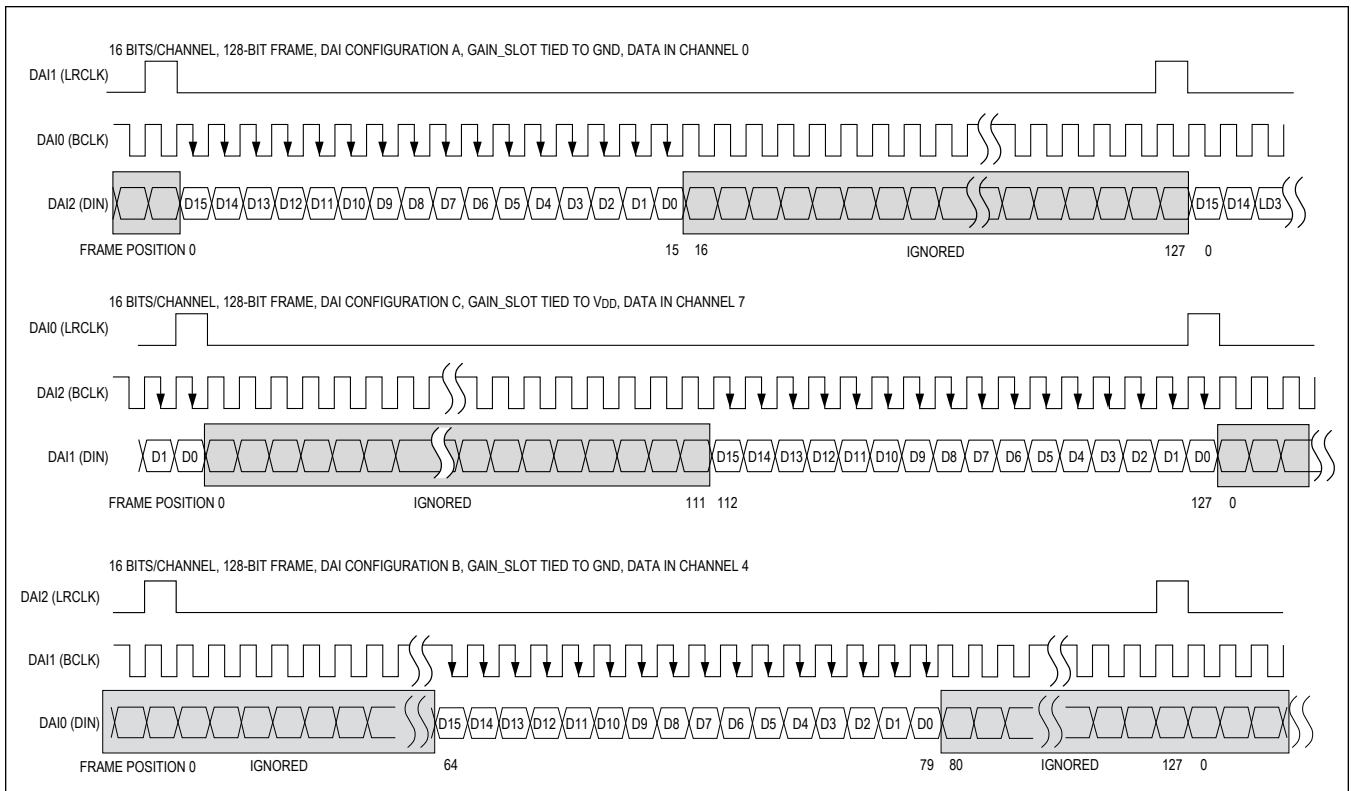

Figure 11. MAX98361B and MAX98361D TDM Protocol, 16-Bit Resolution

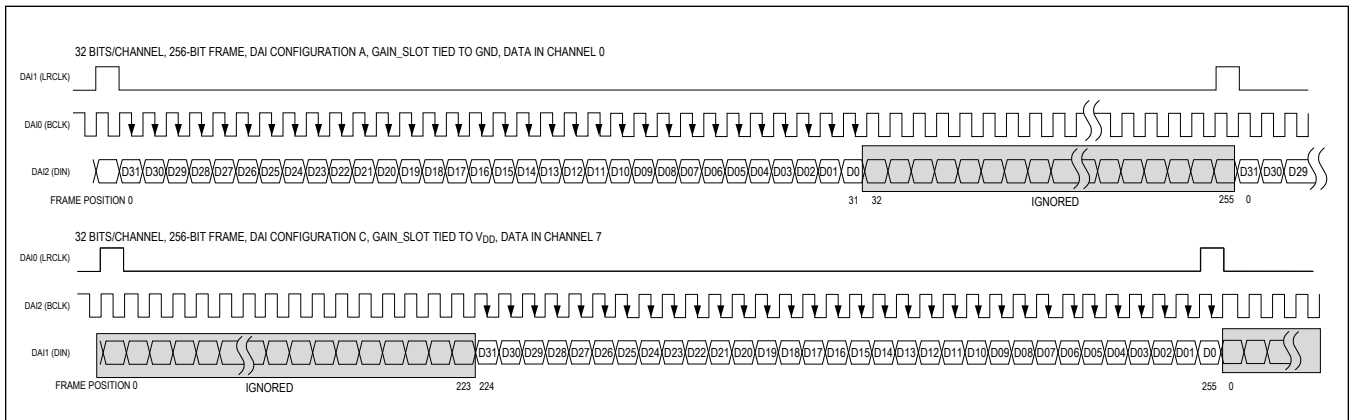

Figure 12. MAX98361B and MAX98361D TDM Protocol, 32-Bit Resolution

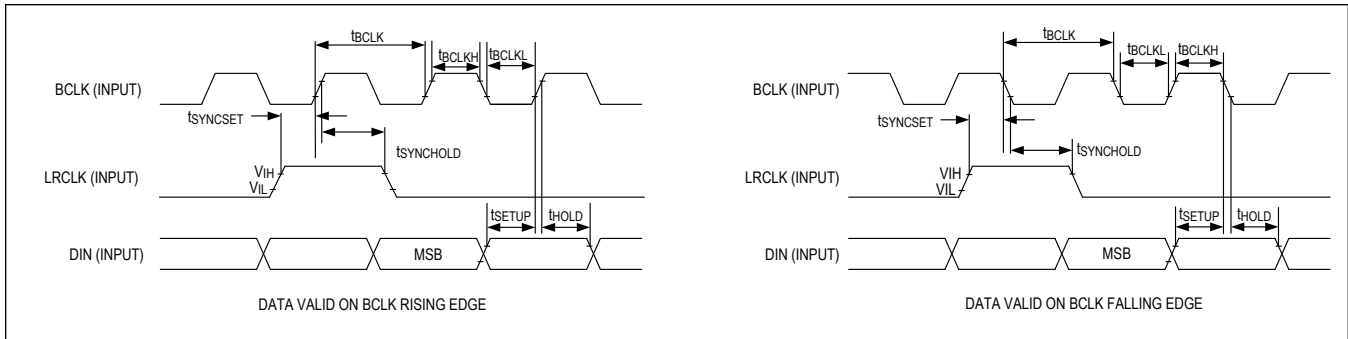

Figure 13. TDM Timing Diagrams—BCLK Rising Edge (MAX98361A/C) and BCLK Falling Edge (MAX98361B/D)

Gain Selection

In I²S and left-justified modes, one of five gain settings is selected through the GAIN_SLOT pin (Table 9). In TDM mode, the gain is automatically set at a fixed 12dB.

Gain is referenced to the full-scale output of the DAC, which is 2.3dBV. Assuming that the desired output swing is not limited by the supply voltage rail, the output level can be calculated based on the digital input signal level and selected amplifier gain according to the following equation:

$$\text{Output signal level (dBV)} = \text{input signal level (dBFS)} + 2.3\text{dB} + \text{amplifier gain (dB)}$$

Table 9. Gain Selection

| GAIN_SLOT | I ² S/LEFT-JUSTIFIED GAIN (dB) |
|---|---|
| Connect to GND | 12 |
| Unconnected | 9 |
| Connect to V _{DD} | 6 |
| Connect to V _{DD} through 100kΩ ±5% resistor | 3 |
| Connect to GND through 100kΩ ±5% resistor | -3 |

DC Blocking Filter

The digital audio interface includes a DC blocking filter with a -3dB cutoff at f_C (see the [Electrical Characteristics](#) table).

DAC Digital Filters

The DAC features a digital lowpass filter that is automatically configured for voice playback or music playback based on the sample rate that is used. This filter eliminates the effect of aliasing and any other high-frequency noise that might otherwise be present. See the *DAC Digital Filters* section of the [Electrical Characteristics](#) table.

Class-D Amplifier

The filterless Class-D amplifier offers much higher efficiency than Class-AB amplifiers. The high efficiency of a Class-D amplifier is due to the switching operation of the output stage transistors. Any power loss associated with the Class-D output stage is mostly due to the I²R loss of the MOSFET on-resistance and quiescent current overhead.

Class-D Output Short-Circuit Protection

If the output current limit of the Class-D amplifier (I_{LIM}) is exceeded (see the [Electrical Characteristics](#) table), the outputs are disabled for approximately 100μs. At the end of the 100μs, the outputs are re-enabled. If the fault condition still exists, the outputs continue to disable and re-enable until the fault condition is removed.

Turn-On and Turn-Off Volume Ramping

The MAX98361A and MAX98361B have a fast 1ms turn-on time. For optimal click-and-pop performance, ramp down the digital audio amplitude on data presented to DIN before shutting down, removing clocks, or removing power.

The MAX98361C and MAX98361D ramp the audio signal from mute to full scale over 13ms after DAI Configuration. When turned off by pulling EN low, gain is ramped down to mute over 13ms. Turn-off ramping only occurs if BCLK and LRCLK remain valid and V_{DD} remains within its operating range for at least 13ms after EN goes low. If either clock becomes invalid, or if V_{DD} falls below V_{UVLO} , audio stops immediately without ramping.

Click-and-Pop Suppression

The speaker amplifier features Maxim's comprehensive click-and-pop suppression. During turn-on, the click-and-pop suppression circuitry reduces audible transient sources internal to the device. When entering shutdown or standby, the differential speaker outputs simultaneously go to Hi-Z.

The comprehensive click-and-pop suppression of the MAX98361 is unaffected by power-up or power-down sequencing. Applying or removing the clocks before or after the transition of EN yields the same click-and-pop performance. However, note that for MAX98361C and MAX98361D, clocks and V_{DD} must remain valid for 13ms after EN goes low to allow for volume ramping to complete for best click-and-pop performance.

Ultra-Low EMI Filterless Output Stage

Traditional Class-D amplifiers require the use of external LC filters or shielding to meet EN55022B electromagnetic interference (EMI) regulation standards. Maxim's active emissions-limiting, edge-rate control circuitry and spread-spectrum modulation reduces EMI emissions while maintaining high efficiency.

Maxim's spread-spectrum modulation mode flattens wideband spectral components while proprietary techniques ensure that the cycle-to-cycle variation of the switching period does not degrade audio reproduction or efficiency. The device's spread-spectrum modulator randomly varies the switching frequency by f_{SSM} around the center frequency (f_{SW}). Above 10MHz, the wideband spectrum looks like noise for EMI purposes.

Applications Information

Filterless Class-D Operation

Traditional Class-D amplifiers require an output filter to recover the audio signal from the amplifier's output. The filter adds cost, size, and decreases efficiency and THD+N performance. The amplifier's filterless modulation scheme does not require an output filter. The device relies on the inherent inductance of the speaker coil and the natural filtering of both the speaker and the human ear to recover the audio component of the square-wave output.

Because the switching frequency of the amplifier is well beyond the bandwidth of most speakers, voice coil movement due to the switching frequency is very small. Use a speaker with a series inductance $> 10\mu\text{H}$. Typical 8Ω speakers exhibit series inductances in the $20\mu\text{H}$ to $100\mu\text{H}$ range.

Power Supply Input

The device is powered from a single 2.5V to 5.5V supply (V_{DD}). Bypass V_{DD} with a $0.1\mu\text{F}$ and $10\mu\text{F}$ capacitor to GND. Some applications might require only the $10\mu\text{F}$ bypass capacitor, making it possible to operate with a single external component. Apply additional bulk capacitance at the V_{DD} pin if long PCB traces between V_{DD} and the power source are used.

Layout and Grounding

Proper layout and grounding are essential for optimum performance. Good grounding improves audio performance and prevents switching noise from coupling into the audio signal.

For best EMI and audio performance, it is essential that the V_{DD} decoupling capacitor be placed as close as possible to the MAX98361 to minimize the supply loop inductance.

Use wide, low-resistance output traces. As load impedance decreases, the current drawn from the device outputs increases. At higher current, the resistance of the output traces decreases the power delivered to the load. For example, if 2W is delivered from the speaker output to a 4Ω load through $100\text{m}\Omega$ of total speaker trace, 1.95W is being delivered to the speaker. If power is delivered through $10\text{m}\Omega$ of total speaker trace, 1.99W is delivered to the speaker. Wide output, supply, and ground traces also improve the power dissipation of the device.

Parasitic capacitance on the output traces cause higher quiescent current by $V_{\text{DD}} \times f_{\text{SW}} \times C_{\text{PARASITIC}}$. For example, at $V_{\text{DD}} = 5\text{V}$ and a total parasitic capacitance of 100pF (50pF on each output trace), the increase in quiescent current is $5\text{V} \times 300\text{kHz} \times 100\text{pF} = 150\mu\text{A}$.

The device is inherently designed for excellent RF immunity. For best performance, add ground fills around all signal traces on top or bottom PCB planes.

In many applications, the only passive component required is a single capacitor, which results in a tiny solution size of 3.69mm^2 .

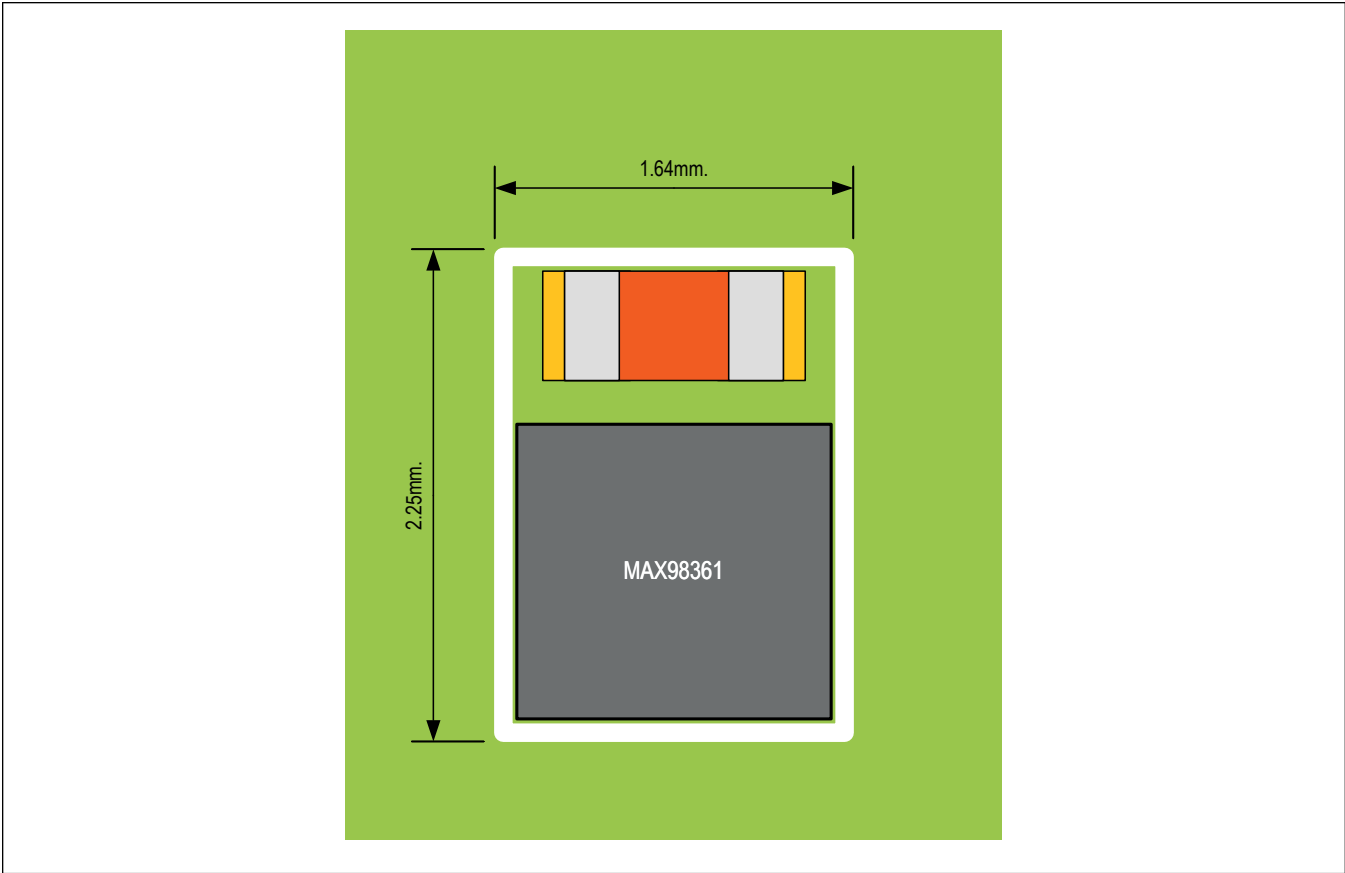

Figure 14. Solution Size

WLP GAIN_SLOT Routing

The intended use for the GAIN_SLOT pin is to either fix the desired gain in I²S and left-justified modes or to select the TDM channel. GAIN_SLOT should not be changed during audio playback as it could result in audible clicks or pops.

Most modes are selectable without using a via or routing out the center bump of the WLP. This simplifies the layout and allows for inexpensive PCB fabrication.

In I²S and left-justified modes, 6dB, 9dB, and 12dB gain settings do not require GAIN_SLOT to be routed out (see [Table 9](#)). In TDM mode, all channels can be selected without routing out GAIN_SLOT (see [Table 8](#)). This is possible because of the GAIN_SLOT pin's placement in relation to the V_{DD} and GND pins.

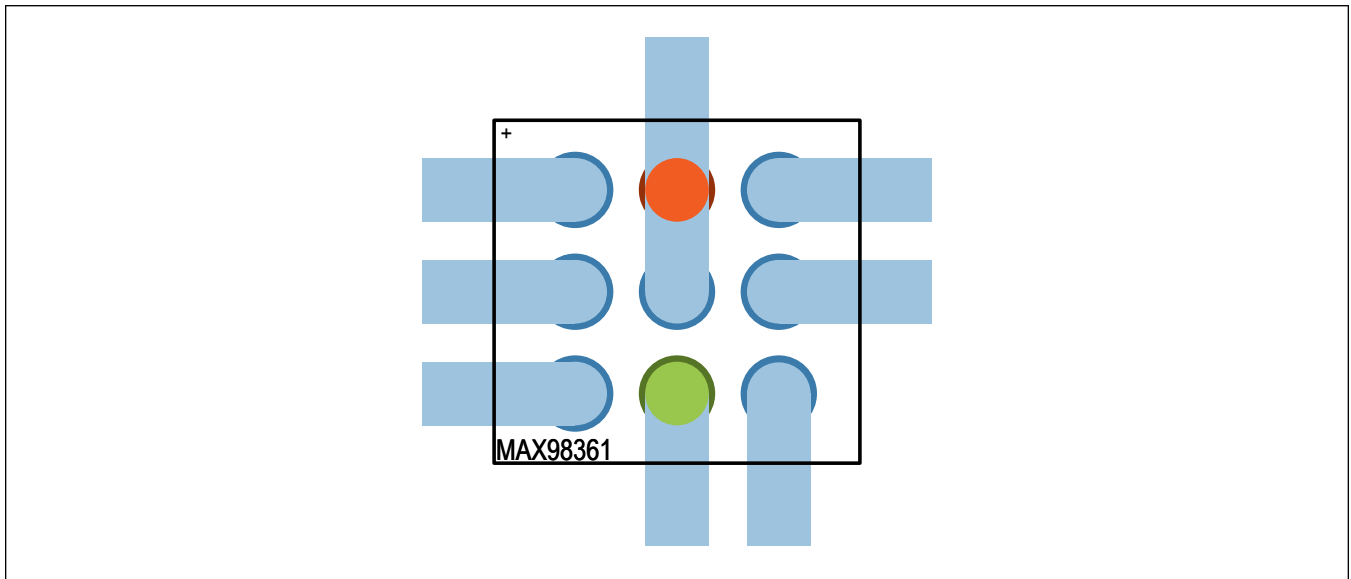

Figure 15. GAIN_SLOT Tied to V_{DD} (Gain is 6dB in I²S and Left-Justified Modes)

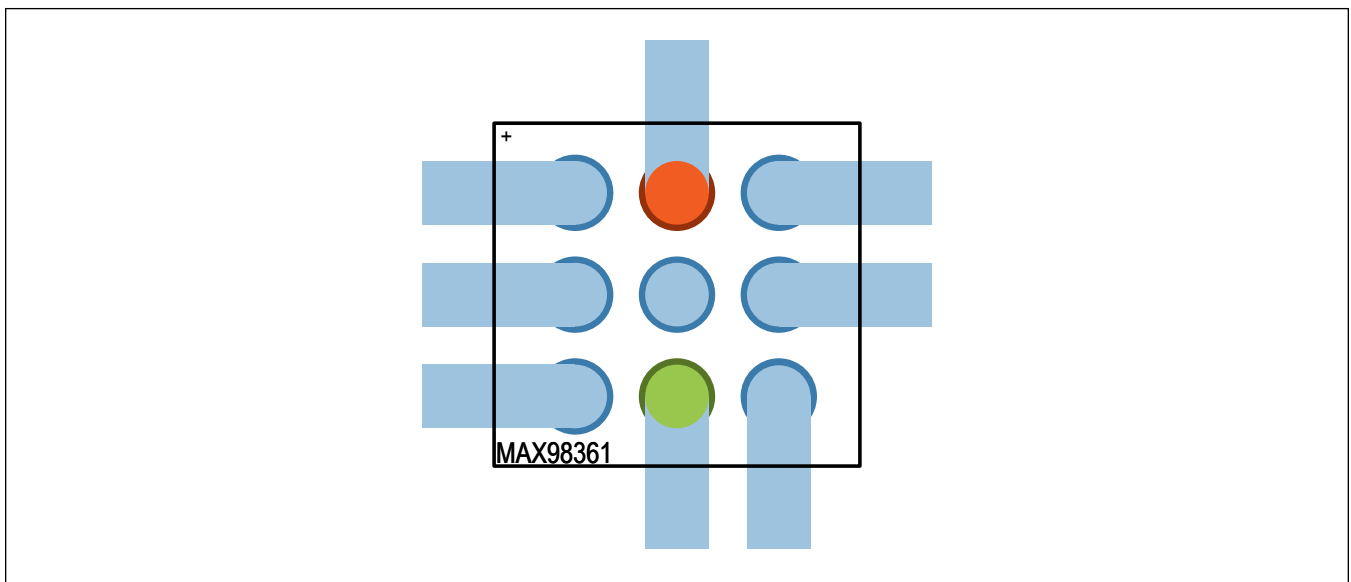

Figure 16. GAIN_SLOT Unconnected (Gain is 9dB in I²S and Left-Justified Modes)

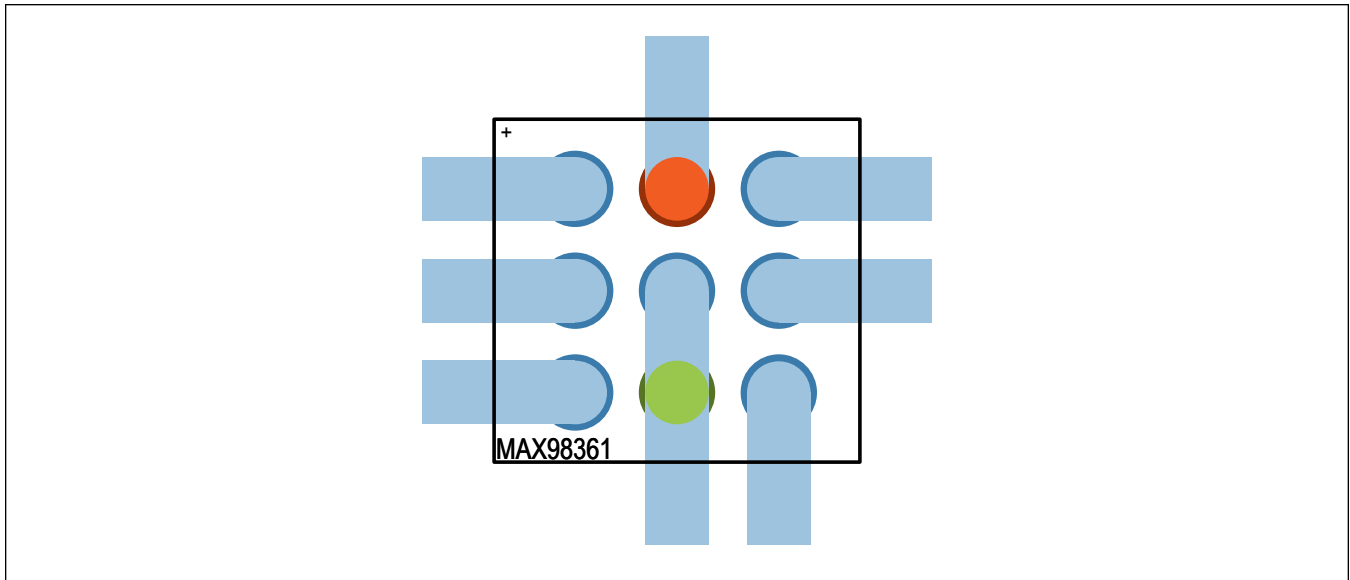

Figure 17. GAIN_SLOT Tied to GND (Gain is 12dB in I²S and Left-Justified Modes)

If using I²S or left-justified modes and a -3dB or 3dB gain setting is required, the GAIN_SLOT pin must be routed to a 100kΩ resistor that is connected to either V_{DD} or GND. Some routing options are:

- Mechanically drilled via: cheaper if PCB volumes are low
- Laser-drilled alternative: cheaper if PCB volumes are high
- Blind and buried vias with dog-boning
- Trace on the top layer: this must be a minimal pitch trace

PCB fabrication technology is constantly evolving, so check with your PCB manufacturer to see what option may work best for your design.

Typical Application Circuits

I²S/Left-Justified Left-Channel Operation with 6dB Gain

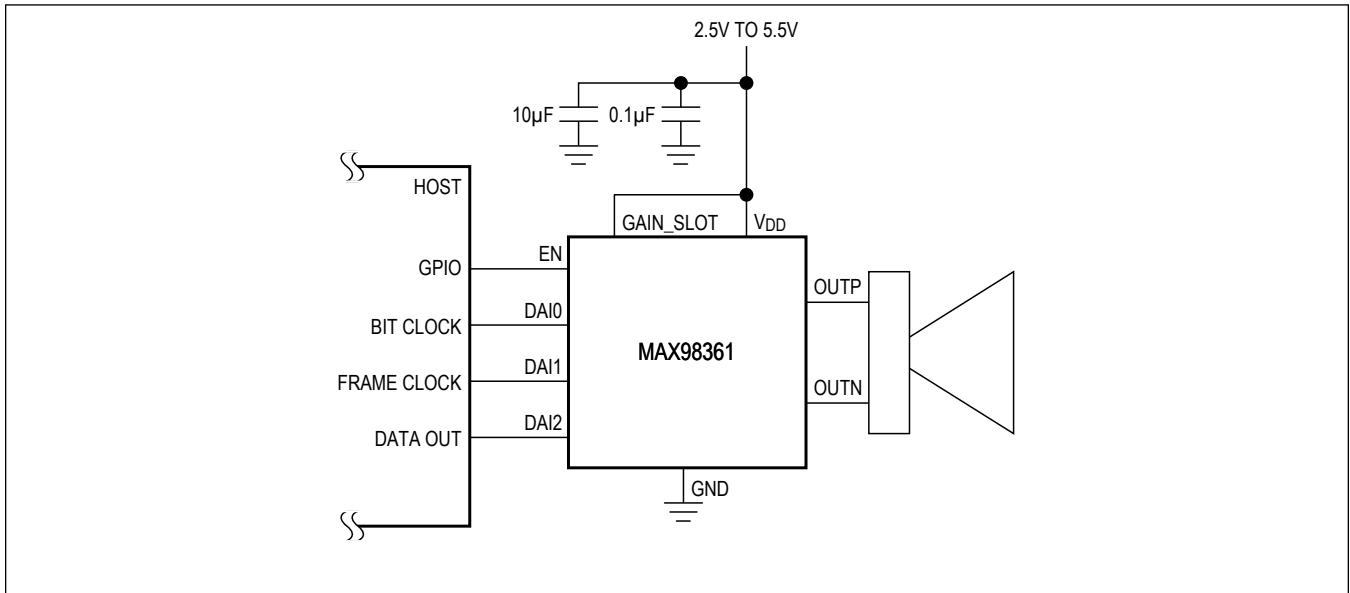

I²S/Left-Justified Left-Channel Operation with 12dB Gain

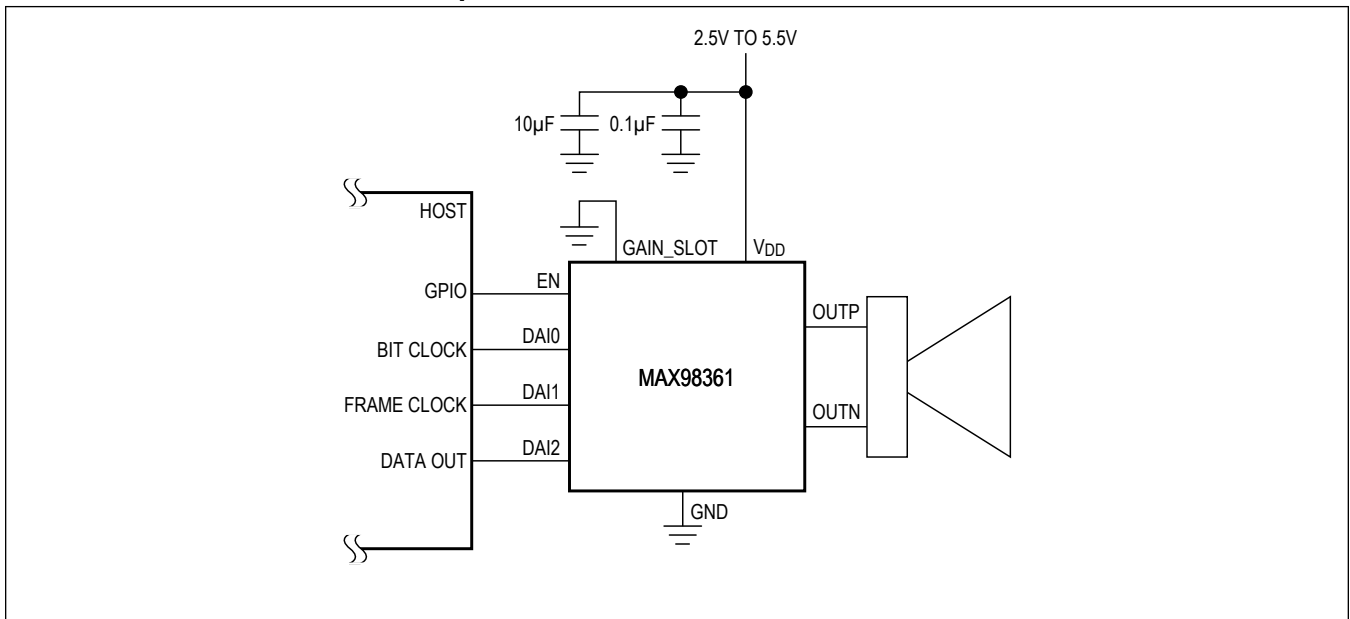

Typical Application Circuits (continued)

I²S/Left-Justified Left-Channel Operation with 3dB Gain

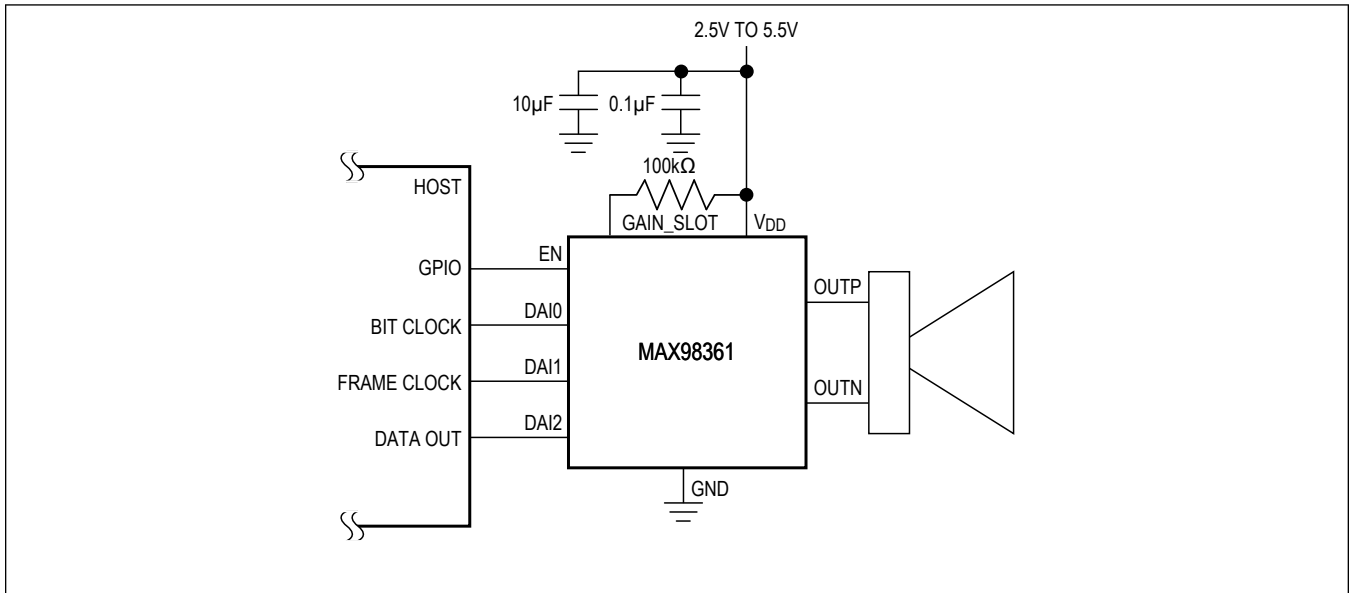

I²S/Left-Justified Right-Channel Operation with 6dB Gain

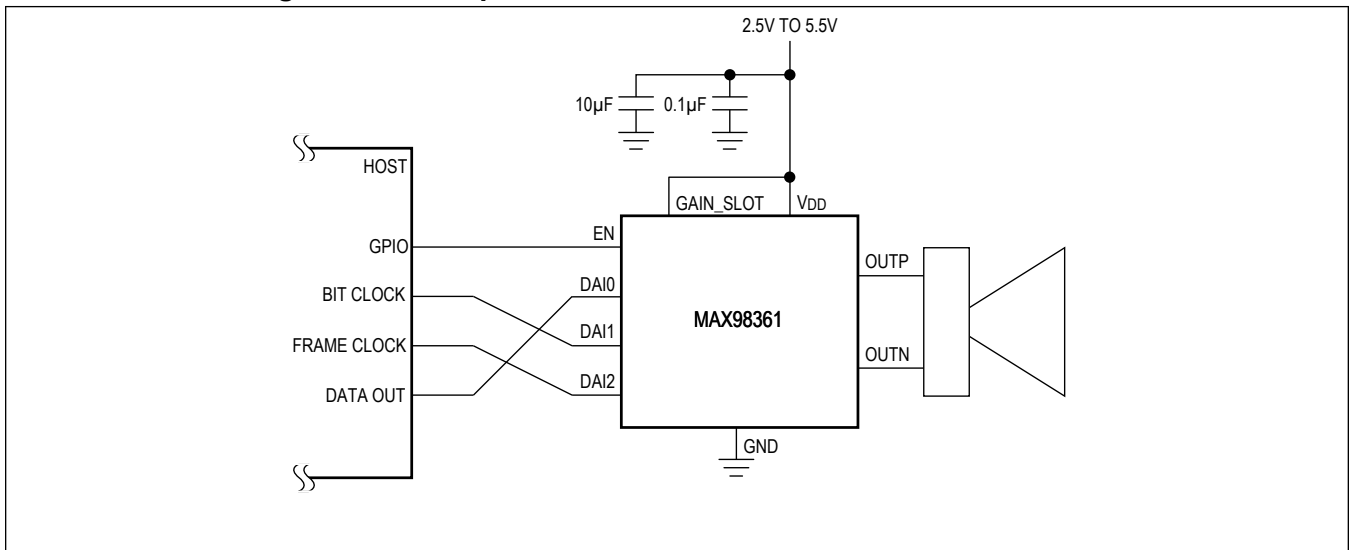

Typical Application Circuits (continued)

I²S/Left-Justified Left/2 + Right/2 Operation with 6dB Gain

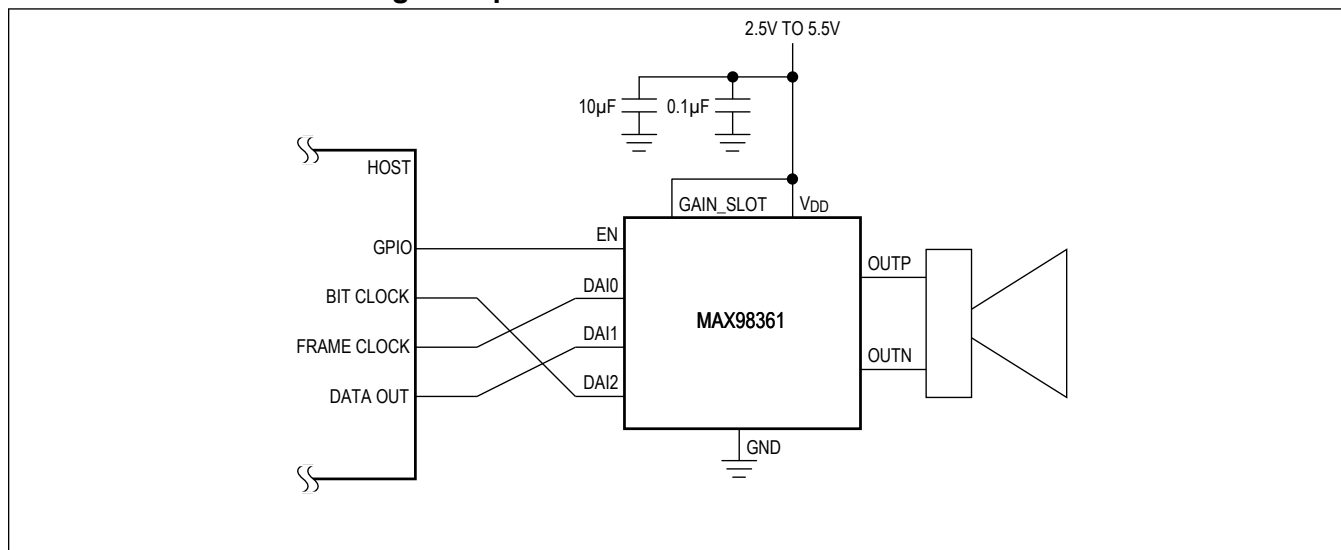

Typical Application Circuits (continued)

I²S/Left-Justified Stereo Operation with 6dB Gain

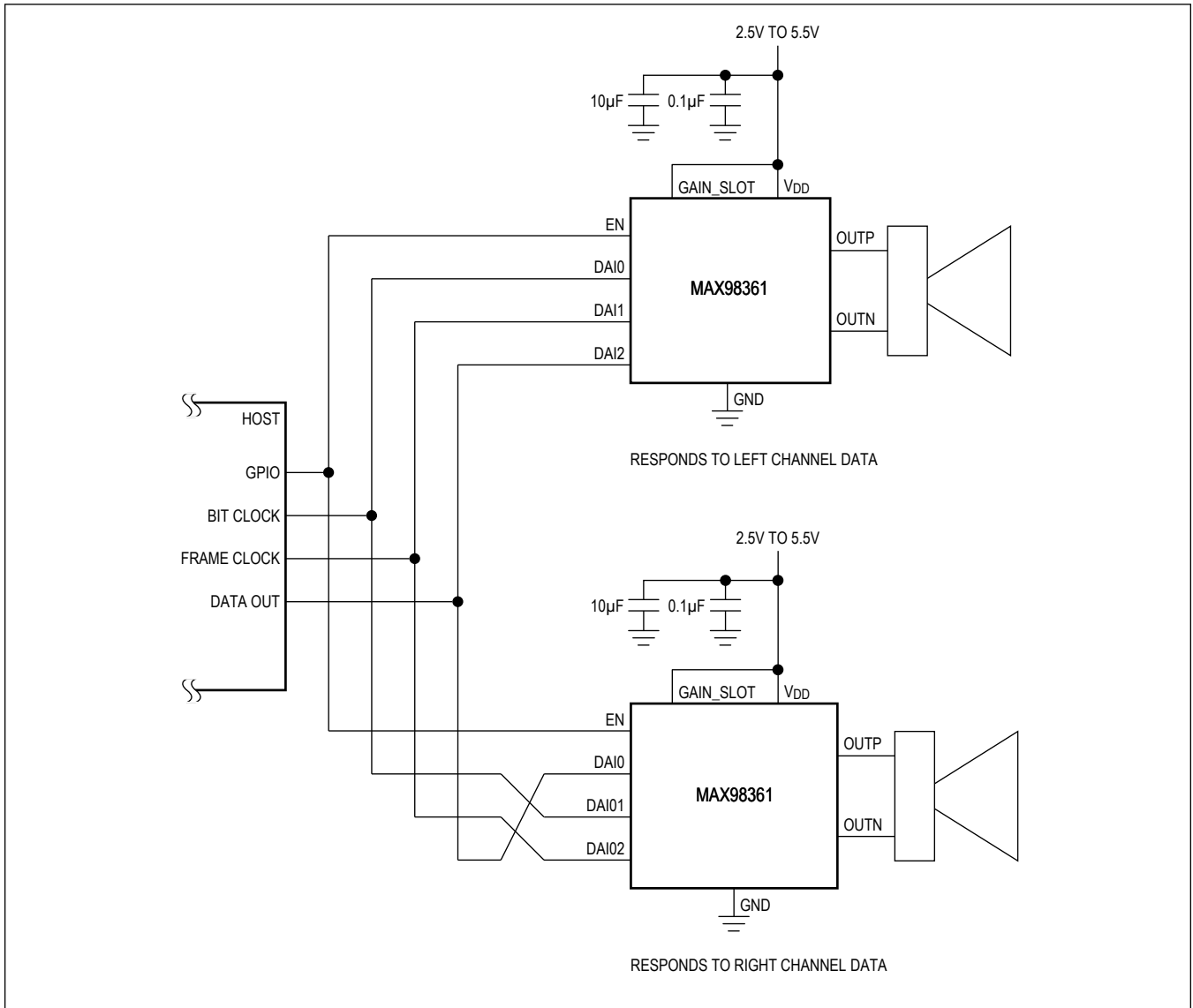

Typical Application Circuits (continued)

TDM Operation (Gain Fixed at 12dB)

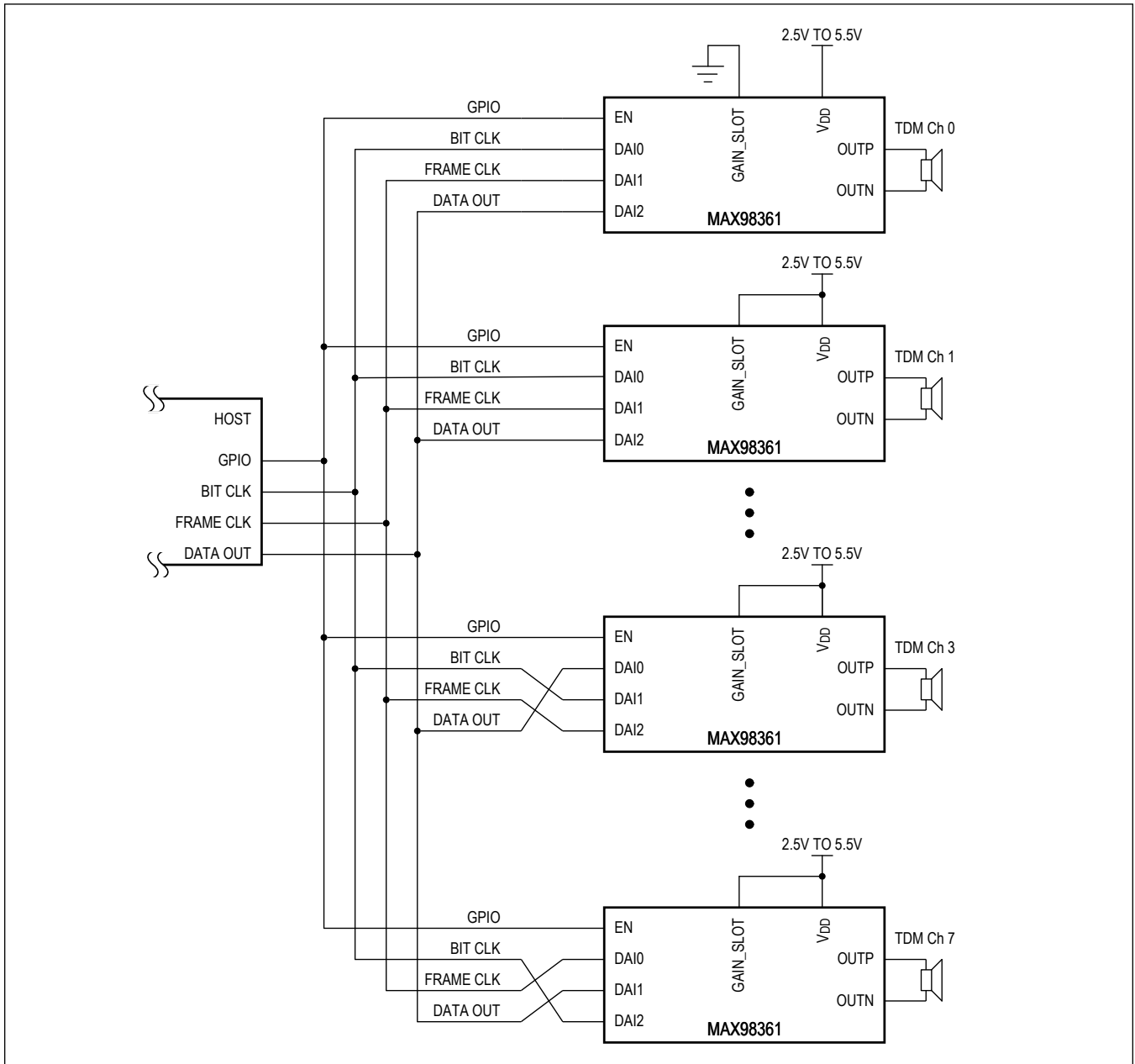

Ordering Information

| PART NUMBER | TEMP RANGE | PIN-PACKAGE | TOP MARKING |
|----------------|----------------|-------------|-------------|
| MAX98361AEWL+ | -40°C to +85°C | 9 WLP | ALZ |
| MAX98361AEWL+T | -40°C to +85°C | 9 WLP | ALZ |
| MAX98361BEWL+ | -40°C to +85°C | 9 WLP | AMA |
| MAX98361BEWL+T | -40°C to +85°C | 9 WLP | AMA |
| MAX98361CEWL+ | -40°C to +85°C | 9 WLP | AMB |
| MAX98361CEWL+T | -40°C to +85°C | 9 WLP | AMB |
| MAX98361DEWL+ | -40°C to +85°C | 9 WLP | AMC |
| MAX98361DEWL+T | -40°C to +85°C | 9 WLP | AMC |

+Denotes a lead(Pb)-free/RoHS-compliant package.

T = Tape and reel.

Revision History

| REVISION NUMBER | REVISION DATE | DESCRIPTION | PAGES CHANGED |
|-----------------|---------------|--|---------------|
| 0 | 2/22 | Release for Market Intro | — |
| 1 | 10/23 | Corrected OOTP and OUTN pin location in the <i>Pin Configuration</i> diagrams and the <i>Pin Description</i> table, added the package height to the <i>Pin Configuration</i> | 19 |