

## x510 Series

Gigabit Ethernet Switches

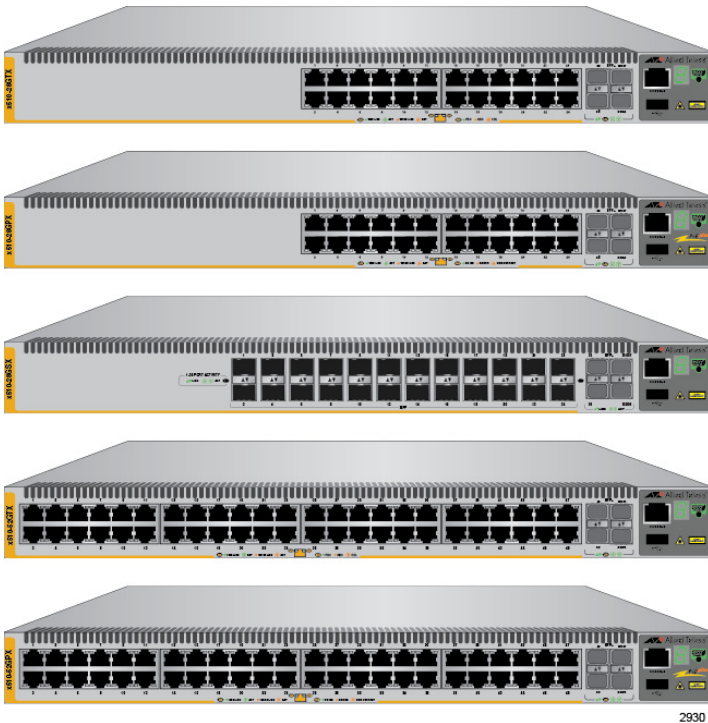

- ❑ AT-x510-28GTX
- ❑ AT-x510-28GPX
- ❑ AT-x510-28GSX
- ❑ AT-x510-28GSX-80
- ❑ AT-x510L-28GT
- ❑ AT-x510L-28GP
- ❑ AT-x510-52GTX
- ❑ AT-x510-52GPX
- ❑ AT-x510L-52GT
- ❑ AT-x510L-52GP

# Installation Guide for Virtual Chassis Stacks

Copyright © 2015 Allied Telesis, Inc.

All rights reserved. No part of this publication may be reproduced without prior written permission from Allied Telesis, Inc.

Allied Telesis and the Allied Telesis logo are trademarks of Allied Telesis, Incorporated. All other product names, company names, logos or other designations mentioned herein are trademarks or registered trademarks of their respective owners.

Allied Telesis, Inc. reserves the right to make changes in specifications and other information contained in this document without prior written notice. The information provided herein is subject to change without notice. In no event shall Allied Telesis, Inc. be liable for any incidental, special, indirect, or consequential damages whatsoever, including but not limited to lost profits, arising out of or related to this manual or the information contained herein, even if Allied Telesis, Inc. has been advised of, known, or should have known, the possibility of such damages.

# Electrical Safety and Emissions Standards

---

This product meets the following standards.

## U.S. Federal Communications Commission

### Radiated Energy

Note: This equipment has been tested and found to comply with the limits for a Class A digital device pursuant to Part 15 of FCC Rules. These limits are designed to provide reasonable protection against harmful interference when the equipment is operated in a commercial environment. This equipment generates, uses, and can radiate radio frequency energy and, if not installed and used in accordance with this instruction manual, may cause harmful interference to radio communications. Operation of this equipment in a residential area is likely to cause harmful interference in which case the user will be required to correct the interference at his own expense.

Note: Modifications or changes not expressly approved of by the manufacturer or the FCC, can void your right to operate this equipment.

## Industry Canada

This Class A digital apparatus complies with Canadian ICES-003.

Cet appareil numérique de la classe A est conforme à la norme NMB-003 du Canada.

RFI Emissions: FCC Class A, EN55022 Class A, EN61000-3-2, EN61000-3-3, VCCI Class A, C-TICK, CE

**Warning:** In a domestic environment this product may cause radio interference in which case the user may be required to take adequate measures. *see* E84

EMC (Immunity): EN55024

Electrical Safety: EN60950-1 (TUV), UL 60950-1 (CUL<sub>US</sub>)



Laser Safety

EN60825

## Translated Safety Statements

---

**Important:** The  indicates that a translation of the safety statement is available in a PDF document titled “Translated Safety Statements” on the Allied Telesis website at <http://www.alliedtelesis.com/support>.

# Contents

---

Document Conventions .....	12
Contacting Allied Telesis .....	13
<b>Chapter 1: Overview</b> .....	<b>15</b>
Features .....	16
x510 Models .....	16
10/100/1000 Mbps Twisted Pair Ports .....	16
Power Over Ethernet .....	16
SFP Slots .....	17
SFP+ Slots .....	17
Stacking Slots .....	18
LEDs .....	18
Installation Options .....	18
MAC Address Table .....	18
Management Software and Interfaces .....	19
Management Methods .....	19
Power Supplies .....	19
Front and Back Panels .....	20
Management Panel .....	24
10/100/1000Base-T Twisted Pair Ports .....	25
Speed .....	25
Duplex Mode .....	25
Wiring Configuration .....	25
Maximum Distance .....	26
Cable Requirements .....	26
Port Pinouts .....	26
Power Over Ethernet .....	27
PoE Standards .....	27
Powered Device Classes .....	27
Cable Requirements .....	28
Power Budget .....	29
Port Prioritization .....	30
Wiring Implementation .....	31
SFP+ Slots .....	32
Stacking SFP+ Slots .....	33
eco-friendly Button .....	34
LEDs .....	35
LEDs for the Twisted Pair Ports .....	35
LEDs for the SFP Slots .....	38
LEDs for the SFP+ Slots .....	39
LEDs for the Stacking Slots .....	40
Switch ID LED .....	41
USB Port .....	44
Console Port .....	45
Power Supplies .....	46
<b>Chapter 2: Virtual Chassis Stacking</b> .....	<b>49</b>
Overview .....	50
Stacking Slots .....	51
Stacking Transceivers .....	52

Stacking Port Topologies .....	54
Master and Member Switches .....	58
Selection of the Master Switch .....	58
ID Numbers .....	59
Specifying Ports in the Command Line Interface .....	60
<b>Chapter 3: Beginning the Installation</b> .....	61
Reviewing Safety Precautions .....	62
Choosing a Site for the Switches .....	68
Planning a Stack .....	69
Unpacking the Switch .....	71
<b>Chapter 4: Installing the Switches on a Table or in an Equipment Rack</b> .....	73
Installing the Switches on a Table or Desktop .....	74
Installing the Switch in an Equipment Rack .....	75
Wiring the DC Connectors on the AT-x510-28GSX-80 Switch .....	78
Required Material and Tools .....	78
Connecting the Grounding Wire .....	79
Connecting the -48/-60VDC and RETURN Wires .....	81
<b>Chapter 5: Verifying the Status of VCStack</b> .....	87
Verifying the Status of VCStack .....	88
Activating the VCStack Feature .....	89
Starting a Local Management Session .....	89
Activating VCStack .....	90
<b>Chapter 6: Cabling the Stacking Ports</b> .....	93
Cabling Switches with AT-StackXS/1.0 Transceivers .....	94
Cabling Switches with AT-StackOP/0.3 or AT-StackOP/9.0 Transceivers .....	99
<b>Chapter 7: Powering On the Stack</b> .....	103
Powering On the Switches Individually .....	104
Powering On the Switches Simultaneously .....	108
Verifying the Stack .....	110
Setting the Priority Numbers .....	111
Monitoring the Initialization Processes .....	113
<b>Chapter 8: Cabling the Networking Ports</b> .....	117
Cabling the Twisted Pair Ports .....	118
Installing SFP and SFP+ Transceivers .....	120
Installing SFP Modules in the AT-x510-28GSX and AT-x510-28GSX-80 Switches .....	121
Installing SFP and SFP+ Modules .....	124
<b>Chapter 9: Troubleshooting</b> .....	127
<b>Appendix A: Technical Specifications</b> .....	133
Physical Specifications .....	133
Environmental Specifications .....	135
Power Specifications .....	135
Certifications .....	137
RJ-45 Twisted Pair Port Pinouts .....	137
RJ-45 Style Serial Console Port Pinouts .....	139
Fiber Optic Specifications for the AT-StackOP/0.3 and AT-StackOP/9.0 Transceivers .....	140

# Figures

---

Figure 1: Front Panels of the AT-x510-28GTX, AT-x510L-28GT, and AT-x510-28GPX Switches .....	20
Figure 2: Front Panels of the AT-x510-28GSX, AT-x510-28GSX-80, AT-x510-52GTX, AT-x510L-52GT, AT-x510-52GPX, and AT-x510L-52GP Switches .....	21
Figure 3: Back Panel of the AT-x510-28GTX, AT-x510-52GTX, and AT-x510-28GSX Switches .....	22
Figure 4: Back Panel of the AT-x510-28GPX and AT-x510-52GPX Switches .....	22
Figure 5: Back Panel of the AT-x510L-28GT and AT-x510L-52GT Switches .....	23
Figure 6: Back Panel of the AT-x510L-28GP and AT-x510L-52GP Switches .....	23
Figure 7: Back Panel of the AT-x510-28GSX-80 DC Powered Switch .....	23
Figure 8: x510 Series Management Panel .....	24
Figure 9: LEDs for the 10/100/1000Base-T Ports on the AT-x510-28GTX, AT-x510L-28GT, AT-x510-52GTX, and AT-x510L-52GT Switches .....	35
Figure 10: LEDs for the 10/100/1000Base-T Ports on the AT-x510-28GPX, AT-x510L-28GP, AT-x510-52GPX, and AT-x510L-52GP Switches .....	37
Figure 11: SFP Slot LEDs on the AT-x510-28GSX and AT-x510-28GSX-80 Switches .....	39
Figure 12: SFP+ Slot LEDs .....	40
Figure 13: Switch ID LED .....	41
Figure 14: Switch ID LED not in Low Power Mode .....	42
Figure 15: Switch ID LED in Low Power Mode .....	43
Figure 16: Stacking Transceivers .....	52
Figure 17: Stack of Two Switches in the Linear Topology .....	54
Figure 18: Stack of Four Switches in the Linear Topology .....	55
Figure 19: Stack of Two Switches in the Ring Topology .....	56
Figure 20: Stack of Four Switches in the Ring Topology .....	57
Figure 21: PORT Parameter in the Command Line Interface .....	60
Figure 22: Components of the x510 Series Switches .....	71
Figure 23: Turning the Switch Upside Down .....	75
Figure 24: Removing the Rubber Feet .....	75
Figure 25: Attaching the Equipment Rack Brackets .....	76
Figure 26: Attaching the Equipment Rack Brackets (Continued) .....	77
Figure 27: Mounting the Switch in an Equipment Rack .....	77
Figure 28: Ring Lug .....	78
Figure 29: Stripping the Stranded Grounding Wire .....	79
Figure 30: Attaching the Stranded Grounding Wire to the Ring Lug .....	80
Figure 31: Removing the Nut from the Grounding Post .....	80
Figure 32: Installing the Grounding Wire .....	81
Figure 33: Loosening the Two Captive Screws on the DC Connector .....	82
Figure 34: Removing the DC Connector .....	82
Figure 35: Loosening the Captive Screws on the DC Connector .....	83
Figure 36: Stripping a Stranded Power Wire .....	83
Figure 37: Inserting the RETURN Wire .....	83
Figure 38: Inserting the -48/-60VDC Wire .....	84
Figure 39: Sliding the DC Connector into the Switch .....	84
Figure 40: Securing the DC Connector to the Switch .....	85
Figure 41: Connecting the Management Cable to the Console Port .....	89
Figure 42: User Exec Mode Prompt .....	90
Figure 43: Moving to the Privileged Exec Mode with the ENABLE Command .....	90
Figure 44: Moving to the Global Configuration Mode with the CONFIGURE TERMINAL Command .....	90
Figure 45: Activating VCStack with the STACK ENABLE Command .....	91
Figure 46: Returning to the Privileged Exec Mode with the EXIT Command .....	91
Figure 47: Saving the Change with the WRITE Command .....	91

Figure 48: Rebooting the Switch with the REBOOT Command..... 91

Figure 49: Removing the Dust Plug from the S1 Slot ..... 94

Figure 50: Removing the Dust Cover from the AT-StackXS/1.0 Transceiver ..... 95

Figure 51: Installing the AT-StackXS/1.0 Transceiver in Slot S1 ..... 96

Figure 52: Removing the Dust Plug from the S2 Slot ..... 97

Figure 53: Installing the AT-StackXS/1.0 Transceiver in Slot S2..... 98

Figure 54: Handle on the AT-StackOP/0.3 and AT-StackOP/9.0 Transceivers..... 99

Figure 55: Installing the AT-StackOP/0.3 or AT-StackOP/9.0 Transceiver..... 100

Figure 56: Removing the Dust Cover from a Stacking Transceiver..... 101

Figure 57: Positioning the Handle in the Upright Position..... 101

Figure 58: Connecting the Fiber Optic Cable to the Stacking Transceiver ..... 102

Figure 59: Plugging in the AC Power Cords ..... 105

Figure 60: SHOW STACK Command ..... 110

Figure 61: Moving to the Global Configuration Mode with the CONFIGURE TERMINAL Command..... 111

Figure 62: Returning to the Privileged Exec Mode ..... 112

Figure 63: Saving the Priority Values with the WRITE Command ..... 112

Figure 64: Switch Initialization Messages ..... 113

Figure 65: Switch Initialization Messages (Continued) ..... 114

Figure 66: Switch Initialization Messages (Continued) ..... 115

Figure 67: Removing the Dust Plug from an SFP Slot..... 121

Figure 68: Installing an SFP Transceiver..... 122

Figure 69: Removing the Dust Cover from an SFP Transceiver..... 122

Figure 70: Positioning the SFP Handle in the Upright Position..... 123

Figure 71: Connecting a Fiber Optic Cable to an SFP Transceiver..... 123

Figure 72: Removing the Dust Plug from an SFP+ Slot ..... 124

Figure 73: Installing an SFP or SFP+ Transceiver ..... 125

Figure 74: Removing the Dust Cover from an SFP or SFP+ Transceiver ..... 125

Figure 75: Positioning the SFP or SFP+ Handle in the Upright Position ..... 126

Figure 76: Connecting a Fiber Optic Cable to an SFP or SFP+ Transceiver ..... 126

Figure 77: RJ-45 Socket Pin Layout (Front View)..... 137



# Tables

---

Table 1: Twisted Pair Cable for the 10/100/1000Base-T Ports .....	26
Table 2: IEEE Powered Device Classes .....	28
Table 3: Twisted Pair Cable Requirements for the 10/100Base-TX Ports at 10 or 100Mbps .....	28
Table 4: Twisted Pair Cable Requirements for the 10/100/1000Base-T Ports at 1000Mbps .....	29
Table 5: LEDs on the AT-x510-28GTX, AT-x510L-28GT, AT-x510-52GTX, and AT-x510L-52GT .....	36
Table 6: LEDs on the 10/100/1000Base-T Ports on the AT-x510-28GPX, AT-x510L-28GP, AT-x510-52GPX, and AT-x510L-52GP Switches .....	37
Table 7: SFP Slot LEDs on the AT-x510-28GSX and AT-x510-28GSX-80 Switches .....	39
Table 8: SFP+ Slot LEDs .....	40
Table 9: Stacking Slot LEDs .....	41
Table 10: Stacking Transceivers .....	52
Table 11: Operating Distances of the AT-StackOP/0.3 Transceiver .....	70
Table 12: Product Dimensions .....	133
Table 13: Product Weights .....	134
Table 14: Ventilation Requirements .....	134
Table 15: Environmental Specifications .....	135
Table 16: Maximum Power Consumption .....	135
Table 17: Input Voltages .....	136
Table 18: Product Certifications .....	137
Table 19: Pin Signals for 10 and 100 Mbps .....	138
Table 20: Pin Signals for 1000 Mbps .....	138
Table 21: RJ-45 Style Serial Console Port Pin Signals .....	139
Table 22: Fiber Optic Port Specifications for the AT-StackOP/0.3 Module .....	140
Table 23: Fiber Optic Port Specifications for the AT-StackOP/9.0 Transceiver .....	141



# Preface

---

This guide contains the installation instructions for the x510 Series of Layer 2+ and Basic Layer 3, Gigabit Ethernet switches. This preface contains the following sections:

- “Document Conventions” on page 12
- “Contacting Allied Telesis” on page 13

---

**Note**

This guide explains how to install the switches in a stack configuration with Virtual Chassis Stacking (VCStack™). For instructions on how to install the switches as stand-alone units, refer to the *x510 Series Installation Guide for Stand-alone Switches*.

---

## Document Conventions

---

This document uses the following conventions:

---

**Note**

Notes provide additional information.

---



---

**Caution**

Cautions inform you that performing or omitting a specific action may result in equipment damage or loss of data.

---



---

**Warning**

Warnings inform you that performing or omitting a specific action may result in bodily injury.

---



---

**Warning**

Laser warnings inform you that an eye and skin hazard exists due to the presence of a Class 1 laser device.

---

## Contacting Allied Telesis

---

If you need assistance with this product, you may contact Allied Telesis technical support by going to the Support & Services section of the Allied Telesis web site at **[www.alliedtelesis.com/support](http://www.alliedtelesis.com/support)**. You can find links for the following services on this page:

- ❑ 24/7 Online Support - Enter our interactive support center to search for answers to your questions in our knowledge database, check support tickets, learn about Return Merchandise Authorizations (RMAs), and contact Allied Telesis technical experts.
- ❑ USA and EMEA phone support - Select the phone number that best fits your location and customer type.
- ❑ Hardware warranty information - Learn about Allied Telesis warranties and register your product online.
- ❑ Replacement Services - Submit an RMA request via our interactive support center.
- ❑ Documentation - View the most recent installation guides, user guides, software release notes, white papers and data sheets for your product.
- ❑ Software Updates - Download the latest software releases for your product.

For sales or corporate contact information, go to **[www.alliedtelesis.com/purchase](http://www.alliedtelesis.com/purchase)** and select your region.



# Chapter 1

# Overview

---

This chapter contains the following sections:

- “Features” on page 16
- “Front and Back Panels” on page 20
- “Management Panel” on page 24
- “10/100/1000Base-T Twisted Pair Ports” on page 25
- “Power Over Ethernet” on page 27
- “SFP+ Slots” on page 32
- “Stacking SFP+ Slots” on page 33
- “eco-friendly Button” on page 34
- “LEDs” on page 35
- “USB Port” on page 44
- “Console Port” on page 45
- “Power Supplies” on page 46

---

### **Note**

This guide explains how to install the switches in a stack configuration with the Virtual Chassis Stack (VCStack™) feature. For instructions on how to install the switches as stand-alone units, refer to the *x510 Series Installation Guide for Stand-alone Switches*.

---

## Features

---

Here are the switches and their features:

### **x510 Models**

Here are the x510 Series switches:

- AT-x510-28GTX
- AT-x510-28GPX
- AT-x510-28GSX
- AT-x510-28GSX-80
- AT-x510L-28GT
- AT-x510L-28GP
- AT-x510-52GTX
- AT-x510-52GPX
- AT-x510L-52GT
- AT-x510L-52GP (not available in North America)

### **10/100/1000 Mbps Twisted Pair Ports**

Here are the basic features of the 10/100/1000 Mbps twisted pair ports:

- 24 or 48 ports per switch
- 10Base-T, 100Base-TX, and 1000Base-T compliant
- IEEE 802.3u Auto-Negotiation compliant
- Auto-MDI/MDIX
- 100 meters (328 feet) maximum operating distance
- IEEE 802.3x flow control in 10/100Base-TX full-duplex mode
- IEEE 802.3x backpressure in 10/100Base-TX half-duplex mode
- IEEE 802.3ab 1000Base-T
- Jumbo frames up to 13KB
- RJ-45 connectors

### **Power Over Ethernet**

Here are the basic features of Power over Ethernet (PoE) on the twisted pair ports on the AT-x510-28GPX, AT-x510L-28GP, AT-x510-52GPX, and AT-x510L-52GP Switches:

- Supported on ports 1 to 24 on the AT-x510-28GPX and AT-x510L-28GP Switches and ports 1 to 48 on the AT-x510-52GPX and AT-x510L-52GP Switches
- Supports PoE (15.4 watts maximum) and PoE+ (30 watts maximum) powered devices
- Supports powered device classes 0 to 4



- ❑ Maximum power budget of 370 watts for the AT-x510-28GPX and AT-x510-52GPX Switches, and 185 watts for the AT-x510L-28GP and AT-x510L-52GP Switches
- ❑ Port prioritization
- ❑ Mode A wiring

**SFP Slots** Here are the basic features of the SFP slots on the AT-x510-28GSX and AT-x510-28GSX-80 Switches:

- ❑ Supports 100Base-FX and 1000Base-SX/LX SFP transceivers
- ❑ Supports single-port BiDi 1000Base-LX SFP transceivers
- ❑ Supports 1000Base-ZX SFP transceivers

---

**Note**

SFP transceivers must be purchased separately. For a list of supported transceivers, contact your Allied Telesis distributor or reseller.

---

**SFP+ Slots** Here are the basic features of the four SFP+ slots on the switches:

- ❑ Supports 10Gbps, 10GBase-SR/LR fiber optic transceivers
- ❑ Supports 10Gbps AT-SP10TW direct connect twinax cables with SFP+ transceiver-style connectors
- ❑ Supports 1000Base-SX/LX SFP transceivers
- ❑ Supports single-port BiDi 1000Base-LX SFP transceivers
- ❑ Supports 1000Base-ZX SFP transceivers

---

**Note**

The SFP+ slots do not support 100Mbps 100Base-FX transceivers.

---

---

**Note**

SFP and SFP+ transceivers must be purchased separately. For a list of supported transceivers, contact your Allied Telesis distributor or reseller.

---

---

**Note**

SFP+ slots 27 and 28 on the AT-x510-28GTX and AT-x510-28GPX Switches and slots 51 and 52 on the AT-x510-52GTX and AT-x510-52GPX Switches are initially configured as stacking slots for the VCStack feature. If you intend to use the switch as a stand-alone unit, you must disable the VCStack feature before using the slots with standard SFP or SFP+ transceivers. The configuration instructions are provided in the *x510 Series Installation Guide for Stand-alone Switches*.

---

**Stacking Slots**

Two of the SFP+ slots can be used to create a VCStack of up to four switches. The slots support these stacking transceivers when the switch is in the stacking mode:

- AT-StackXS/1.0 Twisted Pair Transceiver - 1 meter
- AT-StackOP/0.3 Fiber Optic Transceiver - 300 meters
- AT-StackOP/9.0 Fiber Optic Transceiver - 9 kilometers

**LEDs**

Here are the port LEDs:

- Link/activity and duplex mode LEDs for the twisted pair ports on non-PoE switches
- Link/activity and PoE status LEDs for the twisted pair ports on PoE switches
- Link/activity LEDs for SFP and SFP+ slots
- Stack ID number LED
- eco-friendly button turns off the LEDs to conserve electricity

**Installation Options**

Here are the installation options for the switches:

- 19-inch equipment rack
- Desk or tabletop

**MAC Address Table**

Here are the basic features of the MAC address tables of the switches:

- Storage capacity of 16,000 dynamic MAC address entries
- Storage capacity of 256 static MAC address entries
- Automatic learning and aging

## **Management Software and Interfaces**

Here are the management software and interfaces:

- AlliedWare Plus Management Software
- Command line interface
- Web browser interface

## **Management Methods**

Here are the methods for managing the switches:

- Local management through the Console port
- Remote Telnet and Secure Shell management
- Remote HTTP and HTTPS web browser management
- SNMPv1, v2c, and v3

## **Power Supplies**

The AT-x510-28GTX, AT-x510-28GPX, AT-x510-28GSX, AT-x510-52GTX, and AT-x510-52GPX Switches have two pre-installed AC power supplies. The AT-x510L-28GP, AT-x510L-28GT, AT-x510L-52GP, and AT-x510L-52GT Switches have one pre-installed AC power supply. The AT-x510-28GSX-80 Switch has two pre-installed DC power supplies. The DC power supply option is only available in the AT-x510-28GSX-80 Switch. The power supplies are not field-replaceable.

# Front and Back Panels

The front panels of the x510 Series switches are shown in Figure 1 and Figure 2 on page 21.

**AT-x510-28GTX, AT-x510L-28GT**

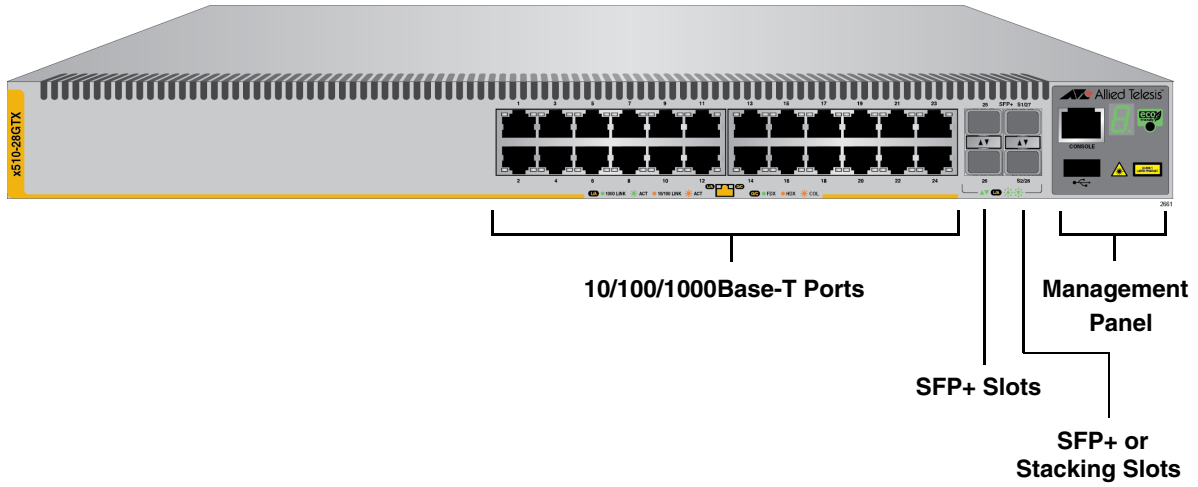

**AT-x510-28GPX**

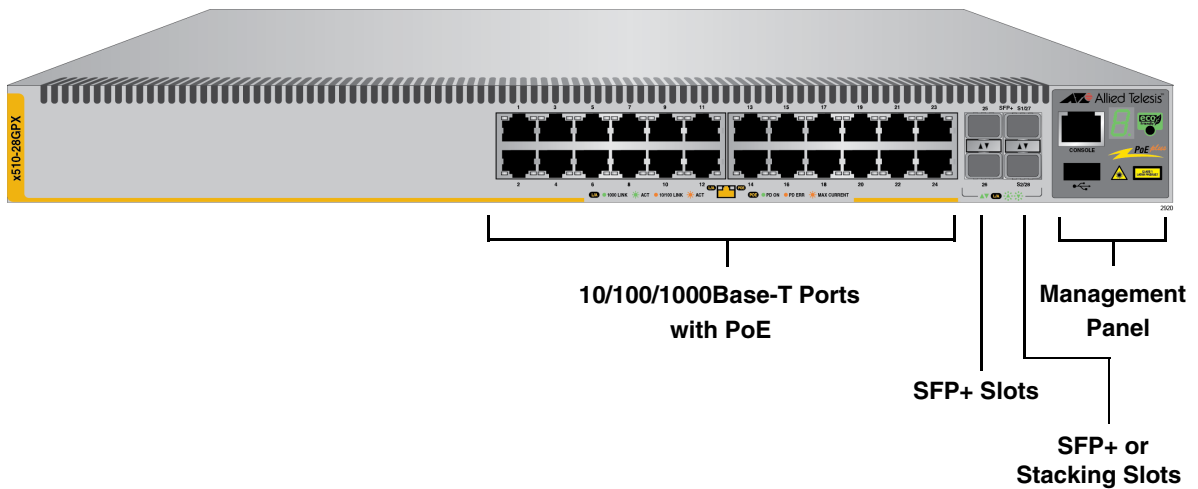
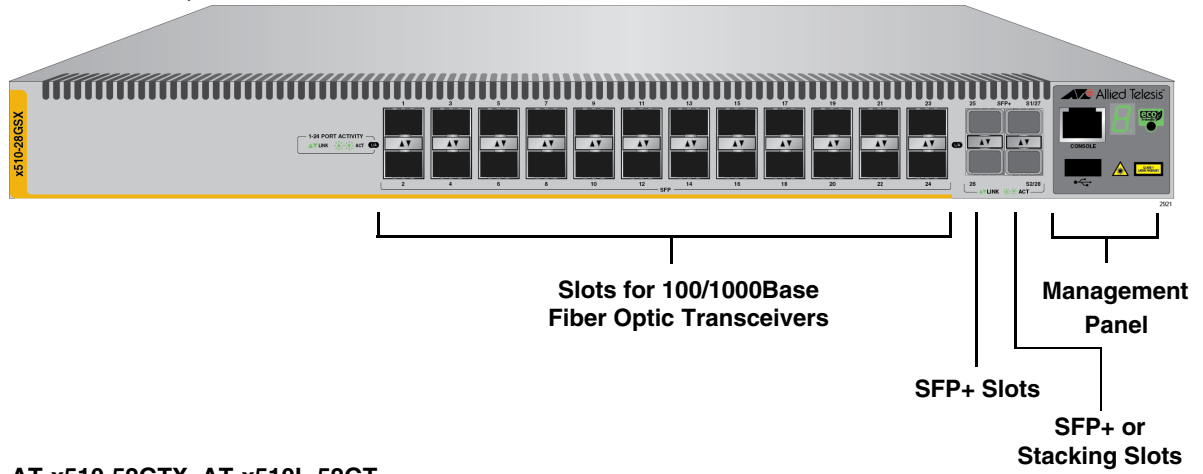
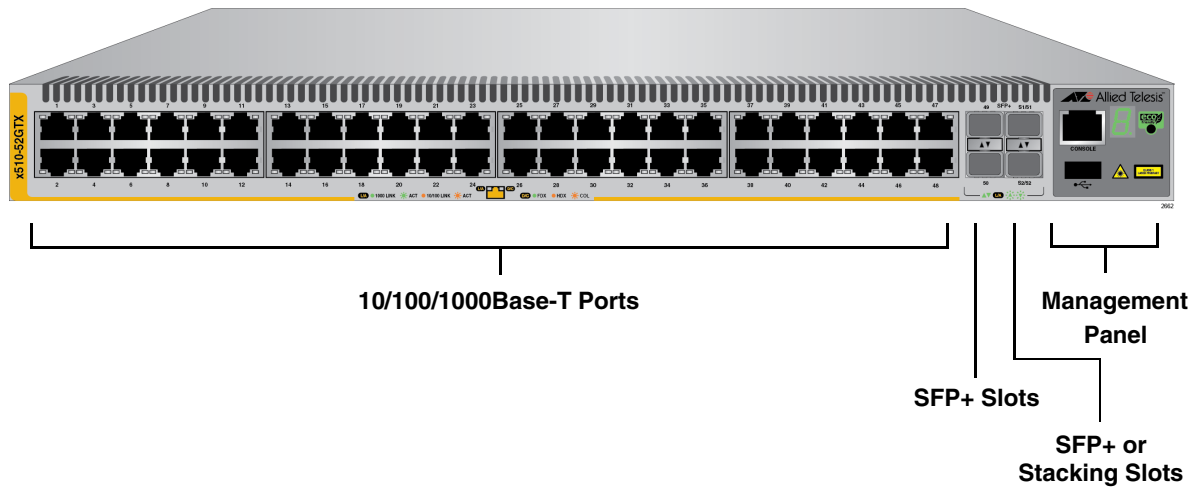

Figure 1. Front Panels of the AT-x510-28GTX, AT-x510L-28GT, and AT-x510-28GPX Switches

**AT-x510-28GSX, AT-x510-28GSX-80**



**AT-x510-52GTX, AT-x510L-52GT**



**AT-x510-52GPX, AT-x510L-52GP**

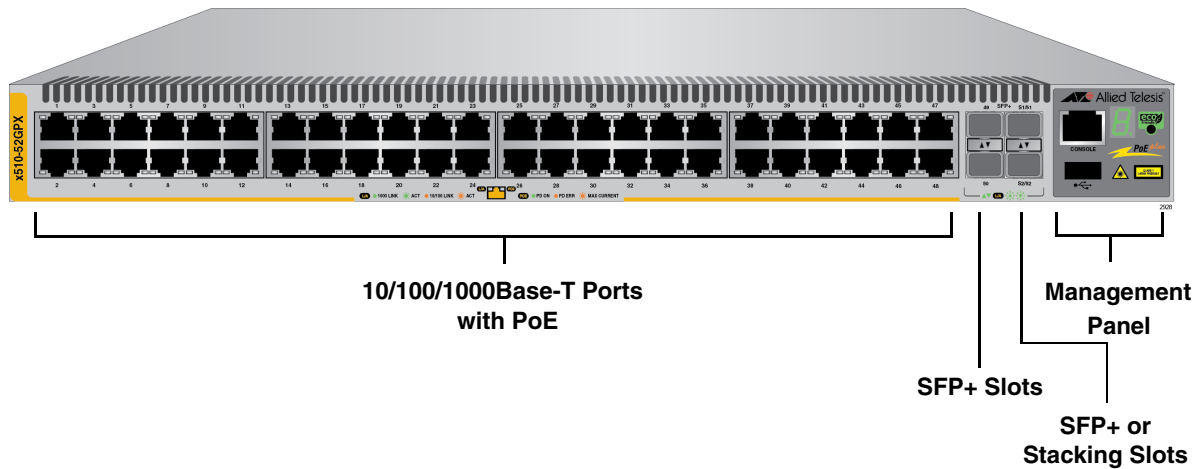

Figure 2. Front Panels of the AT-x510-28GSX, AT-x510-28GSX-80, AT-x510-52GTX, AT-x510L-52GT, AT-x510-52GPX, and AT-x510L-52GP Switches

Figure 3 shows the back panel of the AT-x510-28GTX, AT-x510-52GTX, and AT-x510-28GSX Switches.

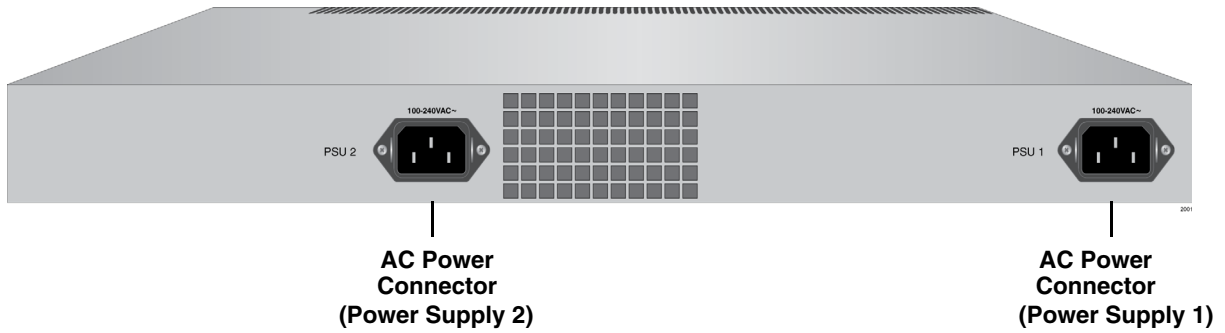

Figure 3. Back Panel of the AT-x510-28GTX, AT-x510-52GTX, and AT-x510-28GSX Switches

Figure 4 shows the back panel of the AT-x510-28GPX and AT-x510-52GPX Switches.

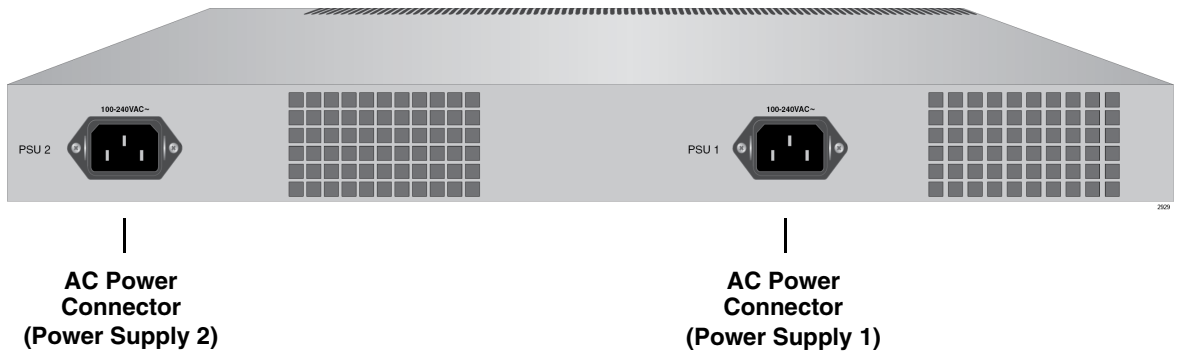

Figure 4. Back Panel of the AT-x510-28GPX and AT-x510-52GPX Switches

Figure 5 shows the back panel of the AT-x510L-28GT and AT-x510L-52GT Switches.

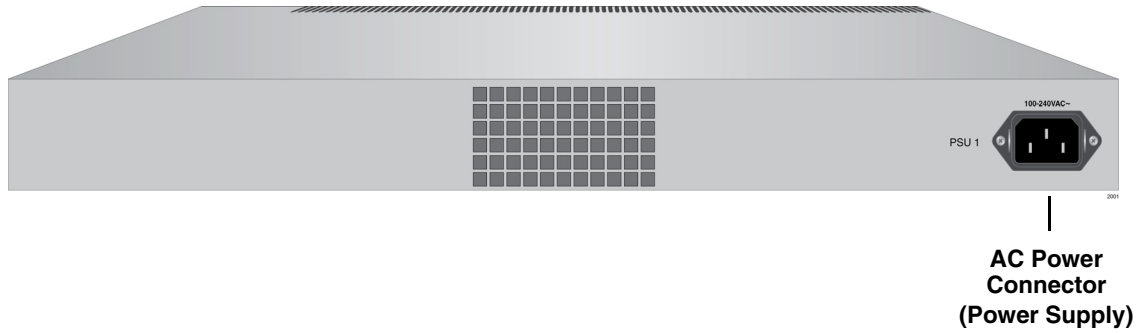

Figure 5. Back Panel of the AT-x510L-28GT and AT-x510L-52GT Switches

Figure 6 shows the back panel of the AT-x510L-28GP and AT-x510L-52GP Switches.

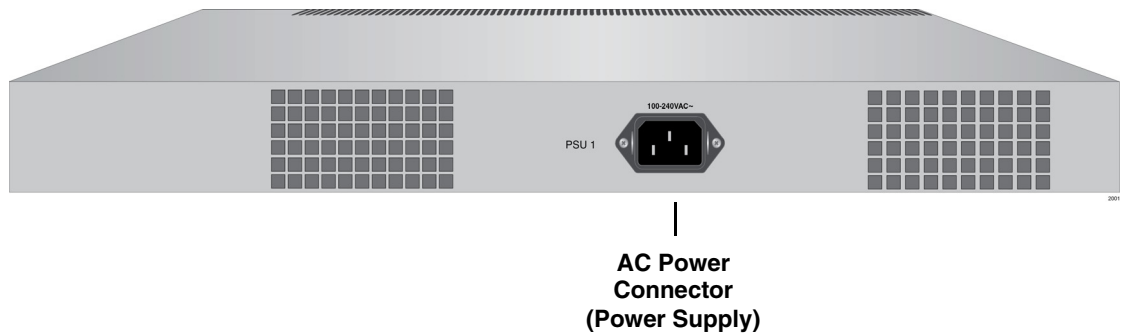

Figure 6. Back Panel of the AT-x510L-28GP and AT-x510L-52GP Switches

Figure 7 shows the back panel of the AT-x510-28GSX-80 DC powered Switch.

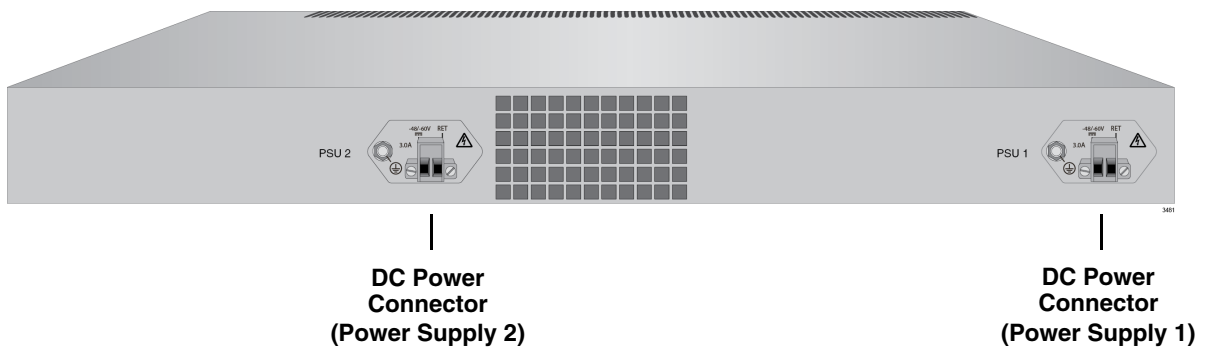

Figure 7. Back Panel of the AT-x510-28GSX-80 DC Powered Switch

# Management Panel

---

Figure 8 identifies the components in the management panel on the x510 Series switches.

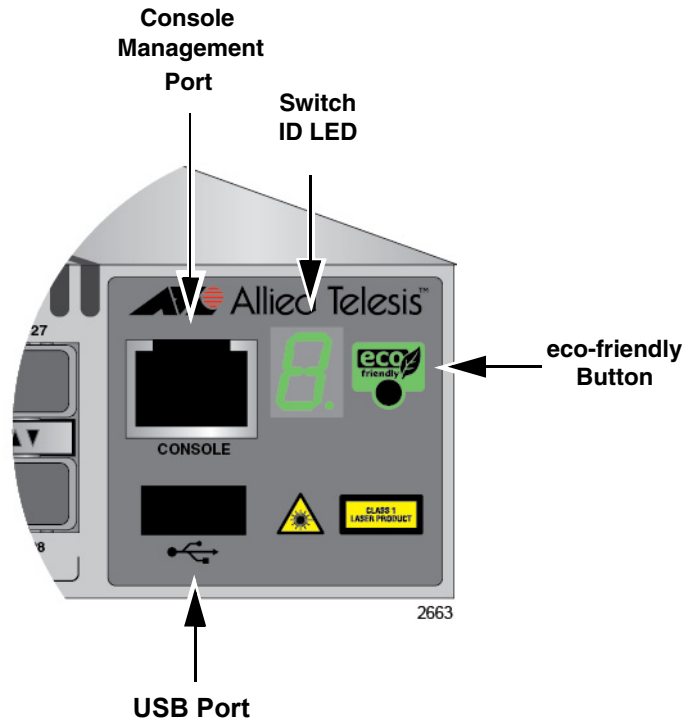

Figure 8. x510 Series Management Panel



## 10/100/1000Base-T Twisted Pair Ports

---

The AT-x510-28GTX, AT-x510-28GPX, AT-x510L-28GT, and AT-x510L-28GP Switches have 24 10/100/1000Base-T ports. The AT-x510-52GTX, AT-x510-52GPX, AT-x510L-52GT, and AT-x510L-52GP Switches have 48 10/100/1000Base-T ports.

**Speed** The ports can operate at 10, 100, or 1000 Mbps. The speeds may be set manually using the management software or automatically with Auto-Negotiation (IEEE 802.3u), the default setting.

---

**Note**

The ports must be set to Auto-Negotiation to function at 1000 Mbps and are not compatible with devices that are not IEEE 802.3u compliant.

---

**Duplex Mode** The twisted pair ports can operate in either half- or full-duplex mode. The duplex mode of a port, like port speed, may be set manually using the management software or automatically with Auto-Negotiation (IEEE 802.3u), the default setting.

The speed and duplex mode settings of a port may be set independently of each other. For example, a port may be configured such that its speed is set manually while its duplex mode is established through Auto-Negotiation.

---

**Note**

A switch port should not use Auto-Negotiation to set its duplex mode if it is connected to a network device that does not support Auto-Negotiation for 10 or 100 Mbps operation and has a fixed duplex mode of full-duplex. Otherwise, a duplex-mode mismatch may occur in which a switch port and a network device operate at different duplex modes. The duplex modes of switch ports that are connected to network devices that do not support Auto-Negotiation should be set manually through the management software.

---

**Wiring Configuration** The wiring configuration of a port operating at 10 or 100 Mbps can be MDI or MDI-X. The wiring configurations of a switch port and a network device connected with straight-through twisted pair cabling have to be opposite, such that one device is using MDI and the other MDI-X. For instance, a switch port has to be set to MDI-X if it is connected to a network device set to MDI.

You may set the wiring configurations of the ports manually or let the switch configure them automatically with auto-MDI/MDI-X (IEEE 802.3ab-compliant). This feature enables the switch to automatically negotiate with network devices to establish their proper settings.

The MDI and MDI-X settings do not apply when ports are operating at 1000 Mbps.

**Maximum Distance**  
**Cable Requirements**

The ports have a maximum operating distance of 100 meters (328 feet).

The cable requirements of the ports are given in Table 1.

Table 1. Twisted Pair Cable for the 10/100/1000Base-T Ports

Cable Type	10Mbps	100Mbps	1000Mbps
Standard TIA/EIA 568-B-compliant Category 3 shielded or unshielded cabling with 100 ohm impedance and a frequency of 16 MHz.	Yes	Yes	No
Standard TIA/EIA 568-A-compliant Category 5 or TIA/EIA 568-B-compliant Enhanced Category 5 (Cat 5e) shielded or unshielded cabling with 100 ohm impedance and a frequency of 100 MHz.	Yes	Yes	Yes
Standard TIA/EIA 568-B-compliant Category 6 or 6a shielded cabling.	Yes	Yes	Yes

**Note**

For the cable requirements for the ports on the AT-x510-28GPX, AT-x510L-28GP, AT-x510-52GPX, and AT-x510L-52GP Switches for PoE devices, refer to Table 3 on page 28.

**Port Pinouts**

Refer to Table 19 on page 138 and Table 20 on page 138 for the port pinouts of the 10/100/1000Base-T twisted pair ports.

## Power Over Ethernet

---

The AT-x510-28GPX, AT-x510L-28GP, AT-x510-52GPX, and AT-x510L-52GP Switches feature Power over Ethernet (PoE) on the 10/100/1000Base-T ports. PoE is used to supply power to network devices over the same twisted pair cables that carry the network traffic.

The main advantage of PoE is that it can make it easier to install a network. The selection of a location for a network device is often limited by whether there is a power source nearby. This often limits equipment placement or requires the added time and cost of having additional electrical sources installed. But with PoE, you can install PoE-compatible devices wherever they are needed without having to worry about whether there are power sources nearby.

A device that provides PoE to other network devices is referred to as *power sourcing equipment (PSE)*. The AT-x510-28GPX, AT-x510L-28GP, AT-x510-52GPX, and AT-x510L-52GP Switches act as PSE units by adding DC power to the network cable, thus functioning as a central power source for other network devices.

Devices that receive their power from a PSE are called *powered devices (PD)*. Examples include wireless access points, IP telephones, webcams, and even other Ethernet switches.

The switch automatically determines whether or not a device connected to a port is a powered device. Ports that are connected to network nodes that are not powered devices (that is, devices that receive their power from another power source) function as regular Ethernet ports, without PoE. The PoE feature remains activated on the ports, but no power is delivered to the devices.

### PoE Standards

The AT-x510-28GPX, AT-x510L-28GP, AT-x510-52GPX, and AT-x510L-52GP Switches support these PoE standards:

- ❑ PoE (IEEE 802.3af): This standard provides up to 15.4 watts at the switch port to support powered devices that require up to 12.95 watts.
- ❑ PoE+ (IEEE 802.3at): This standard provides up to 30.0 watts at the switch port to support powered devices that require up to 25.5 watts.

### Powered Device Classes

Powered devices are grouped into the five classes listed in Table 2 on page 28. The classes are based on the amount of power the devices require. The switches support all five classes.

Table 2. IEEE Powered Device Classes

Class	Maximum Power Output from a Switch Port	PD Power Range
0	15.4W	0.44W to 12.95W
1	4.0W	0.44W to 3.84W
2	7.0W	3.84W to 6.49W
3	15.4W	6.49W to 12.95W
4	30.0W	12.95W to 25.5W

**Cable Requirements** The cable requirements for ports operating at 10 or 100Mbps are given in Table 3.

Table 3. Twisted Pair Cable Requirements for the 10/100Base-TX Ports at 10 or 100Mbps

Cable Type	10Mbps			100Mbps		
	Non-PoE	PoE	PoE+	Non-PoE	PoE	PoE+
Standard TIA/EIA 568-B-compliant Category 3 shielded or unshielded cabling with 100 ohm impedance and a frequency of 16 MHz.	Yes	Yes	No	Yes	Yes	No
Standard TIA/EIA 568-A-compliant Category 5 shielded or unshielded cabling with 100 ohm impedance and a frequency of 100 MHz.	Yes	Yes	No	Yes	Yes	No
Standard TIA/EIA 568-B-compliant Enhanced Category 5 (Cat 5e) shielded or unshielded cabling with 100 ohm impedance and a frequency of 100 MHz.	Yes	Yes	Yes	Yes	Yes	Yes
Standard TIA/EIA 568-B-compliant Category 6 or 6a shielded cabling.	Yes	Yes	Yes	Yes	Yes	Yes

The cable requirements for ports operating at 1000Mbps are given in Table 4.

Table 4. Twisted Pair Cable Requirements for the 10/100/1000Base-T Ports at 1000Mbps

Cable Type	1000Mbps		
	Non-PoE	PoE	PoE+
Standard TIA/EIA 568-B-compliant Category 3 shielded or unshielded cabling with 100 ohm impedance and a frequency of 16 MHz.	No	No	No
Standard TIA/EIA 568-A-compliant Category 5 shielded or unshielded cabling with 100 ohm impedance and a frequency of 100 MHz.	Yes	Yes	No
Standard TIA/EIA 568-B-compliant Enhanced Category 5 (Cat 5e) shielded or unshielded cabling with 100 ohm impedance and a frequency of 100 MHz.	Yes	Yes	Yes
Standard TIA/EIA 568-B-compliant Category 6 or 6a shielded cabling.	Yes	Yes	Yes

## Power Budget

The AT-x510-28GPX and AT-x510-52GPX Switches have a power budget of 370 watts. The AT-x510L-28GP and AT-x510L-52GP Switches have a power budget of 185 watts. This is the maximum amount of power the switches can provide at one time to the powered devices.

The AT-x510-28GPX and AT-x510-52GPX Switches have two power supplies. Each power supply is responsible for providing 185 watts, or half, of the power budget. Both power supplies must be connected to AC power sources for the switch to provide the full 370 watts. The power budget is reduced to 185 watts if only one power supply is connected to a power source.

The power requirements of the PoE devices determine the maximum number of devices the switch can support at one time. So long as the total power requirements of the powered devices is less than the power budget of the switch, the switch can supply power to all the devices. But if the total power requirements exceed the power budget, the switch denies power to one or more ports using a mechanism referred to as port prioritization.

To determine whether the power requirements of the PoE devices you plan to connect to the switch exceed its power budget, refer to their documentation for their power requirements and add the requirements

together. The switch should be able to power all of the devices simultaneously as long as the total is below its power budget. If the total exceeds the available power budget, you should consider reducing the number of PoE devices so that all of the devices receive power. Otherwise, the switch powers a subset of the devices, based on port prioritization.

The switch can handle different power requirements on different ports. This enables you to connect different classes of PoE equipment to the ports on the switch.

## **Port Prioritization**

If the power requirements of the powered devices exceed the switch's power budget, the switch denies power to some ports based on a system called port prioritization. You may use this mechanism to ensure that powered devices critical to the operations of your network are given preferential treatment by the switch in the distribution of power should the demands of the devices exceed the available capacity.

There are three priority levels:

- Critical
- High
- Low

Ports set to the Critical level, the highest priority level, are guaranteed power before any of the ports assigned to the other two priority levels. Ports assigned to the other priority levels receive power only if all the Critical ports are receiving power. Ports that are connected to your most critical powered devices should be assigned to this level. If there is not enough power to support all the ports set to the Critical priority level, power is provided to the ports based on port number, in ascending order.

The High level is the second highest level. Ports set to this level receive power only if all the ports set to the Critical level are already receiving power. If there is not enough power to support all of the ports set to the High priority level, power is provided to the ports based on port number, in ascending order.

The lowest priority level is Low. This is the default setting. Ports set to this level only receive power if all of the ports assigned to the other two levels are already receiving power. As with the other levels, if there is not enough power to support all of the ports set to the Low priority level, power is provided to the ports based on port number, in ascending order.

Power allocation is dynamic. Ports supplying power to powered devices may cease power transmission if the switch's power budget is at maximum usage and new powered devices, connected to ports with higher priorities, become active.

You can use port prioritization on dual power supply PoE switches to protect your important networking devices from loss of power should one of the power supplies fail or lose power. If you limit the power requirements of the critical devices connected to a switch to less than 185 watts, the PoE power provided by a single power supply, a switch will have sufficient power to support the critical devices even if it has only one functional power supply.

## **Wiring Implementation**

The IEEE 802.3af standard defines two methods for the delivery of DC power over twisted pair cable by a PSE, such as the switch, to PDs. These methods, known as modes A and B, identify the wires within the cable that carry the DC power from the PSE to a PD.

Twisted pair cabling typically consists of eight wires. With 10Base-T and 100Base-TX devices, the wires connected to pins 1, 2, 3, and 6 on the RJ-45 connectors carry the network traffic while the wires connected to pins 4, 5, 7, and 8 are unused. With 1000Base-T devices, all eight wires are used to carry network data.

It takes four wires to deliver DC power to a PD. With Mode A, the power is delivered on pins 1, 2, 3, and 6. These are the same pins in 10Base-T and 100Base-TX devices that carry the network data. With mode B, the power is provided over the spare wires.

The ports on the AT-x510-28GPX, AT-x510L-28GP, AT-x510-52GPX, and AT-x510L-52GP Switches deliver the power using pins 1, 2, 3, and 6, which corresponds to mode A in the IEEE 802.3af standard. Powered devices that comply with the IEEE 802.3af standard are required to support both power delivery methods. Legacy devices that do not comply with the standard will work with the switch if they are powered on pins 1, 2, 3, and 6.

## SFP+ Slots

---

The switches have four SFP+ slots that support the following types of SFP 1000Mbps and SFP+ 10Gbps transceivers:

- ❑ 1000Base-SX/LX SFP transceivers
- ❑ Single-port BiDi 1000Base-LX SFP transceivers
- ❑ 1000Base-ZX SFP transceivers
- ❑ 10Gbps, 10GBase-SR/LR fiber optic transceivers
- ❑ 10Gbps AT-SP10TW direct connect twinax cables with SFP+ transceiver-style connectors

You may use the transceivers to connect switches to other network devices over large distances, build high-speed backbone networks between network devices, or connect high-speed devices, such as servers, to your network.

The switches support a variety of short and long distance SFP and SFP+ modules. For a list of supported SFP modules, contact your Allied Telesis representative or visit our web site.

---

### **Note**

SFP+ slots 27 and 28 on the 28-port switches and slots 51 and 52 on the 52-port switches are initially configured as stacking slots for the VCStack feature. If you intend to use the switch as a stand-alone unit, you must disable the VCStack feature before you can use them with standard SFP or SFP+ transceivers. The configuration instructions are provided later in this guide, in “Powering On the Switches Simultaneously” on page 108.

---



## Stacking SFP+ Slots

---

Two of the four SFP+ slots on the front panel of the switch can be used with stacking transceivers to create a VCStack of up to four switches. The switches of a VCStack act as a single virtual unit. They synchronize their actions so that switching operations, like spanning tree protocols, virtual LANs, and static port trunks, span across all the units and ports. The two main advantages of stacks are:

- ❑ You can manage multiple units simultaneously, which can simplify network management.
- ❑ You have more flexibility in how you configure some of the features. For instance, a static port trunk on a stand-alone switch has to consist of ports from the same switch. In contrast, a static trunk on a stack may consist of ports from different switches in the same stack.

The slots for the stacking transceivers are SFP+ slots 27 and 28 on the 28-port switches and SFP+ slots 51 and 52 on the 52-port switches.

---

### **Note**

If you use the switch as a stand-alone device, you can use the slots with regular SFP and SFP+ transceivers by disabling the VCStack feature. For instructions, refer to the *x510 Series Installation Guide for Stand-alone Switches*.

---

## eco-friendly Button

---

You may turn off the port LEDs to conserve electricity when you are not monitoring the switch. The LEDs are toggled with the eco-friendly button on the front panel of the switch or the ECOFRIENDLY LED and NO ECOFRIENDLY LED commands in the Global Configuration mode of the command line interface. The switch is said to be operating in a low power mode when the LEDs are turned off.

Operating the switch in the low power mode with the LEDs turned off does not interfere with the network operations of the device.

The management software on the switch has a command that blinks the LEDs so that you can quickly and easily identify a specific unit among the devices in an equipment rack. It is the FINDME command. The command works on the switch even if you turned off the LEDs with the eco-friendly button or NO ECOFRIENDLY LED command.

The Switch ID LED is always on, but it displays different information depending on whether the LEDs are on or off. When the LEDs are on, the ID LED displays the ID number of the switch. When the switch is operating in the low power mode with the LEDs off, the ID LED indicates whether the switch is a stand-alone unit or the master or member switch of a VCStack, as detailed in Figure 15 on page 43.

---

### **Note**

Before checking or troubleshooting the network connections to the ports on the switch, you should always check to be sure that the LEDs are on by either pressing the eco-friendly button or issuing the ECOFRIENDLY LED and NO ECOFRIENDLY LED commands in the command line interface.

---

## LEDs

Here are descriptions of the LEDs.

### LEDs for the Twisted Pair Ports

The twisted pair ports on the AT-x510-28GTX, AT-x510L-28GT, AT-x510-52GTX, and AT-x510L-52GT Switches have two LEDs that display link, activity and duplex mode information. The LEDs are shown in Figure 9.

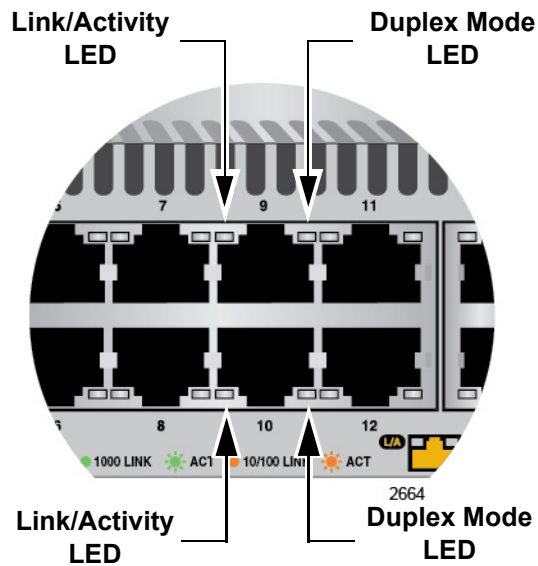

Figure 9. LEDs for the 10/100/1000Base-T Ports on the AT-x510-28GTX, AT-x510L-28GT, AT-x510-52GTX, and AT-x510L-52GT Switches

The LEDs are described in Table 5 on page 36.

Table 5. LEDs on the AT-x510-28GTX, AT-x510L-28GT, AT-x510-52GTX, and AT-x510L-52GT

LED	State	Description
Link/ Activity LED	Solid Green	A port has established a 1000 Mbps link to a network device.
	Flashing Green	A port is transmitting or receiving data at 1000 Mbps.
	Solid Amber	A port has established a 10 or 100 Mbps link to a network device.
	Flashing Amber	A port is transmitting or receiving data at 10 or 100 Mbps.
	Off	A port has not established a link with another network device or the LEDs are turned off. To turn on the LEDs, use the eco-friendly button.
Duplex Mode LED	Green	A port is operating in full-duplex mode.
	Amber	A port is operating in half-duplex mode at 10 or 100 Mbps. (Half-duplex mode does not apply to 1000 Mbps operation.)
	Flashing Amber	Collisions are occurring on a port operating at 10 or 100 Mbps.

The twisted pair ports on the AT-x510-28GPX, AT-x510L-28GP, AT-x510-52GPX, and AT-x510L-52GP Switches have two LEDs that display link, activity and PoE information. The LEDs are shown in Figure 10 on page 37.

---

**Note**

The duplex mode information for the ports on the AT-x510-28GPX, AT-x510L-28GP, AT-x510-52GPX, and AT-x510L-52GP Switches can be viewed with the management software.

---

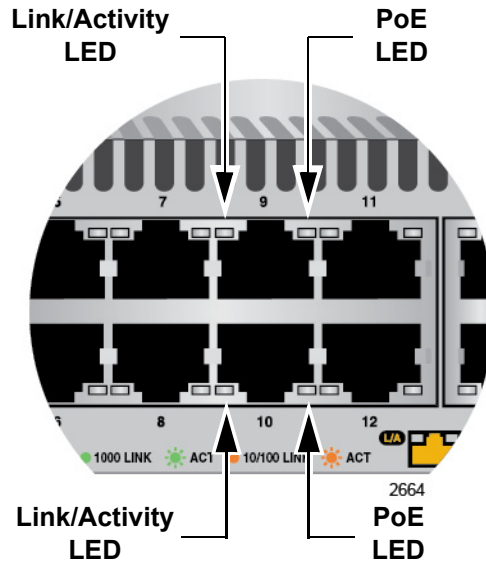

Figure 10. LEDs for the 10/100/1000Base-T Ports on the AT-x510-28GPX, AT-x510L-28GP, AT-x510-52GPX, and AT-x510L-52GP Switches

The LEDs are described in Table 6.

Table 6. LEDs on the 10/100/1000Base-T Ports on the AT-x510-28GPX, AT-x510L-28GP, AT-x510-52GPX, and AT-x510L-52GP Switches

LED	State	Description
Link/ Activity LED	Solid Green	A port has established a 1000 Mbps link to a network device.
	Flashing Green	A port is transmitting or receiving data at 1000 Mbps.
	Solid Amber	A port has established a 10 or 100 Mbps link to a network device.
	Flashing Amber	A port is transmitting or receiving data at 10 or 100 Mbps.
	Off	A port has not established a link with another network device or the LEDs are turned off. To turn on the LEDs, use the eco-friendly button.

Table 6. LEDs on the 10/100/1000Base-T Ports on the AT-x510-28GPX, AT-x510L-28GP, AT-x510-52GPX, and AT-x510L-52GP Switches

LED	State	Description
PoE	Green	The switch is detecting a powered device (PD) on the port and is delivering power to it.
	Solid Amber	The switch has shut down PoE+ on the port because of a fault condition.
	Flashing Amber	The switch is detecting a PD on the port, but is not delivering power to it because the maximum power budget has been reached.
	Off	This LED state can result from the following conditions: <ul style="list-style-type: none"> <li>❑ The port is not connected to a PD.</li> <li>❑ The PD is powered off.</li> <li>❑ The port is disabled in the management software.</li> <li>❑ PoE is disabled on the port.</li> <li>❑ The LEDs on the Ethernet line cards are turned off. To turn on the LEDs, use the eco-friendly button.</li> </ul>

**LEDs for the SFP Slots**

The LEDs for the SFP slots on the AT-x510-28GSX and AT-x510-28GSX-80 Switches are located between the slots, as shown in Figure 11 on page 39. Each SFP slot has one LED. The left-hand LED is for the top slot, and the right-hand LED is for the bottom slot.

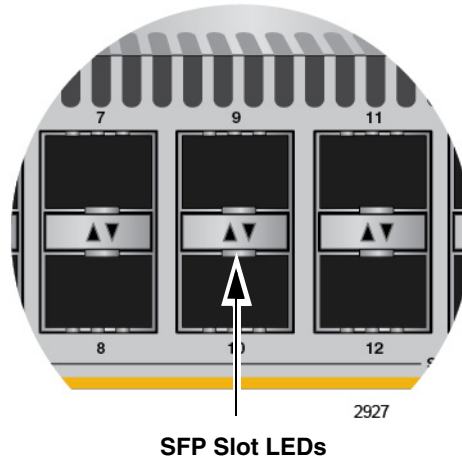

Figure 11. SFP Slot LEDs on the AT-x510-28GSX and AT-x510-28GSX-80 Switches

The LEDs are described in Table 7.

Table 7. SFP Slot LEDs on the AT-x510-28GSX and AT-x510-28GSX-80 Switches

LED	State	Description
Link/Activity	Off	The slot is empty, the SFP transceiver has not established a link to a network device, or the LEDs are turned off. To turn on the LEDs, use the eco-friendly button.
	Solid green	The SFP transceiver has established a link at 10 Mbps, 1000 Mbps or 10 Gbps to a network device.
	Flashing green	The SFP transceiver is receiving or transmitting packets to a network device.

**LEDs for the SFP+ Slots**

The LEDs for the SFP+ slots are located between the slots, as shown in Figure 12 on page 40. Each SFP+ slot has one LED. The left-hand LED is for the top slot, and the right-hand LED is for the bottom slot.

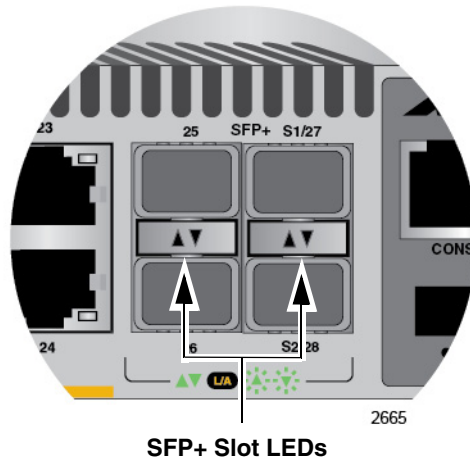

Figure 12. SFP+ Slot LEDs

The LEDs are described in Table 8.

Table 8. SFP+ Slot LEDs

LED	State	Description
Link/Activity	Off	The slot is empty, the SFP or SFP+ transceiver has not established a link to a network device, or the LEDs are turned off. To turn on the LEDs, use the eco-friendly button.
	Solid green	The SFP or SFP+ transceiver has established a link at 1000 Mbps or 10 Gbps to a network device.
	Flashing green	The SFP+ transceiver is receiving or transmitting packets to a network device at 10 Gbps. (The LED does not flash for activity at 1000 Mbps.)

### LEDs for the Stacking Slots

SFP+ slots 27 and 28 on the 28-port switches and slots 51 and 52 on the 52-port switches may be used as stacking slots to build a VCS stack of up to four switches. For background information, refer to Chapter 2, “Virtual Chassis Stacking” on page 49. Table 9 on page 41 defines the LED states when the slots contain stacking transceivers.



Table 9. Stacking Slot LEDs

LED	State	Description
Link/Activity	Off	The slot is empty, the stacking transceiver has not established a link to a network device, or the LEDs are turned off. To turn on the LEDs, use the eco-friendly button.
	Solid green	The stacking transceiver has established a link at 10 Gbps to another switch in the stack.
	Flashing green	The stacking transceiver is receiving or transmitting packets.

### Switch ID LED

The Switch ID LED, shown in Figure 13, displays the ID number of the switch. A stand-alone switch has the ID number 0. Switches in a VCStack have the numbers 1 to 4. Chapter 7, “Powering On the Stack” on page 103 has the procedure for verifying and, if necessary, changing the ID number of the switch.

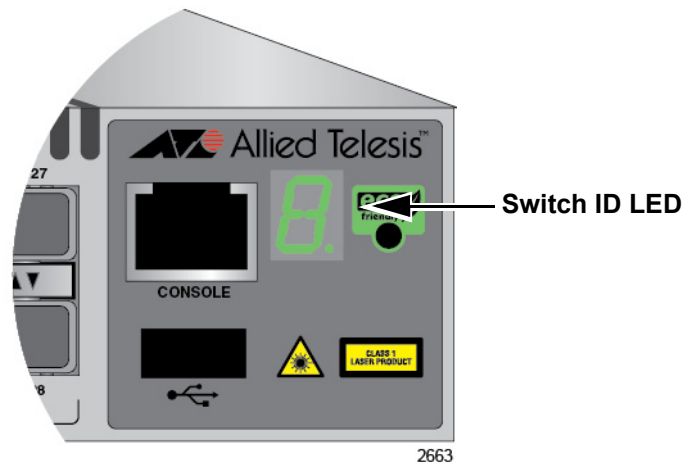

Figure 13. Switch ID LED

The states of the LED when the switch is not operating in the low power mode are shown in Figure 14 on page 42.

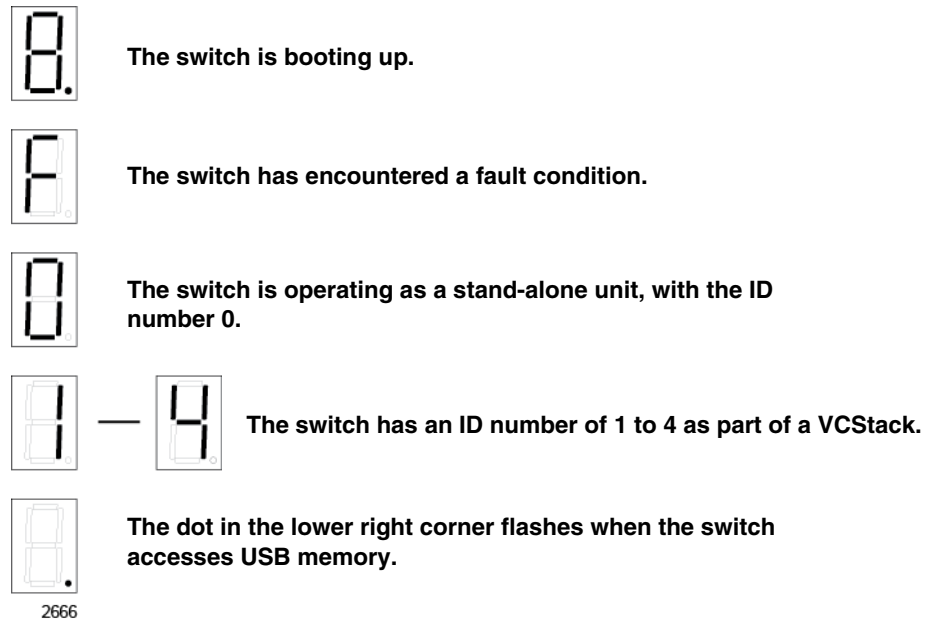

Figure 14. Switch ID LED not in Low Power Mode

The switch displays the letter “F” for fault on the ID LED if it encounters one of the following problems:

- A cooling fan has failed.
- The input voltage on one or both of the power supplies is outside the normal operating range.
- The internal temperature of the switch has exceeded the normal operating range and the switch may shut down.

---

**Note**

You can use the SHOW SYSTEM ENVIRONMENT command in the command line interface to identify the source of the problem.

---

The states of the LED when the switch is operating in the low power mode are shown in Figure 15 on page 43.



**The switch is the master switch of a VCStack.**



**The switch is operating as a stand-alone unit.**



**The switch is a member switch of a VCStack.**

2667

Figure 15. Switch ID LED in Low Power Mode

## **USB Port**

---

The management panel has a USB port. You may use the port to store configuration files on flash drives and to restore configuration files to switches whose settings have been lost or corrupted, or to quickly configure replacement units. You may also use the port and flash drives to update the management firmware on the switches.

The port is USB2.0 compatible.

## Console Port

---

The Console port is used to establish a management session with the switch to configure its features and parameter settings. This type of management uses serial RS-232 and is commonly referred to as local or out-of-band management because it is not conducted over your network. To perform local management, you must be at the location of the switch and must use the management cable included with the switch.

To establish a local management session with the switch, connect a terminal or a personal computer with a terminal emulation program to the Console port, which has an RJ-45 style (8P8C) connector, using the provided management cable. The cable has RJ-45 RJ-style (8P8C) and DB-9 (D-sub 9-pin) connectors.

The Console port is set to the following specifications:

- Default baud rate: 9600 bps (Range is 9600 to 115200 bps)
- Data bits: 8
- Parity: None
- Stop bits: 1
- Flow control: None

---

**Note**

These settings are for a DEC VT100 or ANSI terminal, or an equivalent terminal emulation program.

---

## Power Supplies

---

Please review the following information concerning the power supplies:

- ❑ The AT-x510-28GTX, AT-x510-28GPX, AT-x510-28GSX, AT-x510-52GTX, and AT-x510-52GPX Switches have two pre-installed AC power supplies.
- ❑ The AT-x510L-28GT, AT-x510L-28GP, AT-x510L-52GT, and AT-x510L-52GP Switches have one pre-installed AC power supply.
- ❑ The AT-x510-28GSX-80 Switch has two pre-installed DC power supplies. The DC power supply option is only available in the AT-x510-28GSX-80 Switch.
- ❑ On all switches except the AT-x510L-28GT, AT-x510L-28GP, AT-x510L-52GT, and AT-x510L-52GP Switches, the pre-installed AC or DC power supplies have separate connectors on the back panel. You can protect the network operations of the switch from a power circuit failure by connecting the power supplies to different circuits.
- ❑ The non-PoE AT-x510-28GTX, AT-x510-28GSX, and AT-x510-52GTX Switches require only one power supply for full operations. The second power supply provides power redundancy. It protects against interruptions to network operations in the event one power supply loses power or fails. Power redundancy is available only when both AC or DC connectors on the switch are connected to power sources.
- ❑ The PoE AT-x510-28GPX and AT-x510-52GPX Switches also require only one power supply for network operations, excluding PoE. The switches can continue to operate even if one power supply fails or loses power.
- ❑ The second power supply in the PoE AT-x510-28GPX and AT-x510-52GPX Switches increases the amount of power for PoE. The power budget for powered devices is 185 watts when one power supply is operating and 370 watts when both power supplies are operating. For further information, refer to “Power Budget” on page 29.
- ❑ The power supplies are not field replaceable.
- ❑ For the DC powered AT-x510-28GSX-80 Switch, the DC supply wires should be routed from a DC load center containing appropriate overcurrent branch protection for each DC feed, as required by the cognizant local electrical authority.

Refer to “Technical Specifications” on page 133 for the input voltage range.



**Warning**

Power cord is used as a disconnection device. To de-energize equipment, disconnect the power cord. ⚡ E3

---



**Warning**

This unit might have more than one power cord. To reduce the risk of electric shock, disconnect all power cords before servicing the unit. ⚡ E30

---

---

**Note**

The switches are powered on or off by connecting or disconnecting the power cords.

---





## Chapter 2

# Virtual Chassis Stacking

---

The sections in this chapter are:

- “Overview” on page 50
- “Stacking Slots” on page 51
- “Stacking Transceivers” on page 52
- “Stacking Port Topologies” on page 54
- “Master and Member Switches” on page 58
- “Specifying Ports in the Command Line Interface” on page 60

---

### **Note**

For more information on the VCStack feature, refer to the *Stacking Introduction and Stacking Commands* chapters in the *Software Reference for x510 Series Switches, AlliedWare Plus Operating System* from [www.alliedtelesis.com/support](http://www.alliedtelesis.com/support).

---

## Overview

---

The Virtual Chassis Stacking (VCStack) feature allows you to connect up to four x510 Series switches to form a virtual switch in which the devices function as a single networking unit. The benefits of the VCStack feature are:

- ❑ Simplifies management - You can manage the devices of the stack as a single unit, rather than individually. Your local and remote management sessions automatically give you management access to all the devices.
- ❑ Reduces IP addresses - A stack requires only one IP address for remote management access, thereby reducing the number of IP addresses you have to assign to network devices. The one address gives you management access to all the units.
- ❑ Adds feature flexibility and resiliency - A stack gives you more flexibility in the available configurations of features. For instance, you can create port aggregators of ports from different switches in the stack, rather than from only one switch. If you distribute the ports of an aggregator across two or more switches in a stack, you increase its resiliency because the aggregator will continue to function, though at a reduced bandwidth, if one of the switches stops functioning.
- ❑ Reduces protocol requirements - Creating a stack might eliminate your need to configure some protocols, such as the Virtual Router Redundancy Protocol and Spanning Tree Protocol.

## Stacking Slots

---

The x510 Series Switches come with two stacking slots. The slots are the last two SFP+ slots on the switches and are labeled “S1/27” and “S2/28” on the 28-port switches and “S1/51” and “S2/52” on the 52-port switches.

The slots have two functions. You may use them with the VCStack feature to build a stack of x510 Series Switches or, by disabling the VCStack feature, you may use them with regular SFP or SFP+ transceivers as additional networking slots.

The names of the slots depend on the status of the VCStack feature on the switch. The management software refers to the slots as “S1” and “S2” when the VCStack feature is enabled and the slots are used with the special stacking transceivers to create a stack.

When you disable the VCStack feature to use the slots with regular SFP or SFP+ transceivers on a stand-alone switch, the slots are referred to as slots 27 and 28 on the 28-port switches and 51 and 52 on the 52-port switches. For instructions on how to disable VCStack to use the switches as stand-alone units, refer to the *x510 Series Installation Guide for Stand-alone Switches*.

---

**Note**

When VCStack is enabled on the switch, the stacking slots only work with the stacking transceivers in Table 10 on page 52. If you install regular SFP or SFP+ transceivers in the stacking slots when stacking is activated, the management software disables them and enters an error message in the buffered log.

---

## Stacking Transceivers

You connect the switches of the VCStack with the stacking transceivers listed in Table 10 and shown in Figure 16.

Table 10. Stacking Transceivers

Stacking Transceiver Model	Cable Type	Operating Distance
AT-StackXS/1.0	Twinax cable	1 meter (3.29 feet)
AT-StackOP/0.3	62.5/125 $\mu\text{m}$ multi-mode fiber optic cable	33 meters (108 feet)
	50/125 $\mu\text{m}$ multi-mode fiber optic cable	300 meters (984 feet)
AT-StackOP/9.0	9/125 $\mu\text{m}$ single-mode fiber optic cable	9 kilometers (5.6 miles)

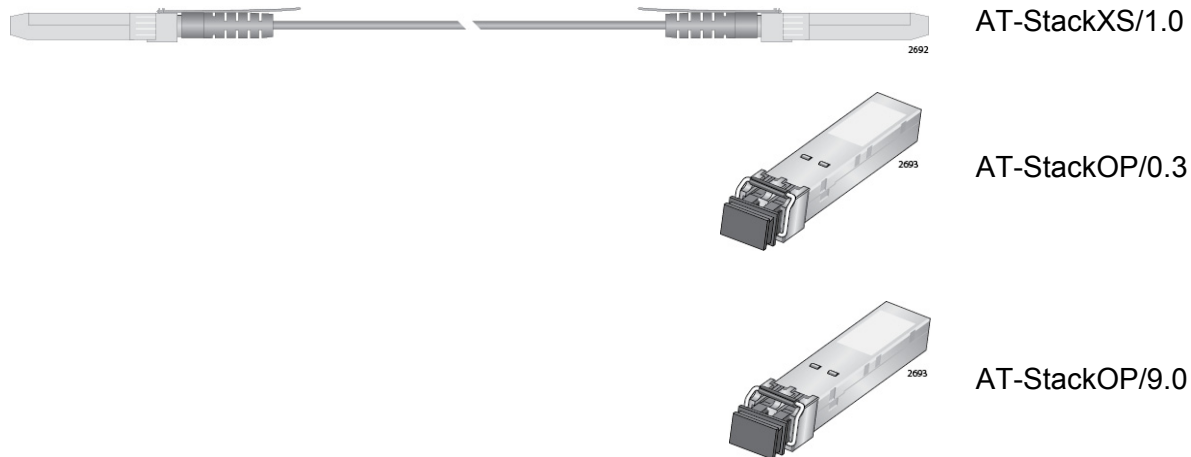

Figure 16. Stacking Transceivers

With its two SFP+ transceiver-style connectors and one meter of twinax cable, the AT-StackXS/1.0 transceiver is appropriate in situations where the x510 Series switches are in the same equipment rack or on the same table.

The fiber optic transceivers are used to build stacks across large distances.

Here are the transceiver guidelines:

- ❑ The stacking transceivers may only be used in the stacking slots and only with the VCStack feature. You may not use the transceivers as regular networking ports.
- ❑ The AT-StackOP/0.3 and AT-StackOP/9.0 transceivers must be connected to other AT-StackOP/0.3 and AT-StackOP/9.0 transceivers. The transceivers do not work with other types of network devices.
- ❑ You may use different types of transceivers to connect the switches of a stack and so build stacks of switches that are at various distances from each other.

## Stacking Port Topologies

---

The switches of a stack are connected with the S1 and S2 ports and the stacking transceivers shown in Figure 16 on page 52.

There are two wiring configurations. The first topology is called the linear topology. In this topology the switches are connected with a single pathway. A stacking transceiver in one switch is connected to a stacking transceiver in the next switch, which is connected to the next switch, and so on. The connections must cross over to different stacking slots on the switches. The stacking transceiver in the S1 slot in one switch must connect to the stacking transceiver in the S2 slot in the next switch.

Figure 17 is an example of a stack of two switches in the linear topology. The transceiver in the S1 slot on the top switch is connected to the transceiver in the S2 slot on the bottom switch.

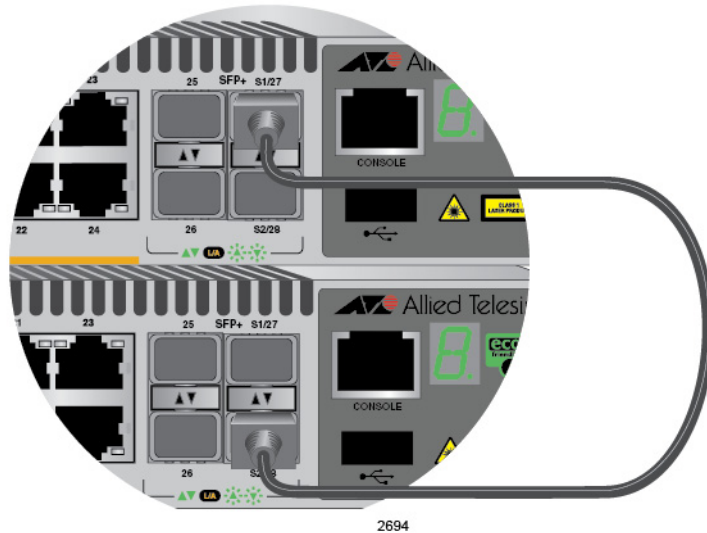

Figure 17. Stack of Two Switches in the Linear Topology



### Caution

The stack will not function if the connections to the S1 and S2 slots do not cross over on the switches. The switches will not form a stack and instead operate as stand-alone devices. E78

---

The stack in Figure 18 on page 55 has four switches in the linear topology.

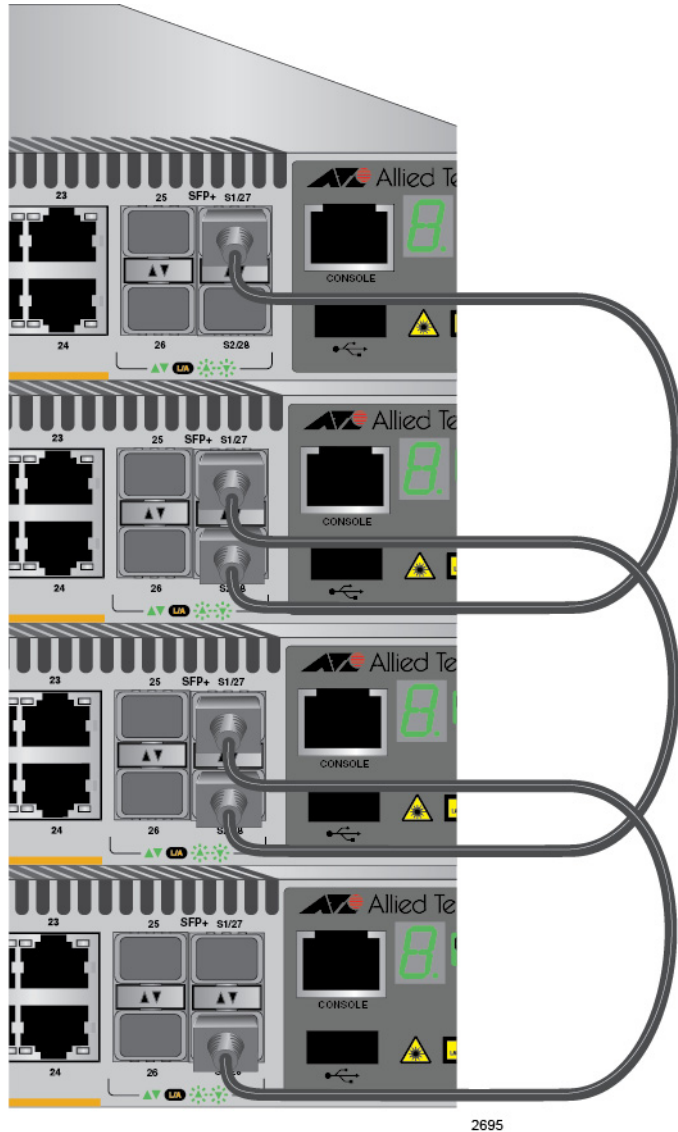

2695

Figure 18. Stack of Four Switches in the Linear Topology

The second topology is called the ring topology. It is similar to the linear topology, except that the unused stacking ports on the end switches of the stack are connected to form a physical loop. This topology is more resilient than the linear topology because there are two pathways through the stack. If one pathway fails, the switches can maintain communications through the alternate pathway. The example in Figure 19 on page 56 shows a ring topology of two switches.

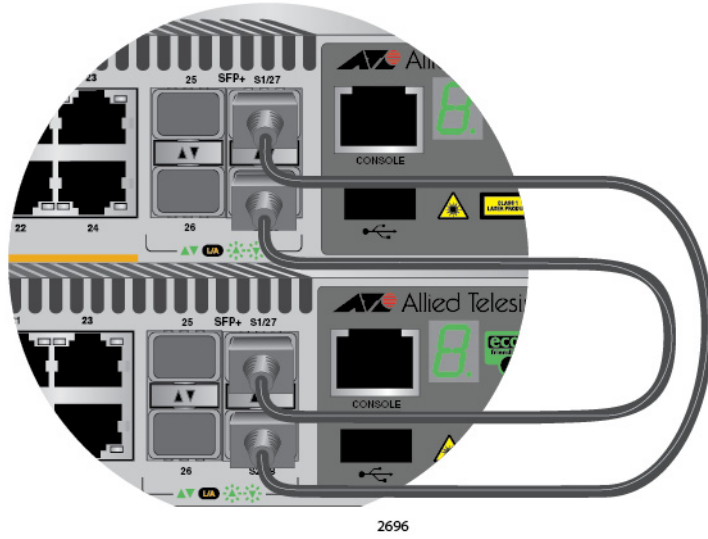

Figure 19. Stack of Two Switches in the Ring Topology

Figure 20 on page 57 is an example of a stack of four switches in the ring topology.



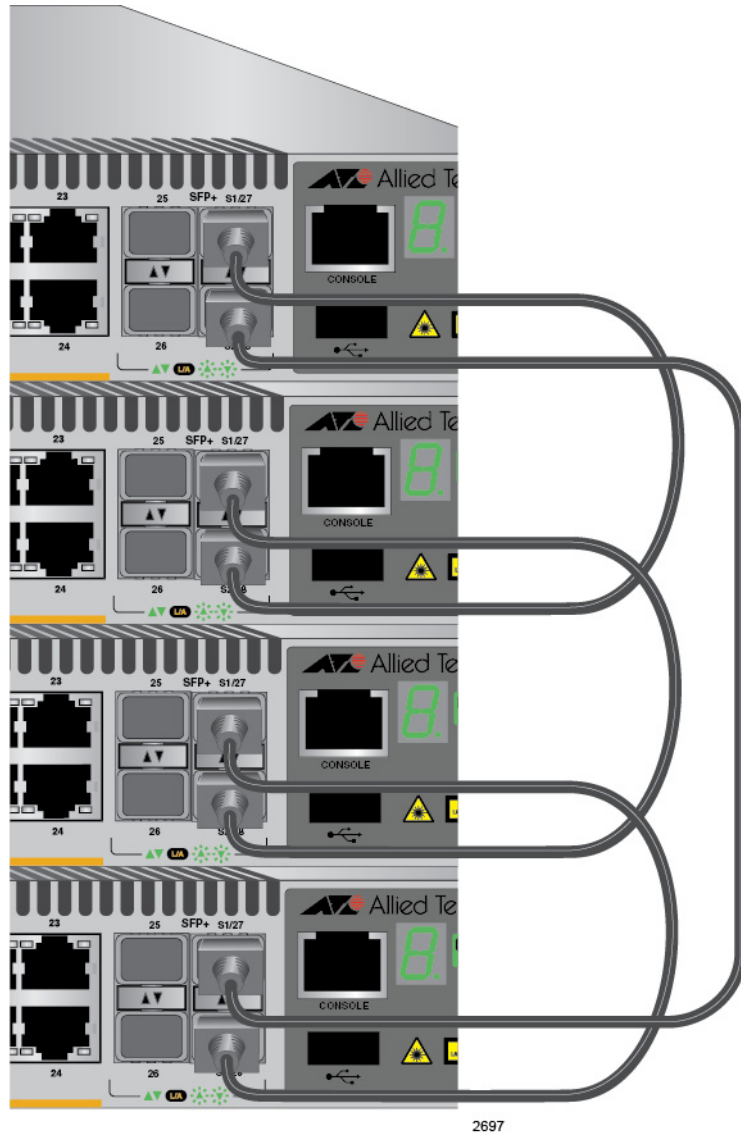

Figure 20. Stack of Four Switches in the Ring Topology

The topologies are the same in terms of network speed and performance. However, the ring topology is the recommended wiring configuration because of the secondary path through the stacking ports. The two pathways protect the switches of the stack against the loss of communications due to a failure of a stacking port, cable, or switch.

The examples in the previous figures showed the twinax AT-StackXS/1.0 stacking transceiver. But the same rules apply to the fiber optic AT-StackOP/0.3 and AT-StackOP/9.0 stacking transceivers. A fiber optic transceiver in the S1 slot must cross over to a fiber optic transceiver in the S2 slot of another switch.

## Master and Member Switches

---

The stack has one master switch. The functions of the master switch include:

- ❑ Coordinating and monitoring stack operations.
- ❑ Verifying that the switches are using the same version of management software. It automatically downloads its management software over the stacking cables to switches with different software versions.
- ❑ Verifying that the switches have different ID numbers. It automatically assigns new ID numbers to resolve situations where two or more switches have the same ID number.
- ❑ Verifying that the stacking transceivers that connect the switches together are cabled correctly.

The other switches are called member switches. There can be up to three member switches in addition to the master switch. A member switch can automatically transition to the master role if the current master switch is removed from the stack or powered off. This ensures continued operations of the stack even if the master switch stops operating.

### Selection of the Master Switch

The devices compare the following numbers to choose the master switch when the stack is reset or powered on:

- ❑ Stack priority numbers
- ❑ MAC addresses

The stack priority number is an adjustable value of 0 to 255, where the lower the number, the higher the priority. Typically, the switch with the lowest priority number (highest priority) becomes the master switch of a stack. The default priority value is 128.

If the switches have the same priority values, the selection of the master switch is based on their MAC addresses. As with the priority value, the lower the MAC address, the higher the priority. The switch with the lowest MAC address becomes the master switch.

If you power on the stack for the first time without adjusting the priority values, the master switch is selected based on the MAC addresses if the units are powered on simultaneously. If you power on the switches one at a time, the master switch is the first switch to be powered on. This is explained in Chapter 7, “Powering On the Stack” on page 103.

After the stack is established and operating, you may, if you choose, change the priority settings on the individual units and so control which switch will be the master switch after subsequent power cycles and resets.

## ID Numbers

Each switch must be assigned an ID number. The range is 1 to 4, and the default is 1. The ID numbers are displayed on the ID LEDs on the front panels of the units. You may assign the numbers yourself or you can let the master switch assign the numbers automatically, as explained in Chapter 7, “Powering On the Stack” on page 103.

You use the ID numbers to identify the individual ports and switches when you configure the devices with the commands in the management software. For further information, refer to “Specifying Ports in the Command Line Interface” on page 60.

The ID numbers are also used to identify the parameter settings that are stored in the configuration file. When the stack is reset or power cycled, the ID numbers identify the devices to which the parameter settings belong.



### Caution

You should not change the ID numbers of the switches after you have started to configure the parameter settings. Otherwise, the parameter settings might be applied to the wrong devices when you reset or power cycle the stack. *see* E79

---

The switches do not use the ID numbers to select the master switch. The selection of the master switch is typically based on the priority numbers and MAC addresses, as previously explained.

## Specifying Ports in the Command Line Interface

---

The command line interface in the management software on the switch has a parameter that you use to specify the individual ports. The parameter is the PORT parameter, and Figure 21 shows its format.

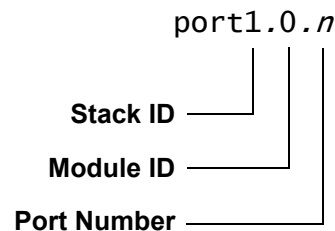

Figure 21. PORT Parameter in the Command Line Interface

The first number is the switch's ID number. The ID numbers of switches in a stack are displayed on their ID LEDs. You can also view the ID numbers with the `SHOW STACK` command in the command line interface.

The module ID value is used with multi-module products. This value does not apply to the x510 Series switches and should always be 0.

The third value is a port number on the switch. You may specify only one port number in a PORT parameter, but you may specify more than one PORT parameter in many of the commands where the parameter is supported.

Here is an example of the PORT parameter. It uses the `INTERFACE` command to enter the Port Interface mode for ports 15 and 17 on the switch with ID 2:

```
awplus> enable
awplus# configure terminal
awplus(config)# interface port2.0.15,port2.0.17
```

For instructions on the command line interface and the PORT parameter, refer to the *Software Reference for x510 Series Switches, AlliedWare Plus Operating System*.

## Chapter 3

# Beginning the Installation

---

The chapter contains the following sections:

- “Reviewing Safety Precautions” on page 62
- “Choosing a Site for the Switches” on page 68
- “Planning a Stack” on page 69
- “Unpacking the Switch” on page 71

## Reviewing Safety Precautions

---

Please review the following safety precautions before beginning the installation procedure.

---

### Note

Safety statements that have the  symbol are translated into multiple languages in the *Translated Safety Statements* document at [www.alliedtelesis.com/support](http://www.alliedtelesis.com/support).

---



---

### Warning

Class 1 Laser product.  L1

---



---

### Warning

Do not stare into the laser beam.  L2

---



---

### Warning

Do not look directly at the fiber optic ends or inspect the cable ends with an optical lens.  L6

---



---

### Warning

To prevent electric shock, do not remove the cover. No user-serviceable parts inside. This unit contains hazardous voltages and should only be opened by a trained and qualified technician. To avoid the possibility of electric shock, disconnect electric power to the product before connecting or disconnecting the LAN cables.  E1

---



---

### Warning

Do not work on equipment or cables during periods of lightning activity.  E2

---



**Warning**

Power cord is used as a disconnection device. To de-energize equipment, disconnect the power cord. ⚡ E3

---



**Warning**

Class I Equipment. This equipment must be earthed. The power plug must be connected to a properly wired earth ground socket outlet. An improperly wired socket outlet could place hazardous voltages on accessible metal parts. ⚡ E4

---

---

**Note**

Only one grounding post on the DC powered AT-x510-28GSX-80 Switch should be connected to the building protective earth. The second grounding post should not be used. Allied Telesis recommends using the grounding post for power supply 1 (PSU 1).

---

---

**Note**

Pluggable Equipment. The socket outlet shall be installed near the equipment and shall be easily accessible. ⚡ E5

---



**Caution**

Air vents must not be blocked and must have free access to the room ambient air for cooling. ⚡ E6

---

---

**Note**

All Countries: Install product in accordance with local and National Electrical Codes. ⚡ E8

---



**Warning**

As a safety precaution, install a circuit breaker with a minimum value of 10 Amps between the equipment and the DC power source.

Always connect the wires to the LAN equipment first before connecting the wires to the circuit breaker. Do not work with HOT leads to avoid the danger of physical injury from electrical shock. Always be sure that the circuit breaker is in the OFF position before connecting the wires to the breaker. ⚡ E9

---



**Warning**

When installing this equipment, always ensure that the power supply ground connection is installed first and disconnected last. ⚡ E11

---



**Warning**

Only trained and qualified personnel are allowed to install or replace this equipment. ⚡ E14

---



**Caution**

Circuit Overloading: Consideration should be given to the connection of the equipment to the supply circuit and the effect that overloading of circuits might have on overcurrent protection and supply wiring. Appropriate consideration of equipment nameplate ratings should be used when addressing this concern. ⚡ E21

---



**Caution**

Risk of explosion if battery is replaced by an incorrect type. Replace only with the same or equivalent type recommended by the manufacturer. Dispose of used batteries according to the manufacturer's instructions.

**Attention:** Le remplacement de la batterie par une batterie de type incorrect peut provoquer un danger d'explosion. La remplacer uniquement par une batterie du même type ou de type équivalent recommandée par le constructeur. Les batteries doivent être éliminées conformément aux instructions du constructeur. ⚡ E22

---



**Warning**

Mounting of the equipment in the rack should be such that a hazardous condition is not created due to uneven mechanical loading. ⚡ E25

---

**Note**

Use dedicated power circuits or power conditioners to supply reliable electrical power to the device. ⚡ E27

---

**Caution**

The chassis may be heavy and awkward to lift. Allied Telesis recommends that you get assistance when mounting the chassis in an equipment rack. ⚡ E28

---

**Warning**

This unit might have more than one power cord. To reduce the risk of electric shock, disconnect all power cords before servicing the unit. ⚡ E30

---

**Warning**

The power input must be provided by a SELV source only, per IEC60950. Do not connect to a centralized DC battery bank. ⚡ E31

---

**Note**

If installed in a closed or multi-unit rack assembly, the operating ambient temperature of the rack environment may be greater than the room ambient temperature. Therefore, consideration should be given to installing the equipment in an environment compatible with the manufacturer's maximum rated ambient temperature (T<sub>mra</sub>). ⚡ E35

---



**Caution**

Installation of the equipment in a rack should be such that the amount of air flow required for safe operation of the equipment is not compromised. *↪* E36

---



**Warning**

Reliable earthing of rack-mounted equipment should be maintained. Particular attention should be given to supply connections other than direct connections to the branch circuits (e.g., use of power strips). *↪* E37

---



**Warning**

Circuit breaker is used as a disconnection device. To de-energize the equipment, shut down the circuit breaker and then disconnect the input wire. *↪* E38

---



**Warning**

To reduce the risk of electric shock, the PoE ports on this product must not connect to cabling that is routed outside the building where this device is located. *↪* E40

---



**Caution**

The unit does not contain serviceable components. Please return damaged units for servicing. *↪* E42

---



**Warning**

When you remove an SFP module from this product, the case temperature of the SFP may exceed 40° C (158° F). Exercise caution when handling with unprotected hands. *↪* E43

---

**Warning**

This equipment must be installed in a Restricted Access location. *⌘* E45

---

**Warning**

Operating Temperatures. All the switches are designed for a maximum ambient temperature of 45° degrees C. *⌘* E52

---

**Caution**

The stack will not function if the connections to the S1 and S2 slots do not cross over on the switches. The switches will not form a stack and instead operate as stand-alone devices. *⌘* E78

---

**Caution**

You should not change the ID numbers of the switches after you have started to configure the parameter settings. Otherwise, the parameter settings might be applied to the wrong devices when you reset or power cycle the stack. *⌘* E79

---

**Warning**

An SFP transceiver can be damaged by static electricity. Be sure to observe all standard electrostatic discharge (ESD) precautions, such as wearing an antistatic wrist strap, to avoid damaging the transceiver. *⌘* E86

---

**Warning**

Switches should not be stacked on top of one another on a table or desktop because that could present a personal safety hazard if you need to move or replace switches. *⌘* E91

---

## Choosing a Site for the Switches

---

Observe these requirements when planning the installation of the switches of a stack.

- ❑ If you plan to install the switches in an equipment rack, check to be sure that the rack is safely secured so that it will not tip over. Devices in a rack should be installed starting at the bottom, with the heavier devices near the bottom of the rack.
- ❑ If you plan to install the switches on a table, check to be sure that the table is level and stable.
- ❑ The power outlet should be located near the switches and be easily accessible.
- ❑ The site should allow for easy access to the ports on the front of the switches, so that you can easily connect and disconnect cables, and view the port LEDs.
- ❑ The site should allow for adequate air flow around the units and through the cooling vents on the front and rear panels. (The ventilation direction is from front to back, with the fan on the back panel drawing the air out of the unit.)
- ❑ The site should not expose the switches to moisture or water.
- ❑ The site should be a dust-free environment.
- ❑ The site should include dedicated power circuits or power conditioners to supply reliable electrical power to the network devices.
- ❑ Do not install the switches in a wiring or utility box because they will overheat and fail from inadequate airflow.



### **Warning**

Switches should not be stacked on top of one another on a table or desktop because that could present a personal safety hazard if you need to move or replace switches. *see* E91

---

## Planning a Stack

---

Here are the guidelines to planning a stack:

- ❑ A stack can have up to four x510 Series switches.
- ❑ A stack can have different models of x510 Series switches.
- ❑ Any x510 Series switch model can be the master switch of a stack.
- ❑ Switches connected with AT-StackXS/1.0 stacking cables should be installed in a standard 19-inch equipment rack and not more than one meter apart, the length of the stacking cable. The end switches cannot be more than one meter apart if you want to create the ring topology, shown in Figure 19 on page 56 and Figure 20 on page 57.
- ❑ You may use the AT-StackOP/0.3 and AT-StackOP/9.0 transceivers to build stacks of switches that are 300 meters and 9 kilometers apart, respectively.
- ❑ The wiring topology of the stack may be either linear or ring. Both topologies offer the same in terms of speed, but the ring topology adds wiring redundancy.
- ❑ You can use combinations of AT-StackXS/1.0, AT-StackOP/0.3, and AT-StackOP/9.0 cables when the individual switches of the stack are at various distances from each other.
- ❑ The x510 Series stack may not contain other stacking switches, such as x600 and x610 Series switches.
- ❑ The x510 Series switches do not need any additional software for stacking. However, they do need stacking transceivers.
- ❑ You may not install a networking device, such as a media converter or Ethernet switch, between two fiber optic stacking transceivers.
- ❑ All the switches must have the same licenses of optional features. If you install an optional feature on one switch, you must install it on all switches before assembling the stack.
- ❑ The AT-StackOP/9.0 transceiver has a maximum operating distance of 9 kilometers and requires 9/125  $\mu\text{m}$  single-mode fiber optic cable. The operating specifications of the transceiver are listed in Table 23 on page 141.
- ❑ Table 11 on page 70 lists the maximum distances of the AT-StackOP/0.3 transceiver. The operating specifications of the transceiver are listed in Table 22 on page 140.

Table 11. Operating Distances of the AT-StackOP/0.3 Transceiver

Fiber Type	Minimum Modal Bandwidth @ 850 nm (MHz*km)	Operating Range
62.5/125 $\mu$ m multi-mode fiber optic cable	160	2 to 26 meters (7 to 85 feet)
	200	2 to 33 meters (7 to 108 feet)
50/125 $\mu$ m multi-mode fiber optic cable	400	2 to 66 meters (7 to 217 feet)
	500	2 to 82 meters (7 to 269 feet)
	2000	2 to 300 meters (7 to 984 feet)

## Unpacking the Switch

Figure 22 lists the items that come with the switch. If any item is missing or damaged, contact your Allied Telesis sales representative for assistance.

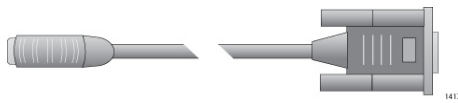

One 2 m (6.6 ft) local management cable with RJ-45 (8P8C) and DB-9 (D-sub 9-pin) connectors

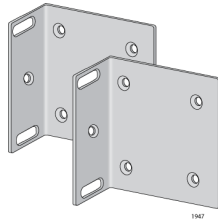

Two rack mounting brackets



One or two regional AC power cords:

AT-x510L-28GT, AT-x510L-52GP, AT-x510L-52GT, AT-x510L-52GP: 1 each

AT-x510-28GTX, AT-x510-28GPX, AT-x510-28GSX, AT-x510-52GTX, AT-x510-52GPX: 2 each

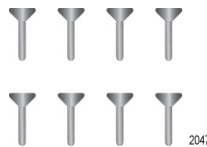

Eight bracket screws

Figure 22. Components of the x510 Series Switches

---

### Note

The DC powered AT-x510-28GSX-80 Switch does not come with the two AC power cords.

---



---

### Note

You should retain the original packaging material in the event you need to return the unit to Allied Telesis.

---

After checking the contents of the shipping containers, go to Chapter 4, “Installing the Switches on a Table or in an Equipment Rack” on page 73.





## Chapter 4

# Installing the Switches on a Table or in an Equipment Rack

---

The procedures in this chapter are:

- “Installing the Switches on a Table or Desktop” on page 74
- “Installing the Switch in an Equipment Rack” on page 75
- “Wiring the DC Connectors on the AT-x510-28GSX-80 Switch” on page 78

## Installing the Switches on a Table or Desktop

---

This section contains the procedure for installing the switch on a table.

---

**Note**

The rubber feet on the bottom of the chassis should be left on for table installation.

---

**Warning**

Switches should not be stacked on top of one another on a table or desktop because that could present a personal safety hazard if you need to move or replace switches. ⚡ E91

---

To install the chassis on a table, perform the following procedure:

1. Review the procedure in “Choosing a Site for the Switches” on page 68 to verify that the selected site is suitable for the unit.
2. Check to be sure that the table is strong enough to support the weight of the switch.
3. Lift the chassis onto the table.
4. Check to be sure that all of the appropriate components are included in the shipping container. Refer to “Unpacking the Switch” on page 71.

After placing the switches on the table or desktop, go to Chapter 5, “Verifying the Status of VCStack” on page 87 to verify that VCStack is activated on the units.

## Installing the Switch in an Equipment Rack

This procedure requires the following items:

- Eight bracket screws (included with the switch)
- Two equipment rack brackets (included with the switch)
- Flat-head screwdriver (not provided)
- Cross-head screwdriver (not provided)
- Four standard equipment rack screws (not provided)

Installation guidelines may be found in “Choosing a Site for the Switches” on page 68. Here is the procedure for installing the switch in a 19-inch equipment rack.



### Caution

The chassis may be heavy and awkward to lift. Allied Telesis recommends that you get assistance when mounting the chassis in an equipment rack. *⚠* E28

1. Place the unit upside down on a level, secure surface.



Figure 23. Turning the Switch Upside Down

2. Using a flat-head screwdriver, pry the rubber feet from the bottom of the switch, as shown in Figure 24.

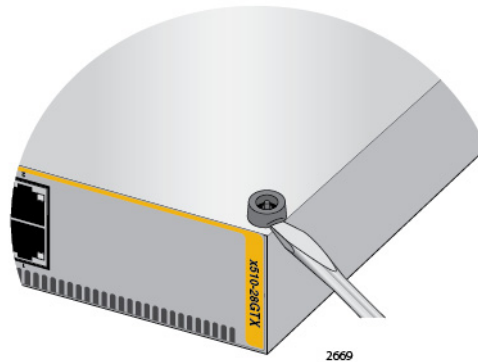

Figure 24. Removing the Rubber Feet

3. Turn the switch over.
4. Attach the two rack mount brackets to the sides of the switch using the eight bracket screws included with the unit. Figure 25 and Figure 26 on page 77 illustrate the four possible bracket positions.

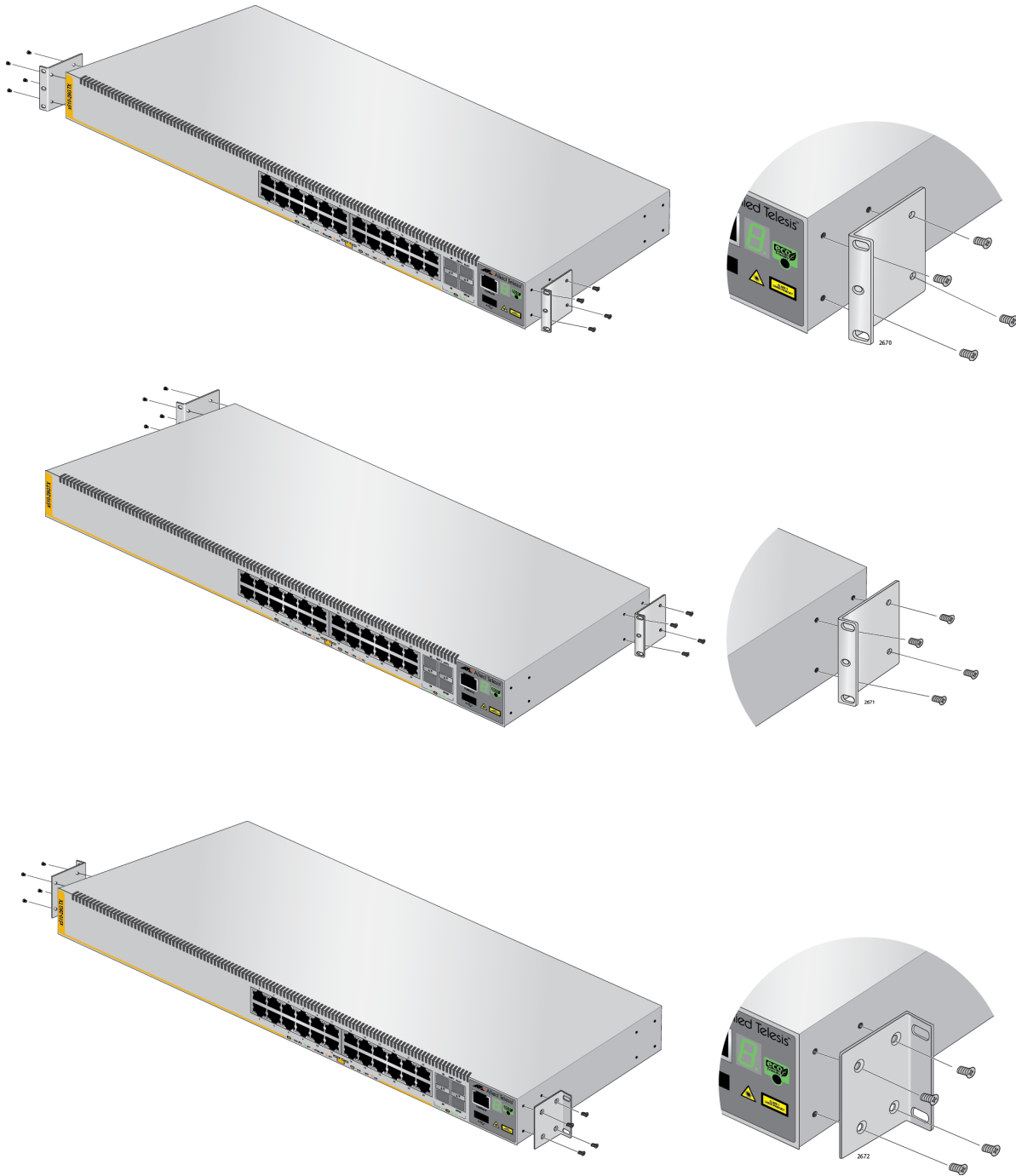

Figure 25. Attaching the Equipment Rack Brackets



Figure 26. Attaching the Equipment Rack Brackets (Continued)

5. While another person holds the switch in the equipment rack, secure it using standard equipment rack screws (not provided), as shown in Figure 27.



Figure 27. Mounting the Switch in an Equipment Rack

6. Repeat this procedure to install the remaining switches in the stack.
7. After installing the switches, go to Chapter 5, “Verifying the Status of VCStack” on page 87 to verify that VCStack is enabled on the units.

## Wiring the DC Connectors on the AT-x510-28GSX-80 Switch

---

The procedures in this section are for the AT-x510-28GSX-80 Switch which has DC power supplies. They explain how to connect the grounding and power wires to the DC connectors on the back panel of the switch. If you do not have a DC powered switch, go to Chapter 5, “Verifying the Status of VCStack” on page 87.

---

**Note**

Do not power on the switch after completing these procedures. Instead, go to Chapter 5, “Verifying the Status of VCStack” on page 87.

---



---

**Warning**

This equipment must be installed in a Restricted Access location. *see* E45

---

### Required Material and Tools

The procedure requires the following material:

- ❑ One 12 AWG stranded grounding wire. The standard color for the wire is green with a yellow stripe.
- ❑ One 16 AWG minimum stranded power wire for the -48/-60VDC connection. The standard color for the wire is red.
- ❑ One 16 AWG minimum stranded power wire for the RETURN connection. The standard color for the wire is black.
- ❑ One ring lug suitable for a M4/#8 stud and 12 AWG wire. An example of a ring lug is shown in Figure 28.



Figure 28. Ring Lug

---

**Note**

The grounding and power wires should be stranded wires. Do not use solid wires.

---

This procedure requires the following tools:

- ❑ Crimping tool
- ❑ 7mm wrench
- ❑ 7mm, 15 in-lb torque wrench (optional)
- ❑ 3mm (0.125 in.) flat-head screwdriver
- ❑ 3mm (0.125 in.), 5 in-lb torque, flat-head screwdriver (optional)

---

**Note**

You must provide the wires, ring lug, and tools. They are not included with the switch.

---

## Connecting the Grounding Wire

To connect the grounding wire to the grounding post, perform the following procedure:



---

**Warning**

When installing this equipment, always ensure that the power supply ground connection is installed first and disconnected last. ⚡ E11

---



---

**Note**

Only one grounding post on the switch should be connected to the building protective earth. The second grounding post should not be used. Allied Telesis recommends using the grounding post for power supply 1 (PSU 1).

---

1. Strip an adequate amount of insulation from one end of the ground cable, for the ring lug. The amount may vary depending on the type of ring lug, but 6.5 mm (0.25 in) is typically sufficient. Refer to Figure 29.

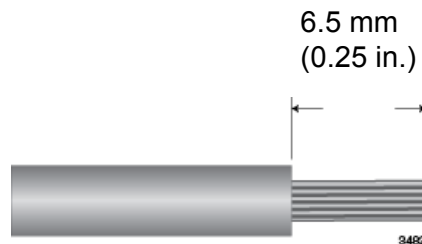

Figure 29. Stripping the Stranded Grounding Wire

2. Insert the grounding wire into the ring lug and use a crimping tool to secure it. Refer to Figure 30 on page 80.

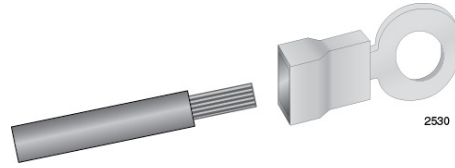

Figure 30. Attaching the Stranded Grounding Wire to the Ring Lug

3. Use a 7mm wrench to remove the top nut from the grounding post on the power supply. Refer to Figure 31.

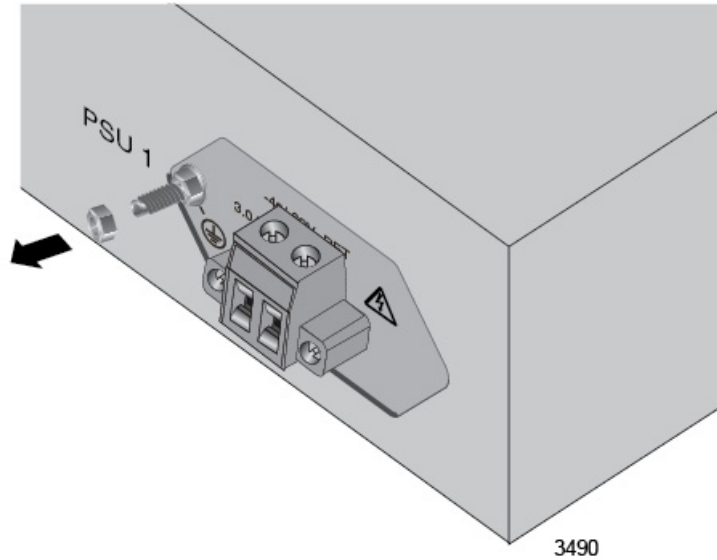

Figure 31. Removing the Nut from the Grounding Post

---

**Note**

Remove only the top nut from the grounding post. If necessary, use a second 7mm wrench to hold the bottom nut still while removing the top nut.

---

4. Attach the grounding lug and wire to the grounding post and secure them with the nut removed in Step 3 and a 7mm wrench. Allied Telesis recommends tightening the nut to 15 in-lbs. Refer to Figure 32 on page 81.



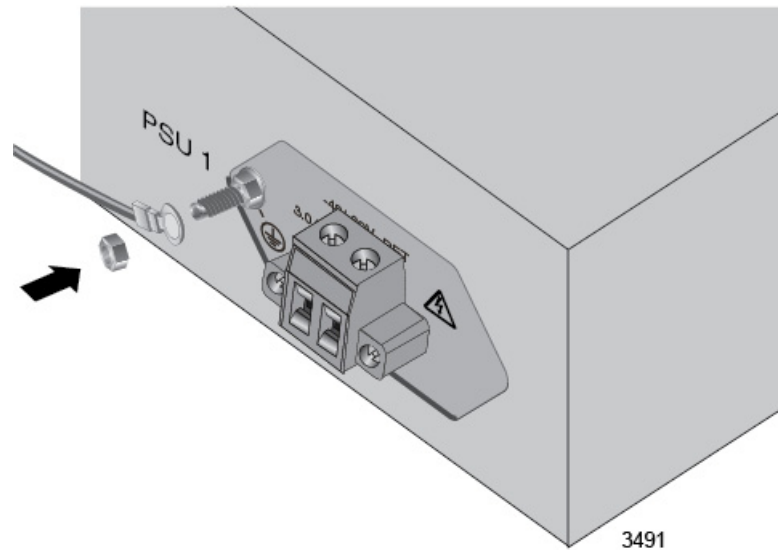

Figure 32. Installing the Grounding Wire

5. Connect the other end of the grounding wire to the building protective earth.
6. After installing the grounding wire, go to “Connecting the -48/-60VDC and RETURN Wires”.

### Connecting the -48/-60VDC and RETURN Wires

After installing the grounding wire, connect the -48/-60VDC and RETURN wires by performing the following procedure:



#### Warning

As a safety precaution, install a circuit breaker with a minimum value of 10 Amps between the equipment and the DC power source.

Always connect the wires to the LAN equipment first before connecting the wires to the circuit breaker. Do not work with HOT leads to avoid the danger of physical injury from electrical shock. Always be sure that the circuit breaker is in the OFF position before connecting the wires to the breaker. ⚡ E9



#### Warning

The power input must be provided by a SELV source only, per IEC60950. Do not connect to a centralized DC battery bank. ⚡ E31

1. Verify that the DC circuit is powered off.

2. Use a 3mm flat-head screwdriver to loosen the two captive screws that secure the DC connector to the chassis. Refer to Figure 33.

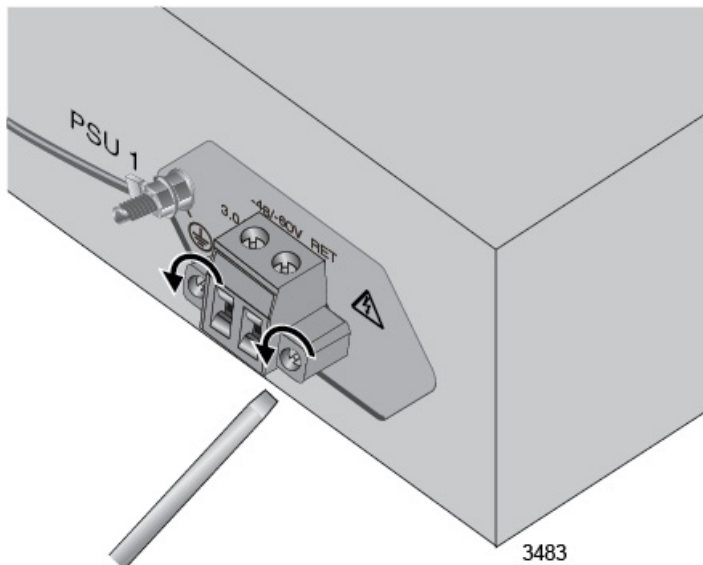

Figure 33. Loosening the Two Captive Screws on the DC Connector

3. Slide the DC connector from the chassis. Refer to Figure 34.

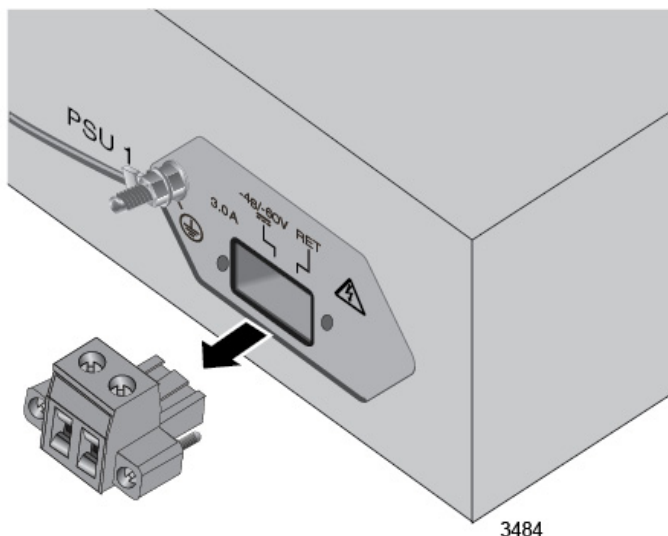

Figure 34. Removing the DC Connector

4. Use a 3mm (0.125 in.) flat-head screwdriver to loosen the two captive screws on the top of the DC connector. Refer to Figure 35 on page 83.

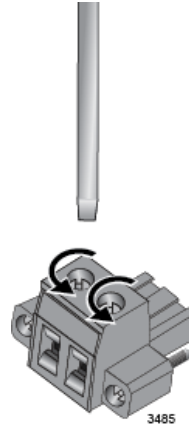

Figure 35. Loosening the Captive Screws on the DC Connector

5. Remove 6.5 mm (0.25 in.) of insulation from one end of the black RETURN wire. Refer to Figure 36.

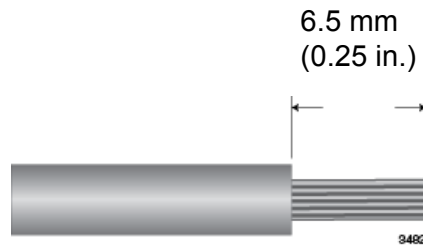

Figure 36. Stripping a Stranded Power Wire

6. Insert the black RETURN wire into the right connector and secure it by tightening the captive screw with a flat-head screwdriver. Allied Telesis recommends tightening the screw to 5 in-lbs. Refer to Figure 37.

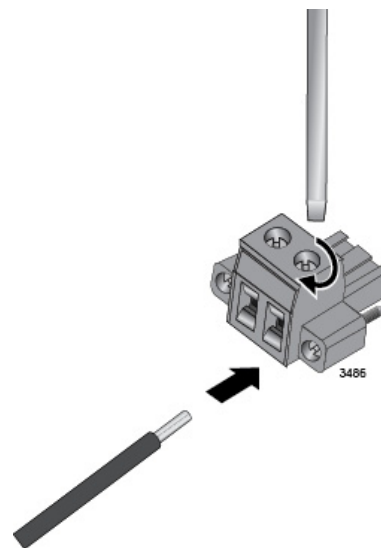

Figure 37. Inserting the RETURN Wire

7. Remove 6.5mm (0.25 in.) of insulation from one end of the red -48/-60VDC wire. Refer to Figure 36 on page 83.
8. Insert the red -48/-60VDC wire into the left connector and secure it by tightening the captive screw with a flat-head screwdriver. Allied Telesis recommends tightening the screw to 5 in-lbs. Refer to Figure 38.

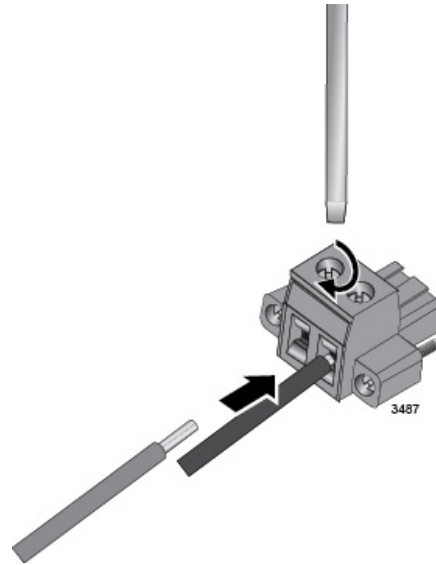

Figure 38. Inserting the -48/-60VDC Wire

9. Slide the DC connector into the slot on the switch. Refer to Figure 39.

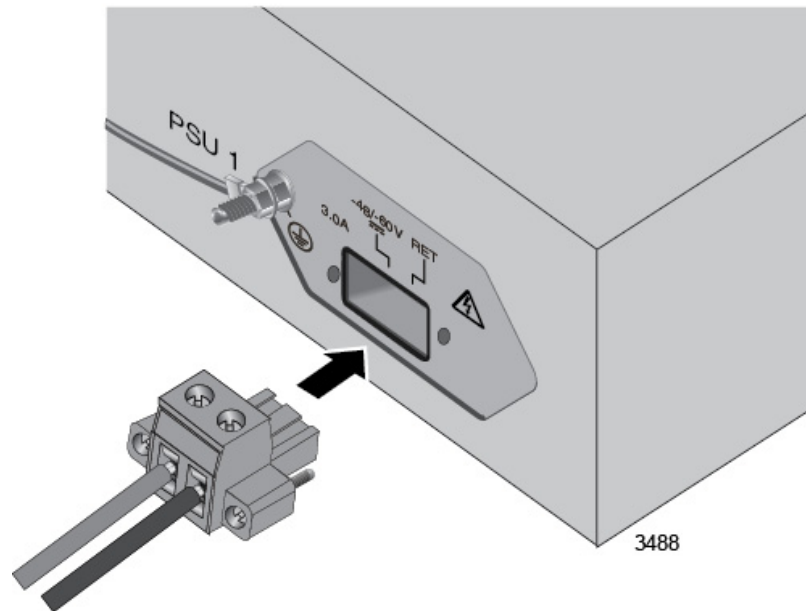

Figure 39. Sliding the DC Connector into the Switch

10. Tighten the two captive screws on the sides of the DC connector to secure the connector to the switch. Refer to Figure 40.

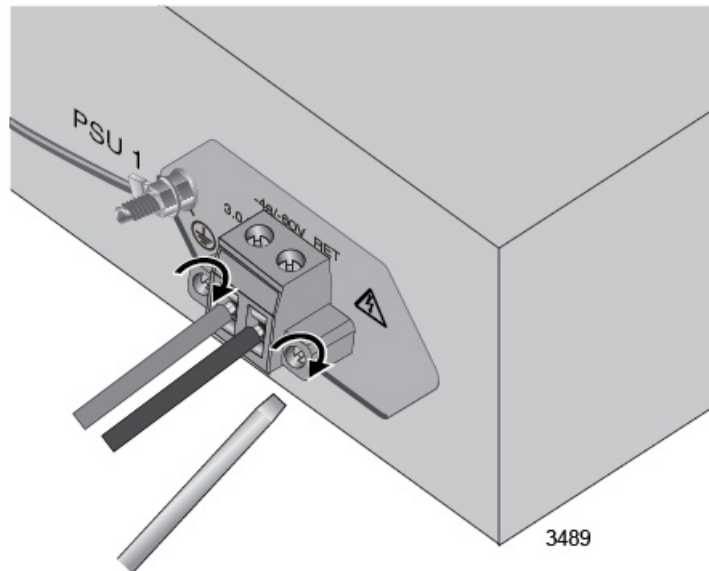

Figure 40. Securing the DC Connector to the Switch

11. Verify that the DC circuit is powered off.
12. Connect the -48/-60VDC and RETURN wires to the DC circuit.



---

**Warning**

Circuit breaker is used as a disconnection device. To de-energize the equipment, shut down the circuit breaker and then disconnect the input wire. ⚡ E38

---

13. Repeat this procedure to connect the power wires to the second DC power supply in the switch.

---

**Note**

Do not power on the switches at this time. Instead, go to Chapter 5, “Verifying the Status of VCStack” on page 87.

---



## Chapter 5

# Verifying the Status of VCStack

---

The procedures in this chapter are:

- “Verifying the Status of VCStack” on page 88
- “Activating the VCStack Feature” on page 89

## Verifying the Status of VCStack

---

Before you install the stacking transceivers to build the stack, you should first test the switches to determine whether the VCStack feature is enabled or disabled, and enable it on any units where it is disabled. On new switches, the feature should be activated because that is the default setting. But on switches that were previously used as stand-alone units, the feature is probably disabled and needs to be enabled.

Testing the status of VCStack is simple. You power on a switch and watch the ID LED. If it displays a number from 1 to 4, VCStack is already enabled. If the LED displays the number 0, the feature is disabled and needs to be enabled.

To test the status of VCStack, perform the following procedure:

1. Power on one of the switches.

For AC model switches, connect an AC power cord to one of the power connectors on the back panel and to an AC power source. For units with two power connectors, you do not need to connect both power cords for this procedure.

For the DC powered AT-x510-28GSX-80 Switch, connect the grounding and power wires to the switch, as explained in “Wiring the DC Connectors on the AT-x510-28GSX-80 Switch” on page 78, and power on the DC circuit.

2. Wait one minute for the switch to initialize its management software.
3. View the ID LED and do one of the following:
  - ❑ If the ID LED is displaying a number from 1 to 4 (1 is the default), VCStack is already enabled on the switch. Power off the unit by disconnecting the power cord and test the remaining switches in the same manner. After testing all the switches, be sure the switches are powered off and go to Chapter 6, “Cabling the Stacking Ports” on page 93.
  - ❑ If the ID LED is displaying “0,” the VCStack feature is disabled on the switch. You must enable it by performing the procedure in “Activating the VCStack Feature” on page 89.



## Activating the VCStack Feature

Perform the following two procedures to activate the VCStack feature on switches that display the number “0” on their ID LEDs in the previous procedure. The tasks assume that you are continuing directly from the previous procedure and that the switch is powered on. The first procedure explains how to establish a local management session on the switch, and the second procedure explains how to activate the VCStack feature.

### Starting a Local Management Session

To start a local management session on the switch, perform the following procedure:

1. Connect the RJ-45 connector on the management cable to the Console port on the front panel of the switch, as shown in Figure 41.

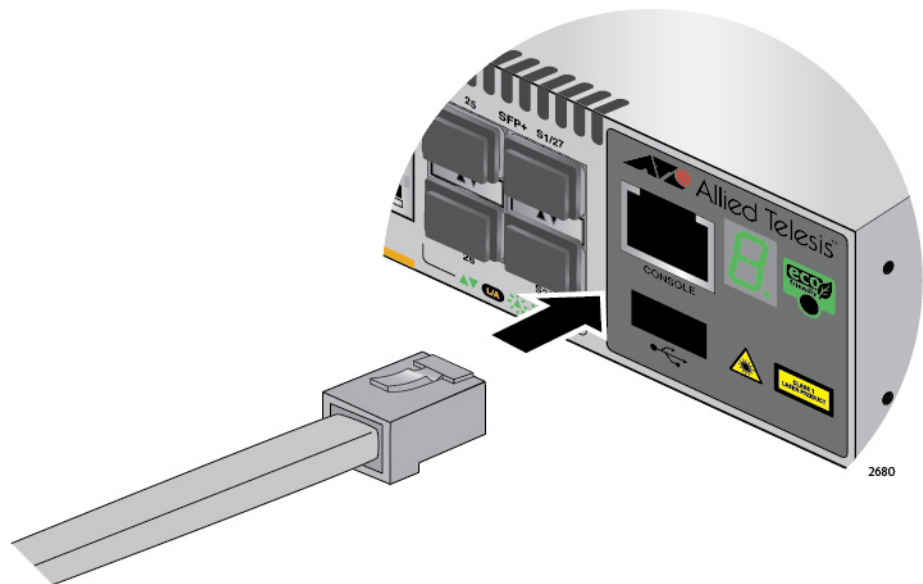

Figure 41. Connecting the Management Cable to the Console Port

2. Connect the other end of the cable to an RS-232 port on a terminal or PC with a terminal emulator program.
3. Configure the terminal or terminal emulator program as follows:
  - Baud rate: 9600 bps (The baud rate of the Console Port is adjustable from 1200 to 115200 bps. The default is 9600 bps.)
  - Data bits: 8
  - Parity: None
  - Stop bits: 1
  - Flow control: None

---

**Note**

The port settings are for a DEC VT100 or ANSI terminal, or an equivalent terminal emulator program.

---

4. Press Enter.

You are prompted for a user name and password.

5. If this is the initial management session of the switch, enter “manager” as the user name and “friend” as the password. The user name and password are case sensitive.

The local management session starts when the User Exec mode prompt, shown in Figure 42, is displayed.

```
awplus>
```

Figure 42. User Exec Mode Prompt

The User Exec mode is the first level in the command mode interface. For complete information on the modes and commands, refer to the *Software Reference for x510 Series Switches, AlliedWare Plus Operating System* from [www.alliedtelesis.com/support](http://www.alliedtelesis.com/support).

## Activating VCStack

To activate the VCStack feature from the local management session, perform the following procedure:

1. Enter the ENABLE command to move from the User Exec mode to the Privileged Exec mode, as shown in Figure 43.

```
awplus> enable  
awplus#
```

Figure 43. Moving to the Privileged Exec Mode with the ENABLE Command

2. Enter the CONFIGURE TERMINAL command to move to the Global Configuration mode, as shown in Figure 44.

```
awplus# configure terminal  
Enter configuration commands, one per line. End with CNTL/Z.  
awplus(config)#
```

Figure 44. Moving to the Global Configuration Mode with the CONFIGURE TERMINAL Command

3. Enter the STACK ENABLE command to activate VCStack on the switch, as shown in Figure 45:

```
awplus(config)# stack enable
% The device needs to be restarted for this change to take effect.
awplus(config)#
```

Figure 45. Activating VCStack with the STACK ENABLE Command

4. Enter the EXIT command to return to the Privileged Exec mode, as shown in Figure 46.

```
awplus(config)# exit
awplus#
```

Figure 46. Returning to the Privileged Exec Mode with the EXIT Command

5. Enter the WRITE command to save your change, as shown in Figure 47.

```
awplus# write
Building configuration ...
[OK]
awplus#
```

Figure 47. Saving the Change with the WRITE Command

---

**Note**

If this is the initial management session of the switch, the WRITE command automatically creates in flash memory a new configuration file called DEFAULT.CFG in which it stores your configuration change. You may change the name of the file or designate a different file after you create the stack.

---

6. Restart the switch with the REBOOT command, as shown in Figure 48.

```
awplus# reboot
reboot system? (y/n):
awplus#
```

Figure 48. Rebooting the Switch with the REBOOT Command

7. Type “Y” for yes.
8. Wait one minute for the switch to initialize its management software.

9. Check the ID LED and do one of the following:
  - ❑ If the ID LED is displaying the number 1, 2, 3, or 4, VCStack is now enabled on the switch. Power off the switch by either disconnecting the power cord or, for the DC powered AT-x510-28GSX-80 Switch, power off the DC circuit, and repeat the procedures in this chapter on the next switch. If there are no further switches to test, go to Chapter 6, “Cabling the Stacking Ports” on page 93.
  - ❑ If the ID LED is still displaying “0,” repeat this procedure. If the procedure was not successful, it might be because you did not issue the WRITE command in Step 5 to save your change.

## Chapter 6

# Cabling the Stacking Ports

---

This chapter contains the following procedures:

- “Cabling Switches with AT-StackXS/1.0 Transceivers” on page 94
- “Cabling Switches with AT-StackOP/0.3 or AT-StackOP/9.0 Transceivers” on page 99

## Cabling Switches with AT-StackXS/1.0 Transceivers

---

To cable the switches of the stack with AT-StackXS/1.0 transceivers, perform the following procedure:



### Warning

An SFP transceiver can be damaged by static electricity. Be sure to observe all standard electrostatic discharge (ESD) precautions, such as wearing an antistatic wrist strap, to avoid damaging the transceiver. *See* E86

---

1. Remove the dust plug from the S1 slot on the top switch of the stack, as shown in Figure 49.

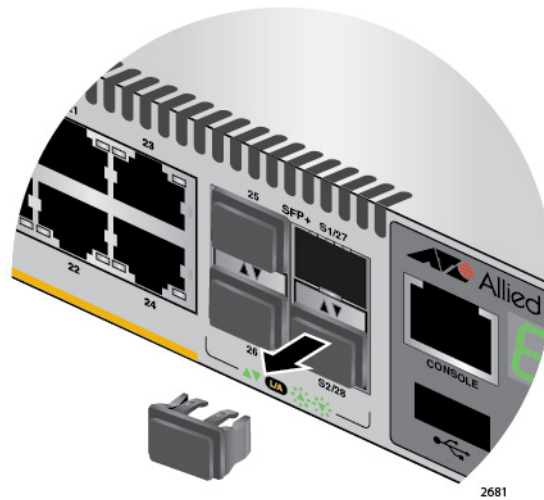

Figure 49. Removing the Dust Plug from the S1 Slot

2. Remove the transceiver from its shipping container and store the packaging material in a safe location.
3. Remove the dust cap from one end of the transceiver, as shown in Figure 50 on page 95.

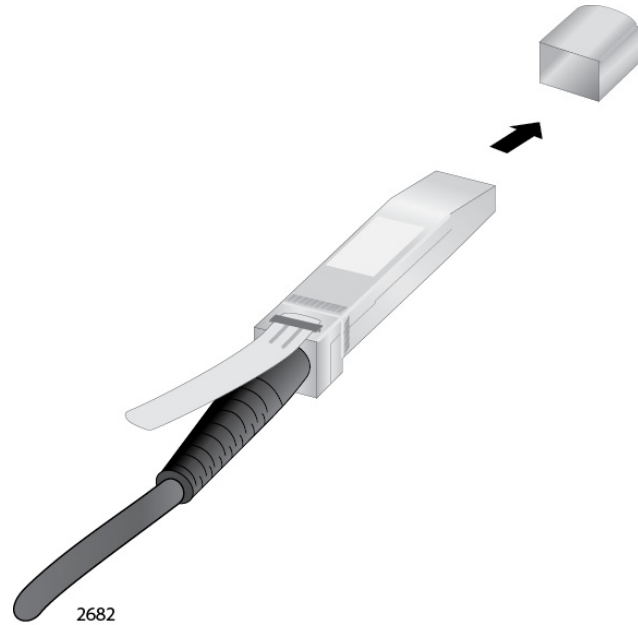

Figure 50. Removing the Dust Cover from the AT-StackXS/1.0 Transceiver

4. Position the transceiver with the release tab on top and slide the transceiver into the slot, as shown in Figure 51 on page 96.

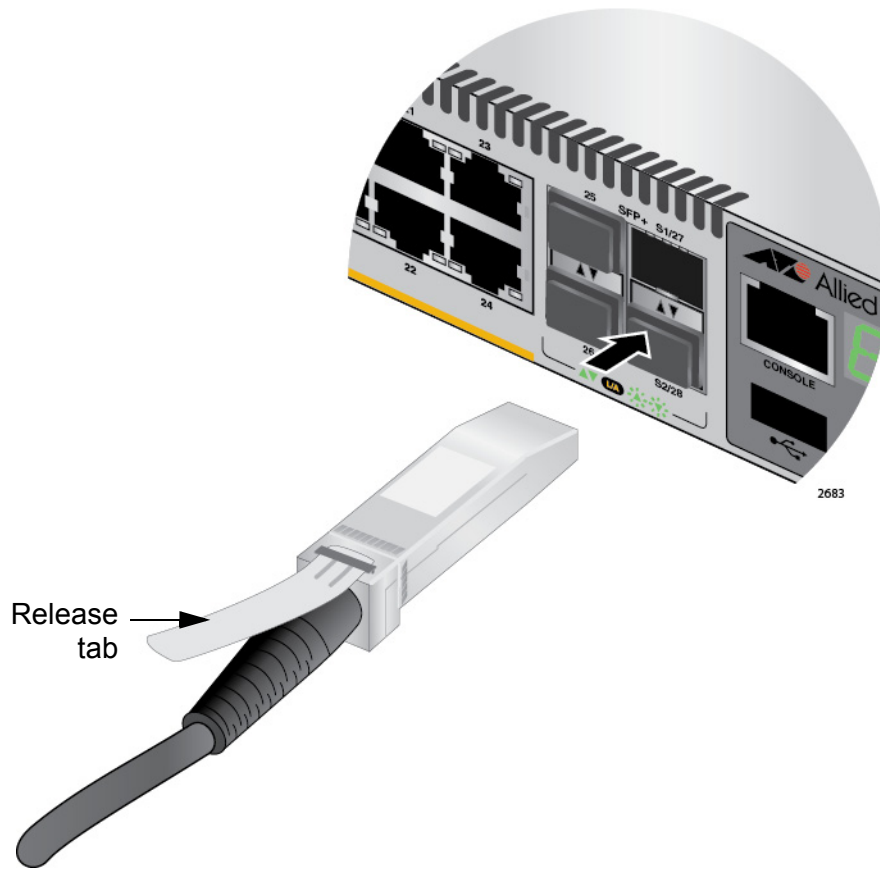

Figure 51. Installing the AT-StackXS/1.0 Transceiver in Slot S1

5. Remove the dust cover from the S2 slot in the next switch in the stack as shown in Figure 52 on page 97.

---

**Note**

The cable must cross over to different slots on the switches. The stack will not work if you connect two S1 or S2 slots together.

---



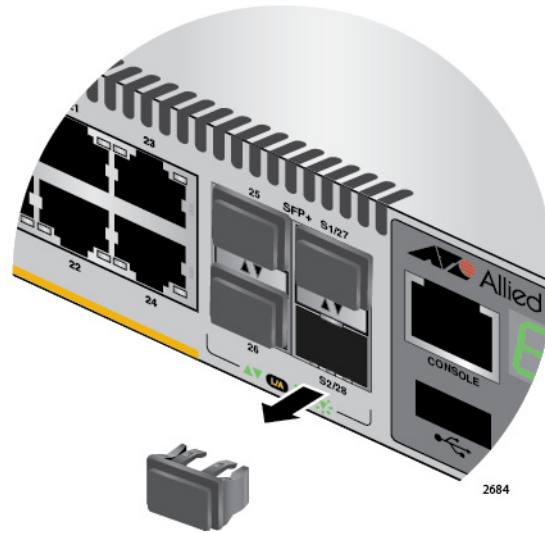

Figure 52. Removing the Dust Plug from the S2 Slot

6. Remove the dust cover from the connector on the other end of the transceiver.
7. Position the transceiver with the release tab on the bottom and slide it into the slot until it clicks into place, as shown in Figure 53 on page 98.

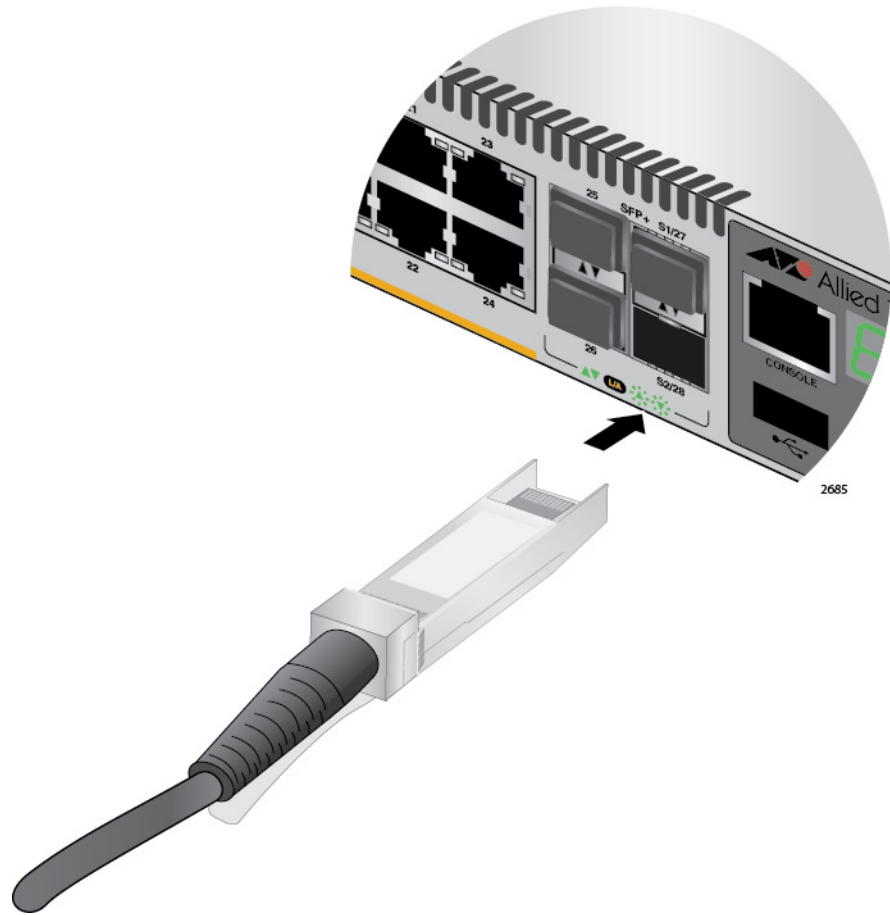

Figure 53. Installing the AT-StackXS/1.0 Transceiver in Slot S2

8. Repeat this procedure to connect additional switches to the stack with AT-StackXS/1.0 transceivers.
9. To create the redundant path with the ring topology shown in Figure 19 on page 56 and Figure 20 on page 57, connect a stacking cable to the empty stacking slots on the top and bottom switches.
10. After connecting the stacking cables to all the switches, go to Chapter 7, "Powering On the Stack" on page 103.

## Cabling Switches with AT-StackOP/0.3 or AT-StackOP/9.0 Transceivers

---

For guidelines to cabling the switches with AT-StackOP/0.3 or AT-StackOP/9.0 fiber optic transceivers, refer to “Planning a Stack” on page 69. To cable switches with fiber optic transceivers, perform the following procedure:

1. Remove a dust cover from either the S1 or S2 slot on the switch.
2. To install the transceiver in the S1 slot, position it with the handle on top, as shown in Figure 54. To install it in the S2 slot, position it with the handle on the bottom.

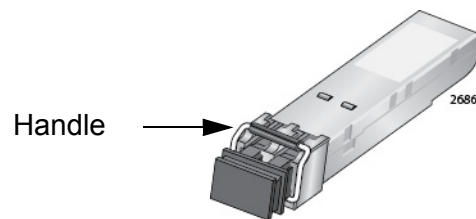

Figure 54. Handle on the AT-StackOP/0.3 and AT-StackOP/9.0 Transceivers

3. Slide the transceiver into the slot until it clicks into place, as shown in Figure 55 on page 100.

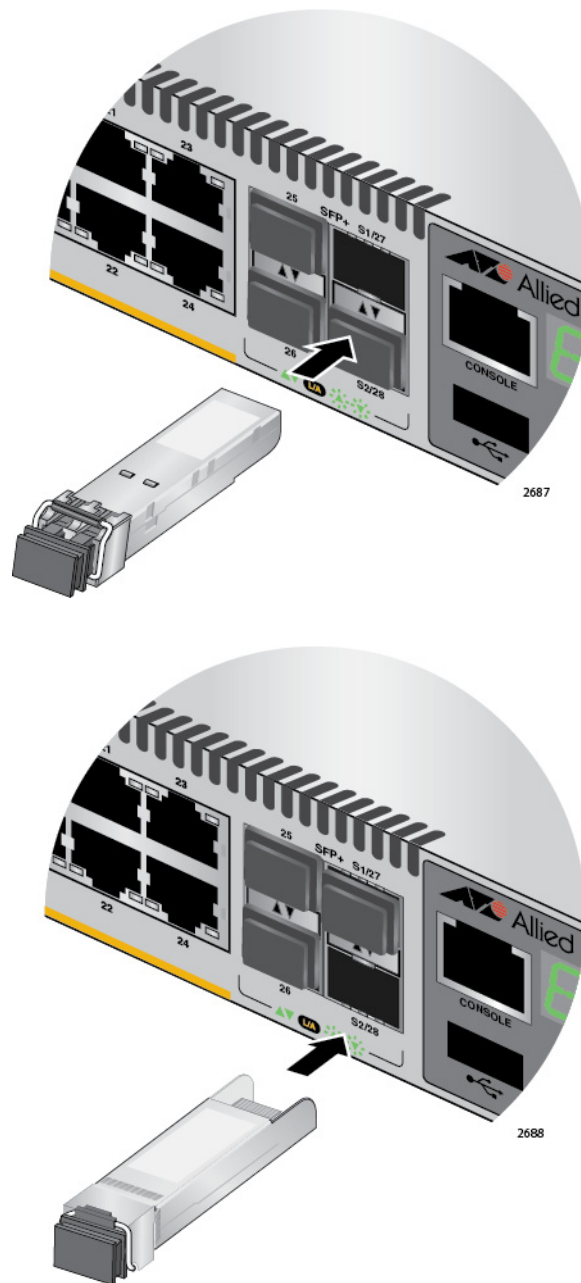

Figure 55. Installing the AT-StackOP/0.3 or AT-StackOP/9.0 Transceiver

4. Remove the dust cover from the transceiver, as shown in Figure 56 on page 101.

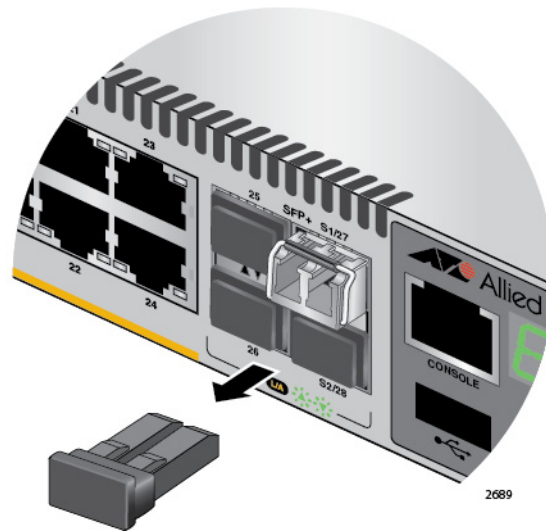

Figure 56. Removing the Dust Cover from a Stacking Transceiver

5. Verify the position of the handle on the transceiver. If the transceiver is in the S1 slot, the handle should be in the upright position, as shown in Figure 57. If the transceiver is in the S2 slot, the handle should be in the down position.

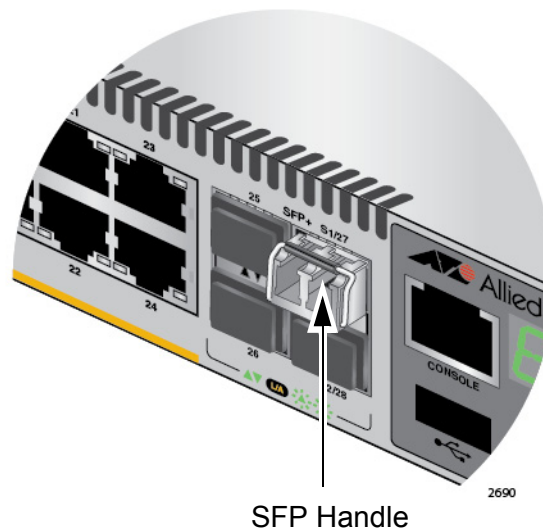

Figure 57. Positioning the Handle in the Upright Position

6. Connect the fiber optic cable to the transceiver, as shown in Figure 58 on page 102. The connector on the cable should fit snugly into the port, and the tab should lock the connector into place.

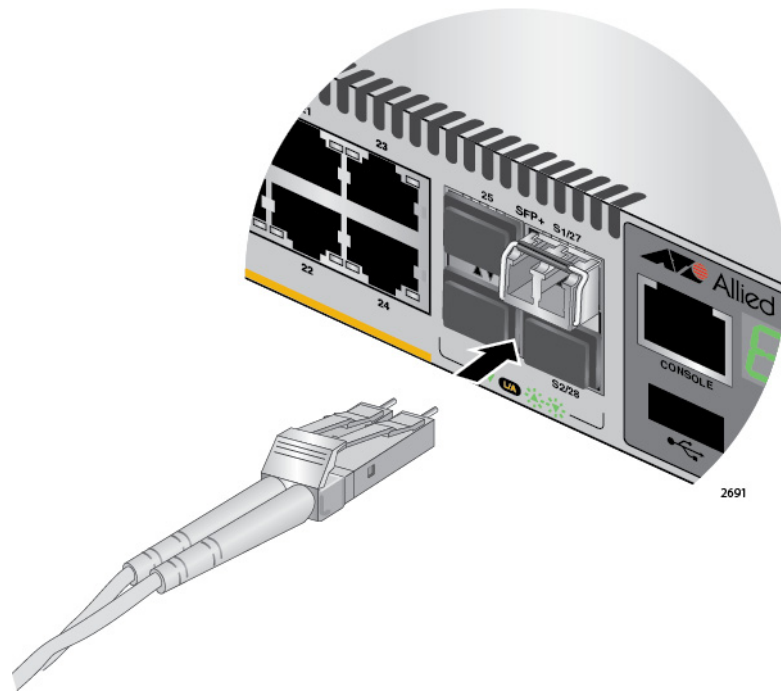

Figure 58. Connecting the Fiber Optic Cable to the Stacking Transceiver

7. Repeat this procedure if the switch is to have two stacking transceivers.
8. Repeat this procedure on the other switches of the stack to install their stacking transceivers. The connections must cross over such that a transceiver in slot 1 connects to a transceiver in slot 2.
9. After you connect the stacking cables to all the switches, go to Chapter 7, “Powering On the Stack” on page 103.

## Chapter 7

# Powering On the Stack

---

This chapter contains the following procedures:

- ❑ “Powering On the Switches Individually” on page 104
- ❑ “Powering On the Switches Simultaneously” on page 108
- ❑ “Verifying the Stack” on page 110
- ❑ “Monitoring the Initialization Processes” on page 113

Perform “Powering On the Switches Individually” on page 104 if you want to control the assignment of the ID numbers to the switches of the stack. The numbers are assigned in the order in which you power on the units. Otherwise, perform “Powering On the Switches Simultaneously” on page 108 to have the switches assign the numbers automatically. After the ID numbers are assigned, you may change them with the STACK RENUMBER command, described in the *Software Reference for x510 Series Switches, AlliedWare Plus Operating System*.



### Caution

You should not change the ID numbers of the switches after you have started to configure the parameter settings. Otherwise, the parameter settings might be applied to the wrong devices when you reset or power cycle the stack. *see* E79

---

## Powering On the Switches Individually

---

This procedure explains how you can control the assignment of the ID numbers of the switches by powering on the units one at a time during the initial power-on sequence. The first switch is assigned ID number 1, the next unit is assigned ID number 2, and so on. This procedure is useful when the switches are installed in the same equipment rack and you want to number them in sequence, such as from top to bottom, to make them easy to identify. After the ID numbers are assigned, the switches retain their assignments even when you power off or reset the stack.

During the initial power-on sequence, the first switch to be powered on becomes the master switch of the stack. However, if you do not change the priority values of the units, the next time you reset or power cycle the stack, the units use their MAC addresses to select the master switch. This might result in a different switch being assigned that role. However, this does not affect their ID number assignments, the configuration of the switches, or the manner in which you manage the stack.

This procedure assumes the following:

- This is the initial power-on sequence of the stack.
- You verified that VCStack is enabled on the switches, as explained in Chapter 5, “Verifying the Status of VCStack” on page 87.
- You connected the switches with stacking transceivers, as explained in Chapter 6, “Cabling the Stacking Ports” on page 93.
- The ID numbers are set to the default 1.
- All the switches are powered off.
- If the stack contains one or more DC powered AT-x510-28GSX-80 Switches, you should have already connected the grounding and power wires to the DC connectors on the back panels of the switches. For instructions, refer to “Wiring the DC Connectors on the AT-x510-28GSX-80 Switch” on page 78.

If you want to monitor the power-on sequence, you may connect a terminal or PC with a terminal emulator program to the Console port on the switch you intend to power on first. The messages are found in “Monitoring the Initialization Processes” on page 113.

To power on the switches, perform the following procedure:

1. Power on the switch you want to have ID number 1.

For an AC model switch, connect the AC power cords to the connectors on the back panel and to the appropriate power sources, as shown in Figure 59 on page 105. To power on the switch, connect the power cords to the connectors on the back panels and to the



appropriate power sources. The AT-x510-28GTX, AT-x510-28GPX, AT-x510-28GSX, AT-x510-52GTX, and AT-x510-52GPX models have two power supplies with separate connectors. The AT-x510L-28GT, AT-x510L-28GP, AT-x510L-52GT and AT-x510L-52GP models have one power supply with one connector.



Figure 59. Plugging in the AC Power Cords

For the DC powered AT-x510-28GSX-80 Switch, connect the grounding and power wires to the switch, as explained in “Wiring the DC Connectors on the AT-x510-28GSX-80 Switch” on page 78, and power on the DC circuits.

Consider the following items as you power on the switch:

- ❑ Connecting the two power cords to power sources that are on different circuits will provide power redundancy to the switch in the event a circuit fails.
- ❑ Refer to “Power Specifications” on page 135 for the power specifications of the switches.



---

**Warning**

Power cord is used as a disconnection device. To de-energize equipment, disconnect the power cord. ⚡ E3

---

---

**Note**

Pluggable Equipment. The socket outlet shall be installed near the equipment and shall be easily accessible. ⚡ E5

---

2. Wait one minute for the switch to initialize its management software.

The switch should be displaying the number 1 on its ID LED.

3. Power on the switch to be assigned ID number 2.

4. Wait two minutes for the new switch to join the stack as a member.

As the new switch boots up, the first switch, which has the ID number 1 and at this point is the master switch of the stack, notifies the new switch that its current ID number is already being used and that it should change its number to the next available number, which is 2. The new switch responds by automatically changing its ID number to 2 and reboots. So the new switch is actually booting up twice, once with the ID number 1 and again with its new ID number 2, which is why it takes two minutes before the device becomes a full member of the stack.

5. If there is a third switch, power it on and wait another two minutes for it to join the stack as a member with the ID number 3.

6. If there is a fourth switch, power it on and wait two minutes for it to join the stack as a member with the ID number 4.

At this point, the stack is operational.

The ID numbers are automatically stored in special files in the flash memories of the switches and are retained by the devices even if you reset or power cycle the stack.

7. To continue with the installation, go to “Verifying the Stack” on page 110.

## Powering On the Switches Simultaneously

---

If you want the switches of the stack to use their MAC addresses to automatically assign the ID numbers during the initial power-on sequence, all you have to do is power them on simultaneously, rather than one at a time as in the previous procedure. Here are the steps the switches perform:

- ❑ They initialize their management software and compare their MAC addresses.
- ❑ The switch with the lowest address is designated as the master switch of the stack.
- ❑ The master switch assigns itself the ID number 1.
- ❑ The master switch assigns ID numbers to the other switches.
- ❑ The other switches reset and initialize their management software again, with their new ID numbers.

This procedure assumes the following:

- ❑ This is the initial power on sequence of the stack.
- ❑ You verified that VCStack is enabled on the switches, as explained in Chapter 5, “Verifying the Status of VCStack” on page 87.
- ❑ You connected the switches with stacking transceivers, as explained in Chapter 6, “Cabling the Stacking Ports” on page 93.
- ❑ All the switches are powered off.
- ❑ If the stack contains one or more DC powered AT-x510-28GSX-80 Switches, you connected the grounding and power wires to the DC connectors on the back panels. For instructions, refer to “Wiring the DC Connectors on the AT-x510-28GSX-80 Switch” on page 78.

If you want to monitor the power-on sequence, you may connect a terminal or PC with a terminal emulator program to the Console port on any of the switches. The messages are found in “Monitoring the Initialization Processes” on page 113.

To have the switches automatically assign the ID numbers, perform the following procedure:

1. Power on all the switches in the stack at the same time.

For an AC model switch, connect the AC power cords to the connectors on the back panel and to the appropriate power sources, as shown in Figure 59 on page 105. All models have two power supplies with separate connectors.

For the DC powered AT-x510-28GSX-80 Switch, connect the grounding and power wires to the switch, as explained in “Wiring the DC Connectors on the AT-x510-28GSX-80 Switch” on page 78, and power on the DC circuits.

Consider the following items as you power on a switch:

- ❑ Connecting the two power cords to power sources that are on different circuits will provide power redundancy to the switch in the event a circuit fails.
- ❑ Refer to “Power Specifications” on page 135 for the power specifications of the switches.



### **Warning**

Power cord is used as a disconnection device. To de-energize equipment, disconnect the power cord. ⚡ E3

---



---

### **Note**

Pluggable Equipment. The socket outlet shall be installed near the equipment and shall be easily accessible. ⚡ E5

---

2. Wait two or three minutes for the switches to select a master switch and to assign the ID numbers.

At this point, the stack is operational. The ID numbers are automatically stored in special files in the flash memories of the switches and are retained by the devices even if you reset or power cycle the stack.

3. To continue with the installation, go to “Verifying the Stack” on page 110.

## Verifying the Stack

To verify stack operations, perform the following procedure:

1. Establish a local management session on any switch in the stack. For instructions, refer to “Starting a Local Management Session” on page 89.
2. From the User Exec mode, enter the SHOW STACK command:

```
awplus> show stack
```

The command lists the switches in the stack. An example is shown in Figure 60.

```
awplus> show stack
Virtual Chassis Stacking summary information
ID      Pending ID      MAC address      Priority  Status  Role
1       -                0015:774f:ed30  128     Ready  Active Master
2       -                0015:774f:65ab  128     Ready  Member
3       -                0015:774f:d4a7  128     Ready  Member
4       -                0015:774f:c431  128     Ready  Member
Operational Status      Normal operations
Stack MAC address      0015:774f:ed30
awplus(config)#
```

Figure 60. SHOW STACK Command

Here are some things to consider:

- ❑ The command should list all the switches in the stack. If the list is incomplete, refer to Chapter 9, “Troubleshooting” on page 127.
  - ❑ The Operational Status field displays “Normal operations” when the switches are connected in the ring topology and “Ring topology is broken” when the switches are connected in the linear topology.
  - ❑ The priority values will be 128, the default value, if they have not been changed on the switches.
  - ❑ Given that there is no relationship between the ID numbers and the selection of the master switch, the active master in the SHOW STACK command might not have the ID number 1.
3. Do one of the following:
    - ❑ If you want to change the priority values of the switches, go to “Setting the Priority Numbers” on page 111. The procedure is optional.

- ❑ Otherwise, go to Chapter 8, “Cabling the Networking Ports” on page 117, to continue with the installation.

## Setting the Priority Numbers

This procedure is optional. It explains how to configure the priority settings of the switches. Changing the priority settings protects the stack configuration should you ever power on the stack with a new member switch that has a lower MAC address than an existing master or member switch.

This procedure assumes you are continuing directly on from the previous procedure.

To set the priority values of the switches, perform the following procedure:

1. Use the CONFIGURE TERMINAL command to move from the Privileged Exec mode to the Global Configuration mode, as shown in Figure 61.

```
awplus# configure terminal
Enter configuration commands, one per line. End with CNTL/Z.
awplus(config)#
```

Figure 61. Moving to the Global Configuration Mode with the CONFIGURE TERMINAL Command

2. Use the STACK PRIORITY command to set the priority numbers. The command has this format:

```
stack ID_number priority priority
```

The ID\_NUMBER parameter is the ID number of the switch whose priority value you are setting. The range is 1 to 4. The PRIORITY parameter is the new priority value for the switch. The range is 0 to 255. The default is 128.

Here are some examples:

To assign the priority value 1 to the switch with the ID number 1, you enter this command:

```
awplus(config)# stack 1 priority 1
```

To set the priority value to 2 on the switch with the ID number 2, you enter:

```
awplus(config)# stack 2 priority 2
```

3. After setting the priority values, enter the EXIT command to return to the Privileged Exec mode, as shown in Figure 62 on page 112.

```
awplus(config)# exit  
awplus#
```

Figure 62. Returning to the Privileged Exec Mode

4. Enter the WRITE command to save your change in the configuration file. The switch displays the confirmation prompt in Figure 63.

```
awplus# write  
Building configuration ...  
[OK]  
awplus#
```

Figure 63. Saving the Priority Values with the WRITE Command

5. To end the management session, enter the EXIT command.
6. Go to Chapter 8, “Cabling the Networking Ports” on page 117, to continue with the installation.



## Monitoring the Initialization Processes

You may monitor the initialization sequence of the stack by connecting a terminal or computer that has a terminal emulator program to the Console port on any switch in the stack. You will see the messages in Figure 64 here to Figure 66 on page 115.

```

Bootloader 2.0.11 loaded
Press <Ctrl+B> for the Boot Menu

Reading filesystem...
Loading flash:x510-5.4.2a-20120727-1.rel...
Verifying release... OK
Booting...
Starting base/first...           [ OK ]
Mounting virtual filesystems...  [ OK ]

      _____
     / \         / / \ \
    /   \       / /   \ \
   /     \     / /     \ \
  /       \   / /       \ \
 /         \ / /         \ \
/           \ /           \ \
/_____ \ /_____ \ \ /_____ \

Allied Telesis Inc.
Alliedware Plus (TM) v5.4.2A
Current release filename: x510-5.4.2a-20120727-1.rel
Original release filename: x510-5.4.2A-20120727-1.rel
Built: Fri Jul 27 04:11:42 NZST 2012 by: maker@maker04-build
Mounting static filesystems...    [ OK ]
Checking flash filesystem...      [ OK ]
Mounting flash filesystem...      [ OK ]
Checking NVS filesystem...        [ OK ]
Mounting NVS filesystem...        [ OK ]
Starting base/dbus...             [ OK ]
Starting base/syslog...           [ OK ]
Starting base/loopback...         [ OK ]
Starting base/poe_done...         [ OK ]
Starting base/sysctl...           [ OK ]

```

Figure 64. Switch Initialization Messages

```

Received event poefw.done
Starting base/portmapper... [ OK ]
Received event syslog.done
Starting base/reboot-stability... [ OK ]
Starting base/autofs-card... [ OK ]
Checking system reboot stability... [ OK ]
Starting base/cron... [ OK ]
Starting base/appmond... [ OK ]
Starting hardware/openhpi... [ OK ]
Starting hardware/timeout... [ OK ]
Starting base/inet... [ OK ]
Starting base/modules... [ OK ]
Received event modules.done
Received event board.inserted
Received event hardware.done
Starting network/startup... [ OK ]
Starting network/stackd... [ OK ]
Starting network/election.timeout... [ OK ]
Received event network.enabled

Initializing HA processes:
openhpid, hostd, cntrd, nsm, auth, epsr, hsl
imiproxyd, irdpd, lldpd, loopprot, mstp, ospf6d, ripd
ripngd, rmon, sflowd, udldd, vrrpd, bgpd, imi
lacpd, ospfd, pdmd, pimd

Received event network.initialized
03:44:11 awplus-1 VCS[826]: No neighboring members found, unit may be in a
stand alone configuration
03:44:11 awplus-1 VCS[826]: Startup speed can be improved by adding 'no stack
1
enable' to configuration
Received event vcs.elected-master
03:44:11 awplus-1 VCS[826]: Member 1 (0015.774f.ed30) has become the Active
Master
Assigning Active workload to HA processes:
hsl, nsm, rmond, sflowd, vrrpd, irdpd, lacpd
lldpd, loopprot, mstpd, authd, epsrd, imi, imiproxyd

```

Figure 65. Switch Initialization Messages (Continued)

```
Received event network.activated

Loading default configuration
warning: flash:/default.cfg does not exist, loading factory defaults.
..
done!
Received event network.configured
awplus login: 21:12:34 awplus VCS[734]: Duplicate member-ID 1 detected for
0015.774f.ed30 and 0011.2233.4455
21:12:34 awplus VCS[734]: Automatically renumbering member-1
(0015.774f.ed30), selecting unused member-ID...
21:12:52 awplus VCS[734]: Renumbering member-1 (0015.774f.ed30) to ID 2
21:12:52 awplus VCS[734]: Automatically rebooting stack member-2
(0015.774f.ed30) due to duplicate member-ID
21:14:02 awplus VCS[734]: Member 2 (0015.774f.ed30) has joined stack
21:14:02 awplus VCS[734]: Please configure 'stack virtual-mac' to minimize
network disruption from failovers
21:14:02 awplus IMI[743]: All users returned to config mode while switch
synchronization is in progress.
21:14:19 awplus NSM[738]: Insertion event on unit 2.0 has been completed
21:14:24 awplus IMI[743]: Configuration update completed for port2.0.1-
2.0.52
awplus login:
```

Figure 66. Switch Initialization Messages (Continued)



## Chapter 8

# Cabling the Networking Ports

---

This chapter contains the following procedures:

- “Cabling the Twisted Pair Ports” on page 118
- “Installing SFP and SFP+ Transceivers” on page 120

## Cabling the Twisted Pair Ports

---

Here are the guidelines to cabling the 10/100/1000Base-T twisted pair ports:

- ❑ The cable specifications for the 10/100/1000Base-T twisted pair ports are listed in Table 1 on page 26.
- ❑ The connectors on the cables should fit snugly into the ports, and the tabs should lock the connectors into place.
- ❑ The default setting for the wiring configurations of the ports is auto-MDI/MDI-X. The default setting is appropriate for switch ports that are connected to 10/100Base-TX network devices that also support auto-MDI/MDI-X.
- ❑ The default auto-MDI/MDI-X setting is not appropriate for switch ports that are connected to 10/100Base-TX network devices that do not support auto-MDI/MDI-X and have a fixed wiring configuration. For switch ports connected to those types of network devices, you should disable auto-MDI/MDI-X and set the wiring configurations manually.
- ❑ The appropriate MDI/MDI-X setting for a switch port connected to a 10/100Base-TX network device with a fixed wiring configuration depends on the setting of the network device and whether the switch and network device are connected with straight-through or crossover cable. If you are using straight-through twisted pair cable, the wiring configurations of a port on the switch and a port on a network device must be opposite each other, such that one port uses MDI and the other MDI-X. For example, if a network device has a fixed wiring configuration of MDI, you must disable auto-MDI/MDI-X on the corresponding switch port and manually set it to MDI-X. If you are using crossover twisted pair cable, the wiring configurations of a port on the switch and a port on a network device must be the same.
- ❑ The default speed setting for the ports is Auto-Negotiation. This setting is appropriate for ports connected to network devices that also support Auto-Negotiation.
- ❑ The default speed setting of Auto-Negotiation is not appropriate for ports connected to 10/100Base-TX network devices that do not support Auto-Negotiation and have fixed speeds. For those switch ports, you should disable Auto-Negotiation and set the port's speed manually to match the speeds of the network devices.
- ❑ The 10/100/1000Base-T ports must be set to Auto-Negotiation, the default setting, to operate at 1000Mbps.
- ❑ The default duplex mode setting for the ports is Auto-Negotiation. This setting is appropriate for ports connected to network devices that also support Auto-Negotiation for duplex modes.

- ❑ The default duplex mode setting of Auto-Negotiation is not appropriate for ports connected to network devices that do not support Auto-Negotiation and have a fixed duplex mode. You should disable Auto-Negotiation on those ports and set their duplex modes manually to avoid the possibility of duplex mode mismatches. A switch port using Auto-Negotiation defaults to half-duplex if it detects that the end node is not using Auto-Negotiation, which can result in a mismatch if the end node is operating at a fixed duplex mode of full-duplex.
- ❑ Do not attach cables to ports of static or LACP port trunks until after you have configured the trunks on the switch. Otherwise, the ports will form network loops that can adversely affect network performance.

## Installing SFP and SFP+ Transceivers

---

This section contains guidelines and procedures for installing SFP and SFP+ transceivers. The installation procedures are listed here:

- ❑ “Installing SFP Modules in the AT-x510-28GSX and AT-x510-28GSX-80 Switches” on page 121
- ❑ “Installing SFP and SFP+ Modules” on page 124

Here are general installation guidelines for SFP and SFP+ transceivers:

- ❑ SFP and SFP+ transceivers are hot-swappable. You may install them while the chassis is powered on.
- ❑ Your Allied Telesis sales representative can provide you with a list of supported transceivers for the line cards.
- ❑ The operational specifications and fiber optic cable requirements of the transceivers are provided in the documents included with the devices.
- ❑ You should install a transceiver before connecting the fiber optic cable.
- ❑ Fiber optic transceivers are dust sensitive. Always keep the plug in the optical bores when a fiber optic cable is not installed, or when you store the transceiver. When you do remove the plug, keep it for future use.
- ❑ Unnecessary removal and insertion of a transceiver can lead to premature failure.



### Warning

An SFP transceiver can be damaged by static electricity. Be sure to observe all standard electrostatic discharge (ESD) precautions, such as wearing an antistatic wrist strap, to avoid damaging the transceiver. *⚡* E86

---

---

### Note

When VCStack is enabled on the switch, the default setting, slots S1/27 and S1/28 on the 28-port switches and slots S1/51 and S1/52 on the 52-port switches are reserved as stacking ports and may not be used for regular SFP or SFP+ transceivers.

---



## Installing SFP Modules in the AT-x510-28GSX and AT-x510-28GSX-80 Switches

To install SFP transceivers in slots 1 to 24 of the AT-x510-28GSX or AT-x510-28GSX-80 Switches, perform the following procedure:

1. Remove the dust plug from a transceiver slot on the switch. Refer to Figure 67.

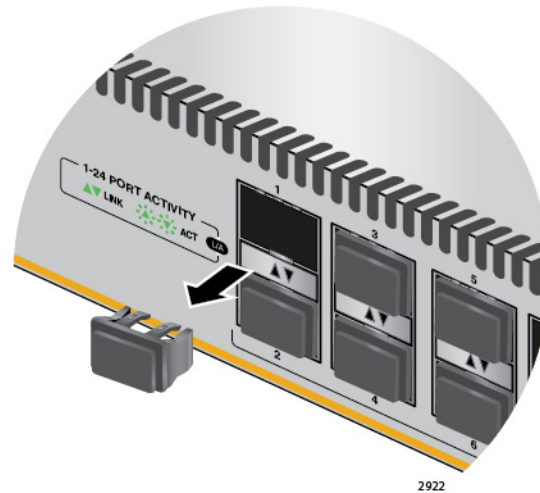

Figure 67. Removing the Dust Plug from an SFP Slot

2. Remove the transceiver from its shipping container and store the packaging material in a safe location.
3. If you are installing the transceiver in a top slot, position the transceiver with the Allied Telesis label facing up. If you are installing the transceiver in a bottom slot, position the transceiver with the label facing down.
4. Slide the transceiver into the slot until it clicks into place, as shown in Figure 68 on page 122.

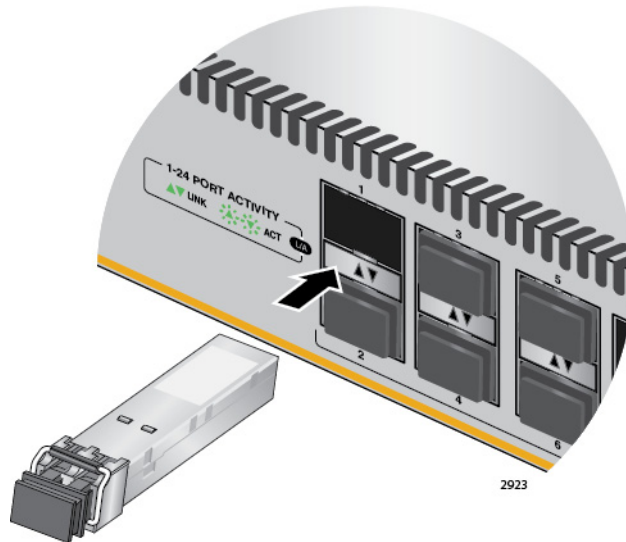

Figure 68. Installing an SFP Transceiver

---

**Note**

If you are ready to attach the fiber optic cable to the transceiver, continue with the next step. Otherwise, repeat Step 1 through Step 4 to install the remaining SFP transceivers in the switch.

---

5. Remove the dust cover from the transceiver, as shown in Figure 69.

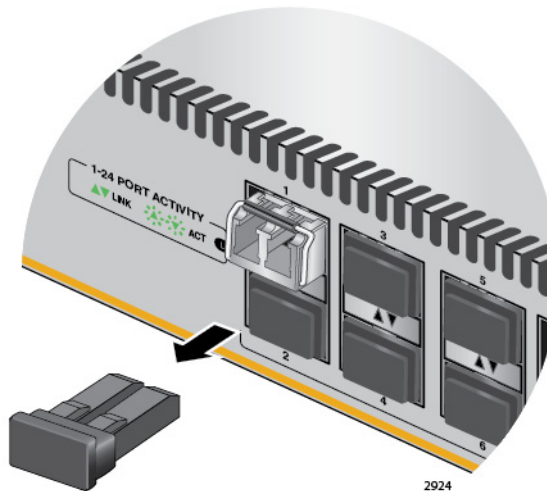

Figure 69. Removing the Dust Cover from an SFP Transceiver

6. Verify the position of the handle on the SFP transceiver. If the transceiver is in a top slot, the handle should be in the upright position, as shown in Figure 70 on page 123. If the transceiver is in a bottom slot, the handle should be in the down position.

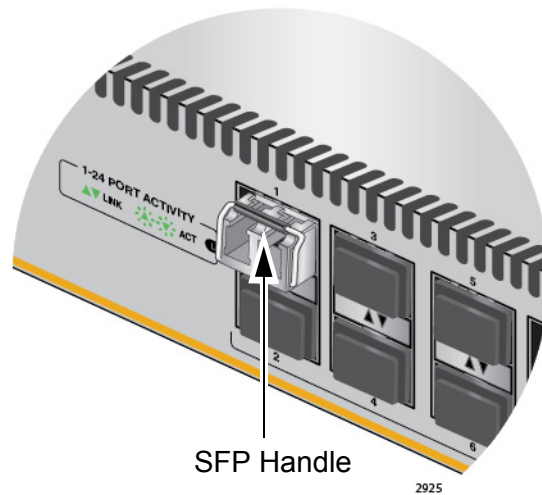

Figure 70. Positioning the SFP Handle in the Upright Position

7. Connect the fiber optic cable to the transceiver, as shown in Figure 71. The connector on the cable should fit snugly into the port, and the tab should lock the connector into place.

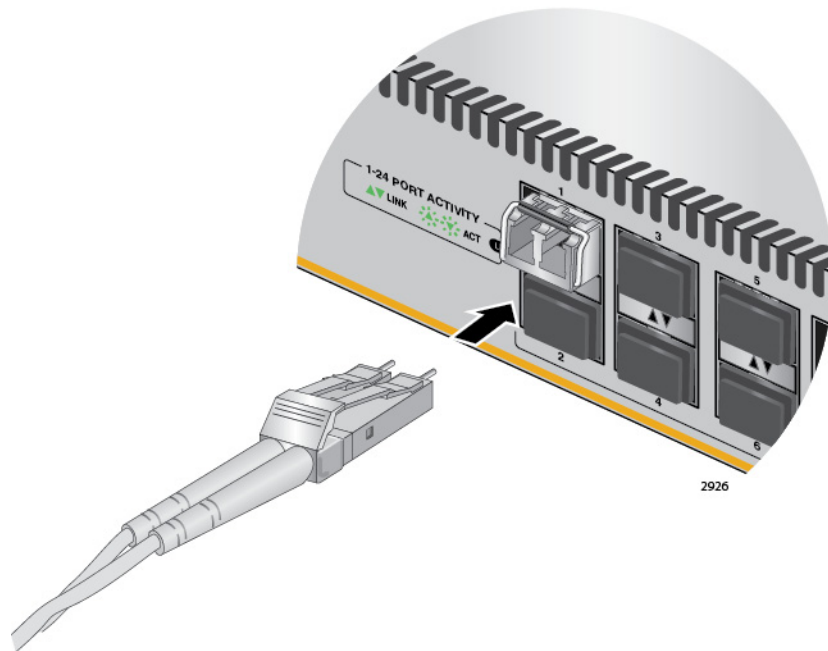

Figure 71. Connecting a Fiber Optic Cable to an SFP Transceiver

8. Repeat this procedure to install additional transceivers.

## Installing SFP and SFP+ Modules

To install SFP and SFP+ transceivers in slots 27 and 28 of the 28-port switches and slots 51 and 52 of the 52-port switches, perform the following procedure:

1. Remove the dust plug from a transceiver slot on the switch.

Figure 72 shows the dust plug being removed from port 25 on the AT-x510-28GTX Switch.

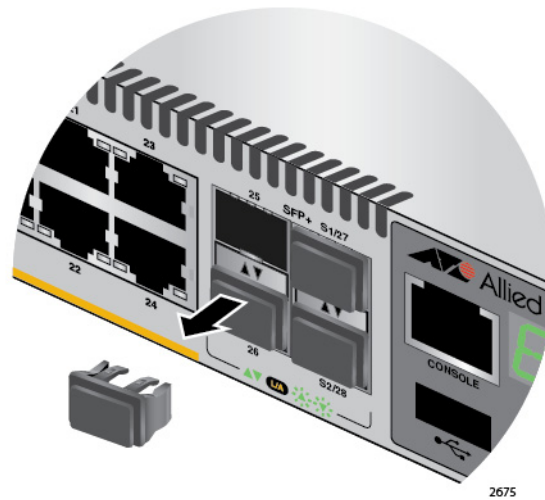

Figure 72. Removing the Dust Plug from an SFP+ Slot

2. Remove the transceiver from its shipping container and store the packaging material in a safe location.
3. If you are installing the transceiver in a top slot, position the transceiver with the Allied Telesis label facing up. If you are installing the transceiver in a bottom slot, position the transceiver with the label facing down.
4. Slide the transceiver into the slot until it clicks into place, as shown in Figure 73 on page 125.

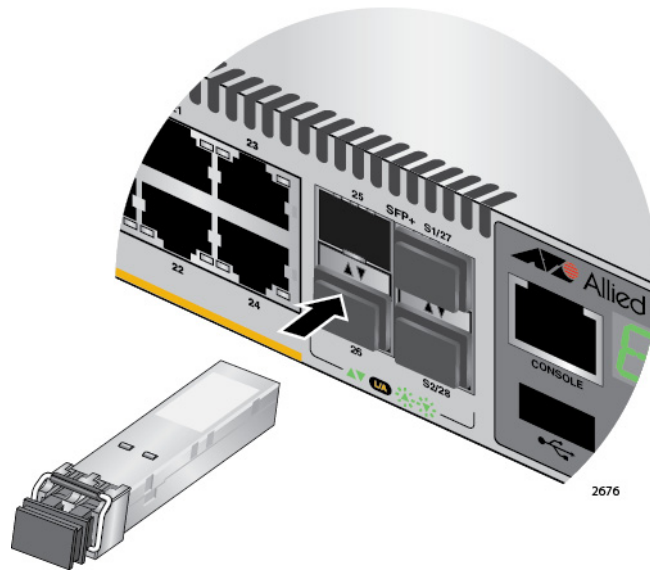

Figure 73. Installing an SFP or SFP+ Transceiver

**Note**

If you are ready to attach the fiber optic cable to the transceiver, continue with the next step. Otherwise, repeat Step 1 through Step 4 to install the remaining SFP or SFP+ transceivers in the line cards.

5. Remove the dust cover from the transceiver, as shown in Figure 74.

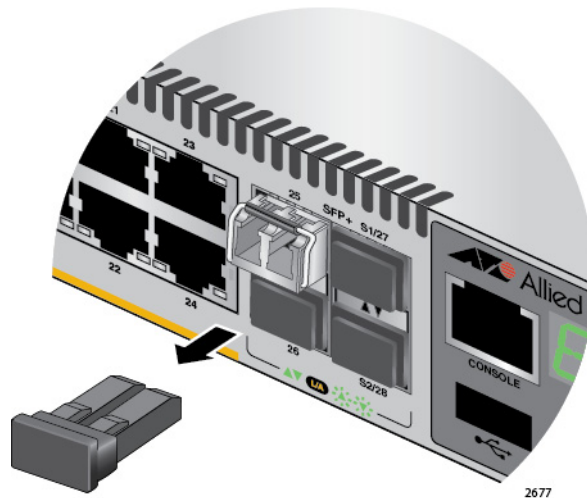

Figure 74. Removing the Dust Cover from an SFP or SFP+ Transceiver

6. Verify the position of the handle on the SFP transceiver. If the transceiver is in a top slot, the handle should be in the upright position, as shown in Figure 75 on page 126. If the transceiver is in a bottom slot, the handle should be in the down position.

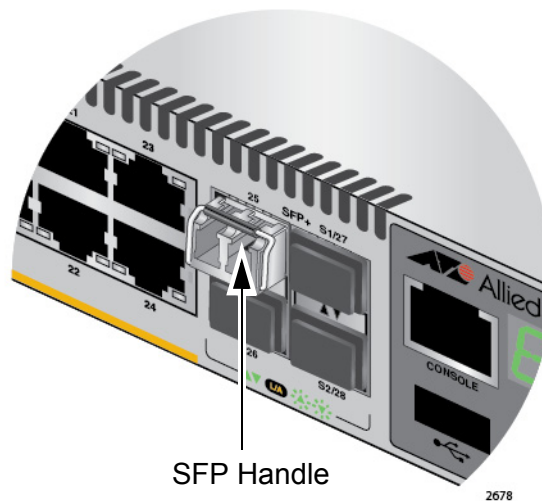

Figure 75. Positioning the SFP or SFP+ Handle in the Upright Position

7. Connect the fiber optic cable to the transceiver, as shown in Figure 76. The connector on the cable should fit snugly into the port, and the tab should lock the connector into place.

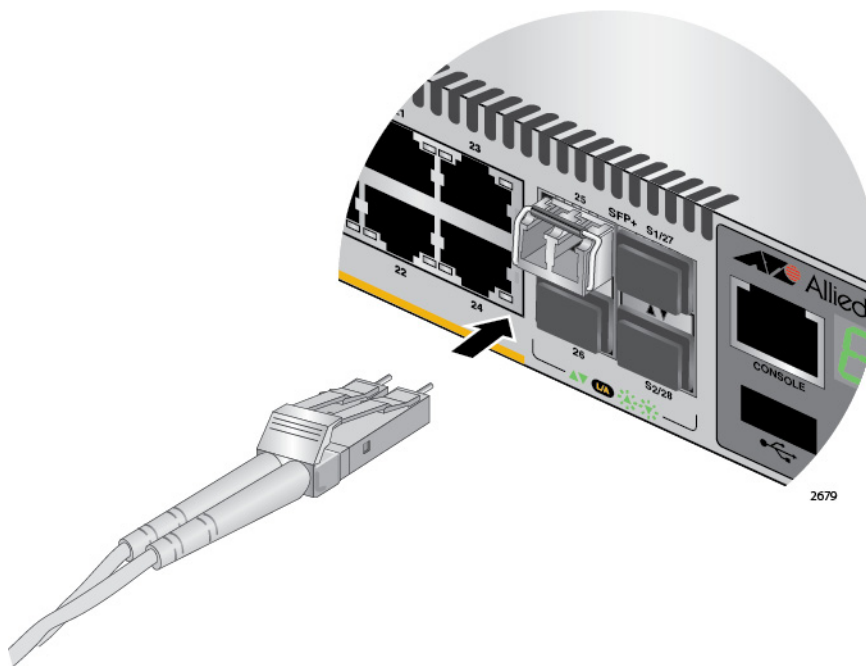

Figure 76. Connecting a Fiber Optic Cable to an SFP or SFP+ Transceiver

8. Repeat this procedure to install additional transceivers.

## Chapter 9

# Troubleshooting

---

This chapter contains suggestions on how to troubleshoot the switch if a problem occurs.

---

**Note**

For further assistance, please contact Allied Telesis Technical Support at [www.alliedtelesis.com/support](http://www.alliedtelesis.com/support).

---

**Problem 1:** The Switch ID LED on the front of the switch is off.

**Solutions:** The unit is not receiving power. Try the following:

- Verify that the power cord is securely connected to the power source and to the AC connector on the back panel of the switch.
- Verify that the power outlet has power by connecting another device to it.
- Try connecting the unit to another power source.
- Try a different power cord.
- Verify that the voltage from the power source is within the required levels for your region.

**Problem 2:** All the port LEDs are off even though the ports are connected to active network devices.

**Solution:** The switch may be operating in the low power mode. To toggle on the LEDs, press the eco-friendly button on the front panel of the switch. You may also toggle the LEDs off and on with the ECOFRIENDLY LED and NO ECOFRIENDLY LED commands in the command line interface.

**Problem 3:** The SHOW STACK command is not displaying all the switches in the stack.

**Solutions:** One or more switches cannot join the stack. Try the following:

- Verify that the stacking transceivers in the S1 and S2 slots of the switches are properly cabled. The stacking cables must cross over to different slots on the switches. For instructions, refer to Chapter 6, “Cabling the Stacking Ports” on page 93.
- Verify that the transceivers are fully inserted into the S1 and S2 slots.

- ❑ Verify that VCStack is activated on the switches. For instructions, refer to Chapter 5, “Verifying the Status of VCStack” on page 87.
- ❑ It could be that the switches have incompatible versions of the management software. When a stack forms or a new switch is added to an existing stack, the master switch downloads its management software to member switches that do not have the same version. If the master switch encounters a problem downloading the management software to a member switch, it does not allow the device to join the stack.

**Problem 4:** A twisted pair port on the switch is connected to a network device, but the port’s LINK/ACT LED is off.

**Solutions:** The port is unable to establish a link to a network device. Try the following:

- ❑ Verify that the port is connected to the correct twisted pair cable. This is to eliminate the possibility that the port is connected to the wrong network device.
- ❑ Verify that the network device connected to the twisted pair port is powered on and is operating properly.
- ❑ Try connecting another network device to the twisted pair port with a different cable. If the twisted pair port is able to establish a link, then the problem is with the cable or the other network device.
- ❑ Verify that the twisted pair cable does not exceed 100 meters (328 feet).
- ❑ Verify that you are using the appropriate category of twisted pair cable. The cable types are listed in Table 1 on page 26 for the 10/100/1000Base-T ports.

---

**Note**

A 1000Base connection may require five to ten seconds to establish a link.

---

**Problem 5:** The LINK/ACT LED for an SFP or SFP+ transceiver is off.

**Solutions:** The fiber optic port on the transceiver is unable to establish a link to a network device. Try the following:

- ❑ Verify that the remote network device connected to the fiber optic port is operating properly.
- ❑ Verify that the fiber optic cable is securely connected to the port on the SFP or SFP+ module and to the port on the remote network device.
- ❑ Check that the transceiver is fully inserted in the slot.



- ❑ If you are using SFP+ slots 27 or 28 on a 28-port switch or slots 51 and 52 on a 52-port switch, check that the VCStack feature is disabled on the switch. The VCStack feature has to be disabled before you can use the slots with regular SFP or SFP+ transceivers. For instructions, refer to “Powering On the Switches Simultaneously” on page 108.
- ❑ Verify that the operating specifications of the fiber optic ports on the transceiver and remote network device are compatible.
- ❑ Verify that the correct type of fiber optic cabling is being used.
- ❑ Verify that the port is connected to the correct fiber optic cable. This is to eliminate the possibility that the port is connected to the wrong remote network device.
- ❑ Try connecting another network device to the fiber optic port using a different cable. If the port is able to establish a link, then the problem is with the cable or other network device.
- ❑ Use the switch’s management software to verify that the port is enabled.
- ❑ If the remote network device is a managed device, use its management firmware to determine whether its port is enabled.
- ❑ Test the attenuation of both directions on the fiber optic cable with a fiber optic tester to determine whether the optical signal is too weak (sensitivity) or too strong (maximum input power).

**Problem 6:** Network performance between a twisted pair port on the switch and a network device is slow.

**Solution:** There might be a duplex mode mismatch between the port and the network device. This can occur when a twisted pair port using Auto-Negotiation is connected to a remote device that has a fixed speed of 10 or 100 Mbps and a fixed duplex mode of full duplex. If this is the cause of the problem, adjust the duplex mode of the port on the network device or switch so that both ports are using the same duplex mode. You can use either the LEDs or management software on the switch to determine the duplex mode settings of the ports. The LEDs are described in Table 5 on page 36.

**Problem 7:** The switch functions intermittently.

**Solutions:** Check the system hardware status through the management software:

- ❑ Use the SHOW SYSTEM ENVIRONMENT command in the Privileged Exec mode to verify that the input voltage from the power source to the switch is stable and within the approved operating range. The unit will shut down if the input voltage fluctuates above or below the approved operating range.

- ❑ Use the SHOW SYSTEM ENVIRONMENT command in the Privileged Exec mode to verify that the fan is operating correctly.
- ❑ Verify that the location of the switch allows for adequate airflow. The unit will shut down if it is in danger of overheating.

**Problem 8:** The Switch ID LED on the front of the switch is flashing the letter “F.”

**Solutions:** One or more of the following problems has occurred:

- ❑ A cooling fan has failed.
- ❑ The input voltage on one or both of the power supplies is outside the normal operating range.
- ❑ The internal temperature of the switch has exceeded the normal operating range and the switch may shut down.

Contact your Allied Telesis sales representative for assistance.

**Problem 9:** The AT-x510-28GPX, AT-x510L-28GP, AT-x510-52GPX, or AT-x510L-52GP Switch is not providing power to a PoE device.

**Solutions:** Try the following:

- ❑ Review the PD’s documentation to confirm that the device supports Mode A of the IEEE 802.3at standard. Mode A is one of two modes that define the connector pins that deliver the power from the port on the line card to the PD. In Mode A, the power is carried on pins 1, 2, 3, and 6 on the RJ-45 port, the same pins that carry the network traffic. The second mode, Mode B, defines pins 4, 5, 7, and 8 as the power carriers. The AT-x510-28GPX, AT-x510L-28GP, AT-x510-52GPX, and AT-x510L-52GP Switches do not support Mode B. Most powered devices are designed to accept power by either mode, but some legacy devices may only support one mode. This can be verified by reviewing the device’s documentation or data sheet. Legacy devices that only support Mode B will not work with the switches.
- ❑ Check that the device’s power requirements do not exceed 30 W. This can be verified by reviewing the device’s documentation or data sheet.
- ❑ Verify that you are using the appropriate category of twisted-pair cable by referring to Table 3 on page 28.
- ❑ Use the management software on the switch to determine whether PoE is enabled on the port. The default setting for PoE is enabled.

- ❑ Use the management software on the switch to determine whether the PoE power setting for the port has been reduced to a value below the power requirements of the device.
- ❑ Try connecting the device to a different port on the switch.



## Appendix A

# Technical Specifications

---

This appendix contains the following sections:

- “Physical Specifications”
- “Environmental Specifications” on page 135
- “Power Specifications” on page 135
- “Certifications” on page 137
- “RJ-45 Twisted Pair Port Pinouts” on page 137
- “RJ-45 Style Serial Console Port Pinouts” on page 139
- “Fiber Optic Specifications for the AT-StackOP/0.3 and AT-StackOP/9.0 Transceivers” on page 140

## Physical Specifications

---

### Dimensions (H x W x D)

Table 12. Product Dimensions

AT-x510-28GTX (AC model)	4.4 cm x 44.0 cm x 32.3 cm (1.7 in. x 17.3 in. x 12.7 in.)
AT-x510-28GPX (AC model)	4.4 cm x 44.0 cm x 39.8 cm (1.7 in. x 17.3 in. x 15.7 in.)
AT-x510-28GSX (AC model)	4.4 cm x 44.0 cm x 32.3 cm (1.7 in. x 17.3 in. x 12.7 in.)
AT-x510-28GSX-80 (DC model)	4.4 cm x 44.0 cm x 32.3 cm (1.7 in. x 17.3 in. x 12.7 in.)
AT-x510L-28GT (AC model)	4.4 cm x 44.0 cm x 29.1 cm (1.7 in. x 17.3 in. x 11.5 in.)
AT-x510L-28GP (AC model)	4.4 cm x 44.0 cm x 32.3 cm (1.7 in. x 17.3 in. x 12.7 in.)
AT-x510-52GTX (AC model)	4.4 cm x 44.0 cm x 32.3 cm (1.7 in. x 17.3 in. x 12.7 in.)

Table 12. Product Dimensions (Continued)

AT-x510-52GPX (AC model)	4.4 cm x 44.0 cm x 40.0 cm (1.7 in. x 17.3 in. x 15.7 in.)
AT-x510L-52GT (AC model)	4.4 cm x 44.0 cm x 29.1 cm (1.7 in. x 17.3 in. x 11.5 in.)
AT-x510L-52GP (AC model)	4.4 cm x 44.0 cm x 32.3 cm (1.7 in. x 17.3 in. x 12.7 in.)

**Weights**

Table 13. Product Weights

AT-x510-28GTX (AC model)	4.3 kg (9.5 lb.)
AT-x510-28GPX (AC model)	5.8 kg (12.8 lb.)
AT-x510-28GSX (AC model)	4.8 kg (10.6 lb.)
AT-x510-28GSX-80 (DC model)	4.8 kg (10.6 lb.)
AT-x510L-28GT (AC model)	4.2 kg (9.3 lb.)
AT-x510L-28GP (AC model)	5.2 kg (11.5 lb.)
AT-x510-52GTX (AC model)	5.2 kg (11.5 lb.)
AT-x510-52GPX (AC model)	6.2 kg (13.7 lb.)
AT-x510L-52GT (AC model)	4.8 kg (10.6 lb.)

**Ventilation**

Table 14. Ventilation Requirements

Recommended Minimum Ventilation on All Sides	10 cm (4.0 in)
--	----------------

## Environmental Specifications

---

Table 15. Environmental Specifications

Operating Temperature	0° C to 45° C (32° F to 113° F)
Storage Temperature	-25° C to 70° C (-13° F to 158° F)
Operating Humidity	5% to 90% noncondensing
Storage Humidity	5% to 95% noncondensing
Maximum Operating Altitude	3,000 m (9,842 ft)
Maximum Nonoperating Altitude	4,000 m (13,100 ft)

## Power Specifications

---

### Maximum Power Consumption

Table 16. Maximum Power Consumption

AT-x510-28GTX (AC model)	40 watts per input
AT-x510-28GPX (AC model)	210 watts per input
AT-x510-28GSX (AC model)	40 watts per input
AT-x510-28GSX-80 (DC model)	40 watts per input
AT-x510L-28GT (AC model)	52 watts per input
AT-x510L-28GP (AC model)	290 watts per input
AT-x510-52GTX (AC model)	70 watts per input
AT-x510-52GPX (AC model)	270 watts per input
AT-x510L-52GT (AC model)	86 watts per input
AT-x510L-52GP (AC model)	320 watts per input

**Input Voltages**

Table 17. Input Voltages

AT-x510-28GTX (AC model)	100-240 VAC, 1.0A maximum, 50/60 Hz per input
AT-x510-28GPX (AC model)	100-240 VAC, 3.0A maximum, 50/60 Hz per input
AT-x510-28GSX (AC model)	100-240 VAC, 1.0A maximum, 50/60 Hz per input
AT-x510-28GSX-80 (DC model)	-48/-60V, 3.0A maximum
AT-x510L-28GT (AC model)	100-240 VAC, 1.0A maximum, 50/60 Hz per input
AT-x510L-28GP (AC model)	100-240 VAC, 3.0A maximum, 50/60 Hz per input
AT-x510-52GTX (AC model)	100-240 VAC, 1.0A maximum, 50/60 Hz per input
AT-x510-52GPX (AC model)	100-240 VAC, 3.0A maximum, 50/60 Hz per input
AT-x510L-52GT (AC model)	100-240 VAC, 1.0A maximum, 50/60 Hz per input
AT-x510L-52GP (AC model)	100-240 VAC, 3.0A maximum, 50/60 Hz per input



## Certifications

Table 18. Product Certifications

EMI (Emissions)	FCC Class A, EN55022 Class A, EN61000-3-2, EN61000-3-3, VCCI Class A, CISPR Class A, C-TICK, CE
EMC (Immunity)	EN55024
Electrical and Laser Safety	EN60950-1 (TUV), UL 60950-1 (cULUS), EN60825
Compliance Marks	CE, cULUS, TUV, C-Tick

## RJ-45 Twisted Pair Port Pinouts

Figure 77 illustrates the pin layout of the RJ-45 connectors and ports.

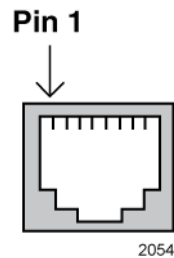

Figure 77. RJ-45 Socket Pin Layout (Front View)

Table 19 lists the pin signals for 10 and 100 Mbps.

Table 19. Pin Signals for 10 and 100 Mbps

<b>Pin</b>	<b>MDI Signal</b>	<b>MDI-X Signal</b>
1	TX+	RX+
2	TX-	RX-
3	RX+	TX+
4	Not used	Not used
5	Not used	Not used
6	RX-	TX-
7	Not used	Not used
8	Not used	Not used

Table 20 lists the pin signals when a port operating at 1000 Mbps.

Table 20. Pin Signals for 1000 Mbps

<b>Pinout</b>	<b>Pair</b>
1	Pair 1 +
2	Pair 1 -
3	Pair 2 +
4	Pair 3 +
5	Pair 3 -
6	Pair 2 -
7	Pair 4 +
8	Pair 4 -

## RJ-45 Style Serial Console Port Pinouts

---

Table 21 lists the pin signals of the RJ-45 style serial Console port.

Table 21. RJ-45 Style Serial Console Port Pin Signals

<b>Pin</b>	<b>Signal</b>
1	Looped to pin 8
2	Looped to pin 7
3	Transmit Data
4	Ground
5	Ground
6	Receive Data
7	Looped to pin 2
8	Looped to pin 1

## Fiber Optic Specifications for the AT-StackOP/0.3 and AT-StackOP/9.0 Transceivers

---

Table 22 lists the fiber optic port specifications for the AT-StackOP/0.3 transceiver.

Table 22. Fiber Optic Port Specifications for the AT-StackOP/0.3 Module

General	
Maximum Distances	33 m with 62.5/125 $\mu\text{m}$ (core/cladding) multimode fiber optic cable 300 m with 50/125 $\mu\text{m}$ (core/cladding) multimode fiber optic cable
Fiber Optic Cable	50/125 $\mu\text{m}$ or 62.5/125 $\mu\text{m}$ (core/cladding) multimode fiber optic cable
Transmitter	
Wavelength	850 nm
Output Optical Power	-7.3 dBm min.
Receiver	
Wavelength	850 nm
Maximum Sensitivity	-9.9 dBm
Maximum Input Power	-1 dBm

Table 23 lists the fiber optic port specifications for the AT-StackOP/9.0 transceiver.

Table 23. Fiber Optic Port Specifications for the AT-StackOP/9.0 Transceiver

General	
Maximum Distances	9 km
Fiber Optic Cable	9/125 $\mu\text{m}$ (core/cladding) single-mode fiber optic cable
Transmitter	
Wavelength	1310 nm
Output Optical Power	-8.2 dBm min. +0.5 dBm max.
Receiver	
Wavelength	1310 nm
Maximum Sensitivity	-14.4 dBm
Maximum Input Power	0.5 dBm

