



EMERSON  
Climate Technologies

**BENELUX**

Deltakade 7  
NL-5928 PX Venlo  
Tel. +31 77 324 02 34  
Fax +31 77 324 02 35  
benelux.sales@emerson.com

**UK & IRELAND**

Unit 17, Theale Lakes Business Park  
Reading, Berks RG7 4GB  
Tel: +44 1189 83 80 00  
Fax: +44 1189 83 80 01  
uk.sales@emerson.com

**BALKAN**

Selska cesta 93  
HR-10 000 Zagreb  
Tel. +385 1 560 38 75  
Fax +385 1 560 38 79  
balkan.sales@emerson.com

**GERMANY, AUSTRIA & SWITZERLAND**

Senefelder Str. 3  
DE-63477 Maintal  
Tel. +49 6109 605 90  
Fax +49 6109 60 59 40  
ECTGermany.sales@emerson.com

**SWEDEN, DENMARK, NORWAY & FINLAND**

Pascalstr. 65  
DE-52076 Aachen  
Tel. +49 2408 929 0  
Fax +49 2408 92 95 28  
nordic.sales@emerson.com

**UKRAINE**

Turgenevskaya Str. 15, office 33  
UA-01054, Kiev  
Tel. +38 - 44 - 4 92 99 24  
Fax. +38 - 44 - 4 92 99 28  
Andrey.Gladchenko@emerson.com

**FRANCE, GREECE & MAGHREB**

8, Allée du Moulin Berger  
FR-69130 Ecully Cédex  
Tel. +33 4 78 66 85 70  
Fax +33 4 78 66 85 71  
mediterranean.sales@emerson.com

**EASTERN EUROPE & TURKEY**

Pascalstr. 65  
DE-52076 Aachen  
Tel. +49 2408 929 0  
Fax +49 2408 929 525  
easterneurope.sales@emerson.com

**ROMANIA**

Tel. +40 - 364 - 73 11 72  
Fax. +40 - 364 - 73 12 98  
Camelia.Tiru@emerson.com

**ITALY**

Via Ramazzotti, 26  
IT-21047 Saronno (VA)  
Tel. +39 02 96 17 81  
Fax +39 02 96 17 88 88  
italy.sales@emerson.com

**POLAND**

Szturmowa 2  
PL-02678 Warsaw  
Tel. +48 22 458 92 05  
Fax +48 22 458 92 55  
poland.sales@emerson.com

**MIDDLE EAST & AFRICA**

PO Box 26382  
Jebel Ali Free Zone - South, Dubai - UAE  
Tel. +971 4 811 81 00  
Fax +971 4 886 54 65  
mea.sales@emerson.com

**SPAIN & PORTUGAL**

C/ LLull, 321 (Edifici CINC)  
ES-08019 Barcelona  
Tel. +34 93 412 37 52  
Fax +34 93 412 42 15  
iberica.sales@emerson.com

**RUSSIA & CIS**

Letnikovskaya 10, Bld. 2, floor 5  
RU-115114 Moscow  
Tel. +7 495 981 98 11  
Fax +7 495 981 98 16  
ECT.Holod@emerson.com

For more details, see [www.emersonclimate.eu](http://www.emersonclimate.eu)

Emerson Climate Technologies - European Headquarters - Pascalstrasse 65 - 52076 Aachen, Germany  
Tel. +49 (0) 2408 929 0 - Fax: +49 (0) 2408 929 570 - Internet: [www.emersonclimate.eu](http://www.emersonclimate.eu)

The Emerson Climate Technologies logo is a trademark and service mark of Emerson Electric Co. Emerson Climate Technologies Inc. is a subsidiary of Emerson Electric Co. Copeland is a registered trademark and Copeland Scroll is a trademark of Emerson Climate Technologies Inc.. All other trademarks are property of their respective owners. Information contained in this brochure is subject to change without notification.

© 2012 Emerson Climate Technologies, Inc.



EMERSON. CONSIDER IT SOLVED.™



Alco Controls

# General Product Guide 2012

For Refrigeration, Air Conditioning and Heat Pumps



General Product Guide 2012



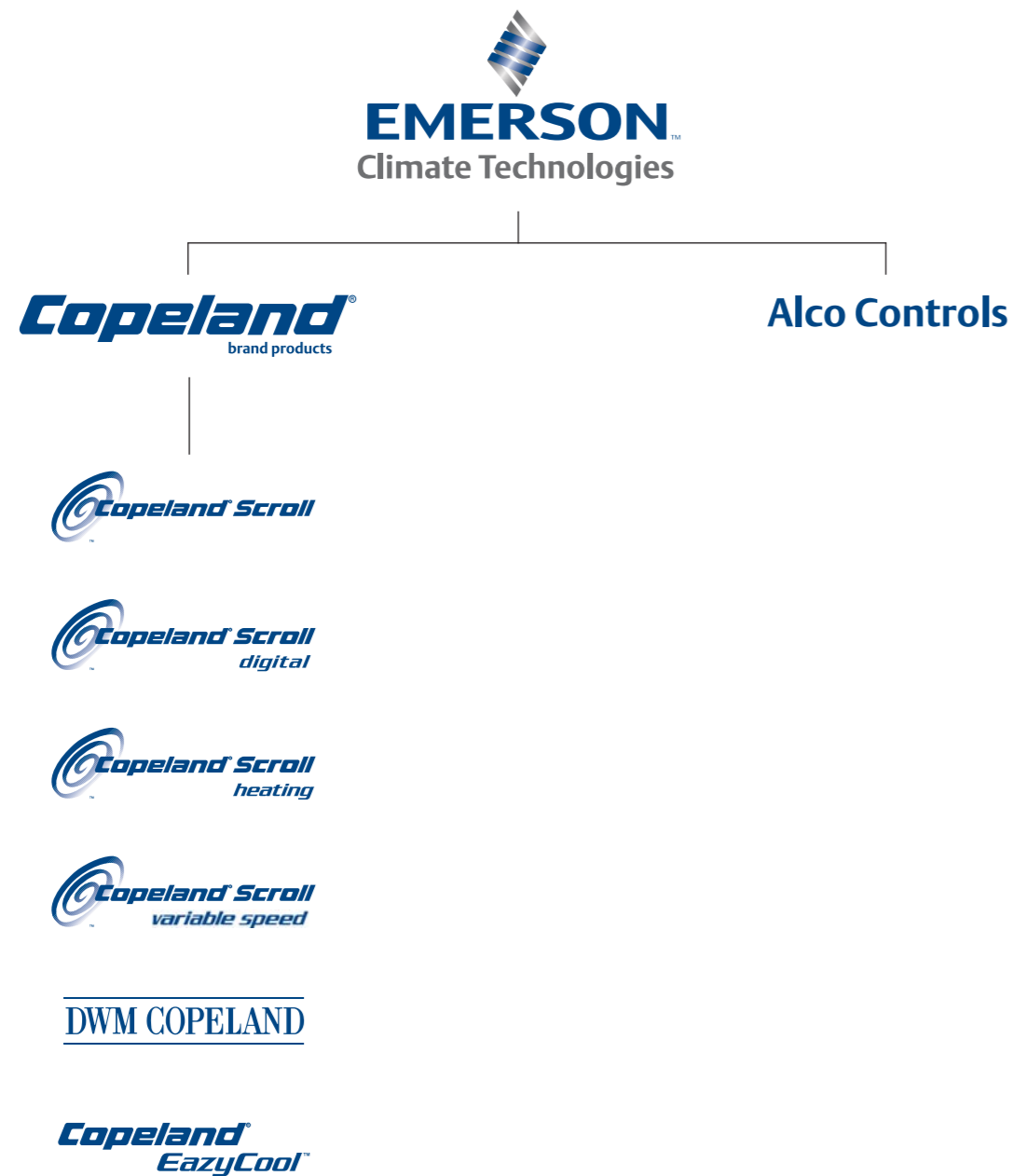

**Note:**

The components listed in this catalogue are not released for use with caustic, poisonous or flammable substances. Emerson Climate Technologies cannot be held responsible for any damage caused by using these substances.

**General Information**

Technical data are correct at time of printing. Updates may occur and should you need confirmation of a specific value please contact Emerson Climate Technologies stating clearly the information required.

Emerson Climate Technologies cannot be held responsible for errors in capacities, dimensions etc., stated herein. Products, specifications and data in this literature are subject to change without notice.

The information given herein is based on data and tests which Emerson Climate Technologies believes to be reliable and which are in accordance with today's technical knowledge. It is intended for use by persons having the appropriate technical knowledge and skill, at their own discretion and risk. Our products are designed and adapted for fixed locations. For mobile applications failures may occur. The suitability for this has to be assured from the plant manufacturer which may include making appropriate tests.

**Scroll Compressors**

- Comfort

• ZR Scroll Compressor Range in R407C and R134a	10
• ZP Scroll Compressor Range in R410A	14
• ZPD & ZRD Digital Scroll™ Compressor Range	18
• ZH Scroll Compressor Range	22
• ZRH/ZBH Scroll Horizontal Compressor	26

- Refrigeration

• ZB Scroll Compressor Range for Medium Temperature Refrigeration	30
• ZF Scroll Compressor Range for Low Temperature Refrigeration	34
• ZFD & ZBD Digital Scroll™ Compressor Range for Low and Medium Temperature Refrigeration	38
• ZO & ZOD Scroll Compressor Ranges for CO <sub>2</sub> -Subcritical Refrigeration	42
• Sound Shell for Copeland Scroll™ Compressors	44
• S-Series & Scroll Booster Compressors	46

**Semi-Hermetic Compressors**

- Stream Series with CoreSense™ Diagnostics	48
• For HFCs Refrigerants	50
• For R744-Transcritical Applications	54
• For Continuous Capacity Modulation	56
- Discus® Reciprocating Compressor Range	58
- S-Series Reciprocating Compressor Range	64
- DK & DL Reciprocating Compressor Range	70

**Condensing Units**

- Copeland EazyCool™ Outdoor Condensing Units with Scroll Compressors	75
- Copeland EazyCool™ Outdoor Condensing Units for Refrigeration Network	82
- Copeland EazyCool™ ZX Outdoor Condensing Units	86
- Copeland Scroll™ Indoor Condensing Units	88
- Digital Receiver Units HLR	92
- Semi-Hermetic Condensing Units DK/DL	94
- Standard Semi-Hermetic Condensing Units	98
- Condensing Units with Semi-Hermetic Discus® compressors	102

**Compressor Motor Codes Table**

106

**Controls**

- Electrical Control Valves	112
- Electronic Controllers and Sensors	137
- Thermo® Expansion Valves	164
- Solenoid Valves	193
- Mechanical Pressure Regulators	200
- Pressure Controls and Thermostats	206
- System Protectors and Moisture Indicators	221
- Oil Management Components	238
- Suction Accumulators, Ball Valves, Acid Test Kit	243
- Accessories, Spare Parts & Appendix	248

## Pioneering Technologies For Best-In-Class Products

Emerson Climate Technologies is the world's leading provider of heating, ventilation, air conditioning and refrigeration solutions for residential, industrial and commercial applications, supporting the industry with advanced technology, technical support and training services.

For more than 80 years we have been introducing innovative technology to the market, from the first semi-hermetic and hermetic compressors in the 1940s and 1950s, plus the high efficiency Discus, air conditioning and heating scroll compressors in the 1980s and 1990s, to the new Stream semi-hermetic and the digital scroll compressor of today and the variable speed scroll with drive technology of tomorrow.

Based on this we have developed an unequalled range of solutions for the refrigeration and air conditioning markets. In recent years, we have become a major solutions provider to the heat pump industry. Our range of Copeland® brand products and Alco® Controls addresses the very diverse needs of all of these markets. With scrolls and semi-hermetic compressors available for all main refrigerants, equipped with smart electronics and capable of Digital and Variable Speed Modulation, Emerson Climate Technologies has taken compression technology to new heights.

1.300 employees develop and deliver Emerson's high class technology and manufacture our products in four European plants: Belgium, Northern Ireland and the Czech Republic (2 plants). R&D centres in Welkenraedt (Belgium), Mikulov (Czech Republic) and Waiblingen (Germany) enable new developments not only to meet our customers' requirements but also to redefine the limits of technology.

With sales points in Germany, France, Spain, Italy, the United Kingdom, Scandinavia, Benelux, Poland as well as in Eastern Europe and Russia, Emerson Climate Technologies supports its European customers in a lean and efficient manner.

Our new 2012 product catalogue gives a comprehensive overview of Copeland® brand and Alco® Controls products. Have a look and discover more about our broad and innovative product ranges:

- new compressor line-up applicable for multi refrigerants and CO<sub>2</sub> such as the new semi-hermetic Stream line-up,
- improved Summit Scroll line-up for comfort and refrigeration applications extended with low-temperature and digital models,
- indoor and outdoor condensing unit line-up for refrigeration applications tailored to the different application requirements of our customers.
- finally our scroll compressors for heat pumps with R410A with and without the enhanced vapor injection technology complete the program and underline our innovation strength.

More in-depth technical data is available through our user-friendly Copeland® selection software tool and Alco® Controls selection tool accessible via our web pages [www.emersonclimate.eu](http://www.emersonclimate.eu)

For individual consultancy and service please contact your European sales office.



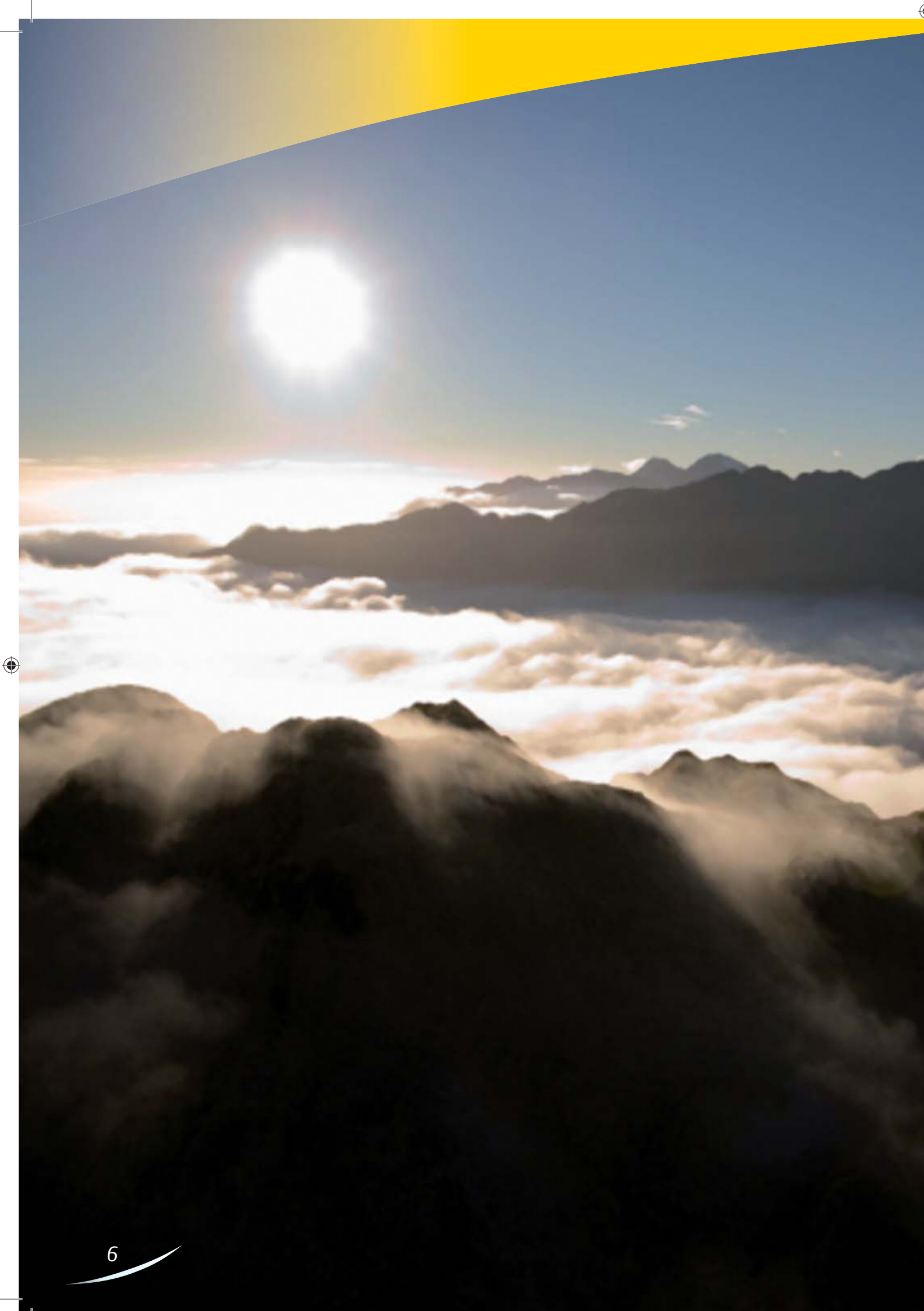

## Copeland Scroll™ Compressors

With the launch of scroll technology in the mid 1980s Emerson revolutionized the market setting new standards in the air conditioning industry. Since then Copeland Scroll™ has become the reference not only in air conditioning but in refrigeration and heating applications too. Thousands of customers trust our proprietary technology: today, 80 million Copeland Scrolls™ are installed worldwide, more than any other scroll compressor brand. Copeland Scroll™ compressors range from 1.5 to 40 hp and are designed to work with all the main refrigerants, including CO<sub>2</sub>. With compressors built in both vertical and horizontal versions, and capable of digital modulation, Emerson Climate Technologies has expanded the capability of scroll technology to new heights.

Additional innovations such as enhanced vapor injection, the new variable speed scroll with drive technology for heat pump compressors or the design of the Emerson sound shell give manufacturers, installers and end users the right tools to reduce the carbon footprint of their installations, optimize system design, efficiency, sound and reliability while ensuring long equipment life time and minimizing capital and operating costs.

Applications for scroll compressors continue to grow thanks to innovation and adaptation. Industry as a whole has embraced its responsibility to put the environment first in its list of priorities, and this has led to strategic imperatives such as the need to introduce larger capacity scrolls with improved seasonal performance, modulated systems and product designed for use with 'green' refrigerants such as CO<sub>2</sub>. Emerson is staying abreast of these challenges by successfully developing its technologies further in each of these areas.



*Today we offer the broadest scroll product line-up in the market*



## Comfort Applications

For decades, Emerson Climate Technologies has driven advancement in the air conditioning and heat pump industry, leading the field with engineering products and systems that maximize the comfort of office and living spaces – while minimizing costs and inefficiencies.

Copeland Scroll™ compressors are designed to deliver the highest performance in residential and commercial applications. Thanks to the widest selection of air conditioning and heating optimized scroll compressors with a range from 1.5 up to 40 hp and the option to combine single compressors in even and uneven tandem and trio versions increasing overall capacity up to 120 hp with four circuits it has never been easier to match all desired applications with the highest efficiency and reliability. Whether your need is a cooling optimized, heating optimized or reversible unit you will find the most advanced technology within our range.

One of the most important innovations in scrolls for comfort application, driven by the need for higher levels of efficiency and comfort, has been the introduction in 1993, of Copeland Digital Scroll™ for capacity modulation and its subsequent launch in 2001 for use in VRF applications. Today, our Digital Scroll™ technology is used in diverse applications such as chillers, rooftops and air-handling systems as well as in smaller systems for residential or light commercial use.

A further innovation has been the introduction of ZH compressors with enhanced vapor injection technology. This technology, when applied in space heating and tap water production, permits to replace traditional boilers without changing the radiators. Additional benefits are the reduction of the discharge temperature and the extension of the operating envelope for the production of high temperature water. ZH compressors are available for R407C and now also for R410A - the latter option allowing OEMs to design more efficient and compact equipment.

In 2012, Emerson will add the ZHW R410A Copeland Variable Speed Scroll with drive technology to its heating portfolio. This new solution for heat pump applications will feature a brushless permanent magnet motor and enhanced vapor injection technology matched with a highly efficient drive. The key benefits of this new technology include high seasonal efficiency enabled by the use of enhanced vapor injection, high water temperature for all applications (condensing at 68°C), with the highest efficiency throughout the operating envelope.



## ZR Copeland Scroll™ Compressor Range in R407C and R134a

ZR Copeland Scroll™ compressors, in R407C and R134a, for comfort and process/precision cooling applications.

Applied in the air conditioning and comfort industry for water chillers, rooftops and close control unit applications, scroll compressors are now the most used compression technology replacing reciprocating and screw compressors due to its undeniable superiority. Several, fully Copeland® qualified, multiple compressor assemblies (tandem and trio) are available to allow the use of Copeland Scroll™ compressors into large capacity systems (ex. up to 500kW air cooled chillers) able to deliver optimal comfort, low operating cost with higher seasonal efficiency (ESEER).

The range of products goes from the ZR18 (1.5hp) to the ZR380 (30hp)



ZR Scroll Compressor

### ZR Scroll Compressor Line-up

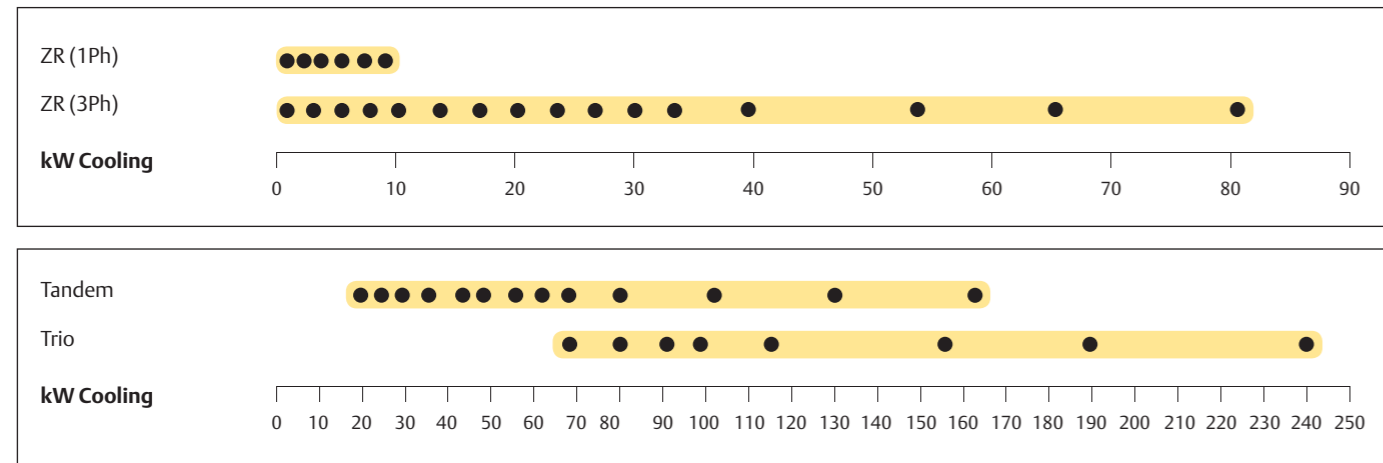

Conditions EN12900: Evaporating 5°C, Condensing 50°C, Superheat 10K, Subcooling 0K

### Features and Benefits

- Copeland Scroll™ axial and radial compliance for superior reliability and efficiency
- Wide scroll line-up in R407C and R134a
- Low TEWI (Total Equivalent Warming Impact)
- Low sound and vibration level
- Low oil circulation rate
- Copeland® qualified tandem and trio configurations for superior seasonal efficiency (ESEER)

### Maximum Allowable Pressure (PS)

- ZR18 to ZR81:  
Low Side PS 20 bar(g) / High Side PS 29.5 bar(g)
- ZR94 to ZR380:  
Low Side PS 20 bar(g) / High Side PS 32 bar(g)

### Operating Envelope R407C

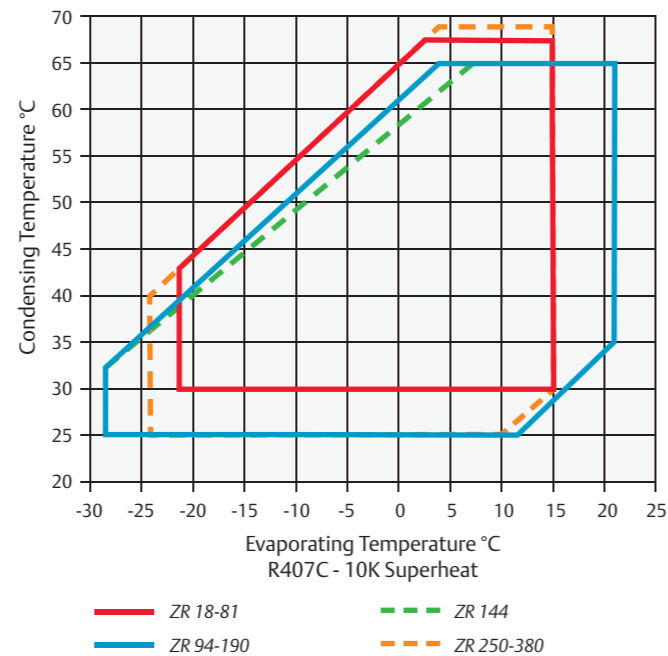

### Technical Overview

R407C	Nominal hp	Capacity (kW)	COP	Displacement (m³/h)	Stub Suction (inch)	Stub Discharge (inch)	Oil Quantity (l)	Length/Width/Height (mm)	Net Weight (kg)	Motor Version/ Code		Maximum Operating Current (A)		Locked Rotor Current (A)		Sound Pressure @1 m (dBA) ***
										1 Ph*	3 Ph**	1 Ph*	3 Ph**	1 Ph*	3 Ph**	
ZR18K5E	1.5	3.7	3.0	4.4	3/4	1/2	0.74	242/242/383	20	PFJ		10		35		54
ZR22K3E	2.0	4.5	2.9	5.3	3/4	1/2	1.00	242/242/363	22	PFJ	TFD	11	4	47	24	54
ZR28K3E	2.5	5.9	2.9	6.8	3/4	1/2	1.00	242/242/363	25	PFJ	TFD	15	5	61	32	54
ZR34K3E	2.8	7.0	3.0	8.0	3/4	1/2	1.10	242/242/386	26	PFJ	TFD	17	6	76	40	57
ZR40K3E	3.5	8.2	3.0	9.4	3/4	1/2	1.10	242/242/400	27	PFJ	TFD	23	7	100	46	57
ZR48K3E	4.0	10.1	3.1	11.4	7/8	1/2	1.36	242/242/417	31	PFJ	TFD	23	10	114	50	57
ZR61KCE	5.0	12.5	3.1	14.4	7/8	1/2	1.66	241/247/451	43	PFZ	TFD	30	11	150	65	60
ZR61KSE	5.0	12.8	3.2	14.4	7/8	1/2	1.42	242/242/430	30		TFM		11		59	61
ZR72KCE	6.0	14.8	3.2	17.1	7/8	1/2	1.77	242/242/438	39		TFD		13		74	61
ZR81KCE	6.8	16.7	3.2	18.7	7/8	3/4	1.77	242/242/446	39		TFD		15		101	61
ZR94KCE	8.0	20.6	3.3	22.1	1 1/8	7/8	2.65	264/285/476	57		TFD		16		95	63
ZR108KCE	9.0	23.0	3.4	24.9	1 3/8	7/8	3.38	264/285/533	60		TFD		17		111	63
ZR125KCE	10.0	27.0	3.4	29.1	1 3/8	7/8	3.38	264/285/533	61		TFD		19		118	63
ZR144KCE	12.0	30.9	3.4	33.2	1 3/8	7/8	3.38	264/285/533	61		TFD		22		118	64
ZR160KCE	13.0	33.4	3.2	36.4	1 3/8	7/8	3.38	264/285/552	65		TFD		28		140	67
ZR190KCE	15.0	39.3	3.2	43.3	1 3/8	7/8	3.38	264/285/552	66		TFD		34		174	69
ZR250KCE	20.0	52.2	3.2	56.6	1 5/8 ID	1 3/8 ID	4.70	432/376/717	140		TWD		41		225	72
ZR310KCE	25.0	65.0	3.2	71.4	1 5/8 ID	1 3/8 ID	6.80	448/392/715	160		TWD		52		272	74
ZR380KCE	30.0	81.7	3.4	87.4	1 5/8	1 3/8	6.30	447/427/724	177		TWD		62		310	76

Conditions EN12900: Evaporating 5°C, Condensing 50°C, Superheat 10K, Subcooling 0K

\* 1 Ph: 230V/ 50Hz

\*\* 3 Ph: 380-420V/ 50Hz

\*\*\* @ 1m: sound pressure level at 1m distance from the compressor, free field condition

### Capacity Data

		Condensing Temperature +40°C													
R407C	Model	Cooling Capacity (kW)						Power Input (kW)							
		Evaporating Temperature (°C)						Evaporating Temperature (°C)							
		-15	-10	-5	0	5	10	15	-15	-10	-5	0	5	10	15
ZR18K4E	ZR18K4E	1.8	2.3	2.8	3.5	4.2	5.1	6.1	1.0	1.0	1.0	1.0	1.0	1.0	1.0
ZR22K3E	ZR22K3E	2.1	2.7	3.4	4.2	5.2	6.3	7.5	1.2	1.2	1.2	1.2	1.2	1.2	1.1
ZR28K3E	ZR28K3E	2.7	3.5	4.4	5.5	6.7	8.1	9.6	1.6	1.6	1.6	1.5	1.5	1.5	1.5
ZR34K3E	ZR34K3E	3.2	4.1	5.2	6.5	7.9	9.6	11.5	1.8	1.8	1.8	1.8	1.8	1.8	1.7
ZR40K3E	ZR40K3E	3.8	4.9	6.1	7.6	9.4	11.3	13.5	2.2	2.2	2.2	2.1	2.1	2.1	2.0
ZR48K3E	ZR48K3E	4.8	6.1	7.6	9.4	11.5	13.8	16.6	2.6	2.6	2.6	2.6	2.6	2.5	2.5
ZR61KCE	ZR61KCE	6.5	8.1	10.0	12.0	14.4	17.2	20.6	3.0	3.1	3.1	3.2	3.2	3.1	2.9
ZR72KCE	ZR72KCE	7.0	9.0	11.3	13.9	16.9	20.3	24.2	3.6	3.7	3.7	3.7	3.7	3.7	3.8
ZR81KCE	ZR81KCE	7.8	10.1	12.7	15.6	19.1	23.0	27.7	4.1	4.1	4.1	4.1	4.2	4.2	4.3
ZR94KCE	ZR94KCE	9.8	12.6	15.8	19.3	23.3	27.9	33.1	4.9	5.0	5.0	5.0	5.0	4.9	4.9
ZR108KCE	ZR108KCE	11.3	14.2	17.6	21.5	26.2	31.5	37.6	5.4	5.4	5.5	5.5	5.5	5.6	5.7
ZR125KCE	ZR125KCE	13.1	16.6	20.5	25.2	30.5	36.7	43.7	6.3	6.3	6.4	6.4	6.4	6.5	6.6
ZR144KCE	ZR144KCE	14.5	18.7	23.4	28.9	35.0	42.0	50.1	7.1	7.1	7.2	7.2	7.3	7.3	7.4
ZR160KCE	ZR160KCE	14.9	19.5	24.9	31.3	38.7	47.3	57.1	8.0	8.1	8.2	8.2	8.3	8.4	8.5
ZR190KCE	ZR190KCE	18.5	23.8	29.8	36.7	44.7	53.8	64.2	9.7	9.7	9.8	9.8	9.9	10.1	10.4
ZR250KCE	ZR250KCE	25.7	32.2	39.9	48.9	59.3	71.3	85.0	12.5	12.6	12.7	12.9	13.0	13.0	13.0
ZR310KCE	ZR310KCE	31.2	39.7	49.7	61.4	75.0	90.7	108.5	15.6	15.7	15.9	16.1	16.3	16.6	17.0
ZR380KCE	ZR380KCE	38.1	49.1	61.7	76.2	93.1	113.0	136.5	18.6	18.8	19.0	19.2	19.4	19.8	20.3

Suction Superheat 10K / Subcooling 0K

Capacity Data

Condensing Temperature +40°C															
R134a		Cooling Capacity (kW)						R134a		Power Input (kW)					
		Evaporating Temperature (°C)								Evaporating Temperature (°C)					
Model	-15	-10	-5	0	5	10	15	Model	-15	-10	-5	0	5	10	15
ZR18K4E	1.1	1.4	1.8	2.3	2.9	3.5	4.2	ZR18K4E	0.8	0.8	0.8	0.8	0.8	0.8	0.8
ZR22K3E	1.4	1.8	2.3	2.9	3.6	4.4	5.3	ZR22K3E	0.9	0.9	0.9	0.9	0.9	0.8	0.8
ZR28K3E	1.8	2.3	3.0	3.8	4.7	5.7	6.9	ZR28K3E	1.1	1.2	1.1	1.1	1.1	1.1	1.1
ZR34K3E	2.2	2.9	3.6	4.5	5.5	6.7	8.1	ZR34K3E	1.4	1.4	1.4	1.3	1.3	1.3	1.3
ZR40K3E	2.5	3.3	4.2	5.2	6.4	7.8	9.3	ZR40K3E	1.6	1.5	1.5	1.5	1.5	1.5	1.5
ZR48K3E	3.1	4.0	5.1	6.3	7.8	9.5	11.5	ZR48K3E	1.8	1.8	1.8	1.8	1.8	1.8	1.8
ZR61KCE	4.0	5.2	6.5	8.1	9.9	12.1	14.6	ZR61KCE	2.1	2.1	2.2	2.2	2.2	2.2	2.3
ZR72KCE	4.8	6.2	7.8	9.7	11.9	14.5	17.4	ZR72KCE	2.6	2.6	2.6	2.6	2.6	2.6	2.7
ZR81KCE	5.5	7.0	8.8	10.8	13.2	16.0	19.2	ZR81KCE	2.8	2.9	2.9	2.9	2.9	3.0	3.0
ZR94KCE	6.5	8.3	10.5	13.0	15.9	19.2	23.0	ZR94KCE	3.4	3.4	3.4	3.5	3.5	3.5	3.5
ZR108KCE	7.3	9.3	11.7	14.5	17.8	21.5	25.7	ZR108KCE	3.7	3.8	3.8	3.9	3.9	3.9	3.9
ZR125KCE	8.6	10.9	13.7	17.0	20.8	25.1	30.0	ZR125KCE	4.4	4.4	4.5	4.5	4.6	4.6	4.5
ZR144KCE	10.5	13.4	16.5	20.0	23.7	27.8	32.4	ZR144KCE	4.7	4.9	4.9	5.0	5.0	5.2	5.5
ZR160KCE	11.0	14.3	17.7	21.4	25.5	30.1	35.3	ZR160KCE	5.4	5.4	5.5	5.6	5.7	5.7	5.6
ZR190KCE	13.3	17.0	21.0	25.5	30.5	36.2	42.7	ZR190KCE	6.5	6.6	6.7	6.8	6.8	6.9	7.0
ZR250KCE	16.6	21.0	26.3	32.5	39.7	48.2	57.9	ZR250KCE	8.8	8.8	8.9	9.0	9.1	9.2	9.4
ZR310KCE	20.5	26.0	32.5	40.1	49.1	59.6	71.7	ZR310KCE	11.0	11.0	11.1	11.2	11.3	11.5	11.7
ZR380KCE	26.0	32.9	41.1	50.8	61.8	74.4	88.6	ZR380KCE	13.0	13.3	13.5	13.8	13.9	14.1	14.2

Suction Superheat 10K / Subcooling 0K

Tandem and Trio Model Overview

Model	Nominal Horsepower hp	Cooling Capacity R407C kW (1)	Cooling Capacity R134a kW (1)	Even Tandem	Uneven Tandem	Trio
<b>Tandem ZRT - Tandem Uneven ZRU - Trio ZRY</b>						
ZRT 96 K3/E	2 x 4	20	14	•		
ZRT 122 K3/E	2 x 5	25	18	•		
ZRT 144 KC/E	2 x 6	30	21	•		
ZRT 162 KC/E	2 x 6.5	33	24	•		
ZRT 188 K/E	2 x 8	41	28	•		
ZRT 216 K/E	2 x 9	46	31	•		
ZRT 250 K/E	2 x 10	52	37	•		
ZRT 288 K/E	2 x 12	59	42	•		
ZRU 315 K/E(2)	10 + 15	66	45		•	
ZRT 320 K/E	2 x 13	67	46	•		
ZRU 350 K/E(2)	13 + 15	73	50		•	
ZRT 380 K/E	2 x 15	78	54	•		
ZRU 440 K/E(2)	15 + 20	92	63		•	
ZRY 480 K/E(2)	3 x 13	99	67			•
ZRT 500 K/E(2)	2 x 20	104	71	•		
ZRU 500 K/E(2)	15 + 25	104	71		•	
ZRU 560 K/E(2)	20 + 25	117	79		•	
ZRY 570 K/E(2)	3 x 15	116	80			•
ZRT 620 K/E(2)	2 x 25	130	88	•		
ZRU 690 K/E(2)	25 + 30	147	99		•	
ZRY 750 K/E(2)	3 x 20	154	105			•
ZRT 760 K/E(2)	2 x 30	163	111	•		
ZRY 930 K/E(2)	3 x 25	192	129			•
ZRY 114 M/E(2)	3 x 30	241	164			•

(1) Conditions EN 12900: Evaporating 5°C, Condensing 50°C, Superheat 10K, Subcooling 0K

(2) Tandem / Trio assemblies by system manufacturers. Emerson Climate Technologies can provide full technical support.

## ZP Copeland Scroll™ Compressor Range in R410A

ZP Copeland Scroll™ compressors, in R410A, for comfort and process/precision cooling applications.

Emerson Climate Technologies has been the pioneer in launching the first complete line-up of commercial scroll compressors in R410A. Copeland Scroll™ technology combined with the advantages of the R410A refrigerant build the ideal conditions for system manufacturers (OEMs) to optimize costs and efficiency of their systems.

ZP Copeland Scroll™ compressors are perfectly suitable for air cooled chiller systems up to 600kW (720kW if water cooled) featuring high comfort and superior seasonal efficiency (ESEER). Whether used in stand-alone, tandem or trio configuration, the ZP Copeland Scroll™ broad line-up meets today's market requirements with unmatched flexibility, efficiency and proven reliability.



ZP Scroll Compressor

### ZP Scroll Compressor Line-up

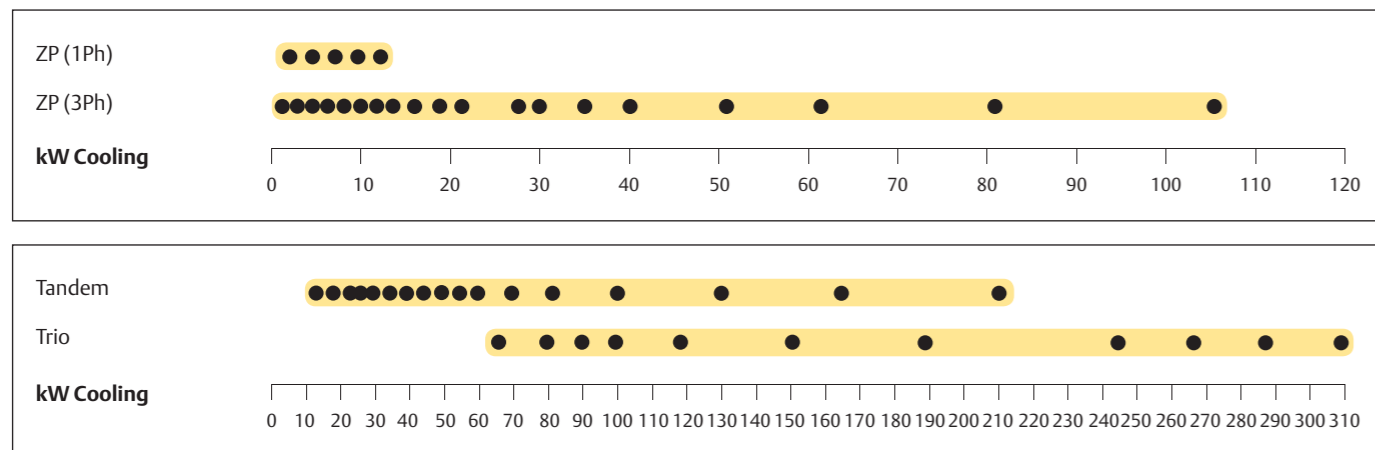

Conditions EN12900: Evaporating 5°C, Condensing 50°C, Superheat 10K, Subcooling 0K

### Features and Benefits

- Copeland® qualified tandem and trio (now also uneven) configurations for superior seasonal efficiency (ESEER and SCOP)
- Copeland Scroll™ axial and radial compliance for superior reliability and efficiency
- Extended 5K operating envelope suitable for HP applications
- Low TEWI (Total Equivalent Warming Impact)
- Wide scroll line-up in R410A
- Low sound and vibration level
- Low oil circulation rate

### Maximum Allowable Pressure (PS)

- ZP24 to ZP91:  
Low Side PS 28 bar(g) / High Side PS 43 bar(g)
- ZP90 to ZP485:  
Low Side PS 29.5 bar(g) / High Side PS 45 bar(g)

### Operating Envelope R410A

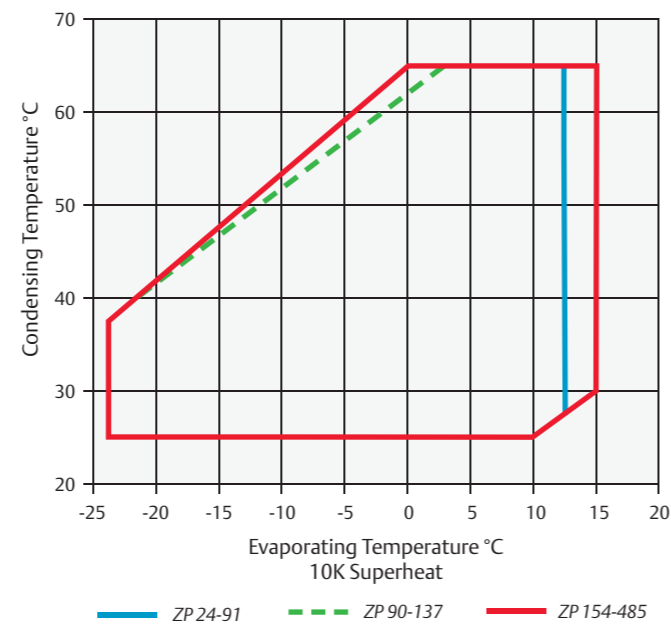

### Technical Overview

R410A	Nominal hp	Capacity (kW)	COP	Displacement (m <sup>3</sup> /h)	Stub Suction (inch)	Stub Discharge (inch)	Oil Quantity (l)	Length/Width/Height (mm)	Net Weight (kg)	Motor Version/Code		Maximum Operating Current (A)		Locked Rotor Current (A)		Sound Pressure @1 m (dBA) ***
										1 Ph*	3 Ph**	1 Ph*	3 Ph**	1 Ph*	3 Ph**	
ZP24KSE	1.9	5.1	2.8	3.9	3/4	1/2	0.74	242/242/407	22	PFZ	TFM	13	5	60	28	55
ZP29KSE	2.2	6.1	2.9	4.8	3/4	1/2	0.74	242/242/407	23	PFZ	TFM	16	6	67	38	55
ZP31KSE	3.0	6.5	2.8	5.0	3/4	1/2	0.74	242/242/388	23	PFZ	TFM	17	6	67	38	55
ZP36KSE	2.6	7.9	3.0	6.0	7/8	1/2	1.25	242/242/421	30	PFZ	TFM	22	7	98	46	57
ZP42KSE	3.4	9.0	2.9	6.9	7/8	1/2	1.25	242/242/421	31	PFZ	TFM	26	8	128	43	57
ZP54KSE	4.6	11.6	3.0	8.9	7/8	1/2	1.24	242/242/422	34	PFZ	TFM	31	10	115	51	69
ZP61KCE	5.0	13.1	3.0	10.1	7/8	1/2	1.66	245/249/440	40		TFD		12		64	60
ZP72KCE	6.0	15.3	3.0	11.7	7/8	1/2	1.77	245/249/440	40		TFD		15		75	64
ZP83KCE	6.5	17.7	3.1	13.4	7/8	1/2	1.77	241/247/440	40		TFD		15		101	61
ZP91KCE	7.5	19.3	3.1	14.7	7/8	3/4	1.77	243/248/443	41		TFD		16		101	61
ZP90KCE	7.5	19.4	3.1	14.6	1 1/8	7/8	2.65	264/284/476	57		TFD		16		95	61
ZP103KCE	9.0	22.4	3.2	16.7	1 3/8	7/8	3.38	264/284/533	59		TFD		21		111	63
ZP120KCE	10.0	26.6	3.2	19.7	1 3/8	7/8	3.38	264/284/533	61		TFD		22		118	63
ZP137KCE	12.0	29.9	3.2	22.1	1 3/8	7/8	3.38	264/284/533	61		TFD		25		118	64
ZP154KCE	13.0	33.5	3.2	24.8	1 3/8	7/8	3.38	264/284/552	65		TFD		31		140	65
ZP182KCE	15.0	39.6	3.2	29.1	1 3/8	7/8	3.38	264/284/552	66		TFD		34		174	66
ZP235KCE	20.0	50.6	3.2	37.8	1 5/8 ID	1 3/8 ID	4.70	432/376/717	140		TWD		40		225	71
ZP295KCE	25.0	63.5	3.2	46.7	1 5/8 ID	1 3/8 ID	6.80	448/392/725	160		TWD		48		272	74
ZP385KCE	30.0	82.4	3.2	60.8	1 5/8 ID	1 3/8 ID	6.30	448/392/715	178		TWD		65		310	74
ZP485KCE	40.0	105.0	3.2	77.3	1 5/8 ID	1 3/8 ID	6.30	448/392/756	190		TWD		82		408	78

Conditions EN12900: Evaporating 5°C, Condensing 50°C, Superheat 10K, Subcooling 0K

\* 1 Ph: 230V/ 50Hz

\*\* 3 Ph: 380-420V/ 50Hz

\*\*\* @ 1m: sound pressure level at 1m distance from the compressor, free field condition



Capacity Data

Condensing Temperature +40°C															
R410A		Cooling Capacity (kW)						R410A		Power Input (kW)					
		Evaporating Temperature (°C)								Evaporating Temperature (°C)					
Model	-15	-10	-5	0	5	10	15	Model	-15	-10	-5	0	5	10	15
ZP24KSE	2.2	3.0	3.9	4.9	5.9	7.1		ZP24KSE	1.5	1.5	1.4	1.4	1.4	1.3	
ZP29KSE	2.9	3.9	4.9	6.0	7.3	8.6		ZP29KSE	1.8	1.8	1.7	1.7	1.7	1.6	
ZP31KSE	3.2	4.1	5.2	6.3	7.6	9.1		ZP31KSE	1.9	1.9	1.9	1.8	1.8	1.8	
ZP36KSE	4.1	5.1	6.3	7.7	9.2	11.0		ZP36KSE	2.2	2.1	2.1	2.1	2.1	2.1	
ZP42KSE	4.4	5.7	7.1	8.7	10.5	12.5		ZP42KSE	2.4	2.4	2.4	2.4	2.3	2.3	
ZP54KSE	6.0	7.5	9.3	11.3	13.5	16.0		ZP54KSE	3.1	3.1	3.0	3.0	2.9	2.9	
ZP61KCE	6.5	8.3	10.4	12.6	15.2	18.1		ZP61KCE	3.7	3.7	3.6	3.5	3.5	3.4	
ZP72KCE	8.2	10.1	12.3	14.8	17.7	20.9		ZP72KCE	4.0	4.0	4.0	4.0	4.1	4.1	
ZP83KCE	9.4	11.6	14.2	17.1	20.4	24.2		ZP83KCE	4.5	4.5	4.5	4.6	4.6	4.7	
ZP91KCE	10.2	12.6	15.4	18.6	22.2	26.3		ZP91KCE	4.9	4.9	4.9	5.0	5.0	5.0	
ZP90KCE	10.4	12.8	15.6	18.8	22.4	26.5	31.1	ZP90KCE	5.0	5.0	5.0	5.0	5.1	5.2	5.3
ZP103KCE	11.7	14.6	17.9	21.6	25.8	30.5	35.7	ZP103KCE	5.7	5.7	5.6	5.6	5.7	5.8	5.9
ZP120KCE	14.0	17.5	21.4	25.8	30.8	36.4	42.5	ZP120KCE	6.6	6.6	6.5	6.5	6.5	6.6	6.7
ZP137KCE	15.9	19.9	24.2	29.2	34.8	41.2	48.3	ZP137KCE	7.4	7.4	7.4	7.4	7.4	7.4	7.5
ZP154KCE	18.2	22.3	27.1	32.6	38.9	46.1	54.3	ZP154KCE	8.1	8.2	8.2	8.3	8.3	8.5	8.8
ZP182KCE	21.4	26.3	32.0	38.4	45.6	53.9	63.3	ZP182KCE	9.5	9.7	9.9	10.0	10.1	10.1	10.0
ZP235KCE	26.5	32.9	40.3	48.8	58.6	69.7	82.3	ZP235KCE	12.5	12.6	12.7	12.8	13.0	13.2	13.5
ZP295KCE	34.2	41.9	50.9	61.3	73.3	86.9	102.5	ZP295KCE	15.8	16.0	16.1	16.2	16.4	16.6	16.8
ZP385KCE	43.7	53.9	65.8	79.5	95.2	113.0	133.5	ZP385KCE	20.3	20.4	20.5	20.7	20.9	21.3	21.7
ZP485KCE	57.5	70.0	84.7	101.6	121.0	143.0	168.0	ZP485KCE	24.9	25.3	25.8	26.3	27.0	27.8	28.8

Suction Superheat 10K / Subcooling 0K

Tandem and Trio Model Overview

Model	Nominal Horsepower hp	Cooling Capacity kW (1)	Even Tandem	Uneven Tandem	Trio	Uneven Trio
<b>Tandem ZPT - Tandem Uneven ZPU - Trio ZPY - Uneven Trio ZPM</b>						
ZPT 72 K/E(2)	2 x 3	16	•			
ZPT 84 K/E(2)	2 x 3,5	18	•			
ZPT 108 K/E(2)	2 x 4	23	•			
ZPT 122 K/E(2)	2 x 5	26	•			
ZPT 144 K/E(2)	2 x 6	31	•			
ZPT 166 K/E(2)	2 x 6,5	35	•			
ZPT 180 K/E(2)	2 x 8	39	•			
ZPT 182 K/E(2)	2 x 8	39	•			
ZPT 206 K/E(2)	2 x 9	45	•			
ZPT 240 K/E(2)	2 x 10	53	•			
ZPT 274 K/E(2)	2 x 12	60	•			
ZPU 302 K/E(2)	10 + 15	66		•		
ZPT 308K/E(2)	2 x 13	67	•			
ZPY 309K/E(2)	3 x 9	66			•	
ZPU 336 K/E(2)	13 + 15	73		•		
ZPY 360 K/E(2)	3 x 10	79			•	
ZPT 364 K/E(2)	2 x 15	79	•			
ZPY 411K/E(2)	3 x 12	88			•	
ZPU 417 K/E(2)	15 + 20	90		•		
ZPY 462 K/E(2)	3 x 13	99			•	
ZPT 470 K/E(2)	2 x 20	101	•			
ZPU 477 K/E(2)	15 + 25	103		•		
ZPU 530 K/E(2)	20 + 25	114		•		
ZPY 546 K/E(2)	3 x 15	117			•	
ZPT 590 K/E(2)	2 x 25	127	•			
ZPU 680 K/E(2)	25 + 30	146		•		
ZPY 705 K/E(2)	3 x 20	150			•	
ZPT 770 K/E(2)	2 x 30	165	•			
ZPU 870 K/E(2)	30 + 40	187		•		
ZPY 885 K/E(2)	3 x 25	188			•	
ZPT 970 K/E(2)	2 x 40	209	•			
ZPY 115 M/E(2)	3 x 30	243			•	
ZPM 125 M/E(2)	30 + 30 + 40	265				•
ZPM 135 M/E(2)	30 + 40 + 40	287				•
ZPY 145 M/E(2)	40 + 40 + 40	309			•	

(1) Conditions EN 12900: Evaporating 5°C, Condensing 50°C, Superheat 10K, Subcooling 0K

(2) Tandem / Trio assemblies by system manufacturers. Emerson Climate Technologies can provide full technical support.

## ZPD & ZRD Digital Scroll™ Compressor Ranges

Stepless capacity modulation in air conditioning applications:  
Flexible solution for R407C and R410A

In many cooling and heating systems the load and the operating conditions vary over a wide range thus requiring the use of capacity modulation. Digital Scroll™ is a simple compressor solution able to assure stepless modulation down to 10% of the nominal capacity, enabling precise temperature control, superior comfort and energy saving.

Digital Scroll™ compressors are the preferred choice for process cooling, refrigeration racks, condensing units, VRF, rooftop and air handling unit systems.

ZPD & ZRD Digital Scroll™ Compressor



### ZPD & ZRD Digital Scroll™ Compressor Line-up R410A

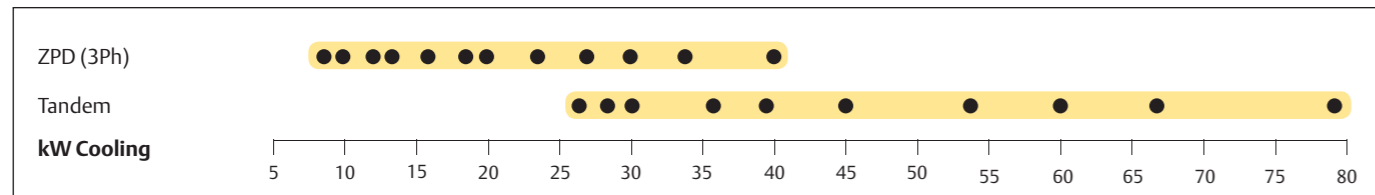

### ZPD & ZRD Digital Scroll™ Compressor Line-up R407C

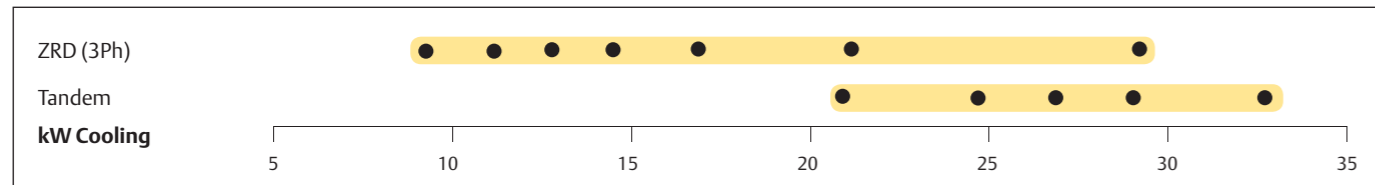

Conditions EN12900: Evaporating 5°C, Condensing 50°C, Superheat 10K, Subcooling 0K

### Features and Benefits

- Wide modulation range from 10% to 100% for immediate load adjustment, close temperature comfort, optimal comfort
- No complex electronics, a quasi-drop-in solution for fast time to market, no EMI/EMC problems, easy installation and maintenance
- No impact on system mechanical balance: no vibration and resonance phenomenon, no frame / piping redesign necessary

### Maximum Allowable Pressure (PS)

- Digital ZRD42 to ZRD81:  
Low Side PS 20bar(g) / High Side PS 29.5 bar(g)
- Digital ZRD94 to ZRD125:  
Low Side PS 20bar(g) / High Side PS 32 bar(g)
- Digital ZPD34 to ZPD91:  
Low Side PS 28 bar(g) / High Side PS 43 bar(g)
- Digital ZPD103 to ZPD182:  
Low Side PS 29.5 bar(g) / High Side PS 45 bar(g)

### Operating Envelope R410A/R407C

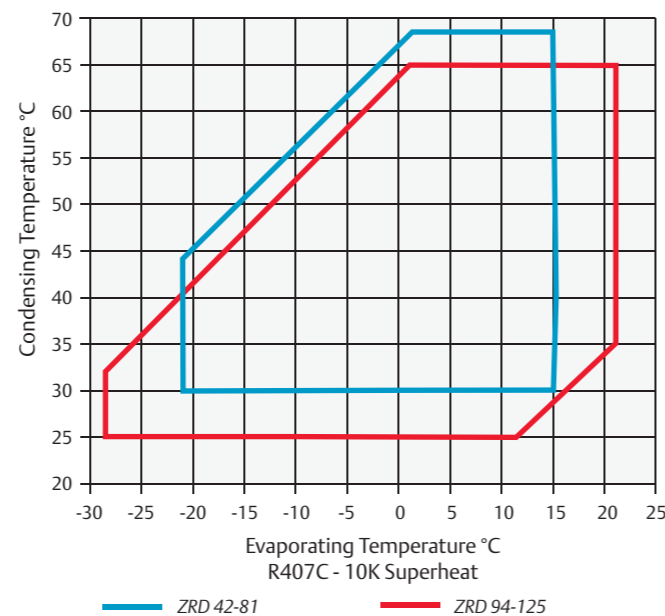
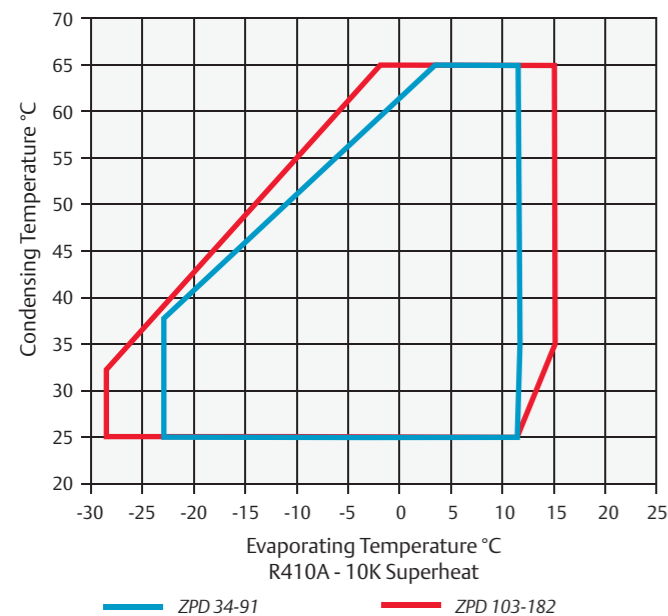

### Technical Overview

R410A	Nominal hp	Capacity (kW)	COP	Displacement (m <sup>3</sup> /h)	Stub Suction (inch)	Stub Discharge (inch)	Oil Quantity (l)	Length/Width/Height (mm)	Net Weight (kg)	Motor Version/Code	Maximum Operating Current (A)	Locked Rotor Current (A)	Sound Pressure @1m (dBA) ***
										3 Ph**	3 Ph**	3 Ph**	
ZPD34KSE	3.0	7.3	2.8	5.7	7/8	1/2	1.24	243/243/448	31	TFM	12	64	66
ZPD42KSE	3.5	9.1	3.0	6.9	7/8	1/2	1.24	243/243/464	31	TFM	8	52	66
ZPD54KSE	4.5	11.5	3.0	8.9	7/8	1/2	1.24	236/236/479	35	TFM	10	62	67
ZPD61KCE	5.0	13.2	2.9	10.1	7/8	1/2	1.89	241/246/484	41	TFD	12	64	63
ZPD72KCE	5.0	15.2	2.9	11.6	7/8	1/2	1.89	241/246/484	40	TFD	15	75	67
ZPD83KCE	6.0	17.7	3.0	13.4	7/8	1/2	1.77	241/246/484	40	TFD	16	101	64
ZPD91KCE	7.5	19.2	3.1	14.7	7/8	3/4	1.80	241/246/484	40	TFD	16	101	69
ZPD103KCE	9.0	22.4	3.2	16.7	1 3/8	7/8	3.25	293/285/533	61	TFD	21	111	63
ZPD120KCE	10.0	26.3	3.2	19.7	1 3/8	7/8	3.25	285/293/533	62	TFD	22	118	63
ZPD137KCE	12.0	29.5	3.1	22.1	1 3/8	7/8	3.25	285/293/533	62	TFD	25	118	63
ZPD154KCE	13.0	32.9	3.1	24.8	1 3/8	7/8	3.25	326/295/552	65	TWD	27	140	66
ZPD182KCE	15.0	39.0	3.1	29.0	1 3/8	7/8	3.25	326/295/552	67	TWD	34	173	68

Conditions EN12900 R410A: Evaporating 5°C, Condensing 50°C, Superheat 10K, Subcooling 0K

\*\* 3 Ph: 380-420V/ 50Hz

\*\*\* @ 1m: sound pressure level at 1m distance from the compressor, free field condition

Preliminary data

R407C	Nominal hp	Capacity (kW)	COP	Displacement (m <sup>3</sup> /h)	Stub Suction (inch)	Stub Discharge (inch)	Oil Quantity (l)	Length/Width/Height (mm)	Net Weight (kg)	Motor Version/Code	Maximum Operating Current (A)	Locked Rotor Current (A)	Sound Pressure @1m (dBA) ***
										3 Ph**	3 Ph**	3 Ph**	
ZRD42KCE	3.5	8.9	2.9	9.9	3/4	1/2	1.24	241/241/462	31	TFD	7	46	60
ZRD48KCE	4.0	10.5	3.0	11.4	7/8	1/2	1.36	241/241/465	32	TFD	10	48	64
ZRD61KCE	5.0	12.5	3.0	14.3	7/8	1/2	1.89	241/246/481	38	TFD	9.6	64	65
ZRD72KCE	6.0	14.3	2.9	17.0	7/8	3/4	1.89	241/246/481	40	TFD	13	74	63
ZRD81KCE	6.0	17.0	3.1	18.7	7/8	3/4	1.89	241/246/481	41	TFD	15	100	67
ZRD94KCE	7.5	21.0	3.3	22.1	1 1/8	7/8	2.51	293/285/476	58	TFD	16	95	64
ZR125KCE	10.0	27.7	3.3	28.8	1 3/8	7/8	3.25	293/285/533	61	TFD	20	118	64

Conditions EN12900 R407C: Evaporating 5°C, Condensing 50°C, Superheat 10K, Subcooling 0K

\*\* 3 Ph: 380-420V/ 50Hz

\*\*\* @ 1m: sound pressure level at 1m distance from the compressor, free field condition

Capacity Data

Condensing Temperature +40°C															
R410A		Cooling Capacity (kW)						R410A		Power Input (kW)					
		Evaporating Temperature (°C)								Evaporating Temperature (°C)					
Model	-15	-10	-5	0	5	10	15	Model	-15	-10	-5	0	5	10	15
ZPD34KSE	3.9	5.0	6.2	7.6	9.2	11.0		ZPD34KSE	2.1	2.1	2.1	2.0	2.0	2.0	
ZPD42KSE	4.8	5.9	7.3	8.8	10.6	12.6		ZPD42KSE	2.3	2.3	2.4	2.4	2.4	2.3	
ZPD54KSE	6.5	7.9	9.5	11.4	13.5	16.0		ZPD54KSE	3.1	3.1	3.1	3.0	3.0	3.0	
ZPD61KCE	6.9	8.6	10.5	12.7	15.3	18.2		ZPD61KCE	3.3	3.4	3.5	3.5	3.6	3.6	
ZPD72KCE	8.2	10.1	12.3	14.8	17.6	20.9		ZPD72KCE	3.9	4.0	4.1	4.1	4.2	4.2	
ZPD83KCE	9.7	11.9	14.4	17.2	20.5	24.1		ZPD83KCE	4.5	4.6	4.7	4.7	4.8	4.9	
ZPD91KCE	10.1	12.6	15.3	18.5	22.1	26.2	30.9	ZPD91KCE	4.9	5.0	5.0	5.0	5.1	5.0	5.0
ZPD103KCE	11.7	14.6	17.9	21.6	25.8	30.5	35.7	ZPD103KCE	5.7	5.7	5.6	5.6	5.7	5.8	5.9
ZPD120KCE	13.8	17.3	21.2	25.6	30.6	36.1	42.2	ZPD120KCE	6.7	6.7	6.6	6.6	6.6	6.7	6.8
ZPD137KCE	15.5	19.4	23.7	28.7	34.2	40.3	47.2	ZPD137KCE	7.5	7.5	7.5	7.4	7.4	7.5	7.6
ZPD154KCE	17.8	22.0	26.6	31.9	38.0	45.0	53.0	ZPD154KCE	8.2	8.3	8.4	8.5	8.6	8.7	8.9
ZPD182KCE	22.3	26.8	32.0	37.9	44.6	52.5	61.6	ZPD182KCE	9.8	9.9	10.0	10.1	10.2	10.4	10.5

Suction Superheat 10K / Subcooling 0K

Preliminary data

Condensing Temperature +40°C															
R407C		Cooling Capacity (kW)						R407C		Power Input (kW)					
		Evaporating Temperature (°C)								Evaporating Temperature (°C)					
Model	-15	-10	-5	0	5	10	15	Model	-15	-10	-5	0	5	10	15
ZRD42KCE	4.3	5.4	6.7	8.3	10.1	12.2	14.6	ZRD42KCE	2.0	2.1	2.1	2.2	2.2	2.3	2.3
ZRD48KCE	4.9	6.4	8.0	10.0	12.3	15.0	18.1	ZRD48KCE	2.5	2.6	2.6	2.7	2.7	2.8	2.9
ZRD61KCE	6.1	7.7	9.5	11.7	14.2	17.3	21.0	ZRD61KCE	3.0	3.1	3.2	3.4	3.4	3.4	3.3
ZRD72KCE	3.5	6.0	8.9	12.3	16.2	20.6	25.6	ZRD72KCE	3.5	3.6	3.7	3.8	4.0	4.1	4.3
ZRD81KCE	8.0	10.2	12.8	15.8	19.2	23.2	27.7	ZRD81KCE	4.3	4.4	4.4	4.5	4.6	4.7	4.8
ZRD94KCE	10.0	12.7	16.0	19.8	24.1	28.9	34.5	ZRD94KCE	5.0	5.1	5.1	5.1	5.1	5.2	5.3
ZRD125KCE	13.2	16.9	21.3	26.3	31.7	37.6	43.7	ZRD125KCE	6.5	6.6	6.6	6.7	6.8	6.9	7.1

Suction Superheat 10K / Subcooling 0K



## ZH Copeland Scroll™ Compressor Range

The ZH compressor range has been optimized for heat pump application. In addition to the R407C range there is now a range optimized for R410A. Both ranges are based on 3 platform sizes and cover 4kW to 38kW.

The ZH heating compressor has been optimized for applications in new buildings where water temperature demand for space heating is 50°C. The Copeland Scroll™ heating compressor delivers higher capacity at low evaporating (heat source) temperatures thereby better responding to heating requirements than reciprocating compressors.

The Copeland Scroll™ heating compressor has a special scroll design, which attains high efficiency in heat pump operating conditions, especially when the heat source temperature is low. It also results in less supplementary heating to cover the full heating demand on the coldest days. As for all Copeland Scroll™ compressors, the run time has a positive impact on the efficiency of ZH heating compressors.

ZH heating compressors have been designed for low sound levels, a specific requirement for indoor heat pumps.

### ZH Scroll Compressors with Enhanced Vapor Injection

The ZH heating compressor with enhanced vapor injection has been further optimized to enable heat pumps to efficiently produce water temperature up to 65°C during cold winter time. This is a new technology in space heating and tap water production, which permits traditional boilers to be replaced by heat pumps in retrofit applications without changing the radiators.

The ZH Copeland Scroll™ heating compressor with enhanced vapor injection has an additional port to inject vapor in the compression process. This improves the performance of the system by increasing the heating capacity for a given compressor displacement. Additional benefits are the reduction of the discharge temperature and the extension of the operating envelope for the production of high temperature water.

The ZH heating compressor reaches the same high standards of durability and reliability as any other Copeland Scroll™ compressor. This includes the ability to handle relatively large amounts of liquid, which is known to damage or break reciprocating compressors. Fewer moving parts, robust running gear and low vibration due to balanced compression mechanism make the ZH range of Copeland Scroll™ compressors the most reliable solution available on the heat pump market.



ZH Scroll Compressors

### ZH Nomenclature Guidelines

#### ZH\*\*K4E

Qualified for **R407C/R134a**  
Without Enhanced Vapor Injection - \*\* capacity in Btu/h

#### ZH\*\*KVE

Qualified for **R407C** only  
Enhanced Vapor Injection - \*\* capacity in kW

#### ZH\*\*K1P

Qualified for **R410A** only  
Without Enhanced Vapor Injection - \*\* capacity in kW

#### ZH\*\*K1P

Qualified for **R410A** only  
Enhanced Vapor Injection - \*\* capacity in kW

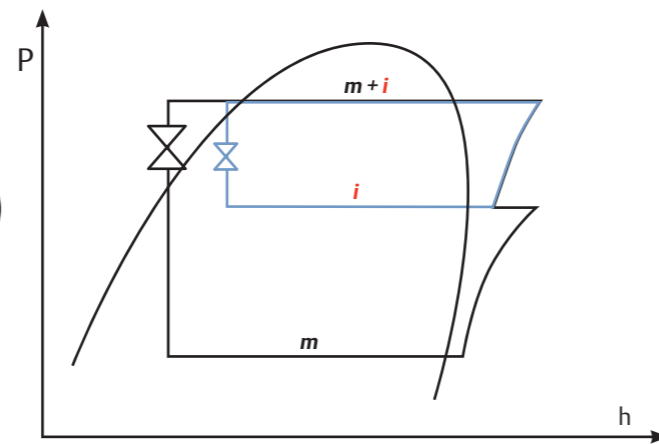
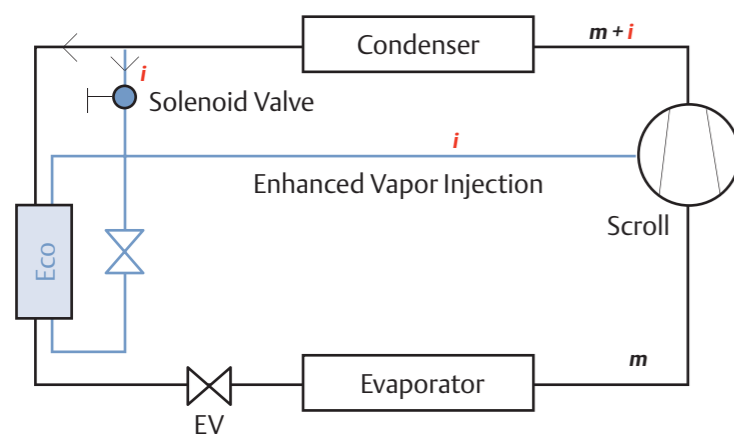

### ZH R407C Compressor Line-up

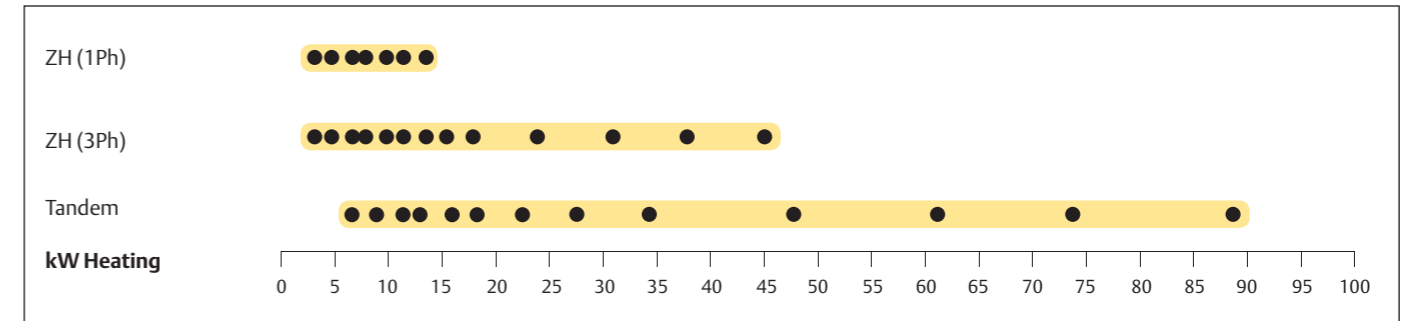

Conditions: Evaporating -7°C, Condensing 50°C, Superheat 5K, Subcooling 4K

### ZH R410A Compressor Line-up

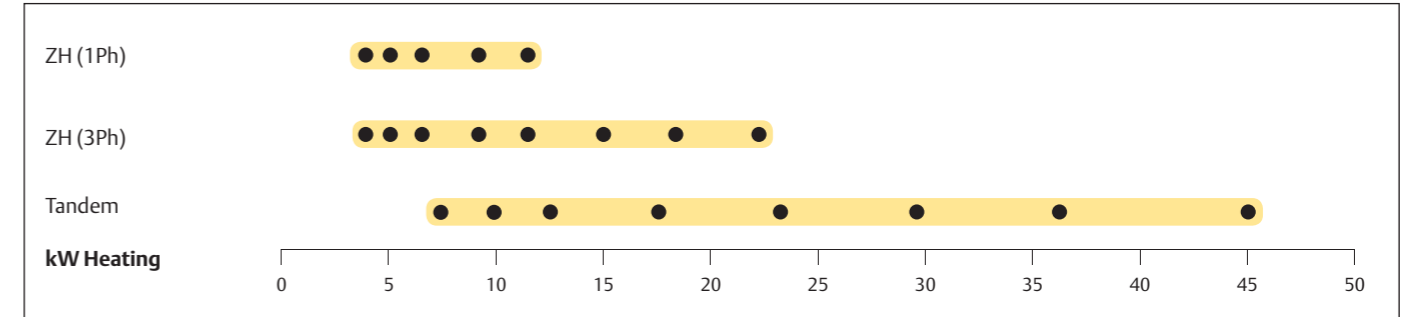

Conditions: Evaporating -7°C, Condensing 50°C, Superheat 5K, Subcooling 4K

### Features and Benefits

- Copeland Scroll™ axial and radial compliance for high reliability
- High efficiency and increased heating capacity
- High water temperature for all applications
- Low sound and low vibration level
- Tandem combination for superior seasonal efficiency
- Enhanced vapor injection technology for best seasonal efficiency

### Maximum Allowable Pressure (PS)

- ZH(I)\*\*K1P:  
Low Side PS 28 bar(g) / High Side PS 45 bar(g)
- ZH12K4E to ZH45K4E:  
Low Side PS 20 bar(g) / High Side PS 32 bar(g)
- ZH56K4E to ZH11M4E:  
Low Side PS 22.6 bar(g) / High Side PS 32 bar(g)
- ZH09KVE to ZH18KVE:  
Low Side PS 20 bar(g) / High Side PS 32 bar(g)
- ZH24KVE to ZH48KVE:  
Low Side PS 22.6 bar(g) / High Side PS 32 bar(g)

### Operating Envelope R407C Heating

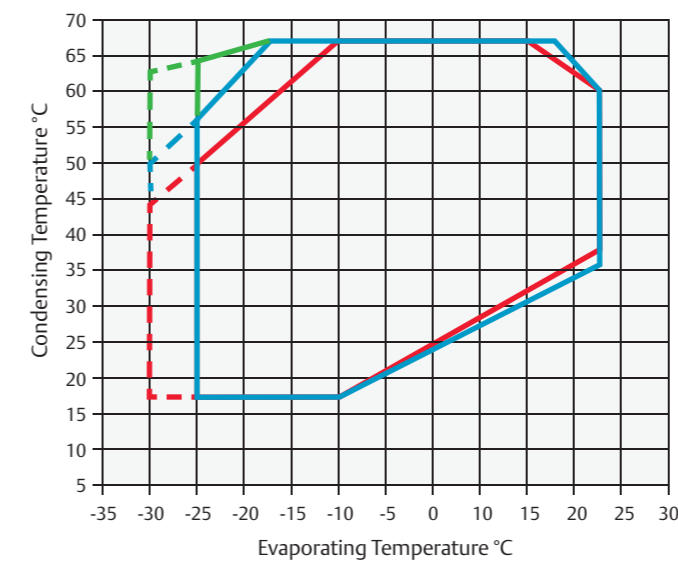

- ZH\*\*K1P w/o Enh. Vapor Inj.
- - ZH\*\*K1P Transient 2000 Hours
- ZH\*\*K1P w/Enh. Vapor Inj.
- - ZH\*\*K1P Transient 2000 Hours
- Wet Injection
- - Wet Injection Transient 2000 Hours

### Operating Envelope R410A Heating

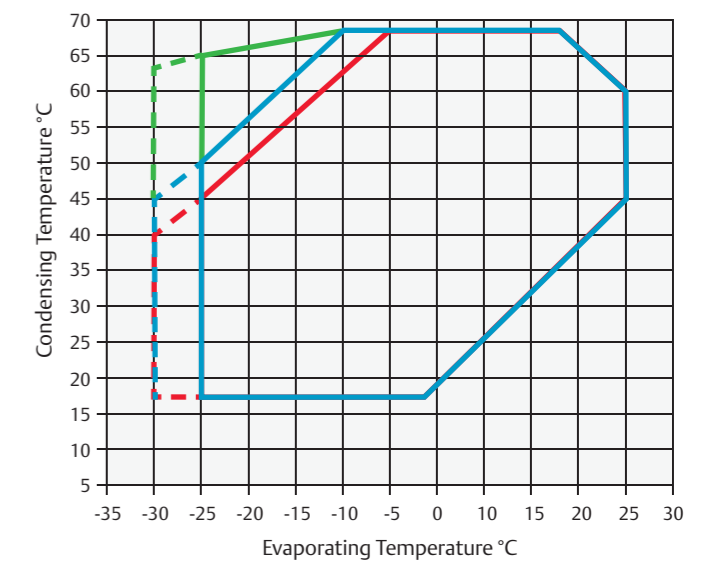

- ZH\*\*K4E w/o Enh. Vapor Inj.
- - ZH\*\*K4E Transient 2000 Hours
- ZH\*\*KVE w/Enh. Vapor Inj.
- - ZH\*\*KVE Transient 2000 Hours
- Wet Injection
- - Wet Injection Transient 2000 Hours

Refer to Emerson's Select 7.5 selection software for individual model operating envelopes and other refrigerants.

Technical Overview

R407C	Nominal hp	Capacity (kW)	COP	Displacement (m³/h)	Stub Suction (inch)	Stub Discharge (inch)	Oil Quantity (l)	Length/Width/Height (mm)	Net Weight (kg)	Motor Version/Code		Maximum Operating Current (A)		Locked Rotor Current (A)		Sound Pressure @1 m (dBA) ***
										1 Ph*	3 Ph**	1 Ph*	3 Ph**	1 Ph*	3 Ph**	
ZH12K4E	1.7	3.7	3.0	4.7	3/4	1/2	0.7	272/193/403	21	PFZ		10		44		53
ZH15K4E	2.0	4.8	2.9	5.9	3/4	1/2	1.3	243/242/364	23	PFJ	TFD	15	5	58	26	60
ZH19K4E	2.5	5.9	3.0	7.3	3/4	1/2	1.5	243/242/386	25	PFJ	TFD	17	6	74	32	60
ZH21K4E	3.0	6.5	3.1	8.0	3/4	1/2	1.5	243/242/406	27	PFJ	TFD	16	5	76	32	59
ZH26K4E	3.5	8.2	3.1	10.0	3/4	1/2	3.1	243/242/419	28	PFJ	TFD	20	7	97	46	63
ZH30K4E	4.0	9.5	3.1	11.7	7/8	1/2	1.9	247/241/438	38	PFJ	TFD	25	8	108	52	62
ZH38K4E	5.0	11.7	3.2	14.4	7/8	1/2	1.9	247/241/438	38	PFZ	TFD	31	10	150	64	63
ZH45K4E	6.0	14.0	3.2	17.1	7/8	1/2	1.9	250/246/450	36		TFD			12	74	64
ZH56K4E	7.5	17.4	3.1	20.9	1-3/8	7/8	4.0	357/321/538	93		TWD		17		99	69
ZH75K4E	10.0	24.2	3.2	28.8	1-3/8	7/8	4.0	357/321/538	93		TWD		21		127	70
ZH92K4E	13.0	30.7	3.3	35.6	1-3/8	7/8	4.1	357/321/545	95		TWD		25		167	72
ZH11M4E	15.0	37.0	3.3	42.8	1-5/8	7/8	4.1	357/321/592	112		TWD		32		198	72
ZH09KVE	3.0	8.2	3.3	8.0	3/4	1/2	1.5	243/243/406	30	PFZ	TFD	21	7	97	40	62
ZH13KVE	4.0	11.8	3.4	11.7	7/8	1/2	1.9	244/241/438	38	PFZ	TFD	30	10	160	64	65
ZH18KVE	6.0	16.7	3.4	17.1	7/8	1/2	1.9	244/241/438	41		TFD		14		101	67
ZH24KVE	7.5	21.3	3.3	20.9	1-3/8	7/8	4.0	368/321/525	93		TWD		18		99	73
ZH33KVE	10.0	29.5	3.4	29.0	1-3/8	7/8	4.0	368/321/525	93		TWD		24		127	73
ZH40KVE	13.0	37.0	3.4	35.5	1-3/8	7/8	4.1	368/321/532	103		TWD		30		167	73
ZH48KVE	15.0	44.7	3.4	42.8	1-5/8	7/8	4.1	368/323/579	112		TWD		36		198	76

Conditions Evaporating -7°C, Condensing 50°C, Superheat 5K, Subcooling 4K

\* 1 Ph: 230V/ 50Hz  
 \*\* 3 Ph: 380-420V/ 50Hz  
 \*\*\* @ 1m: sound pressure level at 1m distance from the compressor, free field condition

R410A	Nominal hp	Capacity (kW)	COP	Displacement (m³/h)	Stub Suction (inch)	Stub Discharge (inch)	Oil Quantity (l)	Length/Width/Height (mm)	Net Weight (kg)	Motor Version/Code		Maximum Operating Current (A)		Locked Rotor Current (A)		Sound Pressure @1 m (dBA) ***
										1 Ph*	3 Ph**	1 Ph*	3 Ph**	1 Ph*	3 Ph**	
ZH04K1P	1.8	4.0		3.2	3/4	1/2	0.7	229/198/388	22	PFZ	TFM					
ZH05K1P	2.0	5.0		4.0	3/4	1/2	0.7	242/242/407	22	PFZ	TFM					
ZH06K1P	2.7	6.4		5.1	7/8	1/2	1.2	242/242/422	31	PFZ	TFM		6		44	62
ZH09K1P	3.5	8.9	3.1	6.9	7/8	1/2	1.2	242/242/422	33	PFZ	TFM	23	7	108	52	62
ZH12K1P	4.5	11.7	3.0	8.9	7/8	1/2	1.2	242/242/422	35	PFZ	TFM	28	10	130	62	65
ZH15K1P	5.0	15.0		11.7	7/8	1/2	1.9	245/249/440	39		TFM					
ZH19K1P	6.5	18.5		14.4	7/8	3/4	1.9	245/249/455	39		TFM					
ZH105K1P	1.9	5.0		3.2	3/4	1/2	0.7	229/198/388	22	PFZ	TFM					
ZH106K1P	2.1	6.2		4.0	3/4	1/2	0.7	229/198/388	22	PFZ	TFM					
ZH108K1P	2.8	7.8		5.1	7/8	1/2	1.2	229/246/418	31	PFZ	TFM					
ZH11K1P	3.6	10.9	3.0	6.9	7/8	1/2	1.2	242/242/421	31	PFZ	TFM	25	9	130	52	63
ZH14K1P	4.6	14.4	3.3	8.9	7/8	1/2	1.2	242/242/421	34		TFM		11		70	64
ZH18K1P	5.0	18.4		11.7	7/8	1/2	1.9	249/245/455	41		TFM					
ZH23K1P	6.5	22.8		14.4	7/8	3/4	1.9	249/245/455	39		TFM					

Conditions Evaporating -7°C, Condensing 50°C, Superheat 5K, Subcooling 4K

\* 1 Ph: 230V/ 50Hz  
 \*\* 3 Ph: 380-420V/ 50Hz  
 \*\*\* @ 1m: sound pressure level at 1m distance from the compressor, free field condition

Models in red: not yet released

Capacity Data

Condensing Temperature +50°C															
R407C	Heating Capacity (kW)							R407C	Power Input (kW)						
	Evaporating temperature (°C)								Evaporating temperature (°C)						
	Model	-30	-15	-10	-5	0	5		15	Model	-30	-15	-10	-5	0
ZH12K4E	1.5*	2.8	3.3	3.9	4.6	5.4	7.5	ZH12K4E	1.1*	1.2	1.2	1.3	1.3	1.3	1.4
ZH15K4E	2.0*	3.7	4.3	5.1	6.0	7.0	9.4	ZH15K4E	1.3*	1.5	1.6	1.6	1.7	1.7	1.8
ZH19K4E	2.5*	4.5	5.3	6.2	7.3	8.6	11.7	ZH19K4E	1.6*	1.9	1.9	2.0	2.1	2.1	2.2
ZH21K4E	2.9*	5.1	5.9	6.9	8.1	9.6	13.2	ZH21K4E	1.8*	2.0	2.1	2.1	2.2	2.3	2.4
ZH26K4E	3.5*	6.3	7.4	8.7	10.3	12.1	16.5	ZH26K4E	2.3*	2.5	2.6	2.7	2.7	2.8	3.0
ZH30K4E	4.2*	7.3	8.6	10.1	11.9	14.0	19.2	ZH30K4E	2.6*	2.9	3.0	3.1	3.2	3.3	3.4
ZH38K4E	4.7*	9.0	10.6	12.5	14.6	17.2	23.4	ZH38K4E	2.9*	3.5	3.6	3.8	3.9	4.0	4.2
ZH45K4E	5.7*	10.8	12.7	14.9	17.4	20.3	27.2	ZH45K4E	3.8*	4.2	4.3	4.5	4.6	4.7	5.1
ZH56K4E	7.1*	13.4	15.8	18.6	21.8	25.5	34.1	ZH56K4E	4.4*	5.3	5.5	5.7	6.0	6.2	6.8
ZH75K4E	9.4*	18.5	21.9	25.8	30.3	35.5	47.6	ZH75K4E	5.4*	7.0	7.4	7.7	8.0	8.2	8.5
ZH92K4E	11.7*	23.4	27.8	32.8	38.5	45.1	60.3	ZH92K4E	6.6*	8.5	9.0	9.5	10.0	10.4	11.2
ZH11M4E	14.8*	28.4	33.6	39.5	46.3	54.3	72.7	ZH11M4E	8.1*	10.3	10.9	11.5	11.9	12.5	13.4
Models with Enhanced Vapor Injection															
	-30	-15	-10	-5	0	5	15		-30	-15	-10	-5	0	5	15
ZH09KVE	4.1*	6.6	7.6	8.7	9.9	11.2	14.3	ZH09KVE	2.1*	2.4	2.4	2.5	2.6	2.6	2.6
ZH13KVE	5.7*	9.5	10.9	12.5	14.3	16.2	20.7	ZH13KVE	3.0*	3.4	3.5	3.5	3.6	3.6	3.7
ZH18KVE	8.0*	13.5	15.4	17.6	20.0	22.6	28.7	ZH18KVE	4.2*	4.8	4.9	5.0	5.1	5.1	5.2
ZH24KVE	9.7*	17.0	19.6	22.5	25.5	28.9	36.7	ZH24KVE	5.2*	6.2	6.4	6.6	6.7	6.8	7.0
ZH33KVE	14.3*	23.7	27.2	31.1	35.3	40.0	50.7	ZH33KVE	7.0*	8.2	8.5	8.8	9.1	9.3	9.6
ZH40KVE	18.1*	29.6	34.1	39.1	44.7	50.9	65.5	ZH40KVE	8.9*	10.2	10.6	11.0	11.3	11.7	12.4
ZH48KVE	21.1*	35.6	41.1	47.2	54.1	61.8	80.4	ZH48KVE	10.0*	12.2	12.7	13.2	13.5	14.0	15.1

\* preliminary value  
 Suction Superheat 5K / Subcooling 4K

Condensing Temperature +50°C															
R410A	Heating Capacity (kW)							R410A	Power Input (kW)						
	Evaporating temperature (°C)								Evaporating temperature (°C)						
	Model	-30	-15	-10	-5	0	5		15	Model	-30	-15	-10	-5	0
ZH06K1P		5.3*	6.1*	7.0*	8.1*	9.3*	12.2*	ZH06K1P		2.2*	2.3*	2.3*	2.3*	2.3*	2.2*
ZH09K1P	4.2*	7.1	8.2	9.5	10.9	12.5	16.4	ZH09K1P	2.5*	2.8	2.9	3.0	3.0	3.0	3.0
ZH12K1P	5.5*	9.3	10.8	12.4	14.2	16.4	21.5	ZH12K1P	3.3*	3.7	3.8	3.8	3.8	3.8	3.8
Models with Enhanced Vapor Injection															
	-30	-15	-10	-5	0	5	15		-30	-15	-10	-5	0	5	15
ZH11K1P	6.2*	9.0	10.1	11.3	12.6	14.0	17.3	ZH11K1P	3.3*	3.3	3.3	3.3	3.3	3.3	3.1
ZH14K1P	8.9*	11.6	13.0	14.6	16.3	18.1	22.2	ZH14K1P	4.0*	4.1	4.2	4.2	4.2	4.2	4.0

\* preliminary value  
 Suction Superheat 5K / Subcooling 4K

## ZRH/ZBH Copeland Scroll™ Horizontal Compressor Range

in R407C and R134a, for the specific needs of transport air conditioning.

Air conditioning for passenger comfort is a pre-requisite in today's public transport vehicles. At the same time, maximization of passenger space and streamlining of high speed trains increasingly impose limitations on height.

ZRH compressors are based on the unique Copeland Scroll™ design and provide the same reliability as a standard Copeland Scroll™. The addition of an oil pump covers the specific needs of transport air conditioning and of horizontal compressor arrangement in general.

The low profile design and modulation capabilities of the ZRH compressor range are the ideal response to these market needs.



Horizontal Scroll Compressors

### ZRH Scroll Compressors Line-up R407C

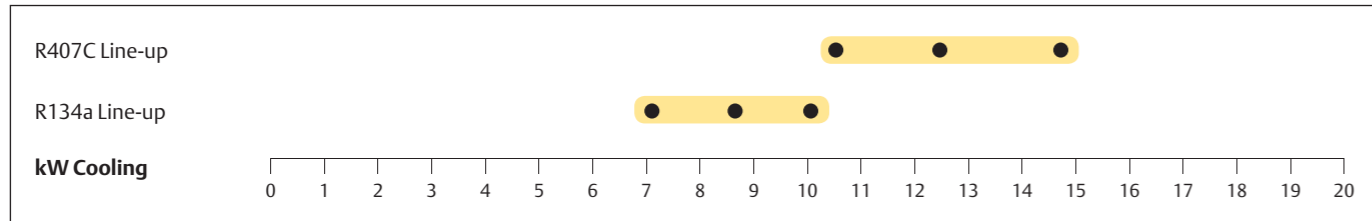

EN12900: Evaporating 5°C, Condensing 50°C, Superheat 10K, Subcooling 0K

### Features and Benefits

- Compactness and low weight
- Horizontal design with less than 250mm height
- Copeland Scroll™ compliance for superior reliability and efficiency
- Additional oil-pump
- Reduction of potential risk of refrigerant leakage through the drive shaft sealing
- Capacity modulation from 70% to 150% for ZRHV/ZBHV

### Maximum Allowable Pressure (PS)

- 29.5 bar

### Operating Envelope R407C

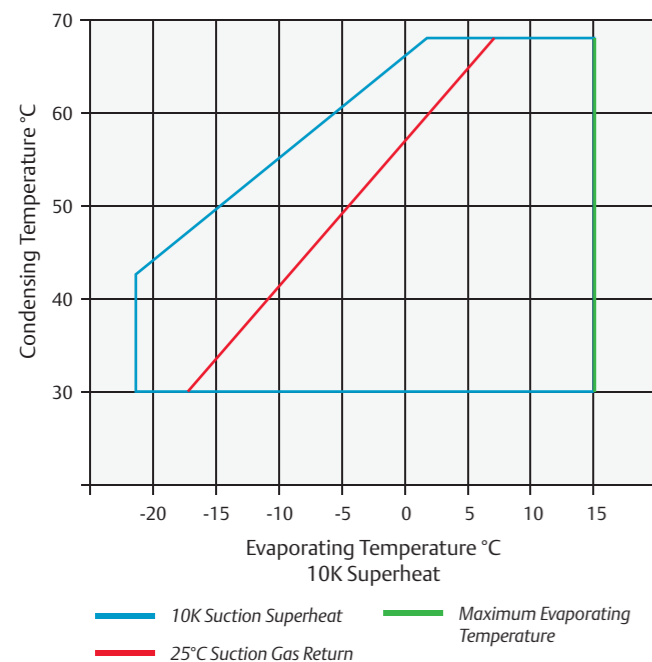

### Technical Overview

R407C	Nominal hp	Capacity (kW)	COP	Displacement (m <sup>3</sup> /h)	Stub Suction (inch)	Stub Discharge (inch)	Oil Quantity (l)	Length/Width/Height (mm)	Net Weight (kg)	Motor Version/ Code	Maximum Operating Current (A)	Locked Rotor Current (A)	Sound Pressure @1 m (dBA) **
										3 Ph*	3 Ph*	3 Ph*	
ZBH30KJE	4.0	9.9	2.85	11.8			1.80	487/290/245	52	TFD	9	52	68
ZRH49KJE	4.0	9.9	2.85	11.8			1.80	487/290/245	52	TFD	9	52	68
ZBH38KJE	5.0	12.4	2.88	14.5			1.80	487/290/245	53	TFD	12	64	69
ZRH61KJE	5.0	12.4	2.88	14.5			1.80	487/290/245	53	TFD	12	64	69
ZBH45KJE	6.0	14.7	2.78	20.6	7/8	1/2	1.80	487/290/245	53	TFD	12	74	66
ZBHV45KJE	6.0	14.8	2.78	17.1			1.80	487/290/245	53	TFD	15	100	66
ZRH72KJE	6.0	14.8	2.78	17.1			1.80	487/290/245	53	TFD	12	74	66
ZRHV72KJE	6.0	14.8	2.78	17.1			1.80	487/290/245	53	TFD	15	100	66

EN12900 R407C - HT: Evaporating +5°C, Condensing +50°C, Suction Superheat 10K, Subcooling 0K

\*TFD: 3Ph 380-420V/50Hz - 460/60Hz; TF5 200-220V/50Hz, 200-230V/60Hz

\*\* @ 1m: sound pressure level at 1m distance from the compressor, free field condition

### Capacity Data

R407C		Condensing Temperature +50°C													
		Cooling Capacity (kW)						Power Input (kW)							
		Evaporating Temperature (°C)						Evaporating Temperature (°C)							
Model	-20	-10	-5	0	5	10	15	Model	-20	-10	-5	0	5	10	15
ZBH30KJE		5,3	6,6	8,2	9,9	11,9	14,1	ZBH30KJE		2,9	3,1	3,3	3,5	3,7	3,9
ZRH49KJE		5,3	6,6	8,2	9,9	11,9	14,1	ZRH49KJE		2,9	3,1	3,3	3,5	3,7	3,9
ZBH38KJE		6,6	8,3	10,2	12,4	14,8	17,5	ZBH38KJE		3,6	3,8	4,1	4,3	4,6	4,9
ZRH61KJE		6,6	8,3	10,2	12,4	14,8	17,5	ZRH61KJE		3,6	3,8	4,1	4,3	4,6	4,9
ZBH45KJE		7,8	9,7	10,1	14,7	17,7	21,0	ZBH45KJE		4,5	4,8	5,0	5,3	5,6	5,9
ZBHV45KJE		7,9	9,9	12,2	14,8	17,7	20,8	ZBHV45KJE		4,5	4,8	5,0	5,3	5,6	5,9
ZRH72KJE		7,9	9,9	12,2	14,8	17,7	20,8	ZRH72KJE		4,5	4,8	5,0	5,3	5,6	5,9
ZRHV72KJE		7,9	9,9	12,2	14,8	17,7	20,8	ZRHV72KJE		4,5	4,8	5,0	5,3	5,6	5,9

Suction Gas Return 10°C / Subcooling 0K





## Refrigeration Applications

Emerson offers a wide range of solutions for commercial refrigeration applications. With its long-lasting expertise in semi-hermetic reciprocating compressor technology as well as in scroll technology we can meet the requirements for most applications: at the small end just like at the large end of commercial refrigeration.

Completed by the various offerings in the segment of condensing units Emerson is able to offer the best solution and performance whether you are looking for applications in foodservice or – processing, supermarkets, hypermarkets, petrol stations or refrigerated warehousing.

Emerson's prime focus for its semi-hermetic reciprocating technology is at the large end of commercial refrigeration. Here aspects such as reliability, serviceability and the ability to implement capacity unloading mechanism are of importance and they are perfectly provided by Emerson's semi-hermetic reciprocating compressors. Innovations like the Discus and Stream technologies, digital modulation and CoreSense™ Diagnostics for advanced protection and preventive maintenance keep semi-hermetic at the forefront of compressor technology.

Especially when compact equipment, energy efficiency and reliability are musts, the scroll technology is the preferred choice for refrigeration applications. With developments such as vapor injection and digital modulation, scroll has become the leading technology and is widely recognized in the refrigeration market.

Whatever the chosen technology and product solution, Emerson's line-up meet the specific refrigeration needs covering the entire spectrum of medium and low temperature applications whether using standard HFC's, low GWP or natural refrigerants.

## ZB Copeland Scroll™ Compressor Range for Medium Temperature Refrigeration using R404A, R134a, R407A/C and R22

Emerson Climate Technologies offers ZB compressors with a wide cooling capacity range starting from 3 kW to 26 kW. It includes digital compressors models that offer continuous capacity modulation technology.

Copeland Scroll™ compressors have 3 times less moving parts than reciprocating compressors and feature a scroll compliance mechanism which makes them particularly robust and reliable under severe conditions including liquid slugging.

They have the advantage of light weight and compactness, making them ideal for the usage in condensing units, compact refrigeration systems or special process units.

The Summit Series from 7 to 15 hp is designed to provide seasonal efficiencies 15% higher than traditional semi-hermetic compressors. These compressors are extremely quiet and can be fitted with an external sound shell for an additional 10 dBA sound reduction, which makes them best choice for refrigeration applications in urban and domestic areas.



ZB Compressor for Medium Temperature Refrigeration

The ZB range also features ZB220 (30hp), the largest refrigeration scroll available on the market. These compressors are qualified for R404A, R134a, R407A/C and R22.

For more details on digital model please refer to page 38 in the catalogue.

### ZB and ZBD Compressor Line-up

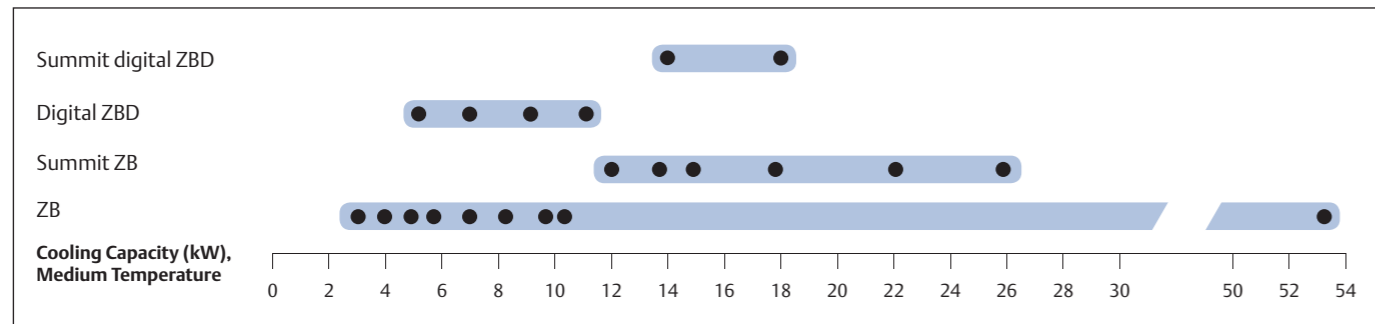

Conditions EN12900, R404A: Evaporating -10°C, Condensing 45°C, Suction Gas Temperature 20°C, Subcooling 0K

### Features and Benefits

- Copeland Scroll™ axial and radial compliance for superior reliability and efficiency
- Wide operating envelope with 10°C condensing limit and fast pull down capabilities
- High seasonal efficiencies as scrolls are designed at the condition where equipment runs most of the time
- Light weight and compactness, more than half the weight of equivalent semi-hermetic compressors
- Availability of optional sound shell on all models providing an additional 10 dBA sound attenuation for silent operation
- Includes 6 digital scroll compressor models for simple, stepless 10 to 100% capacity modulation
- One model for multi refrigerants R404A, R407A/C, R134a, R22

### Maximum Allowable Pressure (PS)

- ZB15 to ZB45:  
Low Side PS 21 bar(g) / High Side PS 28.8 bar(g)
- ZB50 to ZB220:  
Low Side PS 22.6 bar(g) / High Side PS 32 bar(g)
- Digital ZBD:  
Low Side PS 22.6 bar(g) / High Side PS 32 bar(g)

### Operating Envelope R404A

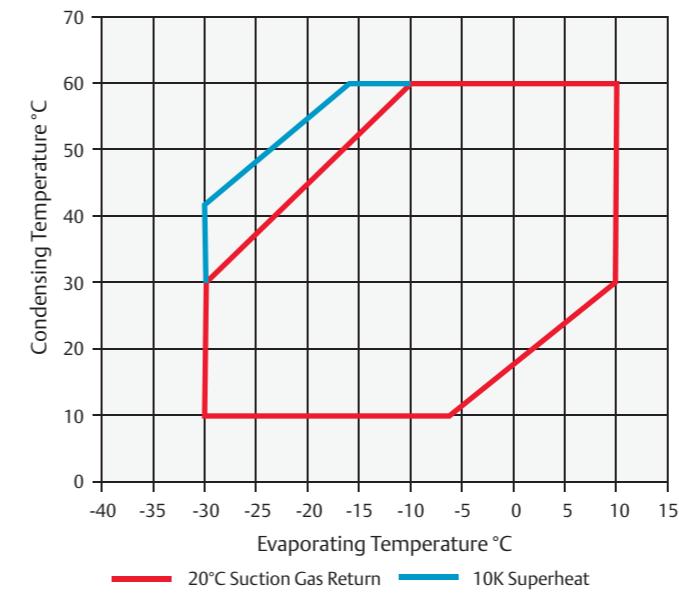

### Operating Envelope R134a

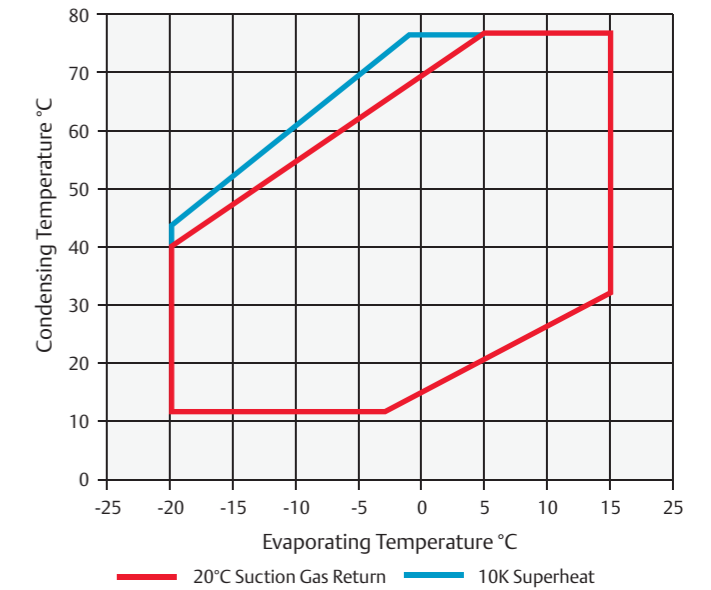

Refer to Emerson's Select 7.5 selection software for individual model operating envelopes and other refrigerants.

### Technical Overview

R404A	Nominal hp	Capacity (kW)	COP	Displacement (m <sup>3</sup> /h)	Rotolock Suction (inch)	Rotolock Discharge (inch)	Oil Quantity (l)	Length/Width/Height (mm)	Net Weight (kg)	Motor Version/Code		Maximum Operating Current (A)		Locked Rotor Current (A)		Sound Pressure @ 1 m (dBA) ***
										1 Ph*	3 Ph**	1 Ph*	3 Ph**	1 Ph*	3 Ph**	
ZB15KCE	2.0	3.3	1.8	5.9	3/4	1/2	1.30	241/241/382	25	PFJ	TFD	13	5	58	26	55
ZB19KCE	2.5	3.9	1.9	6.8	1 1/4	1	1.50	242/242/369	27	PFJ	TFD	13	7	61	32	55
ZB21KCE	3.0	5.1	2.0	8.6	1 1/4	1	1.24	243/244/392	29	PFJ	TFD	16	7	82	40	58
ZB26KCE	3.5	5.8	1.8	10.0	1 1/4	1	1.45	243/244/406	28	PFJ	TFD	18	9	97	46	60
ZB29KCE	4.0	6.3	2.0	11.4	1 1/4	1	1.50	242/242/423	29		TFD		10		50	59
ZB30KCE	4.0	6.9	2.0	11.7	1 1/4	1	1.90	242/242/438	35	PFJ	TFD	26	10	142	49	61
ZB38KCE	5.0	8.5	2.0	14.4	1 1/4	1	1.90	242/242/438	37	PFJ	TFD	32	13	142	66	63
ZB42KCE	5.5	9.7	2.1	16.2	1 1/4	1	1.90	251/246/450	40	PFJ		36		150		62
ZB45KCE	6.0	10.1	2.1	17.1	1 1/4	1	1.90	242/242/458	40		TFD		13		74	61
ZB48KCE	7.0	11.2	2.1	18.8	1 1/4	1 1/4	1.80	241/247/456	39		TFD		14		101	62
ZB50KCE	7.0	11.9	2.1	19.8	1 1/8	7/8	2.65	264/284/480	57		TFD		15		100	64
ZB58KCE	8.0	13.3	2.1	22.1	1 3/4	1 1/4	2.65	264/284/478	57		TFD		15		95	65
ZB66KCE	9.0	15.1	2.1	24.9	1 3/4	1 1/4	3.38	264/284/533	60		TFD		18		111	66
ZB76KCE	10.0	17.9	2.2	29.1	1 3/4	1 1/4	3.38	264/284/546	61		TFD		20		118	66
ZB95KCE	13.0	21.7	2.1	36.4	1 3/4	1 1/4	3.38	264/285/552	65		TFD		28		140	67
ZB114KCE	15.0	25.8	2.0	43.4	1 3/4	1 1/4	3.38	264/285/552	66		TFD		33		174	71
ZB220KCE	30.0	53.2	2.2	87.5	2 1/4 x 12UN	1 3/4 x 12UN	6.30	448/392/717	176		TWM		69		310	78

Conditions EN12900 : MT, Evaporating -10°C, Condensing 45°C, Suction Gas Temperature 20°C, Subcooling 0K

\* 1 Ph: 230V/ 50Hz

\*\* 3 Ph: 380-420V/ 50Hz

\*\*\* @ 1m: sound pressure level at 1m distance from the compressor, free field condition



Capacity Data

Condensing Temperature +40°C																
R404A	Cooling Capacity (kW)							R404A	Power Input (kW)							
	Evaporating Temperature (°C)								Evaporating Temperature (°C)							
	Model	-35	-30	-25	-20	-15	-10		-5	Model	-35	-30	-25	-20	-15	-10
ZB15KCE		1.4	1.9	2.4	3.0	3.7	4.5	ZB15KCE		1.7	1.7	1.7	1.6	1.6	1.5	
ZB19KCE		2.0	2.5	3.1	3.8	4.5	5.4	ZB19KCE		1.9	1.9	1.9	1.9	1.9	1.9	
ZB21KCE		2.4	3.0	3.7	4.5	5.5	6.6	ZB21KCE		2.2	2.2	2.2	2.2	2.2	2.2	
ZB26KCE		2.8	3.5	4.3	5.3	6.4	7.6	ZB26KCE		2.6	2.6	2.6	2.6	2.6	2.6	
ZB29KCE	2.1*	3.2	4.1	5.0	6.2	7.5	9.0	ZB29KCE	2.8*	2.8	2.9	2.9	2.9	2.9	2.8	
ZB30KCE	2.1*	3.2	4.1	5.0	6.2	7.5	9.0	ZB30KCE	3.0*	3.0	3.0	3.0	3.0	3.0	3.0	
ZB38KCE	2.7*	4.1	5.1	6.3	7.7	9.3	11.2	ZB38KCE	3.7*	3.7	3.8	3.8	3.8	3.8	3.8	
ZB42KCE**		4.6	5.7	7.1	8.7	10.6	12.7	ZB42KCE**		4.2	4.2	4.2	4.2	4.2	4.2	
ZB45KCE	3.2*	4.8	6.0	7.4	9.1	11.0	13.2	ZB45KCE	4.2*	4.3	4.3	4.3	4.3	4.3	4.3	
ZB48KCE	3.6*	5.5	6.9	8.6	10.5	12.7	15.2	ZB48KCE	4.9*	4.9	4.9	4.9	4.9	4.9	4.9	
ZB50KCE		2.8*	5.9	8.2	10.6	13.1	15.8	ZB50KCE		5.2*	5.2	5.1	5.1	5.1	5.1	
ZB58KCE		4.2*	7.2	9.4	11.9	14.5	17.5	ZB58KCE		5.6*	5.6	5.6	5.6	5.7	5.7	
ZB66KCE		6.0*	8.9	11.1	13.6	16.4	19.7	ZB66KCE		6.1*	6.2	6.3	6.3	6.4	6.4	
ZB76KCE		7.0*	10.4	13.0	16.0	19.4	23.3	ZB76KCE		7.0*	7.1	7.2	7.3	7.3	7.4	
ZB95KCE		7.6*	10.7*	15.6	19.5	23.8	28.7	ZB95KCE		9.6*	9.4*	9.4	9.3	9.4	9.5	
ZB114KCE		8.5*	12.3*	18.3	23.0	28.3	34.4	ZB114KCE		11.6*	11.4*	11.3	11.3	11.3	11.4	
ZB220KCE			28.4*	39.2	47.7	57.5	68.9	ZB220KCE			21.4*	21.8	22.0	22.2	22.4	

Suction Gas Return 20°C / Subcooling 0K  
 \* Suction Superheat 10K / Subcooling 0K  
 \*\* Single Phase only  
 Preliminary data

Condensing Temperature +40°C																
R407A	Cooling Capacity (kW)							R407A	Power Input (kW)							
	Evaporating Temperature (°C)								Evaporating Temperature (°C)							
	Model	-35	-30	-25	-20	-15	-10		-5	Model	-35	-30	-25	-20	-15	-10
ZB15KCE			1.6*	2.1*	2.8	3.5	4.2	ZB15KCE			1.5*	1.5*	1.5	1.5	1.5	
ZB19KCE			2.1*	2.6*	3.4	4.2	5.2	ZB19KCE			1.7*	1.7*	1.8	1.8	1.8	
ZB21KCE			2.5*	3.2*	4.1	5.1	6.2	ZB21KCE			2.0*	2.1*	2.1	2.1	2.1	
ZB26KCE			2.6*	3.6*	4.7	5.8	7.1	ZB26KCE			2.3*	2.3*	2.3	2.3	2.4	
ZB30KCE			3.4*	4.4*	5.8	7.3	8.9	ZB30KCE			2.7*	2.7*	2.7	2.7	2.8	
ZB38KCE			4.2*	5.4*	7.2	8.9	11	ZB38KCE			3.2*	3.2*	3.3	3.3	3.4	
ZB45KCE			4.9*	6.3*	8.2	10.2	12.4	ZB45KCE			3.8*	3.9*	4.0	4.0	4.0	

Suction Gas Return 20°C / Subcooling 0K  
 \* Suction Superheat 10K / Subcooling 0K

Condensing Temperature +40°C																
R407C	Cooling Capacity (kW)							R407C	Power Input (kW)							
	Evaporating Temperature (°C)								Evaporating Temperature (°C)							
	Model	-35	-30	-25	-20	-15	-10		-5	Model	-35	-30	-25	-20	-15	-10
ZB15KCE			1.6*	1.9*	2.3*	2.9	3.6	ZB15KCE			1.2*	1.3*	1.3*	1.3	1.3	
ZB19KCE			1.6*	2.1*	2.7*	3.5	4.4	ZB19KCE			1.6*	1.6*	1.6*	1.6	1.6	
ZB21KCE			2.1*	2.9*	3.7*	4.7	5.8	ZB21KCE			1.9*	2.0*	2.0*	2.0	2.0	
ZB26KCE			2.2*	2.9*	3.7*	4.9	6.2	ZB26KCE			2.2*	2.2*	2.2*	2.2	2.2	
ZB30KCE			2.7*	3.6*	4.8*	6.2	7.7	ZB30KCE			2.5*	2.5*	2.6*	2.6	2.6	
ZB38KCE			3.1*	4.2*	5.6*	7.4	9.4	ZB38KCE			2.9*	3.0*	3.1*	3.1	3.2	
ZB42KCE**			4.4*	5.7*	7.2*	9.1	11.2	ZB42KCE**			3.8*	3.8*	3.8*	3.8	3.6	
ZB45KCE			3.7*	5.3*	7.1*	9.2	11.5	ZB45KCE			3.4*	3.6*	3.6*	3.7	3.7	

Suction Gas Return 20°C / Subcooling 0K  
 \* Suction Superheat 10K / Subcooling 0K  
 \*\* Single Phase only

Capacity Data

Condensing Temperature +40°C																
R134a	Cooling Capacity (kW)							R134a	Power Input (kW)							
	Evaporating Temperature (°C)								Evaporating Temperature (°C)							
	Model	-35	-30	-25	-20	-15	-10		-5	Model	-35	-30	-25	-20	-15	-10
ZB15KCE				1.4	1.7	2.2	2.7	ZB15KCE				0.9	0.9	0.9	0.9	
ZB19KCE				1.6	2.0	2.5	3.2	ZB19KCE				1.1	1.1	1.1	1.1	
ZB21KCE				2.0	2.5	3.2	4.0	ZB21KCE				1.3	1.3	1.3	1.3	
ZB26KCE				2.3	2.9	3.7	4.6	ZB26KCE				1.5	1.5	1.5	1.5	
ZB30KCE				2.5*	3.4	4.3	5.4	ZB30KCE				1.7*	1.7	1.7	1.8	
ZB38KCE				3.0*	4.2	5.4	6.7	ZB38KCE				2.1*	2.1	2.1	2.2	
ZB42KCE**				3.8	4.8	6.0	7.5	ZB42KCE**				2.5	2.5	2.5	2.4	
ZB45KCE				3.8*	5.1	6.4	8.0	ZB45KCE				2.4*	2.4	2.5	2.5	
ZB50KCE				4.6	5.9	7.4	9.1	ZB50KCE				3.0	3.0	3.0	3.1	
ZB58KCE				5.2	6.6	8.3	10.3	ZB58KCE				3.4	3.4	3.4	3.4	
ZB66KCE				6.0	7.6	9.5	11.8	ZB66KCE				3.8	3.7	3.8	3.8	
ZB76KCE				6.9	8.6	10.8	13.5	ZB76KCE				4.4	4.4	4.4	4.5	
ZB95KCE				8.2	10.8	13.8	17.1	ZB95KCE				5.4	5.5	5.6	5.6	
ZB114KCE				9.6	12.7	16.3	20.4	ZB114KCE				6.6	6.6	6.7	6.7	

Suction Gas Return 20°C / Subcooling 0K  
 \* Suction Superheat 10K / Subcooling 0K  
 \*\* Single Phase only

Condensation Temperature +40°C																	
R22	Cooling Capacity (kW)							R22	Power Input (kW)								
	Evaporating Temperature (°C)								Evaporating Temperature (°C)								
	Models	-35	-30	-25	-20	-15	-10		-5	Models	-35	-30	-25	-20	-15	-10	-5
ZB15KCE				1.4*	2.1*	2.8*	3.5	4.2	ZB15KCE				1.5*	1.4*	1.4*	1.4	1.4
ZB19KCE				1.9*	2.5*	3.2*	4.0	4.8	ZB19KCE				1.6*	1.6*	1.6*	1.6	1.6
ZB21KCE				2.0*	3.0*	4.0*	5.1	6.2	ZB21KCE				2.2*	2.1*	2.0*	2.0	2.0
ZB26KCE				2.7*	3.5*	4.4*	5.6	6.8	ZB26KCE				2.2*	2.2*	2.2*	2.2	2.2
ZB30KCE				2.2*	3.2*	4.5*	6.0	7.7	ZB30KCE				2.6*	2.7*	2.7*	2.7	2.7
ZB38KCE				3.8*	4.9*	6.3*	8.0	10.0	ZB38KCE				2.9*	3.0*	3.1*	3.1	3.2
ZB42KCE**				5.2*	6.6*	8.1*	9.9	11.9	ZB42KCE**				3.9*	3.8*	3.8*	3.7	3.6
ZB45KCE				4.5*	6.4*	8.3*	10.3	12.5	ZB45KCE				3.4*	3.6*	3.7*	3.7	3.8
ZB50KCE				4.6*	6.9*	9.2*	11.7	14.4	ZB50KCE				4.4*	4.4*	4.4*	4.3	4.3
ZB58KCE				5.1*	7.5*	10.1*	13.0	16.1	ZB58KCE				4.8*	4.9*	4.9*	4.9	4.9
ZB66KCE				7.4*	9.6*	12.2*	15.1	18.4	ZB66KCE				5.1*	5.2*	5.3*	5.4	5.4
ZB76KCE				8.9*	11.5*	14.4*	17.8	21.7	ZB76KCE				5.9*	6.1*	6.2*	6.3	6.4
ZB95KCE						16.8*	21.4*	26.5*	ZB95KCE						8.0*	8.1*	8.2*
ZB114KCE						19.9*	25.5*	31.7*	ZB114KCE						9.6*	9.6*	9.7*

Suction Gas Return 20°C / Subcooling 0K  
 \* Suction Superheat 10K / Subcooling 0K  
 \*\* Single Phase only



## ZF Copeland Scroll™ Compressor Range for Low Temperature Refrigeration using R404A, R407A and R22

Emerson Climate Technologies developed the ZF range to provide the best performance in low temperature. The range has a wide application envelope as it can operate from -40°C evaporating temperature to +7°C. They have been optimized in their design to perfectly fit frozen food application requirements. Thanks to their scroll compliance mechanism, these scroll compressors feature particularly high tolerance to liquid slugging.



ZF Compressor for Low Temperature Refrigeration

These compressors are qualified for R404A, R507, R407A, R22 and R134a for certain models. For more details on Digital Scroll™ model please refer to page 38 in the catalogue.

The range consists of:

- The ZF\*KCE models that operate with liquid injection in order to control discharge temperature and increase the operating envelope.
- The ZF\*KVE models are optimized for vapor injection with use of a sub-cooler. This boosts refrigeration system's cooling capacity and efficiency.
- The ZF\*K6E models that operate both with liquid injection or vapor injection.

### ZF and ZFD Compressor Line-up

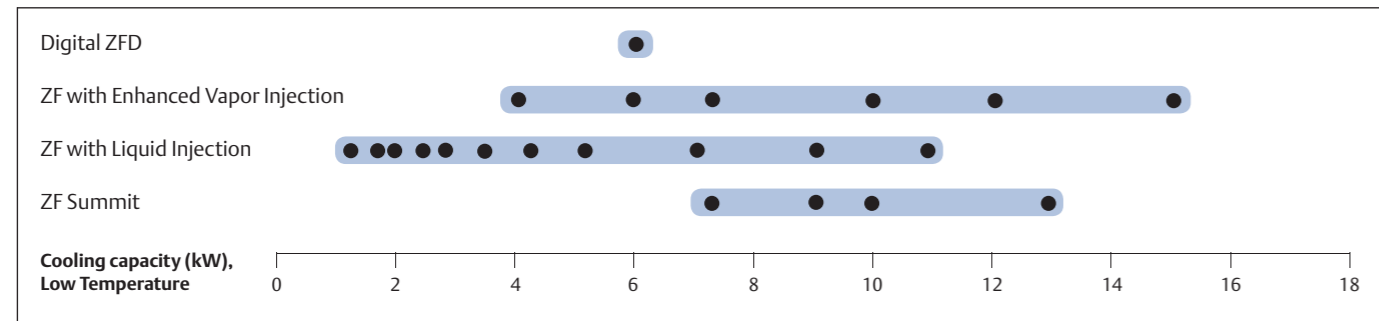

Conditions 12900, R404A: Evaporating -35°C, Condensing 40°C, Suction Gas Temperature 20°C, Subcooling 0K

### Features and Benefits

- Wide operating envelope with 10°C low condensing temperature to minimize energy consumption
- One model for multi-refrigerants
- Light weight and compactness, more than half the weight of equivalent semi-hermetic compressor
- Optional Sound Shell allowing 10 to 12 dBA sound attenuation.
- ZF models with liquid injection
  - Easy, efficient and reliable injection via Discharge Temperature Control Valve (DTC) on the smaller models
- ZF models with Enhanced Vapour Injection
  - Seasonal efficiencies compared to Emerson's best semi-hermetic compressors
  - Improved system capacity and efficiency by 40% and 25% respectively, making them the most efficient compressors on the market.
  - Possibility to reduce the equipment and component sizes by using smaller compressors

### Maximum Allowable Pressure (PS)

- ZF06 to ZF18 (K4E/KVE):  
Low Side PS 21 bar(g) / High Side PS 28.8 bar(g)
- ZF24 to ZF48 (K4E/KVE/K6E):  
Low Side PS 22.6 bar(g) / High Side PS 32 bar(g)
- Digital ZFD:  
Low Side PS 19 bar(g) / High Side PS 28 bar(g)

### Operating Envelope R404A

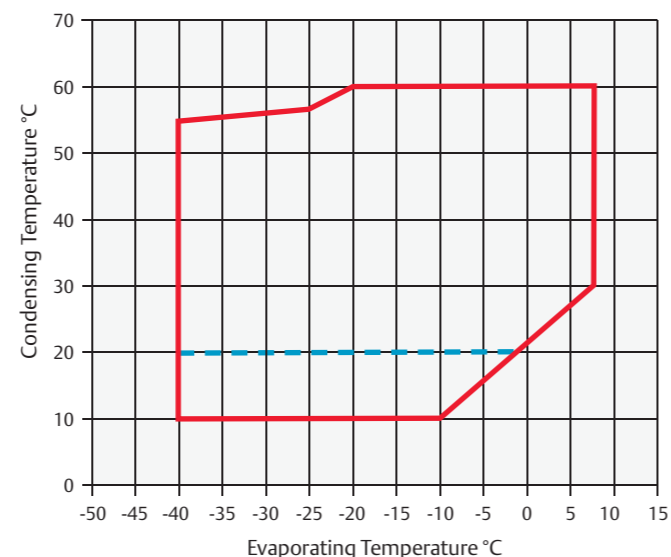

Refer to Emerson's Select 7.5 selection software for individual model operating envelopes and other refrigerants.

### Technical Overview

R404A	Nominal hp	Capacity (kW)	COP	Displacement (m3/h)	Rotolock Suction (inch)	Rotolock Discharge (inch)	Oil Quantity (l)	Length/Width/Height (mm)	Net Weight (kg)	Motor Version/ Code	Maximum Operating Current (A)	Locked Rotor Current (A)	Sound Pressure @ 1 m (dBA) ***
										3 Ph**	3 Ph**	3 Ph**	
ZF06K4E	2.8	1.4	1.0	5.9	1 3/4	1	1.30	242/242/369	25	TFD	10	52	57
ZF08K4E	2.5	1.8	1.1	7.3			1.48	243/244/392	27	TFD	6	32	59
ZF09K4E	2.8	1.9	1.1	8.0			1.50	243/244/392	27	TFD	6	40	62
ZF11K4E	3.5	2.5	1.1	9.9			1.50	243/244/406	28	TFD	7	46	63
ZF13KVE	4.0	4.0	1.3	11.7			1.90	241/244/442	38	TFD	9	64	63
ZF13K4E	4.0	4.6	4.6	11.8			1.40	241/244/490	38	TFD	8	52	65
ZF15K4E	5.0	5.5	4.4	14.5			1.70	241/244/490	39	TFD	10	64	65
ZF18KVE	6.0	6.0	1.5	17.1			1.90	308/246/438	39	TFD	13	74	67
ZF18K4E	6.0	6.6	4.1	17.1			1.70	241/244/490	41	TFD	13	74	67
ZF24K4E	7.5	5.2	1.1	20.9			1 1/4	1 1/4	4.14	368/316/542	100	TWD	16
ZF24KVE	7.5	7.3	1.4	20.9	4.14	316/368/542			100	TWD	16	99	70
ZF33K4E	10.5	7.1	1.2	28.8	1 3/4	1 1/4	4.14	368/319/525	93	TWD	22	127	72
ZF33KVE	10.5	9.9	1.4	28.8			4.14	368/319/525	93	TWD	21	127	72
ZF40KVE	12.5	12.0	1.5	35.6	1 3/4	1 1/4	4.14	316/368/550	96	TWD	27	167	72
ZF40K4E	12.5	8.8	1.2	35.6			4.14	368/324/532	103	TWD	25	167	72
ZF48K4E	15.0	10.6	1.1	42.8	2 1/4	1 1/4	4.14	324/294/579	112	TWD	29	198	72
ZF48KVE	15.0	15.0	1.5	42.8	2 1/4	1 3/4	4.14	324/294/579	112	TWD	31	198	72

Conditions EN12900 : LT, Evaporating -35°C, Condensing 40°C, Suction Gas Temperature 20°C, Subcooling 0K

\*\* 3 Ph: 380-420V/50Hz

\*\*\* @ 1m: sound pressure level at 1m distance from the compressor, free field condition

R404A	Nominal hp	Capacity (kW)	COP	Displacement (m3/h)	Rotolock Suction (inch)	Rotolock Discharge (inch)	Oil Quantity (l)	Length/Width/Height (mm)	Net Weight (kg)	Motor Version/ Code	Maximum Operating Current (A)	Locked Rotor Current (A)	Sound Pressure @ 1 m (dBA) ***
										3 Ph**	3 Ph**	3 Ph**	
ZF25K6E	7.5			21.3	7/8	3/4	1.90	308/246/438	41	TFD		90	68
ZF34K6E	9.0			29.1			3.20	280/279/456	63	TFD		100	68
ZF41K6E	10.0			35.3			3.20	280/279/546	63	TFD	20	118	69
ZF49K6E	13.0			42.3			3.20	280/279/564	63	TFD	20	118	71

Conditions EN12900 : LT, Evaporating -35°C, Condensing 40°C, Suction Gas Temperature 20°C, Subcooling 0K

\*\* 3 Ph: 380-420V/50Hz

\*\*\* @ 1m: sound pressure level at 1m distance from the compressor, free field condition

Preliminary data

Capacity Data

Condensing Temperature +40°C															
R404A	Cooling Capacity (kW)							R404A	Power Input (kW)						
	Evaporation Temperature (°C)								Evaporation Temperature (°C)						
	Model	-35	-30	-25	-20	-15	-10		-5	Model	-35	-30	-25	-20	-15
ZF06K4E	1.4	1.8	2.2	2.6	3.1	3.8	4.5	ZF06K4E	1.4	1.4	1.5	1.5	1.6	1.7	1.8
ZF08K4E	1.8	2.2	2.8	3.4	4.1	4.8	5.7	ZF08K4E	1.6	1.7	1.8	1.9	2.0	2.1	2.2
ZF09K4E	1.9	2.4	3.0	3.6	4.4	5.2	6.3	ZF09K4E	1.8	1.8	1.9	1.9	2.0	2.1	2.2
ZF11K4E	2.5	3.0	3.7	4.5	5.4	6.5	7.8	ZF11K4E	2.2	2.2	2.3	2.4	2.5	2.6	2.7
ZF13K4E	2.8	3.5	4.3	5.3	6.4	7.7	9.1	ZF13K4E	2.3	2.4	2.5	2.6	2.7	2.8	3.0
ZF15K4E	3.4	4.3	5.3	6.4	7.8	9.4	11.2	ZF15K4E	2.8	3.0	3.1	3.2	3.4	3.6	3.8
ZF18K4E	4.2	5.2	6.4	7.8	9.4	11.3	13.5	ZF18K4E	3.4	3.6	3.7	3.8	4.0	4.2	4.4
ZF24K4E	5.2	6.4	7.9	9.6	11.6	13.8	16.4	ZF24K4E	4.5	4.7	5.0	5.2	5.4	5.6	5.8
ZF33K4E	7.1	8.9	10.9	13.3	16.1	19.3	23.0	ZF33K4E	5.8	6.2	6.5	6.9	7.2	7.5	7.8
ZF40K4E	8.8	11.0	13.5	16.4	19.8	23.7	28.2	ZF40K4E	7.4	7.8	8.2	8.6	9.0	9.4	9.8
ZF48K4E	10.6	13.2	16.3	20.0	24.1	28.9	34.4	ZF48K4E	9.7	10.2	10.6	11.1	11.6	12.1	12.7
Models with Enhanced Vapor Injection															
	-35	-30	-25	-20	-15	-10	-5		-35	-30	-25	-20	-15	-10	-5
ZF13KVE	4.0	4.9	6.0	7.2	8.6	10.1	11.7	ZF13KVE	3.0	3.0	3.1	3.2	3.3	3.4	3.5
ZF18KVE	6.0	7.1	8.5	10.1	11.9	14.0	16.4	ZF18KVE	4.0	4.2	4.4	4.6	4.7	4.9	5.0
ZF24KVE	7.3	8.9	10.7	12.7	15.0	17.5	20.4	ZF24KVE	5.2	5.4	5.6	5.8	6.0	6.3	6.5
ZF33KVE	9.9	12.0	14.5	17.3	20.4	24.1	28.1	ZF33KVE	6.9	7.2	7.5	7.7	8.0	8.3	8.6
ZF40KVE	12.0	15.3	18.8	22.5	26.5	30.9	35.7	ZF40KVE	8.0	8.8	9.5	9.9	10.3	10.6	10.9
ZF48KVE	15.0	18.2	21.8	25.7	30.0	34.7	39.9	ZF48KVE	9.8	10.4	11.0	11.6	12.2	12.9	13.5
ZF Summit Models - with Liquid Injection															
	-35	-30	-25	-20	-15	-10	-5		-35	-30	-25	-20	-15	-10	-5
ZF25K6E	5.1	6.3	7.8	9.6	11.7	14.1	16.8	ZF25K6E	4.1	4.4	4.7	4.9	5.1	5.3	5.5
ZF34K6E	6.8	8.5	10.4	12.6	15.3	18.3	21.8	ZF34K6E	5.2	5.5	5.8	6.0	6.3	6.6	6.9
ZF41K6E	8.0	10.0	12.3	14.9	18.0	21.5	25.7	ZF41K6E	6.4	6.7	7.1	7.4	7.8	8.1	8.5
ZF49K6E	10.7	13.3	16.4	20.0	24.1	28.9	34.3	ZF49K6E	9.7	10.2	10.6	11.1	11.6	12.1	12.7
ZF Summit Models - with Enhanced Vapour Injection															
	-35	-30	-25	-20	-15	-10	-5		-35	-30	-25	-20	-15	-10	-5
ZF25K6E	7.8	9.5	11.4	13.5	15.9	18.5	21.4	ZF25K6E	5.0	5.3	5.5	5.7	5.9	6.1	6.2
ZF34K6E	10.2	12.4	14.9	17.6	20.7	24.1	27.8	ZF34K6E	6.3	6.6	6.9	7.2	7.5	7.8	8.1
ZF41K6E	12.6	15.3	18.3	21.7	25.5	29.6	34.2	ZF41K6E	7.8	8.2	8.6	9.0	9.4	9.8	10.2
ZF49K6E	15.1	18.3	21.9	26.0	30.5	35.5	41.0	ZF49K6E	9.6	10.1	10.6	11.1	11.5	12.0	12.5

Suction Gas Return 20°C / Subcooling 0K  
Preliminary data

Condensing Temperature +40°C															
R134a	Cooling Capacity (kW)							R134a	Power Input (kW)						
	Evaporating Temperature (°C)								Evaporating Temperature (°C)						
	Model	-35	-30	-25	-20	-15	-10		-5	Model	-35	-30	-25	-20	-15
ZF13K4E	1.5	2.0	2.5	3.1	3.8	4.6	5.6	ZF13K4E	1.4	1.5	1.5	1.6	1.7	1.8	1.8
ZF15K4E	1.8	2.3	2.9	3.7	4.6	5.6	6.9	ZF15K4E	1.7	1.8	1.9	2.0	2.1	2.2	2.3
ZF18K4E	2.1	2.7	3.4	4.3	5.4	6.7	8.1	ZF18K4E	2.3	2.3	2.4	2.5	2.6	2.8	2.9
ZF24K4E	2.7	3.5	4.4	5.4	6.7	8.2	10.0	ZF24K4E	2.9	3.0	3.1	3.2	3.3	3.4	3.5
ZF33K4E	3.6	4.7	6.1	7.6	9.5	11.6	13.9	ZF33K4E	3.6	3.7	3.9	4.1	4.3	4.6	4.8

Suction Gas Return 20°C / Subcooling 0K

Capacity Data

Condensing Temperature +40°C															
R407A	Cooling Capacity (kW)							R407A	Power Input (kW)						
	Evaporating Temperature (°C)								Evaporating Temperature (°C)						
	Model	-35	-30	-25	-20	-15	-10		-5	Model	-35	-30	-25	-20	-15
ZF09K4E	1.9	2.3	2.9	3.5	4.3	5.2	6.2	ZF09K4E	1.7	1.9	2.1	2.3	2.6	3.0	3.4
ZF11K4E	2.1	2.6	3.3	4.1	5.0	6.1	7.4	ZF11K4E	1.5	1.7	1.9	2.0	2.2	2.4	2.5
ZF13K4E	2.2	2.8	3.5	4.4	5.5	6.5	7.7	ZF13K4E	2.1	2.2	2.3	2.3	2.4	2.5	2.5
ZF15K4E	2.7	3.4	4.3	5.5	6.7	8.1	9.7	ZF15K4E	2.5	2.7	2.8	2.9	3.0	3.1	3.0
ZF18K4E	3.3	4.1	5.2	6.6	8.1	9.7	11.5	ZF18K4E	3.0	3.2	3.3	3.5	3.6	3.7	3.5
Models with Enhanced Vapor Injection															
	-35	-30	-25	-20	-15	-10	-5		-35	-30	-25	-20	-15	-10	-5
ZF13KVE	3.1	4.0	4.9	6.0	7.3	8.7	10.4	ZF13KVE	2.3	2.3	2.4	2.5	2.6	2.7	2.7
ZF18KVE	4.9	6.0	7.3	8.8	10.8	13.3	16.5	ZF18KVE	3.4	3.5	3.6	3.7	3.9	4.1	4.4
ZF24KVE	5.8	7.2	8.8	10.7	12.8	15.1	17.7	ZF24KVE	4.6	4.9	5.1	5.4	5.9	6.4	7.1
ZF33KVE	7.7	9.8	12.2	14.7	17.2	19.3	21.0	ZF33KVE	6.0	6.3	6.5	6.9	7.3	8.0	8.9
ZF40KVE	10.2	12.7	15.5	18.8	22.3	26.1	30.1	ZF40KVE	7.0	7.4	7.8	8.3	8.9	9.6	10.5
ZF Summit Models - with Liquid Injection															
	-35	-30	-25	-20	-15	-10	-5		-35	-30	-25	-20	-15	-10	-5
ZF25K6E								ZF25K6E							
ZF34K6E	8.2	10.1	12.2	14.8				ZF34K6E	5.5	5.6	5.7	5.9			
ZF41K6E	10.1	12.4	15.0	18.2				ZF41K6E	6.8	7.0	7.1	7.4			
ZF49K6E	12.1	14.9	18.1	21.8				ZF49K6E	8.4	8.6	8.8	9.1			

Suction Gas Return 20°C / Subcooling 0K  
Preliminary data

Condensing Temperature +40°C															
R22	Cooling Capacity (kW)							R22	Power Input (kW)						
	Evaporating Temperature (°C)								Evaporating Temperature (°C)						
	Model	-35	-30	-25	-20	-15	-10		-5	Model	-35	-30	-25	-20	-15
ZF09K4E	1.8	2.3	2.8	3.5	4.2	5.1	6.1	ZF09K4E	1.9	1.9	2.0	2.0	2.1	2.1	2.2
ZF11K4E	2.3	2.9	3.5	4.3	5.2	6.3	7.5	ZF11K4E	2.1	2.1	2.2	2.3	2.4	2.5	2.7
ZF13K4E	2.7	3.3	4.1	5.0	6.1	7.3	8.7	ZF13K4E	2.5	2.5	2.6	2.7	2.8	2.9	3.0
ZF15K4E	3.2	4.1	5.0	6.1	7.4	8.9	10.6	ZF15K4E	3.0	3.1	3.2	3.3	3.4	3.6	3.7
ZF18K4E	3.8	4.8	5.9	7.3	8.8	10.7	12.7	ZF18K4E	3.8	3.8	3.9	4.0	4.1	4.3	4.5
ZF24K4E	4.8	5.9	7.3	8.9	10.8	13.1	15.6	ZF24K4E	4.4	4.7	4.9	5.1	5.3	5.4	5.6
ZF33K4E	6.2	7.9	9.9	12.3	15.0	18.1	21.4	ZF33K4E	5.7	6.0	6.2	6.5	6.8	7.2	7.6
ZF40K4E	8.3	10.2	12.4	15.1	18.4	22.2	26.7	ZF40K4E	7.2	7.5	7.8	8.1	8.4	8.8	9.2
ZF48K4E	9.2	11.5	14.1	17.3	21.1	25.5	30.6	ZF48K4E	8.9	9.3	9.7	10.1	10.6	11.0	11.5

Suction Gas Return 20°C / Subcooling 0K

## ZFD & ZBD Copeland Scroll™ Digital Range for Low and Medium Temperature Refrigeration

Copeland Scroll™ Digital ZBD and ZFD compressors for stepless continuous capacity modulation in low and medium temperature refrigeration applications.

Based on the unique Copeland Compliant Scroll® design, the Digital modulation operates on a simple mechanism. Capacity control is achieved by separating the scroll sets axially over a small period of time. It is a simple mechanical solution allowing precise temperature control and system efficiency.

Digital Scroll™ technology is a simple modulation solution that can easily and quickly be implemented into any existing system design as no other components are required.

Digital Scroll™ technology provides continuous, stepless modulation from 10% to 100% with no operating envelope restriction. As a result, system pressures and temperatures are tightly controlled. These compressors provide optimum performance for condensing units, refrigeration packs, process and agricultural units.



Copeland Scroll Digital™ for Low and Medium Temperature Refrigeration

The Digital Scroll™ range consists of:

- ZBD models dedicated to medium temperature applications
- ZFD models with vapor injection for low temperature applications
- ZOD model designed for use in R744 (CO<sub>2</sub>) - see page 42.

These compressors are qualified for R404A, R407A and R22 (ZBD/ZFD).

### Digital Scroll™ Compressor Line-up

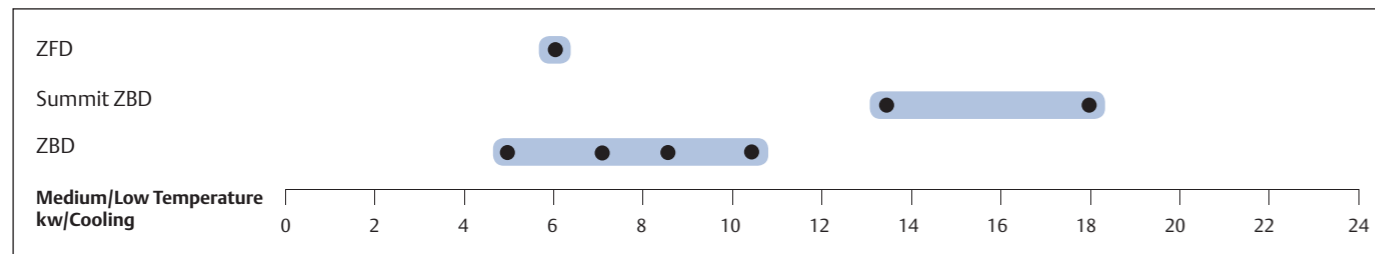

Digital ZBD R404A Evaporating -10°C, Condensing 45°C, Suction Gas Temperature 20°C, Subcooling 0K  
 Digital ZFD: R404A Evaporating -35°C, Condensing 40°C, Suction Gas Temperature 20°C, Subcooling 0K

### Features and Benefits

- Continuous modulation from 10% to 100% ensuring a perfect match of capacity and power to the desired load
- An economical and reliable alternative to variable speed drive
- Precise suction pressure control with associated energy savings
- Food quality is maintained by stable evaporating temperatures in the refrigerated areas
- Longer lasting refrigeration equipment due to fewer compressor cycling
- Quick and easy integration into refrigeration equipment, similar to any other scroll compressor
- Availability of optional sound shell on all model providing an additional 10dBA sound attenuation for silent operation
- Availability of Emerson's series of controllers that operate the Digital Scroll™ compressor

### Maximum Allowable Pressure (PS)

- Digital ZBD:  
Low Side PS 22.6 bar(g) / High Side PS 32 bar(g)
- Digital ZFD:  
Low Side PS 19 bar(g) / High Side PS 28 bar(g)

### Operating Envelope R404A

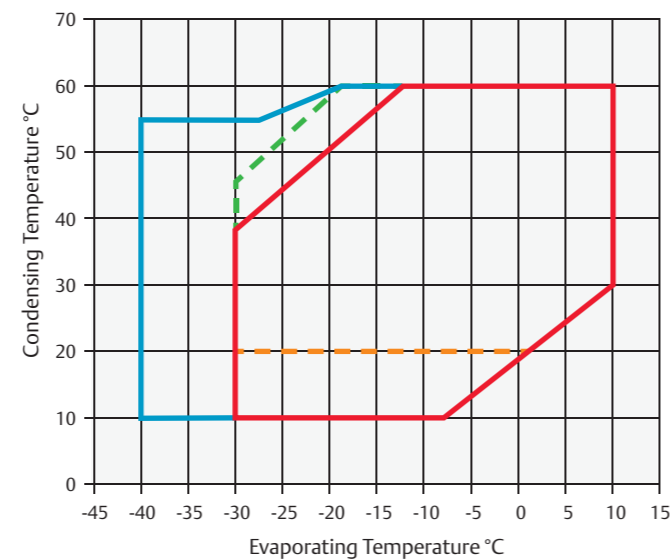

Refer to Emerson's Select 7.5 selection software for individual model operating envelopes and other refrigerants.

### Technical Overview

R404A	Nominal hp	Capacity (kW)	COP	Displacement (m <sup>3</sup> /h)	Rotolock Suction (inch)	Rotolock Discharge (inch)	Oil Quantity (l)	Length/Width/Height (mm)	Net Weight (kg)	Motor Version/Code		Maximum Operating Current (A)		Locked Rotor Current (A)		Sound Pressure @1 m (dBA) ****
										1 Ph*	3 Ph**	1 Ph*	3 Ph**	1 Ph*	3 Ph**	
ZBD21KCE	4.0	5.1	2.1	8	1 1/4	1	1.24	243/243/432	30	PFJ	TFD	17	7	97	40	62
ZBD29KCE	4.0	6.8	2.2	11			1.89	237/243/463	33		TFD		8		48	67
ZBD30KCE	4.0	7.0	2.2	12			1.89	241/246/482	37		TFD		8		52	59
ZBD38KCE	4.0	8.6	2.2	14			1.89	241/246/481	38		TFD		11		66	67
ZBD45KCE	6.0	10.2	2.1	17			1.89	241/246/494	40		TFD		12		74	61
ZBD58KCE	8.0	13.5	2.1	22	1 3/4	1	2.51	264/284/476	60		TFD		15		95	65
ZBD76KCE	10.0	17.9	2.2	29	1 3/4	1 1/4	3.25	293/285/533	62		TFD		20		118	66

Conditions EN12900 : MT, Evaporating -10°C, Condensing 45°C, Suction Gas Temperature 20°C, Subcooling 0K

\* 1 Ph: 230V/ 50Hz

\*\* 3 Ph: 380-420V/ 50Hz

\*\*\* @ 1m: sound pressure level at 1m distance from the compressor, free field condition

R404A	Nominal hp	Capacity (kW)	COP	Displacement (m <sup>3</sup> /h)	Rotolock Suction (inch)	Rotolock Discharge (inch)	Oil Quantity (l)	Length/Width/Height (mm)	Net Weight (kg)	Motor Version/Code		Maximum Operating Current (A)		Locked Rotor Current (A)		Sound Pressure @1 m (dBA) ****
										1 Ph*	3 Ph**	1 Ph*	3 Ph**	1 Ph*	3 Ph**	
ZFD18KVE	6.0	6.0	1.5	17	1 1/4	1	1.89	300/299/494	43		TFD		14		74	62

Conditions EN12900 : LT, Evaporating -35°C, Condensing 40°C, Suction Gas Temperature 20°C, Subcooling 0K

\* 1 Ph: 230V/ 50Hz

\*\* 3 Ph: 380-420V/ 50Hz

\*\*\* @ 1m: sound pressure level at 1m distance from the compressor, free field condition



Capacity Data

Condensing Temperature +40°C															
Medium Temperature															
R404A	Cooling Capacity (kW)							R404A	Power Input (kW)						
	Evaporating Temperature (°C)								Evaporating Temperature (°C)						
Model	-35	-30	-25	-20	-15	-10	-5	Model	-35	-30	-25	-20	-15	-10	-5
ZBD21KCE		2.0*	3.0	3.7	4.5	5.5	6.6	ZBD21KCE		1.8*	1.9	2.0	2.0	2.1	2.1
ZBD29KCE		2.8*	4.1	5.0	6.1	7.4	8.9	ZBD29KCE		2.3*	2.5	2.6	2.7	2.8	2.8
ZBD30KCE		2.9*	4.2	5.1	6.3	7.6	9.1	ZBD30KCE		2.3*	2.5	2.7	2.8	2.9	3.0
ZBD38KCE		3.6*	5.2	6.3	7.7	9.3	11.1	ZBD38KCE		2.9*	3.1	3.2	3.4	3.5	3.7
ZBD45KCE		3.7*	5.6	7.0	8.7	10.8	13.1	ZBD45KCE		4.0*	4.1	4.2	4.3	4.4	4.5
ZBD58KCE		4.3*	7.3	9.5	12.0	14.7	17.7	ZBD58KCE		5.9*	5.7	5.7	5.7	5.7	5.8
ZBD76KCE		6.9*	10.3	12.9	15.9	19.4	23.2	ZBD76KCE		7.2*	7.2	7.3	7.3	7.4	7.5
Low Temperature with Enhanced Vapor Injection															
	-35	-30	-25	-20	-15	-10	-5		-35	-30	-25	-20	-15	-10	-5
ZFD18KVE	6.0	7.1	8.5	10.1	11.9	14.0	16.4	ZFD18KVE	4.0	4.2	4.4	4.6	4.7	4.9	5.0

Suction Gas Return 20°C / Subcooling 0K  
 \*Suction Superheat 10K / Subcooling 0K  
 Preliminary data

Condensing Temperature +40°C															
Medium Temperature															
R407A	Cooling Capacity (kW)							R407A	Power Input (kW)						
	Evaporating Temperature (°C)								Evaporating Temperature (°C)						
Model	-35	-30	-25	-20	-15	-10	-5	Model	-35	-30	-25	-20	-15	-10	-5
ZBD30KCE				4.6	5.8	7.3	9.0	ZBD30KCE				2.8	2.8	2.8	2.8
ZBD45KCE				6.4	8.1	10.1	12.5	ZBD45KCE				3.8	3.8	3.8	3.9
Low Temperature with Enhanced Vapor Injection															
	-35	-30	-25	-20	-15	-10	-5		-35	-30	-25	-20	-15	-10	-5
ZFD18KVE	4.9	6	7.3	8.8	10.8	13.3	16.5	ZFD18KVE	3.4	3.5	3.6	3.7	3.9	4.1	4.4

Suction Gas Return 20°C / Subcooling 0K  
 \* Suction Superheat 10K / Subcooling 0K

Condensing Temperature +40°C															
Medium Temperature															
R22	Cooling Capacity (kW)							R22	Power Input (kW)						
	Evaporating Temperature (°C)								Evaporating Temperature (°C)						
Model	-35	-30	-25	-20	-15	-10	-5	Model	-35	-30	-25	-20	-15	-10	-5
ZBD30KC			3.4*	4.4*	5.5*	6.9	8.4	ZBD30KC			2.4*	2.5*	2.5*	2.6	2.7
ZBD45KC			5.2*	6.6*	8.2*	10.1	12.3	ZBD45KC			3.5*	3.6*	3.6*	3.7	3.8

Suction Gas Return 20°C / Subcooling 0K  
 \* Suction Superheat 10K / Subcooling 0K

## ZO & ZOD Scroll Compressor Range for CO<sub>2</sub>-Subcritical Refrigeration

ZO Copeland Scroll™ Compressors have been designed for use in R744 (CO<sub>2</sub>) low temperature refrigeration systems. These compressors are suitable for usage in CO<sub>2</sub>-subcritical cascade and booster systems.

Increasing environmental concerns about potential direct emissions from HFC-based refrigeration systems into the atmosphere have led to the revival of R744 in parts of the European refrigeration market. Regionally, this trend is reinforced by legislation and taxation schemes which favor the usage of refrigerant R744.

In comparison with HFC refrigerants, the specific properties of R744 require changes in the design of the refrigeration system. The ZO range of Copeland Scroll™ compressors has been particularly designed to exploit the characteristics of R744 refrigeration system. Efficiency, reliability and liquid handling advantages of the Copeland Scroll™ technology equally apply.

The optimized design of ZO compressors addresses effectively the challenges of R744 systems i.e. high pressure levels, higher mass flow for a given displacement while securing proper lubrication.

The range consists of 6 models including 1 digital model for 10 to 100% continuous cooling capacity modulation



ZO Compressor for Low Temperature Refrigeration

### ZO and ZOD Compressor Line-up

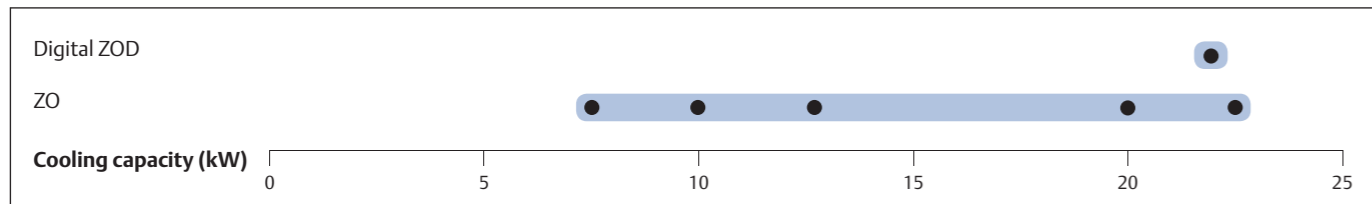

Conditions EN12900 R744: Evaporating -35°C, Condensing -5°C, Suction Superheat 10K, Subcooling 0K

### Features and Benefits

- Optimized for high efficiency in CO<sub>2</sub>-subcritical cascade and booster systems
- High condensing temperature limit allowing for optimized overall system design
- Compact design minimizing required machine room space
- Half the weight of equivalent semi-hermetic compressors
- Optional Sound Shell allowing 10 dBA sound attenuation
- High bearing reliability and lubrication of all critical parts under all conditions including liquid slugging
- Availability of a digital model offering simple, stepless 10 to 100% capacity modulation

### Maximum Allowable Pressure (PS)

- ZO:  
Low Side PS 33 bar(g) / High Side PS 47 bar(g)
- Digital ZOD:  
Low Side PS 33 bar(g) / High Side PS 43 bar(g)

### Operating Envelope R744

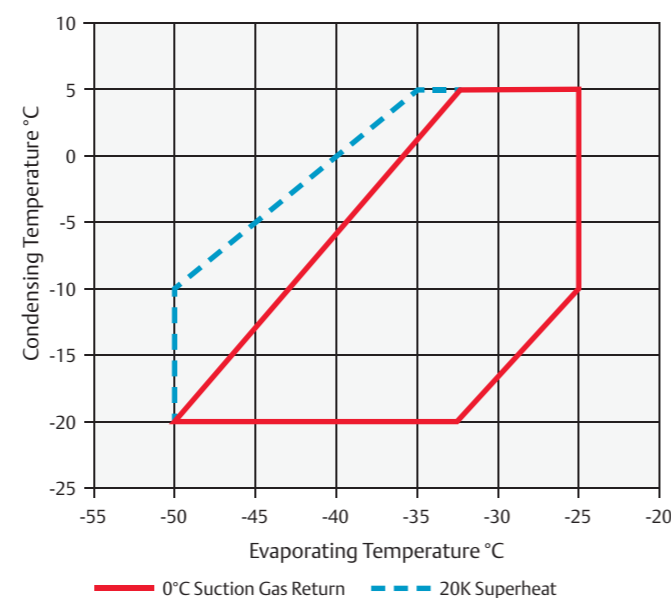

Refer to Emerson's Select 7.5 selection software for individual model operating envelopes and other refrigerants.

### Technical Overview

R744	Nominal hp	Capacity (kW)	COP	Displacement (m <sup>3</sup> /h)	Stub Suction (inch)	Stub Discharge (inch)	Oil Quantity (l)	Length/Width/Height (mm)	Net Weight (kg)	Motor Version/Code	Maximum Operating Current (A)	Locked Rotor Current (A)	Sound Pressure @ 1 m (dBA) **
										3 Ph*	3 Ph*	3 Ph*	
ZO34K3E	2.0	7.2	3.5	4.07	1 1/4	1	1.36	242/242/381	30	TFD	6	26	
ZO45K3E	2.5	10.3	3.9	5.37			1.42	242/242/403	31	TFD	6	35	
ZO58K3E	3.5	13.0	3.9	6.87			1.42	242/242/417	33	TFD	8	48	
ZO88KCE	5.0	19.5	3.9	10.11			1.89	245/249/440	40	TFD	12	64	
ZO104KCE	6.0	22.6	4.0	11.68			1.89	242/242/461	40	TFD	15	74	
ZOD104KCE	6.0	22.1	3.8	11.68			1/2	1	1.89	241/246/484	41	TFD	15

EN12900 R744 - LT: Evaporating -35°C, Condensing -5°C, Suction Superheat 10K, Subcooling 0K

\* 3 Ph: 380-420V/50Hz

\*\* @ 1m: sound pressure level at 1m distance from the compressor, free field condition

### Capacity Data

Condensing Temperature -10°C									
R744	Cooling Capacity (kW)				R744	Power Input (kW)			
	Evaporating Temperature (°C)					Evaporating Temperature (°C)			
Model	-45	-40	-35	-30	Model	-45	-40	-35	-30
ZO34K3E	4.8	6.2	7.8	9.7	ZO34K3E	1.8	1.8	1.8	1.7
ZO45K3E	7.0	8.8	10.9	13.3	ZO45K3E	2.3	2.3	2.3	2.2
ZO58K3E	8.9	11.2	13.9	17.0	ZO58K3E	3.0	3.0	2.9	2.8
ZO88KCE	13.3	17.0	21.0	25.4	ZO88KCE	4.5	4.5	4.4	4.2
ZO104KCE	15.9	19.7	24.1	29.2	ZO104KCE	4.9	5.0	5.1	5.2

Suction Superheat 10K / Subcooling 0K

### Capacity Data - Digital Model

Condensing Temperature -10°C									
R744	Cooling Capacity (kW)				R744	Power Input (kW)			
	Evaporating Temperature (°C)					Evaporating Temperature (°C)			
	-45	-40	-35	-30		-45	-40	-35	-30
ZOD104KCE	15.6	19.1	23.2	27.9	ZOD104KCE	5.0	5.0	5.1	5.3

Suction Superheat 10K / Subcooling 0K

## Sound Shell for Copeland Scroll™ Compressors

### Quiet Operation in Sound Critical Environment

Environmental noise has become a serious problem that can lead to potential contentious situations. It is particularly true for refrigeration applications where kitchen equipment or compressor packs are often source of disturbing noise in domestic areas. Emerson Climate Technologies put sound minimisation at the centre of any of its new compressor development along reliability, seasonal efficiency and size and weight reduction.

A large portion of equipment acoustic emissions come from condensers and compressors and in some critical sound sensitive applications the refrigeration installations need to be acoustically insulated. Simple solutions are now available to contain sound emissions. Emerson Climate Technologies has developed a dedicated Sound Shell for all Copeland Scroll™ compressors from 2–15 hp. It completely encapsulates the compressor, minimizing sound leaks while cooling performance remains uncompromised.

Groundbreaking design techniques and materials, derived from the automotive industry, were utilized to design the Sound Shell. The use of low pressure reaction injection moulded parts (top cap cover, terminal box cover and compressor base plate) allows a 10–12 dBA sound attenuation.

It is a significant improvement over conventional sound jackets available from other suppliers that reduce sound by 3–6 dBA depending on the application. Particular attention was also paid in the design stage to ensure ease of mounting in retrofit, service and new installation situations.

### Sound Shell for Copeland Scroll™



2-4 hp scroll

4-6 hp scroll

4-6 hp scroll  
Zf with DTC

4-6 hp  
Digital Scroll™

Summit Series  
7-15 hp scroll

Summit Series  
Digital Scroll™

### Technical Overview

	Small Scroll	Summit Scroll			Summit Digital Scroll™	
	All sizes	Small size	Medium size	Large size	Small size	Medium size
<b>Technical Data</b>						
Sound attenuation	10 - 12 dBA					
Total Weight (kg)	3.4	4.8	4.9	5.1	5.3	5.6
Mantle Thickness	25mm					
Flammability	Conforms to IEC 60335-1 §30					
<b>Material</b>						
Mantle	Green felt layer (cotton + binder 1.2 kg/m <sup>2</sup> )					
	Heavy layer (PVC 4.5 kg/m <sup>2</sup> )					
	Closure by use of Velcro fastening - High frequency welded on PVC layer					
Base Plate	PU SRIM - Low pressure reaction injection moulding technology					
Top Cap Cover	PU SRIM - Low pressure reaction injection moulding technology					
	Inside insulation green felt and aluminium film					
	High temperature insulation ring					
Terminal Box Cover	PU SRIM - Low pressure reaction injection moulding technology					



## S-Series and Scroll Booster Compressors

Compressors for the low stage in cascade or booster refrigeration systems are available as part of the semi-hermetic reciprocating compressors from 7.5 to 30 hp and as part of the scroll range from 2 to 15 hp. These provide optimized energy efficiency for refrigeration systems operating at low evaporating temperatures.



### S-Series Booster Compressor Line-up

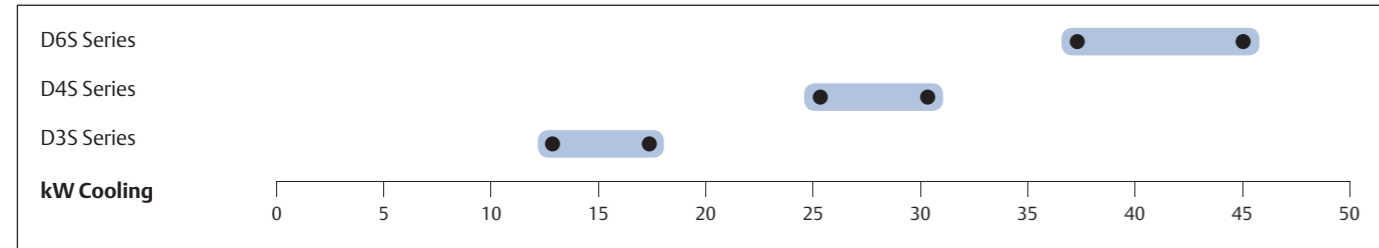

Conditions R404A: Evaporating -35°C, Condensing -10°C, Suction Gas Return 20°C, Subcooling 0K

### Scroll Booster Compressor Line-up

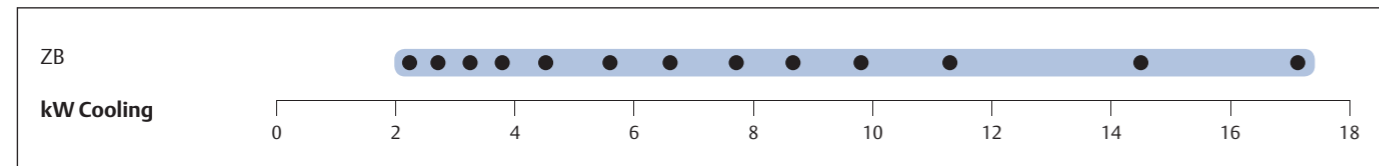

Conditions R404A: Evaporating -35°C, Condensing -10°C, Suction Gas Return 20°C, Subcooling 0K

### Features and Benefits - S-Series Booster

- Positive displacement oil pump for high oil feeding pressure ensuring good lubrication and bearing cooling
- PTFE coated bearings for especially low friction and good protection at start up
- Aluminum piston with optimized geometry for good performance and resistance to liquid handling
- High temperature resistant Molybdenum piston rings preventing wear
- Optimized bearing surface dimension
- Valve reeds of impact resistant spring steel
- Sensor for electronic Oil Pressure Switch OPS2 for durability
- Electronic motor protection module

### Features and Benefits - Scroll Booster

- PTFE coated bearings for especially low friction and good protection at start up
- Copeland Scroll™ axial and radial compliance for superior reliability and efficiency
- Light weight and compactness, more than half the weight of equivalent semi-hermetic reciprocating compressors
- Availability of optional sound shell on all model providing an additional 10dBA sound attenuation for silent operation

### Maximum Allowable Pressure (PS)

- S-Series booster:  
Low Side PS 22.5 bar(g) / High Side PS 28 bar(g)
- Scroll booster:  
Low Side PS 22.6 bar(g) / High Side PS 32 bar(g)

### Operating Envelope R404A - S-Series Booster

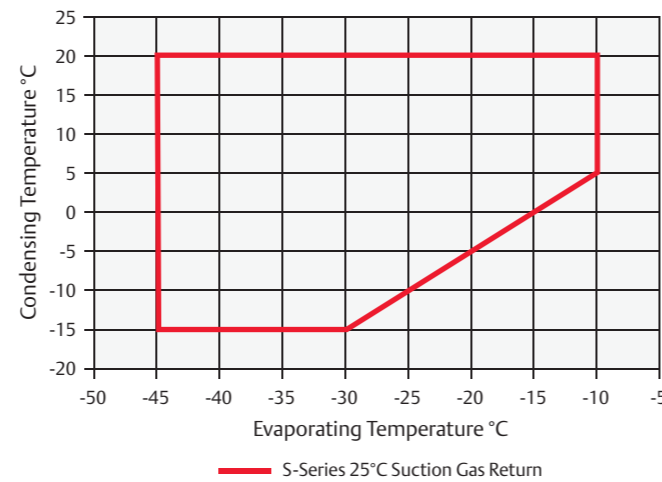

### Operating Envelope R404A - Scroll Booster

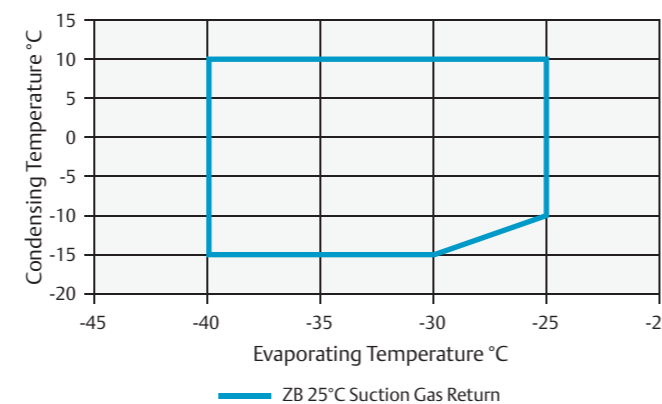

### Capacity Data - S-Series Booster

R404A		Cooling Capacity (kW)							R404A		Power Input (kW)						
		Evaporating Temperature (°C)									Evaporating Temperature (°C)						
		-45	-40	-35	-30	-25	-20	-15			-45	-40	-35	-30	-25	-20	-15
Model								Model									
D3SC-75X-B	7.6	9.9	12.9	16.5	21.0			D3SC-75X-B	2.4	2.7	3.0	3.2	3.2				
D3SS-100X-B	10.5	13.6	17.4	22.0	27.3			D3SS-100X-B	3.6	3.9	4.2	4.4	4.6				
D4SL-150X-B	15.3	20.0	25.7	32.5	40.4			D4SL-150X-B	4.9	5.3	5.6	5.8	5.9				
D4ST-200X-B	18.4	24.0	30.7	38.7	48.1			D4ST-200X-B	5.6	6.1	6.6	6.8	7.0				
D6SL-250X-B	22.4	29.2	37.4	47.2	58.7			D6SL-250X-B	6.7	7.4	8.0	8.5	8.7				
D6ST-320X-B	27.2	35.3	45.2	56.9	70.7			D6ST-320X-B	8.3	9.0	9.6	9.9	10.1				

Suction Gas Return 20°C / Subcooling 0K

### Capacity Data - Scroll Booster

R404A		Cooling Capacity (kW)							R404A		Power Input (kW)						
		Evaporating Temperature (°C)									Evaporating Temperature (°C)						
		-45	-40	-35	-30	-25	-20	-15			-45	-40	-35	-30	-25	-20	-15
Model								Model									
ZB15KCE-B		1.9	2.2	2.7	3.3			ZB15KCE-B		0.4	0.5	0.4	0.4				
ZB19KCE-B		2.1	2.6	3.3	4.2			ZB19KCE-B		0.6	0.6	0.6	0.5				
ZB21KCE-B		2.6	3.1	3.8	4.7			ZB21KCE-B		0.7	0.7	0.7	0.7				
ZB26KCE-B		2.9	3.7	4.6	5.8			ZB26KCE-B		0.8	0.8	0.8	0.8				
ZB30KCE-B		3.5	4.4	5.5	6.8			ZB30KCE-B		0.9	0.9	0.9	0.9				
ZB38KCE-B		4.3	5.5	6.9	8.6			ZB38KCE-B		1.1	1.1	1.1	1.0				
ZB45KCE-B		5.2	6.6	8.3	10.5			ZB45KCE-B		1.2	1.2	1.2	1.2				
ZB50KCE-B		6.2	7.8	9.8	12.1			ZB50KCE-B		1.4	1.3	1.4	1.4				
ZB58KCE-B		6.8	8.7	10.8	13.4			ZB58KCE-B		1.5	1.5	1.5	1.6				
ZB66KCE-B		7.7	9.8	12.3	15.3			ZB66KCE-B		1.8	1.8	1.9	1.9				
ZB76KCE-B		8.9	11.3	14.3	17.7			ZB76KCE-B		2.1	2.1	2.2	2.2				
ZB95KCE-B		11.3	14.4	18.0	22.2			ZB95KCE-B		2.5	2.5	2.5	2.6				
ZB114KCE-B		13.7	17.2	21.4	26.5			ZB114KCE-B		2.9	3.0	3.0	3.1				

Suction Gas Return 20°C / Subcooling 0K

## Semi-Hermetic Reciprocating Compressors

Emerson Climate Technologies offers different ranges of semi-hermetic reciprocating compressors with distinct levels of performance and technical characteristics depending on the application requirements:

### The S-Series:

Its design is based on traditional “reed” valve plates similar as used in reciprocating compressors offered by other manufacturers. The performance of such compressors meets basic market requirements but cannot compete with Discus® compressors in terms of efficiency. The S-Series ranges from 1.5 to 70 hp and is composed of DK, DL, D2S, D3S, D4S, D6S and D8S presented in this catalogue.



### The Discus® range:

It is broadly recognized as the most efficient compressor whatever the running condition. This range is mainly used in refrigeration medium and low temperature applications where system efficiency is a priority for the end-user. The key difference between Discus® and other reciprocating compressors lies in its valve plate design. Traditional “reed” valves are replaced by ‘puck’ type valves that are integrated in the valve plate. This special design eliminates the dead volume at the end of the compression and allows for the highest compressor efficiency.

To date no other reciprocating compressor is able to match Discus® in terms of performance. Available from 4 to 60 hp they are referred to as D2D, D3D, D4D, D6D and D8D in this catalogue.



### The Stream Series:

Emerson Climate Technologies introduces Stream, a brand new line of semi-hermetic 4 and 6 cylinder compressors. The Series provides best in class performance for today’s HFC-based and uprising natural and low GWP refrigerants, significantly reducing cost of operation and environmental impact compared to competing products.

The range is made of 4 and 6 cylinder models, available for inverter applications, and of 4 and 6 cylinder digital models for continuous capacity modulation.

The compressors can be fitted with a dedicated sound shell for sound sensitive applications.

The new Emerson Climate Technologies line-up of 4 cylinder compressors for CO<sub>2</sub>-transcritical applications is the ideal solution for R744 medium temperature cascade and booster systems. It is characterised by a design pressure of 135 bar. Refrigerant flow and heat transfer have been optimized for best performance. In combination with the CO<sub>2</sub>-subcritical scroll for the low temperature refrigeration side, Emerson Climate Technologies offers the most energy efficient package available on the market today.

With advanced protection and diagnostics features for system reliability, reduced service costs and increased equipment uptime, the Stream series is built to last in today’s modern changing world.



Stream 4 Cylinder



Stream 6 Cylinder



Stream Digital 4 Cylinder



Stream Digital 6 Cylinder



Stream for R744



Sound Shell for Stream

## Emerson CoreSense™ Diagnostics for Refrigeration

Emerson CoreSense™ Diagnostics is an innovative technology for Copeland® Stream refrigeration compressors. It goes beyond compressor protection by assisting in system diagnosis and optimization. Providing service engineers with detailed information at the right time, system related problems can be diagnosed faster or even before they occur. Supermarket operators benefit from increased system uptime, reduction in food loss and reduced maintenance costs.

### Technical Specification

- Power supply 120/240V AC, 24V AC
- Front end: 2 x LED, red/yellow, green
- Communication protocol (Modbus®RTU)
- Bus to system controller: RS 485, 3-wire, (+, -, GND)
- Discharge temperature sensor
- Current sensor and sensor module
- Flash memory
- Alarm reset button with remote reset capability
- IP 54

### Benefits

- Reduce applied system costs
- Manage on-site compressor data
- Facilitate predictive maintenance & advanced diagnostics
- Reduce maintenance costs
- Increase system uptime / reduce food loss



Emerson CoreSense™ Diagnostics for Refrigeration. Ensuring Best Performance over Full Lifetime.

### Functions

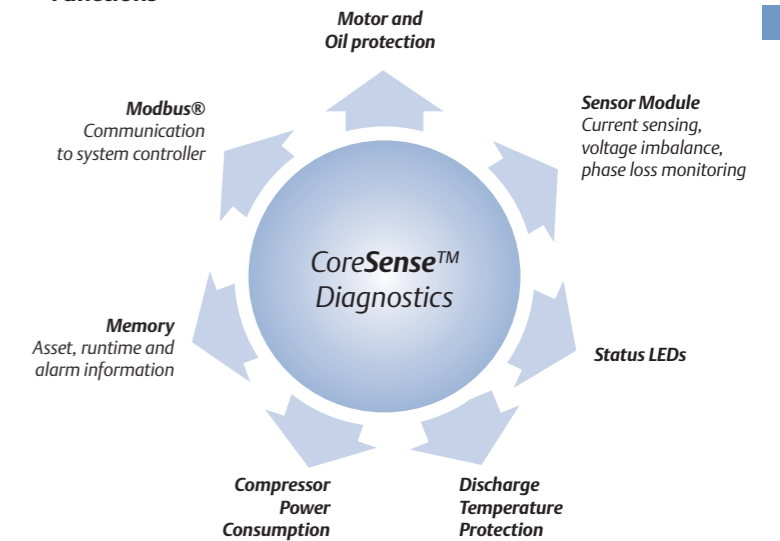

### Scope of Supply

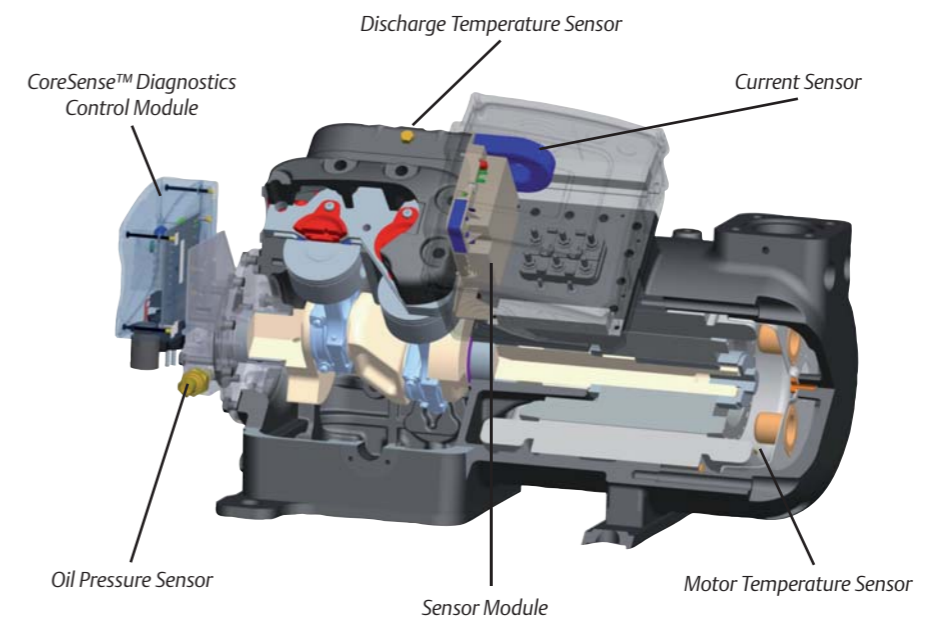

# Copeland® Stream With CoreSense™ Diagnostics, Semi-Hermetic Reciprocating Compressors For HFC

Stream series 4 and 6 cylinder compressors provide best in class performance, thereby significantly reducing cost of operation and environmental impact compared to competing products. With advanced protection and diagnostics features for system reliability, reduced service costs and increased equipment uptime, Stream series is built to last in today's modern changing world.



**Copeland® Stream compressor**  
Designed to Deliver Best-in-Class Performance

### Features and Benefits

- Range of 16 models from 62 to 153m<sup>3</sup>/h
- Best-in-class seasonal efficiencies, up to 15% higher than market standard
- Multi-refrigerant compressor as it is compatible with R404A, R134a, R407A/C and R22
- Stepless capacity modulation by means of inverter or Digital modulation (see separate data sheet)
- Wide Operating Envelope covering Low and Medium Temperature Refrigeration without cooling fan
- Reduced sound level, dimensions and weight by up to 45 kg

### CoreSense™ Diagnostics Features

- Motor and oil protection
- Storage of compressor asset and advanced runtime information
- Runtime/alarm signalling using multi-colour LED flash-codes
- Communication to system controller via Modbus®
- Individual compressor power monitoring

### Stream Line-up with R404A, Medium Temperature

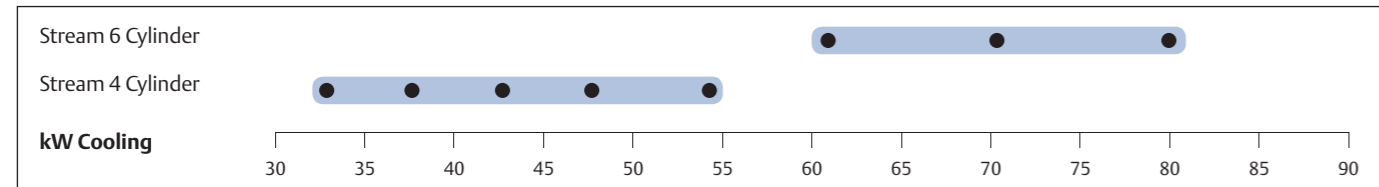

Conditions: EN12900 R404A: Evaporating -10° C, Condensing 45° C, Suction Gas Temperature 20° C, Subcooling 0K

### Stream Line-up with R404A, Low Temperature

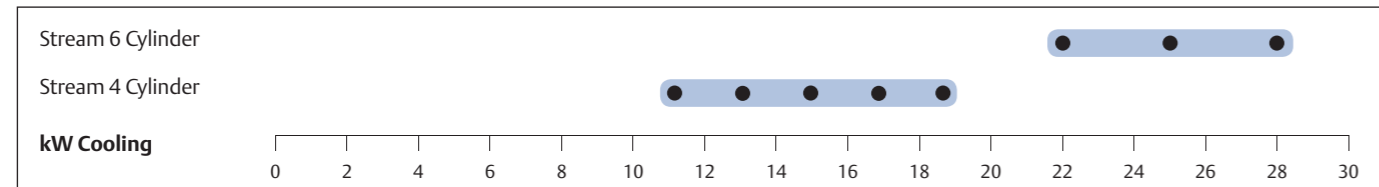

Conditions: EN12900 R404: Evaporating -35° C, Condensing 40° C, Suction Gas Temperature 20° C, Subcooling 0K

### Operating Envelope R404A

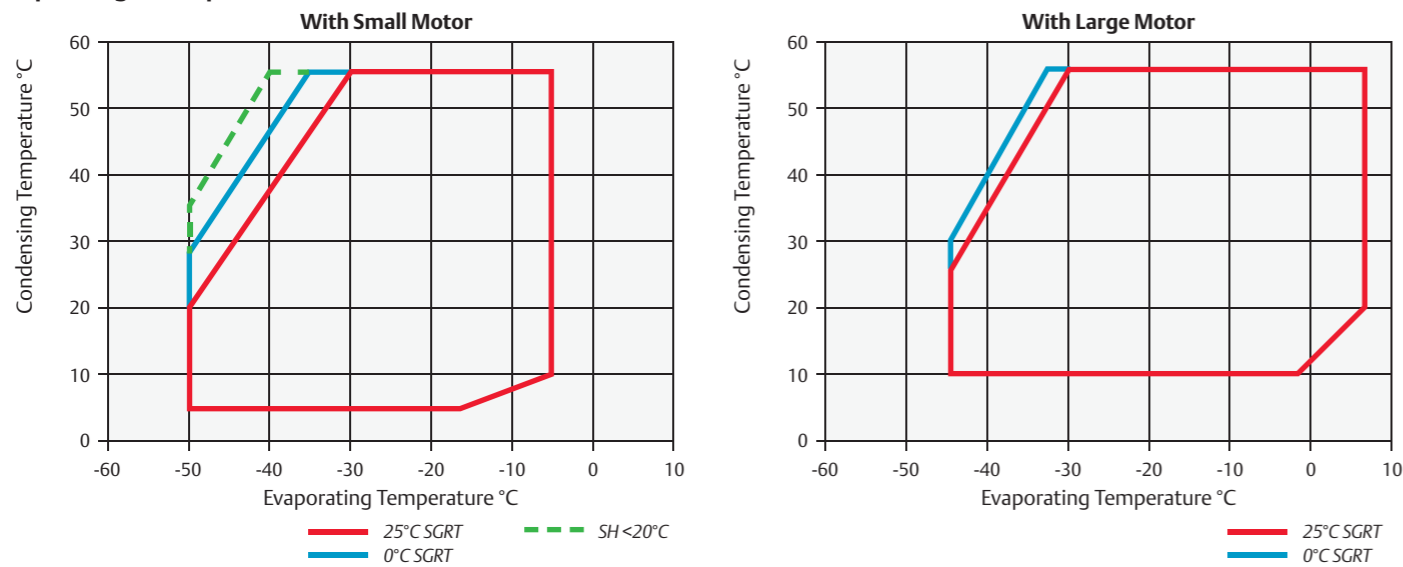

### Maximum Allowable Pressure (PS)

- Low Side PS 22.5 bar(g) / High Side PS 28 bar(g)

### Technical Overview

R404A	Nominal hp	Capacity (kW) 1)	COP 1)	Capacity (kW) 2)	COP 2)	Displacement (m <sup>3</sup> /h)	Oil Quantity (l)	Length/Width/Height (mm)	Net Weight (kg)	Motor Version / Code	Maximum Operating Current (A)	Locked Rotor Current (A)	Sound Pressure @ 1 m (dBA) **	
										3 Ph*	3 Ph*	3 Ph*	1)	2)
<b>All Preliminary Data</b>														
4MF-13X	13.0	33.4	2.4	11.4	1.4	61.7	3.30	636/503/450	177	AWM	26	105	69	73
4MA-22X	22.0	33.6	2.4	10.8	1.4	61.7	3.30	636/503/450	178	AWM	36	175	69	75
4ML-15X	15.0	38.7	2.3	13.2	1.5	71.4	3.30	636/503/450	180	AWM	35	156	70	72
4MH-25X	25.0	38.8	2.4	12.5	1.4	71.4	3.30	655/503/450	187	AWM	39	199	70	74
4MM-20X	20.0	42.6	2.3	14.7	1.5	78.0	3.30	655/503/450	182	AWM	39	175	71	73
4MI-30X	30.0	42.8	2.4	13.9	1.4	78.0	3.30	655/503/450	188	AWM	47	221	71	76
4MT-22X	22.0	47.8	2.3	16.5	1.5	87.7	3.30	655/503/450	183	AWM	45	175	72	74
4MJ-33X	33.0	48.0	2.3	16.0	1.4	87.7	3.30	655/503/450	190	AWM	53	221	72	75
4MU-25X	25.0	54.2	2.3	18.7	1.5	99.5	3.30	655/503/450	186	AWM	52	199	73	73
4MK-35X	35.0	54.4	2.3	17.7	1.4	99.5	3.30	687/503/450	202	AWM	61	255	73	75
6MM-30X	30.0	61.8	2.3	21.6	1.4	120.5	3.30	723/550/447	215	AWM	60	255	73	79
6MI-40X	40.0	64.2	2.4	20.3	1.4	120.5	3.30	723/550/447	219	AWM	71	304	73	79
6MT-35X	35.0	70.4	2.3	25.1	1.5	135.1	3.30	723/550/447	221	AWM	67	255	75	79
6MJ-45X	45.0	72.4	2.3	23.6	1.4	135.1	3.30	773/550/447	223	AWM	81	304	75	80
6MU-40X	40.0	79.8	2.2	28.4	1.4	153.2	3.30	773/550/447	225	AWM	75	306	77	81
6MK-50X	50.0	82.1	2.2	26.6	1.4	153.2	3.30	773/550/447	230	AWM	93	393	77	81

(1) MT= Conditions EN12900 : Evaporating -10°C, Condensing 45°C, Suction Gas Temperature 20°C, Subcooling 0K  
 (2) LT= Conditions EN12900 : Evaporating -35°C, Condensing 40°C, Suction Gas Temperature 20°C, Subcooling 0K  
 \* 3 Ph: 380-420V/ 50Hz  
 \*\* @ 1m: sound pressure level at 1m distance from the compressor, free field condition

### Capacity Data

R404A	Condensing Temperature 40°C							R404A	Condensing Temperature 40°C						
	Cooling Capacity (kW)								Power Input (kW)						
	Evaporating Temperature (°C)								Evaporating Temperature (°C)						
Model	-45	-35	-30	-20	-10	-5	5	Model	-45	-35	-30	-20	-10	-5	5
<b>All preliminary data</b>															
4MA-22X		10.2	14.2	24.0	37.0	45.0	64.4	4MA-22X		7.1	8.5	11.0	13.0	13.7	14.5
4MF-13X	3.5*	10.8	14.3	23.3	35.5	43.1		4MF-13X	4.8*	7.4	8.7	11.1	13.1	13.8	
4MH-25X		12.4	16.9	28.1	43.2	52.5	75.1	4MH-25X		8.7	10.3	13.1	15.4	16.3	17.4
4ML-15X	4.7*	13.3	17.4	28.0	42.4	51.2		4ML-15X	6.2*	9.1	10.5	13.2	15.6	16.6	
4MI-30X		14.3	19.3	31.5	47.5	57.3	81.1	4MI-30X		9.7	11.4	14.6	17.2	18.2	19.6
4MM-20X	5.6*	15.1	19.7	31.4	47.1	56.8		4MM-20X	7.1*	10.3	11.9	14.9	17.4	18.4	
4MJ-33X		16.1	21.6	35.3	53.3	64.3	90.9	4MJ-33X		10.9	12.8	16.3	19.2	20.4	21.9
4MT-22X	6.3*	17.0	22.1	35.2	52.9	63.8		4MT-22X	7.9*	11.5	13.3	16.6	19.5	20.6	
4MK-35X		18.1	24.3	39.6	59.8	72.2	102.0	4MK-35X		12.5	14.6	18.7	22.0	23.4	25.1
4MU-25X	7.1*	19.1	24.8	39.6	59.5	71.7		4MU-25X	9.1*	13.1	15.2	19.0	22.3	23.6	
6MI-40X		21.4	28.8	46.8	70.7	85.4	121.4	6MI-40X		14.6	17.2	21.9	25.7	27.2	29.3
6MM-30X	7.9*	22.6	29.6	46.9	69.3	82.6		6MM-30X	10.7*	15.4	17.8	22.2	26.2	28.0	
6MJ-45X		24.0	32.3	52.8	80.3	97.4	139.7	6MJ-45X		16.6	19.6	24.9	29.5	31.4	34.5
6MT-35X	8.9*	25.3	33.1	52.4	77.5	92.4		6MT-35X	11.9*	17.3	19.9	24.9	29.4	31.4	
6MK-50X		26.9	36.2	59.2	90.1	109.3	156.6	6MK-50X		19.0	22.4	28.5	33.8	36.0	39.6
6MU-40X	9.9*	28.4	37.2	58.9	87.1	103.9		6MU-40X	13.6*	19.7	22.7	28.5	33.6	35.9	

Suction Gas Return 20°C / Subcooling 0K  
 \*Suction Superheat 10K / Subcooling 0K



Capacity Data

R134a Cooling Capacity (kW)								R134a Power Input (kW)							
Evaporating Temperature (°C)								Evaporating Temperature (°C)							
Model	-30	-20	-10	-5	5	10	15	Model	-30	-20	-10	-5	5	10	15
<b>All preliminary data</b>								<b>All preliminary data</b>							
4MA-22X		12.2*	20.7*	26.2*	40.7	49.3	59.2	4MA-22X		5.6*	7.0*	7.6*	8.7	9.0	9.2
4MF-13X		12.4	20.7	26.0	39.7	48.3		4MF-13X		6.0	7.2	7.8	8.6	8.8	
4MH-25X		13.8*	23.3*	29.5*	45.7	55.3	66.4	4MH-25X		7.0*	8.7*	9.4*	10.4	10.6	10.5
4ML-15X		15.3	24.9	31.0	46.5	56.1		4ML-15X		7.0	8.7	9.4	10.5	10.9	
4MI-30X		15.4*	25.9*	32.7*	50.6	61.3	73.5	4MI-30X		7.6*	9.5*	10.5*	12.1	12.8	13.3
4MM-20X		17.1	27.7	34.5	51.6	62.3		4MM-20X		7.9	9.6	10.4	11.6	12.0	
4MJ-33X		17.3*	29.0*	36.7*	56.8	68.7	82.4	4MJ-33X		8.5*	10.7*	11.7*	13.6	14.3	14.8
4MT-22X		19.2	31.1	38.6	57.9	69.9		4MT-22X		8.8	10.8	11.7	13.0	13.4	
4MK-35X		19.4*	32.6*	41.2*	63.7	77.1	92.5	4MK-35X		9.7*	12.2*	13.4*	15.5	16.3	17.0
4MU-25X		21.5	34.9	43.4	65.0	78.5		4MU-25X		10.1	12.3	13.3	14.9	15.4	
6MI-40X		22.6*	38.3*	48.5*	75.6	91.8	110.4	6MI-40X		11.7*	14.7*	16.0*	17.9	18.5	18.6
6MM-30X		25.7	41.4	51.4	76.7	92.4		6MM-30X		11.9	14.6	15.9	18.0	18.7	
6MJ-45X		26.4*	43.5*	54.7*	84.3	101.8	122.0	6MJ-45X		12.8*	16.1*	17.7*	20.6	21.7	22.4
6MT-35X		28.8	46.4	57.6	85.9	103.4		6MT-35X		13.3	16.4	17.8	20.1	20.9	
6MK-50X		29.7*	48.8*	61.4*	94.5	114.2	136.8	6MK-50X		14.7*	18.4*	20.3*	23.6	24.8	25.5
6MU-40X		32.3	52.1	64.7	96.5	116.2		6MU-40X		15.2	18.8	20.4	23.0	23.9	

Suction Gas Return 20°C / Subcooling 0K  
 \*Suction Superheat 10K / Subcooling 0K

# Copeland® Stream Compressors with CoreSense™ Diagnostics for R744-Transcritical Applications

Stream series of 4 cylinder CO<sub>2</sub> compressors is the ideal solution for R744 medium temperature cascade and booster systems. It is characterized by a design pressure of 135 bar. Refrigerant flow and heat transfer have been optimized for best performance. All compressors are equipped with CoreSense™ technology and offer the possibility to diagnose system-related problems faster or even before they occur.



Copeland® Stream Compressors for R744 Refrigeration  
Designed for Durability and Best-in-Class  
Performance in CO<sub>2</sub>-Transcritical Applications

### Features and Benefits

- Stream provides for flexibility in pack design and operation
- Compact dimensions
  - Integrated high and low pressure relief valve
  - Discharge Temperature Protection
  - Service valve 360° rotation for ease of piping design
  - 2 sight glasses for mounting of oil management control and visual inspection
  - One additional sight glass for oil visual inspection at run time
  - One oil port for oil equalization in parallel system
  - Oil splasher system ensuring lubrication at constant and variable speed
- Designed for durability and performance in R744 applications
- Low sound, low vibration and large discharge chamber to eliminate pulsation
  - High design pressures of 135 bar (high side) and 90 bar (low side)
  - Burst pressures in excess of safety factor 3
  - Cylinder head and discharge plenum design minimizing heat transfer to suction side
  - Stepless capacity modulation via inverter from 25 to 75 Hz
  - Copeland® CoreSense™ Diagnostics
  - Individual compressor power consumption monitoring

### Stream for R744 Line-up

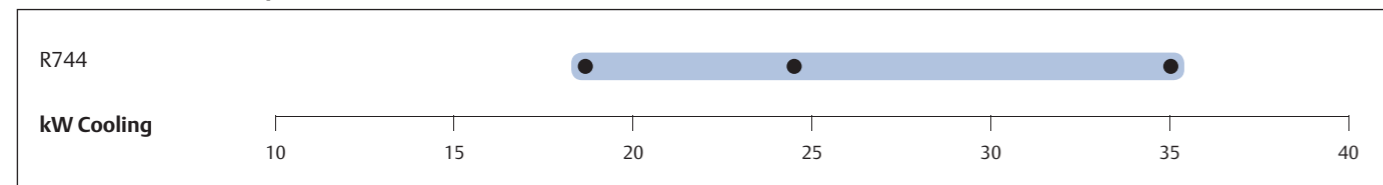

Conditions: EN12900 R744: Evaporating -10°C, Gas cooler exit: 35°C/ 90 bar, Superheat: 10K

### Operating Envelope R744

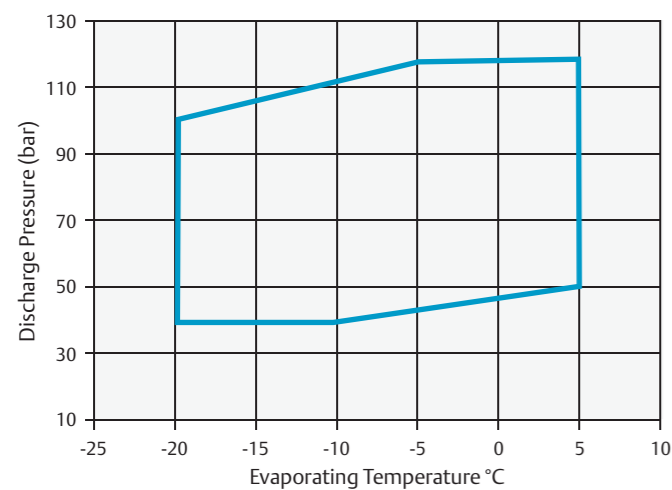

### Technical Overview

R744	Nominal hp	Capacity (kW)	COP	Displacement (m <sup>3</sup> /h)	Oil Quantity (l)	Length/Width/Height (mm)	Net Weight (kg)	Motor Version / Code	Maximum Operating Current (A)	Locked Rotor Current (A)	Sound Pressure @1 m (dBA)
								3 Ph*	3 Ph*	3 Ph*	
<b>All Preliminary Data</b>											
4MTL-10X	10.0	20.0	1.7	9.5	3.30	706/445/423	156	AWM	25	175	63
4MTL-15X	15.0	26.0	1.8	12.5	3.30	706/445/423	157	AWM	21	175	63
4MTL-30X	30.0	38.0	1.8	17.9	3.30	706/445/423	160	AWM	45	175	63

Conditions EN12900 R744: Evaporating -10°C, Gas cooler exit: 35°C/90bar, Superheat: 10K  
\* 3 Ph: 380-420V/ 50Hz  
\*\* @ 1m: sound pressure level at 1m distance from the compressor, free field condition

### Capacity Data

Model		Temperature (°C)	Pressure (bar)	Cooling capacity (kW)					Power Input (kW)					
				Evaporating Temperature (°C)					Evaporating Temperature (°C)					
				-20	-15	-10	-5	0	-20	-15	-10	-5	0	
				Equivalent evaporation pressure (bar)					Equivalent evaporation pressure (bar)					
				19.7	22.9	26.5	30.5	34.9	19.7	22.9	26.5	30.5	34.9	
4MTL-10X	Condensing	5	39.7	26.4	32.0	38.4				5.7	5.3	4.7		
		10	45.0	24.3	29.5	35.4	42.2	49.5	6.4	6.2	5.7	5.1	4.2	
		15	50.9	22.1	26.9	32.4	38.6	45.5	7.1	7.0	6.7	6.2	5.5	
		20	57.3	19.8	24.2	29.2	34.9	41.1	7.8	7.8	7.7	7.4	6.8	
		25	64.3	17.3	21.2	25.6	30.7	36.2	8.5	8.7	8.7	8.5	8.1	
	Gas Cooler	30	75.0	14.9	18.3	22.2	26.7	31.6	9.5	9.8	9.9	10.0	9.8	
		35	90.0	13.3	16.4	20.0	24.1	28.7	10.6	11.1	11.5	11.8	11.9	
		40	100.0	11.6	14.3	17.5	21.2	25.2	11.4	12.0	12.5	12.9	13.2	
		40	110.0				22.1	26.4				13.9	14.3	
														17.8
4MTL-15X	Condensing	5	39.7	34.5	41.8	50.1			7.1	6.7	6.1			
		10	45.0	31.8	38.6	46.3	55.0	64.6	8.1	7.8	7.3	6.6	5.5	
		15	50.9	29.0	35.2	42.4	50.4	59.3	9.0	8.9	8.6	8.0	7.2	
		20	57.3	26.0	31.7	38.2	45.5	53.6	9.9	9.9	9.8	9.4	8.8	
		25	64.3	22.7	27.7	33.5	40.0	47.2	10.7	11.0	11.0	10.9	10.4	
	Gas Cooler	30	75.0	19.5	23.9	29.0	34.8	41.1	11.9	12.4	12.7	12.8	12.6	
		35	90.0	17.4	21.4	26.1	31.4	37.2	13.4	14.1	14.7	15.0	15.2	
		40	100.0	15.0	18.6	22.8	27.4	32.6	14.4	15.2	15.9	16.4	16.8	
		40	110.0				28.6	34.1				17.8	18.3	
														25.6
4MTL-30X	Condensing	5	39.7	49.7	60.2	72.2			10.3	9.7	8.7			
		10	45.0	45.8	55.5	66.7	79.3	93.1	11.6	11.2	10.5	9.5	7.9	
		15	50.9	41.7	50.7	61.1	72.6	85.4	12.9	12.8	12.3	11.5	10.3	
		20	57.3	37.4	45.6	55.0	65.6	77.2	14.2	14.3	14.1	13.6	12.7	
		25	64.3	32.7	39.9	48.3	57.7	68.0	15.5	15.8	15.9	15.6	15.0	
	Gas Cooler	30	75.0	28.1	34.4	41.8	50.1	59.2	17.2	17.8	18.3	18.4	18.1	
		35	90.0	25.0	30.8	37.6	45.2	53.6	19.3	20.3	21.1	21.7	21.9	
		40	100.0	21.7	26.8	32.8	39.5	47.0	20.7	21.9	22.9	23.7	24.2	
		40	110.0				41.2	49.1				25.6	26.3	
														25.6

## Copeland® Stream Digital with CoreSense™ Diagnostics for Continuous Capacity Modulation

Stream Digital series 4 and 6 cylinder compressors provide an alternative means of continuous modulation to inverter. Digital modulation is the most simple and precise method of capacity control and helps to contain applied costs associated with modulation.

Digital technology is based on controlling a high cycle solenoid valve fitted on one of the cylinder heads based on cycle time.

The valve actuates a piston that controls the flow of gas into the suction area of the Stream valve plate.

The compressor always runs at constant speed which resolves the challenges related to oil return, mechanical and electrical stress on the system.

All compressors are equipped with CoreSense™ technology and offer the possibility to diagnose system related problems faster or even before they occur.



Copeland® Stream Digital compressor

### Features and Benefits

- Range of 16 Models from 62 to 153 m<sup>3</sup>/h
- Multi-refrigerant compressor as it is compatible with R404A, R134a, R407A/C and R22
- Continuous modulation from 50–100% (4-cylinder) and 33–100% (6-cylinder) ensuring a perfect match of capacity and power to refrigeration load
- Economical and reliable alternative to frequency inverters
- Precise suction pressure control with associated energy savings and stable evaporating temperatures
- Quick and easy integration into refrigeration equipment, similar to any other standard compressor

- Possibility to easily retrofit existing installations with digital cylinder head kit
- No vibrations or mechanical stress on system piping and compressor parts
- Reduced compressor cycling for longer contactor and compressor life
- Emerson CoreSense™ Diagnostics technology providing advanced protection, diagnostics and preventive maintenance

### Stream Digital Line-up with R404A, Medium Temperature

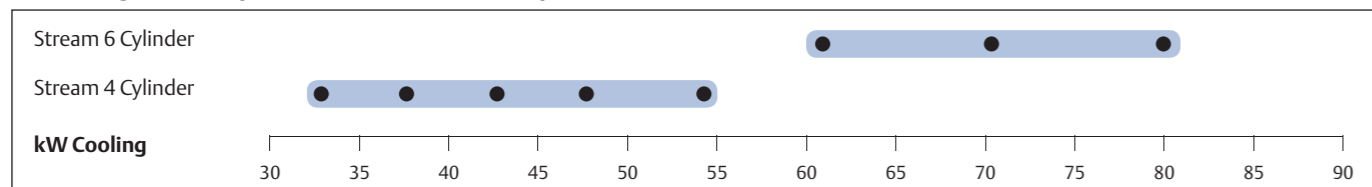

Conditions: EN12900 R404A: Evaporating -10° C, Condensing 45° C, Suction Gas Temperature 20° C, Subcooling 0K

### Stream Digital Line-up with R404A, Low Temperature

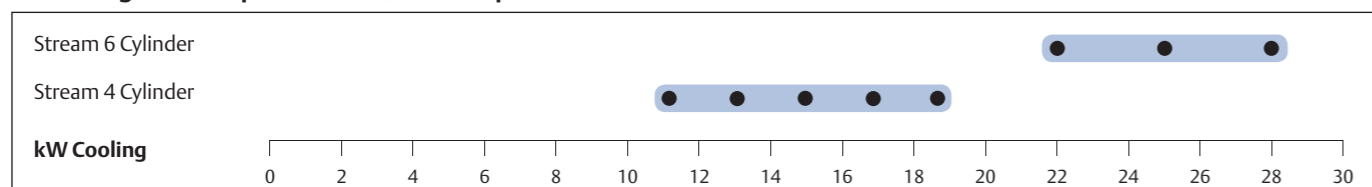

Conditions: EN12900 R404: Evaporating -35° C, Condensing 40° C, Suction Gas Temperature 20° C, Subcooling 0K

### Operating envelope R404A- full load -100% modulation

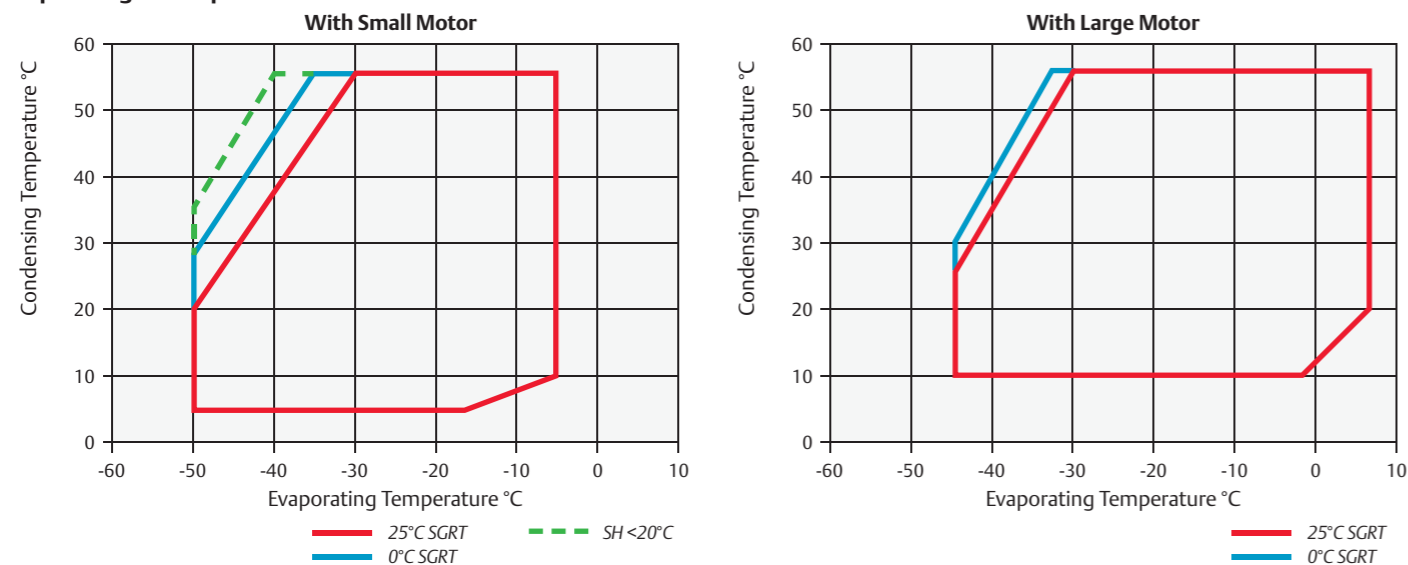

### Technical Overview

R404A	Nominal hp	Capacity (kW) 1)	COP 1)	Capacity (kW) 2)	COP 2)	Displacement (m <sup>3</sup> /h)	Oil Quantity (l)	Length/Width/Height (mm)	Net Weight (kg)	Motor Version / Code	Maximum Operating Current (A)	Locked Rotor Current (A)	Sound Pressure @1 m (dBA) **	
										3 Ph*	3 Ph*	3 Ph*	1)	2)
<b>All Preliminary Data</b>														
4MFD-13X	13.0	33.4	2.4	11.4	1.4	61.7	3.30	636/503/450	177	AWM	26	105	69	73
4MAD-22X	22.0	33.6	2.4	10.8	1.4	61.7	3.30	636/503/450	178	AWM	36	175	69	75
4MLD-15X	15.0	38.7	2.3	13.2	1.5	71.4	3.30	636/503/450	180	AWM	35	156	70	72
4MHD-25X	25.0	38.8	2.4	12.5	1.4	71.4	3.30	655/503/450	187	AWM	39	199	70	74
4MMD-20X	20.0	42.6	2.3	14.7	1.5	78.0	3.30	655/503/450	182	AWM	39	175	71	73
4MID-30X	30.0	42.8	2.4	13.9	1.4	78.0	3.30	655/503/450	188	AWM	47	221	71	76
4MTD-22X	22.0	47.8	2.3	16.5	1.5	87.7	3.30	655/503/450	183	AWM	45	175	72	74
4MJD-33X	33.0	48.0	2.3	16.0	1.4	87.7	3.30	655/503/450	190	AWM	53	221	72	75
4MUD-25X	25.0	54.2	2.3	18.7	1.5	99.5	3.30	655/503/450	186	AWM	52	199	73	73
4MKD-35X	35.0	54.4	2.3	17.7	1.4	99.5	3.30	687/503/450	202	AWM	61	255	73	75
6MMD-30X	30.0	61.8	2.3	21.6	1.4	120.5	3.30	723/550/447	215	AWM	60	255	73	79
6MID-40X	40.0	64.2	2.4	20.3	1.4	120.5	3.30	723/550/447	219	AWM	71	304	73	79
6MTD-35X	35.0	70.4	2.3	25.1	1.5	135.1	3.30	723/550/447	221	AWM	67	255	75	79
6MJD-45X	45.0	72.4	2.3	23.6	1.4	135.1	3.30	773/550/447	223	AWM	81	304	75	80
6MUD-40X	40.0	79.8	2.2	28.4	1.4	153.2	3.30	773/550/447	225	AWM	75	306	77	81
6MKD-50X	50.0	82.1	2.2	26.6	1.4	153.2	3.30	773/550/447	230	AWM	93	393	77	81

(1) MT= Conditions EN12900 : Evaporating -10°C, Condensing 45°C, Suction Gas Temperature 20°C, Subcooling 0K

(2) LT= Conditions EN12900 : Evaporating -35°C, Condensing 40°C, Suction Gas Temperature 20°C, Subcooling 0K

\* 3 Ph: 380-420V/ 50Hz

\*\* @ 1m: sound pressure level at 1m distance from the compressor, free field condition



## Discus® Reciprocating Compressor Range

From 2 to 8 cylinder semi-hermetic reciprocating compressors for medium / low temperature refrigeration applications.

The key difference between Discus® and traditional reciprocating technologies lies in the valve plate design. The Discus® valve plate allows gas to flow into the cylinders with a minimum heat gain, while suction cavities are designed to smoothly route the gas to minimize losses. These effects lead to:

- Superior cooling capacity due to no re-expansion volume
- Up to 10% higher efficiency compared to conventional “cost-effective” reed type compressors
- Lower operating costs for the end-user

The Discus® ranges from 5 to 70 hp and provide cooling capacities from 8 to 96 kW in medium temperature (R404A, -10/45°C) and 2 to 35 kW in low temperature (R404A, -35/40°C). These compressors are qualified for R404A, R507, R134a and R22. All Discus® compressors are designed to deliver maximum performance and reliability:

- Discus® “puck” valve integrated into the valve plate for highest performance whatever the operating condition
- Positive displacement high flow oil pump guarantees high oil feeding pressure for good lubrication and bearings’ cooling



Discus® compressor

- PTFE coated bearings for especially low friction and good protection at start up
- Electronic motor protection module
- Availability of two motor sizes per displacement. The small motor covers all refrigeration applications while the large motor can be used in comfort or inverter applications

### Discus® Compressor Line-up

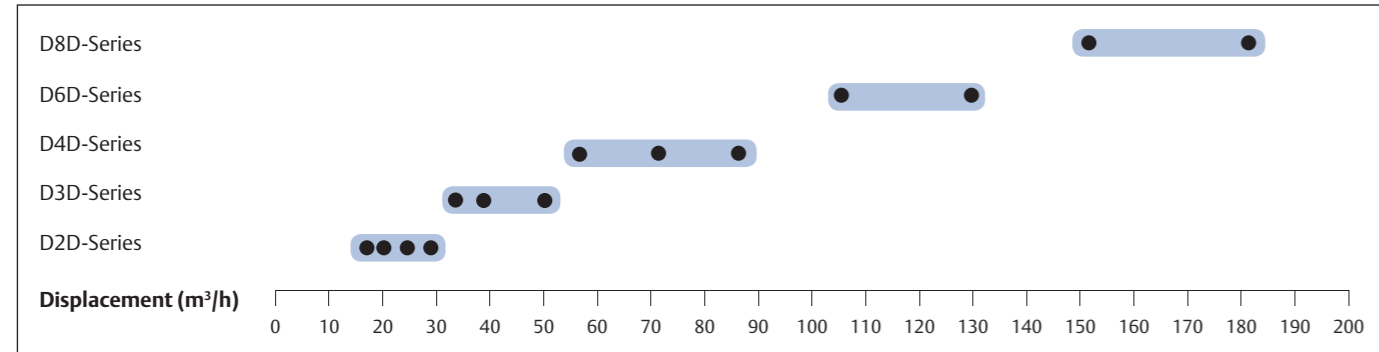

Conditions: EN12900, R404A: Evaporating -10°C, Condensing 40°C, Suction Gas Temperature 20°C, Subcooling 0K

### Features and Benefits

- Highest level of efficiency available on the market, whatever the refrigerant and operating condition
- Integrated oil pump and Electronic Oil Pressure Switch OPS2 for maximum reliability
- Two motor sizes per displacement, optimized for different applications
- Large operating envelope that allows medium and low temperature applications to be covered by one single model with condensing limit as low as 5°C
- Provide cooling capacity modulation either by cylinder head blocked suction or with use of frequency inverters from 25 to 60Hz
- Multi-refrigerant compressor range – one model to cover all standard refrigerants

### Maximum Allowable Pressure (PS)

- Low Side PS 22.5 bar (g)/ High Side PS 28 bar (g)

Refer to Emerson's Select 7.5 selection software for individual model operating envelopes and other refrigerants.

### Operating Envelope R404A

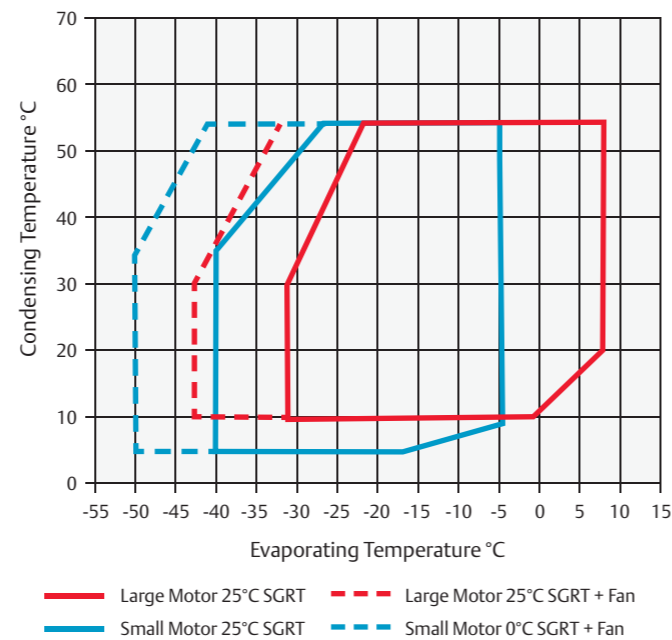

### Technical Overview

R404A	Nominal hp	Capacity (kW 1)	COP 1	Capacity (kW 2)	COP 2	Displacement (m³/h)	Oil Quantity (l)	Length/Width/Height (mm)	Net Weight (kg)	Motor Version / Code	Maximum Operating Current (A)	Locked Rotor Current (A)	Sound Pressure @ 1 m (dBa) **
										3 Ph*	3 Ph*	3 Ph*	
D2DC-50X	5.0	7.9	2.3	2.1	1.2	16.8	2.30	590/330/470	132	AWM	9	55	65
D2DD-50X	5.0	9.7	2.4	2.8	1.3	19.3	2.30	590/330/470	132	AWM	10	55	65
D2DL-40X	4.0	12.0	2.3	3.8	1.4	23.7	2.30	590/330/470	131	AWM	11	55	64
D2DL-75X	7.5	12.2	2.4	3.6	1.3	23.7	2.30	590/330/470	136	AWM	14	70	66
D2DB-50X	5.0	14.6	2.3	4.6	1.4	28.0	2.30	590/330/470	131	AWM	13	55	64
D2DB-75X	7.5	14.9	2.4	5.0	1.5	28.0	2.30	590/330/470	136	AWM	16	70	66
D3DA-50X	5.0	16.3	2.2	5.7	1.4	32.2	3.70	655/370/480	146	AWM	16	55	69
D3DA-75X	7.5	17.2	2.4	5.2	1.3	32.2	3.70	680/370/480	152	AWM	18	106	70
D3DC-100X	10.0	20.6	2.5	6.5	1.4	38.0	3.70	680/370/480	164	AWM	21	121	70
D3DC-75X	7.5	19.8	2.3	7.0	1.4	38.0	3.70	655/370/480	150	AWM	18	70	71
D3DS-100X	10.0	27.1	2.3	9.6	1.5	49.9	3.70	680/370/480	162	AWM	24	121	71
D3DS-150X	15.0	27.5	2.3	9.1	1.4	49.9	3.70	710/370/490	166	AWM	29	129	71
D4DF-100X	10.0	29.1	2.3	9.7	1.4	56.0	3.30	680/535/605	179	AWM	27	105	76
D4DA-200X	20.0	30.2	2.4	9.2	1.4	56.0	3.30	650/535/495	196	AWM	33	175	72
D4DH-250X	25.0	38.6	2.4	12.2	1.4	70.8	3.30	670/535/495	209	AWM	42	199	72
D4DL-150X	15.0	38.4	2.3	13.1	1.4	70.8	3.30	680/535/605	205	AWM	35	156	77
D4DT-220X	22.0	46.5	2.3	16.2	1.5	84.7	3.30	700/535/795	215	AWM	43	175	78
D4DJ-300X	30.0	46.6	2.3	15.4	1.4	84.7	3.30	690/535/495	214	AWM	53	221	74
D6DH-350X	35.0	56.6	2.3	18.7	1.4	160.0	3.30	760/580/490	246	AWM	64	304	76
D6DL-270X	27.0	54.4	2.2	19.0	1.4	106.0	3.30	740/580/490	242	AWM	54	199	80
D6DJ-400X	40.0	68.1	2.3	22.3	1.4	127.0	6.80	760/580/545	261	AWM	83	304	76
D6DT-320X	30.0	66.2	2.2	23.6	1.4	127.0	6.80	740/580/700	261	AWM	62	255	81
D8DH-500X	50.0	81.7	2.4	26.3	1.4	151.0	7.60	835/475/610	330	AWM	88	458	79
D8DL-370X	37.0	81.4	2.3	28.0	1.4	151.0	7.60	835/475/610	323	AWM	74	349	77
D8DJ-600X	60.0	98.0	2.3	32.7	1.4	181.0	7.60	835/475/610	331	AWM	108	476	80
D8DT-450X	45.0	96.0	2.3	34.7	1.5	181.0	7.60	835/475/610	335	AWM	91	441	78

(1) MT= Conditions EN12900 : Evaporating -10°C, Condensing 45°C, Suction Gas Temperature 20°C, Subcooling 0K

(2) LT= Conditions EN12900 : Evaporating -35°C, Condensing 40°C, Suction Gas Temperature 20°C, Subcooling 0K

\* 3 Ph: 380-420V/ 50Hz

\*\* @ 1m: sound pressure level at 1m distance from the compressor, free field condition

Capacity Data

Condensing Temperature 40°C															
R404A	Cooling Capacity (kW)							R404A	Power Input (kW)						
	Evaporating Temperature (°C)								Evaporating Temperature (°C)						
	Model	-45	-35	-30	-20	-10	-5		5	Model	-45	-35	-30	-20	-10
D2DC-50X		2.1	3.0	5.4	8.8	11.0	16.5	D2DC-50X		1.7	2.1	2.7	3.3	3.6	3.8
D2DD-50X		2.8	3.9	6.8	10.8	13.2	19.3	D2DD-50X		2.2	2.5	3.3	3.9	4.1	4.3
D2DL-40X	1.2*	3.8	5.1	8.5	13.2	16.2		D2DL-40X	1.8*	2.7	3.2	4.1	4.9	5.3	
D2DL-75X		3.6	4.9	8.4	13.4	16.5	24.1	D2DL-75X		2.7	3.1	4.0	4.8	5.1	5.5
D2DB-50X	1.7*	4.6	6.2	10.4	16.0	19.4		D2DB-50X	2.2*	3.2	3.8	4.9	5.9	6.3	
D2DB-75X		5.0	6.6	10.7	16.4	20.0	28.8	D2DB-75X		3.4	3.9	5.0	5.9	6.3	6.9
D3DA-50X	2.0*	5.7	7.4	11.9	17.9	21.7		D3DA-50X	2.7*	4.0	4.7	5.9	6.9	7.3	
D3DA-75X		5.2	7.2	12.2	18.9	23.1	33.4	D3DA-75X		3.9	4.6	5.9	6.9	7.3	7.6
D3DC-100X		6.5	8.9	14.7	22.7	27.6	39.7	D3DC-100X		4.5	5.3	6.8	7.9	8.4	8.7
D3DC-75X	2.8*	7.0	9.1	14.4	21.6	26.1		D3DC-75X	3.4*	4.9	5.6	7.0	8.2	8.7	
D3DS-100X	4.0*	9.6	12.5	19.8	29.5	35.5		D3DS-100X	4.7*	6.5	7.5	9.4	11.1	11.7	
D3DS-150X		9.1	12.2	19.9	30.2	36.5	51.9	D3DS-150X		6.3	7.4	9.4	11.1	11.6	12.0
D4DF-100X	3.5*	9.7	12.8	20.9	32.0	38.7		D4DF-100X	4.4*	6.8	8.0	10.2	12.0	12.7	
D4DA-200X		9.2	12.8	21.6	33.2	40.4	57.9	D4DA-200X		6.5	7.8	10.1	11.9	12.6	13.3
D4DH-250X		12.2	16.6	27.6	42.4	51.6	73.9	D4DH-250X		8.8	10.3	13.1	15.4	16.3	17.5
D4DL-150X	5.1*	13.1	17.2	27.6	41.7	50.5		D4DL-150X	6.2*	9.1	10.5	13.3	15.6	16.6	
D4DT-220X	6.6*	16.3	21.2	33.7	50.7	61.1		D4DT-220X	7.7*	11.2	13.0	16.2	19.0	20.1	
D4DJ-300X		15.4	20.7	33.8	51.0	61.5	86.9	D4DJ-300X		10.6	12.5	15.9	18.8	19.9	21.4
D6DL-270X	7.5*	19.1	24.8	39.7	59.8	72.1		D6DL-270X	9.2*	13.6	15.7	19.8	23.4	24.9	
D6DH-350X		18.8	25.2	41.0	61.9	74.7	106.0	D6DH-350X		13.0	15.3	19.5	22.9	24.2	26.1
D6DJ-400X		22.3	30.0	49.1	74.8	90.7	130.0	D6DJ-400X		15.8	18.6	23.7	28.0	29.9	32.8
D6DT-320X	9.0*	23.6	30.9	48.9	72.3	86.2		D6DT-320X	11.3*	16.4	18.9	23.6	27.9	29.8	
D8DH-500X		26.3	35.7	58.8	89.3	108.0	153.5	D8DH-500X		19.1	22.1	27.9	32.8	34.7	37.3
D8DL-370X	10.8*	28.0	36.9	59.3	88.8	106.5		D8DL-370X	13.2*	19.5	22.4	27.9	32.7	34.7	
D8DJ-600X		32.7	44.0	71.3	107.0	128.5	181.0	D8DJ-600X		23.0	26.8	33.7	39.5	41.9	45.5
D8DT-450X	14.2*	34.7	44.9	70.6	105.0	125.5		D8DT-450X	16.9*	23.7	27.2	34.0	40.2	42.8	

Suction Gas Return 20°C / Subcooling 0K  
 \*Suction Superheat 10K / Subcooling 0K  
 High Discharge Temp - Additional cooling required

Capacity Data

Condensing Temperature 40°C															
R134a	Cooling Capacity (kW)							R134a	Power Input (kW)						
	Evaporating Temperature (°C)								Evaporating Temperature (°C)						
	Model	-30	-20	-10	-5	5	10		15	Model	-30	-20	-10	-5	5
D2DC-50X		2.4*	4.7*	6.3*	10.3	12.7	15.4	D2DC-50X		1.6*	2.0*	2.1*	2.3	2.3	2.3
D2DD-50X		3.1*	5.8*	7.6*	12.2	15.0	18.1	D2DD-50X		1.9*	2.3*	2.5*	2.7	2.7	2.6
D2DL-40X		4.0	7.2	9.2	14.4	17.6		D2DL-40X		2.3	2.8	3.1	3.4	3.5	
D2DL-75X		3.6*	6.8*	8.9*	14.3	17.5	21.2	D2DL-75X		2.1*	2.7*	3.0*	3.3	3.4	3.4
D2DB-50X		5.2	9.1	11.6	17.9	21.8		D2DB-50X		2.6	3.3	3.6	4.0	4.1	
D2DB-75X		4.5*	8.2*	10.6*	17.0	20.7	25.0	D2DB-75X		2.6*	3.3*	3.5*	3.9	4.0	4.0
D3DA-50X		6.0	10.2	12.9	19.8	24.1		D3DA-50X		3.0	3.7	4.0	4.4	4.5	
D3DA-75X		5.1*	9.6*	12.5*	20.1	24.5	29.7	D3DA-75X		3.1*	3.8*	4.1*	4.5	4.6	4.5
D3DC-100X		6.8*	12.0*	15.3*	24.2	29.5	35.6	D3DC-100X		3.7*	4.5*	4.8*	5.2	5.2	5.2
D3DC-75X		7.4	12.5	15.7	23.9	29.0		D3DC-75X		3.6	4.5	4.8	5.3	5.4	
D3DS-100X		9.7	16.2	20.4	31.0	37.5		D3DS-100X		4.7	5.9	6.4	7.2	7.4	
D3DS-150X		9.7*	16.3*	20.6*	31.7	38.3	45.8	D3DS-150X		5.0*	6.2*	6.6*	7.3	7.4	7.3
D4DF-100X		11.2	18.6	23.4	35.7	43.4		D4DF-100X		5.5	6.6	7.1	7.9	8.1	
D4DA-200X		11.0*	18.6*	23.6*	36.6	44.3	53.2	D4DA-200X		5.1*	6.4*	7.0*	7.9	8.2	8.4
D4DH-250X		13.5*	22.9*	29*	44.9	54.4	65.2	D4DH-250X		7.0*	8.7*	9.4*	10.4	10.6	10.6
D4DL-150X		15.0	24.5	30.5	45.7	55.2		D4DL-150X		7.0	8.7	9.4	10.5	10.9	
D4DJ-300X		16.5*	27.8*	35.1*	54.3	65.7	78.9	D4DJ-300X		8.3*	10.4*	11.4*	13.2	14.0	14.5
D4DT-220X		18.4	29.7	37.0	55.4	66.9		D4DT-220X		8.6	10.5	11.4	12.7	13.1	
D6DH-350X		19.8*	33.5*	42.5*	66.2	80.3	96.6	D6DH-350X		10.4*	13.1*	14.3*	16.0	16.5	16.6
D6DL-270X		21.4	35.7	44.9	68.1	82.5		D6DL-270X		10.1	12.5	13.6	15.4	15.9	
D6DJ-400X		24.6*	40.5*	50.9*	78.5	94.7	113.5	D6DJ-400X		12.2*	15.3*	16.9*	19.6	20.6	21.2
D6DT-320X		26.8	43.2	53.7	80.1	96.5		D6DT-320X		12.7	15.6	16.9	19.1	19.9	
D8DH-500X		28.6*	47.9*	60.9*	95.6	116.5	140.5	D8DH-500X		15.5*	18.8*	20.2*	22.2	22.7	22.9
D8DL-370X		31.4	51.6	64.5	97.3	117.5		D8DL-370X		15.1	18.5	19.9	22.2	22.8	
D8DJ-600X		34.4*	57.5*	72.9*	114.0	138.0	166.5	D8DJ-600X		18.1*	22.2*	24.0*	26.8	27.7	28.2
D8DT-450X		38.7	62.1	77.1	115.0	139.0		D8DT-450X		18.4	22.5	24.4	27.5	28.5	

Suction Gas Return 20°C / Subcooling 0K  
 \*Suction Superheat 10K / Subcooling 0K

Condensing Temperature 40°C															
R407C	Cooling Capacity (kW)							R407C	Power Input (kW)						
	Evaporating Temperature (°C)								Evaporating Temperature (°C)						
	Model	-30	-20	-10	-5	5	10		15	Model	-30	-20	-10	-5	5
D2DC-50X		4.1	7.4	9.6	15.1	18.5		D2DC-50X		2.1	2.7	2.9	3.3	3.3	
D2DD-50X		4.9	8.7	11.2	17.4	21.3		D2DD-50X		2.5	3.1	3.4	3.8	3.9	
D2DL-75X		6.3	10.9	13.9	21.5	26.2		D2DL-75X		3.1	3.9	4.2	4.8	4.9	
D2DB-75X		8.3	13.5	16.9	25.4	30.7		D2DB-75X		3.9	4.7	5.1	5.7	5.8	
D3DA-75X		9.2	15.4	19.5	29.9	36.3		D3DA-75X		4.5	5.5	5.9	6.4	6.5	
D3DC-100X		11.3	18.5	23.2	35.3	42.7		D3DC-100X		5.3	6.4	6.9	7.6	7.7	
D3DS-150X		15.8	24.8	30.8	46.0	55.4		D3DS-150X		7.4	8.8	9.4	10.3	10.5	
D4DA-200X		17.2	28.0	34.9	52.3	63.1		D4DA-200X		7.7	9.4	10.3	11.4	11.7	
D4DH-250X		22.7	35.7	44.5	66.3	79.2		D4DH-250X		10.9	12.6	13.5	15.0	15.5	
D4DJ-300X		26.5	41.2	50.8	74.8	89.6		D4DJ-300X		12.9	15.7	17.0	19.2	20.0	
D6DH-350X		33.6	53.1	66.0	98.4	118.0		D6DH-350X		15.6	19.0	20.5	22.8	23.3	
D6DJ-400X		38.9	61.8	77.0	115.5	138.5		D6DJ-400X		18.5	22.8	24.9	28.1	29.1	
D8DH-500X		40.0*	70.6	88.9	135.0	163.5		D8DH-500X		22.0*	26.6	28.7	31.8	32.5	
D8DJ-600X		47.9*	84.6	106.5	162.0	195.5		D8DJ-600X		25.9*	31.8	34.6	39.2	40.6	

Suction Gas Return 20°C / Subcooling 0K  
 \*Suction Superheat 10K / Subcooling 0K

Capacity Data

Condensing Temperature 40°C							
R22	Cooling Capacity (kW)						
	Evaporating Temperature (°C)						
Model	-45	-35	-30	-20	-10	-5	5
D2DC-50X				4.9	8.4	10.6	15.9
D2DD-50X				5.8	9.8	12.3	18.4
D2DL-400 DC	1.4	3.1	4.3	7.4	11.7		
D2DL-75X				7.4	12.2	15.2	22.7
D2DB-500 DC	1.9	4.0	5.4	9.1	14.2		
D2DB-75X				9.5	15.0	18.4	26.7
D3DA-500 DC	2.1	4.5	6.0	10.1			
D3DA-75X				10.7	17.3	21.4	31.6
D3DC-750 DC	2.7	5.4	7.3	12.5			
D3DC-100X				12.9	20.6	25.4	37.2
D3DS-1000 DC	3.4	7.5	10.2	17.2			
D3DS-150X				17.7	27.4	33.4	48.3
D4DF-1000 DC	3.8	7.8	10.5	17.4			
D4DA-200X				20.1	31.3	38.2	55.5
D4DL-1500 DC	6.0	11.6	15.2	23.6			
D4DH-250X				25.7	39.5	48.1	69.3
D4DT-2200 DC	7.6	13.9	17.9	28.2			
D4DJ-300X				30.7	46.4	56.2	80.4
D6DH-350X				38.4	59.0	71.9	103.5
D6DL-2700 DC	7.5	15.0	19.9	32.1			
D6DT-3200 DC	9.7	18.7	24.4	37.8			
D6DJ-400X				44.6	69.0	84.3	122.0
D8DH-500X				48.4*	79.3	97.6	143.0
D8DJ-600X				58.0*	95.1	117.0	171.5

Condensing Temperature 40°C							
R22	Power Input (kW)						
	Evaporating Temperature (°C)						
Model	-45	-35	-30	-20	-10	-5	5
D2DC-50X				2.4	2.9	3.1	3.4
D2DD-50X				2.8	3.4	3.6	3.9
D2DL-400 DC	1.7	2.5	2.9	3.7	4.4		
D2DL-75X				3.5	4.2	4.5	4.9
D2DB-500 DC	2.3	3.2	3.6	4.5	5.2		
D2DB-75X				4.3	5.1	5.4	5.8
D3DA-500 DC	2.2	3.4	4.0	5.0			
D3DA-75X				5.0	5.9	6.3	6.6
D3DC-750 DC	2.8	4.0	4.7	6.1			
D3DC-100X				5.9	7.0	7.4	7.8
D3DS-1000 DC	3.9	5.7	6.6	8.4			
D3DS-150X				8.1	9.4	10.0	10.6
D4DF-1000 DC	3.7	5.8	6.8	8.8			
D4DA-200X				8.7	10.4	11.0	11.9
D4DL-1500 DC	5.9	8.5	9.8	12.2			
D4DH-250X				11.5	13.6	14.4	15.6
D4DT-2200 DC	7.2	10.0	11.5	14.3			
D4DJ-300X				13.9	16.5	17.7	19.5
D6DH-350X				17.5	20.5	21.8	23.6
D6DL-2700 DC	8.0	11.8	13.7	17.0			
D6DT-3200 DC	10.0	14.4	16.6	20.1			
D6DJ-400X				20.8	24.9	26.7	29.3
D8DH-500X				24.6*	28.9	30.7	33.1
D8DJ-600X				29.2*	34.8	37.3	41.0

Suction Gas Return 20°C / Subcooling 0K  
 \*Suction Superheat 10K / Subcooling 0K  
 High Discharge Temp - Additional cooling required



## S-Series Reciprocating Compressor Range

From 2 to 8 cylinder semi-hermetic reciprocating compressors for medium / low temperature refrigeration and comfort applications.

The S-series ranges from 5 to 70 hp and provide cooling capacities from 11 to 90 kW in medium temperature (R404A, -10/45°C) and 4 to 29 kW in low temperature (R404A, -35/40°C). These compressors are qualified for R404A, R507, R134a, R22 and R407C (some models).

The S-series comprises the 2S, 3S, 4S, 6S and 8S models. It is suction gas cooled and uses reed valve technology, found on all reciprocating compressors except Discus® and Stream. It is suited for numerous single or multi-compressor applications such as condensing units or compact compressor packs for medium to large supermarkets.



S-Series Compressor

All compressors are designed for unquestionable reliability.

- Positive displacement high flow oil pump guarantees high oil feeding pressure for good lubrication and bearings' cooling
- PTFE coated bearings for especially low friction and good protection at start up
- Aluminium piston with optimized geometry for good performance and resistance to liquid handling
- High temperature resistant Molybdenum piston rings preventing from wear
- Optimized bearing surface dimensions
- Valve reeds of impact resistant spring steel
- Pre-set internal pressure relief valve between suction and discharge that opens if the maximum differential pressure is exceeded
- Electronic motor protection module

### S Series compressor Line-up

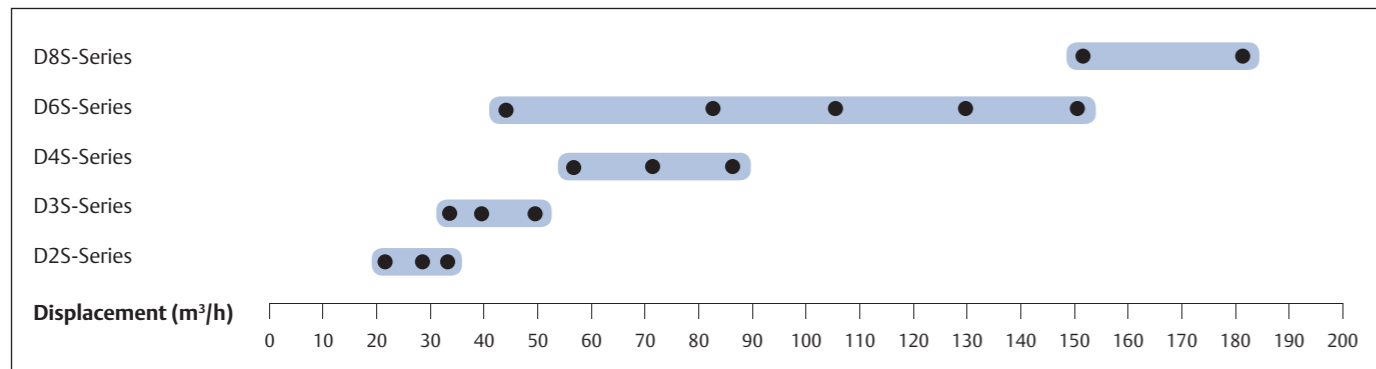

Conditions: EN12900, R404A: Evaporating -10°C, Condensing 40°C, Suction Gas Temperature 20°C, Subcooling 0K

### Features and Benefits

- Integrated oil pump and Electronic Oil Pressure Switch OPS2 for durability
- Two motor sizes per displacement, optimized for different applications
- Ability of the refrigeration compressors with small motor size to operate as low as 10°C condensing
- Large operating envelope that allows medium and low temperature applications to be covered by one single model
- Provide cooling capacity modulation either by cylinder head blocked suction or with use of frequency inverters from 25 to 60Hz with the standard AWM motors
- Multi-refrigerant compressor range – one model to cover all standard refrigerants

### Maximum Allowable Pressure (PS)

- Low Side PS 22.5 bar (g)/ High Side PS 28 bar (g)

### Operating Envelope R404A

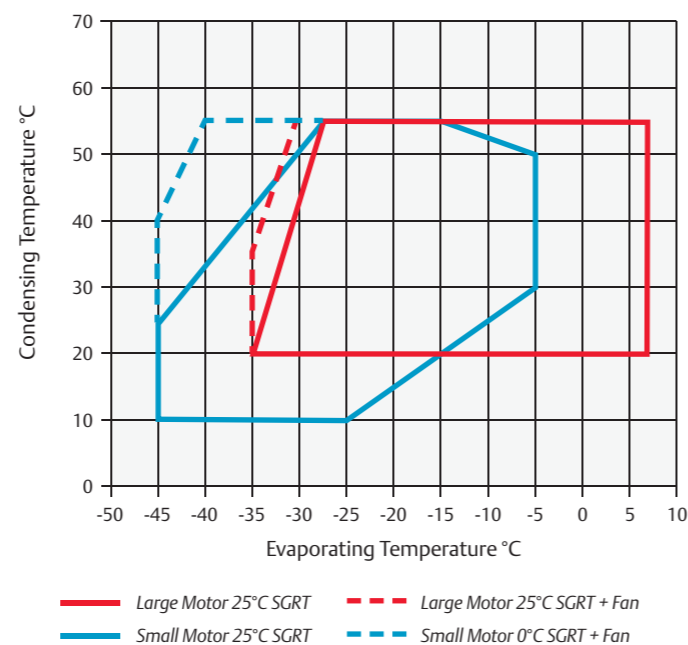

### Technical Overview

R404A	Nominal hp	Capacity (kW) 1	COP 1	Capacity (kW) 2	COP 2	Displacement (m³/h)	Oil Quantity (l)	Length/Width/Height (mm)	Net Weight (kg)	Motor Version / Code	Maximum Operating Current (A)	Locked Rotor Current (A)	Sound Pressure @1 m (dBA) **
										3 Ph*	3 Ph*	3 Ph*	
D2SA-45X	4.5			3.5	1.2	22.4	2.40	560/330/395	90	EWL	11	69	
D2SC-55X	5.5			4.1	1.3	26.8	2.40	560/330/395	91	EWL	13	74	67
D2SK-65X	6.5			4.9	1.2	31.2	2.40	560/330/395	92	EWL	16	85	
D3SC-75X	10.0			5.5	1.3	38.0	3.70	655/370/480	159	AWM	19	82	66
D3SS-100X	10.0			8.2	1.3	49.9	3.70	680/370/480	162	AWM	26	109	67
D4SF-100X	10.0			8.9	1.3	56.0	3.30	680/485/495	178	AWM	27	105	72
D4SL-150X	15.0			11.9	1.4	70.8	3.30	680/490/495	186	AWM	36	156	72
D6SF-200X	20.0			13.5	1.4	84.0	3.30	740/540/490	212	AWM	38	175	
D4ST-200X	20.0			14.5	1.4	84.7	3.30	700/490/495	198	AWM	42	175	72
D6ST-300X	32.0			21.3	1.4	127.0	6.80	740/540/545	252	AWM	63	255	
D6ST-320X	32.0			21.3	1.4	127.0	6.80	740/540/545	252	AWM	63	255	
D8SH-370X	37.0			24.6	1.4	151.0	7.60	835/467/610	314	AWM	71	349	
D6SU-400X	40.0			26.6	1.4	151.8	6.80	740/540/545	265	AWM	78	304	
D8SJ-450X	45.0			28.7	1.4	181.0	7.60	835/527/610	345	AWM	91	441	
D2SA-55X	5.5	11.2	2.0			22.4	2.40	560/330/395	90	EWL	13	67	
D2SC-65X	6.5	13.3	2.0			26.9	2.40	560/330/395	91	EWL	16	85	
D3SA-75X	7.5	15.6	2.2			32.2	3.70	655/370/480	159	AWM	18	82	
D3SC-100X	10.0	18.9	2.2			38.0	3.70	682/370/480	159	AWM	22	106	
D3SS-150X	15.0	25.9	2.1			49.9	3.70	680/370/480	162	AWM	30	125	
D4SA-200X	20.0	27.5	2.2			56.0	3.30	650/485/495	183	AWM	32	175	70
D4SH-250X	25.0	35.1	2.1			70.8	3.30	670/490/495	194	AWM	42	199	71
D6SA-300X	30.0	41.8	2.2			84.0	3.30	740/540/490	214	AWM	50	221	75
D4SJ-300X	30.0	42.8	2.2			84.5	3.30	690/515/495	210	AWM	48	221	70
D6SJ-400X	40.0	62.7	2.2			127.0	6.80	760/565/545	252	AWM	75	304	74
D8SH-500X	50.0	78.2	2.2			151.0	7.60	835/467/610	326	AWM	95	458	77
D6SK-500X	50.0	73.1	2.1			152.0	6.80	770/570/539	268	AWM	89	393	78
D8SJ-600X	60.0	90.4	2.2			181.0	7.60	835/527/610	346	AWM	106	476	76

(1) MT= Conditions EN12900 : Evaporating -10°C, Condensing 45°C, Suction Gas Temperature 20°C, Subcooling 0K

(2) LT= Conditions EN12900 : Evaporating -35°C, Condensing 40°C, Suction Gas Temperature 20°C, Subcooling 0K

\* 3 Ph: 380-420V/ 50Hz

\*\* @ 1m: sound pressure level at 1m distance from the compressor, free field condition

Capacity Data

Condensing Temperature 40°C																
R404A	Cooling Capacity (kW)							R404A	Power Input (kW)							
	Evaporating Temperature (°C)								Evaporating Temperature (°C)							
	Model	-45	-35	-30	-20	-10	-5		5	Model	-45	-35	-30	-20	-10	-5
D2SA-45X	1.1*	3.5	4.8	7.9	12.2	14.8		D2SA-45X	1.9*	2.9	3.4	4.5	5.4	5.8		
D2SA-55X			4.7	7.9	12.3	15.0	21.5	D2SA-55X			3.3	4.3	5.2	5.6	6.2	
D2SC-55X	1.1*	4.1	5.5	9.4	14.7	18.0		D2SC-55X	1.9*	3.2	3.9	5.2	6.3	6.8		
D2SC-65X			5.6	9.4	14.6	17.8	25.6	D2SC-65X			4.2	5.3	6.3	6.7	7.3	
D2SK-65X	1.2*	4.9	6.7	11.3	17.5	21.4		D2SK-65X	2.6*	4.0	4.7	6.2	7.5	8.2		
D3SA-75X			6.3	10.9	17.2	21.2	30.9	D3SA-75X			4.2	5.6	7.0	7.5	8.3	
D3SC-100X			8.0	13.5	20.9	25.4	36.6	D3SC-100X			5.3	6.9	8.4	9.1	10.0	
D3SC-75X	1.6*	5.5	7.5	12.9	20.3	24.9		D3SC-75X	2.8*	4.3	5.2	6.9	8.6	9.4		
D3SS-100X	2.7*	8.2	10.8	17.6	26.8	32.5		D3SS-100X	4.4*	6.2	7.2	9.5	11.9	12.9		
D3SS-150X			11.4	18.6	28.3	34.4	49.2	D3SS-150X			7.6	9.8	11.8	12.7	14.3	
D4SA-200X			11.3	19.3	30.4	37.2	54.0	D4SA-200X			7.5	10.0	12.1	13.1	14.4	
D4SF-100X	3.0*	8.9	11.9	19.6	30.1	36.6		D4SF-100X	4.4*	6.8	8.0	10.5	12.7	13.6		
D4SH-250X			14.6	24.7	38.7	47.4	68.6	D4SH-250X			9.8	12.9	15.7	16.9	18.8	
D4SL-150X	3.8*	11.9	15.9	26.1	40.0	48.6		D4SL-150X	5.6*	8.6	10.2	13.3	16.3	17.6		
D4SJ-300X			17.7	30.5	47.1	57.2	81.2	D4SJ-300X			11.2	15.1	18.5	19.9	22.0	
D4ST-200X	5.2*	14.5	19.2	31.3	47.7	57.8		D4ST-200X	6.7*	10.2	12.0	15.8	19.5	21.3		
D6SA-300X			17.2	29.3	46.3	57.1	83.8	D6SA-300X			11.3	15.0	18.3	19.8	21.9	
D6SF-200X	4.4*	13.5	18.3	30.3	46.1	55.5		D6SF-200X	6.1*	9.6	11.5	15.3	18.7	20.2		
D6SJ-400X			26.4	44.9	69.4	84.4	121.0	D6SJ-400X			16.6	22.3	27.8	30.2	34.3	
D6ST-300X	6.6*	21.3	28.5	46.8	71.2	85.9		D6ST-300X	10.0*	15.5	18.3	23.9	29.3	31.8		
D6ST-320X	6.6*	21.3	28.5	46.8	71.2	85.9		D6ST-320X	10.0*	15.5	18.3	23.9	29.3	31.8		
D6SU-400X	9.4*	26.6	35.0	56.2	84.4	101.5		D6SU-400X	12.4*	18.7	22.0	28.8	35.5	38.6		
D6SK-500X			30.7	52.1	80.9	98.6	142.5	D6SK-500X			19.9	26.5	32.9	35.8	40.0	
D8SH-370X	7.9*	24.6	32.9	53.8	81.2	97.6		D8SH-370X	11.2*	17.6	20.9	27.6	33.7	36.3		
D8SH-500X			33.7	55.6	85.9	105.0	150.5	D8SH-500X			23.0	29.1	34.6	36.9	40.1	
D8SJ-450X	8.4*	28.7	38.8	64.7	99.5	121.0		D8SJ-450X	13.4*	20.6	24.4	32.0	39.1	42.2		
D8SJ-600X			38.9	64.7	99.6	121.5	174.5	D8SJ-600X			24.3	31.8	38.9	42.1	47.2	

Suction Gas Return 20°C / Subcooling 0K  
 \*Suction Superheat 10K / Subcooling 0K  
 High Discharge Temp - Additional cooling required

Condensing Temperature 40°C																
R407C	Cooling Capacity (kW)							R407C	Power Input (kW)							
	Evaporating Temperature (°C)								Evaporating Temperature (°C)							
	Model	-30	-20	-10	-5	5	10		15	Model	-30	-20	-10	-5	5	10
D4SA-200X		15.7*	27.1	33.7	50.6	61.2	73.3	D4SA-200X		7.9*	9.8	10.7	12.0	12.4	12.5	
D4SH-250X		19.1*	33.5	41.9	63.3	76.6	92.0	D4SH-250X		9.8*	12.4	13.5	15.3	15.9	16.3	
D4SJ-300X		22.8*	40.5	50.5	75.3	90.4	107.5	D4SJ-300X		11.8*	15.3	16.8	18.9	19.6	19.9	
D6SA-300X		20.1*	37.3	47.2	72.3	87.9	106.0	D6SA-300X		11.9*	14.7	15.9	18.0	18.7	19.2	
D6SJ-400X		34.3*	59.9	74.7	112.0	135.0	162.0	D6SJ-400X		17.6*	22.5	24.7	28.2	29.3	29.8	
D6SK-500X		38.6*	70.8	89.1	135.0	163.0	195.5	D6SK-500X		21.1*	26.7	29.2	33.2	34.7	35.7	
D8SJ-600X		48.8*	86.4	107.5	160.5	193.0	230.0	D8SJ-600X		25.2*	32.7	35.8	40.5	41.8	42.3	
D8SK-700X		53.8*	98.2	124.0	189.0	229.0	276.0	D8SK-700X		29.7*	38.1	41.9	47.7	49.5	50.2	

Suction Gas Return 20°C / Subcooling 0K  
 \*Suction Superheat 10K / Subcooling 0K

Capacity Data

Condensing Temperature 40°C																
R134a	Cooling Capacity (kW)							R134a	Power Input (kW)							
	Evaporating Temperature (°C)								Evaporating Temperature (°C)							
	Model	-30	-20	-10	-5	5	10		15	Model	-30	-20	-10	-5	5	10
D2SA-45X		4.2	7.0	8.9	13.7	16.8		D2SA-45X		2.5	3.0	3.3	3.6	3.7		
D2SC-55X		5.2	8.5	10.7	16.2	19.7		D2SC-55X		2.9	3.6	4.0	4.5	4.6		
D2SK-65X		5.7	9.5	12.0	18.3	22.2		D2SK-65X		3.3	4.2	4.5	5.1	5.4		
D3SC-75X		6.9	11.3	14.3	22.0	27.0		D3SC-75X		3.8	4.8	5.4	6.4	6.9		
D3SS-100X		9.0	14.9	18.7	28.8	35.3		D3SS-100X		5.0	6.4	7.1	8.3	8.8		
D4SA-100X		11.3	18.6	23.1	34.4	41.3		D4SA-100X		5.2	6.6	7.3	8.4	8.8		
D4SF-100X		10.3	17.7	22.4	34.4	41.9		D4SF-100X		5.4	6.9	7.6	8.7	9.1		
D4SH-150X		12.2	21.5	27.4	42.3	51.5		D4SH-150X		6.3	8.2	9.0	10.3	10.5		
D4SL-150X		13.6	23.0	29.0	44.1	53.6		D4SL-150X		6.8	8.7	9.6	11.2	11.8		
D4SJ-200X		17.0	28.0	34.9	52.1	62.6		D4SJ-200X		8.2	10.7	11.9	14.1	15.0		
D4ST-200X		16.5	27.7	34.8	52.9	64.2		D4ST-200X		8.1	10.5	11.6	13.6	14.3		
D6SF-200X		16.1	27.2	34.4	52.6	63.8		D6SF-200X		7.9	10.2	11.3	13.2	13.9		
D6SH-200X		20.5	33.2	41.4	62.0	74.9		D6SH-200X		10.5	13.1	14.5	16.9	17.9		
D6SJ-300X		23.9	39.6	49.7	75.3	91.3		D6SJ-300X		12.2	15.6	17.3	20.4	21.6		
D6ST-300X		24.0	41.1	52.1	79.8	97.1		D6ST-300X		12.4	15.9	17.6	20.4	21.4		
D6ST-320X		24.2	41.3	52.2	79.9	97.2		D6ST-320X		12.3	15.9	17.6	20.5	21.7		
D6SU-400X		29.9	49.6	62.1	93.9	113.5		D6SU-400X		15.2	19.2	21.1	24.5	25.9		
D6SK-400X		27.0	45.5	57.4	88.0	107.0		D6SK-400X		13.7	18.2	20.3	23.6	24.7		
D8SH-370X		28.8	47.9	60.1	90.9	110.0		D8SH-370X		14.8	18.7	20.6	23.8	25.1		
D8SH-400X		27.7	46.7	58.8	89.7	109.0		D8SH-400X		14.0	18.2	20.0	22.8	23.7		
D8SJ-500X		31.9	54.0	68.1	104.0	126.5		D8SJ-500X		17.6	22.1	24.3	28.1	29.6		
D8SJ-450X		33.4	57.4	72.7	111.5	135.5		D8SJ-450X		16.8	21.5	23.7	27.3	28.5		
D8SK-600X		36.1	62.4	79.9	123.0	148.0		D8SK-600X		18.9	24.7	27.6	32.4	33.9		

Suction Gas Return 20°C / Subcooling 0K

Capacity Data

Condensing Temperature 40°C							
R22	Cooling Capacity (kW)						
	Evaporating Temperature (°C)						
Model	-45	-35	-30	-20	-10	-5	5
D2SA-45X		2.4*	3.5*	6.9	10.9	13.4	
D2SA-45X Air	1.1*	3.3	4.5	7.4	11.5	14.0	
D2SA-55X				6.6	10.9	13.6	20.4
D2SC-55X		2.4*	4.0*	8.4	13.7	16.9	
D2SC-55X Air	1.3*	4.0	5.4				
D2SC-65X				9.4	14.6	17.8	25.6
D2SK-65X		3.6*	5.4*	10.3	16.1	19.8	
D3SA-75X				9.5	15.5	19.3	29.0
D3SC-100X				11.7	18.6	23.0	34.4
D3SC-750-DTC	2.0	4.9	6.8	12.0	19.4	23.9	
D3SS-150X				16.4	25.6	31.4	46.0
D3SS-1000-DTC	2.6	6.7	9.4	16.3	25.7	31.5	
D4SF-100X			9.2*	16.8*	27.0*	33.3*	
D4SA-200X				18.0*	29.2	36.0	52.7
D4SH-250X				22.6*	37.2	45.9	67.2
D4SL-150X			13.0*	22.4*	35.8	44.0	
D4SL-1500-DTC	4.5	9.7	13.3	22.7	35.8	44.0	
D4SJ-300X				25.7*	43.5	53.9	79.6
D4ST-200X			15.0*	26.1*	42.0	51.6	
D4ST-2000-DTC	5.2	11.2	15.3	26.4	41.9	51.6	
D6SA-300X				24.6*	41.9	52.0	76.8
D6SF-200X			13.8*	24.8*	39.7*	48.9*	
D6ST-3200-DTC	7.3	16.1	22.1	38.0	60.0	73.6	
D6SJ-400X				37.2*	63.2	78.3	115.5
D6SU-4000-DTC	9.7	21.2	28.9	49.5	77.9	95.5	
D6SK-500X				45.8*	76.2	94.1	139.0
D8SH-370X			27.1*	46.7*	72.3*	87.6*	
D8SJ-450X			31.6*	55.1*	87*	107*	
D8SJ-600X				53.8*	92.0	114.0	168.5
D8SK-700X				62.8*	103.5	127.5	191.0

Condensing Temperature 40°C							
R22	Power Input (kW)						
	Evaporating Temperature (°C)						
Model	-45	-35	-30	-20	-10	-5	5
D2SA-45X		2.4*	2.9*	3.8	4.6	4.9	
D2SA-45X Air	1.7*	2.5	3.0	3.8	4.6	4.9	
D2SA-55X				3.8	4.5	4.7	5.2
D2SC-55X		2.9*	3.5*	4.6	5.5	5.9	
D2SC-55X Air	2.1*	3.1	3.6				
D2SC-65X				5.3	6.3	6.7	7.3
D2SK-65X		3.7*	4.3*	5.5	6.6	7.1	
D3SA-75X				5.1	6.1	6.6	7.2
D3SC-100X				6.3	7.4	7.9	8.6
D3SC-750-DTC	2.6	3.9	4.6	6.0	7.5	8.2	
D3SS-150X				8.6	10.3	11.1	12.3
D3SS-1000-DTC	3.5	5.6	6.6	8.6	10.7	11.9	
D4SF-100X			7.0*	9.0*	10.8*	11.5*	
D4SA-200X				9.0*	10.7	11.4	12.4
D4SH-250X				11.3*	13.6	14.6	16.0
D4SL-150X			9.1*	11.8*	14.2	15.4	
D4SL-1500-DTC	5.3	7.8	9.1	11.8	14.2	15.4	
D4SJ-300X				13.1*	16.1	17.4	19.5
D4ST-200X			10.4*	13.5*	16.5	18.0	
D4ST-2000-DTC	6.1	8.9	10.4	13.5	16.5	18.0	
D6SA-300X				13.4*	16.2	17.3	19.0
D6SF-200X			10.5*	13.8*	16.6*	17.7*	
D6ST-3200-DTC	9.0	13.4	15.7	20.5	25.8	28.5	
D6SJ-400X				20.2*	24.5	26.4	29.3
D6SU-4000-DTC	11.6	16.9	19.7	25.1	30.3	32.7	
D6SK-500X				23.1*	28.4	30.7	34.3
D8SH-370X			18.9*	24.5*	29.2*	31.0*	
D8SJ-450X			21.4*	28.3*	34.4*	36.9*	
D8SJ-600X				28.9*	35.0	37.6	41.6
D8SK-700X				33.8*	41.1	44.3	49.2

Suction Gas Return 20°C / Subcooling 0K  
 \*Suction Superheat 10K / Subcooling 0K  
 High Discharge Temp - Additional cooling required



## DK and DL Reciprocating Compressor Range

Small 2-cylinder semi-hermetic reciprocating compressors for medium and low temperature refrigeration applications and transport refrigeration.

These small compact compressors are ideal for medium and low temperature refrigeration applications and for integration in condensing units or refrigerated transport systems.

Designed on the principle of standard reed valve type technology, these compressors feature an internal oil pump that guarantees optimum reliability in all operating conditions.

The DK-series ranges from 0.5 to 2 hp and the DL-series from 2 to 4 hp and provide cooling capacities from 1.5 to 9 kW in medium temperature (R404A, -10/45°C) and 0.5 to 3.5kW in low temperature (R404A, -35/40°C).

These compressors are qualified for R404A, R507, R134a and R22.



### K & L Series compressor Line-up

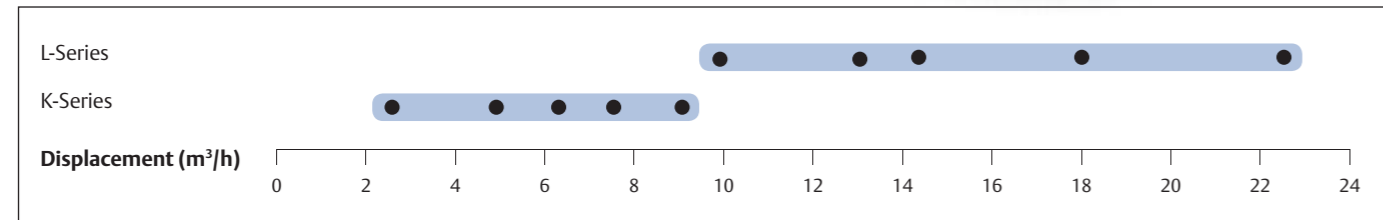

Conditions EN12900, R404A: Evaporating -10°C, Condensing 40°C, Suction Gas Temperature 20°C, Subcooling 0K

### Features and Benefits

- Large operating envelope from 5°C to -45°C evaporating and up to 55°C condensing
- Two motor sizes per displacement, optimized for different applications
- Compact and light compressors
- Ideal for condensing unit or transport applications
- Integrated oil pump for maximum reliability

### Maximum Allowable Pressure (PS)

- Low Side PS 22.5 bar (g)/ High Side PS 28 bar (g)

### Operating Envelope R404A

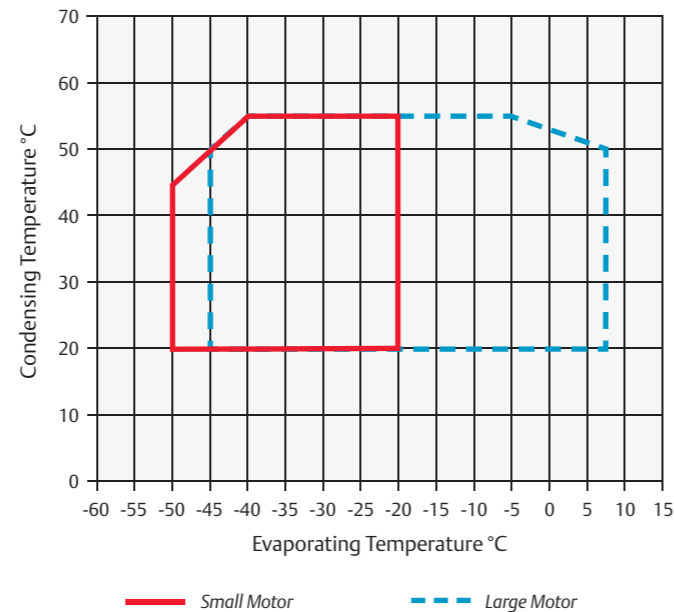

### Technical Overview

R404A	Nominal hp	Capacity (kW) 1)	COP 1)	Capacity (kW) 2)	COP 2)	Displacement (m³/h)	Oil Quantity (l)	Length/Width/Height (mm)	Net Weight (kg)	Motor Version / Code	Maximum Operating Current (A)	Locked Rotor Current (A)	Sound Pressure @ 1m (dBA)***
										3 Ph*	3 Ph*	3 Ph*	
DKM-7X	0.8	1.8	2.0			4.0	0.65	365/235/280	39	EWL	2	12	45
DKJ-10X	1.0	2.5	1.9			5.1	0.65	365/235/280	39	EWL	3	16	45
DKSJ-15X	1.5	3.2	1.9			6.3	0.65	365/235/280	40	EWL	3	20	53
DKL-20X	2.0	3.7	2.1			7.4	0.65	365/235/280	39	EWL	4	20	
DKSL-20X	2.0	4.6	1.9			9.1	0.65	365/235/280	40	EWL	5	20	
DLE-20X	2.0	4.6	2.2			9.9	2.00	470/330/385	78	EWL	6	38	51
DLF-30X	3.0	6.5	2.2			12.9	2.00	470/330/385	80	EWL	7	53	51
DLJ-30X	3.0	7.2	2.1			14.5	2.00	470/330/385	83	EWL	8	53	52
DLL-40X	4.0	9.2	2.2			18.2	2.00	470/330/385	87	EWL	10	69	63
DKM-5X	0.5			0.6	1.1	4.0	0.65	365/235/280	39	EWL	2	12	45
DKJ-7X	0.8			0.8	1.1	5.1	0.65	365/235/280	39	EWL	2	12	45
DKSJ-10X	1.0			1.0	1.1	6.3	0.65	365/235/280	40	EWL	3	16	50
DKL-15X	1.5			1.2	1.2	7.4	0.65	365/235/280	39	EWL	3	20	47
DLF-20X	2.0			1.6	1.1	12.9	2.00	470/330/385	80	EWL	5	38	51
DLJ-20X	2.0			1.9	1.2	14.5	2.00	470/330/385	78	EWL	6	38	52
DLL-30X	3.0			2.6	1.3	18.2	2.00	470/330/385	85	EWL	7	53	52
DLSG-40X	4.0			3.5	1.4	22.5	2.00	470/330/385	77	EWL	9	69	63

(1) MT= Conditions EN12900 : Evaporating -10°C, Condensing 45°C, Suction Gas Temperature 20°C, Subcooling 0K

(2) LT= Conditions EN12900 : Evaporating -35°C, Condensing 40°C, Suction Gas Temperature 20°C, Subcooling 0K

\* 3 Ph: 380-420V/ 50Hz

\*\* @ 1m: sound pressure level at 1m distance from the compressor, free field condition

Capacity Data

Condensing Temperature 40°C															
R404A		Cooling Capacity (kW)						R404A		Power Input (kW)					
		Evaporating Temperature (°C)								Evaporating Temperature (°C)					
Model	-45	-35	-30	-20	-10	-5	5	Model	-45	-35	-30	-20	-10	-5	5
DKM-5X	0.2	0.6	0.8	1.3				DKM-5X	0.3	0.5	0.6	0.7			
DKM-7X	0.2	0.5	0.8	1.3	2.0	2.5	3.6	DKM-7X	0.3	0.5	0.6	0.8	0.9	0.9	1.0
DKJ-10X	0.3	0.7	1.0	1.8	2.8	3.4	4.9	DKJ-10X	0.4	0.7	0.8	1.0	1.2	1.3	1.4
DKJ-7X	0.4	0.8	1.1	1.8				DKJ-7X	0.5	0.7	0.8	1.0			
DKSJ-10X	0.5	1.0	1.4	2.3				DKSJ-10X	0.7	0.9	1.1	1.3			
DKSJ-15X	0.5	1.0	1.4	2.3	3.5	4.2	6.1	DKSJ-15X	0.6	0.9	1.0	1.3	1.6	1.7	1.8
DKL-15X	0.6	1.2	1.6	2.6				DKL-15X	0.8	1.0	1.2	1.5			
DKL-20X	0.4	1.1	1.5	2.6	4.1	5.0		DKL-20X	0.6	0.9	1.1	1.4	1.7	1.8	
DKSL-20X	0.7	1.5	2.0	3.3	5.1	6.1		DKSL-20X	0.8	1.2	1.4	1.9	2.3	2.5	
DLE-20X		1.1	1.7	3.2	5.1	6.4	9.4	DLE-20X		1.0	1.2	1.6	2.0	2.2	2.5
DLF-20X		1.6	2.3	4.0				DLF-20X		1.4	1.7	2.2			
DLF-30X	0.7	1.9	2.6	4.6	7.2	8.8	12.8	DLF-30X	1.0	1.6	1.9	2.4	2.9	3.1	3.4
DLJ-20X		1.9	2.8	5.0				DLJ-20X		1.6	1.9	2.6			
DLJ-30X	0.8	2.1	2.9	5.1	8.0	9.8	14.2	DLJ-30X	1.1	1.8	2.1	2.8	3.3	3.6	3.9
DLL-30X	0.9	2.6	3.7	6.5				DLL-30X	1.1	2.0	2.4	3.3			
DLL-40X	1.1	2.7	3.7	6.4	10.2	12.6	18.4	DLL-40X	1.4	2.2	2.6	3.3	4.0	4.3	4.8
DLSG-40X	1.4	3.5	4.8	8.2				DLSG-40X	1.6	2.6	3.1	4.1			

Suction Gas Return 20°C / subcooling 0K  
 High Discharge Temp - Additional cooling required

Capacity Data

Condensing Temperature 40°C															
R22		Cooling Capacity (kW)						R22		Power Input (kW)					
		Evaporating Temperature (°C)								Evaporating Temperature (°C)					
Model	-45	-35	-30	-20	-10	-5	5	Model	-45	-35	-30	-20	-10	-5	5
DKM-5X		0.4	0.6	1.2	1.9	2.3		DKM-5X		0.4	0.5	0.7	0.8	0.8	
DKM-75/-7X		0.4	0.6	1.2	1.9	2.4	3.5	DKM-75/-7X		0.4	0.5	0.7	0.8	0.8	0.9
DKJ-10X		0.7	0.9	1.6	2.6	3.2	4.7	DKJ-10X		0.6	0.7	0.9	1.0	1.1	1.2
DKJ-75/-7X	0.3	0.7	0.9	1.6	2.5	3.1		DKJ-75/-7X	0.4	0.6	0.7	0.9	1.0	1.1	
DKSJ-10X	0.4	0.9	1.2	2.0	3.2	3.9		DKSJ-10X	0.5	0.8	0.9	1.1	1.3	1.4	
DKSJ-15X		0.9	1.2	2.1	3.3	4.0	5.7	DKSJ-15X		0.8	0.9	1.1	1.3	1.4	1.5
DKL-15X	0.5	1.0	1.4	2.4	3.7	4.6		DKL-15X	0.6	0.9	1.1	1.3	1.5	1.7	
DKSL-20X		1.3	1.8	3.0	4.7	5.7		DKSL-20X		1.1	1.3	1.6	1.9	2.1	
DLE-201/-20X		1.1	1.6	2.9	4.8	6.1	9.1	DLE-201/-20X		1.1	1.3	1.7	2.0	2.1	2.3
DLF-201/-20X	0.6	1.6	2.3	4.1	6.7	8.3		DLF-201/-20X	1.0	1.4	1.7	2.2	2.7	2.9	
DLF-301/-30X		1.6	2.3	4.1	6.8	8.4	12.2	DLF-301/-30X		1.4	1.7	2.2	2.6	2.8	3.0
DLJ-201/-20X	0.8	1.9	2.7	4.8				DLJ-201/-20X	1.1	1.6	1.9	2.5			
DLJ-301/-30X		1.9	2.6	4.8	7.8	9.6	13.8	DLJ-301/-30X		1.6	1.9	2.5	3.0	3.2	3.5
DLL-301/-30X	1.1	2.5	3.5	6.2				DLL-301/-30X	1.4	2.0	2.4	3.1			
DLL-401/-40X		2.5	3.5	6.2	9.8	12.0	17.2	DLL-401/-40X		2.0	2.4	3.0	3.7	3.9	4.3
DLSG-401/-40X	1.6	3.5	4.8	7.9				DLSG-401/-40X	1.8	2.7	3.2	4.0			

Suction Gas Return 20°C / Subcooling 0K  
 High Discharge Temp - Additional cooling required

Condensing Temperature 40°C															
R134a		Cooling Capacity (kW)						R134a		Power Input (kW)					
		Evaporating Temperature (°C)								Evaporating Temperature (°C)					
Model	-30	-20	-10	-5	5	10	15	Model	-30	-20	-10	-5	5	10	15
DKM-5X		0.7	1.2	1.5	2.3	2.8		DKM-5X		0.5	0.6	0.6	0.6	0.7	
DKJ-7X		0.9	1.6	2.0	3.0	3.7		DKJ-7X		0.6	0.7	0.7	0.8	0.9	
DKSJ-10X		1.2	2.0	2.5	3.8	4.6		DKSJ-10X		0.7	0.8	0.9	1.0	1.0	
DKL-15X		1.4	2.3	2.8	4.3	5.2		DKL-15X		0.8	1.0	1.1	1.3	1.3	
DKSL-15X		1.7	2.8	3.5	5.3	6.5		DKSL-15X		1.0	1.3	1.4	1.6	1.7	
DKSL-20X		1.7	2.9	3.7	5.6	6.7		DKSL-20X		1.0	1.2	1.4	1.6	1.6	
DLE-20X		1.5	2.8	3.6	5.6	6.9		DLE-20X		1.0	1.3	1.4	1.5	1.6	
DLF-20X		2.2	3.8	4.9	7.5	9.1		DLF-20X		1.2	1.6	1.7	1.9	2.0	
DLJ-20X		2.6	4.3	5.4	8.3	10.1		DLJ-20X		1.6	1.9	2.1	2.4	2.5	
DLL-30X		3.2	5.5	7.0	10.9	13.2		DLL-30X		1.9	2.4	2.6	3.0	3.1	
DLSG-40X		4.3	7.2	9.0	13.7	16.6		DLSG-40X		2.3	2.9	3.2	3.7	3.9	

Suction Gas Return 20°C / Subcooling 0K  
 High Discharge Temp - Additional cooling required





## Condensing Units

Emerson Climate Technologies offers the broadest and most reliable condensing unit product line-up. Leveraging the latest compressor technology, each platform provides you the option to select the refrigerant, capacity and application temperature combinations that meet your requirements.

A huge variety of Copeland® indoor and outdoor condensing units offer the right solution for applications in food retail and food service, commercial and industrial refrigeration.

Copeland EazyCool™ Scroll Outdoor Condensing Units are designed and fully equipped for a quick and easy installation and ideal to integrate into urban environments. The latest scroll technology is combined with high quality Alco components and covered by a weatherproof housing in a unique design.

The Copeland EazyCool™ Outdoor Condensing Unit ZX Series offers the highest energy efficiency available in a standard unit to lower operators' utility bills. Ranging in size from 2 to 7.5 hp the ZX units are perfectly suited for typical food service and retail applications. The key benefits compactness, silence and efficiency of the standard models will be enhanced by the capability of continuous capacity modulation of the ZX Digital models. This makes ZX Digital condensing units the perfect fit for applications with wide load variations.

Copeland Scroll™ indoor condensing units are equipped with the latest refrigeration scroll compressors and constitute the widest range of their kind. The modular line concept offers base units which can be adapted to the target application by various options including weather housings and fan speed controls.

Copeland Scroll™ Digital Receiver Units HLR are an innovative offering for food service and retail businesses. Their compact design and the power of digital scroll continuous capacity modulation enable optimized environmental integration with highest system efficiency.

Semi-hermetic condensing units: robust, reliable and efficient air-cooled condensing unit platforms featuring semi-hermetic reciprocating compressor technology are for use in high, medium and low temperature refrigeration applications. Products range from 0.8 to 40 hp and are available for R134a, R404A, R407C and R22 refrigerants



# Copeland EazyCool™ Outdoor Condensing Units with Scroll Compressors

Copeland® air-cooled outdoor condensing units for medium temperature and low temperature applications.

Emerson Climate Technologies has developed this series of condensing units especially for outdoor use. The latest Scroll technology is combined with high quality components and covered by an absolutely weather resistant synthetic resin housing in a unique design.



Copeland EazyCool™ Outdoor Condensing Units with Scroll Compressors

The EazyCool line-up offers state of the art technology and models featuring stepless capacity control, vapor injection and fan speed control. This makes it the first choice for target applications in food retail and food service:

- Proximity and convenience stores
- Mini markets and supermarkets
- Bars, restaurants and kitchens
- Beer cellars and beverage coolers

## EazyCool™ OLQ/OMQ Line-up

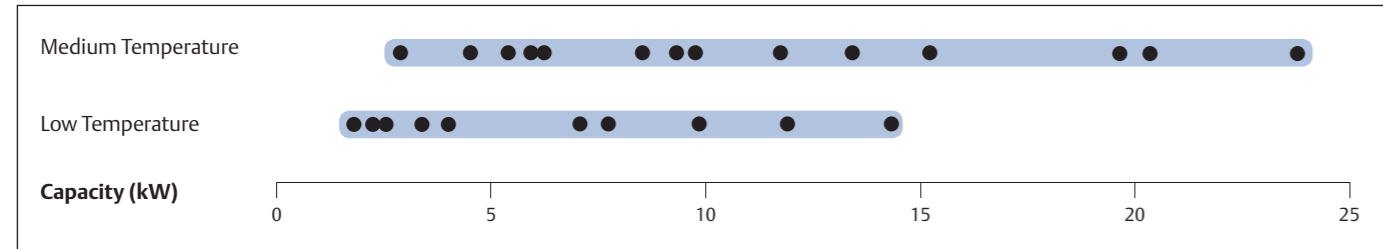

Conditions EN13215 R404A: Evaporating Temperature MT -10°C/ LT - 35°C, Ambient Temperature 32°C, Suction Gas Return 20°C

## EazyCool™ Digital Line-up

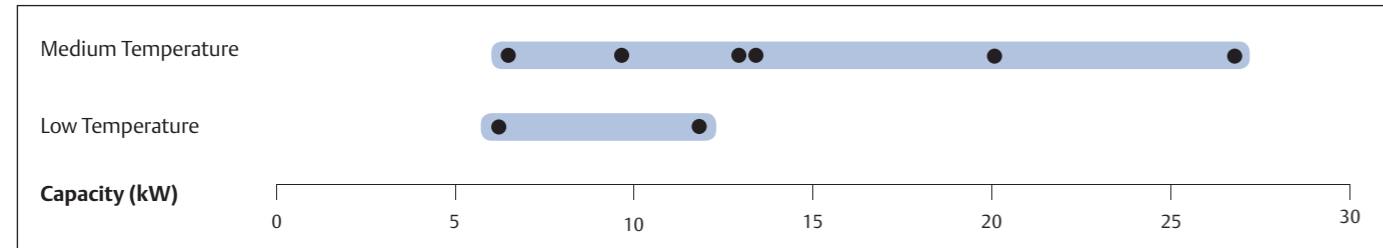

Conditions EN13215 R404A: Evaporating Temperature MT -10°C/ LT - 35°C, Ambient Temperature 32°C, Suction Gas Return 20°C

## Features and Benefits

- Standard equipment: Scroll compressor(s), crankcase heater(s), condenser with thermally protected fan(s), fan speed control, HP and LP switch, liquid receiver, weather resistant housing
- Suitable for multiple refrigerants: R404A, R507, R134a, R407C, R22
- Wide range of quality accessories
- Excellent efficiency

## Maximum Allowable Pressure (PS)

- Low Side PS 22.5 bar (g)
- High Side PS 28 bar (g)

## Technical Overview

R404A	Capacity (kW)	Receiver Capacity (l)	Number of fans	Total Fan Motor Power (W)	Suction Line Diameter (inch)	Liquid Line Diameter (inch)	Width/Depth/Height (mm)	Net Weight (kg)	Motor Version/Code		Maximum Operating Current, A		Locked Rotor Current, A		Sound Pressure @10 m - d(BA)***
									1 Ph*	3 Ph**	1 Ph*	3 Ph**	1 Ph*	3 Ph**	
<b>Medium Temperature Models</b>															
OMQ-15	3.4	7.5	1	145	7/8"	1/2"	1050/630/720	74	PFJ	TFD	13	5	58	26	34
OMQ-21	4.6	7.5	1	145	7/8"	1/2"	1050/630/720	84	PFJ	TFD	16	7	82	40	35
OMQ-26	5.4	7.5	1	145	7/8"	1/2"	1050/630/720	85	PFJ	TFD	18	9	97	46	35
OMQ-30	6.0	7.5	1	145	7/8"	1/2"	1050/630/720	98	-	TFD	-	10	-	49	36
OMQ-38	8.2	7.5	1	145	7/8"	1/2"	1250/642/720	99	-	TFD	-	13	-	66	37
OMQ-45	9.2	7.5	1	145	7/8"	1/2"	1250/642/720	118	-	TFD	-	13	-	74	39
OMQ-56	11.5	14.0	2	290	1 3/8"	5/8"	2100/670/950	224	-	TWD	-	15	-	99	44
OMQ-75	15.3	14.0	2	290	1 3/8"	5/8"	2100/670/950	224	-	TWD	-	22	-	127	44
OMQ-92	20.5	14.0	2	550	1 3/8"	3/4"	2100/670/950	246	-	TWD	-	25	-	167	46
OMQ-110	23.7	14.0	2	550	1 5/8"	3/4"	2100/670/950	255	-	TWD	-	29	-	198	47
OMTQ-60	13.0	14.0	2	290	1 3/8"	5/8"	2100/670/950	209	-	TFD	-	2x10	-	2x49	42
OMTQ-76	15.1	14.0	2	290	1 3/8"	5/8"	2100/670/950	211	-	TFD	-	2x13	-	2x66	43
OMTQ-90	19.9	14.0	2	550	1 3/8"	3/4"	2100/670/950	225	-	TFD	-	2x13	-	2x74	45
<b>Digital Medium Temperature Models</b>															
OMQ-30D	6.2	7.5	1	145	7/8"	1/2"	1050/630/720	98	-	TFD	-	8	-	52	36
OMQ-45D	9.6	7.5	1	145	7/8"	1/2"	1250/642/720	118	-	TFD	-	12	-	74	39
OMTQ-60D	13.1	14.0	2	290	1 3/8"	5/8"	2100/670/950	209	-	TFD	-	8+10	-	52+49	42
OMTQ-90D	19.9	14.0	2	550	1 3/8"	3/4"	2100/670/950	225	-	TFD	-	11+13	-	2x74	45
<b>Low Temperature Models</b>															
OLQ-09	1.9	7.5	1	145	7/8"	1/2"	1050/630/720	83	-	TFD	-	6	-	40	34
OLQ-11	2.4	7.5	1	145	7/8"	1/2"	1050/630/720	86	-	TFD	-	7	-	46	35
OLQ-13	2.7	7.5	1	145	7/8"	1/2"	1050/630/720	96	-	TFD	-	8	-	52	36
OLQ-15	3.4	7.5	1	145	7/8"	1/2"	1250/642/720	100	-	TFD	-	10	-	64	37
OLQ-18	5.9	7.5	1	145	7/8"	1/2"	1250/642/720	119	-	TFD	-	13	-	74	39
OLQ-24V	7.2	14.0	2	290	1 3/8"	5/8"	2100/670/950	228	-	TWD	-	16	-	99	44
OLQ-33V	9.9	14.0	2	550	1 3/8"	5/8"	2100/670/950	228	-	TWD	-	21	-	127	44
OLQ-40V	11.9	14.0	2	550	1 3/8"	3/4"	2100/670/950	238	-	TWD	-	27	-	167	46
OLQ-48V	14.7	14.0	2	550	1 5/8"	3/4"	2100/670/950	259	-	TWD	-	31	-	198	47
OLTQ-26V	8.0	14.0	2	551	1 3/8"	5/8"	2100/670/950	221	-	TFD	-	2x9	-	2x51	42
OLTQ-36V	11.9	14.0	2	552	1 3/8"	3/4"	2100/670/950	235	-	TFD	-	2x14	-	2x74	45
<b>Digital Low Temperature Models</b>															
OLQ-18DV	5.9	7.5	1	145	7/8"	1/2"	2100/670/950	189	-	TFD	-	14	-	74	39
OLTQ-36DV	11.9	14.0	2	550	1 3/8"	3/4"	2100/670/950	235	-	TFD	-	2x14	-	2x74	45

Conditions EN13215: R404A, Evaporating Temperature MT -10°C/ LT - 35°C, Ambient Temperature 32°C, Suction Gas Return 20°C

\* 1 Ph: 230V/ 50Hz

\*\* 3 Ph: 380-420V/ 50Hz

\*\*\* @ 10m: sound pressure level at 10m distance from the compressor, free field condition

Capacity Data

R404A	Cooling Capacity (kW)						
	Ambient Temperature: 32°C						
	Evaporating Temperature (°C)						
	-45	-35	-30	-20	-10	-5	5
<b>Medium Temperature Models</b>							
OMQ-15			1.4	2.3	3.4	3.9	5.2
OMQ-21			2.0*	3.3	4.6	5.3	6.7
OMQ-26			2.3*	3.9	5.4	6.2	8.1
OMQ-30		2.0*	2.6*	4.3	6.0	6.9	8.9
OMQ-38		2.7*	3.5	5.8	8.2	9.5	12.4
OMQ-45		3.1*	3.9*	6.6	9.2	10.6	13.7
OMQ-56			5.6*	8.3	11.5	13.4	17.4
OMQ-75				11.3	15.3	17.4	22.1
OMQ-92				10.2	14.9	20.5	23.7
OMQ-110				17.3	23.7	27.3	35.1
OMTQ-60		4.3*	5.5	9.4	13.1	15.1	19.6
OMTQ-76		5.1*	6.5	11.1	15.1	17.3	
OMTQ-90		6.5*	9.5	14.2	19.9	23.1	30.2
<b>Low Temperature Models</b>							
OLQ-09		1.9	2.3	3.3	4.5	5.2	6.6
OLQ-11		2.4	2.8	3.9	5.2	5.9	7.5
OLQ-13		2.7	3.3	4.7	6.3	7.1	9.0
OLQ-15		3.4	4.2	6.1	8.3	9.5	12.2
OLQ-18		4.1	5.0	7.1	9.6	10.9	13.8
OLQ-24V		7.2	8.8	12.3	16.4	18.6	23.3
OLQ-33V		9.9	12.0	16.9	22.8	26.2	33.7
OLQ-40V		11.9	15.0	21.5	28.5	32.1	39.3
OLQ-48V		14.7	17.7	24.1	30.9	34.4	
OLTQ-26V		8.0	9.7	13.9	19.3	22.5	30.1
OLTQ-36DV		11.9	14.1	19.5	26.4	30.6	
<b>Digital Medium Temperature Models</b>							
OMQ-30D			2.8*	4.6	6.2	7.0	8.8
OMQ-45D			3.6*	6.6	9.6	11.4	15.5
OMTQ-60D			5.7*	9.5	13.1	15.2	19.7
OMTQ-90D			7.9*	13.9	20.0	23.5	31.5
<b>Digital Low Temperature Models</b>							
OLQ-18DV		5.9	6.9	9.5	12.8	14.7	

Conditions: EN13215: Suction Gas Return 20°C, Subcooling 0K  
 \* Conditions: EN13215: Suction Superheat 10K

Capacity Data

R407C	Cooling Capacity (kW)						
	Ambient Temperature: 32°C						
	Evaporating Temperature (°C)						
	-45	-35	-30	-20	-10	-5	5
<b>Medium Temperature Models</b>							
OMQ-15-TFD				1.9*	2.9	3.5	4.9
OMQ-21-PFJ				2.4*	3.8*	4.7	6.5
OMQ-21-TFD				2.7*	4.1*	4.9	6.9
OMQ-26-PFJ					4.3*	5.1*	7.2
OMQ-26-TFD				2.8*	4.4*	5.5	7.8
OMQ-30-TFD				3.4*	5.3*	6.4	8.9
OMQ-38-TFD				4.1*	6.8*	8.5	12.2
OMQ-45-TFD				5.9*	8.0*	10.0	13.8
OMQ-56-TWD				6.9*	10.4*	12.7	17.4
OMQ-75-TWD				9.3*	13.7*	16.2*	22.2
OMQ-92-TWD				12.0*	17.8*	21.7	29.6
OMQ-110-TWD				14.2*	21.1*	25.6	34.7
OMTQ-60-TFD				7.2*	11.3*	13.9	19.3
OMTQ-76-TFD				8.1*	12.9*	15.7*	22.3
OMTQ-90-TFD				10.6*	17.0*	21.0	29.3

Conditions: EN13215: Suction Gas Return 20°C, Subcooling 0K  
 \* Conditions: EN13215: Suction Superheat 10K

R134a	Cooling Capacity (kW)						
	Ambient Temperature: 32°C						
	Evaporating Temperature (°C)						
	-45	-35	-30	-20	-10	-5	5
<b>Medium Temperature Models</b>							
OMQ-15-TFD				1.4	2.2	2.7	3.9
OMQ-21-PFJ				1.8	3.0	3.6	5.1
OMQ-21-TFD				2.0	3.1	3.8	5.4
OMQ-26-PFJ				2.0*	3.3	4.0	5.7
OMQ-26-TFD				2.3	3.6	4.4	6.3
OMQ-30-TFD				2.5*	4.2	5.1	7.2
OMQ-38-TFD				3.1*	5.3	6.5	9.4
OMQ-45-TFD				3.9*	6.3	7.7	11.0
OMQ-56-TWD				4.6*	7.3*	9.1	13.0
OMQ-75-TWD				6.4*	9.8*	12.3	17.2
OMQ-92-TWD				8.1*	12.6*	15.7	22.2
OMQ-110-TWD				9.9*	15.2*	19.0	26.6

Conditions: EN13215: Suction Gas Return 20°C, Subcooling 0K  
 \* Conditions: EN13215: Suction Superheat 10K

Capacity Data

R22	Cooling Capacity (kW)						
	Ambient Temperature: 32°C						
	Evaporating Temperature (°C)						
	-45	-35	-30	-20	-10	-5	5
<b>Medium Temperature Models</b>							
OMQ-15-TFD				2.1*	3.4	4.0	5.5
OMQ-21-PFJ				2.4*	4.1*	5.0	7.1
OMQ-21-TFD				2.9*	4.6*	5.4	7.3
OMQ-26-PFJ					4.9*	5.8*	7.9
OMQ-26-TFD				3.4*	5.1*	6.2	8.5
OMQ-30-TFD				3.1*	5.3*	6.7	9.5
OMQ-38-TFD				4.8*	7.5*	9.2	12.9
OMQ-45-TFD				6.0*	9.3*	11.1	14.9
OMQ-56-TWD				8.1*	11.7*	14.0	19.0
OMQ-75-TWD					14.9*	17.5*	23.5
OMQ-92-TWD				13.8*	20.0*	23.7	32.2
OMQ-110-TWD				16.4*	23.5	27.8	37.3
OMTQ-60-TFD				6.3*	11.1*	14.0	20.4
OMTQ-76-TFD				9.4*	14.3*	17.3	24.0
OMTQ-90-TFD				12.9*	19.3*	23.1	31.5
<b>Low Temperature Models</b>							
OLQ-09-TFD	1.1	1.8	2.3	3.3	4.7	5.5	7.2
OLQ-11-TFD	1.4	2.2	2.8	4.0	5.6	6.4	
OLQ-13-TFD	1.7	2.6	3.2	4.7	6.6	7.6	10.0
OLQ-15-TFD	2.1	3.3	4.0	6.0	8.4	9.8	13.1
OLQ-18-TFD	2.3	3.8	4.7	6.9	9.8	11.4	15.1

R22	Power Input (kW)						
	Ambient Temperature: 32°C						
	Evaporating Temperature (°C)						
	-45	-35	-30	-20	-10	-5	5
<b>Medium Temperature Models</b>							
OMQ-15-TFD				1.5	1.6	1.7	1.8
OMQ-21-PFJ				2.2	2.4	2.5	2.7
OMQ-21-TFD				2.4	2.5	2.7	3.1
OMQ-26-PFJ					3.0	3.1	3.5
OMQ-26-TFD				2.5	2.7	2.9	3.1
OMQ-30-TFD				3.0	3.3	3.5	4.0
OMQ-38-TFD				3.2	3.6	3.8	4.3
OMQ-45-TFD				4.0	4.6	4.9	5.5
OMQ-56-TWD				5.2	5.9	6.3	7.1
OMQ-75-TWD					8.8	9.5	11.0
OMQ-92-TWD				8.7	9.9	10.6	11.9
OMQ-110-TWD				10.7	12.3	13.3	15.2
OMTQ-60-TFD				5.7	6.2	6.5	7.3
OMTQ-76-TFD				6.9	7.8	8.3	9.6
OMTQ-90-TFD				8.6	9.2	9.5	10.4
<b>Low Temperature Models</b>							
OLQ-09-TFD	1.9	2.0	2.1	2.3	2.6	2.7	3.1
OLQ-11-TFD	2.1	2.3	2.4	2.7	3.1	3.4	
OLQ-13-TFD	2.5	2.7	2.8	3.1	3.6	3.8	4.5
OLQ-15-TFD	2.9	3.1	3.2	3.6	4.0	4.3	5.1
OLQ-18-TFD	3.7	3.9	4.1	4.5	5.1	5.5	6.4

Conditions: EN13215: Suction Gas Return 20°C, Subcooling 0K  
 \* Conditions: EN13215: Suction Superheat 10K

## Copeland EazyCool™ Outdoor Condensing Units for Refrigeration Networks

Copeland® outdoor condensing unit networks for medium temperature and low temperature applications.

Emerson Climate Technologies has developed this version of outdoor scroll condensing units with interconnectivity in order to create medium and large size refrigeration network systems.

The EazyCool condensing unit networks perfectly fit in applications where larger cooling capacities and capacity modulation are required.

Typical applications are:

- Cold and freeze stores
- Discount and convenience stores
- Supermarkets and mini-markets
- Petrol station forecourts



Copeland EazyCool™ Outdoor Condensing Units for Refrigeration Networks

### Copeland EazyCool™ Network Line-up

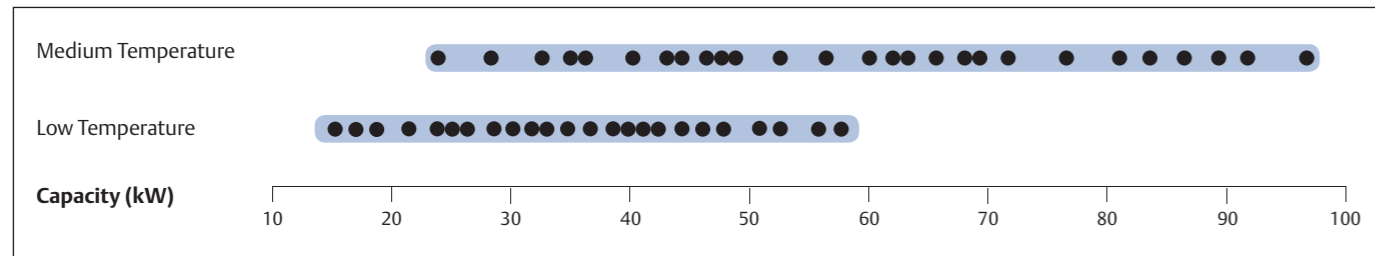

Conditions EN13215 R404A: Evaporating Temperature MT -10°C/LT -35°C, Ambient Temperature 32°C, Suction Gas Return 20°C

### Features and Benefits

- Standard equipment: Copeland Scroll™ compressor(s), crankcase heater(s), condenser with thermally protected low speed fan(s), fan speed controller, oil separator, suction and liquid equalization lines, HP and LP switch, oil reservoir, EC2 Electronic controller, weather resistant housing
- Oil control system with oil separator, TRAX OIL on each compressor, oil distribution lines and additional liquid receiver unit for large networks
- LON Master/Slave communication
- Capacity modulation with up to 8 compressor or step less with Digital Scroll™
- Perfect capacity adjustment by a wide range of combination opportunities

### Maximum Allowable Pressures (PS)

- Low Side PS 22.5 bar(g)
- High Side PS 28 bar(g)

### Capacity Data - OMQ

R404A		Medium Temperature (-10/+32°C)						
Cooling Capacity (kW)	Motor Capacity (kW)	Model Configuration						
		<b>2 Condensing Units Network</b>						
28.0	14.8	OMQ75 NLO	+	OMQ56 NL				
32.2	17.1	OMQ75 NLO	+	OMQ75 NL				
36.0	19.7	OMQ92 NLO	+	OMQ75 NL				
39.8	22.2	OMQ92 NLO	+	OMQ92 NL				
42.8	25.1	OMQ110 NLO	+	OMQ 92 NL				
45.8	28.0	OMQ110 NLO	+	OMQ110 NL				
<b>3 Condensing Units Network</b>								
39.8	21.0	OMQ75 NO	+	OMQ56 N	+	OMQ56 N		
44.0	23.3	OMQ75 NO	+	OMQ75 N	+	OMQ56 N		
48.3	25.7	OMQ75 NO	+	OMQ75 N	+	OMQ75 N		
52.1	28.2	OMQ92 NO	+	OMQ75 N	+	OMQ75 N		
55.9	30.8	OMQ92 NO	+	OMQ92 N	+	OMQ75 N		
59.7	33.3	OMQ92 NO	+	OMQ92 N	+	OMQ92 N		
62.7	36.2	OMQ110 NO	+	OMQ92 N	+	OMQ92 N		
65.7	39.1	OMQ110 NO	+	OMQ110 N	+	OMQ92 N		
68.7	42.0	OMQ110 NO	+	OMQ110 N	+	OMQ110 N		
<b>4 Condensing Units Network</b>								
51.6	27.2	OMQ75 NO	+	OMQ56 N	+	OMQ56 N	+	OMQ56 N
55.9	29.5	OMQ75 NO	+	OMQ75 N	+	OMQ56 N	+	OMQ56 N
60.1	31.9	OMQ75 NO	+	OMQ75 N	+	OMQ75 N	+	OMQ56 N
64.4	34.2	OMQ75 NO	+	OMQ75 N	+	OMQ75 N	+	OMQ75 N
68.2	36.8	OMQ92 NO	+	OMQ75 N	+	OMQ75 N	+	OMQ75 N
72.0	39.3	OMQ92 NO	+	OMQ92 N	+	OMQ75 N	+	OMQ75 N
75.8	41.9	OMQ92 NO	+	OMQ92 N	+	OMQ92 N	+	OMQ75 N
79.6	44.4	OMQ92 NO	+	OMQ92 N	+	OMQ92 N	+	OMQ92 N
82.6	47.3	OMQ110 NO	+	OMQ92 N	+	OMQ92 N	+	OMQ92 N
85.6	50.2	OMQ110 NO	+	OMQ110 N	+	OMQ92 N	+	OMQ92 N
88.6	53.1	OMQ110 NO	+	OMQ110 N	+	OMQ110 N	+	OMQ92 N
91.6	56.0	OMQ110 NO	+	OMQ110 N	+	OMQ110 N	+	OMQ110 N

Conditions: EN13215: Suction Gas Return 20°C, Suction Superheat 10K



Capacity Data - OLQ

R404A		Low Temperature (-35/+32°C)						
Cooling Capacity (kW)	Motor Capacity (kW)	Model Configuration						
		<b>2 Condensing Units Network</b>						
16.4	13.9	OLQ33V NLO	+	OLQ24V NL				
18.7	16.4	OLQ33V NLO	+	OLQ33V NL				
20.9	17.0	OLQ40V NLO	+	OLQ33V NL				
23.0	17.6	OLQ40V NLO	+	OLQ40V NL				
25.4	20.6	OLQ48V NLO	+	OLQ40V NL				
27.8	23.6	OLQ48V NLO	+	OLQ48V NL				
<b>3 Condensing Units Network</b>								
23.4	19.6	OLQ33V NO	+	OLQ24V N	+	OLQ24V N		
25.7	22.1	OLQ33V NO	+	OLQ33V N	+	OLQ24V N		
28.1	24.6	OLQ33V NO	+	OLQ33V N	+	OLQ33V N		
30.2	25.2	OLQ40V NO	+	OLQ33V N	+	OLQ33V N		
32.4	25.8	OLQ40V NO	+	OLQ40V N	+	OLQ33V N		
34.5	26.4	OLQ40V NO	+	OLQ40V N	+	OLQ40V N		
36.9	29.4	OLQ48V NO	+	OLQ40V N	+	OLQ40V N		
39.3	32.4	OLQ48V NO	+	OLQ48V N	+	OLQ40V N		
41.7	35.4	OLQ48V NO	+	OLQ48V N	+	OLQ48V N		
<b>4 Condensing Units Network</b>								
30.4	25.3	OLQ33V NO	+	OLQ24V N	+	OLQ24V N	+	OLQ24V N
32.7	27.8	OLQ33V NO	+	OLQ33V N	+	OLQ24V N	+	OLQ24V N
35.1	30.3	OLQ33V NO	+	OLQ33V N	+	OLQ33V N	+	OLQ24V N
37.4	32.8	OLQ33V NO	+	OLQ33V N	+	OLQ33V N	+	OLQ33V N
39.6	33.4	OLQ40V NO	+	OLQ33V N	+	OLQ33V N	+	OLQ33V N
41.7	34.0	OLQ40V NO	+	OLQ40V N	+	OLQ33V N	+	OLQ33V N
43.9	34.6	OLQ40V NO	+	OLQ40V N	+	OLQ40V N	+	OLQ33V N
46.0	35.2	OLQ40V NO	+	OLQ40V N	+	OLQ40V N	+	OLQ40V N
48.4	38.2	OLQ48V NO	+	OLQ40V N	+	OLQ40V N	+	OLQ40V N
50.8	41.2	OLQ48V NO	+	OLQ48V N	+	OLQ40V N	+	OLQ40V N
53.2	44.2	OLQ48V NO	+	OLQ48V N	+	OLQ48V N	+	OLQ40V N
55.6	47.2	OLQ48V NO	+	OLQ48V N	+	OLQ48V N	+	OLQ48V N

Conditions: EN13215: Suction Gas Return 20°C, Suction Superheat 10K

# Copeland EazyCool™ ZX Outdoor Condensing Units with Scroll Compressors

Copeland® compact outdoor condensing units for medium temperature and low temperature applications.

With this new range of outdoor condensing units Emerson Climate Technologies offers a solution for refrigeration applications with space and noise constraints which responds to the increasing demand for energy efficient condensing units.

Copeland EazyCool™ ZX outdoor condensing units feature the most complete and unique equipment. Their diagnostics module detects and displays the system status, it can communicate and transmit an alarm signal to a remote receiver. Vapor injection and liquid injection technology significantly increase system efficiency and operation map. Electronic protection functions, oil separator and suction accumulator guarantee optimum system safety.

Lowest life cycle costs and comprehensive safety features make Copeland EazyCool ZX a cost efficient and reliable choice for:

- Convenience stores
- Cold rooms
- Fast food stores, bars and restaurants
- Beverage coolers



Copeland EazyCool™ ZX Outdoor Condensing Units with Scroll Compressors

## Copeland EazyCool™ ZX Line-up

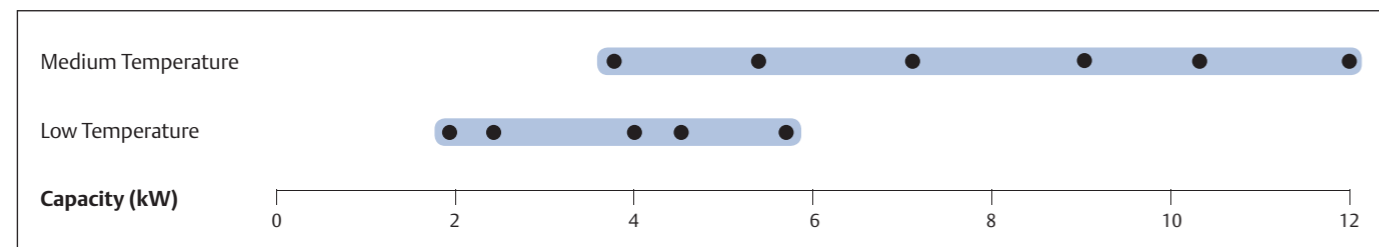

Conditions EN13215 R404A: Evaporating Temperature MT -10°C/LT -35°C, Ambient Temperature 32°C, Suction Gas Return 20°C

## Copeland EazyCool™ ZX Digital Line-up

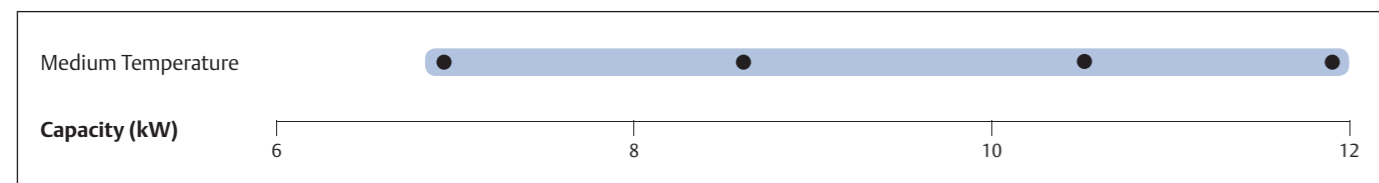

Conditions EN13215 R404A: Evaporating Temperature MT -10°C/LT -35°C, Ambient Temperature 32°C, Suction Gas Return 20°C

## Features and Benefits

- Standard equipment: Copeland Scroll™ compressor, crankcase heater, diagnostics module, fan(s) with speed control, liquid receiver, adjustable LP switch, safety switches, filter drier and sight glass, oil separator and suction accumulator (LT models only)
- Copeland EazyCool™ ZX Digital models allow for 10% to 100% continuous capacity modulation
- Diagnostic capabilities protect the unit from over-current, phase loss and phase imbalance
- LED display shows real time system status
- Energy and operation cost saving due to excellent energy efficiency
- Noise attenuation due to low speed fan motors with sickle blades and fan speed control
- Vapor injection technology for LT models
- Space saving due to compact dimensions
- Easy and quick installation

## Maximum Allowable Pressures (PS)

- Low Side PS 22.5 bar (g)
- High Side PS 30 bar (g)

## Technical Overview

R404A	Capacity (kW)	Receiver Capacity (l)	Number of fans	Total Fan Motor Power (W)	Suction Line Diameter (inch)	Liquid Line Diameter (inch)	Width/Depth/Height (mm)	Net Weight (kg)	Motor Version/Code		Maximum Operating Current, A		Locked Rotor Current, A		Sound Pressure @10 m - d(BA)***		
									1 Ph*	3 Ph**	1 Ph*	3 Ph**	1 Ph*	3 Ph**	Night mode	Day mode	
<b>Medium Temperature Models</b>																	
ZXME020E	3.6	4.4	1	116	3/4"	1/2"	1029/424/840	76	PFJ	TFD	13	5	58	26	36	39	
ZXME025E	4.3	4.4	1	116	3/4"	1/2"	1029/424/840	79	PFJ		12		61		37	40	
ZXME030E	5.3	4.4	1	116	3/4"	1/2"	1029/424/840	79	PFJ	TFD	16	6	82	40	37	40	
ZXME040E	7.0	4.4	1	116	7/8"	1/2"	1029/424/840	91	PFJ	TFD	24	9	114	49	37	40	
ZXME050E	9.1	6.3	2	246	7/8"	1/2"	1029/424/1242	108		TFD		13		66	38	41	
ZXME060E	10.4	6.3	2	246	7/8"	1/2"	1029/424/1242	112		TFD		12		74	38	41	
ZXME075E	11.9	6.3	2	246	7/8"	1/2"	1029/424/1242	118		TFD		15		101	39	42	
<b>Medium Temperature Digital Models</b>																	
ZXDE040E	7.0	4.4	1	116	7/8"	1/2"	1029/424/840	91		TFD		11		64	37	40	
ZXDE050E	9.1	6.3	2	246	7/8"	1/2"	1029/424/1242	108		TFD		12		66	38	41	
ZXDE060E	10.4	6.3	2	246	7/8"	1/2"	1029/424/1242	112		TFD		11		74	38	41	
ZXDE075E	11.9	6.3	2	246	7/8"	1/2"	1029/424/1242	118		TFD		10		46	39	42	
<b>Low Temperature Models</b>																	
ZXLE020E	1.9	4.4	1	116	3/4"	1/2"	1029/424/840	79		TFD		6		39	36	39	
ZXLE030E	2.6	4.4	1	116	3/4"	1/2"	1029/424/840	81		TFD		7		36	37	40	
ZXLE040E	4.0	4.4	1	116	7/8"	1/2"	1029/424/840	93		TFD		9		52	37	40	
ZXLE050E	4.7	6.3	2	246	7/8"	1/2"	1029/424/1242	106		TFD		12		52	38	41	
ZXLE060E	5.7	6.3	2	246	7/8"	1/2"	1029/424/1242	116		TFD		14		74	38	41	

Conditions EN13215: R404A, Evaporating Temperature MT -10°C/ LT -35°C, Ambient Temperature 32°C, Suction Gas Return 20°C

\* 1 Ph: 230V/ 50Hz

\*\* 3 Ph: 380-420V/ 50Hz

\*\*\* @ 10m: sound pressure level at 10m distance from the compressor, free field condition

## Capacity Data

R404A	Cooling Capacity (kW)						Power Input (kW)								
	Ambient Temperature: 32°C						Ambient Temperature: 32°C								
	Evaporating Temperature (°C)						Evaporating Temperature (°C)								
	-45	-35	-30	-20	-10	5	-45	-35	-30	-20	-10	5			
<b>Medium Temperature Models</b>															
ZXME020E-TFD				2.4	3.6	4.2	5.7				1.8	1.8	1.8	1.8	
ZXME020E-PFJ				2.5	3.6	4.3	5.7				1.5	1.6	1.7	1.7	
ZXME025E-PFJ				3.0	4.3	5.1	6.9				1.9	2.0	2.0	2.1	
ZXME030E-TFD				3.7	5.3	6.2	8.2				2.4	2.5	2.6	2.7	
ZXME030E-PFJ				3.8	5.3	6.2	8.3				2.5	2.6	2.7	2.8	
ZXME040E-TFD				5.0	7.0	8.2	10.8				3.2	3.4	3.5	3.8	
ZXME040E-PFJ				4.7	6.8	8.0	10.6				3.2	3.4	3.5	3.8	
ZXDE040E-TFD				5.0	7.0	8.1	10.7				2.8	3.2	3.3	3.7	
ZXME050E-TFD				6.4	9.1	10.7	14.4				4.0	4.1	4.3	4.5	
ZXDE050E-TFD				6.4	9.0	10.6	14.1				3.6	4.0	4.2	4.7	
ZXME060E-TFD				7.3	10.4	12.2	16.2				4.6	4.8	5.0	5.3	
ZXDE060E-TFD				7.4	10.4	12.2	16.1				4.3	4.9	5.2	5.8	
ZXME075E-TFD				8.4	11.9	13.9	18.5				5.1	5.4	5.5	5.9	
ZXDE075E-TFD				8.4	11.8	13.8	18.2				4.7	5.3	5.6	6.3	
<b>Low Temperature Models</b>															
ZXLE020E-TFD		1.4	2.4	3.5	4.9	5.7					1.7	1.8	1.9	2.1	2.2
ZXLE030E-TFD		2.6	3.1	4.6	6.4	7.4					2.0	2.2	2.3	2.6	2.7
ZXLE040E-TFD		4.0	4.9	7.0	9.6	11.0					3.0	3.2	3.7	4.2	4.4
ZXLE050E-TFD		4.7	5.6	7.9	10.7	12.2					3.6	3.8	4.2	4.7	5.0
ZXLE060E-TFD		5.7	7.0	10.0	13.4	15.2					4.4	4.7	5.4	6.3	6.7

Conditions: EN13215: Suction Gas Return 20°C, Subcooling 0K

# Copeland Scroll™ Indoor Condensing Units for Refrigeration

Copeland® air-cooled condensing units for medium temperature and low temperature applications.

Copeland Scroll™ condensing units are equipped with the latest refrigeration scroll compressors and build the widest range of its kind. The modular line concept offers base units which can be adapted to the target application by various options including weather housings and fan speed controls.

Copeland Scroll™ condensing units are available with normal or high capacity condensers to ensure optimum performance even under extreme conditions. They are equipped with dedicated medium or low temperature compressors which makes them suitable for all general refrigeration applications, such as:

- Mini markets and supermarkets
- Bars, restaurants and kitchens
- Beer cellars and beverage coolers
- Cold rooms
- Milk cooling tank



Copeland Scroll™ Indoor Condensing Unit

## Copeland Scroll™ Condensing Units Line-up

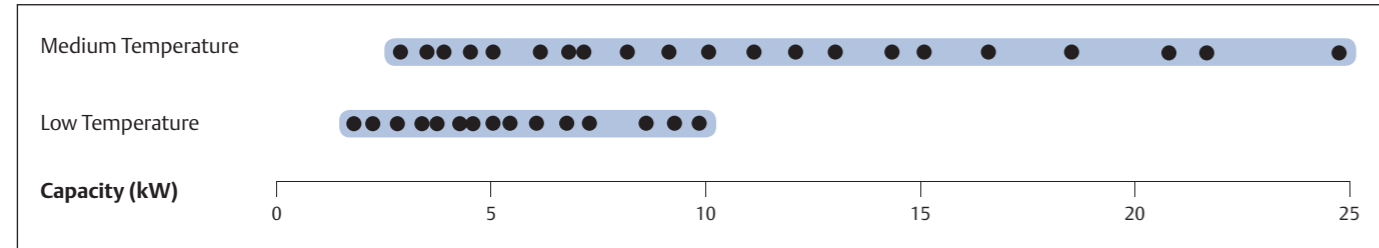

Conditions EN13215 R404A: Evaporating Temperature MT -10°C/LT -35°C, Ambient Temperature 32°C, Suction Gas Return 20°C

## Copeland Scroll™ Digital Condensing Units Line-up

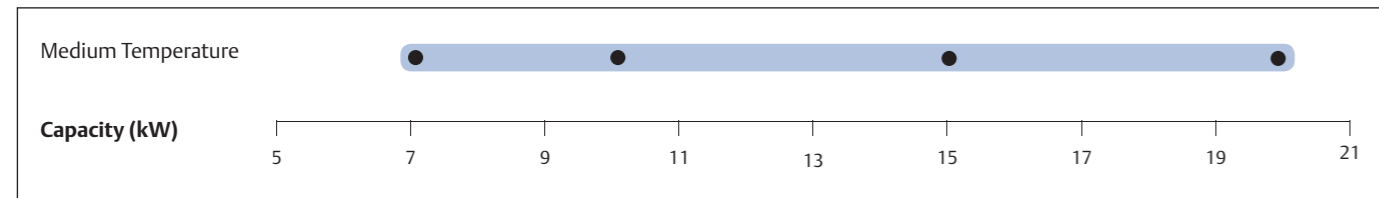

Conditions EN13215 R404A: Evaporating Temperature -10°C, Ambient Temperature 32°C, Suction Gas Return 20°C

### Features and Benefits

- Standard equipment: base plate, scroll compressor, crankcase heater, condenser with 1ph fan(s), HP and LP switch, liquid receiver with rotalock-valve, suction- and discharge shut-off valves
- Suitable for multiple refrigerants: R404A, R507, R134a, R407C, R22
- Wide range of quality accessories
- Excellent efficiency

### Maximum Allowable Pressures (PS)

- Low Side PS 22.5 bar (g)
- High Side PS = 28 bar (g)

## Technical Overview

R404A	Capacity (kW)	Receiver Capacity (l)	Number of fans	Total Fan Motor Power (W)	Suction Line Diameter (inch)	Liquid Line Diameter (inch)	Width/Depth/Height (mm)	Net Weight (kg)	Motor Version/Code		Maximum Operating Current, A		Locked Rotor Current, A		Sound Pressure @10 m - d(BA)***
									1 Ph*	3 Ph**	1 Ph*	3 Ph**	1 Ph*	3 Ph**	
<b>Medium Temperature Models</b>															
MC-D8-ZB15KE	3.3	3.9	1	110	3/4"	1/2"	560/570/446	48	PFJ	TFD	13	5	58	26	46
MC-H8-ZB15KE	3.6	7.9	1	235	3/4"	1/2"	735/680/533	57	PFJ	TFD	13	5	58	26	49
MC-D8-ZB19KE	3.9	3.9	1	110	3/4"	1/2"	560/570/446	49	PFJ	TFD	13	7	61	32	46
MC-H8-ZB19KE	4.3	7.9	1	235	3/4"	1/2"	735/680/533	61	PFJ	TFD	13	7	61	32	49
MC-K9-ZB19KE	4.3	7.9	2	220	3/4"	1/2"	950/640/454	67	PFJ	TFD	13	7	61	32	48
MC-D8-ZB21KE	4.4	3.9	1	110	7/8"	1/2"	560/570/446	50	PFJ	TFD	16	7	82	40	46
MC-H8-ZB21KE	5.1	7.9	1	235	7/8"	1/2"	735/680/533	61	PFJ	TFD	16	7	82	40	49
MC-K9-ZB21KE	5.1	7.9	2	220	7/8"	1/2"	950/640/454	68	PFJ	TFD	16	7	82	40	48
MC-H8-ZB26KE	5.6	7.9	1	235	7/8"	1/2"	735/680/533	62	PFJ	TFD	18	9	97	46	49
MC-K9-ZB26KE	5.6	7.9	2	220	7/8"	1/2"	950/640/454	68	PFJ	TFD	18	9	97	46	48
MC-H8-ZB30KE	6.4	7.9	1	235	7/8"	1/2"	735/680/533	74	PFJ	TFD	26	10	142	49	49
MC-M8-ZB30KE	6.8	7.9	1	235	7/8"	1/2"	735/730/708	87	PFJ	TFD	26	10	142	49	49
MC-P8-ZB30KE	7.1	7.9	2	220	7/8"	1/2"	950/640/633	87		TFD		10		49	49
MC-H8-ZB38KE	7.3	7.9	1	235	7/8"	1/2"	735/680/533	77	PFJ	TFD	32	13	142	66	49
MC-M8-ZB38KE	8.0	7.9	1	235	7/8"	1/2"	735/730/708	89	PFJ	TFD	32	13	142	66	49
MC-P8-ZB38KE	8.4	7.9	2	220	7/8"	1/2"	950/640/633	89	PFJ	TFD	32	13	142	66	49
MC-M8-ZB42KE	8.7	7.9	1	235	7/8"	1/2"	735/730/708	91	PFJ		36		150		49
MC-M8-ZB45KE	8.9	7.9	1	235	7/8"	1/2"	735/730/708	91		TFD		13		74	49
MC-M9-ZB45KE	9.6	7.9	1	400	7/8"	1/2"	735/730/708	96		TFD		13		74	49
MC-R7-ZB42KE	9.8	7.9	2	470	7/8"	1/2"	1130/680/633	101	PFJ		36		150		53
MC-R7-ZB45KE	10.1	7.9	2	470	7/8"	1/2"	1130/680/633	101		TFD		13		74	50
MC-R7-ZB50KE	11.4	7.9	2	470	1 3/8"	1/2"	1130/820/621	110		TFD		15		100	49
MC-S9-ZB50KE	12.0	11.7	2	470	1 3/8"	5/8"	1130/820/707	113		TFD		15		100	49
MC-R7-ZB58KE	12.4	7.9	2	470	7/8"	1/2"	1130/680/633	110		TFD		15		95	49
MC-S9-ZB58KE	13.1	11.7	2	470	7/8"	1/2"	1130/820/703	113		TFD		15		95	50
MC-S9-ZB66KE	14.5	11.7	2	470	1 3/8"	5/8"	1130/820/707	116		TFD		18		111	50
MC-V9-ZB66KE	15.1	15.8	2	470	1 3/8"	3/4"	1330/820/821	150		TFD		18		111	50
MC-V9-ZB76KE	17.2	15.8	2	470	1 3/8"	3/4"	1330/820/835	151		TFD		20		118	50
MC-V6-ZB76KE	18.5	15.8	2	800	1 3/8"	3/4"	1330/820/835	168		TFD		20		118	55
MC-V9-ZB95KE	19.3	15.8	2	470	1 3/8"	3/4"	1330/820/835	155		TFD		28		140	51
MC-V6-ZB95KE	21.5	15.8	2	800	1 3/8"	3/4"	1330/820/835	172		TFD		28		140	55
MC-V6-ZB114KE	24.3	15.8	2	800	1 3/8"	3/4"	1330/820/835	174		TFD		33		174	55
MC-W9-ZB114KE	24.6	15.8	2	800	1 3/8"	3/4"	1640/820/864	174		TFD		33		174	55
<b>Digital Medium Temperature Models</b>															
MC-M8-ZBD30	6.9	11.7	1	235	7/8"	5/8"	735/730/708	87		TFD		8		52	49
MC-M9-ZBD45	9.9	11.7	1	400	7/8"	5/8"	735/730/708	96		TFD		12		74	49
MC-V6-ZBDT60	14.9	18.9	2	800	1 3/8"	3/4"	1330/820/835	207		TFD		8+10		52+49	55
MC-V6-ZBDT90	20.4	18.9	2	800	1 3/8"	3/4"	1330/820/835	218		TFD		11+13		2x74	55

Conditions EN13215: R404A, Evaporating Temperature MT -10°C/ LT - 35°C, Ambient Temperature 32°C, Suction Gas Return 20°C

\* 1 Ph: 230V/ 50Hz

\*\* 3 Ph: 380-420V/ 50Hz

\*\*\* @ 10m: sound pressure level at 10m distance from the compressor, free field condition

Technical Overview

R404A	Capacity (kW)	Receiver Capacity (l)	Number of fans	Total Fan Motor Power (W)	Suction Line Diameter (inch)	Liquid Line Diameter (inch)	Width/Depth/Height (mm)	Net Weight (kg)	Motor Version/Code		Maximum Operating Current, A		Locked Rotor Current, A		Sound Pressure @10 m - d(BA)***
									1 Ph*	3 Ph**	1 Ph*	3 Ph**	1 Ph*	3 Ph**	
									Low Temperature Models						
MC-B8-ZF06KE	1.3	3.3	1	85	7/8"	1/2"	560/570/396	64		TFD		5	26	47	
MC-D8-ZF09KE	1.9	3.9	1	110	7/8"	1/2"	560/570/446	64		TFD		6	40	47	
MC-H8-ZF09KE	2.0	7.9	1	235	7/8"	1/2"	735/680/533	66		TFD		6	40	49	
MC-H8-ZF11KE	2.5	7.9	1	235	7/8"	1/2"	735/680/533	67		TFD		7	46	49	
MC-H8-ZF13KE	2.8	7.9	1	235	7/8"	1/2"	735/680/533	77		TFD		8	52	50	
MC-M8-ZF13KE	2.8	7.9	1	235	7/8"	1/2"	735/730/708	85		TFD		8	52	49	
MC-H8-ZF15KE	3.3	7.9	1	235	7/8"	1/2"	735/680/533	83		TFD		10	64	50	
MC-M8-ZF15KE	3.4	7.9	1	235	7/8"	1/2"	735/730/708	86		TFD		10	64	50	
MC-M8-ZF18KE	4.1	7.9	1	235	7/8"	1/2"	735/730/708	88		TFD		13	74	50	
MC-M9-ZF18KE	4.2	7.9	1	400	7/8"	1/2"	735/730/708	96		TFD		13	74	50	
MC-P8-ZF24KE	5.0	7.9	2	220	1 3/8"	1/2"	950/640/633	146		TWD		16	99	52	
MC-S9-ZF24KE	5.3	11.7	2	470	1 3/8"	1/2"	1130/820/708	170		TWD		16	99	54	
MC-R7-ZF33KE	6.8	11.7	2	470	1 3/8"	5/8"	1130/820/633	160		TWD		22	127	55	
MC-V9-ZF33KE	7.1	11.7	2	470	1 3/8"	5/8"	1330/820/835	195		TWD		22	127	55	
MC-S9-ZF40KE	8.4	11.7	2	470	1 3/8"	5/8"	1130/820/708	180		TWD		25	167	55	
MC-V6-ZF40KE	8.9	11.7	2	800	1 3/8"	5/8"	1330/820/835	218		TWD		25	167	57	
MC-S9-ZF48KE	9.6	11.7	2	470	1 3/8"	5/8"	1130/820/708	189		TWD		29	198	55	

Conditions EN13215: R404A, Evaporating Temperature MT -10°C/ LT -35°C, Ambient Temperature 32°C, Suction Gas Return 20°C

\* 1 Ph: 230V/ 50Hz  
 \*\* 3 Ph: 380-420V/ 50Hz  
 \*\*\* @ 10m: sound pressure level at 10m distance from the compressor, free field condition

Capacity Data

R404A	Cooling Capacity (kW)							Power Input (kW)							
	Ambient Temperature: 32°C							Ambient Temperature: 32°C							
	Evaporating Temperature (°C)							Evaporating Temperature (°C)							
	-45	-35	-30	-20	-10	-5	5	-45	-35	-30	-20	-10	-5	5	
Medium Temperature Models															
MC-D8-ZB15KE			1.2*	2.2	3.3	3.8	5.0			1.8*	1.9	2.0	2.0		
MC-H8-ZB15KE**			1.5	2.5	3.6	4.3	5.8			1.8	1.9	1.9	1.9	1.9	
MC-D8-ZB19KE			1.7*	2.8	3.9	4.5	5.8			2.1*	2.3	2.4	2.5	2.7	
MC-H8-ZB19KE**			2.0	3.1	4.3	5.1	6.8			2.1	2.1	2.2	2.3	2.4	
MC-K9-ZB19KE**			2.1	3.1	4.3	5.1	6.8			2.0	2.1	2.2	2.3	2.4	
MC-D8-ZB21KE			1.9*	3.2	4.4	5.0	6.4			2.5*	2.8	3.1	3.2	3.5	
MC-H8-ZB21KE**			2.4	3.6	5.1	5.9	7.8			2.5	2.6	2.7	2.8	3.0	
MC-K9-ZB21KE**			2.4	3.6	5.1	5.9	7.8			2.4	2.6	2.7	2.8	3.0	
MC-H8-ZB26KE			2.4*	4.1	5.7	6.6	8.6			2.9*	3.1	3.3	3.4	3.7	
MC-K9-ZB26KE**			2.4*	4.1	5.7	6.6	8.7			2.9*	3.1	3.3	3.4	3.6	
MC-H8-ZB30KE	2.1*	2.7	4.6	6.4	7.4	9.6			3.3*	3.4	3.7	3.9	4.1	4.4	
MC-M8-ZB30KE**	2.2*	3.2	4.8	6.8	7.9	10.5			3.1*	3.3	3.4	3.6	3.7	4.0	
MC-P8-ZB30KE**	2.3*	3.3	5.0	7.1	8.3	11.1			3.1*	3.2	3.3	3.5	3.5	3.8	
MC-H8-ZB38KE	2.5*	3.2	5.3	7.3	8.4	10.7			4.2*	4.3	4.8	5.2	5.4	6.0	
MC-M8-ZB38KE**	2.7*	3.4	5.7	8.0	9.2	12.0			4.0*	4.1	4.4	4.8	5.0	5.4	
MC-P8-ZB38KE**	2.7*	3.4	5.7	8.0	9.2	12.0			4.0*	4.1	4.4	4.8	5.0	5.4	
MC-M8-ZB45KE	3.0*	3.9	6.5	8.9	10.3	13.2			4.6*	4.8	5.3	5.7	6.0	6.5	
MC-M9-ZB45KE**	3.2*	4.1	6.9	9.6	11.1	14.5			4.6*	4.8	5.1	5.5	5.7	6.1	
MC-R7-ZB45KE**	3.3*	4.8	7.1	10.1	11.8	15.6			4.6*	4.7	5.0	5.3	5.4	5.8	
MC-R7-ZB50KE		3.1*	7.5	11.4	13.4	17.7			5.5*	6.0	6.5	6.7	7.2		
MC-S9-ZB50KE**		3.3*	7.9	12.0	14.2	18.9			5.3*	5.8	6.1	6.3	6.7		
MC-R7-ZB58KE		4.1*	8.5	12.4	14.5	18.8			6.1*	6.7	7.3	7.6	8.3		
MC-S9-ZB58KE**		4.4*	8.9	13.1	15.4	20.3			5.9*	6.4	6.9	7.1	7.7		
MC-S9-ZB66KE		6.0*	10.3	14.5	16.8	21.7			6.6*	7.4	7.9	8.2	8.9		
MC-V9-ZB66KE**		6.2*	10.7	15.1	17.6	23.0			6.5*	7.1	7.6	7.8	8.5		
MC-V9-ZB76KE		6.9*	12.2	17.2	19.9	25.8			7.5*	8.3	9.0	9.4	10.3		
MC-V6-ZB76KE**		7.4*	12.9	18.5	21.6	28.7			7.4*	8.0	8.6	8.9	9.6		
MC-V9-ZB95KE			12.2*	19.3	22.3	28.7				11.2*	12.4	13.0	14.3		
MC-V6-ZB95KE**		7.8*	14.9	21.5	25.2	33.1				10.2*	10.7	11.4	11.9	13.0	
MC-V6-ZB114KE		8.4*	16.6	24.3	28.4	37.3				12.5*	13.3	14.3	14.8	16.2	
MC-W9-ZB114KE**			8.5*	16.8	24.6	28.8	38.0				12.4*	13.2	14.1	14.7	16.0
Digital Medium Temperature Models															
MC-M8-ZBD30KE			3.0*	5.0	6.9	8.0	10.5			2.5*	3.0	3.4	3.6	4.0	
MC-M9-ZBD45KE			3.7*	6.7	9.9	11.8	16.1			4.4*	4.9	5.5	5.8	6.7	
MC-V6-ZBDT60KE			7.0	10.4	14.9	17.6	23.6			5.8	6.3	6.7	7.0	7.5	
MC-V6-ZBDT90KE			8.0*	14.1	20.4	24.1	32.5			8.8*	9.6	10.4	10.8	11.9	

Conditions: EN13215: Suction Gas Return 20°C, Subcooling 0K

\* Conditions: EN13215: Suction Superheat 10K  
 \*\* Models for high ambient temperatures



## Digital Receiver Unit HLR

Copeland Scroll™ Digital Receiver units are the perfect choice for remote condenser systems.

This series of condensing units is equipped with 2, 3, 4 or 6 cylinder semi-hermetic compressors with Discus® valve technology.

These Copeland Scroll Digital™ receiver units are an innovative offering by Emerson Climate Technologies for food service and retail businesses. Their compact design and the power of Digital Scroll™ continuous capacity modulation allow for optimized environmental integration at highest system efficiency.

Eight models with single or tandem compressors cover the need of medium temperature refrigeration capacities in various applications. The continuous capacity modulation always provides the right performance, especially for system with multiple evaporators and variable loads. The remote condenser concept allows for optimal building integration.



Digital Receiver Unit HLR

### Digital Receiver Unit HLR Line-up

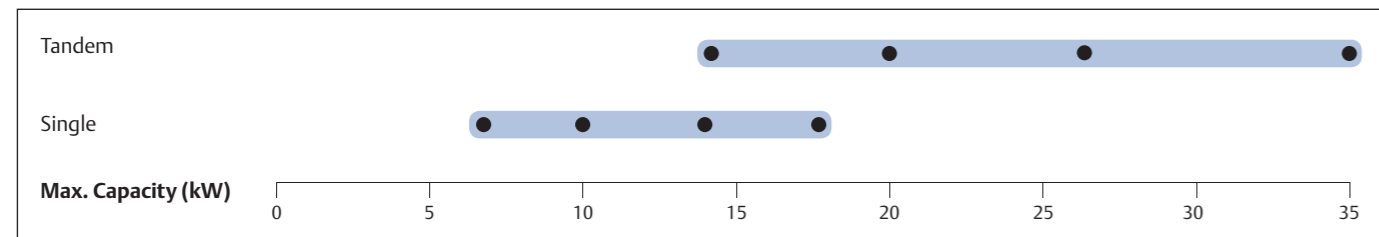

Conditions EN12900 R404A: Evaporating Temperature -10°C, Condensing Temperature 45°C, Suction Gas Return 20°C

### Features and Benefits

- Standard equipment: Digital Scroll™ compressor, liquid receiver, liquid line with filter drier and sight glass, HP/LP switch, complete electrical box including controller with overload protection and communication interface
- Continuous capacity modulation 10-100 % (Single) or 5-100 % (Tandem)
- Precise suction pressure control
- Maximum system flexibility by free choice of third party condensers
- Excellent energy efficiency
- High reliability
- Easy and quick installation

### Maximum Allowable Pressures (PS)

- Low Side PS 22.5 bar (g)
- High Side PS = 28/32 bar (g)

## Technical Overview

R404A	Capacity (kW)	Receiver Capacity (l)	Suction Line Diameter (inch)	Liquid Line Diameter (inch)	Width/Depth/Height (mm)	Net Weight (kg)	Motor Version/Code		Maximum Operating Current (A)		Locked Rotor Current (A)		Sound Pressure @1 m dB(A)***	
							1 Ph*	3 Ph**	1 Ph*	3 Ph**	1 Ph*	3 Ph**		with sound shell
<b>Single Compressor Unit Models</b>														
HLR13-ZBD30KE	7.0	13.0	7/8"	5/8"	690/400/710	72		TFD		8		52	59	49
HLR13-ZBD45KE	10.2	13.0	7/8"	5/8"	690/400/710	75		TFD		12		74	61	51
HLR13-ZBD58KE	13.5	13.0	1 1/8"	3/4"	725/400/710	84		TFD		15		95	65	55
HLR13-ZBD76KE	17.8	13.0	1 3/8"	3/4"	725/400/710	90		TFD		20		118	66	56
<b>Tandem Compressor Unit Models</b>														
HLR31-ZBDT60KE	14.1	31.0	1 3/8"	7/8"	970/480/910	130		TFD		8 + 8		52 + 52	62	-
HLR31-ZBDT90KE	20.3	31.0	1 3/8"	7/8"	970/480/910	138		TFD		12 + 12		74 + 74	64	-
HLR31-ZBDT116KE	26.8	31.0	1 5/8"	1 1/8"	970/480/870	165		TFD		15 + 15		95 + 95	68	-
HLR31-ZBDT152KE	35.7	31.0	1 5/8"	1 3/8"	970/480/870	175		TFD		20 + 20		118 + 118	69	-

Conditions EN12900: R404A, Evaporating Temperature -10°C, Condensing Temperature 45°C, Suction Gas Return 20°C

\* 1 Ph: 230V/ 50Hz

\*\* 3 Ph: 380-420V/ 50Hz

\*\*\* @ 1m: sound pressure level at 10m distance from the compressor, free field condition

### Capacity Data

R404A	Cooling Capacity (kW)							R404A	Power Input (kW)						
	Condensing Temperature: 45°C								Condensing Temperature: 45°C						
	Evaporating Temperature (°C)								Evaporating Temperature (°C)						
	-45	-35	-30	-20	-10	-5	5		-45	-35	-30	-20	-10	-5	5
<b>Single Compressor Units</b>															
HLR13-ZBD30KCE			2.7*	4.8	7.0	8.4	11.8	HLR13-ZBD30KCE			2.4*	2.9	3.1	3.2	3.5
HLR13-ZBD45KCE			3.4*	6.6	10.2	12.5	18.0	HLR13-ZBD45KCE			4.4*	4.6	4.8	4.9	5.2
HLR13-ZBD58KCE				8.6	13.5	16.3	22.9	HLR13-ZBD58KCE				6.4	6.4	6.4	6.4
HLR13-ZBD76KCE				11.8	17.9	21.4	30.2	HLR13-ZBD76KCE				8.1	8.3	8.3	8.4
<b>Tandem Compressor Units</b>															
HLR31-ZBDT60KCE			5.4*	9.6	14.1	16.9	23.6	HLR31-ZBDT60KCE			4.9*	5.8	6.3	6.5	6.9
HLR31-ZBDT90KCE				7.0*	13.4	20.3	35.0	HLR31-ZBDT90KCE				9.2*	9.4	9.6	9.7
HLR31-ZBDT116KE				6.4*	17.0	26.7	45.8	HLR31-ZBDT116KE				13.1*	12.7	12.7	12.8
HLR31-ZBDT152KE				23.7	35.7	42.9	60.3	HLR31-ZBDT152KE				16.2	16.4	16.5	16.8

Conditions: EN12900: Condensing Temperature 45°C, Suction Gas Return 20°C, Subcooling 0K

\* Conditions: EN12900: Condensing Temperature 45°C, Suction Superheat 10K

## Semi-Hermetic Condensing Units DK/DL

Copeland® air-cooled indoor condensing units for medium temperature and low temperature applications.

Long term engineering and manufacturing experience have led to these condensing units with reed valve technology compressors. Their excellent quality and reliability is traditionally well known in the refrigeration industry.

This series of condensing units is equipped with single fan or twin fans which allows for very compact dimensions. The wide range of models offers solutions for most applications including operation in extreme conditions like high evaporation temperatures and high ambient temperatures.



Semi-Hermetic Condensing Unit DK/DL

### Semi-Hermetic DK/DL Condensing Units Medium Temperature Line-up

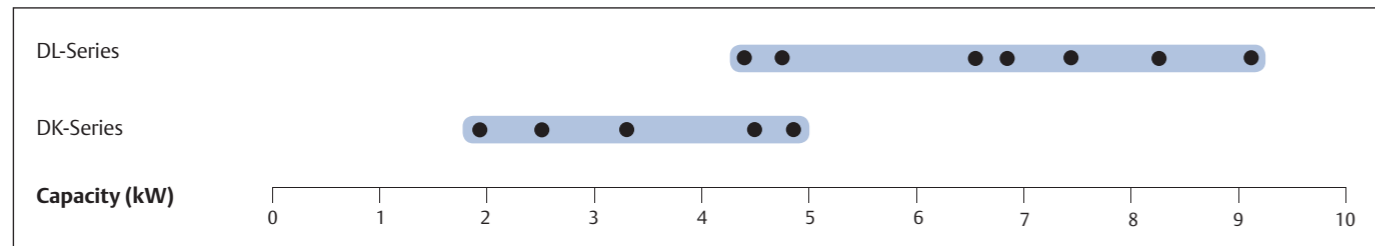

Conditions EN13215 R404A: Evaporating Temperature -10°C, Suction Gas Return 20°C, Subcooling 0K

### Semi-Hermetic DK/DL Condensing Units Low Temperature Line-up

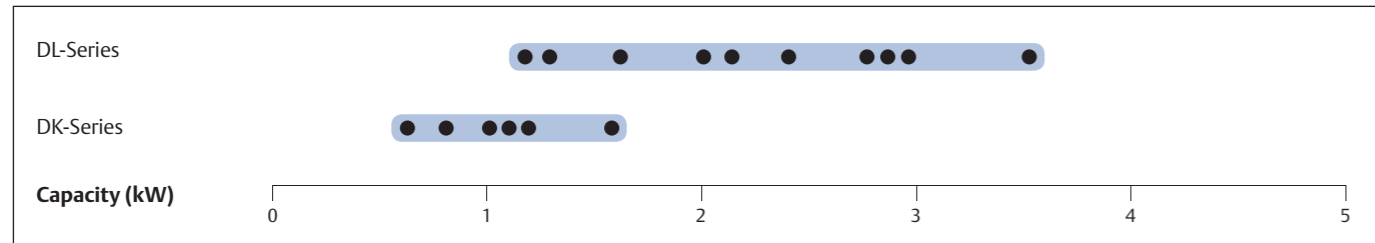

Conditions EN13215 R404A: Evaporating Temperature -45°C, Suction Gas Return 20°C, Subcooling 0K

### Features and Benefits

- Standard equipment: compressor, condenser with thermally protected fan(s), discharge line with flexible pipe loop or vibration absorber, liquid receiver with shut-off-valve, HP/LP switch with automatic reset
- Suitable for a broad range of refrigerants: R404A, R507, R134a, R407C, R22
- Wide range of quality accessories
- Proven reliability

### Maximum Allowable Pressures (PS)

- Low Side PS 22.5 bar (g)
- High Side PS = 28 bar (g)

### Technical Overview

R404A Models	Receiver Capacity (l)	Number of fans	Total Fan Motor Power (W)	Suction Line Diameter (inch)	Liquid Line Diameter (inch)	Width/Depth/Height (mm)	Net Weight (kg)	Motor Version/Code		Maximum Operating Current, A		Locked Rotor Current, A		Sound Pressure @ 1 m - d(BA)***
								1 Ph*	3 Ph**	1 Ph*	3 Ph**	1 Ph*	3 Ph**	
B8-KM-5X	3.1	1	85	5/8	1/2	560/570/396	56	CAG		5		24		
B8-KM-7X	3.1	1	85	1/2	1/2	560/570/396	58		EWL		2		12	
B8-KJ-10X	3.1	1	85	5/8	1/2	560/570/396	58	CAG	EWL	7	3	32	16	39
B8-KJ-7X	3.1	1	85	5/8	1/2	560/570/396	58	CAG	EWL	6	2	35	12,0	
B8-KSJ-10X	3.1	1	85	5/8	1/2	560/570/396	58	CAG	EWL	7	3	32	16	
D8-KSJ-15X	3.7	1	110	7/8	1/2	560/570/446	62	CAG	EWL	9	3	43	20	46
B8-KL-15X	3.1	1	85	5/8	1/2	560/570/396	58	CAG	EWL	8	3	43	20	40
D8-KSL-20X	3.7	1	110	5/8	1/2	560/570/396	60		EWL		5		20	
H8-KSL-20X	7.5	1	235	5/8	1/2	735/680/533	60		EWL		5		20	
D8-LE-20X	3.7	1	110	7/8	1/2	560/715/446	97		EWL		6		38	
H8-LE-20X	7.5	1	235	7/8	1/2	735/680/533	108		EWL		6		38	
D8-LF-20X	3.7	1	110	7/8	1/2	560/715/446	98		EWL		5		38	
H8-LF-30X	7.5	1	235	7/8	1/2	735/680/533	108		EWL		7		53	49
H8-LJ-20X	7.5	1	235	7/8	1/2	735/680/533	103		EWL		6		38	
P8-LF-30X	7.5	2	220	1 1/8	1/2	950/640/633	127		EWL		7		53	48
H8-LJ-30X	7.5	1	235	7/8	1/2	735/680/533	108		EWL		8		53	49
P8-LJ-30X	7.5	2	220	7/8	1/2	950/640/633	127		EWL		8		53	48
H8-LL-30X	7.5	1	235	1 1/8	1/2	735/680/533	110		EWL		7		53	49
K9-LL-30X	7.5	2	220	1 1/8	1/2	950/640/454	134		EWL		7		53	47
H8-LL-40X	7.5	1	235	1 1/8	1/2	735/680/533	112		EWL		10		69	49
P8-LL-40X	7.5	2	220	1 1/8	1/2	950/640/633	128		EWL		10		69	48
H8-LSG-40X	7.5	1	235	1 1/8	1/2	735/680/533	116		EWL		9		69	
K9-LSG-40X	7.5	2	220	1 1/8	1/2	950/640/454	131		EWL		9		69	51

\* 1 Ph: 230V/ 50Hz

\*\* 3 Ph: 380-420V/ 50Hz

\*\*\* @ 1m: sound pressure level at 10m distance from the compressor, free field condition

Capacity Data

R404A	Ambient Temperature +32°C														
	Cooling Capacity (kW)							Input Power (kW)							
	Evaporation Temperature (°C)							Evaporation Temperature (°C)							
Model	-45	-35	-30	-20	-10	-5	5	Model	-45	-35	-30	-20	-10	-5	5
B8-KM-5X	0.3	0.6	0.8	1.3				B8-KM-5X	0.5	0.6	0.6	0.8			
B8-KM-7X	0.3	0.6	0.8	1.3	1.9	2.2	3.0	B8-KM-7X	0.4	0.6	0.7	0.8	1.0	1.1	1.3
B8-KJ-10X	0.4	0.8	1.1	1.7	2.4	2.8	3.6	B8-KJ-10X	0.5	0.8	0.9	1.1	1.4	1.5	1.8
B8-KJ-7X	0.4	0.8	1.1	1.7				B8-KJ-7X	0.6	0.8	0.9	1.1			
B8-KSJ-10X	0.6	1.1	1.3	1.8				B8-KSJ-10X	0.8	1.0	1.2	1.5			
D8-KSJ-15X	0.6	1.1	1.4	2.2	3.2	3.8		D8-KSJ-15X	0.7	1.0	1.1	1.4	1.8	1.9	
B8-KL-15X	0.7	1.2	1.5	2.3				B8-KL-15X	0.9	1.1	1.3	1.6			
D8-KSL-20X	0.9	1.6	2.0	3.1	4.3			D8-KSL-20X	1.0	1.3	1.5	2.0	2.6		
H8-KSL-20X	0.9	1.7	2.2	3.3	4.8	5.7		H8-KSL-20X	1.1	1.5	1.7	2.1	2.6	2.8	
D8-LE-20X		1.2	1.7	2.9	4.3	5.0		D8-LE-20X		1.1	1.3	1.7	2.2	2.5	
H8-LE-20X		1.3	1.9	3.2	4.8	5.8	7.8	H8-LE-20X		1.2	1.4	1.9	2.3	2.5	3.0
D8-LF-20X	0.7	1.7	2.2	3.5				D8-LF-20X	1.0	1.5	1.8	2.4			
H8-LF-30X	0.9	2.1	2.7	4.4	6.3	7.4		H8-LF-30X	1.3	1.9	2.1	2.7	3.3	3.6	
P8-LF-30X	1.0	2.1	2.9	4.7	6.9	8.2	11.1	P8-LF-30X	1.3	1.9	2.1	2.6	3.2	3.4	4.0
H8-LJ-20X	0.8	2.1	2.9					H8-LJ-20X	1.2	1.8	2.2				
H8-LJ-30X	1.1	2.3	3.0	4.7	6.8	7.9		H8-LJ-30X	1.4	2.0	2.4	3.0	3.8	4.2	
P8-LJ-30X	1.1	2.4	3.2	5.1	7.5	8.9	11.9	P8-LJ-30X	1.4	2.0	2.3	3.0	3.6	4.0	4.6
H8-LL-30X	1.2	2.7	3.6	5.7				H8-LL-30X	1.5	2.2	2.7	3.6			
H8-LL-40X	1.4	2.8	3.6	5.6	8.1	9.4		H8-LL-40X	1.7	2.4	2.8	3.7	4.7	5.3	
K9-LL-30X	1.2	2.7	3.6	5.7				K9-LL-30X	1.5	2.2	2.6	3.6			
P8-LL-40X	1.4	2.9	3.9	6.2	9.1	10.8		P8-LL-40X	1.7	2.4	2.8	3.6	4.5	5.0	
H8-LSG-40X	1.7	3.4	4.4	6.7				H8-LSG-40X	1.9	2.8	3.3	4.5			
K9-LSG-40X	1.7	3.4	4.4	6.7				K9-LSG-40X	1.9	2.8	3.3	4.5			

Conditions: EN13215: Suction Gas Return 20°C, Subcooling 0K

R134a	Cooling Capacity (kW)							R134a	Power Input (kW)						
	Ambient Temperature: 32°C								Ambient Temperature: 32°C						
	Evaporating Temperature (°C)								Evaporating Temperature (°C)						
Models	-45	-35	-30	-20	-10	-5	5	Models	-45	-35	-30	-20	-10	-5	5
B8-KM-5X				0.8	1.2	1.5	2.2	B8-KM-5X				0.5	0.6	0.7	0.8
B8-KJ-7X				1.0	1.6	1.9	2.8	B8-KJ-7X				0.7	0.8	0.9	1.0
B8-KSJ-10X				1.2	1.9	2.4	3.4	B8-KSJ-10X				0.8	0.9	1.0	1.2
B8-KL-15X				1.4	2.2	2.6	3.7	B8-KL-15X				0.9	1.2	1.3	1.6
D8-KSL-15X				1.8	2.8	3.4	4.9	D8-KSL-15X				1.1	1.4	1.6	1.9
D8-KSL-20X				1.8	2.9	3.5	5.0	D8-KSL-20X				1.1	1.4	1.5	1.8
H8-KSL-20X				1.9	3.0	3.7	5.4	H8-KSL-20X				1.2	1.5	1.6	1.8
D8-LF-20X				2.2	3.6	4.4	6.2	D8-LF-20X				1.4	1.7	1.9	2.3
H8-LJ-20X				2.7	4.3	5.2	7.5	H8-LJ-20X				1.8	2.2	2.4	2.8
H8-LL-30X				3.2	5.3	6.5	9.2	H8-LL-30X				2.1	2.6	3.0	3.7
H8-LSG-40X				4.2	6.6	7.9	11.0	H8-LSG-40X				2.5	3.2	3.7	4.6

Conditions: EN13215: Suction Gas Return 20°C, Subcooling 0K

Capacity Data

R22	Ambient Temperature +32°C														
	Cooling Capacity (kW)							Motor Capacity (kW)							
	Evaporation Temperature (°C)							Evaporation Temperature (°C)							
Model	-45	-35	-30	-20	-10	-5	5	Model	-45	-35	-30	-20	-10	-5	5
B8-KM-5X	0.2	0.5	0.7	1.2	1.8	2.2		B8-KM-5X	0.4	0.5	0.6	0.7	0.9	1.0	
B8-KM-7X	0.2	0.5	0.7	1.2	1.8	2.2	3.0	B8-KM-7X	0.4	0.5	0.6	0.7	0.9	1.0	1.1
B8-KJ-10X		0.7	0.9	1.6	2.3	2.8	3.8	B8-KJ-10X		0.7	0.8	1.0	1.2	1.3	1.5
B8-KJ-7X	0.3	0.7	0.9	1.5	2.3	2.8		B8-KJ-7X	0.4	0.5	0.6	0.7	0.9	1.0	1.1
B8-KSJ-10X	0.5	0.9	1.2	1.9	2.8	3.3		B8-KSJ-10X	0.6	0.9	1.0	1.2	1.6	1.8	
D8-KSJ-15X		1.0	1.3	2.1	3.2	3.8	5.1	D8-KSJ-15X		0.9	1.0	1.2	1.5	1.6	1.8
B8-KL-15X	0.6	1.1	1.4	2.2				B8-KL-15X	0.7	1.0	1.1	1.4			
D8-KSL-20X		1.4	1.8	2.9	4.3			D8-KSL-20X		1.2	1.4	1.8	2.2		
H8-KSL-20X		1.5	1.9	3.1	4.6	5.5		H8-KSL-20X		1.3	1.5	1.9	2.2	2.4	
D8-LE-20X		1.2	1.6	2.8	4.4	5.2	7.3	D8-LE-20X		1.2	1.4	1.8	2.2	2.4	2.9
H8-LE-20X		1.2	1.7	3.0	4.7	5.7	8.1	H8-LE-20X		1.3	1.5	1.9	2.3	2.4	2.8
D8-LF-20X	0.8	1.7	2.3	3.8				D8-LF-20X	1.1	1.6	1.8	2.4			
H8-LF-30X		1.7	2.4	4.1	6.3	7.5	10.3	H8-LF-30X		1.7	1.9	2.4	3.0	3.3	3.8
P8-LF-30X		1.8	2.5	4.3	6.7	8.0	11.2	P8-LF-30X		1.7	1.9	2.4	2.9	3.1	3.5
H8-LJ-20X	0.9	2.0	2.8	4.7				H8-LJ-20X	1.3	1.8	2.1	2.8			
H8-LJ-30X		2.0	2.7	4.6	7.0	8.3	11.2	H8-LJ-30X		1.8	2.1	2.8	3.4	3.8	4.4
P8-LJ-30X		2.1	2.9	4.9	7.5	9.0	12.3	P8-LJ-30X		1.8	2.1	2.7	3.3	3.6	4.1
H8-LL-30X	1.3	2.6	3.5	5.7				H8-LL-30X	1.6	2.2	2.6	3.4			
H8-LL-40X		2.6	3.5	5.7	8.5	10.0		H8-LL-40X		2.3	2.6	3.4	4.2	4.7	
K9-LL-30X	1.3	2.7	3.5	5.8				K9-LL-30X	1.6	2.2	2.6	3.4			
P8-LL-40X		2.7	3.7	6.1	9.2	10.9	14.7	P8-LL-40X		2.2	2.6	3.3	4.0	4.5	5.3
H8-LSG-40X	1.8	3.5	4.6	7.1				H8-LSG-40X	2.1	3.0	3.5	4.5			
K9-LSG-40X	1.8	3.5	4.6	7.1				K9-LSG-40X	2.1	3.0	3.4	4.4			

Conditions: EN13215: Suction Gas Return 20°C, Subcooling 0K

## Standard Semi-Hermetic Condensing Units

Copeland air-cooled indoor condensing units for medium temperature and low temperature applications.

Long term engineering and manufacturing experience have led to this complete range of condensing units featuring semi-hermetic reciprocating compressor technology for use in high, medium and low temperature applications. Their excellent quality and reliability is traditionally well known in the refrigeration industry.

This series is equipped with compressors using reed valve technology which provide 0.5 to 40 hp motor power. The wide range of models offers solutions for most applications including operation in extreme conditions like high evaporation temperatures and high ambient temperatures.



### Standard Units Line-up

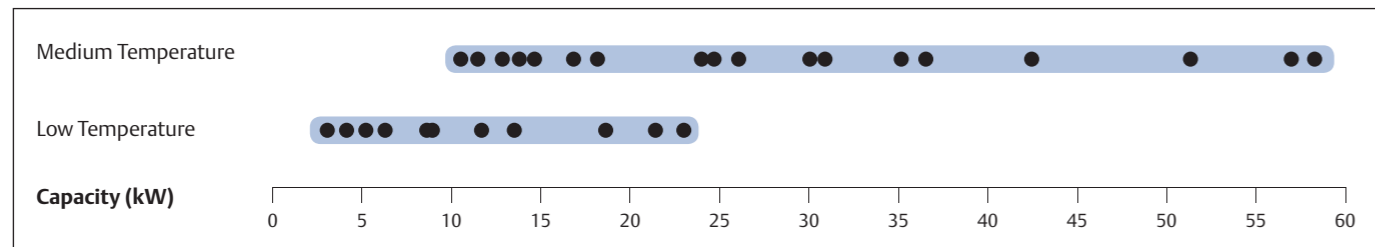

Conditions EN13215 R404A: Evaporating Temperature LT -45°C/MT -10°C, Suction Gas Return 20°C, Subcooling 0K

### Features and Benefits

- Standard equipment: compressor, condenser with thermally protected fan(s), discharge line with flexible pipe loop or vibration absorber, liquid receiver with shut-off-valve, HP/LP switch with automatic reset, oil pressure safety control OPS2
- Multiple choice of refrigerants incl. R404A, R134a and R22
- Robust design with good component accessibility
- Wide range of quality accessories
- Proven reliability

### Maximum Allowable Pressures (PS)

- Low Side PS 22.5 bar (g)
- High Side PS = 28 bar (g)

### Technical Overview

R404A	Receiver Capacity (l)	Number of fans	Total Fan Motor Power (W)	Suction Line Diameter (inch)	Liquid Line Diameter (inch)	Width/Depth/Height (mm)	Net Weight (kg)	Motor Version/Code	Maximum Operating Current, A	Locked Rotor Current, A	Sound Pressure @10 m - d(BA)***
								3 Ph**	3 Ph**	3 Ph**	
M8 - 2SA - 45X	7.9	1	235	1 1/8	1/2	735/730/708	150	EWL	11	69	49
R7 - 2SA - 45X	15.8	2	470	1 1/8	3/4	1130/820/633	150	EWL	11	69	53
M9 - 2SA - 55X	7.9	1	400	1 1/8	1/2	735/730/708	149	EWL	13	67	50
M9 - 2SC - 55X	7.9	1	400	1 1/8	1/2	735/730/708	150	EWL	13	74	50
S9 - 2SC - 55X	15.8	2	470	1 1/8	3/4	1130/820/708	150	EWL	13	74	53
S9 - 2SC - 65X	15.8	2	470	1 1/8	3/4	1130/820/708	161	EWL	16	85	53
M9 - 2SK - 65X	7.9	1	400	1 1/8	1/2	735/730/708	150	EWL	16	85	52
V9 - 2SK - 65X	18.9	2	470	1 1/8	7/8	1330/820/835	150	EWL	16	85	54
V9 - 3SA - 75X	18.9	2	470	1 3/8	7/8	1330/820/835	215	AWM	18	82	55
S9 - 3SC - 75X	15.8	2	470	1 3/8	3/4	1130/820/708	243	AWM	19	82	52
V6 - 3SC - 75X	18.9	2	800	1 3/8	7/8	1330/820/835	280	AWM	19	82	56
V6 - 3SC - 100X	18.9	2	800	1 3/8	7/8	1330/820/835	280	AWM	22	106	56
V6 - 3SS - 100X	18.9	2	800	1 3/8	7/8	1330/820/835	280	AWM	26	109	56
W9 - 3SS - 100X	18.9	2	800	1 3/8	7/8	1640/820/869	303	AWM	26	109	56
W9 - 3SS - 150X	18.9	2	800	1 5/8	7/8	1640/820/869	303	AWM	30	125	57
V6 - 4SL - 150X	18.9	2	800	1 5/8	7/8	1289/955/835	280	AWM	36	156	56
W9 - 4SA - 200X	18.9	2	800	1 5/8	7/8	1600/1108/875	303	AWM	32	175	57
Z9 - 4SA - 200X	18.9	4	1600	1 5/8	7/8	1600/1108/1252	280	AWM	32	175	52
W9 - 4ST - 200X	18.9	2	800	2 1/8	7/8	1600/1108/875	303	AWM	42	175	56
Z9 - 4SH - 250X	18.9	4	1600	2 1/8	7/8	1600/1108/1252	215	AWM	42	199	55
Z9 - 4SJ - 300X	18.9	4	1600	2 1/8	7/8	1600/1108/1252	215	AWM	48	221	55
W9 - 6SL - 250X	18.9	2	800	2 1/8	7/8	1600/1108/875	303	AWM	57	199	57
Z9 - 6SL - 250X	18.9	4	1600	2 1/8	7/8	1600/1128/1252	215	AWM	57	199	55
Z9 - 6ST - 320X	18.9	4	1600	2 1/8	7/8	1600/1128/1252	215	AWM	63	255	55
W99 - 6SH - 350X	44.0	4	1600	2 1/8	7/8	1600/1200/1810	303	AWM	64	304	57
W99 - 6SJ - 400X	44.0	4	1600	2 1/8	7/8	1600/1200/1810	303	AWM	75	304	57

\*\* 3 Ph: 380-420V/ 50Hz

\*\*\* @ 10 m: sound pressure level at 10m distance from the compressor, free field condition



Capacity Data

R404A		Ambient Temperature: 32°C													
		Cooling Capacity (kW)						Input Power (kW)							
		Evaporating Temperature (°C)						Evaporating Temperature (°C)							
Model	-45	-35	-30	-20	-10	-5	5	Model	-45	-35	-30	-20	-10	-5	5
M8-2SA-45X	1.3	2.9	4.5	6.8	9.4	10.2		M8-2SA-45X	2.2	3.1	3.7	4.9	6.2	6.9	
R7-2SA-45X	1.4	3.7	4.9	7.5	10.8	12.6		R7-2SA-45X	2.4	3.4	3.9	5.0	6.2	6.8	
M9-2SC-55X	1.4	4.1	5.3	8.3	11.6	13.5		M9-2SC-55X	2.4	3.6	4.2	5.7	7.3	8.2	
S9-2SC-55X	1.5	4.3	5.7	9.1	13.2	15.5		S9-2SC-55X	2.5	3.7	4.3	5.7	7.1	7.9	
M9-2SK-65X	1.5	4.7	6.2	9.4	13.0			M9-2SK-65X	3.0	4.4	5.1	6.8	8.8		
V9-2SK-65X	1.7	5.2	6.9	10.8	15.6	18.3		V9-2SK-65X	3.1	4.5	5.2	6.7	8.4	9.4	
S9-3SC-75X	2.0	5.7	7.4	11.5	16.3	19.0		S9-3SC-75X	3.3	4.8	5.7	7.6	9.7	10.8	
V6-3SC-75X	2.2	6.0	8.0	12.8	18.9	22.3		V6-3SC-75X	3.6	5.1	6.0	7.7	9.6	10.6	
V6-3SS-100X	3.3	8.5	10.9	16.7	23.5	27.4		V6-3SS-100X	5.2	6.9	8.0	10.5	13.3	14.9	
W9-3SS-100X	3.4	8.5	11.0	16.8	23.8	27.7		W9-3SS-100X	5.2	6.9	8.0	10.5	13.3	14.8	

Conditions: EN13215: Suction Gas Return 20°C, Subcooling 0K

R22		Ambient Temperature: 32°C													
		Cooling Capacity (kW)						Input Power (kW)							
		Evaporating Temperature (°C)						Evaporating Temperature (°C)							
Model	-45	-35	-30	-20	-10	-5	5	Model	-45	-35	-30	-20	-10	-5	5
M8-2SA-45X		2.5	3.6	6.4	9.4	11.2		M8-2SA-45X		2.7	3.1	4.1	5.3	5.9	
M8-2SA-45X Air	1.8	3.4	4.5	7.0				M8-2SA-45X Air	1.9	2.8	3.2	4.1			
R7-2SA-45X		2.6	3.7	6.8	10.3	12.3		R7-2SA-45X		2.9	3.3	4.3	5.2	5.8	
R7-2SA-45X Air	1.8	3.5	4.7	7.4				R7-2SA-45X Air	2.2	3.0	3.4	4.3			
M9-2SC-55X		2.7	4.1	7.9	12.0	14.3		M9-2SC-55X		3.3	3.9	5.1	6.5	7.4	
M9-2SC-55X Air	2.1	4.2	5.4					M9-2SC-55X Air	2.5	3.5	4.0				
S9-2SC-55X		2.9	4.4	8.4	12.9	15.6		S9-2SC-55X		3.4	3.9	5.1	6.3	6.9	
S9-2SC-55X Air	2.1	4.3	5.6					S9-2SC-55X Air	2.6	3.5	4.1				
M9-2SK-65X		3.7	5.3	8.8	13.5	15.9		M9-2SK-65X		4.1	4.7	6.1	7.9	9.0	
V9-2SK-65X		4.1	5.7	10.2	15.2	18.1		V9-2SK-65X		4.1	4.7	6.0	7.4	8.2	

Conditions: EN13215: Suction Gas Return 20°C, Subcooling 0K

## Condensing Units with Semi-Hermetic Discus® Compressors

Copeland® air-cooled indoor condensing units for medium temperature and low temperature applications.

In a further approach to improve compressor performance and reduce compression losses Emerson Climate Technologies engineers developed the Discus® valve technology.

This series of condensing units is equipped with 2, 3, 4 or 6 cylinder semi-hermetic compressors with Discus® valve technology. The models are specifically suitable for those applications where high efficiency and low energy consumption is required.

The wide range of compressor models combined with 2 or 4 fan high capacity condensers covers most application needs of low temperature and medium temperature applications.



Condensing Units with Semi-Hermetic Discus® Compressors

### Discus® Condensing Units Line-up

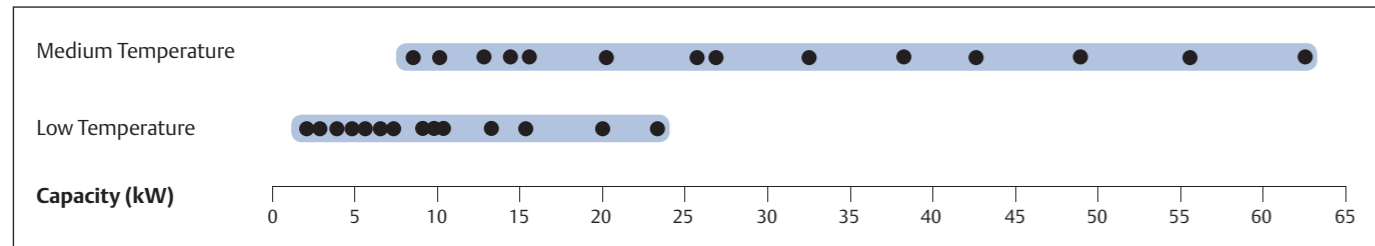

Conditions EN13215 R404A: Evaporating Temperature LT -45°C/MT -10°C, Suction Gas Return 20°C, Subcooling 0K

### Features and Benefits

- Standard equipment: Discus® compressor, condenser with thermally protected fan(s), discharge line with flexible pipe loop or vibration absorber, liquid receiver with shut-off-valve, HP/LP switch with automatic reset, oil pressure safety control OPS2
- Suitable for multiple refrigerants: R404A, R507, R134a, R407C, R22
- Wide range of quality accessories
- Excellent efficiency
- Proven reliability

### Maximum Allowable Pressures (PS)

- Low Side PS 22.5 bar (g)
- High Side PS = 28 bar (g)

### Technical Overview

R404A	Receiver Capacity (l)	Number of fans	Total Fan Motor Power (W)	Suction Line Diameter (inch)	Liquid Line Diameter (inch)	Width/Depth/Height (mm)	Net Weight (kg)	Motor Version/Code	Maximum Operating Current, A	Locked Rotor Current, A	Sound Pressure @ 10 m - d(BA)***
								3 Ph**	3 Ph**	3 Ph**	
P8-2DB-50X	11.7	2	220	1 3/8	5/8	950/740/633	186	AWM	13	55	50
P8-2DB-75X	11.7	2	220	1 3/8	5/8	950/740/633	191	AWM	16	70	52
P8-2DC-50X	11.7	2	220	1 3/8	5/8	950/740/633	186	AWM	9	55	
P8-2DL-75X	11.7	2	220	1 3/8	5/8	950/740/633		AWM	14	70	50
P8-3DA-50X	11.7	2	220	1 3/8	5/8	950/740/633	205	AWM	16	55	52
P8-3DA-75X	11.7	2	220	1 3/8	5/8	950/740/633	211	AWM	18	106	52
R7-2DD-50X	15.8	2	470	1 3/8	3/4	1130/820/633	196	AWM	10	55	
R7-2DL-75X	15.8	2	470	1 3/8	3/4	1130/820/708	205	AWM	14	70	
R7-3DC-100X	15.8	2	470	1 3/8	3/4	1129/820/633	234	AWM	21	121	56
R7-3DC-75X	15.8	2	470	1 3/8	3/4	1130/820/633	278	AWM	18	70	55
S9-2DB-75X	15.8	2	470	1 3/8	3/4	1130/820/708	212	AWM	16	70	
S9-3DA-75X	18.9	2	470	1 3/8	7/8	1130/820/835	259	AWM	18	106	
S9-3DS-100X	15.8	2	470	1 3/8	3/4	1130/820/708	239	AWM	24	121	54
S9-3DS-150X	15.8	2	470	1 5/8	3/4	1129/820/708	243	AWM	29	129	57
V5-4DA-200X	18.9	2	470	1 5/8	7/8	1283/950/835	298	AWM	33	175	54
V6-3DC-100X	18.9	2	800	1 3/8	7/8	1330/820/835	278	AWM	21	121	
V6-3DS-150X	18.9	2	800	1 5/8	7/8	1330/820/835	280	AWM	29	129	
V6-4DF-100X	18.9	2	800	1 5/8	7/8	1283/950/835	295	AWM	27	105	57
V6-4DH-250X	18.9	2	800	2 1/8	7/8	1283/950/835	307	AWM	42	199	
V6-4DL-150X	18.9	2	800	2 1/8	7/8	1289/955/835	303	AWM	35	156	59
W9-3DS-150X	18.9	2	800	1 5/8	7/8	1640/820/869	303	AWM	29	129	
W9-4DJ-300X	18.9	2	800	2 1/8	7/8	1596/1102/875	358	AWM	53	221	
W9-4DT-220X	18.9	2	800	2 1/8	7/8	1600/1108/875	358	AWM	43	175	60
W99-6DH-350X	44.0	4	1600	2 1/8	7/8	1600/1200/1810	548	AWM	64	304	
W99-6DJ-400X	44.0	4	1600	2 1/8	7/8	1600/1200/1810	563	AWM	83	304	
Z9-4DA-200X	18.9	4	1600	1 5/8	7/8	1600/1108/1252	402	AWM	33	175	
Z9-4DH-250X	18.9	4	1600	2 1/8	7/8	1600/1108/1252	411	AWM	42	199	
Z9-4DJ-300X	18.9	4	1600	2 1/8	7/8	1600/1108/1252	416	AWM	53	221	
Z9-6DH-350X	18.9	4	1600	2 1/8	7/8	1596/1125/1252	441	AWM	64	304	
Z9-6DJ-400X	18.9	4	1600	2 1/8	7/8	1596/1125/1252	457	AWM	83	304	57
Z9-6DL-270X	18.9	4	1600	2 1/8	7/8	1600/1128/1257	437	AWM	54	199	
Z9-6DT-320X	18.9	4	1600	2 1/8	7/8	11600/1128/1252	457	AWM	62	255	

\*\* 3 Ph: 380-420V/ 50Hz

\*\*\* @ 10m: sound pressure level at 10m distance from the compressor, free field condition

Capacity Data

R404A	Ambient Temperature +32°C														
	Cooling Capacity (kW)							Input Power (kW)							
	Evaporating Temperature (°C)							Evaporating Temperature (°C)							
Model	-45	-35	-30	-20	-10	-5	5	Model	-45	-35	-30	-20	-10	-5	5
P8-2DC-50X		2.4	3.2	5.2	7.9	9.5	13.0	P8-2DC-50X		2.0	2.3	3.0	3.7	4.0	4.7
R7-2DD-50X		3.1	4.1	6.7	9.9	11.7	15.9	R7-2DD-50X		2.6	3.0	3.8	4.5	4.9	5.6
R7-2DL-75X		3.8	5.0	8.0	11.8	13.9	18.6	R7-2DL-75X		3.2	3.6	4.5	5.6	6.1	7.3
P8-2DB-50X	2.0	4.6	5.9	8.9	12.3			P8-2DB-50X	2.5	3.4	4.0	5.4	7.0		
S9-2DB-75X		5.2	6.7	10.2	14.4	16.8	22.0	S9-2DB-75X		3.8	4.4	5.5	6.8	7.4	8.8
P8-3DA-50X	2.3	5.4	6.7	9.6	11.9			P8-3DA-50X	2.9	4.2	5.0	6.5	8.2		
S9-3DA-75X		5.4	7.1	11.2	16.0	18.7		S9-3DA-75X		4.4	5.1	6.5	8.0	8.7	
R7-3DC-75X	3.1	6.7	8.4	12.1	16.2			R7-3DC-75X	3.9	5.4	6.2	7.9	9.9		
V6-3DC-100X		7.1	9.2	14.5	20.9	24.7	33.0	V6-3DC-100X		5.3	6.1	7.6	9.1	9.9	11.3
S9-3DS-100X	4.2	9.0	11.3	16.2	19.9			S9-3DS-100X	5.1	7.1	8.2	10.7	13.4		
V6-3DS-150X		9.4	12.2	18.5	25.9	30.1	39.1	V6-3DS-150X		7.1	8.2	10.6	12.9	14.1	16.3
W9-3DS-150X		9.4	12.2	18.7	26.2	30.5	39.7	W9-3DS-150X		7.1	8.2	10.5	12.9	14.0	16.2
Z9-4DA-200X		10.4	13.9	22.2	32.5	38.6	52.3	Z9-4DA-200X		8.1	9.3	11.6	13.6	14.6	16.3
V6-4DL-150X	5.7	12.8	16.1	23.8	32.7			V6-4DL-150X	7.1	9.9	11.5	15.0	18.9		
Z9-4DH-250X		13.3	17.5	27.5	39.8	46.8	62.5	Z9-4DH-250X		10.4	11.8	14.8	17.6	19.1	21.8
W9-4DT-220X	7.1	15.4	19.2	27.6	34.3			W9-4DT-220X	8.6	12.1	14.1	18.4	23.0		
Z9-4DJ-300X		16.3	21.2	32.6	46.1	53.7	70.2	Z9-4DJ-300X		12.2	14.0	17.8	21.6	23.5	27.3
W99-6DH-350X		19.4	25.2	38.3	53.6	62.2	80.7	W99-6DH-350X		14.6	16.9	21.6	26.4	28.9	33.9
Z9-6DL-270X	8.8	19.5	24.7	36.9	51.4	59.4		Z9-6DL-270X	10.9	15.1	17.3	22.1	27.2	30.0	
W99-6DJ-400X		22.5	29.1	43.8	60.7	69.9		W99-6DJ-400X		17.4	20.3	26.3	32.7	36.1	
Z9-6DT-320X	10.4	23.5	29.7	43.7	59.4	67.6		Z9-6DT-320X	12.9	18.0	20.7	26.6	33.0	36.4	

Conditions: EN13215: Suction Gas Return 20°C, Subcooling 0K

R407C	Ambient Temperature +32°C														
	Cooling Capacity (kW)							Input Power (kW)							
	Evaporating Temperature (°C)							Evaporating Temperature (°C)							
Model	-20	-15	-10	-5	0	5	10	Model	-20	-15	-10	-5	0	5	10
P8-2DC-50X	4.1	5.3	6.8	8.4	10.2	12.1	14.2	P8-2DC-50X	2.3	2.6	3.0	3.3	3.7	4.2	4.6
R7-2DD-50X	5.1	6.6	8.4	10.4	12.6	15.0	17.6	R7-2DD-50X	2.9	3.3	3.6	4.0	4.4	4.9	5.3
R7-2DL-75X	6.3	8.0	10.1	12.4	14.9	17.7	20.6	R7-2DL-75X	3.5	4.0	4.5	5.1	5.6	6.2	6.9
S9-2DB-75X	8.2	10.2	12.5	15.1	18.0	21.0	24.3	S9-2DB-75X	4.4	4.9	5.5	6.1	6.7	7.4	8.1
S9-3DA-75X	9.0	11.2	13.9	16.8	20.0	23.3	26.9	S9-3DA-75X	5.1	5.6	6.3	7.0	7.8	8.6	9.5
V6-3DC-100X	11.4	14.3	17.6	21.4	25.6	30.2	35.1	V6-3DC-100X	6.1	6.7	7.4	8.2	8.9	9.7	10.6
V6-3DS-150X	15.3	18.7	22.6	26.9	31.7	36.8	42.2	V6-3DS-150X	8.4	9.3	10.3	11.3	12.5	13.8	15.2
W9-3DS-150X	15.4	18.9	22.9	27.4	32.3	37.7	43.3	W9-3DS-150X	8.3	9.2	10.2	11.2	12.3	13.6	14.9
Z9-4DA-200X	18.1	22.8	28.1	34.3	41.2	48.9	57.3	Z9-4DA-200X	9.0	10.0	11.0	12.0	13.0	14.0	14.9
Z9-4DH-250X	23.1	28.4	34.8	42.2	50.5	59.4	68.8	Z9-4DH-250X	12.4	13.4	14.6	15.9	17.3	18.8	20.2
Z9-4DJ-300X	26.5	32.4	39.1	46.8	55.2	64.3	74.1	Z9-4DJ-300X	14.5	16.2	18.1	20.0	22.0	24.1	26.3
W99-6DH-350X	32.6	39.8	48.2	57.6	67.9	78.9	90.4	W99-6DH-350X	17.6	19.7	22.0	24.5	27.0	29.6	32.2
W99-6DJ-400X	34.5	44.4	53.5	63.6	74.5	85.8	97.4	W99-6DJ-400X	20.7	23.5	26.5	29.7	33.0	36.5	39.9

Conditions: EN13215: Suction Gas Return 20°C, Subcooling 0K

Capacity Data

R134A	Ambient Temperature +32°C														
	Cooling Capacity (kW)							Input Power (kW)							
	Evaporating Temperature (°C)							Evaporating Temperature (°C)							
Model	-20	-15	-10	-5	0	5	10	Model	-20	-15	-10	-5	0	5	10
V6-4DH-150X	13.3	17.0	21.2	25.8	31.0	36.5	42.5	V6-4DH-150X	7.4	8.3	9.7	10.5	11.6	12.8	14.0
P8-3DA-50X	5.8	7.4	9.2	11.2	13.4	15.7	18.2	P8-3DA-50X	3.2	3.7	4.2	4.7	5.2	5.8	6.3
S9-3DS-100X	9.5	12.1	14.9	18.1	21.6	25.3	29.3	S9-3DS-100X	5.2	5.9	6.7	7.6	8.4	9.4	10.3
R7-3DC-75X	7.3	9.3	11.5	14.0	16.7	19.6	22.7	R7-3DC-75X	4.1	4.6	5.2	5.8	6.4	7.0	7.7
P8-2DB-50X	5.1	6.7	8.4	10.3	12.3	14.5	16.8	P8-2DB-50X	2.8	3.2	3.7	4.1	4.6	5.1	5.6

Conditions: EN13215: Suction Gas Return 20°C, Subcooling 0K

R22	Ambient Temperature +32°C														
	Cooling Capacity (kW)							Input Power (kW)							
	Evaporating Temperature (°C)							Evaporating Temperature (°C)							
Model	-45	-35	-30	-20	-10	-5	5	Model	-45	-35	-30	-20	-10	-5	5
P8-2DC-50X				4.9	7.9	9.6	13.7	P8-2DC-50X				2.6	3.2	3.6	4.3
R7-2DD-50X				5.9	9.4	11.5	16.4	R7-2DD-50X				3.3	4.0	4.3	5.0
R7-2DL-75X				7.3	11.4	13.9	19.5	R7-2DL-75X				4.0	4.9	5.4	6.5
P8-2DB-500 DC	2.1	4.1	5.3	8.4	12.2			P8-2DB-500 DC	2.5	3.4	3.9	4.9	6.1		
S9-2DB-75X				9.3	14.1	16.8	23.1	S9-2DB-75X				4.8	5.9	6.4	7.6
P8-3DA-500 DC	2.3	4.5	5.9	9.1				P8-3DA-500 DC	2.5	3.6	4.2	5.5			
S9-3DA-75X				10.3	15.8	18.9	26.0	S9-3DA-75X				5.5	6.8	7.5	8.9
R7-3DC-750 DC	3.0	5.6	7.2	11.5				R7-3DC-750 DC	3.3	4.5	5.2	6.9			
V6-3DC-100X				13.0	19.9	23.9	33.2	V6-3DC-100X				6.7	8.0	8.6	10.0
S9-3DS-1000 DC	3.9	7.6	9.8	15.4				S9-3DS-1000 DC	4.4	6.2	7.2	9.4			
V6-3DS-150X				17.3	25.4	30.1	40.9	V6-3DS-150X				9.1	11.0	12.0	14.1
W9-3DS-150X				17.4	25.6	30.4	41.4	W9-3DS-150X				9.0	10.9	11.9	13.9
V6-4DF-1000 DC	4.4	8.2	10.7	17.0				V6-4DF-1000 DC	4.6	6.5	7.6	9.8			
W9-4DA-2000				19.3	28.5	33.8	45.8	W9-4DA-2000				9.8	12.1	13.3	15.9
Z9-4DA-200X				20.7	31.1	37.3	52.0	Z9-4DA-200X				10.2	12.1	13.0	14.8
V6-4DL-1500 DC	6.5	11.8	15.0	22.2				V6-4DL-1500 DC	6.6	9.2	10.6	13.6			
Z9-4DH-250X				25.9	38.2	45.6	62.6	Z9-4DH-250X				13.1	15.7	17.0	19.7
W9-4DT-2200 DC	8.2	14.0	17.5	25.8				W9-4DT-2200 DC	8.0	10.8	12.4	16.1			
Z9-4DJ-300X				30.3	43.8	51.7	69.8	Z9-4DJ-300X				15.7	19.1	20.8	24.6
W99-6DH-350X				37.1	54.4	64.4	87.1	W99-6DH-350X				19.5	23.8	26.1	30.9
Z9-6DL-2700 DC	8.5	15.8	20.4	31.4				Z9-6DL-2700 DC	9.8	13.3	15.1	18.9			
W99-6DJ-400X				42.0	61.1	72.0	96.2	W99-6DJ-400X				23.2	29.0	32.1	38.8
Z9-6DT-3200 DC	10.7	19.3	24.5	36.3				Z9-6DT-3200 DC	11.5	15.8	18.1	22.5			

Conditions: EN13215: Suction Gas Return 20°C, Subcooling 0K

## Compressors Motor Codes Table

Semi-Hermetic						
Motor Codes	Voltage	Connection		Motor Codes	Voltage	Connection
Standard Motor Version						
CAG	220-230/1/50	-				
EWL (DK, DL, D2S)	220-240/3/50	Δ		EWN (DK, DL, D2S)	250-280/3/60	Δ
EWL (DK, DL, D2S)	380-420/3/50	Y		EWN (DK, DL, D2S)	440-480/3/60	Y
AWM	380-420/3/50	YY/Y		AWD	440-480/3/60	YY/Y
Special Motor Version						
EWM	380-420/3/50	Δ/Y-Start		EWD	440-480/3/60	Δ/Y-Start
AWR	220-240/3/50	YY/Y		EWK (not D8)	220-240/3/60	Δ
AWY	500-550/3/50	YY/Y		EWK (not D8)	380-420/3/60	Y
				AWC	208-230/3/60	YY/Y
				AWX	380/3/60	YY/Y
Hermetic & Scroll						
Motor Codes	Voltage	Connection		Motor Codes	Voltage	Connection
Standard Motor version						
PFJ	220-240/1/50	-		PFJ	265/1/60	-
PFT	220-240/1/50	-				
PFZ	220-240/1/50	-				
TFD	380-420/3/50	Y		TFD	460/3/60	Y
TFM	380-420/3/50	Y				
TWD	380-420/3/50	Y		TWD	460/3/60	Y
FWD	380-420/3/50	Δ/Δ				
FWM	380-420/3/50	Δ/Δ				
TWM	380-420/3/50	Y				
Special Motor version						
TF5	200-220/3/50	Y		TF5	200-230/3/60	Y
TWR	220-240/3/50	Y		TW7	380/3/60	Y
TWC	200/3/50	Y		TWC	208-230/3/60	Y
TFE	500/3/50	Y		TFE	575/3/60	Y
TWE	500/3/50	Y		TWE	575/3/60	Y
				TF7	380/3/60	Y
TW5	200-220/3/50	Y		TW5	220-230/3/60	Y
Variable Speed Motor version						
1E9	BPM Motor	-				

YY/Y = part-winding-start  
 Δ/Δ = part-winding-start



Notes

Notes



## Alco Controls

Alco Controls is the leading provider of precision electronic and electromechanical controls for the refrigeration and air conditioning markets. We continue to pioneer the control of refrigerant flow with innovative designs, keeping system performance optimization as central to our product development.

The wide range of Emerson controllers covers all major applications in commercial air conditioning and refrigeration, as well as heat pump systems. There are stand alone controllers and controllers with a communication interface, which can be used in LON networked systems too.

The controllers with TCP/IP Ethernet communication feature a full web server function and provide full data exchange with any user in the World Wide Web. This allows quick and inexpensive monitoring from any PC with a standard web browser.

Emerson offers drivers and superheat controllers designed for the EX4 to EX8 range of electrically driven control valves. The superheat controllers allow stable superheat control with the EX valves, while the digital superheat controllers can be synchronized with the PWM capacity control valve incorporated in the Digital Scroll™ compressor technology.

Display case and cold room controllers provide all functions needed to run commercial refrigeration, like superheat control with electrical control valve, thermostat, fan and defrost control, integrated timer and alarm functions.

Other controllers offer control functions on the “hot side” of the refrigeration circuit: condenser and condensing unit controllers, rack controllers for up to 8 single stage compressors or for multi-stage compressors and dual circuit controllers.

The compressor soft starter allows to keep the starting current below the limit imposed in residential heat pump applications.

Electronic fan speed controllers help to maintain a minimum condensing pressure by reducing fan speed at low ambient temperature.

Sensors and accessories are needed in conjunction with the above mentioned controllers.

Emerson’s controls portfolio is completed by offering a variety of mechanical controls as:

- oil management systems,
- pressostats & thermostats,
- system protectors,
- and valves.

Whatever control you choose you can always expect high reliability and best performance.



## Electrical Control Valves

### Electrical Control Valve Technology

Thermostatic expansion valves and mechanical regulator valves have been used in the refrigeration and air conditioning industry to control superheat and refrigerant mass flow since its very beginning. As today's systems require improved energy efficiency, tighter temperature control, wider range of operating conditions and incorporate new features like remote monitoring and diagnostics, the application of electronically operated valves becomes mandatory. Only they offer the controls performance necessary to meet these needs. Electrical control valves are actuators only. For operation in a system they need sensors, valve drivers and controllers, see next chapter.

**EXM/EXL** biflow valves for OEM use are equipped with an unipolar stepper motor drive. They are mainly used for heat pumps, air conditioning and close control.

**EX2** is designed for pulse width modulation. It is applicable to all common HCFC and HFC refrigerants and for subcritical CO<sub>2</sub> applications and is used mainly for refrigeration applications such as display cases. The EX2 valve is a slide type solenoid valve with an orifice for expansion. It is either completely open or completely closed. One common valve body can be combined with 6 interchangeable orifices to cover 7 capacity ranges.

**EX4/EX5/EX6/EX7/EX8** consist of two main internal assemblies, the valve and the stepper motor. The stepper motor is located next to the electrical plug and connected directly to the slide and cage assembly of the valve. Similar

to the technology used in compressors, the motor is exposed to refrigerant and lubricant and the materials used are identical to the ones in compressor motors. The housing of the motor and valve assembly is made from stainless steel and fully hermetic, utilising exclusively brazing and welding technologies and eliminating all gaskets.

This design offers several technical advantages such as proportional linear mass flow and a wide capacity range. A common feature of all EX2, EX4-8 electrical control valves is the positive shut-off function, which eliminates the need for additional solenoid valves.

**CX4/CX5/CX6/CX7** High Pressure Expansion Valves are stepper motor driven valves for precise control of R744 (CO<sub>2</sub>) refrigerant mass flow in air conditioning, refrigeration, heat pump applications. The Control Valves can be also used for liquid injection duty and hot gas bypass.

### Valve Selection

For **EX2** the published table quotes capacities at 100% duty cycle. i.e. valve open continuously. However, it is recommended to operate the valve at partial load (50-80%) to allow for system load fluctuations.

For **EX4/EX5/EX6/EX7/EX8** and **EXM/EXL** all published capacities are maximum and there are no reserve capacities. Each valve should be selected for the highest possible capacity of the system. A wide range regulation (10... 100%) with one slide orifice for each valve is achievable. To facilitate valve dimensioning for other than the standard conditions Emerson Climate offers an Excel based Alco® selection tool. This can be downloaded from [www.emersonclimate.eu](http://www.emersonclimate.eu).

### Selection Table for Electrical Control Valves and Applicable Controllers

Valve type	Function	Capacity kW R407C	Feature	Min. Evaporating Temp. °C	Main Application	Page	Applicable Controller	Page
EXM EXL	Expansion Valve	5 .. 20.7	Uni polar stepper motor driven	-30	Heat pumps, Air Conditioning, Close Control	113	Customized	s. data sheet
EX2	Exp. Valve	1.0 .. 18.7	PWM	-40	Refrigeration	114	EC2	143
EX4 EX5 EX6 EX7 EX8	Expansion Valve	2 .. 17.4 5 .. 53 15 .. 126 35 .. 347 100 .. 925	Bi polar stepper motor driven	-50 -100	Heat pumps, Refrigeration, A/C, Water Chillers	117	EC3-X .. Superheat Contr. EC3-3 .. Coldroom Contr. EXD-U	141 146 142
EX4 EX5 EX6 EX7 EX8	Capacity Control	4.9 16 37 131 399	Bi polar stepper motor driven	-100	Hot gas bypass regulator	126	EXD-U .. Universal Controls	142
EX6 EX7 EX8	Liquid Mass Flow Control	3.9 14 42	Bi polar stepper motor driven	-50	Suction pressure / Crankcase pressure regulator	127	EXD-U .. Universal Controls	142
EX5 EX6 EX7 EX8	Heat Reclaim	18 43 153 463	Bi polar stepper motor driven	-	Condensing pressure and liquid regulator	128	EXD-U .. Universal Controls	142
EX6 EX7 EX8	Heat Reclaim	11 39 119	Bi polar stepper motor driven	-	Heat Reclaim applications	131	EXD-U .. Universal Controls	142
CX4 CX5 CX6 CX7	Expansion Valve		Bi polar stepper motor driven	-	Refrigeration	136	EXD-U .. Universal Controls	142

## Electrical Control Valves Series EXM/EXL

for OEM use, stepper motor driven

### Features

- Unipolar stepper motor
- Bi-flow (same performance in both flow directions in term of capacity and MOPD)
- High MOPD: 35 bar
- Removable coils in two versions: 12VDC/24VDC
- Continuous modulation of mass flow, no stress (liquid hammering) in the refrigeration circuit
- Linear flow
- Resolution: 500 pulses (half steps) or 250 full steps
- Hermetic design
- Only Bulk packing in boxes of 10 pieces
- Minimum order quantity 100 pcs (per type and delivery)

### Options:

- Special version for transcritical R744 (CO<sub>2</sub>) with 140 bar maximum allowable pressure upon request



EXM/EXL with Coil

### Selection Chart

Type	Part No.	Description	R410A	Nominal Capacity kW			Connection size/style
				R407C	R22	R134a	
EXM-B0B	800 400M	Valve less coil	5.5	5.0	4.8	3.7	1/4" ODM
EXM-B0D	800 401M	Valve less coil	11.6	10.5	9.9	7.7	
EXM-B0E	800 402M	Valve less coil	13.7	12.4	11.8	9.1	
EXM-125	800 403M	Coil 12VDC, 5 wires	-	-	-	-	
EXM-246	800 404M	Coil 24VDC, 6 wires	-	-	-	-	
EXL-B1F	800 405M	Valve less coil	17.0	15.4	14.6	11.3	1/4" ODF
EXL-B1G	800 406M	Valve less coil	23.0	20.7	19.7	15.2	8 mm ODM
EXL-125	800 407M	Coil 12VDC, 5 wires	-	-	-	-	
EXL-246	800 408M	Coil 24VDC, 6 wires	-	-	-	-	

The nominal capacity is based on the following conditions:

Refrigerant	Evaporating temperature	Condensing temperature	Subcooling
R407C	+4°C (dew point)	+38°C bubble point / +43°C dew point	1K
R22, R134a, R410a	+4°C	+38°C	1K

### Technical Data

Max. allowable pressure PS	45 bar
MOPD	35 bar (normal or reverse flow)
Temperature range TS	TS: -30 to +70°C (liquid refrigerant) -30 to +60°C (ambient)
CE marking	Not required
Weight	Valve EXM: 65 g, EXL: 76 g Coil EXM: 124 g, EXL: 156 g
Package and delivery	Bulk pack with 10 pieces

Stepper motor type	Uni-polar, constant voltage
Full travel time	16.6 seconds at 30 pulse/sec. 5.5 seconds at 90 pulse/sec
Reference position	Mechanical stop at fully close position
Total number of pulses	500 half step (250 full step)
Insulation class	EXM: A EXL: E
Cable length	1m

## Electrical Control Valves Series EX2

Pulse width modulated with exchangeable orifices

Can be used with EC2 display case controllers (see page 145)

### Features

- Pulse width modulated
- Shut off function eliminates the necessity of a separate solenoid valve
- Dampened plunger reduces noise effects of water hammer
- One valve body can be combined with 6 orifices to make 7 capacity ranges up to 18.7 kW (R407C)
- Applicable to all common refrigerants (HCFC, HFC) and for subcritical CO<sub>2</sub> applications
- Long lifetime, high reliability
- PS: 40bar, TS: -40 to +65°C



EX2 with Orifice

### Selection Chart

Type	Part No.	Function	Capacity Q <sub>n</sub> at 100% open Valve (kW) *					
			R134a	R22	R404A	R507	R407C	R744
EX2-M00	801 091	10 mm inlet / 12 mm outlet ODF	13.3	17.2	12.1	12.1	18.7	35.0
EX2-I00	801 090	3/8" inlet / 1/2" outlet ODF						
EXO-004	801 089	Orifice 4	8.5	10.9	7.7	7.7	11.8	22.2
EXO-003	801 088	Orifice 3	5.6	7.2	5.1	5.1	7.8	14.6
EXO-002	801 087	Orifice 2	3.3	4.3	3.0	3.0	4.7	8.7
EXO-001	801 086	Orifice 1	2.5	3.2	2.3	2.3	3.5	6.5
EXO-000	801 085	Orifice 0	1.2	1.6	1.1	1.1	1.7	3.3
EXO-00X	801 084	Orifice X	0.7	0.9	0.6	0.6	1.0	1.8
ASC 24V	801 062	Coil 24 VAC 50-60HZ (8W)						

\* Orifice should be selected at max. 80% of Q<sub>n</sub> to allow covering the load fluctuation.

The nominal capacity (Q<sub>n</sub>) is based on the following conditions:

Refrigerant	Evaporating temperature	Condensing temperature	Subcooling
R407C	+4°C (dew point)	+38°C bubble point / +43°C dew point	1K
R22, R134a, R404A, R507	+4°C	+38°C	1K
R744	-40°C	-10°C	1K

For other operating conditions an Excel based selection tool can be downloaded from [www.emersonclimate.eu](http://www.emersonclimate.eu), or use correction factors with following formula:

$$Q_n = Q_o \times K_t \times K_{\Delta p}$$

- Q<sub>n</sub>: Nominal valve capacity  
 Q<sub>o</sub>: Required cooling capacity  
 K<sub>t</sub>: Correction factor for evaporating and liquid temperature  
 K<sub>Δp</sub>: Correction factor for pressure drop at valve

Liquid Temperature entering Valve °C	Correction Factor K <sub>t</sub>											
	Evaporating Temperature °C											
	15	10	5	0	-5	-10	-15	-20	-25	-30	-40	
55	1.21	1.23	1.26	1.29	1.33	1.33	1.39	1.43	1.47	1.52	1.62	
50	1.13	1.15	1.17	1.20	1.23	1.26	1.28	1.32	1.36	1.39	1.48	
45	1.06	1.08	1.10	1.12	1.15	1.17	1.19	1.22	1.26	1.29	1.37	
40	0.99	1.01	1.03	1.05	1.08	1.10	1.12	1.14	1.17	1.20	1.27	
35	0.94	0.96	0.97	0.99	1.01	1.03	1.05	1.07	1.10	1.12	1.18	
30	0.89	0.91	0.92	0.94	0.96	0.98	0.99	1.01	1.03	1.06	1.11	
25	0.85	0.86	0.87	0.89	0.91	0.92	0.94	0.95	0.97	1.00	1.04	
20	0.81	0.82	0.83	0.85	0.89	0.88	0.89	0.91	0.92	0.94	0.98	
15	0.77	0.78	0.79	0.81	0.82	0.84	0.84	0.86	0.88	0.89	0.93	
10		0.75	0.76	0.77	0.78	0.80	0.81	0.82	0.84	0.85	0.89	
5			0.73	0.74	0.75	0.76	0.77	0.78	0.80	0.81	0.84	
0				0.71	0.72	0.73	0.74	0.75	0.76	0.78	0.81	
-5					0.69	0.70	0.71	0.72	0.73	0.74	0.77	
-10						0.68	0.68	0.69	0.70	0.71	0.74	

Correction Factor K <sub>Δp</sub>																								
Δp	3.5	4.0	4.5	5.0	5.5	6.0	6.5	7.0	7.5	8.0	8.5	9.0	10.0	11.0	12.0	13.0	14.0	15.0	16.0	17.0	18.0	19.0	20.0	21.0
K <sub>Δp</sub>	1.34	1.25	1.18	1.12	1.07	1.02	0.98	0.95	0.91	0.88	0.86	0.83	0.79	0.75	0.72	0.69	0.67	0.65	0.63	0.61	0.59	0.57	0.56	0.55

Liquid Temperature entering Valve °C	Correction Factor K <sub>t</sub>											
	Evaporating Temperature °C											
	15	10	5	0	-5	-10	-15	-20	-25	-30	-35	-40
55	1.42	1.46	1.50	1.55	1.61	1.68	1.75	1.83	1.92	2.01	2.13	2.25
50	1.23	1.26	1.30	1.34	1.38	1.43	1.48	1.54	1.61	1.68	1.75	1.84
45	1.10	1.12	1.15	1.18	1.22	1.26	1.30	1.34	1.39	1.45	1.51	1.57
40	0.99	1.02	1.04	1.07	1.09	1.13	1.16	1.20	1.24	1.28	1.33	1.38
35	0.91	0.93	0.95	0.97	1.00	1.02	1.05	1.08	1.11	1.15	1.19	1.23
30	0.84	0.86	0.88	0.90	0.92	0.94	0.96	0.99	1.02	1.05	1.08	1.11
25	0.79	0.80	0.82	0.83	0.85	0.87	0.89	0.92	0.94	0.97	0.99	1.02
20	0.74	0.75	0.77	0.78	0.80	0.81	0.83	0.85	0.87	0.90	0.92	0.95
15	0.70	0.71	0.72	0.73	0.75	0.76	0.78	0.80	0.82	0.84	0.86	0.88
10		0.67	0.68	0.69	0.71	0.72	0.74	0.75	0.77	0.79	0.81	0.83
5			0.65	0.66	0.67	0.68	0.70	0.71	0.73	0.74	0.76	0.78
0				0.63	0.64	0.65	0.66	0.68	0.69	0.71	0.72	0.74
-5					0.61	0.62	0.63	0.65	0.66	0.67	0.69	0.70
-10						0.60	0.61	0.62	0.63	0.64	0.65	0.67

Correction Factor K <sub>Δp</sub>																								
Δp	3.5	4.0	4.5	5.0	5.5	6.0	6.5	7.0	7.5	8.0	8.5	9.0	10.0	11.0	12.0	13.0	14.0	15.0	16.0	17.0	18.0	19.0	20.0	21.0
K <sub>Δp</sub>	1.74	1.63	1.54	1.46	1.39	1.33	1.28	1.23	1.19	1.15	1.12	1.09	1.03	0.98	0.94	0.9	0.87	0.84	0.81	0.79	0.77	0.75	0.73	0.71

Liquid Temperature entering Valve °C	Correction Factor K <sub>t</sub>											
	Evaporating Temperature °C											
	5	0	-5	-10	-15	-20	-25	-30	-35	-40		
5	1.12	1.10	1.09	1.08	1.08	1.08	1.07	1.07	1.08	1.08		
0		1.02	1.01	1.01	1.00	1.00	1.00	1.00	1.00	1.01		
-5			0.95	0.94	0.94	0.94	0.94	0.94	0.94	0.94		
-10				0.89	0.89	0.88	0.88	0.88	0.89	0.89		
-15					0.84	0.84	0.84	0.84	0.84	0.84		
-20						0.80	0.80	0.80	0.80	0.80		
-25							0.76	0.76	0.76	0.76		
-30								0.73	0.73	0.73		
-35									0.70	0.70		
-40										0.67		

Correction Factor K <sub>Δp</sub>																								
Δp	5.0	6.0	7.0	8.0	9.0	10.0	11.0	12.0	13.0	14.0	15.0	16.0	17.0	18.0	19.0	20.0	21.0	22.0	23.0	24.0	25.0	26.0	27.0	28.0
K <sub>Δp</sub>	1.81	1.65	1.53	1.43	1.35	1.28	1.22	1.17	1.12	1.08	1.05	1.01	0.98	0.95	0.93	0.91	0.88	0.86	0.84	0.83	0.81	0.79	0.78	0.77



Liquid Temperature entering Valve °C	Correction Factor Kt																							
	Evaporating Temperature °C																							
	15	10	5	0	-5	-10	-15	-20	-25	-30	-35	-40												
55	1.17	1.19	1.20	1.22	1.24	1.25	1.27	1.29	1.32	1.34	1.37	1.39												
50	1.11	1.11	1.13	1.15	1.16	1.18	1.20	1.22	1.24	1.26	1.28	1.30												
45	1.05	1.05	1.07	1.08	1.10	1.12	1.13	1.15	1.17	1.18	1.20	1.23												
40	1.00	1.01	1.02	1.03	1.04	1.06	1.07	1.09	1.10	1.12	1.14	1.16												
35	0.95	0.96	0.97	0.98	0.99	1.01	1.02	1.03	1.05	1.06	1.08	1.10												
30	0.91	0.92	0.93	0.94	0.95	0.96	0.97	0.98	1.00	1.01	1.03	1.04												
25	0.87	0.88	0.89	0.89	0.91	0.92	0.93	0.94	0.95	0.96	0.98	0.99												
20	0.83	0.84	0.85	0.86	0.87	0.88	0.89	0.90	0.91	0.92	0.93	0.95												
15	0.80	0.81	0.81	0.82	0.83	0.84	0.85	0.86	0.87	0.88	0.89	0.91												
10		0.78	0.78	0.79	0.80	0.81	0.82	0.83	0.84	0.85	0.86	0.87												
5			0.75	0.76	0.77	0.78	0.79	0.79	0.80	0.81	0.82	0.83												
0				0.73	0.74	0.75	0.76	0.77	0.77	0.78	0.79	0.80												
-5					0.72	0.72	0.73	0.74	0.75	0.75	0.76	0.77												
-10						0.70	0.71	0.71	0.72	0.73	0.74	0.74												
Correction Factor KΔp																								
Δp	3.5	4.0	4.5	5.0	5.5	6.0	6.5	7.0	7.5	8.0	8.5	9.0	10.0	11.0	12.0	13.0	14.0	15.0	16.0	17.0	18.0	19.0	20.0	21.0
KΔp	1.59	1.49	1.40	1.33	1.27	1.22	1.17	1.13	1.09	1.05	1.02	0.99	0.94	0.90	0.86	0.83	0.80	0.77	0.75	0.72	0.70	0.68	0.67	0.65

Liquid Temperature entering Valve °C	Correction Factor Kt																							
	Evaporating Temperature °C																							
	15	10	5	0	-5	-10	-15	-20	-25	-30	-35	-40												
55	1.39	1.43	1.47	1.52	1.57	1.62	1.69	1.76	1.83	1.92	2.02	2.12												
50	1.22	1.24	1.28	1.31	1.35	1.40	1.44	1.49	1.55	1.61	1.68	1.76												
45	1.09	1.11	1.14	1.17	1.20	1.23	1.27	1.31	1.36	1.40	1.46	1.52												
40	0.99	1.01	1.03	1.06	1.08	1.11	1.14	1.17	1.21	1.25	1.29	1.34												
35	0.91	0.93	0.95	0.97	0.99	1.01	1.04	1.07	1.10	1.13	1.16	1.20												
30	0.85	0.86	0.88	0.89	0.91	0.93	0.96	0.98	1.01	1.03	1.06	1.09												
25	0.79	0.80	0.82	0.83	0.85	0.87	0.89	0.91	0.93	0.95	0.98	1.01												
20	0.74	0.75	0.77	0.78	0.79	0.81	0.83	0.85	0.87	0.89	0.91	0.93												
15	0.71	0.71	0.72	0.73	0.75	0.76	0.78	0.79	0.81	0.83	0.85	0.87												
10		0.67	0.68	0.69	0.70	0.72	0.73	0.74	0.76	0.78	0.79	0.81												
5			0.64	0.65	0.67	0.68	0.69	0.70	0.72	0.73	0.75	0.76												
0				0.62	0.63	0.64	0.65	0.66	0.68	0.69	0.70	0.72												
-5					0.60	0.61	0.62	0.63	0.64	0.65	0.66	0.68												
-10						0.58	0.59	0.60	0.61	0.62	0.63	0.64												
Correction Factor KΔp																								
Δp	3.5	4.0	4.5	5.0	5.5	6.0	6.5	7.0	7.5	8.0	8.5	9.0	10.0	11.0	12.0	13.0	14.0	15.0	16.0	17.0	18.0	19.0	20.0	21.0
KΔp	1.75	1.64	1.54	1.46	1.4	1.34	1.28	1.24	1.19	1.16	1.12	1.09	1.03	0.99	0.94	0.91	0.87	0.84	0.82	0.79	0.77	0.75	0.73	0.71

Liquid Temperature entering Valve °C	Correction Factor Kt																							
	Evaporating Temperature °C																							
	15	10	5	0	-5	-10	-15	-20	-25	-30	-35	-40												
55	1.26	1.28	1.31	1.34	1.37	1.40	1.44	1.48	1.52															
50	1.15	1.17	1.19	1.22	1.24	1.27	1.30	1.33	1.37															
45	1.06	1.08	1.10	1.12	1.14	1.17	1.19	1.22	1.25															
40	0.99	1.01	1.02	1.04	1.06	1.08	1.11	1.13	1.16															
35	0.93	0.94	0.96	0.98	0.99	1.01	1.03	1.05	1.07															
30	0.88	0.89	0.90	0.92	0.93	0.95	0.97	0.99	1.01															
25	0.83	0.84	0.85	0.87	0.88	0.90	0.91	0.93	0.95															
20	0.79	0.80	0.81	0.82	0.84	0.85	0.86	0.88	0.90															
15	0.75	0.76	0.77	0.78	0.80	0.81	0.82	0.84	0.85															
10		0.73	0.74	0.75	0.76	0.77	0.78	0.80	0.81															
5			0.71	0.72	0.73	0.74	0.75	0.76	0.77															
0				0.69	0.70	0.71	0.72	0.73	0.74															
-5					0.67	0.68	0.69	0.70	0.71															
-10						0.65	0.66	0.67	0.68															
Correction Factor KΔp																								
Δp	3.5	4.0	4.5	5.0	5.5	6.0	6.5	7.0	7.5	8.0	8.5	9.0	10.0	11.0	12.0	13.0	14.0	15.0	16.0	17.0	18.0	19.0	20.0	21.0
KΔp	1.81	1.69	1.59	1.51	1.44	1.38	1.33	1.28	1.23	1.19	1.16	1.13	1.07	1.02	0.98	0.94	0.9	0.87	0.84	0.82	0.8	0.78	0.76	0.74

## Electrical Control Valves Series EX4, EX5, EX6, EX7 & EX8

### Features

- Multifunction as expansion valve, hot gas bypass, suction gas throttling, head pressure, liquid level actuator etc
- Fully hermetic design (no thread joints between valve body and motor compartment)
- Applicable to all common refrigerants (HCFC, HFC) and for subcritical CO<sub>2</sub> applications
- Stepper motor driven
- Short opening and closing time
- Very fast full stroke time
- High resolution and excellent repeatability
- Positive shut-off function to eliminate use of additional solenoid valve
- Bi-flow versions for heat pump applications
- High linear flow capacity
- Extremely wide capacity range (10 ... 100%)
- Continuous modulation of mass flow, no stress (liquid hammering) in the refrigeration circuit
- Direct coupling of motor and valve for high reliability (no gear mechanism)
- Ceramic slide and port for highly accurate flow and minimal wear
- Europe patent No. 0743476, USA patent No. 5735501, Japan patent No. 28225789
- Balanced force design
- Corrosion resistant stainless steel body and stainless steel connections
- PS: 45 bar
- Liquid Inlet Temperature TS:  
Uniflow: -50 to +100°C, Biflow: -40 to +80°C



### Selection Chart (Capacities see following pages)

Type	Part No.	Flow Pattern	Capacity Range	Inlet Connection	Outlet Connection	Electrical Connection
EX4-I21	800 615	Uni-flow	10 ... 100%	3/8" ODF	5/8" ODF	M12 Plug
EX4-M21	800 616			10mm ODF	16mm ODF	
EX5-U21	800 618			5/8" (16mm) ODF	7/8" (22mm) ODF	
EX6-I21	800 620			7/8" ODF	1-1/8" ODF	
EX6-M21	800 621			22mm ODF	28 mm ODF	
EX7-I21	800 624			1-1/8" ODF	1-3/8" ODF	
EX7-M21	800 625			28mm ODF	35mm ODF	
EX8-M21	800 629			42mm ODF	42mm ODF	
EX8-U21	800 630			1-3/8" (35mm) ODF	1-3/8" (35mm) ODF	
EX8-I21	800 631			1-5/8" ODF	1-5/8" ODF	
EX4-U31	800 617	Bi-flow (Heat Pump)	10 ... 100%	5/8" (16mm) ODF	5/8" (16mm) ODF	M12 Plug
EX5-U31	800 619			7/8" (16mm) ODF	7/8" (22mm) ODF	
EX6-I31	800 622			1-1/8" ODF	1-1/8" ODF	
EX6-M31	800 623			28mm ODF	28mm ODF	
EX7-U31	800 626			1-3/8" (35mm) ODF	1-3/8" (35mm) ODF	

Type	Part No.	Temperature Range	Length	Connector type to valve	Connector type to driver or controller	Illustration
EXV-M15	804 663	-50 ... +80°C	1.5 m	M12, 4 pins	Loose wires	
EXV-M30	804 664		3.0 m			
EXV-M60	804 665		6.0 m			

## Capacity Data

### Application Expansion Valve and Liquid Injection Valve - Nominal Capacity kW

Valve Type	R407C	R22	R134a	R404A	R410A	R23 *	R124 *	R744
EX4	2 .. 17.4	2 .. 16.5	1 .. 12.8	1 .. 11.5	2 .. 19.3	2 .. 17.8	1 .. 9.2	3 .. 33.5
EX5	5 .. 53	5 .. 50	4 .. 39	4 .. 35	6 .. 58	5 .. 54	3 .. 28	10 .. 102
EX6	15 .. 126	15 .. 120	10 .. 93	10 .. 84	15 .. 140	13 .. 130	7 .. 67	24 .. 244
EX7	35 .. 347	35 .. 330	25 .. 255	25 .. 230	40 .. 385	-	-	70 .. 670
EX8	100 .. 925	90 .. 880	70 .. 680	60 .. 613	100 .. 1027	-	-	180 .. 1789

\* Biflow versions are not released for R124 and R23  
Capacity for biflow versions identical in both flow directions.

The nominal capacity (Qn) is based on the following conditions:

Refrigerant	Evaporating temperature	Condensing temperature	Subcooling
R407C	+4°C (dew point)	+38°C bubble point / +43°C dew point	1K
R22, R134a, R404A, R410A	+4°C	+38°C	1K
R124	+20°C	+80°C	1K
R23	-60°C	-25°C	1K
R744	-40°C	-10°C	1K

## Guideline for Selection of Electrical Control Valves as Expansion Valves

### Alco® Selection Tool

For easy and quick selection of Electrical Control Valves an Excel based selection tool can be downloaded from the Internet at [www.emersonclimate.eu](http://www.emersonclimate.eu), or use the quick selection tables on the following pages.

The following guideline should be taken into consideration in order to obtain full advantages of the control valves:

- **Published capacities are maximum and there are no reserve capacities**
- Larger size of valve leads to shorter pull down period and shorter travel time i.e. faster response. For example, EX7 has maximum 3.2 seconds travel time. The valve has approximately 1.6 seconds travel time at 50% capacity operation.

### Example:

System with R407C having two different operating conditions:

- 110 kW capacity at +4°C/+50°C with two stages compressor at 50% / 100% capacity
- 137 kW capacity at +4°C/+30°C with two stages compressor at 50% / 100% capacity

EX6 with 126 kW covers condition A, however is not sufficient to cover condition B. It is recommended to select larger valve i. e. EX7 with 337 kW at condition A and 293 kW at condition B.

### Condition A:

$$\text{Full load ratio} = 110 / 337 = 33\%$$

$$\text{Partial load ratio} = (110/2) / 337 = 16\%$$

### Condition B:

$$\text{Full load ratio} = 137 / 293 = 47\%$$

$$\text{Partial load ratio} = (137/2) / 293 = 23\%$$

The capacity ratios of system to valve are in all conditions higher than 10%. It is recommended to use EX7 rather than EX6.

## Application Expansion Valve and Liquid Injection Valve

Condensing Temperature °C	R134a		Extended capacity (kW) Evaporating Temperature (°C)											Valve Type
	15	10	5	0	-5	-10	-15	-20	-25	-30	-35	-40	-45	
60	13	13	13	13	13	13	12	12	12	12	11	11	11	EX4
	39	39	39	39	39	39	38	37	36	35	34	33	32	EX5
	93	94	94	94	93	92	90	89	87	84	82	79	77	EX6
	255	257	258	257	255	252	248	243	237	231	224	217	210	EX7
	679	686	688	686	680	672	661	648	633	616	598	580	560	EX8
55	12	13	13	13	13	13	13	12	12	12	12	11	11	EX4
	38	39	39	39	39	39	38	38	37	36	35	34	33	EX5
	91	92	93	94	93	93	92	90	88	86	84	82	80	EX6
	249	253	256	257	256	254	251	247	242	237	231	225	218	EX7
	663	676	683	685	683	678	670	659	647	632	616	599	582	EX8
50	12	12	13	13	13	13	13	12	12	12	12	12	11	EX4
	36	38	38	39	39	39	38	38	37	37	36	35	34	EX5
	87	90	91	92	93	92	92	91	89	88	86	84	81	EX6
	238	246	250	253	254	253	251	249	245	240	235	229	223	EX7
	636	655	668	675	677	676	671	663	653	640	627	611	595	EX8
45	11	12	12	12	12	13	12	12	12	12	12	12	11	EX4
	34	36	37	38	38	38	38	38	37	37	36	35	35	EX5
	81	85	88	90	91	91	91	90	89	88	86	84	82	EX6
	223	234	241	246	248	249	249	247	244	240	236	231	226	EX7
	595	623	642	655	662	664	663	658	651	641	629	616	602	EX8
40	10	11	11	12	12	12	12	12	12	12	12	12	11	EX4
	31	33	35	36	37	37	37	37	37	36	36	35	34	EX5
	74	79	83	85	87	88	89	88	88	87	85	84	82	EX6
	202	217	227	234	239	242	243	242	240	238	234	230	225	EX7
	539	578	606	625	638	645	647	646	641	634	625	614	601	EX8
35	9	10	10	11	11	12	12	12	12	12	12	11	11	EX4
	27	30	32	34	35	35	36	36	36	36	35	35	34	EX5
	63	71	76	80	83	84	85	86	85	85	84	83	81	EX6
	173	194	209	219	226	231	234	235	234	232	230	227	223	EX7
	463	517	556	584	604	616	623	625	624	620	613	604	594	EX8
30	7	8	9	10	11	11	11	11	11	11	11	11	11	EX4
	20	25	28	30	32	33	34	34	34	34	34	34	33	EX5
	49	60	67	73	76	79	81	82	82	82	81	80	79	EX6
	133	164	184	199	210	217	221	224	225	224	223	221	217	EX7
	356	436	492	534	559	578	590	597	600	599	595	588	580	EX8
25	3	6	8	9	9	10	10	11	11	11	11	11	11	EX4
	10	18	23	26	29	30	31	32	33	33	33	32	32	EX5
	23	121	152	137	188	198	206	210	213	214	213	212	210	EX6
	63	121	152	173	188	198	206	210	213	214	213	212	210	EX7
	169	322	406	462	501	529	548	560	567	570	569	565	559	EX8
20	2	5	7	8	9	9	10	10	10	10	10	10	10	EX4
	5	16	21	25	27	28	29	30	31	31	31	31	31	EX5
	12	38	51	58	64	68	70	72	73	73	73	73	73	EX6
	34	105	139	160	175	186	193	197	200	201	201	201	199	EX7
	90	281	370	427	467	495	514	526	533	536	535	535	532	EX8
15				4	6	7	8	9	9	9	9	9	9	EX4
				13	19	22	25	26	27	28	28	29	29	EX5
				32	45	53	59	62	65	67	68	68	68	EX6
				87	123	145	161	171	178	183	186	187	187	EX7
				231	328	388	428	456	475	488	495	498	498	EX8
10				3	5	6	7	8	8	8	9	9	9	EX4
				9	16	20	22	24	25	26	26	26	26	EX5
				22	38	47	52	56	59	61	62	62	62	EX6
				61	104	128	144	155	162	167	170	171	171	EX7
				162	277	341	384	413	432	445	452	455	455	EX8

Application Expansion Valve and Liquid Injection Valve

Condensing Temperature °C	R22		Extended capacity (kW) Evaporating Temperature (°C)											Valve Type
	15	10	5	0	-5	-10	-15	-20	-25	-30	-35	-40	-45	
60	17	17	18	18	18	18	18	18	18	17	17	17	17	EX4
	51	52	53	54	54	54	54	54	53	53	52	52	51	EX5
	123	126	128	129	130	130	130	129	128	127	126	124	122	EX6
	337	345	351	355	357	358	357	356	353	350	345	340	335	EX7
	900	921	936	946	952	954	953	948	941	932	921	908	893	EX8
55	16	17	17	18	18	18	18	18	18	17	17	17	17	EX4
	50	51	52	53	54	54	54	54	54	53	53	52	52	EX5
	119	123	126	128	129	130	130	130	129	128	127	126	124	EX6
	328	339	346	352	355	357	358	357	356	353	350	345	340	EX7
	876	903	923	938	948	953	955	953	949	941	932	921	908	EX8
50	16	16	17	17	18	18	18	18	18	18	17	17	17	EX4
	48	50	51	52	53	54	54	54	54	54	53	53	52	EX5
	114	119	123	125	127	129	129	129	129	128	127	126	125	EX6
	314	327	337	345	350	354	355	356	355	353	351	347	343	EX7
	838	873	899	919	933	943	948	949	947	942	935	925	914	EX8
45	15	16	16	17	17	17	17	18	18	18	17	17	17	EX4
	45	47	49	51	52	52	53	53	53	53	52	52	52	EX5
	107	113	118	121	124	126	127	128	128	127	127	126	124	EX6
	295	311	324	334	341	346	349	351	351	350	348	346	342	EX7
	787	830	864	890	909	923	932	936	937	934	929	922	912	EX8
40	13	15	15	16	16	17	17	17	17	17	17	17	17	EX4
	41	44	46	48	50	51	52	52	52	52	52	52	51	EX5
	98	106	111	116	119	122	124	125	125	125	125	124	123	EX6
	270	290	306	319	328	335	340	343	345	345	344	342	339	EX7
	719	774	817	850	875	894	907	915	919	919	916	911	903	EX8
35	12	13	14	15	16	16	16	17	17	17	17	17	17	EX4
	36	40	43	45	47	49	50	50	51	51	51	51	50	EX5
	86	96	103	109	113	117	119	121	122	122	122	122	121	EX6
	237	264	284	300	312	321	327	332	335	336	336	335	333	EX7
	632	703	757	799	831	856	873	885	893	896	896	893	888	EX8
30	10	11	13	14	15	15	16	16	16	16	16	16	16	EX4
	29	35	39	42	44	46	47	48	49	49	49	49	49	EX5
	70	83	93	100	106	110	113	116	117	118	118	118	118	EX6
	194	229	256	276	291	303	312	318	322	325	326	326	324	EX7
	516	611	682	735	776	808	831	848	859	866	869	868	865	EX8
25	7	9	11	12	13	14	15	15	15	16	16	16	16	EX4
	20	28	33	37	40	43	44	46	46	47	47	48	48	EX5
	47	67	80	90	97	102	106	109	112	113	114	114	114	EX6
	130	184	220	246	266	281	292	301	307	311	313	314	314	EX7
	347	491	587	656	709	749	779	802	818	829	835	837	836	EX8
20	6	9	10	12	13	13	14	14	15	15	15	15	15	EX4
	18	26	32	36	39	41	42	44	45	45	45	46	46	EX5
	43	63	76	85	93	98	102	105	107	108	109	109	109	EX6
	117	173	209	235	254	269	280	288	294	298	300	300	300	EX7
	312	461	557	627	678	718	747	768	784	793	799	801	801	EX8
15	5	8	10	11	12	13	13	14	14	14	14	14	14	EX4
	15	24	30	34	37	39	40	42	42	43	43	43	43	EX5
	37	58	71	81	88	93	97	100	102	103	104	104	104	EX6
	101	160	196	222	241	256	266	274	279	283	285	285	285	EX7
	269	426	524	593	644	682	710	731	745	754	759	759	759	EX8
10	4	7	9	10	11	12	13	13	13	13	13	13	13	EX4
	12	22	28	31	34	36	38	39	40	40	40	40	40	EX5
	29	53	66	76	82	87	91	94	96	97	97	97	97	EX6
	80	145	182	208	227	241	251	258	263	267	267	267	267	EX7
	214	386	485	554	604	642	669	689	702	711	711	711	711	EX8

Application Expansion Valve and Liquid Injection Valve

Condensing Temperature °C	R404A / R507		Extended capacity (kW) Evaporating Temperature (°C)											Valve Type
	15	10	5	0	-5	-10	-15	-20	-25	-30	-35	-40	-45	
60	9	9	9	9	9	9	9	8	8	8	7	7	6	EX4
	28	28	28	28	28	27	26	25	24	23	22	21	20	EX5
	68	68	68	67	66	65	63	61	58	56	53	50	47	EX6
	186	187	186	184	181	177	172	166	160	153	145	137	129	EX7
	495	498	496	491	482	471	458	443	425	407	387	366	344	EX8
55	10	10	10	10	10	10	10	9	9	9	8	8	8	EX4
	30	31	31	31	30	30	29	29	28	27	26	25	23	EX5
	72	73	74	74	73	72	70	69	67	64	62	59	56	EX6
	198	201	202	202	200	197	193	188	182	176	169	162	154	EX7
	527	535	538	537	533	525	514	501	486	470	451	432	411	EX8
50	10	10	11	11	11	11	11	10	10	10	9	9	9	EX4
	31	32	32	32	32	32	32	31	30	30	29	28	27	EX5
	74	76	77	78	78	77	76	75	73	71	69	66	64	EX6
	203	208	211	213	219	211	208	204	200	194	188	181	174	EX7
	541	555	564	567	567	562	555	545	532	518	501	484	465	EX8
45	10	10	11	11	11	11	11	11	11	10	10	10	9	EX4
	31	32	33	33	33	33	33	32	32	31	30	29	29	EX5
	74	77	79	80	80	80	80	79	78	76	74	72	69	EX6
	201	210	215	219	220	220	219	216	212	208	202	196	190	EX7
	537	559	574	583	587	586	582	575	566	553	539	524	506	EX8
40	10	10	11	11	11	11	11	11	11	11	11	10	10	EX4
	29	31	33	33	34	34	34	34	34	33	32	32	31	EX5
	71	75	78	80	81	82	82	81	81	79	78	76	74	EX6
	193	205	214	219	223	225	225	223	221	217	213	208	202	EX7
	515	547	570	585	594	598	598	595	588	578	567	553	538	EX8
35	9	10	10	11	11	11	11	11	11	11	11	11	11	EX4
	27	30	31	33	34	34	34	34	34	34	33	33	32	EX5
	65	71	75	79	81	82	83	83	82	81	80	79	77	EX6
	178	195	207	215	221	225	226	226	225	223	219	215	210	EX7
	474	519	551	574	590	599	603	604	600	594	585	573	560	EX8
30	8	9	10	10	11	11	11	11	11	11	11	11	11	EX4
	23	27	30	31	33	34	34	34	34	34	34	33	33	EX5
	56	65	71	75	78	81	82	83	83	82	81	80	79	EX6
	153	177	194	206	215	221	224	226	226	225	223	219	215	EX7
	409	472	517	550	573	588	598	603	603	600	593	584	573	EX8
25	6	8	9	10	10	11	11	11	11	11	11	11	11	EX4
	17	23	27	29	31	32	33	34	34	34	34	34	33	EX5
	42	55	64	70	74	78	80	81	82	82	81	80	79	EX6
	114	150	174	191	204	213	218	222	224	224	223	220	217	EX7
	305	400	465	510	543	566	582	592	596	597	593	587	579	EX8
20	1	5	7	8	9	10	10	11	11	11	11	11	11	EX4
	3	16	22	26	28	30	32	33	33	33	33	33	33	EX5
	8	40	53	62	68	73	76	78	80	80	80	80	79	EX6
	21	108	146	170	187	200	208	214	218	219	220	218	216	EX7
	56	289	388	453	499	532	555	571	580	585	585	582	576	EX8
15	5	7	8	9	10	10	10	11	11	11	11	11	11	EX4
	15	21	25	28	29	31	32	32	32	32	32	32	32	EX5
	37	51	60	66	71	74	76	77	78	78	78	78	78	EX6
	101	139	164	181	194	202	208	212	213	213	214	213	213	EX7
	268	371	437	484	516	540	555	564	569	569	566	566	566	EX8
10	5	7	8	9	9	10	10	10	10	10	10	10	10	EX4
	14	20	24	26	28	30	31	31	31					

Application Expansion Valve and Liquid Injection Valve

Condensing Dew Point °C	Temperature Bubble Point °C	R407C		Extended capacity (kW) Evaporating Temperature (°C)											Valve Type
		15	10	5	0	-5	-10	-15	-20	-25	-30	-35	-40	-45	
64	60	16	17	17	17	17	17	16	16	16	15	15	15	14	EX4
		50	51	51	51	51	50	50	49	48	47	46	45	43	EX5
		119	120	121	121	121	119	118	116	114	112	109	106	103	EX6
		328	332	333	333	332	329	325	320	314	308	301	293	285	EX7
		874	884	889	889	885	877	867	854	838	821	802	781	759	EX8
59	55	17	17	17	17	17	17	17	16	16	16	15	15	EX4	
		50	51	52	52	52	52	51	51	50	49	48	47	EX5	
		120	122	123	124	124	123	122	121	119	117	114	112	109	EX6
		330	336	339	341	341	339	336	332	328	322	315	308	301	EX7
		879	895	904	909	908	904	897	886	873	858	840	821	801	EX8
54	50	16	17	17	17	17	17	17	17	17	16	16	16	EX4	
		50	51	52	52	53	53	52	52	51	51	50	49	EX5	
		118	121	123	125	125	125	125	123	122	120	118	116	113	EX6
		326	334	340	343	345	345	343	340	336	331	325	319	312	EX7
		869	891	906	915	919	919	914	907	896	883	868	851	832	EX8
50	45	16	16	17	17	17	17	17	17	17	17	16	16	EX4	
		48	50	51	52	53	53	52	52	51	51	50	49	EX5	
		115	119	122	124	125	125	125	124	122	120	118	116	EX6	
		316	327	336	341	344	346	345	344	341	337	332	326	320	EX7
		843	873	894	909	918	921	920	916	908	897	884	869	853	EX8
45	40	15	16	16	17	17	17	17	17	17	17	16	16	EX4	
		46	48	50	51	52	52	52	52	52	52	51	50	49	EX5
		109	114	118	121	123	124	125	125	124	123	121	120	118	EX6
		300	315	326	334	339	342	344	343	341	338	334	330	324	EX7
		801	840	870	891	905	913	916	915	910	902	891	878	864	EX8
40	35	14	15	16	16	17	17	17	17	17	17	17	16	EX4	
		42	45	48	49	50	51	52	52	52	51	51	50	50	EX5
		101	108	113	117	120	122	123	123	123	122	121	120	118	EX6
		278	297	312	323	330	335	338	339	338	337	334	330	325	EX7
		742	793	832	860	880	894	901	904	902	897	889	879	866	EX8
35	30	12	14	15	15	16	16	16	17	17	17	17	16	EX4	
		38	42	45	47	48	49	50	51	51	51	50	50	49	EX5
		90	99	106	111	115	118	119	120	121	120	120	119	117	EX6
		248	273	292	306	317	324	329	331	332	331	329	326	323	EX7
		661	729	779	817	844	864	876	883	885	884	878	870	860	EX8
30	25	10	12	13	14	15	15	16	16	16	16	16	16	EX4	
		32	37	41	44	46	47	48	49	49	49	49	49	48	EX5
		75	88	97	103	108	112	115	116	117	117	117	116	115	EX6
		207	241	266	285	299	309	316	320	322	323	322	320	317	EX7
		552	644	710	760	796	823	841	853	860	861	859	854	846	EX8
26	20	7	10	12	13	14	14	15	15	16	16	16	15	EX4	
		23	30	36	39	42	44	46	47	47	48	48	48	47	EX5
		54	72	85	94	100	105	108	111	112	113	113	113	112	EX6
		148	199	233	258	276	289	299	305	309	312	312	311	309	EX7
		395	530	621	687	735	770	796	814	825	831	832	829	824	EX8
21	15	7	9	11	12	13	14	14	15	15	15	15	15	EX4	
		21	29	34	38	40	42	44	45	45	46	46	46	EX5	
		50	69	81	90	96	101	104	106	108	108	108	108	EX6	
		137	189	223	247	265	277	287	293	297	299	299	298	EX7	
		365	503	594	658	705	740	764	781	791	796	796	795	EX8	
16	10	6	9	11	12	13	13	14	14	14	14	14	14	EX4	
		19	27	32	36	38	40	42	43	43	43	43	43	EX5	
		45	64	76	85	91	96	99	101	103	103	103	103	EX6	
		123	176	210	234	251	264	273	279	282	282	284	284	EX7	
		329	470	561	624	670	704	727	743	753	753	753	758	EX8	

Application Expansion Valve and Liquid Injection Valve

Condensing Temperature °C	R410A		Extended capacity (kW) Evaporating Temperature (°C)											Valve Type
	15	10	5	0	-5	-10	-15	-20	18	-30	-35	-40	-45	
60	17	17	18	18	18	18	18	18	18	18	18	17	17	EX4
	51	52	53	54	54	54	54	54	53	53	52	51	50	EX5
	123	126	129	130	131	131	131	130	129	127	125	123	120	EX6
	339	348	354	358	360	361	360	358	354	350	344	338	331	EX7
	-	-	-	-	-	-	-	-	-	-	-	-	-	EX8
55	18	18	19	19	19	19	19	19	19	19	19	19	18	EX4
	53	55	56	57	57	58	58	58	57	57	56	55	54	EX5
	127	132	135	137	138	139	139	139	138	137	135	133	131	EX6
	350	362	370	377	381	383	383	382	380	377	372	366	360	EX7
	935	965	988	1005	1016	1021	1023	1020	1014	1005	992	978	961	EX8
50	18	18	19	19	20	20	20	20	20	20	20	19	19	EX4
	53	55	57	58	59	60	60	60	60	59	59	58	57	EX5
	128	133	137	140	142	144	145	145	144	143	142	140	138	EX6
	351	366	377	386	392	396	398	398	397	394	391	386	380	EX7
	936	975	1006	1029	1045	1056	1061	1062	1059	1052	1043	1030	1015	EX8
45	17	18	19	19	20	20	20	20	20	20	20	20	20	EX4
	52	54	57	58	60	60	61	61	61	61	61	60	59	EX5
	124	131	136	141	144	146	147	148	148	147	146	145	143	EX6
	342	361	375	387	395	401	405	407	407	405	403	399	394	EX7
	913	962	1001	1031	1054	1070	1080	1085	1085	1082	1075	1064	1052	EX8
40	16	17	18	19	20	20	20	21	21	21	21	20	20	EX4
	49	52	55	57	59	60	61	62	62	62	62	61	61	EX5
	118	126	133	138	142	145	147	149	149	149	149	148	146	EX6
	324	348	366	381	392	400	406	409	411	411	409	406	402	EX7
	864	927	977	1015	1045	1067	1082	1091	1095	1095	1091	1084	1073	EX8
35	15	16	18	18	19	20	20	20	21	21	21	20	20	EX4
	45	49	53	55	58	59	60	61	62	62	62	62	61	EX5
	108	118	127	134	139	143	146	148	149	149	149	149	148	EX6
	296	326	349	368	382	393	401	406	409	411	410	409	406	EX7
	789	869	932	981	1019	1048	1069	1083	1092	1095	1095	1090	1082	EX8
30	13	15	16	17	18	19	20	20	20	20	20	20	20	EX4
	38	44	49	52	55	57	59	60	61	61	61	61	61	EX5
	93	107	118	126	133	138	142	145	147	148	148	148	147	EX6
	255	294	325	348	366	380	390	398	403	406	407	406	405	EX7
	680	786	866	928	976	1013	1041	1061	1075	1083	1086	1084	1079	EX8
25	10	13	15	16	17	18	19	19	20	20	20	20	20	EX4
	29	38	44	48	52	54	56	58	59	60	60	60	60	EX5
	71	91	106	117	125	131	136	140	143	144	145	146	145	EX6
	195	251	291	321	344	361	375	385	392	397	399	400	399	EX7
	520	669	775	855	916	964	1000	1027	1046	1058	1065	1067	1065	EX8
20	4	9	12	14	16	17	18	18	19	19	19	20	20	EX4
	13	28	37	43	47	51	53	55	57	58	58	59	59	EX5
	31	68	89	103	114	122	129	133	137	139	141	142	142	EX6
	84	188	244	284	314	337	354	367	377	383	388	390	390	EX7
	225	501	652	758	837	898	944	979	1005	1023	1034	1040	1042	EX8
15	3	9	12	14	15	16	17	18	18	19	19	19	19	EX4
	10	27	36	42	46	49	52	54	55	56	57	57	57	EX5
	23	65	86	100	111	119	125	130	133	135	137	137	137	EX6
	64	178	236	276	305	327	344	357	366	372	376	376	378	EX7
	172	475	629	735	813	873	917	951	976	992	1003	1008	1008	EX8
10	1	8	11	13	1									



Application Expansion Valve and Liquid Injection Valve

Condensing Temperature °C	R124		Extended capacity (kW) Evaporating Temperature (°C)					Valve Type
	30	25	20	15	10	5	0	
100	7	7	7	6	6	6	5	EX4
	22	21	20	19	18	17	16	EX5
	53	51	49	47	44	42	39	EX6
95	8	8	7	7	7	7	6	EX4
	24	23	23	22	21	20	19	EX5
	57	56	54	52	50	47	45	EX6
90	8	8	8	8	7	7	7	EX4
	25	25	24	24	23	22	21	EX5
	61	59	58	56	54	52	50	EX6
85	9	9	8	8	8	8	7	EX4
	26	26	25	25	24	23	23	EX5
	63	62	61	60	58	56	54	EX6
80	9	9	9	8	8	8	8	EX4
	27	27	26	26	25	25	24	EX5
	64	63	63	62	61	59	57	EX6
75	9	9	9	9	9	8	8	EX4
	27	27	27	26	26	25	25	EX5
	64	64	64	63	62	61	60	EX6
70	9	9	9	9	9	9	8	EX4
	26	26	27	27	26	26	25	EX5
	62	63	64	63	63	62	61	EX6
65	8	8	9	9	9	9	8	EX4
	25	26	26	26	26	26	26	EX5
	60	61	62	63	63	62	62	EX6
60	8	8	8	8	8	8	8	EX4
	23	24	25	26	26	26	26	EX5
	56	58	60	61	62	62	61	EX6

Condensing Temperature °C	R23		Extended capacity (kW) Evaporating Temperature (°C)										Valve Type
	-45	-50	-55	-60	-65	-70	-75	-80	-85	-90	-95	-100	
-10	17	18	19	19	19	19	19	19	19	19	19	18	EX4
	53	55	56	57	58	58	58	58	58	57	57	56	EX5
	127	132	135	138	139	140	140	140	139	138	137	135	EX6
-15	16	17	18	18	19	19	19	19	19	19	18	18	EX4
	50	52	54	55	56	57	57	57	57	57	56	55	EX5
	119	125	130	133	135	137	137	137	137	136	135	134	EX6
-20	15	16	17	17	18	18	18	18	18	18	18	18	EX4
	45	48	51	53	54	55	55	55	55	55	55	54	EX5
	109	117	122	127	130	132	133	134	133	133	132	131	EX6
-25	13	14	15	16	17	17	17	18	18	18	18	17	EX4
	40	44	47	49	51	52	53	53	53	53	53	53	EX5
	96	106	113	118	122	125	127	128	129	128	128	127	EX6
-30	11	13	14	15	16	16	16	17	17	17	17	17	EX4
	33	38	42	45	47	49	50	51	51	51	51	51	EX5
	78	92	101	108	114	117	120	122	122	123	123	122	EX6
-35	7	10	12	13	14	15	15	16	16	16	16	16	EX4
	22	30	36	40	43	45	46	47	48	48	48	48	EX5
	53	73	86	96	103	108	111	114	115	116	116	116	EX6
-40	6	9	11	12	13	14	14	15	15	15	15	15	EX4
	19	28	33	37	40	42	43	44	45	45	45	45	EX5
	46	67	80	90	96	101	104	106	108	108	108	108	EX6
-45	5	8	10	11	12	13	13	13	14	14	14	14	EX4
	15	25	30	34	37	39	40	41	41	41	41	41	EX5
	37	60	73	82	88	93	96	98	99	99	100	100	EX6

Application Expansion Valve and Liquid Injection Valve

Condensing Temperature °C	R744		Extended capacity (kW) Evaporating Temperature (°C)											Valve Type
	8	5	0	-5	-10	-15	-20	-25	-30	-35	-40	-45	-50	
10	5	12	18	22	26	29	31	33	34	35	36	37	38	EX4
	15	36	55	68	79	87	94	99	104	108	110	113	114	EX5
	36	86	132	164	189	208	225	238	249	257	264	269	273	EX6
	99	237	362	450	518	572	617	653	683	707	726	740	750	EX7
	-	-	-	-	-	-	-	-	-	-	-	-	-	EX8
5			12	19	23	27	29	32	33	35	36	37	38	EX4
			37	57	71	81	90	96	102	106	110	113	115	EX5
			89	137	170	195	215	231	244	254	263	269	274	EX6
			244	376	466	535	589	634	670	699	722	739	753	EX7
0			-	-	-	-	-	-	-	-	-	-	-	EX8
			12	19	24	27	30	32	34	35	36	37	37	EX4
			38	58	72	83	91	98	103	107	111	113	113	EX5
			90	139	173	198	218	234	247	257	265	271	271	EX6
-5			247	383	475	544	598	642	677	705	727	744	744	EX7
			659	1023	1267	1452	1598	1715	1809	1883	1942	1987	1987	EX8
				12	19	24	27	30	32	34	35	36	36	EX4
				97	59	73	83	91	98	103	107	110	110	EX5
-10				89	140	174	199	219	234	247	257	264	264	EX6
				245	385	477	547	601	644	678	705	725	725	EX7
				654	1028	1275	1460	1604	1718	1809	1881	1937	1937	EX8
					12	19	24	27	30	32	34	35	35	EX4
-15					36	58	72	83	91	97	102	106	106	EX5
					87	139	173	198	217	233	245	254	254	EX6
					239	382	475	544	597	639	671	697	697	EX7
					639	1021	1269	1452	1594	1705	1793	1861	1861	EX8
-20						11	19	23	27	29	31	33	33	EX4
						35	57	71	82	89	96	100	100	EX5
						84	137	171	195	214	229	240	240	EX6
						229	376	468	536	588	628	660	660	EX7
-25														EX8
														EX4
														EX5
														EX6
-30														EX7
														EX8
														EX4
														EX5
-35														EX6
														EX7
														EX8
														EX4
-40														EX5
														EX6
														EX7
														EX8
-45														EX4
														EX5
														EX6
														EX7

**Application Hot Gas Bypass - Nominal Capacities (kW)**

Valve Type	Kv, m <sup>3</sup> /h	R22 / R407C	R134a	R404A / R507
EX4	0.21	4.9	3.4	4.6
EX5	0.68	16	11	15
EX6	1.57	37	26	35
EX7	5.58	131	92	126
EX8	16.95	399	278	382

The nominal capacity (Qn) is based on the following conditions:

Refrigerant	Evaporating temperature	Condensing temperature	Subcooling
R407C	+4°C (dew point)	+38°C bubble point / +43°C dew point	1K
R22, R134a, R404A, R507	+4°C	+38°C	1K

For other operating conditions use Excel based Selection Tool (download from [www.emersonclimate.eu](http://www.emersonclimate.eu)) or use the following quick selection tables.

Biflow versions are not released for hot gas bypass applications. EX4 .. EX8 must be installed with motor downward in hot gas line applications. This insures the valve life expectancy. Install a check valve on main hot gas line just after branch to Control Valve.

Condensing Temperature °C	Extended Capacity kW			Valve type
	R22 / R407C	R134a	R404A / R507	
60 bubble point for all refig. (64 dew point for R407C)	7	4.9	5.8	EX4
	23	16	19	EX5
	54	38	45	EX6
	191	135	161	EX7
	581	411	488	EX8
50 bubble point for all refig. (54 dew point for R407C)	6.1	4.3	5.5	EX4
	20	14	18	EX5
	46	32	41	EX6
	163	115	147	EX7
40 bubble point for all refig. (45 dew point for R407C)	4.9	3.7	4.9	EX4
	16	12	16	EX5
	38	27	36	EX6
	136	95	130	EX7
30 bubble point for all refig. (35 dew point for R407C)	4.3	2.8	4	EX4
	14	9	13	EX5
	32	22	31	EX6
	112	78	111	EX7
	340	236	336	EX8

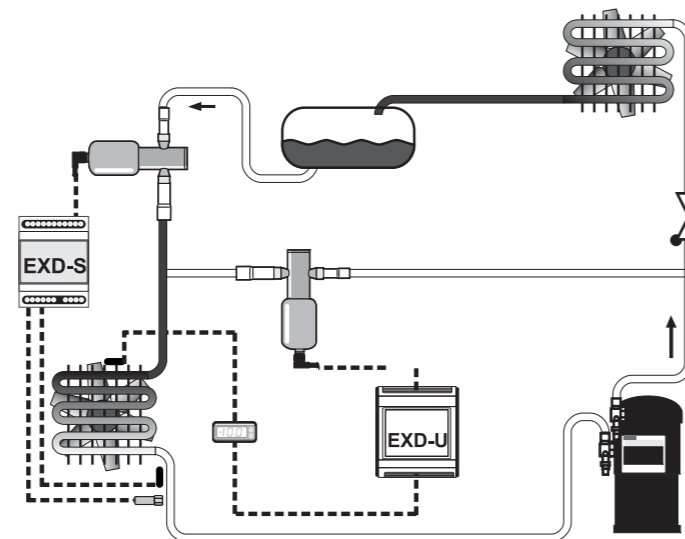

**Application Suction Pressure Regulation (Evaporating or Crankcase Pressure) - Nominal Capacities (kW)**

Valve Type	Kv, m <sup>3</sup> /h	R407C	R22	R134a	R404A
EX6	1.57	3.9	4.1	3.1	3.5
EX7	5.58	14	15	11	13
EX8	16.95	42	45	34	38

The nominal capacity (Qn) is based on the following conditions:

Refrigerant	Evaporating temperature	Condensing temperature	Subcooling	Pressure Drop
R407C	+4°C (dew point)	+38°C bubble point / +43°C dew point	1K	0.15 bar
R22, R134a, R404A	+4°C	+38°C	1K	0.15 bar

For other operating conditions use Excel based Selection Tool (download from [www.emersonclimate.eu](http://www.emersonclimate.eu)) or use the following quick selection tables.

For biflow versions attention should be paid to the temperature range TS -40°C bis +80°C ! EX6 .. EX8 must be installed with motor downward in suction line applications. This insures the valve life expectancy.

**Example:**

EX6 provides 3.5 kW at 0.15 bar pressure drop with R404A or 3.5\*1.41=4.9 kW at 0.3 bar pressure drop.

Multiply above nominal capacities by following factors to obtain capacities at different pressure drops:

**Typical Order Package**

- 1) Valve EX6, EX7 or EX8  
Plug and cable assembly EXV-M60
- 2) Controller Kit EXD-U00 Part No. 808 038

ΔP, bar	0.10	0.15	0.20	0.30
Correction factor	0.82	1.00	1.15	1.41

Condensing Temperature °C	R134a					Valve Type
	Extended capacity (kW) Evaporating Temperature (°C)					
	10	5	0	-10	-20	
60	3	2	2	2	1	EX6
	10	9	8	6	4	EX7
	30	27	24	18	13	EX8
50	3	3	2	2	1	EX6
	11	10	9	7	5	EX7
	34	30	27	21	15	EX8
40	3	3	3	2	2	EX6
	12	11	10	8	6	EX7
	38	34	30	23	17	EX8
30	4	3	3	2	2	EX6
	14	12	11	8	6	EX7
	41	37	33	26	19	EX8
20	4	4	3	3	2	EX6
	15	13	12	9	7	EX7
	45	40	36	28	21	EX8

Condensing Temperature °C	R22							Valve Type
	Extended capacity (kW) Evaporating Temperature (°C)							
	10	5	0	-10	-20	-30	-40	
60	4	3	3	3	2	2	1	EX6
	13	12	11	9	7	5	4	EX7
	41	37	34	27	22	17	12	EX8
50	4	4	3	3	2	2	1	EX6
	15	13	12	10	8	6	5	EX7
	45	41	37	30	24	19	14	EX8
40	5	4	4	3	2	2	1	EX6
	16	15	13	11	9	7	5	EX7
	49	45	41	33	27	21	15	EX8
30	5	4	4	3	3	2	2	EX6
	17	16	14	12	9	7	5	EX7
	53	48	44	36	29	22	16	EX8
20	5	5	4	4	3	2	2	EX6
	19	17	15	13	10	8	6	EX7
	56	52	47	39	31	24	18	EX8

**Application Suction Pressure Regulation (Evaporating or Crankcase Pressure)**

Condensing Temperature °C	<b>R404A/R507</b>							Valve Type
	Extended capacity (kW) Evaporating Temperature (°C)							
	10	5	0	-10	-20	-30	-40	
60	3	2	2	2	1	1	1	EX6
	9	8	8	6	4	3	2	EX7
	29	26	23	18	13	10	7	EX8
50	3	3	3	2	2	1	1	EX6
	12	11	9	7	6	4	3	EX7
	36	32	29	23	18	13	9	EX8
40	4	3	3	3	2	1	1	EX6
	14	12	11	9	7	5	4	EX7
	42	38	34	27	21	16	12	EX8
30	4	4	4	3	2	2	1	EX6
	16	14	13	10	8	6	5	EX7
	48	43	39	31	25	19	14	EX8
20	5	4	4	3	3	2	1	EX6
	17	16	14	12	9	7	5	EX7
	53	48	44	35	28	21	16	EX8

Condensing Temperature		<b>R407C</b>					Valve Type
Dew point °C	Bubble point °C	Extended capacity (kW) Evaporating Temperature (°C)					
		10	5	0	-10	-20	
64	60	3	3	3	2	2	EX6
		12	11	10	8	6	EX7
		36	33	29	23	18	EX8
54	50	4	3	3	2	2	EX6
		14	12	11	9	7	EX7
		41	37	34	27	21	EX8
45	40	4	4	3	3	2	EX6
		15	14	12	10	8	EX7
		46	42	38	30	23	EX8
35	30	5	4	4	3	2	EX6
		17	15	14	11	9	EX7
		51	46	41	33	26	EX8
26	20	5	5	4	3	3	EX6
		18	16	15	12	9	EX7
		55	50	45	36	28	EX8

**Application Condensing Pressure Regulation and Liquid Duty - Nominal Capacities (kW)**

Valve Type	Kv, m <sup>3</sup> /h	R407C	R22	R134a	R404A
EX5	0.68	18	20	18	13
EX6	1.57	43	46	42	30
EX7	5.58	153	162	151	106
EX8	16.95	463	491	458	323

The nominal capacity (Qn) is based on the following conditions:

Refrigerant	Evaporating temperature	Condensing temperature	Subcooling	Pressure Drop
R407C	+4°C (dew point)	+38°C bubble point / +43°C dew point	1K	0.35 bar
R22, R134a, R404A	+4°C	+38°C	1K	0.35 bar

For other operating conditions use Excel based Selection Tool (download from [www.emersonclimate.eu](http://www.emersonclimate.eu)) or use the following quick selection tables.

For biflow versions attention should be paid to the temperature range TS -40°C bis +80°C ! EX6 .. EX8 must be installed with motor downward in suction line applications. This insures the valve life expectancy.

**Example:**

EX6 provides 30kW at 0.35bar pressure drop with R404A or 30\*0.76=22.8 kW at 0.2 bar pressure drop.

Multiply above nominal capacities by following factors to obtain capacities at different pressure drops:

ΔP, bar	0.15	0.20	0.35
Correction factor	0.65	0.76	1.00

Condensing Temperature °C	<b>R134a</b>				Valve type
	Extended Capacity Evaporating Temperature (°C)				
	10	0	-10	-20	
60	14	13	13	12	EX5
	32	31	29	27	EX6
	115	109	104	98	EX7
	350	332	315	296	EX8
50	16	15	15	14	EX5
	37	36	34	32	EX6
	133	127	121	115	EX7
	405	387	369	350	EX8
30	18	18	17	16	EX5
	42	41	39	37	EX6
	151	145	139	133	EX7
	458	440	422	403	EX8
40	20	20	19	18	EX5
	47	46	44	42	EX6
	168	162	156	150	EX7
	512	493	474	455	EX8
20	22	22	21	20	EX5
	52	51	49	47	EX6
	186	180	173	167	EX7
	564	546	526	507	EX8

Condensing Temperature °C	<b>R22</b>		Extended Capacity Evaporating Temperature (°C)				Valve type
	10	0	-10	-20	-30	-40	
60	15	15	15	14	14	13	EX5
	36	35	34	33	32	30	EX6
	128	124	120	116	112	108	EX7
	387	377	365	353	341	328	EX8
50	17	17	16	17	16	15	EX5
	41	40	36	39	36	35	EX6
	144	141	129	137	129	124	EX7
	439	428	391	416	391	377	EX8
30	19	19	19	18	17	17	EX5
	45	44	43	42	41	39	EX6
	161	157	153	149	145	140	EX7
	488	477	465	453	439	426	EX8
40	21	21	20	20	19	19	EX5
	50	49	48	46	45	44	EX6
	177	173	169	165	160	156	EX7
	536	525	513	500	486	472	EX8
20	23	23	22	22	21	21	EX5
	54	53	52	51	49	48	EX6
	192	188	184	180	175	171	EX7
	584	572	560	547	533	519	EX8

**Application Condensing Pressure Regulation and Liquid Duty**

Condensing Temperature °C	R404A/507		Evaporating Temperature (°C)				Valve type
	10	0	-10	-20	-30	-40	
60	8	8	7	6	6	5	EX5
	19	17	16	15	13	12	EX6
	66	62	58	53	48	43	EX7
	202	189	175	160	146	130	EX8
50	11	10	9	9	8	8	EX5
	24	23	22	20	19	17	EX6
	87	82	78	73	67	62	EX7
	264	250	236	220	205	189	EX8
30	13	12	12	11	10	10	EX5
	30	28	27	26	24	23	EX6
	106	101	96	91	85	80	EX7
	321	306	291	276	260	243	EX8
40	15	14	14	13	12	12	EX5
	35	33	32	30	29	27	EX6
	123	119	114	108	103	97	EX7
	375	360	345	329	312	295	EX8
20	17	16	16	15	14	14	EX5
	40	38	37	35	34	32	EX6
	141	136	131	125	120	114	EX7
	427	412	397	380	363	346	EX8

Condensing Temperature		R407C	Evaporating Temperature (°C)				Valve type
Dew Point °C	Bubble Point °C		10	0	-10	-20	
64	60	14	13	12	12	EX5	
		32	30	29	28	EX6	
		112	108	103	98	EX7	
		340	327	313	298	EX8	
54	50	16	15	15	14	EX5	
		37	36	35	33	EX6	
		132	128	123	118	EX7	
		402	388	373	358	EX8	
45	30	18	18	17	17	EX5	
		43	41	40	38	EX6	
		152	147	142	137	EX7	
		460	446	431	415	EX8	
35	40	21	20	19	19	EX5	
		48	47	45	44	EX6	
		170	166	160	155	EX7	
		517	503	487	471	EX8	
26	20	23	22	22	21	EX5	
		53	52	50	49	EX6	
		189	184	179	173	EX7	
		573	558	543	526	EX8	

**Application Hot Gas Flow such as Heat Reclaim Application - Nominal Capacities (kW)**

Valve Type	Kv, m <sup>3</sup> /h	R22 / R407C	R134a	R404A / R507	R410A
EX6	1.57	11	9	10	13
EX7	5.58	39	33	36	47
EX8	16.95	119	101	108	144

The nominal capacity (Qn) is based on the following conditions:

Refrigerant	Evaporating temperature	Condensing temperature	Subcooling	Pressure Drop	Isentropic Efficiency
R407C	+4°C (dew point)	+38°C bubble point / +43°C dew point	1K	0.35 bar	80%
R22, R134a, R404A, R507	+4°C	+38°C	1K	0.35 bar	80%

For other conditions see following tables.

Valves must be installed with motor downward in hot gas line applications. This insures the valve life expectancy. Bi-flow versions are not released for hot gas flow applications.

Condensing Temperature °C	Pressure Drop bar	R134a		Extended Capacity KW Evaporating Temperature (°C)											Valve type	
		15	10	5	0	-5	-10	-15	-20	-25	-30	-35	-40	-45		
60	0,1	5	5	4	4	4	4	4	4	4	3	3	3	3	EX6	
		16	16	16	15	15	14	14	13	13	12	12	11	10	EX7	
		50	49	47	46	44	43	41	40	38	37	35	33	32	EX8	
	0,5	10	10	10	9	9	9	8	8	8	7	7	7	6	EX6	
		36	35	34	33	32	31	30	29	28	26	25	24	23	EX7	
		110	107	104	101	97	94	91	87	84	80	77	74	70	EX8	
	1,0	14	14	13	13	12	12	12	11	11	10	10	9	9	EX6	
		50	49	47	46	44	43	41	40	38	37	35	34	32	EX7	
		152	148	144	139	135	130	126	121	116	112	107	102	97	EX8	
	50	0,1	5	4	4	4	4	4	4	4	4	3	3	3	3	EX6
			16	16	15	15	14	14	14	13	13	12	12	11	11	EX7
			49	48	47	45	44	43	41	40	39	37	36	35	33	EX8
0,5		10	10	9	9	9	9	8	8	8	8	7	7	7	EX6	
		35	35	34	33	32	31	30	29	28	27	26	25	24	EX7	
		108	105	102	99	97	94	91	88	85	82	79	76	73	EX8	
1,0		14	13	13	13	12	12	12	11	11	10	10	10	9	EX6	
		49	48	46	45	44	43	41	40	39	37	36	34	33	EX7	
		148	145	141	137	133	129	125	121	117	113	109	105	100	EX8	
40		0,1	4	4	4	4	4	4	4	4	4	3	3	3	3	EX6
			16	15	15	14	14	14	13	13	13	12	12	11	11	EX7
			47	46	45	44	43	42	40	39	38	37	36	34	33	EX8
	0,5	10	9	9	9	9	8	8	8	8	7	7	7	7	EX6	
		34	33	32	32	31	30	29	28	27	26	26	25	24	EX7	
		103	100	98	96	93	91	88	86	83	80	78	75	73	EX8	
	1,0	13	13	12	12	12	12	11	11	11	10	10	10	9	EX6	
		46	45	44	43	42	41	40	39	38	36	35	34	33	EX7	
		141	138	134	131	128	124	121	117	114	110	107	103	100	EX8	
	30	0,1	4	4	4	4	4	4	4	3	3	3	3	3	3	EX6
			15	14	14	14	13	13	13	12	12	12	11	11	11	EX7
			44	43	42	42	41	40	39	38	37	35	34	33	32	EX8
0,5		9	9	9	8	8	8	8	8	7	7	7	7	6	EX6	
		32	31	30	30	29	28	28	27	26	25	25	24	23	EX7	
		96	94	92	90	88	86	84	81	79	77	75	72	70	EX8	
1,0		12	12	12	11	11	11	10	10	10	10	9	9	9	EX6	
		43	42	41	40	39	38	37	36	35	34	33	32	31	EX7	
		130	128	125	122	119	117	114	111	108	105	102	98	95	EX8	



Application Hot Gas Flow such as Heat Reclaim Application

Condensing Temperature °C	Pressure Drop bar	R22/R407C		Extended Capacity KW Evaporating Temperature (°C)											Valve type
		15	10	5	0	-5	-10	-15	-20	-25	-30	-35	-40	-45	
60	0,1	6	5	5	5	5	5	5	5	4	4	4	4	4	EX6
		20	19	19	18	18	17	17	16	16	15	15	14	14	EX7
		59	58	57	55	54	53	51	50	48	47	45	44	42	EX8
	0,5	12	12	12	11	11	11	10	10	10	10	9	9	9	EX6
		43	42	41	40	39	38	37	36	35	34	33	32	31	EX7
		131	129	126	123	119	116	113	110	107	103	100	97	94	EX8
	1,0	17	17	16	16	15	15	15	14	14	13	13	13	12	EX6
		60	59	58	56	55	53	52	51	49	48	46	45	43	EX7
		183	179	175	171	167	162	158	154	149	145	140	135	131	EX8
50	0,1	5	5	5	5	5	5	5	4	4	4	4	4	EX6	
		19	19	18	18	17	17	17	16	16	15	15	14	14	EX7
		58	57	56	54	53	52	51	49	48	47	45	44	42	EX8
	0,5	12	12	11	11	11	11	10	10	10	10	9	9	9	EX6
		42	41	40	40	39	38	37	36	35	34	33	32	31	EX7
		128	126	123	120	117	115	112	109	106	103	100	97	94	EX8
	1,0	17	16	16	15	15	15	14	14	14	13	13	13	12	EX6
		59	57	56	55	54	52	51	50	49	47	46	44	43	EX7
		178	175	171	167	163	159	155	151	147	143	139	135	131	EX8
40	0,1	5	5	5	5	5	5	4	4	4	4	4	4	EX6	
		18	18	18	17	17	16	16	16	15	15	15	14	14	EX7
		56	55	54	52	51	50	49	48	47	45	44	43	42	EX8
	0,5	11	11	11	11	10	10	10	10	9	9	9	9	8	EX6
		40	40	39	38	37	36	35	35	34	33	32	31	30	EX7
		123	120	118	115	113	110	108	105	103	100	97	94	92	EX8
	1,0	16	15	15	15	14	14	14	14	13	13	12	12	12	EX6
		56	55	54	53	52	50	49	48	47	46	44	43	42	EX7
		170	167	163	160	157	153	149	146	142	139	135	131	127	EX8
30	0,1	5	5	5	5	4	4	4	4	4	4	4	4	EX6	
		17	17	17	16	16	16	15	15	15	14	14	14	13	EX7
		53	52	51	50	49	48	46	45	44	43	42	41	40	EX8
	0,5	11	10	10	10	10	10	9	9	9	9	9	8	8	EX6
		38	37	37	36	35	34	34	33	32	31	30	30	29	EX7
		115	113	111	109	107	104	102	100	97	95	93	90	88	EX8
	1,0	15	14	14	14	14	13	13	13	12	12	12	12	11	EX6
		52	51	50	49	48	47	46	45	44	43	42	41	40	EX7
		159	156	153	150	147	144	141	138	134	131	128	124	121	EX8

Application Hot Gas Flow such as Heat Reclaim Application

Condensing Temperature °C	Pressure Drop bar	R404A		Extended Capacity KW Evaporating Temperature (°C)											Valve type	
		15	10	5	0	-5	-10	-15	-20	-25	-30	-35	-40	-45		
60	0,1	4	4	4	4	4	4	3	3	3	3	3	3	2	2	EX6
		15	14	14	13	13	12	11	11	10	10	9	8	8	EX7	
		45	43	42	40	38	36	35	33	31	29	27	25	23	EX8	
	0,5	9	9	8	8	8	7	7	7	6	6	6	5	5	EX6	
		32	31	30	29	28	26	25	24	22	21	20	18	17	EX7	
		99	95	92	88	84	80	76	72	68	64	60	56	52	EX8	
	1,0	13	12	12	11	11	10	10	9	9	8	8	7	7	EX6	
		45	44	42	40	39	37	35	33	31	29	27	26	24	EX7	
		137	132	127	122	117	112	106	101	95	89	84	78	72	EX8	
50	0,1	5	4	4	4	4	4	4	4	3	3	3	3	3	EX6	
		16	16	15	15	14	14	13	13	12	11	11	10	10	EX7	
		49	47	46	44	43	41	40	38	36	35	33	31	30	EX8	
	0,5	10	10	9	9	9	8	8	8	7	7	7	6	6	EX6	
		35	34	33	32	31	30	29	28	26	25	24	23	22	EX7	
		107	104	101	98	95	91	88	84	80	77	73	69	65	EX8	
	1,0	14	13	13	13	12	12	11	11	10	10	9	9	8	EX6	
		49	48	46	45	43	42	40	38	37	35	33	32	30	EX7	
		149	145	141	136	131	127	122	117	112	107	102	96	91	EX8	
40	0,1	5	4	4	4	4	4	4	4	4	3	3	3	3	EX6	
		16	16	16	15	15	14	14	13	13	12	12	11	11	EX7	
		50	49	47	46	45	43	42	40	39	37	36	34	33	EX8	
	0,5	10	10	10	9	9	9	9	8	8	8	7	7	7	EX6	
		36	35	34	33	32	31	30	29	28	27	26	25	24	EX7	
		109	107	104	101	98	95	92	89	86	83	79	76	73	EX8	
	1,0	14	14	13	13	13	12	12	11	11	11	10	10	9	EX6	
		50	49	48	46	45	44	42	41	39	38	36	35	33	EX7	
		152	148	144	140	136	132	128	124	119	115	110	105	101	EX8	
30	0,1	5	4	4	4	4	4	4	4	4	3	3	3	3	EX6	
		16	16	15	15	15	14	14	13	13	13	12	12	11	EX7	
		49	48	47	46	45	43	42	41	40	38	37	36	34	EX8	
	0,5	10	10	10	9	9	9	9	8	8	8	8	7	7	EX6	
		35	35	34	33	32	31	31	30	29	28	27	26	25	EX7	
		108	105	103	101	98	95	93	90	87	84	81	78	76	EX8	
	1,0	14	13	13	13	13	12	12	12	11	11	10	10	10	EX6	
		49	48	47	46	45	43	42	41	40	38	37	36	34	EX7	
		149	146	142	139	135	132	128	124	120	117	113	109	104	EX8	

\* Condensing temperatures R407C:  
The relation between bubble points and dew points is as follows:

Bubble point °C	Dew point °C
60	64
50	54
40	45
30	35

### Application Hot Gas Flow such as Heat Reclaim Application

Condensing Temperature °C	Pressure Drop bar	R410A		Extended Capacity KW Evaporating Temperature (°C)											Valve type
		15	10	5	0	-5	-10	-15	-20	-25	-30	-35	-40	-45	
60	0,1	6	6	6	6	5	5	5	5	5	5	4	4	4	EX6
		21	21	20	20	19	19	18	18	17	16	16	15	15	EX7
		64	63	62	60	58	57	55	53	52	50	48	46	44	EX8
	0,5	13	13	13	12	12	12	11	11	11	10	10	10	9	EX6
		47	46	45	44	43	41	40	39	38	36	35	34	32	EX7
		143	140	137	133	130	126	122	118	115	111	107	103	99	EX8
	1,0	19	18	18	17	17	16	16	15	15	14	14	13	13	EX6
		66	64	63	61	60	58	56	55	53	51	49	47	46	EX7
		200	196	191	186	182	177	171	166	161	155	150	144	138	EX8
50	0,1	6	6	6	6	6	5	5	5	5	5	5	5	4	EX6
		22	22	21	21	20	20	19	19	18	18	17	17	16	EX7
		67	66	65	63	62	60	59	57	55	54	52	50	48	EX8
	0,5	14	14	13	13	13	12	12	12	11	11	11	10	10	EX6
		49	48	47	46	45	44	43	42	40	39	38	37	35	EX7
		149	146	143	140	137	133	130	126	123	119	115	111	108	EX8
	1,0	19	19	19	18	18	17	17	16	16	15	15	14	14	EX6
		69	67	66	64	63	61	60	58	57	55	53	51	50	EX7
		209	204	200	196	191	186	182	177	172	167	161	156	151	EX8
40	0,1	6	6	6	6	6	5	5	5	5	5	5	5	5	EX6
		22	22	21	21	20	20	19	19	18	18	17	17	16	EX7
		67	66	65	63	62	60	59	58	56	54	53	51	50	EX8
	0,5	14	13	13	13	13	12	12	12	11	11	11	11	10	EX6
		49	48	47	46	45	44	43	42	41	40	39	37	36	EX7
		148	146	143	140	137	134	131	127	124	121	117	114	110	EX8
	1,0	19	19	18	18	18	17	17	16	16	16	15	15	14	EX6
		68	67	66	64	63	61	60	59	57	55	54	52	51	EX7
		207	203	199	195	191	187	182	178	173	168	164	159	154	EX8
30	0,1	6	6	6	6	6	5	5	5	5	5	5	5	5	EX6
		21	21	21	20	20	19	19	19	18	18	17	17	16	EX7
		65	64	63	61	60	59	58	56	55	53	52	51	49	EX8
	0,5	13	13	13	13	12	12	12	12	11	11	11	10	10	EX6
		47	46	45	45	44	43	42	41	40	39	38	37	36	EX7
		143	141	138	135	133	130	127	124	121	118	115	112	109	EX8
	1,0	18	18	18	17	17	17	16	16	16	15	15	14	14	EX6
		65	64	63	62	61	60	58	57	56	54	53	51	50	EX7
		199	195	192	188	185	181	177	173	169	165	160	156	152	EX8

## Electrical Control Valves Series EX4, EX5, EX6, EX7, EX8

### Technical Data

Compatibility *	HCFCs, HFCs, CO <sub>2</sub> Mineral and POE lubricants
MOPD (maximum operating pressure differential)	EX4/EX5/EX6/EX7: 35 bar EX8: 30 bar
Max. allowable pressure, PS	45 bar
Medium temperature range: Uniflow version Biflow version	Liquid inlet temperature TS: -50 ... +100°C TS: -40 ... +80°C
Ambient temperature Storage temperature	-40 ... +55°C -40 ... +70°C
CE marking EX4/EX5 EX6/EX7/EX8	not required required, Cat I, Module A
Salt spray test	non-corrosion stainless steel body
Humidity	5 ... 95% R.H.

Connections	ODF stainless steel fittings
Protection accordance to IEC 529, DIN 40050	IP 67 with Alco supplied cable connector assembly
Vibration for non-connected and fastened valve	4 g (0 .. 1000 Hz, 1 Oktave /min.)
Shock	20g at 11 ms, 80g at 1 ms
Net weight	0.5 kg (EX4), 0.52 kg (EX5), 0.6 kg (EX6), 1.1 kg (EX7), 1.5 kg (EX8)
Full travel time	EX4/EX5/EX6: 1.5 s EX7: 3.2 s, EX8: 5.2 s
Seat leakage	Positive shut-off better than solenoid valve
External leakage	≤ 3 g / Year
Package and delivery	Single pack, without electrical connector

\* Valves are not released for use with inflammable refrigerants.

### Block Diagrams

**Superheat Control with EC3-X33** (see page 141)  
optional display unit ECD-002

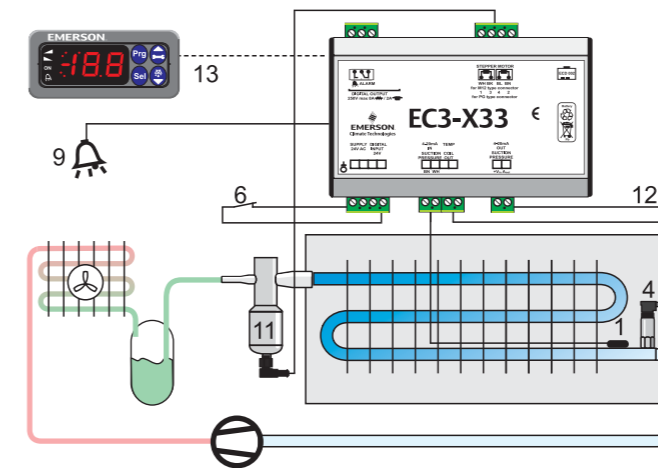

- 1 ECN-N60 sensor
- 4 PT5 pressure transmitter
- 6 Supply / Digital Input
- 9 Alarm out
- 11 EX4 ... EX8 valve
- 12 Suction pressure 4..20mA out
- 13 ECD-002 Display unit

**Refrigerant Mass Flow Control with EXD-U**  
(see page 142)

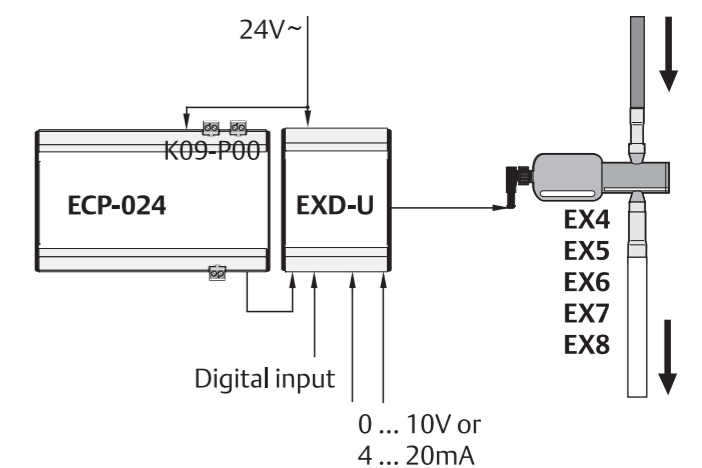

## High Pressure Expansion Valves Series CX4, CX5, CX6, CX7

Emerson Climate Technologies CX series are stepper motor driven valves for precise control of R744 (CO<sub>2</sub>) refrigerant mass flow in air conditioning, refrigeration, heat pump applications. The Control Valves can be used as high pressure expansion valve, liquid injection duty, hot gas bypass.

### Features and Benefits

- Maximum allowable pressure, PS: 120 bar
- Test pressure, PT: 132 bar
- Burst pressure: >360 bar
- Fully hermetic design (no thread joints between valve body and motor compartment)
- Applicable to transcritical CO<sub>2</sub> applications
- Very short full stroke time
- High resolution and excellent repeatability
- Positive shut-off of valve to eliminate the use of an additional solenoid valve
- Linear flow capacity
- Extremely wide capacity range (10 ... 100%)
- Continuous modulation of mass flow, no stress (liquid hammering) in the refrigeration circuit
- Direct coupling of motor and valve for high reliability (no gear mechanism)
- Ceramic slide and port for accurate flow and minimal wear
- Balanced force design
- Corrosion resistant stainless steel body and connections
- 40 micron internal strainer



### Selection Chart

Type	Part No.	Kv, m <sup>3</sup> /h	Capacity Range	Inlet Connection ODF	Outlet Connection ODF	Electrical Connection
CX4-CO <sub>2</sub>	801 990	0.21	10 ... 100%	3/8"	5/8"	M12 plug
CX5-CO <sub>2</sub>	801 991	0.68		5/8" (16 mm)	7/8" (22 mm)	
CX6-CO <sub>2</sub>	801 992	1.57		7/8"	1-1/8"	
CX7-CO <sub>2</sub>	801 996	5.58		1-1/8"	1-1/8"	

### Cable and Connector Assemblies

Type	Part No.	Temperature Range	Length	Connector type to valve	Connector type to driver or controller	Illustration
EXV-M15	804 663	-50 ... +80°C	1.5 m	M12, 4 pins	Loose wires	
EXV-M30	804 664		3.0 m			
EXV-M60	804 665		6.0 m			

## Electronic Controllers and Sensors

### Selection Table Electronic Controllers

Description	Network communication			Page
	without	TCP/IP	LON	
<b>Superheat Controllers and Stepper Motor Drivers</b>				
Superheat controller for electrical control valves EX4 ... EX8	EC3-X33	EC3-X32		141
Digital superheat controller for electrical control valves EX4 ... EX6	EC3-D73	EC3-D72		141
Universal stepper driver module for electrical control valves EX4 ... EX8	EXD-U00			142
<b>Display case and cold room controllers for Thermo expansion valve applications</b>				
Thermostat control		EC2-212	EC2-211	143
	<i>version for use with a compressor pack system</i>	EC2-292	EC2-291	143
<b>Display case and cold room controllers for electrical control valve</b>				
Temperature + superheat control of EX2 (pressure/temperature input)		EC2-352	EC2-351	143
	<i>version for use with a compressor pack system</i>	EC2-292	EC2-291	143
Temperature + superheat control of EX2 (temperature/temperature input)		EC2-312	EC2-311	143
	<i>version for use with a compressor pack system</i>	EC2-392	EC2-391	143
Temperature + superheat control of EX4 ... EX8 (stepper motor)		EC3-332	EC3-331	146
<b>Condensing unit controllers</b>				
For 2 single stage compressors and 2 fans, on/off control		EC2-512		149
For 1 Digital Scroll™ and 1 single stage or 2 single stage compressors, fans speed control with FSP		EC2-552		149
<b>Rack controllers and dual circuit controllers</b>				
For 8 single stage compressors or 7 compressors and 1 Digital Scroll™		EC3-652		152
For multistage compressors		EC3-672		152
Dual circuits with 4 + 3 single stage compressors		EC3-812		152
Dual circuits, 4 compressors one of which a Digital Scroll™, 3 condenser fans + speed control		EC3-932		152
<b>Condenser controllers</b>				
For up to 4 fans		EC2-712	EC2-711	149
With fan speed control, 2 digital outputs		EC2-742	EC2-741	149
For up to 6 stages, one with continuous control output 0 ... 10V, heat recovery control		EC3-752		154
<b>Electronic fan speed controllers</b>				
Pressure actuated, current range 0.1 ... 4A		FSY		160
Current range 0.3 ... 8A, 1- or 3-phase versions		FSP/FSE		162
<b>Electronic smart starter</b>				
For single phase compressor motors with up to 32A		CSS		157
<b>Pressure transmitter</b>				
Output signal 4 ... 20mA		PT5		158
<b>Universal controllers</b>				
With 2 digital inputs, 3 temperature inputs, 4 relay outputs		EC2-112	EC2-111	143

## Electronic Superheat Controllers and Stepper Motor Drivers

Emerson Climate Technologies designed superheat controllers and valve drivers for stepper motor driven control valves for all commercial refrigeration and airconditioning applications.

**EC3-X33** is a universal superheat controller without network communication for air conditioning, refrigeration and industrial applications such as chillers, industrial process cooling, rooftops, heat pumps, package unit, close control, cold room, food process and air driers. The ECD-002 Display/ keypad Unit is necessary for setup but not for operation of the controllers. ECD-002 can be connected or disconnected to EC3-X33 at any time.

In the event of a cooling request and compressor start-up, EC3-X33 needs to be informed. This can be achieved by a digital input. EC3-X33 will start to control the refrigerant mass flow stand-alone by precise positioning of the Control Valve under different operating conditions such as compressor start-up, start of a further compressor, high head pressure, low head pressure, high load, low load and partial load operation. EC3-X33 is capable for diagnostics and alarm. The alarm can be received via relay output as well as optical LED/ alarm code on ECD-002.

The **EC3-X32** has a similar function as EC3-X33 but with a TCP/IP Ethernet communication interface enabling the controller to be directly connected to a network or a PC via the standard Ethernet port. The EC3-X32 controller has

## Display Case and Coldroom Controllers

The compact **EC2** series is available with either TCP/IP or LON communication protocols and covers also applications where the display cases are connected to a multiple compressor application. In this case, the dedicated compressor relay on the controller is no longer required and is available as a spare relay to perhaps switch the display case lighting.

The controllers can therefore be split into two groups; controller is required to switch the compressor directly; integral application and those connected to a multiple compressor (rack) system.

The **EC2-21x**, **EC2-31x** and **EC2-35x** have the dedicated compressor relay.

The **EC2-29x**, **EC2-39x** and **EC2-37x** are for use with the rack system.

The **EC2-200** series of controllers are specifically designed for display cases for use **with TXV**. The controller performs the function of thermostat, defrost and fan management and is capable of operating a standalone condensing unit or being incorporated into a distributed system controlled by a rack.

The **EC2-300** series incorporate the functionality of the EC2-200 model but additionally have a superheat algorithm to control the EX2 control valve:

embedded WebPages to enable the user to visualise the parameter list with a standard WebBrowser like Internet Explorer®. When connected to a suitable connection, the controller is able to automatically send alarms by email to a PC or mobile phone.

For use with **Copeland Scroll™ Digital** technology two other models are available. **EC3-D73** is a stand-alone version for use with the ECD-002 Display / Keypad unit whilst the **EC3-D72** has a TCP/IP Ethernet interface.

A 0-10V demand signal is required from a third party controller to control a tandem system with one fixed and one digital compressor. A patented algorithm synchronises the operation of the PWM digital compressor valve and the EX series electrical control valve.

**EXD-U Universal Drivers** are stepper motor drivers and enable the operation of ALCO® stepper motor driven valves EX4 ... EX8 as Electronic expansion valve, Capacity control by means of hot gas bypass or evaporating pressure regulator, Crankcase pressure regulator, Condenser pressure regulator, Liquid level and Liquid injection.

The universal driver module can be connected to any controller which can provide a 4-20mA or 0-10V analogue signal. The output is the opening/closing of EX4 ... EX8 and consequently the control of the refrigerant liquid or vapour mass flow in accordance with the analogue input.

**EC2-31x / EC2-39x** (Temp / Temp): the superheat is controlled using two temperature sensors.

**EC2-35x / EC2-37x** (Pressure / Temp): the superheat is controlled using a pressure transmitter (PT5 series) in conjunction with a temperature sensor.

Whilst the products were developed for display cases, they may also be applied to control a simple coldroom.

The **EC3 series** utilize in principle the same software technology of the EC2 series but provide additional inputs and outputs to satisfy the requirements of even the most demanding systems. Like the EC2, the EC3 series may be connected together to form larger systems combining the control of multiple compressors and fans. The optional **ECD-001 Display/keypad Unit** is available to display the system temperatures, indicate system status and to modify parameters.

The **EC3-300** series are specifically for use with stepper valve series (EX4, EX5, EX6, EX7, EX8). In case of power loss the Electrical Control Valve needs to be closed to avoid flooding of the compressor, therefore each valve requires a battery backup. For this reason, the battery together with its automatic charging circuit has been incorporated into the controller housing significantly saving installation time as well as space in the electrical enclosure.

## Condensing Units, Rack and Condenser Controllers

### Condensing Unit Controllers

The **EC2-500** series of controllers are suitable for controlling the compressors and fans of a condensing unit. Digital inputs are available for individual compressor feedback loops from the safety chain, which typically consists of low and high pressure switches together with motor protection and oil management controls. A common feedback is also available for the fans.

Following models are available:

**EC2-512**: to control up to 2 compressors (on/off control) and 2 fans (on/off control)

**EC2-552**: to control up to 2 single stage compressors or tandem compressor condensing units with a **Copeland Scroll™ Digital** compressor. It features a 0...10V output to connect to an Alco Controls **FSP fan speed power module** for variable fan speed control. Alternatively this output may be used to control fan motor speed with an inverter or to connect to ECM type fan motors directly.

### Rack and Condenser Controllers

The **EC3 series** utilize in principle the same software technology of the EC2 series but provide additional inputs and outputs to satisfy the requirements of even the most demanding systems. Like the EC2, the EC3 series may be connected together to form larger systems combining the control of multiple compressors and fans. Many controllers include 0...10V outputs that may be used in conjunction with frequency inverters and/or the **FSP series of fan speed power modules**.

Commonly referred to as "hot application controllers", the **EC3-600, -700, -800 & -900** series controllers are designed for the control of compressors and condensers. Racks with one or two suction groups and up to 8 single stage compressors including a **Copeland Scroll™ Digital** or 6 multistage compressors can be managed. **EC3-65x** and **EC3-93x** series have been designed to control a **Copeland Scroll™ Digital** and incorporate a triac to switch the PWM solenoid.

The control of condenser arrays with up to 6 fan stages as well as a combined control of Rack and Condenser is also possible. Refer to the table on page 137 for a complete product listing.

The optional **ECD-000 Display/keypad Unit** is available to display the system temperatures, indicate system status and to modify parameters.

### Condenser Controllers

The **EC2-700** series provide an economical solution for condenser control.

Two models are available:

**EC2-71x**: to control up to 4 fans, on/off. A feedback loop is available for each fan.

**EC2-74x**: provides a 0...10V output to feed **FSP series fan speed power modules**. Several FSP modules may be connected in parallel to speed control all fans simultaneously.

The **EC3 series** provides additional inputs and outputs to satisfy the requirements of even the most demanding systems:

**EC3-75x**: for condensers with up to 6 stages, one with continuous control output 0 ... 10V, heat recovery control.

The optional **ECD-001 Display/keypad Unit** is available to display the system temperatures, indicate system status and to modify parameters.

### The Universal Series of Controllers

are useful additions to the series. They are typically used to enable the monitoring of temperatures from integral display cases that do not have communication facilities as well as potentially providing additional input and output functionality to control systems. Example of such applications could be for switching display case lighting or for the monitoring of individual pressure switches on multiple compressor Racks.

**PT5 series pressure transmitters** are used to measure the suction and discharge pressures to modulate the compressor and fan capacities.



## Network Communication and System Management

The Alco EC Series of drivers and controllers utilise the very latest in communication technology which is setting new standards in the refrigeration industry. Energy saving algorithms are incorporated into many of the controllers including: Adaptive superheat and thermostat modulation, defrost on demand & suction and discharge setpoint shift. All **EC2** or **EC3** controllers are available in two communication protocols **TCP/IP Ethernet** and **LON**.

### TCP/IP Ethernet:

The controllers are Ethernet based enabling them to be connected directly to any computer via the Ethernet port (RJ45 connector). The controllers act as web server enabling the engineer to pick-up standard configuration pages directly from the controllers without the need of any additional hardware or software. Each controller can be connected to the PC using a crossover cable however, the most convenient way to connect a controller to the PC is to use a router that will automatically assign a TCP/IP address. Either way, the engineer can access the monitoring and parameter configuration pages by entering the TCP/IP number into the address line of an Internet browser such as Mozilla or Microsoft Internet Explorer. User name and password protection is provided to protect the controller from unauthorized access.



A new TCP/IP driver has been added to the EMS Monitoring Server enabling the TCP/IP controllers to be incorporated into a system whereby the temperature and status data from multiple controllers can be visualised simultaneously on one screen.

### LON Protocol:

An identical range of free-topology LON FTT10 based controllers is available and compliments the TCP/IP controller series. LON is an open system protocol created by Echelon and therefore benefits from not being tied to a restrictive third party protocol.

LON based controllers can be connected to each other to form simple networks for applications requiring master / slave or synchronized defrosting. However, they can also be connected to a Monitoring Server to fulfill the most sophisticated system requirements.

The Monitoring Server acts as an interface from the LON network containing EC2 and EC3 to the outside world. Remote access can be made using standard telephone line; analog or digital ISDN. Alternatively, data can be transmitted via the Internet or a dedicated company Intranet using TCP/IP. Either way, visualization may be made using an industry standard Internet web browser.

By transmitting the system status information as temperatures or pressures, used to control the refrigeration circuit in each subsystem, together with other vital system data, the system administrator can potentially identify system failures before they become an expensive stock loss situation. Should a system failure occur, the controllers automatically transfer to an emergency-operating mode whilst sending a system error message to the monitoring server.

The benefit of a **centralized data acquisition system** is that it can dramatically reduce the costs associated with food, which cannot be sold as a result of failing to meet the criteria set by the food hygiene regulations.

The **monitoring server** is typically connected to an analog or digital phone line and can communicate a system alarm to a remote location via fax, email or SMS. In a similar way to the TCP/IP controllers, the engineer can visualize the system without the need of any additional hardware or software. The system can be visualized by entering the TCP/IP address of the EMS Monitoring server into the address line of the Internet web browser. In fact, the advancement of telecommunication systems are such that a maintenance engineer equipped with a laptop computer and mobile telephone can interact with the system from any location.

The **TCP/IP based Controllers** offer a practical solution particularly for smaller installations that require communication for monitoring purposes without the need for customized visualization. For many installations, an additional monitoring server is not required.

### Other Functions:

- Monitoring of system temperatures and pressures as well as relay status information
- Read/write of EC2 & EC3 control parameters
- Real time graphical visualization
- Log function of up to one months data directly on the controller
- Log function of data to a PC \*
- Storage and retrieval of system parameter
- Local alarms via email \*
- Remote alarms via email \*\*

\* Controller must be connected to the PC

\*\* Router must be connected to an external telephone line and / or the Internet via an Internet Service Provider (ISP).

## Superheat Controllers Series EC3-X32 / EC3-X33

for stable superheat control with stepper motor driven electrical control valves Series EX4 - EX8

## Digital Superheat Controllers Series EC3-D72 / EC3-D73

for stable superheat control with EX4...EX6 electrical control valves and automatic synchronisation of the PWM capacity control valve incorporated into the Copeland Scroll™ Digital compressor technology

### Features

- Limitation of evaporating pressure (MOP)
- Feed-through of 4 ... 20mA signal of evaporating pressure transmitter to operate third party controllers with a common pressure transmitter
- Intelligent alarm management, superheat alarm
- Monitoring of sensors and sensor wiring, detection of sensor and wiring failures
- Integral rechargeable battery to close Electrical Control Valve in case of power loss
- Electrical connection via plug-in type screw terminals
- Aluminum housing for DIN rail mounting

### Additional features EC3-X32 and EC3-D72 with TCP/IP

- WebServer functionality allows monitoring and configuration of controllers through a standard WebBrowser (e.g. Internet Explorer®)
- Internal data logging and alarm messaging by email
- Multiple language support ([www.emersonclimate.eu](http://www.emersonclimate.eu))



- Freeze protection
- Low and high superheat alarm
- Low pressure switch function/Alarm

### ECD-002 Display Unit

- Front panel mounted interface for parameter and status read-out and controller setup via keypad
- Indicator LEDs for valve opening/closing, external ON and alarm

### Selection Chart

Description	TCP/IP			Stand alone		
	Type	Part No. single unit	Part No. Kit*	Type	Part No. single unit	Part No. Kit*
Superheat Controller	EC3-X32	807 782	808 037	EC3-X33	807 783	808 036
Terminal Kit for EC3-X32/-X33	K03-X32	807 644		K03-X33	807 645	
Digital Superheat Controller	EC3-D72	807 805	808 042	EC3-D73	807 804	808 041
Terminal Kit for EC3-D72/-D73	K03-331	807 648		K03-331	807 648	

\* Kits contain terminal kit, pressure transmitter PT5-07M with cable assembly, NTC sensor 6m, transformer 60VA (see page 246)

### Accessoires

Description	Type	Part No.	Note
Display	ECD-002	807 657	
Connection cable EC3 to ECD	ECC-N10	807 860	1m cable length
	ECC-N30	807 861	3m cable length
	ECC-N50	807 862	5m cable length
Pressure Transmitter	PT5-07M	802 350	for R134a, R22, R404A, R407C, R507C, R124
	PT5-18M	802 351	for R410A only
	PT5-30M	802 352	for R744
Cable Assembly for PT5	PT4-M60	804 805	other cable lengths see page 158
Temperature Sensor NTC	ECN-N30	804 496	3m cable length
	ECN-N60	804 497	6m cable length
	ECN-N99	804 499	12m cable length
Transformer 25VA 230V/24V AC 60VA	ECT-323	804 424	for EX4 to EX7
	ECT-623	804 421	for EX8

### Typical Ordering package

System with 100 kW cooling capacity and refrigerant R22 requires the following parts:

EX6	Electronic Expansion Valve	ECN-N60	NTC Temperature Sensor
EX5-N60	Electrical Cable and Plug assembly	PT5-07M	Pressure Transmitter
EC3-X33	Superheat Controller Stand-alone	PT4-M60	Cable assembly PT5 6.0m
K03-X33	Terminal Kit for EC3-X33	ECD-002	Display (optional)
ECT-323	Transformer 25VA	ECC-N30	Connection cable EC3 to ECD (opt.)



## Universal Driver Modules Series EXD-U00

for the operation of ALCO® stepper motor valves EX4 / EX5 / EX6 / EX7 / EX8 as

- Solenoid Valve
- Electrical Expansion Valve
- Hot Gas Bypass or Evaporating Pressure Regulator as capacity control
- Crankcase Pressure Regulator
- Heat Reclaim Regulator
- Liquid Level Control

### Features

- Plug and play, no parameter setting
- Valve opening proportional to 4-20mA or 0-10V analogue input signal
- Digital input can be used to force valve closing
- Dip-switches for selection of Electrical Control Valves, analogue input and start mode
- Aluminium housing for DIN Rail mounting
- Easy wiring
- Fully tested and ready for operation
- CE-marking for electromagnetic compatibility

### Options

- Uninterruptible Power Supply ECP-024 to automatically close valve after power down



EXD-U00

### Selection Chart

Description	Type	Part No. single unit	Part No. Kit*
Universal Driver Module	EXD-U00	804 557	808 038
Electrical Terminal Kit	K09-U00	804 559	

\* Controller Kit contains terminal kit

### Accessoires

Description	Type	Part No.	Note
Uninterruptible Power Supply	ECP-024	804 558	for up to 2 driver modules
Electrical Terminal Kit	K09-P00	804 560	for ECP-024
Transformer 25VA	ECT-323	804 424	
230V/24V AC 60VA	ECT-623	804 421	

### Capacity Data

see Electrical Control Valve EX4 ... EX8 data.

For function as:

- Expansion Valve - Superheat Control see page 117
- Capacity Control by means of Hot Gas Bypass see page 125
- Evaporating Pressure Regulator or Crankcase Pressure Regulator see page 126
- Condensing Pressure Regulation and Liquid Duty see page 128
- Application hot gas flow such as heat reclaim application see page 130

See datasheet A3.5.048 for detailed application drawings and technical data. For other than the specified operating conditions an Excel based Selection Tool can be downloaded from [www.emersonclimate.eu](http://www.emersonclimate.eu)



ECP-024



ECT-323

## Display Case and Universal Controllers Series EC2

with Web Server functionality and TCP/IP Protocol or with LON Protocol (FTT-10)

### Features of EC2-3 models:

- Superheat control for Pulse Width Modulated Valves (e.g. EX2-Series) see Selection Table
- Self-adapting controller, no user setup necessary
- Limitation of evaporating temperature (MOP)

### Features of all models:

- Air temperature control
- Defrost timer for natural, electric or hot-gas defrost with fan control
- Integrated timer and alarm functions
- All parameters and functions are programmable:
  - via standard web browser (EC2-xx2 models)
  - via LON communication (EC2-xx1 models)
  - with integral keypad
- Password protection to eliminate unauthorised use
- Multiple language support ([www.emersonclimate.eu](http://www.emersonclimate.eu))
- Standard 29 x 71 mm cutout dimensions
- 2 1/2 digit display in °C or °F
- CE approved

### Communication LON (see page 140)

- Echelon® LON FTT-10 interface based on the Lonworks® standard for monitoring and configuration through a supervisory system such as the EMS Monitoring Server

### Communication TCP/IP Ethernet

- Web Server function provides monitoring and configuration through a standard web browser. Ethernet interface, as used in most office PCs.
- Graphical visualisation via built-in webpages
- Fixed or dynamic TCP/IP address with username and password
- Alarms via e-mail
- Up to 30 days datalog



EC2 Controller

### Options

- Standard screw terminal kit K02-000 available for all models. OEM crimp versions available upon request.
- Ethernet cable ECX-N60 for EC2-xx2
- NTC temperature sensors
- Transformers for 230VAC mains



### Example for Webpage monitoring



### Selection Table

Functional Overview	TCP/IP			LON		
	Type	Part No. single unit	Part No. Kit*	Type	Part No. single unit	Part No. Kit*
<b>Display Case and Cold Room Controllers</b>						
Temperature and Superheat Control of EX2 (Press. / Temp. input) version for use with a compressor pack system	EC2-352	807 772	808 009	EC2-351	807 771	808 008
	EC2-372	807 688	808 011	EC2-371	807 689	808 010
* Kit contains terminal kit, pressure transmitter PT5-07M with cable assembly, transformer 25VA, 4 NTC sensors 6m fin, pipe and air version (EC2-35x only)						
Temperature and Superheat Control of EX2 (Temp. / Temp. input) version for use with a compressor pack system	EC2-312	807 682	808 005	EC2-311	807 681	808 004
	EC2-392	807 692	808 007	EC2-391	807 691	808 006
* Kit contains terminal kit, transformer 25VA, 3 NTC sensors 6m fin, pipe (EC2-29x only) and air version (EC2-21x only), see also page 246.						
Thermostat control, for Thermo-Expansion valve version for use with a compressor pack system	EC2-212	807 482	808 001	EC2-211	807 481	808 000
	EC2-292	807 672	808 003	EC2-291	807 671	808 002
* Kit contains terminal kit, transformer 25VA, 3 NTC sensors 6m fin, pipe (EC2-29x only) and air version (EC2-21x only), see also page 246.						
<b>Universal Controllers</b> with 2 digital inputs, 3 temperature inputs, 4 relay outputs	EC2-112	807 472		EC2-111	807 471	

## Accessoires

	Type	Part No.		
<b>Terminal kits, cables</b>				
Terminal kit for EC2-31x, -35x, -37x, -39x	K02-000	800 050	 K02-000  PT5 PT4-Mxx  ECT-323	
Terminal kit for EC2-11x, -21x, -29x	K02-211	807 647		
Ethernet Cable RJ45/4-pin-conn.	6m cable length	ECX-N60		804 422
<b>Sensors</b>				
Air-Sensors, single insulated (10 kΩ at 25°C) for EC2-21x, -31x, -35x	1,5m cable length	ECN-S15	804 304	
	3m cable length	ECN-S30	804 305	
	6m cable length	ECN-S60	804 284	
Pipe-Sensors * (10 kΩ at 25°C) Air sensors for EC2-29x, EC2-3xx	3m cable length	ECN-N30	804 496	
	6m cable length	ECN-N60	804 497	
	12m cable length	ECN-N99	804 499	
Defrost sensor (10 kΩ at 25°C) (including fin clip)	6m cable length	ECN-F60	804 283	
Pressure transmitter	-0.8...7 bar	PT5-07M	802 350	
	0 ... 18 bar	PT5-18M	802 351	
Cable plug assembly for PT5	1.5m cable length	PT4-M15	804 803	
	3m cable length	PT4-M30	804 804	
	6m cable length	PT4-M60	804 805	
*it is possible to use ECN-Nxx series as alternative to ECN-Pxx series.				
<b>Transformer</b>	230VAC Input, 24V output, 25VA, DIN rail	ECT-323	804 424	
	230VAC Input, 24V output, 20VA	ECT-523	804 332	

## Technical Data

Supply voltage	24V AC ±10% 50/60 Hz class II only
Power consumption	20VA incl. EX2 valve (EC2-3xx) 4VA (EC2-11x, -21x, -29x)
Inputs	up to 5 Temperature sensors: Refrigerant inlet (saturated temp.) Refrigerant outlet (suction temp.) Air into / Air out of evaporator Defrost termination
Output contact rating cos φ = 0.5:	SPDT & SPST relays, 250V max / 8A resistive load EC2-3xx 6A resistive load EC2-2xx 2A inductive load all EC2 (defrost, compressor, fan)
(Voltage free contacts)	(defrost, compressor, fan)
Triac output to EX2	24VAC, 1 A max.
Communication	LON: FTT10, TCP/IP: Ethernet

Temperature storage	-10 ... +70°C
operation	0 ... +50°C (housing)
operation	-50 ... +50°C (NTC sensor)
Display	2 1/2 digits red LED Automatic decimal point between -19.9 & +19.9 Switchable between °C & °F
Indicator LEDs	Compressor, defrost, fan, alarm, service LED
Protection	IP 65 (front protection with gasket)
Sensor type	NTC 10KΩ @ 25°C Order codes see above
Weight	~ 150g

## Typical Order Package for a display case

Case Controller	EC2-312	807 682
Terminal Kit	K02-000	800 050
Electrical Control Valve	EX2-M00	801 091
Orifice size 3	EXO-003	801 088
Coil 24VAC / 2W	ASC 24V	801 062
Cable Assembly for ASC	ASC-N15	804 570
2 pipe sensors	ECN-P60	804 281
2 air sensors	ECN-S30	804 305
Defrost sensor	ECN-F60	804 283
Transformer 25VA	ECT-323	804 424
Ethernet Cable 6m	ECX-N60	804 422

## Block Diagrams

### EC2-35x / -37x Case Controller (EX2, Press/Temp)

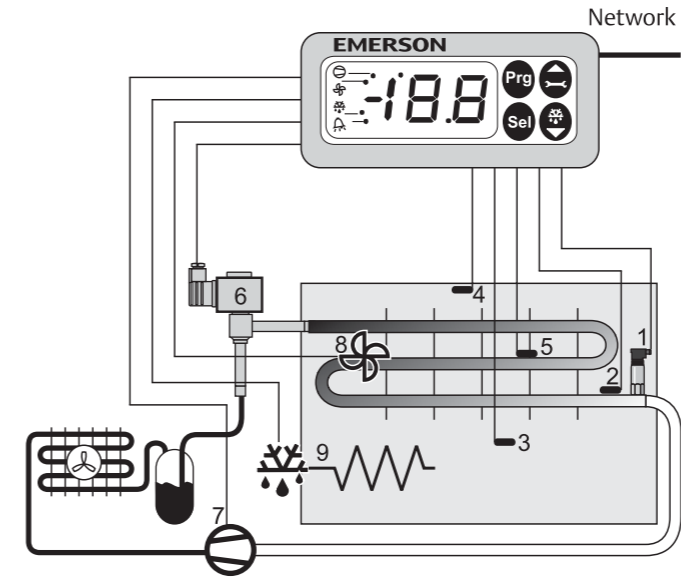

#### Inputs

- 1 = Suction pressure
- 2 = Coil out temperature
- 3 = Air in temperature
- 4 = Air out temperature
- 5 = Defrost temperature

#### Outputs

- 6 = EX2 Expansion valve
- 7 = Compressor (EC2-35x only)
- 8 = Fan
- 9 = Defrost heater
- 10 = spare relay (EC2-37x only)

### EC2-31x / -39x Case Controller (EX2, Temp/Temp)

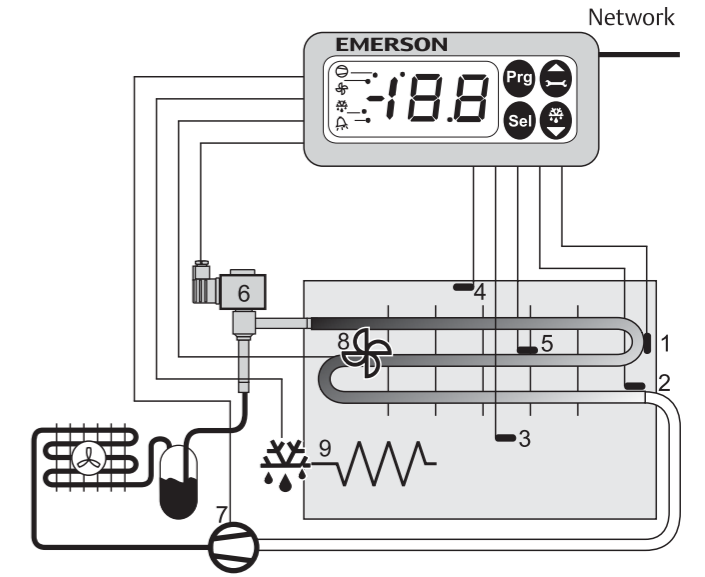

#### Inputs

- 1 = Coil in temperature
- 2 = Coil out temperature
- 3 = Air in temperature
- 4 = Air out temperature
- 5 = Defrost temperature

#### Outputs

- 6 = EX2 Expansion valve
- 7 = Compressor (EC2-31x only)
- 8 = Fan
- 9 = Defrost heater
- 10 = spare relay (EC2-39x only)

### EC2-21x / -29x Case Controller (TXV)

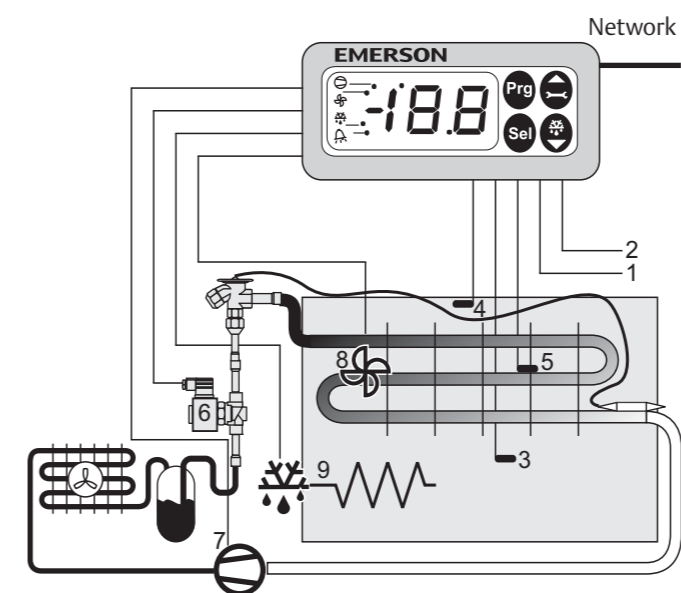

#### Inputs

- 1 = Digital Input
- 2 = Digital Input
- 3 = Air in temperature
- 4 = Air out temperature
- 5 = Defrost temperature

#### Outputs

- 6 = Solenoid valve
- 7 = Compressor (EC2-21x only)
- 8 = Fan
- 9 = Defrost heater
- 10 = spare relay (EC2-29x only)

### EC2-11x Universal I/O Controller

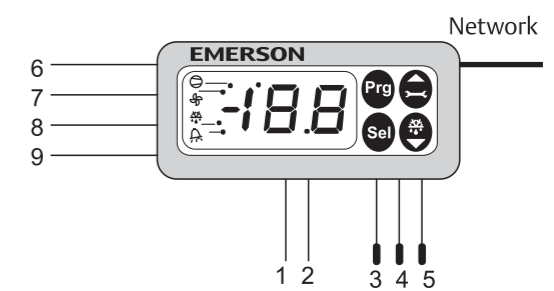

#### Inputs

- 1 = Digital Input
- 2 = Digital Input
- 3 = Temperature input
- 4 = Temperature input
- 5 = Temperature input

#### Outputs

- 6 = Digital output
- 7 = Digital output
- 8 = Digital output
- 9 = Digital output



## Coldroom Controller Series EC3

Temperature and Superheat Control of EX4 .. EX8 (Stepper Motor)

### Features

- Superheat control with self-adapting algorithm for Stepper Motor driven ECVs (EX4 ... EX8)
- Thermostat, fan & defrost control
- Limitation of evaporating temperature (MOP)
- Analog inputs: 3 NTC temperature sensors
- with integral backup battery to close Control Valve in case of power loss
- Analog input for suction pressure measurement using Alco PT5 Series pressure transmitters
- Digital inputs for compressor safety and coldroom door contact
- Relay outputs for compressor, defrost and alarm plus programmable relay
- All parameters and functions are programmable:
  - via TCP/IP Ethernet controller (EC3-xx2)
  - via LON communication (EC3-xx1 models)
  - with keypad of optional display unit ECD-001
- Electrical connections via plug-in type screw terminals
- Lightweight aluminum enclosure for DIN rail mounting
- Multiple language support (see [www.emersonclimate.eu](http://www.emersonclimate.eu))
- CE approved



EC3-332

ECD-001

### Features of ECD-001 Display Unit

- Connection to EC3 Series via a RJ45 Western Digital plug. No further power cables required
- 2 1/2 digit display
- Indicator LEDs for compressor, fan, heater and alarm
- 4 keys allow parameter modification if necessary
- Easy mounting in panels with 71 x 29 mm cutout
- IP65 if mounted in front panel

### Options

- Front mounted ECD-001 Display Unit for temperature and output status indication
- NTC temperature sensors
- EMS Series Monitoring Server for remote visualisation and programming

### Communication TCP/IP Ethernet

detailed information on page 140

### Communication LON

detailed information on page 140

### Typical Order Package

Coldroom Controller	EC3-332	807 632
Terminal Kit	K03-331	807 648
Display Unit (optional)	ECD-001	807 641
Connection cable EC3 to ECD 1m	ECC-N10	807 860
Transformer 25VA	ECT-323	804 424
<i>Sensors: depending on application (see page 144)</i>		
Ethernet Cable 5m	ECC-N50	807 862

### Selection table

Description	TCP/IP			LON		
	Type	Part No. single unit	Part No. Kit*	Type	Part No. single unit	Part No. Kit*
Coldroom Controller ECV Stepper Motor Drive	EC3-332	807 632	808 013	EC3-331	807 631	808 012

\*Kit contains terminal kit, pressure transmitter PT5-07M with cable assembly, transformer 25VA, NTC sensors 6m fin, pipe and single insulated version (see also page 246)

### Accessories

Terminal Kits				
Description	Type	Part No.		
Terminal kit for EC3-33x	K03-331	807 648		
ECD Series Display Units				
Display for EC3-33x	ECD-001	807 641		
Connection cable EC3 to ECD	1m (3m/5m see page 158)	ECC-N10	807 860	
NTC Sensors (Air type) (10 kΩ at 25°C)	1,5m cable length	ECN-S15	804 304	
	3m cable length	ECN-S30	804 305	
	6m cable length	ECN-S60	804 284	
NTC Sensors (Pipe type) (10 kΩ at 25°C)	3m cable length	ECN-N30	804 496	
	6m cable length	ECN-N60	804 497	
	8m cable length	ECN-N99	804 499	
NTC Sensors (Fin type) (10 kΩ at 25°C)	6m cable length	ECN-F60	804 283	
Pressure transmitter	-0.8...7 bar	PT5-07M	802 350	
Cable plug assembly (see page 160)	1.5m length	PT4-M15	804 803	
Transformer for DIN rail mounting, Class II	230VAC Input / 24V output	25VA	ECT-323	804 424
		60VA	ECT-623 *	804 421

\* EX8 only



K03-331



PT5 PT4-Mxx



ECT-623

### Technical Data

Controller EC3-33x	
Supply voltage	24 VAC ± 10%, 50/60 Hz Class II only
Power consumption	25VA max. for EX4 .. EX7 28VA max. for EX8
Plug-in connector size	Removable screw version wire size 0.14 ... 1.5 mm <sup>2</sup>
Communication interface	LON FTT10 (EC3-331) TCP/IP Ethernet with Webserver (EC3-332)
Temperature storage operating	-20 ... +65°C 0 ... +60°C
Humidity	0 ... 80% r.h. non condensing
Protection class	IP 20
Weight	~ 800 g
Mounting	DIN rail mounted

Display Unit ECD-001	
Supply voltage	via ECC-N10 from EC3 controller
LED indicators	Compressor, fan, defrost, alarm outputs LON service pin
Display LED	Numeric segmental display, red, 2 1/2 digits with automatic dec. point between ±19.9 switchable between °C and °F
Operating Keys	4 operating keys: Programming, select service/up, defrost/down
Connecting lead	1m (ECC-N10) with RJ45 connectors
Temperature storage operating	-20 ... +65°C 0 ... +60°C
Humidity	0 ... 80% r.h. non condensing
Protection class	IP 65 (front panel with gasket)
Weight	~ 52 g
Mounting	Panel door (71 x 29mm cutout)



## Block Diagram

### EC3-33x Coldroom Controller for stepper motor driven ECV

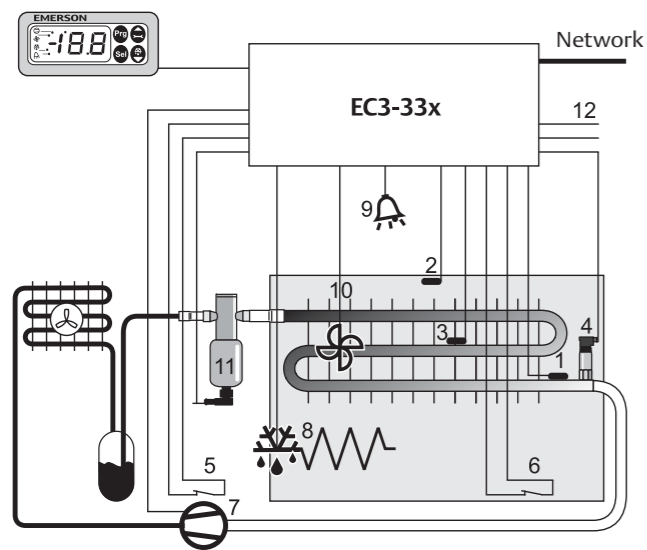

#### Inputs

- 1 = Coil out temperature
- 2 = Air temperature
- 3 = Defrost temperature
- 4 = Suction pressure
- 5 = Compressor safety
- 6 = Door contact

#### Outputs

- 7 = Compressor
- 8 = Defrost heater
- 9 = Alarm
- 10 = Fan
- 11 = Stepper motor ECV
- 12 = Output signal (4...20 mA)

## Condenser- and Condensing Unit Controllers Series EC2

with Webserver Function and TCP/IP or with LON FTT-10 Interface

#### Common Features

- Maintenance and alarm management
- Sensor failure handling
- Inputs for common low and common high pressure alarms
- Configuration data stored in non-volatile memory
- Electrical connection via plug-in type screw terminals
- with Webserver Function and TCP/IP or with LON FTT-10 Interface (see page 140)
- Operation and commissioning via local or remote PC
- CE approved



EC2 Controller

#### Condenser Controllers

- Compact controller to control condensing pressure by modulation of fan capacity

#### Condensing Unit Controllers

- To control a combination of compressors and condenser fans based on suction and condensing pressure respectively
- Control of Copeland Scroll™ Digital Compressors

#### Communication LON

- Echelon® LON FTT10 interface based on the LonWorks® standard for monitoring and configuration through a supervisory system such as the EMS Monitoring Server

#### Communication TCP/IP Ethernet

- Web Server Function provides monitoring and configuration through a standard web browser. Ethernet interface, as used in most office PCs
- Graphical visualisation via built-in webpages
- Fixed or dynamic TCP/IP address with username and password
- Alarms via e-mail
- Up to 30 days datalog
- Multiple language support (see [www.emersonclimate.eu](http://www.emersonclimate.eu))

**Selection table**

Description	TCP/IP			LON		
	Type	Part No. single unit	Part No. Kit*	Type	Part No. single unit	Part No. Kit*
<b>Condenser Controllers</b>						
Condenser Controller for up to 4 fans	EC2-712	807 752	808 021	EC2-711	807 751	
Condenser Controller with FSP fan speed control module	EC2-742	807 762	808 023	EC2-741	807 761	808 022
* EC2-7xx Kits contain terminal kit, pressure transmitter PT5-30M with cable assembly, transformer 25VA (see also page 246).						
<b>Condensing Unit Controllers</b>						
Condensing Unit Controller for 2 compressors, 2 fans, with on/off control	EC2-512	807 732	808 015			
Condensing Unit Controller for 2 compressors or 1 Digital Scroll™ and 1 single stage compressor, variable fan speed control with FSP module	EC2-552	807 738	808 019			
* EC2-5xx Kits contains terminal kit, pressure transmitters PT5-07M and PT5-30M with cable assemblies, transformer 25VA (see also page 246).						

**Accessories**

Description	Type	Part No.
Terminal kits for EC2-51x, -71x series	K02-211	807 647
Terminal kits for EC2-55x, -74x series	K02-540	800 070
NTC Sensor ECN single insulated for ambient temperature sensing -50 ... +50°C (10 kΩ at 25°C)		
	1,5m	ECN-S15 804 304
	3m	ECN-S30 804 305
	6m	ECN-S60 804 284
Pressure transmitter PT5 for suction and condensing pressure sensing (details see page 158)		
-0.8 ... 7 bar, 4 ... 20 mA		PT5-07M 802 350
0 ... 18 bar, 4 ... 20 mA		PT5-18M 802 351
0 ... 30 bar, 4 ... 20 mA		PT5-30M 802 352
Cable assembly (3,0/6,0m see page 160)	1,5m	PT4-M15 804 803
Transformer		
230VAC Input, 24V output, 25VA, DIN rail	ECT-323	804 424
230VAC Input, 24V output, 20VA	ECT-523	804 332



K02-211



PT5 PT4-Mxx



ECT-323

**Block Diagrams**

**EC2-74x Condenser Controller with fan speed control**

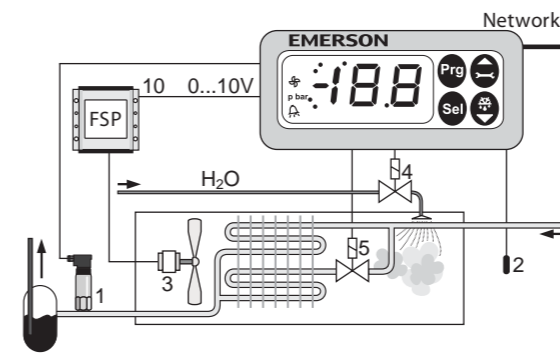

- Inputs**  
 1 = Condenser pressure  
 2 = Ambient temperature
- Outputs**  
 3 = Speed controlled fan  
 4 = Sprinkler  
 5 = Solenoid valve at 2 stage condenser coil  
 10 = Fan speed Power Module

**EC2-71x Condenser Controller for up to 4 fans**

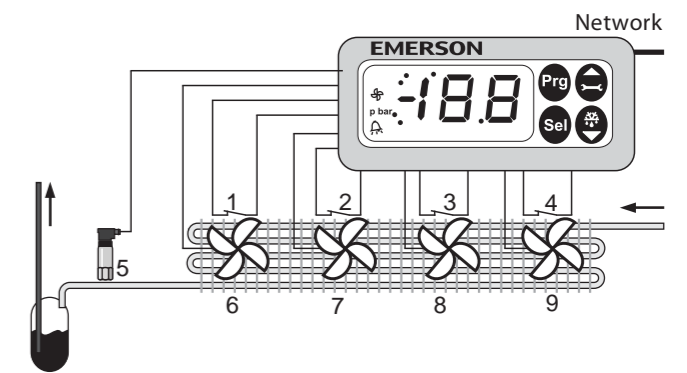

- Inputs**  
 1 = Safety switch fan 1  
 2 = Safety switch fan 2  
 3 = Safety switch fan 3  
 4 = Safety switch fan 4  
 5 = Condenser pressure
- Outputs**  
 6 = Fan 1  
 7 = Fan 2  
 8 = Fan 3  
 9 = Fan 4

**EC2-512 Condensing Unit Controller for up to 2 compressors and 2 fans**

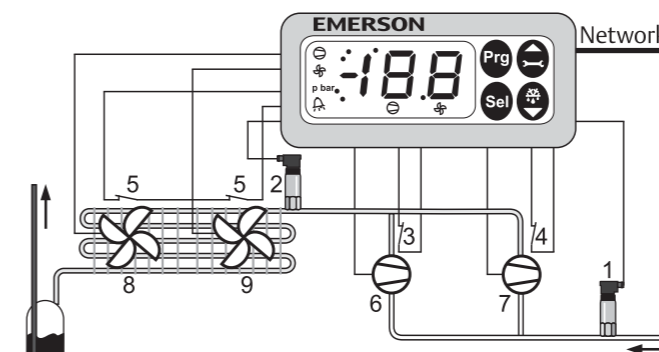

- Inputs**  
 1 = Suction pressure  
 2 = Condenser pressure  
 3 = Safety switch comp 1  
 4 = Safety switch comp 2  
 5 = Safety switches fans
- Outputs**  
 6 = Compressor 1  
 7 = Compressor 2  
 8 = Fan 1  
 9 = Fan 2

**EC2-552 Condensing Unit Controller for 2 single stage compressors or 1 Digital Scroll™ and 1 single stage compressor**

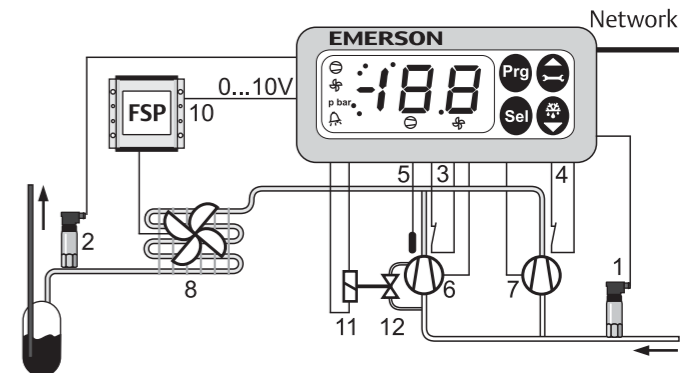

- Inputs**  
 1 = Suction pressure  
 2 = Condenser pressure  
 3 = Safety switch comp 1  
 4 = Safety switch comp 2  
 5 = Temperature input
- Outputs**  
 6 = Digital Scroll™ Compressor  
 7 = Single Stage Compressor  
 8 = Speed controlled fan  
 10 = Fan Speed Power Module  
 11 = PWM Digital Scroll™ Solenoid valve

# Rack and Condenser Controllers Series EC3-652, -672, -752, -812, -932

with Webserver Function and TCP/IP Ethernet Protocol

## Common Features

- Maintenance and alarm management
- Sensor failure handling
- Inputs for common low and common high pressure alarms
- Configuration data stored in non-volatile memory
- Aluminum enclosure for DIN-rail mounting
- Electrical connection via plug-in type screw terminals
- Operation and commissioning via local or remote PC
- Control of Copeland Scroll™ Digital Compressors (EC3-652, EC3-932)

- CE approved
- Communication via:  
**TCP/IP Ethernet** with Web Server function (see page 140)



EC3-6xx



ECD-000

## Features of ECD-000

- Connection to EC3 Series via RJ45 Western digital plug. No further power cables required.
- 2 1/2 digit display
- Indicator LEDs for compressor and alarm status
- 4 keys allow parameter modification if necessary
- Easy mounting in panels with 71 x 29 mm cutout
- IP65 if mounted in front panel

## Selection table

Description	TCP/IP		
	Type	Part No. single unit	Part No. Kit*
<b>Rack Controller</b>			
for 8 compressors or 1 Digital Scroll™ and 7 single-stage compressors	EC3-652	807 534	808 046
for Multistage Compressors	EC3-672	807 562	808 029
<b>Condenser Controller</b>			
for up to 6 stages, one with continuous control output 0...10V, heat recovery control	EC3-752	807 592	808 031
<b>Dual Circuit Controllers</b>			
for 4 + 3 Compressors	EC3-812	807 602	808 033
for 4 single stage compressors or 1 Digital Scroll™ and 3 single-stage compressors & 3 Fans plus Speed Control	EC3-932	807 624	808 044

\* Kit contains terminal kit, pressure transmitters PT5-07M and PT5-30M with cable assemblies, transformer 60VA, and 5 NTC sensors 6m (see also page 246).

## Accessories

Description	Cable Length	Type	Part No.
Terminal kit for EC3-65x / EC3-67x / EC3-93X		K03-110	807 656
Terminal kit for EC3-67x		K03-750	807 654
Terminal kit for EC3-81x		K03-640	807 653
Display unit for EC3-6xx to EC3-9xx		ECD-000	807 640
Connection cable EC3 to ECD 1m (3m/5m see page 156)		ECC-N10	807 860
NTC Sensor, single insulated for ambient temp., sensing -50 ... +50°C (10 kΩ at 25°C)	1.5 m	ECN-S15	804 304
	3 m	ECN-S30	804 305
	6 m	ECN-S60	804 284
NTC Sensor, single insulated for discharge temp., sensing +50 ... +150°C (1 MΩ at 25°C)	6 m	ECN-H60	804 359
Pressure transmitter PT5 for suction and condensing pressure sensing (details see page 158)			
-0.8 ... 7 bar, 4 ... 20mA		PT5-07M	802 350
0 ... 18 bar, 4 ... 20mA		PT5-18M	802 351
0 ... 30 bar, 4 ... 20mA		PT5-30M	802 352
0 ... 50 bar, 4 ... 20mA		PT5-50M	802 353
Cable assembly (3m / 6m see page 158)	1,5 m	PT4-M15	804 803
Transformer for DIN rail mounting, EN 60742 class II			
230 VAC Input, 24V output	24VA	ECT-323	804 424
	60VA	ECT-623	804 421



K03-110



ECD-000



PT5 PT4-Mxx



ECT-323

## Technical Data

### EC3 Controller

Supply voltage	24 VAC ±10%, 50/60 Hz Class II only
Power consumption	20 VA max.
Plug-in connector	Removable screw terminals
Digital I/Os	wire size 0.5 ... 2.5 mm <sup>2</sup>
Analog I/O	wire size 0.14 ... 1.5 mm <sup>2</sup>
Communication interface	LON: FTT10 TCP/IP: Ethernet with Web Server
Temperature storage	-20 ... +65°C
operating	0 ... +60°C
Humidity	0 ... 80% r.h. non condensing
Protection class	IP20
Weight	~ 810 g
Mounting	DIN-rail mount

### ECD-000 Display Unit

Supply voltage	via ECC-N10 from EC3 controller
Display	Numeric segmental display, LED red, 2 1/2 digits, numeric value device status and alarm indication
LEDs	1 x unit indicator bar/°C 1 x alarm LED
Connecting lead	1,0 m (ECC-N10)
Operating Keys	4 operating keys: programming, service/up, select/down
Temperature storage	-20 ... +65°C
operating	0 ... +60°C
Humidity	0 ... 80% r.h. non condensing
Protection class	IP65 (front panel with gasket)
Weight	~ 52 g
Mounting	Panel mount (71x29mm cutout)

## Block Diagrams

**EC3-652 Rack Controller for 8 single-stage compressors or 7 single-stage Compressors and 1 Digital Scroll™**

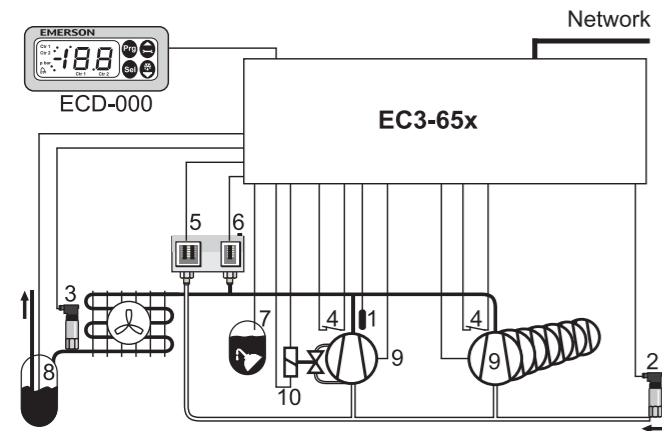

### Inputs

- 1 = Discharge temperatures of up to 8 compressors
- 2 = Suction pressure
- 3 = Discharge pressure
- 4 = Serial alarm inputs for up to 8 compressors
- 5 = Low pressure alarm
- 6 = High pressure alarm
- 7 = Oil level alarm
- 8 = Refrigerant level alarm

### Outputs

- 9 = for up to 8 compressors
- 10 = to control a Digital Scroll™

**EC3-672 Rack Controller for Capacity Controlled Compressors**

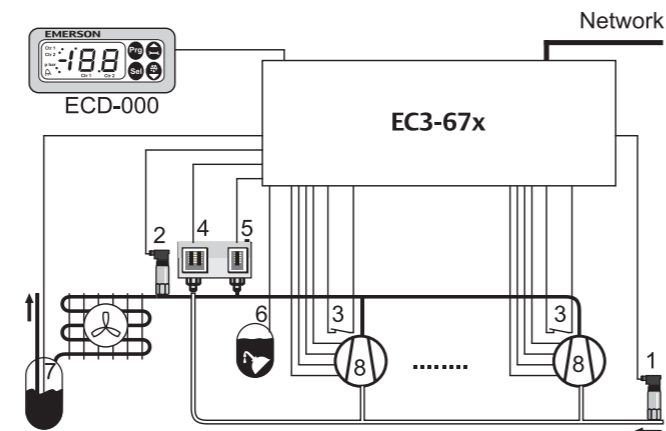

### Inputs

- 1 = Suction pressure
- 2 = Discharge pressure
- 3 = Serial alarm inputs for up to 6 compressors
- 4 = Low pressure alarm
- 5 = High pressure alarm
- 6 = Oil level alarm
- 7 = Refrigerant level alarm

### Outputs

- 8 = 12 outputs for up to 6x2 / 4x3 / 3x4 capacity controlled compressors

**EC3-752 Condenser Controller**

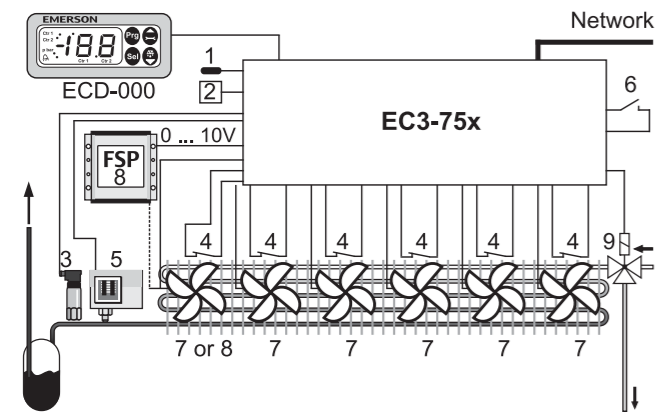

### Inputs

- 1 = Ambient temperature
- 2 = Humidity sensor
- 3 = Condensing pressure
- 4 = Serial alarm inputs for up to 6 fans
- 5 = High pressure alarm
- 6 = Heat recovery demand

### Outputs

- 7 = For up to 6 stages, from which 1 can be speed controlled
- 8 = Speed controlled fan (see 7)
- 9 = Heat recovery solenoid

## Block Diagrams

**EC3-812 Dual Circuit Rack Controller (4 + 3 compressors)**

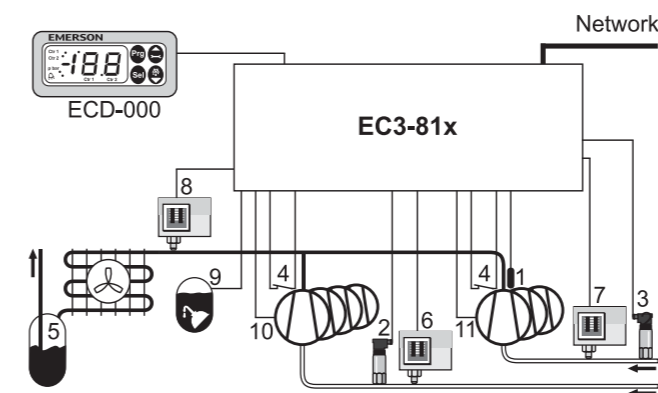

### Inputs

- 1 = Discharge temperature inputs of 3 compressors
- 2 = Suction pressure group A
- 3 = Suction pressure group B
- 4 = Serial alarm input for each compressor respectively
- 5 = Refrigerant level alarm
- 6 = Low pressure alarm group A
- 7 = Low pressure alarm group B
- 8 = High pressure alarm
- 9 = Oil level alarm

### Outputs

- 10 = For up to 4 compressors suction group A
- 11 = For up to 3 compressors suction group B

**EC3-392 Rack and Condenser Controller (up to 4 compressors + condenser)**

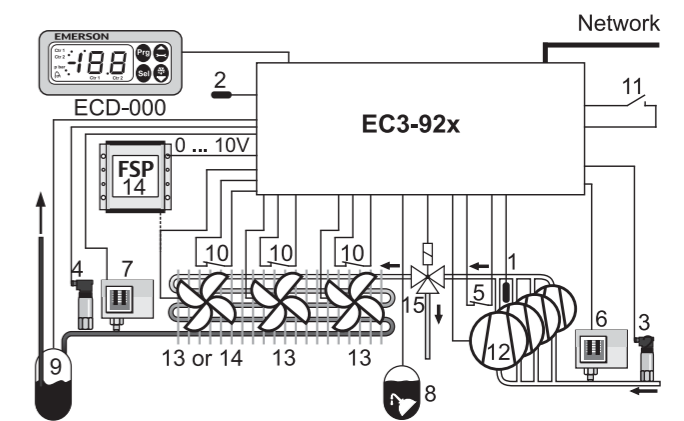

### Inputs

- 1 = Discharge temperature
- 2 = Ambient temperature
- 3 = Suction pressure
- 4 = Condensing pressure
- 5 = Serial alarm inputs for 4 compressors
- 6 = Low pressure alarm
- 7 = High pressure alarm
- 8 = Oil level alarm
- 9 = Refrigerant level alarm
- 10 = Serial alarms for 3 fans
- 11 = Heat recovery demand

### Outputs

- 12 = Up to 4 compressors
- 13 = Up to 3 fans, from with 1 fan can be speed controlled
- 14 = Speed controlled fan (see 13)
- 15 = Heat recovery solenoid
- 16 = to control a Digital Scroll™



## Network Accessories

Description	Cable Length	Type	Part No.
Echelon USB-FTT10 interface Stick (with USB cable)		ECC-034	804 385
RJ45 to RJ45 Ethernet connection cable	1.5m	ECC-N10	807 860
RJ45 to RJ45 Ethernet connection cable	3.0m	ECC-N30	807 861
RJ45 to RJ45 Ethernet connection cable	5.0m	ECC-N50	807 862
RJ45 to 4pin-connector cable for EC2 TCP/IP Contr.	6.0m	ECX-N60	804 422



ECC-034



ECC-N10

### Examples for Use of Network Accessories

LON connected to Laptop ECC-034 interface.

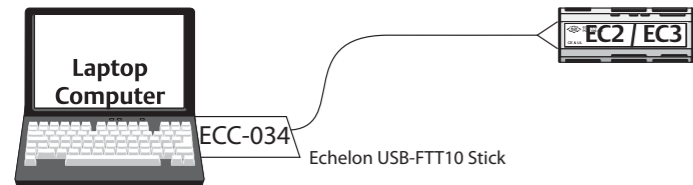

ECC-N10 RJ45 to RJ45 cable for connection between EC3 and ECD

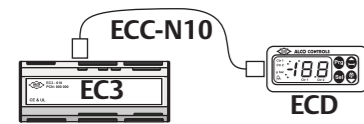

## Compressor Soft Starter CSS-25U / CSS-32U

The Compressor Soft Starter CSS-25U / CSS-32U is used for switching, protection and starting current limitation of single phase compressors in refrigeration and air conditioning applications



CSS-25V

### Features

- For motors with maximum operating current up to 25A/32A
- Limitation of starting current to less than 45 A
- Self adjusting for use in 50 Hz or 60 Hz supply
- Self adjusting to motor current - no manual adjustment or calibration necessary
- Alarm relay output
- Start capacitor for improved motor acceleration is switched off after start
- Low voltage shutdown
- Locked rotor recognition and shutdown
- Delay function to limit number of motor starts per hour
- Thyristor protected contactor for long life
- No extra motor contactor needed
- Self diagnostics
- Mounting clip for easy installation allows DIN rail mounting in two directions
- Easy connection by cage type screw terminals

### CE Standards:

- LVD 2006/95/EC Low Voltage Directive
- EN 60947-1 Low voltage switchgear and controlgear
- EN 60947-4-2 Contactors and motor-starters - AC semiconductor motor controllers and starters
- EN 60335-1: VDE released version CSS-32V planned for 4Q 2011
- EMC 2004/108/EC
- ROHS 2002/95/EC
- UL pending; planned for 4Q 2011

### Selection Chart CSS

Type	PCN	I <sub>max</sub>	Description	Packing
CSS-32U	805 200M	32A	Soft Starter with mounting clip and operating manual	Box with 20 pieces
CSS-25U	805 201M	25A	Soft Starter with mounting clip and operating manual	Box with 20 pieces
K00-003	807 663		3-pol Screw connector to alarm output for wires up to 2.5mm <sup>2</sup>	Bag with 50 pieces

### Technical Data

Operating voltage	230 V 50/60 Hz nominal
Compressor starting current	limited to max. 45A
Operating temperature	-20 ... +55°C non condensing
Storage temperature	-20 ... +65°C non condensing
Start capacitor	200 ... 240 uF

Weight	430 g
Protection acc. IEC 529	IP 20
Max. vibration	4 g (at 10 ... 1000 Hz)
Time delay after stop	0,5 to 5 min
Alarm relay, AgNi (SPDT)	250VAC / 3A

### Wiring Diagram

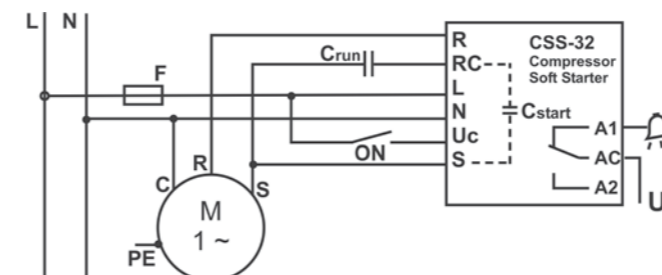

### CSS Contacts:

- R = Output motor run winding
- RC = Output run capacitor
- L = 230V / AC power input
- N = Neutral line
- ON = Start input (ON if connected to 230V)
- S = Output start winding from start capacitor
- A1, AC, A2 = Alarm relay contact

## Pressure Transmitter Series PT5

Pressure Transmitters convert a pressure into a linear electrical output signal. PT5 has been optimized for Refrigeration applications.

### Features

- Sensitive pressure cells with strong primary output signals for the precise operation of superheat, compressor or fan controls systems
- Fully hermetic
- PT5-xxM pressure connector 7/16-20 UNF with Schrader valve opener
- PT5-xxT with 6mm x 50mm long tube for applications requiring a fully hermetic system solution
- Vibration, shock and pulsation resistant
- Protection class IP 65
- Easy install M12 electrical connection with pre-assembled cable assemblies available in various lengths
- Output signal 4 to 20 mA
- Calibrated for specific temperature and pressure ranges to fulfill application demands in air conditioning and refrigeration systems
- Standard pressure ranges compatible with former Emerson pressure transmitters - Sealed gauge pressure

### Options

- Other pressure ranges and calibrations
- Delivery in multipacks

### Standards:



- per EMC Directive
- UL Listing



PT5-xxM



PT5-xxT

### Selection Chart Transmitters

Type	Part No.	Output signal	Pressure range (bar)	Max. allowable pressure PS (bar)	Test pressure PT (bar)	Burst pressure (bar)	Pressure Connection
PT5-07M	802 350	4 ... 20 mA	-0.8 ... 7	27	30	150	7/16" -20 UNF (with schrader valve opener)
PT5-18M	802 351		0 ... 18	55	63	250	
PT5-30M	802 352		0 ... 30	60	100	400	
PT5-50M	802 353		0 ... 50	100	150	400	
PT5-07T	802 370	4 ... 20 mA	-0.8 ... 7	27	30	150	6mm tube x 50mm long
PT5-18T	802 371		0 ... 18	55	63	250	
PT5-30T	802 372		0 ... 30	60	100	400	
PT5-50T	802 373		0 ... 50	100	150	400	

### Cable Assemblies

Type	Part No.	Temperature range (°C)	Cable length (m)	Leads	
PT4-M15	804 803	-50 ... +80 °C static application -25 ... +80 °C mobile application	1.5	2 x 0,34 mm <sup>2</sup>	
PT4-M30	804 804		3.0		
PT4-M60	804 805		6.0		

### Technical Data

Supply Voltage	Nominal	24 Vdc
Range (polarity protected)		7 ... 30 Vdc
Operating current		max. ≤ 24 mA output
Protection class acc. to EN 60529		IP65
Load resistance		$R_L \leq \frac{U_B - 7.0V}{0.02A}$
Temperatures PT5		
Operating ambient housing		-40 ... 80 °C
Medium		-40 ... 100 °C
Transportation and storage		-25 ... 80 °C

Sensor lifetime at full stroke at 25°C	> 10.000.000 cycles
Burst pressure	see selection chart
Medium compatibility not suitable for ammonia and inflammable refrigerants!	HFC, HCFC, CFC
Materials PT5	
Housing cover, pressure connector, diaphragm with medium contact	Stainless steel 1.4534 / AISI 316L
Vibration at 10 ... 2000 Hz	5g (IEC 68-2-6)

### Accuracy Performance PT5

	Temperature range	Total error*
PT5-07M/T	-40 ... +20°C	≤ ± 1 % FS
PT5-18M/T	-20 ... +20°C	≤ ± 1 % FS
PT5-30M/T	0 ... +40°C	≤ ± 1 % FS
	-20 ... +60°C	≤ ± 2 % FS
	-40 ... +80°C	typically ≤ ± 2 % FS
PT5-50M/T	0 ... +40°C	≤ ± 1 % FS
	-20 ... +60°C	≤ ± 2 % FS
	-30 ... +80°C	typically ≤ ± 2 % FS

\*) Total error includes non-linearity, hysteresis, repeatability as well as offset and span drift due to the temperature changes.  
Note: % FS is related to Percentage of Full sensor Scale.

### Electrical connection

Pressure transmitters PT5 with current output (2-wire connection) offer following advantages:

1. More suitable for signal transmission over long distances
2. Higher immunity to electromagnetic interference

Note: Changing the length of the electrical connection lead beyond 1.5 m can have a negative impact on electromagnetic compatibility. Additional protection may be required.

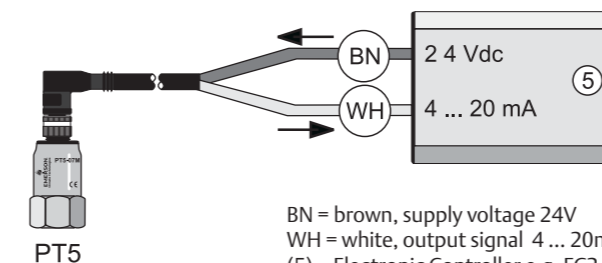

# Electronic Fan Speed Controller Series FSY

## Features

- Pressure actuated fan speed control
- Adjustable pressure for Cut-off
- High Voltage Triac (800 Volts)
- Integrated protection circuit against voltage peaks
- Compact design
- Protection IP65
- Easy mounting and adjustment
- Easy retrofit in existing plants
- No additional gasket required (completely molded into plug)
- Multi-position plug with EMC filter incl. 1,5m (opt. 3 and 6m) cable for flexible installation
-  per EC 89/336/EC (together with FSF cable)
- UL file E183816



FSY-43S

## Selection Table

Type	Part No.	Operational Current A	Adjustment Range bar	Factory Setting bar	Max. Operating Pressure PS bar	Test Pressure PT bar	Pressure Connection
FSY-41S	0 715 533	0.1 ... 4	4.0 ... 12.5	8.0	27	30	S: 7/16"-20 UNF female
FSY-42S	0 715 534						S: 7/16"-20 UNF female
FSY-42U	0 715 535		9.2 ... 21.2	15.0	32	36	U: 6mm - ODF
FSY-42X	0 715 536						X: 1/4" - ODF
FSY-43S	0 715 537		12.4 ... 28.4	21.8	43	48	S: 7/16"-20 UNF female
FSY-43U	0 715 538						U: 6mm - ODF
FSY-43X	0 715 539	X: 1/4" - ODF					

## Cable Assemblies with plug and EMC filter

Type	Part No.	Temperature Range °C	Cable length mtr.
FSF-N15	804 640	-50 .. +80	1.5
FSF-N30	804 641		3.0
FSF-N60	804 642		6.0



FSF-N15

## Technical Data

Supply voltage	230V AC +10%, -15%
Nominal current (see diagram below)	0.1 ... 4 (3) A
Starting current	max. 8 Ampère/5 sec.
Medium compatibility	HFC, HCFC (not released for use with inflammable refrigerants)
Protection Class according to IEC529 /DIN 40050	IP 65 (with fitted connectors FSF-xxx)
Temperature ranges ambient storage, transportation medium	-20 to +55 °C >40°C see diagramm -30 to +70°C -20 to +70°C

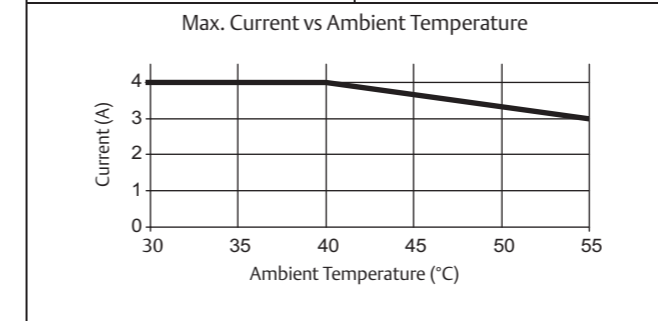

## Function Diagram

The control behaviour can be easily described by looking at the function of output voltage versus input pressure: In the **maximum range** the FSY provides a constant output voltage of approximately 1% below the supply voltage. The fan is running at maximum speed. Along the **proportional range** the output voltage varies between maximum and minimum voltage of approximately 50% of the supply voltage. This causes the fan to slow down from maximum to minimum speed.

Pressure change per turn of adjustment screw	FSY-41: 4,0 .. 12.5 bar clockwise ~ +1.2 bar counter clockwise ~ -1.2 bar
	FSY-42: 9,2 .. 21.2 bar clockwise ~ +2.5 bar counter clockwise ~ -2.5 bar
	FSY-43: 12,4 .. 28.4 bar clockwise ~ +3.3 bar counter clockwise ~ -3.3 bar
Proportional Range	FSY-41: 2.5 bar FSY-42: 3.8 bar FSY-43: 4.6 bar
Weight	approx.
FSY-41, -42	0.12 kg
FSY-43	0.15 kg
FSF-N15	0.14 kg
FSF-N30	0.20 kg
FSF-N60	0.22 kg
Housing material	PC and PA

Further decrease of pressure in the minimum range leads to cut-off of the fan motor. Reincrease of input pressure will start the motor with a hysteresis of approximately 0.7 bar to avoid cycling. The pressure from which motor cuts off is adjustable (see pressure range).

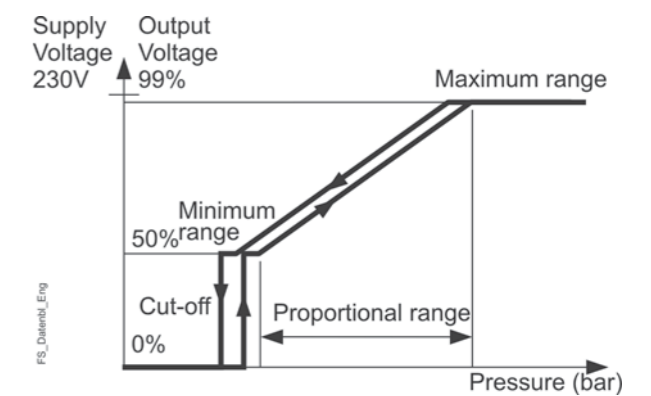

# Electronic Fan Speed Power Module FSP and Control Module FSE

## Features FSP

- Can be used in combination with ALCO® FSE Control Module, EC2, EC3 and other electronic controllers which provide a 0...10 V output signal for condensing pressure control
- Versions for 3- and 1- phase motors approved for phase cut operation
- Paralleling of fan motors up to maximum current
- Reduced fan noise level during low ambient temperature conditions
- Energy saving due to improved cooling efficiency
- Short start impulse during partial load to overcome friction and windmilling
- Easy installation with cables for power supply and motor connection factory wired
- IP67 protection for outdoor mounting

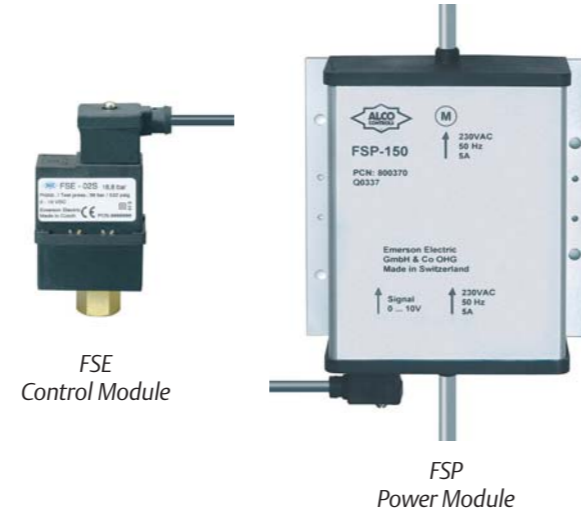

## Standards:

- per Low Voltage Directive
- per EMC

## Selection Chart FSP

Type	Part No.	Supply Voltage	Current Range (A)	Max. Start Current max. 1sec (A)	Power Supply Cable Length (mtr)	Motor Cable Length (mtr)	Wire Diameter	Weight (g)
FSP-150	800 370	230V /50 Hz	0.3 - 5	15 A	1.5	0.75	3 x 1 mm <sup>2</sup>	1 050
FSP-180	800 373		0.3 - 8	24 A				
FSP-340	800 376	400V/3/50 Hz	0.3 - 4	12 A				

## Selection Chart FSE Control Modules

Type	Part No.	Refrigerants	Adjustment Range P <sub>cut</sub> * (bar)	Cut-off Pressure factory set (bar)	Test Pressure	Pressure Connection	Weight (g)
FSE-01S	804 701	R134a	4 ... 12.5	7.8	30 bar	7/16"-20 UNF female	125
FSE-02S	804 706	R22, R404A, R407C, R507	10 ... 21	15.5	36 bar	7/16"-20 UNF female	125
FSE-03S	804 711	R410A	12 ... 28	20.4	48 bar	7/16"-20 UNF female	150

\* Pressure at which fan is cut-off.

## Selection Chart Cable Assemblies

Temperature Range -25 to 80°C / no UL		Temperature Range -50 to 80°C / UL appr.		Length (mtr.)	Weight (g)
Type	Part No.	Type	Part No.		
<b>for connection to FSE Control Module:</b>					
FSE-N15	804 680			1.5	80
FSE-N30	804 681			3.0	130
FSE-N60	804 682			6.0	220
<b>for connection to EC2, EC3 and other controllers:</b>					
		FSP-L15	804 693	1.5	
		FSP-L30	804 694	3.0	



# Selection Dependent on Product Combination

## Selection

1. Select a **Power Module FSP** by the total maximum operating current and phases of condenser fan motors
2. Select a **Control Module FSE** based on the pressure requirements of the refrigerant used:
  - FSE-01S for R134a,
  - FSE-02S for R22 / R404 A / R407C / R507
  - FSE-03S for R410A
 - or a controller of the EC Series  
 - or another electronic controller which provides a 0...10 V output signal
3. Select a **Cable Assembly**
  - a) for connection of **FSE to FSP**:
    - FSE-Nxx**: -25 ... +80°C
    - 3 lengths: (1.5 - 3.0 - 6.0 m)
  - b) or for use with an electronic controller with 0...10V signal output:
    - (e.g. EC2-74x, EC2-54x, EC3-75x, EC3-92x):
    - FSP-Lxx**: -50 ... +80°C
    - 2 lengths (1.5 - 3.0 m)

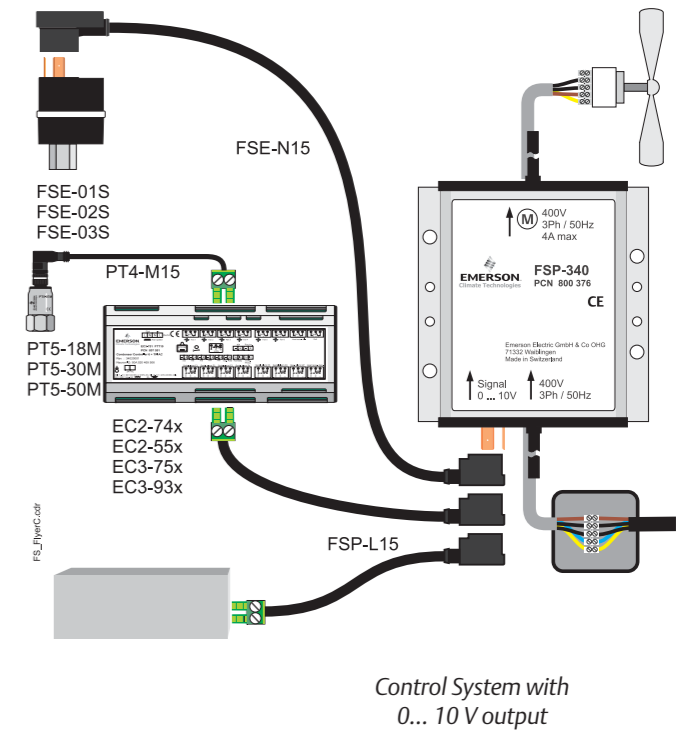

## Function Diagram

The behaviour of FSP together with FSE can be described by the following control diagram:

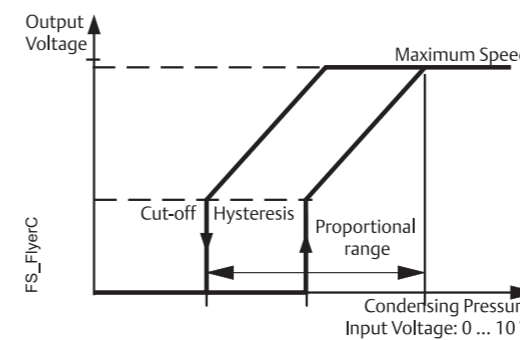

The top curve describes the fan speed at decreasing, the lower curve at rising pressure. At high condensing pressure fan is running with maximum speed (top right). In the proportional range of the curve fan speed is decreased with pressure. If the pressure falls below the specified limit the fan is cut-off.

A large hysteresis is built-in to prevent fan cycling at this point. Pressure must increase by approximately 1 bar before fan restarts. A short start pulse helps fan to overcome friction or windmilling before it supplies the proportional value.

Along the proportional range the fan speed varies between 20% and 100% for 3-phase motors and between 30% and 100% for single phase motors.

## Technical Data FSP

Temperature Range Operation	-20°C to +65°C
Protection class (IEC 529 / EN 60529)	IP 67
Signal Input Voltage	0 ... 10 VDC
Mounting	Direct with screws or with optional DIN Rail Kit FSP-K00 Ord. No. 800 379

## Technical Data FSE

Temperature Range Operation	-20°C to +65°C
Protection class (IEC 529 / EN 60529)	IP 65
Supply Voltage	10V, supplied by FSP Module
Operating Current 0 ... 10 VDC output	max. 1 mA
Medium Compatibility	HFC, HCFC, synth. / mineral oils
Pressure Connection	FSE-01S / FSE-02S brass FSE-03S stainless steel



# Thermo® Expansion Valves

## Basic Terms and Technical Information

### Operating principles

Alco® Thermo®-Expansion valves control the superheat of refrigerant vapour at the outlet of the evaporator. They act as a throttle device between the high pressure and the low pressure sides of refrigeration systems and ensure that the rate of refrigerant flow into the evaporator exactly matches the rate of evaporation of liquid refrigerant in the evaporator. Thus the evaporator is fully utilized and no liquid refrigerant may reach the compressor.

### Description of bulb charges

The application ranges of Thermo®-Expansion valves are heavily influenced by the charge selected.

### Liquid charges

The behaviour of Thermo®-Expansion valves with liquid charges is exclusively determined by temperature changes at the bulb and not subject to any cross-ambient interference. They feature a fast response time and thus react quickly in the control circuit. Liquid charges cannot incorporate MOP functions. Maximum bulb temperatures shall not exceed 75°C.

### Gas charges

The behaviour of Thermo®-Expansion valves with gas charges will be determined by the lowest temperature at any part of the expansion valve (power assembly, capillary tube or bulb). If any parts other than the bulb are subject to the lowest temperature, malfunction of the expansion valve may occur (i.e. erratic low pressure or excessive superheat). Alco® Thermo®-Expansion valves with gas charges always feature MOP functions and include ballasted bulbs. Ballast in the bulb leads to slow opening and fast closure of the valve. Maximum bulb temperature is 120°C.

### Adsorption charges

These charges feature control characteristics much like MOP charges but avoid the difficulties of cross-ambient interference. Response time is slow but perfectly suitable for common refrigeration systems. Maximum bulb temperature is 130°C.

### MOP (Maximum Operating Pressure)

MOP functionality is somewhat similar to the application of a crankcase pressure regulator. Evaporator pressures are limited to a maximum value to protect compressor from overload conditions. MOP selection should be within maximum allowed low pressure rating of the compressor and should be at approximately 3K above evaporating temperatures.

**Practical hint:** Superheat adjustments influence the MOP:

Increase of superheat: Decrease of MOP  
Decrease of superheat: Increase of MOP

### Static superheat

Alco® Thermo®-Expansion valves are factory preset for optimum superheat settings. This setting should be modified only if absolutely necessary. The readjustment should be at the lowest expected evaporating temperature.

### Subcooling

Subcooling generally increases the capacity of refrigeration system and may be accounted for when dimensioning an expansion valve by applying the correction factor  $K_c$ . The capacity corrections for evaporating temperature, condensing temperature and subcooling are all incorporated in  $K_c$ . These are in particular the liquid density upstream from the expansion valve, the different enthalpies of liquid and vapour phase refrigerants as well as certain part of flash gas after expansion. The percentage of flash gas differs with various refrigerants and depends on system conditions.

Heavy subcooling results in very small flash gas amounts and therefore increases expansion valve capacities. These conditions are not covered by  $K_c$ . Likewise, small flash gas amounts lead to reduced evaporator capacities and may result in substantial discrepancies between the capacities of the Thermo®-expansion valve and the evaporator. These effects must be considered during component selection when designing refrigeration circuits. In cases when subcooling exceeds 15 K, sizing of components ( $K_c$ ,  $K_{\Delta p}$ ) should be modified accordingly. The field practice indicates the following correction factors can be used to compensate the effect of the subcooling (liquid hammering) in addition to the use of correction factors  $K_c$  and  $K_{\Delta p}$ .

Subcooling	20K	30K	40K	50K	60K
Correction factor	0.8	0.7	0.6	0.5	0.4

Emerson Climate Technologies will be happy to assist you. Please contact application engineering department.

### Dimensioning

To correctly select a Thermo®-Expansion valve on a system, the following design conditions must be available:

- Cooling capacity  $Q_o$
- Effective pressure differential across Thermo®-Expansion valve  $\Delta p$
- Evaporating temperature/pressure
- Lowest possible condensing temperature/pressure
- Liquid temperature
- Type of refrigerant

As opposed to single substances (e.g. R22, R134a etc.) where the phase change takes place at a constant temperature/pressure, the evaporation and condensation of **zeotropic blend R407C** is in a gliding form (e.g. at a constant pressure the temperature varies within a certain range) through evaporators and condensers. The evaporating/condensing pressure must be determined at saturated temperatures (bubble/dew points) for dimensioning of Thermo®-Expansion valves.

To facilitate valve dimensioning for other than the standard conditions Emerson Climate Technologies offers an Excel based Alco® Selection Tool. This can be ordered from all Emerson sales offices. See [www.emersonclimate.eu](http://www.emersonclimate.eu) for contact addresses, email or phone numbers.

### Example

Cooling capacity of a system: 18 kW  
Refrigerant: R407C  
Condensing temperature (saturated liquid): +35°C  
(Condensing pressure will be 15.5 bar)  
See appendix page 251 for  
Evaporating temperature (saturated vapour): 0°C  
(Evaporating pressure will be 4.61 bar)  
Subcooling: 1 K  
Pressure drops through liquid line: 2.2 bar  
Pressure drops through evaporator: 0.3 bar  
Required type of Thermo®-Expansion valve: T-series

To calculate the nominal capacity the following formula has to be used:

$$\text{Cooling capacity} \times K_t \times K_{\Delta p} = \text{Nominal capacity}$$

1. Selected **Kt-factor** according to refrigerant, liquid and evaporating temperature from table on page 182.  
 $K_t = 0.98$  (for this example)

2. Determine pressure differential across the Thermo®-Expansion valve using condensing pressure, subtract evaporating pressure and all other possible pressure losses (pressure drops in evaporator, drier, solenoid valve, liquid distribution...).

For this example:  
 $\Delta p = 15.5 - (4.61 + 2.2 + 0.3) = 8.39$  bar  
Select **K $\Delta p$**  factor from table on page 182:  
 $K_{\Delta p} = 1.15$  (for this example)

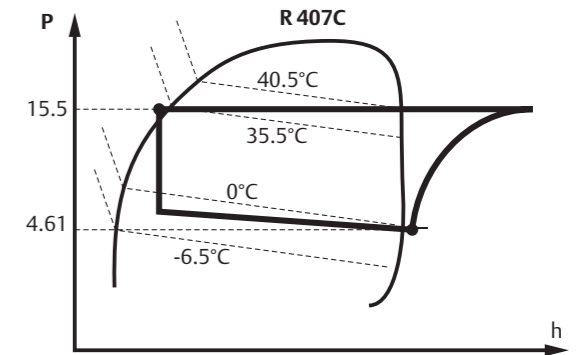

3. Multiply cooling capacity with **Kt** and **K $\Delta p$** , to find nominal capacity for Thermo®-Expansion valve.

$$Q_n = 18 \times 0.98 \times 1.15 = 20.29 \text{ kW}$$

Select Thermo®-Expansion Valve from table on page 178: TCLE 550 NW (for this example).

Please note that all evaporating/condensing temperatures in this catalogue are based on saturated vapour/liquid temperatures.

### Selection Guide for Expansion Valves

Series	Selection Criteria				Catalogue Page
	Capacity Range kW (R 404A)	Evaporating Temp. Range °C	Main Application	Features	
TI	0.5 to 14.2	+20 to -45	Refrig./Air-Cond. Heat Pumps	Interchangeable Orifices	168
TX3	0.8 to 15.0	+20 to -45	Refrig./Air-Cond. Heat Pumps	Hermetic. Superheat adjustable, optional with check valve	174
TX6	13.3 to 57.0	+20 to -45	Air-Cond. Heat Pumps	Hermetic Superheat adjustable	176
T	2 to 209	+30 to -45	Refrig./Air-Cond. Heat Pumps	Interchangeable Orifices, Power-Assembly and Flange	178
ZZ	1.9 to 81.2	-45 to -120	Low Temperature Application	Interchangeable Orifices, Power-Assembly and Flange	183
L	2 to 154	+30 to -50	Liquid Injection Superheat Control	Interchangeable Orifices, Power-Assembly and Flange	186
935	5.2 to 43.5	+30 to -45	Liquid Injection Temperature Control	Interchangeable Orifices, Power-Assembly and Flange	188

# Thermo®-Expansion Valves Series TI

new valve design, exchangeable Orifices

## Features

- Laser welded diaphragm with large diameter for high reliability and maximum life time
- Constant superheat across wide application ranges
- Easy and precise superheat setting by modified threads
- TILE with stainless steel fittings allow brazing without wet rags
- With capacities between 0.4 kW and 14.2 kW (R404A) ideally suited for service work
- Internal or external equaliser
- Brazing and flare connections available
- Capillary tube length 1.5 m
- PS: 45 bar. TS: -45 ... +75°C
- No CE marking according art. 3.3 PED 97/23 EC

## Type Code

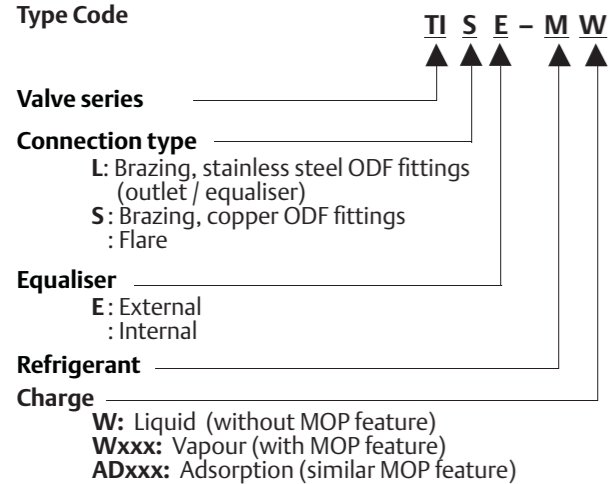

TILE



TIE

## Orifice assembly with strainer for inlet connection

Type	Nominal Capacity* (kW)							
	TIO-00X	TIO-000	TIO-001	TIO-002	TIO-003	TIO-004	TIO-005	TIO-006
Part No.	800 532	800 533	800 534	800 535	800 536	800 537	800 538	800 539
R134a	0.3	0.8	1.9	3.1	5.0	8.3	10.1	11.7
R22	0.5	1.3	3.2	5.3	8.5	13.9	16.9	19.5
R404A	0.4	1.0	2.3	3.9	6.2	10.1	12.3	14.2
R407C	0.5	1.4	3.5	5.7	9.2	15.0	18.3	21.1
R410A	0.6	1.5	3.7	6.2	9.9	16.2	19.7	22.8
R507	0.4	1.0	2.3	3.9	6.2	10.1	12.3	14.2

## Brazing Adapter for TILE and TIS(E)

Type	Part No.	Connection. ODF	
		mm	inch
TIA-M06	802 500	6.0	-
TIA-M10	802 501	10.0	-
TIA-014	802 502	-	1/4"
TIA-038	802 503	-	3/8"
Gasket Set	803 780	100 pieces	



\*Nominal capacity is based on the following conditions:

Refrigerant	Evaporating temperature	Condensing temperature	Sub-cooling
R407C	+4°C dew point	+38°C bubble p. +43°C dew point	1K
R22, R134a, R404A, R410A, R507	+4°C	+38°C	1K

Valve selection for other operating conditions see page 180, quick selection tables on page 168 or Excel based Alco® Selection Tool (download from [www.emersonclimate.eu](http://www.emersonclimate.eu)).

## TI Valve bodies without cage and nut

Refrigerant	Outlet/ Equalizer Connection	Type	Part No.	Type	Part No.	MOP °C	Evaporating temperature range °C
-------------	------------------------------	------	----------	------	----------	--------	----------------------------------

Refrigerant	Outlet/ Equalizer Connection	external Equalizer		internal Equalizer		MOP °C	Evaporating temperature range °C
		Type	Part No.	Type	Part No.		
R404A / R507	Brazing stainless steel	TILE-SW (12mm)	802465			-	-45 ... +20
		TILE-SW (1/2")	802466			-	-45 ... +20
	Brazing copper	TISE-SW (12mm)	802462	TIS-SW (12mm)	802461	-	-45 ... +20
		TISE-SW (1/2")	802464	TIS-SW (1/2")	802463	-	-45 ... +20
		TISE-SAD10 (1/2")	802479	TIS-SAD10 (1/2")	802478	+10	-45 ... 0
		TISE-SW75 (12mm)	802471			0	-45 ... -3
		TISE-SW75 (1/2")	802472			0	-45 ... -3
		TISE-SAD-20 (12mm)	802474			-20	-45 ... -27
	Flare	TISE-SAD-20 (1/2")	802475			-20	-45 ... -27
		TIE-SW	802460	TI-SW	802459	-	-45 ... +20
		TIE-SAD10	802477	TI-SAD10	802476	+10	-45 ... 0
		TIE-SW75	802470	TI-SW75	802469	0	-45 ... -3
		TIE-SAD-20	802473		-20	-45 ... -27	

R134a	Brazing stainless steel	TILE-MW (12mm)	802451			-	-45 ... +20
		TILE-MW (1/2")	802452			-	-45 ... +20
	Brazing copper	TISE-MW (12mm)	802448	TIS-MW (12mm)	802447	-	-45 ... +20
		TISE-MW (1/2")	802450	TIS-MW (1/2")	802449	-	-45 ... +20
		TISE-MW55 (12mm)	802457			+14	-45 ... +11
		TISE-MW55 (1/2")	802458			+14	-45 ... +11
Flare	TIE-MW	802446	TI-MW	802445	-	-45 ... +20	
	TIE-MW55	802456	TI-MW55	802455	+14	-45 ... +11	

R407C	Brazing stainless steel	TILE-NW (12mm)	802486			-	-45 ... +20
		TILE-NW (1/2")	802485			-	-45 ... +20
	Brazing copper	TISE-NW (12mm)	802438	TIS-NW (12mm)	802437	-	-45 ... +20
		TISE-NW (1/2")	802440	TIS-NW (1/2")	802439	-	-45 ... +20
Flare	TIE-NW	802436	TI-NW	802435	-	-45 ... +20	

R22	Brazing stainless steel	TILE-HW (12mm)	802426			-	-45 ... +20
		TILE-HW (1/2")	802427			-	-45 ... +20
	Brazing copper	TISE-HW (12mm)	802423	TIS-HW (12mm)	802422	-	-45 ... +20
		TISE-HW (1/2")	802425	TIS-HW (1/2")	802424	-	-45 ... +20
		TISE-HW100 (12mm)	802431			+15	-45 ... +13
		TISE-HW100 (1/2")	802432			+15	-45 ... +13
Flare	TIE-HW	802421	TI-HW	802420	-	-45 ... +20	
	TIE-HAD10	802430			+10	-45 ... 0	

R410A	Brazing stainless steel	TILE-ZW (12mm)	802488			-	-35 ... +20
		TILE-ZW (1/2")	802489			-	-35 ... +20
		TILE-ZW175 (12mm)	802490			+16.4	-35 ... +15
		TILE-ZW175 (1/2")	802491			+16.4	-35 ... +15

Inlet: Flare 5/8"-18UNF for 6mm, 8mm., 10mm, 1/4", 5/16" and 3/8" tubes

Outlet: Flare 3/4"-16UNF for 12mm and 1/2" tubes.  
Solder metric: ODF for 12mm tubes. Solder inch: ODF for 1/2" tubes

Ext. Equalizer: Flare 7/16"-20UNF for 6mm and 1/4" tubes.  
Solder metric: ODF for 6mm tubes. Solder inch: ODF for 1/4" tubes

# Quick Selection Tables

Published capacity data at 1 K subcooling at the inlet of the expansion valve and 1.5 bar pressure drop in the refrigeration system. For proper valve selection especially in case of high pressure drops, we recommend the use of correction factors (see page 180).

To facilitate valve dimensioning for other than the standard conditions Emerson Climate Technologies offers an Excel based Alco® Selection Tool ([www.emersonclimate.eu](http://www.emersonclimate.eu)).

Condensing Temperature °C	R134a		Capacity (kW) Valve Type TI ... - M.... Evaporating Temperature (°C)										Cage Size		
	30	20	10	5	0	-5	-10	-15	-20	-25	-30				
50	0.23	0.27	0.29	0.29	0.30	0.30	0.30	0.26	0.22	0.19	0.16				TIO-00X
	0.60	0.71	0.76	0.78	0.79	0.79	0.79	0.68	0.59	0.50	0.43				TIO-000
	1.42	1.68	1.81	1.85	1.87	1.88	1.87	1.63	1.39	1.20	1.01				TIO-001
	2.32	2.74	2.96	3.02	3.05	3.07	3.06	2.65	2.27	1.95	1.66				TIO-002
	3.74	4.42	4.77	4.87	4.92	4.94	4.93	4.28	3.66	3.15	2.67				TIO-003
	6.21	7.34	7.93	8.08	8.17	8.21	8.19	7.10	6.08	5.23	4.43				TIO-004
	7.56	8.93	9.64	9.84	9.95	9.99	9.97	8.64	7.40	6.36	5.39				TIO-005
8.76	10.34	11.17	11.40	11.52	11.57	11.55	10.01	8.57	7.37	6.25				TIO-006	
40	0.12	0.21	0.25	0.26	0.27	0.28	0.28	0.25	0.21	0.18	0.16				TIO-00X
	0.33	0.56	0.67	0.67	0.73	0.74	0.75	0.66	0.57	0.49	0.42				TIO-000
	0.79	1.34	1.60	1.60	1.73	1.76	1.78	1.56	1.35	1.17	1.00				TIO-001
	1.29	2.18	2.60	2.73	2.82	2.88	2.91	2.55	2.20	1.91	1.63				TIO-002
	2.08	3.52	4.20	4.40	4.55	4.64	4.69	4.11	3.56	3.08	2.63				TIO-003
	3.45	5.84	6.97	7.31	7.55	7.70	7.79	6.83	5.90	5.12	4.37				TIO-004
	4.19	7.10	8.48	8.90	9.19	9.38	9.48	8.31	7.18	6.23	5.32				TIO-005
4.86	8.23	9.83	10.31	10.64	10.86	10.98	9.63	8.32	7.22	6.16				TIO-006	
35	0.17	0.23	0.24	0.26	0.26	0.27	0.24	0.21	0.18	0.15					TIO-00X
	0.44	0.60	0.65	0.68	0.70	0.72	0.63	0.55	0.48	0.41					TIO-000
	1.06	1.43	1.54	1.61	1.67	1.70	1.50	1.31	1.14	0.98					TIO-001
	1.72	2.33	2.50	2.63	2.72	2.78	2.45	2.13	1.86	1.59					TIO-002
	2.78	3.75	4.04	4.24	4.39	4.48	3.95	3.44	3.00	2.57					TIO-003
	4.62	6.23	6.71	7.05	7.28	7.43	6.56	5.71	4.97	4.27					TIO-004
	5.62	7.58	8.16	8.57	8.86	9.05	7.99	6.95	6.05	5.19					TIO-005
6.51	8.79	9.45	9.93	10.26	10.48	9.25	8.05	7.01	6.01					TIO-006	
30	0.09	0.19	0.21	0.23	0.24	0.25	0.23	0.20	0.17	0.15					TIO-00X
	0.25	0.51	0.57	0.62	0.65	0.67	0.60	0.52	0.46	0.40					TIO-000
	0.60	1.20	1.35	1.46	1.54	1.59	1.42	1.25	1.09	0.94					TIO-001
	0.98	1.96	2.21	2.39	2.51	2.60	2.32	2.03	1.78	1.54					TIO-002
	1.58	3.16	3.57	3.85	4.05	4.19	3.74	3.28	2.87	2.48					TIO-003
	2.63	5.25	5.92	6.39	6.73	6.96	6.21	5.44	4.77	4.11					TIO-004
	3.20	6.39	7.20	7.78	8.19	8.47	7.56	6.62	5.81	5.00					TIO-005
3.71	7.40	8.34	9.01	9.49	9.82	8.75	7.67	6.73	5.80					TIO-006	
25	0.14	0.18	0.20	0.22	0.23	0.23	0.21	0.18	0.16	0.14					TIO-00X
	0.37	0.47	0.54	0.58	0.61	0.56	0.49	0.43	0.38						TIO-000
	0.89	1.12	1.27	1.38	1.46	1.32	1.17	1.03	0.90						TIO-001
	1.45	1.82	2.08	2.25	2.38	2.15	1.91	1.68	1.46						TIO-002
	2.33	2.94	3.35	3.64	3.84	3.47	3.07	2.72	2.36						TIO-003
	3.87	4.88	5.56	6.03	6.37	5.76	5.10	4.51	3.91						TIO-004
	4.71	5.94	6.76	7.34	7.75	7.01	6.21	5.49	4.76						TIO-005
5.45	6.88	7.84	8.51	8.98	8.12	7.19	6.36	5.52						TIO-006	
20	0.02	0.12	0.16	0.19	0.20	0.19	0.17	0.15	0.13						TIO-00X
	0.04	0.33	0.43	0.50	0.54	0.50	0.45	0.40	0.35						TIO-000
	0.10	0.77	1.02	1.18	1.29	1.19	1.07	0.96	0.84						TIO-001
	0.17	1.26	1.66	1.92	2.10	1.94	1.75	1.56	1.37						TIO-002
	0.27	2.04	2.68	3.10	3.39	3.13	2.82	2.52	2.20						TIO-003
	0.44	3.38	4.45	5.14	5.62	5.20	4.68	4.18	3.66						TIO-004
	0.54	4.11	5.41	6.25	6.84	6.33	5.69	5.09	4.45						TIO-005
0.62	4.76	6.27	7.24	7.92	7.33	6.59	5.89	5.15						TIO-006	

Condensing Temperature °C	R404A		Capacity (kW) Valve Type TI ... - S.... Evaporating Temperature (°C)												Cage Size
	30	20	10	5	0	-5	-10	-15	-20	-25	-30	-35	-40	-45	
50	0.27	0.32	0.34	0.35	0.35	0.35	0.34	0.30	0.25	0.22	0.18	0.15	0.13	0.10	TIO-00X
	0.71	0.82	0.88	0.89	0.89	0.89	0.88	0.77	0.65	0.56	0.47	0.39	0.33	0.27	TIO-000
	1.65	1.91	2.04	2.07	2.08	2.07	2.05	1.80	1.53	1.30	1.10	0.92	0.76	0.62	TIO-001
	50.00	2.82	3.28	3.50	3.55	3.57	3.55	3.52	3.08	2.62	2.24	1.88	1.58	1.30	TIO-002
	4.47	5.19	5.54	5.62	5.65	5.63	5.57	4.88	4.14	3.54	2.98	2.50	2.06	1.69	TIO-003
	7.29	8.47	9.05	9.17	9.21	9.18	9.09	7.96	6.76	5.78	4.86	4.07	3.37	2.76	TIO-004
	8.85	10.29	10.99	11.15	11.20	11.16	11.04	9.67	8.22	7.02	5.90	4.95	4.09	3.36	TIO-005
10.26	11.93	12.74	12.92	12.98	12.93	12.80	11.21	9.53	8.13	6.84	5.74	4.75	3.89	TIO-006	
40	0.20	0.29	0.34	0.35	0.36	0.37	0.37	0.33	0.28	0.24	0.21	0.18	0.15	0.12	TIO-00X
	0.51	0.75	0.87	0.91	0.93	0.95	0.95	0.84	0.73	0.63	0.54	0.46	0.38	0.32	TIO-000
	1.19	1.75	2.04	2.12	2.18	2.21	2.22	1.97	1.70	1.47	1.25	1.06	0.89	0.74	TIO-001
	2.03	3.00	3.49	3.64	3.73	3.78	3.80	3.38	2.91	2.52	2.14	1.82	1.53	1.27	TIO-002
	3.22	4.76	5.53	5.76	5.91	5.99	6.02	5.35	4.61	3.99	3.39	2.88	2.42	2.01	TIO-003
	5.25	7.76	9.02	9.40	9.64	9.78	9.83	8.73	7.52	6.50	5.54	4.70	3.94	3.28	TIO-004
	6.38	9.43	10.96	11.42	11.71	11.88	11.94	10.61	9.14	7.90	6.73	5.71	4.79	3.98	TIO-005
7.40	10.93	12.71	13.23	13.58	13.77	13.84	12.30	10.59	9.16	7.80	6.62	5.55	4.62	TIO-006	
35	0.25	0.32	0.34	0.36	0.37	0.37	0.33	0.29	0.25	0.21	0.18	0.15	0.13	0.10	TIO-00X
	0.65	0.83	0.88	0.92	0.94	0.95	0.85	0.74	0.64	0.55	0.47	0.40	0.33	0.27	TIO-000
	1.53	1.93	2.06	2.14	2.20	2.23	1.99	1.73	1.50	1.29	1.10	0.93	0.77	0.62	TIO-001
	2.62	3.32	3.52	3.67	3.76	3.82	3.42	2.96	2.58	2.21	1.88	1.59	1.33	1.07	TIO-002
	4.15	5.25	5.58	5.81	5.96	6.05	5.41	4.69	4.08	3.50	2.98	2.51	2.10	1.69	TIO-003
	6.77	8.56	9.10	9.48	9.72	9.86	8.83	7.65	6.66	5.70	4.87	4.10	3.43	2.82	TIO-004
	8.22	10.41	11.06	11.51	11.81	11.98	10.73	9.30	8.09	6.93	5.92	4.99	4.17	3.46	TIO-005
9.53	12.06	12.82	13.35	13.69	13.89	12.44	10.78	9.38	8.03	6.86	5.78	4.83	4.01	TIO-006	
30	0.19	0.29	0.32	0.34	0.36	0.36	0.33	0.29	0.25	0.22	0.19	0.16	0.13	0.10	TIO-00X
	0.49	0.75	0.83	0.88	0.91	0.94	0.85	0.74	0.65	0.56	0.48	0.41	0.34	0.28	TIO-000
	1.15	1.75	1.93	2.05	2.13	2.19	1.98	1.73	1.51	1.30	1.12	0.95	0.79	0.64	TIO-001
	1.97	3.01	3.30	3.51	3.66	3.75	3.39	2.96	2.59	2.23	1.92	1.62	1.36	1.10	TIO-002
	3.13	4.76	5.23	5.56	5.79	5.94	5.36	4.69	4.10	3.53	3.03	2.57	2.16	1.75	TIO-003
	5.10	7.77	8.53	9.07	9.44	9.69	8.75	7.65	6.70	5.77	4.95	4.19	3.52	2.91	TIO-004
	6.20	9.44	10.36	11.02	11.48	11.77	10.63	9.29	8.14	7.01	6.01	5.09	4.27	3.56	TIO-005
7.18	10.94	12.01	12.77	13.30	13.65	12.33	10.77	9.43	8.12	6.97	5.90	4.95	4.13	TIO-006	
25	0.25	0.29	0.32	0.34	0.35	0.32	0.28	0.25	0.22	0.19	0.16	0.13	0.10	0.08	TIO-00X
	0.63	0.74	0.81	0.86	0.90	0.82	0.73	0.64	0.55	0.48	0.41	0.34	0.28	0.22	TIO-000
	1.48	1.72	1.90	2.02	2.10	1.92	1.69	1.49	1.29	1.12	0.95	0.80	0.64	0.50	TIO-001
	2.53	2.95	3.25	3.46	3.60	3.29	2.90	2.56	2.22	1.91	1.63	1.37	1.11	0.85	TIO-002
	4.01	4.68	5.14	5.48	5.71	5.21	4.60	4.06	3.51	3.03	2.58	2.17	1.76	1.35	TIO-003
	6.54	7.63	8.39	8.94	9.31	8.51	7.50	6.62	5.73	4.95	4.21	3.55	2.94	2.33	TIO-004
	7.95	9.27	10.20	10.86	11.31	10.34	9.11	8.04	6.96	6.01	5.11	4.31	3.59	2.98	TIO-005
9.22	10.75	11.82	12.59	13.11	11.98	10.56	9.32	8.07	6.97	5.93	5.00	4.28	3.56	TIO-006	
20	0.17	0.24	0.28	0.31	0.33	0.									

Condensing dew point °C	Temperature bubble point °C	R407C		Capacity (kW) Valve Type TI ... - N.... Evaporating Temperature (°C)							Cage Size
		20	10	5	0	-5	-10	-15	-20	-25	
54	50	0.49	0.52	0.52	0.53	0.53	0.53	0.46	0.38	0.32	TIO-00X
		1.27	1.34	1.36	1.37	1.37	1.36	1.19	1.00	0.83	TIO-000
		3.17	3.35	3.39	3.42	3.42	3.41	2.99	2.49	2.07	TIO-001
		5.16	5.45	5.53	5.57	5.57	5.55	4.86	4.06	3.37	TIO-002
		8.33	8.80	8.92	8.98	9.00	8.96	7.85	6.55	5.44	TIO-003
		13.58	14.35	14.55	14.65	14.67	14.61	12.80	10.69	8.87	TIO-004
		16.57	17.50	17.75	17.87	17.89	17.82	15.61	13.04	10.82	TIO-005
		19.11	20.18	20.46	20.60	20.63	20.55	18.00	15.03	12.47	TIO-006
45	40	0.44	0.49	0.51	0.52	0.53	0.53	0.47	0.39	0.33	TIO-00X
		1.14	1.28	1.32	1.34	1.36	1.37	1.21	1.02	0.85	TIO-000
		2.86	3.19	3.29	3.36	3.40	3.42	3.02	2.54	2.13	TIO-001
		4.66	5.19	5.36	5.47	5.54	5.58	4.93	4.14	3.46	TIO-002
		7.52	8.38	8.65	8.83	8.95	9.00	7.95	6.69	5.59	TIO-003
		12.25	13.66	14.10	14.40	14.58	14.67	12.96	10.91	9.11	TIO-004
		14.95	16.67	17.20	17.57	17.79	17.90	15.82	13.31	11.12	TIO-005
		17.24	19.22	19.83	20.25	20.52	20.64	18.24	15.34	12.82	TIO-006
40	35	0.40	0.47	0.49	0.50	0.51	0.52	0.46	0.39	0.33	TIO-00X
		1.03	1.21	1.26	1.30	1.33	1.34	1.19	1.01	0.85	TIO-000
		2.58	3.02	3.15	3.25	3.32	3.36	2.99	2.52	2.12	TIO-001
		4.20	4.91	5.14	5.30	5.41	5.47	4.86	4.11	3.45	TIO-002
		6.78	7.93	8.29	8.55	8.73	8.84	7.85	6.63	5.56	TIO-003
		11.06	12.93	13.52	13.94	14.23	14.41	12.79	10.81	9.07	TIO-004
		13.49	15.77	16.49	17.01	17.36	17.58	15.61	13.19	11.06	TIO-005
		15.56	18.19	19.02	19.61	20.02	20.27	18.00	15.21	12.75	TIO-006
35	30	0.34	0.43	0.46	0.48	0.49	0.50	0.45	0.38	0.32	TIO-00X
		0.88	1.11	1.18	1.24	1.28	1.30	1.16	0.99	0.83	TIO-000
		2.19	2.78	2.96	3.09	3.19	3.25	2.91	2.47	2.08	TIO-001
		3.57	4.53	4.82	5.04	5.20	5.30	4.74	4.02	3.39	TIO-002
		5.76	7.30	7.78	8.13	8.39	8.56	7.64	6.49	5.47	TIO-003
		9.39	11.91	12.69	13.26	13.67	13.95	12.46	10.58	8.92	TIO-004
		11.46	14.53	15.48	16.18	16.68	17.02	15.21	12.91	10.88	TIO-005
		13.22	16.75	17.85	18.66	19.23	19.62	17.53	14.89	12.54	TIO-006
30	25	0.38	0.42	0.44	0.46	0.48	0.43	0.37	0.31	TIO-00X	
		0.98	1.08	1.15	1.21	1.24	1.12	0.96	0.81	TIO-000	
		2.46	2.70	2.88	3.01	3.11	2.80	2.39	2.02	TIO-001	
		4.01	4.40	4.70	4.91	5.06	4.55	3.89	3.29	TIO-002	
		6.47	7.11	7.58	7.92	8.16	7.35	6.28	5.32	TIO-003	
		10.55	11.59	12.36	12.91	13.31	11.98	10.24	8.67	TIO-004	
		12.87	14.14	15.07	15.75	16.24	14.62	12.49	10.58	TIO-005	
		14.84	16.31	17.38	18.17	18.72	16.86	14.40	12.19	TIO-006	
26	20	0.37	0.40	0.43	0.45	0.41	0.35	0.30	TIO-00X		
		0.95	1.04	1.11	1.16	1.06	0.91	0.78	TIO-000		
		2.37	2.61	2.78	2.91	2.65	2.28	1.94	TIO-001		
		3.86	4.25	4.54	4.74	4.31	3.71	3.16	TIO-002		
		6.23	6.86	7.32	7.65	6.96	6.00	5.11	TIO-003		
		10.16	11.19	11.93	12.47	11.35	9.77	8.33	TIO-004		
		12.40	13.65	14.56	15.22	13.85	11.92	10.16	TIO-005		
		14.30	15.74	16.79	17.55	15.97	13.75	11.71	TIO-006		

Condensing Temperature °C	R410A		Capacity (kW) Valve Type TI ... - Z.... Evaporating Temperature (°C)											Cage Size
	+15	+10	+5	0	-5	-10	-15	-20	-25	-30	-35	-40	-45	
50	0.53	0.55	0.57	0.58	0.59	0.60	0.53	0.47	0.40	0.33	0.28	0.23	0.20	TIO-00X
	1.38	1.44	1.49	1.52	1.54	1.56	1.39	1.21	1.03	0.87	0.73	0.61	0.51	TIO-000
	3.40	3.55	3.66	3.74	3.80	3.84	3.41	2.98	2.54	2.14	1.79	1.49	1.25	TIO-001
	5.64	5.87	6.06	6.20	6.29	6.36	5.65	4.94	4.21	3.54	2.96	2.48	2.08	TIO-002
	9.04	9.42	9.72	9.94	10.09	10.20	9.06	7.92	6.75	5.68	4.75	3.97	3.33	TIO-003
	14.79	15.41	15.89	16.25	16.51	16.67	14.82	12.94	11.03	9.28	7.76	6.49	5.44	TIO-004
	17.98	18.73	19.32	19.76	20.07	20.27	18.02	15.74	13.42	11.28	9.44	7.89	6.62	TIO-005
	20.75	21.61	22.29	22.79	23.16	23.39	20.79	18.16	15.48	13.02	10.89	9.11	7.63	TIO-006
40	0.49	0.53	0.55	0.58	0.59	0.61	0.54	0.48	0.41	0.35	0.29	0.25	0.21	TIO-00X
	1.28	1.37	1.44	1.50	1.54	1.58	1.41	1.24	1.07	0.90	0.76	0.64	0.54	TIO-000
	3.14	3.37	3.55	3.69	3.80	3.88	3.48	3.06	2.63	2.22	1.87	1.57	1.32	TIO-001
	5.20	5.58	5.88	6.11	6.29	6.42	5.76	5.07	4.35	3.68	3.10	2.60	2.19	TIO-002
	8.35	8.95	9.43	9.81	10.09	10.30	9.24	8.13	6.98	5.91	4.97	4.18	3.52	TIO-003
	13.65	14.64	15.42	16.04	16.50	16.85	15.11	13.30	11.41	9.66	8.13	6.83	5.76	TIO-004
	16.60	17.80	18.75	19.50	20.06	20.48	18.37	16.17	13.88	11.75	9.88	8.31	7.00	TIO-005
	19.15	20.54	21.64	22.50	23.15	23.64	21.20	18.66	16.01	13.55	11.40	9.58	8.07	TIO-006
35	0.45	0.49	0.53	0.56	0.58	0.60	0.54	0.47	0.41	0.35	0.29	0.25	0.21	TIO-00X
	1.17	1.28	1.38	1.45	1.51	1.55	1.40	1.23	1.06	0.90	0.76	0.64	0.54	TIO-000
	2.87	3.16	3.39	3.57	3.70	3.81	3.44	3.04	2.62	2.22	1.88	1.58	1.34	TIO-001
	4.75	5.23	5.61	5.91	6.14	6.31	5.69	5.03	4.34	3.68	3.11	2.62	2.21	TIO-002
	7.62	8.39	9.00	9.47	9.84	10.12	9.13	8.07	6.96	5.91	4.99	4.20	3.55	TIO-003
	12.46	13.73	14.72	15.49	16.09	16.55	14.93	13.20	11.38	9.66	8.15	6.87	5.80	TIO-004
	15.15	16.69	17.89	18.84	19.57	20.12	18.15	16.05	13.83	11.75	9.91	8.35	7.05	TIO-005
	17.48	19.26	20.65	21.73	22.58	23.22	20.94	18.52	15.96	13.55	11.44	9.64	8.14	TIO-006
30	0.39	0.45	0.49	0.53	0.55	0.58	0.52	0.47	0.40	0.34	0.29	0.25	0.21	TIO-00X
	1.00	1.16	1.28	1.37	1.44	1.50	1.36	1.21	1.05	0.89	0.76	0.64	0.54	TIO-000
	2.47	2.86	3.15	3.37	3.55	3.69	3.35	2.98	2.58	2.20	1.86	1.57	1.33	TIO-001
	4.10	4.73	5.21	5.59	5.88	6.10	5.55	4.93	4.27	3.64	3.08	2.61	2.21	TIO-002
	6.57	7.59	8.36	8.96	9.43	9.79	8.89	7.91	6.85	5.84	4.94	4.18	3.54	TIO-003
	10.74	12.41	13.67	14.66	15.42	16.01	14.54	12.94	11.20	9.55	8.09	6.83	5.79	TIO-004
	13.06	15.09	16.63	17.82	18.75	19.46	17.68	15.73	13.62	11.61	9.83	8.31	7.04	TIO-005
	15.07	17.41	19.18	20.56	21.63	22.46	20.40	18.15	15.71	13.40	11.34	9.59	8.12	TIO-006
25	0.30	0.38	0.44	0.49	0.52	0.55	0.50	0.45	0.39	0.34	0.29	0.24	0.21	TIO-00X
	0.77	0.99	1.15	1.26	1.35	1.42	1.31	1.17	1.02	0.87	0.74	0.63	0.53	TIO-000
	1.89	2.43	2.82	3.11	3.33	3.50	3.21	2.88	2.51	2.15	1.83	1.55	1.32	TIO-001
	3.13	4.03	4.67	5.15	5.52	5.80	5.32	4.77	4.16	3.56	3.03	2.57	2.18	TIO-002
	5.03	6.46	7.49	8.26	8.85	9.31	8.54	7.65	6.66	5.71	4.85	4.11	3.49	TIO-003
	8.22	10.57	12.24	13.50	14.47	15.22	13.97	12.51	10.90	9.34	7.93	6.73	5.71	TIO-004
	10.00	12.85	14.89	16.42	17.60	18.51	16.98	15.22	13.25	11.35	9.65	8.18	6.95	TIO-005
	11.53	14.83	17.18	18.95	20.31	21.36	19.59	17.56	15.29	13.10	11.13	9.44	8.01	TIO-006
20	0.13	0.28	0.37	0.43	0.48	0.51	0.47	0.43	0.38	0.32	0.28	0.24	0.20	TIO-00X
	0.33	0.74	0.96	1.12	1.24	1.33	1.23	1.12	0.98	0.84	0.72	0.61	0.52	TIO-000
	0.82	1.82	2.37	2.76	3.04	3.26	3.04	2.75	2.41	2.08	1.77	1.51	1.29	TIO-001
	1.35	3.02	3.93	4.57	5.04	5.41	5.03	4.55	3.99	3.44	2.94	2.50	2.13	TIO-002
	2.17	4.84	6.30	7.32	8.09	8.67	8.06	7.30	6.40	5.52	4.71	4.01	3.42	TIO-003
	3.55	7.91	10.30	11.98	13.23	14.18	13.18	11.93	10.47	9.02	7.70	6.56	5.59	TIO-004
	4.32	9.62	12.52	14.56	16.08	17.24	16.03	14.51	12.73	10.97	9.36	7.97	6.79	TIO-005
	4.98	11.10	14.45	16.80	18.55	19.89	18.50	16.74	14.68	12.65	10.81	9.20	7.84	TIO-006



Condensing Temperature °C	R507		Capacity (kW) Valve Type TI ... - S.... Evaporating Temperature (°C)												Cage Size	
	30	20	10	5	0	-5	-10	-15	-20	-25	-30	-35	-40	-45		
50	0.29	0.34	0.36	0.37	0.37	0.37	0.37	0.32	0.27	0.23	0.19	0.16	0.13	0.11	TIO-00X	
	0.73	0.85	0.91	0.92	0.93	0.93	0.92	0.80	0.68	0.58	0.49	0.40	0.33	0.26	TIO-000	
	1.68	1.95	2.09	2.12	2.13	2.13	2.11	1.83	1.57	1.33	1.12	0.92	0.76	0.61	TIO-001	
	2.85	3.31	3.54	3.59	3.62	3.61	3.58	3.10	2.66	2.26	1.89	1.57	1.28	1.03	TIO-002	
	4.54	5.26	5.63	5.71	5.75	5.74	5.69	4.93	4.23	3.59	3.01	2.49	2.04	1.64	TIO-003	
	7.39	8.57	9.17	9.31	9.36	9.35	9.28	8.04	6.88	5.85	4.90	4.06	3.32	2.67	TIO-004	
	9.00	10.44	11.16	11.33	11.40	11.39	11.30	9.79	8.38	7.12	5.97	4.94	4.04	3.26	TIO-005	
	10.39	12.05	12.89	13.08	13.16	13.15	13.04	11.31	9.68	8.22	6.89	5.70	4.66	3.76	TIO-006	
	40	0.21	0.31	0.36	0.37	0.38	0.39	0.39	0.34	0.30	0.26	0.22	0.18	0.15	0.12	TIO-00X
		0.52	0.77	0.89	0.93	0.96	0.97	0.98	0.86	0.75	0.64	0.54	0.46	0.38	0.31	TIO-000
1.20		1.77	2.05	2.14	2.20	2.23	2.25	1.98	1.71	1.47	1.25	1.05	0.87	0.71	TIO-001	
2.04		3.00	3.48	3.63	3.73	3.79	3.82	3.35	2.91	2.50	2.12	1.78	1.47	1.20	TIO-002	
3.24		4.76	5.54	5.77	5.93	6.02	6.07	5.33	4.62	3.97	3.37	2.82	2.34	1.91	TIO-003	
5.28		7.76	9.02	9.40	9.66	9.81	9.88	8.68	7.53	6.47	5.49	4.60	3.80	3.10	TIO-004	
6.43		9.45	10.99	11.45	11.76	11.95	12.04	10.57	9.17	7.88	6.68	5.60	4.63	3.78	TIO-005	
7.42		10.91	12.68	13.22	13.58	13.79	13.90	12.20	10.59	9.10	7.72	6.46	5.35	4.36	TIO-006	
35		0.27	0.34	0.36	0.37	0.38	0.39	0.35	0.30	0.26	0.22	0.19	0.16	0.13	TIO-00X	
		0.67	0.84	0.90	0.94	0.96	0.98	0.86	0.75	0.65	0.56	0.47	0.39	0.32	TIO-000	
	1.53	1.94	2.06	2.15	2.21	2.25	1.99	1.74	1.50	1.28	1.08	0.90	0.73	TIO-001		
	2.60	3.29	3.50	3.65	3.75	3.81	3.37	2.94	2.55	2.17	1.83	1.52	1.25	TIO-002		
	4.14	5.23	5.56	5.80	5.96	6.06	5.36	4.68	4.05	3.45	2.90	2.41	1.98	TIO-003		
	6.74	8.52	9.06	9.45	9.71	9.87	8.73	7.62	6.59	5.62	4.73	3.93	3.23	TIO-004		
	8.21	10.38	11.04	11.50	11.82	12.02	10.63	9.28	8.03	6.84	5.76	4.79	3.93	TIO-005		
	9.47	11.98	12.74	13.28	13.65	13.87	12.27	10.72	9.27	7.90	6.65	5.53	4.54	TIO-006		
	30	0.20	0.31	0.34	0.36	0.37	0.38	0.34	0.30	0.26	0.22	0.19	0.16	0.13	TIO-00X	
		0.50	0.76	0.84	0.89	0.93	0.96	0.85	0.75	0.65	0.56	0.47	0.40	0.33	TIO-000	
1.16		1.75	1.93	2.05	2.14	2.20	1.96	1.73	1.50	1.29	1.09	0.91	0.75	TIO-001		
1.96		2.98	3.27	3.48	3.63	3.73	3.33	2.93	2.55	2.19	1.85	1.54	1.27	TIO-002		
3.12		4.73	5.19	5.53	5.77	5.93	5.29	4.66	4.05	3.47	2.94	2.45	2.02	TIO-003		
5.08		7.71	8.46	9.01	9.40	9.66	8.62	7.59	6.60	5.66	4.79	4.00	3.29	TIO-004		
6.18		9.38	10.30	10.97	11.44	11.76	10.50	9.24	8.04	6.89	5.83	4.87	4.01	TIO-005		
7.14		10.83	11.90	12.66	13.21	13.58	12.12	10.67	9.28	7.96	6.73	5.62	4.63	TIO-006		
25		0.26	0.30	0.33	0.35	0.37	0.33	0.29	0.26	0.22	0.19	0.16	0.13	TIO-00X		
		0.64	0.75	0.82	0.88	0.92	0.83	0.73	0.64	0.56	0.47	0.40	0.33	TIO-000		
	1.48	1.72	1.90	2.02	2.11	1.90	1.69	1.48	1.28	1.09	0.91	0.75	TIO-001			
	2.50	2.92	3.21	3.43	3.58	3.23	2.87	2.51	2.17	1.84	1.55	1.28	TIO-002			
	3.98	4.64	5.11	5.45	5.68	5.13	4.56	3.99	3.45	2.93	2.46	2.03	TIO-003			
	6.48	7.56	8.32	8.87	9.26	8.36	7.42	6.51	5.61	4.77	4.01	3.32	TIO-004			
	7.89	9.20	10.13	10.80	11.28	10.18	9.04	7.92	6.84	5.82	4.88	4.04	TIO-005			
	9.11	10.63	11.70	12.47	13.02	11.76	10.44	9.15	7.89	6.71	5.63	4.66	TIO-006			
	20	0.18	0.25	0.29	0.32	0.34	0.31	0.28	0.25	0.22	0.19	0.16	0.13	TIO-00X		
		0.45	0.62	0.73	0.80	0.86	0.79	0.71	0.63	0.54	0.46	0.39	0.33	TIO-000		
1.04		1.42	1.67	1.85	1.97	1.81	1.63	1.44	1.25	1.07	0.90	0.75	TIO-001			
1.76		2.41	2.84	3.13	3.34	3.07	2.76	2.44	2.12	1.81	1.53	1.27	TIO-002			
2.80		3.84	4.51	4.98	5.32	4.88	4.38	3.88	3.37	2.88	2.43	2.02	TIO-003			
4.57		6.25	7.34	8.11	8.66	7.95	7.14	6.31	5.49	4.70	3.96	3.29	TIO-004			
5.56		7.61	8.94	9.88	10.55	9.68	8.69	7.69	6.68	5.72	4.82	4.01	TIO-005			
6.42		8.78	10.32	11.40	12.18	11.17	10.04	8.88	7.71	6.60	5.57	4.63	TIO-006			

Condensing Temperature °C	R22		Capacity (kW) Valve Type TI ... - H.... Evaporating Temperature (°C)												Cage Size	
	30	20	10	5	0	-5	-10	-15	-20	-25	-30	-35	-40	-45		
50	0.38	0.45	0.50	0.51	0.52	0.53	0.53	0.46	0.41	0.35	0.30	0.26	0.22	0.19	TIO-00X	
	0.98	1.17	1.29	1.33	1.35	1.38	1.36	1.20	1.05	0.91	0.78	0.66	0.57	0.48	TIO-000	
	2.40	2.86	3.16	3.26	3.32	3.39	3.33	2.95	2.58	2.24	1.91	1.62	1.40	1.19	TIO-001	
	4.03	4.78	5.29	4.47	5.56	5.67	5.57	4.95	4.32	3.75	3.20	2.72	2.35	2.00	TIO-002	
	6.41	7.64	8.42	8.70	8.85	9.03	8.87	7.88	6.87	5.97	5.10	4.34	3.45	3.18	TIO-003	
	10.50	12.51	13.79	14.26	14.50	14.80	14.53	12.90	11.26	9.79	8.35	7.10	6.14	5.21	TIO-004	
	12.80	15.24	16.81	17.37	17.67	18.03	17.70	15.72	13.72	11.93	10.18	8.66	7.49	6.35	TIO-005	
	14.76	17.58	19.38	20.04	20.38	20.79	20.42	18.14	15.82	13.76	11.74	9.98	8.64	7.32	TIO-006	
	40	0.24	0.37	0.44	0.46	0.48	0.50	0.49	0.44	0.39	0.34	0.29	0.25	0.22	0.18	TIO-00X
		0.61	0.95	1.14	1.20	1.25	1.29	1.27	1.15	1.01	0.88	0.75	0.64	0.56	0.47	TIO-000
1.51		2.33	2.78	2.94	3.07	3.17	3.12	2.82	2.47	2.16	1.85	1.58	1.38	1.17	TIO-001	
2.52		3.90	4.66	4.92	5.13	5.30	5.23	4.73	4.14	3.62	3.10	2.65	2.31	1.96	TIO-002	
4.02		6.21	7.42	7.84	8.18	8.44	8.33	7.53	6.59	5.76	4.94	4.23	3.68	3.12	TIO-003	
6.59		10.17	12.16	12.85	13.39	13.83	13.65	12.33	10.79	9.44	8.10	6.92	6.03	5.12	TIO-004	
8.03		12.40	14.82	15.65	16.32	16.85	16.63	15.03	13.15	11.50	9.87	8.44	7.35	6.23	TIO-005	
9.26		14.30	17.09	18.05	18.82	19.43	19.18	17.33	15.17	13.26	11.38	9.73	8.48	7.19	TIO-006	
35		0.30	0.40	0.43	0.45	0.47	0.48	0.43	0.38	0.33	0.29	0.24	0.21	0.18	TIO-00X	
		0.79	1.03	1.11	1.17	1.22	1.23	1.11	0.98	0.85	0.74	0.63	0.55	0.47	TIO-000	
	1.93	2.53	2.72	2.88	3.00	3.01	2.71	2.40	2.09	1.81	1.55	1.35	1.15	TIO-001		
	3.24	4.23	4.56	4.82	5.02	5.03	4.54	4.02	3.50	3.03	2.60	2.27	1.93	TIO-002		
	5.16	6.74	7.27	7.68	8.00	8.01	7.23	6.40	5.57	4.83	4.14	3.61	3.07	TIO-003		
	8.45	11.04	11.90	12.58	13.11	13.13	11.85	10.49	9.13	7.92	6.78	5.92	5.03	TIO-004		
	10.30	13.46	14.50	15.32	15.97	16.00	14.44	12.78	11.12	9.65	8.27	7.21	6.13	TIO-005		
	11.87	15.52	16.73	17.67	18.42	18.45	16.65	14.74	12.83	11.13	9.53	8.32	7.07	TIO-006		
	30	0.21	0.34	0.38	0.41	0.44	0.44	0.41	0.36	0.31	0.27	0.24	0.21	0.18	TIO-00X	
		0.55	0.89	0.99	1.07	1.13	1.15	1.05	0.93	0.81	0.70	0.61	0.53	0.46	TIO-000	
1.35		2.19	2.44	2.63	2.78	2.81	2.57	2.29	1.99	1.72	1.50	1.31	1.12	TIO-001		
2.26		3.67	4.09	4.41	4.66	4.71	4.30	3.83	3.33	2.88	2.52	2.20	1.88	TIO-002		
3.59		5.84	6.51	7.02	7.42	7.50	6.84	6.10	5.30	4.59	4.01	3.51	2.99	TIO-003		
5.89		9.56	10.66	11.50	12.16	12.28	11.21	10.00	8.68	7.51	6.57	5.75	4.90	TIO-004		
7.18		11.65	12.99	14.02	14.81	14.97	13.66	12.18	10.58	9.16	8.01	7.01	5.98	TIO-005		
8.28		13.44	14.98	16.16	17.08	17.26	15.76	14.05	12.20	10.56	9.24	8.08	6.89	TIO-006		
25		0.28	0.33	0.38	0.40	0.41	0.38	0.34	0.30	0.26	0.23	0.20	0.17	TIO-00X		
		0.71	0.85	0.97	1.04	1.07	0.98	0.88	0.78	0.68	0.59	0.51	0.44	TIO-000		
	1.76	2.10	2.37	2.56	2.62	2.40	2.16	1.91	1.67	1.44	1.26	1.08	TIO-001			
	2.94	3.51	3.97	4.29	4.39	4.03	3.62	3.21	2.79	2.42	2.12	1.81	TIO-002			
	4.68	5.59	6.33	6.84	7.00	6.41	5.77	5.11	4.45	3.85	3.37	2.88	TIO-003			
	7.67	9.16	10.36	11.20	11.46	10.50	9.46	8.37	7.29	6.31	5.52	4.72	TIO-004			
	9.35	11.16	12.63	13.64	13.96	12.80	11.52	10.19	8.89	7.69	6.73	5.75	TIO-005			

## Thermo®-Expansion Valve Series TX3 for OEM use, hermetic Design

### Features

- Hermetic design with solder connections
- Internal or external equalizer
- External superheat adjustment
- Large diaphragm eliminates disturbances to the valve and provides smoother valve control
- Very compact size
- Version with internal check valve eliminates external check valve for heat pump applications
- Capillary tube length 1.5m
- PS: 45bar. TS: -45 ... +120°C
- Packaging units with 24 pieces, no single packs



TX3

### MOP

MOP (bar)	Upper limit of Evaporating Temperature Range					
	R134a	R22	R407C	R404A	R410A	R507
2.3				-18°C		-18.7°C
3.3	+11°C					
6.4		+13°C	+14.5°C			
12.9					+17°C	

Pressures are given in gauge pressure.

### Selection Charts

#### R134a

Nominal Capacity	less MOP		with Standard-MOP		Equalizer	Inlet x Outlet Solder/ODF
	Type	Part No.	Type	Part No.		
0.6	TX3-M01	801765M	TX3-M11	801777M	Internal	1/4" x 3/8"
1.8	TX3-M02	801766M	TX3-M12	801778M	Internal	1/4" x 3/8"
2.8	TX3-M03	801767M			Internal	1/4" x 3/8"
4.0	TX3-M04	801768M			Internal	3/8" x 1/2"
1.8	TX3-M22	801769M	TX3-M32	801781M	Ext. 1/4"	1/4" x 3/8"
2.8	TX3-M23	801770M	TX3-M33	801782M	Ext. 1/4"	1/4" x 3/8"
4.0	TX3-M24	801771M	TX3-M34	801783M	Ext. 1/4"	3/8" x 1/2"
6.1	TX3-M25	801772M	TX3-M35	801784M	Ext. 1/4"	3/8" x 1/2"
8.3	TX3-M26	801773M	TX3-M36	801785M	Ext. 1/4"	3/8" x 1/2"
10.2	TX3-M27	801774M	TX3-M37	801786M	Ext. 1/4"	1/2" x 5/8"
12.1	TX3-M28	801775M	TX3-M38	801787M	Ext. 1/4"	1/2" x 5/8"
16.5	TX3-M29	801776M	TX3-M39	801788M	Ext. 1/4"	1/2" x 5/8"

#### R22

Nominal Capacity	less MOP		with Standard-MOP		Equalizer	Inlet x Outlet Solder/ODF
	Type	Part No.	Type	Part No.		
5.2	TX3-H04	801729M			Internal	3/8" x 1/2"
2.3	TX3-H22	801739M			Ext. 1/4"	1/4" x 3/8"
3.6	TX3-H23	801740M	TX3-H33	801749M	Ext. 1/4"	1/4" x 3/8"
5.2	TX3-H24	801741M	TX3-H34	801750M	Ext. 1/4"	3/8" x 1/2"
7.8	TX3-H25	801742M	TX3-H35	801751M	Ext. 1/4"	3/8" x 1/2"
10.7	TX3-H26	801743M	TX3-H36	801752M	Ext. 1/4"	3/8" x 1/2"
13.1	TX3-H27	801744M	TX3-H37	801753M	Ext. 1/4"	1/2" x 5/8"
15.6	TX3-H28	801745M	TX3-H38	801754M	Ext. 1/4"	1/2" x 5/8"
21.3	TX3-H29	801746M	TX3-H39	801755M	Ext. 1/4"	1/2" x 5/8"

#### R404A / R507

Nominal Capacity	less MOP		with Standard-MOP		Equalizer	Inlet x Outlet Solder/ODF
	Type	Part No.	Type	Part No.		
0.6	TX3-S21	801865M			Ext. 1/4"	1/4" x 3/8"
1.6	TX3-S22	801866M			Ext. 1/4"	1/4" x 3/8"
2.5	TX3-S23	801867M			Ext. 1/4"	1/4" x 3/8"
3.7	TX3-S24	801868M	TX3-S34	801877M	Ext. 1/4"	3/8" x 1/2"
5.5	TX3-S25	801869M			Ext. 1/4"	3/8" x 1/2"
7.6	TX3-S26	801870M			Ext. 1/4"	3/8" x 1/2"
9.2	TX3-S27	801871M			Ext. 1/4"	1/2" x 5/8"
11.0	TX3-S28	801872M			Ext. 1/4"	1/2" x 5/8"
15.0	TX3-S29	801873M	TX3-S39	801882M	Ext. 1/4"	1/2" x 5/8"

#### R410A

Nominal Capacity	less MOP		with Standard-MOP		Equalizer	Inlet x Outlet Solder/ODF
	Type	Part No.	Type	Part No.		
2.8			TX3-Z32	801942M	Ext. 1/4"	1/4" x 3/8"
4.3			TX3-Z33	801943M	Ext. 1/4"	1/4" x 3/8"
6.3			TX3-Z34	801944M	Ext. 1/4"	3/8" x 1/2"
9.4			TX3-Z35	801945M	Ext. 1/4"	3/8" x 1/2"
12.9			TX3-Z36	801946M	Ext. 1/4"	3/8" x 1/2"
15.8			TX3-Z37	801947M	Ext. 1/4"	1/2" x 5/8"
18.8			TX3-Z38	801948M	Ext. 1/4"	1/2" x 5/8"

#### R407C

Nominal Capacity	less MOP		with Standard-MOP		Equalizer	Inlet x Outlet Solder/ODF
	Type	Part No.	Type	Part No.		
0.9	TX3-N01	801813M			Internal	1/4" x 3/8"
2.5	TX3-N02	801814M	TX3-N12	801827M	Internal	1/4" x 3/8"
3.9	TX3-N03	801815M	TX3-N13	801828M	Internal	1/4" x 3/8"
2.5	TX3-N22	801818M	TX3-N32	801831M	Ext. 1/4"	1/4" x 3/8"
3.9	TX3-N23	801819M	TX3-N33	801832M	Ext. 1/4"	1/4" x 3/8"
5.6	TX3-N24	801820M	TX3-N34	801833M	Ext. 1/4"	3/8" x 1/2"
8.4	TX3-N25	801821M	TX3-N35	801834M	Ext. 1/4"	3/8" x 1/2"
11.6	TX3-N26	801822M	TX3-N36	801835M	Ext. 1/4"	3/8" x 1/2"
14.2	TX3-N27	801823M	TX3-N37	801836M	Ext. 1/4"	1/2" x 5/8"
16.9	TX3-N28	801824M	TX3-N38	801837M	Ext. 1/4"	1/2" x 5/8"
23.0	TX3-N29	801825M	TX3-N39	801838M	Ext. 1/4"	1/2" x 5/8"

#### R407C for heat pump applications

Nominal Capacity	less MOP		Adjustable with internal check valve and special liquid charge for heat pump applications	Equalizer	Inlet x Outlet Solder/ODF
	Type	Part No.			
3.9	TX3-N63	806801M		Ext. 1/4"	1/4" x 3/8"
5.6	TX3-N64	806802M		Ext. 1/4"	3/8" x 1/2"
8.4	TX3-N65	806803M		Ext. 1/4"	3/8" x 1/2"
11.6	TX3-N66	806804M		Ext. 1/4"	3/8" x 1/2"
14.2	TX3-N67	806805M		Ext. 1/4"	1/2" x 5/8"
16.9	TX3-N68	806806M		Ext. 1/4"	1/2" x 5/8"
23.0	TX3-N69	806807M		Ext. 1/4"	1/2" x 5/8"

Nominal capacity (Qn) is based on the following conditions:

Refrigerant	Evaporating temperature	Condensing temperature	Subcooling
R407C	+4°C dew point	+38°C bubble p. +43°C dew point	1K
others	+4°C	+38°C	1K

Valve selection for other operating conditions see page 180 or use the Excel based Alco® Selection Tool (download from [www.emersonclimate.eu](http://www.emersonclimate.eu)).

## Thermo®-Expansion Valve Series TX6 Hermetic Design

### Features

- Balanced port design for constant superheat operation over a wide application range under variation of condensing pressure
- Hermetic monobloc design with solder connections for minimal leakage
- Large diaphragm eliminates disturbances to the valve and provides smoother and consistent valve control
- Tailored charges for different applications
- External equalizer
- External superheat adjustment
- PS: TX6-H/N/M/Sxx : 31bar. TX6-Zxx: 42bar
- TS: -45 ... +65°C
- No CE marking according art. 3.3 PED 97/23 EC



TX6

### Standard-MOP

Refrigerant	MOP			Evaporating temperature range
	Code	(bar)	°C	
R134a	M1	3.8	+14	-45 ... +10°C
R22	H1	6.9	+15	-45 ... +12°C
R407C	N1	6.9	+17	-45 ... +14°C
R410A	Z1	12.1	+16	-45 ... +15°C

Note: All temperatures are saturated/dew point. Pressures are given in gauge pressure.

### Selection Charts

#### R134a

Nominal Capacity Q <sub>n</sub> kW	less MOP		with Standard-MOP		Connection straight through Solder/ODF
	Type	Part No.	Type	Part No.	
10.3	TX6 - M02	801 543	TX6 - M12	801 547	12 mm x 16 mm
10.3	TX6 - M02	801 541	TX6 - M12	801 545	1/2" x 5/8"
18.4	TX6 - M03	801 544	TX6 - M13	801 548	12 mm x 16 mm
18.4	TX6 - M03	801 542	TX6 - M13	801 546	1/2" x 5/8"
25.6	TX6 - M04	801 569	TX6 - M14	801 577	16 mm x 22 mm
25.6	TX6 - M04	801 565	TX6 - M14	801 573	5/8" x 7/8"
32.5	TX6 - M05	801 570	TX6 - M15	801 578	16 mm x 22 mm
32.5	TX6 - M05	801 566	TX6 - M15	801 574	5/8" x 7/8"
48.1	TX6 - M06	801 571	TX6 - M16	801 579	22 mm x 28 mm
48.1	TX6 - M06	801 567	TX6 - M16	801 575	7/8" x 1-1/8"
62.8	TX6 - M07	801 572	TX6 - M17	801 580	22 mm x 28 mm
62.8	TX6 - M07	801 568	TX6 - M17	801 576	7/8" x 1-1/8"

Nominal capacity (Q<sub>n</sub>) is based on the following conditions:

Refrigerant	Evaporating temperature	Condensing temperature	Subcooling
R407C	+4°C dew point	+38°C bubble p. +43°C dew point	1K
R22, R134a, R410A	+4°C	+38°C	1K

Valve selection for other operating conditions see page 180 or use the Excel based Alco® Selection Tool (download from [www.emersonclimate.eu](http://www.emersonclimate.eu)).

#### R134a

Nominal Capacity Q KW	less MOP		with Standard-MOP		Connection straight through Solder/ODF
	Type	Part No.	Type	Part No.	
14.4	TX6 - N02	801 651	TX6 - N12	801 655	12 mm x 16 mm
14.4	TX6 - N02	801 653	TX6 - N12	801 534	1/2" x 5/8"
25.6	TX6 - N03	801 652	TX6 - N13	801 656	12 mm x 16 mm
25.6	TX6 - N03	801 654	TX6 - N13	801 535	1/2" x 5/8"
35.7	TX6 - N04	801 659	TX6 - N14	801 667	16 mm x 22 mm
35.7	TX6 - N04	801 663	TX6 - N14	801 536	5/8" x 7/8
45.2	TX6 - N05	801 660	TX6 - N15	801 668	16 mm x 22 mm
45.2	TX6 - N05	801 664	TX6 - N15	801 537	5/8" x 7/8
66.9	TX6 - N06	801 661	TX6 - N16	801 669	22 mm x 28 mm
66.9	TX6 - N06	801 665	TX6 - N16	801 538	7/8" x 1-1/8"
87.3	TX6 - N07	801 662	TX6 - N17	801 670	22 mm x 28 mm
87.3	TX6 - N07	801 666	TX6 - N17	801 539	7/8" x 1-1/8"

#### R22

Nominal Capacity Q KW	less MOP		with Standard-MOP		Connection straight through Solder/ODF
	Type	Part No.	Type	Part No.	
13.3	TX6 - H02	801 551	TX6 - H12	801 555	12 mm x 16 mm
13.3	TX6 - H02	801 549	TX6 - H12	801 553	1/2" x 5/8"
23.7	TX6 - H03	801 552	TX6 - H13	801 556	12 mm x 16 mm
23.7	TX6 - H03	801 550	TX6 - H13	801 554	1/2" x 5/8"
33.0	TX6 - H04	801 585	TX6 - H14	801 593	16 mm x 22 mm
33.0	TX6 - H04	801 581	TX6 - H14	801 589	5/8" x 7/8
41.8	TX6 - H05	801 586	TX6 - H15	801 594	16 mm x 22 mm
41.8	TX6 - H05	801 582	TX6 - H15	801 590	5/8" x 7/8
61.9	TX6 - H06	801 587	TX6 - H16	801 595	22 mm x 28 mm
61.9	TX6 - H06	801 583	TX6 - H16	801 591	7/8" x 1-1/8"
80.8	TX6 - H07	801 588	TX6 - H17	801 596	22 mm x 28 mm
80.8	TX6 - H07	801 584	TX6 - H17	801 592	7/8" x 1-1/8"

#### R410A

Nominal Capacity Q KW	less MOP		with Standard-MOP		Connection straight through Solder/ODF
	Type	Part No.	Type	Part No.	
16.0	-	-	TX6 - Z12	801 510	12 mm x 16 mm
16.0	-	-	TX6 - Z12	801 511	1/2" x 5/8"
28.0	-	-	TX6 - Z13	801 512	12 mm x 16 mm
28.0	-	-	TX6 - Z13	801 513	1/2" x 5/8"
40.0	-	-	TX6 - Z14	801 514	16 mm x 22 mm
40.0	-	-	TX6 - Z14	801 515	5/8" x 7/8
50.0	-	-	TX6 - Z15	801 516	16 mm x 22 mm
50.0	-	-	TX6 - Z15	801 517	5/8" x 7/8
74.0	-	-	TX6 - Z16	801 518	22 mm x 28 mm
74.0	-	-	TX6 - Z16	801 519	7/8" x 1-1/8"
97.0	-	-	TX6 - Z17	801 520	22 mm x 28 mm
97.0	-	-	TX6 - Z17	801 521	7/8" x 1-1/8"

Nominal capacity (Q<sub>n</sub>) is based on the following conditions:

Refrigerant	Evaporating temperature	Condensing temperature	Subcooling
R407C	+4°C dew point	+38°C bubble p. +43°C dew point	1K
R22, R134a, R410A	+4°C	+38°C	1K

Valve selection for other operating conditions see page 180 or use the Excel based Alco® Selection Tool (download from [www.emersonclimate.eu](http://www.emersonclimate.eu)).

# Thermo®-Expansion Valve Series T

Exchangeable Power Assemblies and Orifices

## Features

- Modular design for economical logistics and easy assembly and servicing
- Very good stability is attained because of the large forces generated by the large diaphragm diameter
- High quality materials and processes for high reliability and long lifetime
- Superior partial load performance due to double seat orifice design (TJRE, TERE, TIRE & THRE)
- Biflow capability for applications in heat pumps
- Capillary tube length 1.5 m (TCLE, TJRE) and 3m (TERE, TIRE & THRE)
- PS: 31 bar. TS: -45 ... +65°C
- No CE marking according art. 3.3 PED 97/23 EC

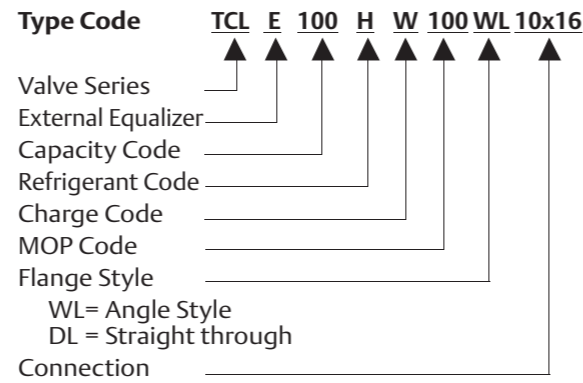

## Available upon special request:

- Power assembly with solder connection for external pressure equalization
- Non-standard MOPs
- Non-standard charges
- Non-standard connection sizes. see page 192

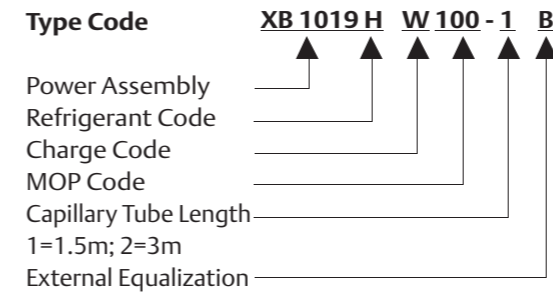

## Selection Chart for Orifices

Series	R134a		R22		R404A/R507		R407C		Orifice	Orifice	Connection Standard-Flange. Angle (see page 192)		Power Assembly
	Type	Nominal Capacity kW	Type	Nominal Capacity kW	Type	Nominal Capacity kW	Type	Nominal Capacity kW			mm	Solder/ODF	
TCLE	25 MW	1.5	50HW	1.9	25 SW	1.3	50 NW	2.1	X 22440-B1B	X 22440-B1B X 22440-B2B X 22440-B3B X 22440-B3.5B X 22440-B4B X 22440-B5B X 22440-B6B X 22440-B7B X 22440-B8B	C 501 - 5 mm 10 x 16	C 501 - 5 3/8 x 5/8	XB1019...1B
	75 MW	2.9	100 HW	3.7	75 SW	2.6	100 NW	4.0					
	150 MW	6.1	200 HW	7.9	150 SW	5.6	200 NW	8.5					
	200 MW	9.3	250 HW	11.9	200 SW	8.4	300 NW	12.9					
	250 MW	13.5	300 HW	17.3	250 SW	12.2	400 NW	18.7	X 22440-B4B		C 501 - 7 mm 12 x 16	C 501 - 7 1/2 x 5/8	
	350 MW	17.3	500 HW	22.2	400 SW	15.7	550 NW	24.0	X 22440-B5B				
	550 MW	23.6	750 HW	30.4	600 SW	21.5	750 NW	32.9	X 22440-B6B		A 576 mm 16 x 22 (22 x 28 ODM)	A 576 5/8 x 7/8 (7/8 x 1 1/8 ODM)	
	750 MW	32.0	1000 HW	41.1	850 SW	29.0	1000 NW	44.4	X 22440-B7B				
900 MW	37.2	1200 HW	47.8	1000 SW	33.8	1150 NW	51.7	X 22440-B8B	10331 22 x 22	10331 7/8 x 7/8 (1 1/8 x 1 1/8 ODM)			
TJRE	11 MW	45	14 HW	58	12 SW	40	14 NW	62			X 11873-B4B	X 11873-B4B X 11873-B5B	
TERE	13 MW	57	18 HW	74	14 SW	51	17 NW	80	X 11873-B5B	X 9117-B6B X 9117-B7B X 9117-B8B X 9117-B9B	9153 mm 22 x 22		9153 7/8 x 7/8 (1 1/8 x 1 1/8 ODM)
	16 MW	71	22 HW	91	18 SW	63	21 NW	99	X 9117-B6B				
	19 MW	81	26 HW	104	20 SW	72	25 NW	112	X 9117-B7B				
	25 MW	112	35 HW	143	27 SW	99	33 NW	155	X 9117-B8B				
TIRE	31 MW	135	45 HW	174	34 SW	120	42 NW	188	X 9117-B9B	X 9166-B10B	9149 22 x 22	9149 7/8 x 7/8 (1 1/8 x 1 1/8 ODM)	
	45 MW	174	55 HW	223	47 SW	154	52 NW	241	X 9166-B10B				
THRE	55 MW	197	75 HW	253	61 SW	174	71 NW	273	X 9144-B11B	X 9144-B11B X 9144-B13B	9149 22 x 22	9149 7/8 x 7/8 (1 1/8 x 1 1/8 ODM)	
	68 MW	236	100 HW	302	77 SW	209	94 NW	327	X 9144-B13B				

## Selection Chart for Power Assemblies and Recommended Flanges

MOP		Evaporating Temperature Range °C				
Code	bar	R134a MW	R22 HW	R404A SW	R407C NW	R507 SW
35	2.4	-45 .. 0	-45 .. -15			
40	2.8			-45 .. -18		-45 .. -18
55	3.8	-45 .. 11		-45 .. -10		-45 .. -10
65	4.5		-45 .. 0			
75	5.2			-45 .. -2		-45 .. -2
80	5.5			-45 .. 0		-45 .. 0
100	6.9				-45 .. 14	

Nominal capacity (Qn) is based on the following conditions:

Refrigerant	Evaporating temperature	Condensing temperature	Subcooling
R407C	+4°C dew point	+38°C bubble p. +43°C dew point	1K
R22, R134a, R410A	+4°C	+38°C	1K

Valve selection for other operating conditions see page 180 or use the Excel based Alco® Selection Tool (download from [www.emersonclimate.eu](http://www.emersonclimate.eu)).

## Spare Parts

	Type	Part No.
Gasket Set for T Series Valves	X 13455 -1	027 579
Service Tool for T Series	X 99999	800 005
Steel screws for following flange types: C501, 9761, 6346, A576 9148, 9149, 9152, 9153, 10331, 10332	Screw ST 32 Screw ST 48	803 573 803 574





## Thermo®-Expansion Valve Series ZZ

for Low Evaporating Temperatures between -45 and -120°C

### Features

- Modular design for economical logistics and easy assembly and servicing
- Very good stability is attained because of the large forces generated by the large diaphragm diameter
- High quality materials and processes for high reliability and long lifetime
- Capillary tube length 3 m
- PS: 31 bar. TS: -120 ... +65°C
- No CE marking according art. 3.3 PED 97/23 EC



ZZCE

### Type Code

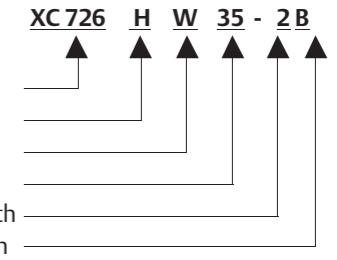
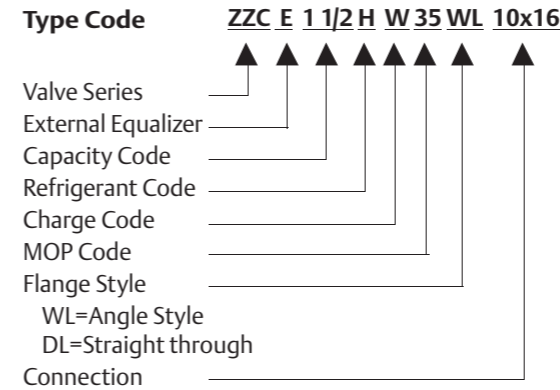

### Available upon special request:

- Power assembly with solder connection for external pressure equalization
- Non-standard MOPs
- Non-standard charges
- Non-standard connection sizes (Selection see page 192)

Liquid Temperature entering Valve °C	R407C				Correction Factor kt Evaporating Temperature (°C)														
	+30	+25	+20	+15	+10	+5	0	-5	-10	-15	-20	-25							
+55	1.20	1.21	1.23	1.26	1.28	1.31	1.34	1.37	1.40	1.63	1.98	2.42							
+50	1.10	1.11	1.13	1.15	1.17	1.19	1.22	1.24	1.27	1.48	1.79	2.18							
+45	1.02	1.03	1.05	1.06	1.08	1.10	1.12	1.14	1.17	1.35	1.64	2.00							
+40	0.95	0.96	0.98	0.99	1.01	1.02	1.04	1.06	1.08	1.25	1.52	1.84							
+35	0.89	0.90	0.92	0.93	0.94	0.96	0.98	0.99	1.01	1.17	1.41	1.71							
+30	0.85	0.85	0.87	0.88	0.89	0.90	0.92	0.93	0.95	1.10	1.32	1.60							
+25		0.81	0.82	0.83	0.84	0.85	0.87	0.88	0.90	1.03	1.25	1.51							
+20			0.78	0.79	0.80	0.81	0.82	0.84	0.85	0.98	1.18	1.43							
+15				0.75	0.76	0.77	0.78	0.80	0.81	0.93	1.12	1.35							
+10					0.73	0.74	0.75	0.76	0.77	0.89	1.07	1.29							
+5						0.71	0.72	0.73	0.74	0.85	1.02	1.23							
0							0.69	0.70	0.71	0.81	0.98	1.18							
-5								0.67	0.68	0.78	0.94	1.13							
-10									0.65	0.75	0.90	1.08							
Correction Factor kΔp																			
Δp (bar)	0.5	1.0	1.5	2.0	2.5	3.0	3.5	4.0	4.5	5.0	5.5	6.0	6.5	7.0	8.0	9.0			
KΔp	4.78	3.33	2.72	2.36	2.11	1.92	1.78	1.67	1.57	1.49	1.42	1.36	1.31	1.26	1.18	1.11			
Δp (bar)	10.0	11.0	12.0	13.0	14.0	15.0	16.0	17.0	18.0	19.0	20.0	21.0	22.0	23.0	24.0	25.0			
KΔp	1.05	1.01	0.96	0.92	0.89	0.86	0.83	0.81	0.79	0.76	0.75	0.73	0.71	0.70	0.68	0.67			

Liquid Temperature entering Valve °C	R507				Correction Factor kt Evaporating Temperature (°C)														
	+30	+25	+20	+15	+10	+5	0	-5	-10	-15	-20	-25	-30	-35	-40	-45			
+60	1.54	1.57	1.61	1.65	1.71	1.76	1.83	1.90	1.98	2.36	2.84	3.44	4.23	5.25	6.61	8.45			
+55	1.30	1.33	1.36	1.39	1.43	1.47	1.52	1.57	1.62	1.92	2.29	2.75	3.35	4.11	5.11	6.44			
+50	1.15	1.17	1.19	1.22	1.24	1.28	1.31	1.35	1.40	1.64	1.95	2.33	2.81	3.43	4.23	5.29			
+45	1.03	1.05	1.07	1.09	1.11	1.14	1.17	1.20	1.23	1.45	1.71	2.04	2.45	2.97	3.64	4.53			
+40	0.94	0.96	0.97	0.99	1.01	1.03	1.06	1.08	1.11	1.30	1.53	1.82	2.18	2.63	3.22	3.98			
+35	0.87	0.88	0.90	0.91	0.93	0.95	0.97	0.99	1.01	1.18	1.39	1.65	1.97	2.37	2.89	3.56			
+30	0.81	0.82	0.83	0.85	0.86	0.88	0.89	0.91	0.93	1.09	1.28	1.51	1.80	2.17	2.63	3.23			
+25		0.77	0.78	0.79	0.80	0.82	0.83	0.85	0.87	1.01	1.18	1.40	1.66	1.99	2.42	2.97			
+20			0.73	0.74	0.75	0.77	0.78	0.79	0.81	0.94	1.10	1.30	1.54	1.85	2.24	2.74			
+15				0.70	0.71	0.72	0.73	0.75	0.76	0.88	1.03	1.21	1.44	1.73	2.09	2.55			
+10					0.67	0.68	0.69	0.70	0.72	0.83	0.97	1.14	1.35	1.62	1.95	2.38			
+5						0.64	0.65	0.67	0.68	0.78	0.92	1.07	1.27	1.52	1.83	2.23			
0							0.62	0.63	0.64	0.74	0.87	1.02	1.20	1.43	1.73	2.10			
-5								0.60	0.61	0.70	0.82	0.96	1.14	1.35	1.63	1.98			
-10									0.58	0.67	0.78	0.91	1.08	1.28	1.54	1.87			
Correction Factor kΔp																			
Δp (bar)	0.5	1.0	1.5	2.0	2.5	3.0	3.5	4.0	4.5	5.0	5.5	6.0	6.5	7.0	8.0	9.0			
KΔp	4.63	3.27	2.67	2.31	2.07	1.89	1.75	1.64	1.54	1.46	1.40	1.34	1.28	1.24	1.16	1.09			
Δp (bar)	10.0	11.0	12.0	13.0	14.0	15.0	16.0	17.0	18.0	19.0	20.0	21.0	22.0	23.0	24.0	25.0			
KΔp	1.03	0.99	0.94	0.91	0.87	0.85	0.82	0.79	0.77	0.75	0.73	0.71	0.70	0.68	0.67	0.65			

In cases of subcooling of more than 15K please use additionally the correction factors on page 164 of this brochure.

Series	R22		R23		R404A / R507		Orifice	Connection Standard-Flange, Angle Solder/ODF		Power Assembly
	Type	Nominal Capacity kW	Type	Nominal Capacity kW	Type	Nominal Capacity kW		mm	inch	
ZZCE	3/4 HW	1.8	2 BG	1.9	2/4 SW	1.2	X 10-B01	C501 - 5mm 10 X 16	C501 - 5 3/8" X 5/8"	XC726 ... 2B
	1 1/2 HW	3.8	6 BG	4.0	1 1/2 SW	2.6	X 10-B02			
	2 1/2 HW	6.4	8 BG	6.8	2 1/2 SW	4.4	X 10-B03			
	4 HW	10.2	12 BG	10.8	3 1/2 SW	7.0	X 10-B04	C501 - 7mm 12 X 16	C501 - 7 1/2" X 5/8"	
	6 HW	15.4	17 BG	16.3	5 SW	10.6	X 10-B05			
	8 HW	20.5	25 BG	21.7	8 SW	14.1	X 10-B06	A 576mm 16 X 22 (22 X 28 ODM)	A 576 5/8" X 7/8" (7/8" X 1 1/8" ODM)	
10 HW	25.6	31 BG	27.1	9 SW	17.6	X 10-B07				

Attention: To withstand stress at extremely low temperatures, thermo expansion valves series ZZ feature bronze bolts.

MOP Code	MOP		Evaporating Temperature Range °C		
	bar	Tmax	R22	R23	R404A/R507
20	1.4	-66°C		-100 ... -71	
35	2.4	-11°C	-70 ... -15		
40	2.8	-14°C			-75 ... -18
55	3.8	-7°C			-75 ... -10
60	4.1	-48°C		-100 ... -51	
125	8.6	-32°C		-100 ... -35	

Nominal capacity (Qn) is based on the following conditions:

Refrigerant	Evaporating temperature	Condensing temperature	Subcooling
R22, R23, R404A, R507	+4°C	+38°C	1K

Valve selection at other operating conditions see page 184

**Spare Parts**

	Type	Part No.
Gasket Set for T Series Valves	X 13455 -1	027 579
Service Tool for T Series	X 99999	800 005
Steel screws for following flange types: C501, 9761, 6346, A576 9148, 9149, 9152, 9153, 10331, 10332	Screw ST 32 Screw ST 48	803 575 803 576

**Correction Tables for Series ZZ**

Valve selection for operating conditions other than specified on page 183:

$$Q_n = Q_o \times K_t \times K_{\Delta p}$$

- Q<sub>n</sub>: Nominal valve capacity
- Q<sub>o</sub>: Required cooling capacity
- K<sub>t</sub>: Correction factor for evaporating and liquid temperature
- K<sub>Δp</sub>: Correction factor for pressure drop at valve

Liquid Temperature entering Valve °C	R22		Correction Factor kt Evaporating Temperature (°C)									
	-45	-50	-55	-60	-65	-70						
+10	1.02	1.21	1.42	1.66	1.97	2.30						
0	0.94	1.12	1.30	1.53	1.75	2.02						
-10	0.88	1.04	1.21	1.42	1.61	1.83						
-20	0.82	0.98	1.13	1.32	1.50	1.71						
-30	0.77	0.92	1.05	1.23	1.39	1.56						
-40		0.86	1.00	1.15	1.30	1.47						
-50				1.09	1.25	1.42						
Correction Factor kΔp												
Δp (bar)	0.5	1.0	1.5	2.0	2.5	3.0	3.5	4.0	4.5	5.0	6.0	7.0
KΔp	4.40	3.10	2.50	2.20	2.00	1.80	1.70	1.60	1.50	1.40	1.30	1.20
Δp (bar)	8.0	9.0	10.0	11.0	12.0	13.0	14.0	15.0	16.0	17.0	18.0	19.0
KΔp	1.10	1.04	0.98	0.94	0.90	0.87	0.83	0.81	0.78	0.76	0.74	0.72

Liquid Temperature entering Valve °C	R23				Correction Factor kt Evaporating Temperature (°C)							
	-45	-50	-55	-60	-65	-70	-75	-80	-85	-90	-95	-100
-10	1.18	1.18	1.19	1.21	1.28	1.48	1.86	2.21	2.73	3.36	4.15	5.06
-15	1.11	1.11	1.12	1.13	1.20	1.39	1.74	2.07	2.56	3.14	3.88	4.72
-20	1.04	1.05	1.06	1.07	1.13	1.31	1.64	1.95	2.41	2.95	3.64	4.43
-25	0.99	0.99	1.00	1.01	1.07	1.24	1.55	1.84	2.27	2.78	3.43	4.17
-30	0.94	0.94	0.95	0.96	1.02	1.17	1.47	1.75	2.15	2.63	3.24	3.94
-35	0.89	0.90	0.91	0.91	0.97	1.12	1.40	1.66	2.04	2.50	3.08	3.74
-40	0.85	0.86	0.86	0.87	0.92	1.06	1.33	1.58	1.94	2.38	2.92	3.55
-45		0.82	0.83	0.83	0.88	1.02	1.27	1.51	1.85	2.27	2.79	3.38
-50			0.79	0.80	0.84	0.97	1.22	1.44	1.77	2.17	2.86	3.23
-55				0.76	0.81	0.93	1.17	1.38	1.70	2.07	2.55	3.09
-60					0.78	0.90	1.12	1.33	1.63	1.99	2.44	2.96
-65						0.86	1.08	1.27	1.57	1.91	2.35	2.84
-70							1.04	1.23	1.51	1.84	2.26	2.73
-75								1.18	1.45	1.77	2.18	2.63
-80									1.40	1.71	2.10	2.54
Correction Factor kΔp												
Δp (bar)	0.5	1.0	1.5	2.0	2.5	3.0	3.5	4.0	4.5	5.0	6.0	7.0
KΔp	4.20	2.97	2.43	2.10	1.88	1.72	1.59	1.49	1.40	1.33	1.21	1.12
Δp (bar)	8.0	9.0	10.0	11.0	12.0	13.0	14.0	15.0	16.0	17.0	18.0	19.0
KΔp	1.05	0.99	0.94	0.90	0.86	0.82	0.79	0.77	0.74	0.72	0.70	0.68

Liquid Temperature entering Valve °C	R404A				Correction Factor kt Evaporating Temperature (°C)							
	-40	-45	-50	-55	-60	-65	-70	-75				
+40	1.40	1.76	2.21	2.77	3.56	4.30	4.87	5.61				
+35	1.24	1.55	1.94	2.42	3.09	3.71	4.17	4.77				
+30	1.12	1.39	1.73	2.15	2.74	3.27	3.66	4.17				
+25	1.02	1.26	1.57	1.94	2.46	2.93	3.27	3.70				
+20	0.94	1.16	1.44	1.77	2.24	2.66	2.96	3.34				
+15	0.87	1.07	1.33	1.63	2.06	2.44	2.71	3.05				
+10	0.81	1.00	1.23	1.52	1.91	2.26	2.49	2.80				
+5	0.76	0.94	1.15	1.42	1.78	2.10	2.32	2.60				
0	0.71	0.88	1.08	1.33	1.67	1.97	2.17	2.43				
-5	0.68	0.83	1.02	1.25	1.57	1.85	2.04	2.28				
-10	0.64	0.79	0.97	1.19	1.49	1.75	1.92	2.14				
-15	0.61	0.75	0.92	1.13	1.41	1.66	1.82	2.03				
-20	0.58	0.72	0.88	1.07	1.34	1.57	1.73	1.92				
-25	0.56	0.69	0.84	1.03	1.28	1.50	1.65	1.83				
-30	0.54	0.66	0.80	0.98	1.22	1.43	1.57	1.75				
-35	0.51	0.63	0.77	0.94	1.17	1.36	1.49	1.66				
-40		0.60	0.74	0.90	1.12	1.31	1.43	1.59				
-45			0.71	0.86	1.07	1.25	1.37	1.52				
-50				0.83	1.03	1.21	1.32	1.46				
Correction Factor kΔp												
Δp (bar)	0.5	1.0	1.5	2.0	2.5	3.0	3.5	4.0	4.5	5.0	6.0	7.0
KΔp	4.73	3.34	2.73	2.36	2.11	1.93	1.79	1.67	1.58	1.50	1.37	1.26
Δp (bar)	8.0	9.0	10.0	11.0	12.0	13.0	14.0	15.0	16.0	17.0	18.0	19.0
KΔp	1.18	1.11	1.06	1.01	0.97	0.93	0.89	0.86	0.84	0.80	0.79	0.77

For the proper sizing of thermo expansion valves in cases of subcooling of more than 15K please use additionally the correction factors on page 164 of this brochure.

Liquid Temperature entering Valve °C	R507		Correction Factor kt Evaporating Temperature (°C)									
	-45	-50	-55	-60	-65	-70						
+30	1.26	1.67	2.10	2.68	3.48	4.58						
+20	1.07	1.41	1.77	2.25	2.89	3.78						
+10	0.94	1.22	1.52	1.92	2.46	3.23						
0	0.83	1.08	1.33	1.68	2.16	2.82						
-10	0.75	0.95	1.19	1.49	1.92	2.48						
-20	0.67	0.86	1.07	1.34	1.70	2.20						
-30	0.61	0.78	0.96	1.21	1.54	2.00						
-40	0.55	0.71	0.86	1.08	1.38	1.79						
-50			0.79	0.99	1.24	1.62						
Correction Factor kΔp												
Δp (bar)	0.5	1.0	1.5	2.0	2.5	3.0	3.5	4.0	4.5	5.0	6.0	7.0
KΔp	4.77	3.37	2.75	2.38	2.13	1.95	1.80	1.69	1.59	1.51	1.38	1.27
Δp (bar)	8.0	9.0	10.0	11.0	12.0	13.0	14.0	15.0	16.0	17.0	18.0	19.0
KΔp	1.19	1.12	1.07	1.02	0.97	0.94	0.90	0.87	0.84	0.82	0.79	0.77

For the proper sizing of thermo expansion valves in cases of subcooling of more than 15K please use additionally the correction factors on page 164 of this brochure.

# Liquid Injection Valve Series L

## Exchangeable Power Assemblies and Orifices

### Features

- Applications for Series L valves include superheat control (de-superheating of suction gas i.e. in hotgas bypass systems and interstage cooling in multiple stage compressors)
- Modular design for economical logistics and easy assembly and servicing
- Very good stability is attained because of the large forces generated by the large diaphragm diameter
- High quality materials and processes for high reliability and long lifetime
- Superior partial load performance due to seat orifice design (LJRE, LERE & LIRE)
- Capillary tube length 3 m
- PS: 31 bar. TS: -45 ... +65°C
- No CE marking according art. 3.3 PED 97/23 EC

### Type Code

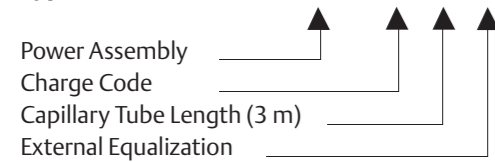

LJRE

### Type Code

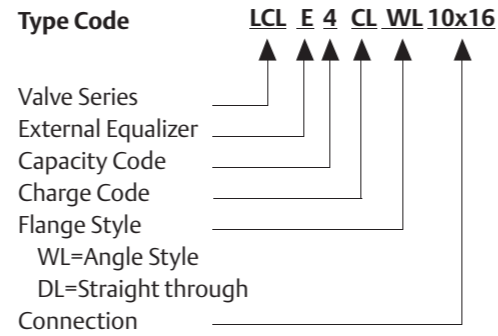

Series	Nominal Capacity Q <sub>n</sub> kW	Orifice					Connections Standard Flange. Angle Solder/ODF		Power Assembly
		R134a	R22	R404A	R407C	R507	mm	inch	
LJRE	1 *	1.5	1.9	1.3	2.1	1.3	X 22440-B1B	C 501 – 5 mm 10 x 16	XB1019...2B
	2 *	2.9	3.7	2.6	4.0	2.6	X 22440-B2B		
	3 *	6.1	7.9	5.6	8.5	5.6	X 22440-B3B		
	3.5 *	9.3	11.9	8.4	12.9	8.4	X 22440-B3.5B		
	4 *	13.5	17.3	12.2	18.7	12.2	X 22440-B4B		
	6 *	17.3	22.2	15.7	24.0	15.7	X 22440-B5B		
	7 *	23.6	30.4	21.5	32.9	21.5	X 22440-B6B		
	9 *	32.0	41.1	29.0	44.4	29.0	X 22440-B7B		
LJRE	11 *	45	58	40	62	40	X 11873-B4B	10331 22 x 22	10331 7/8 x 7/8 (1 1/8 x 1 1/8 ODM)
	12 *	57	74	51	80	51	X 11873-B5B		
LERE	13 *	71	91	63	99	63	X 9117-B6B	9153 mm 22 x 22	9153 7/8 x 7/8 (1 1/8 x 1 1/8 ODM)
	14 *	81	104	72	112	72	X 9117-B7B		
	15 *	112	143	99	155	99	X 9117-B8B		
	16 *	135	174	120	188	120	X 9117-B9B		
LIRE	17 *	174	223	154	241	154	X 9166-B10B		

### Superheat selection

* Charge Code	Refrigerant				
	R134a	R22	R404A	R407C	R507
CL	-	15 K	22 K	13 K	22 K
GL	15 K	30 K	35 K	25 K	35 K
UL	30 K	45 K		40 K	

\* Please indicate designation character for desired superheat

Nominal capacity (Q<sub>n</sub>) is based on the following conditions:

Refrigerant	Evaporating temperature	Condensing temperature	Sub-cooling
R407C	+4°C dew point	+38°C bubble p. +43°C dew point	1K
R22, R134a, R404A, R507	+4°C	+38°C	1K

Valve selection for other operating conditions see page 180

### Available upon special request

- Power assembly with solder connection for external pressure equalization
- Non-standard connection sizes see page 192

### Spare Parts

	Type	Part No.
Gasket Set for L Series Valves	X 13455 -1	027 579
Service Tool for L Series	X 99999	800 005
Steel screws for following flange types: C501, 9761, 6346, A576 9148, 9149, 9152, 9153, 10331, 10332	Screw ST 32 Screw ST 48	803 573 803 574

### Correction Tables for Series L

#### Valve selection for desuperheating of suction gas:

The required desuperheating capacity Q<sub>des</sub> has to be multiplied with the correction factors on page 180.

$$Q_{des} \times K_t \times K_{\Delta p} = Q_n$$

- Q<sub>des</sub>: Required desuperheating capacity  
K<sub>t</sub>: Correction factor for evaporating and liquid temperature  
K<sub>Δp</sub>: Correction factor for pressure drop at valve  
Q<sub>n</sub>: Nominal valve capacity

#### Valve selection for desuperheating of suction gas in conjunction with hotgas-bypass regulation:

The required bypass capacity Q<sub>byp</sub> has to be multiplied with correction factor K<sub>ti</sub> per table below.

$$Q_{byp} \times K_{ti} = Q_n$$

- Q<sub>byp</sub>: Required bypass capacity  
K<sub>ti</sub>: Correction factor for evaporating temperature  
Q<sub>n</sub>: Nominal valve capacity

Condensing Temperature Bubble point °C	Refrigerant	Correction Factor k <sub>t</sub> Evaporating Temperature (°C)							
		+10	+5	0	-10	-20	-30	-40	-50
+50 (R407C: + 54 dew point)	R22	0.33	0.36	0.40	0.47	0.56	0.66	0.78	0.93
	R407C	0.41	0.45	0.49	0.58	0.69			
	R134a	0.38	0.42	0.44	0.54	0.64			
	R507/R404A	0.50	0.54	0.59	0.70	0.83	0.98	1.18	1.38
+40 (R407C: + 45 dew point)	R22	0.26	0.29	0.32	0.38	0.46	0.55	0.66	0.78
	R407C	0.32	0.35	0.39	0.46	0.55			
	R134a	0.31	0.33	0.36	0.44	0.52			
	R507/R404A	0.38	0.42	0.45	0.54	0.64	0.76	0.90	1.08
+30 (R407C: + 35 dew point)	R22	0.20	0.22	0.25	0.31	0.38	0.46	0.55	0.66
	R407C	0.25	0.28	0.31	0.37	0.45			
	R134a	0.24	0.26	0.29	0.35	0.43			
	R507/R404A	0.29	0.32	0.35	0.42	0.51	0.60	0.72	0.86
+20 (R407C: + 26 dew point)	R22	0.15	0.17	0.19	0.25	0.31	0.38	0.46	0.56
	R407C	0.19	0.21	0.24	0.30	0.37			
	R134a	0.18	0.20	0.22	0.28	0.35			
	R507/R404A	0.22	0.25	0.27	0.33	0.40	0.48	0.58	0.70

Correction factors based on 20K superheat suction gas at the inlet of compressor, discharge temperature 28K above isentropic compression and 1K subcooling.



# Liquid Injection Valves Series 935

## Exchangeable Power Assemblies and Orifices

### Applications

- Series 935 valves are applied as temperature controls.
- Applications include:
  - Desuperheating of discharge gas on compressors. In this case bulbs are mounted on the high pressure outlet of the compressor
  - Control of compressor oil temperatures
- Series 935 valves shall not be used to control superheat



935

### Features

- Modular design for economical logistics and easy assembly and servicing
- Very good stability because of the large forces generated by the large diaphragm diameter
- High quality materials and processes for high reliability and long lifetime
- Combinations of different charges with various orifice springs cover a very large application range
- PS: 31 bar. TS: -45 ... +65°C
- No CE marking according art. 3.3 PED 97/23 EC
- Non-standard connection sizes see page 192

### Type Code

Valve Series  
 Temperature Code  
 Capacity Code  
 Flange Style  
 WL=Angle Style  
 DL=Straight through  
 Connection Size

935 - 7 - B WL 10x16

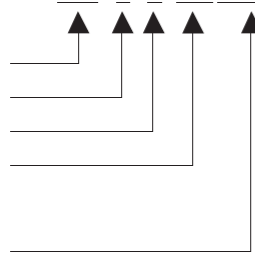

### Type Code

Power Assembly  
 Charge Code  
 Capillary Tube Length (3m)

XB1019 YL -2A

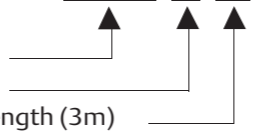

Series	Nominal Capacity Q <sub>n</sub> kW					Orifice	Standard Flange. Angle Solder/ODF		Power Assembly
	R134a	R22	R404A	R407C	R507		mm	inch	
935-*	A	4.0	5.2	3.8	5.6	3.8	X10-*01	C 501 - 5 mm 10 x 16	XB1019- * - 2A
	B	7.8	10.1	7.4	10.9	7.4	X10-*02		
	C	11.1	14.2	10.3	15.4	10.3	X10-*03		
	D	16.3	21.1	15.6	22.8	15.6	X10-*04	C 501 - 7 mm 12 x 16	
	E	22.5	28.9	21.0	31.2	21.0	X10-*05	C 501 - 7 1/2 x 5/8	
	G	32.0	41.2	29.9	44.5	29.9	X10-*06	A 576 mm 16 x 22 (22 x 28 ODM)	
	X	46.6	60.0	43.5	64.9	43.5	X10-*07	A 576 5/8 x 7/8 (7/8 x 1-1/8 ODM)	

* = Temperature Code	Temperature Range °C	* = Spring Code	* = Charge Code
3	-1 / +17	B	UL
6	+14 / +38	C	KL
7	+36 / +50	A	YL
105	+44 / +70	C	YL
106	+66 / +94	C	JL
100	+94 / +121	C	LL

Nominal capacity (Q<sub>n</sub>) is based on the following conditions:

Refrigerant	Evaporating temperature	Condensing temperature	Subcooling
R407C	+4°C dew point	+38°C bubble p. +43°C dew point	1K
R22, R134a, R404A, R507	+4°C	+38°C	1K

Valve selection for other operating conditions see page 189.

### Spare Parts

Description	Type	Part No.
Gasket Set for 935 Series Valves	X 13455 -1	027 579
Service Tool for 935 Series	X 99999	800 005
Steel screws for following flange types: C501, 9761, 6346, A576	Screw ST 32	803 573

### Correction Tables for Series 935

Valve selection for operating conditions other than nominal conditions:

$$Q_n = Q_o \times K_t \times K_p$$

Q<sub>n</sub>: Nominal valve capacity  
 Q<sub>o</sub>: Required cooling or desuperheating capacity  
 K<sub>t</sub>: Correction factor for evaporating and liquid temperature  
 K<sub>p</sub>: Correction factor for pressure drop at valve

Liquid Temperature entering Valve °C	R134a					Correction Factor k <sub>t</sub> Evaporating Temperature (°C)										
	+30	+25	+20	+15	+10	+5	0	-5	-10	-15	-20	-25	-30			
+60	1.22	1.25	1.27	1.30	1.33	1.36	1.40	1.44	1.48	1.51	1.56	1.61	1.67			
+55	1.14	1.16	1.18	1.21	1.23	1.26	1.29	1.33	1.36	1.39	1.43	1.47	1.52			
+50	1.07	1.08	1.10	1.13	1.15	1.17	1.20	1.23	1.26	1.28	1.32	1.36	1.39			
+45	1.00	1.02	1.04	1.06	1.08	1.10	1.12	1.15	1.17	1.19	1.22	1.26	1.29			
+40	0.93	0.96	0.98	0.99	1.01	1.03	1.05	1.08	1.10	1.12	1.14	1.17	1.20			
+35	0.90	0.91	0.92	0.94	0.96	0.97	0.99	1.01	1.03	1.05	1.07	1.10	1.12			
+30	0.85	0.86	0.88	0.89	0.91	0.92	0.94	0.96	0.98	0.99	1.01	1.03	1.06			
+25		0.82	0.83	0.85	0.86	0.87	0.89	0.91	0.92	0.94	0.95	0.97	1.00			
+20			0.80	0.81	0.82	0.83	0.85	0.89	0.88	0.89	0.91	0.92	0.94			
+15				0.77	0.78	0.79	0.81	0.82	0.84	0.84	0.86	0.88	0.89			
+10					0.75	0.76	0.77	0.78	0.80	0.81	0.82	0.84	0.85			
+5						0.73	0.74	0.75	0.76	0.77	0.78	0.80	0.81			
0							0.71	0.72	0.73	0.74	0.75	0.76	0.78			
-5								0.69	0.70	0.71	0.72	0.73	0.74			
-10									0.68	0.68	0.69	0.70	0.71			
Correction Factor k <sub>Δp</sub>																
Δp (bar)	0.5	1.0	1.5	2.0	2.5	3.0	3.5	4.0	4.5	5.0	5.5	6.0	6.5	7.0	7.5	8.0
k <sub>Δp</sub>	3.50	2.48	2.02	1.75	1.57	1.43	1.32	1.24	1.17	1.11	1.06	1.01	0.97	0.94	0.90	0.88
Δp (bar)	8.5	9.0	9.5	10.0	10.5	11.0	11.5	12.0	13.0	14.0	15.0	16.0	17.0	18.0	19.0	20.0
k <sub>Δp</sub>	0.85	0.83	0.80	0.78	0.76	0.75	0.73	0.72	0.69	0.66	0.64	0.62	0.60	0.58	0.57	0.55

Liquid Temperature entering Valve °C	R22				Correction Factor kt Evaporating Temperature (°C)											
	+30	+25	+20	+15	+10	+5	0	-5	-10	-15	-20	-25	-30	-35	-40	-45
+60	1.22	1.23	1.24	1.25	1.27	1.28	1.30	1.32	1.34	1.36	1.38	1.41	1.44	1.47	1.50	1.53
+55	1.15	1.16	1.17	1.18	1.19	1.20	1.22	1.24	1.25	1.27	1.29	1.32	1.34	1.37	1.39	1.42
+50	1.08	1.09	1.10	1.11	1.12	1.14	1.15	1.16	1.18	1.20	1.22	1.24	1.26	1.28	1.30	1.33
+45	1.03	1.04	1.04	1.05	1.06	1.07	1.09	1.10	1.12	1.13	1.15	1.17	1.18	1.20	1.23	1.25
+40	0.98	0.99	0.99	1.00	1.01	1.02	1.03	1.04	1.06	1.07	1.09	1.10	1.12	1.14	1.16	1.18
+35	0.93	0.94	0.95	0.95	0.96	0.97	0.98	0.99	1.01	1.02	1.03	1.05	1.06	1.08	1.10	1.12
+30	0.89	0.90	0.90	0.91	0.92	0.93	0.94	0.95	0.96	0.97	0.98	1.00	1.01	1.03	1.04	1.06
+25		0.86	0.87	0.87	0.88	0.89	0.90	0.91	0.92	0.93	0.94	0.95	0.96	0.98	0.99	1.01
+20			0.83	0.84	0.84	0.85	0.86	0.87	0.88	0.89	0.90	0.91	0.92	0.93	0.95	0.96
+15				0.80	0.81	0.82	0.82	0.83	0.84	0.85	0.86	0.87	0.88	0.89	0.91	0.92
+10					0.78	0.79	0.79	0.80	0.81	0.82	0.83	0.84	0.85	0.86	0.87	0.88
+5						0.76	0.76	0.77	0.78	0.79	0.79	0.80	0.81	0.82	0.83	0.85
0							0.74	0.74	0.75	0.76	0.77	0.77	0.78	0.79	0.80	0.81
-5								0.72	0.72	0.73	0.74	0.75	0.75	0.76	0.77	0.78
-10									0.70	0.71	0.71	0.72	0.73	0.74	0.75	0.75
Correction Factor kΔp																
Δp (bar)	0.5	1.0	1.5	2.0	2.5	3.0	3.5	4.0	4.5	5.0	5.5	6.0	6.5	7.0	8.0	9.0
KΔp	4.25	3.00	2.46	2.13	1.90	1.74	1.61	1.50	1.42	1.35	1.28	1.23	1.18	1.14	1.06	1.00
Δp (bar)	10.0	11.0	12.0	13.0	14.0	15.0	16.0	17.0	18.0	19.0	20.0	21.0	22.0	23.0	24.0	25.0
KΔp	0.95	0.91	0.87	0.83	0.80	0.78	0.75	0.73	0.71	0.69	0.67	0.66	0.64	0.63	0.61	0.60

Liquid Temperature entering Valve °C	R404A				Correction Factor kt Evaporating Temperature (°C)											
	+30	+25	+20	+15	+10	+5	0	-5	-10	-15	-20	-25	-30	-35	-40	-45
+60	1.56	1.59	1.64	1.69	1.74	1.81	1.88	1.96	2.06	2.16	2.28	2.42	2.57	2.75	2.95	3.19
+55	1.32	1.35	1.38	1.42	1.46	1.50	1.55	1.61	1.68	1.75	1.83	1.92	2.01	2.13	2.25	2.39
+50	1.16	1.18	1.20	1.23	1.26	1.30	1.34	1.38	1.43	1.48	1.54	1.61	1.68	1.75	1.84	1.94
+45	1.04	1.05	1.07	1.10	1.12	1.15	1.18	1.22	1.26	1.30	1.34	1.39	1.45	1.51	1.57	1.64
+40	0.94	0.96	0.97	0.99	1.02	1.04	1.07	1.09	1.13	1.16	1.20	1.24	1.28	1.33	1.38	1.43
+35	0.87	0.88	0.90	0.91	0.93	0.95	0.97	1.00	1.02	1.05	1.08	1.11	1.15	1.19	1.23	1.27
+30	0.81	0.82	0.83	0.84	0.86	0.88	0.90	0.92	0.94	0.96	0.99	1.02	1.05	1.08	1.11	1.15
+25		0.76	0.77	0.79	0.80	0.82	0.83	0.85	0.87	0.89	0.92	0.94	0.97	0.99	1.02	1.05
+20			0.73	0.74	0.75	0.77	0.78	0.80	0.81	0.83	0.85	0.87	0.90	0.92	0.95	0.97
+15				0.70	0.71	0.72	0.73	0.75	0.76	0.78	0.80	0.82	0.84	0.86	0.88	0.90
+10					0.67	0.68	0.69	0.71	0.72	0.74	0.75	0.77	0.79	0.81	0.83	0.85
+5						0.65	0.66	0.67	0.68	0.70	0.71	0.73	0.74	0.76	0.78	0.80
0							0.63	0.64	0.65	0.66	0.68	0.69	0.71	0.72	0.74	0.75
-5								0.61	0.62	0.63	0.65	0.66	0.67	0.69	0.70	0.72
-10									0.60	0.61	0.62	0.63	0.64	0.65	0.67	0.68
Correction Factor kΔp																
Δp (bar)	0.5	1.0	1.5	2.0	2.5	3.0	3.5	4.0	4.5	5.0	5.5	6.0	6.5	7.0	8.0	9.0
KΔp	4.55	3.21	2.62	2.27	2.03	1.86	1.72	1.61	1.52	1.44	1.37	1.31	1.26	1.21	1.14	1.07
Δp (bar)	10.0	11.0	12.0	13.0	14.0	15.0	16.0	17.0	18.0	19.0	20.0	21.0	22.0	23.0	24.0	25.0
KΔp	1.02	0.97	0.93	0.89	0.86	0.83	0.80	0.78	0.76	0.74	0.72	0.70	0.69	0.67	0.66	0.64

Liquid Temperature entering Valve °C	R407C				Correction Factor kt Evaporating Temperature (°C)											
	+30	+25	+20	+15	+10	+5	0	-5	-10	-15	-20	-25				
+55	1.20	1.21	1.23	1.26	1.28	1.31	1.34	1.37	1.40	1.44	1.48	1.52				
+50	1.10	1.11	1.13	1.15	1.17	1.19	1.22	1.24	1.27	1.30	1.33	1.37				
+45	1.02	1.03	1.05	1.06	1.08	1.10	1.12	1.14	1.17	1.19	1.22	1.25				
+40	0.95	0.96	0.98	0.99	1.01	1.02	1.04	1.06	1.08	1.11	1.13	1.16				
+35	0.89	0.90	0.92	0.93	0.94	0.96	0.98	0.99	1.01	1.03	1.05	1.07				
+30	0.85	0.85	0.87	0.88	0.89	0.90	0.92	0.93	0.95	0.97	0.99	1.01				
+25		0.81	0.82	0.83	0.84	0.85	0.87	0.88	0.90	0.91	0.93	0.95				
+20			0.78	0.79	0.80	0.81	0.82	0.84	0.85	0.86	0.88	0.90				
+15				0.75	0.76	0.77	0.78	0.80	0.81	0.82	0.84	0.85				
+10					0.73	0.74	0.75	0.76	0.77	0.78	0.80	0.81				
+5						0.71	0.72	0.73	0.74	0.75	0.76	0.77				
0							0.69	0.70	0.71	0.72	0.73	0.74				
-5								0.67	0.68	0.69	0.70	0.71				
-10									0.65	0.66	0.67	0.68				
Correction Factor kΔp																
Δp (bar)	0.5	1.0	1.5	2.0	2.5	3.0	3.5	4.0	4.5	5.0	5.5	6.0	6.5	7.0	8.0	9.0
KΔp	4.78	3.33	2.72	2.36	2.11	1.92	1.78	1.67	1.57	1.49	1.42	1.36	1.31	1.26	1.18	1.11
Δp (bar)	10.0	11.0	12.0	13.0	14.0	15.0	16.0	17.0	18.0	19.0	20.0	21.0	22.0	23.0	24.0	25.0
KΔp	1.05	1.01	0.96	0.92	0.89	0.86	0.83	0.81	0.79	0.76	0.75	0.73	0.71	0.70	0.68	0.67

Note: See page 164 for determining of conditions for systems with R407C.

Liquid Temperature entering Valve °C	R507				Correction Factor kt Evaporating Temperature (°C)											
	+30	+25	+20	+15	+10	+5	0	-5	-10	-15	-20	-25	-30	-35	-40	-45
+60	1.54	1.57	1.61	1.65	1.71	1.76	1.83	1.90	1.98	2.08	2.18	2.30	2.43	2.58	2.75	2.95
+55	1.30	1.33	1.36	1.39	1.43	1.47	1.52	1.57	1.62	1.69	1.76	1.83	1.92	2.02	2.12	2.25
+50	1.15	1.17	1.19	1.22	1.24	1.28	1.31	1.35	1.40	1.44	1.49	1.55	1.61	1.68	1.76	1.84
+45	1.03	1.05	1.07	1.09	1.11	1.14	1.17	1.20	1.23	1.27	1.31	1.36	1.40	1.46	1.52	1.58
+40	0.94	0.96	0.97	0.99	1.01	1.03	1.06	1.08	1.11	1.14	1.17	1.21	1.25	1.29	1.34	1.39
+35	0.87	0.88	0.90	0.91	0.93	0.95	0.97	0.99	1.01	1.04	1.07	1.10	1.13	1.16	1.20	1.24
+30	0.81	0.82	0.83	0.85	0.86	0.88	0.89	0.91	0.93	0.96	0.98	1.01	1.03	1.06	1.09	1.13
+25		0.77	0.78	0.79	0.80	0.82	0.83	0.85	0.87	0.89	0.91	0.93	0.95	0.98	1.01	1.03
+20			0.73	0.74	0.75	0.77	0.78	0.79	0.81	0.83	0.85	0.87	0.89	0.91	0.93	0.96
+15				0.70	0.71	0.72	0.73	0.75	0.76	0.78	0.79	0.81	0.83	0.85	0.87	0.89
+10					0.67	0.68	0.69	0.70	0.72	0.73	0.74	0.76	0.78	0.79	0.81	0.83
+5						0.64	0.65	0.67	0.68	0.69	0.70	0.72	0.73	0.75	0.76	0.78
0							0.62	0.63	0.64	0.65	0.66	0.68	0.69	0.70	0.72	0.73
-5								0.60	0.61	0.62	0.63	0.64	0.65	0.66	0.68	0.69
-10									0.58	0.59	0.60	0.61	0.62	0.63	0.64	0.65
Correction Factor kΔp																
Δp (bar)	0.5	1.0	1.5	2.0	2.5	3.0	3.5	4.0	4.5	5.0	5.5	6.0	6.5	7.0	8.0	9.0
KΔp	4.63	3.27	2.67	2.31	2.07	1.89	1.75	1.64	1.54	1.46	1.40	1.34	1.28	1.24	1.16	1.09
Δp (bar)	10.0	11.0	12.0	13.0	14.0	15.0	16.0	17.0	18.0	19.0	20.0	21.0	22.0	23.0	24.0	25.0
KΔp	1.03	0.99	0.94	0.91	0.87	0.85	0.82	0.79	0.77	0.75	0.73	0.71	0.70	0.68	0.67	0.65

## Flanges for Valves

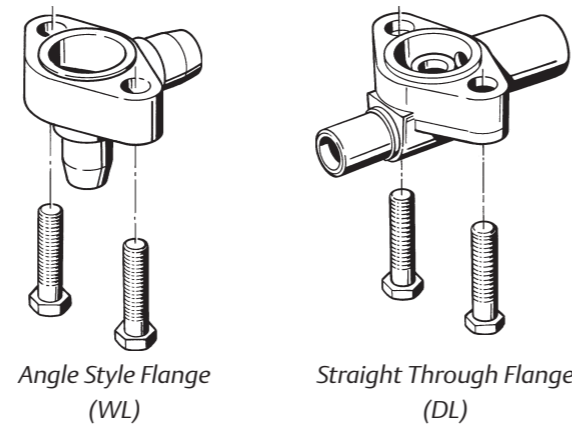

Angle Style		Straight Through		Connections				for Valve Series
Type	Part No.	Type	Part No.	mm		inch		
				Solder ODF	Solder ODM	Solder ODF	Solder ODM	
C 501 - 5	803 232	9761 - 3	803 240	-	-	3/8 x 5/8	-	TCLE
C 501 - 5 MM	803 233	9761 - 3 MM	803 241	10 x 16	-	-	-	ZZCE
C 501 - 7	803 234	9761 - 4	803 350	-	-	1/2 x 5/8	-	LCLE
C 501 - 7 MM	803 235	9761 - 4 MM	803 243	12 x 16	-	-	-	935 A-X
-	-	6346 - 17	803 330	16 x 22	-	5/8 x 7/8	-	CPHE 1
A 576	803 238	-	-	-	-	5/8 x 7/8	7/8 x 1-1/8	CPHE 2
A 576 - MM	803 239	-	-	16 x 22	22 x 28	-	-	
10331	803 338	10332	803 324	22 x 22	-	7/8 x 7/8	1-1/8 x 1-1/8	TJRE LJRE CPHE 3
9153 9153 MM	803 244 803 245	9152 9152 MM	803 286 803 287	- 22 x 22	- 28 x 28	7/8 x 7/8 -	1-1/8 x 1-1/8	TERE TIRE LERE LIRE CPHE 3.5 CPHE 4 CPHE 5
9149	803 284	9148	803 283	22 x 22	-	7/8 x 7/8	1-1/8 x 1-1/8	THRE CPHE 6

## Solenoid Valves

### Basic Terms and Technical Information

#### Operating principles

**Directly actuated:** The magnetic field of the solenoid coil forces a movement of the plunger and thus causes the opening of the valve seat.

**Servo actuated:** The magnetic field of the solenoid coil is only utilized for the opening of the pilot valve seat. The necessary energy to actuate the piston or diaphragm of the main valve seat is provided by the refrigerant flow and results in a certain pressure drop.

#### Minimum pressure drop

Directly actuated solenoid valves do not require a minimum pressure drop for proper operation. Servo operated solenoid valves require a minimum pressure drop of approximately 0.05 bar to remain fully open. In case of insufficient refrigerant flow this value will not be reached and the solenoid valve may close unintentionally. These closures may lead to malfunctions and oscillations in the refrigeration circuit. Improper sizing of solenoid valves (i.e. use of excessively large solenoid valves) is the main cause of this effect. This is particularly important in capacity controlled refrigeration circuits.

Therefore the decisive factor for proper solenoid valve sizing is the respective capacity of the valve and not its connection size.

Formula for calculating the actual pressure drop of a solenoid valve:

$$\Delta_{p1} = \Delta_{p2} \times (Q_{n1}/Q_{n2})^2$$

$\Delta_{p1}$ : Actual pressure drop  
 $\Delta_{p2}$ : Nominal pressure drop at  $Q_{n1}$   
 $Q_{n1}$ : Calculated nominal capacity  
 $Q_{n2}$ : Nominal capacity of selected valve

#### Maximum Operating Pressure Differential (MOPD)

MOPD is the maximum pressure differential between inlet and outlet of the solenoid valve which permits proper opening of the valve. When used with Alco® AC solenoid coils all Alco® solenoid valves employ 25 bar MOPD.

Operation in conjunction with DC solenoid coils lead to reduced MOPD values depending on valve type and size.

The **DS2 Chopper Plugs** allow the use of 24VAC coils with 24VDC by converting the DC in an AC voltage. Please contact Emerson Climate Technologies application engineering for additional details.

### Selection Guide for Solenoid Valves

Selection Criteria	Series						
	110 RB	200 RB	240 RA		540 RA		M36
			8/9/12/16T9	16T11/20	8/9/12/16	20	
2-Way	+	+	+	+	+	+	
3-Way							+
Normally Closed (NC)	+	+	+	+			
Normally Open (NO)					+	+	
Min. Pressure Differential (bar)	0.00	0.05	0.05	0.05	0.05	0.05	
MWP (bar)	31	31	31	31	31	28	35
Media Temp. Range (°C)	-40 / +120	-40 / +120	-40 / +120	-40 / +120	-40 / +120	-40 / +120	-40 / +120
Coil Type	ASC	ASC	ASC	ASC	ASC	ASC	ASC
Catalogue Page	195	195	195	195	196	196	199

#### Type Code

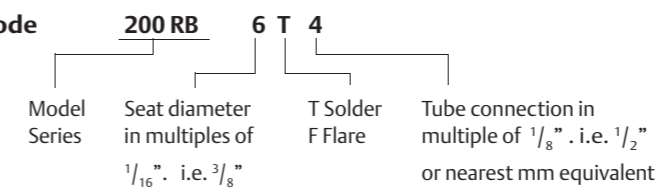

## Coils ASC

### Standards

- Alco® ASC Coils and cable assemblies conform to Low Voltage Directive



ASC

Type	Part No.	Voltage	Power Input	Electr. Connection	Protection
ASC 230V / 50Hz	801 064		8 W	without plug, see cable assemblies	IP65 with plug / cable assembly
ASC 120V / 50Hz	801 063				
ASC 24V / 50Hz	801 062				
ASC 24V DC	801 974	DC	15 W		
DS2-N15 + ASC 24VAC	804 620 + 801 062	DC	3 W	with plug and cable assembly	IP65

Note: Coils are delivered with mounting clip.  
Please order cable assemblies separately.



ASC-N15

### Cable Assemblies for ASC Coils

Type	Part No.	Temperature Range	Cable length	Wire diameter	Connector Type
ASC-N15	804 570	-50 .. +80°C for stationary use only	1.5m	3 x 0.75 mm <sup>2</sup>	loose wires
ASC-N30	804 571		3.0m		
ASC-N60	804 572		6.0m		



DS2-N15 ASC 24V / 50Hz

### Cable Assembly with 24V DC Chopper Plug

- Enables standard 24V AC Coil to be used for DC applications
- Low power assumption (3W only)
- No MOPD degradation

Type	Part No.	Temperature Range	Cable length	Wire diameter	Connector Type
DS2-N15	804 620	-25 .. +80°C	1.5 m	2 x 0.75 mm <sup>2</sup>	loose wires

### Other Accessories for Solenoid Valves

Type	Part No.	Description
X 11981-1	027 451	Service tool for 110RB, 240RA, 540RA, 3031
X 13740 -1	027 600	Clip for coil
PG9 Plug	801 012	Plug according to DIN 43650 with cable gland PG 9
PG11 Plug	801 013	Plug according to DIN 43650 with cable gland PG 11

## 2-Way Solenoid Valves Series 110. 200. 240

### Normally Closed

### Features

- Compact size
- Snap-on clip for attaching solenoid coils
- No disassembly necessary for soldering



110RB



200RB



240RA

### Standards

- 240 RA 16T11 and 20 are CE marked per PED

### Capacity Data

Type	Nominal Capacity Q <sub>n</sub> (kW)												kv-value m <sup>3</sup> /h	Δp min bar
	Liquid				Hot Gas				Suction Gas					
	R134a	R22	R404A R507	R407C	R134a	R22	R404A R507	R407C	R134a	R22	R507	R407C		
110 RB 2	3.5	3.8	2.5	3.6	1.6	2.0	1.7	2.1					0.2	0
200 RB 3	6.6	7.1	4.6	6.8	3.0	3.7	3.2	3.9					0.4	0.05
200 RB 4	15.5	16.8	10.9	16.1	7.1	8.8	7.5	9.2					0.9	0.05
200 RB 6	27.3	29.5	18.9	28.0	12.5	15.4	13.1	16.1					1.6	0.05
240 RA 8	36.3	39.3	25.2	37.3	16.7	20.5	17.4	21.4	4.2	5.6	4.6	5.2	2.3	0.05
240 RA 9	76.2	82.5	52.9	78.4	35.1	43.1	36.5	44.9	8.8	11.7	9.7	10.9	4.8	0.05
240 RA 12	85.7	92.8	59.5	88.1	39.4	48.4	41.1	50.5	9.9	13.1	10.9	12.3	5.4	0.05
240 RA 16	139.1	150.5	96.5	142.9	64.0	78.5	66.6	81.9	16.0	21.3	17.7	19.9	8.8	0.05
240 RA 20	202.6	219.3	140.7	208.3	93.2	114.4	97.1	119.3	33.0	31.0	25.7	29.0	12.8	0.05

Nominal capacities at +38°C condensing temperature, +4°C evaporating temperature, 0.15 bar pressure drop between valve inlet and outlet in liquid applications (for hot gas applications 1 bar pressure drop and +18 °C suction gas temperature); subcooling 1 K. Correction tables for other operating conditions see page 197

### Selection Guide

Type	Part No.	Connection Solder / ODF	
		mm	Inch
110 RB 2	T2	801 217	6
	T2	801 210	1/4
	T3	801 209	3/8
200 RB 3	T3	801 239	10
	T3	801 176	10
200 RB 4	T3	801 190	3/8
	T4	801 178	12
	T4	801 179	1/2
200 RB 6	T4	801 182	12
	T4	801 183	1/2
	T5	801 186	16
240 RA 8	T5	801 160	5/8
	T7	801 143	7/8
240 RA 9	T5	801 161	5/8
	T7	801 162	7/8
	T9	801 142	1-1/8
240 RA 12	T9	801 163	7/8
	T11	801 144	1-1/8
240 RA 16	T9	801 164	1-1/8
	T11	801 166	35
240 RA 20	T11-M	801 172	35
	T13-M	801 224	42
	T13-M	801 173	1-5/8
	T17-M	801 174	54

### Special Versions:

- Manual stems available upon request for Series 240 RA 8 to 240 RA 16 (Type M).

Manual stems standard on Series 240 RA 20.

### Options:

- Actuation coils available for various voltages, see page 194



## 2-Way Solenoid Valves Series 540

Normally Open

### Features

- Compact size
- Snap-on clip for attaching solenoid coils
- No disassembly necessary for soldering



### Capacity Data

Type	Nominal Capacity $Q_n$ (kW)												kv-value m <sup>3</sup> /h	$\Delta p$ min bar
	Liquid				Hot Gas				Suction Gas					
	R134a	R22	R404A R507	R407C	R134a	R22	R404A R507	R407C	R134a	R22	R507	R407C		
540 RA 8	36.3	39.3	25.2	37.3	16.7	20.5	17.4	21.4	4.2	5.6	4.6	5.2	2.3	0.05
540 RA 9	76.2	82.5	52.9	78.4	35.1	43.1	36.5	44.9	8.8	11.7	9.7	10.9	4.8	0.05
540 RA 12	85.7	92.8	59.5	88.1	39.4	48.4	41.1	50.5	9.9	13.1	10.9	12.3	5.4	0.05
540 RA 16	139.1	150.5	96.5	142.9	64.0	78.5	66.6	81.9	16.0	21.3	17.7	19.9	8.8	0.05
540 RA 20	202.6	219.3	140.7	208.3	93.2	114.4	97.1	119.3	23.3	31.0	25.7	29.0	12.8	0.05

Nominal capacities at +38°C condensing temperature, +4°C evaporating temperature, 0.15 bar pressure drop between valve inlet and outlet in liquid applications (for hot gas applications 1 bar pressure drop and +18 °C suction gas temperature); subcooling 1 K. Correction tables for other operating conditions see page 197

### Selection Guide

Type	Part No.	Connection Solder / ODF	
		mm	Inch
540 RA 8	T5	046 265	5/8
540 RA 9	T5	046 266	5/8
	T7	046 268	7/8
540 RA 12	T7	046 269	7/8
540 RA 16	T9	046 270	1-1/8
540 RA 20	T11	047 953	1-3/8

### Options:

- Actuation coils available for various voltages, see page 194

### Accessories and spare parts for solenoid valves

Description	Type	Part No.
Service tool for 110 RB, 240 RA, 540 RA	X 11981 - 1	027 451
Gasket kits		
110RB	KS 30040-2	801 232
200RB	KS 30039-1	801 233
240RA8	KS 30061-1	801 234
240RA9/12	KS 30062-1	801 235
240RA16	KS 30065-1	801 236
240RA20	KS 30097-1	801 237

Description	Type	Part No.
110RB	KS 30040-1	801 206
200RB	KS 30039/ KS 30109	801 205
240RA8	KS 30061	801 262
240RA9	KS 30062	801 263
240RA12	KS 30063	801 264
240RA16	KS 30065	801 200
240RA20	KS 30097	801 216

## Correction Tables for the Selection of Solenoid Valves

For use with 110 RB, 200 RB, 240 RA and 540 RA Series

Valve selection for operating conditions other than nominal:

$$Q_n = Q_o \times K_t \times K_{\Delta p}$$

$Q_n$ : Nominal valve capacity  
 $K_t$ : Correction factor for evaporating and liquid temperature  
 $K_{\Delta p}$ : Correction factor for pressure drop at valve  
 $Q_o$ : Required cooling capacity

The pressure drop can be calculated with the following formula:

$$\Delta P_o = \Delta P_n \times \frac{Q_o^2}{Q_n^2}$$

$$\Delta P_n = 0.15 \text{ bar}$$

$\Delta P_n$ : Pressure drop under nominal conditions

### 1. Suction Gas Application

Evaporating Temperature °C	Correction Factor $k_t$ Condensing Temperature (°C)										
	+60	+55	+50	+45	+40	+35	+30	+25	+20		
+10	1.03	0.97	0.92	0.88	0.84	0.80	0.76	0.74	0.71		
0	1.40	1.32	1.25	1.20	1.14	1.10	1.04	1.01	0.96		
-10	1.71	1.62	1.53	1.47	1.40	1.34	1.27	1.23	1.18		
-20	2.20	2.08	1.97	1.88	1.80	1.72	1.64	1.58	1.51		
-30	2.79	2.63	2.50	2.39	2.27	2.19	2.07	2.01	1.92		
-40	3.68	3.47	3.29	3.15	3.00	2.89	2.73	2.65	2.53		
Correction Factor $k_{\Delta p}$											
$\Delta p$ (bar)	0.05	0.10	0.15	0.20	0.25	0.30	0.35	0.40	0.45	0.50	0.55
$K_{\Delta p}$	1.73	1.22	1.00	0.87	0.77	0.71	0.65	0.61	0.48	0.55	0.52

### 2. Liquid Application

Liquid Temperature entering valve °C	R134a					Correction Factor $k_t$ Evaporating Temperature (°C)						R22			
	+10	0	-10	-20	-30	+10	0	-10	-20	-30	-40				
+60	1.33	1.40	1.48	1.56	1.67			1.26	1.30	1.38	1.38	1.44	1.50		
+55	1.23	1.29	1.36	1.43	1.52			1.19	1.22	1.29	1.29	1.34	1.39		
+50	1.15	1.20	1.26	1.32	1.39			1.12	1.15	1.21	1.22	1.26	1.30		
+45	1.08	1.12	1.17	1.22	1.29			1.06	1.08	1.15	1.15	1.18	1.23		
+40	1.01	1.05	1.10	1.14	1.20			1.01	1.03	1.09	1.09	1.12	1.16		
+35	0.96	0.99	1.03	1.07	1.12			0.96	0.98	1.03	1.03	1.06	1.10		
+30	0.91	0.94	0.98	1.01	1.06			0.92	0.94	0.99	0.98	1.01	1.04		
+25	0.86	0.89	0.92	0.95	1.00			0.88	0.89	0.94	0.94	0.96	0.99		
+20	0.82	0.85	0.88	0.91	0.94			0.84	0.86	0.90	0.90	0.92	0.95		
+15	0.78	0.81	0.84	0.86	0.89			0.81	0.82	0.87	0.86	0.88	0.91		
+10	0.75	0.77	0.80	0.82	0.85			0.78	0.79	0.83	0.83	0.85	0.87		
+5		0.74	0.76	0.78	0.81			0.76		0.80	0.79	0.81	0.83		
0		0.71	0.73	0.75	0.78			0.73		0.77	0.77	0.78	0.80		
-5			0.70	0.72	0.74			0.74			0.74	0.75	0.77		
-10			0.68	0.69	0.71			0.72			0.71	0.73	0.74		
Correction Factor $k_{\Delta p}$															
$\Delta p$ (bar)	0.05	0.10	0.15	0.20	0.25	0.30	0.35	0.40	0.45	0.50	0.55	0.60	0.65	0.70	0.75
$K_{\Delta p}$	1.73	1.22	1.00	0.87	0.77	0.71	0.65	0.61	0.58	0.55	0.52	0.50	0.48	0.46	0.45

## 2. Liquid Application

Liquid Temperature entering valve °C	Correction Factor kt Evaporating Temperature (°C)														
	R404A							R507							
	+10	0	-10	-20	-30	-40			+10	0	-10	-20	-30	-40	
+60	1.74	1.88	2.06	2.28	2.57	2.95			1.71	1.83	1.98	2.18	2.43	2.75	
+55	1.46	1.55	1.68	1.83	2.01	2.25			1.43	1.52	1.62	1.76	1.92	2.12	
+50	1.26	1.34	1.43	1.54	1.68	1.84			1.24	1.31	1.40	1.49	1.61	1.76	
+45	1.12	1.18	1.26	1.34	1.45	1.57			1.11	1.17	1.23	1.31	1.40	1.52	
+40	1.02	1.07	1.13	1.20	1.28	1.38			1.01	1.06	1.11	1.17	1.25	1.34	
+35	0.93	0.97	1.02	1.08	1.15	1.23			0.93	0.97	1.01	1.07	1.13	1.20	
+30	0.86	0.90	0.94	0.99	1.05	1.11			0.86	0.89	0.93	0.98	1.03	1.09	
+25	0.80	0.83	0.87	0.92	0.97	1.02			0.80	0.83	0.87	0.91	0.95	1.01	
+20	0.75	0.78	0.81	0.85	0.90	0.95			0.75	0.78	0.81	0.85	0.89	0.93	
+15	0.71	0.73	0.76	0.80	0.84	0.88			0.71	0.73	0.76	0.79	0.83	0.87	
+10	0.67	0.69	0.72	0.75	0.79	0.83			0.67	0.69	0.72	0.74	0.78	0.81	
+5		0.66	0.68	0.71	0.74	0.78				0.65	0.68	0.70	0.73	0.76	
0		0.63	0.65	0.68	0.71	0.74				0.62	0.64	0.66	0.69	0.72	
-5			0.62	0.65	0.67	0.70					0.61	0.63	0.65	0.68	
-10			0.60	0.62	0.64	0.67					0.58	0.60	0.62	0.64	
Liquid Temperature entering valve °C	Correction Factor kt Evaporating Temperature (°C)														
	R407C														
	+10	0	-10	-20											
+60															
+55	1.28	1.34	1.40	1.48											
+50	1.17	1.22	1.27	1.33											
+45	1.08	1.12	1.17	1.22											
+40	1.01	1.04	1.08	1.13											
+35	0.94	0.98	1.01	1.05											
+30	0.89	0.92	0.95	0.99											
+25	0.84	0.87	0.90	0.93											
+20	0.80	0.82	0.85	0.88											
+15	0.76	0.78	0.81	0.84											
+10	0.73	0.75	0.77	0.80											
+5		0.72	0.74	0.76											
0		0.69	0.71	0.73											
-5			0.68	0.70											
-10			0.65	0.67											
Correction Factor kΔp															
Δp (bar)	0.05	0.10	0.15	0.20	0.25	0.30	0.35	0.40	0.45	0.50	0.55	0.60	0.65	0.70	0.75
KΔp	1.73	1.22	1.00	0.87	0.77	0.71	0.65	0.61	0.58	0.55	0.52	0.50	0.48	0.46	0.45

## 3. Hot Gas Application

	Correction Factor kt Evaporating Temperature (°C)											
	+10	+5	0	-5	-10	-15	-20	-25	-30	-35	-40	
Kt	0.96	1.00	1.03	1.06	1.10	1.13	1.17	1.20	1.24	1.29	1.33	
Correction Factor kΔp												
Δp (bar)	0.35	0.50	0.70	1.00	1.50	2.00	2.50	3.00	4.00			
KΔp	1.72	1.49	1.22	1.00	0.86	0.78	0.73	0.70	0.65			

## 3-Way Solenoid Valves Series M36

### Features

- For heat reclaim application
- Pilot connection to suction line required. no minimum pressure drop
- Compact size
- Snap-on clip for attaching solenoid coils
- No disassembly necessary for brazing
- Max. allowable pressure PS: 35 bar

### Options:

- Actuation coil and cable assemblies available for various voltages. see page 198



M36-118

M36-078 with ASC Coil and DS2 Chopper Plug

### Capacity Data

Type	Part No.	Connection Solder/ODF		Nominal Capacity Q <sub>n</sub> (kW)			kv-Value m <sup>3</sup> /h	Coil Type
		mm	inch	R134a	R22	R404A / R507		
M36-078	801 420	22	7/8	28.9	35.1	31.3	6.7	ASC (Page 194)
M36-118	801 421		1-1/8					

Nominal capacities at +38°C condensing temperature, +4°C evaporating temperature (saturated pressures / dew point), 0.15 bar pressure drop between valve inlet and outlet.

For other operating conditions multiply required capacity Q<sub>o</sub> with correction factors K<sub>t</sub> and K<sub>Δp</sub>.

$$Q_o \times K_t \times K_{\Delta p} = Q_n$$

Q<sub>o</sub>: Required cooling capacity  
 K<sub>t</sub>: Correction factor for evaporating and liquid temperature  
 K<sub>Δp</sub>: Correction factor for pressure drop at valve  
 Q<sub>n</sub>: Nominal valve capacity

### Correction Tables

Correction Factor K <sub>t</sub> Evaporating Temperature (°C)											
	10	5	0	-5	-10	-15	-20	-25	-30	-35	-40
K <sub>t</sub>	0.96	1.00	1.03	1.06	1.10	1.13	1.17	1.20	1.24	1.29	1.33
Correction Factor K <sub>Δp</sub> Pressure drop across Valve (bar)											
	0.10	0.14	0.20	0.30	0.40	0.50	0.60	0.70	0.80	0.90	1.00
K <sub>Δp</sub>	1.22	1.00	0.87	0.71	0.61	0.55	0.50	0.46	0.43	0.41	0.39

### Accessories and spare parts for series M36

Description	Part No.
Repair Kit for M36-UNF (O-Ring Gasket & pilot assembly)	801 440

### Conversion Table 3031 Series to M36

3031 Series has been replaced by M36 Series

former type	Part No.	Replacement	Part No.
3031 RC 12S7	055 939	M36-078	801 420
3031 RC 12S9	055 940	M36-118	801 421

## Mechanical Pressure Regulators

### Basic Terms and Technical Information

#### Capacity regulators

Regulator series ACP and CPHE are hot gas bypass regulators and serve the purpose of compensating excess compressor capacity. Thus they prevent the generation of evaporator pressures below predetermined levels.

In case of hot gas injection into the suction line, a liquid injection valve in conjunction with a solenoid valve is required to desuperheat the excessively hot suction gas. The capacity should not be reduced below 60 % of maximum in this application to avoid oil return problems.

With hot gas injection at the evaporator inlet, no liquid injection valve is necessary. The injection must be such that the incremental gas volume is taken into account. No problems with oil return should be expected even when regulating 100% of capacity.

#### Evaporator pressure regulators

Series PRE regulators serve the purpose of maintaining evaporator pressure above certain predetermined levels. The most important application is the use of several evaporators with different evaporating temperatures in conjunction with a common suction line.

The freezing of water in water chillers and air conditioning systems can be safely prevented if evaporating temperatures are kept above 0°C, even when loads are greatly reduced.

#### Crankcase pressure regulators

Series PRC regulators serve the purpose of preventing excessively high suction pressures to protect compressor motors from overloading.

Excessively high suction pressures can occur at start-up of a refrigeration circuit in case of high loads and after defrost. Crankcase regulators are adjusted to the maximum allowed suction pressure rating of the compressors as given by the compressor manufacturers.

### Selection Guide for Pressure Regulators

Selection Criteria	Series			
	ACP	CPHE	PRE	PRC
Capacity Regulator	+	+		
Evaporator Pressure Regulator			+	
Crankcase Pressure Regulator				+
Catalogue Page	201	202	205	206

## Hot Gas Bypass Regulators Series ACP

### Features

- High quality materials and processes for high reliability and long lifetime
- Internal equalization
- Compact size

### Technical Data

Adjustment Range	0 ... 5 bar
Factory Setting	2.7 bar
Max. allowable Pressure PS	31 bar
Medium Temperature Range TS	-40°C ... 120°C
Ambient Temperature Range	-40 ... 50°C
Transport Temperature Range	-40 ... 70°C



ACP

### Capacity Data

Type	Part No.	Connection. Angle Solder/ODF inch	Nominal Bypass Capacity* Q <sub>n</sub>			
			R134a	R22	R407C	R404A / R507
ACP 1	047 680	1/4 x 3/8"	0.21	0.35	0.41	0.30
ACP 3	047 283	1/4 x 3/8"	0.50	0.77	0.89	0.68
ACP 5	053 374	3/8 x 3/8"	1.18	1.83	2.12	1.59

\* Nominal capacities at +38°C condensing temperature, +4°C evaporating temperature (saturated temperatures / dew point) and 1 K liquid subcooling at the inlet of the expansion valve.

## Hot Gas Bypass Regulators Series CPHE

### Features

- High quality materials and processes for high reliability and long lifetime
- Superior partial load performance due to double seat orifice design (CPHE3 to CPHE6)
- Modular design for economical logistics and easy assembly and servicing
- External equalization

Specific connection sizes and flanges available on request. Selection see page 192

### Technical Data

Adjustment Range	-0.4 ... 5 bar
Factory Setting	1.4 bar
Max. allowable Pressure PS	35 bar
Medium Temperature Range TS	-40°C ... 120°C
Ambient Temperature Range	-40 ... 50°C
Transport Temperature Range	-40 ... 70°C



### Capacity Data CPHE

Type	Nominal Bypass Capacity Q <sub>n</sub>				Orifice	Standard Flange		Power Assembly
	kW					Solder/ODF		
	R134a	R22	R407C	R404A / R507		mm	inch	
CPHE - 1X	3.5	5	5.8	4.5	X 22440-B5B	C 501 - 7 mm 12 x 16	C 501 - 7 1/2 x 5/8	X7818 - 1
CPHE - 2X	6.4	9	10.4	8.1	X 22440-B8B	A 576 mm 16 x 22 (22 x 28 ODM)	A 576 5/8 x 7/8 (7/8 x 1-1/8 ODM)	
CPHE - 3X	12	17	20	15	X 11873-B5B	10331 22 x 22	10331 7/8 x 7/8 (1-1/8 x 1-1/8 ODM)	
CPHE - 3.5X	13	19	22	17	X 9117-B7B	9153 mm 22 x 22	9153 7/8 x 7/8	
CPHE - 4X	16	23	27	21	X 9117-B9B			
CPHE - 5X	21	29	34	26	X 9166-B10B	9149 22 x 22	9149 7/8 x 7/8	
CPHE - 6X	35	50	58	45	X 9144-B13B			

Nominal capacities at +38°C condensing temperature, +4°C evaporating temperature (saturated temperatures / dew point) and 1 K liquid subcooling at the inlet of the expansion valve.

Specific connection sizes and flanges available on request. Selection see page 192

### Correction Tables for Series ACP and CPHE

For other evaporating temperatures the bypass capacity  $Q_{Byp}$  shall be multiplied with the correction factor  $K_{Byp}$ .

$$Q_{Byp} \times K_{Byp} = Q_n$$

- $Q_{Byp}$ : Required bypass capacity  
 $K_{Byp}$ : Correction factor for evaporating temperature  
 $Q_n$ : Nominal valve capacity

Refrigerant	Condensing Temperature °C	Correction Factor $K_{Byp}$ Evaporating Temperature °C					
		+10	0	-10	-20	-30	-40
R134a	50	0.78	0.77	0.78	0.80		
	40	0.99	0.94	0.93	0.94		
	30	1.35	1.21	1.15	1.14		
R22	50	0.80	0.77	0.77	0.77	0.79	0.82
	40	1.00	0.93	0.91	0.91	0.92	0.95
	30	1.34	1.19	1.12	1.10	1.09	1.12
R407C	50	0.83	0.82	0.83	0.86		
	40	0.99	0.95	0.95	0.97		
	30	1.26	1.17	1.13	1.13		
R404A / R507	50	0.86	0.85	0.87	0.91	0.97	1.06
	40	0.99	0.95	0.94	0.96	1.00	1.05
	30	1.26	1.13	1.09	1.08	1.10	1.14



## Evaporator and Crankcase Pressure Regulator Series PRE and PRC

### Features

- Compact design permits minimal space requirements
- Schrader valve on Inlet for ease of setting
- Direct operated regulator
- Balanced Port design provides accurate pressure control
- Copper tubes for easy soldering



### Technical Data

Refrigerants	HFC, HCFC
Oil compatibility	Mineral, Alkyl Benzene and Polyol-Ester (POE) lubricants
Max. allowable pressure PS Max. test pressure PT	25 bar 30 bar
Material, housing	CW509L (EN12420)
Temperature range	Storage -30°C to 80°C Medium TS -30°C to 80°C Ambient -30°C to 80°C

Pressure change per turn: Valve size 1 Valve size 2	0.6 bar 0.4 bar
Pressure range Factory setting	0.5 to 6.9 bar 2 bar
Weight: PRC/PRE-1.. PRC/PRE-2..	0.6 kg 1.3 kg

### Evaporator Pressure Regulator Series PRE

#### Selection

Type	Part No.	Tube Connection ODF	Nominal Capacity* Q <sub>n</sub> (kW)			
			R134a	R404A / R507	R407C	R22
PRE - 11A	800 380	16 mm - 5/8"	3.0	4.5	4.5	4.8
PRE - 11B	800 381	22 mm - 7/8"				
PRE - 21C	800 382	28 mm	7.4	11.1	11.1	11.9
PRE - 21D	800 383	1 - 1/8"				

\*Nominal capacities are based on evaporating Temperature +4°C, condensing temperature +38°C and a pressure drop of 1K.

### Correction Table

Selection for operating conditions other than +38°C/+4°C and 1 K liquid subcooling at the inlet of the valve:  $Q_n = Q_n \times K_c$

Q<sub>n</sub>: Nominal valve capacity  
Q<sub>r</sub>: Required cooling capacity

Refrigerant	Condensing Temperature °C	Correction Factor K <sub>c</sub> Evaporating Temperature °C				
		10	0	-10	-20	-30
R404A / R507	60	1.35	1.91	2.77	4.18	6.53
	50	1.05	1.46	2.07	3.05	4.62
	40	0.88	1.22	1.71	2.48	3.69
	30	0.77	1.06	1.48	2.12	3.13
R407C	55	1.02	1.42	2.04		
	50	0.94	1.31	1.87		
	40	0.84	1.17	1.66		
	30	0.77	1.06	1.50		
R134a	60	1.04	1.51	2.17		
	50	0.92	1.34	1.91		
	40	0.83	1.20	1.71		
	30	0.76	1.10	1.55		
R22	60	1.02	1.37	1.87	2.67	3.91
	50	0.93	1.25	1.70	2.42	3.53
	40	0.86	1.15	1.57	2.22	3.23
	30	0.80	1.07	1.45	2.05	2.98

## Crankcase Pressure Regulator Series PRC

### Selection

Type	Part No.	Tube Connection ODF	Nominal Capacity* Q <sub>n</sub> (kW)			
			R134a	R404A / R507	R407C	R22
PRC - 11A	800 384	16 mm - 5/8"	3.0	4.5	4.5	4.8
PRC - 11B	800 385	22 mm - 7/8"				
PRC - 21C	800 386	28 mm	7.4	11.1	11.1	11.9
PRC - 21D	800 387	1 - 1/8"				
PRC - 21C	800 388	35 mm - 1-3/8"				

\*Nominal capacities are based on evaporating temperature +4°C and condensing temperature +38°C and a pressure drop of 1 K.

### Capacity Table

Selection for operating conditions other than +38°C / +4°C and 1 K liquid subcooling at the inlet of the valve: (capacities are based on a pressure drop of 0.07 bar)

Refrigerant	Evaporating Temperature °C	Capacity (kW) Valve setting °C													
		Valve Size 1: PRC-11x							Valve Size 2: PRC-21x						
		-20	-15	-10	-5	0	5	10	-20	-15	-10	-5	0	5	10
R22	-29	2.3	3.4	4.4	4.8	4.9			5.8	8.8	10.0	10.0	10.0		
	-21		2.4	4.1	5.4	5.8				6.5	12.1	12.1	12.1		
	-14			2.7	4.9	6.2					8.1	13.8	13.8		
	-8				3.5	5.3						9.0	15.4		
	-3					3.1							9.9		
R407 C	-6				3.1	4.8						7.9	13.9		
	-1					2.9							9.2		
R134 a	-6					2.1	3.9	5.3					5.2	10.3	12.9
	1						2.4	4.7						6.1	12.2
	7							3.3							8.1
R404A / R507	-27	1.6	2.9	3.7	3.9				4.8	8.2	8.2	8.2			
	-20		1.9	3.5	4.5					5.7	9.8	9.8			
	-14			2.2	4.5						6.8	11.6			
	-10				3.1							8.1			

# Pressure Controls

## Basic Terms and Technical Information

### Characteristics

Pressure controls serve various functions, which may be divided into control and protection functions. Examples for control functions are compressor cycling, pump-down or defrost control. Protection functions include, pressure limiting and cut out against excessive pressures, against loss of charge or for freeze protection. These functions are performed by operating a set of electrical contacts when exceeding a preset lower or upper pressure limit. Depending on whether they are type tested (TÜV approved) or not they may be referred to by the following terms:

without TÜV approval: Pressure Control  
 with TÜV approval: Pressure Limiter, Pressure Cut Out or Safety Pressure Cut Out

Pressure controls with TÜV approval are tested according to EN 12263 as required by DIN 8901 and EN 378.

#### 1. Pressure controls (without TÜV approval)

Pressure controls without type approval may either be of the automatic or manual reset type. Manual reset versions are available for decreasing (manual reset min.) or increasing pressure (manual reset max.)

#### 2. Pressure limiters PSL/PSH

Pressure limiters are of the automatic reset type. Limiters for high pressure applications have a double bellows design to act as fail-safe controls.

#### 3. Pressure cut outs PZH/PZL

Pressure cut outs are of the manual reset type where reset is possible from the outside of the control without the need for a tool (external reset). Cut outs for high pressure applications have a double bellows design to act as fail-safe controls.

#### 4. Safety pressure cut outs PZHH/PZLL

Pressure cut outs are of the manual reset type where the reset requires the use of a tool. Typically, the removal of a cover is required in order to press the reset button (internal reset). Cut outs for high pressure applications have a double bellows design to act as fail-safe controls.

### Adjustment of switching points

A pressure gauge should always be used for comparison when adjusting the switching points on pressure controls. The setting scale on the device is intended to serve for orientation, showing the setting range of the upper switching point  $p_{max}$  in bar/psig and the value of the pressure differential  $\Delta p$  as difference between upper switching point  $p_{max}$  and the lower switching point  $p_{min}$ . The upper switching point  $p_{max}$  has to be adjusted on the scale, whereas the lower switching point  $p_{min}$  is given by adjustment of the desired switching differential  $\Delta p$ .

The formula is:

$$\text{Upper switching point} - \text{Differential} = \text{Lower switching point}$$

$$P_{max} - \Delta p = P_{min}$$

### Function of contacts SPDT

On pressure rise above setting 1-2 opens and 1-4 closes. On pressure drop below setting 1-2 closes and 1-4 opens.

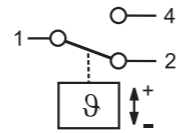

### SPDT with manual reset max.

On pressure rise above setting 1-2 opens and 1-4 closes and latches. The device can be manually reset when the pressure has dropped below setting.

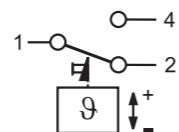

### SPDT with manual reset min.

On pressure drop below setting 1-2 closes, 1-4 opens and latches. The device can be manually reset when the pressure has risen above setting.

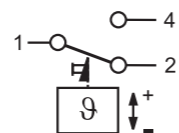

### Unit of pressure

All pressures are given in gauge pressure

$$P_{absolute} = P_{gauge} + 1\text{bar}$$

1 bar = 100 kPa  
 1 bar = 14.5 psi

### Pulsation damping

All high pressure controls with A-connection (1/16"-20UNF. " SAE male) are equipped with a snubber to protect the pressure element from pulsations.

### Standards and Regulations

BGV D4 (VBG20)	Accident prevention regulations for refrigeration plant.
DIN 8901	Heat pumps with fluorocarbon refrigerants. Protection of soil, underground and surface water.
EN 60947-1/ EN 60947-5-1	Specifications for low-voltage switchgear.
EN 378	Refrigerating systems and heat pumps - Safety and environmental requirements.
EN 12263:	Refrigerating systems and heat pumps - Safety switching devices for limiting the pressure requirements and tests.

### Selection Guide for Pressure Controls

Series	Selection Criteria						Catalogue Page
	Design	Number of Contacts (SPDT)	Adjustable	Protection DIN 40050 IEC 529	Rated Operational Current at 230 V AC		
					Inductive Amp. AC 15	Motor Rating UL	
PS1	Standard Model	1	yes	IP 44	10 A	24 A	208
PS2	Dual Pressure Switch	1+1	yes	IP 44	10 A	24 A	210
PS3	Pressure Switch Standard-Types	1	Factory set to fixed values	IP 30 / IP 65	3 A	6 A	212
PS3	Pressure Switch OEM-Types	1	Fixed values acc. to customer spec. depending on volume	IP 30 / IP 65	3 A	6 A	214
FD 113	Differential Pressure Switch	1	yes pressure diff. + time delay	IP 30	3 A / 6 A	-	215

## Pressure Controls Series PS1 / PS2

### Features

- Adjustable pressure range
- Automatic and manual reset versions
- Flare and solder connections
- Shatter resistant contacts
- High operational current, locked rotor max. 144 Amps (LRA)
- Standard SPDT with same operational current rating for both contacts
- Dual pressostat with two separate SPDT for high and low pressure side
- Including sealable blocking plate and mounting screws

### Options



- Convertible reset to reduce stock
- Further pressure connections
- Factory set to customer specification

### Technical Data PS1 / PS2

Type of Contacts	1 SPDT for PS1 2 separate SPDT for PS2
Inductive Amp. (AC15) Inductive Amp. (DC13)	10 A / 230V AC 0.1 A / 230V DC
Motor Rating, Full Load Amp. Motor Rating, Locked Rotor Amp.	24 A / 120/240V AC 144 A / 120/240V AC



### Standards

- CE per Low Voltage Directive
- CE per PED Directive 97/23 EG. TÜV appr. versions only
- Manufactured and tested to  standards on our own responsibility
-  US LISTED Underwriter Laboratories
- German Lloyd for use on ships, when equipped with marine-type cable gland

Protection acc. DIN 40050 / IEC 529	IP 44
Ambient Temperature Range Max. Temperature at Pressure Connection	-50°C .. +70°C +70°C
Vibration Resistance (10 to 1000 Hz)	4 g
Cable Entry	Grommet PG 16
Locking Device	Blocking Plate
Mounting Screws	M4 / UNC 8-32

### Single Pressure Controls PS1

Type	Part No.	Adjustment Range		Lowest Setpoint bar	Factory Setting bar	Leakage Test Pressure bar	Pressure Connection
		Upper Setpoint bar	Differential bar				
<b>Low Pressure Controls</b>							
PS1-A3A	4 370 700	-0.5 ... 7	0.5 ... 5	-0.9	3.5 / 4.5	25	<sup>7</sup> / <sub>16</sub> "-20 UNF
PS1-A3K	4 370 600						capillary/nut
PS1-A3L	4 714 945						cap./solder
PS1-A3U	4 712 201						solder 6 mm
PS1-A3X	4 713 430						solder 1/4"
PS1-R3A	4 350 100	-0.5 ... 7	external reset approx. 1 bar above setpoint	-0.9	3.5	25	<sup>7</sup> / <sub>16</sub> "-20 UNF
PS1-R3K	4 713 431						capillary nut
<b>High Pressure Controls</b>							
PS1-A5A	4 350 500	6 ... 31	2 ... 15	3	16 / 20	36	<sup>7</sup> / <sub>16</sub> "-20 UNF
PS1-A5K	4 370 400						capillary nut
PS1-A5L	4 715 136						cap./solder
PS1-A5U	4 713 325						solder 6 mm
PS1-A5X	4 713 434						solder 1/4"
PS1-R5A	4 350 700	6 ... 31	ext. manual reset low approx. 3 bar under setpoint	-	20	36	<sup>7</sup> / <sub>16</sub> "-20 UNF
PS1-R5K	4 370 300						capillary nut
PS1-R5X	4 713 436						solder 1/4"

## Single Pressure Controls Series PS1 TÜV / EN 12263

Type	Part No.	Adjustment Range		Lowest Setpoint bar	Factory Setting bar	Leakage Test Pressure bar	Pressure Connection
		Upper Setpoint bar	Differential bar				
<b>Pressure Limiter for Low Pressure Protection PSL - Automatic Reset</b>							
PS1-W3A	4 368 300	-0.5 ... 7	0.5 ... 5	-0.9	3.5 / 4.5	25	<sup>7</sup> / <sub>16</sub> "-20 UNF
PS1-W3K	4 321 400						capillary/nut
PS1-W3U	4 713 437						solder 6 mm
<b>Pressure Cut Out for Low Pressure Protection PZL - External Reset</b>							
PS1-B3A	4 470 400	-0.5 ... 7	external reset approx. 1 bar above setpoint	-0.9	3.5	25	<sup>7</sup> / <sub>16</sub> "-20 UNF
PS1-B3U	4 715 141						solder 6 mm
<b>Pressure Limiter for High Pressure Protection PSH - Automatic Reset</b>							
PS1-W5A	4 353 200	6 ... 31	2 ... 15	3	16 / 20	36	<sup>7</sup> / <sub>16</sub> "-20 UNF
PS1-W5K	4 359 100						capillary/nut
PS1-W5L	4 715 143						cap./solder
PS1-W5U	4 713 439						solder 6 mm
<b>Pressure Cut Out for High Pressure Protection PZH - External Manual Reset</b>							
PS1-B5A	4 353 300	6 ... 31	external reset approx. 3 bar under setpoint	-	20	36	<sup>7</sup> / <sub>16</sub> "-20 UNF
PS1-B5L	4 715 144						cap./solder
PS1-B5U	4 712 332						solder 6 mm
PS1-B5X	4 713 441						solder 1/4"
<b>Safety Pressure Cut Out for High Pressure Protection PZHH - Internal Manual Reset</b>							
PS1-S5A	4 368 400	6 ... 31	internal reset approx. 3 bar under setpoint	-	21	36	<sup>7</sup> / <sub>16</sub> "-20 UNF
PS1-S5L	4 715 145						cap./solder
PS1-S5U	4 711 591						solder 6 mm
PS1-S5X	4 713 442						solder 1/4"

## Dual Pressure Controls Series PS2



PS2

Type	Part No.	Adjustment Range				Factory Setting		Leakage Test Pressure		Pressure Connection
		Upper Setpoint		Differential				left bar	right bar	
		left bar	right bar	left bar	right bar	left bar	right bar			
<b>Combined Low and High Pressure Controls</b>										
PS2-A7A	4 353 400	-0.5 ... 7	6 ... 31	0.5 <sup>a)</sup> ... 5	ca. 4 fix	3.5 / 4.5	20	25	36	7/16"-20 UNF
PS2-A7K	4 350 900									capillary/nut
PS2-A7L	4 713 565									cap./solder
PS2-A7U	4 713 415									solder 6 mm
PS2-A7X	4 713 416									solder 1/4"
PS2-L7A	4 351 100	-0.5 ... 7	6 ... 31	0.5 <sup>a)</sup> ... 5	external reset approx. 4 bar under setpoint	3.5 / 4.5	20	25	36	7/16"-20 UNF
PS2-L7K	4 370 500									capillary/nut
PS2-L7U	4 713 417									solder 6 mm
PS2-L7X	4 713 418									solder 1/4"
PS2-R7A	4 351 300	-0.5 ... 7	6 ... 31	external reset approx. 1 bar above setpoint		3.5	20	25	36	7/16"-20 UNF
PS2-R7K	4 713 421									capillary/nut
PS2-R7U	4 713 419									solder 6 mm

## Dual Pressure Controls Series PS2 TÜV / EN 12263

<b>Combined Pressure Limiter for Low Pressure / High Pressure Protection</b>										
<b>PSL / PSH - automatic / automatic</b>										
Type	Part No.	left bar	right bar	Differential	Factory Setting	left bar	right bar	Leakage Test Pressure	Pressure Connection	
PS2-W7A	4 360 100	-0.5 ... 7	6 ... 31	0.5 <sup>a)</sup> ... 5	ca. 4 fix	3.5 / 4.5	20	25	36	7/16"-20 UNF
PS2-W7K	4 450 200									capillary/nut
PS2-W7L	4 450 300									cap./solder
PS2-W7U	4 712 436									solder 6 mm
PS2-W7X	4 713 429									solder 1/4"

<b>Combined Pressure Limiter / Pressure Cut Out for Low Pressure / High Pressure Protection</b>										
<b>PSL / PZH - automatic / external manual reset</b>										
Type	Part No.	left bar	right bar	Differential	Factory Setting	left bar	right bar	Leakage Test Pressure	Pressure Connection	
PS2-C7A	4 353 500	-0.5 ... 7	6 ... 31	0.5 <sup>a)</sup> ... 5	external reset approx. 4 bar under setpoint	3.5 / 4.5	20	25	36	7/16"-20 UNF
PS2-C7K	4 348 400									capillary/nut
PS2-C7L	5 715 131									cap./solder
PS2-C7U	4 713 422									solder 6 mm
PS2-C7X	4 713 423									solder 1/4"

<b>Combined Pressure Limiter / Safety Pressure Cut Out for Low Pressure / High Pressure Protection</b>										
<b>PSL / PZHH - automatic / internal manual reset</b>										
Type	Part No.	left bar	right bar	Differential	Factory Setting	left bar	right bar	Leakage Test Pressure	Pressure Connection	
PS2-T7A	4 368 500	-0.5 ... 7	6 ... 31	0.5 <sup>a)</sup> ... 5	external reset approx. 4 bar under setpoint	3.5 / 4.5	20	25	36	7/16"-20 UNF
PS2-T7U	4 713 424									solder 6 mm

<sup>a)</sup> lowest possible setpoint: -0.9 bar

## Dual Pressure Controls PS2 TÜV / EN 12263

Type	Part No.	Adjustment Range				Factory Setting		Leakage Test Pressure		Pressure Connection
		Upper Setpoint		Differential				left bar	right bar	
		left bar	right bar	left bar	right bar	left bar	right bar			
<b>Combined Pressure Cut Out for Low Pressure / High Pressure Protection</b>										
<b>PZL / PZH external manual reset / external manual reset</b>										
PS2-B7A	4 360 200	-0.5 ... 7	6 ... 31	external reset approx. 1 bar above setpoint	external reset approx. 4 bar under setpoint	3.5	20	25	36	7/16"-20 UNF
PS2-B7K	4 446 600									capillary/nut
PS2-B7L	4 446 700									cap./solder
PS2-B7U	4 449 400									solder 6 mm

<b>Combined Pressure Cut Out / Safety Pressure Cut Out for High Pressure / High Pressure Protection</b>										
<b>PZH / PZHH external manual reset / internal manual reset</b>										
Type	Part No.	left bar	right bar	Differential	Factory Setting	left bar	right bar	Leakage Test Pressure	Pressure Connection	
PS2-G8A	4 368 600	-0.5 ... 7	6 ... 31	external reset approx. 4 bar under setpoint	external reset approx. 4 bar under setpoint	20	21	36	36	7/16"-20 UNF
PS2-G8K	4 445 500									capillary/nut
PS2-G8U	4 713 427									solder 6 mm
PS2-G8X	4 713 428									solder 1/4"

### Accessories

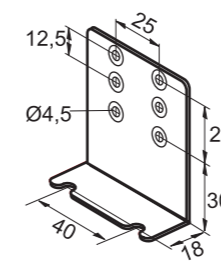

**Mounting bracket angle**  
Part No.: 803 799

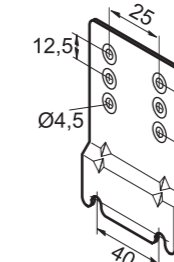

**Mounting plate for units with hood**  
Part No.: 803 801

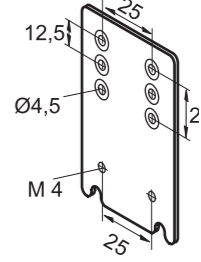

**Extension bracket**  
Part No.: 803 800

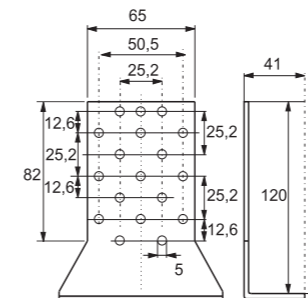

**Universal mounting bracket**  
Part No.: 803 798

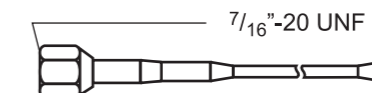

**Capillary Tube with two flare nuts 7/16"-20 UNF. R "**  
1.5m  
Part No.: 803 804

**Copper Gasket Set for R "**  
(7/16"-20 UNF. female)  
100 pcs package  
Part No.: 803 780







## Pressure Controls Series PS3 / Standard types

Compact Pressure Switch with fixed switch-point settings

### Features

- **Maximum allowable pressure up to 43 bar / test pressure up to 48 bar**
- Standard factory settings from stock in small volumes
- High and low pressure switches
- High temperature version with snubber for direct compressor mounting (range 6)
- Direct mounting reduces the number of joints and thus avoiding potential leakage
- Precise setting and repeatability
- IP 65 protection if used with PS3-Nxx and PS3-Lxx cables with plug (acc. EN 175301-803), no additional gasket required (molded into plug)
- Cables with plug to be ordered separately

### Standards

-  per Low Voltage Directive
-  per PED Directive 97/23 EG, TÜV appr. versions only
- Manufactured and tested to  standards on our own responsibility
-  Underwriter Laboratories



PS3

### Technical Data

Protection acc. to DIN 40050 / IEC 529	IP 00 IP 30 with terminal cover IP 65 with PS3-Nxx/-Lxx cables with plug or Plug DIN 43650
Inductive Amp. (AC)	3A / 230V AC
Inductive Amp. (DC)	0.1A / 230V DC
Motor rating, full load Amp.	6A / 120/240V AC
Motor rating, locked rotor Amp.	36A / 120/240V AC

\*Note: For high temperature applications, i. e. medium temperatures between 70 °C and 150 °C, the maximum ambient temperature must be derated as per drawing. E.g.: on medium temperature 120 °C the ambient temperature of 55 °C around the switch housing should not be exceeded.

Temperature range TS * ambient, storage and transportation medium	40 °C .. 70 °C -40 °C .. 70 °C (150 °C range 6)
Pressure Range PS	- 0.6 .. 43 bar
Vibration resistance (10..1000 Hz)	4 g
Type of contacts	1 SPDT
Medium compatibility	HFC, HCFC

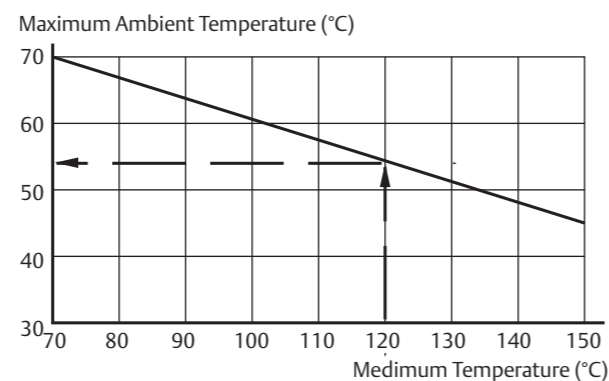

## Pressure Controls Series PS3 / Standard types

Pressure Control Type	Part No.	Fixed setting		Reset	Max. Temperature		Leakage Test Pressure bar	Pressure Connection
		Cut out	Cut out		Ambient	Pressure Connection		
		bar	bar		°C	°C		
<b>High Pressure Controls</b>								
PS3-A6S	0 715 603	16.0	11.0	auto	+70	+150	48	7/16"-20UNF female thread with Schrader opener
PS3-A6S	0 715 604	19.0	15.0					
PS3-A6S	0 715 600	26.5	22.5					
<b>Low Pressure Controls / Pressure Limiter for low pressure protection PSL TÜV / EN 12263</b>								
PS3-W1S	0 714 760	-0.3	1.2	auto	+70	+70	30	7/16"-20UNF female thread with Schrader opener
PS3-W1S	0 714 761	0.3	1.8					
PS3-W1S	0 714 762	2.0	3.5					
<b>Pressure Limiter for high pressure protection PSH TÜV / EN 12263</b>								
PS3-W6S	0 715 831	14.0	10.0	auto	+70	+150	48	7/16"-20UNF female thread with Schrader opener and snubber
PS3-W6S	0 715 556	21.0	16.0					
PS3-W6S	0 715 555	25.0	20.0					
PS3-W6S	0 715 567	29.0	23.0					
PS3-W6S	0 715 550	33.5	27.5					
PS3-W6S	0 715 553	40.0	33.0					
<b>Pressure Cut Out for high pressure protection PZH with snubber for direct compressor mounting TÜV / EN 12263</b>								
PS3-B6S	0 715 568	19.2	approx. 5 bar below cut-out	external manual reset	+70	+150	48	7/16"-20UNF female thread with Schrader opener and snubber
PS3-B6S	0 715 564	22.7						
PS3-B6S	0 715 563	27.3						
PS3-B6S	0 715 569	29.5						
PS3-B6S	0 715 560	36.0						

### Selection Chart Cable Assemblies

Temperature Range -50 to 80°C / no UL		Length (mtr.)	Leads	
Type	Part No.			
PS3-N15	804 580	1.5	3 x 0.75 mm <sup>2</sup>	
PS3-N30	804 581	3.0		
PS3-N60	804 582	6.0		

## Pressure Controls Series PS3 / Special types

For OEM use with settings according to customer's specification, minimum order quantity 100 pcs.

### Features

- Maximum allowable pressure up to 43 bar / Test pressure up to 48 bar
- For direct mounting on a pressure connection (free standing) or with a capillary tube
- Direct mounting reduces the number of joints and thus avoiding potential leakage
- Direct mounting saves cost for flexible hose and additional fittings
- Precise setting and repeatability
- High temperature version with snubber, for direct compressor mounting (range 6)
- Micro switch for narrow pressure differentials
- Gold plated contacts for low voltage / current applications
- Worldwide approvals
- Easy mounting

### Options

- Low pressure switch with automatic or manual reset
- High pressure switch with automatic or manual reset, standard or high temperature version
- Pressure limiter PSH - standard or high temperature version
- Pressure cut-out PZH - external reset, standard or high temperature version
- Safety pressure cut-out PZHH - internal reset, standard or high temperature version

### Electrical connections (optional)

- Cables with plug in lengths of 1.5m, 3.0m and 6.0m available. No additional gasket required.
- Appliance socket DIN 43650

### Type of contacts (optional)

- Standard (SPDT)
- Micro switch (SPDT)
- Gold plated contacts upon request

### Technical Data

Protection acc. to DIN 40050 / IEC 529	IP 00 IP 30 with terminal cover IP 65 with PS3-Nxx/-Lxx cables with plug or Plug DIN 43650
Inductive Amp. (AC15)	3 A / 230V AC 1.5 A with microswitch standard 0.1 A with gold plated contacts
Inductive Amp. (DC)	0.1 A / 230V DC
Motor rating, full load Amp.	6 A / 120/240V AC 2.5 A with microswitch
Motor rating, locked rotor Amp.	36 A / 120/240V AC 15 A with microswitch

For more information see datasheet PS3\_e35003.



### Standards

- per Low Voltage Directive
- per PED Directive 97/23 EG. TÜV appr. versions only
- Manufactured and tested to standards on our own responsibility
- Underwriter Laboratories

### Pressure connections

- S: 7/16"-20UNF, female with Schrader opener and snubber (snubber only with high temperature diaphragm)
- A: 7/16"-20UNF, 1/4" SAE male
- U: 6 mm solder. 80 mm length. ODF
- X: 1/4" solder. 80 mm length. ODF
- K: 1 m capillary tube with 1/4" SAE flare nut and Schrader opener
- L: 1 m capillary tube and 1/4" ODM solder connector

### Installation

- Depending on pressure connection, free-standing or with console.

Temperature range TS Ambient. storage and transportation Medium	-40°C ... 70°C -40°C ... 70°C (150°C range 6)
Pressure Range PS	- 0.6 .. 43 bar
Vibration resistance (10..1000 Hz)	4 g (10 to 1000 Hz)
Type of contacts	1 SPDT
Medium compatibility	HFC, HCFC
Available approvals	TÜV, UL
Weight (approx.)	0.1 kg

## Differential Pressure Controls Series FD 113

### Features

- Immediate reset (no cooling down period)
- Precise timing
- Adjustable time delay from 20 to 150 sec (ZU types)
- Separate output signals for operation and alarm
- Suitable for supply voltage 24 to 240 V AC / V DC
- Pressure connection: Flare 7/16"-20 UNF. 1/4" SAE male

### Standards

- per Low Voltage Directive
- Manufactured and tested to standards on our own responsibility



Differential Pressure Controls Type	Part No.	Time Delay		Cut out		Cut in Fixed Setting	Max. Differential Pressure	Max. Proof Pressure
		Adjustable	Factory Setting	Adjusting Range Δp	Factory Setting			
		Sec.	Sec.	bar	bar			
FD 113	0 710 173	-	-	0.3 ... 4.5	0.7	0.2 above cut out	-0.8 ... 12	25
FD 113 ZU	3 465 300	20 ... 150	120	-	0.63 fix	appr. 0.9		
FD 113 ZU (A22-057) Copeland® brand products	0 711 195	-	115 fix	-	0.63 fix	appr. 0.9		

### Technical Data

Inductive Amp. (AC)	3.0 A / 230 V AC
Inductive Amp. (DC)	0.1 A / 230 V DC
Protection acc. to EN 60 529	IP 30
Nominal Voltage FD 113 ZU	24 ... 240V AC / DC

Ambient Temperature Range	-20°C to +70°C
Max. Temperature at Pressure Connection	+70°C
Vibration resistance (10 to 1000 Hz)	4 g

### Accessories

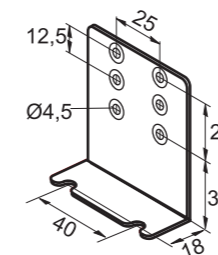

**Mounting bracket angle**  
Part No.: 803 799

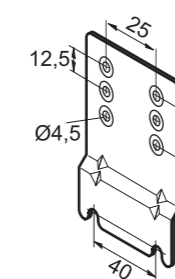

**Mounting plate for units with hood**  
Part No.: 803 801

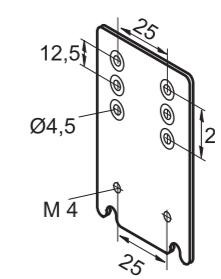

**Extension bracket**  
Part No.: 803 800

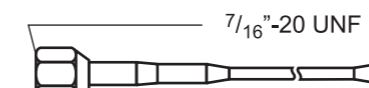

**Capillary Tube with two flare nuts 7/16"-20 UNF. R 1/4"**  
1.5m  
Part No.: 803 804

**Copper Gasket Set for R 1/4" (7/16"-20 UNF. female)**  
100 pcs package  
Part No.: 803 780

# Thermostats

## Basic Terms and Technical Information

### Characteristics

**Alco®** thermostats are electric circuit control devices which open or close an electric contact depending on temperature changes at the bulb.

### Description of bulb charges

The application range of thermostats is mainly determined by the charge. Accordingly various bulb shapes and sizes are necessary.

- Vapour charge, bulb type A, E, P**

The thermosystem is filled with a medium in vapour phase. A thermostat with vapour charge operates in accordance with temperature changes at the bulb as long as the bulb is the coldest part in the whole system (bellows, capillary tube, bulb). Alco® thermostats are equipped with a bellows heater (82 k Ohm, 230 V) to avoid such conditions. On applications with low current the bellows heater has to be removed. Max. bulb temperature is 150°C (70°C for bulb type E). Response time is very fast.

- Adsorption charge, bulb type F**

This charge only reacts on temperature changes at the bulb. Max. bulb temperature is 100°C. Response time is slow but perfectly suitable for common refrigeration systems.

### Adjustment of switching points

A thermometer should always be used for comparison when adjusting the switching points on temperature controls. The setting scale on the device is intended to serve for orientation, showing the setting range of the upper switching point  $t_{max}$  in °C and °F and the value of the temperature differential  $\Delta t$  in K as difference between the upper switching point  $t_{max}$  and the lower switching point  $t_{min}$ . The upper switching point  $t_{max}$  has to be adjusted on the scale, whereas the lower switching point  $t_{min}$  is given by adjustment of the desired switching differential  $\Delta t$ . The formula is:

$$\text{Upper switching point} - \text{Differential} = \text{Lower switching point}$$

$$t_{max} - \Delta t = t_{min}$$

### Important!

The differential  $\Delta t$  mentioned on the differential scale and in the technical data refers to the upper part of the setting range and the upper switching point.

In the lower part of the setting range an increase of the differential  $\Delta t$  can be expected. The lowest possible lower switching point  $t_{min}$  is mentioned in the selection tables and is helpful to select switching points with large differentials  $\Delta t$  in the lower temperature range.

### Bulb Sizes

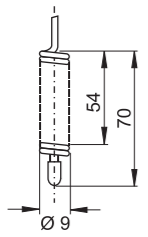
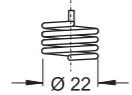
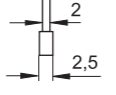
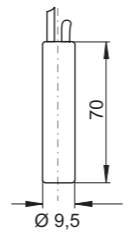
A	E	P	F
			
Vapour 2m, capillary with bulb	Vapour coil, 0m	Vapour 2m, capillary with function C and D 6m	Adsorption 2m, capillary with bulb

### Function of contacts

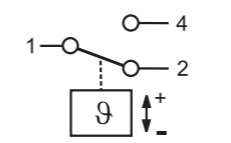
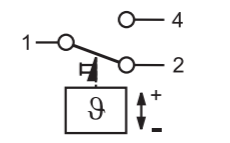
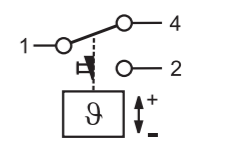
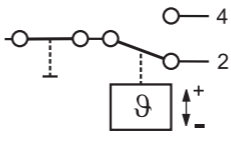
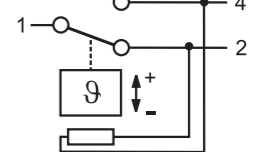
		
<b>SPDT</b> - On temperature rise above setting 1-2 opens and 1-4 closes. - On temperature drop below setting 1-2 closes and 1-4 opens.	<b>SPDT with manual reset min.</b> - On temperature drop below setting 1-2 closes. 1-4 opens and latches. - The device can be manually reset when the temperature has risen at least 2K above setting.	<b>SPDT with manual reset max.</b> - On temperature rise above setting 1-2 opens and 1-4 closes and latches. - The device can be manually reset when the temperature has dropped 2K below setting.
		
<b>PDT with off switch</b> <b>AUTOmatic - STOP</b>		<b>SPDT with bellows heater</b> includes a 82 k Ohm, 230 V AC/DC resistor

### Standards and regulations

Important for the installation of thermostats:

- EN 60730-2-9 Specification for temperature controls and temperature cut-outs.
- EN 60947-1/  
EN 60947-5-1 Specifications for low-voltage switchgear.
- EN 378: Refrigerating systems and heat pumps. Safety and environmental requirements.

# Thermostats Series TS1

## Features

- Adjustable temperatures and differentials
- Shatter resistant contacts
- High operational current, locked rotor max. 144 Amps (LRA)
- Standard SPDT with same operational current rating for both contacts
- Captive terminal and cover screws
- Range and differential individually lockable

## Technical Data

Type of Contacts	1 SPDT
Inductive Amp. (AC15)	10 A / 230 V AC
Inductive Amp. (DC13)	0.1 A / 230 V DC
Heating load (AC1)	24 A / 230 V AC
Motor Rating, Full Load Amp.	24 A / 120/240V AC
Motor Rating, Locked Rotor Amp.	144 A / 120/240V AC
Ambient Temperature Range	-50°C to +70°C
Vibration Resistance (10 to 1000 HZ)	4 g
Cable Entry	Grommet PG 16
Protection acc. to DIN 40050 / IEC 529	IP 44 (IP 30 with Selector Switch)
Bellows Heater at Vapour Charge	82 K Ohm. 230 V AC / DC (12 and 24 V DC upon request)



TS1 Top Operated

TS1 Flush Mounted

TS1 Front Operated

## Standards

- per Low Voltage Directive
- Manufactured and tested to standards on our own responsibility
- Underwriter Laboratories

Type	Part No.	Adjustment Range		Lowest Setpoint	Factory Setting	Max. Bulb Temp.	Temperature Sensor				
		Upper Setpoint	Differential Setpoint ΔT				Charge	Cap. tube length			
		°C	K	°C	°C	°C					
<b>Thermostats Top Operated</b>											
<b>Thermostats without Off-Switch</b>											
TS1-A2P	4 530 400	-30 ... +15	1.5 ... 16	-36	-1 / -6	+150	Vapour	2m capillary			
TS1-A3P	4 356 700	-10 ... +35	1.5 ... 16	-23	+3 / -2						
TS1-A1A	4 351 500	-45 ... -10	1.5 ... 16	-55	-18 / -20						
TS1-A2A	4 351 600	-30 ... +15	1.5 ... 16	-36	-1 / -6	+150	Vapour	2m capillary and bulb			
TS1-A3A	4 352 500	-10 ... +35	1.5 ... 16	-23	+3 / -2						
TS1-A4F Defrost- and Universal Thermostat	4 351 800	-30 ... +35	2.8 ... 20	-35	+5 / 0						
TS1-A5F	4 458 400	+20 ... +60	3 ... 10	+10	+35 / +30	+100	Adsorption	2m capillary and bulb			
<b>Thermostats with Off-Switch</b>											
TS1-B1A	4 366 700	-45 ... -10	1.5 ... 16	-55	-18 / -20				+150	Vapour	2m capillary and bulb
TS1-B2A	4 366 800	-30 ... +15	1.5 ... 16	-36	-1 / -6						
TS1-B3A	4 366 900	-10 ... +35	1.5 ... 16	-23	+3 / -2						
TS1-B4F	4 367 000	-30 ... +35	2.8 ... 20	-35	+5 / 0	+100	Adsorption	2m capillary and bulb			
<b>Frost Monitors Top Operated</b>											
<b>Frost Monitors without Off-Switch</b>											
TS1-C0P	4 352 100	+4.5 ... +20	2.5 fix	+2	4.5 / +2	+150	Vapour	6m capillary			
TS1-D0P Low temp. cut out	4 352 200	+4.5 ... +20	man. reset ca. 2.5 fix	+2	+2						

Type	Part No.	Adjustment Range		Lowest Setpoint	Factory Setting	Max. Bulb Temp.	Temperature Sensor	
		Upper Setpoint	Differential Setpoint ΔT				Charge	Cap. tube length
		°C	K	°C	°C	°C		
<b>Room Thermostats Top Operated</b>								
<b>Room Thermostats without Off-Switch, including insulation console</b>								
TS1-A1E	4 362 800	-45 ... -10	1.5 ... 16	-55	-18 / -20	+70	Vapour	0m coil
TS1-A2E	4 355 200	-30 ... +15		-36	+4 / +2			
TS1-A3E	4 355 300	-10 ... +35		-23	+20 / +18			
<b>Room Thermostats with Off-Switch, including insulation console</b>								
TS1-B2E	4 344 400	-30 ... +15	1.5 ... 16	-36	+4 / +2	+70	Vapour	0m coil
TS1-B3E	4 344 500	-10 ... +35		-23	+20 / +18			
<b>Thermostats Front Operated</b>								
<b>Thermostats without Off-Switch</b>								
TS1-E1A	4 361 000	-45 ... -10	2 ... 16	-55	-18 / -20	+150	Vapour	2m capillary and bulb
TS1-E2A	4 356 200	-30 ... +10	1.5 ... 15	-36	+4 / +2			
TS1-E3A	4 365 200	-10 ... +25	1.5 ... 15	-23	+3 / -2			
TS1-E4F Defrost- and universal thermostat	4 367 500	-25 ... +30	2.8 ... 20	-30	+5 / 0	+100	Adsorption	2m capillary and bulb
TS1-E5F	4 338 100	+20 ... +60	3 ... 10	+10	+35 / +30			
TS1-E7F Milk and beer cooler thermostat	4 367 600	+0 ... +10	2.5 fix	-2.5	+5.5 / +3			
<b>Thermostats with Off-Switch</b>								
TS1-F1A	4 367 100	-45 ... -10	2 ... 16	-55	-18 / -20	+150	Vapour	2m capillary and bulb
TS1-F2A	4 367 200	-30 ... +10	1.5 ... 15	-36	-1 / -6			
TS1-F3A	4 367 400	-10 ... +25	1.5 ... 15	-23	+3 / -2			
<b>Room Thermostats Front Operated</b>								
<b>Room Thermostats without Off-Switch, including insulation console</b>								
TS1-E1E	4 365 300	-45 ... -10	2 ... 16	-55	-18 / -20	+70	Vapour	0m coil
TS1-E2E	4 356 800	-30 ... +10	1.5 ... 15	-36	+4 / +2			
TS1-E3E	4 356 900	-10 ... +25	1.5 ... 15	-23	+20 / +18			
<b>Room Thermostats with Off-Switch, including insulation console</b>								
TS1-F1E	4 368 000	-45 ... -10	2 ... 16	-55	-18 / -20	+70	Vapour	0m coil
TS1-F2E	4 368 100	-30 ... +10	1.5 ... 15	-36	+4 / +2			
TS1-F3E	4 368 200	-10 ... +25	1.5 ... 15	-23	+20 / +18			
<b>Thermostats for Flush Mounting</b>								
<b>Thermostats for Flush Mounting without Off-Switch</b>								
TS1-G2A	4 355 400	-30 ... +15	1.5 ... 15	-36	+4 / +2	+150	Vapour	2m capillary and bulb
TS1-G3A	4 364 800	-10 ... +35	1.5 ... 15	-23	+20 / +18			
TS1-G4F Defrost- and universal thermostat	4 355 600	-30 ... +35	2.8 ... 20	-35	+5 / 0 +100	+100	Adsorption	bulb
TS1-G7F Milk and beer cooler thermostat	4 356 000	0 ... +10	2.5 fix	-2.5	+5.5 / +3			
<b>Thermostats for Flush Mounting with Off-Switch</b>								
TS1-H1A	4 364 600	-45 ... -10	1.5 ... 15	-55	-18 / -20	+150	Vapour	2m capillary and bulb
TS1-H2A	4 355 500	-30 ... +15	1.5 ... 15	-36	-1 / -6			
TS1-H3A	4 367 900	-10 ... +35	1.5 ... 15	-23	+3 / +2			
TS1-H4F	4 355 800	-30 ... +35	2.8 ... 20	-35	+5 / 0	+100	Adsorption	2m capillary and bulb
TS1-H7F Milk and beer cooler thermostat	4 365 500	0 ... +10	2.5 fix	-2.5	+5.5 / 3			

Thermostats for flush mounting are delivered with mounting angle Order No. 803 805.







## Bi-flow Filter Driers Series BFK

hermetic design, for liquid refrigerants

### Features

- Solid block style
- Integrated check valves insure Bi-flow capability, eliminate the need for external check valves and reduce the external piping
- ODF Copper fittings for easy soldering
- Pattern flow for non-turbulent performance
- High water, acid adsorption capacity
- Temperature range TS: -40°C to +65°C
- Max. allowable pressure PS: 45 bar
- No CE marking according art. 3.3 PED 97/23 EC
- HP marking according to German Pressorized Vessel Directive
-  US LISTED Underwriter Laboratories



BFK

Type	Part No.	Connection size & type	Nominal Flow Capacity (KW)									
			at 0.07 bar pressure drop					at 0.14 bar pressure drop				
			R134a	R22	R407C	R404A/R507	R410A	R134a	R22	R407C	R404A/R507	R410A
BFK-052	007 343	1/4 "(6mm)SAE	5.2	5.7	5.4	3.7	5.6	8.0	8.8	8.4	5.7	8.7
BFK-052S	007 344	1/4"ODF	6.8	7.3	7.0	4.8	7.2	10.1	11.1	10.6	7.2	10.9
BFK-083	007 345	3/8 "(10mm)SAE	10.6	11.5	11.0	7.5	11.4	16.9	18.4	17.6	12.0	18.2
BFK-083S	007 346	3/8"ODF	12.0	13.1	12.5	8.5	12.9	20.6	22.5	21.5	14.7	22.2
BFK-084	007 347	1/2 "(12mm)SAE	15.2	16.6	15.8	10.8	16.4	25.8	28.1	26.8	18.3	27.8
BFK-084S	007 348	1/2"ODF	15.6	17.0	16.2	11.1	16.8	28.7	31.3	29.9	20.4	30.9
BFK-163	007 349	3/8 "(10mm)SAE	13.6	14.9	14.2	9.7	14.7	21.0	22.9	21.8	14.9	22.6
BFK-163S	007 350	3/8"ODF	15.5	16.9	16.1	11.0	16.7	23.8	26.0	24.8	17.0	25.7
BFK-164	007 351	1/2 "(12mm)SAE	20.3	22.1	21.1	14.4	21.9	27.5	30.0	28.6	19.6	29.6
BFK-164S	007 352	1/2"ODF	24.3	26.5	25.3	17.3	26.1	34.4	37.6	35.9	24.5	37.1
BFK-165	007 353	5/8 "(16mm)SAE	25.1	27.4	26.2	17.9	27.1	35.3	38.5	36.8	25.1	38.0
BFK-165S	007 354	5/8"ODF	25.6	28.0	26.7	18.3	27.6	37.0	40.4	38.5	26.3	39.9
BFK-305S	007 356	5/8"(16mm) ODF	34.1	37.3	35.6	24.3	36.8	52.8	57.7	55.0	37.6	56.9
BFK-307S	007 357	7/8"(22mm) ODF	40.6	44.3	42.3	28.9	43.7	65.7	71.7	68.4	46.8	70.8
BFK-309S	007 358	1 1/8"ODF	47.0	51.3	49.0	33.5	50.7	79.9	87.2	83.2	56.9	86.1

The rated flow capacities are in accordance with ARI standard 710-86 and DIN 8949 at +30°C liquid temperature and -15°C evaporating temperature.

Selection method for other conditions:

1. Determine the correction factor (page 230) based on type of refrigerant, liquid and evaporating temperature.
2. Multiply the correction factor by cooling capacity or heating capacity whatever is more.
3. Select the filter drier according to determined capacity corresponding to flow capacity at 0.07 bar pressure drop.

### Water and Acid Adsorption Capacity

Type	Water adsorption capacity (gram)										Acid Adsorption Capacity (g)
	Liquid Temperature 24 °C					Liquid Temperature 52 °C					
	R134a	R22	R404A/R507	R407C	R410A	R134a	R22	R404A/R507	R407C	R410A	
BFK-05...	4.4	4.1	4.5	3.4	2.8	4.1	3.8	4.3	2.8	2.2	0.3
BFK-08...	9.6	9.0	9.9	7.5	6.2	8.9	8.2	9.4	6.0	4.7	0.6
BFK-16...	18.9	17.7	19.5	14.8	12.2	17.5	16.2	18.5	11.9	9.3	1.2
BFK-30...	34.5	32.3	35.6	27.1	22.4	31.9	29.6	33.7	21.7	17.0	2.0

## Filter Driers Series ADK

Hermetic Design, for Liquid Refrigerants

### Features

- Robust block with optimum blend of molecular sieve and activated alumina
- ODF Copper fittings for easy soldering
- High water and acid capacity
- Filtration down to 20 micron
- Temperature range TS: -40°C to +65°C
- Max. allowable pressure PS: 45 bar
- No CE marking according art. 3.3 PED 97/23 EC
- HP marking according to German Pressorized Vessel Directive
-  US LISTED Underwriter Laboratories



ADK

Type	Part No.	Nominal Flow Capacity (kW)						nom. Conditions see next page					
		at 0.07 bar pressure drop						at 0.14 bar pressure drop					
		R22	R134a	R404A/R507	R407C	R410A	R744	R22	R134a	R404A/R507	R407C	R410A	R744
ADK-032	003 595	7.3	6.7	4.8	7.0	7.2	10.6	10.6	9.7	6.9	10.1	10.5	15.4
ADK-036MMS	003 597	8.0	7.3	5.2	7.6	7.9	11.6	12.0	11.0	7.8	11.4	11.8	17.4
ADK-032S	003 596	8.8	8.1	5.7	8.4	8.7	12.8	12.9	11.8	8.4	12.3	12.7	18.8
ADK-052	003 598	7.6	6.9	4.9	7.2	7.5	11.0	11.0	10.1	7.2	10.5	10.9	16.0
ADK-056MMS	003 600	10.0	9.2	6.5	9.5	9.9	14.5	15.0	13.7	9.8	14.3	14.8	21.8
ADK-052S	003 599	10.8	9.9	7.0	10.3	10.7	15.7	17.1	15.6	11.1	16.3	16.9	24.8
ADK-053	003 601	14.2	13.0	9.2	13.5	14.0	20.6	21.3	19.5	13.9	20.3	21.0	31.0
ADK-0510MMS	003 603	16.4	15.0	10.7	15.6	16.1	23.8	24.1	22.1	15.7	23.0	23.8	35.1
ADK-053S	003 602	16.4	15.0	10.7	15.6	16.1	23.8	24.1	22.1	15.7	23.0	23.8	35.1
ADK-082	003 604	7.8	7.1	5.1	7.4	7.7	11.3	11.3	10.4	7.4	10.8	11.2	16.4
ADK-086MMS	003 606	10.7	9.8	7.0	10.2	10.5	15.5	16.0	14.7	10.4	15.3	15.8	23.3
ADK-082S	003 605	11.9	10.9	7.8	11.4	11.8	17.4	17.3	15.9	11.3	16.5	17.1	25.2
ADK-083	003 607	16.4	15.0	10.7	15.6	16.2	23.8	23.9	21.9	15.6	22.8	23.6	34.8
ADK-0810MMS	003 609	16.4	15.0	10.7	15.6	16.2	23.8	24.1	22.1	15.7	23.0	23.8	35.0
ADK-083S	003 608	16.4	15.0	10.7	15.7	16.2	23.9	24.1	22.1	15.7	23.0	23.8	35.1
ADK-084	003 610	25.7	23.5	16.7	24.5	25.3	37.3	39.1	35.8	25.5	37.3	38.6	56.9
ADK-0812MMS	003 612	26.3	24.1	17.2	25.1	26.0	38.3	39.5	36.2	25.8	37.7	39.0	57.4
ADK-084S	003 611	26.8	24.5	17.5	25.6	26.4	39.0	40.4	37.0	26.3	38.5	39.8	58.7
ADK-162	003 613	8.0	7.3	5.2	7.6	7.8	11.6	11.5	10.5	7.5	10.9	11.3	16.7
ADK-163	003 614	16.8	15.4	10.9	16.0	16.5	24.4	24.1	22.1	15.7	23.0	23.8	35.1
ADK-1610MMS	003 616	18.7	17.1	12.2	17.8	18.5	27.2	26.8	24.5	17.5	25.6	26.5	39.0
ADK-163S	003 615	18.7	17.2	12.2	17.9	18.5	27.2	26.8	24.5	17.5	25.6	26.5	39.0
ADK-164	003 617	31.3	28.7	20.4	29.9	30.9	45.5	47.1	43.2	30.7	45.0	46.5	68.6
ADK-1612MMS	003 619	32.3	29.6	21.1	30.8	31.9	47.0	48.5	44.4	31.6	46.3	47.9	70.5
ADK-164S	003 618	36.0	33.0	23.5	34.3	35.5	52.3	49.9	45.7	32.6	47.6	49.3	72.6
ADK-165	003 620	44.8	41.1	29.2	42.8	44.3	65.2	66.5	60.9	43.4	63.5	65.7	96.7
ADK-165S	003 621	49.7	45.6	32.4	47.4	49.1	72.3	72.4	66.3	47.2	69.1	71.5	105.3
ADK-303	003 622	17.7	16.2	11.5	16.9	17.5	25.7	25.4	23.2	16.5	24.2	25.0	36.9
ADK-304	003 623	31.3	28.7	20.4	29.9	30.9	45.5	47.1	43.2	30.7	45.0	46.5	68.6
ADK-304S	003 624	36.0	33.0	23.5	34.4	35.6	52.4	51.6	47.2	33.6	49.2	50.9	75.0
ADK-305	003 626	52.6	48.2	34.3	50.2	52.0	76.6	72.1	66.0	47.0	68.7	71.1	104.8
ADK-305S	003 627	52.8	48.4	34.4	50.4	52.1	76.8	72.9	66.8	47.6	69.6	72.0	106.1
ADK-307S	003 628	66.3	60.7	43.2	63.2	65.4	96.4	104.6	95.8	68.2	99.8	103.2	152.1
ADK-414	003 629	36.8	33.7	24.0	35.1	36.3	53.5	55.2	50.6	36.0	52.7	54.5	80.3
ADK-415	003 632	58.6	53.7	38.2	55.9	57.8	85.2	87.9	80.5	57.3	83.9	86.8	127.8
ADK-415S	003 633	63.0	57.7	41.1	60.1	62.2	91.6	94.5	86.6	61.6	90.2	93.3	137.4
ADK-417S	003 634	77.9	71.4	50.8	74.3	76.9	113.3	116.9	107.1	76.2	111.5	115.4	170.0
ADK-757S	003 635	105.5	96.7	68.8	100.7	104.2	153.5	158.3	145.0	103.2	151.0	156.2	230.2
ADK-759S	003 636	117.2	107.4	76.4	111.8	115.7	170.4	175.8	161.0	114.6	167.7	173.5	255.6

## Water and Acid Capacity

Size	Water adsorption capacity (gram)										Acid Adsorption Capacity (gram)
	Liquid Temperature 24 °C					Liquid Temperature 52 °C					
	R134a	R22	R404A/R507	R407C	R410A	R134a	R22	R404A/R507	R407C	R410A	
ADK-03	4.9	4.5	4.9	3.4	2.8	4.4	4.0	4.6	2.9	2.4	0.8
ADK-05	11.8	10.8	11.8	8.2	6.8	10.6	9.6	10.9	7.0	5.8	2.3
ADK-08	17.9	16.4	18.0	12.4	10.3	16.2	14.6	16.6	10.7	8.8	3.3
ADK-16	23.0	21.0	23.1	16.0	13.2	20.8	18.8	21.3	13.8	11.4	4.5
ADK-30	51.8	48.6	53.5	36.9	30.6	47.4	43.3	49.3	31.8	26.3	11.3
ADK-41	81.7	76.6	84.3	58.2	48.3	74.8	68.3	77.8	50.2	41.4	16.8
ADK-75	143.5	134.5	148.1	102.1	84.8	131.4	120.0	136.6	88.1	72.8	29.9

The water capacities are according to ARI-Standard 710 for R22 and are based on an equilibrium point dryness (EPD) of 60 PPM water in refrigerant. The EPD for all other mentioned refrigerants according to DIN 8949 is 50 PPM.

## Connections

Type	Part No.	Connection			
		Solder/ODF		Flare/SAE	
		mm	inch	mm	inch
ADK-032	003 595			6	1/4
ADK-036MMS	003 597	6			
ADK-032S	003 596		1/4		
ADK-052	003 598			6	1/4
ADK-056MMS	003 600	6			
ADK-052S	003 599		1/4		
ADK-053	003 601			10	3/8
ADK-0510MMS	003 603	10			
ADK-053S	003 602		3/8		
ADK-082	003 604			6	1/4
ADK-086MMS	003 606	6			
ADK-082S	003 605		1/4		
ADK-083	003 607			10	3/8
ADK-0810MMS	003 609	10			
ADK-083S	003 608		3/8		
ADK-084	003 610			12	1/2
ADK-0812MMS	003 612	12			
ADK-084S	003 611		1/2		
ADK-162	003 613			6	1/4
ADK-163	003 614			10	3/8
ADK-1610MMS	003 616	10			
ADK-163S	003 615		3/8		
ADK-164	003 617			12	1/2
ADK-1612MMS	003 619	12			
ADK-164S	003 618		1/2		
ADK-165	003 620			16	5/8
ADK-165S	003 621		5/8		
ADK-303	003 622			10	3/8
ADK-304	003 623			12	1/2
ADK-304S	003 624		1/2		
ADK-305	003 626			16	5/8
ADK-305S	003 627		5/8		
ADK-307S	003 628	22	7/8		
ADK-414	003 629			12	1/2
ADK-415	003 632			16	5/8
ADK-415S	003 633		5/8		
ADK-417S	003 634	22	7/8		
ADK-757S	003 635	22	7/8		
ADK-759S	003 636		1-1/8		

## Nominal Operating Conditions

Nominal capacity is based on the following conditions:

Refrigerant	Evaporating temperature	Liquid temperature
R744	-40°C	-10°C
R22, R134a, R404A, R407C, R410A, R507	-15°C	+30°C

Correction factors for other than the nominal conditions see page 230.

## Filter Driers Series FDB

Hermetic design, bead style, for liquid refrigerants

### Features

- Compacted bead style (spring loaded)
- Optimum blend of molecular sieve and activated alumina combined with high filtration capacity
- Final filtration 20 micron
- Filtration first for more effective use of surface area of desiccant
- High water and acid capacity
- Cushioned flow for non-turbulent performance
- ODF Copper fittings for easy soldering
- Rugged steel shells
- Corrosion resistant epoxy paint
- Temperature range TS: -40°C to +65°C
- Max. allowable pressure PS: 45 bar
- No CE marking according art. 3.3 PED 97/23 EC
- HP marking according to German Pressurized Vessel Directive
-  US LISTED Underwriter Laboratories



FDB

Type	Part No.	Nominal Flow Capacity (kW)					nom. Conditions see next page				
		at 0.07 bar pressure drop					at 0.14 bar pressure drop				
		R134a	R22	R407C	R404A/R507	R410A	R134a	R22	R407C	R404A/R507	R410A
FDB-032	059 305	6.3	6.9	6.6	4.5	6.8	8.9	9.7	9.3	6.3	9.6
FDB-032S	059 306	9.7	10.6	10.1	6.9	10.5	13.7	15.0	14.3	9.8	14.8
FDB-052	059 307	6.5	7.1	6.8	4.6	7.0	9.3	10.2	9.7	6.7	10.1
FDB-052S	059 309	9.7	10.6	10.1	6.9	10.5	13.7	15.0	14.3	9.8	14.8
FDB-053	059 308	15.5	16.9	16.1	11.0	16.7	22.2	24.2	23.1	15.8	23.9
FDB-053S	059 310	19.3	21.1	20.1	13.8	20.8	27.6	30.1	28.7	19.6	29.7
FDB-082	059 311	6.8	7.4	7.1	4.8	7.3	9.8	10.7	10.2	7.0	10.6
FDB-082S	059 314	9.9	10.8	10.3	7.0	10.7	14.2	15.5	14.8	10.1	15.3
FDB-083	059 312	15.8	17.2	16.4	11.2	17.0	22.6	24.7	23.6	16.1	24.4
FDB-083S	059 315	19.8	21.6	20.6	14.1	21.3	28.4	31.0	29.6	20.2	30.6
FDB-084	059 313	26.4	28.8	27.5	18.8	28.4	37.7	41.2	39.3	26.9	40.7
FDB-084S	059 316	28.3	30.9	29.5	20.1	30.5	40.4	44.1	42.1	28.8	43.5
FDB-162	059 317	6.8	7.4	7.1	4.8	7.3	9.8	10.7	10.2	7.0	10.6
FDB-163	059 318	16.2	17.7	16.9	11.5	17.5	23.1	25.2	24.0	16.4	24.9
FDB-163S	059 321	23.0	25.1	23.9	16.4	24.8	32.9	35.9	34.2	23.4	35.4
FDB-164	059 319	27.9	30.5	29.1	19.9	30.1	39.9	43.6	41.6	28.4	43.0
FDB-164S	059 322	36.0	39.3	37.5	25.6	38.8	51.5	56.2	53.6	36.6	55.5
FDB-165	059 320	36.6	40.0	38.2	26.1	39.5	52.4	57.2	54.6	37.3	56.5
FDB-165S	059 323	48.8	53.3	50.8	34.8	52.6	69.7	76.1	72.6	49.6	75.1
FDB-303	059 324	18.0	19.7	18.8	12.8	19.4	25.7	28.1	26.8	18.3	27.7
FDB-304	059 325	31.8	34.7	33.1	22.6	34.2	45.3	49.5	47.2	32.3	48.9
FDB-304S	003 667	38.0	41.5	39.6	27.1	41.0	54.2	59.2	56.5	38.6	58.4
FDB-305	059 326	40.3	44.0	42.0	28.7	43.4	57.7	63.0	60.1	41.1	62.2
FDB-305S	059 327	53.8	58.7	56.0	38.3	57.9	76.9	83.9	80.0	54.7	82.8
FDB-307S	059 328	60.5	66.1	63.1	43.1	65.2	86.6	94.5	90.2	61.6	93.3
FDB-415	059 329	49.7	54.3	51.8	35.4	53.6	71.1	77.6	74.0	50.6	76.6
FDB-417S	059 330	77.2	84.3	80.4	55.0	83.2	110.3	120.4	114.9	78.5	118.8



## Water Adsorption Capacity

Type	Unit Size	Water adsorption capacity (net) in grams							
		25 °C liquid refrigerant				52 °C liquid refrigerant			
		R134a	R22	R407C	R404A/R507	R134a	R22	R407C	R404A/R507
FDB-03...	3	1.9	2.0	1.7	1.9	1.8	1.7	1.6	1.9
FDB-05...	5	5.5	5.8	5.0	5.5	5.2	4.9	4.5	5.3
FDB-08...	8	8.8	9.3	8.0	8.8	8.4	7.9	7.2	8.5
FDB-16...	16	17.7	18.5	15.9	17.6	16.8	15.7	14.5	17.1
FDB-30...	30	31.7	33.0	28.5	31.6	30.1	28.2	26.0	30.5
FDB-41...	41	44.2	46.2	39.9	44.1	42.1	39.4	36.3	42.7

The water capacities are according to ARI-Standard 710 for R22 and are based on a equilibrium point dryness (EPD) of 60 PPM water in refrigerant. The EPD for all other mentioned refrigerants according to DIN 8949 is 50 PPM.

## Connections

Type	Part No.	Connection	
		Solder/ODF or Flare/SAE	
		inch	mm
FDB-032	059 305	1/4"SAE	6mm SAE
FDB-032S	059 306	1/4"ODF	
FDB-052	059 307	1/4"SAE	6mm SAE
FDB-052S	059 309	1/4"ODF	
FDB-053	059 308	3/8"SAE	10mm SAE
FDB-053S	059 310	3/8"ODF	
FDB-082	059 311	1/4"SAE	6mm SAE
FDB-082S	059 314	1/4"ODF	
FDB-083	059 312	3/8"SAE	10mm SAE
FDB-083S	059 315	3/8"ODF	
FDB-084	059 313	1/2"SAE	12mm SAE
FDB-084S	059 316	1/2"ODF	
FDB-162	059 317	1/4"SAE	6mm SAE
FDB-163	059 318	3/8"SAE	10mm SAE
FDB-163S	059 321	3/8"ODF	
FDB-164	059 319	1/2"SAE	12mm SAE
FDB-164S	059 322	1/2"ODF	
FDB-165	059 320	5/8"SAE	16mm SAE
FDB-165S	059 323	5/8"ODF	
FDB-303	059 324	3/8"SAE	10mm SAE
FDB-304	059 325	1/2"SAE	12mm SAE
FDB-304S	003 667	1/2"ODF	
FDB-305	059 326	5/8"SAE	
FDB-305S	059 327	5/8"ODF	16mm SAE
FDB-307S	059 328	7/8"ODF	
FDB-415	059 329	5/8"SAE	16mm SAE
FDB-417S	059 330	7/8"ODF	

## Nominal Operating Conditions

Nominal capacity is based on the following conditions:

Refrigerant	Evaporating temperature	Liquid temperature
R22, R134a, R404A, R407C, R410A, R507	-15°C	+30°C

Correction factors for other than the nominal conditions see page 230

## Filter Drier Shells Series ADKS-Plus

for Liquid- and Suction Applications with Replaceable Cores

### Features

- Rustproof Aluminum flange cover with notch hole for ease of mounting
- ODF Copper fittings for easy soldering
- Rigid core holder from steel (no plastic)
- Service friendly core holder and flange cover
- Optimum flow capacity at low pressure drop
- Temperature range TS: -45°C to +65°C
- Max. allowable pressure PS:  
34,5 bar (-10°C to +65°C)  
25,9 bar (-45°C to -10°C)
- CE marking according PED 97/23 EC
-  US LISTED Underwriter Laboratories



Type	Part No.	Connection Solder/ODF		Nominal Flow Capacity (kW)										Number of Blocks S48, H48 W48, F48
		mm	inch	Pressure Drop 0.07 bar					Pressure Drop 0.14 bar					
				R22	R134a	R404A R507	R407C	R410A	R22	R134a	R404A R507	R407C	R410A	
<b>Conformity assessment cat. I, procedure module A</b>														
485T	883 551	16	5/8"	78	72	51	75	77	100	92	65	95	99	1
487T	883 552	22	7/8"	145	133	95	138	143	182	167	119	174	180	
489T	883 553		1 1/8"	204	187	133	195	202	262	240	171	250	258	
4811T	883 554	35	1 3/8"	285	261	186	272	281	355	325	231	338	350	
4813T MM	883 836	42		310	284	202	196	306	390	357	254	372	385	
4817	882 603	54	2 1/8"	Primary for suction line applications										2
967T	883 555	22	7/8"	159	146	104	152	157	199	182	129	189	196	
969T	883 556		1 1/8"	250	229	163	239	247	300	275	196	286	296	
9611T	883 557	35	1 3/8"	305	279	199	291	301	402	369	262	384	397	
9613T	883 558		1 5/8"	350	321	228	334	345	470	431	306	448	464	
9613T MM	883 559	42		355	325	231	339	350	480	440	313	458	474	
9617	887 215	54		350	321	228	334	345	470	431	306	448	464	
1449T	883 560		1 1/8"	252	231	165	241	249	313	287	204	299	309	
14411T	883 561	35	1 3/8"	351	322	229	335	347	438	401	285	417	432	
14413T	883 562		1 5/8"	354	325	231	338	350	482	441	314	460	476	
14413T MM	883 563	42		360	330	235	343	355	490	449	319	467	484	
14417T	883 564	54	2 1/8"	420	385	274	401	415	560	513	365	534	553	
<b>Conformity assessment cat. II, procedure module D1</b>														
19211T	883 565	35	1 3/8"	358	328	233	342	353	440	403	287	419	434	4
19213T	883 566		1 5/8"	395	362	258	377	390	506	464	330	483	500	
19213T MM	883 567	42		400	366	261	382	395	510	467	333	487	503	
19217T	883 568	54	2 1/8"	430	394	281	411	425	567	519	370	541	560	

Correction factors for other than the nominal conditions see page 230

Cores see page 228

## Nominal Operating Conditions

Nominal capacity (Qn) is based on the following conditions:

Refrigerant	Evaporating temperature	Liquid temperature
R744	-40°C	-10°C
R22, R134a, R404A, R407C, R410A, R507	-15°C	+30°C

Correction factors for other than the nominal conditions see page 230

## Filter Drier Shells Series FDH for Liquid- and Suction Applications with Replaceable Cores

### Features

- Steel flange cover with notch hole for ease of mounting
- Plated steel ODF connections
- Rigid core holder from steel (no plastic)
- Service friendly core holder and flange cover
- Optimum flow capacity at low pressure drop
- Temperature range TS: -45°C to +65°C
- Max. allowable pressure PS:  
46 bar (-10°C to +65°C)  
25,9 bar (-45°C to -10°C)
- CE marking according PED 97/23 EC



FDH

Type	Part No.	Connection Solder/ODF		Nominal Flow Capacity (kW)												Number of Blocks
				Pressure Drop 0.07 bar						Pressure Drop 0.14 bar						
				mm	inch	R22	R134a	R404A R507	R407C	R410A	R744	R22	R134a	R404 R507	R407C	
<b>Conformity assessment cat. I, procedure module A</b>																
FDH-485	880 300	16	5/8"	78	72	51	75	77	114	100	92	65	95	99	146	1
FDH-487	880 301	22	7/8"	145	133	95	138	143	211	182	167	119	174	180	265	
FDH-489	880 302		1 1/8"	204	187	133	195	202	297	262	240	171	250	258	380	
FDH-969	880 306		1 1/8"	250	229	163	239	247	364	300	275	196	286	296	436	2
FDH-9611	880 307	35	1 3/8"	305	279	199	291	301	443	402	369	262	384	397	585	

Nominal conditions see page 227

Correction factors for other than the nominal conditions see page 230



Core H48

Cores for ADKS-Plus and FDH have to be ordered separately

Size	Part No.	Water Adsorption Capacity (gram)								Acid Adsorption capacity (g)
		Liquid Temperature 24°C				Liquid Temperature 52°C				
		R134a	R22	R404A R507	R407C	R134a	R22	R404A R507	R407C	
S48	003 508	79,7	74,7	82,3	56,7	73,0	66,7	75,9	48,9	16,3
H48	006 969	35,0	31,7	37,0	24,4	29,0	24,5	28,9	18,1	44,6
W48	006 970	24,7	22,1	26,2	17,1	19,9	16,4	19,5	12,1	39,7
F48	006 973	Filter for suction line								
<b>H100 / W100 are for use with phased-out ADKS-300/-400 only</b>										
H100	006 971	59,9	53,3	63,8	41,2	47,4	38,3	46,0	28,5	105,1
W100	006 972	52,7	47,1	56,0	36,4	42,4	34,7	41,4	25,7	85,5

## Filter-Drier Shells With Quick-Cap Series FDS-24 for Liquid- and Suction Applications with Replaceable Cores

### Features

- Quick-cap flange (one bolt) design makes replacing of cores in a matter of seconds
- Ideal for retrofit, reducing installation / material cost
- Ideal for refrigerant recovery / reclaim units with regular change of filter-drier
- Compatible with CFC, HCFC and HFC refrigerants
- Free volume as a receiver in FDS-24... (580 cm<sup>3</sup>)
- ODF Copper fittings for easy soldering
- Corrosion resistant powder painting of shell body
- Temperature range TS: -45°C to +65°C
- Max. allowable pressure PS:  
4,5 bar (-10°C to +65°C)  
25,9 bar (-45°C to -10°C)
- No CE marking according art.3.3 PED 97/23 EC
- HP marking according to German Pressurized Vessel Directive



FDS-24

### Selection Chart Suction Application

Type	Part No.	Connection		Nominal Flow Capacity (kW)							
				Block Core S24				Filter F24			
				mm	inch	R134a	R22	R407C	R507/R404A	R134a	R22
FDS-245	003 573	16	5/8	22.3	30.6	28.5	26.0	24.7	33.9	31.5	28.8
FDS-247	003 574	22	7/8	32.2	44.1	44.1	37.5	37.8	51.8	48.2	44.0
FDS-249	003 575		1-1/8	46.0	63.0	58.6	53.6	50.7	69.4	64.5	59.0
FDS-249	003 576	28		44.2	60.5	56.3	51.4	48.6	66.9	61.9	56.6

### Selection Chart Liquid Application

Type	Part No.	Connection Solder/ODF		Nominal Flow Capacity (KW)									
				Pressure Drop 0.07 bar					Pressure Drop 0.14 bar				
				mm	inch	R22	R134a	R507/R404A	R407C	R410A	R22	R134a	R507/R404A
FDS-245	003 573	16	5/8	75	68	49	71	74	98	90	64	93	97
FDS-247	003 574	22	7/8	112	102	73	107	110	151	139	99	144	149
FDS-249	003 575		1-1/8	113	104	74	108	112	160	147	104	153	158
FDS-249	003 576	28		114	104	74	108	112	163	150	106	156	161

Correction factors for other than the nominal conditions see page 230

### Selection Chart Cores

Type	Part No.	Water Capacity in Grams at a Liquid Temperature of 24°C (52°C)			Application	Acid Adsorption capacity (g)
		R134a	R22	R404A/R507		
S24	003 504	35.2 (32.3)	34.8 (29.5)	35.4 (32.1)	Liquid and suction line	8,9
W24	003 505	12.5 (9.2)	12.3 (8.9)	13.5 (10.4)	For motor burn-out (Suction)	25,6
F24	003 506	- (-)	- (-)	- (-)	Filter for suction line	-

Cores have to be ordered separately. 1 piece needed for FDS24 shell.

### Spare Parts

Description	Type	Part No.	Description	Type	Part No.
<b>ADSK-Plus, FDH</b>					
Gasket Set	X 99961	003 710	Gasket Set	X 99967	003 716
Schrader Nipple 1/4" NPT	X 11562-2	803 251	O-Ring Set	X 99968	003 717
Core Holder	X 99963	003 712	Core Holder	X 99969	003 718

**Correction Tables for Filter Driers ADK, ADKS, BFK, FDB, FDH and FDS**

Filter drier selection for operating conditions other than -15°C/+30°C (R744: -40°C/-10°C):

Q<sub>n</sub>: Nominal flow capacity  
 Q<sub>0</sub>: Required cooling capacity  
 K<sub>t</sub>: Correction factor for evaporating and liquid temperature

$Q_n = Q_0 \times K_t$

Refrigerant	Liquid Temperature °C	Correction factor Kt Evaporating Temperature °C													
		20	15	10	5	0	-5	-10	-15	-20	-25	-30	-35	-40	-45
R134a	60	1.29	1.32	1.35	1.39	1.42	1.46	1.50	1.55	1.59	1.65	1.70			
	55	1.20	1.22	1.25	1.28	1.31	1.34	1.38	1.41	1.45	1.50	1.54			
	50	1.11	1.14	1.16	1.19	1.21	1.24	1.27	1.30	1.34	1.38	1.42			
	45	1.04	1.06	1.09	1.11	1.13	1.16	1.18	1.21	1.24	1.27	1.31			
	40	0.98	1.00	1.02	1.04	1.06	1.08	1.11	1.13	1.16	1.19	1.22			
	35	0.93	0.94	0.96	0.98	1.00	1.02	1.04	1.06	1.08	1.11	1.14			
	30	0.88	0.90	0.91	0.93	0.94	0.96	0.98	1.00	1.02	1.04	1.07			
	25	0.84	0.85	0.86	0.88	0.89	0.91	0.93	0.95	0.96	0.98	1.01			
	20		0.81	0.82	0.84	0.85	0.87	0.88	0.90	0.92	0.93	0.95			
	15			0.79	0.80	0.81	0.83	0.84	0.85	0.87	0.89	0.90			
	10				0.76	0.78	0.79	0.80	0.82	0.83	0.84	0.86			
	5					0.74	0.76	0.77	0.78	0.79	0.81	0.82			
	0						0.73	0.74	0.75	0.76	0.77	0.79			
	-5							0.71	0.72	0.73	0.74	0.75			
-10								0.69	0.70	0.71	0.72				
R404A	60	1.77	1.83	1.90	1.97	2.06	2.16	2.27	2.39	2.54	2.70	2.89	3.12	3.39	3.70
	55	1.48	1.52	1.56	1.62	1.67	1.74	1.81	1.90	1.99	2.09	2.21	2.34	2.50	2.67
	50	1.28	1.31	1.34	1.38	1.43	1.47	1.53	1.59	1.65	1.73	1.81	1.90	2.00	2.11
	45	1.13	1.16	1.18	1.21	1.25	1.29	1.33	1.38	1.43	1.48	1.54	1.61	1.68	1.76
	40	1.02	1.04	1.06	1.09	1.12	1.15	1.18	1.22	1.26	1.30	1.35	1.40	1.46	1.52
	35	0.93	0.95	0.97	0.99	1.01	1.04	1.07	1.10	1.13	1.17	1.20	1.25	1.29	1.34
	30	0.86	0.87	0.89	0.91	0.93	0.95	0.97	1.00	1.03	1.06	1.09	1.12	1.16	1.20
	25	0.80	0.81	0.83	0.84	0.86	0.88	0.90	0.92	0.94	0.97	1.00	1.03	1.06	1.09
	20		0.76	0.77	0.79	0.80	0.82	0.84	0.85	0.87	0.90	0.92	0.95	0.97	1.00
	15			0.72	0.74	0.75	0.77	0.78	0.80	0.82	0.84	0.86	0.88	0.90	0.93
	10				0.69	0.71	0.72	0.73	0.75	0.77	0.78	0.80	0.82	0.84	0.86
	5					0.67	0.68	0.69	0.71	0.72	0.74	0.75	0.77	0.79	0.81
	0						0.65	0.66	0.67	0.68	0.70	0.71	0.73	0.74	0.76
	-5							0.63	0.64	0.65	0.66	0.67	0.69	0.70	0.72
-10								0.61	0.62	0.63	0.64	0.65	0.67	0.68	
-15									0.59	0.60	0.61	0.62	0.64	0.65	
-20										0.56	0.57	0.58	0.59	0.61	
R507	60	1.68	1.73	1.78	1.84	1.91	1.99	2.07	2.17	2.27	2.39	2.53	2.69	2.87	3.08
	55	1.43	1.46	1.50	1.54	1.59	1.65	1.71	1.77	1.85	1.93	2.02	2.12	2.24	2.36
	50	1.25	1.28	1.31	1.34	1.38	1.42	1.47	1.52	1.57	1.63	1.70	1.77	1.85	1.94
	45	1.12	1.14	1.17	1.20	1.23	1.26	1.30	1.34	1.38	1.42	1.48	1.53	1.59	1.66
	40	1.02	1.04	1.06	1.08	1.11	1.13	1.16	1.20	1.23	1.27	1.31	1.36	1.40	1.46
	35	0.94	0.95	0.97	0.99	1.01	1.04	1.06	1.09	1.12	1.15	1.18	1.22	1.26	1.30
	30	0.87	0.88	0.90	0.92	0.94	0.96	0.98	1.00	1.02	1.05	1.08	1.11	1.14	1.18
	25	0.81	0.83	0.84	0.85	0.87	0.89	0.91	0.93	0.95	0.97	1.00	1.02	1.05	1.08
	20		0.77	0.79	0.80	0.81	0.83	0.85	0.86	0.88	0.90	0.92	0.95	0.97	1.00
	15			0.74	0.75	0.77	0.78	0.79	0.81	0.83	0.84	0.86	0.88	0.91	0.93
	10				0.71	0.72	0.74	0.75	0.76	0.78	0.79	0.81	0.83	0.85	0.87
	5					0.68	0.70	0.71	0.72	0.73	0.75	0.76	0.78	0.80	0.81
	0						0.66	0.67	0.68	0.70	0.71	0.72	0.74	0.75	0.77
	-5							0.64	0.65	0.66	0.67	0.68	0.70	0.71	0.73
-10								0.62	0.63	0.64	0.65	0.66	0.68	0.69	
-15									0.60	0.61	0.62	0.63	0.64	0.65	
-20										0.58	0.59	0.60	0.61	0.62	

Refrigerant	Liquid Temperature °C	Correction factor Kt Evaporating Temperature °C													
		20	15	10	5	0	-5	-10	-15	-20	-25	-30	-35	-40	-45
R22	60	1.28	1.29	1.30	1.32	1.34	1.36	1.38	1.40	1.42	1.45	1.48	1.51	1.54	1.57
	55	1.20	1.21	1.23	1.24	1.26	1.27	1.29	1.31	1.33	1.35	1.38	1.41	1.43	1.46
	50	1.13	1.14	1.16	1.17	1.18	1.20	1.22	1.23	1.25	1.27	1.29	1.32	1.34	1.37
	45	1.07	1.08	1.09	1.11	1.12	1.13	1.15	1.16	1.18	1.20	1.22	1.24	1.26	1.29
	40	1.02	1.03	1.04	1.05	1.06	1.08	1.09	1.10	1.12	1.14	1.15	1.17	1.19	1.21
	35	0.97	0.98	0.99	1.00	1.01	1.02	1.04	1.05	1.06	1.08	1.09	1.11	1.13	1.15
	30	0.93	0.94	0.95	0.96	0.97	0.98	0.99	1.00	1.01	1.03	1.04	1.06	1.07	1.09
	25	0.89	0.90	0.91	0.91	0.92	0.93	0.94	0.95	0.97	0.98	0.99	1.01	1.02	1.04
	20		0.86	0.87	0.88	0.88	0.89	0.90	0.91	0.93	0.94	0.95	0.96	0.98	0.99
	15			0.83	0.84	0.85	0.86	0.87	0.88	0.89	0.90	0.91	0.92	0.93	0.95
	10				0.81	0.82	0.82	0.83	0.84	0.85	0.86	0.87	0.88	0.89	0.91
	5					0.79	0.80	0.81	0.82	0.83	0.84	0.85	0.85	0.86	0.87
	0						0.76	0.77	0.78	0.79	0.80	0.81	0.82	0.83	0.84
	-5							0.74	0.75	0.76	0.77	0.78	0.79	0.80	0.81
-10								0.73	0.73	0.74	0.75	0.76	0.77	0.78	
-15									0.71	0.72	0.72	0.73	0.74	0.75	
-20										0.69	0.70	0.71	0.72	0.72	
R407C	60	1.40	1.42	1.45	1.49	1.52	1.56	1.61	1.65	1.70	1.76	1.82			
	55	1.27	1.29	1.32	1.35	1.38	1.41	1.44	1.48	1.52	1.57	1.61			
	50	1.17	1.19	1.21	1.23	1.26	1.28	1.31	1.35	1.38	1.42	1.46			
	45	1.08	1.10	1.12	1.14	1.16	1.18	1.21	1.24	1.26	1.30	1.33			
	40	1.01	1.02	1.04	1.06	1.08	1.10	1.12	1.14	1.17	1.20	1.22			
	35	0.95	0.96	0.98	0.99	1.01	1.03	1.05	1.07	1.09	1.11	1.14			
	30	0.89	0.91	0.92	0.93	0.95	0.96	0.98	1.00	1.02	1.04	1.06			
	25	0.85	0.86	0.87	0.88	0.90	0.91	0.93	0.94	0.96	0.98	1.00			
	20		0.81	0.82	0.84	0.85	0.86	0.88	0.89	0.91	0.92	0.94			
	15			0.79	0.80	0.81	0.82	0.83	0.85	0.86	0.88	0.89			
	10				0.76	0.77	0.78	0.79	0.81	0.82	0.83	0.85			
	5					0.74	0.75	0.76	0.77	0.78	0.79	0.81			
	0						0.72	0.73	0.74	0.75	0.76	0.77			
	-5							0.70	0.71	0.72	0.73	0.74			
-10								0.68	0.69	0.70	0.71				
R410A*	60	1.62	1.64	1.66	1.68	1.70	1.73	1.76	1.80	1.83	1.87	1.92	1.96	2.02	2.07
	55	1.42	1.43	1.44	1.46	1.48	1.50	1.53	1.55	1.58	1.61	1.64	1.68	1.72	1.76
	50	1.27	1.28	1.29	1.31	1.32	1.34	1.36	1.38	1.40	1.43	1.45	1.48	1.51	1.55
	45	1.16	1.17	1.18	1.19	1.20	1.22	1.24	1.25	1.27	1.29	1.31	1.34	1.36	1.39
	40	1.07	1.08	1.09	1.10	1.11	1.12	1.14	1.15	1.17	1.18	1.20	1.22	1.24	1.27
	35	1.00	1.01	1.01	1.02	1.03	1.04	1.06	1.07	1.08	1.10	1.11	1.13	1.15	1.17
	30	0.94	0.94	0.95	0.96	0.97	0.98	0.99	1.00	1.01	1.03	1.04	1.06	1.07	1.09
	25	0.89	0.89	0.90	0.90	0.91	0.92	0.93	0.94	0.95	0.96	0.98	0.99	1.00	1.02
	20		0.84	0.85	0.86	0.86	0.87	0.88	0.89	0.90	0.91	0.92	0.93	0.95	0.96
	15			0.81	0.81	0.82	0.83	0.84	0.84	0.85	0.86	0.87	0.88	0.90	0.91
	10				0.78	0.78	0.79	0.80	0.80	0.81	0.82	0.83	0.84	0.85	0.86
	5					0.75	0.75	0.76	0.77	0.77	0.78	0.79	0.80	0.81	0.82
	0						0.72	0.73	0.73	0.74	0.75	0.76	0.76	0.77	0.78
	-5							0.70	0.70	0.71	0.72	0.72	0.73	0.74	0.75
-10								0.6							

## Suction Line Filters and Filter Driers Series ASF and ASD

Hermetic design

### Features

- Minimum pressure drop due to internal construction and compacted bead style
- Service friendly with 2 Schrader valves for pressure drop measurement
- ODF Copper fittings for easy soldering
- Filtration down to 10 micron
- Temperature range TS: -45°C to +50°C
- Max. allowable pressure PS: 27,5 bar
- No CE marking according art. 3.3 PED 97/23 EC
- HP marking according to German Pressurized Vessel Directive



ASF, ASD

Suction Line Filters									
Type	Part No.	Connection Solder/ODF		Nominal Capacity Qn kW					
		mm	inch	R134a	R22	R404A	R407C	R507	
ASF-28 S3	008 965		3/8	6.0	8.4	7.7	7.8	7.7	
ASF-28 S4	008 941		1/2	9.9	14.4	13.4	13.4	13.4	
ASF-35 S5	008 915	16	5/8	15.9	23.2	21.4	21.6	21.4	
ASF-15 S6	008 946		3/4	23.3	34.5	32.0	32.1	32.0	
ASF-45 S7	008 904	22	7/8	32.5	42.5	34.5	39.5	34.5	
ASF-50 S9	008 908		1 1/8	46.0	67.1	55.5	62.4	55.5	
ASF-75 S11	008 919	35	1 3/8	60.2	85.4	70.7	79.4	70.7	
ASF-175 S13	008 940		1 3/8	65.4	87.5	73.1	81.4	73.1	

Suction Line Filters Driers									
Type	Part No.	Connection Solder/ODF		Nominal Capacity Qn kW					
		mm	inch	R134a	R22	R404A	R407C	R507	
ASD-28 S3	008 909		3/8	5.5	8.1	7.4	7.5	7.4	
ASD-28 S4	008 910		1/2	9.1	13.4	12.7	12.5	12.7	
ASD-35 S5	008 899	16	5/8	14.3	20.4	19.0	19.0	19.0	
ASD-15 S6	008 925		3/4	19.1	24.6	22.5	22.9	22.5	
ASD-45 S7	008 896	22	7/8	25.0	32.3	26.4	30.0	26.4	
ASD-50 S9	008 881		1 1/8	35.3	46.4	38.3	43.2	38.3	
ASD-75 S11	008 891	35	1 3/8	42.9	56.9	47.8	52.9	47.8	
ASD-175 S13	008 953		1 3/8	45.2	60.8	51.0	56.5	51.0	

Nominal flow capacity at +4°C evaporating temperature (saturated condition/dew point) and a pressure drop of 0.21 bar between inlet and outlet of ASF/ASD. Correction factor for other evaporating temperatures than +4°C:

$$Q_n = Q_o \times K_s$$

- $Q_n$ : Nominal capacity  
 $K_s$ : Correction factor for a pressure drop corresponding 1 K saturation temperature  
 $Q_o$ : Required cooling capacity

Evaporating Temperature (°C)	+4	0	-5	-10	-15	-20	-25	-30	-35	-40
Correction Factor kt	1.00	1.12	1.35	1.75	2.00	2.50	3.00	3.75	5.00	6.60

### Water and Acid Adsorption Capacity

Type	Water Adsorption Capacity (gram)										Acid Adsorption Capacity (g)
	Liquid Temperature 24°C					Liquid Temperature 52°C					
	R134a	R22	R404A R507	R407C	R410A	R134a	R22	R404A R507	R407C	R410A	
ASD-28	11.8	5.7	12.2	9.1	8.0	10.0	3.6	9.7	6.7	5.6	3.0
ASD-35	14.5	7.0	15.0	11.2	9.9	12.3	4.4	12.0	8.2	6.9	3.6
ASD-45	18.0	8.8	18.6	13.9	12.3	15.3	5.5	14.9	10.2	8.6	4.5
ASD-50	21.4	10.4	22.2	16.5	14.6	18.2	6.5	17.7	12.1	10.2	5.4
ASD-75	31.5	15.4	32.6	24.3	21.5	26.7	9.6	26.0	17.8	15.0	7.9

## Suction Line Filter and Filter Drier Shells Series BTAS

for replaceable Filters and Filter Drier Cores

### Features

- Corrosion resistant brass body ideal for suction line applications
- Extremely large filtration area for optimum flow capacity
- Low pressure drop
- Filtration down to 10 micron
- Temperature range TS: -45°C ... +50°C
- Max. allowable pressure PS: 24 bar



BTAS

Suction LineShells with Filters Cores										
Type	Part No.	Connection Solder/ODF		Nominal Capacity Qn kW					Filter Core	
		mm	inch	R134a	R22	R404A	R407C	R507	Type	Part No.
No CE marking according to art. 3.3 PED 97/23. HP marking according to German pressurised vessel directive										
BTAS 25	015 353		5/8	12.5	17.1	13.9	15.9	13.9	A2F	009 907
BTAS 27	015 354	22	7/8	22.3	29.6	24.3	27.5	24.3		
BTAS 39	015 355		1 1/8	37.7	50.4	40.6	46.9	40.6	A3F	009 909
BTAS 311	015 356	35	1 3/8	60.3	80.7	65.2	75.1	65.2		
BTAS 313	015 357		1 5/8	73.4	97.5	81.1	90.7	81.1		
BTAS 342	015 358	42		73.4	97.5	81.1	90.7	81.1		
BTAS 317	015 359	54	2 1/8	97.6	127.7	104.8	118.8	104.8		
BTAS 417	015 360	54	2 1/8	134.7	178.2	145.3	165.7	145.3		
CE marked, Conformity assessment cat. I, procedure module A										
BTAS 521			2 5/8	209.0	282.4	229.8	262.6	229.8	A5F	009 913
BTAS 525			3 1/8	260.1	346.1	283.9	321.9	283.9		
BTAS 580		80		260.1	346.1	283.9	321.9	283.9		
Filter and filter drier cores have to be ordered separately.										
Suction LineShells with Filters Driers Cores										
Type	Part No.	Connection Solder/ODF		Nominal Capacity Qn kW					Filter Drier Core	
		mm	inch	R134a	R22	R404A	R407C	R507	Type	Part No.
No CE marking according to art. 3.3 PED 97/23. HP marking according to German pressurised vessel directive										
BTAS 25	015 353		5/8	11.6	15.5	12.8	14.3	12.8	A2F-D	009 908
BTAS 27	015 354	22	7/8	19.1	25.2	20.6	23.4	20.6		
BTAS 39	015 355		1 1/8	34.4	45.7	37.5	42.5	37.5	A3F-D	009 910
BTAS 311	015 356	35	1 3/8	49.2	65.5	53.7	60.9	53.7		
BTAS 313	015 357		1 5/8	57.1	77.3	62.5	71.9	62.5		
BTAS 342	015 358	42		57.1	77.3	62.5	71.9	62.5		
BTAS 317	015 359	54	2 1/8	77.1	94.1	77.7	87.5	77.7		
BTAS 417	015 360	54	2 1/8	106.8	144.5	118.3	134.4	118.3		
CE marked, Conformity assessment cat. I, procedure module A										
BTAS 521			2 5/8	153.3	205.1	169.0	190.7	169.0	A5F-D	009 914
BTAS 525			3 1/8	181.2	242.0	199.4	225.1	199.4		
BTAS 580		80		181.2	242.0	199.4	225.1	199.4		
Filter and filter drier cores have to be ordered separately.										



Nominal capacity at +4°C evaporating temperature (saturated condition/dew point) and a pressure drop of 0.21 bar between inlet and outlet of BTAS. Correction factor for other evaporating temperatures than +4°C:

$$Q_n = Q_o \times K_s$$

Q<sub>n</sub>: Nominal capacity  
 K<sub>s</sub>: Correction factor for a pressure drop corresponding 1K saturation temperature  
 Q<sub>o</sub>: Required cooling capacity

Evaporating Temperature (°C)	+4	0	-5	-10	-15	-20	-25	-30	-35	-40
Correction Factor kt	1.00	1.12	1.35	1.75	2.00	2.50	3.00	3.75	5.00	6.60

BATS - Water and Acid Adsorption Capacity									
Core	Water Adsorption Capacity (gram)								Acid Adsorption capacity (g)
	Liquid Temperature 24°C				Liquid Temperature 52°C				
	R134a	R22	R404A R507	R407C	R134a	R22	R404A R507	R407C	
A2F-D	2.8	2.5	2.9	4.8	2.3	1.9	2.3	5.0	3.7
A3F-D	7.6	6.8	8.0	13.3	6.3	5.3	6.2	13.8	10.3
A4F-D	14.8	13.3	15.7	25.9	12.2	10.3	12.2	26.9	20.1
A5F-D	21.8	19.6	23.1	38.2	18.0	15.1	17.9	39.7	29.6

Spare parts		
Repair Kits with cover, screws and gaskets	Type	Part No.
Repair kit BTAS 2	KD 30519-2	065 970
Repair kit BTAS 3	KD 30519-3	065 971
Repair kit BTAS 4	KD 30519-4	065 972
Repair kit BTAS 5	KD 30519-5	065 973

## Moisture Liquid Indicators Series MIA

### Features

- Fully hermetic
- Corrosion free stainless steel body
- Crystal Indicator element for long lifetime and reliability
- Indication of dryness according to ASERCOM recommendation
- Easy determination of moisture content
- Sensitive indicator with calibrated four colours
- Large clear viewing area
- Lightweight (only 60g MIA-M06/014)
- ODF extended tube configurations suitable for all commercial applications
- For R22, R407C, R134a, R404A, R507 and R410A together with Mineral- and POE oils
- Max. allowable pressure PS: 45 bar
- UL certified for Canada, see SA 4876 (except MIA-078)



MIA

### Selection Chart

Type	Part No.	for Tube Outside Ø	Height A (mm)	Length B (mm)	Weight (g)
MIA 014	805 851	1/4"	22.5	98.0	60
MIA 038	805 852	3/8"	35.5	109.0	80
MIA 012	805 853	1/2"	35.5	113.0	90
MIA 058	805 854	5/8"	35.5	108.5	95
MIA 078	805 864	7/8"	35.5	122.5	170
MIA M06	805 846	6 mm	25.5	98.0	60
MIA M10	805 847	10 mm	35.5	109.0	80
MIA M12	805 848	12 mm	35.5	113.0	90
MIA M16	805 854	16 mm	35.5	108.5	95

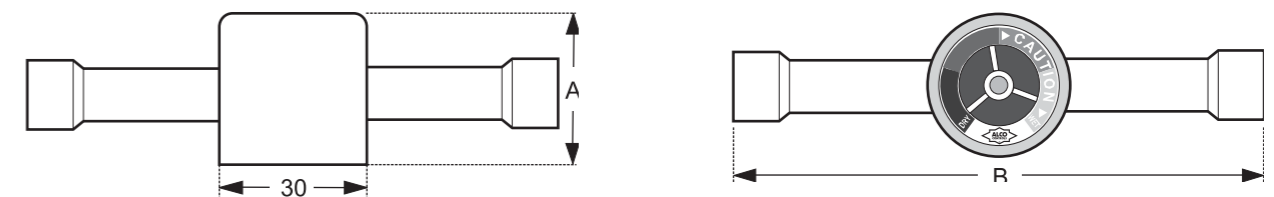

### Water Contents\* by Indicator Color

Refrigerant	Liquid Temperature °C	blue dry	purple	fushia Caution	rose Caution - wet
R22	25	25	40	80	145
	38	35	65	130	105
	52	50	90	185	290
R404/R507	25	15	33	60	120
	38	25	50	110	150
	52	45	60	140	180
R134a	25	20	35	90	130
	38	35	55	120	160
	52	50	85	150	190
R407C	25	26	42	94	151
	38	40	68	144	232
	52	64	109	230	371
R410A	25	30	50	110	165
	38	55	85	190	290
	52	75	120	270	420

\* Water content in mg Water per kg refrigerant (ppm)

## Moisture Liquid Indicators Series AMI

### Features

- First choice for R134a, R22, R404A, R407C, R507 and polyolester lubricants
- High accuracy of moisture indication according to ASERCOM recommendation
- Fused glass - no leakage
- Long lifetime of indicators by utilization of crystals
- Indicator with high resistance against acid and water
- Wide angle view for exact distinction of vapour and liquid
- Max. allowable pressure PS: 31 bar

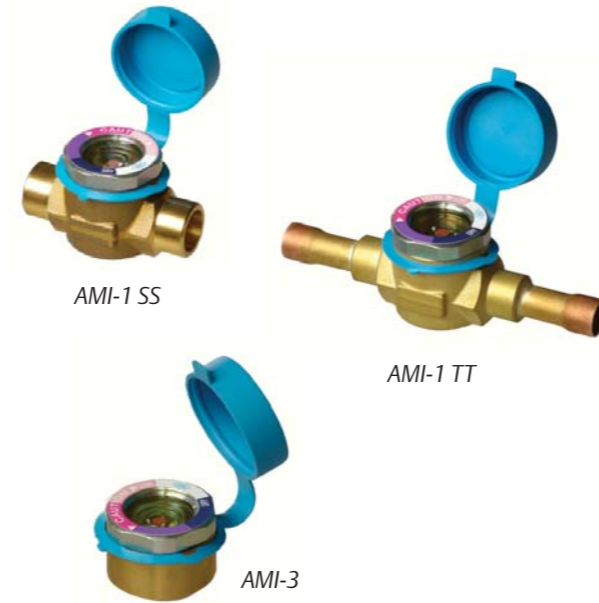

### Selection Chart

Type	Part No.	Connection		Configuration	
		mm	inch		
AMI-1	SS 2 MM	805 732	6	Female solder x female solder ODF x ODF	
	SS 2	805 713	1/4		
	SS 3 MM	805 733	10		
	SS 3	805 714	3/8		
	SS 4 MM	805 734	12		
	SS 4	805 715	1/2		
	SS 5	805 716	16		5/8
	SS 7	805 717	22		7/8
	SS 9 MM	805 703	28		
	SS 9	805 705			1 1/8
	TT 2 MM	805 697	6	Female solder x female solder ODF x ODF (with extended copper tubes)	
	TT 2	805 655			1/4
	TT 3 MM	805 698	10		
	TT 3	805 654			3/8
	TT 4 MM	805 699	12		
	TT 4	805 653			1/2
	TT 5	805 652	16		5/8
	TT 7	805 656	22		7/8
	TT 9 MM	805 700	28		
	TT 9	805 651			1 1/8
AMI-2	MM 2	805 706	6	Male flare x male flare	
	MM 3	805 707	10		3/8
	MM 4	805 708	12		1/2
	MM 5	805 709	16		5/8
	FM 2	805 710	6		1/4
AMI-2	FM 3	805 711	10	Female flare x male flare	
	FM 4	805 712	12		1/2
	S 11	805 704	35		1 3/8
AMI-2	S 13	805 659	42	Male solder ODM (for soldering into fittings)	
	S 17	805 687	54		2 1/8
	S 7	805 650	22		7/8
AMI-3	S 9	805 649	28	Saddle type (for soldering onto the pipe)	
	S 11	805 648	35		1 3/8

### Water Contents\* by Indicator Color

Refrigerant	Liquid Temperature °C	blue dry	Purple	fushia Caution	rose Caution - wet
R22	25	25	40	80	145
	38	35	65	130	205
	52	50	90	185	290
R404/R507	25	15	33	60	120
	38	25	50	110	150
	52	45	60	140	180
R134a	25	20	35	90	130
	38	35	55	120	160
	52	50	85	150	190
R407C	25	26	42	94	151
	38	40	68	144	232
	52	64	109	230	371

\* Water content in mg Water per kg refrigerant (ppm)

### Accessories

	Type	Part No.
Lens assembly kit	X 12978-1	805 742
O-Ring	x 99995	805 643

## Oil Management Components

### Technical Information

Refrigeration compressors are lubricated by refrigeration oil that circulates from the compressor crankcase or housing. As refrigerant gas is discharged by the compressor, it will leave with a fine oil mist, that will be circulated throughout the entire system. Small amounts of oil circulating through the system will not affect the system performance. Too much refrigeration oil circulating in the system will have adverse effects on the components in the system. Circulating oil reduces the ability of the system to effectively remove the heat. Condensers, evaporators and other heat exchangers lose efficiency when coated internally with an oil film.

Refrigeration oil not returning to the compressor causes improper lubrication and eventual compressor failure. At low temperature application, refrigeration oil thickness becomes difficult to move, causing oil to be trapped in the system.

### Oil separator function

Refrigerant gas leaving the compressor through the discharge line contains refrigeration oil in a vaporous mist. As this mixture enters the oil separator, the velocity is reduced to allow oil separation to begin.

The refrigerant gas and oil mixture enters the oil separator and passes through an inlet screen, causing the fine particles to combine. Larger oil particles are formed and drop to the bottom of the oil separator.

The refrigerant gas then passes through an outlet screen to remove residual oil particles. The oil gathers in the bottom of the oil separator until a float operated needle valve opens to allow the return of oil to the compressor. Oil returns quickly to the compressor, because of the higher pressure in the oil separator than in the compressor crankcase. When the oil level has lowered, the needle valve retracts to prevent refrigerant gas from returning back to the compressor. The refrigerant gas leaves through the outlet of the oil separator and goes to the condenser.

### Oil level management system function

This system provides oil level balancing as well as oil level monitoring including alarm and compressor shut-down functions. The oil level is measured inside the compressor's crankcase. By operating an integrated solenoid valve, missing oil can be fed from the oil receiver or from the oil separator directly into the compressor sump. If oil level drops to a dangerous level the alarm contact changes into alarm state. The alarm contact may be used to shut down the compressor. The integrated electronics includes delay times in order to avoid short-cycling and nuisance alarms.

This system applies to compressor pack applications with multiple parallel compressor arrangements but also to stand-alone compressor applications for compressors without differential oil pressure monitoring.

## Electronic Oil Level Management Systems OM3 / OM4 with alarm function and compressor shut down

### Features

- **OM4 for high pressure refrigerants**
- IP65 rating due to molded housing and electrical connection with molded cable assemblies
- 3 Zone 100% level control by using precise Hall-sensor measurement
- Self contained unit with oil level sensor and integral solenoid to manage oil level supply
- SPDT output contact for compressor shut down or alarming, rating 230 VAC/3A
- Power supply 24 VAC, 50/60 Hz
- Alarm, status and 3 zone indication by LED's
- Easy installation by sightglass replacement and frontside installation without nuts
- Visual inspection of oil level still possible



OM3 / OM4 TRAXOIL

- Adapters suitable for various types of compressors
- Signal generated by gravity based float - not prone to errors by foaming or light like optical sensors
- Recommended by leading compressor manufacturers
- CE marking under Low Voltage and EMC Directive

### Selection Chart OM3

<b>OM3-CUA</b> 805 030	Oil system with flange adapter 3/4-hole	
	Artic Circle	G2, G4, G6
	Bitzer	4VC, 4TC, 4PC, 4NC, 4J, 4H, 6J, 6H, 6G, 6F, 8GC, 8FC
	Bock	HA, HG (except HG/HA-34/22, see -CBB), O-Series
	Copeland® products D2, D3, , D6, D9, 4CC, 6CC	
	Dorin	all KP, K sizes (except those mentioned under -CBB)
<b>OM3-CBB</b> 805 032	Oil system with screw adapter 1 1/8" - 18UNEF	
	Bitzer	2KC, 2JC, 2HC, 2GC, 2FC, 2EC, 2DC, 2CC, 4FC, 4EC, 4DC, 4CC
	Bock	HA12/22/34, HG12/22/34
	Dorin	all H, K100CC/CS, K150CC/CS, K180CC/CS, K200CC, K230CS, K235CC, K240SB, K40CC, K50CS, K75CC/CS-
	L'Unité Hermetique	TAH, TAG
	Maneurop	LT, MT, SM, SZ
<b>OM3-CCA</b> 805 033	Oil system with screw adapter 3/4" - 14NPTF	
	Bitzer	ZL, ZM
	Copeland® products ZB (except ZB50,58,66,76,95,114), ZF, ZS	
<b>OM3-CCB</b> 805 034	Oil system with screw adapter 1 1/8" - 12UNF	
	Copeland® products DK, DL	
<b>OM3-CCC</b> 805 035	Oil system with flange adapter 3 holes	
	Copeland® products	D8D, D8S, except D8SJ and D8SK, installation only with one sight glass)
<b>OM3-CCD</b> 805 031	Oil system with rotalock adapter 1 3/4" - 12 UNF	
	Copeland® products	ZR90 ... ZR19M, ZR250 ... ZR380, ZRT180K to 760K, ZRU280K-560K, ZRY480K - 1140K
<b>OM3-CCE</b> 805 029	Oil system with rotalock adapter 1 1/4" - 12 UNF	
	Copeland® products ZR108/125/144, ZR94/160/190, ZB50/58/66/76/95/114	

### Selection Chart OM4 for high pressure refrigerants

<b>OM4-CUA</b> 805 060	Oil system with flange adapter 3/4-hole	
	Bitzer	4VHC-10K, 4THC-12K, 4PHC-15K, 4NHC-20K
	Bock	HGX4/310-4, 385-4, 464-4, 555-4
	Dorin	SCC 250/300/350/380/500/750/1500/1900/2000/2500/-B, SCS 340/351/362/373/385/3K8/-D
	Frascold	Series A-SK, D-SK, Series F-SK, Q-SK, Series S-SK
<b>OM4-CBB</b> 805 062	Oil system with screw adapter 1 1/8" - 18UNEF	
	Bitzer	2-HKC-05K/HK-07K/HHC-2K/GHC-2K/FHC-3K/EHC-3K/DHC-3K/CHC-4K, 4-FHC-5K/EHC-6K/DHC-7K/CHC-9K
	Bock	HGX12P/40-4, 50-4, 60-4, 75-4, HGX22P/110-4, 125-4, 160-4, 190-4, HGX34P/215-4/255-4
<b>OM4-CCA</b> 805 063	Oil system with screw adapter 3/4" - 14NPTF	
	Copeland® products Z034, Z045, Z058, Z0104	
<b>OM4-CCB</b> 805 064	Oil system with screw adapter 1 1/8" - 12UNF	
	Copeland® products DK, DL	
<b>OM4-CCC</b> 805 065	Oil system with flange adapter 3 holes	
	Copeland® products	D8D, D8S, except D8SJ and D8SK, installation only with one sight glass)
<b>OM4-CCD</b> 805 061	Oil system with rotalock adapter 1 3/4" - 12 UNF	
	Copeland® products	ZP235/295/385
<b>OM4-CCE</b> 805 066	Oil system with rotalock adapter 1 1/4" - 12 UNF	
	Copeland® products	ZP103/120/137/90/154/182

See also EXCEL based Alco® Selection Tool. Cable assemblies and accessories, see next page.

### Cable Assemblies for OM3 / OM4

OM3-P30	805 151	Power Supply Cable 3.0 m
OM3-P60	805 152	Power Supply Cable 6.0 m
OM3-N30	805 141	Relay Cable 3.0 m
OM3-N60	805 142	Relay Cable 6.0 m



### Accessories

ECT-323	804 424	Transformer 230VAC / 24VAC, 25VA (supply of 1 pc. OM3/OM4)
ECT-623	804 421	Transformer 230VAC / 24VAC, 60VA (supply of 3 pcs. OM3/OM4)
ODP-33A	804 366	Differential oil check valve 3.5 bar, inlet 15/16 -18UNF female, outlet 5/8 -18UNF male

### Ordering Information (Example)

Standard system requires the following parts:

Type	Part No.	Description
OM3-CUA	805 030	Oil level system with flange adapter 3- / 4-hole
OM3-P30	805 151	Power Supply Cable 3.0m
OM3-N30	805 141	Relay Cable 3.0m
ECT-323	804 424	Transformer 230 VAC / 24 VAC, 25 VA
ODP-33A	800 366	Differential Oil Check Valve 3.5 bar



### Technical Data

Supply voltage / current	24 V AC, 50/60 Hz / 0.7 A
Maximum allowable pressure PS	OM3: 31 bar, OM4: 45 bar
Solenoid valve MOPD	OM3: 21 bar, OM4: 24 bar
Medium temperature	-20 to 80°C
Ambient temperature	-20 to 50°C
Time delay filling	10 s
Time delay alarm	20 s
Body material	Aluminum
Screw material	Stainless Steel

Medium compatibility	HCFC, HFC, mineral, synthetic, and ester lubricants
Orientation of base unit	horizontal
Level Control	40 to 60% of sightglass height
Protection class	IP 65 (IEC529/EN 60529)
Solenoid Coil	Alco® ASC 24 VAC, 50/60 Hz: 8VA
Weight	850 ... 930g (dep. on adapter)
Alarm contact	max. 3A, 230VAC, SPDT dry contact

### Application Traditional low pressure oil level management system

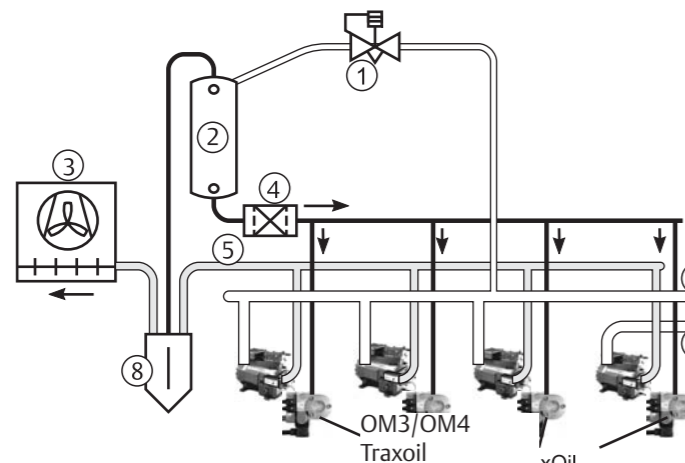

- 1: Differential pressure valve
- 2: Oil reservoir
- 3: Condenser
- 4: Filter Drier
- 5: Common Discharge
- 6: Common Suction Normal Temp
- 7: Suction Line Low Temp
- 8: Oil Separator

### High pressure oil level management system

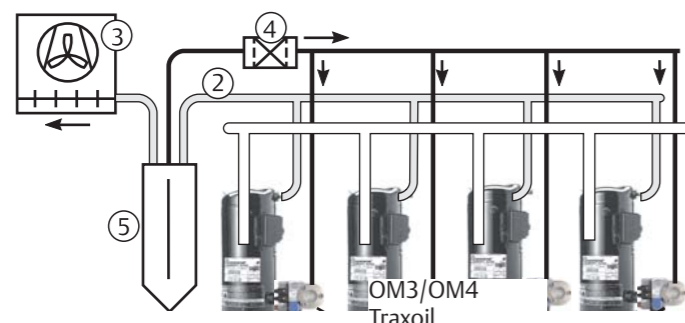

- 1: Common Suction
- 2: Common Discharge
- 3: Condenser
- 4: Filter Drier
- 5: Oil Separator

## Oil Separator Series OS

### Features

- Three different construction styles:
  - Hermetic
  - Top flange
  - Bottom flange with support bracket
- Stainless steel needle valve and floater
- Permanent magnet to catch iron particles out of the system
- Corrosion resistant epoxy powder painting
- ODF Copper fittings for easy soldering
- Temperature range TS: -10°C ... +150°C
- Max. allowable pressure PS: 31 bar
- CE marking according PED 97/23 EC



OSH

OST

### Type Code

Product line Oil Separators **OS X-X XX**

#### Construction

- H: Hermetic
- T: Top flange
- B: Bottom flange with supporter

#### ODF connection

- 04: 1/2"
- 05: 5/8" (16mm)
- 07: 7/8" (22mm)
- 09: 1 1/8"
- 11: 1 3/8" (35mm)
- 13: 1 5/8"
- 17: 2 1/8"

#### Nominal shell diameter

- 4: approx. 10 cm
- 6: approx. 15 cm



OSB

Type	Part No.	Connec-tion	Conformity Assessment Category	Conformity Assessment Procedure	Nominal capacity (kW)			Volume Lit.		
					R22/R407C	R134A	R404A/R507			
OSH-404	881 598	1/2"	Cat. I	Module D1*	7.0	4.9	7.3	2.0		
OSH-405	881 599	5/8"			18.7	13.1	19.4	2.4		
OSH-407	881 600	7/8"			28.1	19.7	29.0	2.8		
OSH-409	881 792	1 1/8"			37.4	26.2	38.7	3.0		
OSH-411	881 794	1 3/8"			46.8	32.8	48.4	3.6		
OSH-413	881 856	1 5/8"			65.5	45.9	67.8	3.6		
OSH-611	881 940	1 3/8"	Cat. II	Module D1	51.5	36.1	53.3	6.5		
OSH-613	881 953	1 5/8"			65.5	45.9	67.8	7.9		
OSH-642	889 022	42 mm			65.5	45.9	67.8	7.9		
OSH-617	881 970	2 1/8"			105.3	73.8	108.9	7.9		
OST-404	881 860	1/2"			7.0	4.9	7.3	1.8		
OST-405	881 861	5/8"			18.7	13.1	19.4	2.6		
OST-407	881 862	7/8"	Cat. I	Module D1*	28.1	19.7	29.0	3.2		
OST-409	881 863	1 1/8"			37.4	26.2	38.7	3.8		
OST-411	881 938	1 3/8"			46.8	32.8	48.4	3.8		
OST-413	881 939	1 5/8"			65.5	45.9	67.8	3.8		
OSB-613	881 971	1 5/8"			Cat. II	Module D1	65.5	45.9	67.8	7.8
OSB-617	881 972	2 1/8"					105.3	73.8	108.9	7.8

\* applied higher module as required



## Capacity Data for other than Nominal Operating Conditions

Nominal capacities at +38°C condensing temperature (+38°C bubble point or +43°C dew point for R407C), +4°C evaporating temperature (saturated temperatures / dew point) and 1 K liquid subcooling at the inlet of the expansion valve.

Correction factor for other evaporating temperatures than nominal:

$$Q_n = Q_o \times K_t$$

$Q_n$ : Nominal capacity  
 $K_t$ : Correction factor for a pressure drop corresponding 1 K saturation temperature  
 $Q_o$ : Required cooling capacity

### Correction Factors

Refrigerant	Condensing Temperature °C	Correction factor Kt Evaporating Temperature °C						
		10	0	-10	-20	-30	-40	-50
R22 R407	25	1.29	1.31	1.33	1.36	1.40	1.44	1.49
	30	1.16	1.17	1.20	1.23	1.27	1.31	1.36
	35	1.05	1.07	1.09	1.11	1.13	1.17	1.23
	40	0.95	0.96	0.98	1.00	1.03	1.07	1.12
	45	0.87	0.88	0.90	0.92	0.95	0.99	1.04
	50	0.81	0.83	0.85	0.87	0.89	0.93	0.99
Refrigerant	Condensing Temperature °C	Correction factor Kt Evaporating Temperature °C						
		10	0	-10	-20	-30	-40	-50
R134a	25	1.31	1.36	1.39	1.43	1.50		
	30	1.18	1.21	1.24	1.28	1.35		
	35	1.06	1.08	1.11	1.15	1.21		
	40	0.95	0.98	1.01	1.05	1.10		
	45	0.86	0.88	0.92	0.95	1.02		
	50	0.80	0.81	0.85	0.89	0.97		
Refrigerant	Condensing Temperature °C	Correction factor Kt Evaporating Temperature °C						
		10	0	-10	-20	-30	-40	-50
R404A R507	25	1.22	1.25	1.30	1.33	1.43	1.53	1.63
	30	1.12	1.15	1.20	1.26	1.32	1.42	1.54
	35	1.03	1.06	1.11	1.16	1.24	1.34	1.46
	40	0.95	0.99	1.04	1.09	1.17	1.28	1.41
	45	0.90	0.92	0.97	1.03	1.14	1.26	1.39
	50	0.86	0.89	0.93	1.00	1.13	1.26	1.39

## Suction Accumulators, Ball Valves, Acid Test Kit

### Features

- Hermetic design
- ODF Copper fittings for easy soldering
- Corrosion resistant epoxy powder painting
- Internal orifice with strainer for optimum oil return
- Temperature range TS: -45°C to +65°C
- Max. allowable pressure PS:
  - 20.7 bar (-10°C to +65°C)
  - 15.5 bar (-45°C to -10°C)
- CE marking for certain types according PED 97/23 EC
- HP marking for certain types according German pressurised vessels directive



A08

Type	Part No.	Connection "(inch)	Nominal Capacity Qn (KW)						Conformity Assessment		Volume Lit.
			R22/R407		R134a		R404A/R507		Category	procedure	
			Max.	Min.	Max.	Min.	Max.	Min.			
A08-304	001 973	1/2	7.0	1.1	4.2	0.6	4.6	0.7	HP Marking (CE Marking not required)	0.73	
A10-305	001 977	5/8	10.5	1.6	6.0	0.9	7.0	1.1		0.93	
A12-305	001 978	5/8	10.5	1.6	6.0	0.9	7.0	1.1		1.16	
A12-306	001 979	3/4	14.0	2.1	8.1	1.2	9.1	1.4		1.16	
A14-305	001 980	5/8	10.5	1.6	6.0	0.9	7.0	1.1		1.40	
A14-306	001 987	3/4	14.0	2.1	8.1	1.2	9.1	1.4		1.40	
A06-405	001 989	5/8	10.5	1.6	6.0	0.9	7.0	1.1		0.93	
A10-405	001 990	5/8	10.5	1.6	6.0	0.9	7.0	1.1		1.75	
A10-406	001 994	3/4	14.0	2.1	8.1	1.2	9.1	1.4		1.75	
A09-506	881 995	3/4	14.0	2.1	8.1	1.2	9.1	1.4		Cat. I Mod. D1*	2.33
A09-507	882 455	7/8	25.6	3.8	14.0	2.1	16.1	2.4			2.33
A12-506	881 996	3/4	14.0	2.1	8.1	1.2	9.1	1.4			3.29
A12-507	881 998	7/8	25.6	3.8	14.0	2.1	16.1	2.4			3.29
A13-507	882 007	7/8	25.6	3.8	14.0	2.1	16.1	2.4			3.80
A13-509	882 011	1 1/8	41.4	6.2	25.3	3.8	26.7	4.0	3.80		
A17-509	882 012	1 1/8	41.4	6.2	25.3	3.8	26.7	4.0	4.87		
A17-511	882 013	1 3/8	66.0	9.9	37.6	5.6	42.8	6.4	4.87		
A11-607	882 014	7/8	25.6	3.8	14.0	2.1	16.1	2.4	4.30		
A13-607	882 015	7/8	25.6	3.8	14.0	2.1	16.1	2.4	4.98		
A13-609	882 019	1 1/8	41.4	6.2	25.3	3.8	26.7	4.0	4.98		
A14-611	882 020	1 3/8	66.0	9.9	37.6	5.6	42.8	6.4	5.48		
A17-613	882 022	1 5/8	100.0	15.0	59.7	9.0	63.9	9.6	6.85		
A17-642	889 023	42 mm	100.0	15.0	59.7	9.0	63.9	9.6	6.85		
A20-613	882 021	1 5/8	100.0	15.0	59.7	9.0	63.9	9.6	8.21		
A25-613	882 023	1 5/8	100.0	15.0	59.7	9.0	63.9	9.6	Cat II	Mod. D1*	10.23

\* applied higher module as required

Correction factor for other evaporating temperatures than nominal:

$$Q_n = Q_o \times K_t$$

$Q_n$ : Nominal capacity  
 $K_t$ : Correction factor for a pressure drop corresponding 1 K saturation temperature  
 $Q_o$ : Required cooling capacity

Evaporating Temperature (°C)	+4	0	-5	-10	-15	-20	-25	-30	-35	-40
Correction Factor Ks	1.00	1.12	1.35	1.75	2.00	2.50	3.00	3.75	5.00	6.60

### Special seal caps to protect valve from unauthorized use

BVE / BVS Valve Size	Part No.	Thread (3)	Quantity per pack
1/4" ... 7/8" (6 ... 22mm)	806 770	M18x1	10 pcs
1-1/8" ... 1 3/8" (28 ... 35mm)	806 771	M27x1	10 pcs
1-5/8 (42 mm) ... 2-5/8"	806 772	M36x1	10 pcs

## Ball Valves Series BVE / BVS new version

### Features

- BVS version with schrader valve
- Feature mounting capability
- Hermetic design
- Max. allowable pressure PS: 45 bar
- Compatible for high pressure Refrigerants as R410A and CO<sub>2</sub> (sub-critical)
- Light weight design
- Virgin PTFE seat gaskets
- Bi-directional flow characteristics
- Valve cap retained by strap attached to main body
- Pressure relief port design
- UL approval and CE marking acc. PED 97/23 EC
- Applied Standards EN 12284, EN 378, EN12420, PED 97/23/EC, RoHS 2002/95/EC
- To protect valve from un-authorized use a special cap is available as accessory (see page 252)



BVE



BVS

Type BVE	Part No.	Type BVS	Part No.	Connection size ODF	
				inch	metric
BVE-014	806 730	BVS-014	806 750	1/4"	
BVE-M06	806 731	BVS-M06	806 751		6mm
BVE-038	806 732	BVS-038	806 752	3/8"	
BVE-M10	806 733	BVS-M10	806 753		10mm
BVE-012	806 734	BVS-012	806 754	1/2"	
BVE-M12	806 735	BVS-M12	806 755		12mm
BVE-058	806 736	BVS-058	806 756	5/8"	16mm
BVE-034	806 737	BVS-034	806 757	3/4"	
BVE-078	806 738	BVS-078	806 758	7/8"	22mm
BVE-118	806 739	BVS-118	806 759	1 1/8"	
BVE-M28	806 740	BVS-M28	806 760		28mm
BVE-138	806 741	BVS-138	806 761	1 3/8"	35mm
BVE-158	806 742	BVS-158	806 762	1 5/8"	
BVE-M42	806 743	BVS-M42	806 763		42mm
BVE-218	806 744	BVS-218	806 764	2 1/8"	54mm
BVE-258	806 745	BVS-258	806 765	2 5/8"	

### Technical Data

Max. allowable pressure PS	45 bar
Medium temperature TS	-40 ... 120°C (150°C short term)
Medium compatibility	HFC, HCFC, CO <sub>2</sub> , Mineral, Synthetic and Polyol-Ester (POE) lubricants

## Acid Test Kid Series AOK

### Features

- Quick & easy test kit
- Universal acid test kit for use with all oils: Mineral, POE etc
- By changing the percentage of oil sample taken, the acid number of the oil can be accurately determined
- Phase separation of the chemicals in the kit provide a positive colour change regardless of the colour and condition of the oil

Type	Part No.
AOK-U01	804 166



AOK

## Controller Kits Parts List

Controller Kit	PCN	Terminal Kits										Sensors				Transformers				Pressure Transmitters			Cable Assembly PT5	PT4-M60
		807 644	807 645	804 559	800 050	807 647	800 070	807 656	807 648	807 653	807 654	804 283	804 359	804 497	804 284	804 424	804 332	804 421	802 350	802 351	802 352			
<b>Superheat</b>																								
EC3-D72 Ctr. Kit TCP/IP	808 042									1							1	1			1			
EC3-D72 Ctr. Kit TCP/IP, R410A	808 049																		1			1		
EC3-D73 Ctr. Kit	808 041																					1		
EC3-X32 Ctr. Kit TCP/IP	808 037	1																				1		
EC3-X33 Ctr. Kit	808 036		1																			1		
EXD-U00 Ctr. Kit	808 038			1																				
<b>Display Case</b>																								
EC2-211 Ctr. Kit LON	808 000					1							1			2								
EC2-212 Ctr. Kit TCP/IP	808 001						1						1			2								
EC2-291 Ctr. Kit LON	808 002						1						1			2								
EC2-292 Ctr. Kit TCP/IP	808 003						1						1			2								
EC2-312 Ctr. Kit TCP/IP	808 005					1							1			2	2					1		
EC2-351 Ctr. Kit LON	808 008					1							1			1	2				1	1		
EC2-352 Ctr. Kit TCP/IP	808 009					1							1			1	2				1	1		
EC2-371 Ctr. Kit LON	808 010					1							1			3					1	1		
EC2-372 Ctr. Kit TCP/IP	808 011					1							1			3					1	1		
EC2-391 Ctr. Kit LON	808 006					1							1			4					1			
EC2-392 Ctr. Kit TCP/IP	808 007					1							1			4					1			
<b>Cond. Unit &amp; Condenser</b>																								
EC2-512 Ctr. Kit TCP/IP	808 015						1											1		1	1	2		
EC2-552 Ctr. Kit TCP/IP	808 019							1												1	1	2		
EC2-741 Ctr. Kit LON	808 022																				1	1		
EC2-742 Ctr. Kit TCP/IP	808 023																				1	1		
<b>Cold Room</b>																								
EC3-331 Ctr. Kit LON	808 012												1			1	1	1			1	1		
EC3-332 Ctr. Kit TCP/IP	808 013												1			1	1	1			1	1		
<b>Rack &amp; Condenser</b>																								
EC3-652 Ctr. Kit TCP/IP	808 046																				1	2		
EC3-672 Ctr. Kit TCP/IP	808 029																				1	2		
EC3-752 Ctr. Kit TCP/IP	808 031																				1	1		
EC3-812 Ctr. Kit TCP/IP	808 033																				1	1		
EC3-932 Ctr. Kit TCP/IP	808 044																				1	2		

## Cable Assemblies with Plug

Emerson Climate Technologies offers cables with preconfigured plugs. This makes installation very easy and quick, only cable with crimped ends has to be connected.

The cable assemblies are available in various lengths:

Product Type			Cable length		
			1.5m	3.0m	6.0m
	ASC Solenoid Coils		ASC-N15 804 570	ASC-N30 804 571	ASC-N60 804 572
	ASC 24V for DC-applications		DS2-N15 804 620		
	EX4 ... EX8 new loose wires		EXV-M15 804 663	EXV-M30 804 664	EXV-M60 804 665
	FSY Fan Speed Controls		FSF-N15 804 640	FSF-N30 804 641	FSF-N60 804 642
	FSP Power Module connection to FSE Control Module		FSE-N15 804 680	FSE-N30 804 681	FSE-N60 804 682
	FSP 2-Pin Plug connection to EC2, EC3 or third Party Controllers		FSP-L15 804 693	FSP-L30 804 694	
	OM3 / OM4 Relays Cable			OM3-N30 805141	OM3-N60
	OM3 / OM4 Power Cable			OM3-P30 805151	OM3-P60 804 805
	PT5 Pressure Transmitter		PT4-M15 804 803	PT4-M30 804 804	PT4-M60 804 805
	PS3 Pressure Controls		PS3-N15 804 580	PS3-N30 804 581	PS3-N60 804 582

## Accessories, Spare Parts & Appendix

Description	Type	Part No.
<b>Electronic controllers</b>		
EC3 Replacement battery		807 790
<b>Thermo - Expansion Valves</b>		
Bulb clamp XB1019	X A 1728-4	803 260
Bulb clamp XC726	X A 1728-5	803 261
Service Tool for T Series	X 99999	800 005
Gasket sets for T, ZZ, L, 935 and TG Series valves	X 13455-1	027 579
Bronze Screws for following flange types: (ZZ-Valves)		
	C500, C501, 9761, X6346, X6669, A576	Screw BZ 32 803 575
	9148, 9149, 9152, 9153, 10331, 10332	Screw BZ 48 803 576
Steel Screws for following flange types:		
	C500, C501, 9761, X6346, X6669, A576	Screw ST 32 803 573
	9148, 9149, 9152, 9153, 10331, 10332	Screw ST 48 803 574
<b>Solenoid Valves</b>		801 295
Coil clip		
Service tool for 110RB, 240RA, 540RA, M36	X 11981 - 1	027 451
Plug acc. To DIN 43650 cable gland PG9	GDM 2009/PG9	801 012
Plug acc. To DIN 43650 cable gland PG11	GDM 211/PG11	801 013
Repair kits:		
	110 RB	KS 30040-1 801 206
	200 RB	KS 30039/ 801 205
		KS 30109 801 205
	240 RA8	KS 30061 801 262
	240 RA9	KS 30062 801 263
	240 RA12	KS 30063 801 264
	240 RA16	KS 30065 801 200
	240 RA20	KS 30097 801 216
	M36-078 / M36-118 / 3031 (upper assembly inc. Gasket)	M36-UNF 801 440
Gasket kits:		
	110 RB	KS 30040-2 801 232
	200 RB	KS 30039-1 801 233
	240 RA8	KS 30061-1 802 234
	240 RA9/12	KS 30062-1 802 235
	240 RA16	KS 30065-1 803 236
	240 RA20	KS 30097-1 803 237
	all 3031	KS 30177-1 801 268
<b>Pressure Controls</b>		
Mounting bracket, angle, including screws		
	Universal for PS1, PS2, FD113	803 799
Mounting bracket universal		803 798
Extension bracket for PS1, PS2		803 800
Mounting plate for units with hood		803 801
Plug acc. To DIN 43650 for PS3		
	Cable gland PG9	801 012
	Cable gland PG11	801 013
Capillary tube with flare nuts 7/16" - 20UNF, 1/4" SAE, 1.5 m		803 804
Copper gasket set (100 pcs) for R1/4" (7/16" - 20UNF, female)		803 780
<b>Thermostats</b>		
Mounting bracket angle		803 799
Universal mounting bracket		803 798
Extension bracket for TS1		803 800
Insulation console TS1 standard		803 777
Capillary tube glands R" thread, for bulb style A/C		803 807
Capillary tube holder (5 pcs)		803 778
Capillary tube with flare nuts 7/16" - 20UNF, 1/4" SAE, 1.5m		803 804

Description	Type	Part No.
<b>Oil Management</b>		
OM3/OM4	Flange adapter 3-/4-hole	OMO-CUA 805 037
	Screw adapter 1 1/8" - 18UNEF	OMO-CBB 805 038
	Screw adapter 3/4" - 14NPTF	OMO-CCA 805 039
	Screw adapter 1 1/8" - 12UNF	OMO-CCB 805 040
	Flange adapter 3-hole	OMO-CCC 805 041
	Rotalock adapter 1-3/4" - 12UNF	OMO-CCD 805 042
	Rotalock adapter 1-1/4" - 12UNF	OMO-CCE 805 043
	Solenoid coil 24 VAC, 50/60 Hz, 15VA	ASC 24VAC 801 062
	Transformer 230 VAC / 24VAC, 25VA	ECT-323 804 424
	Transformer 230 VAC / 24VAC, 60VA	ECT-623 804 421
	Differential oil check valve 3.5 bar	
		(inlet 5/8" - UNF female, outlet 5/8" - UNF male) ODP-33A 800 366
	Repair kit for all OM3/OM4 types	
		(all necessary gaskets, coil clip and oil adapter with screen) OM3-KO1 805 036
OS	Gasket set for OSB / OST (50 pcs)	X 99956 007 591
<b>Filter Driers</b>		
All ADKS, ADKS-Plus		
	Gasket set	X 99961 003 710
	Schrader nipple 1/4" NPT	X 11562-2 803 251
	Core holder	X 99963 003 712
FDS 48		
	O'Ring set	X 99962 003 711
FDS 24		
	Gasket set	X 99967 003 716
	O'Ring set	X99968 003 717
	Core holder	X99969 003 718
BTAS	Repair kits with screws, gaskets, spring and brass cover:	
	BTAS 2	KD 30519-2 065 970
	BTAS 3	KD 30519-3 065 971
	BTAS 4	KD 30519-4 065 972
	BTAS 5	KD 30519-5 065 973
<b>Indicators</b>		
AMI upper parts with indicator		X 12978-1 805 742
O'Rings 20 pcs		X 99995 805 643
<b>Ball Valves</b>		
BVE/BVS special cap to protect valve from unauthorized use (10 pcs)		
	1/4" - 7/8" (6-22mm)	806 770
	1 1/8" - 1 3/8" (28-35mm)	806 771
	1 5/8" - 3 1/8" (42-54mm)	806 772



**Conversion Table**

**Power**

kW / h = Kcal / h : 860	Kcal / h = kW / h x 860
kW = US ton of refrigeration : 0,284	US ton of refrigeration = kW x 0,284
kW = BTU / h : 3413	BTU / h = kW x 3413

**Temperature**

°C = (°F - 32) : 1,8	°F = (°C x 1,8) + 32
----------------------	----------------------

**Pressure**

bar = PSI : 14,5	PSI = bar x 14,5
1 bar = 100 000 Pascal	100 Pascal = 1 mbar

**Connections**

Specification		Connection Tube			Thread
		SAE	inch	metric	
SAE	Flare	SAE 1/4"	1/4"	6mm	7/16" - 20UNF
		SAE 5/16"	5/16"	8mm	5/8" - 18UNF
		SAE 3/8"	3/8"	10mm	5/8" - 18UNF
		SAE 1/2"	1/2"	12mm	3/4" - 16UNF
		SAE 5/8"	5/8"	16mm	7/8" - 14UNF
		SAE 3/4"	3/4"	18mm	1 1/16" - 14UNF
		SAE 7/8"	7/8"	22mm	1 1/4" - 12UNF
		SAE 1"	1"	25mm	1 1/2" - 12UNF
			1 1/8"		
			1 3/8"	35mm	
	1 5/8"				
	2 1/8"	54mm			
	2 5/8"				
	3 1/8"				
R or G same as BSP	Pipe thread female cylindrical	Male thread: R / NPT / BSP / G			Withworth-Pipe thread DIN 2999 / ISO 228
R same as BSP	Pipe thread male tapering	Female thread: R / NPT / BSP / G			Withworth-Pipe thread DIN 2999
G	Pipe thread male cylindrical	Female thread: R / BSP / G			Withworth-Pipe thread ISO 228
NPT	Pipe thread female tapering	Male thread: R / NPT / BSP			Standard taper Pipe thread ASA B 2.1
	Pipe thread male tapering	Female thread: R / NPT / BSP / G			
ODF Outside Diameter Female	Solder female	Given dimension is outside tube diameter. Tube has to be pushed into ODF connection.			
ODF Outside Diameter Male	Solder male	Given dimension is outside tube diameter. Expanded tube can be pushed onto ODM connection or tube can be connected through a sleeve with the ODM connection.			

**Saturation Pressure Table for Refrigerants (bar, absolute)**

Temperature °C	R410A	R134a	R22	R404A	ALCO-Symbol		R507	R407C	R23	Temperature °C
	Z	M	H	S		S	N			
				Liquid	Vapor		Liquid	Vapor		
85		29.29	40.29						47.24	25
80		26.35	36.52						41.84	20
75		23.65	33.40						36.97	15
70		21.17	29.83	33.34	33.01				32.58	10
65		18.89	26.87	31.95	31.84	32.91			28.62	5
60	38.44	16.81	24.15	28.75	28.63	29.59			25.04	0
55	34.47	14.91	21.64	25.80	25.66	26.54	24.91	22.48	21.83	-5
50	30.79	13.17	19.33	23.08	22.94	23.73	22.24	19.80	18.94	-10
45	27.41	11.59	17.21	20.58	20.44	21.14	19.79	17.52	16.35	-15
40	24.31	10.16	15.27	18.29	18.15	18.78	17.55	15.39	14.03	-20
35	21.47	8.87	13.50	16.20	16.06	16.62	15.50	13.46	11.97	-25
30	18.90	7.70	11.88	14.29	14.15	14.65	13.63	11.73	10.14	-30
25	16.56	6.65	10.41	12.55	12.42	12.86	11.93	10.17	8.53	-35
20	14.45	5.72	9.08	10.98	10.85	11.24	10.41	8.78	7.12	-40
15	12.55	4.88	7.88	9.56	9.44	9.78	9.03	7.54	5.89	-45
10	10.85	4.15	6.80	8.28	8.17	8.47	7.79	6.44	4.83	-50
8	10.22	3.88	6.40	7.80	7.70	7.98	7.33	6.03	4.45	-52
6	9.62	3.62	6.02	7.35	7.25	7.52	6.90	5.65	4.09	-54
4	9.04	3.38	5.66	6.92	6.82	7.08	6.48	5.28	3.75	-56
2	8.49	3.15	5.31	6.51	6.41	6.65	6.09	4.94	3.44	-58
0	7.97	2.93	4.98	6.11	6.01	6.25	5.71	4.61	3.14	-60
-2	7.48	2.72	4.66	5.74	5.64	5.86	5.34	4.30	2.87	-62
-4	7.00	2.53	4.36	5.38	5.29	5.50	5.00	4.00	2.61	-64
-6	6.55	2.34	4.08	5.04	4.95	5.15	4.68	3.72	2.37	-66
-8	6.12	2.17	3.81	4.71	4.63	4.82	4.37	3.46	2.15	-68
-10	5.72	2.01	3.55	4.40	4.32	4.50	4.08	3.21	1.95	-70
-12	5.33	1.86	3.31	4.11	4.03	4.20	3.80	2.97	1.76	-72
-14	4.97	1.71	3.08	3.83	3.76	3.92	3.53	2.75	1.58	-74
-16	4.62	1.58	2.86	3.57	3.50	3.65	3.29	2.54	1.42	-76
-18	4.29	1.45	2.65	3.32	3.25	3.40	3.05	2.34	1.28	-78
-20	3.98	1.33	2.46	3.09	3.02	3.15	2.83	2.16	1.14	-80
-22	3.69	1.22	2.27	2.86	2.80	2.93	2.62	1.99	1.02	-82
-24	3.42	1.12	2.10	2.65	2.59	2.71	2.42	1.82	0.90	-84
-26	3.16	1.02	1.94	2.46	2.40	2.51	2.23	1.67	0.80	-86
-28	2.91	0.93	1.78	2.27	2.21	2.32	2.06	1.53	0.71	-88
-30	2.68	0.85	1.64	2.10	2.04	2.14	1.89	1.40	0.62	-90
-32	2.47	0.77	1.51	1.93	1.88	1.98	1.74	1.28	0.55	-92
-34	2.27	0.70	1.38	1.78	1.73	1.82	1.60	1.16	0.48	-94
-36	2.08	0.63	1.26	1.63	1.58	1.67	1.46	1.05	0.42	-96
-38	1.90	0.57	1.16	1.49	1.45	1.53	1.34	0.96	0.36	-98
-40	1.74	0.52	1.05	1.37	1.33	1.40	1.22	0.87	0.32	-100
-42	1.58	0.47	0.96	1.25	1.21	1.28	1.11	0.78	0.27	-102
-44	1.44	0.42	0.87	1.14	1.10	1.17	1.01	0.70	0.23	-104
-46	1.31	0.37	0.79	1.04	1.00	1.07	0.92	0.63	0.20	-106
-48	1.18	0.34	0.72	0.94	0.91	0.97	0.83	0.57	0.17	-108
-50	1.07	0.30	0.65	0.85	0.82	0.88	0.75	0.51	0.14	-110
-52	0.96	0.27	0.58	0.77	0.74	0.80	0.68	0.45	0.12	-112
-54	0.87	0.24	0.52	0.70	0.67	0.72	0.61	0.40	0.10	-114
-56	0.78	0.21	0.47	0.63	0.60	0.62	0.55	0.36	0.09	-116
-58	0.70	0.19	0.42	0.56	0.54	0.59	0.49	0.32	0.07	-118
-60	0.62	0.16	0.38	0.51	0.48	0.53	0.44	0.28	0.06	-120

## CE per Pressure Vessel Directive CE 97 / 23 / EC

Filter driers							
Product	Fluid group	Volume (liter)	TS (°C)	PS (bar)	Hazard category	Conformity assessment module	Marking
ADK-03 / 05 / 08 / 16 ...	II	0.10 ... 0.38	-40 ... +65	45	SEP	-	HP & UL
ADK-30 / 41 / 75 ...	II	0.40 ... 0.65					
FDB-03 / 05 / 08 / 16 ...	II	0.10 ... 0.38					
FDB-30 / 41 ...	II	0.45 ... 0.50					
BFK-05 / 08 / 16 ...	II	0.18 ... 0.32					
BFK-30 ...	II	0.40					
FDS-24 ...	II	1.00	-10 ... +65 (-45 ... -10)	34.5 (25.9)	I	A	CE & UL
ADKS-48 ...	II	2.10					
ADKS-96 ...	II	3.80					
ADKS-144 ...	II	5.40					
ADKS-192 ...	II	7.00					
ASD/ASF-28 ... / 35... / 45...	II	<1.00					
ASD/ASF50... / 75 ...	II	<1.40	-45 ... +50	28	SEP	-	HP & UL
BATS-2...	II	0.42					
BATS-3...	II	1.10					
BATS-4...	II	1.97					
BATS-5...	II	3.19					
			-10 ... +150	31	I	A	CE & UL
OSH-404	II	2.0					
OSH-405	II	2.4					
OSH-407	II	2.8					
OSH-409	II	3.0					
OSH-411 / -413	II	3.6					
OST-404	II	1.8	II	D1		CE 0036 & UL	
OST-405	II	2.6					
OST-407	II	3.2					
OST-409 / -411 / -413	II	3.8					
OSH-611	II	6.5					
OSH-613 / -617	II	7.9					
OSB-613 / -617	II	7.8	45	SEP		CE under low voltage and EMC Directive	
OM3	II	DN 6mm					
OM4	II	DN 6mm					
Suction accumulators							
A08-304	II	0.9	-10 ... +65 (-45 ... -10)	20.7 (15.5)	SEP	-	HP & UL
A10-305		1.1					
A12-305 / -306		1.3					
A14-305 / -306		1.6					
A06-404 / -405		1.2					
A10-405 / -406		2.1					

Suction accumulators (continuation)													
Product	Fluid group	Volume (liter)	TS (°C)	PS (bar)	Hazard category	Conformity assessment module	Marking						
A09-506 / -507	II	2.7	-10 ... +65 (-45 ... -10)	20.7 (15.5)	I	A	CE & UL						
A12-506 / -507		3.8											
A13-506 / -509		4.3											
A17-509 / -511		5.4											
A11-607		5.1											
A13-607 / -609		5.8											
A14-611		6.4											
A17-613		7.9											
A20-613		9.4											
A25-613		11.6											
											II	D1	CE0036 & UL
Pressure switches													
Product	Fluid group	DN (mm)	TS (°C)	PS (bar)	Hazard category	Conformity assessment module	Marking						
PS1-B3 ..., PSA-B3 ...		6	-50 ... +70	22	IV	B, D	CE0035 & UL						
PS1-S3 ..., PSA-S3 ...													
PS1-W3 ..., PSA-W3 ...				32									
PS1-B5 ..., PSA-B5 ...													
PS1-S5 ..., PSA-S5 ...													
PS1-W5 ..., PSA-W5 ...													
All other PS1 types				22 / 32				Under LVD, excluded from PED	CE & UL				
PS2-B7 ..., PSB-B7 ...								6	-50 ... +70	22	IV	B, D	CE0035 & UL
PS2-C7 ..., PSB-C7 ...													
PS2-T7 ..., PSB-T7 ...													
PS2-B7 ..., PSB-B7 ...													
PS2-C7 ..., PSB-C7 ...													
PS2-C8 ..., PSB-C8 ...													
PS2-G8 ..., PSB-G8 ...	32												
PS2-S8 ..., PSB-S8 ...													
PS2-T7 ..., PSB-T7 ...													
PS2-W7 ..., PSB-W7 ...													
All other PS2 types		22 / 32	Under LVD, excluded from PED		CE								
PS3-B.1 ..., PS3-W.1 ...			6		-40 ... +70	27	IV			B, D			
PS3-B.4 ..., PS3-S.4 ...													
PS3-B.5 ..., PS3-S.5 ...	32												
PS3-W.4 ..., PS3-W.5													
PS3-C.4 ..., PS3-T.4 ..., PS3-X.4 ...													
PS3-C.5 ..., PS3-T.5 ..., PS3-X.5													
PS3-B6 ..., PS3-B6	43												
PS3-W6 ..., PSC-W6 ...													
PS3-S6 ..., PSC-S6 ...													
All other PS3 type				-40 ... +150									
						-40 ... +70		27 / 32	Under LVD, excluded from PED		CE		
FD113 ...									Under LVD, excluded from PED		CE & UL		

LVD = Low Voltage Directive

Fan Speed controllers							
Product	Fluid group	DN (mm)	TS (°C)	PS (bar)	Hazard category	Conformity assessment module	Marking
FSY-41 ...	II	6	-20 ... +70	27	Under LVD, excluded from PED		CE
FSY-42 ...	II			32			
FSY-43 ...	II			43			
<b>Transmitters</b>							
PT5-07M/T	II	6	-50 ... +80	27	SEP	-	CE
PT5-18M/T, PT5-30M/T	II		mobile applic.	45			
PT5-50M/T	II		-25 ... +80	72			
<b>Thermo® Expansion Valves and Electrical Control Valves</b>							
TI	II	max. 16	-45 ... +65	45	SEP	-	-
TX3	II	max. 16		45			
TX6-H/M/N/S	II	max. 22		31			
TX6-Z...	II	max. 22		42			
T-series	II	max. 28		31			
L-series	II	max. 28		31			
935-series	II	max. 28		31			
ZZ-series	II	max. 28	-120 ... +65	31	I	A	CE
EX2	II	max. 12	-40 ... +50	40			
EX4/EX/EX6	II	max. 22	-50 ... +100	45	I	A	CE
EX7	II	35		45			
EX8	II	42		45			
<b>Solenoid Valves</b>							
110RB 2 ...	II	6 ... 10	-40 ... +120	31	SEP	-	v
200 RB 3/4/6 ...	II	10 ... 16		31			
240 RA 8/9/12 ...	II	16 ... 28		31			
240 RA 16T9	II	28		31	I	A	CE
240 RA 16T11	II	35		31			
240 RA 20T11/13/17	II	35 ... 54		31	SEP	-	-
540 RA 8/9/12/16 ...	II	16 ... 28		31			
540 RA 20T11	II	35 ... 54	28				
M36-078	II	28	35				
M36-118	II	28	35				
<b>Regulators</b>							
ACP	II	6 ... 10	-40 ... +120 -30 ... +80	31	SEP	-	-
CHPE ...		12 ... 28		28			
PRE/PRC		16 ... 35		25			
<b>Ball Valves</b>							
BVE/BVS ...	II	≤ 28	-40 ... +120	45	SEP	-	-
BVE/BVS ...		≥ 35		45	I	A	CE
hazard category SEP = Sound Engineering Practice acc. To art. 3.3 of PED							