

# MODERN STEEL CONSTRUCTION



November 1994

\$3.00



In the past it was necessary to show special loadings, such as this example, on the structural drawings and call for a special (SP)

example

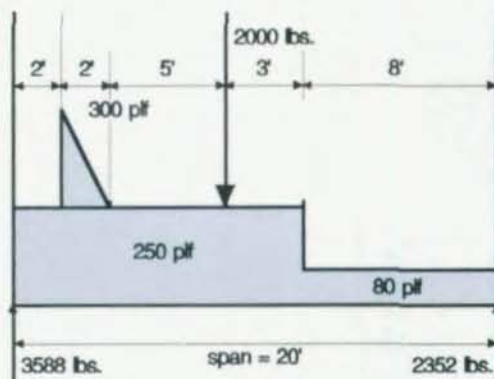

maximum moment = 243 k. inch  
maximum shear = 3588 lbs.

joist. Now, tables for new KCS joists can be used to find a joist with sufficient moment and shear values. The new KCS joists have constant moment and shear strengths -- in the case of the illustrated example a 16KCS2 joist is found to resist a moment of 349 inch kips and a shear of 4000 pounds. By specifying this joist it is no longer necessary to call for a SP joist or show the diagram.

In addition to the tables on the new K Series KCS joists the new SJI specification contains other important revisions:

1. New bridging requirements for K, LH, and DLH joists.
2. Metric load tables.
3. Revised joist girder bearing seat depths.

The latest SJI information is now available.



NICHOLAS J. BOURAS, INC.  
Executive Offices, Engineering and Sales  
475 Springfield Ave., Summit, NJ 07902-0652  
(908) 277-1617



Please circle # 33

09284

# **ARBED** *Tailor-Made* *Beams speed repairs of* *nation's oldest steel bridge.*

Gateway Western Railway's bridge at  
Glasgow, MO. after the flood of July 1993.

60 days after award; thanks to 140 tons of  
ARBED W44 x 335 Tailor-Made Beams.

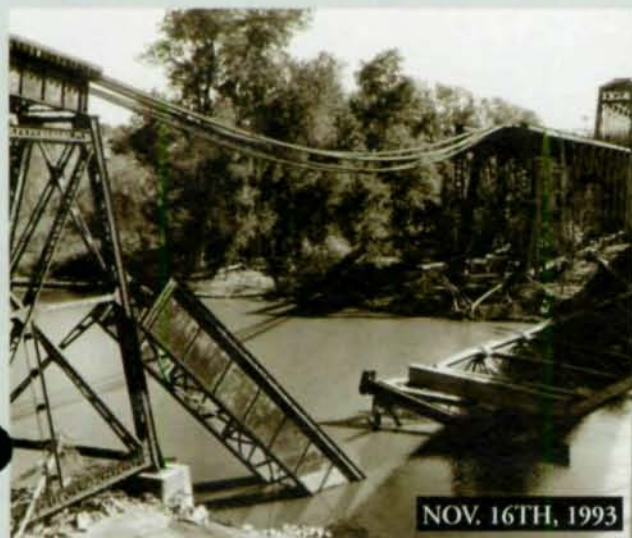

Constr. Mgr.: Design Nine, Inc. St. Louis, MO.  
Photography : Dale Graham, Fayette, MO.

Fabricator : Phoenix Steel, Inc., Eau Claire, WI.  
Erector : St. Louis Bridge Co., Arnold, MO.

*Consulting Engineers:* Modjeski & Masters, New Orleans, LA.

*Steel supplier:* 140 tons of ARBED W44x16x335 rolled WTM (Tailor-Made) beams in ASTM A572/Gr50,  
from the TradeARBED stock in Blytheville, AR.

When you need Big Beams, Service and Quality;  
The name is **ARBED**.

WTM (Tailor-Made) rolled beams are available in 24" through 44" and from 129 lbs/ft through 798 lbs/ft; in ASTM A36, A572, A709 with most sections available in ARBED's new **HISTAR®** Grade 65 (ASTM A913). Sectional properties are available on a free floppy disc (Lotus 1-2-3, Quattro Pro and ASCII versions for IBM, Excel for Macintosh) and the complete ARBED database is ready to use in the design softwares GTSTRUDL, ETABS, SAP90 and STAAD-III.

HISTAR® is a registered trade-mark of ARBED

For complete information, availability, literature and floppy disc,  
contact one of our TradeARBED offices at the following locations:

- 825 Third Ave., New York, NY 10022. (212) 486-9890, Fax (212) 355-2159.
- 60 E. Sir Francis Drake Blvd., Suite 202, Larkspur, CA 94939 (415) 925-0100, Fax (415) 461-1624 / 8257.
- 390 Brant Street, Suite 300, Burlington, Ontario, Canada L7R 4J4. (905) 634-1400, Fax (905) 634-3536.

Please circle # 35

# MODERN STEEL CONSTRUCTION

Volume 34, Number 11

November 1994

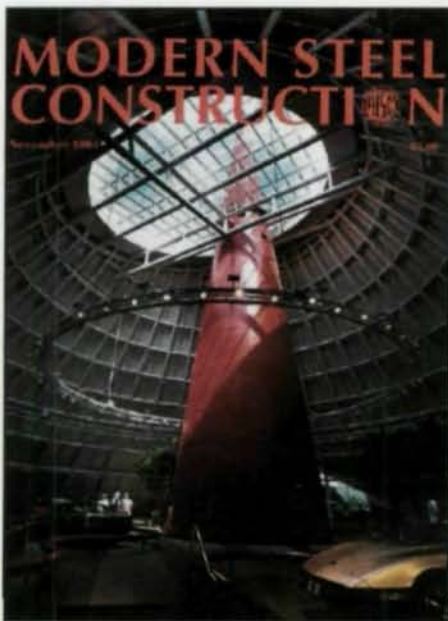

*Bold exhibition spaces should help attract a crowd of Corvette enthusiasts. The story of the exciting museum begins on page 24.*

## FEATURES

- 14 GAMBLING ON SUCCESS**  
*Due to the rampant popularity of casino gambling, speed of erection was a critical factor in the design of a massive addition to the Foxwoods Casino*
- 24 AERODYNAMIC MUSEUM**  
*The design of the new National Corvette Museum is fittingly as sleek and stylish as is its subject*
- 30 NATIVE ACCENTS**  
*Structural steel proved to be the best material to reinterpret a traditional Solomon Island form into a modern Parliament Building*
- 36 LARGE SCALE GIRDER TESTING FOR MORE ECONOMICAL STEEL BRIDGES**  
*A three-year project aims to develop advanced inelastic design provisions for steel girder bridges*

## DEPARTMENTS

- 6 EDITORIAL**
- 9 STEEL INTERCHANGE**  
•Lateral instability in exterior wall assemblies with lightweight narrow flange sections as girts  
•Can non-shrink grout be omitted under a proper bearing plate?  
•Bracing of compression flanges  
•Anchor bolt threads
- 12 STEEL NEWS**  
•Oktoberfest New Product Introductions  
•Upcoming T.R. Higgins Lectures
- 42 CONTROLLING SLAB CRACKING**
- 42 DECKING PRODUCTS**
- 45 STEEL MARKETPLACE**
- 46 AD INDEX**

Modern Steel Construction (Volume 34, Number 11). ISSN 0026-8445. Published monthly by the American Institute of Steel Construction, Inc., (AISC), One East Wacker Dr., Suite 3100, Chicago, IL 60601-2001.

Advertising office: The Ramage Group, O'Hare Lake Office Plaza, 2400 E. Devon Ave., Des Plaines, IL 60618 (708) 699-6049.

Subscription price:  
Within the U.S.—single issues \$3;  
3 years \$85.  
Outside the U.S.—single issues \$5;  
1 year \$36; 3 years \$100.

Postmaster: Please send address changes to Modern Steel Construction, One East Wacker Dr., Suite 3100, Chicago, IL 60601-2001.

Second class postage paid at Chicago, IL and at additional mailing offices.

# It's tomorrow ...

## in Computerized Structural Engineering

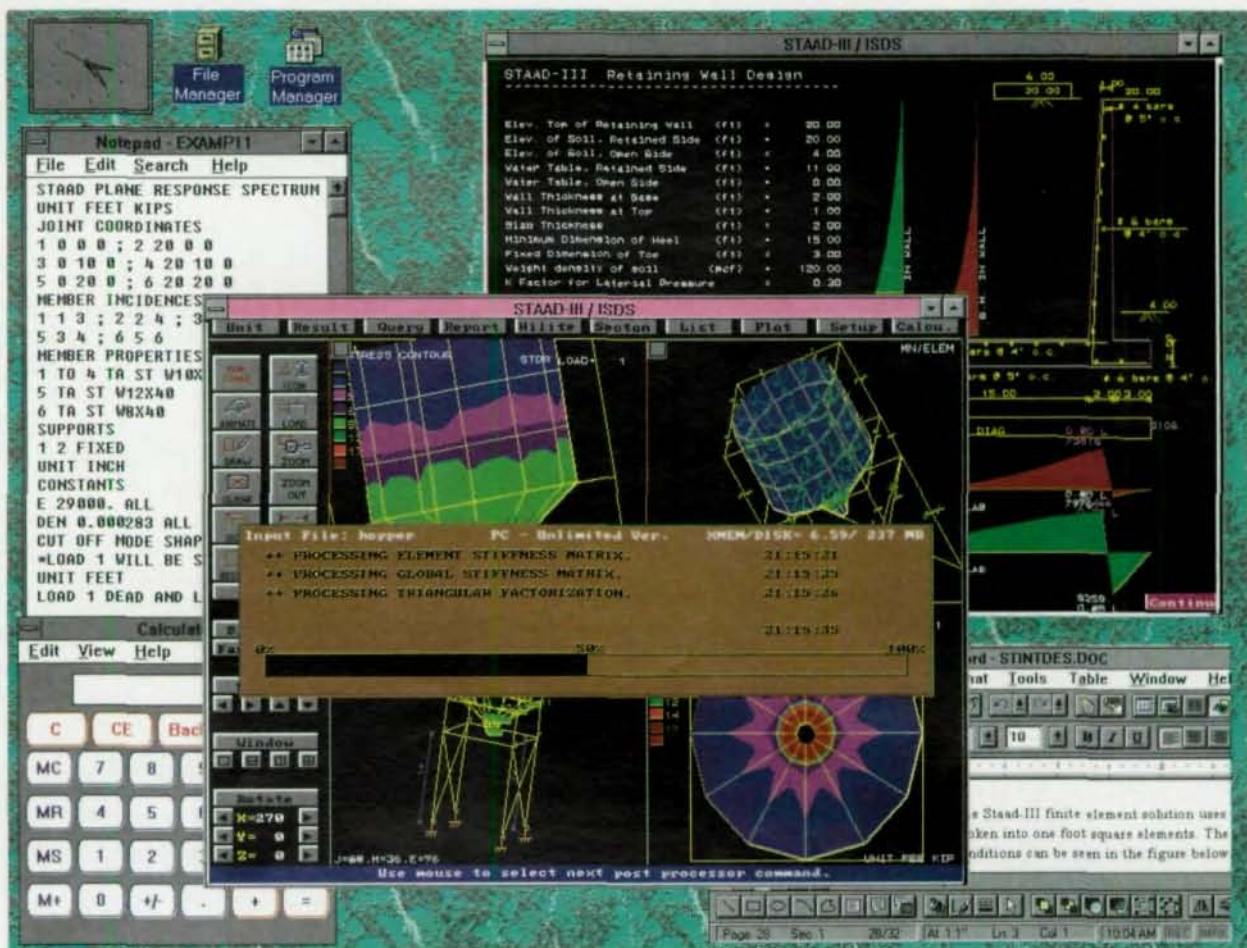

## Experience STAAD - III

### "Concurrent Engineering" on DOS/Windows/Unix/NT

Welcome to tomorrow in Computerized Structural Engineering. The latest release of STAAD-III, based on the principles of "Concurrent Engineering", is redefining the way you engineer your structure. Whether you are on DOS, WINDOW, UNIX, or NT, STAAD-III is guaranteed to enhance the performance and productivity to a whole new level.

STAAD-III, from Research Engineers, is an acknowledged world leader in structural software. State-of-the-art Static/Dynamic/Nonlinear analysis, innovative finite element techniques, comprehensive Steel/Concrete/Timber design, powerful graphics and seamless CAD integration have always been our forte. Our deep rooted R & D base, spread over four continents, and our association with the world's leading institutions, have resulted in a solid technological foundation for STAAD-III.

Today's STAAD-III, brings you the latest in modern Computer Aided Engineering. Based on the principles of "concurrent engineering", it unifies leading-edge graphics and visualization techniques with proven and time tested analysis/design. A live and unified associative data base provides seamless integration across all mission critical applications, from concept design and analysis to detail design, simulation and visualizations. Today's STAAD-III - a productivity concept for tomorrow.

With over 10,000 installations, more than 30,000 engineers worldwide rely on STAAD-III for the state-of-the-art in technology.

*Experience tomorrow today - experience STAAD-III*



**Research Engineers, Inc.**

22700 Savi Ranch Pkwy., Yorba Linda, CA 92687

Tel: (714) 974-2500 Fax: (714) 974-4771 Toll Free: (800) FOR-RESE

• USA • UK • GERMANY • FRANCE • CANADA • JAPAN • KOREA • NORWAY • TAIWAN • INDIA

Please circle # 34

# BUILDING BOOM

## Editorial Staff

Scott Melnick,  
Editor and Publisher  
Patrick M. Newman, P.E.  
Senior Technical Advisor  
Charlie Carter,  
Senior Technical Advisor  
Jacques Cattan,  
Technical Advisor

## Editorial Offices

Modern Steel Construction  
One East Wacker Dr.,  
Suite 3100  
Chicago, IL 60601-2001  
(312) 670-5407  
Fax 312/670-5403

## Advertising Sales

The Ramage Group  
O'Hare Lake Office Plaza  
2400 E. Devon Ave.  
Des Plaines, IL 60018  
(708) 699-6049  
Fax 708/699-6031

## AISC Officers

Frank B. Wylie, III,  
Chairman  
Robert E. Owen,  
First Vice Chairman  
H. Louis Gurthet,  
Second Vice Chairman  
Robert D. Freeland,  
Treasurer  
Neil W. Zundel,  
President  
David Ratterman,  
Secretary &  
General Counsel  
Morris Caminer,  
Vice President,  
Finance/Administration

**W**HEN AISC FIRST MOVED TO ITS NEW OFFICES IN 1989, I HAD A GREAT VIEW FROM MY 31ST FLOOR OFFICE. Since then, two high rises have gone up—substantially obscuring my once-grand vista. Oh, the many hours I've daydreamed about blowing up one of the offending structures. Apparently, I'm not the only one with these daydreams.

The *Chicago Reader*, an "alternative" free weekly, recently asked prominent Chicago architects about buildings they'd like to see blown up (though, ostensibly, the reasons were supposed to be for aesthetic value not mere personal pique). Since most in the building industry are familiar with Chicago's skyline, I thought I'd share with you some of these architect's top choices. Remember, the sampling was decidedly unscientific—consisting of only 29 votes with the top vote-getter receiving only four votes.

The top choice for destruction deeply distressed me, because it's my wife-to-be's favorite Chicago building: 150 North Michigan Ave. (better known as the Associates Building and best known for its diamond-shaped roofline that is so prominent in skyline photos and in such movies as the "Adventures in Babysitting") was decried because it's too noticeable and doesn't pay homage to Chicago's architectural traditions. I was a lot happier about the fourth building on the list: R.R. Donnelly Center at 77 W. Wacker. Besides being unattractive, this is one of the buildings that blocks my view.

Perhaps the most expected building on the list is number 14, the James R. Thompson Center (Helmut Jahn's curving "spaceship"). This building was exceedingly controversial when built—most people hated it, some loved it, no one was neutral. Personally, I always loved it visually, though I've had friends who worked in the building who were miserable due to the horrifying acoustics created by the full-height, open atrium in the building's center.

The most unexpected building was number 19, Mies van der Rohe's brilliant IBM Center at 330 N. Wabash. However, it wasn't cited for any fault of its own, but as a precursor of numerous bad Mies knockoffs scattered haphazardly around the city.

On the more serious side, some of the architects did make relevant points about city planning. One designer chided the Stouffer Riviere Hotel (across the street from my office but too low to affect my view) because while it is sited on a bend in the Chicago River, the guest rooms are set back, effectively nullifying one of the best vantage points in the city.

The Museum of Contemporary Art was criticized even before its completion for similar reasons. Its squat form will block one of the last potentially open views of Lake Michigan from the shopping mecca of Michigan Avenue. The Harold Washington Library Center was blasted for its overblown details (the owls on top are oversized and pedestrians sometime cross the other side of the street out of fear they'll fall off the building) and its lack of user-friendliness; quite simply, it is not an inviting or easy-to-use structure. And finally, the Robert Taylor Homes were decried as being misplanned social policy—something I doubt anyone would disagree with.

If you want a complete list of architect's least favorite Chicago building's, you'll have to get it from the *Reader*. However, if you want to add to the list—or nominate a building in another city, jot me a note. I always like hearing from MSC readers. **SM**

00286  
● How to get  
from here



Estimating Module

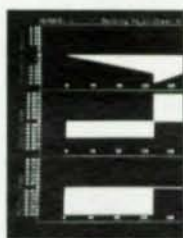

Engineering, Analysis  
and Design Module



Detailing Module



Production Control  
Module



CNC Interface  
Module

● to here.



## Design Data's SDS/2 Steel Fabrication System.

SDS/2 gives you the flexibility to integrate all aspects of your business with one software system. That concept is called Information Management. Each module by itself will save you time and money and by combining products to implement Information Management you receive more than twice the benefit in savings and productivity. So whether you need one SDS/2 software module or all these tools working together, Design Data can provide the most productive system for you.

For more information about SDS/2, information management in the steel industry or future product demonstrations call **800-443-0782**.

Please circle # 32

**DESIGN  
DATA**

"First in...software, solutions, service"  
402-476-8278 or 1-800-443-0782

© 1992 Design Data Corporation

# AISC Design Guides



AISC has published a series of seven Design Guides to supplement the *Manual of Steel Construction*. To order any of the publications listed below, call 312/670-2400.

**\*D801—Column Base Plates:** Contains a compilation of existing information on the design of base plates for steel columns and anchor bolts in building frames. Design guidelines are included. (\$20.00)

**\*D802—Design of Steel and Composite Beams with Web Openings:** Summarizes design concepts for the practicing engineer and presents a unified design approach to both steel and composite beams with web openings, including reinforcement requirements. (\$20.00) Companion computer program is available.

**\*D803—Serviceability Design Considerations for Low-Rise Buildings:** Summarizes existing research and criteria and presents requirements for deflections, vibration, drift and other serviceability limits. (\$16.00)

**\*D804—Extended End Plate Moment Connections:** Covers the design, fabrication and erection of extended end-plate connections and gives recommendations for four-bolt and eight-bolt end-plate connections. (\$20.00)

**\*D805—Design of Low- and Medium-Rise Steel Buildings:** Consolidates a vast quantity of information on this subject into one booklet. Also includes rules for economic design for engineers, loading requirements, and joist and composite floor systems. (\$20.00)

**\*D806—Load and Resistance Factor Design of W-Shapes Encased in Concrete:** Covers design of composite columns comprised of rolled wide-flange shapes encased in structural concrete with vertical deformed reinforcing bars. The advantages and disadvantages of composite construction, as well as practical design suggestions, are covered. (\$20.00) Companion computer disk also is available.

**\*D807—Industrial Buildings: Roofs to Column Anchorage:** Covers industrial buildings both with and without cranes. Information is provided on load conditions and combinations, roof systems, framing systems, wall systems, column design and column anchorage. (\$30.00)

**CALL 312/670-2400**



**Setting Standards For Over 70 Years**



# STEEL INTERCHANGE

*Steel Interchange* is an open forum for *Modern Steel Construction* readers to exchange useful and practical professional ideas and information on all phases of steel building and bridge construction. Opinions and suggestions are welcome on any subject covered in this magazine. If you have a question or problem that your fellow readers might help you to solve, please forward it to *Modern Steel Construction*. At the same time, feel free to respond to any of the questions that you have read here. Please send them to:

**Steel Interchange**  
**Modern Steel Construction**  
**One East Wacker Dr., Suite 3100**  
**Chicago, IL 60601-2001**

Answers and/or questions should be typewritten and double-spaced. Submittals that have been prepared by word-processing are appreciated on computer diskette (either as a Wordperfect file or in ASCII format).

The opinions expressed in *Steel Interchange* do not necessarily represent an official position of the American Institute of Steel Construction, Inc. and have not been reviewed. It is recognized that the design of structures is within the scope and expertise of a competent licensed structural engineer, architect or other licensed professional for the application of principals to a particular structure.

Information on ordering AISC publications mentioned in this article can be obtained by calling AISC at 312/670-2400 ext. 433.

*The following responses from previous Steel Interchange columns have been received:*

**The use of channel sections or other light-weight narrow flange sections as girts supporting non-bearing exterior wall assemblies against wind load is common practice. How is lateral instability of the unsupported compression flange accounted for when the wall is subject to outward pressure due to suction at the leeward face of the building? These outward forces are equal to or greater than the inward forces.**

It is instructive to determine the force required to prevent buckling. A C8 x 11.5 is commonly used as a girt. For simplicity, assume the full flange is stressed to 20 ksi. The force developed by the flange is 17.6 kips ( $0.081 \text{ in.}^2 \times 20 \text{ ksi} = 17.6 \text{ kips}$ ). Invoking the 2 percent rule gives a required resisting force to prevent buckling of 350 pounds. This is small compared to the forces structural engineers usually consider.

I note that girts are generally held level with one or more sag rods spaced along the girt's span. The sag rods commonly pass through the girt web and are secured with a single nut placed beneath the girt.

If the girt is installed with a slight bow downward, the girt flange can only laterally buckle downward since it is not possible to reverse initial curvature. Provided the sag rod is placed close enough to the compression flange, any tendency to buckle will be resisted by the sag rod in tension. The relevant question is how close to the unbraced flange must the sag rod be? I do not know of any authoritative guidance on this matter.

However, if the girt is initially set with an upward deflection and supported by a single nut below the web, the girt may laterally displace upward *unhindered except by gravity*. This problem may be overcome by providing a double nut connection - one below and one bolt above the web. This would place the sag rod in compression. Although

the sag rod's capacity in compression is small, the force required to resist flange buckling is also small.

In any event, thousands if not hundreds of thousands of industrial buildings have been constructed with metal siding supported by girts and the failure of girts under wind loading does not appear to be a serious problem. I believe that in many of these buildings little thought was given to the unbraced girder flange. I have personally observed "pre-engineered" buildings where light gage Cee or Zee girts are stayed between columns by the exterior siding only.

I speculate that girt supported walls perform satisfactorily for several reasons, regardless of the potential for flange instability. One, code dictated wind loads are conservative and rarely achieved. When achieved, it is likely that the wall diaphragm is breached relieving some of the loading. Also, wind loads are short-lived and the inertia of the girt-wall system results in a time-lag before the girt is fully deflected and stressed. During that delay the gusting wind may slow or change direction. Should the girt flange buckle, additional load carrying capacity may be developed through catenary action. In other words, the girt becomes a tension member restrained by its supports. And of course, the girt to column connection may afford substantial continuity.

**Robert Busch**  
**Leonard Busch Associates**  
**Trenton, NJ**

**When erecting steel beams on a brick wall, could the non-shrink grout be omitted under a proper bearing plate if the surface of the brick is smooth, clean of any and all debris and leveled?**

Even though the author of the question describes the brick bearing surface as "smooth, clean...., and leveled", the degree of perfection commonly found in brick masonry is no match for the flatness of a steel bearing plate.

# STEEL INTERCHANGE

Without grout the load will not be uniform but rather will be concentrated at the high points of the brick. This may lead to fragmentation of the brick masonry. One of the purposes of grout is to help distribute the load uniformly. It should not be omitted.

**David Ricker, P.E.**  
Payson, AZ

**What type of framing is considered bracing the compression flange? Does the member bracing the flange have to be attached to the flange? If a 4 inch deep member frames into mid-depth of a 10 inch deep beam is that considered bracing the compression flange (centerlines of each member at same point)?**

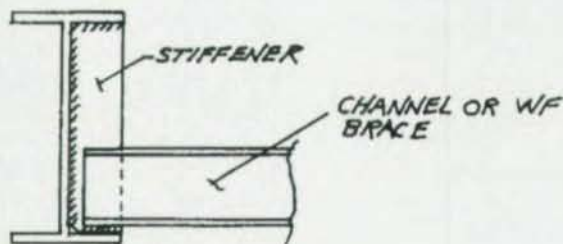

As discussed in the ASD 9th Edition Section C-F1, strong-axis-bending lateral-buckling can be prevented either by bracing the compression flange directly or by preventing the section from twisting. The first of these methods can be done using a concrete slab, properly attached deck or steel framing. Due to coping or framing considerations, steel braces often are not directly attached to the compression flange. A rule of thumb is that the connection for a brace should extend at least into the upper  $\frac{1}{3}$  of the beam depth to consider it as a lateral support for the top compression flange. Where this is not possible, the detail shown could be used to assure lateral support.

**Kenneth Wislocky, P.E.**  
**Raytheon Engineers & Constructors**  
Philadelphia, PA

**Can threads on anchor bolts be either rolled or cut? Is one method better than the other?**

Anchor bolt threads may be cut or rolled, depending on the project specification requirements. Allowable stresses published in AISC and other codes account for any differences in strength which may result from one method or the other.

A good article on this subject is titled, "Rolled

Threads vs. Cut Threads," dated June 20, 1966. This article was published in Fastener Facts and was released in the mid 1970's by the Bowman Products Division of the Associated Spring Corp. of Cleveland Ohio. To summarize, the article states that rolling and deforming the grain structure, rather than cutting through it, results in additional strength or resistance to thread shear.

**Dennis D. Havranek**  
**Valmont Industries, Inc.**  
Valley, NE

## New Questions

Listed below are questions that we would like the readers to answer or discuss.

If you have an answer or suggestion please send it to the Steel Interchange Editor, Modern Steel Construction, One East Wacker Dr., Suite 3100, Chicago, IL 60601-2001.

Questions and responses will be printed in future editions of Steel Interchange. Also, if you have a question or problem that readers might help solve, send these to the Steel Interchange Editor.

In regard to single plate shear connections, Table X of allowable loads in ASD 9th Ed. is based on conservative assumptions such that in many cases the bolt diameter, type, or quantity must be increased to satisfy the required loads. Is the method used in Engineering for Steel Construction (University of Arizona research) still acceptable, particularly when the job specifications call for using the "latest AISC standards"?

**Aaron Snyder**  
**Leonard/Mercurio & Associates**  
Pittsburgh, PA

Specifications currently exist which require minimum pretensioning loads for slip critical connections. There is, however, no guidance regarding minimum pre-loading of anchor bolts which occur at column bases. While in most situations this issue is academic since the anchor bolt nut and thread projection are below the plane of the concrete slab on grade and are eventually embedded in concrete at the slab isolation joint, there are instances where the nut and thread projection remain exposed. Is tightening the nut to "snug tight" and tack welding the nut to the bolt thread the only solution in preventing the nut from backing off?

**Charles F. Canitz, P.E.**  
**U.S. Army Corps of Engineers**  
Baltimore, MD

# Join The Wasser Revolution!

Stop using 2-part epoxies, 2-part urethanes and inorganic zincs. After 40 years, it's time to move to a coating system that's far better. Wasser has revolutionized the industry. **Join Us!**

## BRIDGES AND LEAD OVERCOAT



**ASTORIA BRIDGE, OREGON COAST** - Hundreds of bridge projects in environments like Oregon's coast, prove Wasser outperforms all other coatings.

## WATER AND WASTEWATER



**NORTH POLE ALASKA** - Painting continues on these sludge beds, while standing in snow. Wasser outperforms epoxy coatings on these demanding projects.

1. Industry's **BEST Corrosion Resistance**
2. **Single Component.**
3. **No Application Restrictions for Humidity, Dewpoint or Temperature (20°F)**
4. **World's Largest Producer of Single Component Moisture Cure Urethanes.**
5. **North America's Largest Manufacturer of Micaceous Iron Oxide Coatings.**

## UTILITIES, DAMS AND LOCKS



**PRIEST RAPIDS DAM, COLUMBIA RIVER** - Wasser has been chosen for their superior performance by agencies throughout the world.

## PULP AND PAPER



**CHIP CRANE, ROSEBURG LUMBER** - Wasser Coatings allow perfect results in outdoor winter painting or indoor painting on paper machinery, for virtually every paper company. Imagine, immersion after only minutes, and superior performance.

# WASSER

HIGH-TECH COATINGS

FOR FREE VIDEOS

Call 800-MC-PAYNT

For Information About Wasser  
Circle Reader Response #50

## Wasser, the Leader of the Coating Revolution!

# Wasser Coatings Aren't Just Better...They're A Lot Better Look What Experts Are Saying....

"Wasser's system outperformed every high performance coating system even when applied on poorly prepared surfaces. It has solved our state's bridge painting problems."

• *State Highway Report*

"This is Alaska paint. It would be crazy to use anything else but Wasser in this environment."

• *Alaska Coating Inspector*

"Our tank painting project was delayed for months because of the humidity. With Wasser, we finished in three days."

• *Hawaiian Contractor*

"We can't say enough about the MC-Tar. It saved our tail on our clarifier tanks. We would still be painting with the epoxy."

• *Paper Mill Engineer*

"We are very pleased with Wasser for lead overcoating. Everyone is calling it 'steel on steel'. Wasser solved our overcoat problems."

• *Highway Official*

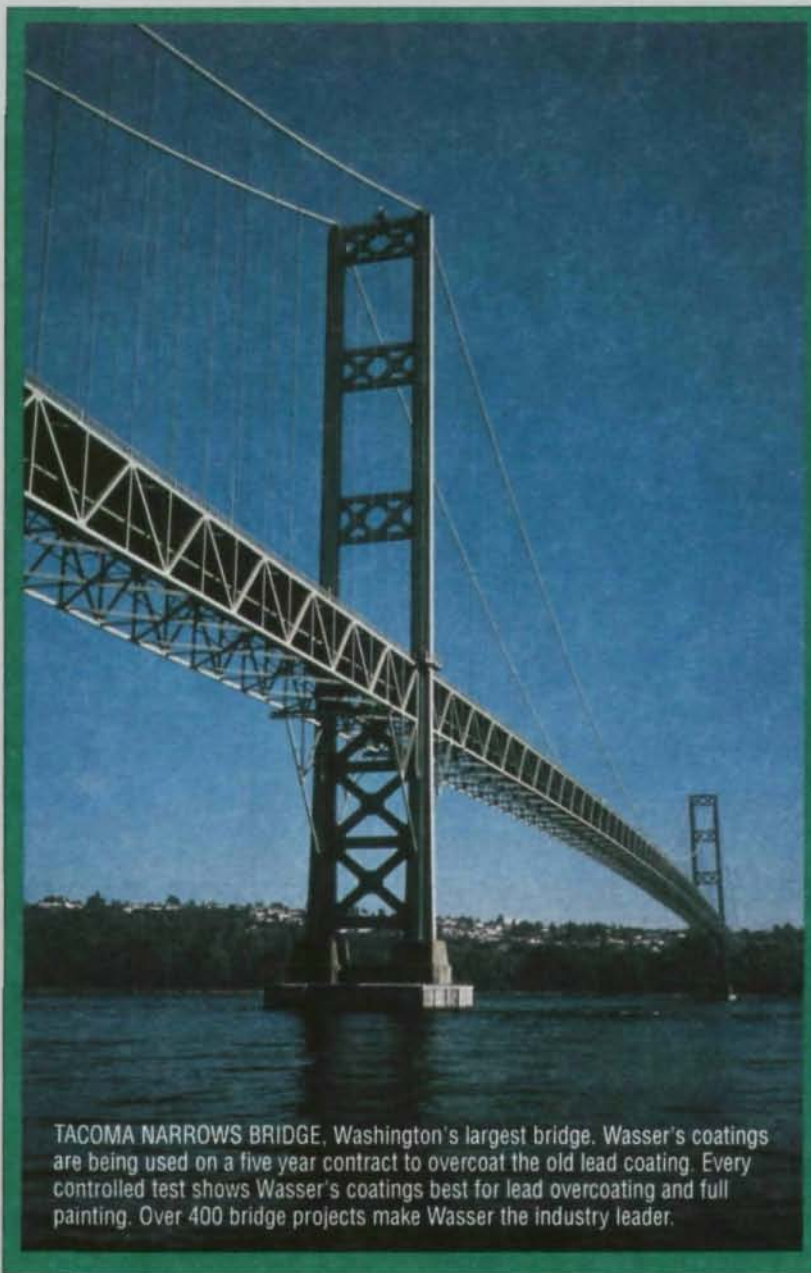

TACOMA NARROWS BRIDGE, Washington's largest bridge. Wasser's coatings are being used on a five year contract to overcoat the old lead coating. Every controlled test shows Wasser's coatings best for lead overcoating and full painting. Over 400 bridge projects make Wasser the industry leader.

"We used the ice as scaffolding in 22' tide and painted down to within four inches of low tide. Four years later, the coating is still perfect on these pilings."

• *Alaska Contractor*

"We coated the interior areas in 99% humidity and the performance is perfect after five years. We'll never use anything else."

• *Army Corps Locks*

"If it wasn't for Wasser, we would still be out there trying to get that darn inorganic zinc to work."

• *Bridge Engineer*

"Wasser is the answer to all our field painting problems. We'll never use epoxy again."

• *Waste Water Engineer*

"Wasser beat every other coating in our tests, and contractors love them."

• *Paper Mill Engineer*

**WASSER**  
HIGH • TECH COATINGS

World Leader in  
Single-Component,  
Moisture-Cure  
Urethane

Call 800-MC-PAYNT

The Best Coatings in the Industry are also the Easiest to Apply!

CIRCLE #50 ON SERVICE CARD

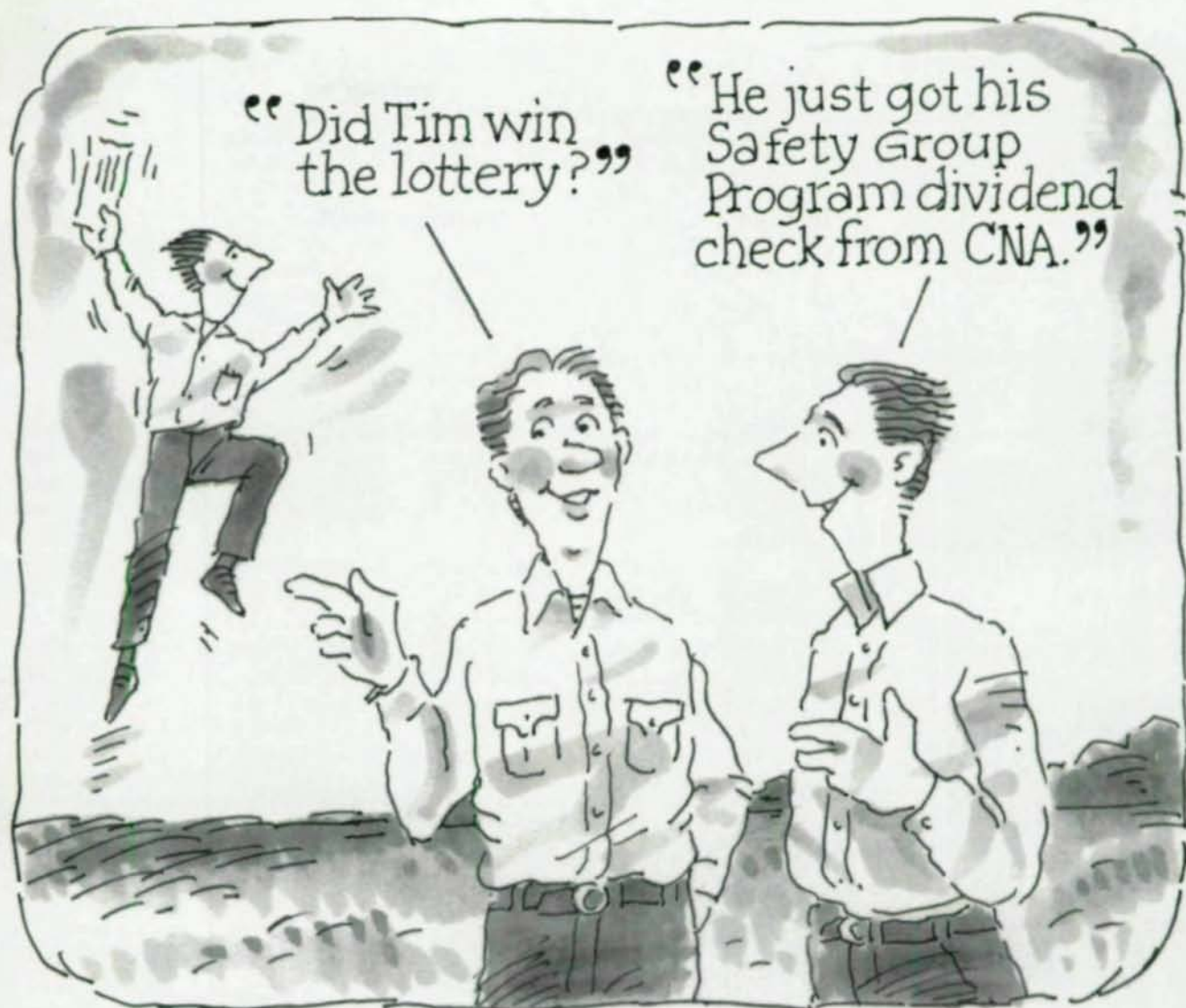

## Recently, CNA distributed \$744,968 to participating AISC members in the Safety Group Dividend Program.

Through the combined safety efforts of the American Institute of Steel Construction, CNA and plan participants, losses have been kept low. This resulted in a dividend\* which was shared by participants in AISC's Safety Group Dividend Program for the 1992-1993 policy year.

If your insurance carrier isn't paying you a dividend, take advantage of our comprehensive plan designed especially for structural steel fabricators. Call CNA at 1-800-CNA-6241.

\*Safety group dividends, available in most states, are declared by CNA's Board of Directors and cannot be guaranteed.

**CNA INSURANCE WORKING HARDER FOR YOU.®**

ENDORSED  
BY:



**CNA**

For All the Commitments You Make®

Available in the Continental U.S. only. This program is underwritten by one or more of the CNA Insurance Companies. CNA is a registered service mark of the CNA Financial Corporation/CNA Plaza/Chicago, IL 60685.

## PEDDINGHAUS SHOWS STATE-OF-THE-ART FABRICATION

**P**eddinghaus' biennial Oktoberfest open house (September 26 - October 7) attracted its usual packed house of foreign and domestic visitors anxious to view the latest in fabrication equipment. And, as usual, attendees were not disappointed.

Perhaps the most exciting among the new products shown by Peddinghaus is a new heavy-duty bandsaw (model 38-18) specifically designed for the structural steel fabricator and capable of cutting shapes up to W14x730. The bandsaw is considerably faster than a cold saw and wastes less material.

Also new this year is an inexpensive Anglemaster (model AFPCPS 623K) for processing angles, flats and punching channel sections. It features an improved roller feed drive and

measuring system to increase productivity. Another Anglemaster introduction is the "Ring of Fire" (model AFPCPB-623), which features two punches and a three-axis plasma torch system to process angle, channel and flat stock. For more information on Peddinghaus products, please circle **92** on the reader service card in the back of this magazine.

In addition to the Peddinghaus products on display, more than a dozen other tool and software vendors displayed their wares.

Representatives from Design Data demonstrated their SDS/2 Steel Fabrication System, a modular system including: engineering, analysis & design; detailing; estimating; production control; and CNC. In addition, Design Data offered information on

DesignLink, their electronic data interchange software product to transfer data from the design engineer to the steel detailer to the fabricator. For information on either SDS/2 or DesignLink, circle **32**.

CadVantage also was at the Oktoberfest and was demonstrating their PenWare system, which was first introduced earlier this year at the National Steel Construction Conference. PenVantage allows fabricators and detailers to enter information into CadVantage's detailing program with a pen, rather than using a computer keyboard or mouse. They also offered special discount packages, which they agreed to extend to MSC readers in November. For more information, circle **45**.

Dogwood Technologies demonstrated their detailing system,

## A Quick Quiz For Structural Engineers

The more a computer program costs, the better it is.

TRUE FALSE

A program that solves complex, difficult problems must be complex and difficult to use.

TRUE FALSE

Structural engineering software can never be fun to use.

TRUE FALSE

If you answered *TRUE* to any of the above, or you would like to know more about a truly innovative software program, call us!

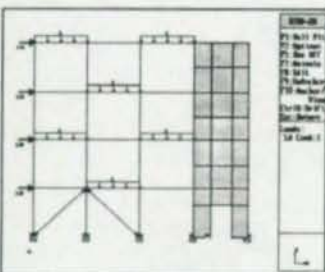

## RISA-2D

Your complete solution for frames, trusses, beams, shear walls and much more!

**RISA**  
TECHNOLOGIES

26212 Dimension Drive, Suite 200  
Lake Forest, CA 92630  
1-800-332-7472

### Sixth International Symposium



**TUBULAR STRUCTURES**  
14 - 16 December 1994

MONASH UNIVERSITY  
Melbourne, Australia

83 papers from 14 countries

For registration, brochures, and exhibition information contact

Michael O'Brien  
Office of Continuing Education  
Monash University  
PO Box 197, Caulfield East, Vic 3145  
Australia  
Tel : +61 3 903 2291 Fax : +61 3 903 2805  
e-mail : mobrien@monu6.cc.monash.edu.au

SPONSORED BY



which includes modules for fabrication control, miscellaneous iron, material management, and billing. Circle 98.

Steel Solutions showed their production systems for estimating, accounting, fabrication (mill orders, inventory, drawing control & bills of material), and for service centers, as well as provided a free demonstration disk. For information, circle 92.

Acecad demonstrated its Strucad software, which has an extensive track record overseas. The new PC version of the program performs detailing and CNC operations for structural steel detailers. For information, circle 93.

Another detailing package demonstrated at the Oktoberfest was CompuSTEEL. Its developers also were offering a special purchase plan. For information, circle 94.

More specialized is MTC, which demonstrated its CNC Profile Cutting Software. For information, circle 95.

Topping off the software vendors was SteelCAD, which demonstrated its detailing package. For information, circle 84.

Other exhibitors at the show included: Pullmax (manufacturers of forming, bending, shearing, punching, rolling and beveling equipment for plates)—circle 96. LeJeune Bolt Company—circle 73; and J&M Turner (manufacturers of direct tension indicators)—circle 97.

## T.R. HIGGINS LECTURES

Upcoming T.R. Higgins Lectures, featuring Lawrence Griffis, P.E., speaking on composite construction, are scheduled for Atlanta (Nov. 15), Bethlehem, PA (Dec. 8), St. Louis (Feb. 9), and Milwaukee (Feb. 10). Contact Robert Lorenz at 312/670-2400 or your local AISC Marketing Regional Engineer for more information.

# RAMSTEEL Asks: "How Much Time Do You Spend On These Tasks?"

See how RAMSTEEL can help you  
do this work in a *fraction of the time!*

30-DAY TRIAL AVAILABLE

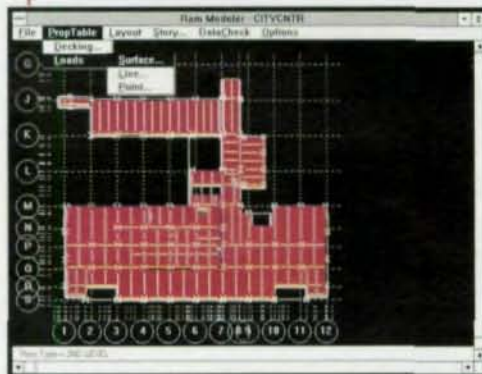

- ▲ Computing tributary loads, computing live load reductions and tracking the reaction of one member to the next.
- ▲ Designing beams, girders, bar joists, joist girders, columns and base plates.
- ▲ Preparing calculations and creating framing plans.

INTEGRATED ANALYSIS,  
DESIGN AND DRAFTING OF  
STEEL BUILDINGS

### Ram Analysis

5315 Avenida Encinas,  
Suite M, Carlsbad, CA 92008  
Tel 800-726-7789  
Fax 619-431-5214

Please circle # 41

## DESCON DESIGNS AND DETAILS STEEL CONNECTIONS

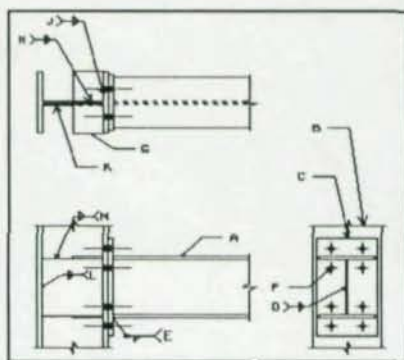
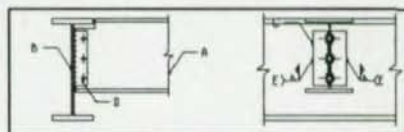

FOR A FREE DEMO DISK  
CALL OR WRITE TO

**OMNITECH ASSOCIATES**  
P.O. BOX 7581  
BERKELEY, CA 94707  
(510) 658-8328

Please circle # 52

## FLOORVIB

an expert system for  
**FLOOR VIBRATION  
ANALYSIS**

Developed by  
Thomas M. Murray, Ph.D., PE  
Souhail Elhouar, Ph.D.

- Far exceeds the capability of all other floor vibration software.
- Choose from six tolerance criteria including one for rhythmic activities.
- Beam, joist or built-up member framing.
- Complete user's manual with examples and tutorial.
- PC-Based. On line expert advice.

To order send P.O., check, or credit card information for \$250 + \$10 S&H to:

Structural Engineers, Inc.  
537 Wisteria Drive  
Radford, VA 24141  
Fax 703-639-0713  
Voice 703-731-3330

Please circle # 78

# GAMBLING ON SUCCESS

Due to the rampant popularity of casino gambling, speed of erection was a critical factor in the design of a massive addition to the Foxwoods Casino

By Peter G. Celella, P.E.



**T**HE HOTTEST SEGMENT OF THE ENTERTAINMENT INDUSTRY TODAY is undoubtedly casino gambling. Where once only Nevada could boast legal activity, casinos can now be found in every region of the U.S. While much of this boom is occurring on "riverboats", many states are allowing land-based casinos to be built on Indian reservations. One of the most successful is the Foxwoods Casino in Ledyard, CT.

Even as the original 250,000-sq.-ft. facility was being opened by the Mashantucket Pequot Indian Tribe in mid-February 1992, it was obvious that demand would outstrip the small facility.

Phase IV, which opened in 1993, and Phase V, which opened this year, added a total of 1.5 million sq. ft. to the popular complex. Phase IV included a five-level, 1,600-car parking garage, and above it, a concourse/lobby area, a 50,000-sq.-ft. casino, and a six-story, 300-room hotel. The project also included areas for a theater complex, shops, restaurants, and other entertainment facilities. Phase V included a 20,000-sq.-ft. bus terminal, a 62,000-sq.-ft. food court, a 44,000-sq.-ft. office building for casino staff, and a 60,000-sq.-ft. multi-purpose room for daytime bingo and evening entertainment. A connecting bridge between the theaters and the food court also was constructed over a roadway that had to remain unobstructed during the construction period.

Adding to the complexity of designing a complex for such

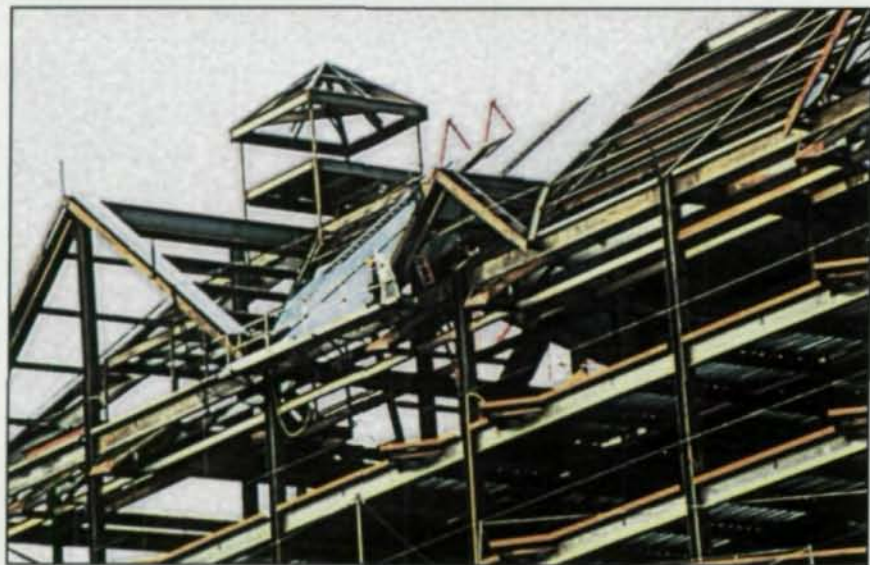

*Because speed was crucial on this project, a structural steel frame was chosen for expansion project, which encompassed a five-level parking garage, casino, 300-room hotel, a theater complex, restaurants and shopping. Top photo by Russell Studios, Inc.*



diverse uses, the lateral load-resisting systems for both Phases IV and V needed to be designed to resist both wind and seismic forces.

New England Design of Mansfield, CT, was the planning and design consultant on the project. Jeter, Cook and Jepson of Hartford, CT, was the architect and BVH Engineers, Inc., of Bloomfield, CT, was the structural engineer. Steel detailing, fabrication and erection was performed by AISC-member Berlin Steel Construction Co.

Virtually from the day it opened, Foxwoods Casino has operated near maximum capacity, 24-hours-a-day, seven-days-a-week. When BVH Engineers, Inc., began the structural design of the expansion, the original casino was already under operation, and every day spent on design or construction would result in a loss of projected revenues from an expanded facility. Obviously, an extremely accelerated construction schedule was the driving impetus for the project. Adding to the desire to increase revenues was a concern for minimizing the time period of the project's construction loan.

Because the project was fast-tracked—or "flash-tracked" as it was often referred to during construction—it also was important that the choice of material for the structural framing have the flexibility to accommodate the inevitable design changes that were to occur before, during and after construction.

#### PHASE IV

The design for phase IV was complicated by the need to accommodate a wide variety of uses. The various parts of the structure, stacked one upon another and equivalent in height of a 15-story building, were being designed while the levels below were under construction. The design of Phase IV was started in May of 1992—at the same time that excavation began—and opened to the public on Labor Day Weekend of 1993,

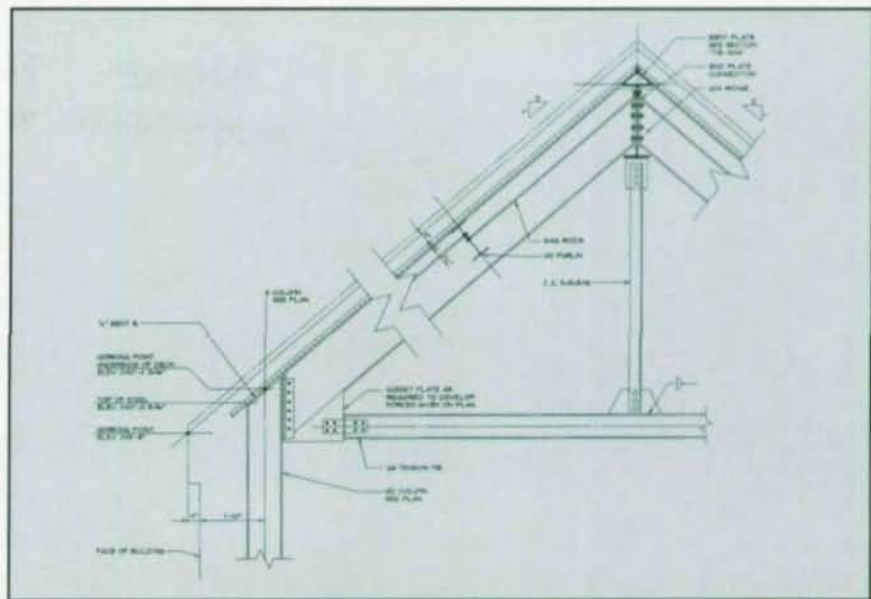

a mere 14 months later. The project required the use of 9,000 tons of structural steel, 700 precast double tees, and 52,000 cubic yards of cast-in-place concrete.

#### PARKING GARAGE

Because of a large grade differential, a 70-ft.-high concrete retaining wall was required along one side of the garage while the other side was left open. Because of schedule concerns, a common cast-in-place concrete garage was clearly not a practical alternative. Instead, the design used 60-ft.-long precast concrete tees supported on steel girders and columns. While

the 60-ft. spans presented some difficulties for the framing of the non-parking levels above, that column spacing was chosen as the most appropriate for parking layout and circulation.

Steel columns were W14 sections, as large as W14x426, that were encased in concrete after the erection was completed. The girders supporting the precast tees were W24 sections, one on each side of the columns, and outriggered off the column centerlines in order to pick up tees framing in from each side. Clips with thru-bolts mechanically fastened the girders to the tees. After erection, the steel girders were sprayed with a cementi-



tious fire-proofing.

Lateral loads were transferred through the garage using steel braced frames that were later encased in concrete walls. At several locations, it was necessary to transfer uplift loads from the braced frame columns into the footings using high-strength anchor bolts with steel anchor plates.

While the costs were comparable with a conventionally constructed cast-in-place garage, the choice of a hybrid steel/precast system had several advantages. The primary advantage was the speed of erection. Precast tees were being cast while the design for the rest of the structure was proceeding and the foundations were being built. Once erection began, it took approximately two months to erect the entire garage. A secondary advantage of using this system was improved life cycle costs. New England winters—as in much of the northeastern and midwestern U.S.—are particularly hard on cast-in-place concrete parking structures because of an almost constant exposure to freezing and salts. Precast tees, due to pretensioning, are very resistant to cracking, and therefore road salts do not have a pathway to travel along to corrode the reinforcing. The cementitious fire-proofing on the girders provides a degree of protection against corrosion, but in any case, since the girders are under the precast tees, they are not directly exposed to a corrosive environment.

When scheduling was considered along with the life cycle benefits, the use of a hybrid system using a combination of precast tees and a supporting steel frame was determined to be the most economical long-term solution.

#### CASINO & ENTERTAINMENT FACILITIES

Levels for the casino, theaters and shopping, along with the hotel lobby and operation support levels, were constructed



# CALL TODAY FOR YOUR FREE DEMO KIT!

## STRUCTURAL MATERIAL MANAGER 5.0

SMM 5.0 gives fabricators and detailers the fastest, most accurate material list manager available. No more time-consuming manual calculations! The software's speed and efficiency delivers an easy-to-use system that's second to none. Call today for a FREE, no-obligation demo disk with all modules and the complete system's user's guide.



ASSOCIATE MEMBER

The race is on: get on the fast track with SMM 5.0!

- Main Module computes weights, surface areas, bolt counts & lineal totals
- Length-Nesting module produces optimal cut lists from in-house stock, vendor stock or the best combination of both
- Plate-Nesting Module draws the best layout for cutting plates from stock sheets
- Estimating Module tallies material costs, shop hours & field hours
- Production-Control Module prints shipping lists, loading tickets & job status reports

**E.J.E. INDUSTRIES, INC.**

287 Dewey Avenue, Washington, PA 15301

**1-800-321-3955 or 412-228-8841**

immediately above the garage. The typical live load in the casino areas was required to be 250 psf due to the loadings imposed by the type of occupancy and gaming equipment. In order to electrify the floors for providing power to the slot machines and other gaming equipment, a double slab system (composed of a 5 1/2-in.-thick composite slab and a 4 1/2-in. electrified, light-weight topping) was chosen. In addition, an area used for hard count (coinage) storage required a design live loading of 700 psf.

Normally, spans of 30 ft. to 40 ft. would be used in areas with such high loadings. But since the column grid of 60 ft. was chosen for the garage below, and because of a need to maintain relatively long clear spans in the public use spaces, the same 60-ft. grid was continued through the casino and lobby levels. Conventional steel framing was used to frame these areas, but because of the 60-ft. spans and heavy loadings, W30 and W36 beams, 30-ft. on-center, were used.

Also constructed on these levels was an entertainment complex. It includes a 360-degree projection theater, a turbo-ride theater and a 1,300-seat Las Vegas type showroom. All of these areas were constructed of steel framing above the garage levels—i.e., the floors of the theaters were not slab on grade construction. Shop-welded steel trusses, 150-ft. long and 14-ft. deep, were used to clear span the required distance across the performance theater. The top and bottom chords on the trusses were W14 sections rotated horizontally. The trusses were shop fabricated with a construction joint in the span that allowed for field erection of only two pieces per truss. All of the shop fabrication was welded, while the construction joint was made using high-strength bolts. A penthouse, triangular in cross-section, was built on top of the theater roof to allow for the raising and lowering of a 30 ft. x 50 ft.

# GET ON THE FAST TRACK.

HIGH PERFORMANCE  
3D SPACE FRAME ANALYSIS  
AT A LOW PRICE

**\$ 199.00\***  
REG. \$495.00

- FULLY INTERACTIVE
- 500 JOINTS, 2000 MEMBERS
- POST-TENSIONING, APPLIED TORSION TRAPEZOIDAL AND THERMAL LOADS
- MEMBER MOMENT RELEASE OPTION
- BIAXIAL MOMENTS, SHEAR, AXIAL FORCES AND TORSION AT 1/10 POINTS
- NODAL DISPLACEMENTS & ROTATIONS
- STRESS RATIO
- GRAPHICS :VIEW AND PRINT SHAPE
- ADD ON DESIGN MODULES IN CONCRETE, STEEL AND TIMBER
- FREE TECHNICAL SUPPORT
- PROVEN; OVER 1000 USERS

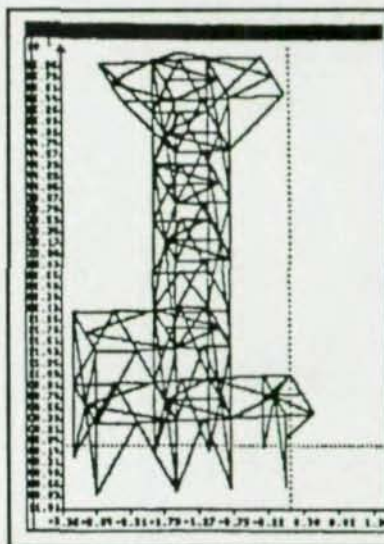

OVER 80 PROGRAMS AVAILABLE IN  
CONCRETE - STEEL - MASONRY - TIMBER

800-793-6285

\* ADD \$ 10 S&H  
FL RESIDENTS ADD 6% TAX  
OFFER ENDS JAN. 31, 1995

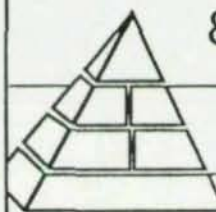

**INTRASOFT, Inc.**

The Most Productive Structural Design Software Since 1966

555 South Federal Highway, Suite 220 • Boca Raton, Florida 33432

Please circle # 46

Please circle # 99

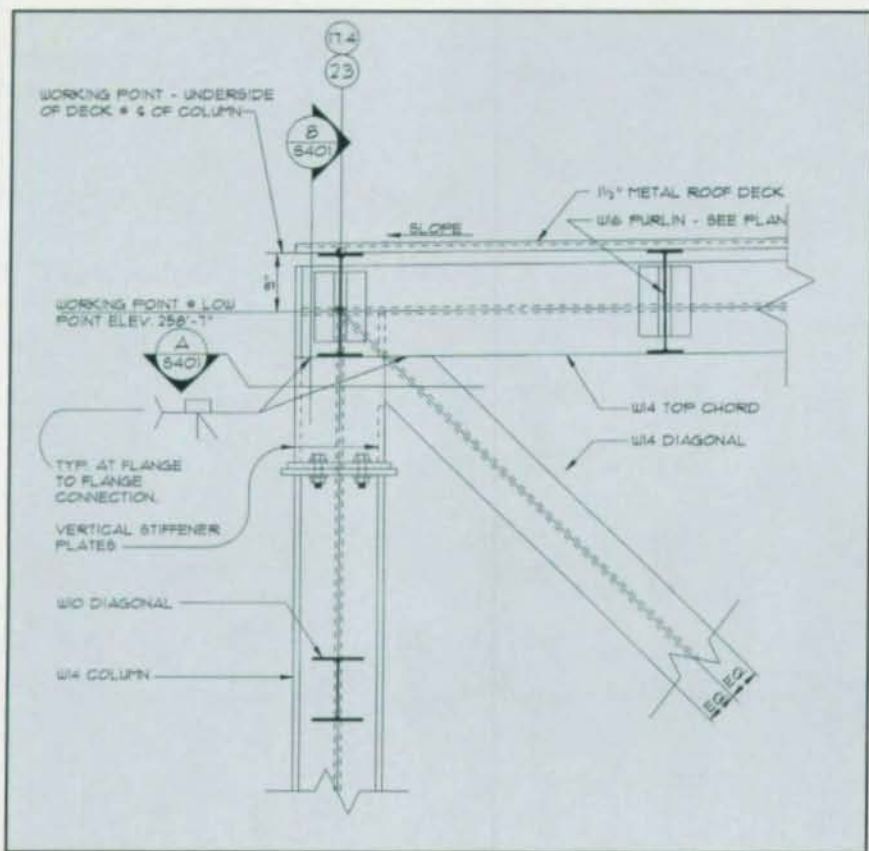

movie screen. When lowered in the middle of the showroom, the screen converts the space into a 300-seat Iwerks movie theater.

#### HOTEL

The six-story, 300-room hotel was erected on top of the casino and entertainment level. Cast-in-place or precast concrete is commonly chosen to frame this type of residential construction; but, given the aforementioned speed concerns, coupled with the difficulty inherent in building a concrete structure on top of a steel structure, it was decided to frame the hotel in steel.

The hotel, due to its footprint geometry, could no longer coincide with the 60-ft. column grid below. It was necessary to build a column transfer for the smaller spacings in the hotel. Although various alternatives were considered, including a staggered truss system, the column transfer was most easily accomplished by

*Introducing...*

## RISA-3D

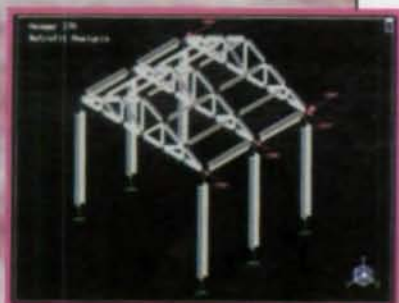

For the last 5 years our **RISA-2D** program has been setting the standard for 2 dimensional structural analysis and design. **RISA-2D** is, in fact, rated higher than most of the 3 dimensional programs currently available! See the Jan., '94 issue of *Modern Steel Construction*.

We are pleased to announce that **RISA-2D** has finally been surpassed!

Introducing **RISA-3D**, the new standard for structural analysis and design software. Statics, dynamics, P-Delta effects, steel design and many other features are incorporated into this powerful new program. **RISA-3D** provides a fast, intuitive problem solving environment absolutely unmatched by any other program.

Give **RISA-3D** a try and see for yourself!

**RISA**  
TECHNOLOGIES

26212 Dimension Dr.  
Suite 200  
Lake Forest, CA 92630  
Voice: 800-332-7472  
FAX: 714-951-5848

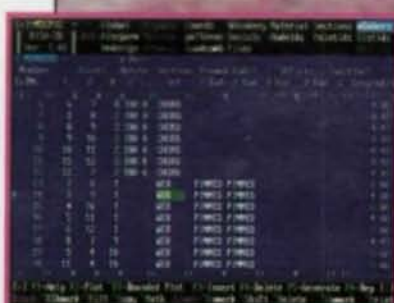

*Setting the Standard, Again.*

Call or FAX us  
for a free demo!

Please circle # 40

incorporating a series of transfer trusses into the bottom level of the hotel. Since steel lateral bracing frames were already being located with the demising walls of the hotel, it was simple to design these frames to include the extra gravity loading components necessary to span the 60-ft. column spacings below. These braced frames were used in combination with moment frames in the perpendicular direction to provide the lateral support for the hotel portion of the project.

Typical columns in the hotel were W14 sections. The moment frame beams were W21 and W24 sections, while the floor beams were composed of light W12 and W16 sections with W21 girders. The roof of the hotel was gabled and framed with W24 sloping girders and W12 beams with sag rods.

#### PHASE V

Although the design of Phase

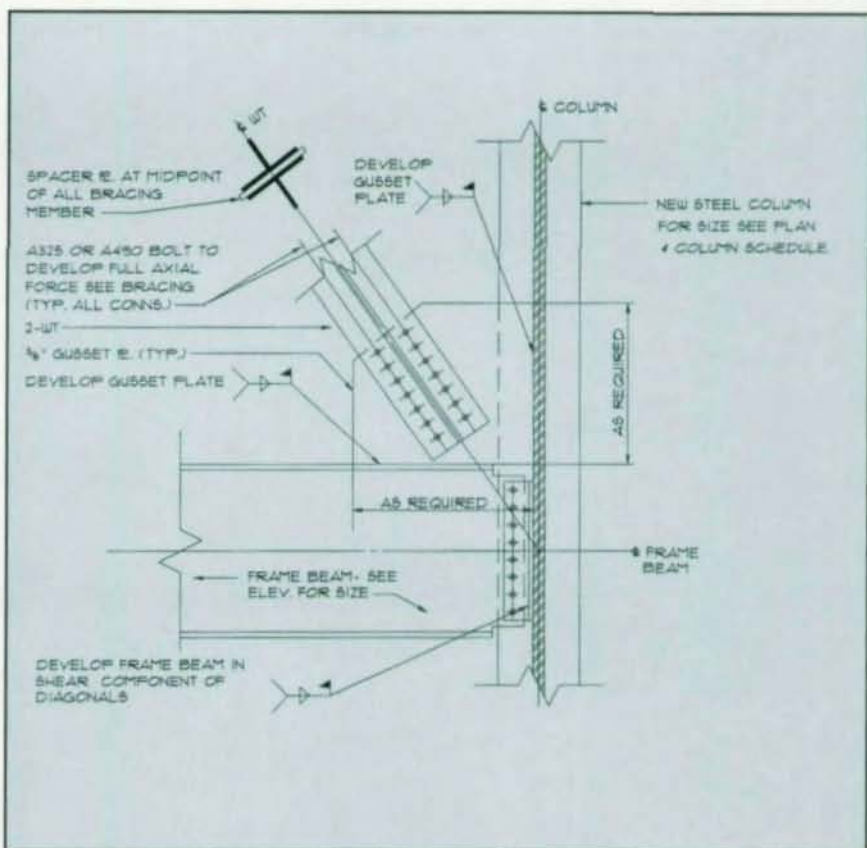

## LOOK What's New!

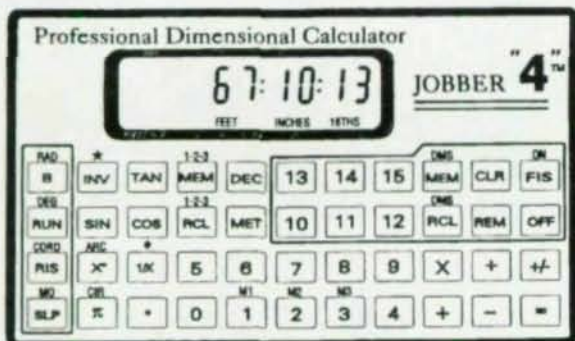

*It's like having a computer in your pocket.*

### "THE CALCULATOR THAT DOES IT ALL"

1. Feet, inches, sixteenths (calculator)
  2. Decimal (of feet) (or standard calculator)
  3. Metric calculator (millimeters, etc.)  
**Instant Conversion Between Formats**
  4. Scientific calculator (complex math problems made easy)
  5. Works directly with Degrees, Minutes, Seconds.
  6. Dimension like  $9' - 10\frac{15}{16}"$  takes only 3 keystrokes
- Add, subtract, multiply, and divide directly in feet, inch, and fractions. Calculating stairs, rail, ramps, trusses, rafters, hip-valley, bracing, hoppers, ducts, curves, circles, volume, area, and etc. **Quickly and Easily!**

The best friend your computer will ever have!

Use it with your computer.

## JOBBER "4"™

The world's best DIMENSIONAL CALCULATOR just got better!

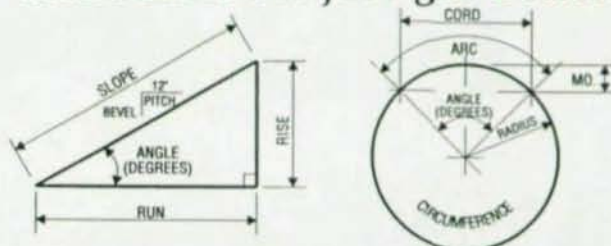

We now solve both **TRIANGLES** and **CIRCLES** instantly and automatically.

- We do Degrees, Minutes & Seconds plus much, much more.
- We do it easier and faster than you would believe. There is so much more we would like to tell you.

For more information or to order, call

**Toll Free 1-800-635-1339**

**Jobber Instruments**

P.O. Box 4112

Sevierville, TN 37864 U.S.A.

Discount for Larger Orders

**SPECIAL**

**PRICE**

**\$99.<sup>95</sup>**

**+ 5.<sup>50</sup> S&H**

# MAX WEISS

## STEEL SHAPING SPECIALISTS



UNUSUAL SHAPES AREN'T UNUSUAL AT MAX WEISS.

ROLLING & FORMING  
BLACKSMITHING  
WELDING & MACHINING  
INDUSTRIAL AND CONTRACTORS SUPPLIES



IRREGULAR CURVES,  
VERTICAL OFFSETS,  
ELLIPTICAL SHAPES,  
CIRCLES, OR SEGMENTS  
WITH OR WITHOUT TANGENTS

If it's structural steel that needs to be bent, for major architectural projects or for unique applications, chances are, Max Weiss bends it. If you have a question or problem in bending, call, FAX or write Dept. M93 for a solution. **TAKE IT TO THE MAX.**

**max weiss**

MAX WEISS CO., INC.  
8625 W. Bradley Road  
Milwaukee, WI 53224 USA  
Telephone: 414-355-8220  
MAX FAX 414-355-4698



Top photo by Robert Benson Photography

V was not fast-tracked in the same manner as Phase IV, speed of construction was still extremely important. As part of this phase, the existing bingo hall was converted into a slot machine hall simultaneous with the construction of a new bingo/multipurpose room. It was important that this work occur in a timely manner, with a minimum of disruption to the existing facilities. Design began in September of 1993, erection started in November of 1993, and the doors opened for business in May 1994—a time span of only nine months from first

pencil on paper to the opening of the new facility. A total of 2,000 tons of structural steel were utilized in Phase V.

### BINGO/MULTI-PURPOSE ROOM

The bingo/multi-purpose room was spanned with 14-ft.-deep, 160-ft.-long steel trusses. These trusses were fabricated and erected in a manner similar to those in the Phase IV theater. The bingo hall trusses also included a catwalk system servicing the lighting and sound systems used at boxing and musical events. The framing for the catwalks had to be coordinat-

ed and incorporated into the bottom chord bracing provided for the trusses. Mechanical mezzanines were located to either side of the room, at the level of the bottom chord, for the placement of fans for ventilating the large open space.

#### BUS TERMINAL/FOOD COURT

The food court floor had columns located on a 28-ft. x 28-ft. grid. Typical beams were W18x35 sections and the girders were W24x76 sections. The roof framing was designed to support 28-ft. x 56-ft. skylights. A canopy cantilevering 28 ft. out from the structure was provided to shelter patrons being dropped off at the bus terminal below. A tubular hangar runs from the outside edge of these canopies to the exterior building columns.

#### OFFICE BUILDING

A three-story office building for the use of the casino administrative staff was erected on top of the food court. The floors were framed using W16 beams and W24 girders. Lateral loads were transferred using a series of braced frames. The roof framing included a series of sloped screening and curved roof pent-houses.

#### CONCLUSION

The massive additions to the Foxwoods Casino were a unique and challenging project. A very large quantity of structural steel was raised in a very short period of time. The structures boasted a number of unique uses and configurations that offered many opportunities for investigating creative solutions to engineering problems. The most important reason for being able to accomplish such a feat of rapid design and erection is the extremely close cooperation and coordination of all the project's consultants.

*Peter G. Cerella, P.E., is a project manager with BVH Engineers, Inc., Bloomfield, CT.*

## IN STOCK! YOUR SOURCE FOR HIGH STRENGTH WEATHERING & ABRASION RESISTANT STEEL

### HIGH STRENGTH WEATHERING

**A588**

BARS • SHAPES • PLATES  
FLATS • ROUNDS • SQUARES  
ANGLES • CHANNELS • BEAMS

**A242-1**

PLATES

**A606-4**

HOT ROLLED COILS & SHEETS

### HIGH STRENGTH

**A572-50**

BARS • SHAPES  
FLATS • ROUNDS • SQUARES  
ANGLES • CHANNELS • BEAMS

### ABRASION RESISTANT

**AR 360**

PLATES

**Hardox 400 & 500**

PLATES

### QUENCHED & TEMPERED

**A514 Gr. A**

PLATES

**A517 Gr. E**

PLATES



Central Steel  
Service, Inc.

**1-800-868-6798**

**P.O. Box 326 • Pelham, AL 35124**  
205/664-2950 • Fax 205/663-3391

Please circle # 65

## SHOP DETAILS with AutoCAD®

Version 5.3

If your present CAD system doesn't detail everything you fabricate, then you should look at one that does - in English or Metric.

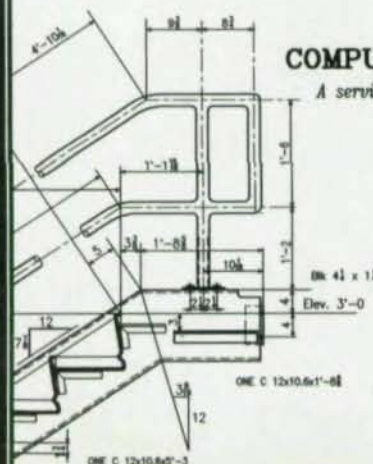
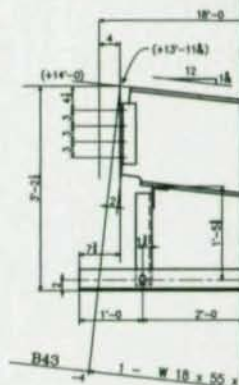

### COMPUTER DETAILING CORPORATION

A service company for Steel Fabricators and Detailers

80 Second Street Pike - Suite 10  
Southampton, PA 18968

215-355-6003

Fax 215-355-6210

**NEW**

**OCP** An Optimal Cutting Program  
for linear nesting (milling) to  
optimize cutting lists for maximum savings -  
current stock, warehouse, or both.  
Introductory price \$ 169.00



# 1995 Nat Construct San Antonio,

## New This Year — Four P

### 1. Structural Engineering:

- Reducing structural steel costs
- Interpreting the Mexican market
- New concepts in industrial building design
- Weldability, fracture mechanics, and metallurgy
- Seismic design solutions after the Northridge Earthquake
- Connections for hollow structural sections

### 2. Engineering Management:

- Protecting your firm from lawsuits
- Effective project specifications
- Steel erection & the building team
- Inspection of welded and bolted joints

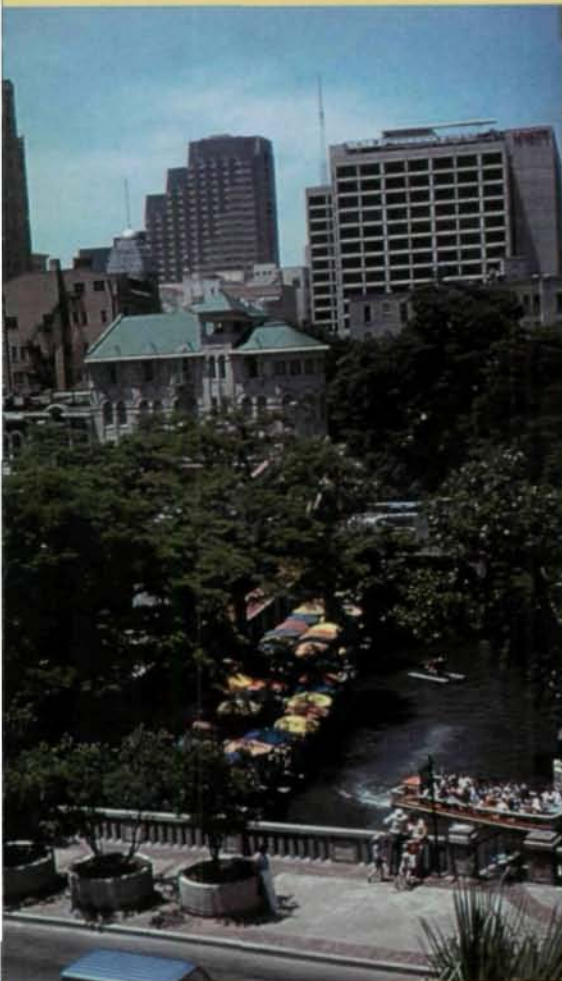

## 1995 NSCC Co-Sponsors

American Galvanizers Association  
American Iron and Steel Institute  
American Welding Institute  
American Welding Society  
Canadian Institute of Steel Construction  
Construction Industry Institute

Council of American  
Edison Welding Inst  
Mexican Institute of  
National Erecto As  
National Institute of  
Steel Deck Institute



# International Steel Conference May 17-19

## Professional Tracks

### 3. Steel Fabrication:

- Economical painting
- Avoiding painting system field failures
- OSHA training for fabrication shops
- EPA legislation
- Improving plant performance
- Fabricating hollow structural sections
- Fabrication equipment and methods
- Flame straightening technology

### 4. Construction Management:

- Construction Industry Institute-presented seminars
- Team building & partnering
- Constructability issues
- Bar coding for material management
- Total Quality Management



### Mark Your Calendar Now!

**Registration \$270 for  
AISC members (\$320 for  
non-members) for three-  
day conference and  
trade show**

**For more information, contact:  
American Institute of Steel  
Construction  
1 East Wacker Dr., Suite 3100  
Chicago, IL 60601-2001**

**phone: 312/670-2400  
fax: 312/670-5403**

Structural Engineers  
Steel Construction  
Steel Detailing

Steel Joist Institute  
Steel Plate Fabricators Association  
Steel Service Center Institute  
Steel Structures Painting Council  
Steel Tube Institute of North America  
Structural Engineers Association of Texas  
Texas Structural Steel Institute

# AERODYNAMIC MUSEUM



The design of the new National Corvette Museum is fittingly as sleek and stylish as is its subject

By Mehdi Setareh, P.E., and William Lefkofsky, P.E.

Photography by Timothy Hursley

**W**ITH ITS SLEEK, CURVING FACADE, THE NEW NATIONAL CORVETTE MUSEUM in Bowling Green, KY, evokes an appropriately aerodynamic image. The museum houses an exhibit on the 40 year history of the Corvette car—the first time a museum was devoted entirely to a single car model.

Funded by donations from Corvette enthusiast groups and General Motors Corporation, it includes a theater, automobile display area and a pavillion for car display. The budget for the entire 65,000-sq.-ft. complex was only \$8 million, which makes its construction costs very economical compared with other museums. The museum is expected to attract approximately half a million visitors annually to its displays of more than 50 Corvettes, including several limited edition models. In addition, the museum will house a special driving simulator.

The building's striking geometry is the result of a design by the architectural firm of Neumann/Smith and Associates, Southfield, MI. "This is not a typical quiet museum, but a the-

atrical one, in which the building itself is part of the show," explained Kenneth Neumann, the design architect. "Not a quiet place but a provocative one."

The entire complex includes three major zones interconnected by an atrium. The office atrium portion, which exhibits the history of the Corvette since its creation in 1953, is steel framed, using 8x8 tubes for the columns, W8x35 sections for the beams, and steel joists for the roof.

General contractor on the project was a joint venture of Alliance/Turner. Steel fabricator was AISC-member Grace & Wylie Fabricators, Inc. Erector was Al-Tenn.

## COMPLEX EXHIBIT SPACE

THE EXHIBIT AREA ALSO IS STEEL FRAMED, though the design is more complex. It features a saw-toothed roof profile reminiscent of original automobile manufacturing facilities. The structure includes exposed steel beams and stiffeners, which frame into exposed steel tube column stubs over concrete column bases. At the north end of the building, a 14-ft.-deep truss is tilted out-





board 60 degrees and spans 54 ft. with a 16-ft. cantilever. The truss is formed from both 8x8 tube and W8x48 members. The rest of the exhibit area is framed with 8x8 tubes and joists and joist girders.

On the exterior, the cladding is curved, which gives a circular appearance to the truss. The exhibit area will include about 25 different models of the car and provide information on the design and technology, including showing cut-aways of engines, mold shapes, scenes from racing tracks, gas station models, an assembly line and car crash testing models. The exhibit area even includes an area for purchasing a new car.

#### COMPLEX DESIGN

THE FINAL AREA, THE CAR DISPLAY PAVILLION, is the most complex. It includes a 60-ft.-high frustum-shaped steel structure with a 15-degree monoslope roof.

## Over 30 Years Of Successful Construction Dispute Resolution.

Since the early 1960s, the registered professional engineers and consultants of McDonough Bolyard Peck have helped owners, contractors and attorneys successfully resolve over one billion dollars in construction disputes.

■ \$3 billion of collective construction field experience.

■ Proven, forensic approach to delays, impacts, acceleration, and inefficiency.

■ Detailed research, articulate reports and testimony, ADR.



Call today for a free  
brochure.

(703) 641-9088

MCDONOUGH BOLYARD PECK • 8260 WILLOW OAKS CORP. DRIVE, FAIRFAX, VA 22031 • FAX: (703) 641-8965

Please circle # 100

## GRINDER SOFTWARE COMPANY

### MATERIAL ESTIMATING FOR STEEL FABRICATORS

- ✓ Accomplish in 3 hours time what used to take 8 hours with pencil and paper.
- ✓ Keep material waste to the absolute minimum using our unique length optimizing process.
- ✓ Produces 12 precise, easy to read reports for use by the shop and office.
- ✓ Handles ferrous and non-ferrous metals, fasteners, hardware, misc. items and assembled units. Also tracks shop and field labor.
- ✓ Interfaces with the SteelCad™ international detailing software.
- ✓ A "Competitive Upgrade" is available.
- ✓ "Test Drive" our fully functional demo for 30 days and start saving today.

1774 Rose Valley Road  
P.O. Box 431  
Kelso, WA 98626

Tel 800 677-4474  
Fax 206 577-4474

### COMPUTER SOFTWARE FOR SUCCESSFUL STEEL FABRICATORS

Please circle # 83

This portion is used for the display of about 20 different models of Corvette cars. Also, from the inside of the pavillion, a 108-ft.-high spire extends out of the frustum. This has a bright yellow color, so that it can be distinguished from afar, and it's topped with a red light, which is suggestive of the tail-light of a Corvette. In the spire, pictures and photos of historic events during the last 40 years, including different car models, are displayed. Both the pavillion and the spire have natural light from skylights.

The structural design of the pavillion was the most difficult part of the project. Because the structure was not symmetric, and therefore, it was not possible to reduce input data. However, a computer finite element model, using beam elements for the vertical and horizontal members and plate elements to represent the siding panels, was created of

the entire structure and STAAD-III was used for analysis and design.

Wind was the main structural design factor in determining member sizes and lateral stiffness requirements. While the aerodynamic shape of the building will reduce wind drag, this factor was neglected to arrive at a conservative overall factor of safety for the structure. Also, to prevent damage to the skylight, the relative movements of points on the structure was limited.

#### MIXING TUBES AND WIDE FLANGE

Due to the curved configuration and architectural requirements, the entire structure was originally designed using exposed 6-in. and 8-in. diameter structural pipes for the horizontal girts and 10-in. structural pipes for the vertical members. However, due to budget constraints resulting in part from

the high cost of the ground-smooth welded connections of the vertical and horizontal members, this plan had to be modified.

Various schemes were considered to reduce costs, with the final design featuring W12x40 (A36) vertical members and 6-in. and 8-in. pipes for the horizontal girts. As a result, the connections of the horizontal and vertical members was greatly simplified. Plates were shop-welded to the horizontal girts, which in turn were field bolted to the vertical members.

The fustrum includes a compression ring, formed from 12-in. pipe, at its base and a tension ring at top. The compression ring supports all of the sloped vertical and horizontal members. The tension ring supports two welded trusses, which support the structure's roof. The trusses, which are oriented perpendicular to each other, are made of 12-in.

## **TONE** Shear Wrench Tools for Tension Set Fasteners

**AND**

### **ALL Break-Off Type Bolts**

SALES • REPAIRS • RENTALS • PARTS

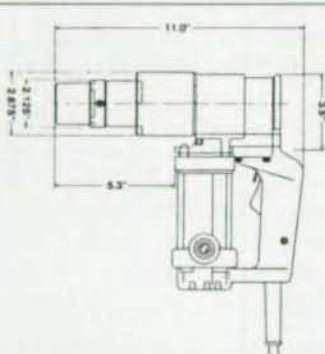

#### **S-60EZ Specifications**

Weight ..... 13 lbs.  
 Torque ..... 425 ft./lbs.  
 Speed ..... 16 RPM  
 Capacity ..... 5/8" - 3/4"  
 (+7/8" A325 only)  
 Voltage ..... 110 V. AC

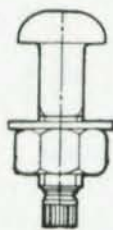

FULL  
 RANGE OF  
 BOLTS  
 5/8" - 1-1/8"  
 A325

**A490**  
 Are Also  
 Available

**CALL US For Domestic  
 Tension Control Bolts!**

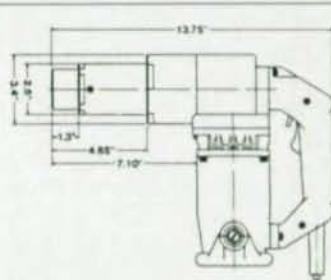

#### **S-90EZ Specifications**

Weight ..... 18.5 lbs.  
 Torque ..... 550 ft./lbs.  
 Speed ..... 16 RPM  
 Capacity ..... 3/4" - 7/8"  
 (+1" A325 only)  
 Voltage ..... 110 V. AC

## **BRISTOL** MACHINE COMPANY

19844 Quirpz Court, Walnut, CA 91789 • (909) 598-8601 • Fax (909) 598-6493 • (800) 798-9321

# NEW SPECS AND LOAD TABLES FOR STEEL JOISTS AND GIRDERS

Fortieth Edition  
Standard Specifications  
Load Tables and Weight  
Table for Steel Joists and  
Joist Girders.

Metric and U.S. Customary Units

## 40TH EDITION INCLUDES METRIC AND STANDARD UNITS

- Includes specs and load table on the all-new KCS Joist, an extension of the K-Series Joist. KCS Joists are useful in designing for concentrated loads and other non-uniform loads.
- Covers new K and LH Series erection stability requirements derived from over two years of study and field research by the Institute.
- Fire resistance portion has been updated and revised.
- Also included is a one-page method for converting load tables for LRFD design.

### ORDER TODAY!

Just \$20.00 per copy in the U.S. and its possessions (payment includes first class postage and handling and must accompany order)

\$30.00 (U.S. currency) for international shipments

Number of Copies \_\_\_\_\_

Total enclosed \_\_\_\_\_

Name \_\_\_\_\_

Firm \_\_\_\_\_

Address \_\_\_\_\_

City \_\_\_\_\_

State \_\_\_\_\_ Zip \_\_\_\_\_

Send to:  
Managing Director  
Steel Joist Institute  
Modern Steel Const Div. A-1  
1205 48th Avenue North  
Myrtle Beach, SC 29577



pipe and are connected to the frustum by end plates welded to the pipes and field bolted to the vertical members of the structure, which consist of W8x28 sections. The total weight of the structural steel for the frustum alone was 93 tons. In the case of the spire, the lateral loading was not significant because most of the structure is enclosed by the frustum.

*Mehdi Setareh, P.E., Ph.D., is a consulting engineer and associate professor at the colleges of architecture and engineering, Lawrence Technological University, Southfield, MI. William Lefkowsky, P.E., is president of L&A Inc., a structural engineering firm located in Southfield.*

*The exterior of the National Corvette Museum features an obviously appropriate sleek, aerodynamic appearance, while the interior offers strong exhibition spaces. Photography by Timothy Hursley*

# We designed our mill with the same convenience in mind.

When you're in the market for steel, and you need it fast, you know there's nothing convenient about waiting for a rolling schedule. Maybe it's time you switched from a rolling mill to a stocking mill: Chaparral.

Our \$50-million on-site steel inventory is one of the largest in the world. It's so large, in fact, that we can fill over 80% of our steel orders from stock — in two weeks or less. Special orders? Fast track jobs? We'll process those within

72 hours. Even if your order changes, we'll work with you to fill it as quickly as possible.

So what are you waiting for? Next time you're shopping for steel, call Chaparral. You'll always get the right steel...right away.



**CHAPARRAL  
STEEL.**

Toll Free (800) 527-7979 U.S. and Canada • Local (214) 775-8241  
Fax (214) 775-6120 • 300 Ward Road, Midlothian, Texas 76065-9651



Please circle # 43

# NATIVE ACCENTS



Structural steel proved to be the best material to reinterpret a traditional Solomon Island form into a modern Parliament Building

By Steven M. Baldrige, C.E., P.E., S.E.

ON AUGUST 7, 1942, THE U.S. MARINES LANDED IN THE SOLOMON ISLANDS at Guadalcanal, beginning what was to become a hard-fought six-month battle critical to the outcome of World War II. During the ensuing days the U.S. Navy would suffer one of its worst defeats. Under the cover of night the Japanese would position their fleet to open fire at point-blank range on the U.S. and Australian naval forces.

Off the coast of Guadalcanal around Cape Esperance and Savo Island this area would become appropriately named "Iron Bottom Sound." Tens of thousands of tons of steel would be laid to rest during this battle, whose eventual toll included more than 50 ships and planes belonging to the U.S., Australia and Japan. In the end the Allied forces would persevere and the Battle for Guadalcanal would become a pivotal victory in the Pacific War. Historians have said that the men who had fought there "bore an aura of

endurance" which veterans of almost no other Pacific Campaign acquired.

It was in this historical context that Congressman Stephen Solarz (D, New York) sponsored an amendment to the 1990 Defense Appropriation Bill providing funding for a \$5 million Parliament Building for the Solomon Islands. Congressman Solarz said the building will give "tangible support for democracy in that part of the world" and will be a fitting monument to the American G.I.'s who died in the Battle of Guadalcanal. The building would be built as a gift from the United States in commemoration of the 50th anniversary of the World War II Battle of Guadalcanal.

## Architectural Design

THE PROJECT WAS ADMINISTERED BY THE Department of the Navy, Pacific Division Naval Facilities Engineering Command, who selected the Honolulu, HI-based architectural firm Wimberly Allison Tong &



Goo to design the Parliament Building.

WAT&G was founded within a few miles of Pearl Harbor at the end of World War II and has been a pioneer since the 1950s in the design of environmentally sensitive projects in more than 50 countries. Their experience in the Pacific vernacular has included projects in Bora Bora, Pago Pago, and Fiji as well as in the Hawaiian Islands.

Project designer Michael J. Batchelor, RIBA, AIA, said that in describing what they wanted in the design of a Parliament Facility, Solomon Island officials requested that it be representative of their emerging democracy and that it should be "essentially Solomon Islands in style, not an imposed architecture."

The design solution is a two-story, 22,000 square-foot building of reinforced concrete and steel frame with extensive glazing. Its shell roof is an abstracted version of two local roof styles—those of Tamotu and Guadalcanal provinces.

The roof's defining conical shape is derived from native Tamotu roofs and has the unusual ridge characteristic of indigenous Guadalcanal roofs. Detail at the top is unique to the Solomon Islands. It has seven major elements symbolizing the seven provinces of those islands.

### System Selection

FOR THE PROJECT'S HONOLULU-BASED STRUCTURAL ENGINEER, Martin & Bravo, Inc., the most challenging aspect of this project would be the design of the centerpiece Conical Shaped Roof. Not only did this roof have to meet the extreme structural load criteria of a region known for both severe typhoons and earthquakes, but the structural system selected had to take into account the remoteness of the project location as well.

The roof in its completed form would have an overall diameter of 37.1 meters (121.7 ft.) with a rise of 13 m (42.7 ft.) to its apex. The functional requirements of

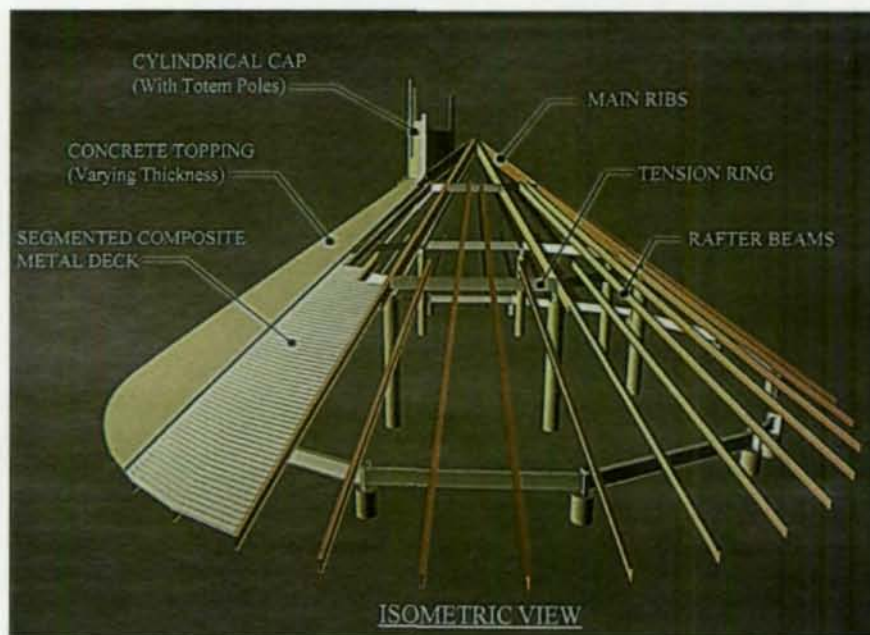

The isometric view and a construction photo reveal the design of the conical-shaped roof of the new Parliament Building.

the Debate Chamber of the Parliament Building meant that the conical-shaped roof would have to be column free for the interior 18 m (59.0 ft.) diameter of the roof. Its geometry is further complicated by a perimeter cantilever extending a minimum of 2.8 m (9.2 ft.). While these dimensions would not be considered difficult by standard U.S. construction practice, in a location as remote as the Solomon Islands, more than a two-day series of flights from Honolulu, this geometry would complicate the goals of the constructibility and economy of the final design.

With the aid of cost consultants Rider Hunt Ltd., structural steel was chosen to frame the Conical Shaped Roof of the Parliament Building. Julian Anderson of Rider Hunt Ltd.,

summarized the selection as follows:

"Structural steel was chosen for the framing system because it was able to handle the spans required by the Architect and achieve the desired roof profile. Conventional poured-in-place concrete was not an option because it could not easily achieve the spans without excessively-sized members. Post-tensioned concrete was not an option because there was insufficient skill and quality control in the area to ensure that work could be carried out properly. On the other hand, the structural steel is cheaply imported from Korea, New Zealand and Australia, and can be erect-



Shown above is the apex of the Parliament Building, while an interior view of the space is pictured on the opposite page. As with the exterior, the interior features traditional forms and designs.

ed with imported labor over a short period of time and at a relatively modest price."

### Design Criteria

THE PROJECT WAS DESIGNED TO CONFORM WITH APPLICABLE Solomon Island Building Codes, which is a combination of the Australian and New Zealand Building Codes. All drawings were required to follow metric standards.

The design wind loads followed Australian Standard AS 1170.2, a detailed 96-page document devoted entirely to wind loads. With a Basic Wind Speed of 60 m/s (134.2 mph) the equivalent static pressure acting on the sloped surface of the roof was 2.50 kPa (52.2 psf) inward, 3.45 kPa (72.1 psf) outward. At the cantilevered portion of the roof the design loads were as high as 8.90 kPa (185.9 psf).

For seismic loads New

## STRUCTURAL ANALYSIS SOFTWARE

developed by COMPU-TEC ENGINEERING

<b>BEAMS AND FRAMES</b> .....	<b>\$149.00</b>	<b>FEM3D</b> .....	<b>\$495.00</b>
Interactively performs analyses of continuous beams and selected 2-D frames quickly and accurately. Convenient to use instead of larger, general purpose programs.		Performs finite element stress analyses of 2-D and 3-D structures for thermal and mechanical loading conditions. Element library includes plate bending elements, planar isoparametric elements and solid elements. Includes all of the features of <b>FRAME3D</b> (Version 4.0). Model, distorted shape and stress contour plot files are generated.	
<b>FRAME3D (Version 3.0)</b> .....	<b>\$295.00</b>	<b>FEHEAT</b> .....	<b>\$195.00</b>
Performs structural analyses of space frame structures (2000 nodes maximum) for a variety of loading and support conditions. Element library includes beam, truss and spring elements. Model, deformed shape, shear and bending moment plot files are generated.		Calculates the temperature distribution in flat plates and 3-D solid structures using the finite element method.	
<b>FRPLOT</b> .....	<b>\$99.00</b>	<b>PLOTIT</b> .....	<b>\$149.00</b>
Transforms data files generated by <b>FRAME3D</b> into plots of 3-D structural models or deformed shapes. These plots may be viewed on a computer monitor or printed.		Provides model, distortion and color contour plots for <b>FEM3D</b> and <b>FEHEAT</b> analysis programs. Plots may be viewed on a monitor or printed.	
<b>BMPLOT</b> .....	<b>\$99.00</b>	<b>BASEPLATE</b> .....	<b>\$149.00</b>
Produces load, displacement, shear and bending moment plots for beam elements and load cases selected by the <b>FRAME3D</b> user. These plots may be viewed on a computer monitor or printed in color or black and white.		Calculates bolt loads and the maximum stress in flexible, rectangular baseplates. Bolts (preloaded) and loads may be placed anywhere on the plate. Prying action is included using a nonlinear finite element approach.	
<b>FRAME3D (Version 4.0)</b> .....	<b>\$395.00</b>	<b>FLATPLATE</b> .....	<b>\$149.00</b>
Includes all of the features of <b>FRAME3D</b> (Version 3.0) plus tension only elements for diagonal bracing, piping elements for piping analysis, curved beam elements and a library of AISC section properties.		Calculates displacements and stresses in flat (rectangular or circular) plates with concentrated or distributed loads. Plates may rest on an elastic subgrade and edges may be free, simply supported, fixed or spring supported.	
<b>SHORE</b> .....	<b>\$195.00</b>		
Performs stress analyses of shells of revolution (pressure vessels, etc.) and axisymmetric solids using the finite element method.		The user's manual for each program contains theoretical background, descriptions of input and output, and examples. Plotting programs support HP Laser Jet and Desk Jet printers.	

For more information,  
please contact:

### COMPU-TEC ENGINEERING, INC.

16100 Chesterfield Parkway, Suite 246 • Chesterfield, MO 63017

(314) 532-4062 • FAX: (314) 536-2154

Zealand Standard NZS 4203 was used. The total horizontal seismic force for the structure was equivalent to 0.32 times the total reduced gravity load (approximately one-third greater than an equivalent structure in UBC Seismic Zone 4). Based on these seismic loads the structure was required to be designed to create a continuous load path capable of carrying 3260 kN (732.9 kips) of horizontal force from the roof down to the foundation.

In addition to the lateral forces, significant gravity loads had to be carried by the steel roof frame as well. The roof system is comprised of composite metal deck with concrete topping enveloped by a waterproofing system and an elaborate interior architectural ceiling which includes mechanical equipment, catwalks and extensive architectural ornamentation. The combination of loads from the structural and architectural



components is a heavy 4.10 kPa (85.6 psf). Near the apex of the roof the additional weight from a cylindrical cap carrying nine wood "totem" carvings, each one weighing as much as 9 kN (2 kips) had to be accommodated by the steel frame as well.

### Structural System

THE STRUCTURAL SOLUTION TO THE CHALLENGING GEOMETRY, LOADS AND PROJECT LOCATION was to utilize the interior ring of eight uniformly spaced columns to support a Steel Ribbed Dome. The Ribbed Dome consists of



## CONSOLIDATED SYSTEMS, INC.

### Deck Division

COLUMBIA  
P.O. BOX 1756  
COLUMBIA, SC 29202

MEMPHIS  
P.O. BOX 181035  
MEMPHIS, TN 38181-1035

- \* INDUSTRY LEADER FOR 20 YEARS
- \* COMPLETE PRODUCT LINE

1-800-654-1912

- \* CODE APPROVAL
- \* ENGINEERING ASSISTANCE

CSI'S NEWEST DECK

## VERSA - DEK

STEEL FLOOR OR  
ROOF DECK SYSTEM



### UNIQUE FEATURES

#### ROOF DECK

Effective acoustical product achieving NRC of .95 to 1.15

Aesthetically pleasing exposed deck

Provides large flat surface area in inverted position.

Long span capacity, 7' to 13'

#### COMPOSITE FLOOR DECK

Flexible hanger system with load capacities up to 1000 lbs.

Retrofit abilities of all hanger systems

Superior UL fire resistance rating without sprayed fireproofing

Long span composite action provided by integral dovetail shape

Please circle # 70

# THE CADVANTAGE DETAILING SYSTEM WON'T DRIVE YOU PSYCHO.



CadVantage Structural cuts through structural detailing like a knife. The program doesn't require tedious job set-up and lets you re-use previous work. With the time saved, the pressure of meeting critical deadlines and budgets will become less horrifying.

## CadVantage®

619 South Cedar Street • Studio A  
Charlotte, North Carolina 28202

704-344-9644  
Please circle # 45

eight identical straight wide-flange 250 MPa yield (equivalent to Grade 36) 610 UB 101 (W24 x 68) "ribs" interconnected at a compression connection at the apex of the cone and stiffened by a 530 UB 82 (W21 x 57) tension ring at the interior circle of columns. The remainder of the roof is framed with 360 UB 45 and 360 UB 57 (W14 x 30 and W14 x 38) rafter beams spanning from the interior tension ring to the perimeter beam where they cantilever out to the outermost edge of the roof.

The cone shape is first approximated by segmenting the steel framing in plan and elevating each connection of the rafter beams above the segmented ring of support beams to match the cone profile. The cone is then completed by varying the thickness of the concrete topping on the segmented composite metal deck. Segmenting of the steel provided a cost savings by eliminating the need to bend the structural steel.

In order to keep the cone shape "true", special considerations had to be made to accommodate differences in the relative deflections of the various roof framing members. For example, deflection control was complicated at the perimeter edge of the roof by a combination of varying rafter beam cantilever lengths and support beam deflections. Inconsistencies in the final edge deflection were balanced by varying the rafter beam member sizes (stiffness) and cambering the support beams.

Lateral loads follow a load path which includes a horizontal channel attached to the top of the perimeter beams to provide the weak axis strength required to transfer loads coming down from the rafter beams out to a steel stub column tied to the structure below. Since the exterior columns were much shorter and therefore much stiffer than the interior columns, the majority of the roof's lateral loads were designed to transfer out at this location.



Another view of the Parliament Building's interior.

### Construction

IRONICALLY, THE CONSTRUCTION OF THIS PROJECT included representatives of each of the countries which had fought on Guadalcanal 50 years earlier. The general contractor on the project was the Japan-based Kitano Construction. The United States was represented by the design team and Australia by the subcontractor for the fabrication and erection of the structural steel.

The teamwork required to successfully complete this project is an example that as time passes and our world grows smaller, historical and cultural differences diminish as well. The construction was completed within budget and the Solomon Islands Parliament Building was turned over to the people of the Solomon Islands in a ceremony which included U.S. dignitaries and veterans in November of 1993.

*Steven M. Baldrige, C.E., P.E., S.E. is a structural engineer with Martin & Bravo, Inc. Consulting Structural Engineers in Honolulu, HI.*

# Why should I use the new 2nd Edition LRFD Manual of Steel Construction?

*Here are a dozen good reasons:*

1. LRFD is **THE** AISC recommended method of structural steel design!
2. Since LRFD directly accounts for the most variable aspect of steel design—loads—it offers the most uniform reliability of any steel design method.
3. LRFD increases an engineer's international competitiveness—almost every other industrialized country has adopted limit state design.
4. In most structures, LRFD is more economical.
5. The 2nd Edition Manual combines and updates four previous AISC publications into a single two-volume set. It also includes the AISC Seismic Provisions. And, NEHRP's, SBCCI's and BOCA's seismic provisions are based on LRFD.
6. It will be easier to directly compare LRFD Steel Designs with concrete designs because the next ACI 318 Specification is expected to incorporate the ASCE 7 load factors as an alternative.
7. The 2nd Edition is a complete improvement over any previous AISC Manual—ASD or LRFD. It offers tremendously expanded coverage of connections and factored uniform load tables, as well as coverage of frame stability and leaning columns, floor deflections and vibrations, and single angle struts.
8. The 2nd Edition includes a 45-page introduction, Essentials of LRFD, that makes it easy for engineers to upgrade to LRFD.
9. Extensive editorial changes make this the easiest-to-use Manual in AISC's history.

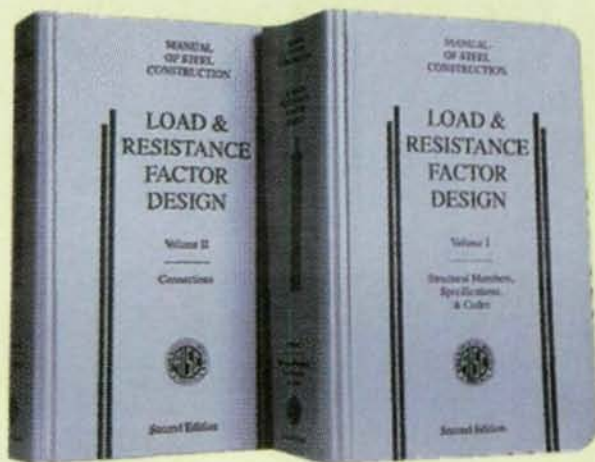

10. All design problems are complete solutions — not just sample calculations for a few limit states.
11. The 2nd Edition incorporates all of the latest steel research, including Astaneh's shear tab work and Thornton's Uniform Force Method for bracing connections and new approach to tee connection design.
12. As professionals, it is incumbent upon engineers to utilize the best, most advanced design method available—LRFD.

**Two-volume set only \$132  
(\$99 for AISC members)**

To order or for more information, phone the American Institute of Steel Construction at 312/670-2400 or fax an order to 312/670-5403 (include your VISA or Mastercard number plus expiration date).



Setting Standards For Over 70 years

# LARGE-SCALE GIRDER TESTING FOR MORE ECONOMICAL STEEL BRIDGES

by Michael G. Barker, P.E.,  
and Bryan A. Hartnagel

**R**ECENTLY, A 98-FT. LONG, THREE-SPAN (30ft.-38ft.-30ft.) composite steel bridge girder was tested in the Remote Test Facility at the University of Missouri-Columbia. The experimental test is part of a three-year project to develop advanced inelastic design provisions for steel girder bridges.

The study's primary objectives are to verify design limit behavior of current inelastic design provisions for compact shapes and to extend the inelastic procedures to include noncompact plate girder designs. Inelastic design procedures allow the designer more flexibility and the possibility of more economical designs by eliminating cover plates and flange transitions over negative moment regions.

The study is part of the joint venture Innovations in Steel Construction sponsored by the National Science Foundation, the American Iron and Steel Institute, and the American Institute of Steel Construction. The Missouri Highway and Transportation Department is also supplying funds for the test girders. In addition, major improvements in laboratory facilities were possible through industrial support from Bethlehem Steel, US Steel, Nucor-Yamato Steel, St. Louis Screw & Bolt Co., and AISC-member Stupp Bros. Inc., St. Louis. AISC-member Delongs Inc., Jefferson City, MO, fabricated the steel beam.

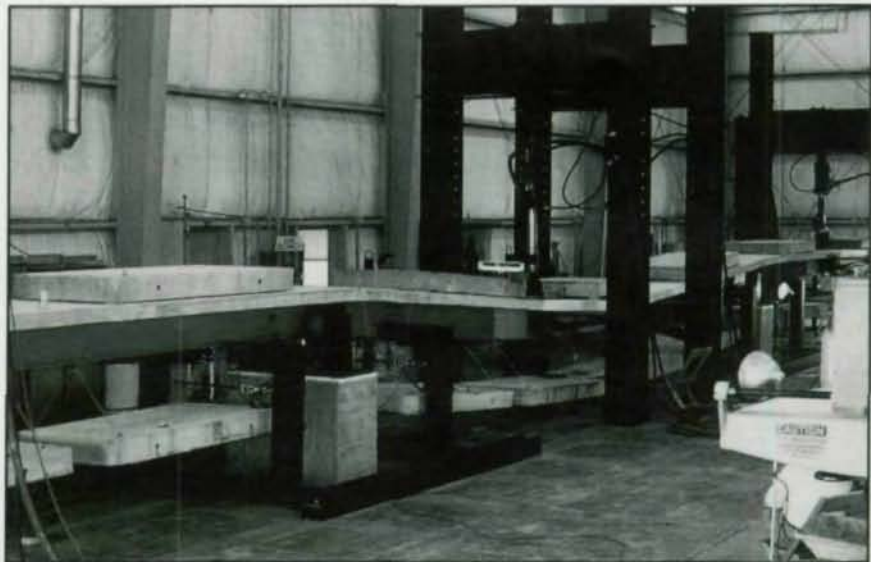

*Overall view of beam during the plastic collapse test. Compensatory dead load concrete blocks were hung from the beam to simulate modeled dead loads. Concrete blocks on top represent composite dead loads.*

In total, three approximately 100 ft long girders will be tested: one representing a rolled shape compact girder (the above test) and two representing plate girder designs with thin webs (noncompact). This article discusses the results of the first girder test.

## INELASTIC BRIDGE DESIGN PROCEDURES

Alternate Load Factor Design (ALFD) procedures (inelastic design) were adopted by AASHTO in 1986. The procedures account for the reserve strength inherent in multiple-span steel girder bridges by allowing redistribution of interior pier region elastic moments to adjacent posi-

tive moment regions. The design procedures specify requirements at service load levels (normal traffic), overload levels (occasional heavy vehicle), and maximum load levels (one-time maximum vehicle).

ALFD procedures can result in more economical designs. However, current ALFD provisions apply only to steel beam bridges with compact sections. For more economical and more consistent designs for all types of steel bridges, the ALFD provisions need to be extended to include noncompact sections.

## TEST GIRDER

The test girder was a one-half-scale model of an interior girder

from a three-span (60ft-76ft-60ft) four-girder composite bridge. The design was based on inelastic design provisions from the Fourth Draft of the proposed Load and Resistance Factor Design (LRFD) Bridge Design Specifications, which incorporate the ALFD provisions. The test girder consisted of a W14x26 continuous steel shape with a fully-composite 50.5 in wide by 4 in thick concrete deck. The steel material was A572 Grade 50 and the concrete design strength was 4000 psi.

A one-half-scale model only weighs one-quarter as much as the prototype. Therefore, compensatory concrete blocks were hung from the bottom of the W-shape before placing the concrete deck to restore the self-weight lost due to the scaling. Additional concrete blocks were placed on top of the deck after it hardened to represent the composite dead loads (wearing surface, barriers, etc.).

Modeled truck loads were applied by four individually controlled hydraulic rams. One ram was in each of the two outer spans and the other two were located in the center span. The rams were synchronized to simulate a truck traveling across the structure. The truck load sequence could be linearly adjusted to represent any percentage of the modeled truck design weight (LL).

#### TEST PROGRAM

Load sequences were applied to the test beam cyclically at various load levels. Experimental measurements were recorded throughout the testing. The service load, overload and maximum load design levels were rigorously examined to verify the girder behavior at the design limits. Afterwards, the girder was tested to failure (center span) to examine the load-deflection response and to determine the collapse capacity.

Elastic low-level tests were carried out at 10, 20, 40, 60, 70,



*Close up of north interior pier showing large inelastic rotation. Also shown are the lateral bracing, reaction load cell and pin support, and strain gage instrumentation.*

80, and 90%LL. Lower load levels provided the opportunity to confirm elastic behavior and instrumentation performance. Service level loads (100%LL) were applied to validate fatigue and deflection requirements of the LRFD provisions. Increasing the loads towards the overload level, loads of 110 and 120%LL were applied to chart the behavior in this modeled truck weight range.

At the overload level (130%LL), the girder experienced significant inelastic behavior. This is characterized by residual deflection or permanent set. Design provisions predict this residual deflection and limits stresses in positive moment portions of the structure.

Cyclic loads were applied at 140, 155, and 166%LL to examine the inelastic behavior above the overload level. The last simulated moving truck load was at the maximum load level (175%LL plus additional dead load). This loading represents the worst possible maximum design load level applied to a bridge. After the cyclic tests, the

girder was tested to failure by monotonically increasing loads proportioned to represent the theoretical design collapse configuration.

#### TEST RESULTS

The girder performed well throughout the entire test. The elastic and inelastic response of the test beam met all the LRFD inelastic design requirements. The following compares the model response to the predicted prototype design response and presents results of this test.

Permanent set was first observed at 70%LL. This corresponds to an expected first yield at 67% when considering residual stresses in the prototype girder. As the modeled truck weight increased, the residual deflection grew. After the last cycle of the maximum load level (175%LL plus additional dead load), the total permanent set was 2.56 in.

At service level loads (100%LL), the experimental live load deflection was within 5% of the theoretical modeled deflection. Fatigue requirements were

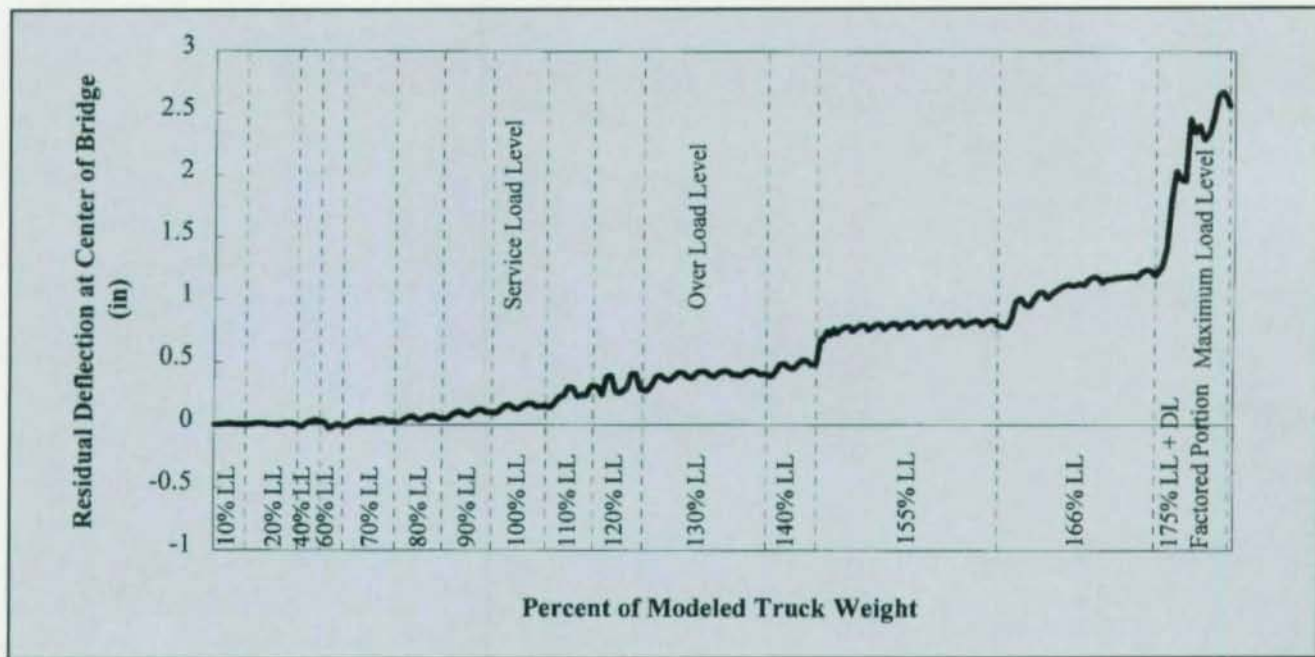

The permanent set during the moving load tests grew as the modeled truck weight increased. The residual deflection stabilized at all loads except at the maximum load level.

At the overload level (130%LL), the measured maximum positive moment stress (derived from strain) satisfied the design requirements and

matched the theoretical stress within 14%. The residual deflection was 0.38 in. which was significantly larger than the LRFD inelastic design provisions esti-

# STRUCTURAL SOFTWARE CO.

offers a full line of computer programs specifically for the steel fabrication industry. Wouldn't you like to realize the benefits that our existing 400 customers have been enjoying over the past 10 years?

SSC's integrated family of computer programs includes:



**STRUCTURAL SOFTWARE CO.**  
SOFTWARE FOR THE STEEL INDUSTRY  
P.O. Box 19220, Roanoke, VA 24019  
(703)362-9118

Estimating  
Production Control  
Inventory  
Purchase Orders  
Combining  
Automated Beam & Column Detailing

## New Automated Drawing Log

Tracks drawings, revisions, and transmittals

Only \$299<sup>00</sup>

Ask for a free demo disk

**(800)776-9118 Call for a FREE demo disk!**



# MODERN STEEL CONSTRUCTION Reader Service Card

Please type or print only

name \_\_\_\_\_

company name \_\_\_\_\_

address \_\_\_\_\_

city \_\_\_\_\_ state \_\_\_\_\_ zip code \_\_\_\_\_  
( ) ( )

business telephone \_\_\_\_\_ fax number \_\_\_\_\_

Check this box to renew or start a **FREE\*** subscription to *Modern Steel Construction* \*this offer good only for practicing professionals within the U.S.

signature \_\_\_\_\_

For free information on advertisers and other companies mentioned in this issue, circle the appropriate number below:

- |     |     |     |     |     |     |     |     |     |     |     |     |
|-----|-----|-----|-----|-----|-----|-----|-----|-----|-----|-----|-----|
| 1   | 2   | 3   | 4   | 5   | 6   | 7   | 8   | 9   | 10  | 11  | 12  |
| 13  | 14  | 15  | 16  | 17  | 18  | 19  | 20  | 21  | 22  | 23  | 24  |
| 25  | 26  | 27  | 28  | 29  | 30  | 31  | 32  | 33  | 34  | 35  | 36  |
| 37  | 38  | 39  | 40  | 41  | 42  | 43  | 44  | 45  | 46  | 47  | 48  |
| 49  | 50  | 51  | 52  | 53  | 54  | 55  | 56  | 57  | 58  | 59  | 60  |
| 61  | 62  | 63  | 64  | 65  | 66  | 67  | 68  | 69  | 70  | 71  | 72  |
| 73  | 74  | 75  | 76  | 77  | 78  | 79  | 80  | 81  | 82  | 83  | 84  |
| 85  | 86  | 87  | 88  | 89  | 90  | 91  | 92  | 93  | 94  | 95  | 96  |
| 97  | 98  | 99  | 100 | 101 | 102 | 103 | 104 | 105 | 106 | 107 | 108 |
| 109 | 110 | 111 | 112 | 113 | 114 | 115 | 116 | 117 | 118 | 119 | 120 |
| 121 | 122 | 123 | 124 | 125 | 126 | 127 | 128 | 129 | 130 | 131 | 132 |

### 1. Type of work

Please circle **all** that apply

- a. Bridges
- b. Office Buildings
- c. Hospitals
- d. Retail
- e. Industrial
- f. Schools
- g. Multifamily
- h. Institutional
- i. Low-Rise
- j. High-Rise

### 3. Type of business

Please circle **ONLY** one

- a. Structural engineer
- b. Civil engineer
- c. Structural steel fabricator
- d. Other fabricator
- e. Educator/library
- f. Architect
- g. Building owner/developer
- h. Steel mill
- i. Erector
- j. Steel product manufacturer
- k. GC/CM
- l. Student
- m. Other

### 2. Your position

Please circle **ONLY** one

- a. Owner/President
- b. Chief Engineer/Chief Architect/Department Head
- c. Staff Engineer/Staff Architect/Construction Manager
- d. Other

### 4. Reason for Inquiry

Please circle **ONLY** one

- a. Information file
- b. Immediate or Future Purchase

NOVEMBER

Please type or print only

name \_\_\_\_\_

company name \_\_\_\_\_

address \_\_\_\_\_

city \_\_\_\_\_ state \_\_\_\_\_ zip code \_\_\_\_\_  
( ) ( )

business telephone \_\_\_\_\_ fax number \_\_\_\_\_

Check this box to renew or start a **FREE\*** subscription to *Modern Steel Construction* \*this offer good only for practicing professionals within the U.S.

signature \_\_\_\_\_

For free information on advertisers and other companies mentioned in this issue, circle the appropriate number below:

- |     |     |     |     |     |     |     |     |     |     |     |     |
|-----|-----|-----|-----|-----|-----|-----|-----|-----|-----|-----|-----|
| 1   | 2   | 3   | 4   | 5   | 6   | 7   | 8   | 9   | 10  | 11  | 12  |
| 13  | 14  | 15  | 16  | 17  | 18  | 19  | 20  | 21  | 22  | 23  | 24  |
| 25  | 26  | 27  | 28  | 29  | 30  | 31  | 32  | 33  | 34  | 35  | 36  |
| 37  | 38  | 39  | 40  | 41  | 42  | 43  | 44  | 45  | 46  | 47  | 48  |
| 49  | 50  | 51  | 52  | 53  | 54  | 55  | 56  | 57  | 58  | 59  | 60  |
| 61  | 62  | 63  | 64  | 65  | 66  | 67  | 68  | 69  | 70  | 71  | 72  |
| 73  | 74  | 75  | 76  | 77  | 78  | 79  | 80  | 81  | 82  | 83  | 84  |
| 85  | 86  | 87  | 88  | 89  | 90  | 91  | 92  | 93  | 94  | 95  | 96  |
| 97  | 98  | 99  | 100 | 101 | 102 | 103 | 104 | 105 | 106 | 107 | 108 |
| 109 | 110 | 111 | 112 | 113 | 114 | 115 | 116 | 117 | 118 | 119 | 120 |
| 121 | 122 | 123 | 124 | 125 | 126 | 127 | 128 | 129 | 130 | 131 | 132 |

### 1. Type of work

Please circle **all** that apply

- a. Bridges
- b. Office Buildings
- c. Hospitals
- d. Retail
- e. Industrial
- f. Schools
- g. Multifamily
- h. Institutional
- i. Low-Rise
- j. High-Rise

### 3. Type of business

Please circle **ONLY** one

- a. Structural engineer
- b. Civil engineer
- c. Structural steel fabricator
- d. Other fabricator
- e. Educator/library
- f. Architect
- g. Building owner/developer
- h. Steel mill
- i. Erector
- j. Steel product manufacturer
- k. GC/CM
- l. Student
- m. Other

### 2. Your position

Please circle **ONLY** one

- a. Owner/President
- b. Chief Engineer/Chief Architect/Department Head
- c. Staff Engineer/Staff Architect/Construction Manager
- d. Other

### 4. Reason for Inquiry

Please circle **ONLY** one

- a. Information file
- b. Immediate or Future Purchase

NOVEMBER



NO POSTAGE  
NECESSARY  
IF MAILED  
IN THE  
UNITED STATES

**BUSINESS REPLY MAIL**

FIRST CLASS MAIL PERMIT NO. 12522 CHICAGO, IL

POSTAGE WILL BE PAID BY ADDRESSEE

**MODERN STEEL  
CONSTRUCTION**

c/o CREATIVE DATA SERVICES  
650 S CLARK ST  
CHICAGO, IL 60605-9960



Use these cards to request information from manufacturers and other companies mentioned in this issue. Simply circle the numbers referenced in the advertisement or article, fill out the rest of the information requested on the card, and either mail it to: Modern Steel Construction, Creative Data Center, 650 South Clark St., Chicago, IL 60605-9960 or fax it to: **312/922-3165.**



NO POSTAGE  
NECESSARY  
IF MAILED  
IN THE  
UNITED STATES

**BUSINESS REPLY MAIL**

FIRST CLASS MAIL PERMIT NO. 12522 CHICAGO, IL

POSTAGE WILL BE PAID BY ADDRESSEE

**MODERN STEEL  
CONSTRUCTION**

c/o CREATIVE DATA SERVICES  
650 S CLARK ST  
CHICAGO, IL 60605-9960



**MODERN STEEL  
CONSTRUCTION**  
Reader Service Card

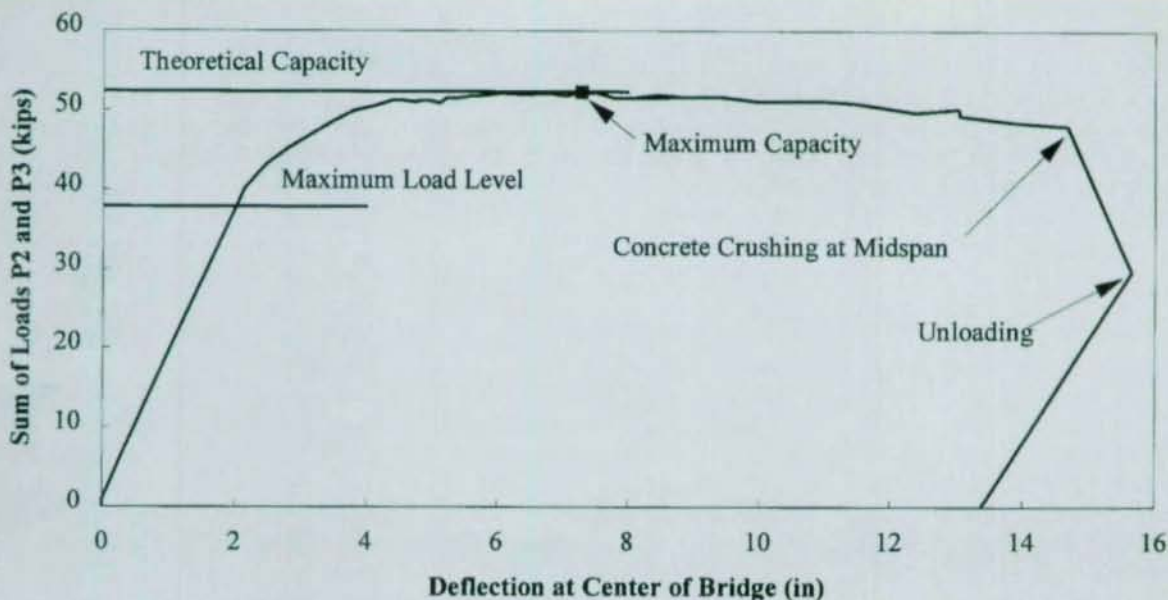

ated. However, using recent improved moment-rotation behavior models at the piers, the residual deflection was estimated within 5%.

The experimental plastic collapse capacity exceeded the maximum load level (175%LL plus additional dead load) by 34% consistent with the design. The

*The plastic collapse test showed tremendous ductility at near maximum loads. The ultimate capacity was well above the maximum load level as designed.*

## WHEN YOU BUY ST. LOUIS, YOU BUY AMERICAN!

AND YOU GET: • FULL TRACEABILITY  
• LOT CONTROL  
• CERTIFICATIONS

Registered Head Markings on all structural and machine bolts:



A-325  
Type 1



A-325  
Type 3



A-307-A



A-449



A-307-B

Products from 1/2" — 3" diameter include:



### ST. LOUIS SCREW & BOLT COMPANY

6900 N. Broadway • St. Louis, MO 63147  
(314) 389-7500 • 1-800-237-7059 • Fax (314) 389-7510



experimental model collapse load and the theoretical collapse load matched within 1%. The girder maintained nearly ultimate loads up to 14 in. of deflection (in addition to the 2.56 in. during the cyclic tests). This deflection (length/deflection = 33) shows tremendous ductility for this compact girder.

#### SUMMARY

The test results reported herein give an overview of the general elastic, inelastic, and plastic behavior of the one-half-scale three-span composite test beam. The experimental results compared well with theoretical expectations. However, the LRFD inelastic design provisions significantly under-estimated the overload level (130%LL) residual deflections. For inelastic design, this permanent set would be cambered out along with the dead load deflections. Therefore, it is a fairly important

quantity. Using more current behavior models, the residual deflection was accurately estimated. Future analysis of this test and others will yield insight into the best approach for estimating these deflections.

The plastic collapse test illustrated the ductility in compact composite beams. The measured collapse was within 1% of the predicted ultimate capacity. The primary reason that the beam behaved so well is that it is compact with the flanges being well below the compactness requirements (ultra-compact). This will not be the case for the second two girder tests. The flanges will still be ultra-compact, but the web will have typical plate girder width/thickness ratios. However, previous work has shown that, although these girders are not as ductile, the noncompact sections have predictable moment-rotation behavior that can be incorporat-

ed into inelastic design provisions.

More economical steel bridge designs can be realized using inelastic design provisions. The results of this test and others validate these procedures for bridges with compact girders. Provisions for the inelastic design for bridges comprising noncompact sections would be very beneficial. However, even though the analytical tools exist for inelastic design of these girders, large-scale testing is necessary to validate theoretical engineering practice. The second two noncompact girder tests from this project will provide vital information for the development of these provisions.

*Michael G. Barker, P.E., is an Assistant Professor and Bryan A. Hartnagel is a PhD student at the University of Missouri-Columbia*

For the BEST in Bridge Software...

## DESCUS-PLUS

Design of Curved Girder Bridges

#### NEW FEATURES:

- Live Load Distribution - Automatic (Longitudinal & Transverse)
- Mesh Generation - Automatic
- Rating - Auto Rating Factors
- Influence Line Output (From Influence Surfaces)
- Metric Conversion
- Uses AASHTO 15th Edition
- Lease or License
- Timesharing

Free Trial...  
FULL Program!

#### MERLIN DASH

Design & Analysis of Steel Girder Bridges

- AASHTO - Uses New 15th Ed.
- FHWA - Endorsed and Used by
- DOT's - Used by 35 States
- Design - Cost Optimized
- Friendly - Menu-Driven Input
- Graphics Display of Output
- Output Report Selection
- Quality and Performance
- Continuous to 6-spans
- Prestressed Trusses
- Cable Members
- Design & Rehab.
- AASHTO and LL Vehicles to 20 Axles
- Auto. computation Inv. Operating & Posting Load

#### TRAP

Truss Rating and Analysis Program

Available Exclusively Thru:

## OPTI-MATE, INC.

P.O. Box 9097, Dept A, Bethlehem, PA 18018  
(610) 867-4077

Please circle # 53

# Curved & Straight Steel Bridge Design English & Metric

## Serious Design Power on Your PC

- Complex grid and roadway geometries, I girders, box girders, rolled shapes
- Influence surface (grid) or influence line approach (grid or line girder)
- Powerful nonprismatic girder optimization processing (curved and straight)
- 1992 AASHTO Spec. w/ 1993 interims & 1993 Curved Girder Guide Spec.

30-day trials available

Call for Free Demo Version

# MDX software

Phone (314) 446-3221

Fax (314) 446-3278

Please circle # 47

# TO MAKE SURE OUR TENSION CONTROL SYSTEMS OUTPERFORM THE COMPETITION, WE PUT A HEX ON THEM.



Our Tru-Tension® bolt was designed with one very important advantage over other twist-off bolts: a hex head. So removing this bolt or checking the installation with a torque wrench is just as easy as installing it.

Using a quiet, hand-held power tool, our Tru-Tension system always provides the correct tension. It also eliminates operator error during assembly, the bolts come pre-assembled and you can even save money thanks to the quick, easy installation and lower costs for visual inspection.

But, install any button head fastener compared to our hex head fastener, and there's no turning back. Because it's almost impossible to remove a button head fastener, you may even need a welder to burn it off. That costs you time and money. If you'd installed our hex head bolt in the first place you could remove it with a simple, four dollar wrench.

What if you have to verify the proper installation of a button head bolt? Again, it's almost impossible since you can't even get a wrench on the head to test or remove it. But you can verify installation of our hex head bolt with the turn of a wrist and a calibrated torque wrench.

Clearly, this is one bolt that won't let you screw up. Our Tru-Tension system is also fully traceable to our domestic sources, like all Nucor fasteners. They're fully tested and certified, including compliance with FHWA, DOT and AASHTO specifications for bridge construction.

So, forget about cutting bolts off with a torch if something goes wrong. Call us at 800/955-6826, FAX 219/337-5394 or write PO Box 6100, St. Joe, IN 46785 to find out more about our Tru-Tension system. And get a fastener that has a good head for business.

**NUCOR FASTENER**  
A Division of Nucor Corporation

Please circle # 38

# CONTROLLING SLAB CRACKING

By Richard B. Heagler, P.E.

**C**RACKS OCCURRING IN COMPOSITE DECK FLOOR SLABS IN BUILDINGS do not generally represent a structural problem. The most common cracks are those over beams (or girders) at column lines, while cracks over interior floor beams are less common. Deck manufacturers assume the concrete will crack over every beam and publish live load tables for single span composite slabs.

When asked about the effect of slab cracking on composite beam behavior, the late Dr. Roger Slutter from Lehigh University pointed out that cracking along the beam occurred at an early stage in every composite beam test and, therefore, the composite beam design formulas were based on a cracked system. However, while concrete cracking is not a structural concern under most loading conditions, it can be an appearance problem if carpeting or some other covering is not going to be used.

The Steel Deck Institute (SDI) makes the comment: "If welded wire fabric is used with a steel area given by [0.00075 times the concrete area above the deck flutes] it will generally not be sufficient to be the total negative reinforcement; however, the mesh does a good job of crack control especially if kept near the top of the slab (3/4 in. to 1 in. cover)." The 0.00075 rule is based on experience with mesh as the temperature reinforcement. Other experience factors, such as 0.002 times the area (the ACI requirement for flat slabs), are also used. Again, 0.002 rein-

forcement will not, in most cases, furnish enough steel to develop the full negative moment capacity.

Reinforcing to control cracking is still primarily a judgement call. In my opinion, the amount of reinforcing steel (for slabs over beams at column lines) should be somewhere between the amount needed to develop the negative moment caused by the design load and the 0.00075 factor of the SDI. The 0.002 factor is in this range and some designers may prefer this as a general rule of thumb. Special loading cases, such as cantilever and moving

concentrated loads, do require full negative steel, though.

For transverse reinforcement over girders, where the deck flutes are parallel to the structural steel, the 0.00075 factor should be sufficient for most cases. The position of the reinforcing steel is probably more important than the amount used, and it is necessary that the steel be located near the top of the slab.

*Richard B. Heagler, P.E., is Director of Engineering with Nicholas J. Bouras, Inc.*

**G**rid Reinforced Bridge Decks, comprised of both a fabricated steel grid and concrete, are lighter than traditionally reinforced decks and are still strong enough to withstand high traffic volumes over long periods of time (some applications are already in their sixth decade of service). The Bridge Grid Flooring Manufacturers Association maintains a computerized data base of grid related research and welcomes inquiries. The association can provide design recommendations and also publishes a newsletter.

For more information, contact: BGFMA, 231 South Church St., Mt. Pleasant, PA 15666 (412) 547-2660 or circle no. **87** on the reader service card near the back of this magazine.

**B**owman Metal Deck offers permanent metal deck forms for bridge construction. According to the manufacturer, PMD forms offer three dis-

tinct advantages: time savings; cost reduction (\$4/sq. ft. estimated savings compared to wood forms); and increased safety (installation of a PMD form provides an immediate and safe working platform for all crews). In addition, PMD forms provide a lower cost means of using more widely spaced girders, which results in more cost effective steel framing. Some research also indicates that stay-in-place forms may slightly decrease deck cracking.

For more information, contact: Bowman Metal Deck Division, ARMCO Inc., P.O. Box 260, Pittsburgh, PA 15230-0260 (412) 429-7560; Fax (412) 276-6057 or circle no. **88**.

**E**pic Metals Corp. offers MAXSPAN BRIDGE DECK FORM, an entirely new concept in the design of permanent metal deck forms for bridge deck slabs. The forms are designed to accommodate today's

## DECKING

wider girder spacing with greater efficiency at spans ranging from 10 ft. to 18 ft. They provide a flat top surface, which reduces concrete usage and slab dead load. This results in allowing virtually all the concrete to contribute to the structural strength of the slab.

For more information, contact: Robert Paul, Product Engineer, Epic Metals Corp., Eleven Talbot Ave., Rankin, PA 15104 (412) 351-3913 or circle no. 89.

The Steel Deck Institute offers an expert design system, based on LRFD, for composite and non-composite beams and girders with steel deck. This software is part of the design Advisor expert system developed for the AISC and the SDI by Structural Engineers, Inc., of Radford, VA. Complete bay design as well as individual beams and girders can be investigated and optimized for the least cost. Design tables in the SDI format can be produced using any combination of material properties. Detailed reports are produced showing vibration analysis and provide stud spacing. Concentrated loads and line loads can be applied in addition to uniform loading. Cost is \$295.

For more information, contact: Steel Deck Institute, P.O. Box 9506, Canton, OH 44711 (216) 493-7886 or circle no. 77.

United Steel Deck has enhanced its ability to produce custom deck systems by networking with the affiliated companies of Nicholas J. Bouras, Inc. Special finishes, such as plasticol, or materials such as stainless steel, are being used to produce custom decks and panels that solve durability and environmental problems caused by some industrial atmospheres. Special finishes combined with the roll forming and bending capabilities of United Steel Deck, Inc., can provide solutions to most unique

# COMPUTER DETAILING

Ask Those Who've  
Been There



1-800-456-7875

Please circle # 84

# WHITEFAB INC.

BIRMINGHAM  
ALABAMA

IN ADDITION TO ANGLE, RAIL, PIPE, CHANNEL, AND BEAM ROLLING  
CAPABILITIES, WE ROLL TUBES, CHANNELS, AND BEAMS THE HARD WAY.

Phone (205)791-2011 FAX (205)791-0500

Please circle # 55



## Mound Architectural

Fabricators of Quality Railing and  
other Decorative Metal Products

Pricing available for standard products.  
NO CHARGE FOR QUOTATIONS  
on most custom projects.

Standard picket rail from \$17.00 a lineal foot.

940 Holman Ave., Monroe, OH 45050  
513-422-0584 513-422-5184 (FAX)



Please circle # 101

Full  
featured  
program  
simplifies  
the most  
complex  
structure

## DAST™

### Design and Analysis of Structures

#### Analysis

Sophisticated 2D/3D static including P-Delta,  
seismic, dynamic with time history and response  
spectra, and more

#### Design

Steel and concrete design per American, Canadian,  
and other international codes and tables

#### Features

- Integrated menu system
- Interactive input generator
- Built-in-editor and browser with advanced graphics and context sensitive help
- Integrated interface module for operation inside AutoCAD®
- Plots of original and displaced structures with optional animation, bending moment/shear force diagrams, stress contours, and more

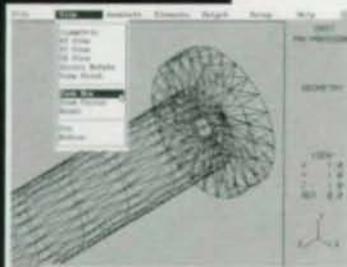

Free technical  
support!



Das Consulting, Inc.

865 Turnpike Street  
North Andover, MA 01845 USA  
Tel 508-794-1487 Fax 508-685-7230

Demo package available  
Call 800-322-1487

Please circle # 82

## DECKING

decking demands.

For more information, contact:  
United Steel Deck, Inc. (Nicholas  
J. Bouras, Inc.), 475 Springfield  
Ave., Summit, NJ 07902-0662  
(908) 277-1617; fax (908)  
277-1619 or circle no. 33.

Walker Division of Butler  
Manufacturing offers a  
new concept in PLEC  
distribution for steel-framed  
buildings; one that combines the  
triple-service capacity and aes-  
thetic appeal of an in-floor sys-  
tem with the up-front economy of  
a poke-thru system. The low-cost  
Presource III bottomless activa-  
tion modules are installed in a  
grid pattern on standard steel  
deck before the concrete pour,  
providing access to services in a  
predetermined pattern. Activa-  
tion costs are deferred until the  
time of fit-out. Walker also offers  
a line of service fittings in flush,  
pedestal and multiplex configu-  
rations for new construction or  
renovation.

For more information, contact:  
Mary Williams, Walker, P.O.  
Box 1828, Parkersburg, WV  
26101 (800) 222-PLEC or circle  
no. 90.

Heavy Duty Grip Strut  
bridge inspection walk-  
ways are suspended  
beneath bridge deck to enable  
close inspection of load-carrying  
members. The well-made cat-  
walks span 24-ft. openings with  
minimal deflection, which  
reduces the need and expense of  
extra supports. Also, gravel,  
mud, snow and ice fall through  
large diamond-shaped openings.  
Choices include 9, 10, or 11  
gauge grating with serrated or  
non-serrated steel, and widths  
up to 36-in. with 5-in. integral  
toeboards, which eliminate extra  
welding.

For more information, contact:  
GS Metals Corp., R.R. 4, Box 7,  
Pinckneyville, IL 62274 (800)  
851-9341 or (618) 357-5353  
inside Illinois or circle no. 91.



## Help Wanted — Chief Draftsman

Aggressive, expanding structural steel fabricator in the midwest is seeking an experienced Chief Draftsman. Department has (12) to (14) detailers. Must be a take charge individual with total control over department and outside detailers. Great assistant on board. CAD experience a plus. Send resume with salary history and requirements to:

President  
Doing Steel, Inc.  
2125 North Golden  
Springfield, MO 65803

## Help Wanted

Hirschfeld Steel Co., Inc., is searching for experienced structural steel detailers & checkers with at least 5 yrs. minimum experience for our Houston, TX, office. SDS/2, Microstation or other CAD system experience a plus.

Fax resume to Personnel: (916) 659-8916

## FOR SALE

Very successful \$3MM/Yr. Ohio Valley Structural and Misc. Fabricator and Erector w/\$2MM backlog. Plant, property, equipment and backlog: \$1.3MM

Reply Box 6700-F, The Fabricator, 833 Featherstone Road, Rockford, IL 61107-6302

## Experienced Steel Detailer/Checker Wanted

Minimum (15) years experience required. Salary is negotiable. If you're tired of the rat race, then this beautiful rural Idaho setting is for you! Lots of recreation. Please send resume to:

Corbett Structural, Inc.  
115 East Main St., Suite 10  
St. Anthony, ID 83445

## ANGLE ROLLING

PULLMAX offers a line of angle roll machines that make the "Hard Way" easy. Types and sizes to meet your needs with high section modulus capacities.

Call us toll free for more information:

**800/255-0502**  
**PULLMAX INC.**

## Steel FAXLINE

Call AISC's toll FREE steel information faxline to receive information on AISC's numerous publications, including manuals, specifications, design guides, electronic publications and software.

**AISC FAX Information Line**  
**800/644-2400**

## Structural & Miscellaneous Steel Detailing CAD Programs

AutoCAD parametric LISP programs for preparing structural AND misc. steel shop drawings. Anchor bolts to roof opening frames and "everything between". Imperial and metric versions with USA, Canadian and European sections. 30 DAY MONEY BACK GUARANTEE. Discounts up to 30%. Buy only what you need. Used in the field for 6 years. Programs written by a detailer with 38 years experience. Extremely "flexible" programs. FREE telephone support. No maintenance fee. Reasonable yearly update fee. EXCELLENT PROGRAMS at a REASONABLE PRICE. Call for a FREE demo disk, list of programs, and prices.

### SSDCP

110 Shady Oak Circle, Florence, MS 39073  
Tel: 601/845-2146 (fax same)

## Water Reducible Primers

Rowe Bisonite Inc. offers the steel industry a state-of-the-art water reducible primer line. With America becoming more conscious toward the environment, the age of water reducible and low VOC coatings has erupted. With that in mind, we have also developed an excellent and durable lead-free and chromate-free series as well as a low VOC Vinyl Toluene Ethyl Silicate Topcoat.

For more information, contact:

**Rowe Bisonite Inc., 470 Niagara Parkway,  
North Tonawanda, NY 14120**  
**phone: (716) 693-6130 fax: (716) 693-8244**

Statement of Ownership, Management, and Circulation

### Modern Steel Construction

Publication no.:	0026-8445
Filing date:	September 20, 1994
Address:	One East Wacker Dr., Suite 3100 Chicago, IL 60601-2001
Publisher/Editor:	Scott Melnick
Owner:	American Institute of Steel Construction, Inc. One East Wacker Dr., Suite 3100 Chicago, IL 60601-2001

Known bondholders, mortgagees and other security holders:	None
---	------

### Circulation Information

Total no. of copies:	
12 month avg.	39,000
September 1994	39,500
Requested subscriptions	
12 month avg.	31,000
September 1994	30,640
Free distribution by mail	
12 month avg.	4,000
September 1994	4,868
Free distribution outside the mail	
12 month avg.	2,500
September 1994	3,030
Total free distribution	
12 month avg.	6,500
September 1994	7,898
Total distribution	
12 month avg.	37,500
September 1994	38,538
Copies not distributed	
12 month avg.	1,500
September 1994	962
Total	
12 month avg.	39,000
September 1994	39,500
Percent paid and/or requested circulation	
12 month avg.	82.7%
September 1994	79.5%

## Computerized Structural Steel Detailing

Experienced Staff including licensed Professional Engineers with many years of detailing experience.  
30 Years of service to steel fabricators and contractors

**R.A. GRESS & ASSOCIATES**  
176 Planebrook Road, Frazier, PA 19355  
(610) 644-3250  
FAX (610) 889-4836

## Rolling

Beam-Angle-Tube-Pipe-Channel-Plate  
Easy/Hardway Heavy Capacities  
Up to **36"** W.F. Beam  
209-466-9707  
N.J. McCutchen, Inc.  
123 W. Sonora St., Stockton, CA 95203

## Northridge Jan. 17, 1994 Earthquake Slides

The one and only available technical photographic slides showing close-up view of damages to office buildings, hotels, parking structures, bridges, university facilities and apartments. Each slide is an excellent quality picture and explained individually. Great material for discussions and meetings. A must for design and construction professionals.

**70 slides — \$89.00 (including shipping & handling)**

Please send request to: MA Associates  
5105 E. Los Angeles Ave., Suite E157, Simi Valley, CA 93063  
Phone/Fax (805) 579-8291

## Images—3D

2D-3D Structural/Finite Element Analysis  
Easy to learn and use  
Shear & Moment Diagrams  
AISC Code Check  
Large Problems to 3,000 Joints

Automesh Generation  
Static, Modal, Dynamic  
Enforced Displacements  
P-δ Analysis

**Complete Static Package—Only \$795**

Celestial Software, 2150 Shattuck Ave., Suite 1200  
Berkeley, CA 94704

Tel: 510-843-0977 / Fax: 510-848-9849

Fifty-node fully functional evaluation package for only \$49.95

## GT STRUDL

New PC Version with Interactive Graphics and Links to CAD Systems.

Static, Nonlinear & Dynamic Analyses and Integrated Steel Design

Curved Steel Girder Bridge Module

For information, contact: Alex Krimotat at SC Solutions  
(415) 903-5050

## Engineering Journal

The only technical magazine in the U.S. devoted exclusively to the design of steel structures, the *AISC Engineering Journal* provides structural engineers, fabricators, and educators with the latest information on steel design, research and construction.

**For a one-year subscription, send \$15 to:**  
**American Institute of Steel Construction,**  
**P.O. Box 806276, Chicago, IL 60680-4124**  
**or phone 312/670-2400**

## HEWLETT-PACKARD Computers/Peripherals

A complete line of used and refurbished HP Equipment to fill all your computer needs. Laser printers, scanners, disk drives, plotters (Draftpro, Draftmaster & Designjet), PC's and 9000 series workstations are available for immediate delivery. Call our toll free number for additional information and pricing.

**Ted Dasher & Associates**  
4117 2nd Avenue South  
Birmingham, AL 35222  
800-638-4833 fax (205) 591-1108

## AISC Professional Membership

Receive a **FREE Manual of Steel Construction** and 25% discounts on AISC publications, seminars and the National Steel Construction Conference. In addition, be eligible to serve on AISC Committees.

**For more information, contact:**  
**LeAnn Schmidt at 312/670-5432.**

## Advertisers' Index

Advertiser	Page Number	Circle No.
AISC Design Guides	8	
AISC Publications	11	
Nicholas J. Bouras	CII	33
Bristol Machine	27	62
Central Steel Service	21	65
Chaparral Steel	29	43
Compu-Tec	32	85
Computer Detailing	21	
Computers & Structures, Inc.	CIV	31
Consolidated Systems	33	70
Das Consulting, Inc.	44	82
Design Data	7	32
EJE Industries	17	46
Intrasoft	17	99
Gründer	26	83
Jobber Instruments	19	114
LRFD	35	
MDX	40	47
McDonough Bolyard Peck	26	100
Metrosoft	CIII	51
Monash University	12	
Mound Architectural	44	101
National Steel Construction Conference	22&23	
Nucor Fastener	41	38
Omnitech Associates	13	52
Optimate	40	53
Ram Analysis	13	41
Research Engineers	5	34
Risa Technologies	12&18	40
St. Louis Screw & Bolt	39	36
SteelCAD	43	84
Steel Joist Institute	28	54
Structural Engineers	13	78
Structural Software	38	42
TradeARBED	3	35
Max Weiss	20	56
Whitefab	43	55

To receive free information on the advertisers listed above, circle the appropriate reader service numbers on the reader service card provided in this magazine.

# ROBOT V6

## THE FINEST IN STRUCTURAL ANALYSIS AND DESIGN SOFTWARE

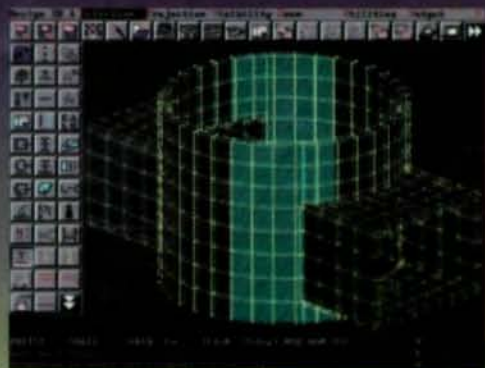
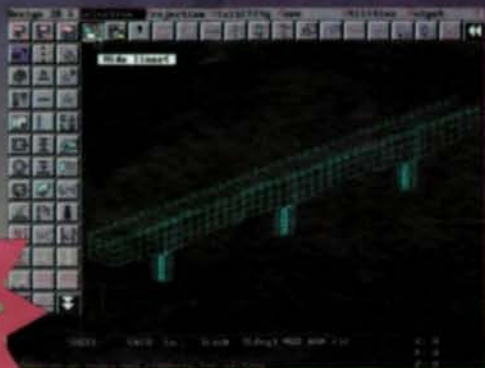
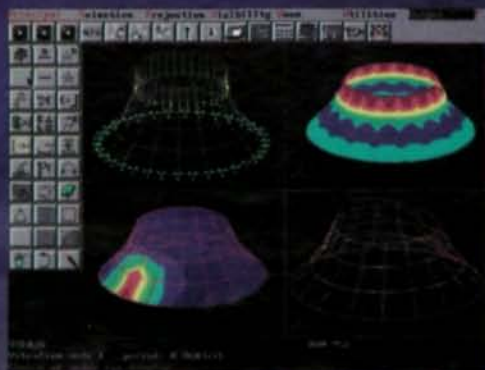

HIGHEST RATING  
**4.5**

IN 1994  
STRUCTURAL ENGINEERING SOFTWARE SURVEY  
MODERN STEEL CONSTRUCTION  
JANUARY '94

TOP RATING  
**10**  
FOR COMPUTING POWER,  
STRUCTURAL ENGINEERING FORUM  
MARCH '94

**NEW RELEASE**

**NEW.** Faster calculations.  
**NEW.** Concrete design and detailing.  
**NEW.** Interface to AISC's CONPRT.  
**NEW.** Completely revised, improved manual.

- very easy to learn and use, become a productive user in just one day
- extremely fast, shortens the concept through design cycle
- most powerful on PC platform - 3D FEM, buckling, nonlinear, P-delta, dynamic, 3D moving loads, parametric structures, phase constructions, US and foreign codes
- buy the power you need, starts from \$495 version - 150 node/3D plus plate elements
- easy payment plans for 1500 and 32500 node versions
- no risk, 30 day money back guarantee

See for yourself. Have fun. Any questions? Call us. **1-800-60-ROBOT**

Please circle # 51



metrosoft

332 Paterson Ave.  
E. Rutherford, NJ 07073

DEMO AVAILABLE (WORKING VERSION OF PROGRAM AND PRE-RECORDED EXAMPLES) OVER 1200 USERS WORLDWIDE. FOR MORE INFORMATION CALL 201-438-4915 OR FAX TO 201-438-7058

**ROBOT V6**

Name: \_\_\_\_\_

Company: \_\_\_\_\_

Address: \_\_\_\_\_ State \_\_\_\_\_ Zip \_\_\_\_\_

Tel.: \_\_\_\_\_ Fax: \_\_\_\_\_

I am:  structural engineer,  architect,  educator,  dealer,  other: \_\_\_\_\_

Please have a product specialist call me  Please send more information

Please send working demo version (limited to 20 elements and 30 nodes), with recorded macros of real design examples. Enclosed is a check for \$25 (plus applicable Tax in NJ and NY). I have a system equal to or better than 386SX with math coprocessor,  4 MB  8 MB RAM, 25 MB of free disk space, VGA monitor.

Metrosoft, 332 Paterson Avenue, E. Rutherford, NJ 07073. Tel 201 438-4915, Fax 201 438-7058.

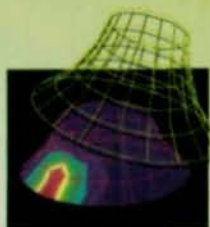

MSC

STATE OF THE ART

# Structural Engineering Software

INTEGRATED ANALYSIS AND DESIGN SOFTWARE FOR TALL BUILDINGS

Developed by Ashraf Habibullah & Edward L. Wilson

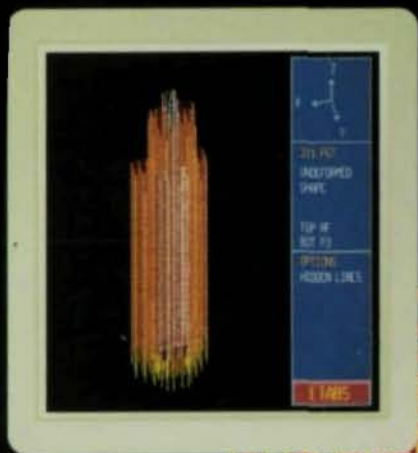

BH.PST  
UNDEFORMED  
SHAPE

MECH  
2ND

IONS  
IDENTALINE



**ETABS®**  
Building Analysis & Design

**SAP90®**  
General Analysis & Design

For further information:

**Computers & Structures, Inc.**  
1995 University Avenue  
Berkeley, California 94704

**TEL: 510/845-2177**  
**FAX: 510/845-4096**

ETABS is a registered trademark of Computers & Structures, Inc.  
SAP90 is a registered trademark of Computers & Structures, Inc.  
© 1993 Computers & Structures, Inc.

Please circle # 31