

# WELDED-WELDED DOUBLE FRAMING ANGLE CONNECTION MOMENTS

1295

a design report prepared for

AMERICAN INSTITUTE OF STEEL CONSTRUCTION  
400 NORTH MICHIGAN AVENUE  
CHICAGO, ILLINOIS 60611

by

Marc C. LeBouton, M.S.C.E.

and

Ralph M. Richard, Ph.D., P.E.

of

THE DEPARTMENT OF CIVIL ENGINEERING AND ENGINEERING MECHANICS

## THE UNIVERSITY OF ARIZONA

TUCSON, ARIZONA 85721

STEEL CONNECTION DESIGNS

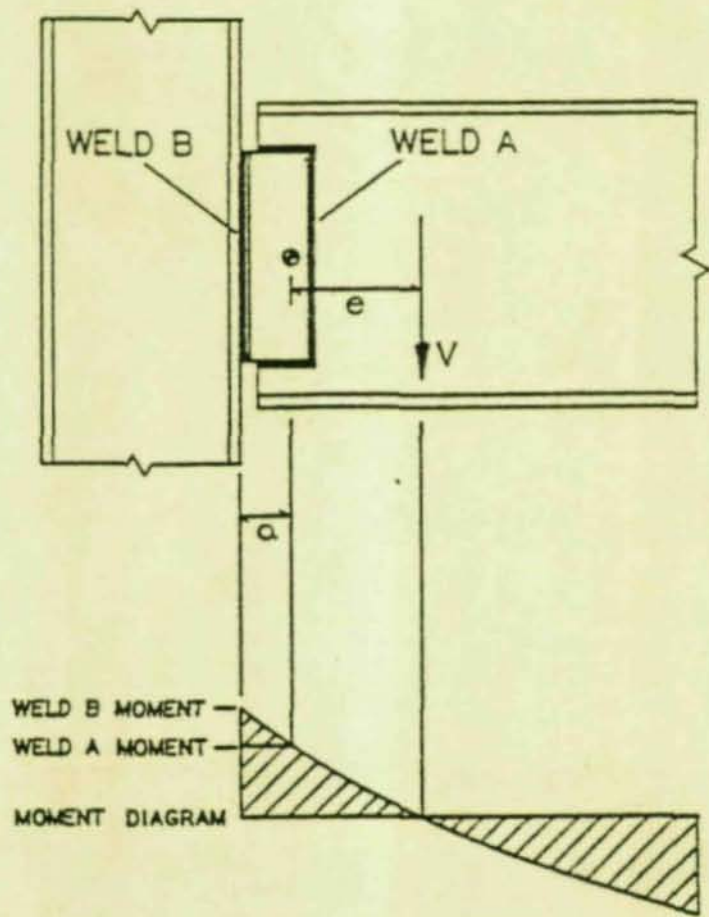

JUNE 1987



**The University of Arizona**

College of Engineering and Mines  
Department of Civil Engineering  
and Engineering Mechanics  
Tucson, Arizona 85721  
(602) 621-2266

27 July 1987

Nestor Iwankiw  
Director of Research and Codes  
American Institute of Steel Construction, Inc.  
The Wrigley Building, Eighth Floor  
400 N. Michigan Ave.  
Chicago, IL 60611-4185

Dear Nestor:

Enclosed are two copies of our research report on the capacity of welds A & B for double framing angle connections. This research was funded by AISC through an Educational Fellowship to Marc C. LeBouton. Messrs Astaneh and McMullin obtained the force-deflection data for the welded-bolted double angles at the Fears Laboratory of the University of Oklahoma.

A quick synopsis of this research can be made by reviewing Table 11 on page 101 and Table 12 on page 107 where the weld capacities evaluated herein are compared with the AISC Manual. Also in Table 16 on page 119, a very simple method using AISC Table XIX is presented for sizing Weld B.

Best regards,

Ralph M. Richard, Ph.D., P.E.  
Professor of Civil Engineering  
and Engineering Mechanics  
and Optical Science

RMR:sss

Enclosures

✓ xc: Robert O. Disque  
Director  
Building Design Technology

N.B. Marc has graduated and has accepted a position as a stress analyst at Hercules Powder in Salt Lake City.

# WELDED-WELDED DOUBLE FRAMING ANGLE CONNECTION MOMENTS

a design report prepared for

AMERICAN INSTITUTE OF STEEL CONSTRUCTION  
400 NORTH MICHIGAN AVENUE  
CHICAGO, ILLINOIS 60611

by

Marc C. LeBouton, M.S.C.E.

and

Ralph M. Richard, Ph.D., P.E.

of

THE DEPARTMENT OF CIVIL ENGINEERING AND ENGINEERING MECHANICS

## THE UNIVERSITY OF ARIZONA

TUCSON, ARIZONA 85721

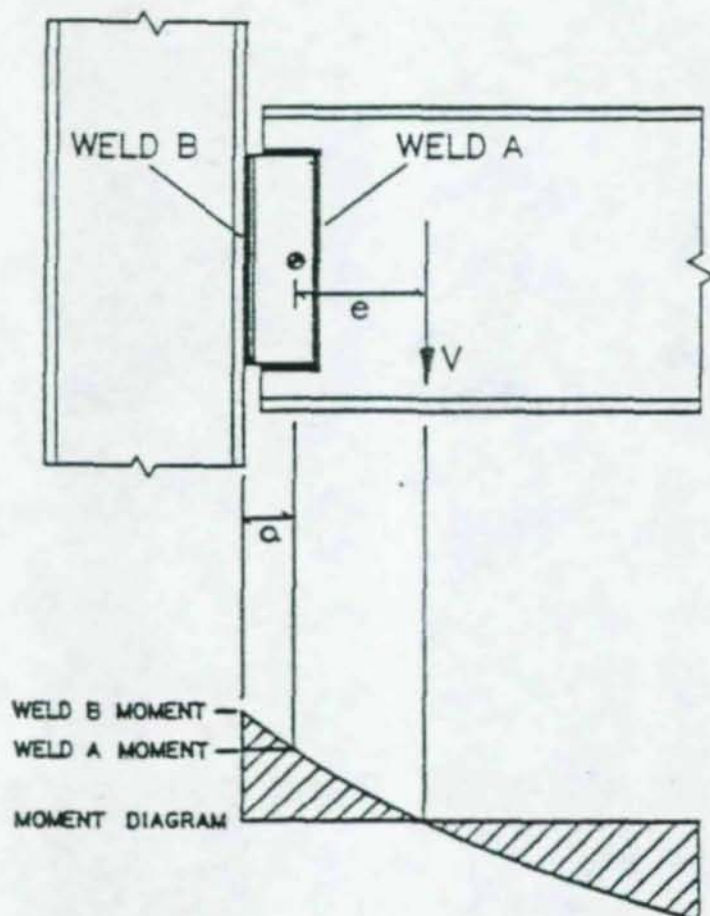

STEEL CONNECTION DESIGNS

JUNE 1987

01106

PREFACE

The purpose of the following research is two-fold: first, to establish the moment-rotation characteristics of several common welded double angle framing connections; and second, to review the capacity of Weld A and Weld B in the Welded Framed Beam Connections Design Table IV on pages 4-36 and 4-37 of the Eighth Edition of the Manual of Steel Construction by the American Institute of Steel Construction.

This research was funded by an Educational Fellowship from the American Institute of Steel Construction for the 1986-1987 academic year at the University of Arizona.

I would like to give a sincere and honest thank you to my major professor, Dr. Ralph M. Richard, for sharing with me his conceptual ideas which made this research possible, and for allowing me the freedom to develop my own skills both as an engineer and as a writer.

I would also like to thank my parents for their support, both financially and developmentally, and for their encouragement throughout my life to achieve a higher education.

Finally, I would like to thank my fiancée, Tammy, for her love and emotional support during this past year in graduate school.

## TABLE OF CONTENTS

	Page
LIST OF ILLUSTRATIONS.....	v
LIST OF TABLES.....	vii
ABSTRACT.....	viii
INTRODUCTION.....	1
FORCE-DEFORMATION CURVES.....	10
Tension tests.....	10
Compression tests.....	18
Shear tests.....	25
MOMENT-ROTATION CURVES.....	29
BEAM LINE THEORY.....	57
WELD DESIGN AND COMPARISON.....	94
Weld "A" Design: Elastic Analysis.....	94
Weld "A" Design Example: Elastic Analysis.....	97
Weld "A" Design Example: Ultimate Strength Analysis..	99
Weld "B" Design: Elastic Analysis.....	100
Weld "B" Design Example: Elastic Analysis.....	102
Weld "B" Design Example: Ultimate Strength Analysis..	103
SIMPLIFYING ASSUMPTIONS AND PROCEDURES.....	108
CONCLUSIONS.....	120
APPENDIX A: THE RICHARD EQUATION.....	123
APPENDIX B: PROGRAM MRCURVE.....	124
APPENDIX C: PROGRAM NRMRSOL.....	130
REFERENCES.....	134

## LIST OF ILLUSTRATIONS

Figure		Page
1.	Typical Framed Beam Connections.....	2
2.	Typical Force Deformation Curve with Richard Parameters.....	3
3.	Moment Rotation Curve with Richard Parameters for a Typical Connection.....	5
4.	Moment Rotation Curve with Beam Line for a Typical Connection.....	6
5.	AISC Design Philosophy for Weld A and Weld B....	8
6.	Research Design Philosophy for Weld A and Weld B	9
7.	The Three Primary Modes of Deformation shown in their respective regions of Beam to Column Connection.....	11
8.	Tension Test Configuration.....	12
9.	Elastic Stiffness of Tension Specimens.....	19
10.	Force Deformation Curve 2-L4 x 3-1/2 x 1/4 x 3..	21
11.	Force Deformation Curve 2-L4 x 3-1/2 x 3/8 x 3..	22
12.	Force Deformation Curve 2-L4 x 3-1/2 x 1/2 x 3..	23
13.	Force Deformation Curve 2-L5 x 3-1/2 x 5/8 x 3..	24
14.	Connection Modeled with Rigid Bars and Non-linear Springs.....	30
15-38.	Moment Rotation Curve for Welded Double Angle Connection.....	33-56
39.	Beam Line Equation Development.....	58
40.	AISC Connection Types with Beam Line.....	60
41.	Elastic Modulus vs Angle Length for various Connections.....	63

42.	Plastic Modulus vs Angle Length for various Connections.....	64
43.	Reference Moment vs Angle Length for various Connections.....	65
44.	Shape Parameter vs Angle Length for various Connections.....	66
45-68.	Moment Rotation Curve with Beam Line for Welded Connection.....	69-92
69.	Shear Force Transfer for Weld A Design.....	95
70.	Center of gravity and polar moment of inertia for weld geometry shown.....	98
71.	Equations for computing stresses on Weld B.....	105
72.	Eccentric Loads on Weld Groups (AISC Table XIX page 4-76).....	106
73.	Beam Length to Beam Depth Ratio (L/d) vs Connection Moment: Curves are for various lengths of L4 x 3 x 1/4 Angles.....	110
74.	Beam Length to Beam Depth Ratio (L/d) vs Connection Moment: Curves are for various lengths of L4 x 3 x 5/16 Angles.....	111
75.	Beam Length to Beam Depth Ratio (L/d) vs Connection Moment: Curves are for various lengths of L4 x 3 x 3/8 Angles.....	112
76.	Beam Length to Beam Depth Ratio (L/d) vs Connection Moment: Curves are for various lengths of L4 x 3 x 1/2 Angles.....	113
77.	Beam Length to Beam Depth Ratio (L/d) vs Connection Moment: Curves are for various lengths of L5 x 3 x 5/8 Angles.....	114

## LIST OF TABLES

Table	Page
1. Force-Deformation Data for Welded Double Angle Connection: 2-L4 x 3-1/2 x 1/4 x 3 inch.....	14
2. Force-Deformation Data for Welded Double Angle Connection: 2-L4 x 3-1/2 x 3/8 x 3 inch.....	15
3. Force-Deformation Data for Welded Double Angle Connection: 2-L4 x 3-1/2 x 3/8 x 3 inch.....	15
4. Force-Deformation Data for Welded Double Angle Connection: 2-L4 x 3-1/2 x 1/2 x 3 inch.....	16
5. Force-Deformation Data for Welded Double Angle Connection: 2-L5 x 3-1/2 x 5/8 x 3 inch.....	17
6. Elastic Stiffness, K, for Tension Test Specimens..	20
7. Richard Equation Parameters for Three Inch Segments of Welded Double Angles Loaded in Compression.....	26
8. Richard Equation Parameters for Three Inch Specimens of Welded Double Angles Loaded in Tension and in Compression.....	28
9. Beam Line Parameters for Weld "A" Comparison.....	62
10. Resisting Moment and Rotation at End Connection for various Welded Connection Geometries.....	93
11. Weld "A" Comparison.....	101
12. Weld "B" Comparison.....	107
13. Richard Equation Parameters for Various Welded Connection Geometries.....	115
14. Comparison between Beam Line Method and L/d Method.....	117
15. Flexibility Ratios for Welded Connections.....	118
16. Eccentric Load Coefficients.....	119



01111

## ABSTRACT

Results of tension and compression tests on angle segments are used to generate moment-rotation curves for welded-welded double framing angle connections. The beam line concept is then used to determine the connection moments for connection depths of 18 to 32 inches.

With the connection moments known, the two welds, denoted as Weld A and Weld B in the AISC Manual Table IV are evaluated. Because the analytical model used to generate the weld sizes published in the AISC Manual and the analytical model used in this research differ, it was found that the capacities of the connection designs in the AISC Manual for Weld B have factors of safety ranging from 2.5 to 3.0.

Design aids are included which give the connection moments for a variety of designs as a function of the length to depth ratio of the beam for the case of uniform loading.

## INTRODUCTION

Framed beam connections are used to connect beams to girders and girders to columns. The design of these connections involves the properties of steel angles which are given in the AISC manual. These angle connections may be fastened to the girder web or to the column flange by high strength bolts, fillet welds, or a combination of bolts in one leg of the angle and welds along the other leg. This research involves welded-welded framed beam connections as shown in Figure 1.

In order to analyze the structural behavior of double angle connections, the Richard equation (Appendix A) is used to analytically define the load-deformation characteristics of double angle framing connections. A typical Richard curve is defined by four parameters: (1) the elastic stiffness or initial slope of the curve, (2) the plastic stiffness or final slope of the curve, (3) the reference load or the intercept of a line asymptotic to the plastic stiffness with the vertical axis, and (4) the shape parameter, a dimensionless parameter that defines the sharpness of transition between the elastic stiffness and plastic stiffness (Figure 2). This equation, in short, defines the deformation associated with load for a given double angle connection. This deformation

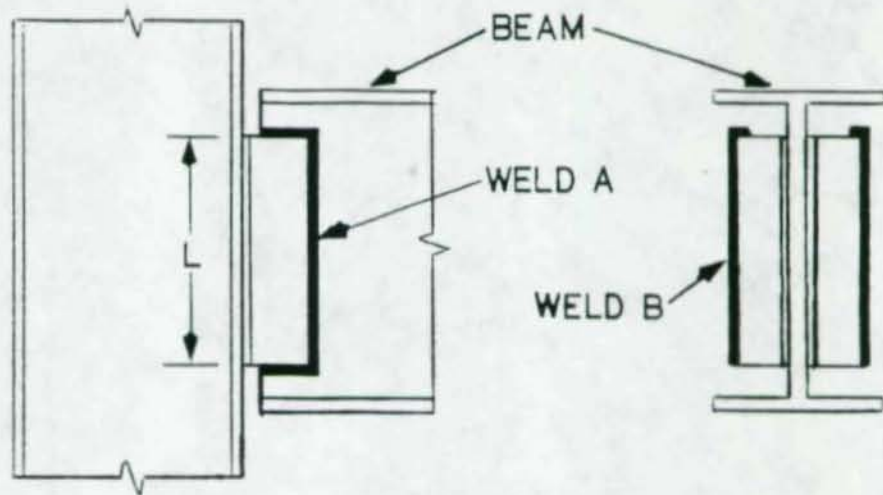

a) Beam web to column flange connection.

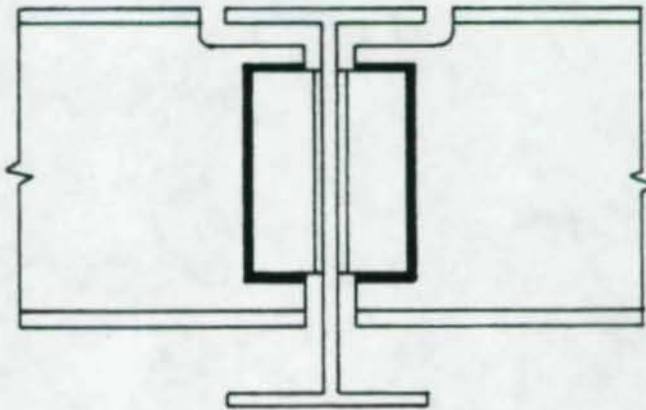

b) Beam web to beam web connection.

Figure 1. Typical Framed Beam Connections.

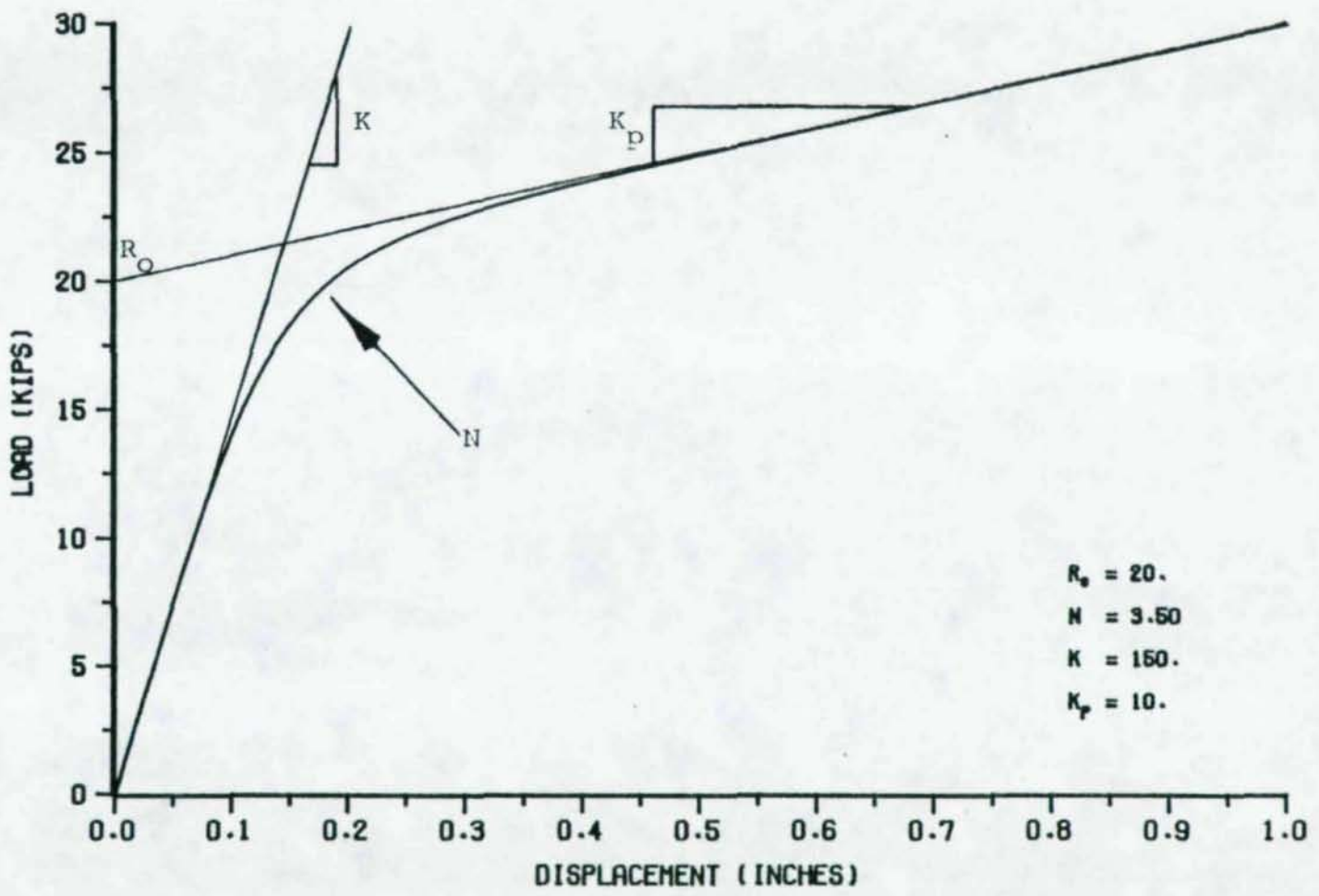

TYPICAL FORCE DEFORMATION CURVE WITH RICHARD PARAMETERS

Figure 2.

may be in the form of a translational displacement associated with a force, or it may be in the form of a rotation associated with an applied moment (Figure 3).

When the beam shown in Figure 1 is loaded with a given loading, a displacement and rotation will occur at the ends of the beam. Blewitt and Richard [1] used the Richard equation to describe force-deformation curves for bolted three inch angle segments based on experimental testing. Hsia and Richard [2] used the force-deformation characteristics of these three inch connection segments to generate moment-rotation curves for various connection geometries. If the moment-rotation curve for a particular connection is known, the moment which occurs at the connection can be determined.

In order to determine the restraining moment which occurs at the connection, the beam line [3] is superimposed on the moment-rotation curve and the intersection of these two curves gives the restraining moment and end rotation that occur at the connection for a beam with a given loading (Figure 4). With the restraining moment known, the welds at the connection can be designed for strength and safety.

This research reviews the strength of Weld A and Weld B in the Welded Framed Beam Connections Design Table IV on pages 4-36 and 4-37 of the Eighth Edition of the Manual of Steel Construction by the American Institute of Steel Construction (AISC). In the AISC design guide, Weld B was

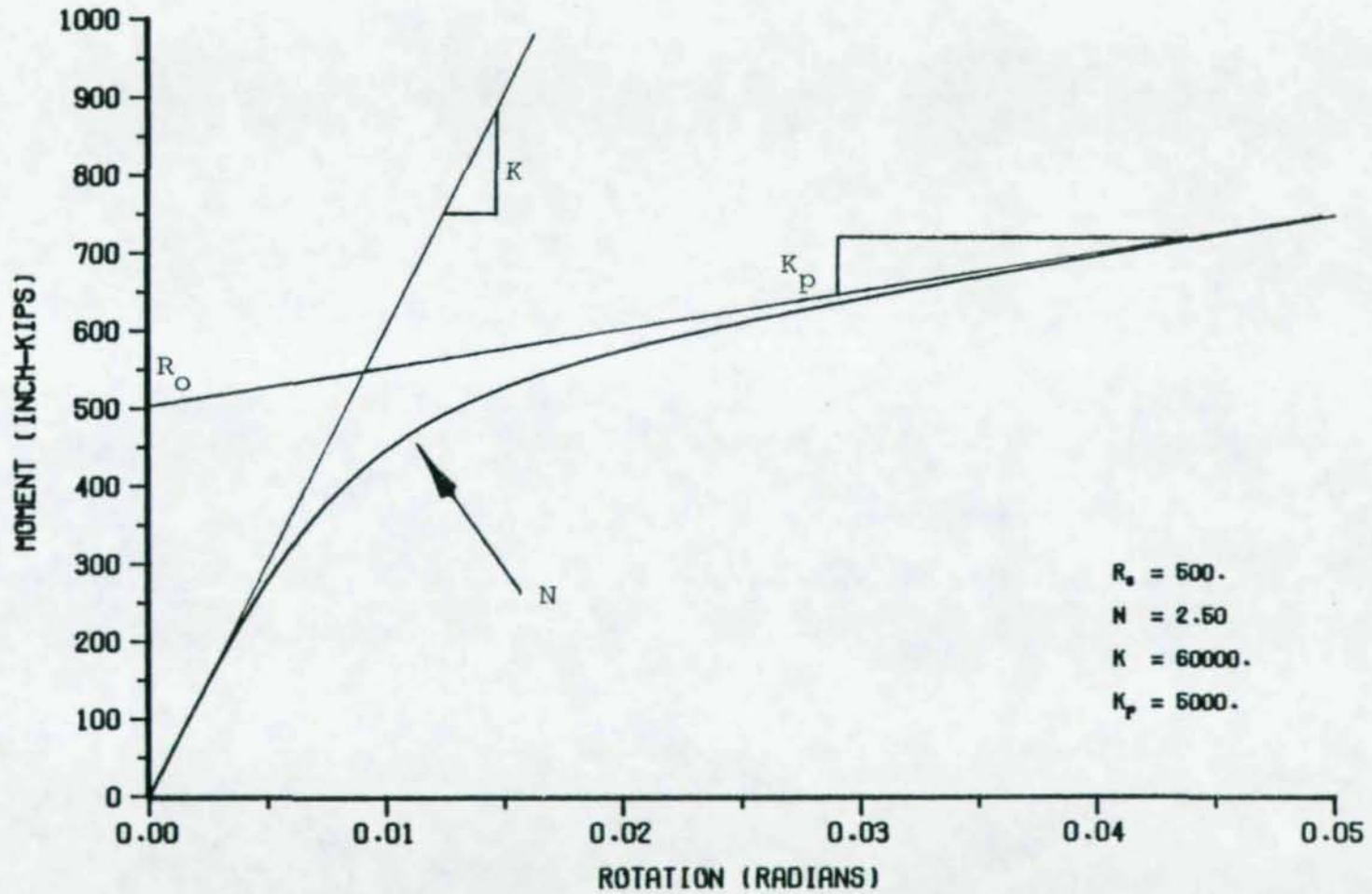

MOMENT ROTATION CURVE WITH RICHARD PARAMETERS FOR A TYPICAL CONNECTION

Figure 3.

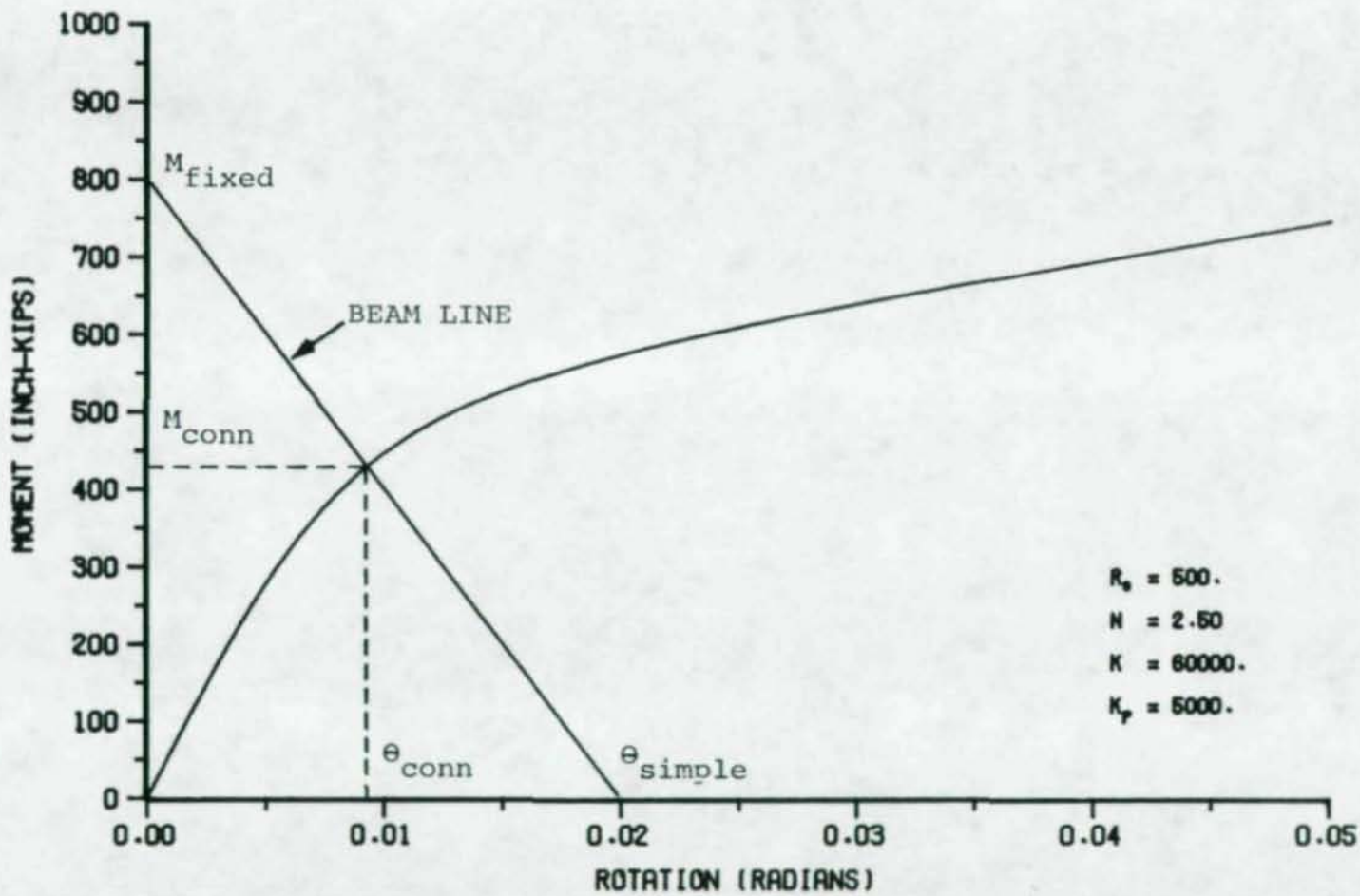

MOMENT ROTATION CURVE WITH BEAM LINE FOR A TYPICAL CONNECTION  
 FIXED-END MOMENT = 800.0 INCH-KIPS SIMPLE-END ROTATION = 0.02 RADIAN

Figure 4.

designed for only a vertical shear force and a torsional moment in a plane normal to the beam axis which were assumed to act along the interface of the column flange and the angle clip legs. Weld A, however, was designed for this shear force and the torsional moment that this force causes about the centroid of Weld A (Figure 5).

This design model does not account for the connection moment as shown in Figure 6. The shear force acts at an eccentricity,  $e$ , from the centroid of Weld A, so that both Weld A and Weld B are subjected to both shear and moment acting on the welds (Figure 6).

The evaluation of the strength of Weld A and Weld B is accomplished through the following three steps:

- 1) Force-deformation curves for double framing angle geometries are generated from physical tests.
- 2) Moment-rotation curves are then derived from the force-deformation curves for various connections.
- 3) The beam line for a given loading condition is then superimposed on the moment-rotation curve for the connection under consideration to determine the end moment.

These welds are designed and compared with those given in the AISC manual.



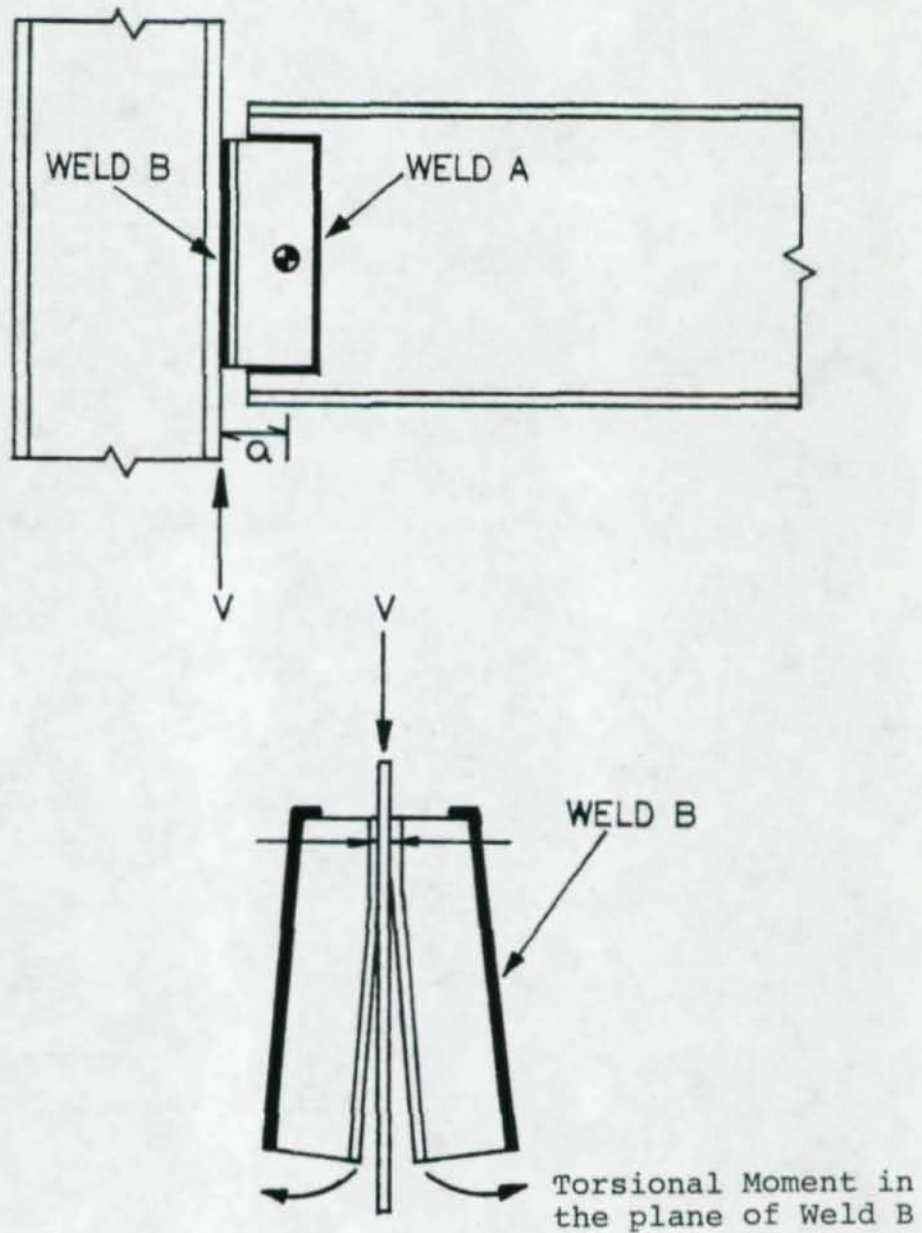

Weld A: Designed for shear force  $V$  and torsional moment  $M = V \times a$

Weld B: Designed for shear force  $V$  and torsional moment in the plane of Weld B

Figure 5. AISC design philosophy for Weld A and Weld B.

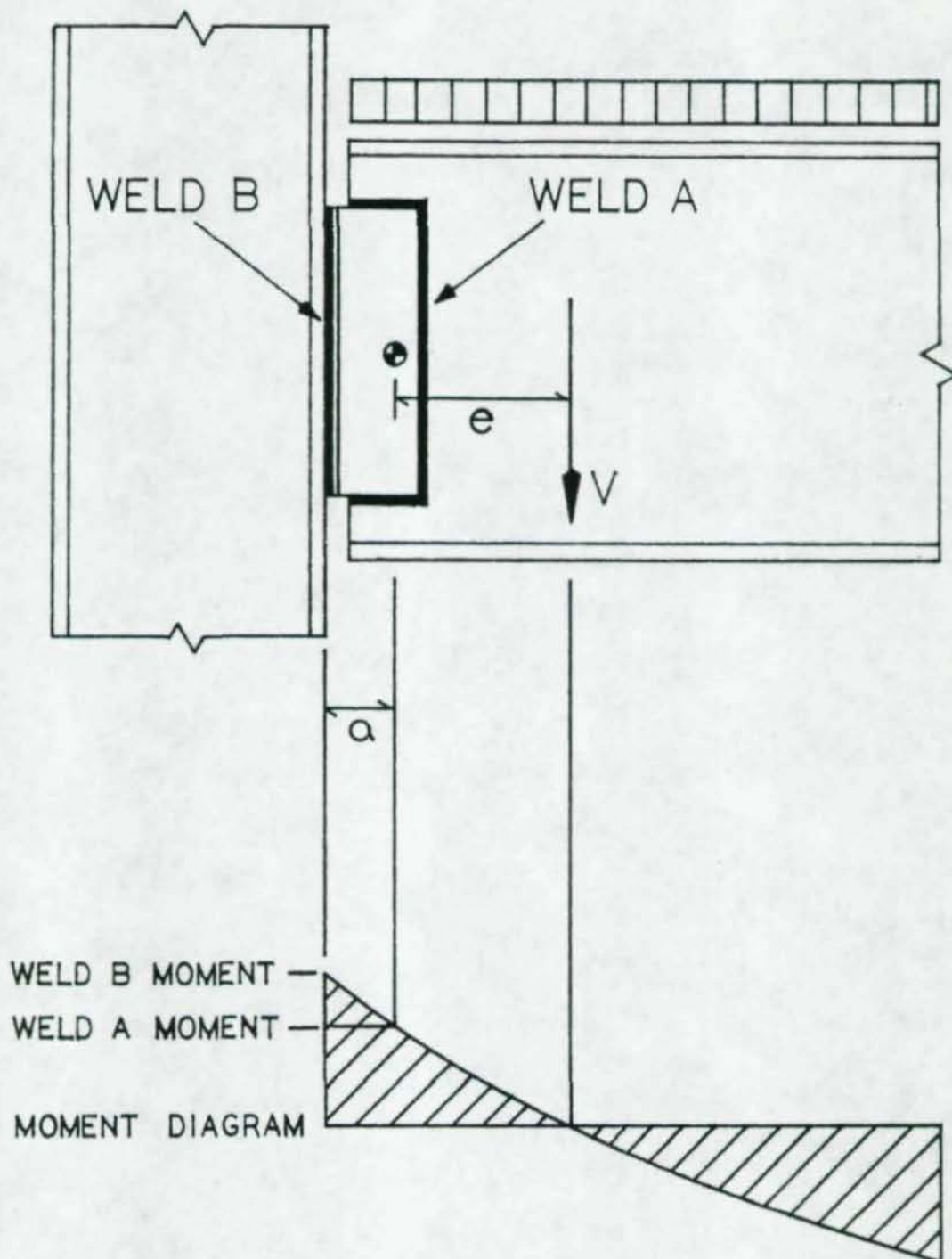

Weld A: Designed for shear force  $V$  and torsional moment  $M = V \times e$

Weld B: Designed for shear force  $V$  and bending moment  $M = V \times (a + e)$

Figure 6. Research design philosophy for Weld A and Weld B.

## FORCE-DEFORMATION CURVES

The Richard equation (Appendix A) is used to analytically describe the force-deflection characteristics of a segment of a welded double framing angle connection. The parameters of this curve are determined from physical testing of segments of welded double framing angle connections. Astaneh and McMullin of the University of Oklahoma [3] performed the physical tests for four different connection angle geometries:

- |                                       |   |                      |
|---------------------------------------|---|----------------------|
| 1) L 4 X 3-1/2 X 1/4 X 3 inch segment |  | ASTM A36<br>Material |
| 2) L 4 X 3-1/2 X 3/8 X 3 inch segment |   |                      |
| 3) L 4 X 3-1/2 X 1/2 X 3 inch segment |   |                      |
| 4) L 5 X 3-1/2 X 5/8 X 3 inch segment |   |                      |

For any one segment of connection, a different Richard curve is found for each of the various modes of deformation the connection segment exhibits. There are three modes of deformation to consider: 1) displacement caused by a tensile force; 2) displacement caused by a compressive force; and 3) displacement caused by a shear force. These three modes of deformation in relation to a beam to column connection are shown in Figure 7.

### Tension tests

The tension test configuration is shown in Figure 8.

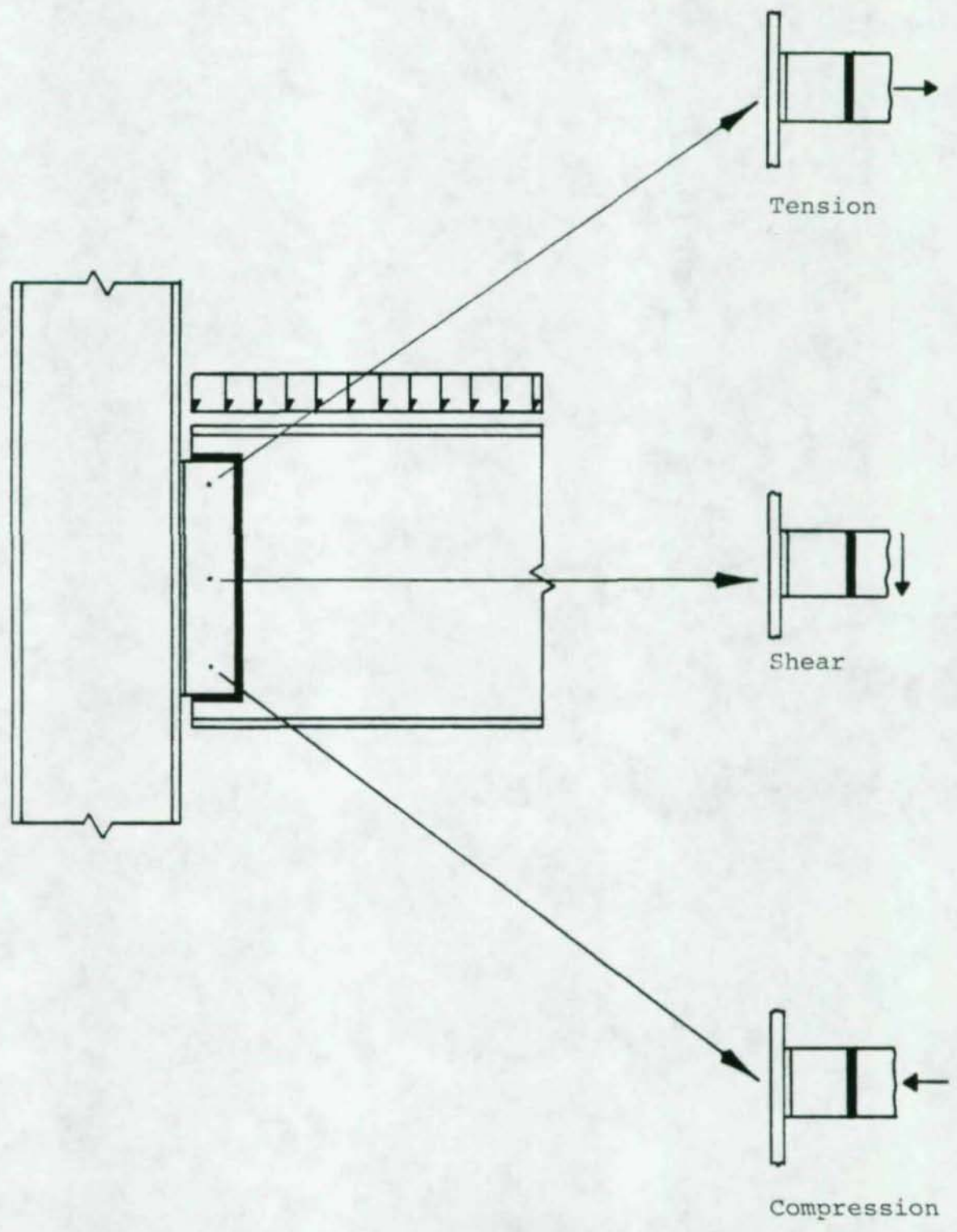

Figure 7. The three primary modes of deformation shown in their respective regions of beam to column connection.

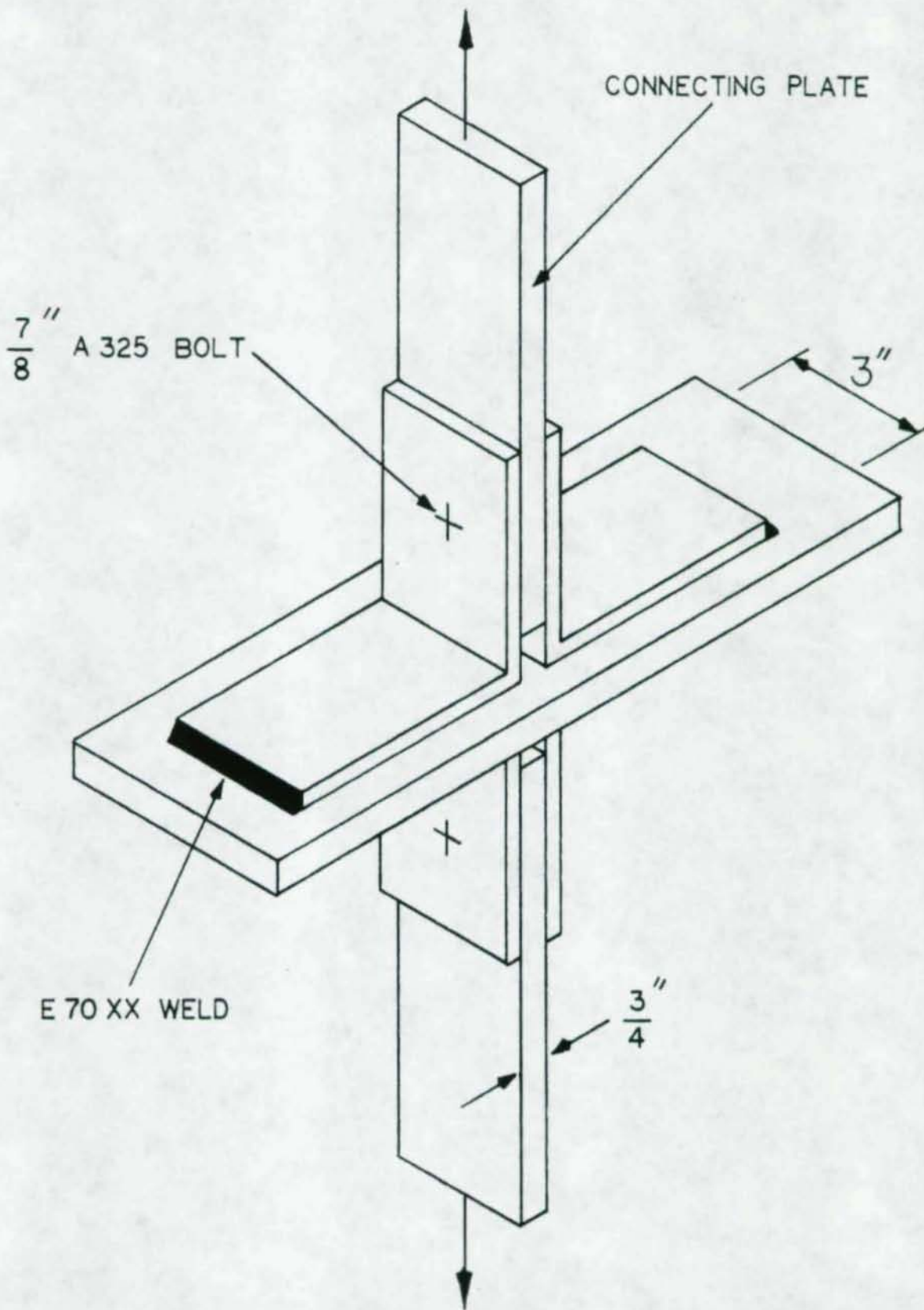

Figure 8. Tension test configuration.

In each test, an initial load was applied to the angles to allow the bolts to slip into bearing against the connecting plate and angles. Under static loading conditions (approximately ninety minutes from start to failure) force and displacement readings were taken at sufficient intervals until failure occurred. In each test, the failure mode was weld fracture. These force and displacement data are given in Tables 1 through 5.

As explained previously, a Richard curve is defined by the elastic stiffness of the angles  $K$ , the plastic stiffness of the angles  $K_P$ , the reference load  $R$ , and the shape parameter  $N$ . These values are determined by fitting a least squares curve to the experimental data given in Tables 1-5. The values of  $K_P$ ,  $R$ , and  $N$  are determined using a least squares criterion. The value of  $K$ , the elastic stiffness, however, must be determined beforehand using principles of structural mechanics.

To determine the elastic stiffness of the angles,  $K$ , the outstanding leg of the angle with the weld is modeled as a beam fixed at one end and simply supported at the other (Figure 9). The beam has a modulus of elasticity  $E$ , a moment of inertia  $I$ , and a length  $g$  which is the length of the outstanding leg  $L$  minus the dimension  $k$ , the fillet dimension given in the AISC manual. The dimension  $k$  is subtracted from the overall length because  $k$  defines the critical section where the slope of the outstanding leg becomes zero.

TABLE 1 FORCE-DEFORMATION DATA FOR WELDED DOUBLE ANGLE  
CONNECTION: 2-L 4 X 3-1/2 X 1/4 X 3 INCH

<u>Load (kips)</u>	<u>Displacement (inches)</u>	
	<u>top angles</u>	<u>bottom angles</u>
0.08	0.000	0.000
0.50	0.016	0.014
1.00	0.046	0.041
1.60	0.085	0.079
2.09	0.119	0.115
2.50	0.147	0.145
3.01	0.207	0.218
3.51	0.320	0.343
4.06	0.443	0.474
6.50	1.125	1.063

TABLE 2 FORCE-DEFORMATION DATA FOR WELDED DOUBLE ANGLE  
CONNECTION: 2-L 4 X 3-1/2 X 3/8 X 3 INCH

<u>Load (kips)</u>	<u>Displacement (inches)</u>	
	<u>top angles</u>	<u>bottom angles</u>
0.15	0.000	0.000
0.20	0.002	0.001
1.00	0.011	0.022
2.00	0.033	0.037
4.00	0.083	0.083
5.15	0.183	0.184
5.50	0.256	0.236
6.25	0.353	0.294
6.25	0.423	0.335
6.45	0.444	0.355
8.35	0.750	0.625

TABLE 3 FORCE-DEFORMATION DATA FOR WELDED DOUBLE ANGLE  
CONNECTION: 2-L 4 X 3-1/2 X 3/8 X 3 INCH

<u>Load (kips)</u>	<u>Displacement (inches)</u>	
	<u>top angles</u>	<u>bottom angles</u>
0.26	0.000	0.000
0.50	0.002	0.003
1.04	0.009	0.011
2.06	0.023	0.025
3.01	0.036	0.038
3.99	0.050	0.053
5.13	0.070	0.078
6.07	0.111	0.153
7.15	0.220	0.282
7.52	0.263	0.330
8.08	0.319	0.391
8.56	0.361	0.437
10.50	0.625	0.594



TABLE 4 FORCE-DEFORMATION DATA FOR WELDED DOUBLE ANGLE  
CONNECTION: 2-L 4 X 3-1/2 X 1/2 X 3 INCH

<u>Load (kips)</u>	<u>Displacement (inches)</u>	
	<u>top angles</u>	<u>bottom angles</u>
0.35	0.000	0.000
1.02	0.002	0.002
1.50	0.004	0.004
2.00	0.006	0.006
3.14	0.011	0.011
4.08	0.017	0.015
5.25	0.025	0.021
6.04	0.029	0.025
7.05	0.036	0.033
8.12	0.046	0.041
9.05	0.055	0.049
10.05	0.067	0.059
11.12	0.085	0.075
12.07	0.118	0.108
13.10	0.167	0.156
13.54	0.194	0.185
14.08	0.231	0.247
14.56	0.269	0.284
15.02	0.314	0.318
15.65	0.369	0.356
16.07	0.413	0.383
16.57	-----	0.407
17.00	-----	0.439
17.50	-----	0.514
17.50	0.500	0.438

TABLE 5 FORCE-DEFORMATION DATA FOR WELDED DOUBLE ANGLE  
CONNECTION: 2-L 5 X 3-1/2 X 5/8 X 3 INCH

<u>Load (kips)</u>	<u>Displacement (inches)</u>	
	<u>top angles</u>	<u>bottom angles</u>
0.00	0.000	0.000
0.98	0.011	0.008
1.70	0.013	0.012
2.00	0.015	0.013
3.00	0.021	0.018
4.02	0.028	0.024
5.02	0.036	0.032
6.04	0.047	0.039
7.03	0.057	0.045
8.05	0.067	0.053
9.26	0.078	0.063
10.00	0.086	0.069
11.04	0.100	0.084
12.02	0.125	0.109
12.70	0.168	0.132
13.00	0.187	0.171
13.42	0.211	0.190
14.00	0.241	0.220
14.51	0.294	0.247
14.73	0.322	0.263
15.01	0.378	0.273
15.25	0.423	0.290
15.35	0.439	0.303
15.66	0.498	0.379
15.99	0.498	0.379
16.26	0.517	0.402
16.50	0.534	0.428
17.00	0.563	0.468
17.25	0.577	0.490
17.50	0.591	0.509
17.99	0.614	0.544
18.50	0.638	0.580
21.40	0.750	0.750

Using the moment-area method of structural mechanics with the stiffness method of structural analysis, the derivation of the elastic stiffness of the angles is given in Figure 9.

$$K = [2] \times 3EI/g^3$$

Using  $E = 30,000$  ksi

$$g = L - k \text{ (inches)}$$

$$I = (1/12) \times (\text{base}) \times (\text{height})^3$$

$$= (1/12) \times (3 \text{ inch}) \times (t)^3$$

$$= [t]^3/4$$

$t =$  angle leg thickness in inches

the elastic stiffness of two welded double angles (3 inch segments) becomes

$$K = 45,000 \times [t/g]^3 \quad (\text{Kips/inch}).$$

The elastic stiffnesses for each of the four tension test specimens are given in Table 6.

The elastic stiffness along with the data points were input into the computer program XYPLOT (Williams) for each tension test. Program XYPLOT contains a subroutine RCFIT (Gillett and Hormby) which gives the least squares Richard curve fit and supplies the Richard parameters  $KP$ ,  $R$ , and  $N$ . Figures 10 through 13 give the force-deformation curves for the four welded double angle specimens in tension.

#### Compression tests

Physical testing for compression was not necessary

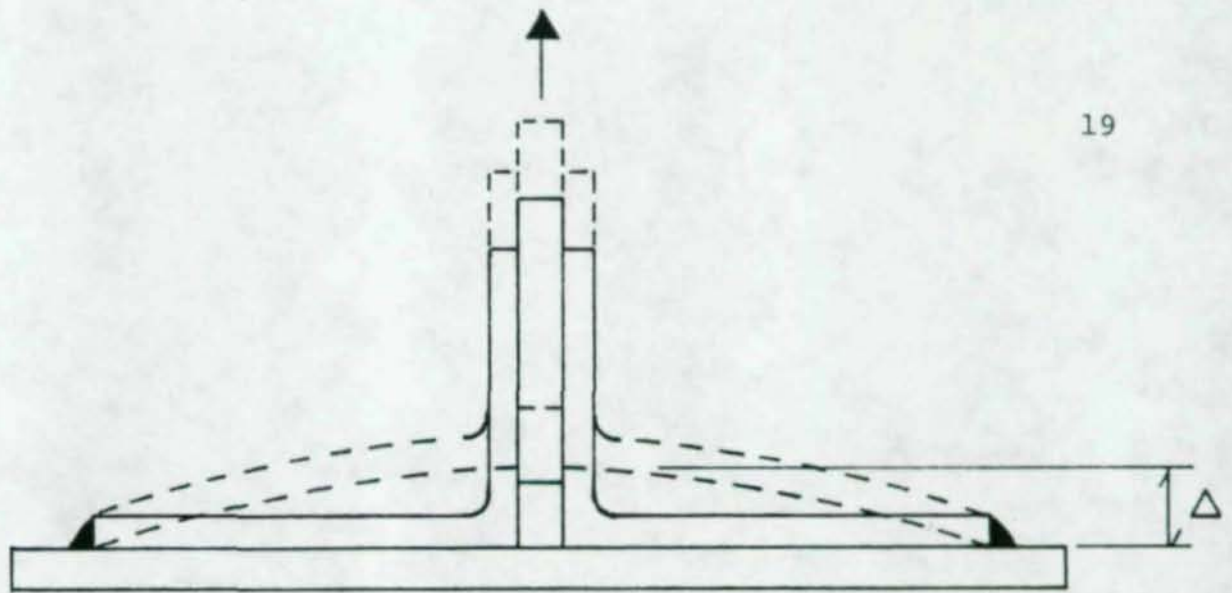

ANGLE LEG IDEALIZED  
AS A PROPPED CANTILEVER  
BEAM OF LENGTH  $g$

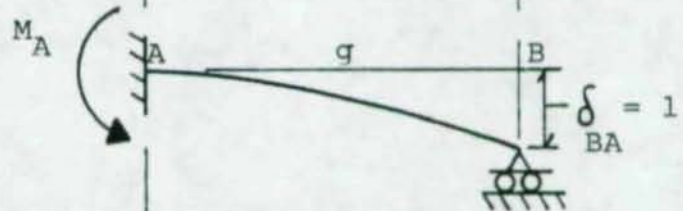

USING THE MOMENT-  
AREA METHOD

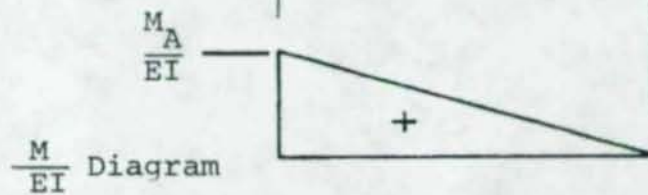

$$\delta_{BA} = \frac{2}{3} g \left[ \frac{1}{2} \frac{M_A}{EI} g \right] = 1 \quad M_A = \frac{3EI}{g^2}$$

USING THE STIFFNESS  
METHOD

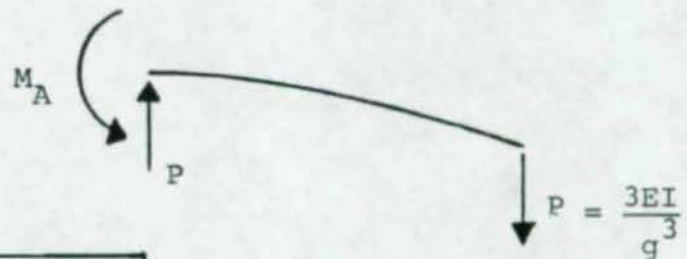

$$P = K \Delta \quad (\Delta = 1)$$

$$K = \frac{3EI}{g^3}$$

Figure 9. Elastic stiffness of tension specimens.

TABLE 6 ELASTIC STIFFNESS, K, FOR TENSION TEST SPECIMENS

<u>Angles</u>	<u>L</u>	<u>k</u>	<u>t</u>	<u>g</u>	<u>K</u>
L-4 x 3-1/2 x 1/4	4	11/16	1/4	3.3125	19
L-4 x 3-1/2 x 3/8	4	13/16	3/8	3.1875	73
L-4 x 3-1/2 x 1/2	4	15/16	1/2	3.0625	196
L-5 x 3-1/2 x 5/8	5	1-1/8	5/8	3.8750	189

L = length of outstanding angle leg in inches

k = AISC dimensioning detail in inches

t = angle thickness in inches

g = L - k

K = elastic stiffness of 3 inch segment of double angles loaded in tension (kips/inch)

$K = 45,000 \times [t/g]^3$

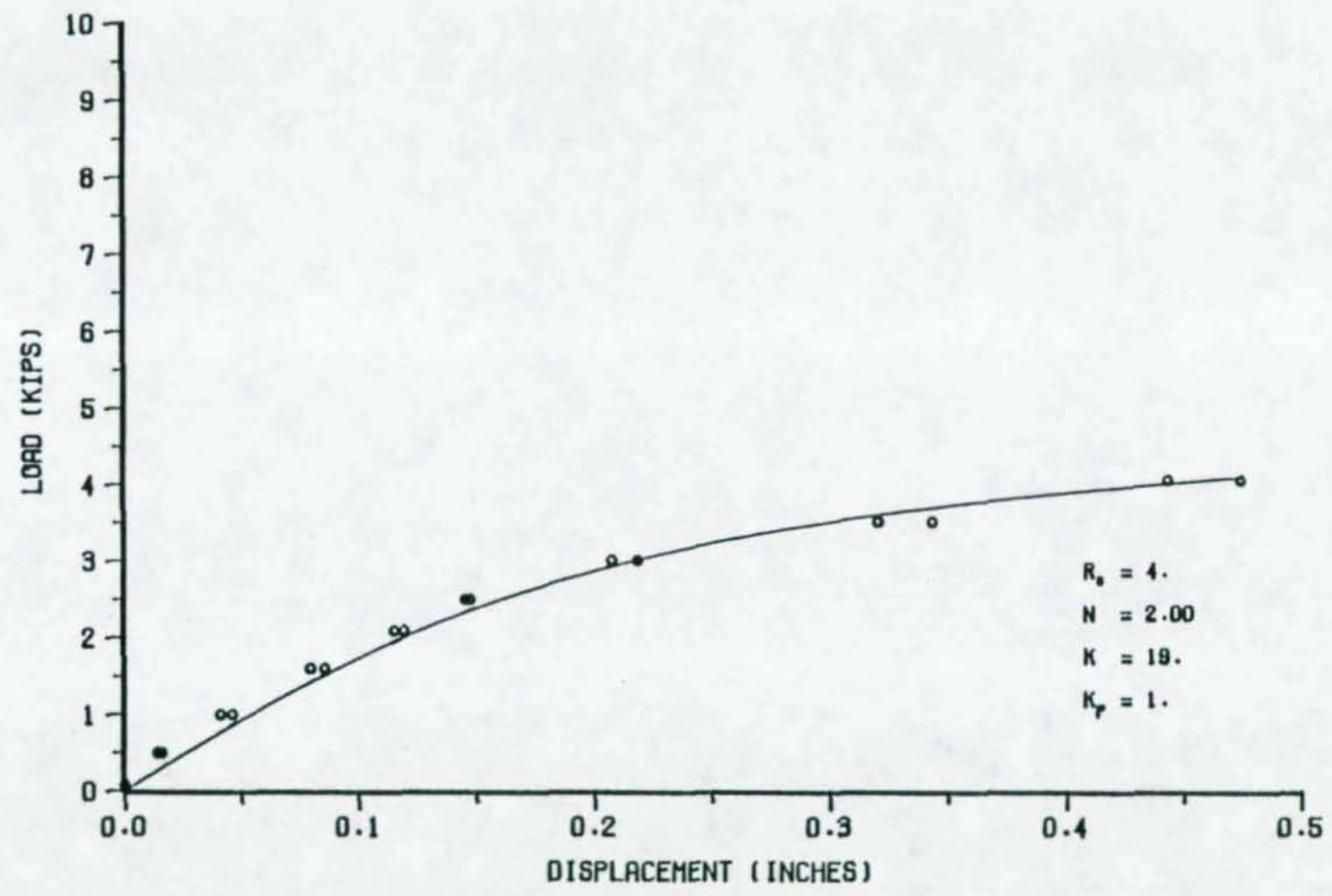

FORCE DEFORMATION CURVE 2-L4 X 3-1/2 X 1/4 X 3

Figure 10.

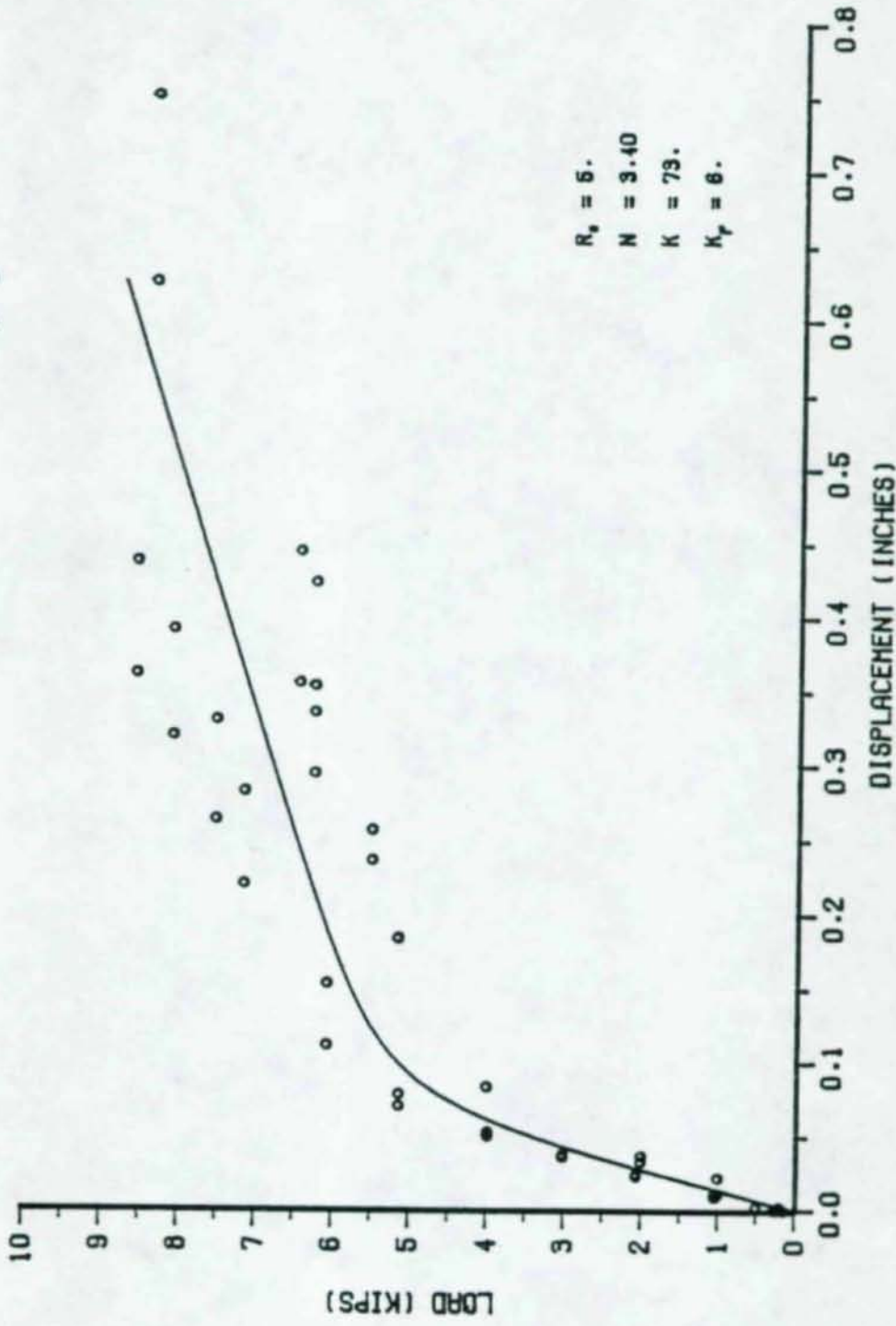

FORCE DEFORMATION CURVE 2-L4 X 3-1/2 X 3/8 X 3

Figure 11.

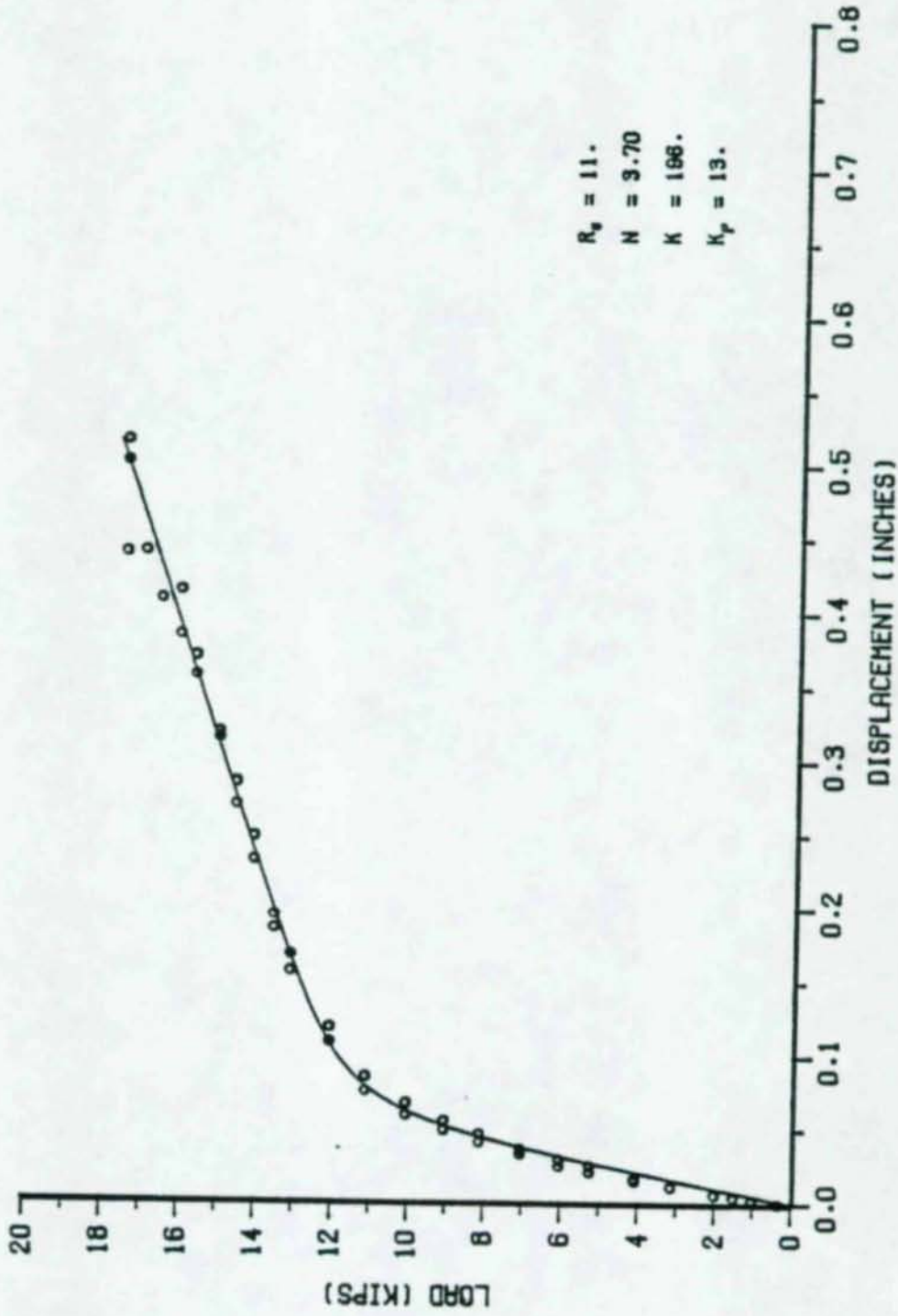

FORCE DEFORMATION CURVE 2-L4 X 3-1/2 X 1/2 X 3

Figure 12.



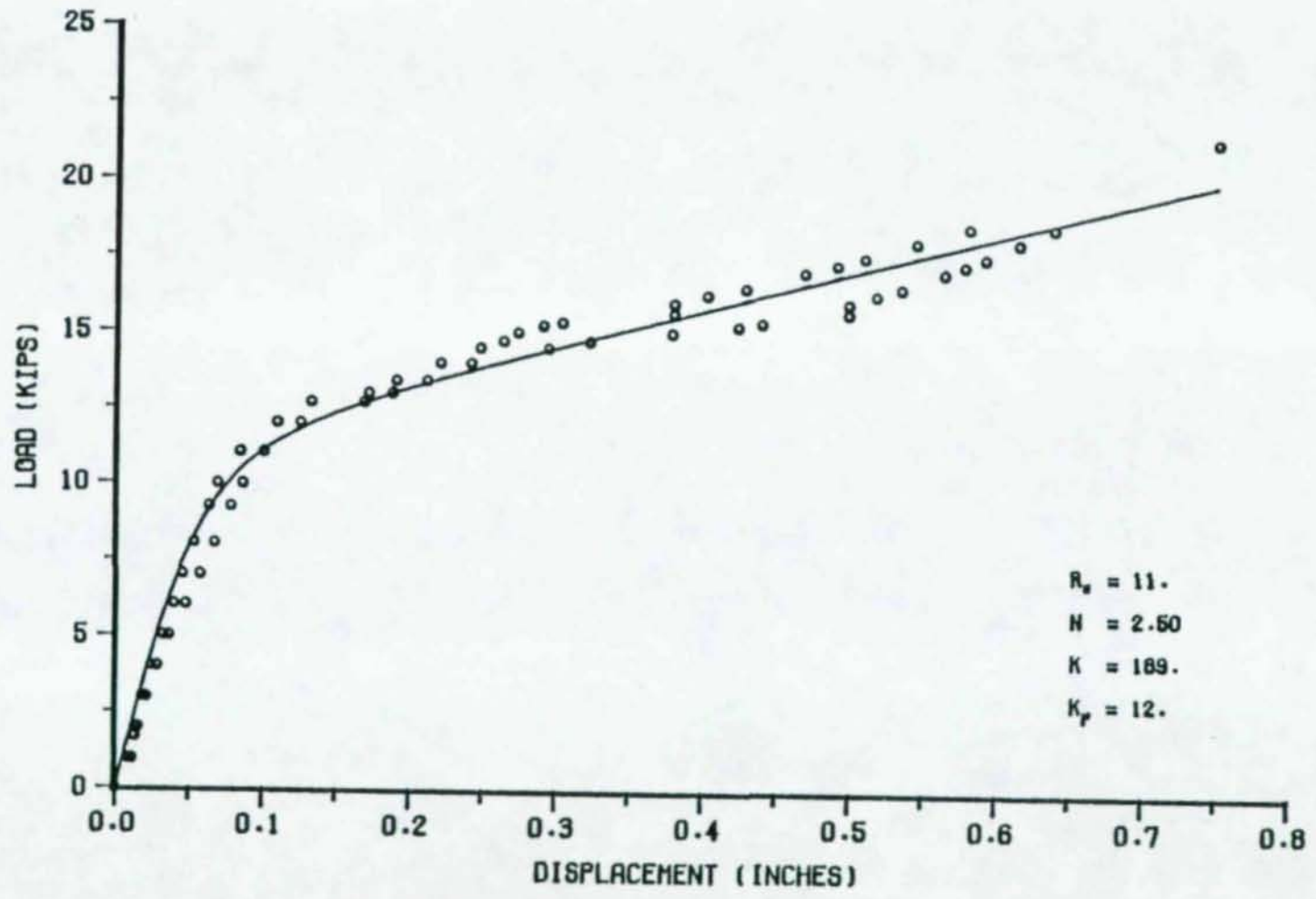

$R_y = 11.$   
 $N = 2.50$   
 $K = 189.$   
 $K_r = 12.$

FORCE DEFORMATION CURVE 2-L5 X 3-1/2 X 5/8 X 3

Figure 13.

since the four Richard parameters have previously been established for a three inch segment of double framing angles loaded in compression. Blewitt and Richard [1] have developed the following empirical formulas for the four Richard parameters for a three inch segment of bolted framing angles loaded in compression.

$$K = 180,000 \times [t/1.75] \quad (\text{Kips/inch})$$

$$KP = 138 \times [t_c/8] \quad (\text{Kips/inch})$$

$$R = 142 \times [t_c/8] \quad (\text{Kips})$$

$$N = 1.2$$

where

$t$  = angle leg thickness in inches

$t_p$  = connecting plate thickness

$t_c$  = critical thickness

=  $t_p$  or  $2t$  in sixteenths of an inch whichever is smaller.

The fact that the above formulas were developed for compression specimens with bolts in the outstanding angle legs and this research involves welds along the outstanding angle legs is irrelevant. The Richard parameters for compression are only dependent on bearing considerations of the angles, and not on any flexural action of the angles, in which case the support conditions would in fact make a difference in the Richard parameters. The Richard parameters for the four compression specimens are given in Table 7.

TABLE 7 RICHARD EQUATION PARAMETERS FOR THREE INCH SEGMENTS OF WELDED DOUBLE ANGLES LOADED IN COMPRESSION

<u>Angles</u>	<u>Richard Parameters</u>						
	<u>t</u>	<u>t<sub>p</sub></u>	<u>t<sub>c</sub></u>	<u>K<sub>c</sub></u>	<u>KP<sub>c</sub></u>	<u>R<sub>c</sub></u>	<u>N<sub>c</sub></u>
L-4 x 3-1/2 x 1/4	1/4	3/4	1/2	525	138	142	1.2
L-4 x 3-1/2 x 3/8	3/8	3/4	3/4	1771	207	213	1.2
L-4 x 3-1/2 x 1/2	1/2	3/4	3/4	4198	207	213	1.2
L-5 x 3-1/2 x 5/8	5/8	3/4	3/4	8200	207	213	1.2

t = angle leg thickness in inches

t<sub>p</sub> = connecting plate thickness in inches

t<sub>c</sub> = critical thickness in sixteenths of an inch  
= t<sub>p</sub> or 2t whichever is smaller

K<sub>c</sub> = 180,000 x [t/1.75]<sup>3</sup> in kips/inch

KP<sub>c</sub> = 138 x [t<sub>c</sub>/8] in kips/inch

R<sub>c</sub> = 142 x [t<sub>c</sub>/8] in kips

N<sub>c</sub> = 1.2

### Shear tests

Hsia and Richard [2] demonstrated that the deformation caused by shearing forces in a double angle connection are negligible compared to deformations caused by tensile and compressive forces. This agrees with an intuitive understanding of the structural behavior of a double framing angle connection like that shown in Figure 7. Most of the deformation results from the tensile and compressive forces at the connection which are resisting the applied loads, and very little from the shearing forces caused by the loads.

In summary, the Richard parameters for the three inch segments of welded double angle connections loaded in tension and loaded in compression are given in Table 8. These values are used in the next section to develop the moment-rotation curves for various connections.

TABLE 8 RICHARD EQUATION PARAMETERS FOR THREE INCH SPECIMENS OF WELDED DOUBLE ANGLES LOADED IN TENSION AND IN COMPRESSION

<u>Angles</u>	<u>Tension Parameters</u>				<u>Compression Parameters</u>			
	<u><math>K_t</math></u>	<u><math>KP_t</math></u>	<u><math>R_t</math></u>	<u><math>N_t</math></u>	<u><math>K_c</math></u>	<u><math>KP_c</math></u>	<u><math>R_c</math></u>	<u><math>N_c</math></u>
L-4 x 3-1/2 x 1/4	19	1	4	2.0	525	138	142	1.2
L-4 x 3-1/2 x 3/8	73	6	5	3.4	1771	207	213	1.2
L-4 x 3-1/2 x 1/2	196	13	11	3.7	4198	207	213	1.2
L-5 x 3-1/2 x 5/8	189	12	11	2.5	8200	207	213	1.2

$K_t$ ,  $KP_t$ ,  $K_c$ , and  $KP_c$  are in kips/inch

$R_t$ , and  $R_c$  are in kips

## MOMENT-ROTATION CURVES

The force-deformation curves defined previously establish the characteristics of a three inch segment of welded double framing angles. Therefore, by "stacking" three inch segments one on top of the other, a connection of any length can be constructed.

Hsia and Richard [2] used this concept to develop moment-rotation curves for bolted-bolted double framing angle connections of various lengths. They idealized the angle clip connection as a rigid bar with non-linear springs attached to the bar. The force-deformation characteristics of each spring are given by the force-deformation curves established earlier. When the beam is loaded, the ends of the beam will rotate about a point of rotation. Since the connection angles are an integral part of the beam, they must also rotate about this rotation point. This means that some of the non-linear springs used to model the connection will be acted upon by tensile forces and some will be acted upon by compressive forces (shearing deformations are neglected). This concept is illustrated in Figure 14.

For a given end rotation of the connection, the forces that are developed in the non-linear springs must obey the laws of equilibrium. Therefore, by summing moments of forces

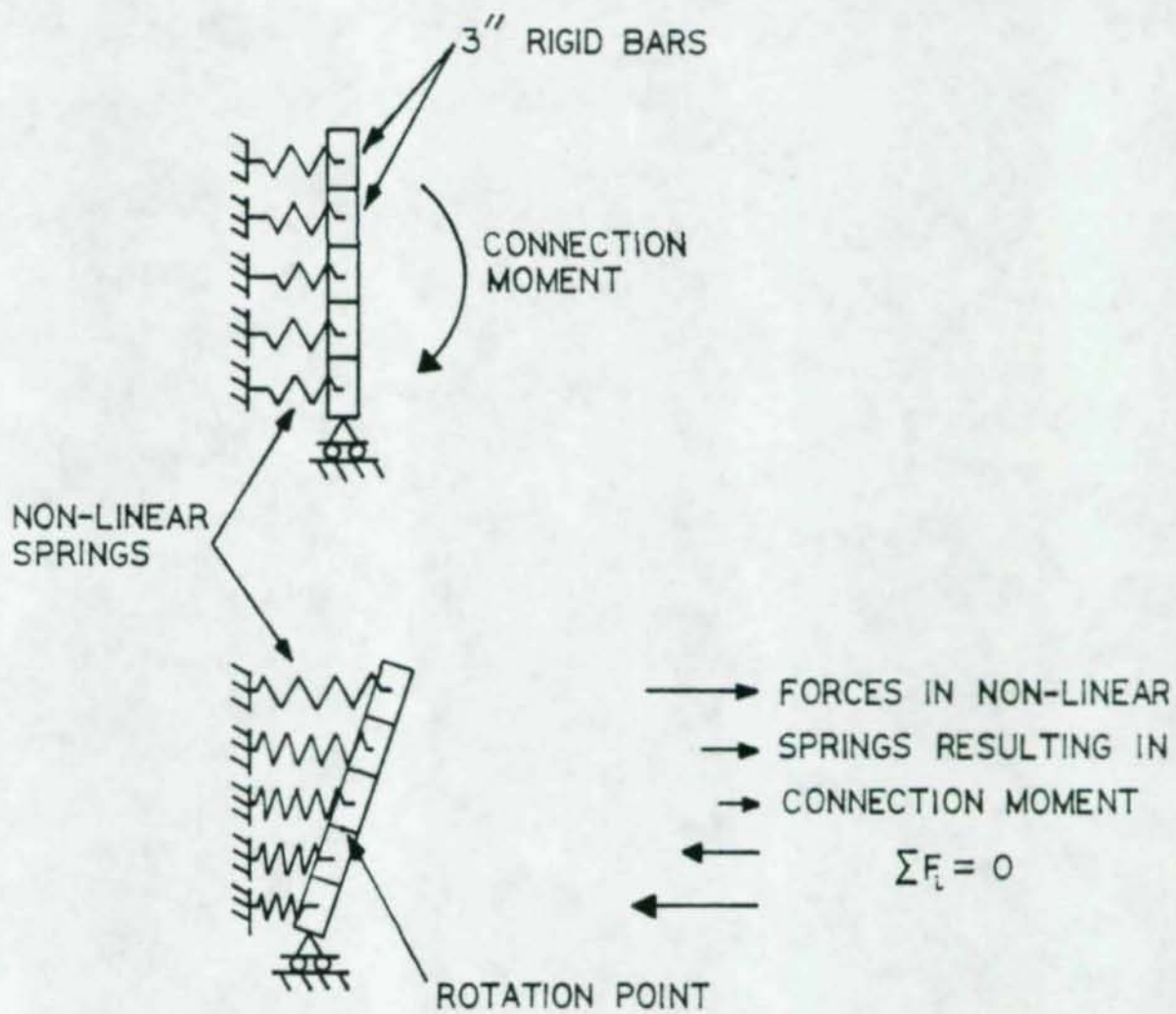
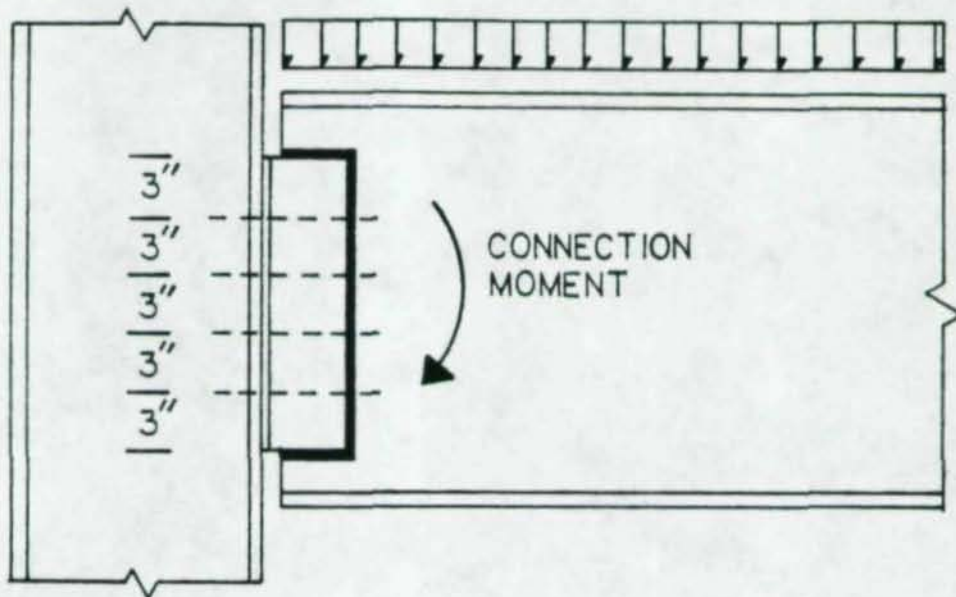

Figure 14. Connection modeled with rigid bars and non-linear springs.

about the rotation point, the moment that occurs at the connection for a specified rotation of the connection or beam end can be determined. If the end rotation is increased, different forces will result in the non-linear springs. Repeating this process, moment-rotation curves are then generated. Using a least squares fit of the Richard equation (Appendix A), an analytical expression for these moment-rotation curves is obtained.

Given in appendix B is a Fortran program called MRCURVE which was adapted from a similar program developed by Hsia and Richard [2]. This program calculates the moment and rotation data points and also gives the four Richard parameters associated with the curve passing through these data points.

The numerical procedure outlined above and used in program MRCURVE was compared by Hsia and Richard [2] to a more advanced non-linear finite element procedure used by Hamm and Richard [4]. The two methods gave essentially the same results.

Program MRCURVE was used to develop moment-rotation curves for the following connections.

2 - L4 x 3 x 1/4 x 33 inches	
2 - L4 x 3 x 1/4 x 30 inches	
2 - L4 x 3 x 1/4 x 27 inches	(see Figures 15-20)
2 - L4 x 3 x 1/4 x 24 inches	
2 - L4 x 3 x 1/4 x 21 inches	
2 - L4 x 3 x 1/4 x 18 inches	



2 - L4 x 3 x 3/8 x 33 inches  
2 - L4 x 3 x 3/8 x 30 inches  
2 - L4 x 3 x 3/8 x 27 inches (see Figures 21-26)  
2 - L4 x 3 x 3/8 x 24 inches  
2 - L4 x 3 x 3/8 x 21 inches  
2 - L4 x 3 x 3/8 x 18 inches

2 - L4 x 3 x 1/2 x 33 inches  
2 - L4 x 3 x 1/2 x 30 inches  
2 - L4 x 3 x 1/2 x 27 inches (see Figures 27-32)  
2 - L4 x 3 x 1/2 x 24 inches  
2 - L4 x 3 x 1/2 x 21 inches  
2 - L4 x 3 x 1/2 x 18 inches

2 - L5 x 3 x 5/8 x 33 inches  
2 - L5 x 3 x 5/8 x 30 inches  
2 - L5 x 3 x 5/8 x 27 inches (see Figures 33-38)  
2 - L5 x 3 x 5/8 x 24 inches  
2 - L5 x 3 x 5/8 x 21 inches  
2 - L5 x 3 x 5/8 x 18 inches

In the next section, beam line theory is used to determine the actual end rotation and end moment that exists at a particular connection.

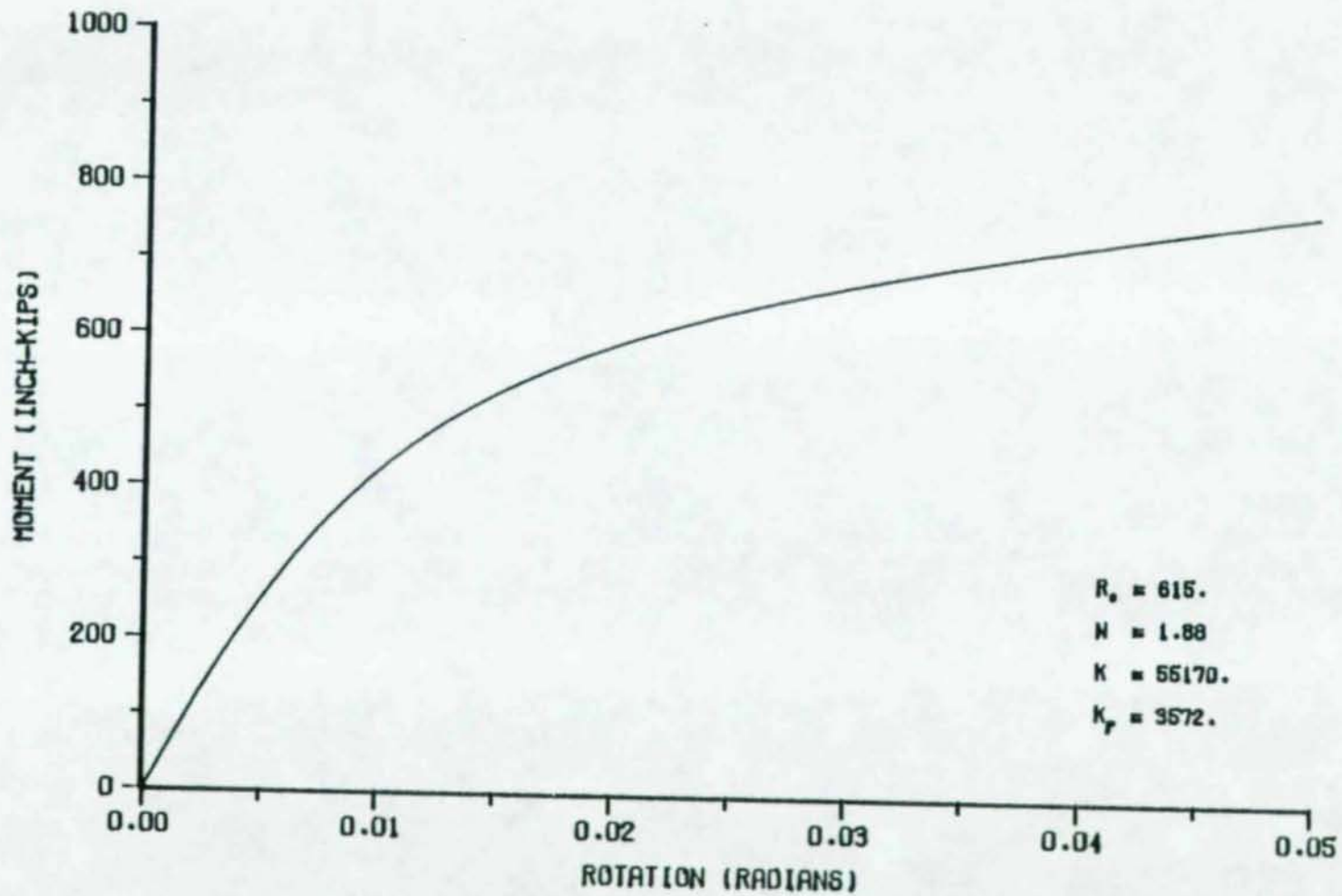

MOMENT ROTATION CURVE FOR WELDED DOUBLE ANGLE CONNECTION  
DOUBLE ANGLES ARE L 4 X 3 X 1/4 X 93 INCHES

Figure 15.

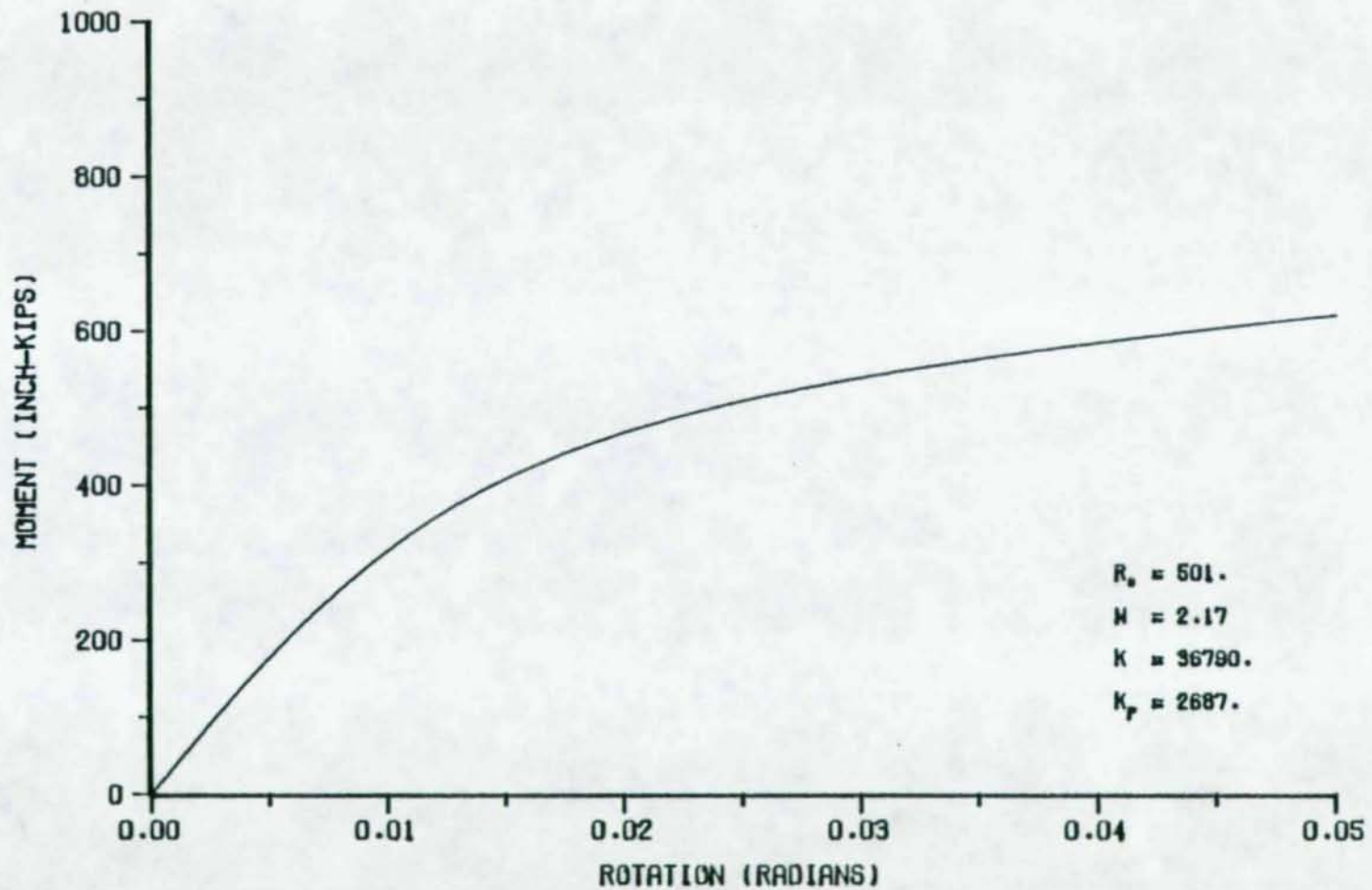

MOMENT ROTATION CURVE FOR WELDED DOUBLE ANGLE CONNECTION

DOUBLE ANGLES ARE L 4 X 3 X 1/4 X 30 INCHES

Figure 16.

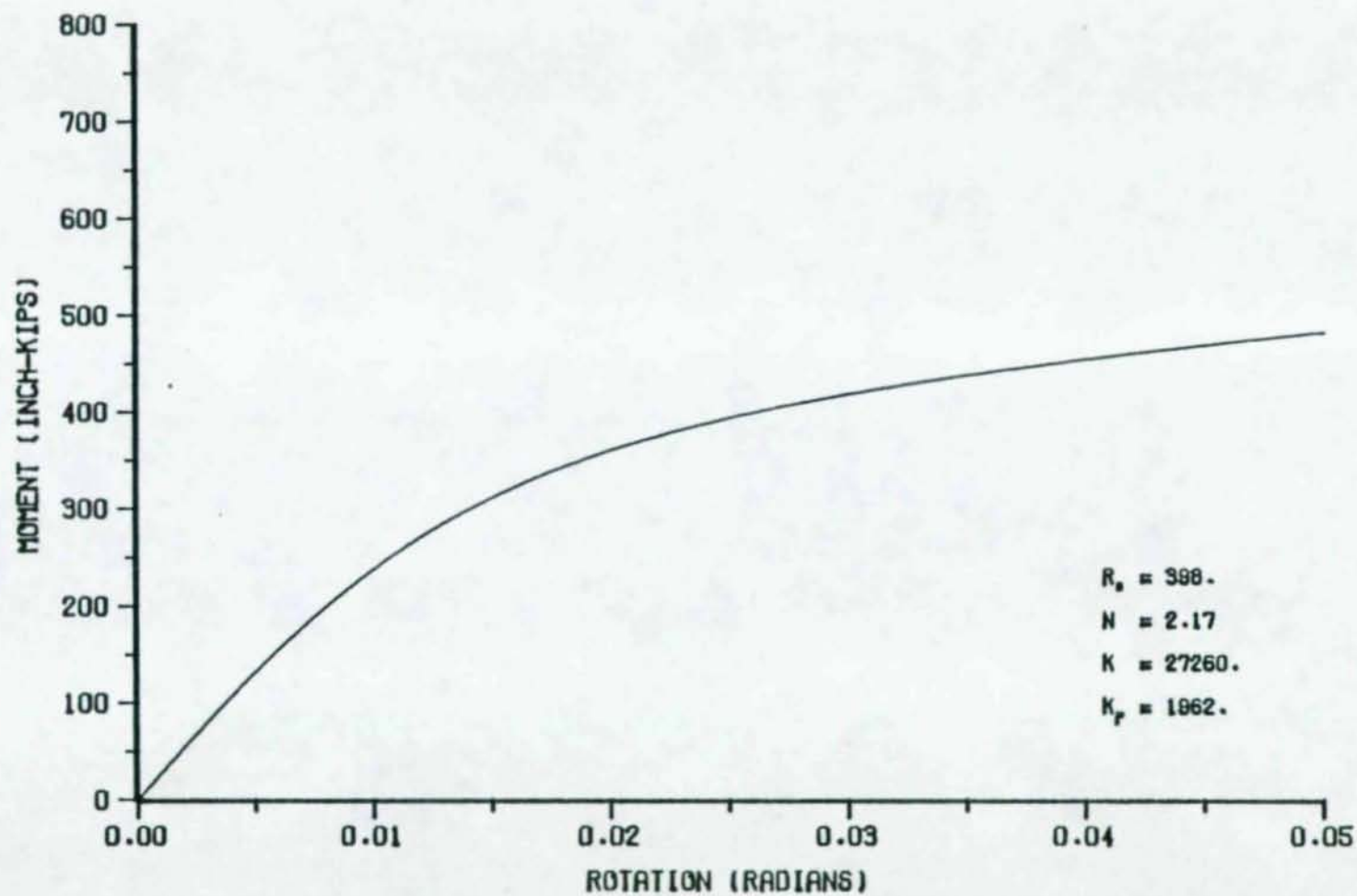

MOMENT ROTATION CURVE FOR WELDED DOUBLE ANGLE CONNECTION

DOUBLE ANGLES ARE L 4 X 3 X 1/4 X 27 INCHES

Figure 17.

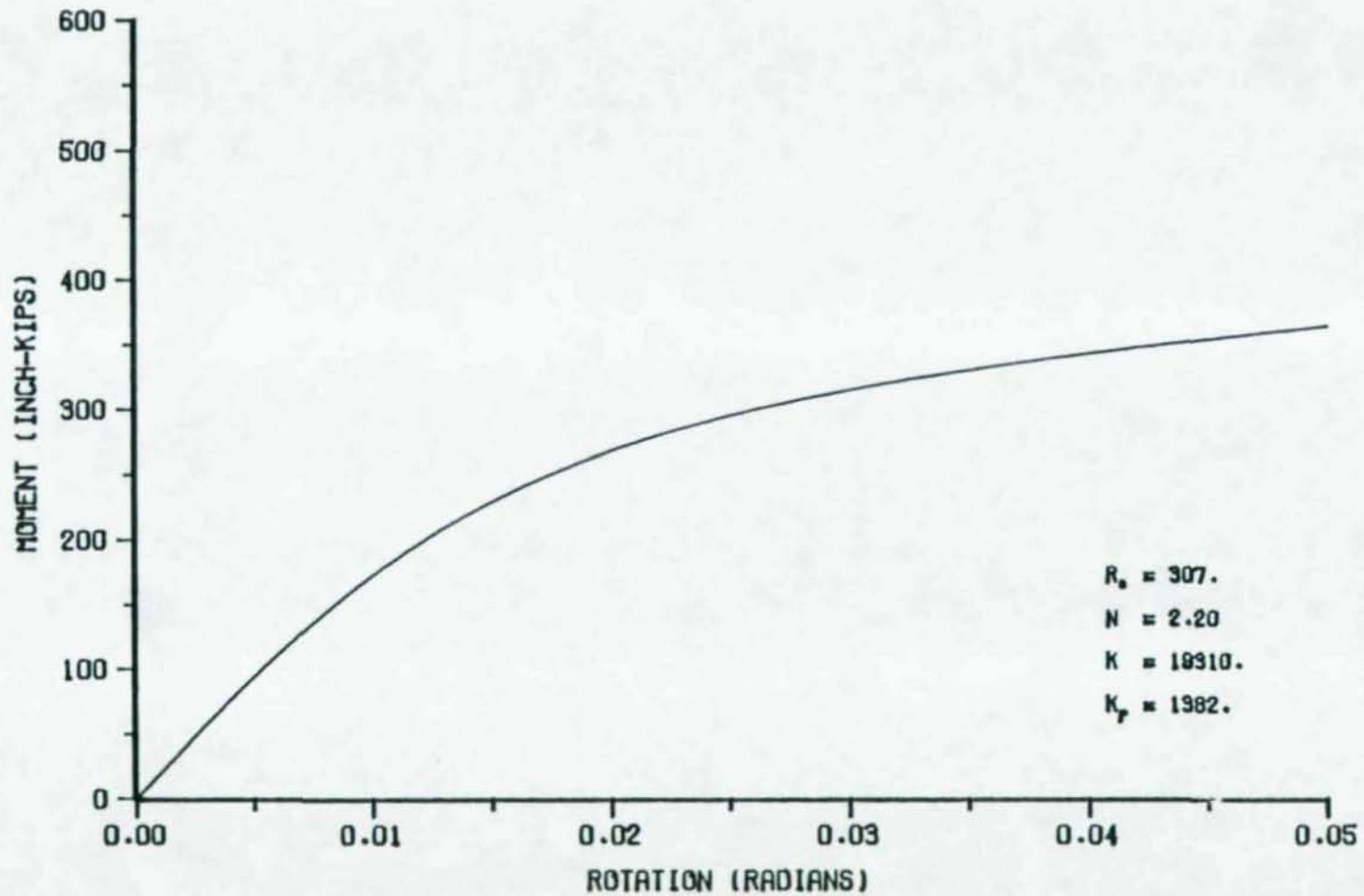

MOMENT ROTATION CURVE FOR WELDED DOUBLE ANGLE CONNECTION  
DOUBLE ANGLES ARE L 4 X 3 X 1/4 X 24 INCHES

Figure 18.

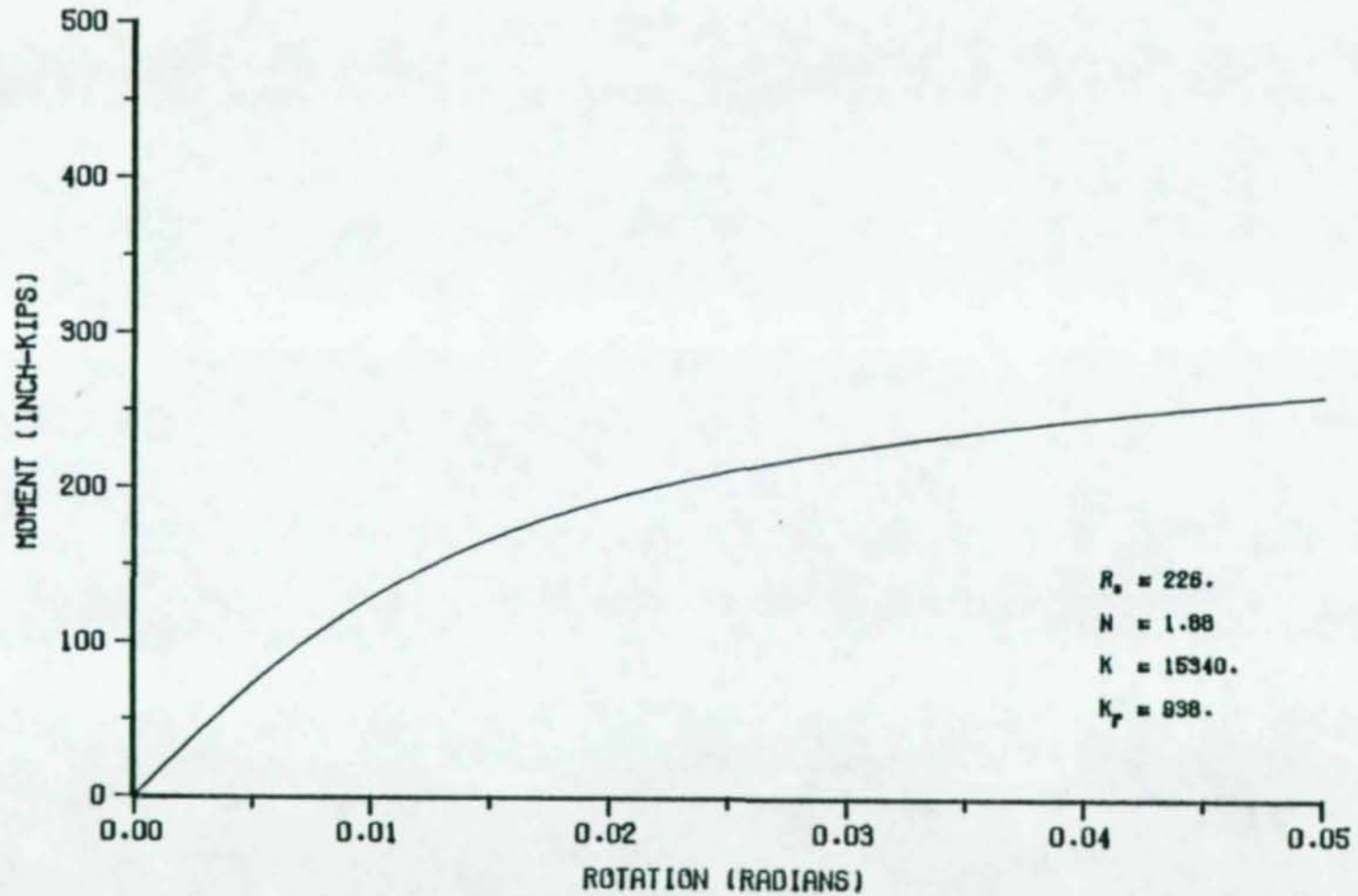

MOMENT ROTATION CURVE FOR WELDED DOUBLE ANGLE CONNECTION  
DOUBLE ANGLES ARE L 4 X 9 X 1/4 X 21 INCHES

Figure 19.

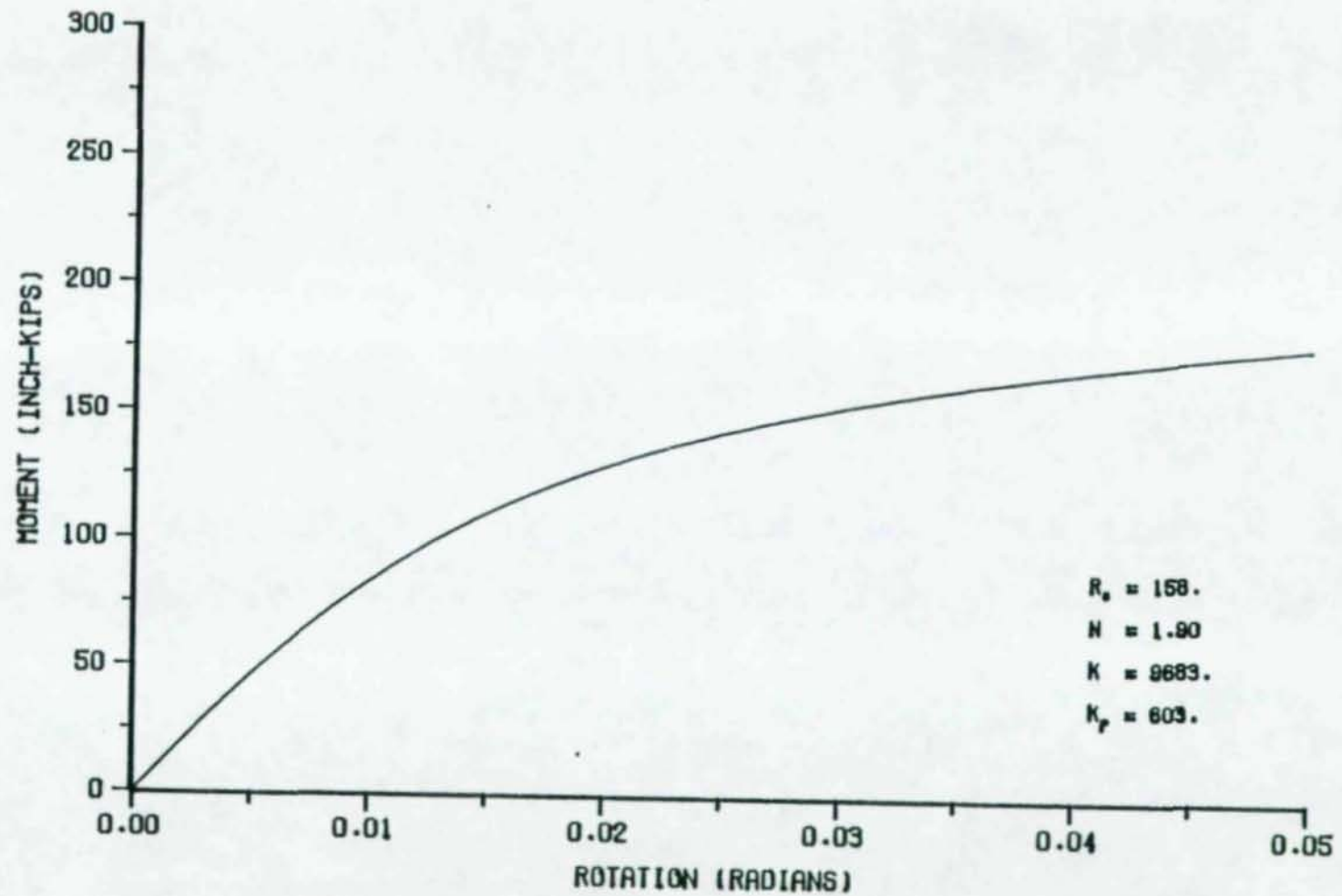

MOMENT ROTATION CURVE FOR WELDED DOUBLE ANGLE CONNECTION  
DOUBLE ANGLES ARE L 4 X 3 X 1/4 X 18 INCHES

Figure 20.

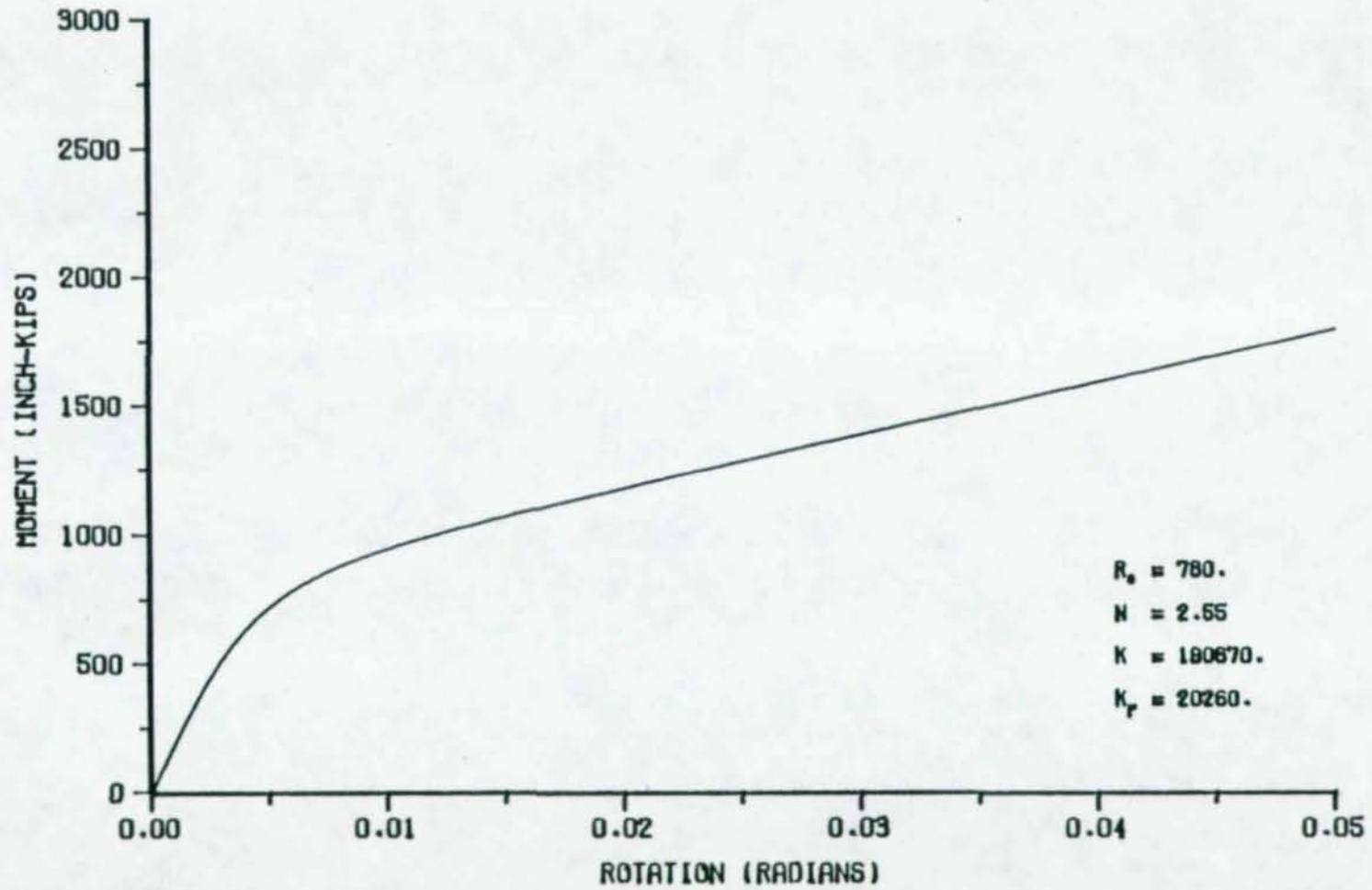

MOMENT ROTATION CURVE FOR WELDED DOUBLE ANGLE CONNECTION  
DOUBLE ANGLES ARE L 4 X 3 X 3/8 X 93 INCHES

Figure 21.



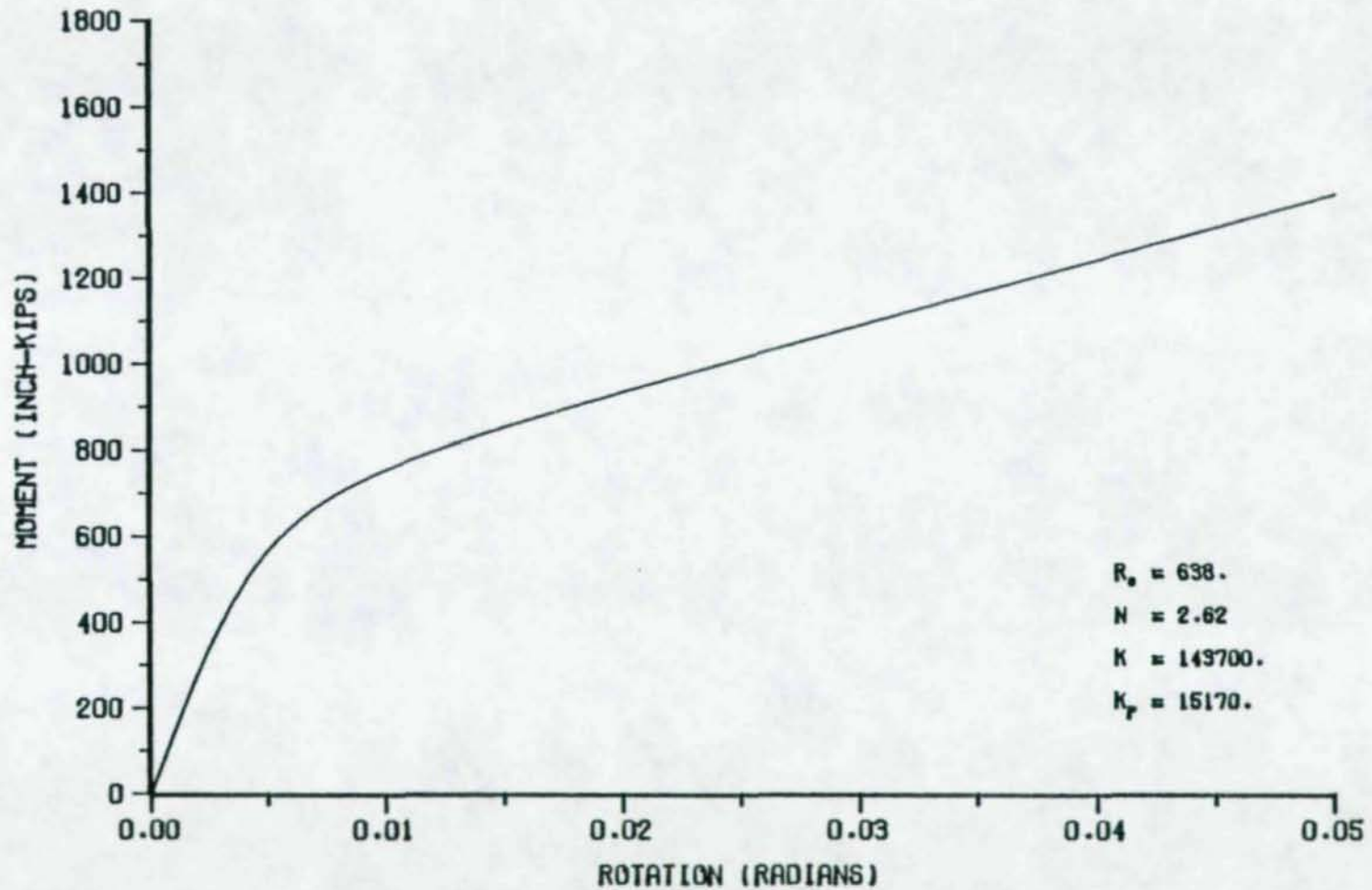

MOMENT ROTATION CURVE FOR WELDED DOUBLE ANGLE CONNECTION  
DOUBLE ANGLES ARE L 4 X 9 X 3/8 X 30 INCHES

Figure 22.

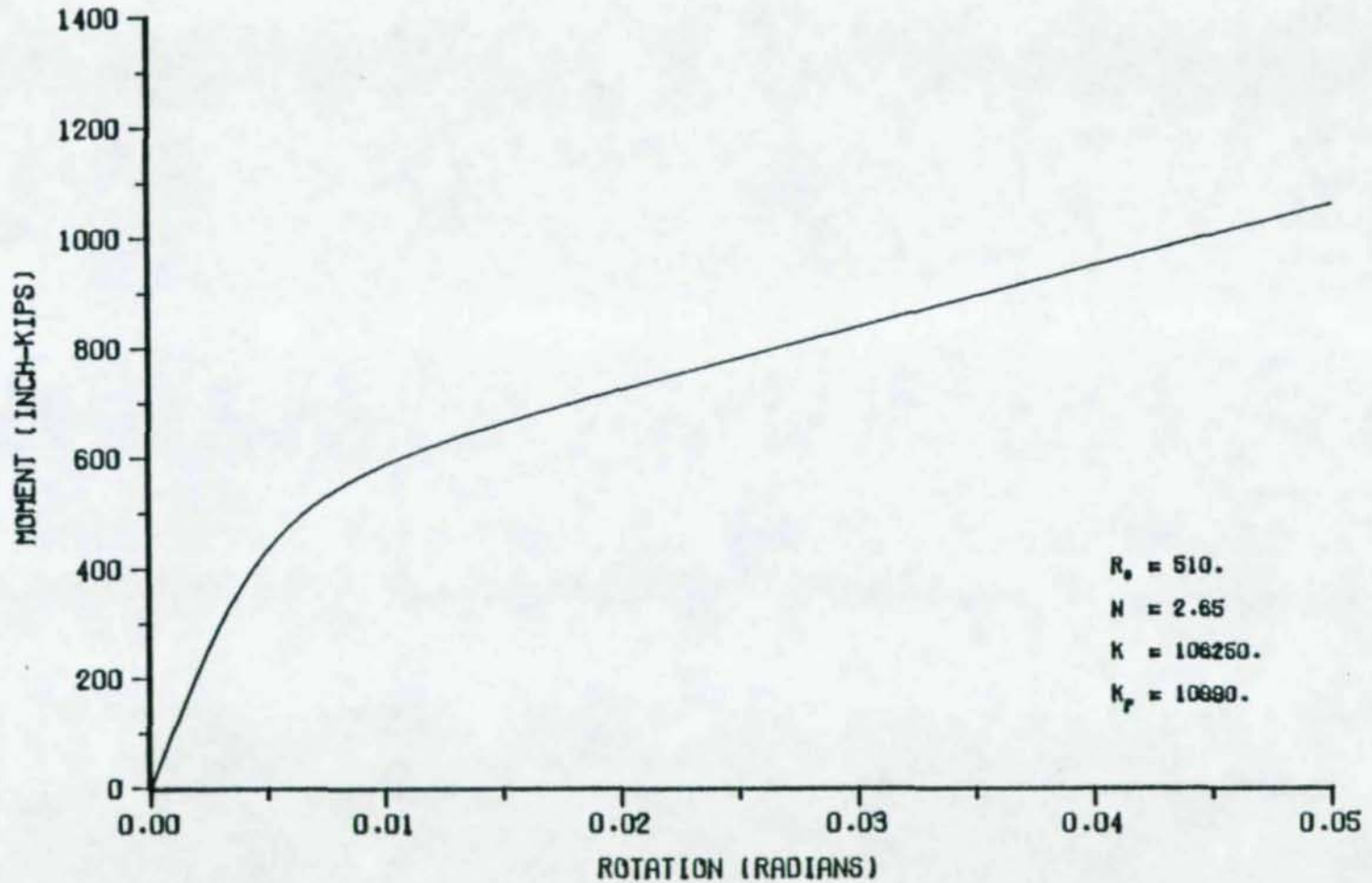

MOMENT ROTATION CURVE FOR WELDED DOUBLE ANGLE CONNECTION  
DOUBLE ANGLES ARE L 4 X 3 X 3/8 X 27 INCHES

Figure 23.

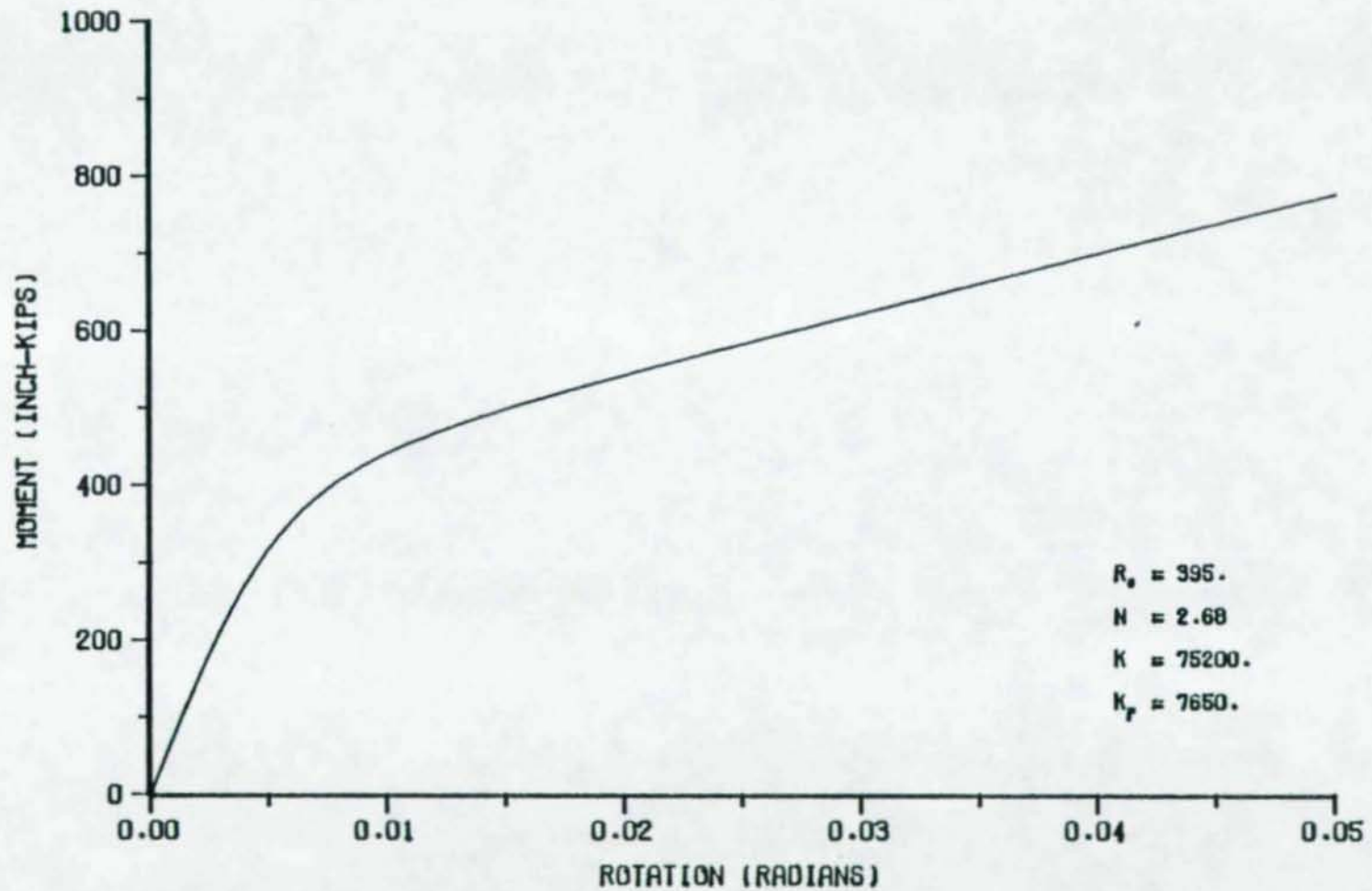

MOMENT ROTATION CURVE FOR WELDED DOUBLE ANGLE CONNECTION  
DOUBLE ANGLES ARE L 4 X 3 X 3/8 X 24 INCHES

Figure 24.

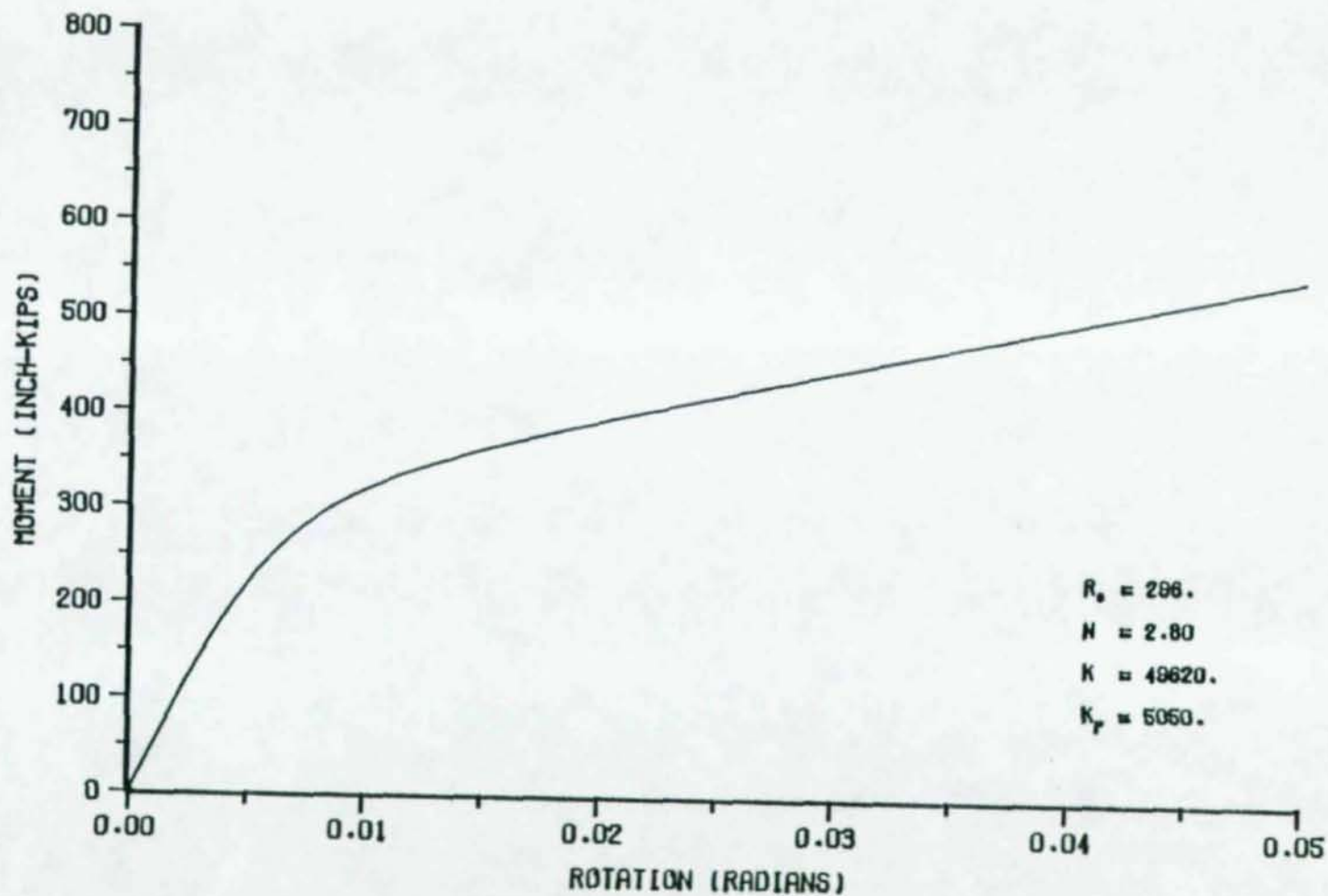

MOMENT ROTATION CURVE FOR WELDED DOUBLE ANGLE CONNECTION

DOUBLE ANGLES ARE L 4 X 3 X 3/8 X 21 INCHES

Figure 25.

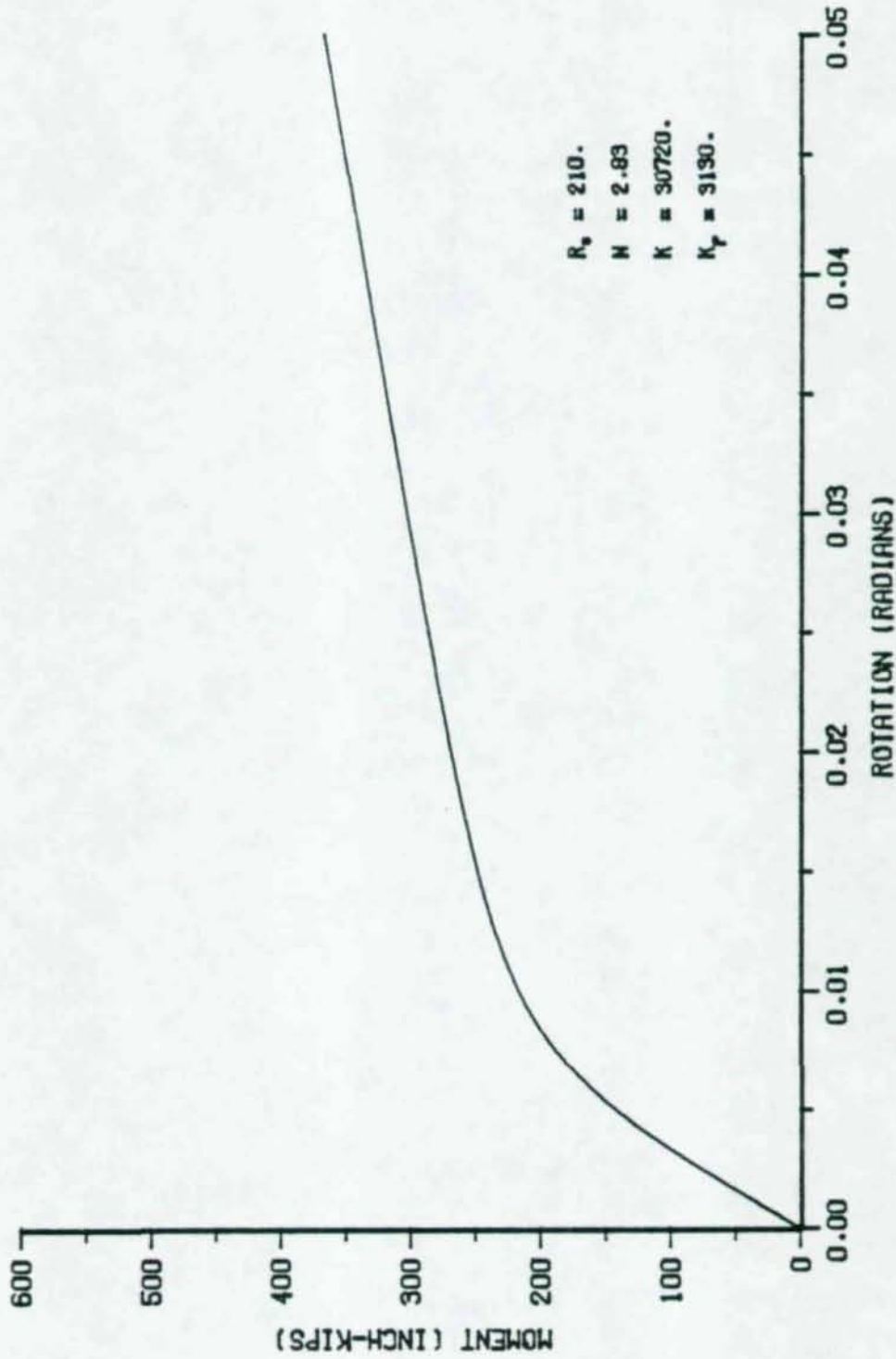

MOMENT ROTATION CURVE FOR WELDED DOUBLE ANGLE CONNECTION  
DOUBLE ANGLES ARE L 4 X 3 X 3/8 X 18 INCHES

Figure 26.

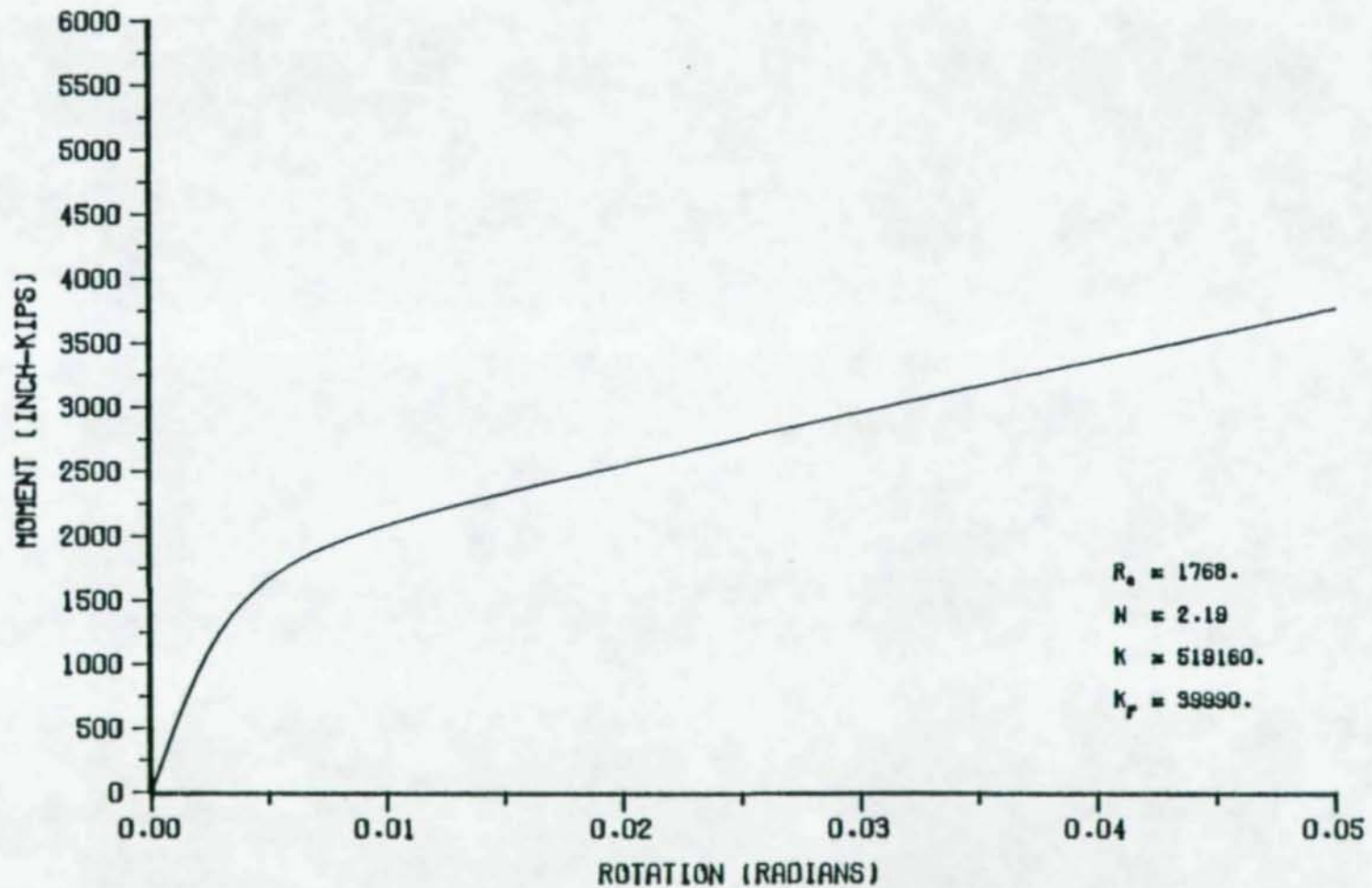

MOMENT ROTATION CURVE FOR WELDED DOUBLE ANGLE CONNECTION  
DOUBLE ANGLES ARE L 4 X 3 X 1/2 X 33 INCHES

Figure 27.

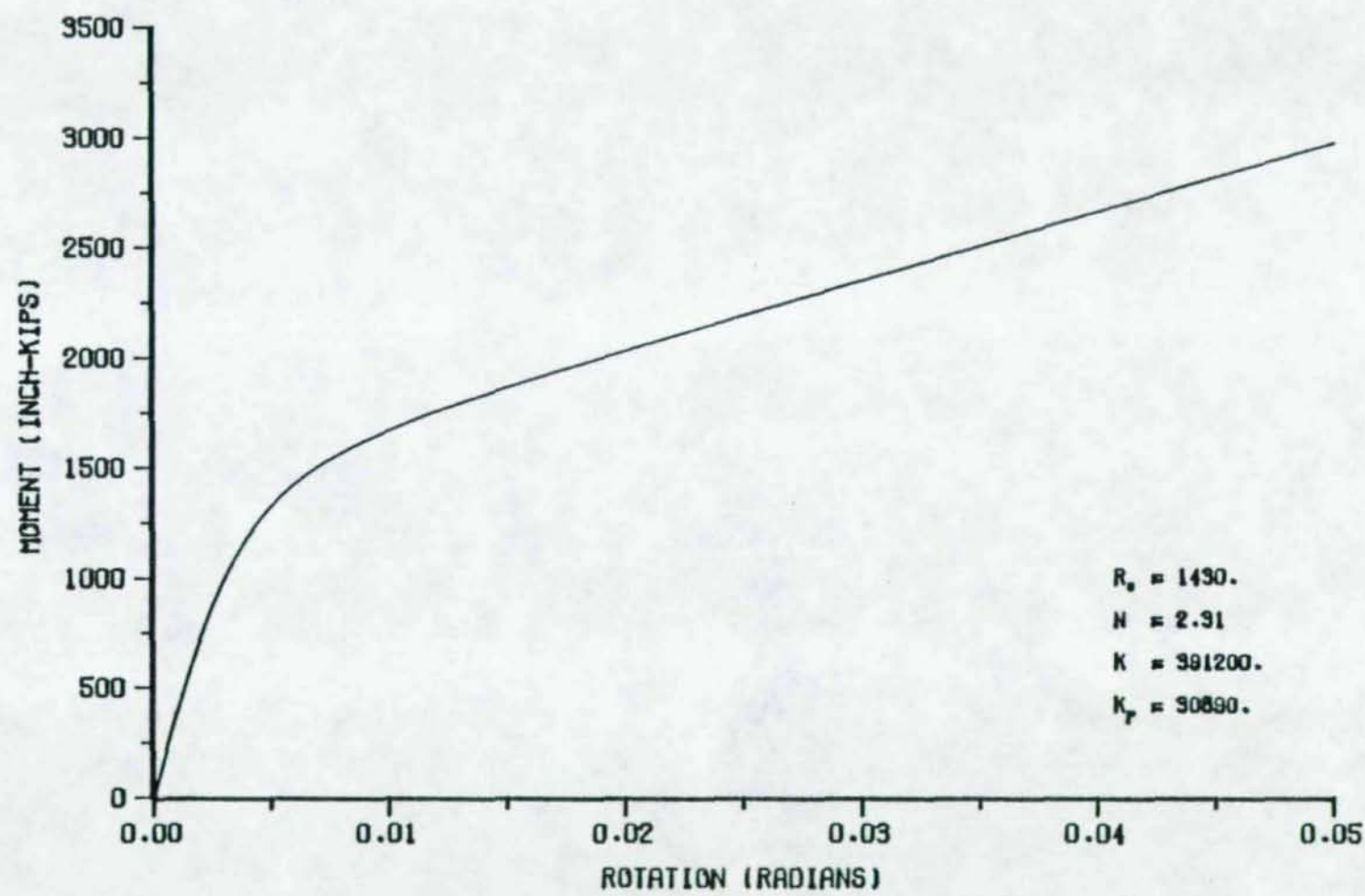

MOMENT ROTATION CURVE FOR WELDED DOUBLE ANGLE CONNECTION  
DOUBLE ANGLES ARE L 4 X 3 X 1/2 X 30 INCHES

Figure 28.

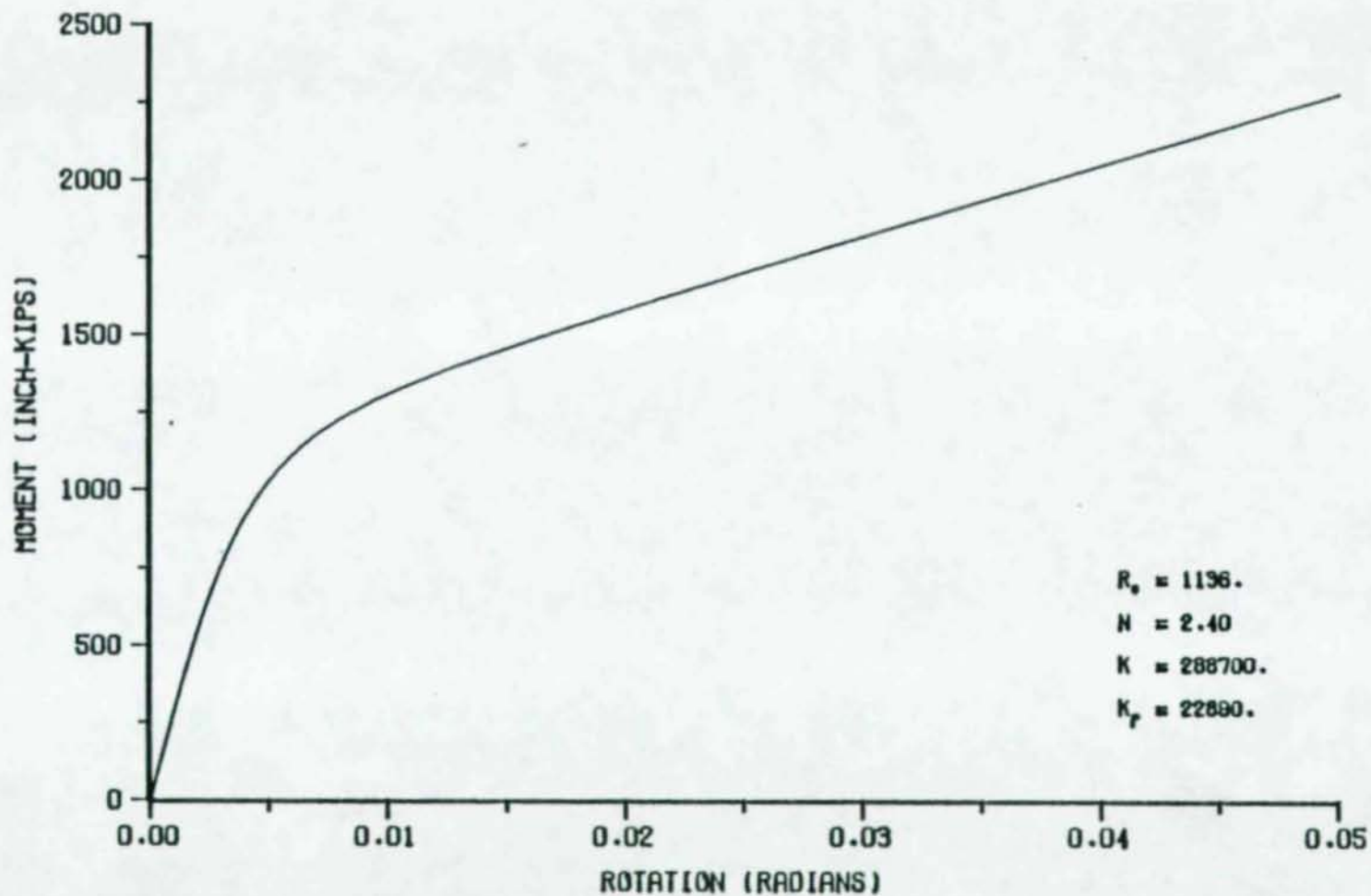

MOMENT ROTATION CURVE FOR WELDED DOUBLE ANGLE CONNECTION

DOUBLE ANGLES ARE L 4 X 3 X 1/2 X 27 INCHES

Figure 29.



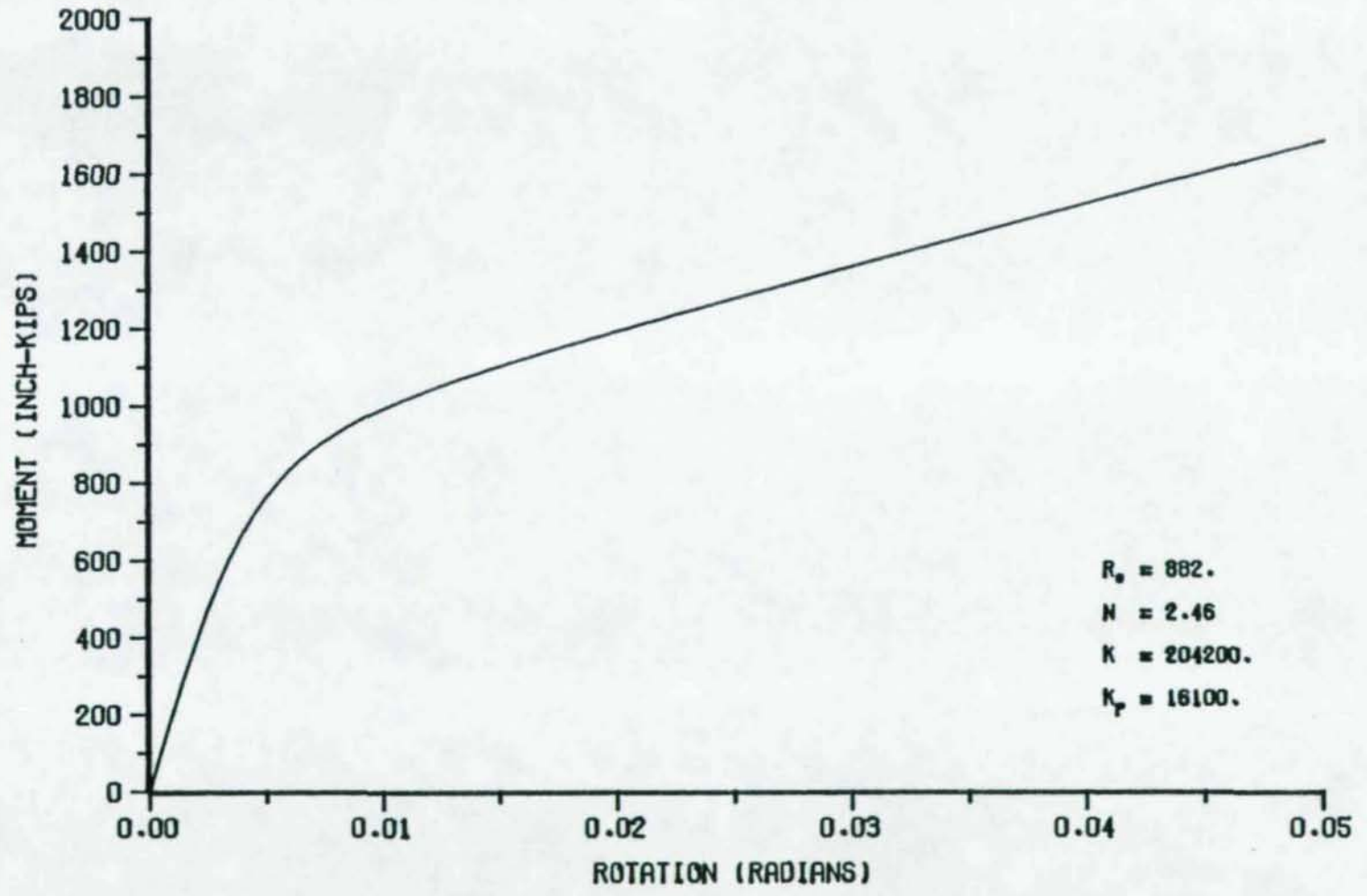

MOMENT ROTATION CURVE FOR WELDED DOUBLE ANGLE CONNECTION  
DOUBLE ANGLES ARE L 4 X 3 X 1/2 X 24 INCHES

Figure 30.

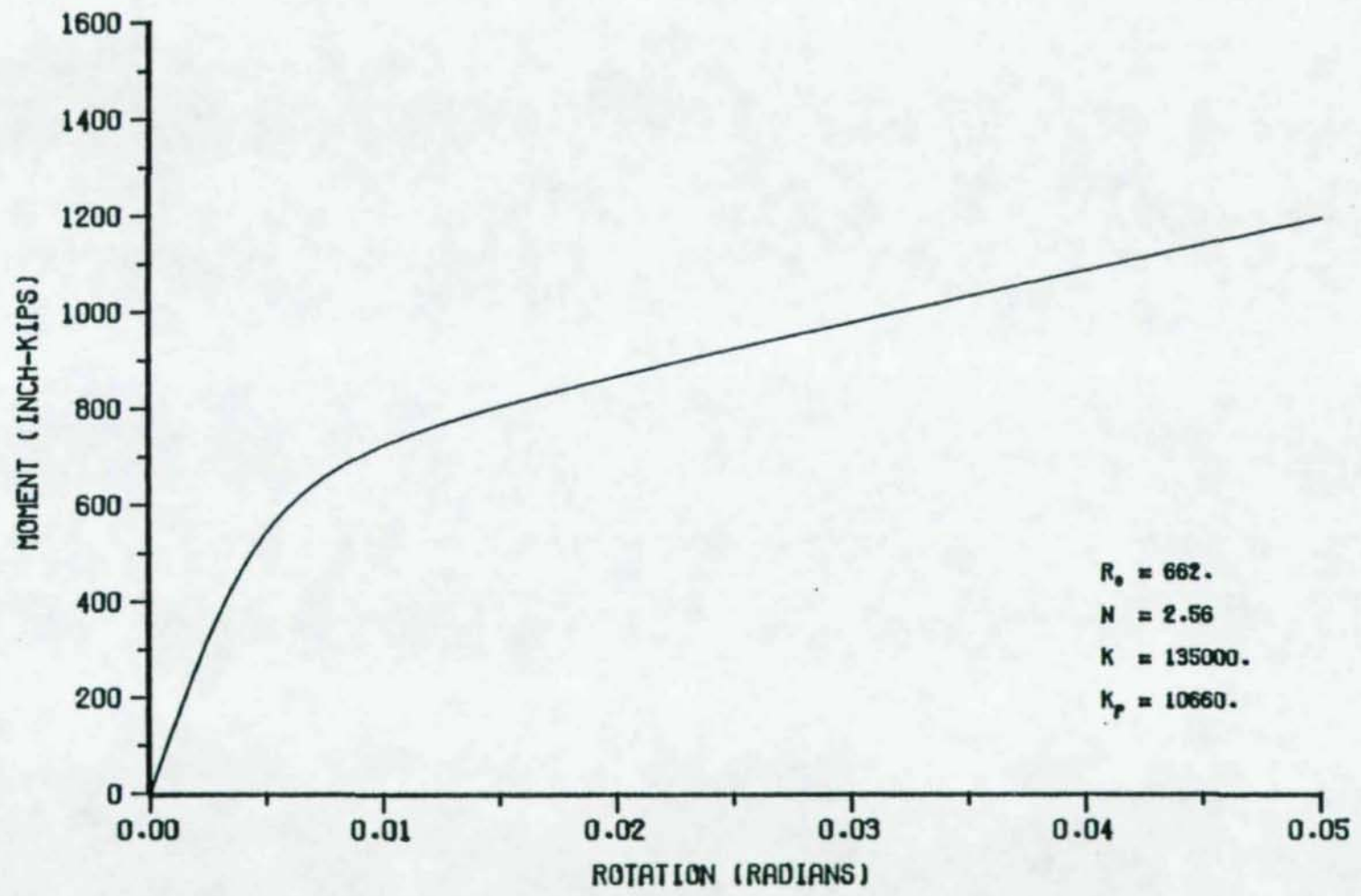

MOMENT ROTATION CURVE FOR WELDED DOUBLE ANGLE CONNECTION  
DOUBLE ANGLES ARE L 4 X 3 X 1/2 X 21 INCHES

Figure 31.

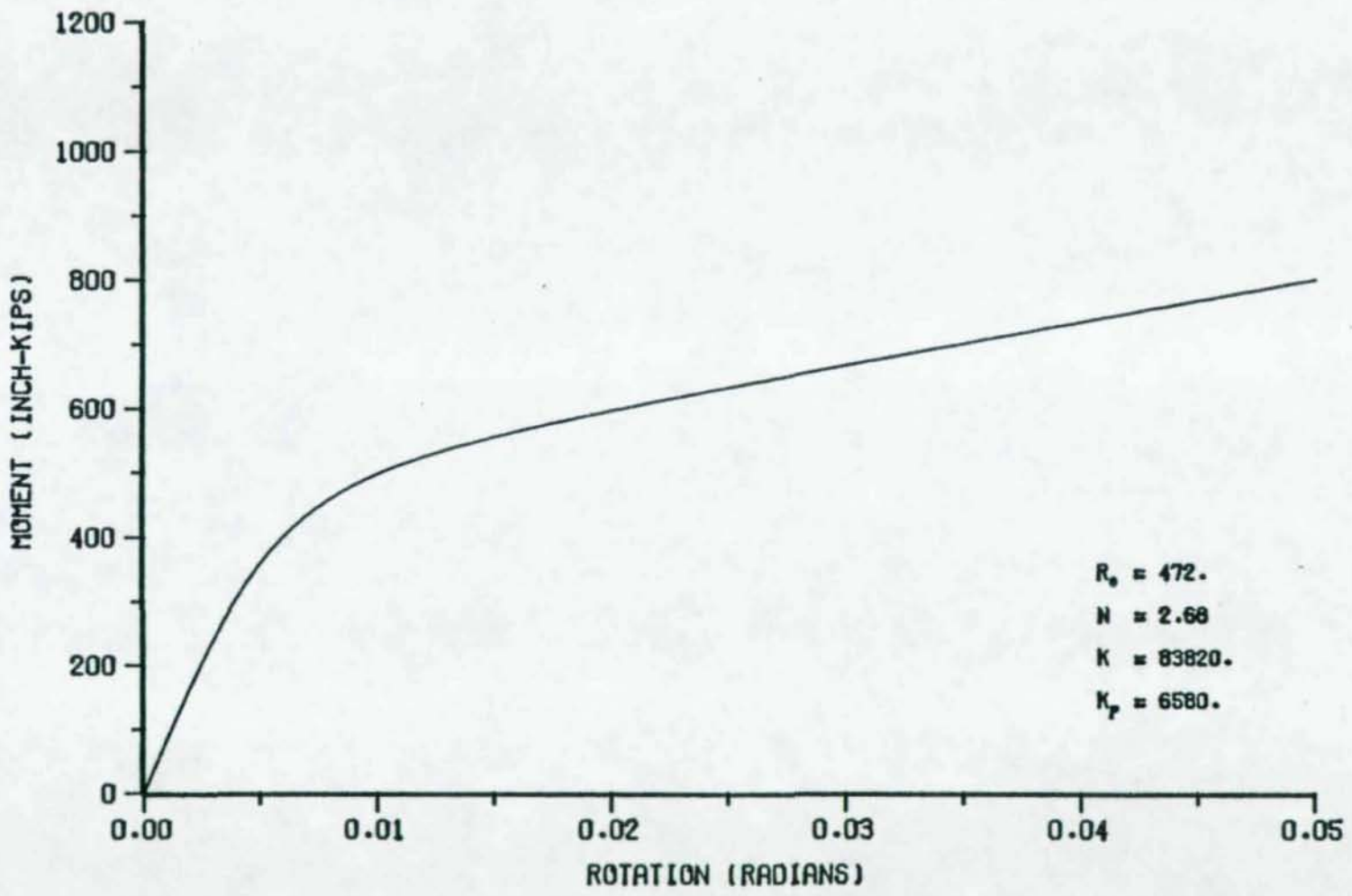

MOMENT ROTATION CURVE FOR WELDED DOUBLE ANGLE CONNECTION  
DOUBLE ANGLES ARE L 4 X 3 X 1/2 X 18 INCHES

Figure 32.

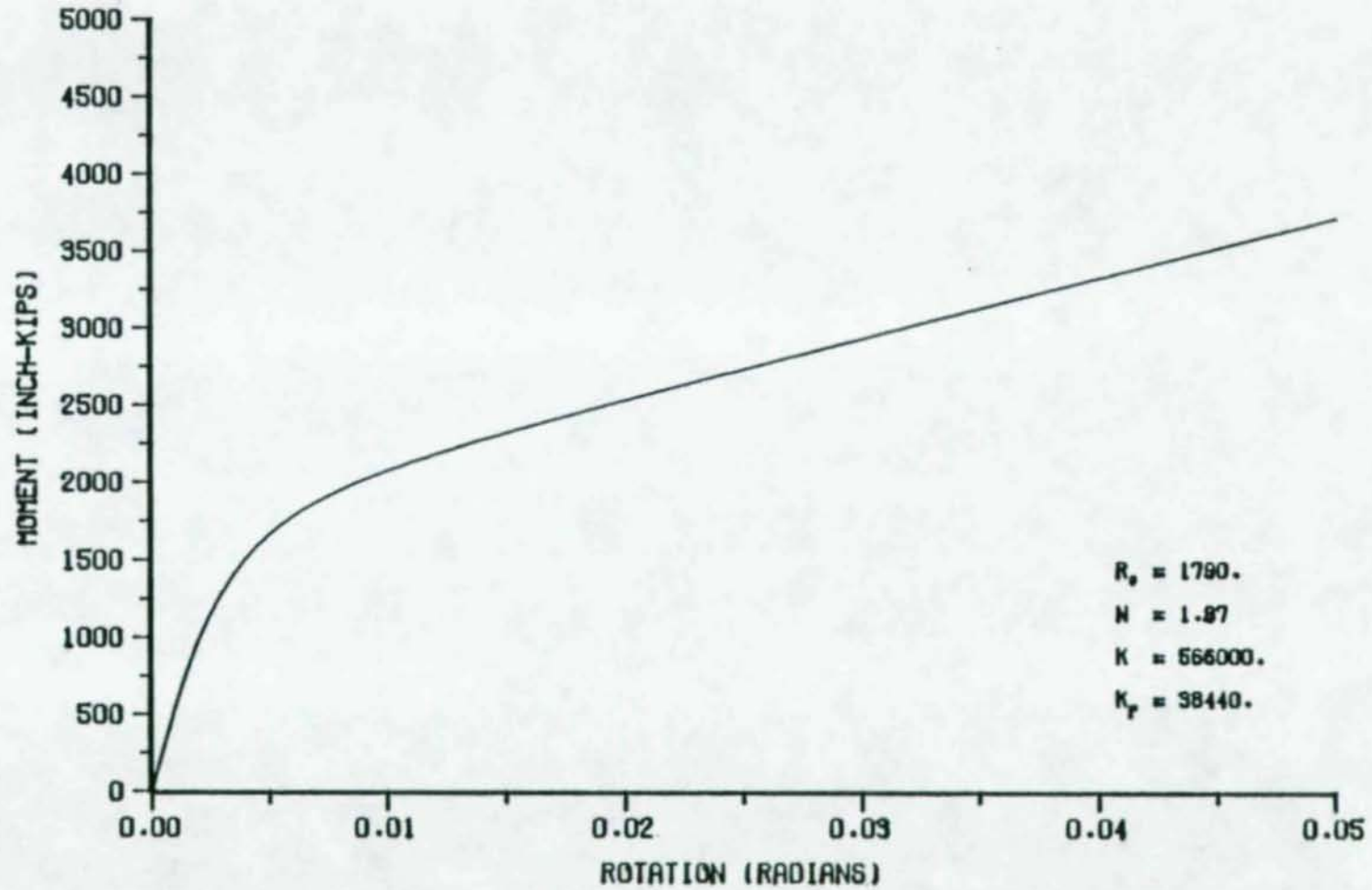

MOMENT ROTATION CURVE FOR WELDED DOUBLE ANGLE CONNECTION  
DOUBLE ANGLES ARE L 5 X 3 X 5/8 X 33 INCHES

Figure 33.

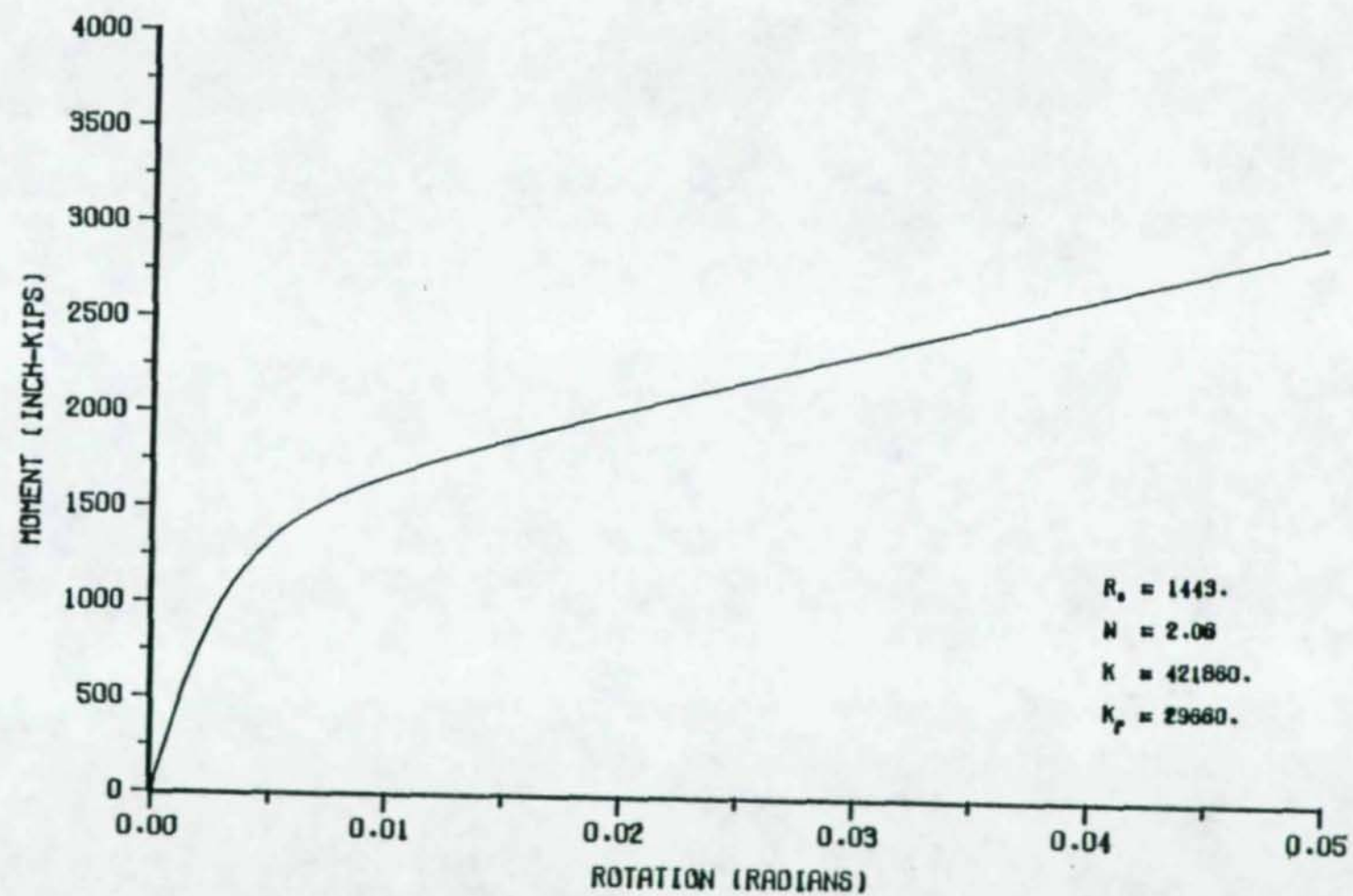

MOMENT ROTATION CURVE FOR WELDED DOUBLE ANGLE CONNECTION  
DOUBLE ANGLES ARE L 5 X 3 X 5/8 X 90 INCHES

Figure 34.

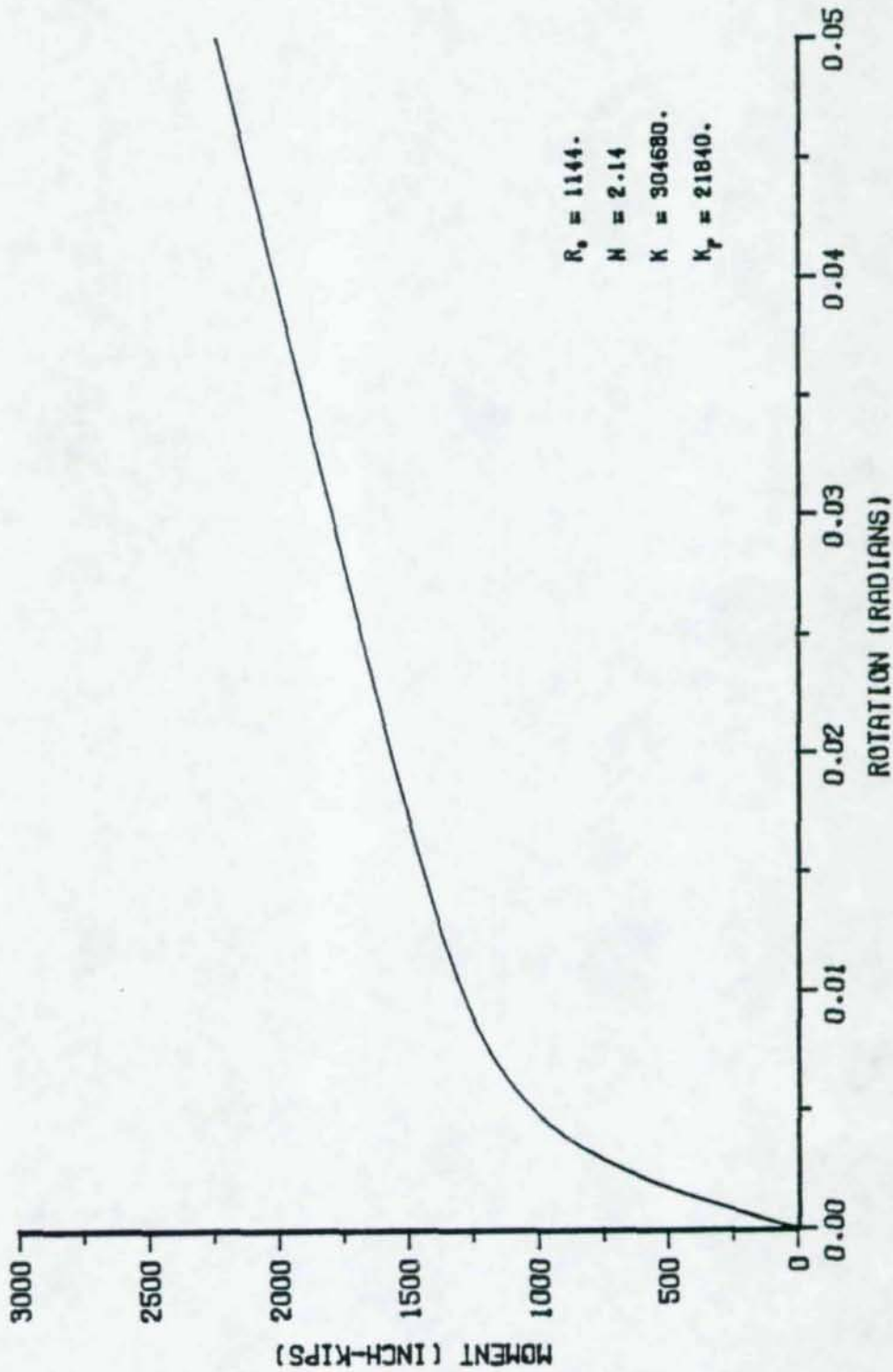

MOMENT ROTATION CURVE FOR WELDED DOUBLE ANGLE CONNECTION  
DOUBLE ANGLES ARE L 5 X 3 X 5/8 X 27 INCHES

Figure 35.

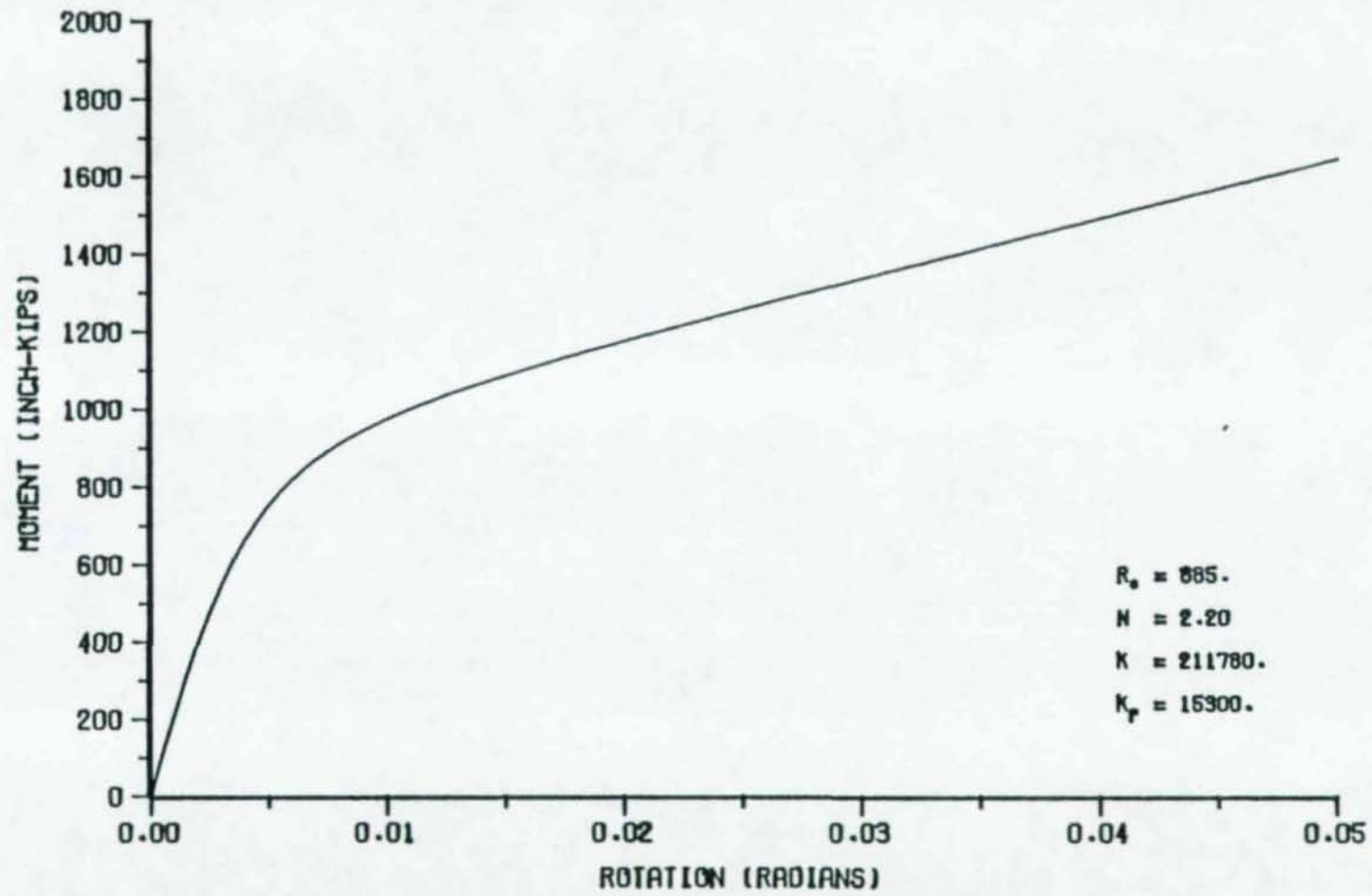

MOMENT ROTATION CURVE FOR WELDED DOUBLE ANGLE CONNECTION  
DOUBLE ANGLES ARE L 5 X 3 X 5/8 X 24 INCHES

Figure 36.

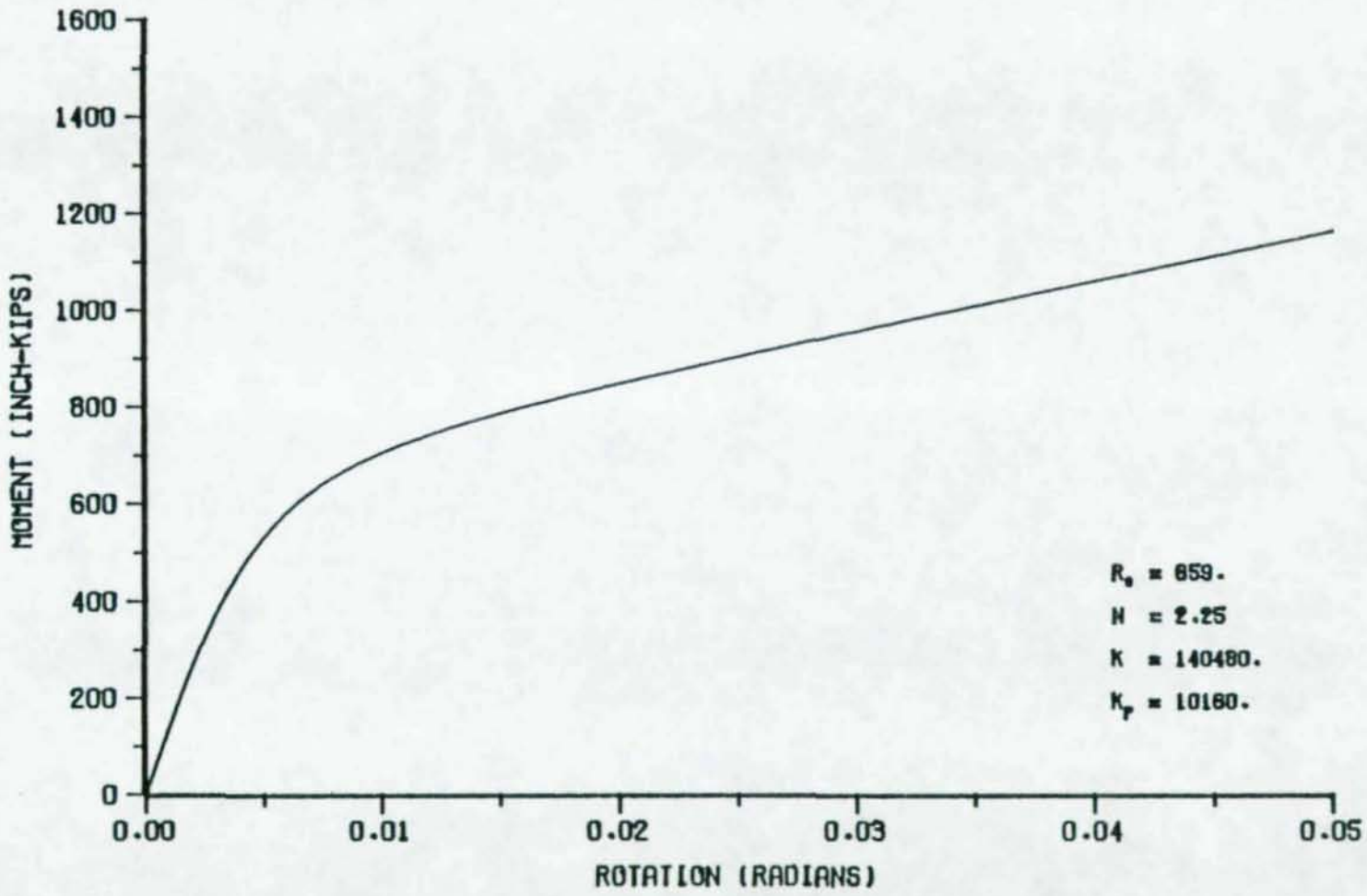

MOMENT ROTATION CURVE FOR WELDED DOUBLE ANGLE CONNECTION  
DOUBLE ANGLES ARE L 5 X 3 X 5/8 X 21 INCHES

Figure 37.



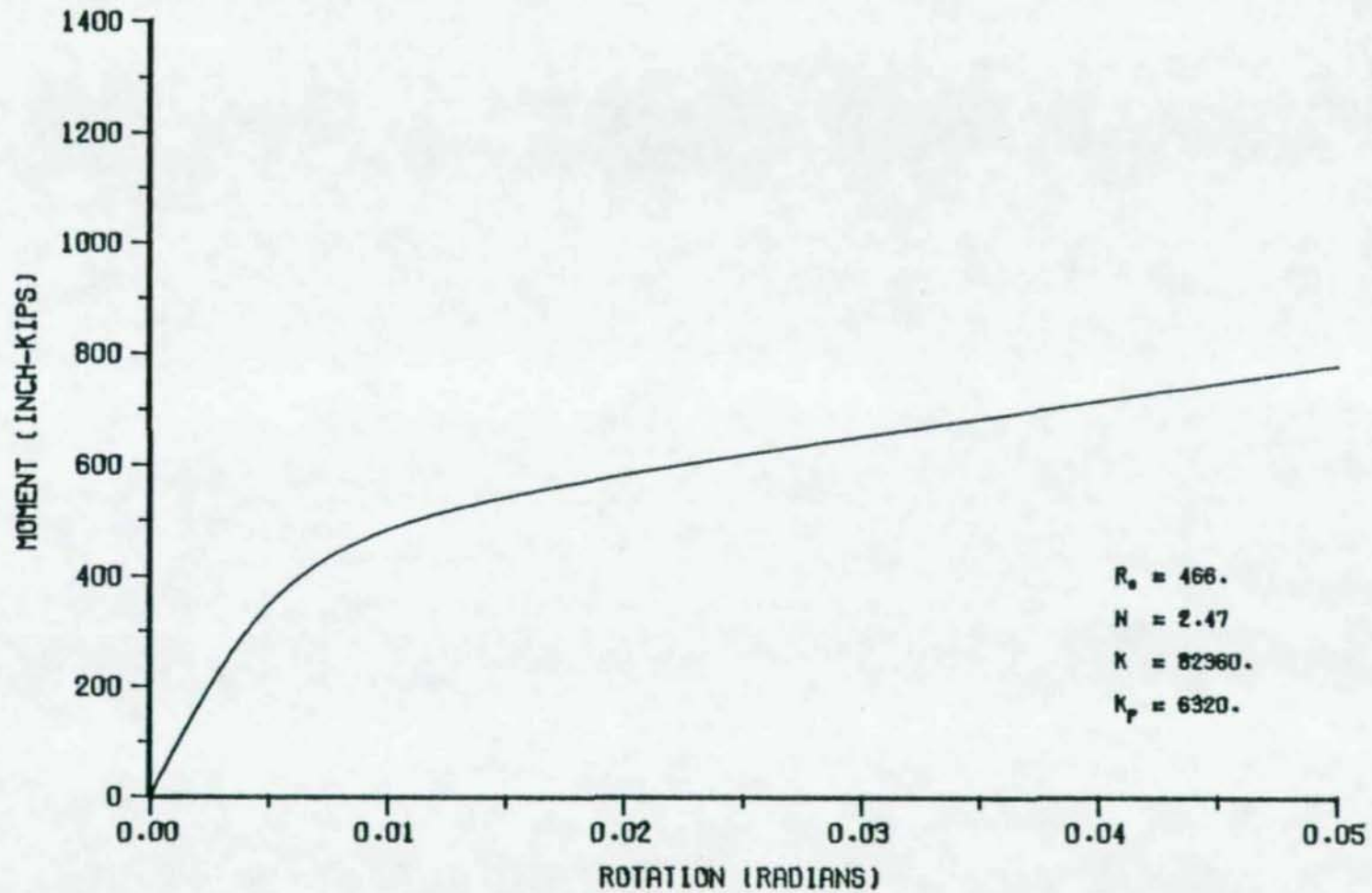

MOMENT ROTATION CURVE FOR WELDED DOUBLE ANGLE CONNECTION  
DOUBLE ANGLES ARE L 5 X 3 X 5/8 X 18 INCHES

Figure 38.

## BEAM LINE THEORY

The beam line (5) is a linear equation which for a particular loading on a beam gives the relationship between the end rotation and the end restraining moment (Figure 4). The beam line is developed using the slope-deflection equations from structural analysis. For the beam shown in Figure 39 and defining counterclockwise as positive for moments and rotations, the slope-deflection equations are given below.

$$M_A = M_{FA} + 4EI\theta_A/L + 2EI\theta_B/L \quad (1)$$

$$M_B = M_{FB} + 2EI\theta_A/L + 4EI\theta_B/L \quad (2)$$

According to the counterclockwise notation, the moment at B is the negative of the moment at A and the rotation at B is the negative of the rotation at A. Subtracting equation (2) from equation (1), with the appropriate substitutions, gives

$$M_A = M_{FA} + 2EI\theta_A/L$$

Note, however, that according to this sign convention, the moment and fixed end moment at A are both positive whereas the rotation at A is negative. Because of the symmetry in loading and geometry of the beam in Figure 39, the following beam line equation is valid for either end of the beam and the subscripts can therefore be eliminated.

$$M = M_{FIXED} - 2EI\theta/L$$

Thus, the beam line gives the end moment of the beam for a

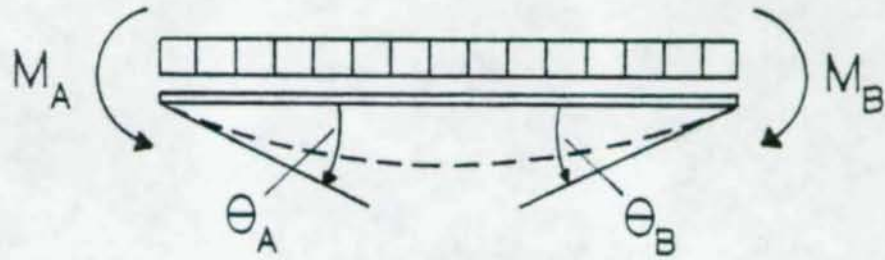

FINAL END MOMENTS AND SLOPES

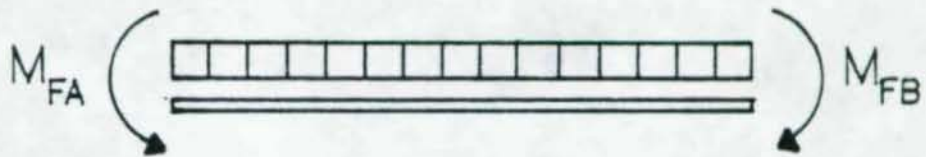
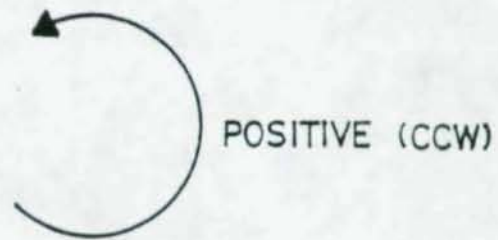

FIXED-END MOMENTS

Figure 39. Beam line equation development.

given end rotation.

AISC-1.2 defines three types of connections.

Type 1 - Rigid-frame connection

Type 2 - Simple framing connection

Type 3 - Semi-rigid framing connection

These three connection types are shown with the beam line in Figure 40 wherein "fixed" connections are seen to have some small amount of end rotation which results in an end moment that is slightly smaller than the fixed-end moment. Similarly, "simple" connections are not truly simple. These are restrained slightly from rotating and this results in some moment developing at the connection. The moment that actually exists at the connection occurs at the intersection of the beam line and the connection moment-rotation curve. This is true because there can be only one end rotation for a particular loading, or looking at it another way, the end rotation must be compatible with that caused by the loads and end restraint.

In order to compare Weld A in Table IV of the AISC Manual, the following procedure was used to achieve loading situations that are compatible with those given in Table IV.

- 1) For a given angle size and angle length and capacity  $V$  of weld A from Table IV (AISC pages 4-36 and 4-37), the uniform load on a simply supported beam of length  $L$  is

$$w = 2V/L.$$

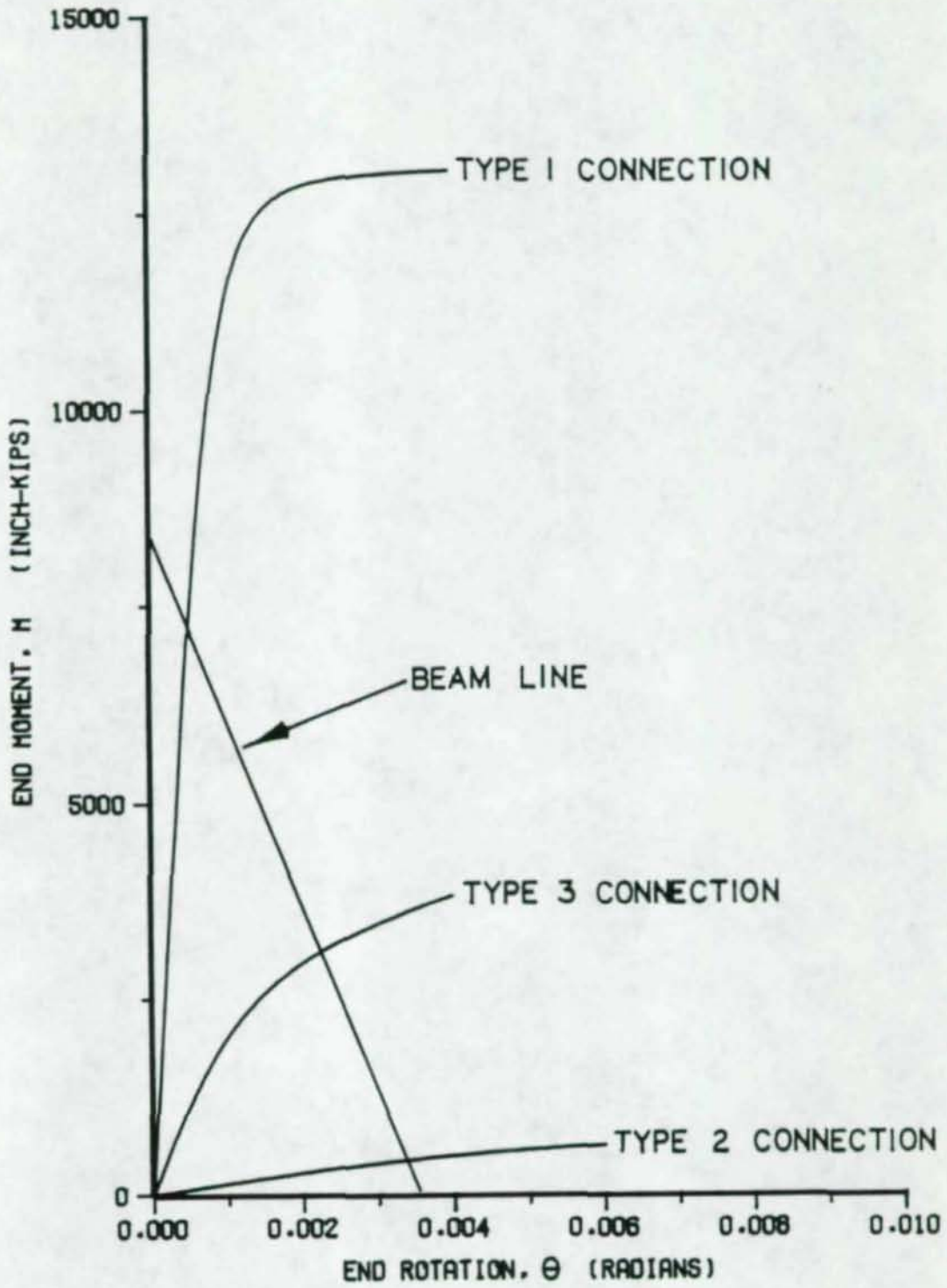

Figure 40. AISC connection types with beam line.

- 2) For a simply supported beam of length  $L$  and uniform load  $w$ , the maximum bending moment occurs at the middle of the beam and is

$$M_{MAX} = wL^2/8$$

- 3) Using the maximum bending moment and considering beams that have full lateral support of the compression flange (so that the allowable bending stress may be taken as 0.66 times the yield stress of the beam), a beam may be chosen from the Allowable Stress Design Selection Table given in the AISC Manual.
- 4) The two parameters that define the beam line may now be calculated.

$$M_{FIXED} = wL^2/12$$

$$\theta_{SIMPLE} = wL^3/24EI$$

In the above procedure,  $E = 30,000$  ksi and  $L = 20$  feet was used for all beams. Table 9 gives the values associated with steps 1 through 4 above for all connection geometries considered.

The beam line for the particular loading can now be superimposed on the moment-rotation curve for the particular connection to determine the end rotation and resisting moment at the connection. Since the connection geometries in AISC Table IV are given in multiples of two inch lengths and the previous moment-rotation curves are given in multiples of three inch lengths, generalized curves with the Richard parameters versus angle length were generated to determine

TABLE 9 BEAM LINE PARAMETERS FOR WELD "A" COMPARISON

<u>Connection</u>	<u>V</u>	<u>w</u>	<u>M<sub>max</sub></u>	<u>Beam</u>	<u>M<sub>FIXED</sub></u>	<u>θ<sub>SHPL</sub></u>
L-4x3x1/2x32	277	27.7	1385	W36 x 210	11,076	.00336
L-4x3x3/8x32	221	22.1	1105	W36 x 170	8,844	.00337
L-4x3x5/16x32	166	16.6	830	W36 x 135	6,636	.00341
L-4x3x1/2x30	262	26.2	1310	W36 x 194	10,476	.00346
L-4x3x3/8x30	210	21.0	1050	W36 x 160	8,400	.00345
L-4x3x5/16x30	157	15.7	785	W33 x 130	6,276	.00374
L-4x3x1/2x28	248	24.8	1240	W36 x 182	9,924	.00351
L-4x3x3/8x28	198	19.8	990	W36 x 150	7,920	.00350
L-4x3x5/16x28	149	14.9	745	W33 x 130	5,964	.00355
L-4x3x1/2x26	234	23.4	1170	W36 x 182	9,360	.00331
L-4x3x3/8x26	187	18.7	935	W36 x 150	7,476	.00331
L-4x3x5/16x26	140	14.0	700	W33 x 118	5,604	.00380
L-4x3x1/2x24	218	21.8	1090	W36 x 170	8,724	.00332
L-4x3x3/8x24	174	17.4	870	W36 x 135	6,960	.00357
L-4x3x5/16x24	131	13.1	655	W30 x 116	5,244	.00425
L-4x3x1/2x22	204	20.4	1020	W36 x 160	8,160	.00335
L-4x3x3/8x22	163	16.3	815	W36 x 135	6,516	.00334
L-4x3x5/16x22	122	12.2	610	W30 x 116	4,884	.00396
L-4x3x1/2x20	188	18.8	940	W36 x 150	7,524	.00333
L-4x3x3/8x20	151	15.1	755	W33 x 130	6,036	.00360
L-4x3x5/16x20	113	11.3	565	W30 x 108	4,524	.00404
L-4x3x1/2x18	172	17.2	860	W36 x 135	6,876	.00353
L-4x3x3/8x18	138	13.8	690	W33 x 118	5,520	.00374
L-4x3x5/16x18	103	10.3	515	W30 x 99	4,116	.00413

V is chosen from AISC Table IV for weld "A" comparison  
w = uniform load in kips/ft = 2V/L (L = 20 feet for all beams)  
M<sub>max</sub> = maximum bending moment in beam = wL<sup>2</sup>/8 (kip-ft)  
The beams are selected from AISC Beam Selection Tables  
M<sub>FIXED</sub> = fixed end moment = wL<sup>2</sup>/12 (kip-inch)  
θ<sub>SHPL</sub> = simple (pinned) end rotation = wL<sup>2</sup>/24EI (radians)

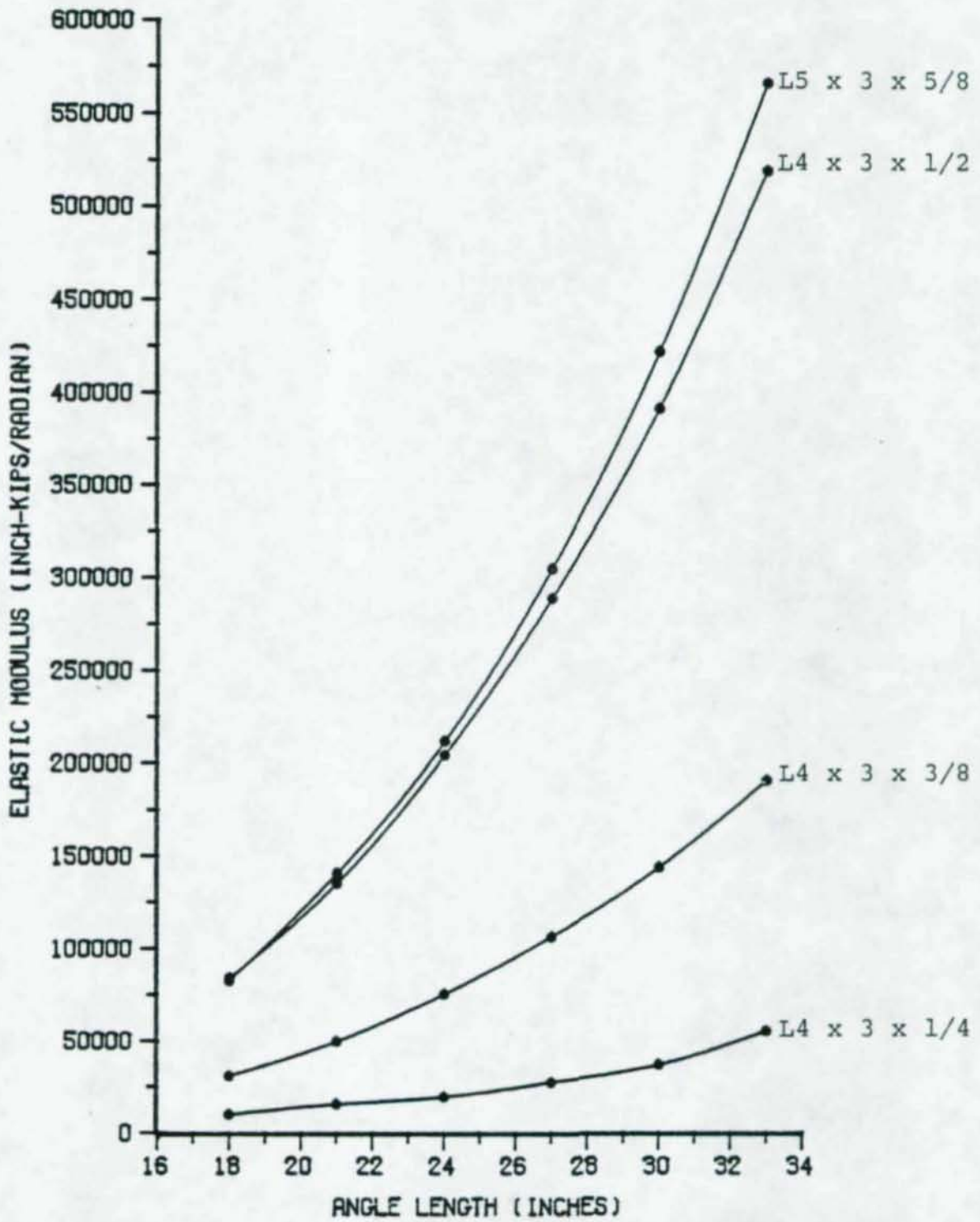

ELASTIC MODULUS VS ANGLE LENGTH FOR VARIOUS CONNECTIONS

Figure 41.



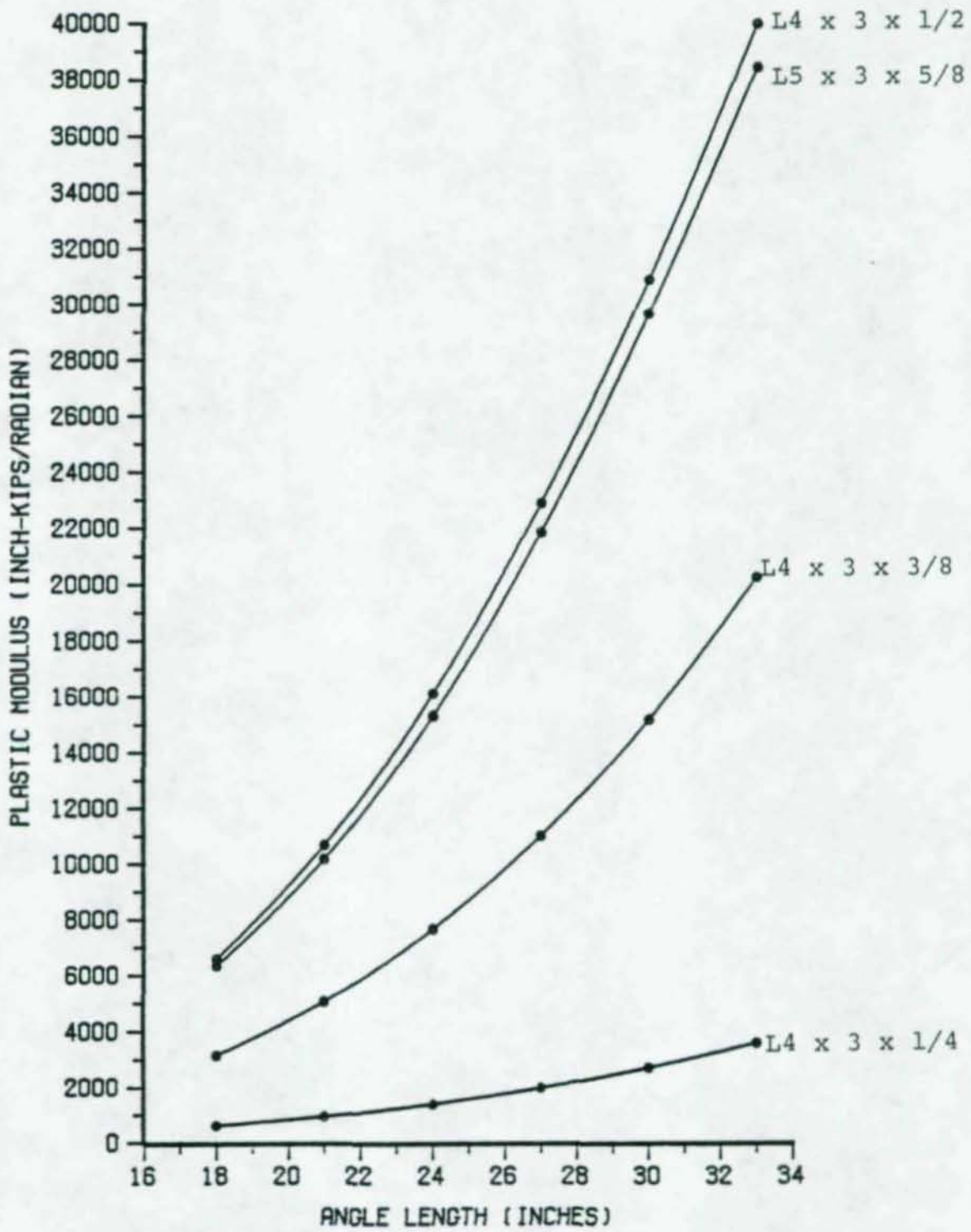

PLASTIC MODULUS VS ANGLE LENGTH FOR VARIOUS CONNECTIONS

Figure 42.

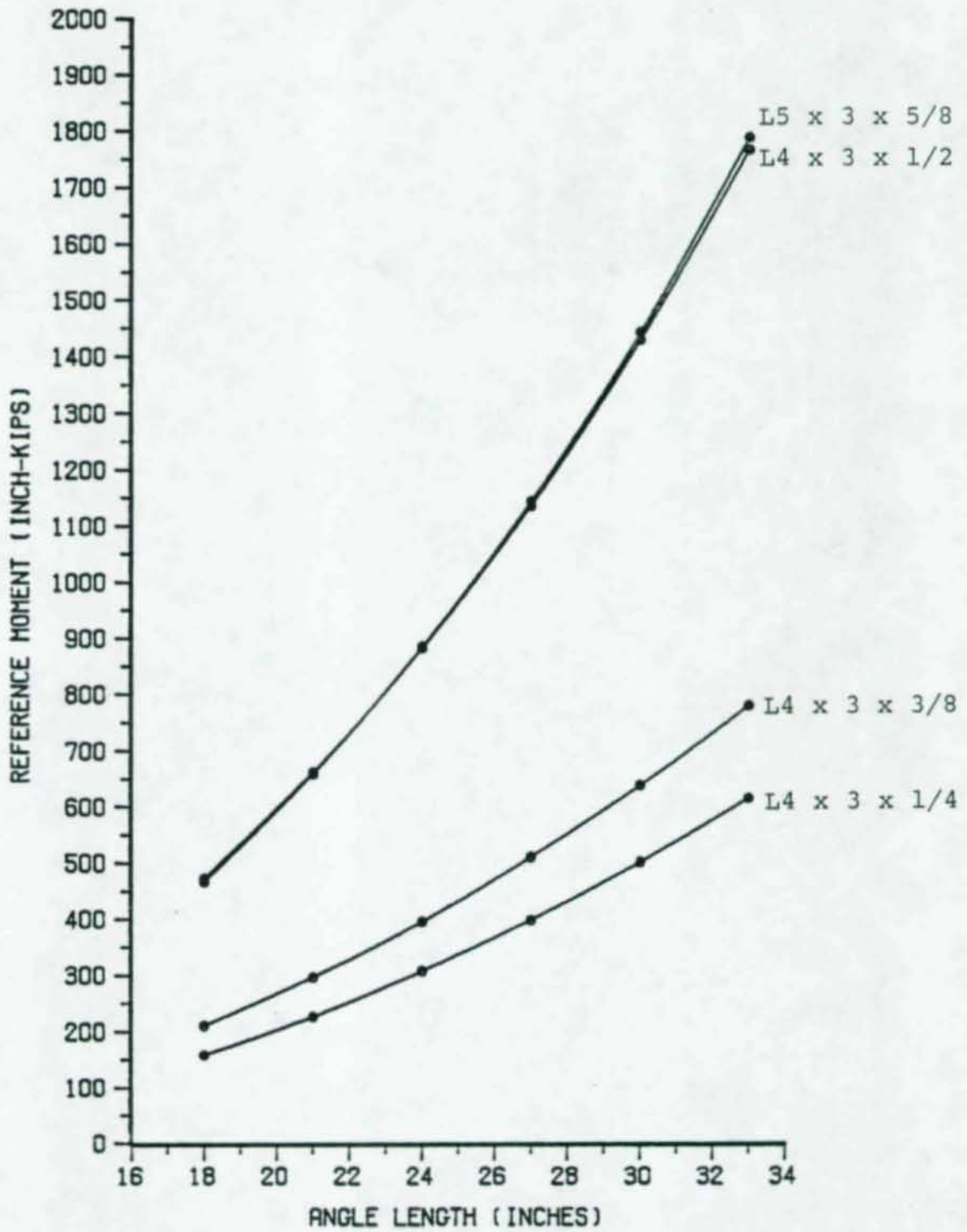

REFERENCE MOMENT VS ANGLE LENGTH FOR VARIOUS CONNECTIONS

Figure 43.

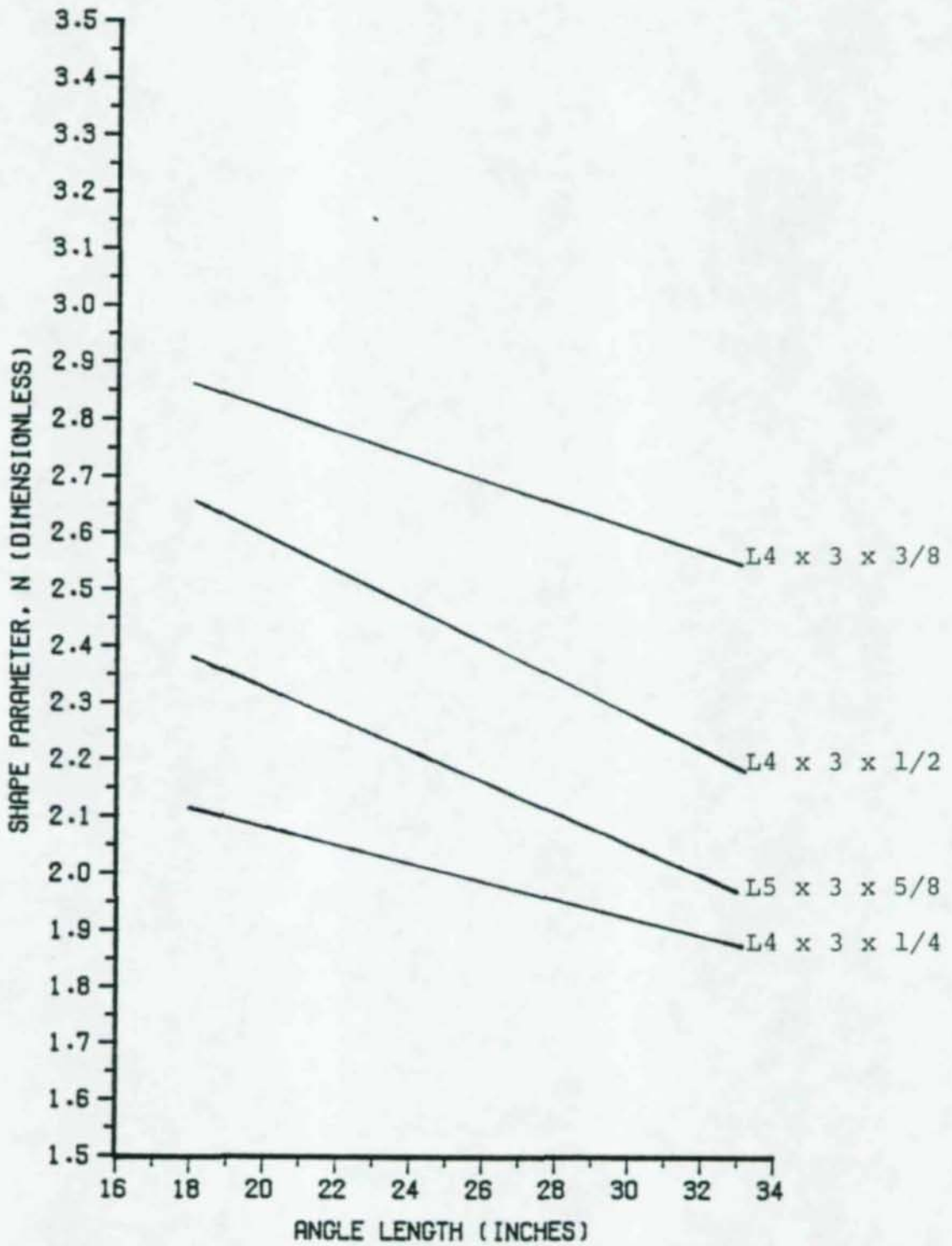

SHAPE PARAMETER VS ANGLE LENGTH FOR VARIOUS CONNECTIONS

Figure 44.

the Richard parameters that describe the moment-rotation curves for the connection geometries in AISC Table IV (Figures 41-44). The parameters for the 5/16 inch thick angles were interpolated halfway between the 1/4 inch and 3/8 inch angle parameters. The shape parameter values were averaged and held constant for all connection lengths for each angle thickness. This assumption changed the values of resisting moment (where the beam line intersects the connection curve) by less than two percent, which shows that the shape parameter is not critical in defining the connection curve. Figures 45 through 68 show the beam line with the moment-rotation curve for each of the connection geometries and loadings considered in Table 9.

The resisting moment and end rotation, which are represented graphically by the intersection of the beam line and the moment-rotation curve, can be determined numerically using a Newton-Raphson root finding procedure. The Fortran program NRMRSOL (Newton-Raphson Moment Rotation SOLution) in appendix C uses the Newton-Raphson algorithm to determine the intersection point of the beam line with the moment-rotation curve. Using this method, the end rotation and resisting moment for each connection considered are given in Table 10.

It is apparent from Table 10 that the beam rotation at the connection is of the order of 0.003 to 0.004 radians. From program MRCURVE (appendix B) the distance from the bottom

of the connection to the rotation point can be determined, and hence the maximum displacement at the top of the connection can be calculated. These maximum displacements were determined to be well within the range of displacements achieved during the physical tests of the angle clips (see Tables 1-5).

With the resisting moment at the connection known, Weld A and Weld B can be designed to resist not only the shear but also the resisting moment that is developed at the connection.

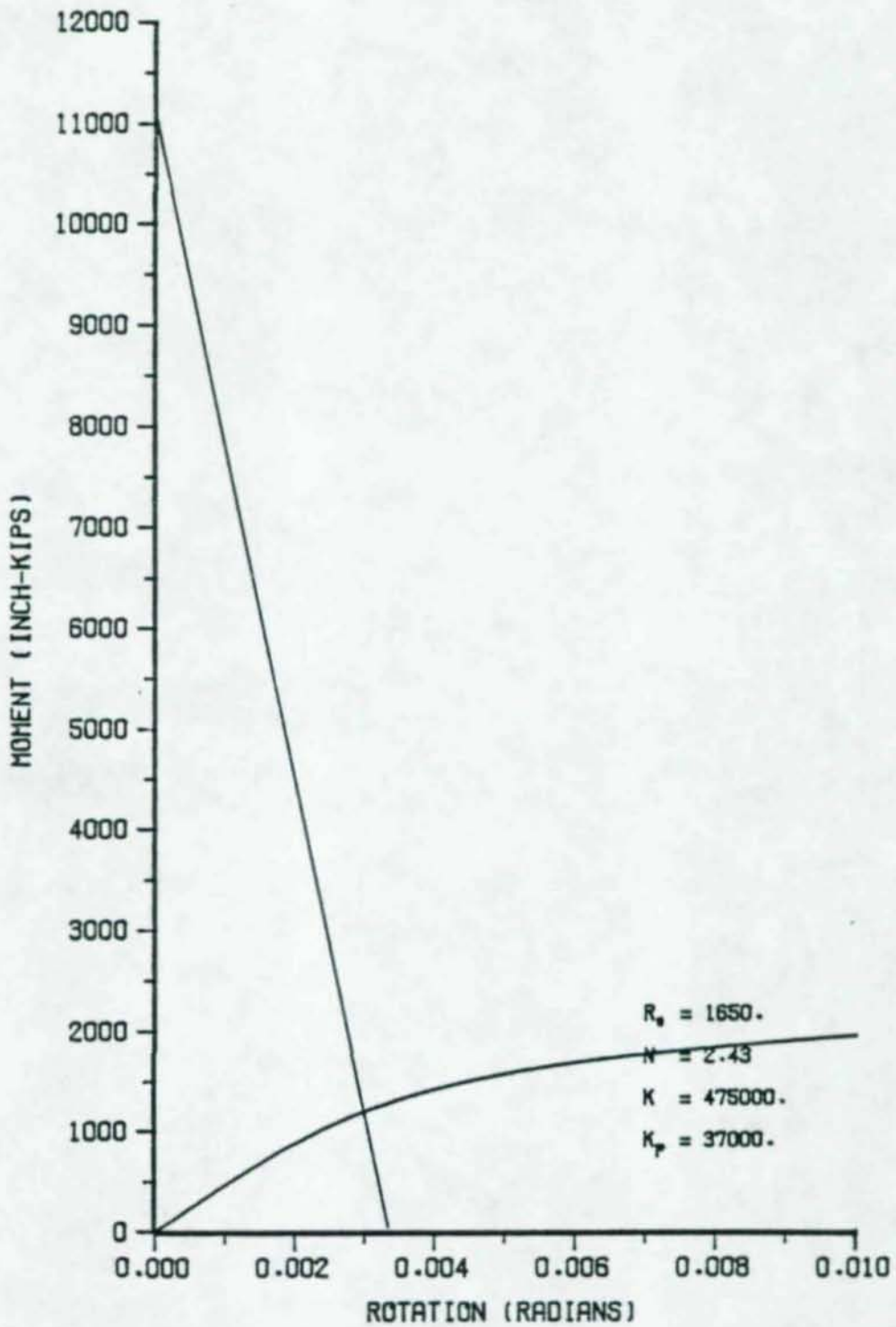

MOMENT ROTATION CURVE WITH BEAM LINE FOR WELDED CONNECTION  
DOUBLE ANGLES ARE L 4 X 3 X 1/2 X 32 INCHES  
BEAM: W36 X 210 LOAD: 27.7 KIPS/FT LENGTH: 20 FEET

Figure 45.

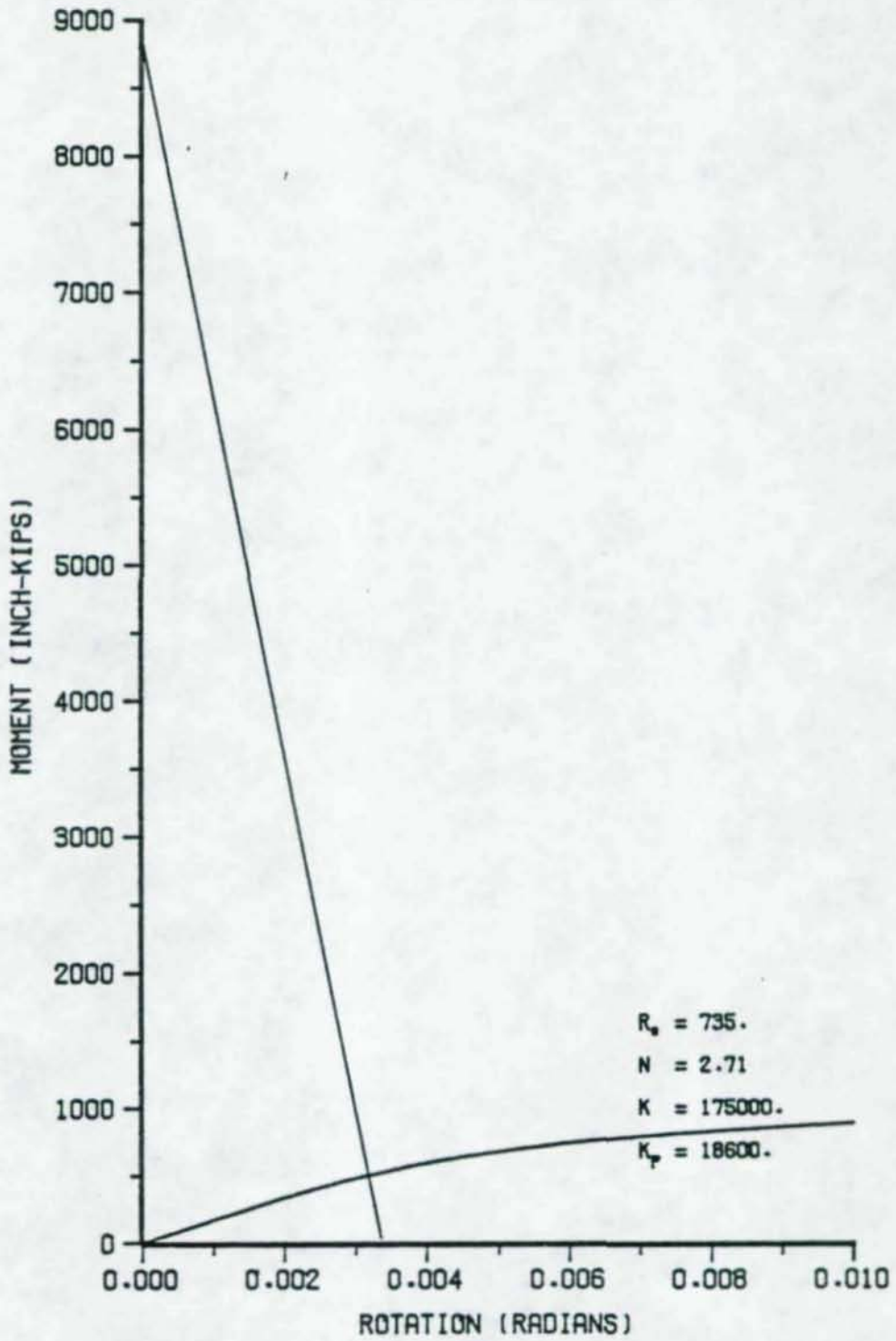

MOMENT ROTATION CURVE WITH BEAM LINE FOR WELDED CONNECTION  
DOUBLE ANGLES ARE L 4 X 3 X 3/8 X 32 INCHES  
BEAM: W36 X 170 LOAD: 22.1 KIPS/FT LENGTH: 20 FEET

Figure 46.

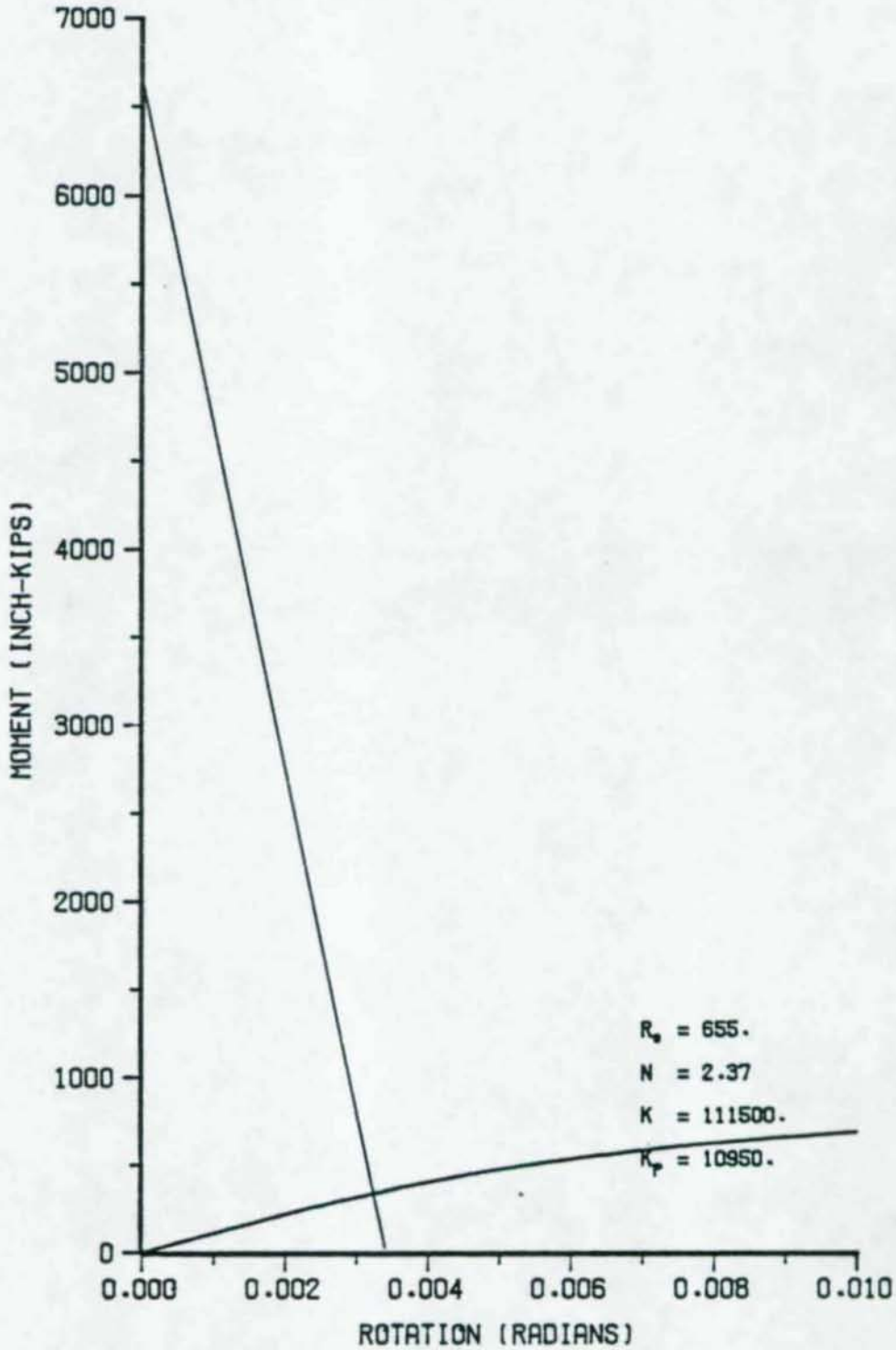

MOMENT ROTATION CURVE WITH BEAM LINE FOR WELDED CONNECTION  
 DOUBLE ANGLES ARE L 4 X 3 X 5/16 X 32 INCHES  
 BEAM: W36 X 135 LOAD: 16.6 KIPS/FT LENGTH: 20 FEET

Figure 47.



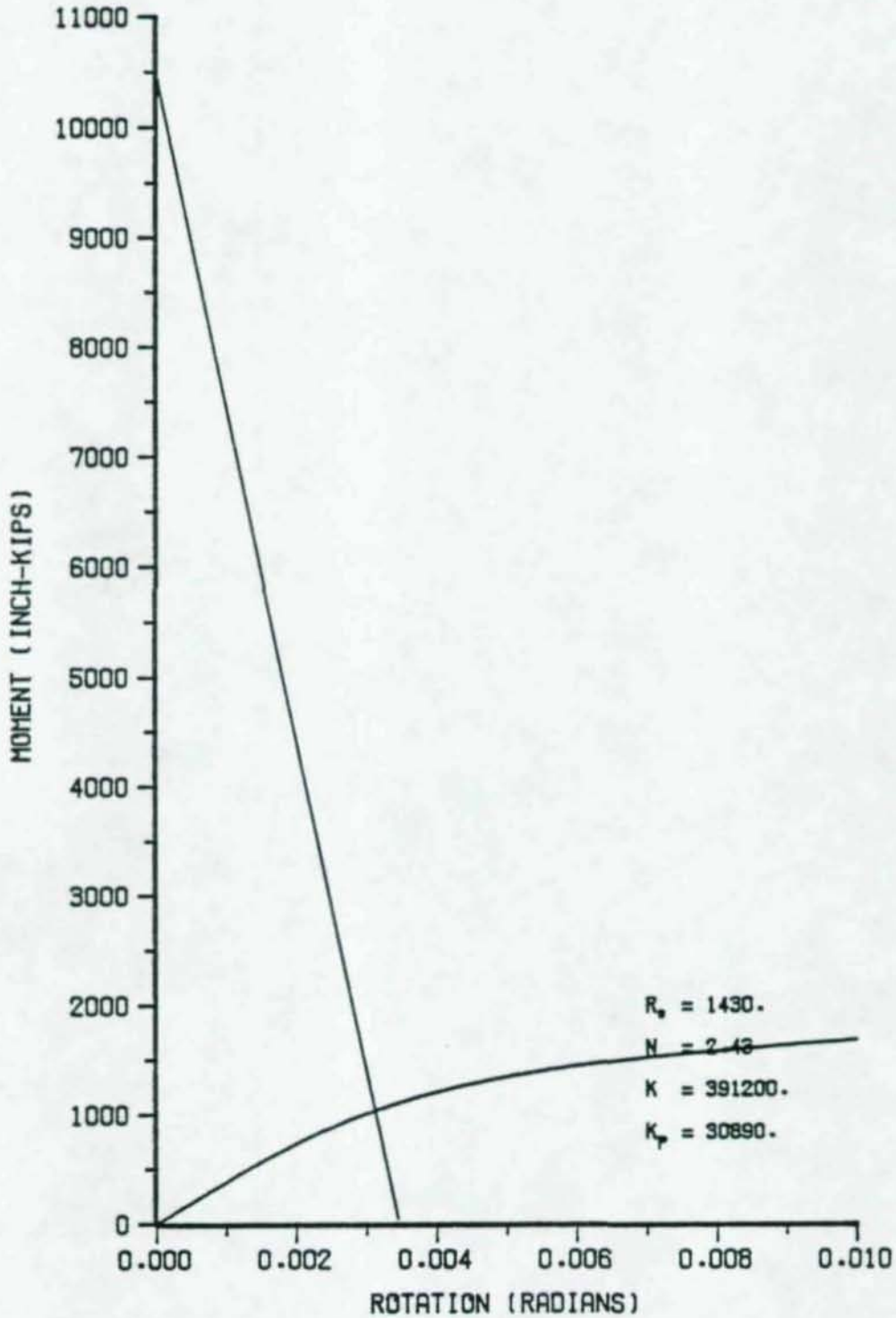

MOMENT ROTATION CURVE WITH BEAM LINE FOR WELDED CONNECTION  
 DOUBLE ANGLES ARE L 4 X 3 X 1/2 X 30 INCHES  
 BEAM: W36 X 194 LOAD: 26.2 KIPS/FT LENGTH: 20 FEET

Figure 48.

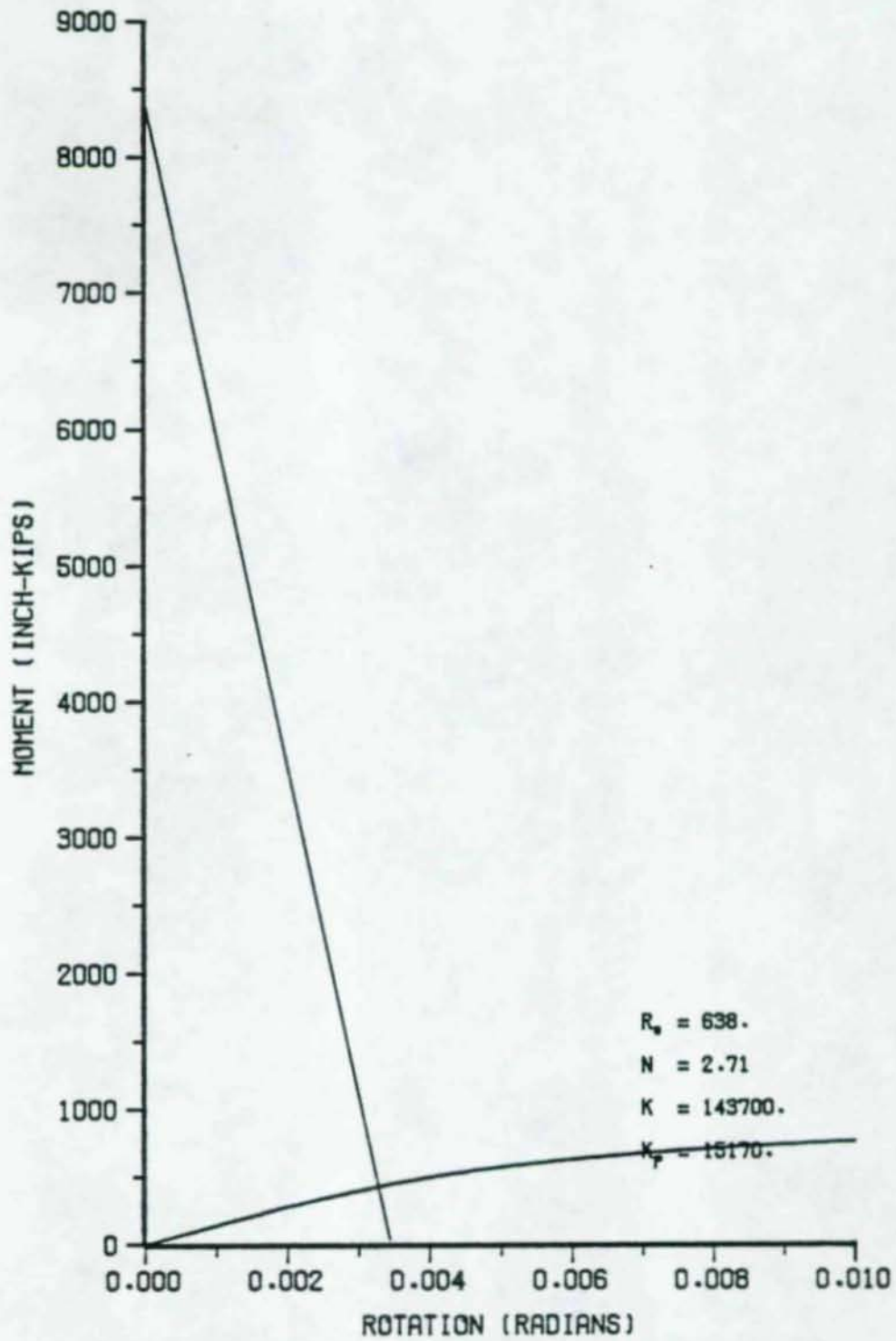

MOMENT ROTATION CURVE WITH BEAM LINE FOR WELDED CONNECTION  
DOUBLE ANGLES ARE L 4 X 3 X 3/8 X 30 INCHES  
BEAM: W36 X 160 LOAD: 21.0 KIPS/FT LENGTH: 20 FEET

Figure 49.

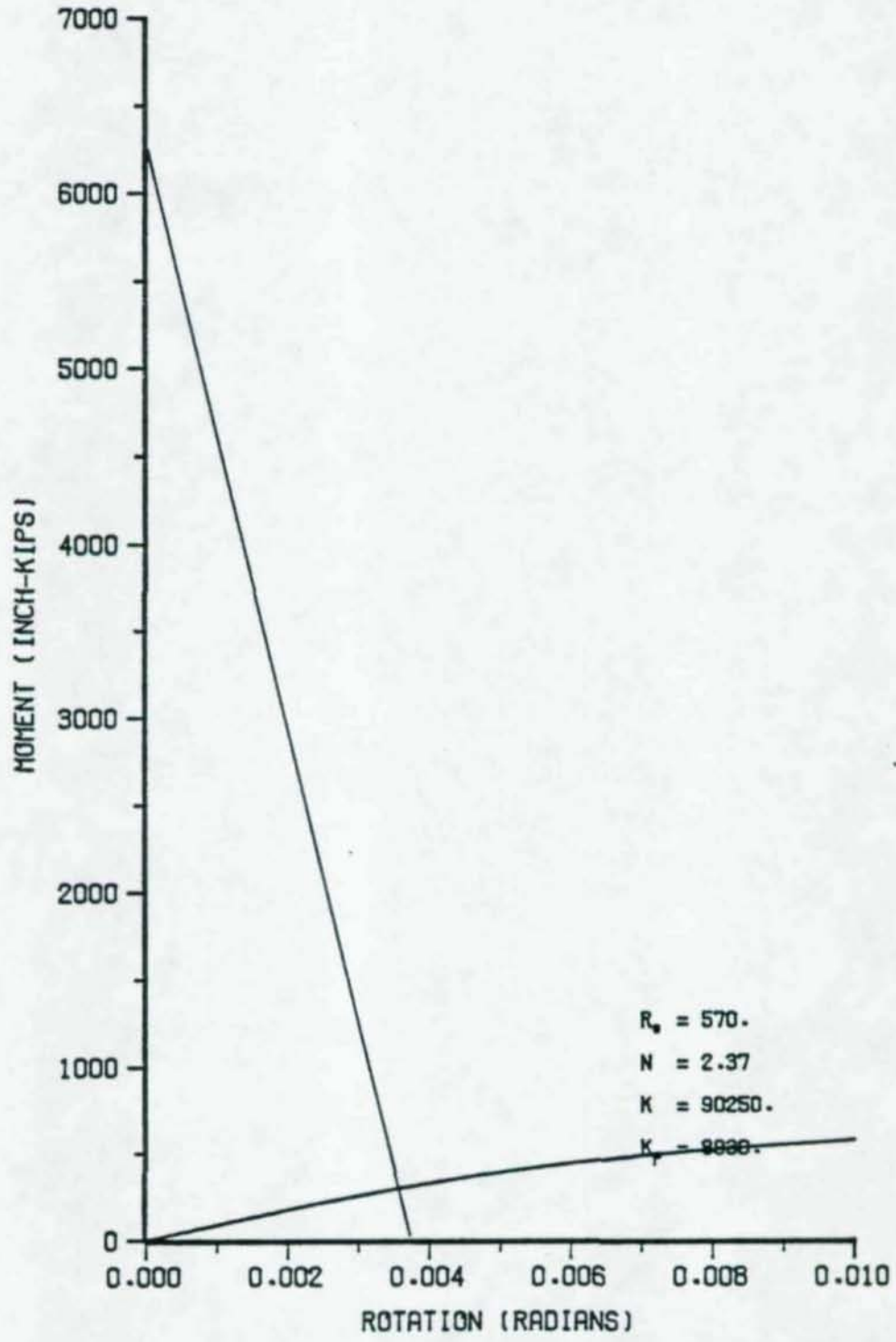

MOMENT ROTATION CURVE WITH BEAM LINE FOR WELDED CONNECTION  
DOUBLE ANGLES ARE L 4 X 3 X 5/16 X 30 INCHES  
BEAM: W33 X 130 LOAD: 15.7 KIPS/FT LENGTH: 20 FEET

Figure 50.

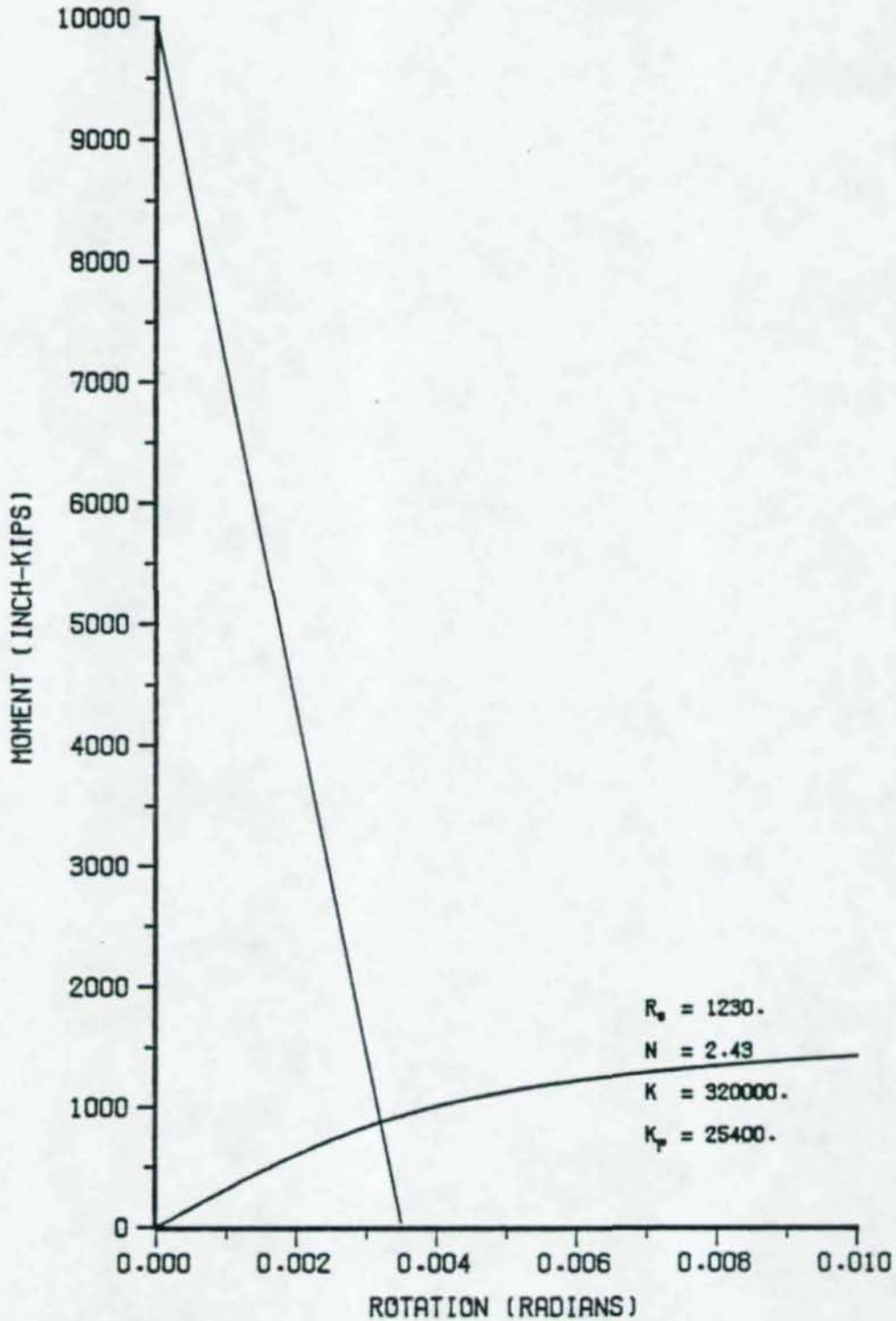

MOMENT ROTATION CURVE WITH BEAM LINE FOR WELDED CONNECTION

DOUBLE ANGLES ARE L 4 X 3 X 1/2 X 28 INCHES

BEAM: W36 X 182 LOAD: 24.8 KIPS/FT LENGTH: 20 FEET

Figure 51.

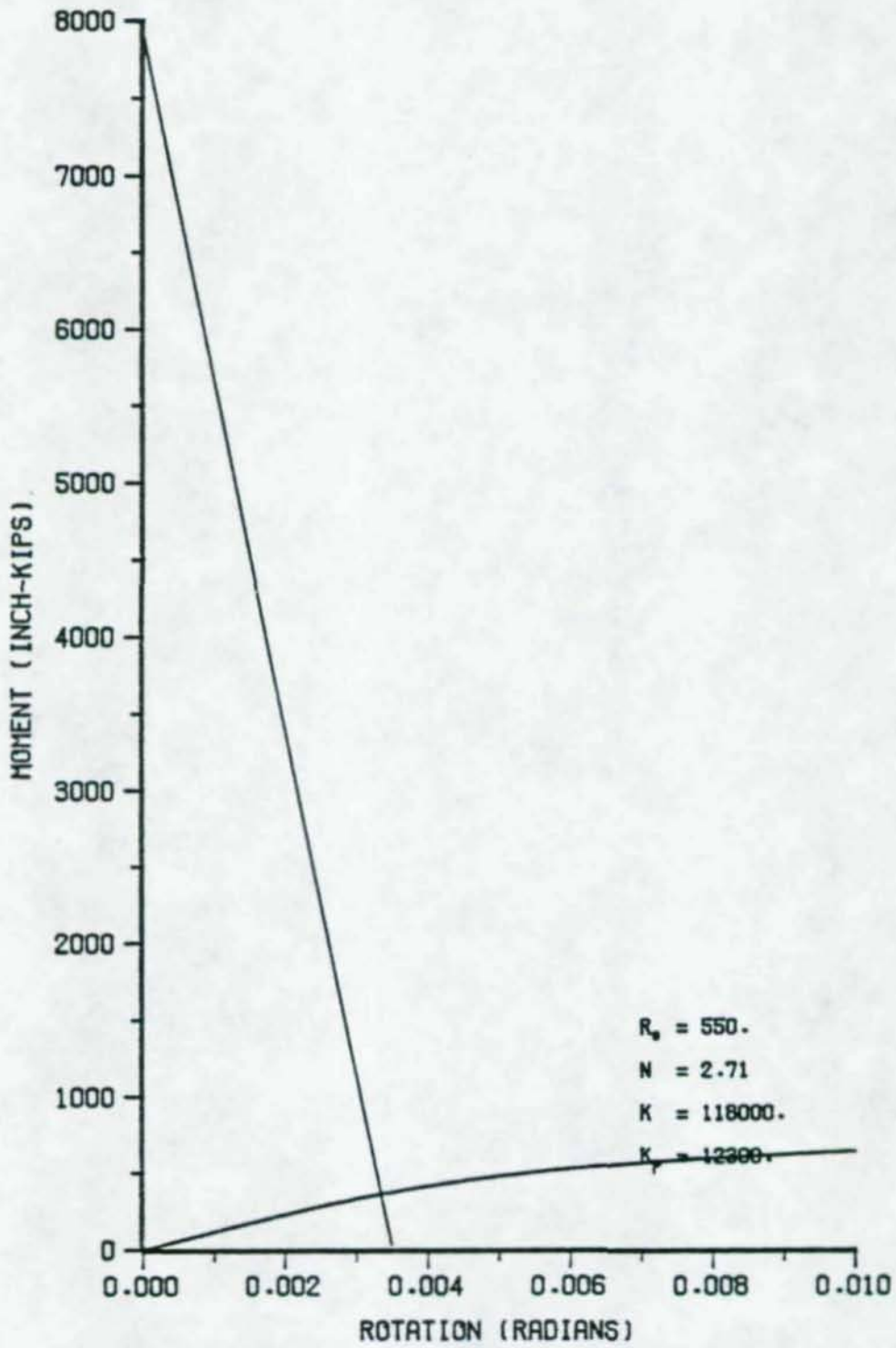

MOMENT ROTATION CURVE WITH BEAM LINE FOR WELDED CONNECTION  
DOUBLE ANGLES ARE L 4 X 3 X 3/8 X 28 INCHES  
BEAM: W36 X 150 LOAD: 19.8 KIPS/FT LENGTH: 20 FEET

Figure 52.

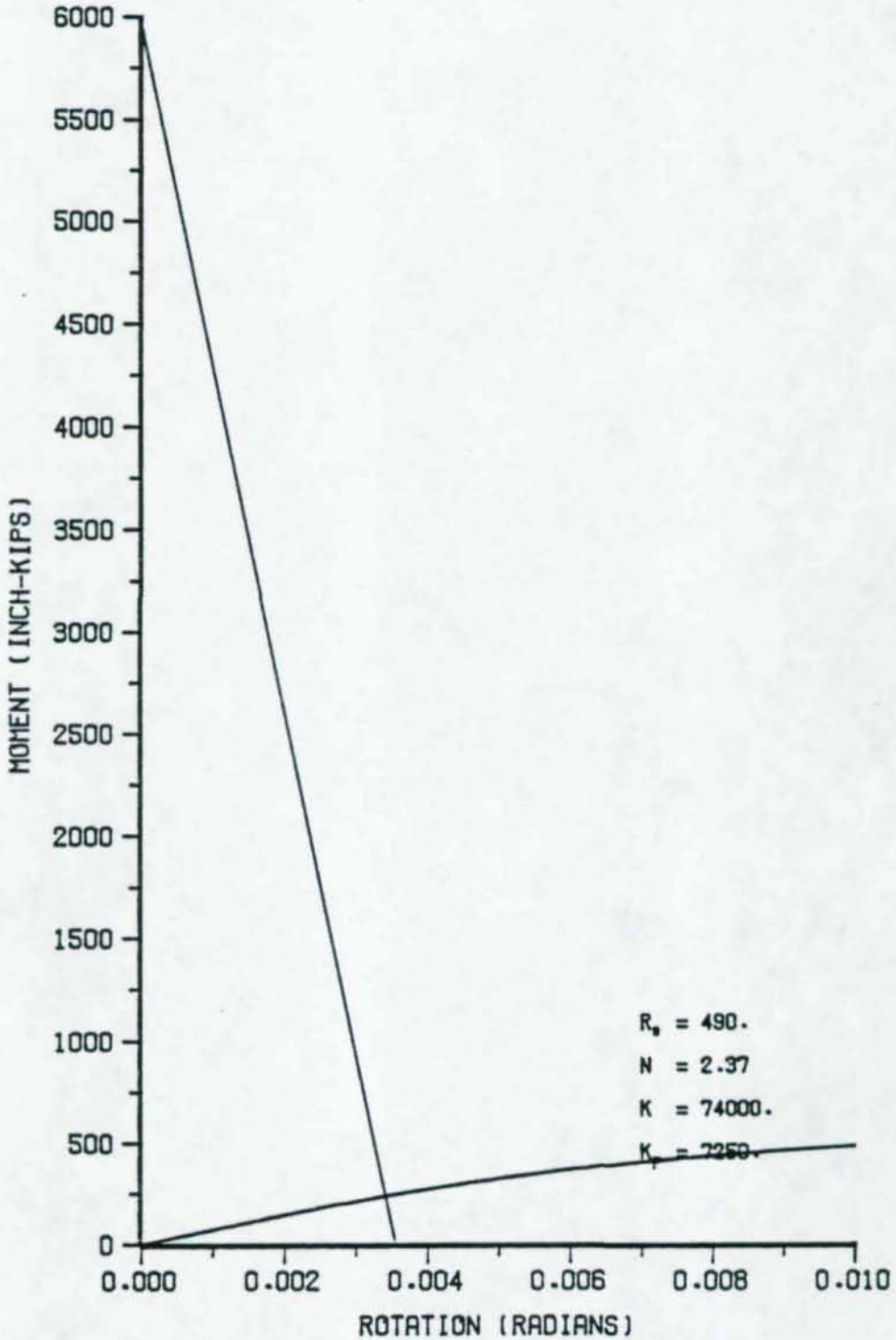

MOMENT ROTATION CURVE WITH BEAM LINE FOR WELDED CONNECTION  
DOUBLE ANGLES ARE L 4 X 3 X 5/16 X 28 INCHES  
BEAM: W33 X 130 LOAD: 14.9 KIPS/FT LENGTH: 20 FEET

Figure 53.

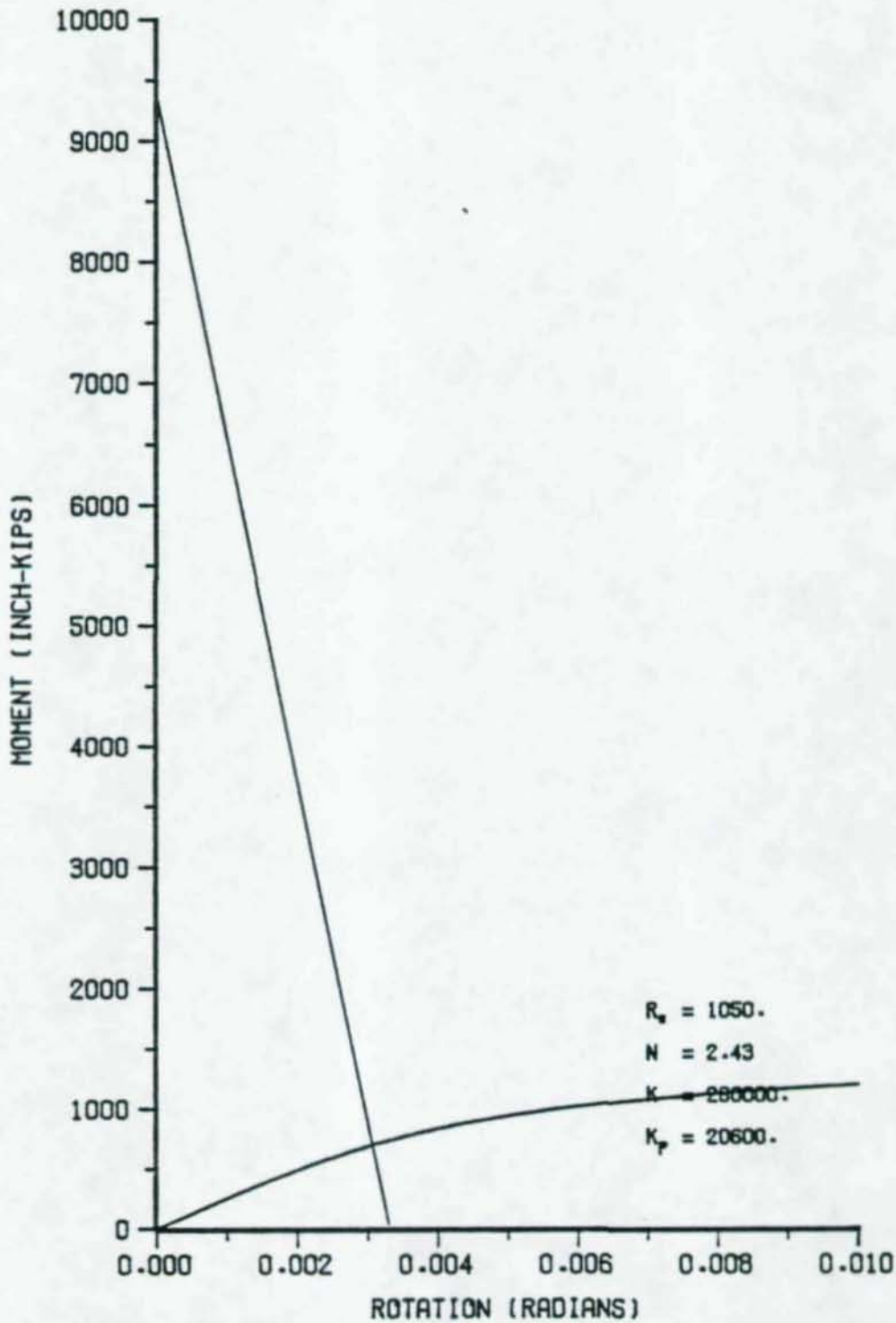

MOMENT ROTATION CURVE WITH BEAM LINE FOR WELDED CONNECTION  
DOUBLE ANGLES ARE L 4 X 3 X 1/2 X 26 INCHES  
BEAM: W36 X 182 LOAD: 23.4 KIPS/FT LENGTH: 20 FEET

Figure 54.

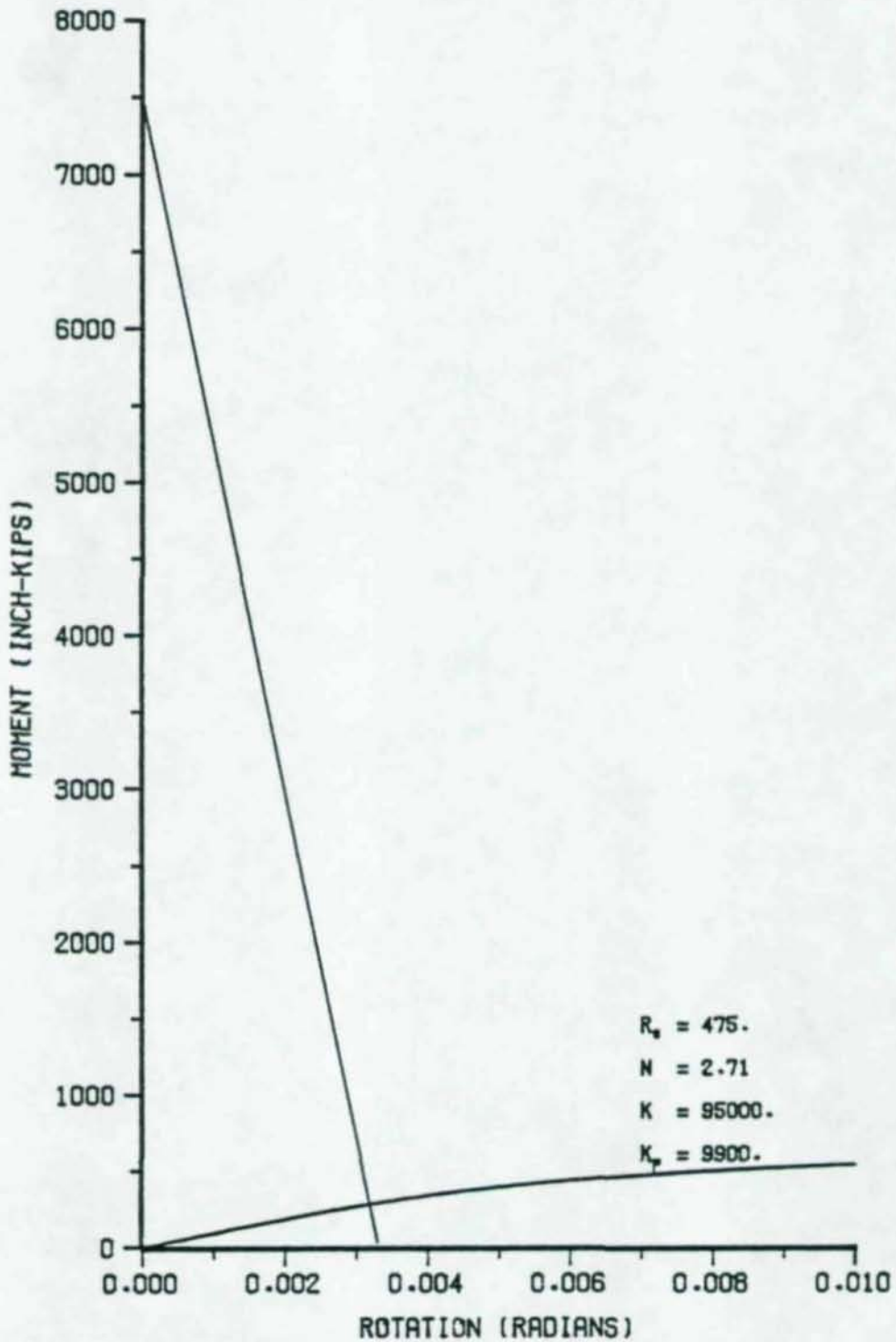

MOMENT ROTATION CURVE WITH BEAM LINE FOR WELDED CONNECTION

DOUBLE ANGLES ARE L 4 X 3 X 3/8 X 26 INCHES

BEAM: W36 X 150 LOAD: 18.7 KIPS/FT LENGTH: 20 FEET

Figure 55.



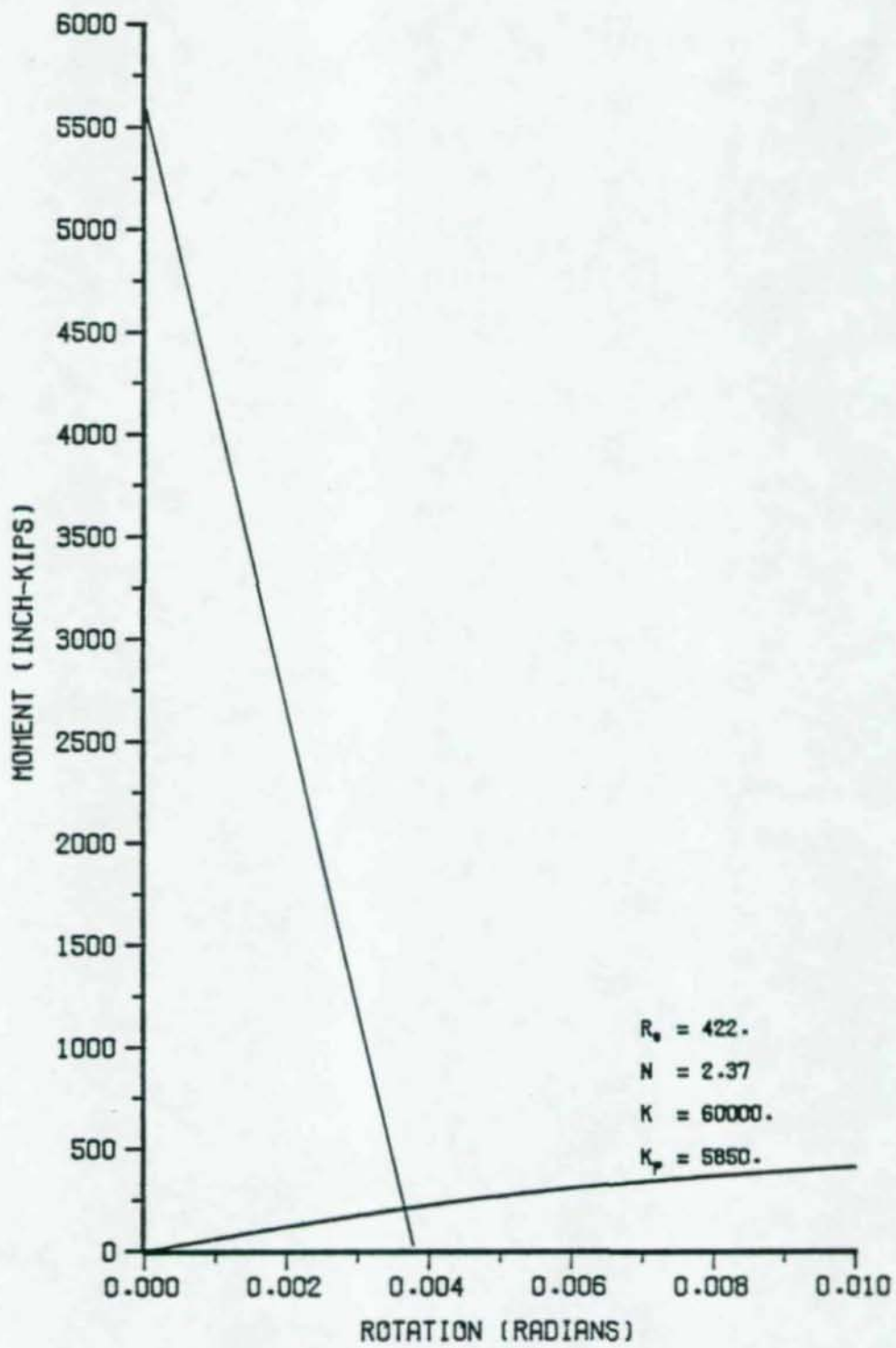

MOMENT ROTATION CURVE WITH BEAM LINE FOR WELDED CONNECTION  
DOUBLE ANGLES ARE L 4 X 3 X 5/16 X 26 INCHES  
BEAM: W33 X 118 LOAD: 14.0 KIPS/FT LENGTH: 20 FEET

Figure 56.

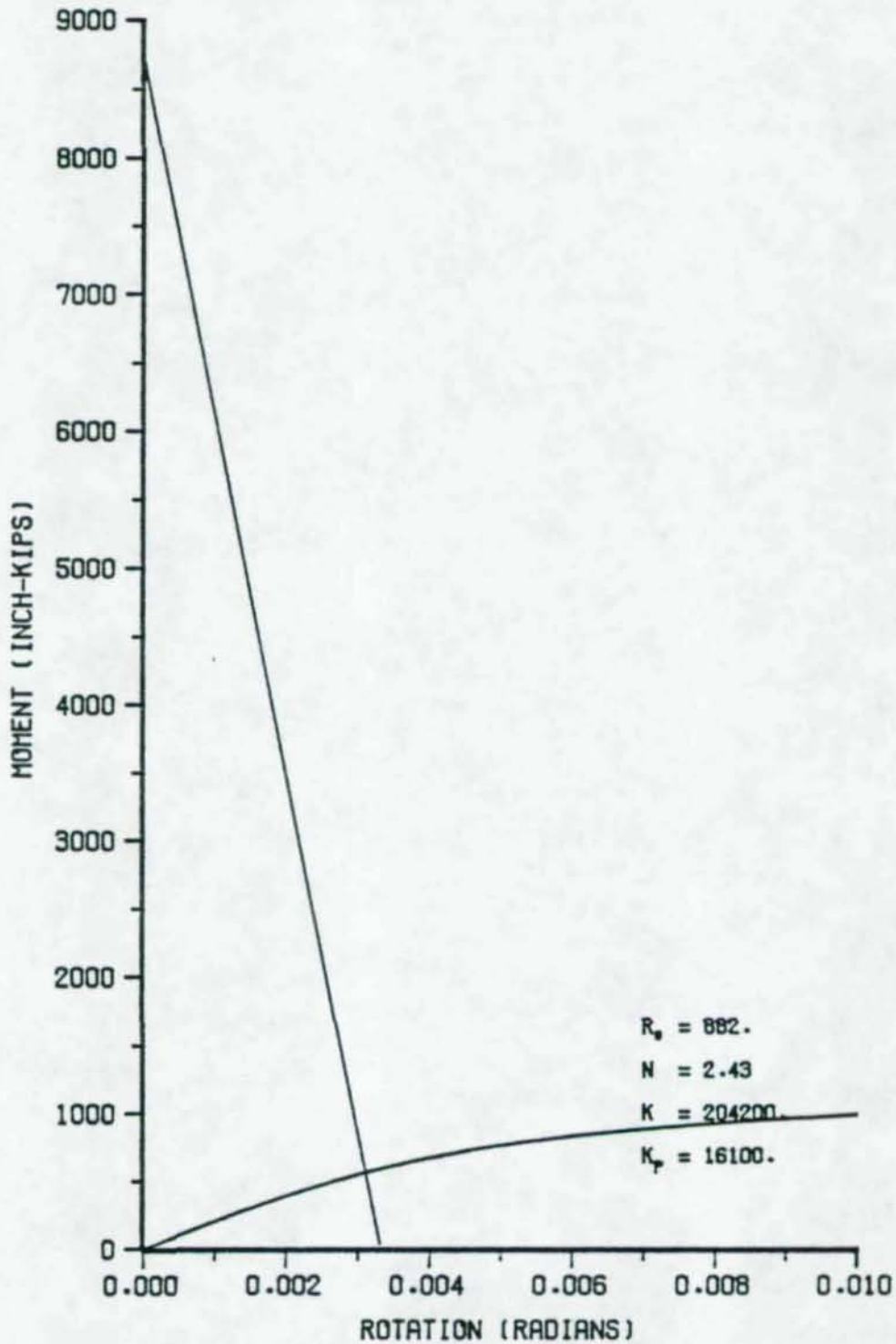

MOMENT ROTATION CURVE WITH BEAM LINE FOR WELDED CONNECTION

DOUBLE ANGLES ARE L 4 X 3 X 1/2 X 24 INCHES

BEAM: W36 X 170 LOAD: 21.8 KIPS/FT LENGTH: 20 FEET

Figure 57.

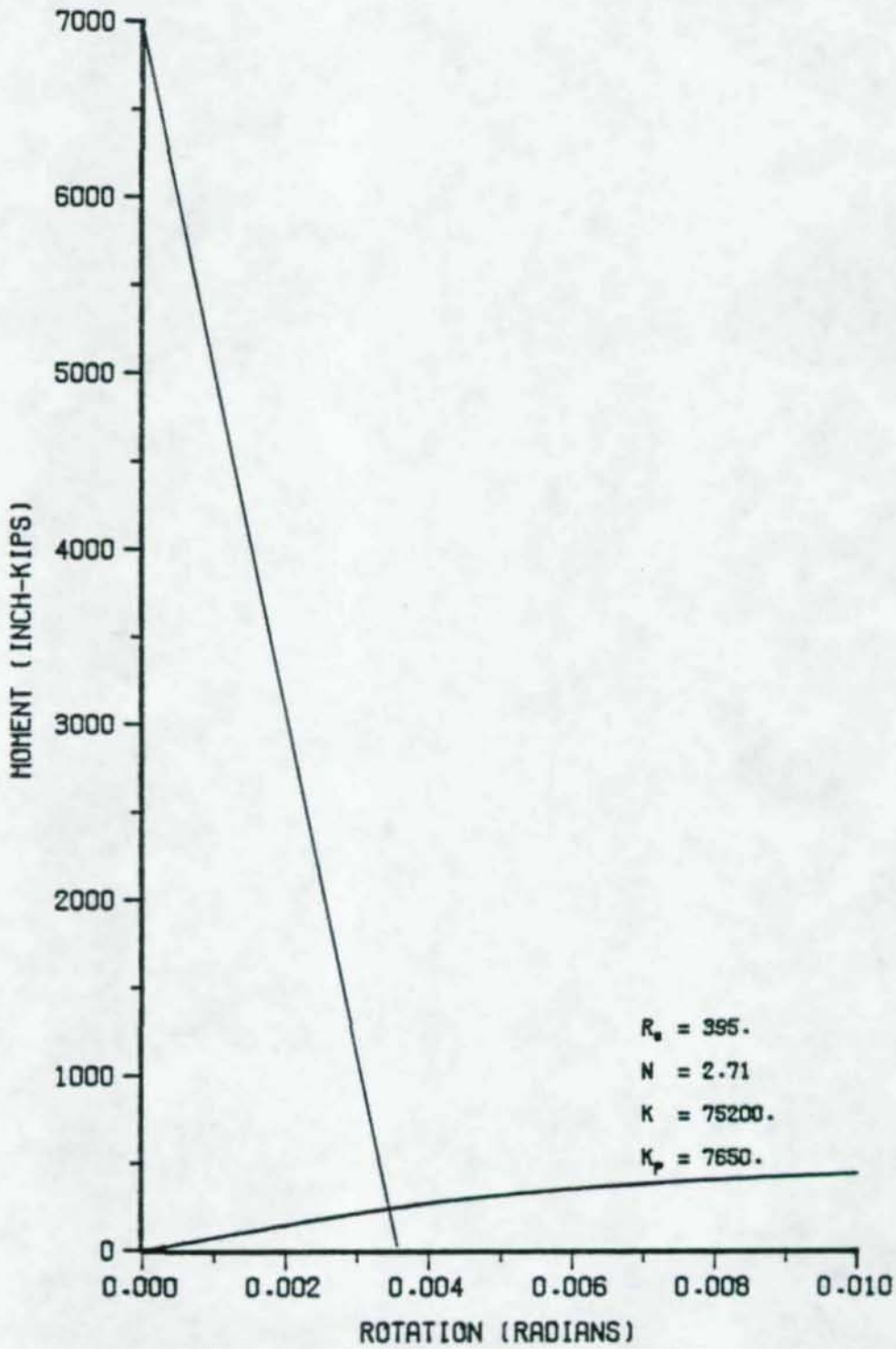

MOMENT ROTATION CURVE WITH BEAM LINE FOR WELDED CONNECTION  
DOUBLE ANGLES ARE L 4 X 3 X 3/8 X 24 INCHES  
BEAM: W36 X 135 LOAD: 17.4 KIPS/FT LENGTH: 20 FEET

Figure 58.

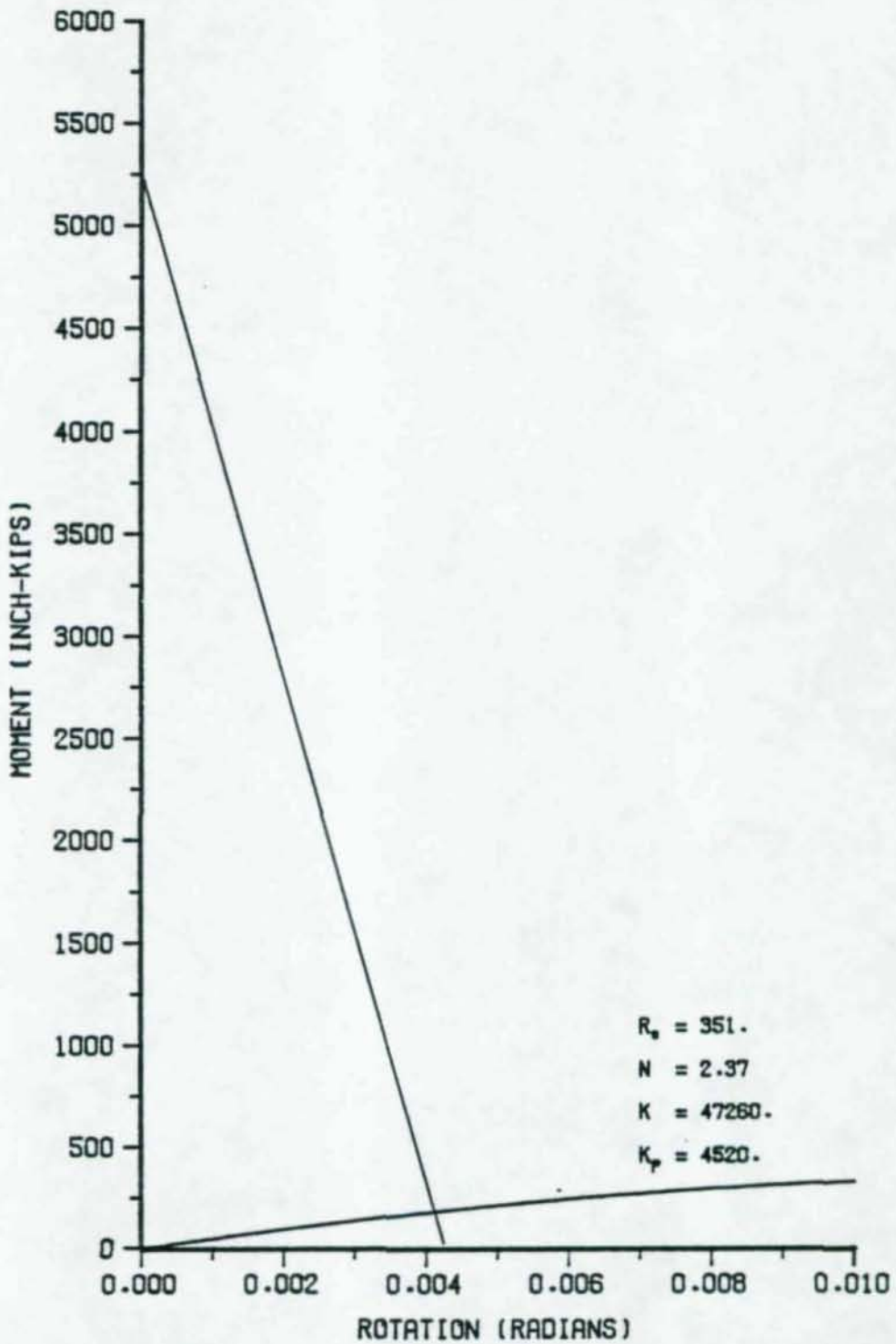

MOMENT ROTATION CURVE WITH BEAM LINE FOR WELDED CONNECTION  
DOUBLE ANGLES ARE L 4 X 3 X 5/16 X 24 INCHES  
BEAM: W30 X 116 LOAD: 13.1 KIPS/FT LENGTH: 20 FEET

Figure 59.

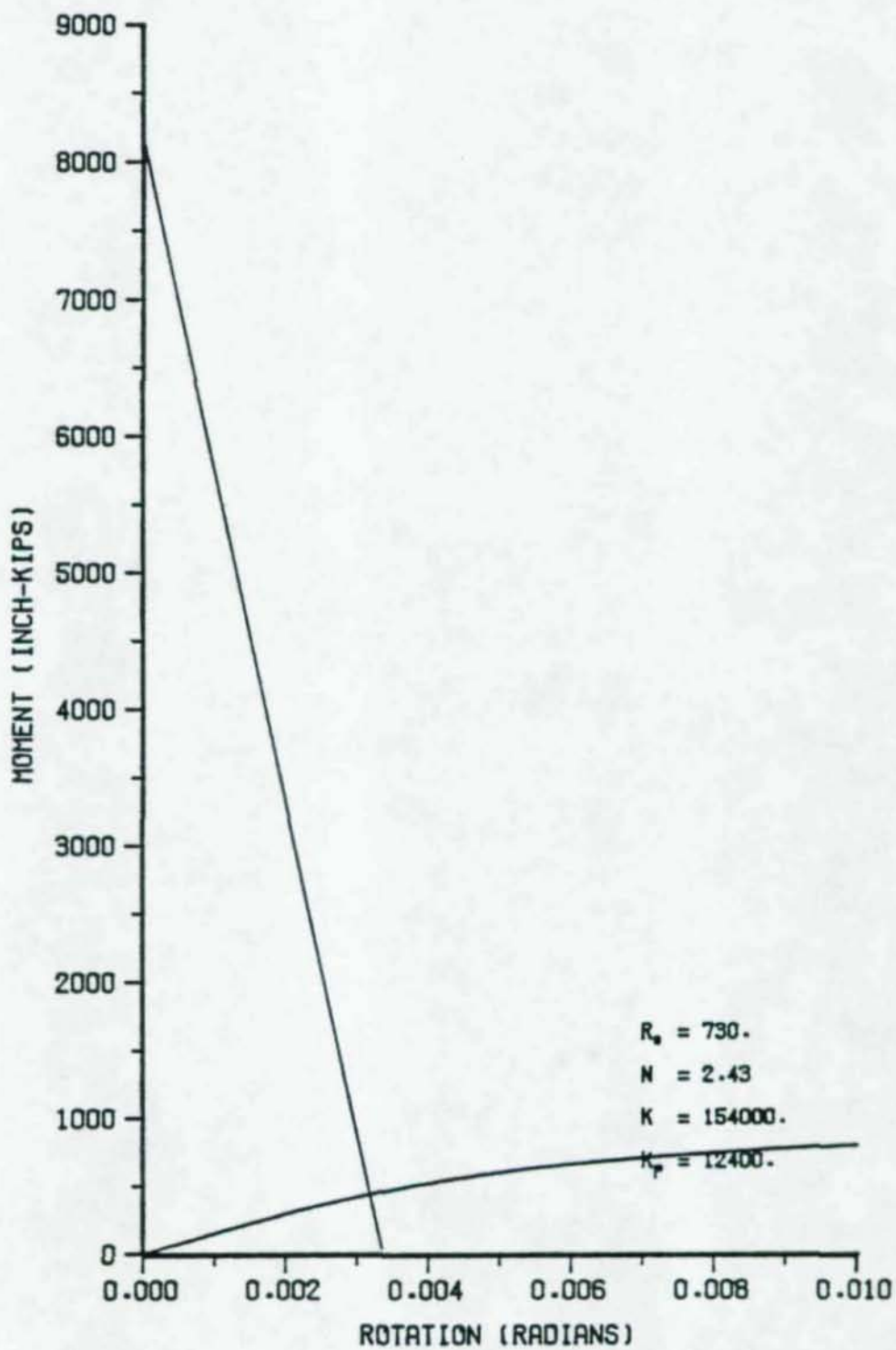

MOMENT ROTATION CURVE WITH BEAM LINE FOR WELDED CONNECTION  
DOUBLE ANGLES ARE L 4 X 3 X 1/2 X 22 INCHES  
BEAM: W36 X 160 LOAD: 20.4 KIPS/FT LENGTH: 20 FEET

Figure 60.

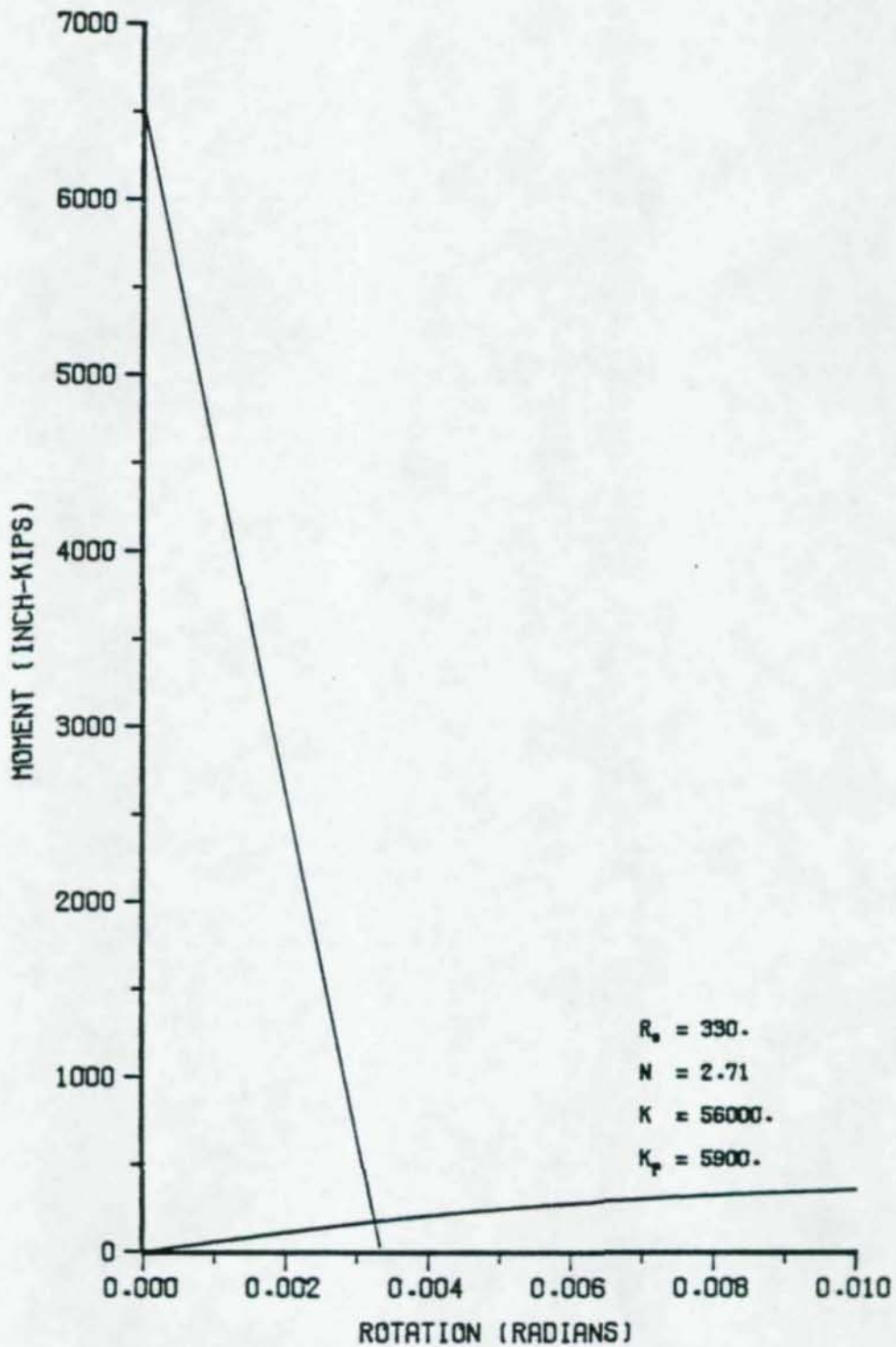

MOMENT ROTATION CURVE WITH BEAM LINE FOR WELDED CONNECTION

DOUBLE ANGLES ARE L 4 X 3 X 3/8 X 22 INCHES

BEAM: W36 X 135 LOAD: 16.3 KIPS/FT LENGTH: 20 FEET

Figure 61.

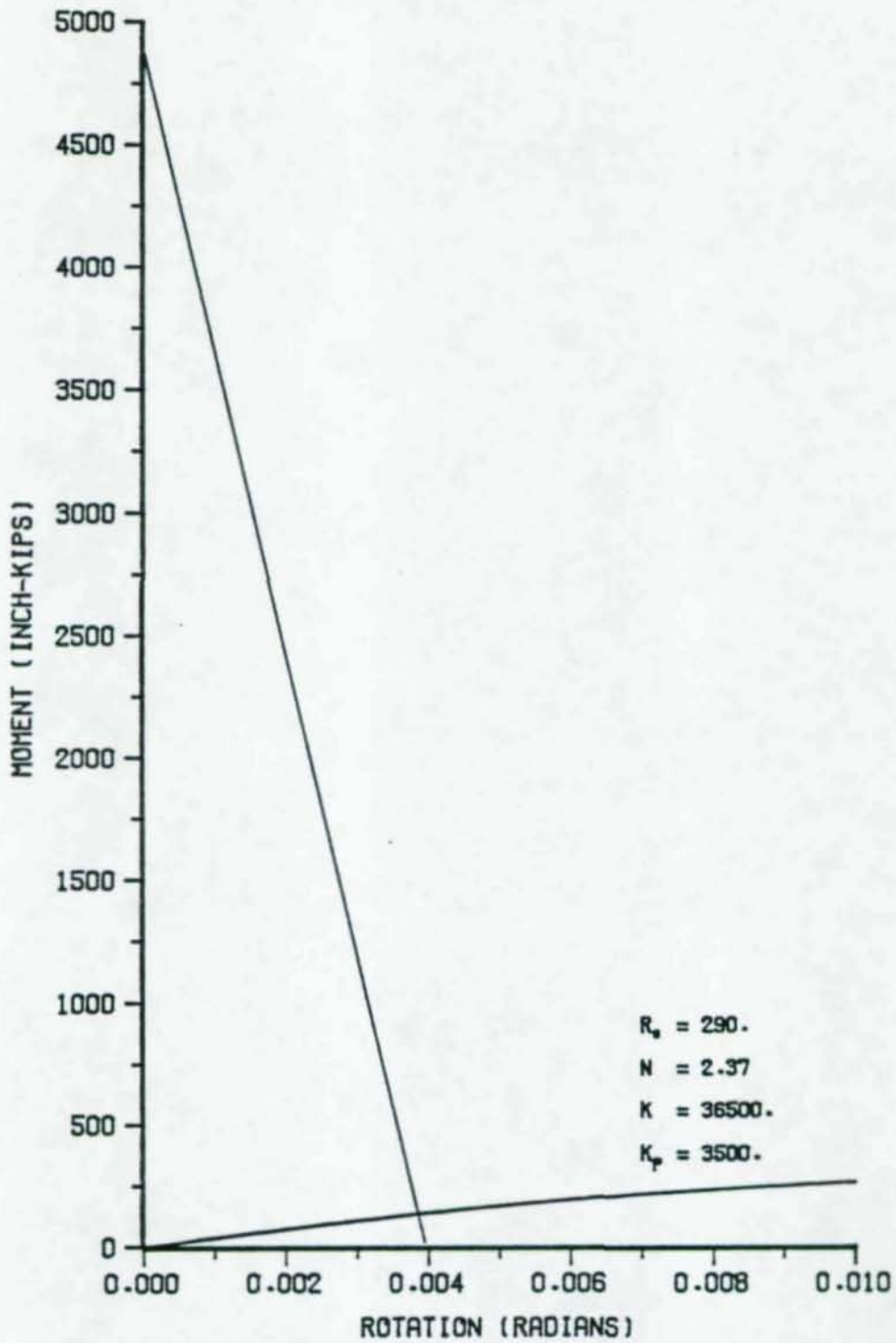

MOMENT ROTATION CURVE WITH BEAM LINE FOR WELDED CONNECTION

DOUBLE ANGLES ARE L 4 X 3 X 5/16 X 22 INCHES

BEAM: W30 X 116 LOAD: 12.2 KIPS/FT LENGTH: 20 FEET

Figure 62.

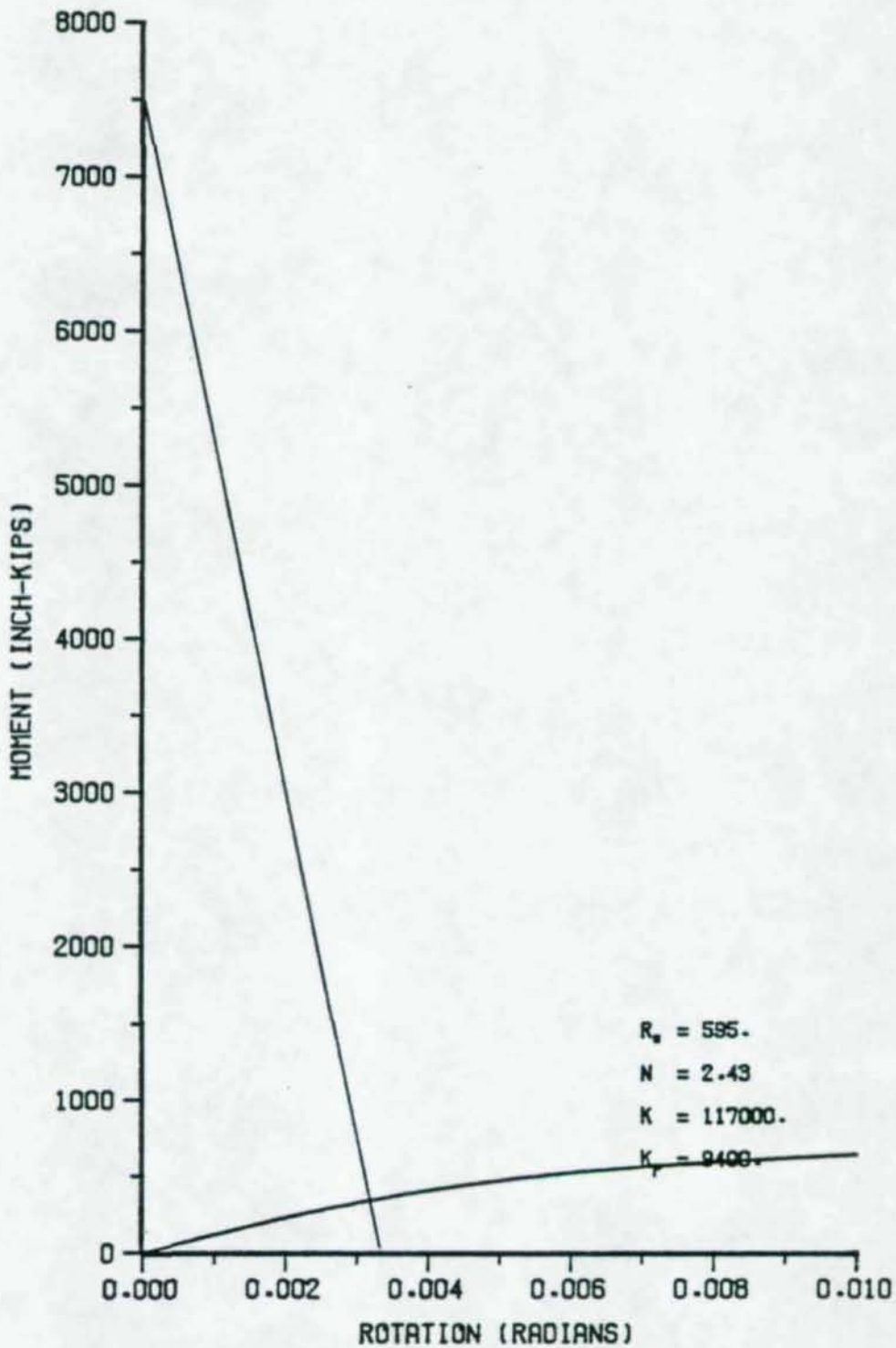

MOMENT ROTATION CURVE WITH BEAM LINE FOR WELDED CONNECTION  
DOUBLE ANGLES ARE L 4 X 3 X 1/2 X 20 INCHES  
BEAM: W36 X 150 LOAD: 18.8 KIPS/FT LENGTH: 20 FEET

Figure 63.



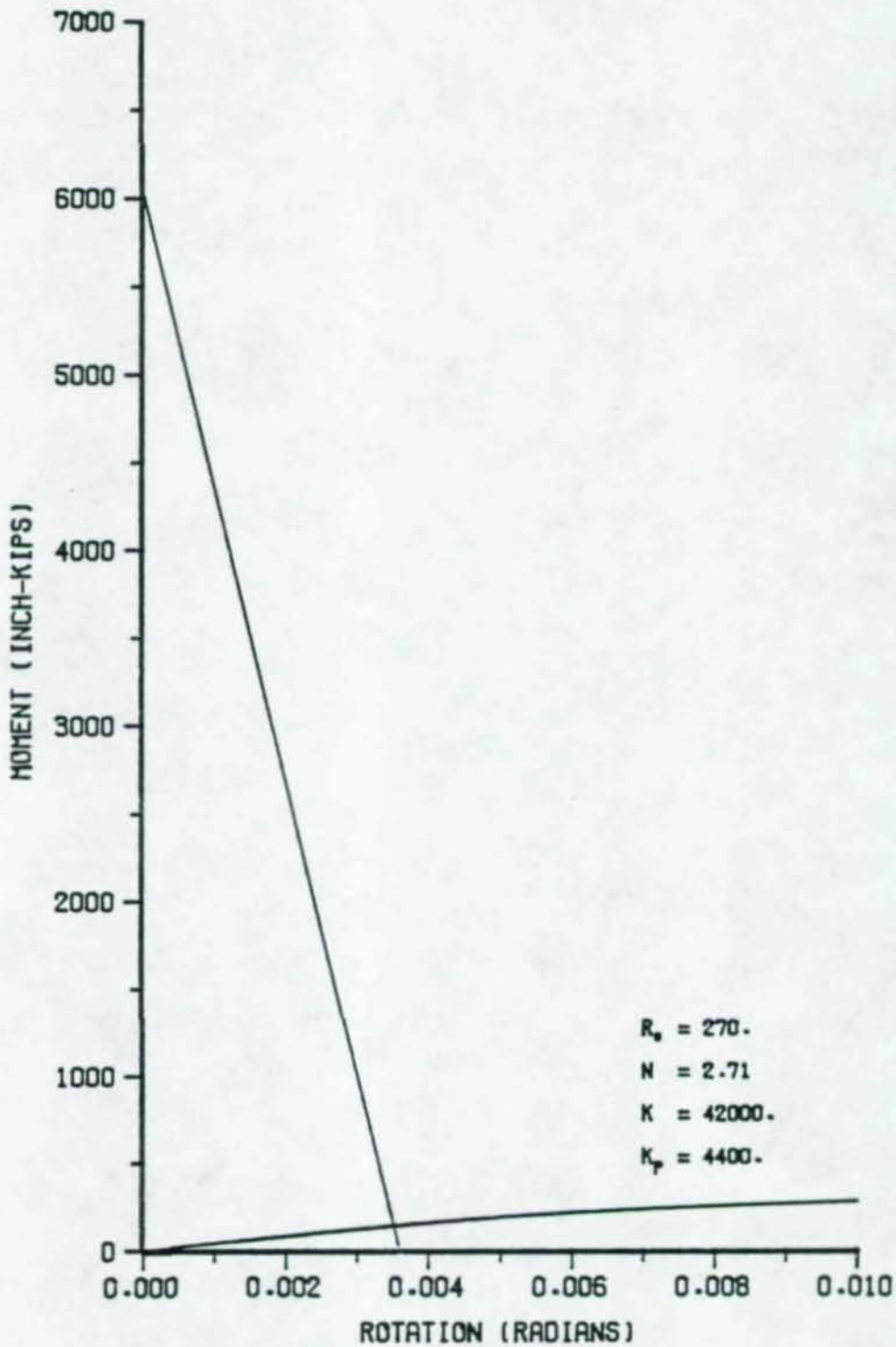

MOMENT ROTATION CURVE WITH BEAM LINE FOR WELDED CONNECTION  
DOUBLE ANGLES ARE L 4 X 3 X 3/8 X 20 INCHES  
BEAM: W33 X 130 LOAD: 15.1 KIPS/FT LENGTH: 20 FEET

Figure 64.

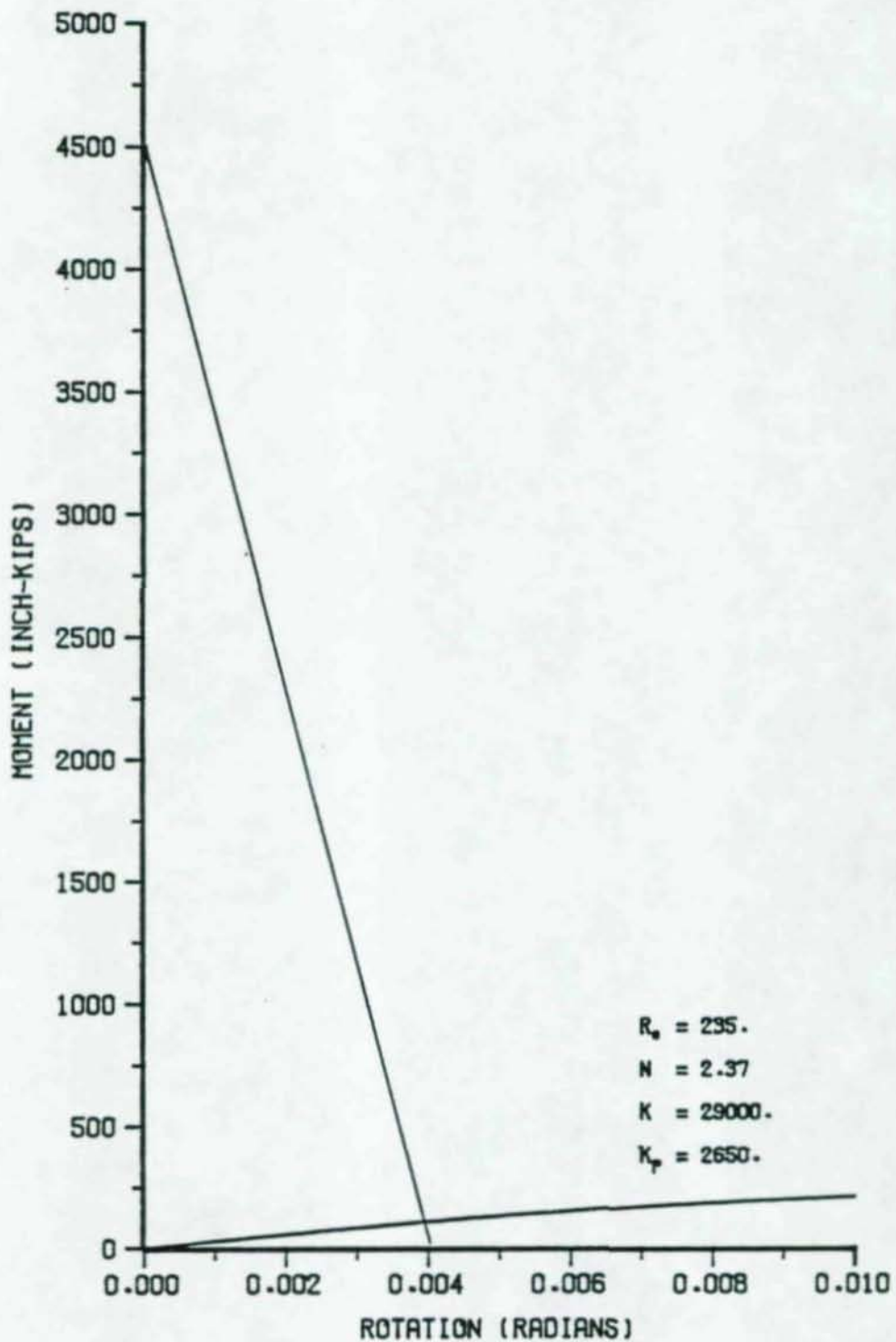

MOMENT ROTATION CURVE WITH BEAM LINE FOR WELDED CONNECTION  
DOUBLE ANGLES ARE L 4 X 3 X 5/16 X 20 INCHES  
BEAM: W30 X 108 LOAD: 11.3 KIPS/FT LENGTH: 20 FEET

Figure 65.

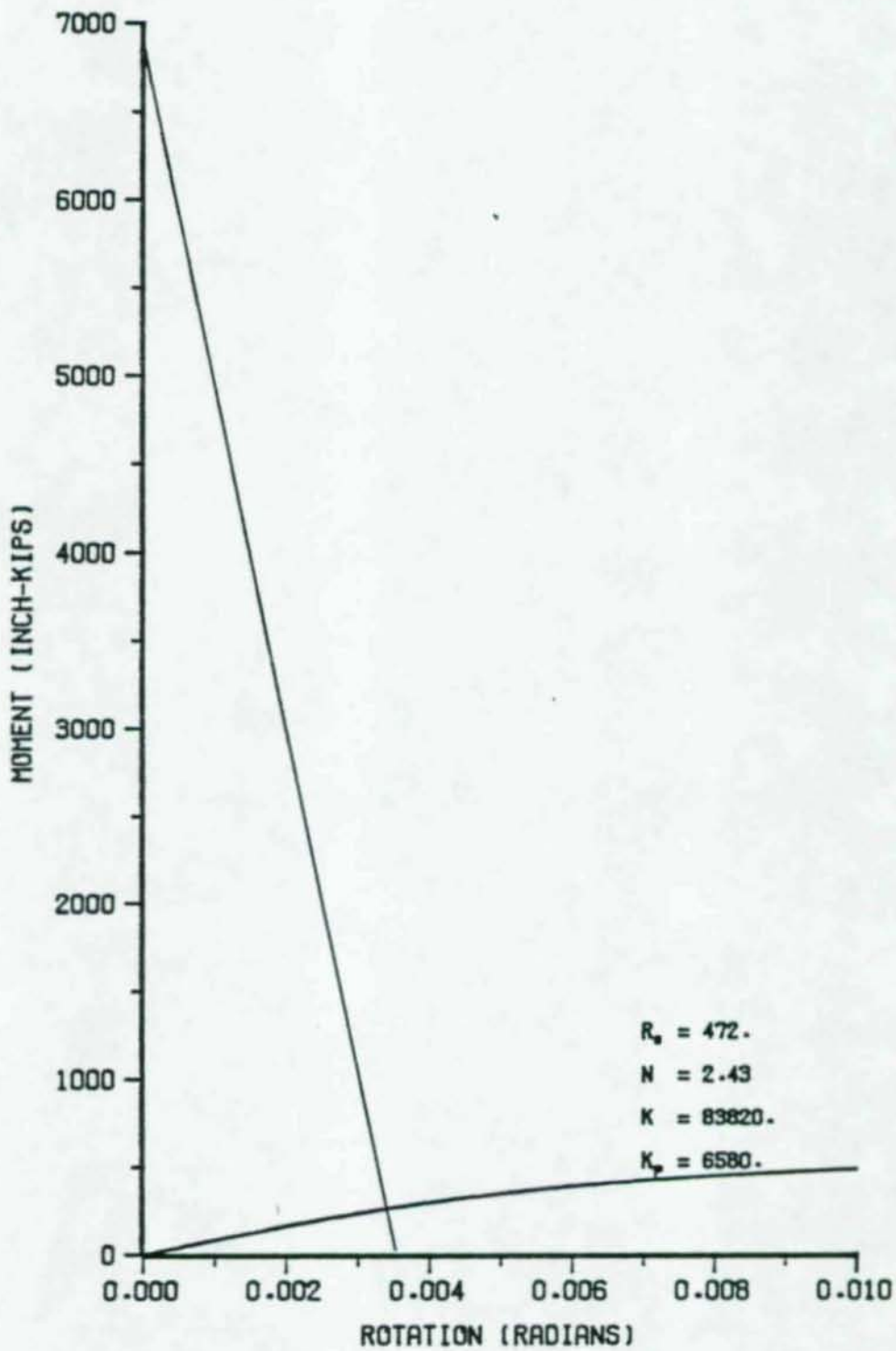

MOMENT ROTATION CURVE WITH BEAM LINE FOR WELDED CONNECTION  
DOUBLE ANGLES ARE L 4 X 3 X 1/2 X 18 INCHES  
BEAM: W36 X 135 LOAD: 17.2 KIPS/FT LENGTH: 20 FEET

Figure 66.

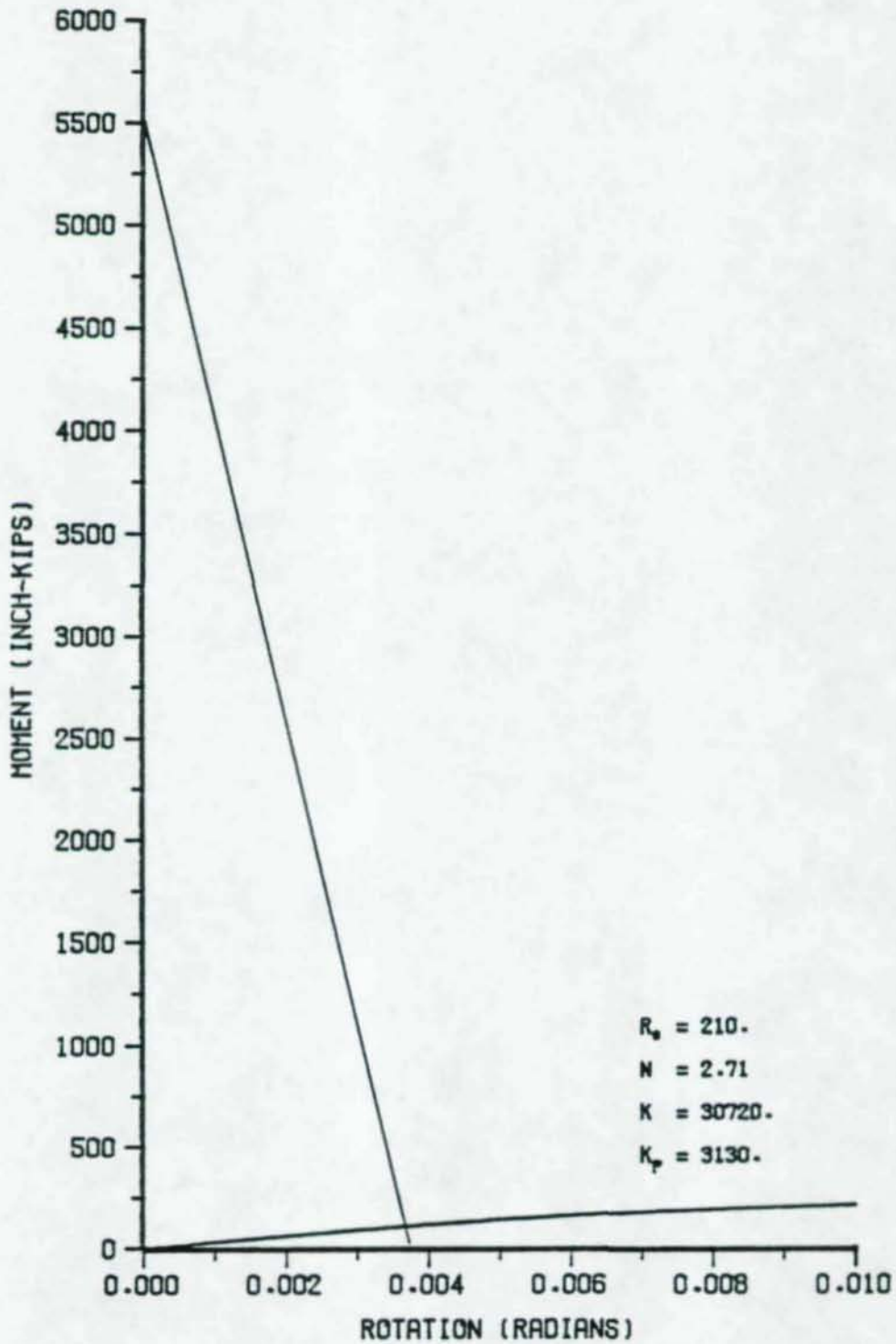

MOMENT ROTATION CURVE WITH BEAM LINE FOR WELDED CONNECTION  
DOUBLE ANGLES ARE L 4 X 3 X 3/8 X 18 INCHES  
BEAM: W33 X 118 LOAD: 13.8 KIPS/FT LENGTH: 20 FEET

Figure 67.

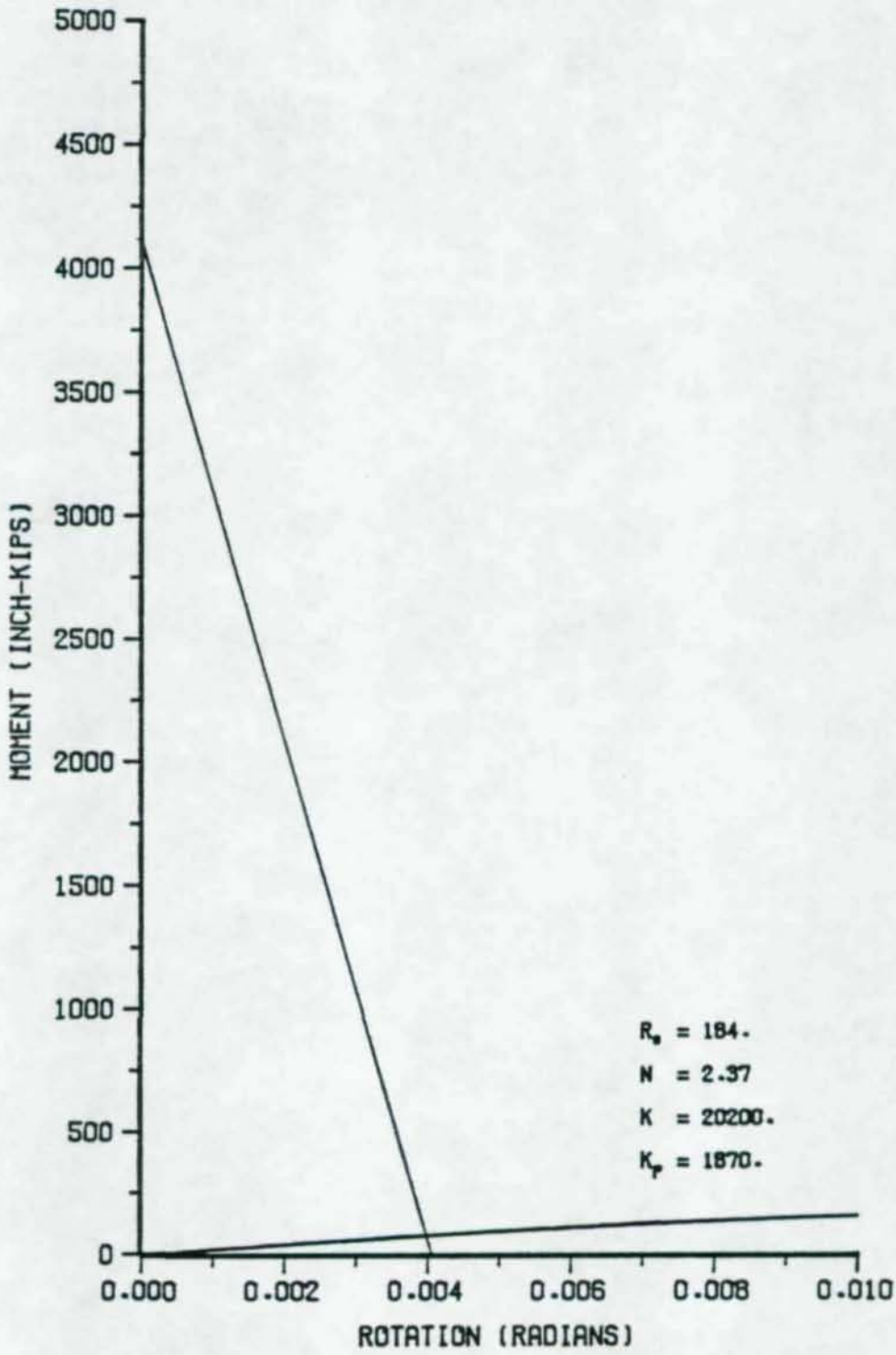

MOMENT ROTATION CURVE WITH BEAM LINE FOR WELDED CONNECTION  
DOUBLE ANGLES ARE L 4 X 3 X 5/16 X 18 INCHES  
BEAM: W30 X 99 LOAD: 10.3 KIPS/FT LENGTH: 20 FEET

Figure 68.

TABLE 10 RESISTING MOMENT AND ROTATION AT END CONNECTION  
FOR VARIOUS WELDED CONNECTION GEOMETRIES

<u>Connection Geometry</u>	<u>End Rotation (radians)</u>	<u>M<sub>conn</sub> (in.-kip)</u>	<u>M<sub>fixed</sub> (in.-kip)</u>	<u>M<sub>conn</sub> / M<sub>fixed</sub> (%)</u>
L-4 x 3 x 1/2 x 32	.002994	1199	11076	10.8
L-4 x 3 x 3/8 x 32	.003176	504	8844	5.7
L-4 x 3 x 5/16 x 32	.003232	337	6636	5.1
L-4 x 3 x 1/2 x 30	.003123	1034	10476	9.9
L-4 x 3 x 3/8 x 30	.003270	429	8400	5.1
L-4 x 3 x 5/16 x 30	.003565	300	6276	4.8
L-4 x 3 x 1/2 x 28	.003202	874	9924	8.8
L-4 x 3 x 3/8 x 28	.003344	362	7920	4.6
L-4 x 3 x 5/16 x 28	.003411	238	5964	4.0
L-4 x 3 x 1/2 x 26	.003066	699	9360	7.5
L-4 x 3 x 3/8 x 26	.003184	283	7476	3.8
L-4 x 3 x 5/16 x 26	.003656	207	5604	3.7
L-4 x 3 x 1/2 x 24	.003107	564	8724	6.5
L-4 x 3 x 3/8 x 24	.003445	241	6960	3.5
L-4 x 3 x 5/16 x 24	.004104	181	5244	3.5
L-4 x 3 x 1/2 x 22	.003167	441	8160	5.4
L-4 x 3 x 3/8 x 22	.003254	174	6516	2.7
L-4 x 3 x 5/16 x 22	.003851	134	4884	2.7
L-4 x 3 x 1/2 x 20	.003177	341	7524	4.5
L-4 x 3 x 3/8 x 20	.003516	141	6036	2.3
L-4 x 3 x 5/16 x 20	.003947	109	4524	2.4
L-4 x 3 x 1/2 x 18	.003394	262	6876	3.8
L-4 x 3 x 3/8 x 18	.003669	108	5520	2.0
L-4 x 3 x 5/16 x 18	.004052	78	4116	1.9

## WELD DESIGN AND COMPARISON

AISC Table IV uses an ultimate strength criterion (instantaneous center solutions for eccentric loads on weld groups) to design Weld A. Weld B, however, is designed in AISC Table IV using traditional vector (elastic) analysis.

In designing Weld A and Weld B for comparison purposes, both the elastic analysis and the ultimate strength analysis will be used. Although the elastic analysis is not required for comparison for Weld A, it will be performed to gain a physical appreciation for the stress state on the welds. Weld B, however, requires the elastic analysis for comparison, but will also be designed using the more realistic ultimate strength analysis.

### Weld "A" Design: Elastic Analysis

To design the weld connecting the angle clips to the beam web (Weld A), both the shear and the connection moment must be considered. Instead of considering the shear force acting at the centroid of the weld together with an applied moment, the vertical shear may be transferred a distance  $e = M/V$  from the weld centroid as shown in Figure 69. This produces a statically equivalent loading and the weld may be designed by considering the eccentric shear.

The allowable stresses for shear on the effective

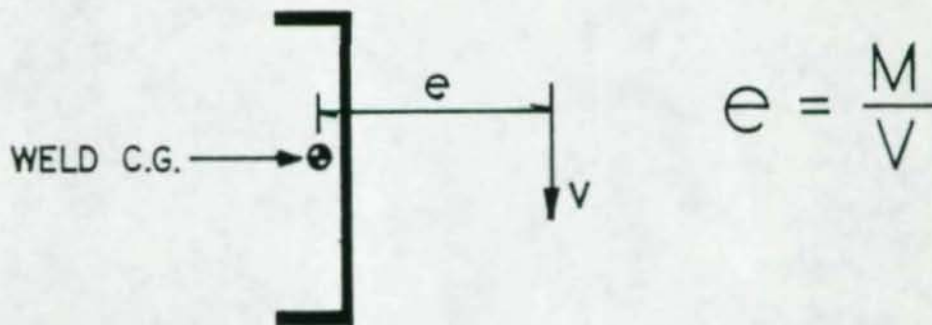
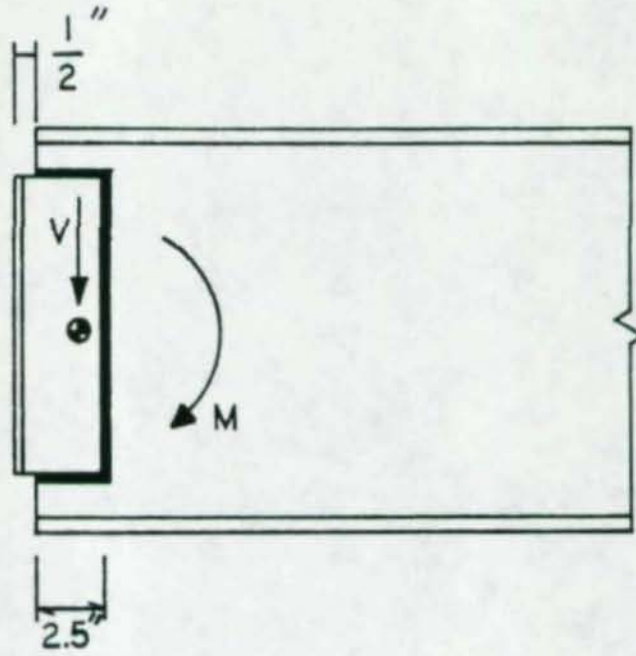

Figure 69. Shear force transfer for Weld A design.



area of all welds is equal to 0.30 times the electrode tensile strength. The electrode tensile strength for the welds involved in this research and for the welds in Table IV of the AISC Manual is equal to 70 ksi. The effective area of fillet welds is equal to the product of the effective throat dimension times the length of the weld [6]. The effective throat dimension of a fillet weld is equal to 0.707 times the weld size, "a" [6]. The allowable shear stress per unit length of weld is therefore equal to the following.

$$\begin{aligned} f_{\text{allowable}} &= (0.30)(70 \text{ ksi})(0.707)(a/16) \\ &= 0.928a \quad \text{kips/inch} \end{aligned}$$

Here, a is the weld size in sixteenths of an inch.

The actual stresses that occur on Weld A of Figure 69 are caused by shear and by moment. The stress per unit length of weld caused by the direct shear force V is the following.

$$f' = V/(\text{length of weld}) \quad \text{kips/inch}$$

The stress per unit length of weld caused by the torsional moment is the following.

$$f'' = Tr/J \quad \text{kips/inch}$$

In the above equation, T is the torsional moment and is equal to the connection moment M. The polar moment of inertia is J, and r is the radial distance from the weld centroid to the point of stress computation.

In order to derive useful expressions for the polar moment of inertia and the location of the centroid of the weld, the welds are treated as lines ignoring the weld thick-

ness (weld size "a") of the welds. For the geometry of Weld A shown in Figure 70, the location of the centroid is given by the following expression.

$$X_{c.g.} = b^2 / (2b + d)$$

The polar moment of inertia of the weld geometry shown in Figure 70 is given by the following expression.

$$\begin{aligned} J &= I_p = I_x + I_y \\ &= I_{xx} + (\text{Area})(d_y)^2 + I_{yy} + (\text{Area})(d_x)^2 \\ J &= \{(8b^3 + 6bd^2 + d^3)/12\} - b^4/(2b + d) \end{aligned}$$

#### Weld "A" Design Example: Elastic Analysis

Given: W36 x 210 beam with a uniform load of 27.7 kips/ft  
 L = 20 feet, t(web) = .83 inch  
 Double angles are 2-L4 x 3 x 1/2 x 32 inches

#### Solution:

$$\begin{aligned} V &= wL/2 = (27.7 \text{ kips/ft})(20 \text{ ft})/2 = 277 \text{ kips} \\ M &= 1199 \text{ inch-kips (see Table 10)} \\ e &= M/V = 1199/277 = 4.33 \text{ inches} \\ J &= \{8(2.5)^3 + 6(2.5)(32)^2 + (32)^3\}/12 \\ &\quad - (2.5)^4/(2(2.5) + 32) \\ J &= 4020 \text{ inch}^3 \\ X_{c.g.} &= (2.5)^2/(2(2.5) + 32) = 0.17 \text{ inches} \\ f_x' &= 0 \\ f_y' &= V/(2b + d) = 277/(5 + 32) = 7.49 \text{ kips/inch} \\ f'' &= T_r/J \quad T = M = 1199 \text{ inch-kips} \end{aligned}$$



$$\bar{x} = \frac{b^2}{2b + d}$$

$$J = \frac{8b^3 + 6bd^2 + d^3}{12} - \frac{b^4}{2b + d}$$

Figure 70. Center of gravity and polar moment of inertia for weld geometry shown.

$$f_{x''} = (1199)(32/2)/4020 = 4.77 \text{ kips/inch}$$

$$f_{y''} = (1199)(2.5 - 0.17)/4020 = 0.69 \text{ kips/inch}$$

$$f = [(f_{x'} + f_{x''})^2 + (f_{y'} + f_{y''})^2]^{1/2}$$

$$f = [(0 + 4.77)^2 + (7.49 + 0.69)^2]^{1/2}$$

$$f = 9.47 \text{ kips/inch}$$

This actual stress must be less than or equal to the allowable stress.

$$9.47 = 0.928a \quad \text{or} \quad a = 10.2 \text{ sixteenths}$$

The load is resisted by two welds, one on either side of the beam web. Therefore:

$$a = (10.2/2)/16 = 5.1/16 \text{ inch}$$

$$\text{or} \quad \underline{\text{Weld size } a = 5/16 \text{ inch}}$$

Check minimum web thickness

Shear stress on base metal shall not exceed 0.40 times yield stress of base metal:

$$(0.928)(10) = (0.40)(36 \text{ ksi})t$$

$$t_{\text{web min}} = 0.64 \text{ inch}$$

Weld "A" Design Example: Ultimate Strength Analysis

Given: same information as elastic Weld A example.

Solution:

The solution involves AISC Table XXIV page 4-81.

$$e = 4.33 \text{ inches} = a_1$$

$$a = 4.33/32 = 0.135$$

$$k_1 = 2.5 \text{ inches}$$

$$k = 2.5/32 = 0.078$$

Interpolating from AISC Table XXIV gives  $C = 0.876$

$$P = 2 \times CDl$$

$P$  = capacity of weld

$C$  = eccentric load coefficient

$D$  = weld size in sixteenths of an inch

$l$  = length of weld

The factor of 2 is for welds on both sides of beam web.

$$P = 2 \times (0.876)(5)(32)$$

$$P = \underline{280 \text{ kips}}$$

Results summarized in Table 11 show that the sizes and capacities of Weld A for different connection geometries obtained by using the procedures outlined in this research with those given in the AISC Manual in Table IV are essentially identical.

#### Weld "B" Design: Elastic Analysis

To design the weld that connects the outstanding angle to the column flange (Weld B), the effects of shear and moment are considered. Thus Weld B is designed for shear and bending by considering the shear force  $V$  acting at a distance  $(a + e)$  from Weld B as shown in Figure 6. This requires that Weld B be designed to resist a bending moment  $M = V \times (a + e)$ .

For the purpose of comparison, instead of designing the size of Weld B and comparing this to the AISC Manual,

TABLE 11 WELD "A" COMPARISON

Connection Geometry	e (inch)	Weld A Size (inch)		Weld A Capacity (kips)	
		AISC Table IV	Research (Elastic)	AISC Table IV	Research (Ult Strength)
4x3x1/2x32	4.33	5/16	5/16	277	280
4x3x3/8x32	2.28	1/4	1/4	221	227
4x3x5/16x32	2.03	3/16	3/16	166	170
4x3x1/2x30	3.95	5/16	5/16	262	265
4x3x3/8x30	2.04	1/4	1/4	210	213
4x3x5/16x30	1.91	3/16	3/16	157	159
4x3x1/2x28	3.52	5/16	5/16	248	250
4x3x3/8x28	1.83	1/4	1/4	198	200
4x3x5/16x28	1.60	3/16	3/16	149	150
4x3x1/2x26	2.99	5/16	5/16	234	235
4x3x3/8x26	1.51	1/4	1/4	187	186
4x3x5/16x26	1.48	3/16	3/16	140	140
4x3x1/2x24	2.59	5/16	5/16	218	219
4x3x3/8x24	1.39	1/4	1/4	174	172
4x3x5/16x24	1.38	3/16	3/16	131	129
4x3x1/2x22	2.16	5/16	5/16	204	205
4x3x3/8x22	1.07	1/4	1/4	163	162
4x3x5/16x22	1.10	3/16	3/16	122	122
4x3x1/2x20	1.81	5/16	5/16	188	190
4x3x3/8x20	0.93	1/4	1/4	151	151
4x3x5/16x20	0.96	3/16	3/16	113	113
4x3x1/2x18	1.52	5/16	5/16	172	175
4x3x3/8x18	0.78	1/4	1/4	138	139
4x3x5/16x18	0.76	3/16	3/16	103	104

the capacity of Weld B for the given weld size is determined and compared to the capacities given in Table IV of the AISC Manual (This procedure is used because the beams and loadings have already been selected for Weld A to compare with AISC Table IV).

The actual stresses that occur on Weld B of Figure 6 are caused by a shear force and a bending moment. The stress per unit length of weld caused by the direct shear force  $V$  is the same as for Weld A.

$$f' = V / (\text{length of weld}) \quad \text{Kips/inch}$$

The stress per unit length of weld caused by the bending moment is determined from the flexure formula.

$$f'' = Mc/I \quad \text{Kips/inch}$$

In the above equation,  $M$  is the bending moment which may be calculated from

$$M = V \times (a + e)$$

where  $V$  is the capacity of Weld B, " $a$ " is the distance from Weld B to the centroid of Weld A, and " $e$ " is the eccentricity defined as the distance from the centroid of Weld A to the point where the shear force  $V$  acts. The moment of inertia of the weld geometry is  $I$ , and " $c$ " is the distance (perpendicular to the axis of bending) to the point of stress computation.

Again, the welds are treated as lines ignoring the thickness (weld size " $a$ ") of the welds. The necessary equations for the stresses per unit length of weld are given in Figure 71.

Weld "B" Design Example: Elastic Analysis

Given: W36 x 210 beam, length = 20 feet,  
 $t(\text{web}) = .83$  inch, Weld B size =  $3/8$  inch.

Solution:

$$f_y' = V/2L = V/2(32) = 0.0156 V \text{ kips/inch}$$

$$f_x'' = 3V(a + e)/L^2$$

$$e = 4.33 \text{ inches (Table 11)}$$

$$a = 3 - 0.17 = 2.83 \text{ inches}$$

$$L = 32 \text{ inches}$$

$$f_x'' = 3V(2.83 + 4.33)/32^2 = 0.02098V \text{ kips/inch}$$

$$f = [(f_y')^2 + (f_x'')^2]^{1/2}$$

$$f = [(0.0156 V)^2 + (0.02098 V)^2]^{1/2}$$

$$f = 0.02614 V \text{ kips/inch}$$

This stress must be less than or equal to the allowable stress.

$$0.02614 V = .928(6)$$

$$\underline{V = 213 \text{ kips}}$$

Weld "B" Design Example: Ultimate Strength Analysis

Given: same information as elastic Weld B example.

Solution:

The solution involves AISC Table XIX page 4-76. Since this weld geometry is a special case ( $k = 0$ ), a graph of the eccentric load coefficients versus the parameter "a" has been plotted in Figure 72 as



an aid to interpolation.

$$P = CDl$$

P = capacity of weld

C = eccentric load coefficient

D = weld size in sixteenths of an inch

l = length of weld

$$a_1 = (a + e) = 2.83 + 4.33 = 7.16 \text{ inches}$$

$$a = 7.16/32 = 0.22$$

$$C = 1.325 \text{ (Figure 72)}$$

$$D = 3/8$$

$$l = 32$$

$$P = (1.325)(6)(32)$$

$$P = \underline{254 \text{ kips}}$$

In Table 12, the capacities of Weld B given in the AISC Table IV are compared with the capacities of Weld B determined using the methods outlined in this research.

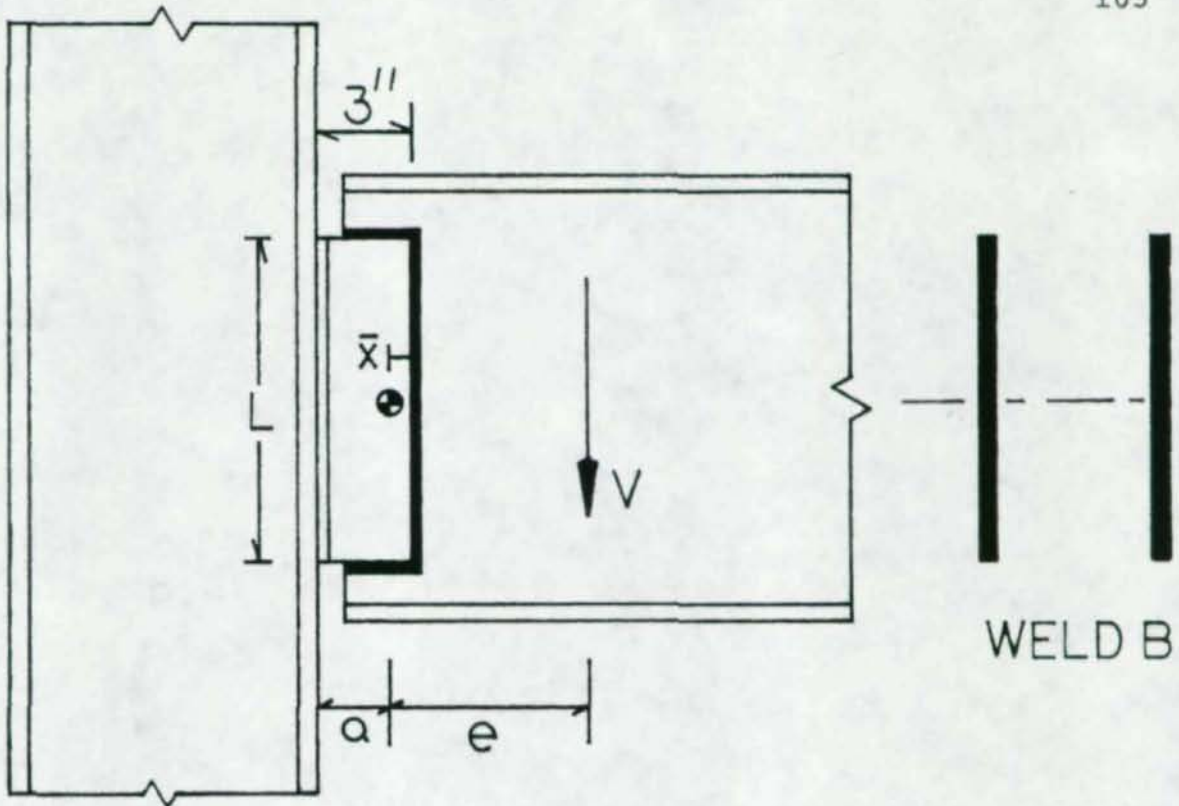

$$f' = \frac{V}{2L}$$

$$f'' = \frac{Mc}{I}$$

where

$$I = 2 \times (1/12) (1) (L)^3 = \frac{L^3}{6}$$

$$c = L/2$$

$$M = V \times (a + e)$$

$$a = 3 - \bar{x} \quad (\text{see Figure 70})$$

$$e = (\text{see Table 11})$$

$$f'' = \frac{3V(a + e)}{L^2}$$

Figure 71. Equations for computing stresses on Weld B.

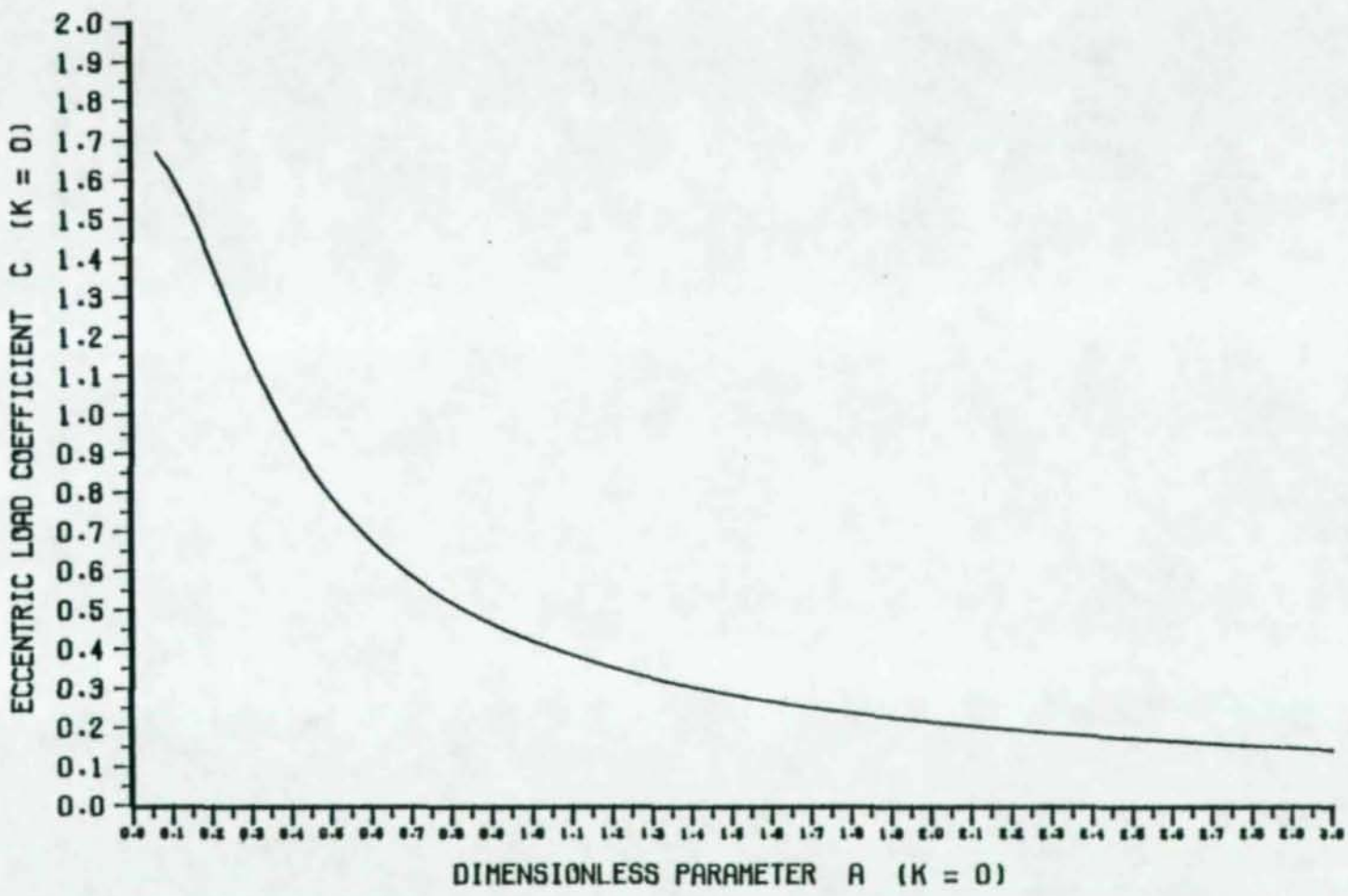

ECCENTRIC LOADS ON WELD GROUPS (AISC TABLE XIX PAGE 4-76)

Figure 72.

TABLE 12 WELD "B" COMPARISON

<u>Connection Geometry</u>	<u>e (inch)</u>	<u>a (inch)</u>	<u>Weld "B" Capacity (kips)</u>		
			<u>AISC Table IV</u>	<u>Research (Elastic)</u>	<u>Research (Ult Strength)</u>
4x3x1/2x32	4.33	2.83	326	213	254
4x3x3/8x32	2.28	2.83	271	214	237
4x3x5/16x32	2.03	2.83	217	175	192
4x3x1/2x30	3.95	2.82	302	198	238
4x3x3/8x30	2.04	2.82	251	199	222
4x3x5/16x30	1.91	2.82	201	162	177
4x3x1/2x28	3.52	2.81	278	185	222
4x3x3/8x28	1.83	2.81	231	184	206
4x3x5/16x28	1.60	2.81	185	151	166
4x3x1/2x26	2.99	2.80	254	173	206
4x3x3/8x26	1.51	2.80	211	171	192
4x3x5/16x26	1.48	2.80	169	137	153
4x3x1/2x24	2.59	2.78	230	160	191
4x3x3/8x24	1.39	2.78	191	154	175
4x3x5/16x24	1.38	2.78	153	123	140
4x3x1/2x22	2.16	2.77	206	146	175
4x3x3/8x22	1.07	2.77	171	141	161
4x3x5/16x22	1.10	2.77	137	112	128
4x3x1/2x20	1.81	2.75	181	131	157
4x3x3/8x20	0.93	2.75	152	124	142
4x3x5/16x20	0.96	2.75	121	99	114
4x3x1/2x18	1.52	2.73	157	116	140
4x3x3/8x18	0.78	2.73	131	108	126
4x3x5/16x18	0.76	2.73	105	87	100

## SIMPLIFYING ASSUMPTIONS AND PROCEDURES

Upon careful examination of the connection curve/beam line plots (Figures 45-68), it is apparent in nearly all cases that the connection moment is much less than the fixed end moment and that the beam line intersects the connection curve on the relatively flat or horizontal portion of the connection curve. Therefore, as an approximate simplifying analysis, the pinned end rotation, which can be easily calculated, can be used in conjunction with the connection curve to determine the restraining moment at the connection.

In order to simplify the procedure even more, the pinned end rotation angle should be in a more tangible form rather than in radians. This form involves the ratio  $L/d$  which is a ratio of the beam length to the beam depth. To do this, consider the following expression for the pinned end rotation.

$$\theta_{\text{SIMPLE}} = wL^3/24EI \quad (1)$$

To replace the uniform load,  $w$ , the following two expressions for the maximum moment in a simply supported beam and the maximum bending stress,  $f$ , associated with this maximum bending moment will be used.

$$M_{\text{MAX}} = wL^2/8 \quad (2)$$

$$f_{\text{MAX}} = M_{\text{MAX}}(d/2)/I \quad (3)$$

Solving equation (2) for the uniform load,  $w$ , in terms of the maximum moment and solving equation (3) for the maximum moment in terms of the maximum bending stress and substituting these results into equation (1) gives the following expression for the end rotation of a simply supported beam in terms of the  $L/d$  ratio for the beam.

$$\theta_{\text{SIMPLE}} = (2/3)(f/E)(L/d) \quad (4)$$

As done previously, if the bending stress is taken as 0.66 times the yield stress of the steel ( $f = 0.66 \times 36 \text{ ksi} = 24 \text{ ksi}$ ) and  $E = 30,000 \text{ ksi}$ , then equation (4) simplifies to the following.

$$\theta_{\text{SIMPLE}} = 0.000533 \times (L/d) \quad (5)$$

For a given range of  $L/d$  ratios (typically 6 to 20), equation (5) can be used in the Richard equation (Appendix A) to describe the end restraining moment for a particular connection. This was done for 1/4 inch, 5/16 inch, 3/8 inch, and 1/2 inch thick angles with an outstanding leg length of four inches and for 5/8 inch thick angles with an outstanding leg length of five inches for various lengths of connection (Figures 73-77). Table 13 gives the Richard parameters used to develop Figures 73-77.

This simplifies the procedure in that the determination of the restraining moment is now no longer directly dependent on the particular loading condition and on determining the intersection of the beam line with the connection

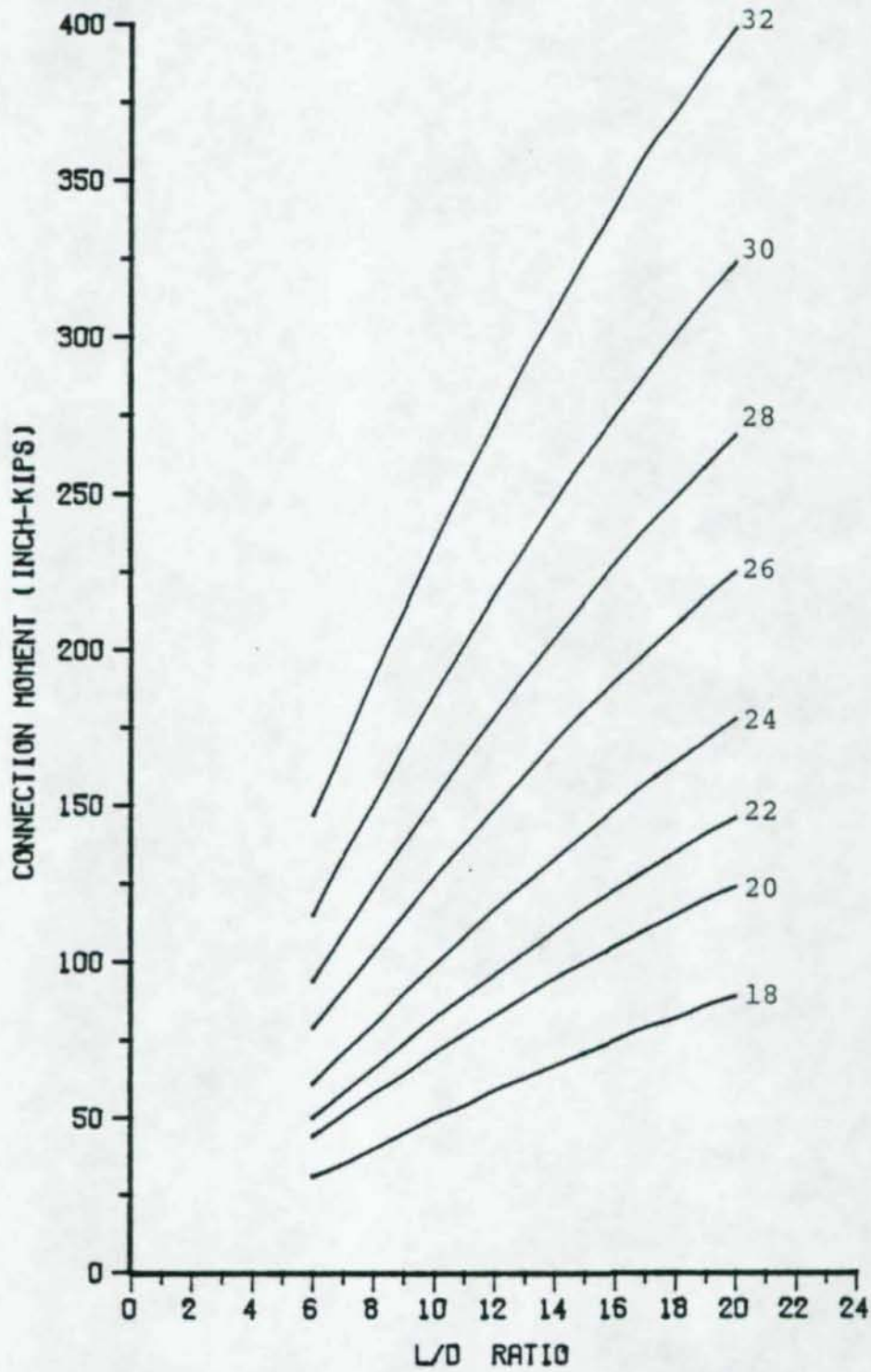

BEAM LENGTH TO BEAM DEPTH RATIO (L/D) VS CONNECTION MOMENT  
CURVES ARE FOR VARIOUS LENGTHS OF L 4 X 3 X 1/4 ANGLES

Figure 73.

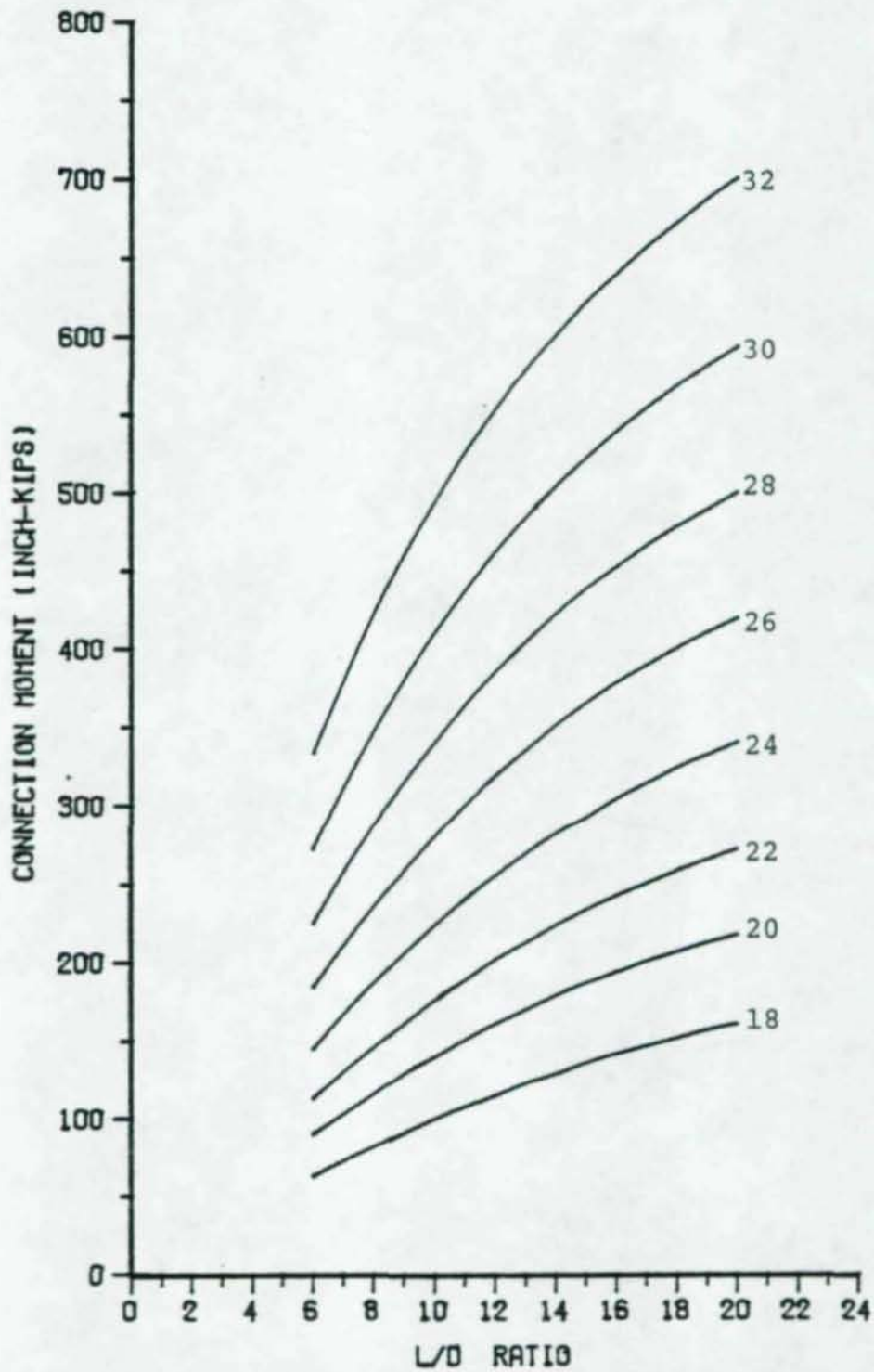

BEAM LENGTH TO BEAM DEPTH RATIO (L/D) VS CONNECTION MOMENT  
CURVES ARE FOR VARIOUS LENGTHS OF L 4 X 3 X 5/16 ANGLES

Figure 74.



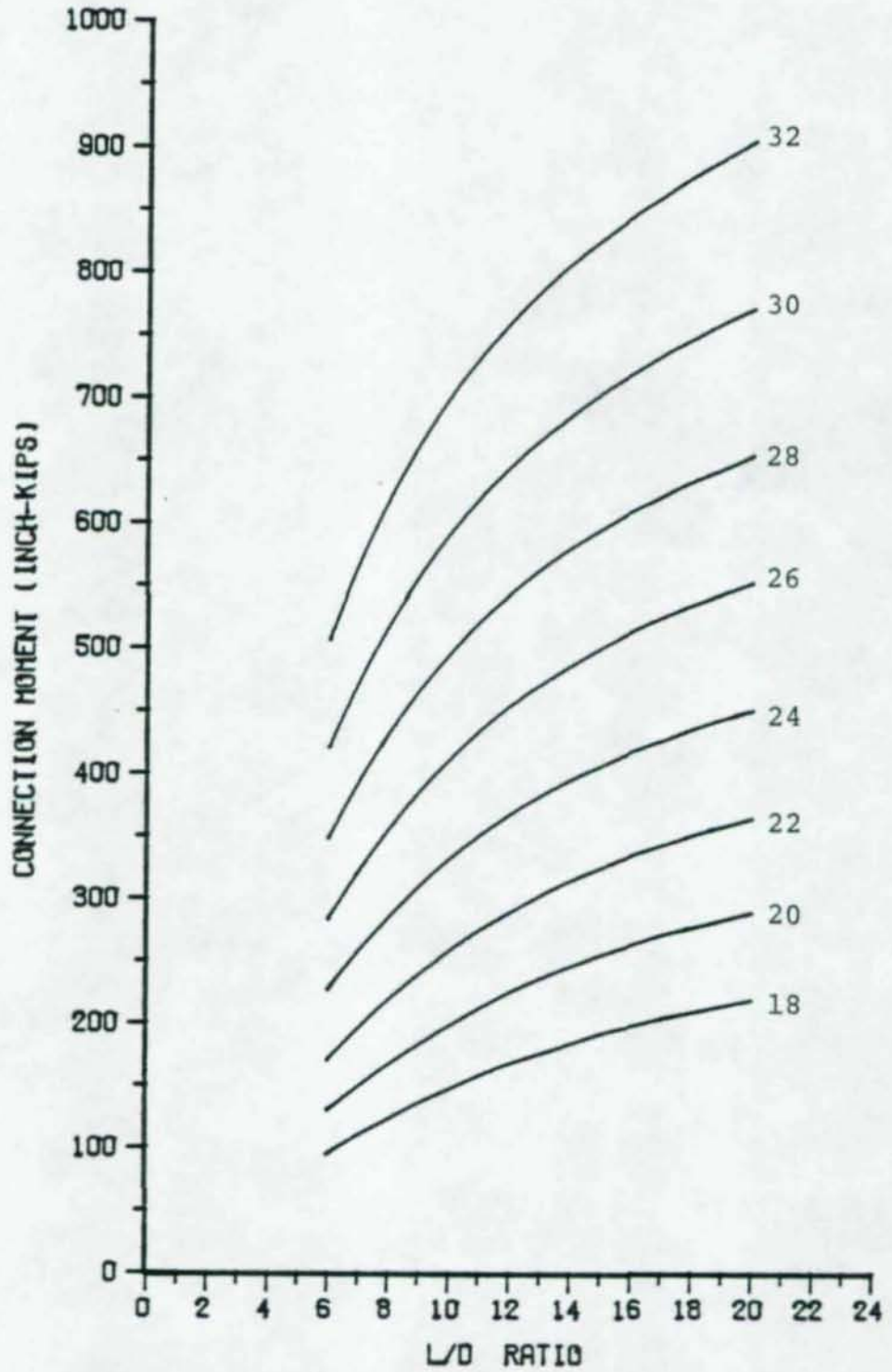

BEAM LENGTH TO BEAM DEPTH RATIO (L/D) VS CONNECTION MOMENT  
CURVES ARE FOR VARIOUS LENGTHS OF L 4 X 3 X 3/8 ANGLES

Figure 75.

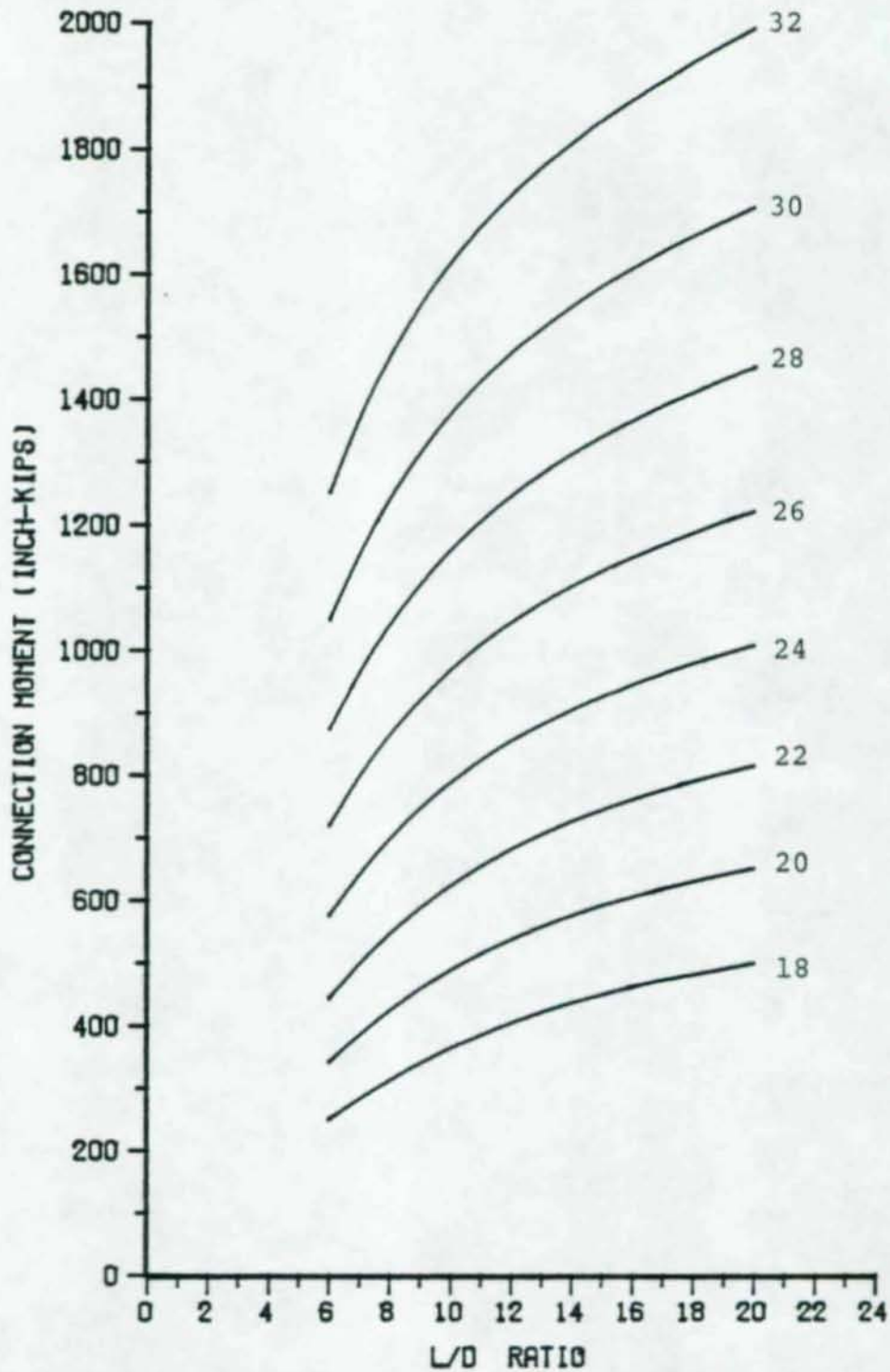

BEAM LENGTH TO BEAM DEPTH RATIO (L/D) VS CONNECTION MOMENT  
CURVES ARE FOR VARIOUS LENGTHS OF L 4 X 3 X 1/2 ANGLES

Figure 76.

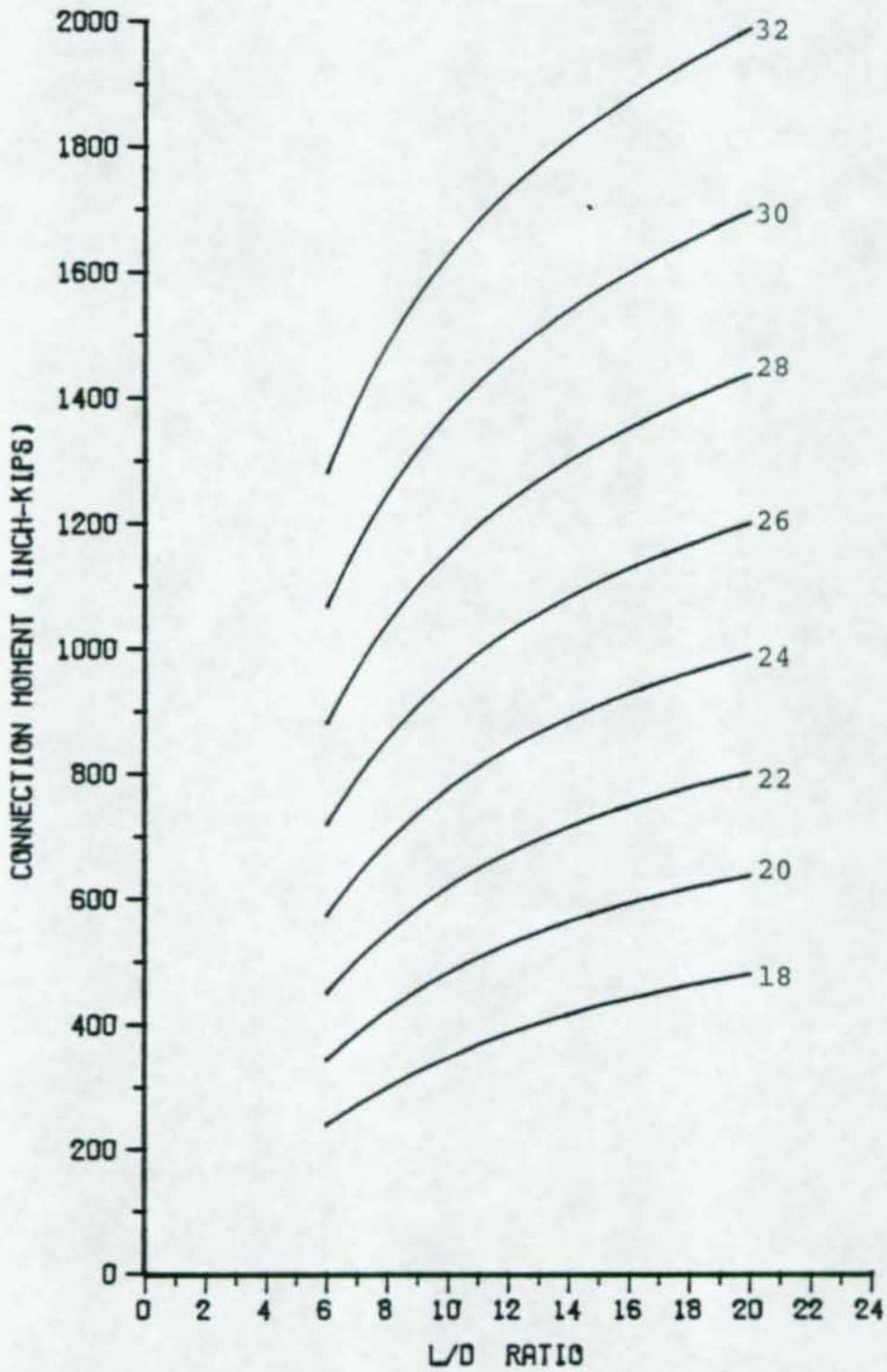

BEAM LENGTH TO BEAM DEPTH RATIO (L/D) VS CONNECTION MOMENT  
CURVES ARE FOR VARIOUS LENGTHS OF L 5 X 3 X 5/8 ANGLES

Figure 77.

TABLE 13 RICHARD EQUATION PARAMETERS FOR VARIOUS  
WELDED CONNECTION GEOMETRIES

<u>Connection</u>	<u>K</u>	<u>KP</u>	<u>R</u>	<u>N</u>
L-4x3x1/4x32	47000	3300	575	2.03
L-4x3x1/4x30	36790	2690	501	2.03
L-4x3x1/4x28	30000	2200	433	2.03
L-4x3x1/4x26	25000	1800	367	2.03
L-4x3x1/4x24	19310	1380	307	2.03
L-4x3x1/4x22	16000	1000	251	2.03
L-4x3x1/4x20	14000	800	200	2.03
L-4x3x1/4x18	9680	600	158	2.03
L-4x3x5/16x32	111500	10950	655	2.37
L-4x3x5/16x30	90250	8930	570	2.37
L-4x3x5/16x28	74000	7250	490	2.37
L-4x3x5/16x26	60000	5850	422	2.37
L-4x3x5/16x24	47260	4520	351	2.37
L-4x3x5/16x22	36500	3500	290	2.37
L-4x3x5/16x20	29000	2650	235	2.37
L-4x3x5/16x18	20200	1870	184	2.37
L-4x3x3/8x32	175000	18600	735	2.71
L-4x3x3/8x30	143700	15170	638	2.71
L-4x3x3/8x28	118000	12300	550	2.71
L-4x3x3/8x26	95000	9900	475	2.71
L-4x3x3/8x24	75200	7650	395	2.71
L-4x3x3/8x22	56000	5900	330	2.71
L-4x3x3/8x20	42000	4400	270	2.71
L-4x3x3/8x18	30720	3130	210	2.71
L-4x3x1/2x32	475000	37000	1650	2.43
L-4x3x1/2x30	391200	30890	1430	2.43
L-4x3x1/2x28	320000	25400	1230	2.43
L-4x3x1/2x26	260000	20600	1050	2.43
L-4x3x1/2x24	204200	16100	882	2.43
L-4x3x1/2x22	154000	12400	730	2.43
L-4x3x1/2x20	117000	9400	595	2.43
L-4x3x1/2x18	83820	6580	472	2.43
L-5x3x5/8x32	520000	35600	1670	2.18
L-5x3x5/8x30	421860	29660	1440	2.18
L-5x3x5/8x28	340000	24350	1240	2.18
L-5x3x5/8x26	272000	19600	1050	2.18
L-5x3x5/8x24	211780	15300	885	2.18
L-5x3x5/8x22	163000	11800	730	2.18
L-5x3x5/8x20	122000	8800	595	2.18
L-5x3x5/8x18	82360	6320	466	2.18

K and KP are in inch-kips/radian, R is in inch-kips

curve. For a given span length and loading, a beam is selected from the AISC Beam Selection Tables. The L/d ratio is then computed and a connection size and length along with the associated restraining moment are determined from Figures 73-77. The welds are then designed with the aid of AISC Eccentric Design Tables. Table 14 compares the restraining moment determined using the beam line procedure with the restraining moment determined using the more simplified L/d procedure. The two methods differ on average by about eight percent in determining the connection moment. This difference in connection moment between the two methods translates to a decrease in weld capacity of less than four percent in the worst case.

For a further simplifying assumption, it is helpful to have an understanding of the degree of flexibility of the connection. To gain this understanding, consider the ratio of the distance from Weld B (column flange) to the point of inflection (where the shear force V acts) divided by the length of the connection. From Figure 71 this ratio is  $(a + e)/L$ . This is also equivalent to simply "a" in AISC Table XIX Eccentric Loads on Weld Groups page 4-76. A ratio near a value of three indicates a very stiff connection whereas a ratio near zero indicates a relatively flexible connection. Table 15 gives the values of these flexibility ratios for the connections, weld geometries and loads considered in this research. For the L-4 x 3 x 1/2 inch angles, the flexibility ratios average to 22.6 percent, for the L-4 x

TABLE 14 COMPARISON BETWEEN BEAM LINE METHOD AND L/d METHOD

<u>Connection</u>	<u>L/d</u>	<u>End Moment (inch-kips)</u>		<u>% Difference</u>
		<u>Beam Line</u>	<u>L/d Method</u>	
L-4x3x1/2x32	6.54	1199	1320	10.0
L-4x3x3/8x32	6.64	504	547	8.5
L-4x3x5/16x32	6.75	337	369	9.5
L-4x3x1/2x30	6.58	1034	1114	7.7
L-4x3x3/8x30	6.66	429	456	6.3
L-4x3x5/16x30	7.25	300	321	7.0
L-4x3x1/2x28	6.61	874	932	6.6
L-4x3x3/8x28	6.69	362	380	5.0
L-4x3x5/16x28	7.25	238	265	11.3
L-4x3x1/2x26	6.61	699	770	10.2
L-4x3x3/8x26	6.69	283	311	9.9
L-4x3x5/16x26	7.30	207	218	5.3
L-4x3x1/2x24	6.64	564	620	9.9
L-4x3x3/8x24	6.75	241	250	3.7
L-4x3x5/16x24	8.00	181	187	3.3
L-4x3x1/2x22	6.66	441	481	9.1
L-4x3x3/8x22	6.75	174	190	9.2
L-4x3x5/16x22	8.00	134	146	9.0
L-4x3x1/2x20	6.69	341	373	9.4
L-4x3x3/8x20	7.25	141	153	8.5
L-4x3x5/16x20	8.05	109	117	7.3
L-4x3x1/2x18	6.75	262	275	5.0
L-4x3x3/8x18	7.30	108	114	5.6
L-4x3x5/16x18	8.09	78	83	6.4

See Table 9 for beam selection and length to determine L/d

Note: The % Difference was calculated by  

$$\left[ \frac{\text{L/d Moment} - \text{Beam Line Moment}}{\text{Beam Line Moment}} \right] \times 100$$

TABLE 15 FLEXIBILITY RATIOS FOR WELDED CONNECTIONS

<u>Connection</u>	<u>e</u>	<u>a</u>	<u>L</u>	<u>(a + e)/L</u>
L-4 x 3 x 1/2	4.33	2.83	32	0.224
L-4 x 3 x 3/8	2.28	2.83	32	0.160
L-4 x 3 x 5/16	2.03	2.83	32	0.152
L-4 x 3 x 1/2	3.95	2.82	30	0.226
L-4 x 3 x 3/8	2.04	2.82	30	0.162
L-4 x 3 x 5/16	1.91	2.82	30	0.158
L-4 x 3 x 1/2	3.52	2.81	28	0.226
L-4 x 3 x 3/8	1.83	2.81	28	0.166
L-4 x 3 x 5/16	1.60	2.81	28	0.158
L-4 x 3 x 1/2	2.99	2.80	26	0.222
L-4 x 3 x 3/8	1.51	2.80	26	0.166
L-4 x 3 x 5/16	1.48	2.80	26	0.165
L-4 x 3 x 1/2	2.59	2.78	24	0.224
L-4 x 3 x 3/8	1.39	2.78	24	0.174
L-4 x 3 x 5/16	1.38	2.78	24	0.174
L-4 x 3 x 1/2	2.16	2.77	22	0.224
L-4 x 3 x 3/8	1.07	2.77	22	0.175
L-4 x 3 x 5/16	1.10	2.77	22	0.176
L-4 x 3 x 1/2	1.81	2.75	20	0.228
L-4 x 3 x 3/8	0.93	2.75	20	0.184
L-4 x 3 x 5/16	0.96	2.75	20	0.186
L-4 x 3 x 1/2	1.52	2.73	18	0.236
L-4 x 3 x 3/8	0.78	2.73	18	0.195
L-4 x 3 x 5/16	0.76	2.73	18	0.194

e, a, L are in inches

3 x 3/8 inch angles, 17.3 percent, and for the L-4 x 3 x 5/16 inch angles, 17.0 percent.

With this in mind, it is possible to properly design a welded connection using AISC Table XIX Eccentric Loads on Weld Groups page 4-76. The capacity of the weld group is  $P = CDL$  where C is the eccentric load coefficient, D is the weld size in sixteenths of an inch, and L is the weld length. Table 16 gives the eccentric load coefficients associated with the three connection geometries and flexibility ratios listed above.

TABLE 16 ECCENTRIC LOAD COEFFICIENTS

<u>Connection</u>	<u>Flexibility Ratio</u>	<u>C</u>
L-4 x 3 x 1/2	0.226	1.322
L-4 x 3 x 3/8	0.173	1.455
L-4 x 3 x 5/16	0.170	1.462

By using this procedure to calculate the Weld B capacities and comparing these capacities with the previous capacities using the beam line intersection method and AISC Table XIX (see Table 12 Weld "B" Comparison/Research Ultimate Strength column) an average difference of less than two percent results.



01231

## CONCLUSIONS

Only those angles for which moment-rotation curves could be generated from adequate test data were reviewed and compared. AISC Table IV gives weld sizes and capacities for connections with outstanding leg lengths of three inches and four inches. Consequently, only angles with an outstanding leg length of four inches could be compared. Angles with an outstanding leg length of three inches could not be compared because of a lack of adequate test data.

If more test data were available, generalized curves for the three Richard equation parameters,  $R$ ,  $KP$ , and  $N$ , could be constructed as was done by Blewitt and Richard [1]. These curves plot either the value of  $R$ , the reference load, or the value of  $KP$ , the plastic stiffness, or the value of  $N$ , the shape parameter, for various angle lengths and for various angle thicknesses. The elastic stiffness,  $K$ , can always be determined if the angle length and thickness are known, and with these four Richard parameters, the moment-rotation curves can be developed.

All of the connections that were evaluated indicated no difference in the size of Weld A required. This is because the method used to design Weld A in the AISC Manual also accounted for both a direct shear force and a torsional moment (as did the method used in this research), but the

moment arm for the calculation of this torsional moment was approximately the same as the moment arm or eccentricity,  $e$ , determined in this research. In the AISC design philosophy, the shear force was assumed to act at the column flange and so the torsional moment arm was the distance from the column flange to the centroid of Weld A. In this research, the shear force was assumed to act at the inflection point in the beam which is on the opposite side of the Weld A centroid. These two moment arms were approximately equal to each other. Thus, the two methods gave the same weld size since both were designed for approximately the same torsional moment.

The capacities of Weld B, however, varied significantly. This is because the method used to calculate the weld sizes for Weld B in the AISC Manual assumed that only a shearing force was transmitted at the column flange creating a torsional moment in the plane of the welds that caused the bottom of the angles to rotate away from each other in the plane of the column flange, which is not correct. The shear force is transmitted through the centroid of Weld A, and since there is a restraining moment being developed in the connection (due to the somewhat inflexible angles) this shear force and moment are statically equivalent to a shear force acting at an eccentric distance,  $e$ , away from the Weld A centroid, at the inflection point in the beam. Thus, Weld B is not acted upon by only the shear force, but also a bending moment. As a result, the factors of safety against failure

$$F_v = 0.6 F_u$$
$$\frac{F_v}{2} = 0.3 F_u$$

on Weld B range from about 2.5 to 3.0 which is less than the usual design factor of safety of 3.3.

The techniques used in the research provided a method of design for welded connections that is consistent with the observed deformation in connections of this type. It also provided for an extremely simplified procedure that practicing engineers could readily use. It is recommended that several full-scale tests be conducted to provide a high level of confidence in the design guide presented herein.

In summary, the analysis model used for Weld A in the AISC Manual, as well as for Weld B, is inadequate. The sizes of welds for Weld A, however, are satisfactory because the torsional moments used in these designs were approximately equal to those determined in this research. The AISC design philosophy for Weld A and Weld B assumes that only shear force acts at the column flange/angle leg interface. But if this were the case, there would exist no mechanism (mainly the shear force acting at the inflection point of the beam an eccentric distance,  $e$ , away from the Weld A centroid) to explain the rotation of the connection at the beam end (i.e. the relative "pulling out" of the angles at the top of the connection and the "pushing in" at the bottom). It is this "pulling out" at the top and "pushing in" at the bottom of the connection that causes the tendency for the angles to want to spread out at the bottom as noted in the AISC design philosophy.

## APPENDIX A

## THE RICHARD EQUATION

The Richard Equation, published by Richard and Abbott in 1975, is the equation used to describe the non-linear behavior of welded connections presented in this research. This relationship, shown in Figure 2, relates the strength to the stiffness of a structural system, in this case, welded double framing angles. The Richard Equation is given below along with an explanation of the parameters.

$$M = \frac{(K - KP) \times \theta}{\left[ 1 + \frac{(K - KP) \times \theta}{R_0} \right]^{1/N}} + (KP \times \theta)$$

M = Load (moment or force)

$\theta$  = Deformation (rotation or displacement)

K = Elastic stiffness or initial slope of the curve

KP = Plastic stiffness or final slope of the curve

N = Shape parameter or the sharpness in transition in slope from K to KP

$R_0$  = Reference load or the intersection of a line asymptotic to the curve at a slope equal to KP with the load axis

01235

## APPENDIX B

### MRCURVE

Program MRCURVE is a Fortran computer program that gives the moment and rotation data points and the four Richard equation parameters for the connection under consideration.

The program reads from the input data file, FDINPUT.DAT, and writes to the output data file, OUTPUT.DAT.

The input file consists of three lines:

Line 1 = N,DL

Line 2 = TK,TKP,TRO,TN

Line 3 = CK,CKP CRO,CN

where N = number of three inch segments that the connection can be divided into. Suppose the connection is 24 inches long, then  $N = 24/3 = 8$ .

DL = maximum rotation of connection to be considered. Choose a rotation that is consistent with the type of connection considered. For welded connections, let  $DL = 0.05$  radians.

TK = elastic stiffness of three inch segment of connection loaded in tension

TKP = plastic stiffness of three inch segment of connection loaded in tension

TRO = reference load for three inch segment of connection loaded in tension

TN = shape parameter for three inch segment of  
connection loaded in tension  
CK = elastic stiffness (compression)  
CKP = plastic stiffness (compression)  
CRO = reference load (compression)  
CN = shape parameter (compression)

After these three lines, which represent one connection, another three lines of input data representing another connection may be input, and so on for all connections being considered. After all connection data, the user must include a final line to stop the program.

Final line = 0,0 (two zeros)

As for the program itself, the first ten lines are simply dimensioning arrays, opening input and output files, and reading input data from the input file. Do loop 100 together with Do loop 200 determine the point of rotation and the forces associated with each three inch segment of connection by invoking equilibrium of forces. The resisting moment for that particular rotation angle is then calculated by summing moments of forces about the bottom of the connection. This gives one moment-rotation data point. This process is repeated ten times (Do loop 100) to give eleven moment-rotation data points.

The program then computes the four Richard equation parameters that are associated with a least squares curve passing through the moment-rotation data points. The elastic

stiffness is computed by calculating the slope of the line passing through the origin and the first moment-rotation point. The plastic stiffness is computed by calculating the slope of the line passing through the last two moment-rotation data points. The reference load is computed by calculating the intercept of the line asymptotic to the curve and with a slope equal to the plastic stiffness with the load axis. The shape parameter is computed by starting with a value of 0.01 for the shape parameter and incrementing this value by 0.01 until the sum of the least square errors between the data points obtained earlier and the data points obtained using the incremented value of the shape parameter is a minimum.

SAMPLE INPUT FOR PROGRAM MRCURVE

The following input data is for a 30 inch long welded double framing angle connection with angles that are 2L-4 x 3 x 3/8 inch.

10,0.05

73,6,5,3.4

1771,207,213,1.2

0,0

SAMPLE OUTPUT FOR PROGRAM MRCURVE

The following output is for the above input data.

MOMENT =	7.02	THETA =	.0000	ROTATION POINT =	5.34
MOMENT =	14.03	THETA =	.0001	ROTATION POINT =	5.34
MOMENT =	28.99	THETA =	.0002	ROTATION POINT =	5.12
MOMENT =	57.98	THETA =	.0004	ROTATION POINT =	5.12
MOMENT =	115.84	THETA =	.0008	ROTATION POINT =	5.12
MOMENT =	229.00	THETA =	.0016	ROTATION POINT =	5.12
MOMENT =	421.53	THETA =	.0031	ROTATION POINT =	5.02
MOMENT =	631.39	THETA =	.0063	ROTATION POINT =	4.63
MOMENT =	804.98	THETA =	.0125	ROTATION POINT =	3.81
MOMENT =	1016.79	THETA =	.0250	ROTATION POINT =	3.07
MOMENT =	1396.06	THETA =	.0500	ROTATION POINT =	2.65

ELASTIC MODULUS K = 143704.38

PLASTIC MODULUS KP = 15171.11

REFERENCE MOMENT MO = 637.51

SHAPE PARAMETER N = 2.6200



PROGRAM MRCURVE

```

IMPLICIT DOUBLE PRECISION (A-H,O-Z)
REAL MOMENT
DIMENSION ARM(50),DELTA(50),R(50),MOMENT(50),BM1(50)
OPEN(UNIT=5,FILE='FDINPUT.DAT',STATUS='OLD')
OPEN(UNIT=6,FILE='OUTPUT.DAT',STATUS='NEW')
501 READ(5,*) N,DL
    IF(N.EQ.0) GO TO 999
    H=3.*N-1.5
    READ(5,*) TK,TKP,TRO,TN
    READ(5,*) CK,CKP,CRO,CN
    DO 100 I=1,11
    THETA = DL/(2.**((11-I)))
    X1 = H
    X2 = 0.0
900  X = (X1+X2)/2.
    DO 200 J=1,N
    ARM(J) = (J-1)*3. + 1.5
    DELTA(J) = (ARM(J)-X)*THETA
    IF(DELTA(J).GE.0.0) GO TO 250
    IF(DELTA(J).LT.0.0) GO TO 260
250  T1 = (TK-TKP)*DELTA(J)
    T2 = (ABS(T1/TRO))**TN
    T3 = (1.+T2)**(-1./TN)
    T4 = TKP*DELTA(J)
    R(J) = (T1*T3) + T4
    GO TO 200
260  T1 = (CK-CKP)*DELTA(J)
    T2 = (ABS(T1/CRO))**CN
    T3 = (1.+T2)**(-1./CN)
    T4 = CKP*DELTA(J)
    R(J) = (T1*T3) + T4
200  CONTINUE
    SUM = 0.0
    DO 300 K=1,N
300  SUM = SUM + R(K)
    IF(ABS(SUM).LT.0.1) GO TO 400
    IF(SUM.GT.0.0) X2=X
    IF(SUM.LT.0.0) X1=X
    IF(SUM.EQ.0.0) GO TO 400
    GO TO 900
400  MOMENT(I)=0.0
    DO 500 K=1,N
500  MOMENT(I) = MOMENT(I) + R(K)*ARM(K)
    WRITE(6,7) MOMENT(I),THETA,X
7    FORMAT(1X,'MOMENT = ',1F10.2,5X,'THETA = ',1F10.4,5X,
$ 'ROTATION POINT = ',1F10.2)
100  CONTINUE
    TK = MOMENT(1)/((0.5)**10*DL)
    TKP = (MOMENT(11)-MOMENT(10))/(0.5*DL)

```

```
TRO = MOMENT(11)-2.0*(MOMENT(11)-MOMENT(10))
WRITE(6,1) TK
1  FORMAT(//1X,'ELASTIC MODULUS K = ',1F10.2)
   WRITE(6,2) TKP
2  FORMAT(//1X,'PLASTIC MODULUS KP = ',1F10.2)
   WRITE(6,3) TRO
3  FORMAT(//1X,'REFERENCE MOMENT MO = ',1F10.2)
   TN1 = 0.0
   CHECK2 = 1.0E25
101 TN1 = TN1 + 0.01
    IF(TN1.GT.100.0) GO TO 999
    CHECK1 = 0.0
    DO 201 I=1,11
      THETA = ((0.5)**(11-I))*DL
      T1 = (TK-TKP)*THETA
      T2 = (ABS(T1/TRO))**TN1
      T3 = (1.+T2)**(-1./TN1)
      T4 = TKP*THETA
      BM1(I) = (T1*T3) + T4
201 CHECK1 = CHECK1 + ((MOMENT(I)-BM1(I))**2)*THETA
    IF(CHECK1.GT.CHECK2) GO TO 301
    CHECK2 = CHECK1
    TN2 = TN1
    GO TO 101
301 WRITE(6,6) TN2
    GO TO 501
6  FORMAT(//1X,'SHAPE PARAMETER N = ',1F10.4)
999 STOP
    END
```

## APPENDIX C

## NRMRSOL

Program NRMRSOL is a fortran computer program that uses a Newton-Raphson root-finding algorithm to determine the intersection point (moment, rotation) of the beam line and the moment-rotation curve.

The program is very easy to use. The computer will prompt the user via the screen three times. The first prompt will ask for the uniform load in kips/inch on the beam. The second prompt will ask for the length of the beam in inches and the moment of inertia of the beam (strong axis bending). Finally, the third prompt will ask for the four Richard equation parameters defining the moment-rotation curve for the connection under consideration. The input format is free field, so decimal points are not necessary after whole numbers, but commas must separate entries. The output of the program appears on the screen and consists of one line. This output line gives the end rotation in radians and the end moment in inch-kips, the two coordinates corresponding to the intersection of the beam line and the moment-rotation curve.

To understand how the computer program works, the theory behind the Newton-Raphson algorithm is presented herein. Consider a point  $x$  which is not a root of the function  $f(x)$  but is "reasonably close" to a root. The function  $f(x)$  can

be expanded in a Taylor's series expansion about  $\underline{x}$ :

$$f(x) = f(\underline{x}) + f'(\underline{x})(x - \underline{x}) + f''(\underline{x})(x - \underline{x})^2/2! + \dots +$$

Taking only the first two terms in the expansion:

$$f(x) = f(\underline{x}) + (x - \underline{x})f'(\underline{x})$$

Setting  $f(x) = 0$  and solving for  $x$  gives:

$$x = \underline{x} - f(\underline{x})/f'(\underline{x})$$

The function is a function of the rotation, theta, and to obtain this function the expression for the end moment using the moment-rotation curve must be set equal to the expression for the end moment using the beam line equation. Doing this gives:

$$M_{\text{conn}} = M_{\text{beam line}} \quad \text{OR} \quad M_{\text{conn}} - M_{\text{beam line}} = 0 = f(\theta)$$

$$f(\theta) = \frac{K_1 \theta}{\left[ 1 + \left| \frac{K_1 \theta}{M_0} \right| N \right]^{1/N}} + K_p \theta - M_{\text{fixed}} + \frac{2EI}{L} \theta = 0$$

Using the Newton-Raphson method:

$$\theta = \theta_0 - f(\theta_0)/f'(\theta_0) \quad \text{or}$$

$$\theta - \theta_0 = \delta = -f(\theta_0)/f'(\theta_0)$$

To obtain the derivatives, the Quotient Rule and the Power Rule of differentiation must be used, and in doing so, the expression for the root of the function of theta becomes:

$$\theta = \theta_0 - \frac{\frac{K_1 \theta_0}{\left[ 1 + \left| \frac{K_1 \theta_0}{M_0} \right|^N \right]^{1/N}} + K_p \theta_0 - M_{\text{fixed}} + \frac{2EI}{L} \theta_0}{K_p + \frac{2EI}{L} + \frac{K_1}{\left[ 1 + \left| \frac{K_1 \theta_0}{M_0} \right|^N \right]^{\frac{N+1}{N}}}}$$

The above equation is programmed in NRMRSOL as the subroutine FUNCTN. The program converges on the solution very rapidly and stops when the absolute value of delta ( $\delta$ ) is less than a predetermined epsilon or error (= 0.000001). No error exits have been included in the program in case the method diverges or does not find a root in a reasonable number of iterations. The error exits were not necessary because the function is well defined near the root.

PROGRAM NRMRSOL

```

      IMPLICIT DOUBLE PRECISION (A-H,O-Z)
      WRITE (*,1)
1     FORMAT(1X,'ENTER UNIFORM LOAD IN KIPS/INCH')
      READ (*,*) W
      WRITE (*,2)
2     FORMAT(1X,'ENTER BEAM LENGTH (INCHES), MOMENT OF '
$     'INERTIA')
      READ (*,*) XL,XI
      WRITE (*,3)
3     FORMAT(1X,'ENTER RICHARD PARAMETERS K,KP,R,N')
      READ (*,*) TK,TKP,TR,TN
      EPS = 0.000001
      E = 30000.
      THETA0 = 0.
      CALL FUNCTN (DELTA,TK,TKP,TR,TN,THETA0,W,E,XI,XL)
      THETA = THETA0 + DELTA
100    CALL FUNCTN (DELTA,TK,TKP,TR,TN,THETA,W,E,XI,XL)
      THETA = THETA + DELTA
      IF (ABS(DELTA).LT.EPS) GO TO 200
      GO TO 100
200    XMOM = (W*(XL**2)/12.)-(2.*E*XI*THETA/XL)
      WRITE (*,4) THETA, XMOM
4     FORMAT (1X,'END ROTATION =',1F10.8,'RADIANS',5X,'END '
$     'MOMENT =',1F10.0,'INCH-KIPS')
      STOP
      END

C
      SUBROUTINE FUNCTN (DL,TK,TKP,TR,TN,ROT,W,E,XI,XL)
      IMPLICIT DOUBLE PRECISION (A-H,O-Z)
      T1 = TK-TKP
      T2 = (ABS(T1*ROT/TR))**TN
      T3 = (1 + T2)**(1./TN)
      T4 = (T1*ROT)/T3
      FEM = W*(XL**2)/12.
      XNUM = T4 + (TKP*ROT) - FEM + (2.*E*XI*ROT/XL)
      XDEN = TKP + (2.*E*XI/XL) + (T1/((1 + T2)**(TN + 1.))
$     '/TN))
      DL = -1.*XNUM/XDEN
      RETURN
      END

```

01245

## REFERENCES

1. Blewitt, Russell J., and Richard, Ralph M. "Experimental and Analytical Force Deformation Curves for Bolted Double Angle Connections." University of Arizona, Department of Civil Engineering and Engineering Mechanics. A Report prepared for the American Institute of Steel Construction, 1984.
2. Hsia, Wei-Kung, "Double Angle Connection Moments." M.S. Thesis, University of Arizona, Department of Civil Engineering and Engineering Mechanics, 1986. Directed by Professor Ralph M. Richard.
3. Private Communication. Letter to Professor Ralph M. Richard, University of Arizona from Hassan Astaneh, Fears Structural Engineering Laboratory, University of Oklahoma, March 11, 1986.
4. Hamm, Kenneth R. Jr., and Richard, Ralph M. "The Analysis and Behavior of Deep Bolted Angle Connections." University of Arizona, Department of Civil Engineering and Engineering Mechanics. A Report prepared for the American Institute of Steel Construction, July, 1984.
5. Salmon, Charles G., and Johnson, John E. *Steel Structures: Design and Behavior*. Second Edition, New York: Harper & Row, Publishers, 1980, pg. 731-733.
6. Salmon, Charles G., and Johnson, John E. *Steel Structures: Design and Behavior*. Second Edition, New York: Harper & Row, Publishers, 1980, pg. 209.

01246



01247