

industrial power tools



## AEROSPACE RIVETING TOOLS

## RIVET GUN KITS

- Contains our most popular rivet gun
- Our best selling kit 23 piece kit

Complete Kit		
Part Number	Rivet Gun Included	Shank
AIT-RGK-3X	3X	.401"
AIT-RGK-4X	4X	.401"

## 23 Piece Kit Includes:

Part Number	Description
SM10-4703	3/32" Rivet set, 3-1/2" O. A. L.
SM10-4704	1/8" Rivet set, 3-1/2" O. A. L.
SM10-4705	5/32" Rivet set, 3-1/2" O. A. L.
SM10-4706	3/16" Rivet set, 3-1/2" O. A. L.
SM11-4703	3/32" Rivet set, 5-1/2" O. A. L.
SM11-4704	1/8" Rivet set, 5-1/2" O. A. L.
SM11-4705	5/32" Rivet set, 5-1/2" O. A. L.
SM11-4706	3/16" Rivet set, 5-1/2" O. A. L.
SM140	Offset flush mushroom set
SM170	Flush mushroom rivet set w/ guard
SM20-4703	3/32" Offset rivet set, 3-1/2" O. A. L.
SM20-4704	1/8" Offset rivet set, 3-1/2" O. A. L.



AIT-RGK

Part Number	Description
SM20-4705	5/32" Rivet set, 3-1/2" O. A. L.
SM92	Flush mushroom rivet set
TP1111	Bucking bar
TP1112	Bucking bar
TP669	Bucking bar
TP670	Bucking bar
TP2012	Power regulator
A1006-234X	Beehive retainer spring
A1007-234X	Handi retainer spring
	Rivet gun (see charts above)
AIT62-14	Molded plastic carrying case

## STUDENT RIVET KIT

This kit meets most school requirements for basic sheet metal tools.



Complete Kit	
Part Number	Rivet Gun Included
TP176ST-3X	3X
TP176ST-4X	4X

## 68 Piece Kit Includes:

Model #	Qty	Item
3X or 4X	1	Offset handle rivet gun
TP2012	1	Deluxe air tool regulator
A1006-234X	1	Beehive spring retainer
A1007-234X	1	Quick change spring retainer
TP89	1	5 pc. straight
TP670	1	Bucking bar
TP346	1	Heavy duty rivet cutter
TP74	1	Cleco pliers
TP75	40	Cleco fasteners (10ea.: 3/32", 1/8", 5/32", 3/16")
FDR-5440	1	3/8" Air drill
TP49	6	Drill bits
TP145DSK	1	4 pc. drill stop kit
TP61K	1	Micro stop countersink & 3 cutters
TP279	1	Military-style tool punch

## GLASTAR KIT



This kit is designed especially for the Glastar kit aircraft. The tools included are recommended by the manufacturer, specifically for the assembly of the sheet metal portion of the kit. Many of these tools will also be used in other areas of its construction

Complete Kit	
TP176G - 3X	3X
TP176G - 4X	4X

### 503 Piece Kit Includes:

Model #	Qty	Item
TP83, TP84	1	3X/4X offset handle rivet gun specify
SM10-4703i	1	3/32" Universal rivet set
SM10-4704i	1	1/8" Universal rivet set
SM10-4705i	1	3/16" Universal rivet set
TP91	1	Flush set with rubber guard
A1007-234X	1	Quick change retainer spring
TP61	1	Stop countersink
TP62	1	100° countersink cutter pilot sizes (12, 21, 30 & 40)
TP62A	1	120° countersink cutter pilots (30)
TP116M	1	Hand rivet squeezer (with TP116A)
TP4235SB	1	1/8" Dimple die set
TP4264SB	1	3/32" Dimple die set
TP45	1	3/8" Capacity air drill
TP75	250	3/32"-3/32" Cleco fastener
TP75	150	1/8"-1/8" Cleco fastener
TP75	25	3/16"-3/16" Cleco fastener
TP74	1	Cleco pliers
TP266	1	Deburring tool with 7 blades
TP838	1	90° Countersink/Deburring set

Model #	Qty	Item
TP216	1	Tool Box
TP638	1 ea.	TP647, TP721, TP760B-1 Bucking bars
TP49	1 ea.	11/64", 1/4", 1/16" Assorted jobber drill bits
TP249	1	60 pcs. #1-#60 jobber drill bit set
TP55-30	1 ea.	TP55-40 -6" Aircraft extension bits
TP55A-40	1 ea.	12" Aircraft extension bits
TP123SG	10 ea.	Side grip clamps
TP538STC	2	Tension Clamps
TP51K	1	Aviation snip kit - left, right, straight
TP46K	1	90° Drill attachment w/ bits #40, #30, #20
TP70	1	Chip chaser
TP844	1	Swivel hand riveter
TPA5588	1	Hook scribe
TP294AP	1	Center punch
BG383-I	1	Tape measure
TP604B	1	12" ruler 32nds, 64ths, 10ths, 100ths, graduations
TP297	1	Spring divider

## MUSTANG KIT

Kit is designed especially for the assembly of the Mustang Kit Aircraft.

Complete Kit	
Part Number	Rivet Gun Included
TP176MUS-3X	3X
TP176MUS-4X	4X

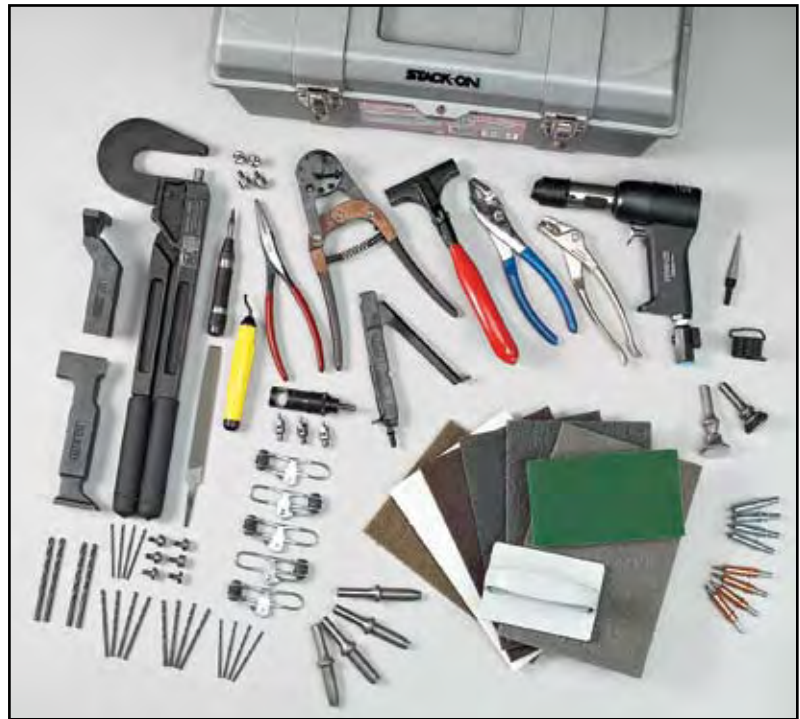

## 317 Piece Kit Includes:

Model #	Qty	Item
3X or 4X	1	Offset handle rivet gun
TP91	1	Flush rivet set
SM10-4703	1	Rivet set
SM10-4704	1	Rivet set
SM10-4705	1	Rivet set
A1007-234X	1	Quick change retainer spring
TP346	1	Heavy duty rivet cutter
TP61K	1	Stop Countersink Kit (1 ea. TP61, TP62-21, 30, 40 & storage tube)
TP722	1	Fluting pliers
TP75-1/8	130	Cleco fasteners
TP75L-1/8	25	Cleco fasteners
TP75-3/32	80	Cleco fasteners
TP74	1	Cleco pliers
TP44	1	Hand seamer
TP227G	1	Duckbill pliers
TP266	1	Deburring tool
TP888-3	1	Hand rivet squeezer
TP116A	1	Squeezer sets (2 flush & 4 universal AN470 head)
TP751	1	Bucking bar
TP670	1	Bucking bar
SM181	1	Swivel flush rivet set

Part Number	Qty	Item
TP641HC	5	Handi-clamp
TP75L-3/32	25	Cleco fastener
TP81	1	Hand nibbler
TP49-30	4	Drill bits
TP49-3/32	4	Drill bits
TP49-40	4	Drill bits
TP49-1/8	4	Drill bits
TP49-12	2	Drill bits
TP49-3/16	2	Drill bits
TPA5611	1	Unibit drill
TP294HD	1	Auto Center Punch
TP735K	1	Hand pack trial kit
TPFS6	1	Flat file
TP4263	1	Dimple and die set
TP4264	1	Dimple and die set
TP216	1	Tool Box

## RV KIT "BUILDER KIT"



Kit is designed for the RV3, RV4 and RV6 Builders.

Complete Kit	
TP176RV - 2X	2X
TP176RV - 3X	3X
TP176RV-4X	4X

### 536 Piece Kit Includes:

Model #	Qty	Item
2X		
3X		
4X	1	2X, 3X or 4X rivet gun
TP89i	1	Straight rivet set (5 pcs., SM10 Series)
		10° Offset rivet sets ( 5pcs., SM20 Series)
TP90i	1	
TP91i	1	Flush rivet set with rubber guard
		Beehive and quick-change retainer springs
TP88	1	
TP97	1	Air tool regulator
TP96	1	Rivet Cutter
TP61	1	Micro stop countersink
TP116	1	Hand rivet squeezer
TP4263	1	Dimple and die set
TP4264	1	Dimple and die set

Model #	Qty	Item
TP116A	1	Squeezer and set mix
TP45	1	3/8" Air drill
TP162	1	Fluting pliers
		Countersink cutter pilots (1 ea. TP62-21, TP62-30, TP62-40)
TP62	3	
		Cleco fasteners (325 pcs. TP75-3/32" & 175 pcs. TP75-1/8")
TP75	500	
TP74	1	Cleco pliers
TP44	1	Hand seamer
TP266	1	Deburring tool
TP216	1	Tool box with tote tray
TP638	1	Bucking bar
TP647	1	Bucking bar
TP670	1	Bucking bar
TP1112	1	Bucking bar

MASTER AIRCRAFT TOOL KIT

Ideal starter sheetmetal kit! This 121-piece complete Aircraft Mechanics Kit is excellent for aircraft restoration, repair and manufacturing. ideal for the A & P mechanic, student and homebuilder, this kit comes with everything from sheet metal tools to riveting tools in a two-drawer tool chest.

Complete Kit	
TP176M - 3X	3X
TP176M - 4X	4X



121 Piece Kit Includes:

Model #	Qty	Item
	1	3X or 4X handle rivet gun
TP75	40	Cleco fasteners (10 ea. 3/32", 1/8", 5/32" & 3/16")
CWN-FW	20	Wing nut fasteners (5 ea. 3/32", 1/8", 5/32" & 3/16")
TP145DSK	4	Drill stop kit (1 ea. #21, #30, #40, & #10)
TP62	3	Integral pilots (1 ea. #21, #30 & #40)
TP54	1	Threaded drill bits (1 ea. #21, #30 & #40)
TP88	2	Spring retainer set
TP89i	5	Straight rivet set mix
TP90i	5	Offset rivet set mix
TP91i	1	Flush set with guard
TP638	1	Bucking bar
TP1112	1	Bucking bar
TP670	1	Bucking bar
TP647	1	Bucking bar
TP97	1	Air tool regulator
TP51	1	Aviation snip - left
TP52	1	Aviation snip - right
TP53	1	Aviation snip - straight

Model #	Qty	Item
TP61	1	Stop countersink
TP45	1	3/8" Pistol grip air drill
TP46	1	90° Angle attachment
TP346	1	Heavy duty rivet cutter
TP116	1	Hand rivet squeezer
TP116A	6	Squeezer set mix
TP74	1	Cleco pliers
TPMM250-1	1	Strap duplicator #40
TPMM250-2	1	Strap duplicator #30
TPMM250-3	1	Strap duplicator #21
TPMM250-5	1	Strap duplicator #10
TP57	1	Cone jaw chuck
TP162	1	Fluting pliers
TP76K	1	Hand punch kit
TP44	1	Hand seamer
TP81	1	Hand nibbler
TP714	1	Aircraft repair manual
TP260	1	2-drawer tool chest
TP123SG	5	Side grip fasteners
TP70	1	Chip chaser
TP675	1	Air vacuum

## DELUXE SHEET METAL RV KIT



Complete Kit	
TP176RVDLX	541 pc. Kit

New for 2003, this complete 541 piece kit provides you with all of the sheetmetal tools you'll need to build a RV aircraft.

- Contains one of the most popular rivet guns, TP83 which features:
  - Precision machined hardened and ground valve
  - "Sure Grip" powder coated finish
  - Teasing trigger
  - Precision machined and hardened cylinder for long life

### 541 Piece Kit Includes:

Qty.	Model #	Item
1	TP808A	Riveters tape - 36 yds.
1	TP83	Rivet gun
1	TP6150	Riveting & dimpling gixture
1	TP45	Drill
1	TP466	Dead blow hammer
1	TP819B	Unibit drill
1	TPA5610	Unibit drill
1	TP740E	6x1x1 Cut & polish med.
1	TPAF10	Flat file
1	TPA5593	File card
1	TP244	Hearing protector
1	A1142	Air tool oil
1	TP843	Plastic rivet set block
1	221	Screwdriver bit
1	222	Hex insert bit
3	TP49-12	Drill bit
1	TP49-19	Drill bit
6	TP49-30	Drill bit
6	TP49-40	Drill bit
1	TP904L	High capacity offset snips
1	TP722	Fluting plier
1	TP904R	High capacity offset snips
1	TP44	Hand seamer
1	TP842	Back riveting plate
1	TP888-3	Hand squeezer
1	TP844	Swivel riveting tool

Qty.	Model #	Item
1	A1007-234X	Quick-change retainer spring
1	AT514	Edge breaker
1	TP55AC-30	Extension bit
1	TP55AC-40	Extension bit
1	TP1	Air tool swivel regulator
1	TP266	Deburring tool
1	TP54-19	Threaded drill bit
1	TP89	Straight rivet set mix
1	TP96	Rivet cutter
1	TP74	Cleco plier
1	TP145DSK	4 pc. drill stop kit
1	TP61	Stop countersink
1	TP62-21	countersink
1	TP62-30	Countersink
1	TP62-40	Countersink
1	TP62-10	Countersink
1	TP604C	Flexible steel rule
1	TP4	Angle drill attachment
1	TP4263	Dimple & die set
1	TP4264	Dimple & die set
1	TP5095	Dimple & die set
1	SM130-4703	Rivet set
1	TP313	Back riveting set
1	TP62-19	Countersink cutter
1	TP62-28	Countersink cutter
175	TP75-1/8	Cleco fastener

Qty.	Model #	Item
10	TP75-3/16	Cleco fastener
325	TP75-3/32	Cleco fastener
4	TP1245G	Side grip fastener
4	TP1265G	Side grip fastener
1	TP54-10	Threaded drill bit
1	TP54-12	Threaded drill bit
1	TP54-21	Threaded drill bit
1	TP54-30	Threaded drill bit
1	TP54-40	Threaded drill bit
1	A1006-234X	Beehive retainer spring
1	TP260	2 drawer tool box
1	TP647	Bucking bar
1	TP670	Bucking bar
1	TP634	bucking bar

## DELUXE SHEET METAL TOOL KIT

This deluxe tool set is designed to meet the professional aircraft mechanics many needs, and includes just about every hand tool required for working with sheet metal.

Complete Kit	
Part Number	Rivet Gun Included
TP176DLX-3X	3X
TP176DLX-4X	4X



## 503 Piece Kit Includes:

Model #	Qty	Item
TP83/TP84	1	3X or 4X offset handle rivet gun
TP109M-3/32	5	Wing nut fastener
TP109M-1/8	5	Wing nut fastener
TP109M-5/32	5	Wing nut fastener
TP109M-3/16	5	Wing nut fastener
TP145DSK	1	Drill stop kit
TP89i	1	Rivet set mix (includes: 1 flush set of 5 .401 shank SM10 series, straight 3/32" - 3/16" w/ pouch)
TP90i	1	Rivet set mix (includes: set of 5 .401 shank SM20 series straight 3/32" - 1/4" with pouch)
TP91	1	Flush rivet set
TP175	1	Bucking bar kit
TP51K	1	Aviation snip combo (left, right, straight)
TP266	1	Deburring Tool
TP61K	1	Stop counter sink kit (1 ea.: TP61, TP62-21, 30, 40 & storage lube)
TP46	1	Angle drill attachment
TP346	1	Heavy duty rivet cutter
TP4263K	1	Dimple & die kit (includes 3/32", 1/8", 5/32" & 3/16" with plastic box)
TP116	1	Hand rivet squeezer
TP722	2	Fluting plier
TP74	1	Cleco plier
TP76K	1	Portable hand punch kit
TP312	1	Hole cutter
US7387RS	1	Rivet shaver
TP143-9/16	1	Rivet shaver cutter
TP294S	1	Noxon spring center punch
TP853	1	Rivet length gauge
TP55-10	1	Extension bit
TP55-21	1	Extension bit
TP55-30	1	Extension bit
TP55-40	1	Extension bit
TP230	1	Cylindrical rotary burr
TP854	1	Shop head rivet gauge set
TP714	1	Std. aviation maint. handbook

Model #	Qty	Item
TP44	1	Hand seamer
TP81	1	Hand nibbler
TP1235G	5	Side grip fastener
TP70AT	1	Chip chaser
TP675	1	Mini vac
TP75K-80	1	Cleco fastener (20 pc. ea. size: 3/32", 1/8", 5/32", 3/16" & 1/4")
A1007-234X	1	Quick change retainer spring
TP875	1	Mini air drill
TP258	1	Angle drill collet & chuck kit
TPMM250K	1	Strap duplicator kit (includes #40, 30, 21 & 10 with pouch)
TP1255G	5	Side grip fastener
US902	1	Cleco fastener installation tool
US114C	1	Rivet Squeezer
US7092DARE-2800	1	Angle Drill
TP276	1	Rivet removal tool
TP844	1	Swivel riveting tool
TP726K	1	Rivet nut tool kit (includes: 6-32, 8-32, 10-32, notcher & handy case)
TP641HC	6	Handi-clamp
TP68K	1	Safety wire twister kit (includes: TP68SR wire twister, TP277, handy twister, 1 ea. of .020, .032, & .041 safety wire & handy carrying case)
TP249	1	Jobber drill set (60 pc number size 1 thru 60, 118°, high speed steel)
A1142	1	Air tool oil
TP604B	1	Flexible steel rule
TPA5588	1	Hook scriber
TP55A-10	1	Extension bit
TP55A-21	1	Extension bit
TP55A-30	1	Extension bit
TP55A-40	1	Extension bit
130	1	Die grinder
TP229B	1	Round tree rotary burr
TP260D	1	Tool box and cabinet
TP854	1	Shop head rivet gauge set



## U.S. INDUSTRIAL JIFFY STYLE

- Teasing trigger
- Black powder coated finish.
- Retainer spring quick change.
- Takes special Jiffy Sets ( see page 21)

Jiffy Type .401" Shank				
Part Number	Blows Per Minute	Capacity (alum. - steel)	Length	Weight
US100B	2,850	1/8" - 1/8"	3-3/4"	2.25 lbs
US200B	2,700	3/16" - 5/32"	4-1/4"	2.625 lbs
AIT100B	2,850	1/8" - 1/8"	5-11/16"	2.25 lbs



**US200B**

## AERO INDUSTRIAL RIVET GUNS

- Teasing trigger
- Aluminum offset pistol handle.
- Includes power regulator & beehive retainer spring.
- Straight handle models available (1X, 2X, 3X & 4X), please inquire.

Economy .401" Shank				
Part Number	Blows Per Minute	Capacity (alum. - steel)	Length	Weight
1X	3,600	1/8" Aluminum	5-11/16"	2.0 lbs
2X	2,580	5/32" - 3/32"	6-11/16"	2.25 lbs
3X	2,160	3/16" - 5/32"	7-5/16"	2.35 lbs
4X	1,740	1/4" - 3/16"	8-5/16"	2.75 lbs

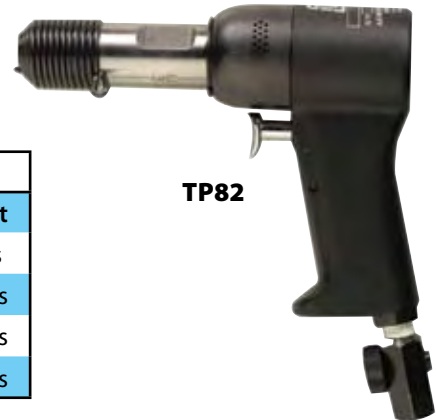

**TP82**

U. S. Industrial Type				
Part Number	Blows Per Minute	Capacity (alum. - steel)	Length	Weight
TP82	2,580	5/32" - 3/32"	6-11/16"	2.25 lbs
TP83	2,160	3/16" - 5/32"	7-5/16"	2.35 lbs
TP84	1,740	1/4" - 3/16"	8-5/16"	2.75 lbs

Economy .498" Shank				
Part Number	Blows Per Minute	Capacity (alum. - steel)	Length	Weight
5X	1,560	9/32" - 3/16"	8-5/16"	4.75 lbs
7X	900	3/8" - 5/16"	11-5/16"	6 lbs
9X	1,140	5/16" - 1/4"	9-5/16"	2.25 lbs

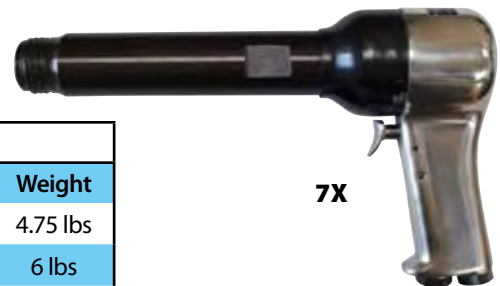

**7X**

CHICAGO PNEUMATIC® RIVET GUNS

- Aluminum offset pistol handle.
- Genuine CP original design.
- Includes retainer spring.
- Built in power regulator.
- Teasing trigger.
- Red powder coated finish.

Note: Rivet set not included.



CP4444RURAB

.401" Shank				
Part Number	Blows Per Minute	Capacity (alum. - steel)	Length	Weight
CP4444RURAB	2,580	1/8" - 3/32"	6-11/24"	2.25 lbs
CP4444RUSAB	2,160	3/16" - 5/32"	7-5/16"	2.25 lbs
CP4444RUTAB	1,740	1/4" - 3/16"	8-5/16"	2.75 lbs



CP4447RUSAB

.401" Shank				
Part Number	Blows Per Minute	Capacity (alum. - steel)	Length	Weight
CP4447RURAB	1,560	9/32" - 3/16"	8-5/16"	4.75 lbs
CP4447RUSAB	900	3/8" - 5/16"	11-5/16"	6 lbs
CP4447RUTAB	1,140	5/16" - 1/4"	9-5/16"	5.125 lbs

U.S. INDUSTRIAL TOOL RIVET GUNS

- Aluminum offset pistol handle.
- Includes retainer spring.
- TP2012 power regulator.
- Teasing trigger.
- Black powder coated finish.



US3X

.401" Shank				
Part Number	Blows Per Minute	Capacity (alum. - steel)	Length	Weight
US1X	3,600	1/8" - 1/8"	5-11/16"	2.0 lbs
US2X	2,580	1/8" - 3/32"	6-11/16"	2.3 lbs
US3X	2,160	3/16" - 5/32"	7-5/16"	2.4 lbs
US4X	1,740	1/4" - 3/16"	8-5/16"	2.8 lbs



US7X

.498" Shank				
Part Number	Blows Per Minute	Capacity (alum. - steel)	Length	Weight
US5X	1,560	9/32" - 3/16"	9-1/4"	5.0 lbs
US7X	900	3/8" - 5/16"	11-1/2"	6.1 lbs
US9X	1,140	5/16" - 1/4"	10"	5.3 lbs

## CLECO® F SERIES RIVET GUNS

- Spool valve for precise speed control.
- Built in power regulator.
- Quick change retainer spring.
- Teasing trigger.

.401" Shank				
Part Number	Blows Per Minute	Capacity (alum. - steel)	Length	Weight
F2-PT-RT-B	3,900	1/8"	6-3/4"	2.7 lbs
F4-PT-RT-B	1,700	1/4"	8-3/4"	3.3 lbs



**F2-PT-RT-B**

## INGERSOLL RAND RIVET GUNS

- Built in power regulator.
- Includes retainer spring.
- Teasing trigger.
- Genuine IR original design

.401" Shank				
Part Number	Blows Per Minute	Capacity (alum. - steel)	Length	Weight
AVC12A1	2,100	1/4" - 3/16"	6-1/2"	3.3 lbs
AV13A1	1,725	5/16" - 1/4"	8-3/4"	3.6 lbs



**AVC12A1**

## SIOUX RIVET GUNS

- Built in power regulator.
- Red power coated finish.
- Teasing trigger.

.401" Shank				
Part Number	Blows Per Minute	Capacity (alum. - steel)	Length	Weight
270A	2,000	3/16" - 5/32"	6-3/4"	
270A-2	2,500	1/8" - 5/32"	5-3/4"	
270A-4	1,700	5/16" - 1/4"	7-3/4"	



**SIOUX 270**

## HI-SHEAR ERGONOMIC RECOILLESS RIVET GUNS

- New advanced ergonomic designs significantly reduce Carpal Tunnel Syndrome & enhance operator comfort.
- All models include retainer spring.



17301

.401" Shank				
Part Number	Blows Per Minute	Capacity (alum. - steel)	Length	Weight
17201	3,000	3/16" - 5/32"	7-9/16"	2.8 lbs
17301	2,000	1/4" - 3/16"	8-3/16"	3.0 lbs
17401	1,725	5/16" - 1/4"	8-1/2"	3.1 lbs
17601	1,350	3/8" - 5/16"	10-1/2"	3.7 lbs
17701	1,125	7/16" - 3/8"	12"	3.9 lbs

## CHICAGO PNEUMATIC® ERGONOMIC RECOILLESS RIVET GUNS

- New advanced ergonomic designs significantly reduce Carpal Tunnel Syndrome & enhance operator comfort.
- All models include retainer spring.
- Also includes built-in regulator.

Note: Rivet set not included.



CP4450

Pistol Grip .401" Shank				
Part Number	Blows Per Minute	Capacity (alum. - steel)	Length	Weight
CP4450-2	2,580	1/8" - 3/32"	8-3/8"	2.7 lbs
CP4450-3	2,160	3/16" - 5/32"	8-7/8"	2.8 lbs
CP4450-4	1,740	1/4" - 3/16"	9-7/8"	3.2 lbs



CP4550S

Inline .401" Shank				
Part Number	Blows Per Minute	Capacity (alum. - steel)	Length	Weight
CP4450-S-2	2,580	1/8" - 3/32"	8.7"	2.8 lbs
CP4450-S-3	2,160	3/16" - 5/32"	9.2"	3.0 lbs
CP4450-S-4	1,740	1/4" - 3/16"	10.2"	3.2 lbs

## U.S. INDUSTRIAL "RECOILLESS" RIVET GUNS

- Unique Viscoelastic dampening system reduces damaging low-frequency vibration
- Ergonomic design, comfortable, balanced tool.
- Compact design.
- "Sure Grip" powder coated finish.
- Teasing trigger
- TP1 swivel regulator supplied as standard equipment.
- Used by most major aircraft manufacturers.



US3R

.401" Shank				
Part Number	Blows Per Minute	Capacity (alum. - steel)	Length	Weight
US2R	2,250	5/32" - 1/8"	6-7/8"	2.8 lbs
US3R	1,900	3/16" - 5/32"	7-7/8"	3.0 lbs
US4R	1,650	7/32" - 3/16"	8-7/8"	3.3 lbs
US5R	1,400	1/4" - 3/16"	9-7/8"	3.5 lbs

## RECOILLESS TOOL KITS



### 12-PIECE RECOILLESS RIVETING TOOL KIT

**PART NO: US2RRBK**

(includes US2R Recoilless Rivet Hammer)

**PART NO: US3RRBK**

(includes US3R Recoilless Rivet Hammer)

**Kit contains:**

Part Number	Qty.	Description
US2R or US3R	1	Recoilless Rivet Hammer
TP111R	1	Recoilless Bucking Bar
TP1500H	1	Bucking Dollie
TP1525S	1	Bucking Dollie
TP15050	1	Bucking Dollie
TP2020B	1	Bucking Dollie
TP1510A	1	Bucking Dollie
TP1530S	1	Bucking Dollie
TP1540S	1	Bucking Dollie
TP1	1	Swivel Regulator
TP218	1	Case with foam insert
A1142	1	4 oz. oil

### 9-PIECE RECOILLESS RIVETING TOOL KIT

**PART NO: US4RRBK**

(includes US4R Recoilless Rivet Hammer)

**PART NO: US5RRBK**

(includes US5R Recoilless Rivet Hammer)

**Kit contains:**

Part Number	Qty.	Description
US4R or US5R	1	Recoilless Rivet Hammer
TP111R	1	Recoilless Bucking Bar
TP0000H	1	Bucking Dollie
TP3553H	1	Bucking Dollie
TP3558H	1	Bucking Dollie
TP3559H	1	Bucking Dollie
TP1	1	Swivel Regulator
TP218-1	1	Large case w/ foam insert
A1142	1	4 oz. oil

## U.S. INDUSTRIAL TOOL RECOILLESS BUCKING BARS

Our Recoilless bucking bars greatly reduce the vibration associated with driving rivets. Designed with the same intent as our recoilless rivet gun, these bucking bars can also be used with all conventional rivet guns.

- For up to 3/16" diameter fasteners and 4 lb. dollies.
- Quick-change design enables you to change the dollies in just seconds.
- Several weights to accommodate a wide range of fastener installations.
- Viscoelastic Dampening System for maximum operator protection.
- "Sure-Grip" powder coat finish for positive handling.
- "Sure-Grip" powder coat finish for positive handling.
- Ergonomic hand grip ball (31042, shown below) is available at additional cost on TP1111 Series tools.
- Manufactured in the U.S.A. by U.S. Industrial Tool.



**TP111R  
WITH TP1500H  
DOLLIE**

### U. S. INDUSTRIAL LARGE CAPACITY "RECOILLESS" BUCKING BARS

The TP1111R/TP1111RA fills the need for additional dampening for large diameter and harder grade fasteners.

A wide selection of Dollie heads are available.

- For up to 3/16" or larger diameter fasteners and 4 lb. dollies.
- Quick-change design enables you to change the dollies in just seconds.
- Several weights to accommodate a wide range of fastener installations.
- Viscoelastic Dampening System for maximum operator protection.
- "Sure-Grip" powder coat finish for positive handling.
- Comes with TP0000H2 dolly and 31021 shank.
- All dollies include unique safety retainers to retain dolly to bucking bar body
- Manufactured in the U.S.A. by U.S. Industrial Tool.



**TP111RB  
WITH TP1500H2  
INCLUDES HAND  
GRIP BALL**

#### ERGONOMIC HAND GRIP BALL PART NO. 31042

- Standard on TP1111RB, optional on all other types

#### Optional Dolly Shanks:

Part Number	Design	Length	Diameter	Dampened	Weight
TP111R	All Steel	3.78"	1-7/8"	Viscoelastic	2 lbs
TP111RA	Steel Alum.	3.78"	1-7/8"	Viscoelastic	1 lb
TP111RAA	Alum.	3.78"	1-7/8"	Viscoelastic	.91 lbs
TP1111R	All Steel	5.75"	1-7/8"	Viscoelastic	3.20 lbs
TP1111RA	Steel Alum.	5.75"	1-7/8"	Viscoelastic	3.13 lbs
TP1111RB	All Steel	5.75"	1-7/8"	Viscoelastic	3.20 lbs

Part Number	Length
31021	2-1/2" standard
31021-1	3-1/4"
31021-2	4-3/4"
31021-3	6-1/2"

## "RECOILESS" DOLLIES

Bars are cast with Ductile iron to insure a non porous finish which is very important in order to have that highly polished finish. They are heat treated to 38-42 RC and can be repolished many times without charging hardness. Work surfaces are highly polished.

Quantity prices available on request.

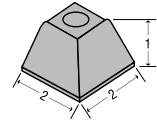

**TP1520S 1 lb.**

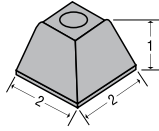

**TP1520S 1 lb.**

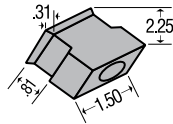

**TP1525S .94 lb.**

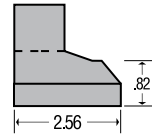

**TP15050 1.19 lb.**

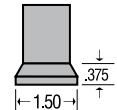

**TP1515C .56 lb.**

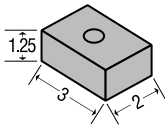

**TP1535S 2.31 lbs.**

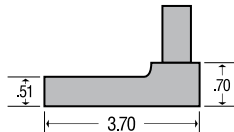

**TP1510A 1.34 lbs.**

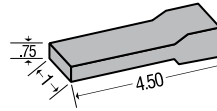

**TP1530S 1 lb.**

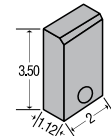

**TP1540S 2.38 lbs.**

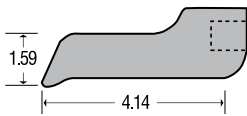

**TP2000B 3.9 lbs.**

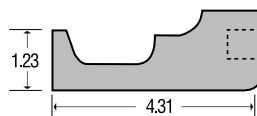

**TP2005B 3.2 lbs.**

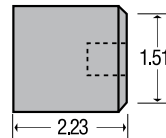

**TP2010B 2.95 lbs.**

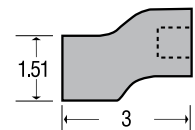

**TP2015B 2.66 lbs.**

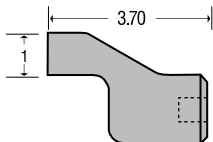

**TP2020B 3.28 lbs.**

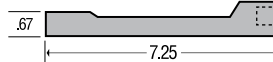

**TP2025B 2.8 lbs.**

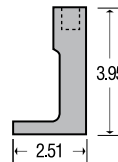

**TP2030B 3.1 lbs.**

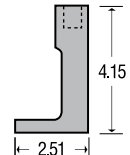

**TP2035B 3.45 lbs.**

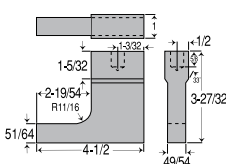

**TP2040B 2.75 lbs.**

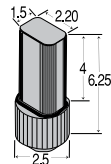

**TP0000H 6.75 lbs.**

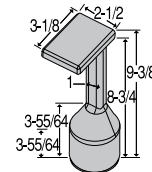

**TP3560H 7.1 lbs.**

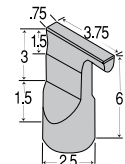

**TP777 6.3 lbs.**

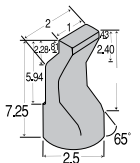

**TP3553H 4.5 lbs.**

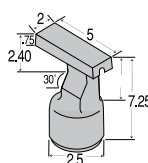

**TP3554H 7.9 lbs.**

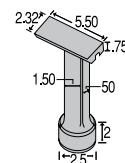

**TP3565H 8 lbs.**

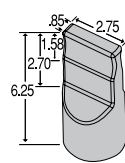

**TP3559H 5.92 lbs.**

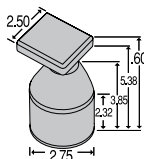

**TP3558H 6.03 lbs.**

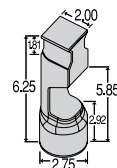

**TP3568H 8.46 lbs.**

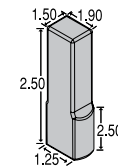

**TP0000H2 6 lbs.**

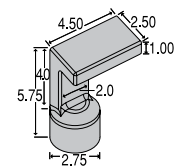

**TP35500H-L 8.241 lbs.**

• Indicates polished side

## 90° ANGLE ATTACHMENT

- Compact & lightweight.
- Gets in where no standard tool can.

Note: Rivet sets sold separately, see charts below.



AT595C

Part Number	Capacity	For Use With:	Weight
AT-595C	3/16"	Cleco E3 & E4; CP 3X & 4X Types	1 lb. (0.5 kgs)
AT-595B	3/16"	Jiffy 200 & 300; IR; AVC 111 & 121	1 lb. (0.5 kgs)

## Cupped Universal AN470 Sets

Part Number	Cupping Size	Set Length
AT1757AP-4703	3/32"	3/8"
AT1757AP-4704	1/8"	3/8"
AT1757AP-4705	5/32"	3/8"
AT1757AP-4706	3/16"	3/8"

## Mushroom Flush Sets

Part Number	Diameter	Set Length
AT1758AP	5/8"	1/4"
AT1758AR	3/4"	1/4"

## RIVET GUN RETAINER SPRINGS



HANDI



BEEHIVE



MECH-AID

Part Number	Type	Size	For Use With:
A1006-234x	Beehive	1-3/32" Dia.	1x, 2x, 3x & 4x; CP4444RURAB, RUSAB & RUTAB; Cleco E2, E3 & E4
A1006-AVC	Beehive	1-5/32" Dia.	IR; AVC 10, 11, 12, 13, 24 & 26; Jiffy; Sioux; Cleco G4, G8, F2 & F4
A1006-579x	Beehive	1-3/16" Dia.	5x, 7x & 9x; CP4477RUSAB, RUVAB & RUTAB
A1007-234x	Handi	1-3/32" Dia.	1x, 2x, 3x & 4x; CP4444RURAB, RUSAB & RUTAB; Cleco E2, E3 & E4
A1007-AVC	Handi	1-5/32" Dia.	IR; AVC 10, 11, 12, 13, 24 & 26; Jiffy; Sioux; Cleco G4, G8, F2 & F4
A1007-579x	Handi	1-3/16" Dia.	5x, 7x & 9x; CP4477RUSAB, RUVAB & RUTAB
AIT896	Mech-Aid	1-3/32" Dia. (.401")	2x, 3x & 4x; CP4444RURAB, RUSAB & RUTAB; Cleco E2, E3 & E4
AIT897	Mech-Aid	1-3/16" Dia. (.498")	5x, 7x & 9x; CP4477RUSAB, RUVAB & RUTAB
A1006-100B	Mech-Aid	1-5/32" Dia.	-100B & 17-200B (compact design models)
TP88	1 ea. A1006-234x, A1007-234x		2x, 3x & 4x; CP4444RURAB, RUSAB & RUTAB; Cleco E2, E3 & E4

## RIVET GUN POWER REGULATORS

Part Number	Type
TP97	Steel
TP2012	CP Solid Brass Construction
TP1	360° Swivel Regulator

- Provides regulation of air intake for accurate adjustment of hammer blow



TP97



TP2012



TP1



## Order Rivet sets the E-Z way!









To Determine Part Number:

1. Select desired rivet set length and note its Model No.
2. Refer to Rivet Style Chart and find desired cupping style.
3. Match cupping style with desired rivet diameter and add that number after the rivet set Model No.

**Example:** For SM10 with AN470 cupping for an 1/8" diameter rivet.

**Specify:** SM10-4704

RIVET STYLE CHART								
Cupping Style	Rivet Diameter						SM50/70 Only	
	1/16"	3/32"	1/8"	5/32"	3/16"	1/4"	5/16"	3/8"
Button AN435	4332	4333	4334	4335	4336	4338	43310	43312
Round AN430	4302	4303	4304	4305	4306	4308	43010	43012
Flat AN442	4422	4423	4424	4425	4426	4428	44210	44212
Brazier AN455	4552	4553	4554	4555	4556	4558	45510	45512
Mod. Brazier AN456	4562	4563	4564	4565	4566	4568	45610	45612
Universal AN470	4702	4703	4704	4705	4706	4708	47010	47012
Button AN435	4352	4353	4354	4355	4356	4358	43510	43512
Tubular AN450	4502	4503	4504	4505	4506	4508	45010	45012
Briles Bacr15ft	-	BAC	BAC	BAC	BAC	BAC	BAC	-

RIVET STYLE CHART								
								
AN435 Button	AN430 Round	AN455 Brazier	AN456 Brazier	AN470 Universal	AN442 Flat	BACR 15FT Briles Boeing	AN426 Countersunk	AN450 Semi-Tubular

## RIVET SETS

.401" Shank		.498" Shank		Overall Length
Part # Straight	Part # Offset	Part # Straight	Part # Offset	
SM15	-	-	-	2-1/2"
SM10	SM20	SM30	SM40	3-1/2"
SM11	SM21	SM31	SM41	5-1/2"
SM12	SM22	SM32	SM42	7-1/2"
SM13	SM23	SM33	SM43	10-1/2"
SM14	SM24	SM34	SM44	13-1/2"

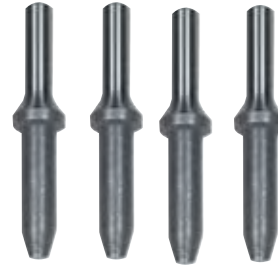

## AN470 DOUBLE OFFSET RIVET SETS

.401" Shank	.498" Shank	Overall Length
Part #	Part #	
SM130	SM132	5-1/2"
SM131	SM133	7-1/2"



SM130

## AN470 GOOSENECK RIVET SETS

.401" Shank			
Part #	Rivet Size	Rivet Style	Overall Length
SMGN500H	-	Flat	7-1/4"
SMGN-4703	3/32"	AN470	7-1/4"
SMGN-4704	1/8"	AN470	7-1/4"
SMGN-4705	5/32"	AN470	7-1/4"
SMGN-4706	3/16"	AN470	7-1/4"
SMGN-4708	1/4"	AN470	7-1/4"



**BOEING® BACR15FT MODIFIED UNIVERSAL RIVET SETS**



**SM10**



**SM20**

Example: For a 3-1/2" O.A.L. straight rivet set with a 1/8" cupping, use part number SM10-4704BAC

.401" Shank		
Part # - Straight	Part # - Offset	Overall Length
SM15	-	2-1/2"
SM10	SM20	3-1/2"
SM11	SM21	5-1/2"
SM12	SM22	7-1/2"

Cupping Size	3/32"	1/8"	5/32"	3/16"	7/32"	1/4"	9/32"
Part No. Mod. Univ. AN470	4703BAC	4704BAC	4705BAC	4706BAC	4707BAC	4708BAC	4709BAC

**BOEING® BACR15FT MODIFIED UNIVERSAL BELL TYPE RIVET SETS**



**SM50**

Example: For a 3-1/2" O.A.L. straight rivet set with a 3/8" cupping, use part number SM50-47012BAC

.401" Shank		.498" Shank		Overall Length
Part # Straight	Part # Offset	Part # Straight	Part # Offset	
SM50	SM60	SM70	SM80	3-1/2" (89 mm)
SM51	SM61	SM71	SM81	5-1/2" (140 mm)
SM52	SM62	SM72	SM82	7-1/2" (191 mm)

Cupping Size	5/16"	11/32"	3/8"
Part No. Mod. Univ. AN470	47010BAC	47011BAC	47012BAC

**ELLIPTICAL FACE FLUSH SET FOR BACR15FV**

Specifically designed to drive countersunk rivets and prevent damage to skin surface. The elliptical face concentrates all forces on the center area of the rivet. Specifically designed for use on the following fasteners: BOEING BACR 15FV & BRILES BRFZ & BRFR shear head.



**SM1111-1**

.401" Shank Part Number	Diameter	Overall Length
SM1111-1	3/4"	2-1/4"
SM1111-2	1-1/4"	2-1/4"

**BELL TYPE RIVET SETS**

Example: For a 3-1/2" O.A.L. straight rivet set with a 1/4" cupping AN455, use part number SM50-4558



**SM50**

.401" Shank		.498" Shank		Overall Length
Part # Straight	Part # Offset	Part # Straight	Part # Offset	
SM50	SM60	SM70	SM80	3-1/2" (89 mm)
SM51	SM61	SM71	SM81	5-1/2" (140 mm)
SM52	SM62	SM72	SM82	7-1/2" (191 mm)

Cupping Size	Part Number Round AN430	Part Number Button AN435	Part Number Flat AN442	Part Number Brazier AN455	Part Number Mod. Brazier AN456	Part Number Universal AN470
1/4"	-	-	-	4558	-	-
5/16"	43010	43510	44210	45510	45610	47010
3/8"	43012	43512	44212	45512	45612	47012

## .401 RIVET GUN SET MIX

**UNIVERSAL STRAIGHT  
5 PIECE SET MIX  
PART NO. TP89**  
(U.S Made)

- 3-1/2" sets
- Contains one of each:  
SM10-4703-3/32"  
SM10-4704-1/8"  
SM10-4705-5/32"  
SM10-4706-3/16"  
SM90- Flush Set 1" dia.
- Includes pouch



**UNIVERSAL STRAIGHT  
6 PIECE SET MIX  
PART NO. TP89-6**  
(U.S Made)

- 3-1/2" sets
- Contains one of each:  
SM10-4703-3/32"  
SM10-4704-1/8"  
SM10-4705-5/32"  
SM10-4706-3/16"  
SM90- Flush Set 1" dia.
- Includes pouch



**UNIVERSAL STRAIGHT LONG  
5 PIECE SET MIX  
PART NO. TP89L**  
(U.S Made)

- 5-1/2" long sets
- Contains one of each:  
SM11-4703-3/32"  
SM11-4704-1/8"  
SM11-4705-5/32"  
SM11-4706-3/16"  
SM92- Flush Set 1" dia.
- Includes pouch



**UNIVERSAL OFFSET LONG  
4 PIECE SET MIX  
PART NO. TP90-L**  
(U.S Made)

- 5-1/2" sets
- Contains one of each:  
SM21-4703-3/32"  
SM21-4704-1/8"  
SM21-4705-5/32"  
SM21-4706-3/16"
- Includes pouch



**UNIVERSAL OFFSET  
5 PIECE SET MIX  
PART NO. TP90**  
(U.S Made)

- 3-1/2" sets
- Contains one of each:  
SM20-4703-3/32"  
SM20-4704-1/8"  
SM20-4705-5/32"  
SM20-4706-3/16"  
SM20-4708-1/4"
- Includes pouch



**UNIVERSAL GOOSENECK  
4 PIECE SET MIX  
PART NO. SMGNK-4**  
(U.S Made)

- 7-1/2" sets
- Contains one of each:  
SMGN-4703-3/32"  
SMGN-4704-1/8"  
SMGN-4705-5/32"  
SMGN-4706-3/16"
- Includes pouch



**BACR15FT STRAIGHT  
4 PIECE SET MIX  
PART NO. TP89-BAC**  
(U.S Made)

- 3-1/2" sets
- Contains one of each:  
SM10-4703-BAC  
SM10-4704-BAC  
SM10-4705-BAC  
SM10-4706-BAC
- Includes pouch



**BACR15FT OFFSET  
4 PIECE SET MIX  
PART NO. TP90-BAC**  
(U.S Made)

- 3-1/2" sets
- Contains one of each:  
SM20-4703-BAC  
SM20-4704-BAC  
SM20-4705-BAC  
SM20-4706-BAC
- Includes pouch



## "SHORTIE" FLUSH MUSHROOM SETS



SM110

.401" Shank Part Number	Face Diameter	Overall Length
SM110	3/4"	1-3/4" to 2"
SM111	1"	1-3/4" to 2"
SM112	1-1/4"	1-3/4" to 2"
SM113	1-1/2"	1-3/4" to 2"

## FLUSH MUSHROOM SETS



SM90

.401" Shank		
Part Number	Diameter	Overall Length
SM89	3/4"	3"
SM90	1"	2-1/2"
SM91	1"	3"
SM92	1"	5-1/2"
SM93	1"	7-1/2"
SM94	1-1/4"	3"
SM95	1-1/4"	5-1/2"
SM96	1-1/2"	3-1/8"
SM97	1-3/4"	3-1/4"
SM98	1-1/8"	2-1/4"
SM99	1-1/4"	2-1/4"

.498" Shank		
Part Number	Diameter	Overall Length
SM100	1"	2-1/2"
SM101	1"	3"
SM102	1"	5-1/2"
SM103	1"	7-1/2"
SM104	1-1/4"	3"
SM105	1-1/4"	5-1/2"
SM106	1-1/4"	3-1/2"
SM107	1-3/4"	3-1/2"
SM108	1-1/8"	2-1/4"
SM109	1-1/8"	2-1/4"

## OFFSET FLUSH MUSHROOM SETS



SM140

.401" Shank Part Number	.498" Shank Part Number	Diameter	Overall Length
SM140	SM160	1"	3-1/2"
SM141	SM161	1"	5-1/2"
SM142	SM162	1"	7-1/2"
SM143	SM163	1-1/4"	3-1/2"
SM144	SM164	1-1/4"	5-1/2"
SM145	SM165	1-1/4"	7-1/2"

## FLUSH MUSHROOM SETS WITH RUBBER GUARD



SM170

.401" Shank Part Number	.498" Shank Part Number	Diameter	Overall Length
SM170	SM173	3/4"	2-1/4" to 2-5/8"
SM171	SM174	1"	2-1/4" to 2-5/8"
SM172	SM175	1-1/4"	2-1/4" to 2-5/8"

## CUPPED RIVET SETS FOR JIFFY TYPE (SERIES B) RIVET GUNS

Straight Cupped .401" Shank		
Part Number	Diameter	Overall Length
SMJ510	1/2"	1-3/16"

Offset Cupped .401" Shank		
Part Number	Diameter	Overall Length
SMJ520	1/2"	1-5/8"
SMJ521	1/2"	1-3/4"
SMJ522	1/2"	1-7/8"
SMJ523	1/2"	2"

Example: For a 2" O. A. L. offset cupped rivet set with a 1/8" AN470 cupping, use part number: SMJ523-4704



**SMJ510**

**SMJ520**

Cupping Size	1/16"	3/32"	1/8"	5/32"	3/16"	1/4"
Part Number AN470	4702	4703	4704	4705	4706	4708

## FLUSH RIVET SETS FOR JIFFY TYPE (SERIES B) RIVET GUNS

Mushroom Flush .401" Shank		
Part Number	Diameter	Overall Length
SMJ559	3/4"	1-1/4"
SMJ560	1"	1-5/8"



**SMJ500**

**SMJ560**

**SMJ530**

Mushroom Flush w/ Rubber Guard .401" Shank		
Part Number	Diameter	Overall Length
SMJ530	3/4"	1-1/8" to 1-3/8"
SMJ531	1"	1-1/8" to 1-3/8"
SMJ532	1-1/4"	1-1/8" to 1-3/8"

Straight Flush .401" Shank		
Part Number	Diameter	Overall Length
SMJ500	3/8"	1-3/16"
SMJ501	1/2"	1-3/16"
SMJ502	5/8"	1-3/16"

## DRIVE SETS FOR HUCK® LOCKBOLTS

.401" Shank		.498" Shank		Overall Length
Part # Straight	Part # Offset	Part # Straight	Part # Offset	
SMH10	SMH20	SMH30	SMH40	3-1/2" (89 mm)
SMH11	SMH21	SMH31	SMH40	5-1/2" (140 mm)



**SMH10**

Rivet Size	1/8"	5/32"	3/16"
Part Number	-4	-5	-6

Example: For a 3-1/2" O. A. L. offset cupped rivet set with a 1/8" rivet, use part number H 07-10-4.

## BELL TYPE DRIVE SETS FOR HUCK® LOCKBOLTS

.401" Shank		.498" Shank		Overall Length
Part # Straight	Part # Offset	Part # Straight	Part # Offset	
SMH50	SMH60	SMH70	SMH80	3-1/2" (89 mm)
SMH51	SMH61	SMH71	SMH80	5-1/2" (140 mm)



**SMH50**

Example: For a 3-1/2" O. A. L. offset cupped rivet set with a 3/8" rivet, use part number SMH50-12.

Rivet Size	1/4"	5/16"	3/8"
Part Number	-8	-10	-12

## NOTCHED SETS FOR HI-SHEAR® RIVETS

.401" Shank Part Number	Overall Length
SMHS150	4-1/2"

Rivet Size	1/8"	5/32"	3/16"	1/4"
Part Number	-4	-5	-6	-8

Example: For a .401" shank rivet set with a 1/4" rivet, use part number SMHS150-8



SMHS150

## DRIVET SETS FOR HI-SHEAR® RIVETS

.401" Shank		
Part # - Straight	Part # - Offset	Overall Length
SMHS10	SMHS20	3-1/2" (89 mm)
SMHS11	SMHS21	5-1/2" (140 mm)
SMHS12	SMHS22	7-1/2" (190 mm)
SMHS15	-	2-3/4" (70 mm)

Rivet Size	1/8"	5/32"	3/16"	1/4"
Part Number	-4	-5	-6	-8



SMHS10

Example: For a 3-1/2" O. A. L. straight rivet set with a 1/4" rivet, use part number SMHS10-8

## BELL TYPE DRIVE SETS FOR HI-SHEAR® RIVETS

.401" Shank		.498" Shank		Overall Length
Part # Straight	Part # Offset	Part # Straight	Part # Offset	
SMHS50	SMHS60	SMHS70	SMHS80	3-1/2"
SMHS51	SMHS61	SMHS71	SMHS81	5-1/2"

Rivet Size	5/16"	3/8"
Part Number	-10	-12



SMHS50

Example: For a .401" shank rivet set with a 3/8" rivet, use part number SMHS50-10

## HUCK AND HI-SHEAR® GOOSENECK INSERT ADAPTERS

.401" Shank Part Number	.498" Shank Part Number	Insert Size	Overall Length
SMA450	SMA455	.406"	4-1/2"
SMA451	SMA456	.531"	4-1/2"

• Inserts not included order below.



SMA450

## INSERTS FOR GOOSENECK ADAPTERS

Hi-Shear Type Part Number	Huck Type Part Number	Insert Size	For Rivet Sizes
SMHS460	SMH465	.406"	1/8", 5/32", 3/16"
SMHS461	SMH466	.531"	1/4", 5/16", 3/16"

Example: For a .406" Hi-Shear insert for a 3/8" rivet, use part number SMHS460-12



SMHS460

Rivet Size	1/8"	5/32"	3/16"	1/4"	5/16"	3/8"
Part Number	-4	-5	-6	-8	-10	-12

## KNOCKOUT PUNCHES



**HI-SHEAR TYPE**  
3-3/8 OAL



**SMK TYPE**  
3-1/2 OAL



**SMK0 TYPE**  
3-1/2 OAL

Hi-Shear .401" Shank	
Part Number	Rivet Size
SMHS401K-3	3/32"
SMHS401K-4	1/8"
SMHS401K-5	5/32"
SMHS401K-6	3/16"
SMHS401K-8	1/4"
SMHS401K-10	5/16"
SMHS401K-12	3/8"

SMK .401" Shank	
Part Number	Rivet Size
SMK-3	3/32"
SMK-4	1/8"
SMK-5	5/32"
SMK-6	3/16"
SMK-8	1/4"
SMK-10	5/16"
SMK-12	3/8"

SMK0 .401" Shank	
Part Number	Rivet Size
SMK010-3	3/32"
SMK010-4	1/8"
SMK010-5	5/32"
SMK010-6	3/16"
SMK010-8	1/4"
SMK010-10	5/16"
SMK010-12	3/8"

## HUCK/HI-SHEAR® COLLAR REMOVERS

- Can be furnished with a 10° offset near the chisel edge. \*
- Rivet gun or hand type.



**SMHC**



**SMHC401**

\*Note: To order with a 10° offset, add a 'B' to the end of the part number.

Example: For a 1/8" rivet size (.401 shank) offset collar remover, use part number SMHSC401-4B

.401" Shank					
Part Number	Rivet Size	'A' Dimension (+.001 -.000)	'B' Dimension	'C' Dimension	Overall Length
SMHSC401-4	1/8"	.125"	3/4"	1/2"	5-1/2"
SMHSC401-5	5/32"	.156"	3/4"	1/2"	5-1/2"
SMHSC401-6	3/16"	.187"	3/4"	5/8"	5-1/2"
SMHSC401-8	1/4"	.250"	3/4"	5/8"	5-1/2"
SMHSC401-10	5/16"	.312"	7/8"	3/4"	5-1/2"
SMHSC401-12	3/8"	.375"	7/8"	3/4"	5-1/2"

Hand Type						
Part Number	Rivet Size	Stock Hex	'A' Dimension (+.001 -.000)	'B' Dimension	'C' Dimension	Overall Length
SMHC-4	1/8"	1/2"	.136"	9/16"	.083"	5-1/2"
SMHC-5	5/32"	1/2"	.167"	9/16"	.104"	5-1/2"
SMHC-6	3/16"	5/8"	.199"	11/16"	.125"	6-1/2"
SMHC-8	1/4"	3/4"	.259"	13/16"	.165"	7"

## AN450 TUBULAR RIVET SETS

.401" Shank		
Part # - Straight	Part # - Offset	Overall Length
SM10	SM20	3-1/2" (89 mm)
SM11	SM21	5-1/2" (140 mm)



**SM10**

**Example:** For a 3-1/2" O. A. L. straight rivet set with an 1/8" rivet size, use part number: SM10-4504

Rivet Size	1/16"	3/32"	1/8"	5/32"	3/16"	1/4"	5/16"
Part No. Flaring	4502	4503	4504	4505	4506	4508	45010

## STRAIGHT & OFFSET FLUSH SETS

.401" Shank		.498" Shank		Overall Length
Part # Straight	Part # Offset	Part # Straight	Part # Offset	
SM10-500H	SM20-500H	SM30-500H	SM40-500H	3-1/2"
SM11-500H	SM21-500H	SM31-500H	SM41-500H	5-1/2"
SM12-500H	SM22-500H	SM32-500H	SM42-500H	7-1/2"



## SWIVEL FLUSH SETS

.401" Shank Part Number	.498" Shank Part Number	Diameter	Overall Length
SM180	SM182	3/4"	3"
SM181	SM183	1-3/16"	3"



**SM180**

## SWIVEL FLUSH SETS WITH RUBBER GUARDS

.401" Shank Part Number	Diameter	Overall Length
AT106A	1-1/4"	3-1/2"



## SPECIAL NO-MAR FLUSH SETS

.401" Shank Part Number	Replacement Heads	Diameter	Overall Length
SM50-1A	SM-1A	1" Alum.	3-1/2"
SM50-1B	SM-1B	1" Brass	3-1/2"
SM50-1P	SM-1P	1" Plastic	3-1/2"



**SM50-1B**

Note: Screw on type heads

## NO-MAR RIVET SETS

- Holds sheet firmly in down position while riveting.
- For flush rivets & ack riveting.

.401" Shank Part Number	Overall Length
SM2470	5-1/2"



**SM2470**



## BREAK LOOSE TOOLS

- Will remove most frozen screws, nuts or bolts quickly & easily.

Note: TP328 comes with 1/4" hex adapter



**TP328**

.401" Shank Part Number	Tool Description	Overall Length
TP328	Long Tool (3/8" sq. drive) with wrench	7"
AT540S	Short Tool (3/8" sq. drive) with wrench	4-1/2"

Part Number	Description
54K	Adapter Kit: 1/4 hex, 4 bits ( one for #2 & #3 Phillips, and #8 & #10 slotted screws)

## SWIVELING DIMPLING TOOLS

- 3-1/2" long.



**SM10SP**

.401" Shank - Female Straight Swivel Rivet Set	
Part Number	Rivet Diameter
SM10SD-4263	3/32"
SM10SD-4264	1/8"
SM10SD-4265	5/32"
SM10SD-4266	3/16"

.401" Shank - Male Straight Swivel Rivet Set	
Part Number	Rivet Diameter
SM10SP-4263	3/32"
SM10SP-4264	1/8"
SM10SP-4265	5/32"
SM10SP-4266	3/16"

## RIVET SET ADAPTER

- Allows use of squeezer sets with your rivet gun.
- Accepts standard squeezer sets, dimple punch & die sets.

.401" Shank Part Number	Set Hole Size	Overall Length
SM10-187	.187"	3-1/2"



## .187 BUCKING BLOCK SET

### TP93

Bucking blocks are actually holding squeezer sets or dimple dies. They enable the fabricator to perform the operation with a rivet gun.

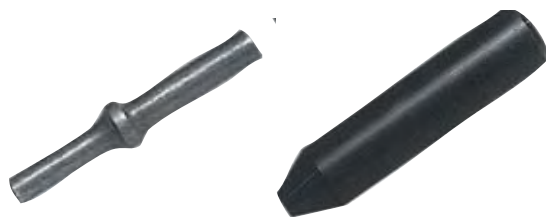

## LIMITED ACCESS OFFSET RIVET SETS FOR HUCK® LOCKBOLTS

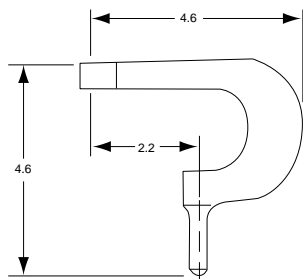

**SMH140C-7**

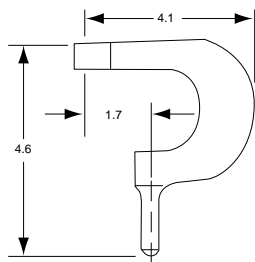

**SMH140C-4**

.401" Shank Part Number	Rivet Size
SMH140C-4	1/8"
SMH140C-5	5/32"
SMH140C-6	3/16"
SMH140C-7	1/8"
SMH140C-8	5/32"
SMH140C-9	3/16"

## LIMITED ACCESS OFFSET RIVET SETS

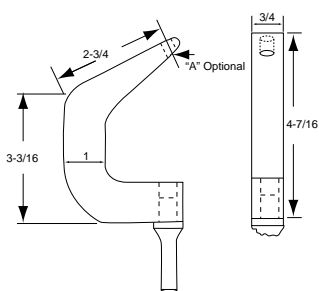

**SMGP**

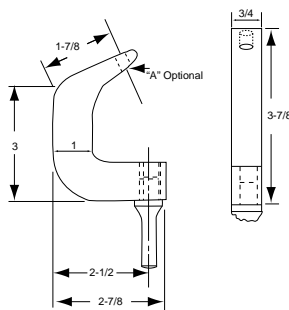

**SMG2**

- Set hole model allows use of squeezer sets with your rivet gun.
- Accepts standard squeezer sets, dimple punch & die sets.

.401" Shank Part Number	Type
SMG-P	Flush
SMG-PA	.250" Set Hole
SMG2-P	Flush
SMG2-PA	.250" Set Hole

## LIMITED ACCESS OFFSET RIVET SETS

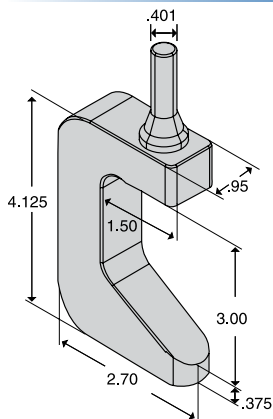

**SM0F-C**

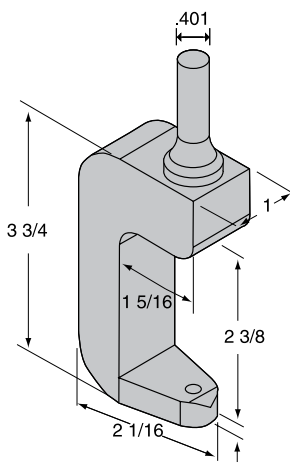

**SMCK**

- Set hole model allows use of squeezer sets with your rivet gun.
- Accepts standard squeezer sets, dimple punch & die sets.

.401" Shank Part Number	Type
SMCK-1A	Flush
SMCK-1	.187" set hole
SM0F-C-401A	Flush
SM0F-C-401	.187" set hole

## CHISEL & CUTTER TOOLS

### Assorted Tooling

#### .401 shank riveting tools

- Retainer tools used with standard aircraft riveting guns
- .401 shank diameter



.401" Shank		
Part Number	Description	Uses
905	Scraper	For removing sealant & deadener without heat.
912	Rivet Buster	For shearing all types of rivets. 3/4" wide
910	Chisel	For breaking spot welds, splitting nuts, shearing etc.
1955	Ripper	For clean, short radius cuts. Very tough.
1957	Panel Cutter	For straight & radius cuts
1959	Sheet Metal Trimmer	For edging sheet metal without stretch or distortion.
1960	Spot Weld Breaker	For cutting spot welds, works well on molding & rivets.

.498" Shank		
Part Number	Description	Uses
H1972	Chisel	For breaking spot welds, splitting nuts, shearing etc.

## RIVET SET EXTENSION ADAPTER



SM401E

- Quickly convert any standard length rivet set to an extra long style.

.401" Shank Part Number	.498" Shank Part Number	Accepts	Overall Length
SM401E	SM498E	.401" Shank Sets	8"

## SHANK ADAPTERS



SM401B



SM498A

- Includes handi retainer spring.

.401" Shank Part Number	Accepts	Overall Length
SM401B	.498" Shank Sets	3-3/4"

.498" Shank Part Number	Accepts	Overall Length
SM498A	.401" Shank Sets	3-3/4"

## SHANK ADAPTER SLEEVE



AIT99705

- Convert any .401" shank rivet set to .498" shank.
- Excellent where tooling space is limited.

Part Number	Accepts
AIT-99705	.401" Shank Sets

## RIVET FAN SPACING TOOL

- Used for layout & marking of equally spaced rivet holes.
- Accordion gate style.
- Unequalled for accuracy, save lots of time.

Part Number	Number of Fingers	Spacing Range	Overall Length
TP621	20	1/2"-2"	38"

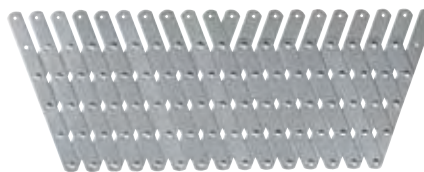

## RIVET REMOVING TOOL

Rivet removal tool is designed to keep the drill bit centered on the AN470 or brazier rivet head. The cupped drill guide also keeps the bit from slipping off and ruining the sheet metal around it. This tool is completely adjustable for drilling depth. It comes complete with four guides and drill bits for #3, #4, #5 and #6 rivets.

*Note: Not for use with steel-stemmed blind rivets.*

Part Number	Description
TP276	Removal Tool & 4 bits for AN470 with guides.
TP276B	Removal Tool For AN455/456 Brazier rivets.
TP54L-10	#10 replacement bit
TP54L-21	#21 replacement bit
TP54L-30	#30 replacement bit
TP54L-40	#40 replacement bit



TP276

## RIVET CUTTER

- Precision ground alloy steel shear plates.
- Adjustable steps in 1/16" increments.
- Vinyl grips or handles.

Part Number	Capacity
TP96	3/32", 1/8", 5/32" & 3/16" (1/4" aluminum only)



## HEAVY-DUTY RIVET CUTTER

- Adjustable for 1/4" to 3/4" length rivets in 1/16" increments
- Vinyl grips on handles.

Part Number	Capacity
TP346	1/16" - 1/4"



## RIVET CUTTER

- Will cut wire and screws
- Steps vary in 1/16" increments
- Bench or vise mounted.

Part Number	Capacity
TP626	Rivets 1/16", 1/8", 3/32", 5/32" & 3/16"



## RIVET LENGTH GAUGE

- Checks proper length of rivets before setting.
- Color coded.
- For both universal head & flush rivets.



Part Number	For Rivets
TP853	-3, -4, -5 & -6

## SHOP HEAD RIVET GAUGE SET

- Measures minimum height & diameter of shop heads after setting.
- For both universal head & flush rivets.
- Color coded.



Part Number	For Rivets
TP854	-3, -4, -5 & -6

## PRO MECHANIC PRECISION RIVET GAUGE SET

Part Number	For Rivets
TP854P-3	-3 or 3/32"
TP854P-4	-4 or 1/8"
TP854P-5	-5 or 5/32"
TP854P-6	-6 or 3/16"
TP854P-7	-7 or 7/32"
TP854-8	-8 or 1/4"

- Precision machined.
- Provides accurate rivet shank measurement of minimum to maximum. Dovetail finished diameters, as driven.
- Approximately 1" x 1" size.
- Nominal gauge slot for identification of rivet diameter
- Dovetail heights based on 1.5 D (rivet diameter versus length of shank minus actual material stack up)



## SNAP SOC RIVET CAPS

- Protects rivets & skin from damage.
- Lasts for approx. 50-75 rivets.
- Fits all standard 1/2" body rivet sets.

Part Number	Rivet Size	Color
JE10003	3/32"	White
JE10004	1/8"	Red
JE10005	5/32"	Green
JE10006	3/16"	Yellow
JE10007	1/4"	Blue



## 3M RIVETER'S TAPE

- Reduces manpower and time on large riveting jobs.
- Adhesive-free center window ensures easy visibility of rivets.

Part Number	Width	Thickness	Overall Length
TP808A	3/4"	4 mil.	36 yards
TP808B	1"	4 mil.	36 yards



TP808B

## BUCKING BAR SETS

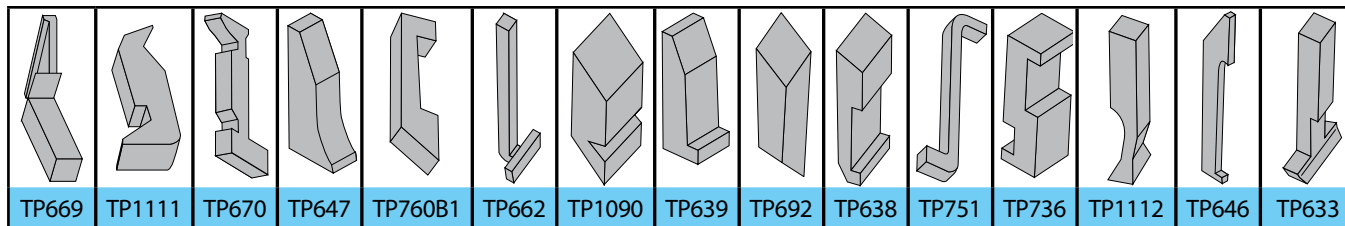

Note: See following pages for dimensional data.

Part Number	Bucking Bars Included	Weight
TP150	TP638, TP647, TP670, TP1112	5.88 lbs.
TP150-6	TP150 + TP669, TP1111	9.86 lbs.
TP150-10	TP150-6 + TP692, TP736, TP751, TP1090	18.60 lbs.
TP150-15	TP150-10 + TP639, TP662, TP646, TP633, TP760B1	27.0 lbs.



**TP150**

## TUNGSTEN BUCKING BAR

Bucking bars made of tungsten provide increased weight (density) to allow riveting in confined areas. The weight to size ration provides good kinetic energy transfer and will expedite the intallation process. We offer a standard shape and a consistent weight that should allow up to 3/16 diameter fastener installation.

<b>TP1111T 7.03 lbs.</b>	<b>TP51T 3.50 lbs.</b>	<b>TP52T 3.80 lbs.</b>	<b>TP54T 2.20 lbs.</b>	<b>TP55T 1.76 lbs.</b>
<b>TP56T 2.97 lbs.</b>	<b>TP601T 12.25 lbs.</b>	<b>TP605T 3.39 lbs.</b>	<b>TP634T 2.02 lbs.</b>	<b>TP639T 3.77 lbs.</b>
<b>TP646T 6.05 lbs.</b>	<b>TP647T 3.15 lbs.</b>	<b>TP662T 4.38 lbs.</b>	<b>TP670T 5.23 lbs.</b>	<b>TP721T 3.30 lbs.</b>
<b>TP723T 3.08 lbs.</b>	<b>TP736T 4.63 lbs.</b>	<b>TP760B-1T 2.86 lbs.</b>	<b>TP760B-10T 3.55 lbs.</b>	

## ATI AND U.S.I. BUCKING BARS

- We offer both ATI and U.S.I. bucking bars.

Cast with Ductile Iron to insure a non porous finish which is very important for a highly polished finish. Heat treated to 38-42 RC and can be repolished many times without changing hardness. Work surfaces are highly polished. Quantity prices available on request.

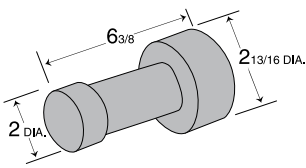
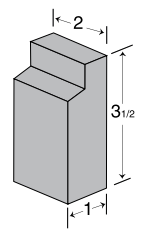
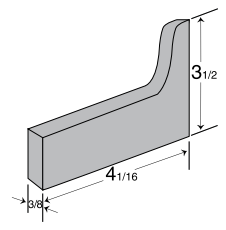
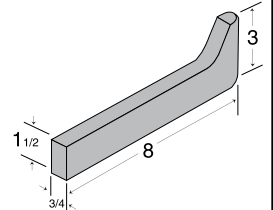
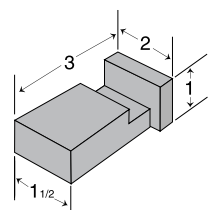
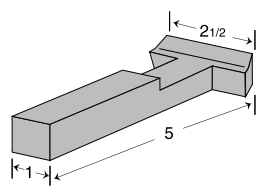
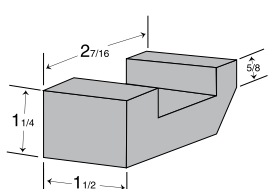
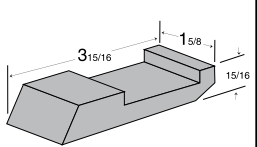
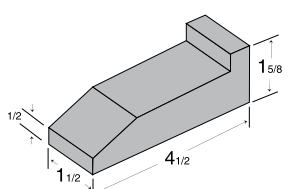
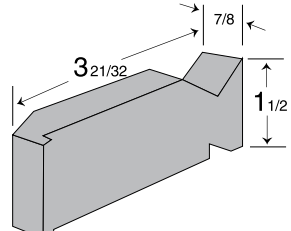
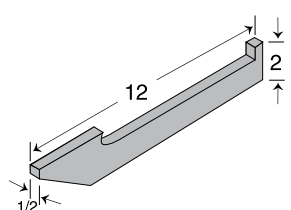
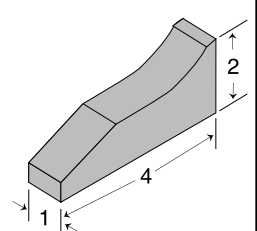
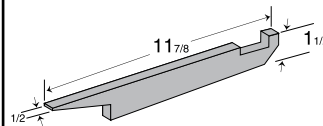
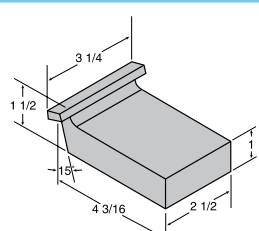
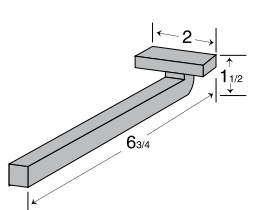
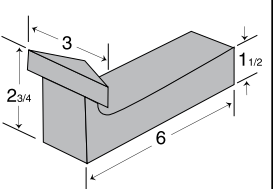
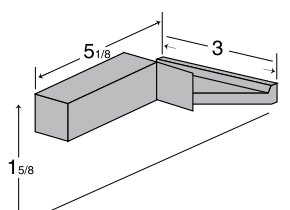
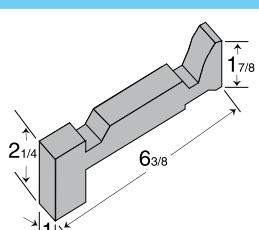
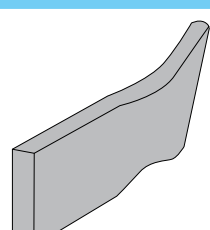
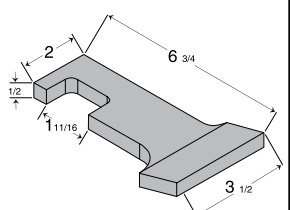
			
<b>AT601 - 5.25 lbs.</b>	<b>AT605 - 1.5 lbs</b>	<b>AT610 - .75 lbs.</b>	<b>AT614 - 2.75 lbs.</b>
			
<b>AT619 - 1.25 lbs.</b>	<b>AT633 - 1.50 lbs. TP633 - 1.25 lbs.</b>	<b>AT634 - 1.0 lbs.</b>	<b>AT638 - 1.25 lbs.</b>
			
<b>AT639 - 2.0 lbs. TP639 - 2.0 lbs.</b>	<b>AT643 - 1.25 lbs.</b>	<b>AT646 - 2.25 lbs. TP646 - 2.25 lbs.</b>	<b>AT647 - 1.5 lbs. TP647 - 1.5 lbs.</b>
			
<b>AT649 2.0 lbs.</b>	<b>AT658 - 3.75 lbs.</b>	<b>AT662 - .75 lbs. TP662 - 1.82 lbs.</b>	<b>AT667 - 4.0 lbs.</b>
			
<b>AT669 - 1.5 lbs. TP669 - 1.38 lbs.</b>	<b>AT670 - 1.75 lbs. TP670 - 1.75 lbs.</b>	<b>AT676 - .75 lbs.</b>	<b>AT671 - 2.25 lbs.</b>

• Indicates polished side.

ATI AND U.S.I. BUCKING BARS

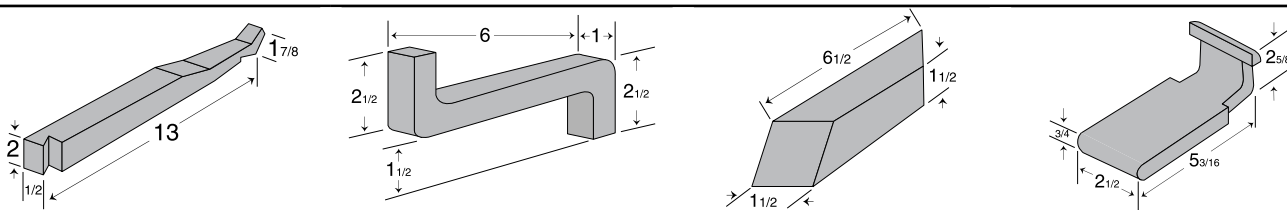

AT683 3.0 lbs.

AT690 2.5 lbs

AT692 3.0 lbs.  
TP692 3.0 lbs.

AT701 2.75 lbs.

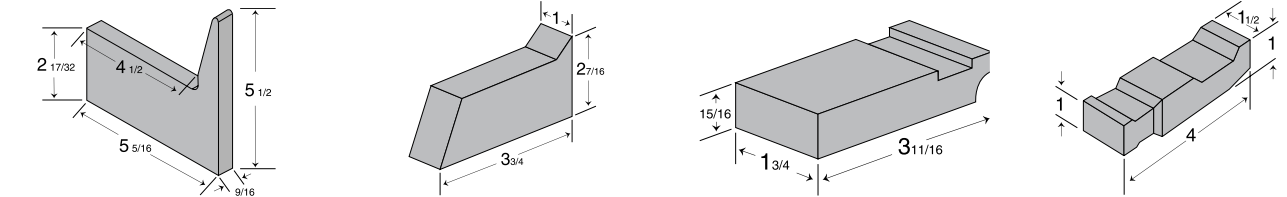

AT715 2.0 lbs.

AT721 1.75 lbs.

AT723 1.25 lbs.

AT730 1.25 lbs.

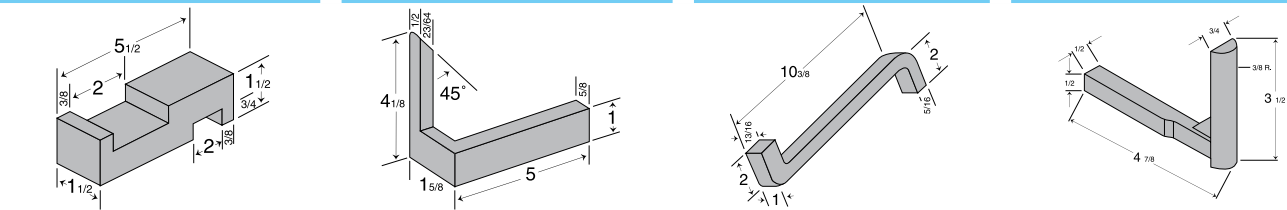

AT736 - 2.25 lbs.  
TP736 - 2.38 lbs.

AT750V-1 - 1.25 lbs.

AT751S-1 - 2.75 lbs.

AT751V-1 - 1.25 lbs.

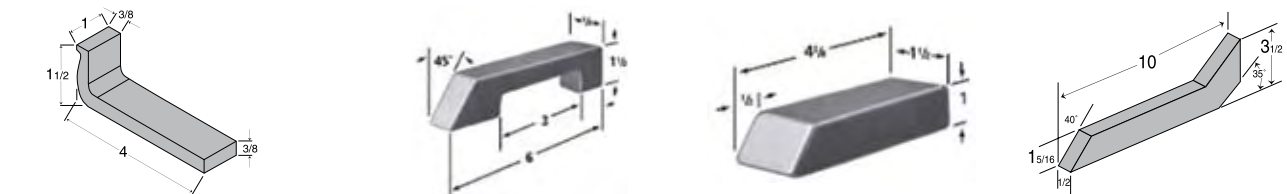

AT752P-1 - 1.0 lb.

AT760B-2 - 1.25 lbs.  
TP760B-1 - 1.13 lbs.

AT760B-10 - 2.0 lbs.

AT760C-1 - 1.20 lbs.

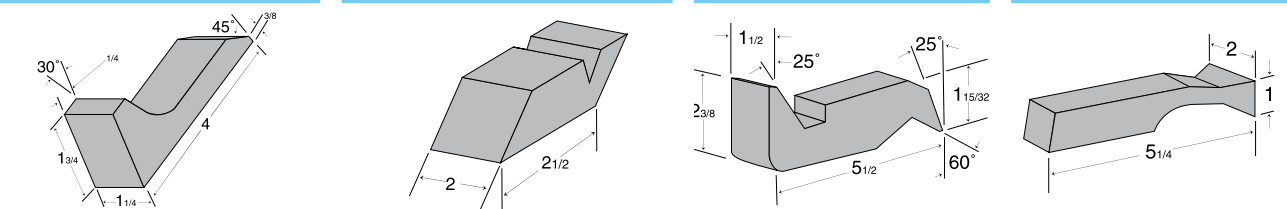

AT763 - 1.5 lbs.

TP1090 - 1.38 lbs.

AT750P-3 - 2.75 lbs.  
TP1111 - 2.6 lbs.

AT681 - 1.5 lbs.  
TP1112 - 1.38 lbs.

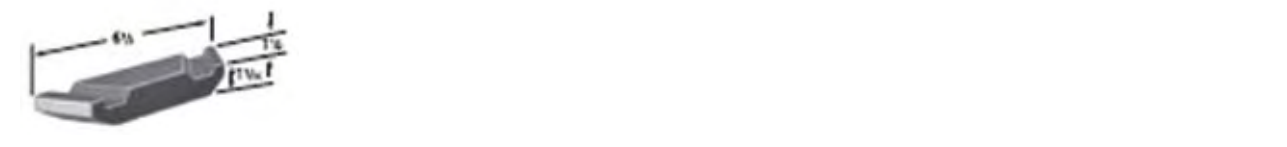

AT702 - 2.0 lbs.

• We offer both ATI and U.S.I. bucking bars.

• Indicates polished side.



## RIVET TIPS & TECHNICAL INFORMATION

### RIVET DESIGNATIONS

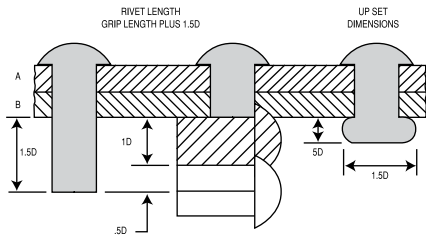
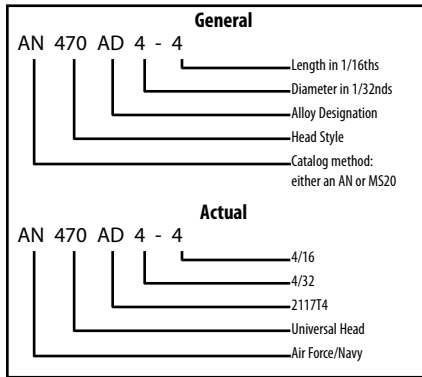

A RIVET IS DRIVEN 1.5D WIDE AND .5D HIGH. IT MUST EXTEND THROUGH THE GRIP LENGTH PLUS 1.5 DIA. A + B EQUALS GRIP LENGTH.

### COUNTERSINK/DIMPLING

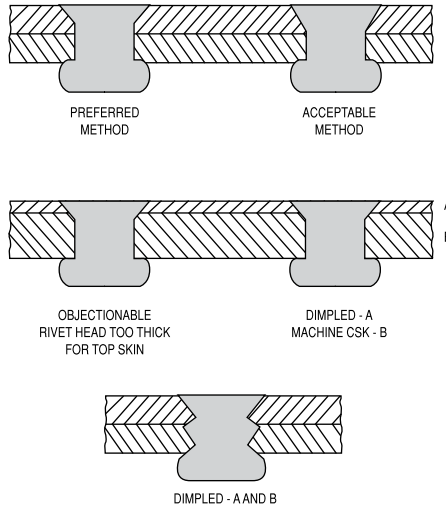

### RIVET SETTING DIMENSIONS

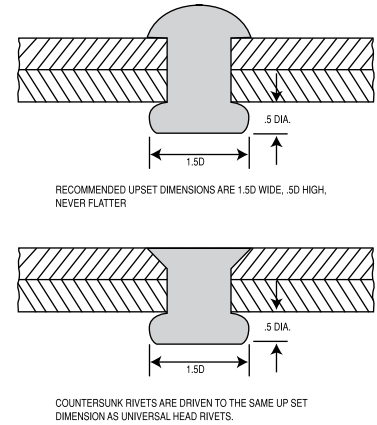

### COMMON RIVET PROBLEMS & REASONS

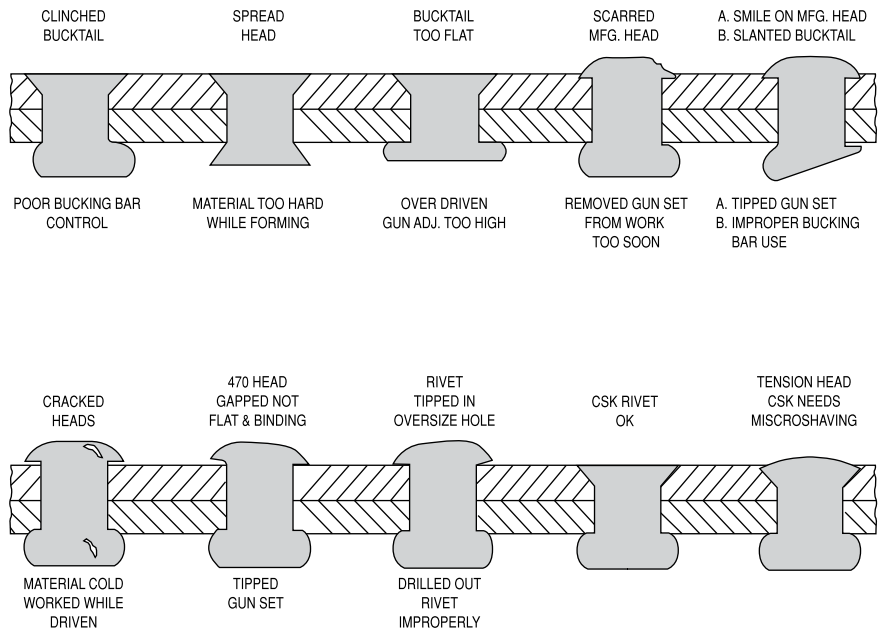

### RIVET SETTING DIMENSIONS

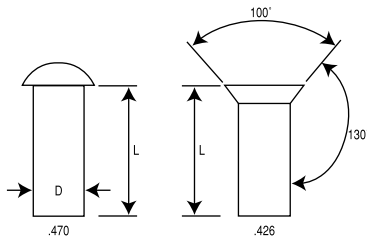

THE .470 UNIVERSAL AND .426 COUNTERSINK RIVETS ARE THE MOST COMMONLY USED SOLID-SHANK FASTENERS.

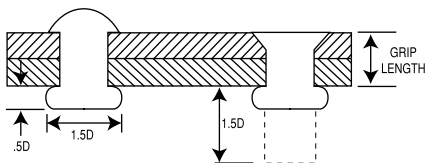

THE DRIVEN DIMENSIONS OF .470 OR .426 RIVETS ARE THE SAME.

Rivet Size	Rivet Dia. Decimal	Drill Number	Drill Decimal	Hole over Size	Cleco Color	Bucking Bar Weight	Min. Edge Distance	Min. Rivet Pitch
3/32	.0937	40	.0980	.0043	Silver	2-3 lbs.	3/16	9/32
1/8	.125	30	.1285	.0035	Copper	3-4 lbs.	1/4	3/8
5/32	.15625	21	.1590	.0028	Black	3-4.5 lbs.	5/16	15/32
3/16	.1875	11	.1910	.0035	Gold	4-5 lbs.	3/8	9/16

## U.S. INDUSTRIAL HAND RIVET SQUEEZERS

A basic tool for all riveting operations. It has a unique adjustable rivet set holder which can be adjust for varioius rivet lengths.

- All parts are heat treated.
- .187 shank rivet set holes.
- Comes with 4 Universal AN470 rivet sets and 2 flush sets (TP116A)
- 14" length
- Storage pouch included.



TP116

Part Number	Reach	Gap	Aluminum Capacity
TP116	1-1/2"	1-1/2"	3/32" - 5/32"

## U.S. INDUSTRIAL HEAVY DUTY HAND RIVET SQUEEZERS

This versatile tools is available individually as a 1", 2", 3" or 5" model or as combination units. By simply removing 3 hardened pins you can change the yoke to match your riveting or dimpling application. Longer, redesigned handle for increased force and ease of operation.

- Capable of forces in excess of 3,600 lbs.
- .187 shank rivet set holes.
- Comes with 4 Universal AN470 rivet sets and 2 flush sets (TP116A), .187 shank
- Adjustable set holder.
- 3/32" to 3/16" rivet capacity.
- Removable "C" yoke.
- 15.2" length
- Made from ductile steel.
- Storage pouch included.



TP888-3

Part Number	Yokes Included	Description	Replacement Yoke
TP888-1	1"	No set hole in yoke	9070-1
TP888-2	2"	1-1/4" gap	9070-2
TP888-3	3"	1-1/4" gap	9070-3
TP888-4	2" & 3"	both yokes	n/a
TP888-5	1", 2", 3"	3 yokes	n/a
TP888-6	5"	2-3/8" gap	9070-5
TP888-7	1", 2", 3", 5"	four yokes	n/a



## DA SERIES 360° SWIVEL HAND RIVET SQUEEZERS

- Full 360° yoke can be locked in any position.
- Adjustable ram.
- Tool squeezes with 3,500 lbs. of pressure.
- Uses squeezer sets or 3/8"-24 adapter dolly (see below)
- Tool requires dolly adpater.



DA5

Part Number	Reach	Aluminum Capacity	Overall Length	Weight
DA-2	2-1/2"	5/32"	18-1/2"	6.5 lbs.
DA-5	6"	5/32"	18-1/2"	9 lbs.

## DA ADAPTER DOLLIES

- Enables use of any of our .187" shank riveting or dimpling sets.
- Includes lock nut (two per set).

Part Number	'A' Dim	'B' Dim	'C' Dim	'D' Dim	Thread Size
3824-3/16	.187"	1"	1/2"	7/16"	3/8"-24

## TATCO STAINLESS STEEL HAND RIVET SQUEEZERS

- USA made.
- A portable, rugged solution for light to medium duty rivet squeezing.
- Heat-treated on all wear & deflecting components.
- Takes standard .187" shank rivet sets.

Part Number	Reach	Gap	Replacement Yoke
THS10	1"	1-1/4"	THY10
THS15	1-1/2"	1-1/4"	THY15
THS20	2"	1-1/4"	THY20
THS25	2-1/2"	1-1/4"	THY25
THS30	3"	1-1/4"	THY30
THS35	3-1/2"	1-1/4"	THY35
THS40	4"	1-1/4"	THY40
THS50	5"	1-1/4"	THY50
THS60	6"	1-1/4"	THY60



## TATCO COMBO KITS

- Includes hand squeezer.
- Includes 1ea. 3/32, 1/8, 5/32, 3/16 and two flush set (TP116A)
- Heat-treated on all wear & deflecting components.
- Takes standard .187" shank rivet sets.

Part Number	Yokes Included
THS15-2	THY15 & 20
THS20-3	THY20 & 30
THS15 3KIT	THY15, 20 & 30



## ATI 360° SWIVEL HAND RIVET SQUEEZERS

- Full 360° yoke can be locked in any position.
- Tool has a 3/8" stroke & 5/8" ram adjustment (no washers needed).
- Takes standard .187" shank rivet sets.

Part Number	Description	Aluminum Capacity
AT502AHD	1-1/2" Yoke w/ adj. ram	5/32"
AT502AHE	3" Yoke w/ adj. ram	5/32"



## ATI POWER HAND RIVET SQUEEZER

- Heat-treated tool steel jaws.
- Deep throat with ample leverage.
- Takes standard .187" shank rivet sets.

Part Number	Reach	Aluminum Capacity
AT501A	2-1/2"	3/16"



## AERO, CP, HI-SHEAR, U.S. INDUSTRIAL



AIT214C



CP0214 CELEL



8520-538



US114C, CC

Single Cylinder							
Part Number	Reach	Gap	Capacity (alum. - steel)	Closed Yoke Height	Overall Length	Weight	Force
AIT214C	1-1/2"	1-1/4"	1/8" - 3/32"	11/16"	10-5/16"	4.5 lbs.	3000
CP0214- CELEL	1-1/2"	1-1/4"	1/8" - 3/32"	11/16"	10-5/16"	4.0 lbs.	3000
US114C	1-1/2"	1-1/4"	1/8" - 3/32"	11/16"	10-5/16"	3.0 lbs.	3000
US114CC	1-1/2"	1-1/4"	5/32" - 1/8"	11/16"	10-5/16"	3.0 lbs.	4200
8520-538	1-1/2"	1-1/4"	5/32" - 1/8"	11/16"	10-5/16"	4.5 lbs.	4500

\* For squeezer-less yoke, add "ly" after part number.



AIT214T C



CP0214 FALEL

8522-538

US114TC, TCC

Tandem Cylinder							
Part Number	Reach	Gap	Capacity (alum. - steel)	Closed Yoke Height	Overall Length	Weight	Force
AIT214TC	1-1/2"	1-1/4"	3/16" - 5/32"	11/16"	14"	5.5 lbs.	6000
CP0214- FALEL	1-1/2"	1-1/4"	3/16" - 5/32"	11/16"	14"	5.5 lbs.	6000
US114TC	1-1/2"	1-1/4"	3/16" - 5/32"	11/16"	14"	5.5 lbs.	6000
US114TCC	1-1/2"	1-1/4"	1/4" - 3/16"	11/16"	14"	5.5 lbs.	7700
8522-538	1-1/2"	1-1/4"	1/4" - 3/16"	11/16"	14"	5.5 lbs.	7700

## ADJUSTABLE SET HOLDER

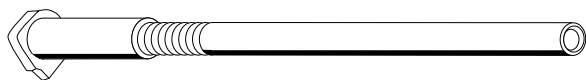

## Part Number

5052ADJ

## Description

Converts US114 &amp; CP214 to adjustable set holder

## 360° SWIVEL YOKE RIVETER



US114C-YB

Single Cylinder							
Part Number	Reach	Gap	Capacity (alum. - steel)	Closed Yoke Height	Overall Length	Weight	Force
US114C-YB	3	1-1/4"	1/8" - 3/32"	11/16"	12"	5.0 lbs.	3000
US114TC-YB	3	1-1/4"	3/16" - 5/32"	11/16"	16"	6.0 lbs.	6000

\* 360° swivel yoke locks in any position.

## HIGH FORCE SQUEEZERS

- Up to 13,500 lbs. of force through stroke.
- Eliminates squeezer set shims.
- 360° swivel yoke looks in any direction.
- Air-hydraulic.

**CP0341CUDEL**



Part Number	Reach	Gap	Capacity (alum. - steel)	Closed Yoke Height	Overall Length	Weight	Force
CP0341CUDEL	2-1/8"	2-3/4"	9/32" - 1/4"	1.0	17-1/2"	12.5 lbs.	13,500

## HI-SHEAR HI-FORCE "C" SQUEEZER

- Ergonomic design.
- High strength yoke 3/4" thick.
- Precision bearings and shafts.



**16357-7479**

Multi Cylinder							
Part Number	Reach	Gap	Capacity (alum. - steel)	Stroke at Max Force	Overall Length	Weight	Force
16357-7479	1-1/2"	1-1/4"	5/16" - 1/4"	1/8"	21.0"	10.1 lbs.	11,000

## ATLANTIC HI-FORCE "C" SQUEEZER

- High output tool under 9 lbs.
- Precision bearings and shafts.



**90C15**

Multi Cylinder							
Part Number	Reach	Gap	Capacity (alum. - steel)	Closed Yoke Height	Overall Length	Weight	Force
90C15	1-1/2"	1-1/4"	1/4" - 3/16"	11/16"	18-3/4"	8.5 lbs.	9,000

- Available swivel backhead - SH.
- Stationary backhead - FH.
- Uses same wedge to convert from "C" to Alligator by changing front end assembly.



**444CFH**

Multi Cylinder							
Part Number	Reach	Gap	Capacity (alum. - steel)	Stroke at Max Force	Overall Length	Weight	Force
444CFH	2-1/8"	1-1/2"	5/16" - 1/4"	3/32"	23-3/16"	15-1/2"	12,000
444CSH	2-1/8"	1-1/2"	5/16" - 1/4"	3/32"	23-3/16"	16-1/2"	12,000

## CHICAGO PNEUMATIC® C-YOKE RIVETERS

- Safety throttle guard included
- Optional yoke available
- Red powdered coat finish
- .187 set holes



CP0351CUDEL

Single Cylinder							
Part Number	Reach	Gap	Capacity (alum. - steel)	Closed Yoke Height	Overall Length	Weight	Force
CP0351CUDEL	2-1/8"	1-3/16"	3/16" - 5/32"	25/32"	17-1/2"	12.5 lbs.	6,000

Tandem Cylinder							
Part Number	Reach	Gap	Capacity (alum. - steel)	Closed Yoke Height	Overall Length	Weight	Force
CP0351FUDEL	2-1/8"	1-3/16"	1/4" - 7/32"	25/32"	21-3/4"	15.25	12,000

## U.S. INDUSTRIAL C-YOKE RIVETERS

- Plunger speed can be controlled by throttle
- Swivel air inlet aids maneuverability
- Optional yokes available
- Develops full squeezing force with only 90 p.s.i. air pressure
- Cast alloy steel lever positioned for user comfort
- Made in the U.S.A.
- CE certified
- US155 has .250 set holes
- Black powdered coat finish

US151C  
SINGLE CYLINDER

US155

Part Number	Reach	Gap	Capacity (alum. - steel)	Closed Yoke Height	Overall Length	Weight	Force
US151C	2-1/8"	1-3/16"	3/16" - 5/32"	25/32"	17-1/2"	9.5 lbs.	6,000
US151TC	2-1/8"	1-3/16"	1/4" - 7/32"	25/32"	21-3/4"	12.5 lbs.	12,000
US155	2-1/8"	1-7/8"	1/4 - 7/32"	25/32"	20"	21 lbs.	12,000

## U.S. INDUSTRIAL SHORT STROKE FOR US151C

Part Number	Description
2449-2450	Guard assembly for short stroke



## HI-SHEAR (APT)

- 2-1/16" bolt frame, style 2
- Safety approved throttle lever
- Anodized aluminum housing
- 90° elbow swivel air inlet
- Tool steel roller bearing and shaft



Hi-Shear Heavy Duty "C" Squeezer							
Part Number	Reach	Gap	Capacity (alum. - steel)	Closed Yoke Height	Overall Length	Weight	Force
9475-991	2-1/8"	1-3/32"	3/16" - 5/32"	13/16"	17-3/4"	12.75 lbs.	6,000

## AERO, CHICAGO PNEUMATIC, HI-SHEAR, U.S. INDUSTRIAL

- .187" set hold.
- Sure Grip finish
- Force at 90 PSI



**AIT214A-1-1/2**



**CP0214ANBEL**



**US114AA  
8521-7360**

Single Cylinder							
Part Number	Reach	Gap	Capacity (alum. - steel)	Closed Yoke Height	Overall Length	Weight	Force
AIT214A-1-1/2	1-1/2"	1-5/8"	1/8" - 3/32"	7/8"	9-3/16"	3.75 lbs.	3,000
AIT214A-2-1/4	2-1/4"	1-3/4"	1/8" - 3/32"	7/8"	10-1/8"	4.25 lbs.	2,200
AIT214A-3	3"	2-1/8"	3/32" - 1/16"	7/8"	10-3/4"	4.50 lbs.	1,800

## CHICAGO PNEUMATIC® ALLIGATOR YOKE RIVETERS

Tandem Cylinder							
Part Number	Reach	Gap	Capacity (alum. - steel)	Closed Yoke Height	Overall Length	Weight	Force
CP0214ANBEL	1-1/2"	1-5/8"	1/8" - 3/32"	7/8"	9-3/16"	3.75 lbs.	3,000
CP0214ANFEL	2-1/4"	1-3/4"	3/32" - 3/32"	7/8"	10-1/8"	4.25 lbs.	2,200
CP0214ANGEL	3"	2-1/8"	3/32" - 1/16"	7/8"	10-3/4"	4.50 lbs.	1,800

U. S. Industrial Tandem Cylinder Hi-Shear							
Part Number	Reach	Gap	Capacity (alum. - steel)	Closed Yoke Height	Overall Length	Weight	Force
US114A-1-1/2	1-1/2"	1-5/8"	1/8" - 3/32"	7/8"	9-3/16"	3.75 lbs.	3,000
US114A-2-1/4	2-1/4"	1-3/4"	1/8" - 3/32"	7/8"	10-1/8"	4.25 lbs.	2,200
US114A-3	3"	2-1/8"	3/32" - 1/16"	7/8"	10-3/4"	4.50 lbs.	1,800
US114AA-1-1/2"	1-1/2"	1-5/8"	1/8" - 3/32"	7/8"	9-3/16"	3.75 lbs.	4,300
US114AA-2-1/4"	2-1/4"	1-3/4"	3/32" - 1/16"	7/8"	10-1/8"	4.25 lbs.	3,900
US14AA-3	3"	2-1/8"	3/32" - 1/8"	7/8"	10-3/4"	4.50 lbs.	3,400
8521-7360	1-1/2"	1-5/8"	3/16" - 5/32"	7/8"	9-3/16"	3.75 lbs.	4,500
8521-7362	2-1/4"	1-3/4"	5/32" - 1/8"	7/8"	10-1/8"	4.25 lbs.	3,300
8521-7364	3"	2-1/8"	1/8" - 3/32"	7/8"	10-7/8"	4.75 lbs.	2,700

- High joint integrity independent of operator skill level.
- Speed of squeeze riveter can be controlled by throttle.
- Swivel air inlet aids maneuverability.
- Tandem cylinder doubles compression force available from tool.
- Develops full squeezing force with only 90 psi air pressure.
- One piece baring for long life.

- Yellow "Sure Grip" finish for positive handling.
- Cast alloy steel lever positioned for user comfort.
- Made in the USA.



**US114TA**

Long Beach USI Tandem Cylinder Squeezer							
Part Number	Reach	Gap	Capacity (alum. - steel)	Closed Yoke Height	Overall Length	Weight	Force
US114TA-5-1/4"	5-1/2"	7/8"	1/8" - N/A	7/8"	16"	7.9 lbs.	2,600
US114TAA-5-1/4"	5-1/2"	7/8"	5/32" - N/A	7/8"	16"	7.9 lbs.	3,000

## AERO, CHICAGO PNEUMATIC, HI-SHEAR, U.S. INDUSTRIAL

Sure Grip finish



AIT214TA



CP0214EANBL

US114TAA  
8522

Aero Tandem Cylinder							
Part Number	Reach	Gap	Capacity (alum. - steel)	Closed Yoke Height	Overall Length	Weight	Force
AIT214TA-1-1/2	1-1/2"	1-5/8"	1/8" - 3/32"	7/8"	12"	5.0 lbs.	6,000
AIT214TA-2-1/4	2-1/4"	1-3/4"	1/8" - 3/32"	7/8"	13"	5.5 lbs.	4,300
AIT214TA-3	3"	2-1/8"	3/32" - 1/16"	7/8"	13-3/4"	6.0 lbs.	3,400

CP Tandem Cylinder							
Part Number	Reach	Gap	Capacity (alum. - steel)	Closed Yoke Height	Overall Length	Weight	Force
CP021EANBEL	1-1/2"	1-5/8"	3/16" - 5/32"	7/8"	11-5/16"	4.7 lbs.	6,000
CP0214ENFEL	2-1/4"	1-3/4"	5/32" - 1/8"	7/8"	12-3/4"	5.25 lbs.	4,300
CP0214ENGEL	3"	2-1/8"	1/8" - 3/32"	7/8"	13-1/2"	5.5 lbs.	3,400

U. S. Industrial Tandem Cylinder Hi-Shear							
Part Number	Reach	Gap	Capacity (alum. - steel)	Closed Yoke Height	Overall Length	Weight	Force
US114TA-1-1/2	1-1/2"	1-5/8"	1/8" - 3/32"	7/8"	12"	5.0 lbs.	6,000
US114TA-2-1/4	2-1/4"	1-3/4"	1/8" - 3/32"	7/8"	13"	5.5 lbs.	4,300
US114TA-3	3"	2-1/8"	3/32" - 1/16"	7/8"	13-3/4"	6.0 lbs.	3,400
US114TAA-1-1/2"	1-1/2"	1-5/8"	1/4" - 3/16"	7/8"	12"	5.0 lbs.	7,500
US114TAA-2-1/4"	2-1/4"	1-3/4"	3/16" - 5/32"	7/8"	13"	5.5 lbs.	6,300
US14TAA-3	3"	2-1/8"	3/16" - 1/8"	7/8"	13-3/4"	6.0 lbs.	5,600
8522-7360	1-1/2"	1-5/8"	1/4" - 3/16"	7/8"	12"	5.5 lbs.	8,000
8522-7362	2-1/4"	1-3/4"	3/16" - 5/32"	7/8"	13"	6.0 lbs.	6,450
8522-7364	3"	2-1/8"	5/32" - 1/8"	7/8"	13-3/4"	6.25 lbs.	5,100

## 702 HI-SHEAR ULTRALITE SQUEEZER

- Safety throttle
- 90° elbow air inlet
- .187 set holes



22360-22342

Part Number	Reach	Gap	Capacity (alum. - steel)	Closed Yoke Height	Overall Length	Weight	Force
22360-22342	1"	1-7/64"	1/8" - 3/32"	.843	7.320	2.2 lbs.	2200



## CHICAGO PNEUMATIC HEAVY-DUTY ALLIGATOR RIVETERS

- Tandem cylinder model nearly doubles thrust.
- Safety throttle guard included.
- Swivel air inlet.
- Red powdered coated finish.
- Made in the USA.



**CP0351ESGEL**



**CP0351ASKEL**

Single Cylinder						
Part Number	Reach	Gap	Capacity (alum. - steel)	Closed Yoke Height	Overall Length	Weight
CP0351ASGEL	2-7/8"	1-5/8"	5/32" - 1/8"	7/8"	19-1/2"	15.75 lbs.
CP0351ASKEL	5"	1-5/8"	1/8" - 3/32"	7/8"	21-5/8"	19.75 lbs.
CP0351ASREL	7"	2"	1/8" - 3/32"	1-1/2"	23-5/8"	24.25 lbs.
CP0351ASVEL	9-1/8"	2-3/16"	1/8" - 3/32"	3/4"	25-3/4"	26.25 lbs.

Tandem Cylinder						
Part Number	Reach	Gap	Capacity (alum. - steel)	Closed Yoke Height	Overall Length	Weight
CP0351ESGEL	2-7/8"	1-5/8"	1/4" - 3/16"	7/8"	23-3/4"	18.5 lbs.
CP0351ESKEL	5"	1-5/8"	3/16" - 5/32"	7/8"	25-7/8"	22.5 lbs.
CP0351ESREL	7"	2"	3/16" - 5/32"	1-1/2"	27-7/8"	27.0 lbs.
CP0351ESVEL	9-1/8"	2-3/16"	3/16" - 5/32"	3/4"	30"	29.0 lbs.

## U.S. INDUSTRIAL HEAVY-DUTY ALLIGATOR RIVETERS

- Black powdered coated finish.
- Speed of squeeze riveter can be controlled by throttle
- Swivel air inlet aids maneuverability.
- Tandem cylinder doubles compression force available from tool.
- Develops full squeezing force with only 90 p.s.i. air pressure.
- One piece bearing for long life.
- Cast alloy steel lever positioned for user comfort.
- Made in the USA.



**US151A**

Single Cylinder							
Part Number	Reach	Gap	Capacity (alum. - steel)	Closed Yoke Height	Overall Length	Weight	Force
US151A-2-7/8	2-7/8"	1-5/8"	5/32" - 1/8"	7/8"	19-1/2"	15.0 lbs.	5,200
US151A-4	4"	2-19/32"	3/16" - 5/32"	1-1/32"	20-5/8"	20.5 lbs.	6,500
US151A-5	5"	1-5/8"	1/8" - 3/32"	7/8"	21-5/8"	19.0 lbs.	3,400
US151A-7	7"	2"	1/8" - 3/32"	1-1/2"	23-5/8"	23.0 lbs.	3,000
US151A-9-1/8	9-1/8"	2-3/16"	1/8" - 3/32"	3/4"	25-3/4"	25.0 lbs.	3,000

Tandem Cylinder							
Part Number	Reach	Gap	Capacity (alum. - steel)	Closed Yoke Height	Overall Length	Weight	Force
US151TA-2-7/8	2-7/8"	1-5/8"	1/4" - 3/16"	7/8"	23-3/4"	17.5 lbs.	10,400
US151TA-4	4"	2-19/32"	7/32" - 3/16"	1-1/32"	25"	22.8 lbs.	11,000
US151TA-5	5"	1-5/8"	3/16" - 5/32"	7/8"	25-7/8"	21.5 lbs.	6,800
US151TA-7	7"	2"	3/16" - 5/32"	1-1/2"	27-7/8"	26.0 lbs.	6,000
US151TA-9-1/8	9-1/8"	2-3/16"	3/16" - 5/32"	3/4"	30"	28.0 lbs.	6,000

## HIGH FORCE SQUEEZERS

- FH - Fixed Head
- SH - Swivel Head



444ASH

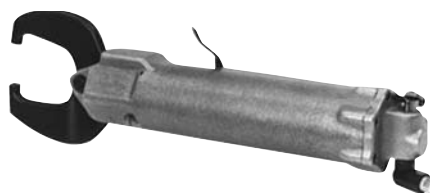

ATLANTIC 90A

FH - Alligator Yoke Tri-Cylinder							
Part Number	Reach	Gap	Capacity (alum. - steel)	Closed Yoke Height	Overall Length	Weight	Force
444AFH-A32	3-1/4"	2-1/8"	9/32" - 7/32"	7/8"	22-1/2"	14.5 lbs.	9,800
444AFH-A52	5-1/4"	2-1/8"	1/4" - 3/16"	7/8"	24-1/2"	16.0 lbs.	6,800
444AFH-A72	7-1/4"	2-1/8"	3/16" - 5/32"	7/8"	26-1/2"	17.5 lbs.	6,000
444AFH-A92	9-1/8"	2-1/8"	3/16" - 5/32"	7/8"	28-1/2"	21.5 lbs.	6,000

SH - Alligator Yoke Tri-Cylinder							
Part Number	Reach	Gap	Capacity (alum. - steel)	Closed Yoke Height	Overall Length	Weight	Force
444ASH-A32	3-1/4"	2-1/8"	9/32" - 7/32"	7/8"	22-1/2"	15.5 lbs.	9,800
444ASH-A52	5-1/4"	2-1/8"	1/4" - 3/16"	7/8"	24-1/2"	17.0 lbs.	6,800
444ASH-A72	7-1/4"	2-1/8"	3/16" - 5/32"	7/8"	26-1/2"	18.5 lbs.	6,000
444ASH-A92	9-1/8"	2-1/8"	3/16" - 5/32"	7/8"	28-1/2"	22.5 lbs.	6,000

Alligator Yoke Tri-Cylinder							
Part Number	Reach	Gap	Capacity (alum. - steel)	Closed Yoke Height	Overall Length	Weight	Force
90A15HD	1-1/2"	1-5/8"	1/4" - 3/16"	7/8"	16"	7 lbs.	9,000
90A22HD	2-1/4"	1-3/4"	3/16" - 5/32"	7/8"	16-3/4"	7.5 lbs.	7,000
90A30HD	3"	2-1/8"	3/16" - 5/32"	7/8"	17-1/2"	8 lbs.	5,200

## HI SHEAR ULTRALITE® TRI-CYLINDER RIVETERS

- .187 set holes.
- High strength forged jaw.
- Precision bearings and shafts.
- 1/4 holes available.



17283

Alligator Yoke Tri-Cylinder						
Part Number	Jaw Reach	Capacity (alum. - steel)	Max. Force @ 90 psi	Overall Length	Weight	
17283-17148	3"	1/4" - 3/16"	10,000 lbs.	20-1/4"	8.4 lbs.	
17283-17146	5"	3/16" - 5/32"	6,800 lbs.	22-1/2"	9.5 lbs.	
17283-19000	7"	5/32" - 1/8"	4,400 lbs.	24-1/2"	13.0 lbs.	

## U.S. INDUSTRIAL TRAILER SQUEEZERS

### US151-1A-2F

C-Yoke solid design with hardened upper anvil, eliminating removable sets, provides faster spotting of rivet shank by operator.



### US151-1A-3M

Standard set holder has a 3/16 brazier cupping integral (also available with replaceable set holder)

Specially designed c-yokes with or without removable set holder holes capable of fitting most rails for trailer and box manufacturers

New ergonomic lever assembly 95508AS (not shown in photo; see diagram below)



Ruggedly built cylinder assembly capable of the most demanding applications

Part No.	Reach	Gap	Capacity (alum-steel)	Closed Yoke Height	Overall Length	Weight	Force
US151-1A-2F	1"	1	3/16" - 5/32"	.4375	17-1/2"	10.0 lbs.	6000
US151-1A-3M			3/16" - 5/32"	-	18-1/2"	11.0 lbs.	6000

## U.S. INDUSTRIAL TRAILER SQUEEZERS



CP0351PU



US151PU

### CHICAGO PNEUMATIC® & U.S. INDUSTRIAL PUNCHES

Part No.	Reach	Gap	Capacity (alum)	Max Hole Dia.	Length	Weight	Force
CP0351PU	1-7/8"	1/2	3/16"	5/16"	21-1/2"	20.5 lbs.	5400
US151PU	1-7/8"	1/2	3/16"	5/16"	21-1/2"	20.5 lbs.	5400
US151SPU	1-7/8"	1/2	.480	5/16"	21-1/2"	22.4 lbs.	5400

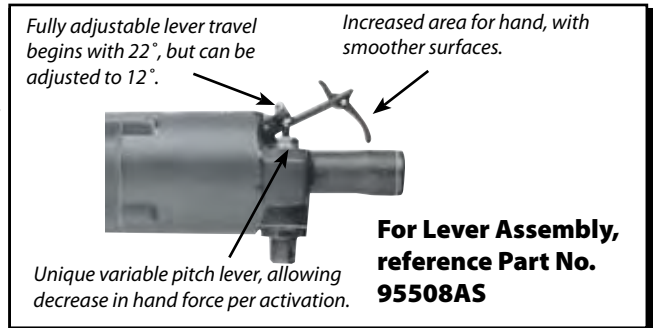
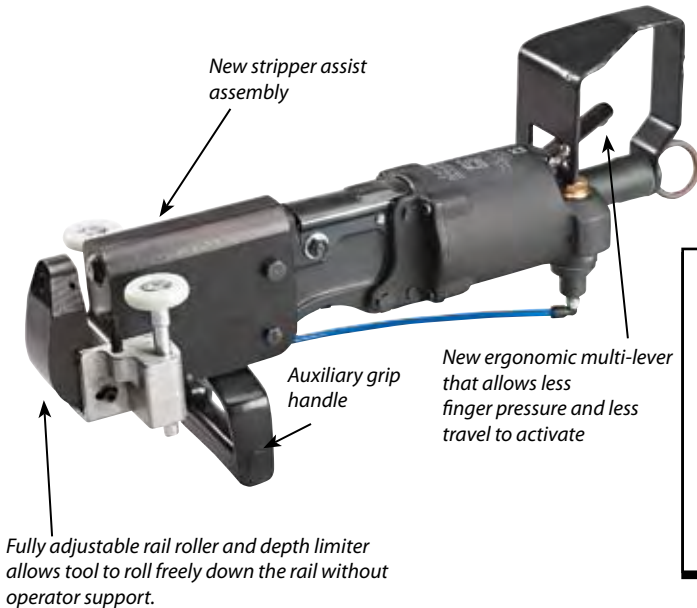

## C YOKES

### U.S. INDUSTRIAL "C" YOKES TO FIT

Note: Some yokes might require longer set holders

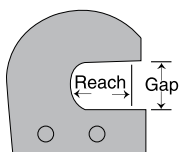

### U.S. INDUSTRIAL "C" YOKES TO FIT

**US151 & CP0351 CUNEL COMPRESSION RIVETERS WITH STANDARD #1A YOKE FRAME**

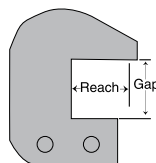

### U.S. INDUSTRIAL "C" YOKES TO FIT US151 & CP0351 CUNEL COMPRESSION RIVETERS WITH #2A YOKE FRAME

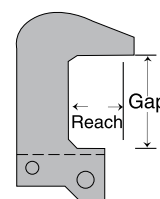

Part Number	Reach	Gap
YK1-2-1/2-2	2-1/2"	2"
YK1-3-3	3"	3"
YK1-3-3-1/2	3"	3-1/2"
YK1-3-1/2-2	3-1/2"	2"
538	1-1/2"	1-1/4"
958	2"	1-1/4"
959	2-1/2"	1-3/8"
960 HD	3"	1-1/2"
961 HD	3-1/2"	1-1/2"
1310C	5"	2-1/2"
1337C	2-1/16"	2-1/16"
1349C	1-3/4"	1-3/4"
1925C	2-3/8"	2-5/16"
2282C	4-1/2"	1-1/2"
2319C	1-3/16"	1-5/16"
872004	3-7/8"	1-3/16"
872006	5-3/8"	1-1/4"
872009	2-3/4"	1-3/16"
872016	5-23/32"	1-3/16"
872017	1-3/4"	1-1/4"
872019	1-3/16"	1-3/16"
872025	5"	2"

Part Number	Reach	Gap
982	4-7/16"	1-3/16"
986T-3091	4-1/16"	1-7/16"
987	1-7/16"	2-5/8"
990	2-1/8"	1-3/16"
990FM	1-1/4"	1-17/32"
990-T3091	2-3/8"	1-3/16"
1004	3-1/2"	1-1/4"
1005	2"	2"
1887C	6"	1-1/4"
2060C	3-1/2"	2"
10005	7/8"	1"
35230	5"	2-1/2"

Part Number	Reach	Gap
991	2-1/16"	1"
994	3-3/4"	1-1/4"
995	3-5/16"	3"
35231	5"	2-1/2"
35237	1-1/2"	3-1/2"
4545	4-1/2"	4-1/2"
35235	6-1/2"	3-1/2"
35233	2"	3-3/4"
35232	2-1/2"	5"
10015	2-1/8"	2-1/8"

### U.S. INDUSTRIAL "C" YOKES TO FIT US155 & CP355 CEBEL COMPRESSION RIVETER

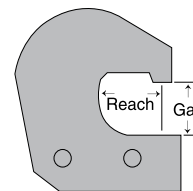

Part Number	Reach	Gap
1010	2-1/8"	1-7/8"
1045	4-1/2"	1-15/16"
35234	12"	3-1/2"

## C YOKES FOR SEMI-TUBULAR RIVETS

Part Number	Reach	Gap	CP214C & US114C
060,061	1"	1-9/16"	1-5/16"
060,008	1-1/2"	2"	
060,009	1-1/2"	2-1/2"	
060,022	1-1/2"	3"	
060,034	1-1/2"	3-1/2"	
060,038	1-1/2"	3-3/4"	

- Designed especially for semi-tubular rivets to 5/16"
- Takes standard .187" shank rivet sets



## CP214, US114 ALLIGATOR YOKES

- Will fit US114A and other like tools
- Complete with all bearings and pins
- Straight type
- .187 set hole

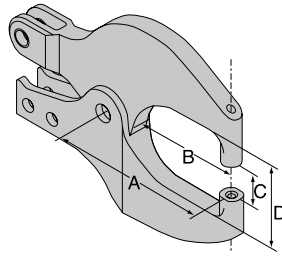

5108

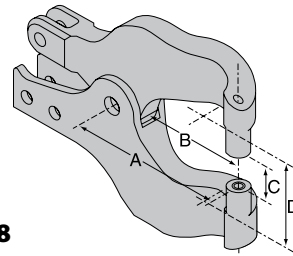

2242

Part Number	A	B	C	D
5107	2-1/8"	1-1/2"	7/8"	1-5/8"
5113	2-1/4"	1-9/16"	11/16"	1-7/64"
5112	3"	2-1/2"	39/64"	1-23/64"
5108	3"	2-1/4"	7/8"	2-1/8"
5110	3"	2-3/8"	7/8"	2-1/8"
5109	3-3/4"	3"	7/8"	2-1/8"
5114	6-1/8"	5-1/2"	7/8"	2-1/8"
5115	6-1/8"	5-1/2"	7/8"	3-1/2"

Offset - Right Hand				
Part Number	A	B	C	D
2242	3-3/4"	3-1/8"	7/8"	2-1/8"
1961	3-3/16"	2-19/32"	7/8"	2-1/8"
5115	6-1/8"	5-1/2"	7/8"	3-1/2"

## CP214, US114 ALLIGATOR YOKES

- Will fit CP351, US151 and other like models
- Includes all bearings and pins, guards and adapter for proper installation onto cylinder (May require wedge change at extra charge.) Standard set hold size .187.

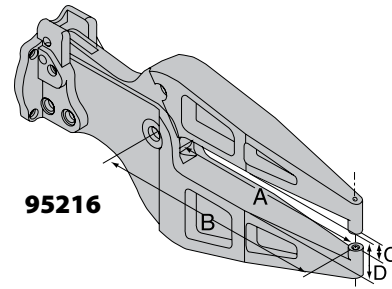

95216

Offset - Right Hand					
Part Number	A	B	C	D	Opt. Wedge
95216	2-7/8"	4"	29/32"	1-41/64"	35161
95217	5"	6-3/16"	7/8"	1-15/16"	35161
95222	7"	8-1/8"	13/16"	1-7/8"	35161
95218	9"	10-1/4"	13/16"	1-7/8"	35162
95226	3-55/64"	5-1/32"	1-1/32"	2-19/32"	35161-7
95315	3-1/4"	4-3/8"	1-23/32"	2-1/8"	35161-7
95336	4-7/8"	6"	1"	4-3/4"	35161-7
95224	5"	6-1/8"	1-3/8"	3-41/64"	35161
95219RBS	9-1/8"	10-1/4"	3"	1-7/8"	35162

## ATI 360° SWIVEL C YOKES

- Will fit CP214C, US114C and other like models
- Locks in any position
- Adjustable tool holder eliminates the need for shimming

Part Number	Will Fit	Reach	Gap
AT502YA	CP0214CENEL, US114C, TC and AIT214C	1-1/2"	1-1/4"
AT502YB		3"	1-1/4"



AT502YA

## BENCH TOP HAND RIVETING & DIMPLING FIXTURE

- Heavy duty solid steel yoke design
- Includes .187 die holder and die extension to accept any standard dimple and die set or squeezer type rivet sets
- 19" throat reach x 4" gap
- 16 lbs.

Part No.	Gap	Reach
TP6150	4"	19"

**TP6150**



- Includes bench mounting brackets
- Includes air activated foot control with safety guard
- Features adjustable lower set holder
- Tandem cylinder
- Made in the USA by U.S. Industrial Tool
- .187" shank hole

**US114TC-98**



C-YOKE							
Part No.	Cap. Alum.	Cap. Steel	Reach	Gap	Force (lbs.)	Max. Travel	Weight (lbs.)
US114TCC-98	3/16"	1/4"	9"	3-1/2"	7700	9/16"	62
US114TCC-98G	3/16"	1/4"	10"	3-1/2"	7700	9/16"	70
3000CS-6	1/8"	3/32"	6"	3-1/2"	3000	9/16"	28
60C120B	3/16"	5/32"	12"	4"	6000	9/16"	175
60C180B	3/16"	5/32"	18"	4"	6000	9/16"	400
6000CS-6	3/16"	5/32"	18"	3-1/2"	6000	9/16"	29
Description							
C15000	Floor stand for above except 60C180B						
AATC15010	Floor stand for 601C80B						



**AATC15000**



**3000CS-6**

*Note: Models 3000CS and 6000CS have return stroke adjustment.*

## ALLIGATOR JAW BENCH RIVETERS

### Model 3000AS and Model 6000AS

This unique tool may be ideal for your special dedicated assembly requirements. It features a single cylinder, alligator type with our standard stroke adjustment. It is designed for foot control FC-2, and simple bench mounting. Assemblers hands are freed for easy workpiece manipulation. A large selection of standard squeezer tooling is readily available for small solid and semi-tubular rivets, eyelets, and many types of captive hardware.

ALLIGATOR YOKE .187" SHANK HOLE						
Part No.	Reach	Gap	Capacity (alum - steel)	Closed Yoke Height	Length	Force
3000AS-1-1/2	1-1/2"	1-5/8"	3/16" - 5/32"	7/8"	14"	4200
3000AS-2-1/4	2-1/4"	1-3/4"	1/8" - 3/32"	7/8"	14-3/4"	3000
3000AS-3	3"	2-1/8"	3/32" - 1/8"	7/8"	15-3/4"	2500
6000AS-1-1/2	1-1/2"	1-5/8"	7/32" - 3/16"	7/8"	16-3/4"	6500
6000AS-2-1/4	2-1/4"	1-3/4"	3/16" - 5/32"	7/8"	18-1/2"	5000
6000AS-3	3"	2-1/8"	5/32" - 9/64"	7/8"	18-1/2"	4000
6000AS-3-1/2	3-1/2"	2-1/8"	5/32" - 1/8"	7/8"	19"	3500



**3000AS**

## GENERAL PNEUMATIC

### Model 8000CS

Model 8000CS is normally used where high power is required but not a large yoke. This tool is used for staking, swaging, punching, riveting or pressing in captive hardware. Although this is a hi-power tool, it can also be used for the lightest and most delicate work. As with all General Pneumatic Tools, a maximum power rating is specified. With proper adjustment any fraction of the maximum rating is at the operators command. This unit can be tooled for your specific needs. Shipped complete with our FC-4 foot control and guard, adjustable mandrel, plus all hoses and connectors.

### Model 15 KCS

This is our largest, heaviest and most powerful machine. Despite the size and weight it offer the widest power range of any General Pneumatic Tool. The squeezing force, ranging from less than an ounce to seven and one-half tons is infinitely adjustable and under direct control of the operator. When properly tooled and adjusted it will render consistently accurate finished work. It is capable of meeting the most rigid specifications. This machine can be used for swaging, staking, hold punching, riveting and pressing in captive hardware. The 15 KCS can be fitted to any of our standard yokes. If your needs are special we will build a special tool to meet your requirements. Shipped complete with our FC-4 foot control and guard, adjustable mandrel, all hoses, fittings and connectors ready to go.

GENERAL PNEUMATIC						
Part No.	Reach	Gap	Capacity (alum - steel)	Closed Yoke Height	Length	Weight (lbs.)
8000CS	6"	5-1/8"	5/16" - 1/4"	2-3/8"	14-1/2"	135
8000CS6-8	6"	8-1/2"	5/16" - 1/4"	5-3/8"	14-1/2"	135
15KCS-6	6"	3"	3/8" - 5/16"	2-3/8"	14-1/2"	150
15KCS6-8	6"	8"	3/8" - 5/16"	5-3/8"	14-1/2"	155
FC-4	Replacement Guard and Valve					

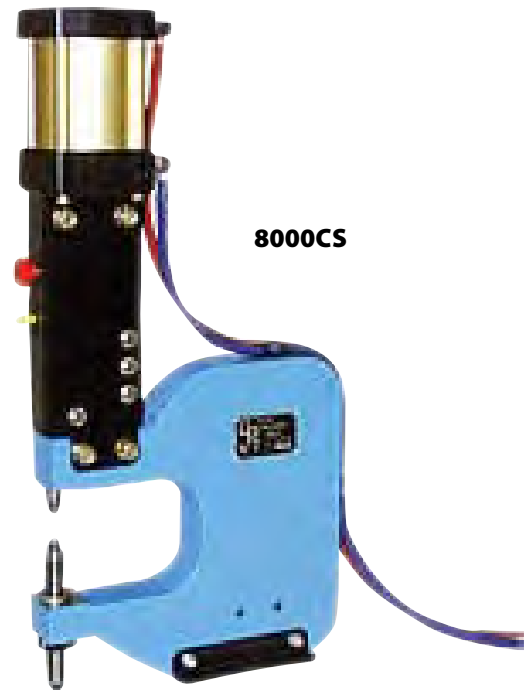

## CSA - REMOVEABLE TOOLBAR SYSTEM

The CSA is the ideal tool for inserting PEM® style captive hardware, such as threaded inserts, studs, standoffs, floating nut plates, semi-tubular rivets.

The CSA system includes the standard accessories group including the flanger, standard and special tooling bars, tooling bar spacer, wrenches, squeezer sets, spacer shims, adjustable mandrel and other miscellaneous hardware items. Everything is useful in many ways to accommodate the nearly infinite number of special demands of the workpiece.

The CSA accepts standard squeezer tooling for rivets of all descriptions including semi-tubular and eyelets. The unique design of the CSA offers precise pressure settings and stroke control which guarantees first quality finished work. The CSA provides a smooth squeezing action necessary to generate proper cold metal flow. All hardware manufacturers emphasize the necessity for cold metal flow to assure proper retention of captive hardware and in most cases caution against attempting hardware installation with a hammer blow.

The CSA is shipped complete with foot control, hoses, connectors, standard accessories group, and is ready to operate.

Part No.	Reach	Gap	Capacity (alum - steel)	Closed Yoke Height	Length	Weight (lbs.)
8000CSA	9-1/2"	5"	5/16" - 1/4"	2-3/8"	29-3/8"	180
8000CSA	12-1/2"	5"	5/16" - 1/4"	2-3/8"	33-3/4"	220
8000CSA	24-1/2"	5"	5/16" - 1/4"	2-3/8"	78-1/4"	680
15KCSA	9-1/2"	5"	3/8" - 5/16"	2-3/8"	29-3/4"	183
15KCSA	12-1/2"	5"	3/8" - 5/16"		33-3/4"	226
15KCSA	24-1/2"	5"			78-1/4"	686
110,001	Floor stand with FRL for 9-1/2" or 12-1/2"					
A-KIT	PEM® Stand Off Kit					
B-KIT	PEM® Stand Off Kit for longer studs					

Note: 24" reach includes floor stand.



"A" TOOLING KIT



"B" TOOLING GROUP



STANDARD ACCESSORY GROUP

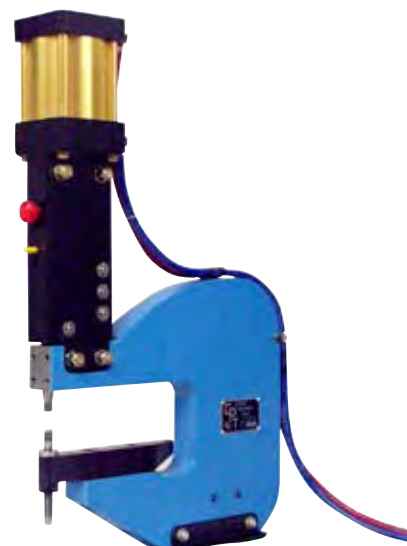

8000CSA-12-1/2



8000CSA-24



## U.S. INDUSTRIAL BRAKE RIVETERS

### TP95

- Supplied with rivet removal punch, anvil and rivet set for 1/8" rivets

### TP950

- Same as TP95 just with "T" handle

Part No.	Description
TP95	Hammer or Press style
TP950	"T" Handle for compression control



TP95

TP950

## U.S. INDUSTRIAL FLOOR RIVETING MACHINE

These tools are manufactured in strict accordance with Goodyear/Loral™ standards

- US150BR-8 – 235 lbs.
- US150BR-12 – 275 lbs.
- US150BRS – 10" ID with 17" OD
- CE certified (requires machine to be factory installed with US13046MPB Two Stage, Hi-Low Pressure system)
- Machines shipped freight collect

For optimal machine safety, specify with two stage, pinch point protection, at additional cost.

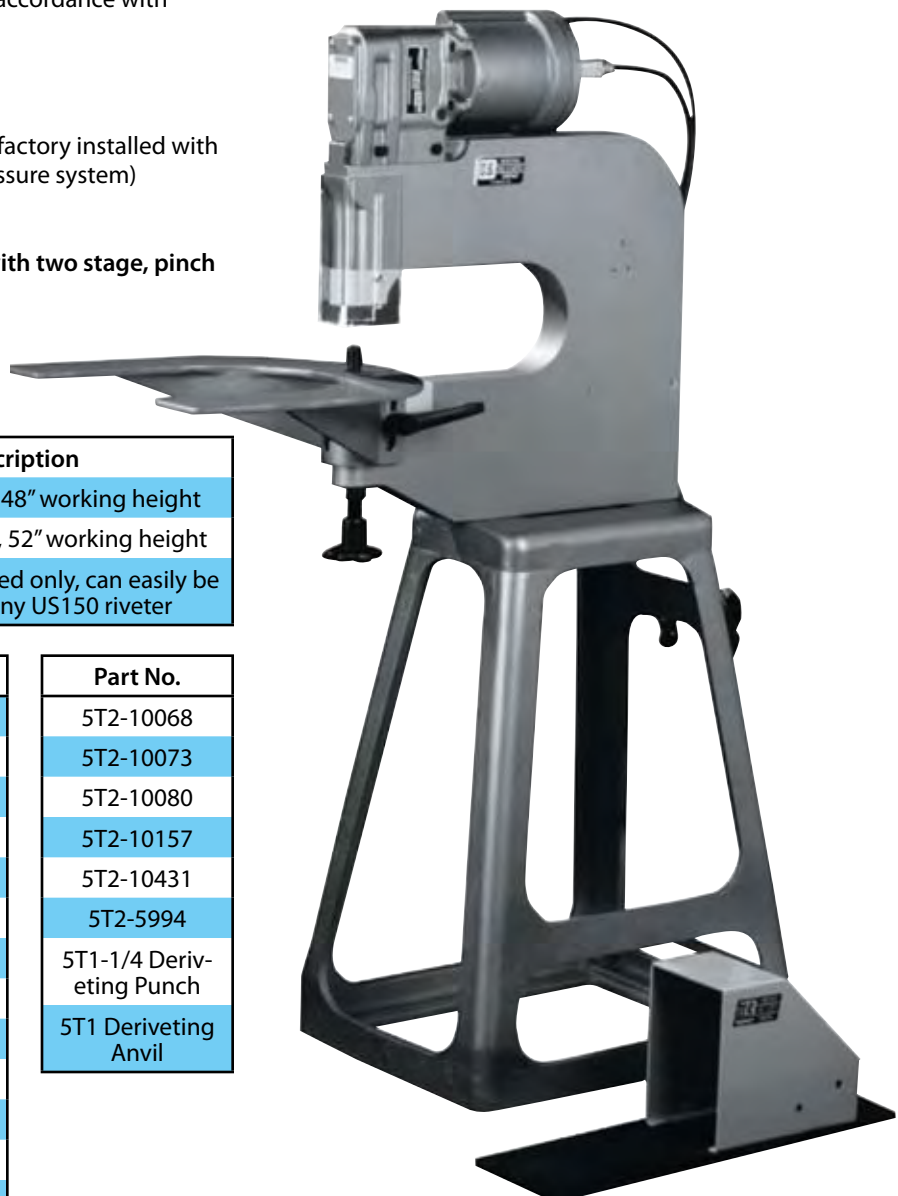

Part No.	Description
US150BR-8	8" reach, 4" gap, 48" working height
US150BR-12	12" reach, 4" gap, 52" working height
US150BRS	Horseshoe workbed only, can easily be installed on any US150 riveter

Part No.
114-13-1
114-151-1
5T1-25092
5T1-25286
5T1-25287
5T1-25309
5T1-25310
5T1-25311
5T1-25355
5T1-25453
5T1-25455
5T1-25460
5T1-25465-1

Part No.
5T1-25465-2
5T1-25775
5T1-25807
5T1-25855
5T1-26037
5T1-26123
5T1-26150
5T1-26206
5T1-26245
5T1-70948
5T1-71785
5T2-10066
5T2-10067

Part No.
5T2-10068
5T2-10073
5T2-10080
5T2-10157
5T2-10431
5T2-5994
5T1-1/4 Deriveting Punch
5T1 Deriveting Anvil

## U.S. INDUSTRIAL COMPRESSION RIVETERS

A new stationary pneumatic compression riveter providing high volume riveting and dimpling. This one-man pedestal riveter is capable of exceptional accuracy and has the capacity to cold squeeze 3/8" solid stainless steel rivets with 16,000 lbs. of force. Our machine is designed to allow the user to vary the machine speed with foot touch control. The user can bring sets down to work surface at any speed adjustment with no loss of power. Standard equipment includes air actuated foot control, and filter-regulator-lubricator combo.

Made in the USA by U.S. Industrial Tool.

OPTION: US14032 - As the operator depresses the foot pedal providing a momentary signal (press and release), the set holder will move forward and upon full stroke complete the rivet upsetting and automatically retract to start position, awaiting an operator follow-up signal. Shipped freight collect.

**Also available with a two stage Hi-low pressure system.  
Providing operator pinch point protection for CE certification.**

**TWO STAGE HI-LOW PRESSURE System**

**Part No: US13046MPB**

- CE certified (requires system to be factory installed)





**Featuring:** Variable foot control for improved operator control is provided at no extra charge.

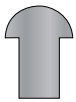
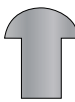

**US150**

USI 150							
Part No.	Reach	Gap	Solid S/S	Stroke	Height	Shank	Weight
US150-8	8"	4"	3/8"	1-3/8"	48"	.312	190
US150-12	12"	4"	3/8"	1-3/8"	52"	.312	230
US150-24	24"	5"	3/8"	1-3/8"	57"	.312	475
US150-36	36"	8-1/2"	3/8"	1-3/8"	78"	.375	1800

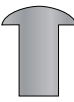
## RIVET HEAD STYLES

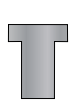
																	
RIVET DIA. (inches)	AN-435 BUTTON			AN-430 ROUND			AN-455 BRAZIER			AN-456 MODIFIED BRAZIER		AN-470 UNIVERSAL				AN-442 FLAT	
A	B	C	R	B	C	R	B	C	R	B	C	B	C	R	E	B	C
1/16"	.109	.047	.055	.125	.047	.065	.156	.031	.113	.117	.023	.125	.027	.054	.031	.125	.025
3/32"	.166	.070	.084	.187	.070	.098	.234	.047	.170	.156	.031	.187	.041	.082	.047	.187	.037
1/8"	.219	.094	.111	.250	.094	.130	.312	.063	.226	.235	.046	.250	.054	.108	.063	.250	.050
5/32"	.273	.117	.138	.312	.117	.162	.390	.078	.283	.312	.063	.312	.067	.135	.078	.312	.062
3/16"	.328	.141	.166	.375	.141	.195	.468	.094	.340	.390	.078	.375	.082	.164	.094	.375	.075
1/4"	.437	.188	.221	.500	.188	.260	.225	.125	.433	.468	.094	.500	.107	.217	.125	.500	.100
5/16"	.546	.234	.276	.648	.234	.325	.781	.156	.565	.625	.125	.648	.136	.272	.156	.648	.125
3/8"	.656	.281	.332	.750	.281	.391	.940	.187	.680	.781	.156	.750	.164	.328	.187	.750	.150

## INSTRUCTIONS FOR SELECTING SQUEEZER SETS

To develop maximum power, the riveter must drive the rivet near the end of the riveter's stroke. For maximum power the combined length of the two rivet sets must be of the correct length. Determine the correct length as follows:

WHEN TWO FLUSH SETS ARE USE - The sum of the two rivet sets "L" dimension should equal the closed height dimension of the yoke minus the overall length of the rivet after it is driven.

WHEN ONE CUPPED SET & ONE FLUSH SET ARE USED - The sum of the two rivet sets "L" dimension should equal the closed height dimension of the yoke minus the total thickness of the material being riveted and the height of the finished rivet head driven by the flush set. If necessary, select rivet sets a little short and shim to proper length with hardened shims listed in the table. The closed height dimension of the yoke referred to above is the opening available when jaws of plunger are in extreme closed or forward position with both rivet sets in place.

## CUPPED SQUEEZER SETS

- High alloy steel, made in U.S.A
- Faces polished to high luster
- Precision ground shanks
- Heat-treated for long wear and tool life.



Body Length	.187" Shank		.250" Shank	.312" Shank	.375" Shank
	Part No. 3/8" Dia.	Part No. 1/2" Dia.	Part No. 5/8" Dia.	Part No. 5/8" Dia.	Part No. 5/8" Dia.
1/8"	-	SM205-1/8	-	-	-
1/4"	SM200-3/8	SM200	SM220	SM240	SM260
3/8"	SM201-3/8	SM201	SM221	SM241	SM261
1/2"	SM201-3/8	SM202	SM222	SM242	SM262
5/8"	SM201-3/8	SM203	SM223	SM243	SM263
3/4"	SM201-3/8	SM204	SM224	SM244	SM264

Note: Select the size set required (chart above), then add the desired cupping (chart below).

Cupping Size	Part No. Round AN430	Part No. Button AN435	Part No. Flat AN442	Part No. Brazier AN455	Part No. Brazier AN456	Part No. Universal AN470
1/16"	4302	4352	4422	4552	4562	4702
3/32"	4303	4353	4423	4553	4563	4703
1/8"	4304	4354	4424	4554	4564	4704
5/32"	4305	4355	4425	4555	4465	4705
3/16"	4306	4356	4426	4556	4566	4706

Cupping Size	Part No. Round AN430	Part No. Button AN435	Part No. Flat AN442	Part No. Brazier AN455	Part No. Brazier AN456	Part No. Universal AN470
7/32"	4307	4357	4427	4557	4567	4707
1/4"	4308	4358	4428	4558	4568	4708
5/16"	43010	43510	44210	45510	45610	47010
3/8"	43012	43512	44212	45512	45612	47012

Example: For a .187" shank, 1/2" diameter, 1/4" L dim. squeezer set with a 1/8" AN470 universal cupping, use part number SM200-4704.

## CUPPED SQUEEZER SETS FOR BOEING® BACR15FT TYPE



Note: Select the size set required (chart on right), then add the desired cupping (chart below).

Example: For a .187" shank, 1/2" diameter, 1/4" 'L' dim. squeezer set with a 1/8" BACR15FT cupping, use part number SM200-4704BAC.

Body Length	.187" Shank	.250" Shank
	Part Number	Part Number
1/4"	SM200	SM220
3/8"	SM201	SM221
1/2"	SM202	SM222

Cupping Size	3/32"	1/8"	5/32"	3/16"	7/32"	1/4"	9/32"
Part Number	4703BAC	4704BAC	4705BAC	4706BAC	4707BAC	4708BAC	4709BAC

## SETS FOR AN450 TUBULAR RIVETS

- High alloy steel, made in U.S.A.
- Precision ground shanks
- Heat-treated for long tool life



FLARING



OVAL

Body Length	.187" Shank	.250" Shank	.312" Shank	.375" Shank
	Part Number	Part Number	Part Number	Part Number
1/4"	SM200	SM220	SM240	SM260
3/8"	SM201	SM221	SM241	SM261
1/2"	SM202	SM222	SM242	SM262
5/8"	SM203	SM223	SM243	SM263
3/4"	SM204	SM224	SM244	SM264

Note: Select the size set required (chart above), then add the desired rivet size and type (chart below).

Example: For a .187" shank, 1/4" 'L' dim. set with a 1/8" rivet size (flaring), use part number SM200-450H; for oval, use SM200-4 Oval.

Rivet Size	1/16"	3/32"	1/8"	5/32"	3/16"	1/4"	5/16"
Part No. Flaring	4502	4503	4504	4505	4506	4508	45010
Part No. Oval	-2 Oval	-3 Oval	-4 Oval	-5 Oval	-6 Oval	-8 Oval	-10 Oval

## FLUSH SQUEEZER SETS

- High alloy steel, made in U.S.A.
- Precision ground shanks
- Heat-treated for long tool life



SM210

Body Length	.187" Shank		.250" Shank	.312" Shank	.375" Shank
	Part No. 3/8" Dia.	Part No. 1/2" Dia.	Part No. 5/8" Dia.	Part No. 5/8" Dia.	Part No. 5/8" Dia.
1/8"	SM210-3/8	SM210	SM230	SM250	SM270
3/16"	SM210A-3/8	SM210A	-	-	-
1/4"	SM211-3/8	SM211	SM231	SM251	SM271
3/8"	SM212-3/8	SM212	SM232	SM252	SM272
1/2"	SM213-3/8	SM213	SM233	SM253	SM273
5/8"	SM214-5/8	SM214	SM234	SM254	SM274
3/4"	SM215-3/8	SM215	SM235	SM255	SM275
7/8"	SM216-3/8	SM216	SM236	SM256	SM276
1"	SM217-3/8"	SM217	SM237	SM257	SM277

## SOFT BLANK SETS

Body Length	.187" Shank
	Part No.
1/4"	SM211S
3/8"	SM212S
1/2"	SM213S
5/8"	SM214S

Body Length	.187" Shank
	Part No.
3/4"	SM215S
7/8"	SM216S
1"	SM217S

- Not heat-treated, easily machinable
- Retainer spring provided



## SLEEVED & SPRING LOADED FLUSH SQUEEZER SETS

.187" Shank		Inside Diameter	Outside Diameter
Part No.	Shank		
SM2143	3/16"	3/8"	9/16"
SM2144	3/16"	19/64"	1/2"



SM2143

## HI-SHEAR SQUEEZER SETS



SMHS200-4

For Hi-Shear Rivets		
Rivet Size	.187" Shank Part Number	.250" Shank Part Number
1/8"	SMHS200-4	SMHS220-4
5/32"	SMHS200-5	SMHS220-5
3/16"	SMHS200-6	SMHS220-6
1/4"	SMHS200-8	SMHS220-8
5/16"	-	SMHS220-10
3/8"	-	SMHS220-12

For Huck Lockbolts		
Rivet Size	.187" Shank Part Number	.250" Shank Part Number
1/8"	SMH205-4	SMH225-4
5/32"	SMH205-5	SMH225-5
3/16"	SMH205-6	SMH225-6
1/4"	SMH205-8	SMH225-8
5/16"	-	SMH225-10
3/8"	-	SMH225-12

## SPACER SHIMS

- Hard steel
- Invaluable for building up standard length body sets
- Enables operator to upset rivet to the 'nth' degree

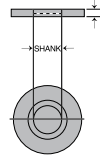

.187" Shank	
Part Number	Thickness
SMS0	1/64"
SMS1	1/32"
SMS2	1/16"

.250" Shank	
Part Number	Thickness
SMS3	1/32"
SMS4	1/16"
SMS5	1/8"

.312" Shank	
Part Number	Thickness
SMS6	1/32"
SMS7	1/16"
SMS8	1/8"

## SHANK ADAPTERS

Part Number	Dimension Height	Male (shank)	Female (shank)
SMSA1	1/2"	.250"	.187"
SMSA2	3/8"	.312"	.187"

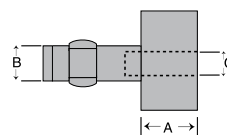

## DIMPLE PUNCH &amp; DIES (AN426)

- Use in pneumatic or hand squeezers

*Example: For a .187" shank, 1/4" 'L' dim. punch with a 1/8" rivet size, use part number SMP211-4264.*



Body Length	.187" Shank		.250" Shank		.312" Shank	
	Part No. Punch	Part No. Die	Part No. Punch	Part No. Die	Part No. Punch	Part No. Die
1/4"	SMP211	SMD211	SMP231	SMD231	SMP251	SMD251
3/8"	SMP212	SMD212	SMP232	SMD232	SMP252	SMD252
1/2"	SMP213	SMD213	SMP233	SMD233	SMP253	SMD253

Rivet Size	1/16"	3/32"	1/8"	5/32"	3/16"	1/4"
Part Number	4262	4263	4264	4265	4266	4268

## DIMPLE PUNCH &amp; DIES FOR 100° SCREWS (AN509)

.187" Shank	
Part Number	Screw Size
5094	#6
5095	#8
5096	#10

.187" Shank	
Part Number	Screw Size
5098	1/4"
50910	5/16"

*Example: For a 3/8" body 'L' punch with #6 screw, use part number SMP212-5094.*

## 'SPRING BACK' DIMPLE DIE SETS

- Forms a perfect 100° dimple
- .187" shank



Rivet Size	3/32"	1/8"	5/32"	#6	#8	#10
Part Number	TPA4263SB	TPA4264SB	TPA4265SB	TPA5094SB	TPA5095SB	TPA5096SB

## POP STYLE DIMPLE &amp; DIE SET AN426

- Forms a perfect 100° dimple
- Includes extra mandrels for repeat work

Rivet Size	3/32"	1/8"
Part Number	TP635	TP636



## DIMPLE PUNCH &amp; DIE KITS

- .187" shank

Part Number	Description
TP4263K	6 pc. Dimple & Die Kit includes 3/32", 1/8" 5/32", (1/4" L) and plastic case
SMPD-24K	33 pc. kit includes 3/32"-3/16", 1/4", 3/8" & 1/2" body 'L' and plastic case
AT206A-24PC	24 pc. kit includes 3/32"-3/16", 1/4", 3/8" & 1/2" body 'L' and plastic case



TP4263K

*AT206A-24PC Kit offers 12 pair of male and female dimple-die combinations, for rivet sizes 3/32", 1/8", 5/32" and 3/16". Each rivet set is furnished with body lengths of 1/4", 3/8" and 1/2". The 3/16" (.187) diameter shank adapts to standard hand and stationary rivet squeezers. The sturdy kit box is engraved to ensure FOD and tool control, size identification, and protection of the polished surfaces of the tools.*

## U.S. INDUSTRIAL BAIL (HANGER)

- Rotates 360°
- For US151 tools
- While the tool is suspended by the balancer, the operator is allowed to effortlessly position the tool for most applications
- Ball bearing design
- Tool not included



**US151-3600**

Part Number	Description
US151-3600	360° Rotation
US151-3615	360° TwoDirections

## RIVET SQUEEZER SETS KITS



**TP116A**



**TP116M**

Part Number	Description
TP116A	6 pc. Assortment Kit includes 2 ea. flush set; 1 ea. 4703-4:5 & -6
TP116A-11	11 pc. Assortment Kit includes 1 ea. SM200-4703; 4; 5 and -6; flush set 1/8" high thru -3/4"; plastic case
TP116M	36 pc. Assortment Kit includes assorted cupped & flush set; 3/8" & 1/2" dia. spacer shims; plastic case
24FSK	24 pc. flush kit includes assorted hard & soft flush sets (3/8" & 1/2" dia.); spacer shims; plastic case

*Note: Other kits available upon request.*

## ATI RIVET SQUEEZER KITS

- Each kit plate is engraved for identification and tool control

Part Number	Description
ATI08A-28PC	28 pc. Assortment Kit includes assorted cupped & flush sets, 1/2" dia. and plastic case
ATI08A-33PC	33 pc. Assortment Kit includes ATI08A-28PC plus 5 3/8" dia. flush sets



**ATI08A-33PC**

## FOOT CONTROL ATTACHMENT

- Air actuated valves & remote foot pedal. Provides a safety guarded design variable speed remote foot pedal and 8 feet of hose, all necessary hardware and installation instructions. For US and APT models only. (Not shown)
- Replaces lever actuated throttle
- For use on all US151 & CP351 series squeezers
- Aids in mounting of portable squeezers for bench or special applications
- All required hardware included
- Foot pedal can be moved for convenient use
- 6' cable included
- Tool not included

Part Number	For Use With
FCT-151	CP0351, US151
FCT-151AK	USI and APT only

- Replaces lever actuated throttle
- Air line connects directly to foot control throttle
- Includes easy-to-install backhead
- Tool not included
- 6' hose

Part Number	For Use With
FCT-151AK	USI and APT only



FCT-151



FCT-114

## US151 AND CP351 POWER BOOSTER ASSEMBLY

- Increase power 6,000 to 12,000 lbs. force

Part Number	For Use With
US305	CP0351, US151 and APT



## RIVET SQUEEZER FLOOR AND BRAKE STAND

- Fits alligator yoke CP0351A, APT and US151A
- Converts riveters to hands-free foot operation
- Simple, rugged design

Part Number	Includes	Height
151BS	Bench stand only (not shown)	10"
SRPS-151	Stand & foot guard	45"
US114BMS	Stand & FCT114	12"

**Note:** Please specify make and model number of riveter to be mounted.

- Rotates 360°

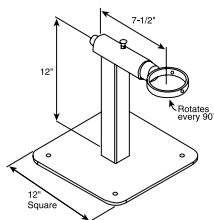

US114BMS



SRPS-151



## U.S. INDUSTRIAL COLD RIVETER

- CE certified
- 3200 lbs.

Includes everything except US14050 Force Monitor (optional). Shipped freight collect.

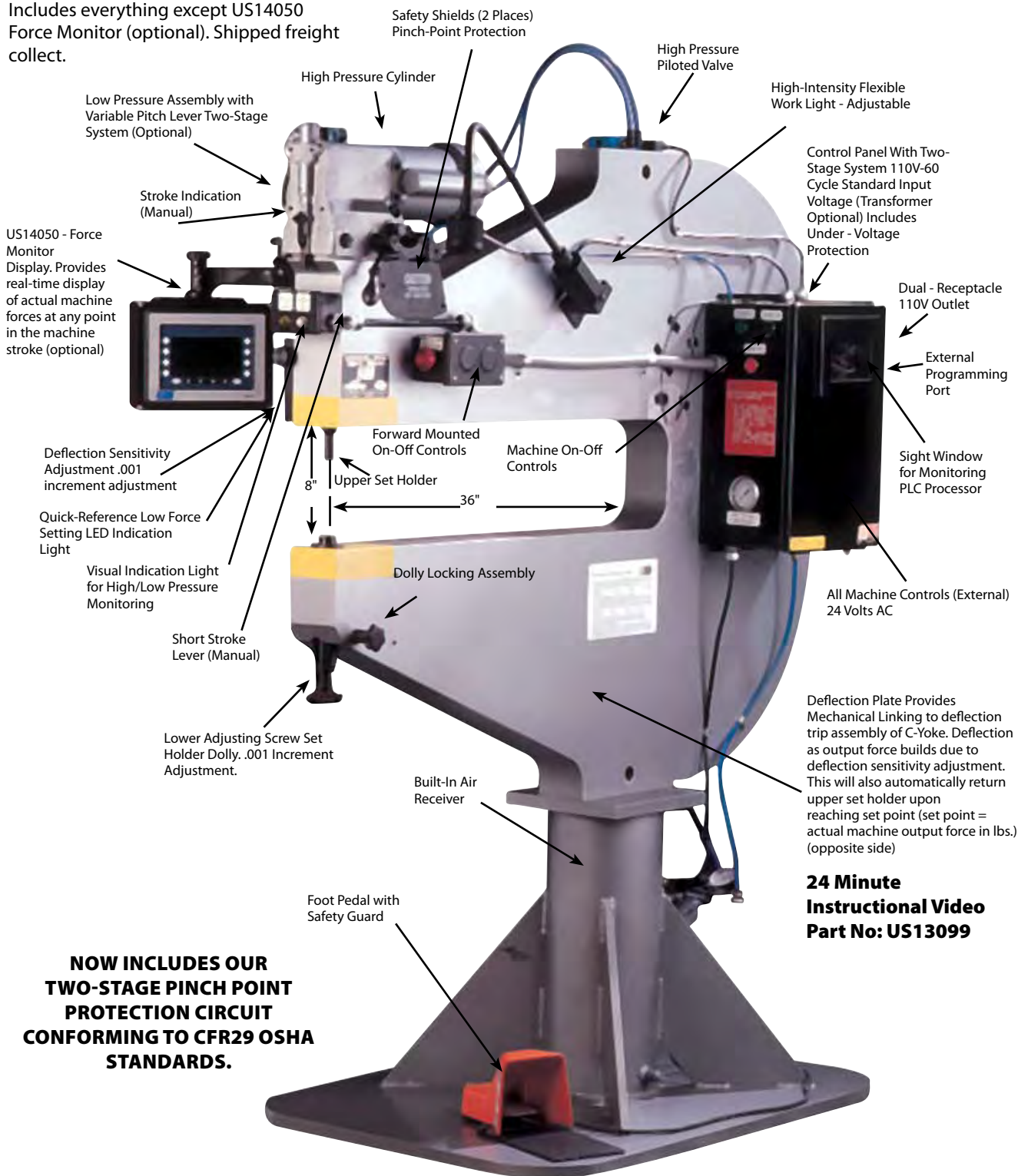

**NOW INCLUDES OUR TWO-STAGE PINCH POINT PROTECTION CIRCUIT CONFORMING TO CFR29 OSHA STANDARDS.**

**24 Minute Instructional Video Part No: US13099**

Part No.	Cold Rivet Capacity		Max. Force (lbs)	Max. Set Holder	Part of Stroke at	Voltage (Input)
US150EA-36 Cold	Alum	Steel	With 90 lbs. air pressure	Travel (Inches) 1-3/4"	Max. force 1-3/4" Final 3/16"	110V-AC 60HZ
	1/2"	3/8"	24,000 lbs.			

# U.S. INDUSTRIAL HOT DIMPLER – RIVETER

- CE certified
- Shipped freight collect
- 3200 lbs.

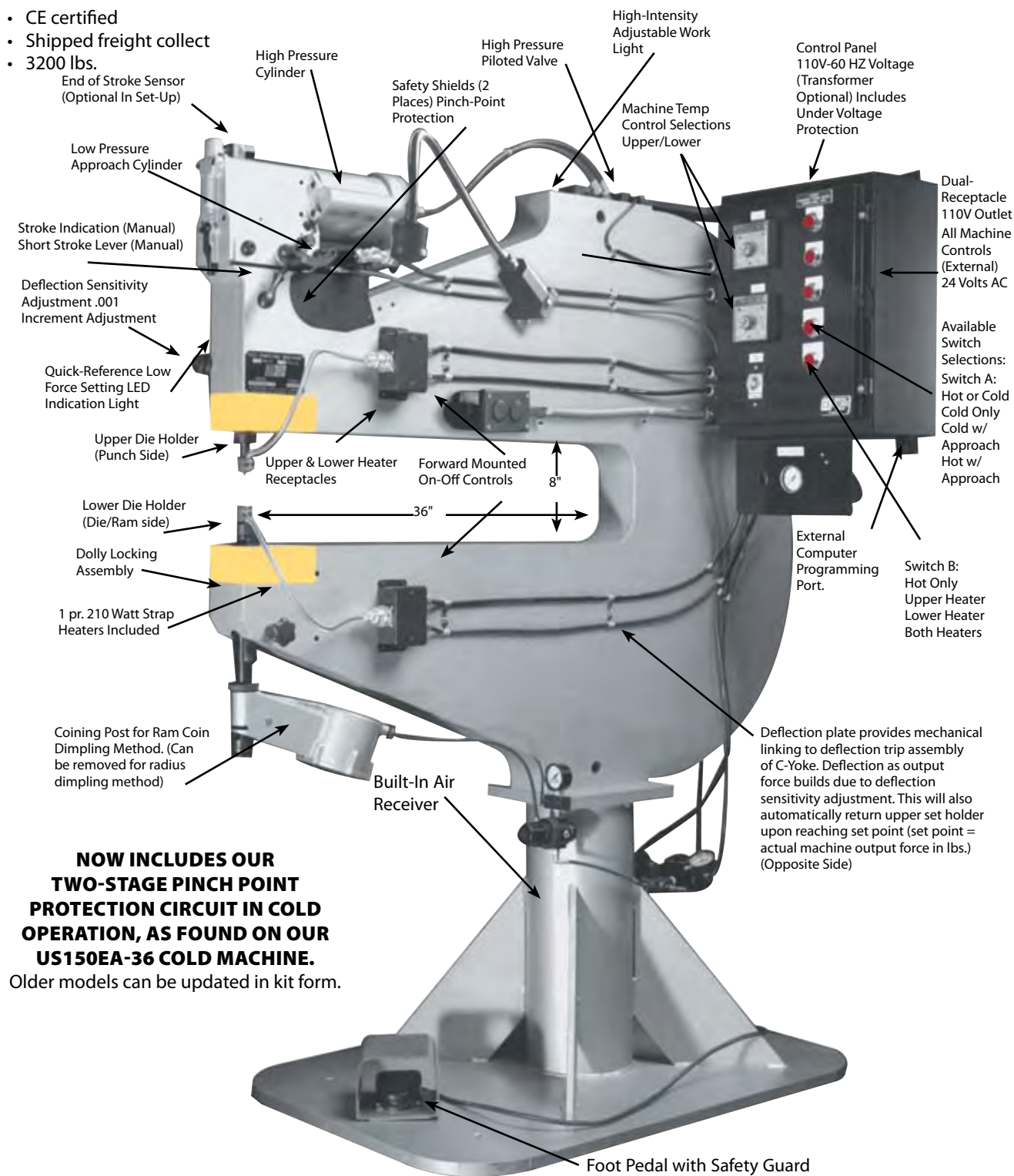

**NOW INCLUDES OUR TWO-STAGE PINCH POINT PROTECTION CIRCUIT IN COLD OPERATION, AS FOUND ON OUR US150EA-36 COLD MACHINE.**  
Older models can be updated in kit form.

Tool No.	Heat Controlers Temp. Range	Dwell Timer Range	Set Holder Plunger Stroke			Voltage (Input)
US150EA 36 Hot	0°-800°	0-30 sec.	Max. force (lbs) at 90 PSI	Max Set Holder Travel (inches)	Part of stroke at max force	110V-AC 60 HZ
			24,000 lbs.	1-3/4"	Final 3/16"	

## COLD - HOT CONVERSION KITS

### U.S. INDUSTRIAL HOT DIMPLER CONVERSION KIT

**Part No: \*US450SSCK**

Update any older Chicago Pneumatic or Zephyr hot dimpler to latest value and P.L.C. Control Circuit Design. Features included can be found on our full page US150EAHOT-36 Display.

Shipped freight collect.

Basic kit includes:

- Complete electrical control panel with foot pedal
- Complete power head assembly set-up for two-stage circuit
- High pressure piloted valve.
- Hoses and hardware as required
- Installation instructions
- CE certified
- NEW!! Two-stage Hi-Low pinch point cold operation now included in hot panel operation circuit.



*Special Note: \*The kit in itself covers the dimpling machine's main operating systems. You may require other parts not supplied in the kit, due to the condition of the existing machine.*

### U.S. INDUSTRIAL COLD RIVETER CONVERSION KIT

**Part No: \*US450CKEAB**

Update any older style Chicago Pneumatic or Zephyr & (EA) Cold type riveter to our latest valve and P.L.C. Control Circuit Design. Included is our Two-Stage HI/Low Pressure System. Features included can be found on our full page US150EACOLD-36 display.

Shipped freight collect.

Basic kit includes:

- Complete electrical control panel with foot pedal
- Complete power head assembly set-up for two-stage circuit
- High pressure piloted valve
- Hoses and hardware as required
- Instructions
- CE certified

*Special Note: \*The kit itself covers the riveting machines main operating systems you may require other parts not supplied in the kit due to the condition of the existing machine.*

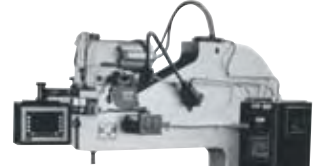

## FORCE AND TEMPERATURE METERS

### HAND HELD TRANSIENT FORCE RECORDER

{Includes recorder and one compression load cell (specify size)}

**Part No: US13095**

Available Load Cells:

- USCLC-500 - Compression Load cell - 500 lbs. maximum capacity (for EA type Two-Stage Cold Machines)
- USCLC-15000 - Compression Load Cell - 15,000 lbs. max. capacity (for portable rivet squeezers)
- USCLC-30000 - Compression Load Cell - 30,000 lbs. max. capacity (For all stationary type riveting machines)

Our transient force recorder and compression load cells have been designed for U.S. Industrial Tool for the expressed intent to be used on rivet squeezing tools. The portability of the recorder allows shop floor use in even the worst environments. The data is supplied in "real time" on 3 x 5 LCD display. A necessary tool for calibration of all two-stage cold riveting circuits. Or to provide set-up conformation for your portable squeezers. (For more information ask for our complete product bulletin).



### TEMPERATURE METER

**Part No: SM805TM**

This meter is used to verify that heater temperature is accurate to the heat controller setting.



## STRAP HEATERS & END PLATE CONTROL UPGRADE

STRAIGHT TYPE PART NO.	OFFSET TYPE PART NO.	CONNECTOR TYPE
US2881-B15 Heater Assembly - 210 Watt	US2880-B15 Heater Assembly -210 Watt	CANNON
US2881-22 Heater Element Only - 210 Watt	US2881-22 Heater Element Only - 210 Watt	-
US1982-B15 Heater Assembly - 350 Watt	-	CANNON
US1982-B22 Heater Element Only - 350 Watt	US1982-B22 Heater Element Only - 350 Watt	-
US28810- B150 Heater Element Only - 210 Watt	US28800- B150 Heater Element Only - 210 Watt	MIL-C-26482



Part No.	Description
CP450-AirCon	Cylinder plate and foot control

- Better control forward & reverse



DIMPLER AND RIVETER ACCESSORIES

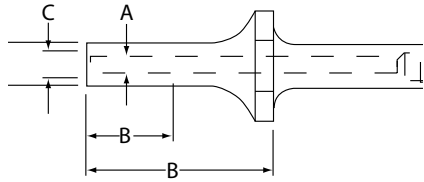

U.S. INDUSTRIAL RIVET SET ADAPTERS

Part No.	Type	A	B	C	D	E
US81392	CR-1	3/16"	7/8"	9/32"	7/16"	1-7/8"
US81393	CR-2	1/4"	7/8"	3/8"	9/16"	1-7/8"
US82189	CR-3	5/16"	1-1/8"	7/16"	21/32"	1-7/8"
US82190	CR-4	3/8"	1-1/4"	1/2"	3/4"	1-7/8"
US85030	CR-1	3/16"	7/8"	9/32"	9/16"	4-1/8"
US85031	CR-2	1/4"	7/8"	3/8"	9/16"	4-1/8"
US85032	CR-3	5/16"	1-1/8"	7/16"	3/4"	4-1/8"
US85033	CR-4	3/8"	1-1/4"	1/2"	3/4"	4-1/8"

U.S. INDUSTRIAL COINING POST ADAPTERS

- Allows you to remove coining post die tooling and adapt coin in post for Cold Riveting without having to replace coining post with conventional adjusting screw assembly.

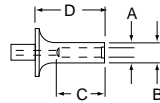

DIMENSION SIZE				
Part No.	A	B	C	D
SM153-375-2	0.375	3/4	1-3/8	1-3/4
SM153-312-2	0.312	5/8	1-3/8	1-3/4
SM153-375-1	0.312	5/8	1-3/8	1-3/4
SM153-250-2	0.250	5/8	3/4	1-3/4
SM153-250-1	0.250	5/8	3/4	7/16
SM153-187-2	0.187	1/2	3/4	1 3/4
SM153-187-1	0.187	1/2	3/4	7/16

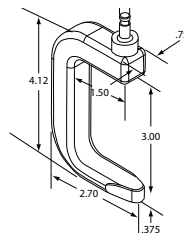
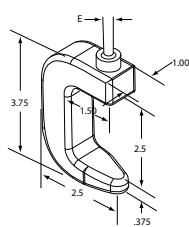

U.S. INDUSTRIAL OFFSET RIVET SETS

Part No.	E
SMOFA1	3/16"
SMOFA2	1/4"
SMOFA3	15/16"
SMOFA4	3/8"

U.S. INDUSTRIAL OFFSET RIVET SETS

Part No.	E
SMOFA1	3/16"
SMOFA2	1/4"
SMOFA3	15/16"
SMOFA4	3/8"

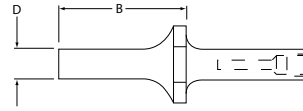

U.S. INDUSTRIAL FLUSH SETS

Part No.	A	B
US81391	23/64"	2-1/4"
US81390	31/64"	2-1/4"
US81389	39/64"	2-1/4"
US85110	23/64"	3-1/2"
US85111	31/64"	3-1/2"
US85112	39/64"	3-1/2"

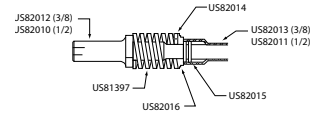

U.S. INDUSTRIAL PRESSURE PAD DOLLIES

Part No.	Description
US78692	Assembly complete 1/2" Pressure Pad Dolly
US78691	Assembly complete 3/8" Pressure Pad Dolly

U.S. INDUSTRIAL COINING POST ASSEMBLY DIE TOOLING

- For use on lower side - coining post to accept die and ram assembly for Hot Dimpling
- Available in different heights and diameters (Ref: Dim. A.)
- Die holder and pin must be purchased together

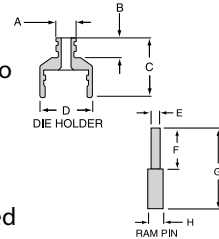

DIE HOLDER TYPE		DIMENSION SIZE			
Part No.	A	B	C	D	
US89730 (Std. Shaft)	0.499	0.500	1.500	1.310	
US89730-1 (Ext. Shaft)	0.499	1.590	2.590	1.310	
US89730-JUMBO (Jumbo)	0.875	0.875	2.000	1.312	

RAM PIN TYPE		DIMENSION SIZE			
Part No.	E	F	G	H	
US89729 (Std. Shaft)	0.248	1.200	0.2400	0.437	
US89729-1 (Ext. Shaft)	0.248	2.290	0.3490	0.437	
US89729-JUMBO (Jumbo)	0.248	1.700	0.2900	0.437	

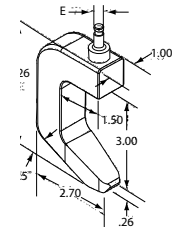
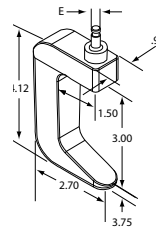

U.S. INDUSTRIAL OFFSET RIVET SETS

Part No.	E
SMOFC1	3/16"
SMOFC2	1/4"
SMOFC3	15/16"
SMOFC4	3/8"

U.S. INDUSTRIAL OFFSET RIVET SETS

Part No.	E
SMOFC1	3/16"
SMOFC2	1/4"
SMOFC3	15/16"
SMOFC4	3/8"

## COIN DIMPLE PUNCH ASSEMBLIES FOR HOT & COLD DIMPLING

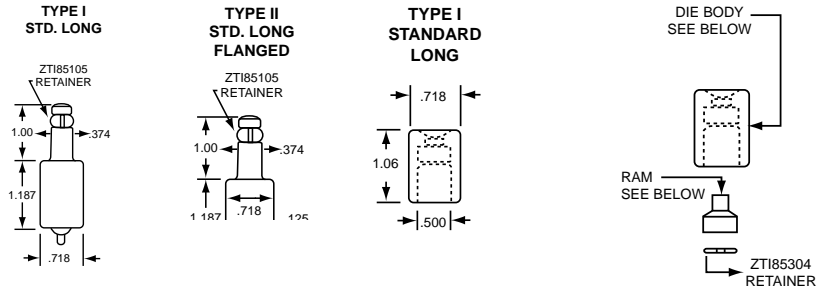

Fastener	Size	Parts in Die Assembly				
		Type 1	Type 2	Die Assembly	Die Body	Ram
AN426 Rivet (100°)	3/32	ZT1855-3/32		ZT1853-1/32	ZT185301-3/32	ZT185302-3/32
	1/8	ZT1855-1/8		ZT1853-1/8	ZT185301-1/8	ZT185302-1/8
	5/32	ZT185-5/32		ZT1853-5/32	ZT18501-5/32	ZT185302-5/32
	3/16	ZT1855-3/16		ZT1853-3/16	ZT18501-3/16	ZT185302-5/16
See note #1	1/4		ZT1855-1/4	ZT1853-1/4	ZT18501-1/4	ZT185302-1/8
AN & NAS Screw 100°	#6	ZT1865-#6		ZT1863-#6	ZT186301-#6	ZT186302-#6
	#8	ZT1865-#8		ZT1863-#8	ZT186301-#8	ZT186302-#8
	#10	ZT1865-#10		ZT1863-#10	ZT186301-#10	ZT186302-#10
	#1/4-28		ZT1867-#1/4-28	ZT1863-#1/4-28	ZT186301-#1/4-28	ZT186302-#1/4
See note #1	#3/16-24 ⑤		ZT186-#3/15-24	ZT1863-#3/16-24	ZT186301-3/16-24	ZT179402-1
HS47 Hi-Shear Rivet (100°)	3/16	ZT1875-3/16		ZT1873-3/16	ZT187301-3/16	ZT187302-3/16
	1/4	ZT1875-1/4		ZT1873-1/4	ZT187301-1/4	ZT187302-1/4
	5/16		ZT1875-5/16	ZT1873-5/16	ZT187301-5/16	ZT187302-5/16
AN & NAS Screw (100°) High Stress Drill-Out Type	#8	ZT1867-#8		ZT1868-#8	ZT186301-#8	ZT186802-#8
	#10	ZT1867-#10		ZT1868-#10	ZT186301-#10	ZT186802-#10
	#1/4-28		ZT1867-#1/4-28	ZT1868-#1/4-28	ZT186301-#1/4-28	ZT186802-#1/4-28
	See note #2	#3/16-24		ZT1867-#3/16-24	ZT1860-#3/16-24	ZT186002-#3/16-24
HS47 Hi-Shear Rivet (100°)	1/8	ZT1877-1/8		ZT1878-1/8	ZT187801-1/8	ZT175202-1/8
	3/32	ZT1877-3/32		ZT1878-3/32	ZT187801-3/32	ZT185302-1/8
	3/16	ZT1877-3/16		ZT1878-3/16	ZT187801-1/16	ZT187802-3/16
	1/4	ZT1877-1/4		ZT1878-1/4	ZT187801-1/4	ZT187802-1/4
	See note #2	5/16		ZT1877-5/16	ZT1878-5/16	ZT187801-5/16
Blind Rivet (100°) (Huck, Cherry, DuPont) High Stress Drill-Out Type	1/8	ZT1751-1/8		ZT1752-1/8	ZT175201-1/8	ZT175202-1/8
	3/32	ZT1751-3/32		ZT1752-3/32	ZT175201-3/32	ZT175202-3/32
	See note #2	3/16		ZT1751-3/16	ZT1752-3/16	ZT175201-3/16
B.F. Goodrich Rivnut (100°) Drill-Out Type	#4	ZT1748-#4		ZT1747-#4	ZT186301-#6	ZT174902-#4
	#6		ZT1748-#6	ZT1747-#6	ZT174901-#6	ZT174902-#6
	#8		ZT1748-#8	ZT1747-#8	ZT174901-#8	ZT174902-#8
	#10		ZT17448-#10	ZT1747-#10	ZT174901-#10	ZT174902-#10
	See note #2	1/4 ④		ZT1748-1/4"	ZT1747-1/4	ZT174901-1/4
Airloc Fastener w/o Grommet	3/4" (100°)		ZT1791-3/4	ZT1792-3/4	ZT179201-3/4	ZT179202-3/4
	1" (100°) ④		ZT1791-1	ZT1792-1	ZT179201-1	ZT179202-1
	See notes #1 and #3		1-3/8" (128°)			
Airloc Fastener w/Grommet	1" (120°) ④		ZT1793-1	ZT1794-1	ZT17401-1	ZT179402-1
	See note #1		1-3/8" (128°)			
Camloc Fastener	CLC-457		ZT1723	ZT1724	ZT172401	ZT172402
	See note #1		4510-1	ZT1718	ZT1717	ZT171701
DZUS Fastener Type F	F4 Spring ④		ZT1710	ZT1709	ZT170901	ZT171602
	F4 w/Grommet ④		ZT1715	ZT1716	ZT171601	ZT171602

1. For pilot drill and dimple type installation.  
 2. For pilot drill, dimple and redrill type installation.  
 3. Punches to Cowl fastener specification "AND 10076" made to customer installation requirements.

④ Flange diameter is increased from 1.06 to 1.22.  
 ⑤ Flange diameter is increased from 1.06 to 1.31. Flange thickness increased to .25.  
 6. Coin Dimple Punches ordered by fastener size, an D punch type, and not shown here, are made to special order.

## DOTCO® ANGLE DRILLS

- Vibration & noise reducing ergonomic design.
- Thermal insulation of handle.
- Textured grip for maximum comfort.

**Heavy-Duty Models Also Feature:**

- Extra powerful motor & sturdy angle head.
- Great tool for tough jobs not suitable for lighter models.

**15LN288-52****15LF283-62**

Standard 1/4" Capacity, 1/4"-28 Thread - 0.4hp (0.30)kW				
Part Number* Front Exhaust	Part Number* Rear Exhaust	RPM (no load)	Overall Length	Weight
15LF251-62	15LF281-62	5,300	10.0" (254 mm)	1.5 lbs (0.7 kgs)
15LF252-62	15LF282-62	4,000	10.0" (254 mm)	1.5 lbs (0.7 kgs)
15LF253-62	15LF283-62	3,300	10.0" (254 mm)	1.5 lbs (0.7 kgs)
15LF254-62	15LF284-62	2,400	10.4" (264 mm)	1.7 lbs (0.8 kgs)
	15LF285-62	1,000	11.1" (282 mm)	1.8 lbs (0.8 kgs)
	15LF286-62	750	11.1" (282 mm)	1.8 lbs (0.8 kgs)
	15LF287-62	600	11.1" (282 mm)	1.8 lbs (0.8 kgs)

Heavy-Duty 1/4" Capacity, 1/4"-28 Thread - 0.9 hp (0.67 kW)				
Part Number** Front Exhaust	Part Number** Rear Exhaust	RPM (no load)	Overall Length	Weight
15LN258-52	15LN288-52	3,900	11.5" (292 mm)	2.5 lbs (1.1 kgs)
	15LN281-52	3,500	11.5" (292 mm)	2.5 lbs (1.1 kgs)
15LN252-52	15LN282-52	2,170	11.5" (292 mm)	2.5 lbs (1.1 kgs)
	15LN283-52	1,300	11.5" (292 mm)	2.5 lbs (1.1 kgs)
	15LN284-52	1,070	12.8" (325 mm)	2.9 lbs (1.3 kgs)
15LN255-52	15LN285-52	870	12.8" (325 mm)	2.9 lbs (1.3 kgs)
	15LN286-52	540	12.8" (325 mm)	2.9 lbs (1.3 kgs)

'500' Heavy-Duty Angle Head	
Suffix	Spindle Thread
-51	10-32
-52 (standard)	1/4"-28
-53	9/32"-40
-54	5/16"-24
-55	3/8"-24
-59	3-Jaw Chuck
-59NC	3/8"-24

'600' Mini Angle Head	
Suffix	Spindle Thread
-62 (standard)	1/4"-28
-63	9/32"-40
-64	5/16"-24

45° Mini Angle Head	
Suffix	Spindle Thread
-42	1/4"-28
-43	9/32"-40
-44	5/16"-24

360° Mini Angle Head	
Suffix	Spindle Thread
-92	1/4"-28
-93	9/32"-40
-94	5/16"-24

'700' Compact Angle Head	
Suffix	Spindle Thread
-72	1/4"-28
-73	9/32"-40
-74	5/16"-24

Note: All Suffix numbers are not available on all models.

\*Note: Standard equipment is the 600 series Mini Angle Head with 1/4"-28 internal thread (-62). To order other head types/sizes please select from the charts above the correct suffix required.

\*\*Note: Standard equipment is the 500 Series Heavy-Duty Angle Head with 1/4"-28 internal thread (-52). To order other head types please select from the charts above the correct suffix required.

Example: For a 360° Mini Angle Head with 10-32 internal thread at 5,300 RPM, the part number would be 15LF251-91 instead of 15LF251-62 (standard)

## CHICAGO PNEUMATIC® COMPACT ANGLE DRILLS

- High precision, durable drills for long life.
- Compact lever start & 9/32"-40 thread also available.

90° Angle Head - 3/16" Capacity, 1/4"-28 Thread - 0.38 hp (0.28 kW)			
Part Number	RPM (no load)	Overall Length	Weight
D32-L-2800S	2,800	9-7/8" (251 mm)	1.6 lbs (0.7 kgs)

30° Angle Head - 3/16" Capacity, 1/4"-28 Thread - 0.38 hp (0.28 kW)			
Part Number	RPM (no load)	Overall Length	Weight
D33-L-3000S	3,000	10-1/8" (258 mm)	1.4 lbs (0.6 kgs)

360° Angle Head - 3/16" Capacity, 1/4"-28 Thread - 0.38hp (0.28 kW)			
Part Number	RPM (no load)	Overall Length	Weight
D370-L-3000S	3,000	10-1/4" (262 mm)	1.6 lbs (0.7 kgs)



**D370-L-3000S**

## SIOUX® COMPACT ANGLE DRILLS

- High precision, durable drills for long life.
- Compact lever start & 9/32"-40 thread also available.

90° Angle Head - 3/16" Capacity, 1/4"-28 Thread - 0.33 hp (0.25 kW)			
Part Number	RPM (no load)	Overall Length	Weight
1AM1551	2,800	9-7/8" (251 mm)	1.5 lbs (0.7 kgs)

45° Angle Head - 3/16" Capacity, 1/4"-28 Thread - 0.38 hp (0.28 kW)			
Part Number	RPM (no load)	Overall Length	Weight
1AM1541	2,800	10-1/8" (258 mm)	1.5 lbs (0.7 kgs)

180° Angle Head - 1/4" Capacity, 1/4" - 0.75 hp (0.56 kW)			
Part Number	RPM (no load)	Overall Length	Weight
2L1380	3,350	13-3/4" (349 mm)	2.3 lbs (1.1 kgs)



**1AM1551**



**2L1380**

## U.S. INDUSTRIAL® COMPACT ANGLE DRILLS

1/4" Capacity - 0.5 hp (0.37 kW) - Non-Reversible			
Part Number	RPM (no load)	Overall Length	Weight
US7092DARE	2,800	12.6" (310 mm)	2.6 lbs (1.2 kgs)
US7092DARE	4,500	12.6" (310 mm)	2.6 lbs (1.2kgs)



**US7092DARE**

## ECONOMY ANGLE DRILLS

- Affordable close quarter drilling tools

90° Angle Head - 1/4" Capacity, 1/4"-28 Thread - 0.3 hp (0.22 kW)			
Part Number	RPM (no load)	Overall Length	Weight
AIT-9750	2,800	10-1/2" (267 mm)	1.6 lbs (0.7 kgs)

45° Angle Head - 1/4" Capacity, 1/4"-28 Thread - 0.3 hp (0.22 kW)			
Part Number	RPM (no load)	Overall Length	Weight
AIT-9751	2,800	11" (279 mm)	1.6 lbs (0.7 kgs)



**AIT9750**



**AIT9751**

## SIOUX® LEVER GRIP AIR DRILLS

- Comfort grip.
- Lever start, rear exhaust.
- Includes keyed chuck.

1/4" Capacity - 0.33 hp (0.25 kW) - Non-Reversible			
Part Number	RPM (no load)	Overall Length	Weight
1420	2,600	8" (203 mm)	1.2 lbs (0.5 kgs)
DR1422	3,600	8" (203 mm)	1.2 lbs (0.5 kgs)



1420

## DOTCO® LEVER GRIP AIR DRILLS

1/4" Capacity - 0.4 hp (0.30 kW) - Non-Reversible			
Part Number	RPM (no load)	Overall Length	Weight
15LF081-38	5,300	8" (203 mm)	1.4 lbs (0.6 kgs)
15LF082-38	4,000	8" (203 mm)	1.4 lbs (0.6 kgs)
15LF083-38	3,000	8" (203 mm)	1.4 lbs (0.6 kgs)



15LF081

## U.S. INDUSTRIAL® LEVER GRIP AIR DRILLS

1/4" Capacity - 0.75hp (0.45 kW) - Non-Reversible			
Part Number	RPM (no load)	Overall Length	Weight
US70925DRE-2800	2,800	8" (203 mm)	2 lbs (0.91 kgs)
US70925DRE-4500	4,500	8" (203 mm)	2 lbs (0.91 kgs)



US7092DRE

## U.S. INDUSTRIAL® FLAT ANGLE DRILLS

1/4" -28 Spindle Thread			
Part Number	RPM (no load)	Overall Length	Weight
US7092PAN-2800	2,800	11" (274 mm)	2.65 lbs (1.2 kgs)
US7092PAN-4500	4,500	11" (274 mm)	2.65 lbs (1.2 kgs)



US7092PAN

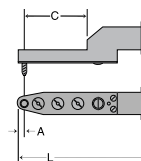

1/4" -28 Spindle Thread			
Part Number	RPM (no load)	Overall Length	Weight
US7092FO-2800	2,800	8.75" (222 mm)	2.2 lbs (0.99 kgs)
US7092FO-4500	4,500	8.75" (222 mm)	2.2 lbs (0.99 kgs)



US7092FO

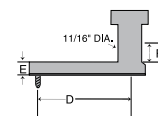

Specifications	
A = 7/16"	E = 5/8 lbs.
C = 2-1/8"	F = 2-3/8 lbs.
D = 2-7/16"	L = 4-1/8 lbs.



## SIoux® ERGONOMIC MINI AIR DRILLS

- New ergonomic housing with comfort grip.
- Teasing throttle for precise control.
- Includes 1/4" keyed chuck.

1/4" Capacity - 0.2 hp (0.15 kW) - Non-Reversible			
Part Number	RPM (no load)	Overall Length	Weight
1410	2,600	6-1/4" (159 mm)	1.3 lbs (0.6 kgs)
DR1412	3,600	6-1/4" (159 mm)	1.3 lbs (0.6 kgs)
DR1414	4,300	6-1/4" (159 mm)	1.3 lbs (0.6 kgs)

1/4" Capacity - 0.2 hp (0.15 kW) - Reversible			
Part Number	RPM (no load)	Overall Length	Weight
1410R	2,000	6-1/4" (159 mm)	1.3 lbs (0.6 kgs)
1412R	2,600	6-1/4" (159 mm)	1.3 lbs (0.6 kgs)



**1410**

## DOTCO® ERGONOMIC MINI AIR DRILLS

- Dramatically redesigned ergonomics promote operator comfort.
- Perfect for tight quarters and cramped spaces.
- Includes 1/4" keyed chuck.

1/4" Capacity - 0.2 hp (0.15 kW) - Non-Reversible			
Part Number	RPM (no load)	Overall Length	Weight
14CFS90-38	29,000	5-3/4" (146 mm)	1.5 lbs (0.7 kgs)
14CFS91-38	5,200	5-3/4" (146 mm)	1.5 lbs (0.7 kgs)
14CFS92-38	3,800	5-3/4" (146 mm)	1.5 lbs (0.7 kgs)
14CFS93-38	3,200	5-3/4" (146 mm)	1.5 lbs (0.7 kgs)
14CFS94-38	2,400	5-3/4" (146 mm)	1.6 lbs (0.7 kgs)
14CFS95-38	1,000	6-7/8" (175 mm)	1.8 lbs (0.8 kgs)
14CFS96-38	700	6-7/8" (175 mm)	1.8 lbs (0.8 kgs)
14CFS97-38	600	6-7/8" (175 mm)	1.7 lbs (0.8 kgs)



**14CFS90-38**

## CHICAGO PNEUMATIC® MINI AIR DRILLS

- An incredibly compact and lightweight general purpose tool.
- Teasing throttle.
- Includes Jacobs 1/4" keyed chuck.
- Economically priced.

1/4" Capacity - 0.25 hp (0.19 kW) - Non-Reversible			
Part Number	RPM (no load)	Overall Length	Weight
CP7300	2,800	5" (127 mm)	1.35 lbs (0.6 kgs)
CP7300R	2,700	5" (127 mm)	1.35 lbs (0.6 kgs)



**CP7300**

## SIOUX® HIGH POWER AIR DRILLS

- Ergonomic design
- Teasing trigger and down handle exhaust.
- Includes keyed chuck.

1/4" Capacity - 1.0 hp (0.75 kW) - Non-Reversible			
Part Number	RPM (no load)	Overall Length	Weight
SDR10P60N2	6,000	6-1/2" (165 mm)	2.3 lbs (1.05 kgs)

3/8" Capacity - 1.0 hp (0.75 kW) - Reversible			
Part Number	RPM (no load)	Overall Length	Weight
SDR10P26N3	2,600	7" (180 mm)	2.45 lbs (1.10 kgs)
SDR10P12N3	1,200	8" (205 mm)	2.9 lbs (1.3 kgs)
SDR10P7N3	700	8" (205 mm)	2.9 lbs (1.3 kgs)

1/4" Capacity - 1.0 hp (0.75 kW) - Non-Reversible			
Part Number	RPM (no load)	Overall Length	Weight
SDR10P60N2	6,000	6-1/2" (165 mm)	2.3 lbs (1.05 kgs)



SDR10P60N2

## CHICAGO PNEUMATIC® HIGH POWER AIR DRILLS

- Ergonomic & lightweight design.
- Teasing trigger and down-handle exhaust.
- Includes keyed chuck.

5/16" Capacity - 0.5 hp (0.35 kW) - Non-Reversible			
Part Number	RPM (no load)	Overall Length	Weight
DR350-P4500-C8	4,500	5.34" (136 mm)	1.4 lbs (0.62 kgs)

5/16" Capacity - 0.38 hp (0.28 kW) - Non-Reversible			
Part Number	RPM (no load)	Overall Length	Weight
DR350-P3000-C8	3,000	5.34" (136 mm)	1.4 lbs (0.62 kgs)



DR350

## CHICAGO PNEUMATIC® HIGH POWER DRILLS

- Ergonomic design
- Teasing trigger and down handle exhaust.
- Includes keyed chuck.

5/16" Capacity - 1.0 hp (0.75 kW) - Non-Reversible			
Part Number	RPM (no load)	Overall Length	Weight
DR750-P4100-C8	4,100	8-3/8" (213 mm)	2.43 lbs (1.1 kgs)

1/2" Capacity - 1.0 hp (0.75 kW) - Non-Reversible			
Part Number	RPM (no load)	Overall Length	Weight
DR750-P750-C13	750	8-7/8" (225 mm)	3.52 lbs (1.6 kgs)



DR750

## DOTCO® ERGONOMIC AIR DRILLS

- Dramatically redesigned ergonomics promote operator comfort.
- Perfect for tight quarters and cramped spaces.
- Gears are heat-treated alloy steel, with fixed cages to control centers.
- Includes 1/4" keyed chuck.



**14CSL**

1/4" Capacity - 0.6 hp (0.45 kW) - Non-Reversible			
Part Number	RPM (no load)	Overall Length	Weight
14CSL90-38	20,000	6.3" (160 mm)	2.1 lbs (1.0 kgs)
14CSL98-38	6,000	6.3" (160 mm)	2.1 lbs (1.0 kgs)
14CSL91-38	5,200	6.3" (160 mm)	2.1 lbs (1.0 kgs)
14CSL92-38	3,200	6.3" (160 mm)	2.1 lbs (1.0 kgs)
14CSL95-38	1,300	8.1" (205 mm)	2.9 lbs (1.3 kgs)
14CSL97-51	500	8.1" (205 mm)	2.9 lbs (1.3 kgs)

## DOTCO® HIGH ERGONOMIC AIR DRILLS

- Dramatically redesigned ergonomics promote operator comfort.
- Perfect for tight quarters and cramped spaces.
- Gears are heat-treated alloy steel, with fixed cages to control centers.
- Includes 1/4" keyed chuck.



**14CNL**

1/4" Capacity - 0.9 hp (0.45 kW) - Non-Reversible			
Part Number	RPM (no load)	Overall Length	Weight
14CNL90-38	20,000	6.8" (173 mm)	2.2 lbs (1.0 kgs)
14CNL98-38	6,000	6.8" (173 mm)	2.2 lbs (1.0 kgs)
14CNL91-38	5,200	7.2" (183 mm)	2.4 lbs (1.0 kgs)
14CNL92-38	3,200	7.2" (183 mm)	2.4 lbs (1.0 kgs)
14CNL95-38	1,300	8.6" (218 mm)	2.8 lbs (1.3 kgs)
14CNL97-51	500	9.1" (231 mm)	3.5 lbs (1.3 kgs)

## CLECO® VARIABLE SPEED AIR DRILLS

- Calibrated dial on rear of tool simplifies drill speed selection.
- Choice of three governed speed models to match material.
- Can be used with feed assist for accurate, perpendicular holes.
- Includes keyed chuck.



**135DPV-7B-43**

Part Number	Description
861006	*Required Support Handle for 1/2" Capacity Models

3/8" Capacity - 0.7 hp (0.52 kW) - Non-Reversible				
Part Number	RPM (no load)	RPM (governed)	Overall Length	Weight
135DVP-7B-43	600	150-550	9.4" (244 mm)	3.625 lbs (1.6 kgs)
135DVP-14B-51	1,250	400-1,200	9.1" (235 mm)	3.375 lbs (1.5 kgs)
135DVP-28B-51	2,600	700-2,400	8" (216 mm)	3.125 lbs (1.4 kgs)

1/2" Capacity - 0.7 hp (0.52 kW) - Non-Reversible				
Part Number	RPM (no load)	RPM (governed)	Overall Length	Weight
135DVP-7B-50*	600	150-550	9.4" (244 mm)	3.625 lbs (1.6 kgs)
135DVP-14B-50*	1,250	400-1,200	9.1" (235 mm)	3.375 lbs (1.5 kgs)

## SIOUX® HEAVY-DUTY ERGO ANGLE DRILLS

- Lever start, rear exhaust
- Operates quietly & effectively in areas inaccessible to other tools.

## 1/4" Capacity - 0.5 hp (0.37 kW) Non-Reversible

Part Number	RPM (no load)	Overall Length	Weight
2S1310	2,200	7-3/4" (197 mm)	2.6 lbs (1.2 kgs)



2S1310

## 1/4" Capacity Chuck, 3/8"-24 Thread - 0.75 hp (0.56 kW)

Part Number	RPM (no load)	Overall Length	Weight
2A1310	2,200	7-3/4" (197 mm)	2.6 lbs (1.2 kgs)

## 1/2" Capacity Chuck, 1/2"-20 Thread - 1.0 hp (0.75 kW)

Part Number	RPM (no load)	Overall Length	Weight
3A1240	600	15-1/8" (384 mm)	6.5 lbs (2.9 kgs)



3A1240

## FORCE SIOUX DRILLS

## Economy Models

## 3/8" Capacity - Non-Reversible

Part Number	RPM (no load)	Overall Length	Weight
FDR5440	2,300	7.9" (201 mm)	2.1 lbs (.95 kgs)



FDR5440

## 3/8" Capacity - Reversible

Part Number	RPM (no load)	Overall Length	Weight
SX5445R	1,800	8" (203 mm)	2.5 lbs (1.13 kgs)



SX5445R

## 1/2" Capacity - Reversible

Part Number	RPM (no load)	Overall Length	Weight
SX5450R	550	9.25" (235 mm)	4.3 lbs (1.95 kgs)



SX5450R

\*Note: Supplied support handle

## 3/8" Capacity - Reversible

Part Number	RPM (no load)	Overall Length	Weight
FDR5430	1200	8" (203 mm)	2.5 lbs (1.13 kgs)



FDR5430

## CHICAGO PNEUMATIC® ECONOMY ANGLE DRILLS

- Teasing throttle & triple idler planetary gears.
- Double ball bearing supported spindle.
- Includes Keyed chuck. • Compact lever start & 9/32"-40 thread also available.



**CP785**

3/8" Capacity - 0.5 hp (0.37 kW) - Non-Reversible			
Part Number	RPM (no load)	Overall Length	Weight
CP785	2,400	7" (178 mm)	2.25 lbs (1.0 kgs)

1/2" Capacity - 0.5 hp (0.37 kW) Non-Reversible			
Part Number	RPM (no load)	Overall Length	Weight
CP785H	500	7-3/4" (197 mm)	3 lbs (1.4 kgs)

## PLAIN BEARING CHUCKS

Part Number	Capacity	Mount Thread	Key Number	Fluted/Smooth
*J0532	5/32"	0 JT-1/4-28	K0	Smooth
1B	1/4"	3/8-24	K1	Smooth
7BA	1/4"	3/8-24	K7	Fluted
41BA	3/8"	3/8-24	K30	Fluted
33BA-3/8	1/2"	3/8-24	K32	Fluted
33BA-1/2	1/2"	1/2-20	K32	Fluted



**J0532**

\*J0532 comes with 1/4-28 adapter.

## CHUCK KEYS

Part Number	Model - Type	Pilot Size
K0	K0 - 'T' Handle	1/8"
K1	K1 - 'T' Handle	1/8"
K7	K7 - Thumb Handle	7/32"
K30	K30 - Thumb Handle	15/64"
K32	K32 - Thumb Handle	1/4"



**K0**

## ROHM KEYLESS CHUCKS

Part Number	Capacity Range	Mount Thread
TP248	0 - 1/4"	3/8" - 24
TP248A	0 - 1/4"	3/8" - 24
TP248B	0-3/8"	3/8" - 24



**TP248A  
TP248B**



**TP248**

## CONE-JAW CHUCK WITH WRENCH

- Light-duty tool fits most angle drills with female thread.
- Use standard drills.

Part Number	Capacity Range	Mount Thread
TP57	1/4"	1/4"-28



**TP57**

## HI-SHEAR ULTRALITE®

- Ergonomic, lightweight design.
- Only one hand required to locate, drill & countersink both holes in 4 seconds.
- Easily convert rivet spacings with interchangeable foot attachments.
- Available in single wing, double wing & mickey mouse models.
- Accommodates all nutplate spindle spacings from 0.219" to 1.125".
- Fully adjustable feed rate.
- Many options available, please inquire.



Stroke Length	Spindle Speed	Horsepower	Feed Rate Change	Collet Stroke Length	Weight
1/2"	600 or 7,000 RPM	0.54 HP	0.001" to 0.012" Per Revolution	1/4"	4.75 lbs (2.2 kgs)

## NUTPLATE DRILL/COUNTERSINK

- Drills are H.S.S. standard
- 100° countersink, 8-32 thread.
- Cobalt also available, please add: M42

**Example:** HPD40-M42-100-35-8



**HPD40-100**

'L' Dim. = 0.295"		
Part Number	Body & C'sink Dia.	Drill Diameter
HPD40-100-25-8	.187"	.0980"
HPDS40-100-25-8	.250"	.0980"
HPD30-100-25-8	.250"	.1285"

'L' Dim. = 0.420"		
Part Number	Body & C'sink Dia.	Drill Diameter
HPD40-100-35-8	.187	.0980"
HPDS40-100-35-8	.250"	.0980"
HPD30-100-35-8	.250"	.1285"

'L' Dim. = 0.560"		
Part Number	Body & C'sink Dia.	Drill Diameter
HPD40-100-50-8	.187	.0980"
HPDS40-100-50-8	.250"	.0980"
HPD30-100-50-8	.250"	.1285"

## BOELUBE® LUBRICANT

- High-strength polar lubricating film reduces friction & heat generation.
- Greatly improves tool life, surface finish & hole quality.
- Superior lubricity when machining aluminum, titanium and inconel.
- Non-corrosive, non-flammable, chemically stable, with no hazardous substances.

Part Number	Type	Size
70200-00	Solid	14.5 oz. Cartridge
70200-13	Solid	1.6 oz. Push Tube
70307-12	Paste	12 oz. Jar
70104-04	Liquid	1 gal. Container
70104-05	Liquid	5 gal. Pail



**70307-12**



**70200-13**



**70104-05**

## COLLETS

• For use on 9/32"-40 internal thread angle drills. • Suitable for Desoutter, Atlas Copco & Chicago Pneumatic drills.  
 • For Aro Tools: Substitute AD for ARO before part number. Example: ARO-0312 for 1/32" collet.



Part #	Hole Size	Atlas Copco	Chicago Pneumatic	Desouter	Dotco/Buckeye
AD-0312	1/32	*****	*****	2152	*****
AD-0315	0.8	*****	C-144387	*****	*****
AD-0354	0.9	*****	C-144388	*****	*****
AD-0394	1.0	4110043801	C-144389	2172	*****
AD-0400	60	*****	*****	*****	1005994
AD-0410	59	*****	*****	*****	1006523
AD-0420	58	*****	*****	*****	1005624
AD-0430	57	*****	*****	*****	1005625
AD-0433	1.1	*****	C-144390	2182	*****
AD-0465	56	*****	*****	*****	1005626
AD-0469	3/64	*****	*****	2192	*****
AD-0472	1.2	*****	C-144391	*****	*****
AD-0512	1.3	*****	C-144392	2202	*****
AD-0520	55	*****	*****	*****	1006527
AD-0550	54	*****	*****	*****	1006528
AD-0551	1.4	*****	C-144393	2212	*****
AD-0591	1.5	4110043802	*****	2222	*****
AD-0595	53	*****	C-144394	*****	1006408
AD-0625	1/16	4110043819	*****	2232	1005180
AD-0630	1.6	*****	C-144395	*****	*****
AD-0635	52	*****	*****	*****	1006446
AD-0669	1.7	*****	C-144396	2242	*****
AD-0670	51	*****	*****	*****	1006412
AD-0700	50	*****	*****	*****	1005685
AD-0709	1.8	41100438828	C-144397	2252	*****
AD-0730	49	*****	*****	*****	1006049
AD-0748	1.9	*****	C-144398	2262	*****
AD-0760	48	*****	*****	*****	1006316
AD-0781	5/64	*****	*****	2272	1005181
AD-0785	47	*****	C-144399	*****	1006393
AD-0787	2	4110043803	*****	*****	*****
AD-0810	46	*****	*****	*****	1005875
AD-0820	45	*****	*****	*****	1006028
AD-0827	2.1	4110043829	C-144400	2282	*****
AD-0860	44	*****	*****	*****	1006297
AD-0866	2.2	4110043804	C-144401	2292	*****
AD-0890	43	*****	*****	*****	1006394
AD-0906	2.3	4110043830	C-144402	2302	*****
AD0935	42	*****	*****	*****	1006058
AD0938	3/32	4110043820	*****	2312	1005928
AD0945	2.4	4110043805	C-144403	*****	*****
AD0960	41	*****	*****	*****	1005928
AD0980	40	*****	*****	*****	1005684
AD-0984	2.5	4110043806	C-144404	2322	*****

Part #	Hole Size	Atlas Copco	Chicago Pneumatic	De-souter	Dotco/Buckeye
AD-0995	39	*****	*****	*****	1006395
AD-1015	38	*****	*****	*****	1006396
AD-1024	2.6	4110043807	C-144405	2332	*****
AD-1040	37	*****	*****	*****	1006397
AD-1063	2.7	4110043831	C-144406	2342	*****
AD-1065	36	*****	*****	*****	1006397
AD-1094	7/64	*****	*****	2352	1005183
AD-1102	2.8	4110043832	C-144407	*****	1006027
AD-1142	2.9	4110043808	C-144408	2362	*****
AD-1181	3.0	4110043809	C-144409	2372	*****
AD-1220	3.1	4110043810	C-144410	2382	*****
AD-1250	1/8	4110043821	*****	2392	1005184
AD-1260	3.2	4110043811	C-144411	*****	*****
AD-1299	3.3	4110043812	C-144412	2402	*****
AD-1339	3.4	4110043833	C-144413	2412	*****
AD-1378	3.5	4110043813	C-144414	2422	*****
AD-1406	9/64	*****	*****	2432	1005967
AD-1417	3.6	4110043824	C-144415	*****	*****
AD-1457	3.7	4110043834	C-144416	2442	*****
AD-1470	26	*****	*****	*****	1006373
AD-1496	3.8	4110043814	C-144417	2452	1006318
AD-1520	24	*****	*****	*****	1006372
AD-1535	3.9	4110043835	C-14418	2462	1006315
AD-1562	5/32	4110043822	*****	2472	1005186
AD-1575	4.0	4110043815	C-144419	*****	1005926
AD-1590	21	*****	*****	*****	1005682
AD-1614	4.1	4110043825	C-144420	2482	1005876
AD-1654	4.2	4110043826	C-144421	2492	*****
AD-1660	19.0	*****	*****	*****	1006035
AD-1693	4.3	4110043836	C-144422	2502	1005964
AD-1719	11/64	*****	*****	2512	1005187
AD-1732	4.4	4110043837	C-144423	*****	1005977
AD-1772	4.5	4110043816	C-144424	2522	1006346
AD-1800	15	*****	*****	*****	1006399
AD-1811	4.6	4110043838	C-144425	2532	*****
AD-1820	14	*****	*****	*****	1006400
AD-1850	4.7	4110043839	C-144426	2542	1005927
AD-1875	3/16	4110043823	*****	2552	1005188
AD-1890	4.8	4110043818	C-144427	*****	1005871
AD-1910	11	*****	*****	*****	1006001
AD-1929	4.9	4110043840	C-144428	*****	*****
AD-1935	10	*****	*****	*****	1005681
AD-1960	9	*****	*****	*****	*****
AD-1969	5.0	4110043827	C-14429	*****	*****

## COLLETS

- Collets for Atlas Copco 6.6mm capacity head  
LBV24 S010, LBVS020, & LBVS045



Part #	Hole Size	Atlas Copco	Part #	Hole Size	Atlas Copco	Part #	Hole Size	Atlas Copco	Part #	Hole Size	Atlas Copco
AC-0312	1/32	*****	AC-0709	1.8	4110141102	AC-1040	37	*****	AC-1660	19	*****
AC-0315	0.8	*****	AC-0730	49	*****	AC-1063	2.7	*****	AC-1693	4.3	*****
AC-0354	0.9	*****	AC-0748	1.9	*****	AC-1065	36	*****	AC-1719	11/64	*****
AC-0394	1.0	*****	AC-0760	48	*****	AC-1094	7/64	*****	AC-1732	4.4	411014115
AC-0400	60	*****	AC-0781	5/64	*****	AC-1102	2.8	4110141107	AC-1772	4.5	*****
AC-0410	59	*****	AC-0785	47	*****	AC-1142	2.9	*****	AC-1800	15	*****
AC-0420	58	*****	AC-0787	2	4110141103	AC-1181	3.0	4110141108	AC-1811	4.6	411014116
AC-0430	57	*****	AC-0810	46	*****	AC-1220	3.1	*****	AC-1820	14	*****
AC-0433	1.1	*****	AC-0820	45	*****	AC-1250	1/8	*****	AC-1850	4.7	*****
AC-0465	56	*****	AC-0827	2.1	*****	AC-1260	3.2	4110141109	AC-1875	3/16	*****
AC-0472	1.2	*****	AC-0860	44	*****	AC-1299	3.3	*****	AC-1890	4.8	411014117
AC-0512	1.3	*****	AC-0866	2.2	4110141104	AC-1339	3.4	4110141110	AC-1910	11	*****
AC-0520	55	*****	AC-0890	43	*****	AC-1378	3.5	*****	AC-1929	4.9	*****
AC-0550	54	*****	AC-0906	2.3	*****	AC-1406	9/64	*****	AC-1935	10	*****
AC-0551	1.4	*****	AC-0935	42	*****	AC-1417	3.6	4110141111	AC-1960	9	*****
AC-0591	1.5	*****	AC-0938	3/32	4110043820	AC-1457	3.7	*****	AC-1969	5.0	411014118
AC-0595	53	*****	AC-0945	2.4	4110141105	AC-1470	26	*****	AC-2047	5.2	411014119
AC-0625	1/16	*****	AC-0960	41	*****	AC-1520	24	*****	AC-2126	5.4	411014120
AC-0630	1.6	4110141101	AC-0980	40	*****	AC-1535	3.9	*****	AC-2205	5.6	411014121
AC-0635	52	*****	AC-0984	2.5	*****	AC-1562	5/32	*****	AC-2283	5.8	411014122
AC-0669	1.7	*****	AC-0995	39	*****	AC-1575	4.0	4110141113	AC-2362	6.0	411014123
AC-0670	51	*****	AC-1015	38	*****	AC-1590	21	*****	AC-2441	6.2	411014124
AC-0700	50	*****	AC-1024	2.6	4110141106	AC-1614	4.1	*****	AC2520	6.4	411014125
						AC-1654	4.2	4110141114	AC-2598	6.6	411014126

\*Note: When ordering collets please specify

## COLLET CHUCKS

**400 Series** - Integral unit holds one specific size only.

Part #	Number Size	Part #	Fractional Size	Part #	Letter Size
400-10	#10	400-3/32	3/32"	400-F	F
400-11	#11	400-1/8	1/8"		
400-20	#20	400-5/32	5/32"		
400-21	#21	400-3/16	3/16"		
400-27	#27	400-F	1/4"		
400-30	#30				
400-40	#40				

• 1/4"-28 thread

**400-10**



**200 Series** - Integral prongs grip the flute of the drill - 1/4" x 28 thread

Part #	Decimal Size	Part #	Decimal Size
200-40	.0980	200-21	.1590
200-30	.1285	200-12	.1890
200-28	.1405	200-11	.1910



**200-40**



## ANGLE DRILL ATTACHMENTS

- Quickly connect to any drill chuck.
- A convenient & inexpensive close quarter drilling tool.



**NO. 3**

Part Number	Type	Capacity	Spindle Thread	Height	Side to Center	Diameter	Length
No. 3	90°	5/16"	1/4"-28	1.5"	.750"	3/4"	7-1/8"
No. 0	90° Midget	1/4"	10-32	.750"	.212"	1/2"	6"
No. 345	45°	1/4"	1/4"-28	1.375"	.400"	3/4"	7-1/2"
No. 1-1	90°	3/16"	1/4"-28	1"	.290"	1/2"	6"
TP4	90°	5/16"	1/4"-28	.9375"	.312"	3/4"	7"

## 360° ANGLE DRILL ATTACHMENT



**NO. 4-1**

Part Number	Capacity	Spindle Thread	Height	Side to Center	Shaft Offset	Diameter	Length
No. 4-1	1/4"	1/4"-28	1-1/4"	.384"	1-7/16"	3/4"	7-5/8"

## ANGLE DRILL ATTACHMENT WITH CHUCK



**NO. 2**

Part Number	Capacity	Height	Side to Center	Diameter	Length
No. 2	5/32"	2-7/16" (62mm)	.425" (11 mm)	3/4" (19 mm)	7-1/8" (181 mm)

## 90° ANGLE DRILL ATTACHMENT KIT

- Everything you need in one sturdy plastic box (included).
- Kit includes:
  - Angle Drill Attachment (No. 3)
  - Threaded Shank Drills (1 each #40, #30, #21)



**NO. 3**

Part Number	Description
TP4K	Complete Kit

## ANGLE DRILL COLLET & CHUCK KIT

- Each shank is 1/4" x 28 which will thread most drill spindles that angle attachments and angle drills are supplied with.
- Kit includes:
  - (4) #200 collets & adapters - drill sizes #40, #30, #21 & #10
  - (4) threaded drill bits (1-1/4" length) - drill sizes #40, #30, #21 & #10
  - (1) cone jaw chuck (TP57)

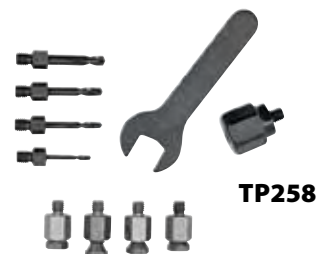

**TP258**

Part Number	Description
TP258	10 Piece Kit

Snake Drill Attachments

Part #	Type	Capacity	Spindle Thread	Height	Side to Center	Diameter	Length
N522	Straight Head	5/16"	1/4"-28	11/16"	5/8"	11/16"	22"
N602	Straight Jacobs Chuck	5/32"	N/A	N/A	N/A	N/A	30"
N602-1	Straight Jacobs Chuck	1/4"	N/A	N/A	N/A	N/A	30"
N63	90° Angle Head	1/4"	1/4"-28	1-3/8"	.384"	N/A	30"
N51-1	90° Mini Angle Head	5/16"	10-32	15/16"	.275"	11/16"	22"
N6345	45° Angle Head	1/4"	1/4"-28	1-3/16"	.400"	3/4"	30"
N634	360° Adjustable Angle Head	1/4"	1/4"-28	1-1/4"	.384"	3/4"	30"
TP47	90° Angle Head	5/16"	1/4"-28	.937"	.312"	3/4"	26"



360° Snake Drill Attachment

- Angle head rotates a full 360° & can be locked in any position.
- TP54 chuck (accepts straight shank drills).
- Includes wrenches & allen key.

Part #	Capacity	Spindle Thread	Height	Side to Center	Diameter	Length
TP367	1/4"	1/4"-28	3"	.385"	.608"	30"



Snake Drill Attachment Kit

- Everything you need
- Kit includes:
  - Angle Drill Attachment (N63)
  - Threaded Shank Drills (1 each #40, #30, #21)

Part Number	Description
N63K	Complete Kit

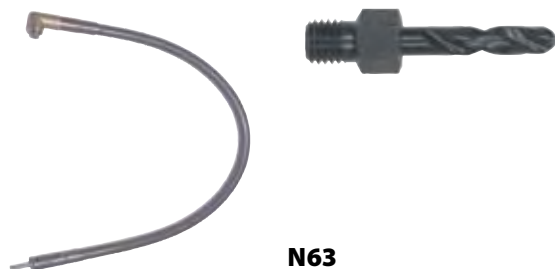

## FLAT OFFSET ANGLE DRILL ATTACHMENTS

- Available with either #10-32 or 1/4-28 spindle thread, please specify.

1/8" Capacity - 'T' Thickness: 1/4"			
Part Number	'L1' Shaft Offset	'L2' Overall Length	'H' Overall Height
T-21	3/4"	1-1/2"	5-5/8"

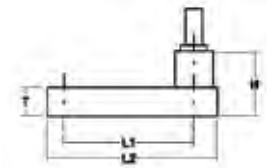

**T-25**

1/4" Capacity - 'T' Thickness: 7/16"			
Part Number	'L1' Shaft Offset	'L2' Overall Length	'H' Overall Height
T-23	1-5/32"	2-3/16"	6-1/2"
T-25	2-5/16"	3-3/16"	2"
T-235	2-5/16"	3-3/16"	6-5/8"
T-635	2-5/16"	3-3/16"	30"



**T635**

## THIN OFFSET ANGLE DRILL ATTACHMENTS

- Hardened & ground bearing support shafts.
- 1/4"-28 thread standard.

Straight - 'T' Thickness: 3/8"			
Part Number	'L1' Shaft Offset	'L2' Overall Length	'H' Overall Height
BE720	2-7/16" (62 mm)	3-3/16" (81 mm)	1-1/8" (29 mm)
BE725	2-7/16 (62 mm)	3-3/16" (81 mm)	4-9/16" (116 mm)
BE730	3-3/4" (95 mm)	4-1/2" (114 mm)	1-1/8" (29 mm)
BE735	3-3/4" (95 mm)	4-1/2" (114 mm)	4-9/16" (116 mm)

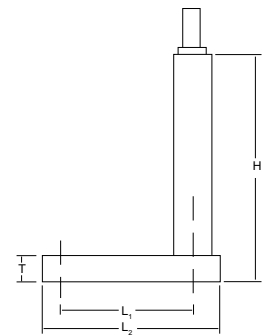

**BE720  
BE820**

Straight - 'T' Thickness: 1/4"			
Part Number	'L1' Shaft Offset	'L2' Overall Length	'H' Overall Height
BE820	2-7/16" (62 mm)	-	11/16" (18 mm)
BE825	2-7/16 (62 mm)	-	5-3/16" (132 mm)
BE830	3-3/4" (95 mm)	-	11/16" (18 mm)
BE835	3-3/4" (95 mm)	-	5-3/16" (132 mm)

30° Offset - 'T' Thickness: 3/8"			
Part Number	'L1' Shaft Offset	'L2' Overall Length	'H' Overall Height
BE745	3-1/8" R (79 mm)	4" (102 mm)	4-9/16" (116 mm)
BE755	3-1/8" L (79 mm)	4" (102 mm)	4-9/16" (116 mm)

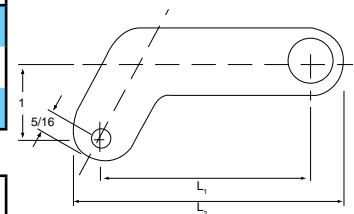

**BE745  
BE845**

30° Offset - 'T' Thickness: 1/4"			
Part Number	'L1' Shaft Offset	'L2' Overall Length	'H' Overall Height
BE845	Right	-	4-1/8" (105 mm)
BE855	Left	-	4-1/8" (105 mm)

## NUT PLATE DRILL JIGS

- Designed for accurate drilling of rivet holes for plate nuts.
- Flexible handle provides hand clearance when jig is in use.

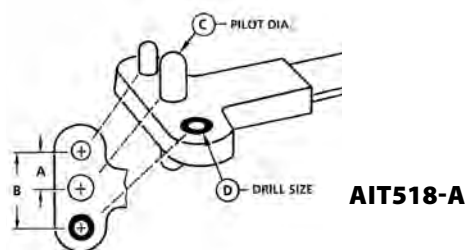

Two Lug					
Part Number	Bolt Size Ref.	'A' Dim.	'B' Dim.	Pilot Diameter	Drill Size
AIT518-A	#6	.344"	.688"	.139"	#40
AIT518-B	#8	.344"	.688"	.164"	#40
AIT518-C	#10	.344"	.688"	.191"	#40
AIT518-D	1/4"	.500"	1.000"	.248"	#40
AIT518-E	5/16"	.500"	1.000"	.312"	#30
AIT518-F	3/8"	.500"	1.000"	.372"	#30
AIT518-M	-	.375"	.750"	.4375"	#40
AIT518-N	-	.500"	1.000"	.6875"	#30
AIT518-P	-	.6875"	1.375"	.811"	#30

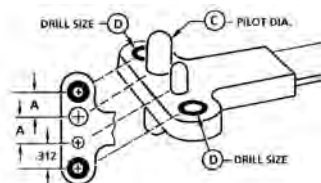

AIT518-G

One Lug Type				
Part Number	Bolt Size Ref.	'A' Dim.	Pilot Diameter	Drill Size
AIT518-G	#6	.344"	.139"	#40
AIT518-H	#8	.344"	.164"	#40
AIT518-J	#10	.344"	.191"	#40
AIT518-K	1/4"	.344"	.248"	#40
AIT518-L	#10 Sp.	.344"	.213"	#40

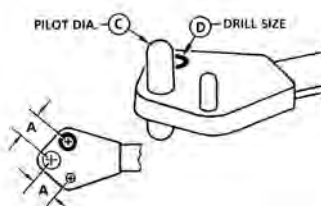

AIT518-R

Corner Type				
Part Number	Bolt Size Ref.	'A' Dim.	Pilot Diameter	Drill Size
AIT518-R	#6	.344"	.139"	#40
AIT518-S	#8	.344"	.164"	#40
AIT518-T	#10	.344"	.191"	#40
AIT518-U	1/4"	.500"	.248"	#40
AIT518-V	5/16"	.500"	.312"	#30
AIT518-W	3/8"	.500"	.372"	#30

## NUT PLATE DRILL JIGS

- Designed for accurate drilling of rivet holes for plate nuts.
- Flexible handle provides hand clearance when jig is in use.

Miniature Corner Wing					
Part Number	Bolt Size Ref.	'A' Dim.	Pilot Diameter	Drill Size	
AIT518-SA	#4	.203"	.112"	#40	
AIT518-SB	#6	.218"	.139"	#40	
AIT518-SC	#8	.234"	.164"	#40	
AIT518-SD	#10	.250"	.191"	#40	
AIT518-SE	1/4"	.281"	.248"	#40	
AIT518-SF	5/16"	.312"	.312"	#30	

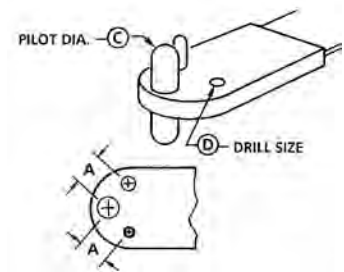

**AIT518-SA**

Miniature One Lug					
Part Number	Bolt Size Ref.	'A' Dim.	Pilot Diameter	Drill Size	
AIT518-PA	#4	.203"	.112"	#40	
AIT518-PB	#6	.218"	.139"	#40	
AIT518-PC	#8	.234"	.164"	#40	
AIT518-PD	#10	.250"	.191"	#40	
AIT518-PE	1/4"	.281"	.248"	#40	

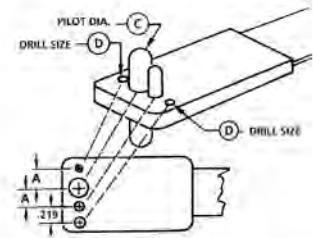

**AIT518-PA**

Miniature Anchornut						
Part Number	Bolt Size Ref.	'A' Dim.	'B' Dim.	Pilot Diameter	Drill Size	
AIT518-TA	#10	.250"	.219"	.191"	#40	
AIT518-TB	1/4"	.281"	.219"	.248"	#40	
AIT518-TC	5/16"	.312"	.250"	.312"	30	

Miniature Two Lug						
Part Number	Bolt Size Ref.	'A' Dim.	'B' Dim.	Pilot Diameter	Drill Size	
AIT518-NA	#4	.203"	.406"	.112"	#40	
AIT518-NB	#6	.218"	.436"	.139"	#40	
AIT518-NC	#8	.234"	.468"	.164"	#40	
AIT518-ND	#10	.250"	.500"	.191"	#40	
AIT518-NE	1/4"	.281"	.562"	.248"	#40	
AIT518-NF	5/16"	.3125"	.625"	.312"	#30	

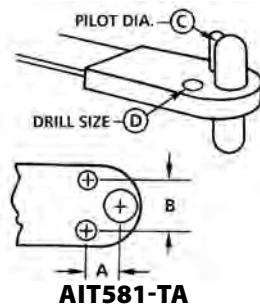

**AIT518-TA**

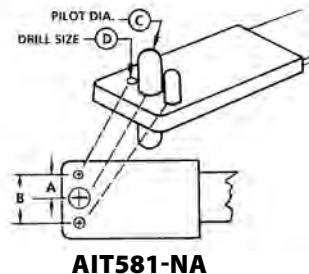

**AIT518-NA**

## STRAP DUPLICATORS

Strap duplicators are ideal tools for quickly locating the proper alignment of rivet holes for panel replacement. Three styles are available in either 6-1/4" or 13-1/4" lengths. The Bushing Style duplicator is used by sliding the end with the pin between the sheets and locating the hole to be duplicated from inside. The inverted type staggers both sheets (top and bottom) and locates the hole to be duplicated from the bottom. The Punch type locates the hole in the same manner as the Bushing type; however, instead of drilling through the bushings, you lightly tap this one with a hammer to center punch the new panel and drill it later.



Bushing Type (with jig, for drilling duplicate holes from overlapping sheet)		
Part # 6-1/4" O. A. L.	Part # 13-1/4" O. A. L.	Drill Size & Pilot Diameter
TPMM250-1	TPMM350-1	#40
TPMM250-2	TPMM350-2	#30
TPMM250-3	TPMM350-3	#21
TPMM250-4	TPMM350-4	#19
TPMM250-5	TPMM350-5	#10
TPMM250-8	TPMM350-8	1/4"
TPMM250-7	TPMM350-7	F



Bushing Inverted Pilot Type (same as bushing type with inverted pilot)		
Part # 6-1/4" O. A. L.	Part # 13-1/4" O. A. L.	Drill Size & Pilot Diameter
TPMM255-1	TPMM355-1	#40
TPMM255-2	TPMM355-2	#30
TPMM255-3	TPMM355-3	#21
TPMM255-4	TPMM355-4	#19
TPMM255-5	TPMM355-5	#10
TPMM255-8	TPMM355-8	1/4"
TPMM255-7	TPMM355-7	F



Punch Type (marks sheet from hidden pilot hole)		
Part # 6-1/4" O. A. L.	Part # 13-1/4" O. A. L.	Drill Size & Pilot Diameter
TPMM260-1	TPMM360-1	#40
TPMM260-2	TPMM360-2	#30
TPMM260-3	TPMM360-3	#21
TPMM260-4	TPMM360-4	#19
TPMM260-5	TPMM360-5	#10
TPMM260-8	TPMM360-8	1/4"
TPMM260-7	TPMM360-7	F

## STRAP DUPLICATOR SETS



Part Number	Description
TPMM250K	4 pc. set includes 1 ea. TPMM250-1,2,3,5
TPMM255K	4 pc. set includes 1 ea. TPMM255-1,2,3,5
TPMM260K	4 pc. set includes 1 ea. TPMM260-1,2,3,5

## DRILL HOUSINGS AND BUSHINGS

- Keeps drills & taps perpendicular to work surface.
- Hardened bushings are interchangeable.
- No-mar transparent plastic allows a clear view of the work.

Part Number	Type
TP483 Housing Only	Flange Lock



**TP483 HOUSING**

Replacement Bushings	
Part Number	Drill Size
TP483A	#40
TP483B	3/32"
TP483C	#30
TP483D	1/8"
TP483E	#21

Replacement Bushings	
Part Number	Drill Size
TP483F	5/32"
TP483G	#10
TP483H	3/16"
TP483I	7/32"
TP483J	1/4"



**TP483 BUSHING**

## THREAD TYPE DRILL HOUSING & BUSHING

Part Number	Type
TP783 Housing Only	Thread

Replacement Bushings	
Part Number	Drill Size
TP783A	#40
TP783B	3/32"
TP783C	#30
TP783D	1/8"
TP783E	#21

Replacement Bushings	
Part Number	Drill Size
TP783F	5/32"
TP783G	#10
TP783H	3/16"
TP783I	7/32"
TP783J	1/4"

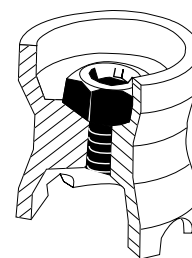

**TP783A**

## DRILL HOUSINGS AND BUSHING KIT

Complete Kit		
Part Number	Includes	For Drill Sizes
AT590DBK	Three housings & nine bushings with case.	#40, #30, #21, #10, 5/32", 3/16", 7/32", 1/4" & F



**AT590DBK**

## THREADED SHANK ADAPTER DRILLS

- Drills made to NAS965 specifications.
- When ordering specify part number and add desired size to the end of the part number.  
**Example:** To order a 5/8" long HSS drill in #40 size, specify TP54A-40.  
 TP54 = 1/4-28 rnd TP53 = 10/32 rnd



Part #	TP53	TP54A	TP54	TP54L	TP54CA	TP54C	TP54CL	
Size	Dec. Equiv.	HSS L=1-1/4"	HSS L=5/8"	HSS L=1-1/4"	HSS L=2-1/2"	Cobalt L=5/8"	Cobalt L=1-1/4"	Cobalt L=2-1/2"
40	.0980	•	•	•	•	•	•	•
30	.1285	•	•	•	•	•	•	•
27	.1440	•	•	•	•	•	•	•
21	.1590	•	•	•	•	•	•	•
20	.1610		•	•	•	•	•	•
19	.1660		•	•	•	•	•	•
16	.1770		•	•	•	•	•	•
13	.1850		•	•	•	•	•	•
3/16	.1875	•	•	•	•	•	•	•
12	.1890		•	•	•	•	•	•
11	.1910		•	•	•	•	•	•
10	.1935	•	•	•	•	•	•	•
8	.1990		•	•	•	•	•	•
5	.2055		•	•	•	•	•	•
3	.2130		•	•	•	•	•	•
7/32	.2188		•	•	•	•	•	•
D	.2460		•	•	•	•	•	•
1/4	.2500		•	•	•	•	•	•
F	.2570		•	•	•	•	•	•
5/16	.3125		•	•	•	•	•	•

## THREADED SHANK ADAPTER DRILL SETS

- Includes the most popular sizes, 1/4"-28 threaded shank.



Part Number	Quantity	Type	Sizes
TP54K-8	8	HSS Short	#10, #21, #30, #40
TP54CAK-8	8	Cobalt Stubby	#10, #21, #30, #40
TP54K-12	12	HSS Short	#10, #21, #30, #40
TP54K-24	24	HSS Short	#10, #21, #30, #40
TP54CK-24	12	Cobalt Short	#10, #21, #30, #40
TP54L-12	12	HSS Long	#10, #21, #30, #40
TP54LK-8	8	HSS Long	#10, #21, #30, #40
TP54CLK-12	12	Cobalt Long	#10, #21, #30, #40
TP54CLK-8	8	Cobalt Long	#10, #21, #30, #40



## JOBBER, 6" & 12" DRILL SETS

### High Speed Steel - Cobalt

- TP49 Type - Self-centering for aluminum, 118° split point
- TP49B Type - Self-centering for hard steels & titanium, 135° split point
- TP49C Type - Self-centering for high tensile strength material, 135° split point

- TP55 Type - 6" 135° SP HSS
- TP55A Type - 12" 135° SP HSS
- TP55C Type - 12" 135° SP Cobalt
- TP55AC Type - 12" 135° SP Cobalt

### Number Sizes

Size	Dec. Equiv.	Flute Length	Part # OAL	TP49B	TP49C	TP55	TP55A	TP55C	TP55AC
				HSS 135° SP	Cobalt 135° SP	HSS 135° SP 6" OAL	Cobalt 135° SP 6" OAL	HSS 135° SP 12" OAL	Cobalt 135° SP 12" OAL
1	.2280	2-5/8	3-7/8	•	•	•	•	•	•
2	.2210	2-5/8	3-7/8	•	•	•	•	•	•
3	.2130	2-1/2	3-3/4	•	•	•	•	•	•
4	.2090	2-1/2	3-3/4	•	•	•	•	•	•
5	.2055	2-1/2	3-3/4	•	•	•	•	•	•
6	.2040	2-1/2	3-3/4	•	•	•	•	•	•
7	.2010	2-7/16	3-5/8	•	•	•	•	•	•
8	.1990	2-7/16	3-5/8	•	•	•	•	•	•
9	.1960	2-7/16	3-5/8	•	•	•	•	•	•
10	.1935	2-7/16	3-5/8	•	•	•	•	•	•
11	.1910	2-5/16	3-1/2	•	•	•	•	•	•
12	.1890	2-5/16	3-1/2	•	•	•	•	•	•
13	.1850	2-5/16	3-1/2	•	•	•	•	•	•
14	.1820	2-3/16	3-3/8	•	•	•	•	•	•
15	.1800	2-3/16	3-3/8	•	•	•	•	•	•
16	.1770	2-3/16	3-3/8	•	•	•	•	•	•
17	.1730	2-3/16	3-3/8	•	•	•	•	•	•
18	.1695	2-1/8	3-1/4	•	•	•	•	•	•
19	.1660	2-1/8	3-1/4	•	•	•	•	•	•
20	.1610	2-1/8	3-1/4	•	•	•	•	•	•
21	.1590	2-1/8	3-1/4	•	•	•	•	•	•
22	.1570	2	3-1/8	•	•	•	•	•	•
23	.1540	2	3-1/8	•	•	•	•	•	•
24	.1520	2	3-1/8	•	•	•	•	•	•
25	.1495	1-7/8	3	•	•	•	•	•	•
26	.1470	1-7/8	3	•	•	•	•	•	•
27	.1440	1-7/8	3	•	•	•	•	•	•
28	.1405	1-3/4	2-7/8	•	•	•	•	•	•
29	.1360	1-3/4	2-7/8	•	•	•	•	•	•
30	.1285	1-5/8	2-3/4	•	•	•	•	•	•

\*When ordering, specify part number and add desired size to the end of the part number.

**Example:** To order a 135° SP cobalt drill in 1/64" size, specify TP49C-1/64.

(Jobber drill sets 31-60 continued on following page)

## JOBBER, 6" &amp; 12" DRILL SETS

## Number Sizes (CONTINUED)

			Part #	TP49B	TP49C	TP55	TP55A	TP55C	TP55AC
Size	Dec. Equiv.	Flute Length	OAL	HSS 135° SP	Cobalt 135° SP	HSS 135° SP 6" OAL	Cobalt 135° SP 6" OAL	HSS 135° SP 12" OAL	Cobalt 135° SP 12" OAL
31	.1200	1-5/8	2-3/4	•	•	•	•	•	•
32	.1160	1-5/8	2-3/4	•	•	•	•	•	•
33	.1130	1-1/2	2-5/8	•	•	•	•	•	•
34	.1110	1-1/2	2-5/8	•	•	•	•	•	•
35	.1100	1-1/2	2-5/8	•	•	•	•	•	•
36	.1065	1-7/16	2-1/2	•	•	•	•	•	•
37	.1040	1-7/16	2-1/2	•	•	•	•	•	•
38	.1015	1-7/16	2-1/2	•	•	•	•	•	•
39	.0995	1-3/8	2-3/8	•	•	•	•	•	•
40	.0980	1-3/8	2-3/8	•	•	•	•	•	•
41	.0960	1-3/8	2-3/8	•	•	•	•	•	•
42	.0935	1-1/4	2-1/4	•	•	•	•	•	•
43	.0890	1-1/4	2-1/4	•	•	•	•	•	•
44	.0860	1-1/8	2-1/8	•	•	•	•	•	•
45	.0820	1-1/8	2-1/8	•	•	•	•	•	•
46	.0810	1-1/8	2-1/8	•	•	•	•	•	•
47	.0785	1	2	•	•	•	•	•	•
48	.0760	1	2	•	•	•	•	•	•
49	.0730	1	2	•	•	•	•	•	•
50	.0700	1	2	•	•	•	•	•	•
51	.0670	1	2	•	•	•	•	•	•
52	.0635	7/8	1-7/8	•	•	•	•	•	•
53	.0595	7/8	1-7/8	•	•	•	•	N/A	N/A
54	.0550	7/8	1-7/8	•	•	•	•	N/A	N/A
55	.0520	7/8	1-7/8	•	•	•	•	N/A	N/A
56	.0465	3/4	1-3/4	•	•	•	•	N/A	N/A
57	.0430	3/4	1-3/4	•	•	•	•	N/A	N/A
58	.0420	11/16	1-5/8	•	•	•	•	N/A	N/A
59	.0410	11/16	1-5/8	•	•	•	•	N/A	N/A
60	.0400	11/16	1-5/8	•	•	•	•	N/A	N/A

\*When ordering, specify part number and add desired size to the end of the part number.

**Example:** To order a 135° SP cobalt drill in 1/64" size, specify TP49C-1/64.

(Fractional size Jobber drill sets continued on following page)

## JOBBER, 6" & 12" DRILL SETS

### Fractional Sizes

		Part #		TP49B	TP49C
Size	Dec. Equiv.	Flute Length	OAL	HSS 135° SP	Cobalt 135° SP
1/64	.0156	3/16	3/4	N/A	•
1/32	.0312	1/2	1-3/8	N/A	•
3/64	.0469	3/4	1-3/4	N/A	•
1/16	.0625	7/8	1-7/8	•	•
5/64	.0781	1	2	•	•
3/32	.0938	1-1/4	2-1/4	•	•
7/64	.1094	1-1/2	2-5/8	•	•
1/8	.1250	1-5/8	2-3/4	•	•
9/64	.1406	1-3/4	2-7/8	•	•
5/32	.1562	2	3-1/8	•	•
11/64	.1719	2-1/8	3-1/4	•	•
3/16	.1875	2-5/16	3-1/2	•	•
13/64	.2031	2-7/16	3-5/8	•	•
7/32	.2188	2-1/2	3-3/4	•	•
15/64	.2344	2-5/8	3-7/8	•	•
1/4	.2500	2-3/4	4	•	•

		Part #		TP49B	TP49C
Size	Dec. Equiv.	Flute Length	OAL	HSS 135° SP	Cobalt 135° SP
17/64	.2656	2-7/8	4-1/8	•	•
9/32	.2812	2-15/16	4-1/4	•	•
19/64	.2969	3-1/16	4-3/8	•	•
5/16	.3125	3-3/16	4-1/2	•	•
21/64	.3281	3-5/16	4-5/8	•	•
11/32	.3438	3-7/16	4-3/4	•	•
23/64	.3594	3-1/2	4-7/8	•	•
3/8	.3750	3-5/8	5	•	•
25/64	.3906	3-3/4	5-1/8	N/A	•
13/32	.4062	3-7/8	5-1/4	•	•
27/64	.4219	3-15/16	5-3/8	N/A	•
7/16	.4375	4-1/16	5-1/2	•	•
29/64	.4531	4-3/16	5-5/8	•	•
15/32	.4688	4-5/16	5-3/4	•	•
31/64	.4843	4-1/2	6	•	•
1/2	.5000	4-1/2	6	•	•

### Jobber Length Drill Bit Sets

#### TP249

60 pc.

Number sizes 1 through 60 - 118°, HSS

#### TP249A

15 pc.

Fractional sizes 1/16" through 1/2" by 32nds - 135° Split Point, HSS

#### TP249B

21 pc.

Fractional sizes 1/16" through 3/8" by 64ths - 135° Split Point, HSS

#### TP249C

60 pc.

Number sizes 1 through 60 - 135° Split Point, Cobalt

#### TP249D

21 pc.

Fractional sizes 1/16" through 3/8" by 64ths - 135° Split Point, Cobalt

*\*All sets come complete with steel storage box.*



**TP249**

## DRILL STOPS

Designed as a visual aid that helps eliminate drill bit breakage and provides a sure stop to regulate hole depth.

- Locks in drill with two set screws.
- Unique rounded face eliminates surface marring.



TP145DSK

Part Number	Drill Sizes
CDS50	#50
CDS40	#40
CDS30	#30
CDS28	#28
CDS27	#27
CDS21	#21
CDS20	#20
CDS12	#12
CDS11	#11
CDS10	#10
CDS-1/4	1/4"
CDS-5/16	5/16"

\* Note: Other sizes available.

Drill Stop 4 piece Set	
Part Number	Included Sizes
TP145DSK	1 ea: #10, #21, #30, #40

Drill Stop 8 piece Set	
Part Number	Included Sizes
TP145DSK1	1 ea: #10, #12, #20, #21, #28, #30, #40, #50

Drill Stop 10 piece Set	
Part Number	Included Sizes
TP145DSK2	1 ea: 1/4", 5/16", #10, #12, #20, #21, #28, #30, #40, #50

## EXTENDRILL



770A4



770A9

- For deep or long reach jobs.
- 1/4" shank extension rods.
- Uses 770A collets.

Part Number	Length
770A4	4"
770A9	9"

Part Number	Collet Size
770A-#40	#40
770A-#30	#30
770A-#21	#21
770A-#10	#10

\* Note: Other sizes available.

## THREE STEP HAND TAP



TP231

- Ideal for retapping stripped heads.
- Taps 3 thread sizes: 6-32, 8-32 and 10-32.

Part Number	Description
TP231	3 Stop Tap
TP231R	Replacement Tap

## IRWIN UNIBIT® SELF-STARTING STEP DRILLS

- Many other styles available, please inquire.



**TPA5611**

Part Number	Fractional H.S.S.	Number of Holes	Hole Sizes	Increments	Shank Size	Max. Material Thickness
TPA5611		13	1/8" to 1/2"	1/32"	1/4"	1/8"
TPA5612		6	3/16" to 1/2"	1/16"	1/4"	3/8"
TPA5610		9	1/4" to 3/4"	1/16"	3/8"	1/8"
TPA5613		12	3/16" to 7/8"	1/16"	3/8"	1/8"
TPA5614		10	1/4" to 1-3/8"	1/8"	1/2"	1/8"

## IRWIN UNIBIT® STEP DRILL SETS

- Money saving sets provide a range of hole sizes.
- Preferred by homebuilders.

### 3 Piece Set

Hole Sizes: 1/8" to 3/4" (1/8" material) & 3/16" to 1/2" (3/8" material)

Part Number	Description
TPA561KIT	3 Piece Set



**TPA561KIT**

## DRILL GAUGES

- Made of heavy gauge steel, machined & ground to close tolerances.
- Hole sizes & decimal equivalents permanently etched into face.

Part Number	Drill Types & Sizes
TP565A	Fractional Size Drills (1/16" to 1/2" x 64ths)
TP565B	Number Size Drills (1 to 60)
TP565C	Letter Size Drills (A to Z)
TP565M	Metric Size Drills (to 13mm x .05mm)



**TP565A**

industrial power tools



## Aerospace Blind Riveters

## HUCK-CLINCH / HUCKMAX

**Model 2013**

- Pneumatic
- High speed production
- Small, light-weight tool for fast, uniform installations

**2013****99-3442****99-3443****99-3443****99-1333****99-1336****99-1334****99-3467****99-1335**

NAS Part No.	Cherrymax Part No.	Military Part No.	Boeing Part No.	Huckmax Part No.
NAS9301B	CR3213	M7885/2		HR3213
NAS9301E	CR3223			HR3223
NAS9302B	CR3212	M7885/3		HR3212
NAS9302E	CR3222			HR3222
NAS9303B	CR3214			HR3214
NAS9303E	CR3224			HR3224
NAS9304B	CR3243	M7885/6	BACR15FR()B()R	HR3243
NAS9304E	CR3253		BACR15FR()E()R	HR3253
NAS9305B	CR3242	M7885/7	BACR15FP()B()R	HR3242
NAS9305E	CR3252		BACR15FR()E()R	HR3252
NAS9306B	CR3245			HR3245
NAS9306E	CR3255			HR3255
NAS9307M	CR3523	M7885/4		HR3523
NAS9307MP	CR3523P			
NAS9308M	CR3522	M7885/5		HR3522
NAS9308MP	CR3522P			
NAS9309M	CR3524			HR3524
NAS9309MP	CR3524P			
NAS9310M	CR3553	M7885/8		HR3553
NAS9310MP	CR3553P		BACR15FR()MP()R	
NAS9310C	CR3853		BACR15FR()M()R	
NAS9311M	CR3552	M7885/9	BACR15FP()M()R	HR3552
NAS9311MP	CR3552P		BACR15FP()MP()R	
NAS9311C	CR3852			
NAS9312M	CR3555			
NAS9312MP	CR3555P			

*Note: CherryMAX is a registered trade name of Textron Aerospace Fasteners. HuckMAX is a registered trade name of Alcoa Fastening Systems. All rights reserved.*

**Nose Assemblies for all Diameters of HUCK-CLINCH**

Huckmax Rivets	Part No.
Straight in-line long nose assembly	99-1335
Straight in-line heavy duty nose assembly, 4 gripper jaws	99-3442
Straight in-line long heavy duty nose assembly, 4 gripper jaws	99-3443
Offset single jaw nose assembly	99-1333
Offset unitized jaw nose assembly	99-1336
90° angle nose assembly	99-1334
90° angle nose for 202 or 2012 tool	99-3467
Straight in-line for 202 or 2012 tool	99-3458-202

*Note: HUCK-CLINCH® nose assemblies can be used on Cherry or Allfast tools.*

## UNIMATIC SINGLE ACTION – BLIND BOLT

Fastener Diameters	Installation Tool Model No.	Nose Assembly Part No.	Nose Assembly Part No. (if required)	Stroke Limiter Needed in Tool
5/32 (-05)	2025,244 and 202 pneudraulics tool	99-2071 or 99-2702	-	-
	2440S	99-3712 or 99-3712-1	-	Adjustable stroke
	245/255 Pneudraulic Tool	99-2701 or 99-2702	10243	-
		99-2074 or 99-2705	-	-
		99-3712 or 99-3712-1	119400-1 w/118362	118362
	206-375 / A206-375 Hydraulic Tool	99-3712 or 99-2702	-	-
		99-3712 or 99-3712-1	122145-3	Self-contained
	2502 Hydraulic Tool/ A2502	99-2701 or 99-2702	102463	-
		99-2704 or 99-2705	-	-
		99-3712 or 99-3712-1	119400-1	-
705BB Hydraulic Tool	Self-contained	-	-	
3/16 (-06)	Pneudraulic Tool 2025, 202/244	99-2702 or 99-2708	-	-
	2440S Pneudraulic	99-3713 or 99-3713-1	-	Adjustable stroke
	245 / 255 Pneudraulic Tool	99-2707 or 99-2708	102463	-
		99-2710 or 99-2711	-	-
		99-3713 or 99-3713-1	119400-1 w/118362	118362
	705BB Hydraulic Tool, A705BB	99-3713 or 99-3713-1	-	-
	2480 Hydraulic Tool, A2480	99-2707 or 99-2708	-	-
		99-3713 or 99-3713-1	-	-
	2502 Hydraulic Tool, A2502	99-2707 or 99-2708	-	-
		99-2710 or 99-2711	-	-
		99-3713 or 99-3713-1	119400-1	-
	2580 Hydraulic Tool, A2580	99-2707 or 99-2708	102463	-
		99-2710 or 99-2711	-	-
99-3713 or 99-3713-1		119400-1	-	
706BB Hydraulic Tool, A706BB	Self-contained	-	-	

MS21141U()(UBR-EU)  
MS90354U9()(UBR-T)  
MS90353S(SB100-T)  
MS90354(SBP-T)  
OBSP-EU()  
OBP-EU()  
OBP-T()  
UBP-MV()  
SB100-T05 & 06  
S7B100-EU  
4B100-T08

MS21140U()(UB-100-EU)  
MS90353U()(UB100-T)  
MS21140S(UBP-EU)  
MS21141S(UBP-EU)  
OSB100-EU()  
OB100-EU()  
OB100-T()  
UB100-MB()  
SB100-EU05 & 06  
S4B100-T06

### Model 244

- Pneudraulic
- High speed production



### Model 2440S

- Pneudraulic
- High speed production



### Model 202/2025

- Pneudraulic
- High volume production



### Model 2480/ A2480/5202/A2502

- Hydraulic
- High speed production



### Model 206-375/A206-375

- Hydraulic
- Limited clearance



**Note:** 2480, 2502, 705BB, 2580 require 940 power rig. A2480, A2502, A2580, A705BB require 956 power rig.



UNIMATIC SINGLE ACTION – BLIND BOLT

MS21141U()(UBR-EU) MS21140U()(UB-100-EU)  
 MS90354U9()(UBR-T) MS90353U()(UB100-T)  
 MS90353S(SB100-T) MS21140S(UBP-EU)  
 MS90354(SBP-T) MS21141S(UBP-EU)  
 OBSP-EU() OSB100-EU()  
 OBP-EU() OB100-EU()  
 OBP-T() OB100-T()  
 UBP-MV() UB100-MB()  
 SB100-T05 & 06 SB100-EU05 & 06  
 S7B100-EU S4B100-T06  
 4B100-T08

**Model 2025**

- Pneudraulic
- High volume production



**Model 245/255**

- Pneudraulic
- High speed production



**Model 246/256**

- Pneudraulic
- High speed production



**Model 700/A700 Series**

- Hydraulic
- Limited clearance
- Built-in nose assembly for convenience and dependability in an extremely small package



*Note: 2480, 2502, 705BB, 2580 require 940 power rig. A2480, A2502, A2580, A705BB require 956 power rig.*

Fastener Diameters	Installation Tool Model No.	Nose Assembly Part No.	Nose Assembly Adapters (if required)	Stroke Limiter Neede in Tool
1/4 (-08)	2025 Pneudraulic Tool	99-2713 or 99-2714	-	-
		99-3714 or 99-3714-1	122145-3	-
	206-375, A206-375 Hydraulic Tool	99-3714 or 99-3714-1	-	-
		99-2713 or 99-2714	102463	-
		99-2716 or 99-2717	-	-
	245 / 255 Pneudraulic Tool	99-3714 or 99-3714-1	119400-1	-
		99-2713 or 99-2714	-	-
		99-2716 or 99-2717	-	-
	2480 Hydraulic Tool, A2480	99-2713 or 99-2714	-	-
		99-3714 or 99-3714-1	122145-3	-
	2502 Hydraulic Tool, A2502	99-2713 or 99-2714	102463	-
		99-2716 or 99-2717	-	-
99-3714 or 99-3714-1		119400-1	-	
2580 Hydraulic Tool, A2580	99-2713 or 99-2714	102463	-	
	99-2716 or 99-2717	-	-	
	99-3714 or 99-3714-1	119400-1	-	
708BB Hydraulic Tool, A708BB	Self-contained	-	-	
5/16 (-10)	246 / 256 Pneudraulic Tool	99-2719 or 99-2720	-	-
	2502 Hydraulic Tool, A2502	99-2719 or 99-2720	-	-
	2580 Hydraulic Tool, A2580	99-2719 or 99-2720	-	-
	701BB Hydraulic Tool, A710BB	Self-contained	-	-
3/8 (-12)	246 / 256 Pneudraulic Tool	99-2722 or 99-2723	-	-
	2502 Hydraulic Tool, A2502	99-2722 or 99-2723	-	-
	2580 Hydraulic Tool, A2580	99-2722 or 99-2723	-	-
	712BB Hydraulic Tool, A712BB	Self-contained	-	-

## UNIMATIC SINGLE ACTION – BLIND RIVET

Installation Tools and Nose Assemblies required for installation of UNIMATIC® Blind Rivets		
Fastener Diameter	Installation Tool Model No. and Tool Type	Nose Assemblies
1/8, 5/32, 3/16	HK150-5456 Field Hand Tool	99-S456 with 1/8, 5/32 & 3/16 insert
1/8 (04)	2012 & 2025 In-line Pneumatic Tool	99-2724 short, 99-2725 medium, 99-2726 long
	244OS Pneumatic Tool In-line	99-3715 1" offset 99-375-1 1-3/8" offset
	206-375, A206-375 Offset Hydraulic Tool	99-3715 1" offset or 99-3715-1 1-3/8" offset
	704BR, A704BR	Self-contained
5/32 (05)	202, 2012 & 2025 In-line Pneumatic Tool	99-2730 short, 99-2731 medium, 99-2732 long
	244OS Pneumatic Tool In-line	99-3716 1" offset 99-3716-1 1-3/8" offset
	206-375, A206-375 Offset Hydraulic Tool	99-3716 1" offset or 99-3716-1 1-3/8" offset
	705BR, A705BR	Self-contained
3/16 (06)	202, 2012 & 2025 In-line Pneumatic Tool	99-2736 short, 99-2737 medium, 99-2738 long
	244OS Pneumatic Tool In-Line	99-3717 1" offset or 99-3717-1 1-3/8" offset
	206-375, A206-375 Hydraulic Tool Offset	99-3717 1" offset or 99-3717-1 1-3/8" offset
	706BR, A706BR	Self-contained
1/4 (08)	245 In-line Pneumatic Tool	99-2745 short, 99-2746 medium, 99-2747 long
	206-375, A206-375 Hydraulic Tool Offset	99-3718 1" offset 99-3718-1 1-3/8" offset
	708BR, A708BR	Self-contained

NAS1919B(JS)  
NAS1919M(JS)  
NAS1919C(JS)  
NAS1921(JS)  
NAS1921M(JS)

NAS1912C(JS)  
OSMLS100()  
SMLS100-BT  
OSMLSP()  
SMLSP-BT

### Model 202

- Pneudraulic
- High volume production



### Model 2012/2025

- Pneudraulic
- Medium production



### Model 244OS

- Pneudraulic
- Application: where offset tooling is being used
- 99-37XX series nose mount direct on tool without adapters
- Noses rotate 90°



### Model 245/255

- Pneudraulic
- High speed production



*Note: 700 Series & 206-375 require 940 power rig. A700 Series & A206-375 require 956 power rig.*

## UNIMATIC SINGLE ACTION – BLIND RIVET

NAS1919B(-)S(-)U  
 NAS1919C(-)S(-)U  
 NAS1919M(-)S(-)U  
 NAS1921B(-)S(-)U  
 NAS1921C(-)S(-)U  
 NAS1921M(-)S(-)U  
 SMLS(-)PB(-)S(-)U  
 SMLS(-)PEU(-)S(-)U  
 SMLS(-)PM(-)S(-)U

SMLS100B(-)S(-)U  
 SMLS100EU(-)S(-)U  
 SMLS100M(-)S(-)U  
 OSMLS(-)PB(-)S(-)U  
 OSMLS(-)PEU(-)S(-)U  
 OSMLS(-)PM(-)S(-)U  
 SOMLS100B(-)S(-)U  
 OSMLS100EU(-)S(-)U  
 OSMLS100M(-)S(-)U

### Model 202

- Pneudraulic
- High volume production



### Model 2012

- Pneudraulic
- Medium production



Installation Tools and Nose Assemblies required for installation of NAS1919/1921U Blind Rivets		
Fastener Diameter	Installation Tool Model No. and Tool Type	Nose Assemblies
1/8, 5/32, 3/16	202, 2012 Pneumatic Tool	99-3458-202 straight 2.136 long
	2012, 202 Pneumatic Tool	99-3459-202 straight 4.636 long
	2012 Pneumatic Tool	99-3466 offset
	2012	99-3467 right angle

## ASP FASTENERS

2Asp509F  
 2AspFF & FP

2Asp509F & 509P  
 2AspPF & PP

The Asp fastening system provides a simplified method of fastening composite, soft core, metallic, or other materials which are sensitive to fastener clamp-up or installation force considerations. Clamping force can be infinitely adjusted and then sustained by installation – accommodating the unique requirements of a give structural design.

ASP® INSTALLATION EQUIPMENT			
Fastener Diameter	Hex Wrench Size	Sleeve Driver HUCK Part No.	Max. Installation Torque (1)
13/64" (06)	5/64"	106524	20 Inch Pounds
17/64" (08)	3/32"	106525	30 Inch Pounds
21/64" (10)	1/8"	107735	40 Inch Pounds

(1) Installation torque must be adjusted to determine the controlled clamping force required for the soft-core material being fastened. Over-torquing could result in damage to the installation sleeve driver.

### Model 244OS

- Pneudraulic



#### Note:

- (1) Requires adapter part number 102463
- (2) Requires adapter part number 119400-1
- (3) 244OS adapter not required

Removal Instructions: When removal is required the installed fastener can be removed by drilling through the pin head using the hex as a center. Drill to depth of head only.

Fastener Diameter	Drill Guide Bushing
13/64" (06)	103617
17/64" (08)	103618
21/64" (10)	103619

Drill Diameter	Drill Depth
.1562"	3/64"
.1875	1/16"
.2880	5/64"

Fastener Diameter	HUCK Installation Tool Model No.	HUCK Nose Assembly Standard Length	HUCK Nose Assembly Long Length
13/64" (06)	244OS/202/2012 and 244	99-2642 Straight	99-2643
	245	99-2642 (1) Straight	99-2643 (1)
	245	99-3728 (2) Offset	-
	2502 or A2502	99-2642 (1) Straight	99-2643 (1)
	2502 or A2502	99-3728 (2) Offset	-
	206-375 or A206-375	99-3728 Offset	-
17/64" (08)	244OS/202/2012 and 244	99-2645	99-2646
	245	99-2645 (1)	99-2646
	245	99-3729 (2)	-
	2502 or A2502	99-2645 (1)	99-2646 (1)
	2502 or A2502	99-3729 (2)	-
	206-375 or A206-375	99-3729	-
21/64" (10)	245	99-2648	99-2649
	245	99-3730 (2)	-
	2502 or A2502	99-2648	99-2649
	2502 or A2502	99-3730 (2)	-
	206-375 or A206-375	99-3730	-

## MODEL 200

### Model 200

The Model 200 is designed to install fasteners requiring double action installation tooling. It provides a separate lock collar driving function - the double action that drives the lock of blind rivet, and blind bolt fasteners.



- Pneudaulic
- 10.5 lbs.
- 90-100 PSI
- 18 CFM (0.009 m3/s) based on 30 fastener installation per minute
- Rebuilds available

Part Number	Description
101300	Test Kit

*Note: Tool requires adjusting for different size fasteners. Use 101300 KIT*

## DOUBLE ACTION FASTENER – BLIND BOLTS

NOSE ASSEMBLY SPECIFICATIONS		
Part Number	Fastener Size	Adapter Required
99-600	-5	-
99-600-1	-5	-
99-589	-6	-
99-589-1	-6	-

Nose Assembly Specifications for:

MS21141(BP-EU)	OBP-T05 & 06
MS90354(BP-T)	7B100-EU05 & 06
OBP-EU05 & 06	4B100-T06
MS21140(B100-EU)	OB100-T05 & 06
MS90353(B100-T)	7B120-EU06
OB100-EU05 & 06	4B100-EU06



**99-600**

## ALUMINUM DOUBLE ACTION FASTENERS – BLIND RIVETS

NOSE ASSEMBLY SPECIFICATIONS		
Part Number	Size	Adapter
78972	-4	104406
78973	-5	104406
78974	-6	104406
99-1013	-4	-
99-458	-5	-
99-459	-6	-
99-740	-8	-

Nose Assembly Specifications for:

NAS1919B	MLSP
NAS1921B	MLS100



**78972**



**99-458**

## MONEL AND A-286 DOUBLE ACTION – BLIND RIVET

NOSE ASSEMBLY SPECIFICATIONS		
Part Number	Size	Adapter
78972	-4	104406
99-1013	-4	-
99-458	-5	-
99-459	-6	-

Nose Assembly Specifications for:

NAS1919M	NAS1931M
NAS1919C	NAS1921C
7MLS100M	



**78972**



**99-459**

## LOCKBOLT FASTENERS – LGP

LGPL2SC/SP  
 LGPL4SC/SP  
 LGPL7SC  
 LGPL8SC  
 LGPL9SC/SP  
 LGPL12SP  
 CIL9SC/SP

CIL8SC  
 MLGPL22SC/SP  
 MLGPL28SC  
 MLGPL29SC/SP  
 MCIL28SC  
 MCIL29SC/SP

### Model 244

- Pneudraulic
- High speed production



### Model 244OS Tool

- Pneudraulic



### Model 245/255

- Pneudraulic
- High speed production



### Model 246/256

- Pneudraulic



### Model 208-625

#### A208-625

- Hydraulic
- Limited clearance



*Note: For metric MLGP tooling and noses contact Aero Industrial Tool*

Fastener Diameter	Fastener Part No.	Installation Tool Model No.	Installation Tool Nose Assembly	Installation Pull-In Nose Assembly
5/32" (05)	( )LGPL2SCEB05( ) ( ) ( )LGPL2SPEB05( ) ( )	244	99-2500 In-line Short 99-2501 In-line Medium 99-2502 In-line Long	99-1840
3/16" (06)	( )LGPL2SCEB06( ) ( ) ( )LGPL2SCEB06( ) ( )	244	99-2506 In-line Short 99-2507 In-line Medium 99-2508 In-line Long	99-1841
1/4" (08)	( )LGPL2SCEB08( ) ( ) ( )LGPL2SCEB08( ) ( )	245/255 245/255	99-2515 In-line Short 99-2516 In-line Medium 99-2517 In-line Long	99-1845

Fastener Diameter	Installation Tool Model No.	Installation Tool Nose Assembly No.	Tool/Adapter
5/32" (05)	244 Pneumatic	99-2500 In-line Short 99-2501 In-line Medium 99-2502 In-line Long	-
	245 Pneumatic 2502/A2502 Hydraulic 2503/A2503 Hydraulic	99-2503 In-line Short 99-2504 In-line Medium 99-2505 In-line Long	-
	A206-375 2060375 Hydraulic	99-3700 Offset 99-3700-1 Offset	Noses can be used on 244OS w/o adapter
3/16" (06)	244 Pneudraulic	99-2506 In-line Short 99-2507 In-line Medium 99-2508 In-line Long	-
	245/255 Pneudraulic 2502/A2502 Hydraulic 2503/A2503 Hydraulic	99-2509 In-line Short 99-2510 In-line Medium 99-2511 In-line Long	-
	206-375 Hydraulic A206-375	99-3701 Offset 99-3701-1 Offset	Can be used on 244OS w/o adapter
	706LGP/A706LGP	Self-contained	-
1/4" (08)	244 Pneudraulic	99-2512 In-line Short 99-2513 In-line Stub Long 99-2514 In-line Long	-
	245/255 Pneudraulic 246/256 Pneudraulic 2502/A2502 Hydraulic 2503/A2503 Hydraulic	99-2515 In-line Short 99-2516 In-line Medium 99-2517 In-line Long 99-2590 Shark bite	-
	A206-375 206-375 Hydraulic	99-3702 Offset 99-3702-1 Offset	Noses can be used on 244OS w/o adapter
	708LGP/A708LGP	Self-contained	-
7/32" (07)	245/255	99-2678 In-line Medium	-
	206-375/A206-375	99-3762 Offset	-
5/16" (10)	245/255 Pneudraulic 246/256 Pneudraulic 2502/A2502 Hydraulic 2503/A2503 Hydraulic	99-2518 In-line Short 99-2518 In-line Medium 99-2520 In-line Long 99-2951 Shark bite	-
	208-625 Hydraulic	99-1719DG Offset	-
	710LGP/A710LGP	Self-contained	-
3/8" (12)	245 Pneudraulic 246 Pneudraulic	99-2521 In-line Short 99-2522 In-line Medium	-
	2502/A2502 Hydraulic 2503/A2503 Hydraulic	99-2523 In-line Long 99-2956 Shark bite	Raise hydraulic pressure to 8400 PSI
	208-625 Hydraulic	99-1754DG Offset	-
	712LGP/A712LGP	Self-contained	-

## LOCKBOLT FASTENERS – GP, SHEAR AND TENSION

Fastener Diameter	Installation Tool Model No.	Installation Tool Nose Assembly No.	Tool Adapter
1/8" (04)	244 Pneudraulic	99-2651 In-line Standard	-
5/32" (05)	244 Pneudraulic	99-2549S In-line Medium 99-2549T In-line Medium	-
	244 Pneudraulic 2502/A2502 Hydraulic 2503/A2503 Hydraulic	99-2552S In-line Medium 99-2552T In-line Medium	-
	244OS Pneudraulic 206-375/A206-375 Hydraulic	99-3703S 99-3703S-1 99-3703 Offset 99-3703T 99-3703-1 Offset 99-3703T-1	-
3/16" (06)	244 Pneudraulic	99-2555 In-line Medium	-
	245/255 Pneudraulic 2502/A2502 Hydraulic 2503/A2503 Hydraulic	99-2557 In-line Short 99-2558 In-line Medium 99-2559 In-line Long	-
	706GP/A706GP	Self-contained	-
	244OS Pneudraulic 206-375/A206-375 Hydraulic	99-3704 Offset 99-3704-1	-
1/4" (08)	244 Pneudraulic	99-2560 In-line Short 99-2561 In-line Medium 99-2562 In-line Long	-
	245/246 Pneudraulic 2502/A2502 Hydraulic 2503/A2503 Hydraulic	99-2563 In-line Short 99-2564 In-line Medium 99-2565 In-line Long	-
	244OS Pneudraulic 206-375/A206-375 Hydraulic	99-3705 Offset 99-3705-1 Offset	-
	708GP/A708GP	Self-contained	-
5/16" (10)	245/246 Pneudraulic 2502/A2502 Hydraulic 2503/A2503 Hydraulic	99-2566 In-line Short 99-2567 In-line Medium 99-2568 In-line Long	-
	208-625/A208-625 Hydraulic	99-3720 Offset	-
	710GP/A710GP	Self-contained	-
3/8" (12)	245/246 Pneudraulic	99-2569 In-line Short 99-2570 In-line Medium	-
	2502/A2502 Hydraulic 2503/A2503 Hydraulic	99-2571 In-line Long	Increase pull pressure to 8400 PSI
	208-625/A208-625 Hydraulic	99-1756 Offset	-
	712GP/A712GP	Self-contained	-

### Model 244

- Pneudraulic
- High speed production



### Model 244OS Tool

- Pneudraulic



### Model 245/255/246/256

- Pneudraulic
- High speed production



### Model 700/A700 Series

- Hydraulic
- Limited clearance
- Built-in nose assembly for convenience and dependability in an extremely small package



NAS Part No.	Cherry Part No.	HUCK Part No.
<b>Tension Lockbolts = T</b>		
NAS1456-1462	R3002-T	R3002-T
NAS1465-1472	R3001-T	R300-T
NAS1475-1482	R3014-T	R3014-T
NAS1486-1492	-	2LS509-T
NAS1496-1502	-	2LSP-T
NAS1516-1522	2L509-E	2L509-E
NAS1525-1532	2LP-E	2LP-E
NAS1535-1542	2L426-E	2L426-E
NAS1546-1552	-	2LS509-E
NAS1555-1562	-	2LSP-E
NAS2005-2012	-	-
NAS2105-2112	-	-
NAS2115-2122	-	-
NAS2125-2132	-	-
NAS2205-2212	-	-
NAS2306-2312	-	-
NAS6915-6922	-	2LS426-E
NAS6925-6932	-	2LS426-T
NAS6935-6942	-	2L200-T
NAS6946-6952	2L509-EU	-
NAS6955-6962	2L426-EU	-
NAS6965-6972	2LP-EU	-

**Note:** Shear fasteners "S" after nose number; tension fasteners "T" after nose number.

NAS Part No.	Cherry Part No.	HUCK Part No.
<b>Shear Lockbolts = S</b>		
NAS1414-1422	-	SLS100-T
NAS1424-1432	-	SLSP-T
NAS1436-1442	SAL100-T	SAL100-T
NAS1446-1452	SALP-T	SALP-T
NAS2406-2412	-	-
NAS2506-2512	-	-
NAS2605-2612	-	-
NAS2705-2712	-	-
NAS6974-6982	-	SLS100-EU
NAS6984-6992	-	SLSP-EU

NAS Part No.	Cherry Part No.	HUCK Part No.
NAS7004-7012	S3L100-EU	S3L100-EU
NAS7014-7022	S3LP-EU	S3LP-EU
NAS7024-7032	S3L100-DT	S3L100-DT
NAS7034-7042	S3LP-DT	S3LP-DT
<b>Groove Proportioned</b>		
GPL35	GPL6S	-
GPL8T	GPL7T	-

## POWERIG® HYDRAULIC UNITS

### Model 956

Portable air powered, air actuated single 40 cubic in/min hydraulic power source. Designed to operate hydraulic installation tools identified by a prefix A (ie., A206-375) in the model number. Delivers 8,400 psi working pressure. Hydraulic fluid directional flow is remotely controlled by a trigger in the installation tool. Twin hydraulic pumps operate independently resulting in rapid tool pull piston movement. The unit has a built-in regulator for adjusting hydraulic pressures. Quick disconnect hydraulic couplings and air control socket are included to attach equipment hydraulic hoses and air control tube.

- Single open center circuit with 8,600 psi, max. 40 cu in/min at 5,000 psi
- Pump: 2 independent air motors rapid advance and swage
- Oil control: 4-way air piloted directional valve
- Reservoir capacity: 2 quarts, 1.9 liters
- Air consumption: 2 cfm
- 12" long, 8" wide, 13-1/4" high
- 21 lbs. dry; 29.75 lbs. Operational
- Hydraulic fluid: Automatic transmission fluid – Dexron III or equivalent



956

### Model 940

Portable electrically powered, single 70 cu in/min system designed to operate hydraulic installation tools. Delivers 8,400 psi working pressure. Simple adjustable hydraulic outputs. Pump output directional valve is controlled from installation equipment by 24 volt control circuit. Unit automatically turns off when the equipment switch is released and installation cycle is completed.

- Single open center circuit with 8,400 psi, max. 70 cu in/min at 5,000 psi
- Pump: 2 stage, gear piston type
- Oil control: 4-way solenoid operated directional valve
- Reservoir capacity: 1.5 gallons
- Remote control: 24 volt control circuit
- Power source: 1 1/8 hp, 12,000 rpm 115 volt, 50/60 hertz, AC single phase
- 12.5" long, 10.5" wide, 18" high
- 66 lbs. dry; 74.5 lbs. Operational
- Hydraulic fluid: Fire-resistant hydraulic fluid – Dexron III or equivalent
- Options: 940-220 electrical system 200 volt, 50/60 hertz, AC single phase



940

Part No.	Description
T124833CE	Pressure setting gauge for 940 and 956
118309-12	12 ft. extension hose/electric kit 940 only
118309-26	26 ft. extension hose/electric kit 940 only
118309-38	38 ft. extension hose/electric kit 940 only

## HUCK ACCESSORIES – HYDRAULIC COLLAR CUTTERS

- Requires Power Rig
- A = 956 Power Rig
- Others use 940 Power Rig



6CCFT

Model No.	Fastener Dia.	POWERIG® Hydraulic Unit
5CCFT	5/32"	940
5CCLGP	5/32"	940
6CCFT	3/16"	940
8CCFT	1/4"	940
6CCGP/LGP	3/16"	940
8CCGP/LGP	1/4"	940
A5CCFT	5/32"	956
A6CCFT	3/16"	956
A8CCFT	1/4"	956
A6CCGP/LGP	3/16"	956
A6CCGP/LGP	1/4"	956

## MANUAL COLLAR CUTTERS – MODEL 105 SERIES

Model	Diameter	Fastener Type
105-5	5/32"	GP, LGP, NAS Tension & Shear lockbolts
105-6	3/16"	GP, LGP, NAS Tension & Shear lockbolts
105-8	1/4"	GP, LGP, NAS Tension & Shear lockbolts
105-10	5/16"	GP, LGP, NAS Tension & Shear lockbolts
105-12	3/8"	GP, LGP, NAS Tension & Shear lockbolts



## TOOL MOUNTED COLLAR CUTTERS

Model	Diameter	Fastener Type
TM5CCLGP/GP	5/32"	GP, LGP, NAS lockbolts
TM6CCFT	3/16"	Flanged titanium lockbolts
TM6CCLGP/GP	3/16"	GP, LGP, NAS lockbolts
TM8CCFT	1/4"	Flanged titanium lockbolts
TM8CCLGP/GP	1/4"	GP, LBP, NAS lockbolts
548-05	5/32"	Non-flanged aluminum GP, LGP and NAS lockbolts
546	3/16"	Non-flanged aluminum GP, LGP and NAS lockbolts
548	1/4"	Non-flanged aluminum GP, LGP and NAS lockbolts
548-10	5/16"	Non-flanged aluminum GP, LGP and NAS lockbolts

Designed to attach to installation tool models 202, 244, 2480, HK150<sup>1</sup>, 245<sup>2</sup>, 246<sup>2</sup>, 2052<sup>2</sup>, 2503<sup>2</sup>, and 4081<sup>2</sup>.

- (1) Requires adapter part number 121991
- (2) Requires adapter part number 120463



## BLIND FASTENER REMOVAL KITS – MODEL 105 SERIES

Blind Bolts Diameter	Kit No.	Blind Rivets Diameter	Kit No.
5/32"	105-50	1/8"	105-24
3/16"	105-60	5/32"	105-25
1/4"	105-80	3/16"	105-26
5/16"	105-100	1/4"	105-28
3/8"	105-120		

Model 105 Series removal kits are used in conjunction with a portable electric drill to remove installed blind bolts and blind rivets.



## GRIP GAUGE / SWAGE & PIN POSITION GAUGES

GRIP GAGE	
Part No.	Description
105093	For NAS, MS21140, MS21141, MS90353, NAS 1919 & 1921
122666	For GP lockbolts and LGP
122667	For MLGP lockbolts

Through visual inspection of pin position and swage is usually adequate, HUCKBOLT® pins and stumps may be checked with Huck gages. Various gages are available, determined by the type and material combination of the installed fasteners.





## CHERRYMAX® POWER RIVETERS

- Unit installs 1/8", 5/32" & 3/16" CherryMAX rivets
- Split Power Riveter allows installation in many limited access areas
- Includes 3" hose for long reach on SH
- Includes 3" hose for long reach on SR

STANDARD MODEL			
Part No.	Stroke	Pulling Force	Weight
G704B	.510"	3100 lbs.	4.25 lbs.

SPLIT POWER MODEL			
Part No.	Stroke	Pulling Force	Weight
G704B-40SH	.510"	3100 lbs.	6 lbs.
G704B-SR	.510"	3136 lbs.	4.5 lbs.

*Note: Pulling heads ordered separately.*



**G704B**

- Lightweight ergonomic design with high pulling force
- Uses existing CherryMAX tooling
- 15° angled head allows user to install rivets using a natural hand position
- Unit installs 1/8", 5/32" & 3/16" CherryMAX rivets

Part No.	Stroke	Pulling Force	Weight
G747	.437"	2100 lbs.	3.5 lbs.



**G747**

- Unit installs 1/8", 5/32" & 3/16" CherryMAX, AB and CherryLock "A"

Part No.	Stroke	Pulling Force	Weight
G746A	.875"	1850 lbs.	4.25 lbs.



**G746A**

## CHERRYMAX® PULLING HEADS

Part No.	Description	Tool Used On
H753A-456 99-1334	Right Angle for installing 1/8", 5/32", & 3/16" nominal and oversize CherryMAX rivets	HUCK 2013  Cherry G704B/G746A/G747
H781-456 99-1333	Offset for installing 1/8", 5/32", & 3/16" nominal and oversize CherryMAX rivets	For G700/G784 adapter 680B205
H701B-456 99-3442  H680B-200A	Straight for installing 1/8", 5/32", & 3/16" nominal and oversize CherryMAX rivets	HUCK 2013 Cherry G704B/G746A/G747
H680B208	1/4" CherryMAX rivets	G784/G700
H827-8	Offset for installing 1/4" nominal and oversize CherryMAX rivets Note: for G744 only	For G83/G84 use adapter 744-200
H828-8	Right Angle for installing 1/4" nominal and oversize CherryMAX rivets Note: for G744 only	For G83/G84 use adapter 744-200
H84A-8	Straight for installing 1/4" nominal and oversize CherryMAX rivets	Cherry G83/G84
		HUCK 244



**H753A-456  
99-1334**



**H781-456  
99-1333**



**H701B-456  
99-3442**



**H827-8**



**H680B-200A**



**H828-8**



**H84A-8**



**H680B-208**

## CHERRYMAX® HAND/HYDRAULIC RIVETERS

- Great in areas with limited access or power limitations
- Pulling head is an integral part of tool
- Unit installs 1/8" CherryMAX rivets

Part No.	Description	Weight
G27	Tool only	0.8 lbs.
G27KIT	Kit includes tool, gauge, selection card & box	

G27KIT



## HAND HYDRAULIC

- Lightweight, compact & versatile
- Double stage hydraulic pump for rapid advance, low effort & high pulling force
- Simple, durable construction
- Unit installs:
  - 4, -5, & -6 CherryMAX rivets
  - 4, -5, & -6 CherryMAX "A" rivets
  - 4 & -5 Maxibolt rivets
  - 4, -5 & -6 InterMAX rivets

Part No.	Stroke	Pulling Force	Weight
G750A	.750"	4200 lbs.	1.9 lbs.
H750A-8	Pulling head for 1/4" CherryMAX		

G750A



H750A-8

## CMR KIT

- Lightweight & versatile kit
- Unit installs -4, -5, & -6 CherryMAX rivets

Part No. Complete Kit	Pulling Heads Included	Accessories Included
G750ACMR	Straight Pulling Head H781-456 (Offset) H753A-456 (Right Angle)	750A088 adapter Molded plastic case & all necessary manuals

G750ACMR



## CHERRYMAX® HAND/HYDRAULIC RIVETERS

- Lightweight, versatile
- Hand type (D100)
- Pneumatic type (PT100-1)
- Unit installs -4, -5, -6 and 1/4" CherryMax/HUCK clinch rivets
- Complete kit contents:
  - D100
  - F156 3/32" nose piece
  - F159 1/8" nose piece
  - F143 5/32" - 3/16" nose piece
  - F152 1/4" nose piece

Part No.	Description
D100-R	Complete kit
PT100-1	Complete kit



**D100-R  
PT100-1**

## CHERRYMAX® CORDLESS RIVETER

- Fast and efficient
- Over 1900 lbs. of pulling force
- Pulls most all blind rivets through 3/16" diameter, including CherryMAX®

Types of rivets installable with the PT-3000 include, but are not limited to, CherryMAX® (M7885), nut plate rivets, self plugging rivets (MS 20600), CherryMAX® 'A' (NAS 1400A), Avdel MBC (NAS1722L), Cherry Interlock® and Huck Magnalock® (M7885/10). Cherry and Avdel Monobolts®, Avdel Avex and standard pop type rivets (MIL-R-24243). In addition, a wide variety of nosepieces are available to satisfy customer needs.

The PT-3000-MIL-1 kit includes the PT-3000 riveter, seven different nosepieces (3/32 thru 1/4), an adapter assembly to permit use of the special right, offset, and extended straight CherryMAX® pulling heads (the special pulling heads are not a part of the kit), a spare parts canister with extra jaws, jaw follower spring, and jaw follower (for use with the 3/16 MS and 1/4 pop nosepieces, two 12 volt DC battery packs, one 12 volt DC, 120 volt AC/60 Hz battery charger, and a metal carrying case.

Part No.	Description
PT3000-MIL-1	Complete kit with charger, batteries

Qty.	Part No.	Description
1	PT-3000-N	Cordless riveter
1	F3000	Battery charger
2	F3001	Battery pack
1	F187-1A	Adapter sleeve, CM
1	F187-2A	Adapter shaft, CM
1	F501	Spare parts canister
2	F123	Jaws, 3 pc.
1	F3622	Jaw follower, 3/16 MS-1/4
1	F140	Nosepiece, 3/32 NP
1	F159	Nosepiece, 1/8
1	F156	Nosepiece, 1/8 MS-5/32 Pop
1	F143	Nosepiece, 3/16 CM
1	F168	Nosepiece, 3/16 MO
1	F580	Nosepiece, 3/16 MS
1	F142	Nosepiece, 1/4 pop
1	F3120	Metal carrying case
1	F3110	Operating manual



**PT3000-MIL-1**

PULLING HEAD EXTENSIONS



704A12

- Great for limited access areas
- Any combination may be used to reach desired length
- Increases overall length of H753A-456 to approximately 2-3/16"
- Better reach in limited areas

Part No.	Description
753B21	Right angle pulling head extension

For G747, G704B, HUCK 2013	
Part No.	Extension Length
704A12-2	2"
704A12-4	4"
704A12-6	6"
704A12-12	12"

CHERRY® RIVETER ACCESSORIES



Part No.	Description
701B32	<b>Magnetic Driving Anvil Catcher</b> Slips on nose of pulling head, no permanent attachment.
670A20	<b>Stem Catcher Bag</b> Plastic bag with heavy-duty zipper. Fits G701A, G704B, G744, G845A & G846 riveters.

CHERRY® GAUGES



269C3

Part No.	Description
269C3	Rivet Grip & Diameter Gauge
269C5	Material Thickness & Grip Gauge
269B12	Maxibolt Gauge

CHERRY® 209 TYPE HAND NIPPER



209

Part No.	Description
209	Rivet Stem Trimmer

## CHERRYLOCK® UNIVERSAL POWER RIVETER

- H681 series pulling heads fit directly on this tool
- Unit installs 1/8" to 1/4" CherryLock rivets in all materials (bulbed and standard)
- Rebuilds available

Part No.	Stroke	Pulling Force	Weight
G784	7/8"	2600 lbs.	8 lbs.



**G784**

## CHERRYLOCK® H681 PULLING HEADS

Part No.	Type	Size
H681-3C	Universal Countersunk Head (MS 20426)	3/32"
H681-4C	Universal Countersunk Head (MS 20426)	1/8"
H681-4F	Countersunk Head (156°)	
H681-4S	Countersunk Head (NAS 1097)	
H681B166-4	Uni-Sink Head	5/32"
H681-5C	Universal Countersunk Head (MS 20426)	
H681-5F	Countersunk Head (156°)	
H681-5S	Countersunk Head (NAS 1097)	3/16"
H681B166-5	Uni-Sink Head	
H681-6C	Universal Countersunk Head (MS 20426)	
H681-6F	Countersunk Head (156°)	1/4"
H681-6S	Countersunk Head (NAS 1097)	
H681B166-6	Uni-Sink Head	
H681-8C	Universal Countersunk Head (MS 20426)	1/4"
H681-8S	Countersunk Head (NAS 1097)	

- Nominal head length is 2-9/16"
- Fit directly on all Cherry hydroshift riveters
- Separate pulling head is required for each diameter rivet



**H681**

## CHERRYLOCK® "A" RIVET

- Great in areas with limited access or power limitations
- Pulling head is an integral part of tool
- Unit installs 3/32" "A" code rivets

Part No.	Stroke	Pulling Force	Weight
G30	3/4"	1000 lbs.	13 oz.



**G30**

## CHERRY® NUT-PLATE POWER RIVETER

- Designed specifically for efficient installation of Cherry nut-plate rivets
- Can be operated in any position with one hand
- Unit installs Cherry nut-plate rivets

Part No.	Stroke	Pulling Force	Weight
G702A	3/4"	1100 lbs.	3.5 lbs.

## Pulling Heads for G702A Riveter

Part No.	Included Nosepieces
H702-3NPR	728A9-3 (3/32") & 728A9-104 (1/8")

## Pulling Heads for G747 Riveter

Part No.	Included Nosepieces
H747-3NPR	728A9-3 (3/32") & 728A9-104 (1/8")



G702A



H702-3NPR

## HUCK® LIGHT-WEIGHT NUT-PLATE POWER RIVETERS

- Compact handle design
- Unit installs
  - 3, 2.5MM, 3MM & -4 nut-plate rivets
  - 3 SPR
  - 3 CherryLock 'A' rivets

Part No.	Stroke	Pulling Force	Weight
302-20	.918	1050 @ 90 psi	3.5 lbs.



302-20

## For 302-20

Part No.	Rivet	Rivet Diameter	Max. Grip
RV355-3	Nut-plate & SPR	3/32", 2.5MM & 3MM	-9
RV365-4	Nut-plate	1/8"	-9
RV812-3	CherryLock 'A'	3/32"	-9

## CHERRY® NUT-PLATE HAND RIVETER

- Great in areas with limited access or power limitations
- Includes 728A9-3 (3/32") & 728A9-104 (1/8") nosepieces
- Unit installs 3/32" & 1/8" Cherry nut-plate rivets

Part No.	Pulling Force	Weight
G29	1000 lbs.	0.8 lbs.



G29

## MAXI-BOLT® POWER RIVETERS

- Compatible with Huck 244/202 riveter pulling heads
- Unit installs Cherry Maxibolt 5/32", 3/16" & 1/4"

Part No.	Stroke	Pulling Force	Weight
G83	7/16"	3750 lbs.	4.95 lbs.
G84	9/16"	5750 lbs.	7.7 lbs.

*Note: Pulling heads ordered separately.*



**G83**

## MAXI-BOLT® PULLING HEADS

- Please inquire for appropriate riveter/pulling head combinations

Part No.	Description	Tool Required
H83B-5MB	<b>Straight</b> for installing 5/32" Maxi-Bolts	G83, G84 HUCK 244/202
H83B-6MB	<b>Straight</b> for installing 3/16" Maxi-Bolts	
H84A-8MB	1/4 Maxi-Bolt	G84
H828MB-5MB	<b>Right Angle</b> for installing 5/32" Maxi-Bolts	G83 with 744-200 adapter G84 no adapter required
H828MB-6MB	<b>Right Angle</b> for installing 3/16" Maxi-Bolts	
H828MB-8MB	<b>Right Angle</b> for installing 1/4" Maxi-Bolts	G84



**H83B-5MB**



**H828MB**

## ADAPTERS FOR PULLING HEADS

Part No.	For Use With	Allows
680B46	All Cherry Hydroshaft riveters G700/G784	H9015 pulling heads H9055 pulling heads
680B57		H9040 pulling heads
704A6	G701, G704 & G749 CherryMAX riveters HUCK 2013	H9040 screw-on type pulling head
704A9		H9055 & H9015 screw-on type pulling head
689B205	G686S, G689, G700 & G784 riveters	H701-456, H753A- 456 & H781-546 pulling heads
750A-088	G750A	H701-456, H781-456 H753A-456 pulling heads



**680B46**



**680B57**



**704A6**



**680B205**



## POWER RIVETER KITS

These kits save space and keep tools and nose assembly organized.



G747CMR



244UNIKIT

Part No.	Description	Pulling Heads Included	Accessories Included
G746ACMRB	G746A CherryMAX Kit installs -3 & -6 CherryMAX rivets	H701B-456 (straight) H781-456 (offset) H735A-456 (right angle)	700A77 bleeder bottle, 269C3 grip selector gauge, 670A20 stern catcher bag, P1393 molded plastic case & all necessary manuals
G746ACMRW	G746A CherryMax Kit installs SST & -3 & -6 CherryLock 'AB' rivets	H955-3 (3/32" straight) H955-4 (1/8" straight) H955-5 (5/32" straight) H955-6 (3/16" straight)	
G747CMR	G746A CherryMax Kit installs NAS 9301 to 9312, 1/8" to 3/16". MS90353/4 & MS21140/1. TAF 'S' Type, 1/8" & 5/32". MS20604/5, 3/32"	H701B-456 (straight) H781-456 (offset) H735A-456 (right angle) H747-3NPR (3/32" nut plate)	
G83AKT	G83 Maxibolt Kit installs 5/32" & 3/16" MS blind bolts & LockBOLTS	H701B-456 (straight) H781-456 (offset) H735A-456 (right angle) H83A-5MB (blind bolt) H83A-6MB (blind bolt) H513-05-35 (LockBOLT) H513-06-60 (LockBOLT)	700A77 bleeder bottle, 269C5 grip selector gauge, 269B12 grip selector gauge, 670A20 stern catcher bag, P1393 molded plastic case & all necessary manuals
G83BKT	G83 Maxibolt Kit installs 5/32" & 3/16" MS blind bolts & NAS style LockBOLTS	H83A-5MB (-5 blind bolt) H83A-6MB (-6 blind bolt) H513-05-35 (-5 LockBOLT) H513-06-60 (-6 LockBOLT)	700A77 bleeder bottle, 269C5 grip selector gauge, 269B12 grip selector gauge, P1393 molded plastic case & all necessary manuals
G84LBK	G84 LockBOLT Kit installs 5/32", 3/16", & 1/4" NAS style LockBOLTS	H513S-05-20 (-5 NAS) H513S-06-20 (-6) H513-08-35 (-8)	700A77 bleeder bottle, 269C5 grip selector gauge, 670A20 stern catcher bag, P1393 molded plastic case & all necessary manuals
G84MBK	G84 Maxibolt Kit installs 5/32", 3/16" & 1/4" MS blind bolts	H83A-5MB (-5) H83A-6MB (-6) H84-8MB (-8)	700A77 bleeder bottle, 269B12 grip selector gauge, 670A20 stern catcher bag, P1395 molded plastic case & all necessary manuals
G784CLRA	G784 CherryLock Kit installs 1/8" to 3/16" NAS 1398/9-' type CherryLock rivets	H681-4C (-4) H681-5C (-5) H681-6C (-6)	700A77 bleeder bottle, 269C3 grip selector gauge, 680A159 stroke setting gauge, P1395 molded plastic case & all necessary manuals
244UNIKIT	HUCK 244 Universal Kit installs 5/32" & 3/16" blind bolts; 1/8", 5/32" & 3/16" blind rivets; 1/8"-5/32" & 3/16" CherryMAX	99-2725-1/8" 99-3442 99-2731-5/32" 99-1336 99-2737-3/16" 99-2701-5/32" 99-2707-3/16"	Max adapter (123437-2) grip gauge, pintail bag, fill bottle and foam-padded case

## ECONOMY POP® RIVETERS

- Quick release air valve
- Unit installs aluminum & steel blind rivets
- For monobolts, use 39064

Part No.	Capacity	Pulling Force	Weight
39054	3/16"	1940 lbs.	3.5 lbs.
39064	1/4"	4200 lbs.	5.5 lbs.



39054

## HAND RIVETER

- Heavy-duty
- Steel nosepiece insert for longer tool life

Part No.	Nosepieces Included
39000	3/32", 1/8", 5/32" & 3/16"



39000

## 360° SWIVEL HAND RIVETER

- Rivets in any position
- Powerful, with hardened steel construction

Part No.	Nosepieces Included
39005	3/32", 1/8", 5/32" & 3/16"



39005

## HAND RIVETER KIT

- For maintenance, repair and overhaul work
- Includes 200 assorted rivets (alum)

Part No.	Kit Includes
39001	Hand riveter & 4 nosepieces, an assortment of rivets, and carrying case



39001

## POP® RIVETERS – AIR

- Nosepieces and air line assembly included
- Unit installs 3/32" - 3/16" POP rivets in aluminum

Part No.	Capacity	Weight
PRG510A-PLUS	9-5/8"	4 lbs.



PRG510

## POP® POWER RIVETERS – PNEUDRAULIC

- Rugged, lightweight construction
- Ergonomic design for balance, comfort and power for productivity
- Nosepieces and air line included

Part No.	Capacity	Description
PRT5400	All rivets to 1/4"	Standard model, with auto valve shutoff
MCS5400	All rivets to 1/4"	Includes mandrel collection system, with auto valve shutoff



PRT5400

## POP® RIVETERS – PNEUDRAULIC

- Rugged, lightweight construction
- Ergonomic design for balance, comfort and power for productivity
- 1/4 NPT swivel inlet
- RAC180A capacity 1/4 S/S
- RAC171 capacity 1/4 monobolt

Part No.	Capacity	Description
RAC180A	All rivets to 1/4"	3/32" – 1/4" noses included. Includes mandrel collection system
RAC171		



RAC180A

## RIV-NUT® DRIVER KIT

Kit includes Riv-Nut® Driver Hand Tool, 6-32, 8-32 & 10-32, two nosepieces and conversion kits in box.

Part No.	Description
L6000K	Complete kit



**L6000K**

## RIVET NUT KIT

Kit includes Riv-Nut tool, 7 mandrels, 4 nosepieces, 10 each aluminum rivet nuts (6-32, 8-32, 10-32, 10-24 and 1/4-20), 6 each rivet nuts (5/16"-18 & 3/16"-16), and plastic case.

Part No.	Description
39213	Complete kit with case
39200	Hand tool plus 8/32, 10/24, 10/32 conversions
39280	6/32 conversion
39258	1/4-20 mandrel
39259	5/16-18 mandrel
39260	3/8-16 mandrel



**39000**



**39200**

## HAND HYDRAULIC RIV-NUT

- Lightweight and versatile
- Hand type (D100C)
- Unit installs 6/32, 8/32, 10/32 and 1/4-28 riv-nut
- Complete kit contents: D100C and plastic case

Part No.	Description
D100-N	Complete kit



**D100-N**

## WRENCH TYPE

L722 Series suitable for field repair and experimental installation.

- Includes allen wrench
- For replacement pull-up stud, specify J70-size

For Riv Nuts	
Part No.	Thread
L845-440	4/40
L845-632	6/32
L845-832	8/32
L845-1024	10/24
L845-1032	10/32
L8452520	1/4"-20
L8452528	1/4"-28
L845-M5	M5
L845-M6	M6

For Riv Nuts - Larger Sizes*	
Part No.	Thread
L722-3118	5/16"-18
L722-3124	5/16"-24
L722-3716	3/8"-16
L722-3724	3/8"-24
L722-5013	1/2"-13
L722-5020	1/2"-20
L722-M8	M8
L722-M10	M10

*Note: For pull-up loads greater than provided with lever type hand tools.*



L722



L845

## SPEED DRIVER

- Complete interchangeability with original design parts
- High speed push-pull spiral action

Part No.	Part No. Conversion Kit*	Part No. Replacement Stud	Thread Size
L6000-4/40	SCA-4/40	L16-4/40	4/40
L6000-6/32	SCA-6/32	L16-6/32	6/32
L6000-8/32	SCA-8/32	L16-8/32	8/32
L6000-10/32	SCA-10/32	L16-10/32	10/32
L6000-1/4-28	SCA-1/4-28	L16-1/4-28	1/4-28
L6000-1/4-20**	SCA-1/4-20	L16-1/4-20	1/4-20
L7000-1/4-28	SCA-1/4-28	L16-1/4-28	1/4-28
L7000-1/4-20	SCA-1/4-20	L16-1/4-20	1/4-20

*Note: L7000 series have longer stroke for slotted riv-nuts.*

\*Converts to a different size tool easily.

\*\*Aluminum only.



L6000

## KEY WAY CUTTERS

Part No.	Size
100° Countersunk Rivnuts	
L3600-4	#4
L3600-6	#6
L3600-8	#8
L3600-10	#10
L3600-1/4	1/4"



L3600

## WRENCH TYPE

This driver is a quick way to set threaded inserts (thru type only). Specify size 4-40 thru 3/8"-16.

- Uses standard socket head cap screws

Base Model No.	Capacity		Free Speed (rpm)	Max. Torque		Weight		Length	
	Alum	Steel		in lb.	Nm	lb.	KG	in	mm
<b>Pistol Grip</b>									
CN9P4	3/8"	3/8"	400	350	40	3.4	1.6	10.4	265
CN9P7	3/8"	5/16"	700	200	23	3.4	1.6	10.4	265
CN9P12	1/4"	10/32"	1200	120	14	3.4	1.6	10.4	265
CN9P20	10/32"	8/32"	2000	70	8	2.9	1.3	9.0	230
CN9P25	4/40"	8/32"	2500	55	6	2.9	1.3	9.0	230

Power units can be ordered separately using part number above. For ordering complete tools select the appropriate power unit from the chart above and head assembly from the chart below and combine their part numbers as shown in the following example: CN9P4-20 for 400 rpm tool with 1/4"-20 thread.

Order Number Suffix		
Thread Size	Serrated Nose	Smooth Nose
#4-40	440	440S
M3 x 0.5	M305	M305S
#6-32	632	632S
#8-32	832	832S
M4 x 0.7	M407	M407S
#10-24	1024	1024S
#10-32	1032	1032S
M5 x 0.8	M508	M508S
1/4-20	420	420S
M6 x 10	M610	M610S
5/16-18	518	518S
M8 x 1.25	M8125	M8125S
3/8-16	616	616S
M10 x 1.5	M1015	M1015S



**CN9P**

## PNEUMATIC THREADED INSERT DRIVER KITS

- Totally adjustable stroke length
- Swivel air inlet
- Metric kits available by adding 'M' after part number
- 1/4-28 not included in either kit

Part No.	Capacity	Includes*
KJ60	6/32 to 5/16"-18 threaded inserts in aluminum or steel	Pneumatic insert driver, 6/32" to 5/16"-18 mandrels & nosepieces
KJ45	6/32 to 1/2"-20 threaded inserts in aluminum or steel	Pneumatic insert driver, 6/32" to 1/2"-20 mandrels & nosepieces

\* Other mandrels and nosepieces available. Please inquire.



**KJ60**

HLH110 SERIES

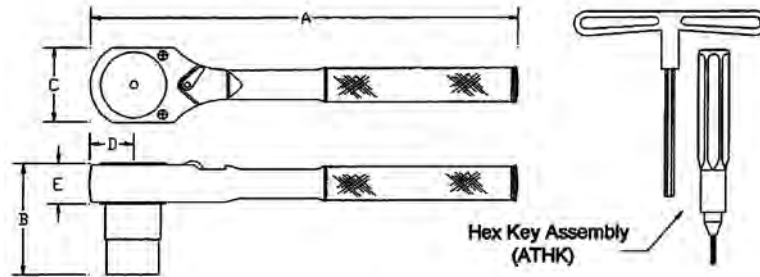

Socket Hex	Hex Key Size	Dimensions					Hex Key Part No.	Ratchet Wrench Part No.	Socket Part No.	Complete Assembly Part No.	
		A	B	C	D	E					
3/16"	1/6"	5"	1-1/4"	15/64"	7/16"	3/8"	ATHR250 1/4" sq. dr.	ATHK062	ATHS187	ATHA1	
7/32"									ATHS218	ATHA2	
1/4"									ATHS250	ATHA3	
9/32"									ATHS281	ATHA4	
5/16"									ATHS312	ATHA5	
11/32"									ATHS343	ATHA6	
7/32"	5/64"	5"	1-1/4"	15/64"	7/16"	3/8"	ATHR250 1/4" sq. dr.	ATHK079	ATHS218	ATHA7	
1/4"									ATHS250	ATHA8	
9/32"									ATHS281	ATHA9	
5/16"									ATHS312	ATHA10	
11/32"									ATHS343	ATHA11	
3/8"									ATHS375A	ATHA12A	
5/16"	3/32"	5"	1-1/4"	15/64"	7/16"	3/8"	ATHR250 1/4" sq. dr.	ATHK094	ATHS312	ATHA13	
11/32"									ATHS343	ATHA14	
3/8"									ATHS375A	ATHA15A	
3/8"									ATHS375	ATHA15	
7/16"									ATHS437	ATHA16	
1/2"									ATHS500	ATHA21	
3/8"	1/8"	7"	1-1/2"	1-1/4"	5/8"	1/2"	ATHR375 3/8" sq. dr.	ATHK125 "T"	ATHS375	ATHA17	
7/16"									ATHS437	ATHA18	
1/2"									ATHS500	ATHA22	
7/16"									ATHK156 "T"	ATHS437	ATHA19
1/2"									ATHK156 "T"	ATHS500	ATHA20
1/2"									5/32		

HI-LOK INSTALLATION KIT

- All kits include fitted plastic case

Ratchet & Socket Kit - 1/4" Square Drive Reversible		
Part No.	Sockets Included	Accessories Included
ATSK3594K	3/16", 7/32", 1/4", 9/32", 5/16", 11/32" & 3/8"	1/16" Hex Key & 3/32" T-Hex Wrench

Ratchet & Socket Kit - 1/4" & 3/8" Square Drive Reversible		
Part No.	Sockets Included	Accessories Included
ATSK3594/95K	3/16", 7/32", 1/4", 9/32", 5/16", 11/32", 3/8", 7/16" & 1/2"	1/16" Hex Key, 5/64", 3/32", 1/8" & 5/32" T-Hex Wrenches

Installation/Removal Kit	
Part No.	Description
AT590LPR	Low Profile Kit consists of: Two Clutch Driven Handles, Seven Sockets, Allen Wrenches in box



ATSK3594/95



AT590LPR

## HI-LOK ROLLER RATCHET INSTALLATION TOOLS

Stepped Socket Type					
Part No.	Socket S1	Socket S2	Max. Torque (S1/S2)	Head Height (S1/S2)	Overall Length
OMDD1	7/32", 1/4" & 5/16"	11/32" & 3/8"	90/150 ft-lbs.	0.47"/0.47"	6"
OMDD2	7/32", 1/4" & 5/16"	11/32", 3/8" & 7/16"	90/250 ft-lbs.	0.47"/0.63"	8"
OMDD3	11/32" & 3/8"	7/16" & 1/2"	250/400 ft-lbs.	0.63"/0.63"	10"

- Ideal for installing Hi-Lok & other fasteners in limited access areas
- Uses standard 1/4" / 3/8" drive sockets & Hi-Shear style set screw sockets
- Allen wrench through hole for Hi-Lock & Hi-Lite pins



**OMDD**

1/4" Drive Socket Type			
Part No.	Max. Torque	Head Height	Overall Length
RR40S-SP	40 ft-lbs.	0.47"	3.5"
RR40S	40 ft-lbs.	0.47"	6.5"
RR80S	150 ft-lbs.	1.00"	6.25"
RR130SP	250 ft-lbs.	1.00"	7.0"



**RR40S-SP**

3/8" Drive Socket Type			
Part No.	Max. Torque	Head Height	Overall Length
RR250	400 ft-lbs.	0.63"	7.75"
RR400	600 ft-lbs.	0.63"	8.5"

Note: Use ATHS sockets, page 110.

## DOUBLE BOX RATCHET WRENCHES WITH EJECTOR

- For installation of frangible collars on threaded pins in interference & non-interference fastener pin conditions



**ATBR**

**ATBRO**

Standard Models					
Part No. Straight	Part No. 25° Offset	Hex #1	Hex #2	Tool Thickness	Overall Length
ATBR-2125	ATBRO-2125	7/32"	1/4"	3/8"	4-3/32"
ATBR-2528	ATBRO-2528	1/4"	9/32"	3/8"	4-3/32"
ATBR-3134	ATBRO-3137	5/16"	11/32"	3/8"	4-3/32"
ATBR-3137	ATBRO-3137	5/16"	3/8"	3/8"	5-7/32"
ATBR-4350	ATBRO-4350	7/16"	1/2"	3/8"	5-7/32"

Ejector Models					
Part No. Straight	Part No. 25° Offset	Hex #1	Hex #2	Tool Thickness	Overall Length
ATBR-2125E	ATBRO-2125E	7/32"	1/4"	3/8"	4-3/32"
ATBR-2528E	ATBRO-2528E	1/4"	9/32"	3/8"	4-3/32"
ATBR-3134E	ATBRO-3137E	5/16"	11/32"	3/8"	4-3/32"
ATBR-3137E	ATBRO-3137E	5/16"	3/8"	3/8"	5-7/32"
ATBR-4350E	ATBRO-4350E	7/16"	1/2"	3/8"	5-7/32"

Note: ATBR-2125E has a 5/16" tool thickness.



HI-SHEAR HI-LOK RATCHETS

**Straight Ratchet Wrench Driver Assembly with Multi-Length Socket & Super-Key™ (T-Series)**

Ordering Information:

1. Match pin and collar hexes with Super-Key hex and socket hex. Reference hex Match Diagram.
2. See Table 1 for corresponding complete driver assembly part number.
3. Example of complete driver assembly part number.

**HLA2002-312(E)-078 T**

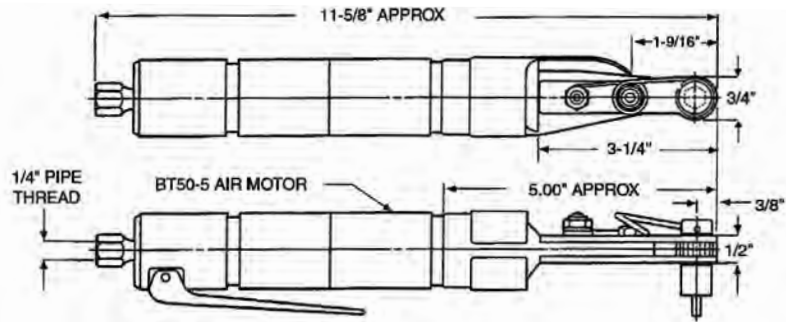
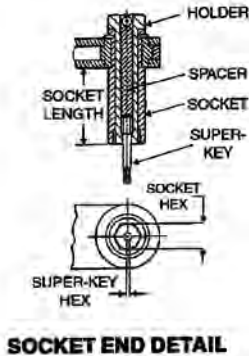
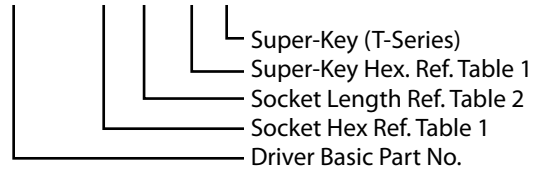

Table 1

Collar Driving Hex (Matching Socket Head)	Pin Recess Hex (Matches Super-Key Hex)	Complete Driver Assembly Part No.	Replacement Super-Key	Socket Assembly Part No.
3/16"	1/16"	HLA2002-187( )-062T	HLT140K-062	HLS76-187( )-062T
7/32"		HLA2002-218( )-062T		HLS76-218( )-062T
1/4"		HLA2002-250( )-062T		HLS76-250( )-062T
9/32"		HLA2002-281( )-062T		HLS76-281( )-062T
5/16"		HLA2002-312( )-062T		HLS76-312( )-062T
11/32"		HLA2002-343( )-062T		HLS76-343( )-062T
7/32"	5/64"	HLA2002-218( )-078T	HLT140K-078	HLS76-218( )-078T
1/4"		HLA2002-250( )-078T		HLS76-250( )-078T
9/32"		HLA2002-281( )-078T		HLS76-281( )-078T
5/16"*		HLA2002-312( )-078T		HLS76-312( )-078T
11/32"		HLA2002-343( )-078T		HLS76-343( )-078T
3/8"		HLA2002-375( )-078T		HLS76-375( )-078T
5/16"	3/32"	HLA2002-312( )-094T	HLT140K-94	HLS76-312( )-094T
11/32"		HLA2002-343( )-094T		HLS76-343( )-094T
3/8"		HLA2002-375( )-094T		HLS76-375( )-094T
7/16"		HLA2002-437( )-094T		HLS76-437( )-094T

Table 2

A = .050	E = 0.75
B = 1.00	F = 1.75
C = 1.50	X = 4.00
D = 2.00	

Technical Data

Operating Pressure	90 psia
Max. Torque Rating (Motor)	110 in. lb. at 90 psia
Socket Speed	250 rpm
Horsepower Rating	.50
Air Consumption	22 cfm
Weight	2 lbs.

HI-SHEAR HI-LOK RATCHETS

**20° Offset Ratchet Wrench Driver Assembly with Multi-Length Socket & Super-Key™ (T-Series)**

Ordering Information:

1. Match pin and collar hexes with Super-Key hex and socket hex. Reference hex Match Diagram.
2. See Table 1 for corresponding complete driver assembly part number.
3. Example of complete driver assembly part number.

**HLA2016-312(E)-078 T**

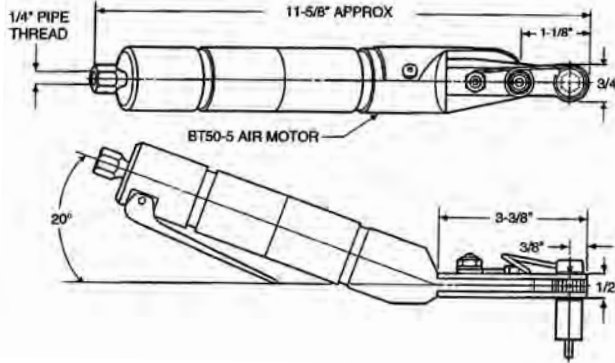
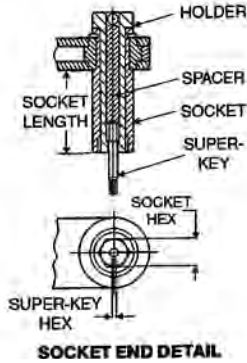
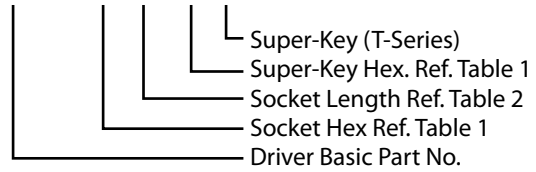

Table 1

Collar Driving Hex (Matching Socket Head)	Pin Recess Hex (Matches Super-Key Hex)	Complete Driver Assembly Part No.	Replacement Super-Key	Socket Assembly Part No.
3/16"	1/16"	HLA2016-187( )-062T	HLT140K-062	HLS76-187( )-062T
7/32"		HLA2016-218( )-062T		HLS76-218( )-062T
1/4"		HLA2016-250( )-062T		HLS76-250( )-062T
9/32"		HLA2016-281( )-062T		HLS76-281( )-062T
5/16"		HLA2016-312( )-062T		HLS76-312( )-062T
11/32"		HLA2016-343( )-062T		HLS76-343( )-062T
7/32"	5/64"	HLA2016-218( )-078T	HLT140K-078	HLS76-218( )-078T
1/4"		HLA2016-250( )-078T		HLS76-250( )-078T
9/32"		HLA2016-281( )-078T		HLS76-281( )-078T
5/16"*		HLA2016-312( )-078T		HLS76-312( )-078T
11/32"		HLA2016-343( )-078T		HLS76-343( )-078T
3/8'		HLA2016-375( )-078T		HLS76-375( )-078T
5/16"	3/32"	HLA2016-312( )-094T	HLT140K-94	HLS76-312( )-094T
11/32"		HLA2016-343( )-094T		HLS76-343( )-094T
3/8"		HLA2016-375( )-094T		HLS76-375( )-094T
7/16"		HLA2016-437( )-094T		HLS76-437( )-094T

Table 2

A = .050	E = 0.75
B = 1.00	F = 1.75
C = 1.50	X = 4.00
D = 2.00	

Technical Data

Operating Pressure	90 psia
Max. Torque Rating (Motor)	119 in. lb. at 90 psia
Socket Speed	250 rpm
Horsepower Rating	.50
Air Consumption	22 cfm
Weight	2 lbs.

## HI-SHEAR HI-LOK PISTOL TOOL

### Straight Driver Assembly with Extended Socket & Super-Key™ (T-Series)

#### Ordering Information:

1. Match pin and collar hexes with Super-Key hex and socket hex. Reference hex Match Diagram.
2. See Tables 1 & 2 for corresponding complete driver assembly part number.
3. Example of complete driver assembly part number.

### HLA1051-312(X)-078 T

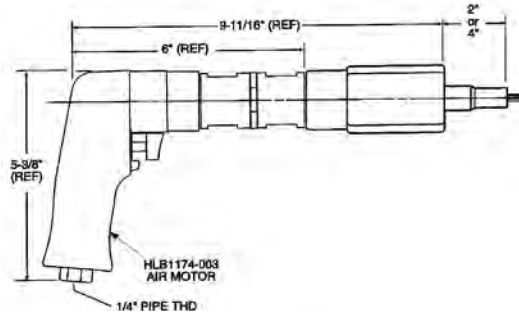
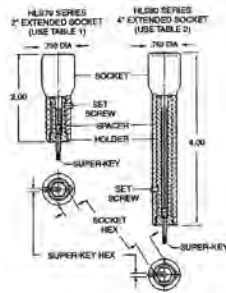
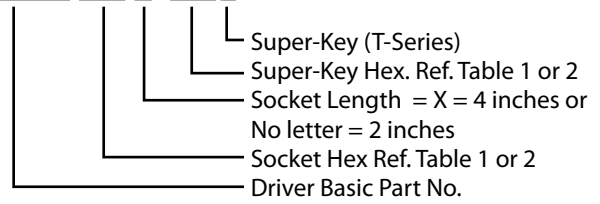

Table 1				Table 2		
Collar Driving Hex (Matches Socket Head)	Pin Recess Hex (Matches Super-Key Hex)	Complete Driver Assembly Part No. with HLS79 Series 2\"/>				
3/16"	1/16"	HLA1051-187-062T	HLT140K-062	3/16"	1/16"	HLA1051-187X-062T
7/32"		HLA1051-218-062T		7/32"		HLA1051-218X-062T
1/4"		HLA1051-250-062T		1/4"		HLA1051-250X-062T
9/32"		HLA1051-281-062T		9/32"		HLA1051-281X-062T
5/16"		HLA1051-312-062T		5/16"		HLA1051-312X-062T
11/32"		HLA1051-343-062T		11/32"		HLA1051-343X-062T
7/32"	5/64"	HLA1051-218-078T	HLT140K-078	7/32"	5/64"	HLA1051-218X-078T
1/4"		HLA1051-250-078T		1/4"		HLA1051-250X-078T
9/32"		HLA1051-281-078T		9/32"		HLA1051-281X-078T
5/16"		HLA1051-312-078T		5/16"		HLA1051-312X-078T*
11/32"		HLA1051-343-08T		11/32"		HLA1051-343X-078T
3/8"		HLA1051-375-078T		3/8"		HLA1051-375X-078T
5/16"	3/32"	HLA1051-312-094T	HLT140K-094	5/16"	3/32"	HLA1051-312X-094T
11/32"		HLA1051-343-094T		11/32"		HLA1051-343X-094T
3/8"		HLA1051-375-094T		3/8"		HLA1051-375X-094T
7/16"		HLA1051-437-094T		7/16"		HLA1051-437X-094T

Technical Data	
Operating Pressure	90 psia
Max. Torque Rating (Motor)	300 in. lb. at 90 psia
Socket Speed	250 rpm
Horsepower Rating	.70
Air Consumption	22 cfm
Weight	3.8 lbs.

**Air Tool Services +44 (0)1772 557700**

HI-SHEAR HI-LOK OFFSET TOOL

**2" Offset Driver Assembly with Multi-Length Socket & Super-Key™ (T-Series)**

Ordering Information:

1. Match pin and collar hexes with Super-Key hex and socket hex. Reference hex Match Diagram.
2. See Table 1 for corresponding complete driver assembly part number.
3. Example of complete driver assembly part number.

**HLA1076-312(E)-078 T**

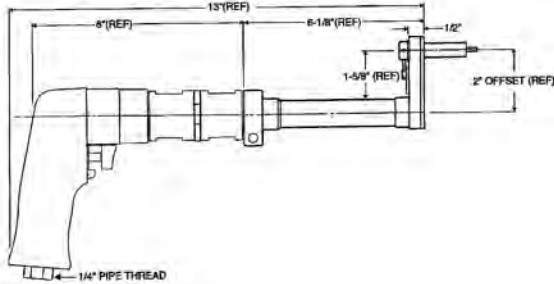
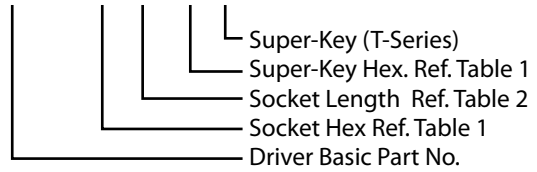

Table 1

Collar Driving Hex (Matching Socket Head)	Pin Recess Hex (Matches Super-Key Hex)	Complete Driver Assembly Part No.	Replacement Super-Key	Extended Socket Assembly Part No.
3/16"	1/16"	HLA1076-187( )-062T	HLT140K-062	HLS76-187( )-062T
7/32"		HLA1076218( )-062T		HLS76-218( )-062T
1/4"		HLA1076-250( )-062T		HLS76-250( )-062T
9/32"		HLA1076-281( )-062T		HLS76-281( )-062T
5/16"		HLA1076-312( )-062T		HLS76-312( )-062T
11/32"		HLA1076-343( )-062T		HLS76-343( )-062T
7/32"	5/64"	HLA1076-218( )-078T	HLT140K-078	HLS76-218( )-078T
1/4"		HLA1076-250( )-078T		HLS76-250( )-078T
9/32"		HLA1076-281( )-078T		HLS76-281( )-078T
5/16"*		HLA1076-312( )-078T		HLS76-312( )-078T
11/32"		HLA1076-343( )-078T		HLS76-343( )-078T
3/8'		HLA1076-375( )-078T		HLS76-375( )-078T
5/16"	3/32"	HLA1076-312( )-094T	HLT140K-94	HLS76-312( )-094T
11/32"		HLA1076-343( )-094T		HLS76-343( )-094T
3/8"		HLA1076-375( )-094T		HLS76-375( )-094T
7/16"		HLA1076-437( )-094T		HLS76-437( )-094T
3/8"	1/8'	HLA1076-375( )-125T	HLT140K-125	HLS76-375( )-125T
7/16"		HLA1076-437( )-125T		HLS76-437( )-125T

Table 2

A = .050	E = 0.75
B = 1.00	F = 1.75
C = 1.50	X = 4.00
D = 2.00	

Technical Data

Operating Pressure	90 psia
Max. Torque Rating (Motor)	300 in. lb. at 90 psia
Socket Speed	250 rpm
Horsepower Rating	.70
Air Consumption	22 cfm
Weight	3.8 lbs.

## HI-LOK REMOVAL KITS

## Roller Clutch Wrench Kit - 1/4" Square Drive

Part No.	Sockets Included	Accessories Included
ATSK3539A	7/32", 1/4", 5/16" & 11/32" Wrench-Socket Combos	Diamond Cut Removal Pliers

## Deluxe Roller Clutch Wrench Kit - 1/4" Square Drive Reversible

Part No.	Sockets Included	Accessories Included
ATSK3539A8	7/32", 1/4", 5/16", 11/32", 3/8" & 7/16" Wrench-Sockets	Diamond Cut Removal Pliers



ATSK3539A8

## HI-LOK &amp; HI-TIQUE COLLAR REMOVAL TOOL KIT

Part No.	Description
HLK10	Complete Kit

Part No.	Description
HLH128-6	5/32" & 3/16" Collar Removal Tool
HLH128-8	1/4" Collar Removal Tool
HLH128-10	5/16" Collar Removal Tool
HLH128-12	3/8" Collar Removal Tool
HLH128-14	7/16" Collar Removal Tool
HLH128-16	1/2" Collar Removal Tool
HLH132	1/4" Drive Extension (3" OAL) for -6, -8 & -10 Removal Tools
HLH130	1/4" Drive Flex Handle for -6, -8 & -10 Removal Tools
HLH133	1/4" Drive Extension (3" OAL) for -12, -14 & -16 Removal Tools
HLH131	1/4" Drive Flex Handle for -12, -14 & -16 Removal Tools
HLH134	Box Assembly



HLK10

## HI-LOK &amp; HI-TIQUE COLLAR REMOVAL TOOL ASSEMBLIES

Part No.	Size	Connector	'A' Height	'B' Width
HLH128-6	3/16"	1/4" Square Drive	0.400"	0.800"
HLH128-8	1/4"	1/4" Square Drive	.0400"	0.800"
HLH128-10	5/16"	1/4" Square Drive	0.500"	0.800"
HLH128-12	3/8"	3/8" Square Drive	0.562"	1.070"
HLH128-14	7/16"	3/8" Square Drive	0.687"	1.150"
HLH128-16	1/2"	3/8" Square Drive	.0687"	1.200"

Note: Larger sizes available (POA)

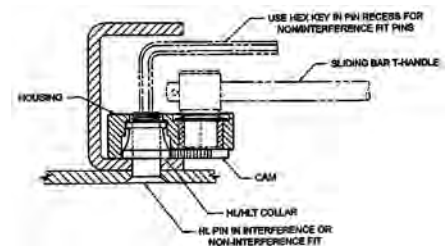

HLH128

## SIX-WING COLLAR REMOVAL TOOLS



Standard Socket Models							
Part No. Complete Tool	Part No. Socket Only	Pin Dash No.	Pin Size	'B' Dimension	'C' Dimension	'D' Dimension	Overall Length
CAT19-15	CAT18-15	-5	5/32"	1/2"	.35"	.38"	4-1/4"
CAT19-18	CAT18-18	-6	3/16"	1/2"	.35"	.38"	4-1/4"
CAT19-25	CAT18-25	-8	1/4"	1/2"	.47"	.38"	4-1/4"
CAT19-31	CAT18-31	-10	5/16"	.65"	.59"	.38"	5-1/2"
CAT19-37	CAT18-37	-12	3/8"	.65"	.66"	.38"	5-1/2"

Extended Socket Models							
Part No. Complete Tool	Part No. Socket Only	Pin Dash No.	Pin Size	'B' Dimension	'C' Dimension	'D' Dimension	Overall Length
CAT19-15-1	CAT18-15-1	-5	5/32"	1"	.35"	.38"	4-1/4"
CAT19-18-1	CAT18-18-1	-6	3/16"	1"	.35"	.38"	4-1/4"
CAT19-25-1	CAT18-25-1	-8	1/4"	1"	.47"	.38"	4-1/4"
CAT19-31-1	CAT18-31-1	-10	5/16"	1-1/4"	.59"	.38"	5-1/2"
CAT19-37-1	CAT18-37-1	-12	3/8"	1-1/4"	.66"	.38"	5-1/2"

## HI-LOK COLLAR HAND REMOVAL TOOLS

- Slips down over Hi-Lok or similar collar and gently unscrews
- Clean removal in limited access areas with no cutting or prying
- Add "S" for straight handle; example REM100-56S

Part No.	Part No. Crow Foot	Pin Dash No.	Nominal Pin Diameter	Width
REM100-56	REM100-56CF	-5	5/32"	.42"
		-6	3/16"	.42"
REM100-8	REM100-8CF	-8	1/4"	.55"
REM100-10	REM100-10CF	-10	5/16"	.67"
REM100-12	REM100-12CF	-12	3/8"	.75"
REM100-14	REM100-14CF	-14	7/16"	.95"



REM100-56



REM100-CF

## COMPOSI-LOK & VISU-LOCK FASTENER SHAVER

- Uses long lasting abrasive cutting discs for smooth, uninterrupted cuts
- Spindle lock plunger for quick change of discs

Part No.	Description	Depth Adjustment	Weight
MAPS-01	Shaver	0.001"	1.25 lbs.
MAPSD-01	Shaving Disc	NA	NA



MAPS-01

## HI-LOK REMOVAL SOCKETS

These new ATSK3581 Series Sockets are the ultimate for removal of stubborn Hi-Lok's. Using a left-handed taper thread, these hardened chromium-alloy tools bite into the aluminum faster for easy removal. **Ratchet not included.**



ATSK3581

Part No.	Description
ATSK3581-5/32	Socket, Removal, for 5/32" aluminum Hi-Lok fastener, 1/4" sq. drive thru-hole
ATSK3581-3/16	Socket, Removal, for 3/16" aluminum Hi-Lok fastener, 1/4" sq. drive thru-hole
ATSK3581-1/4	Socket, Removal, for 1/4" aluminum Hi-Lok fastener, 1/4" sq. drive thru-hole
ATSK3581-5/16	Socket, Removal, for 5/16" aluminum Hi-Lok fastener, 1/4" sq. drive thru-hole
ATSK3581-3/8	Socket, Removal, for 3/8" aluminum Hi-Lok fastener, 1/4" sq. drive thru-hole
ATSK3581-7/16	Socket, Removal, for 7/16" aluminum Hi-Lok fastener, 1/4" sq. drive thru-hole

## REMOVABLE SOCKET FOR FRANGIBLE COLLARS

- Adapts to reversible power or hand ratchets
- For removal of Hi-Lok, Hi-Lite & similar interference fit pin collars

Part No.	For Collar	Nominal Pin Diameter
OMAR100-5	-5	5/32"
OMAR100-6	-6	3/16"
OMAR100-8	-8	1/4"
OMAR-10	-10	5/16"
OMAR-12	-12	3/8"



OMAR100

## THREADED SHANK HI-SHEAR® COLLAR REMOVERS

- For collar removal of Hi-Shear and Huck fasteners
- 1/4" x 28 male threaded shank

Part No.	'D' Diameter	'A' Diameter	Fastener Type	Fastener Size
221-1	.365	.124	Hi-Shear	1/8"
221-2	.365	.157	Hi-Shear	5/32"
221-3	.438	.1875	Hi-Shear	3/16"
221-4	.500	.250	Hi-Shear	1/4"
221-5	.562	.310	Hi-Shear	5/16"
221-6	.625	.373	H-Shear	3/8"
221-11	.373	.1875	Huck	L6 Lock Bolt
221-12	.413	.250	Huck	L8 Lock Bolt
221-13	.372	.265	Huck	OS8 Blind Rivet
221-14	.528	.3125	Huck	L10 Lock Bolt



221-2

## HI-LOK REMOVAL PLIER

- Diamond cut jaws for a patterned grip on fasteners from any angle
- Hardened & tapered head
- ATSK has serrated jaws

Part No.	Description
ZHP-100	Hi-Lok Removal Plier
ATSK3579	Hi-Lok Removal Plier



ZHP-100

## HI-LOK PIN PROTRUSION GAUGE

- For inspection of pins for correct grip length

Part No.	Type	Sizes Included
2-1522	Hi-Lok	5/32", 3/16", 1/4", 5/16" & 3/8"
2-1522HST	H-Lite	5/32", 3/16", 1/4", 5/16" & 3/8"
2-1522HLM	Hi-Lok	4, 5, 6, 8, 10 & 12mm
2-1522HSTM	Hi-Lite	4, 5, 6, 8, 10 & 12mm

**2-1522HST**



## GRIP SCALES - HI-LOK

- Spring temper stainless steel, 3/4" x 6-1/4"

Part No.	Description
2-612	1/16" increments to 3"; 1mm increments to 75mm
2-615	Grip Gauge Slide (for 2-612 above)
2-651	Grip Scale Assembly (includes 2-612 & 2-615 above)



**2-651**

## GRIP SCALES - VISU-LOK

- Spring temper stainless steel, 3/4" x 6-1/4"

Part No.	Description
LFVLG-1	For Visu-Lok Jo-Bolt Fasteners
LFVCLG-1	For Composi-Lok Fasteners



**LFVLG-1**

## K-FAST 8-SPLINE INSTALLATION & REMOVAL SOCKETS

- For Kaynar KFN fasteners (used in Airbus aircraft, A10 Thunderbolt etc.)
- Tamper proof
- Uses standard square drive ratchet wrenches

Part No.	Size	Drive
ATSK3686-2T	#8	1/4"
ATSK3686-3T	#10	1/4"
ATSK3686-4T	1/4"	1/4"
ATSK3686-5F	5/16"	3/8"
ATSK3686-6F	3/8"	3/8"
ATSK3686-7S	7/16"	1/2"
ATSK3686-8S	1/2"	1/2"
ATSK3686-9S	9/16"	1/2"
ATSK3686-10S	5/8"	1/2"



**ATSK3686**



## COMPOSI-LOK / JO-BOLT / VISU-LOK

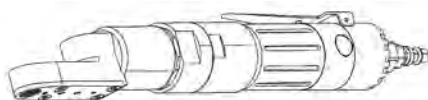

7440M-5

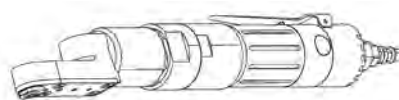

7440C-5

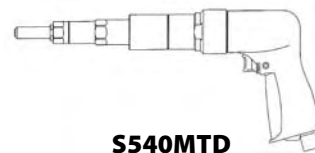

S540MTD

Pneumatic Torque Responsive Adapters		
Part No.	Visu-Lok Series	Dia.
7440M-5	Flush -5	5/32"
7440M-6	Flush -6	3/16"
7440M-8	Flush -8	1/4"
7440M-5P	Protruding -5	5/32"
7440M-6P	Protruding -6	3/16"
7440M-8P	Protruding -8	1/4"
7440M-5A	Millable -5	5/32"
7440M-6A	Millable -6	3/16"
7440M-8A	Millable -8	1/4"
7440M-5T	Reduced Flush -5	5/32"
7440M-6T	Reduced Flush -6	3/16"
7440M-8T	Reduced Flush -8	1/4"

Pneumatic Close Quarter Tools		
Part No.	Visu-Lok Series	Dia.
7440C-5	Flush -5	5/32"
7440C-6	Flush -6	3/16"
7440C-8	Flush -8	1/4"
7440C-5P	Protruding -5	5/32"
7440C-6P	Protruding -6	3/16"
7440C-8P	Protruding -8	1/4"
7440C-5A	Millable -5	5/32"
7440C-6A	Millable -6	3/16"
7440C-8A	Millable -8	1/4"
7440C-5T	Reduced Flush -5	5/32"
7440C-6T	Reduced Flush -6	3/16"
7440C-8T	Reduced Flush -8	1/4"

Pneumatic Master Torque Drivers		
Part No.	Visu-Lok Series	Dia.
S540MTD-5	Flush -5	5/32"
S540MTD-6	Flush -6	3/16"
S540MTD-8	Flush -8	1/4"
S540MTD-10	Flush -10	5/16"
S540MTD-12	Flush -12	3/8"
S540MTD-5P	Protruding -5	5/32"
S540MTD-6P	Protruding -6	3/16"
S540MTD-8P	Protruding -8	1/4"
S540MTD-10P	Protruding -10	5/16"
S540MTD-12P	Protruding -12	3/8"
S540MTD-5A	Millable -5	5/32"
S540MTD-6A	Millable -6	3/16"
S540MTD-8A	Millable -8	1/4"
S540MTD-10A	Millable -10	5/16"
S540MTD-12A	Millable -12	3/8"
S540MTDA-5T	Reduced Flush -5	5/32"
S540MTDA-6T	Reduced Flush -6	3/16"
S540MTDA-8T	Reduced Flush -8	1/4"
S540MTDA-10T	Reduced Flush -10	5/16"
S540MTDA-12T	Reduced Flush -12	3/8"

Ratchet Hand Tools		
Part No.	Visu-Lok Series	Dia.
HWF165	Flush -5	5/32"
HWF200	Flush -6	3/16"
HWF260	Flush -8	1/4"
HWF312	Flush -10	5/16"
HWF375	Flush -12	3/8"
HWF165	Protruding -5	5/32"
HWF200	Protruding -6	3/16"
HWF260	Protruding -8	1/4"
HWF312	Protruding -10	5/16"
HWF375	Protruding -12	3/8"
HWA165	Millable -5	5/32"
HWA200	Millable -6	3/16"
HWA260	Millable -8	1/4"
HWF165T	Reduced Flush -5	5/32"
HWF200T	Reduced Flush -6	3/16"
HWF260T	Reduced Flush -8	1/4"
HWF312T	Reduced Flush -10	5/16"
HWF375T	Reduced Flush -12	3/8"

Close Quarter Hand Tools		
Part No.	Visu-Lok Series	Dia.
HWF5	Flush -5	5/32"
HWF6	Flush -6	3/16"
HWF8	Flush -8	1/4"
HWF10	Flush -10	5/16"
HWF12	Flush -12	3/8"
HWP5	Protruding -5	5/32"
HWP6	Protruding -6	3/16"
HWP8	Protruding -8	1/4"
HWP10	Protruding -10	5/16"
HWP12	Protruding -12	3/8"
HWA5	Millable -5	5/32"
HWA6	Millable -6	3/16"
HWA8	Millable -8	1/4"
HWF5T	Reduced Flush -5	5/32"
HWF6T	Reduced Flush -6	3/16"
HWF8T	Reduced Flush -8	1/4"
HWF10T	Reduced Flush -10	5/16"
HWF12T	Reduced Flush -12	3/8"

**Note:** For Composi-Lok, add 'BF' after part number; example: for 5/32" flush hand tool, order HWF165BF. For more information or assistance in ordering separate components for Jo-Bolt tools, please inquire.



HWF165

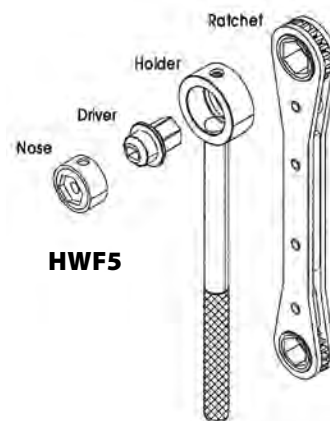

HWF5

## VISU-LOK II / COMPOSI-LOK II

### Visu-lok II Ratchet Hand Tool

**Includes:**

- Ratchet wrench
- Holder
- Nose tip connector
- Universal nose tip
- Wrench gear

Spare parts or conversion of kits to another size upon request.

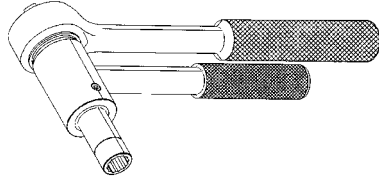

### Composi-Lok II Ratchet Hand Tool

**Includes:**

- Ratchet wrench
- Holder
- Nose tip connector
- Universal nose tip
- Wrench gear

Spare parts or conversion of kits to another size upon request.

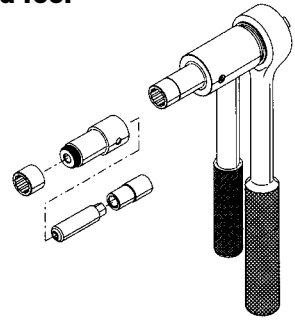

Fastener Size	Complete Assembly Part No.
5/32"	DNH5AA
3/16"	DNH6AA
1/4"	DNH8AA
5/16"	DNH10AA
3/8"	DNH12AA

Fastener Size	Complete Assembly Part No.
5/32"	DNH5AA-BF
3/16"	DNH6AA-BF
7/32"	DNH7AA-BF
1/4"	DNH8AA-BF
9/32"	DNH9AA-BF
5/16"	DNH10AA-BF
3/8"	DNH12AA-BF

## KITS

This complete 14 piece kit contains everything you need to easily install 5/32", 3/16" & 1/4" Jo-bolts in both Protruding Head and Flush styles. Kit includes Hand Ratchet Tool, Jo-Bolt, Grip Gage, and all Drivers and Socket Heads. Packaged in a heavy duty plastic case for easy storage when not in use.



Part No.	Description
VLHK-102	14 pcs. kit 5/32" thru 1/4"

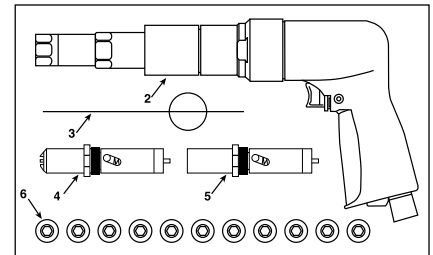
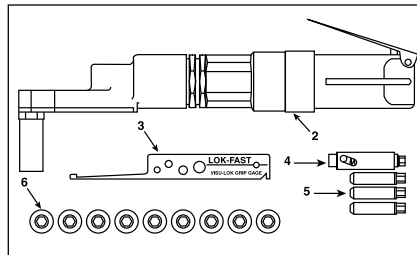
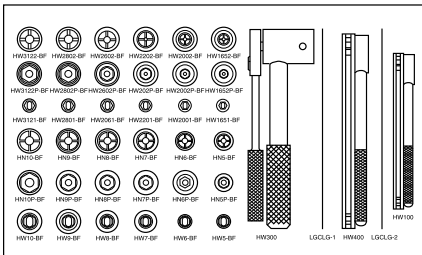

### Visu-Lok Ratchet Hand Tool (Jo-bolt) 5/32 thru 3/8

**Part No: 4000 Kit**

- Tool Box
- Ratchet Hand Tool
- Visu-Lok Grip Gauge
- Fastener Driver, (5, 6, 8, 10, 12)
- Flush Nose, (-5, -6, -8, -10, -12)
- Protruding Nose, (-5, -6, -8, -10, -12)
- Millable Nose, (-5, -6, -8)
- Reduced Flush Nose, (-5, -6, -8, -10, -12)

### Lockfast Composi-Lok Right Angle Master Torque Driver Assembly

**Part No: 4060 Kit 5/32 thru 1/4**

- 1 Tool Box
- 2 Complete Driver Assy.
- 3 Composi-Lok Grip Gauge
- 4 Master Torque Driver
- 5 Fastener Drivers, (5, 6, 8)
- 6 Reduced Flush Nose, (-5, -6, -8)
- 6 Protruding Nose, (-5, -6, -8)
- 6 Flush, (-5, -6, -8)

### Visu-lok Pistol Master Torque Driver (Jo-bolt) 5/32 thru 3/8

**Part No: 4090 Kit**

- 1 Tool Box
- 2 Pneumatic Motor & Master Driver
- 3 Grip Gauge
- 4 Flush Nose, (-5, -6, -8, -10, -12)
- 5 Protruding Nose, (-5, -6, -8, -10, -12)
- 6 Millable Nose, (-5, -6, -8, -10, -12)

Manufactured in the U.S.A. by our affiliated company, HP-Omni Manufacturing and Zephyr, major suppliers to Boeing Aircraft. Our Clecos are plier operated, spring loaded with a durable steel plated body. Designed for sheets that require precise holding of the material while other operations are completed. Fasteners are the standard button plunger type "Clecos." Use TP74 manual plier or US902 pneumatic installation tool for ease of operation.

## CLECO FASTENERS



"C" Type		
Part No.	Material Capacity	Drill Size
C-1/16	0" - 1/4"	1/16"
C-3/32	0" - 1/4"	#40
C-1/8	0" - 1/4"	#30
K-27	0" - 1/4"	#27
C-5/32	0" - 1/4"	#20
K-4.5mm	0" - 1/4"	#16
C-3/16	0" - 1/4"	#10
K-7/32	0" - 1/4"	#2
K-1/4	0" - 1/4"	1/4"



"CHD" Type (Heavy Duty)		
Part No.	Material Capacity	Drill Size
CHD-3/32	0" - 1/2"	#40
CHD-1/8	0" - 1/2"	#30
CHD-5/32	0" - 1/2"	#20
CHD-3/16	0" - 1/2"	#10
KHD-7/32	0" - 1/2"	#2
KHD-1/4	0" - 1/2"	1/4"



"CL" Type		
Part No.	Material Capacity	Drill Size
CL-3/32	1/4" - 1/2"	#40
CL-1/8	1/4" - 1/2"	#30
CL-5/32	1/4" - 1/2"	#20
CL-3/16	1/4" - 1/2"	#10



Mini "CC" Type (Heavy Duty)		
Part No.	Material Capacity	Drill Size
CC-3/32	0" - 1/4"	#40
CC-1/8	0" - 1/4"	#30
CC-5/32	0" - 1/4"	#20
CC-3/16	0" - 1/4"	#10

*Note: TP75NM can be installed on fasteners at an extra charge.*



Cleco Kits		
Part No.	Type	Description
CK-40	"C"	40 pcs., 10 each
CK-80	"C"	80 pcs., 20 each
CLK-40	"CL"	40 pcs., 10 each
CLK-80	"CL"	80 pcs., 20 each
CHDK-40	"CHD"	40 pcs., 10 each
CHDK-80	"CHD"	80 pcs., 20 each
CCK-40	"CC"	40 pcs., 10 each
CCK-80	"CC"	80 pcs., 20 each

"KEL" Type		
Part No.	Material Capacity	Drill Size
KEL-3/32	1/2" - 3/4"	#40
KEL-1/8	1/2" - 3/4"	#30
KEL-5/32	1/2" - 3/4"	#20
KEL-3/16	1/2" - 3/4"	#10

## HEX/WING NUT TEMPORARY FASTENERS

- Spin-free design allows nut to completely back off
- High clamping force
- Metric fasteners available



Hole Diameter	Part No. Hex Nuts	Grip Range	Part No. Wing Nut	Grip Range	Color Code	Drill Size
3/32"	CHN-FW-3/32	0" - 1/2"	CWN-FW-3/32	0" - 1/2"	Silver	#40
	CHNL-FW-3/32	0" - 1"	CWNL-FW-3/32	0" - 1"		
	KHNEL-FW-3/32	1/2" - 1-1/2"	KWNL-FW-3/32	1/2" - 1-1/2"		
1/8"	CHN-FW-1/8	0" - 1/2"	CWN-FW-1/8	0" - 1/2"	Copper	#30
	CHNL-FW-1/8	0" - 1"	CWNL-FW-1/8	0" - 1"		
	KHNEL-FW-1/8	1/2" - 1-1/2"	KWNL-FW-1/8	1/2" - 1-1/2"		
5/32"	CHN-FW-5/32	0" - 1/2"	CWN-FW-5/32	0" - 1/2"	Black	#20
	CHNL-FW-5/32	0" - 1"	CWNL-FW-5/32	0" - 1"		
	KHNEL-FW-5/32	1/2" - 1-1/2"	KWNL-FW-5/32	1/2" - 1-1/2"		
3/16"	CHN-FW-3/16	0" - 1/2"	CWN-FW-3/16	0" - 1/2"	Brass	#10
	CHNL-FW-3/16	0" - 1"	CWNL-FW-3/16	0" - 1"		
	KHNEL-FW-3/16	1/2" - 1-1/2"	KWNL-FW-3/16	1/2" - 1-1/2"		
7/32"	KHN-FW-7/32	0" - 1/2"	KWN-FW-7/32	0" - 1/2"	Silver	7/32"
	KHNL-FW-7/32	0" - 1"	KWNL-FW-7/32	0" - 1"		
1/4"	KHN-FW-1/4	0" - 1/2"	KWN-FW-1/4	0" - 1/2"	Copper	1/4"
	KHNL-FW-1/4	0" - 1"	KWNL-FW-1/4	0" - 1"		
	KHNEL-FW-1/4	1/2" - 1-1/2"	KWNL-FW-1/4	1/2" - 1-1/2"		
5/16"	KHN-FW-5/16	0" - 1/2"	KWN-FW-5/16	0" - 1/2"	Black	5/16"
	KHNL-FW-5/16	0" - 1"	KWNL-FW-5/16	0" - 1"		
	KHNEL-FW-5/16	1/2" - 1-1/2"	KWNL-FW-5/16	1/2" - 1-1/2"		

Note: TP109NM can be installed on fastener at an extra charge.

## NO-MAR SHEET METAL FASTENERS

- Instantly spins up or down with the flick of a finger
- Specially designed tip provides maximum gripping strength
- No-mar plastic caps are color coded for easy identification

Part No.	Standard Length		
	Material Capacity	Drill Size	Color Code
TPSSL-3/32	0" - 1/4"	#40	Red
TPSSL-1/8	0" - 1/4"	#30	Yellow
TPSSL-5/32	0" - 1/4"	#20	Blue
TPSSL-3/16	0" - 1/4"	#10	Black
TPSEL-3/32	0" - 1/2"	#40	Red
TPSEL-1/8	0" - 1/2"	#30	Yellow
TPSEL-5/32	0" - 1/2"	#20	Blue
TPSEL-3/16	0" - 1/2"	#10	Black
TPSEL-1/4	0" - 1/2"	1/4"	White



TPSSL

## SIDE GRIP TYPE SHEET METAL FASTENERS

"Side Grip" Type		
Part No.	Material Capacity	Reach
CSG-1/2-1/2	0" - 1/2"	1/2"
CSG-3/4-1/2	0" - 3/4"	1/2"
CSG-1/2-1	0" - 1/2"	1"
CSG-3/4-1	0" - 3/4"	1"



## SIDE GRIP TYPE SHEET METAL FASTENERS

- Apply in a fraction of the time required for ordinary screw clamps
- Assures uniform pressure
- Steel alloy yoke & steel spring provides 70 lbs. of force

Part No.	Throat Depth	Jaw Capacity
AIT542	2"	0" - 7/16"
AIT543	3"	1/4" - 1/2"



## QUICK-CLAMP LEVER LOCKS

Part No.	Clamp Capacity	Jaw Depth
W1	0" - 5/32"	1"
W2	0" - 5/32"	1-1/2"



## PROTECTIVE CAPS FOR SHEET METAL FASTENERS

- Caps are easily installed
- Caps installed on fastener at extra charge
- TP75NM for all except CC Series
- Polyurethane - Black

Part No.	Hole Diameter
TP75NM	1/16" - 3/16"
TP109NM	3/32" - 1/4"



TP75NM



TP109NM

## TEMPORARY FASTENER PLIERS

- Designed for the installation of C, CC, CHD, M, MHD, CSG, etc.
- Compatible with all spring loaded type fasteners: Cleko-Lok, Monogram and Zephyr

Part No.	Type
TP74	Pliers without grips
TP74V	With vinyl handle grips
TP74B	Reverse Plier



TP74V



TP74B

## SPRING TEMPORARY FASTENER INSTALLATION TOOL

- 6' hose included

Standard Nose		
Part No.	Overall Length	Weight
US902	5-1/2"	.75 lbs.



US902



US902E

Extended Nose		
Part No.	Overall Length	Weight
US902E	9-1/2"	1.0 lbs.

## WING/HEX BODY TEMPORARY FASTENER DRIVER

Developed to install all types of wing nut and hex nut reusable fasteners. Can be used with any power tool that has a 1/4" capacity chuck or a 1/4" hex female spindle. We recommend a driving tool with an adjustable clutch since damage to the aircraft structure can occur if excessive torque is applied.



TP835



Part No.	Overall Length	Weight
TP835	3-1/2"	.14 lbs.

## SIOUX HEX BODY TEMPORARY FASTENER INSTALLATION TOOL

Pistol Grip				
Part No.	RPM (no load)	Torque	Overall Length	Weight
SR9A-25	2500	55 in-lbs.	9-1/4"	2.7 lbs.



SR9A-25

"Z" Handle Type				
Part No.	RPM (no load)	Torque	Overall Length	Weight
2S2300SR	2500	55 in-lbs.	5-3/4"	2.6 lbs.

2S2300SR

## CYLINDRICAL BODY TEMPORARY FASTENER INSTALLATION TOOL

- No 'fastener to tool' orientation problems, drives all diameter and grip accommodations
- Patented roller bearing drive system allows faster installation and removal
- A lightweight and compact tool with adjustable clamping loads from 100 to 600 lbs.

Part No.	Description
CBHT-01	Manual Installation & Removal Tool
W500-30-931	Pneumatic Installation & Removal Tool



W500-30-931

## CYLINDRICAL BODY TEMPORARY FASTENERS

- Lightweight and efficient fasteners with a unique cylindrical design
- Longer lasting reusability with a maximum 100 lbs. clamping pressure
- Larger diameter available
- Metric sizes available; please inquire



CBXL

Hole Diameter	Part No. Standard	Grip Range	Color Code	Drill Size
3/32"	CBX-3/32	0" - 1/2"	Zinc	#40
	CBXL-3/32	1/2" - 1"		
	CBXEL-3/32	1/2" - 1-1/2"		
1/8"	CBX-1/8	0" - 1/2"	Copper	#30
	CBXL-1/8	1/2" - 1"		
	CBXEL-1/8	1/2" - 1-1/2"		
	CBXK-1/8	2" - 2-1/2"		
5/32"	CBX-5/32	0" - 1/2"	Black	#20
	CBXL-5/32	1/2" - 1"		
	CBXEL-5/32	1/2" - 1-1/2"		
	CBXK-5/32	2" - 2-1/2"		
3/16"	CBX-3/16	0" - 1/2"	Brass	#10
	CBXL-3/16	1/2" - 1"		
	CBXEL-3/16	1/2" - 1-1/2"		
	CBXK-3/16	2" - 2-1/2"		
7/32"	CBX-7/32	0" - 1/2"	Zinc	#2
	CBXL-7/32	1/2" - 1"		
	CBXEL-7/32	1/2" - 1-1/2"		
	CBXK-7/32	2" - 2-1/2"		
1/4"	CBX-1/4	0" - 1/2"	Copper	F
	CBXL-1/4	1/2" - 1"		
	CBXEL-1/4	1/2" - 1-1/2"		
	CBXK-1/4	2" - 2-1/2"		

## APEX® SLOTTED INSERT BITS



**445-1X**

1/4" Hex				
Part No.	Screw Size	Blade Thickness	Blade Width	OAL
445-1X	4F-5R	.034"	3/16"	1"
445-2X	6F-8R	.040"	7/32"	1"
445-3X	8F-10R	.042"	1/4"	1"
445-4X	10F-12R	.046"	9/32"	1"
445-5X	12F-14R	.050"	5/16"	1-1/2"
445-6X	14F-16R	.055"	23/64"	1-1/2"



**480-2X**

5/16" Hex				
Part No.	Screw Size	Blade Thickness	Blade Width	OAL
485-1X	8F-10R	.042"	3/16"	1-1/2"
485-2X	10F-12R	.046"	7/32"	1-1/2"
485-3X	12F-14R	.050"	1/4"	1-1/2"
445-4X	14F-16R	.055"	19/64"	1-1/2"

## APEX® SLOTTED POWER BITS

- Longer lengths available

1/4" Hex				
Part No.	Screw Size	Blade Thickness	Blade Width	OAL
320-1X	4F-5R	.034"	.187"	1-15/16"
320-2X	6F-8R	.036"	.250"	1-15/16"
320-4X	8F-10R	.042"	.275"	1-15/16"
320-5X	10F-12R	.046"	.312"	1-15/16"
320-6X	12F-14R	.050"	.360"	1-15/16"



**320-2X**

## LIMITED CLEARANCE PHILLIPS INSERT BITS

1/4" Hex Drive		
Part No.	Point Size	OAL
446-1X	1	1"
446-2X	2	1"
446-3X	3	1"



**446-2X**

## APEX® PHILLIPS INSERT BITS



**480-2X**

1/4" Hex Drive		
Part No.	Point Size	OAL
440-1X	1	1"
440-2X	2	1"
440-3X	3	1"
440-4X	4	1-5/16"

5/16" Hex Drive		
Part No.	Point Size	OAL
480-1X	1	1-1/4"
480-2X	2	1-1/4"
480-3X	3	1-1/4"
480-4X	4	1-1/4"



## APEX® PHILLIPS ACR INSERT BITS

- ACR anti-camout bits prevent workpiece damage and permit higher torque
- Special wing-face ribs grip screw recesses to prevent stripping



480-2-ACR2-RX

1/4" Hex Insert ACR			
Part No.	Type	Point	OAL
440-1-ACR1-RX	Removal	1	1"
440-1-ACR1-DX	Driving	1	1"
440-1-ACR1X	Both	1	1"
440-2-ACR2-RX	Removal	2	1"
440-2-ACR2-DX	Driving	2	1"
440-2-ACR2X	Both	2	1"
440-2-ACR2-DX	Both	2	1"
440-3-ACR3-RX	Removal	3	1"
440-3-ACR3-DX	Driving	3	1"
440-3-ACR3X	Both	3	1"

5/16" Hex Insert ACR			
Part No.	Type	Point	OAL
480-2-ACR2-RX	Removal	2	1-1/4"
480-2-ACR2X	Both	2	1-1/4"
480-3-ACR3X	Both	3	1-1/4"
480-3-ACR3X	Both	4	1-1/4"

## APEX® PHILLIPS ACR POWER BITS

- ACR anti-camout bits prevent workpiece damage and permit higher torque
- Special wing-face ribs grip screw recesses to prevent stripping



492-ACR2-RX

1/4" Hex Power ACR			
Part No.	Type	Point	OAL
491-ACR1-RX	Removal	1	1-15/16"
491-ACR1-DX	Driving	1	1-15/16"
491-ACR1X	Both	1	1-15/16"
492-ACR2-RX	Removal	2	1-15/16"
492-ACR2-DX	Driving	2	1-15/16"
492-ACR2X	Both	2	1-15/16"

1/4" Hex Power ACR			
Part No.	Type	Point	OAL
493-ACR3-RX	Removal	3	1-15/16"
493-ACR3-DX	Driving	3	1-15/16"
493-ACR3X	Both	3	1-15/16"

Note: Available without ACR. Example: 492X

## APEX® BIT HOLDERS



855

Hex Bit Holder			
Part No.	Drive	Hex Size	OAL
825	1/4" sq.	1/4"	1"
838	3/8" sq.	1/4"	1-1/2"
835	3/8" sq.	5/16"	1-1/2"
858	1/2" sq.	1/4"	1-3/4"
855	1/2" sq.	5/16"	1-3/4"



M490

Hex Bit Holder			
Part No.	Drive	Hex Size	OAL
490	1/4" sq.	1/4"	2-1/8"
M490	1/4" sq.	1/4"	2-31/32"
498	1/4"	5/16"	2-3/8"
M498	1/4"	5/16"	3-1/16"

Note: "M" for magnetic.

## APEX® TORQ-SET BITS



**212-2**

1/4" Hex Insert		
Part No.	Point	OAL
212-0	0	1"
212-1	1	
212-2	2	
212-3	3	
212-4	4	
212-5	5	
212-6	6	
212-8	8	
212-10	10	
212-1/4	1/4"	



**212-6-ACR**

1/4" Hex Insert ACR		
Part No.	Point	OAL
212-6-ACR	6	1-1/4"
212-8-ACR	8	
212-10-ACR	10	
212-1/4-ACR	1/4"	



**212-8A**

5/16" Hex Insert		
Part No.	Point	OAL
212-8A	8	1-1/4"
212-10A	10	
212-1/4A	1/4"	
212-5/16A	5/16"	
212-3/8A	3/8"	

*Note: ACR removal only.*

5/16" Hex Insert ACR (Removal)		
Part No.	Point	OAL
212-1/4A-ACR	1/4"	1-1/4"
212-5/16A-ACR	5/16"	



**170-2**

1/4" Hex Power Drive		
Part No.	Point	OAL
170-0	0	1-1/4"
170-1	1	
170-2	2	
170-3	3	
170-4	4	
170-5	5	
170-6	6	
170-6-ACR	6	
170-8	8	
170-8-ACR	8	
170-10	10	
170-10-ACR	10	
170-1/4R	1/4"	
170-5/16R	5/16"	
170-3/8R	3/8"	



**170-8A**

**170-10A**

5/16" Hex Power Drive		
Part No.	Point	OAL
170-8A	8	1-1/4"
170-10A	10	
170-1/4A	1/4"	
170-5/16A	5/16"	
170-3/8A	3/8"	



**170-1/4**

7/16" Hex Power Drive		
Part No.	Point	OAL
170-1/4	1/4"	1-1/4"
170-5/16	5/16"	
170-3/8	3/8"	
170-7/16	7/16"	



**170-1/4-ACR**

7/16" Hex Power Drive ACR*		
Part No.	Point	OAL
170-1/4-ACR	1/4"	1-1/4"
170-5/16-ACR	5/16"	

*Note: ACR removal only.*



**170-1/2**

5/8" Hex Power Drive		
Part No.	Point	OAL
170-1/2	1/2"	1-1/4"
170-9/16	9/16"	
170-5/8	5/8"	

APEX® TRI-WING BITS



**TWD-2**

1/4" Hex Insert				
Part No.	Point Size	Screw Size Tension Head	Screw Size Shear Head	OAL
TWD-0	0	0-80	-	1"
TWD-1	1	2-56	4-40	
TWD-2	2	4-40	6-32	
TWD-3	3	6-32	8-32	
TWD-4	4	8-32	10-32	
TWD-4-ACR	4	8-32	10-32	
TWD-5	5	10-32	1/4"-28	
TWD-5-ACR	5	10-32	1/4"-28	
TWD-6	6	1/4"	5/16"	
TWD-7	7	5/16"	3/8"	



**TWA-6**

5/16" Hex Power Drive				
Part No.	Point Size	Screw Size Tension Head	Screw Size Shear Head	OAL
TWA-6	6	1/4"-28	5/16"-24	1-1/4"
TWA-7	7	5/16"-24	3/8"-24	
TWA-8	8	3/8"-24	7/16"-20	



**TW-6**

7/16" Hex Power Drive				
Part No.	Point Size	Screw Size Tension Head	Screw Size Shear Head	OAL
TW-6	6	1/4"-28	5/16"-24	1-1/4"
TW-7	7	5/16"-24	3/8"-24	



**TW-2**

1/4" Hex Power Drive				
Part No.	Point Size	Screw Size Tension Head	Screw Size Shear Head	OAL
TW-0	0	0-80	-	1-1/4"
TW-1	1	2-56	4-40	
TW-2	2	4-40	6-32	
TW-3	3	6-32	8-32	
TW-4	4	8-32	10-32	
TW-5	5	10-32	1/4"-28	
TWB-6	6	1/4"-28	5/16"-24	
TWB-7	7	5/16"-24	3/8"-24	
TWB-8	8	3/8"-24	7/16"-20	



**TWE-4**

5/16" Hex Insert				
Part No.	Point Size	Screw Size Tension Head	Screw Size Shear Head	OAL
TWE-4	4	8-32	10-32	1-1/4"
TWE-5	5	10-32	1/4"-28	

Note: ACR removal only.

## APEX® HI-TORQUE BITS



**HTN-B-2**

### 1/4" Hex - 1-1/4" OAL

Part No.	Screw Size	Body Dia.	Blade Thickness	Blade Width	Recess
HTN-B-1	3,4,5,6	9/32"	.049"	.274"	1
HTN-B-2	8	5/16"	.059"	.295"	2
HTN-B-3	10	3/8"	.059"	.377"	3
HTN-B-4	1/4	1/2"	.073"	.502"	4



**HTS-3A**

### 3/8" Square Drive - 1-1/4" OAL

Part No.	Screw Size	Body Dia.	Blade Thickness	Blade Width	Recess
HTS-3A	10	9/32"	.049"	.274"	3
HTS-4A	1/4	5/16"	.059"	.295"	4
HTS-5	5/16	3/8"	.059"	.377"	5
HTS-6	3/8	1/2"	.073"	.502"	6



**HTS-2**

### 1/4" Square Drive - 1" OAL

Part No.	Screw Size	Body Dia.	Blade Thickness	Blade Width	Recess
HTS-0	0,1,2	1/2"	.029"	.167"	0
HTS-1	3,4,5,6	1/2"	.049"	.274"	1
HTS-2	8	1/2"	.059"	.295"	2
HTS-3	10	1/2"	.059"	.377"	3
HTS-4	1/4	1/2"	.073"	.502"	4



**HTS-7**

### 1/2" Square Drive - 1-1/4" OAL

Part No.	Screw Size	Body Dia.	Blade Thickness	Blade Width	Recess
HTS-7	7/16	1"	.112"	.884"	7
HTS-8	1/2	1"	.142"	.995"	8
HTS-9	9/16	1-1/4"	.162"	1.136"	9
HTS-10	5/8	1-1/4"	.182"	1.250"	10
HTS-12	3/4	1-1/4"	.216"	1.500"	12

## HI-TORQUE BITS



### 1/4" Square Drive - 1" OAL

Part No.	Screw Size	Body Dia.	Blade Thickness	Blade Width	Recess
ZHTS-0	0,1,2	1/2"	.029"	.167"	0
ZHTS-1	3,4,5,6	1/2"	.049"	.274"	1
ZHTS-2	8	1/2"	.059"	.295"	2
ZHTS-3	10	1/2"	.059"	.377"	3
ZHTS-4	1/4	1/2"	.073"	.502"	4

### 3/8" Square Drive - 1-1/4" OAL

Part No.	Screw Size	Body Dia.	Blade Thickness	Blade Width	Recess
ZHTS-3A	10	9/32"	.049"	.274"	3
ZHTS-4A	1/4	5/16"	.059"	.295"	4
ZHTS-5A	5/16	3/8"	.059"	.377"	5
ZHTS-6A	3/8	1/2"	.073"	.502"	6

### 1/2" Square Drive - 1-5/8" OAL

Part No.	Screw Size	Body Dia.	Blade Thickness	Blade Width	Recess
HTS-7	7/16	1"	.112"	.884"	7
HTS-8	1/2	1"	.142"	.995"	8

## SIOUX® RATCHET WRENCHES

- For light duty assembly and repair work
- Reverse button and teasing throttle
- Composite grip
- Steel angle head



SX5009



SX5011

1/4" Drive						
Part No.	RPM (no load)	Max. Torque	Square Drive	Bolt Capacity	Weight	OAL
SX5009	265	5-15 ft-lbs.	1/4	5/16	1.5 lbs.	6.6"

3/8" Drive						
Part No.	RPM (no load)	Max. Torque	Square Drive	Bolt Capacity	Weight	OAL
SX50011	185	50 ft-lbs.	3/8	7/16	2.6 lbs.	10.8"

1/2" Drive						
Part No.	RPM (no load)	Max. Torque	Square Drive	Bolt Capacity	Weight	OAL
SX50013	185	50 ft-lbs.	1/2	7/16	2.6 lbs.	10.8"

## SIOUX® IMPACT WRENCHES

- Built-in air regulator for positive speed and torque control
- Friction ring socket retainer



SX5038B



SX5045

3/8" Pistol Grip						
Part No.	RPM (no load)	Max. Torque	Square Drive	Bolt Capacity	Weight	OAL
SX5038B	8500	185 ft-lbs.	3/8	3/8	3.7 lbs.	6.3"

3/8" Pistol Grip						
Part No.	RPM (no load)	Max. Torque	Square Drive	Bolt Capacity	Weight	OAL
SX5045	9500	175 ft-lbs.	3/8	3/8	2.5 lbs.	7.6"

3/8" Pistol Grip						
Part No.	RPM (no load)	Max. Torque	Square Drive	Bolt Capacity	Weight	OAL
SX5000	8000	425 ft-lbs.	1/2	5/8	5.6 lbs.	7.4"

## REVERSIBLE IMPACT DRIVER

- Two knurled bands for sure grip
- Quick action reversing ring
- May also be used with impact sockets
- Includes metal case

Part No.	Square Drive	Bits Included
TP130	3/8"	#2 & 3 Phillips, 5/16" & 9/32" Slotted



TP130

**Air Tool Services +44 (0)1772  
557700**

## JET ECONOMY SCREWDRIVERS

- Quick action reversing valve and quick change chuck
- Variable speed trigger for positive control on pistol models
- Ball and needle bearing construction for efficient performance
- Adjustable clutch



**JSM-812**

Pistol Grip 0.5 HP - 1/4" Hex				
Part No.	RPM (no load)	Torque Range	Weight	OAL
JSM-812	1800	45 to 115 in-lbs.	4 lbs.	7"

Lever Grip 0.5 HP - 1/4" Hex				
Part No.	RPM (no load)	Torque Range	Weight	OAL
JSM-842	1800	45 to 115 in-lbs.	4 lbs.	10"
JSM-843	800	45 - 145 in-lbs.	3.5 lbs.	11"

## CLECO SCREWDRIVERS

- Designed to handle high-volume assembly line tasks
- Ergonomically designed housing is low vibration and lightweight
- Reversible motor with low-force tapered trigger (sliding knob)
- 1/4" quick change
- External torque adjustment
- Made in the U.S.A.



**14TTA**

Pistol Grip 0.5 HP - 1/4" Hex					
Part No. Large Handle	Screw Size	RPM (no load)	Max. Torque	Weight	OAL
14TTA04Q	#10	1100	3 to 40 in-lbs.	1.9 lbs.	8.3"

## 1/4" SQUARE ANGLE ATTACHMENT

- 1/4" square drive - male
- 1/4" square drive - female
- Takes 1/4" hand ratchets only
- Not recommended for power tools

Angle Attachment		
Part No.	Head Height	OAL
5-3	1-5/8"	7-1/4"



**5-3**

## BRUTUS® SCREW EXTRACTOR

- Used on tip caps for copters
- Chosen to standardize aircraft and missile maintenance DOD wide
- Works on Phillips, Tri-Wing and Hi-Torque
- Heat-treated, plated and built for a lifetime
- Folds up for easy storage with accessory compartment in handle



TP855

Part No.	For Screws	Weight	OAL (open)
TP855	#8 to #14	3.2 lbs.	17"
TP855-7	1/4" to 3/8"	4.5 lbs.	18-3/4"

**Note:** Bits and ratchet not included.

## STRAIGHT-FLUTE SCREW EXTRACTOR SETS

- Straight flute extractors will not expand material removed (easier removal)
- Includes plastic pouch

Part No.	Description	Extractor Included
AIT53625	4 pc. set	#2, 3, 4 & 5
TP9500A	5 pc. set	#1, 2, 3, 4 & 5
AIT53645	6 pc. set	#1, 2, 3, 4, 5 & 6



TP9500A



AIT53625

## SPIRAL FLUTE SCREW EXTRACTOR SETS

- Spiral flute extractors have an aggressive left hand spiral design for extra power
- Includes plastic pouch

Part No.	Description	Extractor Included
AIT52425	4 pc. set	#2, 3, 4 & 5
AIT53535	5 pc. set	#1, 2, 3, 4 & 5
AIT53545	6 pc. set	#1, 2, 3, 4, 5 & 6



AIT53535

## SPIRAL FLUTE SCREW EXTRACTOR &amp; DRILL BIT SET

- Spiral flute extractors have an aggressive left hand spiral design for extra power
- Each extractor is packaged with the correct size cobalt drill bit
- Metal index case

**10 Piece Kit includes:**

- Spiral Flute Extractors (#1, 2, 3, 4 & 5), Cobalt Drill Bits (5/64", 7/64", 5/32", 1/4" & 19/64") & Plastic Pouch

Part No.	Description
IRW11119	Complete Set



IRW11119

industrial power tools



EZVV? WS^7cg[b\_ Wf



## ECKOLD HF80CH HANDFORMER

This is a manually operated machine which is suitable for shrinking, stretching, punching, notching and edging in metal sheets and profiles up to 16 gauge. It is supplied with a set of FWA405SSP shrinker and FWR407SSP stretcher jaws. Many other optional jaws are available.

Reach x Gap	Capacity			Adj. Working Height	Weight	Shipping Weight
	Steel	Alum.	Stainless Steel			
3"R x 2-1/4" G	16 ga.	14 ga.	19 ga.	32-1/2" to 44-1/2"	53 lbs.	69 lbs.

Optional Jaw Assembly		
<b>Shrinking Jaws</b> FWA405SSP(STD) HS40ASSP Beaked HLFA70SSP Nomar HLA60SSP Nomar Beaked HLR60SSP Nomar Beaked	<b>Stretching Jaws</b> FWR407SSP (STD) HSR60SSP Beaked HFLR70SSP Nomar	<b>Specialty Jaws</b> LSW1SSP Punching Jaws AK250 Edging Jaws ASW442SSP Notching Jaws



## ECKOLD PA80 PNEUMATIC DRIVE KIT

The PA80 drive unit is a power assist for the HF80CH Handformer. By adding this unit to the handformer you will have both hands free to hold and guide your work piece. Every application of the air foot pedal results in a single working stroke. The amount of pressure applied to the project depends on how much you step on the pedal.

HF80CH shown with PA80 attached. To order assembled, use part number HF80CH-702.



## ECKOLD HZ51 HAND PLIER

Manually operated, plier type tool which can be used for 3 different ranges of applications. By simply changing the jaws, shrinking, stretching or clinching operations can be achieved. Clinching is the joining of 2 sheets of metal without using rivets, bolts, staples, welds, etc. Jaws are not included and must be ordered separately. Call for more information regarding clinching tooling.

Available Jaws	
FWA405SSP	Shrinker Jaw
FWR407SSP	Stretcher Jaw

Specifications			
Capacity			
Part No.	Steel	Alum.	Weight
HZ51	0.039"	0.059"	10 lbs.



## BENCH MODEL SHRINKER & STRETCHER

These exceptional metal formers are great for making smooth radius bends in sheet metal without cutting, heating, or hammering the material. Reproduce just about anything with a curved edge. Mount them on your work bench or in a vise. Use the shrinker to contract metal, to make inside curves and use the stretcher to expand the metal for outside curves. The hand operated press gives a 45-to-1 leverage, works metal up to 18 gauge mild steel, 20 gauge stainless, and 17 gauge aluminum. Specially hardened jaws are reversible for double life. Each 12 lb. unit comes completely assembled and ready to use.



**TP371**



**TP372**



**TP395**



**TP371PSS  
550NB  
STAND ONLY**



**TP371ST**

Part No.	Description	Capacity	Weight
TP371	Metal Shrinker	18 gauge mild steel 20 gauge stainless steel 17 gauge aluminum	11 lbs.
TP372	Metal Stretcher		11 lbs.
TP372C	Combo Units		13 lbs.
TP395	Deep Throat 8" Reach Shrinker		64 lbs.
TP371PSS	Complete power stand (550 NB) with foot pedal, TP371 and TP372		30 lbs.

Accessories		
Part No.	Description	Weight
TP371ST	36" high floor stand	16 lbs.
9084	Conversion Assembly (Stretcher)	.05 lbs.
9078	Conversion Assembly (Shrinker)	.05 lbs.

## FOOT OPERATED FLOOR MODEL SHRINKER & STRETCHER

- Low cost, high quality
- Small footprint: only 2' x 2' at floor
- Restippling service available for worn jaws, please inquire
- Special jaw configurations also available, please inquire
- Made in the U.S.A.
- FOB factory

Part No.	Model	Capacity*	Reach	Floor to Jaw	Shipping Weight
6F-1	Shrinker	5/64"	6"	43-1/2"	400 lbs.
6F-2	Stretcher				

\*Capacity based on a tensile strength of 70,000 psi

Accessories	
Part No.	Description
6F-A-7	Conversion Assembly (stretcher to shrinker)
6F-B-7	Conversion Assembly (shrinker to stretcher)
6F-A-3	Replacement Shrinker Jaws (4 pc. set)
6F-B-3	Replacement Stretcher Jaws (4 pc. set)



**6F**

## ECKOLD KF170PD POWER FORMER

The KF170PD is the smallest machine in the Kraftformer Series. Unique to this machine is the fact that the machine can be switched from a single stroke per pedal activation to a continuous stroke mode. This is an ideal, low cost, power unit for fabrication, correcting and adjusting. Standard equipment includes the FWA405K shrinker and FWR407K stretcher jaws.



Reach x Gap	Capacity			Working Height	Weight	Shipping Weight
	Steel	Alum.	Stainless Steel			
7"R x 4" G	16 ga.	14 ga.	19 ga.	45" (slightly adjustable)	332 lbs.	400 lbs.

Available Jaws			
<b>Shrinking Jaws</b> FWA405K (std) 40 mm FWA602K 60 mm HSA40K Beaked HFLA70K	<b>Stretching Jaws</b> FWR407K (std) 40 mm FWR603K 60 mm HSR60K Beaked HFLR70K Nomar	<b>Specialty Jaws</b> TP15K 015/15 Planishing Jaws LSW1K Hole Punch* ASW42K Notching Jaws DFW1K Clinching Tool Holder (only)**	<b>Doming Jaws</b> PFW40K 040/R min .50 PFW50K 050/R min .75

\* Punch and dies ordered separately; inquire about sizes.

\*\* Inquire regarding rectangular and round inserts.

## AIR OPERATED FLOOR MODEL SHRINKER & STRETCHER

- Handwheel screw and indicator adjustment for accurate control
- Adjustable air blow-off safety valve with air gauge
- Restippling service for worn jaws
- Small footprint: only 1-1/2' x 1-1/2' at floor
- FOB factory
- Made in the U.S.A.

12A



Part No.	Model	Capacity Stainless*	Reach	Floor to Jaw	Weight
6A-1	Shrinker	1/4" thick, 1-1/2" wide	6"	42"	575 lbs.
6A-2	Stretcher				

\* Other capacities: aluminum 2024, 1/4" x 1-1/2"; aluminum 5052, 1/4" x 2"; titanium, 5/32" x 1"

Part No.	Model	Capacity Stainless*	Reach	Floor to Jaw	Weight
12A-1	Shrinker	3/32" thick, 1" wide	12"	42"	575 lbs.
12A-2	Stretcher				

\* Other capacities: aluminum 2024, 5/32" x 1"; aluminum 5052, 3/16" x 1"; titanium, 3/32" x 3/4"

Accessories	
Part No.	Description
T3A1	Conversion Assembly (stretcher to shrinker)
T3B1	Conversion Assembly (shrinker to stretcher)
HD1A3	Replacement Shrinker Jaws (4 pc. set)
HD1B3	Replacement Stretcher Jaws (4 pc. set)

## U.S. INDUSTRIAL / ECKOLD FOOT FORMER

- Includes 1 each FWA405K & FWR407K jaws
- Designed and developed through a team effort between Eckold AG and U.S. Industrial Tool
- Ideal for use in sheet metal shops, schools, auto restoration facilities, aircraft maintenance shops and manufacturers
- Quick change tooling allows change-over in seconds
- Cast iron base with built in work shelf for tool storage
- Adjustable stroke to compensate for metal thickness
- Foot operation allows the use of both hands on large jobs
- Provides compound leverage and is much more comfortable for the operator
- Allows for greater control in correcting operations



USPFI150

Reach x Gap	Capacity			Working Height	Weight	Shipping Weight
	Steel	Alum.	Stainless Steel			
6" x 3-1/2"	16 ga.	14 ga.	19 ga.	40"	365 lbs.	420 lbs.

Available Jaws	
<b>Shrinking Jaws</b> FWA602K 60 mm HSA40K Beaked HFLA70K Nomar	<b>Stretching Jaws</b> FWR603K 60 mm HSR60K Beaked HFLR70K Nomar

## ECKOLD KF324 &amp; KF330 PICCOLO KRAFTFORMER

Both the KF324 and KF330 are driven by electric motors (specify voltage when ordering). The KF324 has a hand wheel for the jaw pressure adjustment while the KF330 is adjusted by an electro-mechanical foot pedal. The jaws can be replaced in a matter of seconds so that you can quickly change from task to task. Mounted on heavy duty casters allows you to move the units around the shop or out of the way when not in use. These units are extremely popular in auto restoration and fabrication shops, as well as throughout the aviation industry. All tooling must be ordered separately. (Specify voltage when ordering.)



Reach x Gap	Capacity			Working Height	Weight	Shipping Weight
	Steel	Alum.	Stainless Steel			
14"R x 9-1/2"G	16 ga.	14 ga.	19 ga.	45" (slightly adjustable)	970 lbs.	1125 lbs.

Available Jaws					
<b>Shrinking Jaws</b> FWA402S 40 mm FWA502S 50 mm FWA602K 60 mm LFA70S Nomar 40 x 70 mm LFA120S Nomar 70 x 120 mm HSA40K Beaked KS50S Beaked	<b>Doming Jaws</b> PFW60S 60 mm PFW80S 80 mm	<b>Planishing Jaws</b> TP15S 85/15 mm TP25S 85/25 mm	<b>Stretching Jaws</b> FWR403S 40 mm FWR603K 60 mm LFR70S Nomar 40 x 70 mm LFR90S Nomar 55 x 90 mm SW2S 60 mm	<b>Straightening Jaws</b> RWS 80 x 150 mm (Lower Part) RW-TP25S (Upper Part) RW-WT80S (Upper Part)	<b>Flattening Jaws</b> FWS60S 60 mm LFS60S Nomar 60 mm

## ECKOLD PLANISHING HAMMER KIT

The GL2 is essential for the manual cold forming of metal and aluminum sheet. A portable design where the work can be brought to the tool on the work. Any industry that has to do prototype manufacture or repairs of existing product can use this kit successfully!

- Quick Change Tooling Design
- Includes: Three (3) different forming dies for planishing, stretching and curving.
- Handy Storage Shelf "The Eckold Tool for a Perfect Finish."

Part No.	Blows per minute	Description
GL2	2500	Planishing hammer
023-400-1069	-	Stretcher insert
023-400-1066	-	Planishing insert
023-400-1067	-	Curving insert



## MITTLER BROS. PLANISHING HAMMER KIT

Speed up fabrication time on complex multi form aluminum and steel panels. This tool is ideal for making those impossible-to-find replacement parts, as well as making your own custom designs. Adjuster sets load force and makes anvil changes a breeze. Foot pedal controller frees your hands for complete control.

- 4,600 hits per minute at 90 PSI
- Bench mount
- Floor stand available

Part No.	Description
MIT2700-12	12" hammer with 9 anvils
MIT2700-24	24" hammer with 9 anvils
MIT2700-018	Flat anvil
MIT2700-010	3/4" radius anvil
MIT2700-011	1-1/2" radius anvil
MIT2700-012	2" radius anvil
MIT2700-013	3" radius anvil
MIT2700-014	4" radius anvil
MIT2700-015	6" radius anvil
MIT2700-016	8" radius anvil
MIT2700-017	12" radius anvil
MIT2700-100	9 pc. complete set
MIT3100-100	Universal tool stand



## ENGLISH WHEEL

**U.S. INDUSTRIAL ENGLISH WHEEL (Non-Powered)****What is a Wheel Machine?**

English wheel gets its name from the two steel wheels between which metal is formed. The wheels - one above and one below - are rolled against one another with a piece of sheet metal between, under a pre-adjusted pressure setting. The wheels roll as the sheet metal is moved back and forth. Shaping results as the lower wheel is forced under pressure into the metal, stretching and forming it.

It is especially useful on large panels. The wheel works equally well on aluminum or steel. Two men work together to form a large panel. The wheel can produce very smooth, very complicated curved shapes.

The upper wheel - always with a flat rolling surface - is fixed to the machine. The curve, or crown, of the interchangeable lower wheel - the roller - determines the shape of the piece being formed. The more curve in the roller, the more curve in the work. An adjustment on the lower wheel varies the amount of pressure exerted against the metal by the roller. A knob below the roller sets this pressure. In addition to the pressure adjustment, U.S. wheels have a quick-release lever. This allows the operator to drop the roller away from the upper wheel so the work can be removed and inserted quickly without losing the pressure setting. MADE IN THE U.S.A.

US1001 Specifications

Capacity	Reach	Opening Height Inside Tooling Post	Max. Gap W/D Lower Anvil Wheel	Overall Height	Weight
.125 thick Soft Alum.	44"	38"	3"	77-3/4"	1450 lbs.*
.063 thick Mild Steel	44"	38"	3"	77-3/4"	1450 lbs.*

\* Shipped freight collect. Export crating at extra cost.

**US1001\***

Includes 3 standard wheels:

**TP1001-1**

Anvil Wheel - 12" radius

**TP1001-2**

Anvil Wheel - 2-3/8" radius

**TP1001-3**

Anvil Wheel - 5" radius

**Optional Wheels**

(Wheels complete with axle & bearings)

**TP1001-4**

Anvil Wheel - 8-1/2" radius

**TP1001-5**

Anvil Wheel - 3-1/4" radius

**TP1001-6**

Flat Anvil Wheel



\* Shipped Freight Collect Export crating at extra cost.



## ENGLISH WHEEL/SHAPER

**U.S. Industrial  
Fournier Quick Shaper  
Part No: USFPMS-2001**

U.S. Industrial Tool has teamed with Ron Fournier, widely recognized master metal worker and international author, to create this innovative new machine. Ron's decades of experience shines through in his answer to efficient access to the most widely utilized cold working/metal forming process. Fournier recognized that sheet metal replication requires the following multiple tasks:

- Hammering for pre-forming
- Wheeling and raising of metal panel
- Shrinking or stretching
- Planishing

Ron's goal was to provide a mobile forming center that can be navigated within the shop, allowing the worker to do many tasks right at the work site, as well as store the many different forming tools needed for truly professional results.

Each machine comes equipped as follows:

- Mobile unit on large casters
- English wheel and raising machine – foot activated design with six (6) different forming rollers
- Shot bag
- Interchanged pre-forming and planishing dollies – one (1) different crown
- Foot operated shrinker
- Hands tools not included
- Throat opening: 24" deep x 19" high
- Overall height: 51"
- Replacement wheels available
- Optional stretcher jaws available
- Made in the U.S.A.
- 385 lbs.



## BOX AND PAN BRAKE

- Slotted clamping bar permits bending of any size box to 16" (1-1/2" depth)
- Can also bend 16 gauge at 8" wide
- Cam-action for quick, high pressure clamping
- Offset handles stay out of the way



Part No.	Capacity (mild steel)	Maximum Bend Length	Maximum Box Depth	Maximum Bend Angle	Minimum Reverse Bend	Shipping Weight
B16	18 ga.	16"	1-1/2"	135°	1/2"	32 lbs.

## HEAVY-DUTY BENDING BRAKES

- Rugged all steel construction with machined bending edge
- Can also bend heavier gauge in narrower widths
- Maximum 36 width stock
- Bench mount or optional stand mount
- Made in U.S.A.



Part No. Bending Brake	Capacity (mild steel)	Maximum Bend Length (unlimited throat)	Minimum Reverse Bend	Shipping Weight
B36	20 ga.	36"	1"	65 lbs.

Part No. Floor Stand	Shipping Weight
B36S	40 lbs.

## HEAVY-DUTY BENDING BRAKES

- A vice mounted tool with a capacity of 18 gauge mild steel
- Max. sheet width 24"
- Produces up to 100° folds - suitable for channel and sections
- Clamping blade is spring-lift assisted for easier operation
- Includes a protractor attachment which permits the angle of fold to be measured in degrees



Part No. Bending Brake	Capacity (mild steel)	Maximum Bend Length	Maximum Bend Angle	Minimum Reverse Bend	Shipping Weight
TP866	18 ga.	24"	135°	1/4"	29 lbs.



## TENNSMITH® BENCH BRAKES

- Welded steel plate construction
- Heavy truss rods and braces provide strength and rigidity
- Roller type thrust bearing to prevent upper leaf creep
- Dual position apron angle with removeable apron insert
- Bench stands also available\*
- Made in U.S.A.
- FOB factory



**HBU48-12**

Part No.	Capacity (mild steel)	Maximum Bend Length	Maximum Box Depth	Minimum Reverse Bend	Shipping Weight
HBU48-12	12 ga.	48-1/4"	4"	1/4"	1330 lbs.
HBU48-16*	16 ga.	48-1/4"	4"	1/4"	495 lbs.
S48S	Stand	-	-	-	95 lbs.

## TENNSMITH® HEAVY-DUTY BENCH BRAKES

- Welded steel plate construction
- Heavy truss rods and braces provide strength and rigidity
- Roller type thrust bearing to prevent upper leaf creep
- Dual position apron angle with removeable apron insert
- Heavy counterweights and apron stop rod
- Made in U.S.A.
- FOB factory



**HB97-16**

Part No.	Capacity (mild steel)	Maximum Bend Length	Minimum Reverse Bend	Shipping Weight
HB97-16	16 ga.	97"	1/4"	1675 lbs.
HB121-16	16 ga.	121"	1/4"	2875 lbs.

## JET® BENCH MODEL BOX & PAN

- Incorporates all the features of our standard hand brakes but with greater range of application
- Welded steel plate construction
- With fingers installed it can be used as a full-length nose bar, turning the machine into a straight brake
- Sectioned fingers are easily removed for box bending and special forming operations
- Total of 16 assorted size section fingers
- FOB factory



**BP2248N**

Part No.	Capacity (mild steel)	Maximum Bend Length	Minimum Box Depth	Finger Nose Radius	Shipping Weight
BP2248N	22 ga.	48"	3"	1/32"	258 lbs.
BP1648N	16 ga.	48"	4"	1/32"	441 lbs.

## NATIONAL/TENNSMITH® FOOT SQUARING SHEARS

- Sheer comes standard with tool steel blades and front arm extensions
- Includes protractor gauges, graduated slide gauges and front squaring arm
- Unit will also shear plastic, lead, zinc aluminum, brass and copper
- Made in U.S.A.
- FOB factory



36

Part No.	Capacity (mild/stainless)	Maximum Cutting Length	Gauge Ranges (back/Front)	Shipping Weight
36	16/20 ga.	37"	30"/37"	700 lbs.
52	16/20 ga.	52-1/4"	30"/37"	950 lbs.
N52-16	16/20 ga.	52"	30"/37"	980 lbs.

## JET® FOOT SHEARS

- Sheer comes standard with high carbon, chrome steel blades
- Includes finger guards and front, side and back gauges
- Unit will also shear plastic, lead, zinc aluminum, brass and copper
- A quality import
- FOB factory



FS1636N

Part No.	Capacity (mild/stainless)	Maximum Cutting Length	Gauge Ranges (back/Front)	Shipping Weight
FS1636N	16 ga.	36"	25-1/2" / 28	754 lbs.
FS1652N	16 ga.	52"	25-1/2" / 28	1100 lbs.

## NATIONAL/TENNSMITH® HYDRAULIC POWERED SQUARING SHEARS

- Sheer comes standard with tool steel blades and front arm extensions
- Includes bevel gauges, graduated slide gauges, foot control and stroke counter
- Unit has neoprene padded-hold down feet
- 75 psi maximum operating pressure (except NH5216)
- Made in U.S.A.
- FOB factory
- NH5216 240/460 volts 3 phase motor



52A

Part No.	Capacity (mild/stainless)	Maximum Cutting Length	Gauge Ranges (back/Front)	Strokes per Minute (approx.)	Shipping Weight
36A	16/20 ga.	37"	30"/37"	40	800 lbs.
52A	16/20 ga.	52-1/4"	30"/37"	40	1085 lbs.
NH5216	16/20 ga.	52"	30"/37"	25	1400 lbs.
NH5212	16/16 ga.	52"	30"/37"	25	1600 lbs.

## TENNSMITH® SLIP ROLLS

- An affordable heavy-duty production tool
- Includes 3/16", 1/4" and 5/16" wire grooves (except SR-48: 3/8", 1/2" and 5/8")
- Three full length rear starting grooves are standard
- Front mounted handle to lift upper roll for material removal
- Oilite bearings eliminate need for lubrication during the life of the unit
- Stands available
- Made in U.S.A.
- FOB factory



**SR24**

Part No. Slip Roll	Part No. Stand	Capacity (mild/stainless)	Maximum Forming Length	Minimum Forming Radius	Roll Dia.	Shipping Weight
SR24	SR24FS	20 ga.	24"	1"	2"	190 lbs.
SR36	SR36FS	22 ga.	36"	1"	2"	250 lbs.
SR42	SR42FS	24 ga.	42"	1"	2"	270 lbs.
SR48	SR48FS	16 ga.	48"	1-1/2"	3"	775 lbs.

## JET® SLIP ROLLS

- Suitable for many industrial, educational and vocational shop uses
- Precision tuned carbon steel rolls are ground and polished
- Includes 3/16", 1/4" and 5/16" wire grooves (except SR1650: 1/4", 5/16" and 3/8")
- Large roll adjusting screws and front mounted handle
- Stands available
- FOB factory



**SR2024N**

Part No. Slip Roll	Part No. Stand	Capacity (mild/stainless)	Maximum Forming Length	Minimum Forming Radius	Roll Dia.	Shipping Weight
SR2024	SRS24N	20 ga.	24"	1"	2"	182 lbs.
SR2236	SRS36N	22 ga.	36"	1"	2"	240 lbs.
SR1650N	SRS50N	16 ga.	50"	2"	3"	600 lbs.

## JET® SHEAR, BRAKE & ROLL COMBO

- Includes applicable dies, dual edge shear blade and back gauge
- Brake equipped with removeable fingers for complex bending operations
- Right or left hand operation
- FOB factory



**SBR30**

Part No. Slip Roll	Part No. Stand	Capacity (mild/stainless)	Slip Roll Size	Upper Die Height*	Minimum Forming Radius	Shipping Weight
SBR30N	SRS30N	20 ga. @ 30" wide	30" x 1-1/2"	4-3/8"	3/4"	320 lbs.
SBR40N	SRS40N	20 ga. @ 40" wide	40" x 1-5/8"	3-3/8"	1"	575 lbs.

## TENNSMITH® NOTCHER

- Front gauges and large surface ground work table standard
- Straight shearing: notches over 90° are accomplished in two operations
- Especially useful where box, chassis and panel blanks are to be made
- Reversible upper blades
- Made in U.S.A.
- Stand available

Part No.	Capacity (mild steel)	Blades Included	Shipping Weight
16-18	16 ga. (notching)	Regular	170 lbs.
16-18BF	18 ga. (piercing)	Tab	170 lbs.



16-18

## JET® NOTCHER

- Front gauges and large surface ground work table standard
- Straight shearing: notches over 90° are accomplished in two operations
- Especially useful where box, chassis and panel blanks are to be made
- Reversible upper blades
- FOB factory

Part No.	Capacity (mild steel)	Blades Included	Shipping Weight
HN16N	16 ga. (notching)	Regular	66 lbs.
S16N	Stand	–	90 lbs.



HN16N

## TENNSMITH® HAND ROTARY MACHINE

- Six rolls included: beading, turning, closing, jogging, flanging and crimping
- Adjustable roll pressure and table mount with clamp standard
- Can be used in both forward and reverse
- Operation is smooth, fast and precise
- Made in the U.S.A.

Part No.	Capacity (mild steel)	Throat	Height	Shipping Weight
R22	22 ga.	7"	16"	67 lbs.



R22

## JET® HAND ROTARY MACHINE

- Six rolls included: beading, turning, closing, jogging, flanging and crimping
- Adjustable roll pressure and table mount with clamp standard
- Can be used in both forward and reverse
- Operation is smooth, fast and precise

Part No.	Capacity (mild steel)	Throat	Height	Shipping Weight
RM22N	22 ga.	7"	16"	60 lbs.



RM22N

## BEVERLY THROATLESS SHEARS

- Ideal all-purpose metal cutting tools
- Units allow any cut in heavy gauges, yet handle lighter materials without distortion
- Alloy steel rack and pinion for great power with little effort
- Removeable handle for easy portability (not shown)
- Two-point lower blade adjustment
- Exclusive shoulder design permits turning work to any shape or position



**B1**

Part No. Shears	Part No. Extra Blade Pair	Capacity (mild/stainless)	Blade Length	Height Less Handle	Overall Length	Weight
B1	B-1-1	14/18 ga.	4-1/2"	14"	9"	18 lbs.
B2	B-2-1	10/14 ga.	4-3/8"	14"	10"	35 lbs.
B3	B-3-1	3/16" / 10 ga.	5-5/8"	15"	14"	58 lbs.
B-Stand		Floor stand for above				25 lbs.

## BEVERLY SLITTING SHEAR

Part No.	Part No. Blade Pair	Capacity (mild/stainless)	Blade Cut Length	Weight
SS2	SS2-1	10/14 ga.	3-1/2"	10.5 lbs.
SS3	SS3-1	3/16 / 1/4 ga.	4-1/4"	25 lbs.
B-Stand		Floor stand for above		25 lbs.



**SS2**

## JET® SLITTING SHEAR

Part No.	Capacity (mild/stainless)	Blade Cut Length	Weight
SS-8N	3/16 / 1/4 ga.	2-3/4"	49 lbs.
SS-12N	10/14 ga.	2-3/8"	48 lbs.
B-Stand	Floor stand for above		25 lbs.



**SS-8N**

## ZT MICRO-STOP COUNTERSINK CAGE

- Hardened and ground spindles
- Ball thrush and bronze bearings



**330S**

Part No.	Max. Capacity	Shaft Travel	Depth Adjustment	Max. RPM
330S	5/8"	9/32"	0.001"	3000

### Replacement Skirts

Image	Type	Part No.
	Bell 7/8" Cap	ZT330013
	Flange S	ZT63008
	Flange N	ZT33005N
	Swage 5/16" Cap	ZT330018
	Cutaway	ZT330017

## NYLON FLANGE SKIRT MICRO-STOP COUNTERSINK CAGE

- Compact and heavy-duty
- Bronze bearings
- Postive stop to connect shaft eliminates work damage
- 1.250 nylon flange on TP61N



**TP61N**



**TP61M**

Part No.	Max. Capacity	Shaft Travel	Depth Adjustment	Max. RPM
TP61N	5/8"	9/32"	0.001"	3000
TP61M	7/16"	9/32"	0.001"	3000

Note: TP61M has steel skirt

## MICRO-STOP COUNTERSINK CAGE

- Hardened and ground spindles
- Double bearings and precision depth control



**TP61BB**

Part No.	Max. Capacity	Shaft Travel	Depth Adjustment	Max. RPM
TP61BB	5/8"	9/32"	0.001"	10000

### Replacement Skirts for TP61, TP61N, TP61BB and ATI441

Image	Type	Part No.
	Bell 3/4" Cap	TP61BL-1
	Flange S	TP61WF-1
	Flange N	TP61WF-1T
	Colose 5/16" Cap	TP61CT-1
	Cutaway	TP61ST-1

## THREADED SHANK MICRO-STOP COUNTERSINK CAGE

- 1/4"-28 shaft thread
- Postive adjustment lock



**AIT362**

Part No.	Max. Capacity	Shaft Travel	Depth Adjustment	Max. RPM
AIT362	5/8"	3/32"	0.001"	3000

## EXTENDED MICRO-STOP COUNTERSINK CAGE

- Hardened and ground spindles
- Bronze bearings and precision depth control
- See page ?? for cutters



**AIT284**

Part No.	Max. Capacity	O.D.	Shaft Travel	Depth Adjustment	RPM
AIT284-A	1/4"	.375	9/32"	0.001"	3000
AIT284-B	5/16"	.425	9/32"	0.001"	3000
AIT284-C	3/8"	.500	9/32"	0.001"	3000
AIT284-D	5/8"	.750	9/32"	0.001"	3000

*Note: AIT284-A has 10/32 thread*

## EXTENDED TRAVEL MICRO-STOP COUNTERSINK CAGE

- Compact and heavy-duty
- Dual bearings for continuous high-speed use
- Positive stop to connect shaft eliminates work damage
- 1-1/2" travel allows users the all-in-one operation of drilling-reaming-countersinking all at once and with precision hole diameter and depth control

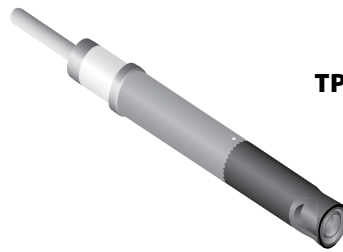

**TP61BBEX**

Part No.	Max. Capacity	Shaft Travel	Depth Adjustment	Max. RPM
TP61BBEX	3/8"	1-1/2"	0.001"	10000

## JUMBO MICRO-STOP COUNTERSINK CAGE

- Hardened and ground spindles, 3/8" shaft diameter, 3/8-24 thread
- Bronze bearings and precision depth control
- See page 153 for cutters



**TP59**

Part No.	Max. Capacity	Shaft Travel	Depth Adjustment	Max. RPM
TP59	1-1/4"	1/2"	0.001"	3000

## SNAP ON TYPE NYLON PROTECTIVE FOOT PIECE

- Just snap-on and snap-off protector

Part No.	ID	OD
286-1	.499	.750"
346-1	.680	.875"
304-1	.859	1.00"



**286-1**

## ATI MICRO-STOP COUNTERSINK CUTTER KIT

- Countersink versatility in a convenient and portable kit

**Kit Includes:**

- Countersink cage
- Six foot pieces
- 9 1/2" diameter cutters (3/32", 1/8", 5/32", 3/16", 1/4", #40, #30, #21 and #10)
- Plastic case

Part No.	Description
AT590CSK	17 pc. Countersink Cutter Kit

AT590CSK



## AERO MICRO-STOP COUNTERSINK CUTTER KIT

- Countersink versatility in a convenient and portable kit

**Kit Includes:**

Countersink cage, 330S, 4 cutters, 7/16" diameter #10, #21, #30 and #40 pcs, 304-1 protective cap and storage box.

Part No.	Description
AIT61K	6 pc. Countersink Cutter Kit

AIT61K



## ELLIPTICAL FASTENER COUNTERSINK CUTTER KIT

This kit provides countersinking capabilities for the installation of the NAS1734 or 1735 elliptical head blind nuts, for fasteners -3 (#10) thru -8 (1/2") hole preparation IAW NAS1736. The cutter and rockers are driven by common hand-held drill motors.

**Kit Includes:**

Kit includes two microstops with stabilizing rockers, and four cobalt cutters as follows:

- ATSK2260 - Microstop with Wobble Skirt and Arm Assembly (1/4"-28 threaded; 1/2" maximum diameter for fasteners #10, 1/4" and 5/16")
- ATSK2266 - Jumbo Microstop with Wobble Skirt and Arm Assembly (3/8"-24 threaded; 3/4" maximum diameter for fasteners 3/8", 7/16" and 1/2")
- C15374-3 - Elliptical Nut Countersink Assembly, #10
- C15374-4 - Elliptical Nut Countersink Assembly, 1/4"
- C15374-5 - Elliptical Nut Countersink Assembly, 5/16"
- C15374-6 - Elliptical Nut Countersink Assembly, 3/8"

Part No.	Description
AT2200CSK	8 pc. Countersink Cutter Kit

AT2200CSK





## BRILES MICRO-STOP COUNTERSINK CAGES

- 1/4"-28 thread
- Ball bearings



**AT441HSBRS**

Standard Skirt Model			
Part No.	Max. Capacity	Depth Adjustment	Max. RPM
AT441HSBRS	5/8"	0.001"	10000

Flanged Skirt Model			
Part No.	Max. Capacity	Depth Adjustment	Max. RPM
AT441HSBRF	5/8"	0.001"	10000

*Note: Other skirts available.*

## BRILES MICRO-STOP COUNTERSINK CUTTERS

- Cutter, counterbore and countersink
- Manufactured from M42 H.S.S. heat-treated to 63-66 Rc.

120° Countersink Cutters - 1/4"-28 Thread			
Part No.	Rivet Size	Diameter	Body Dia.
FZP-3	-3	3/32"	3/8"
FZP-4	-4	1/8"	3/8"
FZP-5	-5	5/32"	3/8"
FZP-6	-6	3/16"	3/8"
FZP-7	-7	7/32"	3/8"
FZP-8	-8	1/4"	1/2"



**FZP**

## BRILES DUAL GAUGES

Part No.	Nominal Diameter	No Go
FZDG-3	3/32"	.1265"
FZDG-4	1/8"	.1655"
FZDG-5	5/32"	.2140"
FZDG-6	3/16"	.2625"
FZDG-7	7/32"	.3170"
FZDG-8	1/4"	.3640"

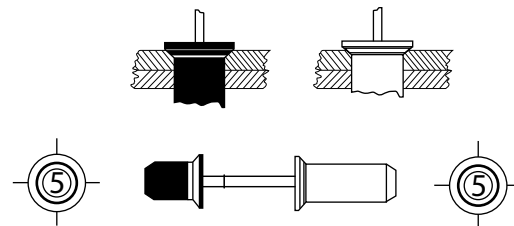

**FZDG**

## ROSEBUD DEBURRING CUTTER

Especially suited for use in angle drills and angle attachments for hole deburring in close quarters. Precision ground angle to insure concentricity. Can also be used with TP120 speed deburring tool.

- 3 flute
- 3/4" OAL

HSS 1/4"-28 Thread		
Part No.	Diameter	Angle
TPCR3438	3/8"	100°
TPCR3438-7/16	7/16"	100°
TPCR3438-1/2	1/2"	100°



**TPCR**

## EXTENDED FOOTPIECE MICRO-STOP COUNTERSINK CUTTERS

- High speed steel
- 82° available

Integral Pilot Cutters		
Model No.	Diameter	Part No.
AIT284-A	1/4"	AIT285-17
AIT284-B	5/16"	AIT286-17
AIT284-C	3/8"	TP61-1
AIT284D	5/8"	TP64



AIT285-17

**Note:** When ordering cutters, please specify dash number and pilot diameter. Example: AIT285-17-1/8

## INTEGRAL PILOT CUTTERS



TP62

100° HSS				
Pilot Dia.	Part No. 3/8" Dia.	Part No. 7/16" Dia.	Part No. 1/2" Dia.	Part No. 5/8" Dia
3/32"	TP62-1-3/32	TP62-3/32	TP63-3/32	TP64-3/32
1/8"	TP62-1-1/8	TP62-1/8	TP63-1/8	TP64-1/8
5/32"	TP62-1-5/32	TP62-5/32	TP63-5/32	TP64-5/32
3/16"	TP62-1-3/16	TP62-3/16	TP63-3/16	TP64-3/16
7/32"	TP62-1-7/32	TP62-7/32	TP63-7/32	TP64-7/32
1/4"	TP62-1-1/4	TP62-1/4	TP63-1/4	TP64-1/4
#40	TP62-1-#40	TP62-#40	TP63-#40	TP64-#40
#30	TP62-1-#30	TP62-#30	TP63-#30	TP64-#30
#21	TP62-1-#21	TP62-#21	TP63-#21	TP64-#21
#10	TP62-1-#10	TP62-#10	TP63-#10	TP64-#10

**Note:** Available in 82° and 120° angle and solid carbide.

100° Carbide Tip			
Pilot Dia.	Part No. 3/8" Dia.	Part No. 7/16" Dia.	Part No. 1/2" Dia.
3/32"	TP62C-1-3/32	TP62C-3/32	TP63C-3/32
1/8"	TP62C-1-1/8	TP62C-1/8	TP63C-1/8
5/32"	TP62C-1-5/32	TP62C-5/32	TP63C-5/32
3/16"	TP62C-1-3/16	TP62C-3/16	TP63C-3/16
7/32"	-	TP62C-7/32	TP63C-7/32
1/4"	-	TP62C-1/4	TP63C-1/4
#40	TP62C-1-#40	TP62C-#40	TP63C-#40
#30	TP62C-1-#30	TP62C-#30	TP63C-#30
#21	TP62C-1-#21	TP62C-#21	TP63C-#21
#10	TP62C-1-#10	TP62C-#10	TP63C-#10



TP62C

## HSS REPLACEABLE PILOT CUTTERS AND PILOTS

- Precision ground, 1/4"-28 thread

HSS Replaceable Pilot Cutters, .086" Pilot Hole 100°		
Part No.	Body Diameter	Angle
MM307-1-100	3/8"	100°
MM307-2-100	7/16"	100°
MM307-3-100	1/2"	100°
MM307-4-100	5/8"	100°

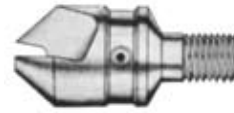

**MM307**

.086" Replaceable Pilots	
Part No.	Pilot Diameter
MM311-3/32	3/32"
MM311-1/8	1/8"
MM311-5/32	5/32"
MM311-3/16	3/16"
MM311-7/32	7/32"
MM311-1/4	1/4"
MM311-#40	#40
MM311-#30	#30
MM311-#21	#21
MM311-#10	#10



**MM311**

## JUMBO MICRO-STOP COUNTERSINK CUTTERS

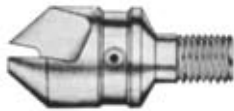

**MM307**



**MM311-2**

HSS Replaceable Pilot Cutters, .170" Pilot Hole 100°	
Part No.	Pilot Diameter
MM307-5-100	3/4"
MM307-6-100	7/8"
MM307-7-100	1"
MM307-8-100	1-1/8"
MM307-9-100	1-1/4"

*Note: Cutters available in 82° and 120°.*

.170" Replaceable Pilots	
Part No.	Pilot Diameter
MM311-2-3/16	3/16"
MM311-2-1/4	1/4"
MM311-2-5/16"	5/16"
MM311-2-3/8"	3/8"
MM311-2-7/16"	7/16"
MM311-2-1/2"	1/2"
MM311-2-5/8"	5/8"

## INTERCHANGEABLE PILOT AIRCRAFT COUNTERBORES

- Short flute type
- The OD is precision ground with back taper to ensure concentricity
- Corner radii ground to aircraft standards
- Sharp corner available - P.O.A.

848-1



1/4" Shank, 3/32" Pilot Hole			
Part No. HSS	Part No. Carbide Tip	Cutter Dia.	OAL
848-1	850-1	1/4"	2-3/8"
848-2	850-2	9/32"	2-3/8"
848-3	850-3	5/16"	2-3/8"
848-4	850-4	11/32"	2-3/8"
848-5	850-5	3/8"	2-3/8"

1/4" Shank, 1/8" Pilot Hole			
Part No. HSS	Part No. Carbide Tip	Cutter Dia.	OAL
848-6	850-6	13/32"	2-3/4"
848-7	850-7	7/16"	2-3/4"
848-8	850-8	15/32"	2-3/4"
848-9	850-9	1/2"	2-3/4"
848-10	850-10	17/32"	2-3/4"
848-11	850-11	9/16"	2-3/4"
848-12	850-12	19/32"	2-3/4"
848-13	850-13	5/8"	2-3/4"

1/4" Shank, 3/16" Pilot Hole			
Part No. HSS	Part No. Carbide Tip	Cutter Dia.	OAL
848-14	-	21/32"	2-3/4"
848-15	-	11/16"	2-3/4"
848-16	-	23/32"	2-3/4"
848-17	-	3/4"	2-3/4"
848-18	-	25/32"	2-3/4"
848-19	02-275-19C	13/16"	2-3/4"
848-20	02-275-20C	27/32"	2-3/4"
848-21	02-275-21C	7/8"	2-3/4"
848-22	02-275-22C	29/32"	2-3/4"
848-23	02-275-23C	15/16"	2-3/4"
848-24	02-275-24C	31/32"	2-3/4"
848-25	02-275-25C	1"	2-3/4"

Note: All HSS Counterbores: 1/32" corner radius.

Note: All Carbide Tipped Counterbores: 1/64" corner radius.

## AIRCRAFT COUNTERBORE PILOTS

- Made from precision ground, finest quality tool steel
- Exacting size and concentricity tolerances
- Will fit almost all standard aircraft counterbores



3/32" Shank	
Part No.	Pilot Head Dia.
-	3/32"
855-2-3/32	1/8"
855-3-3/32	5/32"
855-4-3/32	#20
855-5-3/32	3/16"
855-6-3/32	#10
855-7-3/32	7/32"
855-8-3/32	1/4"
855-9-3/32	F
855-10-3/32	9/32"
855-11-3/32	-

1/8" Shank	
Part No.	Pilot Head Dia.
-	1/8"
855-3-1/8	5/32"
855-4-1/8	#20
855-5-1/8	3/16"
855-6-1/8	#10
855-7-1/8	7/32"
855-8-1/8	1/4"
855-9-1/8	F
855-10-1/8	9/32"
855-11-1/8	5/16"
855-12-1/8	11/32"
855-13-1/8	3/8"

3/16" Shank	
Part No.	Pilot Head Dia.
855-5-3/16	3/16"
855-6-3/16	#10
855-7-3/16	7/32"
855-8-3/16	1/4"
855-9-3/16	F
855-10-3/16	9/32"
855-11-3/16	5/16"
855-12-3/16	11/32"
855-13-3/16	3/8"
855-14-3/16	13/32"
855-15-3/16	7/16"
855-16-3/16	15/32"
855-17-3/16	1/2"

## INTERCHANGEABLE PILOT AIRCRAFT COUNTERBORE KITS

### 13 Piece Short Series HSS Kit includes:

- 1 each Counterbores (1/4", 5/16", 3/8", 7/16", 1/2", 9/16", 5/8", 11/16", 3/4", 13/16", 7/8", 15/16" and 1")
- Polyethylene case

### 25 Piece Short Series HSS Kit includes:

- 1 each Counterbores (Same as 13 pc, PLUS 9/32", 11/32", 13/32", 15/32", 17/32", 19/32", 21/32", 23/32", 15/32", 27/32", 29/32" and 31/32")
- Polyethylene case

Part No.	Description
848K13	13 pc. Counterbores
848K23P	13 pc. Counterbores & 10 Pilots
848K25	25 pc. Counterbores
848K45P	25 pc. Counterbores & 20 Pilots



**848K25**

## REVERSE COUNTERSINKS AND SPOTFACERS KITS

### Back Spotface Kit includes:

- 1 each Pilots (3/32", 1/8", 5/32", 3/16", 1/4" and 5/16")
- 1 each Cutter (190-1J, 190-1K, 190-2K, 190-3K, 190-3L, 190-4K, 190-4L, 190-5K, 190-5L, 190-6K, 190-6L, 190-7K, 190-7L)
- Plastic case

Part No.	Description
190K20	Reverse Spotfacer Kit (20 pcs.)

### Reverse Countersink Cutter Kit includes:

- 1 each Pilots (3/32", 1/8", 5/32", 3/16", 1/4" and 5/16")
- 1 each 100° Cutters (180-1J, 180-1K, 180-2J, 180-2K, 180-3K, 180-3L, 180-4K, 180-4L, 180-5K, 180-5L, 180-6K, 180-6L, 180-7K and 180-7L)
- Metal tray and plastic case

Part No.	Description
180K20	Reverse Countersink Cutter Kit (20 pcs.)



**180K20**

## REVERSE COUNTERSINKS AND SPOTFACERS

Reverse spotfacers are designed for use in restricted areas where conventional spotfacers cannot be utilized. Cutter furnished with 1/32" corner radius.

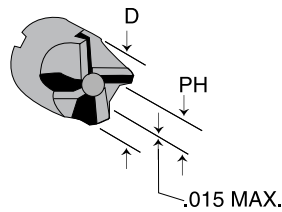

Reverse countersinks are designed for use in restricted areas where conventional countersinks cannot be utilized.

- 100° countersink angle

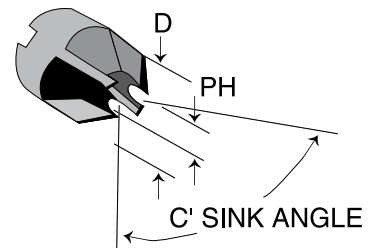

HSS		
Part No.	"D" Cutter Dia.	"PH" Pilot Hole
190-1J	1/4	3/32
190-1K	1/4	1/8
190-2J	5/16	3/32
190-2K	5/16	1/8
190-2L	5/16	5/32
190-3J	3/8	1/8
190-3K	3/8	5/32
190-3L	3/8	3/16
190-4J	7/16	1/8
190-4K	7/16	5/32
190-4L	7/16	3/16
190-5J	1/2	5/32
190-5K	1/2	3/16
190-5L	1/2	1/4
190-6J	9/16	5/32
190-6K	9/16	3/16
190-6L	9/16	1/4
190-7J	5/8	3/16
190-7K	5/8	1/4

Solid Carbide		
Part No.	"D" Cutter Dia.	"PH" Pilot Hole
191-1J	1/4	3/32
191-1K	1/4	1/8
191-2J	5/16	3/32
191-2K	5/16	1/8
191-2L	5/16	5/32
191-3J	3/8	1/8
191-3K	3/8	5/32
191-3L	3/8	3/16
191-4J	7/16	1/8
191-4K	7/16	5/32
191-4L	7/16	3/16
191-5J	1/2	5/32
191-5K	1/2	3/16
191-5L	1/2	1/4
191-6J	9/16	5/32
191-6K	9/16	3/16
191-6L	9/16	1/4
191-7J	5/8	3/16
191-7K	5/8	1/4

HSS		
Part No.	"D" Cutter Dia.	"PH" Pilot Hole
180-1J	1/4	3/32
180-1K	1/4	1/8
180-2J	5/16	3/32
180-2K	5/16	1/8
180-2L	5/16	5/32
180-3J	3/8	1/8
180-3K	3/8	5/32
180-3L	3/8	3/16
180-4J	7/16	1/8
180-4K	7/16	5/32
180-4L	7/16	3/16
180-5J	1/2	5/32
180-5K	1/2	3/16
180-5L	1/2	1/4
180-6J	9/16	5/32
180-6K	9/16	3/16
180-6L	9/16	1/4
180-7J	5/8	3/16
180-7K	5/8	1/4

Solid Carbide		
Part No.	"D" Cutter Dia.	"PH" Pilot Hole
181-1J	1/4	3/32
181-1K	1/4	1/8
181-2J	5/16	3/32
181-2K	5/16	1/8
181-2L	5/16	5/32
181-3J	3/8	1/8
181-3K	3/8	5/32
181-3L	3/8	3/16
181-4J	7/16	1/8
181-4K	7/16	5/32
181-4L	7/16	3/16
181-5J	1/2	5/32
181-5K	1/2	3/16
181-5L	1/2	1/4
181-6J	9/16	5/32
181-6K	9/16	3/16
181-6L	9/16	1/4
181-7J	5/8	3/16
181-7K	5/8	1/4

## REVERSE COUNTERSINK & SPOTFACER PILOTS

- Interchangeable among countersink and counterbore cutters
- Standard 6" overall length

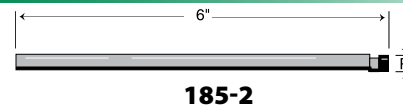

Part No.	Pilot Diameter
185-1	3/32"
185-2	1/8"
185-3	5/32"
185-4	3/16"

Part No.	Pilot Diameter
185-5	1/4"
185-6	5/16"
185-7	3/8"
185-8	1/2"

## REVERSE COUNTERSINK & SPOTFACER STEP PILOTS

- Interchangeable among countersink and counterbore cutters
- Standard 6" overall length

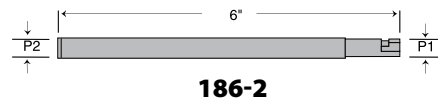

Part No.	Pilot Dia. P2	Pilot Dia. P1
186-1	3/32"	1/8"
186-2	1/8"	5/32"
186-3	5/32"	3/16"
186-4	3/16"	1/4"
186-5	1/4"	5/16"
186-6	5/32"	3/16"
186-7	3/16"	1/4"
186-8	1/4"	5/16"

Part No.	Pilot Dia. P2	Pilot Dia. P1
186-9	5/16"	3/8"
186-10	3/8"	1/2"
186-11	1/2"	9/16"
186-12	1/4"	5/16"
186-13	5/16"	3/8"
186-14	3/8"	1/2"
186-15	5/16"	3/8"
186-16	3/8"	1/2"

## ZERO FLUTE COUNTERSINK CUTTERS

- Single cutting edge for fast stock removal and chatter free finish in all materials

82° Zero Flute, 1/4" Shank		
Part No.	Capacity (Min. - Max.)	OAL
CSK3S	3/32" - 15/64"	1-3/4"
CSK18	3/16" - 17/32"	1-7/8"
CSK26A	5/16" - 3/4"	2-1/16"

100° Zero Flute, 1/4" Shank		
Part No.	Capacity (Min. - Max.)	OAL
CSKA8	3/32" - 1/4"	1-1/2"
CSKA14	1/8" - 27/64"	1-11/16"
CSKA18	3/16" - 35/64"	1-7/8"



**CSK3S**

## CARBIDE / HSS COUNTERSINK CUTTERS

- Radial relief ground angle to assure free cutting clearance and prevent chatter
- 82°, 100° and 120° available\*



**MM312-1**

Three Flute Chatterless			
Part No. HSS	Part No. Carbide	Dia.	Shank
MM312-1	MM312-1C	1/4"	1/4"
MM312-2	MM312-2C	3/8"	1/4"
MM312-5	MM312-5C	1/2"	1/4"

Six Flute Chatterless			
Part No. HSS	Part No. Carbide	Dia.	Shank
MM612-1	MM612-1C	1/4"	1/4"
MM612-2	MM612-2C	3/8"	1/4"
MM612-5	MM612-5C	1/2"	1/4"

**Note:** Select the cutter required (charts) then add the desired cutting angle (82, 100 or 120). Example: For a 3/8 dia. HSS 3 Flute with 100°, use Part No. MM312-2.

## CARBIDE TIPPED STOP COUNTERBORES & PILOTS

- 1/4-28 thread



**730-1**

Part No.	"D" Body Dia.	"PH" Pilot Hole	"S" Shank Size
730-1	3/8	3/32	1/4-28
730-2	7/16	1/8	1/4-28
730-3	1/2	1/8	1/4-28
730-4	9/16	1/8	1/4-28
730-5	5/8	1/8	1/4-28



**755-1**

Part No.	Pilot Head Nom. Dia.	Std. Shank Diameters	
		3/32	1/8"
755-1	1/8 (.125)	•	
755-2	#30 (.128)	•	
755-3	5/32 (.156)	•	•
755-4	#20 (.161)	•	•
755-5	3/16 (.187)	•	•
755-6	#10 (.193)	•	•
755-7	7/32 (.218)	•	•
755-8	1/4 (.250)	•	•
755-9	F (.257)	•	•
755-10	9/32 (.281)	•	•
755-11	5/16 (.312)	•	•

## LIGHTENING HOLE PUNCHES

- Precision machined and heat treated
- Forms lightening holes for access or strengthening
- Punches and flares tool in one operation
- Punches 1" to 4" diameter holes
- Capacity 1/8" aluminum/mild steel

Arbor Press Type	
Part No.	Diameter
LHPA	1"
LHPAA	1-1/4"
LHPB	1-1/2"
LHPBB	1-3/4"
LHPC	2"
LHPCC	2-1/4"
LHPD	2-1/2"
LHPDD	2-3/4"
LHPE	3"
LHPPE	3-1/4"
LHPF	3-1/2"
LHPFF	3-3/4"
LHPG	4"

Note: Larger sizes available.

Portable (Draw Bolt Type)	
Part No.	Diameter
LHP-3/4	3/4"
LHP-1-1/4	1-1/4"
LHP-1-1/2	1-1/2"
LHP-1-3/4	1-3/4"
LHP-2	2"
LHP-2-1/4	2-1/4"
LHP-2-1/2	2-1/2"
LHP-2-3/4	3/4"
LHP-3	3"

13 Pc. Arbor Press Hole Punch Kit	
Part No.	Diameter Range
LHPK	1" - 4"



LHP-2

## COMBO INSTRUMENT PANLE HOLE CUTTERS

- Quickly cut 3-1/8" and 2-1/4" standard instrument mounting holes
- Aluminum panels 1/8" thick are easily handled

Part No.	Description
TP688	Panel Punch



TP688

## INSTRUMENT PANEL HOLE CUTTER

- Cuts clean burr-free holes
- Uses ordinary wrench
- Requires 7/16 pre-drill hole
- Capacity 10 gauge mild steel

Part No.	Description
TP292	2-1/4" cutter
TP292A	3-1/8" cutter



TP292



## FINE & COARSE TOOTH HOLES SAWS

Part No.	Description	For Use With
400	Fine Tooth	Aluminum, Sheet Steel & Plastics
401	Coarse Tooth	Thick Material (deep teeth for proper chip flow)

**Note:** Select the type saw required, then add the desired diameter number (chart below). Example: For a Fine Tooth Hole Saw with a 3/8" diameter, the part number would be 400-1.



400

Part No. (Prefix)	Diameter
-1	3/8"
-2	13/32"
-3	7/16"
-4	15/32"
-5	1/2"
-6	17/32"
-7	9/16"
-8	19/32"
-9	5/8"
-10	21/32"
-11	11/16"
-12	23/32"

Part No. (Prefix)	Diameter
-13	3/4"
-14	25/32"
-15	13/16"
-16	27/32"
-17	7/8"
-18	29/32"
-19	15/16"
-20	31/32"
-21	1"
-22	1-1/16"
-23	1-1/8"
-24	1-3/16"

Part No. (Prefix)	Diameter
-25	1-1/4"
-26	1-5/16"
-27	1-3/8"
-28	1-7/16"
-29	1-1/2"
-30	1-9/16"
-31	1-5/8"
-32	1-11/16"
-33	1-3/4"
-34	1-13/16"
-35	1-1/4"
-36	1-15/16"

Part No. (Prefix)	Diameter
-37	2"
-38	2-1/8"
-39	2-1/4"
-40	2-3/8"
-41	2-1/2"
-42	2-5/8"
-43	2-3/4"
-44	2-7/8"
-45	3"

**Note:** 3/8" to 1-1/4" diameter furnished with 5/16"-24 thread, 1-5/16" to 3" diameter furnished with 1/2"-20 thread.

## HOLE SAW ARBORS

- Precision ground to ensure concentricity



402-1

Part No.	Pilot Dia.	Shank Dia.	Thread Size
402-1	3/16"	1/4"	5/16"-24
402-2	1/4"	1/4"	5/16"-24
402-3	1/4"	1/2"	5/16"-24
402-4	3/8"	1/2"	5/16"-24
402A	Hole Saw Adapter - 1/2-20 outside to 5-1/6"-24 inside		

## HOLE FLANGING TOOL

- Ideal tool for flanging lightening holes
- Ball bearing construction
- Easy to use



TP326

Part No.	Description
TP326	Hole Flanger

## HAND METAL PUNCH KITS

- 2.75 lbs.
- 1.2 tons of punching power

**Kit Includes:**

- Punch
- Punch Dies (3/32", 1/8", 5/32", 3/16", 7/32", 9/32", and 1/4")
- Plastic case

Part No.	Description
5JR	Complete Kit (USA)
TP76K	Complete Kit (Economy Model)



TP76K

TP76 Replacement Punch & Die Sets	
Part No.	Size
TP77	3/32
TP78	1/8
TP79	5/32
TP80	3/16
TP40	7/32
TP41	1/4
TP42	9/32

5JR Replacement Punch & Die Sets	
Part No.	Size
200050063	1/16
200050094	3/32
200050125	1/8
200050156	5/32
200050188	3/16
200050219	7/32
200050250	1/4
200050281	9/32

## BLAIR HOLE CUTTER KIT

- Retractable, spring-loaded pilot pops slug out on completion

**Blaircutter Sheet Metal Cutter Kit Includes:**

- Arbor with retractable pilot
- Three extra pilots
- Cutters (1/4", 5/16", 3/8", 7/16", 1/2", 9/16" and 5/8")

Part No.	Capacity
13218	3/16" thick



13218

- Retractable, spring-loaded pilot pops slug out on completion

**Blaircutter Sheet Metal Cutter Kit Includes:**

- Arbor with retractable pilot
- Extra pilots
- Cutters (5/16", 3/8", 7/16", 1/2", 9/16", 5/8" and 3/4")

Part No.	Capacity
11090	1/4" thick



11090

## OPTICAL CENTER PUNCH

- Removeable magnifier cylinder with crosshair accurate and easy to use
- Non-skid cone holds punch in position

Part No.	Description
14517	Optical Center Punch

**14517**



## AUTOMATIC CENTER PUNCH

- Automatic, spring-loaded operation
- TP249HD light-duty
- TP294HD heavy-duty
- Ground and hardened replaceable point

Part No.	Overall Length
TP249HD	5"
TP294HD	6"



**TP294HD**

## POCKET AUTOMATIC CENTER PUNCH

- Slim design for better visibility
- Can be adjusted for light or heavy strokes

Part No.	Description
AIT87	Tool with Centering Point
AIT87A	Spare Centering Point



**AIT87**

## HAND PIN PUNCH SETS

- Made of hardened and tempered tool steel with ground points (45-52 Rc.)
- Knurled body for better grip
- Includes fitted case and clear size markings



**AIT-S75**

**AIT-76**

Part No.	Description	Point Sizes Included	Overall Length
AIT-S75	8 pc. Drive Pin	1/16", 3/32", 1/8", 5/32", 3/16", 7/32", 1/4", 5/16"	4"
AIT-76	5 pc. Ex. Long Dr. Pin		8"

## CIRCLE CUTTERS

- Replaceable 3/16" HSS blade and 1/4" pilot drill
- 3/8" round shank

Part No.	Description
TP461	Circle Cutter (1" - 6")
TP461B	Replacement Pilot Drill
TP461A	Replacement Cutting Blade



## CIRCLE CUTTERS

- Cuts holes up to 20" diameter in 20 gauge sheet metal
- Use with any standard 1/4" drill (includes drill bit and allen key, not shown)
- Patented shoe feature permits smooth finishing of holes
- Drill not included

Part No.	Description
TP312	Hole Cutter
TP312B	Replacement Bit



## GASKET CUTTER KIT

- Provides clean, accurate cuts in all non-metallic gasket materials
- Unique 'snap-lock' quick release allows user to change punches in seconds

**Kit Includes:**

- Power Punch
- Centering Pin
- 10 Punches (1/4" to 1" x 16ths)
- Carrying case

Part No.	Description
TP460	Complete Kit



## PUNCH &amp; CHISEL HOLDER

- Heavy-duty 4" plastic handle with nylon tip in steel frame
- Holds chisels and punches up to 1" diameter
- Rust resistant finish

Part No.	Overall Length
AIT1286	6" (152 mm)



## P.B.S. DIAMOND PLATED INTEGRAL SHANK HOLE SAWS

- Piloted integral shank
- Furnished with windows and slots 1/8 return
- 2" drilling depth (inside depth)
- .050" smaller than 1" diameter
- .090" 1" diameter and larger
- When ordering, specify shank and pilot diameter

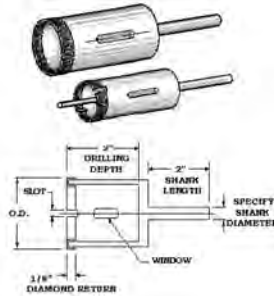

40 Mesh - 1/8" Return	
Part No.	OD Diameter
HS-1/2	1/2"
HS-3/4	3/4"
HS-7/8	7/8"
HS-1	1"
HS-1-1/4	1-1/4"

40 Mesh - 1/8" Return	
Part No.	OD Diameter
HS-1-1/2	1-1/2"
HS-1-3/4	1-3/4"
HS-2	2"
HS-2-1/4"	2-1/4"
HS-2-1/2"	2-1/2"

40 Mesh - 1/8" Return	
Part No.	OD Diameter
HS-2-3/4"	2-3/4"
HS-3	3"
HS-4	4"
HS-5	5"

## P.B.S. DIAMOND PLATED HOLE SAWS

- MHS series, arborless
- Furnished with windows and slots 1/8 return
- 1-1/2" drilling depth (inside depth)



40 Mesh - 1/8" Return	
Part No.	OD Diameter
MHS-9/16	9/16"
MHS-5/8	5/8"
MHS-3/4	3/4"
MHS-7/8	7/8"
MHS-1	1"
MHS1-1/16	1-1/16"
MHS1-1/8	1-1/8"
MHS1-3/16	1-3/16"

40 Mesh - 1/8" Return	
Part No.	OD Diameter
MHS1-1/4	1-1/4"
MHS1-3/8	1-3/8"
MHS1-1/2	1-1/2"
MHS1-3/4	1-3/4"
MHS1-7/8	1-7/8"
MHS-2	2"
MHS-2-1/4	2-1/4"
MHS-2-1/2	2-1/2"

40 Mesh - 1/8" Return	
Part No.	OD Diameter
MHS-2-1/4	2-1/4"
MHS-3	3"
MHS-3-1/4	3-1/4"
MHS-3-1/2	3-1/2"
MHS-4	4"
MHS-4-1/4	4-1/4"
MHS-4-1/2	4-1/2"
MHS-5	5"

## HOLE SAW ARBORS

- For MHS series hole saws above, standard lenox type
- Quick release for change of hole saws without removing arbor from chuck
- Setscrew body for pilot drill adjustment
- Also available with pilots, please inquire

Part No.	Fits Hole Saw Dia.	Screw Thread	Shank Size
NA-01	9/16" to 1-3/16"	1/2"-20	3/8"
NA-06	1-1/4" to 5"	5/8"-18	7/16"



NA-01



NA-06

## P.B.S. DIAMOND PLATED SAW BLADES

40 Mesh - 1/8" Return				
Part No. Slotted	Part No. Unslotted	Outside Dia.	Arbor Hole	Plated Thickness (Kerf)
SB1S	SB1U	1"	1/4	.060 to .080"
SB1-1/2S	SB1-1/2U	1-1/2"	1/4	.060 to .080"
SB2S	SB2U	2"	3/8	.060 to .080"
SB2-1/2S	SB2-1/2U	2-1/2"	3/8	.060 to .080"
SB3S	SB3U	3"	3/8	.060 to .080"
SB3-1/2S	SB3-1/2U	3-1/2"	3/8"	.060 to .080"
SB4S	SB4U	4"	3/8	.060 to .080"

Arbors	
Part No.	Description
TP467A	3/8 arbor x 1/4 shank
TP467B	1/4 arbor x 1/4 shank

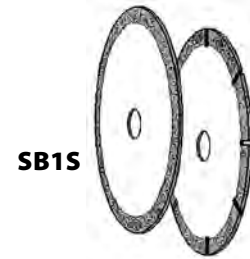

## P.B.S. DIAMOND PLATED MOUNTED SAW BLADES

- One-piece construction, 2-1/2" overall shank length

40 Mesh - 1/8" Return			
Part No. Slotted	Part No. Unslotted	Outside Dia.	Plated Thickness (Kerf)
MS3/4S	MS3/4U	3/4"	.080" to .100"
MS1S	MS1U	1"	.080" to .100"
MS1-1/4S	MS1-1/4U	1-1/4"	.080" to .100"
MS1-1/2S	MS1-1/2U	1-1/2"	.080" to .100"
MS3S	MS3U	3"	.080" to .100"
MS3-1/2S	MS3-1/2U	3-1/2"	.080" to .100"
MS4	MS4U	4"	.102" to .130"



MS1S

*Note: Please specify arbor diameter when ordering.*

## P.B.S. DIAMOND PLATED ROUTERS

- 2-1/2" shank length



40/60 Mesh					
Part No. Unfluted, Square End	Part No. Unfluted, Radius End*	Part No. Fluted, Square End*	Part No. Fluted, Radius End*	Outside Diameter	Head Length
R1US	R1UR	-	-	1/8"	1/4"
R5US	R5UR	R5FS	R5FR	1/4"	3/4"
R10US	R10UR	R10FS	R10FR	3/8"	3/4"
R15US	R15UR	R15FS	R15FR	1/2"	1"
R20US	R20UR	R20FS	R20FR	5/8"	1"
R25US	R25UR	R25FS	R25FR	3/4"	1"
R30US	R30UR	R30FS	R30FR	1"	1"

*Note: Please specify shank diameter. On .750" and larger outside diameter routers, min. shank diameter is 1/2".*

*Note: Different head lengths available, please inquire.*

*Note: Larger sizes are available, please inquire.*

## GRAPHITE & KEVLAR DRILLS

These drills are designed specifically for use when drilling graphite and dupont Kevlar composites. The unique point configuration has been optimized to provide superior hole quality in composite materials. High RPM drilling with a low feed rate is recommended for best results.



**AT473F-1/4**

Carbide, Brad Point	
Part No.	O.D. Diameter
AT473F-1/8	1/8"
AT473F-3/16	3/16"
AT473-1/4	1/4"
AT473-5/16	5/16"

Carbide, Brad Point	
Part No.	O.D. Diameter
AT473-3/8	3/8"
AT473-7/16	7/16"
AT473-1/2	1/2"

## P.B.S. DIAMOND PLATED TWIST DRILLS

- All drills are general purpose, standard length
- Diamond length 3/16" - 1/4"



**TD1**

40 Mesh	
Part No.	O.D. Diameter
TD1	1/8"
TD2	1/4"
TD3	3/8"
TD4	7/16"
TD5	1/2"

40 Mesh	
Part No.	O.D. Diameter
TD6	5/8"
TD7	3/4"
TD8	7/8"
TD9	1"

## P.B.S. DIAMOND PLATED INTEGRAL PILOT COUNTERSINKS

1/2 Dia. - 1/4"-28 Thread - 100° Cutter Angle - 40 Mesh	
Part No.	O.D. Diameter
TP62D-40	#40
TP62D-30	#30
TP62D-21	#21
TP62D-3/16	3/16"



**TP62D**

## P.B.S. DIAMOND PLATED JIGSAW BLADES

Part No.	Fits Jig Saws	OAL
AIT1002	Black & Decker & competitive	3"
AIT2002	Rockwell Bayonet	3"
AIT3002	Rockwell Tiger & competitive	4"
AIT5002	Bosch Style	3"
AIT6002	Bosch Style	4"



**TP587**

## FLEXIBLE DIAMOND HAND SANDING PADS

- These diamond hand sanding pads work best when used wet
- Excellent for composite work

Part No.	Grit	Type	Size
PFHP-70	70	Plated / Flexible (for grinding)	2-1/2" x 4-1/4" 1" Thick
PFHP-120	120		
PFHP-220	220		
PFHP-400	400		
PFHP-600	600		
RFHP-220	220	Resin / Flexible (for finishing)	
RFHP-600	600		
RFHP-1800	1800		
RFHP-3500	3500		



## P.B.S. DIAMOND PLATED HAND FILES

- P.B.S.<sup>™</sup> bonded technology
- 10" overall length, 6" abrasive length, 3/4" wide
- Diamond abrasive 4 sides



AIT1001

Part No.	Description
AIT1001	30 Mesh
AIT1003	60 Mesh
AIT1004	100 Mesh

## KEVLAR HAND FABRIC SHEARS

These hand shears are intended for use in cutting composite fabric and thin cured laminates.

Part No.	Type	Cut Length	Overall Length
AIT468	Knife Edge	2-3/4"	8-1/4"
AIT330	Serrated	4-3/8"	10"



## EASY GRIP ROLLERS

- Roller is highly dense and medium soft (50 Durometer), free revolving on tubular bearing
- Heavy-duty black plastic handle with brass insert

Part No.	Description
TP262A	1-1/4 OD x 3" long
TP262B	1-1/4 OD x 4" long



TP262A



CHIP CHASER

- Designed for removing chips between sheets after drilling rivet holes

Part No.	Handle Type	Blade Replacement	Blade Length
AIT511	Plastic, 1 pc.	-	2-3/4"
AIT512	Plastic, 1 pc.	-	5-7/8"
SP200-3	Alum., 2 pcs.	SP20004	2-3/4"
SP200-1	Alum., 2 pcs.	SP20002	5-7/8"
AIT3512	Alum., 1 pc.	-	5-7/8"
SP200	Alum. Handle-Only	-	-



SP200-1



AIT511



AIT512



AIT3512

PILOTED RIVET HOLE BRUSHES

- Stainless steel
- Cleans paint, dirt, rust or varnish from around rivet holes
- 3/8" length wire

Part No.	Description
TP465	5 pc. Kit (1/2" brush diameter)



06781

Part No.	Pilot Diameter	Brush Diameter	Shank Diameter	Wire Diameter	Safe RPM (no load)
06721-1/4	3/32"	1/4"	1/4"	.005"	20000
06741-1/4	1/8"				
06761-1/4	5/32"				
06781-1/4	3/16"				
06701-1/4	1/4"				
06721-3/8	3/32"	3/8"	1/4"	.005"	20000
06741-3/8	1/8"				
06761-3/8	5/32"				
06781-3/8	3/16"				
06701-3/8	1/4"				
06721	3/32"	1/2"	1/4"	.005"	20000
06741	1/8"				
06761	5/32"				
06781	3/16"				
06801	1/4"				

## BURRAWAY DEBURRING TOOL KIT

- Contains 5 tools and replacement blades in a fitted plastic case

**Kit Includes:**

- 1/8" tool and replacement blade
- 5/32" tool and replacement blade
- 3/16" tool and replacement blade
- 7/32" tool and replacement blade
- 1/4" tool and replacement blade
- Fitted plastic case



TP479K

Part No.	Description
TP479K	Complete Kit

## BURRAWAY DEBURRING TOOLS

- Deburr both sides in one pass
- Setscrew adjustment controls depth of cut and releases for blade replacement
- Metric sizes available

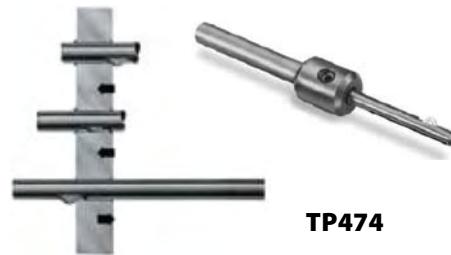

TP474

Type A: 1/4" Shank					
Part No. Complete Tool	Part No. Replacement Blade	Hole Size	Decimal Equivalent	Pilot Length	Overall Length
TP474	TP474B	3/32"	.0938"	.45"	3-3/8"
TP474-7/64	TP474B	7/64"	.1094"	.45"	3-3/8"
TP475	TP475B	1/8"	.1250"	.45"	3-3/8"
TP476	TP476B	5/32"	.1562"	.45"	3-3/8"
TP477	TP477B	3/16"	.1875"	.45"	4-1/8"

Type B: Straight Shank					
Part No. Complete Tool	Part No. Replacement Blade	Hole Size	Decimal Equivalent	Pilot Length	Overall Length
TP478-7/32	TP478B-1	7/32"	.2188"	.87"	4-1/2"
TP478	TP478B-1	1/4"	.2500"	.87"	4-1/2"
TP478-9/32	TP478B-1	9/32"	.2812"	.87"	4-1/2"
TP478-5/16	TP478B-2	5/16"	.3125"	.96"	4-1/2"
TP478-11/32	TP478B-2	11/32"	.3438"	.96"	4-1/2"
TP478-3/8	TP478B-3	3/8"	.3750"	1.00"	5"
TP478-13/32	TP478B-3	13/32"	.4062"	1.00"	5"
TP478-7/16	TP478B-3-1/2	7/16"	.4375"	1.03"	5-1/2"
TP478-15/32	TP478B-3-1/2	15/32"	.4688"	1.03"	5-1/2"
TP478-1/2	TP478B-3-1/2	1/2"	.5000"	1.03"	5-1/2"

## REVERSIBLE COUNTERSINK DEBURR TOOL

- Deburrs both inside and outside of very small holes
- Can be used in both clockwise and counterclockwise directions
- To use, hold between fingers and rotate back and forth
- To insert/withdraw blade into/from hole, push knob and release slowly



**ROY22455**



Part No.	Description
ROY22455	1/8 - 7/32 Hole
ROY22137	Blade Only

## COGSDILL BURR-OFF TOOLS

- Deburr both sides in one pass
- Deburr 5 to 15 thousand holes per grind, up to four grinds per tool
- Handles tough jobs: interrupted/interference cuts, holes close to shoulders, etc.
- The original clothes pin tool



**CP-9**

Part No.	Hole Sizes	Shank Dia.	Overall Length
CP-6	.093" - 1.09"	.092"	4"
CP-7	.109" - .125"	.108"	4"
CP-8	.125" - .140"	.124"	4"
CP-9	.140" - .156"	.139"	4"
CP-10	.156" - .172"	.155"	4"
CP-11	.172" - .187"	.171"	4"
CP-12	.187" - .203"	.186"	4"
CP-13	.203" - .219"	.202"	4"
CP-14	.219" - .234"	.218"	4"
CP-15	.234" - .250"	.233"	4"
CP-16	.250" - .266"	.249"	4"
CP-17	.266" - .281"	.265"	4"
CP-18	.281" - .297"	.280"	4"

Part No.	Hole Sizes	Shank Dia.	Overall Length
CP-19	.297" - .313"	.296"	4"
CP-20	.313" - .328"	.312"	4"
CP-21	.328" - .343"	.327"	4"
CP-22	.343" - .359"	.342"	4"
CP-23	.359" - .375"	.358"	4"
CP-24	.375" - .390"	.374"	4-1/2"
CP-25	.390" - .406"	.389"	4-1/2"
CP-26	.406" - .422"	.405"	4-1/2"
CP-27	.422" - .437"	.420"	4-1/2"
CP-28	.437" - .453"	.436"	5-1/2"
CP-29	.453" - .468"	.452"	5-1/2"
CP-30	.468" - .484"	.467"	5-1/2"
CP-31	.484" - .500"	.483"	5-1/2"

### "SPEED DRIVER" HOLE DEBURRING TOOL

- Provides rapid deburring of drilled holes with high torque
- Cutter not included

Part No.	Description
TP120	Speed Driver



TP120

100° Cutters	
Part No.	Diameter
TPCR3438	3/8"
TPCR3438-7/16	7/16"
TPCR3438-1/2	1/2"



TPCR3438

### TELESCOPING DEBURR TOOLS

- Very useful for chamfering deep holes
- Telescoping ratchet-action
- Great where normal rotational deburring is impossible

Part No.	Type	Telescope Action	Cutter Included
ROY22650	Standard	1/4" - 3-1/4"	3/4"



ROY22650

Replacement Cutters	
Part No.	Diameter
ROY22155	1/2"
ROY22160	3/4"

### SPEE-D-BURR TOOL

- Aluminum handle
- Unique action allows constant turning without removing hand

Part No.	Description
TP796	1/4" straight shank tools



TP796

### ROTO-DRIVE TOOL

- Single flute countersink 5/16" dia.

Part No.	Description
ROY22510	5/16" Roto-Drive Tool



ROY22510

**POCKET DISPOSABLE BURR**

- For removing burrs from steel and aluminum
- Heavy-duty E-100 blade is non-replaceable

Part No.	Description
ROY22050	Slim Grip with Pocket Clip



**ROY22050**

**MULTI-BURR**

- Lifetime guarantee on handle
- Curved blades swivel freely for easier reach
- Blades are stored in lightweight plastic handle
- Includes one of all five blades offered below

Part No.	Description
ROY22022	Multi-burr with 5 blades



**ROY22022**

Replacement Blades	
Part No.	For Use On
E-100	Steel & Aluminum
E-200	Brass & Cast Iron (cw/ccw)
E-350	Straight edges on all materials
E-101	Small holes in steel & aluminum
E-102	Small holes in Brass & Cast Iron (cw/ccw)

**ECONOMY MULTI-BURR**

- Interchange with E-Series blades
- Curved blades swivel freely for easier reach
- Blades are stored in lightweight plastic handle
- Includes seven TP266A blades

Part No.	Description
TP266	Multi-Burr with 7 blades

Replacement Blades	
Part No.	For Use On
TP266A	Steel & Aluminum
TP266B	Brass & Cast Iron (cw/ccw)
TP266C	Straight edges on all materials
TP266D	Removes internal & external burrs simultaneously
TP266E	Small holes in steel & aluminum
TP266F	Small holes in Brass & Cast Iron (cw/ccw)



**TP266**



**TP266A**



**TP266B**



**TP266C**



**TP266D**



**TP266E**



**TP266F**

## REMOVAL BLADE SCRAPER

- Excellent for scraping, trimming and deburring almost any material

Part No.	Description
ROY22745	Scraper with 5/32" blade height
ROY22760	5/32" replacement blade



ROY22745

## FIXED BLADE SCRAPER

- Excellent for scraping, trimming and deburring almost any material
- 4" blade
- Wood handle

Part No.	Description
TP790	Scraper with 60° angle (3 side)



TP790

## DOUBLE EDGE DEBURR TOOL

- Deburrs both sides of the workpiece
- Blades can be rotated around circumference & reversed for long life
- Blades are M-2 steel and hardened to 64RC
- Includes safety guard

Part No.	Description
ROY22060	1/32" - 1/2"



ROY22060

Replacement Blade	
Part No.	Description
ROY22065	One set of replacement blades

## MASTER DEBURRING TOOL KIT

A deluxe kit that gives you a complete assortment of deburring tools for every job.

**This 21-piece kit includes:**

- 1 keyway burr
- 1 double burr
- 1 C holder with 3/4" countersink
- 1 D holder with mini-scraper
- 1 double header with B/E holder
- 1 chamfering tool, holder, blade
- 1 versa/burr handle
- 1 1/2" countersink
- 1 scraper
- 4 miscellaneous replacement bits

Part No.	Description
TP375	Complete kit

TP375



## USI RIVET SHAVER KIT

This 16-piece shave kit includes the tools necessary to work on all types and sizes of aluminum and steel rivets.

- Includes the US7387RS pistol grip rivet shaver
- Handy accessory box and sturdy toolbox
- 7 cutters with matching skirts

**US7387RSK**



Part No.	Cutters Included	Skirts Included
US7387RSK	5/16", 3/8", 7/16", 1/2", 9/16", 5/8", 3/4"	3685-5/16", 3/8", 7/16", 1/2", 9/16", 5/8", 3/4"

## USI RIVET SHAVERS

- Easily adjustable positive lock
- Spring loaded nosepiece and stabilizer
- 9/16" skirt included on RS model
- Model US7092RSS has 5/8" capacity, 1/2" on RSE model



**US7092RSS**



**US7387RSE**



**US7387RS**

0.75 HP with Stabilizer				
Part No. Small Handle	RPM (no load)	Cutter Adjustment	Overall Length	Weight
US7092RSS	18000	.001	8-1/2"	2.0 lbs.
US7387RS	18000	.001	6-3/4"	2.7 lbs.
US7387RSE	18000	.001	10-3/4"	3.5 lbs.

## DOTCO® RIVET SHAVERS

- Ergonomic design, rear exhaust
- Easily adjustable positive lock
- Spring loaded nosepiece and stabilizer
- 1/2" skirt included
- 5/8" capacity



**14CF60-95**

14CF Series Pistol Grip 0.4 HP with Stabilizer				
Part No. Small Handle	RPM (no load)	Cutter Adjustment	Overall Length	Weight
14CFS60-95	29000	.0005"	8"	2.3 lbs.

## SIOUX® RIVET SHAVERS

- Ergonomic design promotes operator comfort
- 1/2" skirt included



**RS9A-210-8**

Pistol Grip .75 HP with Stabilizer				
Part No. Small Handle	RPM (no load)	Overall Length	Weight	
RS9A-210-8	21000	8-1/4"	3.0 lbs.	

Inline .90 HP with Stabilizer				
Part No. Small Handle	RPM (no load)	Overall Length	Weight	
RS9AS-210-8	21000	10-1/4"	3.0 lbs.	

## CARBIDE RIVET SHAVER CUTTERS

- Precision ground for chatter-free cuts and longer life

Part No. Coarse Cut	Part No. Fine Cut 14 Flutes	Body Diameter
TP143-5/16	TP791-5/16	5/16"
TP143-3/8	TP791-3/8	3/8"
TP143-7/16	-	7/16"
TP143-1/2	TP791-1/2	1/2"
TP143-9/16	-	9/16"
TP143-5/8	-	5/8"
TP143-3/4	-	3/4"
TP143-1	-	1"



TP791-3/8



TP143-1/2

## RIVET SHAVER SKIRTS

- Highly polished working surfaces prevent marring

Part No. Dotco Type	Part No. Sioux Type	USI	USI Extended	Body Diameter
14-4391	2925-5	3685	3692	5/16"
14-4392	2925-6	3686	3693	3/8"
14-4393	2925-7	3687	3694	7/16"
14-4394	2925-8	3688	-	1/2"
14-4395	2925-9	3689	-	9/16"
14-4396	2925-10	3690	-	5/8"
-	-	3691	-	3/4"
-	-	3695	-	1"



14-4394

## DOTCO® QUAD WELD &amp; RIVET SHAVER

- Four functions in one pneumatic tool: weld shaver, POP & blind rivet bolt trimmer, disc sander, right angle grinder
- Height of cut can be controlled to a tolerance of .001" or less
- Accepts many 1/4" shank sanding and grinding tools
- Rear exhaust

Part No.	RPM (no load)
12L1280-36	12000
12L1281-36	20000
14-1723	Attachment only



12L1281-36

14-1723

## Replacement Cutters, End Cut

Part No.	Type	Style	Used For	Diameter	Shank	Overall Length
14-1732	Carbide	Inverted Cone	Steel Rivets	3/4"	1/4"	1-7/8"
14-1332	Carbide	Cylindrical	Shaving Welds	1/2"	1/4"	1-7/8"



## DOTCO® STRAIGHT ROUTERS

- Front and rear exhaust

**12L2080-01RT**



12-10 Series 0.3 HP					
Part No. Front Exhaust	Part No. Rear Exhaust	RPM (no load)	Shank Diameter Capacity	Overall Length	Weight
12L1001-36RT	–	34000	1/4"	6-3/4"	1.4 lbs.
12L1000-36RT	–	30000	1/4"	6-3/4"	1.4 lbs.

12-20 Series 0.6 HP					
Part No. Front Exhaust	Part No. Rear Exhaust	RPM (no load)	Shank Diameter Capacity	Overall Length	Weight
12L2000-01RT	12L2080-01RT	25000	1/4"	7-1/2"	1.9 lbs.

12-25 Series 0.9 HP					
Part No. Front Exhaust	Part No. Rear Exhaust	RPM (no load)	Shank Diameter Capacity	Overall Length	Weight
12L2500-01RT	12L2580-01RT	23000	1/4"	7-1/8"	2.6 lbs.
12L2500-0124RT	12L2580-0124RT	23000	3/8"	7-1/8"	2.6 lbs.

*Note: Router guide not included.*

## DOTCO® ROUTERS

- Front and rear exhaust models
- Collet, applicable wrenches and oilless blades included
- 1/2 collet available on some models

12-40 Series 1.7 HP				
Part No. Front Exhaust	RPM (no load)	Shank Diameter Capacity	Overall Length	Weight
12L4018-01	18000	1/4"	11-3/8"	4.2 lbs.
12L4018-03	18000	3/8"	11-3/8"	4.2 lbs.



**12L4018-01**

10-43 Series 1.7 HP with Base Mount				
Part No. Front Exhaust	RPM (no load)	Shank Diameter Capacity	Overall Length	Weight
10T4318-62	18000	3/8"	7-1/8"	7.4 lbs.
10T4316-62	16000	3/8"	7-1/8"	7.4 lbs.
10T4309-62	9000	3/8"	7-1/8"	7.4 lbs.

**10T4318-62**



11-43 Series 1.7n HP Power Unit Only				
Part No. Front Exhaust	RPM (no load)	Shank Diameter Capacity	Overall Length	Weight
11T4318-62	18000	3/8"	7-1/8"	5.5 lbs.
11T4316-62	16000	3/8"	7-1/8"	5.5 lbs.
11T4309-62	9000	3/8"	7-1/8"	5.5 lbs.



**11T4318-62**

## USI ROUTERS

- Lightweight straight handle router
- Includes 14-2501 router guide
- Manufactured in the U.S.A.



**US7092RO**

Lever Grip .05 HP				
Part No.	RPM (no load)	Shank Diameter Capacity	Overall Length	Weight
US7092RO	12000	1/4"	6"	2.12 lbs.

## DOTCO® ROUTER ASSEMBLIES

- Assembly components available separately, please inquire

Part No.	For Series	Cutter Shank Diameter
14-2187	12-10	1/4"
14-2180	12-20, 12-25	1/4"



**14-2180**

## DOTCO® ROUTER GUIDES

- 3/8 shank guides available

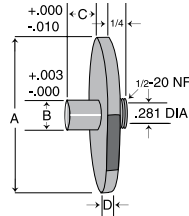

For 1/4" Shank Bits				
Part No.	"A" Dim.	"B" Dim.	"C" Dim.	"D" Dim
14-2703	3/4"	3/8"	1/2"	1/8"
14-2400	1"	3/8"	1/8"	1/8"
14-2401	1"	3/8"	1/4"	1/8"
14-2402	1"	3/8"	3/8"	1/8"
14-2406	1"	7/16"	1/8"	1/8"
14-2407	1"	7/16"	1/4"	1/8"
14-2408	1"	7/16"	1/2"	1/8"
14-2411	1"	1/2"	1/4"	1/8"
14-2412	1"	1/2"	1/2"	1/8"
14-2413	1"	1/2"	5/8"	1/8"
14-2414	1"	1/2"	3/4"	1/8"
14-2417	1"	9/16"	1/8"	1/8"

For 1/4" Shank Bits				
Part No.	"A" Dim.	"B" Dim.	"C" Dim.	"D" Dim
14-2420	1"	5/8"	1/8"	1/8"
14-2421	1"	5/8"	5/8"	1/8"
14-2500	1-1/2"	3/8"	1/8"	1/8"
14-2501	1-1/2"	3/8"	1/4"	1/8"
14-2502	1-1/2"	3/8"	3/8"	1/8"
14-2505	1-1/2"	7/16"	1/8"	1/8"
14-2506	1-1/2"	7/16"	1/4"	1/8"
14-2507	1-1/2"	7/16"	3/8"	1/8"
14-2510	1-1/2"	1/2"	1/4"	1/8"
14-2511	1-1/2"	1/2"	3/8"	1/8"
14-2512	1-1/2"	1/2"	1/2"	1/8"
14-2600	1-1/2"	1/2"	1/2"	3/16"

## HSS TAPER ROUTER BITS

Taper pin router bits are used for cutting, trimming and routing around cowling, door sills, plexiglass, elongating door latch holes and cable holes, trimming on wing terminals on bulkheads, ribs on fuselage, etc. Taper pin bits allow you to start a cut without drilling first.

Part No.	Size	Point Diameter	Shank Diameter
TP465A	1	.081"	.098"
TP465B	2	.110"	.128"
TP465C	3	.165"	.1875"
TP465D	4	.224"	.250"



**TP465D**

2 Flute Pattern, Left Hand Spiral, Right Hand Cut, No End Cut				
Part No.	CED	CEL	Shank	OAL
40-102	1/8"	5/16"	1/4"	2-5/8"
40-104	3/16"	5/8"	1/4"	2-7/8"
40-106	1/4"	5/8"	1/4"	2-3/4"



**40-106**

Composite Router Bit		
Part No.	Shank Diameter	OAL
67-608	3/16"	2"
67-611	1/4"	2"
67-620	3/8"	3"
67-623	1/2"	3-1/2"



**67-611**

## SOLID CARBIDE ROUTER BITS

Down Cut Spiral "O" Flute				
Part No.	CED	CEL	Shank	OAL
62-606	1/8"	1/4"	1/4"	2"
62-618	3/16"	5/8"	1/4"	2"
62-622	1/4"	3/4"	1/4"	2-1/2"
62-624	1/4"	1-1/4"	1/4"	3"
62-626	3/8"	1-1/8"	3/8"	3"



**62-622**

## DOTCO® OSCILLATING SAWS

- Designed especially for cutting cured and uncured graphite composites
- Performs equally well on wood, fiberglass, plaster and plastic
- Unlike conventional saws, sectioned blades can be used for special applications
- Includes applicable wrenches and oilless blades
- 3/8" arbor hole



12L2240-90

## 12-20 Series 0.6 HP Inline

Part No.	Rear Exhaust	CPM	Blade Capacity	Max. Depth of Cut	Weight	Overall Length
12L2065-90		14000	2-1/2"	9/16"	2.1 lbs.	8-7/8"

## 12-20 Series 0.6 HP Right Angle

Part No.	Rear Exhaust	CPM	Blade Capacity	Max. Depth of Cut	Weight	Overall Length
12L2240-90		14000	2-1/2"	9/16"	2.3 lbs.	10-7/8"

## DOTCO® ADJUSTABLE DEPTH CONTROL SAWS

- Includes applicable wrenches and oilless blades
- 1/4" arbor hole



12S1274-03



12S1283-02

## 12-12 Series 0.3 HP Standard Model

Part No.	Rear Exhaust	RPM (no load)	Blade Capacity	Max. Depth of Cut	Weight	Overall Length
12S1283-02		20000	2"	7/16"	1.3 lbs.	7-1/8"
12S1282-02		12000	2"	7/16"	1.3 lbs.	7-1/8"
12S1289-02		3600	2"	7/16"	1.6 lbs.	8-7/8"
12S1288-02		2400	2"	7/16"	1.6 lbs.	8-7/8"

## 12-12 Series 0.3 HP Vacuum Ready Model

Part No.	Rear Exhaust	RPM (no load)	Blade Capacity	Max. Depth of Cut	Weight	Overall Length
12S1274-03		20000	2"	7/16"	2.3 lbs.	7-1/8"
12S1273-03		12000	2"	7/16"	2.3 lbs.	7-1/8"



12S2794-02

- Includes wrenches
- 3/4" arbor hole

## 12-27 Series .09 HP Vacuum Ready Model

Part No.	Rear Exhaust	RPM (no load)	Blade Capacity	Max. Depth of Cut	Weight	Overall Length
12S2794-02		4700	4"	1"	5.2 lbs.	14.5"
12S2792-02		940	4"	1"	6.2 lbs.	16.2"

## DOTCO® SAW BLADES



1/4" Arbor Hole					
Part No.	Type	Diameter & Teeth/Grit	Max. Cut	Recommended RPM	Recommended Use
14-1875	HSS	1-1/4" x 22	3/32"D x 1/16"W	12000	Aluminum Laminated Plastics Pressboard Wood
14-0930		1/14" x 44	3/32"D x 1/16"W		
14-1895		1-1/2" x 22	7/32"D x 1/16"W		
14-1890		2" x 22	7/16"D x 1/16"W		
14-1891		2" x 44	7/16"D 1/16"W		
14-1892		2" x 60	7/16"D x 1/16"W		
14-1396	Carbide Chip	1-1/2" x 30/80 Grit	7/32"D x 3/32"W	20000	Fiberglass Rubber
14-2395		2" x 30/80 GriT	7/16"D x 3/32"W		
14-1400	Diamond Chip	2" x 40/60 Grit	7/16"D x 5/64"W		

3/8" Arbor Hole, Oscillating				
Part No.	Type	Diameter & Teeth/Grit	Max. Cut	Recommended Use
14-1740	Carbide Chip*	2" x 36/80 Grit	7/16"D x 3/32"W	Fiberglass
14-1741	Diamond Chip*	2" x 40/60 Grit	7/16"D x 5/64"W	Fiberglass & Carbon Composites
14-1742	Stainless Steel	2-1/2" x 124	9/16"D 9/16"D x 3/64"W	Wood, Composites, Aluminum & Plastic
14-1743	Carbide	2-1/2" x 120	9/16"D x 1/16"W	Cured Graphite Composites
14-1744	Razor	2-1/2"	9/16"D x 3/64"W	Cardboard & Light Plastic
14-1745	Stainless Steel	2-1/2" x 120	9/16"D x 3/64"W	Cardboard & Light Plastic
14-1746	Flush Stainless	2-1/2" x 124	9/16"D x 3/64"W	Wood Composites, Aluminum & Plastic
14-1747	Razor	3"	9/16"D x 3/64"W	Cardboard & Light Plastic

7/16" Arbor Hole, Oscillating				
Part No.	Type	Diameter & Teeth	Max. Cut	Recommended Use
14-2147	HSS	2-1/2" x 44	9/16"D	1/4" Alum., 1/2" Plywood & 1/2" Phenolic
14-1741		2-1/2" x 80	9/16"D	16 Gauge Steel
14-2928		3-3/8" x 60	15/16"	1/8" Alum, 1/2" Plywood & 1/2" Phenolic
14-2929		3-3/8" x 80	15/16"	20 Gauge Steel, Panneling & Plywood
14-2930		3-3/8" x 100	15/16"	20 Gauge Steel, Panneling & Soft Metals

1/2" Arbor Hole				
Part No.	Type	Diameter & Teeth/Grit	Max. Cut	Recommended Use
14-2701**	Carbide Chip*	4" x 36/80 Grit	1"D x 1/8"W	Fiberglass & Hard Rubber
14-2697	Carbide Chip*	4" x 80 Grit	1"D x 1/8"W	Fiberglass
14-2700	Carbide Tip*	4" x 20	1"D x 7/64"W	Fiberglass, Plastic Laminates to 1/2"
14-2710		4" x 20	1"D x 7/64"W	Thin Non-Ferrous Materials to 1/8"
14-2711		4" x 12	1"D x 7/64"W	Non-Ferrous Materials to 1/2"
14-2690	Diamond Chip*	4" x 60/80 Grit	1"D x 5/64"W	Fiberglass

\*Note: For sawing non-metallic materials only.

\*\*Note: Slim blade for fiberglass cutting with minimal dust.

### SIoux® RECIPROCATING SAW

- Low vibration and excellent balance
- Variable speed motor with ball and needle bearings
- Includes three blades



1300

Part No.	Strokes Per Minute	Stroke Length	Weight	Overall Length
1300	1800	5/8"	7.8 lbs.	17-1/8"

Part No.	Recommended Applications	Teeth Per Inch	Overall Length
SIP-1810	Metals over 1/8" thick	14	6"
SIP-1811	Metals to 1/8" thick	18	6"
SIP-1812	Metals over 1/8" thick	18	4"
SIP-1813	Metals to 1/8" thick	14	4"
SIP-1814	Metals to 18 gauge	24	6"
SIP-1815	Metals, Hard Rubber & Fiber over 1/4"	10	6"
SIP-1816	Roughing in on Wood Composition & Non-Ferrous Materials	6	6"
SIP-1817	Roughing in on Wood Composition & Non-Ferrous Materials	10	6"

### SIoux® RECIPROCATING AIR SAW

- Lightweight slim design for cutting in confined areas
- Positive blade retention with adjustable blade guide
- Comes with 5 blades



SX5302A

Part No.	Strokes Per Minute	Stroke Length	Weight	Overall Length
SX5302A	10000	3/8"	2.0 lbs.	9-1/4"

### BOSCH ORBITAL ACTION JIG SAW

- Steel footplate retracts and adjusts to 45° in either direction
- Tool-free blade change with exclusive clamp mechanism for superior hold
- Low vibration design for smooth operation
- Adjustable 4 stage orbital action and low position roller guide for stability
- Includes three assorted blades and anti-splintering insert
- Uses standard Bosch blades



7561-118

0.75 HP				
Part No.	Strokes Per Minute	Stroke Length	Weight	Overall Length
7561-118	2200	1"	3.5 lbs.	10"

## USI SHEAR

- Aluminum swivel head provides precise control with straight or contour cuts
- Shearing action leaves a clean, burr free edge and won't warp or bend the metal

**US7387PS**



Part No.	Capacity Steel	Capacity Stainless	Width of Cut	Weight	Overall Length
US7387PS	18 gauge	20 gauge	7/32"	2.4 lbs.	8-1/4"

## SIOUX® SHEARS

- Excellent for a large variety of sheet metal work
- Cuts curves and straight lines

### Pistol Grip 0.9 HP

Part No.	Cap. Steel	Overall Length	Weight
1445ES	18 gauge	8"	2.9 lbs.

**1446ES**



### Lever Grip 0.75 HP

Part No.	Cap. Steel	Overall Length	Weight
1446HPL	18 gauge	10"	2.8 lbs.

**1446HPL**



## KETT PNEUMATIC SCISSOR SHEARS

- No need to file or deburr
- 1/4" soft plastic or rubber

Part No.	Capacity Steel	Weight
P-1041	18 gauge	5 lbs.
P-541	18 gauge	5 lbs.

**P-0141**



**P-541**



### USI PANEL SAWS

- Variable speed trigger for smooth, easy starting cuts
- Highly maneuverable saw can cut through up to 5/8" thick material
- Includes 4 each 1-3/4 saw blades
- 7/16" arbor hole



**US7387PAS**

Part No.	RPM	Material Capacity	Blade Capacity	Depth of Cut	Weight	Overall Length
US7387PAS	2800	16 gauge mild steel	1-1/4" – 2"	5/16"	4.0 lbs.s	11-3/4"

### KETT PANEL SAWS

- Variable speed trigger for smooth, easy starting cuts
- Vacuum models available (PSV)
- 7/16" arbor hole



**PS-526**

Part No.	RPM	Material Capacity	Blade Capacity	Depth of Cut	Weight	Overall Length
PS-526	2200	16 gauge mild steel	1-3/4" – 2"	5/16" – 3/8"	5.0 lbs.	13-1/2"
PS-523	2200	16 gauge mild steel	2" – 2-1/2"	5/8"	6.0 lbs.	14"
PS-544	2200	16 gauge mild steel	3-1/2"	1-1/16"	5.0 lbs.	14"

### ADEL NIBBLING HAND TOOL

- Cuts round, square or irregular holes to any shape & size over 7/16"
- Cuts clean like a punch and die

Part No.	Description	Capacity Steel
TP81	Nibbling Hand Tool	18 gauge
TP81A	Replacement Punch	-



**TP81**

### ADEL NIBBLING HAND TOOL

- Cuts a tight 3/8" radius with great accuracy
- Balanced, lightweight design for easy handling



**CP835**

0.5 HP (0.37kW)				
Part No.	Cap. (steel)	Strokes Per Minute	Overall Length	Weight
CP835	16 gauge	2750	7-1/2"	2.2 lbs.

Replacement Punch & Dies	
Part No.	Description
KF137273	Punch
KF137310	Die



## CHICAGO PNEUMATIC AIR SCRIBE

- Lightweight (only 5 oz.) and easy to operate – writes like a ballpoint friend
- Simple piston supplied power for trouble free use
- Graduated sleeve throttle permits accurate power selection for each job
- Change of stylus converts tool to scaler or hammer
- Writes on materials up to 64R hardness

**Kit Includes:**

Air scribe, anvil, flat chisel, chisel blank, round nose chisel, 2 carbide tipped stylus, 8' air hose (3/16" ID), air filter assembly and carrying case.

**CP9361-1**



Part No.	Description
CP9361-1	Complete Kit
CP9361	Air Scribe, Stylus, Hose & Filter Assembly Only
P058425	Replacement Kit (4 pcs.)
P054177	Carbide Tipped Stylus Only
VP2-X	Air Scribe and Hose Assembly
63213	Replacement Stylus



**VP2-X**

## TAB SHEAR

- For precision shearing of router tabs
- Full length bosses with bolts and self-locking nuts
- Standard anodized aluminum frame with carbide wear faces
- Tool steel blades are regrindable
- Replacement blades available, please inquire
- Bench stand available BMS
- Bench stand with foot pedal BMST



**US7000**



**US7000BMS**



**US7000T**

Part No.	Capacity (steel - aluminum)	Max. Throat Opening	Shearing Force	Weight
UAT750	1/16" – 3/32"	1/8" x 3"	4200 lbs.	7.0 lbs.
US7000	1/16" – 3/32"	1/8" x 3"	4500 lbs.	6.5 lbs.
US7000T	1/8" – 3/16"	1/8" x 3"	6500 lbs.	9.8 lbs.
US7000BMS	Stand Only			
US7000BMST	Stand with Foot Pedal (not shown)			

## NATIONAL DETROIT® STRAIGHT LINE SANDER

- Includes built-in water spray system
- Palm control
- 5/16" stroke
- Applications include: wet sanding, polishing & finish blending on stainless

Part No.	Pad Capacity	SPM (no load)	Weight
600	3-2/3" x 9"	3200	5.4 lbs.



600

## NATIONAL DETROIT® ORBITAL ACTION SANDERS

- Small & lightweight
- Palm control
- 3/16" stroke
- Applications include: feather edging, finish sanding, blending & blocking

Part No.	Pad Capacity	SPM (no load)	Weight
400	3-2/3" x 9"	12000	4.4 lbs.

Note: Units require 60 to 75 PSI.



400

## DYNABRADE® STRAIGHT LINE SANDER

- Ideal for work on metals, composites & other solid surfaces
- For use with PSA coated & non-woven sheets & rolls
- High quality gear for smooth running performance
- .3 HP
- Pad rotates 360°

Part No.	Pad Capacity	SPM (no load)	Overall Length	Weight
DYN51350	2-3/4" x 11"	0 - 2400	11"	3.3 lbs.



DYN51350

## NATIONAL DETROIT® ORBITAL ACTION SANDERS

- 3/16 orbital
- Vinyl or hook & loop pad (specify)
- Adjustable speed control

Part No.	Motor Muffler		Weight
	Pad Capacity	SPM (no load)	
PGSS-5	5"	12000	2.0 lbs.
PGSS-6	6"	12000	2.0 lbs.



PGSS

## DOTCO ORBITAL ACTION SANDER

- Small & lightweight
- Palm control
- 3/16" orbital action
- Applications include feather edging, finish sanding, blending & blocking
- Clip paper holders

Part No.	Pad Capacity	SPM (no load)	Weight
12L1850-09	3-2/3" x 9"	10000	2.28 lbs.

**12L1850-09**

## DOTCO ORBITAL ACTION SANDERS

- Central vacuum
- Small & lightweight
- Palm control
- 3/16" orbital action
- Applications include feather edging, finish sanding, blending & blocking
- Clip paper holders

Part No.	Pad Capacity	SPM (no load)	Weight
12L1850-19	3-2/3" x 9"	10000	2.28 lbs.

**12L1850-19**

## DYNABRADE® ORBITAL ACTION SANDER

- Ideal for working on metals, composites & other solid surfaces
- 3/32" orbital action
- Clip paper holder

Part No.	Pad Capacity	SPM (no load)	Weight
DYN51810	3-2/3" x 9"	10000	2.8 lbs.

**DYN51810**

## DYNABRADE® ORBITAL ACTION SANDER

- Ideal for working on metals, composites & other solid surfaces
- Central vacuum 1" dia. hose
- 3/32" orbital action
- Clip paper holder

Part No.	Pad Capacity	SPM (no load)	Weight
DYN57814	3-2/3" x 9"	10000	2.6 lbs.

**DYN57814**

## DOTCO® ORBITAL ACTION SANDERS

- Low profile for more sanding control
- 3/16" orbit
- Lightweight for reduced operator fatigue
- For hook & loop pad, add 'HL' to part number
- Vinyl pad

Non-Vacuum 0.24 HP				
Part No.	Pad Capacity	RPM (no load)	Overall Length	Weight
12L1820-05	5"	12000	5-1/2"	1.6 lbs.
12L1820-06	6"	12000	5-1/2"	1.7 lbs.

Central Vacuum 0.24 HP - Includes Vacuum Attachment & Shroud				
Part No.	Pad Capacity	RPM (no load)	Overall Length	Weight
12L1820-15	5"	12000	7-3/4"	1.7 lbs.
12L1820-16	6"	12000	7-3/4"	1.9 lbs.

Self-Generated 0.24 HP - Includes Vacuum Hose & Floor Bag				
Part No.	Pad Capacity	RPM (no load)	Overall Length	Weight
12L1820-25	5"	12000	8-3/8"	1.7 lbs.
12L1820-26	6"	12000	8-7/8"	1.8 lbs.

*Note: Units require 60 to 75 PSI.*



**12L1820-05**



**12L1820-25**

## DYNABRADE® ORBITAL ACTION SANDERS

- Low profile for more sanding control
- 3/16" orbit
- Lightweight for reduced operator fatigue
- Vinyl pad

Non-Vacuum 0.28 HP			
Part No.	Pad Capacity	RPM (no load)	Weight
DYN56815	5"	12000	2.0 lbs.
DYN56826	6"	12000	2.1 lbs.

Central Vacuum 0.28 HP – with 1" dia. Vacuum Port			
Part No.	Pad Capacity	RPM (no load)	Weight
DYN56819	5"	12000	2.8 lbs.
DYN56830	6"	12000	2.9 lbs.

*Note: Units require 60 to 75 PSI.*



**DYN56819**



**DYN56815**

## DOTCO® RIGHT ANGLE GRINDER/SANDER

- Includes collet, wrenches, grease gun & gear lube
- Front or rear exhaust
- Other models available, please inquire
- Also available with additional collet sizes



12L1201-36

## 12-12 Series 0.3 HP

Part No. Front Exhaust	Part No. Rear Exhaust	Grinder/Sander Capacity	RPM (no load)	Collet/Thread	Overall Length	Weight
12L1201-36	12L1281-36	1/2" - 2"	20000	1/4 collet	6.3"	1.1 lbs.
12L1200-36	12L1280-36	1/2" - 3"	12000	1/4 collet	6.3"	1.1 lbs.
12L1201-32	12L1281-32	1/2" - 2"	20000	1/4"-28 Internal Thread	6.3"	1.1 lbs.
12L1200-32	12L1280-32	1/2" - 3"	12000	1/4"-28 Internal Thread	6.3"	1.1 lbs.

## 12-22 Series 0.6 HP

Part No. Front Exhaust	Part No. Rear Exhaust	Grinder/Sander Capacity	RPM (no load)	Collet/Thread	Overall Length	Weight
-	12L2218-36	3/4" - 3"	18000	1/4 collet	7.5"	1.7 lbs.

## DYNABRADE® RIGHT ANGLE DISC SANDER

- Front or rear exhaust



DYN52315

## 0.4 HP

Part No. Front Exhaust	Part No. Rear Exhaust	Sanding Disc Capacity	RPM (no load)	Collet	Overall Length	Weight
DYN51800	52315	3"	12000	1/4 collet	5-3/4"	1.7 lbs.
DYN51802	52317	3"	20000	1/4 collet	5-3/4"	1.7 lbs.

## DOTCO® PRECISION GRINDERS

- Includes collet, wrenches, 1" overhose & 5' air hose (3/16" I.D. - 1/8" NPT)
- Rear exhaust



12R0410-18

## 12-04 Series 0.1 HP

Part No. w/ Collet Guard	Part No. w/o Collet Guard	Capacity	RPM (no load)	Collet	Overall Length	Weight
12R0410-13	12R0400-13	1/4" Carbide Burr	60000	3 mm	5.8"	0.3 lbs.
12R0410-16	-		60000	3/32"	5.8"	0.3 lbs.
12R0410-18	12R0400-18		12000	1/8"	5.8"	0.3 lbs.

## DOTCO® ANGLE HEAD PRECISION GRINDERS

- Includes collet, wrenches, 1" overhose & 5' air hose (3/16" I.D. - 1/8" NPT)
- Rear exhaust
- 3/32 collet available

**12R0380-18**

## 12-03 Series 0.1 HP

Part No. w/ Collet Guard	Capacity	RPM (no load)	Collet	Overall Length	Weight
12R0380-13	1/4" Diamond Pin	80000	3 mm	5.5"	0.3 lbs.
12R0380-18	1/4" Diamond Pin	80000	1/8"	5.5"	0.3 lbs.

## DOTCO® PRECISION TURBINE GRINDERS

- Includes collet, wrenches, hose filter & 7' air hose (3/16" I.D. - 1/8" NPT)
- Front exhaust motor requires no oil

**10R9000-08**

## 12-03 Series 0.1 HP

Part No.	Capacity	RPM (no load)	Collet	Overall Length	Weight
10R9000-03	3/16" Carbide Burr	100000	3 mm	5.4"	0.5 lbs.
10R9000-08	3/16" Diamond Pin		1/8"	5.4"	0.5 lbs.

## DOTCO® PRECISION TURBINE GRINDER

- Includes collet, wrenches, hose filter & 8' air hose (5/16" I.D. - 1/4" NPT)
- Front exhaust motor requires no oil
- Built-in speed regulator

**10R9000-08**

## 10-95 Series 0.1 HP

Part No.	Capacity	RPM (no load)	Collet	Overall Length	Weight
10L9500-36	1/4" Carbide Burr 3/16" Diamond Pin	80000	1/8"	5.8"	1.9 lbs.

## DOTCO® PRECISION TURBINE GRINDERS

- Includes collet, wrenches, collet guard & 5' air hose (3/16" I.D. - 1/8" NPT)
- Only one moving part, requires no oil
- Extended spindle for convenient pencil style grip

**12R9180-03**

## 12-03 Series 0.1 HP

Part No.	Capacity	RPM (no load)	Overhose incl.	Collet	Overall Length	Weight
12R9180-03	1/8" Carbide Burr	65000	None Front Exhaust	3 mm	5.8"	0.4 lbs.
12R9180-08				1/8"		
12R9180-43			4" Overhose	3 mm		
12R9180-48				1/8"		

## DOTCO® DIE GRINDERS

- Includes collet, wrenches (1/4" I.D. air hose)
- Front or rear exhaust
- Lock-off lever standard
- Other collet sizes available



12L1001-36

12-10 Series 0.3 HP						
Part No. Front Exhaust	Part No. Rear Exhaust	Capacity	RPM (no load)	Collet	Overall Length	Weight
12L1000-36	12L1080-36	1/2" Carbide Burr 1" Mounted Wheel	30000	1/4"	6"	0.8 lbs.
12L1000-36	12L1080-36		34000			
12L1003-36	12L1083-36		25000			

Note: Oilless blades.

## DOTCO® DIE GRINDERS

- Includes collet, wrenches (1/4" NPT - use 1/4" I.D. air hose)
- Front or rear exhaust
- Lock-off lever standard



12L2080-01

12-20 Series 0.6 HP						
Part No. Front Exhaust	Part No. Rear Exhaust	Capacity	RPM (no load)	Collet	Overall Length	Weight
12L2000-01	12L2080-01	3/4" Carbide Burr 1-1/2" M. Wheel	25000	1/4"	6.9"	1.4 lbs.

12-25 Series 0.9 HP						
Part No. Front Exhaust	Part No. Rear Exhaust	Capacity	RPM (no load)	Collet	Overall Length	Weight
12L2500-01	12L2580-01	1" Carbide Burr 1-1/2" M. Wheel	23000	1/4"	7.3"	1.8 lbs.

## DOTCO® EXTENSION DIE GRINDERS

- Includes collet, wrenches (1/4" NPT - use 1/4" I.D. air hose)
- Front exhaust
- Other collet sizes available
- Lock-off lever standard



12L1180-36

12-11 Series 0.3 HP – with 3" Extension					
Part No.	Capacity	RPM (no load)	Collet	Overall Length	Weight
12L1100-36	1/2" Carbide Burr 1" Mounted Wheel	28000	1/4"	8.9"	1.1 lbs.
12L1111-36		25000	1/4"	8.9"	1.1 lbs.

12-11 Series 0.3 HP – with 5" Extension					
Part No.	Capacity	RPM (no load)	Collet	Overall Length	Weight
12L1101-36	1/2" Carbide Burr 1" Mounted Wheel	28000	1/4"	10.9"	1.3 lbs.
12L1112-36		25000	1/4"	10.9"	1.3 lbs.

## DYNABRADE® DYNAFILE KIT

- Ergo handle and quick belt change design
- Work metal, plastic, fiberglass & composites
- Over 30 interchangeable contact arms available, please inquire
- Motor easily adjusts for the most comfortable throttle lever position



DYN14000



DYN14010

**Complete Versatility Kit includes:**

- Dynafile, five contact arms with abrasive belt assortment, and sturdy carrying case

Dynafile 0.5 HP - For 24" Sanding Belts					
Part No. Dynafile Only	Part No. Versatility Kit	Sanding Belt Capacity	RPM (no load)	Overall Length	Weight
DYN14000	14010	(1/8" to 1/2") x 24"	20000	14-5/8"	3.7 lbs.

## DYNABRADE® DYNAFILE II KIT

- 7" offset design with 360° pivoting grinding head
- Ergo handle and quick belt change design
- Work metal, plastic, fiberglass & composites
- Over 30 interchangeable contact arms available, please inquire
- Motor easily adjusts for the most comfortable throttle lever position



DYN40320



DYN43021

**Complete Versatility Kit includes:**

- Dynafile II, three contact arms with abrasive belt assortment, 1/4" die grinder collet and sturdy carrying case

Dynafile 0.5 HP - For 24" Sanding Belts					
Part No. Dynafile Only	Part No. Versatility Kit	Sanding Belt Capacity	RPM (no load)	Overall Length	Weight
DYN40320	40321	(1/4" to 3/4") x 18"	20000	14-1/4"	2.5 lbs.

## DOTCO® BELT SANDER

- Ergo handle and quick belt change design
- Work metal, plastic, fiberglass & composites

**Kit includes:**

- Tool with 3/4" wide straight arm (1)
- Additional arms (2)
  - 1 - 1/2" wide straight arm
  - 1 - offset arm
- 1/4" x 18" aluminum oxide belts (3)
  - 1 - 60 grit
  - 1 - 80 grit
  - 1 - 120 grit
- 1/2" x 18" aluminum oxide belts (3)
  - 1 - 60 grit
  - 1 - 80 grit
  - 1 - 120 grit
- 3/4" x 18" aluminum oxide belts (2)
  - 1 - 60 grit
  - 1 - 80 grit
- 3/4" x 18" non-woven belt (1)
  - 1 - Medium
- Wrenches & misc. items
  - 1 ea. - 3/4" & 9/16" open end wrench
  - 1 ea. - 9/64" & 3/16" hex wrench
  - 1 - 1/4" collet
  - 1 - collet cap
  - 1 - chuck body
- Carrying case with foam insert (1)



12-23 Series 0.5 HP - Gearless - Woven - Non-Woven Belts			
Sanding Belt Capacity	RPM (no load)	Overall Length	Weight
(1/4" to 3/4") x 18"	20000	15.0"	2.5 lbs.



## DOTCO® BELT SANDERS

- Includes #80 and #120 grit sanding belts, wrenches, grease gun and gear lube
- Front or rear exhaust
- Many other models available, please inquire



**12L1281-36B2**

12-12 Series 0.3 HP - Sanding Belt					
Part No. Front Exhaust	Part No. Rear Exhaust	Sanding Belt Capacity	RPM (no load)	Overall Length	Weight
-	12L1281-36B1	1/4" x 12"	20000	11.3"	1.4 lbs.
12L1201-36B2	12L1281-36B2	1/2" x 12"	20000	11.3"	1.4 lbs.
12L1200-36B2	12L1280-36B2	1/2" x 12"	12000	11.3"	1.4 lbs.
12L1201-36B4	-	1" x 12"	20000	11.3"	1.7 lbs.
12L1200-36B4	12L1280-36B4	1" x 12"	12000	11.3"	1.7 lbs.
-	12L1281-36B3	1/2" x 24"	20000	16.4"	1.6 lbs.
-	12L1280-36B3	1/2" x 24"	12000	16.4"	1.6 lbs.
12L1201-36B5	-	1" x 24"	20000	16.4"	2.2 lbs.

## DOTCO® PRECISION COLLETS

- HG collets for models 10-04, 10-90, 12-03 and 12-04
- 200 Series on -01 models
- 300 Series on -36 models



**204**



**301**

200 Series		
Part No.	Size	Capacity
204	1/8"	3/32" to 1/8"
205	5/32"	1/8" to 5/32"
206	3/16"	5/32" to 3/16"
207	7/32"	3/16" to 7/32"
208	1/4"	7/32" to 1/4"
209	9/32"	1/4" to 9/32"
210	5/16"	9/32" to 5/16"
211	11/32"	5/16" to 11/32"
212	3/8"	11/32" to 3/8"
213	6 mm	5.2 to 6 mm
216	8 mm	5.2 to 8 mm

300 Series		
Part No.	Size	Capacity
301	3/64"	1/64" to 3/64"
302	5/64"	3/64" to 5/64"
303	3/32"	1/16" to 3/32"
304	1/8"	3/32" to 1/8"
305	5/32"	1/8" to 5/32"
306	3/16"	5/32" to 3/16"
307	7/32"	3/16" to 7/32"
308	1/4"	7/32" to 1/4"
309	3 mm	2.2 to 3 mm
310	6 mm	5.2 to 6 mm

HG Series - not shown		
Part No.	Size	Capacity
103	1/16"	1/16"
102	3/32"	3/32"
100	1/8"	3/32"
146	1 mm	1 mm
131	2.35 mm	2.35 mm
148	3 mm	3 mm

## GRINDING &amp; SURFACE PREP KITS

**Kit Includes:**

- 1 - 1/4" 90° angle die grinder with composite handle (AP1240)
- 5 - 2" surface prep pads with holder
- 5 - 3" surface prep pads with holder
- 1 - Spanner wrench
- 1 - 1/8" collet
- 10 pc. stone assortment

**AP1220**

Part No.	Description
AP1220	23 pc. kit

## SANDING &amp; POLISHING KIT

**Kit Includes:**

- 1 - Pistol grip dual action sander/polisher tool - 13,000-16,000 rpm
- 1 - 3" sanding/polishing back-up pad (20303P)
- 1 - 1-1/2" sanding pad (20305P)
- 1 - 3" polishing foam pad (20306P)
- 2 - 3" 400 grit sanding disc (3400P)
- 2 - 3" 600 grit sanding disc (3600P)
- 2 - 3" 1000 grit sanding disc (31000P)
- 10 - 1-1/2" 2000 grit sanding disc (2000P)
- 1 - Spanner wrench
- 1 - Blow molded case

**AP3050**

Part No.	Description
AP3050	22 pc. kit

## COMPOSITE HANDLE GRINDER

- 1/4" collet
- Composite handle
- 1/3 hp
- Built-in regulator

Part No.	RPM	Length	Weight
AP1205	25000	4-3/4"	.8125 lbs.
AP1206A	22000	6-3/4"	1.125 lbs.
AP1240	20000	5-3/4"	1.0 lbs.

**AP1205****AP1206A****AP1240**

industrial power tools



3T dSe[hVø ~ DafSck 8[Vø

## CARBIDE ROTARY FILE KIT

**Available in:**

- High speed steel
- Standard Cut: Double
- Optional Cut: Coarse, Diamond, Fine, Fast Mill
- 3/32" and 1/8" shank burrs



Part No.	Description
C927-9	1 ea.: SC1, SD2, SA5, SF1, SG3, SE5, SM1, SL3, SH5

## CARBIDE ROTARY FILES



Part No.	Cylindrical Flat End	Diameter	Cut Length
SA12	1/8"	5/8"	
SA14	3/16"	5/8"	
SA1	1/4"	5/8"	
SA2	5/16"	3/4"	
SA3	3/8"	3/4"	
SA4	7/16"	1"	
SA5	1/2"	1"	
SA6	5/8"	1"	
SA7	3/4"	1"	
SA9	1"	1"	



Part No.	Cylindrical Round	Diameter	Cut Length
SC12	1/8"	5/8"	
SC14	3/16"	5/8"	
SC1	1/4"	5/8"	
SC2	5/16"	3/4"	
SC3	3/8"	3/4"	
SC3A	3/8"	1"	
SC4	7/16"	1"	
SC5	1/2"	1"	
SC6	5/8"	1"	
SC7	3/4"	3/4"	



Part No.	Bail Shape	Diameter	Cut Length
SD12	1/8"	3/32"	
SD14	3/16"	5/32"	
SD1	1/4"	7/32"	
SD2	5/16"	9/32"	
SD3	3/8"	5/16"	
SD4	7/16"	3/8"	
SD5	1/2"	7/16"	
SD6	5/8"	9/16"	
SD7	3/4"	11/16"	
SD9	1"	15/16"	



Part No.	Tree Pointed	Diameter	Cut Length
SG1	1/4"	5/8"	
SG3	3/8"	3/4"	
SG13	1/2"	3/4"	
SG5	1/2"	1"	
SG6	5/8"	1"	
SG7	3/4"	1"	
SG15	3/4"	1-1/2"	



Part No.	Tree Radius	Diameter	Cut Length
SF1	1/4"	5/8"	
SF3	3/8"	3/4"	
SF4	7/16"	1"	
SF5	1/2"	1"	
SF6	5/8"	1"	
SF7	3/4"	1"	
SF14	3/4"	1-1/2"	



Part No.	Inverted Cone	Diameter	Cut Length
SN1	1/4"	5/16"	
SN1E	1/4"	5/16"	
SN3	1/2"	1/2"	
SN3E	1/2"	1/2"	
SN6	5/8"	3/4"	

Note: "E" denotes end cut.



Part No.	Flame	Diameter	Cut Length
SH2	5/16"	3/4"	
SH4	7/16"	1-1/8"	
SH6	5/8"	1-7/16"	



Part No.	Concave Radius	Diameter	Cut Length
CBU-W	1/4"	3/16"	
GEU-W	1/2"	3/8"	



Part No.	60° Deburring	Diameter	Cut Length
SJ1	1/4"	3/16"	
SJ3	3/8"	5/16"	
SJ5	1/2"	7/16"	
SJ6	5/8"	9/16"	
SJ7	3/4"	11/16"	

## ARC POWER LOCK DISC HOLDERS



**TYPE R - ROLOC (3M)**



**TYPE S - SOCATT (NORTON)**



**50251**

Type III - Roll On Type "R"			
Part No.	Hardness	Size	Max. RPM
50257	Medium	1"	40000
50258	Medium	1-1/2"	25000
50259SF	Soft	2"	25000
50259	Medium	2"	25000
50259FM	Firm	2"	25000
50260SF	Soft	3"	20000
50260	Medium	3"	20000
50260FM	Firm	3"	20000

Type II - Twist On Type "S"			
Part No.	Hardness	Size	Max. RPM
50251	Medium	1"	40000
50252	Medium	1-1/2"	25000
20253SF	Soft	2"	25000
50253	Medium	2"	25000
50253FM	Firm	2"	25000
50254SF	Soft	3"	20000
50254	Medium	3"	20000
50254FM	Firm	3"	20000

## ALUMINUM OXIDE - QUICK-LOC DISC - SURFACE CONDITIONER

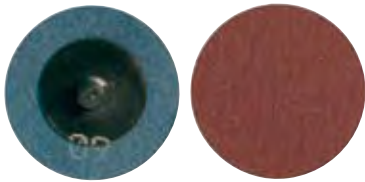

**31414**



**59242**

Dia.	Grit	Type S	Type R
		Socatt (Norton)	Rolok (3M)
1	36	31414	31614
	60	31417	31617
	80	31418	31618
	100	31419	31619
	120	31420	31620
	180	31422	31622
1-1/2	36	31438	31638
	60	31441	31641
	80	31442	31642
	100	31443	31643
	120	31444	31644
	180	31446	31646
2	36	31450	31650
	60	31453	31653
	80	31454	31654
	100	31455	31655
	120	31456	31656
	180	31458	31658
3	36	31462	31662
	60	31465	31665
	80	31466	31666
	100	31467	31667
	120	31468	31668
	180	31470	31670

Type II	1"	2"	3"
Very Fine	59211	59241	59261
Medium	59212	59242	59262
Coarse	59213	59243	59263

Type III	1"	2"	3"
Very Fine	59311	59341	59361
Medium	59312	59342	59362
Coarse	59313	59343	59363



**TYPE R - ROLOC (3M)**



**TYPE S - SOCATT (NORTON)**

## CUT SHEETS FOR SANDERS

- Cut to fit hand, orbital and palm sanding requirements
- Pre-cut to eliminate waste
- Aluminum oxide grain
- Closed coat designed for more surface removal
- Full resin over resin
- Durable and flexible backing
- Ideal for hand, orbital and palm sanders
- Use on ferrous and nonferrous metals
- Wood, fiberglass and plastics

3-2/3 x 9"		
Part No.	Grit	Std. Pkg.
73693	60	100
73694	80	100
73696	120	100

## NON-WOVEN ABRASIVE BELTS

- Equal to 3M Scotchbrite
- Designed for consistent buffing, polishing, finishing & light deburring
- Perfect for uniform surface preparation & high quality finishing on metals

Size	Part No. 20 Pack Coarse	Part No. 20 Pack Medium	Part No. 20 Pack Very Fine
1/2" x 18"	630050181	630050182	630050183
1/2" x 24"	630050241	630050242	630050243
3/4" x 18"	630080181	630080182	630080183



**630050181**

## ABRASIVE BELTS

- Premium aluminum oxide 'X' weight
- Recommended for medium to heavy grinding & finishing
- For use on regular and high tensile steel, cast iron, non-ferrous materials and alloys
- Other sizes and grits available, please inquire



**70072**

Size	Part No.	Grit
1/2" x 12" (10 pack)	70072	36
	70073	40
	70074	50
	70075	60
	70076	80
	70078	120
	70080	180

Size	Part No.	Grit
1/2" x 18" (10 pack)	70081802	36
	70081803	40
	70081804	50
	70081805	60
	70081806	80
	70081807	120
	70081808	180

Size	Part No.	Grit
3/4" x 18" (10 pack)	70124Z09	36
	70124Z1GRSZ	40
	70124Z1LE	50
	70124Z1SZ	60
	70124Z12	80
	70124Z2GR	120
	70124Z25	180

## ECONOMY SAFETY WIRE TWISTERS

- For use on wire up to .060" diameter
- Fast spiral action

Part No.	Type	Nose Style	Overall Length
TP68SR-6	Spring Return	Tapered	6"
TP68SR	Spring Return	Tapered	9"



TP68SR

## MILBAR® REVERSIBLE SAFETY WIRE TWISTERS

- Patented reversible twist action
- Spring return twist rod & sure grip clutch action knob
- Quick acting reversible sleeve
- Aerospace standard AS567

Part No.	Wire Capacity	Overall Length
AIT45W	.041"	6" Diagonal
AIT41W	.060"	9" Diagonal
AIT42W	.060"	12" Diagonal



AIT45W

Cushion Throat		
Part No.	Type	Nose Style
AIT25W	6" Auto Return	Diagonal
AIT26W	9" Auto Return	Diagonal



AIT25W

## MILBAR® SAFETY WIRE TWISTERS

Part No.	Type	Overall Length
AIT11WS	Auto Return	6" Diagonal
AITIW393	Auto Return	9" Diagonal



AIT11WS

## EZ SAFETY WIRE TWISTER

- Makes fast, neat twists in tight or hard to reach places
- One hand operation
- Use on wire .060" diameter

Part No.	Overall Length
TP277	6"
TP277A	18"



TP277

## SAFETY WIRE TWISTER KITS

### Professional Safety Kit includes:

Three Safety Wire Twisters (9" Auto, 6" Mini & 19" Deep Reach), Three 1/4 lb. Spools of Safety Wire (.020", .032" & .040") & Plastic Kit Box

### Limited Access Kit includes:

Two Safety Wire Twisters (6" Mini & 19" Deep Reach), Three 1/4 lb. Spools of Safety Wire (.020", .032" & .040") & Plastic Kit Box

Part No.	Description	Weight
AIT105W	Professional Kit	4.0 lbs.
AIT109W	Limited Access Kit	2.75 lbs.



**AIT105W**

## AERO SAFETY WIRE TWISTER KIT

### Kit includes:

1 each 9" Safety Wire Twisters, TP277 Handy Twister, Three 1 lb. Spools of Safety Wire (.020", .032", & .041") & Plastic Kit Box

Part No.	Description
TP68K	Complete Kit



**TP68K**

## STAINLESS STEEL AIRCRAFT SAFETY WIRE

- Conforms to government spec QQW-423, Milspec MS-20995-C
- Convenient 1 lb. dispensing packages
- Other sizes available, please inquire

Part No.	Diameter
TP65	.032
TP66	.041
TP67	.020



**TP65**

## SAFETY WIRE JIGS

Part No.	Description	Use
TP402	Nut Jig	Drill Nuts/Bolt Heads to 3/4" dia.
TP401	Drill Jig*	Drill Holes Accurately w/o Breakage
TP402A	Both Jigs	TP401 and TP402
TP401A	Fits bolt sizes: Metric - 6 x 1.0, 8 x 1.0, 8 x 1.25, 10 x 1.25 & 10 x 1.5	

*Note: Bolt sizes 8-32, 10-32, 1/4"-20, 1/4"-20, 1/4"-28 & 5/16"-24*



**TP401**

**TP402**



## TURNBUCKLE WRENCH CABLE RIGGING TOOL

- Consists of two clamps joined by a 12" length of sprocket type chain
- Accommodates all sizes of aircraft cable 0 - 1/2"
- Allows free adjustment of the turnbuckle

Part No.	Description
SP100-1	Cable Rigging Tool

SP100-1



## CABLE SWAGING TOOLS

Part No.	Will Swage	Overall Length	Weight
TP64	1/16", 3/32" & 1/8"	7"	1 lbs.

TP64



## CABLE SWAGING KIT

Part No.	Description
TP64K	Complete Kit

TP64K



## LOCOLOC® HAND SWAGING TOOLS

**Will swage**

Ovals: 1/16", 3/32", 1/8", 5/32" &amp; 3/16"

Stops: 1/16", 3/32", 1/8", 5/32", 3/16" &amp; 7/32"

Part No.	Type	Overall Length	Weight
1-SC	Hand Held	26-1/2"	6.5 lbs.
1-BSC	Bench Mounted	16"	6.6 lbs.

1-SC



## LOCOLOC® HAND SWAGING KIT

- Contains 1-SC Hand Tool, C-7 Cable Cutter, assortment of stop and oval sleeves, assortment of thimbles.
- Will handle all sizes from 1/16" up to and including 3/16"
- Packaged in rugged steel tool box
- Supplied with aluminum sleeves and zinc plated steel thimbles or with copper sleeves and stainless steel thimbles

Part No.	Description
CSS-KIT	Complete Kit

CSS-KIT



## LOCOLOC® SLEEVE GAUGES/DIAMETER GAUGE

- To assure proper swaging of sleeves

Part No.	Description
GA-1P	1/32", 3/64", 1/16", 3/32", 1/8", 5/32" & 3/16"
GA-4	Measures 1/16" - 3/8" cable (not shown)

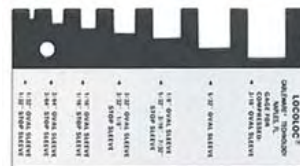

GA-1P

## FELCO HEAVY-DUTY CABLE CUTTERS

- Rubber grips & shear-cut blades that cut smooth, clean & with little distortion

Part No.	Cable Capacity	Overall Length
C-3	1/4"	8"



C-3

## PORTABLE MANUAL CABLE SWAGER KIT

- Roll type tool will swage MS type terminals to 3/16"
- Includes heavy-duty steel carrying case

**Kit includes:**

Portable Manual Swager, Dies (rolls): 5 Straight Shank Sets (1/16" - 3/16"), 3 Ball Terminal Sets (1/16" - 1/8") & Appropriate Gauges

Part No.	Description	Weight
M1-K	Complete Kit	64 lbs.



M1-K

## BENCH MOUNTED CABLE SWAGING MACHINE KIT

- Hand powered with a geared down crank for easy operation
- Will swage AN or MS type fittings to 3/8"
- Power kit 115/230 volt single phase

**Kit includes:**

Swager with Bench Mount, Dies (rolls): 10 Straight Shank Sets (1/16" - 3/8") & 7 Ball Terminal Sets (1/16" - 1/4"), Straight Shank Die Auxiliary Adapter, Appropriate Gauges, Spring Clip & Adjustable Stop Guide Assemblies

Part No.	Description	Weight
M2-K	Complete Kit	425 lbs.
M2P-K	Powered Kit	550 lbs.



M2-K

## PORTABLE PNEUMATIC CABLE TERMINAL SWAGER KIT

- All swaging & cutting dies of hardened, heat treated steel
- Each die is clearly marked indicating type & size swaged terminal or cable cut
- Meets government specification GGG-S-00825A (GSA-FSS)
- Includes heavy-duty steel carrying case
- Certified & calibrated

**Kit includes:**

Cylinder & Yoke Assembly (Easily accessible for quick changing of dies), Dies, Air Hose Assembly, Single Action Foot Control Valve Assembly with Lubricator & Air Filter, Baseplate, Gauges & Instruction Manual

Part No.	Description	Weight
AT520JK	Complete Kit	105 lbs.
AT520J	Swager Only	19 lbs.



AT520J

AT520JK

## PORTABLE PNEUMATIC CABLE TERMINAL SWAGER KIT

- Can pull test all types and sizes of terminals to 1/4" diameter
- Lightweight & compact, requires no experience to test swaged terminals
- Includes heavy-duty steel carrying case
- Certified & calibrated

**Kit includes:**

Pull Tester, Terminal Adapters: AN667 (5/32" - 1/4"), AN663/664 (1/16" - 3/16"), AN666/669 Right Thread (1/16" - 7/32"), AN666/669 Left Thread (1/16" - 1/4"), AN667/668 (3/16" - 3/8") Terminal Pins, Jaws for 1/16" to 1/4" Cables

- Calibration Kit eliminates outside calibration

Part No.	Description	Weight
AT520CTK	Complete Kit	70 lbs.
AT520CGC	Calibration Kit	8 lbs.

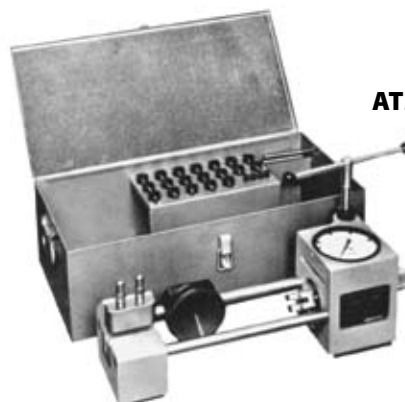

AT520CTK



AT520CGC

## HEAVY DUTY INDUSTRIAL TUBE CUTTER

- Includes flare cut-off groove rollers, fold-away reamer & spare cutting wheel
- Cuts most metal tubing

Part No.	Capacity	Weight
TC1000	1/8" to 1-1/8" O.D.	6.5 oz.



**TC1000**

## COMPACT TUBE CUTTER

- Enclosed feed requires only 1-1/4" clearance
- Replaceable hardened steel cutter wheel with two friction reducing steel rollers

Part No.	Capacity	Weight
TC1050	1/8" to 5/8" O.D.	3.0 oz.



**TC1050**

## INNER-OUTER REAMERS

- Reams inside/outside edges of tube with three hollow ground tool steel cutters

Part No.	Material	Capacity	Weight
208-F	Aluminum & Soft Metals	3/16" to 1-1/2" O.D.	0.6 lbs.



**208-F**

## TRIPLE HEADER TUBE BENDERS

- Bends most metal tubing
- Calibrated markings for making accurate left, right or offset bends
- 90° start requires less effort, is fast & easy

Part No.	Capacity
367-FH	1/8", 3/16" & 1/4" O.D. 9/16" radius to center of tube
368-FH	1/4", 5/16" & 3/8" O.D. 15/16" radius to center of tube

**367-FH**



**368-FH**

## TRIPLE HEADER TUBE BENDERS

- Each tool bends one size
- Open side design slips over tube at any point with wide hook for secure grip
- Calibrated markings with up to 180° bend
- No scoring or flattening of tubing

Part No.	Tube O.D.	Radius to Center of Tube	Weight
364-FH-02	1/8"	3/8"	0.5 lbs.
364-FH-03	3/16"	7/16"	0.5 lbs.
364-FHA-04	1/4"	1/4"	1.0 lbs.
364-FHA-05	5/16"	11/16"	1.0 lbs.
364-FHA-06	3/8"	15/16"	1.75 lbs.
364-FHA-07	7/16"	1-1/2"	3.5 lbs.
364-FHA-08	1/2"	1-1/2"	3.5 lbs.



**364FH-06**

## 37" SINGLE &amp; DOUBLE LAP FLARING TOOL KIT

- Flares soft copper & aluminum to AN standards: 3/16", 1/4", 5/16", 3/8" & 1/2" O.D.
- Also flares single 37" S.A.E. standard & oversize
- For portable use or can be vise mounted
- Sliding handle for maximum leverage
- Adapters revolve for quick size change

Part No.	Includes
256FK	Flaring Tool, Inner-Outer Reamer, Tubing Cutter, Instructions & Carrying Case

256FK



## ROL-AIR 37" FLARING TOOL

- Faceted, hard chrome finished cone for perfect scoreless flares
- Slip on yoke permits use in tight quarters

Part No.	Materials	Sizes	Weight
507-FB	Soft Copper, Aluminum & Brass	3/16", 1/4", 5/16" 3/8", 1/2" & 5/8" O.D.	1.7 lbs.



507-FB

## ROL-FLAIR 37" ROTARY FLARING TOOL

- Depth gauge auto positions tube for correct flare

Part No.	Materials	Sizes	Weight
212-FB	Soft Copper & Aluminum Alloys	1/8", 3/16", 1/4", 5/16" 3/8", 1/2", 5/8" & 3/4" O.D.	3.0 lbs.



212-FB

## ROL-FLAIR 37" ROTARY FLARING TOOL

- Swivel head clamp locks tubing in smooth bare die blocks
- Lathe type tube feed
- Ball bearing mounted flaring cone
- Tool must be clamped in vise
- Includes heavy-duty steel carrying case

Part No.	Materials	Sizes	Weight
407-FA	Stainless Steel & Other Tubing	1/8", 3/16", 1/4", 5/16" 3/8", 1/2", 5/8", 3/4", 1", 1-1/4" & 1-1/2" O.D.	50 lbs.



407-FA

## 37" HEAVY DUTY FLARING TOOL KIT

Flares to government specifications in steel, stainless steel (including MIL-T-6845), titanium and other metal tubing.

**Kit includes:**

Flaring & Reaming Kit contains 400-F Flaring Tool and 401-FA Reaming Yoke for 1/4" to 5/8" O.D. tubing.

Part No.	Materials	Sizes	Weight
402-FA	Stainless Steel & Other Tubing	1/8", 3/16", 1/4", 5/16" 3/8", 1/2" & 5/8" O.D.	3.2 lbs.



**402-FA**

## PRO TUBE BEADING KIT

- Meets MIL Spec MS33660D and S.A.E. AS5131 standards
- Copy of original Packer beading tool

Part No.	Description
AP145	1/4", 3/8", 1/2", 5/8", 3/4" & 1"



**AP145**

## EZ-BEADER

- Designed to replace the original Parker beading tools.
- Compact design
- Capable of tubing wall thickness from .035" to .065" thick
- Larger sizes available

Part No.	Sizes	Description
TP885A	1/8"	EZ-Beader
TP885B	1/2"	EZ-Beader 1
TP885C	5/8"	EZ-Beader
TP885D	3/4"	EZ-Beader



**TP885C**

## LED MAG-LITE® FLASHLIGHTS

- A powerful projecting beam
- Balanced optics
- Interchangeable light sourcing
- Use either LED or krypton lamp stored in the tail cap



3 Watt Mag-LED			
Part No.	Batteries Req. (not included)	Weight (with batteries)	Overall Length
2D	2 D-Cell	23 oz.	10"
3D	3 D-Cell	30 oz.	12-11/32"

3 Watt Mini Mag-LED			
Part No.	Batteries Req. (not included)	Weight (with batteries)	Overall Length
2AA	2 AA	4.15 oz.	6-5/8"
3AA	3 AA	5.44 oz.	8-5/8"

## PROVISION BOROSCOPES

- Offers the same performance and results as boroscopes costing 10x as much
- Powerful halogen lamp powered by 2AA batteries (not included)
- 'Obedient' 0.4" cable maintains its fixed position until readjusted
- 6" ergo designed handle with integrated focus ring
- Includes fitted case



Part No.	Cable Length	Field of View	Optimal View Dist.	Weight (with case)	Overall Length
PV-100	18"	40°	0.8"	1.5 lbs.	24"
PV-300	36"	40°	0.8"	2.6 lbs.	42"

Accessories	
Part No.	Description
PVW-45	Clip-On 45° Mirror
PM-1	Magnetic Tip
PL-1000	Replacement Halogen Bulb
PVCC37	Camera Coupler
PVK-45	Clip-On 45° Mirror, Bulb
PVKM-45	Complete Set: Clip-On 45° Mirror, Magnetic Tip & Bulb

## ALL-ANGLE INSPECTION MIRRORS

- Replaceable copper backed clear view mirrors
- Non-rotating inner hex rods on telescoping models prevent mirror swing
- Insulating grip
- HT models have clear glass mirror for perfect reflection



**K-2**

Pocket Type – Telescoping					
Part No.	Replaceable Mirror	Rep. Head Assembly	Mirror Size	Overall Length	Extends to
A-2T	–	A-2HD	7/8" dia.	4-1/2"	18"
B-2T	B-2R	B-2HD	1" x 2" oval	4-1/2"	19-1/2"
E-2T	–	E-2HD	1-1/4" dia.	4-1/2"	18-1/2"

Telescoping					
Part No.	Replaceable Mirror	Rep. Head Assembly	Mirror Size	Overall Length	Extends to
C-2	–	C-2HD	2-1/4" dia.	10"	14"
K-2	K-2R	K-2HD	2-1/8" x 3-1/2"	11-1/4"	15-1/4"
HTE-2	–	–	1-1/4" dia.	6-1/2"	35"
HTC-2	–	–	2-1/4" dia.	6-1/2"	36-3/8"
S-2L	–	S-2HD	3-1/4" dia.	6-1/2"	29-1/2"

Telescoping with Magnetic Pick Up					
Part No.	Replaceable Mirror	Rep. Head Assembly	Mirror Size	Overall Length	Extends to
A-2TM	–	A-2HD	7/8" dia.	5-5/8"	19-1/2"
E-2TM	–	E-2HD	1-1/4" dia.	5-5/8"	19-7/8"
B-2TM	–	B-2HD	1" x 2"	5-5/8"	20-3/4"

Telescoping with Magnifying Glass*					
Part No.	Replaceable Mirror	Rep. Head Assembly	Mirror Size	Overall Length	Extends to
MG-2	–	–	2-3/8" dia.	6-7/8"	36-1/8"

*Note: With shatter-resistant glass magnifying head*

## MASTER CLAMPS

- Attaches inspection mirror above to flashlights

Part No.	Description	Mirror Type
87	Fits "AA" cell flashlights	A-2T, B-2T & E-2T
88	Fits "D" cell flashlights	K2, C2, S2 & HTE



**87**

**88**



## 13 WATT SAFTLITE STUBBY LIGHT

- 25" 16/3 SJTOW oil resistant, all weather cord
- 10 AMP rated tool tap in handle
- Popular model - heavy duty cord

Part No.	Description
2113-2506	13 Watt Stubby



2113-2506

## K &amp; H INDUSTRIAL QUALITY PORTABLE WORK LIGHT

- Rugged, safe & simple to maintain
- FM approved
- Replacements parts can be ordered directly from USATCO
- Tubes & starters are standard

8 Watt Midget - 120 VAC, 60 Hz (NEMA 1-15 Plug Included)			
Part No.	Cord	Diameter	Overall Length
8CC-MIG	13' (coiled)	1.25"	16"
825-MIG	25' (straight)	1.25"	16"

15 Watt Mighty - 120 VAC, 60 Hz (NEMA 1-15 Plug Included)			
Part No.	Cord	Diameter	Overall Length
1525T8	25'	2.38"	26.5"
1550T8	50'	2.38"	26.5"

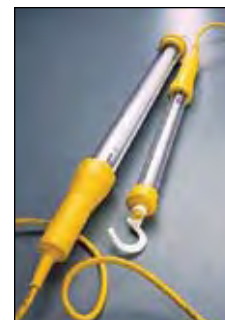

1525T8

**Note:** 120 VAC, 50 Hz & 220 VAC, 50/60 Hz also available. Please inquire.

## K &amp; H HAZARDOUS LOCATION WORK LIGHTS

- FM approved cord, ballast & lamp unit\*
- All aluminum body with specially compounded bumper guards
- NEMA 4 watertight

120 VAC, 60 Hz* (Plug Not Included)				
Part No.	Power	Cord	Weight	Overall Length
EP313-16S25	13 Watts	25'	10 lbs.	14-3/4"
EP313-16S50	13 Watts	50'	13 lbs.	14-3/4"
EP326-16S25	26 Watts	25'	10 lbs.	14-3/4"
EP326-16S50	26 Watts	50'	13 lbs.	14-3/4"

**Note:** 120 VAC, 50 Hz & 220 VAC, 50/60 Hz also available. Please inquire.

**Note:** Units furnished without plug and are suitable for Class I, Division I Groups C & D; Class II, Division I Groups E, F & G; Class III, Division I.

- FM approved cord, ballast & lamp unit\*
- All aluminum body with special rod cage protection
- Tubeshield specially annealed glass with built-in metal reflector

120 VAC, 60 Hz (Plug Not Included)				
Part No.	Power	Cord	Weight	Overall Length
EP215-161-25	15 Watts	25'	12.25 lbs.	27"
EP215-161-50	15 Watts	50'	14.5 lbs.	27"

**Note:** Units furnished without plug and are suitable for Class I, Division I Group D.



EP313-16S25

EP215-161-26

## TYPE T5 AIRCRAFT CABLE TENSIO METERS

- These ruggedly constructed, durable instruments are accurate and reliable
- May be used continuously without resetting or checking
- No temperature error
- Small & lightweight (only 12 oz.)
- Includes appropriate riser blocks, case & documentation
- Many other models available, please inquire



Part No.	For Use on Cables	Reading Interval	Ranges	Riser Used
T5-2006-115-00 TP222-B	1/16"	2 (6 to 22) lbs.	0 to 60 lbs.	#1 Fixed
		5 (25-40) lbs.		
		10 (50 to 60) lbs.		
T5-2002-401-00 TP222F	1/16"	5 (10 to 50) lbs.	10 to 150 lbs.	#1
	3, 5 & 10 CWT	10 (50 to 150) lbs.	10 to 150 lbs.	#2C
	5/32" & 3/16"	5 (10 to 50) lbs.		
	15 & 25 CWT	10 (50 to 150) lbs.	10 to 150 lbs.	#3
	7/32" & 1/4"	5 (10 to 150) lbs.		
35 & 45 CWT	10 (50 to 150) lbs.			
T5-2002-101-00 TP222	1/16", 3/32" & 1/8"	5 (0 to 50) lbs.	10 to 100 lbs.	#1
	5/32" & 3/16"	10 (50 to 150) lbs.	15 to 150 lbs.	#2C
	7/32" & 1/4"	10 (50 to 150) lbs.	20 to 150 lbs.	#3
T5-2002-104-00 TP222A	1/16", 3/32" & 1/8"	10 (30 to 200) lbs.	30 to 200 lbs.	#1
	5/32" & 3/16"	10 (30 to 200) lbs.	30 to 300 lbs.	#2C
	7/32" & 1/4"	20 (30 to 300) lbs.	30 to 300 lbs.	#3
T5-8008-106-00 TP222C	1/8" & 5/32"	20 (40 to 600) lbs.	40 to 600 lbs.	#2
	3/16"			#2C
	1/4"			#3
T5-8003-106000 TP222I	3/16", 7/32", 1/4"	20 (40 to 600) lbs.	40 to 600 lbs.	#2C
	5/16"	50 (300 to 600) lbs.		#3A

## T5 TENSIO METER RISER BLOCKS

- In stock
- For T5 type tensiometers

Part No.	Size
T5-1	#1
T5-2	#2
T5-2C	#2C
T5-3	#3
T5-3A	#3A

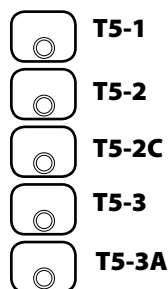

## AIRCRAFT CONTROL CABLE TENSIOMETERS

- These rugged units require no oiling & require a minimum of care
- Convenient dial pointer lock
- Adjustable zero setting dial for cables of different diameters
- Cable size indicator to measure unknown cable diameters
- Includes reference test bar (check calibration), fitted carrying case & instructions

Part No.	For Use on Cables*	Ranges
C8	1/16", 3/32", 1/8", 5/32", 3/16", 7/32" & 1/4"	10 to 200 lbs.
		30 to 200 lbs.
		80 to 200 lbs.
C9	1/8", 5/32", 3/16", 7/32" & 1/4"	150 to 450 lbs.

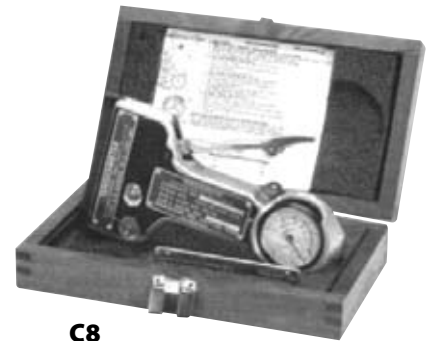

C8

## DIGITAL AIRCRAFT CABLE TENSIOMETERS

- Large, easy to read graphic display with adjustable backlighting
- Select tension values to indicate lbs., kg, or Newtons
- Memory function allows you to store and average up to five readings
- Accuracy is +/-2% full scale for all menu-selectable calibrations
- Weighs 1.5 lbs.
- Rechargeable NiMH battery with power supply provided
- Approximately 6 hours of operation per battery charge
- Includes heavy duty, custom fitted storage case

Part No.	For Use on Cables	Ranges	Resolution
ACX250	1/16", 3/32", 1/8" & 5/32"	20 to 50 lbs.	0.5 lbs.
ACX500	3/32", 1/8" & 5/32"	40 to 500 lbs.	1.0 lbs.



ACX250

## AIRCRAFT CABLE TENSIOMETER

Small, lightweight and easy to use, these cable tensiometers are designed to handle a variety of cable sizes

- Calibration charge extra

Part No.	For Use on Cables	Range
TP170	1/16", 1/8" & 3/32"	10 to 70 lbs.
TP170A	5/32" & 3/16"	50 to 350 lbs.



TP170

## USI DIFFERENTIAL CYLINDER PRESSURE TESTERS

Differential Cylinder Pressure Tester is a fast and accurate test to help determine worn or cracked rings, locate defective intake or exhaust valves, worn or stripped spark plug bushings or leaky head gaskets, among others. This unit is the best on the market.

- Pre-calibrated
- .040 orifice
- Includes storage pouch
- 2 lbs.

Part No.	Description
TP104	Tester with 18mm Adapter
TP104-9A	18mm Adapter
TP104-9B	14mm Adapter
646953A	Master Orifice Tool



**TP104**

## INDUCTOR DUAL MAGNETO TIMING LIGHT

- 100% solid state
- Bright, color coordinated LED readout & four phase audio signal
- Strong anodized aluminum case

Part No.	Lead Wire Length
TP300B	4'



**TP300B**

## AIRCRAFT DUAL MAGNETO TIMING LIGHT

- Fail safe
- Heavy duty unbreakable case
- Loud variable pitch buzzer & extra bright flashing lights
- Includes batteries & instructions

Part No.	Lead Wire Length	Weight
TP105	3'	1.5 lbs.
E5*	3'	1.5 lbs.



**TP105**

*Note: Made by Eastern Tech*

## HIGH VOLTAGE CABLE TESTER

- Fused, fail safe circuitry locates defective high voltage leads
- Heavy duty lead wires (36" long, 18 gauge), clips & unbreakable case
- Simulates magneto high voltage output
- Includes warranty & instructions

Part No.	Lead Wire Length	Weight
TP103	3'	1.3 lbs.
E5*	3'	1.5 lbs.



**TP103**

*Note: Made by Eastern Tech*

## TIMING INDICATOR

- Heavy scratch resistant aluminum face, all aluminum body
- Counterweight plumb indicator
- Top dead center locator dial
- Includes mounting bands, warranty & instructions

Part No.	Accuracy
TP102	0.5° +/-
E25*	1.5 lbs.



**TP102**

*Note: Made by Eastern Tech*

## TEST KIT

This small test kit is designed to allow the aircraft mechanic a convenient and economical way to purchase the basic small engine test equipment.

**Kit includes:**

- TP104 cylinder pressure tester
- TP105 magneto timing light
- TP102 timing indicator
- TP103 high voltage cable tester
- TP216 tool box

Part No.	Description	Weight
TP615	Complete Kit	16 lbs.

**TP615**

## AERO ANGLE® DIGITAL PROTRACTOR

- Instant measurements of level, angle & tilt
- Hold button freezes the displayed angle
- 'V' groove in edges for accurate reading on curved surfaces
- Storage box

Part No.	Range	Overall Length
TP464	+/- 45°	5"

**TP464**

## SMART TOOL DIGITAL ANGLE FINDER

- Durable & convenient, beeps at level & plumb
- Preferred by homebuilders
- Reads all angles

Part No.	Description	Accuracy	Overall Length
AIT92346	Angle Finder	1/10°	6-1/2"
AIT92288	Angle Finder w/Bar	1/10°	23-3/4"

**AIT92346****AIT92288**

## SMART TOOL DIGITAL ANGLE FINDER

- Aluminum construction with wooden handle
- Measures angles between any two planes or any number of planes
- Includes carrying case

Part No.	Range	Resolution & Accuracy	Weight	Overall Length
KS2113	+/-180°	6 minutes	2.0 lbs.	7-1/4"

**KS2113**

## PROTRACTOR &amp; DEPTH GAUGE

- Stainless steel construction with permanently etched gradations
- Spring tension nut locks rule for making both depth & angle measurements
- Narrow 6"x1/4" depth gauge rule has etched gradations in 32nds & 64ths

Part No.	Range
AIT19	+/-180°

**AIT19**

## FEELER (THICKNESS) GAUGES

- 26 leafs made of the finest precision gauge steel
- Numbers permanently etched into each leaf
- Knurled lock nut holds leaves in desired position
- Meets government specification GGG-G-17b



**AIT226**

Part No.	Range	Leaf Size
AIT226	.0015" to .025"	3" x 1/2" wide

## WIRE & SHEET METAL GAUGE

- American standard wire gauge (0 to 36) for non-ferrous metals
- Chrome finished, heavy gauge hardened & tempered tool steel
- Decimal equivalents stamped on reverse side
- 3-1/4" diameter



**AIT20**

Part No.	Size	Description
AIT20	0-36	Wire Gauge
AIT21	0-36"	Metal Gauge

## BOLT GAUGE

- Sizes all bolts up to 5/8" diameter & 5" long
- Complete instructions & bolt identification data on reverse side



**TP789**

Part No.	Overall Dimensions
TP789	5-1/2" x 6"

## QUICK CHECK SCREW GAUGE

The Quick Check Screw Gauge provides a simplistic way to identify the diameters of machine screws, bolts, wood screws, rivets and cotter pins (up to 5/16"). The cross-reference table matches drill bit and tap sizes, and threaded holes indicate threads per inch. There is also a 3" rule for measuring screw lengths.

- For identifying screws, bolts, rivets and common cotter pin sizes (up to 5/16")
- Cross-reference drill bit and tap guide
- Threaded holes for measuring threads per inch
- Screw sizes indicated in numbers and fractions of an inch
- 3" rule for measuring screw lengths
- Made of durable engineering plastic



**AIT714**

Part No.	Description
AIT714	Gauge for screws, bolts & rivets

## TRAMMEL SET

The Precision Trammel Set attaches easily to a large rule or yard stick for expeditious marking of arcs and circles. The set includes two scriber points and two pencil points, with storage in the body. The steel features a reversible point for safe storage within the body.

- Set will fit any rule 1/2" to 1-1/8" thick
- Includes 2 scriber points and 2 pencil points
- Storage in body
- Reversible points for storage
- Aluminum knurled body
- Ruler not included in set



AIT524

## ULTRATEST® STEEL RULERS

- Ultra fine black gradations on hard satin chrome finish for easy reading
- Easy read type are black with with graduations

5R Graduations*			
Part No.	Type	Width	Overall Length
CF645	Flex	1/2"	6"
CF1245	Flex	1/2"	12"
CF1216	Flex	15/32"	12"
CF1845	Flex	3/4"	18"
CF2445	Flex	3/4"	24"

4R Graduations*			
Part No.	Type	Width	Overall Length
CF634	Flex	15/32"	6"
CF1264	Rigid	1"	12"

English/Metric			
Part No.	Type	Width	Overall Length
CF649MD	Flex	1/2"	6"
CF1249MD	Flex	1/2"	12"

**Note:** 4R Graduation: 8ths, 16ths, 32nds & 64ths. 5R Graduations: 32nds, 64ths, 10ths & 100ths. English/Metric Graduations: 32nds, 64ths, 0.5mm & 1mm.



CF645

CF2445

## FABRIC TESTER

- Test for FAA requirements without removing or punching holes in fabric
- Stainless steel construction

Part No.	Accuracy	Overall Length
TP180	+/-1 in. lbs.	7"



TP180

## TRUTACH II DIGITAL PROPELLER TACHOMETER

The new all digital TruTach II measures propeller RPM to a remarkable accuracy of 1 RPM. It features a digital signal filter that eliminates noise and gives solid readings. TruTach II works on single or multi-engine propeller aircraft with 2, 3, 4 or 5 blades, and it never needs adjustment. Easily check calibration anytime with a standard light. RPM range 240-7000 RPM. Uses a standard 9 volt battery (included). Compact 3.8 x 2.4 x 1.5 inches and weighs just 4 ozs. Includes impact resistant carrying case. 5 year warranty. Designed and built in the USA by Pilots for Pilots.



Part No.	Description
TruTach II	Digital Tach

## CERMARK DIGITAL PROPELLER TACHOMETER

The all-digital design of this tachometer makes it accurate to within 10 RPM at all scales. Its large LCD display updates two times a second for nearly continuous readout. Use it from inside your cockpit to monitor the performance of your aircraft tachometer.

- One hand operation - control everything by pressing only one button
- Automatic power off feature saves battery power
- Reads 10 to 10,000 RPM in 10 RPM increments
- Direct reading of 2, 3 and 4 bladed propellers
- Uses standard 9 volt battery (not included)



**AIT310B**

Part No.	Description
AIT310B	Digital Tach

## TORQUE WRENCHES

- Dual scales lbs., nm
- Positive lock with spring-loaded pull down lock ring
- Meets or exceeds ASME B107.14M-1994, ISO 6789 standards
- Fast, accurate & easy to set
- Ratchet head
- Fitted plastic case included



**TCI-250FRN**

Inch Pound						
Part No.	Square Drive	Torque Range in-lbs.	nm	Increments	Weight	Overall Length
TCI-150RA	1/4"	30-150	2.8-17.5	1.0	0.9 lbs.	9.5"
TCI-150RA-3/8	3/8"	30-150	2.8-17.5	1.0	0.9 lbs.	9.5"
TCI-250R	3/8"	50-250	5.0-28	1.0	3.0 lbs.	12.5"
TCI-750R-1/2	1/2"	150-750	-	5.0	2.5 lbs.	14.5"

Foot Pound						
Part No.	Square Drive	Torque Range ft-lbs.	nm	Increments	Weight	Overall Length
TCI-75RN	3/8"	15-75	24-105	.5	2.2 lbs.	14.25"
TCI-150FRD	1/2"	30-150	47-210	1.0	2.8 lbs.	18.5"
TCI-250FRN	1/2"	50-250	75-346	1.-	3.5 lbs.	21.5"



## MAGNAFLUX® PORTABLE SPOTCHECK KIT

An undetected crack can be deadly! Critical aircraft areas, especially around stud mounts can and do crack. And sometime the flaw is too small to be noticed with the naked eye. That's why you need the new Magnaflux Spotcheck Portable Kit. It's a complete dye penetrant test kit containing everything you'll need to find surface defects in welds, castings, and forgings. The Spotcheck Portable Kit comes in a rugged plastic case and includes complete instructions.

- 2 cans of SKC-S Cleaner/Remover
- 1 can of SKL-SP1 Penetrant
- Marking pen
- Wiping cloth
- 1 can of SKD-S2 Developer
- Carrier/dispenser rack
- Packet of SCRUBS™ Hand Cleaner
- Complete instructions



SK416

Part No.	Description
SK416	Complete Kit

## MAGNAFLUX® SPOTCHECK DYE PENETRANT TEST KITS

The General Purpose Dye Penetrant inspection kit is used throughout the industry for the detection of surface defects. Suitable for the inspection of most solids, Spotcheck Dye Penetrants give clear, vivid indications of surface flaws, for just pennies a check. The compact carrying case permits this complete, lightweight kit to be taken anywhere. Kit consists of 2 cans Spotcheck SKL-HF/S Penetrant, 4 cans SKC-NF/AC-7B Cleaner/Remover, and 2 cans SKD-NF Developer. Includes brush, cloth and instructions. Cans are 16 oz. aerosol.



SK3

Part No.	Description
SK3	Complete Kit

## MAGNAFLUX ZYGLO® PENETRANT TEST KIT

Zyglo, long accepted as the standard industrial penetrant test detects cracks, pores, leaks and other defects open to the surface in solids - metallic or otherwise. Under the high-intensity Zyglo Black Light you see cracks and defects as glowing signals - even ones you'd miss entirely by any other penetrant test method. The test is quick, easy and positive. The portable 100-watt black light supplied with the kit is unique in high-intensity black light output. With this intense black light and the extremely bright Zyglo Family Penetrants, defects glow brilliantly in normally lighted area. Specify Zyglos and you get increased inspection efficiency and accuracy at a remarkably low cost. Kit consists of 2 cans ZL-22A Zyglo Family Penetrant, 2 cans ZP-9B Developer, 1 pint ZP-4B Dry Developer, 3 cans SKC-NF/ZC-7B Cleaner/Remover, and a portable 100-watt black light (115 AC, 60Hz). Complete with instructions, brush and cloth.



ZA70

Part No.	Description
ZA70	Complete Kit
ZL-22A	Penetrant, 16 oz. Aerosol Can
ZP-9B	Developer, 16 oz. Aerosol Can
ZC-7B	Cleaner/Remover, 16 oz. Aerosol Can
ZB-23A	100 Watt Black Light

## CYLINDER BASE NUT WRENCHES

Designed with a 1/2" square drive, these rugged hex head cylinder base wrenches are made to last. The hex heads are extra thin for easy access over the cylinder bolts. They are available individually or as a complete 4-piece set. A few of the engines and required size wrenches are in chart on right.

- For continental engines
- 12 point hex wrench end
- Made from alloy steel forgings, heat-treated for maximum strength and toughness
- .88 lbs.



Part No.	Size
TP2882	9/16" hex
TP2882-2	1/2" hex
TP2882-3	5/8" hex
TP2882-4	3/4" hex
TP2882K4	Set of 4

Engine Type	Wrench
A40, A50, A75, A80	1/2" - 9/16"
O200, C75, C85, C90	1/2" - 9/16"
O300, C125, C145	1/2" - 9/16"
IO360	1/2" - 9/16"
E165, E185, E225	1/2" - 9/16"
520 & 470	5/8" - 9/16"
IO232 series	Hex LH & RH Std. Type

- For lycoming engines (narrow deck)
- For socket type nuts (internal wrenching)
- Standard 1/2" square female drive end
- Made from alloy steel forgings, heat treated for maximum toughness

Part No.	Size
TP6494-2	1/2" hex
TP6494-3	3/8" hex
TP6494K	Set of 2



## PUSH ROD SPRING COMPRESSOR

For compressing and holding push rod springs on all engines with spring-loaded tubes. The tool compresses the spring that can then be removed with furnished clips. Eliminates wiring springs together - to install, simply insert springs & pull of clip.



Part No.	Size
TP384	Push Rod & Clips

## PUSH ROD FLARING TOOL

- For A & C series - expanding ball type tool
- Balls rotate inside housing, expanding it into the boss



Part No.	Size
TP385	Complete Tool

## BUSHING &amp; BEARING DRIVE SET

- Remove or install internal bushings and bearings
- All parts are hardened and rustproof plated
- Handy storage case

Part No.	Description	Weight
TP348	22 pcs. 3/8" to 1-3/8"	5.0 lbs.
TP348A	10 pcs. 15/16" to 1-7/8"	3.5 lbs.



TP348

## VALVE SPRING COMPRESSOR - LYCOMING TYPE

- Fits all Lycoming parallel valve and angle valve, horizontally opposed engines
- Lightweight aluminum construction
- Fits on rocker shaft

Part No.	Description
TP686	Rocker Shaft



TP686

- Fits all Continental and Lycoming engines
- Small case, easy to use - the hook installs on rocker shaft (or on special rocker nut furnished) and c-shaped collar compresses spring to allow keeper removal
- All stress parts heat-treated

Part No.	Description
TP227	18" Long



TP227

## ENGINE CYLINDER HONE

Hone and remove glaze from engine cylinders from 2" to 7" in diameter. Adjust spring tension for positive cutting action and set diameter with spread limiter.

240 Grit	
Part No.	Description
KD2833	Hone with Stones
KD2835	Replacement Stones 4"



KD2833

## PISTON RING GROOVE CLEANER

Effectively removes carbon from ring grooves on pistons 2" to 5". The two 6-bladed cutters cover all major piston ring grooves in SAE and metric sizes. Cutters rotate to any selected size, locking in place with hold-down nut.

Part No.	Description
KD1722	6 Blade Cutter
KD1722-71	Replacement Blade Kit

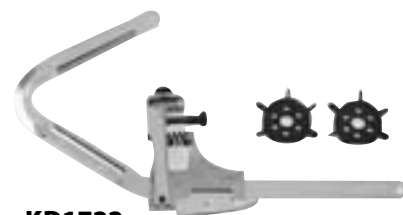

KD1722

## PISTON RING FILER

File piston rings with this portable rotary filer. Use to accurately size any make or diameter ring. Filer includes extra-hard, fine-grit carbide-coated cutter file.

Part No.	Size
KD870	Filer
KD872	Replacement Cutter



**KD870**

## PISTON RING COMPRESSORS

Use these bands to compress piston rings from 2-7/8" to 4-5/8" in diameter. Band width: 1-1/2".

Part No.	Size
KD1119	2-7/8" to 3-1/8"
KD1120	3-1/8" to 3-3/8"
KD1121	3-3/8" to 3-5/8"
KD1122	3-5/8" to 3-7/8"
KD1123	3-7/8" to 4-1/8"
KD1124	4-1/8" to 4-3/8"
KD1125	4-3/8" to 4-5/8"
KD1114	Pliers



**KD1119**



**KD1114**

## MAGNETO LOCK TOOL

- "E" gap timing aid for Bendix magnetos
- Locates and secures magneto position while out of engine
- Holds position during installation

Part No.	Size
TP259	Lock Tool



**TP259**

## P-LEADS ADAPTERS

The P-Lead Adapter is unique in it allows connection to the magneto timer leads for all aircraft bendix magnetos. It provides immediate and positive connection and eliminates those old stripped blade P-Leads. It also insures the proper spring pressure against the intense contact.

Part No.	Works With
AIT8765	Early S-2- mags 3/8"
AIT8766	All other S-series mags 1/4"
AIT8767	D2000 & D3000 series mags
AIT8768	Set of all 3 adapters



**AIT8766**

## SPARK PLUG CLEANER

- Cleans any size plug without changing grommet
- 2-way valve
- Complete with abrasive powder and bag

Part No.	Description
TP12	Cleaner
TP163	Powder
TP164	Replacement Bag



TP12

## SPARK PLUG SERVICE KIT

Part No.	Description
TP12K	Includes 1 ea: TP12, TP164, TP163, TP298, TP339 & TP340

TP12K



## SPARK PLUG VIBRATING CLEANER

Ideal tool for removing stubborn lead & carbon deposits around the electrodes, without damaging the plug.

- Hand held
- 120V - 60Hz power required
- Includes 2 replacement tips, collets, and storage pouch

Part No.	Description
TP857A	Vibrator Cleaner
TP857-1	Replacement Blade



TP857A

## SPARK PLUG CLEANER/TESTER

This is a very good, yet relatively inexpensive, method for both cleaning and testing your spark plugs. Cleans with a powerful blast of air and abrasive to quickly remove the carbon deposits. Once cleaned, the plug is screwed into the test side of the unit and by observing the quality of the spark at the electrode you can determine the effectiveness of the plug. This test is done using up to 150psi air pressure.

Part No.	Description	Weight
TP237	115 Volt supplied with a 12mm, 14mm & 18mm threaded adapter	20.5 lbs.



TP237

## SPARK PLUG GAPPER

- Designed for use on all massive electrode spark plugs
- Eliminates guessing of plug gap

Part No.	Description
TP340	Gapper



**TP340**

## AIRCRAFT SPARK PLUG GAUGE

Part No.	Description
KD165	Wire Guage Size .015, .018, .020, .022, .028, .030, .045



**KD165**

## SPARK PLUG GAP SETTING TOOL

Designed for use as a hand tool, bench or vise hold

- Low cost, efficient gap tool
- Close gaps on massive electrodes type spark plugs

Part No.	Description
TP200	Complete with two adapters and gap gauge



**TP200**

## SPARK PLUG SOCKET

- 1/2" square drive x 7/8" hex - extra deep
- A "built-in" permanent magnet holds plug from dropping
- Especially designed for shielded aviation spark plugs

Part No.	Description
TP329	Spark Plug Socket



**TP329**

## LEAD-MASTER WRENCH

- Reduce time to remove and install spark plug ignition leads
- Permits short arc turning with 12 point grip head

Part No.	Size
TP644	3/4"
TP645	7/8"



**TP644**

## SPARK PLUG CHASER

- Renews damaged threads

Part No.	Description
TP784	Fits 14mm and 18mm threads



**TP784**

## SPARK PLUG TRAY

- Sturdy steel tray holds up to 12 aviation spark plugs
- Holes numbered to correspond with engine cylinders

Part No.	Description	Weight
TP339	12 Hole Tray	1 lbs.

TP339



## ECONOMY SPARK PLUG HOLDER

- Manufactured from 100% recycled plastic
- Impervious to water, chemicals & solvents that could be associated with the cleaning of spark plugs.
- 9" long x 4" wide x 4" high
- Each tray holds 12 plugs and each hole is labeled for easy identification
- Made in the U.S.A.

Part No.	Weight
TP797	3 lbs.



TP797

## CHAMPION PLUG THREAD LUBRICANT

- High temperature graphite lubricant
- Used to prevent galling and seizure of spark plug thread
- Sturdy plastic 4 oz. bottle, with brush attached to cap

Part No.	Description
TP470	Lubricant

TP470



## FOWLER SPARK PLUG INSPECTION MAGNIFIER

A 10x magnifier of the highest optical quality. This is the type of tool recommended by spark plug manufacturers such as Champion for the inspection of spark plug firing end insulators. Includes optical scales to take measurements of the inspection area. Requires two "C" batteries (not included).

Part No.	Description	Weight
AIT1966	10x Magnifier	.38 lbs.



AIT1966

## OIL FILTER CUTTERS

- Ball bearing rollers & replaceable cutter wheel
- All aluminum construction

Part No.	Description
TP271	Standard Oil Filter Cutter
TP271-7	Replacement Cutter Wheel



TP271

### Airwolf Oil Filter Cutter

- Anodized 6061-T6 aluminum with stainless steel rollers
- Hardened 60 rockwell cutting wheel

Part No.	Description
TP876	Airwolf Oil Filter Cutter
TP876-1	Replacement Cutter Wheel



TP876

- Made of anodized 6061 aluminum
- Cutter wheel is easily replaced

Part No.	Description
TP881	Standard Oil Filter Cutter
TP881A	Replacement Cutter Wheel



TP881

## OIL FILTER DRAIN KIT

Usable on any horizontal mounted oil filter. Allows you to drain oil from filter prior to removal. No spills or additional mess to clean up.

Part No.	Description
TP433	Fitting, Hose Complete Kit

TP433



## PROPELLER SHAFT OIL SEAL INSTALLER

- Fits both continental and lycoming engines
- For all flanged shafts
- Installs one piece stretch seals without damaging sealing surfaces

Part No.	Description
TP398	Flanged Shaft Installer



TP398





## HELI-COILS AND KITS

**Heli-Coil® Aviation Spark Plug Thread Repair Kits**

Using Heli-Coli® serrated aviation inserts is the only FAA approved method of repairing damaged spark plug threads. It is also the only method certified by engine manufacturers such as Teledyne-Continental and Textron-Lycoming. Serrated inserts, unlike regular inserts, require special tools to insert, expand and stake them in place. These kits contain everything you will need including: piloted tap, insertion tool, offset and staking tool, expanding tool, 20 serrated inserts (10 each 1/2" and 13/16" long inserts for the 18mm kit and 10 each 3/8" and 1/2" long inserts for the 14mm kit), and complete instructions.

Part No.	Description
4260-18	18mm Aviation Spark Plug Repair Kit
4260-14	14mm Aviation Spark Plug Repair Kit

**4260-18****Heli-Coil® Spark Plug Repair Kit (non-serrated)**

These repair kits are very popular with experimentalists and kit builders as an economical alternative to serrated inserts. They contain everything you'll need to make on-the-spot engine repairs. Includes piloted tap, and installation tool, and 24 inserts. *Note that the use of non-aviation Heli-Coil inserts may not be approved for your engine. Check with the manufacturer before using.*

Part No.	Description
5523-18	18mm Spark Plug Repair Kit
5523-14	14mm Spark Plug Repair Kit

**5523-18****Heli-Coil® Master Repair Kit**

Kit includes taps, inserts, drill specifications and instructions for repairing a wide range of the most commonly experience coarse thread repair problems. Includes inserts in the following sizes (and quantity): 1/4x20 (12), 5/16x18 (12), 3/8x16 (12), 7/16x14 (6), 1/2x13 (6). Custom molded case also included.

Part No.	Thread
4934	Coarse
4936	Fine

**4934**

Each pack includes inserts, insertion tool, and tap.

Part No.	Thread
5401-04	4-40
5401-05	5-40
5401-06	6-32
5401-1	12-24
5401-2	8-32
5401-3	10-24
5401-4	1/4-20
5401-5	5/16-18
5401-6	3/8-16
5401-7	7/16-14
5401-8	1/2-13

Part No.	Thread
5402-06	6-40
5402-2	8-36
5402-3	10-32
5402-4	1/4-28
5402-5	5/16-24
5402-6	3/8-24
5402-7	7/16-20
5402-8	1/2-20
5402-9	9/16-18
5402-10	5/8-18
5402-12	3/4-16

**5401-04**

OLEO AIRCRAFT STRUT PUMP

- Simple, safe & economical factory rebuilt units
- 1/8" NPT female thread

Part No.	Description
TP286	1500 lbs.



TP286

HIGH PRESSURE STRUT VALVES

- Manufactured in strict accordance with AN & MS specifications
- Made of corrosion resistant alloy steel to withstand high pressures

Part No.	Max. Operating Pressure	Includes
8990-C	3000 psi	302-DN Core, 637 Cap
9019-C	5000 psi	MS-28889-2
SK-15171	2000 psi	302-DN Core, 637 Cap



9019-C

VALVE CORES & CAPS

- Manufactured in strict accordance with AN & MS specifications
- Precision built, rigidly tested & 100% electronically inspected

Valve Cores			
Part No.	Pressure Range	Operating Temp.	Meets Military Spec.
402-AH	0 to 550 psi	-65° to 350°F	MIL-V-27317, TR C-4 & MS-51377-4
302-DN	70 to 2000 psi	-65° to 225°F	MIL-C-5499 & AN-809-1
70-HT	0 to 450 psi	-40° to 350°F	MIL-V-27317



402-AH

Caps			
Part No.	Pressure Range	Operating Temp.	Meets Military Spec.
637	0 to 5000 psi	-65° to 160°F	MS-20813-1
2114**	0 to 250 psi	-40° to 450°F	-

\*Note: When oiled.

\*\*Note: Large bore model.

TIRE VALVE REPAIR TOOL

- Handy 4-in-1 standard valve tool repairs cap & core threads
- Easy out feature for removing damaged cores & screwdriver for standard cores

Part No.	Description
3522	Tire Valve Repair Tool



3522

VALVE CORE REMOVAL TOOL

- For rapid & safe tire deflation
- Exhausts air towards wheel & traps the valve core within the tool
- Knurled design for easy handling

Part No.	Description
ATSK3614	Valve Core Removal Tool



ATSK3614

## VALVE CORES &amp; CAPS

Part No.	Type	Thread	Side Hose Connector
TP506	T-Handle	.305"-32	1/8 NPT
TP506S		Replacement Seal	



TP506

## VALVE CORES &amp; CAPS

- .305-32 thread
- 1/8" NPT female thread

Part No.	Style	Working Pressure	Proof Pressure
TP505	Gooseneck	3000	10,000
TP5055S		Replacement Seal	



TP505

## LEVER CONTROL TYPE INFLATING GAUGES

- Three foot hose length for safe distance when mounting tires

Part No.	Air Chuck	Range
AIT3500C-D	Clip-On	10 to 120 psi
AIT3651C-D	Dual Foot	10 to 120 psi

AIT3651C-D



## TIRE &amp; PRESSURE GAUGES

- Bourdin type dial gauge with flexible hose & 6" dual chuck
- Includes recalibration screw for adjustments & metal carrying case

Part No.	Range	Overall Length
TP377	6 to 160	12"
TP377A	6 to 300	12"
AIT8844B	0-400 psi	18"

TP377



*Note: Includes three metal extensions.*

## HYDRAULIC SHOCK STRUT GAUGE

- Screw type locking chuck securely attaches to valve
- Includes drain cock for bleeding pressures & metal carrying case

Part No.	Range	Overall Length
AIT8874*	0 to 400 psi	18"
AIT8875	0 to 1500 psi	25"
AIT8876	0 to 3000 psi	18"

*Note: Includes three metal extensions.*



8874

## TIRE BEAD BREAKER

- Bourdin type dial gauge with flexible hose & 6" dual chuck
- Includes recalibration screw for adjustments & metal carrying case

Part No.	Description	Weight
TP301TB	Bead Breaker	31 lbs.



**TP301TB**

## AMMCO BRAKE BLEEDER

- Diaphragm type
- Separates fluid from pressurized air
- Safety relief valve
- Equipped with swivel casters
- 4 gallon fluid reservoir
- 12' hose assembly
- Quick-change and auto shutoff
- Dual scale pressure gauge 0-31 psi range
- Compatible with mil-spec 5606 type fluid

Part No.	Description	Weight
TP293	Fills & Bleeds	2.1 lbs.



**TP293**

## BRAKE BLEEDER TANK

- Fills and bleeds brakes in a single operation
- One gallon capacity with handle and dip stick
- Pressure release safety valve and pressure gauge
- 3" neoprene hose
- Compatible with MIL 5606
- Plastic tank

Part No.	Description	Weight
TP458	Fills & Bleeds	6 lbs.



**TP458**

## HOSE ASSEMBLY TOOLS

These are hand assembly tools for use on MS24587 and MS27404AN flared fittings. Use of the correct tool will reduce damage to the inner sleeve and speed assembly line time.

Part No.	Use on Fitting
TP491-3	-3 3/8-24 Thread
TP491-4	-4 7/16-20 Thread
TP491-5	-5 1/2-20 Thread
TP491-6	-6 9/16-18 Thread
TP491-8	-8 3/4-16 Thread
TP491-10	-10 7/8-14 Thread



**TP491-3**



# Polishing, Cleaning & Sealant Equipment

industrial power tools **air**  
SERVICES

## DYNABRADE® DYNABUFFER

- Excellent for buffing out sanding scratches
- .55 diameter offset orbit
- Tool slows to 5000 RPM when running under load
- Patented balancer compensates for vibration for smooth operating performance
- Rear exhaust muffler reduces sound levels
- 5/16-24 thread
- Pad not included



DYN58455

0.21 HP				
Part No.	Pad Capacity	RPM (no load)	Overall Length	Weight
DYN58455	5"	10000	11"	2.7 lbs.

## 5" PAD FOR DYNABUFFER

- Non-vacuum pads
- Hook-face
- 3/16-24 thread
- Short nap

Backing Pads	
Part No.	Density
DYN56180	Medium
DYN56195	Soft

Polishing Pads			
Part No.	Description	Type	Color
DYN90036	Sheepskin	Polishing	Tan
DYN90040	Foam Flat	Polishing	White
DYN90045	Foam Flat	Cutting	Yellow

## CYCLO® ORBITAL AIRCRAFT POLISHERS

- Does not mar, burn or leave swirl marks
- Exclusive dual 4" orbital action heads with exceptional stability and smoothness
- Counterbalanced heads for efficiency in both large & confined contours
- Polishing motion simulates a gentle hand-rubbed quality
- Lightweight, heavy-duty cast aluminum housing
- Rubber pad holder and polishing pad not included



80-010

Part No.	Motor	RPM (no load)	Weight
80-010	115V - 60 Hz	3000	6.5 lbs.
80-020	230V - 50 Hz	3000	6.5 lbs.

## RUBBER PADS AND POLISHING PADS

Part No.	Description
79-101	Hook & Loop Rubber Pad
72-110	White Foam, Finishing Pad
72-120	Green Foam, Polishing Pad
72-125	Orange Foam, Compounding & Polishing
72-135	Yellow Foam, Cutting Pad
72-160	Yellow Foam, Scrubbing Pad
72-455	Light Cutting Wool Pad



79-101



71-110

## NORTECH HEAVY-DUTY PNEUMATIC VACUUMS

- Models mount on standard 30 or 55 gallon drums
- No moving parts for dependable, trouble-free operation
- Additional accessories & options also available, please inquire

### Wet/Dry Vacuum Kit includes:

Vacuum generating head with internal filter & exhaust silencer; 20 gauge drum with drum dolly; 20' vacuum hose; Floor tool with 4" wand & crevice tool; and 20' air supply hose.

### Compact Vacuum Kit includes:

Vacuum generating head with exhaust silencer & carrying handle; Canister-style drum with external filter; 10' x 1-1/4" vacuum hose; Surface utility tool; 20" extension wand; Crevice tool; 3" round plastic brush; and 12' hose.



Compact Vacuum Kit						
Part No.	Drum Size	Hose Fitting	Air Consumption SCFM	Min. Size Compressor	Vacuum Lift (INH20)	Shipping Weight
N041MC	4 Gallon	1-1/4"	20	5 HP	100	28 lbs.
N081MC	8 Gallon	1-1/4"	20	5 HP	105	82 lbs.

Wet/Dry Vacuum Kit						
Part No.	Drum Size	Hose Fitting	Air Consumption SCFM	Min. Size Compressor	Vacuum Lift (INH20)	Shipping Weight
N151SC	15 Gallon	1-1/2"	20	5 HP	105	72 lbs.
N301DCP	30 Gallon	1-1/2"	47	15 HP	213	100 lbs.
N551BC	55 Gallon	2"	68	15 HP	185	113 lbs.

## USI AIR VACUUMS

- Venturi type design with 1" I.D.
- Picks up ferrous and non-ferrous chips, bolts and rivets
- Throttle with special lock-on feature
- TP575-10 - 18' flexible hose included
- 1/4" inlet
- .5 lbs.

Part No.	Description
TP575	Aluminum vacuum with bag and 18" flexible hose
TP675	Plastic vacuum with bag and 18" flexible hose

Accessories	
Part No.	Description
TP275B	Spare Bag and Clip
TP275-1	Spare Bag only
TP275B-1	Spare Clip only
TP575-10	18" Flex Hose
TP575-24	24" Flex Hose
TP575-36	36" Flex Hose
TP575R-10	12" Rigid Tube



TP575



TP675

## ATI ALUMINUM MINA-VAC

This vacuum is the result of a challenge for a design with superior pickup performance yet low noise level. The AT560M emerged as the highest-rated vacuum in the industry. Its one-piece aluminum construction is virtually indestructible, and all moving parts including the trigger mechanism are replaceable. This unit pulled six inches of mercury, three times that of our nearest competitor.



AT560M1

Part No.	Description
AT560M	MINA-VAC, Venturi Type, one piece aluminum construction, locking trigger, complete with air fitting, bag and bag clip
AT560MFE-12	Extension Tube, Flexible, Clear Plastic, 42" OAL
AT560MFE-18	Flexible, Clear Plastid, 18" OAL
AT560MFE-24	Flexible, Clear Plastid, 24" OAL
AT560MFE-36	Flexible, Clear Plastid, 36" OAL
AT560MRE-12	Extension Tube, Rigid, Clear Plastic, 42" OAL
AT560MRE-18	Rigid, Clear Plastic, 18" OAL
AT560MRE-24	Rigid, Clear Plastic, 24" OAL
AT560MRE-36	Rigid, Clear Plastic, 36" OAL
AT560MF-12	Aluminum MINA-VAC Assembly with 12" Clear Flex Tube (AT560M with A560MFE-12)
AT560MF-18	with 18" Clear Flex Tube (AT560M with A560MFE-18)
AT560MF-24	with 24" Clear Flex Tube (AT560M with A560MFE-24)
AT560MF-36	with 36" Clear Flex Tube (AT560M with A560MFE-36)
AT560MR-12	Aluminum MINA-VAC Assembly with 12" Clear Rigid Tube (AT560M with A560MRE-12)
AT560MR-18	with 18" Clear Rigid Tube (AT560M with A560MRE-18)
AT560MR-24	with 24" Clear Rigid Tube (AT560M with A560MRE-24)
AT560MR-36	with 36" Clear Rigid Tube (AT560M with A560MRE-36)
AT560A-3	Vacuum Bag, Replacement for use with AT560C or AT560M
AT560A-4	Clip, Vacuum Bag, Replacement
AT560H0-3	Vacuum Bag, Heavy-Duty, with Vinyl Reinforcement

## SIPHON SPRAY GUN

- Designed for spraying solvents, soaps, etc.
- 8' clear plastic suction tubing
- 6" nose extension
- Pistol grip style



TP702

Part No.	Description	Weight
TP702	Pistol Gun with Hose	1 lbs.

## HYDRO-AIR PRESSURE WASHER KITS

- Blast grime and grease from motors, machinery, tools, etc.
- Includes gun with siphoning attachment, nozzle extensions, and snap-on adapter
- Hot or cold water



DM2000K

Part No. Complete Kit	Gun Type
DM2000K	Trigger
DM1000K	Hand Control Valve



## AIR OPERATED SEALANT GUNS

- Smooth, uniform flow of material applied exactly where you want it
- Included zinc plated corrosion resistant retainer prevents cartridge split
- Hose assembly ordered separately

Part No. Pistol Grip Style	Part No. Palm Grip Style	Capacity
950-25HA	950-25A	2.5 oz.
950-60HA	950-60A	6 oz.
950-120HA	950-120A	12 oz.



950-60A



950-60HA

## AIR OPERATED SEALANT GUN KITS

- Convenient & economical

**Kit includes:**

- Pistol Grip Sealant Gun, 6 ea. Cartridges/Plungers, 1 ea. Cartridge Cap & Plug, 6 Assorted Nozzles and Air Hose

Part No.	Description
12053A	2.5 oz. Capacity Kit
12054A	6 oz. Capacity Kit
12055A	12 oz. Capacity Kit



12054A

## MANUAL SEALANT GUNS

- Portable, no air supply required
- Excellent for 'in-field' application on sealants
- Utilizes all standard cartridges & nozzles

Part No.	Cartridge Capacity
1832-2	2.5 oz.
1832-6	6 oz.
1832-12	12 oz.



1832-6

## AIR HOSE ASSEMBLIES

- Includes 'B' nut for attachment to any of our air operated sealant guns

Part No. Aro Connect	Part No. Hansen Connect	Part No. Schrader Connect	Overall Length
SEM280012	SEM280000	SEM280006	5'
SEM280013	SEM280001	SEM280007	10'



SEM280012

## SEMCO SEALANT GUN RETAINERS

- Zinc plated corrosion resistant retainers prevent cartridge split

Part No.	Capacity
SEM220256	2.5 oz.
SEM220928	6 oz.
SEM220923	12 oz.



SEM220928

## SEMCO DISPOSABLE PLASTIC CARTRIDGES

- For use with air or manual operated dispensing devices
- Low-density polyethylene\*
- High-density available, please inquire

Part No. Cartridge Only	Part No. Cartridge & Plunger	Capacity
SEM220315	SEM220323	2.5 oz.
SEM220317	SEM220325	6 oz.
SEM220321	SEM220329	12 oz.



SEM220317

Note: 'P' type plunger

## PLASTIC PLUNGERS

- 'P' type - other styles available

Part No.	Size
SEM220252	One Size Fits All



SEM220252

## PLASTIC CARTRIDGE CAPS

Part No.	Description	Size
SEM220245	Front End Cap "TS" Seal Type	One Size Fits All
SEM22-238	Flange End Cap	One Size Fits All



SEM220245

## NOZZLES

Part No.	Orifice	Overall Length	View
SEM252	1/16"	2-1/2"	
SEM254	1/8"		
SEM410	1/32"	4"	
SEM415	No Orifice		
SEM420	1/16"		
SEM430	3/32"		
SEM440	1/8"		
SEM620	1/16"	6"	
SEM640	1/8"		
SEM8613	3/64" x 3/8"	5"	
SEM8615	1/16" x 1/2"	4"	
SEM8643	1/8" x 3/4"	4-1/2"	
SEM8645	1/8" x 1"	4-3/8"	
SEM8646	1/16"	3-15/16"	
SEM8648	1/8"	5-3/16"	

## FILLET NOZZLES

- For application of sealant fillets over lap joints
- Can eliminate the need for working of sealant with spatulas
- Built-in step guides nozzle along lap joint

Part No.	Step	Overall Length
SEM425	.12" Right	3-3/4"
SEM426	.06" Right	3-3/4"
SEM427	.12" Left	3-3/4"
SEM428	.06" Left	3-3/4"

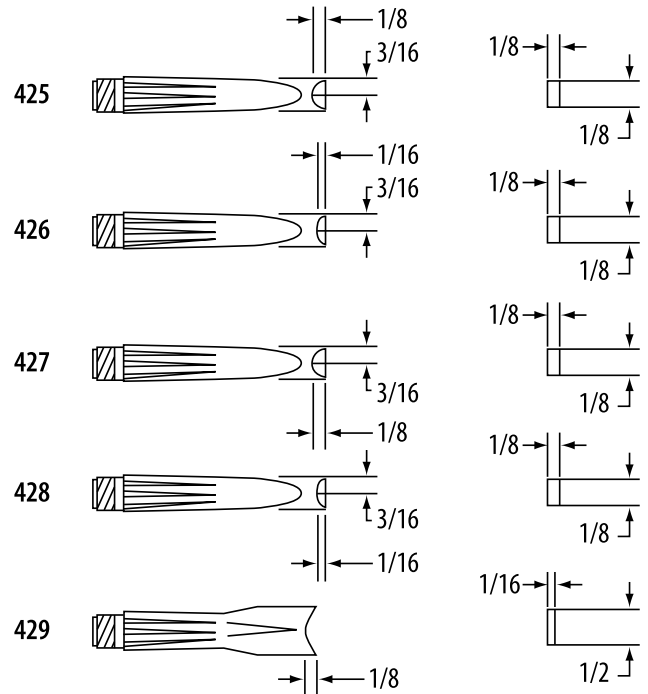

## SEALANT SMOOTHING TOOL

- Reinforced plastic spreaders for tooling & smoothing sealants

Part No.	Description
SEM231349	Sealant Smoothing Tool
SEM226243	Sealant Smoothing Tool

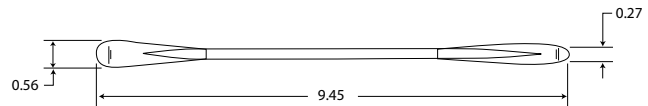

SEM231349

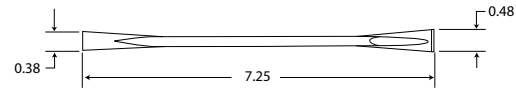

SEM226243

## SCRAPER

- Reinforced plastic scraper designed for aircraft sealants, paints & glue

Part No.	Description
SEM23450	Scraper

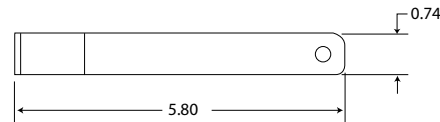

SEM234350

## PAINT CUTTERS

- Reduces excess paint chip during screw removal process
- Cuts a ring into paint around the screw head

Part No.	Screw Size	Shank
AIT13400	#4	1/4"-28
AIT13401	#6	1/4"-28
AIT13402	#8	1/4"-28
AIT13403	#10	1/4"-28
AIT13407	1/4"	1/4"-28



AIT13400

## RAZOR SOCKETS

The Razor Socket was specifically designed to cut quickly through mastic-coated nuts, in aviation-specific areas such as fuel tank inspection panels. Eliminates the need to scrape prior to removal. Effective and efficient!

Part No.	Description
STM8RAZ	Socket, Razor Cut, 1/4" Square Drive for 1/4" Nut
STM10RAZ	Socket, Razor Cut, 1/4" Square Drive for 5/16" Nut
STM12RAZ	Socket, Razor Cut, 1/4" Square Drive for 3/8" Nut



STM12RAZ



STM10RAZ



STM8RAZ

## MASTIC REMOVAL KIT

Specifically formulated for T-3 aluminum, the blades in this kit were designed to remove mastics, PRC and other applications without scratching sensitive and painted surfaces. Approved for use by the U.S. Air Force, the AT590MRK Kit contains an assortment of 16 blades and an ergonomic rubber handle.



Part No.	Description
AT590MRK	16 Blades & Holder

Part No.	Description
AT590MRK	Mastic Removal Kit, consisting of 1 ea. AT580H handle, 6 ea. AT7001 Blade, 6 ea. AT7005 Blade & 3 ea. AT7014 Blade
AT580H	Handle, ergonomic rubber
AT7001	Blade, Mastic Removal, T-3 Grade, 1" diameter
AT7034	Blade, Mastic Removal, T-3 Grade, 3/4" diameter
AT7005	Blade, Mastic Removal, T-3 Grade, 1/2" diameter
AT7014	Blade, Mastic Removal, T-3 Grade, 1/4" diameter
AT7018	Blade, Mastic Removal, T-3 Grade, 1/8" diameter

## GROUND WIRE HOLE BURNISHING KIT

Specifically designed to clean the paint and oxidation from the surfaces surrounding holes used for ground wire attachment. Each kit contains four reversible "Type N" burnishing pads, four extensions, one positive screw-in type burnishing head, and one negative and positive collet-type burnishing head.

Kit	
Part No.	Description
AT3767	10 pc. Kit
ATSK3767-10	#10 Burnishing Head
ATSK3767-20	#20 Burnishing Head
ATSK3767-30	#30 Burnishing Head
ATSK3767-40	#40 Burnishing Head



Hole prepared by a typical wire brush demonstrating terrible overall surface contact.



Hole prepared by the new ATI Burnishing Kit using the type 'N' pads demonstrating an absolute perfect surface for overall contact.

### WISE GRIP/IRWIN® LOCKING C-CLAMPS



11SP



11R

Steel Pad Tips				
Part No.	Throat Depth	Jaw Capacity	Weight	Overall Length
6SP	1-1/2"	0 to 2-1/8"	0.6 lbs.	6"
11SP	2-5/8"	0 to 4"	1.8 lbs.	11"
18SP	9-1/2"	0 to 8"	2.8 lbs.	18"
24SP	15-1/2"	0 to 10"	3.6 lbs.	24"

Regular Tips				
Part No.	Throat Depth	Jaw Capacity	Weight	Overall Length
6R	1-1/2"	0 to 2-1/8"	0.5 lbs.	6"
11R	2-5/8"	0 to 4"	1.7 lbs.	11"
18R	9-1/2"	0 to 8"	2.7 lbs.	18"

### WISE GRIP/IRWIN® SHEET METAL CLAMP



8R



9AC



9R

Locking Sheet Flanger				
Part No.	Throat Depth	Jaw Capacity	Weight	Overall Length
8R	1-3/4"	1/2"	1.0 lbs.	3-1/8"

Locking Welding Clamp				
Part No.	Throat Depth	Jaw Capacity	Weight	Overall Length
9R	1-5/8"	2-3/4"	1.0 lbs.	9"

Locking Panel Clamp				
Part No.	Throat Depth	Jaw Capacity	Weight	Overall Length
9AC	1-3/4"	3/8"	1.0 lbs.	3-1/8"

**WISE GRIP/IRWIN® LOCKING JAW PLIERS**

- ProTouch™ Cushioned Grips on most models (SG)

Straight Jaw			
Part No.	Jaw Capacity	Overall Length	Weight
03SG	1-5/16"	7"	0.9 lbs.
01SG	1-3/4"	10"	1.3 lbs.



**03SG**

Curved Jaw			
Part No.	Jaw Capacity	Overall Length	Weight
13SG	1-1/2"	7"	0.8 lbs.
11SG	1-7/8"	10"	1.2 lbs.



**11SG**

**Long Nose Locking Pliers with Wire Cutter**

- Tapered nose ideal for delicate work, tight spaces & clamping of small parts

Part No.	Jaw Capacity	Overall Length	Weight
14SG	2"	6"	0.8 lbs.
15SG	2-3/4"	9"	1.2 lbs.



**14SG**

**Curved Jaw Locking Pliers with Wire Cutter**

- Wire cutter will handle anything up to 1/4" bolt

Part No.	Jaw Capacity	Overall Length	Weight
4WR	15/16"	4"	0.3 lbs.
09SG	1-1/8"	5"	0.4 lbs.
07SG	1-1/2"	7"	0.8 lbs.
05SG	1-7/8"	10"	1.2 lbs.



**4WR**

**Large Jaw Locking Pliers**

- Heavy duty jaw locks around work of all shapes and will not slip
- Ideal for plumbers, mechanics & welders

Part No.	Maximum Opening	Overall Length
12LC	3-1/8"	12"
12SG	3-1/8"	12"



**12LC**

**NICKEL PLATED SPRING CLAMPS**

- Corrosion resistant
- Ergonomic handle shape with protective handles & tips

Part No.	Jaw Capacity	Overall Length
1HT	1"	4"
2HT	2"	6"
3HT	3"	9"



**2HT**

### WISE GRIP/IRWIN® SPRING CLAMPS

- Non-slip handles
- Jaws configured to hold odd shapes
- Non-marring soft, pliable pads

Part No.	Jaw Capacity/Depth
IRW58100	1"
IRW58200	2"
IRW58300	3"



IRW58200

### WISE GRIP/IRWIN® QUICK-GRIP BAR CLAMP & SPREADERS

- Reverse clamping pad to use as a spreader
- Soft but durable pads protect work surfaces
- Heat-treated steel bar

Part No.	Throat Depth	Clamping Capacity	Spreading Capacity	Weight
506QC	3-1/4"	6"	7-1/2" – 14-5/8"	1.5 lbs.
512QC	3-1/4"	12"	7-1/2" – 20-5/8"	1.9 lbs.
518QC	3-1/4"	18"	7-1/2" – 26-5/8"	1.8 lbs.
524QC	3-1/4"	24"	7-1/2" – 32-5/8"	2.1 lbs.
5366QC	3-1/4'	36"	7-1/2" – 44-5/8'	3.1 lbs.



506QC

### LIGHT & MEDIUM DUTY C-CLAMPS

- Ductile iron frames are ribbed to resist strain
- Steel screws & swivel pads
- Sliding handle

Regular Throat			
Part No.	Throat Depth	Opening	Load Limit
ADJ231	1-1/8"	1"	900
ADJ232	2"	1"	1000
ADJ5233	1-1/2"	1-1/2"	800
04-531	1-3/8"	3"	1800
ADJ252	1-1/2"	2"	400
ADJ244	2-1/2"	2-1/2"	1600

Deep Throat			
Part No.	Throat Depth	Opening	Load Limit
ADJ237	3-1/2"	1-1/2"	300
ADJ245	4-3/4"	2-1/2"	1200
ADJ246	6-1/4"	2-1/2"	1200



ADJ231



## LIGHT DUTY C-CLAMPS

Part No.	Load Limit	Opening	Depth
ADJ1410	400 lbs.	1"	1"
ADJ1420	400 lbs.	2"	1"
ADJ1430	800 lbs.	3"	2"



**ADJ1420**

## WARREN SUPER-JUNIOR CLAMPS

Part No.	Load Limit	Opening	Depth
51	500 lbs.	1"	1"
52	800 lbs.	1-1/4"	1-1/4"
53	850 lbs.	1-1/2"	1-1/2"
54	875 lbs.	2"	1-1/4"
55	1100 lbs.	3"	1-3/8"
56	850 lbs.	2-1/2"	2-1/2"



**52**

## FAST ACTION UNIVERSAL CLAMPS

- Lightweight & rugged, plates made from high tensile steel & 300 stainless
- Meets federal specification GGG-406 Type V

Part No.	Description	Opening	Depth
KAN-401	Standard "T" Handle Model	1"	1/2"
KAN-405		2"	1-1/8"
KAN-410		3"	1-1/4"
KAN-420		6"	2-1/8"
KAN-401-4	Standard "T" Handle Model No-Mar Rubber Pads	1"	1/2"
KAN-405-4		2"	1-1/8"
KAN-410-4		3"	1-1/4"
KAN-415-4		4-1/2"	2-1/4"



**KAN-401**



**KAN-401-4**









## DESTACO TOGGLE CLAMPS

- Extra strong, quality construction
- Neoprene tips on these models

Part No.	Quick Release Lever	Holding Pressure	Spindle Thread Size	Reach	Max. Clamp Thickness	Overall Length	View
DES431	No	100 lbs.	1/4"-20	2-15/16"	1/2"	6-7/8"	
DES424	No	200 lbs.	1/4"-20	1-1/16"	3/4"	4-1/2"	
DES424-2	No	200 lbs.	1/4"-20	1-1/16"	1/2"	4-1/2"	

### GNU-VISE TOGGLE CLAMPS

- Extra strong, quality construction
- Great where space is limited
- Clamps available with single or double spindle

Part No.	Quick Release Lever	Holding Pressure	Spindle Thread Size	Reach	Max. Clamp Thickness	Overall Length	View
P400	No	400 lbs.	1/4"-20	1-3/16"	23/32"	4-3/4"	
P403	No	400 lbs.	5/16"-24	2-3/8"	2-3/4"	4-3/4"	
P800	No	800 lbs.	5/16"-24	2-1/8"	1-1/2"	8-1/16"	
P803	Yes (1) Swivel; (1) Hex	700 lbs.	5/16"-18	2-3/8"	2-7/32"	8-1/16"	
P1200	No	1200 lbs.	3/8"-24	2-1/4"	1-7/32"	8-3/8"	
P1200X4	No	600 lbs.	3/8"-24	4"	1-17/64"	10-7/16"	
P1200X4X45	No	Varies w/Length	3/8"-24	4"+1-5/8"	1-33/64"	11-3/32"	
FGP400	No	10 to 45 lbs.	-	1-3/16"	15/16"	4-3/4"	

### NEOPRENE SPINDLE FOOT ASSEMBLY

Part No.	Thread Size
KNU80011	1/4-20 Spindles
KNU80014	5/16-18 Spindles
KNU80012	5/16-24 Spindles
KNU80013	3/8-24 Spindles



**KNU80011**

### STEEL SWIVEL FEET

Part No.	Thread Size
KNU80080	1/4-20 x 5/16 deep
KNU80084	5/16-24 x 3/8 deep
KNU80032	5/16-18 x 3/8 deep
KNU80015	3/8-24 x 7/16



**KNU80084**

AVIATION SNIPS

- Easy cutting action on up to 18 gauge metal
- Forged blades with serrated cutting edges to prevent slipping
- Handles have smooth vinyl grops with thumb stops
- TP are import type
- Wiss are U.S. made

Part No.	Description
TP51K	3 pc. Set (Left, Right & Straight)
M123K	3 pc. Set (Left, Right & Straight)

Part No.	Cut Length	Description
M3R	1-1/2"	Straight, Left, Right
M2R	1-3/8"	Right
M1R	1-3/8"	Left



M1R



M2R



M3R

OFFSET SNIPS

- Wiss are U.S. made

Part No.	Cut Length	Description
M6R	1-1/4"	Left Handed
M7R		Right Handed



M6R



M7R

ERGONOMIC AVIATION SNIPS

- Ergonomic grip maximizes power stroke of hand
- Riveted handle will not loosen
- Jaw tips ground to point for access in tight spaces

Part No.	Standard	Type
M2001		Cuts Left
M2002		Cuts Right
M2003		Cuts Straight, Left & Right



M2001



M2006

## WISS ALUMINUM SNIPS

- Reverse clamping pad to use as a spreader
- Soft but durable pads protect work surfaces
- Heat-treated steel bar

Pattern Snips – Cuts Straight & Mild Curve Cuts				
Part No. Snip	Part No. Replacement Blad	Cut Length	Overall Length	Weight
W12LMP	W12LRK	3"	12"	1.0 lbs.

W12LMP



## WISS STANDARD TINNER SNIPS

- For cutting straight cuts, wide curves & notching
- Flat inside edge guides straight line cutting
- Hot forged, molybdenum steel

Part No.	Cut Length	Overall Length	Weight
A13N	1-3/4"	7"	0.5 lbs.
A10N	2-1/2"	11"	0.9 lbs.

A10N

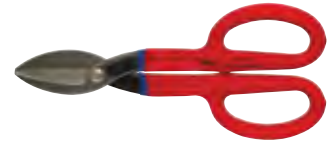

## WISS DUCKBILL TINNER SNIPS

- For cutting patterns & smooth, tight curves in either direction
- Hot forged, molybdenum steel

Part No.	Cut Length	Overall Length	Weight
V10N	2-1/4"	10-1/4"	0.6 lbs.
V19N	3"	13"	1.6 lbs.

V19N



## WISS BULLDOG PATTERN TINNER SNIPS

- Heavy duty, high leverage
- For heavy gauge notching, etc.
- Hot forged, molybdenum alloy steel

Part No.	Cut Length	Overall Length	Weight
W5N	2-1/2"	16-1/2"	3.8 lbs.

W5N



## WISS LIGHT METAL CUTTING SNIPS

- Polished straight blades
- Superior hardened edges for cutting light metal

Part No.	Type	Blade Length	Overall Length
J7S	Straight	1-1/4"	7"

J7S



WISS HAND SEAMERS

- Makes permanent, tight fitting seams
- Scaled depth marks on jaws are in 1/4" increments

Standard Model				
Part No.	Jaw Width	Jaw Depth	Overall Length	Weight
HS1V	3-1/4"	1/4" to 1-1/4"	8-3/4"	1.5 lbs.

Offset Model				
Part No.	Jaw Width	Jaw Depth	Overall Length	Weight
HS2	3-1/4"	1/4" to 1-1/4"	8-3/4"	1.5 lbs.



HS1V



HS2

ECONOMY HAND SEAMER

- Makes permanent, tight fitting seams
- Strong, lasting construction

Part No.	Jaw Width	Jaw Depth	Overall Length	Weight
TP44	3-1/4"	1/4" to 1"	8"	1.5 lbs.



TP44

WISS BLADE CRIMPER

- Main components are drop forged
- Spring return handle

Part No.	Jaw Depth	Overall Length	Weight	Blades
HC3V	1-1/4"	9"	1.0 lbs.	3
HC5V	1-1/4"	9"	1.0 lbs.	5



HC3V



HC5V

FLUTING PLIERS

- Designed for work on aircraft components
- No-mar fluting plier jaws have special coating that will not scratch surfaces
- An inexpensive, quality tool

Part No.	Weight	Length	Description
TP162	.39 lbs.	8"	No-Mar Larger Flute
TP722	.40 lbs.	9-1/2"	Narrow Type Fluting Plier



TP162



TP722

## WISS HAND NOTCHER

- Makes clean 30° v-shaped cuts in sheet metal

Part No.	Blade & Jaw Depth
HN1V	1-3/16"



HN1V

## A-N ELECTRICAL CONNECTOR PLIER

- With replaceable nylon inserts for protection of A-N connectors
- Three adjustments positions
- Serrated plastic jaws

Part No.	Description
AT508K	A-N Electrical Connector Plier
AT508K-4	Replacement Jaws



AT508K

## LINE CLAMP PLIERS

- Simultaneously hold the clamp bolt, compress line clamp(s) & retain them
- Up to three clamps on one assembly are held in position by retaining pawl
- More than three clamps or clamps with spacers can also be handled manually

Part No.	For Use With
AIT82	Clamps or studs anchored on flat surfaces. #10 Hex - 3/8 Hex Head
AIT83	Tubes or wires clamped together w/point of screw on back of clamp
AIT84	

Note: AIT84 #8 Hex - 5/16 Hex Head



AIT83

## CAMLOC PLIERS

- For Camloc fasteners
- With black-ox coating

Part No.	For Use With
4P3	2600, 2700 & 4002 Stud Series



TP876

## AIRLOC INSTALLATION TOOLS

- Places cross-pin into hole of stud

Part No.	Description
AIT59995	For #7 Airloc Stud
AIT59996	For #5 Airloc Stud
28617	For #1 Airloc Stud



AIT59995

**METAL FORMING SHOT BAG**

Stretch metal without nicks or gouges with this pliable 3/4 oz. top grain cowhide bag. This double-stitched bag fills through a 1" opening sealed with velcro. The filled bag gives you a surface to pound sheet metal into, absorbs the hammer blows and gives smooth results. The bag is 12" round or 8" x 1-1/2" thick and is easy to use with minimum practice. Shot is not supplied with bag.

Part No.	Description
TPA5526	12" diameter
TPA5526-8	8" diameter



**TPA5526**

**BOSSING MALLETS**

After years of frustration with the mallets commonly available, Ron Fournier decided to have custom bossing mallets made to his specifications, specifically for metal shaping professionals.

- Use with a shot bag to shape aluminum or AK steel without the handle striking the edge of your workpiece
- Non-marring plastic for long life and sturdy hickory handles
- Made in the USA

Part No.	Small Radius	Large Radius	Diameter	Head Length	Weight
TPA5522	3/4"	1-3/8"	2-3/4"	8"	23 oz.
TPA5522-1	1/2"	2-1/4"	2"	7"	11.7 oz.
TPA5522-2	1"	3"	3"	7"	26 oz.



**TPA5522**

**NO-MAR HAMMERS**

- Replaceable vinyl screw-on tips, one tough & one medium
- Hickory wood handle with an aluminum head
- Meets all relevant government specs
- Hammers supplied -1 (green) and -2 (red)













Part No.	Head Size	Overall Length	Weight
770A	1"D x 3-1/2"L	11"	6 oz.
772A	1-1/2"D x 4-1/2"L	12"	14 oz.
774A	2"D x 5"L	13"	25 oz.



**770A**

Replaceable Screw-On Tips				
Type & Color	Material	Part No. 1" Dia.	Part No. 1-1/2" Dia.	Part No. 2" Dia.
Tough (green)	Vinyl	771-1	773-1	775-1
Medium (red)	Vinyl	771-2	773-2	775-2
Soft (brown)	Vinyl	771-3	773-3	775-3
Med. Hard (cream)	Nylon	771-4	773-4	775-4
Hard (black)	Nylon	771-5	773-5	775-5

## MARTIN METAL WORKING HAMMERS &amp; DOLLY

Part No.	Type	View	Description
150G	Dinging Hammer		For fender & high-crowned panel dinging or bumping. Both high & low-crown faces for "on or off" dolly work. Faces, 1-1/4" and 1-3/16". Round heads, 6" overall. Weight 1.04 lbs.
153G	Cross Chisel Hammer		Excellent for finishing. Corss peen used for working in sharp corners around mouldings and for caulking. Round face 1-3/16". Chisel - 3" long. Weight .87 lbs.
153GB	Curved Cross Chisel Hammer		Excellent for finishing. Corss peen used for working in sharp corners around mouldings and for caulking. Round face 1-9/16". Chisel - 3" long. Weight .85 lbs.
153S	Cross Chisel Shrinking Hammer		Cross grooved. Extra wide faces are cross grooved & used for shrinkage on large surfaces – chisel and used on sharp corners. Flat round face - 1-9/16". Chisel - 3" long. Weight .87 lbs.
158G	General Purpose Pick Hammer		Medium size point and reach for general work. Low crown strawberry point for perfect balance. Face - 1-9/16" round point, 3/32" radius. Length of pick end - 3-3/4". Weight .91 lbs.
161G	Dinging Hammer		Short-reach, lightweight. One low-crown, square face. Lightest dinging hammer in line. Faces - 1-9/16" round point, 3/32" radius. Length of pick end - 3-3/4". Weight .83 lbs.
162G	Shrinking Hammer		For work in close quarters. Expertly machined serrations on the round face. Plain square face - 1-1/8" round serrated face, 1-1/4" diameter. 4" overall. Weight .78 lbs.
169G	Large Face Pick Finishing Hammer		For finishing & caulking. Round face - 1-7/8" diameter. 4-1/2" overall head length. 13" handle. Weight 1.0 lbs.
1058	Toe Dolly		Thinness & length provide easy accessibility to narrow pockets. Large, flat face is frequently used in shrinking & dinging flat panels. The flat sides furnish a convenient anvil for repairing flanges. Sizes 4-3/4" x 2-3/8" x 1-1/8". Weight 3.0 lbs.
1058S	Shrinking Dolly (Serrated)		Shaped like a toe dolly but has one face covered with raised serrations for shrinking metal stretched by dents. Weight 3.4 lbs.
1059	Heel Dolly		Design makes it possible to reach easily inot sharp corners & wide radii. These features are exclusive to the Heel Dolly & continue its high demand. Sizes 3-1/4" x 2-1/2" x 1-7/16. Weight 2.7 lbs.
1060	General Purpose Dolly		Provides convenient & comfortable hand hold during heaviest blows. Weight, balance & several differently crowned working faces, together with two beading & flange lips, give this dolly broad general use. Sizes 2-7/8" x 2-3/8" x 2-1/4". Weight 3 lbs.
1067	Wedge Dolly		Long, slender general pupose dolly. Widely favored by many body repair men for all-around use. The long, thin lip is very useful in working behind reinforcements. Sizes 5-3/4" x 2-3/8" x 2-3/16". Weight 4 lbs.



**HOOK SCRIBER**

- Ideal for separating wires, removing small fuses & retrieving small parts
- Knurled handle
- Chrome finished

Part No.	Type	Includes
TPA5588	4 pc. Individual Set	Straight, 90°, Long Arm



**TPA5588**

**POCKET CARBIDE METAL SCRIBER**

- Replacement carbide tip assembly not shown
- Pocket scriber with adjustable carbide tip assembly for easy resharpening or replacement
- Fitted with pocket clip - tip automatically retractable
- 1/16 point

Part No.	Description	Length
TP603	Retractable Pocket Scribe	6-1/2"
TP603A	Replacement Tip Assembly	6-1/2"



**TP603**

**STRAIGHT EDGE SCRIBE**

With this unique tool you can quickly and accurately scribe sheet metal and plastics without measuring. Simply determine the distance required and draw the scribe along the edge. Very simple to use and extremely accurate.

- Magnetic back attaches to tool box
- Hole for hanging

Part No.	Description
TP817	Scribes edges 1/8", 3/16", 5/16", 3/8", 1/2", 5/8" & 3/4"



**TP817**

**FLEXIBLE SPRING CLAW**

- Perfect for objects dropped in hard to reach places
- Grasps with 4 jaws

Part No.	Overall Length
AIT16	23-1/2"



**AIT16**

**MAGNETIC RETRIEVERS**

- High-power permanent magnets provide a lifetime of pulling power
- Perfect for use in water, oil, etc.

Telescopic Magnetic Retriever	
Part No.	Description
AIT394	13"-27" Extension

Pocket Telescopic Magnetic Retriever	
Part No.	Description
AIT383NX	5-1/2"-23-1/2" Extension



**AIT394**

Mechanic's Pocket Magnetic Retriever		
Part No.	Overall Length	Pull Capacity
AIT392	8-3/4"	2 lbs.



**AIT383NX**

## RIVET SET POUCH

- Hold up to 5 pc. 3-1/2" or 5-1/2" rivet sets

Part No.	Description
TP-POUCH-S	Pouch Only

TP-POUCH-S



## FASTENER ORGANIZER CASE

- Keep you small parts organized in a high impact polystyrene plastic case
- See through, spring loaded compartment covers
- Curved tray bottoms for quick part removal

Part No.	Compartments	LxWxH
TP840	8	12-3/8" x 7-1/4" x 2"
TP840-2	1	Half Divider



TP840

## TOUCH POUCH

Features extra-heavy duty nylon construction with a sewn-in rigid bottom & industrial grade zipper

- Military type
- 8 inner, 6 outer pockets with Sure Locks
- Oil and chemical resistant
- Convenient tote handles
- 12"L x 6"W x 7"D
- Tools not included

Part No.	Description	Weight
TP279	Tool Pouch	.94 lbs.



TP279

## VISE SLEEVES

- Molded rubber

Part No.	Size
AT528	4" width
AT530	4-1/2" width

AT528



## PORTABLE AIR TANK

- 7 gallon capacity
- Enamel finish
- Safety valve release

Part No.	Description
TP239	4' Hose & Air Chuck

TP239



**MASTER HEAT GUN**

- Adjustable rubber backed base permits 90° rotation for benchtop use
- Adjustable air intake
- Double-jacketed heater housing
- Convenient three position rocker switch

Part No.	Power	Heat Range	Weight
HG501A	120v - 60 Hz	500-750°F	3.5 lbs.
HG502A	220/240v - 50 Hz	500-750°F	3.5 lbs.
HG751B	120v - 60 Hz	750-1000°F	3.5 lbs.



**HG501A**

**MASTER HEAT GUN**

Part No.	Description
A-160-HG	Shrink attachment for tubing up to 3/4" OD
A-170-HG	Shrink attachment for tubing up to 3/4" to 2" OD
A-203-HG	Extra-wide 8" attachment for long tubing up to 3/4"
HAS011K	Replacement element for HG501A
HAS043K	Replacement element for HG751B
HAS014K	Replacement element for HG502A

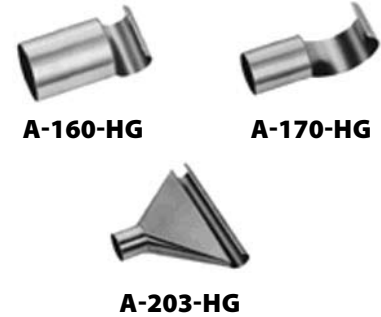

**A-160-HG**

**A-170-HG**

**A-203-HG**

**STANDARD AVIATION MAINTENANCE HANDBOOK**

Hundreds of the most commonly used charts, diagrams, scales and measurements for aviation maintenance, plus a tool box sized, spiral bound, up-to-date reference guide.

Part No.	Description
TP714	Standard Aviation Maintenance Handbook



**TP714**

**AIRCRAFT SHEET METAL**

Nick Bonacci addresses aircraft structures and materials; tool and fasteners; layout, setback, bends and repairs; and practical applications of dies, jigs and fixtures. Fully illustrated with glossary.

Part No.	Description
TP427	Aircraft Sheet Metal

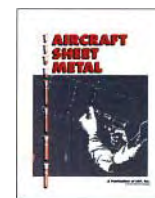

**TP427**

### MINI-LUBE® HIGH PRESSURE GREASE PUMP

- Patented two-way system delivers grease at 10000 psi
- Fully sealed system ensures contaminant & air pocket free greasing
- Supplied with KR gun

Part No.	Capacity
MAC-K6-24	5 lb. Pail (included)
MAC-K6-67	11 lb. Pail (included)

**MAC-K6-24**



### SUPER-LUBE® HIGH PRESSURE GREASE PUMP

- Patented two-way system delivers grease at 10000 psi
- Fully sealed system ensures contaminant & air pocket free greasing
- If air pockets occur unit is designed to pump air out - avoiding air locks
- Primer is depressed by hand & loads for 60 shots of grease
- Includes 10' hose & rubber edged for follwer plate
- Supplied with KR gun

Part No.	Capacity
MAC-K3	35 lb. Pail

**MAC-K3**



### MAXI-LUBE® AIR OPERATED HIGH PRESSURE GREASE PUMP

- Corrosion resistant oilless air motor delivers greast at 10000 psi
- Fully sealed system ensures contaminant & air pocket free greasing
- Features booster gun with 3 jaw super grip coupler
- 360° swivel assembly for maximum flexibility
- Includes 13' grease hose & follwer plate assembly
- Supplied with B2 gun

Part No.	Capacity
MAC-P3	35 lb. Pail
MAC-P6	120 lb. Drum

**MAC-P3**



### TRANSFER GREASE PUMP

Transfer pump designed for bulk filling grease dispensing equipment

- Includes 5' delivery hose
- Supplied with B2 gun

Part No.	Capacity
MAC-J2	35 lb. Pail

**MAC-J2**



**BEARING PACKER**

Fast, efficient, thorough. Simply place the bearing between the plastic cones, tighten and apply grease through the fitting on the end of the threaded shaft. Forces out old grease and evenly injects fresh grease into the bearing. Cone diameter is 5".

Part No.	Description
TP309	Grease Gun Type
TP309A	Hand Packer



**TP309**



**TP309A**

**AVIATION LUBE KIT**

- Handy kit includes all accessories typically required for lubricating aircraft
- Create custom setups for almost any situation
- Includes one of each accessory listed below
- Molded plastic case with replacement parts list

Part No.	Includes
ACK2	1 of each Item Below & Case



**ACK2**

Replacement Accessories	
Part No.	Description
KY	Standard Supergrip Coupler
KDN	90° Needlepoint Coupler
KDS	90° Limited Access Coupler
KZHY	Hyperdermic Needlepoint Coupler
KZDXL	Straight Needlepoint Coupler (4-1/4")
KZLNJ	'J' Needlepoint Coupler (12")
KZLNS	Straight Needlepoint Coupler (12")

Replacement Accessories	
Part No.	Description
KZLNR	90° Needlepoint Coupler (12")
KZLN45	45° Needlepoint Coupler (12")
KZSNR	90° Needlepoint Coupler (4-1/4")
KDE8	Rigid Extension (8")
KDF21	Flex Extension (21")
J65	Filler Nozzle Adapter

**HAND GREASE GUNS**

- One hand operation
- Handles up to and including NILGI No. 2 greases
- Supplied complete with 230mm (9") flexible extension and KY coupler
- Can be filled by bulk, cartridge or the J2 Grease Pump
- Optional range of couplers and extensions available

Pistol Grip	
Part No.	Description
MAC-K32	With 9" Flex Extension



**MAC-K32**

## ECONOMY BLOW GUN

- Tough zinc die cast body with replaceable brass tip & vinyl thumb grip
- Rubber tip included

Part No.	Includes
TP98	Safety Blow Gun



## 600 SERIES BLOW GUN

- Tough zinc die cast body with replaceable brass tip & vinyl thumb grip
- Four self-lubricating 'O' rings prevent valve leakage
- OSHA standard

Part No.	Includes
600PS	Safety Blow Gun



## DELUXE BLOW GUN KIT

**Deluxe Blow Gun kit includes:**

- Blow Gun - 771 Pistol Grip Blow Gun
- Tips - Non-Safety Tip, Standard Safety Tip\*, Safety Booster Tip\*, High Volume Safety Tip\*, Inflator Tip, Rubber Tip, Assortment of 5 Needle Tips, 10 Safety Extension Tips & Storage Box
- Connectors - Industrial Interchange Connector and Automotive Interchange Connector

Part No.	Description
BG-KITC	15 pc. Kit



*Note: These tips meet or exceed OSHA specifications.*

## AIR TOOL LUBRICANT

- Specially formulated high grade 10 weight lubricant
- Adheres to motor parts, giving better & longer lubrication
- Prevents rust & removes moisture for longer tool life

Part No.	Part No. Wintergrade	Size
ATL004	ATL004W	4 oz.
ATL016	ATL016W	1 pint
ATL032	-	1 quart
ATL128	ATL128W	1 gallon



ATL016

## CUB COIL® POLYURETHANE AIR HOSE

Cub Coil is the economical solution to applications where polyurethane self-storing air hose is the best choice, but cost is an overriding factor. Produced from industrial grade raw material, CUB Coil is a tough, durable hose that will withstand the rigors of the toughest applications. To assure superior and reliable retention, CUB Coil is offered with special barb fittings designed for use on polyurethane. Available in black.

- Kink & abrasion resistant - 1/4" NPT on both end
- Lightweight yet durable, retains its resiliency over a long period of time



**PC-14-20AK**

Part No.	Overall Length	I.D.	Fitting Type
PC14-10AK	10"	1/4"	Rigid or Swivel
PC14-20AK	20"	1/4"	Rigid or Swivel
PC38-10AK	10"	3/8"	Rigid or Swivel
PC38-20AK	20"	3/8"	Rigid or Swivel

## NITRILE BLEND AIR HOSE

Made with a tough, durable nitrile blend cover, this hose is able to withstand working pressures up to 300 psi and temperatures up to 180°F, yet maintain excellent flexibility. The nitrile blend tube is reinforced with braided high-tensile rayon cored for extra strength. Nitrile Blend hose can be used with reusable fittings for crimped-on barb fittings.



**R14025**

Nitrile Air Hose				
Part No.	Overall Length	I.D.	Fitting	Max. Working Pressure
R14012	12'	1/4"	Rigid	300 psi
R14025	25'			
R14050	50'			
R380124	12'	3/8"	Rigid	300 psi
R380254	25'			
R380504				

Pigtail Hose				
Part No.	Overall Length	I.D.	Fitting	Max. Working Pressure
RP0412S	12"	1/4"	Swivel, Rigid	300 psi

*Note: All hose 1/4" NPT on both ends.*

## TRI-POD MANIFOLDS

- With 1/4" NPT outlets

Solid Aluminum Tri-Pod	
Part No.	Type
CH3002	3 Port, 1/4" Inlet
CH3003	3 Port, 3/8" Inlet



**CH3002**

## DYNABRADE® DYNASWIVEL AIR LINE CONNECTORS

- Patented universal joint swivels 360° at two points
- Allows air line to drop to the floor while providing superb tool handling



**95460**

Part No.	Type	Thread Size	Recommended Air Flow	Weight
95460	The Original	1/4" NPT	0 to 25 CFM	0.20 lbs.
95461	The Original	3/8" NPT	26 to 45 CFM	0.40 lbs.
95462	The Original	1/2" NPT	46 to 65 CFM	0.80 lbs.
94300	No-Mar Composite	1/4" NPT	0 to 33 CFM	0.13 lbs.
95734	Flow Control	1/4" NPT	0 to 25 CFM	0.25 lbs.

## INDUSTRIAL INTERCHANGE COUPLER



**CH159**



**CH158**



**CH153**

Socket Male Pipe Thread Coupler	
Part No.	Description
CH159	1/4" Series, 1/8" MPT Pipe Thread
CH152	1/4" Series, 1/8" MPT Pipe Thread
CH155	1/4" Series, 3/8" MPT Pipe Thread
CH583	3/8" Series, 1/4" MPT Pipe Thread
CH581	3/8" Series, 3/8" MPT Pipe Thread

Socket Female Pipe Thread Coupler	
Part No.	Description
CH158	1/4" Series, 1/8" FPT Pipe Thread
CH150	1/4" Series, 1/8" FPT Pipe Thread
CH151	1/4" Series, 3/8" FPT Pipe Thread
CH582	3/8" Series, 1/4" FPT Pipe Thread
CH580	3/8" Series, 3/8" FPT Pipe Thread

Socket Hose Stem Coupler	
Part No.	Description
CH153	1/4" Series, 1/4" Hose Stem
CH154	1/4" Series, 5/16" Hose Stem
CH156	1/4" Series, 3/8" Hose Stem
CH586	3/8" Series, 3/8" Hose Stem



**CH1504**



**CH1509**



**CH1506**

Plug Male Pipe Thread	
Part No.	Description
CH1504	1/4" Series, 1/8" MPT Pipe Thread
CH1501	1/4" Series, 1/4" MPT Pipe Thread
CH1506	1/4" Series, 3/8" MPT Pipe Thread
CH5803	3/8" Series, 1/4" MPT Pipe Thread
CH5801	3/8" Series, 3/8" MPT Pipe Thread

Plug Female Pipe Thread	
Part No.	Description
CH1509	1/4" Series, 1/8" FPT Pipe Thread
CH1502	1/4" Series, 1/4" FPT Pipe Thread
CH1505	1/4" Series, 3/8" FPT Pipe Thread
CH5804	3/8" Series, 1/4" FPT Pipe Thread
CH5802	3/8" Series, 3/8" FPT Pipe Thread

Plug Hose Stem	
Part No.	Description
CH1506	1/4" Series, 1/4" Hose Stem
CH1507	1/4" Series, 5/16" Hose Stem
CH1508	1/4" Series, 3/8" Hose Stem
CH5806	3/8" Series, 3/8" Hose Stem
CH5805	3/8" Series, 1/2" Hose Stem

## FOSTER/SCHRADER INTERCHANGE COUPLER



**TLC15**



**TLC16**



**TLP15**



**TLP16**

Part No.	Description
TLC15	1/4 Male NPT

Part No.	Description
TLC16	1/4 Female NPT

Part No.	Description
TLP15	1/4 Male NPT
TLP16	1/4 Female NPT

*Note: We carry a full line of filter, regulator & lubricator accessories, please inquire.*



## MINI- FILTER - REGULATOR - LUBRICATOR

- Traditional trio design
- Polycarbonate bowls, metal bowls optional
- Gauge provided for uninstalled for installation in either side
- 2 oz. capacity

Mini Assemblies	
Part No.	Pipe Size
CHMFRL1-G	1/8"
CHMFRL2-G	1/4"

Separate Units	
Part No.	Description
CHMF1	1/8" Filter
CHMF2	1/4" Filter
CHMR1G	1/8" Regulator with Gauge
CHMR2G	1/4" Regulator with Gauge
CHML1	1/8" Lubricator
CHML2	1/4" Lubricator



**CHMFRL1-G**

## HEAVY-DUTY - FILTER - REGULATOR - LUBRICATOR

- Bowl guard standard
- Gauge provided for uninstalled for installation in either side
- Bayonet locking ring allow easy bowl removal
- Larger sizes available

Standard Assemblies	
Part No.	Pipe Size
CH8882-AAGR	1/4"
CH8883-AAGR	3/8"
CH8884-AAGR	1/2"
CH8886-AAGR	3/4"

Separate Units			
Size	Filter	Regulator	Lubricator
1/4"	CH8822R	CH8802G	CH8842R
3/8"	CH8823R	CH8803G	CH8843R
1/2"	CH8824R	CH8804G	CH8844R
3/4"	CH8826R	CH8806G	CH8846R



**CH8882-AAGR**