

GYROS

RCA 2610 SERIES DIGITAL ATTITUDE INDICATORS



The RCA2610 is the updated version of the popular RCA2600 Electric Digital Attitude Indicator. It is the perfect companion to the RCA1510 Digital Heading Indicator. This version has the same form, fit, and function as the original but has dual processors, improved screen resolution and updated software. The optional Pitch Sync feature allows pilots to instantly synchronize the airplane symbol to the horizon line when flying in a pitch up or pitch down attitude.

The RCA2610-G version comes without the Pitch Sync feature and functions like the original model with the brightness controls only.

The RCA2610 is designed to handle the high vibration environment found on helicopters and yet, their light weight makes them perfect for soaring. This makes the RCA2610 the most versatile and dependable Digital AI on the market today. With no moving parts to wear out, this instrument will provide years of reliable service - that's why it includes a full two-year warranty! All RCA2610 models can be ordered with an optional slip indicator (inclinometer) which satisfies FAA AC 91-75 for even greater versatility.

The panel tilt angle can be set from 0 to 90 degrees in one degree increments, but must be specified at time of order. Operating Voltage: 9 to 32VDDC. Made in the USA.

Features:

- Fast Dual Processors • Pitch Sync Feature • Sharp Anti-Aliased Screen • Black Anodized Bezel • Fast Response in Roll & Pitch • 2 Year Warranty • Vibration Resistant • Multi-volt plug & fly • Lighter weight • FAA/EASA Certified

Specifications:

- Operating Voltage: 9 to 32VDDC • Starting Current: 9VDC: 0.18 to 0.22 AMPS MAX • Running Current: (14VDC system) 0.20 AMPS MAX, (28VDC system) 0.18 AMPS MAX • Circuit Breaker Size: 2AMP • Settling Error: 1 Degree Maximum in Roll and Pitch • Operating Temperature Range: -30° to +50° C • Dimensions: Please see specifications document. • FAA Specification Conformance: TSO-C4c, TSO-C113a, DO-160F & DO-178B • EASA Specification Conformance: ETSO-C4c and ETSO-C113a

RCA 2610-2 SERIES DIGITAL ATTITUDE INDICATORS - 2 INCH - FAA TSO

Pitch Sync	Slip / Turn	Part Number	Price
With Pitch Sync	Standard (No Digital Slip / Turn)	10-06428	\$2,595.00
With Pitch Sync	With Slip Indicator + Turn Rate	10-06996	\$2,650.00
With Pitch Sync	With Slip Indicator Only	10-06997	\$2,595.00
No Pitch Sync	Standard (No Digital Slip / Turn)	10-06434	\$2,595.00
No Pitch Sync	With Slip Indicator + Turn Rate	10-07003	\$2,595.00
No Pitch Sync	With Slip Indicator Only	10-07004	\$2,595.00
With Pitch Sync + Pitot Static	Standard (No Digital Slip / Turn)	10-06440	\$2,889.00
With Pitch Sync + Pitot Static	With Slip Indicator + Turn Rate	10-07015	\$2,795.00
With Pitch Sync + Pitot Static	With Slip Indicator Only	10-07016	\$2,795.00
Pitot Static / No Pitch Sync	Standard (No Digital Slip / Turn)	10-06447	\$2,889.00
Pitot Static / No Pitch Sync	With Slip Indicator + Turn Rate	10-07021	\$2,795.00
Pitot Static / No Pitch Sync	With Slip Indicator Only	10-07022	\$2,795.00

RCA 2610-3 SERIES DIGITAL ATTITUDE INDICATORS - 3 INCH - FAA TSO

Pitch Sync	Slip / Turn	Battery	Part Number	Price
With Pitch Sync	Standard (No Digital Slip / Turn)	Without Battery Backup	10-06431	\$2,650.00
With Pitch Sync	Standard (No Digital Slip / Turn)	With Battery Backup	10-07008	\$2,750.00
With Pitch Sync	With Slip Indicator + Turn Rate	Without Battery Backup	10-06993	\$2,625.00
With Pitch Sync	With Slip Indicator + Turn Rate	With Battery Backup	10-07006	\$2,795.00
With Pitch Sync	With Slip Indicator Only	Without Battery Backup	10-06994	\$2,625.00
With Pitch Sync	With Slip Indicator Only	With Battery Backup	10-07007	\$2,750.00
No Pitch Sync	Standard (No Digital Slip / Turn)	Without Battery Backup	10-06437	\$2,650.00
No Pitch Sync	Standard (No Digital Slip / Turn)	With Battery Backup	10-07011	\$2,755.00
No Pitch Sync	With Slip Indicator + Turn Rate	Without Battery Backup	10-06999	\$2,635.00
No Pitch Sync	With Slip Indicator + Turn Rate	With Battery Backup	10-07009	\$2,797.00
No Pitch Sync	With Slip Indicator Only	Without Battery Backup	10-07001	\$2,595.00
No Pitch Sync	With Slip Indicator Only	With Battery Backup	10-07010	\$2,750.00
With Pitch Sync + Pitot Static	Standard (No Digital Slip / Turn)	Without Battery Backup	10-06444	\$2,889.00
With Pitch Sync + Pitot Static	Standard (No Digital Slip / Turn)	With Battery Backup	10-07026	\$2,945.00
With Pitch Sync + Pitot Static	With Slip Indicator + Turn Rate	Without Battery Backup	10-07012	\$2,795.00
With Pitch Sync + Pitot Static	With Slip Indicator + Turn Rate	With Battery Backup	10-07024	\$2,945.00
With Pitch Sync + Pitot Static	With Slip Indicator Only	Without Battery Backup	10-07013	\$2,795.00
With Pitch Sync + Pitot Static	With Slip Indicator Only	With Battery Backup	10-07025	\$2,945.00
Pitot Static / No Pitch Sync	Standard (No Digital Slip / Turn)	Without Battery Backup	10-06450	\$2,889.00
Pitot Static / No Pitch Sync	Standard (No Digital Slip / Turn)	With Battery Backup	10-07029	\$2,945.00
Pitot Static / No Pitch Sync	With Slip Indicator + Turn Rate	Without Battery Backup	10-07018	\$2,795.00
Pitot Static / No Pitch Sync	With Slip Indicator + Turn Rate	With Battery Backup	10-07027	\$2,945.00
Pitot Static / No Pitch Sync	With Slip Indicator Only	Without Battery Backup	10-07019	\$2,795.00
Pitot Static / No Pitch Sync	With Slip Indicator Only	With Battery Backup	10-07028	\$2,945.00
With Pitch Sync + Pitot Static	Standard (No Digital Slip / Turn)	Without Battery Backup	10-06444	\$2,889.00
Pitot Static / No Pitch Sync	Standard (No Digital Slip / Turn)	Without Battery Backup	10-06450	\$2,889.00

Options:

- RC ALLEN 2600 Series Screw on Inclinometer P/N 10-03862 \$149.95
- RC ALLEN Digital Indicator Custom Tilt P/N 10-07138 \$5.00
- RC ALLEN Digital Indicator Night Vision NVIS P/N 10-07139 \$650.00

GYROS



RCA 1510 SERIES DIGITAL HEADING INDICATORS

The RCA1510 Series Digital Heading Indicator is the latest addition to the RC Allen Digital Instrument Lineup. It is the perfect companion to the RCA2610 Digital Attitude Indicator. The RCA1510 is designed as a fully FAA Certified direct replacement for your mechanical Directional Gyro. It is totally self-contained and fits in a standard 3-inch panel cut-out. There are no special external connections other than power and an external GPS antenna. The

Multi-Volt function (9-32V) allows installation in both 14 Volt and 28 Volt systems. The RCA1510 combines data from its own internal magnetometer and GPS receiver for a more stable and accurate heading reading which also eliminates the need to "cage" or "zero" the instrument. Because the RCA1510 has no mechanical gyroscope, it is much more accurate than traditional heading indicators. Unlike a mechanical gyroscopic unit, the RCA1510 is not affected by drifting or wandering. The unit is designed to work without GPS input if the GPS signal is lost. The highly visible screen has adjustable brightness controls. It has a traditional rotating dial display with digital numeric headings. The pilot can adjust the Heading Bug just like a mechanical instrument or use the Quick-Set Heading Bug; a double-push of the HDG knob sets the Bug to the current heading. The panel tilt angle can be set from 0 to 90 degrees in one degree increments, but must be specified at time of order. Made in the USA

Features: • Totally self-contained • Quick-set Heading Bug • Internal Magnetometer and GPS • Sharp Dimmable Display • Dual Processor Performance • Multi-volt Operation (9 to 32 Volts) • Fits standard panel cutout • Vibration Resistant • All digital - No moving parts • Black anodized bezel • Lightweight - 8oz. Max • FAA Certified

Description	Part No.	Price
Dedicated Antenna (SMA) Standard	10-06580	\$2,835.00
Dedicated Antenna (SMA) With Backup Battery	10-07407	\$3,375.00
Dedicated Antenna (SMA) Standard NVIS	10-07408	\$3,059.00
Dedicated Antenna (SMA) NVIS w/Backup Battery	10-07409	\$3,825.00
RS232 Serial Standard	10-07410	\$2,875.00
RS232 Serial With Backup Battery	10-07411	\$3,437.50
RS232 Serial Standard NVIS	10-07412	\$3,062.50
RS232 Serial NVIS with Backup Battery	10-07413	\$3,625.00
RC Allen Digital Indicator Custom Tilt Option	10-07138	\$5.00

RC ALLEN DIRECTIONAL GYROS (ELECTRIC)



The RCA15 Series electric directional gyro employs and electrically driven gyro motor and is a direct reading, azimuth indicator. Rotor run up time is 3 min. They have a built in inverter which converts aircraft DC power to the required AC voltage and frequency. May be used in both fixed wing and rotor wing aircraft and is easily installed in standard 3 1/8" panel cut out. Power failure flag drops into view when supply voltage is lost or has dropped below a level for proper operation of the gyro. Made in the USA

Pictured is RCA15AK-1
Electrical Requirements: • Starting Current @ 14 VDC: 2.4A Max • Running Current @ 14 VDC: 1.2A • Starting Current @ 28 VDC: 1.4A Max • Running Current @28 VDC: .6A • Recommended Circuit Breaker 3A

Model	Description	Part No.	Price
RCA15AK-1	14 VDC, Lighted	10-01681	\$2,295.00
RCA15AK-2	14 VDC	10-01390	\$2,229.00
RCA15EK-2	12-30V, TSO	10-03454	\$2,229.00
RCA15BK-1	28 VDC, Lighted	10-01682	\$2,279.00
RCA15BK-2	28 VDC	10-00501	\$2,229.00
RCA15AK-16	14 Volt, 400HZ, 5K.	10-02530	\$2,955.00
RCA15AK-17	14 Volt, Heading Bug only.	10-02529	\$2,669.00
RCA15BK-16	28 Volt, 400HZ, 5K.	10-02533	\$2,955.00
RCA15BK-17	28 Volt, Heading Bug only.	10-02532	\$2,669.00
15BK-1	Factory Overhauled	10-05690	\$1,145.00
Accessories			
MS3116E8-4S	4 Pin Connector	10-00791	\$42.50
444-0011-0	Mini Slip Indicator - Add this to your new or current Electric Gyro Horizon. Replaces 444-0007-01.	10-04623	\$149.85

RC ALLEN ATTITUDE GYROS (ELECTRIC)



10-02524

The RCA26 Series is the top of the line and has been designed for precision and reliability. The RCS26EK Series is a 10-30VDC instrument. You have a choice of a fixed or moveable pointer, and a 14 or 28 volt lighting. Performance characteristics include roll indication of 360°. Pitch ± 30°. Pitch trim range ±7°. Slip Indicator can be added upon request. Mating connector (MS3116E8-4S) is also available.

Additional core charge added to purchase at time of checkout. Exchange core must be a like core and the core must be returned no later than 20 days from the invoice date to receive core credit.

Model No.	Description	Part No.	Price
RCA26EK-11	Fixed Pointer, unlit. 0 Degree Tilt	10-02524	\$2,229.00
RCA26EK-11 Custom Tilt	Fixed Pointer, unlit. Specify Tilt	10-04984	\$2,229.00
RCA26EK-12	Fixed Pointer, lighted. 0 Degree Tilt	10-02526	\$2,279.00
RCA26EK-12 Custom Tilt	Fixed Pointer, lighted. Specify Tilt	10-04985	\$2,279.00
RCA26EK-13	Moveable pointer, unlit. 0 Degree Tilt	10-02527	\$2,229.00
RCA26EK-13 Custom Tilt	Moveable pointer unlit. Specify Tilt	10-04986	\$2,229.00
RCA26EK-14	Moveable pointer, lighted. Voltage and tilt must be specified at time of order.	10-02528	\$2,279.00
RCA26AK-1	Standard look, 14V, Lighted, Moveable pointer, Stationary roll dial. 0 degree tilt.	10-00608	\$2,295.00
RCA26AK-1 Custom Tilt	Standard look, 14V, Lighted, Moveable pointer, Stationary roll dial. Specify tilt.	10-04989	\$2,279.00
RCA26AK-2	Standard look, 14V, Lighted, fixed pointer, moveable roll dial. 0 Degree Tilt	10-01683	\$2,279.00
RCA26AK-2 Custom Tilt	Standard look, 14V, Lighted, fixed pointer, moveable roll dial. Specify Tilt	10-04990	\$2,279.00
RCA26AK-3	Standard look, 14V, Moveable pointer, Stationary roll dial. 0 Degree Tilt.	10-01118	\$2,229.00
RCA26AK-3 Custom Tilt	Standard look, 14V, Moveable pointer, Stationary roll dial. Specify Tilt.	10-04991	\$2,229.00
RCA26AK-4	Standard look, 14V, Fixed Pointer, Moveable roll dial.	10-01392	\$2,225.00
RCA26BK-2	Standard look, 28V, Lighted, Moveable pointer, Stationary Roll Dial.	10-01119	\$2,279.00
RCA26BK-6	Standard look, 28V, Fixed Pointer, Moveable Roll Dial.	10-01393	\$2,229.00
RCA26BK-8	Standard look, 28V, Moveable pointer, Stationary Roll Dial.	10-01120	\$2,229.00
RCA26BK-9	Standard look, 28V, Lighted, Fixed pointer, Moveable Roll Dial.	10-00466	\$2,279.00
RCA26BK-12	5° Tilt, 28V, Lighted, Moveable pointer, fixed roll dial	10-01122	\$2,389.00
26BK-9	Factory Overhauled*	10-05685	\$1,145.00
26BK-2	Factory Overhauled*	10-05686	\$1,025.00
26AK-4	Factory Overhauled*	10-05687	\$1,375.00
MS3116E8-4S	4 Pin Connector MS3116E8-4S	10-00791	\$42.50
444-0011-01	Slip indicator/inclinometer for RCA26 & RCA22 Series manufactured before 03/04/2011	10-04623	\$149.85



CORE CHARGES APPLY TO OVERHAULED GYROS.

WWW.AIRCRAFTSPRUCE.COM

GYROS

RC ALLEN VACUUM HORIZON GYRO



The RCA22 Series of vacuum artificial horizon are controlled by air driven precision gyros to present the pilot with pitch and roll information. The attractive color scheme of blue sky and brown ground presents a realistic spherical display of flight. Unless otherwise indicated all instruments have a dark blue/brown display, fixed pointer and are unlighted. This is the "standard" display. Instruments equipped with a warning flag

will let you know when vacuum has dropped below 3.8 inch Hg. Flag retracts from view at 4.3 inch. Hg. Instrument fits in a standard 3 1/8" panel cutout.

Meets or exceeds all requirements of FAA TSO C4C and Aeronautical Standard AS396B. *Additional core charge added to purchase at time of checkout. Exchange core must be a like core* and the core must be returned no later than 20 days from the invoice date to receive core credit.

Model No.	Description	Part No.	Price
RCA22-7	Standard display, 0 Degree Tilt	10-01371	\$925.00
RCA22-7F	Standard Display with a warning flag. 0 Degree Tilt	10-00504	\$1,049.00
RCA22-7F	Standard Display with a warning flag. Specify Tilt	10-04996	\$1,035.00
RCA22-11	Standard display, lighted 14V, 0 Degree Tilt.	10-00502	\$1,035.00
RCA22-11	Standard display, lighted 14V, Custom Tilt.	10-04995	\$1,035.00
RCA22-11	Standard display, lighted 28V, 0 Degree Tilt	10-01391	\$1,035.00
RCA22-11	Standard display, lighted 28V, 8 Degree tilt	10-03635	\$1,035.00
RCA22-11	Standard display, lighted 28V, Custom Tilt	10-05011	\$1,035.00
RCA22-11F	Standard display, lighted, with a warning flag. (14V) 0 Degree Tilt	10-00094	\$1,159.00
RCA22-11F	Standard display, lighted, with a warning flag. (14V) Custom Tilt	10-04993	\$1,149.00
RCA22-11F	Standard display, lighted, with a warning flag. (28V). 0 Degree Tilt.	10-03574	\$1,149.00
RCA22-11F	Standard display, lighted, with a warning flag. (28V). Custom Tilt.	10-05009	\$1,149.00
RCA22-15	Display is blue over black 0 Degree Tilt.	10-01109	\$925.00
RCA22-15	Display is blue over black 8 Degree Tilt.	10-05007	\$915.00
RCA22-15	Display is blue over black. Custom Tilt.	10-04997	\$15.00
RCA22-7	Overhauled RCA22-7 Horizon Gyro*	10-05439	\$595.00
RCA22-7F	Overhauled RCA22-7F	10-05869	\$725.00
RCA22-11	Overhauled RCA22-11	10-05870	\$595.00
RCA22-11F	Overhauled RCA22-11F	10-05871	\$595.00
RCA22-15	Overhauled RCA22-15	10-05872	\$625.00

RC ALLEN DIRECTIONAL GYROS VERTICAL CARD (VACUUM)



RCA11A-8

RCA11A-15

The RCA-11A series of vacuum directional gyros utilize an air driven precision gyro that controls a vertical rotating azimuth gimbal. The R.C. Allen Model RCA11A has been designed to provide a long life of accurate operation even when subjected to severe operating requirements. This instrument

is engineered with a minimum of machined parts, providing lower initial cost and lower maintenance cost through its lifetime. The RCA11A is non-tumbling within $\pm 85^\circ$ limits in pitch and roll and can be easily installed in any 3 1/8" panel cut out. Meets or exceeds all requirements of FAA TSO C5c and Aeronautical Standard AS397.

Dimensions: Length: 6.7" Height: 3.4" Width: 3.4" Weight: 2.3 Pounds

Model No.	Description	Part No.	Price
RCA11A-8	Standard Display	10-01370	\$925.00
RCA11A-8F	Standard Display with Flag	10-01680	\$1,035.00
RCA11A-15	Cardinal Heading markers N., S., E., & W. (Piper/Cessna display)	10-00390	\$925.00
RCA11A-15F	Same as RCA11A-15 with flag	10-01116	\$1,035.00
RCA11A-16B	Standard Display, Lighted, 14 Volt.	10-01369	\$1,035.00
RCA11A-17B	Standard Display, Lighted, 28 Volt	10-01389	\$796.00
RCA11D-4	Single Pointer, 400hz Autopilot with heading bug.	10-01117	\$1,626.00
RCA11D-5	Dual Auto Pilot with Heading Bug	10-03430	\$1,626.00
RCA11D-7	With Heading Bug Only	10-02931	\$1,345.00
11A Series	Factory Overhauled 11A Series Gyro (Core Charges Apply)	10-05683	\$595.00
RCA11A-15	Factory Overhauled (Piper/Cessna Display)(Core Charges Apply)	10-06263	\$595.00

RC ALLEN MINI6 MULTIFUNCTION DIGITAL INSTRUMENT



The MINI6 indicator is the newest addition to RC Allen's groundbreaking line of digital instruments. It offers all the instrumentation of a traditional six-pack in one clean, customizable and easy to read presentation. The fully certified, easy to install indicator comes equipped with an internal battery backup providing an exceptional level of redundancy to any application.

Easy to Install: • Fits standard 3" cutout • No panel modifications • Rear mounted, matching the installation of standard 3" mechanical units

Customizable • Wide range of customization options including range marks, units and display features • Selectable Heading Type (Magnetic Heading or Ground Track)

Reliable • Internal battery backup • Self-contained • Solid state • 2 year warranty P/N 10-07331 \$3,250.00

SIGMA-TEK 5000B SERIES STANDARD ATTITUDE GYROS



The 5000B is an air-driven gyro that has a pictorial horizon mask and fixed airplane. The mask moves to indicate climb, dive, and bank. Bank and pitch attitudes are displayed so that the pilot's sensing of the gyro indication is the same as the interpretation of the relation between the wings of the aircraft and the natural horizon during visual flight.

This instrument is FAA certified, and can be used to replace the aircraft's turn coordinator when equipped with an inclinometer.

The Standard configuration can replace most air driven gyros with the major difference being in the layout and colors of the display.

NOTE: Lighted instruments do not include lamp trays, please see accessories to purchase separately.

Sigma-Tek	Model	Display Colors	Inclino-meter	Lighted	Panel Tilt	Part Number	Price
1U149-010	5000E-13	Blue/Black	No	Yes	0	10-04790	\$1,874.00
1U149-010-1	5000B-37	Blue/Brown	No	Yes	0	10-01071	\$1,648.00
1U149-010-4	5000B-54	Blue/Brown	No	Yes	8	10-04655	\$1,870.00
1U149-010-5	5000B-64	Blue/Black	No	Yes	8	10-04660	\$1,879.00
1U149-013-1	5000B-45	Blue/Brown	Yes	Yes	0	5000B-45	\$2,237.00
1U149-013-3	5000B-53	Blue/Brown	Yes	Yes	8	5000B-53	\$2,237.00
23-501-06-9	5000B-20	Blue/Black	No	No	0	10-00389	\$1,543.00
23-501-06-12	500B-24	Blue/Black	No	No	8	10-04652	\$1,554.00
23-501-06-16	5000B-36	Blue/Brown	No	No	0	5000B	\$1,450.00
23-501-06-17	5000B-42	Blue/Brown	No	No	8	5000B-42	\$1,543.00
23-501-033-3	5000B-46	Blue/Brown	Yes	No	0	5000B-46	\$1,964.00
23-501-034-4	500B-51	Blue/Brown	Yes	No	8	5000B-51	\$2,006.00

Accessories

BA14-24-BW3G (14 Volt Lamp Tray).....P/N 10-02757\$95.75

BA28-24-BW3G (28 Volt Lamp Tray).....P/N 10-02758\$95.75

SIGMA-TEK 5000B SERIES ATTITUDE GYROS WITH WARNING FLAG



This gyro is a variation of the popular 5000B air-driven attitude gyro. It includes a warning flag that drops into view upon the loss of vacuum. This can be a life saving feature during an emergency in a busy cockpit. The horizon mask moves to indicate

climb, dive, and bank attitudes, which are portrayed against a fixed airplane. The fluid movements and intuitive presentation provide the pilot with a realistic sense of the aircraft's attitude in relation to the natural horizon.

This instrument is FAA certified, and can be used to replace the aircraft's turn coordinator when equipped with an inclinometer.

This configuration includes a "Warning Flag" that is visible immediately upon Loss of vacuum or pressure. It is a very valuable upgrade as a safety feature. **Display Colors: Blue/Brown Note: Lighted instruments do not include lamp trays, please see accessories to order separately.**

Sigma-Tek	Model	Inclino-meter	Lighted	Panel Tilt	Part Number	Price
23-501-031-1	5000B-38	No	No	0	10-02078	\$1,679.00
1U149-012	5000B-40	No	Yes	0	10-00132	\$1,922.00
23-501-032-2	5000B-43	No	No	8	10-04653	\$1,921.00
1U149-012-2	5000B-52	No	Yes	8	10-04654	\$2,216.00
23-501-041-1	5000B-60	Yes	No	0	10-04656	\$2,217.00
23-501-042-2	5000B-61	Yes	No	8	10-04657	\$2,206.00
1U149-016-7	5000B-62	Yes	Yes	0	10-04658	\$2,237.00
1U149-016-8	5000B-63	Yes	Yes	8	10-04659	\$2,237.00

Accessories

BA14-24-BW3G (14 Volt Lamp Tray).....P/N 10-02757\$95.75

BA28-24-BW3G (28 Volt Lamp Tray).....P/N 10-02758\$95.75

IN

GYROS

SIGMA-TEK 5000E/L SERIES AUTOPILOT ATTITUDE GYROS



The 5000E air-driven attitude gyro is another variation of our standard 5000B model. It includes inductive pickoffs that generate the signals necessary to drive an autopilot. The intuitive display has a moving horizon mask that indicates the position of the aircraft's wings in relation to the natural horizon. This attitude information is passed along to the autopilot system.

This is one of our most popular primary instruments. It is FAA approved, and can replace the turn coordinator when equipped with an inclinometer.

Many Sigma-Tek autopilot gyros are FAA PMA approved for use in ARC and Century CII, CIIB, CIII and CIV autopilot installations.

NOTE: Lighted instruments do not include lamp trays, please see accessories to purchase separately.

Specifications: • Height: 3.38" • Width: 3.38" • Depth: 7.51" • Weight: 2.2 lbs. max. • Markings: Matte white • Finish: Dull black • Temperature: -30° to 50° C • Vibration: (CPS:5 to 50 / Maximum Double Amplitude:0.020 in./ Maximum Acceleration:1.5 G's) • Humidity:0% to 95% at 32° C • Altitude:0 to 40,000 ft.

Display Colors: Blue / Black								
Sigma-Tek	Model	Autopilot Model	Autopilot Output	Lighted	Panel Tilt	PMA	Part Number	Price
23-501-04-2	5000E-8	CFS 52D66	Roll	No	0	Yes	10-04892	\$2,522.00
23-501-05-2	5000E-9	CFS 52D67	Pitch & Roll	No	0	Yes	10-04894	\$3,210.00
1U149-006-1	5000E-10	CFS 52D66M	Roll	Yes	0	Yes	5000E-10	\$2,685.00
1U149-007-1	5000E-11	CFS 52D67M	Pitch & Roll	Yes	0	Yes	5000E-11	\$3,225.00
Display Colors: Blue / Brown								
23-501-04-24	5000E-20	CFS 52D66	Roll	No	0	Yes	10-04893	\$2,553.00
23-501-05-25	5000E-21	CDS 52D67	Pitch & Roll	No	0	Yes	10-04895	\$3,279.00
1U149-006-8	5000E-22	CFS 52D66M	Roll	Yes	0	Yes	10-04890	\$2,915.00
1U149-007-9	5000E-23	CFS 52D67M	Pitch & Roll	Yes	0	Yes	10-04891	\$3,410.00

Accessories

BA14-24-BW3G (14 Volt Lamp Tray).....P/N 10-02757\$95.75
 BA28-24-BW3G (28 Volt Lamp Tray).....P/N 10-02758\$95.75

SIGMA-TEK FACTORY OVERHAULED GYROS



5000B-36



4000B-30

These units are factory-overhauled gyros that are like new and carry the same warranty as a new units. Provided installation is within 6 months of factory ship date, full replacement warranty is 12 months from date of installation.

Exchange core must be a like core* and the core must be returned no later than 20 days from the invoice date to receive core credit.

*Like cores include: any 4000B series Sigma Tek core as exchange for a 4000B-30 any 5000B series Sigma Tek core as exchange for a 5000B-36

*All lighted units must order light tray separately.

Description	Sigma-Tek Model No.	Our Part No.	Price
Attitude Gyro	5000B-36	10-03360	\$814.00
Directional Gyro	4000B-30	10-03359	\$815.00

SIGMA-TEK 5000M SERIES CAGEABLE ATTITUDE GYROS



The 5000M is an air-driven gyro that has a pictorial horizon mask and fixed airplane. The mask moves to indicate climb, dive, and bank. Bank and pitch attitudes are displayed so that the pilot's sensing of the gyro indication is the same as the interpretation of the relation between the wings of the aircraft and

the natural horizon during visual flight. The instrument is provided with a caging system which is functional through 360° of roll and 90° of pitch. When caging is engaged, pitch and roll indices are aligned within two degrees. This instrument is FAA certified, and can be used to replace the aircraft's turn coordinator when equipped with an inclinometer. The caging feature is very useful for quick erection and display alignment; a high priority for occasional aerobatic maneuvers and operations with short stops.

Display Colors: Blue/Brown

NOTE: Lighted instruments do not include lamp trays, please see accessories to purchase separately.

Sigma-Tek	Model	Warning Flag	Caging	Inclino-meter	Light-ed	Panel Tilt	Part Number	Price
1U149-021-1	5000M	No	Yes	No	Yes	0	10-02326	\$2,437.00
23-501-035-5	5000M-1	No	Yes	No	No	0	10-02327	\$2,448.00
23-501-036-6	5000M-2	No	Yes	No	No	8	10-02328	\$2,342.00
23-501-037-7	5000M-3	No	Yes	Yes	No	0	10-02329	\$3,211.00
23-501-038-8	5000M-4	No	Yes	Yes	No	8	10-02330	\$3,100.00
1U149-022-2	5000M-5	No	Yes	No	Yes	8	10-02331	\$2,437.00
1U149-023-3	5000M-6	No	Yes	Yes	Yes	0	10-02332	\$3,115.00
1U149-024-4	5000M-7	No	Yes	Yes	Yes	8	10-02333	\$3,189.00
1U149-025-5	5000M-8	Yes	Yes	Yes	Yes	0	10-04882	\$3,499.00
1U149-026-6	5000M-9	Yes	Yes	Yes	Yes	8	10-04883	\$3,332.00
23-501-039-9	5000M-10	Yes	Yes	Yes	No	0	10-04884	\$2,897.00
23-501-040-10	5000M-11	Yes	Yes	Yes	No	8	10-04885	\$2,897.00
23-501-043-3	5000M-12	Yes	Yes	No	No	0	10-04886	\$2,658.00
23-501-044-4	5000M-13	Yes	Yes	No	No	8	10-04887	\$2,658.00
1U149-027-7	5000M-14	Yes	Yes	No	Yes	0	10-04888	\$2,974.00
1U149-028-8	5000M-15	Yes	Yes	No	Yes	8	10-04889	\$3,039.00

Accessories

BA14-24-BW3G (14 Volt Lamp Tray).....P/N 10-02757\$95.75
 BA28-24-BW3G (28 Volt Lamp Tray).....P/N 10-02758\$95.75

SIGMA-TEK 4000B SERIES STANDARD DIRECTIONAL GYROS



The 4000B is a standard air-driven directional gyro. As the aircraft turns left or right, gears on the sensing unit and dial shaft translate this rotation into rotation of the instrument's vertical dial. Left turns produce clockwise dial rotation and right turns produce counter-clockwise rotation. The gyro is controlled by a heading selector knob located on the lower left of the instrument. Pressing and turning the knob first disengages the dial shaft and then resets the dial to a new heading, which results in a new course indication. Releasing the selector knob re-engages the dial shaft. The on-course position of the pointer is always at the top of the azimuth circle (0° on the dial with the aircraft headed north). The Standard configuration can replace most air driven gyros with the major difference being in the layout and colors of the display.

NOTE: Lighted instruments do not include lamp trays, please see accessories to purchase separately.

Sigma-Tek	Model	Airplane Color	Index Markers	Dial @ 30°	Letters @ 90°	Light-ed	Part Number	Price
1U262-001-9	4000B-8	White	White	White	No	No	10-05123	\$1,579.00
1U262-002-32	4000B-22	White	White	White	Yes	Yes	10-05124	\$1,874.00
1U262-001-39	4000B-30	Orange	Orange	White	Yes	No	4000B	\$1,450.00
1U262-002-42	4000B-31	Orange	Orange	White	Yes	Yes	10-00588	\$1,606.00

GYROS



SIGMA-TEK 4000C / D SERIES AUTOPILOT DIRECTIONAL GYROS

The 4000C/D is an air-driven directional gyro with A.C. autopilot pickoffs. Left turns produce clockwise dial rotation and right turns produce counter-clockwise rotation. Two knobs control the gyro. The left knob is used to cage the unit, and the right knob is used to select the instrument's heading. To change course, the right selector knob is pressed and turned to disengage the dial shaft and set the pointer to a new heading. Releasing the selector knob re-engages the pointer with the dial shaft. As the aircraft turns onto a new course, the pointer returns to its original position. The on-course position of the pointer is always at the top of the azimuth circle (0° on the dial with the aircraft headed north).

Some Auto-Pilot gyros are FAA PMA approved for use in several models of the Century and S-Tec Auto-Pilot systems.

and the right knob is used to select the instrument's heading. To change course, the right selector knob is pressed and turned to disengage the dial shaft and set the pointer to a new heading. Releasing the selector knob re-engages the pointer with the dial shaft. As the aircraft turns onto a new course, the pointer returns to its original position. The on-course position of the pointer is always at the top of the azimuth circle (0° on the dial with the aircraft headed north).

Sigma-Tek	Model	Autopilot Model	Airplane Index	Dial @ 30°	Letters @ 90°	Lighted	PMA	Part Number	Price
1U262-003-14	4000C	52D54	White	White	No	No	Yes	11-05908	\$2,511.00
1U262-004-15	4000C-1	52D54M	White	White	Yes	Yes	Yes	10-02929	\$2,711.00
1U262-042-3	4000C-17	King	White	White	Yes	Yes	No	10-05137	\$3,027.00
1U262-003-65	4000C-18	52D54	Orange	White	No	No	Yes	10-05138	\$2,578.00
1U262-004-66	4000C-19	52D54M	Orange	White	Yes	Yes	Yes	10-05139	\$2,816.00
1U262-005-20	4000D-1	ARC 40760-0114 (G502A)	Yellow	White	Yes	No	No	10-05141	\$3,269.00
1U262-006-45	4000D-6	S-TEC (6404)	White	White	Yes	Yes	Yes	10-00049	\$3,121.00



SIGMA-TEK 4000H SERIES XYZ BOOTSTRAP DIRECTIONAL GYROS

A cost effective link to "bootstrap" other instruments requiring heading information for: display orientation to aircraft heading, heading stabilization functions, and other navigational calculations and/or solutions. Specific applications include:

Argus Moving Map Display®, L-3 Avionics Stormscope®, and Insight Strike Finder®. The heading output exactly tracks the aircraft heading as depicted under the index pointer on the Directional Gyro. The synchro index and rotation reference is set to ARINC characteristics. The 26 VAC, 400 HZ heading synchro requires a readily available external excitation, preferable from the instrument/system receiving the heading output or from an independent inverter. Sigma Tek's Directional "Bootstrap" gyro includes options for lighting and interfaces for ARC, Century Flight System, and S-Tec autopilots.

Airplane Index: Orange; Dial: White at 30°

Sigma-Tek	Model	Autopilot Interface	Letters @ 90°	Lighted	Part Number	Price
1U262-031-1	4000H	None	Yes	Yes	10-05142	\$3,246.00
1U262-033-3	4000H-2	ARC	Yes	Yes	10-05143	\$4,532.00
1U262-034-4	4000H-3	ARC	Yes	No	10-05144	\$4,447.00
1U262-033-5	4000H-4	S-TEC	Yes	Yes	10-05145	\$4,447.00
1U262-034-6	4000H-5	S-TEC	Yes	No	10-02106	\$4,342.00
1U262-035-7	4000H-6	CFS	Yes	Yes	10-05146	\$4,521.00
1U262-036-8	4000H-7	CFS	Yes	No	10-05147	\$4,199.00
1U262-039-11	4000H-10	KING (DC)	Yes	Yes	10-05149	\$4,273.00
1U262-040-12	4000H-11	KING (DC)	Yes	No	10-05150	\$4,184.00
1U262-237-9	4000H-8	CFS (DC)	Yes	Yes	10-05148	\$4,183.00

Accessories for the above gyros

BA14-24-BW3G (14 Volt Lamp Tray).....P/N 10-02757\$95.75
BA28-24-BW3G (28 Volt Lamp Tray).....P/N 10-02758\$95.75

SIGMA-TEK 4000HR-SERIES HEADING REFERENCE DIRECTIONAL GYROS



The 4000HR air-driven directional gyro offers some of the best features of our other popular models. It inherited all of the functionality and reliability of the industry standard 4000B upon which it's based, and it picked up a heading reference bug from the 4000C autopilot model.

Many pilots find the heading reminder a valuable feature whenever the cockpit is busy, such as during an approach with heavy ATC traffic.

Setting a new heading during a long, cross-country flight eliminates the tedious math associated with frequent navigational crosschecks. A quick glance at the instrument instantly reminds the pilot of his heading. The heading bug can be positioned anywhere around the heading card by turning the right knob.

Dial: White at 30°; Letters at 90°

Sigma-Tek	Model	Airplane Color	Index Markers	Lighted	Heading Reminder	Part Number	Price
1U262-007-33	4000HR-1	White	White	No	Yes	10-05151	\$1,934.00
1U262-007-40	4000HR-2	Orange	Orange	No	Yes	10-00469	\$1,735.00
1U262-010-41	4000HR-3	Orange	Orange	Yes	Yes	10-00095	\$1,974.00

Note: Lighted instruments do not include lamp trays, please specify aircraft voltage:

BA14-24-BW3G (14 Volt Lamp Tray).....P/N 10-02757\$95.75
BA28-24-BW3G (28 Volt Lamp Tray).....P/N 10-02758\$95.75

SIGMA-TEK 4000B ARINC-STYLE DIRECTIONAL GYROSCOPES



This instrument was developed for those pilots that prefer the distinct, professional look of an ARINC-styled cockpit. It is identical to the standard 4000B model differing mainly in aesthetics. Besides its distinct bezel and airplane, the display graphics and colors differentiate it from the standard model. A heading reminder bug is available as an option.

The ARINC gyros have a 3" bezel that matches existing ARINC flight director systems.

Airplane Color: Orange; Dial: White at 30°;

Sigma-Tek	Model	Index Markers	Letters @ 90°	Lighted	Part Number	Price
1U262-011-1	4000B-23	White	Yes	14 or 28V	10-05128	\$3,636.00
1U262-012-2	4000B-24	White	No	5V	10-05129	\$3,636.00
1U262-013-3	4000B-25	White	Yes	No	10-05136	\$3,562.00



SIGMA-TEK 1U367 ARINC-STYLE ATTITUDE GYRO

The 1U367 has a pictorial horizon mask and a fixed airplane. The mask moves to indicate climb, dive, and bank. Bank and pitch attitudes are displayed so that the pilot's sensing of the gyro's horizon indication is the same as the interpretation of the relationship between the wings of the aircraft and the natural horizon during visual flight. The instrument is operable following maneuvers of 360° in roll and 360° in pitch. Controlled precession is employed to achieve the 360° in pitch.

Note: Arinc-bezel lighted gyros have integral lighting as noted.

Display Colors: Blue/Brown

Sigma-Tek Part No.	Model	Lighted	Panel Tilt	Our Part No.	Price
1U367-205-5	1U367	none	0	10-05117	\$2,764.00
1U367-210-11	1U367	14V or 28V	8	10-05118	\$3,027.00

SIGMA-TEK HIGH-FLOW FITTINGS



53B423-001 - A 3/8" fitting is used for the pump output (pressure) in a typical vacuum installation having 5/8" hoses. P/N 10-01150\$63.75



53B423-002 - A 3/8" 45° fitting used for either inlet or outlet ports with installations having 5/8" hoses. P/N 10-01151\$63.75



53B423-003 - A 3/8" 90° short high-flow fitting used for either inlet or outlets with installations having 5/8" hoses. P/N 10-01152\$63.75



53B423-004 - A 3/8" 90° short high-flow fitting used for either inlet or outlets with installations having 5/8" hoses. P/N 10-01153\$63.75

GYROS



MID-CONTINENT INSTRUMENTS AND AVIONICS ELECTRIC ATTITUDE INDICATOR

Engineered as a primary or standby artificial horizon in fixed-wing aircraft and helicopters, this indicator's single connection makes installation a snap. This indicator is standard equipment on many OEM aircraft including the Beech Baron and Bonanza. Featuring 10-32 volt DC operation, anti-reflective glass, long-life lighting and 7,500 hours MTBF, this is a cost-effective and safe alternative to unreliable vacuum systems.

4300-311 - 10/32V, lighted, 0-20° P/N 10-00751 **\$3,475.00**
 4300-313 - 10/32V, Lighted, 0-20°, Delta ... P/N 10-03899 **\$3,695.00**
 Emergency power supply TS420 P/N 11-05540 **\$2,679.00**
 Knob Cover P/N 10-06803 **\$60.75**

MID-CONTINENT INSTRUMENTS AND AVIONICS 3300 ELECTRIC DIRECTIONAL GYRO



Features: • Weighs just 1.9 lbs. – One pound less than most electric directional gyros • Multi-voltage 10–32 volt DC, remains valid until the aircraft main battery discharges to 10VDC • Direct replacement for many AIM205 and RC Allen RC15A units • Designed specifically for use in high vibration applications • Warning flag monitors rotor speed and power input • Anti-reflective glass enhances visibility and reduces fatigue • Approved to FAA TSO-C5e and RTCA DO-160E • Requires less than half the power of standard DG units • Long-

life LED lighting, user selectable to 5, 14 or 28 volt input • One year limited warranty **Specifications:** Power Input: 10–32 VDC, Current Rating: At 14 VDC Start: 1.4A Max., Run: 0.44A nominal, At 28 VDC Start: 0.6A Max., Run: 0.22A nominal, Lighting: Internal LED lighting switchable to 5, 14 or 28 VDC input; wired through main connector, Weight: 1.9 lbs., Length: 4.65 inches, MTBF: 2,500 hours, Mating Connector: MS3116F8-4S .Mounting: Rear panel mount in standard 31/8" round panel cutout
 3300-10 no lighting P/N 10-02821 **\$2,995.00**
 3300-11 14V LED Lighting P/N 10-04773 **\$3,475.00**
 3300-11 28V LED Lighting P/N 10-04774 **\$3,475.00**
 4 Pin Connector MS3116E8-4S P/N 10-00791 **\$42.50**



MID-CONTINENT INSTRUMENTS AND AVIONICS "LIFESAVER" ELECTRIC ATTITUDE INDICATOR

Fly with confidence and peace of mind with the Lifesaver® gyro. Even if every other system in your aircraft's avionics panel goes dark, the Lifesaver powers on. The only attitude indicator

with a self-contained battery backup, it delivers one full hour of emergency attitude reference. 1 hr of precious time to pull you through when trouble strikes and all other power fails. Optional slip indicator can be installed anytime. No removal of gyro necessary. **Benefits:** Field replaceable lighting, Anti-reflective glass enhances visibility and reduces fatigue, Battery life 3 years in average aircraft environment, 10-32 VDC replacement for use in either 14 or 28V aircraft, May be installed in place of an existing turn coordinator or turn, and slip indicator per FAA advisory circular AC91-75. Lighted, 0–20° ..P/N 10-00750 **\$3,695.00**
 Beechcraft (Inclinometer) P/N 10-06794 **\$4,885.00**
 Fixed Dial..... P/N 10-06797 **\$3,816.00**
 Delta P/N 10-06798 **\$4,395.00**
 Slip Indicator Kit P/N 10-00764 **\$282.95**
 Remote Battery Mounting Kit P/N 10-00763 **\$93.75**
 Replacement Battery Pack P/N 10-01054 **\$295.00**
 3/32" Front Mount Adapter P/N 10-00765 **\$93.95**
 1/2" Front Mount Adapter P/N 10-00766 **\$491.00**



CASTLEBERRY ELECTRIC ATTITUDE INDICATOR

The high quality electric attitude indicator replaces the turn and bank and may be installed in the same panel location, freeing up crowded panel space. Installation of these units is straight-forward. It has an inclinometer for use in standard rate turns and a failure warning flag to indicate loss of gyro RPM.

When used together with the Castleberry Emergency Power Unit, Model EPU 28-24RMT, this instrument provides the pilot with a welcome margin of insurance in case of aircraft electrical power failure.

Features: • Inclinometer • Power failure flag • Pull to cage knob • Backlit • Standard 3 1/8 in. diameter

Model No.	Description	Part No.	Price
300-14EL	14V Gyro **	10-02823	\$3,195.00
300-14EL	28V Gyro With 8° Tilt	10-02829	\$3,295.00
300-14ELP	300-14EL With Auto Pilot outputs.*	10-02826	\$4,125.00

*Please Specify at time of order 10-32V or tilt if desired.
 **Light Tray required.

FALCON ATTITUDE GYRO (VACUUM)



This Gyro Horizon is controlled by an air driven precision gyroscope to present the pilot with pitch and roll information, through the full 360° "pictorial" presentation leads to faster interpretation of airplane attitude. A zero pitch adjustment knob is provided. Dims: 3-1/8 x 3-1/8 x 8 max. Non-TSO'd for Experimental Aircraft Only

Non-TSO'd P/N 10-22955 **\$798.00**
 Gyro with 8° tilt Falcon P/N 10-02242 **\$894.00**



FALCON ATTITUDE GYRO (ELECTRIC)

This factory new electric attitude gyro fits the standard gyro instrument cut-out. Features push-to-cage knob, low power/power failure flag, longer life & reliability due to lower operating temp.; Black case, black adjustment knob, & bright yellow/green airplane marker with sky blue/brown ground dial. Roll & loop without worry. Size: 6.4", Wt: 2.4 lbs., Power: 14VDC req. MS3116E8 connector (included). Non-TSO'd for Experimental Aircraft Only.

Size	Model No.	Description	Part No.	Price
3-1/8"	GH02E-3	Non-TSO'd, 14V	10-04671	\$1,596.00
4 Pin	MS3116E8-4S	4 Pin Connector MS3116E8-4S	10-00791	\$42.50



FALCON DIRECTIONAL GYRO (VACUUM)

The vertical rotating azimuth card is controlled by a precision gyroscope air-driven. The directional gyro will give correct heading information through ±60° of aircraft attitude in roll and pitch, 360° in yaw. A caging knob is provided to reset the gyro to the magnetic compass. Similar to Air Italia Gyros. Non-TSO'd for Experimental Aircraft Only
 P/N 10-22950 **\$790.00**

Falcon gyros can tolerate some aerobatic flight, but aerobatics can reduce the life of the gyro. It is recommended that the gyros be removed when the aircraft will be performing extensive aerobatic maneuvers. The Falcon electric gyros have caging knobs, but the vacuum gyros do not. Made in china.

MPL 503 AIR PRESSURE SWITCHES



MPL 503 Series pressure switches sensitive inches/H₂O or Knots. Accuracy and reliability offer the designer an excellent general purpose low pressure to electric interface for monitoring and control applications. The miniature size make the 503 Series ideal for OEM applications.

Description	Part No.	Price
MPL503E Air Pressure Switch Adjustable: 40-100" of H ₂ O	11-02379	\$45.50
MPL503DO Air Pressure Switch Normally Open Setting	11-13476	\$43.95
MPL503DC Air Pressure Switch Normally Closed Setting	11-13477	\$44.50

CASTLEBERRY EMERGENCY POWER BACK-UP EPU-2



TSO'd emergency power supply, Model EPU 28-24RMT that can replace some older non TSO'd units made by Terra and AIM that are no longer in production. This unit provides a 24 VDC output up to 5 Amps for 30 minutes for emergency buss power to operate the standby attitude gyro with extra capacity of up to 4 amps for other critical instrument or avionics. This is economical insurance in a 7.5 pound package for aircraft frequently involved in IFR operations.

Emergency Power Supply EPU-2 P/N 11-05822 **\$2,235.00**
 EPU Connector..... P/N 11-07713 **\$71.00**
 Rack Mount and Connector for EPU-2 P/N 11-05823 **\$286.00**
 Component Maintenance Manual..... P/N 11-00187 **\$895.00**

GYROS – STANDBY VACUUM SYSTEMS

MID-CONTINENT INSTRUMENTS AND AVIONICS MINI 2-INCH ATTITUDE INDICATORS



The Mini Gyro offers big features in a compact package. At half the cost of the competition, the Mini Gyro not only saves panel space, but also time and money. An ideal standby instrument, this TSO-approved indicator has 10-32 volt DC operation and is an attractive alternative to vacuum systems. It features unique LED lighting selectable to 5, 14 or 28 volts. Remote emergency power supply available for this indicator (P/N 11-05540).

Standard airplane display P/N 10-01721 **\$3,795.00**
 Delta airplane display P/N 10-01722 **\$3,795.00**
 Slip indicator (inclinometer) P/N 10-04775 **\$290.95**
 Emergency Power Supply P/N 11-05540 **\$2,679.00**

MID-CONTINENT INSTRUMENTS & AVIONICS STANDBY ATTITUDE MODULE MD302



SAM® is the industry's first digital standby instrument to provide attitude, altitude, airspeed and slip information to the pilot in an advanced, 2-inch format. SAM delivers an easy-to-fit, compact design with selectable orientation (horizontal and vertical) like no other, ensuring a perfect fit within any panel. The unique two-screen display

features high-definition graphics and extra-wide viewing angles, and at 1.6 pounds, SAM weighs less than just one of the three instruments it's designed to replace.

See www.aircraftspruce.com for complete list of features and specifications.

Model No.	Configuration	Part No.	Price
MD302 - 6420302-1	Digital, 10-32 VDC, Attitude, Altitude, Airspeed, Slip, Internal battery, Black bezel	10-05081	\$8,211.00
MD302 - 6420302-2	Digital, 10-32 VDC, Attitude, Altitude, Airspeed, Slip, No battery, Black bezel	10-06017	\$8,212.00
MD302 - 6420302-3	Digital, 10-32 VDC, Attitude, Altitude, Airspeed, Slip, Internal battery, Gray bezel	10-06018	\$8,340.00
MD302 - 6420302-4	Digital, 10-32 VDC, Attitude, Altitude, Airspeed, Slip, No battery, Gray bezel	10-06019	\$8,340.00
MD302 - 6420302-5	No display, 10-32 VDC, Remote mounted, ARINC output, No battery	10-06020	\$8,340.00

MID-CONTINENT INSTRUMENTS & AVIONICS MD32 MAGNETOMETER



The MD32 Magnetometer is designed specifically for the MD302 Standby Attitude Module – SAM®. The MD32 is FAA TSO-certified and delivers independent heading reference without orientation limitations or the need for special installation hardware. Its compact size, unique mounting flexibility, and convenient cockpit calibration ensure easy, economical installation.

P/N 10-06594 **\$1,284.00**

VOLT & VAC ALERT



A gyro instrument can start giving false information in less than one minute, and it is important that the pilot become instantly aware of a vacuum loss. The Volt & Vac Alert monitors instrument vacuum and electrical voltage. Should either fall below set values, the system will provide an instantly recognizable voice warning directly in the pilots headset, and then flash a light positioned within the normal gyro scan area, providing him with instant recognition of a problem. The Volt & Vac Alert is STC - PMA approved

P/N 10-00393 **\$495.00**

SIGMA TEK CAGEABLE ATTITUDE GYROS



Short stops (engine off less than twelve minutes) and some aerobatic maneuvers may cause your attitude gyro to tumble or precess from its vertical reference. When the rotor is spinning, the gyros normal erection system is slow and can take several minutes to correct a large erection error. This non-locking caging feature allows the pilot to quickly align the gyro display and rotor to gyro case reference. The attitude gyro should only be caged for quick alignment during straight and level VFR flight using

well defined earth horizon for reference or prior to take off. **All lighted gyros must order tray separately.**

Part No.	Description	Price
5000B	Standard Gyro, Unlighted (non-cageable)	\$1,450.00
5000B-46	With Inclinometer, 0° Panel Tilt	\$1,964.00
5000B-45	With Inclinometer, 0° Panel Tilt, Lighted	\$2,237.00
5000B-51	With Inclinometer, 8° Panel Tilt	\$2,006.00
5000B-53	With Inclinometer, 8° Panel Tilt, Lighted	\$2,237.00
10-00111	5000B Light Tray 14V	\$116.85
10-00112	5000B Light Tray 24V	\$116.75

B&C LYCOMING VACUUM PUMP PAD ADAPTER INVERTED OIL PICKUP



This provides a direct replacement for the Lycoming vacuum pump pad adapter. Its unique design offers both a standard vacuum pump pad adapter AND provision for inverted oil pickup. The vacuum pump pad is often used for a B&C spline-driven alternator, such as the SD8 or SD20. Aircraft with oil systems using the standard "T" fitting on the firewall will typically experience a 3 to 5 second drop into the "yellow" oil pressure range after rolling inverted. However with this installed, the oil pressure will have a momentary blip or "wiggle" on the oil pressure gauge as the ball valve switches ends. As a result, the engine receives better lubrication and prop surges are lessened. The comes with oil seal installed,

gaskets, and an MS20822-10D 90 degree fitting. Just slip the existing vacuum pump gear and thrust washer in, and it is ready for installation on the engine. The standard Lycoming vacuum pump gear and washer will fit (gear and washer not included). Alternate PN: VAC-2/4

BC704-H For 4 Cylinder Engines P/N 07-06790 **\$224.95**
 BC706-H For 6 Cylinder Engines P/N 07-06795 **\$242.95**

VENTURI

2" VENTURI



This small aluminum venturi provides 2" Hg vacuum for operating turn/bank indicator. Has 1/8" NPT port. Use 1/4" tubing for hookup.

Wt. 3.5 oz P/N 15045 **\$63.75**

4" VENTURI



This venturi develops 4" Hg suction from double-throat venturi and 10" long horn. Used to operate a directional gyro or gyro horizon. When operating a directional gyro there is sufficient capacity to also operate a turn/bank. All aluminum construction. May require a suction regulator. Wt. 0.9 lb.

P/N 15050 **\$89.75**

9" VENTURI



This "super venturi" is similar in appearance to the 4" venturi but with redesigned air passages and a recontoured, long (11-1/4") horn. It pulls enough vacuum to operate a gyro horizon, directional gyro and a turn/bank. Must be used with a suction regulator

P/N 15052 **\$92.75**

IN

TURN COORDINATORS – TURN & BANKS

RC ALLEN TURN COORDINATOR 3 INCH INDICATORS



Used in many production aircraft. Incorporates an electrical Gyro Turn Indicator with an inclinometer. The inclinometer, by movement of a ball in relation to the lubber lines, indicates the slip angle of aircraft while in a turn. The airplane on the dial rotates with reference to the indices. A power failure flag drops into view whenever the supply voltage is lost or when voltage has dropped below a level acceptable for proper operation of the gyro. Operates on 14 to 28V DC. New manufacture. First installation requires electrical connector and clamp.

Dimensions: Length: 6 1/5 in. Max, Width: 3 3/8 in Max, Height: 3 3/8 in Max, Weight: 1.9 lbs. Meets or exceeds requirements of FAA TSO C3b

Description	Model	Part No.	Price
Unlighted - Mating Connector: MS3106A-10SL-3S	RCA82A-11	10-01372	\$949.00
Lighted (14V) - Mating Connector: MS3106A-10SL-3S	RCA83A-11-14	10-00485	\$1,075.00
Lighted (28V) - Mating Connector: MS3106A-10SL-3S	RCA83A-11-28	10-01685	\$1,065.00
Mating Connector	MS3106A-10SL-3S	10-00789	\$26.50



WINTER SLIP INDICATORS

The basic flight instrument for co-ordinated turns. Available in two styles: Rectangular model fits easily in cramped panel space. Square model matches a 2-1/4" instrument hole, fits on either side of the panel. Both feature finely crafted metal cases and precision ball and tube assemblies.

Square.....P/N 10-03812**\$93.75**
Rectangle.....P/N 10-03857**\$114.75**

BANK INDICATORS (BALL TYPE)



In turning, instantly register slightest departure from the correct banking angle. Bank scale has white markings on black background. New manufacture. Available in 2 models:

10°-10° Scale, 2.25" between mounting holes.
P/N 10-00600**\$127.75**
20° - 20° Scale, 5" between mounting holes.
P/N 10-00700**\$75.75**

SWIFT BANK INCLINOMETER



The bank indicator has the function of slip indication. A very practical and simple instrument. It can be installed on an LSA, it is particularly useful in flight training.

Center distance of two Installation Holes is 48.6mm.
P/N 10-06984**\$153.80**

MID-CONTINENT INSTRUMENTS TURN & SLIP INDICATOR



2 Inch - Widely used in the turbo-prop market as standard equipment, this dependable instrument fits into the tightest panel space. The AC brushless rotor offers great reliability. Internal lighting options of 5, 14 and 28 volt offer greater flexibility. These were factory installed on the DeHavilland Dash 8 and Boeing Chinook CH47

14V Turn & Slip...P/N 10-00305**\$2,550.00**
28V Turn & Slip...P/N 10-00310**\$2,550.00**



CABLE CLAMP MS3057-4A

This MS3057-4A can be used with Turn Coordinator TC02E-3-2 or Turn & Bank Indicator TB02E-2-1P/N 11-04969**\$4.80**

MID-CONTINENT INSTRUMENTS TURN & SLIP (ELECTRIC)



Built-in voltage regulator allows it to be used in either 14V or 28V systems. Small, compact unit and weighs only 1.2 lbs. Incorporates a small "power out" warning window which is black when normal current is being supplied but turns red in the case of electrical power failure. This turn and bank is now being used in many production aircraft. New installation requires electrical connector and cable clamp. New manufacture by Electrical Gyro Corp.
Size: 3-3/8" x 3-3/8" x 3-3/4" long.

Unlighted P/N 1234T100. **\$1,317.00**
14V Bezel-Lit P/N 10-22614. **\$1,725.00**
28V Bezel-Lit P/N 10-22628. **\$1,725.00**
MS3106A-10SL-3S Electrical Plug Connector.. P/N 10-00789.....**\$26.50**

MID-CONTINENT INSTRUMENTS TURN COORDINATORS (ELECTRIC)



Certified to FAA TSO C3b. OEM standard - proven reliability. Includes power warning indicator. **Features:** - 4500 hours MTBF, more than double the original "Z" design - Brushless AC rotor operates on 14 or 28 VDC - Proven reliability through HALT (Highly Accelerated Life Testing) requirements and OEM usage since 1999 - Improved "Off" warning flag pulls out of view when rotor is up to speed - Is a direct replacement for the popular 1394T100-7Z and most standard 3-pin turn coordinators.

1394T100-7B Unlighted 12-32V..... P/N 10-02108.....**\$976.00**
28V unit- 11-32V Bezel Lighting..... P/N 10-01024. **\$1,295.00**
14V unit- 11-32V Bezel Lighting..... P/N 10-01025. **\$1,228.00**
Unlighted G300A Autopilot, ARC..... P/N 10-02653. **\$1,922.00**
1394T100-10RB (Cessna, KAP 140, Autopilot).. P/N 10-02311. **\$1,996.00**
1394T100-14RB Low Wing Turn Coordinator Autopilot -
For use on low wing aircraft. P/N 10-04022. **\$1,997.00**
MS3106A-10SL-3S Electrical Plug Connector... P/N 10-00789.....**\$26.50**

RC ALLEN TURN & BANK (ELECTRIC)



Instrument is powered by an electrically driven DC precision gyro with an inclinometer. It gives the pilot turn and bank information. The RCA56 series is an all volt instrument, with a power warning flag, a black or white ball inclinometer and either lighted or non-lighted. **DIMENSIONS:** Length: 6 1/4 in. Max Width: 3 3/8 in. Max Height: 3 3/8 in. Max Weight: 1.9 lbs.

Meets or exceeds requirements of FAA TSO C3b. New manufacture by A.I.D. RC Allen. New installation requires plug connector & cable clamp.
RCA56-3B, UNLIT P/N 10-01684**\$949.00**
RCA56-3BL, LIT P/N 10-02138**\$1,065.00**

AN5820-1 TURN & BANK (VACUUM)



AN5820-1 Turn & Bank indicator completely overhauled and certified to FAA requirements. Fresh matte-white dial markings with "dog-houses". Power: 1.8" to 2.2" Hg vacuum produced by a 2" venturi or vacuum pump. Size: 3.25"x 3.25"x 4.75" long. Weight: 1.5 lbs. 1 year warrantyP/N AN5820-1**\$526.00**



TURN & BANK KIT

Consists of an overhauled and certified Turn & Bank indicator, 2" venturi, hoses, fittings and instrument screws. P/N 10-00300**\$625.00**

TEMPEST DRY AIR PUMPS



TEMPEST TORNADO 3000 DRY AIR PUMPS

New revolutionary LRT oil drain, patent pending feature is designed to drain oil, caused by a leaking Garlock Seal, before it reaches the drive coupler. Provides a tell tale leak path. Closed front ends, designed to eliminate oil and oil residues from entering into the pump. Helps prevent pump failures caused by oil entering into the drive mechanism or rotor and vanes. 3 year 1300 hour warranty
 Tempest Tornado 3000 Model AA3215CC..... P/N 10-00609...**\$459.00**
 Tempest Tornado 3000 Model AA3216CW P/N 10-00610...**\$457.00**
 Tempest Tornado 3000 Model AA3215CC-9.... P/N 10-00611...**\$457.00**
 Tempest Tornado 3000 Model AA3226CW P/N 10-06598...**\$498.00**

VACUUM PUMP COOLING SHROUDS FOR AIRBORNE AND TEMPEST



Cooling shrouds have been proven to reduce pump operating temperature and therefore extend service life. Testing has proven reduction in operating temperature by as much as 15%. Saves money - extends service life of dry air pumps. AA20T fits all 200/240 series pumps. AA40T fits all 400 series pumps. Sigma - Tek® pumps are not eligible.
 AA207P/N 10-02796**\$97.85**
 AA40TP/N 10-02797**\$114.75**

VACUUM PUMP APPLICATION

See www.aircraftspruce.com for complete listing of vacuum pump applications for most general aviation aircraft.

TEMPEST WEAR INDICATOR TOOL KIT



Tempest Wear Indicator Tool Kit.
 Kit includes: 3 Star Lockwashers (82-50122-2A2), 3 Hole Plugs (82-50122-2A1), 1 WIP Tool (82-501222A6T)P/N 10-04814**\$64.85**

TEMPEST ELECTRIC AUXILIARY DRY AIR PUMPS



Electric auxiliary dry air pumps are recommended for single engine aircraft flown in IFR conditions as a back-up in the event the primary vacuum pump fails. These pumps are FAA-PMA approved as direct replacements for Airborne pumps previously installed under STC eligibility and STC approval for these pumps for many additional aircraft is pending.
 28VECElectric Auxiliary Dry Air Pump Model AA4A2-1 P/N 10-00585 **\$2,093.00**
 14VECElectric Auxiliary Dry Air Pump Model AA4A3-1 P/N 10-00584 **\$2,310.00**

TEMPEST DRY AIR PUMPS



Tempest dry air pumps, from Aero Accessories, are 100% new production and use all new components. They are FAA-PMA approved replacements for like and similar models on many installations. These pumps are available in the 200, 240, and 400 series.
 The AA215CC series come with a 1-year, unlimited hour warranty and the AA241CC, AA242CW, and the AA441CC and AA442CW series come with a 1-year, 500 hour warranty. Warranties expire 2-years from date of manufacture. **Addition Core Charge applied to Overhauled Pumps**
***Core Rebate available for new pumps.**



TEMPEST DRY AIR PUMPS - OVERHAULED

Model	Description	Part No.	Price
215CCWIP	Overhauled Dry Air Pump w/WIP	10-24000-1	\$316.00
216CWWIP	Overhauled Dry Air Pump w/WIP	10-24600-1	\$316.00
241CC	Overhauled Dry Air Pump	10-24700-1	\$520.00
243CC-13	Overhauled Dry Air Pump	10-01969	\$525.00
243CC-15	Overhauled Dry Air Pump	10-01968	\$525.00
242CW	Overhauled Dry Air Pump	10-24800-1	\$520.00
244CW-4	Overhauled Dry Air Pump	10-01971	\$525.00
244CW-10	Overhauled Dry Air Pump	10-01972	\$700.00
441CC-OH	Overhauled Dry Air Pump	10-23500-1	\$699.00
441CC-3	Overhauled Dry Air Pump	10-01974	\$688.00
441CC-7	Overhauled Dry Air Pump	10-01975	\$725.00
441CC-9	Overhauled Dry Air Pump	10-01977	\$655.00
441CC-11	Overhauled Dry Air Pump	10-01978	\$688.00
441CC-17	Overhauled Dry Air Pump	10-01979	\$725.00
441CC-23	Overhauled Dry Air Pump	10-01980	\$655.00
442CW	Overhauled Dry Air Pump	10-23600-1	\$699.00
442CW-4	Overhauled Dry Air Pump	10-01981	\$715.00
442CW-6	Overhauled Dry Air Pump	10-01982	\$715.00
442CW-8	Overhauled Dry Air Pump	10-01983	\$715.00
442CW-10	Overhauled Dry Air Pump	10-01984	\$688.00
442CW-12	Overhauled Dry Air Pump	10-01146	\$734.00
442CW-14	Overhauled Dry Air Pump	10-01985	\$688.00
442CW-20	Overhauled Dry Air Pump	10-01986	\$688.00

TEMPEST DRY AIR PUMPS - NEW

Model	Description	Part No.	Price
AA241CC	New Dry Air Pump	10-24700	\$770.00
AA243CC-13	New Dry Air Pump	10-01987	\$803.00
AA243CC-15	New Dry Air Pump	10-01988	\$803.00
AA243CW	New Dry Air Pump	10-24800	\$770.00
AA244CW-4	New Dry Air Pump	10-01989	\$803.00
AA244CW-10	New Dry Air Pump	10-01990	\$803.00
AA3215CC	New Dry Air Pump	10-00609	\$459.00
AA3216CW	New Dry Air Pump	10-00610	\$457.00
AA3215CC-9	New Dry Air Pump	10-00611	\$457.00
AA441CC	New Dry Air Pump	10-23500	\$1,165.00
AA441CC-3	New Dry Air Pump	10-01991	\$1,110.00
AA441CC-7	New Dry Air Pump	10-01992	\$1,145.00
AA441CC-9	New Dry Air Pump	10-01993	\$1,110.00
AA441CC-11	New Dry Air Pump	10-01994	\$1,133.00
AA441CC-17	New Dry Air Pump	10-01995	\$1,110.00
AA442CW	New Dry Air Pump	10-23600	\$1,075.00
AA442CW-4	New Dry Air Pump	10-01996	\$1,110.00
AA442CW-6	New Dry Air Pump	10-01997	\$1,165.00
AA442CW-8	New Dry Air Pump	10-01998	\$1,134.00
AA442CW-10	New Dry Air Pump	10-01999	\$1,132.00
AA442CW-12	New Dry Air Pump	10-02001	\$1,229.00
AA442CW-14	New Dry Air Pump	10-02002	\$1,110.00
AA442CW-20	New Dry Air Pump	10-02003	\$1,110.00

IN

TEMPEST PNEUMATIC COMPONENTS

PNEUMATIC FITTINGS

Model	Description	Part No.	Price
AA1K1-4-6	Fitting -1/4 NPT x 3/8 Hose	10-00914	\$47.50
AA1K1-4-8	Fitting -1/4 NPT x 1/2 Hose	10-01923	\$79.75
AA1K1-6-6	Fitting -3/8 NPT x 3/8 Hose	10-01924	\$328.40
AA1K1-6-8	Fitting -3/8 NPT x 1/2 Hose	10-00915	\$69.80
AA1K1-6-10	Fitting -3/8 NPT x 5/8 Hose	10-00916	\$42.75
AA1K1-8-10	Fitting -1/2 NPT x 5/8 Hose	10-00917	\$66.75
AA1K1-8-12	Fitting -1/2 NPT x 3/4 Hose	10-01925	\$89.95
AA1K8-6-8	Fitting -3/8 NPT x 1/2 Hose	10-01926	\$126.75
AA1K8-6-10	Fitting -3/8 NPT x 5/8 Hose	10-01147	\$84.75
AA1K9-4-6	Fitting -1/4 NPT x 3/8 Hose (A-45O)	10-01927	\$49.50
AA1K9-6-10	Fitting -3/8 NPT x 5/8 Hose (A-45O)	10-01928	\$58.75
AA1K10-2-4	Fitting -1/8 NPT x 1/4 Hose	10-01929	\$65.75
AA1K10-4-6	Fitting -1/4 NPT x 3/8 Hose	10-00918	\$36.95
AA1K10-4-8	Fitting -1/4 NPT x 1/2 Hose	10-01932	\$69.80
AA1K10-6-10	Fitting -3/8 NPT x 5/8 Hose	10-01933	\$55.75
AA1K10-6-12	Fitting -3/8 NPT x 3/4 Hose	10-01934	\$141.90
AA1K10-8-12	Fitting -1/2 NPT x 3/4 Hose	10-01935	\$121.75
AA1K14-6-6-6	Fitting -3/8 NPT x 3/8 x 3/8 Hose	10-01936	\$80.75
AA1K22-10-10	Fitting -5/8 NPT x 5/8 Hose	10-01148	\$117.75
AA1K24-2	Fitting -3/4 Hose Flange	10-01939	\$249.95
AA1K30-6-6-4	Fitting -3/8 x 3/8 x 1/4 Hose	10-01940	\$112.75
AA1K30-10-6-6	Fitting -5/8 x 3/8 x 3/8 Hose	10-01942	\$91.75
AA1K31-4-6-4	Fitting -1/4 NPTx1/2x3/8x1/4 Hose	10-01943	\$76.99
AA1K43-10-10	Fitting -5/8 x 5/8 Hose	10-01949	\$64.75

PNEUMATIC FILTERS

Model	Description	Part No.	Price
AAD9-14-3	Filter	10-00923	\$23.50
AAD9-14-5	Filter	10-00924	\$22.60
AAD9-18-1	Filter	10-01354	\$23.50
AA2J4-4	Filter	10-01945	\$44.95
AA2J4-6	Line Mounted Filter	10-01946	\$41.90
AA2J4-7	Line Mounted Filter	10-01947	\$42.75
AA1J7-1	Gyro Filter Assembly	10-01948	\$49.50
AA1J7-2	Gyro Filter Assembly	10-01949	\$64.75
ARB3-5-1	Garter Filter	10-01333	\$3.60

MISCELLANEOUS PARTS

Model	Description	Part No.	Price
82-06768	Coupling	10-01951	\$86.90
82-50130B	Flange Gasket	10-01952	\$3.55
82-50195	WIP Plug-New Pumps Only	10-01954	\$7.90
82-50195P	WIP Plug-New Pumps Only-Pkg. of 10	10-01955	\$64.85
82-50195A	WIP Plug-O/H Pumps Only	10-01958	\$11.50
82-50195AP	WIP Plug-O/H Pumps Only-Pkg. of 10	10-01959	\$91.75
82-50155DP	LRT Diverter Kit	10-01961	\$15.50
AA9144	Prop Governor Gasket	10-01962	\$20.50
AAD5-77-1	WIP Plug-O/H Pumps Only-Pkg. of 10	10-01963	\$69.75
AAF7-236-1	Aux. Switch 14 Volt DC	10-01964	\$343.00

NEW VACUUM REGULATORS

Model	Description	Part No.	Price
AA1H5-25A	Regulating Valve	10-03457	\$854.00
AA2H3-2	Regulating Valve	10-03458	\$354.00
AA2H3-5	Regulating Valve	10-03459	\$342.00
AA2H3-6	Regulating Valve	10-03460	\$277.95
AA2H3-12	Regulating Valve	10-03461	\$334.00
AA2H3-23	Regulating Valve	10-03462	\$331.00
AA2H3-48	Regulating Valve	10-03463	\$372.00
AA2H3-27	Piper Aircraft (PA44-180 and PA44-180T) Vacuum Regulator	10-06257	\$380.00

PNEUMATIC CHECK VALVES

Model	Description	Part No.	Price
AA1H37-1	Tempest Check Valve	10-06618	\$1,060.00
AA1H37-3	Tempest Check Valve	10-06619	\$908.00
AA1H37-4	Tempest Check Valve	10-06620	\$1,040.00

OVERHAULED AIRBORNE SOLENOIDS

Model	Description	Part No.	Price
1H15-6	Solenoid	10-01860	\$851.00

OVERHAULED AIRBORNE VACUUM MANIFOLDS

Model	Description	Part No.	Price
1H5-1	Vacuum Manifold	10-01861	\$586.00
1H5-2	Vacuum Manifold	10-01862	\$733.00
1H5-3	Vacuum Manifold	10-01863	\$806.00
1H5-4	Vacuum Manifold	10-01864	\$831.00
1H5-6	Vacuum Manifold	10-01865	\$919.00
1H5-8	Vacuum Manifold	10-01866	\$917.00
1H5-9	Vacuum Manifold	10-01867	\$690.00
1H5-10	Vacuum Manifold	10-01868	\$833.00
1H5-13	Vacuum Manifold	10-01869	\$1,142.00
1H5-14	Vacuum Manifold	10-01870	\$869.00
1H5-18	Vacuum Manifold	10-01871	\$644.00
1H5-19	Vacuum Manifold	10-01872	\$1,053.00
1H5-20	Vacuum Manifold	10-01873	\$899.00
1H5-21	Vacuum Manifold	10-01874	\$1,265.00
1H5-22	Vacuum Manifold	10-01875	\$1,036.00
1H5-23	Vacuum Manifold	10-01876	\$656.00
1H5-24	Vacuum Manifold	10-01877	\$833.00

OVERHAULED AIRBORNE PRESSURE MANIFOLDS

Model	Description	Part No.	Price
1H24-3	Pressure Manifold	10-01879	\$995.00
1H24-6	Pressure Manifold	10-01880	\$1,097.00
1H24-7	Pressure Manifold	10-01881	\$1,265.00
1H24-8	Pressure Manifold	10-01882	\$1,097.00
1H24-10	Pressure Manifold	10-01883	\$1,038.00
1H24-11	Pressure Manifold	10-01884	\$1,357.00
1H24-12	Pressure Manifold	10-01885	\$1,696.00
1H24-18	Pressure Manifold	10-01886	\$1,290.00
1H24-20	Pressure Manifold	10-01887	\$1,543.00

OVERHAULED AIRBORNE CHECK VALVES

Model	Description	Part No.	Price
1H37-1	De-Ice Valve	10-01888	\$559.00
1H37-3	De-Ice Valve	10-01889	\$558.00
1H37-4	De-Ice Valve	10-01890	\$563.00
1H43-11	De-Ice Valve	10-01891	\$2,310.00
1H43-12	De-Ice Valve	10-01892	\$2,348.00
1H43-13	De-Ice Valve	10-01893	\$1,997.00
1H43-14	De-Ice Valve	10-01894	\$2,225.00
1H43-15	De-Ice Valve	10-01895	\$1,980.00
1H43-16	De-Ice Valve	10-01896	\$1,909.00
1H43-20	De-Ice Valve	10-01897	\$2,582.00
1H43-21	De-Ice Valve	10-01898	\$2,435.00
1H44-12	De-Ice Valve	10-01899	\$2,243.00
1H44-16	De-Ice Valve	10-01906	\$2,119.00
1H44-17	De-Ice Valve	10-01907	\$2,856.00
1H44-18	De-Ice Valve	10-01908	\$2,856.00
2H22-11	De-Ice Valve	10-01909	\$1,821.00
2H22-16	De-Ice Valve	10-01910	\$2,765.00
2H48-14	De-Ice Valve	10-01911	\$1,396.00
2H48-22	De-Ice Valve	10-01913	\$1,507.00
2H48-23	De-Ice Valve	10-01914	\$1,277.00
2H48-24	De-Ice Valve	10-01916	\$1,625.00
2H59-3	De-Ice Valve	10-01917	\$2,494.00
2H59-4	De-Ice Valve	10-01919	\$2,577.00
2H59-8	De-Ice Valve	10-01920	\$2,374.00
2H59-16	De-Ice Valve	10-01921	\$2,577.00

IN

TEMPEST PNEUMATIC COMPONENTS

TEMPEST OVERHAULED AIRBORNE VACUUM REGULATORS

Model	Part No.	Price
2H3-1	10-02970	\$1,264.00
2H3-2	10-05733	\$276.95
2H3-12	10-05734	\$276.95
2H3-4	10-02972	\$963.00
2H3-7	10-02976	\$748.00
2H3-25	10-03013	\$732.00
2H3-11	10-02980	\$310.00
2H3-13	10-02982	\$945.00
2H3-14	10-02983	\$833.00
2H3-22	10-03007	\$805.00
2H3-8	10-02977	\$747.00
2H3-9	10-02978	\$727.00
2H3-5	10-02973	\$278.95
2H3-10	10-02979	\$805.00
2H3-23	10-05737	\$277.95
2H3-15	10-02984	\$349.00
2H3-27	10-03015	\$314.00
2H3-32	10-03017	\$874.00
2H3-35	10-03018	\$928.00
2H3-38	10-03019	\$963.00
2H3-44	10-03022	\$1,126.00
2H3-45	10-03023	\$1,180.00
2H3-46	10-03024	\$745.00
2H3-48	10-03025	\$314.00
2H3-19	10-03006	\$523.00
2H3-1	10-06901	\$1,384.00
2H3-9	10-06912	\$726.00
2H3-10	10-06902	\$801.00
2H3-13	10-06903	\$1,036.00
2H3-16	10-06904	\$664.00
2H3-21	10-06905	\$805.00
2H3-22	10-06906	\$805.00
2H3-25	10-06907	\$805.00
2H3-39	10-06908	\$1,178.00
2H3-47	10-06911	\$1,178.00
1E15-4	10-06876	\$850.00
1E15-7	10-06877	\$850.00
1H30-1	10-06882	\$738.00
1H30-2	10-06886	\$880.00
1H30-3	10-06887	\$726.00
1H30-6	10-06888	\$911.00
1H30-8	10-06889	\$1,678.00
1H30-9	10-06890	\$707.00
1H30-11	10-06883	\$887.00
1H30-13	10-06884	\$834.00
1H30-14	10-06885	\$988.00
1H30-16	10-06898	\$1,269.00
1H30-25	10-06899	\$761.00

TEMPEST OVERHAULED VACUUM MANIFOLD

Model	Description	Part No.	Price
2H3-1	Vacuum Manifold	10-02970	\$1,264.00
2H3-4	Vacuum Manifold	10-02972	\$963.00
2H3-5	Vacuum Manifold	10-02973	\$278.95

TEMPEST OVERHAULED PRESSURE MANIFOLD

Model	Description	Part No.	Price
2H3-7	Pressure Manifold	10-02976	\$748.00
2H3-8	Pressure Manifold	10-02977	\$747.00
2H3-10	Pressure Manifold	10-02979	\$805.00
2H3-11	Pressure Manifold	10-02980	\$310.00
2H3-13	Pressure Manifold		\$945.00
2H3-14	Pressure Manifold	10-02983	\$833.00
2H3-15	Pressure Manifold	10-02984	\$349.00
2H24-8	Pressure Manifold	10-06897	\$1,098.00
1H24-16	Pressure Manifold	10-06879	\$1,278.00
1H24-19	Pressure Manifold	10-06880	\$1,150.00
1H24-21	Pressure Manifold	10-06881	\$1,278.00

TEMPEST OVERHAULED CHECK VALVE

Model	Description	Part No.	Price
2H3-19	Check Valve	10-03006	\$523.00
2H3-22	Check Valve	10-03007	\$805.00

TEMPEST OVERHAULED DE-ICE VALVE

Model	Description	Part No.	Price
O/H 2H3-20	Overhauled Regulating Valve	10-03399	\$847.00
2H3-25	De-Ice Valve	10-03013	\$732.00
2H3-27	De-Ice Valve	10-03015	\$314.00
2H3-32	De-Ice Valve	10-03017	\$874.00
2H3-35	De-Ice Valve	10-03018	\$928.00
2H3-38	De-Ice Valve	10-03019	\$963.00
2H3-44	De-Ice Valve	10-03022	\$1,126.00
2H3-45	De-Ice Valve	10-03023	\$1,180.00
2H3-46	De-Ice Valve	10-03024	\$745.00
2H3-48	De-Ice Valve	10-03025	\$314.00
1H22-11	De-Ice Valve	10-06878	\$1,731.00
1H43-11	De-Ice Valve	10-06891	\$2,232.00
1H43-23	De-Ice Valve	10-06892	\$2,232.00
1H44-11	De-Ice Valve	10-06893	\$2,239.00
1H44-20	De-Ice Valve	10-06894	\$2,853.00
1H44-22	De-Ice Valve	10-06895	\$2,853.00

TEMPEST AA1H43 SERIES DE-ICE VALVES

Model	Description	Part No.	Price
AA1H43-13	De-Ice Valve	10-07099	\$2,457.00
AA1H43-14	De-Ice Valve	10-07101	\$2,692.00
AA1H43-15	De-Ice Valve	10-07102	\$2,438.00
AA1H43-16	De-Ice Valve	10-07103	\$2,366.00
AA1H43-20	De-Ice Valve	10-07104	\$3,068.00
AA1H43-21	De-Ice Valve	10-07105	\$2,924.00

TEMPEST OVERHAULED AIRBORNE PRESSURE REGULATORS CROSS-REFERENCE

Model	Description	Superseded by
1H30-1	Overhauled Airborne Pressure Regulators	2H30-1
1H30-2	Overhauled Airborne Pressure Regulators	2H30-2
1H30-3	Overhauled Airborne Pressure Regulators	2H30-3
1H30-6	Overhauled Airborne Pressure Regulators	2H30-6
1H30-8	Overhauled Airborne Pressure Regulators	2H30-8
1H30-9	Overhauled Airborne Pressure Regulators	2H30-9
1H30-11	Overhauled Airborne Pressure Regulators	2H30-11
1H30-13	Overhauled Airborne Pressure Regulators	2H30-13
1H30-14	Overhauled Airborne Pressure Regulators	2H30-14

TEMPEST OVERHAULED PRESSURE REGULATORS

Model	Description	Part No.	Price
2H30-1	Pressure Regulators	10-03029	\$786.00
2H30-2	Pressure Regulators	10-03037	\$927.00
2H30-3	Pressure Regulators	10-03039	\$761.00
2H30-6	Pressure Regulators	10-03042	\$964.00
2H30-8	Pressure Regulators	10-03043	\$1,765.00
2H30-9	Pressure Regulators	10-03045	\$783.00
2H30-11	Pressure Regulators	10-03047	\$936.00
2H30-13	Pressure Regulators	10-03053	\$880.00
2H30-14	Pressure Regulators	10-03054	\$1,042.00
2H30-17	Pressure Regulators	10-03056	\$1,268.00
2H30-27	Pressure Regulators	10-03057	\$765.00
2H30-28	Pressure Regulators	10-03060	\$767.00
2H30-32	Pressure Regulators	10-03066	\$710.00
2H30-35	Pressure Regulators	10-05944	\$732.00

IN

VACUUM PUMP FITTINGS – VACUUM PUMPS

RAPCO FAA APPROVED FITTINGS



RA1K1-6-10 - This 90° fitting with 5/8" hose and 3/8" NPT is used in most inlet threaded ports of 200 series vacuum pumps and is a FAA PMA direct replacement for the Airborne Model 1K1-6-10. This 90° fitting has superior flow and low pressure loss.
P/N 10-00395 **\$38.75**

RA1K8-6-10 - This 152° fitting with 5/8" hose and 3/8" NPT is used in most outlet threaded ports of 200 series vacuum pumps and is a FAA PMA direct replacement for the Airborne.
P/N 10-00396 **\$68.75**



RA1K31-4-6-4 - This 3/8" and 1/4" hose, 1/4" NPT, "T" fitting is used in most threaded ports of the flight instruments and is a FAA PMA direct replacement for the Airborne Model 1K31-4-6-4. P/N 10-00397 **\$55.75**

RA1K10-4-6 - This 3/8" hose, and 1/4" NPT fitting is used in most inlet threaded ports of the flight instruments and is a direct replacement for the Airborne Model 1K10-4-6.
P/N 10-00398 **\$36.50**



RA1K10-6-10 - This fitting with 5/8" hose and 3/8" NPT is used in most inlet and outlet threaded ports of the 200 series vacuum pump. The fitting is 5/8" hose with 3/8" NPT threads. The Rapco, Inc. fitting is a FAA PMA direct replacement for the Airborne Model 1K10-6-10 P/N 10-01849 **\$41.75**

RA1K1-4-6 - This 90° fitting with 3/8" hose, 1/4" NPT is used in most threaded ports of the flight instruments and is a FAA PMA direct replacement for the Airborne. P/N 10-01130 **\$42.70**



RAPCO RA1H5-1 MANIFOLD CHECK VALVE



This valve is used in many Multi-Engine General Aviation applications. The Rapco, Inc. FAA PMA Multi-Engine manifold check valve is a direct replacement for the Airborne Model 1H5-1.
P/N 10-01131 **\$557.00**

AIRBORNE VACUUM PUMP REPAIR KITS



Basic Kits – These FAA/PMA kits include rotor, vanes, gasket, and drive coupling.

For Airborne 211/212 Pumps
P/N 10-00901 **\$118.75**

For Airborne 200 cc/cw Pumps
P/N 10-00902 **\$148.75**

For Airborne 241/242 Pumps P/N 10-00903 **\$124.75**

For Airborne 441/442 Pumps P/N 10-01001 **\$186.95**

Deluxe Kits – These FAA/PMA kits include rotor, coupler, external spline, bushing, blades, nut, cushion washer and band gaskets. Washer and gaskets not included on 200CC kits. Installation instructions included.

For Airborne 211/212 pumps P/N 10-01901 **\$173.75**

For Airborne 241/242 pumps P/N 10-01903 **\$172.75**

For Airborne 441/442 pumps P/N 10-01904 **\$249.95**

PUMP STATOR HOUSINGS



215/216 Pump Stator Housing 82-50122A
P/N 10-00919 **\$89.75**

241/242 Pump Stator Housing 82-50122-1
P/N 10-00920 **\$89.95**

Core Charge will be added.

TEMPEST RUDDER BOOST FILTER



The AA101-524009-0163 is approved on the Beechcraft B200, B200C, B200CT, B200T and B200GT. This filter is manufactured using a stainless steel housing and .3 micron media.

Designed to withstand the toughest environments, the AA101-524009-0163 rudder boost filter continues the long line of dependable and pilot preferred Tempest pneumatic products. P/N 08-17160 **\$73.75**

RAPCO VACUUM SYSTEM KIT



This Vacuum System Kit is ideal for use on experimental aircraft, allowing the kit builder to obtain all of the necessary components of their vacuum system in one convenient kit. The price of this kit reflects a substantial discount over the individual prices of the components if purchased separately.

This Kit Includes:

- 1 RAP215CC Vacuum Pump w/Gasket
- 1 RA2H3-12 Vac. Regulator w/Garter Filter
- 1 RA1J7-1 Filter Assembly
- 1 RA1K1-6-10 90° 5/8" Fitting
- 1 RA1K8-6-10 152° 5/8" Fitting
- 2 RA1K31-4-6-4 3/8" and 1/4" T-Fitting
- 2 RA1K10-4-6 3/8" Fitting
- 1 - 5/8" x 3' Hose
- 1 - 3/8" x 5' Hose
- 1 - 1/4" x 6' Hose
- 10 - #8 Hose Clamps
- 4 - #4 Hose Clamps
- 1 Installation Diagram
- 1 Suction Gauge

Kit with RAP215CC Pump - For engines with COUNTER CLOCKWISE turning accessory drives. P/N 11-00099 **\$923.00**

Kit with RAP216CW Pump - For engines with CLOCKWISE turning accessory drives. P/N 06-00635 **\$940.00**

Kit Without Pump P/N 10-02010 **\$850.00**

RAPCO SHEAR SHAFT / COUPLER



Rapco Shear Shaft / Coupler.
P/N 08-13898 **\$17.50**

RAPCO SHEAR COUPLER KIT



Includes: Coupler, Spline, Gasket Kit. Rapco PN RA-Shear Coupler Kit
P/N 08-13890 **\$34.80**

RAPCO VACUUM MEASURE KIT



Includes: Caliper, Screw, Washer Kit.
Rapco PN RA-Vac Measure Kit.
P/N 08-13900 **\$19.90**

GARWIN / PESCO REMANUFACTURED WET PUMPS



Our supplier remanufactures run-out Pesco and Garwin wet pumps to factory specifications. FAA Approved.

Note: Pump Drive is included.

Pesco 194 pump P/N 10-00028 **\$559.00**

Pesco 207 pump P/N 10-00029 **\$725.00**

Garwin G455 pump P/N 10-00027 **\$559.00**

Garwin G450 pump P/N 10-00026 **\$559.00**

VACUUM RESTRICTOR VALVE



AN5829-2 manually adjustable needle valve complete with locking collar and mounting flange. For reducing vacuum to 2" Hg for operation of turn/bank. Manufactured by ACS Products Co.

P/N AN5829-2 **\$56.95**

VACUUM PUMPS

RAPCO DRY AIR PUMPS - VACUUM / PRESSURE



RAPCO FAA approved quality dry air pumps are available in brand new replacement models or overhauled. All are backed by warranty.

BRAND NEW RAPCO DRY AIR PUMPS are FAA-PMA approved and come with an inspection port to help determine replacement time. An exclusive internal shaft seal helps to keep out destructive oil and solvents. Mounting gasket included. Warranty period for 200 series is three year 1300 hours, 240 and 400 series is 1 year 500 hours, whichever comes first. No core charge on new pumps. Core rebate available.



OVERHAULED DRY AIR PUMPS by RAPCO are FAA approved and shipped with FAA form 8130-3. Mounting gasket included. Warranty period for 200 series is two years 1000 hours, 240 and 400 series is one year 400 hours, whichever comes first.

Mounting flange gasket is included.

Rapco New Dry Air Vacuum Pumps

Description	Rapco Part Number	Our Part Number	Price
RAP215CC	RAP215CC	10-23925	\$395.00
RAP215CC-9	RAP215CC-9	10-03401	\$398.00
RAP216CW	RAP216CW	10-23935	\$393.00
RAP241CC	RAP241CC	10-23950-1	\$695.00
RAP241CC-13	RAP241CC-13	10-03447	\$697.00
RAP241CC-15	RAP241CC-15	10-03448	\$695.00
RAP242CW	RAP242CW	10-23960-1	\$699.00
RAP242CW-4	RAP242CW-4	10-03449	\$695.00
RAP242CW-10	RAP242CW-10	10-03450	\$695.00
RAP441CC	RAP441CC	10-01126	\$995.00
RAP441CC-3	RAP441CC-3	10-03074	\$967.00
RAP441CC-7	RAP441CC-7	10-03075	\$995.00
RAP441CC-9	RAP441CC-9	10-03076	\$967.00
RAP441CC-17	RAP441CC-17	10-03077	\$995.00
RAP441CC-23	RAP441CC-23	10-03078	\$995.00
RAP442CW	RAP442CW	10-01127	\$995.00
RAP442CW-4	RAP442CW-4	10-03079	\$995.00
RAP442CW-6	RAP442CW-6	10-03080	\$995.00
RAP442CW-8	RAP442CW-8	10-03081	\$995.00
RAP442CW-12	RAP442CW-12	10-01128	\$1,065.00
RAP442CW-14	RAP442CW-14	10-03082	\$967.00
RAP442CW-20	RAP442CW-20	10-03083	\$967.00

Rapco Overhauled Dry Air Vacuum Pumps

Description	Rapco Part Number	Our Part Number	Price
211CC	211CC	10-23930	\$266.95
211CC-9	211CC-9	10-23931	\$269.00
212CW	212CW	10-23940	\$269.00
215CC	215CC	10-03084	\$269.95
216CW	216CW	10-03085	\$269.95
241CC	241CC	10-23950	\$449.00
241CC-13	241CC-13	10-03086	\$465.00
241CC-15	241CC-15	10-03087	\$440.00
242CW	242CW	10-23960	\$465.00
242CW-4	242CW-4	10-03088	\$440.00
242CW-10	242CW-10	10-03089	\$440.00
441CC	441CC	10-02349	\$597.00
441CC-3	441CC-3	10-03090	\$585.00
441CC-7	441CC-7	10-03091	\$654.00
441CC-9	441CC-9	10-03092	\$585.00
441CC-11	441CC-11	10-03093	\$585.00
441CC-17	441CC-17	10-03095	\$619.00
441CC-23	441CC-23	10-03096	\$585.00
442CW	442CW	10-02350	\$615.00
442CW-4	442CW-4	10-03097	\$615.00
442CW-6	442CW-6	10-03098	\$619.00
442CW-8	442CW-8	10-03099	\$619.00
442CW-10	442CW-10	10-03101	\$585.00
442CW-12	442CW-12	10-02351	\$645.00
442CW-14	442CW-14	10-03102	\$615.00
442CW-20	442CW-20	10-03105	\$594.00

IN

SIGMA-TEK DRY AIR PUMP



The Sigma-Tek 1U128-006 is a pump which carries a warranty for 2-years or 1000 hours. It uses an aluminum rotor and rotor housing, making the pump very resistant to damage from ingestion of foreign objects, excessive loads or engine oil. It provides clean, dry air for operation of air driven instruments in aircraft operating at medium altitudes. Pump rotates clockwise or counterclockwise in vacuum or pressure mode. May be mounted in either a vertical or horizontal position. FAA approved as a direct replacement for all instrument pumps but is not intended for supplying air to deicing boots. Mounting gasket furnished. Install suction regulator in line to instruments. Delivers 6 In. Hg vacuum (2.9-8.5 minimum CEM) or 6 In. Hg pressure (3.7-8.5 minimum CEM) from 1500 to 4000 RPM. No core charge.

Specifications: • Height: 3.825" ± .03" • Width: 3.55" ± .03" • Depth: 3.91" ± .06" • Weight: 2.2 lbs. (max)

Environmental: • Ambient Temperature: -40° C to 93° C (typ.) • Exhaust Temp. (Intermittent): 375° F for 5 mins. (max) • Exhaust Temp. (Continuous): 300° F • Vibration: CPS: 5 to 150 • Maximum Double Amplitude: 0.100 in. • Maximum Acceleration: 10 G's • Humidity (Dewpoint): -70° C • Altitude: -1,000 to 30,000 ft.

P/N 10-02778\$875.00

VACUUM PUMP SHEAR COUPLINGS

These parts fit Airborne 200 & 400 series pumps.

Shear Coupling.....P/N 07-03568\$18.90 ea.
Standard Bushing.....P/N 82-20095\$23.50 ea.

TEMPEST VACUUM FILTERS

FAA-PMA Approved

AAD9-14-3.....P/N 10-00923\$23.50
AAD9-14-5.....P/N 10-00924\$22.60
AAD9-18-1.....P/N 10-01354\$23.50

TEMPEST VACUUM PUMP WRENCH



Case hardened steel, with nickel-chrome plating for corrosion resistance. Slip resistant vinyl grip. Rare earth magnet allows efficient and easy installation of hard-to-get-to install nuts. Eligibility: Fits all 200, 240, 400 and 3200 series vacuum pumps.....P/N 10-02654\$35.50

RAPCO VACUUM PUMP REMOVAL & INSTALLATION TOOL



The RA716 Pump Wrench provides superior access to the vacuum pump flange nuts. This new tool is made from quality hardened steel with corrosion resistant nickel plating. The shank is shaped to provide easy access to tight areas between the pump and accessories. The open end head is laser cut providing a close tolerance fit on the nut. Plastic coating on the handle provides a firm grip.

P/N 10-13911\$26.50

SUCTION REGULATORS – PNEUMATIC FILTERS

RAPCO VACUUM REGULATORS



RAPCO RA2H3-2 VACUUM REGULATOR
This FAA Approved Rapco vacuum regulator is designed to maintain a constant setting at various pressure altitudes. Adjustable setting. Vacuum regulators come with the RAB3-5-1 garter filter. 5/8" Hose Fitting (Pump), 1/2" Hose Fitting (instruments). Replaces - Airborne PN. 2H3-2, 133A3, Aero Accessories PN. 2H3-2
P/N 10-03895\$297.95



RAPCO RA2H3-5 VACUUM REGULATOR
This FAA Approved Rapco vacuum regulator is designed to maintain a constant setting at various pressure altitudes. Adjustable setting. Vacuum regulators come with the RAB3-5-1 garter filter. 5/8" Hose Fitting (Pump), 5/8" Hose Fitting (instruments). Replaces - Airborne PN. 2H3-5, 133C1, Aero Accessories PN. 2H3-5
P/N 10-03894\$292.95



RAPCO RA2H3-6 VACUUM REGULATOR
This FAA Approved Rapco vacuum regulator is designed to maintain a constant setting at various pressure altitudes. Adjustable setting. Vacuum regulators come with the RAB3-5-1 garter filter. 5/8" Hose Fitting (Pump), 5/8" Hose Fitting (instruments). Replaces - Airborne PN. 2H3-6, 133B3, Aero Accessories PN. 2H3-6, Piper PN. 584-324.....P/N 10-03918\$297.95



RAPCO RA2H3-11 VACUUM REGULATOR
This FAA Approved Rapco vacuum regulator is designed to maintain a constant setting at various pressure altitudes. Adjustable setting. Vacuum regulators come with the RAB3-5-1 garter filter. AN-10A Flared Tube Fitting (Pump), AN-10A Flared Tube Fitting (instruments) Replaces - Airborne PN. 2H3-11, 133A13P/N 10-03919\$330.00



RAPCO RA2H3-12 VACUUM REGULATOR
This FAA Approved Rapco vacuum regulator is designed to maintain a constant setting at various pressure altitudes. Adjustable setting. Vacuum regulators come with the RAB3-5-1 garter filter. 5/8" Hose Fitting (Pump), Two 3/8" Hose Fitting (instruments). Replaces - Airborne PN. 2H3-12, 2H3-16, 133A16, Cessna PN. C482001-0401P/N 10-00289\$289.95



RAPCO RA2H3-15 VACUUM REGULATOR
This FAA Approved Rapco vacuum regulator is designed to maintain a constant setting at various pressure altitudes. Adjustable setting. Vacuum regulators come with the RAB3-5-1 garter filter. One AN-10A Pump fitting. . Replaces - Airborne PN. 2H3-15.
P/N 10-04842\$371.00



RAPCO RA2H3-19 VACUUM REGULATOR
This FAA Approved Rapco vacuum regulator is designed to maintain a constant setting at various pressure altitudes. Adjustable setting. Vacuum regulators come with the RAB3-5-1 garter filter. 5/8" Hose Fitting (Pump), Two 3/8" Hose Fittings (Instrument) Replaces - Airborne PN.2H3-19, Piper PN. 492-240.....P/N 10-04780\$553.00



RAPCO RA2H3-23 VACUUM REGULATOR
This FAA Approved Rapco vacuum regulator is designed to maintain a constant setting at various pressure altitudes. Adjustable setting. Vacuum regulators come with the RAB3-5-1 garter filter. 5/8" Hose Fitting (Pump), Two 3/8" Hose Fitting (instruments). Replaces - Airborne PN. 2H3-23, 133A4, Piper PN. 492-272
P/N 10-03009\$292.95



RAPCO RA2H3-48 VACUUM REGULATOR
This FAA Approved Rapco vacuum regulator is designed to maintain a constant setting at various pressure altitudes. Adjustable setting. Vacuum regulators come with the RAB3-5-1 garter filter. 5/8" Hose Fitting (pump), AN-10A Flared Tube (instrument). Replaces - Airborne PN. 2H3-48, Aero Accessories PN. AA2H3-48
P/N 10-03921\$337.00



TEMPEST VACUUM REGULATORS

FAA/PMA Approved

AA 2H3-2P/N 10-03458\$354.00
AA 2H3-6P/N 10-03460\$277.95
AA 2H3-12P/N 10-03461\$334.00
AA 2H3-23P/N 10-03462\$331.00

AIRBORNE CENTRAL AIR FILTERS



Increase gyro life with Airborne gyro air filter. Incorporates a 0.3 micron filter element that protects gyro instruments by filtering out tobacco smoke and cabin dust. Small, lightweight, easily installed. Fits most planes. Dual 3/8" beaded tubes simplify 2-gyro installations.

Part No.	Description	Price
1J7-1	Vacuum Instrument Central Gyro Air Filter: 0.3 micron pleated paper element with two 3/8" installation tubes.	\$88.75
1J10-1	Line mounted Filter 3/8"x3/8" non-beaded tube. 5-3/4"long.	\$49.75
REPLACEMENT FILTERS		
Part No.	Description	Price
10-05902	Replacement Filter 2J4-4	\$84.50

RAPCO REPLACEMENT PNEUMATIC FILTERS

Part No.	Description	Recommended Replacement	OEM Number	RAPCO Number	Price
10-23810	Line Mounted Filter, 1/2"x1/2" Tube	1 yr / 500 Hrs	2J4-4	RA2J4-4	\$48.50
10-23820	Line Mounted Filter, 5/8"x5/8" Tube	1 yr / 500 Hrs	2J4-6	RA2J4-6	\$48.75
10-23830	Line Mounted Filter, 5/8"x5/8" Tube Overall length 5-1/2"	1 yr / 500 Hrs	2J4-7	RA2J4-7	\$48.50
10-23840	Vacuum Central Gyro Air Filter Assy.	1 yr / 500 Hrs	1J7-1	RA1J7-1	\$42.50
10-00287	Line Mounted Filter 3/8" x 3/8"	1 yr / 500 Hrs	1J10-1	RA1J10-1	\$41.50
05-15253	Rudder Boost Filter. Two 5/8" hose fittings, overall length 5-1/2" x 3-1/4" dia.	--	101-524009-0163, 101-524009-0161, 101-524009-91	RA101-524009-0163	\$67.75
10-23850	Vacuum Pump Inlet Garter Filter	1 yr / 100 Hrs	B3-5-1	RA-B3-5-1	\$2.95
10-23860	Replacement Element, 1J2-2 filter	1 yr / 100 Hrs	D9-14-3	RA-D9-14-3	\$22.50
10-23870	Rep. Element for 1J2 series (except 1J2-2)	1 yr / 100 Hrs	D9-14-5	RA-D-9-14-5	\$22.50
10-23880	Replacement Element, 1J7-1 Filter	1 yr / 500 Hrs	D9-18-1	RA-D9-18-1	\$23.50

UMA GAUGES



UMA 1" GYRO SUCTION GAUGES

Case: Molded ABS Plastic. Weight: 1.4 oz.

Part No.	Range	Dial Markings	Price
10-02361	3-7 IN.HG	B & W	\$187.75
10-00311	3-7 IN.HG	GA 4.5-5.4	\$206.00
10-02464	3-7 IN.HG	GA 3.5-5.0, RR 3.5 & 5.0	\$193.75



UMA 1-1/4" GYRO SUCTION GAUGES

Case: Molded ABS Plastic. Weight: 1.4 oz.

Part No.	Range	Dial Markings	Price
10-01010	3-7 IN. HG.	GA 4.5-5.2, RR 4.5 & 5.2	\$211.95
10-02465	3-7 IN. HG.	GA 4.75-5.25, RR 4.75 & 5.25	\$231.95
10-02466	3-7 IN. HG.	GA 4.5-5.0	\$230.95
10-02467	2-6 IN. HG.	GA 3.8-4.4, RR 3.8 & 4.4	\$230.95
10-02358	3-7 IN. HG.	B & W	\$224.95
10-02468	2-6 IN. HG.	GA 4.0-5.0	\$230.95
10-02469	2-6 IN. HG.	GA 4.5-5.4, YA 2.0-4.5, RR 6.0	\$230.95
10-02470	2-6 IN. HG.	GA 3.5-5.0, RR3.5	\$230.95
10-02471	0-10 IN. HG.	B & W	\$230.95



UMA 2-1/4" UMA GYRO SUCTION

Case: Cast Aluminum. Weight: 4.7 oz.

Part No.	Range	Dial Markings	Price
10-00090	2-8 IN. HG.	GA 4.6-5.4	\$225.95
10-01000	0-10 IN. HG.	B & W	\$219.95
10-02359	0-10 IN. HG.	GA 4-5, RR 5	\$225.95
10-02360	0-10 IN. HG.	GA 4.2-4.4, RR 4.2 & 5.3	\$225.95



UMA 1-1/4" PNEUMATIC PRESSURE

Case: Molded ABS Plastic. Weight: 1.4 oz.

Part No.	Range	Dial Markings	Price
10-02364	0-25 PSI	GA 5.0-10, YA 10-21	\$287.95
10-02365	0-25 PSI	GA 15-21, YA 21-25, RR 14.9	\$286.95
10-12305	0-25 PSI	GA 15-21, RR 24	\$286.95
10-02366	0-25 PSI	GA 2.5-7.5, YA 7.5-21	\$287.95



1-1/4 INCH GYRO PRESSURE GAUGE

These units are designed to save space in cockpit panels. These gauges utilize an internal diaphragm for accuracy and reliability. Miniature 1-1/4" instrument. Case: Molded ABS Plastic. Weight: 1.4 oz.

Part No.	Range	Dial Markings	Price
10-01105	3-7 IN. HG.	GA 4.25-6.25	\$227.95
10-02462	3-7 IN. HG.	GA 4.25-5.2, RR 4.25 & 5.2	\$225.95
10-02463	3-7 IN. HG.	GA 4.5-5.2, YA 3.8-4.5, RR 3.8 & 5.2	\$225.95



UMA 2-1/4" GYRO PRESSURE GAUGES

These units are designed to save space in cockpit panels. These gauges utilize an internal diaphragm for accuracy and reliability. Case: Cast Aluminum. Weight: 4.7 oz.

Part No.	Range	Dial Markings	Price
10-02362	2-8 IN. HG.	B & W	\$218.95
10-02363	2-8 IN. HG.	GA 4.5-5.5	\$225.95



UMA 2-1/4" CABIN ALTITUDE DIFFERENTIAL PRESSURE GAUGE

Case: Valox 420 Plastic Weight: 7.4 oz.

Part No.	Range	Dial Markings	Price
10-02370	0-25,000 Ft. 0-6 PSI	B & W	\$603.00
10-02371	0-30,000 Ft. 0-6 PSI	GA 0-10, YA 10-28	\$603.00
10-02460	0-30,000 Ft. 0-6 PSI	GA 0-10, YA 10-28	\$603.00
10-02461	0-35,000 Ft. 0-8 PSI	B & W	\$603.00

IN

AIRSPED INDICATORS



UMA AIRSPED INDICATORS (NON-TSO'D)

These quality UMA, non-TSO'd airspeed indicators are available in MPH, Knots or Dual Scales.
Note: An inverter is required for the Internal Lighting Option (P/N 10-02083 UMA 14V LIGHT INVERTER)

Description	Dial	Part No.	Price
3-1/8"	20-80 mph	10-04905	\$237.95
3-1/8"	20-100 mph	10-04910	\$238.95
3-1/8"	20-120 mph	10-04915	\$238.95
3-1/8"	20-140 mph	10-04920	\$238.95
3-1/8"	20-160 mph	10-04925	\$238.95
3-1/8"	40-180 mph	10-04930	\$238.95
3-1/8"	40-200 mph	10-01029	\$238.95
3-1/8"	40-240 mph	10-00512	\$238.95
3-1/8"	40-260 mph	10-01030	\$238.95
3-1/8"	40-280 mph	10-01031	\$237.95
3-1/8"	40-300 mph	10-01032	\$252.95
3-1/8"	20-80 Knots	10-01033	\$237.95
3-1/8"	20-100 Knots	10-01034	\$237.95
3-1/8"	20-120 Knots	10-04950	\$237.95
3-1/8"	20-140 Knots	10-04955	\$237.95
3-1/8"	20-160 Knots	10-01035	\$237.95
3-1/8"	40-180 Knots	10-04965	\$237.95
3-1/8"	40-200 Knots	10-04970	\$238.95
3-1/8"	40-240 Knots	10-00514	\$238.95
3-1/8"	40-260 Knots	10-01036	\$237.95
3-1/8"	40-280 Knots	10-01037	\$237.95
3-1/8"	40-300 mph	10-01038	\$252.95
3-1/8" Dual	20-140 mph/20-120 Knots	10-00511	\$264.95
3-1/8" Dual	40-160 mph/20-135 Knots	10-02200	\$263.95
3-1/8" Dual	40-180 mph/20-150 Knots	10-02300	\$263.95
3-1/8" Dual	40-200 mph/40-170 Knots	10-02400	\$264.95
3-1/8" Dual	40-240 mph/40-205 Knots	10-02600	\$264.95
3-1/8" Dual	40-260 mph/40-225 Knots	10-01039	\$262.95
3-1/8" Dual	40-300 mph/40-250 Knots	10-01040	\$262.95
3-1/8" Dual	40-350 mph/40-300 Knots	10-01041	\$262.95
3-1/8" Dual	40-260 Knots/50-300 mph	10-01042	\$262.95
3-1/8" Dual	40-300 Knots/40-340 mph	10-01043	\$264.95
Range Markings	UMA Range Markings on NON-TSO Units	10-02792	\$125.00

UMA 3-1/8" AIRSPED INDICATORS (TSO'd)



These quality UMA airspeed indicators are available in MPH, Knots or Dual Scales.

3-1/8" TSO'd Single Scale	Part No.	Price	3-1/8" not TSO'd Single Scale	Part No.	Price
40-160 MPH	10-03250	\$664.00	40-160 Knots	10-03257	\$664.00
40-180 MPH	10-03251	\$595.00	40-180 Knots	10-03258	\$592.00
40-200 MPH	10-03252	\$665.00	40-200 Knots	10-03259	\$592.00
40-240 MPH	10-03253	\$665.00	40-240 Knots	10-03260	\$664.00
40-260 MPH	10-03254	\$664.00	40-260 Knots	10-03261	\$664.00
40-280 MPH	10-03255	\$664.00	40-280 Knots	10-03262	\$664.00
40-300 MPH	10-03256	\$664.00	40-300 Knots	10-03263	\$664.00

3-1/8" TSO'd Dual Scale	Part No.	Price	3-1/8" not TSO'd Dual Scale	Part No.	Price
40-160 MPH/40-135 Knots	10-03270	\$572.00	40-240 MPH/40-205 Knots	10-03276	\$572.00
40-180 MPH/40-150 Knots	10-03271	\$591.00	50-270 MPH/40-240 Knots	10-03277	\$572.00
40-200 MPH/40-170 Knots	10-03272	\$584.00	50-300 MPH/40-260 Knots	10-03278	\$572.00
40-240 MPH/40-205 Knots	10-03273	\$585.00	Outside/Inside Scale: 300 Knots	10-03279	\$572.00
40-260 MPH/40-225 Knots	10-03274	\$591.00	40-300 MPH/40-250 Knots	10-03275	\$572.00



UNITED AIRSPED INDICATORS (TSO'D)

These 8000 series United airspeeds are TSO'd for installation on certificated aircraft. Factory new. Available in dual scale MPH/knots, or in MPH or knots only. Fits standard 3-1/8" panel hole. Wt: 0.7 lb.

Part No.	Range	Lighted	Price
10-00190	40-200 mph/40-170 knots	No	\$955.00
10-00190-1	40-200 mph/40-170 knots	Yes	\$1,095.00
10-00191	40-250 mph/40-200 knots	No	\$954.00
10-00191-1	40-250 mph/40-200 knots	Yes	\$1,095.00
10-00192	40-300 mph/40-260 knots	No	\$954.00
10-00192-1	40-300 mph/40-260 knots	Yes	\$1,095.00
10-00198	0-170 knots	No	\$963.00
10-00198-1	0-170 knots	Yes	\$1,102.00
10-00201	0-260 knots	No	\$954.00
10-00201-1	40-260 knots	Yes	\$1,038.00

Available with custom range marksP/N 10-02614\$215.95

UNITED TRUE AIRSPED INDICATORS



The true airspeed indicator corrects the indicated airspeed for changes in temperature and pressure encountered as aircraft changes altitude. By aligning outside temperature and pressure altitude with setting knob, movable airspeed scale is rotated proper amount so pointer registers true airspeed. Factory new 8100 series by United. TSO'd for certificated aircraft. Dual scale. Not Lighted. Add \$215.95 for custom range marks & specify exact range marks needed.

Series	Range	Part No.	Price
8100	40-200 mph/40-160 knots	10-00203	\$1,042.00
8125	55-250 mph/55-215 knots	10-00204	\$1,042.00
8100	40-170 knots	10-00216	\$1,042.00
8125	40-210 knots	10-00217	\$1,042.00
8130	55-260 knots	10-00218	\$1,015.00
8140	60-350 Knots	10-00219	\$1,010.00

LIGHTED UNITED AIRSPEEDS

Add -1 to P/N's above for internally lighted airspeed indicators.



UMA 2-1/4" MINIATURE AIRSPEEDS

A fine quality instrument of new manufacture for the exceptional homebuilt aircraft. Matte-white dial markings. Fits standard 2-1/4" instrument panel opening. Space saving dims: 2-3/8"x2-3/8"x3.25"L. All ranges available in knots.

Range	Part No.	Part No.
20-100 MPH	10-03992	\$244.95
20-120 MPH	10-03993	\$244.95
20-140 MPH	10-03994	\$244.95
0-120 Knot	10-03995	\$244.95
40-180 Knot	10-00508	\$245.95
40-160 MPH	10-03996	\$245.95
40-180 MPH	10-03997	\$244.95
40-200 MPH	10-03998	\$245.95
40-140 Knot	10-00507	\$244.95
40-200 Knot	10-00509	\$244.95
40-240 MPH	10-04000	\$244.95
40-260 MPH	10-04001	\$244.95
40-300 MPH	10-04002	\$245.95
40-160 Knot	10-01787	\$245.95
40-240 Knot	10-00510	\$245.95

AIRSPEEDS

FALCON 3 1/8" SINGLE RANGE AIRSPEEDS



These Airspeed Indicators have been one of the most chose flight instruments by kit plane builders and pilots. There are many great advantages to using these gauges: excellent slow speed characteristics; very progressive increments; a variety of ranges, light weight; short length, and affordable price. All Airspeed Indicators are housed in an aluminum case and consist of all metal parts. Available

ranges: mph, knots, km/hr; single range reading or dual range readings. Non-Tso'd.

Model No.	Length	Range	Part No.	Price
ASI200M-3	3.5"/97.3mm	30-200 MPH	10-02918	\$257.95
ASI180M-3	3.5"/97.3mm	30-180 MPH	10-03000	\$257.95
ASIO80M-3	2.2"/56.5mm	0-80 MPH	10-02905	\$239.95
ASI100M-3	2.2"/56.5mm	0-100 MPH	10-02910	\$239.95
ASI120M-3	2.2"/56.5mm	0-120 MPH	10-02915	\$239.95
ASI140M-3	3.5"/97.3mm	0-140 MPH	10-02916	\$257.95
ASI150M-3	2.2"/56.5mm	0-150 MPH	10-02225	\$239.95
ASI160M-3	3.5"/97.3mm	0-160 MPH	10-02917	\$257.95
ASIO80N-3	3.5"/97.3mm	0-80 Knots	10-02896	\$239.95
ASI100N-3	2.2"/56.5mm	0-100 Knots	10-02897	\$239.95
ASI120N-3	2.2"/56.5mm	0-120 Knots	10-02898	\$239.95
ASI140N-3	3.5"/97.3mm	0-140 Knots	10-02899	\$257.95
ASI160N-3	3.5"/97.3mm	0-160 Knots	10-02900	\$257.95
ASI180N-3	3.5"/97.3mm	0-180 Knots	10-02217	\$257.95
ASI200N-3	3.5"/97.3mm	0-200 Knots	10-02218	\$258.95
ASI220N-3	3.5"/97.3mm	0-220 Knots	10-02219	\$258.95
ASI120K-3	2.2"/56.5mm	0-120 KPH	10-02625	\$239.95
ASI150K-3	2.2"/56.5mm	0-150 KPH	10-02221	\$239.95
ASI200K-3	2.2"/56.5mm	0-200 KPH	10-02222	\$257.95
ASI300K-3	2.2"/56.5mm	0-300 KPH	10-02223	\$257.95

FALCON 3 1/8" DUAL RANGE AIRSPEEDS



These Airspeed Indicators have been one of the most chose flight instruments by kit plane builders and pilots. There are many great advantages to using these gauges: excellent slow speed characteristics; very progressive increments; a variety of ranges, light weight; short length, and affordable price. All Indicators are housed in an aluminum case and consist of all metal parts.

Falcon Gauge Dual Dial Airspeed Indicators provide dual readings and are suitable for higher performance type aircraft flying at moderate to high speeds. Matte-white dial markings, housed in a sturdy protective aluminum case. Weight: approx. 10.5 oz./301g. Length: 3.5" or 97.3mm Size: 3-1/8"

Model No.	Range	Part No.	Price
ASI164MN-3	20-160 MPH/20-140 Knots	10-02227	\$257.95
ASI186MN-3	30-180 MPH/30-160 Knots	10-02228	\$257.95
ASI208MN-3	30-200 MPH/30-180 Knots	10-02901	\$255.95
ASI252MN-3	30-250 MPH/30-220 Knots	10-02229	\$257.95
ASI306MN-3	40-300 MPH/40-260 Knots	10-02230	\$252.95
ASI316KN-3	30-300 KPH/30-160 Knots	10-02231	\$257.95

SIGMA-TEK RESTRAINED AIRSPEEDS



These airspeed indicators have restrained movements. These instruments are actuated by ram air and ambient atmospheric pressure obtained from the aircraft pitot and static pressure systems. A moveable pointer and a fixed dial indicate airspeed with the zero index at the 12 o'clock position. Temperature compensation is internal and there is no external zero adjustment. Pointer damping is internally adjustable. **Note: Lighted Instruments do not include lamp trays, see website for accessories.**

Model No.	Lighted	MPH	Knots	Part No.	Price
EA5174-()L	X	40-200	40-170	10-05158	\$1,027.00
EA5175-()		40-250	40-200	10-05159	\$843.00
EA5175-()L	X	40-250	40-200	10-05160	\$1,059.00
EA5176-()		40-300	40-260	10-05162	\$995.00
EA5176-()L	X	40-300	40-260	10-05163	\$1,043.00



Dual Scale (MPH/Knots) with multicolor markings

UMA 2-1/4 TSO'D AIRSPEED INDICATORS

UMA indicators are FAA TSO'd to C2d specifications. Installable in a fixed wing aircraft with a reciprocating or Turboprop Engine. Must be installed in a temperature controlled environment from -55 to +85 °C, to a max altitude of 25,000 ft. UMA offers indicators with full scale ranges available, from 160 to 300 in MPH or Knots.

UMA Part No.	Range	Part No.	Price
T16-210-121	20-120 MPH	10-03577	\$664.00
T16-211-121	20-120 Knots	10-03578	\$664.00
T16-210-141	20-140 MPH	10-03579	\$664.00
T16-211-141	20-140 Knots	10-03580	\$664.00
T16-210-142	30-140 MPH	10-03582	\$664.00
T16-211-142	30-140 Knots	10-03583	\$664.00
T16-210-160	40-160 MPH	10-03584	\$664.00
T16-211-160	40-160 Knots	10-03585	\$664.00
T16-210-161	20-160 MPH	10-03586	\$664.00
T16-211-161	20-160 Knots	10-03587	\$589.00
T16-210-180	40-180 MPH	10-03588	\$664.00
T16-211-180	40-180 Knots	10-03589	\$664.00
T16-210-200	40-200 MPH	10-03590	\$665.00
T16-211-200	40-200 Knots	10-03591	\$664.00
T16-210-240	40-240 MPH	10-03592	\$664.00
T16-211-240	40-240 Knots	10-03593	\$664.00
T16-210-260	40-260 MPH	10-03594	\$664.00
T16-211-260	40-260 Knots	10-03595	\$664.00
T16-210-300	40-300 MPH	10-03596	\$664.00
T16-211-300	40-300 Knots	10-03597	\$662.00
T16-210-400	40-400 MPH	10-03598	\$664.00
T16-211-400	40-400 Knots	10-03599	\$664.00
T16-212-240	40-240 KmH	10-03602	\$664.00
T16-212-260	40-260 KmH	10-03603	\$664.00
T16-212-280	40-280 KmH	10-03604	\$664.00
T16-212-300	40-300 KmH	10-03605	\$665.00
T16-212-320	40-320 KmH	10-03606	\$665.00
T16-212-380	40-380 KmH	10-03607	\$560.00
T16-212-400	40-400 KmH	10-03608	\$664.00
T16-212-440	40-440 KmH	10-03609	\$664.00



SIGMA-TEK AIRSPEEDS (TSO'D)

Sigma-Teks precision airspeeds are original equipment on a variety of aircraft and over 144,000 have been delivered worldwide. Select from a single MPH scale or dual scale showing MPH / Knots. New manufacture. TSOD for certificated aircraft unlit. Add \$95 for custom range markings. (Specify exactly)

Model	Lighted	MPH	Part No.	Price
Dual Scale Airspeed	No	40-250	10-03210	\$820.00
Dual Scale Airspeed	No	40-300	10-03215	\$816.00
Standard Airspeed	No	40-200	10-05152	\$799.00
Standard, Lit Airspeed	Yes	40-200	10-05153	\$1,051.00
Standard, Lit Airspeed	Yes	40-250	10-05154	\$1,005.00
Standard Airspeed with decal and calibration card	No	40-250	10-05155	\$1,361.00
Standard, Lit Airspeed	Yes	40-300	10-05156	\$974.00

SIGMA-TEK 3-1/8" TRUE AIRSPEEDS



These true speed indicators are differential pressure indicators that measure the difference between static and total pressure produced by ram air from the pitot. The indicated airspeed can be corrected for changes in altitude by turning the knob to align the outside air temperature with the altitude. The moveable airspeed scale will then show the actual, or true, airspeed. Model No.: EA5175-()PTL. Lighted.

MPH: 40-250. Knots: 40-200. **Note:** Lighted Instruments do not include lamp trays, see accessories.....P/N 10-05161\$1,143.00

Sigmathek Accessories

14V Lamp Tray.....	P/N 10-02757	\$95.75
28V Lamp Tray.....	P/N 10-02758	\$95.75
Sigmathek Airspeed Range Markings.....	P/N 10-04961	\$203.95

AIRSPEED INDICATORS - ALTIMETERS



WINTER 2-1/4 INCH AIRSPEED INDICATORS

This precision instrument is enclosed in a compact housing and operates by means of a measuring tube. This ensures high accuracy even at very low speeds. EBF-series airspeed indicators are available with a pitot tube and static pressure connection.

Description	Part No.	Price
Winter 2-1/4 ASI 8020 EBF Various Range 360 Degree Dial	10-05625	\$374.00
Winter 2-1/4 ASI 8022 EBF Various Range 360 Degree Dial	10-05627	\$374.00
Winter 2-1/4 ASI 8026 EBF Various Range 510 Degree Dial	10-05629	\$455.00
Winter 2-1/4" ASI 7 FMS 213 Range 0 To 100 Knot 360 Dial	10-05908	\$603.00



WINTER 3 INCH AIRSPEED INDICATORS

This precision instrument is enclosed in a compact housing and operates by means of a measuring tube. This ensures high accuracy even at very low speeds. EBF-series airspeed indicators are available with a pitot tube and static pressure connection.
Diameter: 3". Depth: 3"

Description	Part No.	Price
Winter 3" ASI 8021 EBF Various Range 360 Degree Dial	10-05626	\$375.00
Winter 3" ASI 8023 EBF Various Range 360 Degree Dial	10-05628	\$374.00
Winter 3" ASI 6 FMS 403 Range 0 to 100 Knots 510 Dial	10-05906	\$600.00
Winter 3" ASI 6 FMS 213 Range 0 to 100 Knots 360 Dial	10-05907	\$603.00

MID-CONTINENT INSTRUMENTS AND AVIONICS AIRSPEED INDICATORS



Customizable range markings can be added to match aircraft operating handbook. Affordable, certified 2-inch instrument which can be used as standby or primary indicator. Combine with a Mid-Continent MD15 Altimeter and 4200 Attitude Indicator for a complete standby package designed for tight panel applications. Approved to FAA TSO-C2d. Integral long life 5, 14 or 28 volt LED lighting. Anti-reflective glass enhances visibility and reduces pilot fatigue. Rear-mounted in standard 2 1/4" cutouts horizontally, vertically or individually. Designed and built in the USA. One year limited warranty.

Model	Description	Part No.	Price
MD25-160	2-Inch 20-160 knots, Lighted	10-04761	\$1,895.00
MD25-200	2-Inch 40-200 knots, Lighted	10-04763	\$1,895.00
MD25-260	2-Inch 40-260 knots, Lighted	10-04764	\$1,895.00
MD25-300	2-Inch 40-300 knots, Lighted	10-04765	\$1,895.00

FALCON MINIATURE AIRSPEED INDICATORS WITH PITOT KIT



This package includes a ASI080M-2 airspeed indicator, as well as a pitot kit consisting of 1/4" aluminum tubing, vinyl tube, Polyethylene Hose Adapter, and Breeze Clamp.

Falcon Miniature airspeed indicators are designed for ultralights. They offer ultralight pilots an affordable alternative to other higher priced airspeed indicators. They have excellent slow speed features which make them perfect for ultralight flying.

Size	Range	Part No.	Price
3-1/8"	0-80 MPH	AS020	\$248.95
3-1/8"	0-100 MPH	AS021	\$247.95
3-1/8"	0-120 MPH	AS022	\$248.95



WINTER 3-INCH ALTIMETERS

Standard Precision Altimeters 4 FGH 10. Airtight, black plastic housing. Connection via hose from static pressure sensor to hose connector on rear. Kollsman window with millibar scale, reading from 940 to 1050 millibars. See scale drawing for installation dimensions.

Weight 0.330 kg. Linear scale

The 4 FGH 10 altimeter can be fitted with a scale ring.

Description	Part No.	Price
Winter 3 Altimeter 4 FGH 10 1000-20000 FT MB	10-05621	\$1,202.00
Winter 3 Altimeter 4 FGH 10 1000-20000 FT INHG	10-05622	\$1,198.00

WINTER 2-1/4 INCH ALTIMETERS



The pressure-sensitive measuring element is a diaphragm capsule (aneroid capsule) which reacts to the effect of changing air pressure as the aircraft changes altitude. Tempered, aged copper-beryllium diaphragms ensure highly accurate readings. Diaphragm movement is transmitted to the instrument pointers by a linkage and gearwheels - the whole is insensitive to shock and vibration. A bimetal link compensates the effect of temperature change.

Description	Part No.	Price
Winter 2-1/4 Altimeter EBH 8032 0-5000 FT MB	10-24105	\$587.00
Winter 2-1/4 Altimeter EBH 8034 0-5000 FT INHG	10-05632	\$429.00
Winter 2-1/4 Altimeter EBH 8035 0-10000 FT INHG	10-05634	\$595.00

TASKEM 5000 DIGITAL ALTIMETER



Unlike mechanical altimeters, the Taskem 5000 is insensitive to the high vibration of 2-stroke engines frequently used on ultralight aircraft. This has literally shaken many mechanical altimeters. The 5000 is all solid state and can withstand severe shock and vibration without damage. It has a full 4.5 digit liquid crystal (LCD) display with large, 1/2" high characters. Because the LCD uses direct drive, it is easily readable from most viewing angles and does not disappear when viewed from an angle or does not washout in bright sunlight. Includes a backlight for night or dusk viewing. The altitude range extends from below sea level to well above the need for supplementary oxygen. The limits are -1000 to 19,990 ft. (-305 to 6,093 meters). Increments are in 10 ft./1m steps. The instrument is powered from DC in the range of 7-30V and is protected for accidental polarity reversal. A 9V battery is a common power source and a battery holder for this is provided on the back, external to the case. An alkaline battery will provide over 40 hours of operation, without the backlight illuminated. The backlight is not powered in the ON power switch position to conserve battery life.

FeetP/N 10-24010\$309.00
Meters.....P/N 10-24020\$331.00



HALL WINDMETER

Designed for hang gliders but can be mounted on low speed aircraft as an airspeed indicator. Easy to read. Mounting bracket clamps to 7/8 or 1 1/8" dia. tube. Short bracket is 3' long, Long bracket 15" long.
Windmeter (0-55 mph) .P/N 10-04100\$19.75
Windmeter (0-80 mph) .P/N 10-04105\$19.75
Windmeter (0-130 kph) .P/N 15-04602\$18.50
Short Bracket.....P/N 10-04200\$6.50
Long Bracket.....P/N 10-04300\$10.50

ALTIMETERS

UNITED SENSITIVE ALTIMETERS



Designed to help the pilot determine altitude by measuring existing atmospheric pressure, this altimeter translates this measurement into "height-above-sea-level." This is indicated on the dial of the instrument in feet, which requires setting the barometric pressure in the Kollsman window. Standard 3-1/8" size.

Specifications: • Typical Weight: 13 oz • Number of Pointers: 3 • Barometric Setting: 28.1 to 31.0 in HG / 946 to 1050 mb • Calibrated Ranges: -1,000 to +20,000 or +35,000 feet • Static Pressure Connection: 1/8-27 ANPT • Installation: Removable Spring Nuts and screws

Range	Scale	Manufacturer	Part No.	Price Ea.
0-20000 ft.	Inches	United (TSO)	10-04550	\$1,558.00
0-35000 ft.	Inches	United (TSO)	10-04570	\$1,725.00
0-20000 ft.	Millibar	United (TSO)	10-04560	\$1,558.00
0-20000 ft.	Inches	United (Lighted)	10-00929	\$1,805.00
0-35000 ft.	Inches	United (Lighted)	10-00930	\$1,972.00
0-20000 ft.	Millibar	United (Lighted)	10-00931	\$1,790.00
0-20000 ft.	In/Mil	United (Lighted)	10-00932	\$1,831.00
0-20000 ft.	In/Mil	United (Unlighted)	10-00933	\$1,555.00
0-35000 ft.	In/Mil	United (Unlighted)	10-02696	\$1,777.00
0-35000 ft.	In/Mil	United (Lighted)	10-02697	\$1,974.00
0-35000 ft.	Millibar	United (Lighted)	10-02698	\$1,925.00
0-35000 ft.	Millibar	United (Unlighted)	10-02699	\$1,715.00

UNITED ALTIMETER WITH CORRECTED BAROMETRIC OUTPUT



True airspeed all the time! No need to correct the barometer, the altimeter does it automatically for the pilot. • Compatible with most Air Data Systems • 35,000 ft., dual barometric scale • Internally lighted – light tray included • TSO C10d certified • Standard D.C. voltage barometric output • Mounts in standard 3 1/8" panel cutout • Requires just 5" depth behind the panel • 1/8" NPT static port • Connector included • Manufactured by United Instruments.

P/N 10-02718**\$3,125.00**

MID-CONTINENT INSTRUMENTS AND AVIONICS ALTIMETER, 2-INCH



Reliable for primary or standby use, these altimeters provide flight critical data with a three-pointer or counter drum pointer display. The compact, 2-inch size is ideal for complex panel installations. Lighting is included. These altimeters are used in many popular OEM and STC packages. Call for application assistance.

Model	Description	Part No.	Price
MD15-212	20K, 3-ptr., Left-Hand knob, Millibars, lighted	10-04754	\$6,963.00
MD15-221	20K, 3-ptr., Right-Hand knob, Inches, lighted	10-04755	\$6,969.00
MD15-222	20K, 3-ptr., Left-Hand knob, Inches, lighted	10-04756	\$6,969.00
MD15-322	35K, 3-ptr., Left-Hand knob, Inches, lighted	10-04760	\$7,495.00

FALCON 3 1/8" SENSITIVE ALTIMETERS



1. Three Pointer Altimeter with Barometric Window and Low Altitude Warning Stripes is a modern type. The easy to read striped sector will show while flying below 16,000 ft. 2. Three Pointer Altimeter with a Barometric Window enables the pilot to adjust the altimeter to the barometric conditions existing at the point of landing. 3. Two Pointer Altimeter without Barometric Window. This type of altimeter is designed to meet the demands of some pilots who

either live or fly the area's barometric pressure beyond 28.1 to 31 inches of mercury, or 950 to 1050 millibars, or some pilots prefer to set the altimeter to "0" altitude before taking off without regard to the barometric pressure. By installing this altimeter, the pilot can fly anywhere in the world without having to care about the barometric pressure changes. Non-TSO'd.

Falcon Gauges are made in China.

WWW.AIRCRAFTSPRUCE.COM

UMA 3-1/8" ALTIMETERS



This UMA standard altimeter utilizes a single pointer and is designed to meet the needs of the low-cost Non-IFR user. This altimeter utilizes a single pointer and adjustable barometric scale, viewed through a Kollsman Window. Can be ordered in inches of mercury or millibar. Available in feet or meters. Aluminum case.

Range	Dial Markings	Scale	Part No.	Price
0-20,000 Ft.	B & W	w/ IN HG	10-22965	\$193.85
0-10,000 Ft.	B & W	w/ IN HG	10-02436	\$191.75
0-5,500 Ft.	B & W	w/ IN HG	10-02369	\$191.75
0-5,500 Ft.	B & W	w/ Millibar	10-05120	\$213.95
0-10,000 Ft.	B & W	w/ Millibar	10-05125	\$213.95
0-20,000 Ft.	B & W	w/ Millibar	10-05126	\$213.95
0-3,000 M	B & W	w/ Millibar	10-05127	\$220.95

UMA 2-1/4" ALTIMETERS



This UMA standard altimeter utilizes a single pointer and is designed to meet the needs of the low-cost Non-IFR user. This altimeter utilizes a single pointer and adjustable barometric scale, viewed through a Kollsman Window. Can be ordered in inches of mercury or Millibar. Scale is available in feet or meters.

Range	Dial Markings	Scale	Part No.	Part No.
0-10,000 Ft.	B & W	w/ IN HG	10-05131	\$376.00
0-20,000 Ft.	B & W	w/ IN HG	10-05132	\$376.00
0-10,000 Ft.	B & W	w/ Millibar	10-05133	\$396.00
0-20,000 Ft.	B & W	w/ Millibar	10-05134	\$396.00
0-3000 Mtrs.	B & W	w/ Millibar	10-05883	\$427.00

FALCON 3 1/8" NON-SENSITIVE ALTIMETERS



These light weight altimeters feature a non-sensitive altimeter on a 3-1/8", single pointer, and a barometric window. A setting knob allows the pilot to set the barometric reading to the correct field elevation or barometric pressure setting. They are weight conservative, economical, yet very precision and accurate instruments that provide excellent altitude measuring capabilities; designed for ultra-light airplanes. 3-1/8" is non-sensitive. Standard Types are either feet reading with

barometric window inches of mercury or millibars reading; or meters reading with barometric window millibars reading. Length: 2 3/8" Weight: 10.7 oz.

Part No.	Range	Price
10-03422	10,000 ft./20,000 ft. Inches	\$266.95
10-02251	6,000 ft., Millibars	\$266.95
10-02252	10,000 ft., Millibars	\$266.95

FALCON 2 1/4" SENSITIVE ALTIMETERS



2-1/4" is sensitive. Single Pointer, and a barometric window. A setting knob allows the pilot to set the barometric reading to the correct field elevation or barometric pressure setting. They are weight conservative, economical, yet very precision and accurate instruments. It is suitable where space and weight is a consideration. This type is available in Feet or Meter reading, the barometric window can be either in inches of mercury or in millibars reading. Length: 2 3/8" Weight: 3.6 oz.

Model No.	Part No.	Range	Price
ALTN6INF-2	10-02205	5,500 ft, Inches	\$278.95
ALTN10INF-2	10-04510	10,000 ft, Inches	\$278.95
ALTN6MBF-2	10-04070	6,000 ft., Millibars	\$278.95
ALTN10MBF-2	10-04071	10,000 ft., Millibars	\$278.95
ALTN3ME-2	10-02207	3,000 Meters, Millibars	\$278.95
ALTN6ME-2	10-02254	6,000 Meters, Millibars	\$278.95

ALTIMETERS – BUGS – REDUCING MASKS



STADIA AGL LIDAR LANDING ALTIMETER

Stadia is an AGL altimeter landing aid that uses LIDAR to measure the aircraft's height above ground with incredible precision. Stadia connects to the pilot's smartphone via Bluetooth and alerts the pilot to their altitude with audible cues. Stadia has a maximum altitude of 130ft, and a rechargeable battery life of up to 12 hours. Per the manufacturer "Because Stadia is considered a temporary attachment it is not subject to FAA regulatory purview."

Specifications: • Model A & Model B: 2.25 lbs, 8.5" x 6" x 3.75" • Model L: 12 oz, 4" x 5" x 4.75"

Model A - Strut Braced - Struts with Thickness from 1-5/32" - 1-3/4" P/N 11-19068\$565.00

Model B - Strut Braced - Struts with Thickness from 1-3/4" - 2-3/8" P/N 11-19069\$565.00

Model L - For Most Aircraft with Tie Down Ring P/N 11-19070\$565.00



WINTER ALTIMETERS

Casing made of black plastic-airtight. Connection via hose line from static pressure pick-up point to connection coupling at the rear. Scale window with millibar or inch-HG scale.

Description	Part No.	Price
Winter 2-1/4 Altimeter 4 FGH 40 1000-20000 Ft Mb	10-05623	\$1,198.00
Winter 2-1/4 Altimeter 4 FGH 40 1000-20000 Ft INHG	10-05624	\$1,243.00
Winter 3 Altimeter EBH 8034 0-5000 FT INHG	10-05633	\$404.00
Winter 3 Altimeter EBH 8035 0-10000 FT INHG	10-05635	\$534.00
Winter 3 Altimeter EBH 8038 0-5000 FT MB	10-05636	\$404.00
Winter 3 Altimeter EBH 8039 0-10000 FT MB	10-05637	\$429.00
Winter 3 Altimeter 4 FGH 10 1000-20000 FT MB	10-05621	\$1,202.00
Winter 3 Altimeter 4 FGH 10 1000-20000 FT INHG	10-05622	\$1,198.00

INSTRUMENT BUGS



"Bugs" are perfect for pilots who rent aircraft, and for owners. The transparent suction cup works on all instruments. A thumb screw friction lock lets the yellow pointer tip rotate 360°. Fly with it day & night. Includes: 2 "Bugs" in a plastic reusable storage box with instructions and 4 disposable alcohol swabs, which are used to clean the instrument face and bugs so that they stick well.

P/N 10-00114\$9.85

OPERATING RANGE DECALS

Yellow, red, green and white, pressure sensitive. Just pull off backing and place on instrument lens.

P/N 10-03905\$2.95/set



AIRCRAFT INSTRUMENT COVER



The instrument cover is a plastic disk approximately 2 3/4" in diameter and 1/16" thick. By use of the attached suction cup, the cover will mask the face of most general aviation flight instruments. It is useful in many training situations one of which is partial panel work. As a safety aid, the cover can be used to mask an instrument when it is non-functional, as is required by Regulations. Each package has two covers.

P/N 13-04968\$7.45

INOPERATIVE INSTRUMENT AID



Designed with static cling polyester, the IIA will stick to your glass instrument face without licking and will stay there until you want to remove it. Practicing instrument failures during flight is a requirement by the Federal Aviation Administration for your practical test. One package includes four Inoperative Instrument Aids.

Developed by a Certified Instrument Flight Instructor with the intent to improve instrument instruction. Measures 3" in diameter.

P/N 13-04173\$5.75

REDUCING MASK



Precision die-cut black anodized aluminum masks simplify installation of small instruments in large instrument panel cut-outs.

3-1/8" size cut-out to 2-1/4" size P/N 10-06100\$10.95



MOUNTING PLATE FOR THE 3 ATI INSTRUMENT

Quick fix for a hard to cut out opening. Plate is .500 wider than instrument. For easy mounting, material is .080 aluminum.....P/N 10-00154\$13.50



REDUCING PLATE FROM 2-1/4" DIA.

Reduce from 2.25" to 2" diameter instrument. For oil pressure, ammeter gauge etc.

P/N 10-00155\$9.80



INSTRUMENT PANEL COVER-UPS

These white stick on instrument size covers are ideal for partial panel practice or to cover an actual failed instrument. These covers are reusable and are furnished in a package of 5 covers.

P/N 10-00066\$5.80

3ATI REDUCER PLATES



3ATI Reducers to 3 1/8" - Use a 3ATI hole cut out to mount 3 1/8" diameter instrument. Plate can be shimmed to instrument panel thickness. Simple installation. Heat-treated aluminum .080 thick with black anodize finishP/N 07-01331\$20.80

07-01331

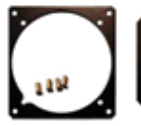

3ATI Reducers to 2 1/4" - Use a 3ATI hole cut out to mount 2 1/4" diameter instruments. Plate can be shimmed to instrument panel thickness, comes with 4 rivets. Simple installation. Heat-treated aluminum .080 thick with black anodize finish. BACK PLATE 3.8 X 3.8

07-01330

P/N 07-01330\$20.80

INSTRUMENT PANEL COVER-UPS FOR PFD / MFD



Cover ups for PFD and MFD screens for glass cockpit training. For partial panel practice & actual instrument failures. • Reusable, 3 per pack • "Cling" type plastic covers, with lift tab • Zip lock plastic bag for convenient storage.

P/N 13-06116\$9.50

INSTRUMENT HOLE COVER PLATES



Use these plates to attractively cover unused panel cut-outs. Aluminum and plastic plates have raised center, which brings the plug face about even with the front surface of the panel.

Plastic plate for 2-1/4" Cut-Out No Holes P/N 10-06900\$7.50

Plastic plate for 3-1/8" Cut-Out No Holes P/N 10-07000\$7.50

Predrilled

Plastic plate for standard altimeter hole..... P/N 10-07100 ..\$10.50

Aluminum plate for 2-1/4"hole, black wrinkle P/N 10-00427 ..\$12.80

Aluminum plate for 2-1/4"hole, no paint.....P/N 10-00428 ..\$12.90

Aluminum plate for 3-1/8"hole, black wrinkle P/N 10-00429 ..\$13.95

Aluminum plate for 3-1/8"hole, no paint.....P/N 10-00430 ..\$13.75

Plastic plate for 3ATI hole, black fire retardant... P/N 10-00433 ..\$10.50

Aluminum plate for 3ATI hole, black wrinkle..... P/N 10-00434 ..\$13.70

Aluminum plate for 3ATI hole, no paint.....P/N 10-00436 ..\$12.50

Plastic plate for half ATI hole, black fire resist.... P/N 10-00437\$9.75

INSTRUMENT PANEL LAYOUT TEMPLATE



Use this template for precise positioning of instrument holes and mounting screw holes in panel. For both 2-1/4" & 3-1/8" dia. instruments. With transfer punch for marking screw hole centers and instructions.

P/N 12-14600\$29.70

VSI - ACCELEROMETERS - SKYSPORTS

UNITED VERTICAL SPEED INDICATORS



The vertical speed indicator is a precision instrument which provides an accurate indication of rate of change of altitude. This instrument is temperature compensated and is provided with a zero adjustment screw on the face of the case in the seven o'clock position. Power: Static system. Manufactured by United Instruments. Used in most production aircraft. Size: 3-1/8" x 3-1/8" x 4", Wt. 0.7 lb. TSO-C88.

Unlighted VSI's

0-2000 FPM	P/N 10-05200	\$885.00
0-3000 FPM	P/N 10-20400	\$868.00
0-4000 FPM	P/N 10-20500	\$868.00
0-6000 FPM	P/N 10-05250	\$1,503.00

Lighted VSI's

0-2000 FPM	P/N 10-00925	\$1,124.00
0-3000 FPM	P/N 10-00926	\$1,124.00
0-4000 FPM	P/N 10-00927	\$1,124.00
0-6000 FPM	P/N 10-00928	\$1,682.00

FALCON VERTICAL SPEED INDICATORS



These Vertical Speed Indicators (Rate of Climb), have been installed in thousands of planes. Available in climb ranges from 2,000 feet per minute to 3,000 feet per minute, and 10 meters per second. This precision aircraft instrument provides immediate climb and descent information with an easy to read dial and is extremely reliable and durable. Over several decades, they have been servicing and satisfying pilots and kit plane builders worldwide.

The 2-1/4" altimeter is perfect for the ultra-light models and where space and weight are a factor of consideration. Made in China.

Specifications: • Model No: VS12FM-3 • Size: 3-1/8" • Length: 4.25"/105mm • Range: 2,000 - 4,000 ft/min • Weight: 12.7 oz

Part No.	Size	Range	Length	Weight	Price
10-05352	3 1/8"	2,000 ft/min	4.25"/105mm	12.7 oz	\$277.95
10-05210	3 1/8"	3,000 ft. / Min.	4.25"/105mm	12.7 oz	\$311.00
10-02246	3 1/8"	10 meter/second	4.25"/105mm	12.7 oz	\$277.95
10-01643	2 1/4"	2,000 ft. / Min.	4.8"/112mm	9.2 oz	\$364.00
10-00983	2 1/4"	10 Meters / Sec.	4.8"/112mm	9.2 oz	\$365.00

3-1/8" UMA VERTICAL SPEED INDICATORS



The vertical speed indicator is a precision instrument which provides an accurate indication of rate of change of altitude. This instrument is temperature compensated and is provided with a zero adjustment screw on the face of the case in the seven o'clock position. Power: Static system.

Part No.	Name	Range	Price
10-20505	Vertical Speed	0-2,000'	\$259.95
10-02368	Vertical Speed	0-3,000'	\$259.95
10-20506	Vertical Speed	0-4,000'	\$321.00
10-20508	Vertical Speed	0-6,000'	\$325.00
11-07239	Optional internal lighting		\$58.75

UMA MINIATURE 2 1/4" VERTICAL SPEED INDICATORS



This instrument mounts in a standard 2-1/4" instrument panel cutout. New manufacture with brilliant easy-to-read matte-white numerals on black background. Size: 23/8"x 23/8"x 31/4" long.

Part No.	Name	Range	Price
10-05500	Vertical Speed	0-2,000 Ft.	\$347.00
10-00079	Vertical Speed	0-3,000 Ft.	\$347.00
10-05550	Vertical Speed	0-4,000 Ft.	\$381.00
10-05560	Climb	0-4,000 Ft.	\$398.00
10-05570	Rate of Change	0-4,000 Ft.	\$398.00
10-05580	Cabin Climb	0-4,000 Ft.	\$398.00
10-05600	Vertical Speed	0-6,000 Ft.	\$381.00
10-05610	Climb	0-6,000 Ft.	\$398.00
10-06910	Rate of Change	0-6,000 Ft.	\$398.00
11-07239	Optional internal lighting		\$58.75

FLIGHT DATA G-METER GT50 12/28



Note: Now FAA Approved as a replacement clock in non-transport category aircraft.

The GT-50 is a Six Function: Accelerometer - Clock - Voltmeter - Temperature for Experimental Aircraft.

G-Meter: • Continuous Instantaneous Display to +12/-10 G's • Records and Saves Max and Min G's • 30 Degree (Sonex) Tilted Panel Compatible
Flight Timer: Automatically Records Flight Time
Clock: 12 or 24 Hour Format

Timer/Stopwatch Voltmeter Features: • Best G-Meter Value Available • Extreme Operating Temperature Display • Soft Orange Backlight • 2-1/4" Panel Mounted • Weighs 2.5oz • Includes Pre-Wired Connector • 12-28 Volt Compatible
Standard P/N 10-03691 \$173.95
With USB P/N 10-07330 \$229.00
Flight Data OAT Probe GT50 P/N 10-03694 \$29.85



WINTER VARIOMETERS

The instrument consists of a cylindrical chamber with a precision-fit baffle plate (vane) rotating on shock proof jewel bearings and centered by a coil spring. The tiny housings mean that these instruments can be installed even where space is restricted. Available in 2-1/4" and 3" sizes.

Description	Part No.	Price
Winter 2-1/4 Variometer 1000 FT Min	10-05638	\$760.00
Winter 2-1/4 Variometer 10 Knots	10-05639	\$760.00
Winter 2-1/4 Variometer 2000 FT Min	10-05642	\$765.00
Winter 2-1/4 Variometer 1000 FT Min Log	10-05644	\$680.00
Winter 3 Variometer 1000 Ft Min	10-05640	\$760.00
Winter 3 Variometer 10 Knots	10-05641	\$760.00
Winter 3 Variometer 2000 Ft Min	10-05643	\$760.00
Winter 3 Variometer 1000 Ft Min Log	10-05646	\$680.00
Flask for Winter Variometer	10-03856	\$33.00

SKYSPORTS VACUUM ATTITUDE GYRO



The Skysports Vacuum Attitude Gyro is a standard artificial horizon gyro powered by the vacuum system in the aircraft. It is ideal for use in a wide variety of experimental aircraft. Non-TSO'd. Size: 3-3/8"x6.46/164mm. Weight: 2.4lb/984g.

Specifications: • Ambient temperature: -30 to +50 degree centigrade • Ambient relative humidity: no more than 95% • Anti-vibration tensity: 1.5g • Height: 4600m • Driving power: 15 ~18K Pa for vacuum or air pressure • Pressure for starting: 7KPa P/N 10-05423 \$886.00

SKYSPORTS ELECTRIC ATTITUDE GYRO



The Skysports Electric Attitude Gyro is a high quality gyro which is excellent for a wide variety of experimental aircraft. It features a power failure flag which drops into view if voltage is below operational requirements. It also includes a "Pull to Cage" knob. Non-TSO'd. Power Supply: 14V. Dimension: 3-3/8" x 6.46/164mm Weight: 2.4lb/984g. **Specifications:** • Operating voltage: 14 ± 10% VDC • Ambient Temperature: -40 ~ +50°C • Relative Humidity: It can reach 95% at 20 ± 5°C • Vibration Strength: not more than 1.5g
P/N 10-05422 \$1,595.00

NON-TSO'D VERTICAL SPEED INDICATORS



Skysports vertical speed indicators are easy to read, lightweight, and durable. These rate of climb indicators are available in several different ranges and are in use in a wide variety of experimental aircraft worldwide.

Non-TSO'd
Size: 3-1/8"
Length: 4.25"/105mm
Weight: 12.7 oz

Part No.	Size	Range	Length	Weight	Price
10-05361	3 1/8"	2,000 ft/min	4.25"/105mm	12.7 oz	\$364.00
10-05360	3 1/8"	10 meter/second	4.25"/105mm	12.7 oz	\$364.00

Skysports Instruments are made in China.

IN

SKYSPORTS NON-TSO'D INSTRUMENTS



SKYSPORTS VACUUM DIRECTIONAL GYRO

The Skysports Vacuum Directional Gyro is a standard gyro powered by the vacuum system in the aircraft. It is ideal for use in a wide variety of experimental aircraft. Non-TSO'd. **Dimensions:** 3-3/8" x 5-5/16"/134.95mm. **Weight:** 2.25lb/984g.

Specifications: • Air-pressure for operation: 15 ~18Kpa • Air-pressure for starting: 7Kpa • Ambient temperature: -30 to +50 degree centigrade; • Relative humidity: 0-95% • Anti-vibration intensity: 1.5g • Height: 40000 feet • Range for operation: indicates direction within the range of 360° P/N 10-05421 **\$675.00**



SKYSPORTS ELECTRIC DIRECTIONAL GYRO

The Skysports electric directional gyro is a high quality gyro providing smooth operation, long life, and reliability. It features a warning flag which is displayed when voltage drops below operation requirements, and the instrument is LED lighted with automatic dimming. A good choice for a wide variety of experimental aircraft. Non-TSO'd. **Dimensions:** 3-3/8".

Specifications: • Operating Voltage: DC. 14 ±1%V • Ambient Temperature: -40 ~ +50°C • Relative Humidity: It can reach 95% at 20 ± 5°C • Vibration Strength: not more than 1.5g.....P/N 10-05077 **\$1,552.00**



SKYSPORTS 3-1/8" SENSITIVE ALTIMETERS

Skysports sensitive altimeters feature three pointers and knob to set correct barometric pressure enroute and destination. High quality sensitive altimeters which are in use in thousands of experimental aircraft worldwide. Non-TSO'd

Size: 3 1/8" **Weight:** 1.4 lbs. or 592g **Pointers:** 3

Barometric Window	Range	Warning Stripes	Part No.	Price
Yes	20,000 ft, Inches	Yes	10-04400	\$649.00
Yes	20,000 ft, Millibars	Yes	10-05371	\$649.00
Yes	20,000 ft, Inches & Millibars	Yes	10-05374	\$649.00
Yes	20,000 ft, Inches	No	10-05372	\$844.00
Yes	20,000 ft, Millibars	No	10-05373	\$649.00



SKYSPORTS 3-1/8" NON-SENSITIVE ALTIMETERS

Skysports non-sensitive altimeters feature a single pointer and barometric window. These altimeters are lightweight, and very accurate, making them ideal for a wide variety of experimental and ultralight aircraft. The setting knob allows the pilot to set the barometric pressure or field elevation. Non-TSO'd **Length:** 2-3/8". **Weight:** 10.7 oz

Gauge Size	Range	Part No.	Price
3-1/8"	10,000 ft/ 20,000 ft, Inches	10-05367	\$372.00
3-1/8"	6,000 ft, Millibars	10-05366	\$285.95



SKYSPORTS 3 1/8" SINGLE RANGE AIRSPEEDS

Skysports airspeed indicators are lightweight, reliable, and are housed in short length aluminum cases. They give accurate indications at slow speeds and are available in a variety of ranges. These airspeed indicators are excellent for a wide range of experimental and ultralight aircraft. Non-TSO'd. **Size:** 3 1/8" **Length:** 3.5in/97.3mm **Weight:** 10.2oz/290g

Model No.	Length	Range	Part No.	Price
BK-33	97.3mm	20-180 MPH	10-05394	\$322.00
BK-9C	58mm	20-180 MPH	10-05409	\$285.95
BK-7B	58mm	20-120 MPH	10-05406	\$310.00
BK-31	97.3mm	20-140 MPH	10-05392	\$321.00
BK-6C	58mm	20-150 MPH	10-05405	\$404.00
BK-12	58mm	20-80 KNT	10-05381	\$310.00
BK-13A	58mm	20-100 KNT	10-05384	\$310.00
BK-14A	58mm	0-120 KNT	10-05386	\$278.95
BK-3A	97.3mm	20-140 KNT	10-05399	\$312.00
BK-15	97.3mm	0-160 KNY	10-05387	\$280.95
BK-34	97.3mm	30-180 KNT	10-05395	\$324.00
BK-5A	97.3mm	30-220 KNT	10-05404	\$322.00
BK150-1A	58mm	30-150 KPH	10-05388	\$322.00
BK200-1A	58mm	0-200 KPH	10-05389	\$318.00
BK300	58mm	40-300 KPH	10-05391	\$322.00



SKYSPORTS 2-1/4" SENSITIVE ALTIMETERS

Skysports sensitive altimeters feature three pointers and knob to set correct barometric pressure enroute and destination. High quality sensitive altimeters which are in use in thousands of experimental aircraft worldwide.

Non-TSO'd **Length:** 2-3/8" **Weight:** 3.6 oz.

Size	Range	Part No.	Price
2-1/4"	6,000 ft, Millibars	10-05369	\$332.00



SKYSPORTS NON TSO 2-1/4" ALTIMETER

Skysports NON TSO 2-1/4". Barometric Altitude Indicator - 3000 meters. Millibar Scale.....P/N 10-05441 **\$322.00**



SKYSPORTS 3-1/8" DUAL AIRSPEEDS

Skysports dual dial airspeeds provide the pilot with airspeed indications in MPH and Knots, and are housed in a lightweight, durable aluminum case. These airspeed indicators are ideal for a wide variety of experimental aircraft flying at higher cruise speeds. Non-TSO'd. **Weight:** 10.5 oz / 301g. **Length:** 2.2" or 56.5mm **Size:** 3 1/8" **Length:** 3.5" or 97.3mm **Weight:** 10.5 oz / 301g

Model No.	Range	Part No.	Price
BK-3	120-160 MPH/20-140 KNT	10-05390	\$320.00
BK-4	30-180 MPH/30-160 KNT	10-05400	\$327.00
BK-10	30-200 MPH/30-180 KNT	10-05380	\$327.00
BK-5	30-250 MPH/30-220 KNT	10-05402	\$325.00

Skysports Instruments are made in China.

WWW.AIRCRAFTSPRUCE.COM

Prices Subject to Change Without Notice - Valid as of June 3, 2022.

SKYSPORTS NON-TSO'D INSTRUMENTS



SKYSPORTS VERTICAL CARD COMPASSES

The Skysports Vertical Card compass features a 2 inch vertical card dial which presents the entire 360 degree heading range at all times for easy interpretation. It is a dry compass which eliminates the leaking and much of the precessing common in wet compasses.
Lighted 12VDC.
Non-TSO'd.

Description	Part No.	Price
Northern Hemisphere, Compass Only	10-04173	\$329.00
Northern Hemisphere, Compass & Mounting Bracket	10-05425	\$345.00
Southern Hemisphere, Compass Only	10-05426	\$338.00
Southern Hemisphere, Compass & Mounting Bracket	10-05427	\$270.95



SKYSPORTS PANEL MOUNT COMPASSES

Skysports aircraft compasses are similar in design and function to the industry standard C2300 and C2400 series compasses. High quality and economically priced. Error of the compass is no more than 2.5 degree; Friction error is no more than 1 degree; When an aircraft tilts for 10, the error is no more than 4 degree; Ambient temperature is -55TO +60 degree centigrade.
Non-TSO'd.
Size: 2-1/4"
Mount: Panel Mount (Lighted or unlighted)
Weight: 6.9oz/198g

Description	Part No.	Price
Northern Hemisphere, Not Lighted	10-05412	\$108.75
Northern Hemisphere, 12V-24V Lighted	10-05413	\$114.85
Southern Hemisphere, Not Lighted	10-05415	\$113.95

FLYEFII DUAL SYSTEM32 ENGINE MANAGEMENT SYSTEM



The FlyEFii System32 Engine Management System Hardware is the first electronic engine management system ever designed specifically for the needs of experimental aviation. System32 is a state of the art, high speed, fully redundant system that represents the fulfillment of a ten year wish list of functionality. Dual 32 bit high speed ECUs and a sunlight readable graphical LCD Cockpit Controller combine for seamless power and efficiency in managing your engine's electronic fuel injection and electronic ignition functions. System32 will

be offered in ignition only and full ignition + injection versions.

Description	Part No.	Price
EFii System 32 4 Cylinder Lycoming	07-19980	\$6,795.00
EFii Dual Ignition Dual ECU 4 Cylinder Lycoming Ignition and Injection	07-19978	\$3,061.00
EFii System 32 6 Cylinder Lycoming	07-19981	\$8,295.00
EFii Dual Ignition Dual ECU 6 Cylinder Lycoming Ignition and Injection	07-19979	\$3,776.00

SKYSPORTS 2-1/4 OIL TEMP 50-150C 120-300°F



2-1/4" Oil Temp Gauge, 50-150° C / 120-300°F
P/N 10-05950 **\$77.95**

SKYSPORTS 2-1/4 ROTOR TACHOMETER & SENDER 0-700 RPM



2-1/4", 0-700 RPM P/N 10-05947 **\$160.75**

SKYSPORTS 2-1/4 OIL PRESSURE GAUGE 0-10 BAR 0-145 PSI



2-1/4" Oil Pressure Gauge, 0-10 BAR 0-145 PSI
P/N 10-05951 **\$88.75**



SKYSPORTS 2-1/4 CHT 50-150C 120-300°F

2-1/4" CHT Gauge, 50-150C / 120-300F P/N 10-05948 **\$75.75**



SKYSPORTS ROTAX 582 TACHOMETER 2-1/4 0-8000 RPM

Tachometer 2-1/4", 0-8000 RPM, 9-30 VDC P/N 10-05946 **\$100.85**

IN

Skysports Instruments are made in China.

SWIFT INSTRUMENTS

SWIFT AIRSPEED INDICATORS



2-1/4"



3-1/8"

2-1/4 INCH

Model No.	Description	Part No.	Price
ASI2-120M	0-120 MPH	10-06290	\$197.75
ASI2-120N	0-120 Knots	10-06291	\$197.75
ASI2-160K	0-160 KPH	10-06292	\$174.90
ASI2-160M	0-160 MPH	10-06293	\$227.95
ASI2-160N	0-160 Knots	10-06294	\$197.75
ASI2-200K	0-200 KPH	10-06295	\$174.90
ASI2-200M	0-200 MPH	10-06296	\$197.75
ASI2-200N	0-200 Knots	10-06297	\$174.90

3-1/8 INCH

Model No.	Description	Part No.	Price
ASI3S-80M	0-80 MPH	10-06331	\$198.75
ASI3S-100M	0-100 MPH	10-06311	\$227.95
ASI3S-120M	0-120 MPH	10-06314	\$197.75
ASI3S-140M	0-140 MPH	10-06316	\$227.95
ASI3S-160M	0-160 MPH	10-06319	\$227.95
ASI3S-180M	0-180 MPH	10-06321	\$174.90
ASI3S-200M	0-200 MPH	10-06324	\$174.90
ASI3S-120K	0-120 KPH	10-06313	\$174.90
ASI3S-160K	0-160 KPH	10-06318	\$174.90
ASI3S-200K	0-200 KPH	10-06323	\$174.90
ASI3S-220K	0-220 KPH	10-06326	\$174.90
ASI3S-250K	0-250 KPH	10-06327	\$174.90
ASI3S-300K	0-300 KPH	10-06328	\$174.90
ASI3S-350K	0-350 KPH	10-06329	\$174.90
ASI3S-400K	0-400 KPH	10-06330	\$174.90
ASI3S-80N	0-80 Knots	10-06332	\$174.90
ASI3S-100N	0-100 Knots	10-06312	\$174.90
ASI3S-120N	0-120 Knots	10-06315	\$174.90
ASI3S-140N	0-140 Knots	10-06317	\$174.90
ASI3S-160N	0-160 Knots	10-06320	\$174.90
ASI3S-180N	0-180 Knots	10-06322	\$174.90
ASI3S-200N	0-200 Knots	10-06325	\$174.90

SWIFT SWITCHABLE AIRSPEED INDICATORS



These 3-1/8" Airspeed Indicators can be switched between MPH, KPH, and Knots scales.

Model No.	Description	Remarks	Part No.	Price
ASI3-80	0-80 MPH/KPH/Knots	Unit Switchable	10-06310	\$281.95
ASI3-100	0-100 MPH/KPH/Knots	Unit Switchable	10-06298	\$281.95
ASI3-120	0-120 MPH/KPH/Knots	Unit Switchable	10-06299	\$281.95
ASI3-140	0-140 MPH/KPH/Knots	Unit Switchable	10-06300	\$281.95
ASI3-150	0-150 MPH/KPH/Knots	Unit Switchable	10-06301	\$281.95
ASI3-160	0-160 MPH/KPH/Knots	Unit Switchable	10-06302	\$281.95
ASI3-180	0-180 MPH/KPH/Knots	Unit Switchable	10-06303	\$281.95
ASI3-200	0-200 MPH/KPH/Knots	Unit Switchable	10-06304	\$281.95
ASI3-220	0-220 MPH/KPH/Knots	Unit Switchable	10-06305	\$281.95
ASI3-240	0-240 MPH/KPH/Knots	Unit Switchable	10-06306	\$281.95
ASI3-260	0-260 MPH/KPH/Knots	Unit Switchable	10-06307	\$281.95
ASI3-300	0-300 MPH/KPH/Knots	Unit Switchable	10-06308	\$281.95
ASI3-400	0-400 MPH/KPH/Knots	Unit Switchable	10-06309	\$281.95

SWIFT ALTIMETER AND BAROMETERS



2-1/4"



3-1/8"

2-1/4 INCH

Model No.	Description	Remarks	Part No.	Price
ALT2-10F1	10,000 FT 1 Pointer	Barometric unit switchable: mb/inHg	10-06284	\$238.95
ALT2-1.5M1	1,500 M 1 Pointer	Barometric unit switchable: mb/inHg	10-06283	\$210.95
ALT2-3M1	3,000 M 1 Pointer	Barometric unit switchable: mb/inHg	10-06285	\$210.95
ALT2-5F1	5,000 FT 1 Pointer	Barometric unit switchable: mb/inHg	10-06286	\$210.95

3-1/8 INCH

Model No.	Description	Remarks	Part No.	Price
ALT3-40f3	40,000 FT 3 Pointer	Barometric unit switchable: mmHg/inHg/mb	10-06256	\$437.00
ALT3-10F2	10,000 FT 2 Pointer	Barometric unit switchable: mmHg/inHg/mb	10-06287	\$515.00
ALT3-10M2	10,000 M 2 Pointer	Barometric unit switchable: mmHg/inHg/mb	10-06288	\$450.00
ALT3-10M3	10,000 M 3 Pointer	Barometric unit switchable: mmHg/inHg/mb, 100m/circle	10-06289	\$437.00

SWIFT VERTICAL SPEED INDICATORS



2-1/4"



3-1/8"

2-1/4 INCH

Model No.	Description	Part No.	Price
VSI2-10MS	2000 ft/min	10-06348	\$327.00
VSI2-20FM	10 m/sec	10-06349	\$317.00

3-1/8 INCH

Model No.	Description	Remarks/Depth	Part No.	Price
VSI3-10MS	10 m/sec	56mm	10-06350	\$240.95
VSI3-20MS	20 m/sec	Large Range/96mm	10-06352	\$240.95
VSI3-30MS	30 m/sec	Large Range/96mm	10-06354	\$240.95
VSI3-20FM	2000 ft/min	56mm	10-06351	\$239.00
VSI3-30FM	3000 ft/min	96mm	10-06353	\$240.95
VSI3-60FM	6000 ft/min	Large Range/96mm	10-06355	\$240.95
VSI3S-10MS	10 m/sec	56mm	10-06461	\$192.75
VSI3S-20FM	2000 ft/min	56mm	10-06462	\$217.95
VSI3S-30FM	3000 ft/min	56mm	10-06463	\$192.75

INSTRUMENT MOUNTING & ADAPTER KITS

INSTRUMENT MOUNTING KITS

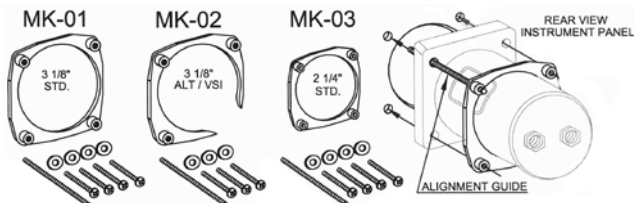

Kits come with "special" self-locking black pan head screws and nylon washers

Precision machined "Nut Ring" instrument mounting kit. Designed to slide on from the back side of the instrument using the alignment guide pin inserted through a screw hole. Pulling on the alignment pin from the front side of the panel allows you to hold the instrument in correct alignment in the panel. Specially designed self-locking pan head black brass mounting screws and nylon washers are then easily installed from the front. Countersunk self-locking black brass screws are also available. Extra screws & washers are sold in packs of 12. The nylon washer keeps from chipping the instrument panel. All self-locking screws are extra long to accommodate the extra thickness of light wedges and internally lighted instruments. Nut Rings can be installed without removing hoses, tubing, or electrical connections. Designed to replace "grasshopper nuts". PMA'd.

Alignment guide pin sold separately. (P/N 10-03696)

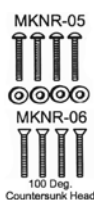

Model	Description	Part No.	Price
MK-01	3-1/8" Std.	10-00335	\$16.70
MK-02	3-1/8" ALT/VSI	10-00336	\$16.70
MK-03	2-1/4" Std.	10-00337	\$16.70
MKNR-05	Pan Head Screws	10-00338	\$13.50
MKNR-06	Countersunk Screws	10-00339	\$15.50
Accessories			
AP-01	Alignment Mounting Kit	10-03696	\$1.95

"EZ NUTS" INSTRUMENT MOUNTING SYSTEM BY SPT

Take the frustration out of mounting instruments with the use of Superior Panel Technology's EZ Nuts. Adhesive tape securely holds nut ring in place. No realignment if instrument is later removed. Aluminum bezel is treated to prevent corrosion. The pressed in stainless steel inserts eliminate the problem of striped threads. Simply cut off one corner if only three screws are needed. Save labor time when compared to "grasshopper nuts".

Includes four 1-1/2" non-magnetic black oxide stainless steel, pan-head screws. Stronger than brass. Includes four black nylon washers to prevent marring of the panel.

*100 degree countersunk screws available and are sold in packs of eight.
 3-1/8" BezelP/N 11-01830\$9.90
 2-1/4" BezelP/N 11-01831\$9.90
 Black-Oxide Stainless Steel Countersunk screw package (set of 8)P/N 11-06546\$4.95
 Black-Oxide Stainless Steel Pan head screw package - Note: Includes eight black nylon washers that will enhance the appearance of the panel and will prevent the marring and scratching of the panel during instrument installation and removal.
 (set of 8)P/N 11-09911\$2.95

PITOT TUBE PROTECTORS

These hinged pitot tube protectors open automatically in take off at speed of about 40 mph and close automatically at end of landing roll.

Model No.	Part No.	Fits Pitot Tube Sizes	Price
1	10-02000	1/4" O.D.	\$14.60
2	10-02100	1/2" O.D.	\$14.85
3	10-04968	3/16" O.D.	\$14.85

REMOVE BEFORE FLIGHT RIBBON



This 3" x 24" orange vinyl streamer with black letters, features a grommet for a clip ring to attach anywhere on the aircraft. High visibility, fire resistant material.P/N 15200\$19.50

INSTRUMENT ADAPTER KITS

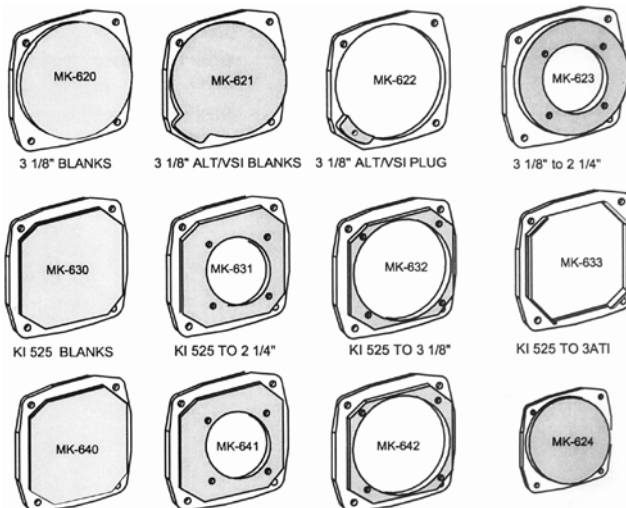

CNC Machined from aircraft grade aluminum. The adapter face is raised .075" to give the flush panel look. Easy to install and easily painted.

See www.aircraftspruce.com for specifications.

Model	Description	Part No.	Price
MK-620	3-1/8" Blank	10-00340	\$18.75
MK-621	3-1/8" ALT/VSI Blank	10-00341	\$18.75
MK-622	3-1/8" ALT/VSI Plug	10-00342	\$23.95
MK-623	3-1/8" to 2-1/4"	10-00343	\$23.95
MK-624	2-1/4" Blank	10-00344	\$18.75
MK-630	KI525 Blank	10-00345	\$18.75
MK-631	KI525 to 2-1/4"	10-00346	\$21.85
MK-632	KI525 to 3-1/8"	10-00347	\$23.95
MK-633	KI525 to 3 ATI	10-00348	\$22.60
MK-640	3 ATI Blank	10-00349	\$18.75
MK-641	3 ATI to 2-1/4"	10-00350	\$23.95
MK-630	3 ATI to 3-1/8"	10-00351	\$23.95

PITOT TUBE COVERS



PITOT TUBE BOOTY - Durable leather-like cover provides optimum protection. Velcro strap attaches booty to 5/8" or 11/16" dia. L-shaped pitot tube. Bright red "Remove Before Flight" streamer. Made of flame-proof & weather-resistant National Aerospace materialP/N 15210\$5.95

SLIP-ON PITOT TUBE COVER - Not shown. Same as above except is slip fit over 1/4" or 1/2" dia. pitot tube. Red "Remove Before Flight" streamer is attached to cover. Made of flame-proof and weather-resistant National Aerospace materialP/N 15220\$6.95

DEGROFF'S PITOT SHIELDS



PITOT SHIELDS are a "fail-safe" pitot tube cover that will protect the pitot tube from contamination by insects, debris and ice while the airplane is on the ground. It is friction-fit to the pitot tube and has a calibrated "flat-plate-forward" design that, upon reaching a specific velocity, will release from the pitot tube and fall harmlessly away, allowing for normal airspeed indications. The cover utilizes EVA foam that is UV resistant and stable at temperatures reached by heated pitot tubes. It is a highly visible color with the words "REMOVE BEFORE FLIGHT" printed and visible from all directions. This pitot tube cover is soft, but tough. It will not damage aircraft surfaces when it comes off during ground roll, nor will it be a potentially hazardous foreign-object on the runway.

For 5/8" pitot tubeP/N 10-00491\$25.50
 For 3/4" pitot tubeP/N 10-00492\$26.50
 For Piper pitot tubeP/N 10-00493\$23.95

ALUMINUM PITOT MAST



Custom manufactured aluminum pitot mast designed for the popular Van's Aircraft RV kit aircraft. Aluminum streamline tubing is correct size for all popular pitot tubes. Aluminum mounting plate is .070" thick aluminum, precision welded to the tubing. Mounting plate measures 3" wide X 4" long. Streamlined mast is 5" long. The mounting plate has a jog on the forward side to overlap the spar flange inside the wing. This mast can be used on other popular aircraft that require a mast for the pitot tube. Blue anodized finish. Mounting instructions and template included. Made in the USA.P/N 12-04764\$71.85

PITOT TUBES

UNHEATED PITOT TUBES



STRAIGHT TYPE – Flange-mounted through leading edge of spar. Aluminum tube 24" long, 1/4" dia. May be cut to shorten.
P/N 15133 **\$22.50**



L-SHAPED TYPE – Flange mounted L-shaped model for under-the-wing mounting. 1/4" dia. aluminum tube.
P/N 15135 **\$31.75**



L-SHAPED PITOT-STATIC TUBE – Same design with static tube added. For pitot tube cover order #15220 or 10-02100 (flip up).....P/N 15144 **\$37.80**



STRAIGHT TYPE PITOT-STATIC TUBE

Clamp-mounted for leading edge of wing. 14-1/2" long. May be shortened, formed or shaped to best angle of attack. 1/4" dia. aluminum tubes. All installation hardware furnished.
P/N 10-01800 **\$29.70**



STRUT TYPE PITOT-STATIC TUBE – Simple L-shaped design for clamping to strut. 1/4" dia. aluminum tubes.
P/N 10-01900 **\$38.00**



MAST-MOUNT PITOT TUBE

Designed for mounting in 3/4" O.D. x .049" wall aluminum tubing (not furnished). Machined from solid aluminum. Includes Polyethylene hose fitting for 1/4" I.D.....P/N 15170 **\$39.95**



RAVEN PITOT STATIC TUBE

Pitot system combines pitot and static functions in one tube. Used for years on many different aircraft. Comes complete with mounting block to install it.
P/N 10-00476 **\$323.00**



PITOT STATIC SUMP BOTTLE

This pitot-static sump bottle collects moisture in the aircraft's static system which prevents water damage to panel mounted instruments. Used in many Cessna aircraft. Measures 1.625" dia. x 4.75" long. Thread size: 7/16-20 for a nylon fitting & 1/8" NPT to the static portP/N 10-00630 **\$19.95**

STATIC PORTS



Aluminum static port for mounting through 9/16" dia. hole in side of fuselage. Base has 1/8" NPT female port for connecting to static line (polyethylene fitting included). Install with 3/32" dia. flush rivets.....P/N 15160 **\$19.95**

Aluminum static port mounts from outside of fuselage through 9/16" dia. hole. Secure to skin with 9/16" Pal nut & lock washer on inside. Includes (1) 0700-153 polyethylene fitting.
KitP/N 15165 **\$22.95**
Static port only.....P/N 10-00658 **\$21.50**



Aluminum static port mounts from outside of fuselage through .560 dia hole. Secure with four countersunk 1000 3/32" rivets. Includes one 0700-153 polyethylene fitting.
P/N 15175 **\$22.95**

Aluminum single engine Cessna type static port. External mounted through a 19/64" hole. Can be used on fabric, composite or aluminum. No need for rivets. 1-3/8" dia.x1" depth. Ideal for homebuilts of all types....P/N 10-00250 **\$17.75**

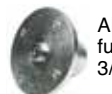

Aluminum static ports mount 1-1/4" base OD from outside of fuselage through 5/16" ID hole. Secure with 4 countersunk 3/32" rivets to skin with pal nut & lock washer on inside.
P/N 10-00659 **\$18.55**

Aluminum static ports mount 1-1/4" base OD from outside of fuselage through 5/16" ID hole. Secure with 4 countersunk 3/32" rivets to skin with pal nut & lock washer on inside.
P/N 10-00660 **\$21.50**

BOND-IN STATIC PORT SET



This aluminum static port is designed for high performance composite aircraft. Simply bond through the fuselage from the outside. Base has a 1/8" NPT for connecting to the static line. Furnished with installation instructions. Sold in set of 2.P/N 10-00229 **\$48.90**

WINTER PITOT TUBE



The pitot tube is the sensor for aircraft instruments. It consists of a cylindrical tube open at the front to sense total pressure (measuring pressure for airspeed indicators) and slotted along the sides to sense static pressure. These pressures must then be carried to the instruments by hoses. Pitot TubeP/N 10-03854 **\$65.75**
Venturi Tube.....P/N 10-03855 **\$57.75**

HEATED PITOT TUBES



AN5812 PITOT TUBE - This heated pitot tube mounts under the wing. Used on Mooney, Beech, Piper, Maule, American Aviation aircraft, Glasair & Glastar. Threaded outlet fits 1/4" size AN tube fittings. Use 2.023x.857x.049 4130 Streamline Tubing to fabricate mount.

(12V) (10 amp.)P/N AN5812-12 ... **\$3,455.00**
(24V) (15 amp.)P/N AN5812-1 **\$2,095.00**
Phenolic connector receptacleP/N 10-00032 **\$92.75**



AN5813-1 PITOT TUBE - The AN5813-1 (PH500) is the standard replacement heated pitot tube for twin Cessnas with 24V systems. Draws 3-4 amps and measures 93/4" long. Mounts in 1.18 diameter tube. Dull finishP/N 10-00064 **\$3,395.00**



FALCON HEATED PITOT TUBES

The AN5812 heated pitot tube has been used on a wide variety of aircraft over the years and is now available for experimental aircraft. Made from brass and weighing 1.5 lbs, these imported pitot tubes meet the AN specifications. Made in China.

Model No.	Description	Part No.	Price
12-AN5812	12V, standard	10-00984	\$689.00
12-AN5812-1	12V, Long Pipe for RV's	10-04199	\$689.00
24-AN5812-1	24V Long Pipe for RV	10-05820	\$880.00
12-AN5812-2	12V, left and right drain holes	10-04201	\$880.00
24-AN5812	24V, standard	10-00985	\$795.00
24-AN5812-2	24V, left and right drain holes	10-04202	\$679.00
PT-001	non-heated, 1 drain hole	10-04224	\$417.00

FALCON GAUGE PITOT TUBE MOUNTING BRACKET



Works with heated and non-heated tubes. Aluminum Alloy Standard Mounting Bracket
P/N 10-01063 **\$82.75**
Mounting Bracket for RV's.....P/N 10-02276 **\$116.75**

GRETZ GA-1000 HEATED PITOT TUBE



Molded from a very high-tech polymer material. Electronics embedded in the Pitot tube. Comes with a small electronic control module to control the heat of the Pitot and information to the pilot regarding performance. A LED board that will mount conveniently on the panel. Will fit the Gretz mounting bracket kits. Come with the electronic control module, the LED board and cable, Pitot mounting screws, electronic control module mounting hardware, and complete instructions for installation and use.....P/N 10-01715 **\$425.00**

GRETZ GA-500 UNHEATED PITOT TUBE FOR EXPERIMENTAL AIRCRAFT ONLY

Same shape and color as the heated GA-1000 Pitot tube, but does not include the heater, electronic instructions, etc. It will mount into the same Gretz mounting bracket kits.P/N 10-01716 **\$149.85**

WELDED PITOT TUBE ASSEMBLY



This non-heated non-IFR welded pitot tube assembly. It is intended for the experimental VFR aircraft market. The tube and mast are from 4130 tube welded in a fixture to assure alignment. The orifice is produced from aircraft grade aluminum. The pressure tube is polyethylene for easy connection to the aircraft pitot system.

Dimension: 6" x 5" x 2-1/2".....P/N 10-03637 **\$175.75**

PITOT TUBE KIT



1/4" Aluminum Tubing (03-39300). Vinyl Tube for ASU (AS010.2). 1/4T x 1/8P Polyethylene Hose Adapter (0700-153). 3/8" ID Snapper Clamp (05-00940).....P/N AS010.4 **\$9.65**

PNEUMATIC TOGGLE SWITCHES



2-Way Toggle Switch, (1/8" NPT Male Inlet) for alternate static air source.
Steel.....P/N 11-12169 **\$25.70**
PlasticP/N 11-12168 **\$22.50**

ANGLE OF ATTACK INDICATORS

BENDIX KING KLR 10 LIFT RESERVE INDICATOR



The easiest stall to recover is the one that never happens. The KLR 10 Lift Reserve Indicator provides at-a-glance awareness and audible cues of remaining lift, in an easy-to-install, easy-to-read device that's ready for your experimental aircraft. Mounted on the glare shield, it's at eye-level, exactly where you need it. Helping you takeoff with confidence, grease more landings and fly with better Angle of Attack.

The KLR 10 Advantage: Lightweight, Low-cost, easy installation with low power consumption. Accurate and instantaneous displays of lift reserve, which is the safety margin above a stall. Visual and audible cues alert you of decaying lift much earlier than traditional warning systems. Allows for quick and timely reactions. Independent of pilot-static systems, so it can be used even if the existing air-data system is compromised by ice, water or other contaminants. Optional heated probe.

12V Standard Probe, Swivel Mount	11-12949	\$2,825.00
12V Heated Probe, Swivel Mount	11-12945	\$1,755.00
24V Heated Probe, Swivel Mount	11-12946	\$3,062.00
12V Heated Probe, Standard Mount	11-12947	\$2,286.00
24V Heated Probe, Standard Mount	11-12948	\$1,595.00

Accessories

Heated Probe Option, +12vDC	11-12024	\$269.95
Angle of Attack Probe Cover with flag	11-12027	\$37.95
Swivel Mount	11-12028	\$86.75

ANGLE OF ATTACK CYA 100



The CYA-100 Angle of Attack system is the only affordable FAA APPROVED TRUE Angle of Attack system on the market today! Extremely light, and extremely small, the CYA-100 is easy to install, with no extra computer boxes or hoses. The vane driven sensor is magnetically coupled. There are no small pressure ports to plug and no ball bearings to seize.

P/N 10-05682**\$625.00**

RITEANGLE™ BASIC SYSTEM AOA



The RiteAngle Basic, is a high quality AOA system for aircraft without flaps. This is the most accurate low cost AOA system available to customers today.

Note: The Basic system is for aircraft without flaps only. The RiteAngle™ Basic uses electronics not available during earlier designs of RiteAngle™ systems. Although operationally similar to prior RiteAngle products, the RiteAngle Basic is a totally new, more efficient, economical design. It is a modern up to date system, that accurately determines your aircraft's angle of attack. This series uses our proven, easy-to-understand, five LED display. Green indicates Safe, Amber indicates Caution, and Red indicates Danger. The "On Speed" AOA, 1.3 Vso will be correct, regardless of bank angle, density altitude, or any of the other variables where the airspeed might be inaccurate.

P/N 11-10388**\$395.00**

RITEANGLE™ BUDDY AOA



The RiteAngle™ Buddy also uses electronics not available during design of the initial RiteAngle™ systems. Although it is similar to the prior RiteAngle systems, for aircraft with no flaps, The RiteAngle Buddy operationally, is a totally new design using an enhanced display. **Note: The Buddy**

is for aircraft without flaps only. The RiteAngle™ Buddy is a modern, up to date system that accurately determines your aircraft's angle of attack. This series uses an improved easy-to-understand LED display. This instrument is designed to FAA standards. Green indicates safe, amber indicates caution, and red indicates danger.

P/N 11-06626**\$549.00**

Ema AOA Basic And Buddy Sensor.....P/N 11-10392**\$50.00**

RITEANGLE™ ELITE SYSTEM AOA



With the RiteAngle Elite system you have the advantage of having a system which was designed to the FAA guidelines for use on certified aircraft, without all the expense of tracking of parts and having it assembled by a PMA facility, and of course not having to pay for the time, effort, and work involved in getting the STC!

The RiteAngle™ Elite is a modern, up dated system that accurately determines your aircraft's angle of attack. Easy to understand - Green Safe, Amber Caution, Red Danger. There are no computed values, the vane actually measures the relative wind.

Elite+ AOA System.....	P/N 11-10389	\$995.00
Ema AOA Small Vane Option.....	P/N 11-10390	\$85.95
Ema Elite Enhanced Display Opt.....	P/N 11-10391	\$200.00

LIFT MONITOR SYSTEM



Lift Monitor is FAA approved for installation on all GA aircraft, not just experimentals. The low cost of the Lift Monitor and simplicity of installation leave little excuse for not availing yourself of the safety and performance afforded by an AOA system. Working completely independently of all other aircraft systems, installation requires only a log book entry on the part of your mechanic.

Lift Monitor models are available as either a panel mount or glare shield installation. Adapters are provided for existing 2 1/4" and 3-18" instrument holes. A "Remove Before Flight" protective cover for the probe is included with each system.

Description	Part No.	Price
Monitor System With Panel Mount Kit	05-14964	\$389.00
Monitor System With Glare Shield Mount Kit	05-14966	\$389.00

SAFE FLIGHT PRE-STALL WARNER



Warns by light and horn of any danger of an approaching stall regardless of the flight maneuver. Never signals unless a stall is imminent. Consists of an instrument panel unit (fits standard 2.25" hole) containing a warning horn & signal light, and a small vane wing unit which operates a relay. Operation of the instrument doesn't depend upon air speed but rather on the air flow conditions of the wing. Complete with installation kit & instructions. Installation time: 2-6 hours.

Description	Model	Part No.	Price
Horn & Light	R (12V)	10-22712	\$2,449.00
	S (24V)	10-22724	\$2,465.00

SAFE FLIGHT SCC LEADING EDGE AOA SYSTEM



The SCc system is tailored specifically for certified aircraft in the general aviation market. In designing the SCc, Safe Flight built on its nearly 70 years of experience in providing aircraft manufacturers primary stall warning and AoA utilizing our patented wing lift sensor technology. The SCc system is comprised of a Lift Transducer mounted on the leading edge of the wing and an Indexer Computer that provides a heads-up display of AoA. The SCc system delivers precise AoA information to help achieve consistent takeoff, climb, cruise, and landing approach performance through an innovative visual display and audio output. Simply stated, the SCc was designed by pilots, for pilots. The system is the most accurate and comprehensive Angle of Attack system available for your aircraft.

Note: The SCc was recently approved for use in certified aircraft. There are no STC's available. Approval is limited to single engine aircraft. Check "Application Guide" located on our website to verify eligibility.....P/N 11-13582**\$2,875.00**

STALL HORN TESTER



Quickly and easily test your stall warning horn without inhaling bugs or putting your mouth on a freezing wing. With the stall warning horn tester you no longer need a ladder to test stall horn on high wing aircraft.

It is an FAA requirement that you test the stall warning device before flight. This effective device eliminates the old way of testing the stall horn - by simply depressing the bellow and releasing the bellow "quickly". Instantly, you can tell if the stall warning horn is functioning. Thousands of this product have been sold throughout the world. The compact size allows you to store it in your flight bag or aircraft compartment.

P/N 14-01021**\$9.95**

THE REDDISH STALL WARNER



Developed in the UK by Nigel Reddish, these stall warners have been installed in many RV series aircraft. The vane is ground adjustable and installation is simple. Includes a micro switch and vane. For experimental aircraft only.

Note: The Mark 2 Version is practically the same as the Mark 1, the only difference is the vane on the Mark 2 is longer. The installation is the same as the Mark 1 only.

Mark I	P/N 10-00189	\$105.75
Mark II	P/N 10-02686	\$104.95

IN

ANGLE OF ATTACK INDICATORS

ALPHA SYSTEMS AOA FALCON KIT



(H: 2.5" D: 1.25" W: 0.865" Weight: Less than 3.00 lbs) Kit Features The Falcon display is a Light Bar Style display with a remote switch panel. With the Falcon display, when you come in for a landing you want to fly to the blue LED (on speed for landing). Should you come in with too low of an angle of attack, the display will illuminate into the yellow, telling you to put your nose up. Should you come in with too high of an angle of attack, the display will illuminate red, telling you to put your nose down.

Standard.....P/N 11-12667**\$2,173.00**
 Pressurized.....P/N 11-13468**\$2,898.00**
 Pressurized Kit With Hud.....P/N 11-17380**\$3,261.00**
 Pressurized Kit With Hud & Mount.....P/N 11-17379**\$2,799.00**

ALPHA SYSTEMS AOA EAGLE KIT



(H: 2.5" D: 1.25" W: 0.865" Weight: Less than 3.00 lbs) Kit Features - The Eagle Display is a Chevron plus Diamond Style display with a remote switch panel. With the Eagle Display, when you come in for a landing you want to fly to the blue donut (on speed for landing). Should you come in with too low of an angle of attack, the yellow chevron will light up and tell you to put your nose up. Should you come in with too high of an angle of attack, the red chevron will light up and tell you nose down.

Standard.....P/N 11-12666**\$2,174.00**
 Pressurized.....P/N 11-13466**\$2,898.00**

RITEANGLE™ INTEGRITY AOA SYSTEM FAA



Does the AOA system you are considering automatically correct for 5 positions of flaps? When you lower flaps you lower stalling AOA! Uses a vane like military and airliners. Automatically corrects for up to 5 flap positions. Designed to install easily. Many parts prefabricated. Nothing required to set up you didn't practice prior to solo! Accurate within 1 degree. Enhanced display. Modify your aerodynamics - Simply plug in set-box and reset i.e.: s.t.o.l. modification with stc. A "stand alone system". Does not tie into pitot or static lines.

P/N 11-14300**\$1,675.00**

CALL OR VISIT WWW.AIRCRAFTSPRUCE.COM FOR ADDITIONAL ALPHA SYSTEMS PARTS AND KITS.

GARMIN AOA SYSTEMS



Provides AOA with a single glance during critical flight phases. Intuitive display provides both visual and audible indications of AOA. Normalized AOA provides superior performance in all flight phases. Works with G3X™ systems with GSU 25 and GAP 26 – just add the indicator. Available for installation as a standalone system for GA aircraft. The GI 260 receives AOA input from a GSU 25 air data computer connected to a GAP 26 probe. Since these are key components of the G3X™ flight display system, pilots of experimental/amateur built aircraft can add the dedicated AOA indicator to their aircraft by connecting as few as 4 wires. For pilots of general aviation aircraft, the GI 260, GAP 26 and GSU 25 can be added as a complete package. A universal inspection plate mount is included to aid in installation.

Description	Part No.	Price
AOA System 14/28 Volt Unheated GAP 26, GI 260, GSU 25	10-05793	\$1,549.00
AOA System 14 Volt Heated GAP 26, GI 260, GSU 25	11-13453	\$1,699.00
AOA System 28 Volt Heated GAP 26, GI 260, GSU 25	11-16608	\$1,699.00

AOA EAGLE STANDARD KIT WITH HUD



The Eagle kit has a display that is a chevron plus diamond style display. With the chevron plus diamond display, when you come in for a landing you want to fly to the blue donut (on speed for landing). Should you come in with too low of an angle of attack, the yellow chevron will light up and tell you to put your nose up. Should you come in with too high of an angle of attack, the red chevron will light up and tell you nose down. This kit comes

with the HUD (Heads Up Display) adapter kit.

Standard Kit with HUDP/N 11-17377**\$2,695.00**
 Pressurized Kit with HUD.....P/N 11-17378**\$3,261.00**

AOA FALCON KIT WITH HUD



The Falcon kit has a vertical light bar style display. With the vertical light bar display, when you come in for a landing you want to fly to the blue LED (on speed for landing). Should you come in with too low of an angle of attack, the display will illuminate into the yellow, telling you to put your nose up. Should you come in with too high of an angle of attack, the display will illuminate red, telling you to put your nose down. This kit comes with the HUD (Heads Up Display) adapter kit.

Standard Kit with HUDP/N 11-17379**\$2,799.00**
 Pressurized Kit with HUD.....P/N 11-17380**\$3,261.00**

ALPHA SYSTEMS ANGLE OF ATTACK INDICATOR ACCESSORIES



Model Number	Description	Part No.	Price
DSTR-AOA-7000K	12VDC Heated AOA Probe	11-14694	\$435.00
DSTR-AOA-7001K	24VDC Heated AOA Probe	11-14693	\$200.00
DSTR-AOA-7001K-12V	12VDC Heated AOA Probe	11-17382	\$450.00
DSTR-AOA-7001K-24V	24VDC Heated AOA Probe	11-17383	\$400.00
AOA-4051	6" Round + 11ft. Additional Hose	11-09304	\$408.00
AOA-4046	3.5" Round	11-09303	\$408.00
AOA-4150	8" x 4.5" Elliptical + 11ft. Additional Hose	11-09305	\$408.00
AOA-4030E	AOA Probe Installation Kit (AOA Kit Standard Wing Components)	11-12677	\$271.95

ALPHA SYSTEMS MERLIN AOA KIT



The Merlin Display is a Light Bar Style display. With the Merlin display, when you come in for a landing you want to fly to the blue LED (on speed for landing). Should you come in with too low an angle of attack, the display will lit into the yellow, telling you to put your nose up. Should you come in with too

high an angle of attack, the display will be lit into the red, telling you to put your nose down.

Standard.....P/N 11-13472**\$2,173.00**
 Pressurized.....P/N 11-13473**\$2,898.00**

AOA HEATED PROBES



Heated Probe has a built in heater of 12V DC that minimizes the potential for ice build up on the leading edge of the probe. Probe comes complete with high temperature fittings and tubing. It is a drop in replacement and can be used or upgraded in the existing Alpha Systems AOA mounting plate.

12V Heated Probe.....P/N 11-14694**\$435.00**

COMPASSES



AIRPATH COMPASSES

Factory-new Airpath compasses as used in almost all production aircraft. 2.25" size.

Model	Mounting	Lighting	Part No.	Price
C2300	Panel	None	10-01340	\$209.00
C2300- S. Hemisphere	Panel	12V Red	10-01342	\$204.95
C2300-L4	Panel	12V Red	10-01341	\$247.00
C2300-L4- S. Hemisphere	Panel	12V Red	10-01387	\$243.95
C2400-L4P	Pedestal	12V Red	10-01343	\$279.00
C2400-L4P - S. Hemisphere	Pedestal	12V Red	10-01344	\$274.95
C2400-L4VT	Overhead	12V Red	10-01345	\$356.00
C2400-L4VT - S. Hemisphere	Overhead	12V Red	10-01346	\$356.00
C2200-L4 N. Hemisphere	Cessna "Bonded Bracket"	12V Red	10-00592	\$265.95
C2200-L4 S. Hemisphere	Cessna "Bonded Bracket"	12V Red	10-05355	\$266.95

BULBS FOR AIRPATH COMPASSES

14VP/N 11-04016 **\$0.95 ea** 28V P/N 11-04015.....**\$0.50 ea**

AIRPATH COMPASS REPAIR KITS

Kit consists of diaphragm, 1/2pt of compass fluid & face glass gasket.
 Repair Kit (with fluid).....P/N 10-08000.....**\$12.50**
 Repair Kit (without fluid).....P/N 10-08020.....**\$10.50**
 Compass Fluid: 1/2 Pint.....P/N 10-08100.....**\$2.40**
 Quart.....P/N 10-08200.....**\$9.50**
 Airpath Compass Deviation Card Holder.....P/N 10-01658.....**\$2.26**
 Deviation Card.....P/N 10-01659.....**\$0.95**
 CB21-914H - Inner gasket.....P/N 10-00505.....**\$11.65**
 C21-915G Spacer gasket.....P/N 10-00368.....**\$2.35**
 Diaphragm Only.....P/N 10-01386.....**\$14.50**
 Glass Compass Lens for C2300/C2400 series compasses.
 P/N 10-08010.....**\$27.90**



ECONOMY COMPASS SEAL KITS

Kit without fluid - includes: (2) Gaskets, (1) Deviation Card, (1) Diaphragm.....P/N 10-04943...**\$10.50**
 Kit with Fluid - includes: (2) Gaskets, (1) Deviation Card, (1) Diaphragm, (1) 1/2pint Compass Fluid.. P/N 10-04944...**\$12.50**



C2400 SERIES COMPASS HOUSINGS

C24-730A Housing for C2400L4P Top Panel Mount
 P/N 10-04696.....**\$33.50**
 C24-727A Housing for C2400L4VT Windshield Mount.
 P/N 10-04697.....**\$33.55**



C2400 W/R INNER CASE

This is inner case compass only. Designed to fit Airpath 2-1/4" as replacement only (for models 2400-L4VT, C2400-L4P).....P/N 10-04718.....**\$146.75**



FALCON AIRCRAFT COMPASSES

These compasses are very similar to the Airpath C2300 & C2400 style compasses above but are priced more economically. New manufacture. Not certified. Made in China.

Size	Model No.	Description	Part No.	Price
Northern Hemisphere				
2-1/4"	MCPN-2L	Panel Mount, Lighted	10-02069	\$123.75
2"	MCDN-2	Pedestal Mount	10-02071	\$127.85
2"	MCDN-2L	Pedestal Mount, Lighted	10-02070	\$132.95
Southern Hemisphere				
2-1/4"	MCPS-2	Panel Mount	10-02068	\$120.95
2-1/4"	MCPS-2L	Panel Mount, Lighted	10-02243	\$126.95
2"	MCDS-2	Pedestal Mount	10-01704	\$127.85
2"	MCDS-2L	Pedestal Mount, Lighted	10-05220-SO	\$134.85

FALCON VERTICAL CARD COMPASSES

It is easy to read presentation and see the complete 360 degree dial in proper relation to your aircraft heading. 14V, lighting. 2-1/4". Made in China.

Model	Description	Part No.	Price
MCVC-2L-A	N. Hemisphere Compass Only	10-05276	\$289.00
MCVC-2L-A-M	N. Hemisphere Compass & Bracket	10-04174	\$315.00
MCVC-2SL-A	S. Hemisphere Compass Only	10-04489	\$285.95
MCVC-2SL-AM	S. Hemisphere Compass & Bracket	10-04490	\$303.00
30-V-0001	Vertical Card Compass Universal Mounting Bracket	10-04175	\$31.50

PRECISION AVIATION COMPASS KEY

Precision Aviation PD-1 Compass Key.
 P/N 10-06424.....**\$1.94**



PRECISION VERTICAL CARD COMPASS

It is a dry compass, designed to replace the float/liquid type compass; no more leaking fluid or backward azimuth readings. It uses eddy current damping and as such has no overshoot. It consists of a 2" vertical rotating dial which is compared with a fixed miniature airplane (lubber line) to present the magnetic heading of the aircraft at all times.

Heading information is more natural because the heading is read at the 12 o'clock position and off the nose of the miniature aircraft. The compass card rotates and presents all quadrants in their true relation to line of flight. Requires no power (except for lighting) to operate. Fully TSO'd. Installed in many current production aircraft and helicopters. Size: 2-7/8"H x 2-3/8"W x 2-1/8"D. Wt. 0.6 lb. After installation, compass must be compensated using standard compensation procedures.

Bracket / mount is required for installation and is not included with unit.

Northern Hemisphere 14V.....P/N 10-00421.....**\$445.00**
 Northern Hemisphere 28V.....P/N 10-00423.....**\$445.00**
 Southern Hemisphere 14V.....P/N 10-00422.....**\$462.00**
 Southern Hemisphere 28V.....P/N 10-00424.....**\$466.00**

PAI-700 COMPASS REPLACEMENT LIGHT ASSEMBLY

14V.....P/N 10-00092.....**\$41.50**
 28V.....P/N 10-00093.....**\$41.50**
 5V Light Assy.....P/N 10-02956.....**\$42.75**

PRECISION COMPASS MOUNTS

PACMG-2 - Universal mount for many aircraft using a glare shield or deck mount. Models include Beech Baron and Bonanza, Cessna Skyhawk, Skylane and Cardinal.....P/N 10-07500.....**\$48.70**
PACMO-U - Universal overhead bracket kit for customer adaptation.
 P/N 10-07600.....**\$36.50**

PACMO-CESNO - Custom mount for several Cessna models using one-piece windshield & compass mounting block. Models include Cessna 150, 152, 170, 180, 182, 185 & 210.....P/N 10-07700.....**\$73.75**
PACMO-PIPER - Custom mount for several Piper models with 5/8" hat-section center windshield post. Models include Piper Cherokee, Warrior, Arrow, Archer, Lance, Comanche, Navajo & Cherokee Six.
 P/N 10-07800.....**\$61.80**

PACMO-APZ21 - Custom mount for use in Piper Apache, Aztec, & Cessna 421.....P/N 10-07910.....**\$60.75**
PACMO-SRN - Custom mount for use in Beech Sierra using windshield mount.....P/N 10-07920.....**\$61.80**
PACMO-KA - Beech King Air.....P/N 10-07921.....**\$59.75**
PACMO-EB - Early Bellanca. Compass mounted overhead.
 P/N 10-07922.....**\$68.75**

PACMO-LB - Late Bellanca. Compass mounted on windshield.
 P/N 10-07923.....**\$61.80**
PACMO-2CN - Cessna early 172, 182 with compass mounted on windshield with 1" center with 1" divider strip.....P/N 10-07924.....**\$61.80**
PACMO-340R - Cessna 340 Twin.....P/N 10-07925.....**\$86.75**
PACMO-310R - Cessna 310.....P/N 10-07926.....**\$71.75**
PACMO-GTR - Grumman Tiger, Cheetah.....P/N 10-07936.....**\$59.95**
PACMO-MHN - Mooney compass mounted on housing covering center post.....P/N 10-07927.....**\$60.75**
PACMO-HMN - Mooney compass mounted on center post with horizontal screws.....P/N 10-07928.....**\$73.75**
PACMO-VMN - Mooney compass mounted on center post with vertical screws.....P/N 10-07929.....**\$60.75**
PACMO-PCN - Comanche with no center post use PACMG-2, twin, SE.
 P/N 10-07931.....**\$61.80**

PACMO-R22 - Robinson R22.....P/N 10-07932.....**\$69.75**
PACMO-R44 - Robinson R44.....P/N 10-07933.....**\$69.75**
PACMO-RV6C - RV6 kit. (Sliding Canopy only, not tip-up)
 P/N 10-07934.....**\$68.75**

PACMO-HSN3A - 32.50 40.63 Schweizer 300 & 300 CB.
 P/N 10-07935.....**\$85.75**
PACMO-3/4P - w/ a 3/4" post.....P/N 10-00426.....**\$68.75**
PACMO-5/8P - w/ a 5/8" post.....P/N 10-00431.....**\$68.75**
PACMO-7/8P - w/ a 7/8" post.....P/N 10-00432.....**\$68.75**
PACMO-ARCP - Ercoupe.....P/N 10-00435.....**\$68.75**

COMPASS COMPENSATOR

Very sensitive to stray magnetic fields within the aircraft. If the compensators of the compass will not bring the compass within tolerances, it will be necessary to install the PBB475 compensator ("balanced balls"). These balls contain magnets which permit the compass to be properly compensated. Instructions furnished.
 P/N 10-07900.....**\$61.80**

MAGNETIC COMPASS SHIELD

Use this .005" x 5" x 12" metal strip to shield the precision PAI-700 compass from magnetic interference in the instrument panel.....P/N 11-00973.....**\$27.50**

NON-MAGNETIC SCREWDRIVER FOR COMPASSES

This small non-magnetic screwdriver blade is ideal for adjusting magnetic compasses. This blade is durable, corrosion resistant, & can be put on a key chain until needed.....P/N 10-07930.....**\$7.50**



COMPASSES – ENGINE GAUGES

SIRS "PEGASUS" LIT (TSO'D)



Utilizes high quality components throughout, including Silicone rubber seals, metal expansion bellows, and Tungsten Carbide pivots. Has a high-visibility spherical display, and can be viewed over a 140° arc instead of the standard 90°. Fits standard 2-1/4" panel hole (by 2-1/4" deep) and weighs only 30% of a typical liquid compass. Blue/white lighted or unlighted versions, and has a 3-yr. warranty.

NORTHERN HEMISPHERE		
Voltage	Part Number	Price
12V	10-00498	\$425.00
28V	10-00946	\$425.00
SOUTHERN HEMISPHERE		
Voltage	Part Number	Price
12V	10-02136	\$495.00
28V	10-02137	\$495.00

SIRS "NAVIGATOR" (TSO'D)



Delivers extremely accurate readings due to its fully integrated, 4 magnet correction facility. Same features as "Pegasus", but is mounted with a fully adjustable bracket. This allows the compass to be mounted in a variety of positions located away from magnetic influences. Size: 20-3/8" h x 2-1/4" w. "Navigator" comes in lighted or unlighted versions; 3yr. warranty.

NORTHERN HEMISPHERE					
Part No.	Light	Price	Part No.	Light	Price
10-00496	None	\$395.00	10-00949	28V Blue	\$425.00
SOUTHERN HEMISPHERE					
Part No.	Light	Price	Part No.	Light	Price
10-02129	None	\$452.00	10-02131	28V Lit	\$455.00

NAVIGATOR MOUNTING BRACKETS & ACCESSORIES

Description	Part No.	Price
Install Kit for Pegasus Compass	10-02124	\$60.00
MF1 Short foot (self adhesive)	10-00277	\$65.00
Glareshield Mount for SIRS Nav Compasses	10-00276	\$65.00

SIRS NAVIGATOR NV2-2400X



Designed to be installed on the glareshield using the same location holes required for other compass installations. Features silicone seals. The display shows 140° of heading, as opposed to the 90° view offered by standard compasses. TSO'd Navigator comes in 6, 12, & 28V configurations, with a 3 year warranty.

Northern Hemisphere		
Description	Part No.	Price
NV2A-2400 Unlit Compass	10-00401	\$395.00
NV2C-2400 Lit Compass 28V	10-00468	\$425.00
Southern Hemisphere		
Description	Part No.	Price
NAV TSOD Compass 28V LIT SH	10-02131	\$455.00
NAV NV2A-2400 Unlit Compass SH	10-02132	\$425.00
NV2C-2400 Lit Compass 28V SH	10-02134	\$455.00
NAV TSOD Compass Unlit SH	10-02129	\$452.00
Accessories		
Part No.	Price	
Install Kit Nav. Series Compass	10-02123	\$60.00

SIRS MASTER COMPASS



Graduated in 1/2 degree intervals and the compass is supplied with a calibration chart indicating any deviations in minutes of arc. Ideal for use with larger aircraft. A special reverse-read version (954-2399REV) is available to indicate the same headings as those read from the aircraft instruments during the compass swing operation, when viewing from the front of the aircraft. Magnetic headings are viewed through a magnified prism and a special mounting Tripod is available (non-magnetic tripod) to ensure steady readings PN 10-04231 Warranty: 3 years Accuracy: Better than 30 Minutes Tilt: 7 Degrees

Standard Compass.....	P/N 10-04230	\$3,775.00
Reverse Read Compass.....	P/N 10-04817	\$3,775.00
Tripod.....	P/N 10-04231	\$1,525.00

SIRS HAND HELD PRISMATIC MASTER COMPASS



Designed to meet demanding requirements of the Aviation and Military environments where accurate bearings are required. Supplied with a calibration certificate and can be configured with reversed readings to assist with aircraft wings. Ideal for use with small to medium aircraft. The liquid damped card is divided in 2 degree increments. Warranty: 3 years. Dial Markings: Degrees/Tilt: 15 Degrees.

Standard Compass.....	P/N 10-04232	\$2,510.00
Reverse Read Compass.....	P/N 10-04816	\$2,506.00

BARFIELD SIGHT CALIBRATION COMPASS



The SC063 is used to check the mounted aircraft compass. Our sight compass, is a portable, self contained calibration device consisting of a modified aircraft compass which has been re-screened to indicate 180° from normal. Since the sight compass is 180° away from normal, it permits the operator to stand facing the aircraft, making it considerably easier to transmit signals to and from the aircraft cockpit. The SC063 is unique in that the compensating magnets have been removed and a combination magnifying lens and collimating sight added. The compensator has been removed so the compass indicates magnetic direction at all times and is not subject to calibration offsets. The magnifying lens increases the readability of the dial and the collimating lens insures precise sighting alignment. Attached to the rear of the compass is an adjustable sight lens.....P/N 10-05357\$1,520.00

ARP CARBURETOR ICE DETECTION SYSTEM



Made in USA. Available in three (3) different mounting configurations (Panel Mount, Remote Mount and Universal Mount) thus providing flexibility for any aircraft installation. GIVES UP TO 5 MINUTES WARNING TIME by illuminating a RED visual ice warning light. LIGHT WEIGHT less than 13 ounces. SIMPLIFIED INSTALLATION keeps installation cost down – approx. 1 to 3 man-hours. WARRANTY 3-Years on Electronics Box and 1-Year on Probe. FAA-STC SA489EA APPROVED for normal, utility and acrobatic airplanes and helicopters equipped with Continental, Franklin and Lycoming type engines and Precision Air-Motive (Facet or Marvel-Schebler) MA-2, MA-3, MA-3A, MA-3SPA, MA-4, MA-4-5, MA-4SPA, MA-5, MA-6, MA-6AA and HA-6 series carburetors. Installation on other aircraft not specified on the STC may be performed via FAA Form 337. FAA-PMA APPROVED for installation on Type Certificated aircraft. Panel Mount, 12V (107AP-12).....P/N 10-09900\$454.00 Remote Mount, 12V (107AP-R-12)P/N 10-03708\$521.00 Remote Mount, 24V (107AP-R-24)P/N 10-03709\$527.00 Universal Mount, 12 (107AP-U-12)P/N 10-03697\$485.00 Universal Mount, 24 (107AP-U-24)P/N 10-03698\$537.00 Spare Probe (107AP-P).....P/N 10-03710\$206.95

FLIGHT DATA SYSTEMS FC-10 WITH FT-60 TRANSDUCER



Flow: Instantaneous Display of Fuel Flow
 • Used: Fuel Used • Remaining: Fuel Remaining • Endurance: Time or Distance Remaining • Required: Fuel Required to Active GPS Waypoint • Reserve: Fuel or Time Remaining at Active GPS Waypoint
 • Efficiency: Miles Per Gallon (or Liter) Displays Fuel Flow and Fuel Used for Each Engine (Two Engine Systems)

Features: Communicates with Handheld or Panel Mount GPS • User Selectable Units (Gallons, Liters, Nautical Miles, Statute Miles) • Low Fuel Warning • Best Fuel Computer Value Available • Large Extreme Operating Temperature Display • Soft Orange Backlight with Automatic Brightness • 2-1/4" Panel Mount • Weighs 2.6oz, 12-28 Volt Compatible • Includes EI FT 60 (less than 350 HP - Fuel Pump) • Includes Pre-Wired Harness • Connector is pin to pin compatible with many JPI, Hoskins, and Shadin Systems.

FC-10 Single Engine (additional sender req.)..	P/N 10-03150	\$399.95
FC-10 Twin Engine.....	P/N 10-03151	\$589.00
FC-10 Without Sender.....	P/N 10-03152	\$249.00

FLIGHT DATA SYSTEMS AFP-30 FUEL COMPUTER



Designed for the experimental aircraft owner who wants instantaneous flight information previously reserved only for transports and private jets. Features complete Winds Aloft information, Airspeed information including: True Airspeed and Mach number, Altitude information such as Density Altitude and Vertical speed, and both Total and Saturated Air Temperature. Complete with GPS communication enabling it to display fuel computer data. The Performance Computer function calculates, instantaneously, Percent Horsepower based on the engine manufacturer's power chart. Backup Tachometer and Manifold Pressure indications. Compatible with most handheld and panel mount GPS units.. P/N 10-03154\$699.00

ENGINE GAUGES

MID-CONTINENT INSTRUMENTS AND AVIONICS CARBURETOR TEMPERATURE INDICATORS



The MD-11 carburetor temperature gauge & B-5 temp. probe are designed to help eliminate carburetor icing by early detection, reduce spark plug fouling, extend engine life, increase range & power, and maximize fuel economy. Designed for use with most Marvel-Schebler & Bendix float type carburetors. FAA approved. Mounts in 2-1/4" instrument hole.

28V carb air temp indicator onlyP/N MD-11-4.....**\$543.00**
 B-5 probe onlyP/N B-5.....**\$395.00**
 Mating ConnectorP/N 10-01563**\$17.50**
 28V Carburetor Air Temperature KitP/N 10-02760**\$1,047.00**

2-1/4" UMA MANIFOLD PRESSURE GAUGES



Manifold pressure is one factor used to obtain correct power setting of the engine. The indicators are temperature and altitude compensated. Matte-white dials. Units are new. Manufactured by UMA.

2-1/4" Gauge, 10-50 Hg.P/N 10-11200...**\$185.75**
 2-1/4" Gauge, 10-35 Hg.P/N 10-11250...**\$185.75**
 UMA optional internal lighting ..P/N 11-07239 ..**\$58.75**

FALCON 3 1/8" MANIFOLD GAUGE



Falcon Gauge Manifold Pressure Gauge is designed and manufactured for use on aircrafts and is a standard diaphragm pressure instrument. This indicator is temperature and altitude compensated. Manifold pressure is one of the factors required to obtain the correct power setting of the aircraft engine. Made in China.

10-50 IN HG.....P/N 10-02269**\$237.95**
 10-35 IN HG.....P/N 10-02270**\$237.95**

3-1/8" UMA MANIFOLD PRESSURE GAUGES



3-1/8" Gauge, 10-35Hg.P/N 10-00080 **\$312.00**
 3-1/8" Gauge, 10-50Hg.P/N 10-11300 **\$315.00**
 UMA optional internal lighting .. P/N 11-07239 ..**\$58.75**

P/N 10-00080

UNITED TSO'D MANIFOLD PRESSURE GAUGES



Range	Part Number	Price
10 TO 35	10-05452	\$1,172.00
10 TO 35	10-05453	\$1,839.00
10 TO 50	10-05454	\$1,184.00
10 TO 50	10-05455	\$1,839.00
10 TO 75	10-05456	\$1,184.00
10 TO 75	10-05457	\$1,839.00

UMA FUEL/AIRBOX DIFFERENTIAL PRESSURE GAUGE



Displays the differential pressure between the fuel system and air box on turbo charge engines where it is necessary to maintain constant fuel pressure that is above the airbox pressure. Sender sold separate. (Requires the use of a 1EU007D UMA different pressure sender.)

1 1/4"P/N 10-00979**\$219.95**
 Sender 0-7 PSIP/N 10-00980**\$160.75**

ROCHESTER OIL PRESSURE GAUGE



Rochester oil pressure gauges have matte-white dial with black bezel. Mount in 2-1/16" dia. hole. 1/8" NPT port fits AN910-1D coupling. New mfg.

0-80 PSI*.....P/N 10-00015**\$51.75**

*Chrome Bezel

MINI WATER PRESSURE GAUGE



Range	Part Number	Price
(-5)-25 PSI	10-22241	\$248.95
(-15)-15 PSI	10-22248	\$248.95

ROCHESTER OIL TEMPERATURE GAUGES



Rochester oil temperature gauges have matte-white dial with black bezel. Mount in 2-1/16" dia. hole. New manufacture. Furnished with one 5/8-18UNF X 5/8-18UNF adapter nut. Available in the following temperature ranges and capillary lengths.

P/N 10-11600 100-250°F..... 60" Cap.....**\$89.95**
 P/N 10-11700 100-250°F..... 72" Cap.....**\$117.75**
 P/N 10-11800 100-250°F..... 144" Cap.....**\$116.75**
 P/N 10-11900 100-250°F..... 48" Cap.....**\$114.75**
Adapter Nuts Only:.....44-0024 5/8-18UNF x 5/8-18UNF.....**\$11.95**

MCI OVERHAULED MANIFOLD PRESSURE GAUGE



The manifold pressure indicator is used in aircrafts to indicate the absolute pressure of the aircrafts engine intake measured in inches of mercury.

• **Model:** 6111D.22 • **Range:** 10-35 inch hg • **Size:** 3-1/8" • **Weight:** 13.5oz or 386g. P/N 10-07284**\$695.00**

MECHANICAL OIL TEMPERATURE GAUGE



A quality gauge which is complete with all installation fittings. Range is 100-250° F. 5/8"-18 female capillary adapter fitting. 60" lead length Not FAA approved.

P/N 10-00954**\$118.75**

OIL TEMPERATURE BULB ADAPTER



Brass fitting used to shorten long capillary bulbs for use in light aircraft engines. Internal 5/8-18 threads mate with fitting on bulb. External 5/8-18 threads fit into engineP/N 95527**\$19.50**

MILITARY OIL PRESSURE GAUGE



AN5771-2 Military style gauge with sq. case. Mounts in 2-1/4" dia. hole. New surplus. Matte-White Dial (0-150 PSI)P/N 10-00955**\$259.00**

MECHANICAL OIL PRESSURE GAUGE



Scott's quality Oil Pressure Gauge features 0-120 PSI range and 1/8 NPT thread on flared tube fitting. Not FAA Approved.....P/N 10-00956**\$259.95**

OIL PRESSURE INSTALLATION KIT



This kit contains 4 Weatherhead brass fittings with 1/8" pipe thread & 6 ft. of 1/8" Nyl-Seal tubing. Compatible with most mechanical oil pressure gauge installations. P/N 10-12000**\$9.65**

RV-12 REMOTE OIL PRESSURE SENSOR MOUNTING KIT



A new remote oil sensor kit for the Rotax 912 engine. While the lengths of this package are designed specifically to fit an RV-12, the hose length should work in virtually any 912 installationP/N 05-11919**\$174.85**

MS28034-3 ENGINE TEMPERATURE SENSOR



Presently in use in government and general aviation industry under liquid and gaseous conditions, this sensing device exceeds stringent U.S. Military Specifications for response time, burst pressure, and AC high potential testsP/N 10-01668**\$793.00**

KELLY MANUFACTURING TORQUE INDICATORS



Torque Indicators are a wet line, direct reading bourdon tube type instrument, housed in a 2" diameter case. Unit can be calibrated over a wide range of PSI input to direct read torque. Units can be furnished to your specifications. Indicate needed pressure input and pressure-to-torque conversion. This unit cannot be damaged by oil back up in vent line. **Dimensions:** 2" diameter x 2.125" length, **Weight:** 0.4 lbs, **Power:** Wet line direct reading pressure gauge

Model No	Description	Part No.	Price
27-3007-1	0 to 1800 FT/LB. Green Arc 0 - 1628, Red Line at 1628	10-03441	\$515.00
27-3007-7	0 to 75 PSI 0 to 53	10-03443	\$645.00

KELLY MANUFACTURING OIL TEMPERATURE INDICATOR



Housed in a 2" diameter case, this instrument can be calibrated in C° or F°. Oil Temperature is sensed by a MS28034-1 resistance bulb. **Dimensions:** 2" Dia. x 3.12" L **Weight:** 0.4 lbs **Power:** 28VDC Connector: MS3112E8-4P **29-1004-10** - Green Arc 0° C -110° C, Yellow Arc -40° C - 0° C Red Line -40° & 110° C

P/N 10-03445**\$709.00**

IN

UMA ENGINE GAUGES

UMA 2-1/4" SINGLE EGT GAUGES

These highly reliable and lightweight gauges are self-contained, requiring no external power source. Specify probe size and type. Standard markings are black and white.



P/N 10-22275

2-1/4" EGT Gauge

700-1700°F- 90° Sweep...P/N 10-22275**\$169.75**
700-1700°F- 270° Sweep...P/N 10-02427**\$185.80**

Type K EGT Probes

1-5/8" - 2-1/2" Clamp.....P/N 10-04791**\$99.95**
1-2" ClampP/N 10-00966**\$99.95**
8mm, Bayonet-RotaxP/N 10-00967**\$99.85**

Optional internal lighting for all UMA 2-1/4", 3-1/8" instruments (except altimeter)... P/N 11-07239**\$58.75**

UMA 2-1/4" CHT GAUGES

NON-TSO GAUGES



Probe/Range	Part No.	Price
UMA Probe Range: 100-300°F	10-05709	\$207.95
UMA Probe Range: 40-150°C	10-05710	\$207.95
VDO Probe Range: 40-150°C	10-05712	\$207.95
Thermocouple Type J Range: 100-600°F	10-05713	\$207.95
Thermocouple Type J Range: 50-300°C	10-05714	\$207.95

TSO GAUGES

Probe/Range	Part No.	Price
MA 1BX Thermistor Probe Range: 40-150°F	10-05716	\$256.95
MA 1BX Thermistor Probe Range: 100-300°F	10-05717	\$256.95
VDO Probe Range: 100-300°F	10-05718	\$256.95
Type J Thermocouple Probe Range: 50-300°C	10-05719	\$256.95
Type J Thermocouple Probe Range: 100-600°F	10-05720	\$257.95

Senders not included with the above 2-1/4" CHT Gauges.

UMA 2-1/4" EGT GAUGES

NON-TSO GAUGES



Probe/Range	Part No.	Price
700-1700 F Type K Sender Req.	10-05699	\$208.95
1000-2000 F Type K Sender Req.	10-05701	\$207.95
100-900 C Type K Sender Req.	10-05698	\$207.95

TSO GAUGES

Probe/Range	Part No.	Price
2-1/4 TSO EGT 100-900 C Type K Sender Required	10-05706	\$256.95
2-1/4 TSO EGT 400-1700 F Type K Sender Required	10-05707	\$257.95

UMA 2-1/4 INCH EGT GAUGE WITH OPTI ALERT



The 2 1/4", 270°, Opti-Alert warning instruments, signal the pilot when there is a problem by illuminating a Light Emitting Diode (LED). This warning indicates that an improper range condition has arisen. Operate with a 14V or 28V system. Pressure and temperature gauges use remote mounted sensors which are sold separate.

Operate with a 14V or 28V system. Pressure and temperature gauges use remote mounted sensors which are sold separate.

Description	Part No.	Price
100-900 C W/ Opti Alert Type K Sender Req.	10-05702	\$231.95
700-1700 F W/ Opti Alert Type K Sender Req.	10-05704	\$231.95
1000-2000 F W/ Opti Alert - Type K Sender Req.	10-05705	\$231.95

UMA 2-1/4" WATER TEMPERATURE GAUGE



This instrument is designed to be durable yet lightweight. Excellent for a wide variety of homebuilt aircraft applications. Made in USA. Order probe separately.

0-300°FP/N 10-02058**\$184.95**

Probes

1/8" NPT (Rotax).....P/N 10-00968**\$86.75**
3/8-24 (automotive).....P/N 10-00969**\$86.75**

UMA 2-1/4" OIL TEMPERATURE GAUGE



This instrument is designed to be durable yet lightweight. Excellent for a wide variety of homebuilt aircraft applications. Made in USA. Order probe separately.

100-300°FP/N 10-22285**\$184.85**

UMA OPTIONAL INTERNAL LIGHTING - Optional internal lighting for all UMA 2-1/4", 3-1/8" instruments (except altimeter). This is just a lighted option. Order the instrument in addition to the internal lighting.
P/N 11-07239**\$58.75**



UMA 2-1/4 INCH ELECTRICAL OIL PRESSURE TACH 0-130 PSI ROTAX 912/914

UMA 2-1/4 Inch Electrical Oil Press Tach 0-130 PSI Rotax 912/914. 2 1/4" Air Core (270° Sweep)
P/N 10-05510**\$207.95**

MECHANICAL UMA 2-1/4" FUEL PRESSURE GAUGE

These factory new fuel pressure gauges from UMA fit standard 2-1/4" panel hole. They are mechanical, wet-line gauges and require no sending unit.

0-25 PSIP/N 10-02356**\$238.95**
0-50 PSIP/N 10-00316**\$239.95**
0-10 PSIP/N 10-22201**\$238.95**
0-30 PSIP/N 10-22203**\$239.95**
0-100 PSIP/N 10-22205**\$239.95**

MECHANICAL UMA 2-1/4" OIL PRESSURE GAUGE

These factory new oil pressure gauges from UMA fit standard 2-1/4" panel hole. They are mechanical, wet-line gauges and require no sending unit.

0-50 PSIP/N 10-22240**\$238.95**
0-130 PSIP/N 10-22242**\$238.95**
10-100 PSIP/N 10-02357**\$238.95**

UMA 1" PRESSURE GAUGES

This mechanical, direct hook-up pressure indicator is ideal for monitoring the engine pump cooling system. Suitable to a wide variety of homebuilt aircraft applications. Made in USA. 0-10 PSI (water)

P/N 10-22247**\$225.95**

UMA 1" OIL PRESSURE GAUGE

Case is molded ABS plastic. Wt:1.4oz. Black and white dial markings. 25-125 PSI.

P/N 10-22251**\$225.95**

UMA 1" FUEL PRESSURE GAUGE

Case is molded ABS plastic. Wt:1.4oz. Black and white dial markings. 0-10 PSI.....P/N 10-22252**\$227.95**

MECHANICAL UMA 2 1/4" WATER PRESSURE GAUGE

This mechanical, direct hook-up pressure indicator is ideal for monitoring the engine pump cooling system. Suitable to a wide variety of homebuilt aircraft applications. Made in USA. -15 to +15 PSI

P/N 10-22249**\$239.95**

2-1/4 INCH UMA WATER TEMPERATURE 100-300F

2-1/4 inch UMA Electronic (UMA P/N 12-360-300F°) Water Temperature Gauge, Range: 100-300 deg. F°
P/N 10-02058**\$184.95**

UMA 2 1/4"

FLAP POSITION INDICATOR

This 2-1/4" flap indicator uses a resistance potentiometer as a flap position sensor. Transmitter required. Wt: 9.8 oz.

Indicator (0-40°)P/N 10-22250**\$226.95**
Indicator (0-60°)P/N 10-02442**\$226.95**
TransmitterP/N AN5785**\$265.95**

UMA OPTIONAL INTERNAL LIGHTING

Optional internal lighting for all UMA 2-1/4", 3-1/8" instruments (except altimeter). This is just a lighted option. Order the instrument in addition to the internal lighting.P/N 11-07239**\$58.75**

MINI OIL PRESSURE GAUGE

Miniature mechanical instrument, only 1-1/4" dia., as used in many production aircraft. New manufacture.
0-125 PSI Oil Press.P/N 10-12400**\$244.95**

MINI FUEL PRESSURE GAUGES

1-1/4" Dia. New manufacture by UMA.
0-10 PSI Fuel Press.....P/N 10-12100**\$243.95**
0-35 PSI Fuel Press.....P/N 10-12200**\$244.95**
0-50 PSI Fuel Press.....P/N 10-12300**\$244.95**

UMA 3 IN 1 ELECTRONIC INSTRUMENT

Combine any three electronic instruments into a 3-1/8" case. Standard product is with black and white dials, but custom range markings are available to meet customer demand for specific design.

***Note - Senders are required and sold separately.**
P/N 10-03452**\$563.00**
UMA Range MarkingsP/N 10-02792**\$125.00**

UMA ENGINE GAUGES



2-1/4 inch
UMA Electronic
Oil Pressure Gauge
Case: Valox 420
Plastic
Weight: 4.7 oz.

UMA 2-1/4" ELECTRONIC OIL PRESSURE 270° GAUGE

Electronic Oil Pressure Gauges connect to a pressure transducer and connects to the gauge with wires. Standard dial markings are black and white.

- 2-1/4", 0-60 PSI, TSO'd... P/N 10-02415.....\$256.95
- 2-1/4", 0-80 PSI, TSO'd... P/N 10-02416.....\$256.95
- 2-1/4", 0-100 PSI, TSO'd... P/N 10-02417.....\$256.95
- 2-1/4", 0-100 PSI..... P/N 10-02424.....\$184.95
- 2-1/4", 150 PSI..... P/N 10-02761.....\$184.75

**SENDER NOT INCLUDED
SEE NEXT PAGE FOR SENDERS**



DATCON OIL PRESSURE SENDER

Thread sizes: 1/8"-27 NPTF, #10-32 terminals, Common ground through mounting thread, 0-80 psi/0-5 bar range and 240-33.5 Ohms..... P/N 10-05329.....\$51.75



2-1/4 inch
UMA Electronic
Fuel Pressure Gauge
Case: Valox 420
Plastic
Weight: 4.7 oz.

UMA ELECTRONIC FUEL PRESSURE 270° GAUGE

Electronic Fuel Pressure Gauges connect to a pressure transducer and connects to the gauge with wires. Standard dial markings are black and white.

- 2-1/4", 0-7 PSI, TSO'd... P/N 10-02412.....\$257.95
- 2-1/4", 0-15 PSI, TSO'd... P/N 10-02413.....\$257.95
- 2-1/4", 0-60 PSI, TSO'd... P/N 10-02414.....\$257.95
- 2-1/4", 0-30 PSI..... P/N 10-02422.....\$185.80

**SENDER NOT INCLUDED
SEE NEXT PAGE FOR SENDERS**



2-1/4 inch
UMA Electronic
Hydraulic Pressure Gauge
Case: Valox 420
Plastic Weight: 4.7 oz.

UMA ELECTRONIC 2-1/4" HYDRAULIC PRESSURE 270° GAUGE

Electronic Hydraulic Pressure gauge connects to a precision, high pressure transducer which mounts directly to the aircraft's hydraulic system. Standard markings are black and white. 2-1/4", 0-2000 PSI, TSO'd..... P/N 10-02459.....\$257.95

**SENDER NOT INCLUDED
SEE NEXT PAGE FOR SENDERS**



2-1/4 inch
UMA Electronic
Oil Temperature Gauge
Case: Valox 420
Plastic Weight: 4.8 oz.

UMA 2-1/4" ELECTRONIC OIL TEMPERATURE 270° GAUGE TSO'D

These rugged aircore gauges work with either thermocouple or thermister probes. Standard markings are black and white.

100-300° F, TSO'd..... P/N 10-02443.....\$257.95

**SENDER NOT INCLUDED
SEE NEXT PAGE FOR SENDERS**



P/N 10-02057
2-1/4", 100-600 °F - 90° sweep for use with thermocouple powered aircraft... P/N 10-02429.....\$175.75

UMA ELECTRONIC 2-1/4" CHT 270° GAUGE

These gauges are available for either thermocouple or thermister probes. Standard markings are black and white.

2-1/4", 100-300 °F - compatible with VDO
P/N 10-02426.....\$185.80

2-1/4", 100-600 °F - 270° sweep for use with internal powered aircraft
P/N 10-02057.....\$185.80

TYPE J CHT PROBES

- 10mm Spark Plug Ring..... P/N 10-00960.....\$85.75
- 12mm Spark Plug Ring..... P/N 10-00961.....\$85.75
- 14mm Spark Plug Ring..... P/N 10-00962.....\$86.75
- 18mm Spark Plug Ring..... P/N 10-00963.....\$86.75
- 3/8"-24 Bayonet w/snap..... P/N 10-00795.....\$113.75

UMA TSO'D TEMPERATURE PROBES

- T3B1 1/8 NPT TSP Type K with 6' Lead..... P/N 10-05164.....\$116.75
- T3B2 3/8-24 TSO Type K with 6' Lead..... P/N 10-05165.....\$117.75
- T3B3 5/8-18 TSO Type K with 6' Lead..... P/N 10-05166.....\$117.75
- T3B3A 5/8-18 TSO Type K with 6' Lead..... P/N 10-05167.....\$117.75
- T3B11 1/4-18 TSO Type K with 6' Lead..... P/N 10-05168.....\$115.80



UMA ELECTRONIC 2-1/4" WATER TEMPERATURE 270° GAUGE

2-1/4 inch UMA Electronic (UMA P/N T12212U300-F000) Water Temperature Gauge Range: 100-300°F TSO2-1/4", 100-300°F TSO'd.

P/N 10-02428.....\$256.95

UMA ELECTRONIC 2-1/4" CARBURETOR AIR TEMPERATURE 270° GAUGE

These gauges use either thermistor or electronic sensors. Standard markings are black and white.

- 2-1/4", -60-120 °F TSO'd... P/N 10-04670...\$257.95
- 2-1/4", -20-120 °F..... P/N 10-02391...\$185.80



UMA TSO'D 2-1/4" CARBURATOR AIR TEMPERATURE GAUGE

TSO'd Carburetor Temperature 2 1/4" gauge. Range from -60 - 120°F. **Note:** This is the standard black and white gauge. For color range markings as shown you must add the color range markings part no. to your order..... P/N 10-03465.....\$257.95

UMA Color Range Markings..... P/N 10-02792.....\$125.00



UMA 2-1/4" ELECTRONIC MANIFOLD PRESSURE 270° GAUGE

Electronic Manifold Pressure gauges connect to a pressure transducer which connects to the aircraft's engine and indicates the absolute pressure in the intake manifold of the aircraft. These units are very precise and avoid plumbing issues. Standard markings are black and white.

- 2-1/4", 5-35 IN. HG..... P/N 10-02389.....\$185.85
- 2-1/4", 5-50 IN/ HG..... P/N 10-02390.....\$184.99

SENDER NOT INCLUDED SEE NEXT PAGE FOR SENDERS



UMA 2-1/4" ELECTRONIC OUTSIDE AIR TEMPERATURE

The digital Outside Air Temperature (O.A.T.) is available in either Fahrenheit or Celsius. Standard models use a Red LED display.

- 2-1/4", -40-60 °C, 270°..... P/N 10-02387.....\$245.95
- 2-1/4", -40-140 °F, 270°..... P/N 10-02388.....\$245.95

SENDER NOT INCLUDED SEE NEXT PAGE FOR SENDERS

UMA DUAL AMP/VOLTMETERS

These 2-1/4" dual amp voltmeters are ideal for any aircraft where panel space is limited. Amperage is displayed at all times, and simply push a button to display voltage. Complete with gauge and shunt. Voltage range 0-30 volts.

- Range: 30 amp..... P/N 10-14680.....\$348.00
- 60 amp..... P/N 10-14685.....\$349.00
- 80 amp..... P/N 10-14690.....\$348.00
- 100 amp..... P/N 10-14695.....\$347.00
- 0-150 amp..... P/N 10-00082.....\$348.00

UMA Optional internal lighting..... P/N 11-07239.....\$58.75

AMMETERS

These new manufactured ammeters offer accuracy, rugged construction, and contemporary styling. Made in U. S. A. Furnished with shunt. Size: 2-1/4".

- Range: 0-30 (0 center).... P/N 10-14650.....\$233.95
- 0-60 (0 center).... P/N 10-14655.....\$233.95
- 0-80 (0 center).... P/N 10-14660.....\$233.95
- 0-100 (0 center).. P/N 10-02788.....\$233.95

REPLACEMENT UMA AMMETER SHUNTS 30/60/80/100AMP

UMA Ammeter shunt 30AMP, 60AMP, 80AMP, and 100AMP.

- Shunt 30AMP 1C1..... P/N 10-02072.....\$51.75
- Shunt 60AMP 1C2..... P/N 10-02073.....\$51.75
- Shunt 80 AMP 1C3..... P/N 10-02352.....\$51.75
- Shunt 100AMP 1C4..... P/N 10-02074.....\$51.75

UMA NON-CERTIFIED LIGHT INVERTER

UMA 24/28v & 12/14v DC TO 120 VAC/400 hz Light Inverter large capacity. Non FAA/PMA

- 12/14 Volt..... P/N 10-07131.....\$287.95
- 24/28 Volt..... P/N 10-07132.....\$286.95

UMA OPTIONAL INTERNAL LIGHTING

Optional internal lighting for all UMA 2-1/4", 3-1/8" instruments (except altimeter). This is just a lighted option. Order the instrument in addition to the internal lighting..... P/N 11-07239.....\$58.75

IN

UMA ENGINE GAUGES



2-1/4 inch Fuel Flow Gauge

UMA 2-1/4" FUEL FLOW 270° GAUGE

These affordable indicators display gallons/hour fuel flow in a conventional analog instrument package. Standard markings are black and white.

2-1/4" 0-80 GPH.....P/N 10-02407\$217.95
 2-1/4" 0-20 GPH.....P/N 10-02408\$217.95
 2-1/4" 0-30 GPH.....P/N 10-02409\$218.95
 2-1/4" 0-20 GPH.....P/N 10-03706\$218.95

UMA 2-1/4" FUEL AIR BOX 270° PRESSURE

Electronic, Fuel/Air-box Differential Pressure gauges and senders are designed for the Rotax 914 engine but have other applications where differential pressures need to be measured. It eliminates having to calculate the fuel/air-box differential pressure by looking at two separate gauges and having two separate senders.

2-1/4" 0-7 diff. PSI (U)
 P/N 10-00979\$219.95

SENDER NOT INCLUDED

UMA OPTIONAL INTERNAL LIGHTING

Optional internal lighting for all UMA 2-1/4", 3-1/8" instruments (except altimeter). This is just a lighted option. Order the instrument in addition to the internal lighting.P/N 11-07239\$58.75



2-1/4 inch UMA Fuel Airbox Pressure Case: Valox 420 Plastic Weight: 4.8 oz.



UMA 2-1/4" ELECTRONIC FUEL QUANTITY GAUGE

SENDER NOT INCLUDED

Description	Part No.	Price
2-1/4 inch UMA Electronic Fuel Quantity Indicator Range/Sweep: E-F/270° Sender: (C) 0-5V	10-02392	\$256.95
2-1/4 inch UMA Electronic Fuel Quantity Indicator Range/Sweep: E-F/180° Sender: (C) 0-5V	10-02393	\$256.95
2-1/4 inch UMA Electronic Fuel Quantity Indicator Range/Sweep: E-F/270° Sender: (F) 240/30 ohms	10-02394	\$257.95
2-1/4 inch UMA Electronic Fuel Quantity Indicator Range/Sweep: E-F/180° Sender: (F) 240/30 ohms	10-02395	\$256.95
2-1/4 inch UMA Electronic Fuel Quantity Indicator Range/Sweep: E-F/180° Sender: (F) 0-30 ohms	10-02396	\$256.95
2-1/4 inch UMA Electronic Fuel Quantity Indicator Range/Sweep: E-F/270° Sender: (F) 0-90 ohms	10-02397	\$256.95
2-1/4 inch UMA Electronic Fuel Quantity Indicator Range/Sweep: E-F/180° Sender: (F) 0-90 ohms	10-02398	\$256.95
2-1/4 inch UMA Electronic Fuel Quantity Indicator Range/Sweep: E-F/270° Sender: (F) 78-6 ohms	10-02399	\$256.95
2-1/4 inch UMA Electronic Fuel Quantity Indicator Range/Sweep: E-F/180° Sender: (F) 78-6 ohms	10-02401	\$256.95
2-1/4 inch UMA Electronic Fuel Quantity Indicator Range/Sweep: E-F/ Sender: (C) 0-5V	10-02410	\$170.75
2-1/4 inch UMA Electronic Fuel Quantity Indicator Range/Sweep: E-F/ Sender: (F) 240/30 ohms	10-02411	\$166.75

UMA PRESSURE SENDERS

UMA's pressure senders offer high reliability and accuracy at an affordable cost. They use precision solid state sensors and are designed for rugged use in just about any environment.



UMA Pressure Sender (U)(G)(D) 1/8"-27 NPTF Connection(s) 1' Cable 5/8-18 Mounting Thread

Description	PSI	Part No.	Price
UMA Pressure Sender (U)	0-7 PSI Differential	10-00980	\$160.75
UMA Pressure Sender (U)	0-7 PSI	10-01057	\$155.75
UMA Pressure Sender (U)	0-35 PSI	10-01058	\$155.75
UMA Pressure Sender (U)	0-70 PSI	10-01059	\$155.75
UMA Pressure Sender (U)	0-100 PSI	10-01060	\$155.75
UMA Pressure Sender (U)	0-150 PSI	10-01061	\$155.75
UMA Pressure Sender (U)	0-60 InHg Absolute	10-01062	\$160.75
UMA Pressure Sender T1EU35(G)(D)	0-35 PSI	10-02646	\$202.95
UMA Pressure Sender T1EU100(G)(D)	0-100 PSI	10-02647	\$202.95
UMA Ashcroft Precision Sender	0-2000 PSI	10-02420	\$222.95
UMA Differential Pressure Sender	0-70 PSI	10-06223	\$160.75

TSO'D PRESSURE SENDERS

These units are the most economical TSO'd units on the market. They feature precision, solid state sensors and circuitry to give unequalled performance for the money. Available in gauge, differential and absolute types, they are compatible with avgas, jet fuel, engine oil and many other fluids. Compatible with indicating instruments that do not have precision output voltages. Units for fuel and oil pressure are certified under TSO C47. Units for manifold pressure are under TSO C45a.



UMA Precision Sender (A)

Manufacturer Number	Range	Max Pressure	Part Number	Price
T1EU35(G)(D)	0-35 PSI	145 PSI	10-02646	\$169.95
T1EU100(G)(D)	0-100 PSI	406 PSI	10-02647	\$170.75
T1EU150(G)(D)	0-150 PSI	580 PSI	10-04312	\$170.75

UMA TEMPERATURE PROBES NON-TSO'D



(U) All 1Bx Temperature Probes contain a thermistor for temperature sensing. 6" Lead Wires.



(J) All 2B1x & 2B0x Temperature Probes use Type J Thermocouple. 6' Lead Wires.



(K) All 2B2x & 2B3x Temperature Probes use Type K Thermocouple. 6' Lead wires

UMA Part No.	Sizes	Our Part No.	Price
1B1	Thread: 1/8 NPT, 1/2 Hex Head	10-00968	\$86.75
1B2	Thread: 3/8-24, 5/8 Hex Head (Auto)	10-00969	\$86.75
1B3	Thread: 5/8-18, 7/8 Hex Head (Lyc.)	10-00418	\$86.75
1B4	Thread: 10mm x 1.5 Pitch (Rotax 912 & 914)	10-00973	\$86.75
1B5F	Thread: 3/8-24, 2-1/4" OAT F°	10-02374	\$99.75
1B6	Thread: 16mm x 1.5 Pitch	10-02375	\$85.75
1B7	Thread: 12mm x 1.5 Pitch	10-02376	\$86.75
1B8	Thread: 1/4-20 (Carb. Temp.)	10-01156	\$85.75
1B10	Thread: 1/4-28	10-02377	\$86.75
---	Uma 1/4-28 Carb Temp Probe 100 Ohm Rtd Sensor	10-06269	\$90.75
1B11	Thread: 1/4-18 NPT	10-02378	\$86.75
2B10	10mm Spark Plug Ring	10-00960	\$85.75
2B12	12mm Spark Plug Ring	10-00961	\$85.75
2B14	14mm Spark Plug Ring	10-00962	\$86.75
2B18	18mm Spark Plug Ring	10-00963	\$86.75
2B01	Bayonet Type: 1/8 NPT	10-02448	\$109.75
2B02	Bayonet Type: 3/8"-24, w/snap	10-00795	\$113.75
2B20	Clamp Size: 1-5/8 - 2-1/2" Length: 1" Tip	10-04791	\$99.95
2B21	Clamp Size: 1 - 2" Length: 1" Tip	10-00966	\$99.95
2B30	Clamp Size: 8mm, Bayonet Length: (Rotax)	10-00967	\$99.85

UMA 1-1/4" ENGINE INSTRUMENTS



Monitor your engine's vitals with a full line of space saving 1-1/4" engine instruments with 240 degree analog sweep. These instruments allow you the opportunity to utilize panel space without compromising readability. No longer do you have to decipher cluster gauges or push buttons for readings or try to concentrate on flashing numbers. These premiere UMA instrument are electronic and can be powered from 14 or 28 volts. Signals are acquired from remote mounted sensors, processed and displayed on analog dials with easy to read markings. Each gauge uses rugged aircore meter movement for vibration resistance and repeatability. Each gauge can be placed in a 1-1/4" diameter hole and mounted behind the panel with (4) 6-32 screws. They can be cluster mounted as close as 11/2" centers. **Senders are sold separately.**
UMA Technical Support: 800-842-5578.

STREAMLINE • STACKABLE • EASY TO READ • RUGGED DESIGN

CYLINDER HEAD TEMP. (CHT)		
Description	Part No.	Price
CHT Gauge 100-300°F	10-00035	\$207.95
CHT Gauge 100-600°F	10-00036	\$207.95
CHT Thermocouple 14mm Plug (Rotax)	10-00962	\$86.75
CHT Thermocouple 18mm Plug (Lyc.)	10-00963	\$86.75
CHT Thermocouple 3/8-24 Bayonet (Lyc.)	10-00795	\$113.75
OIL PRESSURE		
Description	Part No.	Price
Oil Pressure Gauge 0-80 PSI	10-00037	\$207.95
Oil Pressure Gauge 0-130 PSI	10-00038	\$208.95
Oil Pressure Gauge 0-130 PSI Rotax 912/914	10-05509	\$207.95
FUEL QUANTITY		
Description	Part No.	Price
Fuel Qty. Ind. (Float 240-30)	10-00039	\$208.95
Fuel Qty. Ind. (Cap. 5v)	10-00040	\$208.95
Sender (Float type 240-30 ohms)	10-00056	\$51.75
Sender (Capacitance 0-5V)	10-00797	\$159.75
AMMETER		
Description	Part No.	Price
Ammeter ±30 Shunt incl.	10-00041	\$258.95
Ammeter ±100 Shunt incl.	10-00043	\$257.95
Ammeter +60	10-00581	\$257.95
Ammeter +80	10-00582	\$257.95
WATER PRESSURE		
Description	Part No.	Price
Water Press. Gauge 0-15 PSI	10-00044	\$207.95
Water Press. Gauge 0-30 PSI	10-00045	\$207.95
WATER TEMPERATURE		
Description	Part No.	Price
Water Temp. Gauge 100-300°F	10-02457	\$207.95
CARB. TEMPERATURE		
Description	Part No.	Price
Carb. Temp -60-120°F	10-05769	\$207.95
OUTSIDE AIR TEMPERATURE		
Description	Part No.	Price
OAT (-25) -40°C	10-02385	\$278.95
OAT (-10) -110°F	10-02386	\$278.95
TACHOMETERS		
Description	Part No.	Price
0-7000 RPM for Rotax 447/503/582	10-05507	\$235.95
0-7000 RPM for Rotax 912/914	10-05506	\$235.95

EXHAUST GAS TEMPERATURE (EGT)		
Description	Part No.	Price
EGT Gauge 700-1700°F	10-00046	\$208.95
EGT Gauge 100-900°C	10-05696	\$207.95
EGT Gauge 1000-2000°F	10-05697	\$207.95
EGT Thermocouple Clamp style (Lyc.)	10-04791	\$99.95
EGT Thermocouple 8mm, Bayonet (Rotax)	10-00967	\$99.85
FUEL AIRBOX PRESSURE		
Fuel Airbox Pressure Range: 0-7 Diff.	10-02401	\$256.95
FUEL FLOW		
Description	Part No.	Price
Fuel Flow 0-8 6PH	10-02403	\$217.95
Fuel Flow 0-20 6PH	10-02404	\$217.95
Fuel Flow 0-30 6PH	10-02405	\$218.95
OIL TEMPERATURE		
Description	Part No.	Price
Oil Temp. Gauge 100-300°F	10-00047	\$207.95
1-1/4 inch VDO - TSO'd Electronic Temperature Gauges 100-300 deg F	10-02779	\$207.95
Oil Temp. Probe 3/8-24 (Automotive)	10-00969	\$86.75
Oil Temp. Probe 5/8-18 (Lyc./Cont.)	10-00418	\$86.75
Oil Temp. Probe 10mm (Rotax 912/914)	10-00973	\$86.75
FUEL PRESSURE		
Description	Part No.	Price
Fuel Pressure Gauge 15 PSI	10-00048	\$207.95
Fuel Pressure Gauge 30 PSI	10-00049	\$207.95
Fuel Pressure Gauge 0-80 psi	10-00050	\$207.95
VOLTMETER		
Description	Part No.	Price
Voltmeter 18-36V	10-00052	\$207.95
Voltmeter 9-17V	10-00578	\$207.95
FLAP INDICATOR		
Description	Part No.	Price
Flap Position Indicator 0-30°	10-00053	\$226.95
Flap Position Indicator 0-40°	10-00054	\$226.95
Flap Position Indicator up-full	10-00055	\$226.95
Flap Indicator Transducer	AN5785	\$265.95
MANIFOLD PRESSURE		
Description	Part No.	Price
5-35"	10-02438	\$207.95
5-50"	10-02439	\$207.95

For Experimental aircraft only. See next page for TSO'd Gauges. Mount individually or as a cluster.

MOUNTING INFORMATION

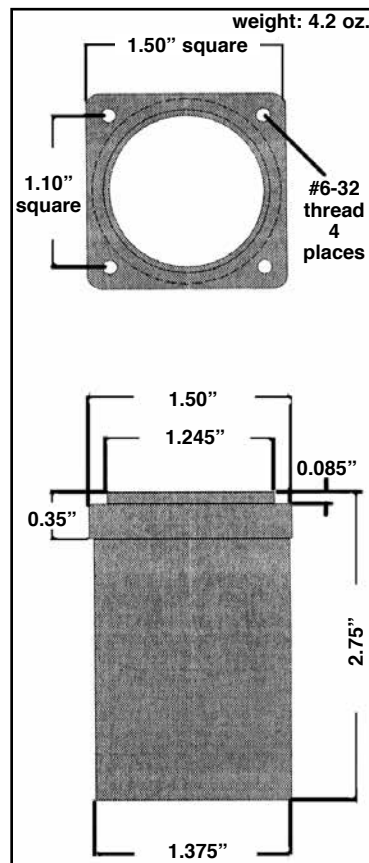

IN

UMA 1-1/4" TSO'd ENGINE INSTRUMENTS

These 1 1/4" instruments are identical to the 1 1/4" UMA Gauges on previous page, except these are TSO'd for certified aircraft. (Except Ammeters)



UMA No.	Size & Type	Range / Sender - Sender Range	Markings & Sweep	Part No.	Price
OIL PRESSURE					
TO4 113V 080P 000	1 1/4" Oil Pressure	0-80 PSI (Vdo)	B & W	10-00037	\$207.95
TO4 113V 130P 000	1 1/4" Oil Pressure	0-130 PSI (Vdo)	B & W	10-00533	\$256.95
TO4 1135 060P 000	1 1/4" Oil Pressure	0-60 PSI (Ashcroft)	B & W	10-00534	\$256.95
FUEL PRESSURE					
TO4 112V 015P 000	1 1/4" Fuel Pressure	0-15 PSI (Vdo)	B & W	10-00538	\$257.95
TO4 112V 030P 000	1 1/4" Fuel Pressure	0-30 PSI (Vdo)	B & W	10-00539	\$257.95
TO4 112V 080P 000	1 1/4" Fuel Pressure	0-80 PSI (Vdo)	B & W	10-00540	\$256.95
TO4 1125 150B 000	1 1/4" Fuel Pressure	0-150 PSI (Ashcroft)	GA 59-115, RR@ 59-115	10-00545	\$256.95
WATER PRESSURE					
TO4 115V 015P 000	1 1/4" Water Pressure	0-15 PSI (Vdo)	B & W	10-00546	\$256.95
HYDRAULIC PRESSURE					
TO4 1145 2K0P 000	1 1/4" Hydraulic Pressure	0-2000 PSI (Ashcroft)	B & W	10-00550	\$257.95
OIL TEMPERATURE					
T12 113U 150C 000	1 1/4" Oil Temp	40-150 °C	B & W	10-00555	\$256.95
T12 113U 300F 000	1 1/4" Oil Temp	100-300 °F	B & W	10-00556	\$256.95
WATER TEMPERATURE					
T12 115U 150C 000	1 1/4" Water Temp	40-150 °C	B & W	10-00557	\$256.95
T12 115U 300F 000	1 1/4" Water Temp	100-300 °F	B & W	10-00558	\$256.95
CYLINDER HEAD TEMP. (CHT)					
T12 116J 530C 000	1 1/4" CHT	50-300 °C	B & W (Thermocouple)	10-00561	\$256.95
EXHAUST GAS TEMPERATURE (EGT)					
T12 117K 1K7F 000	1-1/4" EGT	400-1700 °F	B & W (Thermocouple)	10-04945	\$256.95
T12 117K 1K7F 000	1 1/4" EGT	100-900 °C	B & W (Thermocouple)	10-00562	\$256.95
MANIFOLD PRESSURE					
T07 11MU A35H 000	1-1/4" Manifold Pressure	5-35 In.	B & W	10-05523	\$256.95
FUEL QUANTITY					
T18 1125 1C10 000	1 1/4" Fuel Qty. Ind.	Empty To Full (Cap 5v)	B & W (2700)	10-00566	\$256.95
T18 1125 2C10 000	1 1/4" Fuel Qty. Ind.	Empty To Full (Cap 5v)	B & W (1800)	10-00567	\$256.95
T18 112F 1F10 000	1 1/4" Fuel Qty. Ind.	Empty To Full (Float 240-30 Ohms)	B & W (2700)	10-00568	\$256.95
T18 112F 1F20 000	1 1/4" Fuel Qty. Ind.	Empty To Full (Float 0-30 Ohms)	B & W (2700)	10-00569	\$256.95
T18 112F 1F30 000	1 1/4" Fuel Qty. Ind.	Empty To Full (Float 0-90 Ohms)	B & W (2700)	10-00570	\$256.95
T18 112F 1F40 000	1 1/4" Fuel Qty. Ind.	Empty To Full (Float 78-6 Ohms)	B & W (2700)	10-00571	\$256.95
T18 112F 1F50 000	1 1/4" Fuel Qty. Ind.	Empty To Full (Float 10-180 Ohms)	B & W (2700)	10-00572	\$256.95
T18 112F 2F10 000	1 1/4" Fuel Qty. Ind.	Empty To Full (Float 240-30 Ohms)	B & W (1800)	10-00573	\$256.95
T18 112F 2F20 000	1 1/4" Fuel Qty. Ind.	Empty To Full (Float 0-30 Ohms)	B & W (1800)	10-00574	\$256.95
T18 112F 2F30 000	1 1/4" Fuel Qty. Ind.	Empty To Full (Float 0-90 Ohms)	B & W (1800)	10-00575	\$256.95
T18 112F 2F40 000	1 1/4" Fuel Qty. Ind.	Empty To Full (Float 78-6 Ohms)	B & W (1800)	10-00576	\$256.95
T18 112F 2F50 000	1 1/4" Fuel Qty. Ind.	Empty To Full (Float 10-180 Ohms)	B & W (1800)	10-00577	\$256.95
(AMMETERS) not TSO'd					
15 11S0 P30A 000	1 1/4" Ammeter (2700) (w/shunt)	-30 to 30 A	B & W	10-00041	\$258.95
15 11S0 P60A 000	1 1/4" Ammeter (2700) (w/shunt)	-60 to 60 A	B & W	10-00581	\$257.95
15 11S0 P80A 000	1 1/4" Ammeter (2700) (w/shunt)	-80 to 80 A	B & W	10-00582	\$257.95
15 11S0 P1CA 000	1 1/4" Ammeter (2700) (w/shunt)	-100 to 100A	B & W	10-00043	\$257.95

Senders sold separately, optional internal lighting available, Range Markings available at additional cost.



HOUR METERS – ENGINE GAUGES

HONEYWELL HOUR METERS



The LM series has been designed as a sealed, digital hour meter suitable for monitoring and recording elapsed running time. This is displayed on a digital LCD and normally shows hours and tenths of hours. They are ideally suited for applications where maintenance needs to be carried out on expensive manufacturing or transportation equipment after a desired time frame of operation. Round Shape.....P/N 10-07146**\$157.75**

PRESSURE SWITCH FOR HONEYWELL HOBBS HOUR METERS



Normally open. Closes at 4 PSI. Single circuit with 2 insulated terminals. Switch has silver contacts enclosed in weatherproof case. 1/8" male pipe thread connection.....P/N 10-00813**\$48.75**
Water Compatible Pressure Switch for Rotax engines. P/N 10-00326**\$68.95**

For pressure switches with 1/8" male pipe threads. For 1/4" O.D oil pressure lines P/N 10-04846**\$11.50**



871
3-Hole Flange
Mounting 2.54" Bolt
Circle 1.45" Dia. Holes



873
Mounts in
Standard 2-1/4"
Instrument Hole



876
Bracket Mount in
2-1/32" - 2-1/8"
Panel Hole

DATCON HOUR METERS

Standard equipment in most production aircraft. Operate on any DC voltage from 4-40V. Recommended for use on aircraft because they start or stop instantly when power is applied or removed. Furnished with mounting hardware. If meter is connected improperly it will not operate but meter will not be damaged. The running indicator indexes every 6 seconds.

Model 871 12/24V.....P/N 56456-3**\$74.75**
Model 873 12/24V.....P/N 56457-3**\$74.75**
Model 876 12/24V.....P/N 56458-4**\$79.75**

TINY TACH TACHOMETER/HOUR METERS



RPM reading adjustable from 1 spark per 2 revolutions to 8 sparks per revolution. One TINY-TACH™ now works for most gas engines. RPM display from 1 to 19,000. RPM update time 1/2 second. Hour meter records total actual running time on your engine. Job timer can be reset to record run time for record keeping. Coax cable transmits signal without EMF interference. 1 Antenna cable winds around your spark plug wire to give you the RPM reading – clean and simple to attach. Signal strength can be controlled by the antenna wire. Standard cable length is 6 feet. This unit is potted to prevent damage from moisture and vibration. Lithium battery life 5+ years, not replaceable. One year warranty.

TT2A Standard ModelP/N 10-04182**\$59.95**
For Diesel Engines - 6mm transducer.....P/N 10-04016\$139.75
For Diesel Engines - 1/4 inch transducer ..P/N 10-04017\$105.85

SWIFT VOLTMETERS AND AMMETERS



Swift Gauge Voltmeters and ammeters are 6-16V and are available in 2-1/4" and 2" Round. **MADE IN CHINA.**

Size	Model No.	Description	Part No.	Price
2 1/4"	VM16-ZQ	Voltmeter, 6-16V	10-02271	\$77.75
2 1/4" round	VM16-ZQ	Voltmeter, 6-16V	10-02272	\$64.90
2-1/4"	VM30-2Q	Voltmeter, 0-30V	10-04040	\$120.75
2 1/4" round	A30-001R	Ammeter, +/-30A	10-03411	\$64.85
2 1/4"	AV60-001	Ammeter, +/-60A	10-04041	\$59.75
2 1/4" round	AV60-001R	Ammeter, +/-60A	10-03415	\$120.75
2 1/4"	AV3016-002	Amp/Voltmeter +/-30A, 6-16V	10-03412	\$99.95
2 1/4" round	AV3016-001R	Amp/Voltmeter +/-30A, 6-16V	10-03413	\$120.75
2-1/4"	AV3030-002	Amp/Voltmeter +/-30A, 30V	10-04043	\$134.75
2-1/4"	AV2-6616	Amp/Voltmeter 30-0-60, 6-10V	10-03414	\$173.90
30A	SHT-030	Shunt for Amp/Voltmeter, 50mV/30A	10-03416	\$47.70
60A	SHT-060	Shunt for Amp/Voltmeter, 50mV/60A	10-03417	\$36.65

ENM HOUR METERS



Features 6-digits with an hour glass as a running indicator - operates only when engine is vibrating. Install anywhere with no wired connection or power source to operate. Internal battery supplies all the necessary power for the gauge to operate for years of service. Total operating hours are always shown on the LCD display. Compact tamper-proof meter is sealed against the environment to provide years of service.

- Voltage: 10-80 V DC
- Total dimensions: 1.43"W x 0.92"H x 2.13"D
- Face dimensions: 2.12"W x 1.25"H
- Weight: 2oz
- Power: 0.03W
- 6 Digit display
- Analog
- No reset
- Back of panel mounting

ENM Hourmeter DC Power Analog P/N 10-05278**\$52.75**
ENM Hourmeter AC Power Analog P/N 10-05279**\$88.78**
ENM Hourmeter Digital Vibration Activated..... P/N 10-05277**\$54.75**

UNIVERSAL DIGITAL TACH/HOURMETER



Now both a digital tachometer and an hourmeter in the same low cost and small size package! No power required yet there is a large 7 segment LCD display. Solid state electronics with quartz crystal technology make this instrument highly reliable. Easy to install - just wrap the attached wire around your spark plug cable. The case is completely sealed, it operates in a wide temperature range and the service interval is programmable.....P/N TLPT14.....**\$61.75**



BISHOP AIR SWITCH FOR HOURMETERS

Externally mounted air switch.
P/N 11-02378**\$55.75**

TASKEM DIGITAL TACH / HOURMETER 4000



The Model 4000 Tachometer/Timer displays RPM in both digital and analog formats. The digital format uses a liquid crystal display (LCD) showing up to 19,990 RPM in 10 RPM steps. The LCD is backlit for night viewing and since it uses "direct drive" it does not washout in sunlight or when viewed from an angle. The analog format is presented as a ring of light emitting diodes (LEDs) around the perimeter of the front panel. The user can easily set the range of RPM that the LEDs representP/N 15-05211**\$285.95**



VOLTMETERS

These new manufacture voltmeters offer accuracy, rugged construction, and contemporary styling. Made in USA. 2 1/4" Range:
9-16VP/N 10-14620**\$185.85**
20-32VP/N 10-02064**\$185.80**



DIGITAL FLAP INDICATOR

The Visual Instruments Flap Indicator system provides a means for owners of older aircraft to upgrade their troublesome indicators to a modern, more reliable design. The system includes a new transmitter, a modern digital display, and all parts necessary to perform the upgrade. The new display incorporates a color LED bar graph. The appearance is similar to flap indications shown on modern glass cockpits. Positions of more than 10° flap are indicated in a different color. This allows for easy identification during an emergency procedure such as a balked landing (go-around). The LEDs are very viewable from a wide angle. This is particularly useful since the indicator on many Cessna models is located on the right side of the panel. The display automatically adjusts to the ambient light for IFR or night operation. The Flap Indicator system includes all necessary parts and typically takes a mechanic approximately 2 hours to install. 2 year factory warranty. STCd for installation on early model Cessna 172s, 182s, 205s, 206s, & 210sP/N 10-00240**\$1,073.00**

INSTRUMENTS

INSTRUMENT MOUNTING PODS



An economical, high-quality, easy-to-install solution to your instrument mounting problems. Made of vacuum-molded white and black ABS plastic with attractive black matte ABS faces. The white pod may be easily spray-painted with acrylic enamel to match your aircraft. Two-piece mounting brackets fit snugly around 1" tubing, secured with screws provided. Available for 2, 3, 4 or 5 instruments with the face precut and mounting holes drilled for either 2-1/4" or 2" instruments. Blank face plates also available. May be used horizontal or vertically. When you order, specify either 2-1/4" or 2" instruments holes or blank face plate. Instruments not included.

- 2 Instrument Pods: 7-1/2" Wide x 3-3/4" Tall x 3-3/4" Deep
- 3 Instrument Pods: 10-3/8" Wide x 3-3/4" Tall x 3-3/4" Deep
- 4 Instrument Pods: 13-1/8" Wide x 3-3/4" Tall x 3-3/4" Deep
- 5 Instrument Pods: 16" Wide x 3-3/4" Tall x 3-3/4" Deep

Part No.	Instr 2-1/4" Hole	Color	Price	Part No.	Instr. 2" Hole	Color	Price
10-01513	2	White	\$73.00	10-01538	2	Black	\$77.75
10-01517	3	White	\$85.50	10-01539	3	Black	\$83.00
10-01521	4	White	\$88.50	10-01540	4	Black	\$89.50
10-01525	5	White	\$85.75	10-01541	5	Black	\$92.00
10-01529	2	Black	\$78.00		Blank		
10-01530	3	Black	\$82.75	10-01542	2	White	\$73.00
10-01531	4	Black	\$89.50	10-01543	3	White	\$88.75
10-01533	5	Black	\$92.00	10-01544	4	White	\$89.50
	2" Hole			10-01545	5	White	\$85.75
10-01534	2	White	\$73.00	10-01546	2	Black	\$78.00
10-01535	3	White	\$88.75	10-01547	3	Black	\$83.00
10-01536	4	White	\$89.50	10-01548	4	Black	\$89.50
10-01537	5	White	\$79.25	10-01549	5	Black	\$92.00

SHOCK MOUNTS

For vibration and shock proofing on instruments and radios.



SQUARE PLATE MOUNT

1" Square Plate Type Lord Mounts, 6 lb. rating. Monel mounting plate. Base holes .141" dia. for 6-32 screws. Center hole .166" dia. for 8-32 screw. New surplus item - like new mfg. P/N 10-02183 \$12.50



ROUND MOUNT

As used in Cessna aircraft. Overall length 1.25". Rubber molded on 8-32 threaded projections. New manufacture. Similar to Cessna P/N J6984-8. P/N 10-14700 \$15.60



ROUND INSTRUMENT PANEL SHOCK MOUNT

Replacement Instrument Panel Shock Mount. Replaces Lord J6984-1, -8 and Cessna 0411059-1 Shockmount. P/N 10-06506 \$2.85



LORD J-14290-4 INSTRUMENT SHOCK MOUNT

5 lb rating • Metal mounting plate • .144 dia. base hole (screw size: #6) • .195 dia. center hole (screw size #10) • Aircraft: Cessna 182, 182A-182N P/N 08-00381 \$53.75

SCOTT TYPE AIR THERMOMETER NON-TSO



Not FAA PMA Approved. A direct reading gauge with both Fahrenheit and Centigrade graduations on the dial. It can be installed through plexiglas windshields, sheet metal cowling, or through the center strip of the windshield. Mounting Hole - Drill a .375" (3/8") + .010"/-.000" hole through the part of the window or wall section desired. For use with a 7/16" torque wrench. Do not exceed 20 inch-pounds torque. P/N 10-15500 \$84.85

RC ALLEN 3 INCH ENGINE GAUGES 18-1000 & 18-1002 SERIES



Consists of three independent gages contained within a standard 3" diameter case. Oil temperature and cylinder head temperature gages are moving coil meter movement operated by MS28034-1 and AN5546-1 resistance bulbs respectively. Connection for the temperature gage is by cannon type connector: P/N MS3106A-14S-2S. FAA TSO Approved C47.

Model No.	Description	Part No.	Price
18-1000-1	28 VDC Oil Temp. 50°-250°F, Oil Press. 0-200 PSI, Cylinder head temperature 100 to 500°F	10-03435	\$1,035.00
18-1000-2	28 VDC Oil Temp. 20° to 120°F, Oil Press. 0 to 200 PSI, Cylinder head temp. 50 to 250°F	10-03436	\$1,035.00
18-1000-3	14 VDC Oil Temp 50°-250°F, Oil Press. 0-200 PSI, Cylinder head temp. 100-500°F.	10-03437	\$1,035.00
18-1000-4	14VDC Oil Temp 20° to 120°F, Oil Press 0 - 200 PSI, Cylinder head temp. 50 to 250°F	10-03438	\$1,035.00



18-1002 SERIES - This gage consists of three moving coil meter movements within a 3" diameter case. Oil temperature is sensed by an MS28034-1 resistance bulb and cylinder head temperature is sensed by an AN5546-1 resistance bulb. Oil pressure is sensed by a VDO Transducer. Connection is made by a single cannon type connector: Part Number MS3106A-14S-6S.

Model No.	Description	Part No.	Price
18-1002-1	Oil Temp 50° - 250°F, Oil Press. 0 - 120 PSI, Cylinder temp. 0 - 500°F	10-03439	\$1,035.00
18-1002-5	Oil Temp 50° - 250°F, Green Arc 100° - 200°F, Red line at 249°F, Oil Press. 0 - 120 PSI, Red line 10 PSI & 100 PSI, Yellow Arc 10 PSI - 30 PSI, Green Arc 30psi - 60 PSI, Yellow arc 60 PSI - 100 PSI, Cylinder Temp 0° - 500°F, Green Arc 220° - 420°F, Red Line 460°F	10-03440	\$1,035.00

ACCESSORIES FOR 18-1000 & 18-1002 SERIES

Description	Part No.	Price
Resistance Bulb MS3106A-12S-3S	10-00958	\$24.50
Resistance Bulb MS28034-1	10-00953	\$789.00
MS3106A-14S-2S Cannon Plug	10-00790	\$20.95

Note: Use MS3106A-14S-2S Cannon Plug for instruments and MS3106A-12S-3S for Resistance Bulb MS28034-1.



HYDRAULIC PRESSURE GAUGE

AN5771-4A Military style gauge with steel case. Mounts in 2-1/4" dia. panel opening. Range: 0-2000 PSI. Overhauled and Certified. With fresh Matte-white dial. P/N AN5771-4A \$264.95

CLOCKS – TIMERS

ASTROTECH QUARTZ CHRONOMETERS



A fine quality 2-1/4" instrument to satisfy all cockpit clock/timer needs. 12 or 24 hour clock, 24 hour elapsed timer with time-out or hold feature, month and date. Will operate on internal battery for 2 years or can be connected to electrical system. 12 or 28V DC operation. **Does not include internal battery.**

Part No.	Model	Description	Price
10-05855	LC-2	Panel Mount Two AAA Battery Powered	\$680.00
10-06811	LC-2	Panel Mount Aircraft Powered	\$765.00

NOTE: For Aircraft Application Information on Astrotech Chronometers visit www.aircraftspruce.com

FLIGHT DATA SYSTEM ELECTRIC TACHOMETER



Tachometer: Monitors both left and right ignition systems. Works with magnetos and electronic ignition. Warns when an ignition system has failed. Engine Hour Meter: Saves engine hours in "tach time" or actual time. Flight Timer: Automatically records flight time. Features: Large and easy to read digits. Extreme operating temperature display. Soft orange backlight with automatic brightness. 2-1/4" panel mounted. Weighs 2.6oz. Includes pre-wired connector. 12-28 volt compatible.

P/N 10-03898\$174.95

AEROSPACE LOGIC 200 - CLOCK, OUTSIDE TEMPERATURE KIT



The CA200 is an advanced, next generation airborne timepiece plus a seven input annunciator. It can scan seven 200 Series instruments and report any out-of-limit conditions the moment they occur; all on one instrument. Once identified, simply glance over the panel to view the exact cause for concern.

With the CA200 mounted either in or close to your primary panel scan you will reduce the need for consistent full panel scans and be automatically made aware of any condition requiring attention.

The CO200 is identical to the CA200 with the exception of the annunciator function. Using one of the world's most accurate digital timebases they will provide precise time for years to come.

Outside air temperature functionality is TSO'd and meets the temperature accuracy requirements of SAE AS8005 for a Class IIa (+/- 1%) instrument. Functional displays include:

- UTC Time • Local Time • Chronograph • Flight Time and Interval Timer • Seven annunciator sense inputs (CA200 only)

P/N 10-04348\$586.00

WESTBEND DIGITAL QUARTZ TIMER



This timer from Westbend is the perfect size for cockpit use. It times up and down, and has a large, easily readable display. With a clip on the back for mounting on a kneeboard, and includes battery. The hang card makes it easy to display, too. Counts up to and from 100 hours. Includes clip, stand, magnet and hanging hole for ease in use. LCD readout. Electronic alarm. AAA battery included. 2.5" x 2.5" x .5".....P/N 13-31380\$13.60

XREXS® DIGITAL TIMER



This timer is the perfect size for cockpit use. It times up and down, and has a large, easily readable display. With a clip on the back for mounting on a kneeboard, and includes battery. The hang card makes it easy to display, too. **Specifications:** • Timer size: 2.95x 0.75x 2.56 inches • LCD display: 2.44 x 1.06 inches • Color: White • Weight: 95g • Material: ABS plastic • Power: 2 AAA batteries (included)

P/N 13-23273\$28.85

SUPERCLOCK FROM ELECTRONICS INTERNATIONAL



Displays local and Zulu time. May be set to display in a 12 or 24-hr format. A 10-year lithium battery keeps the clock running even if the aircraft battery is removed. Displays an Up Timer, that will start running when the engine is started. Acts as an automatic Flight Timer. The Up Timer may be started, stopped or reset. A Recurring Alarm may be set to alert you at appropriate time intervals. Displays a Down Timer. Displays an Engine Timer. Acts as a Hobbs Meter. When the engine

starts, the Engine Timer will run. **Specifications:** 2-1/4" mount. 3.65" Depth. 10 Oz. Unit. Viewable in direct sunlight. Backlit for night operation. Operates from 7.5 to 35 volts at .3 amps P/N 10-01612\$359.00

MID-CONTINENT CHRONOS DIGITAL CLOCK / MAX POWER USB CHARGERS



The CH93 series, part numbers 6420093(-), is a multi-function digital clock / chronometer / voltmeter / temperature unit with multiple options for USB Charging Ports. The unit fits into a standard, rear-mounted, 2-1/4" avionics panel cutout. Power is drawn from the aircraft main bus to light a white, six digit, seven segment LED clock. The clock can display several different modes: local time, universal time, flight timers, elapsed and countdown timers and optionally, bus

voltage and up to two temperature inputs. The CH93 display is daylight readable with two methods of brightness control. It can be controlled automatically using the internal photocell or manually with an external dimming bus voltage. The CH93 clock has an internal battery to maintain clock time and flight timer memory when the aircraft is not in use.

The USB Charging Ports are designed as DCPs (Dedicated Charging Ports) to industry-standard protocol per the USB Battery Charging 1.2 Compliance Plan. Some models also comply with the higher power requirements of USB Power Delivery 2.0 and 3.0. Early-generation or smaller consumer electronics typically accept one (1.0) amp during charging. However, newer electronics, such as tablets and larger devices can accept, and in some cases, require up to 3 amps to charge and operate.

Description	Model No.	Part No.	Price
Digital Clock Only	6420093-0	10-07369	\$449.00
Dual USB-A/USB-C PD 75 W/6A	6420093-5	10-07292	\$799.00
Single USB-A Charger 15W/3A Out	6420093-3	10-07294	\$599.00
Dual USB-A 30W/6A Out	6420093-4	10-07295	\$695.00
Dual USB-A Charger 30W/6A Out	6420093-2	10-06963	\$635.00

PRECISION QUARTZ AIRCRAFT CLOCKS



Designed for accuracy, this precision clock is manufactured to meet rugged aircraft environmental standards. High-quality, solid state quartz movement. Comes with a factory one year limited warranty.

Features: FAA/PMA approved. Precision quartz movement. Transient and reverse polarity protected. One year limited warranty. Continuously powered by aircraft battery. Low power consumption (3mA). Fits standard 2-1/4" panel hole

Specifications: Dimensions: 2.5 x 2.5 x 3.2

inches max. Weight: 0.5 lbs.. Altitude: -1,000 to +55,000 feet. Mounting: Front or rear panel.

Lighted Quartz Electric Clock (14V)P/N 10-00460\$357.00
Lighted Quartz Electric Clock (24V)P/N 10-04615\$357.00

QUARTZ ELECTRIC AIRCRAFT CLOCKS



These clocks are constructed for easy installation in a wide variety of aircraft. The rugged quartz movement is accurate within 2 seconds in 24 hours under normal operations and runs accurately in temperatures from -30°-180°F. The clock kit includes a power harness, mounting screws and installation instructions. The clock features adjustable red elapsed time hands.

12VP/N 10-22812\$155.85
24VP/N 10-22824\$153.75

MID-CONTINENT INSTRUMENTS AND AVIONICS QUARTZ ANALOG ELECTRIC CLOCK



FAA PMA approved. Precision quartz movement. Compact 2 1/4-inch size – fits standard panel cutout. Transient and reverse polarity protected. Original equipment for many major aircraft manufacturers. Low power consumption (3 mA). Continuously powered by aircraft battery. One year limited warranty. Lighted.

MD-90L 14VP/N 10-00460\$357.00
MD-90L 28VP/N 10-04615\$357.00

IN

CLOCKS – TIMERS

FLIGHT TIME CONTROL

P Model: Controlled by programmable Airspeed with solid state pressure sensor

G Model: Gets TAS from GPS source
Solid state speed sensor for internal take off and landing speed
Speed level is adjustable for different aircraft from the protected set up menu
Stores up to 4,000 flights with date, departing and landing time
Daily totals with number of landings like a trip meter in cars; this is very helpful if you have a lot of short flights a day. (Example: Glider Towing or Parachuting)
Adjustable plain total as reference for maintenance and log book MFG in Switzerland to precise standard.

FLISYS 57 - FLIGHT TIME INFORMATION SYSTEM



Features:

- Internal Real Time Clock
 - Records Departing - Landing time and date
 - Records Aircrafts Total Flight Time
 - Programmable "On Air" output for Transponders
 - Controlled by programmable Airspeed with solid state pressure sensor
 - Power Supply 12 to 24 V DC
- 2-1/4" TAS From Pilot FLISYS57P.....P/N 10-05102\$955.00
2-1/4" TAS From GPS FLISYS57G.....P/N 10-05103\$499.95

FTC 57 - FLIGHT TIME INFORMATION SYSTEM



Easy Flight Time Controlling for Basic Training, Glider Towing, Parachuting.

FTC 57:

- Counts Time Hours and Minutes
- 57mm (2-1/4") round
- FTC with same front size as Hobbs time counter
- Easy initial time set with 2 push buttons on back side
- Input for On/Air from external switch or GPS system with output
- Power supply is 12 V to 24 V DCP/N 10-05106\$298.00

FLIGHT TIME INFORMATION SYSTEM FTC (RECTANGULAR)



Easy Flight Time Controlling for Basic Training, Glider Towing, Parachuting.

FTC:

- Counts Time Hours and Minutes
- 37x24 mm rectangular
- FTC with same front size as Hobbs time counter
- Easy initial time set with 2 push buttons on back side
- Input for On/Air from external switch or GPS system with output
- Power supply is 12 V to 24 V DC 37x24 mm Rectangular
P/N 10-05107\$298.00



ASA FLIGHT TIMER

Ergonomically designed and engineered for reliability, ease and convenience, the ASA Flight Timer should be considered essential equipment for all aviators. Features: Large LCD backlight display, multi-function clock and three simultaneous timer options. Exclusive digital notepad for squawk codes or frequencies, stores up to 12 approach times, audible and visual alarms.

P/N 13-02357\$39.95



WESTBEND ELECTRONIC TIMER

The jumbo LCD display on this electronic timer displays time in hours, minutes and seconds. Includes clock feature, electronic alarm, clip, stand, magnet and hanging hole for versatile use. AAA Battery included.

P/N 17-00240\$16.75



WESTBEND ELECTRONIC TRIPLE TIMER/CLOCK

Features of this electronic timer include a continuous running clock that displays hours, minutes, seconds, and AM/PM mode, three timing channels that count to and from 100 hours, and three distinctive alarms.

Additional Features: Memory recalls previous time setting. Times three activities at once. Alarm beeps for one minute and counts up to show elapsed time. Easy-to-read large LCD display. Clip, stand, magnet and hanging hole for versatile use. Specifications: One AAA battery included. 2.5" x 3" x 1".

P/N 17-00239\$18.95

MID-CONTINENT CHRONOS DIGITAL CLOCK / MAX POWER USB CHARGERS



The CH93 series, part numbers 6420093-(), is a multi-function digital clock / chronometer / voltmeter / temperature unit with multiple options for USB Charging Ports. The unit fits into a standard, rear-mounted, 2-1/4" avionics panel cutout. Power is drawn from the aircraft main bus to light a white, six digit, seven segment LED clock. The clock can display several different modes: local time, universal time, flight timers, elapsed and countdown timers and optionally, bus voltage and up to two temperature

inputs. The CH93 display is daylight readable with two methods of brightness control. It can be controlled automatically using the internal photocell or manually with an external dimming bus voltage. The CH93 clock has an internal battery to maintain clock time and flight timer memory when the aircraft is not in use.

Description	Model No.	Part No.	Price
Dual USB-A/USB-C PD 75 W/6A	6420093-5	10-07292	\$799.00
Single USB-A Charger 15W/3A Out	6420093-3	10-07294	\$599.00
Dual USB-A 30W/6A Out	6420093-4	10-07295	\$695.00
Dual USB-A Charger 30W/6A Out	6420093-2	10-06963	\$635.00

DAVTRON INSTRUMENTS

DIGITAL CHRONOMETERS AND CLOCKS

MODEL 803



- UT, LT, FT, & ET
- FT & ET Visual Alarm
- External Output for Optional Audio Alarm(FT/ET)
- Aircraft Voltage
- OAT F & C (12Ft. Temperature Probe)
- Internal Lighting
- AA Memory Battery
- Input Voltage 11 to 28 Volts
- NVIS (NVG) Option Green A

Description	Part No.	Price
UT, LT, FT, & ET Digital Clock 5V Lighting, Voltmeter, OAT (F & C)	10-03304	\$480.00
UT, LT, FT, & ET Digital Clock 14V Lighting, Voltmeter, OAT (F & C)	10-25520-14	\$446.00
UT, LT, FT, & ET Digital Clock 28V Lighting, Voltmeter, OAT (F & C)	10-25520-28	\$494.00
803-5V With Night Vision Lighting Green A	10-03342	\$609.00
803-14V With Night Vision Lighting Green A	10-03343	\$605.00
803-28V With Night Vision Lighting Green A	10-03344	\$677.00
C307PS Temperature Probe 12Ft. Coax (Analog)	11-04603	\$148.75
Audio Alarm Son-Alert	11-04610	\$46.65

MODEL 800



- GMT, LT & ET
- ET Counter (UP/DOWN), Visual Alarm
- Model 800 AA Memory Battery (Optional)
- Input Voltage 11 to 28 Volts

MODEL 800 Illuminated Buttons



- External Output for Optional Audio Alarm (ET)
- NVIS (NVG) Option Green A
- Available for Beechcraft yoke
- Internal Lighting

• 5 volt and 28 volt lighting units need at least 20 volts on main power input for clock to operate. For 14 volt systems, order a clock with 14 volt lighting.

Description	Part No.	Price
GMT, LT, & ET Digital Clock 5 Volt Lighting (800)	10-03323	\$203.95
800-5V With Battery Holder (AA)	10-03305	\$223.95
800-5V With Night Vision Lighting Green A	10-03324	\$291.95
800-5V NVG With Memory Battery Holder (AA)	10-03325	\$315.00
GMT, LT, & ET Digital Clock 14V Lighting (800)	10-04508	\$204.95
800-14V With Memory Battery Holder (AA)	10-02050	\$222.95
800-14V With Night Vision Lighting Green A	10-03330	\$339.00
800-14V NVG With Memory Battery Holder (AA)	10-03331	\$365.00
GMT, LT, & ET Digital Clock 28V Lighting(800)	10-24535-28	\$209.95
800-28V With Memory Battery Holder (AA)	10-02051	\$227.95
800-28V With Night Vision Lighting Green A	10-03335	\$376.00
800-28V NVG With Memory Battery Holder (AA)	10-03336	\$398.00
800-5V, Illuminated Buttons, Battery Holder	10-04730	\$309.00
800-14V, Illuminated Buttons, Battery Holder	10-04574	\$312.00
800-5V NVG, Illuminated Buttons, Battery Holder	10-04576	\$400.00
800-14V NVG, Illuminated Buttons, Battery Holder	10-04577	\$495.00
800-28V NVG, Illuminated Buttons, Battery Holder	10-04578	\$564.00

MODEL 811



- Six-digit Display on all 3 Functions.
- Time Function (12 OR 24HR Selectable)
- FT & ET
- Bright Sunlight Readable Displays
- Memory Battery Included
- Input Voltage 11 to 28 Volts
- NVIS (NVG) Option Green A

Description	Part No.	Price
LT, FT, & ET Clock	10-24550-14	\$640.00
811B With Gray Faceplate	11-09414	\$645.00
Model 811 With Night Vision	10-03346	\$720.00

Accessories / Replacement Parts	Part No.	Price
811 Dropping Resistor	11-04607	\$8.55
811 Memory Battery Pack	10-24560	\$32.50
811 Inverting Cable	11-04608	\$41.80
811B Female Connector (Standard Cable)	11-04609	\$38.50
KW-505FDigital Display for Model 811B	11-04613	\$47.95

DIGITAL CHRONOMETERS AND CLOCKS

MB800 (Beechcraft Yoke)



- GMT, LT & ET
- ET Counter (UP/DOWN), Visual Alarm
- Input Voltage 11 to 28 Volts

MB800 Illuminated Buttons



- External Output for Optional Audio Alarm (ET)
- NVIS (NVG) Option Green A
- Available for Beechcraft yoke
- Internal Lighting

Description	Part No.	Price
MB800-5V (Black)	10-03341	\$187.75
MB800-14V (Black)	10-02649	\$199.75
MB800-28V (Black)	10-02651	\$202.95
MB800-5V (Cream)	10-04581	\$196.75
MB800-14V (Cream)	10-02906	\$207.95
MB800-28V (Cream)	10-03340	\$212.95
MB800-5V (Black) NVG Green A	10-04582	\$300.95
MB800-14V (Black) NVG Green A	10-04583	\$334.00
MB800-28V (Black) NVG Green A	10-04584	\$399.00
MB800-5V (Cream) NVG Green A	10-04585	\$326.00
MB800-14V (Cream) NVG Green A	10-04586	\$346.00
MB800-28V (Cream) NVG Green A	10-04587	\$381.00
MB800-5V (Black) Illuminated Buttons	10-04588	\$292.95
MB800-14V (Black) Illuminated Buttons	10-04589	\$292.95
MB800-28V (Black) Illuminated Buttons	10-04590	\$289.95
MB800-5V (Black) NVG Green A, Illuminated Buttons	10-04591	\$315.00
MB800-14V (Black) NVG Green A, Illuminated Buttons	10-04592	\$484.00
MB800-28V (Black) NVG Green A, Illuminated Buttons	10-04593	\$549.00

Model 877 Rear Mount



- GMT, LT, FT, & ET
- FT & ET Visual Alarm
- External Output for Optional Audio Alarm(FT/ET)
- Bright Sunlight Readable displays
- Illuminated Displays

Model 850 NVG Front Mount



- Model 850 N Size Memory Battery
- Model 877 AA Memory Battery
- Input Voltage 11 TO 28 Volts
- NVIS (NVG) Optional Green A (850 & 850-2)

Model 850 Front Mount



Description	Part No.	Price
GMT, LT, FT, & ET Clock 5V Lighting (850)	10-03310	\$484.00
850A-5V-With Gray Faceplate	10-03311	\$490.00
850-5V With Night Vision Compatibility (Green A)	10-03306	\$650.00
850A-5V-NVG With Gray Faceplate	10-03347	\$658.00
850-2-5V Rear Mount Night Vision (Green A)	10-04725	\$658.00
GMT, LT, FT, & ET Clock 14V Lighting (850)	10-03312	\$485.00
850A-14V With Gray Faceplate	10-03348	\$489.00
850-14V With Night Vision Compatibility (Green A)	10-03349	\$696.00
850-2-14V Rear Mount Night Vision (Green A)	10-04726	\$615.00
850A-14V-NVG With Gray Faceplate	10-03350	\$696.00
GMT, LT, FT, & ET Clock 28V Lighting (850)	10-03313	\$515.00
850A-28V With Gray Faceplate	10-03314	\$494.00
850-28V With Night Vision Compatibility (Green A)	10-03351	\$699.00
850-2-28V Rear Mount Night Vision (Green A)	10-04727	\$636.00
850A-28V-NVG With Gray Faceplate	10-03352	\$708.00
GMT, LT, FT, & ET Clock 5V Lighting (877)	10-03308	\$519.00
877A-5V With Gray Faceplate	10-03309	\$522.00
GMT, LT, FT, & ET Clock 14V Lighting (877)	10-24545-14	\$471.00
877A-14V With Gray Faceplate	11-05879	\$477.00
GMT, LT, FT, & ET Clock 28V Lighting (877)	10-24545-28	\$519.00
877A-28V With Gray Faceplate	11-05880	\$532.00
Audio Alarm Son-Alert	11-04610	\$46.65

IN

DAVTRON INSTRUMENTS

MILITARY CHRONOMETER

MODEL M880



- Military clock
- Two button control system
- Control switch has remote capability
- Sunlight readable displays
- N.V.G. Filter, Green A or BG7B
- Manual dimming of the display
- Full 6 digit display selectable, GMT, LT, ET
- Elapsed time is count up or down
- Keep alive battery (2 year life)
- GMT full 6 digit hours/minutes/seconds
- Local Time, 24 hour, 4 digit

Description	Part No.	Price
GMT, LT & ET Clock with night vision compatibility for military (BG7B)	11-08021	\$1,695.00
GMT, LT & ET Clock with night vision compatibility for military (Green A)	11-08022	\$1,365.00

DENSITY & PRESSURE ALTITUDE MODEL 655



FRONT MOUNT



REAR MOUNT

- OAT (F) & OAT (C)
- Pressure & Density Altitude With Pressure ALT. Alarm
- Aircraft Voltage with Flashing Alarm
- Bright Sunlight Readable Displays
- Input Voltage 11 TO 28 Volts.
- Complete with 12 FT. Digital Probe.

Description	Part No.	Price
O.A.T. F&C/Vol/ Pres & Den ALT (Front Mount)	10-24515-1	\$282.95
O.A.T. F&C/Vol/ Pres & Den ALT (Rear Mount)	10-24515-2	\$289.95

DIGITAL VOLTMETER OUTSIDE AIR TEMPERATURE MODEL 303



FRONT MOUNT



REAR MOUNT

- OAT (F) & OAT (C)
- Aircraft Voltage with Flashing Alarm
- Bright Sunlight Readable Displays
- Input Voltage 11 TO 28 Volts.
- Complete with 12 FT. Digital Probe.

Description	Part No.	Price
O.A.T. F & C / Voltage (Front Mount)	10-24565-14-1	\$239.95
O.A.T. F & C / Voltage (Rear Mount)	10-24565-14-2	\$239.95

DIGITAL VOLTMETER AMMETER MODEL 475VA/475VAA



M475VA



M475VAA

- Low current drain .001 amp
- Plus 100.0 volt D.C. range
- 1.3" case depth
- Sunlight readable
- One tenth volt resolution
- Plus or minus 100.0 amp range
- 2 1/4 Standard mount
- 5, 14, or 28 volt back lighting
- One tenth amp resolution

The M475VAA has dual shunts and can read voltage and two current flows (M475VA has a single shunt). The 475VA and the 475VAA were designed for low current drain and are also used in standby and emergency battery packs. One example of safety is if the alternator fails, you can monitor the load current out of the battery.

Description	Part No.	Price
Volt/Amm Meter 14V Lighting (Single Shunt)	10-03319	\$277.95
Volt/Amm Meter 28V Lighting (Single Shunt)	10-03320	\$278.95
Volt/Amm Meter 14V Lighting (Double Shunt)	10-03321	\$310.00
Volt/Amm Meter 28V Lighting (Double Shunt)	10-03322	\$299.95
Volt/Amm Meter 14V Lighting (Single Shunt) With Night Vision Compatibility Green A	10-04562	\$394.00
Volt/Amm Meter 28V Lighting (Single Shunt) With Night Vision Compatibility Green A	10-04564	\$394.00
Volt/Amm Meter 14V Lighting (Double Shunt) With Night Vision Compatibility Green A	10-04566	\$394.00
Volt/Amm Meter 28V Lighting (Double Shunt) With Night Vision Compatibility Green A	10-04567	\$395.00

DIGITAL OUTSIDE AIR TEMPERATURE

MODEL 301



- OAT (F)
- OAT (C)
- Bright Sunlight Readable Displays
- Input Voltage 11 TO 28 Volts.
- Complete with 12 FT. Digital Probe.

Description	Color	Part No.	Price
O.A.T. Celsius (301 C),	Amber LED	10-08312	\$182.75
301C 3 Pin Connector for Probe	Amber LED	10-03316	\$187.75
O.A.T. Fahrenheit (301 F)	Amber LED	10-08512	\$195.75
301F 3 Pin Connector for Probe	Amber LED	10-03317	\$189.75
O.A.T. Celsius,	Green LED	10-04543	\$190.75
O.A.T. Celsius,	White LED	10-04544	\$191.75
301C 3 Pin Connector For Probe	Green LED	10-04545	\$194.75
301C 3 Pin Connector For Probe	White LED	10-04546	\$191.75
O.A.T. Fahrenheit	Green LED	10-04547	\$190.75
O.A.T. Fahrenheit	White LED	10-04548	\$190.95
301F 3 Pin Connector For Probe	Green LED	10-04549	\$196.75
301F 3 Pin Connector For Probe	White LED	10-04551	\$194.75



M307FC



M307FCI



M307FCE

- OAT (F) & OAT (C) Voltage
- Bright Sunlight Readable Displays
- Input Voltage 11 TO 28 Volts.
- Complete with 12 FT. Digital Probe.

Description	Part No.	Price
O.A.T. F & C (307FC)	10-08513	\$230.95
O.A.T. F & C Cabin Air (307FCI)	11-05881	\$212.95
O.A.T. F & C & Voltmeter (307FCE)	10-04552	\$239.00



Description	Part No.	Price
Celsius Differential Intercooler (307 CD)	10-03318	\$286.95
Fahrenheit Differential Intercooler (307 FD)	11-05882	\$391.00



MODEL 450



MODEL 451

- Aircraft Voltage with Flashing Alarm
- Bright Sunlight Readable Display
- Input Voltage 11 TO 28 Volts.
- Aircraft Voltage (451)
- Bright Sunlight Readable Display
- Minimum panel Space
- Input Voltage 11 TO 28 Volts.

Description	Part No.	Price
Voltmeter (450), Amber LED	10-24505	\$152.75
Voltmeter (450), Amber LED, Remote Sensing	10-04555	\$176.75
Voltmeter (450), Green LED	10-04553	\$154.80
Voltmeter (450), Green LED, Remote Sensing	10-04556	\$183.75
Voltmeter (450), White LED	10-04554	\$153.75
Voltmeter (450), White LED, Remote Sensing	10-04557	\$179.75
Voltmeter (451), Red LED	10-02819	\$146.75
Voltmeter (451), Red LED, Remote Sensing	10-04558	\$145.90

ACCESSORIES / REPLACEMENT PARTS

Description	Part No.	Price
KW-105G Display for Model 303, 307, 655, 880, & 903	11-04611	\$47.65
KW-115G Display for Model 303, 655, 850, 877, & 880	11-04612	\$54.75
KW-505F Digital Display for model 811B	11-04613	\$47.95
800 Series Alarm Son-Alert	11-04610	\$46.65
Temp Probe - 7Ft Red/Black Twisted (Analog)	10-00653	\$136.75
Temp Probe - 12Ft COAX C307PS (Analog)	11-04603	\$148.75
Temp Probe for 307CD/307FD (Analog)	11-04602	\$139.95
Temp Probe 12Ft COAX D307PS (Digital)	11-10717	\$88.50

See our website for additional sizes.

TACHOMETERS

MITCHELL MECHANICAL TACHOMETERS



3-1/8" Tach



2-1/4" Tach

In 1985 AC discontinued production of the popular "RT" series of mechanical tachometers. Mitchell immediately entered the market to fill the void. These tachs feature exceptional accuracy and reliability. Mitchell tachs come with a factory-direct 2 year warranty. The range on all models is 500 to 3500 RPM. Accuracy is +/- 25 RPM from 1000 to 3000 RPM. Determine the correct part number from the chart below. All Mitchell tachs are FAA approved to TSO-C49b for certified aircraft. 2-1/4" tachs are direct replacements for the 3-1/8" tachs to save panel space. \$30.00 for custom range marks (specify ranges). \$12.50 to set hours (specify hours).

Mitchell P/N	Our P/N	Price	Mitchell P/N	Our P/N	Price	Mitchell P/N	Our P/N	Price
D1-112-5023	10-24623	\$315.00	D1-112-5025	10-24625	\$315.00	D1-112-5034	10-24634	\$307.00
D1-112-5122	10-24622	\$315.00	D1-112-5032	10-24632	\$325.00	D1-112-5029	10-24629	\$325.00
D1-112-5030	10-24630	\$325.00	D1-112-5028	10-24628	\$305.00	D1-112-5024	10-24644	\$315.00
D1-112-5124	10-24624	\$325.00						

2566 Cruise RPM Clockwise P/N 98480-2 2-1/4" TACH (98480-2) \$322.00
 2300 Cruise RPM Clockwise P/N 10-02046 2 1/4" TACH \$318.00

IFR P/N	Mitchell P/N	Stewart Warner No.	AC Type	Direction of Rotation	Average Cruise RPM	APPLICATION (REPLACEMENT FOR ORIGINAL EQUIPMENT INSTALLATIONS)
55-35-7	D1-112-5023	P-551-AZ	RT-7	Clockwise	2300	Aero Commander: A9, A9A, A9B Aeronca: 15AC Sedan Alon: F1, F1A, A-2, A-4 & 415C. D, E, F, G (Including Ercoupe and Forney) Grumman/American: AA-1, AA1A, AA-5 Beech: C35, D35, E35, F35 Bellanca/Champion: 7EC, 7FC, 7GC, 7HC, 7GCB, 7K, 7ECA, 7GCAA, 7GCBC, KCAB, 8KCAB, 260, 14-19, Viking 300, TurboViking Call: A , 114 Taylorcraft: 19,15A, 20, 20AG, Zephyr Temco: (Swift; GC-1, GA-1B)
55-35-8	D1-112-5122	P-551-AYZ	RT-8	Clockwise	2050	Beech: 35, A3S, B35, 35R
55-35-9	D1-112-5030	P-551-AZH	RT-9	Counter-clockwise	2300	Aeronca: Champion, Chief (early models) Piper: PA15, PA18, (W/TCM eng)
55-35-10	D1-112-5124	P-551-AZJ	RT-10	Counter-clockwise	2050	Aeronca: Champion, Chief (late models) Champion: 7AC, 11AC, 7CCM Beech
55-35-11	D1-112-5025	P-551-TA	RT-11	Clockwise	2566	Bonanza Models: G35 thru V35, V35TC, 36, A36, 95, B95, B95A, D95A- All Musketeer Models. All Debonair Models Cessna: 150,152, 172, 177, 185 & 188 (with IO-520 eng), 206, 207, 210, 310, 320 Helio: H250, H391, H392, H395 Navion: E, F, G Stits: SA9A, SA9B Bellanca/Champion: 7AC
55-35-12	D1-112-5032	P-551-AZK	RT-12	Counter-clockwise	2566	Stinson: 105,108
55-35-14	D1-112-5028	P-551-AZA	RT-14	Clockwise	1800	Aero Commander: (Ayres Corp.) B1A, S2B, S2C, S2D, S2R Stearman: A75 (P & W eng.)
55-35-15	D1-112-5034	P-551-AZB	RT-15	Clockwise	3000	Cessna: 175
55-35-16	D1-112-5029	P-551-AZL	RT-16	Counter-clockwise	1800	Grumman: G164
55-35-17	D1-112-5024	N/A	RT-17	Clockwise	2400	Maule: M5/6/MX7-180, M5/6/7/MX7-235

Cub Face Dial 3" CW.....P/N 10-05450.....\$66.75 Cub Face Dial 3" CCW.....P/N 10-05451.....\$67.75

***The specific tachometer listed is best suited if the installation has this approximate cruise rpm.
 Direction of rotation must be compatible with the previous tachometer that was used.
 Direction of rotation is defined as when viewing the front of the tachometer.**



SLI AIRCRAFT TACHOMETERS

For three decades, Superior Labs, Inc. (SLI) has supplied the aircraft OEM's with the finest quality and most reliable mechanical tachometers in the industry for new production aircraft and can be customized for a variety of aircraft applications. These are now available to the public as aftermarket tachometers

Specifications:
 • Accuracy to within ± 25 RPM • Range 0-3500 RPM • Diameter 3-1/8" • Length 3-1/2" • Weight: 13 Oz. • Two Years Warranty
 Most Models \$739.00

Accessories	Part No.	Price	Accessories	Part No.	Price
SLI Custom Range Markings	10-03685	\$150.00	SLI Tach Hours Set	10-03673	\$150.00
Sli Tach Lighting	10-03672	\$150.75			

SEE WWW.AIRCRAFTSPRUCE.COM FOR APPLICATION CHART, PART NUMBERS, AND PRICES.

TACHOMETERS



RIGHT ANGLE TACH DRIVE

Instrument right angle tach drive. All connections and case are Aluminum and connects from gauge to tach cable. Reversible: Can be configured clockwise & counter clockwise rotations.

P/N 10-05504\$165.75



DUAL TACHOMETER DRIVE

Adapter screws to the male thread on the back of the tachometer. The two tachometer cables screw onto the opposite sides of the dual adapter. 1:1 Ratio.

P/N 10-01445\$179.95



ENGINE RIGHT ANGLE DRIVE

Female end attaches to engine tach drive outlet. Male output end accepts standard tach cable female nut (7/8-18 thread). Eliminates bending of tach cable at the engine in cramped installations. Designed for heavy-duty service. Gears and shafts are of heat-treated alloy steel. Oil impregnated sintered bronze shaft bearings. Cast iron case and fittings. With lubricator fitting for greasing. 1:1 ratio.

P/N 10-00814\$111.75



TACHOMETER CAP

This Tach Cap can be used to close off the tachometer drive of a Lycoming or Continental engine when an electronic tach drive is being used off the magneto or electronic ignition. 7/8" thread and Viton (R) O-ring to seal.

P/N 10-06754\$32.50 ea.



FALCON 2-1/4" MECHANICAL TACH

Falcon T2-001U Tachometer - For both point and Ducati Ignitions. Standard pointer type. Universal, 0-8000rpm, Point and CDI. Compatible with rotax point and CDI ignition, not compatible with 912, 914.

P/N 10-00816\$128.75



WESTACH TACHOMETERS

CLamps to ultralite tubing or motorcycle handle bar. Swivels 360° at any angle. Furnished with chrome plated installation hardware. SINGLE TACH (Tachometer requires no sender.)

PWR By	Application	RPM	Head Type	MFR PN	Part No.	Price
CDI	2 or 6 imp alt (Rotax, 2Si, Hirth, Arcticat)	0-8000	Round	2CT8A-2/6	10-01302	\$147.75
Mag	2/4 cyl. dist/mag & 1/2 VW	0-3500	Square	2AT3-2	10-01275	\$164.75
Mag		0-5000	Square	2AT5-2	10-01294	\$169.50
CDI	2 or 6 imp alt. (Rotax, 2Si, Hirth, Arcticat)	0-8000	Square	2AT8A-2/6	2AT8A-2/6	\$164.75
CDI	Jabiru 5 imp alt.	0-3500	Square	2AT3A-5	10-00478	\$164.75
CDI	Jabiru 6 imp alt.	0-3500	Square	2AT3A-6	10-00479	\$164.75

WESTACH 2-1/4" TACH/HOUR METERS



SQUARE



ROUND

PWR By	Application	RPM	MFR PN	Part No.	Head Type	Price
Mag	2/4 cyl. dist/mag & 1/2 VW	3500	Y2AT3-2	10-01305	Square	\$289.95
Mag		8000	Y2AT8-2	10-01690	Square	\$289.95
CDI	2 or 6 imp alt (Rotax, 2Si, Hirth, Arcticat)	8000	Y2CT8A-2/6	10-01694	Round	\$318.00

Made in the U.S.A

TACHOMETER CABLES



Select the proper length from the listing, but measure old tach cable to verify length in chart is correct for your aircraft, as tach cables can vary from aircraft to aircraft. Over-length cables can cause problems - order one that fits the installation. Select the proper length from the listing, but measure old tach cable to verify length in chart is correct for your aircraft, as tach cables can vary from aircraft to aircraft. Measure original cable from end of Ferrule to end of Ferrule when fully extended. Inner tach cables are measured end to end. Inner assemblies have male ends only. One end is squared and the other is keyed. Tach cable assemblies have 7/8-18 on one end and 5/8-18 on the other, female nuts only. Custom length tach and inner cables are available. Please contact sales for price and lead time of custom cable. You will be required to provide length and rotation. Additional information of aircraft, engine, make, model & dash number may be required.

Note: General rule for installation: Tach cable should be installed as straight as possible - the inner cable length will decrease 11/16" per 360 degrees of bends.

Available in left and right lay rotation. Add -R to the part number for Right Lay.

Tach Cable Ass'y - Lengths to 4ft (Additional charge per foot for longer lengths.)..... 4 foot length\$78.75
Inner Cable Only - Length is 4ft (Additional charge per foot for longer lengths.).....P/N 10-22400\$38.50

See our website for additional lengths.

Part No.	Length	Price	Part No.	Length	Price
10-02675	22"	\$69.90	10-00012	46"	\$78.75
10-15700	29-1/2"	\$73.75	10-16400	42"	\$78.75
10-15800	26"	\$73.75	10-16500	34"	\$73.75
10-15900	29"	\$73.75	10-16600	32"	\$73.75
10-16000	25"	\$73.75	10-16700	35"	\$74.75
10-16100	37"	\$78.75	10-16900	48"	\$78.75
10-16200	36"	\$73.75	10-16910	52"	\$83.75

UNIVAIR TACHOMETER CABLES



Description	Part No.	Price
Recording Tachometer Cable U1713-R325	05-21949	\$157.75
Non-Recording Tachometer Cable U1713-N340	05-21950	\$147.75

BELITE RADIANT TACHOMETER



Radiant Tachometer is designed to work with any engine and provides a brilliant, crisp LCD screen with a soft green back light, for easy visibility. The Digital Tachometer / Hour Meter is a general purpose, ignition spark lead based instrument. Mount it anywhere using the included Velcro patch. Works with two or four stroke engines; also includes a job (oil change) interval countdown timer.P/N 10-06872\$43.75

TACHOMETERS



UMA ELECTRONIC EXPERIMENTAL TACHOMETERS

These electronic tachometers use a 250° sweep meter movement to withstand high levels of vibration and register flight time accurately. The hour meter counts flight hours at RPM settings of 1800 & higher. Power: 12-28VDC. 2-year warranty.

UMA Model#	Range	Description	Part No.	Price
19-819-201	0-7000 RPM	3-1/8" For Rotax 912 Engine B & W Markings, built-in hour-meter	10-00119	\$298.95
19-819-211	0-7000 RPM	3-1/8" For Rotax 912 Engine Color Markings	10-04223	\$329.00
19-519-211	0-7000 RPM	2-1/4" For Rotax 912 Engine Color Markings	10-01852	\$211.95
19-519-213	0-7000 RPM	2-1/4" 3 Pulse Rev Rotax 982	10-05602	\$211.95
19-519-216	0-7000 RPM	2-1/4" 6 Pulse Rev Rotax 447 / 503 / 582	10-05603	\$211.95
19-811-10C	0-3500 RPM	3-1/8" Electric Lick 6C Sender	10-02116	\$373.00
19-801-102	0-3500 RPM	3-1/8" *To replace Mechanical Tachometer (reads CW or CCW; B&W Dial Only) Furnished w/ mechanical sender	10-00120	\$411.00
19-801-112	0-3500 RPM	3-1/8" *To replace Mechanical Tachometer (Green Arc 500-2700 - Red 2700) Furnished w/mechanical sender	10-00121	\$432.00

UMA 2-1/4" ELECTRONIC TACHOMETERS

These tachs have high resolution and easy to read displays. The analog model has a 250° sweep which provides great resolution in both the 3500 & 7000 ranges. The digital model has a bright LED display. Separate power source required. All tachs require power from a 14 or 28V system. Installations are simple with instructions included.



3500 ANALOG TACH

Lycoming/Continental (to replace mechanical tachs) Current: 37 milliamps Size: 2.25"rnd. X 2.75"deep. Magnetic pickup (6 ft. cable length) included with P/N's 10-02141 and 10-02140 (T1A9). 6 ft. harness, sending unit, and .156 diameter tang adapter included with P/N 10-00083 (1A3-4).

0-3500 RPM, 4 cyl., Pulses:1.....P/N 10-02140\$352.00
 0-3500 RPM, 4 cyl., Pulses:2.....P/N 10-00083\$321.00
 0-3500 RPM, 6 cyl.....P/N 10-02141\$299.95



7000 ANALOG TACH - Current: 37 milliamps; Size: 2.25" round X 2.75" deep

Rotax 19-519-206.....P/N 10-01854\$182.80
 Rotax 912.....P/N 10-01853\$182.80
 Rotax 912/914 Lit.....P/N 10-02053\$173.80

* P/N 10-00120, 10-00121, 10-24870, & 10-24885 tachs eliminate the problems associated with mechanical tach cables, and the sending unit is a direct replacement for the tach cable. All models are analog style tachs with hour meters and can read RPM for either clockwise or counter-clockwise revolutions. Sender included. **Slick Mags Only



EM8000 TACH GENERATOR

EM8000 Quality Tach Generator (4-pole). Aircraft tach generators measure an airplane's engine speed electrically. By using the rotation of a magnet to emit voltage, the frequency of the voltage is measured into revolutions per minute. This rpm is then reported to the tachometer for a visual readout to the pilot.

P/N 08-15987\$620.00



UMA ELECTRONIC TSO'D TACHS

Owners of Lycoming & Continental powered airplanes now have an electronic, analog alternative to the old cable driven tachometer. The new UMA tach is certified to FAA TSO C49b standards for fixed wing aircraft. The system uses a tach sender mounted on the engine in place of the mechanical cable and is connected to the indicator with a single, 3-conductor cable. The 3 1/8" indicator utilizes a high torque pivot and jewel movement. The hour meter can be factory set to start at any desired RPM point. This unit gives the pilot the analog display that is easiest to scan and provides electronic accuracy and ease of installation. Custom dial markings in color & internal Electro-Luminescent lighting are available at extra cost. UMA manufactures a complete line of TSO'd & non-TSO'd gauges & instruments in the USA.

UMA Model#	Range	Dial Marking	Part No.	Price
T19-801-10	0-3500 RPM	Black & White	10-01221	\$538.00
T19-801-11	0-3500 RPM	Green Arc 500-2700 & Red Line 2700RPM(Lyc.)	10-01222	\$564.00
T19-801-112N	0-3500 RPM	TSO w/o Hourmeter	10-07143	\$515.00



UMA ELECTRONIC TACHOMETER WITH HOURMETER

3 1/8" Analog Tachometer with hourmeter. 4 Cylinder. 0-3500 RPM. Records engine time above a set RPM point. Standard set point is 1800 RPM. Engine Type: Continental/Lycoming. TSO'd Magnetic pickup for Slick or Bendix Magnetos (6 ft. cable length), alternative to p-lead connections P/N 10-04868\$377.00



TRU-TACH II DIGITAL TACHOMETER

Mechanical tachometers are notoriously inaccurate. The TruTach II Optical Digital Tachometer measures the true speed of your propeller from inside or outside the aircraft. Just point it at the propeller or rotor blades and TruTach II will directly display the rotational speed with a resolution of 1 RPM. No connection to aircraft systems is required and measurements may be made at any speed setting from 240 to 70000 RPM. Direct display is available for 2, 3, 4, and 5 blade propellers. Digital Signal Processing assures rock-solid display in single and multi-engine aircraft as well as helicopters. The compact 4-inch instrument weighs just 4 ounces and may be used with fast turning ultra-lights and kit plane propellers. Automatic shut-off turns the unit off if you forget. Includes 9 volt battery providing 150 hours of operation.

P/N 10-01021\$209.95



2-1/4" REMOTE HEAD TACHOMETER

This tachometer is driven with power supplied by a transducer on the engine tach drive. Range 0-3500 RPM. Wt. 6 oz. Includes Gauge, sender, and tang. Sender only.....P/N 10-02084\$218.95
 Tang only.....P/N 444-2\$8.50



WESTACH TACHOMETERS

KY3GA3-1/2A - 500-3,500 RPM with hourmeter kit, 3-1/8" sq., 1/2 to 1 ratio, adjustable, with 303 DGT sender, 444-2 tang, 208-SS-SS cable. PN 10-02644\$529.00



K3GA3-1/2A - Tachometer 500-3,500 RPM kit, 3-1/8" square, 1/2 to 1 ratio, adjustable with 303DGT sender, 444-2 tang, 208-SS-SS cable. Does not come with a senderPN 10-02643\$204.95

Made in the U.S.A

UMA SENDING UNITS FOR TACHOMETERS



UNIT 1A3-4

Sending Unit 1A3-4 only P/N 10-01706 \$149.75

T1A9

Magnetic pickup for Slick or Bendix Magnetos (6 ft. cable lengths)
 Slick.....P/N 10-02432\$127.80
 Bendix.....P/N 10-02433\$127.80



ALCOR EGT & CHT SYSTEMS

BASIC EGT & CHT SYSTEMS

FAA and PMA approved for all reciprocating-powered aircraft!

2-1/4" GAUGES



A46125

A46150

A46126

A46151

A46127

A46164

3-1/8" GAUGES



A46124

A46155

A46156

A46157

Instruments: Provide a quick and easy way to troubleshoot and determine an engine's efficiency. Alcor's instruments are known for their quick response time, easy-to-read design and long life. All Alcor instruments are FAA/PMA approved for anything piston-powered that flies! Available in 2 1/4" and 3 1/8" diameters, these instruments can be purchased in single or dual configurations with or without internal lighting. Special order options are also available. All Alcor instruments carry a 3 Year Warranty!

Sensors: Recommended by the most popular manufacturers of digital engine monitoring systems because Alcor sensors are: • Made from the highest-quality materials • FAA approved • Provide fast response time • Built to last • Covered by a 5 Year warranty for grounded probes • Manufactured in the USA!

Basic Systems: Kit includes the 2 1/4" or 3 1/8" instrument, one lead and one sensor for single cylinder EGT or CHT monitoring.

Multi-Cylinder Systems: Kit Includes 2 1/4" or 3 1/8" instrument, all leads, switches and sensors for EGT and CHT monitoring of every cylinder. Alcor's 2 1/4" instrument uses Alcor's Universal Cylinder Selector (UCS) (p/n 80825 or 80827) switch to convert the basic system into an affordable Alcor analyzer!

BASIC SYSTEMS		
System	Part No.	Price
EGT	10-08700	\$381.95
CHT	10-08800	\$444.95
EGT/CHT 2-1/4"	10-08900	\$915.00
EGT/CHT 3-1/8"	10-20700	\$818.00

ANALYZER SYSTEMS		
System	Part No.	Price
EGT (4Cyl.)	10-09000	\$985.00
CHT (4 Cyl.)	10-09100	\$1,114.00
EGT/CHT (4 Cyl.)	10-09200	\$2,086.00
EGT (6 Cyl.)	10-09300	\$1,332.00

ALCOR PROBES

Alcor's probe (thermocouples) reliability is legendary in the aviation community, designed to give years of dependable and accurate service.

GROUNDING THERMOCOUPLES

ALCOR	Description
86255	EGT Clamp Type Probe min/max dia.-1.5" to 3.25" (Yellow/Red, Chrome/Alumel)
86240	EGT Screw-In Probe, fitting dims: 7/16" x 20 threads (Yellow/Red) less boss
86245	EGT Screw-In Probe, fitting dims- 7/16" x 20 threads (Yellow/Red, reverse stagger leads) less boss
28113	Weld Boss
86251	CHT Bayonet Probe (Black/Yellow,
28202	Iron/Constantan) AN5541-1 CHT Bayonet Probe Adapter
86202	CHT Gasket Style Thermocouple. Type: J - Black and Yellow. Grounded Style: Gasket. Size: 18 mm. Resistance: .13 + .16 Ω - .05 Ω. Weight: 0.12 lbs.

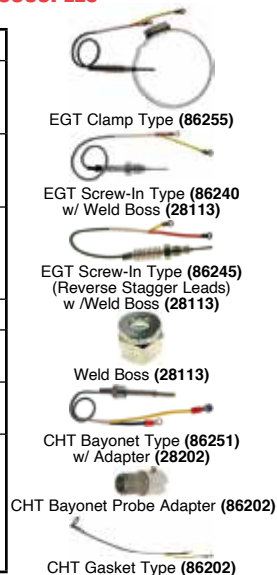

ALCOR ALCAL 2000+ SYSTEM TESTER

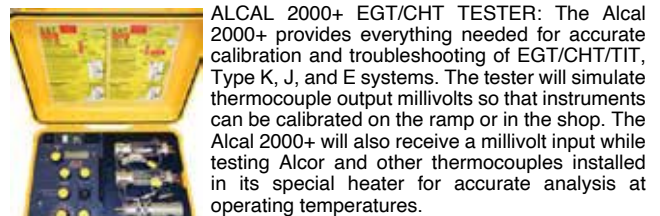

ALCAL 2000+ EGT/CHT TESTER: The Alcal 2000+ provides everything needed for accurate calibration and troubleshooting of EGT/CHT/TIT, Type K, J, and E systems. The tester will simulate thermocouple output millivolts so that instruments can be calibrated on the ramp or in the shop. The Alcal 2000+ will also receive a millivolt input while testing Alcor and other thermocouples installed in its special heater for accurate analysis at operating temperatures.

The Alcal 2000+ is also designed to check the accuracy of an entire system or the individual components. While the thermocouple is in the heater, the instrument can be read in the panel and recalibrated as necessary while simulating temperatures up to 1750 F. An easy-to-read LCD display makes accurate settings a snap. With its rugged Pelican case, the Alcal 2000+ is ready to use anywhere! Certification of the Alcal 2000+ is traceable to National Institute of Standards and Technology (NIST).

Features:

- Redesigned Pelican case with removable lid for stress-free use in any environment
- Internal carrying handle for tranquil transport and handling with or without the lid
- Additional EGT/TIT Heater that accepts competitors' larger probes and tests both digital and analog systems
- Easy access to the fuse and 9V Lithium battery for quick replacement if necessary
- Plus, all the great features of the Alcal 2000 (FAA/PMA not required)

Specifications:

- 9V Lithium Battery-powered
- 12lbs
- Alcor P/N: 85337

2000+ System Tester P/N 10-04981 \$3,325.00

Accessories

28187 Gasket Thermocouple Adapter.....	P/N 10-04959\$76.80
35291 EGT Heater 1.28 Hole.....	P/N 10-04956\$358.00
35309 EGT Heater.....	P/N 10-04953\$357.00
35311 CHT Heater.....	P/N 10-04957\$348.00
86188 EGT Reference Thermocouple.....	P/N 10-04954\$98.75
86261 CHT Reference Thermocouple.....	P/N 10-04958\$125.99

ALCOR 98214 TYPE K THERMOCOUPLE WIRE

Alcor 98214 K Type Thermocouple Wire. 22 awg, 7/30 stranded insulated with FEP. Sold in 50 ft packs.

P/N 05-22849\$123.75

IMPORTANT! EGT systems & components with red/brown color codes are not compatible with systems & components using red/yellow codes.

ALCOR EGT & CHT COMPONENTS

ALCOR COMPONENT PRICE LIST

Alcor	Our P/N	Description	Price
EGT Leads, Type K			
42525	42525	EGT Leads, Type K (90")	\$43.85
42526	42526	EGT Leads, Type K (144")	\$60.85
42527	10-00131	EGT Leads, Type K (240")	\$83.80
42528	42528	EGT Leads, Type K (216")	\$82.85
CHT Leads, Type J			
42535	42535	CHT Leads, Type J (90" 8 ohm)	\$51.80
42536	42536	CHT Leads, Type J (144" 8 ohm)	\$64.85
42537	42537	CHT Leads, Type J (240" 8 ohm)	\$82.85
42543	42543	CHT Leads, Type J (216" 8 ohm)	\$80.75
Meters, Single 2-1/4"			
46149	10-03859	EGT Internal light 24V Type K	\$319.00
46150	46150	EGT Type K Fahrenheit red and yellow	\$258.95
46151	46151	CHT Type J, Fahrenheit black & yellow	\$257.95
46162	10-00992	EGT Type K, Fahrenheit (Green Arc)	\$315.00
46164	10-00993	EGT Type K, Fahrenheit (No Green Arc)	\$299.95
46171	10-00996	CHT Type J, Celsius Black & Yellow	\$294.95
46244	10-00997	EGT 240" Lead Type K, Fahrenheit (Green Arc)	\$344.00
Meters, Dual 2-1/4"			
46124	10-00994	TIT/TIT Type K, Fahrenheit Red & Yellow	\$627.00
46125	10-00126	EGT/EGT Type K Red & Yellow Unlit	\$610.00
46188	10-06035	EGT/EGT Type K Lit	\$665.00
46126	46126	EGT/CHT Type K & J, Fahrenheit	\$643.00
46127	10-00127	CHT/CHT Type J, Fahrenheit	\$603.00
Meters, Dual 3-1/8"			
45993	10-00998	EGT Type E Fahrenheit Red and Brown. Designed for twin engine aircraft.	\$990.00
46115	10-03861	EGT/EGT 24V Type K. Designed for twin engine aircraft.	\$619.00
46155	10-00128	EGT/EGT Type K	\$520.00
46156	46156	CHT/EGT Type J & K, Fahrenheit	\$509.00
46157	10-03860	CHT/CHT Type J Fahrenheit	\$505.00
46224	10-00999	TIT/TIT Type K, Fahrenheit	\$579.00
EGT Probes, Type K			
86143	10-01005	Model N, Screw-In (1/4" NPT)	\$167.95
86159	10-01006	Model H, Screw-In (1/4" NPT)	\$170.90
86160	10-01007	Model J1, Screw-In (7/16"-20)	\$169.95
86161	10-01008	Model K, Screw-In (1/4" NPT)	\$169.95
86226	10-01009	Model A, Clamp, 11.56" length (Reverse Stagger)	\$134.75
86230	10-01011	Model N2, Screw-In (1/4" NPT)	\$165.75
86240	10-00129	Model B, Screw-In (7/16"-20)	\$118.75
86245	86245	Model B, Screw-In (7/16"-20) (Reverse Stagger)	\$115.75

Alcor	Our P/N	Description	Price
EGT Probes, Type K			
86255	86255	Model A, Clamp (Normal Stagger)	\$104.75
86275	10-01012	Model A, Clamp, 13.6" (Rev. Stagger)	\$119.95
86281	10-01013	Model A, Clamp C/A Extended Lead	\$215.95
CHT Probes			
86202	86202	Gasket Style Type J 18mm	\$139.75
86251	86251	Bayonet Style Type J	\$103.75
86252	10-04949	Bayonet Style, Type K, Red/Yellow, reverse stagger	\$103.75
86253	10-04951	Bayonet Style Probe CHT 3/8-24, Type K, screw-in probe and supersedes 86252-3. This unit is also a replacement for Garmin probe 86252	\$129.95
Parts and Accessories			
35309	10-04953	EGT Heater (1004-6)	\$357.00
86188	10-04954	EGT Reference Thermocouple (1004-7)	\$98.75
35291	10-04956	EGT Heater .128 Hole	\$358.00
35311	10-04957	CHT Heater (1004-26)	\$348.00
86261	10-04958	CHT Reference Thermocouple	\$125.99
28187	10-04959	Gasket Thermocouple Adapter (1004-72)	\$76.80
Ungrounded EGT Probes			
86307	10-86307	Screw-In (1/4 NPT)	\$541.00
86341	10-04952	Red/Yellow, Screw-in (1/8 NPT)	\$549.00
86308	10-86308	Screw-In (7/16-20)	\$545.00
86309	10-86309	Screw-In (7/16-20), Extended Lead	\$540.00
86310	10-86310	Clamp - 2.35" max	\$540.00
86343	10-86339	Clamp (with Plug, Short) 3.25" max	\$416.00
Accessories			
28113	10-01017	Weld Boss 7/16 UNF (for B Probe)	\$31.50
28202	28202	CHT Adapter for Bayonet Probe (AN4076-1)	\$31.55
28204	10-01018	Plug for 28113 Weld Boss.	\$31.50
42523	10-01019	EGT Lead Stagger Adapter. Type K	\$12.50
80825	80825	Universal Selector Switch - 7 inputs	\$208.95
80827	80827	Universal Selector Switch - 4 section	\$254.95
Vernier			
93882	10-01020	Vernier Control Assembly 112"	\$181.75
Alcor, CHT Parts			
28202	28202	Bayonet Thermocouple Adapter (1004-4)	\$31.55
38091	05-22271	Alcor 38091 Hardware Kit designed to provide the essentials while installing probes 86245, 86252, 86253, and 86255.	\$13.55

IN

WESTACH INSTRUMENTS

2-1/4" ENGINE INSTRUMENTS

Guaranteed accurate within 2% with a 1-yr. warranty. Weight - an unbelievable 4oz. These instruments are self powered by the thermocouple, except for the lighting.



CYLINDER HEAD TEMPERATURE

100-700°F P/N 2A1 \$96.75
 25°-375°C P/N 2A1-2 \$96.75
SENDERS: CHT Senders have 4 ft. leads.

14mm gasket type
 (VW, Rotax) P/N 712-4W \$39.95
 18mm gasket type (Cont, Lyc.) P/N 712-5W \$39.95
 Bayonet type 3/8" x 24 thread P/N 712-7D \$81.95
 Bayonet type 1/8" NPT thread P/N 712-7DJ \$78.95
 (All Rotax) P/N 712-912K \$86.75



EXHAUST GAS TEMPERATURE

700-1700°F/350-950°C P/N 2A2 \$92.75
 100-1900°F/100-1000C P/N 2A2-1 \$92.75
 400-900°C P/N 2A2-2 \$92.75
 4000-1600°F/200-850°C P/N 2A2-7 \$92.75
SENDERS - Clamp type senders with 3/16" diameter probe. EGT Senders have 4 ft leads.

1" long tip P/N 712-2DWK \$59.95
 1/2" long tip P/N 712-20DWK \$59.95
 Long tip 1/4" threads P/N 712-4D \$73.75
 3/8-24 for Lycomings P/N 712-4D1 \$73.75
 Long tip for VW (1/12" OD tailpipe) P/N 712-24DWK \$59.95
 (All Rotax) P/N 712-32DWK \$59.95
 Bayonet K type, EGT probe for Rotax P/N 712-4D6K \$83.75
 Exposed Tip, model 712-20DWKE - Hose clamp style 1/2" probe.
 P/N 10-01300 \$73.75

Note: Westberg 712 Series Thermocouples are for Non-TSO'd CHT & EGT Gauges only. They have two small pins which are the same size.



OIL TEMPERATURE

100° - 260°F P/N 2A9-2" \$89.75
 Sending Unit P/N 399S7 \$45.65
 *Use Sender #399S9-7/8 for Cont & Lyc Engines.
 (5/8-18 Thread) P/N 399S9 \$63.75



OIL PRESSURE

Guaranteed accurate within 2% with a 1-year warranty.
 Weight an unbelievable 4oz.
 K2A8MM. 0-80 PSI (w/sender)
 P/N 10-01292 \$415.00



FUEL PRESSURE

This specially constructed instrument offers accuracy and durability in a lightweight (3.5oz) package. Perfect for home-built and custom applications. K2A8-8MM. 0-15 PS w/Sender(SET) ... P/N 10-01553 \$415.00



WESTACH 387-15KV PRESSURE SENDER

Electronic Pressure Sender, 15 psi, 0.5-4.5 vdc, 1/8" npt. P/N 10-05273 \$339.00



MANIFOLD PRESSURE GAUGE

2-1/4" Size 0-30 PSI & 0-50 PSI. Not Altitude Compensated (square)
 2A4-14 - 0-50 IN HG P/N 10-04178 \$88.75
 2A6-6 - 0-30 IN HG P/N 10-04797 \$88.75



WESTACH VOLTMETERS

Westach voltmeters, 2" round. Made in USA

Range	Pat No.	Price
18-28 VOLT	10-04184	\$96.75
15-50 VDC	10-04185	\$87.75

FUEL LEVEL GAUGES (SQUARE)



2-1/4 Non-TSO'd fuel quantity indicators available for single or dual tanks. Require 0-5V capacitance senders (not included)

Instrument (Single) P/N 2A7V \$89.95
 Instrument (Dual) P/N 2DA4V \$165.75
 2A7-2, 0-30 OHM P/N 10-04125 \$89.95
 2A7, 240-30 OHM, Uses Float Sender

P/N 11-01210 \$89.95
 2AHT7V, Full Sweep Meter P/N 10-04121 \$129.85
 Sender (6"-12" Depth) P/N 10-00797 \$159.75
 AP-24-D120-5V Sender (12"- 24" Depth) P/N 10-03875 \$159.75
 395-5-5 6" Capacitance, non-bend sender P/N 10-04344 \$159.75
 395-5SB-5 Sender (6"-12" Depth-Bend) P/N 10-00798 \$159.75
 395-5S-1B-5 Sender (12"-24" Depth-Bend) P/N 10-01262 \$179.75
 AP24B5-D120-SV Sender (24", 5" bend. section) P/N 10-04412 \$199.75
 Capacitance sender 12" long, 3" bend section ... P/N 10-05725 \$182.75
 Capacitance sender 24" long, 3" bend section ... P/N 10-05738 \$176.90



FUEL LEVEL GAUGES (ROUND)

2C7V, 2" Round P/N 10-04119 \$76.95
 22C7, 240-30 OHM,
 Uses Float Sender P/N WS2C7 \$83.75
 2CHT7V-5, Fuel Sweep Meter.. P/N 10-04120 \$97.75

WESTACH WATER TEMPERATURE GAUGE

2A9-1 Water Temperature Gauge 100-260f, 2 1/4" square, 8-30 VDC.

2-1/4" Westach Water Temp. Gauge Only
 P/N 2A9-1 \$89.75
 Westach Sender #399S1 Only
 P/N 10-01288 \$43.50
 Westach 2-1/4" Water Temp. Gauge with Sender
 P/N 10-04948 \$132.95



OUTSIDE AIR TEMPERATURE

Square Gauge P/N 2A3-3 \$89.75
 Round Gauge P/N 10-04131 \$79.95



CARBURETOR AIR TEMP

Provides instant icing check of carburetor.
 2A3-1 - 2-1/4" square, -50°C to 50°C
 P/N 10-01243 \$96.75
 2C3-1 - 2" round, -50°C to 50°C
 P/N 10-03949 \$83.75
 Sending Unit - Fits 1/4-28 Thread
 P/N 399W \$59.95



COOLANT TEMPERATURE

100° to 260°F, for aircraft and helicopters using coolants other than oil P/N 10-01301 \$89.75
 Sending Unit P/N 10-01249 \$45.65

WESTACH EGT/CHT COMBINATION KITS HOMEBUILDERS ENGINE ANALYZER KITS



Complete kits include CHT or EGT gauge, selector switch and probes for each cylinder of 4 or 6 cylinder engine. EGT kits furnished with long-life #712-2DWK probes.

Kit	4 Cyl.		6Cyl.	
	Part No.	Price	Part No.	Price
14MM CHT Kit	10-17114	\$311.95	---	---
18MM CHT Kit	---	---	10-17218	\$405.95
EGT Kit	10-17300	\$387.95	10-17400	\$521.00



HOMEBUILDERS ADD-ON KITS
 Add-on kits for single-position system already installed. Consists of selector switch & 3 or

5 probes for CHT or EGT to provide analyzer for 4 or 6 cylinder engines. EGT kits furnished with long-life #712-2DWK probes.

Kit	4-Cyl.		6-Cyl.		Type "k" probe	
	Part No.	Price	Part No.	Price	Part No.	Price
CHT Kit	10-01064	\$163.95	10-01066	\$246.95	10-03892	\$46.95
EGT Kit	10-01065	\$217.95	10-01067	\$343.95	---	---

MADE IN THE U.S.A

* These instruments may be powered by connection to 12V battery, magneto, distributor or alternator. If installation is to be made using other than 12V electric power, order one Magneto Adapter, P/N 103-18 (\$6.30) and one Fuse Adapter, P/N 10-17000 (\$6.30) for each instrument. For 24V operation, order one Adapter, P/N 329-24 (\$2.30) for each instrument.

WESTACH INSTRUMENTS

MADE IN THE U.S.A



AMMETERS (SQUARE)

Westach Ammeter, amp -30-0-+30A adc, 2 1/4" square, 50 mv f/s. Model with or without shunt.
 With Shunt.....P/N10-01267**\$145.75**
 Without Shunt.....P/N 10-04116**\$88.75**
 -60 to +60A, & #237-3A Shunt
P/N K2A6-15 ... **Set \$145.75**



WESTACH AMMETER 2A6-15 (SQUARE)

Westach Ammeter, amp -60-0-+60 adc, 2 1/4"square, 50 mv f/s.
 With Shunt.....P/N 10-01277**\$145.75**
 Without Shunt.....P/N 10-04114**\$88.75**



WESTACH AMMETER 2C6-22 (ROUND)

Westach Ammeter, amp -30-0-30 adc, 2" round, 50 mv f/s. Note: Gauge does not include shunt. Range: -60-0-30 adc. Size: 2" round. Shunt: Model 237-30
 Ammeter 2C6-22.....P/N 10-04108**\$76.85**
 Shunt #237-30.....P/N 10-01306**\$57.75**



WESTACH AMMETER 2C6-15 (ROUND)

Westach Ammeter, amp -60-0-60 adc, 2"round, 50 mv f/s. Note: Gauge does not include shunt. Range: -60-0-60 adc. Size: 2" Round. Shunt (Not Included): Model 237-60
 Ammeter 2C6-15.....P/N 10-04104**\$76.85**
 Shunt #237-60.....P/N 10-01298**\$57.75**



HOURLMETER

Power Range, 5V-40V, Record running time of engine.
 P/N 2A10-2**\$151.75**
No sender required.



VOLTMETERS

Check generator & alternator charging
 6-16 VDCP/N 2A5**\$96.75**
 0-35 VDCP/N 2A5-2.....**\$88.75**
No sender required.



WESTACH 2C4-7 GAUGE

Boost 0-30 psi, 2-Inch round, with 220-9, 203-17, 203-21
 P/N 10-04155**\$75.50**



SELECTOR SWITCHES

These switches are used with the Westach CHT, EGT, or CHT/EGT gauges to allow multiple cylinder engine analyzing. Switches included with Engine Analyzer kits & Add-On kits on following pages, or can order separately below. Non-TSO'd. These switches have two small connectors of same size.
 2-PositionP/N 254-2F**\$44.90**
 4-PositionP/N 254-4F**\$55.75**
 4-Position (Dual)P/N 254-4DF***\$89.75**
 6-PositionP/N 254-6F**\$69.75**



***To convert dual EGT/CHT to Engine Analyzer. FAA APPROVED SWITCHES**

These switches are furnished with 96" leads.

WESTACH INSTRUMENT LIGHTING

An internal lighting fixture may be added to all 2" & 3" instruments. Comes with clear bulb and red & green boots P/N 10-01229**\$8.50ea**

WESTACH BULLET CONNECTORS

Bullets are used to connect sockets and sleeves together on the back of Westach instruments.....P/N 10-02795**\$0.45**

WESTACH INSTRUMENTS FOR ULTRALIGHTS



Single CHTP/N 10-00419**\$85.85**
 Single EGTP/N 10-01268**\$82.50**
 Thermocouple for CHT (14MM)P/N 10-01227**\$39.95**
 Probe for EGTP/N 10-01225**\$59.95**

SINGLE TACH (Tachometer requires no sender.)

Model	RPM	Powered By	Part No.	Price
2CT8A-2/6	0-8000	CDI	10-01302	\$147.75

DUAL TACH/CHT (All CHT's are 0-600° F)

Model	RPM	Powered By	Part No.	Price
2DC9-8A-2/6	0-8000	CDI	10-02911	\$221.95



WESTACH 2DC8 DUAL CHT

Cylinder Head Temp. Range: 100-700°F. Use 48" Type J thermocouples. Input: 9.81 mv @ 400F, Weight: 2.7 oz.
 P/N 10-01791**\$154.00**



BULLET SHELL MOUNTING CASE FOR 2" ROUND WESTACH GAUGES

Molded plastic housing clamps to ultralite tubing or motorcycle handle bar. Swivels 360° at any angle. Furnished with chrome plated installation hardware P/N 10-01290 **\$23.50**



WESTACH TACHOMETERS FOR DUAL IGNITION

2" RoundP/N 10-01302**\$147.75**
 2" SquareP/N 2AT8A-2/6**\$164.75**
 3" SquareP/N 3AT8A-2/6**\$187.75**



WESTACH SENDER 720-14RB

Proximity sensor, Hall effect sender for Bendix mag. 9/16 - 24 thd. 5-12 VDC. Weight: 7 ounces
 P/N 10-00863 **\$296.95**



WESTACH EXTENSION LEADS

Complete extension leads, with connector terminals, for extending CHT or EGT leads up to Complete extension leads, with connector terminals, for extending CHT or EGT leads up to 10 ft. without affecting accuracy. Longer lengths give low reading, requiring recalibration of instrument.

18" Lead ..P/N 10-17900..**\$22.50** 4 Ft. Lead P/N 10-18000 . **\$30.90**
 6ft Lead ...P/N 10-18100..**\$28.85** 8 Ft. Lead P/N 10-18200 . **\$31.50**
 10ft Lead .P/N 10-18300..**\$34.50** 12 Ft. Lead .. P/N 10-18350 . **\$38.50**



WESTACH GAUGE WIRE EXTENSION LEADS

10' and 5', 4 wire and 2 wire "Extension Leads" ideal for quick and easy extending CHT, EGT or Tach leads with simple slide together female ends. Female connectors on both ends mate with male posts on gauge backs and sender ends. Extensions will not effect gauge readings.

10 Foot 4 WireP/N 15-05341**\$25.50**
 5 Foot 4 WireP/N 15-06258**\$18.50**
 5 Foot 2 WireP/N 15-06259**\$17.85**

IN

WESTACH INSTRUMENTS

MADE IN THE U.S.A.

2-1/4-INCH DUAL INSTRUMENTS SAVE PANEL SPACE (SUPREME SPACE SAVERS)

TWO INSTRUMENTS IN ONE 2-1/4" SIZE CASE - PERFECT FOR THE HOME BUILDER

All pressure instruments come complete w/pressure senders only (matched to instrument). On all other instruments, order senders at bottom of page.



DUAL EGT-CHT
700-1700°F EGT
100-700°F CHT
P/N 2DA1....\$164.75



DUAL EGT
700-1700°F
P/N 2DA2....\$169.50



DUAL OIL PRESSURE
OIL TEMPERATURE
0-80 PSI/100-260°F
P/N 2DA3MM....\$536.00
Complete w/ oil pressure sender.



DUAL CHT
100-700°F
P/N 2DA8....\$165.75
Celsius version
P/N 2DA8-2....\$165.75



DUAL FUEL LEVEL
Uses capacitance type senders. 5V output. P/N 2DA4V....\$165.75
2DA4 (Old Style) E-F 240-300HM
Float....\$165.75



DUAL VOLT-AMMETER
6-16V/0-30 A
P/N K2DA10-21....\$220.95
6-16KV/0-60 amp
P/N K2DA10-18....\$219.95
Complete with Shunt



**DUAL CARB TEMP-
OUTSIDE AIR TEMP**
-50° to +50° C.
P/N 2DA3-8....\$164.75
Order 399W & 399-OT
Senders Separately

3-1/8" WESTACH GAUGES



TWIN CHT
3-1/8" Size; Wt. 10 Oz.,
100-800°F
P/N 3DA8....\$188.75
Order 2 thermocouples



TWIN EGT
3-1/8" Size, Wt. 10 Oz.
700-1700°F
P/N 3DA2....\$189.95



COMBINATION EGT & CHT
3-1/8" size, Wt.10oz.,
700-1700°F/ 100-800°F.
P/N 3DA1....\$189.95
Order 1 EGT probe
& 1 thermocouple.



RECORDING TACHOMETER
3-1/8" size Runs directly
off magneto. 12V power
required to run Hour Meter Square CHT P/N 3A1....\$114.75
0-3500 RPM
P/N Y3AT32....\$300.95



EGT - CHT GAUGES
3-1/8" Square EGT
P/N 3A2-1....\$116.75
3-1/8" Round
CHT P/N 3C1....\$96.75

All Pressure Instruments come complete with Pressure Senders only (matched to Instrument). On all other instruments order senders at bottom of page.

SPACE SAVING GAUGES - THE WESTACH QUADS

Four electric instruments in one standard size 3-1/8" aircraft case. Weight - only 6 oz. Guaranteed for accuracy within 2%. 1 year warranty. Get four "like" readings or four different ones. Order Senders below except for pressure instruments.



QUAD CHT
P/N 3AQ1....\$445.00



QUAD EGT.
P/N 3AQ2....\$474.00



**QUAD COMBO CHT/EGT OIL
PRESS/OIL TEMP**
P/N 3AQ4MM....\$898.00

OTHER QUAD COMBOS AVAILABLE:

3AQ1-14 CHT/Volts/EGT/Amps.... \$457.00 Quad Fuel Gauge.....WS3AQ9 \$457.00

Over 75 Quad Combos available. Request availability of unlisted models.

*With Senders

WESTACH SENDERS

EGT					
712-2DWK (Long Life) 1" Tip	P/N 10-01225	\$59.95	Oil Temp-399S7 1/8" NPT.....P/N 10-01249	\$45.65	
712-20DWK 1/2" Tip.....	P/N 10-01233	\$59.95	Oil Temp-399S9 (cont., lyc.)	P/N 10-01236	\$63.75
712-4D (1/4" Pipe Bayonet)	P/N 10-01253	\$73.75	Fuel Level- 6"-12" Depth	P/N 10-00797	\$159.75
712-4D1 (3/8"-24 for Lycomings)	P/N 10-01282	\$73.75	AP-Q12B3-D120-5V Capacitance fuel level sender 12" long	P/N 10-00798	\$159.75
712-4D6K (.8-1MM Bayonet for Rotax).....	P/N 10-01240	\$83.75	AP-Q24B3-D120-5V Capacitance fuel level sender 24" long	P/N 10-01262	\$179.75
712-4D2 (1/8" NPT).....	P/N 10-01263	\$73.75	Temp Send-10X1.5mm thread, 1" tip, 4' lead, with crush washer 1,750 ohms @ 100F.....	P/N 10-02641	\$62.95
CHT			Temp Send 10X1.5mm thread, 5/8" tip, 4' lead, with crush washer 1,750 ohms @ 100F.....	P/N 10-02642	\$62.95
712-5W (18 MM Thermocouple)	P/N 10-01226	\$39.95	Westberg SS Trans-0-100 psi, 1/8" npt	P/N 10-02640	\$319.00
712-4W (14 MM Thermocouple)	P/N 10-01227	\$39.95			
712-7D (3/8-24 Bayonet).....	P/N 10-01230	\$81.95			
712-9W (10MM Thermocouple)	P/N 10-01259	\$39.95			

VISIT OUR WEBSITE FOR CUSTOM QUAD GAUGES!

WWW.AIRCRAFTSPRUCE.COM

UL FLIGHT LINE INSTRUMENTS



UL FLIGHT LINE 2 INCH CHT GAUGE

Gauge electrical, bezel black dial, black, white, pointer red Indicating instrument electrical, black bezel, black dial, white character, pointers red.

- Front: Flat; Black
- Glass: Flat
- Pointer: Red, Hub Black, Night Design

- Dial Face: Background Dull Black, White, Red, Green
 - Installation: Fixation Ring
 - Operating Temperature: 50°C - 150°C / 120°F - 300°F
 - Voltage: 12
 - Dimension: 52 mm
 - Engines: 912A, 912F, 912UL, 912S, 912ULS, 914F, 914UL
 - Illumination: LED White, Dimmable
- 2" CHT 50-150C 150-300F P/N 13-16017 **\$94.80**
 2" CHT 50-150C 125-300F P/N 13-16026 **\$88.85**



UL FLIGHT LINE 2 INCH FUEL LEVEL 0-4/4 UL LSA 12V DLT

Gauge electrical, bezel black dial, black, white, pointer red indicating instrument electrical, black bezel, black dial, white character, pointers red.

- 2" Fuel Level 0-4/4 UI DLT3-180 P/N 13-16019 **\$86.75**
 2" Fuel Level 0-4/4 UI DLT5-60/90 P/N 13-16020 **\$73.95**



UL FLIGHT LINE 2 INCH GAUGE

Gauge electrical, bezel black dial, black, white, pointer red indicating instrument electrical, black bezel, black dial, white character, pointers red.

- Front: Flat; Black
- Glass: Flat
- Pointer: Red, Hub Black, Night Design
- Dial Face: Background Dull Black, White, Red, Green

- Installation: Fixation Ring
 - Operating Temperature: 25°C - 65°C / 120°F - 300°F
 - Voltage: 12
 - Dimension: 52 mm
 - Engines: 912A, 912F, 912UL, 912S, 912ULS, 914F, 914UL
 - Illumination: LED White, Dimmable
- 2" Oil Pressure Gauge 0 - 10 Bar P/N 13-16021 **\$115.75**
 2" Oil Temperature Gauge 0-10 Bar 0-150 PSI . P/N 13-16025..... **\$84.75**



UL FLIGHT LINE 2 INCH TACHOMETER

Gauge electrical, bezel black dial, black, white, pointer red indicating instrument electrical, black bezel, black dial, white character, pointers red.

- 2" Engine Tach 0-7000 12v P/N 13-16023 **\$239.95**
 2" Rotor Tach 0-7000 12v P/N 13-16024 **\$220.95**

UL FLIGHTLINE WING FLAP INDICATOR

Indicating Instrument Electrical. LED Backlight Technology. Stepper Motor. Low Weight. Character White. Wing Flap Sensor.

- Specifications:**
- Operating voltage: 12
 - Installation diameter: 52mm
 - Resistance range: 3.180
 - Special: MF, Option Warn-LED.
- Indicator P/N 10-06466 **\$79.95**
 Angle Transmitter P/N 10-06467 **\$67.75**



UL FLIGHT TEMP GAUGE

Gauge electrical, bezel black dial, black, white, pointer red Indicating instrument electrical, black bezel, black dial, white character, pointers red.

P/N 13-19001 **\$90.75**



UL FLIGHT LINE TEMP SENDER

UL Flight Line Temp Sender 150C M10x1 M10x5 T-6 T-3.
 P/N 13-16029 **\$22.90**



UL FLIGHT LINE 2 INCH FUEL PRESSURE GAUGE

Fuel Pressure Gauge Rotax Flight Line. Gauge electrical, bezel black dial, black, white, pointer red indicating instrument electrical, black bezel, black dial, white character, pointers red.

- Front: Flat; Black
 - Glass: Flat
 - Pointer: Red, Hub Black, Night Design
 - Dial Face: Background Dull Black, White, Red, Green
 - Installation: Fixation Ring
 - Bar: 0 - 1
 - Voltage: 12
 - Dimension: 52 mm
 - Engines: 912A, 912F, 912UL, 912S, 912ULS, 914F, 914UL
 - Illumination: LED White, Dimmable.
- P/N 13-16022 **\$116.75**



UL FLIGHT LINE 2 INCH VOLTMETER

Gauge electric, incident-light, black bezel, black dial, white, pointer red Indicating instrument electrical, floodlight illumination, black bezel, black dial, white character, pointers red. 8-16V UL / LSA.

- Front: Flat; Black
 - Glass: Flat
 - Pointer: Red, Hub Black, Night Design
 - Dial Face: Background Dull Black, White, Red, Green
 - Installation: Fixation Ring
 - Operating Temperature: 8°C - 16°C
 - Voltage: 12
 - Dimension: 52 mm
 - Engines: 912A, 912F, 912UL, 912S, 912ULS, 914F, 914UL
 - Illumination: LED White, Dimmable
- P/N 13-16027 **\$96.99**

UL FLIGHT LINE FUEL PRESSURE CONNECTOR CABLE



UL Flight Line Fuel Pressure Connector Cable.

- Connection: 3-wire DLPHI Packard
- Engines: 912A, 912F, 912UL, 912S, 912ULS, 914F, 914UL

P/N 13-16018 **\$29.60**

UL FLIGHTLINE 2 INCH FUEL LEVEL GAUGE



Fuel level gauge for float-operated sensor UL/LSA. Indicating instrument electrical, LED backlight technology, stepper motor, low weight, character white.

- Specifications:**
- Operating voltage: 12
 - Installation diameter: 52mm
 - Volume range: 0.1/2.1
 - Resistance range: 3.18
 - Special: MF, Option Warn-LED
- P/N 10-06471 **\$87.75**

UL FLIGHTLINE FLOAT OPERATED SENSOR RIGHT WING



Float-operated sensor. Robust passivated metal housing.

- Specifications:**
- Dimensions float-operat. sensor install. lateral: 156 / 148 / 107
 - Full resistance: 180
 - Empty resistance: 3
 - Diameter of pitch circle and angle: 54 / 72°; 68°; 80°; 68°; 72°
 - Operating voltage: 6.24
 - Electrical connection: DIN 6.3x0.8
- Right Wing Sensor P/N 10-06468 **\$63.75**
 Left Wing Sensor P/N 10-06469 **\$62.75**

FUEL LEVEL SENDERS



- ISS Fuel Sender LH 6-12 Tank P/N 10-01099 **\$49.95**
 ISS Fuel Sender RH 6-12 Tank P/N 10-01101 **\$52.75**
 ISS Fuel Sender LH 10-15 Tank P/N 10-01102 **\$42.95**
 ISS Fuel Sender RH 10-15 Tank P/N 10-01103 **\$41.85**
 ISS Fuel Sender LH 15-5-24 P/N 10-01104 **\$44.50**
 ISS Fuel Sender RH 27-36" Tank P/N 10-01107 **\$57.25**
 ISS Fuel Sender Gasket P/N 10-01097 **\$2.64**

IN

MITCHELL INSTRUMENTS

MITCHELL AIRCRAFT INSTRUMENTS 2-1/4" ELECTRIC GAUGES

Mitchell Aircraft Instruments is a high quality, economical line of gauges which is ideal for the homebuilt aircraft market. These electric instruments are lighted, allow easy installation, and feature a 2 year factory warranty. Order gauges and senders separately as shown. 12V operation unless other wise noted. Gauges fit 2-1/4 panel hole. For 24 volt operation, order P/N PE-111-4074 Resistors (\$3.50 each) for each instrument.

OIL TEMPERATURE



100-250° F Gauge P/N 10-25000 ..\$87.75
 100-250° F Sender (Rotax) P/N 10-25005 ..\$33.90
 100-250° F Sender (LYC).. P/N 10-25175 ..\$46.65
 120-300° F Gauge P/N 10-25010 ..\$87.75
 120-300° F Sender (Rotax) P/N 10-25015 ..\$34.50
 120-300° F Sender (LYC).. P/N 10-25180 ..\$54.75

Rotax Senders are 1/8-18 NPT, Lycoming Senders are 5/8-18 VNF.

OIL PRESSURE



0-80 PSI GaugeP/N 10-25030\$82.75
 0-80 PSI SenderP/N 10-25035\$53.75
 0-100 PSI GaugeP/N 10-25040\$81.75
 0-100 PSI SenderP/N 10-25045\$53.75
 0-145 PSI Gauge use with Rotax sender.
 P/N 10-03928\$90.75
 0-150 PSI GaugeP/N 10-25050\$81.75
 0-150 PSI SenderP/N 10-25055\$54.75

FUEL PRESSURE



0-30 PSI GaugeP/N 10-25060\$67.75
 0-15 PSI GaugeP/N 10-25058\$87.75
 0-15 PSI SenderP/N 10-25065\$53.75

EXHAUST GAS TEMPERATURE



0-1600°F EGT Gauge.... P/N 10-02746\$126.99
 KIT - Includes Sender, Weld-on adapter and 6 Ft. Lead with/ connector. 0-1600 EGT kit
 P/N 10-25090\$193.75

CYLINDER HEAD TEMPERATURE



120-300F GaugeP/N 10-02717\$87.75
 18MM Sender (Continental, Lycoming)
 P/N 10-25075\$33.95
 14MM Sender (VW, Rotax)
 P/N 10-25080\$33.60
 10 Ft. CHT Lead w/connector
 P/N 10-25185\$14.50

MITCHELL 2-1/4" MECHANICAL GAUGES



OIL TEMPERATURE

110 - 270 F. 6 foot capillary supplied
 P/N 10-02714\$75.75



OIL PRESSURE

0-100 PSI.....P/N 10-02706\$68.75
 0-150 PSI.....P/N 10-02712\$60.75



FUEL PRESSURE

0-15 PSI.....P/N 10-02702\$60.75



MITCHELL D1-112-5240 ROTAX 912 TACHOMETER

Mitchell 2-1/4 Inch Mechanical Recording, FAA-TSO Approved. D1-112-5240 Special-Rotax 912
 P/N 10-02744\$266.75



AMMETER

60-0-60 Ammeter
 P/N 10-25115\$82.75



FUEL LEVEL

(10-180 ohm) . P/N 10-25130..\$87.75
 (0-90 ohm) P/N 10-02719..\$87.75
 (0-30 ohm) P/N 10-02721..\$93.90
 (240-33 ohm).. P/N 10-02722..\$88.75
Senders
 (10-180 ohm).. P/N 10-25135..\$81.75
 (0-90 ohm) P/N 10-02172..\$81.75
 (240-33 ohm).. P/N 10-02173..\$80.75



VOLTMETER

P/N 10-25105 (8-16V) \$75.75
 P/N 10-02747 (12-31V) .. \$85.99
 No Sender required.



CYLINDER HEAD TEMP GAUGE

For Rotax 120-300°
 P/N 10-02717\$87.75
 Sender: Probe Supplied
 w/ Rotax Engine.



OUTSIDE AIR TEMPERATURE

2-1/4" -10°F to +120°F
 P/N 10-02715\$174.95



OUTSIDE AIR TEMPERATURE

2-1/4" Electric -25°C to +45°C
 P/N 10-03137\$173.80
 Sender P/N 10-02170..... \$33.50



ROTAX OIL PRESSURE GAUGE

2-1/4" Electric 24V 0-150 PSI
 P/N 10-03928\$90.75
 For use with Rotax Senders.

GAUGE WIRING KIT



Fits all 2-1/4" Mitchell GaugesP/N 10-02724\$6.50

MITCHELL MODULAR INSTRUMENTS

MITCHELL MINIATURE MODULAR GAUGES

This line of miniature engine gauges from Mitchell is ideal for a wide variety of general aviation applications. They measure nearly 1.5" square and are stackable. The modular design allows them to be plugged from the front of the panel. The units are internally lighted. Complete standard panels are also available as shown in the steps below. All modular gauges after April 03, 2017 feature a new connector configuration. New style gauges will fit into existing frames but require changing the mating connector plate. Previous style connectors are now obsolete and no longer available.



Step 1 - Select your gauge(s) from the list below:

Choose 14 volt or 24 volt

Note range marking for gauge(s) (free if information given at time of instrument cluster order)

Step 2 - Select your sender(s) for gauge(s) from the list below:

Any sender with a * can also use a Rotax Engine Sender

Gauge Part Number		Gauge Description	Price
Spruce #	Mitchell #		
Pressure Gauges			
10-03621	D1-211-6060	Fuel Pressure 80 PSI	\$126.75
10-10150	D1-211-6061	Fuel Pressure 15 PSI (FAA/PMA)	\$126.75
10-10152	D1-211-6064	Fuel Pressure 30 PSI	\$126.75
10-04094	D1-211-6065	0 - 2 bar Fuel	\$134.75
10-04139	D1-211-6097	Oil Pressure 150 PSI 10Bar	\$105.75
10-02725	D1-211-6092	Oil Pressure 150 PSI (FAA/PMA)	\$112.75
10-10166	D1-211-6090	Oil Pressure 100 PSI (FAA/PMA)	\$120.75
10-02726	D1-211-6093	Oil Pressure 80 PSI	\$112.75
10-10168	D1-211-6091	0 - 9 bar Oil	\$120.75
10-04095	D1-211-6094	0 - 7 bar Oil	\$105.75
10-04096	D1-211-6095	0 - 5 bar Oil	\$134.75
10-02723	D1-211-6089	Liquid Pressure 80 PSI	\$119.75
Temperature Gauges			
10-02279	D1-211-6068	Oil Temp 100F-250F (FAA/PMA)	\$120.75
10-10154	D1-211-6066	Oil Temp 120F-300F (FAA/PMA)	\$121.75
10-10155	D1-211-6067	Oil Temp 40C-120C	\$120.75
10-02728	D1-211-6069	Oil Temp 50C-150C	\$120.75
10-10156	D1-211-6088	Liquid Temp 100F-250F	\$120.75
10-02746	D1-211-6101	EGT 0F-1600F	\$126.99
10-10170	D1-211-6102	CHT 100F-600F	\$126.95
10-02745	D1-211-6109	CHT Rotax 120F-300F	\$100.75
Voltmeter Gauges			
10-10164	D1-211-6086	Voltmeter 8-16 volts (FAA/PMA)	\$107.75
10-10165	D1-211-6087	Voltmeter 12-31 volts	\$93.75
Ammeters Gauges			
10-10174	D1-211-6104	ammeter 45-0-45 amp	\$106.95
10-10176	D1-211-6106	ammeter 75-0-75 amp (FAA/PMA)	\$122.75
Fuel Quantity Gauges			
10-02730	D1-211-6071	right Fuel 240-30 ohm	\$120.90
10-03610	D1-211-6072	left Fuel 240-33 ohm	\$120.90
10-03613	D1-211-6073	Fuel gauge 240-33 ohm	\$120.90
10-10158	D1-211-6074	right Fuel 10-180 ohm (FAA/PMA)	\$120.90
10-10160	D1-211-6075	left Fuel 10-180 ohm (FAA/PMA)	\$120.90
10-10162	D1-211-6076	Fuel gauge 10-180 ohm (FAA/PMA)	\$120.90
10-03614	D1-211-6077	right Fuel 0-30 ohm	\$125.85
10-03615	D1-211-6078	left Fuel 0-30 ohm	\$105.95
10-03616	D1-211-6079	Fuel gauge 0-30 ohm	\$105.95
10-03617	D1-211-6080	right Fuel 0-92 ohm	\$120.95
10-03618	D1-211-6081	left Fuel 0-92 ohm	\$120.90
10-03620	D1-211-6082	Fuel gauge 0-92 ohm	\$100.75
Blank			
10-02740	D1-211-6010	blank face gauge (FAA/PMA)	\$80.99

Sender Part Number		Sender Description	Price
Spruce #	Mitchell #		
Pressure Senders			
10-25035	PS-211-9002	Pressure Sender 80 PSI	
10-25065	PS-211-9000	Pressure Sender 15/30 PSI (FAA/PMA)	\$53.75
10-25065	PS-211-9000	Pressure Sender 15/30 PSI	\$53.75
10-25065	PS-211-9000	Pressure Sender 15/30 PSI	\$53.75
Rotax engine Sender			
10-25055	PS-211-9040	Pressure Sender 150 PSI (FAA/PMA)	\$54.75
10-25045	PS-211-9039	Pressure Sender 100 PSI (FAA/PMA)	\$53.75
10-25035	PS-211-9002	Pressure Sender 80 PSI	\$53.75
10-25055	PS-211-9040	Pressure Sender 150 PSI	\$54.75
10-25045	PS-211-9039	Pressure Sender 100 PSI	\$53.75
10-25035	PS-211-9002	Pressure Sender 80 PSI	\$53.75
10-25035	PS-211-9002	Pressure Sender 80 PSI	\$53.75
Temperature Senders			
10-25005	PS-211-8044	Temp Sender 1/8 250F (FAA/PMA)	\$33.90
10-25175	PS-211-8045	Temp Sender 5/8 250F (FAA/PMA)	\$46.65
10-25015*	PS-211-8090	Temp Sender 1/8 300F (FAA/PMA)*	\$34.50
10-25180*	PS-211-8112	Temp Sender 5/8 300F (FAA/PMA)*	\$54.75
10-25005	PS-211-8044	Temp Sender 1/8 250F	\$33.90
10-25175	PS-211-8045	Temp Sender 5/8 250F	\$46.65
10-25015*	PS-211-8090	Temp Sender 1/8 300F*	\$34.50
10-25180*	PS-211-8112	Temp Sender 5/8 300F*	\$54.75
10-25005	PS-211-8044	Temp Sender 1/8 250F	\$33.90
10-25175	PS-211-8045	Temp Sender 5/8 250F	\$46.65
10-02177	PS-211-8163	EGT Sender clamp - type K	\$39.95
10-25080	PS-211-8152	CHT Sender 14mm - type J	\$33.60
10-02171	PS-211-8154	CHT Sender 12mm - type J	\$33.60
10-25075	PS-211-8168	CHT Sender 18mm - type J	\$33.95
10-25076	PS-211-8156	CHT Sender probe	\$115.75
External Shunts			
10-10184	PS-211-9100	45 amp shunt	\$53.75
10-10185	PS-211-9101	75 amp shunt (FAA/PMA)	\$60.75
Sender Resistance (E- F)			
10-25135	PS-211-8038	Fuel Sender 10-180 ohm (FAA/PMA)	\$81.75
10-25135	PS-211-8038	Fuel Sender 10-180 ohm (FAA/PMA)	\$81.75
10-25135	PS-211-8038	Fuel Sender 10-180 ohm (FAA/PMA)	\$81.75

IN

Step 3 - Select your frame for your gauge(s) from the list below

Select what position your gauge(s) will go into. Positions are counted left to right (block style), top to bottom (vertical) starting at #1

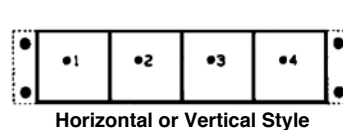

Horizontal or Vertical Style



Block Style

Spruce #	Mitchell #	Gauge Capacity	Configuration	Price
10-02964	PM-211-9811	1 Gauge	1 Gauge	\$80.75
10-04084	PM-211-6826	2 Gauges	1 Wide 2 High	\$87.75
10-02739	PM-211-6808	2 Gauges	2 Wide 1 High	\$72.75
10-04083	PM-211-6824	3 Gauges	1 Wide 3 High	\$94.75
10-04079	PM-211-6809	3 Gauges	3 Wide 1 High	\$94.75
10-04020	PM-211-6825	4 Gauges	2 Wide 2 High	\$101.75
10-04082	PM-211-6823	4 Gauges	1 Wide 4 High	\$101.75
10-01710	PM-211-6805	4 Gauges	4 Wide 1 High	\$101.75
10-04080	PM-211-6810	5 Gauges	1 Wide 5 High	\$93.75
10-01711	PM-211-6806	5 Gauges	5 Wide 1 High	\$93.75
10-02738	PM-211-6807	6 Gauges	1 Wide 6 High	\$100.75
10-01712	PM-211-6804	6 Gauges	6 Wide 1 High	\$122.75
10-01708	PM-211-6803	6 Gauges	3 Wide 2 High	\$122.75

Spruce #	Mitchell #	Gauge Capacity	Configuration	Price
10-04097	PM-211-6802	6 Gauges	2 Wide 3 High	\$122.75
10-04081	PM-211-6822	7 Gauges	1 Wide 7 High	\$122.75
10-04091	PM-211-6833	7 Gauges	7 Wide 1 High	\$114.75
10-04090	PM-211-6832	8 Gauges	8 Wide 1 High	\$121.75
10-01709	PM-211-6801	8 Gauges	1 Wide 8 High	\$135.75
10-03915	PM-211-6800	8 Gauges	2 Wide 4 High	\$135.75
10-04089	PM-211-6831	9 Gauges	9 Wide 1 High	\$128.85
10-04085	PM-211-6827	9 Gauges	3 Wide 3 High	\$128.85
10-04087	PM-211-6829	10 Gauges	2 Wide 5 High	\$151.75
10-04086	PM-211-6828	10 Gauges	5 Wide 2 High	\$136.75
10-04088	PM-211-6830	12 Gauges	2 Wide 6 High	\$150.75
10-04092	PM-211-6835	15 Gauges	5 Wide 3 High	\$194.75

SWIFT ENGINE GAUGES



SWIFT TACHOMETERS
Swift Gauge Tachometers feature both clockwise and standard pointer type configurations. Swift Gauge Universal Tachometers can be used for both point and Ducati ignitions.

Size"	Description	Model	Range	Part No.	Price
2	Standard Pointer Type Tach.	TR-001D	0-8000 RPM CDI	10-00831	\$120.75
2	Standard Pointer Type Tach."	TR-003	"0-8000 RPM Universal Point and CDI"	10-01615	\$124.75
2-1/4	Standard Pointer Type Tach.	T2-001U	0-8000 RPM Universal Point and CDI	10-00816*	\$128.75
2-1/4	Standard Pointer Type Tach.	T2-004	"0-8000 RPM For MZ 202 Engine"	10-04039	\$90.95
3-1/8	Standard Pointer Type Tach.	T3-001U	"0-8000 RPM Universal Point and CDI"	10-00817*	\$164.85
2-1/4	Standard Pointer Type Tach.	R280D	0-8000 RPM Ducatti Ignition	10-00818	\$128.75

*Works with Rotax-point & CDI Ignition, but not 912/914 engines.



SWIFT CHT GAUGES
Swift Gauge Cylinder Temperature Gauges work with most 2 cycle 2 cylinder engines.



Size"	Description	Model	Range	Part No.	Price
3 1/8	Gauge CHT / CHT Dual	C3-002	100-700°F / 100-700°F	10-02280	\$132.85
3 1/8		C3-002C	0-340°C / 0-340°C	10-02281	\$123.75
2 1/4		C2-002	100-700°F / 100-700°F	11-03960	\$124.75
2 1/4		C2-002C	0-340°C / 0-340°C	10-01421	\$134.90
2 Round		CR-002	100-700°F / 100-700°F	10-00486	\$159.75
2 Round		CR-002C	0-340°C / 0-340°C	10-01416	\$123.75
3 1/8	Gauge CHT Single	C3-001	100-700°F	10-02283	\$105.75
3 1/8		C3-001C	0-340°C	10-02284	\$83.75
2 1/4		C2-001	100-700°F	11-03958	\$56.85
2 1/4		C2-001C	0-340°C	11-03959	\$69.95
2 1/4		---	120-300°F	10-06457	\$64.95
2 Round		CR-001	100-700°F	10-01412	\$64.85
2 Round		CR-001C	0-340°C	10-01413	\$49.85
10 x 1.5 mm		CHT Sender	CP-001	Screw-in type, 4 feet metal shield wire	10-04051
10mm	CP-010		10mm dia. ring, 4 ft metal shield wire	10-01438	\$30.60
12mm	CP-012		12mm dia. ring, 4 ft metal shield wire	10-02286	\$29.85
14mm	CP-014		14mm dia. ring, 4 ft metal shield wire	10-02287	\$29.85
18mm	CP-018		18mm dia. ring, 4 ft metal shield wire	10-02288	\$37.55



SWIFT EGT GAUGES

Size"	Description	Range	Part No.	Price
3 1/8	EGT / EGT Dual"	700-1700°F / 700-1700°F	10-02290	\$163.75
3 1/8		200-900°C / 200-900°C	10-02291	\$135.75
2 1/4		700-1700°F / 700-1700°F	10-00487	\$129.75
2 1/4		200-900°C / 200-900°C	10-02292	\$136.75
2		700-1700°F / 700-1700°F	10-01453	\$123.75
2		200-900°C / 200-900°C	10-01454	\$92.75
3 1/8	EGT Single"	700-1700°F	10-02289	\$83.75
3 1/8		200-900°C	10-02293	\$83.75
2 1/4		700-1700°F	10-01457	\$79.75
2 1/4		200-900°C	10-01450	\$51.75
2		700-1700°F	10-01449	\$64.75
2		200-900°C	10-01458	\$68.75
8X1.0mm	EGT Sender"	"8X1.0mm Screw-in Style 4 Feet Metal Shield Wire"	10-00489	\$84.75
Clamp		"1" - 1-3/4" Clamp Style 4 Feet Metal Shield Wire"	10-02294	\$56.75
Clamp		"1-1/4" - 2" Clamp Style 4 Feet Metal Shield Wire"	10-00488	\$43.95

SWIFT GAUGE 2 1/4 INCH VOLTMETER 8-16V



Swift Gauge 2 1/4" Voltmeter. Colored dial markings with illuminated pointer. The graduation spacings of the scale at both ends have been reduced, making it easier to read in the range of 10 to 14 volts. Size: 2 1/4". Range: 8-16V. Similar to Falcon Gauge.....P/N 10-06456.....\$84.75



SWIFT COMBINATION GAUGES

Swift Gauge Temperature Gauges work with most 2 cycle 2 cylinder engines.

Size"	Description	Range	Part No.	Price
3 1/8	CHT / EGT	0-340°C/ 400-900°C	10-02296	\$135.75
3 1/8	EGT / TACH	700-1700°F / 0-8000 RPM	10-02297	\$184.75
2 1/4	CHT / EGT	100-700°F / 700-1700°F Square	10-01404	\$129.75
2 1/4		0-340°C/400-900°C Square	10-01405	\$129.75
2 1/4	CHT / TACH	100-700°F / 0-8000 RPM	10-02317	\$139.75
2 1/4		0-340°C / 0-8000 RPM	10-02318	\$157.75
2	CHT / EGT	100-700°F / 700-1700°F	10-01400	\$123.75
2		0-340°C/ 400-900°C	10-01401	\$94.85
2	CHT / TACH	0-8000 RPM/ 340°C	10-04034	\$152.75
2	EGT / TACH	0-8000 RPM/ 400-900°C	10-04036	\$152.75
2-1/4	EGT / TACH	0-8000 RPM/ 700-1700°F	10-04049	\$104.75
2-1/4	EGT / TACH	0-8000 RPM/ 375-925°C	10-04050	\$104.75



SWIFT WATER TEMPERATURE / PRESSURE & OIL TEMPERATURE/ PRESSURE GAUGES

Size"	Description	Model	Range	Part No.	Price
2-1/4	Water Temp.	WT-001	100-260°F / 40-120°C	10-02320	\$77.75
2 Rnd.		WT-001R	100-260°F / 40-120°C	10-02321	\$49.85
2 Rnd.	Oil Temp.	OT-001R	120-300°F / 50-150°C	10-03404	\$86.75
2-1/4		OT-001	120-300°F / 50-150°C	10-03403	\$77.75
2 Rnd.	Oil Pressure	OP-060-001R	60 PSI	10-04063	\$27.50
2-1/4		OP-100-001	100 PSI	10-04058	\$43.55
2 Rnd.	Oil Press / Oil Temp. Dual	OPT080-001R	120-300°F / 80 PSI	10-04052	\$92.75
2-1/4		OPT080-002	120-300°F / 80 PSI	10-04054	\$129.75
2 Rnd.	Oil Temp. Dual	OPT100-001R	120-300°F / 100 PSI	10-04053	\$92.75
2-1/4		OPT100-002	120-300°F / 100 PSI	10-04055	\$129.90
2-1/4	Oil Pressure Transducer	OPT06-002C	50-150°C/6kg/cm2	10-04066	\$111.75
-		SP-150PV	0-150 PSI, 10 Bar 5V	10-04056	\$73.80
-	Dual Oil Temp	SP-100PV	0-100 PSI, 7 Bar 5V	10-04057	\$73.80
2-1/4		PT2-7K15C	50-150C, 7kg	10-04064	\$88.95
2	Dual Oil Temp	PT1-7K15C	50-150C, 6kg	10-04065	\$52.75
2-1/4		PT2-6K15C	50-150C, 6kg	10-04066	\$111.75
2		PT1-6K15C	50-150C, 6kg	10-04068	\$154.75
"1/8" NPT	"1/8" NPT Oil Temp. Sender	OTS-001	"1/8" NPT Oil Temp. Sender"	10-03406	\$38.50
10X 1.5mm	Oil Temp. Sender For Rotax 914, 912"	OTS-002	"Oil Temp. Sender For Rotax 914, 912"	10-03407	\$27.50
5/8"	Lyc. Oil Temp. Sender	OTS-03	For Gauges 10-03403/10-03404	10-05840	\$43.95



SWIFT FUEL QUANTITY INDICATOR

The Swift Gauge Fuel quantity indicator's resistance Empty R=240 Ohms Full R=40 Ohms. The Swift Gauge Fuel quantity sender is electronic capacitance type. 12" can be cut down to 9.5" 24" can be cut down to 12.5"

Size"	Description	Model	Part No.	Price
2-1/4	Single Gauge, 5V Input	F2-001-5	10-02264	\$59.75
2-1/4	Dual Gauge, 5V Input	F2-002-5	10-02265	\$129.75
2 Round	Single Gauge, 5V Input	FR-001-5	10-03873	\$64.85
2 Round	Dual Gauge, 5V Input	FR-002-5	10-03874	\$89.75
2"	Dual Fuel level 5V w/Alarm	DF1-VA	10-04034	\$152.75
2-1/4"	Dual Fuel level 5V w/Alarm	DF2-VA	10-04036	\$152.75

SWIFT ENGINE GAUGE EXTENSION CABLES

Swift Gauge extension wire is used to lengthen the existing wire that comes with engine gauges. It is temperature compensated wire. Available in lengths of 4-10 ft, 2 or 4 conductors. Pins must be crimped onto wire.

Size	Model No.	Description	Part No.	Price
4'	Wire-042	2 Conductor, 4 Feet	10-02339	\$6.80
4'	Wire-044	4 Conductor, 4 Feet	10-02340	\$10.60
6'	Wire-062	2 Conductor, 6 Feet	10-02341	\$9.95
6'	Wire-064	4 Conductor, 6 Feet	10-02342	\$13.95
8'	Wire-082	2 Conductor, 8 Feet	10-02344	\$13.99
8'	Wire-084	4 Conductor, 8 Feet	10-02345	\$16.50
10'	Wire-102	2 Conductor, 10 Feet	10-02346	\$16.50
10'	Wire-104	4 Conductor, 10 Feet	10-02347	\$21.50

Swift Gauges are made in China.

WWW.AIRCRAFTSPRUCE.COM

SWIFT ENGINE GAUGES

SWIFT TACHOMETER



2-1/4"



3-1/8"

Size	Description	Range	Part No.	Price
2-1/4"	Tach Ducati Engine	0-8000 RPM	10-00818	\$128.75
2-1/4"	Engine Tach	0-3500 RPM	10-06336	\$149.95
2-1/4"	Engine Tach w/ Hourmeter	0-3500 RPM	10-06337	\$176.75
2-1/4"	Rotor Tach	700 RPM	10-06338	\$106.95
2-1/4"	Rotax 912/914 Tach	0-7000 RPM	10-06339	\$128.80
2-1/4"	Rotax 912/914 Tach w/ Hourmeter	0-7000 RPM	10-06340	\$176.75
2-1/4"	Rotax 582 Hirth Tach	0-8000 RPM	10-06341	\$168.95
2-1/4"	Rotax 582 Hirth Tach w/ Hourmeter	0-8000 RPM	10-06342	\$176.75
3-1/8"	Engine Tach	0-3500 RPM	10-06343	\$153.75
3-1/8"	Engine Tach w/ Hourmeter	0-3500 RPM	10-06344	\$199.90
3-1/8"	Rotax 912/914 Tach	0-7000 RPM	10-06345	\$198.75
3-1/8"	Rotax 912/914 Tach w/ Hourmeter	0-7000 RPM	10-06346	\$200.75

SWIFT DUAL FUEL LEVEL GAUGES



Size	Description	Range	Part No.	Price
2"	Dual Fuel Level w/ Alarm	0-5V	10-04044	\$96.95
2-1/4"	Dual Fuel Level w/ Alarm	0-5V	10-03418	\$107.75

SWIFT AMMETERS



Size	Description	Range	Part No.	Price
2"	Ammeter	60A-0-60A	10-05843	\$42.50
2-1/4"	Round Ammeter	+/- 60A	10-05842	\$76.75
2-1/4"	Round Ammeter	60A-0-60A 6-16V	10-03414	\$173.90

SWIFT MANIFOLD PRESSURE GAUGE



Swift MAP2-50 Integrates the Highly Reliable MEMS Sensor: Precise, Durable Wide Voltage Supply Range 9-30 VDC. 10-50 inch Hg ABS. Colored Dial Markings. Size: 2 1/4".....P/N 10-06454\$227.95

SWIFT TACH/CHT/EGT GAUGES



2"



2-1/4"

Size	Description	Range	Part No.	Price
2-1/4"	Round Tach CHT	0-8000 RPM/340°C	10-04034	\$152.75
2-1/4"	Round Tach CHT	0-8000 RPM/100-700°F	10-01626	\$135.75
2-1/4"	Round Tach CHT/EGT	0-8000 RPM/400-900°F	10-04036	\$152.75
2-1/4"	Tach /EGT	0-8000 RPM/700-1700°F	10-04049	\$104.75
2-1/4"	Tach /EGT	0-8000 RPM/ 375-925°C	10-04050	\$104.75
2-1/4"	CHT Compatible with J Type Probes	50-150°C/120-300°F	10-06333	\$82.75
2-1/4"	CHT Compatible w/Rotax Sensors	50-150°C/120-300°F	10-06334	\$82.75
2-1/4"	Oil Pressure	0-10 BAR/145 PSI	10-06335	\$91.75

SWIFT OIL TEMP GAUGES



2-1/4"

Size	Description	Range	Part No.	Price
2-1/4"	Oil Temp	50-150°C/120-300°F	10-06347	\$80.85
2"	Dual Oil Temp	50-150°C / 6KG	10-04068	\$154.75
2"	Dual Oil Temp	50-150°C / 7KG	10-04065	\$52.75
2-1/4"	Dual Oil Temp	50-150°C / 7KG	10-04064	\$88.95

SWIFT OIL PRESSURE GAUGES



Size	Description	Range	Part No.	Price
2-1/4"	Oil Pressure	0-10 BAR / 145 PSI	10-06335	\$91.75
-	Oil Pressure Sensor	0-100 PSI / 7 Bar / 0.5-4.5V	10-04057	\$73.80
-	Oil Pressure Sensor	0-150 PSI / 10 Bar / 0.5-4.5V	10-04056	\$73.80

SWIFT SPEED SENSORS



Model No.	Dimensions	Description	Part No.	Price
SS1-12P	12x60	Proximity, -500Hz, NPN, N.O.	10-06275	\$20.65
SS1-12H	12x26	Hall effect, -1000Hz, NPN, N.O.	10-06277	\$28.50
SS1-18P	18x68	Proximity, -500Hz, NPN, N.O.	10-06278	\$37.50
ST-4128-4	1/4"-28 Thread, 1/4" Tip, 58" Leads	Temp probe - Screw in PT100 Thermistor -400-180°F/-40-80°C	10-06276	\$27.55

MGL VEGA 2 1/4" COLOR INSTRUMENTS

MGL VEGA AIRSPEED INDICATOR



Measures airspeed from 16mph to 250mph and is well suited to slow aircraft due to very good sensitivity and linearity at low air speeds. Includes a flight timer since takeoff. Airspeed units can be set to miles per hour (mph), kilometer per hour (km/h) or knots (kts). Analog tape with programmable ranges for Vs0, Vs1, Vfe, Vno and Vne. Contains a programmable Vs and Vne airspeed alarm output. Records maximum airspeed reached in permanent memoryP/N 11-15989\$395.00

MGL VEGA AIRSPEED INDICATOR / VSI



Meet the World's most lightweight and compact, fully integrated inertial measurement instruments (IMU's) and digital compasses. The AHRS-1 is a 2 1/4" sunlight readable color display instrument providing a display for an artificial horizon reference system (AHRS), an advanced digital compass, or both depending on which sensor packages are connected. P/N 11-16721\$395.00

MGL VEGA ALT-5 ALTIMETER / VSI



An internal high accuracy 24 bit digital altitude sensor calculates altitude from -1000 ft up to a maximum of 35000 ft (-304m to 10668m). The ALT-5 outputs various formatted RS232 serial data protocols compatible with serial input transponders such as that from Garmin, Magellan, Northstar, Trimble, Microair etc. Provides a parallel Gillham code interface for transponders when used in combination with the MGL Avionics CNV-ALT. Built in encoder test function. The altimeter can display altitude in feet or meters. Local pressure can be set in millibars or inches of mercury. Contains a wide range VSI indicator from +/-20 ft/min to as high as +/-10000 ft/min. VSI units can be in feet/minute (ft/min) or in meters/second (m/s).....P/N 11-15988\$375.00

MGL VEGA ASV-1 ALTIMETER / ASI / VSI



An internal high accuracy 24 bit digital altitude sensor calculates altitude from -1000 ft up to a maximum of 35000 ft (-304m to 10668m). The ASV-1 outputs various formatted RS232 serial data protocols compatible with serial input transponders such as that from Garmin, Magellan, Northstar, Trimble, Microair etc.. Provides a parallel Gillham code interface for transponders when used in combination with the MGL Avionics CNV-ALT. Built in encoder test function. The altimeter can display altitude in feet or meters. Local pressure can be set in millibars or inches of mercury. Contains a wide range VSI indicator from +/-20 ft/min to as high as +/-10000 ft/min. VSI units can be in feet/minute (ft/min) or in meters/second (m/s). Measures airspeed from 16mph to 250mph and is well suited to slow aircraft due to very good sensitivity and linearity at low air speeds. Includes a flight timer since takeoff. Airspeed units can be set to miles per hour (mph), kilometer per hour (km/h) or knots (kts). Contains a programmable Vs and Vne airspeed alarm output. Records maximum airspeed reached in permanent memory. P/N 11-15990\$425.00

MGL VEGA AHRS-1 COLOR AHRS COMPASS DISPLAY



Compass with slip indicator (requires MGL Avionics SP-6 sensor package). Horizon with optional slip, turn indicator & G-Force (requires MGL Avionics SP-7/9 sensor package). Turn and bank indicator (requires MGL Avionics SP-7/9 sensor package). Combined compass and horizon display with bank indicator, slip indicator & G-Force (requires MGL Avionics SP6 & SP-7/9 sensor package). Can be setup as an individual compass display, artificial horizon or both. The AHRS-1 / MAG-1 is connected to the AHRS / Compass sensor packages by a simple CAN bus interface. This allows for the optimum placement of the sensor packages in the aircraft. More than one AHRS-1 unit can be connected onto the CAN bus. This allows the compass, artificial horizon and the turn and bank indicator to be displayed on different units. G-Force indicator (MGL Avionics SP7 required)P/N 11-15983\$295.00

MGL VEGA MAP-3

MANIFOLD PRESSURE / RPM TEMP



Advanced fuel computer with various modes of operation. Supports single or dual fuel tanks. The FF-4 can connect to one or two fuel flow senders, fuel level senders or fuel injectors. The FF-4 can connect to a single fuel pressure sender. Differential fuel flow calculations are also supported for fuel return systems. The FF-4 has the ability to connect to a NMEA enabled RS232 GPS receiver for range based calculations. It can also accept a manually entered estimate cruising speed if a GPS is not available. Standard automotive fuel level senders can be used, even with odd shaped tanks due to a comprehensive, multi-point calibration system. External RDAC interfacing via the CAN bus. An external output activates when an alarm condition has been reached.P/N 11-15992\$365.00

MGL VEGA TEMPERATURE/PRESSURE/VOLTS



The TP-3 is a 2 1/4" sunlight readable 4 channel universal analog input color display instrument. Each channel can be individually programmed to display either pressure, temperature, current or volts from a universal analog input that can interface to many sensors such as oil temperature, coolant temperature, oil pressure, fuel pressure, manifold pressure, boost pressure and many more. The TP-3 can display any combination of 1 to 4 analog channels in a horizontal / vertical bargraph or a numeric display format. P/N 11-16579\$295.00

MGL VEGA FF-4 FUEL COMPUTER



Advanced fuel computer with various modes of operation. Supports single or dual fuel tanks. The FF-4 can connect to one or two fuel flow senders, fuel level senders or fuel injectors. The FF-4 can connect to a single fuel pressure sender. Differential fuel flow calculations are also supported for fuel return systems. The FF-4 has the ability to connect to a NMEA enabled RS232 GPS receiver for range based calculations. It can also accept a manually entered estimate cruising speed if a GPS is not available. Standard automotive fuel level senders can be used, even with odd shaped tanks due to a comprehensive, multi-point calibration system. External RDAC interfacing via the CAN bus. An external output activates when an alarm condition has been reached.P/N 11-15991\$315.00

MGL VEGA RPM-1 UNIVERSAL ENGINE / ROTOR RPM INDICATOR



Single or dual RPM display screens. Dedicated dual rotor / engine tachometer. Includes a settable Hobbs meter which is password protected. Includes an engine running and flight timer. Includes a programmable maintenance timer for scheduled routine engine maintenance. Includes a magneto check function. Records maximum RPM reached for each channel. External RDAC interfacing via the CAN bus. An external output activates when a high alarm condition has been reached. P/N 11-15993\$295.00

MGL VEGA TC-4 THERMO-COUPLE EGT/CHT INDICATOR



5 different temperature display screens. Supports J, K and E type thermocouple probes. Temperatures can be displayed in °C or °F from -100°C to 1200°C (-148°F to 2192°F). High accuracy: Built in thermocouple linearization curves and cold junction compensation. Records maximum temperatures reached for each channel. Includes a trend graph display of each thermocouple channel. Engine leaning function according to peak EGT temperatures. Engine cruise mode to instantly identify changing EGT/CHT trends. External RDAC interfacing via the CAN bus. An external output activates when a high alarm condition has been reached. P/N 11-15994\$305.00

MGL VEGA COLOR G-FORCE AND INFO



The INFO-1 is a 2 1/4" sunlight readable multi-function color display instrument. The INFO-1 has the following features:
 • G-force meter • UTC and Local Time display
 • Slip indicator • Battery Voltage, Current and Charge display • OAT display
 P/N 11-16578\$305.00



MGL BLAZE 3 1/8" COLOR INSTRUMENTS

MGL BLAZE AIRSPEED INDICATOR



The ASI-5 is a 3 1/8" sunlight readable instrument that provides a wide range airspeed indication in both digital and analog tape formats. Airspeed is based on the pressure generated by a pitot tube system and a static port is provided as well for use in high speed aircraft. In addition, the ASI-5 provides a flight timer since takeoff and records the maximum airspeed reached. Airspeed can be indicated in statute miles per hour (mph), kilometers per hour (km/h) or knots (kts). The analog airspeed tape can be scaled according to the aircraft's flying speed range and ranges for Vs0, Vs1, Vfe, Vno and Vne can be set. The ASI-4 also provides a programmable Vs and Vne airspeed alarm output. ASI sensitivity can be calibrated by the user to cater for errors caused by pitot tube placement. P/N 11-16584 **\$395.00**

MGL BLAZE AIRSPEED / VSI



The ASV-2 is a 3 1/8" sunlight readable encoding altimeter, airspeed and wide range vertical speed indicator. The altimeter contains an internal high accuracy 24 bit digital altitude sensor which calculates altitude from -1000 ft up to a maximum of 35000 ft. The ASV-2 outputs various formatted RS232 serial data protocols compatible with serial input transponders such as that from Garmin, Magellan, Northstar, Trimble, Microair etc. The altimeter can display altitude in feet or meters and local pressure can be set in millibars or inches of mercury. P/N 11-16586 **\$455.00**

MGL BLAZE ALTIMETER / VSI



The ALT-6 is a 3 1/8" sunlight readable encoding altimeter and a wide range vertical speed indicator. The altimeter contains an internal high accuracy 24 bit digital altitude sensor which calculates altitude from -1000 ft up to a maximum of 35000 ft. The ALT-6 outputs various formatted RS232 serial data protocols compatible with serial input transponders such as that from Garmin, Magellan, Northstar, Trimble, Microair etc. The altimeter can display altitude in feet or meters and local pressure can be set in millibars or inches of mercury. The VSI indicator can be displayed in either feet/minute (ft/min) or meters/second (m/s). The VSI can be calibrated by the user once the instrument has been installed in the aircraft. P/N 11-16582 **\$395.00**

MGL BLAZE ENCODING ALTIMETER / VSI



The ALT-7 is a 3 1/8" sunlight readable encoding altimeter and a wide range vertical speed indicator. The altimeter contains an internal high accuracy 24 bit digital altitude sensor which calculates altitude from -1000 ft up to a maximum of 35000 ft. The ALT-7 outputs various formatted RS232 serial data protocols compatible with serial input transponders such as that from Garmin, Magellan, Northstar, Trimble, Microair etc. The altimeter can display altitude in feet or meters and local pressure can be set in millibars or inches of mercury. The VSI indicator can be displayed in either feet/minute (ft/min) or meters/second (m/s). The VSI can be calibrated by the user once the instrument has been installed in the aircraft. P/N 11-16583 **\$425.00**

MGL BLAZE AHRS / COMPASS



The AHRS-2 / MAG-2 is a 3 1/8" sunlight readable color display instrument providing a display for an artificial horizon reference system (AHRS), an advanced digital compass, or both depending on which sensor packages is connected. P/N 11-16581 **\$335.00**

MGL BLAZE TEMPERATURE / PRESSURE / VOLTS



The TP-4 is a 3 1/8" sunlight readable 4-channel universal analog input color display instrument. Each channel can be individually programmed to display either pressure, temperature, current or volts from a universal analog input that can interface to many sensors such as oil temperature, coolant temperature, oil pressure, fuel pressure, manifold pressure, boost pressure and many more. The TP-4 can display any combination of 1 to 4 analog channels in a horizontal / vertical bargraph or a numeric display format. P/N 11-16595 **\$315.00**

MGL BLAZE FUEL COMPUTER



The FF-5 is a 3 1/8" sunlight readable color display instrument intended for efficient monitoring of fuel related information for single or dual fuel tanks. The FF-5 has many display configurations based on single/dual flow senders, single/dual level senders and a fuel pressure sender. Full functionality is available with a fuel flow and level sender or only with a fuel flow sender using calculated fuel levels based on fuel usage. Differential fuel flow calculations are also supported for fuel return systems. Fuel injector systems are also supported. Standard automotive fuel level senders can be used, even with odd shaped tanks due to a comprehensive, multi-point calibration system. Most fuel flow senders can be used as the K-factor of the sender can be entered into the system for simple calibration. P/N 11-16587 **\$395.00**

MGL BLAZE G-FORCE AND INFO



The INFO-2 is capable of measuring g-forces exerted in an aircraft up to +16g. The INFO-2 also has the facility to record the maximum positive and negative g-forces encountered (typically during a flight) in permanent memory, with a password protected reset facility. It also features two independent cycle counters to capture the amount of times a preset force has been exceeded. The INFO-2 is able to measure g-forces even if the instrument is not mounted exactly on the vertical axis of the aircraft. Also Displays: • UTC and Local Time display • Slip indicator • Battery Voltage, Current and Charge display • OAT display • Flight Timer & Flight log. P/N 11-16588 **\$335.00**

MGL BLAZE MANIFOLD PRESSURE / RPM



The MAP-4 is a 3 1/8" sunlight readable Manifold pressure indicator which can simultaneously display RPM and temperature from a universal RPM and temperature input. The manifold pressure display is also available in the form of a scalable analog bar graph if the RPM input is not displayed. The MAP-4 also has a Hobbs meter (can be set to the current engine time) which is password protected, an engine running timer/flight timer and a programmable maintenance timer to schedule routine engine maintenance. The MAP-4 also features a programmable low/high alarm for manifold pressure, RPM and temperature, a handy magneto check function to easily diagnose magneto problems as well as it records the maximum manifold pressure, RPM and temperature reached in permanent memory. P/N 11-16589 **\$395.00**

MGL BLAZE RPM INDICATOR



The RPM-2 is a 3 1/8" sunlight readable color display instrument providing two universal RPM inputs that is primarily intended to measure engine and/or rotor RPM. The display can be configured to display single or dual RPM or it can be configured to display engine and rotor RPM as used in helicopters and gyroplanes. The RPM-2 also has a maximum values display screen as well as a handy magneto check function. The RPM-2 includes a number of timers such as a Hobbs meter which can be set to the current engine time and is also password protected, an engine running and flight timer as well as a programmable maintenance timer to schedule routine engine maintenance. P/N 11-16591 **\$325.00**

MGL BLAZE 4-CHANNEL TEMP DISPLAY



4-channel Thermocouple (EGT/CHT) Monitor. The TC-5 is a 3 1/8" Sunlight readable 4 channel thermocouple color display instrument. Instrument can be configured for 5 different temperature display screens. The display can be configured to group EGTs and CHTs to common settings or each thermocouple channel can be independently displayed with individual programmable high alarm and probe type. The TC-5 also has a trend graph and maximum values display screen. P/N 11-16593 **\$345.00**

MGL BLAZE 12-CHANNEL TEMP DISPLAY



12-channel Thermocouple (EGT/CHT) Monitor. The TC-6 is a 3 1/8" sunlight readable 12 channel thermocouple color display instrument that contains all the features necessary to monitor EGT's and CHT's. The TC-6 can be configured to display up to 12 thermocouples in an easy to read bargraph format. In addition the TC-6 has an individual programmable EGT and CHT alarm with an external output that can switch an external visual alarm indicator such as a lamp. The TC-6 also has a EGT and CHT trend graph and maximum values display screen. P/N 11-16594 **\$385.00**

MGL BLAZE COLOR UNIVERSAL ENGINE MONITOR



The Blaze EMS-2 is a 3 1/8" universal engine monitor color display instrument. The EMS-2 contains all the necessary functionality to replace several engine monitoring instruments. The EMS-2 light weight, small size and high level of functionality makes it an excellent choice for all types of engines. The EMS-2 can also be interfaced via the CAN bus to an optional external RDAC unit (Remote Data Acquisition Computer). This allows for easier installation as the RDAC unit is normally mounted in the engine compartment. P/N 11-16722 **\$455.00**

IN

CIES SENDERS – SWIFT SENDERS



CIES MAGNETIC FUEL LEVEL SENDER KITS

A better way to measure fuel. This Magnetic Field Sensor technology is patented by CiES Inc. for fuel level senders. These sensors use the basic premise that the electrical properties of certain ferromagnetic alloys, such as permalloy, are influenced by external magnetic fields. Like a compass that always points to magnetic North, no matter how you move the fuel - these fuel level senders always point to the float sitting on the surface.

The initial STC allows the CiES to replace the existing fuel quantity senders in: • Britten Norman BN2 • Beech 33, 35, 36, 55, 58 • Cessna 170, 172, 177, 177RG, 180, 182, 185, 206, 207 • Cirrus SR20 SR22 • Fairchild 24 • Gippsland GA8 • Maule • Mooney • Piper PA 23, PA 24, PA 28, PA 30, PA 31, PA 32, PA 39, PA 44 • Vulcanair P68 • Fairchild 24
Specifications: • CiES CC-Series fuel senders are TSO certified to C55a and associated SAE AS405C. • They have met all the DO-160(F) and DO-254 DAL (Design Assurance Level) Level D requirements for the TSO.

Vendor Part Number	Description	Part No.	Price
CC284022-C170-105	Analog Sender Kit For Cessna C170	10-06510	\$990.00
CC284022-C210-105	Analog Sender Kit For Cessna C210	10-06514	\$990.00
CC284022-0608-101	Digital Sender Kit For Cessna C210 Strut Wing Tip	10-06532	\$870.00
CC284022-C150-101	Digital Sender Kit For Cessna C150/152	10-06533	\$870.00
CC284022-C170-101	Digital Sender Kit For Cessna C170	10-06534	\$870.00
CC284022-C177-101	Digital Sender Kit For Cessna C177	10-06535	\$870.00
CC284022-C210-101	Digital Sender Kit For Cantilener Wing C210	10-06536	\$870.00
CC284022-C172-101	Digital Sender Kit For Cessna 172/175	10-06537	\$870.00
CC284022-BTIP-101	Digital Sender Kit For Osborne Tip Tank	10-06538	\$870.00
CC284022-CESSNA-101	Digital Sender Kit For Cessna C210, 182, 185, 206 Strut Wing	10-06539	\$870.00
CC284022-B55A-101	Digital Sender Kit For Aux Tank B95	10-06540	\$3,480.00
CC284022-B58-101	Digital Sender Kit For B58	10-06541	\$2,610.00
CC284022-T34-101	Digital Sender Kit For Beechcraft 45/T-34	10-06542	\$870.00
CC284022-GA8-101	Digital Sender Kit For Gippsland Airvan GA8	10-06544	\$870.00
CC284022-M20CDE-101	Digital Sender Kit For Mooney M20CDE	10-06545	\$885.00
CC284022-M20FGJK-101	Digital Sender Kit For Mooney M20FGJK	10-06546	\$1,740.00
CC284022-M20LMS-101	Digital Sender Kit For Mooney M20LMS	10-06547	\$1,740.00
CC284022-ARROW-101	Digital Sender Kit For Piper Arrow	10-06548	\$1,740.00
CC284022-P24-101	Digital Sender Kit For Piper PA22/24	10-06549	\$870.00
CC284022-P23-101	Digital Sender Kit For Piper PA28	10-06550	\$1,740.00
CC284022-CHEROKEE-101	Digital Sender Kit For Piper PA28	10-06551	\$1,740.00
CC284022-P30-101	Digital Sender Kit For Piper PA30/40	10-06552	\$1,740.00
CC284022-P31-101	Digital Sender Kit For Piper PA31	10-06553	\$3,960.00
CC284022-P44-101	Digital Sender Kit For Piper PA44	10-06556	\$870.00
CC284022-P68-101	Digital Sender Kit For Vulcanair P.68	10-06557	\$870.00
CC284022-MAULE-101	Digital Sender Kit For Maule	10-06560	\$870.00
CC284022-C195-101	Digital Sender For Cessna 190 / 195	10-06821	\$870.00
CC284022-C208-101	Digital Sender For Cessna 208 / 208B	10-06822	\$2,610.00
CC284022-B20-101	Digital Sender 20 Gallon Main For Beech 33 / 35 / 36	10-06823	\$870.00
CC284022-B25-101	Digital Sender 25 Gallon Main For Beech 33 / 35 / 36	10-06824	\$870.00
CC284022-B10-101	Digital Sender 10 Gallon Aux For Beech 33 / 35 / 36	10-06825	\$870.00
CC284022-B36TC-101	Digital Sender 40 Gallon Main For Beech 33 / 35 / 36	10-06827	\$2,610.00
CC284022-B40-101	Digital Sender 40 Gallon Main For Beech 33 / 35 / 36	10-06828	\$1,740.00
CC284022-NN MAIN-101	Digital Sender BN Main 101 for B-N Group	10-06829	\$870.00
CC284022-BN TIP AFT-101	Digital Sender BN TIP AFT 101 for B-N Group	10-06830	\$1,195.00
CC284022-BN TIP FWD-101	Digital Sender BN TIP FWD 101 for B-N Group	10-06831	\$870.00
CC284022-ACA8-101	Digital Sender For American Champion 8KCAB / 8GCBC	10-06832	\$870.00
CC284022-ACA7-101	Digital Sender For American Champion 7ECA / 7GCAA / 7KCAB	10-06834	\$870.00
CC284022-114-101	Digital Sender For Rockwell Commander 112 / 114	10-06836	\$870.00
CC284022-TB10-101	Digital Sender For Socata TB9 / 10	10-06837	\$986.00
CC284022-TB20-101	Digital Sender For Socata TB20 / 21	10-06838	\$1,972.00
CC284022-108-101	Digital Sender For stinson 108-1 Thru 180-5	10-06839	\$870.00
CC284022-AA5-101	Digital Sender For Grumman AA-5 / AG-5	10-06840	\$870.00



SWIFT FUEL CAPACITY SENDERS



Model Number	Size	Description	Part Number	Price
SF-F-12	12"	Bendable Alarm Sender, 5V Output	10-06660	\$132.75
SF-F-18	18"	Bendable Alarm Sender, 5V Output	10-06661	\$93.75
SF-F-24	24"	Bendable Alarm Sender, 5V Output	10-06662	\$89.75
SF-Z-12	12"	Alarm Sender, 5V Output	10-06663	\$94.75
SF-Z-24	24"	Alarm Sender, 5V Output	10-06664	\$103.99
SF-Z-48	48"	Alarm Sender, 5V Output	10-06665	\$149.95
301-KV-000	--	Sender, Connecting Cable	10-06666	\$18.80

INSTRUMENT TECH CORP FUEL SENDERS

OEM P/N	ITC Mfg Part Number	Eligibility Chart	Our Part Number	Price
PS50149-2	9812-0001-101	Drop-In Fuel Sender Replacement for the Following Models: <ul style="list-style-type: none"> • PA-31/PA-31-300/-325 Navajo 31-1 through 31-861; 31-7300901 through 31-8312019 • PA-31-350 Chieftain/T-1020 31-5001 through 31-5004; 31-7305005 through 31-8553002 • PA-31P Pressurized Navajo 31P-1 through 31P-80; 31P-7300110 through 31P-7730012 	10-06976	\$445.00
PS50149-3	9812-0002-101	Drop-In Fuel Sender Replacement for the Following Models: <ul style="list-style-type: none"> • PA-31/PA-31-300/-325 Navajo 31-1 through 31-861; 31-7300901 through 31-8312019 • PA-31-350 Chieftain/T-1020 31-5001 through 31-5004; 31-7305005 through 31-8553002 • PA-31P Pressurized Navajo 31P-1 through 31P-80; 31P-7300110 through 31P-7730012 	10-06977	\$445.00
PS50149-4	9812-0003-101	Drop-In Fuel Sender Replacement for the Following Models: <ul style="list-style-type: none"> • PA-31/PA-31-300/-325 Navajo 31-1 through 31-861; 31-7300901 through 31-8312019 • PA-31-350 Chieftain/T-1020 31-5001 through 31-5004; 31-7305005 through 31-8553002 • PA-31P Pressurized Navajo 31P-1 through 31P-80; 31P-7300110 through 31P-7730012 	10-06978	\$457.00
PS50149-5	9812-0004-101	Drop-In Fuel Sender Replacement for the Following Models: <ul style="list-style-type: none"> • PA-31/PA-31-300/-325 Navajo 31-1 through 31-861; 31-7300901 through 31-8312019 • PA-31-350 Chieftain/T-1020 31-5001 through 31-5004; 31-7305005 through 31-8553002 • PA-31P Pressurized Navajo 31P-1 through 31P-80; 31P-7300110 through 31P-7730012 	10-06979	\$457.00
7740-0304	9812-0028-101	Drop-In Fuel Sender Replacement for the Following Maule Aircraft Models: Bee Dee M-4, M-4, M-4C, M-4S, M-4T, M-4-180C, M-4-180S, M-4-180T, M-4-210, M-4-210C, M-4-210S, M-4-210T, M-4-220, M-4-220C, M-4-220S, M-4-220T, M-5-180C, M-5-220, M-5-210C, M-5-210TC, M-5-220C, M-5-235C, M-6-180, M-6-235, M-7-235, MX-7-235, MX-7-180, MX-7-420, MXT-7-180, MT-7-235, M-8-235, MX-7-160, MXT-7-160, MX-7-180A, MXT-7-180A, MX-7-180B, M-7-235B, M-7-235A, M-7-235C, MX-7-180C, M-7-260, MT-7-260, M-7-260C, M-7-420AC, MX-7-160C, MX-7-180AC, M-7-420A, MT-7-420, M-4-180V and M-9-235. INSTALLATION WARNING: BE SURE TO CHECK THE TYPE OF FUEL SENDER YOU HAVE. P/N 9812-0028-101 WILL NOT REPLACE THE OLD STEWART WARNER TYPE SENDERS; ONLY ROCHESTER TYPE SENDERS.	10-06980	\$437.00
38789-800	9812-0023-101	PA-28R, PA200T, PA28R-201, PA-28R-201T, PA28RT-201T, PA-34, PA-34-200T, PA-34-220T. INSTALLATION WARNING: BE SURE TO CHECK THE TYPE OF FUEL SENDER YOU HAVE. P/N 9812-0023-101 WILL NOT REPLACE THE OLD STEWART WARNER OR A.C. TYPE SENDERS. IT ONLY REPLACES THE ROCHESTER TYPE SENDERS.	10-06981	\$552.00
38789-801	9812-0024-101	Drop-In Fuel Sender Replacement for the following aircraft: PA-28R, PA28R-201, PA-28RT, PA28RT-201, PA28RT-201T, PA-34, PA-34-200. INSTALLATION WARNING: BE SURE TO CHECK THE TYPE OF FUEL SENDER YOU HAVE. P/N 9812-0024-101 WILL NOT REPLACE THE OLD STEWART WARNER OR A.C. TYPE SENDERS. IT ONLY REPLACES THE ROCHESTER TYPE SENDERS.	10-06982	\$698.00
42470-000	13-10017-501	This Gasket is used with the 9812-0001-101, 9812-0002-101, 9812-0003-101 & 9812-0004-101 Fuel Senders Only.	10-06983	\$12.95

IN

SKYSPORT PROBES

SKYSPORTS CAPACITIVE FUEL SYSTEMS



The Skysports fuel monitoring system is a capacitance system which has no float and no moving parts except the needle on the gauge. Used in hundreds of various ultralight, homebuilt, and military aircraft, these fuel systems have been very popular due to their accuracy and durability. The Skysports fuel probe electronically measures the level of fuel in the tank, and sends the signal through the wire harness to the gauge. Available for single or dual tank use and for 12 or 24 volt operation. The system includes the gauge, probe, 8 ft. wire harness, mounting hardware, & instructions.

The SkySports 240-33ohm fuel systems are no longer available. They have been replaced with a new 0-5V system. These new systems, (listed below) can be used on both 12 or 24 volt aircraft. The older 240-33ohm gauge and probes are not interchangeable with the new 0-5V gauge or probes. However the installation of the systems are the same.

Note: The Skysports 240-33ohm older style probes are only available as special order upon request. Made in USA

ROUND GAUGE SYSTEMS

Description	Part No.	Price
Fuel System 2" Round 6" Straight Probe	10-04509	\$279.66
Fuel System 2" Round 12" Straight Probe	10-04495	\$265.56
Fuel System 2" Round 24" Straight Probe	10-04496	\$273.66
Fuel System 2" Round 12" with 3" Bendable Probe	10-04497	\$269.46
Fuel System 2" Round 24" with 3" Bendable Probe	10-04498	\$269.46
Fuel System 2" Round 12" with 5" Bendable Probe	10-04499	\$269.46
Fuel System 2" Round 24" with 5" Bendable Probe	10-04501	\$283.46

SQUARE GAUGE SYSTEMS

Description	Part No.	Price
Fuel System 2-1/4" Square 6" Straight Probe	10-04511	\$292.66
Fuel System 2-1/4" Square 12" Straight Probe	10-04502	\$278.56
Fuel System 2-1/4" Square 24" Straight Probe	10-04503	\$286.66
Fuel System 2-1/4" Square 12" with 3" Bendable Probe	10-04504	\$282.46
Fuel System 2-1/4" Square 24" with 3" Bendable Probe	10-04505	\$282.46
Fuel System 2-1/4" Square 12" with 5" Bendable Probe	10-04506	\$282.46
2-1/4" Square 24" with 5" Bendable Probe	10-04507	\$296.46

INDIVIDUAL COMPONENTS

Description	Part No.	Price
2" Gauge Only	10-04119	\$76.95
2-1/4" Gauge Only	10-01246	\$89.95
12" Straight Probe	10-03758	\$149.85
6" Straight Probe	10-03753	\$163.95
24" Straight Probe	10-03773	\$157.95
12" with 3" bend probe	10-03746	\$153.75
24" with 3" bend probe	10-03774	\$153.75
12" with 5" bend probe	10-03761	\$153.75
24" with 5" bend probe	10-03776	\$167.75
Installation Kit	10-03731	\$38.75



MGL CAPACITANCE FUEL LEVEL SENDERS

MGL Avionics Capacitance Probe is available in 12" or 24" long. The senders can be bent above the black mark on the probe (first several inches only), and they can be cut to length.

12 inch Sender..... P/N 11-14306..... **\$136.75**
 24 inch Sender..... P/N 11-14307..... **\$136.00**

BELITE INSTRUMENTS

BELITE RADIANT FUEL GAUGE



The RADIANT Single or Dual Tank Fuel Gauge from Belite shows current contents of one or two tanks and the system voltage. Optional Fuel Flow. Works with: float probes, capacitive probes, also Belite fuel probes. Shows fuel consumption trend from two tanks over the last 30 minutes. The picture shows a full left tank and a right tank that has steadily been draining over the last 30 minutes. Voltage is 10.8 volts. Direct sunlight readable (this display is "bright*") Display is friendly with sunglasses, even polarized sunglasses. Single or dual fuel tank display, featuring a visual history of the last 30 minutes of fuel level in each tank. Optional is a digital fuel flow sensor, which adds real time fuel flow information. All instruments are designed for a standard 2.25" cutout, and use approximately 100milliamps of power from a supply of 8 to 14 volts. All instruments are dimmable.

For Capacitive Fuel Senders Or 0-5 Volt Input.... P/N 10-06067. **\$249.95**
For Resistive Or Float Based Fuel Senders..... P/N 10-06068. **\$249.95**



RADIANT UNIVERSAL AIR SPEED INDICATOR

Huge digits; speed trend; three speed ranges; knots and MPH. RADIANT Technology's new Universal Airspeed Indicator works across 3 different speed ranges and Knots / MPH. It has a number of features which are important to pilots, with features that are not available in expensive glass panels or in older steam gauges.

P/N 10-06964 **\$249.95**



BELITE RADIANT TURN COORDINATOR

The RADIANT Turn Coordinator provides a visual indication of turn rate along with a visual indication of slip / skid, utilizing an ultra bright, daylight readable color LCD display. In comparison to all other Turn Coordinators, this unit also provides a digital indication of degrees per second in the turn.

P/N 10-06082 **\$264.00**



BELITE RADIANT MFI (ASI / VSI / ALTITUDE)

This instrument shows simultaneous ASI, Altitude and VSI information in a single glance, easy to read format. All of this information is presented digitally and graphically on a single vivid LCD screen. The MFI is part of the RADIANT instrument line that combines many functions into simple, small, lightweight units. They have sunlight readable full color high contrast LCD screens which are also friendly with sunglasses.

P/N 10-07141 **\$359.00**

BELITE RADIANT TACHOMETER



Radiant Tachometer is designed to work with any engine and provides a brilliant, crisp LCD screen with a soft green back light, for easy visibility. The Digital Tachometer / Hour Meter is a general purpose, ignition spark lead based instrument. Mount it anywhere using the included Velcro patch.

Works with two or four stroke engines; also includes a job (oil change) interval countdown timer..... P/N 10-06872 **\$43.75**

BELITE FUEL PROBE SYSTEM 1/8" PROBES



The Belite liquid level / fuel probe is designed to sense fuel or liquid level of any type and provide an electrical indication to instrumentation along a range of 0 to 5 volts. The unit is not TSO'd or PMA'd. Use only in appropriate aircraft as a backup to certified instruments and pilot calculations. Ideal for monitoring level of liquid in many other applications, such as agricultural spraying. Patent pending. P/N 10-05866 **\$218.95**



BELITE PERFECT LIQUID PROBE FOR RFG A-D GAUGE

Radiant Instruments the Perfect Liquid Probe (PLP), a novel level sensor which mounts on the top of a tank. It uses ultrasonic technology to determine the distance between the sensor and the liquid within the tank. It is compatible with almost all liquid types, including gasoline, jet fuel, diesel and water. Other than two small holes in the top of the tank, no probes, rods, floats or wires enter the tank. The ultrasonic probe heads are metal, not plastic..... P/N 10-07157 **\$249.95**

HEADER TANK AUTOMATIC FILL CONTROLLER



The HTAF2 is a "Smart" Header Tank Automatic Fill Control Relay. This device automatically keeps the aircraft header tank full without over stressing any fuel pumps. It can be operated manually (without any fuel sensors mounted in the header tank), or automatically, with one or two optical fuel sensors mounted in the side of the header tank or the your sight tube plumbing. The fuel sensor used for the HTAF2 is a very reliable optical fuel level sensor (optional) that can be easily installed in the header fuel tank. If the user is not able to install a fuel sensor in the header fuel tank, the HTAF2 can be wired to a normally open push button switch to activate the timed pumping. The unit also has a relay output that can be used for a light to indicate when the fuel in the header tank is low. The light will flash indicating when there are any system malfunctions detected. This detection of low fuel is also damped so that it does not falsely indicate low fuel in the case of sloshing fuel. The system can be powered by +12V or +24V electrical systems.

Without Sensors P/N 10-07107 **\$89.00**
1 Sensor P/N 10-07108 **\$169.00**
2 Sensors P/N 10-07109 **\$249.00**

BELITE RADIANT - ANGLE OF ATTACK SENSOR



The Radiant Angle of Attack Sensor & Display System includes vane, sensor, LCD RADIANT color Display, and aural alert output, which sounds when angle is in the red.

The vane is mounted on the leading edge of your wing (for tractor airplanes) or on the forward side of your fuselage (for pusher airplanes). The Radiant AOA comes complete with fittings for either mount. The actual angle of attack is shown in continuous digital format as well. This is a differential angle from the base (cruise) setting. The bar graph and the numerical value fall rapidly as the elevator is shoved forward. All instruments are designed for a standard 2.25" cutout, and use approximately 100 milliamps of power from a supply of 11 to 14 volts. All instruments are dimmable. FOR USE IN AIRCRAFT AND VEHICLES ONLY. Non-TSO/PMA Experimental status and use only.

P/N 10-07283 **\$599.95**

BELITE BINGO 4 LIQUID DETECTOR



With fuel management issues continuing to plague pilot decision making, Radiant Technology introduces Bingo4, a small sensor device that fits on the outside of the tank and easily shows the presence of absence of liquid in a tank.

Bingo4 mounts on the outside of many different kinds of tanks. It uses ultrasonic technology to indicate the presence of liquid at the point of attachment. It's the perfect instrument to indicate critical level information of the fluid inside a tank. The sender includes a flashing status LED, best for pilots who can see the tank and sender installation.

With USB Port Only P/N 10-07156 **\$129.95**
With USB Port + Panel Display P/N 10-07155 **\$179.95**

IN

MICROFLIGHT GAUGES

MICRO-1000 ENGINE GAUGES

Senders and probes are not included unless specifically noted. See lower half of the page for senders, probes, and other accessories. 2" gauges are round. 2 1/4" gauges are square.



OIL PRESSURE ELECTRIC

MICRO-1000 oil pressure electric includes 1/8 NPT SDR.
 2 1/4" OP031.....P/N 10-01574\$121.95
 2" OP030.....P/N 10-01572\$107.95



OIL TEMPERATURE ELECTRIC

Includes 1/8 NPT Sender
 2 1/4" OT031.....P/N 10-01588\$85.95
 2" OT030.....P/N 10-01586\$71.75



DC VOLTMETER

2 1/4" VM031.....P/N 10-01641\$89.95
 2" VM030.....P/N 10-01639\$74.75



2 IN VOLT METER

2 Inch Volt Meter - Round Only.
 P/N 10-01640\$72.75



AMMETER ±30 AMPS

2 1/4" AG031.....P/N 10-01319\$78.75
 2" AG030.....P/N 10-01317\$64.25



MICROFLIGHT DUAL TACH/EGT

2" Round Gauge Tachometer - Universal for single or dual ignition. EGT range: 700-1700°F EGT probe (clamp type) Sender not included
 P/N 10-01628\$159.99



MICROFLIGHT DUAL TACH/EGT

Dual: CHT/Tachometer. Size: 2" inch round. Range: 700-1700°F/0-8000rpm for single and dual ignition. Similar to Falcon Gauge. Made in China
 P/N 10-01626\$135.75

MICROFLIGHT SENDERS & ACCESSORIES



100# PRESSURE SENDER

HAS A 1/8" NPTF fitting.
 OP030.2.....P/N 10-01573\$49.50



TEMPERATURE SENDERS

Single-station senders for water and oil temperature gauges.
 OT030.2.....P/N 10-01587\$19.50



OIL PRESSURE FITTING ADAPTER FOR ROTAX

Oil pressure fitting adapter for Rotax. Straight Angle Adapter 1/8 NPT 10MM x 1.5.
 P/N 15-08691\$37.95



TUBING KIT FOR OIL PRESSURE

Tubing Kit for Oil Pressure Includes 16' tubing and assorted adapters to fit most any application. Includes 1/8-27 NPT and 1/4-18 NPT adapters.
 P/N 15-04762\$19.50



FLOAT-TYPE FUEL PROBES

6-23" Probe. Adjustable, 6-23"; 240-33 ohms standard: 5-hole ASME pattern. Requires mounting kit.
 FGP031.....P/N 10-01489\$46.50

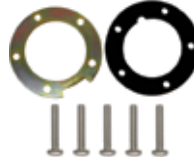

UNIVERSAL PROBE MOUNT

Works well with plastic and other tank. Includes threaded attachment ring, gasket, and hardware. Standard 5-hole SAE pattern.
 FMK01.....P/N 10-01501\$11.50



COLOR TINT LAMPS

Color tint lamp boots. Set of Boots. Changes your instrument backlighting to red for night flying.
 LB001.....P/N 10-01556\$1.85

APPLICATION NOTE: Most current production Rotax® engines require 1/8NPT temperature and pressure senders.



THERMOCOUPLES

BAYONET TYPE

Threaded Fitting with 1/8"
 P/N AN4076\$31.55
 Pipe thread to mate with bayonet type thermocouple.

UNIVERSAL REPLACEMENT PROBES



CHT Probe, Type J, Style AN 5541-1
 P/N AN5541-1\$76.75
 EGT Probe, Type K MM-111
 P/N 11-01022\$73.75
 CHT Probe, Type K (Hose clamps not required)
 P/N 11-01023\$71.75
 Cessna CHT Probe S2334-3 - Must be used with the new Rochester Gauges. Cannot be used with the old Stewart Warner Gauges
 P/N 06-00703\$478.00
Note: These probes will only work with a grounded system.



ROCHESTER 3080-38 TEMPERATURE PROBE

3/8-24 NF3. 250°-550° Aircraft Temperature Probe.....P/N 3080-38\$153.75



ROCHESTER 3080-37 OIL TEMPERATURE PROBE

3080-37 for cluster-type instrument. 5/8"-18, 10/32 Thread.....P/N 3080-37\$152.75

THERMOCOUPLE LEADS

HEAVY-WEIGHT AN SPEC. WIRE LEADS

8 Ohm Resistance, Iron-Constantan, 90"
 P/N 42535\$51.80
 8 Ohm Resistance, Iron-Constantan, 144"
 P/N 42536\$64.85
 8 Ohm Resistance, Iron-Constantan, 216"
 P/N 42537\$82.85
 EGT E.W. Rings.....P/N 11-05672\$72.95

MICROFLIGHT GAUGES / VDO GAUGES

MICRO-1000 PYROMETERS



Superior to any other type of pyrometer, MICRO-1000 pyrometers still read the same. And we guarantee that, when properly installed, these pyrometers will be accurate within 2%. Like other MICRO-1000 gauges, these units come with our standard 2-year warranty. Order gauges, probes, and extension leads separately.

Note: MICRO-1000 pyrometers are not compatible with other thermocouple probes. Order Micro-1000 Probes • 2% Accuracy

• Easy-to-Read Dial • Backlighting • Standard • Temperature Compensated • Shock & Vibration Resistant • Designed & Built for Aircraft

Range	Description	Part No.	Price
0-600F/0-300C	CH131 2-1/4" Square CHT	10-01426	\$149.95
0-600F/32-315C	CH130 2" Round CHT	10-01425	\$136.75
0-600F/0-1600F	CH141 2-1/4" Square CHT EGT Combo	10-01409	\$233.95
0-600F/600-1600F	CH140 2" Round CHT EGT Combo	10-01408	\$227.95
800-1800F/450-950C	CH131 2-1/4" Square EGT	10-01464	\$133.95
800-1800F/430-980C	CH130 2" Round EGT	10-01463	\$136.75
800-1800F	CH141 2-1/4" Square Dual EGT	10-01467	\$258.95
800-1800F	CH140 2" Round Dual EGT	10-02093	\$236.95

MICROFLIGHT PROBES



A more expensive material than that of the more commonly found "J" type, the "E" type probe produces much greater accuracy at lower temperatures (less than 600°F). Extension wire is of the same material as the thermocouple to preserve the accuracy and temperature compensation qualities. **Note:** The 15' extension leads may be shortened up to seven feet. The EGT probes

are high-quality Chrome/Alumel "K" types. Choose the weld-on boss type (below) for new engine installations. Choose the clamp-on type (below) to replace the existing probe. Order gauges, Micro-1000 probes and extensions separately.

Note: These are "K" type grounded probes, not for use on digital gauges. For use with Micro-1000 gauges.

Type	Part No.	Description	Price
EGT	10-01471	EP130 Type K Clamp Type Probe	\$99.75
EGT	10-01475	EP130R Adjustable Rotax M8-1 Probe	\$97.25
EGT	10-01477	EP131 Type K Weld on Boss Probe	\$74.80
EGT	10-01478	EP132 Type K 1/8" NPT Adjustable Adapter Probe	\$93.25
EGT	10-01479	EP133 Type K 1/4" NPT Adjustable Adapter Probe	\$92.25
CHT	10-01441	CP132 Type K 10mm Probe	\$68.85
CHT	10-05122	CP129 Type K 12mm Probe	\$67.80
CHT	10-00823	CP130 Type K 14mm Probe	\$72.75
CHT	10-01440	CP131 Type K 18mm Probe	\$66.85

MICROFLIGHT LEADS

Part No.	Description	Price
10-01442	CHT 18G Thermocouple Lead 7 Ft	\$27.00
10-01443	CHT 18G Thermocouple Lead 15 Ft	\$55.50
10-01480	EGT 18G Thermocouple Lead 7 Ft	\$49.00
10-01481	EGT 18G Thermocouple Lead 15 Ft	\$102.95

Note: For a complete CHT or EGT set, order gauge, probe, and lead.

VDO GAUGES & PROBES



EXHAUST GAS TEMP.

2-1/4" P/N 10-01462... \$229.95
2" P/N 10-01461... \$215.95

250 -1650°F

With weld-on Boss type probe



OIL PRESSURE

2-1/4" P/N 10-01570 .. \$106.95
2" P/N 10-01567 \$92.50
Includes 1/8NPT sender
2" round(Gauge Only)
P/N 10-01569 \$39.95



OIL TEMP.

2-1/4" P/N 10-01583\$68.50
2" P/N 10-01579\$54.00
Includes 1/8NPT probe
2" round(Gauge Only)
..... P/N 10-01581 \$38.50



AMMETER - 12 VDC

2-1/4" P/N 10-02335 \$78.50
2" P/N 10-02334 \$63.95
No shunt required



VOLTMETER-12 VDC

2-1/4" P/N 10-01638\$56.25
2" P/N 10-01637\$41.99
With color arc



FUEL LEVEL-10-180 OHM

2-1/4" P/N 10-01485\$46.00
2" P/N 10-00825\$31.90
Order only P/N 10-04788
probes for this instrument.



WATER TEMP.

2-1/4" P/N 10-01649 ... \$77.75
2" P/N 10-01646\$63.50
Includes 1/8NPT probe



HOOR METER-12VDC

2-1/4" ... P/N 10-01505\$66.00
2" P/N 10-01504\$51.80
With minute hand



FLUID TEMPERATURE GAUGE

2" P/N VDO180902D ...\$65.75
Includes 96" capillary tubing
and adapter kit.

VDO PROBES



VDO Float Probe 10-180ohms..... P/N 10-04788\$62.50
VDO Float Probes - 240 ohms..... P/N 10-00826\$49.85
Fuel Probe Mounting Ring P/N 10-01502.....\$39.50
VDO Temperature Probes - 1/8NPT
Water Probe 1/8" NPT P/N 10-01648.....\$21.75
Oil Probe 1/8" NPT..... P/N 10-01580.....\$15.85
VDO CHT Probe - Type "J"
14mm ring type P/N 10-01439\$82.75
VDO EGT Probe - Type "K" Weld-on Boss.... P/N 10-01461 \$215.95
Oil Pressure Sender 1/8"-27 NPT (30PSI)..... P/N 10-05471\$71.75
Oil Pressure Sender 1/8" NPT (80 PSI) P/N 10-01568\$52.95
Oil Pressure Sender 1/8-27 NPT (150 PSI).... P/N 10-04967\$67.80
VDO Pressure Sender 1/8"-27 NPTF 80 PSI.. P/N 10-06581.....\$72.75
VDO Oil Temp Sender 10MM P/N 15-06252.....\$28.95

WARNING NOTICE:

*VDO pressure senders are not to be used with any type of fuel application.

*VDO pressure senders may not be used in automotive braking systems.

*VDO pressure senders are not suitable for use in aircraft.

AVIASPORT ROTAX INSTRUMENTS



ROTAX 912 2-1/4" CHT GAUGE FARENHEIT

Rotax 912 CHT Temp – F. For use with VDO sensor only. Red: 270-300. Yellow: 100-150, 220-270. Green: 130-220 Diameter: 57mm (2.25 in.). Motor: 912S.....P/N 15-06646\$125.75



ROTAX 912UL 2-1/4" CHT GAUGE

IM-549 - Water Temperature Indicator (CHT) Rotax 912 engine (80HP) and 914.57 mm - Scale in °F. Designed specifically for Rotax 912 (80HP) and 914 with silkscreen red areas green and yellow. Diameter 57mm, 100-300° F range, distance between 2° F indications in central area. Supply voltage 8-35V DC. It works with sensors that come from the factory with Rotax engines.....P/N 15-08392\$125.75



ROTAX 912 2-1/4" EGT GAUGE FAHRENHEIT

A540 Rotax 912 EGT Temp – F. For use with Aviasport Sender only. Red: 1500-2000. Yellow: 600-1100. Green: 1100-1450. Diameter: 57mm(2.25 in) P/N 15-05922\$182.75

OTHER ROTAX EGT GAUGES

- IM-774 2" EGT 300-1000 C Rotax 914..... P/N 15-08550\$109.99
- IM-775 2-1/4 EGT 300-1000 C Rotax 914..... P/N 15-08551\$119.75
- IM-776 2 Dual EGT 300-1000 C Rotax 912.... P/N 15-08552\$118.75
- IM-777 2-1/4 Dual EGT 300-1000 C Rotax 912. P/N 15-08553\$121.75
- IM-778 2 Dual EGT 300-1000 C Rotax 914 P/N 15-08554\$118.75
- IM-779 2-1/4 Dual EGT 300-1000 C Rotax 914. P/N 15-08555\$121.75
- IM-780 2 EGT 600-1800 F Rotax 912..... P/N 15-08556\$112.95
- IM-781 2-1/4 EGT 600-1800 F Rotax 912..... P/N 15-08557\$113.80
- IM-782 2 1/4 Dual EGT 500-1300 F Rotax 503.. P/N 15-08558\$129.99
- IM-783 2.25 Dual EGT 500-1300 F Rotax 582. P/N 15-08559\$129.95



ROTAX 912 2-1/4" OIL PRESSURE GAUGE PSI

A572 Rotax 912 Oil Pressure – PSI. For VDO Sender only. Red: 0-12, 90-150 psi. Yellow: 75-90 psi. Green: 30-75 psi. Diameter: 57mm(2.25 in) P/N 15-05924\$119.85

ROTAX 912/914 OIL PRESSURE GAUGE

- 2 Oil Pressure • Ideal for use on Rotax 912/914
- Ranges from 0-80psi • Includes 1/8 male NPT sender • Fits 2 1/16 cutout • Completely electrical
- Requires 12 volts D/C..P/N 15-06319\$122.75



ROTAX 912 2-1/4" OIL TEMPERATURE GAUGE FARENHEIT

A558 Rotax 912 Oil Temp. For use with VDO Sender only. Red: 90-120, 280-320. Yellow: 120-190, 230-270. Green: 190-230. Note: Not for 912IS and 914 engines. See "Alternate Items" part number 15-08399. Diameter: 57mm (2.25 in.) Motor: 912S/914. P/N 15-05926\$119.85



ROTAX 912 2-1/4" TACHOMETER

A105 Rotax 912 Tachometer. 0-7000 rpm. Electronic Connection only. Red: 0-1200, 5800-7000. Yellow: 1200-1800, 5500-5800. Green: 1800-5500. P/N 15-05932\$158.75



ROTAX 912 3-1/8" TACHOMETER

A149 Rotax 912 Tachometer - 3-1/8". 0-7000 range. Electronic connection only. Red: 0-1200, 5800-7000. Yellow: 1200-1800, 5500-5800. Green: 1800-5500.....P/N 15-05930\$167.75



ROTAX 912 2-1/4" VOLTMETER

A562 Rotax 912 Voltmeter. Red: 8-10, 14-16 volts. Yellow: 10-11, 13-14 volts. Green: 11-13 volts. P/N 15-06650\$115.75



ROTAX 912 2-1/4" FUEL PRESSURE GAUGE BAR

A564 ROTAX 912 Fuel Pressure Bar. Requires Sender below. Red: 0-1.5 , 4-6 bar. Green: 1.5 – 4.0 bar. Diameter: 57mm (2.25 in.). Sensor: 7 PSI. P/N 15-06647\$132.75



FUEL PRESSURE SENDER - 1/8 NPT

A603 Aviasport Fuel Pressure Sender. 1/8" NPT threads.....P/N 15-06648\$154.95



ROTAX 912 EGT 4 READING KIT

The IM-553 instruments have been designed especially to measure the EGT in Rotax® engines 912. Includes the IM-580 EGT Connection Box. 300-1000°C.....P/N 15-08617\$184.99



ROTAX 912UL 912 ULS 2-1/4" EGT KIT

The IM-540 instruments have been designed especially to measure the EGT in Rotax® engines 912. Includes the IM-580 EGT Connection Box. 800-1800°FP/N 15-08620\$155.75

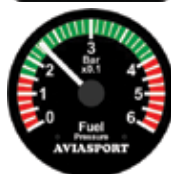

ROTAX 912 2" INCH FUEL PRESSURE KIT

The IM-584 have been designed especially to measure the FUEL Pressure in Rotax® engines 912 (Series). Includes the IM-604 Sensor. The display areas are divided into red, green and yellow zones in line with Rotax limits. 0-6 Bar. P/N 15-08624\$316.95



ROTAX 912 2-1/4" INCH FUEL PRESSURE KIT

Unlike mechanical instruments fuel pressure, electronic instruments use a high precision sensor to be installed close to the engine, avoiding cabin carry fuel lines. Includes the IM-604 Sensor. 0-8 PSI. P/N 15-08629\$276.95

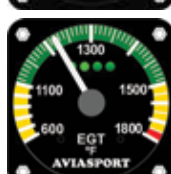

ROTAX 914 3 EGT 4 READING KIT

The IM-576 instruments have been designed especially to measure the EGT in Rotax® engines 914. Includes the IM-580 EGT Connection Box. The instruments use a pointer that turns 240°, which gives them great resolution. Their display areas are divided into red, green and yellow zones in line with the ROTAX limits. 600-1800 °F. P/N 15-08623\$184.95

AVIASPORT ROTAX EGT TYPE K SENSORS



Probe for the measurement of the temperature of exhaust (EGT) for all ROTAX engines. It has a thread metric 8 and it can be installed directly on the M8 nuts that come from manufactures some 912 and 914 engines. On the outlets that do not have these nuts, it is necessary to weld a nut M8. Stainless steel jacket. P/N 15-09438\$56.75
9 ft.....P/N 15-09439\$63.75



AVIASPORT ROTAX EGT TYPE K SENSOR WITH CLAMP

Probe type clamp "K". Designed for engines ROTAX 447/503/582, you don't need welding. Simply drill the holes and tighten the clamp. Protected with stainless steel mesh. 2 meters cable length. P/N 15-09440\$55.65

VISIT WWW.AIRCRAFTSPRUCE.COM FOR A COMPLETE LIST OF INSTRUMENTS AND SENDERS.

WWW.AIRCRAFTSPRUCE.COM

AE FUEL GUARDIAN

AE FUEL GUARDIAN LOW FUEL ANNUNCIATION SYSTEM



This system gets your attention before you have to switch tanks. When the annunciator light flashes, you will know your precise fuel quantity and also the time to engine shut-down for that tank. HOW DOES IT WORK? - The optical fuel sensor is a non-contact sensor mounted in a single hole in the fuel tank. It operates by bouncing a beam of light into the sensors lens. If it is reflected back into the sensor, there is

no liquid present. If it is not reflected back, it is dissipated into the liquid media. The sensor output is pulled down, or activated. The electronics constantly monitors the sensor outputs of both tanks. When a low fuel level is detected, the appropriate light starts to blink, getting the pilot's attention immediately. After the pilot sees the alarm, he can press the acknowledge button. This action turns the light on solid (continuous) denoting a low fuel quantity. This function of the annunciator eliminates the distracting flashing action of the lights for the pilot, yet he can still see that he has a low fuel indication. The AE Fuel Guardian also has an audio output that can be wired into the aircraft intercom or audio system if desired. The audio beep is only present when the annunciator lights are flashing. The AE Fuel Guardian annunciator lights can also be wired into the aircraft dimmer bus if desired for night flight. This system is 100% solid state and is compatible with 12VDC or 24VDC electrical systems. The installer sets the sensors to provide low fuel warning at whatever level is desired. System includes (2) annunciator panel lights, (2) optical sensors, (1) push button, Sensor drive and annunciator electronics enclosure, wiring, and lettering decals. For Experimental aircraft only. Kit With One Sensor.....P/N 10-01811**\$209.00**
Kit With Two Sensor.....P/N 10-00399**\$289.00**

AE RELAY BOARDS



AE Relay Boards - Better than the Competition. These relay contacts are protected against inductive sparking generated from relays switching inductive loads such as motors and solenoids. The relay coils are also protected. This prohibits the relays from early failure. This also protects the switch contacts that drive the relay coils from failure. 10A/20A Relays - (available in 12V to 14V or 24V to 28V operation) and available in in 1 Axis, 2 Axis or 3 Axis control. Stack up to 3 relay boards to save panel space. Terminals are easily accessible. Each board contains two, SPDT relays (Form C). Each relay has one normally closed contact and one normally open contact). Each relay board is 3" wide by 1-3/8" deep by 3/4" high. The fastening standoffs measure 3/8" high. This makes the single board overall height 1-1/8". The relay coils are actuated by pulling them down to common or ground. If you desire to operate them pulled up to + bus voltage, special order requests can be accommodated at no additional charge.

10 AMP

Number of Axis	Voltage	Part Number	Price
1 Axis Relay	12V/14V	10-01814	\$39.00
2 Axis Relay	12V/14V	10-01815	\$66.00
3 Axis Relay	12V/14V	10-01816	\$89.00
1 Axis Relay	24V/28V	10-07090	\$39.50
2 Axis Relay	24V/28V	10-07091	\$66.00
3 Axis Relay	24V/28V	10-07092	\$89.00

20 AMP

Number of Axis	Voltage	Part Number	Price
1 Axis Relay	12V/14V	10-07093	\$59.00
2 Axis Relay	12V/14V	10-07094	\$115.00
3 Axis Relay	12V/14V	10-07095	\$165.00
1 Axis Relay	24V/28V	10-07096	\$59.00
2 Axis Relay	24V/28V	10-07097	\$115.00
3 Axis Relay	24V/28V	10-07098	\$165.00

AE AG6 ANNUNCIATOR GAUGE METER

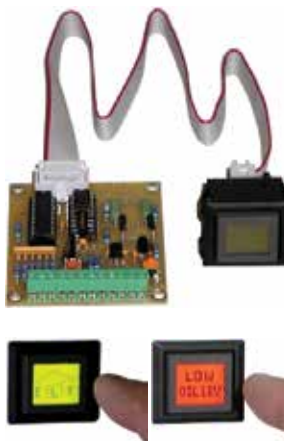

A full Aircraft Annunciator, Fuel Gauge, Oil Level Gauge, Volt & Amp Meter

Model AG6 will monitor up to 6 inputs. Weighs only 2.0 oz. (55 grams)

One Button, Multi-function, Aircraft Annunciator - Fuel Gauge, Several styles available (with low fuel warning and caution zones) Volt Meter & Current Meter (with low & high warnings and caution zones) A full service Aircraft Annunciator, Fuel Gauge, Oil Level Gauge, Volt Meter & Current Meter. Will display many different aircraft warnings. All devices feature user programmable alarms. Utilizes a push-button LCD display that is backlight with a 3 color LED. All functions are fully programmable by the user. The push-button/display can be used for programming, acknowledging the alarms, and paging thru up to 16 different screens or "annunciator points". Can automatically scan thru each screen or it can be done manually using the push-button. The pilot has the ability to mask or unmask annoyance alarms. **NOTE:** Input devices not included. It is up to the user to provide input devices such as fuel senders, shunts, oil level sensors and input switches to drive the

Features: • Full service annunciator (more than 70 alarm to choose from) • Volt & current meter with alarms • 10 types of fuel gauges with alarms • Low oil level gauge • Up to 6 inputs (5 if sound output is selected) • Set-up is fully user programmable • One button programming • Alarm time delays up to 409 seconds • Input signal filtering • Manual or auto scan for screens • Special shunt input • Audio output during alarm

Specifications: • Power in: 10 to 15Vdc • Current draw: 0.6mA max. (AG6 without LED back light) 65.6mA max. (AG6 with LED back light) • Inputs: 6 inputs (0 to 16.383 volts) (5 inputs available if sound output is utilized) • Input impedance: 36.6K Ohms (terminals 1 to 6) • Input terminals: Accepts 16 to 26AWG • Shunt input: 1 input, 0.05V to 0.25V full scale (If utilized, input #5 cannot be used.) • Display: LCD with LED back light (Green, Yellow, Red) • Interconnecting cable: 10 conductor ribbon, 18" [457mm] long • Panel cutout for display: 1.142in. x 0.933in. [.9mm x 23.7mm] • Panel thickness for display: 0.059in. to 0.157in. [1.5mm to 3.98mm] • Motherboard: 2.25" x 2.5" [57.2mm x 63.5mm] , Hole Pattern #6-32 screws, 2.0" x 2.25"[50.8mm x 57.15mm] • Alarms: All screens are programmable with alarms. Ability for pilot to mask annoyance alarms. • Adjustments: Volume & display contrast • Programmable items: Input source, input filtering, input inverted, auto scan screen dwell times, alarm thresholds, time in alarm zone before alarming (409 seconds max.), alarm self reset, scan or auto scan, number of alarm zones, screen colors, sound output, calibration gain & zero for gauges • Programmable screens: Many - many annunciator type screens, fuel gauges (several types), low oil level gauge, volt meter, current meter • AG6 Display & Push Button

12V P/N 10-04180 **\$189.00**
24V P/N 10-07415 **\$199.00**

AUXILIARY FUEL PUMP RELAY



The AFPR is a "Smart" Auxiliary Fuel Pump Relay. This device allows the pilot to flip oneswitch and quickly drain the contents of the auxiliary fuel tank without over stressing the auxiliary fuel pump. The AFPR will pump down the auxiliary fuel tank, and then automatically shut the fuel pump off when no fuel is detected. The AFPR includes a very reliable optical fuel sensor that can be easily installed in the auxiliary fuel tank or in the fuel line. The AFPR can be operated in and one of four modes of operation. The AFPR also has an output that can be used for a light to indicate when the fuel pump-down has been completed. Input Power: 12Vdc or 24Vdc, 0.1A max. Enclosure: 3.5" x 2.25 x 1.25" (89mm x 57 x 32mm) Fuel Sensor Mounting Hole: 0.475" (12mm)

With SensorP/N 10-04343 **\$159.95**
Without SensorP/N 10-07416 **\$97.95**

AEROSPACE LOGIC

AEROSPACE LOGIC FOUR CYLINDER EGT/CHT



The ECT204 is a full color EGT and CHT combination instrument that provides simultaneous, real-time display of all four cylinders. This kit includes four Type-K ungrounded, EGT thermocouple probes of your choice, four Type-J ungrounded, CHT thermocouple probes of your choice, and all connectors and installation hardware. Both Cylinder head and Exhaust gas temperature functionality is TSO'd and meets the temperature accuracy requirements of SAE AS8005 for a Class IIa (+/- 1%) instrument. Functional displays include: Real-time four cylinder temperature display; Menu select option for fast selection of display type, Automated rich-of-peak (ROP) leaning function for EGT, Automated lean-of-peak (LOP) leaning function for EGT, Automated shock cooling monitoring for CHT,P/N 10-05171**\$1,695.00**

AEROSPACE LOGIC FUEL FLOW SINGLE ENGINE



This kit includes both instrument and fuel flow transducer. Fuel flow functionality is TSO'd and meets the repeatable accuracy requirements of SAE AS407B, +/- 0.1US Gallon per hour. Functional displays include: Graphical indication of fuel flow, Digital display of instantaneous fuel flow, Digital display of fuel used since flight commencement, and Fully programmable color indication to meet all aircraft marking requirements. The FF200K30 instrument kit is TSO'd and STC'd as a primary replacement instrument under all flight conditions (day/night VFR and IFR). The FF200K instrument kit includes the full installation wiring harness, fuel flow transducer for a maximum fuel flow of 30gph and all necessary install hardware for the instrument. Installer supplied couplings are needed to be supplied by the installer to mate to the fuel flow transducer, as required.P/N 10-05172**\$1,100.00**

AEROSPACE LOGIC FUEL FLOW TWIN ENGINE



This kit includes both instrument and two fuel flow transducers. Fuel flow functionality is TSO'd and meets the repeatable accuracy requirements of SAE AS407B, +/- 0.1US Gallon per hour. Functional displays include: Graphical indication of fuel flow, Digital display of instantaneous fuel flow, Digital display of fuel used since flight commencement, and Fully programmable color indication to meet all aircraft marking requirements. The FF202K30 instrument kit is TSO'd and STC'd as a primary replacement instrument under all flight conditions (day/night VFR and IFR). Includes the full installation wiring harness, fuel flow transducers for a maximum fuel flow of 30gph and all necessary install hardware for the instrument.P/N 10-05173**\$1,977.00**

AEROSPACE LOGIC SINGLE TANK FUEL LEVEL



The FL201 instrument is an advanced, next generation airborne fuel level reporting instrument that supports two fuel tanks. Fuel level functionality is TSO'd and meets the repeatable accuracy requirements of SAE AS405C, +/- 1US Gallon. Functional displays include: Graphical indication of fuel level in the tank, Digital fuel quantity for the tank, Fully programmable color indication to meet all aircraft marking requirements, and Graphical fuel level indication, starting at power on. The FL201 instrument is TSO'd and STC'd as a primary replacement instrument under all flight conditions (day/night VFR and IFR). It is a requirement of the STC that this be the only fuel level indicator, when installed. The FL201 instrument utilizes the existing fuel senders.P/N 10-05174**\$632.00**

AEROSPACE LOGIC 2-1/4 ELECTRONIC ALTIMETER 35K



The ALT200 is the most accurate altimeter available for your aircraft. It exceeds all the requirements of TSO C10b, AS392C and AS8009B while providing the following functionality: • -1,000' to 35,000' • Digital altitude display • Graphical altitude trend display • User selectable for inHg and mb pressure settings • One press toggle between selected altitude and Standard Pressure Altitude.P/N 10-06270**\$1,592.00**

AEROSPACE LOGIC 2-1/4 ELECTRONIC VERTICAL SPEED INDICATOR 0-6000 FPM



The VSI200 is the most accurate Vertical Speed Indicator available for your aircraft. It exceeds all the requirements of TSO C8e and AS8016A while providing the following functionality: • Installer selectable for 0-2,000fpm, 0-3,000fpm, 0-4,000fpm or 0-6,000fpm rates of change. • Graphic bar indication of rate of change • Precision digital rate of change indication. • Fits standard 2-1/4" mounting hole. • wt: 4.3 oz VSIP/N 10-006271**\$758.00**

AEROSPACE LOGIC MANIFOLD PRESSURE & FUEL FLOW



The MF200 is an advanced, next generation manifold pressure and fuel flow combination instrument for flow rates up to 30gph. Manifold pressure functionality is TSO'd and meets the pressure accuracy requirements of SAE AS8042. Fuel flow functionality is TSO'd and meets the accuracy requirements of TSO C44c. Functional displays include: Primary - Real-Time analog data depiction and digital value display for both manifold pressure and fuel flow, Secondary - Real-Time analog data depiction and digital value display for both manifold pressure and fuel flow as well as fuel used, and Graphical trend display of manifold pressure and fuel flow data. The MF200K30 is TSO'd and STC'd as a primary replacement instrument under all flight conditions (day/night VFR and IFR). This kit includes both an A200-PMP manifold pressure sensor and a A200-201A-6 fuel flow sensor for full functionality.P/N 10-05170**\$1,517.00**

AEROSPACE LOGIC SINGLE MANIFOLD PRESSURE



The MP200 is an advanced, next generation single manifold pressure instrument. Manifold pressure functionality is TSO'd and meets the pressure accuracy requirements of SAE AS8042. Functional displays include: Real-Time analog data depiction and digital value display of manifold pressure, Graphical trend display of manifold pressure data, and The MP200K is TSO'd and STC'd as a primary replacement instrument under all flight conditions (day/night VFR and IFR). This kit includes a A200-PMP manifold pressure sensor and all installation hardware.P/N 10-05177**\$803.00**

AEROSPACE LOGIC MANIFOLD PRESSURE & TACHOMETER - BENDIX



The MT200 is an advanced, next generation manifold pressure and tachometer combination instrument. Manifold pressure functionality is TSO'd and meets the pressure accuracy requirements of SAE AS8042. Tachometer functionality is TSO'd to C49b and accuracy requirements of AS404C. Functional displays include: Simultaneous, real-time analog data depiction and digital value display for both manifold pressure and tachometer, Graphical trend display of both manifold pressure and tachometer data. Display and tracking of engine time. The MT200 is TSO'd and STC'd as a primary replacement instrument under all flight conditions (day/night VFR and IFR) This kit includes a A200-PMP manifold pressure sensor, and a Hall Effect sensor for Bendix type single magnetos. The sensor is mounted in the vent hole (closest to the engine) of the magneto. The instrument will work on all 4, 6 and 8 cylinder aircraft engines. Includes all installation hardware.P/N 10-05178**\$1,318.00**

AEROSPACE LOGIC TM202 DUAL TACHOMETERKIT-BENDIX SINGLE MAGNETO



The TM202 is a precision dual tachometer that provides RPM data accurate to +/- 1RPM. It meets all the requirements of TSOC49b and provides the following functionality: RPM indication in both analog and digital format for both engines, including support for engines that require a limited RPM range, Independent engine time recording, Trend graph function representing RPM vs. Time for both engines simultaneously. This instrument kit includes two Hall Effect sensors for Bendix type single magnetos. The sensors are mounted in the vent hole (closest to the engine) of the magneto. The instrument will work on all 4, 6 and 8 cylinder aircraft engines.P/N 10-05179**\$1,542.00**

AEROSPACE LOGIC MANIFOLD PRESSURE & TACHOMETER - SLICK



The MT200 is an advanced, next generation manifold pressure and tachometer combination instrument. Manifold pressure functionality is TSO'd and meets the pressure accuracy requirements of SAE AS8042. Tachometer functionality is TSO'd to C49b and accuracy requirements of AS404C. Functional displays include: Simultaneous, real-time analog data depiction and digital value display for both manifold pressure and tachometer, Graphical trend display of both manifold pressure and tachometer data., and Display and tracking of engine time. The MT200 is TSO'd and STC'd as a primary replacement instrument under all flight conditions (day/night VFR and IFR) This kit includes a A200-PMP manifold pressure sensor, and a Hall Effect sensor for Slick/Unison type magnetos. The sensor is mounted in the vent hole (closest to the engine) of the magneto. The instrument will work on all 4, 6 and 8 cylinder aircraft engines. Includes all installation hardware.P/N 10-05223**\$1,318.00**

IN

AEROSPACE LOGIC

AEROSPACE LOGIC CHT INDICATORS



Full color CHT instrument that provides simultaneous, real-time display of all cylinders. This kit includes thermocouple probes, all connectors and installation hardware. Functionality TSO'd and meets the temperature accuracy requirements of SAE AS8005 for a Class IIa (+/- 1%) instrument. Functional displays include: Real-time cylinder temperature display Single cylinder temperature monitoring while retaining graphic indications Graphic trend analysis and viewing of all cylinders simultaneously Programmable shock cooling monitor and indication TSO C43c

Part No.	Model No.	Description	Cyl.	Price
10-04485	CT204R2	CHT Instrument With 12mm Ring Probes	4	\$990.00
10-04486	CT204R4	CHT Instrument With 14mm Ring Probes	4	\$989.00
10-04487	CT204R8	CHT Instrument With 18mm Ring Probes	4	\$989.00
10-04484	CT204B	CHT Instrument With Bayonet Probes	4	\$944.00
10-04362	CT206R2	CHT Instrument With 12mm Ring Probes	6	\$1,144.00
10-04365	CT206R4	CHT Instrument With 14mm Ring Probes	6	\$1,144.00
10-04367	CT206R8	CHT Instrument With 18mm Ring Probes	6	\$1,144.00
10-04358	CT206B	CHT Instrument With Bayonet Probes	6	\$1,093.00
10-05171	ECT204	CHT And EGT Combo Kit without probes	---	\$1,695.00

AEROSPACE LOGIC EGT INDICATORS



Full color EGT instrument that provides simultaneous, real-time display of all six cylinders. This kit includes six Type-K ungrounded, 1 1/2" EGT clamp type thermocouple probes, all connectors and installation hardware Exhaust gas temperature functionality is TSO'd and meets the temperature accuracy requirements of SAE AS8005 for a Class IIa (+/- 1%) instrument

Functional displays include: Real-time cylinder temperature display, Menu select option for fast selection of display type, Automated rich-of-peak (ROP) leaning function, Automated lean-of-peak (LOP) leaning function, Single cylinder temperature monitoring while retaining graphic indications for all cylinders, and Graphic trend analysis and viewing of all cylinders simultaneously TSO C43.

Part No.	Model No.	Description	Cyl.	Price
10-04402	ET204P1	EGT Instrument with 1-1/2" Clamp Probes	4	\$997.00
10-04403	ET204P2	EGT Instrument with 2" Clamp Probes	4	\$997.00
10-04404	ET204P3	EGT Instrument with 2-1/2" Clamp Probes	4	\$997.00
10-04405	ET204PB	EGT Instrument with Bayonet Probes	4	\$1,040.00
10-04413	ET206P1	EGT Instrument with 1-1/2" Clamp Probes	6	\$1,150.00
10-04414	ET206P2	EGT Instrument with 2" Clamp Probes	6	\$1,075.00
10-04415	ET206P3	EGT Instrument with 2-1/2" Clamp Probes	6	\$1,150.00
10-04416	ET206PB	EGT Instrument with Bayonet Probes	6	\$1,233.00

AEROSPACE LOGIC FUEL PRESSURE/ AMMETER/VOLTMETER



The FA200 is an advanced, next generation fuel pressure and ammeter combinational instrument This kit includes an A200-PSF fuel pressure sensor, an A200-HAS Hall Effect current shunt and all installation hardware. meets requirements of SAE AS408C. Functional displays include Real-Time analog data depiction and digital value display Graphical trend display of fuel pressure and ammeter data TSO C47a

Part no.	Model No.	Description	Price
10-04449	FA200K	Fuel Pressure and Ammeter Kit	\$956.00
10-04451	FA200VK	Fuel Pressure and Ammeter Kit With Voltmeter	\$1,030.00

AEROSPACE LOGIC TACHOMETER KIT



The TM200 is a precision tachometer that provides RPM data accurate to +/- 1RPM. RPM indication in both analog and digital format, including support for engines that require a limited RPM range, Engine time Trend graph function representing RPM vs. Time This instrument kit includes the Hall Effect sensor for single magnetos. The sensor is mounted in the vent hole (closest to the engine) of the magneto. The instrument will work on all 4, 6 and 8 cylinder aircraft engines. TSOC49b

Part no.	Model No.	Description	Price
10-04478	TM200B	Tachometer Kit for Bendix Mag	\$856.00
10-04477	TM200S	Tachometer Kit for Slick Mag	\$856.00
10-05179	TM202B	Tachometer Kit for Dual Bendix Mag	\$1,542.00
10-05513	TM202S	Tachometer Kit for Dual Slick Mag	\$1,554.00

AEROSPACE LOGIC FL-100 DUAL FUEL LEVEL INDICATORS



Fuel level functionality is TSO'd and meets the repeatable accuracy requirements of SAE AS405C, +/- 1US Gallon. Functional displays include: Graphical indication of fuel level in each tank Selectable digital fuel quantity for each tank Fully programmable color indication to meet all aircraft marking requirements Graphical fuel level indication, starting at power on The FL202 instrument is TSO'd and STC'd as a primary replacement instrument under all flight conditions. It is a requirement of the STC that this be the only fuel level indicator, when installed. The FL202 instrument utilizes the existing fuel senders.

Part No.	Model No.	Description	Price
10-05174	F1201	Single Tank Resistive 300 Ohm Fuel Level	\$632.00
10-04432	FL202	Dual Tank Resistive 300 Ohm Fuel Level	\$752.00
10-05515	FL251	Single Tank 0-5v Fuel Level	\$636.00
10-04443	FL252	Dual Tank 0-5v Fuel Level	\$761.00

AEROSPACE LOGIC OPT200 PRESSURE & TEMPERATURE



The OPT200 is an advanced, next generation oil pressure and temperature combinational instrument. Oil temperature is TSO'd and meets the temperature accuracy requirements of SAE AS8005, while oil pressure meets the requirements of AS408C. Functional displays include: Real-Time analog data depiction and digital value display for both pressure and temperature Graphical trend display of both oil pressure and temperature data The OPT200 is TSO'd and STC'd as a primary replacement instrument under all flight conditions. This kit includes an A200-TSO oil temperature sensor and an A200-PSO oil pressure sensor plus all installation hardware

Part No.	Model No.	Description	Price
10-04465	OPT200K	Oil Pressure and Temperature Kit	\$1,095.00
10-04467	PT200VK	Oil Pressure and Temperature Kit with Voltmeter	\$1,153.00
10-04469	OP202K	Dual Oil Pressure Kit	\$1,225.00
10-04471	OP202VK	Dual Oil Pressure Kit with Voltmeter	\$1,276.00
10-04473	OT202K	Dual Oil Temperature Kit	\$955.00
10-04475	OT202VK	Dual Oil Temperature Kit with Voltmeter	\$1,040.00

AEROSPACE LOGIC VOLTMETER / AMMETER



The VA200 is an advanced, next generation voltmeter and ammeter combinational instrument The ammeter portion of this instrument may be used as either a normal ammeter, indicating both charge and discharge current or a loadmeter, displaying the total load on the alternator/generator. STC'd as a primary replacement. Model No. VA200K. Voltmeter And Ammeter Kit Includes 100amp ShuntP/N 10-04480\$658.00

AEROSPACE LOGIC CLOCK & OUTSIDE AIR TEMPERATURE



The CA200 is an advanced, next generation airborne timepiece plus a seven input annunciator. It can scan seven 200 Series instruments and report any out-of-limit conditions the moment they occur; all on one instrument. The CO200 is identical to the CA200 with the exception of the annunciator function. Outside air temperature functionality is TSO'd and meets the temperature accuracy requirements of SAE AS8005 for a Class IIa (+/- 1%) instrument. Functional displays include: • UTC Time • Local Time • Chronograph • Flight Time and Interval Timer • Seven annunciator sense inputs (CA200 only).

P/N 10-04348\$586.00

AEROSPACE LOGIC SENSORS AND PROBES

Description	Part No.	Price
A200-TEC5 EGT Probe Kit	10-04813	\$173.00
A200-TEC20 EGT Probe Kit	10-04812	\$163.00
A200-TEC25 EGT Probe Kit	10-04800	\$185.75
A200-HAS Hall Effect Current Shunt	10-04808	\$198.00
A200-PSF Fuel Pressure Sensor	10-04804	\$328.00
A200-HMB Bendix Rotational Speed Sensor	10-04806	\$216.00
A200-HMS Slick Rotational Speed Sensor	10-04807	\$245.95
A200-PSO Oil Pressure Sensor	10-04805	\$328.00
A200-TSO Oil Temperature Sensor	10-04801	\$224.95
A200-TCB Bayonet CHT Probe Kit	10-04799	\$172.75
A200-PMP Manifold Pressure Sensor	10-04803	\$335.00
A200-TSA Air Temperature Sensor	10-04802	\$204.95

PLEASE SEE OUR WEBSITE FOR ADDITIONAL MODELS, INCLUDING STC'D MODELS.

JPI ENGINE SCANNERS



J.P. INSTRUMENTS EDM-700 DIGITAL AND ANALOG EGT/CHT SCANNERS

The EDM-700 includes: Computer assisted diagnostics for troubleshooting the entire system, 2-1/4" panel mount, Normalize mode, Graphics resolution, Automatically finds the first EGT to peak, display of OIL, OAT, IAT, CDT, voltage, shock cooling of two TIT's, one degree

temperature resolution, selectable °C or °F, all functions have Hi/Lo pilot programmable limits, supplied with JPI's well known, grounded, fast response probes, TSO quality, FAA TSO/STC approved, 3 year warranty. All probes, harness, and hardware included.

Systems include EGT & CHT probes, harness, memory module, leads, and hardware

EDM-700 SINGLE ENGINE SYSTEMS

Description	Part No.	Price
EDM-700-4C 3-1/8" (No Fuel Flow)	10-02008	\$2,028.00
EDM-700-6C 2-1/4" (No Fuel Flow)	10-00264	\$2,157.00
EDM-700-6C 2-1/4" (No Fuel Flow) All CHT Bayonet	10-06938	\$2,155.00
EDM 700-6C with Fuel Flow 231 3-1/8" (Gravity Fed)	10-02846	\$2,874.00
EDM-700-9C 2-1/4" (No Fuel Flow)	10-28100	\$3,163.00
EDM 700-9C with Fuel Flow 231 2-1/4" (Gravity Fed)	10-02862	\$3,604.00

Accessories		
Description	Part No.	Price
EDM 700 Transducer (Fuel Pump)	10-27089	\$295.00
EDM 700 Transducer (Gravity)	10-27094	\$325.00
JPI EDM RPM Option	10-01720	\$269.00
Fuel Flow Without Transducer	10-05199	\$175.00
Fuel Flow With Transducer	10-05201	\$472.00
JPI Replacement Rpm Sensor For Pressurized Slick Mag	10-05458	\$359.00
JPI Replacement Rpm Sensor For Pressurized Bendix 1200 S	10-05459	\$359.00
JPI Replacement Rpm Sensor For Pressurized Bendix 20 Series	10-05460	\$359.00
JPI Replacement Rpm Sensor For Pressurized Dual Bendix Mag	10-05461	\$359.00
JPI Standard RPM Vent Plug Sensor for Bendix Mag.	10-05651	\$269.00
JPI Standard RPM Vent Plug Sensor For Slick	10-05652	\$269.00
TIT, Turbine Inlet Temperature Probe and Sensor	10-27090	\$175.00
EDM Carb Temp Probe 1/4-24 Thread 400128	10-27103	\$175.00
USB Integrated Option	11-06769	\$235.00
USB Download Box	10-03149	\$179.95
EDM-700/800/900 OAT Probe	10-27095	\$175.00
700/760/800 Oil Temperature Probe & Sender	10-27100	\$175.00
EDM 700 Induction Air Temperature Probe	10-02277	\$169.95
EDM 700 Compressor Discharge Temperature Probe	10-03451	\$175.00
EDM 700 IAT/CDT Induction Air & Compressor Temp.	10-27105	\$375.00
5050-T CHT Bayonet Probe	10-18500	\$106.95
M-113 CHT Gasket Probe	10-27093	\$106.95
JPI Probe M113-3/8	10-03689	\$106.95
M-111 Replacement EGT Probe	10-00830	\$104.85
5/8" Oil Temp Probe Adapter for Lyc./Cont.*	11-09614	\$175.00
Oil Temp Probe 400509 (5/8-18)	11-09614	\$175.00
EDM Option CHT Gasket 14mm Probe	10-04157	\$104.85
VDO Oil Press Sensor 1/4 NPT 0-150 PSI This oil pressure sender will not fit Rochester gauges.	10-04183	\$269.00
EDM PC Interface Cable	10-27112	\$34.95

All Systems which include Fuel Flow come with Transducers. 201 Transducer is for Aircraft with Fuel Pumps. 231 Transducer is for Gravity Fed Aircraft. *Oil Temperature Probe Collar Adapter, 5/8-18 port to 1/8 NPT Continental engines may require a "brass" oil probe adapter.



JPI EDM-730/830

The EDM-730/830 revolutionizes engine monitoring by the integration of brilliant full color graphical LCD display with the extremely popular EDM 700/800 series functionally and yet reduces the package size to the smallest on the market! Mounting is a breeze due to its standard 3-1/8" format.

Model	Part No.	Price
EDM-730-4Cyl	10-03701	\$1,715.00
EDM-730-4Cyl - All CHT Bayonet	10-06946	\$1,725.00
EDM-730-4C W/ FF 201	10-03717	\$2,155.00
EDM-730-4C W/ FF 201 - All CHT Bayonet	10-06947	\$2,173.00
EDM-730-4C W/ FF 231	10-03718	\$2,155.00
EDM-730-4C W/ FF 231 - All CHT Bayonet	10-06948	\$2,155.00
EDM-730-6C	10-03703	\$2,404.00
EDM-730-6C - All CHT Bayonet	10-06949	\$2,398.00
EDM-730-6C W/ FF 201	10-03719	\$2,855.00
EDM-730-6C W/ FF 201 - All CHT Bayonet	10-06951	\$2,855.00
EDM-730-6C W/ FF 231	10-03720	\$2,855.00
EDM-730-6C W/ FF 231 - All CHT Bayonet	10-06952	\$2,855.00
EDM-730-7C	10-05180	\$2,536.00
EDM-730-7C W/ FF 231	10-05182	\$2,993.00
EDM-730-8C	10-05183	\$2,625.00
EDM-730-8C W/ FF 231	10-05198	\$3,082.00
EDM-730-9C	10-05187	\$2,805.00
EDM-730-9C W/ FF 231	10-05186	\$4,363.00
Fuel Flow Without Transducer	10-05199	\$175.00
Fuel Flow With Transducer	10-05201	\$472.00

UPGRADE YOUR EDM 700 TO THE EDM 730, OR YOUR EDM 800 TO THE EDM 830

This upgrade program will allow you to swap out your 700 to the new 730 or 800 to the new 830 as the new 730 and 830 use a standard 3-1/8" mounting hole. The 730/830 will use the same JPI probes and will better display engine parameters with this plug and play upgrade. Core must be sent back to JPI.

Description	Part No.	Price
EDM 800 to EDM 830	10-03864	\$1,495.00

JPI EDM 711 SYSTEMS



4 or 6 Cylinder. Configured like the EDM-700 or EDM-800, this is STC'd as the Primary Replacement for certified aircraft. Includes one primary function; CHT, Oil Temp, or T.I.T. To add a function, select P/N 10-00647, 10-00648, or 10-00649. Fuel Flow may also be added (P/N 10-00650), but the Transducer is sold separately.

Use P/N 10-27089 or 10-27094 for Transducer. When ordering, please provide Aircraft Make & Model, Engine Make & Model, Mag Type, and Redline for each function.

Description	Part No.	Price
EDM711-4C (configured as 700)	10-00641	\$2,058.00
EDM711-6C (configured as 700)	10-00642	\$2,408.00
EDM711-4C (configured as 800)	10-00643	\$3,450.00
EDM711-6C (configured as 800)	10-03858	\$3,959.00
Add Primary Functions to EDM711	10-00647	\$329.00
Add Oil Temp Function to EDM711	10-00648	\$329.00
Add Fuel Flow to EDM711	10-00650	\$425.00
Fuel Flo Harness	10-04650	\$187.75
EDM 4 Cylinder Harness	10-04661	\$179.00
EDM 6 Cylinder Harness	10-04663	\$259.95

JPI ENGINE SCANNERS

JPI EDM-350 EXPERIMENTAL ENGINE MONITORING SYSTEM



If all you want is EGT/CHT then the basic kits gives you everything you could want in a compact size with full customization features and the legendary JPI quality and accuracy. The Engine Data Management 350 system is the most cost effective, reliable piston engine experimental EDM instrument on the market. The basic kit includes: • EGT - Exhaust Gas Temperature • CHT - Cylinder Head Temperature • Included - Probes and Harness • VDC - Voltage • CLD - Shock Cooling on "All" Cylinders • ROP/LOP - Lean Find • DIFF - Engine Health • USB - Data Port built in • Data Record - 600 Hrs. at every 6 sec • EZTrends - Graphing software, including Google Earth Location

The compact Engine Data Management 350 system (3.5" square) is the most advanced and accurate piston experimental engine-monitoring instrument on the market. The EDM 350 is not just another black box along for the ride. It is a Flight Engineer, Maintenance Manager, and Backup Instrument. For the price there is nothing that gets close to it. Customize with 17 options, including FF. You can think of the EDM 350 as your personal flight engineer. It's always there, working in the background, constantly watching over your engine while you concentrate on flying the aircraft. You can make an entire flight without ever pushing a button, if you so choose. Yet your EDM will be monitoring your engine parameters three times a second and will warn you instantly if any parameter exceeds the programmed limit.

Description	Part No.	Price
4 Cylinder Basic Package	10-06582	\$1,049.00
6 Cylinder Basic Package	10-06583	\$1,275.00

Full Package adds Amps, Volts, Fuel Pressure, and Fuel Level.

Description	Part No.	Price
4 Cylinder Full Package	10-06845	\$1,195.00
6 Cylinder Full Package	10-06846	\$1,395.00

J.P. INSTRUMENTS EDM-790 ENGINE MONITORING SYSTEM



The EDM 790 system is the most advanced and accurate twin piston engine-monitoring instrument on the market. TSO'd for quality, the EDM 790 is not just another black box along for the ride. It is a Flight Engineer ... a Maintenance Manager ... For the price there is nothing that gets close to it. You can almost think of the EDM 790 as your personal flight engineer. It's always there, working in the background, constantly watching over your engine while you concentrate on flying the aircraft. You can make an entire flight without ever pushing a button, if you so choose. Yet your EDM will be monitoring your engine parameters three times a second and will warn you instantly if any parameter exceeds the programmed limit.

Features: • EGT 4 or 6 probes • CHT 4 or 6 probes • Volts • Shock cooling • Span (highest to lowest EGT) • EGT Normalize mode • LOP/ROP function • Power connector • All required Harness 20 ft • EZTrends Graphing Software free • Serial Data recording -25 hours • 3 year Warranty

Specifications: • FAA Approved under TSO-C43B, DO-160C, DO-178B Level C & STC, SA 2586 NM • Size 3-1/8 in panel mount 7.5 deep. Weight: 1 LB. • Standard Functions LeanFind, EGT/CHT, Shock Cooling, Voltage, Differential EGT, Normalize, Long term data module for Data Logging and TIT (if applicable for Engine). • Optional Functions Fuel Flow, Oil Temperature 1 & 2, Turbine Inlet 2 (TIT-2), Outside Air (OAT) and Carburetor Temperature (CRB).

4 Cylinder	P/N 10-05648	\$3,450.00
6 Cylinder	P/N 10-05649	\$4,469.00



EDM 930 & 930T PRIMARY

True TFT Transflective Custom Display - Display brightness increases with ambient brightness, always sunlight readable. All gages have a Variable Scale and alarm limit to fit your engine. New form factor, panel size: 6" w X 4" h X 2.9" d. Records all engine parameters at 2 to 255 second intervals. Plot the data with EZplot. All probes and transducers supplied. High Flow transducer (120 GPH) included in EDM930T Compatible with and transmits RS-232 data to most

MFD's, also sold less the display.
PISTON FUNCTIONS: • Tachometer/Hobbs • Manifold Air Press • 6 EGT/CHT • Oil Temp • Oil Press • Fuel Quantity • Fuel Press • OAT • Carb • Temp • TIT, TIT-2 • CDT • GMT • Volts/Amps 1-2 • Differential EGT • Shock cooling • GPH • Fuel remaining • Fuel Endurance • Fuel required to GPS waypoint • Fuel used • Percent of horse power • Receives data from any GPS and transmits data to any GPS.

Features: • Hands-free, automatic scanning • All programming done from the Front Panel • LeanFind™ finds the first and last cylinder to peak with true peak detect eliminates false peaks • Displays both leaned temperature below peak and peak • Battery voltage with alarm • Amperes (load or charge/discharge meter) • Programmable alarm limits • Normalize view • Exhaust Gas Temperatures (EGTs) to stable 1°F resolution • DIF low to high EGT with alarm • EGTs to stable 1°F resolution • Shock cooling monitored on every cylinder • Shock cooling monitored on every cylinder • User selectable index rate • Fast response probes • Non-volatile long term memory • Records and stores data up to 30 hours • Post-flight data retrieval • Download to Palm™ Computer • Data retrieval software • Oil pressure • Oil temperature • Outside air temperature • Fuel level • Fuel Flow • Solid-state rotor fuel flow transducer • Fuel quantity in gallons, kilograms, liters, or pounds • Low fuel quantity alarm • Low fuel time alarm • GPS interface • Instantaneous fuel flow rate • Total amount of fuel consumed • Total fuel remaining • Time to empty at the current fuel flow rate • RPM and manifold pressure • Automatically calculates percent horsepower • History of extreme values during previous flight • Hobbs® timer

IF NECESSARY PAPERWORK IS NOT PROVIDED & ANY CHANGES ARE REQUIRED, THERE WILL BE A \$200 FEE

FAA TSO PRIMARY

Description	Part No.	Price
EDM-930 (4)Cylinder Primary STC No Tank System	10-04909	\$5,925.00
EDM-930 (4) Cylinder Primary STC 2 Tank System	10-02111	\$6,125.00
EDM-930 (4) Cylinder Primary STC 4 Tank System	10-04731	\$6,325.00
EDM-930 (6) Cylinder Primary STC No Tank System	10-04911	\$6,195.00
EDM-930 (6) Cylinder Primary STC 2 Tank System	10-02112	\$6,425.00
EDM-930 (6) Cylinder Primary STC 4 Tank System	10-04732	\$6,610.00
EDM-930 (7) Cylinder Primary STC	10-02632	\$6,196.00
EDM-930 (8) Cylinder Primary STC	10-02633	\$6,310.00
EDM-930 (9) Cylinder Primary STC	10-02634	\$6,765.00

EXPERIMENTAL PRIMARY

Description	Part No.	Price
EDM-930-4CP-0 (4 Cyl) for NO Tanks	10-05236	\$5,112.00
EDM-930-4CP-2 (4 Cyl) for 2 Tanks	10-05237	\$5,326.00
EDM-930-4CP-4 (4 Cyl) for 4 Tanks	10-05238	\$5,497.00
EDM-930-6CP-0 (6 Cyl) for NO Tanks	10-05239	\$5,426.00
EDM-930-6CP-2 (6 Cyl) for 2 Tanks	10-05240	\$5,642.00
EDM-930-6CP-4 (6 Cyl) for 4 Tanks	10-05241	\$5,839.00
EDM-930-7CP (7 Cyl) for 4 Tanks	10-05242	\$5,365.00
EDM-930-8CP (8 Cyl) for 4 Tanks	10-05243	\$5,482.00
EDM-930-9CP (9 Cyl) High Flow Transducer	10-05244	\$6,010.00



ULTRAFLEX BRAIDED FIBERGLASS PROBE SLEEVES

Replacement 1/2 IN X 5 IN braided fiberglass sleeves like those furnished with JPI probes.

P/N 10-06282\$5.95

IN

JPI ENGINE SCANNERS

J.P. INSTRUMENTS EDM-960



The EDM-960 is the latest graphic engine analyzer for Piston Engine Twins from JP Instruments. The EDM-960, STC'd as Primary engine instrument, takes the best from their EDM-760 and adds total engine display monitoring including Tach, % Horsepower, Hobbs, Manifold Pressure, EGT, CHT, Oil Pressure, Oil Temp, Fuel Flow, Outside Air Temp, Volts, and Amps plus optional Fuel Pressure, Fuel Quantity, and Turbine Inlet Temp. Each individual engine display has a scale and alarm limit to fit your particular airplane. As with the popular EDM-760, the EDM-960 has internal memory that records all engine parameters that can be recalled and displayed on your computer to keep track of the health of your engine. Plus: warnings for shock cooling and excess temperatures, leaning assist for both "lean of peak, and "rich of peak".

alarm limit to fit your particular airplane. As with the popular EDM-760, the EDM-960 has internal memory that records all engine parameters that can be recalled and displayed on your computer to keep track of the health of your engine. Plus: warnings for shock cooling and excess temperatures, leaning assist for both "lean of peak, and "rich of peak".

IF NECESSARY PAPERWORK IS NOT PROVIDED & ANY CHANGES ARE REQUIRED, THERE WILL BE A \$200 FEE

Description	Part No.	Price
JPI EDM-960-6C Twin	10-03726	\$14,698.00
JPI EDM 960-6C Twin 4 Tank System	10-04734	\$15,484.00
JPI EDM 960 6C No Tanks	10-04914	\$14,625.00
JPI EDM-960-4C Twin	10-03727	\$13,527.00
JPI EDM 960-4C Twin 4 Tank System	10-04733	\$14,450.00
JPI EDM 960 4C No Tanks	10-04913	\$13,145.00
JPI EDM-960-7C Twin	10-05202	\$15,069.00
JPI EDM-960-8C Twin	10-05196	\$15,239.00
JPI EDM-960-9C Twin	10-05197	\$15,648.00
JPI Type K Thermocouple Wire	10-18600	\$1.25

J.P. INSTRUMENTS SLIM LINE DIGITAL ENGINE INSTRUMENTS



These compact engine instruments from have a bright red display and feature central remote and individual alarms on all gauges. The gauges are easily stackable in a homebuilt aircraft panel, and come complete with sensors. Specify voltage. NOT FAA APPROVED. **This is a secondary unit only. You must keep your original engine instrument**

Tachometer - Features quartz crystal and accuracy of 1 RPM. Resolution is 10RPM and includes red line alarm. Specify engine and magneto models, number of cylinders, voltage, and red line.
P/N 10-24900\$429.00

Manifold Pressure - Features resolution of 0.1 inches mercury, accuracy of 0.1" Hg, solid state sensor, and over boost alarm. Range: 0-50".
P/N 10-24910 \$329.00

Outside Air Temperature (O.A.T.) - Features resolution of 1° and has range of -40 to 195° F P/N 10-24940 \$249.95

Oil Temperature - Features resolution of 1° and over temperature alarm of 235° F P/N 10-24960 \$249.95

Volt/Ammeter - Features resolution of 0.1 volts/amps and discharge alarm.

Ammeter Shunt - (100 Amp) P/N 10-24925 \$67.95

Volt/100 amp-28V P/N 10-24921 \$249.95

Oil Pressure - gives readout in PSI and features resolution of 1 PSI and an under pressure alarm. P/N 10-24930 \$249.95

Turbine Inlet Temperature (T.I.T) - Features resolution of 1° or 10° and a Hi-temperature alarm at 1650° F P/N 10-24950 \$249.95

CHT Gauge - P/N 10-06064 \$249.95

Boom Pressure For Crop Planes - P/N 10-06063 \$249.95

Fuel Pressure - Features Resolution of 1 PSI and under pressure alarm.

Slimline Injected 10-32 PSI P/N 10-24970-30A \$249.95

Slimline Carb 1-8 PSI P/N 10-24970-30B \$249.95

JPI EDM-900 SINGLE ENGINE PRIMARY



The EDM-900 has a built in EDM-800, plus many other gauges in combination together. Fits in a standard 3" hole no panel rework. Made in California. **EDM-900 System Includes:** EDM-900 ALL IN ONE Bright VGA Display, Pre-Wired Harness for all functions, All EGT/CHT probes, Oil Pressure Transducer, Oil Temperature Sensor, Fuel Pressure Transducer, Oat Sensor, RPM Sensor, One required, Manifold Pressure Transducer, 100 amp Shunt (2) (for Amps), Volts pick-up V-1 and V-2, 2 GB memory Download/upload stick, FloScan Fuel Flow Transducer w/firesleeve, Demo DVD, and 3 year warranty.

FAA STC APPROVED

Description	Part No.	Price
900-4CP-0 (4 Cyl) for NO tanks Primary	10-04857	\$4,295.00
900-4CP-2 (4 Cyl) for L/R 2 tanks setup complete Primary	10-04858	\$4,527.00
900-4CP-4 (4 Cyl) for L/R and Aux 4 tanks setup complete Primary	10-04859	\$4,850.00
900-6CP-0 (6 Cyl) for NO tanks Primary	10-04860	\$4,685.00
900-6CP-2 (6 Cyl) for L/R 2 tanks setup complete Primary	10-04861	\$4,895.00
900-6CP-4 (6 Cyl) for L/R and Aux 4 tanks setup complete Primary	10-04862	\$5,095.00
900-7CP-4 (7 Cyl) for L/R and Aux 4 tanks setup complete Primary	10-04863	\$5,285.00
900-8CP-4 (8 Cyl) for L/R and Aux 4 tanks setup complete Primary	10-04864	\$5,485.00
900-9CP-4 (9 Cyl) for L/R and Aux 4 tanks setup complete Primary	10-04865	\$5,675.00

EXPERIMENTAL

Description	Part No.	Price
EDM-900-4CP-0 (4 Cyl) for NO Tanks	10-05226	\$3,469.00
EDM-900-4CP-2 (4 Cyl) for 2 Tanks	10-05227	\$3,675.00
EDM-900-4CP-4 (4 Cyl) for 4 Tanks	10-05228	\$3,965.00
EDM-900-6CP-0 (6 Cyl) for NO Tanks	10-05229	\$3,875.00
EDM-900-6CP-2 (6 Cyl) for 2 Tanks	10-05231	\$4,075.00
EDM-900-6CP-4 (6 Cyl) for 4 Tanks	10-05232	\$4,350.00
EDM-900-7CP-4 (7 Cyl) for 4 Tanks	10-05233	\$4,515.00
EDM-900-8CP-4 (8 Cyl) for 4 Tanks	10-05234	\$4,725.00
EDM-900-9CP-4 (9 Cyl) for 4 Tanks	10-05235	\$4,950.00

J.P. INSTRUMENTS FUEL SCAN - 450



- Continuous display of fuel burned, in upper display in Gallons per Hour. Liters and Lbs per hr also available.
 - An amazingly low price includes Instrument harness and a Flow Scan 201 or 231 transducer.
 - Upgrade your old Hoskins, or Shadin System. Will function with any K factors; connector is pin to pin compatible.
 - Automatically calculates the K factor.
 - All programming done from the front panel.
 - Size 2.25" diameter (small hole)
 - Light Weight 5 oz with Super Thin 1.5" depth
 - Three year warranty. (yes, the only three year warranty around!)
 - Serial port sends and receives data from all GPS units, even handhelds.
 - Calculates fuel to next waypoint.
- FS 450 Scanner Fuel Pump P/N 10-00135 \$529.00
 Fuel Scan 450 Gravity Fed+ P/N 10-00134 \$529.00
 FS-450R Fuel Scan Rotax (2 Transducers for aircraft with return fuel line) P/N 10-00266 \$1,029.00
 FS-450M-3 3-1/8" Twin Engine P/N 10-03692 \$1,095.00
 FS 450 H High Flow up to 120GPH P/N 11-13931 \$1,050.00

ELECTRONICS INTERNATIONAL INSTRUMENTS



UBG-16 ULTIMATE BAR GRAPH ENGINE ANALYZER

UBG-16 features include: Sixteen input channel capability. Any channel may be set to display EGTs and CHTs, TIT, and Oil Temp in either digital or bar graph display, O.A.T, Carb. Temp, Cowl Temp, Other Temp, Oil Pressure, Fuel Pressure, Manifold Pressure, Gyro Pressure, R.P.M., Fuel flow, Bus Voltage or Amps. Engine Analysis is performed automatically with sixteen pilot programmable Over-Temp limits and sixteen Under-Temp limits, a differential limit and a shock-cooling limit. Note: Unit is STC'd/PMA'd. Can only be used as a secondary engine monitor. For primary see the MVP-50.

Model	Description	Part No.	Price
UBG-16-4M	4-Cylinder Package. Includes 4 EGT probes, 4 CHT probes, 8 ea 6' harnesses and Data Recorder (MUX-8A)	10-00593	\$1,515.00
UBG-16-6M	6-Cylinder Package. Includes 6 EGT probes, 6 CHT probes, 12 ea 6' harnesses, and Data Recorder (MUX-8A)	10-00594	\$1,885.00
Remote	UBG-16 Remote Head option. Must be purchased at the same time as the UBG-16	10-02763	\$123.75
UBG-16-4G-MEM	Electronics International UBG-16 Engine Analyzer 4 Cylinder CHT Prime	10-01048	\$1,534.00
UBG-16-6G-MEM	Electronics International UBG-16 Engine Analyzer 6 Cylinder CHT Prime	10-01049	\$2,016.00
UBG-16	UBG-16 Unit Only	10-02737	\$959.00
UBG-16-REMOTE	EGT & CHT Remote Head Option 2-14" TSO'D. Must be purchased with unit. Cannot be purchased alone.	10-02763	\$123.75

The UBG-16 input channels. Any of the following options can be added at any time. Each option uses 1 input channel unless otherwise noted.

Model	Options	Part No.	Price
FM-FLOW-180	FT-180: Fuel Flow Transducer (for very high flow rates), Stainless Steel, 3/4 - 16 (1/2" AN Male w/ 37' flare) 3.6 to 180 GPH, 1.78 PSI drop at 120 GPH, K Factor approx. 48,000, 9.6 Oz.	10-02764	\$497.00
FM-FLOW-60	Flow Transducer Use w/ engine-driven fuel pumps up to 350 HP. 1/4" female NPT, .6-70+ GPH, .6 PSI drop @ 30 GPH, 2.3 PSI drop @ 60 GPH	10-25343	\$330.00
FM-FLOW-90	Transducer For 350 to 550 HP engines or gravity-feed engines, 1/4" NPT, 2 to 125+ GPH, .05 PSI drop @ 20 GPH, .2 PSI drop @ 40 GPH	10-02208	\$349.00
FM-FLOW-P	FM-FLOW-P	10-03206	\$348.95
10-0FM-FP	Secondary Fuel Pressure Includes PT-30GA Pressure Transducer. (Can be used with The UBG-16 and also with the FP-5L (Fuel Flow/Pressure w/ GPS Interface instrument)	10-25337	\$214.95
FM-GYRO	Gyro Vacuum Includes Pressure Transducer	10-25339	\$224.95
FM-MP	Secondary Manifold Pressure Includes Pressure Transducer	10-25338	\$224.95
FM-OP	Secondary Oil Pressure Includes PT-100GA Pressure Transducer. (For use with UBG-16 or FP-5(L))	10-25336	\$224.95
FM-RPM-4C	Secondary RPM Connects directly to the Mag Switch. (For use with UBG-16 or FP-5(L))	10-04818	\$224.95
FM-RPM-6C	Secondary RPM Connects directly to the Mag Switch. (For use with UBG-16 or FP-5(L))	10-01786	\$221.95
FM-TEMP-P-110	EGT Clamp Probe, 6 Cable	10-02188	\$218.95
FM-TEMP-P-111	Tit or Oil Temp Probe, 1/8 Npt, With Function Module	10-02765	\$223.95
FM-TEMP-P-112	Tit or Oil Temp Probe, 7/16-20 Thread 6 Cable	10-02766	\$249.00
FM-TEMP-P-114	Tit or Oil Temp Probe, 1/4" NPT 6 Cable	10-02767	\$249.00
FM-TEMP-P-120	Oil Temp Probe, 5/8-18 Thread 6 Cable	10-02770	\$249.00
FM-TEMP-P-128	OAT or Carb Temp Probe 1/4-28 Thread 6 Cable	10-02769	\$249.00
FM-VA	Secondary Volts/Amps w/S-50 Shunt Volts uses 1 input channel and Amps uses 1 input channel (i.e., monitoring volts and amps require the use of two of the UBG-16's input channels.	10-25342	\$214.95
FM-VA-3	MVP and UBG Option 3 Input Volt Monitor	10-04841	\$178.99
KEYSPAN	Keyspan Serial To USB Adapter	10-04978	\$43.75

E.I. INSTRUMENTS



10-01355

10-01339

10-01348

10-01373

The entire line of Electronics International digital instruments offers precise readings at exceptional prices. All gauges are accurate to 1%. They are FAA-approved under STC No. 1626NM. Furnished complete with all probes & leads.

Single Engine	Description	Part No.	Price
E-1	Single-Channel EGT or CHT, STCd, TSOd, PMA'd 2 1/4" Mount, 2.5" Depth,	10-01355	\$450.00
C-1	12 oz. Kit	10-01338	\$349.00
T-1P	EGT, CHT or TIT, PRIMARY REPLACEMENTS STCd, TSO'd, PMA'd w/ Over-Temp Warning Light, 2 1/4" Mount, 2.5" Depth, 12 oz.	10-01373	\$374.00
E-1P		10-02762	\$395.00
C-1P		10-01339	\$389.00
EC-1	Switchable from EGT to CHT (1 of ea), STCd, TSOd & PMA'd. 2 1/4" Mount, 2.5" Depth, 16 oz	10-01358	\$466.00
EAC-1	STCd, TSOd, PMA'd. - EGT/OAT/CHT Ice Zone Warning Light (from 10 to 39 degrees Celsius)	10-00806	\$526.00
CA-1	STCd, TSOd, PMA'd - CARB TEMP/OAT w/Ice Zone Warning Light. (from 10 to 39 degrees Celsius)	10-01351	\$429.00
A-1	OAT w/ Ice Zone Warning Light, STCd, PMA'd, TSOd (light comes on between 10 and 39 degrees F).	10-01307	\$337.00
E-4	EGT and CHT instruments, STCd, TSOd and PMA'd. Four Channels (EGT or CHT)	10-01356	\$676.00
C-4		10-01348	\$695.00
E-6	EGT and CHT instruments, STCd, TSOd and PMA'd Six Channels	10-01357	\$774.00
C-6		10-01350	\$825.00
EC-1P	3-1/8" EC-1P One Channel EGT/CHT Primary	10-00807	\$664.00
TC-1P	TC-1P Single Channel TIT/CHT Primary	10-02736	\$628.00
FOR TWINS - Orders for following instruments MUST specify type of probes: EGT hose clamp, TIT (hose clamp, 1/8" NPT, 1/4" NPT or 7/16 x 20). CHT, and OverTemp Limits.			
EE-1P	Dual Display EGT (1 L & 1 R), Over-Temp Lights, 3-1/8" mount	10-01447	\$748.00
CC-1P	Dual Display CHT (1 L & 1 R), OverTemp Lights, 3-1/8" mount	10-02735	\$750.00
TT-1P	Dual Display TIT (1 L & 1 R), OverTemp Lights, 3-1/8" mount	10-02733	\$728.00
EC-1PT	Dual Display 1 EGT & 1 CHT w/ OverTemp Lights, 3-1/8" mount	10-02731	\$769.00
TC-1PT	Dual Display 1 TIT & 1 CHT w/ OverTemp Lights, 3-1/8" mount	10-02732	\$751.00
FOR TWINS - Not Primary Replacement Instruments, but STCd, PMA'd, TSOd. Same order requirements and specifications as above:			
E-2	(one display, switchable from left to right engine, either EGT or CHT)	10-00098	\$630.00
C-2		10-01661	\$766.00
EC-2	(one display, switchable from EGT, L/R and CHT L/R).	10-01359	\$785.00
FL-1M	Single Fuel Level Instrument is NON STC Experimental Aircraft Only. Designed to work with E.I.'s Magnetic Float Sensor P-300M.	10-05084	\$424.95
FL-2M	Dual Fuel Level Instrument is NON STC Experimental Aircraft Only. Designed to work with E.I.'s Magnetic Float Sensor P-300M.	10-05085	\$424.95
P-300M	Magnetic Float Sensor	10-05097	\$455.00

IN

ELECTRONICS INTERNATIONAL INSTRUMENTS

FP-5L FUEL FLOW, PRESSURE, HORSEPOWER AND GPS PMA'd & STC'd PRIMARY REPLACEMENT INSTRUMENT



Positively the best Fuel Flow/Horsepower Instrument there is! Nothing else even comes close. The FP-5L's High-Powered Features Include: • HORSEPOWER, to 1 percent hp. No other fuel gauge provides this! • FLOW, displayed in Gallons, Pounds, Liters or British Gallons. • AUTOMATIC K-Factor Calibration for UNSURPASSED ACCURACY. • FUEL DISPLAYS: "Used for Flight", "Used Since Fill Up", "MPG", "Fuel Required to", "Destination", "Fuel Remaining", "Time to Empty." • SCAN MODES: Manual and Automatic. • RECURRING FUEL USED ALARM Pilot Programmable. • 2 LOW FUEL ALARMS Pilot Programmable w/ Red Warning LED. • FUEL REMAINING displayed to 1/10 Gal. • AUTOMATICALLY CALCULATES AND DISPLAYS "Time to Empty", "Fuel Req to Dest," and "Fuel Reserve." Displays Nautical and Statute Miles per Gallon. Multiple Data Outputs & Inputs, Handhelds & Panel Mounts. One-of-a-kind AUXILIARY Channel can be used to monitor an additional function (choose one): EGT, TIT, CHT, OAT, Carb Temp, Oil Temp, Cowl Temp, Fuel Pressure, Gyro Vacuum, Manifold Pressure, Volts or Amps. Specs: 2-1/4" mount, 3.65" deep, 28 oz. pkg, Backlit for Night Operation, Superior Sunlight Viewability, External Warning Line. Operates from 7.5 to 30 volts @ .3 amps.

Models	Description	Part No.	Price
FP-5L	Fuel Flow w/ Horsepower & GPS input/output (instrument only; no transducers)	10-01217	\$415.00
FP-5L/FT-60	Fuel Flow w/ Horsepower & GPS input/output with FT-60 - PRIMARY	10-05017	\$779.00
FP-5L/FT-60/P	Fuel Flow w/ Horsepower & Pressure GPS input/output with FT-60	10-25310	\$947.00
FP-5L/FT-90	Fuel Flow w/ Horsepower & GPS input/output with FT-90	10-05019	\$775.00
FP-5L/FT-90/P	Fuel Flow w/ Horsepower & Pressure GPS input/output with FT-90	10-05018	\$958.00
FP-5L-60	Fuel Flow w/ Horsepower & GPS input/output, includes FT-60 Flow Transducer	10-01045	\$598.00
FP-5L-90	Fuel Flow w/ Horsepower & GPS input/output, includes FT-90 Flow Transducer	10-01050	\$598.00

FP-5 & FP-5L AUXILIARY OPTIONS

The FP-5 & FP-5L feature an Auxiliary Channel. Any one of the following choices can be added to at any time.			
FFDM-1 w/ FT-60	FUEL FLOW Differential Module, for aircraft with a Pressure Carburetor. Includes FT-60 or FT-90 Flow Transducer to measure the returned fuel. Please specify FT-60 or FT-90. DOES NOT use up the FP-5's Auxiliary channel.	10-25325	\$393.00
FM-Temp-P-110	EGT hose clamp probe & 6' cable. Compensates HP reading when leaning.	10-02188	\$218.95
FM-Temp-P-128	OAT or CARB Temp probe (1/4"-28 thread) and 6' cable	10-02769	\$249.00
FM-Temp-P-120	Secondary OIL Temp probe (5/8"-18 thread) and 6' cable	10-02770	\$249.00
FM-Temp-P-111	Secondary TIT or OIL Temp probe (1/8" NPT adjustable depth) and 6' cable	10-02765	\$223.95
FM-Temp-P-112	Secondary TIT or OIL Temp probe (7/16-20 thread adjust. depth) and 6' cable	10-02766	\$249.00
FM-Temp-P-114	Secondary TIT or OIL Temp probe (1/4" NPT adjust. depth) & 6' cable	10-02767	\$249.00
FM-OP	Secondary OIL PRESSURE. Includes PT-100GA Pressure Transducer	10-25336	\$224.95
FM-FP	Secondary Fuel Pressure. Includes PT-30GA Pressure Transducer	10-25337	\$214.95
FM-MP	Secondary Manifold Pressure. Includes Pressure Transducer	10-25338	\$224.95
FM-RPM 6C	Secondary RPM. Connects directly to the Mag Switch	10-01786	\$221.95
FM-Gyro	Gyro Vacuum. Includes Pressure Transducer	10-25339	\$224.95
FM-VA	Secondary Volts or Amps (one or the other) w/ S-50 amp shunt.	10-25342	\$214.95
AV-17	Voice Annunciator. Connects through the Audio Panel or Intercom. The 1"x1" control panel mounts on your instrument panel. The 4.1"x 2.6"x 1.7" control box mounts under the instrument panel. See all Annunciator Panels on our "Accessories" page.	10-00181	\$435.00

E.I. DIGITAL/GRAPHIC INSTRUMENTS

These Digital/Graphic Instruments are solid state and hold their accuracy over time and a range of environmental conditions. The colorful Graphic Analog display emits green, yellow, or red lights enabling the pilot to spot problems immediately without interpreting a needle. Gauges mount in 2-1/4" instrument holes.



TACHOMETER - R-1, TACHOMETER: STC'd, PMA'd and TSO'd as PRIMARY REPLACEMENT. Features a 210 degree graphic analog display with green, yellow, and red LEDs. Accurate 10 RPM resolution digital display. Flight Timer. Tach Timer. Peak RPM Recorder. Automatic Mag Drop Calculation. Connects to both "P" leads through isolators (no magnetic pick-ups required). 2 1/4" Mount. 3.65" Depth. 10 Oz. Unit. Superior sunlight viewability.

Backlit. Operates from 7.5 to 30 volts @ .3 amps. **Note:** This instrument may come with labels on the faceplate rather than silkscreening, depending on your a/c's required markings P/N 10-25200 **\$549.00**



OIL PRESSURE/TEMPERATURE - OPT-1, OIL TEMP/PRESSURE: STC'd, PMA'd and TSO'd as PRIMARY REPLACEMENT. OPT-1 features dual 90 degree graphic analog displays w/ green, yellow, and red LEDs. Accurate to 1 PSI and 1°F Resolution. External Oil Press and Temp Transducers (no oil in the cockpit). 2 1/4" Mount. 3.65" Depth. 22 Oz. Kit. Superior sunlight viewability. Backlit. Operates from 7.5 - 35 volts @ .3 amps. **Note:** This instrument may come with labels on the faceplate rather than silkscreening, depending on your a/c's required markings P/N 10-25205 **\$575.00**



MANIFOLD PRESSURE - M-1, MANIFOLD PRESSURE. STC'd, PMA'd & TSO'd as PRIMARY REPLACEMENT. 210 degree graphic analog display w/ green, yellow, and red LEDs. Accurate 1" Mercury Resolution digital display. Connects to std pressure line through 1/4" male flare union. 2 1/4" Mount. 3.65" Depth. 13 Oz. Unit. Viewable in direct sunlight. Backlit Operates from 7.5 to 30 volts @ .3 amps. **Note:** This instrument may come with labels on the faceplate rather than silkscreening, depending on your a/c's required markings P/N 10-25210 **\$548.00**



VOLTS/AMPS - VA-1A, VOLTS/AMP. STC'd, PMA'd as PRIMARY REPLACEMENT. Internal Shunt. Discharge @ High Voltage Warning Lights. 100 amp capability. .1 volt & .1 amp 1% Resolution. Accuracy: 2 1/4" Mount. 2.5" Depth. 9 Oz. Unit. Viewable in direct sunlight. Backlit. Operates from 7.0 to 40 volts @ .1 amp. VA-1A (internal shunt) P/N 10-00809 **\$395.00**



VA-1A-XX, VOLTS/AMP - STC'd, PMA'd as PRIMARY REPLACEMENT. (For use with External Shunt. Discharge and High Voltage Warning Lights. 100 amp capability (or order VA-1A-300 for 300-amp capability). .1 volt and .1 amp Resolution. Accuracy: 1% . 2 1/4" Mount. 2.5" Depth. 9 Oz. Unit. Superior sunlight viewability. Backlit. Operates from 7.0 to 40 volts @ .1 amp.

VA-1A-50 (S-50 external shunt) P/N 10-01378 **\$439.00**
VA-1A-300 (S-300 external shunt) P/N 10-01394 **\$447.00**
RSVA-3 Remote Switch P/N 10-03207 **\$89.75**

EI 37 DEGREE FLARE FITTING

This is a 1/4" 37 Degree Flare Fitting used to kit the MP tube of a hard line to interface the Vacuum Pressure Transducer P/N 10-06847 **\$18.95**

ELECTRONICS INTERNATIONAL LED INTENSITY CONTROL

Controls the intensity of the green LED's on the UBG-16, R-1, M-1, OPT-1, FL-2, FP-5(L), and other EI instruments. This unit can be connected to any one or all of these instruments at the same time. It provides linear control of the intensity of the green LED's for low ambient light or night operation. Mounts in a 1/4" hole. Operates on a 12 or 24 volt system. E.I. products include all documentation and certifications.

Description	Part No.	Price
EI LED Intensity Control - CP1	10-02035	\$381.00
EI LED Intensity Control - CP1A Allows Pilot to run current (to power lighting)	10-06280	\$68.85

ELECTRONICS INTERNATIONAL INSTRUMENTS



MVP-50P GLASS PANEL ENGINE & SYSTEM MONITOR

MVP-50P Non-Certified Engine Monitoring System For Standard System installs or FADEC System installs. FADEC NOTE: If already equipped with "FADEC System" MVP-50P will pull data directly from FADEC, minimal hardware required but is included. **E.I. products include all documentation and certifications.** The MVP-50P replaces over 15 Engine Instruments and 50 Functions in a single, full color, enhanced TFT glass display instrument. It features excellent viewability, even in direct sunlight. The MVP-50 is an unrivaled Engine and Aircraft System Monitor with an easy-to-read and easy-to-use format. There are Pilot-Programmable colors, ranges and limits and a voice alarm for each instrument displayed. Its "System Page" displays trims, flaps, wheel status lights, many system parameters and annunciators. This is the most powerful engine and system analyzer on the market, featuring the following displays: Bar Graph (with Scan and Hottest Cylinder modes), Rich-of-Peak, Lean-of-Peak, Full Digital, Normalized and Differential. The MVP-50P's instant red and yellow visual warnings, as well as voice annunciators for all Programmed Limits, eliminate the need to constantly

scan an entire panel for possible problems. **In-Flight Data:** The MVP-50P provides many "Flight Data Screens" to reduce cockpit clutter and pilot workload. **Some of these screens are:** Fuel Management, Timers, Clocks and Date, Weight and Balance, Data Recording, Custom Checklists (Start, Taxi, Run-up w/ Mag Drop, Take Off, Landing, Emergency, Custom Flight Plans, General Information (Aircraft Performance, Engine Diagnostics, VSI Lights, Airspeed, VFR Minimums, Altitude Table, Light Gun Signals, Transponder Codes, Frequencies, Real-Time Out (providing telemetry for UAV racers, etc.)). **Plus Additional Screens:** Flight Log, Max Data Log, Min Data Log and others. And it's easy to create your own Custom Screens and download them to the MVP-50P through its USB port. Compatible with OP Technologies and Chelton. EGView Charting Software is also available for use with the MVP-50P.

Experimental	Description	Part No.	Price
MVP-50P-4	4-Cylinder Pkg	10-01192	\$4,917.00
MVP-50P-6	6-Cylinder Pkg	10-01191	\$6,650.00
MVP-50P-7	7-Cylinder Pkg	10-03174	\$5,340.00
MVP-50P-8	8-Cylinder Pkg	10-03175	\$6,007.00
MVP-50P-8W	8-Cylinder Water-Cooled Pkg	10-03178	\$5,168.00
MVP-50P-9	9-Cyl. Radial Pkg	10-03176	\$6,009.00
MVP-50P-12W	12-Cylinder Water-Cooled Pkg	10-03177	\$5,262.00
MVP-50P-4-FADEC	4-Cyl. FADEC Pkg	10-03173	\$4,751.00
MVP-50P-6-FADEC	6-Cyl. FADEC Pkg	10-03172	\$4,751.00
Certified	Description	Part No.	Price
MVP-50P-4-C	4 Cylinder Certified	10-03867	\$6,250.00
MVP-50P-6-C	6 Cylinder Certified	10-03868	\$6,650.00
MVP-50P-8-C	8 Cylinder Certified	10-03869	\$6,830.00
MVP-50P-4T-C	Twin 4 Cylinder Certified	10-05083	\$12,347.00
MVP-50P-9-C	9 Cylinder Certified	10-07088	\$7,749.00
MVP-50P-6T-C	Twin 6 Cylinder Certified	10-05082	\$13,075.00

TEMPERATURE PROBES FOR MVP-50P & MVP-50T

Models	Description	Part No.	Price
P-100-MVP	CHT probe, screw-in, 3/8"-24	10-00808	\$108.75
P-101MVP	CHT probe, Military Bayonet.	10-00438	\$108.75
A-101MVP	CHT Adaptor for P-101 Probe, 3/8"-24	10-00374	\$15.95
P-102-18-MVP	CHT probe, 18mm gasket.	10-01368	\$108.75
P-102-14-MVP	CHT probe, 14mm gasket	10-02037	\$110.75
P-102-12-MVP	CHT probe, 12mm gasket	10-02038	\$110.99
P-102-3/8-MVP	CHT probe, 3/8" gasket, piggy-backs on a primary CHT probe	10-02039	\$108.75
P-110-F-MVP	Fast-Response EGT/TIT probe, Hose Clamp Type, .125" D	10-00376	\$108.75
P-111-MVP	Std TIT probe, 1/8" NPT, .187" D	10-02040	\$116.75
P-111-F-MVP	Fast Response TIT probe, 1/8" NPT, .187" D	10-02041	\$110.75
P-112-MVP	Std TIT probe, 7/16"-20, .187" D	10-00378	\$116.75
P-114-MVP	Std TIT probe, 1/4" NPT, .187" D	10-00379	\$116.75
P-114-F-MVP	Fast Response TIT probe, 1/4" NPT, .125" D	10-02042	\$120.90
P-120-MVP	OIL Temp probe, 5/8"-18	10-00302	\$108.75
P-104-MVP	Universal Temp probe, #6 hole	10-00380	\$110.90

OPTIONAL OUTPUT INTERFACES AVAILABLE FOR MVP PKGS LISTED ABOVE

Models	Description	Part No.	Price
RTDO	Real-Time Data Out. Can be used to provide telemetry for UAV's, racers and other applications.	10-03168	\$570.00
ACCESSORIES FOR MVP PKGS			
USB-64	USB Memory Stick, 64 MB or larger. Used to upload and download data to the MVP-50P.	10-03186	\$32.95
CP-1-MVP	LED Intensity Control Pot. External pot used to control the display intensity.	10-03211	\$50.50
EDC-33P-4/6	4/6 Cylinder Engine Data Converter. Adding a second EDC to the MVP allows. Additional pressures, annunciators and other functions to be monitored on the MVP (uses the Input Port 3 on the MVP).	10-03184	\$1,322.00
MVP-50P Head Only	Display unit only! May be used to display parameters in a second location Display Only	10-01193	\$2,959.00
PT-30ABS-MVP	Absolute Pressure Transducer, 0 to 40 In Hg (Manifold Press or Cabin Altitude).	10-03238	\$208.95
---	Carbon Monoxide Detectors	10-06985	10-06985

PRESSURE TRANSDUCERS AND MODULES

(Each includes a Cbl-4D-6' harness when ordered w/ the MVP-50 & MVP-50T)

PT-30GA-MVP	Pressure Transducer, 0 to 40 PSI (see Accessories page for details)	10-03232	\$198.75
PT-300GA-MVP	Pressure Transducer, 0 to 300 PSI (see Accessories page for details)	10-01203	\$209.95
PT-3000S-MVP	Pressure Transducer, 0 to 3000 PSI (see Accessories page for details)	10-03236	\$318.00
PT-30ABS-MVP	Absolute Pressure Transducer, 0 to 36 In Hg (Manifold Press or Cabin Altitude)	10-03238	\$208.95
PT-30ALT-MVP	Altitude Transducer	10-03239	\$361.00
PT-60ABS-MVP	Absolute Pressure Transducer, 0 to 70 In Hg (Manifold Pressure)	10-03240	\$224.95
PT-05Diff-MVP	Differential Pressure Transducer, 0 to 60 In Hg (Vac Pressure or Cabin Diff Pressure)	10-03241	\$208.95
PT-04H2O-MVP	Differential Pressure Transducer, 0 to 5 In H2O	10-03242	\$227.95
DPIM-1-30-MVP	Differential Pressure Interface Module for aircraft that require fuel pressure to be measured in reference to the upper deck. Includes a PT-30GA pressure transducer to measure the upper deck pressure.	10-03205	\$403.00
Cbl-4D-6'	One 6' 4-wire cable with crimped D-Sub pins. Used to interface any pressure transducer, fuel flow transducer or fuel level probe to the MVP system. Add \$.95 per foot to the price for anything over the standard 6' length.	10-03183	\$52.75

FUEL FLOW TRANSDUCERS AND MODULES

FT-60	Fuel Flow Transducer (Red Cube), .6 to 70+ GPH	10-01196	\$205.95
FT-90	Fuel Flow Transducer (Gold Cube), 3 to 125+ GPH	10-01224	\$231.95
FT-180	Fuel Flow Transducer (Black Cube), 5 to 250+ GPH	10-01197	\$437.00
FFDM-1-MVP-FT60	Fuel Flow Differential Module for aircraft w/ a pressure carburetor. Includes FT-60 or FT-90 transducer to measure the returned fuel. Please specify FT-60 or FT-90 at time of your order.	10-03244	\$403.00
FFDM-1-MVP-FT90		10-03245	\$401.00
FM-Flow-P	Measures Fuel Flow from a pulsed injector signal.	10-03206	\$348.95

FUEL LEVEL PROBES AND MODULES

RFLM-4-12	Resistive Fuel Level Module. Must be used w/ El's "EDC" to measure up to 4 Resistive Fuel Level Sensors.	10-02772	\$89.95
RFLM-4--24		10-03231	\$89.75
P-300C	3/4" Capacitive Fuel Level Probe w/ Accessories. (see our Accessories Page for details.) Specify Probe length at time of order.	10-00382	\$418.00
P-300C-Mini-1/8"	3/16" Capacitive Fuel Level Probe (see our Accessories Page for details)	10-03193	\$332.00
P-300C-Mini-1/4"		10-03194	\$332.00

VOLTS AND AMPS MODULES AND SHUNTS

FM-VA-MVP-50	Volts/Amperes Module. Allows any temperature or pressure channel on	10-03247	\$220.95
FM-VA-MVP-300	El's EDC to measure Voltage and Current on a separate bus. Comes w/ an S-50 or S-300 shunt.	10-03248	\$210.00

MVP SCREEN ANNUNCIATOR INTERFACE UNITS

VI-221	Voltage Interface Unit. Allows any temperature or fuel level channel on our EDC to measure the output voltage of any device. This voltage measurement can then be used to drive an annunciator (Canopy Latch, Gear Lights, Baggage Door, etc.) that will be displayed on the MVP screen.	10-03187	\$26.50
--------	--	----------	---------

SUPER CLOCK INSTRUMENTS



ASC-5A - Displays Local & Zulu Time in 12 or 24 hr format, Up & Down Timers w/ alarms, Altitude (as seen by ATC), and OAT. Several programmable alarms, including Assigned Altitude, Level Off, Deviation Alarm and an Approach Alarm + a recurring alarm to alert you at a programmable interval, for checking fuel.
P/N 10-02914**\$641.00**

SC-5 - Displays Local (12 or 24-hour format) & Zulu Time. 10-year Lithium battery keeps the clock running even if the a/c battery is removed. Displays an Up Timer, which starts running when the engine is started, acting as an automatic Flight Timer. The Up Timer may be started, stopped or reset. Recurring Alarm may be set to alert you at appropriate time intervals, e.g., if set for 30 minutes, there will be an alarm at 30 minutes, 60 minutes, 90 minutes, etc. Alarm can be used as a reminder to check fuel level or switch tanks at set time intervals.
P/N 10-01612**\$359.00**

FUEL LEVEL INSTRUMENTS



For TC holders, STC holders or Experimental Aircraft No STCs. FL-1CA Fuel Level Instrument. The FL-1CA is to be used w/ EI's P-300C Capacitive Fuel Probe (custom order probe length from 6" to 20"). The FL-1CA features a 210 degree Arc of LEDs for an excellent "field of vision" reference and a Digital Display. Can display in gallons (one or one-half gallon increments), pounds or liters.
Specifications: 2 1/4" Mount, 3.65" Depth, 10 Oz. Unit, Viewable in direct sunlight and Backlit for night operations.

Model	Description	Part No.	Price
FL-1CA	The FL-1CA is to be used w/ EI's P-300C capacitive fuel probe (order from 6" to 20" long). 210 degree LED arc + a digital display. Can display in gallons (one or one-half gallon increments), pounds or liters. Specifications: 2 1/4" Mount, 3.65" Depth, 10 Oz. Unit, Viewable in direct sunlight and Backlit for night operations.	10-00386	\$485.00
FL-1RA-12/24	The FL-2RA-12 designed to be used on a 12-volt system w/ resistive fuel probes. Features a 210 degree LED arc + a digital display. Max resistance between 90-270 ohms. Can display in gallons (one or one-half gallon increments), pounds or liters. Specifications: 2 1/4" Mount, 3.65" Depth, 10 Oz. Unit, Viewable in direct sunlight and Backlit.	12V	
		10-03209	\$485.00
		24V	
		10-00388	\$478.00
FL-2CA	The FL-2 is a fuel level instrument featuring dual 90 degree LED arcs + a digital display. The FL-2 can display in gallons (one or one-half gallon increments), pounds or liters. Specifications: 2 1/4" Mount, 3.65" Depth, 10 Oz. Unit, Viewable in direct sunlight, Backlit, Operates from 7.5 to 35 volts at .3 amps.	11-03788	\$478.00
FL-2RA-12/24	The FL-2 is a fuel level instrument featuring dual 90 degree LED analog displays and a digital display. The FL-2 can display in gallons (one or one-half gallon increments), pounds or liters. FL-2. Specifications: 2 1/4" Mount, 3.65" Depth, 10 Oz. Unit, Viewable in direct sunlight, Backlit, Operates from 7.5 to 35 volts at .3 amps. Please specify 12/24 volt at the time of order.	11-03789	\$483.00
FL-2RA-24		11-07104	\$473.00



MVP-50T GLASS PANEL MULTI-FUNCTION DISPLAY

Replaces 15 engine gauges and 50 functions. Remarkable full-color, enhanced TFT Glass Display (excellent viewability, even in direct sunlight) Pilot-Programmable Colors, Range Markings, Limits and Voice Alarms (for each parameter monitored) "System Page" to display Trims, Flaps, Wheel Status Lights, and many other system parameters and annunciators. 27 Pilot-Customized Annunciators at the top of the "Main Page". Fuel Management, Timers, Clocks, Date, Weight & Balance. Data Recording (.33 - 6 min, 665 hours @ 6 seconds). Pilot-Customized Checklists and Flight Plans. General Info, Flight Log, Start Log, Max & Min Data. Pilot easily can generate Custom Screens and download them to the MVP-50P through the USB port. Help Screen, GPS Interface and Data, Fuel Efficiency, Fuel Used for the Trip, Fuel Used Since Fill Up, Time to Empty, Distance to Empty, Fuel to Way Point, Time to Way Point, Distance to Way Point, Fuel Reserve, Time Reserve, Distance Reserve, Up Timer, Down Timer, Flight Timer, Engine Hours, Cycles, Date, Local and Zulu Time. Other functions, such as Fuel Level, Gyro Vac, Hydraulic Pressure, etc., may be added by purchasing an appropriate probe & harness, or transducer, etc. See our Accessories, "Probes and Transducers" section on previous page. Using your current Resistive Fuel probes require our FFLM-4-XX to interface with the MVP-50T System. Torque, Oil Pressure & Temperature, Fuel Flow & Pressure, OAT, Amps, Volts, Multiple Fuel Screens, Pre-wired Harness, N1 and N2 hookups. Includes EDC (Engine Data Converter), cables and harnesses, transducers, shunt (for amps), USB Download/Upload Memory Stick, and our AV-17CP (Voice Warning Control Panel). Only 5.55"x 5.15"x 2.4" deep

Experimental	Description	Part No.	Price
MVP-50T-PT6	Pratt & Whitney PT-6 Turboprop Pkg	10-03160	\$6,535.00
MVP-50T-W	Walters Engine Turboprop Pkg	10-03161	\$6,533.00
MVP-50T-G	Garrett Turboprop Pkg	10-03162	\$6,533.00
MVP-50T-L	Lycoming Turboprop Pkg	10-03163	\$6,533.00
MVP-50T-A	Allison Turboprop Pkg	10-03164	\$6,533.00
MVP-50T-J85	General Electric J85 Jet Engine Pkg	10-03165	\$6,533.00
MVP-50T-L39	L39 Aircraft Pkg	10-03166	\$6,525.00
Certified	Description	Part No.	Price
MVP-50T-PT6-C	Pratt & Whitney PT-6 Turboprop Pkg	10-05090	\$8,965.00
MVP-50T-W-C	Walters Engine Turboprop Pkg	10-05089	\$8,963.00
MVP-50T-G-C	Garrett Turboprop Pkg	10-05091	\$8,963.00
MVP-50T-L-C	Lycoming Turboprop Pkg	10-05092	\$8,963.00
MVP-50T-A-C	Allison Turboprop Pkg	10-05093	\$8,963.00
MVP-50T-J85-C	General Electric J85 Jet Engine Pkg	10-05094	\$8,963.00
MVP-50T-L39-C	L39 Aircraft Pkg	10-05101	\$8,963.00
OPTIONAL INTERFACES AVAILABLE FOR PKGS LISTED ABOVE			
RTDO	Real-Time Data Out. Can be used to provide Telemetry Data for UAV's, racers and other applications.	10-03168	\$570.00
ACCESSORIES			
USB-64	USB Memory Stick, 64 MB or larger. Used to upload & download data to the MVP.	10-03186	\$32.95
CP-1-MVP	LED Intensity Control Pot. External pot used to control the display intensity.	10-03211	\$50.50
EDC-33T	Turboprop/Jet Engine Data Converter. Adding this second EDC to the MVP allows monitoring of additional temperatures, pressures, annunciators and other functions.	10-03185	\$2,520.00
MVP-50T Display Head	May be used to display parameters in a second location. (display only)	10-03202	\$4,593.00

EDC-33T SMART ENGINE DATA CONVERTER



The EDC-33T (Engine Data Converter) is sometimes referred to as a Data Acquisition Unit (DAU) and has a broad range of applications. Its main purpose is to monitor the probes, transducers and sensors mounted on the engine and airframe. It then processes this data and outputs it on a serial bus. This allows a Display Unit or MFD to display the data without having to perform the intense processing required in a set timeframe. Also, annunciators and status switches can be monitored. The EDC-33 can be used on piston, turboprop or jet aircraft as well as helicopters. If an EEC or FADC system needs to be monitored, check out our BC-5 (Bus Converter). P/N 10-03185 **\$2,520.00**

ELECTRONICS INTERNATIONAL INSTRUMENTS

ELECTRONICS INTERNATIONAL CGR-30 PRIMARY ENGINE MONITOR SYSTEM



Easily replace several of your aircraft's primary and non-primary engine instruments with one EI CGR. For example, simply replace your existing tach with a CGR. In addition to replacing our tachometer, the STC'd CGR will replace MANY of your existing primary and non-primary instruments in the same instrument, in the one 3-1/8" hole. The CGR mounts flush with your panel

and doesn't protrude from your panel (as competitor's gauges do). E.I. products include all documentation and certifications.

Available Functions: The CGR-30P comes standard with a state-of-the-art, full color bar graph which assists with ROP/LOP leaning. Additionally, the bar graph has both normalized and digital readout screens. No other bar graph in the industry comes close to providing the number of options the CGR-30P offers. In addition to its bar graph, the CGR-30P can be configured to display a combination of the functions listed: • RPM • M.P. • EGT/CHT Bar Graph • Oil Pressure • Oil Temperature • TIT • Hyd Pressure • C.O. • OAT • Vac. • Fuel Pressure • Fuel Level • Fuel Flow • Fuel Remaining • Fuel Used • Fuel -GPS Related Data • Low Fuel Alarm • Recurring Fuel Alarm • Volts • Amps • Flight Timer • Tach Timer • Local Time • Zulu Time • Annunciators • Data Recording • USB Port • External Caution Lights • And More

Model No.	Description	Part No.	Price
CGR-30P-4-B	4-Cylinder Basic Package with RPM, Fuel Flow, EGT/CHT Bar Graph, Fuel Remaining, Volts, OAT, Tach Time, Local Time, Zulu Time, Flight Timer, Fuel Used for the Flight, Fuel Used Since Fill-up and all GPS/Fuel Flow Data.	10-05428	\$3,398.00
CGR-30P-4-P	4-Cylinder Premium Package with RPM, EGT/CHT Bar Graph, Fuel Remaining, Fuel Used, FPS/Fuel Flow Data, Engine Time, Tach Time, 5 Primary Functions of your choice and 5 Non-Primary functions of your choice.	10-05429	\$4,098.00
CGR-30P-6-B	6-Cylinder Basic Package with RPM, Fuel Flow, EGT/CHT Bar Graph, Fuel Remaining, Volts, OAT, Tach Time, Local Time, Zulu Time, Flight Timer, Fuel Used for the Flight, Fuel Used Since Fill-up and all GPS/Fuel Flow Data.	10-05430	\$4,098.00
CGR-30P-6-P	6-Cylinder Premium Package with RPM, EGT/CHT Bar Graph, Fuel Remaining, Fuel Used, FPS/Fuel Flow Data, Engine Time, Tach Time, 5 Primary Functions of your choice and 5 Non-Primary functions of your choice.	10-05431	\$4,448.00
CGR-30P-7-B	7-Cylinder Basic Package	10-07070	\$4,387.00
CGR-30P-7-P	7-Cylinder Premium Package	10-07071	\$4,790.00
CGR-30P-9-B	9-Cylinder Basic Package	10-07072	\$4,554.00
CGR-30P-9-P	9-Cylinder Premium Package	10-07073	\$5,349.00
CGR-30C-EDC	Stand alone system or companion to CGR-30P. Provides up to 16 Primary Replacement Engine Instruments with EDC	10-05758	\$2,748.00
CGR-30C	Stand alone system or companion to CGR-30P. Provides up to 16 Primary Replacement Engine Instruments w/o EDC	10-05759	\$2,196.00
CGR-30 Combo Packages	Combo Package 4 Cylinder, Single Engine	10-06564	\$5,048.00
	Combo Package 6 Cylinder, Single Engine	10-06565	\$5,398.00
---	Carbon Monoxide Detectors	10-06985	\$595.00

TR-1-ITT TEMPERATURE GAUGE



The TR-1-ITT Instrument was designed as a replacement for existing 2" ITT instruments. Depending on your current installation you may need to wire in aircraft power and ground. The instrument features a 210° analog arc, backlight and a dimmable, digital display. The instrument's faceplate will be custom built to match your aircraft's limits (red/yellow markings). The TR-1-ITT fits into a 2" standard round hole.

Standard Package P/N 10-06612 **\$1,250.00**
Premium Package P/N 10-06613 **\$1,559.00**

TR-1-NG RPM GAUGE



The TR-1-Ng gas generator instrument was designed as a replacement for existing 2" gas generator RPM instruments. Depending on your current installation you may need to wire in aircraft power and ground. The instrument features a 210° analog arc, backlight with auto dimming and a digital display. The instrument's faceplate will be custom built to match your aircraft's limits (red/yellow markings).

The TR-1-Ng fits into a 2" standard round hole.
Standard Package P/N 10-06614 **\$1,250.00**
Premium Package P/N 10-06615 **\$1,559.00**

TR-1-NP RPM INSTRUMENT



The TR-1-Np Prop RPM instrument was designed as a replacement for existing 2" instruments. Depending on your current installation you may need to wire in aircraft power and ground. The instrument features a 210° analog arc, backlight with auto dimming and a digital display. The instrument's faceplate will be custom built to match your aircraft's limits (red/yellow markings).

The TR-1-Np fits into a 2" standard round hole.
Standard Package P/N 10-06616 **\$1,250.00**
Premium Package P/N 10-06617 **\$1,559.00**

TR-1-TQ ENGINE TORQUE GAUGE



The TR-1-TQ Torque Instrument was designed as a replacement for existing 2" engine torque instruments. Depending on your current installation you may need to wire in aircraft power and ground. The instrument features a 210° analog arc, backlight and a dimmable, digital display. The instrument's faceplate will be custom built to match your aircraft's limits (red/yellow markings).

The TR-1-TQ fits into a 2" standard round hole.
Standard without Transducer P/N 10-06608 **\$1,250.00**
Premium without Transducer P/N 10-06610 **\$1,559.00**

M-1 TURBINE OUTLET TEMPERATURE GAUGE



The M-1-TOT provides pilots with Turbine Outlet Temperature readings in Degrees C on this 2-1/4" gauge. The large LCD display is viewable in direct sunlight and is backlit for night operations. A 270 degree analog arc features bright Red, Yellow and Green LEDs to mark each operating zone for quick reference. TSOd/PMAd (no STCs). Instrument Weight: 10 oz. Dimensions: 2.5" x 2.5" x 3.65" Depth, 2.25" Bezel.

P/N 10-03267 **\$790.00**

OPT-1-FV VOLT/ FREQUENCY GAUGE



AC BUS VOLTAGE & FREQUENCY, TSOd/PMAd (no STCs). The "60" instrument is for a 60 Hz. bus and the "400" instrument is for a 400 Hz. bus. Accurate Digital Display can be switched between Voltage and Frequency, displays in Volts and Hz. 2 1/4" Mount, 3.65" Depth, 10 Oz. Instrument.

P/N 10-03268 **\$790.00**

IN

ELECTRONICS INTERNATIONAL ACCESSORIES

AP-7H OR AP-7V LED ANNUNCIATOR PANEL



(H = Horizontal Mount; V = Vertical Mount) When mounted in front of the pilot, the AV-7 Annunciator

Panel's bright red LEDs give a quick warning of any out-of-limit condition. Can be connected to these E.I. instruments: US-8A or SR-8A, FP-5(L) and/or FL-2, R-1, M-1, and OPT-1. A control switch will dim or turn off the warning LEDs. Simple to install (requires only 8 ea. 1/2" holes to mount). Connect to a small 3" x 2" x 1" Control Box tie wrapped to a wire bundle under the instrument panel. Size: 5.3" x .9", 10 Oz. Kit, Operates on a 12 or 24-volt system. Includes: Annunciator Panel, Control Box and all wires and connectors.

Vertical.....P/N 10-03288\$165.00
Horizontal (Pictured).....P/N 10-03289\$165.75

AL-1 RED CHROME ANNUNCIATOR LIGHT



The AL-1 makes an excellent indicator light for displaying boost pump on, gear status, power on, flags, etc. Also, it can be used as a remote warning light for any E.I. instrument featuring an external warning line. The AL-1 is more attractive, operates on less power and is smaller than the old fashioned indicator lights.

The AL-1 has a service life of over 1000 times that of incandescent bulbs. Mounts in a 5/16" hole. Size: .4" diameter x 1" depth. Operates on a 12 or 24-volt system. Comes with 32" leads.

Red.....P/N 10-04164\$27.50
Yellow.....P/N 10-04165\$27.90
Blue.....P/N 10-04166\$27.50
Orange.....P/N 10-04167\$27.50
Green.....P/N 10-04168\$27.90

AV-17 VOICE ANNUNCIATOR



The AV-17 can provide up to 17 verbal warnings through your headset, ending the need to constantly scan the instrument panel. Eliminate concern about missing an alarm at a critical moment. The instant a monitored alarm occurs, the Voice Annunciator will chime in the headset and a pleasant female voice will announce a phrase, such as: "Check Oil Pressure," or "Check Altitude," etc.

The AV-17's voice alarm in the headset provides an instant and clear understanding of what's going on in the cockpit without the hassle of having to scan instruments, decipher functions, interpret readings or translate numerous bells, buzzes or beeps. The AV-17 connects to the headset through the Audio Panel or Intercom or may be connected directly to the headset. The AV-17 receives most of its warning signals from any one or more of Electronics International's instruments which feature a warning light. However, other alarm inputs can be received from any warning device that drives a horn or light. It is not necessary to activate all 17 of the AV-17's warnings. A "Check Bus Voltage" warning is built into each AV-17. Further voice alarms can be activated as EI instruments are added to the panel. The AV-17 is compact. A 4.1" x 2.6 x 1.7" Control Box tie wraps under the instrument panel. A 1" x 1" Control Panel mounts on the aircraft instrument panel. The Control Panel allows you to turn the Voice Annunciator on or off, and allows you to acknowledge, and thereby deactivate, any active alarm for either 1 minute or 10 minutes. The AV-17 voice alarms are activated by pulling the appropriate control line to ground (0 volts).

AVI-1 INVERTER - This inverter allows a positive voltage to activate one AV-17 control line. Use with the AV-17 when utilizing inputs from gauges other than Electronics International's.

AV-17.....P/N 10-00181\$435.00
AVI-1 Inverter.....P/N 10-03292\$18.95

RC-1 TACH DRIVE CAP



The RC-1 is a Tach Drive cap. The thread pattern is 7/8 x 18 and fits most Tach Drive Lines.

.....P/N 10-01223\$5.95

FIELD TEST DEVICES

Models	Description	Part No.	Price
FCD-FF	Outputs a variable fuel flow signal.	10-03295	\$100.75
FCD-FP	Outputs a variable fuel pressure signal (0 to 50+ PSI)	10-03296	\$119.90
FCD-OP	Outputs a variable oil pressure signal (0 to 100+ PSI)	10-03297	\$100.75
FCD-RPM	Outputs a variable RPM signal (800 to 2800 RPM)	10-03298	\$100.75
FCD-AMP	Outputs a 50mV signal. Used to test the VA-1A-XX Volt/Amp Instrument	10-03301	\$100.75
FCD-CFL	Outputs a variable capacitive fuel level signal	10-03302	\$119.90
FCD-RFL	Outputs a variable resistive (0-250 ohms) fuel level signal	10-03303	\$119.90

PROBE EXTENSION CABLES

Description	Part No.	Price
XCO-6 Extension 6 FT Circular to Overlap Connectors	10-05708	\$44.95
EI XO-6 Extension 6 FT Overlap Connectors	10-05620	\$44.95
EI Overlap Connectors OLC-1- Eliminates the need for soldering, crimps, and expensive connectors	10-05470	\$1.55

REMOTE SWITCHES

A remote switch may be used to upgrade many single-channel E.I. instruments to multi-channel EGT and/or CHT engine analyzers. This is an excellent way to insure your engine is operating properly. Specifications for all switches: Body - 1" x 1" x 1.5" depth, front panel - 2" x 1.15", STC'd / PMA'd



RS-4-1S - Upgrades any unit to read four channels of EGT or CHT, Package includes: Unit, (3) 6' cables, (3) probes. Specify probe type with order.
P/N 11-01688\$374.00



RS-4-2S - Upgrades any two channel unit to read four channels of EGT and CHT, Package includes: Unit, (6) 6' cables, (3) EGT probes, (3) CHT probes.
P/N 11-01689\$529.00



RS-6-1S - Upgrades any unit to read six channels of EGT or CHT, Package includes: Unit, (5) 6' cables, (5) probes. Specify probe type with order.
P/N 11-01690\$502.00



RS-6-2S - Upgrades any 2 channel unit to read six channels of EGT and CHT, Package includes: Unit, (10) 6' cables, (5) EGT probes, (5) CHT probes.
P/N 11-01691\$791.00



RS-8-1S - Upgrades any unit to read eight channels of EGT or CHT, Package includes: Unit, (7) 6' cables, (7) probes. Specify probe type with order.
P/N 11-01692\$656.00



RS-12-1S - Upgrades any unit to read 12 channels of EGT or CHT, Package includes: Unit, (11) 6' cables, (11) probes. Specify probe type with order.
P/N 11-01693\$831.00

PRIMARY REMOTE SWITCHES

Remote Switches for use w/ EI 1 or 2 channel EGT/CHT instruments. STC'd, PMA'd. Available for single and twin engine applications.



RS-5-1PS - Upgrades any primary TIT/CHT unit to read 4 channels of EGT or CHT, Package includes: Unit, (4) 6' cables, (4) probes. 15 oz. kit Specify probe type with order.....P/N 11-01694\$621.00

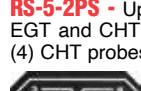

RS-5-2PS - Upgrades any primary TIT/CHT unit to read 4 channels of EGT and CHT, Package includes: Unit, (8) 6' cables, (4) EGT probes, (4) CHT probes. 2.2 lb. kit.....P/N 11-01695\$831.00



RS-7-1PS - Upgrades any primary TIT/CHT unit to read 6 channels of EGT or CHT, Package includes: Unit, (6) 6' cables, (6) probes. 27 oz. kit. Specify probe type with order.....P/N 11-01696\$621.00

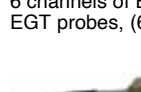

RS-7-2PS - Upgrades any primary TIT/CHT unit to read 6 channels of EGT and CHT, Package includes: Unit, (12) 6' cables, (6) EGT probes, (6) CHT probes. 3.2 lb. kit.....P/N 11-01697\$831.00

PROBES



P-100 - CHT Probe; screw-in type, Standard with most kits. Can be used in a pressure environment. 700°F max.
P/N 10-00808\$108.75



P101 - CHT Probe; Military Bayonet type, 1/4 turn locking for quick removal. To be used with the A-101 adaptor. 700°F max.
P/N 10-00438\$108.75



A101 - CHT Adaptor; 3/8" - 24, to be used with the P-101 CHT probe.
P/N 10-00374\$15.95



P-102 - CHT Probe; Gasket type, 18mm, 700°F max.....P/N 10-01368\$108.75



P-110 - EGT/TIT Probe; Hose clamp type, used with 13/64" hole. Standard with most kits. Weight: 1.6 oz.
P/N 10-01591.....\$108.75



FAST RESPONSE P-110 - EGT/TIT Probe; Hose clamp type, used with .130" hole. Optional with most kits. Weight: 1.6 oz. Probe only....P/N 10-00376\$108.75



P-110-F-XCO-6 - EGT/TIT Fast Response .130" dia Probe with 6ft. Lead.....P/N 10-00377\$139.75



P-111 - TIT Probe; 1/8" NPT with adjustable depth. (with cable) P/N 10-25235\$161.70



P-112 - TIT Probe; 7/16"-20, with adjustable depth. (w/o cable)...P/N 10-00378\$116.75

P-114 - TIT Probe; 1/4" NPT with adjustable depth. (w/o cable)..P/N 10-00379\$116.75

P-104 - Universal Probe; Used to measure surface temperatures, 700°F max.
P/N 10-00380\$110.90

P-128 - Oat Probe 1/4-28" Thread. 700 Degrees Fahrenheit Max....P/N 10-05858\$106.75

P-128 - Carb Temp 1/4-28" Thread. 700 Degrees Fahrenheit Max....P/N 10-05859\$106.75

INSIGHT ENGINE MONITORS

GRAPHIC ENGINE MONITOR 602/603/610 UPGRADES



Graphic Engine Monitor - STC'd Single Engine - Normally Aspirated 4 or 6 Cylinder. The GEM 602 is designed for use with all 4 or 6 cylinder piston engine aircraft. The instrument graphically displays up to 12 critical engine temperatures in a single instrument in an easy-to-read bar-graph format on a brilliant plasma display.

Model No.	Part No.	Description	Price
610-C262-U	10-04932	Insight 4C or 6C Upgrade GEM to G2	\$1,599.00
610C-363-U	10-05261	Insight 4C or 6C Upgrade GEM to G3	\$2,375.00
610-C-463-U	10-05267	Insight 4C or 6C Upgrade GEM to G4	\$3,295.00
1210C-063-U	10-04699	Insight 4C or 6C Upgrade Gemini 1200 to G4 Twin	\$4,625.00
1210-C-063-2-U	10-05271	Insight 4C or 6C Upgrade to G4 Twin	\$1,975.00

GEM PROBES

GEM 602 Wire Harness P/N 10-03576 **\$199.00**
 #2870 EGT Probe P/N 2870 **\$99.75 ea.**
 #2852 CHT Spring Probe P/N 2852 **\$99.75 ea.**
 #2853CHT Gasket Probe P/N 10-00827 **\$98.75 ea.**
 #2855 CHT Adapter Probe* P/N 2855 **\$177.95 ea.**
 #2856 CHT Probe** P/N 2856 **\$177.95 ea.**
 #1200-015 OAT Cable 10ft. P/N 10-05890 **\$27.50**
 *Use with factory spring probe **Use with 3/8 x 24 threaded factory probe

INSIGHT G3 GRAPHIC ENGINE MONITOR



The original GEM was a solitary player. The G3 instrument has two control knobs that operate combination rotary and push button switches. The top knob in general controls screen selection while the bottom knob controls items within the given screen. Each screen assigns its own functional needs to the controls that may change depending on context. A screen may also label the controls with guidance information like "Push to exit". The G3 is also designed to expand and grow with the times. Less than half of its true potential has been released at this time. The instrument can be updated to acquire new features by loading the SD card via the internet. Another great feature is why not have the G3 instrument diagnose itself? Then you don't have to disassemble the airplane or even touch the wiring. The probe diagnosis page indications are in green for normal readings and red for readings that fail the criteria set at the bottom of the screen. System Monitors: EGT, CHT, Fuel Flow, RPM, Manifold Pressure O, il Temp/Pressure, OAT, TIT, Carb Temp, HP%, Prop Balance, Clock/Calendar

G3 is also designed to expand and grow with the times. Less than half of its true potential has been released at this time. The instrument can be updated to acquire new features by loading the SD card via the internet. Another great feature is why not have the G3 instrument diagnose itself? Then you don't have to disassemble the airplane or even touch the wiring. The probe diagnosis page indications are in green for normal readings and red for readings that fail the criteria set at the bottom of the screen. System Monitors: EGT, CHT, Fuel Flow, RPM, Manifold Pressure O, il Temp/Pressure, OAT, TIT, Carb Temp, HP%, Prop Balance, Clock/Calendar

Description	Part No.	Price
Insight GEM G3 4C Single Engine	10-03195	\$3,029.00
Insight GEM G3 4C Single Engine Dual Turbo	10-05262	\$3,345.00
Insight GEM G3 4C Single Engine Turbo	10-04685	\$3,196.00
Insight GEM G3 6C Single Engine	10-03196	\$2,995.00
Insight GEM G3 6C Single Engine Dual Turbo	10-05263	\$3,295.00
Insight GEM G3 6C Single Engine Turbo	10-04686	\$3,149.00

INSIGHT G9 GRAPHIC ENGINE MONITOR



Pilot settable lean threshold target. Colored box appears at peak. Lean boxes show temperature of how much lean or rich. Colored boxes show lean or rich. Lean boxes change at lean threshold. Fuel flow guidance for leaning. Fuel flow at each cylinder peak (GAMI SPREAD). In-flight exhaust valve analysis. EGT temperature bars with numbers. CHT temperature bars with number, yellow warning and redline. TIT temperature bar with number, yellow warning and redline.

INSIGHT G1 SINGLE ENGINE COLOR MONITOR - COMPLETE SYSTEM



Single Engine - 2.25 Bezel. Protect Your Engine By: • Saving Fuel On Every Flight By Leaning Accurately And Safely • Revolutionary New Leaning Process • See Lean Peak In Order And Temperature Spread • Seeing Simultaneous EGT, CHT, TIT Bars And Temperatures • Save Time Trouble-Shooting • Continuous Probe Diagnosis That Confirms System Integrity • Extensive List Of Primary Approved Aircraft Models • SD Card Software Updates • FAA & TC Primary STC • EGT, CHT, & TIT

Also available with Carburetor Temperature and/or for G1 Field Update Kit, see Accessories.

Description	Part No.	Price
Insight G1 4C Single Engine	10-04916	\$1,498.00
Insight G1 4C Single Engine Turbo	10-04918	\$1,595.00
Insight G1 6C Single Engine Turbo	10-04919	\$1,725.00

INSIGHT G2 SERIES SINGLE ENGINE COLOR MONITOR - COMPLETE SYSTEM

G2 Series Single Engine Color Monitor - Complete System - 2.25 Bezel Save Fuel, Save Money, Save Your Engine! Affordable Engine Monitoring you can't afford to be without.

Top reasons to install a G2: • Best lean of peak process in the industry • The only nozzle balance analysis, the key to lean of peak • The only probe diagnostic scree • Comprehensive data log - windows files SD card • Over the web software updates - constant improvement • GEM plug compatible - easy install • Best technical support

Description	Part No.	Price
Insight G2 4C Single Engine	10-04924	\$1,899.00
Insight G2 4C Single Engine Turbo	10-04927	\$2,223.00
Insight G 6C Single Engine	10-04926	\$2,059.00
Insight G 6C Single Engine Turbo	10-04928	\$2,405.00

G4 GRAPHIC ENGINE MONITOR



The original GEM was a solitary player. The G4 will operate standalone too but will also interface with other data sources and report information to other instruments like MFD's. All of the devices the G4 connects to today didn't exist in '79. The G4 is also designed to expand and grow with the times. Less than half of its true potential has been released at this time. The instrument can be updated to acquire new features by loading the SD card via the internet. The G4 update takes only a second while the instrument remains mounted in the airplane.

Single Engine		
Description	Part No.	Price
Insight G4 4C Single Engine	10-04687	\$3,675.00
Insight G4 4C Single Engine Turbo	10-05264	\$4,111.00
Insight G4 4C Single Engine Dual Turbo	10-05265	\$4,125.00
Insight G4 6C Single Engine Dual Turbo	10-05266	\$4,395.00
Insight G4 6C Single Engine	10-04688	\$3,875.00
Insight G4 6C Single Engine Turbo	10-04689	\$4,378.00
Twin Engine		
Description	Part No.	Price
Insight G4 4C Twin Engine	10-04690	\$5,753.00
Insight G4 4C Twin Engine Turbo	10-04692	\$5,995.00
Insight G4 4C Twin Engine Dual Turbo	10-05268	\$5,895.00
Insight G4 6C Twin Engine	10-04691	\$6,068.00
Insight G4 6C Twin Engine Turbo	10-04693	\$6,319.00
Insight G4 6C Twin Engine Dual Turbo	10-05269	\$6,295.00

Description	Part No.	Price
Insight 7 Cylinder G9	10-06229	\$5,412.00
Insight 8 Cylinder G9	10-06230	\$7,765.00
Insight 8 Cylinder G9	10-06231	\$5,530.00
Insight 8 Cylinder G9	10-06232	\$7,883.00
Insight 9 Cylinder G9	10-06233	\$5,648.00
Insight 9 Cylinder G9	10-06234	\$7,995.00
Insight 14 Cylinder	10-06235	\$11,245.00

FUEL TOTALIZERS - FUEL GAUGES

SHADIN MINIFLO TOTALIZERS



MINIFLO SYSTEMS - Miniflo is the miniature fuel flow meter which constantly displays fuel flow in the lower windows. The fuel used and fuel remaining functions are continuously computed and can be displayed in the upper window by pressing the appropriate button. Endurance (time remaining) can be displayed in

the upper window by using the rotary switch. STC's for most aircraft. Power: 12-28V DC Furnished in gallons readout (pounds also available). Weight: 31 oz. (meter & transducer). Size: 3.25" x 1.25" x 7.5". Miniflo now provides all features of standard Miniflo system plus a Loran interface as described in Digiflo above. This gives the pilot NM/Gal, Gallons to Destination and Gallons of Reserve. Specify aircraft and engine model on all Miniflo orders. Prices vary according to aircraft model. Single Engine GPS Miniflo P/N 10-24735 **CALL FOR PRICE**

SHADIN DIGIFLOW TOTALIZERS



Digiflo-L is a Digital Fuel Management System designed to provide complete fuel management information under real flight conditions without any manual entry of data (after entry of the initial fuel on board information). Digiflo-L is connected to the engine fuel flow transducer for fuel flow information and to the Loran-C or GPS receiver serial port for navigation data (ground speed, distance and estimated time en route). This system is also capable of transmitting the fuel information to the Bendix/King KLN-88, KLN-90, and Garmin GPS navigation receivers, for additional calculations and display of fuel management data.

Single Engine GPS Digiflo P/N 10-02212 ... **Please Call**
Twin Engine GPS Digiflo P/N 10-02213 ... **Please Call**

SHADIN F/ADC-200 FUEL/AIR DATA COMPUTER



The affordable Shadin F/ADC-200 Fuel/Air data computer maximizes aircraft range and fuel economy by providing automatic updating to your GPS for true air speed, winds aloft, wind components, density altitude,

OAT, pressure altitude, fuel flow rate, fuel used, fuel required to destination, fuel endurance, and more. Interfaces with most popular GPS units including Bendix King KLN series, Garmin 150, 155, 165, Trimble 2000/3000 series, and Arnav. Please specify aircraft make/model, engine make/model, serial number of aircraft, and GPS make/model at time of order P/N 10-24768 ... **Please Call**

IMPORTANT: For all Shadin orders, please specify engine make and model number; aircraft make and model number; specify gallons, pounds or liters on readout and if Loran or GPS will interface. Specify make and model.

SHADIN SYSTEMS PRICING - Prices for Shadin Microflo, Digiflo, & Miniflo systems vary according to aircraft/engine models. Call Aircraft Spruce for your best pricing on any Shadin system. Aircraft Spruce guarantees to meet or beat any competitor's current advertised prices.

FUEL LEVEL SYSTEM BY DATCON



This Datcon fuel gauge and senders are designed for use with 12 volt electrical systems in automotive, marine and homebuilt aircraft applications. The gauges have a round 2" diameter case with chrome bezel. Mounting brackets and instructions are furnished. 240-33 Ohms. Gauge No. 100177 with steel case P/N 100177 **\$59.85**
Lighting Kit (12V) P/N 06215-00 **\$8.50**

UNIVERSAL SENDER FOR DATCON GAUGES



This Fuel Level Sender has removable mounting plate which can rotate 180° to mounting on either right hand or left hand position. For tanks 6"-15" deep. P/N 05-16710 **\$62.75**

STEARMAN FUEL GAUGE

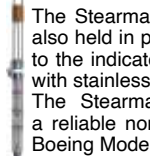

The Stearman High-Quality Fuel Gauge is designed so the cork is also held in place mechanically, using an Aluminum washer crimped to the indicator wire. All of the original steel parts are manufactured with stainless steel.

The Stearman High-Quality Fuel Gauge has become apparent a reliable non-leaking FAA-PMA fuel gauge that is needed for the Boeing Model 75 Stearman. P/N 10-07067 **\$549.00**

SPIRAL ACTION FUEL GAUGE



05-16900

A precision magnetic gauge for narrow vertical tanks. Rubber float travels on spiral rod to record fuel level on hermetically sealed side-reading dial marked E, 1/4, 1/2, 3/4, F. All aluminum construction. Housing has 1-1/2" NPT male threads for connection to threaded bushing (see below). Available in two lengths:

Length 'L' 15", Float Travel 12-3/4" P/N 05-16900 **\$69.85**
Length 'L' 19", Float Travel 16-3/4" P/N 05-17000 **\$81.95**



Welding Bushings - 6061 aluminum, 2-1/4" O.D., 1/4" wall. Available in 1" & 2" length. Use with welding ring to provide base for attaching to fuel tank with bolts or rivets. Ring may be welded at any point along bushing to permit depth adjustment. Specify bushing length. For use with Spiral Action Gauge.



1" Bushing P/N 10362-1 **\$14.45**
2" Bushing P/N 10362-2 **\$18.85**
Welding Ring - 6061 aluminum, 4-3/8" O.D., 2-1/4" I.D. to fit above welding bushings. For use with Spiral Action Gauge. P/N 10363 **\$6.80**

ROCHESTER 8341-R7090 SENDER



These fuel senders are designed for top mounting in unpressurized aluminum, stainless steel, or plastic fuel tanks in all types of marine vessels. They include special features and protection from corrosion problems (internal and external to the fuel tanks) which make them the quality standard for the industry. Standard configuration, with the lead hole at 12:00, has the float arm swinging at 3:00.

The float arm on this sender is 24" [609mm] long measured from the pivot point allowing it to be cut to an appropriate length to gauge any tank depth from 6" [152mm] to 25" [635mm]. The float and the washers are furnished unassembled to the float arm. The cutting and crimping process is to be done prior to the float assembly. The fuel sender is equipped with a thick film resistance card with a range of 0 to 90Ω. The recommended gasket for use under the head is made of nitrile rubber and must be ordered separately P/N 10-02045 **\$26.95**

MECHANICAL FUEL GAUGE



Lever-action gauge measures fuel level from full to empty on fractional dial. Matte-white markings on 2" black dial with red "No Take-off" sector below the 1/4 full mark. Cork float has 4" travel. Wire arm 12" long may be cut off to required length, wire bent to 90° angle to secure cork float. 1-13/16" between mounting hole centers. Hermetically sealed dial assembly has magnetically driven, silicone-damped or position pointer to prevent flutter P/N 05-16700 **\$105.75**

Accessories

Replacement Fuel Float P/N 05-03395 **\$3.60**
Weld Adapt FLANGE 10361 P/N 10361 **\$12.95**
Gasket for 05-16700 P/N 15-4 **\$3.65**

LUSCOMBE/AERONCA TYPE FUEL GAUGE



This direct reading fuel quantity gauge is usable in tank depths up to 9" such as Luscombe & Aeronca. Not FAA approved. Excellent for homebuilt aircraft. Displays fuel level from full to empty. Size: 1-1/2" diameter face.

Rebuild kit for Fuel Gauge P/N 05-00031 **\$13.55**

GAS GAUGE TOOL SETS



Use the Gas Gauge Tool Set to remove or install gauges. It helps prevent damage to chrome inner & outer nuts. Available in standard (economical version) and deluxe (heavy-duty version). The tool used on the standard (outer nut) has been specifically designed to work on the original or new style nut. The tool used on the deluxe (inner nut) has a tight fitting handle, which you will need to hammer in. This offers you better leverage & sure grip. Heavy-duty version.

Standard P/N 05-06813 **\$10.85**
Deluxe P/N 05-06814 **\$21.80**

GAS GAUGE FLOAT



Gas Gauge Float (Modern Neoprene Cork). Modern Neoprene Float: This float is alcohol and gas resistant, and will not sink. It is not affected by modern ethanol based fuels. Highly recommended. USA made.

Modern Neoprene Float P/N 05-06815 **\$10.55**

GAS GAUGE NUT



A9330 Gas Gauge Outer Nut. Large - Chrome Plated.

P/N 05-06817 **\$13.85**

CESSNA S2670-1 FUEL SENDER GASKET



ITC 13-10017-507 gasket used with Rochester fuel senders 7740 series. Cessna P/N S2670-1. Part 15-716 and 0015-00716 has been replaced by S2670-1. Only for used with Rochester type fuel sender P/N 11-18717 **\$63.75**