

**Powerhit** *ACURITE INDUSTRIES CORPORATION*

SERVING THE HAND TOOLS, HOBBY & CRAFT PRODUCTS INDUSTRY SINCE 1986

# ACURITE INDUSTRIES CORPORATION



Manufacturer & Exporter



Company : 5F, NO.81, SECTION 2, CHENG TEH ROAD, TAIPEI (103), TAIWAN (R.O.C.)

Factory : NO. 162-5, LN. 44, SEC. 2, ZHANGCAO RD., CHANGHUA COUNTY (508) , TAIWAN (R.O.C.)

TEL: 886-2-2556-1166

FAX: 886-2-2555-8605

E-MAIL: [acurite@ms5.hinet.net](mailto:acurite@ms5.hinet.net)

Dear Prospective Customer:

ACURITE INDUSTRIES CORPORATION has been established to be the producer, sales and distribution company for "POWERHIT" quality tools since 1986.

We are excited with our quality products and new smarter and stronger tools to come. Our research and development is a non-stop program to design and manufacture innovative tools for the marketing needs. We are well on our way to positioning "POWERHIT" products for growth in hardware tools industry.

We have capability to produce more accuracy and efficient quality tools no matter in our brand name – "POWERHIT" or "OEM" your private label brand products line. Let's work together and to grow together, it is mission to make sure you are 100% guaranteed satisfied. We intend to meet and exceed your expectations at any time, no matter now or in the future.

We have published this booklet as a user friendly guide to show how our products can help to build a more productive job. Our current full range of product is represented in a combined format for easy of reference. But rather a simple – to – use, one stop reference center for one of the most extensive lines of hardware tools industry. The information supplied here will help you make a more informed buying decision, and we believe you will agree that our products can do make your work more efficient and thank you for your considering on us.

Should you need additional information or assistance, please contact us.

Best Regards,

ACURITE INDUSTRIES CORPORATION

Ray Chang  
Manager

A large, stylized handwritten signature in black ink, which appears to read "Ray Chang". The signature is written in a cursive, flowing style.

# Index

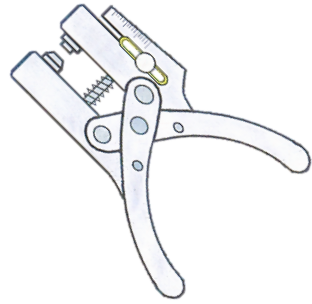

Hand Riveter.....	1-11
Garden Scissors.....	12-21
Knife.....	22-24
Saw.....	25-32
Caulking Gun.....	33-36
Glue Gun / Glue Stick.....	37
Carton Tape Dispenser.....	38
Craft Tools.....	39-41
Staple Gun Tacker.....	42-54
Staples.....	55-68
Wheel.....	69

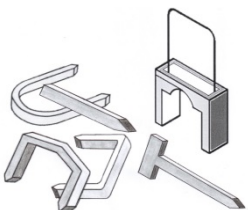

# Hand Riveter

## Heavy Duty Hand Riveter

**Feature:** Aluminum body, drop-forge handle, Jaw made of SCM 435.

**AP-GS701** Equipped – 4 nose piece  
 2.4 mm (3/32") 3.2 mm (1/8")  
 4.0 mm (5/32") 4.8 mm (3/16")

## Heavy Duty Hand Riveter

**Feature:** Aluminum body, drip-forge handle, Jaw made of SCM 435.

**AP-701** Equipped – 4 nose piece  
 2.4 mm (3/32") 3.2 mm (1/8")  
 4.0 mm (5/32") 4.8 mm (3/16")

## Heavy Duty Hand Riveter

**Feature:** Aluminum body, CR-MO steel handle, Jaw made of SCM 435, carbon steel Jaw case and pin.

**AP-721** Equipped – 4 nose piece  
 2.4 mm (3/32") 3.2 mm (1/8")  
 4.0 mm (5/32") 4.8 mm (3/16")



AP-GS701



AP-701



AP-721

## Different Packing



Hand riveter w/ 100pcs rivets  
 Packed by blow case and paper sleeve

**AP-GS701W**  
 1set/blow case, 16sets/ctn/1.85'

**AP-701W**  
 1set/blow case, 16sets/ctn/1.85'

**AP-721W**  
 1set/blow case, 16sets/ctn/1.85'



Hand riveter w/ 100pcs rivets  
 Packed by plastic case and paper sleeve

**AP-GS701B**  
 1set/plastic case, 20sets/ctn/1.70'

**AP-701B**  
 1set/plastic case, 20sets/ctn/1.70'

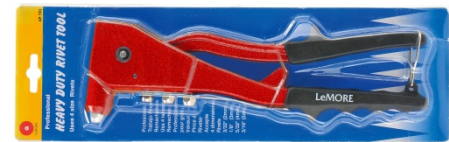

Packed by slide on card

**AP-GS701R**  
 1pc/sliding card, 24pcs/ctn/1.10'

**AP-701R**  
 1pc/sliding card, 24pcs/ctn/1.10'

**AP-721R**  
 1pc/sliding card, 24pcs/ctn/1.10'

# Hand Riveter

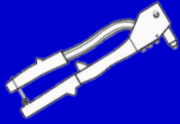

## Top Hand Riveter

**Feature:** Aluminum body, chrome-vanadium handle, Jaw made of SCM 435, carbon steel Jaw case and pin.

**AP-747** Equipped – 4 nose piece  
2.4 mm (3/32") 3.2 mm (1/8")  
4.0 mm (5/32") 4.8 mm (3/16")



AP-747

## Heavy Duty Hand Riveter

**Feature:** Aluminum body, drop-forge handle, Jaw made of SCM 435, carbon steel Jaw case and pin.

**AP-719** Equipped – 4 nose piece  
2.4 mm (3/32") 3.2 mm (1/8")  
4.0 mm (5/32") 4.8 mm (3/16")



AP-719

## Pop Hand Riveter

**Feature:** Aluminum body, drop-forge handle, Jaw made of SCM 435 CR-V Jaw case.

**AP-755** Equipped – 3 nose piece  
2.4 mm (3/32") 3.2 mm (1/8")  
4.0 mm (5/32")



AP-755

## Different Packing



Hand riveter w/ 100pcs rivets  
Packed by blow case and paper sleeve

**AP-747W**  
1set/blow case, 16sets/ctn/1.85'

**AP-719W**  
1set/blow case, 16sets/ctn/1.85'

**AP-755W**  
1set/blow case, 16sets/ctn/1.85'



Hand riveter w/ 80pcs rivets  
Packed by metal case and paper sleeve

**AP-747M**  
1set/metal case, 16sets/ctn/1.10'

# Hand Riveter

## Swivel Hand Rivet Gun

### Feature:

- Aluminum body, sheet iron handle.
- Free function head swivel a full 360° for any angle riveting.
- Makes strong vibration proof joints effortlessly.

**AP-736** Equipped – 4 nose piece  
 2.4 mm (3/32") 3.2 mm (1/8")  
 4.0 mm (5/32") 4.8 mm (3/16")

## Professional Hand Riveter

**Feature:** Aluminum body, drop-forge handle, Jaw made of SCM 435, carbon steel jaw case and pin, suitable for stainless steel rivets.

**AP-715** Equipped – 4 nose piece  
 2.4 mm (3/32") 3.2 mm (1/8")  
 4.0 mm (5/32") 4.8 mm (3/16")

## Professional Hand Riveter

**Feature:** Aluminum body, high carbon steel handle, Jaw made of SCM 435, carbon steel Jaw case and pin.

**AP-725** Equipped – 4 nose piece  
 2.4 mm (3/32") 3.2 mm (1/8")  
 4.0 mm (5/32") 4.8 mm (3/16")



## Different Packing



Hand riveter w/ 100pcs rivets  
 Packed by blow case and paper sleeve

**AP-736W**  
 1set/blow case, 16sets/ctn/1.85'

**AP-715W**  
 1set/blow case, 16sets/ctn/1.85'



Hand riveter w/ 100pcs rivets  
 Packed by plastic case and paper sleeve

**AP-715B**  
 1set/plastic case, 20sets/ctn/1.75'



Pack by slide on card

**AP-736R**  
 1pc/sliding card, 24pcs/ctn/1.40'

**AP-715R**  
 1pc/sliding card, 24pcs/ctn/1.10'

**AP-725R**  
 1pc/sliding card, 24pcs/ctn/1.10'

Hand riveter w/ 80pcs rivets and w/ 20pcs washers  
 Packed by metal case and paper sleeve

**AP-715M**  
 1set/metal case, 16sets/ctn/0.90'



# Hand Riveter

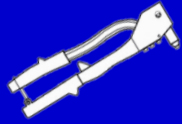

## Professional Heavy Duty Rivet Tool

**Feature:** Sheet iron body.

- AP-722** Equipped – 4 nose piece  
 2.4 mm (3/32") 3.2 mm (1/8")  
 4.0 mm (5/32") 4.8 mm (3/16")
- AP-702** Equipped – 4 nose piece  
 2.4 mm (3/32") 3.2 mm (1/8")  
 4.0 mm (5/32") 4.8 mm (3/16")
- AP-718** Equipped – 3 nose piece  
 2.4 mm (3/32") 3.2 mm (1/8")  
 4.0 mm (5/32")

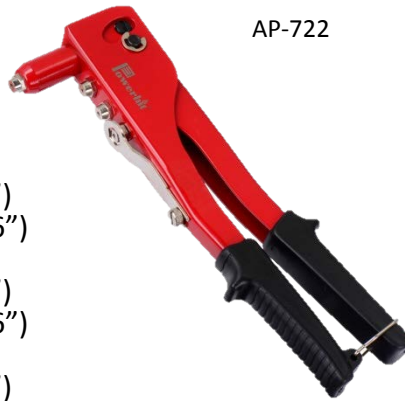

AP-722



AP-702



AP-708



AP-718

## Professional Heavy Duty Rivet Tool

**Feature:** Sheet iron body, carbon steel Jaw case,  
 Jaw made of SCM 435, suitable for stainless steel rivets.

- AP-708** Equipped – 3 nose piece  
 3.2 mm (1/8") 4.0 mm (5/32") 4.8 mm (3/16")

## Different Packing



Hand riveter w/ 100pcs rivets  
 Packed by blow case and paper sleeve

- AP-708W**  
 1set/blow case, 16sets/ctn/1.85'



Pack by color box (Corrugated)

- AP-702X**  
 1pc/color box, 25pcs/ctn/0.80'
- AP-722X**  
 1pc/color box, 25pcs/ctn/0.80'



Packed by slide on card

- AP-722R**  
 1pc/sliding card, 30pcs/ctn/1.30'
- AP-708R**  
 1pc/sliding card, 24pcs/ctn/1.20'
- AP-702R**  
 1pc/sliding card, 24pcs/ctn/1.10'
- AP-718R**  
 1pc/sliding card, 24pcs/ctn/1.25'

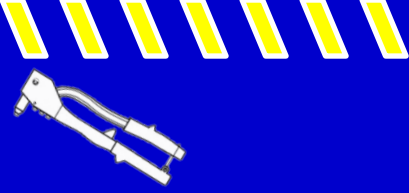

# Hand Riveter

## 2 Way Hand Riveter

**Feature:** Aluminum body, sheet iron handle.

**AP-S706** Equipped – 4 nose piece  
 2.4 mm (3/32") 3.2 mm (1/8")  
 4.0 mm (5/32") 4.8 mm (3/16")

## 2 Way Long Nose Hand Riveter

**Feature:** Aluminum body, sheet iron handle.

**AP-L706** Equipped – 4 nose piece  
 2.4 mm (3/32") 3.2 mm (1/8")  
 4.0 mm (5/32") 4.8 mm (3/16")

## Heavy Duty Hand Riveter

**Feature:** Aluminum body, drop-forge handle, Jaw made of SCM 435.

**AP-703** Equipped – 4 nose piece  
 2.4 mm (3/32") 3.2 mm (1/8")  
 4.0 mm (5/32") 4.8 mm (3/16")

## Packing



Hand riveter w/ 100pcs rivets  
 Packed by blow case and paper sleeve

**AP-S706W**  
 1set/blow case, 16sets/ctn/1.85'

**AP-L706W**  
 1set/blow case, 16sets/ctn/1.85'

**AP-703W**  
 1set/blow case, 20sets/ctn/1.70'



AP-S706



AP-L706



AP-703

## Hand Riveter

**Feature:**

- Ergonomics Design.
- Well-perform easy to aim it provides comfortable operation preventing user fatigue.

**AP-757** Equipped – 4 nose piece  
 2.4 mm (3/32") 3.2 mm (1/8")  
 4.0 mm (5/32") 3.2 mm (1/8") long nose  
 Packing: 1pc/double blister, 24pcs/ctn/1.40'

AP-757





# Hand Riveter

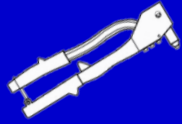

## Two Function Blind Riveter & Thread-Sert Tools

### Top Riveter Nut & Blind Riveter Tool

**Feature:** Aluminum body, CR-MO steel handle.

**AP-BL731** For blind rivets – 4 nose piece  
2.4 mm (3/32") 3.2 mm (1/8")  
4.0 mm (5/32") 4.8 mm (3/16")  
For nut rivets – 4 nose piece  
3.0 mm (M3) 4.0 mm (M4)  
5.0 mm (M5) 6.0 mm (M6)



AP-BL731

### Heavy Duty Riveter Nut & Blind Riveter Tool

**Feature:** Aluminum body, drop-forge handle.

**AP-BL758** For blind rivets – 4 nose piece  
2.4 mm (3/32") 3.2 mm (1/8")  
4.0 mm (5/32") 4.8 mm (3/16")  
For nut rivets – 4 nose piece  
3.0 mm (M3) 4.0 mm (M4)  
5.0 mm (M5) 6.0 mm (M6)



AP-BL758

**Feature:** Aluminum body, high carbon steel handle.

**AP-BL727** For blind rivets – 4 nose piece  
2.4 mm (3/32") 3.2 mm (1/8")  
4.0 mm (5/32") 4.8 mm (3/16")  
For nut rivets – 4 nose piece  
3.0 mm (M3) 4.0 mm (M4)  
5.0 mm (M5) 6.0 mm (M6)



AP-BL727

### Different Packing



**Nut Riveter Tool**  
With 40pcs nut rivets  
Size: M3, M4, M5, M6

Packed by blow case and paper sleeve

**AP-L731W**  
1set/blow case, 16sets/ctn/1.85'

**AP-L758W**  
1set/blow case, 16sets/ctn/1.85'

**AP-L727W**  
1set/blow case, 16sets/ctn/1.85'



**Two Function Tool**  
With 80pcs blind rivets and 40pcs nut rivets

For blind rivets: 2.4 mm, 3.2 mm, 4.0 mm, 4.8 mm  
For nut rivets: M3, M4, M5, M6

Packed by blow case and paper sleeve

**AP-BL731W**  
1set/blow case, 16sets/ctn/1.85'

**AP-BL758W**  
1set/blow case, 16sets/ctn/1.85'

**AP-BL727W**  
1set/blow case, 16sets/ctn/1.85'

# Hand Riveter

## Multi-Function Thread / Blind Riveter Gun

**Feature:** Aluminum body, drop-forge handle.

**AP-GS712X** For blind rivets - 4 nose piece  
2.4 mm (3/32") 3.2 mm (1/8")  
4.0 mm (5/32") 4.8 mm (3/16")  
For nut rivets - 4 nose piece  
3.0 mm (M3) 4.0 mm (M4)  
5.0 mm (M5) 6.0 mm (M6)  
Packing: 1set/corrugated color box, 25sets/ctn/1.00'



AP-GS712

## Professional Riveter Nut Gun

**Feature:** Sheet iron body, PVC hand grips.

**AP-738W** Includes threaded mandrels and 4 nose piece:  
- Metric size: M3, M4, M5, M6  
or  
- SAE size: 6-32, 8-32, 10-24, 1/4"-20  
Packing: 1set/blow case, 16sets/ctn/1.85'  
(Each in blow case w/ 40pcs nut rivets and paper sleeve)

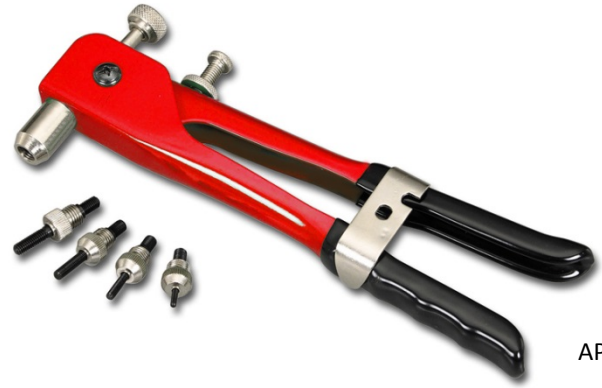

AP-738

## Anchor Riveter

**Feature:** Sheet iron body, PVC hand grips

**AP-707R** For nut rivets - 4 nose piece:  
3.0 mm (M3) 4.0 mm (M4)  
5.0 mm (M5) 6.0 mm (M6)  
Packing: 1pc/sliding card, 30pcs/ctn/1.30'  
(Packed by slide on card)



AP-707

# Hand Riveter

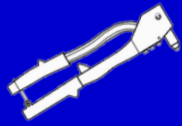

## Lazy Tone Industrial Riveter

**Feature:** Made of durable high carbon steel, adjustable nose assembly.

**AP-L710** For rivets - 4 nose piece  
 2.4 mm (3/32") 3.2 mm (1/8")  
 4.0 mm (5/32") 4.8 mm (3/16")

Packing: 1pc/corrugated color box, 12pcs/ctn/1.40'



AP-L710

## Scissor Action Industrial Riveter

**Feature:** Made of durable high carbon steel, adjustable nose assembly.

**AP-710** For rivets - 4 nose piece  
 2.4 mm (3/32") 3.2 mm (1/8")  
 4.0 mm (5/32") 4.8 mm (3/16")

Packing: 1pc/corrugated color box, 12pcs/ctn/1.40'



AP-710

**Feature:** Made of durable high carbon steel, adjustable nose assembly.

**AP-711** For rivets - 4 nose piece  
 3.2 mm (1/8") 4.0 mm (5/32")  
 4.8 mm (3/16") 6.4 mm (1/4")

Packing: 1pc/corrugated color box, 12pcs/ctn/1.40'



AP-711

# Hand Riveter

## Effortless Heavy Duty Hand Riveter

**Feature:** Aluminum body, CR-MO handle, two-tone hand grips, Jaw made of SCM 435, CR-V Jaw case.

**AP-754** Equipped with 1 compartment for PP nose, wrench and 1 residue collect bottle made of PE.

For blind rivets - 4 nose piece

2.4 mm (3/32") 3.2 mm (1/8")  
4.0 mm (5/32") 4.8 mm (3/16")

AP-754



## Effortless Industrial Hand Riveter

**Feature:** Aluminum body, CR-MO handle, two-tone hand grips, Jaw made of SCM 435, CR-V Jaw case.

**AP-764** Equipped with 1 compartment for PP nose, wrench and 1 residue collect bottle made of PE.

For blind rivets - 4 nose piece

3.2 mm (1/8") 4.0 mm (5/32")  
4.8 mm (3/16") 6.4 mm (1/4")

AP-764



## Packing



Each in color box (Corrugated)

**AP-754X**

1pc/color box, 24pcs/ctn/1.52'

**AP-764X**

1pc/color box, 16pcs/ctn/1.47'



Hand riveter w/ 160pcs rivets

Packed by blow case and paper sleeve

**AP-754W**

1set/blow case, 8sets/ctn/1.87'

**AP-764W**

1set/blow case, 8sets/ctn/1.87'

# Hand Riveter

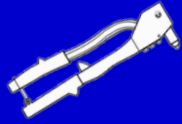

## Effortless Industrial Riveter Nut Tool

**Feature:** Aluminum body, CR-MO handle, two-tone hand grips.

**AP-784** Includes threaded mandrels & 4 nose piece:  
- Metric size: M5, M6, M8, M10  
or  
- Inch size: 10-24, 1/4"-20, 5/16"-18, 3/8"-16



AP-784

## Effortless Two-Function Industrial Riveter Nut & Blind Riveter

**Feature:** Aluminum body, CR-MO handle, two-tone hand grips, Jaw made of SCM 435 & SCM 415 threaded mandrels.

**AP-794** For blind rivets - 4 nose piece  
3.2mm (1/8") 4.0mm (5/32")  
4.8mm (3/16") 6.4mm (1/4")

For nut rivets:  
- Metric size: M5, M6, M8, M10  
or  
- Inch size: 10-24, 1/4"-20, 5/16"-18, 3/8"-16

AP-794



## Packing



Each in color box (Corrugated)

**AP-784X**  
1pc/color box, 12pcs/ctn/1.10'

**AP-794X**  
1pc/color box, 12pcs/ctn/1.30'



**AP-784W** Rivet nut tool w/ 80pcs nut rivets.  
Packed by blow case and paper sleeve  
1set/blow case, 6sets/ctn/1.40'

**AP-794W** Two-function tool w/ 40pcs nut rivets  
and 80 pcs blind rivets.  
Packed by blow case and paper sleeve  
1set/blow case, 8sets/ctn/1.86'

# Hand Riveter

## Lever Riveter

**Feature:** Aluminum body, steel tube with rubber handle grips.

**AP-704** Equipped – 4 nose piece  
 2.4 mm (3/32") 3.2 mm (1/8")  
 4.0 mm (5/32") 4.8 mm (3/16")

Packing: 1pc/corrugated color box, 10pcs/ctn/0.95'



AP-704

## Industrial Lever Riveter

**Feature:** Aluminum body, steel tube with rubber handle grips.

**AP-714** Equipped – 4 nose piece  
 3.2 mm (1/8") 4.0 mm (5/32")  
 4.8 mm (3/16") 6.4 mm (1/4")

Packing: 1pc/corrugated color box, 12pcs/ctn/1.20'



AP-714

## Heavy Duty Riveter Nut Tool

**Feature:** Aluminum body, steel tube with rubber hand grips.

**AP-734** For nut rivets - 4 nose piece:  
 - Metric size: 5.0 mm (M5), 6.0 mm (M6),  
 8.0 mm (M8), 10.0 mm (M10)

OR

- Inch size: 10-24, 1/4"-20, 5/16"-18, 3/8"-16  
 Packing: 1pc/corrugated color box, 10pcs/ctn/1.50'

**AP-L734** For nut rivets - 5 nose piece:  
 - Metric size: 5.0 mm (M5), 6.0 mm (M6),  
 8.0 mm (M8), 10.0 mm (M10), 12 mm (M12)

OR

- Inch size: 10-24, 1/4"-20, 5/16"-18, 3/8"-16  
 Packing: 1pc/corrugated color box, 12pcs/ctn/1.50'



AP-734

AP-L734

# Garden Scissors

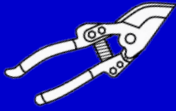

## Feature:

- For cutting hydroponic plant, trimming twig and flower.
- Very sharp tip for precision cutting.

## Trimming Shears



31465

Item No.31465	
SIZE	6.5"(163mm)
KIND OF BLADE & THICKNESS	Stainless steel 420J2, 2.0mm
SURFACE TREATMENT	Polish
HANDLE	Nylon+Fiberglass & TPR
PACKING	1PC/Blister sliding card
INNER	12
CARTON	72
MEAS	1.80'



31443

Item No.31443	
SIZE	7.25" (185mm)
KIND OF BLADE & THICKNESS	Stainless steel 420J2, 2.5mm
SURFACE TREATMENT	Polish
HANDLE	PP & TPR
PACKING	1PC/Blister sliding card
INNER	12
CARTON	120
MEAS	1.90'



31443A

CURVED

Item No.31443A	
SIZE	7.25" (185mm)
KIND OF BLADE & THICKNESS	Stainless steel 420J2, 2.5mm
SURFACE TREATMENT	Polish
HANDLE	PP & TPR
PACKING	1PC/Blister sliding card
INNER	12
CARTON	120
MEAS	1.90'



31451

Item No.31451	
SIZE	6.25" (156mm)
KIND OF BLADE & THICKNESS	Stainless steel 420J2, 2.5mm
SURFACE TREATMENT	Polish
HANDLE	PP & TPR
PACKING	1PC/Blister sliding card
INNER	12
CARTON	144
MEAS	2.30'

Item No.31452	
SIZE	6.75" (172mm)
KIND OF BLADE & THICKNESS	Stainless steel 420J2, 2.5mm
SURFACE TREATMENT	Polish
HANDLE	PP & TPR
PACKING	1PC/Blister sliding card
INNER	12
CARTON	144
MEAS	2.30'



31452

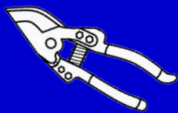

# Garden Scissors



Item No.31452A	
SIZE	6.75" (172mm)
KIND OF BLADE & THICKNESS	Stainless steel 420J2, 2.5mm
SURFACE TREATMENT	Polish
HANDLE	PP & TPR
PACKING	1PC/Blister sliding card
INNER	12
CARTON	144
MEAS	2.30'

## Bonsai Scissors

### Feature:

- For trimming stalk and stem, cutting grape and flower.

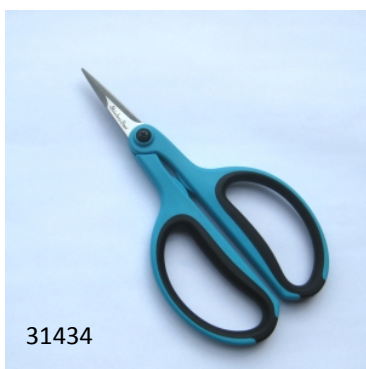

Item No.31434	
SIZE	6" (155mm)
KIND OF BLADE & THICKNESS	Stainless steel 420J2, 2.5mm
SURFACE TREATMENT	Polish
HANDLE	PP & TPR
PACKING	1PC/Blister sliding card
INNER	12
CARTON	144
MEAS	2.00'



Item No.31435	
SIZE	7" (177mm)
KIND OF BLADE & THICKNESS	Stainless steel 420J2, 2.5mm
SURFACE TREATMENT	Polish
HANDLE	PP & TPR
PACKING	1PC/Blister sliding card
INNER	12
CARTON	144
MEAS	2.00'



Item No.31438	
SIZE	6" (153mm)
KIND OF BLADE & THICKNESS	Stainless steel 420J2, 2.5mm
SURFACE TREATMENT	Satin Finished
HANDLE	PP
PACKING	1PC/Blister sliding card
INNER	12
CARTON	144
MEAS	2.00'



Item No.31439	
SIZE	6.25" (161mm)
KIND OF BLADE & THICKNESS	Stainless steel 420J2, 2.5mm
SURFACE TREATMENT	Satin Finished
HANDLE	PP
PACKING	1PC/Blister sliding card
INNER	12
CARTON	144
MEAS	2.00'



# Garden Scissors

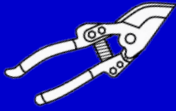

31440

Item No.31440	
SIZE	7.25" (183mm)
KIND OF BLADE & THICKNESS	Stainless steel 420J2, 2.5mm
SURFACE TREATMENT	Satin Finished
HANDLE	PP
PACKING	1PC/Blister sliding card
INNER	12
CARTON	144
MEAS	2.00'



31442

Item No.31442	
SIZE	6.25" (162mm)
KIND OF BLADE & THICKNESS	Stainless steel 420J2, 2.5mm
SURFACE TREATMENT	Satin Finished
HANDLE	PP
PACKING	1PC/Blister sliding card
INNER	12
CARTON	144
MEAS	2.00'



31445

Item No.31445	
SIZE	6" (153mm)
KIND OF BLADE & THICKNESS	Stainless steel 420J2, 2.5mm
SURFACE TREATMENT	Satin Finished
HANDLE	PP
PACKING	1PC/Blister sliding card
INNER	12
CARTON	144
MEAS	2.00'



31464

Item No.31464	
SIZE	6" (154mm)
KIND OF BLADE & THICKNESS	Stainless steel 420J2, 2.5mm
SURFACE TREATMENT	Satin Finished
HANDLE	PP & soft TPR grips
PACKING	1PC/Blister sliding card
INNER	12
CARTON	144
MEAS	2.00'

## Pruning Shears - Plastic Handle

**Feature:** For cutting branch.

Item No.31463	
SIZE	8.25" (211mm)
UPPER KIND OF BLADE & THICKNESS	High carbon steel SK-5, 3.5mm
LOWER KIND OF BLADE & THICKNESS	High carbon steel SK-5, 4.0mm
SURFACE TREATMENT	Fluorine Coating / Hard Chrome Plated
HANDLE	Aluminum & TPR
PACKING	1PC/Blister sliding card
INNER	12
CARTON	72
MEAS	1.60'

31463

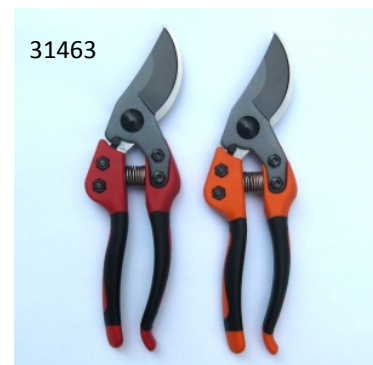

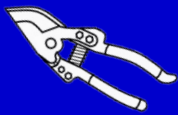

# Garden Scissors



31458-1-7.5

Item No.31458-1-7.5	
SIZE	7.5" (190mm)
UPPER KIND OF BLADE & THICKNESS	High carbon steel SK-5, 3.0mm
LOWER KIND OF BLADE & THICKNESS	Middle carbon steel S50C, 3.5mm
SURFACE TREATMENT	Fluorine Coating / Hard Chrome Plated
HANDLE	Nylon+Fiberglass & TPR
PACKING	1PC/Blister sliding card
INNER	12
CARTON	72
MEAS	2.07'



31459-1

Item No.31459-1	
SIZE	8.75" (221mm)
KIND OF BLADE & THICKNESS	High carbon steel SK-5, 3.0mm / 3.5mm
SURFACE TREATMENT	Hard Chrome Plated
HANDLE	Nylon+Fiberglass & TPR
PACKING	1PC/Blister sliding card
INNER	10
CARTON	60
MEAS	2.07'



31460

Item No.31460	
SIZE	8.25" (210mm)
UPPER KIND OF BLADE & THICKNESS	High carbon steel SK-5, 2.5mm
LOWER KIND OF BLADE & THICKNESS	High carbon steel SK-5, 4.0mm
SURFACE TREATMENT	Black Oxide
HANDLE	Composite material
PACKING	1PC/Blister sliding card
INNER	12
CARTON	72
MEAS	1.90'

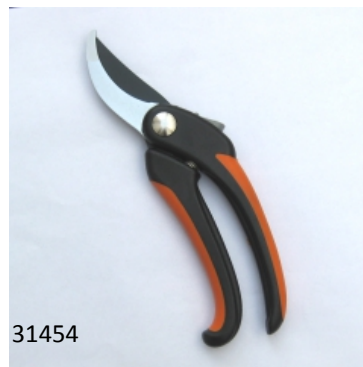

31454

Item No.31454	
SIZE	8.5" (217mm)
KIND OF BLADE & THICKNESS	High carbon steel SK-5, 3.5mm
SURFACE TREATMENT	Fluorine Coating / Hard Chrome Plated
HANDLE	Nylon+Fiberglass & TPR
PACKING	1PC/Blister sliding card
INNER	12
CARTON	72
MEAS	1.96'

Item No.31455	
SIZE	8.00" (200mm)
KIND OF BLADE & THICKNESS	High carbon steel SK-5, 4.0mm
SURFACE TREATMENT	Hard Chrome Plated
HANDLE	Nylon+Fiberglass & TPR
PACKING	1PC/Blister sliding card
INNER	12
CARTON	72
MEAS	1.62'

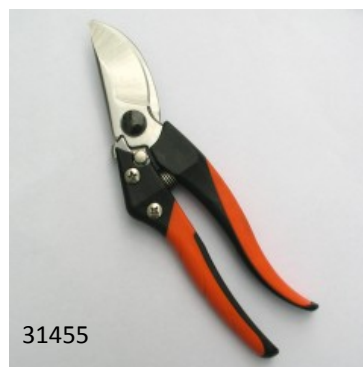

31455

# Garden Scissors

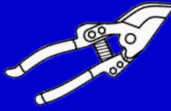

31441

Item No.31441	
SIZE	8.00" (202mm)
KIND OF BLADE & THICKNESS	High carbon steel SK-5, 3.5mm
SURFACE TREATMENT	Black Finished
HANDLE	PP & TPR
PACKING	1PC/Blister sliding card
INNER	10
CARTON	60
MEAS	1.60'



31441S

Item No.31441S	
SIZE	8.00" (202mm)
KIND OF BLADE & THICKNESS	Stainless steel 420J2, 3.5mm
SURFACE TREATMENT	Mirror Polish
HANDLE	PP & TPR
PACKING	1PC/Blister sliding card
INNER	10
CARTON	60
MEAS	1.60'



31446S

Item No.31446S	
SIZE	6.5" (168mm)
KIND OF BLADE & THICKNESS	Stainless steel 420J2, 3.5mm
SURFACE TREATMENT	Mirror Polish
HANDLE	PP
PACKING	1PC/Blister sliding card
INNER	12
CARTON	120
MEAS	2.20'



31447

Item No.31447	
SIZE	6.75" (173mm)
KIND OF BLADE & THICKNESS	Middle carbon steel S50C, 3.5mm
SURFACE TREATMENT	Black Finished
HANDLE	PP
PACKING	1PC/Blister sliding card
INNER	12
CARTON	120
MEAS	2.20'

## Pruning Shears - Aluminum Handle

Item No.31462A	
SIZE	8.25" (210mm)
KIND OF BLADE & THICKNESS	High carbon steel SK-5, 3.5mm
SURFACE TREATMENT	Baked Painting
HANDLE	Aluminum
PACKING	1PC/Blister sliding card
INNER	12
CARTON	72
MEAS	1.60'

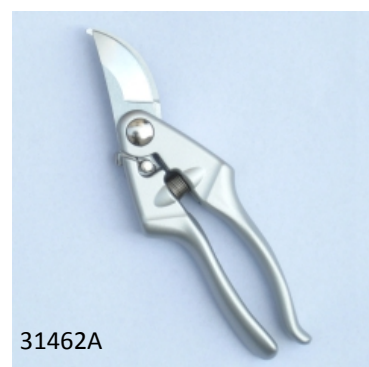

31462A

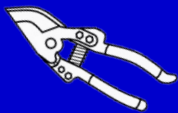

# Garden Scissors

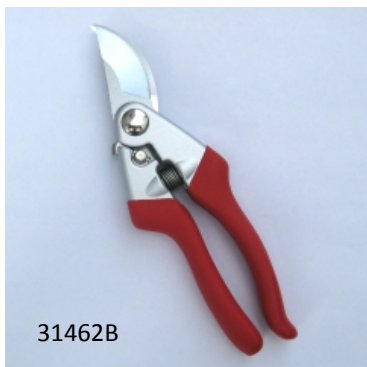

31462B

Item No.31462B	
SIZE	8.25" (210mm)
KIND OF BLADE & THICKNESS	High carbon steel SK-5, 3.5mm
SURFACE TREATMENT	Baked Painting
HANDLE	Aluminum & PVC
PACKING	1PC/Blister sliding card
INNER	12
CARTON	72
MEAS	1.62'



31436

Item No.31436	
SIZE	6.25" (159mm)
KIND OF BLADE & THICKNESS	Stainless steel 420J2, 2.5mm
SURFACE TREATMENT	Polish
HANDLE	Zinc & Soft TPR grips
PACKING	1PC/Blister sliding card
INNER	12
CARTON	120
MEAS	1.95'

Item No.31437	
SIZE	6.00" (148mm)
KIND OF BLADE & THICKNESS	Stainless steel 420J2, 2.5mm
SURFACE TREATMENT	Polish
HANDLE	Zinc & Soft TPR grips
PACKING	1PC/Blister sliding card
INNER	12
CARTON	120
MEAS	1.95'



31437

## Multi-Purpose Shears

**Feature:** For cutting little branch, stalk, cardboard, plastic tape, metal sheet, wire, leather and net.

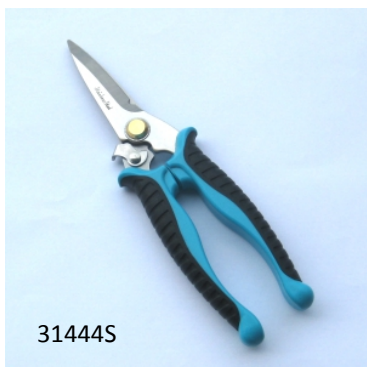

31444S

Item No.31444S	
SIZE	8" (202mm)
KIND OF BLADE & THICKNESS	Stainless steel 420J2, 3.5mm
SURFACE TREATMENT	Polish
HANDLE	PP & TPR
PACKING	1PC/Blister sliding card
INNER	12
CARTON	72
MEAS	1.90'



31453S

Item No.31453S	
SIZE	10.25" (260mm)
KIND OF BLADE & THICKNESS	Stainless steel 420J2, 2.5mm
SURFACE TREATMENT	Polish
HANDLE	Nylon+Fiberglass & TPR
PACKING	1PC/Blister sliding card
INNER	12
CARTON	72
MEAS	2.23'

# Garden Scissors

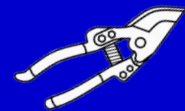

31449S

Item No.31449S	
SIZE	8" (200mm) & 9" (224mm)
KIND OF BLADE & THICKNESS	Stainless steel 420J2, 3.0mm
SURFACE TREATMENT	Polish
HANDLE	Nylon+Fiberglass & TPR
PACKING	1PC/Blister sliding card
INNER	12
CARTON	72
MEAS	1.74'

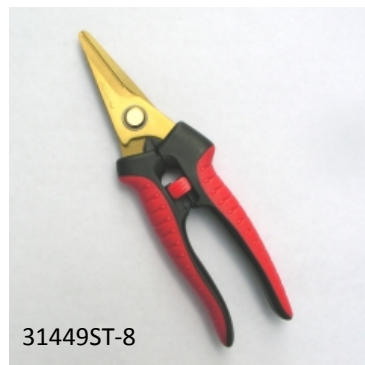

31449ST-8

Item No.31449ST-8	
SIZE	8" (200mm)
KIND OF BLADE & THICKNESS	Stainless steel 420J2, 3.0mm
SURFACE TREATMENT	Titanium Plating
HANDLE	PP+Fiberglass & TPR
PACKING	1PC/Blister sliding card
INNER	12
CARTON	72
MEAS	1.74'

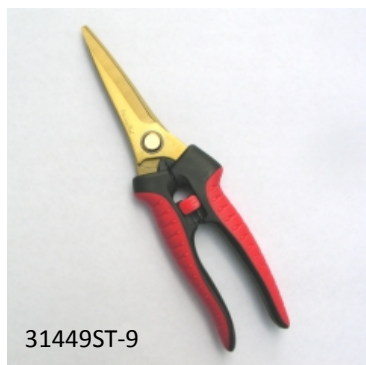

31449ST-9

Item No.31449ST-9	
SIZE	9" (224mm)
KIND OF BLADE & THICKNESS	Stainless steel 420J2, 3.0mm
SURFACE TREATMENT	Titanium Plating
HANDLE	PP+Fiberglass & TPR
PACKING	1PC/Blister sliding card
INNER	12
CARTON	72
MEAS	1.74'

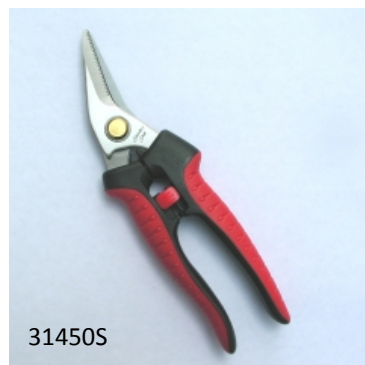

31450S

Item No.31450S	
SIZE	7.75" (197mm)
KIND OF BLADE & THICKNESS	Stainless steel 420J2, 3.0mm
SURFACE TREATMENT	Polish
HANDLE	PP+Fiberglass & TPR
PACKING	1PC/Blister sliding card
INNER	12
CARTON	72
MEAS	1.74'

Item No.31450ST	
SIZE	7.75" (197mm)
KIND OF BLADE & THICKNESS	Stainless steel 420J2, 3.0mm
SURFACE TREATMENT	Titanium Plating
HANDLE	PP+Fiberglass & TPR
PACKING	1PC/Blister sliding card
INNER	12
CARTON	72
MEAS	1.74'

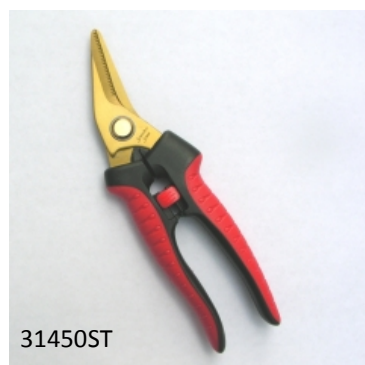

31450ST

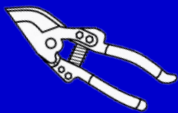

# Garden Scissors



31461S-7.5

Item No.31461S-7.5	
SIZE	7.5" (190mm)
KIND OF BLADE & THICKNESS	Stainless steel 420J2, 4.0mm
SURFACE TREATMENT	Satin Finished
HANDLE	Aluminum & TPR
PACKING	1PC/Blister sliding card
INNER	12
CARTON	72
MEAS	2.00'



31461S-8.25

Item No.31461S-8.25	
SIZE	8.25" (210mm)
KIND OF BLADE & THICKNESS	Stainless steel 420J2, 4.0mm
SURFACE TREATMENT	Satin Finished
HANDLE	Aluminum & TPR
PACKING	1PC/Blister sliding card
INNER	12
CARTON	72
MEAS	2.00'

Item No.31461S-9	
SIZE	9" (230mm)
KIND OF BLADE & THICKNESS	Stainless steel 420J2, 4.0mm
SURFACE TREATMENT	Satin Finished
HANDLE	Aluminum & TPR
PACKING	1PC/Blister sliding card
INNER	12
CARTON	72
MEAS	2.00'



31461S-9

## Topiary shears / Grass shears

Feature: Onion shear, Wool shear.

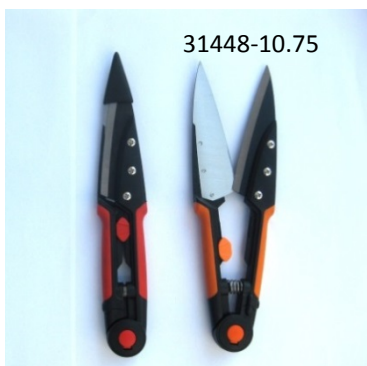

31448-10.75

Item No.31448-10.75	
SIZE	10.75" (274mm)
KIND OF BLADE & THICKNESS	High carbon steel SK-5, 2.0mm
SURFACE TREATMENT	Black Finished
HANDLE	Nylon+Fiberglass & TPR
PACKING	1PC/Blister sliding card
INNER	6
CARTON	36
MEAS	1.54'



31448-13.5

Item No.31448-13.5	
SIZE	13.5" (344mm)
KIND OF BLADE & THICKNESS	High carbon steel SK-5, 2.5mm
SURFACE TREATMENT	Black Finished
HANDLE	Nylon+Fiberglass & TPR
PACKING	1PC/Blister sliding card
INNER	6
CARTON	36
MEAS	1.54'

# Garden Scissors

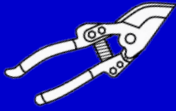

Item No.31433	
SIZE	14.25" (363mm)
KIND OF BLADE & THICKNESS	Stainless steel 420J2, 2.0mm
SURFACE TREATMENT	Polish
HANDLE	Nylon+Fiberglass & TPR
PACKING	1PC/Blister sliding card
INNER	6
CARTON	24
MEAS	1.98'



31433

## Aviation Tin Snips

### Feature:

- Available for round cutting purpose.
- Serrated edged blades induction hardened.

Item No.33591L	
SIZE	9.80" (250mm)
SURFACE TREATMENT & HARDNESS	Sand Blasted HRC 52°
KIND OF BLADE	Drop forged, chrome-vanadium steel curved blades, double side hobbing
PACKING	1PC/Blister sliding card
INNER	20
CARTON	40
MEAS	2.0'

Left cut

Straight cut

Right cut



33591L



33590S



33592R

Item No.33590S	
SIZE	9.80" (250mm)
SURFACE TREATMENT & HARDNESS	Sand Blasted HRC 52°
KIND OF BLADE	Drop forged, chrome-vanadium steel curved blades, double side hobbing
PACKING	1PC/Blister sliding card
INNER	20
CARTON	40
MEAS	2.0'

Item No.33592R	
SIZE	9.80" (250mm)
SURFACE TREATMENT & HARDNESS	Sand Blasted HRC 52°
KIND OF BLADE	Drop forged, chrome-vanadium steel curved blades, double side hobbing
PACKING	1PC/Blister sliding card
INNER	20
CARTON	40
MEAS	2.0'

## Corrugated-sheet Cutters

Item No.30748	
SIZE	22" (560mm)
MATERIAL	CRV
CUTTING CAPACITY	10mm cuts fibre cement sheeting
PACKING	1PC/Sliding card
INNER	
CARTON	10
MEAS	1.40'



30748

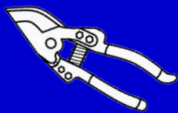

# Garden Scissors

## Bypass Cutter



31428

Item No.31428	
SIZE	8.50" (215mm)
UPPER KIND OF BLADE & HARDNESS	High carbon steel SK-5, HRC 52°-54°
LOWER KIND OF BLADE & HARDNESS	High carbon steel SK-5, HRC 45°
SURFACE TREATMENT	Chrome Plated
HANDLE	Nylon PA 6 + GF 30%
PACKING	1PC/Blister sliding card
CARTON	24
MEAS	0.80'

## PVC Water Pipe Cutter



31429

Item No.31429	
SIZE	8" (200mm)
KIND OF BLADE & HARDNESS	High carbon steel SK-5, HRC 56°
CUTTING CAPACITY	Ø 35mm
SURFACE TREATMENT	Baked Painting
HANDLE	Aluminum & PVC
PACKING	1PC/Blister sliding card
CARTON	24
MEAS	0.80'



31430

Item No.31430	
SIZE	8" (200mm)
KIND OF BLADE & HARDNESS	Steel SK-5, HRC 56°
CUTTING CAPACITY	Ø 35mm
SURFACE TREATMENT	Baked Painting
HANDLE	Aluminum & PVC
PACKING	1PC/Blister sliding card
CARTON	24
MEAS	0.80'



31431

Item No.31431	
SIZE	7.5" (190mm)
KIND OF BLADE & HARDNESS	Steel SK-5, HRC 56°
CUTTING CAPACITY	Ø 42mm
SURFACE TREATMENT	Baked Painting
HANDLE	Aluminum & PVC
PACKING	1PC/Blister sliding card
CARTON	24
MEAS	0.80'



31432

Item No.31432	
SIZE	7.5" (190mm)
KIND OF BLADE & HARDNESS	High carbon steel SK-5, HRC 56°
CUTTING CAPACITY	Ø 42mm
SURFACE TREATMENT	Baked Painting
HANDLE	Aluminum & PVC
PACKING	1PC/Blister sliding card
CARTON	24
MEAS	0.80'



# Knife

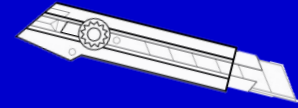
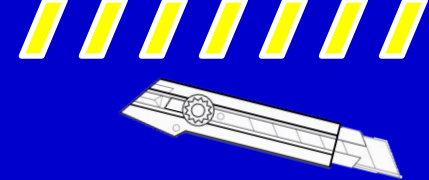

## Heavy Duty Knife



Auto knob can lock the blade



Material of blade: SK5

- |   |   |
|---|---|
| <p><b>01667A</b> Heavy duty knife w/o blade lock<br/>Aluminum alloy with TPR handle<br/>Blade size: 0.5 x 18 x 100 mm (#01623)<br/>Packing: 1pc/blister card,<br/>10pcs/inner, 120pcs/ctn</p> | <p><b>01670</b> Heavy duty knife w/ blade lock knob<br/>ABS (gray color) + TPR (black color) handle<br/>Blade size: 0.7 x 25 x 139 mm<br/>Packing: 1pc/blister card,<br/>10pcs/inner, 60pcs/ctn</p> |
| <p><b>01667K</b> Heavy duty knife w/ blade lock<br/>Aluminum alloy with TPR handle<br/>Blade size: 0.5 x 18 x 100 mm (#01623)<br/>Packing: 1pc/blister card,<br/>10pcs/inner, 120pcs/ctn</p>  | <p><b>01669</b> Heavy duty knife<br/>ABS (gray color) + TPR (black color) handle<br/>Blade size: 0.5 x 18 x 100 mm (#01623)<br/>Packing: 1pc/blister card,<br/>12pcs/inner, 72pcs/ctn</p>           |
| <p><b>01666</b> Non-slip heavy duty knife<br/>Zinc alloy handle<br/>Blade size: 0.7 x 25 x 139 mm<br/>Packing: 1pc/blister card,<br/>12pcs/inner, 72pcs/ctn</p>                               | <p><b>01680</b> Safe utility knife<br/>Zinc alloy with TPR handle<br/>Blade size: 0.6 x 18.9 x 61.5 mm (#01687)<br/>Packing: 1pc/blister card,<br/>12pcs/inner, 72pcs/ctn</p>                       |
| <p><b>01665</b> Non-slip heavy duty knife<br/>Zinc alloy handle<br/>Blade size: 0.5 x 18 x 100 mm (#01623)<br/>Packing: 1pc/blister card,<br/>12pcs/inner, 72pcs/ctn</p>                      | <p><b>01679</b> Four-stage push rod utility knife<br/>Zinc alloy with TPR handle<br/>Blade size: 0.6 x 18.9 x 61.5 mm (#01687)<br/>Packing: 1pc/blister card,<br/>12pcs/inner, 72pcs/ctn</p>        |

# Knife

## Utility Knife



Material of blade: SK5

- 01684** Utility knife  
Zinc alloy handle  
Blade size: 0.6 x 18.9 x 61.5 mm (#01687)  
Packing: 1pc/bag,  
12pcs/inner, 144pcs/ctn
- 01678** Utility knife w/ blade storage handle  
Four-stage push rod  
Aluminum alloy with TPE handle  
Blade size: 0.6 x 18.9 x 61.5 mm (#01687)  
Packing: 1pc/blister card,  
12pcs/inner, 72pcs/ctn
- 01676** Utility knife  
Zinc alloy handle  
Blade size: 0.6 x 18.9 x 61.5 mm (#01687)  
Packing: 1pc/blister card,  
12pcs/inner, 72pcs/ctn

- 01674** Safe utility knife w/ blade storage  
Aluminum alloy handle  
Blade size: 0.6 x 18.9 x 61.5 mm (#01687)  
Packing: 1pc/sandwich type blister card,  
10pcs/inner, 60pcs/ctn
- 01677** Utility knife w/ blade storage  
Aluminum alloy handle  
Blade size: 0.6 x 18.9 x 61.5 mm (#01687)  
Packing: 1pc/blister card,  
12pcs/inner, 72pcs/ctn
- 01681** Utility knife w/ blade storage  
Zinc alloy head & aluminum alloy handle  
Blade size: 0.6 x 18.9 x 61.5 mm (#01687)  
Packing: 1pc/blister card,  
12pcs/inner, 72pcs/ctn
- 01675** Folding utility knife  
Zinc alloy handle  
Blade size: 0.6 x 18.9 x 61.5 mm (#01687)  
Packing: 1pc/blister card,  
12pcs/inner, 72pcs/ctn

# Knife

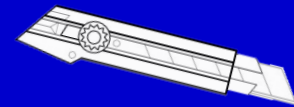
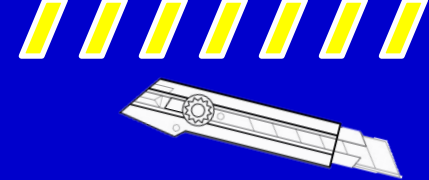

## Utility Knife



The blade can be attracted

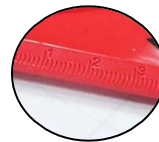

Scale ruler for convenient measurement



Material of blade: SK5

**01673** Utility knife w/ blade magent  
ABS (red color) + TPR (black color) handle  
Blade size: 0.7 x 25 x 139 mm  
Packing: 1pc/blister card,  
10pcs/inner, 120pcs/ctn

**01672** Utility knife  
ABS (red color) + Metal (silver color) handle  
Blade size: 0.5 x 18 x 100 mm (#01623)  
Packing: 1pc/blister card,  
12pcs/inner, 144pcs/ctn

**01604** Utility knife w/ blade locking knob  
Snap-off blade cutters for heavy duty  
ABS (red color) + Metal (silver color) handle  
Blade size: 0.5 x 18 x 100 mm (#01623)  
Packing: 1pc/blister card,  
12pcs/inner, 144pcs/ctn

**01682** Wallpaper edger  
ABS (red color) + Metal (silver color) handle  
Blade size: 0.4 x 9 x 80 mm  
Packing: 1pc/blister card,  
8pcs/inner, 192pcs/ctn

**01668** Utility knife w/ blade locking knob  
Special push rod  
ABS (yellow color) + TPR (black color) handle  
Blade size: 0.5 x 18 x 100 mm (#01623)  
Packing: 1pc/blister card,  
12pcs/inner, 72pcs/ctn

**01671** Utility knife  
ABS (black color) + Metal (silver color) handle  
Blade size: 0.5 x 18 x 100 mm (#01623)  
Packing: 1pc/blister card,  
12pcs/inner, 144pcs/ctn

**01683** Carton cutters  
Zinc coating  
Blade size: 0.3 x 19 x 39 mm (#01620)  
Packing: 12pcs/inner, 600pcs/ctn

**01685** Window scraper  
ABS handle  
Blade size: 0.3 x 19 x 39 mm (#01620)  
Packing: 1pc/OPP bag,  
60pcs/inner, 720pcs/ctn

## Replacement Blades

**01623** Size: 18 x 100 mm  
Packing: 10pcs/tube, 20tubes/inner, 240tubes/ctn/0.90'  
**01620** Size: 19 x 39 mm  
Packing: 5pcs/card, 12cards/inner, 576cards/ctn/1.48'  
**01687** Size: 18.9 x 61.5 mm  
Packing: 10pcs/box, 100boxes/inner, 600boxes /ctn



01620

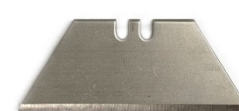

01687

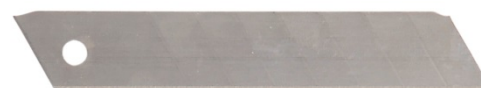

01623

# Saw

## Hacksaw

- 30705**
- Steel frame can be adjustable to fits 8", 10" or 12" saw blade
  - ABS + TPR handle (Thermoplastic elastomers)
- Packing: 1pc/color sleeve, 6pcs/inner, 24pcs/ctn/2.30'



## Saw Introduction

- Feature a comfortable anti-slip tip. Note some are also angle handles which can be used as a quick means of finding 45° or 90° angles.

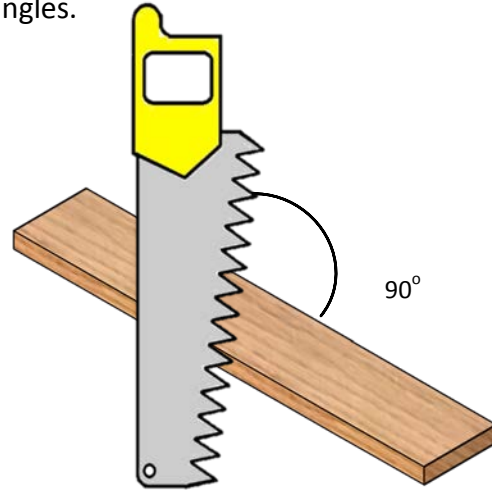
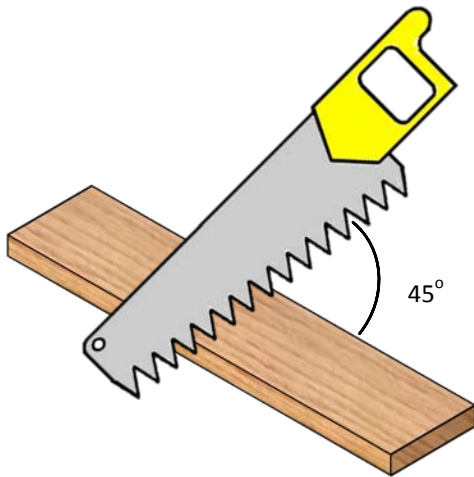

- Teeth/Points per inch:  
The more teeth/points per inch the finer and cleaner the cut. Hand saws average 7 teeth (8 points) to the inch while carpentry saws have up to 13 teeth (14 point) per inch. Super cut teeth give a finer, yet faster, cut compared to the equivalent saw manufactured in the conventional way.

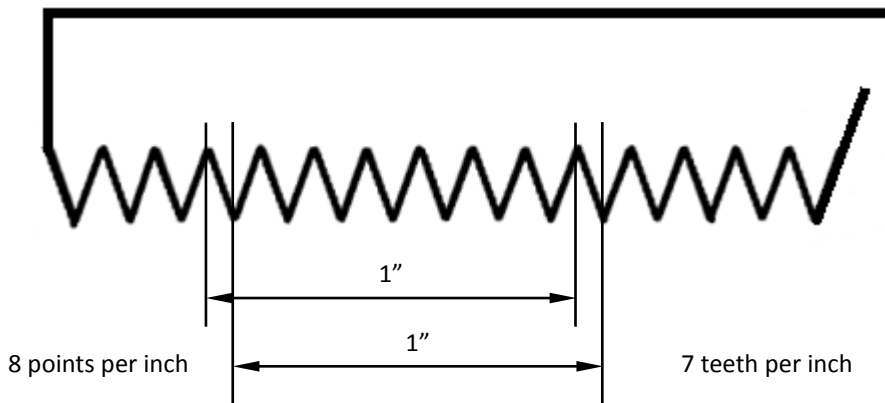

Normal Teeth



File Teeth

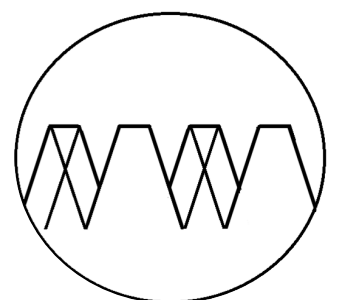

Tapered Back

# Saw

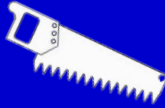

## Hand Saw

### 30381

- Handle material: ABS + TPR
- Blade thickness: 0.8 mm
- Hardness: HRC 48<sup>0</sup>
- Kind of blade: File teeth (7 teeth 8 points per inch)
- Hard-point treatment
- Packing: 1pc/color sleeve

30381 Hand Saw			
SIZE	INNER	CARTON	MEAS
15"	12	48	2.0'
16"	12	48	2.1'
18"	12	48	2.3'
20"	12	36	2.0'
22"	12	36	2.2'
24"	12	36	2.3'
26"	12	36	2.4'



### 30384

- Handle material: ABS + TPR
- Blade thickness: 0.8 mm
- Hardness: HRC 48<sup>0</sup>
- Kind of blade: File teeth (7 teeth 8 points per inch)
- Packing: 1pc/color sleeve

30384 Hand Saw			
SIZE	INNER	CARTON	MEAS
15"	12	48	2.0'
16"	12	48	2.1'
18"	12	48	2.3'
20"	12	36	2.0'
22"	12	36	2.2'
24"	12	36	2.3'
26"	12	36	2.4'



## Woodworking Hand Saws

### 30385

- Drywall saw
- Blade material: SK5
- Handle material: Wooden
- Blade thickness: 1.3 mm
- Hardness: HRC 48<sup>0</sup>
- Kind of blade: File teeth (4 teeth 5 pointer per inch)
- Packing: 1pc/color sleeve

30385 Dry Wall Saw			
SIZE	INNER	CARTON	MEAS
15"	6	48	1.8'
16"	6	48	2.0'



### 30386

- Drywall saw
- Blade material: SK5
- Handle material: TPR
- Blade thickness: 1.3 mm
- Hardness: HRC 48<sup>0</sup>
- Kind of blade: File teeth (4 teeth 5 points per inch)
- Packing: 1pc/color sleeve

30386 Dry Wall Saw			
SIZE	INNER	CARTON	MEAS
16"	6	48	2.0'



# Saw

## General Purpose Saw

### 30682

- Blade material: SK5
- Handle material: Nylon
- Blade thickness: 1.2 mm
- Hardness: HRC 48<sup>0</sup>
- Kind of blade: File teeth (11 teeth 12 points per inch)
- Packing: 1pc/color sleeve

30682 General Purpose Saw			
SIZE	INNER	CARTON	MEAS
15"	12	48	1.6'



30682

## Woodworking Hand Saw

### 30684

- Faner saw
- Blade material: SK5
- Handle material: Plastic
- Blade thickness: 0.6 mm
- Hardness: HRC 47<sup>0</sup>
- Kind of blade: File teeth
- Packing: 1pc/color sleeve

30684 Fanner Saw			
SIZE	INNER	CARTON	MEAS
14"		48	2.0'

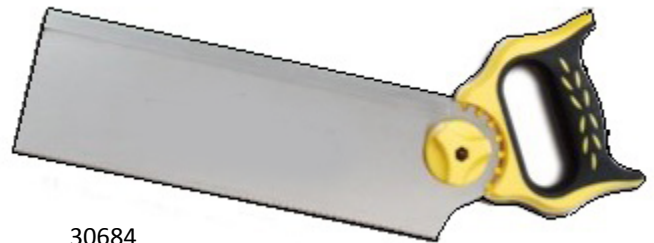

30684

## Back Saw

### 30714

- Blade material: SK5
- Handle material: ABS + TPR (Angle-adjustable)
- Blade thickness: 0.7 mm
- Hardness: HRC 48<sup>0</sup>
- Kind of blade: File teeth (11 teeth 12 points per inch)
- Packing: 1pc/color sleeve

30714 Back Saw			
SIZE	INNER	CARTON	MEAS
10"	6	36	1.6'
12"	6	36	1.8'
14"	6	36	2.0'



30714

### 30710

- Blade material: SK5
- Handle material: ABS + TPR (Angle-adjustable)
- Blade thickness: 0.7 mm
- Hardness: HRC 48<sup>0</sup>
- Kind of blade: File teeth (7 teeth 8 points per inch)
- Packing: 1pc/color sleeve

30710 Back Saw			
SIZE	INNER	CARTON	MEAS
10"	6	36	1.6'
12"	6	36	1.8'
14"	6	36	2.0'



30710

# Saw

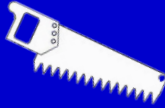

## 30387

- Blade material: SK5
- Handle material: ABS + TPR (Angle-adjustable)
- Blade thickness: 0.7 mm
- Hardness: HRC 48<sup>0</sup>
- Kind of blade: File teeth (11 teeth 12 points per inch)
- Packing: 1pc/color sleeve

30387 Back Saw			
SIZE	INNER	CARTON	MEAS
10"	6	36	1.6'
12"	6	36	1.8'
14"	6	36	2.0'



## 30687

- Blade material: SK5
- Handle material: ABS (Angle-adjustable)
- Blade thickness: 0.7 mm
- Hardness: HRC 48<sup>0</sup>
- Kind of blade: File teeth (11 teeth 12 points per inch)
- Packing: 1pc/color sleeve

30687 Back Saw			
SIZE	INNER	CARTON	MEAS
10"	12	48	1.8'
12"	12	48	2.0'
14"	12	36	1.9'



## 30689

- With mitre box
- Blade material: SK5
- Handle material: ABS
- Blade thickness: 0.7 mm
- Hardness: HRC 47<sup>0</sup>
- Kind of blade: File teeth (11 teeth 12 points per inch)
- Packing: 1set/white box

30689 Back Saw			
SIZE	INNER	CARTON	MEAS
14"		12	2.9'



## 30711

- Key hole saw
- Blade material: SK5
- Handle material: ABS + TPR (Multi angle adjustable)
- Blade thickness: 1.2 mm
- Hardness: HRC 48<sup>0</sup>
- Packing: 1pc/color sleeve

30711 Key Hole Saw			
SIZE	INNER	CARTON	MEAS
14"	12	72	1.9'



# Saw

## Bow Saw

### 30678

- Blade material: SK5 (Steel frame with painted)
- Handle material: PVC coating
- Included 2 x 12" (300 mm):
  - Hack saw for metal & plastic
  - Bow saw for wood
- Packing: 1pc/color sleeve

30678 Bow Saw			
SIZE	INNER	CARTON	MEAS
12"	12	24	1.6'



30678

### 30680

- V-type bow saw set (2pcs)
- Including:
  - 1pc 53 cm round steel tube frame
  - 1pc 20 cm bypass pruner
- Blade material: SK5
- Packing: 1set/color card

30680 Bow Saw			
SIZE	INNER	CARTON	MEAS
21"		24	1.5'

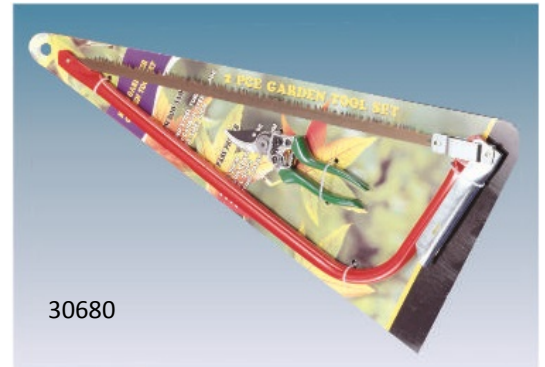

30680

### 30661

- U-type bow saw
- Blade material: SK5 (Steel frame 2 x 1 mm)
- Handle material: PVC coating
- Kind of blade: File teeth + hard point teeth
- Blade thickness: 0.7 mm
- Hardness: HRC 47<sup>0</sup>
- Packing: 1pc/color sleeve

30661 Bow Saw			
SIZE	INNER	CARTON	MEAS
21"		24	1.8'
24"		12	1.2'
30"		12	1.4'
36"		12	2.0'



30661

### 30651

- Blade material: SK5 (Oval steel tube 18/29 x 1 mm)
- Handle material: ABS + TPR
- Kind of blade: File teeth + hard point teeth
- Blade thickness: 0.7 mm
- Hardness: HRC 47<sup>0</sup>
- Packing: 1pc/color sleeve

30651 Bow Saw			
SIZE	INNER	CARTON	MEAS
21"		12	1.27'
24"		12	1.40'
30"		12	1.74'



30651

### 30658

- Blade material: SK5 (Oval steel tube 18/29 x 1 mm)
- Handle material: ABS + TPR
- Kind of blade: File teeth + hard point teeth
- Blade thickness: 0.7 mm
- Hardness: HRC 47<sup>0</sup>
- Packing: 1pc/color sleeve

30658 Bow Saw			
SIZE	INNER	CARTON	MEAS
12"		12	0.85'
15"		12	1.01'



30658



# Saw

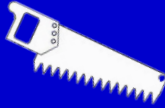

## 09338

- Coping saw
- 4 extra saw blades
- Blade material: SK5 (Steel frame forged)
- Handle material: Wooden
- Packing: 1pc/color sleeve

09338 Coping Saw			
SIZE	INNER	CARTON	MEAS
6.5"	10	60	1.8'



## 30388

- Wall board saw
- Blade material: SK5
- Handle material: Plastic
- Blade thickness: 1.8 mm
- Hardness: HRC 48<sup>0</sup>
- Kind of blade: File teeth (5 teeth 6 points per inch)
- Packing: 1pc/color sleeve

30388 Wall Board Saw			
SIZE	INNER	CARTON	MEAS
6"	12	72	1.9'



## 31456

- Kind of blade & thickness: Stainless steel 420J2, 1.5 mm
- Surface treatment: Polish
- Handle: PP & TPR
- Packing: 1pc/blister sliding card

31456 Garden Knife			
SIZE	INNER	CARTON	MEAS
10"	12	120	2.15'



## 31457

- Kind of blade & thickness: Stainless steel 420J2, 1.5 mm
- Surface treatment: Polish
- Handle: PP & TPR
- Packing: 1pc/blister sliding card

31457 Garden Knife			
SIZE	INNER	CARTON	MEAS
10"	12	120	2.72'



## Pruning Saw

## 30351

- Folding pruning saw
- Blade material: SK5 (Chrome - plated anti rust)
- Handle material: ABS SOFT TPR (Thermoplastic rubber handle)
- Kind of blade:
  - File teeth (8 teeth 9 points per inch) or
  - File teeth (6 teeth 7 points per inch)
- Blade thickness: 1.3 mm
- Packing: 1pc/blister card

30351 Folding Pruning Saw			
SIZE	INNER	CARTON	MEAS
6"	12	72	1.7'



# Saw

## 30683

- Folding pruning saw
- Blade material: SK5 (Chrome-plated anti rust)
- Kind of blade:
  - File teeth (8 teeth 9 points per inch) or
  - File teeth (6 teeth 7 points per inch)
- Handle material: ABS SOFT TPR (Thermoplastic rubber handle)
- Blade thickness: 1.3 mm
- Packing: 1pc/blister card

30683 General Purpose Saw			
SIZE	INNER	CARTON	MEAS
10"	12	72	1.9'



30683

## 30665

- Folding pruning saw
- Blade material: SK5
- Handle material: Wood
- Blade thickness: 1.2 mm
- Kind of blade: File teeth (6 teeth 7 points per inch)
- Packing: 1pc/color sleeve

30665 Folding Pruning Saw			
SIZE	INNER	CARTON	MEAS
9"	12	72	2.4'
12"	12	48	3.1'
14"	12	48	3.4'



30665

## 30380

- Blade material: SK5
- Handle material: Rubber wood
- Blade thickness: 1.2 mm
- Hardness: HRC 48<sup>0</sup>
- Packing: 1pc/color sleeve

30380 Pruning Saw			
SIZE	INNER	CARTON	MEAS
12"	12	72	1.9'
13"	12	72	2.1'
14"	12	72	2.2'



30380

## 30668

- Blade material: SK5
- Handle material: Rubber wood
- Blade thickness: 1.2 mm
- Hardness: HRC 48<sup>0</sup>
- Kind of blade: File teeth
- Packing: 1pc/color sleeve

30668 Pruning Saw			
SIZE	INNER	CARTON	MEAS
12"	12	72	1.9'
13"	12	72	2.0'
14"	12	72	2.2'



30668

## Woodworking Hand Saw

## 30647

- Pruning saw
- Blade material: SK5
- Handle material: ABS + TPR
- Blade thickness: 1.0 mm
- Hardness: HRC 50<sup>0</sup>
- Kind of blade: Tapered back teeth
- Packing: 1pc/color sleeve

30647 Pruning Saw			
SIZE	INNER	CARTON	MEAS
9.5"	6	60	2.8'



30647

# Saw



## 30701

- Rapid saw
- Blade material: SK5 (Blade change quickly)
- Handle material: ABS + TPR
- Blade thickness: 0.6 mm
- Hardness: HRC 49<sup>0</sup>
- Kind of blade: Tapered back teeth (8 teeth 9 points per inch)
- Packing: 1pc/color sleeve

30701 Rapid Saw			
SIZE	INNER	CARTON	MEAS
10.5"	12	72	2.3'



30701

## 30706

- PVC saw
- Blade material: SK5 (Blade change quickly)
- Handle material: ABS + TPR
- Blade thickness: 0.6 mm
- Hardness: HRC 51<sup>0</sup>
- Kind of blade: Tapered back teeth (17 teeth 18 point per inch)
- Packing: 1pc/blister card

30706 PVC Saw			
SIZE	INNER	CARTON	MEAS
210 mm	12	72	2.0'
240 mm	12	72	2.1'



30706

## 30703

- Double edge folding saw
- Blade material: SK5
- Handle material: Wooden
- Kind of blade: Tapered back teeth
  - Left side edge: 11 teeth 12 points per inch
  - Right side edge: 8 teeth 9 points per inch
- Blade thickness: 0.7 mm
- Hardness: HRC 48<sup>0</sup>
- Packing: 1pc/color sleeve

30703 Double Edge Folding Saw			
SIZE	INNER	CARTON	MEAS
8"	6	36	1.5'



30703

## 30709

- Double edge folding saw
- Blade material: SK5
- Handle material: Wooden
- Kind of blade: Tapered back teeth
  - Left side edge: 11 teeth 12 points per inch
  - Right side edge: 8 teeth 9 points per inch
- Blade thickness: 0.7 mm
- Hardness: HRC 48<sup>0</sup>
- Packing: 1pc/color sleeve

30709 Double Edge Folding Saw			
SIZE	INNER	CARTON	MEAS
10"	6	36	2.3'



30709

## 30702

- Board saw
- Blade material: SK5 (Blade change quickly)
- Kind of blade: Tapered back teeth (8 teeth 9 points per inch)
- Handle material: Wooden
- Hardness: HRC 49<sup>0</sup>
- Blade thickness: 0.6 mm
- Packing: 1pc/color sleeve

30702 Board Saw			
SIZE	INNER	CARTON	MEAS
10"	6	36	2.0'
12"	6	36	2.1'



30702

## 30367

- Slitting saw
- Special on both size sharply
- Blade material: SK5
- Blade thickness: 0.6 mm
- Hardness: HRC 48<sup>0</sup>
- Handle material: Wooden
- Kind of blade: File teeth (15 teeth 16 points per inch) + Hard point teeth
- Packing: 1pc/color sleeve

30367 Dovetail Saw			
SIZE	INNER	CARTON	MEAS
10"	12	120	0.8'
12"	12	72	0.7'
14"	12	72	0.8'



30367

# Caulking Gun



Dripless

31391

## 31391

- With dripless function
- Material: Cylinders made by ABS w/ nylon fiber + TPR handle
- Color:
  - Cylinders: Blue + Yellow
  - Handle: Blue & Black combination color

Item No.31391			
SIZE	PACKING	CARTON	MEAS
9" 300ML	1PC/BAG	12	0.90'

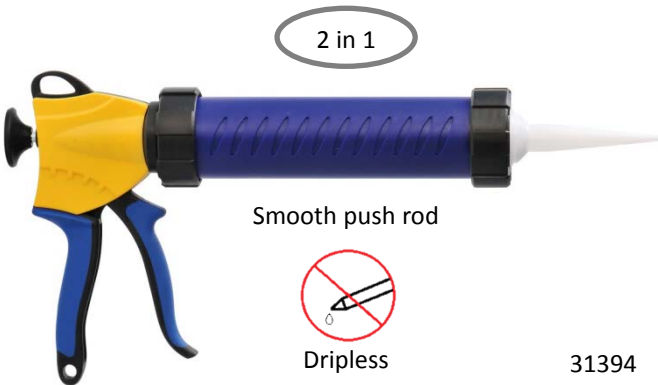

2 in 1

Smooth push rod



Dripless

31394

## 31394

- Smooth push rod & rotary
- 2 in 1 for both pipe dripless & aluminum foil package
- With dripless function
- Material: Cylinders made by ABS w/ nylon fiber + TPR handle
- Color:
  - Cylinders: Blue + Yellow
  - Handle: Blue & Black combination color

Item No.31394			
SIZE	PACKING	CARTON	MEAS
9" 300ML	1PC/BAG	12	1.1'



Smooth push rod



Dripless

31400

## 31400

- Smooth push rod
- With dripless function
- Material: Cylinder made by Metal w/ aluminum + Aluminum Alloy handle
- Color:
  - Cylinders: Orange coating
  - Handle: Black coating

Item No.31400			
SIZE	PACKING	CARTON	MEAS
9" 300ML	1PC/BAG	12	0.90'



Smooth push rod

31398

## 31398

- Smooth push rod & 360° rotary
- Material: Cylinder made by Metal w/ aluminum + Aluminum Alloy handle
- Color:
  - Cylinders: Orange coating
  - Handle: Black coating

Item No.31398			
SIZE	PACKING	CARTON	MEAS
9" 300ML	1PC/BAG	12	0.9'

# Caulking Gun

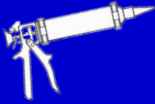

## 31395

- Hexagon push rod
- Material: Cylinders made by Metal w/ aluminum + Aluminum Alloy handle
- Color:
  - Cylinders: Orange coating
  - Handle: Black coating

Item No.31395			
SIZE	PACKING	CARTON	MEAS
9" 300ML	1PC/BAG	12	0.97'



Hexagon push rod

31395

## 31393

- Smooth push rod
- Material: Cylinders made by Metal w/ aluminum + Aluminum Alloy handle
- Color:
  - Cylinders: Orange coating
  - Handle: Black coating

Item No.31393			
SIZE	PACKING	CARTON	MEAS
9" 380ML	1PC/BAG	12	1.2'



Smooth push rod

31393

## 31403

- Hexagon push rod
- Material: Cylinders & handle made by Zinc Alloy
- Color: Orange coating

Item No.31403			
SIZE	PACKING	CARTON	MEAS
9" 300ML	1PC/BAG	24	0.81'

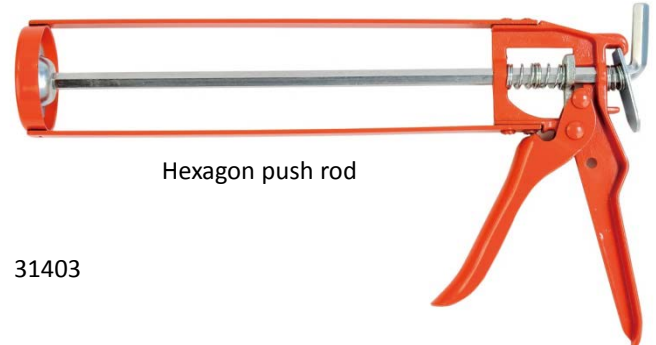

Hexagon push rod

31403

## 31402

- Smooth push rod
- Material: Cylinders & handle made by Zinc Alloy
- Color: Blue coating

Item No.31402			
SIZE	PACKING	CARTON	MEAS
9" 300ML	1PC/BAG	24	1.1'

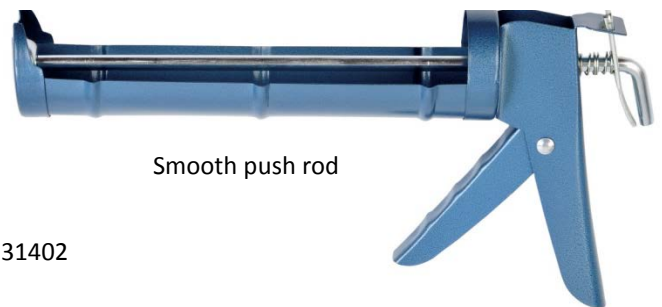

Smooth push rod

31402

## 31406

- Material: Cylinders & handle made by Zinc Alloy
- Color: Orange coating

Item No.31406			
SIZE	PACKING	CARTON	MEAS
10.5" 400ML	1PC/BAG	24	1.0'

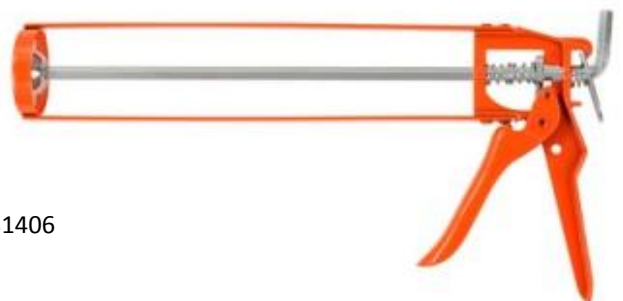

31406

# Caulking Gun

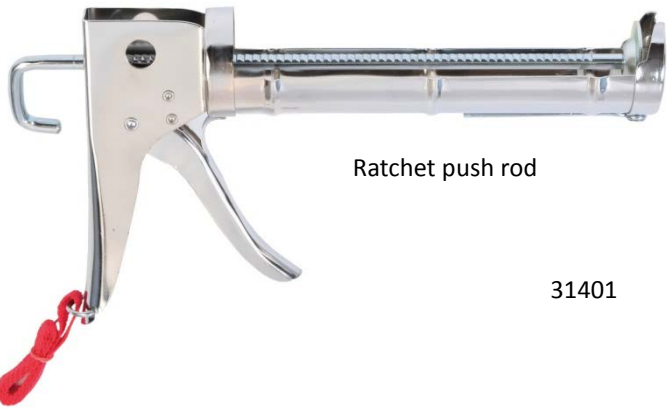

Ratchet push rod

31401

### 31401

- Ratchet push rod
- Material: Metal
- Color: Silver coating

Item No.31401			
SIZE	PACKING	CARTON	MEAS
9" 300ML	1PC/BAG	24	1.27'

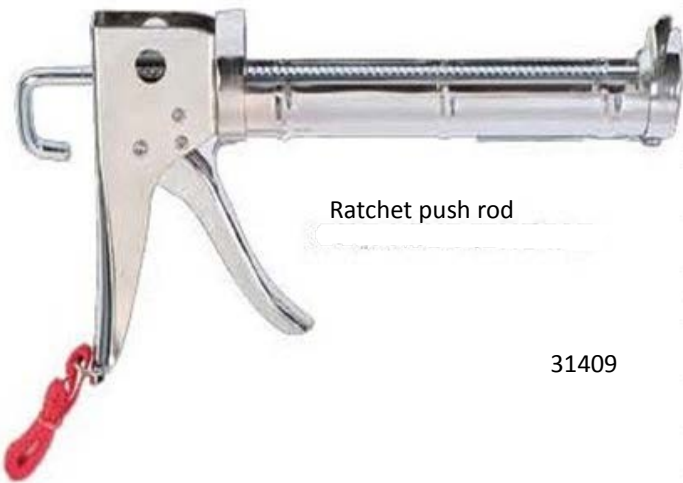

Ratchet push rod

31409

### 31409

- Ratchet push rod
- Material: Metal
- Color: Silver coating

Item No.31409			
SIZE	PACKING	CARTON	MEAS
13" 850ML	1PC/BAG	12	1.3'

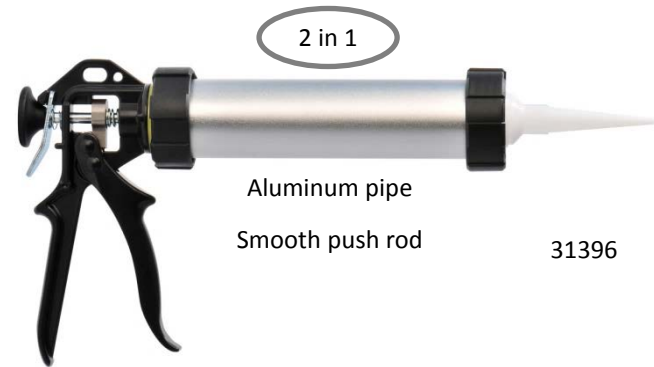

2 in 1

Aluminum pipe

Smooth push rod

31396

### 31396

- 2 in 1 for both pipe & aluminum foil package
- Smooth push rod & 360° rotary
- Material: Cylinders made by Aluminum + Aluminum Alloy handle
- Color:
  - Cylinders: Silver + Black
  - Handle: Black coating

Item No.31396			
SIZE	PACKING	CARTON	MEAS
9" 300ML	1PC/BAG	12	1.1'

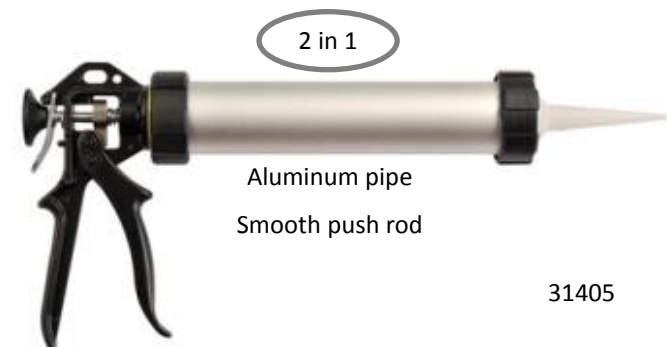

2 in 1

Aluminum pipe

Smooth push rod

31405

### 31405

- 2 in 1 for both pipe & aluminum foil package
- Smooth push rod & 360° rotary
- Material: Cylinders made by Aluminum + Aluminum Alloy handle
- Color:
  - Cylinders: Silver + Black
  - Handle: Black coating

Item No.31405			
SIZE	PACKING	CARTON	MEAS
10.5" 400ML	1PC/BAG	12	1.2'

# Caulking Gun

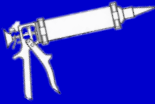

## 31408

- 2 in 1 for both pipe & aluminum foil package
- Smooth push rod & 360° rotary
- Material: Cylinders made by Aluminum + Aluminum Alloy handle
- Color:
  - Cylinders: Silver + Black
  - Handle: Black coating

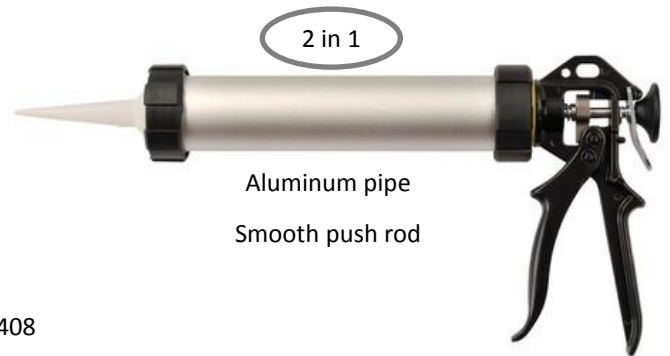

Item No.31408			
SIZE	PACKING	CARTON	MEAS
14.5" 600ML	1PC/BAG	12	1.45'

31408

## 31397

- Smooth push rod
- Material: Cylinders made by clear PVC pipe + Aluminum Alloy handle
- Color:
  - Cylinder: Clear + Black
  - Handle: Black coating



Item No.31397			
SIZE	PACKING	CARTON	MEAS
14.5" 600ML	1PC/BAG	12	1.40'

31397

## 31404

- Smooth push rod
- 2 cylinders are parallel vertically
- Material: Metal
- Color: Blue coating



Item No.31404			
SIZE	PACKING	CARTON	MEAS
3.3" 50ML	1PC/BAG	24	0.86'

31404

## 31399

- Combo set
  - 31391 Caulking gun - Silicon
  - Scraper - Utility knife
  - Tape



31399

Item No.31399			
SIZE	PACKING	CARTON	MEAS
Caulking Gun DIY Set	1SET/BAG	12	3.2'

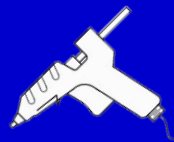

# Glue Gun / Glue Stick

## Glue Gun



09700



09581



09552



09702

Model	09700	09581	09552	09702
Description	Mini Glue Gun		Regular Glue Gun	
Voltage	100-240 V AC			
Input wattage	10 W		55 W	
Heating type	PTC heater			
Glue stick Ø	Ø 7.0 – 7.5 mm		Ø 11.0 – 11.5 mm	
Glue output	5g/min		14g/min	
Operating temperature	165° C (330° F)		193° C (380° F)	
Safety approval	TUV,CE,C-US			
Packed in	Double blister			
Packing	48pcs/ctn/1.90'	48pcs/ctn/1.50'	24pcs/ctn/1.60'	24pcs/ctn/2.00'

## Glue Sticks

Item No.	09492	09565
Size	Ø11.2 x 100 mm	
Packing	20pcs/bag, 125bags/ctn/2.3'	6pcs/bag, 300bags/ctn/2.04'



09492



09565



# Carton Tape Dispenser



## Carton Tape Dispenser

**Material:** ABS

**01426** For 2" wide, 3" inner cord tape  
Packing: 1pc/bag, 144pcs/ctn/1.50'

**Material:** ABS

**01877** For 2" wide, 3" inner cord tape  
Packing: 1pc/bag, 120pcs/ctn/1.40'

01426



01877



**03245** Tape dispenser retractable blade TPR handle  
Packing: 1pc/color box, 24pcs/ctn/2.79'

**01465** Tape dispenser for 2" tapes with blade protector  
Packing: 1pc/color box, 24pcs/ctn/2.50'

03245



01465



**01447** With non-reversing plate & fixed blade  
Packing: 1pc/color box, 24pcs/ctn/2.60'

**01449** With adjustable brake, side plastic bake painted  
Packing: 1pc/color box, 24pcs/ctn/2.50'

01447



01449



**01450** With 2 rolls tape 2" x 50 yards  
Size: 216 x 63 x 146 mm  
Tape size: 48 x 45 x 0.05 mm  
Packing: 1set/shrink, 12sets/ctn/1.15'



01450

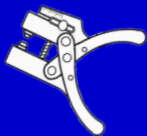

# Craft Tools



**31080 Leather Punch w/ PVC rubber hand grip**  
 ◆ 1.5 mm thickness iron plate  
 ◆ Black oxide for six holes  
 ◆ Split type of zinc alloy base  
 Packing: 1pc/sliding card, 12pcs/inner, 72pcs/ctn/2.40'

- Hole dia.**
- 2.0mm ○ 3.5mm
  - 2.5mm ○ 4.0mm
  - 3.0mm ○ 4.5mm



31080

**31099 Leather Punch w/o PVC rubber hand grip**  
 ◆ 1.5 mm thickness iron plate  
 ◆ Black oxide for six holes  
 ◆ Split type of zinc alloy base  
 Packing: 1pc/sliding card, 12pcs/inner, 72pcs/ctn/2.10'

- Hole dia.**
- 2.5mm ○ 3.7mm
  - 2.8mm ○ 4.2mm
  - 3.2mm ○ 4.5mm



31099

**31101 Leather Punch w/ PVC rubber hand grip**  
 ◆ 1.5 mm thickness iron plate  
 ◆ Black oxide for six holes  
 ◆ Integrated zinc alloy base  
 ◆ Hole blade with heat treatment  
 Packing: 1pc/sliding card, 12pcs/inner, 72pcs/ctn/2.10'

- Hole dia.**
- 2.0mm ○ 3.5mm
  - 2.5mm ○ 4.0mm
  - 3.0mm ○ 4.5mm



31101

**31423 Leather Punch w/ PVC rubber hand grip**  
 ◆ 1.8 mm thickness iron plate  
 ◆ Integrated zinc alloy base  
 ◆ Zinc plating  
 ◆ Hole blade with heat treatment  
 Packing: 1pc/sliding card, 12pcs/inner, 72pcs/ctn/2.40'

- Hole dia.**
- 2.0mm ○ 3.5mm
  - 2.5mm ○ 4.0mm
  - 3.0mm ○ 4.5mm





31423

**30765 Eyelet Punch w/ 100pcs eyelet**  
 Packing: 1set/sliding card, 10sets/inner, 100sets/ctn/2.30'

30765

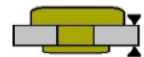
**Hole dia.**



- Bore Ø of rings  about 4 mm
- Max thk. of material  about 2 mm
- Bore Ø of eyelet  about 5 mm



**30766 Eyelet Punch w/ 100pcs eyelet**  
 Packing: 1set/sliding card, 10sets/inner, 50sets/ctn/1.40'

30766

**Hole dia.**



- Bore Ø of rings  about 6 mm
- Max thk. of material  about 2.5 mm
- Bore Ø of eyelet  about 7~8 mm



**30767 Deluxe Eyelet Punch**  
 w/ 100pcs 5 mm eyelet & 50pcs 8 mm eyelet  
 Packing: 1set/sliding card, 10sets/inner, 50sets/ctn/1.40'

30767

**Hole dia.**

- Bore Ø of rings  about 4 & 6 mm
- Max thk. of material  about 2 & 2.5 mm
- Bore Ø of eyelet  about 5 & 7-8 mm



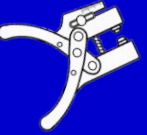

**30768 2-in-1 Snap Button/ Eyelet Punch**  
w/ 100pcs 5 mm eyelet & 8sets snap button  
Packing: 1set/sliding card, 10sets/inner, 60sets/ctn/1.66'



30768

**Hole dia.**

- Bore  $\varnothing$  of rings  
  
about 4 mm
- Max thk. of material  
  
about 2 mm
- Bore  $\varnothing$  of eyelet  
  
about 5 mm
- Max thk. of material for snap button  
  
about 1.5 mm

**30769 Punch for Leather Repairing**  
w/ 30sets of supplementary of metal snap approximately  
Packing: 1set/sliding card, 10sets/inner, 60sets/ctn/1.7'



30769

**Hole dia.**

- Bore  $\varnothing$  of metal cap  
  
about 9 mm
- Max thk. of material  
  
about 5 mm
- Bore  $\varnothing$  of guide  
  
about 3 mm
- Length of the foot of metal snaps  
  
about 8 mm

**30770 Double Sides Grommet Punch**  
w/ 20sets of supplementary 8 mm aluminum grommet & 8 mm punch  
Packing: 1set/sliding card, 10sets/inner, 100sets/ctn/2.3'



30770

**Hole dia.**

- Bore  $\varnothing$  of rings  
  
about 8 mm
- Max thk. of material  
  
about 2.5 mm
- Bore  $\varnothing$  of grommet  
  
about 8 mm

**30771 Double Sides Grommet Punch**  
w/ 10 sets of supplementary 12 mm aluminum grommet & 12 mm punch  
packing: 1set/sliding card, 10sets/inner, 60sets/ctn/1.8'



30771

**Hole dia.**

- Bore  $\varnothing$  of rings  
  
about 12 mm
- Max thk. of material  
  
about 3.5 mm
- Bore  $\varnothing$  of grommet  
  
about 12 mm

**30773 Double Sides Grommet Punch**  
w/ 5sets of 15 mm two-sided brass grommets & 5sets of aluminum grommet  
Packing: 1set/sliding card, 10sets/inner, 60sets/ctn/1.70'



30773

**Hole dia.**

- Bore  $\varnothing$  of rings  
  
about 15 mm
- Max thk. of material  
  
about 4 mm
- Bore  $\varnothing$  of grommet  
  
about 16 mm

# Craft Tools



**31081 Eyelet Plier w/100pcs eyelet**  
 Size: 178 mm  
 Packing: 1set/sliding card, 10sets/inner, 100sets/ctn/1.90'  
**Hole dia.**



31081

- Bore Ø of rings about 7 mm
- Max thk. of material about 1.5 mm
- Bore Ø of grommet about 6.3 mm

**31082 Eyelet Plier w/ 100pcs eyelet**  
 Size: 152 mm  
 Packing: 1set/sliding card, 10sets/inner, 100sets/ctn/2.30'  
**Hole dia.**



31082

- Bore Ø of rings about 5 mm
- Max thk. of material about 1 mm
- Bore Ø of grommet about 4.2 mm

**31083 2-in-1 Eyelet Plier w/ 100pcs eyelet**  
 Packing: 1set/sliding card, 10sets/inner, 50sets/ctn/1.40'  
**Hole dia.**



31083

- Bore Ø of rings about 5 mm
- Max thk. of material about 1 mm
- Bore Ø of grommet about 4.2 mm

**31084 Grommet Punch w/ 8sets grommet**  
 Packing: 1set/sliding card, 10sets/inner, 100sets/ctn/1.90'  
**Hole dia.**



31084

- Bore Ø of rings about 8 mm
- Max thk. of material about 2.5 mm
- Bore Ø of grommet about 8 mm

**31085 Tarp Prepare Kit**  
 w/ 12 mm grommets  
 Packing: 1set/color header, 25sets/inner, 50sets/ctn/1.0'  
**Hole dia.**



31085

- Bore Ø of rings about 12 mm
- Max thk. of material about 3.5 mm
- Bore Ø of grommet about 12 mm

**31424 2-in-1 Snap Button/Eyelet Punch**  
 w/ 100pcs 5 mm eyelet & 8sets snap button &  
 7pcs rubber ring (2pcs for 9, 11, 12 mm & 1pc for 15 mm)  
 Packing: 1set/sliding card, 10sets/inner, 60sets/ctn/1.80'



31424

- Hole dia.**
- Bore Ø of rings about 4 mm
  - Max thk. of material for eyelet about 2 mm
  - Bore Ø of eyelet about 5 mm
  - Max thk. of material for snap button about 1.5 mm

# Staple Gun Tacker

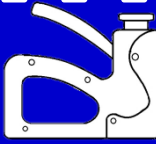

## 4 In 1 The Completer Staple Gun

### Feature:

- Adjustable power control.
- Easy to operate.
- Solid steel case.

■ Model: 30270 & 31600

	10.6 mm 6-14 mm 1.2 mm	7.6 mm 10-14 mm 1.2 mm	1.2 mm 14 mm Pin	1.2 mm 10-14 mm Nail
LeMORE®	90069 6 m/m 90089 8 m/m 90109 10 m/m 90129 12 m/m 90149 14 m/m	12104 10 m/m 12124 12 m/m 12144 14 m/m	12158	12150 12151 12157
Staple Model	ARROW®: T-50 ESCO®: #S500 KWB®: #HT-057 NOVUS®: #11 RAPID®: #140 ROCAFIX®: #4	NOVUS®: #J-19 RAPID®: #36 ROCAFIX®: #88 ROCAFIX®: #MS 40V / 60V	BOSCH®: #14E ESCO®: #300 NOVUS®: #J ROCAFIX®: #36 / 66 ROCAFIX®: #MS 30V	

■ Model: 31601

	11.3 mm 4-14 mm 0.7 mm	6.2 mm 10-14 mm 1.2 mm	1.2 mm 14 mm Pin	1.2 mm 10-14 mm Nail
LeMORE®	10068 6 m/m 10088 8 m/m 10108 10 m/m 10128 12 m/m 10148 14 m/m	12103 10 m/m 12123 12 m/m 12143 14 m/m	12158	12150 12151 12157
Staple Model	ARROW®: JT21 ESCO®: #530 KWB®: #053 NOVUS®: #53 RAPID®: #53 ROCAFIX®: #3	ARROW®: T-18 NOVUS®: #5 RAPID®: #28		ESCO®: #300 NOVUS®: #J



Window

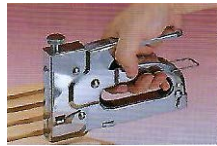

Light joinery

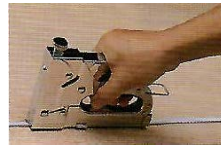

Fasten cable



Upholstery



Floor covering

Adjusts power to match staple impact with material

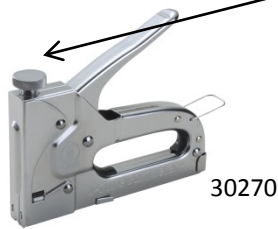

30270

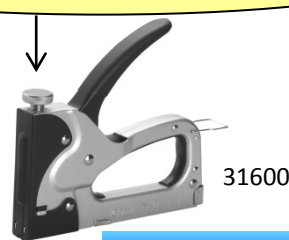

31600



31601

## All In 1 Staple Gun

### Feature:

- This "All in one staple gun" is your preferred choice for the American market.
- One stapler that can do all the major 4 different crown size staples in one.

**30285** Packing: 1pc/double blister, 6pcs/inner, 24pcs/ctn/1.25'

	10.6 mm 6-14 mm 1.2 mm	12.7 mm 6-14 mm 1.2 mm	12.3 mm 6-14 mm 1.2 mm	11.5 mm 6-14 mm 1.2 mm
LeMORE®	90069 6 m/m 90089 8 m/m 90109 10 m/m 90129 12 m/m 90149 14 m/m	12069 6 m/m 12089 8 m/m 12109 10 m/m 12129 12 m/m 12149 14 m/m	12066 6 m/m 12086 8 m/m 12106 10 m/m 12126 12 m/m 12146 14 m/m	12065 6 m/m 12085 8 m/m 12105 10 m/m 12125 12 m/m 12145 14 m/m
Staple Model	ARROW®: T-50 RAPID®: #140	POWER FAST®	SURBONDER® #6	SURBONDER®: #11



30285

## 3 In 1 The Completer Jr. Staple Gun

### Feature:

- Requires less force to set.
- All metal construction.
- Staple chamber pivots for easy access.

**30272** Packing: 1pc/double blister, 12pcs/inner, 24pcs/ctn/1.10'

	10.6 mm 6-14 mm 1.2 mm	1.2 mm 14 mm Pin	1.2 mm 14 mm Nail
LeMORE®	90069 6 m/m 90089 8 m/m 90109 10 m/m 90129 12 m/m 90149 14 m/m	12158	12150 12157
Staple Model	ARROW®: T-50 ESCO®: #11 KWB®: #057 NOVUS®: #11 RAPID®: #140 ROCAFIX®: #4		BOSCH®: #14E ESCO®: #300 NOVUS®: #J ROCAFIX®: #8



30272

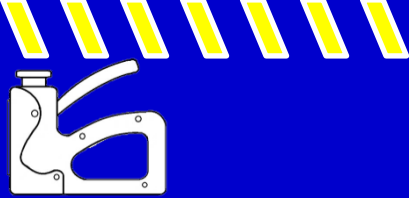

# Staple Gun Tacker

## All In 1 Staple Gun Tacker

### Feature:

The impact power lever can be adjusted to suit on hard and soft wood.

**32273** Packing: 1pc/sliding card, 20pcs/inner, 40pcs/ctn/1.24'



Bottom Loading

LeMORE®	10068 6 m/m 10088 8 m/m 10108 10 m/m	10606 6 m/m 10608 8 m/m 10610 10 m/m	12068 6 m/m 12088 8 m/m 12108 10 m/m 12128 12 m/m 12148 14 m/m		12140 18GAUGE BRAD NAIL
Staple Model	ARROW®: JT21 ESCO®: #530 KWB®: #053 NOVUS®: #53 RAPID®: #53 ROCAFIX®: #3 STANLEY®: #A/53	RAPID®: #13	#24/6-14 mm MAX®: #3	#23/6-14 mm	ARROW®: 1810 ESCO®: #300 NOVUS®: #J ROCAFIX®: #8

## 3 In 1 Staple Gun Tacker

### Feature:

- 3 way staple gun tacker.
- The impact power lever can be adjusted to suit on hard and soft wood.

**32270** Packing: 1pc/sliding card, 20pcs/inner, 40pcs/ctn/1.24'

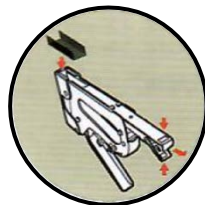

Bottom Loading

LeMORE®	10606 6 m/m 10608 8 m/m 10610 10 m/m 10612 12 m/m 10614 14 m/m	10068 6 m/m 10088 8 m/m 10108 10 m/m 10128 12 m/m 10148 14 m/m	12140 18GAUGE BRAD NAIL
Staple Model	RAPID®: #13	ARROW®: JT21 ESCO®: #530 KWB®: #053 NOVUS®: #53 RAPID®: #53 ROCAFIX®: #3 STANLEY®: #A/53	ARROW®: 1810 ESCO®: #300 NOVUS®: #J ROCAFIX®: #8

## Light Duty Staple Gun

### Feature:

- Very handy.
- Versatile and high quality tacker for one-hand operation literally hundreds of do-it-yourself jobs.
- Sturdily constructed for extra long life.

**30276** Packing: 1pc/sliding card, 20pcs/inner, 40pcs/ctn/1.01'

**32276** Packing: 1pc/sliding card, 20pcs/inner, 40pcs/ctn/1.01'



30276

32276

	Model:30276	Model:32276
LeMORE®	10068 6 m/m 10088 8 m/m	10606 6 m/m 10608 8 m/m
Staple Model	ARROW®: JT21 ESCO®: #530 KWB®: #T-8 NOVUS®: #53 RAPID®: #53	ESCO®: #19 KWB®: #059 NOVUS®: #37 RAPID®: #13

# Staple Gun Tacker

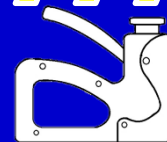

## Professional Staple Gun

- 30279** Packing: 1pc/sliding card, 20pcs/inner, 40pcs/ctn/1.30'
- 32261** Packing: 1pc/sliding card, 20pcs/inner, 40pcs/ctn/1.30'

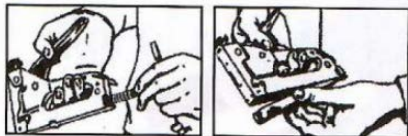

Easy recharging

Quick clogging release

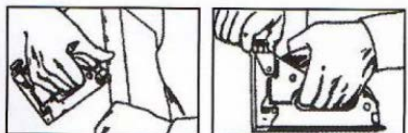

Provided at the rear with a lifting lip for staples

Adjustable power-setting



With adjustable power control



30279

32261

	Model:30279	Model:32261
LeMORE®	10068 6 m/m	12068 6 m/m
	10088 8 m/m	12088 8 m/m
	10108 10 m/m	12108 10 m/m
	10128 12 m/m	12128 12 m/m
	10148 14 m/m	12148 14 m/m
Staple Model	ARROW®: JT21	RAPID®: #23
	ESCO®: #530	MAX®: #T-3
	KWB®: #053	
	NOVUS®: #53	
	RAPID®: #53	

## Professional Staple Gun

- 30278** Packing: 1pc/sliding card, 20pcs/inner, 40pcs/ctn/1.32'
- 32278** Packing: 1pc/sliding card, 20pcs/inner, 40pcs/ctn/1.32'
- 32264** Packing: 1pc/sliding card, 20pcs/inner, 40pcs/ctn/1.32'



With adjustable power control



30278

32278

32264

	Model:30278	Model:32278	Model:32264
LeMORE®	10068 6 m/m	10606 6 m/m	90069 6 m/m
	10088 8 m/m	10608 8 m/m	90089 8 m/m
	10108 10 m/m	10610 10 m/m	90109 10 m/m
	10128 12 m/m	10612 12 m/m	90129 12 m/m
	10148 14 m/m	10614 14 m/m	90149 14 m/m
Staple Model	ARROW®: JT21	ESCO®: #19	ARROW®: T-50
	ESCO®: #530	KWB®: #059	ESCO®: #11
	KWB®: #053	NOVUS®: #37	KWB®: #057
	NOVUS®: #53	RAPID®: #13	NOVUS®: #11
	RAPID®: #53		RAPID®: #140

## Medium Duty Staple Gun

- Feature:**
- Great for light joinery, gardening, vapor barriers, upholstery, window shades.
  - Floor covering and many other household tasks.

- 08610** Packing: 1pc/double blister, 6pcs/inner, 24pcs/ctn/1.30'
- 08611** Packing: 1pc/double blister, 6pcs/inner, 24pcs/ctn/1.30'



08610

08611

	Model:08610	Model:08611
LeMORE®	10068 6 m/m	12068 6 m/m
	10088 8 m/m	12088 8 m/m
	10108 10 m/m	12108 10 m/m
Staple Model	ARROW®: JT-21(1/4" 5/16" 3/8")	SWINGLINE®: 101(3614, 3615, SF-150)
	ESCO®: #RALLYE S-500	MAX®: #2, #3
	KWB®: #053	ESCO®: #RALLYE S-500
	RAPID®: #53	KWB®: #053
	BOSCH®: #1609200365-7	RAPID®: #53
	ROCAFIX®: #MS 50V	BOSCH®: #1609200365-7
		ROCAFIX®: #MS 50V

## Medium Duty Staple Gun

- Feature:**
- Suitable for all kinds of staples crown 10.6-13 mm.
  - New generation of tacker.
  - Ergonomic design.

- 30258** Packing: 1pc/double blister, 20pcs/inner, 40pcs/ctn/1.50'
- 30259** Packing: 1pc/double blister, 20pcs/inner, 40pcs/ctn/1.50'

	Model:30258	Model:30259
LeMORE®	10606 6 m/m	90069 6 m/m
	10608 8 m/m	90089 8 m/m
	10610 10 m/m	90109 10 m/m
	10612 12 m/m	90129 12 m/m
Staple Model	ARROW®: JT21	ARROW®: T-50
	ESCO®: #530	ESCO®: #5500
	KWB®: #053	KWB®: #HT-057
	NOVUS®: #53	NOVUS®: #11
	RAPID®: #53	RAPID®: #140
	ROCAFIX®: #3	ROCAFIX®: #4
	STANLEY®: #A/53	

30258

30259





# Staple Gun Tacker

## 4 In 1 Staple Gun

**30274** Packing: 1pc/sliding card, 10pcs/inner, 40pcs/ctn/2.00'

LeMORE®	10068 6 m/m 10088 8 m/m 10108 10 m/m 10128 12 m/m 10148 14 m/m	12123	12158	12147 12150 12157 12151
Staple Model	ARROW®: JT21 ESCO®: #530 KWB®: #053 NOVUS®: #53 RAPID®: #53 BOSCH®: #1609200365-7	NOVUS®: #J-19S RAPID®: #28 REXEL®: #12		ESCO®: #300 NOVUS®: #J



30274

## 4 In 1 Staple Gun

**30275** Packing: 1pc/sliding card, 10pcs/inner, 40pcs/ctn/2.00'

LeMORE®	90069 6 m/m 90089 8 m/m 90109 10 m/m 90129 12 m/m 90149 14 m/m	12123	12158	12147 12150 12157 12151
Staple Model	ARROW®: T-50 ESCO®: #5500 KWB®: #HT-057 RAPID®: #140	NOVUS®: #J-19S REXEL®: #12		ESCO®: #300 NOVUS®: #J



30275

## 3 In 1 Staple Gun

### Feature:

- All ABS + TPR construction more comfortable, faster and durable use.
- Equipped with power control.
- Handle with locking function.
- Bottom loading system.

**30267** Packing: 1pc/double blister, 10pcs/inner, 40pcs/ctn/2.30'

LeMORE®	10068 6 m/m 10088 8 m/m 10108 10 m/m 10128 12 m/m 10148 14 m/m	10606 6 m/m 10608 8 m/m 10610 10 m/m 10612 12 m/m 10614 14 m/m	12140 18GAUGE BRAD NAIL
Staple Model	ARROW®: JT21 ESCO®: #530 KWB®: #053 NOVUS®: #53 ROCAFIX®: #3 STANLEY®: #A-53	RAPID®: #13	ARROW®: 1810 ESCO®: #300 NOVUS®: #J ROCAFIX®: #8



30267



Bottom Loading

## 4 In 1 Staple Gun

**30264** Packing: 1pc/sliding card, 10pcs/inner, 40pcs/ctn/2.00'

LeMORE®	10068 6 m/m 10088 8 m/m 10108 10 m/m 10128 12 m/m 10148 14 m/m	12104 10 m/m 12124 12 m/m 12144 14 m/m	12158	12157 18GAUGE BRAD NAIL
Staple Model	ARROW®: JT21 ESCO®: #530 KWB®: #053 NOVUS®: #53 RAPID®: #53 BOSCH®: #1609200365-7	ARROW®: T25 NOVUS®: #J-19L RAPID®: #36 ROCAFIX®: #7		ARROW®: 1810 ESCO®: #300 NOVUS®: #J ROCAFIX®: #8



30264



# Staple Gun Tacker



## Compact Tacker

### Feature:

- Fastening tool for small jobs at home, office, work.
- Convenience compact size.
- Easier handling.

**30273** Packing: 1pc/sliding card, 20pcs/inner, 80pcs/ctn/2.40'



LeMORE®	10068 6 m/m 10088 8 m/m 10108 10 m/m
Staple Model	ARROW®: JT21 ESCO®: #530 KWB®: #053 MAX®: 1206F STANLEY®: #A/53

## 2 In 1 Mini Tacker

### Feature:

- Fastening tool for small jobs at home, office, work.
- Convenience compact size.
- Easier handling.

**30266** Packing: 1pc/sliding card, 20pcs/inner, 80pcs/ctn/2.40'



LeMORE®	10068 6 m/m 10088 8 m/m 10108 10 m/m	12068 6 m/m 12088 8 m/m 12108 10 m/m
Staple Model	ARROW®: JT21 ESCO®: #530 KWB®: #053 MAX®: #3 STANLEY®: #A/53	

## Mini Staple Gun

**07610** Packing: 1pc/sliding card, 20pcs/inner, 80pcs/ctn/1.70'



LeMORE®	10068 6 m/m 10088 8 m/m
Staple Model	ARROW®: JT21 ESCO®: #530 KWB®: #053 NOVUS®: #53 RAPID®: #53 ROCAFIX®: #3 STANLEY®: #A/53

## Mini Staple Gun

### Feature:

- With stitch base.
- Steel handle and Steel magazine (used for books too).

**07611** Packing: 1pc/sliding card, 20pcs/inner, 80pcs/ctn/2.80'



LeMORE®	12068 6 m/m 12088 8 m/m
Staple Model	#24/4-8 mm MAX®: #3

## Light Duty Staple Gun

**Feature:** Plastic handle and ABS magazine.

**07856** Packing: 1pc/sliding card, 20pcs/inner, 80pcs/ctn/1.70'



LeMORE®	10068 6 m/m 10088 8 m/m
Staple Model	ARROW®: JT21 ESCO®: #530 KWB®: #053 NOVUS®: #53 RAPID®: #53 ROCAFIX®: #3 STANLEY®: #A/53

## Light Duty Staple Gun

### Feature:

- With stitch base.
- Plastic handle and ABS magazine.

**07857** Packing: 1pc/sliding card, 20pcs/inner, 80pcs/ctn/1.70'



LeMORE®	12068 6 m/m 12088 8 m/m
Staple Model	#24/4-8 mm MAX®: #3

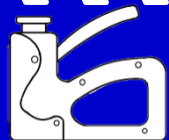

# Staple Gun Tacker

## 3 In 1 Forward Action Staple Gun

### Feature:

- With stitch base to be stapler for paper.
- Can save 30% of used power.

**32271** Packing: 1pc/sliding card, 10pcs/inner, 40pcs/ctn/2.40'



32271



Bottom Loading

	13 mm 0.75 mm 6-10 mm	12.7 mm 0.7 mm 6-10 mm	11.3 mm 0.7 mm 6-10 mm
LeMORE®	12068 6 m/m 12088 8 m/m 12108 10 m/m	10068 6 m/m 10088 8 m/m 10108 10 m/m	
Staple Model	#26/6-10 mm MAX®: #3	#24/6-10 mm ARROW®: JT21 ESCO®: #530 KWB®: #053 NOVUS®: #53 RAPID®: #53 ROCAFIX®: #3 STANLEY®: #A/53	

## 4 In 1 Forward Action Staple Gun

### Feature: Can save 30% of used power.

**32272** Packing: 1pc/sliding card, 10pcs/inner, 60pcs/ctn/2.70'



32272



Bottom Loading

	10.6 mm 0.7 mm 6-10 mm	11.3 mm 0.7 mm 6-10 mm	12.7 mm 0.7 mm 6-10 mm	13 mm 0.75 mm 6-10 mm
LeMORE®	10606 6 m/m 10608 8 m/m 10610 10 m/m	10068 6 m/m 10088 8 m/m 10108 10 m/m	12068 6 m/m 12088 8 m/m 12108 10 m/m	
Staple Model	RAPID®: #13	ARROW®: JT21 ESCO®: #530 KWB®: #053 NOVUS®: #53 RAPID®: #53 ROCAFIX®: #3 STANLEY®: #A/53	#24/6-10 mm MAX®: #3	#23/6-10 mm

## Light Duty Staple Gun

### Feature:

- Very handy.
- Versatile and high quality tacker for one- Hand operation literally hundreds of do-it-yourself jobs.
- Sturdily constructed for extra long life.

**30277** Packing: 1pc/sliding card, 20pcs/inner, 40pcs/ctn/1.00'



30277

	11.3 mm 0.7 mm 4-10 mm
LeMORE®	10068 6 m/m 10088 8 m/m 10108 10 m/m
Staple Model	ARROW®: JT21 ESCO®: #530 KWB®: #053 NOVUS®: #53 RAPID®: #53 ROCAFIX®: #3 STANLEY®: #A/53

## Staple Gun

### Feature: Plastic body.

**30268** Packing: 1pc/sliding card, 10pcs/inner, 60pcs/ctn/2.70'



30268

	11.3 mm 0.7 mm 4-8 mm	12.7 mm 0.7 mm 4-8 mm
LeMORE®	10068 6 m/m 10088 8 m/m	12068 6 m/m 12088 8 m/m
Staple Model	ARROW®: JT-21 ESCO®: #530 KWB®: #053 NOVUS®: #53 RAPID®: #53 ROCAFIX®: #3	#24/6-8 mm MAX®: #3

## Staple Gun

### Feature: Plastic body.

**30269** Packing: 1pc/sliding card, 10pcs/inner, 40pcs/ctn/2.10'



30269

	12.7 mm 0.7 mm 6-14 mm	11.3 mm 0.7 mm 6-14 mm
LeMORE®	12068 6 m/m 12088 8 m/m 12108 10 m/m 12128 12 m/m 12148 14 m/m	10068 6 m/m 10088 8 m/m 10108 10 m/m 10128 12 m/m 10148 14 m/m
Staple Model	#24/6-14 mm	ARROW®: JT21 ESCO®: #530 KWB®: #053 NOVUS®: #53 RAPID®: #53 ROCAFIX®: #3 STANLEY®: #A/53

# Staple Gun Tacker

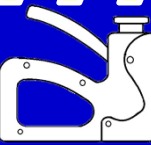

## 2 In 1 Staple Gun Tacker

### Feature:

- Tacking and stapling uses flat wire staples.
- The impact power lever can be adjusted to suit on hard and soft wood.

**30315** Packing: 1pc/sliding card, 12pcs/inner, 24pcs/ctn/2.03'

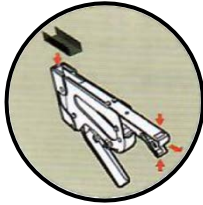

Bottom Loading



30315

LeMORE®	90069 6 m/m 90089 8 m/m 90109 10 m/m 90129 12 m/m 90149 14 m/m	12140 18GAUGE BRAD NAIL
Staple Model	ARROW®: T-50 ESCO®: #S500 KWB®: #HT-057 NOVUS®: #11 RAPID®: #140 ROCAFIX®: #4	ARROW®: 1810 ESCO®: #300 NOVUS®: #J ROCAFIX®: #8

## 3 In 1 Staple Gun

### Feature:

- Handle lock system for additional safety and compact storing.
- Convenient bottom loading for quick and easy jam clearing.
- Durable all-steel construction.
- Painted finish.

**32284** Packing: 1pc/sliding card, 10pcs/inner, 60pcs/ctn/2.70'



32284

LeMORE®	10068 6 m/m 10088 8 m/m 10108 10 m/m 10128 12 m/m 10148 14 m/m	10606 6 m/m 10608 8 m/m 10610 10 m/m 10612 12 m/m 10614 14 m/m	12068 6 m/m 12088 8 m/m 12108 10 m/m 12128 12 m/m 12148 14 m/m
Staple Model	ARROW®: JT21 ESCO®: #530 KWB®: #053 RAPID®: #53	RAPID®: #13, #33 REXEL®: #37 RAWLPUG®: R136	MAX®: #3

## Professional Staple Gun

**Feature:** With adjustable power control.

**32283** Packing: 1pc/sliding card, 20pcs/inner, 40pcs/ctn/1.30'

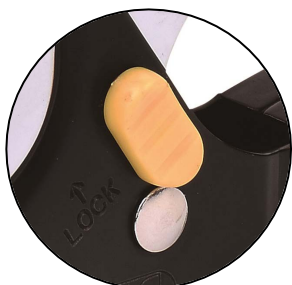

Safety lock (Handle lock)



32283

LeMORE®	10064 4 m/m 10068 6 m/m 10088 8 m/m 10108 10 m/m 10128 12 m/m 10148 14 m/m
Staple Model	ARROW®: JT21 ESCO®: #530 KWB®: #053 NOVUS®: #53 RAPID®: #53 ROCAFIX®: #3 STANLEY®: #A/53

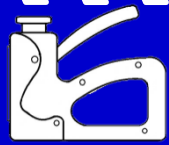

# Staple Gun Tacker

## Heavy Duty Staple And Nail Gun

### Feature:

- Ergonomic design.
- With power control.
- Handle with lock function.
- All steel construction.

**30286** Packing: 1pc/double blister, 6pcs/inner, 24pcs/ctn/1.75'  
**30287** Packing: 1pc/double blister, 6pcs/inner, 24pcs/ctn/1.75'



Tension adjustment

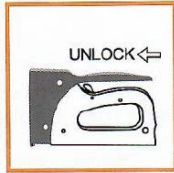

Unlock

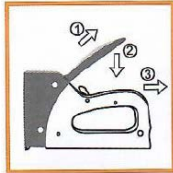

Lock

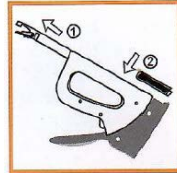

Bottom loading system



30286

30287

■ Model: 30286

■ Model: 30287

LeMORE®	90069 6 m/m 90089 8 m/m 90109 10 m/m 90129 12 m/m 90149 14 m/m 90169 16 m/m	12157 14 m/m 12160 16 m/m
Staple Model	ARROW®: T-50 ESCO®: #11 NOVUS®: #11 RAPID®: #140 ROCAFIX®: #4	ESCO®: #300 NOVUS®: #J ROCAFIX®: #8

LeMORE®	10068 6 m/m 10088 8 m/m 10108 10 m/m 10128 12 m/m 10148 14 m/m 10168 16 m/m	12157 14 m/m 12160 16 m/m
Staple Model	ARROW®: JT21 ESCO®: #530 NOVUS®: #53 RAPID®: #53 ROCAFIX® #3	ESCO®: #300 NOVUS®: #J ROCAFIX® #8

## Heavy Duty 4 In 1 Staple Gun

**30265** Packing: 1set/double blister, 6sets/inner, 24sets/ctn/2.30'

LeMORE®	90069 6 m/m 90089 8 m/m 90109 10 m/m 90129 12 m/m 90149 14 m/m	12103 10 m/m 12123 12 m/m	12158 14 m/m	12150 10 m/m 12151 12 m/m 12157 14 m/m
Staple Model	ARROW®: T-50 ESCO®: #S500 KWB®: #HT-057 NOVUS®: #11 RAPID®: #140 ROCAFIX®: #4	NOVUS®: #J-19S RAPID®: #28 REXEL®: #12		BOSCH®: #14E ESCO®: #300 NOVUS®: #J ROCAGRAF®: #36 / 66 ROCAFIX®: #MS 30V

30265



# Staple Gun Tacker

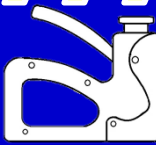

## Power Plus Cable Tacker

**30288** Packing: 1pc/double blister, 6pcs/inner, 24pcs/ctn/1.90'

### Feature:

- Ergonomic design.
- With power control.
- Handle with lock function.
- All steel construction.
- Bottom loading function.
- For low-voltage (max 50V) cables up to 4.5 mm or 6 mm diameter.
- Recoilless for comfortable operation.
- Adjustable impact force, (+, -) maximum setting for hard material or long staples.



Cable line special - purpose



Lock operation



Magazine



Unlock operation

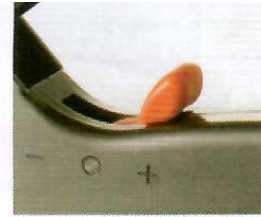

Normal - max (-, +) impact feature

LeMORE®	12104 10 m/m 12124 12 m/m 12144 14 m/m	12103 10 m/m 12123 12 m/m 12143 14 m/m
Staple Model	ARROW®: T-25 RAPID®: #36 ROCAFIX®: #7	ARROW®: T-18 RAPID®: #28 ROCAFIX®: #8

30288



## Cable Tacker

**07601** Dimension: 165 x 160 x 22 mm  
Packing: 1pc/sliding card, 10pcs/inner, 60pcs/ctn/2.50'

### Feature:

The one tool that fastens telephone, intercom, alarm/security, thermostat, doorbell, computer, TV cable, speaker wire and more.

- Built - in wire guide insures accurate staple placement.
- Fastens 5/32" (4 mm) and 1/4" (6.4 mm) wire or cable professionally.

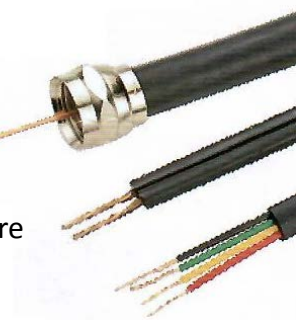

LeMORE®		
Round cable		
Flat wire cable		

07601



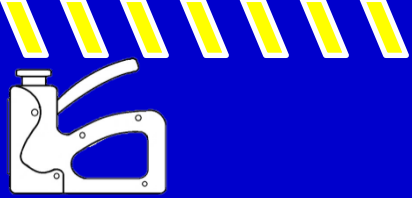

# Staple Gun Tacker

## All In 1 Cable Tacker

### Feature:

- Instead of one tacker for only one size staple, our 3 way cable tacker can be used as one tacker for 3 different size staple only need to adjust the staple guide plate.

**07603** Packing: 1set/blow case, 1set/inner, 10sets/ctn/1.40'

### One set pack in a blow box content:

- 07603 Cable tacker 1PC
- 07650 Cable staple 50PCS
- 07651 Cable staple 50PCS
- 07652 Cable staple 100PCS



LeMORE®	 Model:07650	 Model:07651	 Model:07652
Round cable	1/2" (12.5 mm)	7/16" (11 mm)	11/32" (9 mm)
Flat wire cable	-	-	1/2" (12.5 mm)



07603



## All In 1 Cable Tacker

**07647** Packing: 1set/double blister, 6sets/inner, 36sets/ctn/3.04'

### One set pack in a blister content:

- 07648 50PCS
- 07649 50PCS



07647

LeMORE®	 Model:07648	 Model:07649
Round cable	Height: 4.0 - 6.0 mm	Height: 6.0 - 8.0 mm
Flat wire cable	Height: 2.5 - 4.0 mm Width: Below 8.0 mm	Height: 4.5 - 6.3 mm Width: Below 10.3 mm

# Staple Gun Tacker



## Hand Plier Stapler (Large)

### Feature:

- For home and office use.
- Staple at any angle.
- Contour grip reduces hand fatigue.
- 2 staple sizes.

**05133** Packing: 1pc/double blister, 10pcs/inner, 40pcs/ctn/1.00'

LeMORE®	12064 6 m/m 12084 8 m/m	12068 6 m/m 12088 8 m/m
Staple Model	RAPID®: 26/6-8 mm	RAPID®: 24/6-8 mm MAX®: #3

05133



## Plier Stapler (Mini)

### Feature:

- Power staplers.
- Nailers tackers.
- Staple at any angle.
- Contour grip reduces hand fatigue.
- Easy staple loading.
- All steel construction.

**05144** Packing: 1pc/double blister, 25pcs/inner, 100pcs/ctn/1.34'

LeMORE®	12055 5 m/m

05144



## Anvil Stapler

### Feature:

- 3 Types (A+B+C) Anvil Stapler Use Rapid #73 Staples.
  - ▶ The straight anvil (Type A)
    - ◆ Standard equipped.
    - ◆ Other uses:
      - Staple bags closed sales receipts to packages.
  - ▶ The bag anvil (Type B)
    - ◆ Come separately as accessories.
    - ◆ Floral uses:
      - Floral paper (wrap fresh flowers staple ends).
      - Staple greeting cards to ribbon, lace and bows.
  - ▶ The sword anvil (Type C)
    - ◆ Come separately as accessories.
    - ◆ Fabric uses:
      - Staple fabric price tags to fabric.

**05140** Packing: 1pc/color box, 20pcs/inner, 40pcs/ctn/1.00'

Staple Model	RAPID®: 73/6-12 mm

05140



(A) Straight Anvil

(B) Bag Anvil

(C) Sword Anvil

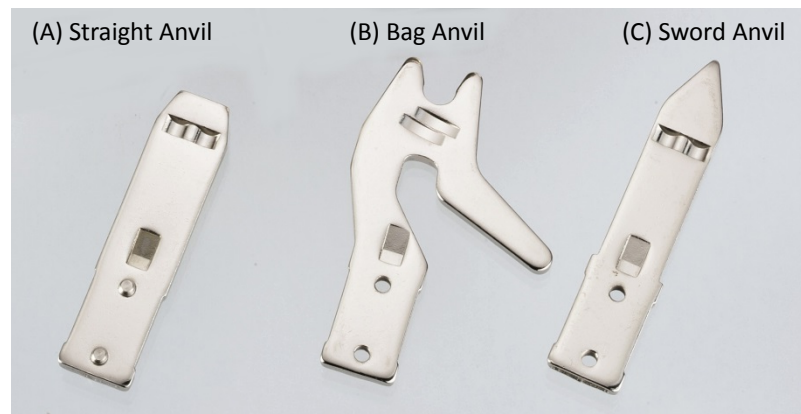



# Staple Gun Tacker

## Heavy Duty Stapler Remover

### Feature:

- Perfect for heavy duty jobs and removing deeply engrained staples.
- This ergonomic design is used as a lever which reduces the amount of strength needed.

**01458** Packing: 1pc/sliding card, 120pcs/ctn/2.10'



01458

## Heavy Duty Stapler Remover

### Feature:

- Staple remover with aluminum handle, double lip ensures safe removal of large staples blade replaceable.

**01472** Packing: 6pcs/inner, 180pcs/ctn/1.00'



01472

## Light Duty Hammer Tacker

### Feature:

- For Flat wire staples 6-10 mm.
- Easy and simple bottom-loading.
- Simple and Durable.
- Ergonomic rubber grip for easy operation.
- Easy-to-use for stapling labels, posters, carpet installation, insulation material, upholstery etc.



**30840** Packing: 1pc/sliding card, 10pcs/inner, 40pcs/ctn/2.20'

**30841** Packing: 1pc/sliding card, 10pcs/inner, 40pcs/ctn/2.20'

**30842** Packing: 1pc/sliding card, 10pcs/inner, 40pcs/ctn/2.20'

**30843** Packing: 1pc/sliding card, 10pcs/inner, 40pcs/ctn/2.20'

	Model:30840 & 30842	Model:30841 & 30842	Model:30843
LeMORE®	10068 6 m/m 10088 8 m/m 10108 10 m/m	10606 6 m/m 10608 8 m/m 10610 10 m/m	12068 6 m/m 12088 8 m/m 12108 10 m/m
Staple Model	ARROW®: JT21 ESCO®: #530 KWB®: #053 NOVUS®: #53 RAPID®: #53 ROCAFIX®: #3 STANLEY®: #A/53	RAPID®: #13	SWINGLINE®: 101(3614, 3615, SF-150) MAX®: #2, #3 ESCO®: #RALLYE S-500 KWB®: #053 RAPID®: #53 BOSCH®: #1609200365-7 ROCAFIX®: #MS 50V

30840

30841

30842

30843

## Heavy Duty Professional Hammer Tacker

### Feature:

- Professional quality for multiple applications.
- For flat wire staple 6-10 mm.
- Easy loading.
- Simple and durable.
- Ergonomically designed rubber grip.
- Four-way grip.
- Easy jam clearing.

**30083** Packing: 1pc/double blister, 10pcs/inner, 20pcs/ctn/1.70'

LeMORE®	90069 6 m/m 90089 8 m/m 90109 10 m/m
Staple Model	ARROW®: T-50 NOVUS®: #A11 RAPID®: #140

30083





# Staple Gun Tacker

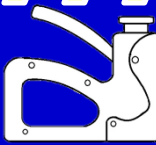

## All In 1 Hammer Tacker

### Feature:

- For the simple labeling and marking of wood, lumber, fencing and other wood products.
- Steel construction for sturdy, long-lasting use.
- Reversible striking plate for longer lasting use.
- Balanced frame design for consistent hammer strokes.
- Contoured grip for comfortable ease of use and reduced slippage.
- Chrome plated all steel construction-high carbon hardened steel working parts.

**30089** Packing: 1pc/blister card, 10pcs/inner, 20pcs/ctn/1.70'



30089

LeMORE®	90069 6 m/m 90089 8 m/m 90109 10 m/m	12069 6 m/m 12089 8 m/m 12109 10 m/m	12066 6 m/m 12086 8 m/m 12106 10 m/m	12065 6 m/m 12085 8 m/m 12105 10 m/m
Staple Model	ARROW®: T50		DUO-FAST®: 5000 SERIES STAPLE	BOSTITCH®: STCR2619 STAPLE, H30-8 PROWN

## Heavy Duty Professional Hammer Tacker

### Feature:

- All steel construction.
- Easy loading.
- The soft shock absorbing grip.
- Professional Quality for Multiple Applications.
- Easy-to-use for stapling carpet installation, insulation material, roofing upholstery etc.

**30088** Packing: 1pc/blister card, 10pcs/inner, 20pcs/ctn/2.00'



30088

LeMORE®	90069 6 m/m 90089 8 m/m 90109 10 m/m 90129 12 m/m 90149 14 m/m
Staple Model	ARROW®: T50 ESCO®: #11 KWB®: #057 NOVUS®: #11 RAPID®: #140 ROCAFIX®: #4 STANLEY®: #G/11

# Staples

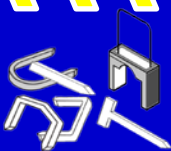

Item No.	Illustration	Size staple fits			Packing
		LeMORE® Stapler	LeMORE® Hammer tacker	Staple Gun Model	
<b>10068</b> 1/4" 6 mm		08610, 30276 30277, 30278 30279, 32273 07856, 30274 30267, 07610 30264, 32273 30287, 30268 30269, 30279 31601, 32270 32271, 32272 30287	30840, 30842	<b>ARROW®</b> : JM-21M, JT-21CM, T27 <b>KWB®</b> : PT8,PT10,T14,PT14N, MT10,HT053 <b>RAPID®</b> : MS853,R453,MS4.1 M10R,R153,M20R,M30 <b>NOVUS®</b> : J-01, J-02,J-08, J-17 J-09ABH, J-08XX,J-09XX, J-18 J-16 EADHG,J-16,J-19 EADHG <b>ROCAFIX®</b> : MS05,MS10, MS30,MS40,MS500B	1,000pcs/color box, 300boxes/ctn/0.59'
<b>10088</b> 5/16" 8 mm		08610, 30276 30277, 30278 30279, 07856 30269, 30274 30267, 07610 30287, 32272 32270, 32273 30264, 31601 32271, 32270 30287	30840, 30842	<b>ARROW®</b> : JM-21M, JT-21CM, T27 <b>KWB®</b> : PT8,PT10,T14,PT14N, MT10,HT053 <b>RAPID®</b> : MS853,R453,MS4.1 M10R,R153,M20R,M30 <b>NOVUS®</b> : J-01,J-02AL,J-08, J-09ABH,J-08XX,J-09XX,J-17, J-16 EADHG,J-19 EADHG,J-219, J-18, J-16 <b>ROCAFIX®</b> : MS05,MS10, MS30,MS40,MS500B	1,000pcs/color box, 300boxes/ctn/0.74'
<b>10108</b> 3/8" 10 mm		08610, 30278 30279, 30287 30274, 32271 32272, 32270 30267, 30269 30295	30840, 30842	<b>ARROW®</b> : JM-21M, JT-21CM, T27 <b>KWB®</b> : PT10,T14,PT14N, MT10 <b>RAPID®</b> : MS853,R453,MS4.1 M20R,M30 <b>NOVUS®</b> : J-02AL,J-16,J-17, J-16 EADHG,J-19 EADHG J-219, J-18,J-17 DA <b>ROCAFIX®</b> : MS10,MS30, MS40,MS500B	1,000pcs/color box, 200boxes/ctn/0.64'
<b>10128</b> 1/2" 12 mm		30278, 30279 30287, 30274 30267, 30269 32270		<b>KWB®</b> : T14,PT14N <b>RAPID®</b> : MS853,R453,MS4.1 M20R,M30 <b>NOVUS®</b> : J-02AL,J-16,J-17, J-16 EADHG,J-19 EADHG J-219, J-18,J-17 DA <b>ROCAFIX®</b> : MS10,MS30, MS40,MS500B	1,000pcs/color box, 200boxes/ctn/0.71'
<b>10148</b> 9/16" 14 mm		30278, 30279 30287, 30274 30267, 30269 32270		<b>KWB®</b> : T14,PT14N <b>RAPID®</b> : MS853,R453 <b>NOVUS®</b> : J-02AL,J-16,J-17 J-17 DA,J-19 EADHG,J-219,J-18 <b>ROCAFIX®</b> : MS500B	1,000pcs/color box, 200boxes/ctn/0.71'
<b>10168</b> 5/8" 16 mm		30287		<b>NOVUS®</b> : J-18 ,J-219	1,000pcs/color box, 200boxes/ctn/0.67'

# Staples

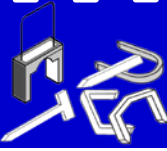

Item No.	Illustration	Size staple fits			Packing
		LeMORE® Stapler	LeMORE® Hammer tacker	Staple Gun Model	
<b>10606</b> 1/4" 6 mm		32276, 32278 30267, 30258 32272, 32270 32273	30841, 30842	<b>RAPID®</b> : M10Y, MS813, R83.	1,250pcs/color box, 200boxes/ctn
<b>10608</b> 5/16" 8 mm		32276, 32278 30267, 30258 32272, 32270 32273	30841, 30842	<b>RAPID®</b> : M10Y, MS813, R83.	1,250pcs/color box, 200boxes/ctn
<b>10610</b> 3/8" 10 mm		32278, 30267 30258, 32270 32273	30841, 30842	<b>RAPID®</b> : MS813, R83.	1,250pcs/color box, 200boxes/ctn
<b>10612</b> 1/2" 12 mm		32278, 30267 32270, 30258		<b>RAPID®</b> : MS813, R83.	1,250pcs/color box, 200boxes/ctn
<b>10614</b> 9/16" 14 mm		32278, 30267 32270		<b>RAPID®</b> : MS813, R83.	1,250pcs/color box, 200boxes/ctn

# Staples



Item No.	Illustration	Size staple fits			Packing
		LeMORE® Stapler	LeMORE® Hammer tacker	Staple Gun Model	
<b>90069</b> 1/4" 6 mm		30270, 30272 30315, 30259 32264, 31600 30285, 30286 30275	30083, 30088 30089	<b>ARROW®</b> : T50, T50OC, T55, T55C <b>RAPID®</b> : MS840, R11, R34, R44, R64, R211 <b>SWINGLINE®</b> : 10060N	1,000pcs/color box, 200boxes/ctn/0.63'
<b>90089</b> 5/16" 8 mm		30270, 30272 30315, 30259 32264, 31600 30285, 30286 30275	30083, 30088 30089	<b>ARROW®</b> : T50, T50OC, T55, T55C <b>RAPID®</b> : MS840, R11, R34, R44, R64, R211 <b>SWINGLINE®</b> : 10060N	1,000pcs/color box, 200boxes/ctn/0.83'
<b>90109</b> 3/8" 10 mm		30270, 30272 30315, 30259 32264, 31600 30285, 30286 30275	30083, 30088 30089	<b>ARROW®</b> : T50, T50OC, T55, T55C <b>RAPID®</b> : MS840, R11, R34, R44, R54, R64, R211 <b>SWINGLINE®</b> : 10060N	1,000pcs/color box, 200boxes/ctn/0.97'
<b>90129</b> 1/2" 12 mm		30270, 30272 30315, 30259 32264, 31600 30285, 30286 30275, 30937	30088	<b>ARROW®</b> : T50, T50OC, T55, T55C <b>RAPID®</b> : MS840, R34, R44, R54, R64, R211 <b>SWINGLINE®</b> : 10060N	1,000pcs/color box, 200boxes/ctn/1.02'
<b>90149</b> 9/16" 14 mm		30270, 30272 30315, 32264, 31600, 30285, 30286, 30275	30088	<b>ARROW®</b> : T50, T50OC, T55, T55C <b>RAPID®</b> : MS840, R34, R44, R54, R64, R211 <b>SWINGLINE®</b> : 10060N	1,000pcs/color box, 200boxes/ctn/1.20'
<b>90169</b> 5/8" 16 mm		30286			1,000pcs/color box, 200boxes/ctn/1.30'

# Staples

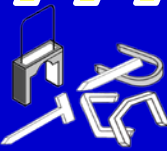

Item No.	Illustration	Size staple fits			Packing
		LeMORE® Stapler	LeMORE® Hammer tacker	Staple Gun Model	
<b>12056</b> 5/32" 4 mm		05146			1,000pcs/color box, 200boxes/ctn
<b>12055</b> 5 mm		05144			1,000pcs/color box, 200boxes/ctn
<b>12064</b> 1/4" 6 mm		05144			1,000pcs/color box, 300boxes/ctn/0.60'
<b>12084</b> 5/16" 8 mm		05133			1,000pcs/color box, 300boxes/ctn/0.70'

# Staples



Item No.	Illustration	Size staple fits			Packing
		LeMORE® Stapler	LeMORE® Hammer tacker	Staple Gun Model	
<b>12066</b> 1/4" 6 mm		30285	30089	WOLFCRAFT®: Tacomat	1,000pcs/color box, 200boxes/ctn/0.60'
<b>12086</b> 5/16" 8 mm		30285	30089	WOLFCRAFT®: Tacomat	1,000pcs/color box, 200boxes/ctn/0.70'
<b>12106</b> 3/8" 10 mm		30285	30089	WOLFCRAFT®: Tacomat	1,000pcs/color box, 200boxes/ctn/0.75'
<b>12126</b> 1/2" 12 mm		30285		WOLFCRAFT®: Tacomat	1,000pcs/color box, 150boxes/ctn/0.60'
<b>12146</b> 9/16" 14 mm		30285		WOLFCRAFT®: Tacomat	1,000pcs/color box, 200boxes/ctn/0.70'

# Staples

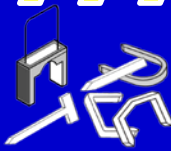

Item No.	Illustration	Size staple fits			Packing
		LeMORE® Stapler	LeMORE® Hammer tacker	Staple Gun Model	
<b>12069</b> 1/4" 6 mm		30285, 30259	30089	SWINGLINE® : 10060N	1,000pcs/color box, 150boxes/ctn/0.60'
<b>12089</b> 5/16" 8 mm		30285, 30259	30089	SWINGLINE® : 10060N	1,000pcs/color box, 150boxes/ctn/0.70'
<b>12109</b> 3/8" 10 mm		30285, 30259	30089	SWINGLINE® : 10060N	1,000pcs/color box, 100boxes/ctn/0.75'
<b>12129</b> 1/2" 12 mm		30285, 30259		SWINGLINE® : 10060N	1,000pcs/color box, 100boxes/ctn/0.90'
<b>12149</b> 9/16" 14 mm		30285		SWINGLINE® : 10060N	1,000pcs/color box, 100boxes/ctn/1.04'

# Staples



Item No.	Illustration	Size staple fits			Packing
		LeMORE® Stapler	LeMORE® Hammer tacker	Staple Gun Model	
<b>12068</b> 1/4" <b>6 mm</b>		08611, 05133 07611, 07857 32261, 32273 32271, 32272 30269, 30268	30843		1,000pcs/color box, 288boxes/ctn/0.75'
<b>12088</b> 5/16" <b>8 mm</b>		08611, 05133 07611, 07857 32261, 32273 32271, 32272 30268	30843		1,000pcs/color box, 300boxes/ctn/0.69'
<b>12108</b> 3/8" <b>10 mm</b>		08611, 32273 32271, 32272 32261	30843		1,000pcs/color box, 200boxes/ctn/0.63'
<b>12128</b> 1/2" <b>12 mm</b>		32273, 30269 32261			1,000pcs/color box, 200boxes/ctn/0.66'
<b>12148</b> 9/16" <b>14 mm</b>		32273, 30269 32261			1,000pcs/color box, 200boxes/ctn/0.79'



# Staples

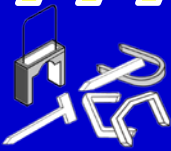

Item No.	Illustration	Size staple fits			Packing
		LeMORE® Stapler	LeMORE® Hammer tacker	Staple Gun Model	
<b>12136</b> 1/4" 6 mm				MAX® : 1006J	1,000pcs/color box, 200boxes/ctn/0.40'
<b>12137</b> 5/16" 8 mm				MAX® : 1008J	1,000pcs/color box, 200boxes/ctn/0.50'
<b>12138</b> 17/32" 13 mm				MAX® : 1013J	1,000pcs/color box, 150boxes/ctn/0.60'
<b>12120</b> 5/8" 15 mm		01722			2,000pcs/color box, 10boxes/ctn/0.71'
<b>12121</b> 18 mm		01723			1,600pcs/color box, 10boxes/ctn/0.71'

# Staples



Item No.	Illustration	Size staple fits			Packing
		LeMORE® Stapler	LeMORE® Hammer tacker	Staple Gun Model	
<b>12065</b> 1/4" 6 mm		30285	30089	<b>BOSTITCH® :</b> H30-8, EHS 50, EHS 300	1,000pcs/color box, 200boxes/ctn/0.50'
<b>12085</b> 5/16" 8 mm		30285	30089	<b>BOSTITCH® :</b> H30-8, EHS 50, EHS 300	1,000pcs/color box, 200boxes/ctn/0.60'
<b>12105</b> 3/8" 10 mm		30285	30089	<b>BOSTITCH® :</b> H30-8, EHS 50, EHS 300, PC 4000, PC 5000, T5-8D4, T15, T15C, T5-80C1, ET5-8	1,000pcs/color box, 200boxes/ctn/0.65'
<b>12125</b> 1/2" 12 mm		30285, 30935		<b>BOSTITCH® :</b> T5-8, T-80C, T15, P4.8, H30-8, EHS 50, EHS 300	1,000pcs/color box, 150boxes/ctn/0.60'
<b>12145</b> 9/16" 14 mm		30285			1,000pcs/color box, 150boxes/ctn/0.70'
<b>10622</b> 1/2" 12 mm		30936			1,000pcs/color box, 200boxes/ctn

# Staples

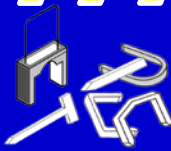

Item No.	Illustration	Size staple fits			Packing
		LeMORE® Stapler	LeMORE® Hammer tacker	Staple Gun Model	
<b>12104</b> 3/8" 10 mm		30270, 30288 31600, 30264		ARROW® : T25 STANLEY® : CT10X RAPID® : R36	1,000pcs/color box, 200boxes/ctn
<b>12124</b> 1/2" 12 mm		30270, 30288 31600, 32064		ARROW® : T25 STANLEY® : CT10X RAPID® : R36	1,000pcs/color box, 200boxes/ctn/0.89'
<b>12144</b> 9/16" 14 mm		30288, 31600 30264		STANLEY® : CT10X RAPID® : R36	1,000pcs/color box, 200boxes/ctn/0.90'
<b>12103</b> 3/8" 10 mm		30288, 31601		RAPID® : R28	1,000pcs/color box, 200boxes/ctn
<b>12123</b> 1/2" 12 mm		30274, 30275 30288, 31601			1,000pcs/color box, 200boxes/ctn/0.72'
<b>12143</b> 9/16" 14 mm		30270, 30288 31601			1,000pcs/color box, 200boxes/ctn



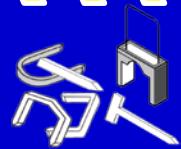

# Staples

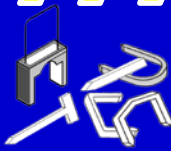

Item No.	Illustration	Size staple fits			Packing
		LeMORE® Stapler	LeMORE® Hammer tacker	Staple Gun Model	
<b>12150</b> 1/2" 12 mm		30270, 30272 30286, 31600 30287, 30274 30275			1,000pcs/color box, 200boxes/ctn/0.38'
<b>12157</b> 9/16" 14 mm		30270, 30272 30286, 31600 30287, 30274 30275			1,000pcs/color box, 150boxes/ctn/0.38'
<b>12140</b> 5/8" 15 mm		30315		<b>NOVUS® :</b> J-170, J-171, J-172A <b>RAPID® :</b> 553 <b>SWINGLINE® :</b> WHAMMER II	1,000pcs/color box, 200boxes/ctn
<b>12160</b> 5/8" 16 mm		30286, 30287			1,000pcs/color box, 200boxes/ctn
<b>12152</b> 3/4" 20 mm				<b>NOVUS® :</b> J-170, J-171, J-172A <b>RAPID® :</b> 553 <b>SWINGLINE® :</b> WHAMMER II	1,000pcs/color box, 150boxes/ctn/0.50'

# Staples

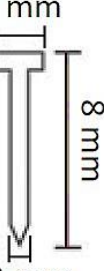

Item No.	Illustration	Size staple fits			Packing
		LeMORE® Stapler	LeMORE® Hammer tacker	Staple Gun Model	
<b>12158</b> 9/16" 14 mm	1.2 mm 	30270, 30272 31600, 30274, 30275		<b>SUREBONDER®</b> : 5600 <b>STANLEY®</b> : TRE300 <b>CRAFTSMAN®</b> : 9-68481	1,000pcs/color box, 200boxes/ctn/0.38'
<b>12159</b> 5/8" 16 mm	1.2 mm 	30270, 30272		<b>SUREBONDER®</b> : 5600 <b>STANLEY®</b> : TRE300 <b>CRAFTSMAN®</b> : 9-68481	1,000pcs/color box, 12boxes/ctn/0.25'
<b>12147</b> 5/16" 8 mm	2 mm 			<b>BOSCH®</b> : PTK 14E <b>ROCAFIX®</b> : MS30V, MS40V	1,000pcs/color box, 200boxes/ctn'
<b>12151</b> 3/8" 10 mm	2 mm 	30286, 30287 30274, 30275		<b>BOSCH®</b> : PTK 14E <b>ROCAFIX®</b> : MS30V, MS40V	1,000pcs/color box, 200boxes/ctn/0.35'

# Staples

Item No.	Illustration	Size staple fits			Packing
		LeMORE® Stapler	Round Cable	Flat Wire Cable	
<b>07651</b> 1/2" <b>12 mm</b>		07603	Height: 9.5 – 11 mm 		200pcs/color box, 80boxes/ctn/2.10'
<b>07650</b> 9/16" <b>14 mm</b>		07603	Height: 11.5 – 12.5 mm 		200pcs/color box, 80boxes/ctn/2.10'
<b>07652</b> 3/8" <b>10 mm</b>		07603	Height: 8.0 – 9.0 mm 	Height: 4.0 – 7.0 mm Width: Below 12.5 mm 	200pcs/color box, 80boxes/ctn/2.10'
<b>07648</b> 5/8" <b>16 mm</b>		07647	Height: 4.0 – 6.0 mm 	Height: 2.5 – 4.0 mm Width: Below 8.0 mm 	200pcs/double blister, 200cards/ctn/2.60'
<b>07649</b> 5/8" <b>16 mm</b>		07647	Height: 6.0 – 8.0 mm 	Height: 4.5 – 6.3 mm Width: Below 10.3 mm 	200pcs/double blister, 200cards/ctn/2.60'

# Staples

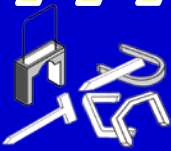

Item No.	Illustration	Size staple fits				Packing
		LeMORE® Stapler	Staple Gun Model	Round Cable	Flat Wire Cable	
<b>07605</b> 3/8" 10 mm		07603		Height: 8.0 – 9.0 mm 	Height: 4.0 – 7.0 mm Width: Below 12.5mm 	200pcs/color box, 80boxes/ctn/2.10'  Cable Staple Sort Pack: #07650 – 50pcs #07651 – 50psc #07652 – 100pcs
<b>07605</b> 1/2" 12 mm				Height: 9.5 – 11 mm 		
<b>07605</b> 9/16" 14 mm				Height: 11.5 – 12.5 mm 		
<b>12046</b> 5/32" 4 mm		07601	<b>POWERFAST®:</b> 31000	4.0 mm (5/32") 	4.0 mm (5/32") 	500pcs/color box, 200boxes/ctn/0.71'
<b>12044</b> 1/4" 6 mm		07601	<b>POWERFAST®:</b> 31000	6.4 mm (1/4") 		500pcs/color box, 200boxes/ctn/0.71'

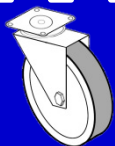

# Wheel

## Wheel

- 30000** 3"Wheel  
 - Material: TPU (red color) + PP (gray color)  
 - Size of wheel (D x W):  $\varnothing$  75 x 30 mm  
 - Size of hole (h):  $\varnothing$  10 mm  
 Packing: 1pc/PE bag, 50pcs/ctn



30000



30001

- 30001** 4"Wheel  
 - Material: TPR (light gray color) + PP (gray color)  
 - Size of wheel (D x W):  $\varnothing$  110 x 32 mm  
 - Size of hole (h):  $\varnothing$  10 mm  
 Packing: 1pc/PE bag, 50pcs/ctn

- 30009** 4"Wheel  
 - Material: TPU (dark gray color) + PP (gray color)  
 - Size of wheel (D x W):  $\varnothing$  110 x 32 mm  
 - Size of hole (h):  $\varnothing$  10 mm  
 Packing: 1pc/PE bag, 50pcs/ctn



30009



30003

- 30003** 5"Wheel  
 - Material: TPR (dark gray color) + PP (gray color)  
 - Size of wheel (D x W):  $\varnothing$  130 x 30 mm  
 - Size of hole (h):  $\varnothing$  10 mm  
 Packing: 1pc/PE bag, 50pcs/ctn

- 30004** 5"Wheel  
 - Material: TPU (blue color) + PP (gray color)  
 - Size of wheel (D x W):  $\varnothing$  130 x 30 mm  
 - Size of hole (h):  $\varnothing$  10 mm  
 Packing: 1pc/PE bag, 50pcs/ctn



30004

- 30008** 7"Wheel  
 - Material: TPR (gray color) + PP (black color) + Metal  
 - Size of wheel (D x W):  $\varnothing$  175 x 35 mm  
 Packing: 1pc/PE bag, 25pcs/ctn



30008

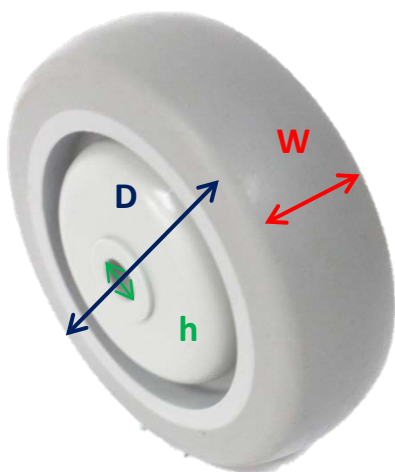

Size illustration









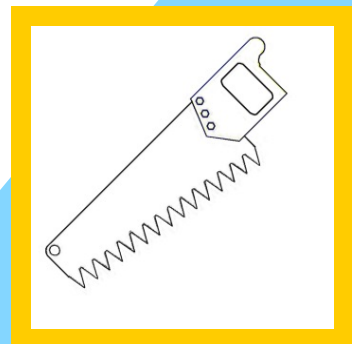
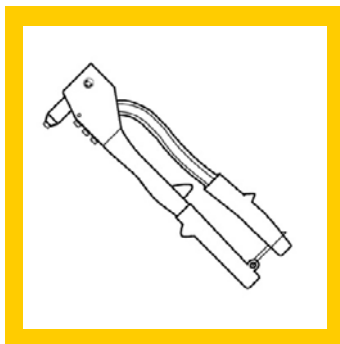
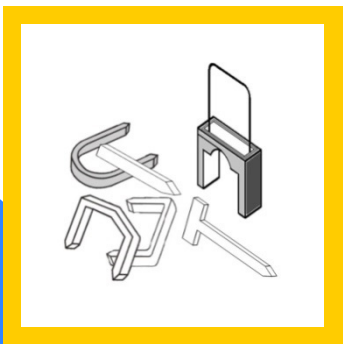
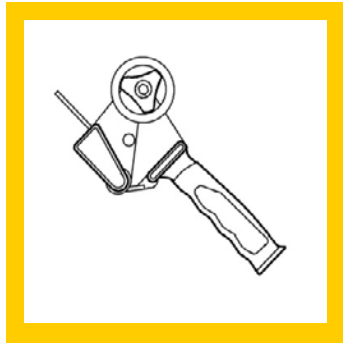
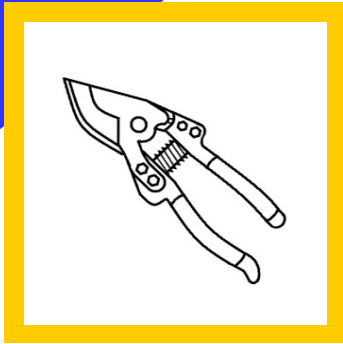
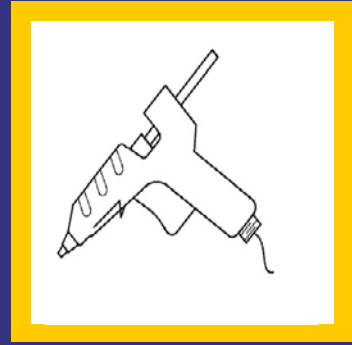
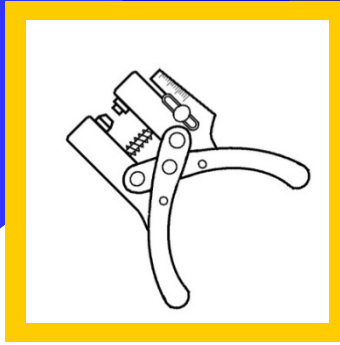
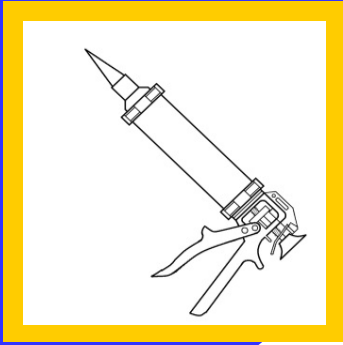

**Powerhit<sup>®</sup> ACURITE INDUSTRIES CORPORATION**

5F, NO.81, SECTION 2, CHENG TEH ROAD, TAIPEI (103), TAIWAN (R.O.C.)

TEL: 886-2-2556-1166

FAX: 886-2-2555-8605

E-MAIL: [acurite@ms5.hinet.net](mailto:acurite@ms5.hinet.net)

