

Instruments and Safety

NEW SECTIONS



Technical Safety
Gas & Flame Detection



Climate & Inspection

Accurate CATALOGUE



FREEPHONE 0800 500 380

www.accurate.kiwi | www.safety.kiwi

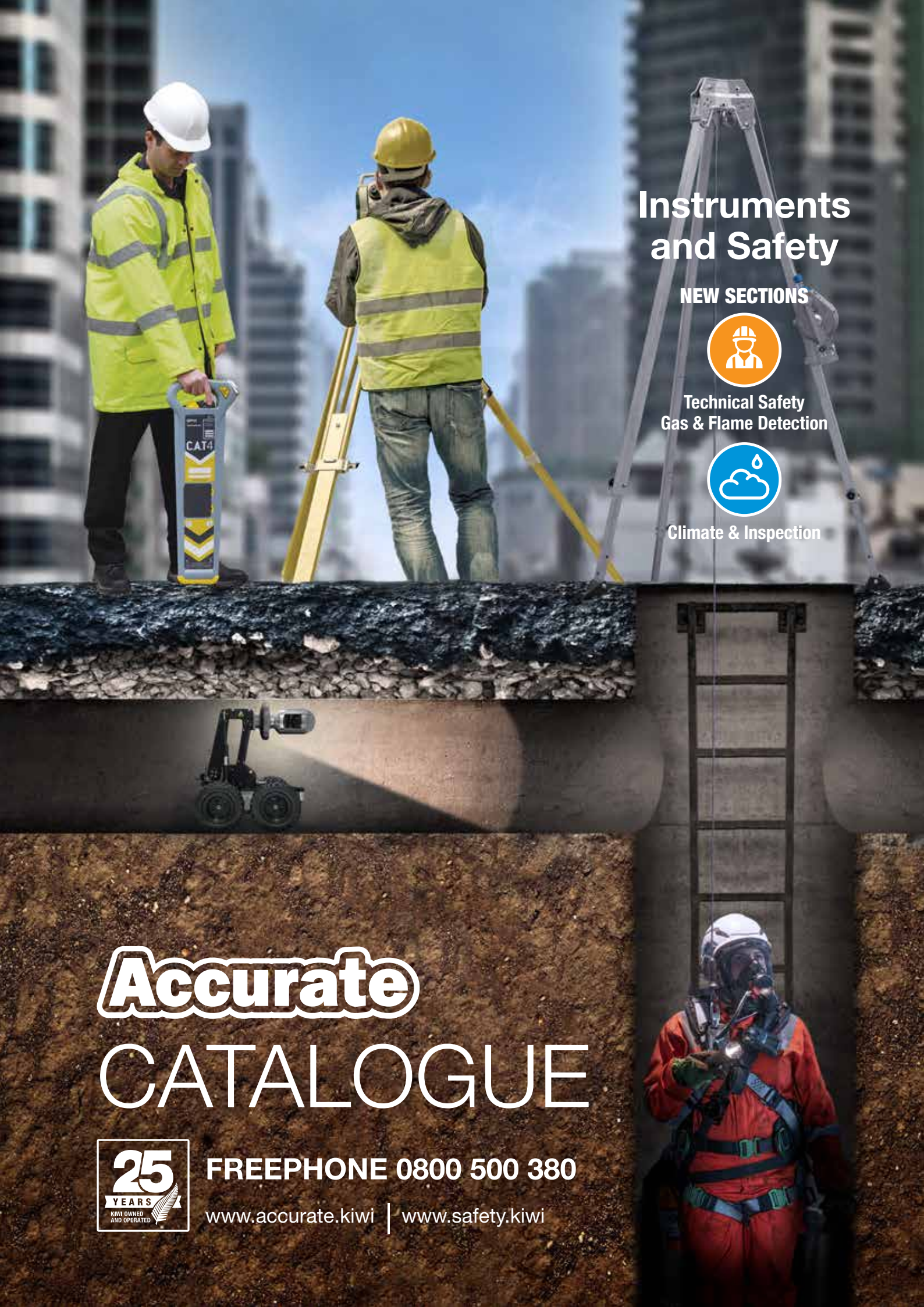

Accurate

CATALOGUE

Accurate Instruments offers some of the world's best renown, professional trade instrumentation available, yet the pricing is often highly competitive. Many of the leveling, measuring, technical safety and inspection products required for use in today's industry are highly technical. Finding knowledgeable people to answer the questions, advise models applicable and suggest best practice operation is near impossible.



Our industry experienced sales and advisory team provide you, the tradesperson, operator, consultant or consumer, with the correct instrument, product information and support backup to meet your demands.

We have two showroom branches with full service and calibration facilities, in Auckland and Christchurch, where many of our products can be viewed and purchased.



Instruments and Safety



Accurate Instruments has been supplying the New Zealand surveying, infrastructure, inspection and technical safety markets since 1994.

FREEPHONE 0800 500 380

www.accurate.kiwi | www.safety.kiwi





Introduction

Be compliant, be safe

The right equipment and the right advice every time.

Accurate prides itself on keeping you and your workplace compliant and safe in your operation, by using the correct equipment that is tested, calibrated and certified - every time.



As an ISO9001 certified company for technology solutions and support, Accurate is a trusted partner to many of the industries' biggest (and smallest) operators.

We have New Zealand and the South Pacific covered.
With showrooms, training facilities and full service
calibration centres in Auckland and Christchurch.
Both showrooms have many of our products
on display for demonstration and purchase.
Products are also available online with
shipping throughout the Pacific.





Health & Safety Compliance

One of Accurate's key goals is to provide a safe workplace and return its employees home each day - safely. We actively promote and practice safety within our business by recognising, minimising and mitigating our risks, administering PPE and ensuring compliance with our company responsibility under the Health and Safety at Work Act 2015.

A proud Kiwi Company

Accurate Instruments (NZ) Ltd is a 100% New Zealand owned company.

Celebrating 25 years in operation in 2019, Accurate is proud to be owned by kiwi's and run by kiwi's.

Carrying significant experience in the industry, the owners actively work in the business and keep their finger on the pulse in this ever changing dynamic world.

Passionate about the industry and the staff, it is important to maintain great relationships with not only our team and customers, but also our suppliers, to ensure we can bring to market the best equipment and technology available.

Service & Calibration Centres

Calibration, QA testing and support

Operating one of the largest technical service departments for survey, leveling and technical safety in Australasia, Accurate's Service Technicians provide the backup and support of our products, with calibration, certification and repairs of our equipment when required.

We have the computer software programmes, specialised tooling, vibration/shock analysis, digital calibration machines, collimator jigs and baselines that allow us to test, calibrate instruments, all within an acceptable industry time period.

Many of Accurate's Service Engineers are trained internationally at our manufacturers' facilities. They have the most current updates on all products, which include both hardware and firmware upgrades, modifications or factory changes.





Accurate

Training & Education

Industry Training Courses

Accurate offers a wide range of training options starting from basic product knowledge, right through to extensive theory and practical training.

Our training caters to a wide variety of industry sectors. The content we provide is recognised and relevant. We regularly update all our content and keep our trainer's knowledge up to date. The courses all focus strongly on Health & Safety procedures and guidelines, so you are working confidently and safely. We make every effort to assist you with any of your applications and answer any questions you have.

Our Industry trainers are based nationwide and training is available anywhere in New Zealand or we can utilise our training centres in either Auckland or Christchurch.

NZ INDUSTRY AND ACADEMIA LEVELS 3 & 4 STATEMENT OF ATTAINMENT CERTIFICATION*

Accurate is proud to share a partnership with the ARA Institute of Canterbury. Together we can provide Skills for Industry Statement of Attainment Certificate Courses.

**Attainment is only available on some courses.*



STANDARD COURSES > NOT LIMITED TO

- **Cable Location**
- **Ground Penetrating Radar GPR**
- **Gas Detection**
- **Moisture Inspection**
- **Soil Testing**
- **Leveling & Setout**

We can customise our courses to suit with combination courses also available.

INDUSTRY STAGE 1

Product Training

Demonstrate and detail key functions of the instrument.

INDUSTRY STAGE 2

Theoretical Training

In addition to product training, we include theory on the founding sciences and methodologies that relate to the instrument's main application.

INDUSTRY STAGE 3

Theory and Practical Training

This comprehensive module contains a combination of product and theory training but also incorporates practical training for on-site procedures.

OUR TRAINERS

BILL GYDE

Cable Location / GPR

Bill has wide experience with radar and electrical networks. He has been trained by IDS GeoRadar and also holds a Certificate of Competency in Opera Duo & GPR Theory. Bill also trains on the Zip Level model for Accurate.

DAVID OPENSHAW

Cable Location / Setout

With a double honours in Geology and Physical Geography, David oversees our Soil Testing, Site Leveling and Setout and Cable Location courses. He has also spent time as a land surveyor and teacher.

MARK GEMMELL

Moisture / CCTV

A Level 1 Certified Thermographer and trained by Trotec on moisture measurement in Germany. With training from Pearpoint in United Kingdom and Australia. Mark delivers our moisture and CCTV content to the industry.

JONO MILLAR

CCTV

Jono oversees our push rod and tractor CCTV pipe cameras for underground pipe surveying. He has been factory trained by CUES Inc in Florida, USA on sewer and manhole inspection.

World's Trusted Brands

Accurate offer only most trusted professional equipment.

As the New Zealand approved suppliers for these manufacturer's equipment, we handle all the sales, support and backup in house.

We back this with knowledgeable factory trained staff to correctly advise on the best suited equipment to meet your application, modes of operation, best practice and technical support.

The MSA logo is displayed in white, bold, sans-serif capital letters on a dark blue background.

MSA Safety is the global leader in the development, manufacture and supply of safety products that protect people and facility infrastructures. MSA's core products include portable and fixed gas detection instruments, flame detection systems, self-contained breathing apparatus and industrial head protection products.

The PRO SHOT LASER logo features the words "PRO SHOT" in a large, bold, sans-serif font, with "—LASER—" in a smaller font below it. Underneath are five small white dots.

Pro Shot lasers are iconic in New Zealand, being found on nearly every building or civil project in the past 25 years. Trusted by contractors and builders for their accuracy, reliability and performance, Pro Shot are designed and manufactured in California, U.S.A.

The RADIODETECTION logo consists of the word "RADIODETECTION" in a bold, sans-serif font, followed by a small square icon with a grid pattern.

Founded in 1970 in Bristol, United Kingdom, Radiodetection has gone on to be one of the global leaders in the Utility locating and cable avoidance sector. Their wide range of products include the industry standard Cat & Genny cable avoidance locator.

The SPECTRA PRECISION logo features the word "SPECTRA" in a bold, sans-serif font above the word "PRECISION" in a smaller font, both enclosed within a white oval border.

Spectra Precision is one of the biggest and most trusted names in the laser levelling and civil construction industries. Owned by Trimble Navigation, Spectra can trace its roots back to the introduction of the first automatic laser level in the 1950's. Spectra equipment is a constant on construction, drainage and civil sites throughout NZ.

IKAR

Founded in 1978 in Germany, IKAR GmbH has a long and successful tradition in the innovation, development and production of personal fall protection systems. Products include confined space entry tripod's, recovery winches and blocks, fall arresters, harnesses and davit arms.

TROTEC

From small beginnings in the late 1980's to a powerhouse today in Europe, Trotec offers diverse solutions in climate and measurement condition monitoring. From dehumidifiers to moisture meters, Accurate are proud to have represented Trotec in New Zealand for the past 15 years.

PLS

The company that started it all, when they developed and produced the very first compact plumb, level and square laser level - the PLS 5, back in the early 1990's. Today, owned by Fluke Corporation, PLS continue to set the standard in the industry for performance, quality and accuracy.

IDS

Popular with Engineers and consultants across the country, IDS Geo Radar, based in Italy, is a world leading provider of high-tech ground penetrating radar solutions, concrete and structural scanning and locating equipment in engineering and civil market sectors.

PEARPOINT

One of the world's leading manufacturers of commercial pipe inspection equipment, Pearpoint's range of fully modular camera systems delivers pipeline inspection capabilities from 32mm pipes up to 1500mm. From simple plumbers push rod systems to the motorized tractor pan and tilt, Pearpoint is also fully serviced by Accurate.

Honeywell

Honeywell Industrial Safety offer personal protection and technical safety equipment with key established brands Howard Leight for hearing protection, Sperian for safety eyewear, Miller for height safety and North for respiration.

Contents



LASER LEVELS

BUILDING & CONSTRUCTION LASERS

Pro Shot Alpha	18
Pro Shot Alpha V	19
Spectra Precision LL300S	20
Spectra Precision HV302	21

GRADE LASERS

Pro Shot Alpha C	19
Pro Shot AS2	22
Pro Shot AS2 Magnum	22
Spectra Precision GL422N	23
Spectra Precision GL622N	24
Spectra Precision GL700	24
Spectra Precision UL633N	25

CONING LASERS

Pro Shot Alpha C	19
------------------------	----

PIPE & DRAINAGE LASERS

Spectra Precision DG613	27
Spectra Precision DG613G	27
Spectra Precision DG813	27
QBL Geomax Zeta Arrow4	28
Pipe Trivets & Accessories	29

DOT & LINE LASERS

PLS3G	30
PLS3R	30
PLS5G	30
PLS5R	30
PLS6G	31
PLS6R	31
PLS180G	31
PLS180R	31
PLS3X360G	33
PLS3X360R	33
Spectra Precision LP51R	34
Spectra Precision LP51G	34
Spectra Precision LT52G	34
Spectra Precision LT52R	34
Spectra Precision LT20G	35
Spectra Precision LT58G	35

LASER RECEIVERS

Spectra Precision HL700	36
Spectra Precision HL760	36
Spectra Precision HL760U	36
Spectra Precision HR1220	37
PLS SLD	37



MACHINE CONTROL

BOOM MOUNTED LASER RECEIVERS

Spectra Precision CR700	41
Spectra Precision LR20	42
Spectra Precision LR30	42
Spectra Precision LR50	42
Spectra Precision LR60	42
MCE R45 BM	43
MCE R45 TC	43
MCE R45 TC Pro	43

2D AND 3D EXCAVATOR CONTROL

Moba XSite Easy	45
Moba Xsite Pro	46

DOZER AND BLADE CONTROL

MCE CB.D2	47
MCE RS007	47
Spectra Precision CB30	48
Spectra Precision CB25	48

PAVING SYSTEMS

Moba Matic 2	50
Moba Big Sonic Ski	51
Moba Matic 3D	52
Moba Pave IR	53



MEASURING EQUIPMENT

LASER TAPE MEASURES

Leica Disto D1	56
Leica Disto D110	56
Leica Disto D2	56
Leica Disto X3	56
Leica Disto X4	56
Leica Disto D510	56
Leica Disto D810 Touch.....	56
Leica Disto S910	56
Top Measure DLT Dual.....	57
Top Measure MLT Mini.....	57

MEASURING WHEELS

Top Measure TM06 Professional.....	58
Top Measure TM12 Professional.....	58
Top Measure DM12 Digital.....	58
Top Measure MS3	58
Rotosure 500 Deluxe	58
Rotosure Classique Deluxe	58
Rotosure Classique Professional.....	58
Meterman MK60M	58

DIGITAL SPIRIT LEVELS & ANGLE FINDERS

Smart Tool Gen2	60
Smart Tool Gen3 Pro	60
Smart Tool Module	61
Nedo Winkeltronic	61

SLOPETERS

Slopemeter No.2 NS	62
Slopemeter SCS1.....	62

MEASURING TAPES

Yamayo Steel Open Reel	62
Komelon Fiberglass Open Reel.....	62
Komelon PE85 8M	63
Komelon MD85 8M	63
Komelon MX82 8M.....	63
Komelon IR85 8M.....	63
Komelon LUR30 30M.....	63

DIAMETER TAPES

Yamayo Million.....	63
---------------------	----

FORESTRY HYPSONETERS

Haglof Vertex 5	65
Haglof Vertex VL5	65
Haglof Vertex Geo	65

CLINOMETERS & RANGEFINDERS

Haglof CI	66
Haglof ECII	66
Haglof HGH.....	66
Nikon Forestry Pro II	66

CALIPERS, BORERS & TAPES

Haglof Mantax Blue	67
Haglof Increment Borers	67
Flagging Tape	67



NON DESTRUCTIVE TESTING (NDT)

ULTRASONIC THICKNESS GAUGES

Olympus 27MG	69
Olympus 45MG	70
Olympus 38DL Plus.....	71
Olympus Gageview.....	71
Olympus Scanners	72

PAINT THICKNESS METERS

Trotec BB20	73
Trotec BB30	73

STRUCTURAL INTEGRITY METERS

James Instruments V Meter	74
James Instruments Vucon	74

REBAR COVER METERS

James Instruments Rebarscope	75
James Instruments Mini-R Meter	75

CONCRETE STRENGTH

James Instruments WM-250.....	76
James Instruments Tester MK III	76

SHOTCRETE PENETROMETERS

Mecmesin 1000N	77
----------------------	----

Contents



TECHNICAL SAFETY EQUIPMENT

PORTABLE GAS DETECTION

MSA Altair 4XR.....	81
MSA Altair 5X	82
MSA Altair	83
MSA Altair 2X	84
MSA Altair Pro	84
MSA Galaxy GX2	85
MSA Safety iO Grid Line Monitor	86
Calibration & Bump Test Gas Mixes	87
Gas Bottle Regulators.....	87
GFG Instrumentation G888.....	88
GFG Instrumentation G999.....	89
MGC Simple.....	90
MGC Infrared.....	91
MGC Pellistor	91

SGC	92
SGC Plus	92
Docking Stations	93
Sensit HXG Series	94
Sensit Gold G2	94
Sensit Trak-It IIIA.....	95
Trotec BG Series	95
CO2 Meter SAN-11	96
Trotec BQ16	96

FIXED GAS AND FLAME DETECTION

MSA Ultima X5000	98
MSA Prima X	99
MSA Prima X IR.....	99
MSA Chillgard 5000.....	100

MSA Chillgard VRF	101
MSA Chillgard NH3	101
MSA Chemgard.....	102
MSA TG5000	102
MSA Observer I	103
MSA Senscient Elds	103
MSA FL500-H2	104
MSA FL4000H.....	104
MSA Hazardwatch.....	105
MSA Gasgard XL.....	105
MSA Suprematouch	106
MSA SMC Sentry IT	106
MSA SMC Classic Sentry	107
MSA SMC Sentry Insite	107



MOISTURE, CLIMATE & INSPECTION EQUIPMENT

MOISTURE METERS

Trotec T660	111
Trotec BM31WP	112
Gann BL Compact B2	112
Protimeter Aquant	113
Protimeter Reachmaster Pro.....	113
Protimeter Surveymaster	114
Protimeter Digital Mini	114
Trotec T510 / T510K	115
Trotec BM22WP	116
Gann BL Compact S	117
Gann BL H 40	117
Trotec Building Inspection Kit.....	118
Trotec T3000 Kit.....	119
Trotec App Sensor Kit.....	120
Protimeter MMS2	121
Protimeter Hygromaster2.....	122
Trotec T20 / T260.....	122
Trotec BC21WP.....	123
Trotec BC21	123
Trotec BC06	123
Trotec TC100	124
Trotec BL30.....	124
Trotec DL200 Series	125
Trotec BZ Series	126
Trotec BF06.....	127
Trotec BW10	127

ANEMOMETERS

Trotec TA300	129
Trotec BA30WP.....	129
Trotec BA16	130
Trotec BA06	130
Trotec BA16WP.....	131
Trotec BV15WP	131

THERMAL IMAGING

Fluke PTi120	133
Fluke TiS+ Series	134
Fluke Ti Series	135
Fluke TiX Series.....	136
MSA Evolution 6000.....	137
Fluke VT04A.....	138
Fluke 62 MAX	138
Trotec Infrared Laser Pyrometers	139
Trotec BP25	140
Trotec BP21 WP.....	140
Trotec BP5F	141
Trotec BT20	142
Trotec BT22WP	142
Trotec VSC206	143
Trotec VSC3008	144
Trotec BO26	145
Trotec BO22	145
Trotec BO21	145

DEHUMIDIFICATION, VENTILATION & HEATING

Trotec TTK-S Series	147
Trotec TTR Compact	148
Trotec TTR Series	149
Trotec TFV Series	150
Trotec TFV-S Series	151
Trotec TTV Series	152
Trotec TTW2500S	153
Venturi ASI Series	153
Trotec TEH Series	154
Trotec IDE-D Series	155

COMING SOON



Geotechnical & Underground Investigation

Cable avoidance and locating equipment, GPR ground penetrating radar and concrete scanning, motorised and push rod CCTV pipe inspection cameras, 3D manhole and asset scanners, acoustic leak detection and correlation, soil compacting testing.



Land & Aerial Surveying

GNSS, GPS and GIS systems, UAV systems, mechanical, reflectorless and robotic total stations and theodolites, toughbook and tablet computing data loggers and fieldbooks, extensive range of survey accessories, mounts, prisms and poles.

Laser Levels

Rotating, Grade, Pipe, Dot and Line Lasers

Site, construction, internal fitout leveling and alignment solutions from the world's best laser brands, all supported and serviced in New Zealand.







PRO SHOT ALPHA

HIGH ACCURACY AUTOMATIC HORIZONTAL LASER WITH SLOPE MATCHING

Accurate's No.1 selling laser level. Made in the USA, the Alpha is a robust automatic self-leveling laser level, designed for builders, concrete placers, landscapers, commercial and civil contractors.

Simply mount the laser on a tripod, press power, and the laser automatically levels itself. The Alpha is powered by 4x C size alkaline batteries that are easy to replace - no worries about recharging.

With a high accuracy of +/- 1.5mm per 30 metres and an operating diameter of over 600 metres, the Alpha covers even the largest construction sites.

Choose the package that includes the HL700, a 'mm' display digital laser receiver, and your height elevation is displayed numerically along with the arrows on the backlit LCD, down to +/- 0.5mm!

For extra large civil projects, the long range Alpha XD model with >1000 metres operational range is available. Waterproof, reliable and with the best standard warranty in the business.

Pro Shot lasers have been trusted by New Zealand trade professionals for 25 years. There yesterday - here today - around tomorrow.



+/- 1.5mm
ACCURACY @ 30M

5
YEAR
WARRANTY

Q
WEBSITE
SEARCH
ALPHA

KEY FEATURES

- Made in the USA – Highest Quality
- High-Accuracy Automatic Self-Leveling
- 610 Metre Operating Range
- Manual Slope Matching Mode
- IP56 Water and Dustproof
- 5 Year Warranty
- 5 Year Knockdown Damage Protection Warranty
- Optional XD Model for >1000m Long-Range

PACKAGES



PRO SHOT ALPHA WITH R9 RECEIVER, BATTERIES AND HARD CASE (INCLUDES TRIPOD)

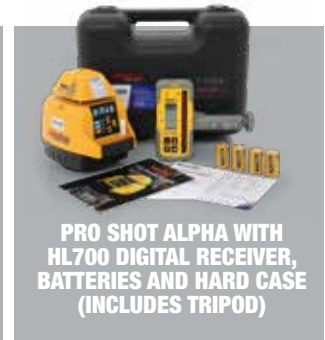

PRO SHOT ALPHA WITH HL700 DIGITAL RECEIVER, BATTERIES AND HARD CASE (INCLUDES TRIPOD)

POPULAR ACCESSORIES

RECHARGEABLE BATTERY SET



5 METER 5MM ALUMINIUM STAFF



M402 MANUAL FINE SLOPE ADAPTER





LASER LEVELS

CONSTRUCTION PLUMB LASERS

PRO SHOT ALPHA V

SPECIALISED HIGHLY VISIBLE LONG RANGE AUTOMATIC PLUMB LASER

The Pro Shot Alpha V is a specialised plumb laser with a high accuracy of +/-0.7mm at 30meters.

Visible in optimum conditions up to nearly 100 meters, the large precise visible red dot projects upwards with the powerful laser and high quality optics creating precision accuracy for commercial applications.

To aid plumbing down applications, the Alpha V also has the option of either a solid or flashing plumb down beam.

- Operating Range up to 100m (optimum conditions)
- Accuracy (Up Beam) +/- 0.7mm per 30 Metres
- Accuracy (Down Beam) +/- 0.3mm per Metre
- Alkaline Battery Life of 65 Hours



OPTIONAL FINE ADJUSTMENT 1.7%
CONE HEAD AVAILABLE

+/- 0.7mm
ACCURACY @ 30M

2
YEAR
WARRANTY

WEBSITE
SEARCH
ALPHA V



LASER LEVELS

AUTOMATIC CONING GRADE LASERS

PRO SHOT ALPHA C

UNIQUE CONING AUTOMATIC GRADE LASER WITH FINE +/- CONING ADJUSTMENT

The Pro Shot Alpha C is a specialised automatic grade laser designed for coning grade applications where a cone or laser light is required.

This unique, adjustable, cone projecting head lets you set-up with the laser tool at the high point, or low point of a conical sloping reference of laser light.

The Alpha C can project as much as a 4% sloped cone of laser light either up or down, with increments of 0.25%.

- High Accuracy +/- 1.6mm per 30 metres
- 610 Metre Operating Range
- Coning Grade Range of +/- 4%
- Coning Increments of 0.5%



CONE LASER CAN PROJECT
EITHER UP OR DOWN

+/- 1.5mm
ACCURACY @ 30M

2
YEAR
WARRANTY

WEBSITE
SEARCH
ALPHA C



SPECTRA PRECISION LL300S

HIGH ACCURACY SELF LEVELING LASER WITH REMOTE CONTROL SLOPE MATCHING CAPABILITY

Backed by a 5 Year Manufacturer's Warranty, the Spectra Precision LL300S is a high accuracy durable electronic self levelling laser with remote control slope matching capability and digital receiver technology.

It is well suited for commercial construction and civil horizontal levelling applications.

From world pioneer of the first rotating laser level - Spectra Precision, the LL300S features fast automatic horizontal self-leveling. Rugged and waterproof to IP66 specification, the LL300S is ideally suited for high accuracy levelling applications up to a long distance of 800 metres.

The LL300S also features fast Slope Matching. This can be easily controlled from the laser (with up/down arrows) or from the optional RC402N remote control or android based Spectra Laser App, paired with the smart ST805 transmitter.

The ST805 also extends the remote control operation of the laser out to over 100 metres! The LL300S can also be used for vertical leveling and string-line setout using the tripod.



+/- 1.6mm
ACCURACY @ 30M

5
YEAR
WARRANTY

 WEBSITE
SEARCH
LL300S

KEY FEATURES

- High accuracy +/- 1.6mm per 30 metres
- Long 800 metre operating range
- Manual vertical leveling ability
- Digital Receiver and fingerprint technology
- Manual Slope Matching mode with remote function
- Android Laser Remote APP capability
- IP66 water and dustproof
- 5 Year Warranty

PACKAGES



SPECTRA LL300S WITH HL700 RECEIVER, BATTERIES AND HARD CASE (INCLUDES TRIPOD)

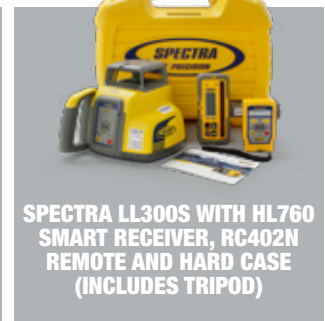

SPECTRA LL300S WITH HL760 SMART RECEIVER, RC402N REMOTE AND HARD CASE (INCLUDES TRIPOD)

POPULAR ACCESSORIES

SPECTRA ST805 TRANSMITTER



SPECTRA LASER APP





SPECTRA PRECISION HV302

AUTOMATIC HORIZONTAL & VERTICAL SELF LEVELING VISIBLE LASER LEVEL WITH SMART TECHNOLOGY

Available in either red beam or highly visible green beam models, the HV302 is one of the most advanced smart rotating lasers available on today's market.

High accuracy - check. Automatic horizontal and vertical self-leveling - check. Multi-speed rotating beam with scanning and squaring - check. Remote control operation - check. All backed by a 5 Year Manufacturers Warranty.

Where the HV302 lifts the game is in its smart technologies, allowing for automated slope matching, fixed elevation laser beam locking, individual beam detection and smart connectivity. HV302 features and capabilities include;

- Automatic Grade Match
- PlaneLok
- Axis Masking
- Fingerprint Receiver Technology
- Android Laser APP

Even in brightly lit interior conditions, the high visibility green beam of the HV302G delivers consistently reliable and accurate performance, enabling you to work faster and smarter. The Spectra Precision HV302G laser level is covered by a 3 Year Manufacturers Warranty.

KEY FEATURES

- Precision horizontal and vertical self-leveling
- Choose either red or highly visible green beams
- Scanning, squaring and remote operation
- Automatic Grade Match for fast slopes
- PlaneLok eliminates beam drift by locking the laser Axis Masking
- Digital Receiver and fingerprint technology
- Android Laser Remote APP capability

POPULAR ACCESSORIES



+/- 1.6mm
ACCURACY @ 30M

5
YEAR WARRANTY

WEBSITE SEARCH HV302



+/- 1.6mm
ACCURACY @ 30M

5
YEAR WARRANTY

WEBSITE SEARCH HV302



PRO SHOT AS2

DIAL-IN AUTOMATIC SELF LEVELING SINGLE GRADE LASER LEVEL

One of New Zealand's most popular grade lasers. The Pro Shot AS2 is an economical yet performance driven dial-in fully automatic single grade laser.

Compared to many lasers in this price point which are simply slope matching or dial-in MANUAL grade lasers, the AS2 models are FULLY automatic. Designed for simple operation, the AS2 is ideal for civil construction, drainage, earthmoving and machine control applications.

Simply mount the laser in the direction of the required slope and dial-in the grade, with fine increments of 0.01%.

A grade of up to 25% can be dialled into the AS2. For long range and higher accuracy applications, the AS2 Magnum has a 1000m working range and a compound dual grade slope kit.



+/- 2.0mm
ACCURACY @ 30M

3
YEAR
WARRANTY

 **WEBSITE SEARCH AS2**

KEY FEATURES

- Accuracy +/- 2mm per 30 metres
- 610 metre Operating Range
- Fully Automatic Dial-in Self-Leveling Single Grade
- 0-25% Single Grade Range
- 0.01% Dial-in Grade Increments
- Automatic Cross Axis self-leveling with Height Alert
- IP56 Water and Dustproof
- Dual Slope, 1000m operating range (AS2 Magnum)

PACKAGES



PRO SHOT AS2 WITH R9 RECEIVER, BATTERIES AND HARD CASE (INCLUDES TRIPOD)



PRO SHOT AS2 WITH HL700 DIGITAL RECEIVER, BATTERIES AND HARD CASE (INCLUDES TRIPOD)

LOOKING FOR BOOM MOUNTED RECEIVERS?

CR700 DIGITAL BOOM RECEIVER



MCE R45 TC PRO BLUETOOTH BOOM RECEIVER





SPECTRA PRECISION GL422N

DIAL-IN AUTOMATIC DUAL GRADE LASER LEVEL WITH SMART TECHNOLOGY

The GL422N from Spectra is one of the most featured packed fully automatic dual grade lasers available in its price bracket.

Compared to many stripped back basic dual grade lasers available, the GL422N is packed with features designed for efficiency, accuracy and performance.

GL422N smart features and capabilities include:

- Automatic Grade Match
- PlaneLok
- Axis Masking
- Fingerprint Receiver Technology
- Vertical Smart Alignment
- Android Laser APP

GL412N SINGLE GRADE MODEL AVAILABLE UPON REQUEST



+/- 1.6mm
ACCURACY @ 30M

5
YEAR WARRANTY

WEBSITE SEARCH GL422N

KEY FEATURES

- Accuracy +/- 1.6mm per 30 Metres
- Long 800 Metre Operating Range
- -10 to +15% Dual Grade Range
- Automatic Grade Match for Fast Slopes
- PlaneLok Eliminates Beam Drift by Locking the Laser Axis Masking
- Digital Receiver and Fingerprint Technology
- Android Laser Remote APP capability

PACKAGES



SPECTRA GL422N WITH HL700 RECEIVER, BATTERIES AND HARD CASE



SPECTRA GL422N WITH HL760 SMART RECEIVER, BATTERIES, RC402N REMOTE AND HARD CASE

POPULAR ACCESSORIES



SPECTRA PRECISION ST805 TRANSMITTER

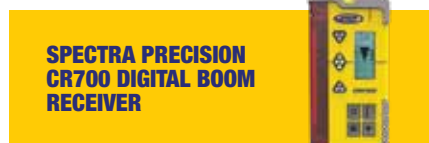

SPECTRA PRECISION CR700 DIGITAL BOOM RECEIVER



SPECTRA PRECISION LASER APP



M402 FINE SLOPE ADJUSTING MOUNT



SECO 5220-13 H/DUTY WOODEN TRIPOD

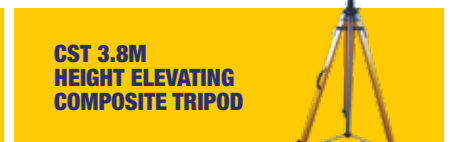

CST 3.8M HEIGHT ELEVATING COMPOSITE TRIPOD



LASER LEVELS

AUTOMATIC DUAL GRADE LASERS

SPECTRA PRECISION GL622N

DIAL-IN AUTOMATIC DUAL GRADE LASER LEVEL WITH SMART TECHNOLOGY & AXIS ALIGNMENT

The GL622N is a high precision dial-in self-leveling dual grade laser level with smart technology for performance critical civil construction, drainage, sports/tennis turf fields, parking lots and earthmoving contractors.

The Automatic Grade Match, PlaneLok and Automatic Axis Alignment features all add up to efficient time and accuracy gains on the job site. The RC602N remote control features a large backlit LCD enabling control of all of the GL622N functions. A Class1 GL622IR model is also available.

- Wide +/-25% Dual Grade Range Capability
- Auto Axis Alignment for Exact Receiver Positioning
- Automatic Grade Matching & PlaneLok
- Axis Masking & Fingerprint Receiver Technology

GL612N SINGLE GRADE MODEL AVAILABLE UPON REQUEST



+/- 1.6mm
ACCURACY @ 30M

5
YEAR
WARRANTY

WEBSITE
SEARCH
GL622N



LASER LEVELS

MACHINE CONTROL DUAL GRADE LASERS

SPECTRA PRECISION GL700 SERIES

EXTRA HIGH PRECISION DUAL GRADE LASER FOR FINE GRADING AND MACHINE CONTROL

For machine fine grading control and finishing, the GL700 series from Spectra are one of the most accurate dual grade laser systems available.

Compared with the GL422N and GL622N, the GL720 models feature a different detection system that is designed to work with machine control receivers as well as a long range radio remote control, with an operation range of up to 230 metres. Standard features include Automatic Grade Match, PlaneLok and Automatic Axis Alignment.

- Precision Machine Detection System
- Rugged Heavy-duty Aluminium Housing
- Long-range Remote Operation of 230 metres
- Auto Axis Alignment, Grade Matching & PlaneLok

GL742 STEEP SLOPE MODEL AVAILABLE WITH GRADE RANGE UP TO 110%



+/- 0.7mm
ACCURACY @ 30M

5
YEAR
WARRANTY

WEBSITE
SEARCH
GL700



SPECTRA PRECISION UL633N

AUTOMATIC DIAL-IN DUAL GRADE UP TO 25% WITH SELF LEVELING GRADE COMPENSATION

The world's first construction laser allowing total automatic control of all three axes. The Spectra Precision UL633N combines dual grade functionality, automatic dual grade axis alignment with trench and pipe laying setout.

Packed with smart technologies, the UL633N is truly an all-round high performance laser leveling system. UL633N features and capabilities include:

- Automatic Spot Align
- Spot Search
- Dual Automatic Axis Alignment
- Automatic Grade Match
- PlaneLok
- Axis Masking
- Electronic Leveling Vibration Filter

All features can be controlled from the intuitive RC603N remote. The UL633N is supplied standard with two HL760 digital laser receivers that can communicate with each other.

- Wide +/-25% Dual Grade Range Capability
- Z Axis Pipe Laser Mode with Automatic Targeting
- Led Sf601 Spot Finder for Pipe Laying
- Auto Axis Alignment for Exact Receiver Positioning
- Automatic Grade Match For Fast Slopes
- Planelok Eliminates Beam Drift by Locking the Laser Axis Masking
- 2x Digital Receivers With Fingerprint Technology



Accurate
WARRANTY
& SERVICE
SITE COMPLIANT
ISO 9001 REGISTERED

+/- 1.6mm
ACCURACY @ 30M

5
YEAR
WARRANTY

WEBSITE
SEARCH
UL633N

PACKAGE

SPECTRA UL622N
WITH TWO HL760
RECEIVERS, LED SF601
SPOT FINDER, RC603N
REMOTE CONTROL,
MOUNTS AND HARD
CARRY CASE



POPULAR ACCESSORIES

<p>CR700 DIGITAL BOOM RECEIVER</p>	<p>R45 TC PRO BT BOOM RECEIVER</p>	<p>SECO 5220-13 H/DUTY WOODEN TRIPOD</p>	<p>CST 3.8M HEIGHT ELEVATING COMPOSITE TRIPOD</p>
--	--	--	---

PIPE LASERS

Unsurpassed in the field of drainage, and with over 50 years experience in the development and production of pipe and drainage lasers, the latest Spectra Precision Dial-grade pipe lasers combine world leading technology and features with the accuracy, performance, reliability and robustness renown to the brand.





SPECTRA PRECISION DG613 & DG813

PRECISION DIAL-IN GRADE PIPE LASERS WITH SMART ALIGNMENT & TARGETING

Performance and featured packed, the Spectra Precision pipe lasers are also intuitive to use. With a -12% to +40% dial-in grade range, all models feature Line-Set/Check for quick manhole 100% alignment – Line Scan, which provides a quick alignment to the centre of the target and Line Alert, which notifies the user if the set-up is disturbed. The DG813 also comes with the SF803 spot finder which automatically centres the laser dot to the target. The DG613 is also available in the DG613G specification, featuring a highly visible green beam.

- Extra bright Red or Green Beam Models
- Line Alert Notification of Laser Datum Changes
- Line Scan Beam Centring
- SF803 Automatic Beam Targeting (DG813)



+/- 4.8mm
ACCURACY @ 100M

5
YEAR
WARRANTY

WEBSITE SEARCH
DG613



RELATED PRODUCTS

PORTABLE GAS DETECTION
COMING SOON



CONFINED SPACE TRIPOD & WINCHES
COMING SOON





LASER LEVELS

PIPE & DRAINAGE LASERS



AVAILABLE WITH EITHER
A RED OR HIGHLY VISIBLE
GREEN LASER DIODE

+/- 4.8mm
ACCURACY @ 100M

5
YEAR
WARRANTY

WEBSITE
SEARCH
ARROW

GEOMAX ZETA ARROW4 SERIES

ECONOMICAL RED BEAM DIAL-IN PIPE LASERS

The Arrow4 pipe lasers have been designed with simplicity in mind. Economical in price but not performance.

The Arrow4 features a durable and rugged design and construction. The heavy duty cast aluminium pipe laser features a grade input range of -10 to +40%, with self leveling in both the main and cross axis.

The Arrow4S model has the additional feature of a rotating vertical beam for out of the trenchline alignment using a handheld digital laser receiver.

- Compact Durable easy-to-use Pipe Laser
- Large -10 to +40% Grade Range
- One Button 'Stake Alignment' Function
- Out of Trench Receiver Alignment Mode (Arrow4s)



PIPE LASER TRIVET SET

Made in New Zealand and specifically designed to be used with a wide variety of pipe lasers, this heavy duty universal trivet is manufactured from stainless steel.

With a solid trivet base with adjustable feet, the concave design of the cradle is designed for various dimension pipe lasers to sit level. The attachable rubber connecting rings fit over the laser to fit it firmly in place.

Both the cradle and pole are height adjustable to suit the dimension of pipes being installed.



WEBSITE SEARCH
PIPE TRIVET

12V PIPE BLOWER

Using pipe lasers inside pipes often ends up with movement of the laser beam. Every drainage contractor somewhere, sometime has experienced this. This is referred to as refraction.

Refraction happens due to varying temperature and humidity inside the pipe as the laser light passes through it.

This 12V pipe blower helps alleviate the problem of refraction by increasing the air distribution in the pipe which in turn reduces the temperature fluctuation.



WEBSITE SEARCH
PIPE BLOWER

HOSE DUCTING: SPIRAL RIBBED VENTILATION
GRADE 80MM HOSE - 5 METERS

PIPE LASER TARGETS & PLATES

Accurate offer a wide array of pipe targets and plates, both small and large, to suit not only the Spectra Precision and QBL/Geomax pipe lasers, but many other well known brands. Red or green, small or large, plates or complete target sets are usually readily available for supply.



WEBSITE SEARCH
PIPE TARGETS



LASER LEVELS

PLUMB & LEVEL DOT LASERS

PLS 3G & 3R

SELF LEVELING PLUMB & LEVEL DOT LASER

The PLS 3G and 3R models are the ideal laser tool for the contractor searching for a professional trade quality plumb dot laser.

Built on the reputation of 25+ years as a market leader in dot and line lasers, the PLS 3 is available as a standard red beam or highly visible green beam laser.

The PLS 3 models are ideally suited to HVAC, steel framers, electrical, interior fit out and general contractors who require the need to transfer floor to ceiling points.

- Accuracy +/- 3mm per 10 Metres
- Self Levelling Range of +/- 4°
- Operating Visibility Range Typically 15-20 Metres
- Alkaline or Rechargeable Battery Systems

**AVAILABLE WITH EITHER
A RED OR HIGHLY VISIBLE
GREEN LASER DIODE**

**+/- 3.0mm
ACCURACY @ 10M**

**3
YEAR
WARRANTY**

**WEBSITE
SEARCH
PLS3**



LASER LEVELS

PLUMB, LEVEL, SQUARE DOT LASERS

PLS 5G & 5R

SELF LEVELING PLUMB, LEVEL & SQUARE DOT LASER

From the company that brought you the original plumb, level and square compact alignment tool, comes the latest generation PLS 5 models.

Available in the standard red or extra bright green laser diodes, the PLS 5 models are designed for general construction, boat builders, electricians, glaziers and commercial interior fit out contractors.

Exclusive to the PLS 5 models, the unique pendulum target transfers to the laser dot directly to the floor so your plumb and square layout can be correctly marked.

- Self Levelling Range of +/- 4°
- Operating Visibility Range Typically 20 metres
- Pendulum Target for Exact Point Markout
- Alkaline or Rechargeable Battery Systems

**AVAILABLE WITH EITHER
A RED OR HIGHLY VISIBLE
GREEN LASER DIODE**

**+/- 3.0mm
ACCURACY @ 10M**

**3
YEAR
WARRANTY**

**WEBSITE
SEARCH
PLS5**



LASER LEVELS

COMBINATION DOT & LINE LASERS

PLS 6G & 6R

COMBINATION PLUMB, LEVEL, SQUARE DOT AND CROSS LINE LASER

Available in either red or green beam, the PLS 6 lasers are a combination of the popular PLS 5 dot and PLS 180 cross line lasers. The PLS 6 eliminates the need for two separate laser tools. It is a five beam point and a crossline laser combined into one easy to use convenient laser product.

The optional SLD receivers for either PLS 6 lasers extend the range of operation for internal or outdoor use.



- Accuracy +/- 3mm per 10 Metres
- Self Levelling Range of +/- 4°
- Operating Visibility Range Typically 15-20 Metres
- Optional Outdoor SLD Receivers Available



+/- 3.0mm
ACCURACY @ 10M

3
YEAR
WARRANTY

WEBSITE
SEARCH
PLS6



LASER LEVELS

CROSS LINE LASERS

PLS 180G & 180R

SELF LEVELING PLUMB & LEVEL CROSS LINE LASER

Always a popular choice among internal fit out contractors, the PLS 180 models are available in the standard red or extra bright green laser diodes. Compared with lower cost models, the spread of the beam width is greater. The PLS 180 models can be placed on the floor, tripod mounted or magnetically mounted.

The optional SLD receivers for either PLS 180 lasers extend the range of operation for internal or outdoor use.



- Accuracy +/- 3mm per 10 Metres
- Self Levelling Range of +/- 4°
- Operating Visibility Range Typically 15-20 Metres
- Optional Outdoor SLD Receivers Available



+/- 3.0mm
ACCURACY @ 10M

3
YEAR
WARRANTY

WEBSITE
SEARCH
PLS180



3x360G Three-Beam Green Laser Level

**The Professional Standard since 1990.
Level. Layout. Build.™**

Get the job done FAST & Accurate with the new generation of PLS dot and line lasers. Our traditional red beam PLS self-levelling line lasers are now also available as bright Green Beam Lasers for continuous straight line horizontal levelling, cross lines, vertical (plumb) alignment.

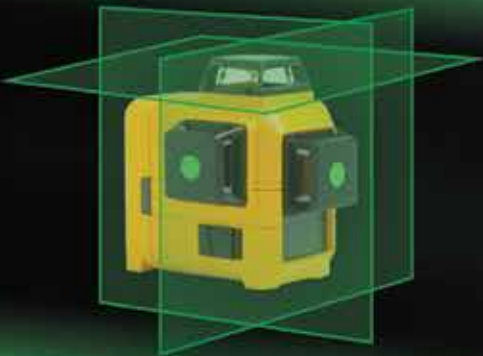

PLS 3x360G

**THREE-BEAM 360 DEGREE LASER
TECHNOLOGY INTEGRATED INTO AN
AUTOMATIC PENDULUM DESIGN**

Accuracy: 2mm @ 10m

Working Range: Upto 35m, 65m with a receiver

Kit Includes: Rechargeable Li-ion battery pack,
power supply, magnetic L-bracket, green reflective
target, canvas pouch and blow mold case

Accurate

Auckland Showroom: 192 Marua Road, Mt Wellington, Christchurch Showroom: 4 Avenger Crescent, Wigram

FREEPHONE 0800 500 380 | www.accurate.kiwi

Available from your
favourite Building Supply
Merchant or Tool Shop.

BUY ONLINE

Accurate Instruments (NZ) Limited is a 100% Kiwi owned company and is the master distributor in New Zealand for a number of international instrument manufacturers.



First PLS laser with 3-beam laser technology integrated to automatic pendulum.



LASER LEVELS

PLUMB & LEVEL DOT LASERS

PLS 3X360G & 3X360R

360 DEGREE SELF LEVELING CROSS AND SQUARE LINE LASER

The PLS3x360 laser is the perfect all round internal fit out laser tool. Available in bright green or red beam models, the 3x360 features three full 360 degree laser beams for level, plumb and square.

This versatile laser level features best-in-class accuracy as well as a rechargeable battery pack and a magnetic bracket, that also allows for fine adjustments of the laser position. Use the superior-range detector with the 3x360G for your challenging work environments

- Accuracy +/- 2mm per 10 Metres
- Self Levelling Range of +/- 4°
- Operating Visibility Range Typically 15-20 Metres
- Rechargeable Battery Systems

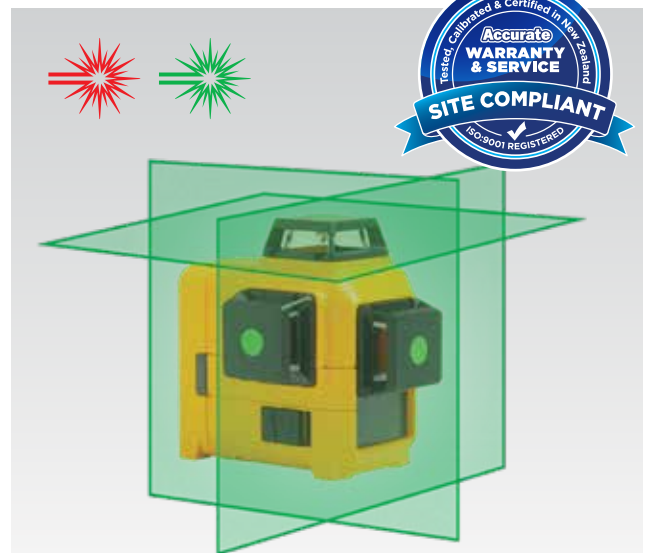

AVAILABLE WITH EITHER A RED OR HIGHLY VISIBLE GREEN LASER DIODE

+/- 2.0mm
ACCURACY @ 10M

3
YEAR
WARRANTY

WEBSITE
SEARCH
PLS3



LASER LEVELS

PLUMB, LEVEL, SQUARE DOT LASERS

SPECTRA PRECISION LP51

SELF LEVELING PLUMB, LEVEL & SQUARE DOT LASER

Available in either red or extra bright green laser diodes, the Spectra LP51 is an economical plumb, level and square dot laser.

It is ideal for transferring points from floor to ceiling, wall to wall or to reference a 90 degree square.

The LP51 will self-level up to 4 degrees. If the surface is too far from level the laser beams will flash twice a second to indicate the user. Package is supplied with a universal magnetic base and either a green or red target.

- Self Levelling Range of +/- 4°
- Operating Visibility Range Typically 20 Metres
- Universal Magnetic Base
- 3 Year Warranty



AVAILABLE WITH EITHER A RED OR HIGHLY VISIBLE GREEN LASER DIODE

+/- 3.0mm
ACCURACY @ 10M

3
YEAR WARRANTY

WEBSITE SEARCH LP51



LASER LEVELS

COMBINATION DOT & LINE LASERS

SPECTRA PRECISION LT52G & LT52R

COMBINATION PLUMB, LEVEL, SQUARE DOT AND CROSS LINE LASER

One of our most popular line and dot lasers, the LT52 from Spectra Precision is available in either standard red or extra bright green beam. This combination plumb, level, square dot and a horizontal cross line laser, eliminates the need for two separate laser tools.

The optional HR220 receiver extends the range of operation for long-range internal or outdoor use.



- Combination Plumb Level, Square, Dot and Line
- Self Levelling Range of +/- 3°
- Rechargeable Battery System
- Optional Outdoor Laser Line Receiver



AVAILABLE WITH EITHER A RED OR HIGHLY VISIBLE GREEN LASER DIODE

+/- 2.0mm
ACCURACY @ 10M

3
YEAR WARRANTY

WEBSITE SEARCH LP52



LASER LEVELS

COMBINATION DOT & LINE LASERS

SPECTRA PRECISION LT20G

GREEN BEAM SELF LEVELING CROSS LINE LASER

The Spectra Precision LT20G Cross Line Laser Tool is an automatic self-levelling green beam laser that projects ultra-bright horizontal and vertical green laser lines. The laser beam fan angle is wide to allow maximum coverage.

The standard package includes a universal magnetic wall and ceiling mount so the laser can be used for suspended ceiling and partitioning. The LT20G has a pendulum lock to help protect the internal leveling mechanism during transport and non-use.

- Two Bright Highly-visible Green Laser Lines
- Accuracy +/- 3mm per 10 metres
- Pendulum Lock
- Operating Visibility Range Typically 15-20 Metres



Tested, Calibrated & Certified in New Zealand
Accurate WARRANTY & SERVICE
SITE COMPLIANT
ISO 9001 REGISTERED

+/- 3.0mm
ACCURACY @ 10M

3
YEAR WARRANTY

WEBSITE SEARCH
LT20G



LASER LEVELS

CROSS LINE LASERS

SPECTRA PRECISION LT58G

360 DEGREE GREEN BEAM SELF LEVELING CROSS AND SQUARE LINE LASER

The ultimate internal laser tool. The LT58G features three extra bright 360 degree laser lines, providing plumb, level and square from the one laser tool. The standard package includes a universal magnetic wall and ceiling mount so the laser can be used for suspended ceiling and partitioning.

The optional HR220 receiver extends the range of operation for long-range internal or outdoor use.



- Three Highly-visible Green 360 Degree Laser Lines
- Accuracy +/- 2mm per 10 metres
- Rechargeable Battery System
- Optional Outdoor Laser Line Receiver



Tested, Calibrated & Certified in New Zealand
Accurate WARRANTY & SERVICE
SITE COMPLIANT
ISO 9001 REGISTERED

AVAILABLE WITH EITHER A RED OR HIGHLY VISIBLE GREEN LASER DIODE

+/- 2.0mm
ACCURACY @ 10M

3
YEAR WARRANTY

WEBSITE SEARCH
LT58G



LASER LEVELS

HANDHELD DIGITAL LASER RECEIVERS

SPECTRA PRECISION HL700

ADVANCED SUPERCCELL DIGITAL MM LASER RECEIVER

Using the same patented technology as the world renowned Apache Storm, the HL700 displays the exact amount of millimetres (high or low) to level on an easy to read backlit dual sided LCD display.

The HL700 is different to all the basic conventional laser receivers AND simple digital receivers on the market. With 'light bar' technology, laser detection resolution is nearly infinite allowing greater accuracy and consistency when compared to basic receivers, as fine as +/- 0.5mm! The heavy-duty clamp includes a circular vial for accuracy.

- Patented SuperCell™ Receiving Technology
- Laser Detection Height of 127mm
- Backlit LCD Display
- Automatic Height Capture Function



NOW UPGRADED TO FEATURE A BACKLIT LCD

127mm
DETECTION WINDOW

DIGITAL SUPERCCELL TECHNOLOGY

3
YEAR WARRANTY

WEBSITE SEARCH HL700



LASER LEVELS

HANDHELD DIGITAL LASER RECEIVERS

SPECTRA PRECISION HL760

ADVANCED SUPERCCELL DIGITAL MM ROTATING LASER RECEIVER WITH SMART COMMUNICATION

The HL760 is a smart communication 'mm digital readout' rotating laser receiver.

The built-in radio communication can be used for long range remote display and monitoring capability when paired with the Spectra Precision radio enabled lasers (HV302, GL422N, GL622N and UL633N) for PlaneLok, Auto Axis alignment and Grade Matching capabilities.

The HL760U model features a special light bar photocell that can detect BOTH red and green beam rotating lasers.

- Patented SuperCell™ Receiving Technology
- Smart Communication with Spectra Model Lasers
- 2-way Connectivity with other HL760 Receivers
- Detects BOTH Red and Green Lasers (HL760U)



AVAILABLE AS HL760 RED MODEL OR HL760U RED & GREEN MODEL DETECTOR

127mm
DETECTION WINDOW

DIGITAL SUPERCCELL TECHNOLOGY

3
YEAR WARRANTY

WEBSITE SEARCH HL760



LASER LEVELS

CROSS LINE LASER RECEIVERS

SPECTRA PRECISION HR1220

SPECIALISED PULSING LASER LINE DETECTOR

The Spectra Precision HR1220 Laser Receiver features a universal photocell, that detects BOTH red and green laser beams, generated from Spectra Precision crossline lasers including;

- LT52R & LT52G
- LT56 & LT58G

The HR1220 receiver can extend the indoor working range of these crossline lasers as well as increasing versatility by allowing outdoor use..

- Detects Both Red & Green Line Lasers
- Integrated Horizontal and Vertical Vials
- Volume Control
- Variable Accuracy Settings



**WORKS WITH BOTH
RED AND GREEN
BEAM SPECTRA
LINE LASERS**

**80mm
DETECTION WINDOW**

**3
YEAR
WARRANTY**

**WEBSITE
SEARCH
HR220**



LASER LEVELS

CROSS LINE LASER RECEIVERS

PLS SLD

SPECIALISED PULSING LASER LINE DETECTOR

The PLS SLD receivers are available in either red or green (SLD-G) models, a unique laser receiver intended for use with PLS cross line lasers which feature a 'pulsing mode'.

They are designed to be used where the laser line cannot be seen by the user, typically outdoors after five metres. Two mounting points for the clamp on the back of the SLD allow for either horizontal or vertical detection.

A bubble on the clamp allows the user to ensure they are as plumb or level as possible when detecting the laser line.

- Dual-sided LCD Display
- Dual Horizontal and Vertical Mounting Points
- Volume Control
- Integrated Circular Bubble Vial on Clamp



**AVAILABLE AS
SLD RED MODEL
OR SLD-G GREEN
MODEL DETECTOR**

**3
YEAR
WARRANTY**

**WEBSITE
SEARCH
SLD**

Machine Control

**2D and 3D Systems
for Excavators, Dozers,
Box Graders and Pavers.**

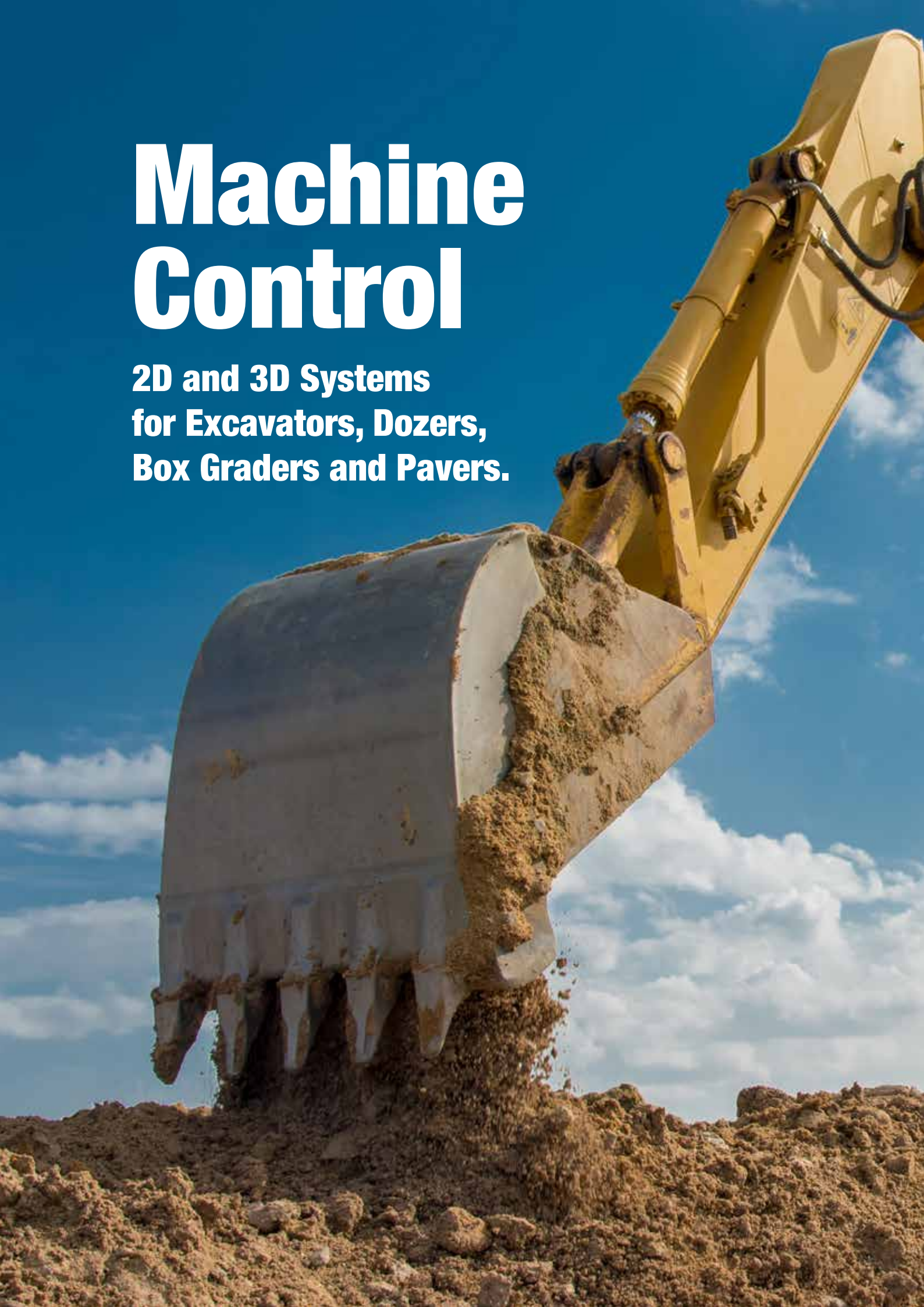

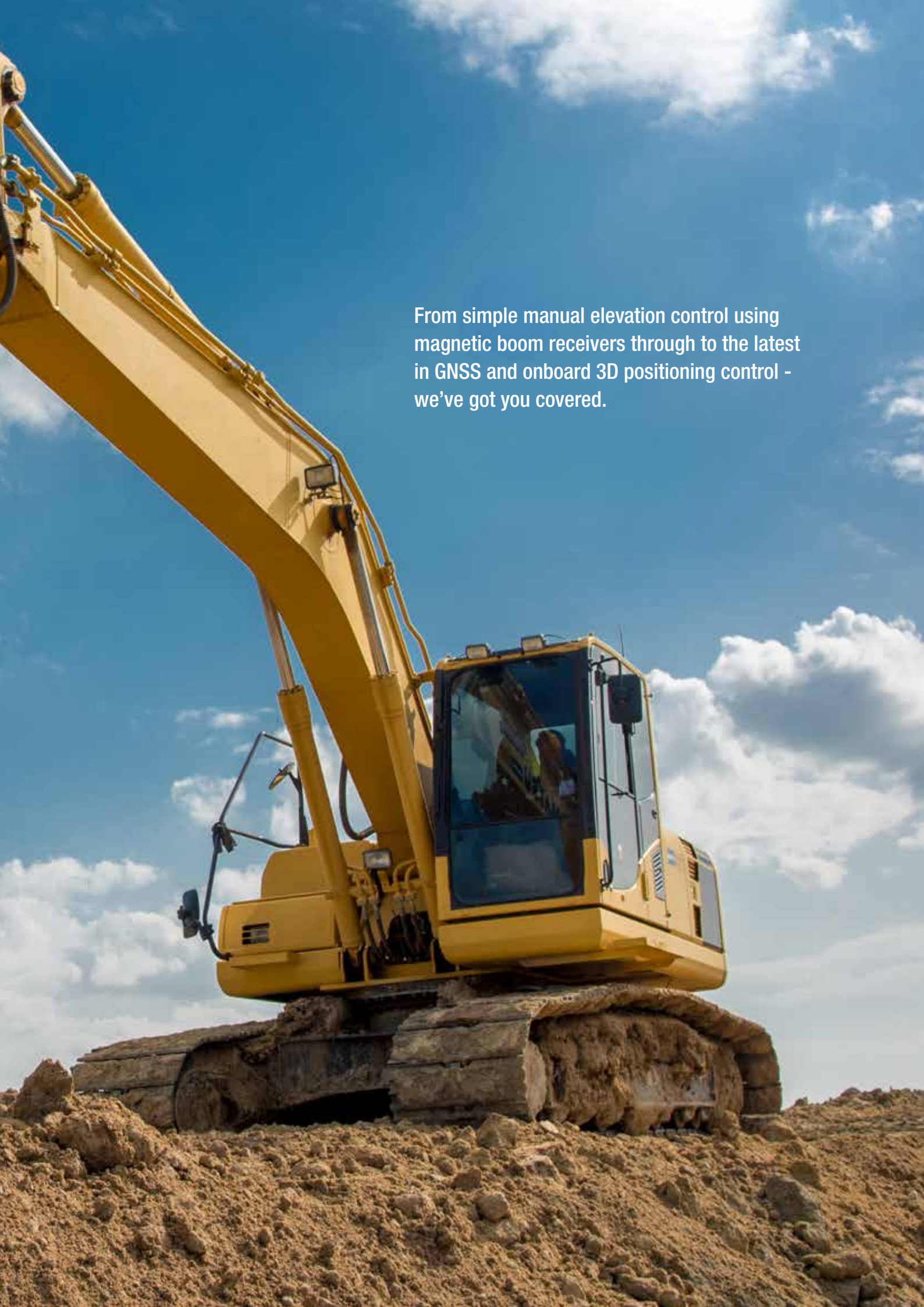
A yellow tracked excavator is shown from a low angle, positioned on a large mound of brown earth. The excavator's long boom extends upwards and to the left. The background is a bright blue sky with scattered white clouds. The excavator's tracks are visible, and the operator's cab is in the center-right of the frame.

From simple manual elevation control using magnetic boom receivers through to the latest in GNSS and onboard 3D positioning control - we've got you covered.



Boom Mounted Laser Receivers

Choose from a range of compact digital magnetic receivers, such as the advanced Spectra Precision CR700, or the heavy duty 360° machine mounted laser receivers



SPECTRA PRECISION CR700

ADVANCED COMBINATION MAGNETIC BOOM/HANDHELD SMART LASER RECEIVER

The best of both worlds - a magnetic boom mounted laser receiver with a digital 'mm' display for precise hand and machine leveling.

The Spectra Precision CR700 combination Laser Receiver is a machine mounted display receiver used on small grading and excavating equipment as well as a traditional laser receiver mounted to a grade rod or staff. The standard delivery package includes BOTH the magnetic mount for quick machine mounting and a grade rod clamp.

With super bright directional LEDs, the CR700 is ideal for entry-level machine grade display, specifically on mini-excavators and backhoes. This provides instant grade information to the operator and eliminates the need for a rod man in the trench.

The CR700 uses Spectra's patented SuperCell digital readout technology incorporated in the HL700 and HL760 laser receivers. This unique technology provides much more accurate and more consistent readings than traditional methods.

If you are using the CR700 with a Spectra Precision laser that already has an HL760 normal hand held receiver, the HL760 can be configured as an in cab display when paired with the CR700!

The LEDs are visible at long range and a vertical drift alarm warns if the laser is disturbed.

- Combination Hand/Magnetic Magnetic Receiver
- Super-Bright Coloured LED Elevation Indicators
- Smart Communication with Spectra Model Lasers
- Two-Way Connectivity with Other HL760 Receivers
- 200 Degrees Angle Detection Range
- 127mm Vertical Detection Range



USE THE CR700 ON A LEVELING STAFF WITH THE HAND CLAMP OR ON A MACHINE USING THE MAGNETIC MOUNT



DIGITAL
SUPERCCELL
TECHNOLOGY

3
YEAR
WARRANTY



WEBSITE
SEARCH
CR700



POPULAR CR700 LASER COMBOS

PRO SHOT AS2 SINGLE GRADE LASER



PAGE 22

SPECTRA GL422N DUAL GRADE LASER



PAGE 23

SPECTRA UL633N UNIVERSAL GRADE LASER



PAGE 25



WEBSITE SEARCH
LR

**SPECTRA
PRECISION
LR20**

The LR20 360° machine mounted laser receiver allows compact machines to achieve tighter tolerances without the need for a grade checker. Designed specifically for the cost-conscious site prep contractor, the LR20 provides simple depth and slope display elevation information and is very easily moved between compact machines. Includes Mini magnetic mount.

**SPECTRA
PRECISION
LR30**

The LR30 is a 5-channel heavy duty 360° machine mounted laser receiver designed primarily for earthmoving equipment including: dozers, backhoes, excavators, scrapers, and box blades. It works with all types of red beam rotating lasers for fast, no-hassle setup. Withstands all weather environments. The wireless LR30W model is designed to work with the in cab RD20 Remote Display.

**SPECTRA
PRECISION
LR50**

The LR50 is a 5-channel multi-purpose 360° machine mounted laser receiver. Compared with the LR30, the LR50 has the added Blade Tilt and Excavator Boom Plumb Indicator functionality. The LR50 display the status of the receiver relating to plumb and tilt direction. It also allows proportional valve control through the optional CB30 dual control box. Optional wireless model available.

**SPECTRA
PRECISION
LR60**

With 8-channels and a larger vertical detection range compared to the LR30 and LR50, the LR60 is an advanced 360° machine mounted laser receiver which also includes patented angle compensation. This allows the operator to check levels with the dipper arm extended or retracted up to 30°. It features the same Blade Tilt and Excavator Boom Plumb Indicator functionality as the LR50.

LR SERIES COMPARISON	LR20	LR30	LR50	LR60
OPERATING RANGE	Typically 300m+ Radius	Up to 460m Radius	Up to 460m Radius	Up to 460m Radius
RECEPTION ANGLE	360°	360°	360°	360°
VERTICAL DETECTION HEIGHT	200mm	170mm	170mm	220mm
ANGLE COMPENSATION	-	-	-	Yes, Up to 30°
PLUMB INDICATION	●	-	●	●
WIRELESS/BLUETOOTH	-	Optional (LR30W)	Optional (LR50W)	Optional (LR60W)
REMOTE IN CAB DISPLAY	-	Optional RD20 display	Optional RD20 display	Optional RD20 display
CONTROL BOX COMPATIBILITY	-	Optional CB30 Control Box	Optional CB30 Control Box	Optional CB30 Control Box
MOUNTING TYPE	Mini Magnetic Mount	Clamping 38 - 50mm	Clamping 38 - 50mm	Clamping 38 - 50mm
MAGNETIC MOUNTING	●	Optional MM-1 Mount	Optional MM-1 Mount	Optional MM-1 Mount

Product specifications are subject to change, please confirm at time of purchase.



**MCE
R45 BM**

Manufactured in Australia, the R45 BM from MCE is a robust cost effective 220° magnetic boom laser receiver for the smaller digger. Economical and compact, the R45 BM has built-in magnets and a vertical detection range of 95mm.



**MCE
R45 TC**

The R45 TC magnetic laser receiver is ideal for earthmoving equipment such as excavators, backhoe, trenchers and dozers. The R45 TC has the additional functionality of tilt compensation, up to 30°. In this mode, automatically compensate for the error introduced by deviations from a vertical position by adjusting the centre band automatically.

WEBSITE
SEARCH
R45



**MCE
R45 TC PRO**

A popular seller, the R45TC Pro model is a Bluetooth equipped magnetic laser receiver. Used in conjunction with an Android device in enabled app, the operator can see everything from the cab of the machine. The Pro model also features CAN communication, working in conjunction with the optional DB Uni Pro display. The R45 TC Pro also includes the Angle Compensation functionality found in the R45 TC, with tilt compensation, up to 30°. In this mode, automatically compensate for the error introduced by deviations from a vertical position by adjusting the centre band automatically.



**ANDROID IN CAB
DISPLAY FOR
R45 TC PRO**

R45 SERIES COMPARISON	R45 BM	R45 TC	R45 TC PRO
OPERATING RANGE	Up to 500m Radius	Up to 500m Radius	Up to 500m Radius
RECEPTION ANGLE	220°	220°	220°
VERTICAL DETECTION HEIGHT	95mm	190mm	190mm
ANGLE COMPENSATION	-	●	●
WIRELESS/BLUETOOTH	-	-	●
REMOTE IN CAB DISPLAY	-	-	Optional Android Device with APP
CONTROL BOX COMPATIBILITY	-	-	Optional DB UNI PRO display
MOUNTING TYPE	Magnetic (built in)	Magnetic (built in)	Magnetic (built in)

Product specifications are subject to change, please confirm at time of purchase.

Excavators & Dozers

From simple blade control through to fully integrated 3D GNSS, Moba/MCE and Spectra offer solutions for any budget, every application and novice to expert level knowledge skill.





MOBA XSITE EASY

AFFORDABLE 2D SYSTEM FOR PRECISION EXCAVATING WITH OPTIONAL LASER CONTROL

Looking to improve the use of your excavator, digger or backhoe? Do you require the next step up from manual indicate boom mounted laser receivers? Then the Xsite® EASY 2D automatic excavation control system is the ideal solution for true one-man automatic control without breaking the budget.

From Moba, a world leader and pioneer in machine control development, the Xsite® EASY 2D excavator control system measures depth, range and incline of the bucket, as well as depicts the bucket position graphically and numerically on the display.

Using this information, the machine operator always knows the exact position, and machine work progress. This allows the operator to work exactly according to plan, design and precisely implementing the specifications.

Adding the Moba EL2 machine laser receiver allows the user to perform automatic grade and height control by laser, with a height detection range of 160mm.

An additional LED display shows at first glance whether the target height has already been reached, or if needs to be raised, further.

The Xsite® EASY system even works under water, allowing the excavator operator to always maintains an overview of the job. The system is ideally suited for use in foundation, trench or slope construction, leveling or underwater excavation.

The Xsite® EASY 2D will allow you to tender for a wider array of civil, infrastructure and earthmoving job tasks, without having to worry about additional human resources and the associated costs.

OPTIONALLY MEASURES THE INCLINE OF THE BUCKET WITH AN ADDITIONAL SENSOR-ANGLE MEASUREMENT

- Graphical & Numerical Display of Bucket Position
- Shows all Data and Bucket Position on Display
- Height Alarm Provides Overhead Cable Protection
- Laser Control Compatible for Height Detection
- Retro-Fittable for easy Machine Changing
- Optionally Measure the Bucket Incline (Sensor)



2D
EXCAVATING SYSTEM

WEBSITE
SEARCH
XSITE EASY



MOBA XSITE PRO

DEPTH, INCLINE AND RANGE OF THE EXCAVATOR BUCKET, DEPICTING THE POSITION ON THE GRAPHIC

3D Excavation control is currently one of the most in demand systems in the Civil Infrastructure Industry and MOBA Mobile Automation AG has been an established name for more than 40 years.

With Xsite® PRO excavator control system, Moba offer a state of the art feature packed system, with simplicity that even a novice user can operate.

The large clear to view 8.4 inch graphic display indicates depth, incline and range of the excavator bucket, depicting the near exact position. The machine operator can then work to implement the specifications, without corrective work. This saves time, fuel, material and increases the efficiency during machine use.

Choosing from either a 2D or 3D GNSS controlled system (Xsite® PRO ADVANCED), the PRO ADVANCED system includes dual GNSS receivers, adding extensive 3D functionality.

Create simple 3D profiles with terrain models, which can be imported via common file formats, used without time-consuming conversion.

With the two GNSS sensors mounted on the machine, both the position and the alignment of the machine, are known at all times so that precise working is possible.

The possibility to save points allows to document the working process. The work log is sent to the office via an Internet connection or USB stick.

Staking out and manual surveying can be reduced. This saves time, money and personnel, while accelerating the workflow.

This system can be used during pipe or cabling installation, documenting completed layers, dredging or slope

2D OR 3D GNSS POSITION AND ON SITE CONTROL

- Choose from either a 2D or 3D System
- Creation of 2D Profiles directly on the system
- Display shows all the data and bucket position
- Enables efficient work underwater or for blind cuts
- Large graphic 8.4 inch touch-screen display
- CAN Interface



2D OR 3D
EXCAVATING SYSTEM

WEBSITE
SEARCH
XSITE PRO



MCE CB.D2

BASIC AUTOMATIC DUAL CHANNEL/RECEIVER BLADE CONTROL

Manufactured in Australia, the CB.D2 from MCE is a simple to operate single or dual channel valve control system, designed for a wide array of earthmoving machinery, from box graders and drag along blade to agricultural land levellers, loaders or even mall graders.

Supporting both proportional or bang bang valve configurations, it is used to control the machine's hydraulics according to the output from the laser receiver. Choose to either automatically control machine's hydraulics or override and manually control the machine via the switches on the control panel.

The CB.D2 also works as an in cab display by replicating the display from the MCE R.ULS.CAN laser receiver inside the machine's cabin. The CB.D2 can also be integrated with an optional elevating mast.



MCE RS007

BASIC AUTOMATIC SINGLE CHANNEL/RECEIVER BLADE CONTROL

The RS007 Laser machine control system from MCE is a simple single channel system with an electric output to control the PT solenoids of machinery. It consists of the CB.2001 control box, connecting cables and the R.3CHS.MC 360° laser receiver.

The CB.2001 features three grade accuracies and the user can choose from automatic control with override facility or manual control.

Simple to use and set-up, the rugged construction of the control box, connecting cables and R.3CHS laser receiver make it able to withstand harsh operating environments.

The R.3CHS.MC laser receiver features highly visible and adjustable LED's indicating the position of the laser beam, with user selectable accuracy and automatic compensation of errors induced by vibration.





SPECTRA PRECISION CB30

AUTOMATIC DUAL CHANNEL/RECEIVER BLADE CONTROL

The CB30 from Spectra Precision, is a in cab control box with dual channel proportional valve control, suitable for dozers, box graders, skidsteer loaders or small graders.

Used in conjunction with either the LR50 or LR60 Spectra machine receivers, it is designed for simple elevation display to more complex grading jobs, that require automatic elevation and slope blade control

The CB30 allows automatic or manual control of the blade, with a temporary offset for large elevation differences or change of heights. Accuracy can be set between 0 and 50mm.

Hydraulic and electric kits are available for installation on different types, brands and sizes of earthmoving equipment.



SPECTRA PRECISION CB25

BASIC AUTOMATIC DUAL CHANNEL/RECEIVER BLADE CONTROL

The CB25 from Spectra Precision, is a economical lower cost alternative to the CB30 system above, whilst still utilising proportional valve control.

Used in conjunction with either the LR50 or LR60 Spectra machine receivers, it is designed for simple elevation display to more complex grading jobs, that require automatic elevation and slope blade control

Switch from automatic to manual control with the quick flip of one switch, so there's no need to stop or change settings.

Hydraulic and electric kits are available for installation on different types, brands and sizes of earthmoving equipment.

**OPTIONAL CB20 SINGLE CHANNEL
HEIGHT ONLY SYSTEM AVAILABLE.**





Paving

Modular Sonic Sensor system for non-contact Surface Scanning.



MOBA MATIC 2 SYSTEM

DIGITAL LEVELLING & SLOPE CONTROLLER FOR PRECISION PAVING

This modular system enables a flexible choice of sensors, depending upon the application. It achieves a high planarity during asphalt paving.

This system is easy to install and simple to operate. Using just four main buttons, all important functions can be controlled, as well as the height and slope of the paver screed, adjusted.

This increases the paving output of the machine, preventing the paving of too little or too much material, thus increasing the paving quality and planarity.

The MOBA-matic II has firmly established itself as the world's leading and most flexible leveling system for pavers.

This modular system enables a flexible choice of sensors, depending upon the application. It achieves a high planarity during asphalt paving.

This system is easy to install and simple to operate. Using just four main buttons, all important functions can be controlled, as well as the height and slope of the paver screed, adjusted. This increases the paving output of the machine, preventing the paving of too little or too much material, thus increasing the paving quality and planarity.

With the MOBA-matic II control panel, screed control is even easier. Operation of the basic functions is extremely simple, through the use of just four buttons and a clearly understandable symbolic representation. In the 3.5 inch colour display, all connected sensors and system status are displayed for the operator.

In addition, slope and height values are displayed. Both sides of the screed can be conveniently operated using a MOBA-matic II, making it unnecessary to change sides. The night design makes it possible for the user to clearly see all details, even in darkness.

- Control the Height & Slope of the Paving Screed
- Flexible Selection of Leveling Sensors Available
- High Precision Paving Results
- Simple Intuitive Icon Driven Operation
- Colour Graphic LCD Display
- Durable Construction made to Handle Paving



COLOUR GRAPHIC DISPLAY WITH CLEAR INDICATION OF ALL SENSORS AND CLEAR, VISUAL ICON DRIVEN INSTRUCTIONS



2D
PAVER LEVELING

WEBSITE
SEARCH
MOBA MATIC



MOBA **BIG SONIC-SKI**

MODULAR SONIC SENSOR SYSTEM FOR NON CONTACT SURFACE SCANNING

The Big Sonic-Ski from Moba kit exists of an up to 13-metre long mechanic assembly with dismantlable swing arms and a respective electronic kit of up to four ultrasonic sensors. Four sensors achieve the most precise and even results, in particular, with respect to road renovation works of large areas. The use of individually adjustable components within the mechanical construction further guarantees highest flexibility, e.g. in curves and over large distances.

The Big Sonic-Ski® extends the advantages of a single ultrasonic sensor. With up to four sensors, even large area unevenness, such as road waves, are compensated for. Through combining several sensors, the sensing of an extremely long range is made possible. With these measurements, the system calculates an average, and provides a virtual reference level.

The Big Sonic-Ski® achieves maximum planarity during asphalt paving, making it unrivalled in its precision. With four sensors, long unevenness that occur in regular intervals of five to seven meters, can be detected. Such unevenness often occurs during resurfacing, and can not be detected by less sensors. The individual sensors can each be positioned separately.

This increases the manoeuvrability of the machine, allowing work to be performed on even curvy roads, without problem.

The Big Sonic-Ski also features real-time temperature compensation with flexible scanning at freely selectable measurement points.

If you operate paving systems in New Zealand, call our FREEPHONE on 0800 500 380 to discuss this high precision paving solution.

- Functions with up to Four Sensors
- Temperature Compensation in Real-Time
- Best Possible Planarity
- Compensates for long stretches of unevenness
- No Artificial Reference Required
- Records the Reference over 13 Metres

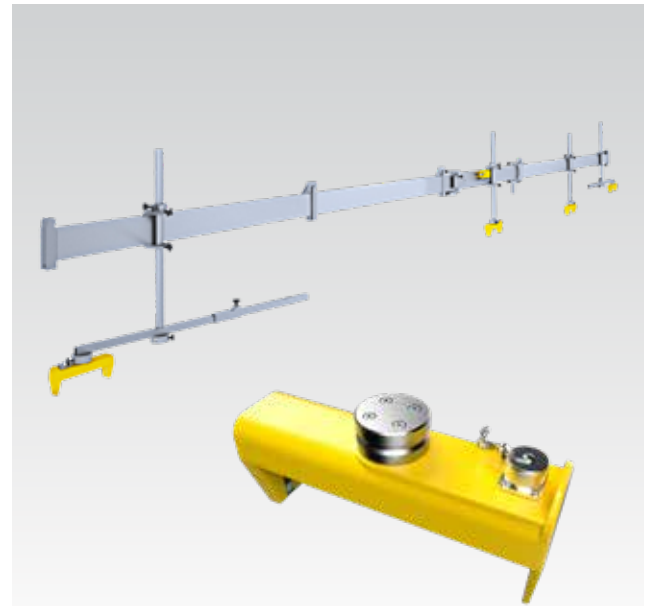

**13 METER LONG MECHANIC ASSEMBLY
WITH DISMOUNTABLE SWING ARMS AND A
KIT OF UP TO FOUR ULTRASONIC SENSORS**



**2D
SONIC PAVER LEVELING**

**WEBSITE
SEARCH
SONIC-SKI**



MOBA MATIC 3D PAVING

3D GNSS REAL-TIME SYSTEM FOR PAVING AND MILLING MACHINERY

Absolute smoothness with every paver.

With the MOBA 3D-matic levelling system, pavers achieve highly precise results. This system is easy to operate and use. The work process is accelerated making surveying and manual control measurement work no longer necessary.

On the well-organised 7-inch touch-screen display, the driver sees the position and height values for the project. If no project data is available, simple profiles can also be created with the system. The colour display is optimised for use in harsh conditions whilst the software was specialised for a particularly user-friendly handling and ease of operation. As such, the split screen mode for example allows the operator to have different values in just one overview.

Utilising an open data format, 3D Terrain models can be easily imported or created on the machine itself.

Both GPS and Total Station control can be used with the 3D-Matic dependant on the customer's needs for vertical accuracy.

As an add-on leveling system for pavers and milling machines, it is the perfect upgrade for any type of machine and can be retrofitted at any time. MOBA's many years of expertise in levelling technologies will pay off for you, too.

Thanks to an exceptional range of compatible sensors and CANbus-based communication, the modular system can be adapted to your individual requirements at any time. Choose between a GNSS antenna or a total station with prism for your personal project.

- Precision 3d Paving Sensor Technology
- Increased smoothness of finished Roothing
- 7" Large Visual Touchscreen Display
- 3D Design File Uploading for Target Height and Slope
- Open Platform Data Format
- GNSS and Total Station Compatible



3D
PAVER LEVELING

WEBSITE
SEARCH
3D MATIC



MOBA PAVE-IR

INTELLIGENT THERMAL REAL-TIME VISUALISATION FOR THE ASPHALT PAVING

The optimal temperature of the installation material is a decisive factor in road construction, on which the quality of the road significantly depends. A thermal visualization of the installation process provides important insights into the quality of the material and opens up completely new optimization potentials.

PAVE-IR is the first system to simply and clearly create a thermal profile of the road - in real-time! The high-precision IR temperature scanner MTPS-100 provides a wide thermal profile of the built-in layer over a total width of up to 13m, which can optionally be used as evidence for all installation and supply temperatures. The fully automatic visualization of the temperature thus offers the possibility to detect individual points which might be affected by thermal segregation, and to react immediately!

Up to four further freely positionable high-performance sensors (IR spots) additionally measure material temperatures exactly at all points where temperature is critical, whether at the hopper, above the ground or at the screw.

This multiple measurement provides extensive, high-precision values. It thus is possible to assess the temperature of the delivered material in real time and, if necessary, to document it. Differences in the temperature of the installation material thus are visible during the entire process. As a result, measures can immediately be taken if necessary.

The unique IR technology of the scanner offers the decisive advantage of being able to accurately determine the temperature of the asphalt surface and the material.

The acquisition over a width of up to 13m is technically superior to camera-based solutions on the market.

- IR Thermal segregation detection
- Detailed thermal profile of the asphalt layer
- Real-time detection and temperature analysis
- Extensive high precision measurement
- Up to 13 meter width operation
- Cloud computing data handling

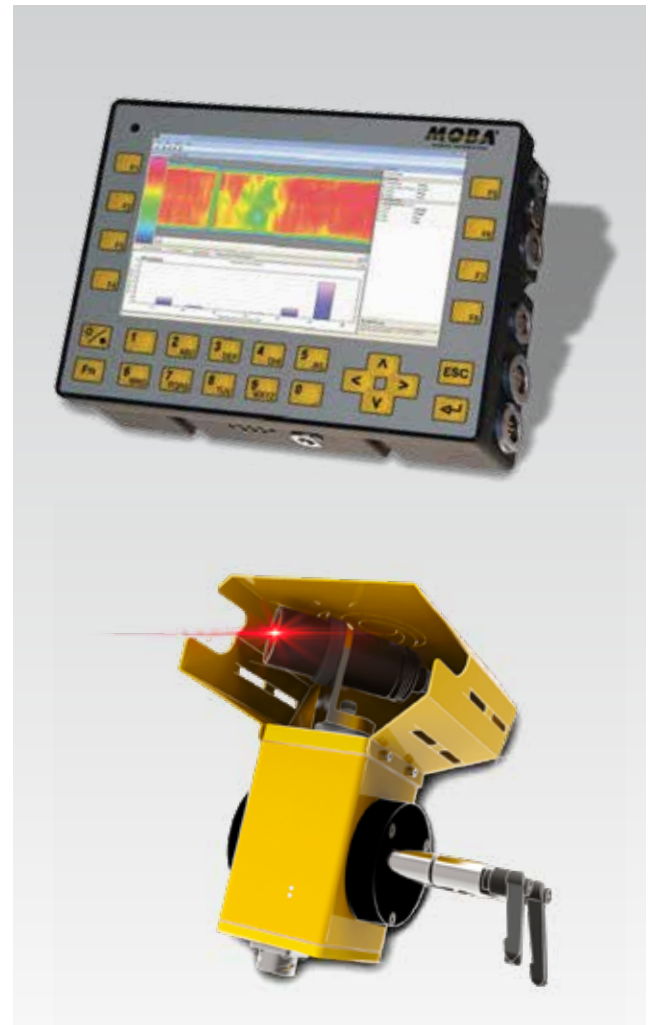

VISUALISATION AND DOCUMENTATION OF THERMAL PROFILE AND ADDITIONAL DATA.



**REAL-TIME
INFRARED PAVER LEVELING**



Measuring Equipment

Distance, Forestry and Angle Measurement





25 + years of experience in the New Zealand market supplying precision laser tape measures, angle and range finders has made Accurate the one knowledge centre for measurement.



MEASURING EQUIPMENT

ACCURATE HAS BEEN THE ONE-STOP SHOP FOR LASER TAPE MEASURES IN NEW ZEALAND FOR NEARLY 25 YEARS

Bluetooth low energy (LE, BLE), is marketed as Bluetooth Smart.



LEICA DISTO **D1**

Low cost, yet high quality reliable laser tape measure. Designed for simple point and shoot non-critical accurate measuring.



LEICA DISTO **D110**

Compact and simple operation +/- 1.5mm accuracy laser measurement. With area calculation and Bluetooth Smart with free apps.



LEICA DISTO **D2**

Our biggest seller, +/- 1.5mm accuracy laser with area, volume, setout, memory recall and Bluetooth Smart with free apps.



LEICA DISTO **X3**

High accuracy 1mm laser with angle compensation. IP65 rugged construction and area, volume and setout calculations with timer.



LEICA DISTO **X4**

1mm laser tape measure with Bluetooth Smart. IP65 design and digital viewfinder with zoom for outdoor measuring where laser dot cannot be seen. Point-to-point capability.



LEICA DISTO **D510**

Outdoor 1mm laser tape measure with Smart features. Bluetooth and a real-time digital viewfinder with zoom for outdoor measuring where laser dot cannot be seen.



LEICA DISTO **D810**

1mm laser measure with camera capture, USB connectivity with dxf download, Bluetooth Smart, touchscreen and zoom digital viewfinder for outdoor measuring.



LEICA DISTO **S910**

Point-to-point measuring between 2-points from a 3rd location! Smart Base enables you to stand back from and measure distances and angles between multiple points.

X3, X4, D810 TOUCH AND S910 MODELS ARE ALSO AVAILABLE AS A PACKAGE KIT INCLUDING FTA ADAPTOR, TRIPOD & HARD CASE.

TOP MEASURE DLT DUAL

MEASURES FROM BOTH THE TOP AND BOTTOM - AT THE SAME TIME!

The DLT Dual laser tape measure is a unique, compact, two-way laser tape measure that can measure both directions simultaneously!

It is ideal for anyone needing fast measurement of areas, volumes of buildings, ceiling heights etc, where ever the laser dots can be seen.

This device makes measuring heights fast, simple and accurate - no more walking around or bending down to set the device on the floor! Just stand and point the two dots to the points you want to measure. It is designed for simplicity of operation.

Save previous measurements, areas, volumes, add and deduct on as well as Pythagoras and tracking.



TOP MEASURE MLT MINI

USB ULTRA COMPACT LASER TAPE MEASURE

The MLT MINI from Top Measure is one of the most compact laser tape measures available on the market today. It also happens to be an affordable price also!

Designed for simplicity of operation, the Top Measure Mini has only one button and a rechargeable battery - that's it.

No hassles, without multiple buttons and modes, no fussy battery doors or replacing batteries, just a simple 3-hour charge by USB will provide up to 5000 measurements.

The Mini has a typical measuring accuracy of +/-2mm and a distance range capability of between 5cm up to 40m.



DISTO SPECIFICATION COMPARISON

	D1	D110	D2	X3	X4	D510	D810	S910
ACCURACY	2.0mm	1.5mm	1.5mm	1.0mm	1.0mm	1.0mm	1.0mm	1.0mm
RANGE	up to 40m	up to 60m	up to 100m	up to 120m	up to 150m	up to 200m	up to 200m	up to 300m
BLUETOOTH	✗	✓	✓	✓	✓	✓	✓	✓
APP CONNECTIVITY	✗	✓	✓	✓	✓	✓	✓	✓
TILT SENSOR	✗	✗	✗	360°	360°	360°	360°	360°
AREA, VOLUME CALCULATION	✗	✗	Area only	✓	✓	✓	✓	✓
LINES OF DISPLAY	3	2	3	4	4	4	5	Graphic
OUTDOOR VIEWFINDER	✗	✗	✗	✗	✓	✓	✓	✓
MEMORY RECALL	✗	✗	10 Values	20 Values	20 Values	30 Values	30 Values	50 Values
TRIPOD MOUNT	✗	✗	✗	✓	✓	✓	✓	✓
P2P MEASURE MODE	✗	✗	✗	✗	✓	✗	✗	✓
WEATHER PROTECTION	IP54	IP54	IP54	IP65	IP65	IP65	IP54	IP54
WARRANTY	2 YEARS*	2 YEARS*	2 YEARS*	2 YEARS*	2 YEARS*	2 YEARS*	2 YEARS*	2 YEARS*

Product specifications are subject to change, please confirm at time of purchase. *3 Year warranty extension if registered with Leica myWorld online.



WIDE RANGE OF MEASURING WHEELS FOR ALL FARMING, CONTRACTING AND GENERAL MEASURING



TOP MEASURE **TM06 PRO**

Small 16cm diameter measure wheel with brake, handle counter reset and carry bag, suitable for measuring smooth internal and external surfaces.

TOP MEASURE **TM12 PRO**

Accurate's best selling measuring wheel, 32cm diameter, with brake, handle counter reset and carry bag, suitable for a wide range of measuring applications.

ROTOSURE **500 DELUXE**

Small diameter 16cm measure wheel from Rotosure with brake, suitable for measuring smooth internal and external surfaces.

ROTOSURE **CLASSIQUE DELUXE**

Popular 32cm diameter measuring wheel from Rotosure with brake, suitable for a wide range of measuring applications.

Optional bag.



ROTOSURE **CLASSIQUE PRO**

High spec model of the Rotosure Classique Deluxe, the Pro model has the additional feature of a handle counter reset.
Optional bag.

KOMELON **METERMAN MK60M**

Large 48cm diameter wheel ideally suited for farming, irrigation and agricultural use due to its large circumference.

TOP MEASURE **DM12 DIGITAL**

A professional, heavy duty electronic measuring wheel with a 32cm diameter featuring an electronic counter with a digital readout.

TOP MEASURE **MS3 MACHINE**

A machine mounted counter wheel featuring dual 10.5cm diameter wheels for measuring fabric and material as they come off a machine roll.



SPECIFICATION COMPARISON

	TM06	TM12	500	DELUXE	PRO	MK60M	DM12
WHEEL DIAMETER	16cm	32cm	16cm	32cm	32cm	48cm	32cm
CIRCUMFERENCE	50cm	1m	50cm	1m	1m	1.5m	1m
MEASUREMENT INCREMENTS	Decimetres, meters	Decimetres, meters	Decimetres, meters	Decimetres, meters	Decimetres, meters	Decimetres, meters	Centimetres, meters
RESETTABLE COUNTER	✓	✓	✓	✓	✓	✓	✓
HANDLE RESET COUNTER	✓	✓	✗	✗	✓	✗	✓
COUNTER LIMIT	9999m	9999m	9999m	9999m	9999m	9999m	9999m
TELESCOPIC HANDLE	✓	✓	✓	✓	✓	✓	✓
BRAKE	✓	✓	✓	✓	✓	✗	✗
KICK STAND	✗	✓	✗	✓	✓	✓	✓
WEIGHT	1.06kg	1.86kg	1.1kg	2.25kg	2.4kg	1.65kg	2.04kg
WARRANTY	2 YEARS	2 YEARS	2 YEARS	2 YEARS	2 YEARS	2 YEARS	2 YEARS

Product specifications are subject to change, please confirm at time of purchase.



SMART TOOL DIGITAL LEVEL

HIGH QUALITY ELECTRONIC SPIRIT LEVEL

The original Smart Tool, today this model still remains the preferred choice for accuracy, reliability and durability. Constructed from aluminium and featuring two built-in acrylic bubble vials, the LCD display is recessed and angled for easy viewing and displays the digital reading in mm/metre, inches/feet, degrees and percentage. A user calibration button allows the operator to check the accuracy of the level.



- Measures Degrees, %, in/ft and mm/m
- Accurate to 1/10 of a Degree
- Recessed LCD
- User Calibration Feature
- Audible BEEP for Level and Plumb

AVAILABLE IN 600MM (24")
AND 1200MM (48") LENGTHS
WITH PADDED BAG

+/- 0.1°
ACCURACY



SMART TOOL PRO DIGITAL LEVEL

WATERPROOF ELECTRONIC SPIRIT LEVEL

Looking for a waterproof electronic spirit level? Based on the original Smart Tool, the GEN3 Pro has all the same features with the addition of a higher IP65 weatherproof construction.

The GEN3 Pro model also includes a auto calibration feature and a backlit LCD for use in low light situations.

Includes a padded level case/bag.



- Measures Degrees, %, in/ft and mm/m
- Accurate to 1/10 of a Degree
- IP65 Weatherproof Design
- Backlit LCD
- Auto Calibration

AVAILABLE IN 600MM (24")
AND 1200MM (48") LENGTHS
WITH PADDED BAG

+/- 0.1°
ACCURACY

IP65
WATERPROOF
RATING





SMART TOOL DIGITAL MODULE

COMPACT ELECTRONIC BUILDERS ANGLE SENSOR

The Builder's Angle Sensor Module measures digitally for all 360 degrees of a complete circle. Installing a deck or stair rail, extending a roof or determining how much an old floor has sagged becomes simpler, faster and more accurate.

Now featuring the latest GEN3 design with IP65 weatherproof construction, auto calibration feature and a backlit LCD for use in low light situations.

Includes a padded level case/bag.

- Measures Degrees, %, in/ft and mm/m
- 170mm compact length
- Measures °, %, in/ft and mm/m
- IP65 Weatherproof Design
- Backlit LCD



AVAILABLE AS A
MODULE ONLY

+/- 0.1°
ACCURACY

IP65
WATERPROOF
RATING

 WEBSITE
SEARCH
MODULE

NEDO WINKELTRONIC

ELECTRONIC ANGLE FINDERS

The Nedo Winkeltronic is a range of German quality, rugged and reliable angle finders, with an accuracy of $\pm 0.1^\circ$ (600mm Pro model). The measured angle can be read on the large easy to read digital LCD display. Two integral spirit levels ensure true horizontal and vertical positioning and the hold function freezes the reading on the display.

The Easy 400 is the base model of the range, designed for simple economical angle measuring. The 600mm Pro model features a larger angle measuring range, precision resolution and a long shank.

- Accuracy of $\pm 0.1^\circ$ (Pro 600mm model)
- Hold Function to keep a Measured Value
- Integrated Horizontal and Vertical Level Vials
- Large easy-to-read LCD Display



+/- 0.1°
ACCURACY

 WEBSITE
SEARCH
WINKELTRONIC



MECHANICAL SLOPEMETERS

MACHINE MOUNTED SLOPE SENSORS

Since 1943, Slope Meter Inc. in the USA has been producing mechanical slope indicators for heavy machinery. Slope meters are typically mounted on the dash in the operator's view and will give fast, accurate readings for any slope.

The Slope Meter No. 2 NS is the most popular indicator and is used to determine the % of grade, and is calibrated to read from 0-12%. It is designed for motor graders, dozers, asphalt pavers, wheel ditches, tunnelling machines and other equipment where exacting specifications are required.

For SCSI model, the safe driving speed for any curve is quickly and accurately determined, with the 'SCSI' mounted in the engineer's vehicle. The scale reads zero when the vehicle is level, and will show 'tilt' up to 25 degrees on each side. The scale is red beyond +/-10 degrees to denote danger zones.



ALUMINIUM CASTED RUGGED DESIGN WITH LARGE NUMERALS FOR EASY VIEWING

+/- 0.1°
ACCURACY

IP65
WATERPROOF
RATING

 WEBSITE
SEARCH
SLOPEMETER



KOMELON & YAMAYO OPEN REEL TAPES

FIBREGLASS AND NYLON COATED STEEL FAST RETRACTING TAPE MEASURES

Komelon from Korea and Yamayo from Japan, are leading manufacturers of long open reel tape measures.

Fibreglass tapes are lightweight and durable and can be washed regularly when dirty. They do however have stretch at distance when tensioned.

Nylon Coated steel tapes have minimal stretch so are more accurate. Looking after a nylon steel tape will pro long it's life as the nylon coating prevents rusting.

The Komelon Unigrip Flex series of fibreglass tapes are dual sided with a quad ended riveted hooks. 30m, 50m and 100m lengths.

Yamayo Stilon tapes are a metric single sided tape measure with a dual riveted hook end. 30m, 50m and 100m lengths.



 WEBSITE
SEARCH
OPEN REEL



KOMELON POCKET TAPES



KOMELON **PE85** 8M

KOMELON **MD85** 8M

KOMELON **MX82** 8M

KOMELON **IR85** 8M

KOMELON **LUR30** 30M



HIGH ACCURACY POCKET TAPES WITH A RUGGED RUBBER DESIGN

Komelon's ergonomic and economical closed pocket metric tape measures offer performance, reliability, high quality durable construction and Class II CE accuracy.

Nylon coated steel with rubber protected casing, thumb tape locks, 8m and 15m lengths.

MODEL SPECS

	PE85	MD85	MX82	IR85	LUR30
TAPE LENGTH	8M	8M	8M	8M	30M
TAPE WIDTH	25mm	25mm	32mm	25mm	10mm
MAGNETIC	✗	✓	✓	✗	✗
CONSTRUCTION	Steel	Steel	Steel	Stainless	Steel

YAMAYO DIAMETER TAPES

SPECIALISED COMPACT DIAMETER TAPES FOR TREE WIDTH MEASUREMENT

Taking tree diameters is simple with this handy pocket size fibreglass tape. Yamayo Diameter Tapes measure both distance and diameter making them the perfect tool for forestry, tree-felling and environmental research. They are also commonly used to measure the diameter of rain water tanks and pipes.

All Yamayo diameter tapes feature a retractable 12.5mm wide PVC coated fibreglass tape that is durable and long lasting.

Available in 3m and 5m diameter models.



Forestry Measurement

Advanced field solutions
for high accuracy results in
height, distance and angle
measurements.





HAGLÖF VERTEX HYPSONETERS

WEBSITE
SEARCH
HAGLOF



HAGLÖF VERTEX 5

Haglöf's latest update to it's best selling instrument the Vertex 5 is the professional foresters' preference for accurate height, distance and horizontal distance measuring. The Vertex can be operated in areas with dense terrain where conventional methods such as measuring tapes, laser instruments are difficult to use.

HAGLÖF VERTEX VL5

An advanced field solution for high accuracy results in height, distance and angle measurements. With an integrated tilt sensor and laser and ultrasound technology, the VL5 offers a variety of method options for any situation and surrounding. The results can be stored, or transferred wirelessly.

HAGLÖF VERTEX GEO

All you need in a Rangefinder Hypsonometer. With a built-in GPS receiver, the Vertex Laser Geo features long range measurement with high precision laser with integrated tilt - and compass sensors for accurate 3D measurements.

SPECIFICATION COMPARISON

	VERTEX 5	VERTEX VL5	VERTEX LASER GEO
SIZE	80 x 54 x 31mm	93 x 63 x 72mm	93 x 63 x 72mm
WEIGHT	173g (incl. Battery)	243g	243g
BATTERY	1 x 1,5AA Alkaline	Chargeable Li-Ion 3.7V	Chargeable Li-Ion 3.7V
TEMPERATURE	-15° to 45°C	NA	-20° to +45° C
ULTRA SONIC DISTANCE	30m	30m	30m
HEIGHT	0-999m	0-999m	0-999m
RESOLUTION HEIGHT	0,1m	0,1m	0,1m
ANGLES	-90° to 90° Degrees	-55° to 85° Degrees	-90° to 90° Degrees
RESOLUTION ANGLE	0,1°	0,1°	0,1°
RESOLUTION DISTANCE	0.01m	0.01m	0.01m
LASER DISTANCE	NA	46cm-700m	46cm-700m

Product specifications are subject to change, please confirm at time of purchase.



HAGLÖF CLINOMETERS

WEBSITE
SEARCH
CLINOMETER



HAGLÖF CI

Simple easy to use electronic clinometer for measuring degrees or percentage of height change. Ideal for foresters, geologists, in construction and building.

HAGLÖF EC II

EC II Electronic Clinometers feature single-key functions for distance setup and height measurement. Measure inclination and height from any known distance and present the results electronically.

HAGLÖF HCH

The HCH instrument will be ideal when building roads and power lines, for demarcation of forest properties etc. Switch from compass to clinometer with one push of the button.

NIKON FORESTRY PRO II

WIDELY USED IN THE FORESTRY AND CRANE INDUSTRY FOR HEIGHT, INCLINATION AND DISTANCE MEASUREMENT

The Forestry Pro II from Nikon is a popular simple to use laser rangefinder designed for simplicity. It is easy and super fast to obtain the height of a tree, building or structure by simply pointing at the desired measurement point.

For forestry applications, the Forestry Pro II can obtain the tree height even when the top or base of a tree is blocked by branches or bushes, giving the height of a tree using the horizontal distance and angles of both the top and base of the tree.

- 500m Distance Range
- Simple Two Button Operation
- Simple Height of Tree/Structure Calculation
- Slope, Distance and Height Measurement

WEBSITE
SEARCH
FORESTRY PRO

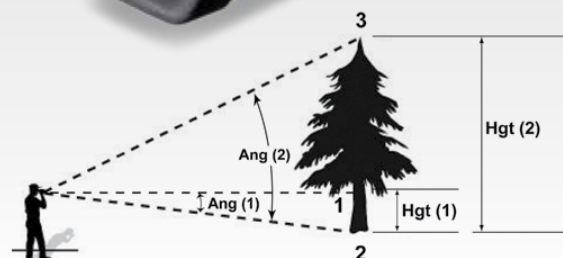



HAGLÖF MANTAX BLUE CALIPERS

Mantax Blue is a classic diameter caliper available in many graduation options and lengths. Mantax Blue have scale print on both sides and they are rugged and durable with detachable jaws and adjustment keys included. This is a simple, smart, durable and economic choice of diameter caliper!

Mantax Blue calipers are used in a wide variety of applications and many different operation areas such as diameter measuring of trees and timber, log scaling, in fishery industry and wildlife management, in construction and in healthcare industry.



HAGLÖF INCREMENT BORERS

Haglöf Sweden is the world's largest producer of increment borers and come in a great variety of models, lengths, core diameters and sizes.

Haglöf borers have blue handles in grip friendly plastic material and a metallic lock. The borer bits are made from hardened steel with PTFE coating for protection and reduced friction. The extractors are produced in stainless steel with metallic head and special design for easy core extraction of the wood core.

Borer bits, extractors, starters and holsters can be purchased separately.



FLAGGING TAPE

Flagging tape is a universally used convenient marking product for use on construction sites, forestry blocks and surveying projects for identifying highly visible marks and localities.

Available in: Pink, Orange, Yellow, White, Blue, Red and Green (sold in packs of 10 for each colour).



Olympus is the leader in the ultrasonic determination of thickness and dry film coatings. Many commercial and industrial companies and consultants throughout New Zealand rely on the performance and reliability that Olympus has become reknown for.



Non Destructive Testing NDT



OLYMPUS 27MG

PROFESSIONAL DIGITAL THICKNESS GAUGE WITH DUAL TRANSDUCER

The 27MG from Olympus is a professional ultrasonic thickness gauge, designed for maintenance engineers and inspectors that need to monitor wall thickness in metal pipes, tanks, beams and structural supports.

Despite its compact size, the 27MG has many innovative measurement features utilising the same technologies that are available on our more advanced thickness gauges. The durable, rugged 27MG is battery-operated and features a large, backlit LCD with easy-to-read numerals, and an intuitive colour-coded keypad with direct access to many key features.

27MG smart features and capabilities include:

- 0.50 mm to 635 mm thickness range
- Automatic Probe Recognition
- Auto Zero Compensation
- Hi-Low Alarm settings
- Min./Max. thickness capture mode (20x per second)

The 27MG is compatible with Olympus' complete line of easy interchangeable dual element transducers that vary in frequencies, diameters, and temperature capabilities to deal with virtually every application. See chart over page.



STANDARD PACKAGE



OLYMPUS®

OLYMPUS IS AN INTERNATIONAL COMPANY OPERATING IN INDUSTRIAL, MEDICAL AND CONSUMER MARKETS, SPECIALISING IN OPTICS, ELECTRONICS AND PRECISION ENGINEERING.



WHY CHOOSE OLYMPUS?

Olympus has an industry-leading portfolio of innovative test, measurement, and imaging instruments. Leading edge testing technologies include remote visual inspection, microscopy, ultrasound, phased array, eddy current, eddy current array, X-ray fluorescence and optical metrology. Our products include ultrasonic flaw detectors and thickness gauges, videoscopes, borescopes, microscopes, in-line and advanced nondestructive testing systems, XRF and XRD analysers, interferometers, and a large selection of scanners, probes, software programmes, and instrument accessories.

Our goal is to supply reliable, economical systems globally that enhance safety, security, quality and productivity for customers and that contribute to society. We are committed to pursuing the development of new technologies, products, and services that offer the best solutions to customers' needs. Our commitment to designing quality products is linked to our customers' responsibility to comply with industry standards and regulations.



OLYMPUS 45MG

HIGH PENETRATION THICKNESS & CORROSION GAUGE WITH DATA LOGGING

Despite its compact size, the 27MG has many innovative measurement features utilizing the same technologies that are available on our more advanced thickness gauges. The durable, rugged 27MG is battery-operated and features a large, backlit LCD with easy-to-read numerals, and an intuitive colour-coded keypad with direct access to many key features.

27MG smart features and capabilities include:

- 0.50 mm to 635 mm thickness range
- Automatic Probe Recognition
- Auto Zero compensation
- Gain Adjust
- Differential mode
- Hi-Low Alarm settings
- Min./Max. thickness capture mode (20x per second)



OLYMPUS TRANSDUCERS

TRANSDUCER	ITEM #	FREQ. (MHz)	CONNECTOR	TIP DIA. mm	RANGE STEEL mm	TEMP RANGE °C	CABLE
D7910	U8454038	5.0	90°	12.7	1.00 to 254	0 to 50	Potted
D790	U8450002	5.0	Straight	11.0	1.00 to 500	-20 to 500	Potted
D790-SM	U8450009	5.0	Straight	11.0	1.00 to 500	-20 to 500	LCMD-316-5B ³
D790-RL	U8450007	5.0	90°	11.0	1.00 to 500	-20 to 500	LCLD-316-5G ³
D790-SL	U8450008	5.0	Straight	11.0	1.00 to 500	-20 to 500	LCLD-316-5H
D791	U8450010	5.0	90°	11.0	1.00 to 500	-20 to 500	Potted
D791-RM	U8450011	5.0	90°	11.0	1.00 to 500	-20 to 400	LCMD-316-5C
D7912	Q4530005	10.0	Straight	7.5	0.50 to 25	0 to 50	Potted
D7913	Q4530006	10.0	90°	7.5	0.50 to 25	0 to 50	Potted
D794	U8450014	5.0	Straight	7.2	0.75 to 50	0 to 50	Potted
D797	U8450016	2.0	90°	22.9	3.80 to 635	-20 to 400	Potted
D797-SM	U8450017	2.0	Straight	22.9	3.80 to 635	-20 to 400	LCMD-316-5D
D7226	U8454013	7.5	90°	8.9	0.71 to 50	-20 to 150	Potted
D798-LF	U8450019	7.5	90°	8.9	0.71 to 50	-20 to 150	Potted
D798	U8450018	7.5	90°	7.2	0.71 to 50	-20 to 150	Potted
D798-SM	U8450020	7.5	Straight	7.2	0.71 to 50	-20 to 150	LCMD-316-5J
D799	U8450021	5.0	90°	11.0	1.00 to 500	-20 to 150	Potted
MTD705 ⁴	U8620225	5.0	90°	5.1	1.00 to 19	0 to 50	LCPD-78-5

Product specifications are subject to change, please confirm at time of purchase.



OLYMPUS 38DL PLUS

ADVANCED SINGLE & DUAL ELEMENT THICKNESS & CORROSION METER

Despite its compact size, the 27MG has many innovative measurement features utilizing the same technologies that are available on our more advanced thickness gauges. The durable, rugged 27MG is battery-operated and features a large, backlit LCD with easy-to-read numerals, and an intuitive colour-coded keypad with direct access to many key features.

27MG smart features and capabilities include:

- 0.50 mm to 635 mm thickness range
- Automatic Probe Recognition
- Auto Zero compensation
- Gain Adjust
- Differential mode
- Hi-Low Alarm settings
- Min./Max. thickness capture mode (20x per second)



0.5-635mm
THICKNESS RANGE

2
YEAR
WARRANTY

WEBSITE
SEARCH
38DL

OLYMPUS GAGEVIEW

PC INTERFACE SOFTWARE PROGRAMME FOR DOCUMENTATION AND DATA TRANSFER

The GageView Interface Program is included with the Data Logger option for either the 45MG or 38DL Plus.

This Windows-based application collects, creates, prints, and manages data from the gauge.

GageView Interface capabilities include:

- Create datasets and surveys
- Store data editing
- View dataset and survey files and setup values
- Download/upload thickness surveys
- Export surveys to spreadsheets and other programs
- Collecting snapshot screens
- Print Thickness, Setup Statistics and Grid Reports
- Download/upload single element transducer setup files
- Software updating



WINDOWS-BASED APPLICATION

45MG / 38DL
DATA LOGGER

WEBSITE
SEARCH
GAUGE VIEW



OLYMPUS **SCANNERS**

OLYMPUS **WELD INSPECTION SCANNERS**

Accurate has a wide range of scanners to address fabrication or maintenance weld inspections needs. We have solutions for small pipes up to flat plates with the capacity to hold multiple probes for complete weld volume coverage.

Whether you choose a motorised or manual option, Olympus' wide range of phased array scanners offer versatility, dependability, and repeatability.



OLYMPUS **CORROSION INSPECTION SCANNERS**

Corrosion mapping is a highly demanding application that requires the capability to precisely encode a probes position in up to two axes.

Corrosion scanners can be mounted on pipes and flat surfaces and are easy to use for fast detection of defects from manufacturing-induced lamination to in-service wall thickness reduction.

The Olympus models include semiautomated and Dual Linear Array (DLA) phased array corrosion systems through to fully automated, steerable motorised 2-axis scanners capable of performing corrosion mapping in remote locations.



OLYMPUS **AEROSPACE INSPECTION SCANNERS**

Inspecting large areas with fast C-scan acquisition is a critical feature for the aerospace industry. Olympus' range of professional scanners with suction cups are well suited to holding onto composite type surfaces, so you can perform mapping with up to two precise encoded axes.

Models include the RollerFORM, a phased array wheel probe, the GLIDER scanner, a two-axis encoding scanner for manual inspection of slightly curved or flat composite surfaces and the VersaMOUSE scanner, designed for linear encoded scans with a phased array probe.

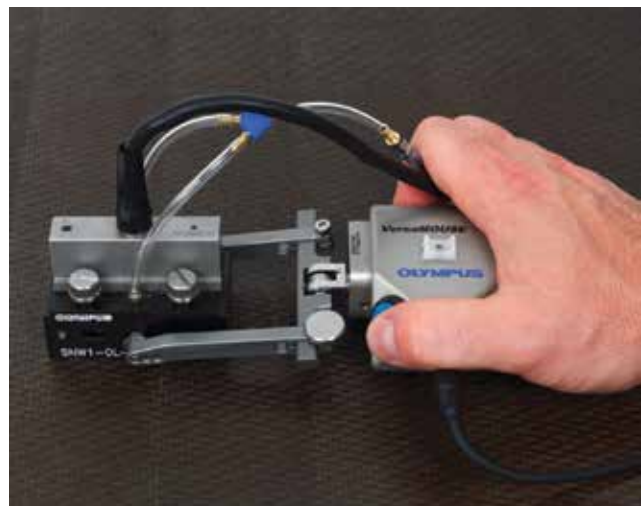



The BB20 and BB30 paint thickness meters from Trotec are the ideal quick assessment tool for you to quickly determine the dry coating thickness of paints over metallic surfaces.

The dual sensor uses magnetic induction for steel (ferrous) metals and eddy current for aluminium (no ferrous) metals.



TROTEC BB30

BASIC DRY FILM ELCOMETER WITH REMOVABLE PROBE FOR COATING THICKNESS OF METALS

Compared with the lower cost BB20 unit, the BB30 features a removal probe and an angled display. The removable probe allows the sensor to be placed away from the meter. It utilises the same dual ferrous and non-ferrous sensor to measure the thickness of metallic coatings as the BB20 albeit with a greater depth capability of up to 2mm (2000 microns).



TROTEC BB20

BASIC DRY FILM ELCOMETER FOR COATING THICKNESS OF METALS

The BB20 is a simple low cost paint/coating thickness meter. The dual ferrous and non-ferrous sensor enables the user to measure the thickness of metal coatings like paint and varnishes, galvanising and enamel on iron or non iron metals like aluminium. The measuring range of the BB20 is up to 1.25mm (1250 microns) with a typical accuracy of 3%.



JAMES INSTRUMENTS V-METER MK IV

THE MOST ADVANCED ULTRA-SONIC TEST SYSTEM FOR ACCURATELY IDENTIFYING BASIC CHARACTERISTICS OF COARSE GRAINED MATERIALS SUCH AS CONCRETE, WOOD, MASONRY, CERAMIC, GRAPHITE AND MORE!

Advanced ultrasonic pulse velocity meter designed to determine the structural integrity of concrete, wood, ceramic and other coarse grained construction materials.

Using the ultrasonic sensors, cracks, voids and honeycombs can be detected up to a depth of 75mm, which can all lead to structural weakness.

Ultrasonic testing can be applied to new and old structures, slabs, columns, walls, fire damaged areas, hydroelectric structures, pipe, prefab and pre-stressed beams, cylinders and other concrete forms. A wide range of transducers are available.



JAMES INSTRUMENTS VUCON

THE VUCON IMPACT ECHO SYSTEM IS FOR MEASURING THE THICKNESS AND QUALITY OF CONCRETE

The impact-echo method is based on the use of impact generated stress waves that propagate through the material and are reflected by both the materials external surfaces and internal flaws. This method can be used to make accurate non-destructive measurements of thickness in concrete slabs and plates, and to locate internal flaws such as honey-combing, debonding and delaminations.

It can measure thickness, locate cracks, voids and other defects in masonry structures where mortar bonds the masonry together. The impact-echo method is not affected by the presence of steel reinforcing bars.

Conforming to ASTM C-1383 it is ideal for bridges, decks, retaining walls, roads and runways.





JAMES INSTRUMENTS REBARSCOPE

ADVANCED AUTOMATIC DEPTH & SIZE COVER METER

The Rebarscope® from James Instruments is an advanced rebar locating system, using electro magnetic eddy current technology.

The Rebarscope, enables the user to not only locate reinforcement bars but also determine rebar depth and the rebar size. Is also capable of locating non ferrous metals: such as copper, aluminium, some stainless steels, wire, and more. The optional Scan Cart logs distance data as well as the location of rebar.



JAMES INSTRUMENTS MINI R-METER

PROFESSIONAL CONCRETE REBAR LOCATOR

The Mini R-Meter is an industry professional accurate rebar and cover meter, for finding and determining the depth of rebar in concrete.

From James Instruments, a world leader in NDT testing equipment, the Mini-R allows the user to select the size diameter of the rebar, then the instrument will automatically correlate the rebar cover. The exact position and orientation of rebar can be measured and rebar-free areas can be identified for drilling, grinding, resurfacing, or insertion of new machinery mountings.



SINGLE HANDHELD SENSOR FOR REBAR DEPTH DETERMINATION UP TO 200MM

RELATED PRODUCT CONCRETE SCANNING GPR

GEORADAR C-THRU

AN EASY-TO-USE AND ROBUST SOLUTION TO SEE THROUGH CONCRETE STRUCTURES AND REVEAL REAL-TIME DATA THAT LEADS TO OPTIMAL DECISION-MAKING.



C-thru – Augmented Reality for Real-Time 3D Data Visualisation.



JAMES INSTRUMENTS WM-250

MANUAL REBOUND 'SCHMIDT TYPE' HAMMER

The WM-250 from James Instruments is a manual rebound hammer, used for the quick determination field testing of the compressive strength of cured concrete structures, primarily floors and vertical surfaces.

This easy-to-use instrument provides a quick and simple test for obtaining an immediate indication of concrete strength in various parts of a structure.

It will also provide the indices of hardness and compressive strength for other construction materials. The unit can be used on plaster and mortar as well to verify consistency. The Test Hammer is also used on brittle rock cores where a larger impact will damage the specimen. It is typically used for thin concrete specimens (between 50mm (2") and 100mm (4") thick) such as sidewalks, bridgedecks and some driveways.

Rebound hammers are easy to record the mean rebound number. It conforms to ASTM C-805 and other international standards.

SPECIFICATIONS

- Weight: 0.9kg
- Size: 267mm with plunger retracted
- Impact Energy: 2.2Nm
- Includes Carrying Case



JAMES INSTRUMENTS JAMES BOND TESTER MK III

FOR TESTING TENSILE STRENGTH OF OVERLAYS, AND OVERLAYMENTS

The James Bond Tester™ MK III or pull off adhesion test measures the bond strength or tensile strength of concrete, asphalt, tile, concrete repair, or other overlay material by the direct tension or pull off method.

Features an adjustable alignment plate with built-in leveling facility for both vertical and horizontal pulls.





MECMESIN DIGITAL SHOTCRETE PENETROMETER 1000N / DELUXE

THE BEST TOOL FOR SHOTCRETE TESTING

The Shotcrete Penetrometer is a complete portable system for testing the compressive strength of the initial curing stage of young sprayed concrete to BS EN 14488-2 (Method A).

It provides accurate readings of the forces required to penetrate sprayed (shotcrete) or poured concrete. These resistive force readings are then used to convert to a compressive strength value. This accuracy—beyond the requirements of the standard—and portability make it ideal for on-site testing.

The deluxe version has a conversion factor entry to convert measurements to KPa and it has a password protect lockable keypad.





Technical Safety Equipment

**Gas Detection, Confined Space Entry,
Height Safety and Intrinsically
Safe Equipment**

Keeping the worker safe is more than just PPE. There is also keeping the equipment and system in optimum working order. Accurate's portfolio of technical sensing, monitoring, height safety and inspection equipment is second to none throughout New Zealand, all supported and serviced in house.





Portable Gas Detection

Industry leading portable single and multi-gas detection systems from MSA Safety, GfG Instrumentation and Gas Clip Technologies, with remote monitoring, live data, subscription support and certification all available from Accurate.

Single and multi-gas detectors also available for short-term and long-term rental.



MSA DETECTORS ARE THE 1ST CHOICE IN MANY OF NZ'S INDUSTRIES INCLUDING UTILITY, OIL & GAS. TOUGH & FUNCTIONAL THEY FEATURE UNSURPASSED DURABILITY, ERGONOMIC DESIGN AND HIGH-CONTRAST DISPLAYS.



MSA ALTAIR 4XR



A CLASS LEADING MULTI-GAS DETECTOR THAT MEASURES UP TO 4-GASES WITH INDUSTRY WARRANTIES UP TO 5 YEARS.

The ALTAIR 4XR Gas Detector is the toughest 4-gas monitor on the market with the ability to survive a 7.5m drop test onto concrete. With glove-friendly buttons and a high-contrast display, the Altair 4XR is easy to operate in any work environment, even low-light conditions.

Outfitted with rapid-response MSA XCell® sensors, the 4XR features double the industry average of expected life, designed for an average life of more than four years. An end-of-sensor-life indicator gives advanced warning to user, eliminating service outages. The sensors' electronics are miniaturised and placed inside the sensor providing superior stability, accuracy, repeatability and fast response.

GASES: Combustible, O2, H2S, CO, NO2, SO2

KEY FEATURES

- Rapid-response sensors XCell Sensors
- Real-time Bluetooth Connectivity
- MotionAlert™ man-down alarms
- Live gas readings
- 4-5 Year Long-Life Sensors



AVAILABLE IN CHARCOAL & GLOW-IN-THE-DARK

OPTIONAL GALAXY GX2 BUMP TEST, CALIBRATION AND CHARGING SYSTEM. SEE PAGE XX

MotionAlert™
MAN DOWN ALARM

5
(UP TO) YEAR WARRANTY

WEBSITE SEARCH
ALTAIR 4

safetyio

LIVE SITE/PERSON MONITORING

- Real-time awareness of gas exposures and readings
- Online notifications of device concerns, man-down alarms and panic button presses
- Live employee location and movement with street and satellite view. **See page XX.**

Google Play

ALTAIR APP

Bluetooth connectivity allows:

- Receive gas detection readings, alarms and man-down alerts
- Configure instruments remotely, without a PC
- Email calibration, sampling, event reports and incident and compliance awareness

XCell®
SENSORS

LONG-LIFE PERFORMANCE

Trusted by many of New Zealand's leading industries.

- XCell Sensors are two times faster than industry average
- Double the industry average of expected life of 4-5 years
- End-of-sensor-life indicator gives advanced warning to user



MSA ALTAIR 5X

ADVANCED MULTI-GAS DETECTOR WITH SIX-GAS, PID AND VOC CAPABILITY

The ALTAIR 5X is an advanced portable detector that is capable of measuring up to 6-gases simultaneously, as well as VOC detection from the integrated PID sensor.

Designed for use in heavy industry markets, the 5X features large buttons for easy use; the molded housing also protects the detector from drops up to 3m. The exclusive MotionAlert™ feature lets others know if a user has become immobile, and the InstantAlert™ activates a manual alarm if a potentially hazardous situation has arisen.

Driven by advanced MSA XCell® Sensor Technology, the detector delivers faster response time, better stability, accuracy, and cost savings over the life of the instrument.

The ALTAIR 5X offers Bluetooth wireless technology that can be used with Android devices and the MSA Connect App to manage instrument data and setup. Also allows you to share status details with **Safety io** Grid Live Monitor service.

GASES: Combustible, O2, H2S, CO, NO2, SO2, CO2, CL2, CLO2, NH3, NO, HCN, PH3, PID

KEY FEATURES

- Rapid-response sensors XCell Sensors
- Real-time Bluetooth Connectivity
- MotionAlert™ man-down alarms
- Live gas readings
- 4-5 Year Long-life Sensors

DETECTING VOCs WITH PID – HOW IT WORKS.



Manufacturers use PID sensors to detect VOC (volatile organic compounds). A PID (photoionisation detector) uses an ultraviolet (UV) light source to break down VOCs in the air into positive and negative ions. The PID then detects or measures the charge of the ionized gas, with the charge being a function of the concentration of VOCs in the air.

AVAILABLE IN PID AND IR MODELS



OPTIONAL BUMP TEST, CALIBRATION AND CHARGING SYSTEM. SEE PAGE XX

MotionAlert™
MAN-DOWN ALARM

3
(UP TO) YEAR WARRANTY

Q
WEBSITE SEARCH ALTAIR 5

IR SENSOR TECHNOLOGY



When compared with regular Pellistor gas sensors, the **infrared technology** used by MSA Safety in their XCell Sensors, offer excellent long-term stability and eliminates the need for frequent calibrations. To minimise false readings, MSA IR sensors do not use a mirror (which can double path lengths and lead to condensation). To overcome this the lamp and detector are placed in line.



MSA ALTAIR

SMART NETWORK CONNECTED LONG-LIFE MULTI-GAS DETECTOR.

The future of portable gas detection for site compliance. The io360 area monitor gas detector has been designed by MSA to quickly deploy a detection device for local or remote monitoring.

Connecting your ALTAIR io360 to **Safety io** Grid gives you the power to remotely manage and monitor your fleet of detectors, capture data, and take action to create safer sites.

Monitor along a fence line, confined space or any high risk area where a gas hazard might occur. When the ALTAIR io360 detects a hazard, all alarms and evacuations are displayed on-site to your workers and to the person overseeing the network. The io360 is pre-configured ready to go, straight out of the box, with all the hallmarks made famous by MSA Safety with their ALTAIR range.

ULTRA-LONG BATTERY LIFE

Four-gas detection with a catalytic bead sensor, compact portability, and 60-days of battery life – no compromises.

WATERPROOF RUGGED DESIGN

IP68 for spray, dust, and submersion, 3m drop-tested.

XCELL SENSORS

Rapid response best in class sensor technology.

GASES: O2, CO, H2S



GAS DETECTION	O₂ OXYGEN	CO CARBON MONOXIDE	H₂S HYDROGEN SULPHIDE	2 UP TO YEAR WARRANTY
-------------------------	--------------------------------	------------------------------	--	---------------------------------

safety io
GRID LIVE MONITORING

- Real-time awareness of gas exposures and readings
- Live monitoring of employee location and movement with street and satellite view





MSA ALTAIR 2X

HI-PERFORMANCE SINGLE OR DUAL GAS DETECTOR

Available in single or dual gas configuration, the ALTAIR 2X gas detector from MSA is the first portable gas detector to introduce revolutionary Xcell pulse technology. Based on proven science and advanced patented sensor capabilities, the detector delivers the world's first stand-alone bump tests to be performed without the need for calibration gas.

GASES: CO, H2S, CL2, NH3, SO2, NO2,
2XT: CO/H2S, CO/NO2, H2S/SO2

KEY FEATURES

- Single (2X or 2XP) or dual (2XT) gas detection
- Four-year expected instrument and sensor life
- Fastest sensor response times, lowest calibration gas flow rate on the market
- Three-year instrument warranty (Two years on Cl2, NH3 models)



INTRINSICALLY-SAFE DESIGN, CERTIFIED DUST AND WATER-TIGHT IP67 CONSTRUCTION.

ALTAIR 2X
SINGLE GAS DETECTOR

ALTAIR 2XT
TWO-TOX GAS DETECTOR

ALTAIR 2XP
SINGLE GAS DETECTOR W/STAND ALONE BUMP TEST

3
UP TO YEAR WARRANTY

MSA ALTAIR PRO

SINGLE GAS SENSOR PORTABLE DETECTOR

The ALTAIR PRO is a single-gas detector available with a wide range of features, including simple intuitive operation, small rugged design (IP67 water and dustproof), and dependable technology that is there when needed.

The Pro is a perfect example of how technology can combine user flexibility and functional simplicity. True single-button operation provides the user with a clear path to any function.

KEY FEATURES

- Accurately measures the gas concentration or percent oxygen
- Adjustable alarm set points are offered for LOW, HIGH, TWA and STEL
- One-button operation
- Event-logging and data-logging



IT IS AVAILABLE FOR THE DETECTION OF EITHER OXYGEN (O2) OR HYDROGEN CYANIDE (HCN).

GAS
DETECTION

O₂
OXYGEN

HCN
HYDROGEN CYANIDE

PH₃
PHOSPHINE GAS

2
UP TO YEAR WARRANTY



MSA GALAXY GX2

The MSA GALAXY GX2 is an easy-to-use automated test stand which offers high performance as either a stand-alone unit or a multi setup integrated portable detector management system.

The GX2 is compatible with the following gas detectors of the ALTAIR range;

- ALTAIR 4X/4XR
- ALTAIR 5X/5XR
- ALTAIR PRO
- ALTAIR 2X, 2XT, 2XP

safetyio

The GX2 is designed to undertake charging, bump testing and calibration (using calibration gas) of the portable Altair gas detectors.

GX2 also integrates with MSA's **Safety io** Grid Fleet Manager Service. This provides active safety management for gas exposure including email alerts, direct data input, live filtering, test and exposure queries, collecting and printing of reports.

For short-term or long-term project management of construction, general industry, oil and gas or plant maintenance site safety, the GX2 system from MSA has everything covered.



KEY FEATURES

- Simultaneous test up to 10 test stands via a single cylinder of test gas
- Safety io provides proactive management, dashboard overview and total record-keeping
- At-a-glance indicators include low calibration gas volume, expiration warnings and test status
- Colour touchscreen for easy setup and viewing
- Extremely simple to use; testing starts automatically without touching a single button
- GALAXY GX2 System is optimised for use with MSA's XCell® Sensors; provides up to 50% cost of ownership reduction





MSA SAFETY iO GRID LINE MONITOR

LIVE GRID GAS DETECTION MONITORING AND FLEET MANAGEMENT



Transform your outdated, manual resource reliant, gas detection programme into a live connected safety platform.

Gas detection is a key part of your safety programme – and a wise investment. However, many admit that there are frustrations, because their gas detectors or long-term contracts don't deliver on their promised value or support.

A manual database, record keeping and monitoring system is reliant on capturing information on the status of workers or the equipment, after an event. Often a gas detector will be discovered as faulty or needing service.

MSA **Safety iO** enables you to confidently protect your co-workers with **LIVE real-time** safety alerts, reports and insights. The status of your gas detectors is also recorded.

With Safety iO you can focus on overall person and site safety, not just the status of your detectors.

- **Grid Fleet Manager** allows the user to assess their MSA fleet status – all from your browser.
- **Grid Live Monitor** keeps you in the know with what's going on - live, so you can take action immediately.

Focus on safety, not just compliance or detectors.



safety iO

GRID LIVE MONITOR INDICATING CONNECTED WORKERS, CURRENT READINGS, THEIR LOCATION AND STATUS

GRID FLEET MANAGER

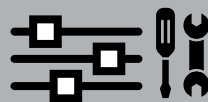

Assess, address and share your MSA fleet status – all from your browser

- Incident and compliance awareness and reports
- Detector and test equipment management
- Secure web-based setup and access
- IT-free maintenance
- Works with MSA detectors and GALAXY GX2 test banks

GRID LIVE MONITOR



Know what's going on – and take action – when seconds count

- Real-time worker health and safety notifications
- Works with ALTAIR 4XR, 5X and io360 detectors
- Secure web-based setup and access
- IT-free maintenance
- Incident and compliance awareness, management and reports



CALIBRATION AND BUMP TEST GAS MIXES

Accurate offer multiple quality test gas mixtures for a variety of industrial and commercial industry applications. Suitable for Bump Testing and Calibration of gas detectors. Precision gravimetrically mixed gases for **non reactive single**, **reactive single** and **reactive quad gas** mixes.

FOR A FULL RANGE OF AVAILABLE GAS MIXTURES, VISIT WWW.SAFETY.KIWI



GAS BOTTLE REGULATORS

Trigger, Fixed and Demand Flow regulators available in stainless steel, aluminium, and nickel plated brass. Suitable for use with a range of various sized aluminium gas cylinders. *See our website for exact regulator/gas bottle compatibility.*

NON-REACTIVE SINGLE GAS MIX 105L

Disposable aluminium alloy cylinders supplied with non-reactive single gas, pressurised to 1200 psi, for demand flow regulators. Two year life from date of manufacture.

POPULAR GASES

- 20.9% Zero Air
- 100% Nitrogen (N₂)
- 2.5% Vol Methane (CH₄)
- 2.5% Carbon Dioxide (CO₂) in Nitrogen (N₂)
- 0.6% Propane (C₃H₈) in air
- 100PPM Isobutylene (C₄H₈) in air

REACTIVE SINGLE GAS MIX

44L and 116L aluminium alloy cylinders supplied with reactive single gas.

POPULAR GASES

- 44L 10PPM Sulfur Dioxide (SO₂) in air
- 44L 10PPM Hydrogen Cyanide (HCN) in air
- 44L 30PPM Hydrogen Chloride (HCL) in air
- 116L 25PPM Ammonia (NH₃) in air
- 116L 40PPM Hydrogen Sulfide (H₂S) in air

REACTIVE MULTI GAS MIX

Gravimetrically mixed multi gas cylinders for MSA, Gas Clip, GfG, BW and Dräger portable gas detectors.

POPULAR MIXES

- 34L 15% Oxygen (O₂), 60PPM Carbon Monoxide (CO), 20PPM Hydrogen Sulfide (H₂S), 1.45% Methane (CH₄)
- 44L 15% Oxygen (O₂), 60PPM Carbon Monoxide (CO), 20PPM Hydrogen Sulfide (H₂S), 29% Methane (CH₄)
- 44L 18% Oxygen (O₂), 100PPM Carbon Monoxide (CO), 25PPM Hydrogen Sulfide (H₂S), 50% LEL



GfG INSTRUMENTATION

G888

POLYTECTOR DETECTOR FOR DETECTION OF 1-7 GASES WITH OPTIONAL RADIO MODULE

The Microtector III G888 from GfG is one of the smallest and lightest 7-portable gas measurement devices with a radio module available. Depending on the sensor equipment, the device will warn against risks caused by toxic poisoning as well as flammable gases and vapours, including depletion and excess of oxygen.

EASY OPERATION

The G888 is immediately ready for operation as soon as it is switched on. The main functions - peak display, LED lamp, alarm reset, display zoom and rotating display are each controlled with a simple keystroke. It is possible to conveniently navigate the G888 with three buttons in the user menu, in order to change the device settings or to read the data logger.

MAN DOWN ALARM

The G888 is equipped with a man down alarm. The time interval when the alarm is triggered can be individually set and password-protected, for the situation. Thus, in critical cases no time is being lost while initiating rescue measures.

GfG LINK

The GfG-Link is a safe link between devices with the panel indicating all linked devices with their current status. Depending on the type, up to ten devices can be linked with a GfG-Link. Rapid identification of the device as well as the current measurement data will be displayed on the screen with an operation in the field of up to 300m.

GASES

- Catalytic sensors for combustible gases
- Electrochemical sensors for O₂, H₂S, CO, NO₂, SO₂, CL₂, NH₃, NO, HCL, HCN, PH₃, ETO, SiH₄, H₂, CLO₂
- Infra-Red sensors for CO₂, CH₄ & Hydrocarbons

KEY FEATURES

- Gas detector for 1 up to 7 Gases
- CO₂ and CH₄ detection via IR
- Man-Down Alarm
- Data logging for measured gas and activated alarms up to 500 hours
- Lifetime warranty on case and electronics
- Manufactured in Germany



GfG LINK FOR CONNECTED DEVICES



1-7 GAS
DETECTION

WEBSITE
SEARCH
GF888

CO₂ AND CH₄ INFRARED DETECTION

Unlike conventional multi-gas detectors, the G888 can detect carbon dioxide (CO₂) and hydrocarbons (such as methane and propane) simultaneously, via IR. Optionally, the infrared sensor can be pressure compensated, for use in big pressure fluctuations (e.g. in the mining sector). Sensor poisoning can be excluded by using IR technology. The IR sensor also has the added advantage that it is not damaged even at highest gas concentrations.



GFG INSTRUMENTATION G999

POLYTECTOR DETECTOR FOR DETECTION OF 1-7 GASES WITH INTEGRATED PUMP

The G999 is based on the G888 (left) with the additional feature of an **integrated electrical suction pump**.

This works differently to the diffusion sensing of the G888. The pump enables users to pre-test the environment before entry, to determine the gas levels. If safe entry has been determined, the user, once they have entered the space, can then switch off the pump and the meter will revert to the conventional diffusion sensing whilst in the confined space, without the annoyance of the pump continually operating.

The GfG999 is capable of connecting to the **GfG-Link** for rapid identification of connected devices as well as the current measurement data.

GASES: Same as G888 plus PID sensor.

KEY FEATURES

- Switchable on the fly between diffusion to sampling pump modes
- Integrated pump for pre-entry sampling
- CO2 and CH4 detection via IR sensor
- Man-Down Alarm
- Data logging for measured gas and activated alarms up to 500 hours
- Lifetime warranty on case and electronics
- Manufactured in Germany
- PID Sensor Option



GFG LINK FOR CONNECTED DEVICES

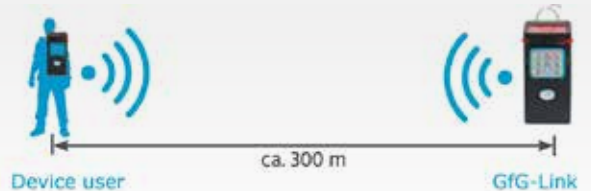

**1-7 GAS
DETECTION**



WHO IS GFG?

GfG (Gesellschaft für Gerätebau) was founded in 1961 in Germany, by Rolf Huebner, after a contract was secured with the Dortmund mining authority to produce the portable gas warning device "Methanprüfer K95" – the first electronic gas detector to be successfully used in the arduous environments found in coal mining. Since then, GfG has positioned itself as a leading specialist for gas detection and gas warning technology in the market. The knowledge of GfG's specialists means that detection solutions are possible for a wide range of industries and markets, including some of the most difficult applications. GfG's range of instrumentation covers portable gas detection, fixed gas systems and water measuring systems.





GAS CLIP TECHNOLOGIES MGC SIMPLE



TWO YEAR BATTERY LIFE FOUR-GAS DETECTOR

Gas detection has been made 'simple' by Gas Clip Technologies. The MGC Simple is a site compliant calibrated 4-gas portable detector that never needs charging – ever!

Just turn it on and have worry-free assurance of protection against toxic gases 24/7 for up to two full years. Reliably test for hydrogen sulfide (H2S), carbon monoxide (CO), oxygen (O2) and combustible gases (LEL) with this simple-to-use and simple-to-maintain detector.

LOW POWER USAGE IS THE KEY!

Gas Clip Technologies' continued refinement of advanced low-power photometric infrared technology for combustible gas measurement helps make gas detection simpler and safer than ever.

Assembled in the USA, the MGC Simple will work in oxygen enriched and oxygen deficient environments, with continuous one second data logging while the LEL sensor is immune to H2S and silicone poison.

KEY FEATURES

- No charging required
- Low cost compliant portable 4-gas detector
- Ergonomic, simple one button operation
- Compatible with MGC Simple Dock or MGC Simple Wall Mount Dock
- LEL sensor is immune to H2S and silicone poison



MGC SIMPLE MODEL WITH A 2 YEAR RUNTIME

MGC SIMPLE PLUS MODEL NOW AVAILABLE WITH AN EXTENDED 3-YEAR RUNTIME!

4-GAS DETECTION

- O₂** OXYGEN
- CO** CARBON MONOXIDE
- H₂S** HYDROGEN SULFIDE
- COMBUSTIBLE GASES**



INGRESS PROTECTION

IP Ratings indicate how well an item is protected against DUST and WATER. The first number references dust, the 2nd - water.

- Highest IP scale rating against fine dust (6)
- Submersible rating against water ingress (8)



EXTRA LONG-LIFE BATTERY

What's the secret of the MGC's extended battery life? MGC employ the use of low-power photo-metric technology for the detection of the gases. It has been refined further in the SIMPLE and SIMPLE PLUS for even longer battery performance.



CONTINUOUS DATA LOGGING

Both the SIMPLE and SIMPLE PLUS models feature continuous 1 second data logging. When used with the MGC Simple Dock, the GCT Manager software can assess the individual event logs from the meter, including time, date, calibration and bump data.



GAS CLIP TECHNOLOGIES MGC INFRARED

LONG 60-DAY BATTERY LIFE, FOUR-GAS DETECTOR

Always forgetting to charge your gas detector? The MGC IR features the longest battery life of any portable gas detector. It can go a full two months without a charge, even without ever having to be turned off. Shut down the detector nightly and the battery can last up to four months!

PUMP VERSION AVAILABLE

With the PUMP version, the operator can attach a connecting hose to the detector and the MGC Pump will then detect a sample for where the hose is placed (e.g. inside a manhole) before the operator enters that space.

KEY FEATURES

- Economical compliant portable 4-gas detector
- Bump/Calibration reminders
- Docking capability with MGC Dock
- PUMP version detects gases via a hose connection before entry to the space



PUMP VERSION AVAILABLE

4-GAS DETECTION



OXYGEN



CARBON MONOXIDE



HYDROGEN SULFIDE



COMBUSTIBLE GASES

GAS CLIP TECHNOLOGIES MGC PELLISTOR

30-HOUR BATTERY LIFE, 4-GAS DETECTOR

The MGC Pellistor is an economical 4-gas portable detector, ideal for simple safety compliance in the workplace. This detector also eliminates the need to frequently calibrate. It can go six months without being calibrated.

PUMP VERSION AVAILABLE

With the PUMP version, the operator can attach a connecting hose to the detector and the MGC Pump will then detect a sample for where the hose is placed (e.g. inside a manhole) before the operator enters that space.

KEY FEATURES

- Economical compliant portable 4-gas detector
- Bump/Calibration reminders
- Docking capability with MGC Dock
- PUMP version detects gases via a hose connection before entry to the space



PUMP VERSION AVAILABLE

4-GAS DETECTION



OXYGEN



CARBON MONOXIDE



HYDROGEN SULFIDE



COMBUSTIBLE GASES



GAS CLIP TECHNOLOGIES SGC

ECONOMICAL SINGLE GAS DETECTOR

Whether it's the hottest environment or the coldest, the Single Gas Clip is designed and tested to provide worker safety in the harshest working conditions.

With simple one button operation, the SGC features unmatched sensor reliability for the detection of hydrogen sulfide H₂S, carbon monoxide CO, or oxygen O₂, with adjustable alarm set points, real-time gas reading capability, two-way IR communication for event downloads and bump testing capability.

KEY FEATURES

- Adjustable alarm set points
- 0.1 ppm resolution for H₂S sensor and display
- Programmable unique 6-digit detector identification
- Docking capability with SGC Dock



THE SGC FEATURES A SINGLE GAS SENSOR. CHOOSE THE TYPE OF GAS YOU NEED TO DETECT.

GAS DETECTION

O₂
OXYGEN

CO
CARBON MONOXIDE

H₂S
HYDROGEN SULFIDE

2
YEAR WARRANTY

GAS CLIP TECHNOLOGIES SGC PLUS

ECONOMICAL SINGLE GAS DETECTOR

Compared with the standard SGC model above, the SGC PLUS features a 'Hibernate' mode, which allows users to place the meter in a rested state when not in use.

This makes the SGC PLUS an ideal single gas detector for rental markets and seasonal contractors. When the job is finished, synchronise the instrument with the IR Link or the SGC Dock and put the detector in a rested state. When required again, simply press the power button to reactivate the detector.

KEY FEATURES

- Hibernate mode puts detector into a rest state when not in use
- One button re-activation mode
- Adjustable alarm set points
- Docking capability with SGC Dock



THE SGC PLUS FEATURES A SINGLE GAS SENSOR. CHOOSE THE TYPE OF GAS YOU NEED TO DETECT.

GAS DETECTION

CO
CARBON MONOXIDE

H₂S
HYDROGEN SULFIDE

2
YEAR WARRANTY



GAS CLIP TECHNOLOGIES **DOCKING STATIONS**

MGC DOCK

Simple to operate, the MGC Dock is an all-in-one stand-alone docking station designed for regular bump testing or calibrating of up to four MGC detectors, simultaneously. Logs are stored on a USB flash drive which can easily be transferred to a computer for analysis of the data results.

Models available to suit: SGC, Simple, IR, IR Pump and Pellistor.

MGC WM DOCK WALL MOUNT

Gas Clip Technologies offers a wall mount solution for our MGC Dock. Instead of being housed in a case, the WM Mount option provides a slim cabinet type case that can be easily mounted on a wall.

This option is a perfect fit for facilities or office environments, where the gas monitors can be easily charged, tested and kept in one location.



ABOUT GAS CLIP TECHNOLOGIES

Based in Texas, USA, Gas Clip Technologies is founded on returning safety, simplicity, reliability, and customer satisfaction to the gas detection business.

Their focus from the beginning has been on one thing, designing and manufacturing simple-to-use portable gas detectors that save precious time, resources and lives.

Over the years, Gas Clip Technologies has pioneered and perfected the development of advanced infrared LEL sensor technology for portable gas detection.

This low-power LED photometric infrared technology for LEL detection of hydrocarbon gases has not only reduced detector maintenance, downtime and expenses, but it has also made daily charging of portable multi-gas detectors a thing of the past.

This technology can be found in each of their multi-gas detectors which enables them to run continuously for days, months or even years at a time.



SENSIT HXG SERIES

COMBUSTIBLE GAS LEAK DETECTORS

The SENSIT HXG-2d and HXG-3 are handheld instruments for detecting and finding natural, methane or propane gas leaks.

The **HXG-2d** incorporates a semi-conductor sensor to measure combustible gases in PPM and auto ranges to percent LEL, when concentrations exceed 990 PPM.

The **HXG-3** shows (LEL) and PPM readings simultaneously for accurate gas leak detection and gas analysis. Audible and visual alarms warn of hazardous conditions. Data Save allows you to save data during any gas leak investigation.

KEY FEATURES

- Direct PPM or LEL Readout
- Adjustable Tick-Dial Leak Detection
- Long-life, Low-Cost combustible sensor
- Infrared Data Downloading (HXG-3)
- Simultaneous LEL and PPM display (HXG-3)



AVAILABLE WITH
OPTIONAL AMMONIA
SENSOR

**GAS
LEAKS**



LEL



WEBSITE
SEARCH
HXG

SENSIT GOLD G2

COMBO COMBUSTIBLE/MULTI GAS DETECTOR

The SENSIT GOLD is a portable gas leak detector and multi-gas confined space monitor, all in the one instrument. The Gold is ideal for determining gas leaks, pinpointing the leak, gas pipeline purging and basic confined space applications.

As an investigative tool, the Sensit Gold is designed to find the source of combustible gas leaks fast. Up to 4-gases can be displayed including PPM, LEL, VOL.

GASES: Combustible, O2, CO, H2S, HCN

KEY FEATURES

- Can determine both combustible and multi gases
- Bright visible easy to read backlit display
- "Tick" Dial Leak Locating
- Data Logging and Internal Memory
- Audible and Visual Alarms



**GAS
LEAKS**



**LEL
+ multi gas**



WEBSITE
SEARCH
GOLD



SENSIT TRAK-IT IIIA

COMBUSTIBLE GAS INDICATOR

Made in the USA, the TRAK-IT® IIIa from Sensit is the most durable and user-friendly combustible gas indicator (CGI) available.

This multi-function instrument is designed for pinpointing underground gas leaks, pipeline gas purging, and confined space applications. Can be configured for combustible gas readings in PPM, LEL and/or percent volume, plus oxygen and a variety of toxic sensors.

GASES: Combustible, O2, CO, H2S, HCN

KEY FEATURES

- Built-in Natural Gas & Propane Calibration
- Internal Two-Speed High-Volume Pump
- Internal Memory & Infrared Data Download
- LED Warning Lights
- Large Bright Graphic Display



**GAS
LEAKS**



COMBUSTIBLE
GASES

**LEL
+ multi gas**



WEBSITE
SEARCH
TRAK-IT

TROTEC BG SERIES

COMBUSTIBLE GAS LEAK DETECTORS

The TROTEC BG30 and BG40 handheld instruments are combustible gas sensors with built-in alarm thresholds, commonly used for the detection of gas leaks on compact pipelines, fittings, gas cartridges or LPG containers.

Both meters detect natural gas, methane, ethane, propane, butane, acetone, alcohol, ammonia, petrol, LPG, turbine fuel, hydrogen sulphide, industrial solvents, paint thinners and other combustible gases.

KEY FEATURES

- Quick and easy detection of gas leaks
- Visual and acoustic alarm signal
- Variable sensitivity control
- Large backlit LCD display (BG40)
- LEL and PPM display (BG40)



THE BG40 HAS A
BACKLIT LCD DISPLAY.

**GAS
LEAKS**



COMBUSTIBLE
GASES

LEL



WEBSITE
SEARCH
TROTEC BG



CO2 METER SAN-11

PORTABLE CO2 DETECTOR

The SAN-11 is a personal 5% CO2 monitor with integrated Data Logger. Designed for people working in enclosed areas where carbon dioxide buildup may cause personal harm.

Features data logging capabilities where the data log files can be downloaded as a csv/xls file and are then displayed using the optional GasLab Software. Popular industries where CO2 build-up is a concern for personal safety include wine production, craft breweries, food and restaurant production.

KEY FEATURES

- Audible, visual strobe light and vibrating alarms
- Man-down alarm – leverages accelerometer technology
- Rechargeable Li-Ion battery, 12+hrs per charge
- Large LCD displays CO2, Temperature & RH%
- Rugged design with protective rubber enclosure



**SENSOR ACCURACY ±200PPM
±10% READING VALUE**

**SINGLE
GAS**



TROTEC BQ16

HCHO (CH2O) / VOC DETECTOR

The BQ16 is used to determine **Formaldehyde** (HCHO) and **Volatile Organic Compounds** (VOC) concentrations for air quality assessments. Both gases are deemed as dangerous substance groups within indoor air exposure.

Easy-to-use, the BQ16 can measure these concentrations simultaneously to ensure that the room air pollution is harmless. Minor concentrations of as low as 0.01 ppm are determined.

KEY FEATURES

- Measures HCHO and VOC simultaneously
- Determination of measured values in ppm or mg/m³
- Detects even minor concentrations as low as 0.01 ppm or 0.01 mg/m³
- MAX, MIN and HOLD function



**SINGLE
GAS**



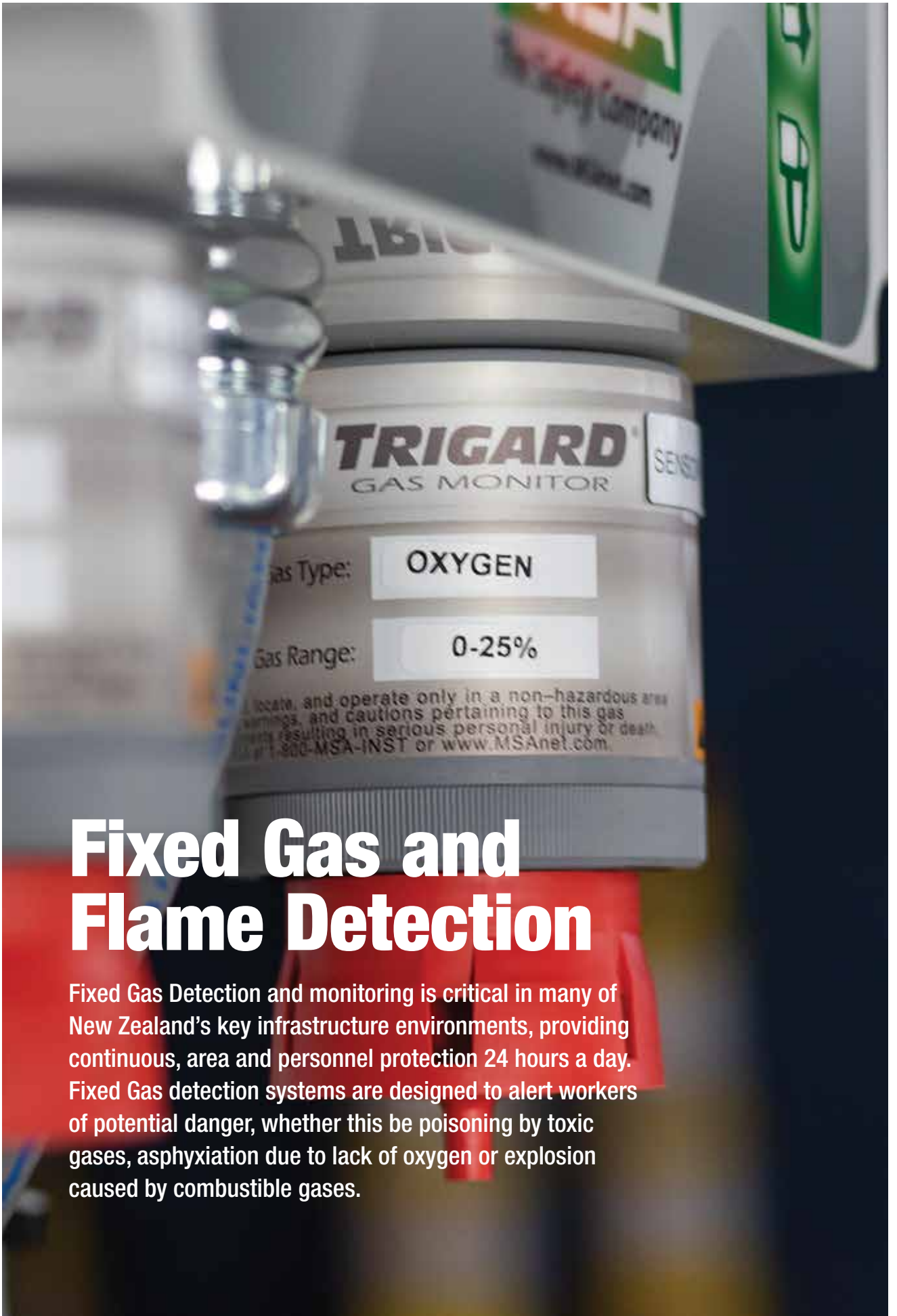

Fixed Gas and Flame Detection

Fixed Gas Detection and monitoring is critical in many of New Zealand's key infrastructure environments, providing continuous, area and personnel protection 24 hours a day. Fixed Gas detection systems are designed to alert workers of potential danger, whether this be poisoning by toxic gases, asphyxiation due to lack of oxygen or explosion caused by combustible gases.



MSA ULTIMA® X5000

DUAL SENSOR CAPABLE BLUETOOTH ENABLED FIXED GAS MONITOR

The ULTIMA® X5000 Gas Monitor is the future of gas detection for oxygen, toxic and combustible gas detection.

The X5000 utilises MSA's advanced longlife XCell® gas sensors with TruCal® technology, with life expectancy typically double that of the industry average sensor life. TruCal technology actively monitors the sensor integrity and compensates for environmental factors that cause traditional electrochemical sensors to drift. An industry first, Diffusion Supervision warns if a sensor inlet becomes blocked and is unable to detect gases.

The gas transmitter's advanced, OLED display is easy to read and the unique touch-screen interface makes it simple to navigate. The gas monitor employs green, yellow and red LEDs to signal normal, fault and alarm conditions.

GASES: Combustible, O2, H2S, CO, CO2, CL2, NH3, SO2, H2, NO2, NO, HCL

KEY FEATURES

- Longlife XCell Sensors, self checks 4x per day
- TruCal* actively monitors the sensor integrity
- OLED display, bright LED's for extreme visibility
- Dual sensor capability doubles the sensing power with half of the footprint of a single gas transmitter
- Bluetooth connectivity with X/S Connect App provides real-time information to your mobile



X/S CONNECT APP INTERFACES THE ULTIMA X5000 VIA BLUETOOTH WITH A SMART PHONE OR TABLET

**MULTI
GAS DETECTION**



AEC SENSOR CHECKING

Using patented pulse check technology and proprietary Adaptive Environmental Compensation (AEC), all TruCal XCell sensors verify operation by actively adjusting the sensor output for changes in sensitivity.



Diffusion supervision actively monitors the sensor inlet for obstructions. If an obstruction is detected, the sensor will go into a fault mode to alert users and the control room that it is not seeing gas due to an obstruction.



SMART & SAFE SENSOR CHANGE

- Patented SafeSwap technology, allows users to change or replace XCell sensors without powering down the instrument
- SwapDelay enables users a 2-minute window to change sensors without triggering fault.



MSA PRIMA X[®]

VERSATILE FLAMEPROOF OR INTRINSICALLY SAFE FIXED GAS TRANSMITTER

Indoors or outdoors, the PrimaX Gas Transmitter from MSA Safety provides dependable, accurate gas detection.

PrimaX I

The PrimaX I features an antistatic, reinforced nylon enclosure, available as a general purpose version or intrinsically safe version, for the detection of toxic gases or oxygen. With easily replaced plug-in sensors, the large LCD screen attaches to a mounting plate for easy installation, while the built-in keypad makes for quick, simple calibration.

PrimaX P

The PrimaX P is a “flameproof” transmitter housed in a powder-coated aluminium enclosure, that will protect it in extremely dangerous conditions, with three LED status indicators for up-to-the-second reporting.

GASES: Combustible, O2, CO, H2S, SO2, NO2, CL2, NH3, NO, HCN, NCL, H2

KEY FEATURES

- Detachable back plate for installation/mounting
- 4-20 mA output signal and optional HART digital communication
- Plug-in sensors and easy installation
- Large LCD screen
- Optional configurable Alarm and Fult relays (PrimaX P)



PRIMAX I GENERAL PURPOSE DETECTOR



PRIMAX P FLAMEPROOF ALUMINIUM HOUSED DETECTOR

**MULTI
GAS DETECTION**



MSA PRIMA X[®] IR

IR DUALSOURCE LEL COMBUSTIBLE GAS TRANSMITTER

Offers LEL (Lower Explosive Limit) combustible gas detection through a patented PrimaX Gas Transmitter IR dual source design. A redundant IR source provides reliability and uninterrupted monitoring should a source failure occur. Furthermore, the possibility of obscurations due to rain, fog, dirt, dust, and other environmental conditions is minimised due to dual source design.





MSA CHILLGARD 5000

INDUSTRIAL AMMONIA AND REFRIGERANT LEAK MONITORING

CHILLGARD AMMONIA

The Chillgard 5000 Ammonia Monitor accurately detects ammonia gas leaks as low as 10 ppm for early notification, keeping your plant safe.

The Photoacoustic Infrared (PIR) technology provides a more accurate measurement, notifies leaks faster and the longlife sensors are not affected by temperature and humidity variations, which helps minimise drift.

CHILLGARD REFRIGERANT LEAKS

Designed for the building and HVAC markets, the Chillgard 5000 Refrigerant Leak Monitor provides the earliest level of detection of costly refrigerant gas leaks in mechanical equipment rooms. Sampling system with patented photoacoustic infrared (PIR) technology detects leaks as low as 1 part per million (ppm).

The Intuitive, touchscreen user interface makes it easy to operate. Select up to six refrigerants to monitor out of the field selectable refrigerant library.

CHILLGARD REMOTE DISPLAY

The Chillgard 5000 Remote Display provides gas monitor information before room entry where potentially hazardous gas levels may exist. This unit is easily installed adjacent to entry ways or walls outside of the monitored area.



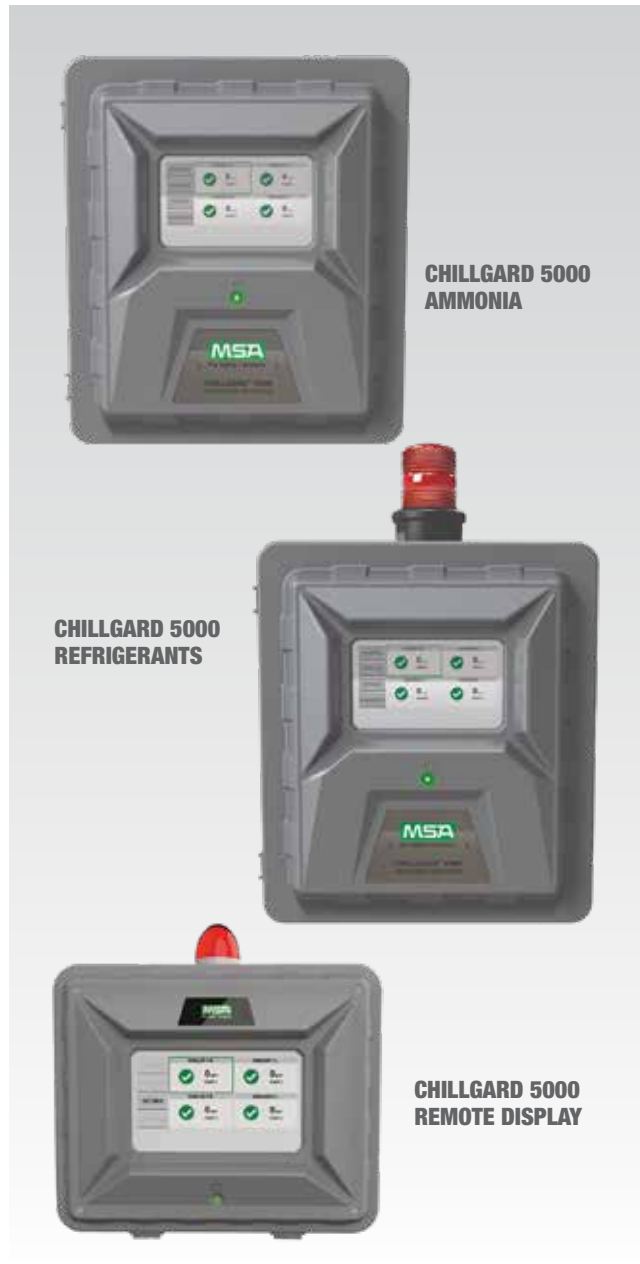

Workers can easily be alerted by the audible alarm and read the monitor status to know the alarm conditions inside the room prior to entry. The Remote Display provides an additional level of hazardous gas detection and communication.



CHILLGARD 5000
AMMONIA

CHILLGARD 5000
REFRIGERANTS

CHILLGARD 5000
REMOTE DISPLAY

 <p>Stability Not affected by temperature and humidity swings, minimizing drift.</p>	 <p>Sensitivity 1 ppm minimum detection level with our patented PIR technology. 10 ppm minimum for ammonia.</p>
 <p>Reliability Worry-free operation with advanced sensor diagnostics and predictive maintenance.</p>	 <p>Versatility Select up to 6 refrigerants to monitor out of our field-selectable refrigerant library.</p>

FIXED GAS DETECTION **HCFC** HYDROFLUOROCARBONS **NH₃** AMMONIA **WEBSITE SEARCH CHILLGARD**

KEY FEATURES

- Accurate 1 ppm detection (Refrigerant model)
- 7" (178 mm) color touch screen
- Patented PIR photacoustic infrared technology
- Long life sensors
- Dedicated calibration port for up to 16 points
- BACnet and Modbus Digital Communications



MSA CHILLGARD VRF

VARIABLE REFRIGERANT FLOW LEAK MONITORING

With a low 25ppm minimum detection, the Chillgard VRF Refrigerant Leak Detector is the first industry detector for Variable Refrigerant Flow Systems (VRF) with integrated BACnet capability. Therefore, it can be directly connected with any Building Management Systems (BMS).

MSA applies its proven photoacoustic infrared sensing technology featuring long sensor life which provides a stable zero baseline and minimises cross-sensitivities.

KEY FEATURES

- Low-level detection at 25 ppm min. detection
- Capable of operating within wide temperature and humidity ranges
- Low maintenance—no moving parts and stable PIR sensor technology



FIXED
GAS DETECTION

REFRIGERANT
LEAK



MSA CHILLGARD NH3

ECONOMICAL AMMONIA MONITORING

The economical Chillgard NH3 monitor utilises reliable, electrochemical sensing technology to detect parts-per-million (ppm) levels of ammonia. It provides fast, reliable detection of measuring ammonia, and is capable of measuring a 10 ppm leak, with full-range scale of 0-1000 ppm, down to -40°C.

The World-class design and engineering offer a single board design for ultimate reliability and serviceability in an economical package.

KEY FEATURES

- Accurate 1 ppm detection (Refrigerant model)
- 7" (178 mm) color touch screen
- Patented PAIR photoacoustic infrared technology
- Long life sensors
- Dedicated calibration port for up to 16 points



FIXED
GAS DETECTION

REFRIGERANT
LEAK





MSA CHEMGARD

PHOTOACOUSTIC INFRARED GAS MONITOR

The Chemgard iR Gas Monitor series are highly sensitive instruments available in many output ranges including;

0-10 ppm, 0-100 ppm, 0-1000 ppm, 0-1% by volume, 0-10% by volume, 0-100% by volume and 0-100% LEL. With three different enclosure styles, the Chemgard is convenient to mount whilst the unit can also be expanded to monitor up to eight locations.

The easy-to-read display shows gas concentrations and three levels of alarms.

KEY FEATURES

- Remote monitor detects traces of hydrocarbons, solvents, alcohols, CO₂, CO and toxics
- Three different styles provides mounting options
- Unit can expand to monitor up to eight locations with three levels of alarms



MSA TG5000

WASTEWATER BLUETOOTH FIXED GAS MONITOR

The TG5000 Gas Monitor is an effective and economical solution to detecting combustible and toxic gases, as well as oxygen deficiency/enrichment, in wastewater, commercial and light industrial applications. The monitor helps personnel to work safely in these environments offering a variety of sensor and configuration options. The OLED display has been designed for extreme visibility, even at distance.

GASES: Combustible, O₂, H₂S, CO, CO₂, CL₂, NH₃, SO₂, H₂, NO₂, NO, HCL

KEY FEATURES

- XCell TruCal gas sensors for H₂S and CO monitoring
- OLED with bright status LEDs for extreme visibility
- Available as single or dual gas monitoring unit





MSA OBSERVER® i

ULTRASONIC GAS LEAK DETECTOR

Ideal for use in complex, outdoor pipeline systems, the Observer® i from MSA instantly detects pressurised gas leaks utilising an omni-direction acoustic detector with gassonic ultrasonic technology.

The Observer i works even when traditional methods of gas detection are unsuitable or dependent on ventilation. The Artificial Neural Network (ANN) technology can distinguish between real gas leaks and false alarm sources.

KEY FEATURES

- Distinguishes real gas leak noise from background noise, suppressing false alarm s
- Detects gas leaks from 2 BAR (29 psi) pressure for rapid detection of small leaks
- Patented Senssonic™ self-test



FIXED
GAS DETECTION

ULTRASONIC
GAS LEAK



MSA SENSCIENT ELDS

TOXIC & FLAMMABLE OPEN PATH GAS DETECTOR

The Senscient ELDS laser-based open path gas detector is available for a wide range of toxic and flammable gases.

The 'SimuGas' self-testing eliminates employees entering hazardous areas for gas checks. Nuisance false alarms are virtually eliminated with its breakthrough Harmonic Fingerprint processing.

GASES: Combustible, H2S, H2S/CH4, CH4, C2H4, NH3, CO2, HCl, HF

KEY FEATURES

- Gas-specific Harmonic Fingerprint detection eliminates false alarms
- SimuGas automated function checks are recorded daily
- ELDS lasers work in fog, rain, and snow



FIXED
GAS DETECTION





MSA FL500-H2

UV/INFRARED FLAME DETECTOR FOR H2 FIRES

The FL500-H2 is an Ultraviolet / Infrared Flame Detector designed specifically to detect hydrogen (H2) fires. The FL500-H2 monitors for radiation emitted by a hydrogen flame in both the ultraviolet (UV) and infrared (IR) spectral ranges.

This UV/IR combination provides a fast response time and increased false alarm immunity against sources of radiation for reliable protection. It is designed to withstand temperature extremes, operating in between -55°C to +85°C environments.

KEY FEATURES

- Wide field of detection view of 130°.
- Continuous Optical Path Monitoring performs self-check to ensure the optical path is clear
- FL500 UV/IR detects: heptane, methane, methanol, propane, ethane and butane



FL500 UV/IR MODEL
AVAILABLE FOR DETECTION
OF UP TO SIX FUEL SOURCES

**FLAME
DETECTION**



WEBSITE
SEARCH
FL500

MSA FL4000H

MULTI-SPECTRUM (MSIR) FLAME DETECTOR

The FL4000H is an advanced multi-spectrum infrared flame detector that provides superior false alarm immunity with the widest field of view. It detects typical fires such as alcohol, n-heptane, gasoline, jet fuels and hydrocarbons.

The FL4000H can also see through dense smoke produced by diesel, rubber, plastics and lube oil fires. The multi-spectral optical IR sensing array reliably detects actual flames and the eliminates the vast majority of false alarms.

KEY FEATURES

- Multi-Spectrum Infrared (MSIR) detector range (70+ m) and field of view of 100° @ 30m
- Event logging records time, date and event
- Neural Network Technology provides superior false alarm immunity



**FLAME
DETECTION**

**INFRARED
MULTI-SPECTRUM**

WEBSITE
SEARCH
FL4000H



MSA HAZARDWATCH

MODULAR FIRE AND GAS DETECTION SYSTEM

An innovative, modular system that combines highly reliable programmable logic controller (PLC) technology with advanced gas and flame field devices.

It is highly scalable, making it suitable for small systems to large plant-wide applications. Offering intelligence, flexibility and reliability, the HazardWatch System's controller hardware configuration and software meets NFPA 72 compliance and the 10.4" touchscreen provides user-friendly graphical interface and supports plot plans.

KEY FEATURES

- FM certified fire network allows for multiple HazardWatch systems to be networked together
- Touchscreen interface (10.4") provides graphical interface and supports plot plans
- Field wiring topology is simple and reliable



**FLAME
DETECTION**

**MODULAR
SYSTEM**

WEBSITE
SEARCH
HAZARDWATCH

MSA GASGARD XL

1-TO-8 CHANNEL GAS CONTROLLER

Monitor up to eight remote gas sensors with the highly accurate wall-mounted GasGard XL Controller. The controller's large, multi-language LCD display provides real-time readings, offers full-system diagnosis and shows intuitive icons.

Housed in durable, fire-retardant ABS plastic, the controller is suitable for a variety of chemical, industrial and waste water environments. The sensor also features a buzzer that sounds up to 85 dB.

KEY FEATURES

- Monitors up to eight remote gas sensors
- Large multi-language LCD display provides real-time gas readings and full-system diagnosis
- Convenient upload system allows for event log transfer via Ethernet or USB



**GAS
CONTROLLER**

WEBSITE
SEARCH
GASGARD



MSA SUPREMATOUCH

CONFIGURABLE FIRE/GAS DETECTION SYSTEM

The SUPREMATouch is compact, modular configurable fire and gas safety detection system used with a wide range of detectors for combustible gas, toxic gas and oxygen deficiency.

The heart of the system is the SUPREMATouch controller, featuring a large colour touchscreen display with a title-based menu structure to optimise intuitive operation.

This is a custom product.

Please consult us for configuration details.

KEY FEATURES

- Compact, modular design
- Connects up to 252 devices
- Digital CAN-bus technology provides reliable internal communication
- Intuitive system configuration with expand-ability



**FIRE & GAS
CONTROLLER**

**MODULAR
SYSTEM**

 **WEBSITE
SEARCH
SUPREMATOUCH**

MSA SMC SENTRY IT

NETWORK-ENABLED GAS DETECTION SYSTEM

The SMC Sentry IT Controller is a powerful network-enabled hazardous gas detection system that operates up to 32 detectors and interfaces with devices over Modbus RTU, 4-20 mA, Sentry PSG Bus, and conventional dry contact.

The SMC Sentry is compatible with all SMC IT products, legacy Sentry products, and third party sensors and devices and the backup battery provides the desired stand-by power in the event of a power outage.

KEY FEATURES

- GlobalCal™ - calibrate all connected sensors at the same time
- Touch-Panel - easily operate and configure
- Intelligent data USB Flash Drive - quickly configure and upgrade new software



POWERFUL GAS DETECTION SYSTEM CONTROLLER.

**GAS
CONTROLLER**

 **WEBSITE
SEARCH
SENTRY IT**



MSA **SMC** **CLASSIC SENTRY**

MICROPROCESSOR GAS CONTROLLER

The SMC Sentry Classic Controller is an 8-channel gas detection system for monitoring combustible gas, oxygen deficiency, and toxic gases.

The Classic is a microprocessor-based system that includes management of gas sensors, alarm relays, user interface via front panel display, printer output, Modbus digital communication, alarm indicators, and relay outputs.

Diagnostics - performs routine checks of operating parameters and alerts user if a condition requires attention

KEY FEATURES

- **Sensor Scan Display** - continuously view current sensor gas exposure readings
- **Diagnostics** - performs routine checks of operating parameters and alerts user if a condition requires attention



GAS
CONTROLLER

WEBSITE
SEARCH
SENTRY CLASSIC

MSA **SMC** **SENTRY INSITE**

WEB BASED GAS CONTROLLER SOFTWARE

The SMC Sentry InSite is an intuitive web-based monitoring application that provides users with the ability to locally and remotely access their facility's fire and gas safety system online.

Local or Remote Access allows the program to be run locally within a facility or securely extended to SMC Cloud for visibility anytime, anywhere. InSite provides full monitoring of a SMC Sentry IT Controller and all connected detectors.

KEY FEATURES

- **Web-based Application** - securely access SMC Sentry InSite through your PC, tablet, or smartphone
- **Maintain statuses of all connected devices from one comprehensive web page**

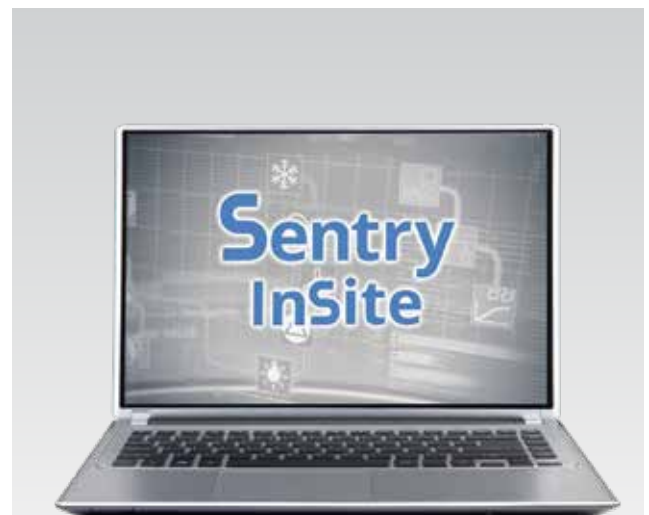

**WEB-BASED APPLICATION FOR MANAGING FIRE
AND GAS SAFETY IN FACILITIES.**

GAS CONTROLLER
SOFTWARE

WEBSITE
SEARCH
SENTRY INSITE

Climate & Inspection

From moisture meters to commercial dehumidifiers, infrared cameras to anemometers, Accurate can meet your climate, moisture and temperature measurement, inspection and drying needs.



 **TROTEC**
AT WORK.





Moisture Meters



Over the past 20 years, Accurate has been the go-to-choice for moisture meters for the building industry in New Zealand. From house inspection, leaky homes, insurance and flood assessment through to new building, timber manufacturing , pre-lining test and council assessment, Accurate's professional range of meters from Protimeter, Trotec and Gann are industry recognised and widely utilised.

 **TROTEC**
AT WORK.



TROTEC T660

CAPACITANCE NON-INVASIVE MOISTURE METER FOR LEAKY HOMES & WEATHERTIGHTNESS

The T660 from Trotec is one of the most commonly used non-destructive moisture meters in NZ, trusted by industry building inspection professionals as well as home owners, insurance assessors and real estate agents.

The T660 is ideal for locating moisture in walls of homes, buildings and apartments, concrete, gib board, timber etc.

Why is the T660 so popular?

Because it is sensitive to locating and tracking moisture and it's easy-to-use. Simply hold the T660 against the surface and the unit will scan up to 40mm from the surface contact point. Where moisture is located, the readings are displayed simply on the large LCD display.

The T660 features a user settable alarm which will alert the user to high readings. For hard to view and reach positions, the "hold" function can be used to lock the reading on the LCD screen.

T610 MICROWAVE MODEL

Used primarily by building surveyors and weather tightness experts, the Trotec T610 differs to the T660 model above by using an advanced microwave sensor system to determine the presence and likelihood of moisture.

With a measuring range of up to 300mm, it is suitable for locating moisture problems in solid construction buildings and floors, where the material thickness is greater than 100mm (i.e. concrete). *Recommended for use in conjunction with the T660.*

KEY FEATURES

- Quick and simple non-destructive determination of moisture up to 40mm from surface
- Large easy to read LCD display
- Capacitive touchscreen control panel
- Moisture alarm warning for high moisture levels
- Hold, Min, Max and Average values
- Microwave T610 model for solid construction moisture determination up to 300mm deep

**T660****T610
MICROWAVE
MODEL****CAPACITANCE
METER****1
YEAR
WARRANTY****WEBSITE
SEARCH
T660**



TROTEC BM31WP



SMARTPHONE APP BASED WIRELESS NON-INVASIVE MOISTURE METER

The Trotec BM31WP is a non-invasive moisture sensor for determining moisture up to 40mm deep, that connects via Bluetooth to Trotec's MultiMeasure APP for smartphones and tablets.

Using the MultiMeasure Mobile APP, individual, min, max and average values can be displayed and a graphic moisture distribution matrix representation, linked to a photo, can be created, saved and sent.

KEY FEATURES

- Bluetooth enabled non-invasive moisture sensor
- MultiMeasure APP software for smartphones and tablets
- Moisture distribution matrix
- Hold, logging and alarm functions

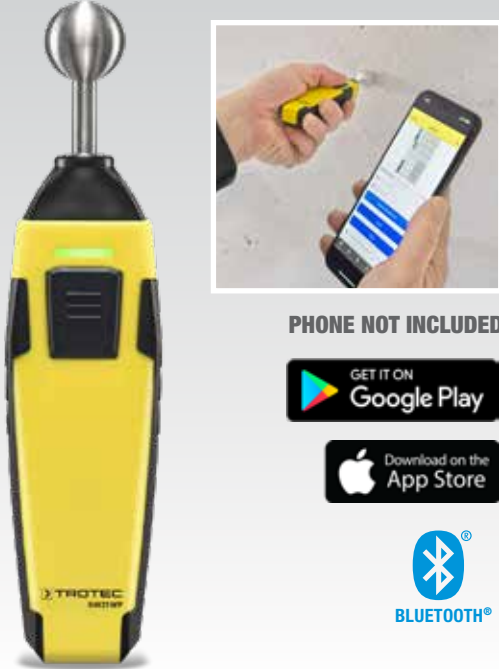

PHONE NOT INCLUDED

GET IT ON
Google Play

Download on the
App Store

BLUETOOTH®

CAPACITANCE METER

1
YEAR WARRANTY

WEBSITE SEARCH
BM31WP

GANN BL COMPACT B2

CAPACITANCE NON-INVASIVE MOISTURE METER FOR WEATHERTIGHTNESS & CONCRETE

The Hydromette BL Compact B2 from Gann is a professional quality non-invasive hand-held moisture meter for fast and accurate determination of moisture in homes, buildings and concrete.

Featuring seven different correction codes including concrete, screen and plaster, the BL Compact B2 is well suited to not only locating moisture in homes and building materials, but also concrete, when the desired measurement is wt. %.

KEY FEATURES

- Rapid non-invasive moisture determination with hold function
- Scan up to 40-60mm from the surface
- Audible moisture exceedance alarm
- Concrete moisture content measurement (wt.%)



CAPACITANCE METER

Made in Germany

WEBSITE SEARCH
GANN B2



PROTIMETER AQUANT

CAPACITANCE NON-INVASIVE MOISTURE METER FOR WEATHERTIGHTNESS & BOATS

The Protimeter Aquant is a simple capacitance non-invasive scanning moisture meter. It is ideal for locating and determining moisture problems in boats, homes and building materials such as timber/wood, gibo board etc.

Simply hold the meter against the wall or surface and the unit will scan, typically up to 19mm from the surface. Where moisture is located, the readings are displayed as digits on the LCD, increase significantly.

KEY FEATURES

- Locate moisture up to 19mm below the surface
- Colour changing LED visual indicator of moisture levels
- Audible tone increases when moisture located
- Hold reading feature



CAPACITANCE METER



2 YEAR WARRANTY



PROTIMETER REACHMASTER PRO

WIRELESS NON-INVASIVE MOISTURE SENSOR

The ReachMaster Pro is a wireless non-invasive moisture meter featuring a telescopic handle that adjusts from 70cm to 114cm. It is ideal for determining moisture in buildings where access may be difficult, such as entrance ways, multi-story apartments and outside under decks.

Using wireless technology, the moisture sensor connects to the end of the adjustable handle, whilst the display sits conveniently beside your hand displaying the reading.

KEY FEATURES

- Wireless connectivity between sensor and display
- Telescopic adjustable handle extends to 114cm
- Colour coded display with red, yellow and green zones for dry, damp, wet moisture values
- Audible alarm setting for high moisture levels



WIRELESS COMMUNICATION BETWEEN SENSOR HEAD AND DISPLAY

CAPACITANCE METER



2 YEAR WARRANTY





PROTIMETER SURVEYMASTER

DUAL MODE NON-INVASIVE & PIN MOISTURE METER

The Surveymaster is a popular dual mode moisture meter with both invasive pin resistance measuring of wood and capacitance non-invasive scanning operation. It is ideal for locating and establishing potential moisture in homes and buildings then measuring the moisture content using the pin mode. A reference function allows a benchmark reading to be saved, and the readings will identify either higher or lower.

KEY FEATURES

- Two Modes - pin resistance and non-invasive capacitance modes
- LED light scale provides the user with DRY (green), RISK (amber) and WET (red) values
- Reference function for benchmarking dry values



NON-INVASIVE SCANNING MODE

DUAL MODE METER **MADE IN BRITAIN** **1 YEAR WARRANTY** **WEBSITE SEARCH SURVEYMASTER**



PROTIMETER DIGITAL MINI

PROFESSIONAL RESISTANCE PIN MOISTURE METER FOR TIMBER

The Protimeter Digital Mini is a simple to use resistance pin type moisture meter, designed to be used by timber/wood manufacturers, council inspectors, builders and constructors to determine the estimated percent of moisture in the wood material. The Mini is supplied with a wood calibration chart, allows the user to correct the timber reading for the right type of wood being measured (i.e. Radiata Pine).

KEY FEATURES

- LED light scale provides the user with DRY (green), RISK (amber) and WET (red) values
- Calibration table supplied for moisture corrections
- Optional sliding hammer probe with 60mm pins for timber framing moisture measurement



RESISTANCE PIN METER **MADE IN BRITAIN** **2 YEAR WARRANTY** **WEBSITE SEARCH DIGITAL MINI**



TROTEC T510

PROFESSIONAL RESISTANCE PIN MOISTURE METER FOR TIMBER

The T510 is a high quality, high accuracy resistance pin type wood moisture meter designed to be used by timber manufacturers, builders and constructors to determine the percentage of moisture in the wood material.

Featuring a built-in wood species menu and temperature correction, the T510 will automatically correct the reading of moisture content to that of the selected species. (e.g. Radiata Pine)

KEY FEATURES

- 0 – 100 WME% measurement range
- Large scratch resistant high-contrast colour OLED display
- Built-in Wood Species Corrections
- Built-in Temperature Correction



RESISTANCE
PIN METER



1
YEAR
WARRANTY

WEBSITE
SEARCH
T510

TROTEC T510K

PROFESSIONAL TIMBER FRAMING MOISTURE METER KIT FOR BUILDING & CONSTRUCTION

The popular choice, and Accurate's No.1 selling wood moisture meter, the T510K is used for measuring the moisture content in timber framing before lining.

This is the type of system used by councils and inspectors for accurately determining the moisture content in the framing. The kit includes a sliding hammer probe with 60mm "insulated" probes, supplied in a lined-hard case with all components.

KEY FEATURES

- Kit features Sliding Hammer Probe with Teflon insulated 60mm pins
- Built-in wood species corrections
- Built-in temperature correction
- Supplied in lined-hard case



SUPPLIED AS A KIT INCLUDING
THE SLIDING HAMMER PROBE

RESISTANCE
METER KIT



1
YEAR
WARRANTY

WEBSITE
SEARCH
T510K



TROTEC BM22WP



SMARTPHONE APP BASED WIRELESS PIN MOISTURE METER

The Trotec BM22WP is a pin type invasive moisture sensor for determining moisture % readings of timber and firewood or soft building materials such as gypsum, plaster or screed. It connects via Bluetooth to Trotec's MultiMeasure APP for smartphones and tablets.

Using the MultiMeasure App, individual, min, max and average values can be displayed and a graphic distribution matrix representation, linked to a photo, can be created.

KEY FEATURES

- Bluetooth enabled pin type moisture sensor
- MultiMeasure APP software for smartphones and tablets
- Moisture distribution matrix
- Suitable for wood and soft building materials



PHONE NOT INCLUDED

GET IT ON
Google Play

Download on the
App Store

BLUETOOTH®

**RESISTANCE
PIN METER**

**1
YEAR
WARRANTY**

WEBSITE
SEARCH
BM22WP

NON-INVASIVE VS INVASIVE PIN MOISTURE METERS

DID YOU KNOW MOISTURE METERS DON'T ACTUALLY MEASURE MOISTURE?

Most **non-invasive moisture meters**, both low cost and professional, use the capacitance method for determining moisture. The relationship between the stored energy, determined by the method, and the presence of water results in significant changes to the di-electric constant. This method is quick, simple and non-destructive however it is subject to several factors that can lead to 'false positives'.

When there are several different materials and/or metal in the 'scanning' range of the meter, results can be skewed.

If confirmation of results or an actual true measurement of moisture content, is required, this is when a pin-type moisture meter is used. Using the theory of resistance, pin meters make solid contact with the material being measured (**invasive**), and different resistance values can be established against wood grain densities and temperature, to relatively accurately determine moisture % readings.





GANN BL COMPACT S

PROFESSIONAL RESISTANCE PIN MOISTURE METER FOR TIMBER

The BL Compact S is a professional German made wood moisture meter, designed for ease of use for determining moisture in different kinds of hard and soft woods.

Unique for its price point, the BL Compact S features a built-in two-stage wood type correction with a supplied wood type chart to identify which code to choose. The Compact S will also determine the ambient temperature of the wood in case a correction is required to be applied.

KEY FEATURES

- Economically priced for a high quality/high accuracy professional pin-type moisture meter
- Rapid fast measurement time
- Two-step correction of wood species
- Ambient Temperature determination



OPTIONAL
HAMMER
ELECTRODE
AVAILABLE

RESISTANCE
PIN METER



1
YEAR
WARRANTY

WEBSITE
SEARCH
COMPACT S

GANN BL H 40

PROFESSIONAL TIMBER FRAMING MOISTURE METER KIT FOR BUILDING & CONSTRUCTION

The BL H 40 is used for measuring the moisture content in timber framing before lining. This is the type of system used by councils and inspectors for accurately determining the moisture content in the framing.

The kit includes a sliding hammer probe with 60mm 'insulated' probes, supplied in a lined-hard case. The pins are driven into the timber or the Gib lining by the hammer action, typically going into the timber at a depth of 20-30mm.

KEY FEATURES

- Built-in 7-level wood species correction
- Rapid fast measurement time
- 60mm Teflon insulated pins on the hammer electrode reduce the effect that timber treatments have on moisture meter readings



RESISTANCE
METER KIT



1
YEAR
WARRANTY

WEBSITE
SEARCH
BL H 40



TROTEC BUILDING INSPECTION KIT

PROFESSIONAL BUILDING INSPECTION KIT FOR NON-INVASIVE AND TIMBER MOISTURE MEASUREMENT

The Trotec Building Inspection Kit features Accurate's two best selling moisture meters, the T660 non-invasive moisture meter and the T510K pin-type timber meter, housed together in one handy convenient case.

ACCURACY AND PERFORMANCE

Both meters provide some of the most accurate determination and measurement of moisture available on the market in New Zealand.

Using the capacitance method for determining moisture in buildings, the T660 is renown for tracking and finding moisture where other meters don't or cannot. With built-in exotic wood species corrections, the T510, with its programmable temperature compensation, can accurately determine the moisture content of timber.

When used with the sliding hammer electrode, supplied in the kit, the T510 can enable invasive moisture measurements at both near surface and depth. The insulated shafts of the pins on the sliding hammer probe help reduce the effect of timber treatment and preservative when taking moisture readings of wood.

NON-INVASIVE VERSUS PINS

The T660, using the capacitance method, is a quick way to determine whether or not moisture may be present within a building structure. The technology however cannot accurately measure the actual moisture content, due to several factors. This is common across all capacitance type non-invasive moisture meters.

This is where the T510 comes in. The T510 uses the resistance contact method to measure the actual moisture % content. Simply find the moisture using the T660 and measure it with the T510!

KEY FEATURES

- One kit for both non-invasive and invasive pin type moisture determination and measuring
- Fast moisture tracking and locating
- Precision timber/wood moisture content (%WME)
- Kit includes sliding hammer electrode with 60mm pins (insulated shafts)



THE TROTEC BUILDING INSPECTION KIT INCLUDES THE SLIDING HAMMER ELECTRODE, CONNECTING CABLES AND 60MM PINS

ALL COMPONENTS OF THE TROTEC BUILDING INSPECTION KIT FIT INSIDE A LINED-HARD CARRY CASE

PROFESSIONAL METER KIT



1 YEAR WARRANTY

WEBSITE SEARCH BUILD INSPECT



TROTEC T3000 KIT

ADVANCED PROFESSIONAL MULTI-FUNCTION MOISTURE, HUMIDITY, TEMPERATURE AND AIRFLOW METER

The T3000 is an advanced data logging component moisture and climate system, for the professional inspector or building surveyor who seeks the highest accuracy, features and performance.

The T3000 can determine and measure;

- Building Moisture
- Wood Moisture
- Air and Surface Temperature
- Relative and Absolute Humidity
- Dew Point
- Air Flow
- Trace Gas (H2)

The comprehensive range of sensors, electrodes and accessories for the T3000 makes it the ideal meter for full climate and moisture investigation, measuring and recording, especially for building diagnostics.

Simply change the sensor and your T3000 becomes exactly the special measuring device you currently need. No further settings are required on the device. The intelligent technology of the T3000 automatically recognises the connected sensor.

More than twenty different sensors and probes are available for the T3000 to measure.

INTEGRATED GRAPHIC GRID FUNCTION

The integrated graphic grid measurement function of the T3000 allows visualisation and assessment of moisture distribution: Simply define the matrix to be evaluated directly at the measuring device and the configured grid will be shown on the display. All measured data is automatically saved in the T3000 in the correct sequence, colour coding the measurement results.

KEY FEATURES

- Multimeasure moisture and climate measurement from the one instrument
- Built-in colour interactive moisture grid and data logging
- Wood species menu and temperature correction
- Vast array of available probes and sensors

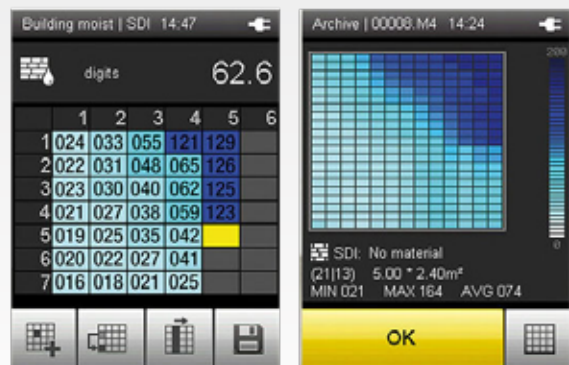

PROFESSIONAL METER KIT

Made in Germany

1 YEAR WARRANTY

WEBSITE SEARCH T3000

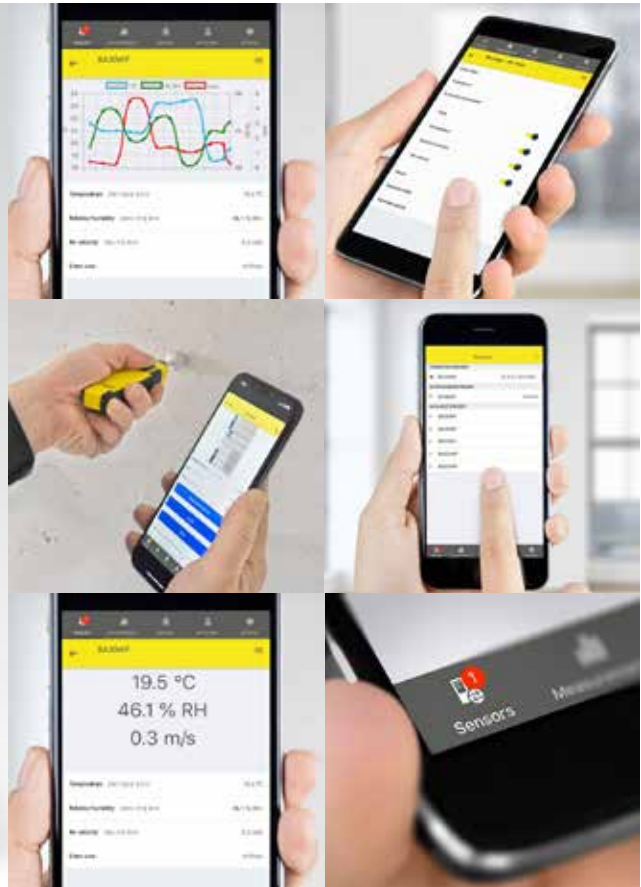

TROTEC APP SENSOR KIT

SMARTPHONE APP BASED WIRELESS MEASUREMENT KIT FOR MOISTURE, TEMPERATURE, AIRFLOW AND SOUND

The Trotec appSensor Kit features a range of modern Bluetooth enabled climate, emission and moisture sensors that connect to the MultiMeasure Mobile app on a smartphone (iOS or Android).

The APP Sensor kit can determine and measure;

- Building Moisture
- Wood Moisture
- Air and Surface Temperature
- Relative and Absolute Humidity
- Dew Point, Mixing Ratio and Wet Bulb
- Air Flow
- Sound Level

Combined with the free app MultiMeasure Mobile all appSensors are automatically identified by the app and can be connected quickly and easily using wireless technology.

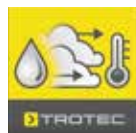

MULTIMEASURE MOBILE APP



MultiMeasure Mobile allows the results not only in live real-time on your device, the data can be saved in a customer management function, with all of the measured data assigned to projects and clients. The built-in report function further facilitates a quick on-site documentation as well as enabling exporting of the results.

The appSensors can be stored in a versatile soft zip pouch or a lined-hard case.

KEY FEATURES

- **Wireless Bluetooth sensors for moisture, temperature, humidity, airflow & noise measuring**
- **Use more than one appSensors at once**
- **Customer management and reporting function with export feature**
- **Link photos to measurement results**



PROTIMETER MMS2

MULTI-FUNCTION MOISTURE, HUMIDITY AND TEMPERATURE METER FOR FLOORING

The MMS2 is the number one flooring moisture meter used in New Zealand, for determining the moisture content of concrete prior to floor coverings being applied.

Moisture measurement of concrete floors in New Zealand require concrete floors to have a relative humidity level of no more than 75% before floor coverings can be installed.

The MMS2 utilises the hygrometric method for determining moisture vapour within the concrete structure. Either a surface box mount or a drill and plug test is used for moisture testing as set out in the NZS/AS 1884:2013 standard.

The MMS2 can determine and measure;

- Building Moisture (scanning non-invasive)
- Wood Moisture (pin invasive)
- Air and Surface Temperature
- Relative and Absolute Humidity
- Dew Point
- Psychrometric Calculations

With the added functionality of a capacitance non-invasive scanning sensor and resistance probes, the MMS2 is ideal for locating and measuring moisture in timber and buildings, with a built-in wood menu and temperature compensation.

A set of 127mm insulated deep wall probes enable moisture readings to be taken at depth into a wall or structure when pre-drilled.

An optional heavy duty hammer electrode is also available for the MMS2, with 100mm hardened probes.

MMS2 FLOORING KIT

The Protimeter MMS2 Flooring kit is a specialised kit that has been developed to perform in-situ moisture measurement of concrete floors (drill method using sleeves) using special adjustable length sleeves.

The kit includes everything needed to perform concrete flooring moisture testing in line with local and international standards including 20 adjustable sleeves, five reusable hygrometric sensors with extension, drill bits and brush, collar and humidity test block, all housed in a lined-hard transport case.



4-1 MULTI FUNCTION MOISTURE METER

PROFESSIONAL METER

MADE IN BRITAIN

2 YEAR WARRANTY

WEBSITE SEARCH MMS2

MMS2 FLOORING KIT INCLUDES THE MMS2 METER PLUS ALL THE ACCESSORIES REQUIRED TO PERFORM MOISTURE TESTING OF CONCRETE FLOORS



KEY FEATURES

- Industry standard for testing moisture in concrete floors in New Zealand
- 4-1 meter including non-invasive & pin moisture measurement, humidity and IR temperature
- Built-in wood species menu selection
- Data Logging



PROTIMETER HYGROMASTER2

HAND-HELD PROFESSIONAL THERMO-HYGROMETER

The Hygromaster2 is a high-quality precision hand-held hygrometer, commonly used for flood damage restoration, building climate and air quality surveys, concrete moisture measurement and HVAC applications.

Simple to use with a functional colour display, features include infrared non-contact surface temperature measurement, psychrometric calculations, data logging and replaceable humidity and temperature sensors.

KEY FEATURES

- Precision high-accuracy replaceable hygrometer sensor
- Fast temperature and humidity response
- Infrared surface temperature measurement
- Data Logging



A WIDE RANGE OF ACCESSORIES AND HARD CARRY CASES ARE AVAILABLE

HUMIDITY METER



2 YEAR WARRANTY

WEBSITE SEARCH HYGROMASTER2



TROTEC T210 / T260

PRECISION HAND-HELD THERMO-HYGROMETERS

The **T210** and **T260** from Trotec are high precision, made in Germany, professional handheld thermo-hygrometers, designed for high accuracy determination and measurement of air temperature and relative humidity.

The large clear 2-line LCD is easy read, with the measurements displayed as large numerals. The **T260** has the added functionality of an IR temperature sensor.

KEY FEATURES

- Precision quality capacitive humidity sensor
- Large colour LCD, clearly viewable in direct sunlight
- Infrared surface temperature measurement (T260 model)



HUMIDITY METER



1 YEAR WARRANTY

WEBSITE SEARCH T200



TROTEC BC21WP



SMARTPHONE APP BASED WIRELESS HAND-HELD THERMO-HYGROMETER

Ideal for HVAC use, the Trotec BC21WP is a thermo-hygrometric sensor for determining air temperature, dew point, relative and absolute humidity.

It connects via Bluetooth to Trotec's MultiMeasure APP for smartphones and tablets. Using the App, individual, min, max and average values can be displayed and using the logging function, chart representation of the measurement data is capable along with report generation.

KEY FEATURES

- Bluetooth enabled hygrometric sensor with MultiMeasure APP software for smartphones and tablets
- Wireless control and display of data via app
- Hold, logging and alarm functions

PHONE NOT INCLUDED

GET IT ON Google Play

Download on the App Store

BLUETOOTH®

WIRELESS HUMIDITY METER

1 YEAR WARRANTY

WEBSITE SEARCH BC21WP



WEBSITE SEARCH BC21

TROTEC BC21

The BC21 is a low cost multi-function thermo-hygrometer from Trotec, measuring air temperature, relative humidity, wet bulb and dew point.

The BC21 is the ideal meter for determining multiple climate measurements for mainly domestic DIY use or non-critical commercial use. Maximum and minimum temperature or humidity values are displayed on the backlit LCD screen.



WEBSITE SEARCH BC06

TROTEC BC06

The BC06 is a basic compact DIY handheld thermo-hygrometer capable of measuring air temperature and relative humidity.

The BC06 is ideal for the simple temperature and humidity measurement of home or office environments, basements, wine and storage cellars or hobby rooms. The LCD is illuminated for easy viewing in low light conditions.



TROTEC TC100

THERMAL HEAT STRESS CLIMATE METER

The TC100 is a multifunctional device used for climate environmental air and humidity checks and quick determination of the WBGT index (wet-bulb globe temperature), for the assessment of thermally stressed workplaces. Other than for the WBGT, the TC100 can also be used to determine the heat index (humidex), which describes the combined effect of humidity, temperature and radiant heat on the human body.

KEY FEATURES

- WBGT index thermal stress indicator
- Fast response time
- Data hold, MAX/MIN and alarm function
- Data memory for 99 measured values
- Humidex determination



HEAT STRESS
METER

1
YEAR
WARRANTY

WEBSITE
SEARCH
TC100



TROTEC BL30

BASIC ECONOMY DATA LOGGER FOR AIR TEMPERATURE AND RELATIVE HUMIDITY

The BL30 is a low cost easy to operate two-channel climate data logger, capable of recording air temperature and relative humidity values.

The BL30 is programmable to record at different time intervals, with values displayed in real-time on the large LCD display. Supplied with wall mount and USB cable.

KEY FEATURES

- Autonomous long-term recording of climate data
- Storage for 32,000 measured values
- Alarm function
- Real-time display of minimum/maximum values
- USB interface for measuring data transfer



CLIMATE
LOGGER

1
YEAR
WARRANTY

WEBSITE
SEARCH
BL30



TROTEC
AT WORK.

TROTEC DL200 SERIES

PROFESSIONAL LAN CAPABLE TEMPERATURE AND HUMIDITY DATA LOGGERS

Made in Germany from the highest precision components, the DL200 data loggers simultaneously record air temperature, dew point and relative, as well as, absolute humidity. This makes the DL200H suited for monitoring the environment in buildings, museums or storerooms and for controlling climate-sensitive processes during industrial production.

With five models available, all DL loggers are multi-channel which record current, minimum, maximum or average values. Each of these four values represents a measurement channel. In total, 20 of these measurement channels can be freely selected for logging and three for display in real-time on the LCD.

Storage for up to 3,200,000 measured values is available while a universal measuring network can operate in real-time due to the DL200's LAN capability.

PRECISION CLIMATE LOGGING - 5 MODELS AVAILABLE



KEY FEATURES

- Storage for up to 3,200,000 measured values
- Precision German manufactured loggers
- Simultaneous recording of up to 20 channels
- LAN capable
- Chose from five models

CLIMATE
LOGGER



1
YEAR
WARRANTY

WEBSITE
SEARCH
DL200



TROTEC BZ SERIES

1
YEAR
WARRANTY



TROTEC BZ05

The **BZ05** is a desktop or wall mountable thermohygrometer that can measure air temperature and relative humidity quickly and reliably and display the readings together with the time and date in large, easy-to-read values.

The BZ05 also features a unique and convenient “feel-good” comfort indication. This indicator assesses the air temperature and humidity to determine the comfort factor of the current environmental conditions. At a quick glance, it is easy to determine the room climate and ensure that levels are comfortable and conducive for a healthy working environment.

- Simultaneous display of room temperature, humidity and time or date
- Alarm function
- Free-standing or wall mount

TROTEC BZ06

The **BZ06** thermohygrometer is a 4-1 combination modern design desktop weather trend and indoor climate data meter, displaying temperature, humidity, time and date, with an integrated alarm function.

The weather trend signals an imminent weather change with graphical weather forecasts. With one glance you can see what’s in store for you outside: based on the humidity values, the BZ06 provides a forecast.

The large LCD display indicates via four weather symbols, whether it will be sunny, slightly cloudy, cloudy or rainy. The BZ06 has a large easy-to-view transparent LCD.

- Graphical weather forecast
- Large LCD display
- Four soft-touch buttons
- Alarm mode with snooze
- 1.5V AAA battery included

TROTEC BZ07

Ideal for the office desk or bedside table, the **BZ07** desktop thermohygrometer shows all the relevant climate values one needs to determine for an optimal indoor or work climate.

In addition to the indoor temperature and the relative humidity, there is also a feel-good indicator with three different climate levels, as well as the weather trend indicator.

The easy-to-read display also shows the day of the week, date, time and an alarm clock (with a snooze function). The weather trend bar graph indicator of the BZ07 tracks the temperature changes of the past 12 hours.

- Weather trend indicator
- Large numerical LED display
- Alarm with snooze function
- Temperature change over the previous 12 hours



TROTEC BF06

BASIC ECONOMICAL HANDHELD LUX METER

This compact low cost luxmeter enables indoor and outdoor light calculations. Due to the integrated spectral filter, infrared radiation is reliably filtered so that only the relevant light spectrum is captured.

The BF06 is suitable for photometry at work or at home, exhibition stand construction, horticulture or film/photo sets. The BF06's detector meets the requirements of the ISO accepted international commission on illumination (CIE).

KEY FEATURES

- Measurement of illuminance & incidence of light
- Large, clearly legible LED display
- Sensor controlled display lighting in low light
- Light Range 0 to 40,000 lux
- Measuring Rate 2.5- times per second



LUX
METER

1
YEAR
WARRANTY

WEBSITE
SEARCH
BF06



TROTEC BW10

ECONOMICAL HANDHELD PH METER

The BW10 is an economical pH meter suitable for testing the acidity of liquids for quality control in the food and beverage industry or for aquariums and swimming pools. The device is equipped with a three-point calibration, which can be carried out using the pH buffer as well as automatic temperature compensation, which permits a quick determination of the pH value over varying temperatures between 0 and 50°C.

KEY FEATURES

- The two-line display showing both pH value and water temperature at the same time
- Automatic temperature compensation
- Three-point factory calibration
- Auto calibration for pH 4.01/7.00/10.01



PH
METER

1
YEAR
WARRANTY

WEBSITE
SEARCH
BW10

Anemometers

Professional hot wire and vane anemometers for the precise determination of air velocity, air temperature and volumetric airflow.





TROTEC TA300

PROFESSIONAL HOT-WIRE ANEMOMETER

The Trotec TA300 is a hot-wire anemometer used primarily for measuring volumetric airflow. Ideally suited for the HVAC industry for measurements in ducts or vents and air conditioning systems, the hand-held probe from the TA300 can be extended to a length of one metre.

The combination of a precision hot-wire sensor and a fast microprocessor ensures quick and precise measuring results for each application. An optional calibration certificate is available for the TA300.

KEY FEATURES

- Functions: Air speed, air volume, air temperature
- Illuminated dual indication LCD display
- Extendable sensor probe to 1m
- Optional calibration certificate available
- TA400 model available with pitot tube



TROTEC TA400 MODEL AVAILABLE WITH PITOT TUBE FOR HIGH FLOW RATES AND DUSTY AIR

HOT WIRE ANEMOMETER

1 YEAR WARRANTY

WEBSITE SEARCH TA300

TROTEC BA30WP



SMARTPHONE APP BASED WIRELESS HOT-WIRE ANEMOMETER

The appSensor BA30 WP is a Bluetooth hot-wire anemometer permitting measurements of air velocity, volumetric flow, air temperature and relative humidity when used in combination with the MultiMeasure Mobile app.

Is ideally suited for performance measurements on home domestic appliances as well as commercial air conditioning and ventilation systems. The Multimeasure APP allows real-time measurement recording, photo backgrounds and exporting of results.

KEY FEATURES

- Precise measuring using hot-wire sensor
- Wireless connectivity to MultiMeasure APP
- Create a measurement with results, background photos and export csv function
- Hold, logging and alarm functions

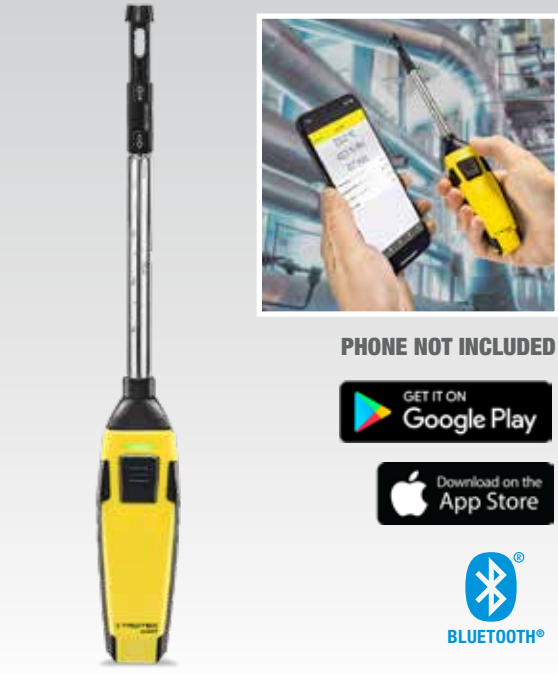

PHONE NOT INCLUDED

GET IT ON Google Play

Download on the App Store

BLUETOOTH®

HOT WIRE ANEMOMETER

1 YEAR WARRANTY

WEBSITE SEARCH BA30WP



TROTEC BA16

ADJUSTABLE NOOSE-TYPE VANE ANEMOMETER

Functional and extremely popular, the BA16 is a hand-held vane anemometer with adjustable 40cm gooseneck designed for measuring cubic airflow volumes, airspeed and air temperature.

It is ideal for HVAC, air conditioning, exhaust, fan and ventilation measurements.

Fast to measure, the large clear LCD has a backlit display which shows the real-time measurement along with maximum, minimum and hold modes.

KEY FEATURES

- Quick and easy measurement of air velocity, air temperature and cubic air volume flow (CMM)
- Maximum or minimum values and hold function
- Semi-rigid 40cm gooseneck probe length
- Smooth precise vane sensor



VANE
ANEMOMETER

1
YEAR
WARRANTY

WEBSITE
SEARCH
BA16

TROTEC BA06

ECONOMICAL VANE ANEMOMETER

The BA06 is a small compact handheld anemometer designed for the simple measurement of airspeed.

Need to measure wind speed for safe operation of cranes, working at heights, gondolas, chairlifts, rooftop operations or platforms - the BA06 is the ideal one handed pocket anemometer, small enough to not interfere when you are working in a cramped space. The BA06 can also display maximum or average values on the backlit LCD display which features a low light sensor.

KEY FEATURES

- Quick and easy airspeed measurement of wind, air or gases in m/s, ft/min, km/h, mph, knots
- Displays maximum and average value
- Sensor controlled backlight for LCD in low light



VANE
ANEMOMETER

1
YEAR
WARRANTY

WEBSITE
SEARCH
BA06



TROTEC BA16WP





SMARTPHONE APP BASED WIRELESS VANE ANEMOMETER

The BA16WP is a Bluetooth vane anemometer sensor for determining air speed, relative humidity and air temperature.

It connects to Trotec's MultiMeasure APP for smartphones and tablets. Using the App, individual, minimum, maximum and average values can be displayed and using the logging function, the measurement data is capable of report generation.

KEY FEATURES

- Rugged precision vane anemometer sensor
- Wireless connectivity to MultiMeasure APP
- Create a measurement with results, background photos and export csv function
- LED Bluetooth connection indicator

PHONE NOT INCLUDED

GET IT ON **Google Play**

Download on the **App Store**

BLUETOOTH®

VANE ANEMOMETER

1 YEAR WARRANTY

WEBSITE SEARCH **BA16WP**



TROTEC BV15WP



DIFFERENTIAL PRESSURE ANEMOMETER

The BV15 WP is a differential pressure measuring sensor that connects to Trotec's MultiMeasure APP for smartphones and tablets.



The compact sensor can detect differential pressure measurement changes in filter, HVAC or ventilation systems and with the aid of an optional pitot tube, the air speed and air volume of air or non-combustible gases can be determined.

KEY FEATURES

- Differential pressure sensor with optional pitot tube
- Wireless connectivity to MultiMeasure APP
- Create a measurement with results, background photos and export csv function

COMING
SOON

EST. NOVEMBER 2021

PHONE NOT INCLUDED

GET IT ON **Google Play**

Download on the **App Store**

BLUETOOTH®

DIGITAL ANEMOMETER SENSOR

1 YEAR WARRANTY

WEBSITE SEARCH **BV15WP**

Thermal Imaging

Infrared Thermal Imaging is one of the key non-contact technologies utilised to determine fault, condition and assessment of equipment, plant and infrastructure and Fluke is one of the most recognised brands in the world.

FLUKE



FLUKE

Headquartered in Everett, Seattle, USA, since its foundation in 1948, Fluke has helped define and grow technology in an increasing number of electrical, diagnostic, inspection and electro-mechanical industries and markets, worldwide.

Fluke's comprehensive line of hand-held test tools, including thermal imaging cameras, are being used by a growing number of service technicians, plant engineers, building and infrastructure consultants and installation and maintenance technicians. These tools provide them the ability to troubleshoot complex new systems and detect problems quickly.

Fluke tools help professionals achieve outstanding performance by delivering the accuracy, reliability, toughness, safety, usability and value for which Fluke tools are famous.



CLIMATE & INSPECTION

BASIC INFRARED CAMERAS

FLUKE PTi120

COMPACT POCKET IR CAMERA

The Fluke PTi120 pocket Thermal Camera, is one of the most compact infrared cameras available, and is seen as the first line of defence for easy troubleshooting.

Infrared inspections are right in your pocket for quick temperature scans of electrical equipment, machinery and other assets, all displayed on a 3.5" LCD touchscreen with IR-Fusion™ to blend visible light images with an infrared image to more easily locate problems. For non-precision simple infrared imaging, the PTi120 is the tool you need.

KEY FEATURES

- 120x90 infrared resolution (10,800 pixels)
- 3.5" LCD touchscreen display
- -20°C to +400°C measurement range
- WIR-Fusion™ visual and infrared image blending



COMPATIBLE WITH THE
FLUKE CONNECT® APP FOR IOS
AND ANDROID

BASIC INFRARED CAMERA

2
YEAR
WARRANTY

WEBSITE
SEARCH
PTI120



COMPATIBLE WITH THE FLUKE CONNECT® APP

FLUKE TiS+ SERIES

CONVENTIONAL ECONOMY THERMAL CAMERAS

The Fluke TiS+ range of hand-held thermal cameras are designed for the electrical, maintenance and building engineer who is required to use an infrared camera day-in, day-out, on the job. With a range of resolutions from 120x90 pixels up to 384x288 pixels, low thermal sensitivities and wide temperature range, there is a TiS+ model to suit almost all everyday thermal imaging applications.

KEY FEATURES

- Continuous touchscreen IR-Fusion™
- Optimal IR resolutions up to 384x288 pixels
- Automatically organise and file thermal images with Fluke Connect™ Asset Tagging
- Choose from five economically priced models

PROFESSIONAL
INFRARED CAMERA

2
YEAR
WARRANTY

WEBSITE
SEARCH
FLUKE TiS+

SPECIFICATION COMPARISON

	TIS20+	TIS55+	TIS60+	TIS75+
SPATIAL RESOLUTION	7.6 mRad	1.91 mRad	1.86 mRad	1.91 mRad
DETECTOR RESOLUTION	10,800 pixels (120x90)	49,152 pixels (256x192)	76,800 pixels (320x240)	110,592 pixels (384x288)
THERMAL SENSITIVITY	60mK (0.06°C)	40mK (0.04°C)	45mK (0.045°C)	40mK (0.04°C)
TEMPERATURE RANGE	-20°C to +150°C	-20°C to +550°C	-20°C to +400°C	-20°C to +550°C

Product specifications are subject to change, please confirm at time of purchase.



COMPATIBLE WITH FLUKE CONNECT®
DESKTOP SOFTWARE



OPTIONAL SMART INFRARED
TELEPHOTO LENS AVAILABLE

FLUKE Ti SERIES

PROFESSIONAL HAND-HELD THERMAL CAMERAS

For predictive and preventive maintenance, electrical inspections, commercial and industrial mechanical systems IR cameras from Fluke are tried, tested and employed industry wide. With interchangeable smart lenses, LaserSharp auto-focussing, Super Resolution and radiometric video recording, you'll get it right everytime with a Ti Series camera.

KEY FEATURES

- SuperResolution combines images to create a 1280x960 image (Ti480 PRO)
- IR-Fusion® technology PIP and full screen
- LaserSharp® Auto Focus
- Wide temperature range -20°C up to +1000°C

PERFORMANCE
INFRARED CAMERA

2
YEAR
WARRANTY

WEBSITE
SEARCH
FLUKE TI

SPECIFICATION COMPARISON

	Ti300+	Ti401 PRO	Ti480 PRO
SPATIAL RESOLUTION	1.85 mRad	0.93 mRad	0.93 mRad
DETECTOR RESOLUTION	76,800 pixels (320x240)	307,200 pixels (640x480)	307,200 pixels (640x480)
THERMAL SENSITIVITY	75mK (0.075°C)	75mK (0.075°C)	50mK (0.05°C)
TEMPERATURE RANGE	-20°C to +650°C	-20°C to +650°C	-20°C to +1000°C

Product specifications are subject to change, please confirm at time of purchase.



FLUKE CONNECT

COMPATIBLE WITH FLUKE CONNECT® SOFTWARE



OPTIONAL SMART INFRARED TELEPHOTO LENS AVAILABLE

FLUKE TiX SERIES

HIGH PERFORMANCE PRECISION THERMAL CAMERAS

When the best performance, functionality and precision results are needed, the TiX expert series from Fluke is the answer. With 240° rotating articulation, this lets you adjust the camera to minimize glare outside and the large 5.7" touchscreen delivers a premium in-field viewing experience. In focus images are easier to capture with LaserSharp Autofocus and 2x digital zoom.

KEY FEATURES

- SuperResolution combines images to create a 1280x960 image (TiX580)
- Real-time temperature graphs
- Radiometric video recording with Auto capture image sequence
- Remote display through Fluke Connect

PRECISION INFRARED CAMERA

2 YEAR WARRANTY

WEBSITE SEARCH FLUKE TiX

SPECIFICATION COMPARISON

	TiX501	TiX580
SPATIAL RESOLUTION	0.93 mRad	0.93 mRad
DETECTOR RESOLUTION	307,200 pixels (640x480)	307,200 pixels (640x480)
THERMAL SENSITIVITY	75mK (0.075°C)	50mK (0.05°C)
TEMPERATURE RANGE	-20°C to +650°C	-20°C to +1000°C

Product specifications are subject to change, please confirm at time of purchase.



The MSA Evolution 6000 is one of the world's most advanced thermal imaging cameras designed to take the guesswork out of firefighting.

MSA EVOLUTION 6000

FIREFIGHTING THERMAL IMAGING CAMERA

The MSA Evolution 6000 is a specialised intrinsically safe thermal imaging infrared camera used to aid and improve fire ground safety, locating and to assist in safe site decision making.

The Evolution 6000 is the one of the most advanced and rugged thermal imaging cameras ever built for use in the firefighting industry.

Enhanced features include best-in-class image quality, lightweight construction, laser pointer and range finder, compass, integrated video and picture capture and an integrated wireless video transmission system.

This NFPA 1801-compliant model provides the industry's best mix of features to support the thermal imaging needs of every fire department, rescue team, or HazMat crew.

Operation includes NFPA Basic Mode and additional features in NFPA Plus Mode.

OPTIONAL TRUCK MOUNTING KIT



KEY FEATURES

- 320 x 240 resolution (76,800 pixels)
- Integrated picture/video capture
- Video transmitter for remote monitoring
- 2x/4x zoom for a closer look
- Measure -40°C to +600°C

**NFPA 1801
FIREFIGHTING CAMERA**

**1
YEAR
WARRANTY**

**WEBSITE
SEARCH
6000**



FLUKE VT04A

INTUITIVE THERMAL IR LASER PYROMETER

The Fluke VT04A is a unique infrared laser thermometer. It features a built-in thermal IR sensor that not only provides the surface temperature, but also a thermal image - all in one! It is designed to help you see it all.

You can see issues in context by blending the infrared heat map with a visual image. Images can be viewed and edited in the basic Smartview® software.

KEY FEATURES

- Built-in thermal IR sensor with near and far modes that automatically aligns visual and thermal lenses
- PyroBlend® Plus optics for IR and visual imaging
- Temperature measuring range -10°C to +250°C
- Field of view 28° x 28°



COMBINATION IR AND THERMAL IMAGING PYROMETER

**THERMAL
LASER PYROMETER**

**2
YEAR
WARRANTY**

WEBSITE
SEARCH
VT04A



FLUKE 62 MAX

SINGLE LASER INFRARED THERMOMETER

The Fluke 62 MAX is a suitable compact infrared laser pyrometer aimed at the electrical assessment markets.

It delivers the reliability and accuracy that Fluke testers are renown for. Just point, shoot, and read the temperature of many types of equipment. Ideal for getting accurate readings from transformers, motors, pumps, panels, breakers, compressors, duct, steam lines, valves, and vents.

KEY FEATURES

- High and low alarms for rapid detection
- Displays Min/Max/Avg/Difference between two measurements
- Temperature measuring range -30°C to +500°C
- Optical resolution 10:1



IDEAL FOR COMMERCIAL AND DOMESTIC ELECTRICAL ASSESSMENT

**CONVENTIONAL
INFRARED PYROMETER**

**2
YEAR
WARRANTY**

WEBSITE
SEARCH
62 MAX



MODELS SHOWN (L-R) BP17, BP21, TP7, TP10

TROTEC INFRARED LASER PYROMETERS

PROFESSIONAL INFRARED LASER THERMOMETERS

Trotec's range of infrared laser thermometers have been designed for quick, simple precision surface non contact temperature measuring.

Trotec's home and domestic BP range (BP17, BP21) are well suited for the DIY, hobbyist and home owner. Economical in cost, fast and quick to measure, they are well suited for pizza ovens, heating and ventilation equipment or any quick temperature needed around the home.

Trotec's higher specified TP series (TP7, TP10) are well featured and equipped for commercial and industrial use.

Features include higher temperature measuring capability, multipoint technology, smaller precision measuring points, adjustable emissivity and type K compatible thermocouple connection (TP10).



**PERFORMANCE
INFRARED
THERMOMETERS**

1
YEAR
WARRANTY

WEBSITE
SEARCH
PYROMETER

SPECIFICATION COMPARISON

	BP17	BP21	TP7	TP10
TEMPERATURE RANGE	-50 °C to + 380 °C	-35 °C to + 800 °C	-50 °C to + 1000 °C	-50 °C to + 1850 °C
OPTICAL RESOLUTION	10:1	12:1	40:1	75:1
SPOT MEASURING SIZE (MIN)	12.7mm@ 0.127m	12.5mm@ 0.150m	12mm@0.480m	12mm@0.480m
IR LASER SPOTS	Single	Dual	Dual	Dual
TYPE K CONTACT TEMP	No	No	No	Yes
LCD INDICATORS	Visual green, amber, red	Monochrome LCD	Visual green, amber, red	Visual green, amber, red
ADJUSTABLE EMISSIVITY	colour No	Yes 0.10 to 1.0	Yes 0.10 to 1.0	colour Yes 0.10 to 1.0

Product specifications are subject to change, please confirm at time of purchase.



TROTEC BP25

DEW POINT INFRARED THERMOMETER

The BP25 is the infrared thermometer you need if you need to determine surface temperature of solid objects AS WELL AS the Dew Point temperature. It features a built-in hygrometric sensor which enables the measurement of air temperature, air humidity and dew point temperature, all from the one instrument.

This makes the BP25 ideal for HVAC and air quality measurements, painting, plastering and coating application, heating systems, road resurfacing and asphaltting.

KEY FEATURES

- 4-1 instrument for surface temperature, dew point temp, air temperature, relative humidity
- Non-contact surface temperature measurement via infrared from -50°C to +260°C
- LCD red, amber, green visual alarm



RED, AMBER, GREEN
VISUAL LCD ALARM
INDICATION

DEW POINT INFRARED
PYROMETER

1
YEAR
WARRANTY

WEBSITE
SEARCH
BP25

TROTEC BP21 WP



SMARTPHONE APP BASED WIRELESS INFRARED THERMOMETER

The BP21WP is a Bluetooth infrared laser pyrometer sensor for determining surface temperature, with an optical resolution of 10:1 and a temperature measuring range between -30 °C and +250 °C.

Connects to Trotec's MultiMeasure APP. Using the App, the multi-coloured graphic representation of temperature curves or of the temperature distribution can be indicated by means of a matrix measurement.

KEY FEATURES

- Contactless measurement from -30°C to +250°C
- 10:1 optical resolution
- Wireless connectivity to MultiMeasure APP
- Create a measurement with results, background photos and export csv function

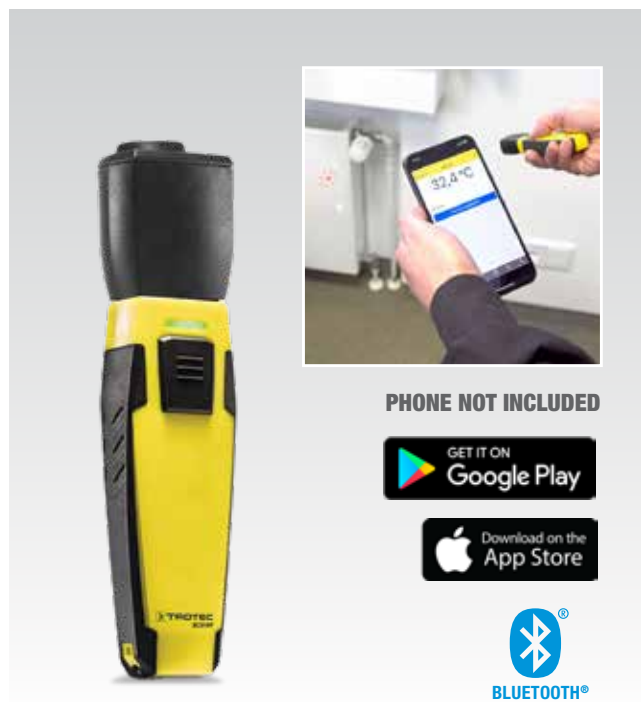

PHONE NOT INCLUDED



INFRARED
PYROMETER SENSOR

1
YEAR
WARRANTY

WEBSITE
SEARCH
BP21 WP



TROTEC BP5F

COMBINATION INFRARED/PROBE FOOD THERMOMETER

The BP5F is a infrared PLUS probe thermometer designed for the the food and beverage industry. It can quickly and reliably measure temperatures hygienically and safely between -40°C to +280°C (200°C contact probe) with values presented on an easy to read backlit display.

The BP5F uses the internationally accepted HACCP standard (Hazard Analysis and Critical Control Points) for ensuring food safety, with LED alarm indicators for too hot or too cold.

KEY FEATURES

- Infrared and insertion thermometer in one combination device
- Measurements from -40°C to +200°C, or up to +280°C contact-free when using infrared
- LED hot and cold safety alert indicators

LOW COST BP2F MODEL ALSO AVAILABLE

BP5F FEATURES BOTH CONTACT AND NON-CONTACT TEMPERATURE MEASUREMENT

FOOD & BEVERAGE PYROMETER

1 YEAR WARRANTY

WEBSITE SEARCH BP5F



TROTEC BT20

INSERTION THERMOMETER

The long, slim, stainless steel measuring tip and the wide measuring range from -40°C to +250°C make the BT20 a practical insertion thermometer ideal for a variety of measuring applications including hot water temperature, in laboratories, penetrable solids and for hobby enthusiasts.

The easy to clean plastic casing is also equipped with a rubberised soft-touch protective sheath, which provides a secure grip in all situations.

KEY FEATURES

- Quick and easy temperature measurements of liquids and penetrable solids
- Maximum or minimum value and hold function
- Soft-touch rubber protective cover
- Stainless steel measuring tip



DIGITAL
THERMOMETER

1
YEAR
WARRANTY

WEBSITE
SEARCH
BT20

TROTEC BT22WP



SMARTPHONE APP BASED WIRELESS INSERTION THERMOMETER

The BT22WP is a Bluetooth insertion/digital sensor for determining temperature, with an optical resolution of 10:1 and a wide temperature measuring range.

It connects to Trotec's MultiMeasure APP for smartphones and tablets. High-quality sensors and numerous measuring functions make the BT22WP the ideal climate measuring device for household, hobby or workshop.

KEY FEATURES

- Quick and easy temperature measurements of liquids and penetrable solids
- Wireless connectivity to MultiMeasure APP
- Create a measurement with results, background photos and export csv function



PHONE NOT INCLUDED



DIGITAL THERMOMETER
SENSOR

1
YEAR
WARRANTY

WEBSITE
SEARCH
BT22WP



The VSC206 industrial videoscope provides razor-sharp videos and digital images in a mobile, user-friendly cost effective system.

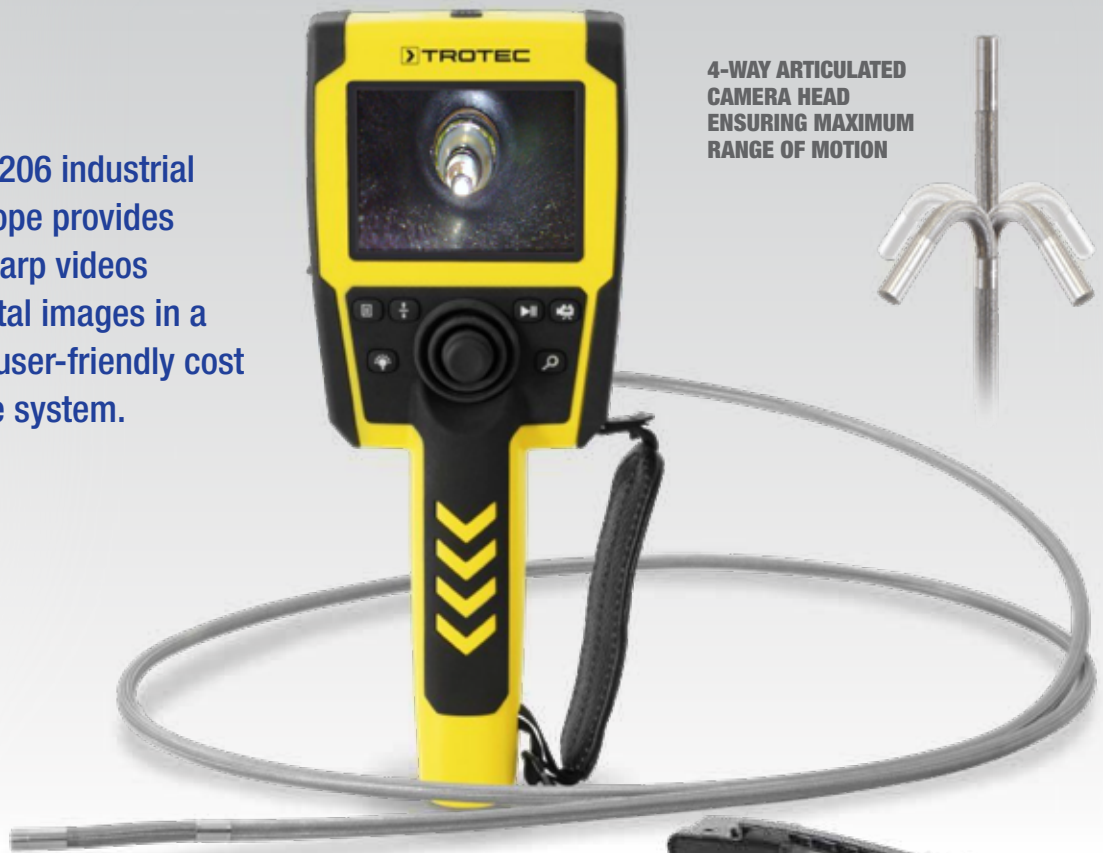

4-WAY ARTICULATED CAMERA HEAD ENSURING MAXIMUM RANGE OF MOTION

TROTEC VSC206

2M ARTICULATED CONTROLLABLE VIDEO AND IMAGING BORESCOPE

The VSC206 is a professional automated borescope featuring high-quality video and image capture and 4-way articulated camera head adjustment for 90° viewing angle.

The 2-metre probe is flexible and the articulated camera head can be steplessly controlled via the joystick. With its titanium-coated camera head, the VSC206 enables perfect panoramic views of the inspection area.

Its multi-ply construction of stainless steel wire mesh and PU on a flexible steel spiral ensures maximum range of motion with simultaneously high torsional strength of the push probe.

Six white LEDs with variable brightness control and 40,000 LUX ensure sharp, detailed images that can be shown on the large VGA display of the VSC206 and saved for documentation purposes, either as video or individual image on an SD 8GB memory card.



KEY FEATURES

- 4-way articulated controllable camera head with step less joystick control
- IP67 rated Titanium coated stainless steel camera
- 350,000 pixels CMOS sensor
- 3.5" TFT VGA LCD display

INDUSTRIAL VIDEOSCOPE

1 YEAR WARRANTY

WEBSITE SEARCH VSC206



With the VSC3008 professional industrial videoscope, photos and videos can optionally be transmitted in real time via a wireless connection to your mobile device serving as a second live screen.

TUNGSTEN WIRE MESH ARTICULATED CAMERA HEAD ENSURING MAXIMUM RANGE OF MOTION

TROTEC VSC3008

3M ARTICULATED CONTROLLABLE VIDEO AND IMAGING BORESCOPE

The VSC3008 is a professional automated borescope with a wide VGA 4.3" display, featuring high-quality video and image capture and 4 way articulated camera head adjustment for 130° viewing angle.

With the VSC3008 photos and videos can optionally also be transmitted in real time via a wireless connection to your mobile device serving as second live screen.

The 3-metre probe is flexible and the articulated camera head can be steplessly controlled via the joystick. With its titanium-coated camera head, the VSC3008 enables perfect panoramic views of the inspection area.

Six white LEDs with variable brightness control and 50,000 LUX ensure sharp, detailed images that can be shown on the large wide VGA display of the VSC3006 and saved for documentation purposes, either as video or individual image on an SD 32GB memory card.

KEY FEATURES

- 4-way articulated controllable camera head with step less joystick control
- IP67 rated Titanium coated stainless steel camera
- 440,000 pixels CMOS sensor
- 4.3" TFT Wide VGA LCD display

INDUSTRIAL VIDEOSCOPE

1 YEAR WARRANTY

WEBSITE SEARCH VSC3008





WEBSITE SEARCH
BO26

TROTEC BO26

Designed for capturing and recording images and video, the BO26 is a cost effective recordable videoscope allowing inspection AND recording of condition monitoring inside machinery, building cavities and in confined spaces. The semi-flexible gooseneck probe is 1-metre in length with optional extensions, 9mm and 6mm camera probes also available.



WEBSITE SEARCH
BO22

TROTEC BO22

The BO22 is a compact solution for visually inspecting poorly accessible areas, with the option to take photos or videos for documentation purposes. The bendable, semi-rigid gooseneck 1m probe can be inserted into small diameter openings. The light provided by six LEDs is dimmable in four stages and illuminates the surroundings, providing good quality inspection images – even in water.



TROTEC BO21

HAND-HELD INSPECTION CAMERA

The BO21 is a multipurpose non-recordable inspection camera for rapid endoscopic visual inspections in hard-to-view areas. The flexible gooseneck probe features a IP67 watertight camera with adjustable lighting.

The quad-LED illumination enables optimally illuminated inspection images in most situations, that are displayed on the colour display on the LCD monitor.

KEY FEATURES

- Probe: Ø 17mm / Length 1,000mm
- Focus area: 50 - 150 mm
- Field of view: 68°
- Display: 2.4 inch LCD (480 x 234 pixels)
- Optional extensions available



INSPECTION
CAMERA

1
YEAR
WARRANTY

WEBSITE SEARCH
BO21

Dehumidification, Ventilation & Heating

Trotec is one of Europe's largest manufacturer's and suppliers of commercial and industrial climate control, drying, ventilating and heating systems.

 **TROTEC**
AT WORK.





The TTK-S commercial series feature robust durable metallic housing are designed to operate commercially for long hours.



TROTEC TTK-S SERIES

COMMERCIAL CONDENSATE BUILDING DEHUMIDIFIERS

Built and designed for commercial drying of new construction building, timber framing and water damage cleaning and restoration, the portable, commercial dehumidifiers of the TTK-S series are the perfect drying dehumidifiers.

With high drying capacities, even in low temperatures, choose from four models, with options for water bucket collection, drain-away or condensate pump operation.

KEY FEATURES

- High dehumidification even at low temperatures
- Portable transportation with adjustable handle
- User adjustable hygostat for drying control
- Bucket, drainaway and optional condensate pump operation
- Manufactured in Europe

COMMERCIAL DEHUMIDIFIER



1 YEAR WARRANTY

WEBSITE SEARCH TTK-S

SPECIFICATION COMPARISON

	TTK125S	TTK175S	TTK355S	TTK655S
MAX DRYING CAPACITY	32L / 24hrs	50L / 24hrs	70L / 24hrs	150L / 24hrs
ROOM SIZE DRYING	150m ³	225m ³	450m ³	750m ³
AIRFLOW MAX.	250m ³ / hour	580m ³ / hour	1000m ³ / hour	1000m ³ / hour
WEIGHT / HEIGHT	26kg / 609mm	35kg / 645mm	39kg / 720mm	55kg / 810mm

Product specifications are subject to change, please confirm at time of purchase.



Universal compact and lightweight absorption dehumidifiers, designed and manufactured in Germany.

TROTEC TTR COMPACT

COMPACT PORTABLE DESICCANT DEHUMIDIFIERS

Made in Germany the TTR Compact range of absorption desiccant dehumidifiers are lightweight in design yet powerful in performance. For drying below 0 °C or above 30 °C, the TTR dehumidifiers are designed for ducted installation either inside a room (exhausting wet air outside) or outside a room (ducting dry air into a room).

The TTR are well suited for climate control of hygienic rooms, food and materials production.

KEY FEATURES

- Wide temperature range of climate control operation, down to below 0 °C
- Continuously regulatable Air flow rate
- Bisorp-Mono or Trisorp-Dual drying operation (TTR400D/500D)
- Optional filters, filter boxes and connecting ventilation grade ducting available

ABSORPTION
DEHUMIDIFIER



1
YEAR
WARRANTY

WEBSITE
SEARCH
TTR

SPECIFICATION COMPARISON

	TTR200	TTR300	TTR400	TTR400D	TTR500D
MAX. DRYING CAPACITY	8.4kg / 24hrs	16.8kg/ 24hrs	28.8kg/ 24hrs	38.4kg / 24hrs	53kg / 24hrs
BISORP-MONO/TRISORP-DUAL	BISORP-MONO	BISORP-MONO	BISORP-MONO	TRISORP-DUAL	TRISORP-DUAL
DRY AIRFLOW MAX.	120m ³ / hour	200m ³ / hour	450m ³ / hour	450m ³ / hour	550m ³ / hour
EXTERNAL COMPRESSION	50Pa	100Pa	150Pa	200Pa	150Pa

Product specifications are subject to change, please confirm at time of purchase.



1. Dehumidification sector
2. Regeneration sector
3. Purging sector for heat recovery
4. Process air
5. Regeneration air
6. Dry air
7. Heating
8. Damp air

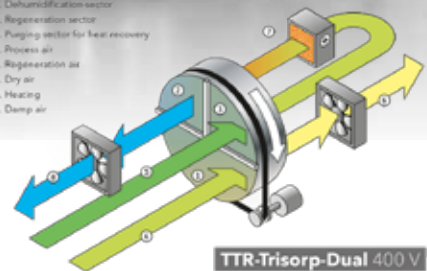

TTR-Trisorp-Dual 400 V

TROTEC TTR SERIES

LARGE STATIONARY INDUSTRIAL DEHUMIDIFIERS

For large drying and climate control of industrial and commercial workplaces, hotels, apartments and businesses, as well as marine, port and vessel use, the TTR large industrial series of desiccant dryers provide the required high dehumidification levels even at very low dew points. With its stainless steel housing and an electrical control box in a IP53 design, the corrosion-resistant TTR even withstand adverse operational environments outside and in coastal/marine applications.

Compared with the smaller compact yellow TTR units, with drying capacities of 8 - 53L per 24hrs, the stainless steel industrial TTR dryers feature large capacity drying of between 86 and 492 kg/24hrs.

For simple ongoing maintenance, the drying cassette and replacement filters are easily changeable.

The internal heat recycling process as well as the high level of performance of the sorption rotors, the TTR series are among the most economical dehumidifiers of their type.

MODEL RANGE

- TTR800: Max Dehumidification (kg/24h) 86.4
- TTR1400: Max Dehumidification (kg/24h) 177.6
- TTR2000: Max Dehumidification (kg/24h) 259.2
- TTR2800: Max Dehumidification (kg/24h) 376.8
- TTR3700: Max Dehumidification (kg/24h) 492

KEY FEATURES

- Robust and durable stainless steel housing
- Configurable air direction reversal
- Trisorp Duoventic air volume regulation
- High dry air flow rate even with in low dew points
- Simple cassette and filter replacement

INDUSTRIAL
DEHUMIDIFIER



1
YEAR
WARRANTY

WEBSITE
SEARCH
TTR800



The professional high-performance solution for construction and restoration work.



TROTEC TFV SERIES

EFFICIENT HIGH CAPACITY TURBO FANS

The Trotec TFV square series redefine the term turbo fan. While standard fans for hollow spaces are, for the most part, identical in every respect, the professional turbo fans of our TFV square series come with unparalleled features.

The distinctive cuboid design in practice offers compelling advantages. The space requirements for storage and transport are much reduced – seeing as all the devices can be stacked a number of times upon one another.

Each TFV square turbo fan accommodates a double-flow radial fan with an extra large shaft and an especially formed air exhaust duct, generating a broad near-ground air current over wet flooring, screeds or bottom timber frames. The room air is optimally distributed which perceptibly reduces the drying time.

The design of the TFV square fans also enable 3 stage positioning for horizontal, 45 degree tilt or vertical blowing applications.

MODEL RANGE

- TFV10: Air volume Level Max. [m³/h]: 380
- TFV20: Air volume Level Max. [m³/h]: 1,185
- TFV30: Air volume Level Max. [m³/h]: 2,200

KEY FEATURES

- Double-flow radial fan with extra-large shaft
- Operating hours counter
- Robust yet light construction
- High energy efficiency
- Can be stacked to save space when stored

**COMMERCIAL
DRYING FANS**

1
YEAR
WARRANTY

**WEBSITE
SEARCH
TFV**



Versatile turbo blowers – ideal for drying carpets and hollows or to assist in the water damage restoration.

STACKABLE
(TFV 30 S)

TROTEC TFV-S SERIES

ECONOMICAL HIGH CAPACITY TURBO FANS

Trotec's TFV-S series are ideal aids for a wide variety of drying and ventilating applications including carpet drying, flood restoration, cavity and wall drying walls or to speed up the drying of screed and entire buildings.

Due to their specially formed air exhaust duct, the turbo fans produce a wide air current near the ground above wet flooring or screeds. The room air is optimally distributed which perceptibly reduces drying time.

The combination of performance, robust, compact construction, high application flexibility and excellent value-for-money ratio makes the turbo fans of the TFV-S series the perfect universal equipment for any business offering restoration, cleaning or building maintenance services.

The stackable TFV 30S comes with three variable power stages, so the air volume can always be optimally adjusted to the different requirements of the object.

WHETHER AT 0°, 45° OR 90° FANS CAN BE USED IN THREE DIFFERENT ANGLES POSITIONS



MODEL RANGE

- TFV 10S: Air volume Level Max. [m³/h]: 355
- TFV 30S: Air volume Level Max. [m³/h]: 2,250

KEY FEATURES

- Robust polyethylene housing
- Double-flow radial fans with extra large shaft
- Three fan stages (TFV 30S)
- Stackable (TFV 30S)
- Optional 3 way hose splitter adapter (TFV 30S)

COMMERCIAL
DRYING FANS

1
YEAR
WARRANTY

WEBSITE
SEARCH
TFVS



High performance 200mm, 300mm, 450mm and 560mm axial direct fans.



TROTEC TTV SERIES

HIGH-PERFORMANCE AXIAL FANS

Whether to speed up construction drying, for dust collection or the ventilation on construction sites, in confined spaces such as manholes and tanks or storage spaces – the TTV Series is a smart ventilation solution for all users looking for a optimised high-performance air changes or air movement.

The combination of a range powerful axial fans and a wide selection of hose connections, ducting and dust bags to connect to the TTV makes a versatile solution for ventilation. The TTV series has been especially designed for the toughest practical requirements in harsh surroundings, even for the stresses and strains resulting from continuous operation.

Choose from the fixed design economical TTV1500 (8"), TTV3000 (12") or TTV4500S fans for direct ducted operation. The TTV4500, 4500HP and 7000 models have the added functionality of tilt adjustment, and a range of hose splitters to separate and direct specific airflow direction.

MODEL RANGE

- TTV1500S: Air Flow Rate Max. [m³/h]: 1050
- TTV3000: Air Flow Rate Max. [m³/h]: 3000
- TTV4500: Air Flow Rate Max. [m³/h]: 5300
- TTV4500HP: Air Flow Rate Max. [m³/h]: 4500
- TTV4500S: Air Flow Rate Max. [m³/h]: 5000
- TTV7000: Air Flow Rate Max. [m³/h]: 8500

KEY FEATURES

- 200mm up to 560mm model fans
- Extremely robust for continuous operation
- Fixed or tilt adjustable models
- Variable hose adapters splitters for TTV4500, 4500HP and 7000 models
- Ventilation grade ducting available

**INDUSTRIAL
AXIAL FANS**

1
YEAR
WARRANTY

WEBSITE
SEARCH
TTV



TROTEC TTW2500S

HIGH CAPACITY PORTABLE AIR CIRCULATOR

Whether for odour venting in agriculture and production, marquee ventilation, auxiliary air circulation in warehouses or temporary assistance in cooling or heating systems – there are many standard ventilation tasks, where a high capacity air mover is called for.

The framed, tilt-adjustable TTW25000S large wind machine features a two stage fan, with a maximum air movement of 27,000 m³/h.

KEY FEATURES

- Air circulation capacity of up to 27,600 m³/h
- Portable wheel frame design with adjustable inclination angle of the air flow direction
- Flexible change of location
- 44kg tare weight



INDUSTRIAL
DEHUMIDIFIER



1
YEAR
WARRANTY

WEBSITE
SEARCH
TTW



VENTURI ASI SERIES

PNEUMATIC AIR BLOWERS

Venturi Pneumatic Air blowers work by speeding the flow of air, by constricting it in a cone shape tube. In the restricted space, the air must increase its velocity in turn reducing its pressure and producing a partial vacuum. As the air escapes, the pressure increases. With no moving parts, Venturi blowers are ideal for ventilating hazardous areas, where dangerous vapours must be removed before entry or occupation.

KEY FEATURES

- Operates on compressed air or steam
- No moving parts
- Galvanised steel horn (replaceable)
- Steel handle design
- Large models available up to 8000 cfm capacity

NO MOVING PARTS.
UP TO 8000 CFM
MODELS AVAILABLE



INDUSTRIAL
PNEUMATIC BLOWER

1
YEAR
WARRANTY

WEBSITE
SEARCH
VENTURI



Electric heating is one of the driest sources available so if moisture is an issue, this method will dry faster and control humidity better.

TROTEC TEH SERIES

COMMERCIAL 3 PHASE ELECTRIC HEATING

If you are looking for the ideal dry/odour free mobile heating solution for large industrial sites, warehouses and agriculture or for heating unventilated rooms with condensation-free warmth, Trotec's German design and manufactured TEH series are the ideal solution.

For use indoors, no inlet or outlet openings are needed, because no oxygen is used in the heating process of the TEH series.

The power source for heating is 3-phase electric power. The condensation-free heating air from the TEH electric heaters are perfect for heating non-ventilated rooms or for commercial buildings and operations.

The stackable TEH electric heaters also feature a hose adapter outlet with optional high temperature grade ducting, which can either direct heat up to 7 meters away or duct heat into another room via a vent inlet.

OPTIONAL
TEMPERATURE
GRADE DUCTING
AVAILABLE

MODEL RANGE

- TEH70: Max Heating Capacity: 12kW - 32amp
- TEH100: Max Heating Capacity: 18kW - 32amp

KEY FEATURES

- Flow-optimised chassis for a focused current of non-turbulent, warm dry odour free air
- Hose connections / temperature grade ducting
- Double-walled metallic heat resistant housing model
- Thermo overload protection

**3-PHASE ELECTRIC
PORTABLE HEATING**

1
YEAR
WARRANTY

**WEBSITE
SEARCH
TEH**



The integrated fuel tank makes the high-performance direct oil heater fan IDE-D Series our best recommendation for use on construction sites



TROTEC IDE-D SERIES

HIGH-PERFORMANCE DIRECT DIESEL HEATING

The direct DIESEL heaters of the IDE series are optimally suited for outdoor/ventilated areas e.g. for heating construction sites, new building drying and agricultural areas.

As opposed to in-direct diesel heaters, the IDE-D emit 100% of the heat they produce.

To use, simply fill the tank reservoir with diesel, plug into 240V mains power and press the start button. The IDE will ignite the spark, engage the fan and start producing heat.

A thermo overload sensor protects the IDE-D models from over heating, and will cut operation in instances where the machine becomes too hot.

The integrated fan, with capacities of up to 1100 m³/h (IDE60D) help distribute the heating evenly.

In addition to the integrated thermostat, an external thermostat is optionally available as accessory for remote temperature control.

MODEL RANGE

- IDE30D (30kW): Air volume Max. [m³/h]: 720
- IDE50D (50kW): Air volume Max. [m³/h]: 750
- IDE60D (60kW): Air volume Max. [m³/h]: 1,100

KEY FEATURES

- Integrated fuel tank with filling level indication
- Overheating thermal protection and cutoff
- Integrated thermostat, with optional remote thermostat availability
- Electronic flame trap
- Three economically efficient models available

**DIRECT DIESEL
PORTABLE HEATING**

1
YEAR
WARRANTY

Q
WEBSITE
SEARCH
IDE

Cable Location Training

PROMOTING INDUSTRY PRACTICES COMBINED WITH THE THEORY OF CABLE LOCATION

Our courses are designed to give those working with cable locators the knowledge and skills they need to work confidently and safely. Using cable location equipment, we provide you with the theory, the science and the correct industry practice. Our trainers will help you develop the knowledge and skills to operate equipment safely and effectively.

KEY LEARNING OUTCOMES

- Demonstrate knowledge and skills in accordance with industry practice
- Have suitable foundation knowledge of using an Intermediate Cable Location System
- Demonstrate basic operation, visual inspection and competent handling of the instrument
- Know the requirements under the Health and Safety at Work Act 2015
- Show awareness of hazards and risks in cable location
- Have an intermediate understanding of the Founding Science

COURSE CONTENT

- Health and Safety relevant to Utility Location practitioners
- Hazard Identification
- Visual Inspection
- Theoretical Science
- Passive, Active and Direct Connection Techniques
- Correct Grid Survey
- Basic Mapping
- Correct Methodologies
- Product Function Inc: Cross Science Brief
- Current On-site Practice and Workflow (Field Working Procedure) Inc SOP
- Current Globally recognised local standards

FREephone 0800 500 380

training@accurate.kiwi | www.accuratetraining.kiwi



COMING SOON



Geotechnical & Underground Investigation

Cable avoidance and locating equipment, GPR ground penetrating radar and concrete scanning, motorised and push rod CCTV pipe inspection cameras, 3D manhole and asset scanners, acoustic leak detection and correlation, soil compacting testing.



Land & Aerial Surveying

GNSS, GPS and GIS systems, UAV systems, mechanical, reflectorless and robotic total stations and theodolites, toughbook and tablet computing data loggers and fieldbooks, extensive range of survey accessories, mounts, prisms and poles.

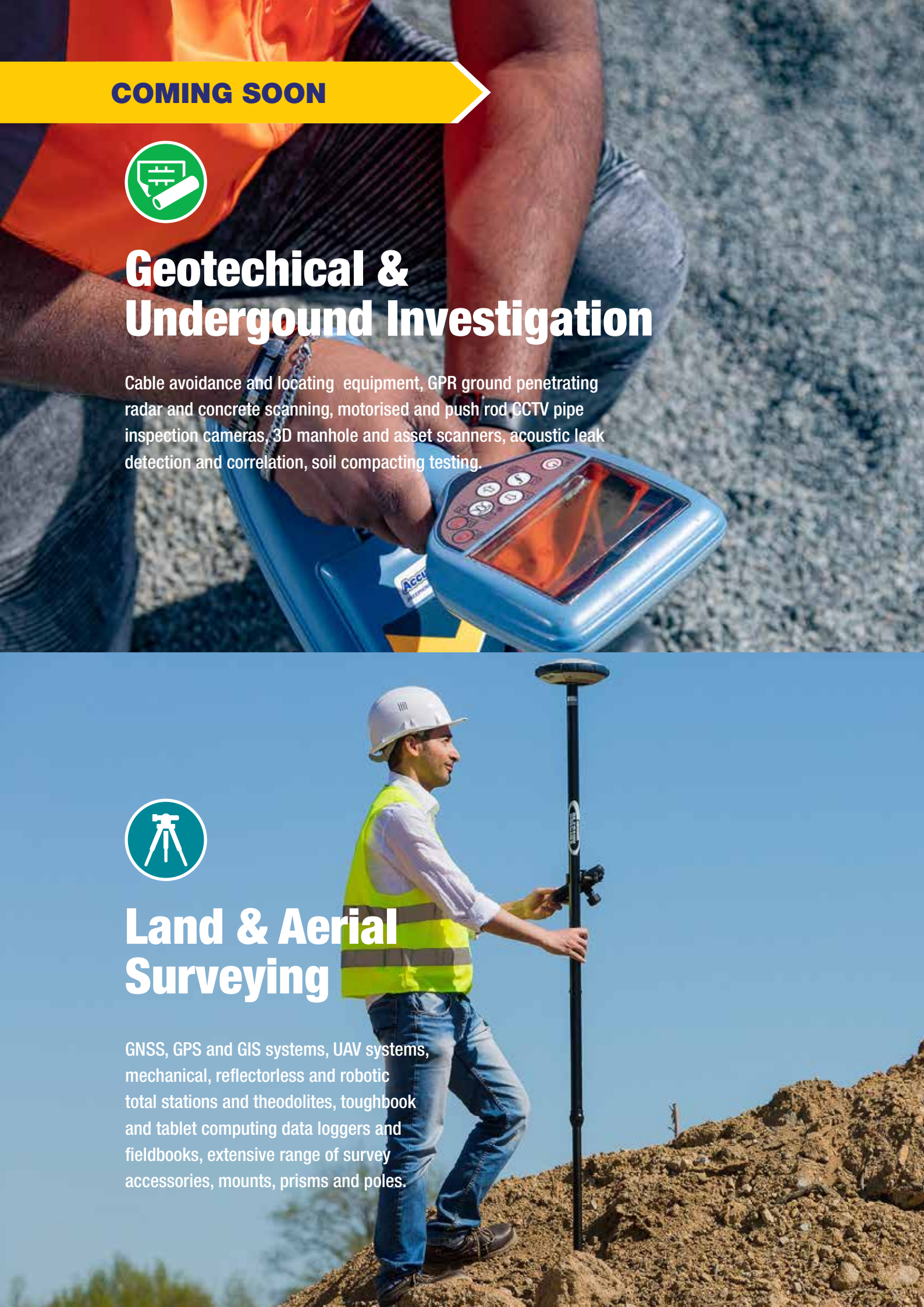

Accurate

Sales . Service . Calibration . Hire . Training

FREEPHONE 0800 500 380

www.accurate.kiwi | www.safety.kiwi



AUCKLAND SHOWROOM

192 Marua Road, Mt Wellington, Auckland 1051
Phone: 09 579-1777, Email: sales@accurate.kiwi

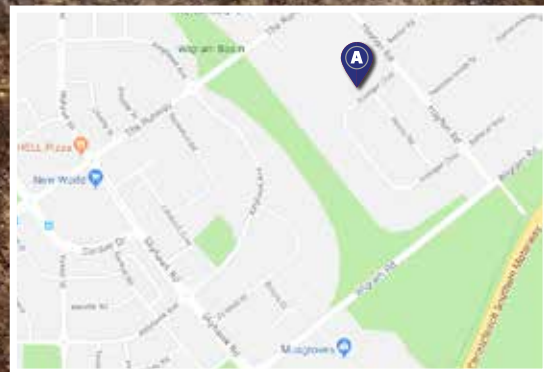

CHRISTCHURCH SHOWROOM

4 Avenger Crescent, Wigram, Christchurch 8042
Phone: 03 348-9898, Email: sales@accurate.kiwi



Official measurement supplier to Emirates
Team New Zealand for the 2021 America's Cup.

