

# DURASOURCE BATTERY WATERING



# DURASOURCE

## BATTERY WATERING



### **Industrial battery watering meets its match.**

Forklift batteries require the proper amount of water to work at optimal capacity. DuraSource carries a full line of Flow-Rite battery watering products so your business can keep running.

### **Business runs faster.**

Flow-Rite's Single Point Battery Watering systems and flip top watering caps eases battery maintenance work. Batteries can be filled faster and more reliably than ever before with the Millennium Evo™, Pro-Fill™, or Qwik-Fill™ on-board watering systems. Each application specific system consists of automatic shut off valves interconnected with tubing that replace the existing vent caps. A quick coupling allows the system to be connected to a water supply. Once connected, water flows into each cell until it reaches the correct level. This entire process takes less than one minute per battery.

### **Keep your business moving.**

For the right supplies, accessories and tools to make battery watering operations easier, DuraSource carries all the Flow-Rite products your business needs to keep moving.



# DURASOURCE BATTERY WATERING



## MILLENNIUM EVO



Millennium Evo is designed for all industrial battery watering needs including fork lift trucks, AGV, walkie pallet jacks, sweepers, scrubbers, and standby batteries.

Pages ... 4 - 21

## PRO-FILL



Pro-Fill is the only watering system designed for use on commercial style batteries typically found in pedestrian transport vehicles, pallet jacks, scissor lifts, sweepers, scrubbers, and small backup power systems.

Pages ... 22 - 30

## WATER SUPPLIES



Water Supplies available include a vast selection of products including portable watering carts and supplies, regulated hose supplies, gravity tanks, Niagara deionizers and hand pumps.

Pages ... 31 - 42

## ACCESSORIES

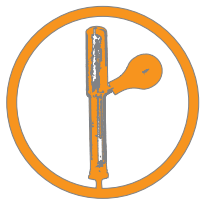

Accessories, including Eagle Eye level indicators, are essential to a proper battery watering function. Eagle Eye indicators accurately monitor and display the status of cell electrolyte levels with a solid green or blinking red light.

Pages ... 43 - 50

## QWIK-FILL & PRO-FILL RV



Qwik-Fill On-Board Battery Watering System works with group size 24 - 27 and most 29 - 31, 12-volt marine deep cycle batteries. Pro-Fill On-Board Battery Watering System, 6-volt RV Edition, provides the most convenient and accurate means of filling and maintaining proper battery water levels.

Pages ... 51 - 54

## CROSS REFERENCE

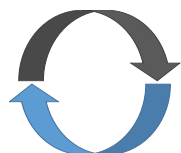

Flow-Rite to DuraSource cross reference part number listing and DuraSource to Flow-Rite cross reference part number listing for easy to order association.

Pages ... 55 - 63



by  **FLOW-RITE**

# MILLENNIUM EVO

## Features and Benefits

Millennium Evo™ is the most innovative, advanced, versatile, and user friendly system on the market today. Advanced materials and molding capabilities produce the most robust and the best performing valve to date. At a glance, you can see many of the superior features listed below. What's more impressive is the structure inside the valve that allows the Millennium Evo valve of working independently of water pressure\*, allowing you to use a variety of water supply options.

### Date Code

Valves include a 5 year warranty and are date coded to ensure quality.

### 3-Port Swivel Tee

Rotates 360° for easier installation

### Color Coded Flip Top

Flip top color matches shroud color for easy valve identification.

### Optical Level Indicator\*\*

Built-in indicator provides a quick and easy way to see when individual cells require water.

### Maximum Venting

Raised vents provide more room inside the cell for fluid expansion.

### Protective Shroud

Protects the displacer from any potential damage.

### Gasket Retention Tabs

Two small tabs keep the gasket in place for simplified installation.  
(highlighted orange for illustrative clarity)

\* 3-35 static psi

\*\* Not available on all valve configurations

# MILLENNIUM EVO

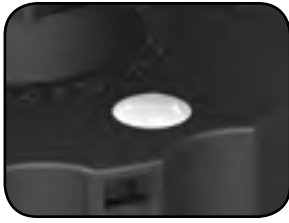

## Optical Level Indicator

Check your electrolyte levels without having to remove your watering system. The built-in indicator is white when the cell is low on water and black when full. Since it operates independently from the valve, it is the only built-in indicator on the market that can truly be used to accurately verify cell electrolyte levels.



## Color Coded Flip-Top Cell Access

Check specific gravity levels with ease. Flip-Top access port gives direct cell access without the need for drilling cell covers or removing the watering system. New color coding allows for easy verification of valve length after the valves have been installed.



## Clampless Polypropylene Tubing

Patented clampless tubing installs in half the time of tubing that requires clamps and holds twice as well. Unlike clear PVC tubing, our patented tubing will not break down and cause system failure.



## 3-Port Swivel Tee

Patented Three-Port Swivel Tee rotates a full 360 degrees, allowing for a more versatile installation. Eliminates kinked tubing, the need for additional plumbing pieces, and allows you to place the feed tube wherever it's most convenient, not just at the end.



## Low Profile

The patented low profile design keeps all components of the watering system out of harm's way by making sure that they all sit below the intercell connectors.



## Wide Pressure Range

Millennium's patented technology eliminates the need to buy expensive water supplies to generate high pressure and flow. Our variable pressure system will work from 3 to 35 PSI, with minimum flow rate of 2 GPM (measured through the purger).

# MILLENNIUM EVO



## Protective Shroud

The shroud protects the internal displacer from potential damage from plate growth, during installation and shipping & handling. When installed, it protects the valve from foreign particles (in the battery) entering and “clogging” the watering system.



## Acid Resistant Components

All Millennium components, including the tubing, are made of the same (polypropylene) plastic as the battery. This means all materials are acid, temperature, and impact resistant to withstand the harsh environment found inside and on top of the battery.



## De-Gas Chamber

The Millennium valve has a built in de-gassing chamber (similar to the factory vent caps) which allows the cell to expel the naturally occurring hydrogen and oxygen gases. The standard cap seen here disperses the gases in a manner which dilutes them with the outside air, reducing the risk of ignition.



## Internal Water Trap

In the event of a fire, this eliminates the possibility of flame propagation between cells via the watering system.



## Flame Arrestor (optional)

The optional flame arrestor is a feature for stationary batteries, utility vehicle batteries and other batteries used in enclosed environments. The flame arrested valve includes an internal flame arrestor that protects against flame propagation in applications where the internal water trap is subject to drying out.



## 5 Year Warranty

A full 5 year warranty applies to Millennium Evo components (excluding water supplies). Each valve is date stamped with the shift, day, month and year.



# MILLENNIUM EVO

## Order Guide for Kits

BK - X X X - X X X - 5 X X

### # of Battery Cells

For batteries with fewer than 10 cells, enter a "0" for the first character.

### Cap Options

00 = None (Select with flame arrested valves)

01 = Flip Top & Optical Level Indicator (Standard, N/A with External Flame Arrestors. Optical is not available on M30 or GNB Valves)

### Valve Length

1 = Yellow (short)

2 = Black (Standard)

3 = Red (Long)

4 = White (XL)

5 = Gray (Crown MaxHaul 155MX)

7 = Orange, no shroud (Crown MaxHaul 110MX)

G = GNB (after May 2012)

K = Extended Black

### Tubing Options

0 = Clampless tubing - precut 6.75"

A = Clampless tubing - preassembled 5.50" spacing  
(5-17 plate, 2-post batteries tubing routed in-between)

B = Clampless tubing - preassembled 6.00" spacing  
(19-29 plate, 4-post batteries)

C = Clampless tubing - preassembled 6.75" spacing  
(5-17 plate, 2-post batteries tubing routed around)

### Millennium SPW Kit Type

C = Standard Clampless (No Flame Arrestors, Black Cover)

Y = Flame Arrested (Internal & External, Yellow Cover)

O = Flame Arrested (Internal Only, Orange Cover)

### Cap Style

1 = Bayonet

2 = 35P (35 mm push-in DIN)

3 = 4 Lug Bayonet

4 = M30 (30 mm threaded)



# MILLENNIUM EVO









The following information is provided as a reference guide. If you are uncertain which valve to use, we recommend measuring the cell depth.

Battery Cross Reference Chart			
Battery Brand	Model #	Valve Length (Color Code)	Cap Style
Battery Builders	All	Black	Bayonet
Bulldog	All	Black	Bayonet
Crown	C-Line, V-Line, Crown Brand	Black	Bayonet
Crown	Max Haul 110 MX	Orange	Bayonet
Crown	Max Haul I55MX	Gray	Bayonet
Deka	D-Series, MaxPower (All)	Black	Bayonet
Douglas	All	Black	35P
EnerSys	E55L, E75L, E85, E90, E100, E110	Black	Bayonet
EnerSys	E140, E155, 130A	Red	Bayonet
EnerSys	E85D, E90D, E100D, E125, E125D	White	Bayonet
General Battery Co. (GBC)	100G	Black	Bayonet
General Battery Co. (GBC)	125G	Red	Bayonet
General Battery Co. (GBC)	75G, 85G	White	Bayonet
GNB made after 5/1/2012	Flat Plate, Liberator, and Tubular	GNB	Bayonet
Hawker	All	Black	Bayonet
Hup	100P	Black	Bayonet
Hup	125P	Red	Bayonet
Hup	85P	White	Bayonet
Interstate Powercare	All	Black	Bayonet
Powerflow	All	Black	Bayonet
Railroad / Stationary	Locomotive Starting Batteries and Some Stationary	XL Black	Bayonet
Reaco	All	Black	Bayonet



# MILLENNIUM EVO

## Pre-cut Clampless Kits

Contents			
 <b>Millennium Evo Valve</b> Qty = 1 per cell	 <b>Coupler with Dust Cover</b> Qty = 1 per kit <small>* May already be preinstalled on feed tube</small>	 <b>Clampless Tubing</b> Qty = 5 precut sections per 6 cells (plus 1 feed tube)	 <b>Red End Caps</b> Qty = 9 per 6 cells
 <b>Battery Refill Record</b> Qty = 1 per kit	 <b>Spanner Tool</b> Qty = 1 per kit <small>* Not included with 35P kits</small>	 <b>Battery Steward</b> Qty = 1 per kit	 <b>Instructions</b> Qty = 1 per kit

Bayonet Kits						
Size	Yellow		Black		Red	
	DuraSource	Flow-Rite	DuraSource	Flow-Rite	DuraSource	Flow-Rite
6 Cell	939-12992	BK-1C0-101-506	939-11216	BK-1C0-201-506	939-11230	BK-1C0-301-506
9 Cell	939-13017	BK-1C0-101-509	939-11217	BK-1C0-201-509	939-11231	BK-1C0-301-509
12 Cell	939-12993	BK-1C0-101-512	939-10967	BK-1C0-201-512	939-10971	BK-1C0-301-512
18 Cell	939-12994	BK-1C0-101-518	939-10968	BK-1C0-201-518	939-10972	BK-1C0-301-518
20 Cell	939-12995	BK-1C0-101-520	939-11218	BK-1C0-201-520	939-11232	BK-1C0-301-520
24 Cell	939-12996	BK-1C0-101-524	939-10969	BK-1C0-201-524	939-10973	BK-1C0-301-524
36 Cell	939-12997	BK-1C0-101-536	939-11219	BK-1C0-201-536	939-11233	BK-1C0-301-536
40 Cell	939-12998	BK-1C0-101-540	939-10970	BK-1C0-201-540	939-11234	BK-1C0-301-540

Bayonet Kits						
Size	White		Gray		GNB (After May 2012)	
	DuraSource	Flow-Rite	DuraSource	Flow-Rite	DuraSource	Flow-Rite
6 Cell	939-11245	BK-1C0-401-506	939-11461	BK-1C0-500-506	939-12999	BK-1C0-G00-506
9 Cell	939-11246	BK-1C0-401-509	939-11462	BK-1C0-500-509	939-13018	BK-1C0-G00-509
12 Cell	939-10974	BK-1C0-401-512	939-11361	BK-1C0-500-512	939-10977	BK-1C0-G00-512
18 Cell	939-10975	BK-1C0-401-518	939-11362	BK-1C0-500-518	939-10978	BK-1C0-G00-518
20 Cell	939-11247	BK-1C0-401-520	939-11363	BK-1C0-500-520	939-11267	BK-1C0-G00-520
24 Cell	939-10976	BK-1C0-401-524	939-11364	BK-1C0-500-524	939-10979	BK-1C0-G00-524
36 Cell	939-11248	BK-1C0-401-536	939-11365	BK-1C0-500-536	939-11268	BK-1C0-G00-536
40 Cell	939-11249	BK-1C0-401-540	939-11366	BK-1C0-500-540	939-11269	BK-1C0-G00-540









# MILLENNIUM EVO

35P (push in) Kits				
Size	Yellow		Black	
	DuraSource	Flow-Rite	DuraSource	Flow-Rite
6 Cell	939-13019	BK-2C0-101-506	939-11287	BK-2C0-201-506
9 Cell	939-13020	BK-2C0-101-509	939-13027	BK-2C0-201-509
12 Cell	939-13021	BK-2C0-101-512	939-11289	BK-2C0-201-512
18 Cell	939-13022	BK-2C0-101-518	939-11290	BK-2C0-201-518
20 Cell	939-13023	BK-2C0-101-520	939-11291	BK-2C0-201-520
24 Cell	939-13024	BK-2C0-101-524	939-11292	BK-2C0-201-524
36 Cell	939-13025	BK-2C0-101-536	939-11293	BK-2C0-201-536
40 Cell	939-13026	BK-2C0-101-540	939-11294	BK-2C0-201-540

35P (push in) Kits				
Size	Red		White	
	DuraSource	Flow-Rite	DuraSource	Flow-Rite
6 Cell	939-13028	BK-2C0-301-506	939-13036	BK-2C0-401-506
9 Cell	939-13029	BK-2C0-301-509	939-13037	BK-2C0-401-509
12 Cell	939-13030	BK-2C0-301-512	939-13038	BK-2C0-401-512
18 Cell	939-13031	BK-2C0-301-518	939-13039	BK-2C0-401-518
20 Cell	939-13032	BK-2C0-301-520	939-13040	BK-2C0-401-520
24 Cell	939-13033	BK-2C0-301-524	939-13041	BK-2C0-401-524
36 Cell	939-13034	BK-2C0-301-536	939-13042	BK-2C0-401-536
40 Cell	939-13035	BK-2C0-301-540	939-13043	BK-2C0-401-540

# MILLENNIUM EVO

## Clampless Preassembled Kits

Contents			
 <b>Millennium Evo Valve</b> Qty = 1 per cell	 <b>Coupler with Dust Cover</b> Qty = 1 per kit <small>* May already be preinstalled on feed tube</small>	 <b>6 Swivel Clampless Tubing Section</b> Qty = 1 per 6 cells (plus 1 feed tube)	 <b>Red End Caps</b> Qty = 9 per 6 cells
 <b>Battery Refill Record</b> Qty = 1 per kit	 <b>Spanner Tool</b> Qty = 1 per kit <small>* Not included with 35P kits</small>	 <b>Battery Steward</b> Qty = 1 per kit	 <b>Instructions</b> Qty = 1 per kit

6.75" / Bayonet Valves						
(5-15 plate 2-post batteries, tubing is routed <u>around</u> the intercell connectors)						
Size	Yellow		Black		Red	
	DuraSource	Flow-Rite	DuraSource	Flow-Rite	DuraSource	Flow-Rite
6 Cell	939-13009	BK-1CC-101-506	939-11220	BK-1CC-201-506	939-11235	BK-1CC-301-506
12 Cell	939-13010	BK-1CC-101-512	939-11221	BK-1CC-201-512	939-11236	BK-1CC-301-512
18 Cell	939-13011	BK-1CC-101-518	939-11222	BK-1CC-201-518	939-11237	BK-1CC-301-518
24Cell	939-13012	BK-1CC-101-524	939-11223	BK-1CC-201-524	939-11238	BK-1CC-301-524

Size	White		GNB (new)		35P Black	
	DuraSource	Flow-Rite	DuraSource	Flow-Rite	DuraSource	Flow-Rite
6 Cell	939-11250	BK-1CC-401-506	939-11270	BK-1CC-G00-506	939-11295	BK-2CC-201-506
12 Cell	939-11251	BK-1CC-401-512	939-11271	BK-1CC-G00-512	939-11296	BK-2CC-201-512
18 Cell	939-11252	BK-1CC-401-518	939-11272	BK-1CC-G00-518	939-11297	BK-2CC-201-518
24Cell	939-11253	BK-1CC-401-524	939-11273	BK-1CC-G00-524	939-11298	BK-2CC-201-524

# MILLENNIUM EVO

## Clampless Preassembled Kits

6" / Bayonet Valves (17-29 plate 4-post batteries, tubing is routed <u>in-between</u> intercell connectors)						
Size	Yellow		Black		Red	
	DuraSource	Flow-Rite	DuraSource	Flow-Rite	DuraSource	Flow-Rite
18 Cell	939-13004	BK-1CB-101-518	939-11225	BK-1CB-201-518	939-11240	BK-1CB-301-518
24Cell	939-13005	BK-1CB-101-524	939-11226	BK-1CB-201-524	939-11241	BK-1CB-301-524

6" / Bayonet Valves (17-29 plate 4-post batteries, tubing is routed <u>in-between</u> intercell connectors)						
Size	White		GNB (new)		35p Black	
	DuraSource	Flow-Rite	DuraSource	Flow-Rite	DuraSource	Flow-Rite
18 Cell	939-13006	BK-1CB-401-518	939-13008	BK-1CB-G00-518	939-11300	BK-2CB-201-518
24Cell	939-13007	BK-1CB-401-524	939-11275	BK-1CB-G00-524	939-11301	BK-2CB-201-524

5.5" / Bayonet Valves (5-15 plate 2-post batteries, tubing is routed <u>in-between</u> intercell connectors)						
Size	Yellow		Black		Red	
	DuraSource	Flow-Rite	DuraSource	Flow-Rite	DuraSource	Flow-Rite
6 Cell	939-13000	BK-1CA-101-506	939-13002	BK-1CA-201-506	939-11243	BK-1CA-301-506
12 Cell	939-13001	BK-1CA-101-512	939-11229	BK-1CA-201-512	939-11244	BK-1CA-301-512

5.5" / Bayonet Valves (5-15 plate 2-post batteries, tubing is routed <u>in-between</u> intercell connectors)						
Size	White		GNB (After May 2012)		35p Black	
	DuraSource	Flow-Rite	DuraSource	Flow-Rite	DuraSource	Flow-Rite
6 Cell	939-11258	BK-1CA-401-506	939-11277	BK-1CA-G00-506	939-11303	BK-2CA-201-506
12 Cell	939-11259	BK-1CA-401-512	939-13003	BK-1CA-G00-512	939-11304	BK-2CA-201-512

# MILLENNIUM EVO

## Layout Diagrams

### 6.75" Layouts

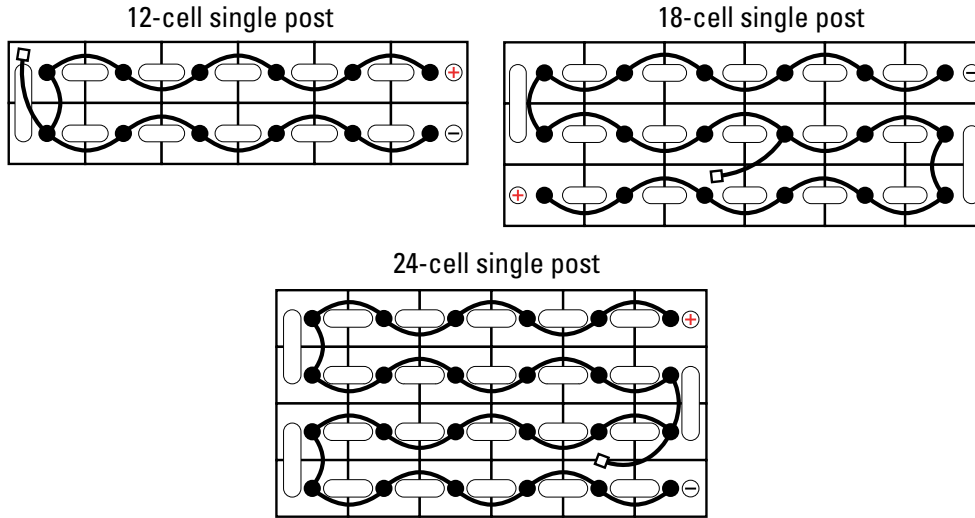

### 6" Layouts

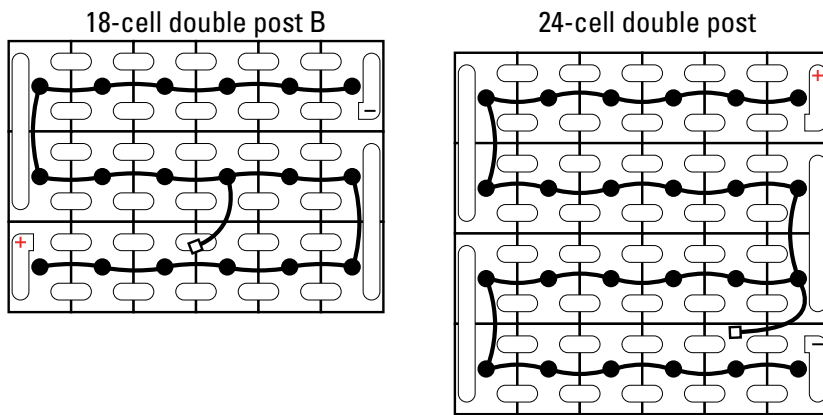



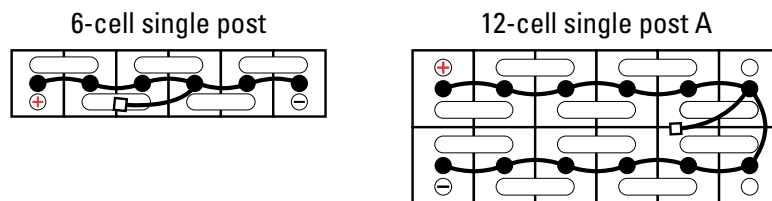

### 5.5" Layouts



\* The layouts above may also utilize closed loops (not shown).

# MILLENNIUM EVO

## Bulk Kits

Contents				
				
Millennium Evo Valve Qty = 60	Clampless Tubing Qty = 40' (uncut tubing)	Red End Caps Qty = 70	Battery Steward Qty = 3 per kit	Instructions Qty = 1 per kit

\* No quick coupler, battery refill record, or spanner tool is included

## Master Packs (60 Valves)

Bayonet		
Description	DuraSource	Flow-Rite
Bayonet cap with yellow valves	939-11312	BA-MMP-11-C
Bayonet cap with black valves (standard)	939-10983	BA-MMP-12-C
Bayonet cap with red valves	939-10984	BA-MMP-13-C
Bayonet cap with white valves	939-10985	BA-MMP-14-C
Bayonet cap with GNB valves (Does not include optical indicator)	939-11313	BA-MMP-1G-C
35P		
Description	DuraSource	Flow-Rite
35P cap with yellow valves	939-12909	BA-MMP-21-C
35P cap with black valves (standard)	939-11314	BA-MMP-22-C
35P cap with red valves	939-12910	BA-MMP-23-C
35P cap with white valves	939-12911	BA-MMP-24-C
4 Lug Bayonet		
Description	DuraSource	Flow-Rite
4 Lug Bayonet cap with yellow valves	939-12912	BA-MMP-31-C
4 Lug Bayonet cap with black valves (standard)	939-12913	BA-MMP-32-C
4 Lug Bayonet cap with red valves	939-12914	BA-MMP-33-C
4 Lug Bayonet cap with white valves	939-12915	BA-MMP-34-C
M30 (Does not include optical indicator)		
Description	DuraSource	Flow-Rite
M30 cap with yellow valves	939-12916	BA-MMP-41-C
M30 cap with black valves (standard)	939-10983	BA-MMP-12-C
M30 cap with red valves	939-12917	BA-MMP-43-C
M30 cap with white valves	939-12918	BA-MMP-44-C





# MILLENNIUM EVO

## Clampless Replacement Valves

\* Only available in 6 packs. Includes red end caps.

Bayonet							
	Flip Top		Internal & External Flame Arrested		Internal Flame Arrested		
	DuraSource	Flow-Rite	DuraSource	Flow-Rite	DuraSource	Flow-Rite	
Yellow	939-11371	BA-C10-11-6P	939-12940	BA-Y10-10-6P	939-12924	BA-O10-10-6P	
Black	939-11370	BA-C10-21-6P	939-12941	BA-Y10-20-6P	939-12925	BA-O10-20-6P	
Red	939-11372	BA-C10-31-6P	939-12942	BA-Y10-30-6P	939-12926	BA-O10-30-6P	
White	939-11373	BA-C10-41-6P	939-12943	BA-Y10-40-6P	939-12927	BA-O10-40-6P	
GNB	n/a	BA-C10-G0-6P	939-12944	BA-Y10-G0-6P	939-12928	BA-O10-G0-6P	
Black Ext	n/a	BA-C10-K0-6P	939-12945	BA-Y10-K0-6P	939-12929	BA-O10-K0-6P	
Gray	939-11374	BA-C15-50-6P	939-12947	BA-Y15-50-6P	939-12930	BA-O15-50-6P	

35P							
	Flip Top		Internal & External Flame Arrested		Internal Flame Arrested		
	DuraSource	Flow-Rite	DuraSource	Flow-Rite	DuraSource	Flow-Rite	
Yellow	939-12894	BA-C20-11-6P	939-12948	BA-Y20-10-6P	939-12931	BA-O20-10-6P	
Black	939-11377	BA-C20-21-6P	939-12949	BA-Y20-20-6P	939-12932	BA-O20-20-6P	
Red	939-12895	BA-C20-31-6P	939-12950	BA-Y20-30-6P	939-12933	BA-O20-30-6P	
White	939-12896	BA-C20-41-6P	939-12951	BA-Y20-40-6P	939-12934	BA-O20-40-6P	

4 Lug Bayonet		
	Flip Top	
	DuraSource	Flow-Rite
Yellow	939-12897	BA-C30-11-6P
Black	939-12898	BA-C30-21-6P
Red	939-12899	BA-C30-31-6P
White	939-12900	BA-C30-41-6P

M30		
	Flip Top	
	DuraSource	Flow-Rite
Yellow	939-12901	BA-C40-11-6P
Black	939-12902	BA-C40-21-6P
Red	939-12903	BA-C40-31-6P
White	939-12904	BA-C40-41-6P

# MILLENNIUM EVO

## Clampless Replacement Parts

 <p>939-10988 BA-142 Swivel Tee with O-Ring</p>	 <p>939-12241 BA-144 Swivel Straight with O-Ring</p>	 <p>939-12240 BA-145 Swivel Elbow with O-Ring</p>
 <p>939-12958 BD-00202 O-Ring for Swivel Tee</p>	 <p>939-10987 BD-00280 Red End Cap for Swivel</p>	 <p>939-11379 BD-T14 Tubing (sold by the foot)</p>
 <p>939-12973 BD-BRR Universal Battery Refill Record Calendar</p>	 <p>939-12868 BA-090 Battery Steward Labels</p>	 <p>939-11345 BD-00871 4-Prong Spanner Tool</p>
 <p>939-12970 BD-00870 35P to Bayonet Adapter</p>	 <p>939-12959 BD-00203 O-Ring for 35P cap</p>	 <p>939-12968 BD-00525 Gasket for Bayonet &amp; M30 caps 2006 and newer</p>
 <p>939-12956 BD-00188 Cross Connector 1/4"</p>	 <p>939-12957 BD-00189 Tee Connector 1/4"</p>	

# MILLENNIUM EVO

## Clampless Replacement Parts

 <p>939-11316 BA-QDV-505 Coupler for Millennium Evo, Pro-Fill or Stealth 1/4" barb</p>	 <p>939-11315 BA-QDV-105 Coupler for PowerStream 1/4" barb</p>	 <p>939-11317 BA-QDV-405 Coupler for BWT 1/4" barb</p>
 <p>939-11318 BA-QDV-705 Coupler for BFS 1/4" barb</p>	 <p>939-11319 BA-QDV-805 Coupler for Philadelphia Scientific Injector</p>	 <p>939-12974 BD-QDV-005 Dust Cover for BA-QDV-505</p>
 <p>939-12960 BD-00204 O-Ring for BA-QDV-500 and BA-QDV-505 Quick Coupler</p>		

# MILLENNIUM EVO

## Technical Specifications

### Bayonet Valve Lengths

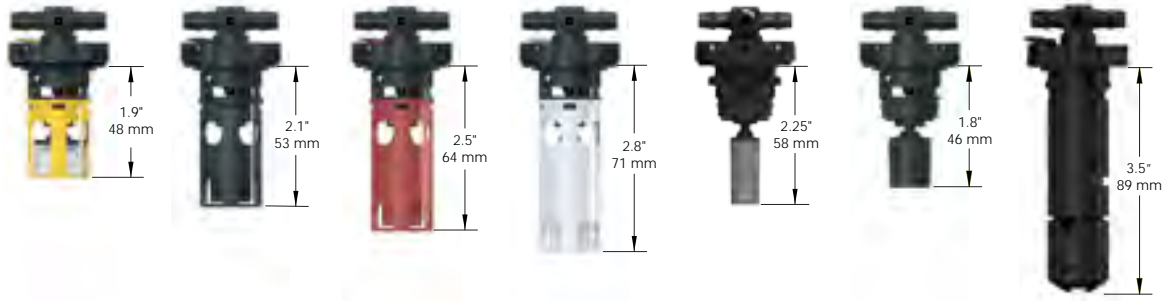

### 35P Valve Lengths



### 4 Lug Bayonet Valve Lengths

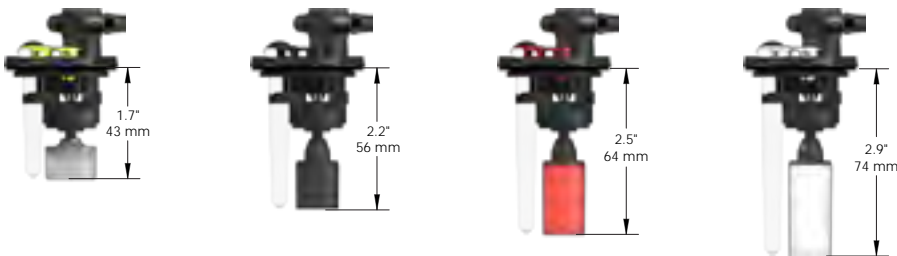

### M30 Valve Lengths



# MILLENNIUM EVO

## Troubleshooting Guide

ALL CELLS OVERFILLING	
Inadequate water supply	Make sure the water supply is producing 3-35 ps static pressure, and at least 2 GPM measured through the purger.
Dirty filter screen	Clean or replace as necessary.
DC Cart Not Charged	Charge Cart

RANDOM CELLS OVERFILLING	
Kinked tubing	Unkink and reroute tubing.
Water supply requires maintenance	Clean all filter screens & make sure the water supply is producing between 3-35 psi static pressure, and at least 2 GPM measured through the purger.
Damaged valve	Replace as necessary.
Incorrect watering frequency (too often)	Only water when needed on a fully charged battery.

ELECTROLYTE IS FOUND ON TOP OF THE BATTERY AFTER CHARGING	
Battery was watered before being fully charged	Only water a fully charged battery! For fast charge applications you should add water after equalize.
Incorrect watering frequency (too often)	Only water when needed.
Water supply requires maintenance	Clean all filter screens & make sure the water supply is producing between 3-35 psi static pressure, and at least 2 GPM measured through the purger.
Water supply left connected for extended period of time	Disconnect water supply immediately after filling has been completed.

DRY CELLS	
Kinked tubing	Unkink & reroute tubing.
Incorrect water frequency	Water more frequently.
Damaged or modified water supply	If water supply produces more than 35 static PSI. Ensure that the regulator is in place. Over pressurizing can damage valves permanently.
Air not purged from water supply	Purge air from water supply before filling battery.
Incorrect water duration	Water to completion. Make sure flow indicator comes to a complete stop before disconnecting water supply.

# MILLENNIUM EVO

## Troubleshooting Guide

LEAKS DURING FILLING CYCLE	
Loose connections	Check all connection points including o-ring on swivel tee, tubing connections, and water supply to SPW kit.
Damaged tubing	Replace as necessary.
Damaged end caps	Replace as necessary.

TUBING COMES OFF SWIVEL TEE DURING FILLING CYCLE	
Improper installation	Make sure the tubing is pushed all the way over the hose barb.
Damaged tubing	Replace as necessary.

RED END CAPS COME OFF SWIVEL TEE DURING FILLING CYCLE	
Damaged end caps	Replace as necessary.
Damaged or modified water supply	Water supply produces more than 35 static PSI. Ensure that the regulator is in place.

SWIVEL TEE POPS OUT OF VALVE DURING FILLING CYCLE	
Improper installation	Ensure Swivel is snapped into the valve fully.
Damaged or modified water supply	If water supply produces more than 35 static PSI, ensure that the regulator is in place.

SWIVEL TEE POPS OUT OF VALVE	
Improper tube routing	Reroute all tubing below battery cables.
Installation error	Ensure swivel is snapped all the way down

### Valve Date Code Key

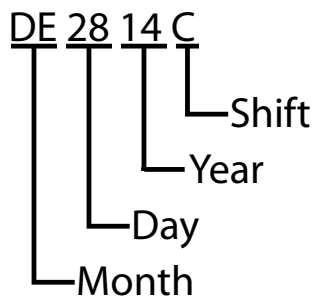





# PRO-FILL

## Features and Benefits

Pro-Fill™ onboard battery watering system is the only system that has been specifically designed for the golf cart/utility vehicle application. At a glance, many of the superior features are evident. Everything from the patented manifolds, standard flame arrestors, three port swivel, and clampless polypropylene tubing, to the new easy install winged caps. What's even more impressive is the structure inside the valve. The Pro-Fill valve is capable of working independent of water pressure (3-35 static PSI, with 2 GPM flow rate), allowing you to use a variety of water supply options. In addition, the Pro-Fill valve includes a built-in water barrier to block the propagation of a flame front from entering adjacent cells in the event of accidental cell gas ignition. Each valve includes an external flame arrested de-gas chamber as a standard.

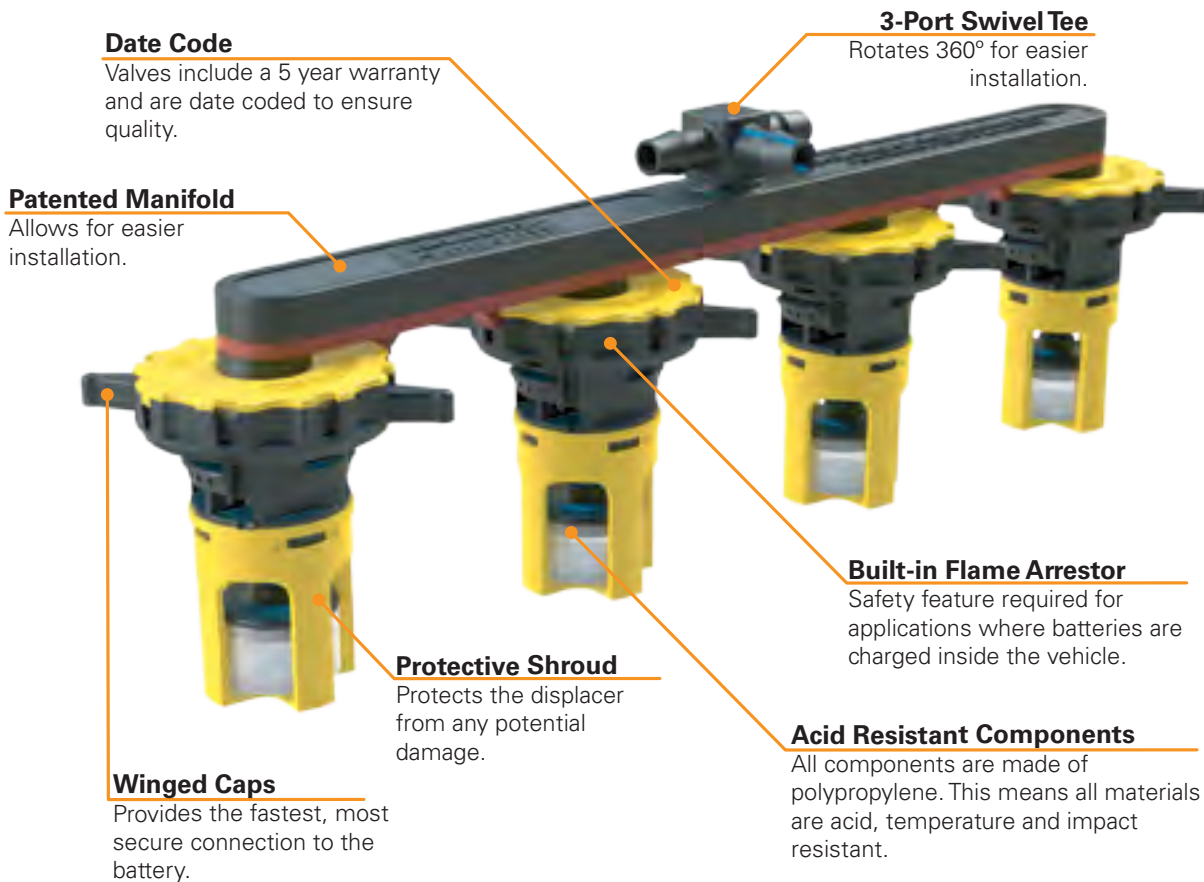

# PRO-FILL



## Flame Arrestor

The flame arrestor inside of each Pro-Fill valve keeps sparks from getting inside the battery. Approved by major battery manufacturers, this built-in feature is used for applications including golf carts, utility vehicles, sweepers, scrubbers, pallet jacks, or anywhere batteries are used in an enclosed space or otherwise potentially dangerous environments.



## Patented Manifold

The patented manifold provides for the quickest and easiest installation.



## Winged Valves

Winged valves make installation quicker and easier than before. Purchase a pre-cut kit and leave your tools at home. With the pre-cut Pro-Fill system, no tools are necessary for installation.



## 3-Port Swivel Tee

The 3-Port Swivel Tee rotates a full 360 degrees, allowing for the most versatile installation. No more worries about kinked tubing or the need for extra plumbing fittings. The swivel also integrates an easy-in, hard-out design to protect the O-ring.



## Clampless Polypropylene Tubing

Clampless tubing installs in half the time of clamp style tubing and holds twice as well. Unlike clear PVC tubing, clampless polypropylene tubing will not break down and cause system failure.



## Wide Pressure Range

With Pro-Fill's technology, you don't have to buy expensive water supplies to generate high pressure and flow. Pro-Fill's variable pressure system will work from 3 to 35 PSI (static) with a minimum flow rate of 2 GPM.



## Protective Shroud

The shroud protects the internal displacer from damages including plate growth, installation or shipping.



## Acid Resistant Components

All Pro-Fill components are made of polypropylene, meaning materials are acid, temperature, and impact resistant.



## De-Gas Chamber

The Pro-Fill valve has a built-in de-gassing chamber (similar to the factory vent caps) which allows the cell to expel the naturally occurring hydrogen and oxygen gases. The standard cap disperses the gases in a manner which dilutes them with the outside air, reducing the risk of ignition.



## 5 Year Warranty

Pro-Fill components (excluding water supplies) have a five year warranty. Each valve is date stamped with the shift, day, month and year to ensure quality.

# PRO-FILL

## Universal Pro-Fill Kits Part Number Scheme

BG - X X X V - X X

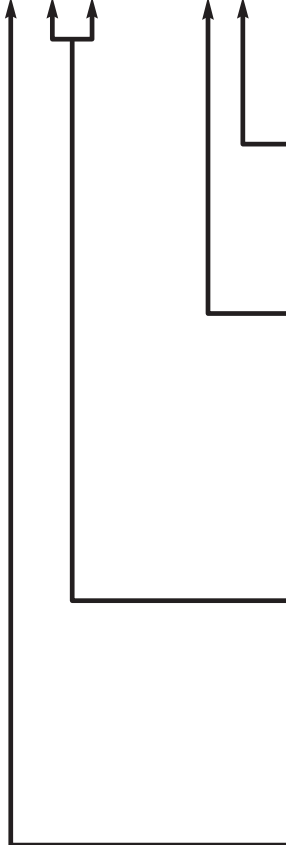

### Valve Options

- A = Winged black bayonet, no shroud
- G = Winged black bayonet, shroud
- J = Non-winged black bayonet, no shroud
- B = Winged black bayonet, blue cover, no shroud

### Manifold Options

- 1 = Blue 6V
- 4 = No manifold
- 5 = Black 8V
- 6 = Red 8V
- 7 = Flex (BA-127-FLEX) 6V
- 8 = Flex (BA-128-FLEX) 12V
- B = Flex (BA-129-FLEX) 8V
- C = Flex (BA-132-FLEX) 12V

### Voltage

- 06 = 6V
- 12 = 12V
- 24 = 24V
- 36 = 36V
- 48 = 48V
- 72 = 72V

### Kit Type

- U = Universal

# PRO-FILL

## Battery Cross Reference Chart





6-Volt Batteries						
Battery Brand	Model #	Cell Spacing	DuraSource Manifold PN	Flow-Rite Manifold PN	DuraSource Valve Style PN	Flow-Rite Valve Style PN
Commander	C105	2.7	939-12871 (1)	BA-121-BLU (1)	939-12953 (G)	BA-Y7A-10 (G)
Continental	Golf Cart	2.7	939-12871 (1)	BA-121-BLU (1)	939-12953 (G)	BA-Y7A-10 (G)
Crown	All	2.7	939-12871 (1)	BA-121-BLU (1)	939-12953 (G)	BA-Y7A-10 (G)
Deka (Pro Master)	GC10-GC45	2.7	939-12871 (1)	BA-121-BLU (1)	939-12953 (G)	BA-Y7A-10 (G)
Deka (Pro Master)	L16	Varies	SWIVEL T's (4)	SWIVEL T's (4)	939-12953 (G)	BA-Y7A-10 (G)
Duracell Ultra (Batteries Plus)	GC2	2.7	939-12871 (1)	BA-121-BLU	939-12953 (G)	BA-Y7A-10 (G)
Energizer (Sam's Club)	GC2	3.3	939-12873 (7)	BA-127-FLEX (7)	939-12953 (G)	BA-Y7A-10 (G)
Interstate	GC2	2.7	939-12871 (1)	BA-121-BLU (1)	939-12953 (G)	BA-Y7A-10 (G)
Pacer (Trojan)	All	2.7	939-12871 (1)	BA-121-BLU (1)	939-12953 (G)	BA-Y7A-10 (G)
Power Volt	All	3.3	939-12873 (7)	BA-127-FLEX (7)	939-12953 (G)	BA-Y7A-10 (G)
Rocket Longest	All	Varies	939-12873 (7)	BA-127-FLEX (7)	939-12953 (G)	BA-Y7A-10 (G)
Rolls	Series 4000, S460, S530	2.7	939-12871 (1)	BA-121-BLU (1)	939-12953 (G)	BA-Y7A-10 (G)
Stow-Away (Exide)	All	3.3	939-12873 (7)	BA-127-FLEX (7)	939-12953 (G)	BA-Y7A-10 (G)
Trojan	T105, T125, T145, T605	2.7	939-12871 (1)	BA-121-BLU (1)	939-12953 (G)	BA-Y7A-10 (G)
Trojan	J250P, J305H, J305P, L16H	Other	Swivel T's (4)	SWIVEL T's (4)	939-12953 (G)	BA-Y7A-10 (G)
Trojan	T105 Plus, T125 Plus, T145 Plus	Other	939-12873 (7)	BA-127-FLEX (7)	939-12952 (A)	BA-Y7A-10 (A)
U.S. Battery	All	2.7	939-12871 (1)	BA-121-BLU (1)	939-12953 (G)	BA-Y7A-10 (G)

8-Volt Batteries						
Battery Brand	Model #	Cell Spacing	DuraSource Manifold PN	Flow-Rite Manifold PN	DuraSource Valve Style PN	Flow-Rite Valve Style PN
Centennial	Golf Cart	2.5	939-12872 (6)	BA-122-RED (6)	939-12953 (G)	BA-Y7A-10 (G)
Commander	C8VGC	2.5	939-12872 (6)	BA-122-RED (6)	939-12953 (G)	BA-Y7A-10 (G)
Crown	All	2.5	939-12872 (6)	BA-122-RED (6)	939-12953 (G)	BA-Y7A-10 (G)
Duracell Ultra (Batteries Plus) Energizer (Sam's Club) Exide	GC8V	2.5	939-12872 (6)	BA-122-RED (6)	939-12953 (G)	BA-Y7A-10 (G)
Rocket, Longest	8190	Other	939-12875 (B)	BA-129-FLEX (B)	939-12953 (G)	BA-F74-10 (B)
Trojan	T-875	2.3	939-12870 (5)	BA-120-BLK (5)	939-12953 (G)	BA-Y7A-10 (G)
U.S. Battery	US 8VGC	2.5	939-12872 (6)	BA-122-RED (6)	939-12953 (G)	BA-Y7A-10 (G)

12-Volt Batteries						
Battery Brand	Model #	Cell Spacing	DuraSource Manifold PN	Flow-Rite Manifold PN	DuraSource Valve Style PN	Flow-Rite Valve Style PN
Club Car (Trojan)	1275	2.7	939-12871 (1)	BA-121-BLU (1)	939-12953 (G)	BA-Y7A-10 (G)
Rocket, Longest	12165 (Straight)	Other	939-12874 (B)	BA-128-FLEX (B)	939-12953	BA-F74-10 (B)
Rocket, Longest	12165 (Chevron)	2.7	939-12871 (1)	BA-121-BLU (1)	939-12952	BA-F74-10 (B)
Trojan	1275	2.7	939-12871 (1)	BA-121-BLU (1)	939-12953 (G)	BA-Y7A-10 (G)
Trojan	1260 Plus, 1275 Plus, J150 Plus, J185P, J185H, J185P-AC	Other	939-12874 (8)	BA-128-FLEX (8)	939-12946 (J)	BA-Y14-10 (J)
Trojan	J185G	2.7	939-12871 (1)	BA-121-BLU (1)	939-12953 (G)	BA-Y7A-10 (G)
U.S. Battery	US185, US12V-XC2	2.7	939-12871 (1)	BA-121-BLU (1)	939-12953 (G)	BA-Y7A-10 (G)

# PRO-FILL

## Pro-Fill Universal Kits

Contents					
					
<b>Manifolds</b>		<b>Coupler with Dust Cover</b> Qty = (1) per kit * May already be preinstalled on feed tube	<b>Clampless Tubing</b> Quantity varies with kit size	<b>Red End Caps</b> Qty = (9)	<b>Instructions</b> Qty = 1 per kit
<b>Kit Size</b>	<b>Qty of Manifolds</b>				
12 volt	2 (6-volt manifolds)				
24 volt	4 (6-volt manifolds)				
36 volt	6 (6-volt manifolds)				
48 volt	8 (6-volt manifolds)				
48 volt	6 (8-volt manifolds)				

12 Volt Systems	DuraSource PN	Flow-Rite PN	Description
	939-12977	BG-U12V-4G	12 volt kit for (2) 6v batteries with non standard spacing
	939-12976	BG-U12V-1G	12 volt kit for (2) 6v batteries with 2.7 inch cell spacing
	939-12978	BG-U12V-7A	12 volt kit for (2) 6v "Trojan Plus" series batteries

24 Volt Systems	DuraSource PN	Flow-Rite PN	Description
	939-12980	BG-U24V-4G	24 volt kit for (4) 6v batteries with non standard spacing
	939-12979	BG-U24V-1G	24 volt kit for (4) 6v batteries with 2.7 inch cell spacing
	939-12848	BG-W24V-1	24 volt kit for pallet jack with (4) 6v batteries with 2.7 inch cell spacing
939-12981	BG-U24V-7A	24 volt kit for (4) 6v "Trojan Plus" series batteries	

36 Volt Systems	DuraSource PN	Flow-Rite PN	Description
	939-12983	BG-U36V-4G	36 volt kit for (6) 6v batteries with non standard spacing
	939-12982	BG-U36V-1G	36 volt kit for (6) 6v batteries with 2.7 inch cell spacing
939-12984	BG-U36V-7A	36 volt kit for (6) 6v "Trojan Plus" series batteries	

48 Volt Systems	DuraSource PN	Flow-Rite PN	Description
	939-12987	BG-U48V-4G	48 volt kit for batteries with non standard spacing
	939-12988	BG-U48V-5G	48 volt kit for (6) 8v batteries with 2.3 inch cell spacing
	939-12989	BG-U48V-6G	48 volt kit for (6) 8v batteries with 2.5 inch cell spacing
	939-12986	BG-U48V-1G	48 volt kit for (8) 6v batteries with 2.7 inch cell spacing
	939-12990	BG-U48V-7A	48 volt kit for (8) 6v "Trojan Plus" series Batteries
	939-12991	BG-U48V-8J	48 volt kit for (4) 12v "Trojan 1275 Plus" series Batteries
939-12985	BG-U48V-1A	(4) 12V Batteries with 2.7 inch cell spacing	

# PRO-FILL

## Replacement Parts

<p><b>G</b></p>  <p><b>939-12953 BA-Y7A-10</b> Pro-Fill Valve, standard, shroud, with wings</p>	<p><b>A</b></p>  <p><b>939-12952 BA-Y74-10</b> Pro-Fill valve, shroudless, clear displacer, with wings (for use on 6 volt Trojan® Plus batteries)</p>	<p><b>J</b></p>  <p><b>939-12946 BA-Y14-10</b> Pro-Fill valve, shroudless, clear displacer, no wings (for use on 12 volt Trojan® Plus batteries)</p>
 <p><b>939-12871 BA-121-BLU</b> Pro-Fill Manifold for 6-volt battery with 2.7 inch center to center cell spacing (Black &amp; Blue in color)</p>	 <p><b>939-12879 BA-1FT-7G</b> Pro-Fill Manifold with valves for 6-volt battery with 2.7 inch center to center cell spacing (Black &amp; Blue in color)</p>	
 <p><b>939-12870 BA-120-BLK</b> Pro-Fill manifold for 8-volt battery with 2.3 inch center to center cell spacing (Solid Black in color)</p>	 <p><b>939-12892 BA-5FT-7G</b> Pro-Fill manifold with valves for 8-volt battery with 2.3 inch center to center cell spacing (Solid Black in color)</p>	
 <p><b>939-12872 BA-122-RED</b> Pro-Fill manifold for 8-volt battery with 2.5 inch center to center cell spacing (Black &amp; Red in color)</p>	 <p><b>939-12893 BA-6FT-7G</b> Pro-Fill manifold with valves for 8-volt battery with 2.5 inch center to center cell spacing (Black &amp; Red in color)</p>	

# PRO-FILL

## Replacement Parts

 <p>939-12873 BA-127-FLEX Flexible Manifold 2.6" - 3.5" spacing</p>	 <p>939-12874 BA-128-FLEX Flexible Manifold for use on 12-volt Trojan™ Plus batteries</p>	 <p>939-12875 BA-129-FLEX Flexible Manifold 2.3" - 2.5" spacing</p>
 <p>939-11379 BD-T14 Clampless Tubing (sold by the foot)</p>	 <p>939-12968 BD-00525 Gasket for Bayonet cap</p>	 <p>939-10987 BD-00280 Swivel Tee End Caps</p>
 <p>939-11316 BA-QDV-505 Coupler</p>	 <p>939-13053 SNK-F124 Coupler w/ Snake Adapter</p>	 <p>939-10988 BA-142 Swivel T with O-ring</p>



# PRO-FILL

## Technical Specifications

### Pro-Fill Operating Requirements

Flow Rate: 2-5 gallons per minute\*  
Pressure Range: 3-35 PSI  
(no flow, static) (0.21-2.4 bar)  
Temp. Range: Freezing - 150° F (Freezing - 65.5° C)

### Water Supply Operating Requirements

Inlet Pressure: 40 - 100 PSI  
(no flow, static) (2.76 - 6.89 bar)  
Temp. Range: 33 - 150° F (1 - 65.5° C)

All product specifications should be met for proper operation of your Flow-Rite SPW system. Contact your battery supplier you have any questions regarding product specifications or how to verify a water supply.

\* Flow rate should be measured at the end of a purger (female/male coupler combination).

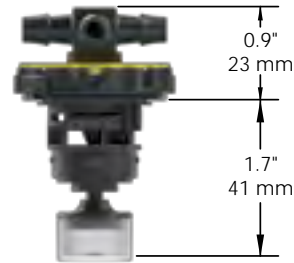
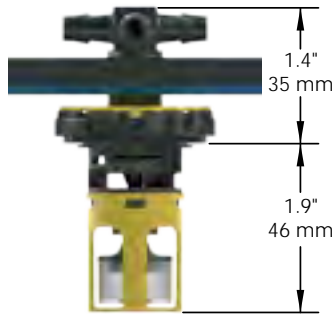

Black Manifold

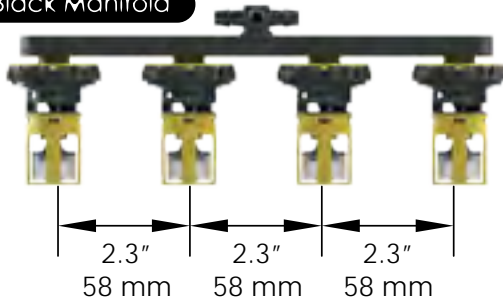

Red Manifold

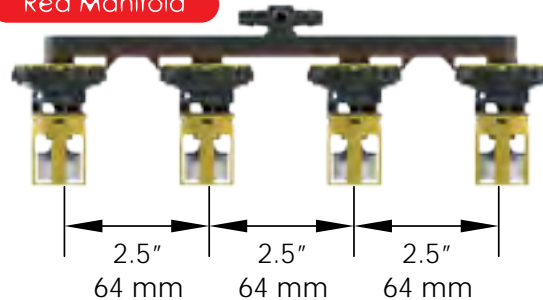

Blue Manifold

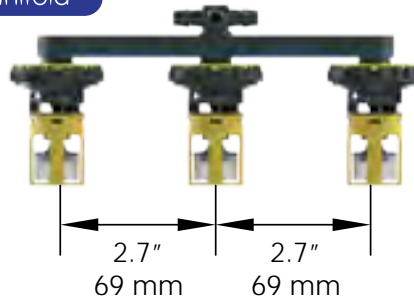

# Water Supplies



PORTABLE  
WATERING  
CARTS



REGULATED  
HOSE  
SUPPLIES

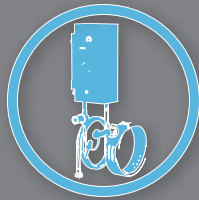

PORTABLE  
WATER  
SUPPLIES

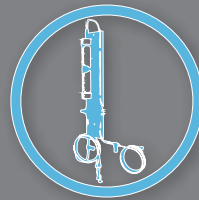

DEIONIZERS

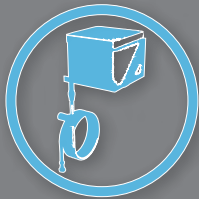

GRAVITY  
TANKS

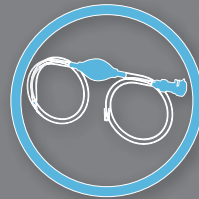

HAND  
PUMP

# WATER SUPPLIES

## Regulated Hose Supply

Regulated Hose Supply with 20' Hose (BA-MS-320-20)	<b>939-10990</b>
Regulated Hose Supply with 5' Hose (BA-MS-320-05)	<b>939-11320</b>

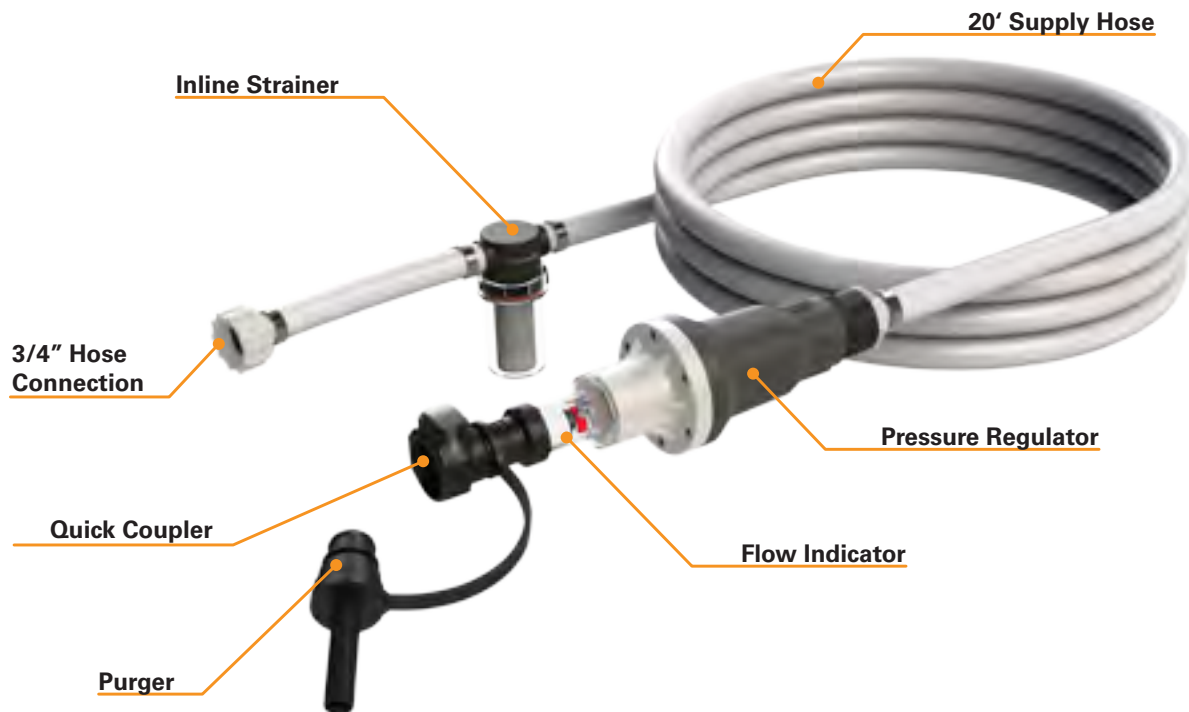

The Regulated Hose Supply, our number one seller, has no bulky components to mount and no valves to open or close. No tools required — just screw the hose onto a standard garden hose bibb.

For use with batteries equipped with Millennium Evo or Pro-Fill systems with DuraSource part number 939-11316 quick coupler.

# WATER SUPPLIES

## Portable Watering Cart

AC / DC Portable Watering Cart (BA-MS-110)

939-11321



The AC / DC portable watering cart is ruggedly constructed of lightweight, yet strong polyethylene plastic, and has a large 22 gallon holding capacity. The new cart automatically shuts down when the battery becomes low on charge, and features LED message lights to alert you to the state of the cart's battery. The cart also features a large refill hole with flip-top lid to keep out particles. A 12-volt sealed battery, with its own on-board charger, powers the watering cart's variable speed pump, or it can be plugged in and run on AC power. All components are DI water compatible.

For use with batteries equipped with Millennium Evo or Pro-Fill systems with DuraSource part number 939-11316 quick coupler.

# WATER SUPPLIES

## Deionizer

Deionizer, battery operated, without low pressure bypass (BA-MS-340)	<b>939-11322</b>
Deionizer, 110-115 VAC Light (BA-MS-341)	<b>939-11279</b>
Deionizer, 220-240 VAC Light (BA-MS-342)	<b>939-12919</b>
Replacement Cartridge (BA-221)	<b>939-11280</b>

### Disposable Cartridge

Removes 76,000 total dissolved solids (PPM) before needing replacement

### Water Quality Light

Green okay, red replace cartridge

### Low Pressure Bypass

Maintains pressure in the event a cartridge is not changed and becomes clogged

### 10 Foot Hose

Connects to spigot

### 20 Foot Supply Hose

With inline strainer

### Pressure Regulator

With flow indicator and quick coupler

Input TDS	Gal. Yield
100	760
150	507
200	380
250	304
300	253

(estimates)

Maximizes battery life by removing ions and heavy metals that are present in tap water. The separate bed deionizer uses an ion exchange cartridge to filter the water before it enters the battery. Cartridge can be discarded when replacement is necessary. This is determined when output exceeds 50 TDS (water quality light will turn red). The low pressure bypass ensures that the deionizer will provide enough pressure and flow to operate your SPW system, even if your cartridge becomes plugged.

For use with batteries equipped with Millennium Evo or Pro-Fill systems with DuraSource part number 939-11316 quick coupler. For inlet water above 300 ppm, it is recommended that a pre-filter is used.

# WATER SUPPLIES

## Gravity Tanks

Gravity tank with shelf and auto refill (BA-MS-700)	<b>939-11326</b>
Gravity tank with shelf, no auto refill (BA-MS-702)	<b>939-11327</b>
Gravity tank no shelf, no auto refill (BA-MS-703)	<b>939-11328</b>
Dropline Only (BA-MS-600)	<b>939-12920</b>



Gravity tanks may be put on a shelf or used with our rugged mounting bracket. Bottom of tank must be at a minimum of six feet above the top of the batteries being watered. Tank automatically refills itself. Compatible with deionized water.

For use with batteries equipped with Millennium Evo or Pro-Fill systems with DuraSource part number 939-11316 quick coupler.

# WATER SUPPLIES

## Portable Water Supply

Portable Water Supply, 110-115 VAC (BA-MS-606)	<b>939-11323</b>
Portable Water Supply, DC Powered (BA-MS-612)	<b>939-11324</b>

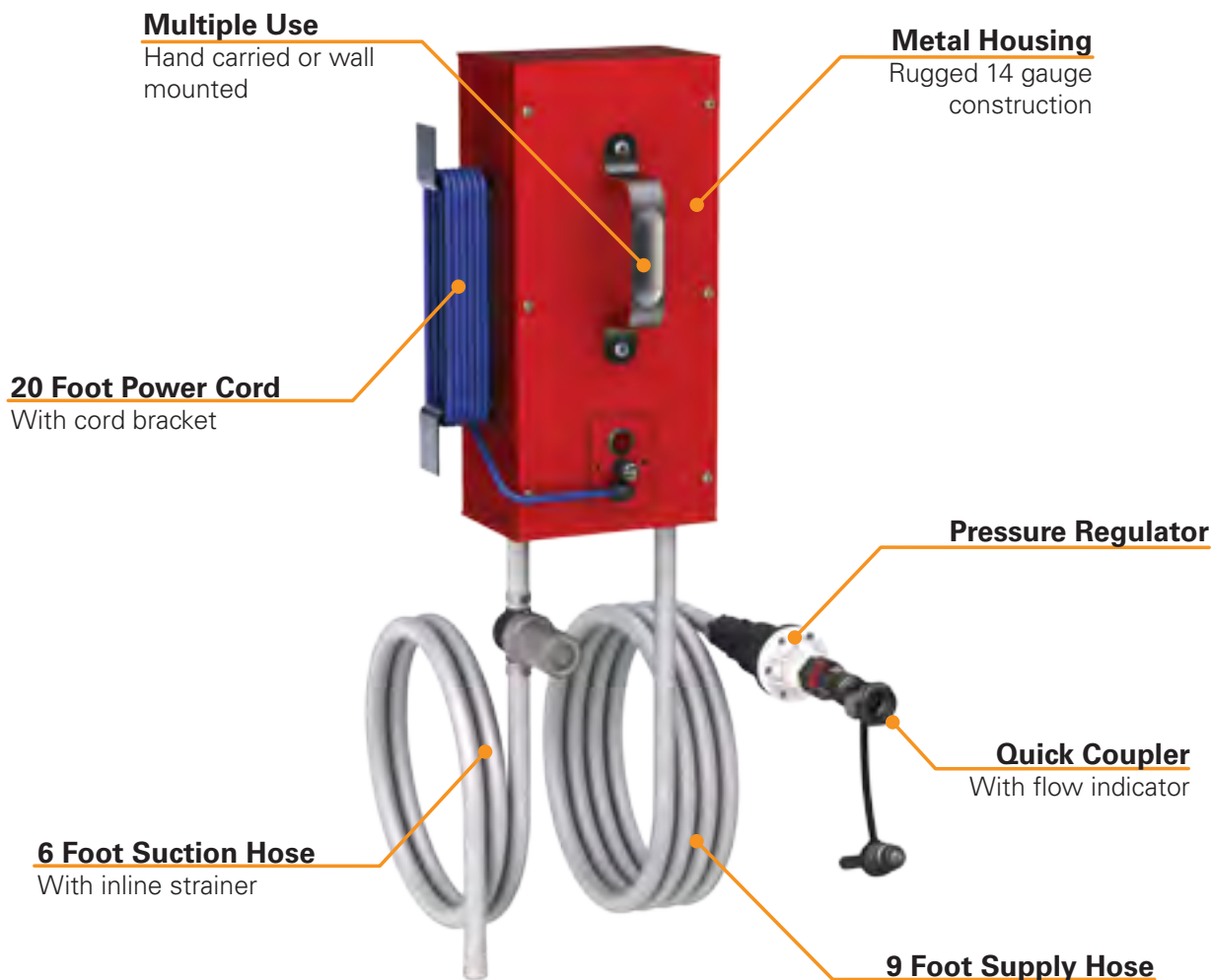

The portable water supply automatically shuts off when filling stops and is commonly used with a portable water tank filled with distilled water. This water supply is designed for batteries equipped with Millennium SPW or Pro-Fill systems with a DuraSource part number 939-11316 quick coupler.

# WATER SUPPLIES

## Mini Pump

Mini Pump w/ Cigarette Lighter Adapter, 12V DC (BA-MS-650)	<b>939-12921</b>
Mini Pump w/ Tank & 110V AC Adapter (BA-MS-651)	<b>939-12849</b>
Mini Pump w/ Tank & 12V DC Ring Terminals (BA-MS-652)	<b>939-12922</b>



This DC powered water supply is practical for light duty applications of 24 cells or fewer. The mini pump is commonly used with a portable water tank filled with distilled water. This product works with batteries equipped with Millennium SPW or Pro-Fill systems that have a DuraSource part number 939-11316 quick coupler.

## Mini Pump Accessories

 <p><b>939-12884</b> BA-550 Adapter Kit Alligator Clips</p>	 <p><b>939-12885</b> BA-551 Adapter Kit 110V Wall Plug</p>	 <p><b>939-12886</b> BA-552 Adapter Kit 250V Wall China</p>
 <p><b>939-12887</b> BA-553 Adapter Kit 5/16" Ring Terminals</p>	 <p><b>939-12888</b> BA-554 5 Gallon Tank for Mini Pump</p>	



# WATER SUPPLIES

## Hand Pump

Hand Pump (BA-MS-630)	939-11325
-----------------------	-----------

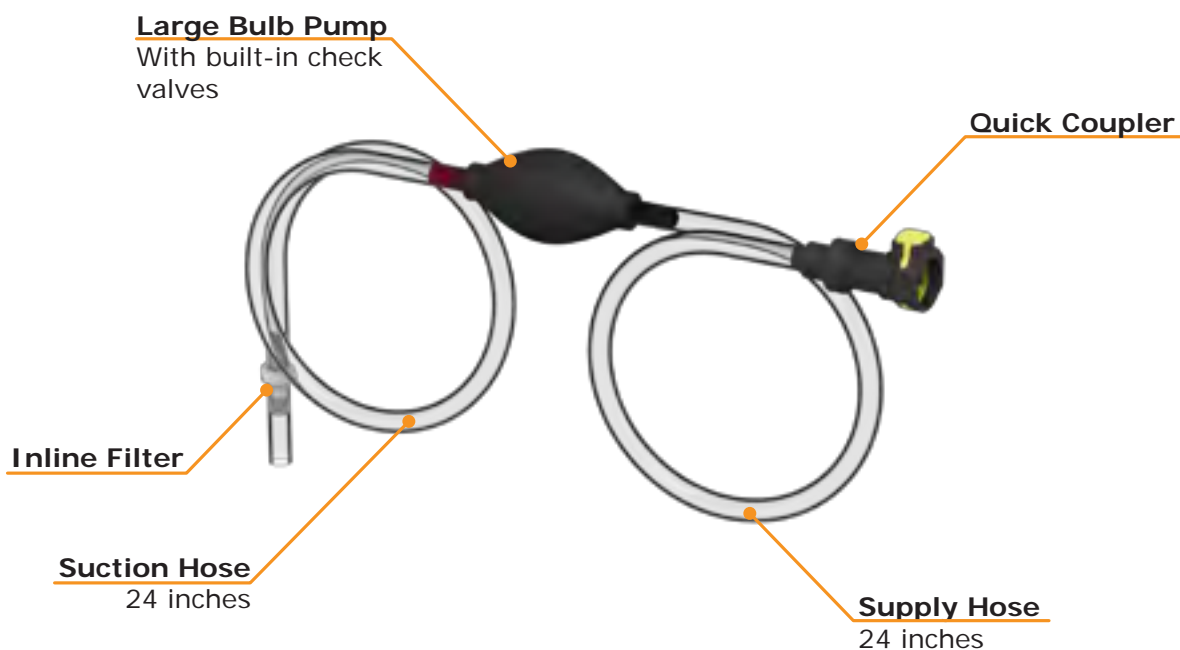

This water supply is perfect for the person who has their own golf cart, utility vehicle, or other light use application. It is commonly used with a jug filled with distilled water. The hand pump is for use with batteries that feature 24 or fewer cells and are equipped with Millennium SPW, Pro-Fill, or Qwik-Fill systems.

# WATER SUPPLIES

## Water Supply Accessories

 <p><b>939-11334</b> BA-QDV-110 Water Supply Converter Male Flow-Rite to Male Hansen</p>	 <p><b>939-11330</b> BA-QDV-710 Water Supply Converter Male Flow-Rite to Female BFS (gray)</p>	 <p><b>939-11331</b> BA-QDV-715 Water Supply Converter Male Flow-Rite to Female BWT (gray)</p>
 <p><b>939-11333</b> BA-QDV-115 Water Supply Converter Female Flow-Rite to Female Hansen</p>	 <p><b>939-11332</b> BA-QDV-720 Water Supply Converter Male BFS (gray) to Female Flow-Rite</p>	 <p><b>939-11329</b> BA-013 Water Supply Converter Philadelphia Scientific to Flow-Rite</p>
 <p><b>939-12865</b> BA-032 Back Flow Preventor</p>	 <p><b>939-12864</b> BA-031 Hose Bibb Pressure Reducer</p>	

# WATER SUPPLIES

## Water Supply Replacement Parts

 <p><b>939-10993</b> BA-MS-320-00 Hose End Assembly</p>	 <p><b>939-11641</b> BA-FLW-20 Flow Indicator (1983-2013) (FGHT x Female Coupler)</p>	 <p><b>939-12859</b> BA-005 Regulator (1983-2013) for use with BA-FLW-20 (FGHT x MGHT)</p>
 <p><b>939-12905</b> BA-FLW-60 Flow Indicator (Current Style) (3/4" NPT x 3/8 inch FNPT)</p>	 <p><b>939-10991</b> BA-FLW-80 Flow Indicator (Current Style) (3/4" NPT x Female Coupler)</p>	 <p><b>939-10992</b> BA-003 Regulator (Current Style) for use with BA-FLW-80 (FGHT X FNPT)</p>
 <p><b>939-11642</b> BA-051 Purger for Millennium Evo Water Supplies</p>	 <p><b>939-12938</b> BA-T03 20' Millennium Evo Braided Hose (FGHT X MGHT)</p>	 <p><b>939-12939</b> BA-T04 5' Millennium Evo Braided Hose (FGHT X MGHT)</p>
 <p><b>939-12954</b> BD-00017 Filter Washer with Stainless Steel Screen for Regulators</p>	 <p><b>939-12862</b> BA-019 Inline Strainer for 1/2 inch ID Hoses</p>	 <p><b>939-12863</b> BA-026 FGHT x 1/2" Barb (includes 1 worm clamp)</p>
 <p><b>939-12704</b> BA-QDV-233 Female Coupler x 3/8" Barb</p>	 <p><b>939-12936</b> BA-QDV-232 Female Coupler x 1/2" Barb</p>	 <p><b>939-12882</b> BA-465 3/8" Check Valves</p>

# WATER SUPPLIES

## Water Supply Replacement Parts

 <p><b>939-12961</b> BD-00205 Hose Washer</p>	 <p><b>939-12955</b> BD-00121 Replacement Cartridge for Deionized Water Supply purchased 2006 or prior</p>	 <p><b>939-12975</b> BD-QDV-800 Male Gardina Fitting</p>
 <p><b>939-11280</b> BA-221 Replacement Cartridge for Deionized Water Supply purchased 2007 or later</p>	 <p><b>939-12967</b> BD-00367 Female Gardina Fitting</p>	 <p><b>939-12866</b> BA-037 Deionizer Bypass Replacement Cross Assembly</p>
 <p><b>939-12883</b> BA-512 Deionizer Bypass Removal Retro Kit</p>	 <p><b>939-12963</b> BD-00319-MLR Pump 110V AC for BA-MS-606 (115 VAC)</p>	 <p><b>939-12861</b> BA-018 Line Strainer for all Gray Carts (includes two worm clamps)</p>
 <p><b>939-12966</b> BD-00327 Rocker Switch, red light, 120V, used on most AC powered water supplies</p>	 <p><b>939-12965</b> BD-00326 Rocker Switch, amber light, 12V, used on most DC powered water supplies</p>	

# WATER SUPPLIES

## Water Supply Replacement Parts



939-12964  
BD-00323  
Variable Speed Pump for  
BA-MS-105 & BA-MS-106 (12v DC)



939-12962  
BD-00298  
Variable Speed Pump  
for BA-MS-205 (110v AC)



939-12969  
BD-00607  
Battery for BA-MS-105  
& BA-MS-110 carts



939-12889  
BA-570  
Water Cart Inlet Pump Hose  
Assembly for carts BA-MS-105,  
BA-MS-205 and BA-MS-110



939-12890  
BA-571  
Water Cart Outlet Pump Hose  
Assembly for carts  
BA-MS-105 and BA-MS-205



939-12860  
BA-006  
Charger  
for BA-MS-105 Cart

# Accessories



BATTERY  
STEWARD



TOOLS



LEVEL  
INDICATORS



VENT CAPS

# ACCESSORIES

## Battery Steward®



The image shows a hand holding a smartphone displaying the Battery Steward app interface. The app screen lists several tasks: 'To-Do List', 'Water Battery', 'Perform Maintenance', 'Schedule Maintenance', 'Check a Battery', and 'Add a Battery'. Below these are sections for 'Assets' and 'Groups' with 'WIKIDBAT' and 'URBAP' listed.

 **BatterySteward®**

- ◇ Do you keep track of your battery maintenance on a disorganized whiteboard or spreadsheet?
- ◇ Do you know when you should water your batteries next?
- ◇ How do know the proper maintenance was completed?
- ◇ How much money are you wasting because of poorly maintained batteries?

If you think it's time to start protecting your investment that keeps your operations up and running, then download Battery Steward® by Flow-Rite.

Battery Steward® is an app and web portal solution that organizes your battery care schedule, alerts you when tasks are due, records maintenance and asset data, and allows you to proactively identify neglected, misused, or abused batteries.

Download the app and create your account



or visit [www.BatterySteward.com](http://www.BatterySteward.com).

# ACCESSORIES

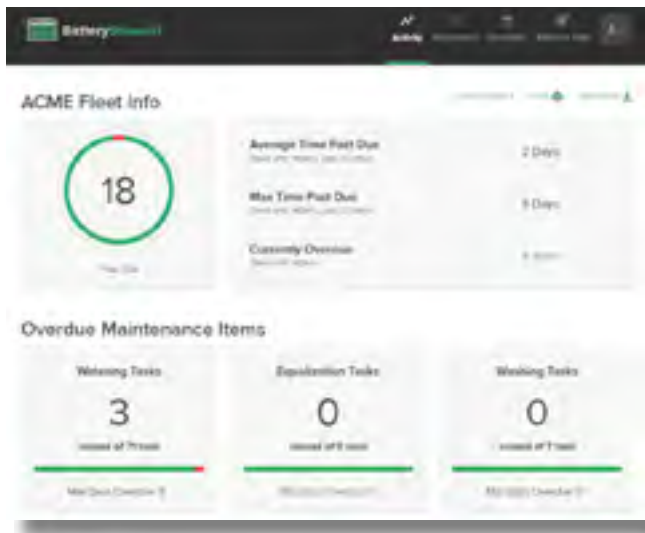

Use your mobile device and identifying labels to create easy-to-follow battery care task lists. Tasks include watering, equalizing, and preventative maintenance.



Concerned about missing or overlooking a task? Battery Steward® alerts you to when a task is due or past due.



Check off batteries by scanning the Battery Steward® identifying label that has been attached to your battery.



Record and analyze important battery maintenance data through the online portal.



Identify neglected, misused, or abused batteries.



## TRACK YOUR BATTERIES

Apply a set of Battery Steward® labels (FREE with Flow-Rite single-point watering kits) to two sides of each battery. Check off your tasks by scanning the label with your mobile device or bar code scanner.

Battery Steward Labels (BA-090)

939-12868



# ACCESSORIES

## Level Indicators Eagle Eye



Eagle Eye accurately monitors and displays the status of cell electrolyte levels with a solid green or blinking red light. Patented Capacitive Sensing Technology, found in many electronics such as touch screen monitors and cell phones, allows Eagle Eye to measure electrolyte levels without running current through the sensing probe. This eliminates any potential corrosion between the plates and the probe.

- Brightest level light on the market!
- Probe may be trimmed to size
- Nickel ring terminals are epoxy sealed to wires to prevent corrosion
- Sealed polypropylene lens protects the LED & electronics from impacts and acid migration
- 3 self resetting fuses
- Reverse polarity protected
- 100% functionally tested

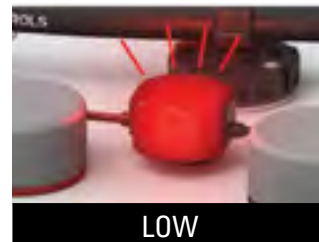





## Level Indicators

Eagle Eye - Local Standard		
	The most popular version of our level indicators is the Eagle Eye Local Standard. This is for use on 11-33 plate batteries where the top of the battery is frequently exposed.	
	1.93" / 49mm, Standard length (BA-491)	939-10994
	2.91" / 77mm (BA-492)	939-10995
	5" / 127mm (BA-488)	939-11335
Eagle Eye - Remote Standard		
	Eagle Eye Remote Standard is used on 11-33 plate batteries where the battery top is not easily viewed. The remote light mounts on the dash or the side of the battery case. It is frequently used on narrow aisle lift truck batteries that remain inside the vehicle and are not readily accessible.	
	1.93" / 49mm, Standard length (BA-494)	939-10996
	3.03" / 77mm (BA-490)	939-10997

# ACCESSORIES

## Level Indicators

### Eagle Eye

Eagle Eye - Small Plate		
	For 5-9 plate batteries, we have our Eagle Eye – Small Plate option. These batteries do not allow room for the light housing to be placed in the same location as the probe, so this version includes a remote light that is attached to a nearby intercell connector.	
	1.93" / 49mm, Standard length (BA-496)	939-11337
	3.03" / 77mm, (BA-497)	939-11338
Standard Level-Lite		
	Our original Level Lite and best seller; when the green light is on your battery is ready to go, and when the light goes out your battery requires water.	
	Standard Length (BA-434)	939-12881
	Long Length (BA-435)	939-11339
	Short length, special order only (BA-433)	939-12880
Optical Level indicators		
	Optical Level Indicator with Sleeve, Standard (BA-134)	939-12876
	Optical Level Indicator with Sleeve, Long (BA-135)	939-12877
	Optical Level Indicator with Sleeve, Short (BA-137)	939-12878
Cell Inspection Plug		
	Cell Inspection Plug (BD-107)	939-11340
	Cell Inspection Plug Bulk Back , 600 ea (BD-107-600)	939-12972
Eagle Eye Demo Unit		
	The Eagle Eye demo unit is a useful tool for Flow-Rite dealers to demonstrate the Eagle Eye level indicator. The two switches turn on and off the red and green light variations.	
	Eagle Eye Demo Unit (BA-MFT-005)	939-12906

# ACCESSORIES

## Tools

 <p>939-11343 BD-00034 Safety Glasses</p>	 <p>939-11345 BD-00871 4-Prong Spanner Tool</p>	 <p>939-11344 BD-00110 2-Prong Spanner Tool</p>
 <p>939-12869 BA-107 Drill Bit</p>	 <p>939-11350 BD-00925 Acid Extractor</p>	 <p>939-11346 BA-007 Tube Cutter</p>
 <p>939-11349 BA-MTF Millennium Test Fixture</p>	 <p>939-12923 BA-MTF-003 Demo Unit</p>	 <p>939-11342 BD-00008 NO-OX-ID Grease</p>
 <p>939-11347 BA-501 XL Tube Cutter</p>	 <p>939-12891 BA-572 Water Quality Tester</p>	



### Hydrometers

Gefo produced hydrometers feature a centered aerometer that has no lateral contact with the outer cylinder. The color coded/numerical scale presents a fast and accurate reading. For use with Millennium Evo flip top valves.

DuraSource PN	Flow-Rite PN	Model	Density Range	Graduations (Scale)	Vol	Therm
939-11351	BA-047	Gefo Centra	1.10-1.30 (g/ml)	.01g	18 cc	No
939-11354	BA-065	Gefo S / Th	1.08-1.30 (g/ml)	.005	42 cc	Yes 0-60 C

Aerometer	Replacement for BA-047 (939-11351) Hydrometer (BD-00166)	939-11352
-----------	----------------------------------------------------------	-----------

# ACCESSORIES

## Water Wise™



### Introducing Water Wise™ The World's First Ever Flip-Top Watering Cap!

Water Wise™ Flip-Top Watering Caps limit the nozzle depth of automatic watering guns to achieve accurate electrolyte levels without the use of adjustable O-rings. Take the guess-work out of refilling battery cells when using a watering gun!

Simply leave the Flip-Top Watering Cap in place. Your batteries will always be filled to the correct level, ensuring optimal battery life.

You'll have peace of mind knowing that every battery cell is watered properly and safely.

- ◇ Fast
- ◇ Reliable
- ◇ Economical
- ◇ Durable



# ACCESSORIES

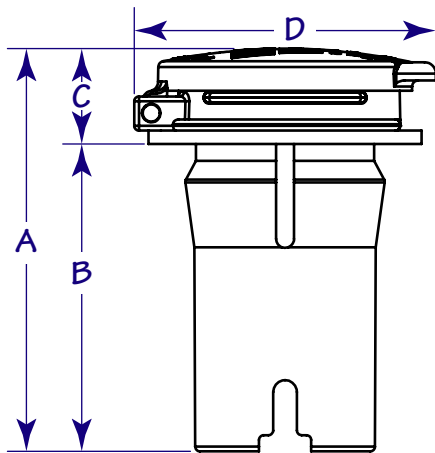

**WaterWise™**  
Flip Top Watering Cap by **FLOW-RITE**

DuraSource PN	Flow-Rite PN	Description	A	B	C	D
939-10998	VNT-1W2	Water Wise, Bayonet, Push-In, Black Length	2.12"	1.62"	0.5"	1.59"
939-10999	VNT-1W3	Water Wise, Bayonet, Push-In, Gray Length	2.50"	2.00"	0.5"	1.59"
939-13054	VNT-3H1	Water Wise, 35P, Push-In, 37mm Length	2.12"	1.52"	0.6"	1.59"
939-13055	VNT-3H2	Water Wise, 35P, Push-In, 47mm Length	2.5"	1.90"	0.6"	1.59"

# **QWIK-FILL™**

ON-BOARD BATTERY WATERING SYSTEM

by **FLOW-RITE**



# **RV EDITION™**

# **PRO-FILL™**

ON-BOARD BATTERY WATERING SYSTEM

by **FLOW-RITE**





# QWIK-FILL & PRO-FILL RV

## Qwik-Fill - Retail



Qwik-Fill On-board Battery Watering Systems fit 12-volt marine deep cycle batteries group 24-27 and most group 29-31. Fill up to 3 batteries from a single remote location with simple hand pump operation.

\*Qwik-Fill may only be operated with a hand pump water supply

<p><b>Kit A</b></p> 	<p><b>939-13046</b></p> <p>MP-2000 Includes all parts necessary to add / set-up two batteries with quick disconnect for filling. Requires squeeze bulb filling kit (sold separately in Kit C).</p>
<p><b>Kit B</b></p> 	<p><b>939-13047</b></p> <p>MP-2010 Includes all parts necessary to add / set-up one battery with quick disconnect for filling. Requires squeeze bulb filling kit (sold separately in Kit C).</p>
<p><b>Kit C</b></p> 	<p><b>939-13052</b></p> <p>RV-2020 Squeeze bulb filler assembly with intake filter and quick connect fitting.</p>









# QWIK-FILL & PRO-FILL RV

## Qwik-Fill OEM Packed Kits



Kit Size / Description	DuraSource PN
1 Battery Kit, no hand pump included (QF-1010)	939-13048
2 Battery Kit, no hand pump included (QF-1020)	939-13049
3 Battery Kit, no hand pump included (QF-1030)	939-13050
3 Battery Kit, hand pump included (QF-1100)	939-13051
Hand Pump (BA-MS-630)	939-11325



## Qwik-Fill Parts

 <p><b>939-13044</b> BM-100-RP Replacement Qwik-Fill Manifold (Universal - Barbs on both sides)</p>	 <p><b>939-12867</b> BA-061 Replacement Pack of Barbs</p>	 <p><b>939-12882</b> BA-465 3/8" Check Valves</p>
 <p><b>939-12937</b> BA-QDV-512 Male Quick Coupler w/ Dust Cover (Keyed 1/4" Barb)</p>	 <p><b>939-12935</b> BA-QDV-201 Female Quick Coupler (Keyed 3/8" Barb)</p>	 <p><b>939-13045</b> BSA-5000 Squeeze Ball with Check Valves</p>



# QWIK-FILL & PRO-FILL RV

## Pro-Fill RV Edition

Kit Size / Description	DuraSource PN
 <p>2 Battery Kit, no hand pump included (RV-2000)</p>	939-13368
 <p>Hand Pump (RV-2020)</p>	939-13052

## Pro-Fill RV Parts

 <p>939-13045 BSA-5000 Squeeze Ball with Check Valves</p>	 <p>939-12935 BA-QDV-201 Female Quick Coupler (Keyed 3/8" Barb)</p>	 <p>939-12937 BA-QDV-512 Male Quick Coupler with Dust Cover (Keyed 1/4" Barb)</p>
 <p>939-12873 BA-127-FLEX Flexible Manifold</p>	 <p>939-11379 BD-T14 Clampless Tubing (purchased by the foot)</p>	 <p>939-10987 BD-00280 Red End Caps (sold in quantity of one)</p>
 <p>939-12882 BA-465 3/8" Check Valves for Hand Pump</p>		

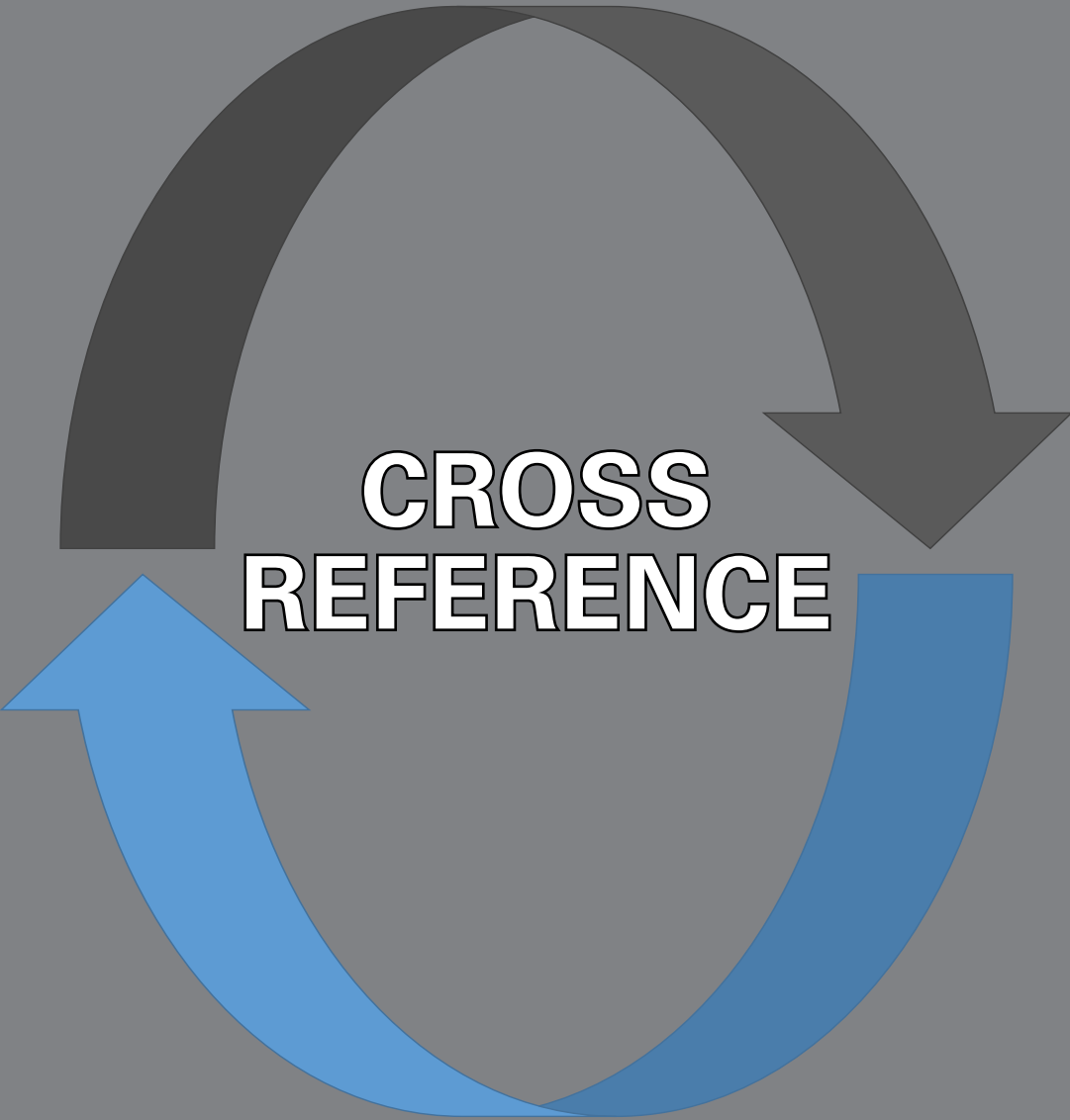

# CROSS REFERENCE

## FLOW-RITE TO DURASOURCE

Flow-Rite PN	DuraSource PN
BA-003	939-10992
BA-005	939-12859
BA-006	939-12860
BA-007	939-11346
BA-010-10-6P	939-12924
BA-013	939-11329
BA-017	939-11381
BA-018	939-12861
BA-019	939-12862
BA-026	939-12863
BA-031	939-12864
BA-032	939-12865
BA-037	939-12866
BA-047	939-11351
BA051	939-11642
BA-061	939-12867
BA-065	939-11354
BA-090	939-12868
BA-107	939-12869
BA-120-BLK	939-12870
BA-121-BLU	939-12871
BA-122-RED	939-12872
BA-127-FLEX	939-12873
BA-128-FLEX	939-12874
BA-129-FLEX	939-12875
BA-134	939-12876
BA-135	939-12877
BA-137	939-12878
BA-142	939-10988
BA-144	939-12241
BA-145	939-12240
BA-1FT-7G	939-12879
BA-221	939-11280
BA-433	939-12880

Flow-Rite PN	DuraSource PN
BA-434	939-12881
BA-435	939-11339
BA-465	939-12882
BA-488	939-11335
BA-489	939-11336
BA-490	939-10997
BA-491	939-10994
BA-492	939-10995
BA-494	939-10996
BA-496	939-11337
BA-497	939-11338
BA-501	939-11347
BA-512	939-12883
BA-550	939-12884
BA-551	939-12885
BA-552	939-12886
BA-553	939-12887
BA-554	939-12888
BA-570	939-12889
BA-571	939-12890
BA-572	939-12891
BA-5FT-7G	939-12892
BA-6FT-7G	939-12893
BA-C10-11-6P	939-11371
BA-C10-21-6P	939-11370
BA-C10-31-6P	939-11372
BA-C10-41-6P	939-11373
BA-C15-50-6P	939-11374
BA-C20-11-6P	939-12894
BA-C20-21-6P	939-11377
BA-C20-31-6P	939-12895
BA-C20-41-6P	939-12896
BA-C30-11-6P	939-12897
BA-C30-21-6P	939-12898
BA-C30-31-6P	939-12899

Flow-Rite PN	DuraSource PN
BA-C30-41-6P	939-12900
BA-C40-11-6P	939-12901
BA-C40-21-6P	939-12902
BA-C40-31-6P	939-12903
BA-C40-41-6P	939-12904
BA-FLW-20	939-11641
BA-FLW-60	939-12905
BA-FLW-80	939-10991
BA-MFT-005	939-12906
BA-MMP-11-C	939-11312
BA-MMP-12-C	939-10983
BA-MMP-13-C	939-10984
BA-MMP-14-C	939-10985
BA-MMP-1G-C	939-12908
BA-MMP-21-C	939-12909
BA-MMP-22-C	939-11314
BA-MMP-23-C	939-12910
BA-MMP-24-C	939-12911
BA-MMP-31-C	939-12912
BA-MMP-32-C	939-12913
BA-MMP-33-C	939-12914
BA-MMP-34-C	939-12915
BA-MMP-41-C	939-12916
BA-MMP-43-C	939-12917
BA-MMP-44-C	939-12918
BA-MS-105	939-10701
BA-MS-110	939-11321
BA-MS-205	939-10700
BA-MS-320-00	939-10993
BA-MS-320-05	939-11320
BA-MS-320-20	939-10990
BA-MS-340	939-11322
BA-MS-341	939-11279
BA-MS-342	939-12919
BA-MS-600	939-12920

# CROSS REFERENCE

## FLOW-RITE TO DURASOURCE

Flow-Rite PN	DuraSource PN
BA-MS-606	939-11323
BA-MS-612	939-11324
BA-MS-630	939-11325
BA-MS-650	939-12921
BA-MS-651	939-12849
BA-MS-652	939-12922
BA-MS-700	939-11326
BA-MS-702	939-11327
BA-MS-703	939-11328
BA-MTF	939-11349
BA-MTF-003	939-12923
BA-O10-20-6P	939-12925
BA-O10-30-6P	939-12926
BA-O10-40-6P	939-12927
BA-O10-G0-6P	939-12928
BA-O10-K0-6P	939-12929
BA-O15-50-6P	939-12930
BA-O20-10-6P	939-12931
BA-O20-20-6P	939-12932
BA-O20-30-6P	939-12933
BA-O20-40-6P	939-12934
BA-QDV-105	939-11315
BA-QDV-110	939-11334
BA-QDV-115	939-11333
BA-QDV-201	939-12935
BA-QDV-232	939-12936
BA-QDV-233	939-12704
BA-QDV-405	939-11317
BA-QDV-500	939-12642
BA-QDV-505	939-11316
BA-QDV-512	939-12937
BA-QDV-705	939-11318
BA-QDV-710	939-11330
BA-QDV-715	939-11331
BA-QDV-720	939-11332

Flow-Rite PN	DuraSource PN
BA-QDV-805	939-11319
BA-T03	939-12938
BA-T04	939-12939
BA-Y10-10-6P	939-12940
BA-Y10-20-6P	939-12941
BA-Y10-30-6P	939-12942
BA-Y10-40-6P	939-12943
BA-Y10-G0-6P	939-12944
BA-Y10-K0-6P	939-12945
BA-Y14-10	939-12946
BA-Y15-50-6P	939-12947
BA-Y20-10-6P	939-12948
BA-Y20-20-6P	939-12949
BA-Y20-30-6P	939-12950
BA-Y20-40-6P	939-12951
BA-Y74-10	939-12952
BA-Y7A-10	939-12953
BD-00008	939-11342
BD-00017	939-12954
BD-00034	939-11343
BD-00110	939-11344
BD-00121	939-12955
BD-00166	939-11352
BD-00188	939-12956
BD-00189	939-12957
BD-00202	939-12958
BD-00203	939-12959
BD-00204	939-12960
BD-00205	939-12961
BD-00280	939-10987
BD-00298	939-12962
BD-00319	939-12963
BD-00323	939-12964
BD-00326	939-12965
BD-00327	939-12966

Flow-Rite PN	DuraSource PN
BD-00367	939-12967
BD-00525	939-12968
BD-00607	939-12969
BD-00870	939-12970
BD-00871	939-11345
BD-00925	939-11350
BD-107	939-11340
BD-107-600	939-12972
BD-BRR	939-12973
BD-QDV-005	939-12974
BD-QDV-800	939-12975
BD-T14	939-11379
BD-U12V-1G	939-12976
BD-U12V-4G	939-12977
BD-U12V-7A	939-12978
BG-1C0-101-506	939-12992
BG-U24V-1G	939-12979
BG-U24V-4G	939-12980
BG-U24V-7A	939-12981
BG-U36V-1G	939-12982
BG-U36V-4G	939-12983
BG-U36V-7A	939-12984
BG-U48V-1A	939-12985
BG-U48V-1G	939-12986
BG-U48V-4G	939-12987
BG-U48V-5G	939-12988
BG-U48V-6G	939-12989
BG-U48V-7A	939-12990
BG-U48V-8J	939-12991
BG-W24V-1	939-12848
BK-1C0-101-509	939-13017
BK-1C0-101-512	939-12993
BK-1C0-101-518	939-12994
BK-1C0-101-520	939-12995
BK-1C0-101-524	939-12996

# CROSS REFERENCE

## FLOW-RITE TO DURASOURCE

Flow-Rite PN	DuraSource PN
BK-1C0-101-536	939-12997
BK-1C0-101-540	939-12998
BK-1C0-201-506	939-11216
BK-1C0-201-509	939-11217
BK-1C0-201-512	939-10967
BK-1C0-201-518	939-10968
BK-1C0-201-520	939-11218
BK-1C0-201-524	939-10969
BK-1C0-201-536	939-11219
BK-1C0-201-540	939-10970
BK-1C0-301-506	939-11230
BK-1C0-301-509	939-11231
BK-1C0-301-512	939-10971
BK-1C0-301-518	939-10972
BK-1C0-301-520	939-11232
BK-1C0-301-524	939-10973
BK-1C0-301-536	939-11233
BK-1C0-301-540	939-11234
BK-1C0-401-506	939-11245
BK-1C0-401-509	939-11246
BK-1C0-401-512	939-10974
BK-1C0-401-518	939-10975
BK-1C0-401-520	939-11247
BK-1C0-401-524	939-10976
BK-1C0-401-536	939-11248
BK-1C0-401-540	939-11249
BK-1C0-500-506	939-11461
BK-1C0-500-509	939-11462
BK-1C0-500-512	939-11361
BK-1C0-500-518	939-11362
BK-1C0-500-520	939-11363
BK-1C0-500-524	939-11364
BK-1C0-500-536	939-11365
BK-1C0-500-540	939-11366
BK-1C0-G00-506	939-12999

Flow-Rite PN	DuraSource PN
BK-1C0-G00-506	939-11265
BK-1C0-G00-509	939-13018
BK-1C0-G00-509	939-11266
BK-1C0-G00-512	939-10977
BK-1C0-G00-518	939-10978
BK-1C0-G00-520	939-11267
BK-1C0-G00-524	939-10979
BK-1C0-G00-536	939-11268
BK-1C0-G00-540	939-11269
BK-1CA-101-506	939-13000
BK-1CA-101-512	939-13001
BK-1CA-201-506	939-13002
BK-1CA-201-512	939-11229
BK-1CA-301-506	939-11243
BK-1CA-301-512	939-11244
BK-1CA-401-506	939-11258
BK-1CA-401-512	939-11259
BK-1CA-401-518	939-11255
BK-1CA-401-524	939-11256
BK-1CA-401-536	939-11257
BK-1CA-G00-506	939-11277
BK-1CA-G00-512	939-13003
BK-1CB-101-518	939-13004
BK-1CB-101-524	939-13005
BK-1CB-201-518	939-11225
BK-1CB-201-524	939-11226
BK-1CB-201-536	939-11227
BK-1CB-301-518	939-11240
BK-1CB-301-524	939-11241
BK-1CB-301-536	939-11242
BK-1CB-401-518	939-13006
BK-1CB-401-524	939-13007
BK-1CB-G00-512	939-11278
BK-1CB-G00-518	939-13008
BK-1CB-G00-524	939-11275

Flow-Rite PN	DuraSource PN
BK-1CB-G00-536	939-11276
BK-1CC-101-506	939-13009
BK-1CC-101-512	939-13010
BK-1CC-101-518	939-13011
BK-1CC-101-524	939-13012
BK-1CC-201-506	939-11220
BK-1CC-201-512	939-11221
BK-1CC-201-518	939-11222
BK-1CC-201-524	939-11223
BK-1CC-201-536	939-11224
BK-1CC-301-506	939-11235
BK-1CC-301-512	939-11236
BK-1CC-301-518	939-11237
BK-1CC-301-524	939-11238
BK-1CC-301-536	939-11239
BK-1CC-401-506	939-11250
BK-1CC-401-512	939-11251
BK-1CC-401-518	939-11252
BK-1CC-401-524	939-11253
BK-1CC-G00-506	939-11270
BK-1CC-G00-512	939-11271
BK-1CC-G00-518	939-11272
BK-1CC-G00-524	939-11273
BK-2C0-101-506	939-13019
BK-2C0-101-509	939-13020
BK-2C0-101-512	939-13021
BK-2C0-101-518	939-13022
BK-2C0-101-520	939-13023
BK-2C0-101-524	939-13024
BK-2C0-101-536	939-13025
BK-2C0-101-540	939-13026
BK-2C0-201-506	939-11287
BK-2C0-201-509	939-13027
BK-2C0-201-512	939-11289
BK-2C0-201-518	939-11290

# CROSS REFERENCE

## FLOW-RITE TO DURASOURCE

Flow-Rite PN	DuraSource PN
BK-2C0-201-520	939-11291
BK-2C0-201-524	939-11292
BK-2C0-201-536	939-11293
BK-2C0-201-540	939-11294
BK-2C0-301-506	939-13028
BK-2C0-301-509	939-13029
BK-2C0-301-512	939-13030
BK-2C0-301-518	939-13031
BK-2C0-301-520	939-13032
BK-2C0-301-524	939-13033
BK-2C0-301-536	939-13034
BK-2C0-301-540	939-13035
BK-2C0-401-506	939-13036
BK-2C0-401-509	939-13037
BK-2C0-401-512	939-13038
BK-2C0-401-518	939-13039
BK-2C0-401-520	939-13040
BK-2C0-401-524	939-13041
BK-2C0-401-536	939-13042
BK-2C0-401-540	939-13043
BK-2CA-201-506	939-11303
BK-2CA-201-512	939-11304
BK-2CB-201-518	939-11300
BK-2CB-201-524	939-11301
BK-2CC-201-506	939-11295
BK-2CC-201-512	939-11296
BK-2CC-201-518	939-11297
BK-2CC-201-524	939-11298
BK-2CC-201-536	939-11299
BK-GNBSH-506	939-11260
BK-GNBSH-509	939-11261
BK-GNBSH-512	939-10980
BK-GNBSH-518	939-10981
BK-GNBSH-520	939-11262
BK-GNBSH-524	939-10982

Flow-Rite PN	DuraSource PN
BK-GNBSH-536	939-11263
BK-GNBSH-540	939-11264
BK-MMP-1G-C	939-11313
BM-100-RP	939-13044
BSA-5000	939-13045
MP-2000	939-13046
MP-2010	939-13047
QF-1010	939-13048
QF-1020	939-13049
QF-1030	939-13050
QF-1100	939-13051
RV-2000	939-13368
RV-2020	939-13052
SNK-F124	939-13053
VNT-1W2	939-10998
VNT-1W3	939-10999
VNT-3H1	939-13054
VNT-3H2	939-13055

# CROSS REFERENCE

## DURASOURCE TO FLOW-RITE

DuraSource PN	Flow-Rite PN
939-10700	BA-MS-205
939-10701	BA-MS-105
939-10967	BK-1C0-201-512
939-10968	BK-1C0-201-518
939-10969	BK-1C0-201-524
939-10970	BK-1C0-201-540
939-10971	BK-1C0-301-512
939-10972	BK-1C0-301-518
939-10973	BK-1C0-301-524
939-10974	BK-1C0-401-512
939-10975	BK-1C0-401-518
939-10976	BK-1C0-401-524
939-10977	BK-1C0-G00-512
939-10978	BK-1C0-G00-518
939-10979	BK-1C0-G00-524
939-10980	BK-GNBSH-512
939-10981	BK-GNBSH-518
939-10982	BK-GNBSH-524
939-10983	BA-MMP-12-C
939-10984	BA-MMP-13-C
939-10985	BA-MMP-14-C
939-10987	BD-00280
939-10988	BA-142
939-10990	BA-MS-320-20
939-10991	BA-FLW-80
939-10992	BA-003
939-10993	BA-MS-320-00
939-10994	BA-491
939-10995	BA-492
939-10996	BA-494
939-10997	BA-490
939-10998	VNT-1W2
939-10999	VNT-1W3
939-11216	BK-1C0-201-506
939-11217	BK-1C0-201-509

DuraSource PN	Flow-Rite PN
939-11218	BK-1C0-201-520
939-11219	BK-1C0-201-536
939-11220	BK-1CC-201-506
939-11221	BK-1CC-201-512
939-11222	BK-1CC-201-518
939-11223	BK-1CC-201-524
939-11224	BK-1CC-201-536
939-11225	BK-1CB-201-518
939-11226	BK-1CB-201-524
939-11227	BK-1CB-201-536
939-11229	BK-1CA-201-512
939-11230	BK-1C0-301-506
939-11231	BK-1C0-301-509
939-11232	BK-1C0-301-520
939-11233	BK-1C0-301-536
939-11234	BK-1C0-301-540
939-11235	BK-1CC-301-506
939-11236	BK-1CC-301-512
939-11237	BK-1CC-301-518
939-11238	BK-1CC-301-524
939-11239	BK-1CC-301-536
939-11240	BK-1CB-301-518
939-11241	BK-1CB-301-524
939-11242	BK-1CB-301-536
939-11243	BK-1CA-301-506
939-11244	BK-1CA-301-512
939-11245	BK-1C0-401-506
939-11246	BK-1C0-401-509
939-11247	BK-1C0-401-520
939-11248	BK-1C0-401-536
939-11249	BK-1C0-401-540
939-11250	BK-1CC-401-506
939-11251	BK-1CC-401-512
939-11252	BK-1CC-401-518
939-11253	BK-1CC-401-524

DuraSource PN	Flow-Rite PN
939-11255	BK-1CA-401-518
939-11256	BK-1CA-401-524
939-11257	BK-1CA-401-536
939-11258	BK-1CA-401-506
939-11259	BK-1CA-401-512
939-11260	BK-GNBSH-506
939-11261	BK-GNBSH-509
939-11262	BK-GNBSH-520
939-11263	BK-GNBSH-536
939-11264	BK-GNBSH-540
939-11265	BK-1C0-G00-506
939-11266	BK-1C0-G00-509
939-11267	BK-1C0-G00-520
939-11268	BK-1C0-G00-536
939-11269	BK-1C0-G00-540
939-11270	BK-1CC-G00-506
939-11271	BK-1CC-G00-512
939-11272	BK-1CC-G00-518
939-11273	BK-1CC-G00-524
939-11275	BK-1CB-G00-524
939-11276	BK-1CB-G00-536
939-11277	BK-1CA-G00-506
939-11278	BK-1CB-G00-512
939-11279	BA-MS-341
939-11280	BA-221
939-11287	BK-2C0-201-506
939-11289	BK-2C0-201-512
939-11290	BK-2C0-201-518
939-11291	BK-2C0-201-520
939-11292	BK-2C0-201-524
939-11293	BK-2C0-201-536
939-11294	BK-2C0-201-540
939-11295	BK-2CC-201-506
939-11296	BK-2CC-201-512
939-11297	BK-2CC-201-518

# CROSS REFERENCE

## DURASOURCE TO FLOW-RITE

DuraSource PN	Flow-Rite PN
939-11298	BK-2CC-201-524
939-11299	BK-2CC-201-536
939-11300	BK-2CB-201-518
939-11301	BK-2CB-201-524
939-11303	BK-2CA-201-506
939-11304	BK-2CA-201-512
939-11312	BA-MMP-11-C
939-11313	BK-MMP-1G-C
939-11314	BA-MMP-22-C
939-11315	BA-QDV-105
939-11316	BA-QDV-505
939-11317	BA-QDV-405
939-11318	BA-QDV-705
939-11319	BA-QDV-805
939-11320	BA-MS-320-05
939-11321	BA-MS-110
939-11322	BA-MS-340
939-11323	BA-MS-606
939-11324	BA-MS-612
939-11325	BA-MS-630
939-11326	BA-MS-700
939-11327	BA-MS-702
939-11328	BA-MS-703
939-11329	BA-013
939-11330	BA-QDV-710
939-11331	BA-QDV-715
939-11332	BA-QDV-720
939-11333	BA-QDV-115
939-11334	BA-QDV-110
939-11335	BA-488
939-11336	BA-489
939-11337	BA-496
939-11338	BA-497
939-11339	BA-435
939-11340	BD-107
939-11342	BD-00008

DuraSource PN	Flow-Rite PN
939-11343	BD-00034
939-11344	BD-00110
939-11345	BD-00871
939-11346	BA-007
939-11347	BA-501
939-11349	BA-MTF
939-11350	BD-00925
939-11351	BA-047
939-11352	BD-00166
939-11354	BA-065
939-11361	BK-1C0-500-512
939-11362	BK-1C0-500-518
939-11363	BK-1C0-500-520
939-11364	BK-1C0-500-524
939-11365	BK-1C0-500-536
939-11366	BK-1C0-500-540
939-11370	BA-C10-21-6P
939-11371	BA-C10-11-6P
939-11372	BA-C10-31-6P
939-11373	BA-C10-41-6P
939-11374	BA-C15-50-6P
939-11377	BA-C20-21-6P
939-11379	BD-T14
939-11381	BA-017
939-11461	BK-1C0-500-506
939-11462	BK-1C0-500-509
939-11641	BA-FLW-20
939-11642	BA051
939-12240	BA-145
939-12241	BA-144
939-12642	BA-QDV-500
939-12704	BA-QDV-233
939-12848	BG-W24V-1
939-12849	BA-MS-651
939-12859	BA-005
939-12860	BA-006

DuraSource PN	Flow-Rite PN
939-12861	BA-018
939-12862	BA-019
939-12863	BA-026
939-12864	BA-031
939-12865	BA-032
939-12866	BA-037
939-12867	BA-061
939-12868	BA-090
939-12869	BA-107
939-12870	BA-120-BLK
939-12871	BA-121-BLU
939-12872	BA-122-RED
939-12873	BA-127-FLEX
939-12874	BA-128-FLEX
939-12875	BA-129-FLEX
939-12876	BA-134
939-12877	BA-135
939-12878	BA-137
939-12879	BA-1FT-7G
939-12880	BA-433
939-12881	BA-434
939-12882	BA-465
939-12883	BA-512
939-12884	BA-550
939-12885	BA-551
939-12886	BA-552
939-12887	BA-553
939-12888	BA-554
939-12889	BA-570
939-12890	BA-571
939-12891	BA-572
939-12892	BA-5FT-7G
939-12893	BA-6FT-7G
939-12894	BA-C20-11-6P
939-12895	BA-C20-31-6P
939-12896	BA-C20-41-6P



# CROSS REFERENCE

## DURASOURCE TO FLOW-RITE

DuraSource PN	Flow-Rite PN
939-12897	BA-C30-11-6P
939-12898	BA-C30-21-6P
939-12899	BA-C30-31-6P
939-12900	BA-C30-41-6P
939-12901	BA-C40-11-6P
939-12902	BA-C40-21-69
939-12903	BA-C40-31-6P
939-12904	BA-C40-41-6P
939-12905	BA-FLW-60
939-12906	BA-MFT-005
939-12908	BA-MMP-1G-C
939-12909	BA-MMP-21-C
939-12910	BA-MMP-23-C
939-12911	BA-MMP-24-C
939-12912	BA-MMP-31-C
939-12913	BA-MMP-32-C
939-12914	BA-MMP-33-C
939-12915	BA-MMP-34-C
939-12916	BA-MMP-41-C
939-12917	BA-MMP-43-C
939-12918	BA-MMP-44-C
939-12919	BA-MS-342
939-12920	BA-MS-600
939-12921	BA-MS-650
939-12922	BA-MS-652
939-12923	BA-MTF-003
939-12924	BA-010-10-6P
939-12925	BA-010-20-6P
939-12926	BA-010-30-6P
939-12927	BA-010-40-6P
939-12928	BA-010-G0-6P
939-12929	BA-010-K0-6P
939-12930	BA-015-50-6P
939-12931	BA-020-10-6P
939-12932	BA-020-20-6P
939-12933	BA-020-30-6P

DuraSource PN	Flow-Rite PN
939-12934	BA-020-40-6P
939-12935	BA-QDV-201
939-12936	BA-QDV-232
939-12937	BA-QDV-512
939-12938	BA-T03
939-12939	BA-T04
939-12940	BA-Y10-10-6P
939-12941	BA-Y10-20-6P
939-12942	BA-Y10-30-6P
939-12943	BA-Y10-40-6P
939-12944	BA-Y10-G0-6P
939-12945	BA-Y10-K0-6P
939-12946	BA-Y14-10
939-12947	BA-Y15-50-6P
939-12948	BA-Y20-10-6P
939-12949	BA-Y20-20-6P
939-12950	BA-Y20-30-6P
939-12951	BA-Y20-40-6P
939-12952	BA-Y74-10
939-12953	BA-Y7A-10
939-12954	BD-00017
939-12955	BD-00121
939-12956	BD-00188
939-12957	BD-00189
939-12958	BD-00202
939-12959	BD-00203
939-12960	BD-00204
939-12961	BD-00205
939-12962	BD-00298
939-12963	BD-00319
939-12964	BD-00323
939-12965	BD-00326
939-12966	BD-00327
939-12967	BD-00367
939-12968	BD-00525
939-12969	BD-00607

DuraSource PN	Flow-Rite PN
939-12970	BD-00870
939-12972	BD-107-600
939-12973	BD-BRR
939-12974	BD-QDV-005
939-12975	BD-QDV-800
939-12976	BD-U12V-1G
939-12977	BD-U12V-4G
939-12978	BD-U12V-7A
939-12979	BG-U24V-1G
939-12980	BG-U24V-4G
939-12981	BG-U24V-7A
939-12982	BG-U36V-1G
939-12983	BG-U36V-4G
939-12984	BG-U36V-7A
939-12985	BG-U48V-1A
939-12986	BG-U48V-1G
939-12987	BG-U48V-4G
939-12988	BG-U48V-5G
939-12989	BG-U48V-6G
939-12990	BG-U48V-7A
939-12991	BG-U48V-8J
939-12992	BG-1C0-101-506
939-12993	BK-1C0-101-512
939-12994	BK-1C0-101-518
939-12995	BK-1C0-101-520
939-12996	BK-1C0-101-524
939-12997	BK-1C0-101-536
939-12998	BK-1C0-101-540
939-12999	BK-1C0-G00-506
939-13000	BK-1CA-101-506
939-13001	BK-1CA-101-512
939-13002	BK-1CA-201-506
939-13003	BK-1CA-G00-512
939-13004	BK-1CB-101-518
939-13005	BK-1CB-101-524
939-13006	BK-1CB-401-518

# CROSS REFERENCE

## DURASOURCE TO FLOW-RITE

DuraSource PN	Flow-Rite PN
939-13007	BK-1CB-401-524
939-13008	BK-1CB-G00-518
939-13009	BK-1CC-101-506
939-13010	BK-1CC-101-512
939-13011	BK-1CC-101-518
939-13012	BK-1CC-101-524
939-13017	BK-1C0-101-509
939-13018	BK-1C0-G00-509
939-13019	BK-2C0-101-506
939-13020	BK-2C0-101-509
939-13021	BK-2C0-101-512
939-13022	BK-2C0-101-518
939-13023	BK-2C0-101-520
939-13024	BK-2C0-101-524
939-13025	BK-2C0-101-536
939-13026	BK-2C0-101-540
939-13027	BK-2C0-201-509
939-13028	BK-2C0-301-506
939-13029	BK-2C0-301-509
939-13030	BK-2C0-301-512
939-13031	BK-2C0-301-518
939-13032	BK-2C0-301-520
939-13033	BK-2C0-301-524
939-13034	BK-2C0-301-536
939-13035	BK-2C0-301-540
939-13036	BK-2C0-401-506
939-13037	BK-2C0-401-509
939-13038	BK-2C0-401-512
939-13039	BK-2C0-401-518
939-13040	BK-2C0-401-520
939-13041	BK-2C0-401-524
939-13042	BK-2C0-401-536
939-13043	BK-2C0-401-540
939-13044	BM-100-RP
939-13045	BSA-5000
939-13046	MP-2000

DuraSource PN	Flow-Rite PN
939-13047	MP-2010
939-13048	QF-1010
939-13049	QF-1020
939-13050	QF-1030
939-13051	QF-1100
939-13052	RV-2020
939-13053	SNK-F124
939-13054	VNT-3H1
939-13055	VNT-3H2
939-13368	RV-2000

# WHY DURASOURCE?

When you purchase DuraSource, you don't just get products. You get answers to problems. We look at your business and recommend solutions based on your unique needs. Choosing DuraSource means working with sales and service professionals who represent the strongest material handling solutions. DuraSource products are built tough to work tough, so your business can keep moving.

Contact Abel Womack  
800.554.2887  
[www.abelwomack.com](http://www.abelwomack.com)

Due to continuous product improvement, specifications are subject to change without notice or obligation. Some systems and features shown are optional at extra cost. DuraSource is a U.S. trademark of The Raymond Corporation. Flow-Rite, Millennium EVO, Pro-Fill, Eagle Eye, Battery Steward, Water Wise, Quick-Fill and Pro-Fill are U.S. trademarks of Flow-Rite Controls, Ltd.

**DURASOURCE**