

Flexible workspace solutions.

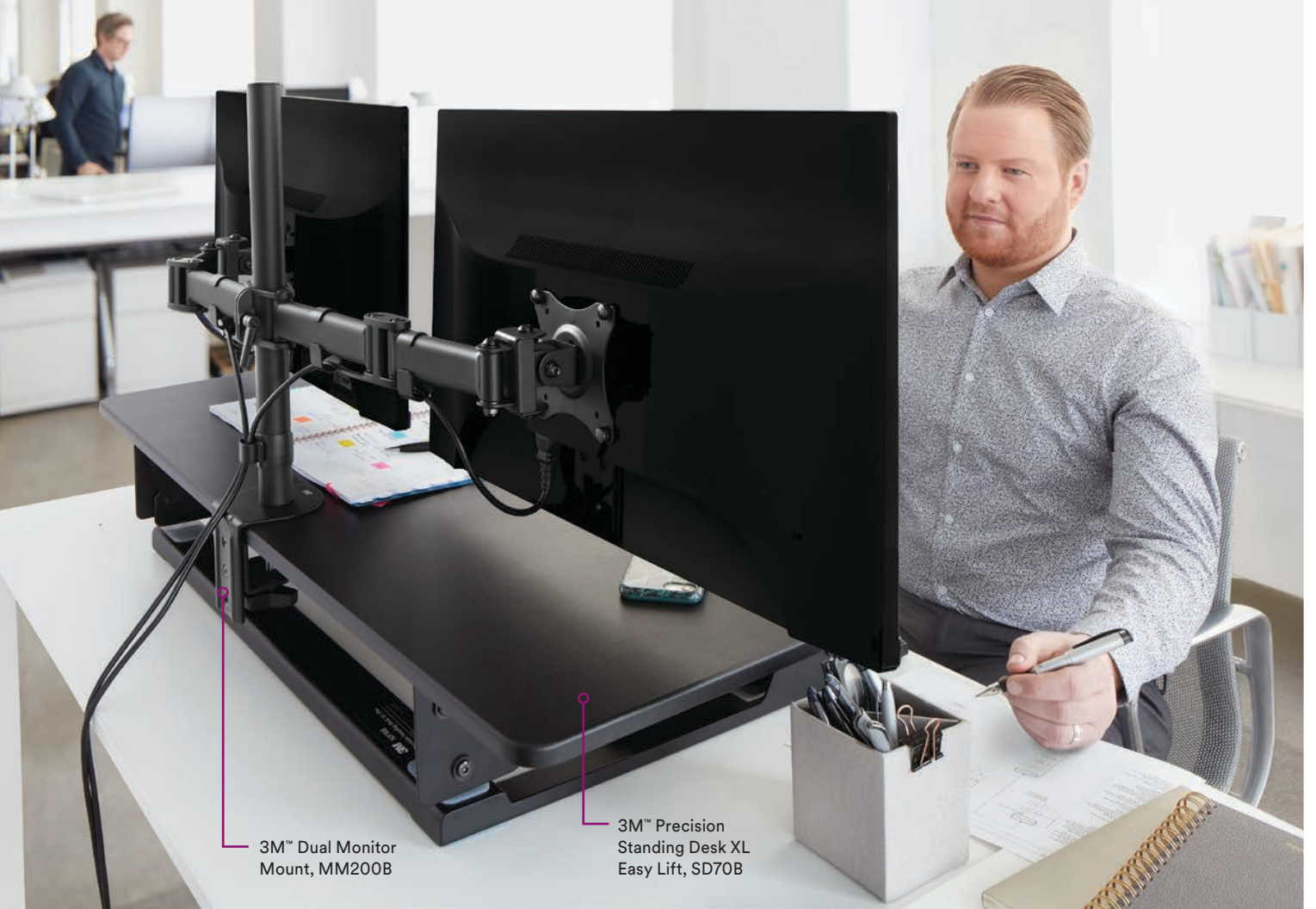



3M™ Dual Monitor Mount, MM200B

3M™ Precision Standing Desk XL Easy Lift, SD70B

Unequaled workspace performance.

Advanced science to improve how you work.

As a leader in technology, 3M strives to make life easier for people around the world. Our team generates breakthroughs in design to maximize space and drive productivity, so you can perform at your best.

The right fit to help you focus.

3M offers a wide range of workspace products that are tailored for the way you work. Our Workspace Solutions are effective for open layouts or private offices, and for spacious or confined environments. Whatever your space, we help create more comfortable and functional work stations.

Love where you work.

Our Workspace Solutions reflect the latest industry designs to help you create a more organized and stylish office. At 3M, we also value sustainability and we make many of our products with recycled content to minimize our environmental impact.

Expect excellence from 3M.

With over a century of performance and ongoing lab testing, 3M strives to offer you exceptional ergonomic Workspace Solutions and high-quality products that allow you to work with confidence.

3M™ Monitor Whiteboard,
MWB100B

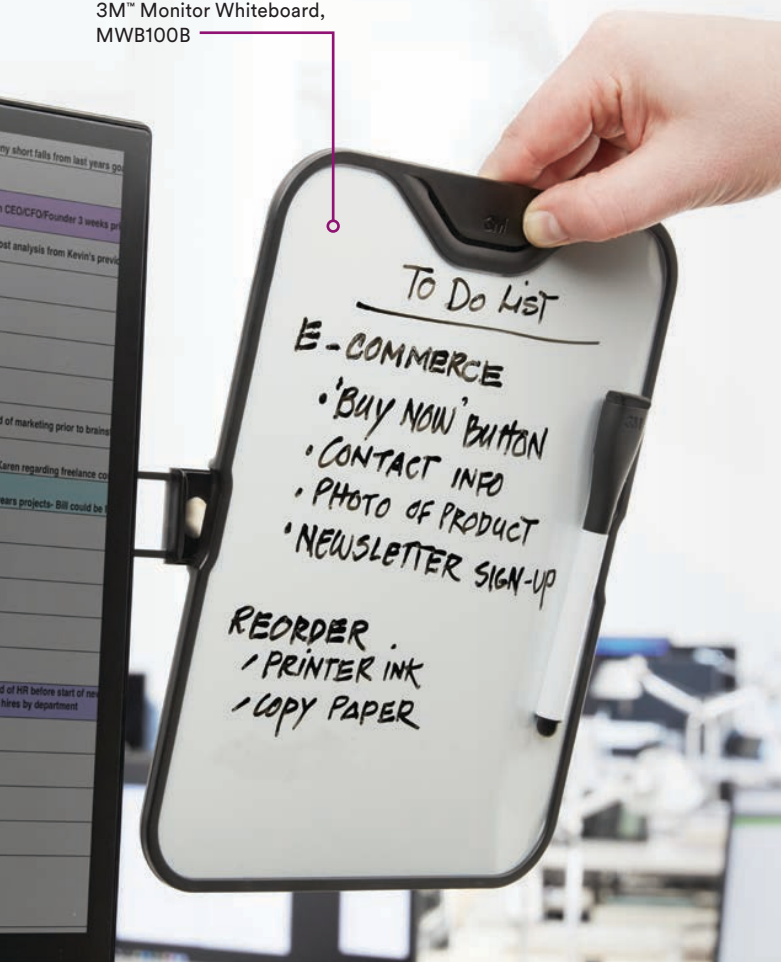

Table of Contents

Standing Desks	4
Dual Monitor Mount	6
Monitor Arms	7
Monitor Stands	9
Laptop Stands	10
Monitor Whiteboard	12
Document Holders	13
Adjustable Keyboard Trays and Accessories	14
Keyboard Drawers	18
Cleaning Solutions	18
CPU Mounts/Stands	19
Foot Rests	19
Ergonomic Mouse	20
Wrist Rest Technology	21
Wrist Rest Platforms	21
Gel Wrist Rests	22
Mouse Pads	23
Privacy Filters	24

**Make the most of your space.
Products accompanied by these
icons feature:**



3M's unique gel technology
for optimal comfort.



Recycled content.



Advanced antimicrobial
product protection.

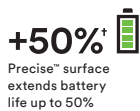

Precise™ surface that can
extend battery life of
wireless mice up to 50%.



Trusted Command™ Brand
mounting solution.

Does your work environment need an upgrade?

Visit our website to learn how 3M Workspace
Solutions can enhance your productivity and
comfort while maximizing your space.

www.3M.com/myworkspace

†3M™ Precise™ Mouse Pads with battery saving design draw less current
than darker mousing surfaces, which results in extended battery life.

3M™ Precision Standing Desks

When it comes to standing comfort, small adjustments can make a big difference!



3M™ Precision Standing Desks provide maximum adjustability to achieve your most comfortable standing work position.

Side-mounted levers control the gas assist height change technology to allow for continuous height settings from 6.2"–20" above the desk surface. The keyboard surface has a tilt adjustment range of -10°/+10° to help achieve your most comfortable typing position.

3M™ Precision Standing Desks also include a 3M™ Gel Wrist Rest for Keyboards and a 3M™ Precise™ Mouse Pad with Battery Saving Design† for added comfort and productivity.

The standing workstations ship fully assembled and easily fit on top of a 24" deep desk or a 32" deep corner desk which eliminates the need for professional installers. 3M™ Precision Standing Desks are made from 45% postconsumer recycled content and have a limited 5-year warranty.

Make the most of your standing desk

3M™ Precision Standing Desks coordinate with the full portfolio of 3M Workspace Solutions to help you get organized and make the most of your space.



Gas assist continuous height adjustment allows you to move smoothly and quietly between sitting and standing positions in seconds.



+10°/-10° keyboard surface tilt to help achieve comfortable typing position.



Standard grommet opening in primary work surface allows cable management or mounting of a monitor arm.



Height adjustment range of 13.8" raises display surface from 6.2"–20" above the desk which accommodates a wide range of users.



Includes 3M™ Gel Wrist Rest for your keyboard and 3M™ Precise™ Mouse Pad with Battery Saving Design.†



+50%†



SD60B/SD60W: primary work surface large enough to fit two 24" monitors and lift up to 35 lbs.

SD70B: primary work surface large enough to fit two 27" monitors and lift up to 45 lbs.

SD80B: primary work surface large enough to fit two 27" monitors and lift up to 35 lbs.

†3M™ Precise™ Mouse Pads with battery saving design extend battery life up to 50%. They draw less current than darker mousing surfaces, which results in extended battery life.

3M™ Precision Standing Desks

Available in three models to meet your workspace needs.



Product	3M™ Precision Standing Desk, SD60B/SD60W	3M™ Precision Standing Desk XL Easy Lift, SD70B	3M™ Precision Standing Desk Corner, SD80B
Suggested Desk Work Tool Configuration	Single monitor or laptop Single monitor and laptop not on monitor arm Two monitors ≤ 24" not on monitor arm	Two monitors 24"-27" Two monitors ≤ 27" on a monitor arm Monitor and laptop on monitor arm Smaller users with most work tool configurations	Corner of a 90° desk One or two monitors up to 27" and/or laptop, with or without monitor arm
Ships Fully Assembled, No Installation Needed	Yes	Yes	Yes
Footprint (Space Needed) on Desk	35.4" W x 23.2" D	42" W x 23.2" D	42" W x 31.2" D
Display Surface Dimensions	35.4" W x 15.7" D	42" W x 15.7" D	42" W x 23.7" D
Keyboard Platform Dimensions	26.4" W x 13" D	26.4" W x 13" D	26.4" W x 13" D
Weight Capacity	35 lbs.	45 lbs.	35 lbs.
Lift	13.8"	13.8"	13.8"
Height of Work Surface Above Desk Surface — Extended	20"	20"	20"
Height Settings	Continuous	Continuous	Continuous
Keyboard Platform Tilt Range	+10°/-10°	+10°/-10°	+10°/-10°
Wrist Rest and Mouse Pad Included	Yes	Yes	Yes
Product Weight	40 lbs.	43 lbs.	42 lbs.
Shipping Weight	48 lbs.	55 lbs.	55 lbs.
Recycled Content 	45% Postconsumer	45% Postconsumer	45% Postconsumer
Warranty	5 Years	5 Years	5 Years
Cord Management Included	Yes	Yes	Yes
Meets BIFMA Specifications (x 5.5-2014)	Yes	Yes	Yes
Available Colors	Black, White	Black	Black

Dual Monitor Mount

Free up valuable desk space and bring your monitor to a comfortable viewing height and distance while sitting or standing.



Shown in use with 3M™ Precision Standing Desk XL Easy Lift, SD70B

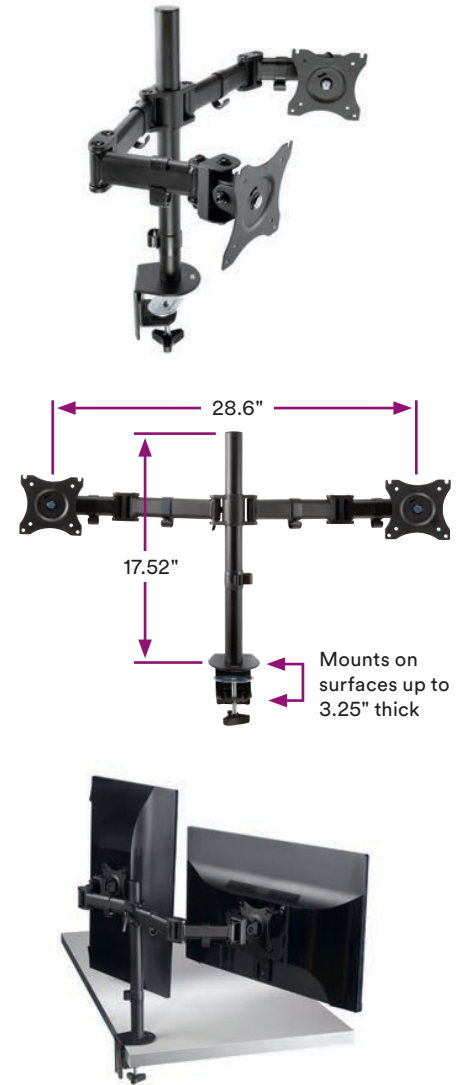

3M™ Dual Monitor Mount, MM200B

- Sturdy steel construction holds two monitors up to 28.5" W and 20 lbs. each
- Fully Adjustable:
 - Height: 15" Range on Pole
 - Rotation (Portrait to Landscape): 360°
 - Tilt (Forward/Back): +45° to -45°
 - Pan (Left/Right): +90° to -90°
 - Arm Swivel with Clamp Mount (Forward/Back): 90°
- Easily clamp mounts to surfaces up to 3.25" thick, no tools needed (grommet mount also available)
- Cord management clips on the arms and pole
- VESA MIS-D 75 mm x 75 mm and 100 mm x 100 mm compatible
- Pair with the 3M™ Precision Standing Desk for comfort and productivity

Specifications

Height Adjustment Range	15"
Tilt Range (Forward/Back)	+45°/-45°
Pan (Left/Right)	+90°/-90°
Arm Swivel with Clamp Mount (Forward/Back)	90°
Arm Swivel with Grommet Mount (Forward/Back)	180°
Rotation (Portrait/Landscape)	360°
Arm Extension Assembled	15"
Weight Capacity Per Arm	20 lbs.
Size Capacity Per Arm	≤ 28.5" W
Clamp Mounting Surface Thickness	up to 3.25"
Grommet Mounting Hole Size	½"-3.5"
Grommet Mounting Surface Thickness	up to 3.25"
Warranty Years	3

Monitor Arms

Use a monitor arm to free up space on your desk and easily move your monitor into a comfortable height for viewing, or out of the way when not in use.



Adjust to reduce screen glare or offer better views of content

Internal cable management keeps cables neatly under arm



MALAPTOP2

Pair an MA265S Easy-Adjust Dual Monitor Arm with an MALAPTOP2 Monitor Arm Laptop Tray Attachment to experience the productivity benefits of using two displays.

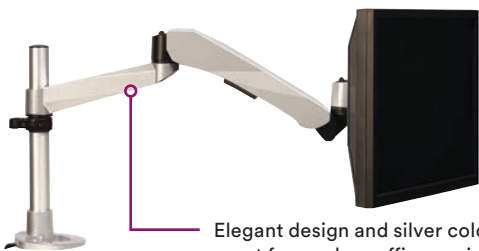

Elegant design and silver color are great for modern office environments

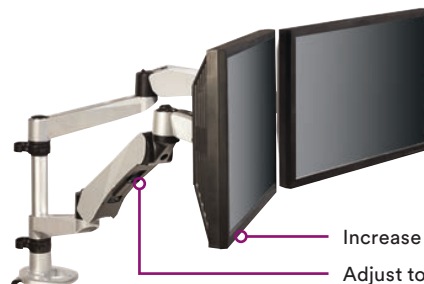

Increase productivity with two displays
Adjust to offer screen sharing

MA245S Easy-Adjust Monitor Arm

- Highly adjustable arm moves up, down, forward and back with just a touch; height adjusts through 10.6" range
- Swivels 180° and tilts forward and back +15°/-90° for optimal ergonomic positioning
- Monitor can rotate portrait or landscape
- Includes clamp mount hardware which fits desks up to 4" thick and grommet mount hardware which fits desks up to 1.75" thick
- Weight capacity of 20 lbs.
- Monitor screen size ≤ 27"
- VESA MIS-D 75 mm x 75 mm and 100 mm x 100 mm compatible
- 5 year warranty

MA265S Easy-Adjust Dual Monitor Arm

- Highly adjustable arms move up, down, forward and back with just a touch; height adjusts through 10.6" range
- Swivels 180° and tilts forward and back +15°/-90° for optimal ergonomic positioning
- Includes clamp mount hardware which fits desks up to 2.25" thick and grommet mount hardware which fits desks up to 2" thick
- Monitor can rotate to portrait or landscape
- Weight capacity of 20 lbs. per arm
- Monitor screen size ≤ 27"
- VESA MIS-D 75 mm x 75 mm and 100 mm x 100 mm compatible
- 5 year warranty

MA140MB Dual-Swivel Monitor Arm

- Provides 7 ½" of pole height adjustability, up to 18 ½" height adjustability from the surface and extends 19 ½" from the base
- Includes clamp mount hardware which fits desks up to 2.25" thick and grommet mount hardware which fits desks up to 2" thick
- Weight capacity of 30 lbs.
- VESA MIS-D 75 mm x 75 mm and 100 mm x 100 mm compatible
- 3 year warranty

MA260MB Easy-Adjust Dual Monitor Arm*

35% 

- Adjustable arms easily move up, down, forward and back; height adjusts through 12.4" range
- Swivels 180° and tilts forward and back +55°/-90° for optimal ergonomic positioning
- Clamp mount hardware fits desk up to 2 5/8" thick and grommet mount hardware fits desks up to 3" thick
- Weight capacity of 20 lbs. per arm
- Monitor screen size ≤ 27"
- VESA MIS-D 75 mm x 75 mm and 100 mm x 100 mm compatible
- 5 year warranty



Comfortable viewing height helps reduce eye, back and neck strain

Arm moves in and out and side to side



Rotates from landscape to portrait for optimal viewing

Extends 19 ½" from the base



*Use of this product helps contribute to LEED® Green Building Certification EB O&M MR Credit 2.2 Sustainable Purchasing: Durable goods because 3M™ Easy-Adjust Dual Monitor Arm MA260MB contains a minimum of 20% preconsumer recycled content, exceeding the recycled content required in Credit 2.2.

Monitor Stands



MS85B Adjustable Monitor Stand

- Maximize your desktop space with the sleek, elevated design of the 3M™ Adjustable Monitor Stand
- Height adjustable from 1.7" to 5.5" in increments of 1.25" to get to a comfortable viewing height
- Stable support for monitors up to 20 lbs.
- Recessed platform helps keep essential tools (phone, pens, notes, etc.) close by and easy to find
- 16" x 12" x 5.54"



MS90B Adjustable Monitor Stand — Extra Wide MS80B Adjustable Monitor Stand

- Contemporary design with stacking columns raises monitor from 1" to 5.875" in increments of 1.625"
- Features ample storage space underneath
- Non-skid base
- 30 day warranty



MS90B

- Weight capacity of 40 lbs.
- 16" clearance between columns
- 20" x 12" x 5.8"

MS80B

- Weight capacity of 80 lbs.
- 11" clearance between columns
- 15" x 12" x 5.8"



Laptop Stands



LX500 Adjustable Laptop Stand

- Height adjustable from 4" to 6" in 0.5" increments
- Cooling slots in platform help keep notebook ventilated
- Weight capacity of 20 lbs.
- Includes side shelves for accessories and an adapter for the 3M™ DH445 Document Holder (sold separately)
- Compatible with docking stations
- 30 day warranty
- 13" x 13" x 4"









LX550 Vertical Laptop Stand





- Space-saving riser provides ideal viewing position
- Features 3" of vertical height adjustment
- Includes a non-skid base and holding ledge with a cable management feature to keep your cords organized
- 30 day warranty
- 7.25" x 12.5" x 3"



Comparison Chart

For Monitor Arms, Monitor Stands and Laptop Stands

	Monitor Arms				Monitor Mount
	MA265S	MA245S	MA260MB	MA140MB	MA200MB
					
Features Easy Adjust Technology	Yes	Yes	Yes	No	No
Monitor Weight Capacity	20 lbs.	20 lbs.	20 lbs.	30 lbs.	20 lbs.
Notebook Weight Range	4.4–20 lbs.	4.4–20 lbs.	2.5–20 lbs.	-	-
Height Range of Adjustable Segments	10.6"	10.6"	12.4"	7.5"	15" on pole
Tilt Range Forward/Backward	+15°/-90°	+15°/-90°	+55°/-90°	+15°/-90°	+45°/-45°
Swivel Left/Right	180°	180°	180°	180°	180°
Rotation Portrait/Landscape	360°	360°	360°	360°	360°
VESA MIS-D 75 mm and 100 mm Compatibility	Yes	Yes	Yes	Yes	Yes
Clamp Mount Max Surface Thickness	2.25"	4"	2.625"	2.25"	3.25"
Clamp Mount Min Surface Thickness	.5"	.5"	.5"	.5"	.5"
Grommet Mount Max Surface Thickness	2"	1.75"	3"	2"	3.25"
Grommet Mount Min Hole Size	.5"	.5"	.5"	.5"	.5"
Grommet Mount Max Hole Size	3"	3"	2"	3"	3.5"
Max Extension Length	24.5"	24.5"	25.5"	19.5"	15"
Max Mount Plate Height From Surface	27.5"	27.5"	27"	18.5"	15.6"
Min Mount Plate Height From Surface	7"	7"	5"	10.5"	7"
Recycled Content 	N/A	N/A	35%	N/A	N/A
Warranty Years	5	5	5	3	3

	Monitor Stands			Laptop Stands	
	MS85B	MS90B	MS80B	LX550	LX500
					
Monitor Weight Range lbs. (kg.)	0-20 (0-9.1)	0-40 (0-18.1)	0-80 (0-36.3)	N/A	N/A
Laptop Weight Range lbs. (kg.)	0-20 (0-9.1)	0-40 (0-18.1)	0-80 (0-36.3)	0-20 (0-9.1)	0-20 (0-9.1)
Height Range of Adjustable Segment Inches (mm)	3.8" (96.5)	4" (102)	4" (102)	3" (76)	2" (51)
Height Adjustable Increments Inches (mm)	1.25" (31.8)	1.625" (41.3)	1.625" (41.3)	Infinite	0.5" (12.7)
Warranty	30 days	30 days	30 days	30 days	30 days

Monitor Whiteboard

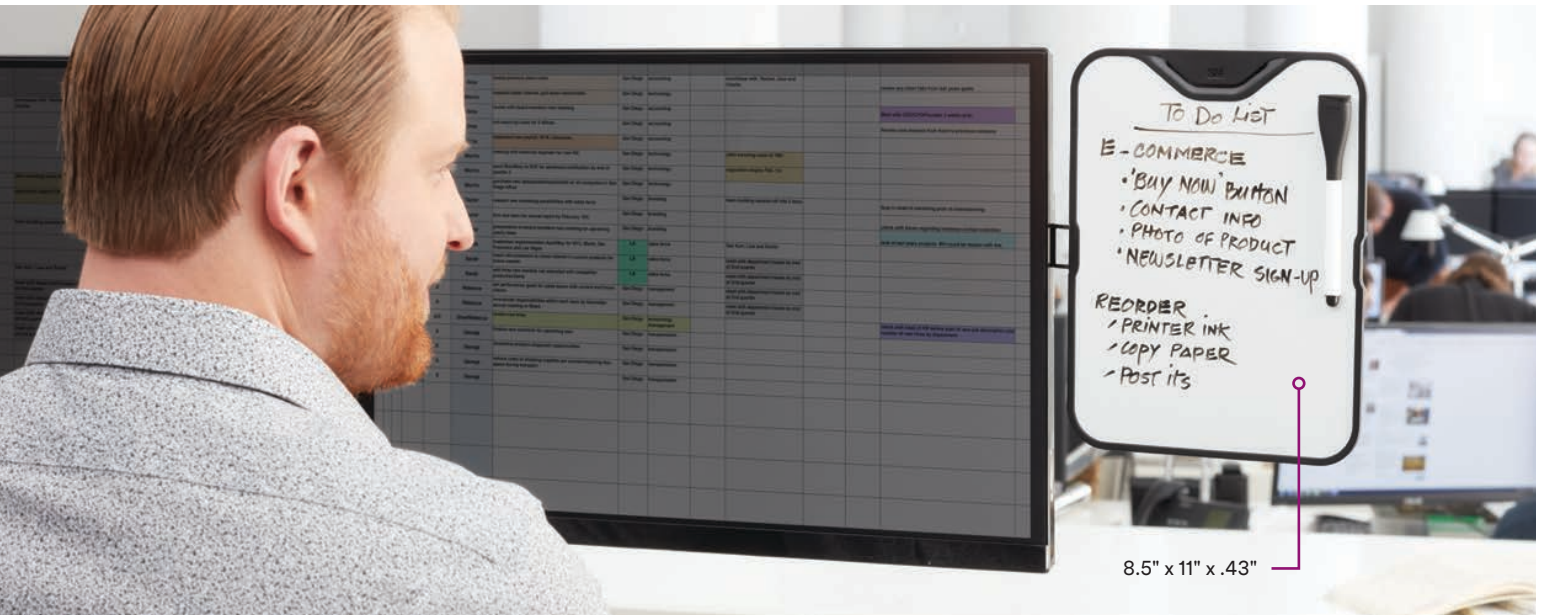

3M™ Monitor Whiteboard MWB100B

A dry erase panel that attaches securely to your computer monitor with a Command™ Adhesive Strip keeping your “to do” list, reminders and tasks organized, front and center so you get more done.

Free up your mind and your space with the 3M™ Monitor Whiteboard.

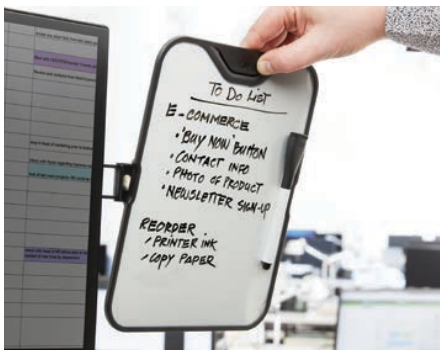

Features a magnetic attachment system (left and right-handed), that's easy to detach for quick and comfortable writing.



Includes dry erase marker with magnetic cap and eraser that attaches directly to the whiteboard.



Built in document clip holds up to 10 sheets.



Attach to your computer monitor with a Command™ Adhesive Strip

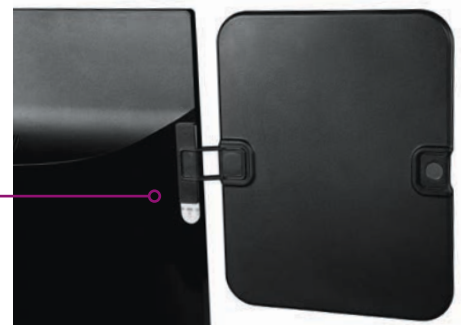

Document Holders



Desktop Mounted

Place documents in-line with your monitor and keyboard reducing movement of eyes, neck and shoulders, minimizing strain and increasing comfort.

DH640 In-Line Document Holder* 40% ♻️ DH630 Compact In-Line Document Holder

- The stable, weighted base allows ledge to dip below the desk edge, increasing desk space
- Elastic line guide marks your place, keeps pages open and stretches to accommodate even the thickest book:
- Hold books, catalogs, manuals or just a single reference sheet



DH640

- 18" wide backplate
- Sheet capacity: 300 sheets**
- 5 year warranty

DH630

- 14" wide backplate
- Sheet capacity: 150 sheets**
- 2 year warranty



DH340MB Desktop Document Holder

- Keep your documents upright and improve their viewing position
- Height-adjustable clip secures documents in portrait or landscape view
- Non-skid base ensures the holder remains just where you need it
- Holds letter or legal-sized documents and folds flat for easy storage
- Sheet capacity: 150 sheets**
- 30 day warranty



Monitor Mounted

Position documents at eye level, right next to your monitor on either the right or left side. All models easily fold away when not in use.

DH445 Flat Panel Document Holder

- Sleek design for use with flat panel monitors
- Height adjustable clip secures sheets in portrait or landscape
- Sheet capacity: 35 sheets**
- 30 day warranty



DH240MB Document Clip

- Lets you slide in up to 5 sheets one-handed or securely clip up to 30 sheets
- Sheet capacity: 30 sheets**
- 30 day warranty



Command™ Adhesive Attachment System

DH630, DH445 and DH240MB feature Command™ Adhesive to hold securely yet remove cleanly.



*Use of this product helps contribute to LEED® Green Building Certification EB O&M MR Credit 2.2 Sustainable Purchasing: Durable goods because 3M™ Document Holder DH640 contains a minimum of 20% preconsumer recycled content, exceeding the recycled content required in Credit 2.2.

**Angle and height position can affect sheet capacity. Test before using.

Selecting the Right Adjustable Keyboard Tray is as Easy as 1-2-3!

1 Select your preferred arm type based on ease of adjustment.



Easy-Adjust Arm
Easy to adjust — just tilt platform, adjust and release to lock in place. Tilt is adjusted by dialing tilt knob to desired angle. Includes height and tilt read-outs.



Lever-Adjust Arm
Lever handle ensures positive lock on platform height. Just flip lever to right, adjust height and move lever back to lock in place. Tilt is adjusted with separate pull lever.



Knob-Adjust Arm
Knob adjusts both height and tilt. Just loosen knob, set height and tilt, and re-tighten.

2 Choose a keyboard platform that's right for you.



Adjustable Platform KP200LE
Sturdy platform has proprietary lateral adjustments for optimal keyboard adjustment. Articulating mousing platform adjusts in all directions, tilts forward and back, and can be mounted on the left or right side of the keyboard platform.



Standard Platform KP100LE
Standard all-in-one platform with wooden construction minimizes bouncing. Mousing surface can be placed to the right or the left of the keyboard.

3 Where are you sitting?

Determine the track length you need for your workstation.

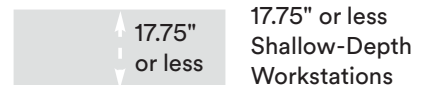
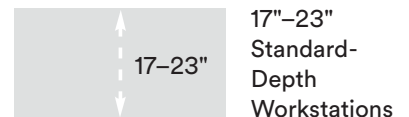
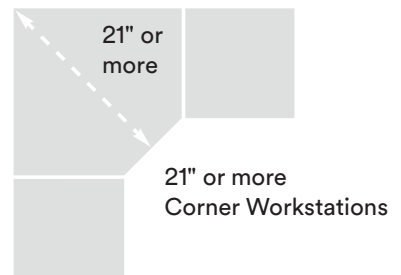

Adjustable Keyboard Tray Accessories

CM100MB Corner Maker

- Transform a 90° corner workstation into a bridged corner so a keyboard tray can be mounted in the corner
- Use with 3M™ Adjustable Keyboard Trays AKT180LE, AKT170LE, AKT150LE, AKT90LE or AKT70LE
- Fits track lengths of 21.75" or greater
- Fits workstations from 0.75" to 1.5" thick
- 2 year warranty
- 17" wide front ledge



Adjustable Keyboard Trays

The Keyboard Tray you need. The features you want. 3M™ Adjustable Keyboard Trays offer a broad line of solutions with innovative features and thoughtful design to fit almost any workstation environment.

AKT150LE Easy Adjust Keyboard Tray

25% 

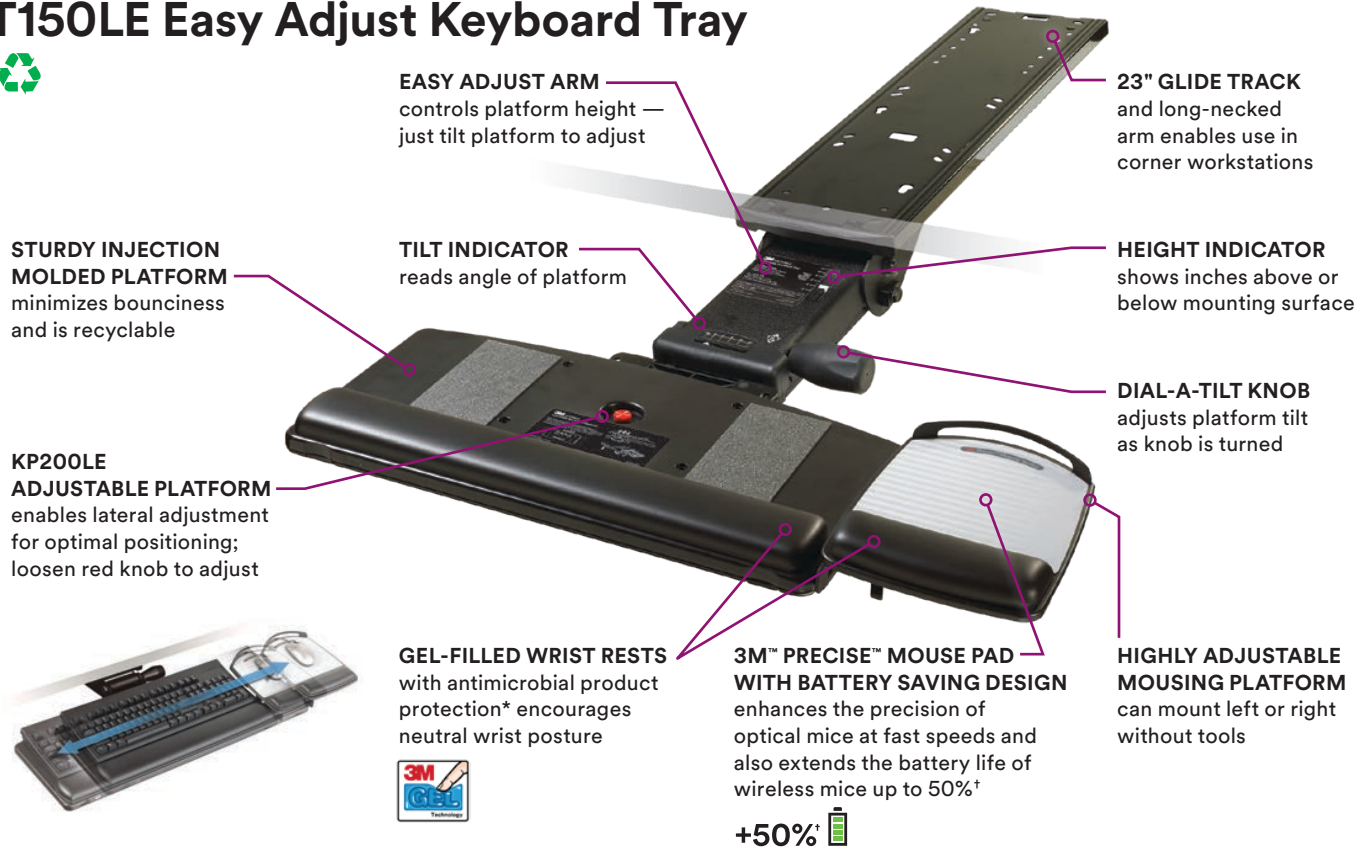

EASY ADJUST ARM
controls platform height — just tilt platform to adjust

23" GLIDE TRACK
and long-necked arm enables use in corner workstations

STURDY INJECTION MOLDED PLATFORM
minimizes bounciness and is recyclable

TILT INDICATOR
reads angle of platform

HEIGHT INDICATOR
shows inches above or below mounting surface

KP200LE ADJUSTABLE PLATFORM
enables lateral adjustment for optimal positioning; loosen red knob to adjust

DIAL-A-TILT KNOB
adjusts platform tilt as knob is turned

GEL-FILLED WRIST RESTS
with antimicrobial product protection* encourages neutral wrist posture

3M™ PRECISE™ MOUSE PAD WITH BATTERY SAVING DESIGN
enhances the precision of optical mice at fast speeds and also extends the battery life of wireless mice up to 50%†

HIGHLY ADJUSTABLE MOUSING PLATFORM
can mount left or right without tools

+50%† 

AKT60LE Knob Adjust Keyboard Tray

70% 

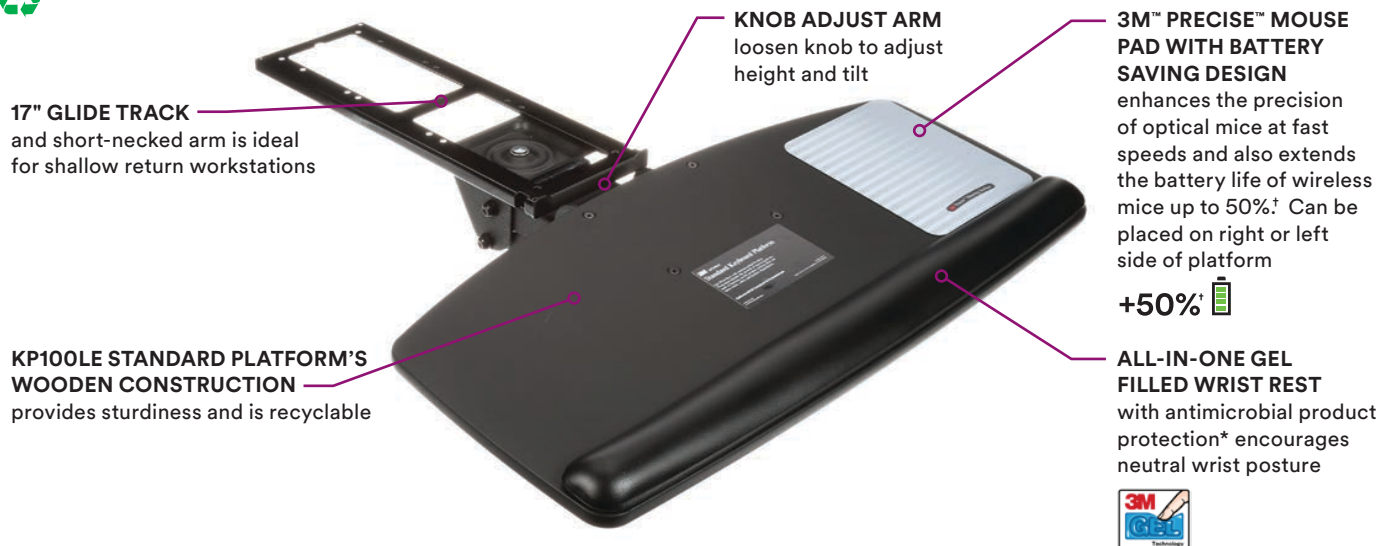

17" GLIDE TRACK
and short-necked arm is ideal for shallow return workstations

KNOB ADJUST ARM
loosen knob to adjust height and tilt

3M™ PRECISE™ MOUSE PAD WITH BATTERY SAVING DESIGN
enhances the precision of optical mice at fast speeds and also extends the battery life of wireless mice up to 50%†. Can be placed on right or left side of platform

KP100LE STANDARD PLATFORM'S WOODEN CONSTRUCTION
provides sturdiness and is recyclable

+50%† 

ALL-IN-ONE GEL FILLED WRIST REST
with antimicrobial product protection* encourages neutral wrist posture

3M™ Keyboard Trays are manufactured using recycled material. The  and corresponding number indicate the percentage of recycled content in a given product.



*Antimicrobial Product Protection: Gel-filled wrist rests with antimicrobial protection inhibit the growth of microorganisms, such as bacteria, on the product surface, that can cause stains, odors and product degradation.

†3M™ Precise™ Mouse Pads with battery saving design draw less current than darker mousing surfaces, which results in extended battery life.

Comparison Chart

For Keyboard Trays with the adjustable platform KP200LE



Product Number	AKT180LE	AKT150LE	AKT80LE
Articulating Arm Type	Sit/Stand Easy Adjust	Easy Adjust	Knob Adjust
			
Track Length	23" (584 mm)	23" (584 mm)	17.75" (451 mm)
Tilt Range Forward/Backward	+10°/-15°	+10°/-15°	+15°/-15°
Height Above Mounting Surface	10" (254 mm)	4" (102 mm)	1.5" (38.1 mm)
Depth Below Mounting Surface	4" (102 mm)	6" (152 mm)	4.5" (114 mm)
Swivel	360°	360°	360°
Platform Width	19.5" (495 mm)	19.5" (495 mm)	19.5" (495 mm)
Minimum Width of Keyboard and Mousing Platforms	23.5" (597 mm)	23.5" (597 mm)	23.5" (597 mm)
Maximum Width of Keyboard and Mousing Platforms	26.5" (673 mm)	26.5" (673 mm)	26.5" (673 mm)
Platform Depth	10.625" (270 mm)	10.625" (270 mm)	10.625" (270 mm)
Required Depth Under Mounting Surface	23.25" (591 mm)	23.25" (591 mm)	18" (457 mm)
Required Width Under Mounting Surface	24" (610 mm)	24" (610 mm)	24" (610 mm)
Suitable for Corner Workstations	Yes	Yes	No
Required Minimum Length for Diagonal Corner	17" (432 mm)	17" (432 mm)	-
Required Minimum Radius for Curved Corner	12" (305 mm)	12" (305 mm)	-
Stows Completely Under Mounting Surface	Yes	Yes	Yes
Height Indicator	Yes	Yes	No
Tilt Indicator	Yes	Yes	No
Tool Free Installation	No	No	No
Gel-filled Wrist Rests with Antimicrobial Product Protection*	Yes	Yes	Yes
3M™ Precise™ Mouse Pad with Battery Saving Design†	Yes	Yes	Yes
Meets BIFMA Specifications (x 5.5-2014)	Yes	Yes	Yes
Warranty Years	Lifetime on Keyboard Arm. 5 years on Keyboard Tray. 1 year on Gel Wrist Rests.		
 % Preconsumer Recycled Content**	25	25	25

*Antimicrobial Product Protection: Gel-filled wrist rests with antimicrobial protection inhibit the growth of microorganisms, such as bacteria, on the product surface, that can cause stains, odors and product degradation.





**Use of this product helps contribute to LEED® Green Building Certification EB O&M MR Credit 2.2 Sustainable Purchasing: Durable goods because 3M™ Adjustable Keyboard Trays contain a minimum of 20% preconsumer recycled content, exceeding the recycled content required in Credit 2.2.

†3M™ Precise™ Mouse Pads with battery saving design draw less current than darker mousing surfaces, which results in extended battery life.

Comparison Chart

For Keyboard Trays with the standard platform KP100LE



Product Number	AKT170LE	AKT90LE	AKT70LE	AKT65LE	AKT60LE
Articulating Arm Type	Sit/Stand Easy Adjust	Easy Adjust	Lever Adjust	Knob Adjust	Knob Adjust
					
Track Length	23" (584 mm)	23" (584 mm)	21.75" (552 mm)	17" (432 mm)	17" (432 mm)
Tilt Range Forward/Backward	+10°/-15°	+10°/-15°	+10°/-15°	+15°/-15°	+15°/-15°
Height Above Mounting Surface	10" (254 mm)	4.5" (114 mm)	.5" (12.7 mm)	1.25" (31.75 mm)	1.25" (31.75 mm)
Depth Below Mounting Surface	4" (102 mm)	6" (152 mm)	5.5" (140 mm)	4.5" (114 mm)	4.5" (114 mm)
Swivel	360°	360°	360°	360°	360°
Platform Width	25.5" (648 mm)	25.5" (648 mm)	25.5" (648 mm)	25.5" (648 mm)	25.5" (648 mm)
Minimum Width of Keyboard and Mousing Platforms	-	-	-	-	-
Maximum Width of Keyboard and Mousing Platforms	-	-	-	-	-
Platform Depth	12" (305 mm)	12" (305 mm)	12" (305 mm)	12" (305 mm)	12" (305 mm)
Required Depth Under Mounting Surface	23.25" (591 mm)	23.25" (591 mm)	22" (559 mm)	17.25" (438 mm)	17.25" (438 mm)
Required Width Under Mounting Surface	26" (660 mm)	26" (660 mm)	26" (660 mm)	26" (660 mm)	26" (660 mm)
Suitable for Corner Workstations	Yes	Yes	Yes	No	No
Required Minimum Length for Diagonal Corner	17" (432 mm)	17" (432 mm)	17" (432 mm)	-	-
Required Minimum Radius for Curved Corner	12" (305 mm)	12" (305 mm)	12" (305 mm)	-	-
Stows Completely Under Mounting Surface	Yes	Yes	Yes	Yes	Yes
Height Indicator	Yes	Yes	No	No	No
Tilt Indicator	Yes	Yes	No	No	No
Tool Free Installation	No	No	No	Yes	No
Gel-filled Wrist Rests with Antimicrobial Product Protection*	Yes	Yes	Yes	Yes	Yes
3M™ Precise™ Mouse Pad with Battery Saving Design†	Yes	Yes	Yes	Yes	Yes
Meets BIFMA Specifications (x 5.5-2014)	Yes	Yes	Yes	Yes	Yes
Warranty Years	Lifetime on Keyboard Arm. 5 years on Keyboard Tray. 1 year on Gel Wrist Rests.				
 % Preconsumer Recycled Content**	70	70	70	70	70

*Antimicrobial Product Protection: Gel-filled wrist rests with antimicrobial protection inhibit the growth of microorganisms, such as bacteria, on the product surface, that can cause stains, odors and product degradation.

**Use of this product helps contribute to LEED® Green Building Certification EB O&M MR Credit 2.2 Sustainable Purchasing: Durable goods because 3M™ Adjustable Keyboard Trays contain a minimum of 20% preconsumer recycled content, exceeding the recycled content required in Credit 2.2.

†3M™ Precise™ Mouse Pads with battery saving design draw less current than darker mousing surfaces, which results in extended battery life.

Keyboard Drawers



+50%† 
 Precise™ surface
 extends battery
 life up to 50%

KD90 Adjustable Under-Desk Keyboard Drawer

- Keyboard tray provides height adjustments and adjustable tilt to create a personal fit
- Wide platform places the mouse directly beside the keyboard for added comfort and convenience
- Includes 3M™ Precise™ Mouse Pad with Battery Saving Design†
- Leatherette gel wrist rest with antimicrobial product protection*
- Installation depth required: 20"; width required: 30"
- 27.8" W x 16.8" D x 4.0" H
- 5 year warranty



KD45 Adjustable Under-Desk Keyboard Drawer

- Featuring three distinct height positions to ensure the ideal working posture
- Includes an extra-wide tray to match virtually all keyboards
- Steel ball bearings provide smooth operation and movement
- Includes a leatherette gel wrist rest and retractable platform for 3M™ Precise™ Mouse Pad with Battery Saving Design†
- Ready to assemble
- 25" W x 16.5" D x 3.2" H
- 2 year warranty



Cleaning Solutions

573 Desk & Office Cleaner

Excellent for most office surfaces. Foaming action helps reduce running on vertical surfaces. Non-abrasive formula cuts through grease, dirt and grime. Not recommended for computer screens, glass, or varnished and natural wood surfaces. 15 oz. aerosol can.



CL610 Electronic Equipment Cleaning Wipes

Pre-moistened wipes make cleaning the outside of electronics easy. Non-abrasive and safe for use on most electronic equipment surfaces. Cuts through grime and grease. 5" x 7" wipes. 80-count canister.

CL630 Notebook Screen Cleaning Wipes

Removes dust, fingerprints and smudges from notebook computer, flat panel and CRT screens. Non-abrasive, non-streaking. 3.9" x 6.9" pre-moistened portable wipes. 24 individual packages.



*Antimicrobial Product Protection: Gel-filled wrist rests with antimicrobial protection inhibit the growth of microorganisms, such as bacteria, on the product surface, that can cause stains, odors and product degradation.

†3M™ Precise™ Mouse Pads with battery saving design draw less current than darker mousing surfaces, which results in extended battery life.

CPU Mounts/Stands

CS200MB Adjustable Under-desk CPU Mount 50%

Placing your CPU in a convenient, accessible place has never been easier. 360° swivel ensures easy access to the back of the CPU. Mounts to the underside of your work surface on 17" glide track to keep it conveniently accessible. Sturdy steel construction. Great for mobile or rolling workstations. Holds up to 50 lbs. 5 year warranty.



CS100MB Adjustable CPU Stand

Access your CPU quickly and easily without twisting or bending to reach cables and ports. Simply roll the CPU stand forward for access. Width adjustable from 3.75" to 9.25" to fit virtually all CPUs. Two wheels lock in place. Holds up to 50 lbs. 5 year warranty.



Foot Rests

Reduce strain and fatigue on legs, back and neck. Both models offer easy foot-controlled platform tilt adjustment and sturdy steel construction.

FR530CB Adjustable Foot Rest

- Extra-wide 22" platform provides ample space for both feet
- Height and tilt adjustable
- Heavy-duty steel construction for extra stability
- 3M™ Safety-Walk™ Slip-Resistant Surface keeps feet from sliding
- 5 year warranty
- 14" x 22" x 4"



FR330 Adjustable Foot Rest

- Contoured, 18" wide non-skid plastic platform with soft bumps to massage and soothe your feet
- Height and tilt adjustable
- Durable, heavy-duty steel base
- 2 year warranty
- 13" x 18" x 4"



Ergonomic Mouse

EM550 Wireless Ergonomic Mouse

It may feel a little different at first, but before you know it you'll begin to feel the benefits of using a mouse that truly displays ergonomic design at its best.

- Keeps your hand and wrist at a neutral angle, while the mouse works as a regular optical mouse
- Optical sensor, wireless, USB compatible plug and play
- Soft-touch painted surface for added comfort
- For right-handed use only
- 2 year warranty

Sizes

EM550GPL — Large
EM550GPS — Small

EM500 Wired Ergonomic Mouse

With the same ergonomic benefits as the wireless model, this mouse also offers an optical sensor, USB plug and play compatibility plus a 6.5' cord for flexible use. Available in original black design. For right-handed use only. 2 year warranty.

Sizes

EM500GPL — Large
EM500GPS — Small

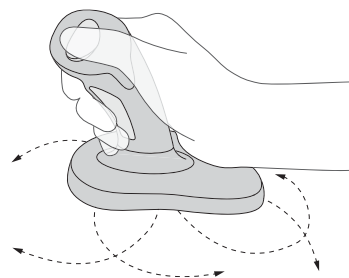

Operate by moving entire mouse around on mousing surface.

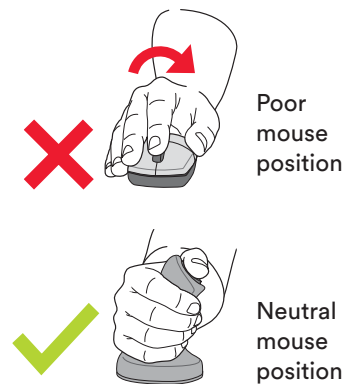

Lay your palm flat along this measuring guide to determine the best mouse size for you.

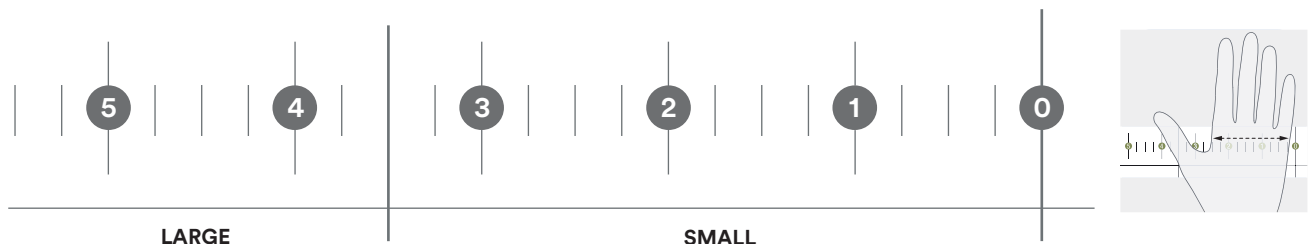

Wrist Rest Technology

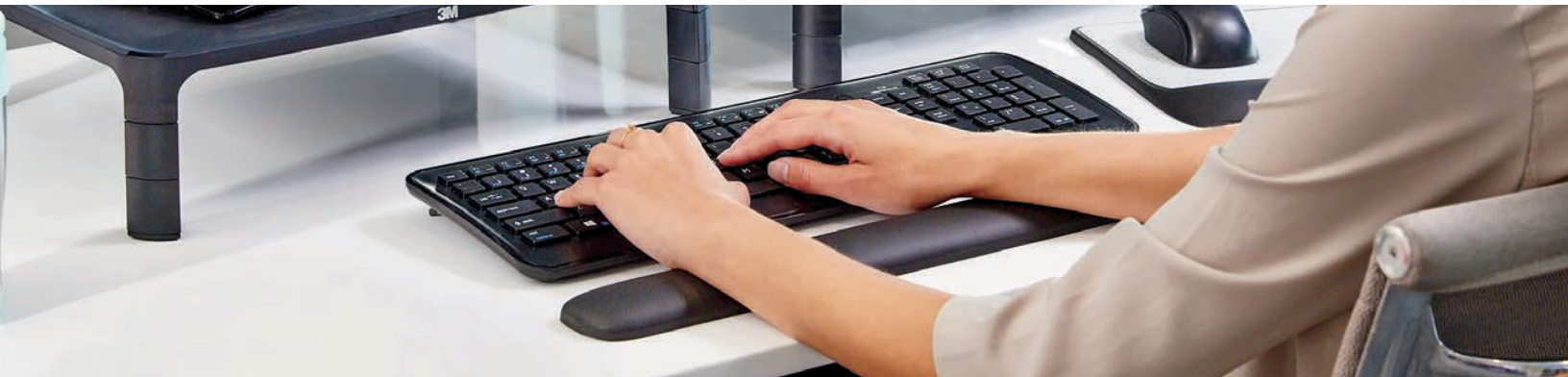

Gel-filled comfort

3M's gel technology creates a wrist rest that is firm enough to provide the support you need, but soft enough for optimal comfort. 3M™ Gel-filled wrist rests are guaranteed not to leak and are puncture-resistant under normal use.



Recycled content

3M™ Gel Wrist Rests with black leatherette coverings are manufactured using preconsumer recycled material. The  and corresponding number indicates the percentage of recycled content by weight in a given product. All 3M™ Wrist Rests are packaged using recyclable material for less environmental impact.



Antimicrobial protection*

3M™ Gel Wrist Rests with black leatherette covers feature antimicrobial product protection which inhibits the growth of microorganisms, such as bacteria, on the product surface, that can cause stains, odors and product degradation.

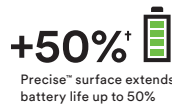

3M™ Precision™ Mouse Pad with Battery Saving Design

Enhance the precision of optical mice at fast speeds and also extend the battery life of wireless mice up to 50%.†

Wrist Rest Platforms

Sleek in appearance and operation, these platforms are designed with tapered wrist rests and rounded corners for comfort beyond compare. Includes incredibly soft gel wrist rests and WR422LE includes 3M™ Precision™ Mouse Pad with Battery Saving Design†. Leatherette wrist rests are easy to clean and feature antimicrobial product protection*.

WR422LE Tilt-Adjustable Platform

For Keyboard and Mouse. Mousing surface repositionable for left handed mousing. 2 year warranty. 25.5" x 10.6" x 1.0"



WR420LE Tilt-Adjustable Platform

For Keyboard. 2 year warranty. 19.6" x 10.6" x 1.0"



*Antimicrobial Product Protection: Gel-filled wrist rests with antimicrobial protection inhibit the growth of microorganisms, such as bacteria, on the product surface, that can cause stains, odors and product degradation.

†3M™ Precision™ Mouse Pads with battery saving design draw less current than darker mousing surfaces, which results in extended battery life.



Gel Wrist Rests

25% 



WR85B*

- Like a satin pillow for your wrist
- Sleek profile takes up minimal desk space
- 1 year warranty
- 19" x 2" x .75"



WR310LE*

- Leatherette Gel Wrist Rest with antimicrobial product protection**
- Can use as replacement wrist rest on keyboard trays with KP200LE adjustable platform
- 1 year warranty
- 19" x 2.8" x .75"



WR340LE*

- Leatherette Gel Wrist Rest with antimicrobial product protection**
- Can use as replacement wrist rest on keyboard trays featuring KP100LE standard platform and KDs 90 and 95CG
- 1 year warranty
- 25" x 2.5" x .75"



WR305LE*

- Leatherette Gel Wrist Rest for Mouse or Trackball with antimicrobial product protection**
- Can use as replacement wrist rest on keyboard trays equipped with KP200LE platform
- 1 year warranty
- 7" x 2.5" x .75"



WR309LE*

- Leatherette Gel Wrist Rest with antimicrobial product protection**
- Can use as replacement wrist rest on keyboard drawer KD45
- 1 year warranty
- 18" x 2.75" x .75"

*Use of this product helps contribute to LEED® Green Building Certification EB O&M MR Credit 2.2 Sustainable Purchasing: Durable goods because 3M™ Gel Wrist Rests contain a minimum of 20% preconsumer recycled content, exceeding the recycled content required in Credit 2.2.



**Antimicrobial Product Protection: Gel-filled wrist rests with antimicrobial protection inhibit the growth of microorganisms, such as bacteria, on the product surface, that can cause stains, odors and product degradation.

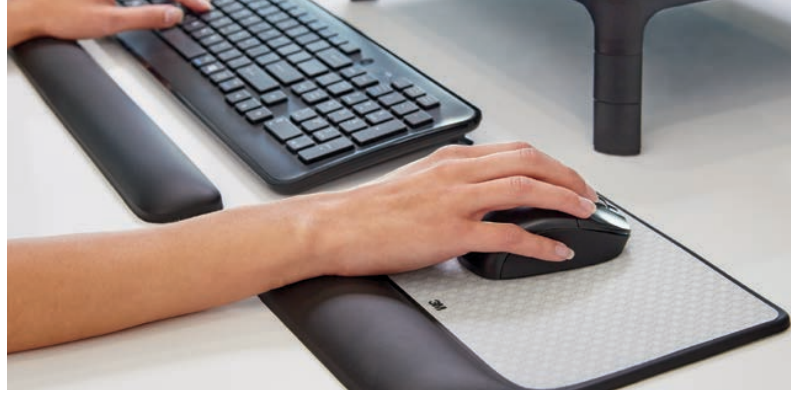

Mouse Pads

Get the most from your wireless or optical mouse with 3M™ Precise™ Mouse Pads with Battery Saving Design. Precise Mouse Pads enhance the precision of optical mice at fast speeds and also extend the battery life of wireless mice up to 50%.†

+50%† 
Precise™ surface extends battery life up to 50%

MW85B Precise™ Mouse Pad with Gel Wrist Rest

- Like a satin pillow for your wrist
- Precise™ mousing surface enhances the precision of optical mice at fast speeds
- Battery saving design extends battery life of wireless mice up to 50%†
- 1 year warranty
- 8.5" x 9" x .7"

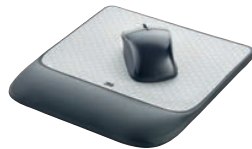

25% 

MP114-BSD1 Precise™ Mouse Pad

- Foam mouse pad with non-skid backing keeps the mouse pad firmly in place
- 9" x 8" x .13"



MW310LE Precise™ Mouse Pad with Gel Wrist Rest — Large

- Leatherette Gel Mouse Pad Wrist Rest with antimicrobial product protection*
- Precise™ surface enhances the precision of optical mice at fast speeds and battery saving design extends the battery life of wireless mice up to 50%†
- 1 year warranty
- 8.7" x 9.2" x .75"



25% 

MP200PS Precise™ Mouse Pad with Repositionable Adhesive Backing

- Ultra-thin pad with 3M repositionable adhesive stays securely positioned on flat surfaces and can be conveniently stored on the back of your laptop computer between uses
- This combination of effortless portability and exceptional functionality makes this mousing surface an ideal solution for anyone computing on the go
- 8.5" x 7" x .06"



MW309LE Precise™ Mouse Pad with Gel Wrist Rest — Small

- Leatherette Gel Mouse Pad Wrist Rest with antimicrobial product protection*
- Precise™ surface enhances the precision of optical mice at fast speeds and battery saving design extends the battery life of wireless mice up to 50%†
- 1 year warranty
- 6.8" x 8.6" x .75"



25% 

†3M™ Precise™ Mouse Pads with battery saving design draw less current than darker mousing surfaces, which results in extended battery life.



*Antimicrobial Product Protection: Gel-filled wrist rests with antimicrobial protection inhibit the growth of microorganisms, such as bacteria, on the product surface, that can cause stains, odors and product degradation.



3M™ Privacy Filters

Keep visual hackers in the dark.

You see your screen with crisp image clarity, while prying eyes beside you see only a black or gold screen. Advanced microlouver technology “blacks out” side views with world-class effective privacy. That’s why people worldwide trust 3M Privacy Products to help keep their private information private, and why 3M is a leader in visual privacy protection.



3M™ Framed Privacy Filters

- Anti-reflective surface creates a quality, high-contrast viewing experience
- Nearly 20% more clarity than standard 3M™ Black Privacy Filters, the best level of clarity for monitors
- Two easy attachment methods: Command™ Strips or Hanger Arms
- Easy to remove for collaboration, sharing or to clean as needed
- Great for high-resolution monitors
- Reduces 35% of blue light transmission from the display

3M™ Gold Privacy Filters

- Proprietary gold effect provides premium privacy with a glossy finish
- Nearly 20% more clarity than standard 3M™ Black Privacy Filters
- Great for high-resolution displays
- Glossy finish for incredible clarity
- Reversible to glossy black
- Reduces 35% of blue light transmission from the display
- Laptop filters come with the 3M™ COMPLY™ Attachment System which allows you to quickly and easily switch from world-class privacy to screen sharing with one simple flip.





3M™ High Clarity Privacy Filters

- Provides excellent privacy while maintaining the glossy clarity of your screen
- Nearly 20% more clarity than standard 3M™ Black Privacy Filters
- Glossy finish on both sides for enhanced clarity
- Great for high-resolution screens
- Reduces 35% of blue light transmission from the display
- Laptop filters come with the 3M™ COMPLY™ Attachment System which allows you to quickly and easily switch from world-class privacy to screen sharing with one simple flip.



3M™ Black Privacy Filters

- Reversible between a glossy side and glare-reducing matte
- Available in landscape or portrait mode
- Maintains incredible image clarity
- Gives screens an added layer of durable protection from dust and scratches
- Easy to attach, remove and clean
- Reduces 35% of blue light transmission from the display
- Laptop filters come with the 3M™ COMPLY™ Attachment System which allows you to quickly and easily switch from world-class privacy to screen sharing with one simple flip.



3M™ Gold Touch Privacy Filters

- Proprietary gold effect provides premium privacy with a glossy finish
- Nearly 20% more clarity than standard 3M™ Black Privacy Filters
- Our thinnest gold privacy filter provides consistent touch responsiveness
- Almost 50% thinner than standard 3M™ Gold Privacy Filters
- Reduces 35% of blue light transmission from the display
- Laptop filters come with the 3M™ COMPLY™ Attachment System which allows you to quickly and easily switch from world-class privacy to screen sharing with one simple flip.



3M™ Black Privacy Filters for Touch Laptops

- Helps protect from visual hackers without getting in the way of using your device
- Ultra-thin and ultra-responsive
- Great for high-resolution screens
- Satin-like matte finish
- Extends edge-to-edge on flat front glass displays
- Reduces 35% of blue light transmission from the display
- Laptop filters come with the 3M™ COMPLY™ Attachment System which allows you to quickly and easily switch from world-class privacy to screen sharing with one simple flip.





Tablet and Phone Privacy and Screen Protection



3M™ Privacy Filters for Tablets

- Easy to attach, remove and reattach so you can share your screen when you want to
- Ultra thin with consistent touch responsiveness
- Fingers slide and swipe easily on satin-like matte surface
- Notice fewer fingerprints and more of what's on your screen
- Reduces 35% of blue light transmission from the display



Virtually invisible protection for smartphones.

Help keep your device looking like new longer with a screen protector that delivers durable scratch resistance, innovative stay-clean edge technology, and such a high degree of optical clarity you'd almost swear there's nothing there.



3M™ Privacy Screen Protectors

- Effective privacy in portrait mode; change device orientation for shareable screen viewing
- Ultra-thin and ultra-responsive to the touch
- Incredible image clarity and glossy finish
- Gives screens an added layer of durable protection from dust and scratches



3M™ Ultra Clear Screen Protectors

- Incredible high-resolution clarity
- Durable protection from dust and scratches
- Smooth, touch-responsive surface
- Attaches easily and removes cleanly



3M™ Anti-Glare Filters and Screen Protectors

Defend against scratches and glare.

Don't let bright light and reflections get between you and your screen. Amazing optical technology from 3M diffuses mirror-like reflections to help keep what's on your screen clear and visible.



3M™ Anti-Glare Filters

- Diffuses light and helps reduce glare
- Improves view in challenging indoor light conditions
- Compatible with most touchscreen displays
- Helps protect from dust and scratches
- Matte surface cleans easily and hides fingerprints



3M™ Anti-Glare Screen Protectors

- Helps diffuse glare and reduce mirror-like reflections
- Lightweight, thin design
- Gives screens an added layer of durable protection from dust and scratches
- Matte surface cleans easily and hides fingerprints

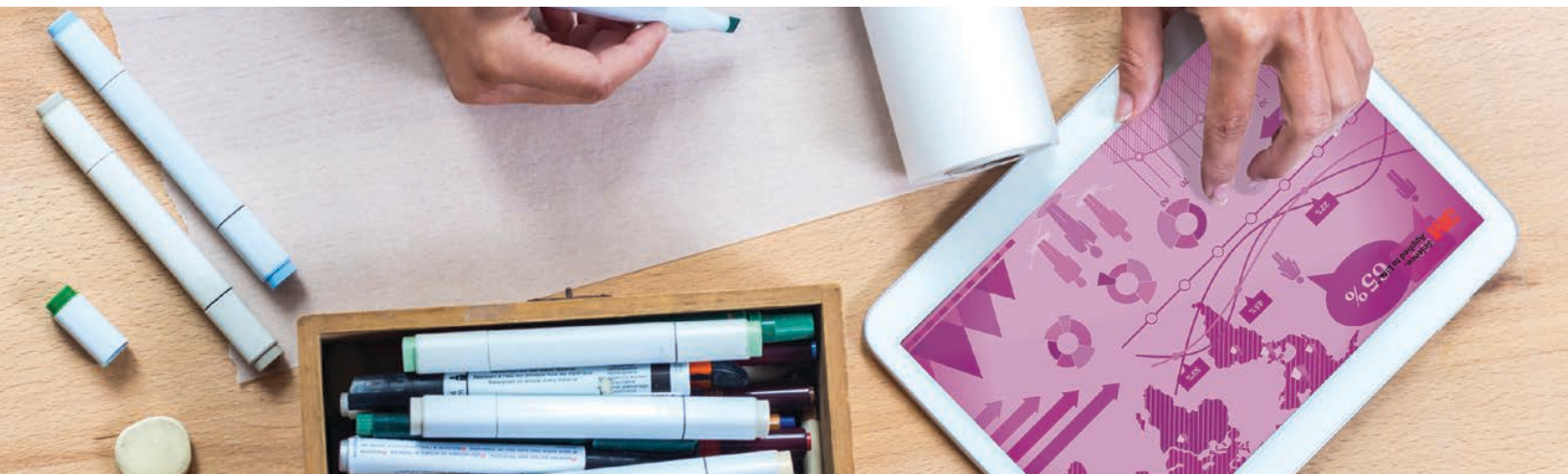

Learn more at 3Mscreens.com
or call 1-800-553-9215.

How to find the right size filter for your device.

Follow these instructions to select the right-size filter for your device.

Step 1: Determine your screen type

Raised Bezel: Screen with a raised frame.

Flat Front Glass Screen: Edge-to-edge glass screen without a raised frame.



Raised Bezel

OR



Flat Front Glass

Step 2: Measure your screen

For a raised bezel screen, measure the height (h) and width (w) of the screen's viewable area within the bezel.

For a flat front glass screen, measure the height (h) and width (w) of the entire glass display.

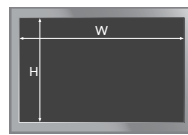

Raised Bezel

OR

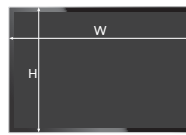

Flat Front Glass

Step 3: Find your filter

Best fit tips:

- Don't see a product that matches your measurements? Select one that is *smaller*, yet closest to your measurements.
- Buying a 3M™ Framed Black Privacy Filter for monitors? Select one that is *larger*, yet closest to your measurements.
- Buying for a custom device? Select the product that matches your device model, size and screen resolution type.



Monitors

- 3M™ Framed Privacy Filters
- 3M™ Gold Privacy Filters
- 3M™ High Clarity Privacy Filters
- 3M™ Black Privacy Filters
- 3M™ Anti-Glare Filters



Laptops

- 3M™ Gold Privacy Filters
- 3M™ Gold Privacy Filters for Touch Laptops
- 3M™ High Clarity Privacy Filters
- 3M™ Black Privacy Filters
- 3M™ Black Privacy Filters for Touch Laptops
- 3M™ Anti-Glare Filters



Tablets

- 3M™ Black Privacy Filters
- 3M™ Anti-Glare Filters
- 3M™ Anti-Glare Screen Protectors



Smartphones

- 3M™ Privacy Screen Protectors
- 3M™ Ultra Clear Screen Protectors

Custom-size privacy and protection solutions

Not finding the size you need? 3M offers custom-size Anti-Glare Filters and Protection Films to help reduce glare and add a layer of protection on screens up to 24". For screens up to 55", 3M offers custom-size Black Privacy Filters to help keep visual hackers in the dark.

Learn more at 3Mscreens.com or call 1-800-553-9215.

Ordering Information

3M™ Privacy Filters

3M™ Framed Privacy Filters for Monitors

Catalog Number	Filter Dimensions		Fits This Device
	Width	Height	
PF170C4F	13 9/16"	10 15/16"	17.0" Standard Monitor
PF185W9F	16 11/16"	9 5/8"	18.5" Widescreen Monitor
PF190C4F	15 5/16"	12 3/8"	19.0" Standard Monitor
PF190W1F	16 5/8"	10 9/16"	19.0" Widescreen Monitor (16:10)
PF200W1F	17 11/16"	10 15/16"	20.1" Widescreen Monitor (16:10)
PF200W9F	18"	10 5/16"	19.5"-20.0" Widescreen Monitor
PF220W1F	19 1/8"	12 1/8"	22.0" Widescreen Monitor (16:10)
PF220W9F	19 13/16"	11 5/16"	20.0"-21.5" Widescreen Monitor
PF230W9F	20 9/16"	11 13/16"	23.0" Widescreen Monitor
PF240W1F	20 7/8"	13 1/8"	24.0" Widescreen Monitor (16:10)
PF240W9F	21 1/4"	12 3/16"	23.6"-24.0" Widescreen Monitor
PF270W9F	24 3/16"	13 7/8"	27.0" Widescreen Monitor

3M™ Gold Privacy Filters for Monitors

Catalog Number	Filter Dimensions		Fits This Device
	Width	Height	
GF170C4B	13 5/16"	10 11/16"	17.0" Standard Monitor
GF190C4B	14 13/16"	11 7/8"	19.0" Standard Monitor
GF190W1B	16 1/16"	10 1/16"	19.0" Widescreen Monitor (16:10)
GF195W9B	17"	9 5/16"	19.5" Widescreen Monitor (16:10)
GF200W9B	17 4/9"	9 4/5"	20.0" Widescreen Monitor (16:10)
GF215W9B	18 3/4"	10 9/16"	21.5" Widescreen Monitor
GF220W1B	18 11/16"	11 11/16"	22.0" Widescreen Monitor (16:10)
GF230W9B	20 1/16"	11 5/16"	23.0" Widescreen Monitor
GF236W9B	20 9/16"	11 9/16"	23.6" Widescreen Monitor
GF238W9B	20 3/4"	11 11/16"	23.8" Widescreen Monitor
GF240W1B	20 7/16"	12 3/4"	24.0" Widescreen Monitor (16:10)
GF240W9B	20 15/16"	11 13/16"	24.0" Widescreen Monitor
GF270W9B	23 1/2"	13 1/4"	27.0" Widescreen Monitor (16:10)

3M™ High Clarity Privacy Filters for Monitors

Catalog Number	Filter Dimensions		Fits This Device
	Width	Height	
HC190C4B	14 4/5"	11 7/8"	19.0" Standard Monitor
HC190W1B	16 1/16"	10 1/16"	19.0" Widescreen Monitor (16:10)
HC195W9B	17"	9 1/3"	19.5" Widescreen Monitor (16:9)
HC200W9B	17 4/9"	9 4/5"	20.0" Widescreen Monitor (16:9)
HC215W9B	18 3/4"	10 9/16"	21.5" Widescreen Monitor
HC220W1B	18 11/16"	11 11/16"	22.0" Widescreen Monitor (16:10)
HC230W9B	20 1/16"	11 5/16"	23.0" Widescreen Monitor
HC236W9B	20 9/16"	11 9/16"	23.6" Widescreen Monitor
HC238W9B	20 3/4"	11 11/16"	23.8" Widescreen Monitor
HC240W1B	20 7/16"	12 3/4"	24.0" Widescreen Monitor (16:10)
HC240W9B	20 15/16"	11 13/16"	24.0" Widescreen Monitor
HC270W9B	23 1/2"	13 1/4"	27.0" Widescreen Monitor

3M™ High Clarity Privacy Filters for Custom Monitors

Catalog Number	Filter Dimensions		Fits This Device
	Width	Height	
HCMAP001	20 3/4"	12 9/16"	Apple® iMac® 21.5"
HCMAP002	25 9/16"	15 9/16"	Apple® iMac® 27"

3M™ Black Privacy Filters for Monitors

Catalog Number	Filter Dimensions		Fits This Device
	Width	Height	
PF170C4B	13 5/16"	10 11/16"	17.0" Standard Monitor
PF181C4B	14 1/8"	11 5/16"	18.1" Standard Monitor
PF185W9B	16 1/8"	9 1/16"	18.5" Widescreen Monitor
PF190C4B	14 13/16"	11 7/8"	19.0" Standard Monitor
PF190W1B	16 1/16"	10 1/16"	19.0" Widescreen Monitor (16:10)
PF195W1B	16 1/2"	10 3/8"	19.5" Widescreen Monitor (16:10)
PF195W9B	17"	9 5/16"	19.5" Widescreen Monitor
PF200W9B	17 7/16"	9 13/16"	20.0" Widescreen Monitor
PF201C3B	16 1/8"	12 1/8"	20.1" Standard Monitor
PF201W1B	17 1/8"	10 11/16"	20.1" Widescreen Monitor (16:10)
PF207W9B	18 1/16"	10 1/5"	20.7" Widescreen Monitor (16:9)
PF213C3B	17"	12 3/4"	21.3" Standard Monitor
PF215W9B	18 3/4"	10 9/16"	21.5" Widescreen Monitor
PF216W1B	18 1/4"	11 7/16"	21.6" Widescreen Monitor (16:10)
PF220W1B	18 11/16"	11 11/16"	22.0" Widescreen Monitor (16:10)
PF230W9B	20 1/16"	11 5/16"	23.0" Widescreen Monitor
PF235W9B	20 4/7"	11 4/7"	23.5" Widescreen Monitor (16:9)
PF236W9B	20 9/16"	11 9/16"	23.6" Widescreen Monitor
PF238W9B	20 3/4"	11 11/16"	23.8" Widescreen Monitor
PF240W1B	20 7/16"	12 3/4"	24.0" Widescreen Monitor (16:10)
PF240W9B	20 15/16"	11 13/16"	24.0" Widescreen Monitor
PF250W9B	21 13/16"	12 1/4"	25.0" Widescreen Monitor
PF260W1B	21 11/16"	13 9/16"	26.0" Widescreen Monitor (16:10)
PF270W1B	22 15/16"	14 5/16"	27.0" Widescreen Monitor (16:10)
PF270W9B	23 9/16"	13 1/4"	27.0" Widescreen Monitor
PF280W1B	23 3/8"	14 5/8"	28.0" Widescreen Monitor (16:10)
PF280W9B	24 7/16"	13 1/2"	28.0" Widescreen Monitor
PF290W2B	26 1/2"	11 1/4"	29.0" Widescreen Monitor (21:9)
PF300W1B	25 3/16"	15 3/4"	30.0" Widescreen Monitor (16:10)
PF315W9B	27 7/16"	15 7/16"	31.5" Widescreen Monitor
PF320W9B	27 8/9"	15 2/3"	32.0" Widescreen Monitor
PF340W2B	31 3/8"	13 3/16"	34.0" Widescreen Monitor (21:9)
PF380W2B	35 3/16"	14 13/16"	38.0" Widescreen Monitor (21:9)
PF430W9B	37 1/16"	21"	43.0" Widescreen Monitor

3M™ Black Privacy Filters for Custom Monitors

Catalog Number	Filter Dimensions		Fits This Device
	Width	Height	
PFMAP001	20 3/4"	12 9/16"	Apple® iMac® 21.5"
PFMAP002	25 9/16"	15 9/16"	Apple® iMac® 27"
PFMAP003	25 9/16"	15 9/16"	Apple® 27" Thunderbolt Display
PFMDE002	20 9/16"	12 11/16"	Dell™ OptiPlex 3240 All-in-One 21.5" Monitor
PFMDE003	22 7/16"	13 7/8"	Dell™ OptiPlex 7440 All-in-One 23.8" Monitor
PF340W2E	32 1/8"	13 5/8"	34.0" Full Screen Display Monitor (21:9)

3M™ Black Privacy Filters for Portrait-Mode Monitors

Catalog Number	Filter Dimensions		Fits This Device
	Width	Height	
PF215W9P	18 3/4"	10 9/16"	21.5" Widescreen Monitor Portrait
PF250W9P	12 1/4"	21 13/16"	25.0" Widescreen Monitor Portrait

Learn more at 3Mscreens.com
or call 1-800-553-9215.

For warranty information, visit 3Mscreens.com

3M™ Privacy Filters (cont.)

3M™ Gold Privacy Filters for Laptops with 3M™ COMPLY™ Attachment System

Catalog Number	Filter Dimensions		Fits This Device
	Width	Height	
GF125W9B	10 15/16"	6 1/8"	12.5" Widescreen Laptop
GF133W1B	11 5/16"	7 1/16"	13.3" Widescreen Laptop (16:10)
GF133W9B	11 9/16"	6 1/2"	13.3" Widescreen Laptop
GF140W9B	12 3/16"	6 7/8"	14.0" Widescreen Laptop
GF141W1B	11 15/16"	7 1/2"	14.1" Widescreen Laptop (16:10)
GF154W1B	13 1/16"	8 3/16"	15.4" Widescreen Laptop (16:10)
GF156W9B	13 9/16"	7 5/8"	15.6" Widescreen Laptop
GF170W1B	14 1/2"	9 1/16"	17.0" Widescreen Laptop (16:10)

3M™ Gold Privacy Filters for Custom Laptops with 3M™ COMPLY™ Attachment System

Catalog Number	Filter Dimensions		Fits This Device
	Width	Height	
GFNAP006	11 3/4"	7 5/8"	Apple® MacBook Pro® 13" (2016 model or newer)
GFNAP007	13 1/2"	8 3/4"	Apple® MacBook Pro® 15" (2016 model or newer)
GFNAP008	12 1/16"	7 15/16"	Apple® MacBook Pro® 13" with Retina display (2018 model or newer)
GFNAP009	13 7/8"	9"	Apple® MacBook Pro® 16"

3M™ Gold Touch Privacy Filters for Full Screen Laptops with 3M™ COMPLY™ Attachment System

Catalog Number	Filter Dimensions		Fits This Device
	Width	Height	
GF125W9E	11 1/4"	6 7/16"	12.5" Full Screen Laptop
GF133W9E	11 7/8"	6 13/16"	13.3" Full Screen Laptop
GF140W9E	12 1/2"	6 7/8"	14.0" Full Screen Laptop
GF156W9E	13 7/8"	7 15/16"	15.6" Full Screen Laptop

3M™ Gold Privacy Filters for Touch Laptops

Catalog Number	Filter Dimensions		Fits This Device
	Width	Height	
GFNGG001	11 15/16"	6 2/3"	Google PixelBook Go

3M™ High Clarity Privacy Filters for Laptops with 3M™ COMPLY™ Attachment System

Catalog Number	Filter Dimensions		Fits This Device
	Width	Height	
HC125W9B	10 15/16"	6 1/8"	12.5" Widescreen Laptop (16:9)
HC133W9B	11 4/7"	6 1/2"	13.3" Widescreen Laptop (16:9)
HC140W9B	12 3/16"	6 7/8"	14.0" Widescreen Laptop
HC156W9B	13 9/16"	7 5/8"	15.6" Widescreen Laptop

3M™ High Clarity Privacy Filters for Custom Laptops with 3M™ COMPLY™ Attachment System

Catalog Number	Filter Dimensions		Fits This Device
	Width	Height	
HCNAP001	11 3/4"	7 5/8"	Apple® MacBook Pro® 13" (2016 model or newer)
HCNAP002	13 1/2"	8 3/4"	Apple® MacBook Pro® 15" (2016 model or newer)
HCNAP003	12 1/16"	7 15/16"	Apple® MacBook Air® 13" with Retina display (2018 model or newer)
HCNAP004	13 7/8"	9"	Apple® MacBook Pro® 16"
HCNMS001	12"	8 3/8"	Microsoft® Surface® Book
HCNMS004	13 1/4"	9 3/16"	Microsoft® Surface® Book 2, 15" Laptop
HCNMS002	11 7/8"	8 1/4"	Microsoft® Surface® Laptop
HCNMS003	11 1/4"	7 5/8"	Microsoft® Surface® Pro

3M™ Black Privacy Filters for Touch Laptops

Catalog Number	Filter Dimensions		Fits This Device
	Width	Height	
PFNGG002	11 15/16"	6 2/3"	Google PixelBook Go

3M™ Black Privacy Filters for Touch Laptops with 3M™ COMPLY™ Attachment System

Catalog Number	Filter Dimensions		Fits This Device
	Width	Height	
PF116W9E	10 3/4"	6 7/16"	11.6" Full Screen Laptop
PF123C3E	10 5/8"	7 9/16"	12.3" Full Screen Laptop (3:2)
PF125W9E	11 9/16"	6 7/8"	12.5" Full Screen Laptop
TF125W9B	10 15/16"	6 1/8"	12.5" Widescreen Laptop - Standard Fit
PF133W9E	12 1/4"	7 1/4"	13.3" Full Screen Laptop
TF133W9B	11 9/16"	6 1/2"	13.3" Widescreen Laptop - Standard Fit
PF140W9E	12 13/16"	7 5/8"	14.0" Full Screen Laptop
TF140W9B	12 3/16"	6 7/8"	14" Widescreen Laptop - Standard Fit
PF156W9E	14 3/16"	8 3/8"	15.6" Full Screen Laptop
TF156W9B	13 9/16"	7 5/8"	15.6" Widescreen Laptop (16:9) - Standard Fit

3M™ Black Privacy Filters for Laptops with 3M™ COMPLY™ Attachment System

Catalog Number	Filter Dimensions		Fits This Device
	Width	Height	
PF116W9B	10 1/8"	5 11/16"	11.6" Widescreen Laptop
PF121W1B	10 5/16"	6 7/16"	12.1" Widescreen Laptop (16:10)
PF125W9B	10 15/16"	6 1/8"	12.5" Widescreen Laptop
PF133C3B	10 5/8"	8"	13.3" Standard Laptop
PF133W1B	11 5/16"	7 1/16"	13.3" Widescreen Laptop (16:10)
PF133W9B	11 9/16"	6 1/2"	13.3" Widescreen Laptop
PF140W9B	12 3/16"	6 7/8"	14.0" Widescreen Laptop
PF141C3B	11 1/4"	8 7/16"	14.1" Standard Laptop
PF141W1B	11 15/16"	7 1/2"	14.1" Widescreen Laptop (16:10)
PF150C3B	12"	9"	15.0" Standard Laptop
PF154W1B	13 1/16"	8 3/16"	15.4" Widescreen Laptop (16:10)
PF156W9B	13 9/16"	7 5/8"	15.6" Widescreen Laptop
PF170W1B	14 1/2"	9 1/16"	17.0" Widescreen Laptop (16:10)
PF173W9B	15 1/16"	8 1/2"	17.3" Widescreen Laptop

3M™ Black Privacy Filters for Custom Laptops with 3M™ COMPLY™ Attachment System

Catalog Number	Filter Dimensions		Fits This Device
	Width	Height	
PFNAP001	10 7/8"	7 1/16"	Apple® MacBook® 12"
PFNAP007	11 3/4"	7 5/8"	Apple® MacBook Pro® 13" (2016 model or newer)
PFNAP009	12 1/16"	7 15/16"	Apple® MacBook Air® 13" with Retina display
PFNAP008	13 1/2"	8 3/4"	Apple® MacBook Pro® 15" (2016 model or newer)
PFNAP010	13 7/8"	9"	Apple® MacBook Pro® 16"
PFNAP001	10 1/8"	5 11/16"	Chromebook 11
PFNDE007	11 1/4"	6 7/16"	Dell™ 12.5" Infinity Display Laptop
PFNDE008	11 7/8"	6 13/16"	Dell™ 13.3" Infinity Display Laptop
PFNDE009	12 1/2"	6 7/8"	Dell™ 14.0" Infinity Display Laptop
PFNDE011	13 7/8"	7 15/16"	Dell™ 15.6" Infinity Display Laptop
PFNDE010	11 15/16"	8"	Dell™ 2-in-1 Latitude™ 5285/5290
PFNDE002	11 7/8"	7 5/8"	Dell™ Latitude™ 12 E7250
PFNDE004	11 3/4"	7 3/8"	Dell™ Latitude™ 13 7000 Series Model 7370
PFNDE001	12 15/16"	8 7/16"	Dell™ Latitude™ 14 E7450
PFNDE005	11 3/4"	7 4/7"	Dell™ Latitude™ 7280
PFNDE006	12 7/8"	8 1/16"	Dell™ Latitude™ 7480
PFNHP012	11 9/16"	8 3/16"	HP® Elite X2 1012 G1
PFNHP001	12 15/16"	8 7/16"	HP® EliteBook 840 G1/G2
PFNHP013	11 1/4"	7 5/8"	HP® EliteBook Folio G1
PFNHP014	12 1/4"	8 1/7"	HP® EliteBook x360 1030 G2
PFNHP005	12 9/16"	8 1/16"	HP® Spectre x360 13.3"

3M™ Privacy Filters (cont.)

3M™ Black Privacy Filters for Tablets

Catalog Number	Filter Dimensions		Fits This Device
	Width	Height	
PFTAP001	6 1/2"	9 5/16"	Apple® iPad Air® 1/2/Pro® 9.7" Portrait
PFTAP002	9 5/16"	6 1/2"	Apple® iPad Air® 1/2/Pro® 9.7"
PFTAP003	5 1/8"	7 3/4"	Apple® iPad mini™ 1/2/3/4 Portrait
PFTAP008	9 4/5"	6 4/5"	Apple® iPad Pro® 10.5" (1st & 2nd Gen)
PFTAP007	11 15/16"	8 9/16"	Apple® iPad Pro® 12.9" (1st & 2nd Gen)
PFTAP009	10 7/8"	8 1/3"	Apple® iPad Pro® 11"
PFTAP010	9 4/7"	6 7/8"	Apple® iPad Pro® 12.9" (3rd Gen)
PFTAP012	6 3/4"	9 13/16"	Apple® iPad 10.2"/Air® 3/Pro® 10.5"
PFTGG002	11 1/8"	7 5/8"	Google™ Pixel Slate
PFTMS001	11 5/16"	7 3/4"	Microsoft® Surface® Pro 3/4
PFTMS002	9.37"	5.61"	Microsoft® Surface® Go

3M™ Black Privacy Screen Protectors for Smartphones

Catalog Number	Filter Dimensions		Fits This Device
	Width	Height	
MPPAP001	2 5/16"	5 1/8"	Apple® iPhone® 6/6S/7/8
MPPAP010	2 3/4"	5 7/8"	Apple® iPhone® 6 Plus/6S Plus/7 Plus/8 Plus
MPPAP014	2 4/7"	5 5/8"	Apple® iPhone® X/XS
MPPAP015	2 4/7"	5 3/4"	Apple® iPhone® XR
MPPAP016	2 3/4"	6 1/5"	Apple® iPhone® XS Max
MPPAP017	2 9/16"	5 7/8"	Apple® iPhone® 11/XR
MPPAP018	2 1/2"	5 5/8"	Apple® iPhone® 11 Pro/XS/X
MPPAP019	2 3/4"	6 3/16"	Apple® iPhone® 11 Pro Max/XS Max
MPPGG002	2 11/16"	5 5/8"	Google™ Nexus 5X
MPPGG001	2 7/8"	6 1/8"	Google™ Nexus 6P
MPPGG003	2 1/2"	5 7/16"	Google™ Pixel Phone
MPPGG004	2 11/16"	5 13/16"	Google™ Pixel XL Phone
MPPGG007	2 7/16"	5 3/4"	Google™ Pixel 2 Phone
MPPGG008	2 11/16"	6"	Google™ Pixel 2XL Phone
MPPGG009	2 4/9"	5 3/4"	Google™ Pixel 3 Phone
MPPGG010	2 3/4"	6 1/4"	Google™ Pixel 3XL Phone

3M™ Ultra Clear Screen Protectors

3M™ Ultra Clear Screen Protectors for Smartphones

Catalog Number	Filter Dimensions		Fits This Device
	Width	Height	
UCPAP001	2 5/16"	5 1/8"	Apple® iPhone® 6/6S/7/8
UCPAP004	2 3/4"	5 7/8"	Apple® iPhone® 6 Plus/6S Plus/7 Plus/8 Plus
UCPAP005	2 3/4"	6 1/5"	Apple® iPhone® X/XS
UCPAP006	2 4/7"	5 3/4"	Apple® iPhone® XR
UCPAP007	2 4/7"	5 5/8"	Apple® iPhone® XS Max

3M™ Anti-Glare Filters and Screen Protectors

3M™ Anti-Glare Filters for Monitors

Catalog Number	Filter Dimensions		Fits This Device
	Width	Height	
AG190C4B	14 13/16"	11 7/8"	19.0" Standard Monitor
AG190W1B	16 1/16"	10 1/16"	19.0" Widescreen Monitor (16:10)
AG195W9B	17"	9 5/16"	19.5" Widescreen Monitor
AG200W9B	17 7/16"	9 13/16"	20.0" Widescreen Monitor
AG215W9B	18 3/4"	10 9/16"	21.5" Widescreen Monitor
AG220W1B	18 11/16"	11 11/16"	22.0" Widescreen Monitor (16:10)
AG230W9B	20 1/16"	11 5/16"	23.0" Widescreen Monitor
AG236W9B	20 9/16"	11 9/16"	23.6" Widescreen Monitor
AG238W9B	20 3/4"	11 11/16"	23.8" Widescreen Monitor
AG240W1B	20 7/16"	12 3/4"	24.0" Widescreen Monitor (16:10)
AG240W9B	20 15/16"	11 13/16"	24.0" Widescreen Monitor
AG270W9B	23 9/16"	13 1/4"	27.0" Widescreen Monitor

3M™ Anti-Glare Filters for Laptops

Catalog Number	Filter Dimensions		Fits This Device
	Width	Height	
AG125W9B	10 15/16"	6 1/8"	12.5" Widescreen Laptop
AG133W9B	11 9/16"	6 1/2"	13.3" Widescreen Laptop
AG140W9B	12 3/16"	6 7/8"	14.0" Widescreen Laptop
AG156W9B	13 9/16"	7 5/8"	15.6" Widescreen Laptop
AG173W9B	15 1/16"	8 1/2"	17.3" Widescreen Laptop

3M™ Anti-Glare Filters for Custom Laptops

Catalog Number	Filter Dimensions		Fits This Device
	Width	Height	
AGNAP001	11 3/4"	7 5/8"	Apple® MacBook Pro® 13" (2016 model or newer)
AGNAP002	13 1/2"	8 3/4"	Apple® MacBook Pro® 15" (2016 model or newer)

3M™ Anti-Glare Filters for Tablets

Catalog Number	Filter Dimensions		Fits This Device
	Width	Height	
AFTMS001	11 5/16"	7 3/4"	Microsoft® Surface® Pro 3/4

3M™ Anti-Glare Screen Protectors for Tablets

Catalog Number	Filter Dimensions		Fits This Device
	Width	Height	
NVAG830864	7 13/16"	5 13/16"	Apple® iPad Air® 1/2/Pro® 9.7"
AFTAP002	7 3/4"	5 1/8"	Apple® iPad mini™ 1/2/3/4

Learn more at 3Mscreens.com or call 1-800-553-9215.

For warranty information, visit 3Mscreens.com

Maximize your workspace.

Whether your workspace is open, private, spacious or confined, 3M products are designed to fit where you work. 3M™ Precision Standing Desks coordinate with the full portfolio of 3M Workspace Solutions to help you get organized and make the most of your space.



Help reduce neck, shoulder and eye strain.

Monitor Arms & Stands	6–9
Laptop Stands	10
Document Holders	13

Help reduce fatigue and strain on legs and lower back.

Foot Rests	19
------------------	----

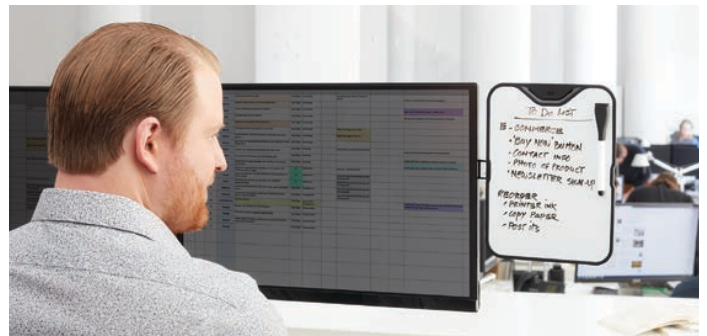

Help free up desk space and reduce clutter.

Monitor Arms	6–8
Monitor Whiteboard	12
Monitor Mount Document Holders	13
CPU Mount.....	19

Help keep information organized, front and center.

Monitor Whiteboard	12
Document Holders	13



Stationery & Office Supplies Division
 3M Center, Building 223-5S-08
 St. Paul, MN 55144-1000
 USA

Phone 1-800-332-7483
 Web www.3M.com/myworkspace

3M, Bumpon, Command, COMPLY, Precise and Safety-Walk are trademarks of 3M.

All other trademarks are the service marks, trademarks, or registered trademarks of their respective owners.

Please recycle. © 3M 2019.

70-0717-4274-9