

# K-kit

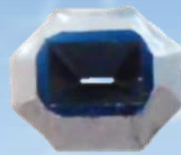

A Specimen Holder for Liquid Sample Analysis in TEM

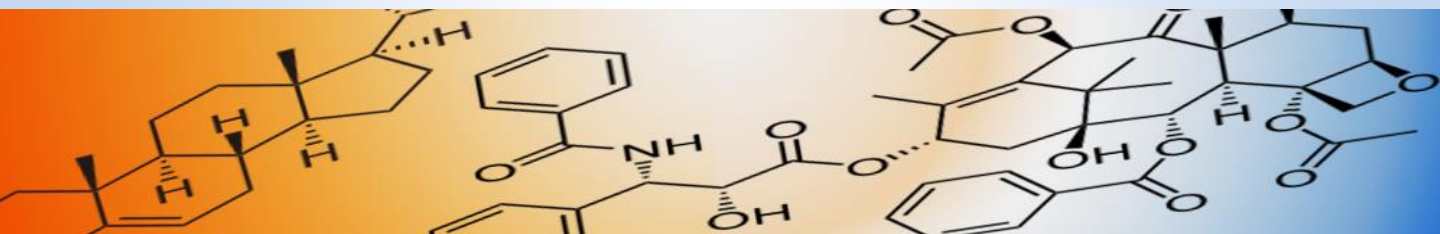
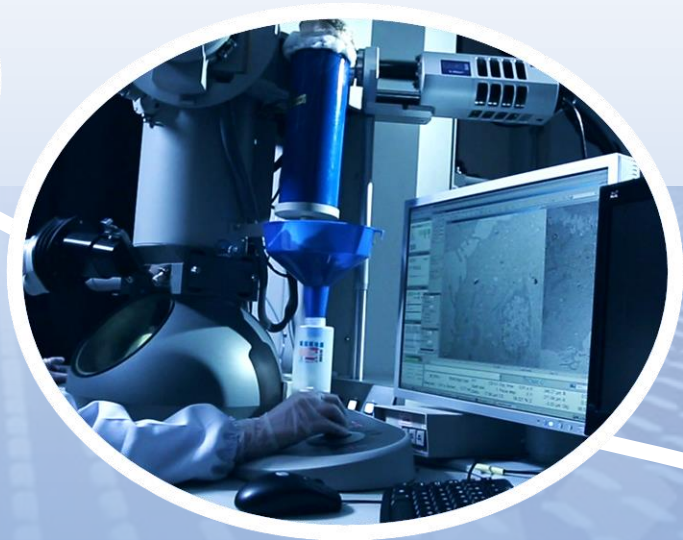
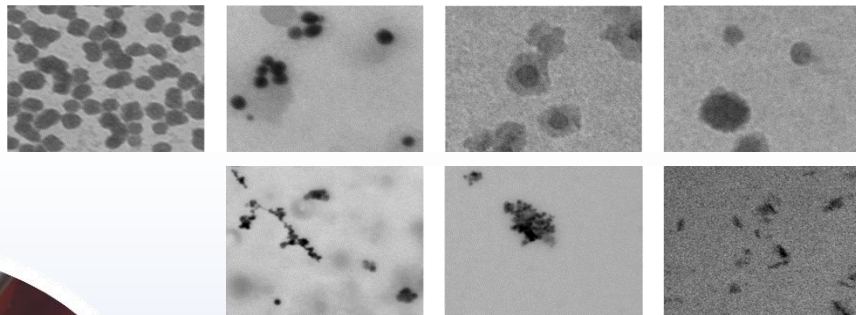

# An Innovative Specimen Holder for Liquid Analysis in TEM

- K-kits are sample holders designed to be used for microscopy observation of liquid samples, allowing nanoobjects, aggregates, and agglomerates (NOAAs) in liquid samples to be imaged and characterized in TEM, FIB, and STEM etc. microscopes.
- With vacuum compatible sealing of liquids in electron-transmitting thickness, K-kits are micro reaction chambers for countless experiments in materials, chemical and biological research.

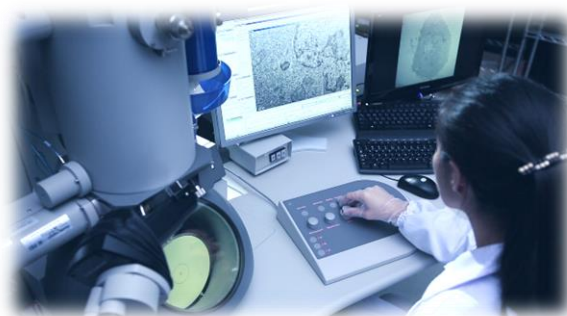
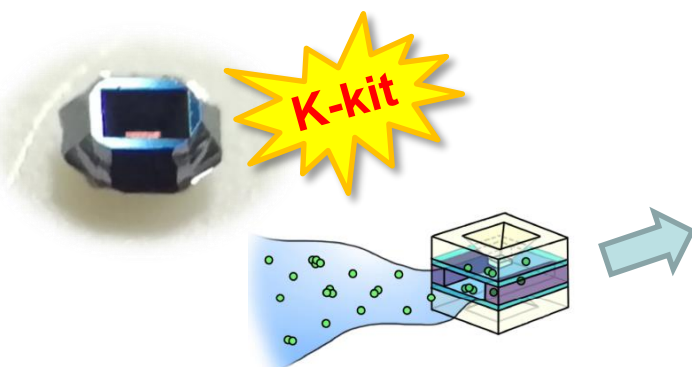

Patents being issued and publication

- ✓ US 7807979 B2
- ✓ US 8969827 B2
- ✓ Anal. Chem. 2012, 84: 6312-6316

Transmission Electron Microscope (TEM)

## Wet

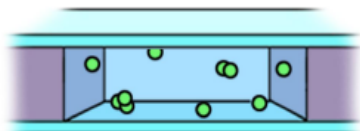

- The loaded liquid sample is sealed and imaged using TEM in the native liquid environment.

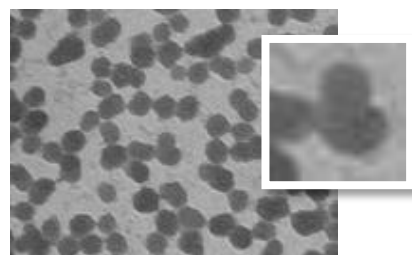

(Acceptable image quality with liquid inside the K-kit.)

## Thin Layer

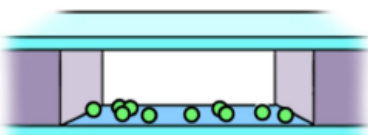

(Loaded liquid was dried out by pumping.)

- A patented liquid drying protocol preserves the original morphology and physical state of nanomaterials with improved imaging resolution.

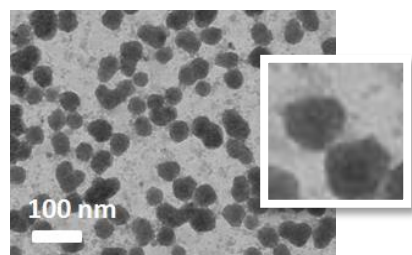

(Very good image quality, when liquid was dried out by pumping.)

TEM images shown:  
Undiluted Chemical-Mechanical Polishing (CMP) slurry directly loaded into K-kit.

# Product Features

Disposable

Free of Cross Contamination

Easy Use

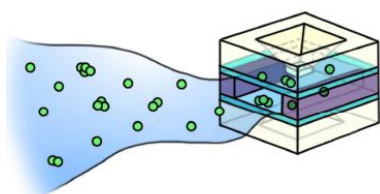

## K-Kit

Original physical state

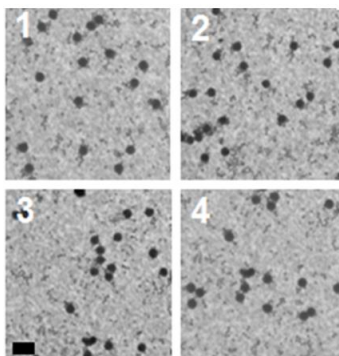

## Conventional

Aggregated after drying on Cu grid

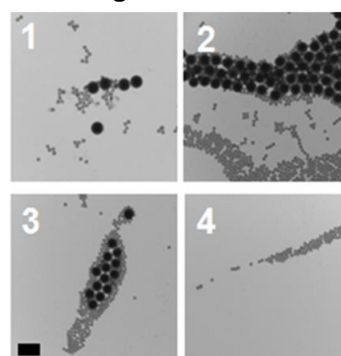

TEM images, as shown: NIST traceable polystyrene beads. Scale bar: 500nm

( ✓ Good    △ Case dependent    ✗ Not available)

Physicochemical Parameters	K-kit	Cu-Grid
1. Composition	✓	✓
2. Size	✓	✓
3. Shape	✓	✓
4. Size distribution	✓	△
5. Aggregation and agglomeration <u>in liquid</u>	✓	✗
6. Particle concentration	✓	✗
7. Liquid TEM observation	✓	✗

## ◆ Compared with other products

Company	Bio MA-Tek	Protochips	Hummingbird Scientific
Liquid Cell	K-kit	E-chip	TEM Holder
Chip Size	1.4 x 1.7 mm (fits in 3 mm grids)	4 x 6 mm	---
Special holder	No need	needed	needed
Cost	US. 100-200	US. 100-200 (+Special Holder: US.100K)	US. 150K



# Applications

- Characterize NOAAs in electronics industry, cosmetics, foods, medical devices, and drugs.

## Slurry

- SiO<sub>2</sub> Nanoparticles in CMP Slurry

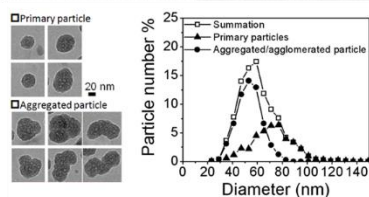
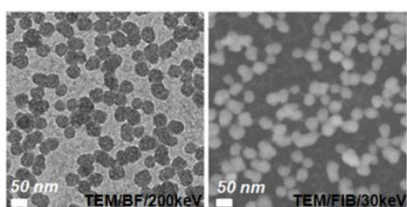

## Electronics



## Lotion

- TiO<sub>2</sub> and ZnO Nanoparticles in Sunscreen

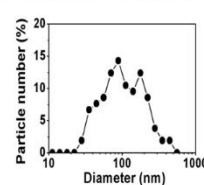
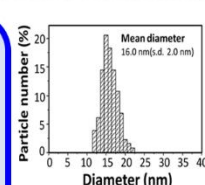
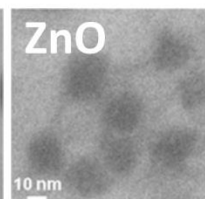
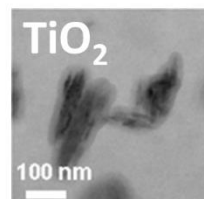

## Cosmetics



## Foods



## Drugs



### Aggregation/agglomeration

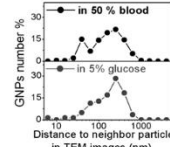

### Particle concentration

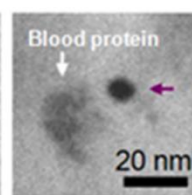
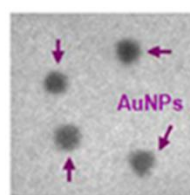
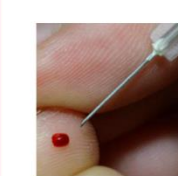
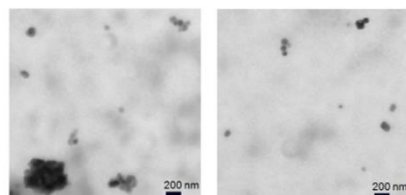
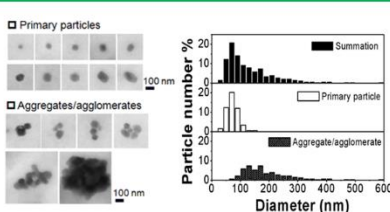
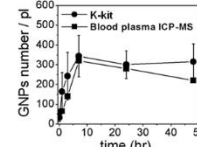

## Beverage

- CaCO<sub>3</sub> Nanoparticles in Milk

## Bio Sample

- Au Nanoparticles in Blood

### Reference :

1. US FDA 2012, Guidance for Industry – Safety of Nanomaterials in Cosmetic Products.
2. EU/JRC July 2012, Requirements on Measurements for the Implementation of the European Commission Definition of the Term “Nanomaterials”.
3. ISO/TR13014: 2012, Nanotechnologies -- Guidance on physico-chemical characterization of engineered nanoscale materials for toxicologic assessment.
4. ICCR 2012, Characterization of Nanomaterials II - Insolubility, Biopersistence and Size Measurement in Complex Media.

# K-kit Adaptability

## ✓ Compatible with all kinds of TEM Holders

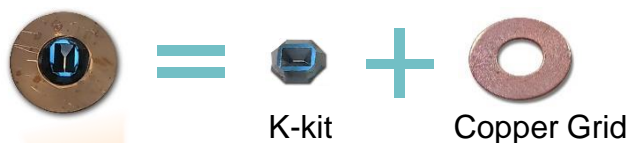

**FEI**  
**TECNAI F20 Holder**



**JEOL**  
**EM31640 STHB Holder**



**Hitachi**  
**H-7501 SS Holder**

## ✓ Strong Structural Reliability under Vacuum

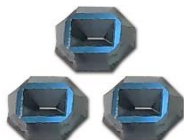

### Silicon Body (MEMS technology)

- Use a Si-based structure, ensuring strength and reliability.

(MEMS, Micro-Electro-Mechanical Systems)

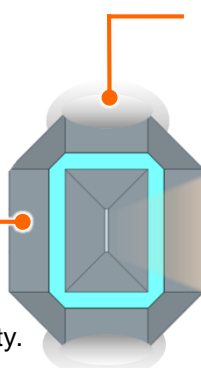

### Torr Seal® Epoxy

- A trusted and widely used glue, suitable for high vacuum systems.

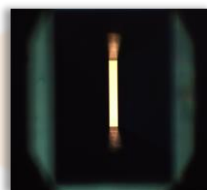

(Observation Window)

### Silicon Nitride Window

- Material intrinsically tough, durable to withstand drastic pressure changes.

(Torr Seal®, a trade mark owned by Agilent Tech. Inc.)

## ✓ Sealing glue compatible to many solvents

- The following table shows the test results of Torr Seal Epoxy soaked in chemical solvents for 24 hours and then examined using FTIR (if dissolved) and visual observation (if dispersed).

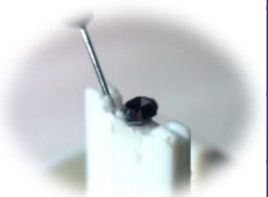

	Water	PEG400	DMSO	Ethanol	0.1 N HCl	0.1 N KOH
<b>Compatibility (FTIR)</b>	✓	✓	✓	✓	✓	✓
	Hexane	IPA	Methanol	DCM	THF	Acetone
<b>Compatibility (FTIR)</b>	✓	✓	✓	✗	✗	✗

(FTIR, Fourier Transform Infrared Spectroscopy)



Compatible (FTIR not detected)



Use with care (FTIR detected)

✗ If you would like to learn more about K-kit or have any question about its applications, do not hesitate to contact us. To enable potential customers to experience the benefits of K-kit, we offer preloaded demo samples for free. Contact us at E-mail: [sales@bioma-tek.com](mailto:sales@bioma-tek.com)

# Shipping Packages and Tool Sets

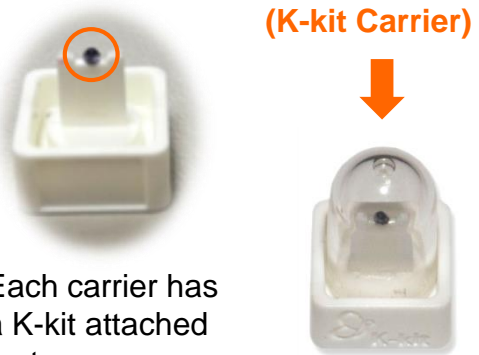
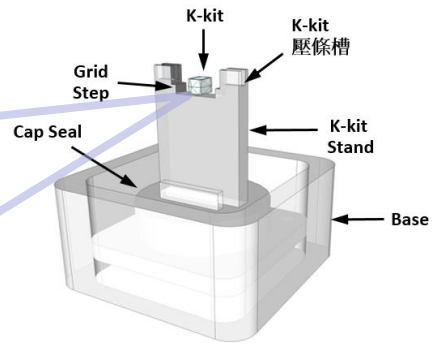
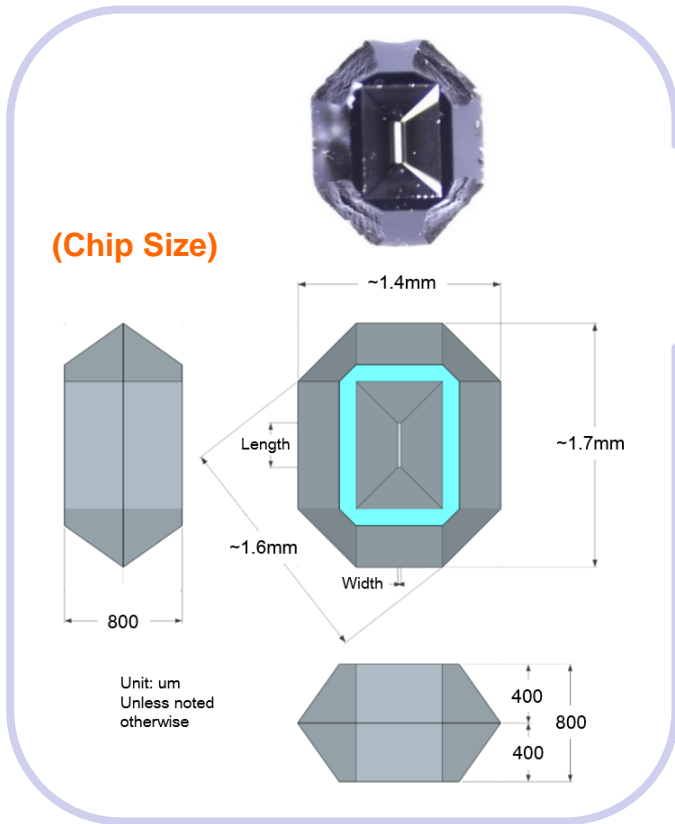

Each carrier has a K-kit attached on top

Protected with a clear cap. (A copper grid is enclosed at the bottom of the carrier.)

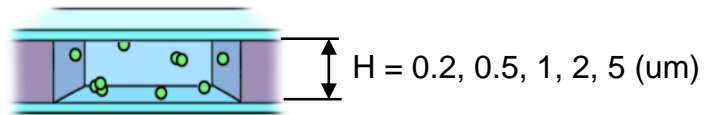

- Window Length  $300 \mu\text{m}$ , Width  $25 \mu\text{m}$
- Channel Height (H):  
**0.2 and 2.0 standard**  
0.5, 1.0 and 5.0 available



4 K-kits

6 K-kits

## (Shipping Packages)





# K-kit Meets All Needs for Liquid TEM



## 1 Native State in Liquid

### QDs Particles in Chloroform

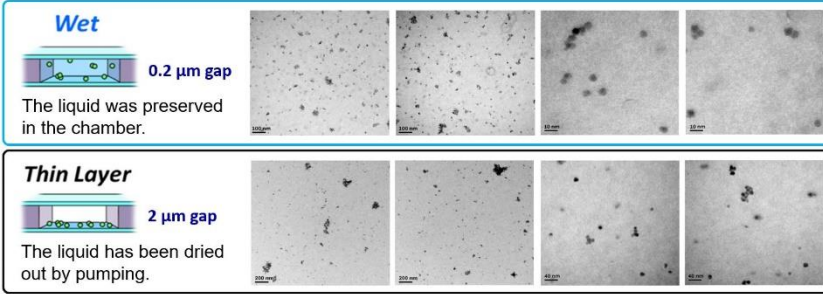

- Available with undiluted solution.
- Preserve the original morphology and physical state in liquid.

## 2 In-situ Observation

- Kinetic mechanism of metal growth or physicochemical reaction process in liquid can be in-situ observed with increased reaction time.

### Dynamic Observation of Silicate Nanoparticles

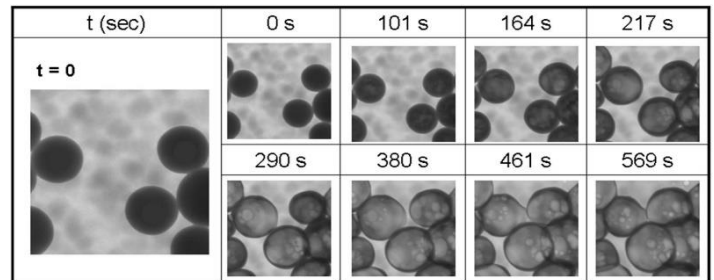

## 3 Quantitative Analysis

- Software of image recognition for nanoparticle size distribution analysis.

### Abrasives in CMP Slurry (K-kit vs. Cyro)

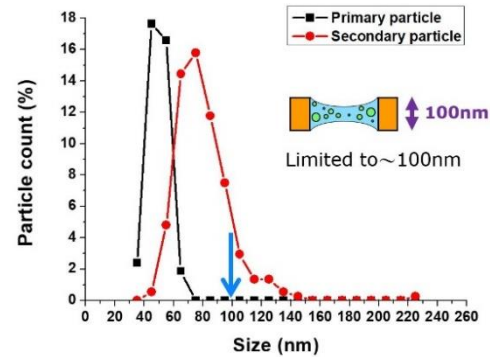
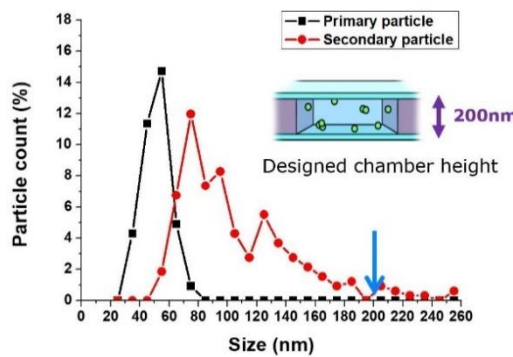

## 4 Compatible to Versatile Microscopy Analyses

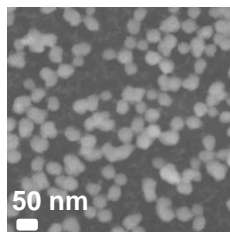
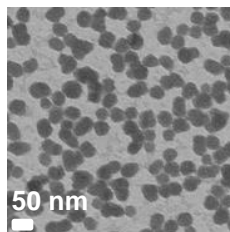
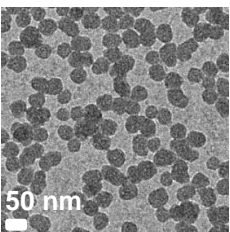

FEI-TEM @200Kev

Hitachi-TEM @100Kev

FEI-STEM @30Kev

- Applicable to TEM, FIB, and STEM.
- Available for EDX analysis.
- High resistance to most chemicals.
- Working temperature range from -40°C to 120°C.

# K-kit Tool Box

- Tool box, we offer a full tool set, including K-kit holder, sample-loading stage, needle pen, K-kit gluing stand, recommended glues, glass slides and some replacement parts.



(Vermilion)



(Silver White)

W275 x D150 x H50 (mm)

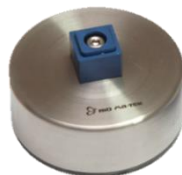

K-kit Gluing Stand



Glass-slide Pack  
(Six slides inside for free)



Sample-loading Stage

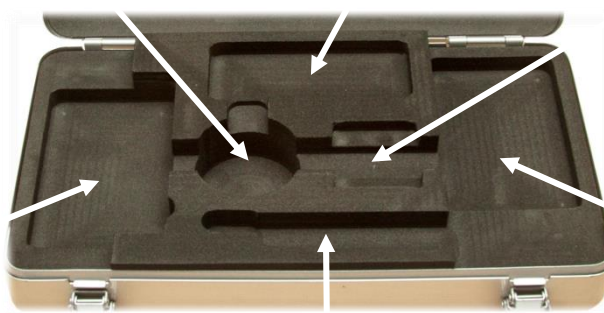

K-kit Holder & Needle Pen



K-kit Shipping Package  
(Without K-kits)



Accessory Box

※ K-kit tool box can be in silver or vermilion colors



# Sample-loading Procedure

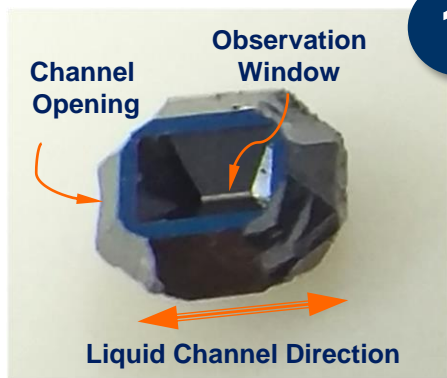

## 1.K-kit:

K-kits are Si-based microchannel devices with silicon nitride windows that allow SEM, FIB, STEM, and TEM observations. The shape is a result of anisotropic wet etching. The liquid channel is parallel to the window, with openings at both sides.

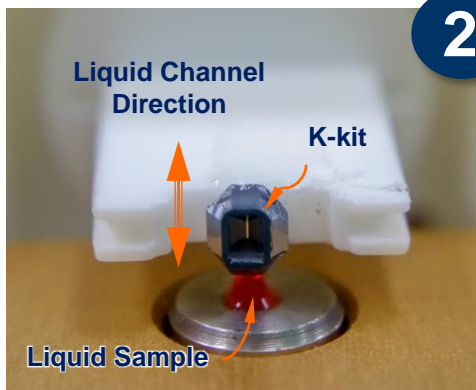

## 2.Filling:

Liquid fills the channel through capillary force. The liquid surface is “pulled up” by the K-kit. Keep the K-kit steady for approximately 1 min to allow the filling to complete. The aqueous liquid sample should be placed on a glass slide. Both the K-kit and glass surface are hygroscopic. Do not immerse the K-kit in liquid to prevent from the window being contaminated.



## 3. Torr-seal:

Cover the channel openings at both ends with Torr Seal epoxy after filling the device with liquid. (No need to do this gluing step, if one would like to dry out the liquid and leave the nanoparticles a Thin Layer mode in K-kit.)



## 4. Copper grid:

Use epoxy to mount the sealed K-kit to a copper grid by fitting it to the precut hole at the center of the grid.

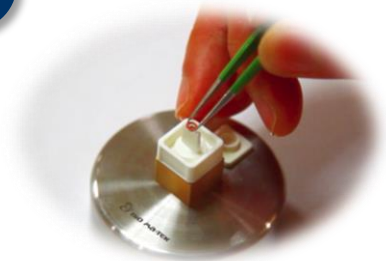
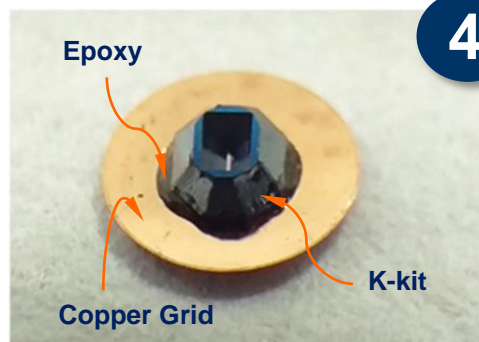

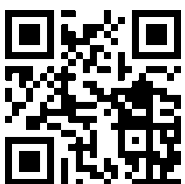

If on-line, please click the link to watch demo video: <https://youtu.be/0QDVI0UTBUM>

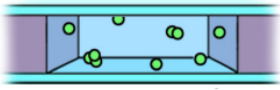
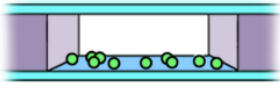

QR code link to demo video

# Wet and Thin Layer Mode of K-kit

Sample Preparation	Wet Mode	Thin Layer Mode
<b>Inner Status of K-kit</b>	With Liquid 	Dried 
<b>Imaging Resolution</b>	Good	Excellent
<b>Gap Size (Considered)</b>	300~500nm	2000~3000nm
<b>Particle Size (Loadable)</b>	10nm~300nm	3nm~2000nm
<b>Particle Shape</b>	Keeping original	Potentially, could be deformed.
<b>Chemical Reduction or Potential Damage by Electron Energy</b>	High	Low

 If making a Thin Layer (Dried) mode of K-kit, it's essential to keep both ends of the channel open to atmosphere, no need to do the channel gluing step.

Gap Height (um)	0.1	0.2	0.5	1.0	2
<b>Wet Mode</b>	●	●	◐		
<b>Thin Layer Mode</b>	◐	●	●	●	●

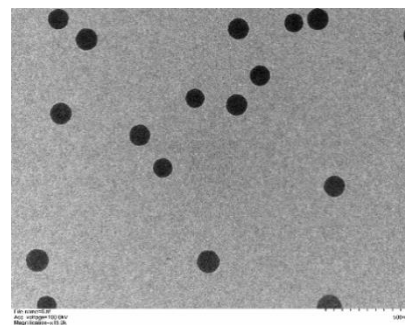
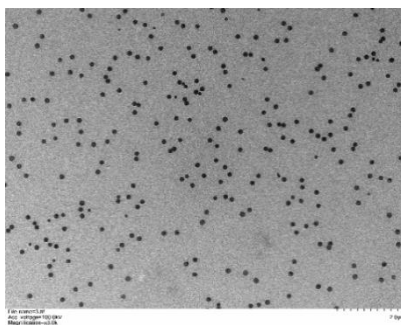
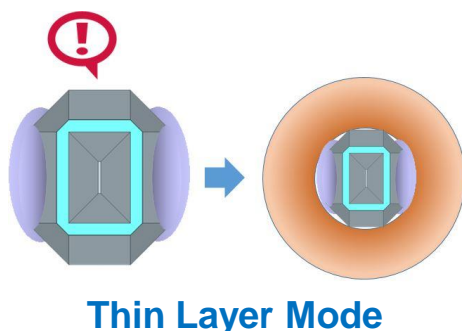
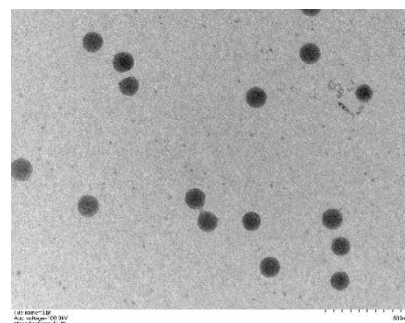
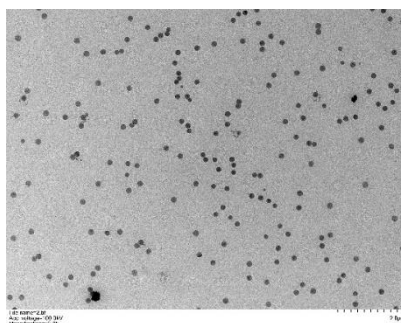
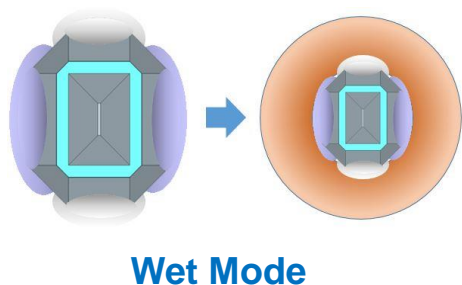

# Matters Needing Attention When K-kit in Use

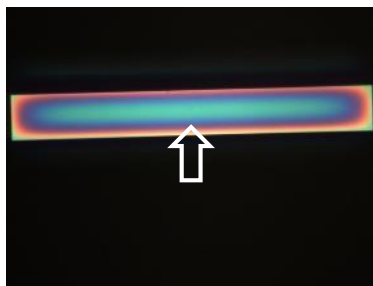
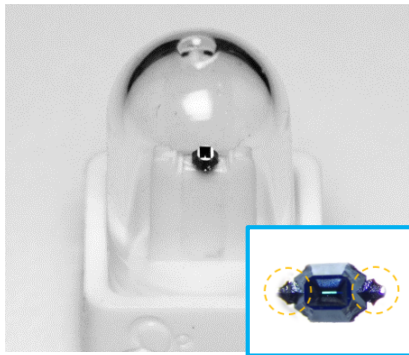

With Newton's rings  
(Sealed by channel tips)

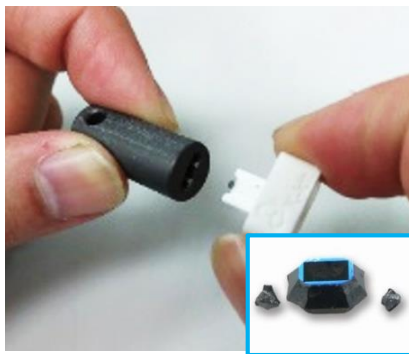

Flat membrane  
(Open to atmosphere)

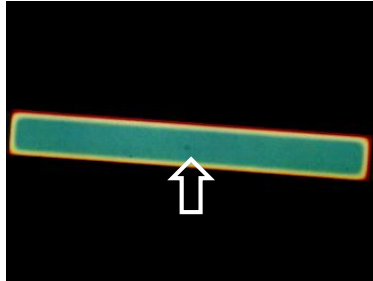
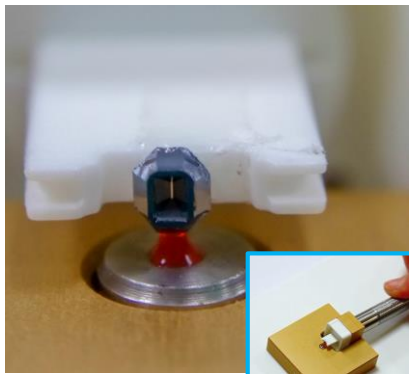

With color patterns  
(After liquid filled)

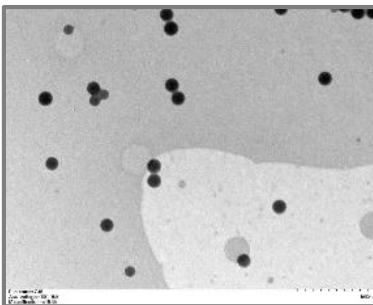

Liquid well reserved  
(Soon to glue the openings)

## Inspection Before Use

- With Newton's rings on the membrane. (Be sure the channel to keep vacuum sealed)
- Free of any damage on Silicon body of K-kit.

## Channel Tips Removal

- Be sure to remove both the channel tips before using K-kit.
- It should be finished the liquid loading within 0.5 hour, after breaking the channel tips.

## Liquid Loading

- Keep the K-kit steadily touching on liquid for around 1 minute, to allow the filling to complete.
- Do not immerse the K-kit in liquid.

## Gluing Process

- Glue both ends of the channel within 1 minute after liquid loaded.
- Be sure not to do the channel gluing step, if making for Thin Layer mode of K-kit.
- Doing the gluing step with care, to avoid the glue flowing into the observation window.



# Available for EDX Analysis (1/2)

## ■ How to Make EDX Analysis Achievable on a K-kit

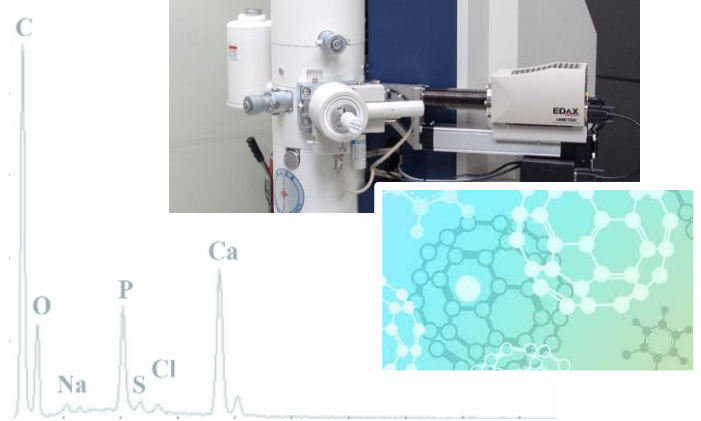
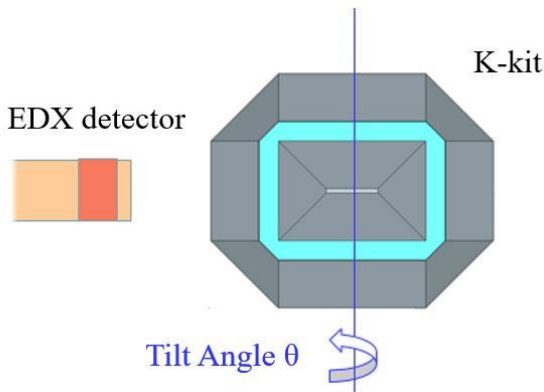

By pointing the window long side to the detector and tilting the holder at some angles, which could make EDX analysis achievable on a k-kit.

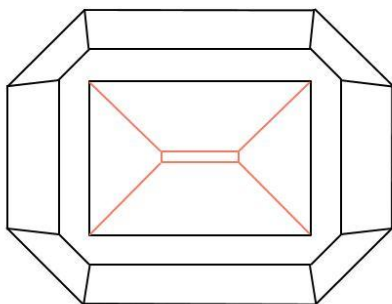
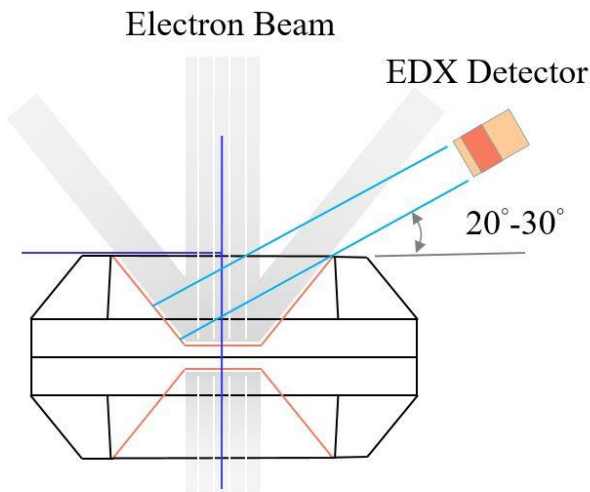

Without tilting

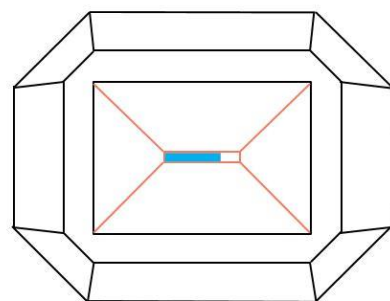
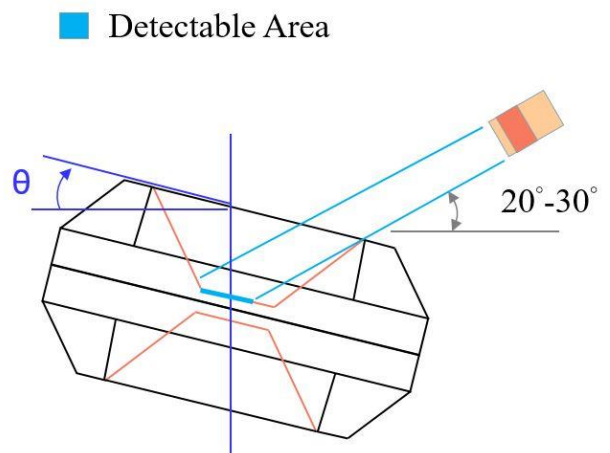



Give a tilt toward the EDX detector

# Available for EDX Analysis (2/2)

## EDX available angles for different kinds of TEM equipment

■ Detectable Area

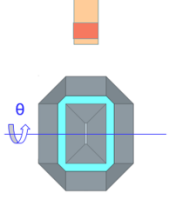
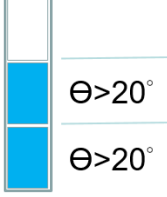
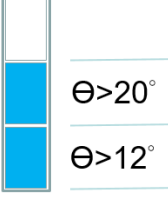
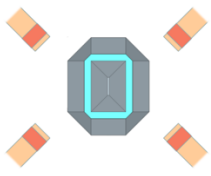
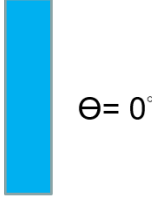
EDX Detector  K-kit 		Hitachi 7700	FEI Tecna-F200	FEI Osiris
Single Detector				
Four Detectors				

For some types of TEM installed with multiple EDX detectors, they usually can get a clear X-ray excited signal from K-kit, no need to turn any of body rotation or tilting.

### Example:

- TEM: Hitachi 7700
- EDX: Single Detector
- Liquid Sample: AuCl<sub>3</sub>
- Tilt Angle: 0°, 10°, 20°

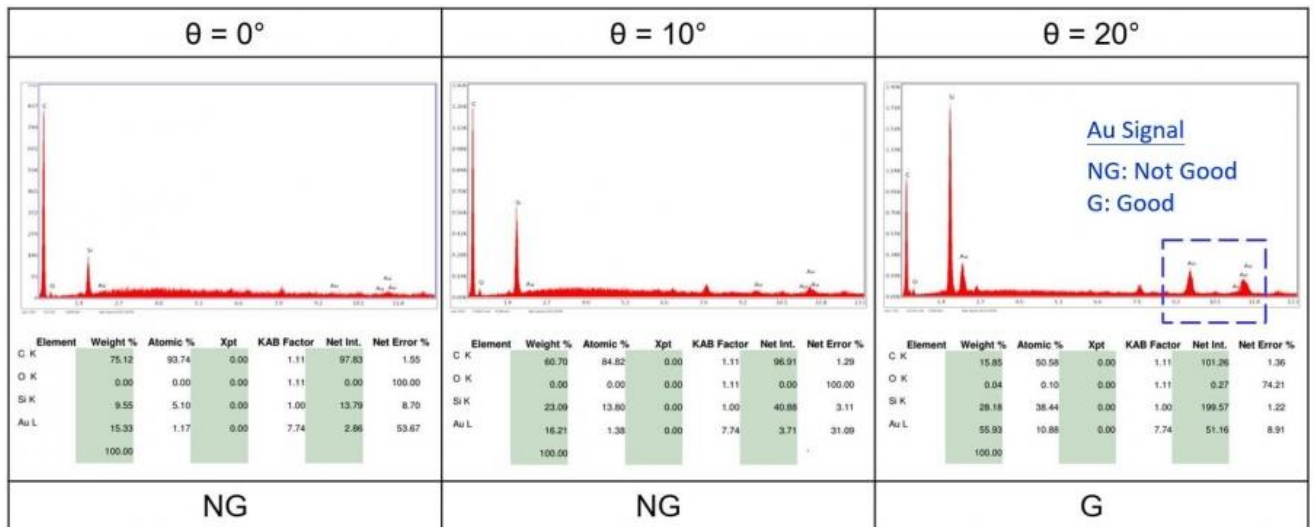
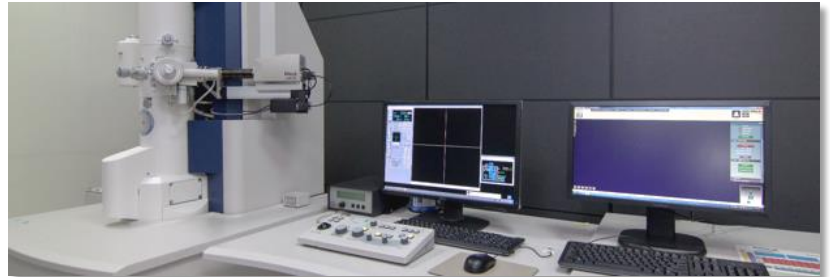

# Example

## Dynamic observation of NOAAs in liquid

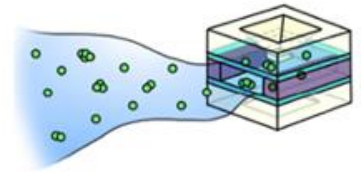

- Dynamic observation of silicate nanoparticles in water

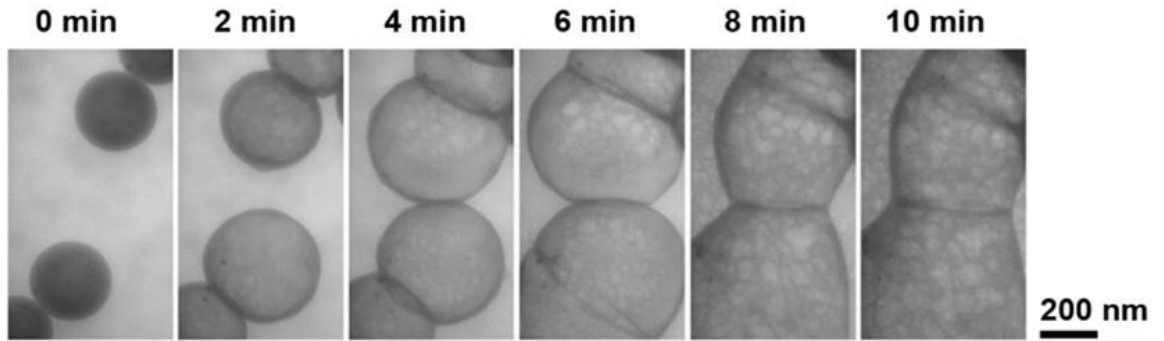

\* Exposed electron (100 keV,  $4 \times 10^4$  A/m<sup>2</sup>)

- Dynamic observation of polystyrene beads

In situ dynamic observation by TEM (Hitachi H-7650)				Observation Environment
0 s	73 s	150 s	199 s	Vacuum, $4.0 \times 10^4$ A/m <sup>2</sup>
0 s	35 s	69 s	98 s	Air, $2.5 \times 10^3$ A/m <sup>2</sup>
0 s	62 s	199 s	396 s	Water, $2.5 \times 10^3$ A/m <sup>2</sup>
0 s	105 s	208 s	425 s	Buffer/ PBS (Sodium ion), $1.0 \times 10^4$ A/m <sup>2</sup>



# Example

## NOAAs of Au nanoparticles (NPs) in blood

- K-kit can be used to perform in-vitro and in-vivo physicochemical characterizations of NPs in blood by TEM.

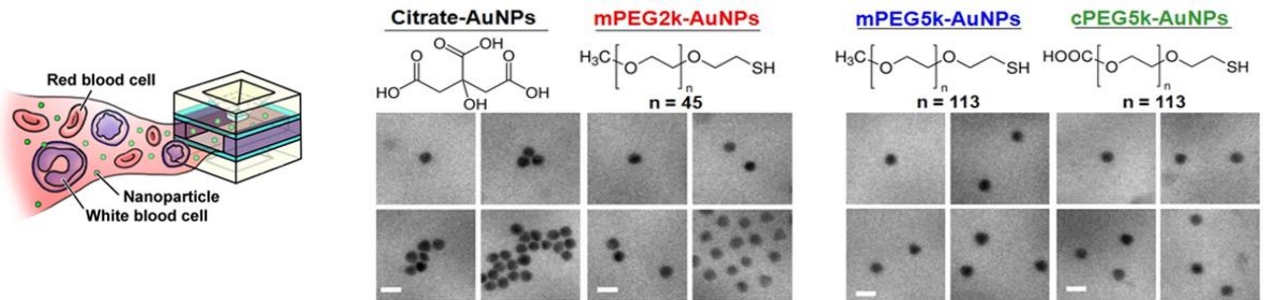

- Image-based statistic analysis of particle concentration (K-kit vs. ICP-MS)

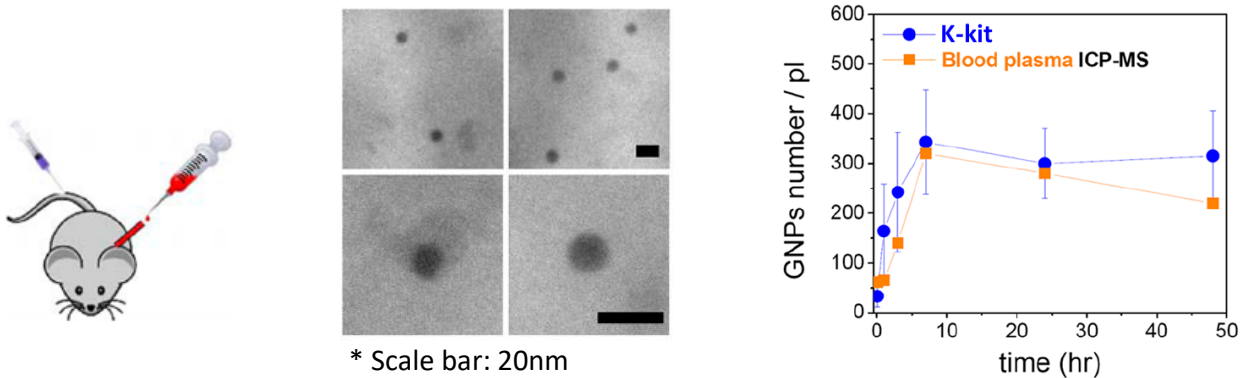

- Image-based statistic analysis of aggregation and agglomeration of Au NPs in blood

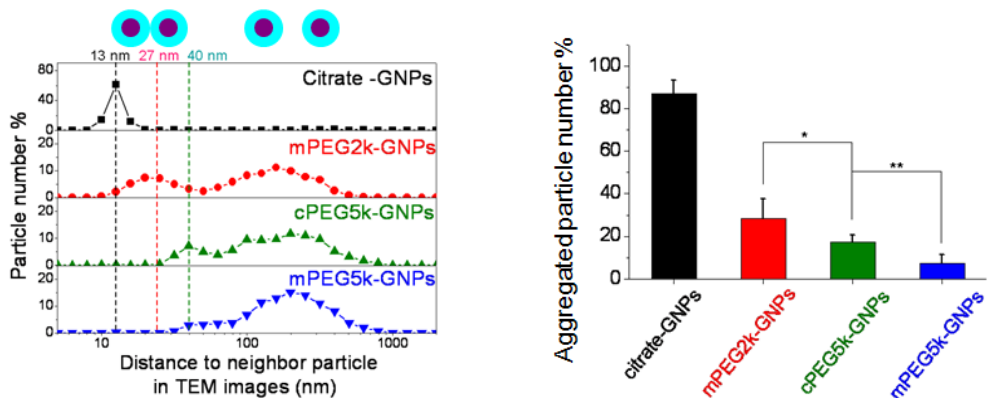

# Example

## Protein particles in Nanopharmaceuticals

- K-kit can be used for characterizing protein particles in Nanopharmaceuticals by imaging the particle morphology, size and size distribution, to evaluate drug formulation or conduct any bioequivalence study.

### □ Protein particles (Paclitaxel@Albumin) in Abraxane®



\* US FDA approved 2005

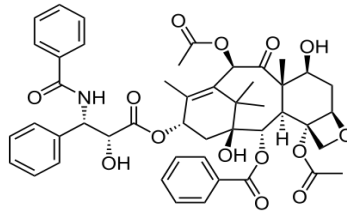

- Hydrophobic
- M.W. 854 Da

Albumin Shell  
(Excipient)

Paclitaxel  
(Drug)

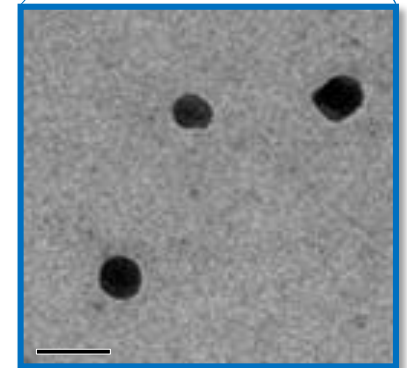
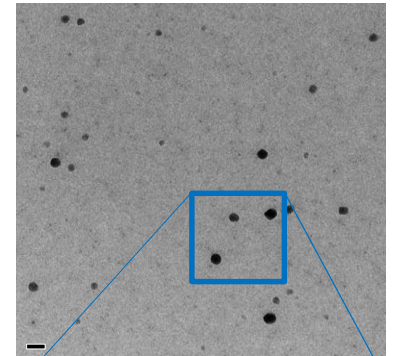
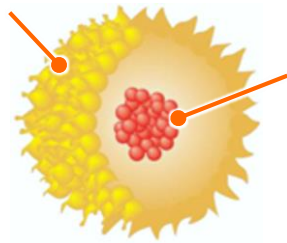

\* Scale bar: 200 nm

### ◆ Abraxane in saline \_ size & size distribution (D10/ D50/ D90)

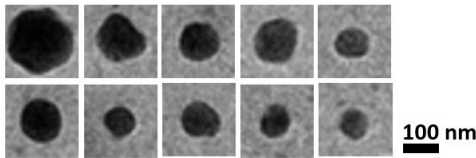
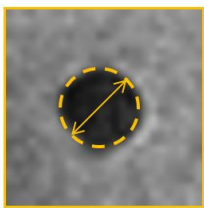

- Total calculated particle #: 319
- Average size: 85.1 nm
- Standard deviation: 27.0 nm

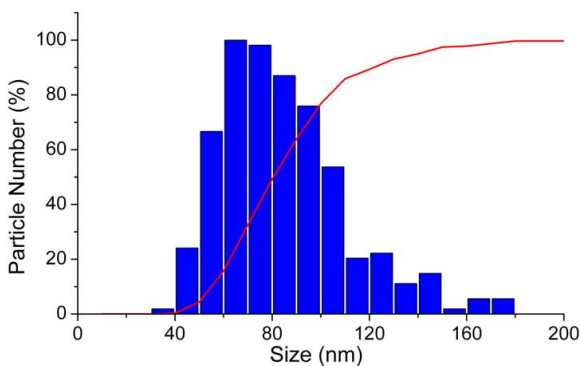

Parameter	Size (nm)
D10	55.6
D50	80.1
D90	122.2
Span: (D90 - D10) / D50	0.831

# Example

## NOAAs of CaCO<sub>3</sub> NPs in milk

- K-kit can be used for characterizing nanoobjects of foods in final product form, to evaluate the safety risks of nanomaterials in food additives and in substances in contact with foods.

### □ Comprehensive physicochemical characterization

Parameter	Results	Methods
1 <b>Composition</b>	Calcite CaCO <sub>3</sub>	TEM/EDX, XRD
2 <b>Size / size distribution</b>	<b>Average Diameter / Standard deviation</b>	
Crystal particle size	36 / 4 nm	XRD
Primary particle size	73 / 26 nm	TEM
Powder size	17 / 10 μm	SEM
3 <b>Shape</b>	Cubic	TEM
4 <b>Aggregation/Agglomeration in relevant media</b>	<b>Average diameter / Standard deviation</b>	K-Kit / TEM
NOAAs	115 / 73 nm	(4wt% in DI water)
Nano-Objects	68 / 20 nm (number 58%)	
Aggregations / Agglomerations	180 / 70 nm (number 42%)	
5 <b>Solubility/Dispersibility</b>	< 0.01% in Ca <sup>2+</sup> form	ICP/MS
	Dispersed in DI water > 4 wt%	K-Kit / TEM
	(20 ~ 450 nm)	
6 <b>Surface charge</b>	-23.4 ± 1.3 mV (in DI water)	Zeta potential
7 <b>Surface chemistry</b>	<u>Surface atom:</u>	XPS
	C (35%), O(48%), Ca(16%)	
8 <b>Specific surface area</b>	18.14 m <sup>2</sup> /g	BET



As Additive



### □ Size and size distribution of CaCO<sub>3</sub> NOAAs in milk



In Product

#### □ NOs (Nano-objects)

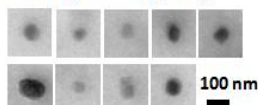

#### □ AAs (Aggregate/Agglomerate)

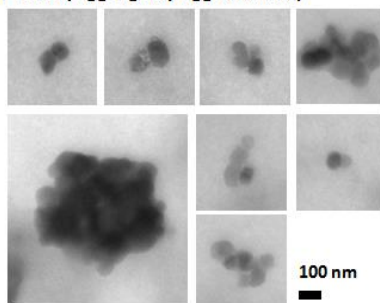

### ◆ Size and size distribution

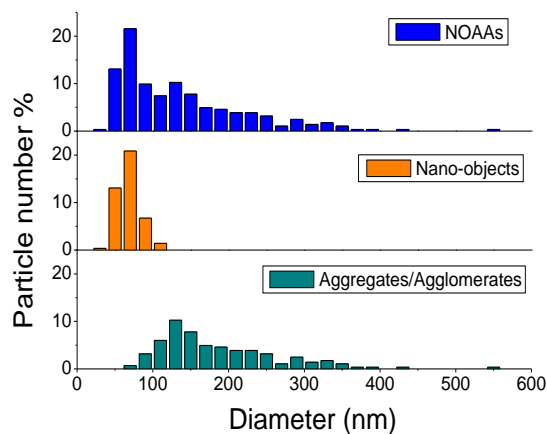



# Example

## NOAAs of ZnO NPs in sunscreen

- K-kit can be used for characterizing NOAAs of cosmetics in final product forms, including lotion, cream, and powder, to assess the safety risks of nanomaterials in cosmetic ingredients.

### ◆ International Cooperation on Cosmetic Regulation Report (ICCR) 2012

Characterization of Nanomaterials II – Insolubility, Biopersistence and Size Measurement in Complex Media.

### ◆ European Union (EU) Cosmetics Regulatory (EC) No. 1223/2009

Mandatory labeling of Nanomaterials as ingredients in Cosmetics (effective 2013/07/11)

### ◆ United States Food and Drug Administration Guidance (US FDA) 2012

Guidance of Industry - Safety of Nanomaterials in Cosmetic Products



### Lotion

ZnO NOAAs  
in sunscreen

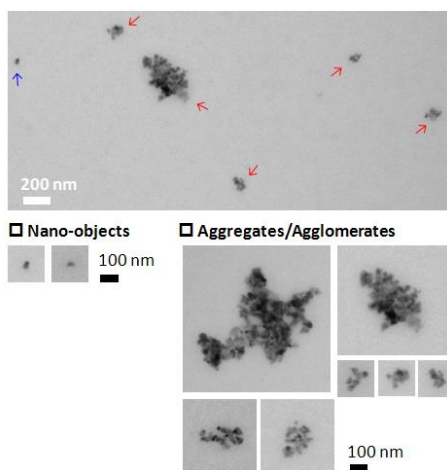

TEM images

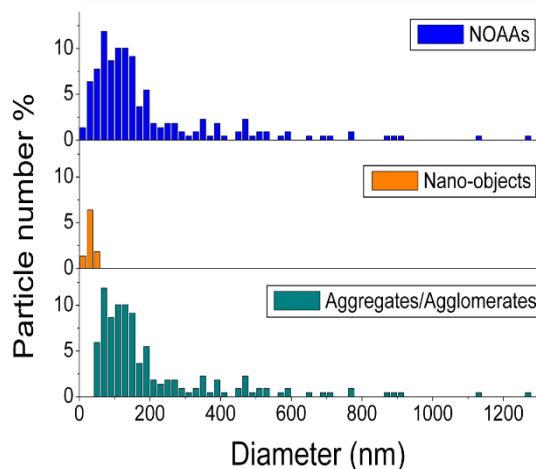

Size and size distribution

### Definitive:

Direct observation in final product form or relevant media, minimizing artifacts.

### Quantitative:

Image-based statistical analysis of aggregation and agglomeration as well as particle concentration.

### Comprehensive:

All physicochemical characterization requirements can be addressed.

# K-kit Application: Abrasives in CMP Slurry

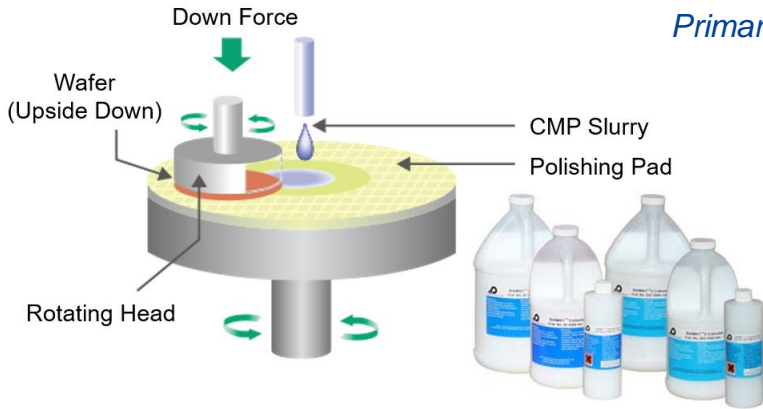

Primary and secondary particles in undiluted slurry

- ❑ Composition
- ❑ Size/size distribution
- ❑ Shape
- ❑ Aggregation state
- ❑ Surface

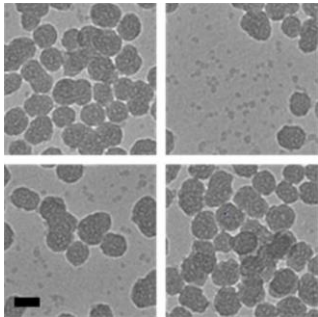

Dried on copper grid

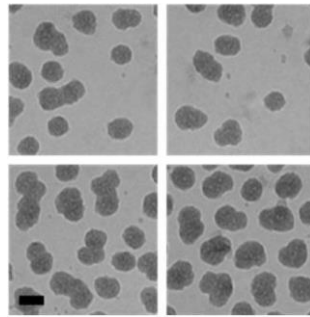

Frozen in Cryo-TEM grid

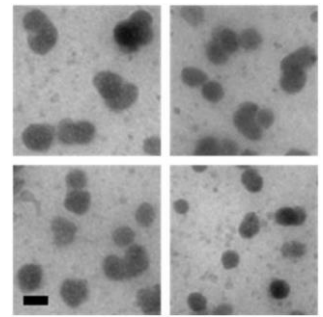

In liquid phase in K-kit

\* Scale bar is 50 nm

Cryo-TEM

Liquid-TEM (K-kit)

\* Abrasive size scales covered by K-kit & cryo-TEM

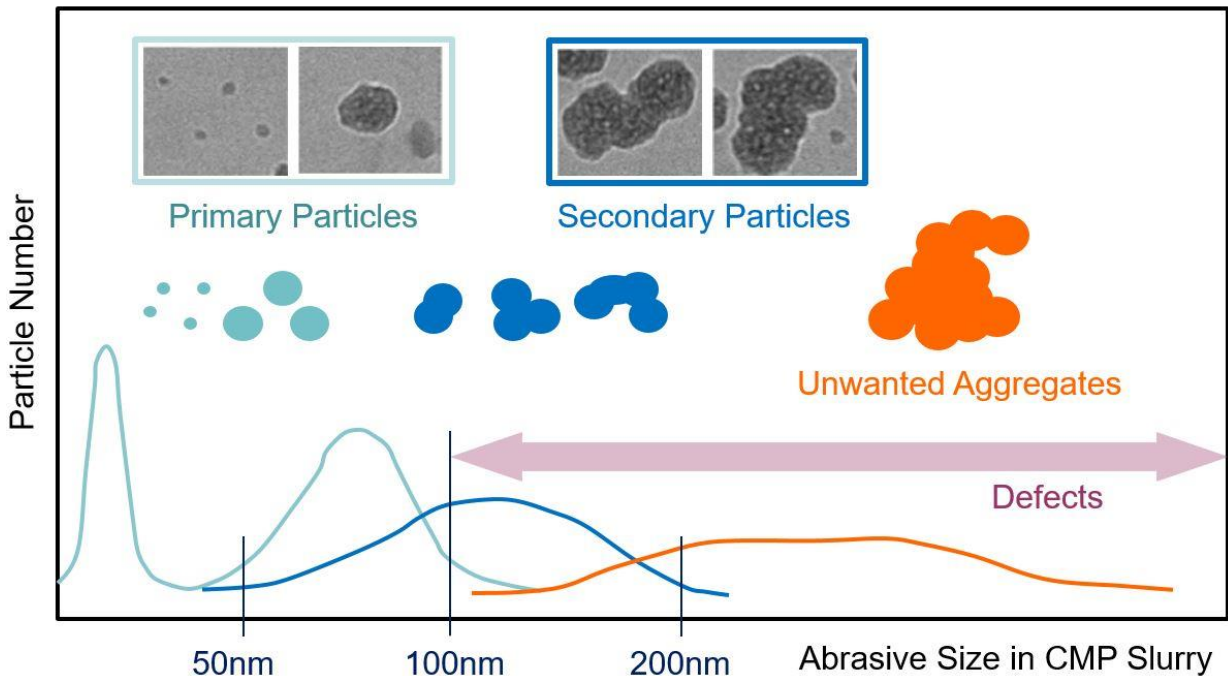

# K-kit Application: Liquid-TEM Observation in Nanopharmaceuticals



Applicable particle concentration for K-kit:  $10^{11} \sim 10^{14}$  particles/ml

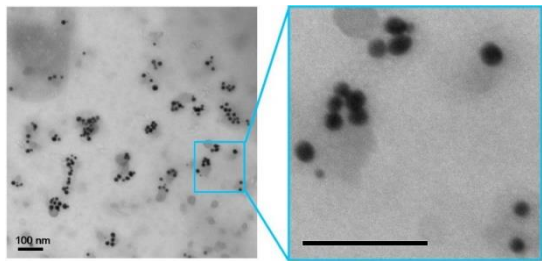

AuroVist® solution was directly loaded and sealed in a K-kit in liquid form.

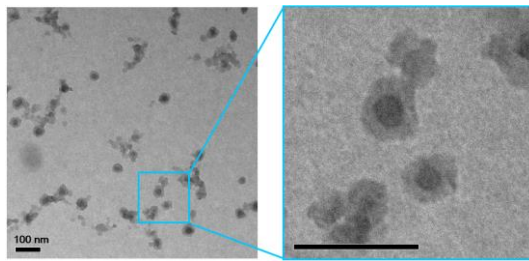

Oil emulsion in water was loaded and sealed in a K-kit in liquid form.



Brand Name of Pharmaceuticals	<b>Doxil ®</b> (1995 approved)	<b>Abraxane ®</b> (2005 approved)	<b>Aurimune ®</b> (Phase II)	<b>Resovist ®</b>	<b>Rexin-G ®</b> (Phase II)
Particle Size	80-100 nm	~ 130 nm	~ 27 nm (AuNPs core), ~ 30-40 nm as hydrated	~ 45-60 nm (Hydradynamic diameter)	~ 100 nm
Particle Concentrations	$1.0 \times 10^{14}$ liposome /ml	$4.3 \times 10^{13}$ albumin particles /ml	$\leq 1.7 \times 10^{12}$ gold particles /ml	$1 \times 10^{14}$ particles /ml	$1-4 \times 10^{11}$ cfu

## Cryo-/ Negative Stain ← TEM Applications in Nanopharmaceuticals → Liquid (K-kit)

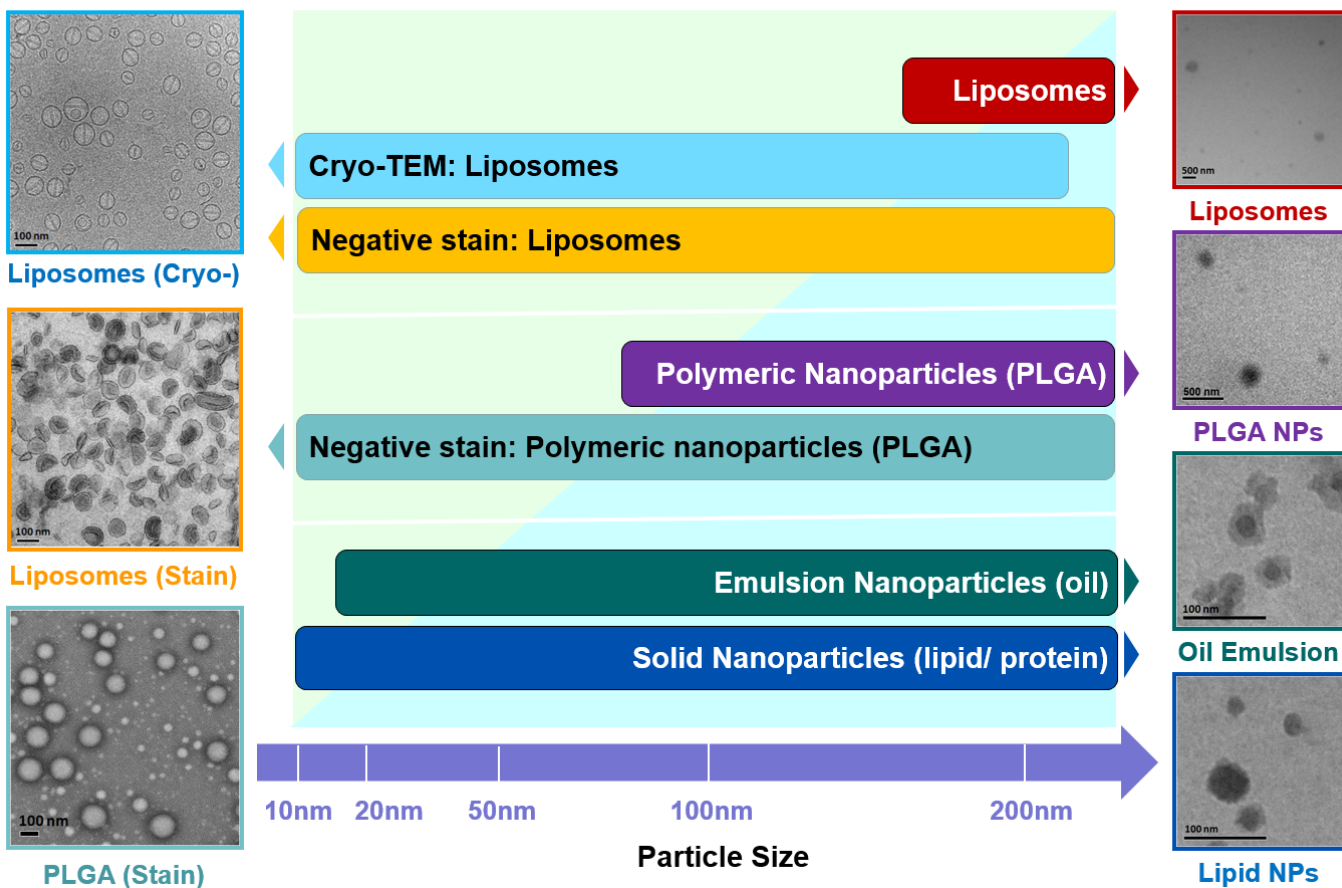



# K-kit Application: Quantum Dots in Solution

Quantum dots will enable a market for devices and components worth over \$11bn by 2026.

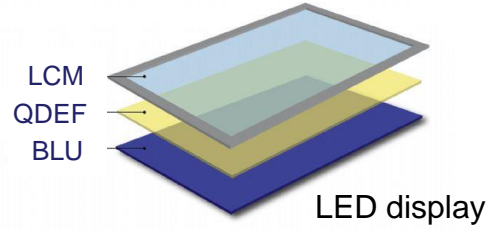
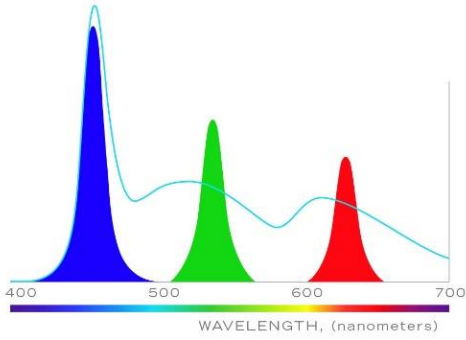

QD inks for printed electronics

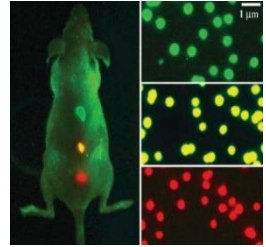

QD imaging diagnosis



- QD: Quantum dots
- BLU: Backlight Unit
- LCM: Liquid Crystal Module
- QDEF: Quantum-dot Enhancement Film

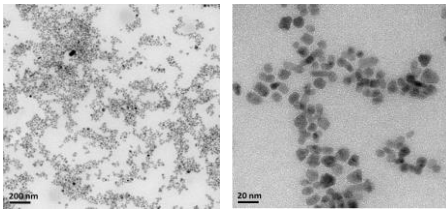
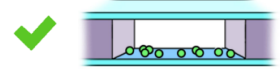
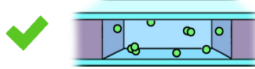

QDs dried on copper grid

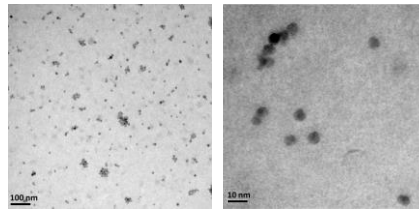

Wet mode of K-kit

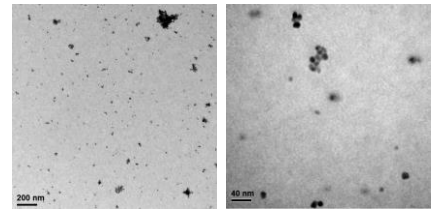

Thin Layer mode of K-kit

## Size and Size Distribution of QDs in Chloroform (Thin Layer Mode of K-kit)

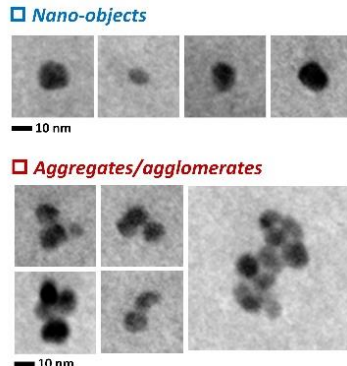
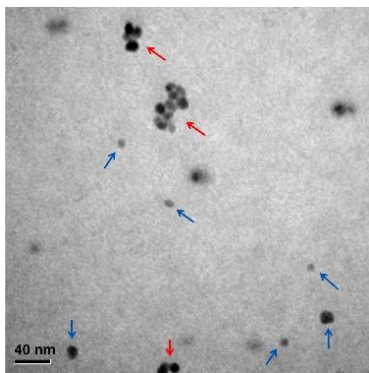

- Sample solution was directly loaded into K-kit
- Nano-objects = Primary particle
- Aggregates/agglomerates = Secondary particle

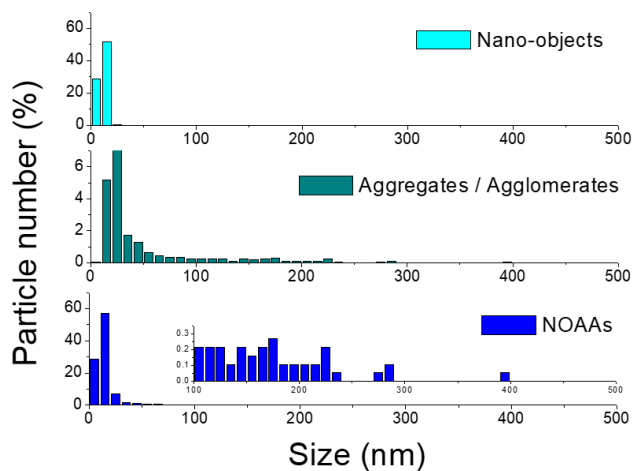

# K-kit Application: In-situ Dynamic Observation

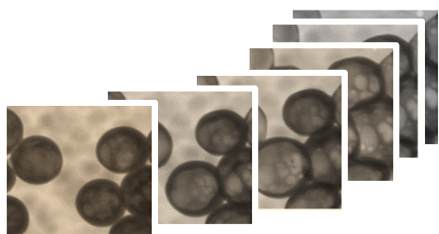

*The dynamic changes of reaction processes in liquid can be observed and studied by K-kit.*

## Dynamic observation of polystyrene beads in PBS buffer (sodium ion)

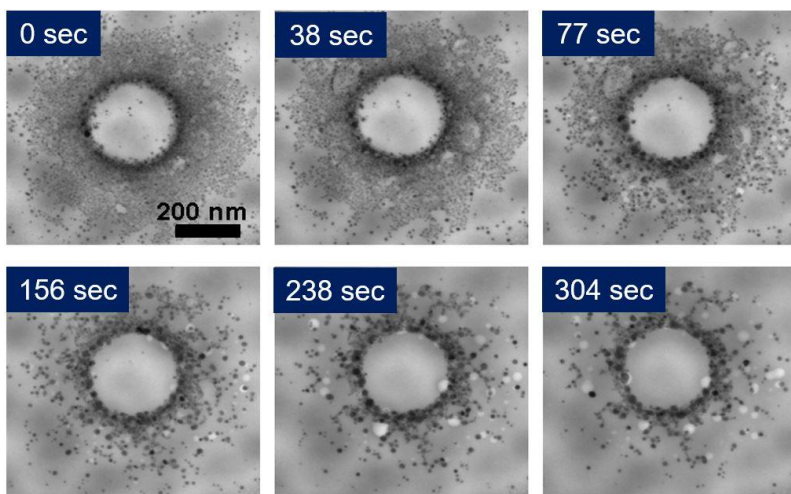

The reduction process of the sodium ions, which induced from the TEM electron energy, in PBS buffer around a polystyrene bead could be observed with prolonged observation time.

## Gold metal growth in water with and without polystyrene beads

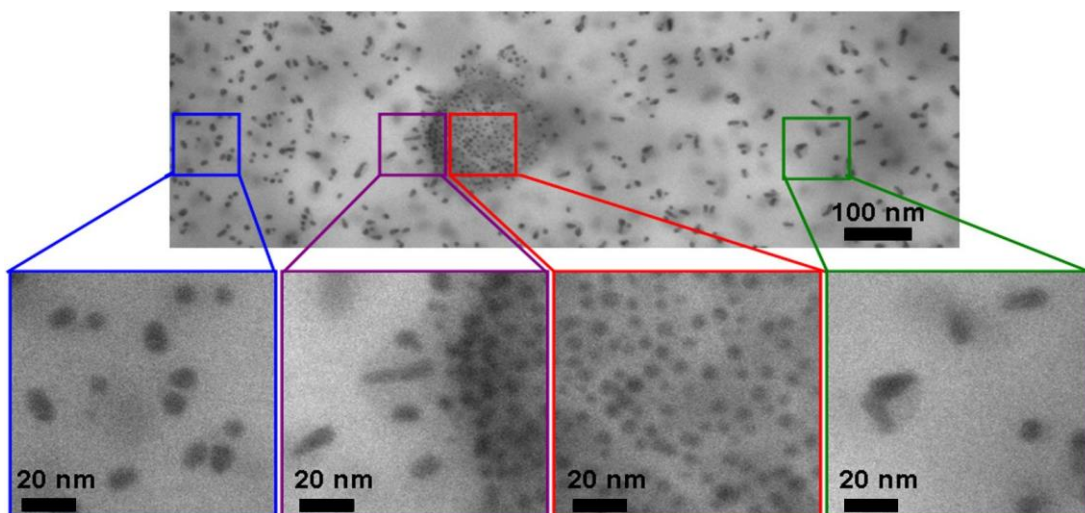

The metal growth of Au ions in water could be observed dynamically at the same time in the areas far away and nearby a polystyrene bead. (As shown in the image, there's a polystyrene bead at the center, with a lot of relatively small Au particles surrounded)



# Not Only K-kit

## Bio MA-tek provides comprehensive services in bio-EM and physicochemical analysis

- Bio Ma-tek total solution services, based on recommendations in ISO/TR13014 – 8 parameters

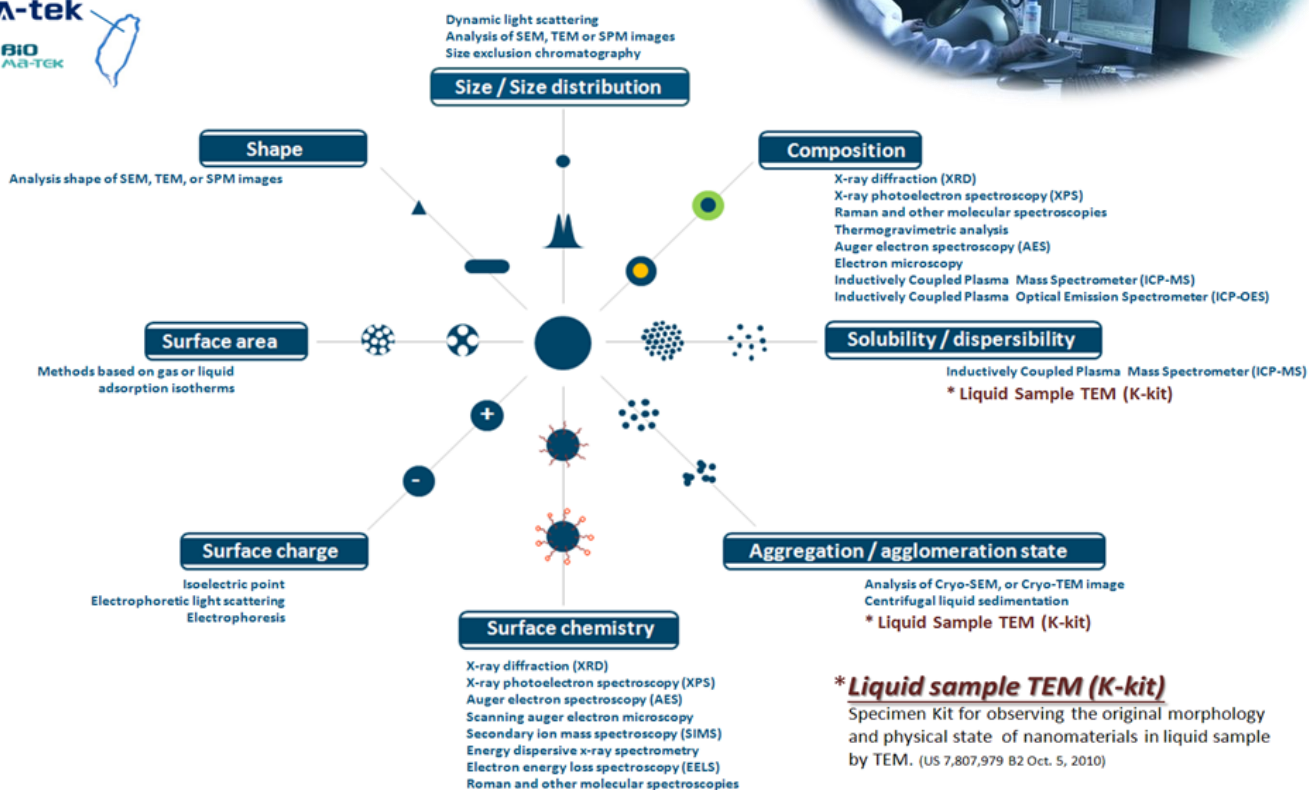
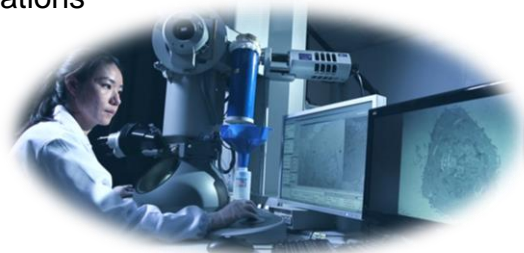

### \*Liquid sample TEM (K-kit)

Specimen Kit for observing the original morphology and physical state of nanomaterials in liquid sample by TEM. (US 7,807,979 B2 Oct. 5, 2010)

Negative stain/TEM

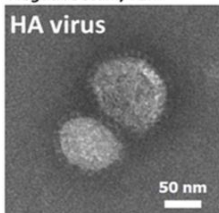

Liquid (K-kit)/TEM

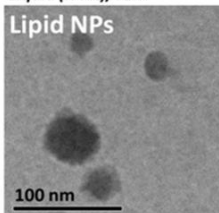

Cryo- /TEM

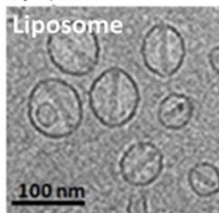

Ultramicrotome/TEM

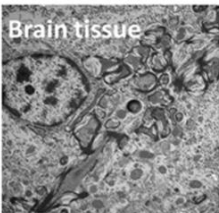

Cryo-ultramicrotome/TEM

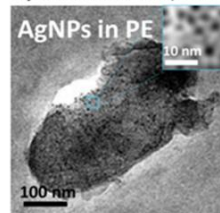

Critical point dryer/SEM

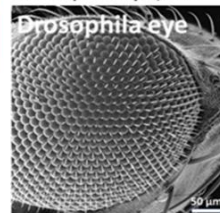

PLGA NPs

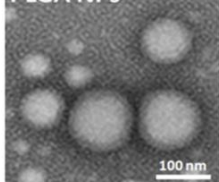

CMP slurry

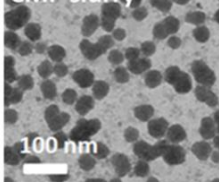

HA virus

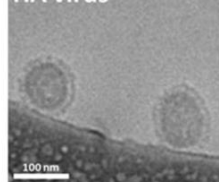

Bacteria

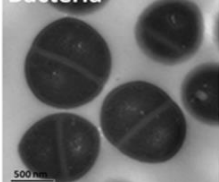

QLED film

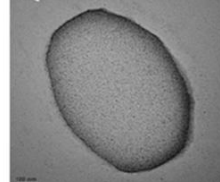

Hydro-gel

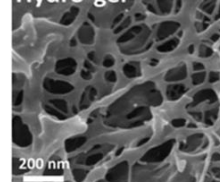



# Our Services



**Bio MA-tek provides analytical services to the following industries:**

- Bio-technology
- Pharmaceutical (nano-formulation, nano-drug, etc.)
- Vaccine (vaccine formulation, adjuvant, etc.)
- Medical devices (dialysis, dressing, etc.)
- Cosmetics (powder, cream, lotion, mask, etc.)
- Foods (additives, packaging materials, etc.)
- Academic & research organizations
- Electronics industry (Semiconductors, TFT-LCD, LED, PCBs, ...)
- Others

[sales@bioma-tek.com](mailto:sales@bioma-tek.com)  
[project@bioma-tek.com](mailto:project@bioma-tek.com)

Tel: +886-3-611-8611

Fax: +886-3-563-0777

## Service Items

### Physico-Chemical Characterization

- Size/Size Distribution: DLS
- Surface Charge: Zeta potential
- Composition and Impurity: TGA, DSC, FT-IR, XRD, UPLC, ICP-MS, LC/MS/MS (QQQ)
- Surface Chemistry: XPS
- Surface Area: BET

### Electron Microscopy Analysis

- Negative Stain
- Resin Embedding
- Ultramicrotome
- Cryo-ultramicrotome
- Critical Point Drier (CPD)
- Cryo-transfer System
- Liquid Sample Preparation
- TEM/ EDX
- SEM/ EDX

# Bio Materials Analysis Technology Inc.



Established on March 31 2014, Bio Materials Analysis Technology Inc. (Bio MA-tek) and its sole investor, MA-tek, serve as the best R&D partners of high-tech industry. To address the demanding needs for physical and chemical characterization of nanomaterials in bio-medical industry. Bio MA-tek has introduced an array of bio-EM sample preparation and image analysis services as well as a comprehensive list of analytical services per the recommendations of ISO/TR13014.



## **Vision:**

To become a leading brand in bio-medical materials analysis

## **Business model:**

Focus on core technology, leverage external resources, deliver proficient and adequate services

## **Positioning:**

Solution provider of nano- biomaterials characterization and analysis

## **Service scope:**

Characterize and analyze nanobiomaterials in foods, cosmetics, medical materials, drugs, vaccines, biological tissue, etc. Provide proficient and adequate sample preparation, analysis, consultation, and contracted services.



***The Best R&D Partner !***





**BIO MA-TEK**

**Bio MA-Tek, the Best R&D Partner for Your Success !**

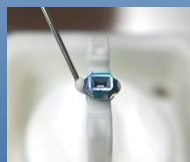

### 閎康生物科技股份有限公司

- 總公司：302 新竹縣竹北市台元街 26-2 號 1 樓
- 實驗室：300 新竹市科學工業園區力行一路 1 號 1A4

Tel: +886-3-611-8611  
Fax: +886-3-563-0777  
www.bioma-tek.com

sales@bioma-tek.com,  
project@bioma-tek.com

### Bio Materials Analysis Technology Inc.

- Office: 1F, No. 26-2, Tai-Yuen St.,  
Jubei City,  
Hsinchu County, 302, Taiwan
- Lab: 1A4, No. 1, Li-Hsin Rd. 1,  
Science-Based Industrial Park,  
Hsinchu City, 300, Taiwan