

X-Band High-Input-Power Low Noise Amplifier

Product Overview

MMA047AA is a Gallium Arsenide (GaAs) monolithic microwave integrated circuit (MMIC) pHEMT distributed amplifier specifically made to operate between 5 and 14 GHz. The bare die amplifier provides reliable operation with up to 30dBm of input RF CW power having 1.5dB of noise, 22.5dB of gain, 34dBm output IP3, and 22.5dBm of output power at 1 dB compression. Die was designed to handle more Input power (more than 35dBm CW and 43dBm pulsed) with external PIN diode, having minimum external circuit requirements and excellent noise figure. The MMA047AA amplifier features compact die size and I/Os that are internally matched to 50 Ohm.

Key Features

- **Frequency range: 5 to 14 GHz**
- **Gain: 22 dB**
- **High IP3: 34 dBm**
- **Low Noise: 1.5 dBm**
- **Die Input Power handling: >30dBm (CW)**
- **Adjustable Self-Bias Operation**
- **On-die Choke**
- **Supply: 7V @ 180mA**
- **100% ESD Protection**
- **50 Ohm Matched Input/Output**
- **Die: 2.02 x 1.47 x 0.1 mm**

Functional Block Diagram

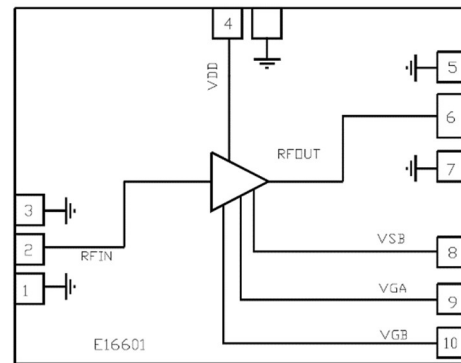

Applications

- Test and measurement instrumentation
- Electronic warfare (EW), electronic countermeasures (ECM), and electronic counter-countermeasures (ECCM)
- Military, A&D, space, SATCOM
- Telecom infrastructure
- Wideband microwave radios
- Microwave and millimeter-wave communications systems

Performance Overview

Parameter	Typ.	Units
Operational frequency range	5-14	GHz
Gain	22	dB
Noise Figure	1.5	dB
P1dB	22	dBm
OIP3	34	dBm

Export Classification: EAR-99

Figure 1 - Typical Responses

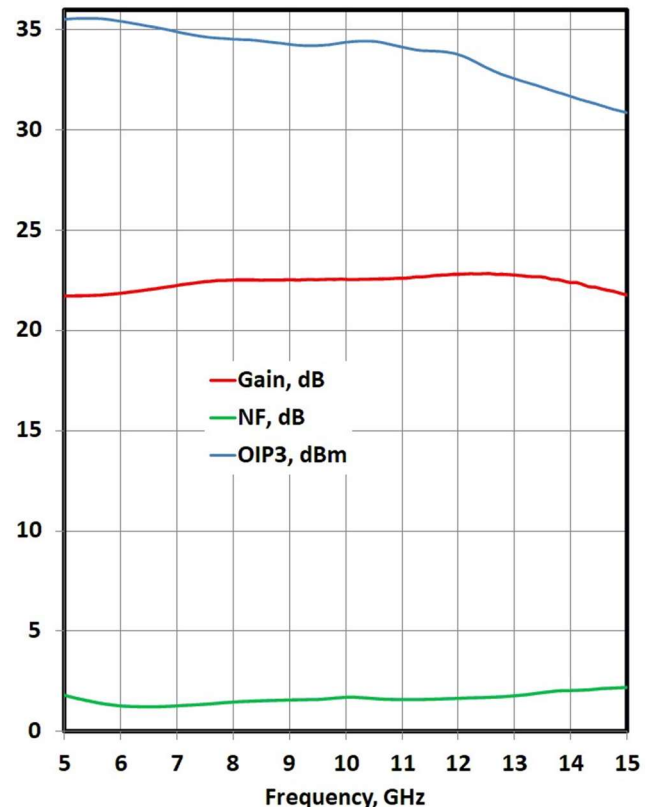

Table of Contents

- 1. Electrical Specifications3
 - 1.1. Typical Electrical Performance3
 - 1.2. Absolute Maximum Ratings.....4
 - 1.3. Typical Performance Curves4
 - 1.3.1 Typical Performances vs. Temperature.....4
 - 1.3.2 Typical Performances vs. Bias..... 10
 - 1.3.3 Typical Performances vs. Output Power..... 13
 - 1.3.4 Typical Performances For Applications Circuit with PIN Diode (Figure 72 -) 15
 - 1.3.5 Typical Performances for Applications Circuit with SLC Capacitance (Figure 73 -) 17
 - 1.4. Die Specifications 18
- 2. Application Circuits 19
- 3. Handling Recommendations..... 22
- 4. Ordering Information..... 22
 - 4.1. Packing Information 22

1. Electrical Specifications

1.1. Typical Electrical Performance

Table 1 - Typical Electrical Performance at 25 C, Vdd=7V, Idd=180 mA (Unless otherwise mentioned)

Parameter	Frequency Range	Min	Typ.	Max	Units
Frequency range		5		14	GHz
Gain	6 GHz -12 GHz	21		23	dB
Gain flatness	6 GHz -12 GHz		±0.5		dB
Noise figure	6 GHz -12 GHz		1.5	2	dB
Input return loss	6 GHz -12 GHz		10		dB
Output return loss	6 GHz -12 GHz		15		dB
P1dB	6 GHz -12 GHz	21	22		dBm
Psat	6 GHz -12 GHz		23		dBm
OIP3	6 GHz -12 GHz	33	34		dBm
Hot Switching (ON/OFF)	6 GHz -12 GHz		50	60	ns
Phase Noise	100Hz Offset		-135		dBc/Hz
	1kHz Offset		-135		dBc/Hz
	10kHz Offset		-150		dBc/Hz
	100kHz Offset		-150		dBc/Hz
Stability k-factor	6 GHz -12 GHz	1.5			
Input Power Survivability (CW)	6 GHz -12 GHz	30		32	dBm
VDD (drain voltage supply)			7		V
IDD (drain current)			180		mA

1.2. Absolute Maximum Ratings

The following table shows the absolute maximum ratings of the MMA047AA device at 25 °C, unless otherwise specified. Exceeding one or any of the maximum ratings potentially could cause damage or latent defects to the device.

Table 2 - Absolute Maximum Ratings

Parameter	Rating
Drain bias voltage (V_{DD})	8 V
Drain bias current (I_{DD})	200 mA
Gate bias voltage (V_G)	-2 V to 0.5 V
RF input power (P_{in})	+32 dBm (CW)
Channel temperature	150 °C
Thermal resistance	12 °C/W
Storage temperature	-65 °C to 150 °C
Operating temperature	-55 °C to 85 °C



1.3. Typical Performance Curves

1.3.1 Typical Performances vs. Temperature

The following graphs show the typical performance curves of the MMA047AA device at specific bias conditions, measurements performed using application circuit shown on Figure 71 -below.

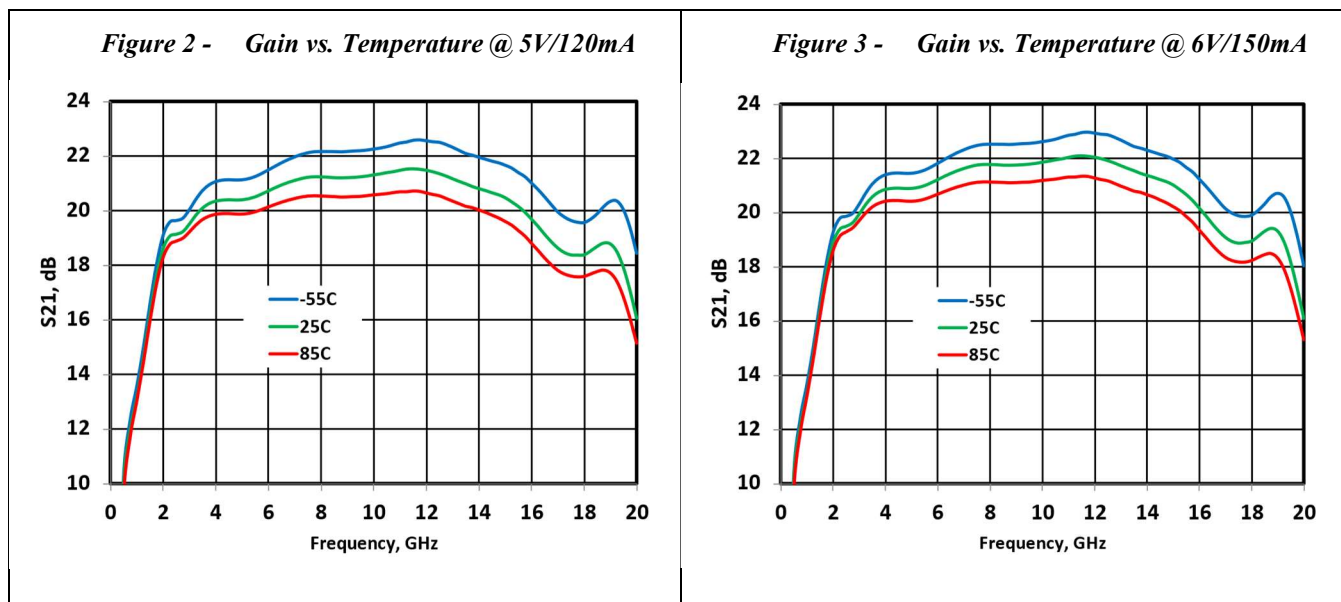

Figure 4 - Gain vs. Temperature @ 7V/180mA

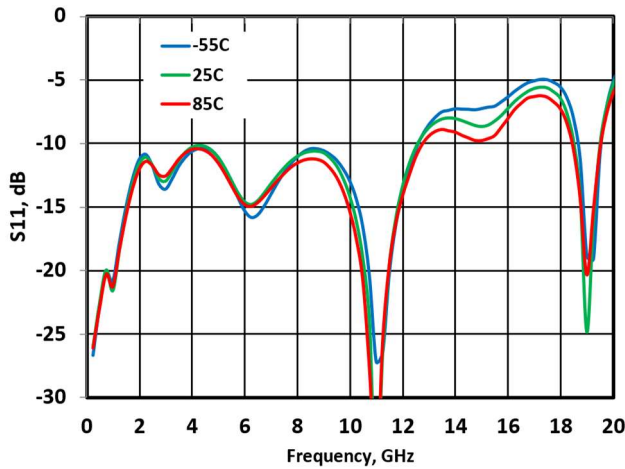

Figure 5 - S11 vs. Temperature @ 5V/120mA

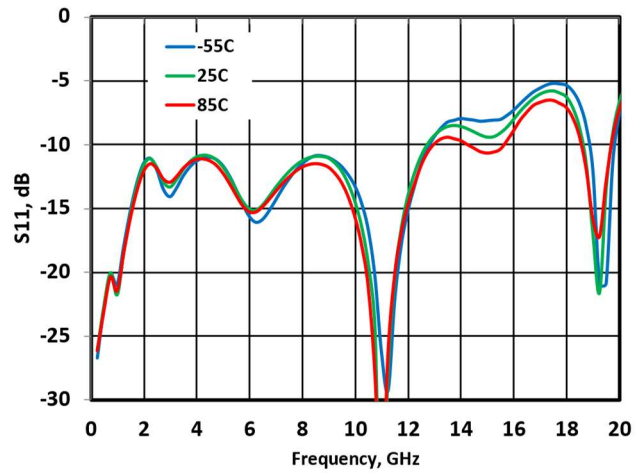

Figure 6 - S11 vs. Temperature @ 6V/150mA

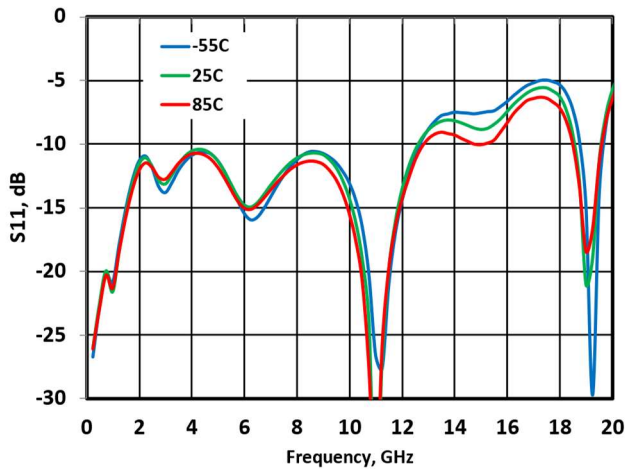

Figure 7 - S11 vs. Temperature @ 7V/180mA

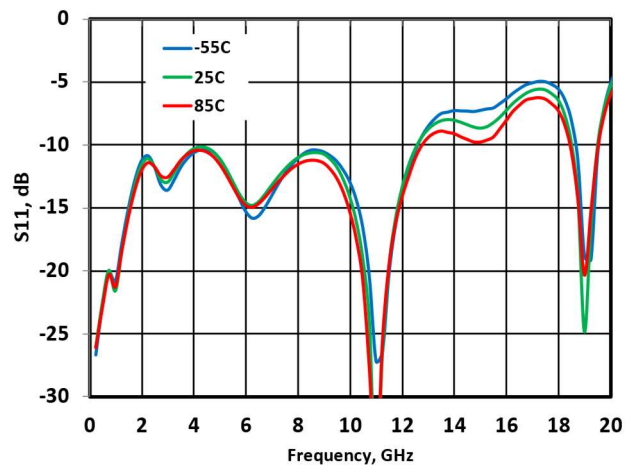

Figure 8 - S22 vs. Temperature @ 5V/120mA

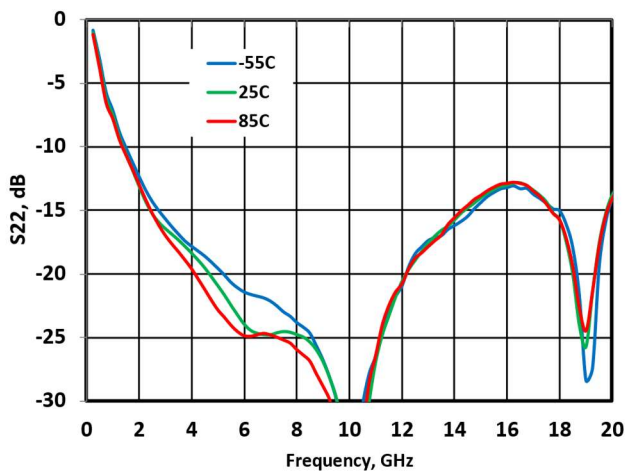

Figure 9 - S22 vs. Temperature @ 6V/150mA

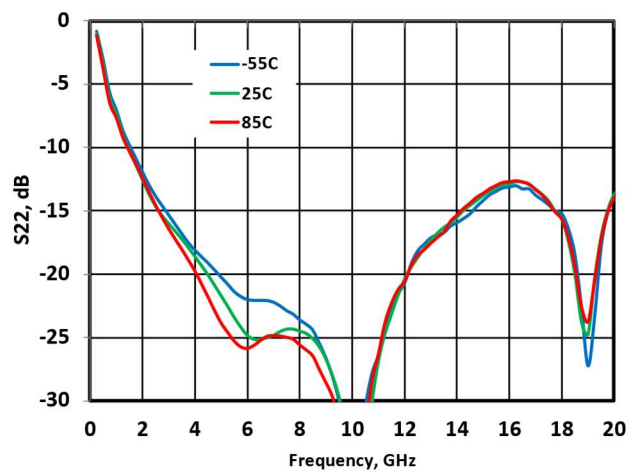

Figure 10 - S22 vs. Temperature @ 7V/180mA

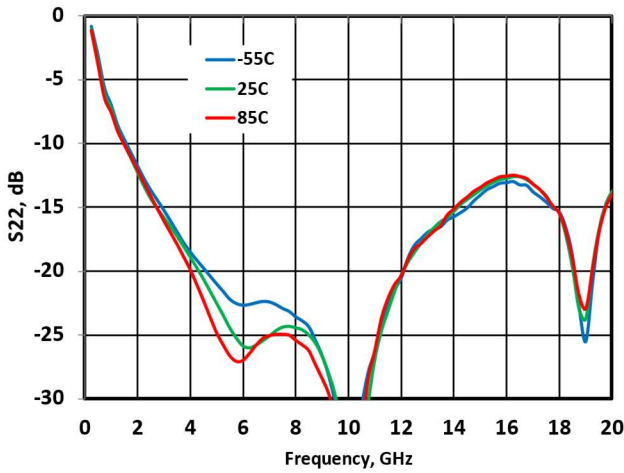

Figure 11 - S12 vs. Temperature @ 5V/120mA

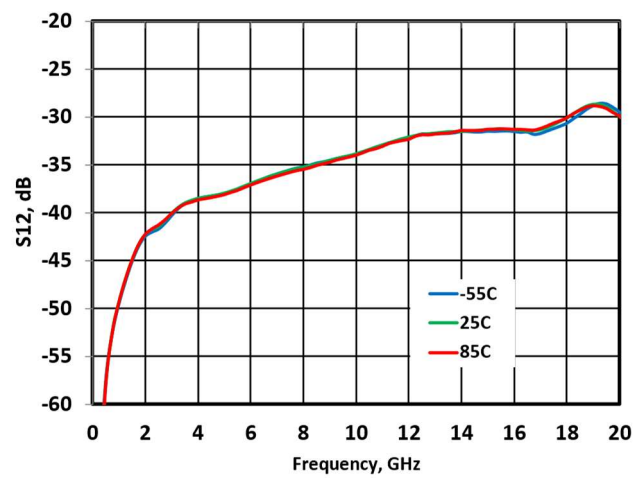

Figure 12 - S12 vs. Temperature @ 6V/150mA

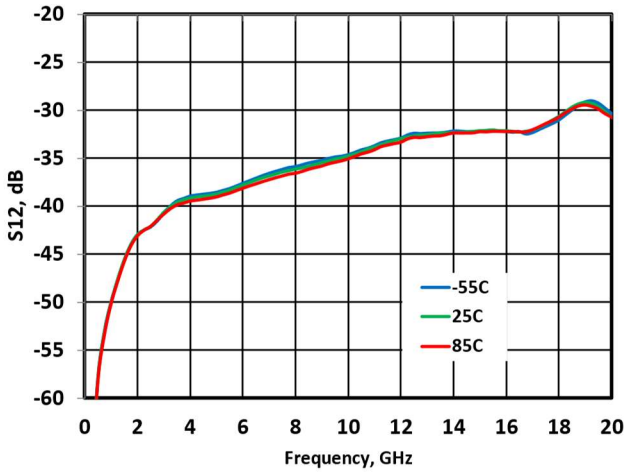

Figure 13 - S12 vs. Temperature @ 7V/180mA

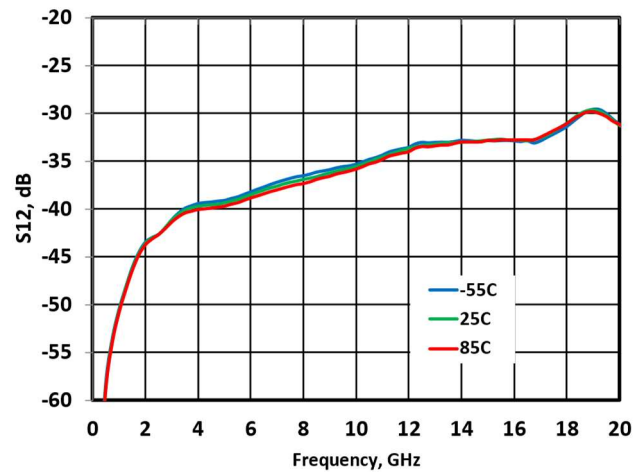

Figure 14 - NF vs. Temperature @ 5V/120mA

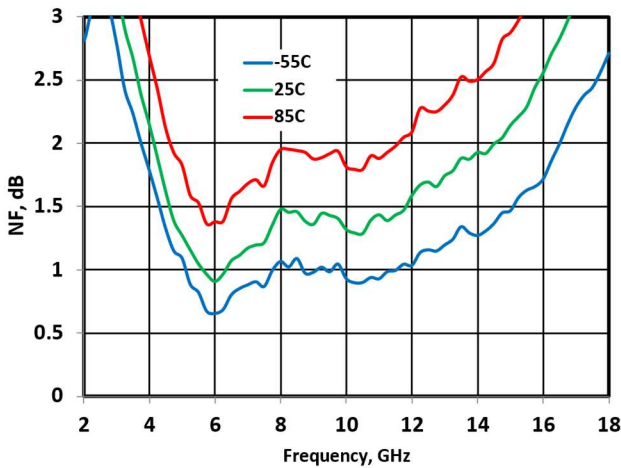

Figure 15 - NF vs. Temperature @ 6V/120mA

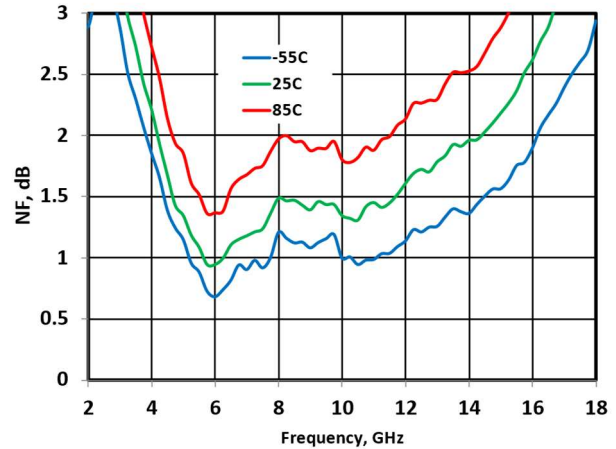

Figure 16 - NF vs. Temperature @ 7V/180mA

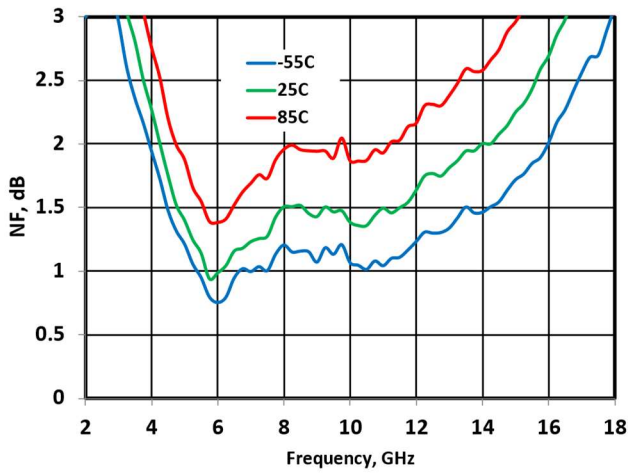

Figure 17 - P1dB vs. Temperature @ 5V/120mA

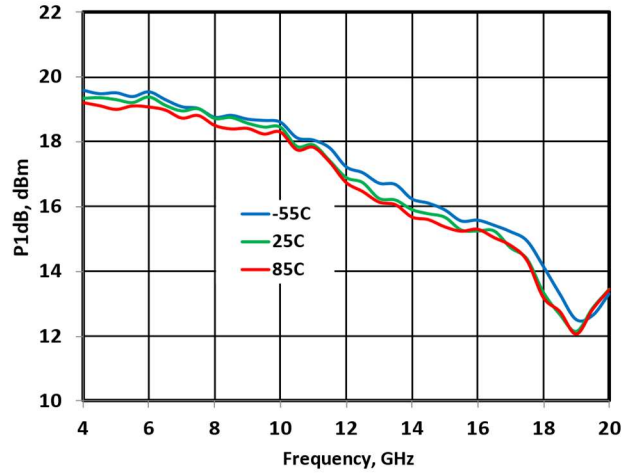

Figure 18 - P1dB vs. Temperature @ 6V/150mA

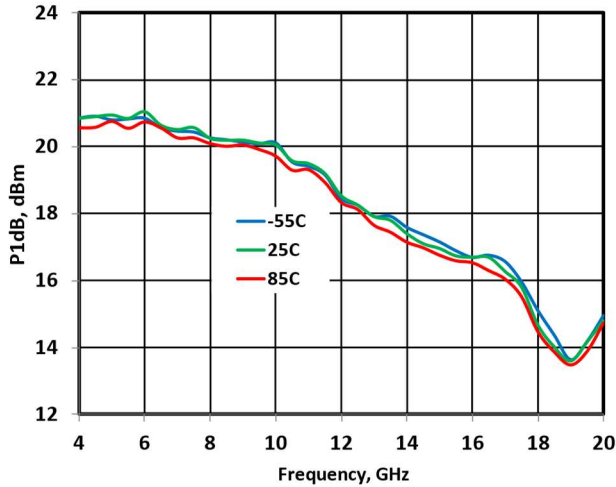

Figure 19 - P1dB vs. Temperature @ 7V/180mA

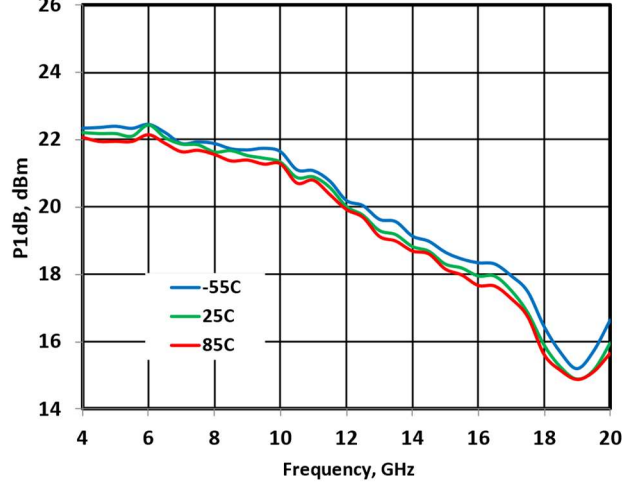

Figure 20 - Psat vs. Temperature @ 5V/120mA

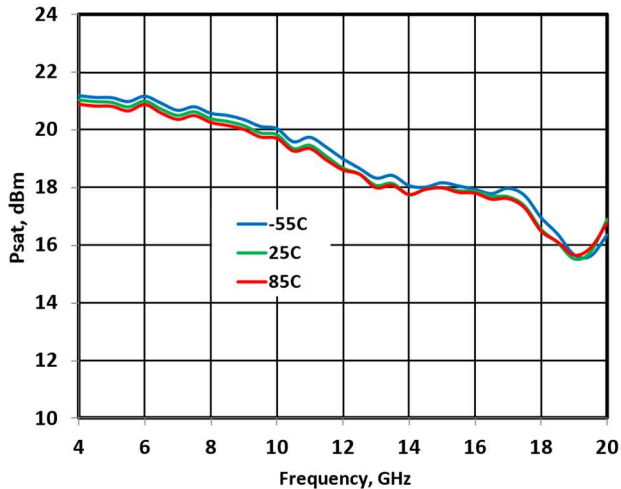

Figure 21 - Psat vs. Temperature @ 6V/150mA

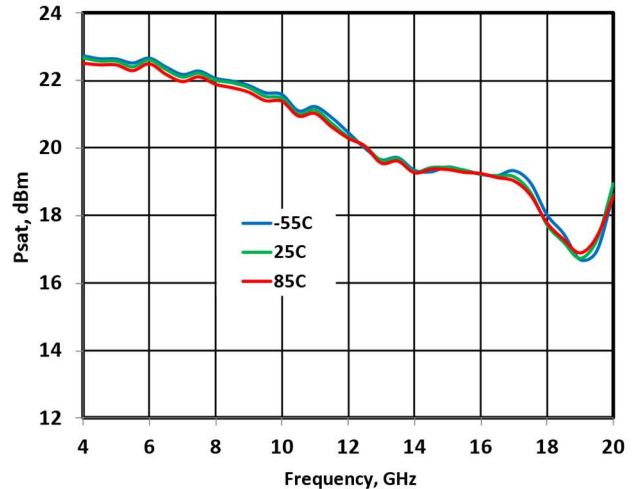

Figure 22 - Psat vs. Temperature @ 7V/180mA

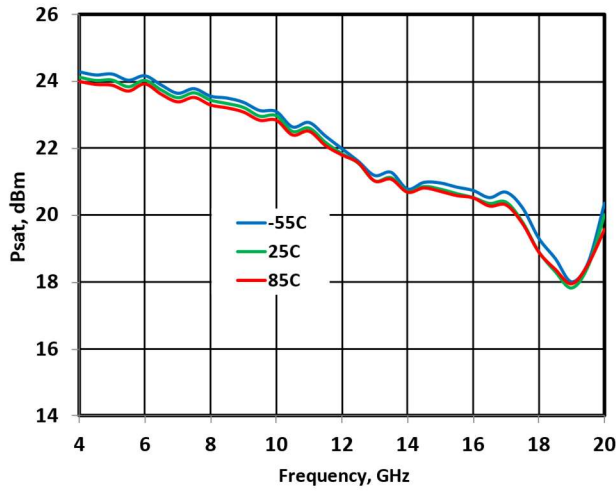

Figure 23 - OIP3 vs. Temperature @ 5V/120mA

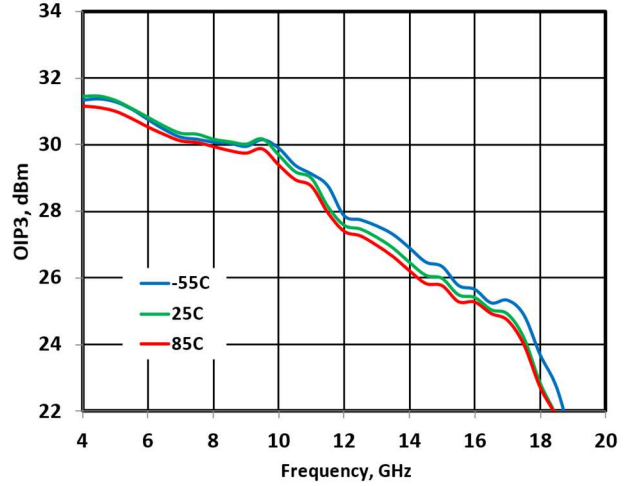

Figure 24 - OIP3 vs. Temperature @ 6V/150mA

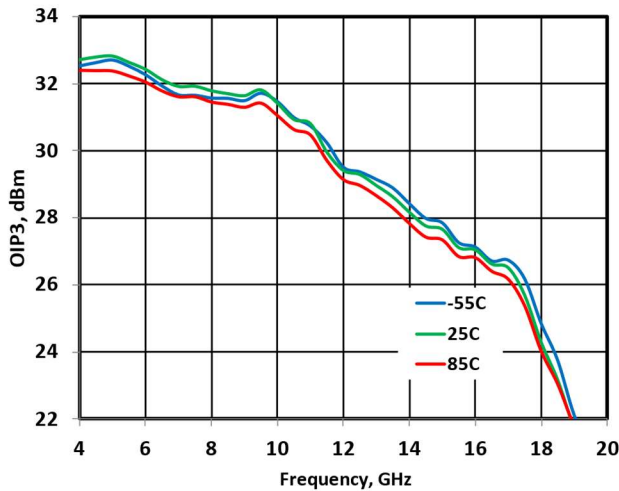

Figure 25 - OIP3 vs. Temperature @ 7V/180mA

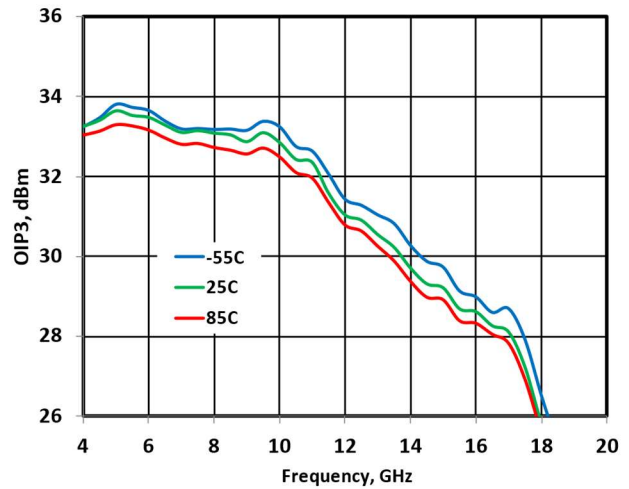

Figure 26 - OIP2(low) vs. Temperature @ 5V/120mA

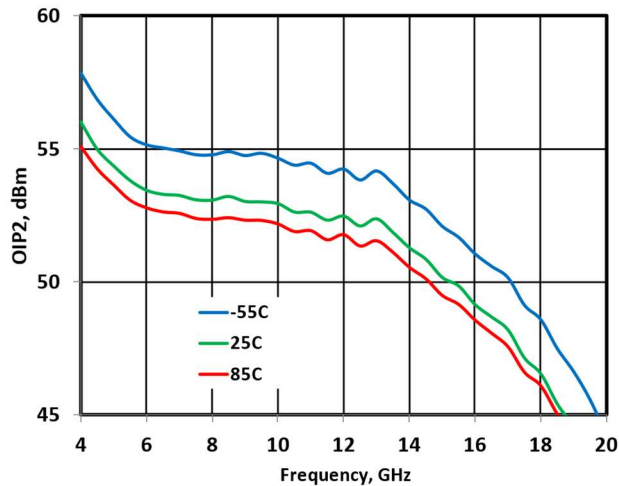

Figure 27 - OIP2(low) vs. Temperature @ 6V/150mA

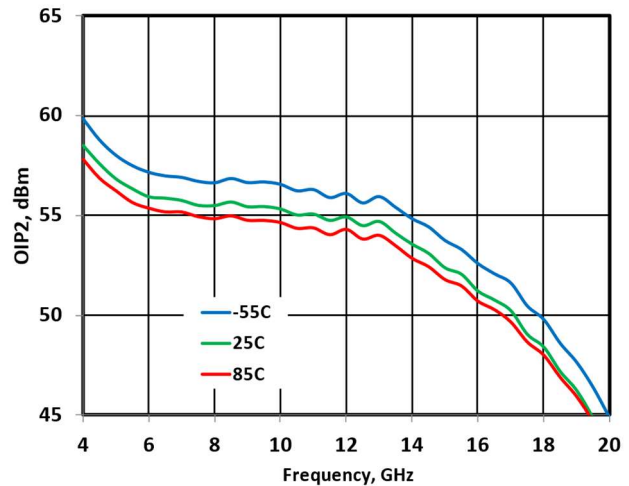

Figure 28 - OIP2(low) vs. Temperature @ 7V/180mA

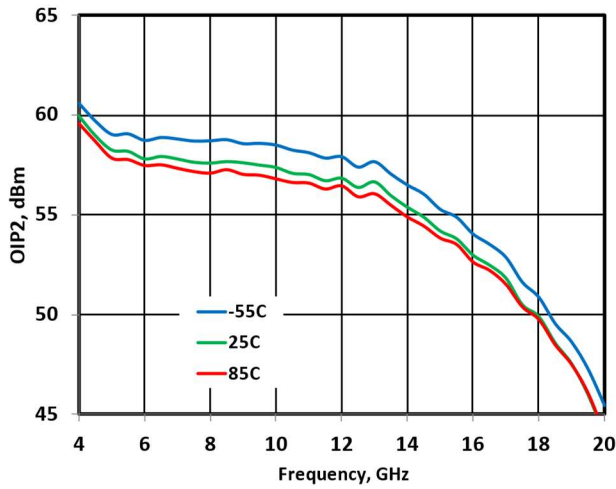

Figure 29 - IM3 vs. Temperature @ 5V/120mA, 10dBm(per tone)

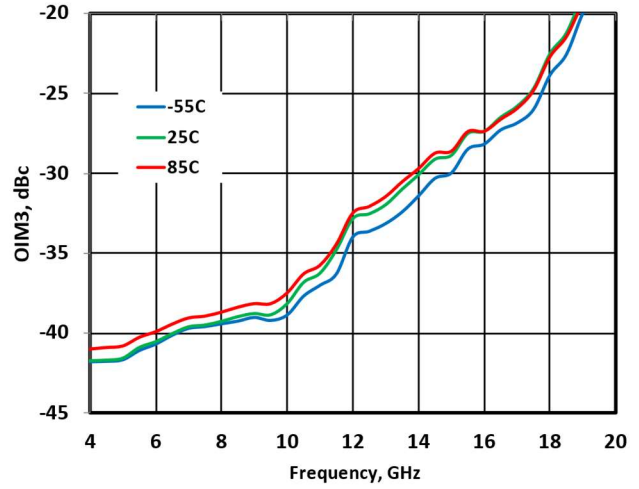

Figure 30 - IM3 vs. Temperature @ 6V/150mA, 10dBm(per tone)

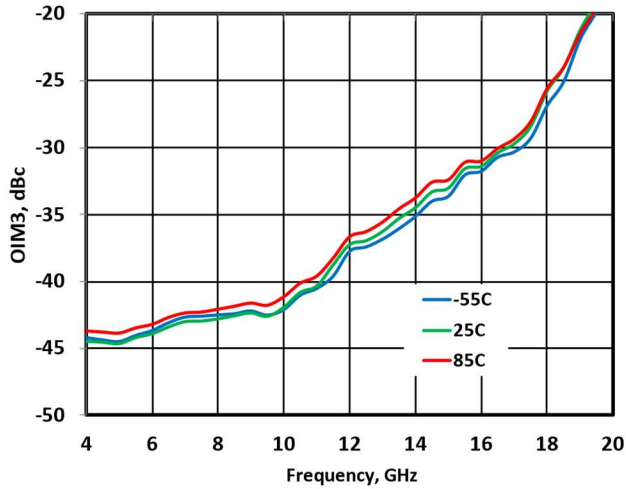
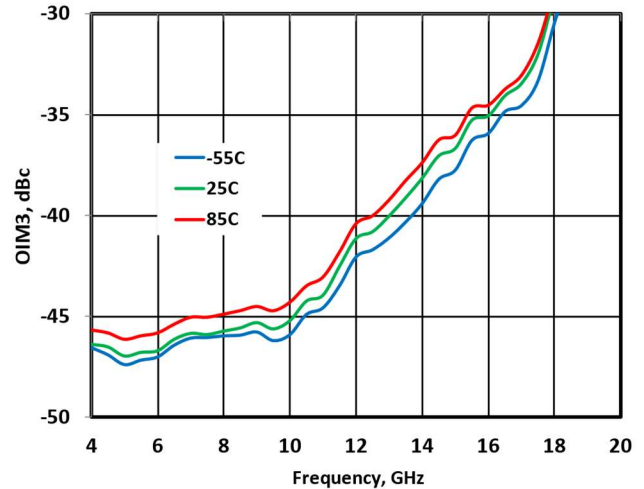

Figure 31 - IM3 vs. Temperature @ 7V/180mA, 10dBm(per tone)



1.3.2 Typical Performances vs. Bias

The following graphs show the typical performance curves of the MMA047AA device at 25 °C vs. Bias conditions, measurements performed using application circuit shown on Figure 71 -below.

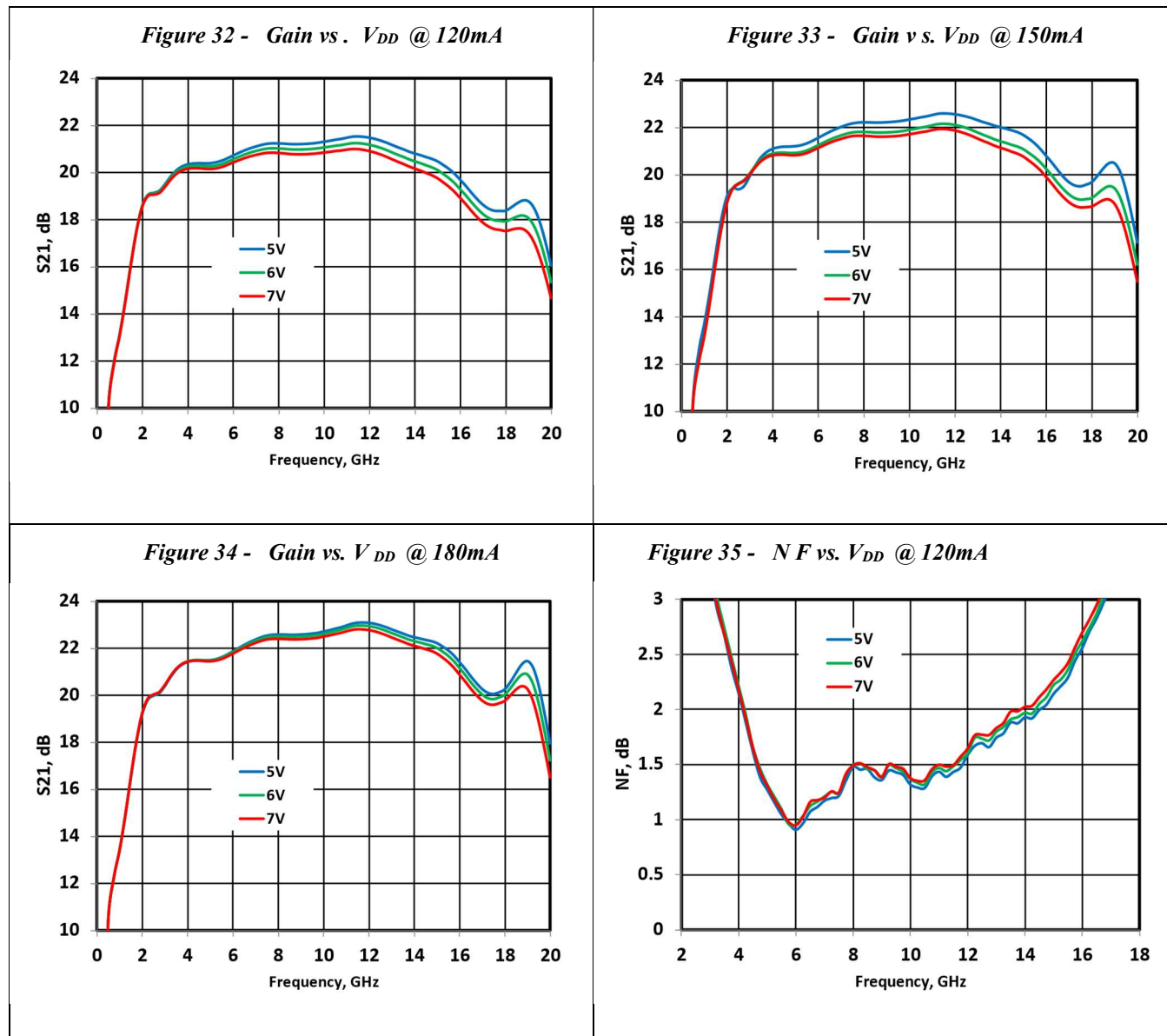

Figure 36 - NF vs. V_{DD} @ 150mA

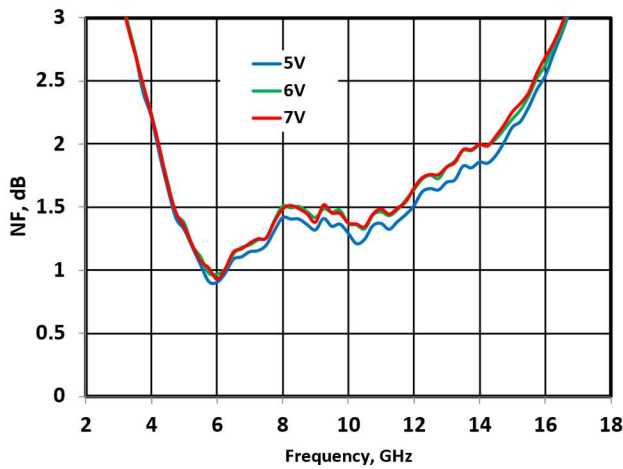

Figure 37 - NF vs. V_{DD} @ 180mA

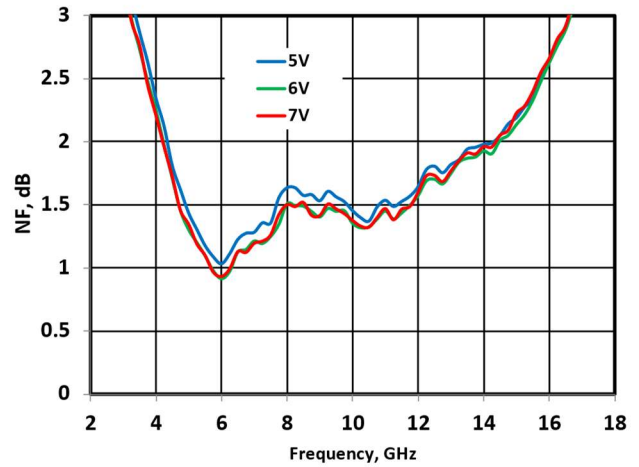

Figure 38 - P1dB vs. V_{DD} @ 120mA

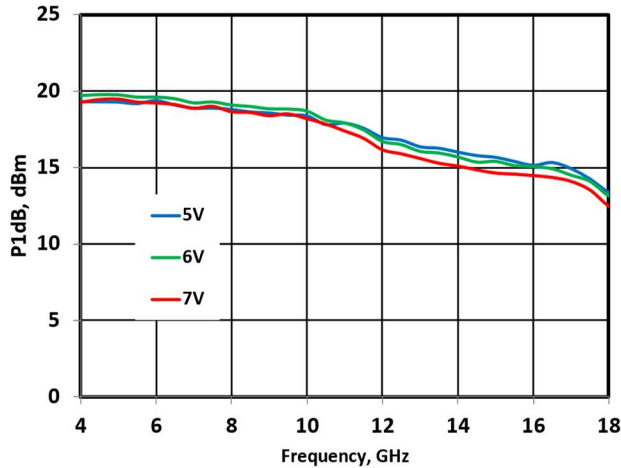

Figure 39 - P1dB vs. V_{DD} @ 150mA

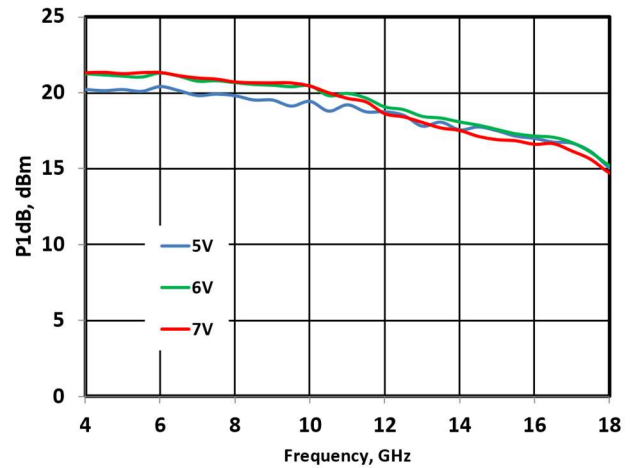

Figure 40 - P1dB vs. V_{DD} @ 180mA

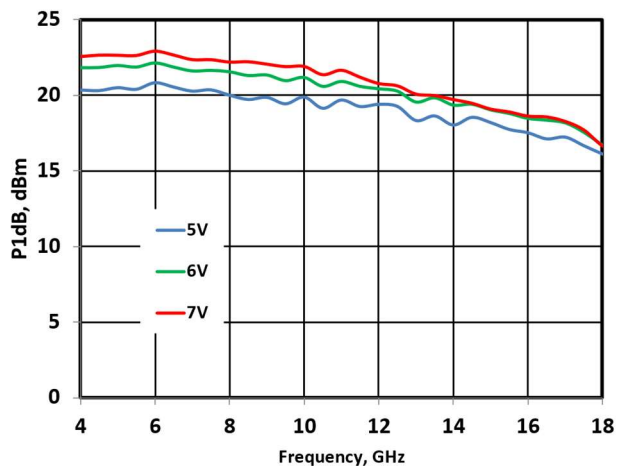

Figure 41 - OIP3 vs. V_{DD} @ 120mA

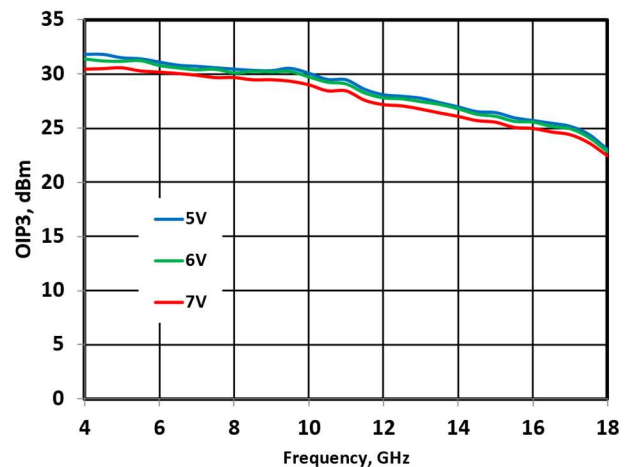

Figure 42 - OIP3 vs. V_{DD} @ 150mA

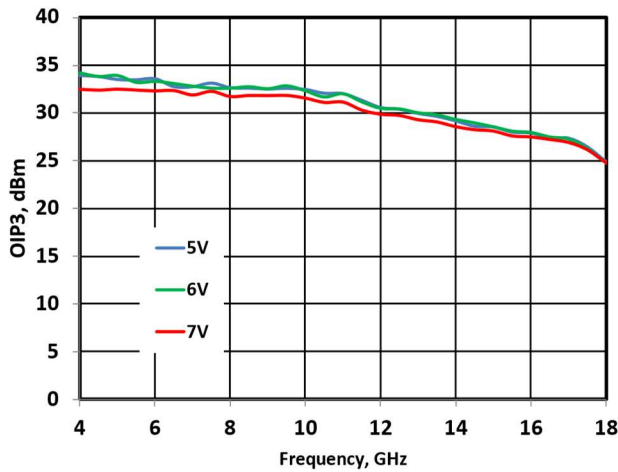

Figure 43 - OIP3 vs. V_{DD} @ 180mA

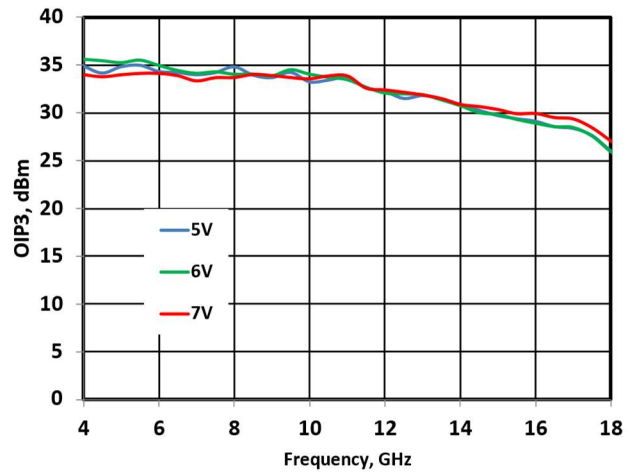

Figure 44 - OIP2 Low at $\Delta=10\text{MHz}$ vs. V_{DD} @ 120mA

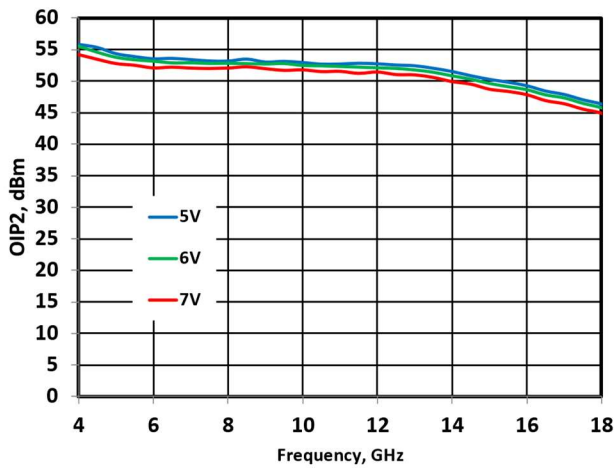

Figure 45 - OIP2 Low at $\Delta=10\text{MHz}$ vs. V_{DD} @ 150mA

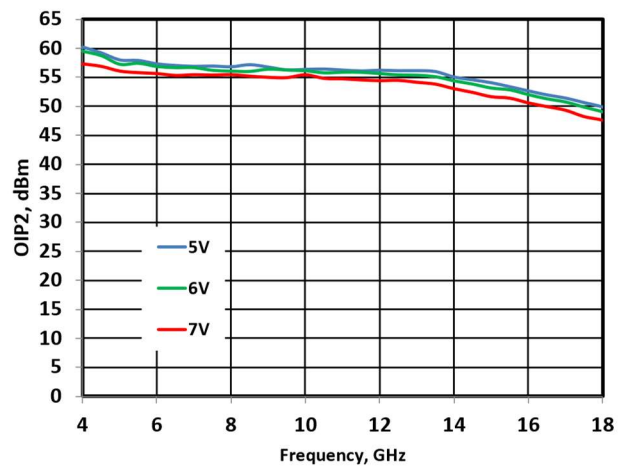

Figure 46 - OIP2 Low at $\Delta=10\text{MHz}$ vs. V_{DD} @ 180mA

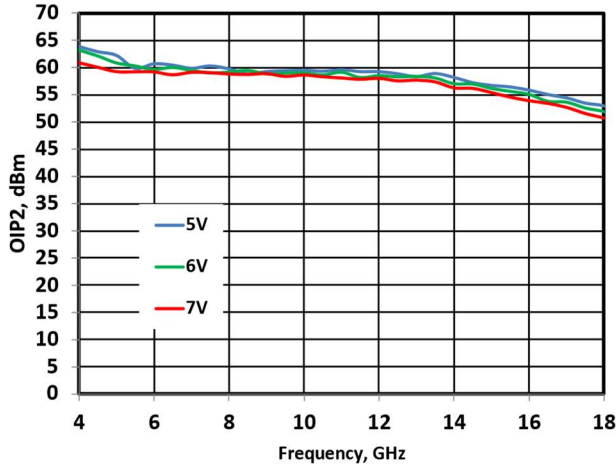

Figure 47 - IM3 vs. V_{DD} @ 120mA, 10dBm(per tone)

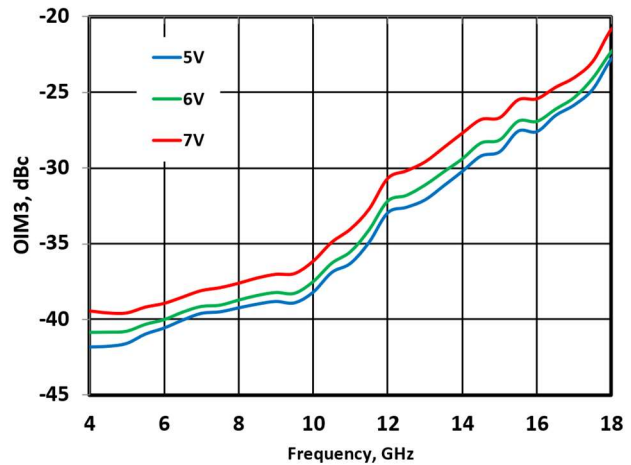

Figure 48 - IM3 vs. V_{DD} @ 150mA, 10dBm(per tone)

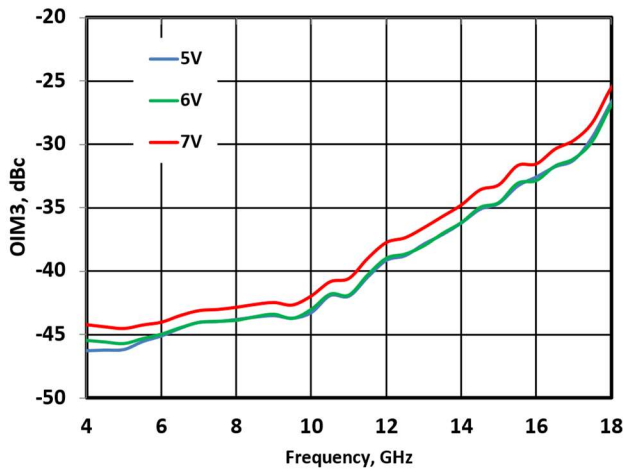
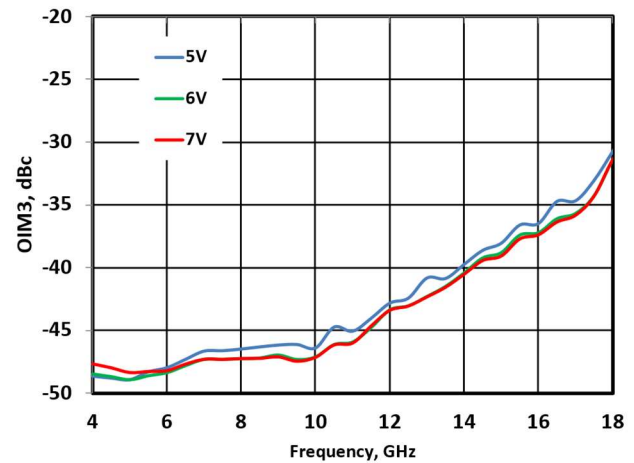

Figure 49 - IM3 vs. V_{DD} @ 180mA, 10dBm(per tone)



1.3.3 Typical Performances vs. Output Power

The following graphs show the typical performance curves of the MMA047AA device at 25 °C vs. Output Power conditions, measurements performed using application circuit shown on Figure 71 -below.

Figure 50 - IM2 vs. Power @ 5V/120mA

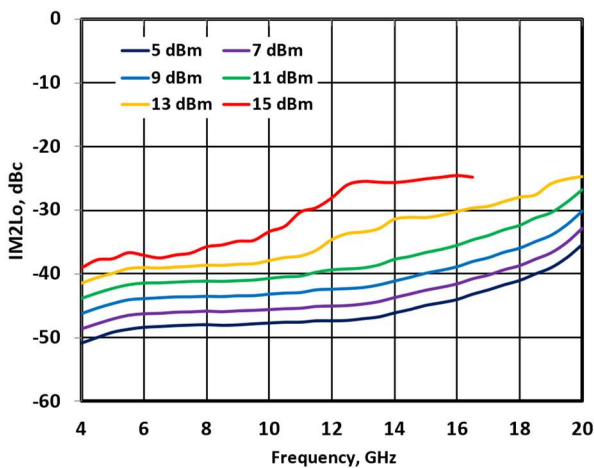

Figure 51 - IM2 vs. Power @ 6V/150mA

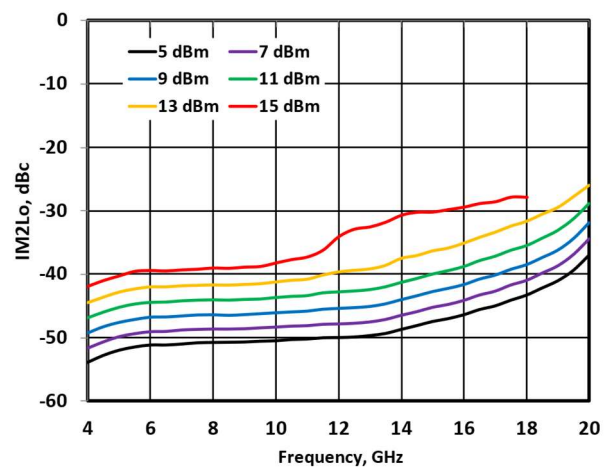

Figure 52 - IM2 vs. Power @ 7V/180mA

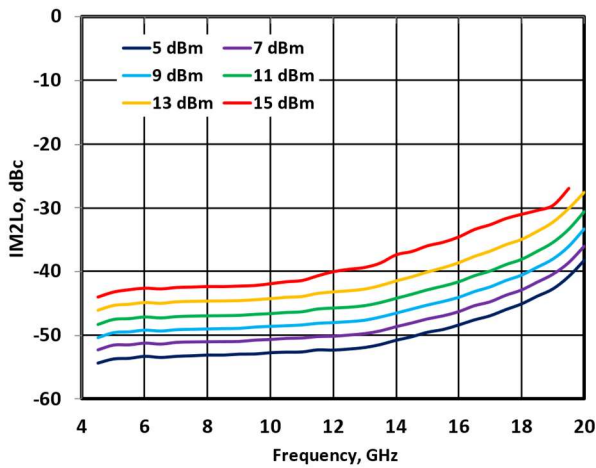

Figure 53 - IM3 vs. Power @ 5V/120mA

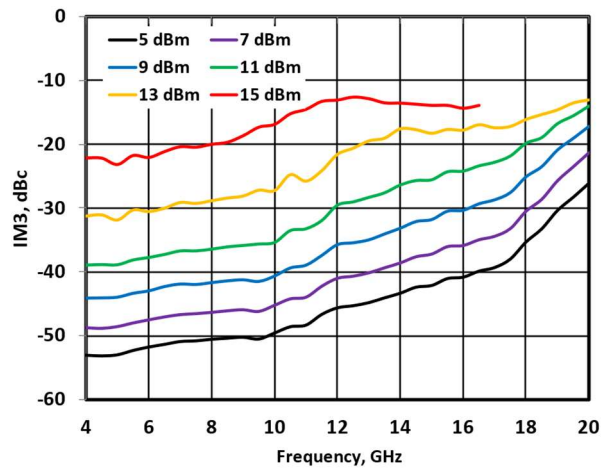

Figure 54 - IM3 vs. Power @ 6V/150mA

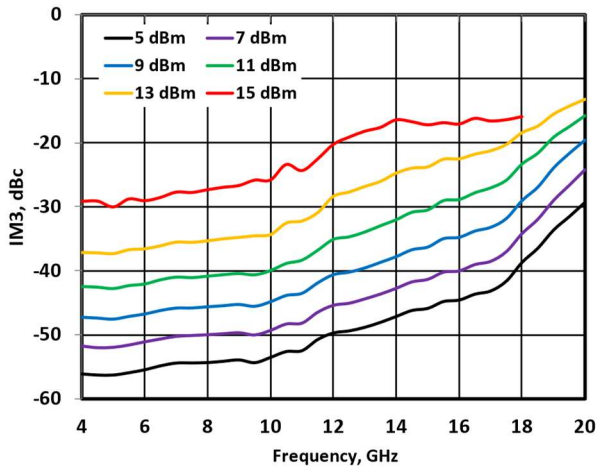

Figure 55 - IM3 vs. Power @ 7V/180mA

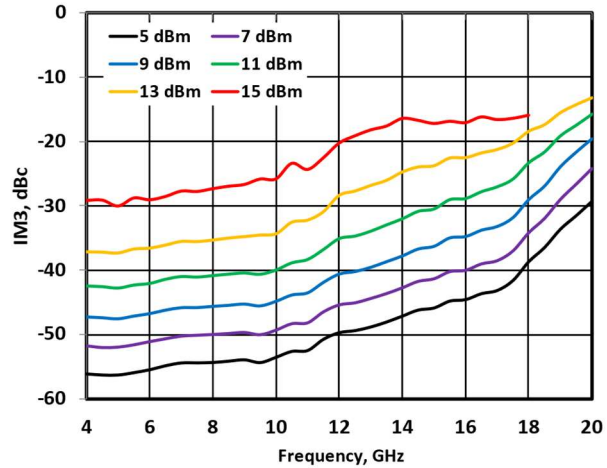

Figure 56 - 2-nd Harmonic vs. Power @ 5V/120mA

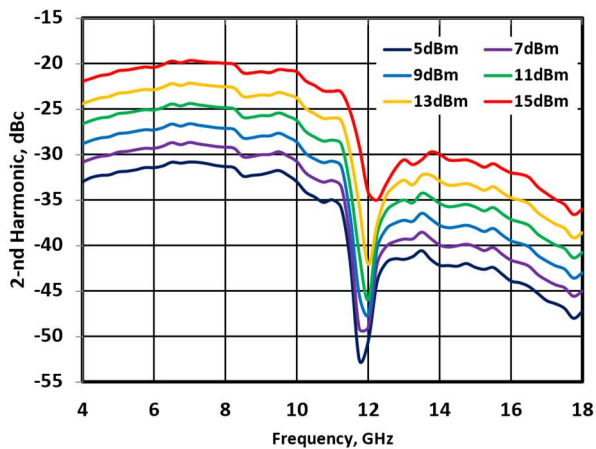
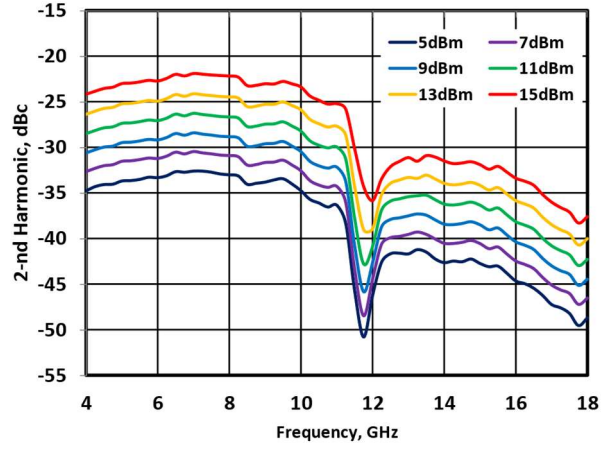
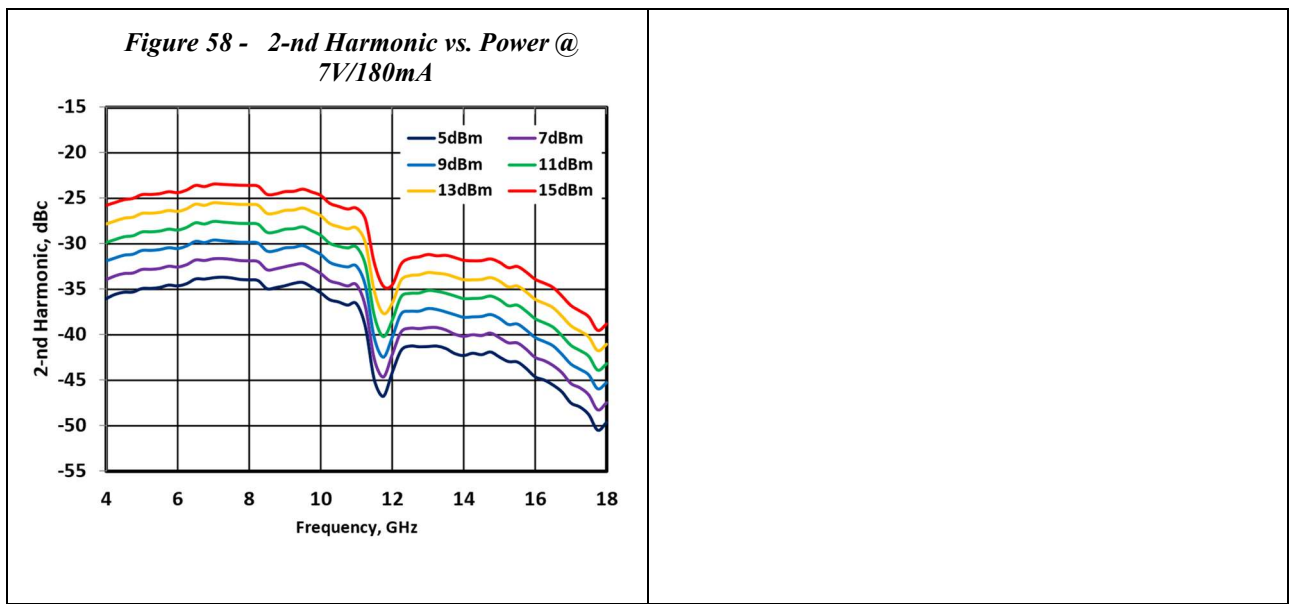

Figure 57 - 2-nd Harmonic vs. Power @ 6V/150mA





1.3.4 Typical Performances For Applications Circuit with PIN Diode (Figure 72 -)

The following graphs show the typical performance curves of the MMA047AA device at 25 °C, measurements performed using application circuit shown on Figure 72 -below.

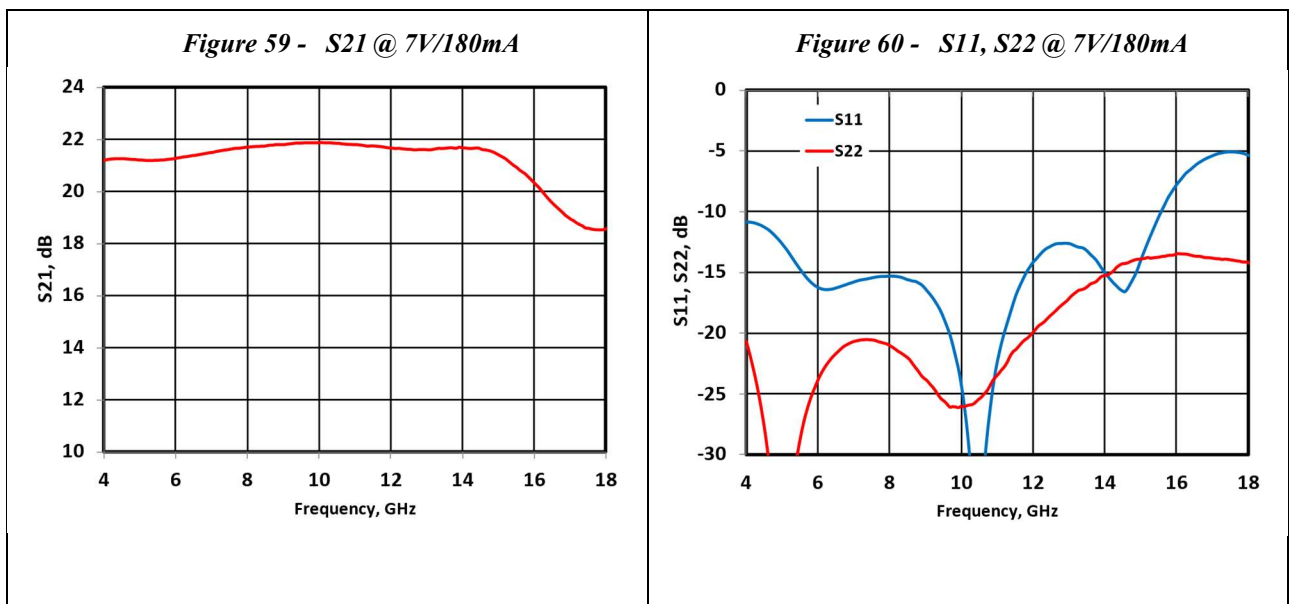

Figure 61 - S12 @ 7V/180mA

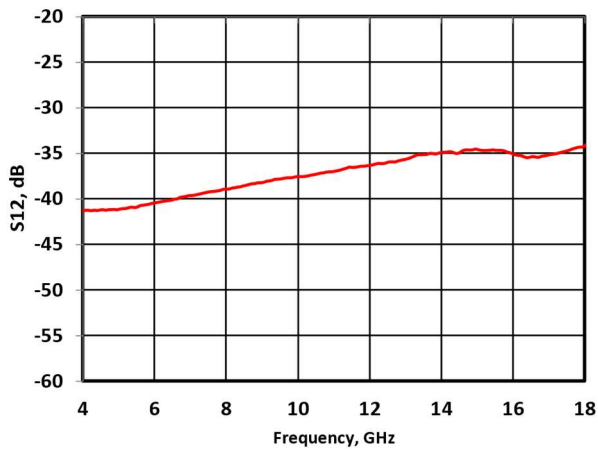

Figure 62 - NF @ 7V/180mA

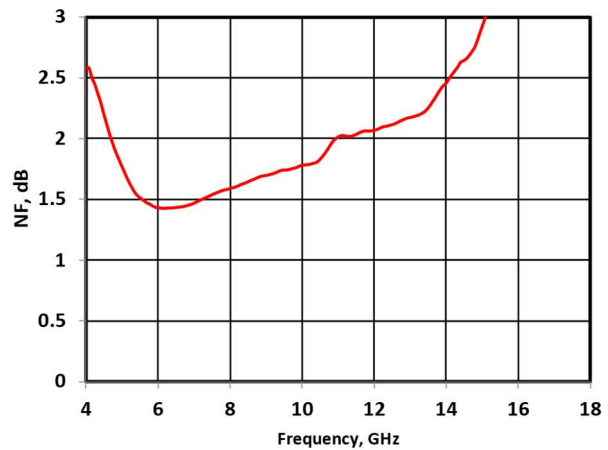
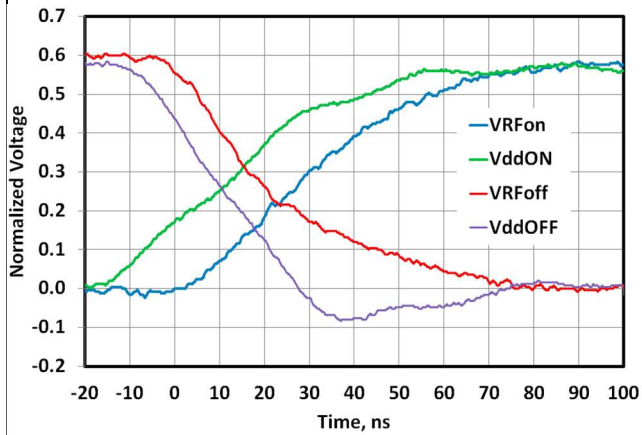
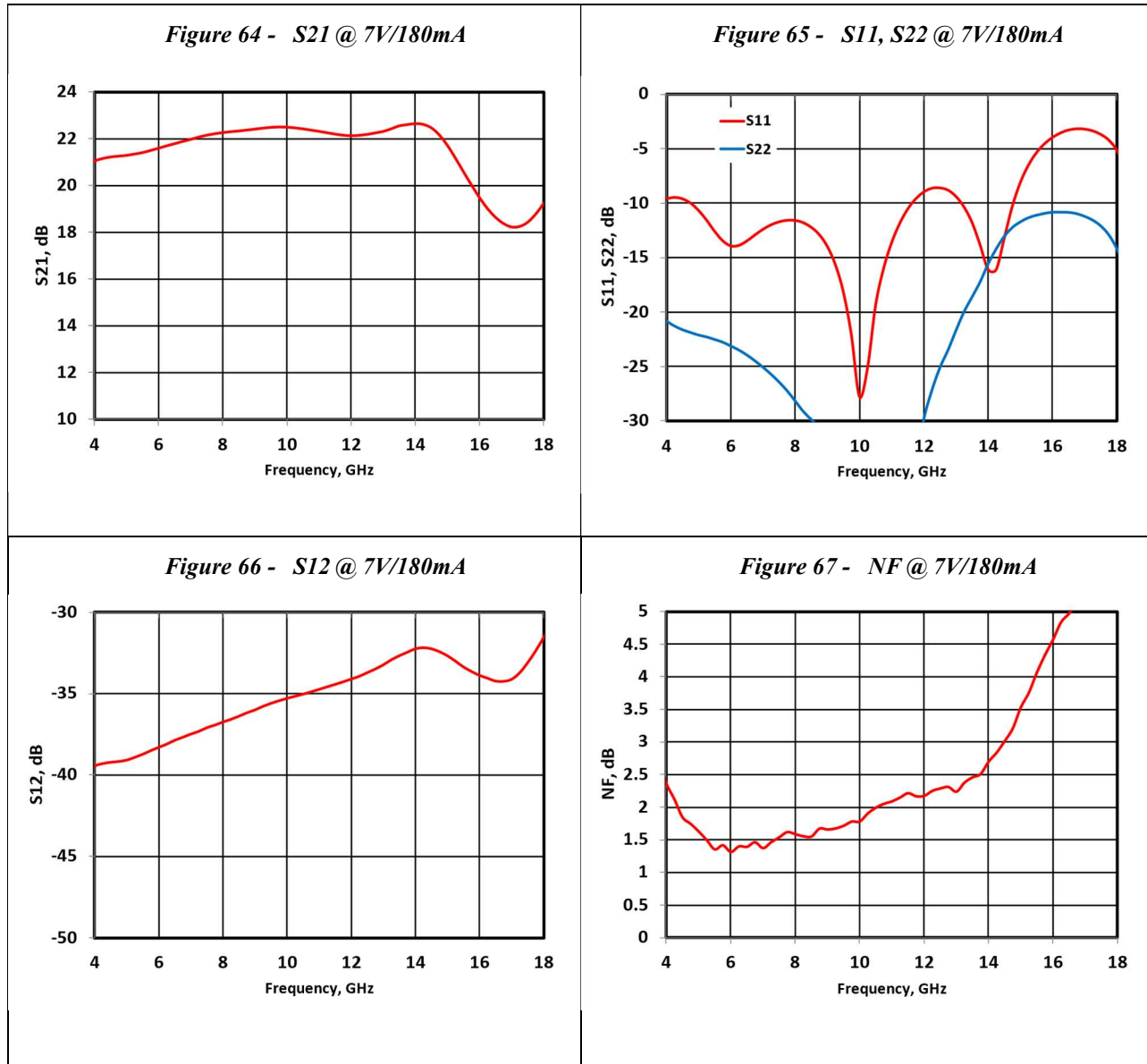

Figure 63 - Hot switching responses



1.3.5 Typical Performances for Applications Circuit with SLC Capacitance (Figure 73 -)

The following graphs show the typical performance curves of the MMA047AA device at 25 °C, measurements performed using application circuit shown on Figure 73 -below.



1.4. Die Specifications

The following illustration shows the chip outline of the MMA041AA device. Dimensions are in millimeters and are relative to the zero datum locations shown in the drawing. The minimum bond pad size is 0.1 mm × 0.1 mm. Both the bond pad surface and the backside metal have 3 μm thick gold. The die thickness is 0.1 mm. The backside is the DC/RF ground. The airbridge keep-out polygon region is shown inside.

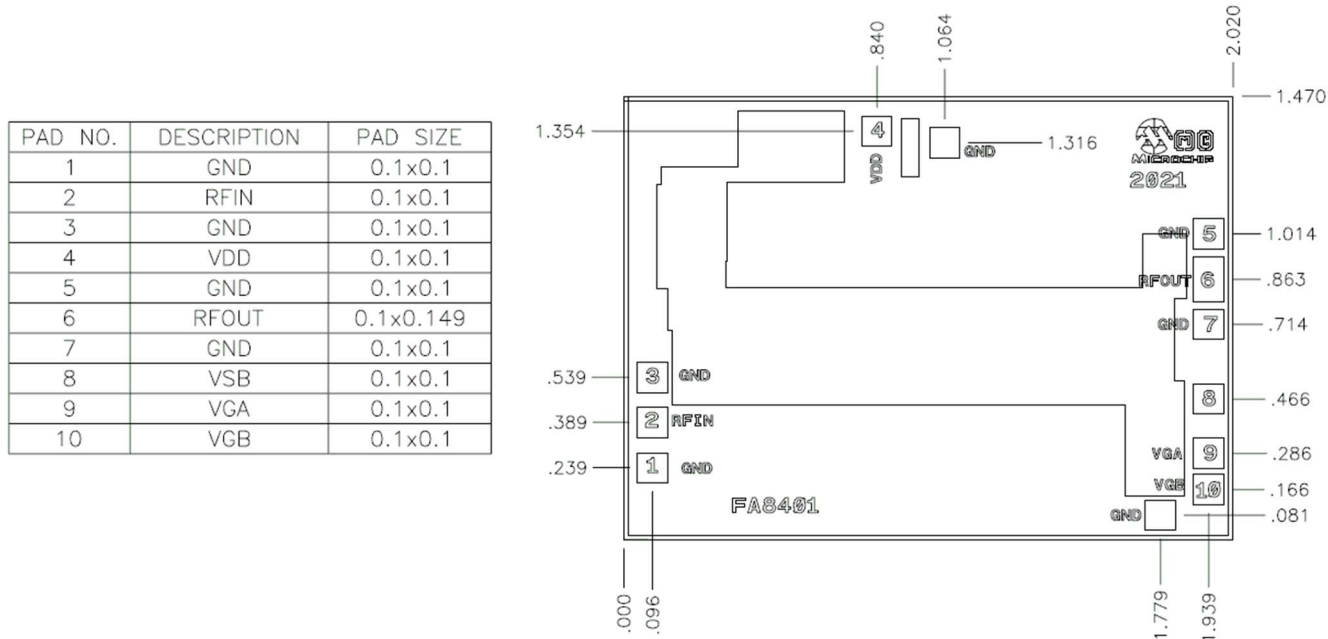

or additional packaging information, contact your Microchip sales representative.

Figure 68 - Die Outline Drawing (mm)

Table 3 - I/O Description

Pad Number	Pad Name	Pad Description
2	RF _{IN}	This pad is DC-short and matched to 50 Ohm.
6	RF _{OUT}	This pad is DC-decoupled and matched to 50 Ohm.
4	V _{DD}	V _{DD} pad for Bias Supply; external bypass capacitor is required to further reduce noise impact from Bias Line
8	V _{SB}	Ground or connect external resistor to change I _{DD}
9, 10	V _{GA} , V _{GB}	Recommended connection to ground. Access to gate 1 DC (not recommended)
1,3,5, 7	Ground	Ground connections used for die test purposes; DC/RF Ground is using Die Backside metal

2. Application Circuits

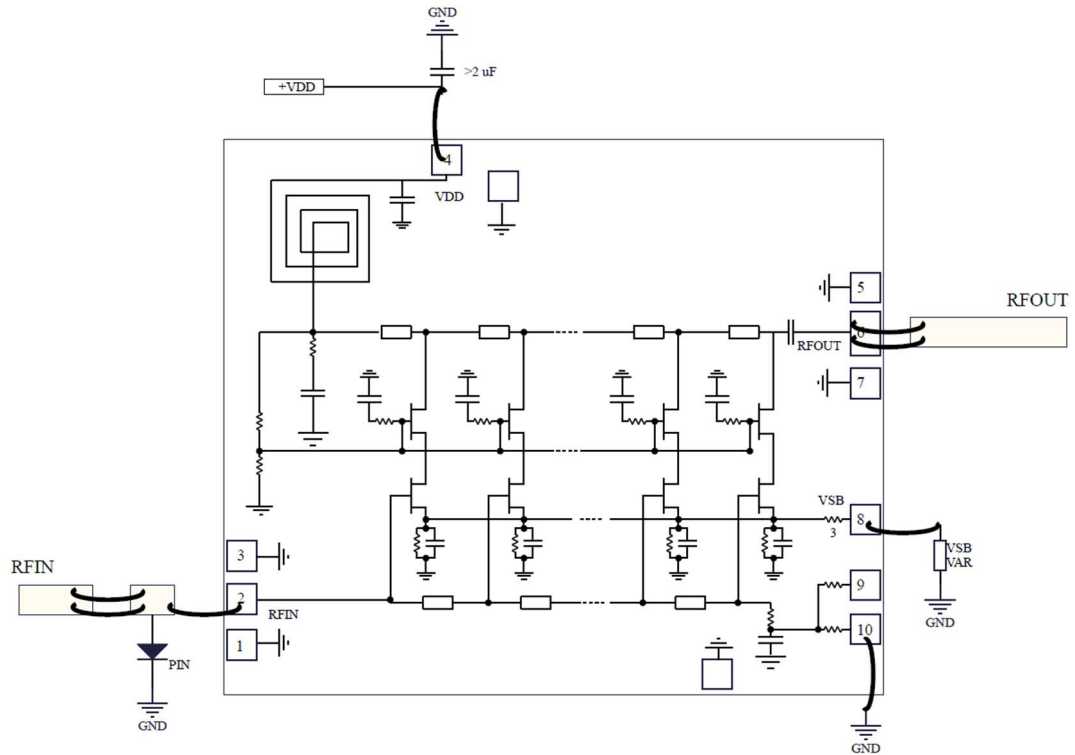

Figure 69 - Application Circuit: Schematic

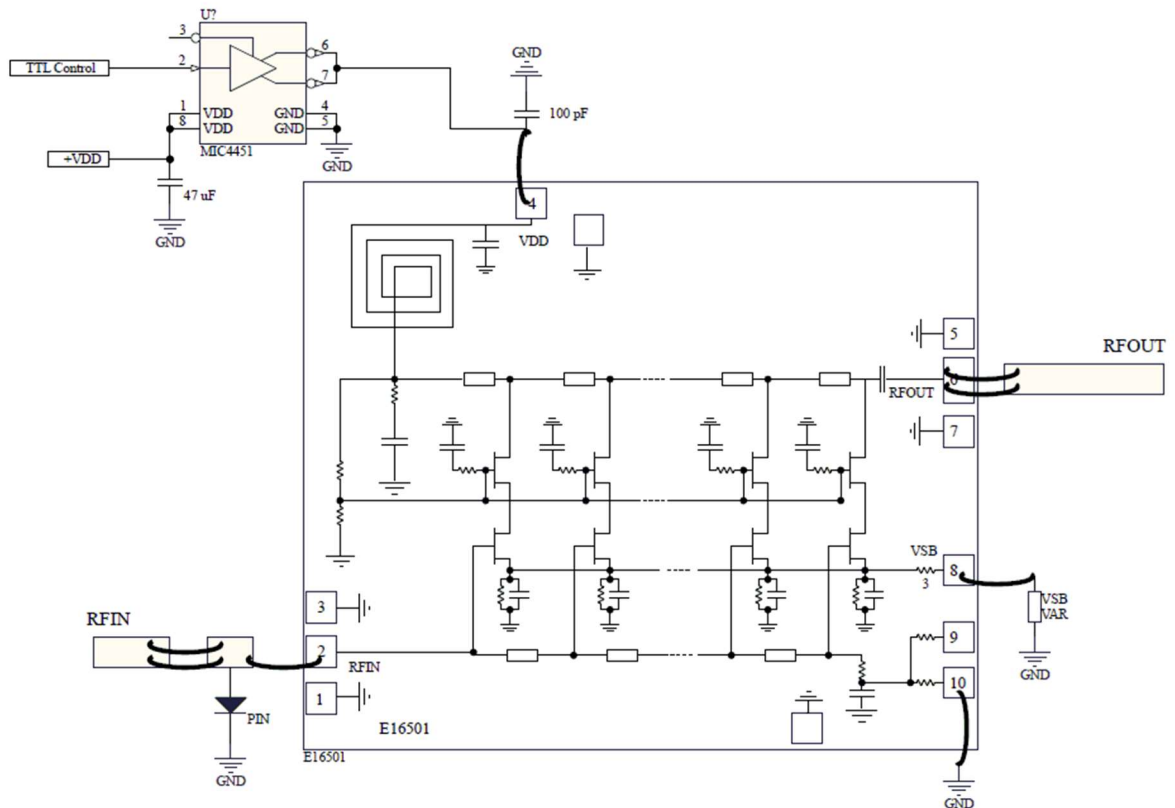

Figure 70 - Applications Circuit for Switching Operation using Microchip MIC4451 Driver

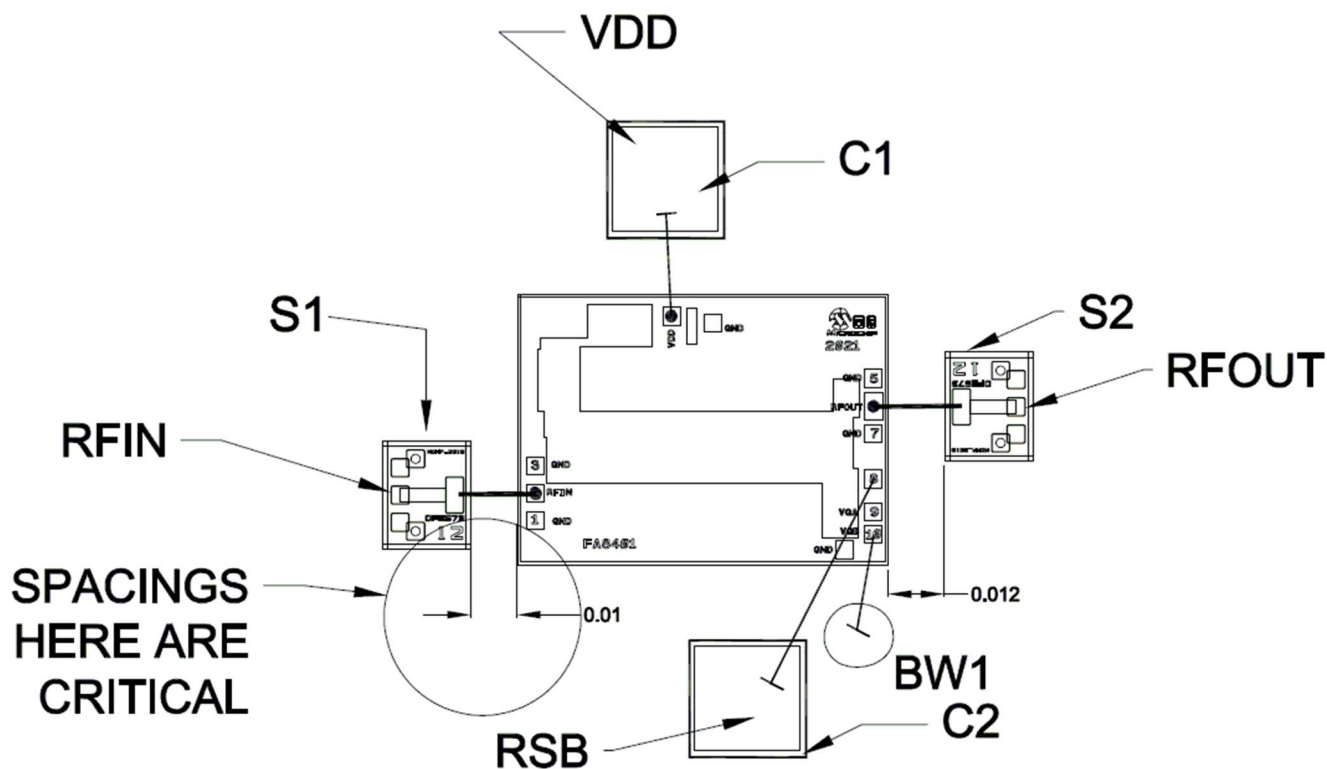

Figure 71 - Die Test Circuits: Assembly Drawing

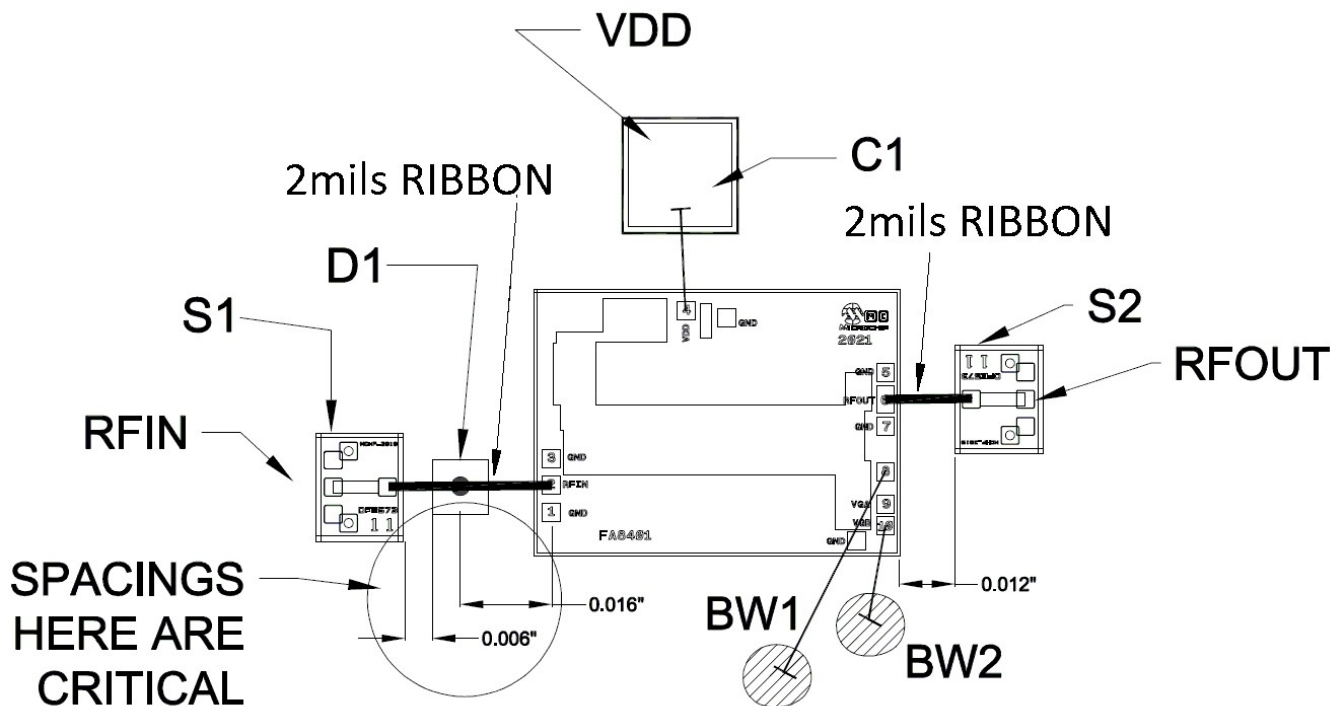

Figure 72 - Applications Assembly with Complimentary External PIN diode (D1)

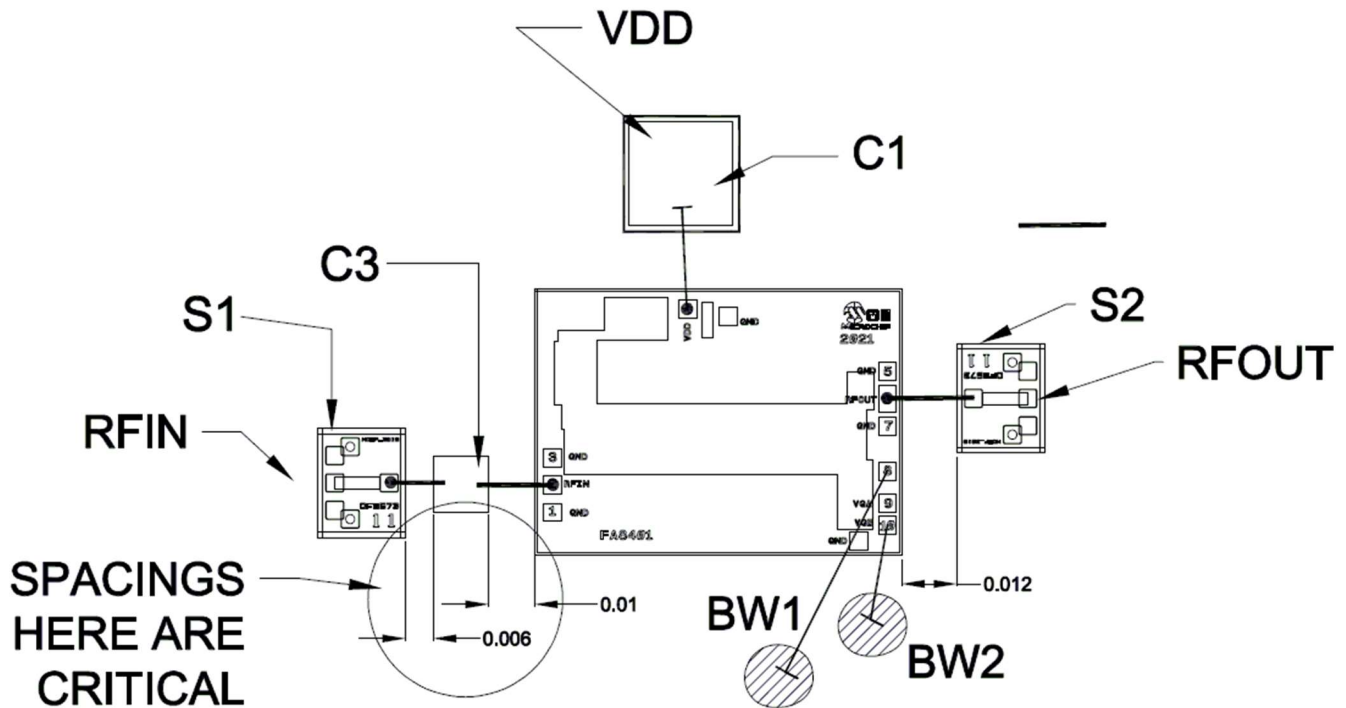

Figure 73 - Applications Assembly with Cap C3 to substitute PIN Diode D1 on Figure 72 -

Table 4 – List of Material for Figures 71-73

Reference	Part Number	Description
FA8401	MMA047AA	MMA047AA Amplifier Die
D1	LP4D03T43G	PIN Diode Chip (Anode pad) (Ask Microchip Sales Dep.)
C1, C2	160U02A102MT4W	Johnson Dielectric, Cer.Cap 1nF
C3	D10CDR15**	SLC Cap 0.15pF (Knowles)
S1, S2	E57311, E57312	Probe Launchers

Table 5 – R_{SB} Values vs Drain Current at 5, 6, 7V

R_{SB} (Ohm)	I_{DD} (mA) at 5V	I_{DD} (mA) at 6V	I_{DD} (mA) at 7V
0	173	179	185
2	140	145	150
3	131	136	140
4	128	133	138
5	125	129	134
6	123	127	131
7	119	123	127
8	116	120	124
9	114	119	123
10	112	117	121
11	110	114	117
12	109	113	117
13	107	111	114
14	106	110	114
15	105	109	113
16	105	108	112
17	103	107	111
18	103	107	110

3. Handling Recommendations

Gallium arsenide integrated circuits are sensitive to electrostatic discharge (ESD) and can be damaged by static electricity. It is recommended to follow all procedures and guidelines outlined in the Microsemi application note AN01: GaAs MMIC Handling and Die Attach Recommendations.

4. Ordering Information

For additional ordering information, contact your Microchip sales representative.

Part Number	Package
MMA047AA	Die

4.1. Packing Information

Standard Format
Gel Pack
50 Pieces per Pack

The Microchip Website

Microchip provides online support via our website at www.microchip.com/. This website is used to make files and information easily available to customers. Some of the content available includes:

- **Product Support** – Data sheets and errata, application notes and sample programs, design resources, user’s guides and hardware support documents, latest software releases and archived software
- **General Technical Support** – Frequently Asked Questions (FAQs), technical support requests, online discussion groups, Microchip design partner program member listing
- **Business of Microchip** – Product selector and ordering guides, latest Microchip press releases, listing of seminars and events, listings of Microchip sales offices, distributors and factory representatives

Product Change Notification Service

Microchip’s product change notification service helps keep customers current on Microchip products. Subscribers will receive email notification whenever there are changes, updates, revisions or errata related to a specified product family or development tool of interest.

To register, go to www.microchip.com/pcn and follow the registration instructions.

Customer Support

Users of Microchip products can receive assistance through several channels:

- Distributor or Representative
- Local Sales Office
- Embedded Solutions Engineer (ESE)
- Technical Support Customers should contact their distributor, representative or ESE for support. Local sales offices are also available to help customers. A listing of sales offices and locations is included in this document.

Technical support is available through the website at: www.microchip.com/support

Microchip Devices Code Protection Feature

Note the following details of the code protection feature on Microchip devices:

- Microchip products meet the specifications contained in their particular Microchip Data Sheet.
- Microchip believes that its family of products is secure when used in the intended manner and under normal conditions.
- There are dishonest and possibly illegal methods being used in attempts to breach the code protection features of the Microchip devices. We believe that these methods require using the Microchip products in a manner outside the operating specifications contained in Microchip’s Data Sheets. Attempts to breach these code protection features, most likely, cannot be accomplished without violating Microchip’s intellectual property rights.
- Microchip is willing to work with any customer who is concerned about the integrity of its code.
- Neither Microchip nor any other semiconductor manufacturer can guarantee the security of its code. Code protection does not mean that we are guaranteeing the product is “unbreakable.” Code protection is constantly evolving. We at Microchip are committed to continuously improving the code protection features of our products. Attempts to break Microchip’s code protection feature may be a violation of the Digital Millennium Copyright Act. If such acts allow unauthorized access to your software or other copyrighted work, you may have a right to sue for relief under that Act.

Legal Notice

Information contained in this publication is provided for the sole purpose of designing with and using Microchip products. Information regarding device applications and the like is provided only for your convenience and may be superseded by updates. It is your responsibility to ensure that your application meets with your specifications.

THIS INFORMATION IS PROVIDED BY MICROCHIP “AS IS”. MICROCHIP MAKES NO REPRESENTATIONS OR WARRANTIES OF ANY KIND WHETHER EXPRESS OR IMPLIED, WRITTEN OR ORAL, STATUTORY

OR OTHERWISE, RELATED TO THE INFORMATION INCLUDING BUT NOT LIMITED TO ANY IMPLIED WARRANTIES OF NON-INFRINGEMENT, MERCHANTABILITY, AND FITNESS FOR A PARTICULAR PURPOSE OR WARRANTIES RELATED TO ITS CONDITION, QUALITY, OR PERFORMANCE.

IN NO EVENT WILL MICROCHIP BE LIABLE FOR ANY INDIRECT, SPECIAL, PUNITIVE, INCIDENTAL OR CONSEQUENTIAL LOSS, DAMAGE, COST OR EXPENSE OF ANY KIND WHATSOEVER RELATED TO THE INFORMATION OR ITS USE, HOWEVER CAUSED, EVEN IF MICROCHIP HAS BEEN ADVISED OF THE POSSIBILITY OR THE DAMAGES ARE FORESEEABLE. TO THE FULLEST EXTENT ALLOWED BY LAW, MICROCHIP'S TOTAL LIABILITY ON ALL CLAIMS IN ANY WAY RELATED TO THE INFORMATION OR ITS USE WILL NOT EXCEED THE AMOUNT OF FEES, IF ANY, THAT YOU HAVE PAID DIRECTLY TO MICROCHIP FOR THE INFORMATION. Use of Microchip devices in life support and/or safety applications is entirely at the buyer's risk, and the buyer agrees to defend, indemnify and hold harmless Microchip from any and all damages, claims, suits, or expenses resulting from such use. No licenses are conveyed, implicitly or otherwise, under any Microchip intellectual property rights unless otherwise stated.

Trademarks

The Microchip name and logo, the Microchip logo, Adaptec, AnyRate, AVR, AVR logo, AVR Freaks, BesTime, BitCloud, chipKIT, chipKIT logo, CryptoMemory, CryptoRF, dsPIC, FlashFlex, flexPWR, HELDO, IGLOO, JukeBlox, KeeLoq, Klear, LANCheck, LinkMD, maXStylus, maXTouch, MediaLB, megaAVR, Microsemi, Microsemi logo, MOST, MOST logo, MPLAB, OptoLyzer, PackeTime, PIC, picoPower, PICSTART, PIC32 logo, PolarFire, Prochip Designer, QTouch, SAM-BA, SenGenuity, SpyNIC, SST, SST Logo, SuperFlash, Symmetricom, SyncServer, Tachyon, TempTrackr, TimeSource, tinyAVR, UNI/O, Vectron, and XMEGA are registered trademarks of Microchip Technology Incorporated in the U.S.A. and other countries.

APT, ClockWorks, The Embedded Control Solutions Company, EtherSynch, FlashTec, Hyper Speed Control, HyperLight Load, IntelliMOS, Libero, motorBench, mTouch, Powermite 3, Precision Edge, ProASIC, ProASIC Plus, ProASIC Plus logo, Quiet-Wire, SmartFusion, SyncWorld, Temux, TimeCesium, TimeHub, TimePictra, TimeProvider, Vite, WinPath, and ZL are registered trademarks of Microchip Technology Incorporated in the U.S.A.

Adjacent Key Suppression, AKS, Analog-for-the-Digital Age, Any Capacitor, AnyIn, AnyOut, BlueSky, BodyCom, CodeGuard, CryptoAuthentication, CryptoAutomotive, CryptoCompanion, CryptoController, dsPICDEM, dsPICDEM.net, Dynamic Average Matching, DAM, ECAN, EtherGREEN, In-Circuit Serial Programming, ICSP, INICnet, Inter-Chip Connectivity, JitterBlocker, KlearNet, KlearNet logo, memBrain, Mindi, MiWi, MPASM, MPF, MPLAB Certified logo, MPLIB, MPLINK, MultiTRAK, NetDetach, Omniscient Code Generation, PICDEM, PICDEM.net, PICkit, PICtail, PowerSmart, PureSilicon, QMatrix, REAL ICE, Ripple Blocker, SAM-ICE, Serial Quad I/O, SMART-I.S., SQI, SuperSwitcher, SuperSwitcher II, Total Endurance, TSHARC, USBCheck, VariSense, ViewSpan, WiperLock, Wireless DNA, and ZENA are trademarks of Microchip Technology Incorporated in the U.S.A. and other countries.

SQTP is a service mark of Microchip Technology Incorporated in the U.S.A.

The Adaptec logo, Frequency on Demand, Silicon Storage Technology, and Symmcom are registered trademarks of Microchip Technology Inc. in other countries.

GestIC is a registered trademark of Microchip Technology Germany II GmbH & Co. KG, a subsidiary of Microchip Technology Inc., in other countries.

All other trademarks mentioned herein are property of their respective companies.

© 2021, Microchip Technology Incorporated, Printed in the U.S.A., All Rights Reserved. ISBN:

Quality Management System

For information regarding Microchip's Quality Management Systems, please visit www.microchip.com/quality.

Worldwide Sales and Service

AMERICAS	ASIA/PACIFIC	ASIA/PACIFIC	EUROPE
Corporate Office 2355 West Chandler Blvd. Chandler, AZ 85224-6199 Tel: 480-792-7200 Fax: 480-792-7277 Technical Support: www.microchip.com/support Web Address: www.microchip.com Atlanta Duluth, GA Tel: 678-957-9614 Fax: 678-957-1455 Austin, TX Tel: 512-257-3370 Boston Westborough, MA Tel: 774-760-0087 Fax: 774-760-0088 Chicago Itasca, IL Tel: 630-285-0071 Fax: 630-285-0075 Dallas Addison, TX Tel: 972-818-7423 Fax: 972-818-2924 Detroit Novi, MI Tel: 248-848-4000 Houston, TX Tel: 281-894-5983 Indianapolis Noblesville, IN Tel: 317-773-8323 Fax: 317-773-5453 Tel: 317-536-2380 Los Angeles Mission Viejo, CA Tel: 949-462-9523 Fax: 949-462-9608 Tel: 951-273-7800 Raleigh, NC Tel: 919-844-7510 New York, NY Tel: 631-435-6000 San Jose, CA Tel: 408-735-9110 Tel: 408-436-4270 Canada - Toronto Tel: 905-695-1980 Fax: 905-695-2078	Australia - Sydney Tel: 61-2-9868-6733 China - Beijing Tel: 86-10-8569-7000 China - Chengdu Tel: 86-28-8665-5511 China - Chongqing Tel: 86-23-8980-9588 China - Dongguan Tel: 86-769-8702-9880 China - Guangzhou Tel: 86-20-8755-8029 China - Hangzhou Tel: 86-571-8792-8115 China - Hong Kong SAR Tel: 852-2943-5100 China - Nanjing Tel: 86-25-8473-2460 China - Qingdao Tel: 86-532-8502-7355 China - Shanghai Tel: 86-21-3326-8000 China - Shenyang Tel: 86-24-2334-2829 China - Shenzhen Tel: 86-755-8864-2200 China - Suzhou Tel: 86-186-6233-1526 China - Wuhan Tel: 86-27-5980-5300 China - Xian Tel: 86-29-8833-7252 China - Xiamen Tel: 86-592-2388138 China - Zhuhai Tel: 86-756-3210040	India - Bangalore Tel: 91-80-3090-4444 India - New Delhi Tel: 91-11-4160-8631 India - Pune Tel: 91-20-4121-0141 Japan - Osaka Tel: 81-6-6152-7160 Japan - Tokyo Tel: 81-3-6880-3770 Korea - Daegu Tel: 82-53-744-4301 Korea - Seoul Tel: 82-2-554-7200 Malaysia - Kuala Lumpur Tel: 60-3-7651-7906 Malaysia - Penang Tel: 60-4-227-8870 Philippines - Manila Tel: 63-2-634-9065 Singapore Tel: 65-6334-8870 Taiwan - Hsin Chu Tel: 886-3-577-8366 Taiwan - Kaohsiung Tel: 886-7-213-7830 Taiwan - Taipei Tel: 886-2-2508-8600 Thailand - Bangkok Tel: 66-2-694-1351 Vietnam - Ho Chi Minh Tel: 84-28-5448-2100	Austria - Wels Tel: 43-7242-2244-39 Fax: 43-7242-2244-393 Denmark - Copenhagen Tel: 45-4485-5910 Fax: 45-4485-2829 Finland - Espoo Tel: 358-9-4520-820 France - Paris Tel: 33-1-69-53-63-20 Fax: 33-1-69-30-90-79 Germany - Garching Tel: 49-8931-9700 Germany - Haan Tel: 49-2129-3766400 Germany - Heilbronn Tel: 49-7131-72400 Germany - Karlsruhe Tel: 49-721-625370 Germany - Munich Tel: 49-89-627-144-0 Fax: 49-89-627-144-44 Germany - Rosenheim Tel: 49-8031-354-560 Israel - Ra'anana Tel: 972-9-744-7705 Italy - Milan Tel: 39-0331-742611 Fax: 39-0331-466781 Italy - Padova Tel: 39-049-7625286 Netherlands - Drunen Tel: 31-416-690399 Fax: 31-416-690340 Norway - Trondheim Tel: 47-72884388 Poland - Warsaw Tel: 48-22-3325737 Romania - Bucharest Tel: 40-21-407-87-50 Spain - Madrid Tel: 34-91-708-08-90 Fax: 34-91-708-08-91 Sweden - Gothenberg Tel: 46-31-704-60-40 Sweden - Stockholm Tel: 46-8-5090-4654 UK - Wokingham Tel: 44-118-921-5800 Fax: 44-118-921-5820