

PRACTICAL

ELECTRONICS

SCIENCE AND TECHNOLOGY

MORSE DECODER

Visually monitoring
the cryptic airwaves

DIY PCS

Guidance for
would-be computer
builders

MOBILE RADIO

Understanding
communications on
the move

HOME BASE

Revealing the keys
to city intelligence

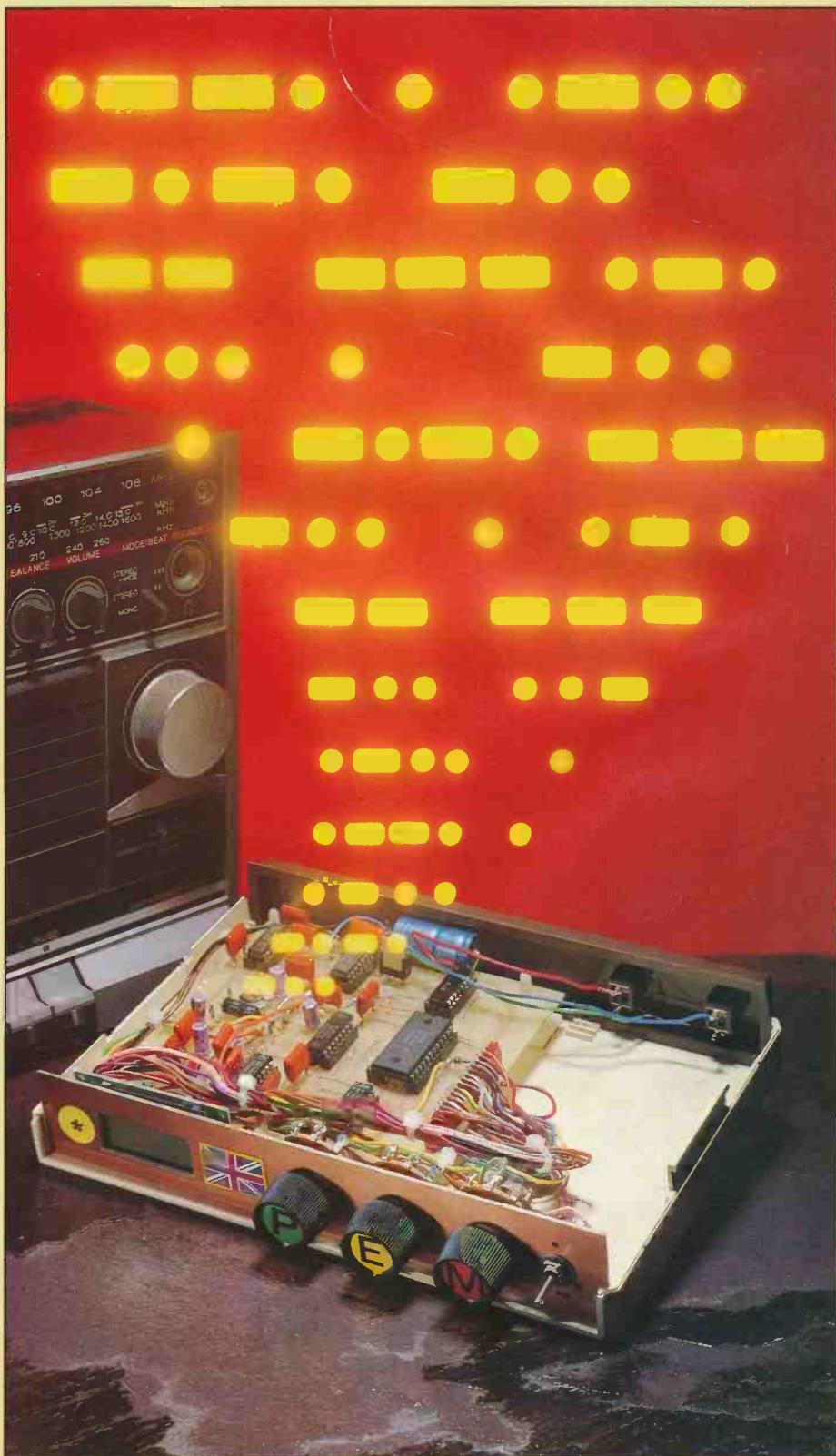

9 770032 637000

EASY-PC, SCHEMATIC and PCB CAD

**NEW VERSION:-
NOW DRAWS EVEN FASTER!**

**Only
£98.00**

**BRITISH
DESIGN
AWARD
1989**

Also:- over 400 Symbols!

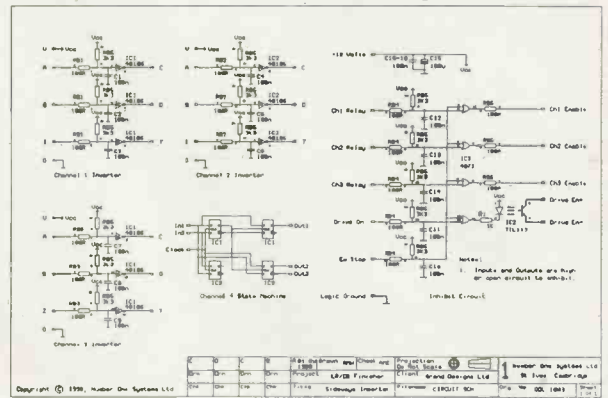
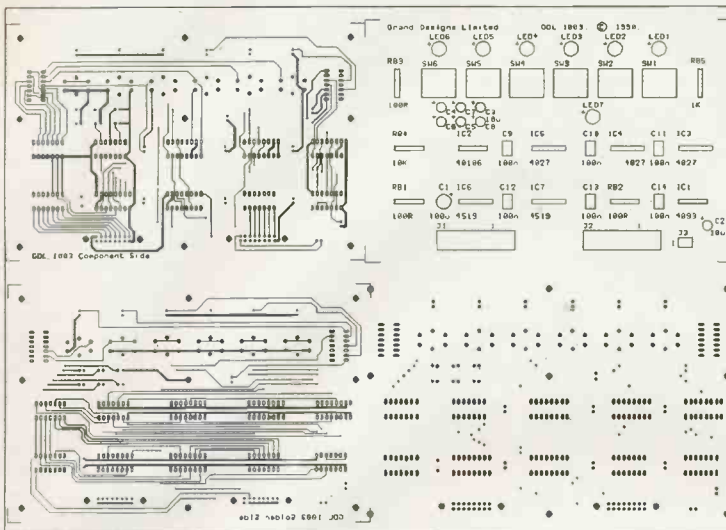

Fast Professional Quality Output - Affordable Price

SMITH CHART PROGRAM - Z-MATCH II

CIRCUIT ANALYSIS BY COMPUTER - ANALYSER II

For IBM, PC/XT/AT and clones.

For IBM, PC/XT/AT and clones.

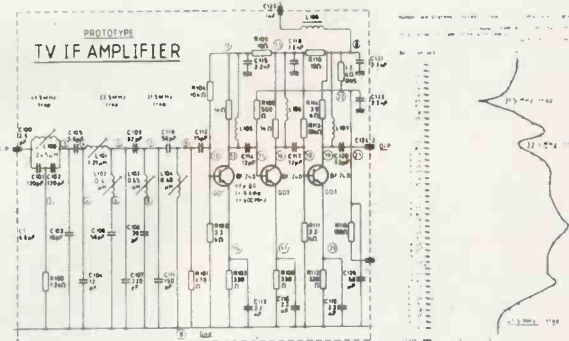
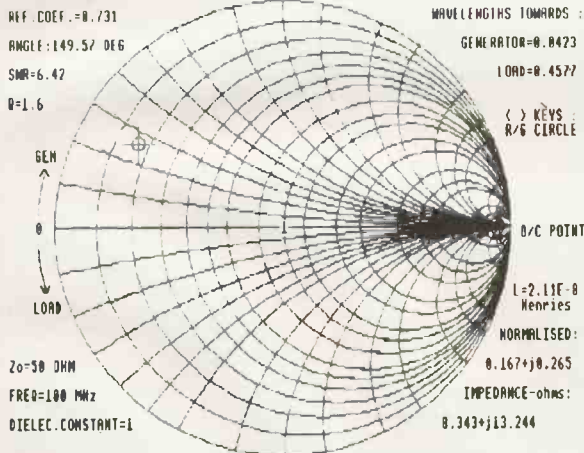

Z-MATCH - Takes the drudgery out of R.F. matching problems. Includes many more features than the standard Smith Chart. Provides solutions to problems such as TRANSMISSION LINE MATCHING for AERIALS and RF AMPLIFIERS with TRANSMISSION LINE TRANSFORMER and STUB MATCHING methods using COAXIAL LINES MICROSTRIP, STRIPLINE and WAVEGUIDES. The program takes account of TRANSMISSION LINE LOSS, DIELECTRIC CONSTANT, VELOCITY FACTOR and FREQUENCY. Z-MATCH is supplied with a COMPREHENSIVE USER MANUAL which contains a range of WORKED EXAMPLES **£195 for PC/XT/AT etc**

"ANALYSER II" - Analyses complex circuits for GAIN, PHASE, INPUT IMPEDANCE, OUTPUT IMPEDANCE and GROUP DELAY over a very wide frequency range. Ideal for the analysis of ACTIVE and PASSIVE FILTER CIRCUITS, AUDIO AMPLIFIERS, LOUDSPEAKER CROSS-OVER NETWORKS, WIDE-BAND AMPLIFIERS, TUNED R.F. AMPLIFIERS, AERIAL MATCHING NETWORKS, TV I.F. and CHROMA FILTER CIRCUITS, LINEAR INTEGRATED CIRCUITS etc. STABILITY CRITERIA AND OSCILLATOR CIRCUITS can be evaluated by "breaking the loop". Can save days breadboarding and thousands of pounds worth of equipment. **£195 for PC/XT/AT etc.**

Write or 'Phone for full details:-
Number One Systems Ltd. I

The CAD Specialists

REF: PE, HARDING WAY, SOMERSHAM ROAD, ST.IVES, HUNTINGDON, CAMBS, PE17 4WR, ENGLAND.
Telephone: 0480 61778 (6 lines) International: + 44 480 61778

ACCESS, VISA, AMEX Welcome.

PRACTICAL ELECTRONICS

VOL 26 NO 7

JULY 1990

CONTENTS

CONSTRUCTIONAL PROJECTS

MORSE DECODER by John Becker12

For amateur radio students and the generally inquisitive, our semiintelligent Icd module helps un-dash the Ts and un-dot-dot the Is.

REMOTE POWERED MICROPHONES by Vivian Capel27

The popular Electret microphone gives years of excellent service, until the internal battery gives-out, sometimes with disastrous results. Our phantom could help you beat the jinx.

AC MOTOR CONTROL by Andrew Armstrong43

As an answer to an *Ask PE* query, we describe one way in which a variable speed control unit can be used with ac series wound motors in the 1-2kW range.

SPECIAL FEATURES

DIY PCS by Robert Penfold20

Authoritative advice on assembling your own IBM PC compatible computer from an expert who has built his own, and written this feature using it.

HISTORY OF TECHNOLOGY - HERTZ by Ian Poole31

A foremost researcher of his time, Hertz proved the existence of electromagnetic waves, laying the firm foundations upon which radio technology was built.

HOME BASE by Ian Burley32

Philips launches CD-I, British Aerospace announces Microtel, BYPS rabbits-on about cordless phones, and will Tron provide the key to city intelligence?

MOBILE RADIO by Mike Sanders35

The popular concept of mobile radio is that it's a vehicle-mounted system with a fixed base station, but hand-held and back-pack systems also qualify. We examine the history and the technology.

BASIC ELECTRONICS - PART SEVEN by Owen Bishop ..49

More on transistors, and a modular demonstration of how to score a good try on the touch-line and never be off-side for frost or fire.

WINNING BONANZAS by the Editor and a few readers52

The winners of our robotic's books competition have been drawn. Some ought to have been hung and quartered as well for their limerical worse-verse!

REGULAR FEATURES

EDITORIAL by John Becker - Heritage9

LEADING EDGE by Barry Fox - Insecure cells8

SPACEWATCH by Dr Patrick Moore - Brown dwarfs46

TRACK FEEDBACK - Readers' letters, and a few answers51

INDUSTRY NOTEBOOK by Tom Ivall - The megacellphone57

PRODUCT FEATURES

NEWS AND MARKETPLACE - what's new in electronics4

SPECIAL SUBS OFFER - saving pounds on PE10

BOOKMARK - the Editor's browse through some new books41

ARMCHAIR BOOKSHOP - haven for practical bookworms58

PCB SERVICE - professional PCBs for PE Projects60

HOW TO DO IT - the route to better board building61

ADVERTISERS' INDEX - locating favourite stockists62

PE TAKES TECHNOLOGY FURTHER - BE PART OF IT!

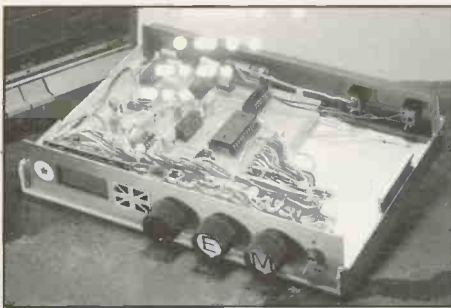

Page 12 ▲

Page 20 ▼



Page 33 ▼



NEXT MONTH

We've an exciting new item of digital test gear that's an ideal add-on for your oscilloscope, increasing the number of traces from a single beam to eight, and providing 8-bit sampling and 16K of memory storage for looped repetition. Audio analysis is the purpose of our AF Octave Measurer, designed to perform rapid assessment and multiple display of signal frequency content. And still on the subject of testing, we've an easy-to-built analogue voltage probe for use with dc and low frequency circuits. All this and more to show you how to enjoy electronics to the full.

★ BE EQUIPPED TO PASS THE TEST

★ DON'T MISS OUR FEATURE FILLED

AUGUST 1990 ISSUE

★ ON SALE FROM FRIDAY JULY 6TH



SPACE AGE STEREOS

Toshiba are introducing a brand new series of personal stereos designed with an image for the 1990s. Due to be introduced in July at around £49, the KT4521 featured in the photograph will be one of the first personal stereos on the market to offer digital tuning at less than £50.

Toshiba's 1990 personal stereo range has been designed to build on the solid foundations which they consider were laid by last year's winning collection. They intend that the stereos will consolidate the company's ever strengthening position in this market sector.

All ten models are styled in a 'new space age' Titanium finish, perpetuating the 'family' theme which significantly contributed to the success of their 1989 range.

In the new range seven of the ten models feature Dyna-Bass earphones which have been specially designed to enhance bass frequencies. Five models feature autoreverse, five use Dolby, five have a three-band graphic equaliser, and two have digital tuning.

The top model, costing around £69, is the KT4551. Its features include an am/fm 2-band radio, digital tuner with ten-station random presets, 3-band graphic equaliser, Dyna-Bass, fast forward and rewind controls, metal tape, and a belt clip.

At the budget end of the range is the KT4111, costing around only £19, which includes Dolby noise reduction, metal tape, a belt clip, plus RR and REW controls.

Watch out for these new models at your local Toshiba stockists.

MAPLIN'S GLOBAL WARNING

The new World Calendar Clock Alarm from Maplin makes it easy to keep check on time and dates worldwide. This superb clock has really taken your Editor's eye (he might even get himself one for his birthday!), for it gives the correct time at any one of 35 cities around the world. Just pressing the touch sensor map will identify the time-zone band and reveal the correct time.

The smart desk-top 24 hour clock calendar shows the date, day of the week, month and year from 1988 to 2037 on an 85mm wide led display. A world map measuring 170 x 75mm is marked with a total of 27 time zones.

and just by touching one of these zones the relative time will be displayed. In addition, a special zone allows for the British Summer time one hour offset. Powered by just two AA size batteries, the alarm can be operated as a time of day reminder or normal alarm clock.

The World Clock is available from all of Maplin's nationwide shops, or from their mail order offices. The cost is only £24.95, including vat, but note that a small carriage charge will be made for mail order.

For further details contact Maplin at PO Box 3, Rayleigh, Essex, SS6 8LR. Tel : 0702 554161.



CATALOGUE

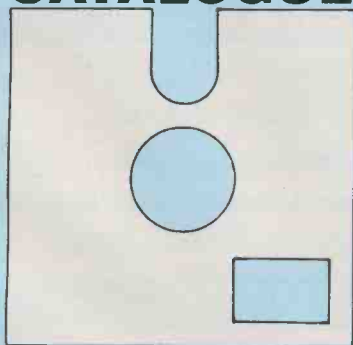

DATABASE

Our browse through recently received literature

Infotech/TIS are mail order distributors and wholesalers of Heinemann Professional books. They also have a wide selection of books, manuals and data sheets relating to many aspects of technology. Their latest 12-page loose-leaf catalogue lists subject matter for tv repair and service, video and radio, audio and domestic, computers, electronics, satellites, and even vehicle

wiring. They also have a selection of books for such diverse subjects as hypnotism and beiting. The company belongs to the Society of TV, Radio and Electrical/Electronic Engineers. You'll find their information highly useful. Infotech/TIS, 76 Church Street, Larkhall, Lanarks, ML9 1HE. Tel : 0698 884585.

Mauritron have sent in their latest catalogue. The company specialise in the supply of workshop service manuals for almost any item of equipment. "No matter what it is or what its age", say they. (They don't seem to have data on the Commodore Pet 3032's vdu driver circuit, though. Mine's died, and I was disappointed that Mauritron couldn't supply data on it.) However, they say they have a vast library covering over 100,000 different makes and models of the earliest vintage valve wireless sets to the latest tvs and videos. But why not those for my machine? Mauritron also run a technical society which they describe as a loosely knit, worldwide association of people with similar interests, amateur and professional, centred around the electrical/electronic industry. Mauritron Technical Services, 8 Cherry Tree Road, Chinnor, Oxfordshire, OX9 4QY. Tel : 0844 51694.

Cricklewood Electronics have a good bumper catalogue. It's their 15th, and the first of 90's decade editions. It has a cover price of £1.50, including post, and you'll no doubt reap the benefits from this small investment. Cricklewood say that they have added around 2,400 items to the catalogue, which is partially due the company having bought out the entire stocks of USD Ltd. They have also branched out into hobby kits, books, microphones, speakers, headphones, video heads and aerials. In the new catalogue there are over 160 pages filled and illustrated with information and prices of a very wide range of electronic products. In addition to the new ranges, their standard items are there in good force, including transistors, ics, triacs, transformers, connectors, passives and tools. There is a very well itemised index at the end to help you find what you're looking for. Cricklewood Electronics Ltd, 40 Cricklewood Broadway, London NW2 3ET. Tel : 071-452 0161.

METERING MAGNETICS

You'll recall that in our May issue, our American correspondent Wayne Green highlighted the possible potential hazards of low level magnetic fields. These hazards, he reported, could even be present in the fields associated with electric blankets. Following on from his report, Wayne has kindly arranged for details of an American magnetic field strength meter to be sent to us.

The photo shows a meter manufactured by Integrity Electronics and Research Inc. of Buffalo, USA. It's their 50Hz Magnetic Field Meter type IER-119 and is for monitoring power line, instrument, wiring and appliance magnetic fields. It has multiple range settings from 2 to 2000 milligauss (0.2 to 200 microtesla) and a narrow bandwidth of 11 Hz. The hand held digital meter has a very readable led display that includes a low battery indicator. It also has a programmable alarm, both audible and visual, and it's easy to use.

The field meter features a standard pushbutton backlight and a strip chart recorder output with an optional ac adaptor. Its maximum sensitivity is 1 microgauss (0.1 nanotesla). Linearity throughout its

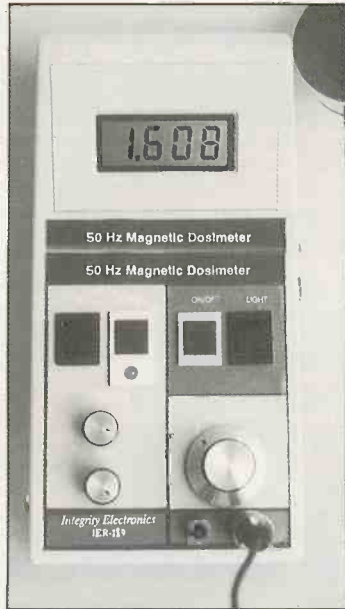

range creates a 0.1% precision and repeatability. Possessing an electrically shielded case, the precision instrument also comes with a shielded and grounded 8 inch long coiled probe attached by coax cable.

The European distributors for the IER-119 are conveniently based in London. They are Perspective Scientific, 100 Baker Street, London, W1M 1LA. Tel: 071-486 6837, and ask for Nick Clough.

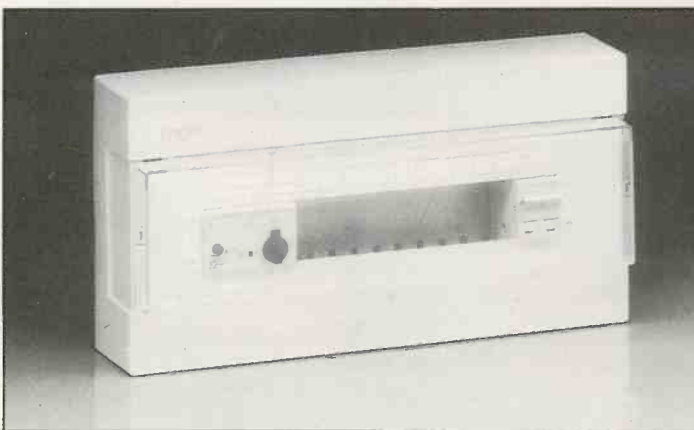

BOB'S SAFER HOUSE

We're sure many of you watched the BBC TV program *Q.E.D. The House that Bob Built* - in January this year. Well, Hager Powertech have proudly told us that they are the manufacturers of one of the units featured in the house.

Bob Symes, the *Q.E.D.* presenter, highlighted many of the benefits of Hager's Split Load Consumer Unit with RCD protection. From the company's Cosmic and Invicta range of consumer units, the SLCU is designed for surface mounting, so simplifying installation. Outgoing ways are protected by miniature circuit breakers or modular fuse carriers incorporating BS1361 HRC cartridge fuses. Any outgoing ways that are not used for the initial

installation can be blanked off providing spare ways for future extension of electrical equipment.

The split load version is equipped with a 100 amp double pole mains switch for isolating all circuits within the unit. The main bus bar system is divided into two electrically separate sections. A maximum of six outgoing ways can be controlled by the main isolating device. An additional RCD is incorporated to control and provide earth leakage protection for a further four or six outgoing ways.

Put safety first, ask for more details from Hager Powertech Ltd. 13 Alexandra Way, Ashchurch Business Centre, Tewkesbury, Glos. GL20 8BNB. Tel : 0684 292901.



If you are organising any event to do with electronics, big or small, drop us a line, we shall be glad to include it here.

Please note : Some events listed here may be trade or restricted category only. Also, we cannot guarantee information accuracy, so check details with the organisers before setting out.

May 30-Jun 1. Computer Training and Services Show. Olympia, London. 01-486 1951.

Jun 26-28. Infrared Technology. Wembley Conference Centre. 0799 26699.

July 14-22. British Amateur Electronics Club (BAEC) exhibition. The Shelter, on the Esplanade, Penarth, South Glamorgan. This is a "hands-on" opportunity to find out more about the BAEC, don't miss it!

Sep 18-21. EFTPOS 90. Exhibition and conference on electronic retailing. Alexandra Palace, London. 0273 722687.

Sep 25-27. British Laboratory Week. Olympia, London. 0799 26699.

Oct 2-4. Eurostat 90. Barbican Red Hall, London. 0799 26699.

Nov 6-8. Total Solutions. NEC Birmingham. 0799 26699.

NICAM GOES WEST

At the time of writing, Nicam digital stereo should have come to ITV and Channel 4 in the West Country and the North West during May as part of an IBA initiative to bring the new digital technology to almost 80% of British viewers by the end of this year. South Wales was due to start receiving the service from the end of April.

Nicam stands for Near-Instantaneously Companded Audio Multiplex, and we're glad the name has been abbreviated! It adds a special digital signal to a standard tv transmission to enable reception of stereo sound with quality similar to compact disc. The system can also be used to provide a second language sound track. Stereo sound for tv is much welcomed for it adds another dimension to the whole viewing experience, especially for music, drama, sport and light entertainment. Most recent feature films have been produced with a stereo sound track.

The number of stereo programmes and films on ITV and Channel 4 is increasing. Those with digital stereo sound are identified in TV Times, and on ITV's Oracle and Channel 4's 4-Tel teletext services.

In order to receive Nicam, it is necessary to have a tv set or video cassette recorder incorporating a Nicam decoder. In the last year or two, a wide variety of receivers and vcrs have been produced with the option of Nicam sound. Older sets with stereo speakers will probably not be suitably equipped. The latter were meant for connection to an external stereo source, such as stereo vcr playing back pre-recorded films. However, it may be possible to 'retrofit' some of these older 'stereo' sets with a Nicam decoder, or make the necessary connections to a Nicam vcr. Local dealers can advise you on this. Once equipped with the hardware, no special aerial arrangements will normally be needed, if the picture is acceptable then the sound should be perfect. Nicam also offers a significant improvement in mono sound.



WIRELESS SOLDERING

Black and Decker are adding a new cordless soldering iron to their Minicraft range. Minicraft is a complete range of high quality, precision miniature tools for both diy and hobby applications.

The new cordless iron, model MB650, is lightweight and has a built in stand for ease of handling and extra convenience. Powered by a

screw in butane gas cartridge with simple ignition, the iron enables the user, say B&D, "to solder anywhere". (Bit of an over-broad statement isn't it, B&D? I can think of many places where you cannot, or should not, use a butane powered soldering iron.)

The price of the iron is £24.99 including vat, and this includes two soldering bits and a ready to use butane cartridge, which gives a minimum of three hours continuous use. Most hobby and craft shops should be stocking the iron.

NUCLEAR EXCHANGE

With all the excitement relating to the 'freeing' of Eastern Europe, it comes as a bit of a party stopper to be told that some of British Telecom's clients continue to regard nuclear war as a continuing threat against which they should prepare. I have to sensibly admit that the current furor could just be a flash in the pan and that the danger of some nutter pushing a nuclear button still exists, even though he/she may not be a Russian with anti-conservationist tendencies.

On those grounds perhaps we should commend BT for their foresight and success in winning a major contract for digital switchboards which will continue to work after a nuclear explosion. Under a £5 million contract, BT will supply Mitel private branch exchanges (pbxs) to more than 300 local authority emergency centres throughout England and Wales, and a further significant number may follow.

The contract demanded that the company met stringent technical requirements, and was awarded against competition from eight other companies. A requirement was that the equipment should be able to withstand the electromagnetic pulse (EMP) that follows a nuclear explosion. EMP, say BT, would have a catastrophic result on any computerised equipment. We think the computer operators would not be too happy, either!

However, BT go on to say that

their successful implementation of the work will provide a modern, resilient network which can provide communications not only for war emergencies but also for peace-time disasters.

BT'S ISDN2 PLANS

British Telecom has announced further plans for its ISDN service, including tariffs and key dates for its introduction, which at the time of writing was due to take place in April. The plans include new support facilities to assist terminal manufacturers and customers developing business applications.

From April, BT will be making a larger number of lines available for manufacturers to involve customers in their testing and development work. This will give customers a taste of the benefits ISDN can bring. From the end of July the service will move into a market development phase. This phase will provide a larger number of lines to customers in several business areas throughout the country. This will enable customers to work together with their terminal suppliers and BT to establish pilot configurations to assess how best to use ISDN.

From January next year the service will progressively become available throughout the country. Deployment to all digital local exchanges serving business communities or high streets will be achieved by the end of 1991.

To find out more about ISDN, give BT a call. Your local exchange staff will be pleased to help you.

CHIP COUNT

SCC66470 VIDEO CONTROLLER

The SCC66470 from Philips is a new video and system controller which can replace up to 30 ics by integrating all of the 'glue' logic normally required for 68000-based systems. This allows for the construction of colour display systems with a quarter of the number of components required.

Featuring a resolution of 768 x 560 pixels, the new controller will appeal to a wide variety of system designers building pcs, colour monitors, videotex terminals, industrial man-machine interfaces and CARIN process control systems. The ic works in CDI (interactive compact disc) systems and supports CDI format.

The chip is a colour display controller, system controller and image manipulator in one ic. Only eight other ics are needed to form a complete display system, including keyboard controller, SCC68070 processor, 512Kbyte dram and 128Kbyte rom. Despite its relatively high performance, the system is a fraction of the cost of multi-chip solutions.

CQL80D VISIBLE WAVELENGTH LASER DIODES

Philips has recently launched a new series of laser diodes which emit visible light. The first type to be released is the CQL80D which emits red light at a typical wavelength of 675nm.

The diode is a gain-guided laser providing a maximum continuous wave output of 5mW. The anticipated lifetime is approximately 250,000 hours at 3mW cw operation.

The laser is built on a ridge structure and is manufactured using a MOVPE (moving organic vapour phase epitaxy) process on a GaAs substrate. It is mounted in a standard 9mm encapsulation. A monitor diode which is optically coupled to the rear facet of the laser controls the optical output level.

The low power consumption and simple supply requirement ensure that the laser is suitable for portable hand held applications as well as for replacing the conventional helium-neon laser in many of its traditional uses.

74F5302 FIBRE-OPTIC LED DRIVER

The new fibre optic led driver 74F5300 and its dual counterpart 74F5302 from Philips are ideally suited for high speed optical transmitter systems.

The driver's input buffer accepts ttl data. Its measuring circuit ensures constant propagation delay and controls the rise and fall times. In the dual type the propagation delays are matched. The output driver is capable of sourcing or sinking more than 160mA at low impedances.

When used with external pre-bias and pre-changing circuits the response can be tailored to a specific led resulting in an optical waveform with minimum duty cycle distortion.

These drivers are intended for use in areas such as high-speed serial data communication, fibre-optic data links, local and metropolitan area networks, as well as digital and pbx systems.

SM DMOS FETS

All small signal vertical dmos transistors from Philips are now being made available in the revolutionary SOT-223 surface mount package. This is the first surface mount type capable of dissipating 1W on a standard printed circuit board.

This move combines the advantages of the fast switching speed of dmos (turn-on times as low as 4ns) with the benefits provided by surface mounting in terms of ease of assembly and cost/space savings.

Principal applications for surface mounted dmos fets include telephony, as line current interrupters in the ringer and flash loop break circuit, as well as electronic hook switch in the hold circuit, and in other applications where low or high voltage switching is required, such as EDP, electronic ballasts, small motors and relays.

MANUFACTURER'S ADDRESS

Philips Components Ltd, Mullard House, Torrington Place, London WC1E 7HD. Tel : 071-580 6633.



BITSTREAM ON STREAM

Philips tell us that their exciting new development, Bitstream, has arrived with the recent official launch of their CD840 cd player.

The CD840 is the first of Philip's cd players to feature the company's revolutionary one-bit digital to analogue conversion system which offers 256 times oversampling. It is claimed to be the most significant improvement in sound reproduction since cd was first introduced.

This new advanced model also boasts a whole host of innovative and user-friendly features. Favourite Track Selection (FTS), an exclusive

facility on the top-of-the range Philips cd players, has been developed to form new Double FTS. This extremely convenient feature has two FTS memories to cater for separate requirements, such as pop and classical pieces, or personal choice tracks and party music.

Another feature, FTS Info, compiles and updates the Double FTS memories summarising their status through display messages which include remaining memory space and title mode. Favourite tracks can be easily identified by words of up to 12 characters once they have been

programmed into the unique Title Memory.

Other features include full infra-red remote control, selectable 10 or 20 second music scan, 3-speed selectable forward/backward search and random order programming.

An amazing feature of this cd is that it will draw your attention to it in your local high street store: it has an innovative Trade Mode, designed to catch the attention of potential customers. In this mode it uses a built-in programme to promote itself in-store by automatically displaying active info messages as it runs

through the player's main features. While in progress the disc is locked into the machine: to prevent theft, say Philips!

The Philips CD840 has digital output, not only through a standard high grade electrical connector with gold plated low-noise contacts, but also through a standard optical outputs.

This superbly styled, high performance player is targeted firmly at the audiophile, and is currently available at a retail price of £349.99.

RUBBER DUCKING

If you're looking for something to protect your favourite bit electronic gadgetry from water, Rubbaweld could possibly provide the answer.

Rubbaweld is a self-amalgamating tape that welds to itself on contact.



It's applied by stretching and wrapping the tape around the object to be sealed. The tape then forms a solid rubber coating which provides excellent electrical insulation properties and protection against water penetration. It protects electrical fittings from water and chaffing, making it ideal for outside aerials and other external electrics. Other applications include general electrical work, as well as hose and pipe connections and repair.

The tape is supplied in a 3m x 25mm roll, complete with instructions, for only 2.65, including vat, post and packing.

Sounds like excellent material for anyone with a waterproofing problem. Perhaps you can now even install electronic remote control in your bathroom rubber duck. Whatever your application, contact **Geodon Performance Coatings**, Commerce Park, Whitehall Road, Colchester, Essex, CO2 8HX. Tel: 0206 47556.

EASY MEASURE

The latest handheld digital multimeter from TMK provides the user with all the basic measurements using a single, easy to use, rotary switch. Model G85 has a clear, unambiguous 1999 count, 3.5 digit liquid crystal display with automatic zero, polarity, overrange and low battery indication.

Housed in a yellow rugged case, the meter has recessed safety sockets and test leads. (Why are all meters seemingly produced in yellow these days? Surely there are other colours in the rainbow to choose from?)

Two dc voltage ranges measure to 200V, have a 10mV resolution and a basic accuracy of 0.7%. AC voltage goes to 500V in one range with a 1V resolution. Direct current is to 10A with a 10mA resolution and a basic accuracy of 1.5%. Ohms are measured in two ranges to 2M ohms.

with a best resolution of 1 ohm. Diode tests are carried out at 3V and 1mA.

Model G85 is supplied ready for use with a battery, test leads, carrying case and instructions. Its size is 73 x 148 x 32mm, and it's fully guaranteed for one year. The price, excluding vat, is 39.95.

For further information contact **Mike Dixon, TMK Instruments**, Building 3, GEC Estate, East Lane, Wembley, Middx, HA9. 7PJ. Tel: 081-908 3355.



ADVERTISERS AWAKE!

Don't let your competitors steal all the glory of PE News Page Publicity - have YOUR interesting new products highlighted here as well as theirs! Send us concise details plus

a good photo and we'll do our best to publicise them

First come first served, and it must be interesting. It's up to you to keep us all informed!

The cellular phone operators, Cellnet and Vodafone, remain seemingly unconcerned about the problem of eavesdropping by people with scanners. More accurately, they seem unconcerned about the way the popular press now paints eavesdropping as a hobby. At Easter my pre-Christmas calls to Cellnet's new head man, Stafford Taylor, still remained unreturned. Oh well, he did once work for IBM.

There is no way to stop eavesdropping. It is not illegal. It is seldom harmful. But the risks are obvious and the law is intended to stop the popular press glorifying it and trade capitalising from it. But if Cellnet and Vodafone made too much fuss they might deter people from subscribing to their services. Education loses customers.

This is exactly why it has taken over seven years for the public to wake up to the fact that domestic cordless telephones are appallingly insecure. If the manufacturers had been frank, sales would have been far slower.

HORROR STORY

INSECURE CELLS

First, let me recount a horror story.

Recently a friend of mine heard a knock at the door. There stood a complete stranger who knew all about his life - the number of his bank account and credit cards, the names of his friends and relations and, most worrying of all, the time when he was due to go into hospital and leave his home unattended.

My friend was lucky. The call was friendly. The visitor, who lived at least a mile away, had for months been picking up calls from his cordless telephone on a medium wave radio. He got the address from a telephoned delivery order and came round with the warning - "watch what you say".

I called round, and we tried several radios in the house and out in the street. All picked up signals, but some far better than others. At first we thought it was a fault on the cordless telephone which, by the way, is a fully approved "green circle" model widely on sale. Foolishly, I had forgotten the fault inherent in the existing (CT1) cordless telephone standard set by the DTI.

LEGAL FREQUENCIES

Originally, all cordless phones were illegal in the UK. Then, in August 1982, the DTI allocated eight radio channels, each 20kHz wide. To control imports, the approved frequencies were deliberately slightly different from those used in the US, around 1.6MHz from base station to handset and 47.45-47.55 MHz from handset to base station (instead of 49.8-49.9MHz for the US). Cordless phones operating on these frequencies became legal on 1st January 1983.

LEADING

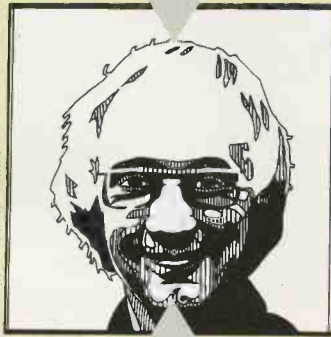

EDGE

BY BARRY FOX
Winner of the
UK Technology Award

It's not necessarily Big Brother who may be listening to you, it could be all your neighbours, friends or foes, on their budget trannies.

It is the choice of frequencies at around 1.6 MHz which causes the trouble. The 20 kHz band channels start at the centre frequency 1.642MHz (Channel 1) and go up to 1.782MHz Channel 8). Although medium wave radio tuners are usually only marked up to 1.602 MHz, there is often a grey area which catches the lower cordless channels.

Although the offending transmissions are from the base unit to the hand-set, the phone system mixes both halves of the conversation, so both are heard. The obvious solution is for shops to sell only cordless phones that operate on the higher channels. But, then there is a higher risk of complaints from two neighbours hearing each other's calls.

IMAGING

Even if people do not tune past Radio Luxembourg and thus never stumble on the cordless phone leakage zone that follows, there is still a risk of medium-wave breakthrough. Any modern superhet radio has the unfortunate ability to pick up the "image" of a signal which

appears at a lower frequency than the original. The image is twice the intermediate frequency, or IF, of the radio receiver away from the radio signal; and for a medium-wave radio the IF is at 470 kHz. So the image of the 1.6 MHz cordless phone signal is slap inside the mw band.

Some radios are more likely to pick up the image signal than others. It all depends on their "image rejection", which in turn depends on the ability of the circuitry at the "front end" of the receiver to reject all frequencies from outside the mw band. And of course quality depends on cost.

Modern budget radios, especially personal stereos, have poor image rejection. Hence they are very good at picking up cordless telephone calls. The saving grace here is that the transmission power of a cordless phone is limited to 10 milliwatts, which is very weak. So pickup usually only happens when the phone and radio are in the same house, or separated by a flimsy party wall.

But, as proved by the above horror story, if the cordless phone is being used at the top of a house, on high ground, and if the user has strung out the wire aerial that comes with the phone, its signal may travel literally miles.

AWARENESS

The most sobering aspect of all this is not so much the DTI allocated frequencies that have caused the problem, but that the makers of cordless telephones and engineers who test them are all fully aware of the situation. In the eight years since cordless phones went on sale in the UK, no-one seems to have made any effort to warn the public that their personal calls are likely to end up being heard on someone else's medium-wave radio.

When Radio 4 recently reported on how Scottish businesses had discovered that their conversations were being overheard by people with medium-wave radios tuned to the far end of the dial, past Radio Luxembourg, there was then a flim-flam response from BT about it being only a "minor problem" with "few complaints".

Of course there have only been a few complaints, because the phone owners whose calls are being overheard, seldom know it.

On the face of things, the simple solution is to buy one of the new "second generation" or CT2 cordless phones. Although the transmission power is the same 910 mW, the frequencies are different and the speech is in digital code, making accidental eavesdropping virtually impossible. The snag here is that CT2 has been sold primarily as a handset-to-public base stations system, and killed by the mish mash of incompatible standards which make that use impractical. If it were sold as a handset-to-home base station it might succeed, provided that the kit cost can be reduced from current levels of several hundred pounds.

Tom Ivall looks at cellphones from a different angle on page 57. We shall be discussing their technicalities in greater depth next month. Ed. **PE**

Three faces of technological conservation have come to my attention recently. Only two of them reflect a positive attitude.

On the positive side, SRIS, the Science Reference and Information Service of The British Library has announced the introduction of its new Environmental Information Service. The intention of the service is to help industry solve the problems of waste, pollution and the quality of our surroundings.

SRIS comments that green enthusiasts are to be seen everywhere in business, not only because of a wish to be 'good corporate citizens', but because it is becoming increasingly difficult to avoid the penalties of falling sales, obsolete products and prosecution. In collaboration with other related information sources, the SRIS is in a unique position to support managers in the environmental control of their products. The Environmental Information Service has been designed to bring the benefits of 'one-stop-shopping', so that a one call to a single enquiry point will give immediate access to all British Library resources.

Conservation is not just about protecting the environment, it's about protecting our heritage as well. This includes preserving items that have played a significant part in our history so that future generations may benefit from direct knowledge about them. Thus I welcome the second positive announcement.

It has come from an organisation devoted to preserving technological history, the Duxford Airfield Radio Society. Associated with, the Imperial War Museum and based

PRACTICAL ELECTRONICS



HERITAGE

near Cambridge, the Society's aims are to document, collate, restore and occasionally operate historic military radios, mainly of British origin. The equipment has come from the collections of the members as well as from the IWM. Among the collections are Special Forces and clandestine radios, and communications equipment. Regular exhibitions relating to particular themes are held periodically. The Society's efforts are warmly applauded.

I do not applaud, though, Commodore's inability to help me with another aspect of conservation. I have a ten-year old Commodore 3032 (PET) computer. It has been an extremely reliable machine, robust and easy to use. For several years its main

function has been as a piece of electronic workshop test equipment, controlling and monitoring experimental digital designs. Recently, a minor screen fault developed which I started to repair, but carelessly shorted out the eht. The screen is now dead.

Not having a circuit diagram for this part of the computer I know neither the crt pin connections, nor those of the eht coil, least of all do I know the required tube voltages. I rang Commodore, who said I should contact their agents. The agents stated that they do not have information for a machine "that old". Back to Commodore, and through a series of different departments. But none of them could supply the required data sheets, nor could several companies who claim to have extensive ranges of ancient and modern data sheets and manuals.

It is with great concern that I regard the apparent inability of at least one manufacturer to supply servicing information for equipment that is not excessively old. The 3032 may be obsolete with regard to the capabilities of current technology, but by the standards of its day it performed excellently and I have no wish to junk it just because I can't get a data sheet. It's ironic that Duxford have working items of equipment over 50 years old, yet here is an item one fifth that age and seemingly not intended to become a working example of past history. Manufacturers and their agents should ensure that data for their past models remains on file for the benefit of those who know how to use it.

THE EDITOR

Editor:

John Becker

Sub-Editor:

Helen Armstrong

Technical Illustrator:

Derek Gooding

Advertisement Executive:

David Bonner

Production Manager:

David Hewett

Office Manager:

Tim Lyster

Publisher:

Angelo Zgorelec

Practical Electronics,
Intra House, 193 Uxbridge Road,
London W12 9RA
Tel: 081-743 8888
Telecom Gold: 87: SQQ567
Fax: 081-743 3062

Readers' Enquiries

All editorial correspondence should be addressed to the editor and **any letters requiring a reply should be accompanied by a stamped addressed envelope, or equivalent payment.**

We regret that lengthy technical enquiries cannot be answered over the phone.

Advertisements

The Publishers of PE take reasonable precautions to ensure that advertisements published in the magazine are genuine, but we cannot take any responsibility in respect of statements or claims made by advertisers. The Publishers also cannot accept any liability in respect of goods not being delivered or not working properly.

© Intra Press 1990. Copyright in all drawings, photographs and articles published in PRACTICAL ELECTRONICS is fully protected, and reproduction or imitations in whole or in part are expressly forbidden. All reasonable precautions are taken by PRACTICAL ELECTRONICS to ensure that the advice and data given to readers is reliable. We cannot, however, guarantee it, and we cannot accept legal responsibility for it. Prices quoted are those current as we go to press. All material is accepted for publication on the express understanding that the contributor has the authority to permit us to do so. ISSN 0032-6372

PE Services

SUBSCRIPTIONS - Annual subscription rates are £18.00 for the U.K. or £21.00 overseas (Air mail overseas is £39.00). Please send your cheques (payable to Intra Press), payment by Visa or Access also accepted, to: Practical Electronics, Subscription Dept., P.O. Box 500, Leicester LE99 0AA. Telephone: 0858 410510 (ask for Practical Electronics Subscriptions).

BACK ISSUES - We still have a limited number of the back issues from the last three years available (Certain issues from earlier years are also available, but check before ordering). Price £1.75 - overseas £2.25 (inclusive of postage). Orders should be sent to our editorial address.

BINDERS - to hold 12 issues of PE are also available from our editorial address. Price £5.95 (overseas £6.95 - surface mail). Post included.

BOOK SERVICE - see the Book Service advertisement in the magazine.

PCB SERVICE - details inside.

Cover Illustration:
Ed Davis

SPECIAL SUBS OFFER !

SAVE!
SAVE!
SAVE!

SUBSCRIBE TO PE
AT THE OLD PRICE:
12 MONTH'S SUBSCRIPTION
FOR ONLY ~~£18~~ £15
(OVERSEAS ~~£21~~ £18)

PLUS:
EXTRA SPECIAL OFFER
TO TEACHERS AND STUDENTS
12 MONTH'S SUBSCRIPTION
FOR ONLY ~~£18~~ £13.50



(Teachers and students please enclose proof of status, eg headed notepaper from school, college, etc.)
If you already subscribe to PE you can take advantage of this special offer by extending your existing subscription - please advise your current subscription number or say from which month you want your subs to run.

You may send a photocopy of this form.

Yes please PE, put me on course to a hi-tech future: Enrol me on your priority subscription list and send me 12 issues for the following special price:

£15

£18 (overseas)

£13.50 (student/teacher)

Proof of my student/teacher status is attached.

I wish my subs to start from the earliest possible issue

I wish to extend my existing subscription for a further 12 months commencing with the issue dated

Please send my monthly copy of PE to:
Name and address

.....
.....
.....

Post Code

I enclose a cheque / postal order

Please charge to my Access / Visa card number

Send this form to: Practical Electronics
Subscriptions, 193 Uxbridge Road, London
W12 9RA

Anyone who believes that, in these days of extremely hi-tech communications, the age of morse code is dead, is thoroughly mistaken! Just take a listen on a reasonable radio receiver with a good aerial. Scan the tuning scale across the frequency bands and you'll find plenty of examples of people communicating around the globe using morse.

Morse has the great benefit of being able to be received and understood under atmospheric conditions that would make speech unintelligible. This makes it an ideal method for communicating over large distances or with relatively low-powered and simple equipment. Proficiency in morse code is still a pre-requisite for anyone wishing to hold a Class 'A' Radio Amateur's Certificate.

The morse decoder to be described here will be of interest to both aspiring radio amateurs and inquisitive radio listeners. For the former the unit can be used as a valuable piece of equipment for checking their code-keying accuracy. For the latter, it offers a means by which seemingly unintelligible di-di-dah-dah-di-dits can be understood without the need to learn morse code.

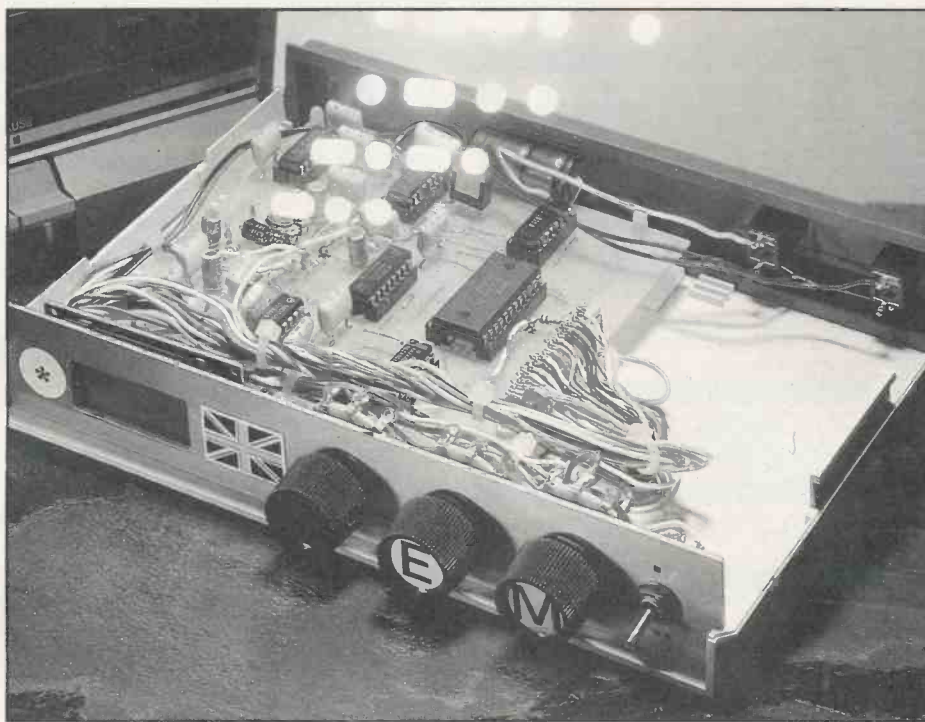

MORSE DECODER

DISPLAY MODULE

The heart of the unit is an intelligent liquid crystal display module. This has a library of pre-programmed alphanumeric and punctuation symbols which can be displayed on the lcd screen in response to specific codes. Basically, the unit receives the morse code and converts it into the correct library address number for the equivalent symbol. The decoded message flows across the eight-symbol lcd screen from right to left at the speed with which it is received. All the user needs to do is adjust three panel controls to match the transmission rates for the dots, dashes and pauses.

The lcd module used is the Sanyo LCM570, which is also available as the Electromail/RS 585-006. It was described in detail in PE May and June 90. Readers who missed the articles can obtain copies at the price quoted on the Editorial page. You don't, however, need those issues in order to build this morse decoder.

The symbol library within the lcd module contains a complete set of alpha characters from A-Z, the numerals 0-9, and punctuation marks. The same symbols are represented in morse code, but the codes relating to them are different. We need, therefore, to translate the morse code into the code which will cause the lcd module to show the correct symbol on the screen. This is carried out in the decoder by using an eeprom or eeprom as the pre-programmed conversion device.

CONVERSION CONCEPTS

Each morse code character is interpreted by the decoder as a binary number relating to

John Becker describes a semi-intelligent aid for inquisitive radio listeners and amateur radio students.

ALPHABET	NUMERALS	
A . - -	0 - - - -	
B - . . .	1 . - - -	
C - - . .	2 . - - -	
D . - . .	3 . - - -	
E . - . .	4 . - - -	
F . . - .	5 . - - -	
G - . - .	6 - . - -	
H	7 - . - -	
I . . - -	8 - . - -	
J . - - -	9 - - - -	
K - . - -		
L . - . .	PUNCTUATION	
M - - . .	! . - - -	
N - . - .	" . - - -	
O - - - -	# . - - -	
P . - . .	\$. - - -	
Q - - . -	% . - - -	
R . - . .	& . - - -	
S . . - .	' . - - -	
T - . - .	(. - - -	
U . - . .) . - - -	
V . . - .	* . - - -	
W . - . .	+ . - - -	
X - . - .	= . - - -	
Y . - . .	? . - - -	
Z - - . .		

Table 1: Morse codes

the dots and dashes that go to make it up. This number is then regarded by the eeprom as the address at which another number is stored. The stored number is that which the lcd module recognises as the code for the character we want to see displayed.

For example, the lcd address code number for character 'C' is 67. In morse code, letter 'C' is represented by the code '-.-.' (dash dot dash dot - usually pronounced dah-di-dah-di). If we regard the dots as 'zeros' and the dashes as 'ones', letter 'C' can be re-coded as '1010'. This, of course, can now be treated as a binary code, the equivalent decimal number of which is ten. If, then, we program the eeprom to hold decimal 67 at its address decimal 10, then each time the morse code converter sends decimal 10 to the eeprom, the eeprom will place decimal 67 at its outputs. Suitably triggered, the lcd will then show letter 'C' on its screen. A similar principle can be used for each character in the morse code.

BIT PROBLEM

If you look at the morse code table in Table 1 you will see that a potential problem exists regarding the conversion of some codes. Take letters E, I, S and H, for example. E is ., I = .., S = ... and H = Translating these codes to binary produces 0, 00, 000, 0000, all of which codes are similar representations of zero. A similar problem arises with T, A, U and V, which all have one or more dots before the final dash, converting from -, -., -. ., -.. to 1, 01, 001, 0001. It is obviously only the final dash, or 1, which has any significance.

There is an electronic factor to be taken into account as well. I use a 6-bit serial to

parallel shift register to clock in each of the zeros and ones, and, in effect, it reverses the order of the bits. (The register is actually an 8-bit one with the final two bits ignored). The shift register is first of all set to zero, so containing binary 000000. If T is received, a single 1 is clocked in from the left of the register, resulting in the contents becoming 100000. If A (- = 01) is being received, the dot is first clocked in as a zero, so the register still holds 000000, then the dash is clocked in as a one, so the register now holds 100000, the same as for T. The same 100000 results with U and V. In this order of reading, each of these four letters therefore produces a decimal address of 32. Similarly, E, I, S and H will produce no apparent change in the contents of the shift register, all resulting in decimal 0.

To overcome the problem, we need to take another factor into account: the total number of dots or dashes that are contained in the

particular morse code character. For the sake of this secondary conversion we ignore the differentiation between the dots and dashes, treating them simply as a single bit of data. In this way E has one data bit, so too does T, I has two data bits, as do A, I, M and N. If you look down the code list you will see that the maximum number of bits shown for any code is six. If we take into account the total number of bits received for a particular character, as well as the order of dots and dashes that go to make it up, then each individual code can be converted into its own specific numerical address equivalent.

By treating the bit count of each code as a binary number and attaching this to the right hand side of the binary conversion of the dots and dashes, you will see how this works. Three binary bits can represent all decimal numbers between 1 and 6, whose binary codes are thus 001, 010, 011, 100, 101 and 110, respectively.

Let's attach these codes to the right hand side of the shift register's 6-bit contents following the receipt of any of T, A, U or V, and convert the new code to decimal:

$$T (-): \text{register } (100000) + \text{count } (001) = 100000001 = 257.$$

$$A (-): \text{register } (100000) + \text{count } (010) = 100000010 = 258.$$

$$U (\cdot -): \text{register } (100000) + \text{count } (011) = 100000011 = 259.$$

$$V (\cdot \cdot -): \text{register } (100000) + \text{count } (100) = 100000100 = 260.$$

Similarly, E, I, S and H will produce codes of decimal 1, 2, 3 and 4, respectively. The full list of converted addresses is given in Table 2.

There are a couple of points you will probably spot in the table. Firstly, the same code is used in morse for both the colon and semi-colon; the unit has been programmed to display the semi-colon on receipt of this code.

Secondly, it would appear that some letters are repeated but with different address numbers. This is to allow for alternative versions of the letters A, E, N, O and U that may be used by some Continental operators. The unit has been programmed to display the English equivalent letters for these codes. It

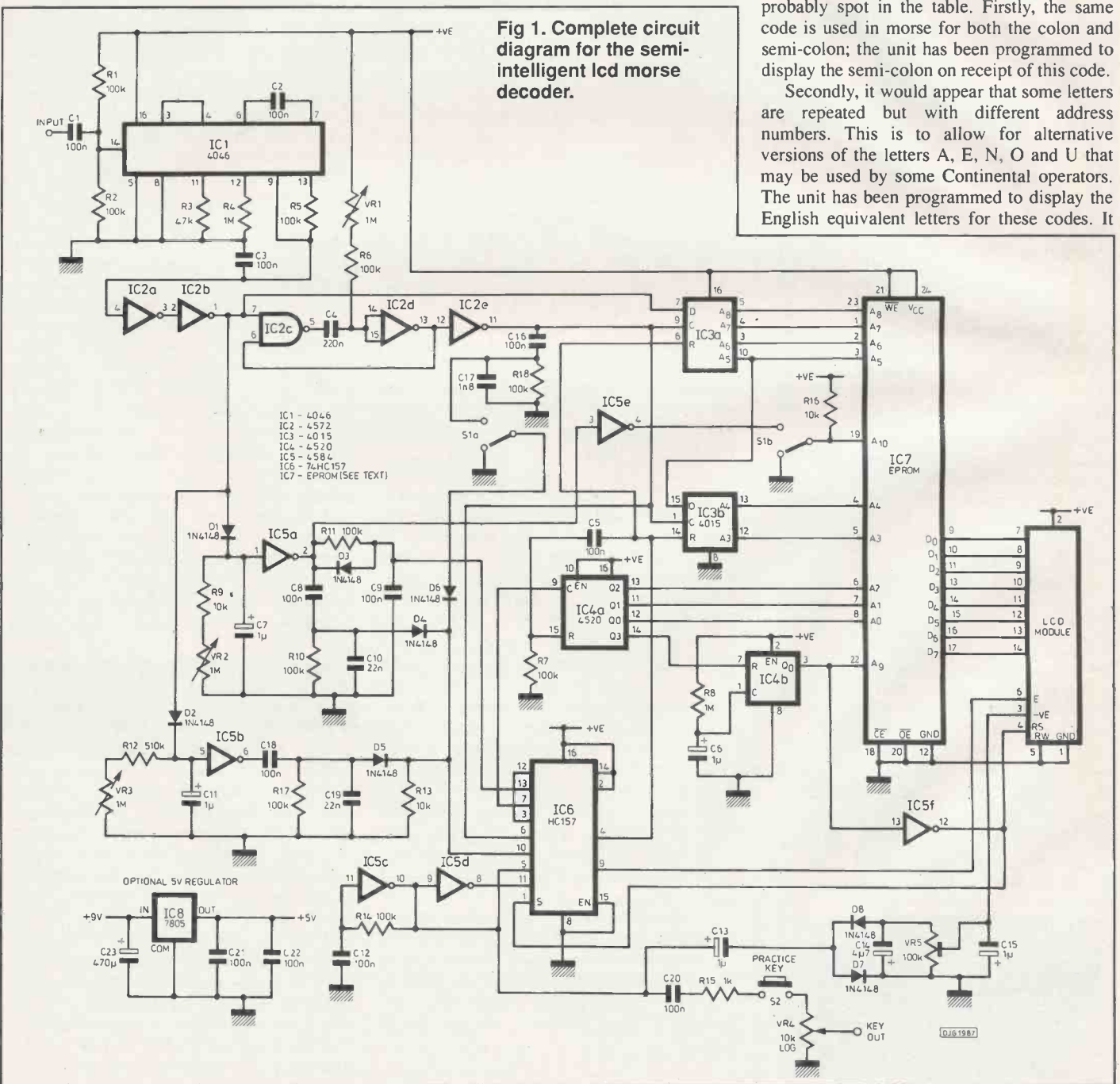

has also been programmed to display a highlighted blank (lcd code 255) for any unrecognised code received.

Although the maximum bit count of any morse code has been taken as six, there are exceptions to this. For example, there is an 8-bit code of '.....' which is transmitted to mean "error". The unit does not allow for this code. Nor does it allow for some other codes which have specific word or phrase meanings, eg. = "long break", and = "understood".

As I said earlier, each of the individual

Table 2. Conversion table.

A	.-	100000010	258	65
B	-..	000100100	036	66
C	-.-.	010100100	164	67
D	-...	001000011	067	68
E	.	000000001	001	69
F	.-.-	010000100	132	70
G	-.-.	011000011	195	71
H	000000100	004	72
I	..	000000010	002	73
J	.-.-.	111000100	452	74
K	-.-.	101000011	323	75
L	.-.-.	001000100	068	76
M	..-	110000010	386	77
N	-.	010000010	130	78
O	---	111000011	451	79
P	.-.-.	011000100	196	80
Q	-.-.-	101100100	356	81
R	.-.-.	010000011	131	82
S	...	000000011	003	83
T	-.	100000001	257	84
U	..-	100000011	259	85
V	...-	100000100	260	86
W	.-.-.	110000011	387	87
X	-.-.-	100100100	292	88
Y	-.--	110100100	420	89
Z	---.	001100100	100	90
0	-----	111110101	501	48
1	-----	111100101	485	49
2	-----	111000101	453	50
3	-----	110000101	389	51
4	-----	100000101	261	52
5	-----	000000101	005	53
6	-----	000010101	021	54
7	-----	000110101	053	55
8	-----	001110101	117	56
9	-----	011110101	245	57
0	-----	101100110	358	33
1	-----	010010110	150	34
2	-----	011110110	246	39
3	-----	011010101	213	40
4	-----	101101110	366	41
5	-----	010100101	165	43
6	-----	110011110	414	44
7	-----	100001110	270	45
8	-----	101010110	342	46
9	-----	010010101	149	47
0	-----	000111110	062	59
1	-----	000111110	062	59
=	-----	100010101	277	61
?	-----	001100110	102	63
A	-----	101000100	324	97
A	-----	101100101	357	97
E	-----	001000101	069	101
N	-----	110110101	437	110
O	-----	011100100	228	111
U	-----	110000100	388	117

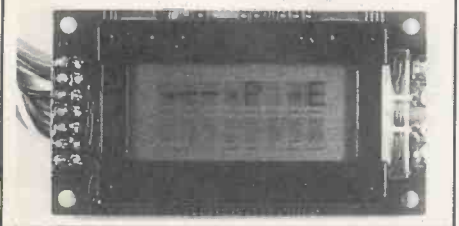

address codes produced by the shift registers causes the eeprom to produce another code number on its output. This number corresponds to the code required by the lcd module in order to display the equivalent symbol or character. The eeprom has also been programmed to perform two other functions. Firstly, at switch on, the eeprom transmits an 'initialisation' routine to the lcd module in order to set it into the correct control mode.

Secondly, I have designed in the option for additionally displaying the actual dots and dashes that make up the code being received. This option can be switched in and out at will. A third option designed in, though not controlled by the eeprom, is the ability to automatically have blank spaces displayed between complete words. This may be switched on or off as required.

TRANSMISSION FACTS

There is a wide variety of rates at which morse code operators can and will transmit. The main requirement for a skilled operator is that his or her transmission rate should be consistent and conform to relative lengths of dots, dashes and pauses.

Transmission rates are usually expressed in terms of the number of words sent per minute. Conventionally, in this context one word is regarded as having a length of five characters. Good operators can send or receive at rates of 25 or more words per minute. Irrespective of the transmission rate, international conventions dictate that operators should ideally make their dashes three times the length of their dots. The spaces between each dot or dash should be the equivalent length of one dot. The pauses between individual letters should be the equivalent of three dots, and the pauses between words should be equal in length to seven dots.

Because operators will vary from each other in their transmission rates, and in the precise timing of dots, dashes and pauses, any automatic morse decoder has to be designed with a wide degree of in-built flexibility. With a sophisticated computer-controlled decoder, the software can be written to make its own assessments and corrections in order to lock on to any skilled morse operator's transmission. Indeed, some years ago I wrote a machine code routine for a 6502-based computer that did just that, taking the signal directly from a radio receiver via a simple amplitude controlling interface.

The unit being described here, though, has been designed as a simple decoder in which panel controls are used to preset the relative rates for the dots, dashes and pauses. The 'intelligence' of the unit then comes into play in the automatic interpretation of the received codes.

The basic functions to be designed for are: detection of the signal pulses, separation of dots from dashes, separation of letter pauses from word pauses, formatting of the received code for visual display. Fig.1 shows the complete circuit diagram of the morse decoder.

PULSE DETECTION

Signal modulation detection is carried out in a fashion closely resembling that which I used in the *PE Radio Clock* (March-June 90). A phase locked loop, IC1, is fed with the audio signal containing the morse code modulation, ie, the frequency pulses. The signal can come from any source, such as a radio, microphone, cassette or tape recorder, morse key, or computer, etc. The main provisos are that the pulse amplitude should be greater than 500mV, but no more than 5V, and that the signal should be relatively free of background noise.

The extracted pulses go to the phase comparator input of IC1 at pin 14. The chip has a second phase comparator input at pin 3 into which is fed a frequency from an internal voltage controlled oscillator, which has its output at pin 4. Internal circuitry detects the difference in phase between the two signals and the voltage level present at pin 13 reflects that difference. Using R5 and C3 to smooth out minor bits of noise fluctuation, the signal is fed from pin 13 to pin 9, which is the vco input. The vco then attempts to vary its frequency so that there is no phase difference between it and the external signal. Since it's a pulsed frequency that is being input to IC1 pin 14, the resulting voltage output at pin 13 will rise and fall in sympathy with the pulses. In the presence of a pulse the output at pin 13 will be high, and when the pulse ends the output will revert low. The actual amplitude swing will depend on the strength of the input pulse. Under ideal strength and signal clarity conditions the swing should be close to maximum, ie, between +5V and 0V. To maximise this condition, the values of C2, R4 and R5, which control the vco primary frequency, have been chosen so that zero phase difference can never actually be maintained between the two signals.

The pulsed signal at IC1 pin 9 is taken to the inverting buffer IC2a. Its output is then inverted by IC2b, so maintaining the same signal phase. The output from IC2b is routed in four directions, to a pulse length extractor, two pause extractors, and to the first of two shift registers.

DOT-DASH EXTRACTION

The pulse length extractor is formed around IC2c-e, and it is this stage which determines whether the pulse is a dot or a dash. When a morse pulse is detected by IC1, the resulting effect is that the output of IC2b goes high. This causes the NAND gate IC2c to trigger its output low, causing a negative-going pulse across C4. In response, IC2d's output changes from low to high, feeding back to the second input of IC2c. Further level changes from IC2b are thus prevented from having any more affect on IC2c until the output of IC2d reverts low again. This will only occur once C4 has recharged via R6 and VR1 to a level above IC2d's trigger point, in other words, IC2c/d have been configured as a

non-retriggerable monostable. If you care to check, this is exactly the same technique as used in the *Radio Clock*.

IC2d's output is inverted by IC2e and becomes the clock signal for the two shift registers IC3a and IC3b. You will have spotted that the pulse length generated by the monostable IC2c/d is independent of the pulse length from IC1. This means that at the end of the monostable's period we can detect whether the output pulse from IC1 is still high, or whether it has by this time reverted low. Thus we can determine whether IC1's pulse can be regarded as a 1 or a 0, as a dash or a dot.

The comparison is automatically carried out by the shift register IC3a. The 'morse' pulse output from IC2b is used as the data signal for the shift register. When the register is triggered by the high-going output from IC2e, the register will clock-in the level present on its data input. So, if the data input is high, a 1 will be clocked in, but if it's

already reverted low, then a 0 will be registered. A similar process will occur each time the register is clocked, shifting all the preceding data through by one place.

The fourth output of the first register is connected to the data input of the second, IC3b, which is clocked by the same signal from IC2e. Between them, IC3a/b have eight outputs (though only six are used) which hold the current parallel equivalent of all the serial data bits clocked in. The outputs are constantly open, putting their data onto the address lines of the eeprom, IC7. The eeprom then places upon its own outputs the data held in memory for that particular address, sending it to the lcd module. The module, though, won't respond to it until its Enable line is suitably triggered.

registers low, allowing them to accept data from that moment onwards, until the reset pins are taken high again.

When IC2b's output falls low, at the ending of the morse pulse, C7 begins to discharge via VR2 and R9. If C7's level has not fallen below the Schmitt threshold level by the time the next morse pulse arrives, C7 will immediately recharge, and there will be no change in state of IC5a. If, however, another morse pulse fails to arrive before C7 has discharged sufficiently, then IC5a's output will revert high once the threshold has been crossed. When this happens, a short positive going pulse is generated across C8, C10 and R10, the negative going edge of which (via IC6) triggers the lcd module into accepting the data from the eeprom. In so doing, it updates its screen display with the symbol corresponding to that data.

The high level on IC5a now allows C9 to charge up via R11. Once C9 has charged sufficiently, the reset pins of the shift registers in IC3 will go high, so resetting the stored data back to zero. The registers are now ready to start building up a new sequence of data for the next letter code transmitted.

COMPONENTS

RESISTORS

R1, R2, R5-R7, R10, R11, R14, R17, R18 100k (10 off)
R3 47k
R4, R8 1M (2 off)
R9, R13, R16 10k (3 off)
R12 510k
R15 1k
All 0.25W 5% carbon film

CAPACITORS

C1-C3, C5, C8, C9, C12, C16, C18, C20-C22 100n polyester (12 off)
C4 220n polyester
C6, C7, C11, C13, C15 1 μ 16V electrolytic (5 off)
C10, C19 22n polyester (2 off)
C14 4 μ 7 16V electrolytic
C17 1n8 polystyrene
C23 470 μ 16V electrolytic (optional - see text)

SEMICONDUCTORS

D1-D8 1N4148 (8 off)
IC1 4046
IC2 4572
IC3 4015
IC4 4520
IC5 4584
IC6 74HC157
IC7 eeprom or eeprom (2048 x 8 bits - see text)
IC8 7805 (optional - see text)

POTENTIOMETERS

VR1-VR3 1M lin rotary (3 off)
VR4 10k log rotary (optional - see text)
VR5 100k skeleton preset

SWITCHES

S1 min dpdt toggle
S2 morse key (see text)

MISCELLANEOUS

Lcd module type LCM570 (see text).
Dil ic sockets : 14-pin, 16-pin (5 off), 24-pin.
Printed circuit board, pcb supports (4 off), knobs (3 or 4 off - see text), 3.5mm jack sockets (2 off), box to suit (approx 180 x 120 x 40mm).

LETTER PAUSES

We constantly need the circuit to check for pauses between groups of pulses so that the end of each transmitted character can be detected. It is only at that moment that we want the lcd module to update its display.

The letter-pause detector is formed around IC5a. This is another monostable, but one which can be retriggered before its previous pulse has ended. The high-going pulse from IC2b almost instantaneously charges C7 via D1, causing IC5a, which is an inverting Schmitt trigger, to be triggered into changing its output state from high to low. This occurrence causes C9 to discharge via D3, so taking (indirectly, via the gate IC6 - more of which presently) the reset pins of the shift

WORD PAUSES

There is a third monostable, around IC5b. This is the one which is responsible for detecting pauses between words. It works on the same principle as that around IC5a, and has its output triggered low by the same positive going pulse from IC2, via D2 feeding into C11. The negative going output from

Fig 2. PCB track layout. When copying ensure ic pin spacing is exactly 0.1 inch.

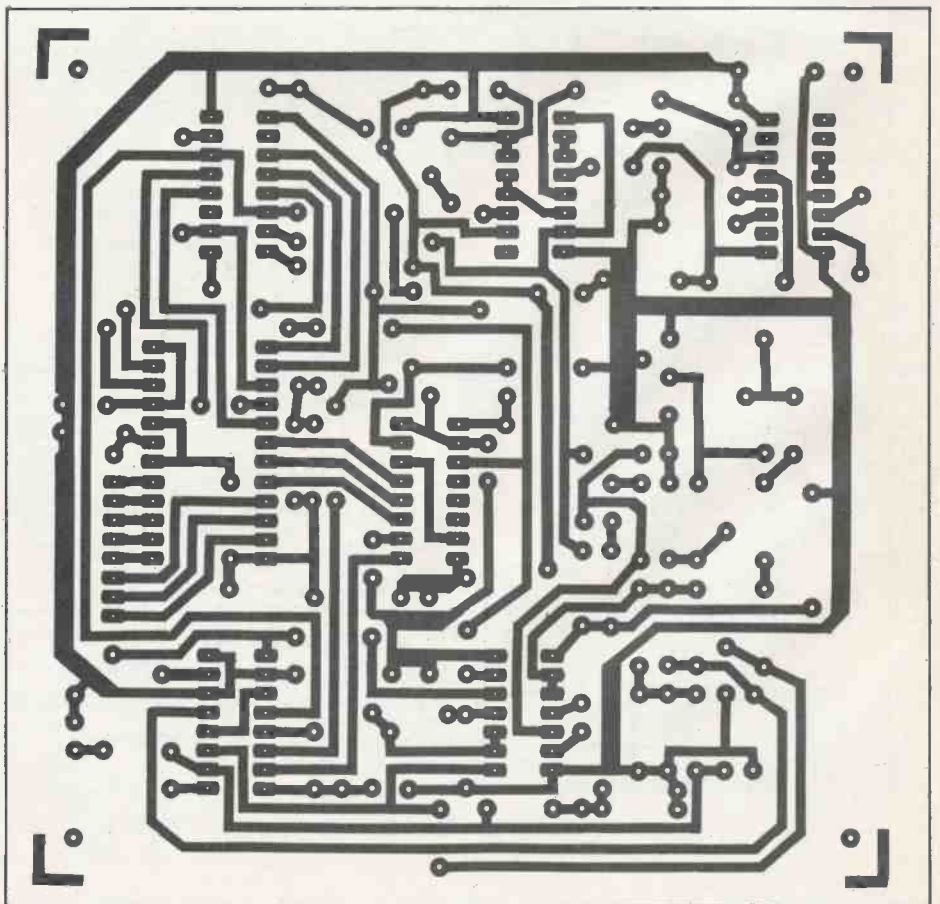

IC5b has no effect upon any subsequent circuitry. It's only the positive-going transition that is relevant. The monostable's timing factor is set for a period longer than that for IC5a. When the morse pulse from IC2b ends, C11 begins to discharge via R12 and VR3, and once the Schmitt threshold has been crossed, IC5b's output reverts high. A positive going pulse is generated across C18, C19 and R17, and passes via D5 to the lcd module's E line. Since the monostable around IC5a has already reset the shift registers by this time, the module is triggered to accept the data at eprom address zero, which is pre-programmed to hold the code for a blank space. Consequently, the lcd screen now has this blank space placed immediately after the previous letter being displayed.

BIT COUNTING

So far we have established how the dots are separated from the dashes, and how the letter and word pauses are detected. The next thing to look at is the counting of the bits that make up each letter.

This is very straightforward, and simply requires the use of a pulse counter. IC4 is used for this purpose and it is a 4-bit (0-15) binary counter of which the first three outputs are primarily used for letter-bit counting. They

are also, together with the fourth output, used in the switch-on initialisation process, as we shall see shortly.

The counter's clock input is fed from the output of IC2e (via the gate IC6) and so is triggered each time the monostable IC2c/d is triggered by a morse pulse, whatever its length. The counter's outputs then become the extra three address data lines required by the eprom to complete the necessary nine digit code. Resetting of the counter occurs at the same time that the registers are reset. The same line from monostable IC5a is used, feeding to IC4a via C5 and R7. The latter generate a short high-going reset pulse, allowing the counter to count even when the registers continue to be held reset. This factor is important to the switch-on initialisation routine.

DISPLAY MODES

There are two modes in which the morse data can be displayed. In the first, only the characters and pauses are displayed on the screen. In the second mode, the same characters and pauses are displayed, but they are preceded by the display of the actual dots and dashes that make up the characters. S1 switches between the two modes.

In the characters-only mode both poles of

S1 are grounded. This causes eprom address line A10 to be held low, and for the output of IC2e to be isolated from the common line feeding indirectly to the lcd module's E line.

In order to have the dots and dashes displayed, S1b is switched to bring the output of IC5e into circuit with eprom address line A10, and S1a switches the monostable IC2c/d onto the E line bus.

As we saw earlier, when the first morse pulse arrives, the monostable around IC5a is triggered so that its output goes low. This level is inverted by IC5e and sets the eprom to a different set of address locations, as determined by line A10. The eprom will remain with A10 high until the letter pause is detected by the monostable. With A10 high, the eprom addresses controlled by the shift registers have been programmed to place the lcd codes for dots and dashes at the eprom's output. If the shift register IC3a clocks in a zero from its data input, then the lcd dot code is produced, and of course, a one produces the dash code.

The lcd module is triggered to display the relevant dot or dash each time it occurs because the E line is simultaneously toggled via D6 by the monostable IC2c/d.

As soon as the letter pause occurs, address line A10 reverts low, so the eprom reverts to its normal set of addresses, and displays the received letter in the normal way, immediately after the last dot or dash.

Fig 3. PCB component layout.

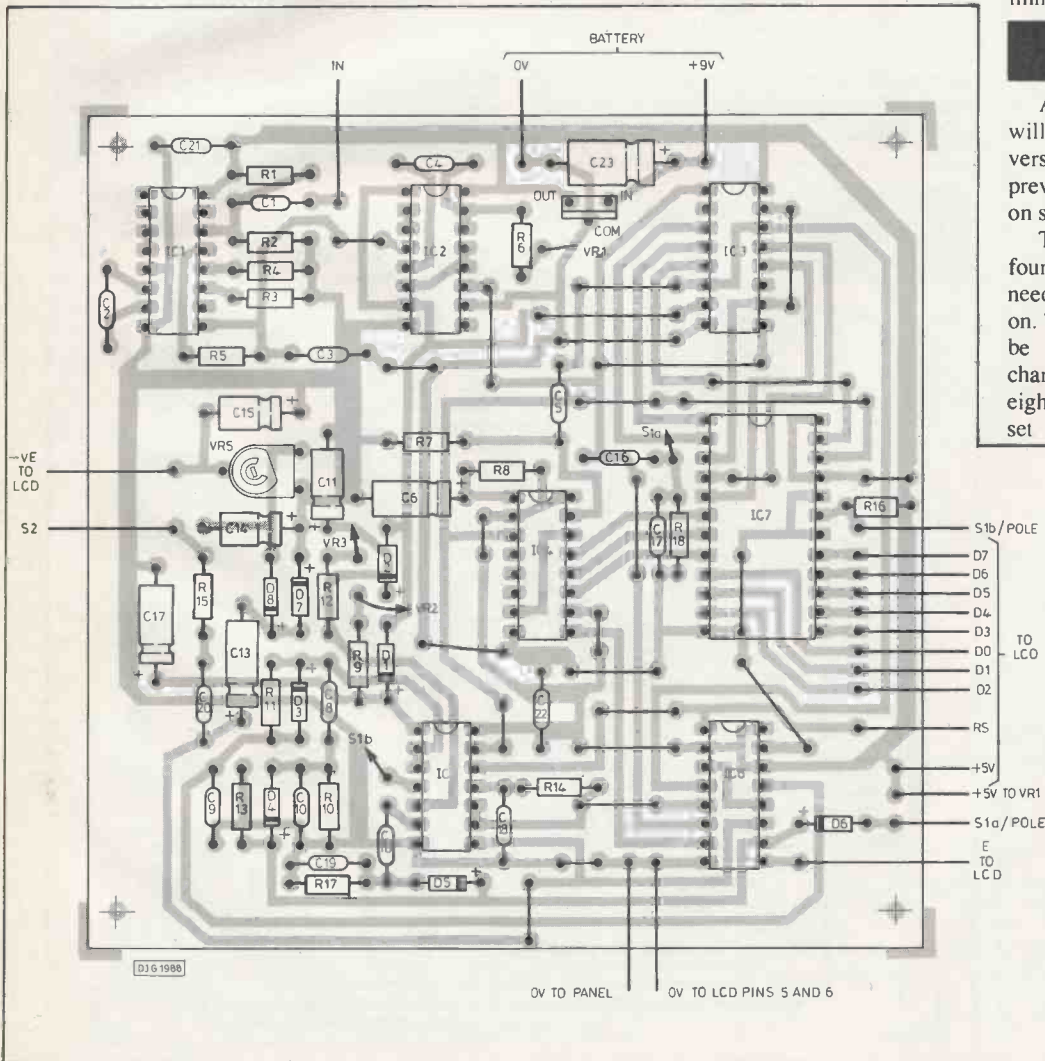

LCD SUMMARY

As readers who read PE May and June 90 will know, the lcd module is an extremely versatile device. For those who missed the previous two articles, I'll just quickly recap on some main points.

The module can be controlled via either four or eight data lines, a parameter which needs to be set immediately following switch-on. There is a choice of whether the data is to be displayed with just one line of eight characters on screen, or two lines each of eight characters. This factor, too, needs to be set after switch-on. So does the mode of screen shifting, for which there are several options. A further factor to be set is the screen position at which you want the newest character to be displayed.

Whatever the number of screen or data control lines chosen, you have access to the entire character library held in the lcd's permanent memory. Any of these characters can be transferred to the screen memory. Each screen line has an associated temporary memory which can store up to 40 characters. Under full module control, as described last month, any consecutive group of eight characters from the total store can be displayed.

The module has three other control lines, RW, RS and E. RW sets whether one can write to or read from the module. Here we are only interested in writing to it, so the RW line is held permanently low. The RS line tells the

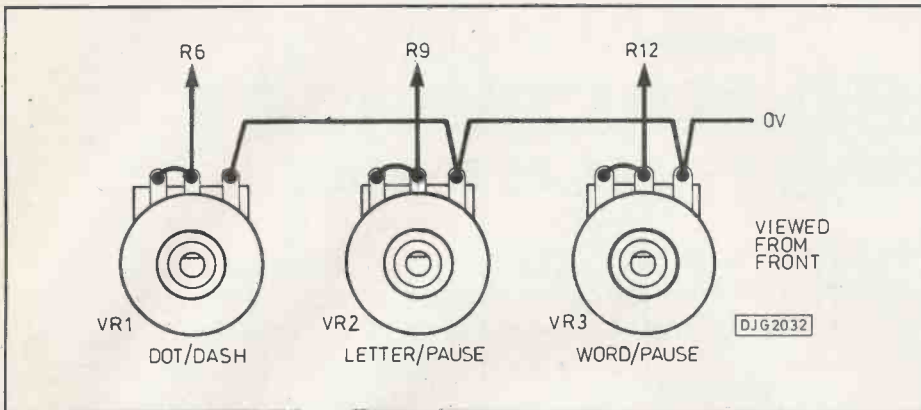

Fig 6. Wiring of VR1-VR3.

CONSTRUCTION

The pcb track and component layouts are shown in Figs. 2 and 3. No special assembly techniques are required; just ensure that you use ic sockets for all ICs 1-7, and that the polarities of the electrolytic capacitors, diodes and the chips themselves, are observed. The wiring for VR1-3 is shown in Fig.6, and that for the lcd module in Fig.7. The inverter referred to in Fig 7. is an optional backlight driver, described in the PE June *LCD Message Maker* article.

The hex dump of the eeprom data is shown in Fig.5. You will, of course, need to use an eeprom programmer to program the data into the eeprom, but that should be no great problem in view of the variety of programmers published in PE over the last couple of years. In my own unit I used an eeprom type 2816 (actually a Zicor X2816AP-35, though another manufacturer's equivalent to this should be ok). If you want to use a normal eeprom, types 2716 or 27C16 are suggested.

IN USE

Some possible signal sources and the level range conditions were given earlier in the text. Once a suitable signal is being fed into the decoder you must set VR1-3 to suit the signal transmission rate and periods.

I found the best method was to switch S1 so that the dots and dashes were displayed on the screen, and then turn all three control pots

to maximum resistance (fully clockwise). VR1 is then slowly decreased until the dots and dashes on the screen correspond with what you are hearing from the signal source. Now slowly reduce VR2 until other screen characters begin to be interspersed with the dots and dashes. This will correspond with the second monostable, IC5a, being roughly timed so that letter pauses are being recognised. Finally, once you recognise consistency in the decoding shown on screen, reduce VR3 until breaks between words are shown as blanks on the screen.

Note, of course, that you may not always understand the decoded messages since they may not be in English, or may have been encrypted prior to transmission. Language translation and de-encryption is beyond the scope of this project!

Anyone wishing to find out more about the Radio Amateur's examination and certificate should write to The City and Guilds of London Institute, 46 Britannia Street, London, WC1X 9RG.

RSGB MORSE

The Radio Society of Great Britain transmits morse code at a slow rate on various frequencies in many parts of the UK. Fig.9 shows a list of the areas covered by the slow morse transmissions, together with the frequencies and times at which they usually occur. Readers who would like to find out more about the RSGB should write to the RSGB HQ, Lambda House, Cranbourne Road, Potters Bar, Herts, EN6 3JW. **PE**

Fig 7. Pin connection for the LCM 570.

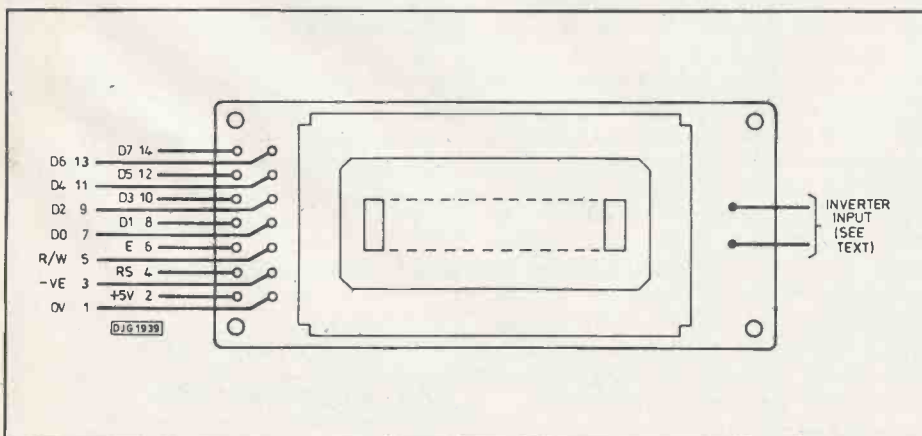

HF TRANSMISSIONS

DAY	TIME	FREQ	AREA
Mon	18.30	3.560	Avon
Tue	12.00	3.550	
Wed	18.30	3.550	
Thu	18.30	3.550	
Fri	18.30	3.550	
Sat	12.00	3.550	
Sun	12.00	3.550	
Sun	10.15	1.875	Gloucestershire
Mon	20.30	1.878	Greater London
Thu	18.30	1.078	
Thu	20.00	1.414	Lincolnshire
Wed	21.30	28.350	Strathclyde
Thu	22.00	28.350	
Wed	19.00	28.450	West Yorkshire
Fri	20.00	3.585	

VHF TRANSMISSIONS

Tue	20.30	144.250	Bedfordshire
Mon	20.00	148.250	Co Antrim
Wed	20.00	146.250	
Wed	18.30	145.250	Co Durham
Fri	18.30	145.250	
Wed	19.00	145.250	Cornwall
Mon	19.00	145.250	Derbyshire
Thu	19.00	145.250	
Mon	20.00	145.250	Essex
Tue	20.00	145.250	
Wed	20.00	145.250	
Thu	20.00	145.250	
Fri	20.00	145.250	
Wed	19.30	144.250	Greater London
Sat	19.30	145.250	
Tue	19.30	145.275	Manchester
Thu	19.30	145.275	
Fri	19.30	145.275	
Sat	19.30	145.275	
Sun	19.30	145.275	
Sun	20.30	144.250	Kent
Tue	19.00	145.250	Lancashire
Wed	19.00	145.250	
Thu	18.00	145.250	
Fri	19.00	145.250	
Sun	12.00	145.275	
Mon	21.00	145.250	Merseyside
Wed	21.00	145.250	
Thu	21.00	145.250	
Fri	21.00	145.250	
Fri	20.30	145.250	Norfolk
Mon	20.00	145.275	Nottinghamshire
Wed	19.00	145.250	Oxfordshire
Thu	20.00	145.250	
Sun	11.00	145.250	
Mon	19.00	144.155	Somerset
Sat	10.00	145.250	Staffordshire
Sun	12.00	145.250	
Mon	19.15	145.250	Strathclyde
Tue	19.15	145.250	
Wed	19.15	145.250	
Wed	21.30	145.250	
Thu	22.00	145.250	
Mon	19.30	145.250	Surrey
Thu	19.30	145.250	
Fri	19.30	145.250	
Sun	19.30	145.250	
Mon	20.00	145.250	Tyne & Wear
Thu	20.00	145.250	
Mon	19.30	144.160	West Midlands
Tue	19.30	144.160	
Wed	22.00	145.250	
Sat	19.30	144.160	
Sun	19.30	144.160	

Fig 9. Some RSGB slow morse transmissions.

The IBM PC and its compatibles are the standard business micro-computers, and the features that have made them popular amongst business users are, in the main, equally valid for home use. Probably their main selling point is the enormous software base. The number of programs available certainly runs into thousands. If you can not find an IBM PC applications program to suit your needs, then it is quite likely that such a program is not available for any microcomputer. For the serious home computer user the main attraction of the PCs is their expandability. Most PCs are supplied equipped with something like two serial ports and one parallel printer-type port. Further expansion is possible by adding "cards" into the expansion slots on the main circuit board (or "motherboard" as it is generally termed). A wide range of these cards are available, and you can add practically any desired facility to a PC with a minimum of fuss and effort. Furthermore, do-it-yourself cards are perfectly possible, making the PCs an attractive proposition for the electronics enthusiast. (We showed one example of an interface board in PE April 90. Ed). PCs are probably more expandable and customisable than any other popular microcomputer.

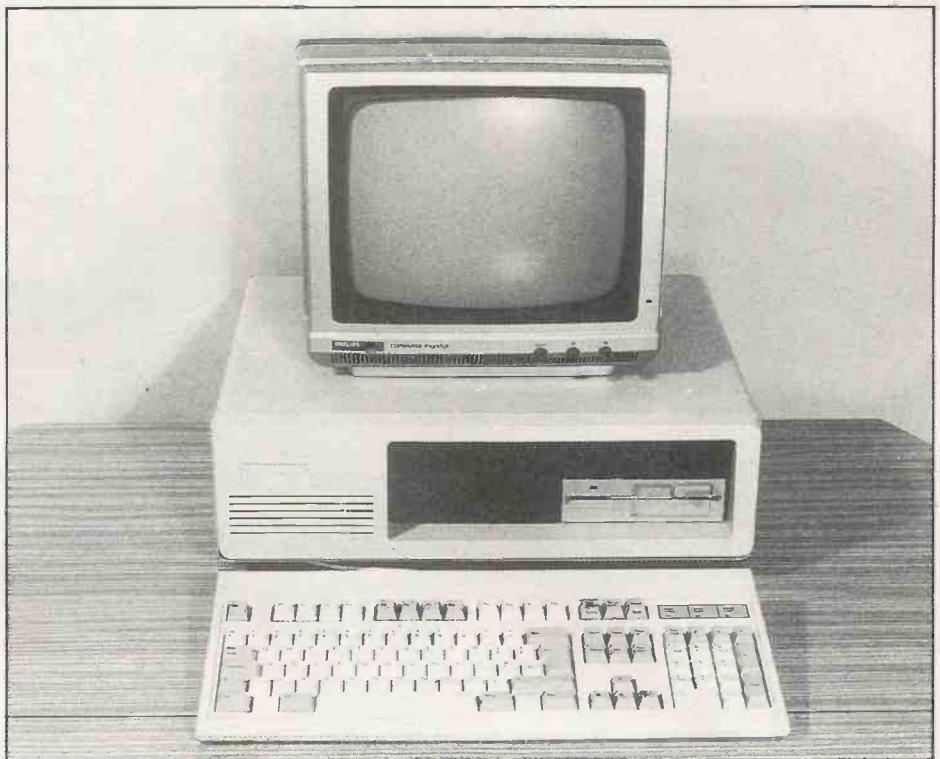

The author's home-made XT, built from cheap parts and leftovers.

DIY PCS

It would not be fair to give the impression that the PCs are the perfect home micros without any drawbacks. For games use they are probably not as good as the Amiga and STs, and fall short of certain 8 bit computers in some respects. In particular, the sound generator is a basic single channel type which falls well short of the standards that can be achieved by the Amiga, or the humble Commodore 64 come to that.

The graphics capabilities of the original PC were non-existent, but these days there are several common graphics options to choose from, plus a number of specialised graphics boards. The cheaper options do not compare too well with most other 16 bit machines, offering more the type of thing found on 8 bit computers (but with the advantage of 16 bit processing power). The more up-market graphics boards offer the sort of performance that the Amiga and STs are hard pressed to match, but at present these take the machine into a different price league.

Often the inadequacies of PCs are exaggerated by quoting items from the specification of the original PC. Current PCs offer something more potent than a 4.77MHz 8088 microprocessor with 64K of ram and a cassette recorder for storage. Most have the full 640K that can be used by the MS-DOS operating system (possibly with some form of memory expansion taking them beyond 640K), an improved processor running at 8MHz to 33MHz, and at least one floppy drive. With the "giveaway" prices of hard disks for PCs a substantial proportion of them are equipped with one of these devices.

Robert Penfold shows that computing your own computer is not inconceivable with a PC.

PC MAKE-UP

All the major parts for a PC are readily available, and building your own PC is an interesting project to undertake. I must stress that we are not talking here in terms of making your own pcbs, soldering all the components onto them, etc. A diy PC can in some cases be put together without the need for any soldering, since the power supply, motherboard, etc, are all available ready-assembled. It is a matter of putting together the right boards, and so on, and configuring everything correctly. It is not quite as easy as some articles and books would suggest, and there are a few pitfalls to avoid. In this article the main problems, and how to avoid them, will be explained. Apart from being of interest to potential diy PC builders, this information should be of value to someone who is thinking about buying a ready-made PC, and to those who may need to do occasional PC repairs and upgrades. It also provides some

useful background knowledge for those who wish to undertake PC oriented construction projects.

A PC consists of about a dozen major parts, and here we will consider each one in turn.

XT MOTHERBOARDS

There are two main types of PC, which are the XT and AT compatible types. The XT is effectively the original form of the computer with an 8088 microprocessor, but modified to take more on-board ram and to permit operation with a hard disc. While the original PC operated at a clock speed of 4.77MHz, all the modern boards seem to be of the "turbo" variety. These mostly had 8MHz clock at one time, but 10MHz (plus a few 15MHz types) now seems to be the order of the day. Some boards use the NEC V20 chip. This has fallen out of favour due to legal wrangles with Intel, the originators of the 8086 series of microprocessors. Press reports would suggest that NEC have won this battle due to Intel not putting copyright notices on their processors, and the V20 might come back into fashion. It uses improved internal architecture to perform some instructions using fewer clock cycles, giving a speed increase over the 8088 running at the same frequency. Some speed tests would suggest that the V20 is more than twice as fast, but in practice the increase is likely to be more in the region of twenty percent or so.

Although some XT compatibles (notably those from Amstrad and Olivetti) use the

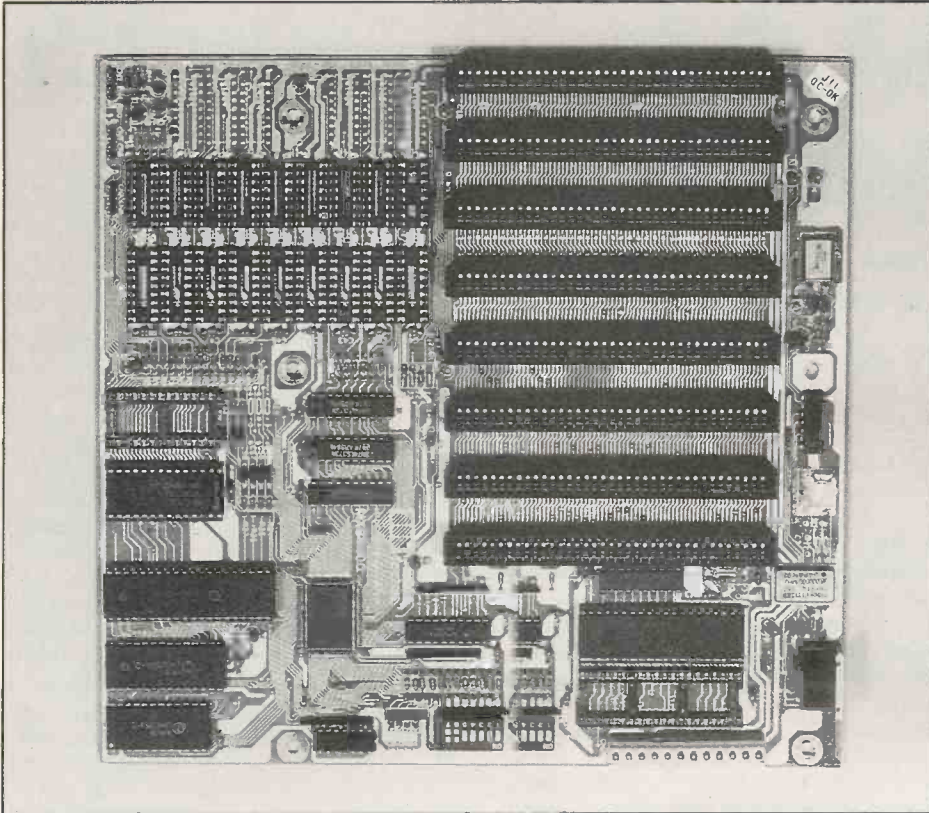

An XT board using a VLSI chip to reduce it to about two-thirds the size of a standard XT board. In "turbo" mode it operates at 15MHz!

8086 or NEC V30 processors, you are unlikely to find anyone selling a motherboard which has either of these. The 8086 and V30 have 16 bit buses, giving higher performance than the 8088 or V20 with their 8 bit data bus. Some clever circuitry is used to permit these computers to operate with the standard IBM 8 bit expansion slots.

The memory limit of the 8088 is 1 megabyte, but as a lot of the memory map is occupied by roms, video ram, etc, this leaves only 640K of the map free for the main ram. Most motherboards will take the full 640K, usually in the form of eighteen 256K x 1 drams (the 41256) for the first 512K. The other 128K used to be mainly in the form of eighteen 64K x 1 drams (the 4164). These days it is more common to have four 64K x 4 drams (the 41464) and four 64K x 1 drams. Some boards now take 1 megabyte of ram in the form of nine 1M x 1 drams (41000 or 51000 chips). The extra 384K of ram presumably operates under some sort of paging technique, and is unusable by programs, but usually the motherboard will be supplied with software to permit it to be used as a ram disk. In other words, the ram can operate as a sort of instant access pseudo disk drive, and this can be used to good effect with some programs. For an 8MHz board 150ns drams are usually satisfactory, but 120ns drams will probably be needed for a 10MHz board.

You really need to buy the motherboard first, and then get the memory chips when you are sure which ones are needed. Fitting the ram chips normally entails no more than plugging them into the sockets already fitted on the board. A few boards are designed to

take drams which have a single line of pins (usually called "sips"). Unless the board comes complete with the ram (which is unusual), it is probably best to avoid these as it may be difficult to obtain the dram chips, and they could be quite expensive if you can locate a source of supply. The cost of memory

This is a full-size "turbo" AT motherboard (most are XT size these days). It has the usual 6 x 16 bit plus 2 x 8 bit expansion slots.

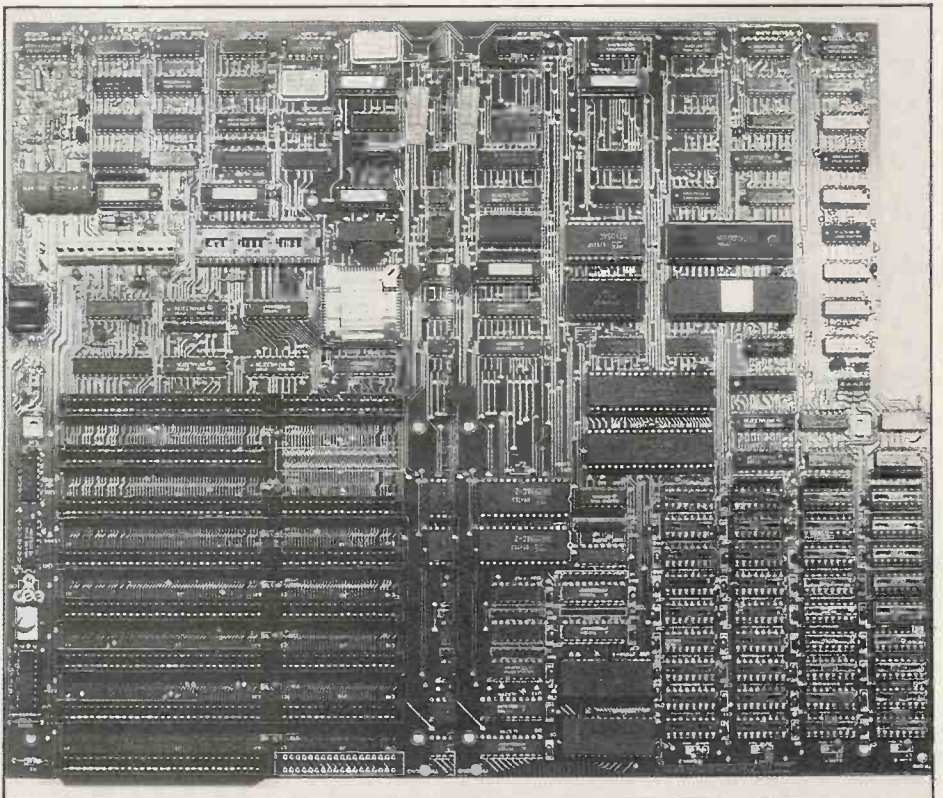

chips in general and drams in particular rose enormously a few years ago, but prices do seem to be moderating a little at last. It is worth considering secondhand drams - I obtained 640K of dram for about £75-00 this way, and have not experienced any problems with it. It is worth pointing out that most major PC software requires a minimum of 512K, and an increasing number of programs require the full 640K.

Apart from memory, the only other essential you will need to complete the motherboard is a rom bios (basic input/output system). Most boards are supplied ready fitted with a bios chip these days, but you might find that this is an optional extra. The bios is very important since compatibility with PC software is dependent on this doing a good job. Tried and tested makes are ALMI, Phoenix, and Award. Many XT boards seem to be fitted with bios chips produced by the board manufacturer rather than a third-party supplier. This could compromise compatibility, but I have not found any problems using a board fitted with a rom bios of this type. It does ensure that changing the clock speed from the keyboard will work. Usually pressing "Ctrl", "Alt", and either "+" or "-" on the numeric keypad toggles between 4.77MHz and the turbo speed. Speed changing via a hardware switch is almost invariably possible as well. Operation at the slower speed is retained because some software will not run at higher speeds. This problem is mainly caused by copy protection techniques.

The standard number of expansion slots is eight, but some boards have only five, six, or seven. This is acceptable if functions like some of the ports are built onto the

motherboard, as you will then not need to plug in so many cards in order to bring the computer up to a usable specification. Eight slots might seem to be more than will ever be needed, but bear in mind that a few essential functions (including the display driver and disk controller) are not included on the motherboard. At least two slots must be occupied in order to produce a usable computer, and three or four will be occupied if you include a few serial and parallel ports. Also bear in mind that it can get a bit crowded inside the computer, and life is much easier when adding your own boards if there are several spare slots available.

AT MOTHERBOARDS

At motherboards are somewhat larger than the XT type, although there seems to be a trend towards XT size AT boards which can fit into cases of either type. The original AT computer ran at 6MHz, and was later superseded by an 8MHz model. These days AT compatible boards usually have one or both of these speeds plus at least one "turbo" speed. This usually means a 10, 12, or 12.5MHz clock rate. This may not seem to be much better than a fast XT, but remember that the 80286 of an AT board does more per clock cycle than the 8088 of an XT board. Also, its 16 bit data bus aids increased speed. A 12MHz AT board is therefore a few times faster than a 10MHz XT board. You need to be careful when comparing AT boards since some have zero wait state operation, while others add in one wait state so that the memory chips can keep up. The zero wait state boards are significantly faster, but need faster and more expensive ram chips.

While AT motherboards are in many ways similar to XT boards, there are some important differences. Most AT boards have eight expansion slots, consisting of two 8 bit types and six 16 bit slots. Note, though, that a 16 bit slot is just an 8 bit type with an additional edge connector which carries the additional data lines plus some other lines. Most 8 bit cards can be plugged into any AT expansion slot without difficulty (but 16 bit AT cards can not usually be used with XT boards, even if they can be physically plugged into place).

XT boards have an octal dip switch which tells the computer certain configuration information, such as the amount of ram fitted and whether or not the maths co-processor socket is occupied. Most XT compatibles have dip switch arrangements which are closely based on the IBM original (Fig.1). The maths co-processor, incidentally, can greatly speed up programs that are written to take advantage of it (mainly spreadsheets and cad programs). A few programs will not run without it, but most software does not make use of it. All XT and AT boards seem to have a socket for their respective 8087 and 80287 maths co-processors. Returning to configuration information, on an AT board this is contained in the cmos ram of the 6818 battery backed clock/calendar/ram chip. A

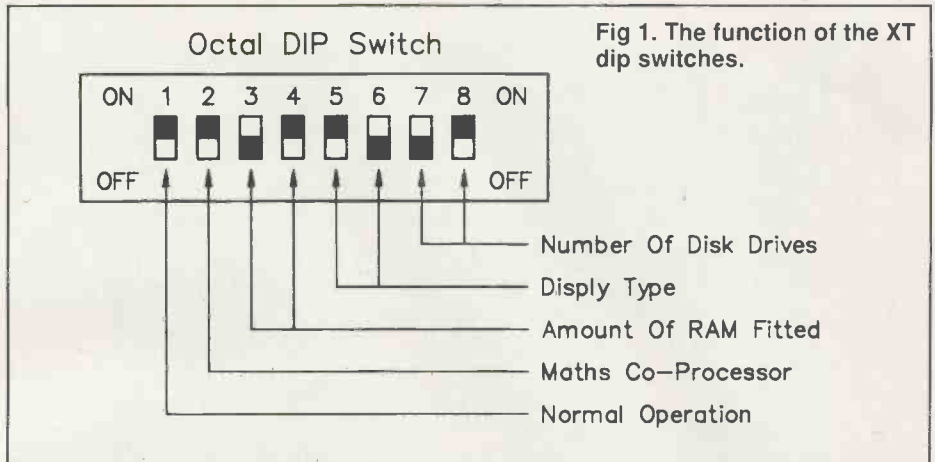

Fig 1. The function of the XT dip switches.

setup program is needed in order to put this information into the 6818. Without this program an AT can not be put into proper working order, and amongst other things will not recognise any hard discs that are fitted. Fortunately, many bios chips have a built-in setup program these days, and a PD/Shareware setup program is available. Being a true 16 bit machine, an AT compatible has two bios roms (two 8 bit types giving 16 bit wide data overall).

The 80286 can operate in 8086 emulation mode (the normal MS-DOS mode), or in a mode that gives a 16M address range. Current AT boards seem to take a minimum of 1M, and using 1M chips plus 1M plug-in memory modules some can take as much as 8M of memory. MS-DOS can utilise this "extended" memory as ram disk, and some software can make direct use of it. Do not confuse "extended" memory with "expanded" memory. The latter is a form of memory expansion for any PC, usually accomplished

using ordinary expansion cards. However, a few recent AT boards can have the extra ram configured as LIM 4.0 standard expanded memory.

80386 based motherboards are widely available, and are effectively AT compatible boards based on the 32 bit 80386 microprocessor. They have the advantage of higher clock rates (usually 16, 20, or 25MHz), but when running ordinary MS-DOS software their 32 bit architecture is not properly utilised. Most have a couple of 32 bit expansion slots, but as there is no true 32 bit bus standard, these might not be of much use. For many purposes one of the new 16 or 20MHz AT motherboards will work just as well. However, for the diy PC builder any clock frequency of more than about 12.5MHz is a bit risky, as not all cards will work with these, and the fast ram needed to do full justice to these boards is not the type of thing you are likely to be able to obtain cheaply.

Interior view with some of the cables removed, showing the general layout of a PC.

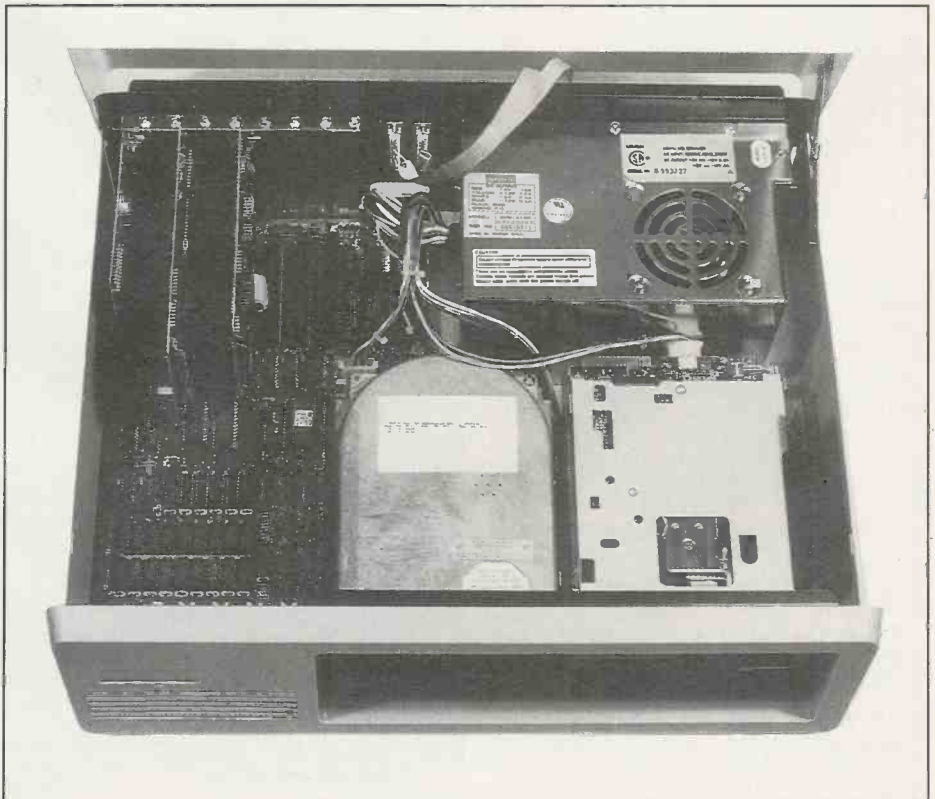

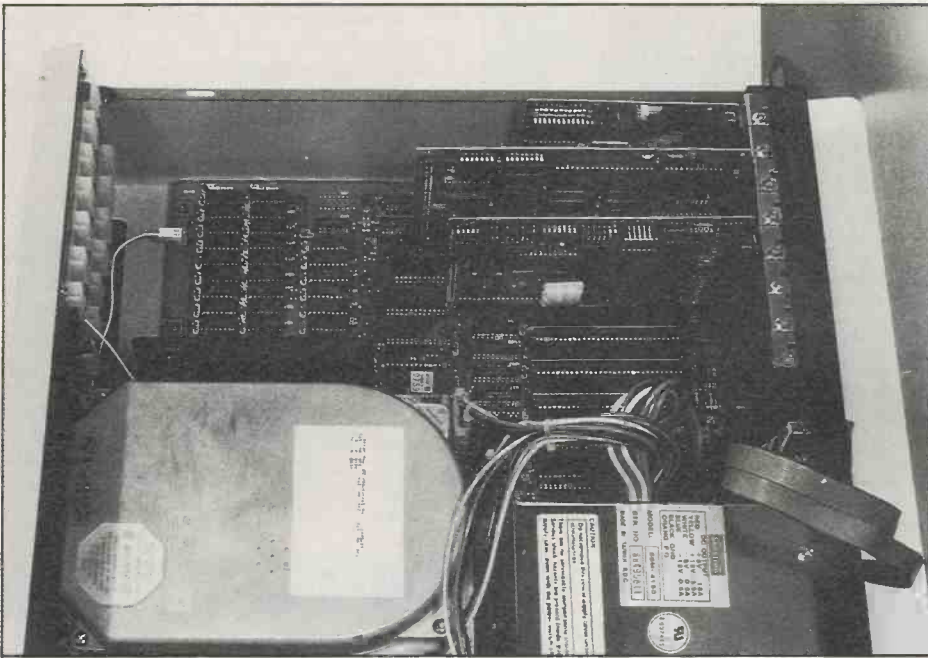

Plug-in cards can provide the PC with standard and unusual features.

CASES AND PSUs

Most XT cases are now of the flip-top type, which is handy if you need to open the case a lot to delve around inside. An AT case is somewhat larger and most have an outer casing which pulls forwards and clear of the chassis, after removing five screws from the rear panel. There are also "baby" AT cases, which are often of the flip-top type. Many AT motherboards will fit an XT case, but there is a lot to be said in favour of a full size AT case. It gives plenty of space for everything, and generally makes life easier. An AT case is pretty huge, but you can get inexpensive stands which enable them to be floor mounted on one end. You can then tuck the unit away under the desk, leaving the desktop free for the keyboard etc. In fact you can get proper floor mounting "tower" cases, but these are mostly quite expensive at about four times the cost of an ordinary AT case.

When buying a case it is important to make sure it is supplied "with kit". In other words, it should come complete with any odd bits of hardware you might need, such as the loudspeaker, disk drive mountings, motherboard mountings, and so on. While some of these odds and ends are standard items, some of them are special plastic mouldings which it would be difficult for the diyer to produce. With an XT the motherboard is bolted to nine threaded mounting pillars fitted on the base of the case (only six may be needed if the board is a small type). AT motherboards are mostly fitted in place using a mixture of plastic stand-offs and threaded mounting pillars. An XT case has a cradle into which up to four half height drives can be mounted directly. The AT method is to have plastic rails which are bolted to the sides of the drives. They then slide into the mounting bays, and are held in place by clips bolted to the fronts of the mounting bays.

The standard power supply for an XT is a 150 watt type. This is sufficient to power an XT board, floppy drives, a hard drive, and a number of expansion cards. An AT has a 200 watt power supply, although 180 watt types are sometimes used with modern vlsi boards which have lower current consumptions. 80386 computers mostly use a 220 or 230 watt supply. These are all fully enclosed switch mode supplies with a built in on/off switch. They are fixed to the rear panel of the case using four bolts. The case should be ready drilled and cut to take the power supply, and everything else for that matter. The power input is via a standard Euro mains connector, and there is usually a switched Euro outlet for the monitor.

FLOPPY DRIVES

The standard floppy drive for an AT machine is the 1.2M 5.25 inch type, but these are now being superseded by the 1.44M 3.5 inch drives. Similarly, the 360K (40 track ds/dd) 5.25 inch XT drives are now being displaced by the 720K (80 track ds/dd) 3.5 inch type. The 5.25 inch types are the safer bets as not all software is available in 3.5 inch format, although there is now very little that is not. Special mounting kits are needed for 3.5 inch drives, and are sometimes supplied with the drive. You need to be a little careful when selecting drive types, since everything will only work properly if the bios and disk controller both support the drives you will be using.

Apart from minor mechanical fitting difficulties, probably the most common floppy drive problem is the setting of the jumper leads. Most disk drives (and many expansion cards) have terminals which can be connected together, or not, depending on whether little "jumper" clips are fitted onto them. This enables you to configure things correctly. Most disk drives seem to have about

a dozen sets of jumper terminals, but are not usually supplied with information on their functions. Your supplier should be willing to provide a data sheet or set up the drive ready for use in a PC. There is a potential problem in that the genuine twin drive IBM PCs have both drives configured as drive 0. The lead to the second drive has a twist which reverses lines 10 to 16, and effectively configures the second drive as drive 1. Not all clones use this system, and you might be supplied with drives set up as drive 0 or 1. Provided you get the right setting for the appropriate jumper, leads with or without the twist should be usable. When fitting a single drive to my home-made XT I must admit that I could only get it to work properly with the twist included in the cable. The standard floppy drive cable is a 34 way type fitted with an IDC connector at the controller end, and a 34 way IDC edge connector at the drive end. Pin numbering should be shown on both the controller card and the drive, leaving no excuse for getting one of the connectors fitted the wrong way round. For twin drive operation another 34 way edge connector must be added a few inches from the drive end of the cable.

HARD DRIVES

Assuming you do not opt for an exotic hard disk drive, this will be a type having an SCSI interface. This has a 34 way cable for control purposes, and like a floppy drive cable it has an IDC connector at one end, and an edge connector at the other. A 20 way cable of the same basic type is needed to carry the data. Note that the XT and AT hard disk control cards are very different. The XT card includes a rom bios, whereas an AT controller does not need this as the bios on the motherboard handles the hard disk drives.

XT controllers usually have dip switches which should be set to suit the type of drive you are using. The number of drives supported might be quite small, but sometimes a built-in program can be run, and this will enable the card to operate with practically any SCSI drive. Most XT controllers operate by storing the disk's vital statistics on the disk itself. This may seem like a genuine analogy to pulling yourself up by your bootlaces, but it works! The controller should include a formatting program which places this information on the disk, as well as performing a low level format. A low level format is what could be regarded as the real format, where the track and sector information is written onto the disk. At this stage any defective tracks must be "mapped" so that they are never used. A hard disk should be supplied with a test sheet giving details of any defective tracks, performance information, number of tracks ("cylinders") and heads, etc. This sheet should provide all the data you will need to successfully perform a low level format.

At least, it will tell you everything but the correct interleave factor. I will not go into great detail about interleaving here, but it is basically a matter of arranging the data on the

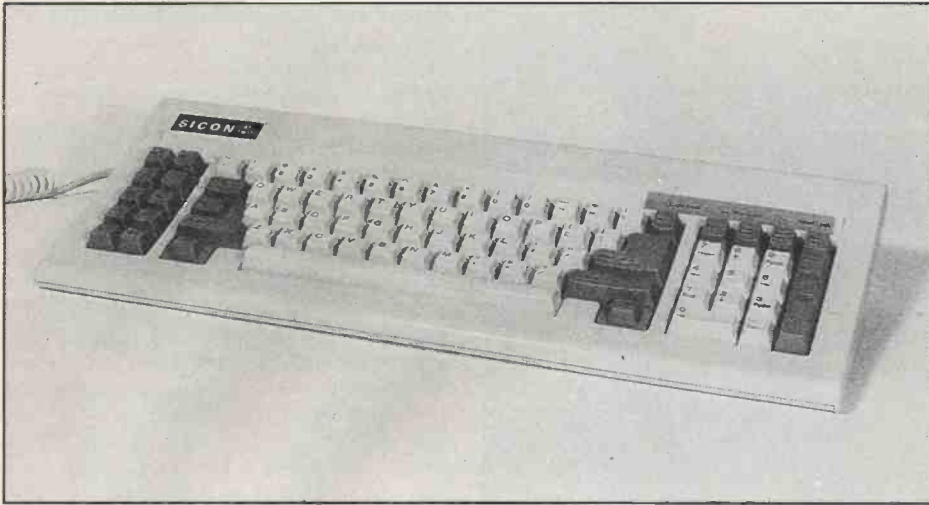

The original 84-key keyboard – now probably less commonly used than the 102-key keyboard.

disk so that when one chunk of data has been read and transferred, the next chunk is almost instantly available, avoiding the need for the disk to do almost a complete rotation before the head is positioned at the beginning of the next piece of data. This can significantly speed up transfers of large amounts of data. For an AT the interleave factor is 2, except when using a "turbo" AT with a special controller having a factor of 1. For an XT the interleave factor is usually much larger at about 7 (and the formatter might simply set a value without consulting you first).

The next step is to use the MS-DOS FDISK command to prepare the boot sector of the disk so that the FORMAT command can operate properly. It can also be used to partition the disk, which means having it effectively operate as two smaller disks. This is usually only done if the disk has a capacity of more than 32M, since this is the largest size that MS-DOS 3.3 (and earlier versions) can accommodate as a single disk. Note that MS-DOS 4 apparently does not have this limitation. Some hard disks are supplied together with partitioning software, and this might be easier to use in these cases. The final stage is to use the MS-DOS FORMAT command to do a high level format of the disk. Presumably you will wish to boot from the hard disk at switch on, and so the /s option

should be used in order to install the MS-DOS system on the disk.

Installing a hard disk in an AT computer is a little different, since the controller does not have any built-in software. For the diy pc builder there is a lot to be said in favour of a rom bios such as a recent "AMI" one, which includes a format program, setup program, diagnostics, and details of the supported disk drive types. Any AT bios should support at least drive types 1 to 15, and some go as high as type 47. However, there seems to be a lack of true standardisation from types 16 to 47. Probably the most common type of drive is type 2, which is the one most 20M drives are covered by. If you opt for something more exotic than a 20M drive you could well find that nothing in the list of drives exactly supports your unit. This is not necessarily a disaster, and it is quite common to choose a near equivalent, although this might mean sacrificing some of the drive's capacity. You must select one having the same number or fewer heads, and the same number or fewer tracks. In a rebuilt AT I used an 853 cylinder/6 head drive as an 820 cylinder/6 head 42M type (drive type 40). This loses about 2M of the drive's capacity, which is a pity but of no great importance.

Preparing a hard disk for operation in an AT is much the same as for an XT. However,

This 102-key layout is probably the most popular type of PC keyboard at present.

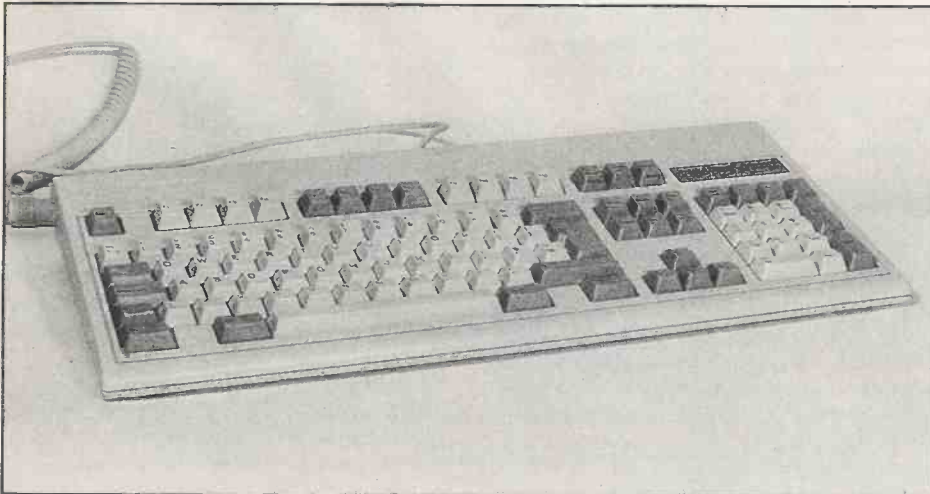

initially the setup program must be used to indicate that no hard disk is fitted, or the computer will probably refuse to go through its start-up routine properly. Use the setup program to indicate that the hard disk is present once the low formatting has been completed.

Most hard disk controllers are of the mfm (modified frequency modulation) type. These operate on the basis of sectors per track with 512 bytes per sector. RLL (run length limited) controllers are now becoming more common, and these use 25 or 26 sectors per track, giving about 50% more capacity and faster data transfer rates. Note though, that rll controllers should only be used with drives that are designed for this higher density system. Using an rll controller with an ordinary drive, as many users can testify, is likely to give very poor reliability.

KEYBOARDS

The 84 key IBM style keyboard is the safest option, but it is less popular than the 102 key type which has 12 rather than 10 function keys, and separate cursor keys etc. Instead of having these merged into the numeric keypad (with a key to toggle between normal and numeric operation). Relatively little software utilises the extra function keys, and I have not encountered any programs where they are essential. There is also a 101 key layout, but this does not seem to be very popular in the UK. There is a potential problem with the 102 key type in that a few keys usually produce the wrong on-screen characters (the # and \ keys often providing troublesome). Ready assembled computers are usually supplied with a utility program to correct this, but commercial, pd, or shareware keyboard definition programs can usually sort things out. Although XT and AT keyboards use slightly different methods of interfacing to the main unit, all the IBM compatible keyboards I have seen have been switchable to operate with either type of computer.

DISPLAY ADAPTORS

The lowest cost display adaptor/monitor combination is the Hercules monochrome type. This gives good quality text plus high resolution (720 x 348) monochrome graphics. This is adequate for many purposes, but there is a great weakness for home use in that little games software supports this mode. For home computer use the cga (colour graphics adaptor) is probably the best budget display. This provides 640 x 200 monochrome and 320 x 200 x 4 colour graphics, plus reasonable text capabilities. Virtually all games software, plus most serious software supports this mode.

By current standards neither of these display standards are particularly outstanding. The ega (enhanced graphics adaptor) type is a definite improvement, with its 640 x 350 resolution in monochrome or 16 colours. Although at one time ega cards and monitors

were extremely expensive, they are now an attractive proposition at prices not that much more than those for a cga display. EGA systems provide the cga modes as well incidentally. VAG (versatile graphics array) displays are becoming very popular, but are still relatively expensive. In addition to all the cga and ega modes they also provide a 320 x 200 mode offering up to 256 colours from a palette of 262,144 colours, and a 640 x 480 16 colour mode. In fact many offer even more impressive modes, such as 800 x 600 in 16 or 256 colours. In order to make use of these modes you need an expensive multi-sync monitor rather than a vga analogue type, plus software that supports them, or (more probably) suitable drivers for your applications programs supplied with the vga board.

MS-DOS

In order to use a PC it must boot up an operating system at switch-on, and by far the most popular operating system is MS-DOS. In theory, MS-DOS is only sold with ready assembled computers, and is either customised to provide complete compatibility with the hardware, or is thoroughly tested to ensure that the standard version operates properly with the hardware. In practice, a few companies sell MS-DOS, usually version 3.3, but a few offer version 4. Either will do, as

will any version from 3.0 onwards (not all programs will run under version 2).

PORTS

With few exceptions, motherboards do not include any ports, and these must be provided by expansion cards. Probably the cheapest way of providing these is to buy a multi-function card. In my home assembled XT computer I use a card which cost £39.00 (excluding vat). It provides parallel, serial, and games ports, plus the floppy disk controller and a clock/calendar. A chip bought for about £12.00, together with two chips plus some cable and connectors from the spares box, added a further serial port. Together with the parallel port included on the cga card, this gives the machine an impressive array of ports at minimal cost.

GETTING IT TOGETHER

Putting the computer together is not particularly difficult, and is reminiscent of assemble-it-yourself furniture. You may need to supply one or two bolts, and it might be necessary to make up a few cables. However, ready-made cables are available, the power supply has flying leads fitted with connectors, and hard disk controllers often come complete

with a pair of cables. The accompanying photographs help to show where everything fits, but it is fairly obvious anyway once you have all the parts. The main point to watch is that you have all the information you need to set up dip switches and jumpers correctly. Ideally, every board and drive should be supplied complete with at least a pamphlet giving any necessary setting up information. In some cases software might be needed as well, such as to enable a clock/calendar to be setup and used correctly (my XT clock/calendar has yet to do anything worthwhile due to a lack of software to set it up and integrate it with the operating system). Before buying anything it is a good idea to ask lots of questions to ensure that the item does what you think it will, and is supplied with any software/information that you will need. You are almost certain to find a few problems to solve, but that is all part of the fun!

Assembling your own PC is certainly an interesting pastime. My XT was built from cheap parts plus a lot of left-overs from upgrades to my other PC. Its cost was about 30% of that of a ready assembled equivalent, although without the left-overs the saving would obviously have been much less than this. Having completed your PC, you have the ideal basis for computer projects. Using PCs with some constructional projects will be the subjects of future articles in PE.

PE

Interak 1

BUILD YOUR OWN COMPUTER



INTERAK can be commenced with the minimum of outlay. Bare boards from £40.95. beg borrow or steal the components, or buy from us - all parts available separately. No special or custom chips (ie PALs, ULAs, ASICs etc) used - no secrets

Go as fast or as slowly as your funds and enthusiasm permit

Made for those who must know what goes inside. Full circuit diagrams and descriptions are provided. And honestly you can really use a computer effectively if you don't know what's inside and nobody will tell you?

Solid engineering construction - something to be proud of. 19" 3U rack mounting plug in circuit boards and modular construction keeps obsolescence at bay.

Flourishing Independent Users Group, and newsletter. Hundreds of programs on disk at little or no cost from the Users Group.

Program in machine code (Assembler), Basic, 'C', Forth, etc Database. Word Processing. Scientific applications.

Cassette tape operation or disk (up to 4 drives, 1 Megabyte 3.5" available from us but you can add 3", 5.25", 8" if you want). Disk operating system CP/M Plus.

64K RAM. Z80 based at present with potential for expansion to a 16 Megabytes address space and Zilog's latest Z80280 in the future.

Needs no specialised knowledge to construct, and we will happily get you out of a jam if you get into one.

Availability of personal and individual after sales service, impossible to obtain from large companies, who are only after your money.

Security of supply - from Greenbank Electronics, established in 1970.

Greenbank

For more details write or phone us:

Greenbank Electronics, Dept (E07P) 460 New Chester Road, Rock Ferry, Birkenhead, Merseyside. L42 2AE. Tel: 051-645 3391

WE HAVE THE WIDEST CHOICE OF USED OSCILLOSCOPES IN THE COUNTRY

H.P. 174A Dual Trace 10MHz Delay Sweep. Tmg	£500
TELEQUIPMENT 083 Dual Trace 50MHz Delay Sweep	£300
GOULD 05300 Oscilloscope Dual Trace 20MHz	£250
GOULD 05300 Oscilloscope Dual Trace 20MHz	£250
GOULD 1421 Digital Storage Dual Trace 20MHz	£750
THANORAR PL3200MD 0.30V 2A Traces Quad Mode Digital Meters	£200
FEEBOBOX FSG 605 Sweep Function Generator 0.01Hz - 1MHz (P&P E7)	£200
SOLARTRON 7045 Multimeter 44 digit LED 30 range AutoManual (P&P E7)	£125
LOGIC PROBE type 3300A TTL CMOS (P&P E3)	£18
FARNELL Oscillator LFM3 10Hz-10MHz Sine/Square	£200
RACAL 8915 Freq Counter 10Hz-50MHz (Crystal Oven)	£150
RACAL 8900 Series Universal Counter Timers from	£750
MARCONI ATTENUATORS TF2162 DC-1MHz 600 ohm 0-111dB (P&P E7)	£35
HATFIELD ATTENUATORS 50 ohm DC-250MHz 0-100dB/600 ohm DC-1MHz (New Price £135)	(P&P E4) ONLY £50

THIS IS JUST A SAMPLE. MANY OTHERS AVAILABLE

TEKTRONIX 2215 DUAL TRACE 60MHz SWEEP DELAY WITH MANUAL, PROBES, FRONT COVER, POUCH, ONLY £500

MARCONI TF2015 AM/FM 10-50MHz Sig Gen with TF2171	£450
MARCONI TF2015 without Synchroniser TF2171	£300
MARCONI TF2016 AM/GM 10Hz-120MHz Sig Gen with TF2173	£400
MARCONI TF2016 without Synchroniser TF2303 from	£250
DYMAR 1525 AM/FM 0.1 - 16MHz Sig Gen	£200
H.P. 620B Signal Generator 7-11 GHz	£400
H.P. 6180 Signal Generator 1.8-1.6 GHz	£400
H.P. 6169 Signal Generator 1.8-4.2GHz	£400
FERRUGRAF-RITS Recorder Test Set	£275
WDELUXE Woe & Filter Meter M108	£100
LEADER LMV186A Two CHANNEL Multimeter	£100
5MHz-500kHz 100 uV - 300V	£100
FEEBOBOX FG801 Sig Gen 0.001Hz-1MHz Sine/Sqr/Tri	£150
MARCONI Automatic Operation Meter TF2337A 40Hz-Z or Measures down to 0.01%	£100
LEVELL OSCILLATORS TG152/TG200 series from	£85
MARCONI TF2700 UNIVERSAL BRIDGE. Battery from	£150

HAMEG MODULAR SYSTEM

HM8007 Mod Frame with HM8002 Sine Wave Generator 20Hz - 20MHz	£100
HM8002 Function Generator 0.1 - 1MHz Sine/Sqr/Triangle and	£100
HM8001 2 Digit Multimeter 4.5 digit	£375
SACDELTA MC321 COLOUR BAR GENERATOR RF Bands 1/3rd & Video, Sound Camer. Unused (P&P E7)	£125
SACDELTA COLOUR BAR GENERATOR PAL MOD 1, 8 PATTERNS PAL. Ser. Nonadjustable. Comp. with Battery Charge Adapter Unused (P&P E4)	£50
Labgear Colour Bar Generator K91 8 line Patterns (P&P E4) only	£40
ABGEAR CROSSHATCH GENERATOR Type CM6038-DB Chromatic Grey Scale/Black Refer. Means or BATTERY Unused £18. Unused £12 (P&P E3)	£18
TRIO RF SIGNAL GENERATOR Type SG402 100kHz-30MHz Unused (P&P E7)	ONLY £50
ADVANCE SG628 AM 150kHz-20MHz	£45 (P&P E7)
MICROINTEK CUB MONITOR 14" COLOUR	£80

TELEPHONES - YES! REAL DIAL TYPE TELEPHONES

- that don't slide around the desk. Type No. 746 supplied with standard BT plug (Used)..... ONLY £5 each. Quantity discount

Used equipment - with 30 days guarantee. Manuals supplied, if possible. This is a VERY SMALL SAMPLE OF STOCK. SAE or Telephone list Lists. Please check availability before ordering. CARRIAGE at units £16. VAT to be added to total of Goods & Carriage.

STEWART OF READING
 110 WYKEHAM ROAD, READING RG6 1PL, BERKS RG6 1PL
 Tel: 0734 68041 Fax: 0734 351696
 Callers welcome 9 am - 5.30 pm (until 8 pm Thursday)

TEKTRONIX OSCILLOSCOPE 2235 Dual Trace 100MHz Delay Sweep £750

PHILIPS OSCILLOSCOPE PM3217 Dual Trace 50MHz Delay Sweep	£500
GOULD 05300 Oscilloscope Dual Trace 20MHz	£250
GOULD 1421 Digital Storage Dual Trace 20MHz	£750
THANORAR PL3200MD 0.30V 2A Traces Quad Mode Digital Meters	£200
FEEBOBOX FSG 605 Sweep Function Generator 0.01Hz - 1MHz (P&P E7)	£200
SOLARTRON 7045 Multimeter 44 digit LED 30 range AutoManual (P&P E7)	£125
LOGIC PROBE type 3300A TTL CMOS (P&P E3)	£18
FARNELL Oscillator LFM3 10Hz-10MHz Sine/Square	£200
RACAL 8915 Freq Counter 10Hz-50MHz (Crystal Oven)	£150
RACAL 8900 Series Universal Counter Timers from	£750
MARCONI ATTENUATORS TF2162 DC-1MHz 600 ohm 0-111dB (P&P E7)	£35
HATFIELD ATTENUATORS 50 ohm DC-250MHz 0-100dB/600 ohm DC-1MHz (New Price £135)	(P&P E4) ONLY £50

AVO MULTIMETERS & P&P 10 all

Avo 85, 85 and Ministry Versions. With Batteries & Leads..... from £50

TEST LEADS for Avo's. Red & Black with 2 croc Clips & 2 probes. (P&P E3)..... £5

Black/EVER READY Case for Avo's. Unused..... (P&P E4)..... £15

BATTERIES 15Volts..... £3 each. 10 for £25 (P&P extra)

AVO TRANSISTOR ANALYSER M42 CT446 suitcase style. With Batteries & operating Instructions..... ONLY £25 (P&P E7)

MARCONI AF Power Meter TF893A 20Hz-35kHz. 20mV - 10W. With Manual..... ONLY £25 (P&P E7)

MARCONI RF Power Meter TF1152A1 DC-500MHz 0.5 - 25W 50 ohm With Manual..... ONLY £30 (P&P E7)

NEW EQUIPMENT

HAMEG OSCILLOSCOPE HM11005 Triple Trace 100MHz Delay Timers	£725
HAMEG OSCILLOSCOPE HM 604 DUAL TRACE 60MHz Delay Sweep	£575
HAMEG OSCILLOSCOPE HM 2015 Dual Trace 20MHz Component Tester	£314
HAMEG OSCILLOSCOPE HM205 2 Dual Trace 20MHz Digital Storage	£527

All other models available & all oscilloscopes supplied with 2 probes.

BLACK STAR EQUIPMENT (P&P all units £5)

APOLLO 10 - 100MHz Counter Timer Ratio/Period/Time interval etc..... £222

APOLLO 100 - 100MHz (AS above with more functions)..... £295

METER 100 FREQUENCY COUNTER 100MHz..... £99

METER 600 FREQUENCY COUNTER 600MHz..... £126

METER 1000 FREQUENCY COUNTER 1GHz..... £178

JUPITER 500 FUNCTION GENERATOR 0.1Hz-500kHz Sine/Sqr/Tri..... £110

ORION COLOUR BAR GENERATOR PAL/Tri/Video..... £200

All other Black Star Equipment available.

HUNG CHANG OHM 7030 3 1/2 digit. Hand Held 28 ranges including 10 Amp/AC/DC 0.1% Acc. (P&P E4)..... £39.50

As above OHM 6010. 0.25% Acc..... £33.50

Camping Cases for above..... £3

OSCILLOSCOPE PROBES Switchable x1, x10..... (P&P E3)..... £11



The New Cirkit Summer Catalogue

- 100s new products
- £10 worth discount vouchers
- Latest books
- Low cost multimeters
- 184 pages
- Only £1.60 available from larger newsagents or directly from Cirkit



Cirkit Distribution Ltd.
 Park Lane, Broxbourne, Herts EN10 7NQ
 Telephone (0992) 444111

OUT NOW! OUT NOW! OUT NOW!

AGE A & G ELECTRONICS LTD.

ELECTRONIC COMPONENTS MAIL ORDER COMPANY.

1990 COMPONENTS Lowest prices for quality components.

CATALOGUE IS

AVAILABLE NOW.

summer special

This offer is for a limited period.

Dont miss out !!!

Order a catalogue now and we send you a

0.5" ORANGE DUAL LED DISPLAY

Value £ 2.00 absolutely free !!!

Simply complete and return the order form below and we will send your free gift.

PLEASE SEND COPIE(S) OF THE A & G ELECTRONICS CATALOGUE AT £1.00 (REFUNDABLE WITH MY FIRST ORDER) AND MY FREE GIFT(S) TO :

NAME

ADDRESS

.....

I HAVE ENCLOSED £.....

A & G ELECTRONICS LTD.
 Free Post ,100 Park Avenue ,
 London E 6 2BR. (No Stamp Required)
 TEL : 081-552 2386 Fax : 081 - 519 3419.

COMPONENT SOLUTIONS LTD.

UNIT 84, ENTERPRISE CENTRE, BEDFORD ROAD, STOKE-ON-TRENT, STAFFS. ST1 4PZ

MICROPROCESSOR + MEMORY SPECIALIST

Z80A CPU	.95	2716F1	£2.35
Z80A S10	.45	2764	£1.60
Z80A P10	.75	27128	£2.35
Z80A CTC	.45	27C256	£2.40
Z80A DART	£1.50	27512	£5.00
8031	£1.50	6116	£1.30
80C39	£1.70	6264 LP	£2.50
80C31	£3.00	62256 LP	£6.00
80C85	£1.60	4164	£2.00
81C55	£2.10	41256	£2.25
82C12	£1.30	1Mb RAM-10	£9.75
82C55	£2.10	SIMMS 1Mx9-10	£75.00
6809	£2.10	256kx9-80	£30.00
6502/6522	£3.90	SIPS 256kx9-80	£40.00
N80186	£10.00	78L08	.08
D80287-8	£110.00		

10% DISCOUNT FOR ALL ORDERS OVER £25.00
 ALL ABOVE ITEMS FROM STOCK, ORDERS BY RETURN POST

C.W.O. TRANSACTIONS PLEASE ADD .75p
P+P THEN 15% TO TOTAL



For some while now the electret microphone has enjoyed increasing popularity as an inexpensive instrument capable of good quality. Basically, it is similar to the condenser or capacitor microphones that have been used for decades in broadcast and recording studios. These consist of a thin plastic diaphragm coated with aluminium or gold stretched over a shallow cavity having a flat metal backplate. A capacitance is thereby created which depends on the spacing between the diaphragm and the plate.

An applied dc voltage usually of 48V charges the capacitor and electrostatic attraction pulls the diaphragm in, keeping it taut. Movement of the diaphragm caused by sound waves varies the capacitance and causes current to flow in and out of the device in sympathy. The current is passed through a load resistor thereby developing a signal voltage across it, but because the current variations are very small, a large value resistor must be used to get an appreciable signal output.

The output impedance is thus very high, in the region of 100 M Ω , and therefore a cable length of more than a few inches would

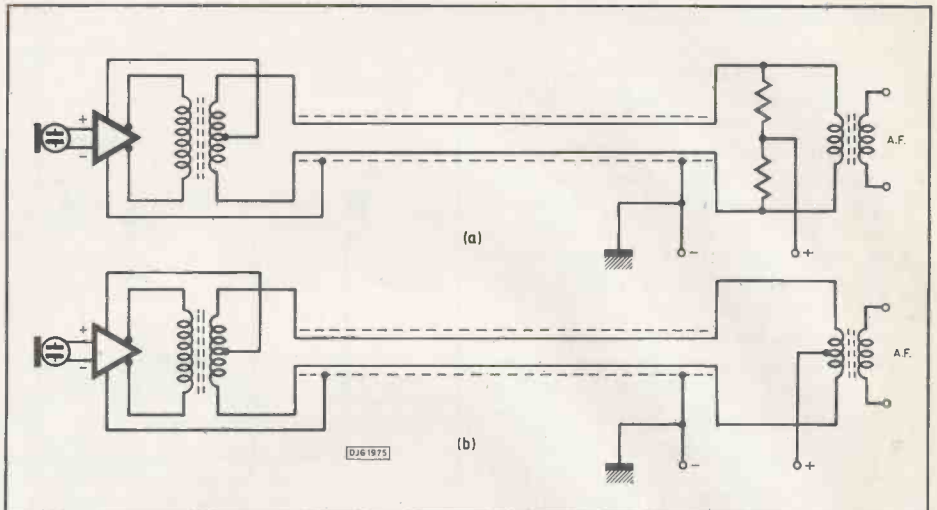

Fig 1 (a) phantom powering using resistors across input transformer; (b) phantom powering with centre-tapped transformer.

This is an improvement over the moving-coil unit which resonates at around 2 kHz and for which little can be done. The electret is therefore very suitable for public address systems where response peaks can initiate feedback, as well as for other applications.

exercising a firm pressure. Because of the high amplification following it, any small contact resistance variations generate large noise signals.

Another source of noise is the on/off switch which is to be found on most electret

REMOTE POWERED ELECTRET MICROPHONES

cause severe loss of high frequencies due to cable capacitance. A built-in preamp to serve as an impedance converter is essential.

A power supply to provide the 48V polarising voltage and also to power the preamp is required, and this is supplied from the mixing desk via the microphone cables.

ELECTRET

Enter the electret microphone. This works in just the same way as its up-market professional relative, but a permanent charge equivalent to about 100V is implanted in the diaphragm during manufacture by heating the plastic between the plates of an air-spaced capacitor. The charge leaks away in time, but it is claimed that with normal use it takes 100 years to fall to half its original value. As none of them has yet been around that long, this claim cannot be substantiated. It is known though that excessive moisture due to condensation can greatly reduce the life.

The diaphragm of the true capacitor microphone is so light that not only does it respond well to high frequencies, but its resonance peak is usually above the normal audio range, thereby imparting a completely flat frequency response. The electret diaphragm needs to be thicker than this in order to retain the charge, so the larger mass results in a lower resonant frequency.

Its resonant peak is usually between 5-8 kHz which can be tamed with a little cut.

Vivian Capel reveals another "phantom" of the opera!

POWERING

The 48V required to polarise the studio capacitor microphone would be a drawback for humbler applications, but with the electret it is not needed because of the in-built charge. However, the preamp is still required and must be powered.

To eliminate the need for external powering, electret microphones contain a preamp designed to run off 1.5V, and therefore a single cell battery can be contained within the microphone. The microphone can be used in place of a moving coil on any conventional mic input socket.

This convenience, though, has its penalties. The current drawn is small so batteries last a long time, consequently, since the contacts are undisturbed for lengthy periods, they tend to oxidise. While frequent cleaning helps (providing both contacts are accessible) it does not solve all contact problems. They can lose their springiness and make merely a 'touch' contact instead

microphones. Contacts oxidise and are difficult to reach for cleaning. An additional hazard for pa operators is that users tend to play with the switch and inadvertently switch themselves off without realising it.

A further possibility is that a battery is left in too long and fails just on an important occasion, or a faulty one can leak and corrode the inside of the microphone before the damage is discovered.

As a result of these problems, many operators have abandoned the electret in spite of its superior performance, and gone back to using dynamic microphones. It was this dilemma that encouraged the development of a means of powering electret microphones from an external supply via the cable, like the studio models, and so dispense with the troublesome battery.

To see just how this can be done we will first take a look at how the studio microphones are powered.

PHANTOM POWERING

Firstly, if we consider the unbalanced circuit commonly used for domestic recorders, it is found that the cable has one conductor and a screen. The screen is earthed at the input socket and forms the return path from the microphone. This disadvantage with this is that, being in series with the microphone circuit, any hum or noise voltages induced in the screen are applied to

the input in series with the microphone signal.

To avoid this, all professional and serious sound systems use a balanced circuit that has two conductors inside the screen. These carry the microphone signal to a transformer winding which is isolated from earth. The screen is earthed at the mixer end and also to the microphone casing, but forms no part of the microphone circuit. The conductors are also twisted together to cancel any hum field that may penetrate the screen.

In conveying the polarising voltage to the microphone, the trick is to do so without any extra wiring, to make use of the existing signal wiring. One method is called phantom powering. There are two versions, as shown in Fig.1. The first has a couple of resistors across the transformer winding with the junction connected to the positive supply. The negative goes to the screen.

At the microphone end there is a centre-tapped transformer which has its centre-tap going to the positive of the preamp. While the screen is taken to the negative. The positive supply current thus flows from the resistor junction, along both conductors and out through the transformer centre-tap. The negative return flows along the screen. The alternative version uses a centre-tapped transformer at the mixer in place of the two shunted resistors, but the principle is exactly the same.

Supply voltage is thus conveyed along the signal cables without interfering with the signal itself, but there is a snag. The screen is in series with the microphone supply, so any random voltages it picks up can modulate the signal. Really, we are almost back to the disadvantages of the unbalanced system.

A B POWERING

The disadvantages of phantom powering are overcome by A B powering as shown in Fig.2. Here, the positive and negative of the supply is conveyed by the two signal wires, and the screen is completely isolated as it should be.

To prevent the supply being short circuited by the transformer, the winding is actually a split winding having a capacitor at its junction. The feed is via two resistors. At the microphone, a capacitor-coupled split winding is also employed, and the supply to

Fig 2. AB powering. This avoids using the screen in the power circuit so reducing possible noise and radio pickup problems.

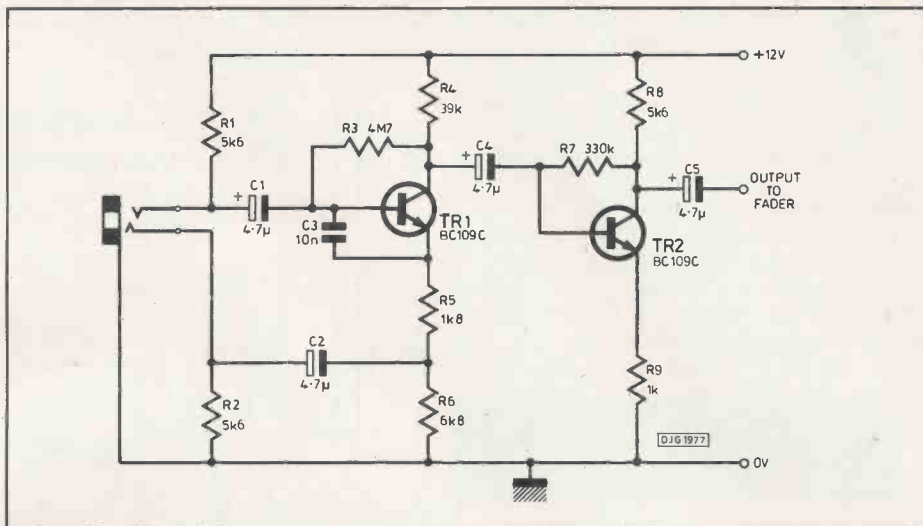
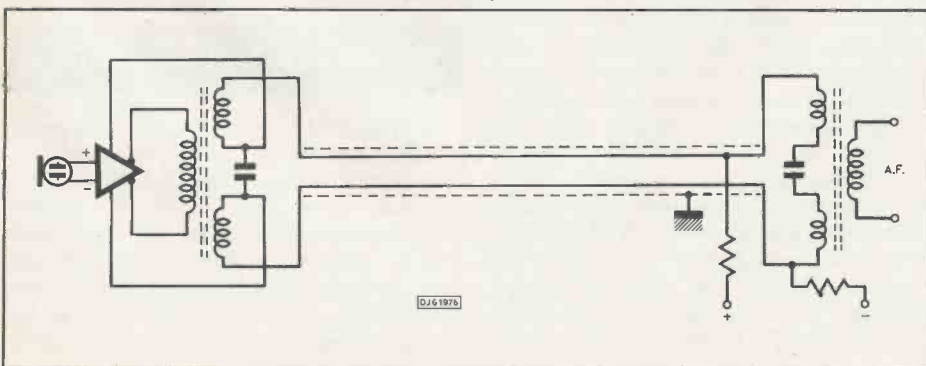

Fig 3. Balanced remote A/B powered input circuit for one channel. A three-contact jack plug is shown, but a Cannon or any other three-contact type could be used.

the preamp is taken from the inner ends of the windings.

POWERING THE ELECTRET

Having some idea of how the professionals do it with studio instruments could suggest a practical method of remote powering for electrets. As most electrets are unbalanced, the conversion can bestow the additional advantage of balanced operation as well as remotely powering the microphone.

The model used for the prototype was the Altai EM 506, an excellent unit with a measured hypercardioid polar response (although the makers claim only cardioid characteristics) and an even frequency response. Other models could be converted if they were physically suitable. The EM 506 has a four pin socket at the base of the handle. This, or a three-pin, is required to connect the twin-plus-screen cable. Most electret capsules are similar to the two types used in this model.

The simplest method would be to use twin screened cable with an unbalanced circuit. One conductor would be used for the signal and the other for the positive supply. The screen would be the microphone return circuit as well as the supply negative. For applications using short leads where noise and hum pickup are less likely, this may

prove satisfactory, but a little extra trouble and a few more components can give all the advantages of a balanced system.

At first, the use of transformers was considered, but the microphone barrel was just too small by about 1 mm to accommodate the smallest transformer available, and there was not a large selection. Availability of split-winding transformers for A B powering was even less. Cost too was high, seeing that a transformer was needed both for the microphone and for the input circuit, and that six microphones were needed for the particular pa system involved.

An electronic balanced input circuit was designed some years ago and has been in successful use ever since, so it was decided to modify this to give balanced A B powering in preference to the phantom system. The input circuit is given in Fig.3. Signal input from the microphone is applied across the base/emitter junction of TR1 via C1 and C2. C3 is included for rf suppression. The supply positive connection is fed to one signal conductor from a 12V source through R1, and the negative through R2.

The transistor is the low-noise BC109C which is rc coupled to the second image. Output goes to a fader and from there to conventional mixer amplifier and output stages.

MICROPHONE MODULE

The circuit for the microphone module is shown in Fig.4. The signal from the fet source and drain is taken through C1 and C2 to the A and B signal pins. These also carry the supply voltage which is fed to the fet via R3 and R4. The voltage drop over these and over R1 and R2 of the mixer input provides a voltage of just over 1.5 volts from the 12V supply.

Note and observe the polarity of C1. The negative goes to the drain in spite of its positive polarity, because the other side at pin A is of a higher positive potential. R2 and C2 are already mounted in the

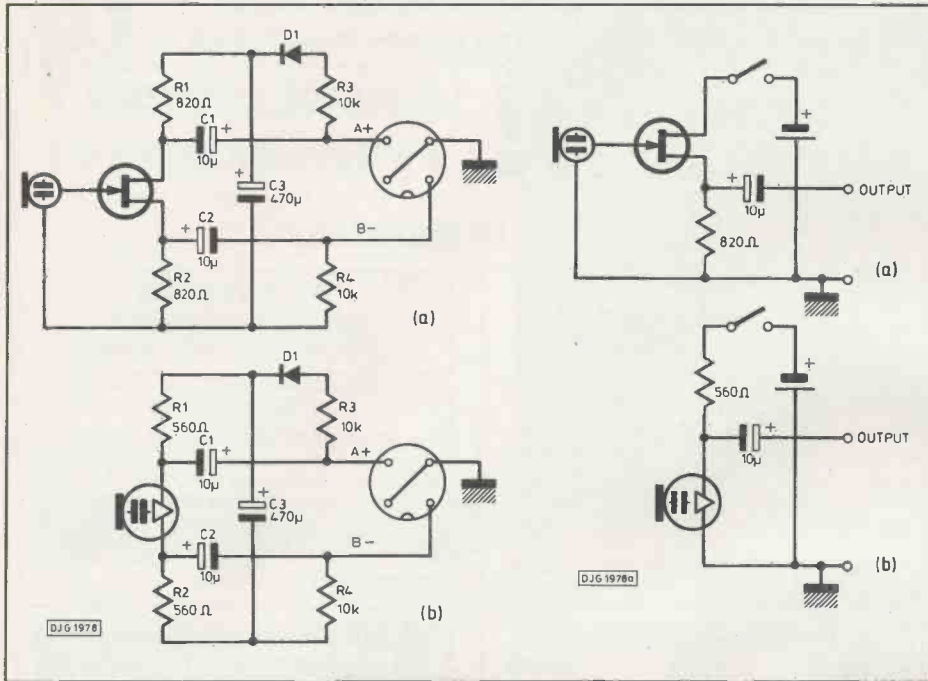

Fig 4 (left) (a) Circuit of microphone module for type 1 capsules having a separate electret and fet. The mic socket is viewed from the free end of the pins also the solder tag ends of the plug. (b) Circuit for type 2 capsule having integrated electret and fet.

Fig 5 (right) (a) Circuit of original type 1 capsule circuit before conversion. (b) Circuit of type 2 capsule before conversion. Notice that the capacitor was connected with incorrect polarity.

microphone capsule in the case of type 1 capsules as these formed part of the original circuit (Fig.5a).

With type 2 capsules the fet is integrated with the electret unit, and the load resistor is in the positive leg (Fig.5b). They can be distinguished by the appearance and layout of the terminals and also by the different resistor value, 560Ω replaces the 820Ω. Whichever it is, the other on the panel should match it. For type 2 capsules, C2 and R2 must be mounted freely from the capsule terminal (Fig.7).

The first step after dismantling is to remove the small transformer at the base of the microphone which is included to give a high-impedance option. As no serious user ever employs the high impedance mode it is totally useless. Next, the battery contacts can be removed and also the wiring. Wiring to the switch can be removed, but the switch itself should be left in place otherwise there will be an unsightly hole in the body.

Having gutted the microphone, all is ready for installing the printed panel. The existing wiring from the capsule may be

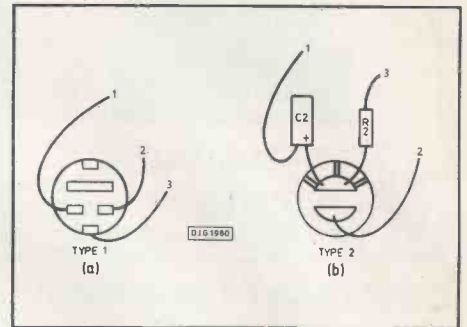

Fig 7 (a) Connections from type 1 capsule to module. (b) Connections from type 2 capsule. C2 and R3 must be suspended from the terminal as shown. These components were inside the type 1 capsule.

usable. If not or if some extra may be needed this should be fitted next.

The socket has four connections which were intended to give the choice of unbalanced, high or low impedance operation, by reversing the connecting plug. This should be connected as shown with the earth lead going to a diagonal pair, as it was originally. The A and B go to the other diagonals. The female plug has two keyways and so can be connected two ways. To ensure correct connection, either replace the plug with a standard one having a single keyway, or block one keyway on the original. This could be done by filling it with Araldite epoxy resin after first scratching its smooth walls to provide a key.

Now ensure that the cable connections are correct. With the keyway at the bottom, the A positive connection goes to the top left viewed from the plug solder tags, and the B negative to the bottom right. The same connections are made to the microphone socket viewed from the free end of the pins, so when soldering inside, the A connection goes to the top right and the B to the bottom left. Either three-contact jack plugs or Cannon connectors can be made to the mixer. If using jacks, the A connection goes to the tip, the B to the ring, and the screen to the body.

The result will provide microphones having excellent acoustic properties, but without all the problems arising from internal batteries.

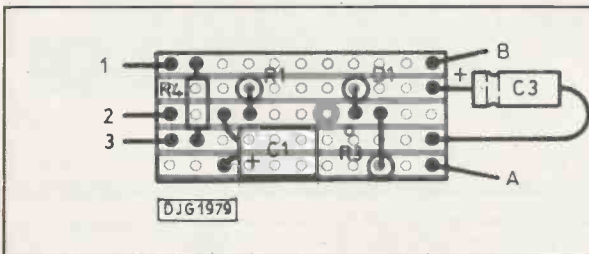
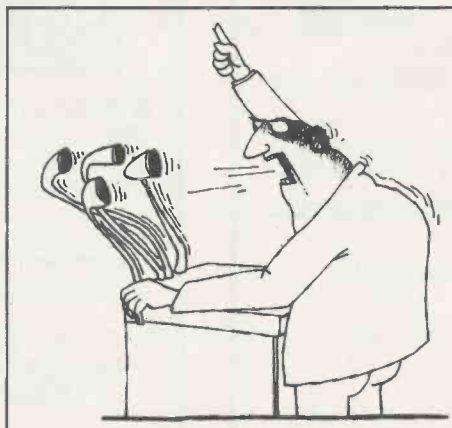

Fig 6. Microphone module Veroboard layout. This just fits into the microphone barrel in place of the battery compartment.

The diode D1 is a protection in case the supply is inadvertently reversed by wrong connections to the plug, C3 decouples the signal from the supply and also bypasses any impulsive noise on the supply voltage.

CONVERTING THE MICROPHONE

The removable barrel facilitates the conversion of the EM 506. The head also needs to be unscrewed; this is the hardest part as it is screwed on very tightly. A well padded vice and strap wrench may be required.



Microphone-feedback redefined.





PE RADIO CLOCK

Tuner unit Kit 298.1 £13.00
 Decoder Unit Kit 298.2 £36.50
 More details in catalogue

Here's just a selection of our kits for PE-published projects.

Many more in our catalyst!

Send medium sized stamped addressed envelope for your copy and with all enquiries. (Overseas send £1.00 to cover postage).

PHONOSONICS,
 DEPT PE97, 8 FINUCANE DRIVE,
 ORPINGTON, KENT, BR5 4ED.
 Tel: 0689-37821 (answering machine)

PHONOSONICS

LEADING SUPPLIERS OF KITS FOR PE PROJECTS SINCE 1972

2 NEW PE PROJECTS!

★ MORSE DECODER ★

★ MESSAGE MAKER ★

DETAILS IN CATALIST

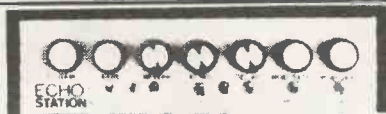

PE ECHO STATION

Multiple extended delays version SET 294L £65.00
 Standard delay version SET 294S £33.50

PE BAROMETER SET285 £41.20

Computer controlled unit for monitoring atmospheric pressure.

PE GEIGER COUNTER SET264 £65.50

A nuclear radiation detector for environmental and geological monitoring. With built in speaker, meter and digital output. This project was demonstrated on BBC TV.

PE MULTIZONE ALARM CONTROLLER SET280 £23.90

Two entry-zones, anti-tamper, personal attack, entry-exit timing, timed duration, auto resetting, latching LED monitors.

PE DUAL BEAM OSCILLOSCOPE SET 290 £57.50.

Electronic comp. incl. pcbs, excluding crt, transformer and case.

PE VOICE SCRAMBLER SET287 £49.50

32 switchable channels to keep your communications confidential.

PE EEPROM PROGRAMMERS DETAILS IN CATALOGUE

ORDERING

Add 15% VAT. Add P&P - Sets over £50 add £3.00. Others add £2.00. Overseas P&P in catalogue. Text photocopies - Oscilloscope £3.00, Geiger £3.00, Radio Clock £3.00, others £1.00, plus 50p post or large SAE. Insurance 50p per £50. MAIL ORDER, CWO, CHQ, PO, ACCESS VISA. Telephone orders: Mon-Fri, 9am - 6pm. 0689 37821. (answering machine).



PE FREQ COUNTER/GEN

Counting to 4MHz, digital generator to 2MHz, variable wave form generator to 20kHz. SET 296 FROM £33.50 (See list for more details)

HAND HELD FREQUENCY COUNTER

INTELLIGENT INSTRUMENT FOR PROFESSIONAL USE

MODEL 1300 H/A

Frequency range from 1Mhz to 1.3Ghz
 Sensitivity: 1 - 10 Mhz : 10 - 150mV, rms
 10 - 100 Mhz : 1 - 50mV, rms
 1 - 1.3 Ghz : 10 - 80mV, rms



MODEL 2400H

Frequency range from 10Mhz to 2.4Ghz
 Sensitivity: 10 - 60 Mhz : 10 - 150mv.rms
 60 - 2 Ghz : 3 - 100mv, rms
 2 - 2.4 Ghz : 5 - 100mv, rms



ACCURACY +/- 1 PART PER MILLION 25 TO 35 DEGREES C.TCXO TIME BASE IS STANDARD.

ALL COUNTERS HAVE 8 DIGIT RED .28" LED DISPLAYS. ALUMINIUM CABINET IS 3.9" H x 3.5" W x 1". INTERNAL NI-CAD BATTERIES.

A FULL LINE OF ANTENNA, CARRYING CASE, AND ACCESSORIES IS AVAILABLE.

ONE YEAR PARTS AND LABOUR GUARANTEE

DAVE TRONICS LTD
 330 KILBURN LANE
 LONDON W9 3EF
 TEL: 081 968 0227
 FAX: 081 968 0194

SPIERS ELECTRONICS

20 Eaton Way, Great Totham, Maldon, Essex. CM9 8EE. Tel: (0621) 892512

MILITARY SPEC. CAPACITORS (5p) AND IC's (10p)

Last few remaining SAE for list

Authorised Amstrad and Roland Plotter Dealers

SECOND HAND CORNER

Western Digital Hardcard 30 Mb £140.00

Miniscribe 20 Mb Hard Disk £85.00

Amstrad PE1512/1640 5 1/4" Disk Drive £60.00

120ms 18 Core Multi Screen Communications Cable

Racal Guardall PIR Sensors £8.00 each

All Prices VAT free but PLUS PIP

SAE FOR FULL STOCK LIST

SOFTMACHINE
 DISTRIBUTION LTD

DEMS/EXPORT ONLY

SPECILIST DISTRIBUTOR for:
 COMPUTER CASINGS & POWER SUPPLY, KEYBOARDs &
 MAIN BOARDs & MEMORY, TRAINING EQUIPMENTs &
 TOOLS, CABLEs, & COMPONENTs etc.

Trade Hours: 10am-6pm
 FAX: 081-961 1975 or 081-453 1138
 TEL: 081-453 1120

SOFTMACHINE DISTRIBUTION LTD
 UNIT 38, CUMBERLAND BUSINESS PARK, CUMBERLAND
 AVENUE, PARK ROYAL, LONDON NW10. U.K.



It is many years now since the name Hertz was adopted as the unit of frequency. It is fitting that this was done for a brilliant man who gave so much to furthering science but died so young. It was he who laid many of the foundations of our modern radio technology and enabled it to be what it is today.

YOUTHFUL YEARS

Heinrich Rudolf Hertz was born on the 22nd February 1859 in Hamburg. His father was a successful lawyer and he also had three brothers and a sister.

The young Hertz started school at the age of six and made steady but not outstanding progress. However, later in his school life an aptitude for practical subjects became apparent as did his liking for languages. At the age of 18 he moved to Frankfurt where he studied for the state examinations. A major part of these studies included science and mathematics which he soon found he liked.

After Frankfurt, Hertz spent a year in Berlin for his military service. Then he moved on to the Munich and entered University to study science. This he greatly enjoyed, but in order to further his studies he transferred to Berlin. Here he met the famous Herman von Helmholtz who was to have a great influence on him.



Ian Poole's thumb-nail history reveals a giant step – and a great loss – for mankind.

FAME

With the publication of the results of his experiments and the many demonstrations he made, Hertz soon became famous. He was offered the position of Professor of Physics at the University of Bonn which he took up in 1889. Here he continued his research, but this time he started to investigate the discharge of electricity in rarified gasses. He continued to publish papers on his work and reinforced his reputation as one of the foremost researchers of his time.

In addition to this he received a number of honours from the various scientific bodies. One of these was from the Royal Society in London.

TRAGEDY

However, while Hertz was still at his prime he started to suffer from ill health. He frequently had headaches and was often depressed. In spite of the fact that his doctors could not diagnose the problem, he still continued to work.

Slowly, Hertz's health began to decline further and at the end of 1893 he completed

HEINRICH HERTZ

AT UNIVERSITY

After Hertz arrived in Berlin it did not take him long to get himself noticed. He did this by winning a competition which had been set by Helmholtz; he showed that electricity had no inertia.

During his time in Berlin, Hertz built up a good relationship with Helmholtz who recognised him as a very good student. The result of this was that after he graduated with a Ph.D. magna cum laude, Hertz became an assistant to Helmholtz. During this time Hertz laid the foundations for his career very well. He published a number of papers on a variety of subjects and became well known and respected amongst the scientific community.

RESEARCH STARTS

Despite the fact that Hertz was enjoying his time in Berlin, he felt he wanted more independence and this would require him to move. This he did when he moved to Kiel University. Unfortunately, there were very poor facilities here and so Hertz had to content himself with a theoretical approach to his research. He looked into Maxwell's famous equations, and saw how he could extend the scope of their application. In doing so he prepared much of the way for his future discoveries.

Again Hertz felt he had to move on. In 1885

he moved to Karlsruhe Polytechnic to take up the post of professor of physics. However, Hertz soon found that there were other attractions to Karlsruhe as he met his future wife. The couple were very happy together and they were soon married. Later, Hertz was to have two daughters from the marriage.

At Karlsruhe, Hertz soon set about his research. He based his work on his previous studies of Maxwell's equations. However, he was now able to perform practical experiments to prove his work. This was particularly important because many people had concurred with Maxwell's equations and had agreed about the presence of electromagnetic waves but nobody had been able to prove they existed experimentally.

Hertz performed many experiments, but the one which is most often described today is the one in which he placed two loops of wire within a few metres of one another. Each loop had a small spark gap and he showed that a spark across the gap in the first caused a spark to jump across the gap in the second. He also showed that for the experiment to work the two loops had to have the same dimensions.

Hertz did not stop here. He went on to investigate the properties of these waves. He deduced their velocity and found that it was almost exactly the same as that of light waves. He performed other experiments and showed that they could be reflected and refracted in the same way as light. From these results he concluded that beyond any reasonable doubt they were the electromagnetic waves that Maxwell had discovered mathematically.

his last book. Then on 1st January 1894 at the age of only 36 he died. This was without doubt one of the greatest losses the scientific world had ever known.

ADVANCING SCIENCE

Hertz had given much to forward the scientific knowledge of the day. In fact, radio waves were called Hertzian waves for many years afterwards, but as they came into more common use the term slowly slipped away. Fortunately, his name has not been lost because in the late 1960s his name was given to the unit of frequency, a fitting but late honour to one who gave so much to the discovery and establishment of radio.

The fruits of the research which Hertz had performed were soon to be felt by the world as a whole. People like Marconi were quick to see the value of Hertzian or radio waves. They refined the experiments which Hertz had performed and made systems which could be given practical uses. In fact it was only ten years after the death of Hertz that Marconi set up the first link between England and America for the swift transmission of news. After this the whole idea of radio snowballed and it became part of modern life. One thing is certain: if it had not been for the insight of Hertz our radio technology would not be where it is today.

PE

Photograph courtesy of The Institution of Electrical Engineers.

HOME BASE

Interactive communications are Ian Burley's theme this month, ranging from Philips' CD-I launch to yet more ambitious plans to get you rabbiting on the blower.

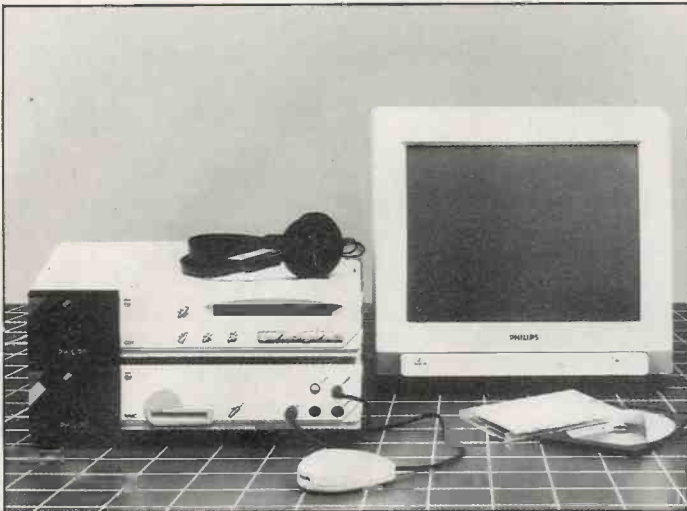

Think of a compact disc or cd which contains video, audio, graphics and text and you have a cd-i disc. CD-I stands for Compact Disc Interactive. Invented by Philips and developed jointly by Sony and Matsushita, cd-i promises to become an extremely important multimedia platform, not only for IT distribution and training but also home entertainment. cd-i effectively brings together the benefits of audio, video, computer applications. As cd-i manufacturing uses the same processes already in use for cd-audio duplications, costs will be low enough for the mass market.

A cd-i disc has the capacity for 72 minutes of cd-quality sound - the same as a standard music cd, or 72 minutes of extremely compressed digital video and sound, or 650 megabytes of computer data - either in the form of raw text, programs or computer images.

The video capacity of a cd-i disc is especially impressive compared with just seven minutes video capacity on existing cd video discs. Data-compression and digital interleaving techniques having expanded D-I video capacity without overly compromising video or sound quality, which is said to be comparable to top-end vhs tape systems currently available.

CD-I will be launched to the public next year, and currently over 200 third party companies are developing systems and products around the new standard. Rough estimates point to a price of around £600 for a cd-i player, which will be compatible with cd-rom and music cds.

At the recent *Which Computer?* show Philips formally unveiled its first prototype cd-i machine (see top picture) which looked more akin to a desktop computer with its mouse controller and tv monitor.

CD-I is expected to be attractive to training institutions because, as its name implies, the user will have considerable control over his or her cd-i system, being able to respond to onscreen prompts, go back and replay portions of video and generally react interactively.

In the home, the uses of cd-i are virtually unlimited, from home education courses, electronic encyclopaedia, interactive games and of course pop videos and other programmes.

TRON INTELLIGENCE

Tron, the brainchild of Professor Ken Sakamura, from the University of Tokyo, is nearing birth. Tron stands for the Real-time Operating system Nucleus and envisages a future world where a large proportion of everyday electrical devices, both public and domestic, will be linked and controlled through an intelligent computer network.

Fujitsu has just announced the completion of the third and final tron 32-bit microprocessor, the Gmicro 300, which joins the Gmicro 100 and 200 models already in production by Mitsubishi and Hitachi. Work can now progress on the development of working tron applications.

Everything from traffic lights to domestic heating could be controlled remotely and intelligently through a tron network. Sakamura's ultimate vision is for a whole city to be built around a massive tron network.

The tron project was started in 1984 and quickly gained firm support from major Japanese industrial giants, despite its fanciful and far reaching goals. Just six years later and tron's original sceptics are already looking worried. Not just the home of the future but the basis of the way communities of the future could be organised and run could be the responsibility of the tron ideal.

BAE MICROTEL

The British Aerospace led Microtel consortium has announced its plans to enter the pcn (Personal Communications Network) race. Microtel unites British, French {Matra} and American {Pacific Telesis} high technology skills in a bid to provide low cost mobile communications to the masses by the end of the decade. What has this to do with a consumer electronics column? Quite simply, in a few short years pcns could threaten the future of today's old-fashioned wired telephone networks and unlike cellular phone networks, Microtel is predicting that pcns will be affordable enough for nearly anybody to use. Indeed Microtel was talking bullishly of 15 million pcn users in the UK alone by the

year 2000, with an ultimate target of half the population into the 21st century. At today's prices, Microtel predicts that compact pcn phones will eventually cost less than £100 to buy and call costs will be substantially cheaper than today's cellular tariffs. On top of that you will eventually be able to take your pcn phone with you on trips to the continent with the advent of a pan-European pcn system.

PCNs are not to be confused with the now emerging telepoint cordless phone networks. Telepoint offers an enhanced alternative to today's public call boxes, enabling users to make outgoing calls at or near busy public places. PCNs are more clearly going to threaten existing cellular mobile phone services as they will offer incoming call capability currently missing from telepoint services. However, both pcns and telepoint have one thing in common, they both transmit conversations using secure, interference and distortion free, digital signals.





Being digital, both pcn and telepoint phones will benefit from advanced vlsi miniaturisation and lower power consumption than their conventional analogue counterparts. As telepoint has already shown, this enables phones to be incredibly small compared with most cellular phones. Microtel says its pcn handsets will incorporate smart card technology for storing user-id and billing information. Overlapping pcn base stations will be strategically positioned all around the country with one metre radio antennas able to be positioned inside buildings or under roof level in towns and cities.

Microtel is one of three competing service providers licensed by the Department of Trade and Industry and is committed to investing around £1.2 billion in setting up its pcn network. The others are Unitel and Mercury. BT and Racal weren't eligible for pcn licenses as they already operate competing cellular phone services. Initial Microtel pcn trials are expected to take place within two years, with the introduction of a public service soon after.

Despite all the bullish optimism, there are plenty of problems to be overcome before pcns are guaranteed success. Microtel, like its other UK counterparts is going for the GSM network standard though this has not yet been unanimously adopted throughout Europe, and the standard itself could require revisions before pcns get going. Cellular networks shouldn't be written off. These are now well established and new micro-cell techniques are already promising to increase capacity and improve the currently near-saturated service. As competition increases, so costs to the customer will come down. Telepoint has got off to a slow start, but this is likely to threaten pcns at the lower end of the market with even lower costs than pcns. Finally, will Microtel's ambitious plans keep to schedule? The record for the introduction of telepoint and cellular services isn't enviable. Only time will tell if

Microtel and the other pcn providers get it right this time.

BYPS TELEPOINTING

If there's one major criticism of the three active telepoint digital cordless phone providers, Ferranti Zonephone, BT Phonepoint and Mercury Callpoint, it's the remarkable failure of their marketing efforts to capture the attention of the ordinary man or woman in the street.

The last DTI licensed telepoint operator to introduce its service, the Barclays Philips Shell consortium or BYPS, appears to have recognised this point and come up with a lively and imaginative marketing campaign based around, of all things, a rabbit. The idea is that you use phones for rabbiting on - get it? OK, so it's corny, but at the recent Comms '90 exhibition it caught the imagination of visitors as no other telepoint campaign had before.

At the moment, none of the telepoint operators, including BYPS is targeting private

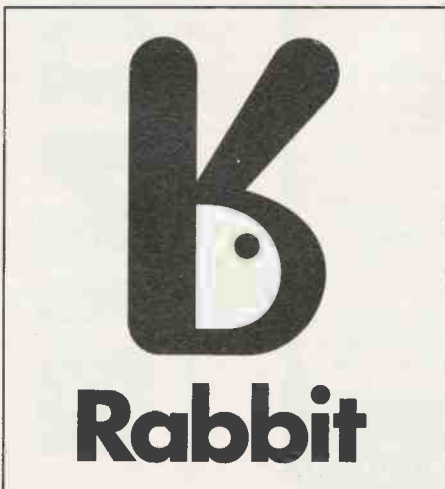

home users directly. The phones and base stations at £200 a piece on average are still far too expensive. However, BYPS is the first to signal clearly to ordinary, non-business, users that telepoint is for them too, though maybe not for a year or two. By then the networks will have expanded considerably and handsets will hopefully have fallen below the magic £100 mark. Today's target is the disaffected cellular phone user who might be fed up with the service or who primarily requires outgoing calls only. BYPS also feels there is an important potential market of many thousands of people who carry electronic pagers.

Future promised enhancements to telepoint include localised user-registration at sites, say at work perhaps, where incoming calls can be diverted. This partially answers the criticism that telepoint is non-viable without an incoming call capability away from your personal base station at home. As for the threat from pcns, BYPS says that these newly announced services won't be available to the public for up to five years, and in any case telepoint will always command a considerable price advantage over either pcn's or cellular services.



Finally, BYPS, with its CPT designed and manufactured handsets and base stations, confirmed that it is to launch its service conforming immediately to the CAI or Common Air Interface which means users will be able to register their phones with other telepoint networks in 1991. Eventually it's hoped that all four telepoint operators will cooperate and provide transparent access for any user via any convenient public telepoint base station.

Ian Burley is the News and Features Editor for BT Micronet, an on-line computer and technology magazine published on Prestel by British Telecom.

We shall have another Home-Base feature for you next month. **PE**

TWO GREAT HOBBIES

ONLY
£129.00
INC VAT

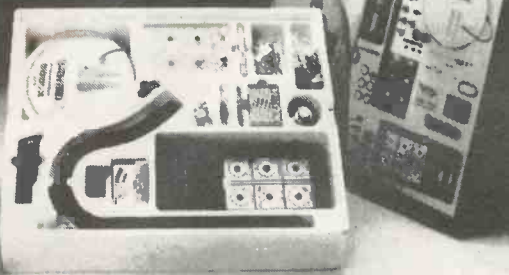

...IN ONE GREAT KIT!

The K5000 Metal Detector Kit combines the challenge of DIY Electronics assembly with the reward and excitement of discovering Britain's buried past.

THE KIT — simplified assembly techniques require little technical knowledge and no complex electronic test equipment. All stages of assembly covered in a detailed 36 page manual.

THE DETECTOR — features Analytical Discrimination & Ground Exclusion, backed by the proven pedigree of C-Scope, Europe's leading detector manufacturer.

Ask at your local Hobby/Electronics shop or contact:—

CSCOPE

C-Scope International Ltd., Dept. PE
Wotton Road, Ashford, Kent TN23 2LN.
Telephone: 0233 629181.

CONTROL THE UNIVERSE!

"I'm totally awed by what you have done!...it's beautiful, especially when the lights are off...congratulations..."

Arthur C. Clarke

author of 2001: A Space Odyssey

Distant Suns (Commodore Amiga™ only), the award-winning planetarium blockbuster, is now available in the UK in PAL! Endless entertainment and education for all. Ask for it!



Virtual Reality Laboratories, Inc.

2341 Ganador Court
San Luis Obispo, CA 93401 USA

SURVEILLANCE PROFESSIONAL QUALITY KITS

A range of high quality kits as supplied to leading UK security companies, all in-house designed and produced, not to be confused with cheap imports. All kits come fully documented with concise assembly and setting-up details, fibreglass PCB and all components. All transmitters are fully tuneable and can be monitored on a normal VHF radio or tuned higher for greater security. Build up service available if required.

MTX Micro Miniature audio transmitter. 17mm x 17mm. 9V operation. 1000m range.	£12.95
VT500 HI-power audio transmitter. 250mW output. 20mm x 40mm. 9-12V operation. 2-3000m range	£15.95
VOX75 Voice activated transmitter. Variable sensitivity. 30mm x 40mm 9V operation. 1000m range	£18.95
CTX900 Sub-carrier scrambled audio transmitter. Cannot be monitored without decoder fitted to radio. 30mm x 40mm. 9V operation. 1000m range	£21.95
DSX900 Sub-carrier decoder unit for monitoring CTX900. Connects to radio earphone socket. Provides output for headphones. 35mm x 50mm. 9-12V operation	£21.95
HVX400 Mains powered audio transmitter. Connects directly to 240V AC supply. 30mm x 35mm. 500m range	£18.95
XT89 Crystal controlled audio transmitter. High performance. 100mW output. Supplied with xtal for 108MHz. Others available to 116MHz. 85mm x 28mm. 9V operation. 2-3000m range.	£36.95
TKX900 Tracker/Beeper transmitter. Transmits continuous stream of audio pulses. Variable tone and rate. Powerful 200mW output. 63mm x 25mm. 9V operation. 2-3000m range.	£21.95
ATR2 Micro size telephone recording interface. Connects between telephone line (anywhere) and cassette recorder. Tape switches automatically with use of phone. All conversations recorded. Powered from line. 10mm x 35mm	£12.95
TLX700 Micro Miniature telephone transmitter. Connects to line (anywhere) switches on and off with phone use. All conversations transmitted. 20mm x 20mm. Powered from line. 1000m range.	£12.95
XML900 RF bug detector. Variable sensitivity. Triggers LED and beeper when in presence of RF field. Detects MTX 15-20 feet. 55mm x 55mm. 9V operation	£26.95
XL7000 Professional bug detector/locator. Variable sensitivity. Twin mode ten segment LED readout of signal strength with variable rate beeper. Second mode AUDIO CONFIRM distinguishes between localised bug transmission and normal legitimate signal such as pagers, cellular etc. 70mm x 100mm. 9V operation.	£54.95

UK customers please send cheques, PO's or registered cash. Please add £1.50 per order for P&P. Goods despatched ASAP allowing for cheque clearance. Overseas customers send sterling bank draft or Eurocheque and add £5.00 per order for shipment. Credit card orders accepted on 0827 714476. Full catalogue available on receipt of 28p stamp. Trade enquiries welcome.

SUMS DESIGNS

THE WORKSHOPS
95 MAIN ROAD BAXTERLEY
Nr Atherstone WARCS CV9 2LE



0827 714476

BINDERS

Binders for Practical Electronics are available for £5.95. Send your cheques or postal orders (payable to Intra Press) to:
Practical Electronics Binders
193 Uxbridge Road
London W12 9RA



Very high frequency (vhf) radio was developed during the second world war in order to communicate with ships and planes. After the war, this development was extended to the police and fire brigade in order to speed up communication and hence rescue.

A licence is required in order to transmit radio frequencies and the first private licences were granted to tugs in the Tyne and Wear rivers as well as to the Camtax taxi service in Cambridge in 1947.

In 1947 the transmitted bandwidth was 100kHz but today eight radio channels each of 12.5kHz fit into this same bandwidth. Such an economy is possible with the use of quartz crystals to keep the transmitter from drifting, and other developments.

INCLUSIONS

Mobile radio can include any radio communication where the transmitter or receiver or both are not fixed in location. It includes communication with aeroplanes (more strictly aeronautic radio) and communication with ships (more precisely maritime radio). It also includes citizen band radio and radio paging.

In this article, the popular concept of mobile radio will be dealt with, ie a radio mounted in a vehicle travelling on land and communicating with a fixed base station. However, land mobile radio does not include



motorbikes are subjected to an even greater level of vibration and dirt than those mounted in cars. The normal receiver output is 2W to 4W but outputs as high as 10W can be provided for noisy locations, eg fire engine pumps.

Handheld portables are of two kinds: handheld and bodyworn. The handheld are usually one piece whereas the bodyworn, as worn by the police foot patrols, incorporate the transceiver and battery in a case on the body. The speaker, microphone, press to talk switch and additional controls are worn on the lapel.

LICENSING

The Radio Regulatory Division in the Department of Trade and Industry is responsible for frequency planning and is also the licensing authority in the UK. Under the wireless Telegraphy Act 1974 a licence is required to operate a private mobile radio system.

An additional licence under the Telegraphy Act 1984 is required for those offering a service to others like radio telephony or message handling.

The mobile user must have the installation approved and must not alter it without permission once approved. The licence conditions include limits on the effective radiated power of the transmitter and talk through must be under the control of the base

MOBILE RADIO

just vehicle mounted but handheld and transportable as a packset as well.

A later article will deal with cellular radio and radio paging. The people who use mobile radio are: the police, ambulance, fire services, taxis and mini-cabs, couriers etc.

PRIVATE AND PUBLIC

The use of mobile radio for closed user groups like police, ambulance, fire and those operated by individual taxi and courier services are called Private Mobile Radio (PMR). These employ a central controller to relay messages on jobs or locations to attend. The resulting saving in time, petrol and the customer satisfaction is well known by those operating such schemes.

As opposed to these private networks there are public networks like British Telecom's System 4 Radiophone which is also connected to the telephone network.

Private mobile users may share channels in congested areas and the authorities that allocate the overlapping channels try to ensure that the trades using these channels are different so that business is not poached, and also to spread the peak loading.

Mobile radio demands a no-hands operation facility which is not usually

By Mike Sanders Now you don't just listen to the car radio - you talk to it.

satisfactory because of the ambient noise. This is overcome partly by mounting the microphone on a boom, as in taxis. For motorcycles the arrangement is easier since the earphones and microphone can be built into the helmet. For safety purposes the wire from the helmet to the transceiver on the motorcycle is via a snatch connector. The press to talk button is usually on the handlebars.

The demands on mobile radio equipment are quite severe since the temperature in a vehicle could be as low as -20°C at night and as high as $+60^{\circ}\text{C}$ in the daytime. The aerial could be poorly sited and also pick up electrical noise. There is also a good deal of noise from traffic, wind in a moving vehicle and other sources like a fire engine pump or construction sites. Mobile radios on

British Telecom kindly supplied the photograph of one of their System 4 Radiophone units.

station operator. Talk through is a simple switch connecting the base station transmitter to the base station receiver so that two mobiles can communicate directly with each other. Alternately, talk through may be controlled by tones from a mobile.

A fixed mobile may not be used as a control point and communications between fixed points is not allowed, except in an emergency. However point to point links are allowed for remote control of base stations.

OPERATING PRINCIPLES

In order to assess the area of coverage an ordnance survey map is used for a field strength survey. The location and direction of the testing vehicle is recorded together with the field strength of the signal both at base and mobile for each location and direction.

Land mobile communication is in the vhf band (40-300MHz) and uhf (300-1000MHz). At the higher frequencies the signals travel in straight lines like light waves, therefore any obstruction would cast a shadow. To overcome this the aerial can be placed as high as possible but then produces interference with other users on the same frequency in a different area.

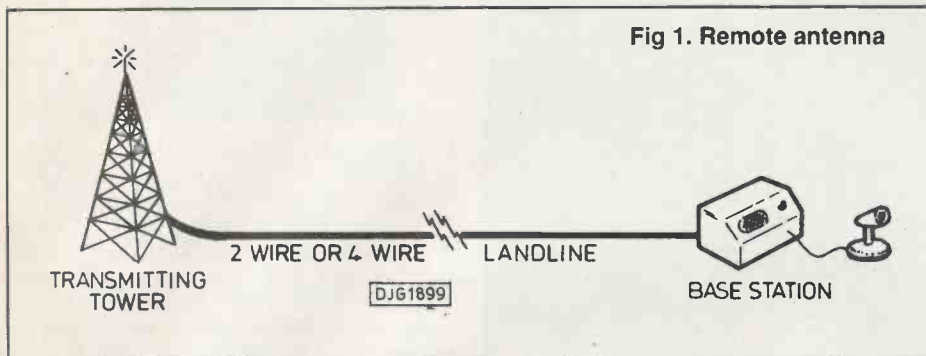

Fig 1. Remote antenna

Tone frequencies in Hz

Digit	ZVEI	ZVEI modified	EEA/CCIR	EIA
1	1060	970	1124	741
2	1160	1060	1197	882
3	1270	1160	1275	1023
4	1400	1270	1358	1164
5	1530	1400	1446	1305
6	1670	1530	1540	1446
7	1830	1670	1640	1587
8	2000	1830	1747	1728
9	2200	2000	1860	1869
0	2400	2200	1981	600

ZVEI Zentralverband der Electrotechnischen Industry
 EEA British Electronic Engineering Association
 EIA British Electrical Industries Association
 CCIR Consultative Committee for International Radio

Fig.2 Mobile radio codes

The operator is usually remote from the transmitting antenna and the usual method of linking the two is by a two wire or four wire land line, as in Fig.1.

A mobile is allotted a five digit code and one of the systems, in Fig.2, ZVEI, OCIR, EIA, etc. chosen for transmission. The system will depend on the equipment manufacturer.

Keying a carrier on and off can also be used for digital transmission instead of the above analogue tones. The disadvantage of the keying method is that it is not possible to distinguish whether a break in transmission means 'spaces' or 'end of transmission'.

To overcome this, Frequency Shift Keying (fsk) or Fast Frequency Shift Keying (ffsk) is used and these methods are taking over from the codes in Fig.2. With fsk, the carrier is radiated to indicate mark and shifted to a lower frequency to indicate space.

With ffsk a modulated carrier is transmitted with the modulation changing from mark to space. The modulating frequencies are 1200Hz for a binary 1 and 1800Hz for binary 0.

With 12.5kHz channels it is generally agreed that in terms of performance and cost, there is little difference between amplitude and frequency modulation.

Speech contains most of its energy in the band 300Hz to 3000Hz and to squeeze even more channels into the spectrum, the top of the band is limited to 2700Hz. If the band is taken as nominally 3kHz then a carrier drift of 2kHz is allowed plus a guard band making 6.25kHz in all or 12.5kHz for double sideband. Fig.3. illustrates how the spectrum is divided.

It may seem that the 2kHz allowable drift is wasteful on top of a 3kHz speech band, but remember that this is only 0.015% of a 150MHz carrier. It is hardly surprising that quartz crystals are required to prevent the frequencies from drifting.

In the receiver a signal of say 0.5uV will need to be amplified some 140dB before it is of a sufficient level to be demodulated. At the carrier frequency it is not practical to amplify uhf or vhf signals to this extent and then provide enough selectivity to extract one speech channel from all the others. In superheterodyne receivers (superhets for short) this problem is overcome by converting the carrier to a lower frequency called an Intermediate Frequency (IF). A typical IF is 10.7MHz.

Fig 3. Dividing up the spectrum.

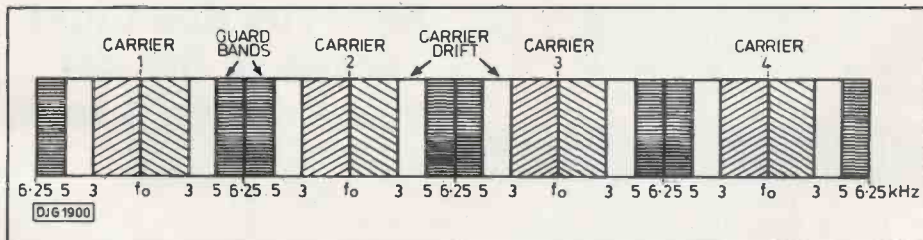

AREAS OF POOR COVERAGE

In areas where the signal is weak the base station could use several aerials spaced apart for receiving only, as in Fig.4. Selecting the best signal is called voting and out of speech band noise frequencies are used. The voltage from these frequencies controls the frequency of a voltage controlled oscillator (vco) which produces a tone. The best tone, and hence aerial, may then be selected by the operator. To make the task easier, the tone may be coded into digits.

The above applies to reception at the base station. For transmitting to the mobiles, the same aerials spaced apart can be used. However, transmitting on all aerials

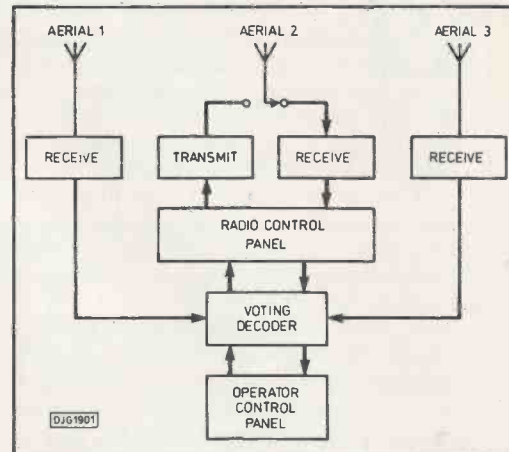

Fig 4. Voting

simultaneously could result in signal cancellation in some areas. An alternative is to transmit on each in turn, though this is time consuming. When the first option is chosen the transmitters are carefully adjusted on the basis of field strength measurements and, once adjusted, should not be touched.

Another choice is to space the transmissions 7kHz apart on each aerial. This means that on 25kHz vhf channels, the beat note is outside the passband. However, with 12.5kHz channels, the transmitter must either be synchronised, or separated by a low enough frequency, so that the beat note is outside the audio range and filtered out.

METHODS OF OPERATION

The set up can be simplex or duplex. In addition, simplex can be subdivided into

single and double frequency, and duplex can be full duplex or semi-duplex.

Since frequency simple (Fig.5) uses the same carrier frequency for transmitting as well as receiving. Operators use such words as "over" or "Roger" to indicate to other users that they have finished speaking. Such a system is adequate for low power applications where it is also useful for all operators to hear each other. Such applications could be where local hand portables are used, as in police crowd control, tackling fires, large construction sites, and so on.

For double frequency simplex, separate frequencies are used for transmitting and receiving, and while a station is transmitting, its receiver is switched off. The mobile stations hear only the base station and would not be aware if any other mobile were transmitting. See Fig.6.

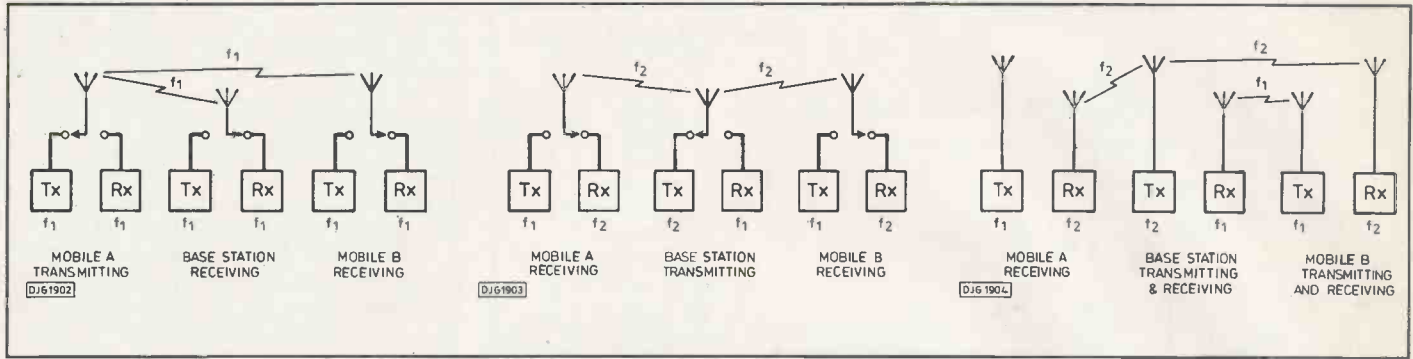

Fig 5. Single frequency simplex.

Fig 6. Double frequency simplex.

Fig 7. Full duplex working.

In full duplex working a mobile can receive and transmit at the same time, as with a telephone except that while a mobile is transmitting, its loudspeaker is switched off to prevent acoustic feedback. Reception is via earphones in this instance. Fig.7 shows full duplex working.

Full duplex working permits any mobile to interrupt a conversation. In general, mobiles receive only the base station, and the base transmits pips when it is engaged.

Full duplex is more than what most mobile users require and while it may be convenient to build earphones into a motorcycle helmet, most automobile users would not be happy to wear an earphone. In the semi-duplex arrangement, the mobiles work simplex, while the base station works full duplex. This is a suitable compromise.

When used as a filter, quartz is more commonly used than ceramic filters. Such filters may consist of crystals wired together in lattice form to give the required response, illustrated in Fig.9.

Ceramic filters are made of piezo electric ceramics with centre frequencies from a few kilohertz to 10.7MHz and bandwidths of 0.05% to 20% of the centre frequency. Crystal filters have a high Q with the bandwidth restricted to a few tenths of 1% of the centre frequency, but this is sufficient for 4kHz telephony. Fig.10 shows a simple crystal filter where the thickness of the crystal is half the wavelength in the fundamental mode.

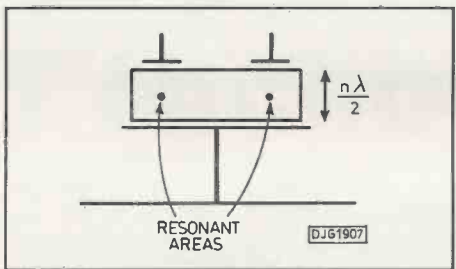

Fig 10. Simple crystal filter.

and a slow. The fast attack is required when the channel is changed or when the equipment is first switched on. Then the slow reaction takes over so that the audio can modulate the carrier.

In simplex operation the transmitter and receiver are not required at the same time, therefore, when switching between transmit and receive, the frequency of the vco can also be changed. But in duplex transmission two vcOs are required.

Synthesisers usually have safety circuits built into them in case the vco is not on lock or a fault develops. This prevents the transmitter from operating so that spurious signals are not sent out.

CRYSTALS, FILTERS AND SYNTHESISERS

Crystals play a major part in modern communications both in oscillators as well as filters. Fig.8 shows the graph of temperature against frequency variation of an AT cut of crystal. In Europe the temperature range of interest is -10°C to +55°C.

Fig 8. Frequency/temperature response of AT crystal.

Fig 9. Required frequency response of filter.

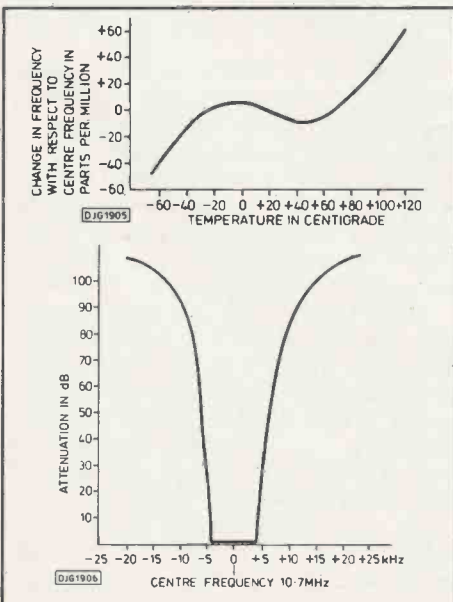

Until recently, a separate quartz crystal was required to generate the transmit and receive frequencies for each channel. Frequency synthesisers have the advantage of using a variable frequency oscillator where the frequency is controlled by a dc voltage and the circuit is then called a voltage controlled oscillator (vco).

A synthesiser operates by comparing the frequency of the vco with the reference frequency from a highly stable quartz crystal oscillator having an accuracy of better than +5 parts per million. The output of the oscillator is divided down by a programmable divider (programmable read only memory - prom) to a frequency equal to half the channel separation.

This is 6.25kHz for 12.5kHz channels. The output of the vco is also divided in half and applied to a comparator together with the quartz oscillator output; shown in Fig.11. A difference in frequency produces a dc voltage in the comparator output and this is used to pull the vco frequency back on track.

But there is a slight problem. With frequency modulation, the carrier frequency needs to deviate according to the modulating signal but the comparator would keep pulling it back to synchronism. Therefore, what is required is two different reaction times, a fast

SQUELCH

Even though frequencies are used at geographic intervals, interference can still occur. This can be overcome by means of squelch circuits where the receiver remains quiet in the presence of background garble but unmutes when a strong enough signal is received.

The noise in the receiver is used to mute it and the noise is swamped in the presence of a strong signal. To prevent the receiver being shut down by frequencies in the speech band, a voltage derived from the signal is used to hold the receive path open.

Squelch circuits can be used which bias the first audio stage to cut off until a strong enough signal is received and the stage is switched on with the assistance of the Automatic Gain Control (agc). This helps to remove background noise in channels shared by multi-users such as citizen's band radio.

Fig.12 shows one kind of squelch circuit whose operation depends on the setting of the squelch control and agc voltage. With the squelch off (base of Q2 earthed), Q3 is

Fig 11. Simple synthesiser.

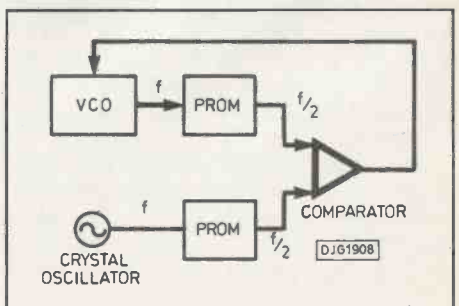
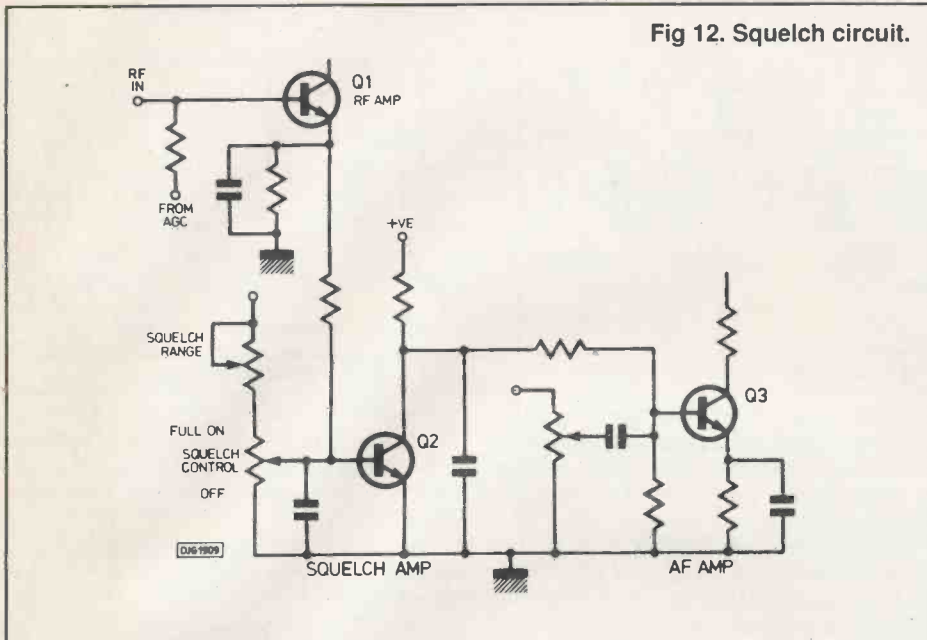

Fig 12. Squelch circuit.



switched on. But with the squelch on, Q3 is cut off and the agc must go more negative to switch Q2 off and allow Q3 on again.

Another method of unmuting the receiver is to send a signal containing a specially coded tone. Since there are so many different transmitting standards the Electronic Industries Association (EIA) has agreed a number of standard tones.

The tone is called a Continuous Tone Coded Squelch System (ctcss) or tone lock. In Australia it has been compulsory since 1984 and is called Quiet Base Station (qb).

The use of ctcss is particularly important when the talk-through switch is thrown so that interference is not relayed to the next link. Incidentally ctcss does not eliminate the interference, it only suppresses it; the garble is still there. The ctcss tones are sub audio between 67Hz and 250Hz and transmitted at a low level, below the signal level, to prevent interference with the signal.

One final point connected with noise suppression is that a mobile could be transmitting background noise if the mobile user forgets to switch off his transmitter. To prevent this, transmission time-out timers are used and the user has to press his 'press-to-talk' button at regular intervals.

CONTROL EQUIPMENT

The transmitted powers can be as low as 3W at vhf in Europe. In the UK the transmitted power is higher, 10W to 25W at vhf and from 5W at uhf. For mobile radio the maximum permitted radiation is 25W but can be as high as 100W for the police and fire brigade. These output powers apply to both amplitude modulation and frequency modulation.

The base station transmitter uses compressors to make loud sounds softer and to also raise the average level of the signal. Sharp peaks could still exist after the compressor, and a clipper usually follows it to

ensure that signals of a high level do not get to the modulator. Any high level signals would cause overmodulation and hence distortion. But a clipper is a non-linear device and spurious frequencies are produced when a signal exceeds the level set by it. Consequently, a low pass filter is included after the clipper to exclude the spurious frequencies. Sometimes a fault could develop on the aerial which could damage the transmitter. Therefore control circuits are included, which measure the standing wave ratio, which is the ratio of forward power to reflected power. If a fault develops, the transmitter can be shut down. Base station transceivers do not have to put up with the vibration, dirt, moisture and temperature variations of transceivers mounted in vehicles.

CALL STACKING

When the channel occupancy is low, for instance for security guards checking out a perimeter fence, there is no reason why all operators should not hear each other and there is little point in complicating the set up with selective calling.

However, when the channel occupancy is high, selective calling is not only necessary but ways must be found of speeding up its procedure. One method of speeding up the process is to acknowledge a call automatically. This can be done by a mobile transmitting its call sign. Additionally, the call sign can be transmitted in an emergency if the equipment is fitted with an alarm button. The call sign can also be used when the mobile presses its bid button to place it in the queue for speaking to the base station.

This is another area that can be automated. For a large pick-up and delivery fleet covering short distances the base station will want a status up-date, for instance location and errand status. Such an update is semi-automatic since the mobile user has to programme his transmitter. However, the

transmission can be automatic when the base station interrogates it or when the mobile transmits next.

At the base station, the calling mobiles can be displayed in a queue on a vdu, by call sign. The base station operator can, if he wishes, select the calls out of turn, and emergency calls can be arranged to reach the top of the stack or with a flashing sign on the vdu.

If the mobile fleet is large only the top 15 mobiles, say, may be displayed on the screen with the rest held in a queue in the memory. This also leaves screen space for other information.

SYSTEM 4 RADIOPHONE

British Telecom operates the System 4 automatic radiophone service. Under the Wireless Telegraphy Act of 1949, British Telecom is permitted to make transmissions between mobiles and base stations, and operates 110 channels in the 160MHz band.

These 110 channels in the vhf band are spaced at 12.5kHz. About 10,000 customers use the service which has good coverage of rural areas, unlike the cellular systems which are primarily aimed at high density urban areas.

The first UK radiophone system was set up in South Lancashire in 1959 and the London service in 1965. This manual system was called System 1 and served 320 customers in London.

A manual service, called System 3, using 37 channels was set up in 1971 and increased to 55 channels in 1973. More than 3000 mobiles in the London area used the service which was more than half the national total (with the Midlands second in demand).

These were half duplex channels and since the Home Office would not make further capacity available it was decided to reduce the channel spacing to 12.5kHz on this already heavily congested service. This increased the channels to 110 and System 3 closed at the end of 1986. However, the pressure of demand in London was satisfied only by the cellular service, which will be dealt with separately.

System 4 is based on the Mobile Automatic Telephone System (MATS-B) developed by TeKaDe which is now part of Philips Kommunikations Industrie AG of West Germany. There are some half a dozen MATS-B systems around the world all operating a 25kHz channel spacing. British Telecom is the only one to operate the system with 12.5kHz channel spacing.

Also the West German system is based on cities whereas System 4 is based on seven independent regions, as in Fig.13. Each region has its exchanges and each exchange has base stations. The TeKaDe exchanges are called Radiophone Control Exchanges (RCE) and each exchange has a maximum capacity of 42 base stations and 96 radio channels.

The base stations have an Effective Radiated Power (erp) of 25W and can provide communication up to 55km. However, the

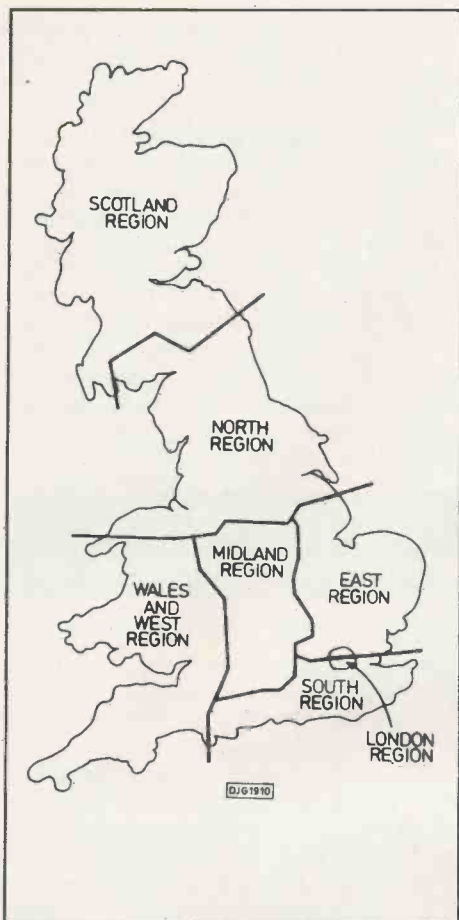

Fig 13. System 4 regional coverage.

needs of customers and the geography of the land usually means that the distance is limited to about 20km.

The mobile transceivers themselves consume as much as 3.5A at 12V so they are not exactly portable. A mobile user can override the automatic selection procedure and choose a base station he knows is nearby. Each base station transmits an Idle Marking Signal (IMS) on all the unoccupied channels and there are seven different IMS codes within each area so that neighbouring base stations can be identified.

The mobile user enters an IMS code to select his base station and hence the channel. In practice this is too complex for most users and the normal process for setting up a call is for the mobile to scan all the channels. If there is more than one free channel, the mobile selects the one with the strongest signal. The scan takes about 2 seconds and some mobile equipments are able to scan the channels twice searching for a suitable link.

Users have to dial the full national number even though the called party may be on the local exchange. This number is transmitted to the base station which transmits it back to the mobile on the other half of the duplex link.

The mobile then carries out a comparison with the dialled digits. If these are incompatible, the information has been corrupted and the mobile tries again. If the transmission has been successful the base station checks with its RCE that the mobile is permitted to use the zone.

For calls to a mobile, the caller needs to

know the area code in which the mobile operates since there is no arrangement for relaying calls from one region to another. Most mobile users choose one or two zones, therefore callers usually know the area code.

The RCE chooses a base station for transmitting the call and pages it. One of the 110 channels is reserved for this purpose and the base stations are divided into seven groups with different paging signals to minimise interference and confusion.

In turn, the mobiles tune into the paging channel automatically when not making or receiving a call. The mobile listens for its number and sounds the bell. If the mobile user does not answer within one minute, the call is abandoned to avoid tying up the link and equipment. No charge is made to the caller for abandoned calls.

Calls can be received from anywhere in the UK and for outgoing calls, even international direct dialling is possible. The System 4 service is available on Sealink ferries and even on some gas production platforms and support vessels near the coast.

RADIO EMISSION DESIGNATION

The International Telecommunications Union (ITU) has agreed a code to describe radio emission. The code is alphanumeric and nine symbols long. It is made up as follows:

- Symbol 1 to 4 bandwidth
- 5 modulation type
- 6 type of modulating signal
- 7 information type for transmission
- 8 signal details
- 9 type of multiplexing

Symbol 1 to 4 : bandwidth

The bandwidth is defined by one character and three digits, for example:
 800Hz is 800H
 25kHz is 25KO
 12.5kHz is 12K5

Symbol 5 : modulation type

N = emission of a carrier without modulation.

AMPLITUDE MODULATION

- A = double sideband
- H = single sideband, full carrier
- R = single sideband, reduced or variable carrier level
- J = single sideband, suppressed carrier
- B = two independent sidebands
- C = vestigial sideband

ANGULAR MODULATION

- F = frequency modulation
- G = phase modulation
- D = amplitude and angular modulation either simultaneously or in a prearranged sequence

PULSE MODULATION

- P = train of unmodulated pulses
- K = train of pulses modulated by amplitude
- L = train of pulses modulated by width
- M = train of pulses modulated by position
- Q = a train of pulses where the carrier is angle modulated during the pulse period
- V = a combination of the above
- W = modulation not covered above, where the carrier is modulated, either simultaneously or in a prearranged manner, in a combination of two or more of the methods; amplitude, pulse, angle
- X = methods not covered above

Note: the above methods involve the modulation of a pulse train by the modulating signal but where a carrier is directly modulated by a pulse train it must be designated under angular or amplitude modulation.

Symbol 6 : type of modulating signal

- 0 = no modulating signal
- 1 = signal channel with digital information without a modulating sub-carrier
- 2 = as 1 but using a modulating sub-carrier
- 3 = signal channel containing analogue information
- 7 = two or more channels with digital information
- 8 = two or more channels with analogue information
- 9 = a mixed system where one or more channels contain analogue information and one or more channels contain digital information
- X = cases not covered above

Symbol 7 : information type for transmission

- N = no information
- A = telegraphy for audio reception
- B = telegraphy for automatic reception
- C = facsimile
- D = data transmission, eg telemetry
- E = telephony including sound broadcast
- F = television
- W = a combination of the above
- X = cases not covered above

Symbol 8 : signal details

- A = a two condition code with elements of different numbers and/or durations
- B = a two condition code with elements of the same number and duration without error correction
- C = as for B but with error correction
- D = a four condition code in which each condition represents a signal element of one or more bits
- E = a multi condition code in which each condition represents a signal element of one or more bits
- F = a multi condition code in which each condition or combination of conditions represents a character

G = monophonic sound of broadcast quality

H = stereophonic or quadraphonic sound of broadcast quality

J = sound of commercial quality excluding categories K and L

K = sound of commercial quality involving frequency inversion or band splitting

L = sound of commercial quality with separate frequency modulated signals to control the level of demodulated signal

M = monochrome signal

N = colour signal

W = a combination of the above

X = cases not covered above

Symbol 9: type of multiplexing

N = no multiplexing

C = code division multiplex

F = Frequency Division Multiplex (fdm)

T = Time Division Multiplex (tdm)

W = combination of fdm and tdm

X = multiplexing not covered above

A mobile radio transmission of 25kHz would be described as 25KO F3EJN indicating that it is frequency modulated with a single channel containing analogue information. The analogue information is telephony of commercial quality and no multiplexing is involved.

CONCLUSIONS

This article has traced the early history of mobile radio and shown how eight 12.5kHz channels now occupy the 100kHz bandwidth formerly occupied by only one channel. Land mobile radio has been concentrated on, to keep the coverage simple.

Even so, land mobile covers not only vehicle mounted but hand held and transportable packets as well. The growth of private mobile radio was noted and the severe operating conditions of dust, vibration and temperature were covered.

Any operator wishing to set himself up as a mobile operator must note the licensing conditions.

Various 5-code systems of transmission are used together with fsk and ffsk. Although guard bands are used to separate transmission, quartz filters are required to keep the frequencies on track. Areas of poor coverage use several antennas which need to be carefully adjusted to prevent the transmitted signal from cancelling. Operating methods using both simplex and duplex were dealt with.

The principles of vcos in frequency synthesisers were outlined as well as the use of squelch in subduing background noises. For an operator with a large fleet of vehicles some form of call stacking can simplify the task.

The growth of the System 4 automatic radiophone was then described as a form of public mobile radio followed by the ITU agreed radio emission designations.

The implementation of cellular radio in cities has supplemented rather than displaced land mobile radio and will be described separately in another article.

It is hardly surprising that a society which relies so heavily on the telephone for communications expects the next development, that of being able to communicate while on the move. No doubt this expectation will continue to grow putting pressure on the radio spectrum as well as the resourcefulness of planners.

There is no doubt that the future will see the use of satellites for mobile radio as well as the expectation of the individual to communicate by radio with anyone even while outside his own country. And that's a tall order. *(But an order that INMARSAT are intent on fulfilling. Ed).*

GLOSSARY

AGC automatic gain control

CTCSS continuous tone coded squelch system

ERP effective radiated power

FFSK fast frequency shift keying

FSK frequency shift keying

IMS idle marking signal

MATS mobile automatic telephone system

PMR private mobile radio

PROM programmable read only memory

QB quiet base

RCE radiophone control exchange

VCO voltage controlled oscillator

PE

Remember the new
Component Catalogue
available from
early 1990

CRICKLEWOOD ELECTRONICS

**BIGGER
AND BETTER**

**1990 COMPONENT
CATALOGUE**



- ONE OF THE LARGEST RANGES OF COMPONENTS IN THE UK
- FAST AND EFFICIENT SAME DAY PERSONAL SERVICE
- VERY COMPETITIVE PRICE; QUANTITY DISCOUNTS AVAILABLE
- DISCOUNT VOUCHERS INCLUDED
- NO MINIMUM ORDER

CRICKLEWOOD SUPPLY MOST OF THE COMPONENTS FOR P.E. PROJECTS. 13,000 STOCKLINES (MANY UNOBTAINABLE ELSEWHERE) PLEASE PHONE US FOR YOUR SPECIFIC NEEDS.

FILL IN THE COUPON AND POST IT WITH YOUR CHEQUE, PO ETC FOR £1.50 TO RECEIVE YOUR 1990 CRICKLEWOOD ELECTRONICS CATALOGUE AND VOUCHERS WHICH YOU CAN USE AGAINST YOUR NEXT PURCHASE

Cricklewood Electronics Ltd
40 CRICKLEWOOD BROADWAY, LONDON, NW2 3ET
Tel: 081-450 0995/452 0161
Fax: 081-208 1441 Telex: 914977



TELEPHONE ORDERS OUR SPECIALITY

CRICKLEWOOD ELECTRONICS 1990 COMPONENTS CATALOGUE

PLEASE SEND COPIES OF THE 1990
CRICKLEWOOD ELECTRONICS CATALOGUE AT
£1.50 TO:

NAME

ADDRESS

Remittance enclosed £.....

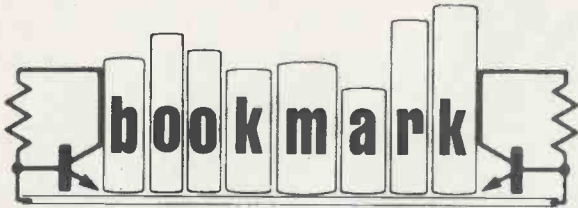

Your Ed looks at some of the new books recently received.

A Concise Introduction to GEM. J.W.Penfold. Babani. £2.95. BP230. ISBN 0-85934-175-5.

GEM is a software system written to make computers easier to use. The system uses pictorial representations, usually known as icons, to visually display disc file names and types on the screen. The icons are accessed and routines selected by using a 'mouse' to control a pointer on the screen. The book has been written as an introduction for new users, and is structured to provide a convenient, compact source of reference for more experienced users. It can also act as a quick 'refresher' for anyone who has not used GEM for some time. The book explains the nature of GEM and what it can and cannot do. It explains how to use GEM for routine housekeeping of disc files, catering for both hard and floppy disc users. You are told how to configure and run applications from the GEM desktop to best advantage, including menus, graphics and other special features available to users from within the applications programs. All versions of GEM up to release 3.01 are covered, including versions supplied with the Amstrad PC and Atari ST computers. This is a book which usefully supplements the manual supplied with the GEM system.

A Concise Introduction to OS/2. N. Kantaris. Babani. £2.95. BP260. ISBN 0-85934-205-0.

OS/2 is a new computer operating system. Users of PC/MS-DOS will immediately detect a certain familiarity with OS/2 as a great deal of this new system is based on it. This book does not seek to replace the documentation you receive with the OS/2 operating system, but only to supplement and explain it. The book covers both command line processing and OS/2's Presentation Manager which should be somewhat familiar to users of DOS version 4.0 as the menus employed in the DOS shell of that version are consistent with those used in Microsoft Windows and hence similar to those used in OS/2. If you are a multitasking PC user and you want to get the most out of your computer in efficiency and productivity, then you really ought to learn OS/2. This book will help you do just that since it was written with the non-expert, busy person in mind. As such it has an underlying structure based on "what you need to know first, appears first". The book covers both the command-line mode of processing and the Presentation Manager of OS/2 Standard Edition 1.1 as implemented by IBM and Microsoft.

A Concise Introduction to Lotus 1-2-3. N. Kantaris. Babani. £2.95. BP261. ISBN 0-85934-206-9.

Lotus 1-2-3 is an integrated software package containing three major types of applications; spreadsheets, graphics and data management. The package is operated by selecting commands from menus or by writing special macros which utilise the Lotus Command Language to chain together menu commands. If you are a PC user and want to get to grips with Lotus 1-2-3, then this book will teach you how in a short and effective way. The book explains how the software can be used to build up simple spreadsheet examples, edit them, save them and retrieve them. You are told how to format labels, enter and format numbers, change the default width of cells, enter formulae and Lotus 1-2-3's built-in functions, and print a work sheet. It goes on to explain how titles can be frozen on screen, and how to add graphs to a worksheet, add legends and titles to graphs, view and print graphs. Explanations are given about setting a database management system, sorting and searching a database, using the find and extract commands to query information held in a database. The creation, use and debugging of simple macros is explained, as is the creation and use of range names. The book lists all Lotus 1-2-3 indicators, functions and macro commands so that it is self contained and can be used as a reference book long after the reader has become an expert in the use of the program.

A Concise Introduction to WordPerfect. R.A.Penfold. Babani. £2.95. BP262. ISBN 0-85934-207-7.

Wordperfect has now become the most popular word processor package for the IBM PC range and the numerous compatibles in use around the world. It is also available in versions for many other computers, including the Atari ST series and the Commodore Amiga range. This book is written for beginners to word processing, and assumes a minimal amount of knowledge about using computers and running applications programs. It explains how to enter and edit text, and quickly move around large documents. Performing block operations is covered, including move, copy, delete, case changing and printing. Text formatting ready for printing is explained, including the use of advanced features such as newspaper columns and graphics, as well as basic formatting, such as line spacing and setting margins. You are also told how to install printers and print out documents using various fonts and printing effects. The use of mail-merge facilities to customise standard letters is explained, and you are shown how exploit useful facilities such as the spell-checker, thesaurus and sort routine. The book covers up to Wordperfect version 5.0.

A Concise Introduction to dBASE. J.W.Penfold. Babani. £3.95. BP263. ISBN 0-85934-208-5.

The software package dBASE is one of the few database systems which can truly said to be 'industry standard'. This family of database programs dates back to CP/M computers with dBASE II, went on to the IBM PC family with dBASE III and III Plus, and continues with the recently introduced dBASE IV. This book covers all versions up to dBASE IV release 1.0. The author says that the purpose of this book is not to teach you all there is to know about databases and programming dBASE. Indeed, he doubts that any one book could do that. Neither is it claimed that this book describes all the dBASE functions and commands. Rather, it is designed to provide the information you need to get started in a concise form, and to provide a convenient source of reference for the future on the most commonly used dBASE features. The book explains what a database is and does, how to create and use a database with dBASE, how to write simple dBASE programs to help you with your work, and what the differences are between the various versions of dBASE.

Learning to Program in C. N. Kantaris. Babani. £4.95. BP258. ISBN 0-85934-203-4.

C is a highly portable general purpose programming language which is structured, modular and compiled. It is a language designed to be faster and more efficient than Basic and yet simpler to write than Assembler. As such it is by far the most up and coming language of today. The book is a guide to C programming, first of all introducing C statements and explaining them with the help of simple but completely working programs. Graded problems are set at the end of each chapter, some with financial or scientific bend, so that users can choose their own level of problem difficulty on which to practice with some additional choice in the preference of field of application. Full working solutions appear at the back of the book. Chapters 1-3 deal with the basic C statements which control program flow and allow the user to manage most aspects of the language. Chapters 4-5 introduce the concepts of string arrays, numeric arrays and function subprograms which expand the programming capabilities of the user beyond the beginner's level. Chapter 6 deals entirely with the data-file handling on disc, while Chapter 7 deals with unique C structures, both of which should be of interest to all those who need to process large quantities of data.

From Atoms to Amperes. F.A. Wilson. Babani. £3.50. BP254. ISBN 0-85934-199-2.

The author says that he has written this book for anybody with a tinge of curiosity, and he has made it easy reading even for those who have never got on well with the subject of physics, or who have forgotten all they ever knew! He has deliberately kept low the level of mathematics required, though a moderate knowledge of school algebra and a little basic trigonometry is preferable. The illustrative calculations used can readily be made using a pocket calculator. The book explains in crystal clear terms the absolute fundamentals behind electricity and electronics. It should really help you to discover and understand the subject, perhaps for the first time ever. I heartily recommend this book to all beginners, and to those looking for a simple memory refresher.

PUBLISHER'S ADDRESS

Bernard Babani (Publishing) Ltd, The Grampians, Shepherds Bush Road, London W6 7NF.

AC MOTOR CONTROL

This month Andrew Armstrong answers the question from D.L Jones of Mid Glamorgan:

Can you supply me with a design for a variable speed control unit for AC series wound motors in the 1-2kW range (for electric tools)? I have a copy of PE October 1987, in which there is a design of a thyristor controlled unit. I am sure that, with the advance of electronics, a better design is possible.

While it is true that advances in device technology have produced much better triacs, thyristors are still more robust, and they offer lower voltage drop when switched on. nevertheless, for low and medium load currents triacs offer a simpler and more economical solution. It should be noted, however, that such devices as high current solid state relays use antiparallel thyristors for load switching.

Phase angle speed control of a motor can be accomplished by means of phase cutting control, like a lamp dimmer. However, because motor loads normally have a lagging power factor (more inductance than resistance when the motor is stationary) the phase reference must be taken from the live of the mains directly rather than through the load. A circuit based on the lamp dimmer principle would receive a false phase reference, and perhaps fail to trigger or perhaps trigger on half cycles only, because the current is out of phase with the voltage. With an inductive load, when the triac switches off at the zero current point, this is not near to the zero voltage crossing of the mains. Consequently, the voltage across the triac rises rapidly towards the mains voltage, slowed only by the time constant of the inductor and whatever capacitance is present across the triac.

This effect can falsely trigger the triac, but more often it simply confuses simple phase control circuitry into malfunctioning.

RAMP GENERATOR

The design shown in Fig.1 takes account of this problem and draws its phase reference from the mains live, via R1 and the optoisolator IC2. The phototransistor in the optoisolator conducts and is saturated except at or very near to the mains zero crossings, when it switches off, allowing TR1 to switch on and reset C3.

After being reset, C3 charges again via R3, to approximately 6.5V. The way in which this voltage is calculated is illustrated in Fig.2. The ramp is exponential rather than linear, but the part of the exponential function used is close enough to linear for the purposes of this design.

The ramp is buffered by IC3A and fed to the IC3B, which is wired as a comparator. When the ramp voltage exceeds the voltage on the inverting input, the comparator switches on and triggers the triac optoisolator. This in turn triggers the output triac. The point on the ramp which the comparator switches is determined partly by the setting of VR1, the speed control, and partly by the feedback signal taken from the output via IC4. Thus the triac is triggered on part-way through each mains half-cycle, and is re-triggered at the same fraction through the next mains half-cycle regardless of the precise timing of the zero current point.

The circuit would work as a simple motor-speed controller without the feedback circuitry (from R12 to R8). This extra circuitry is intended to stabilise the speed of the motor to some extent, by detecting the increase in current as the motor slows. Part of

the impedance of the motor is due to the resistance of the wire, and part due to the inductance. However, when the motor is running, a major part of the motor's effective impedance is due to the back emf of the motor. The reduction of this part of the motor's impedance, and the resulting increase in current, is used to increase the phase angle of the motor drive, supplying it with more power.

This is a positive feedback action, and if too much feedback of this nature is applied, the motor speed will tend to oscillate or run away. The correct amount of feedback, adjustable by means of VR2, will simply reduce the tendency for the motor to slow down if its load is increased.

This feedback circuit has a limited rate of response, because it is working on an ac waveform, and adjusting a triggering phase angle as its response. Its time constant is set by C5 and R11, and may require some experiment to optimise for the motor in use. The value of R12 controls the maximum amount of feedback available. Ideally, its value should be chosen so that the bridge and the led in the optoisolator are just barely forward-biased at the normal operating

Fig 1.

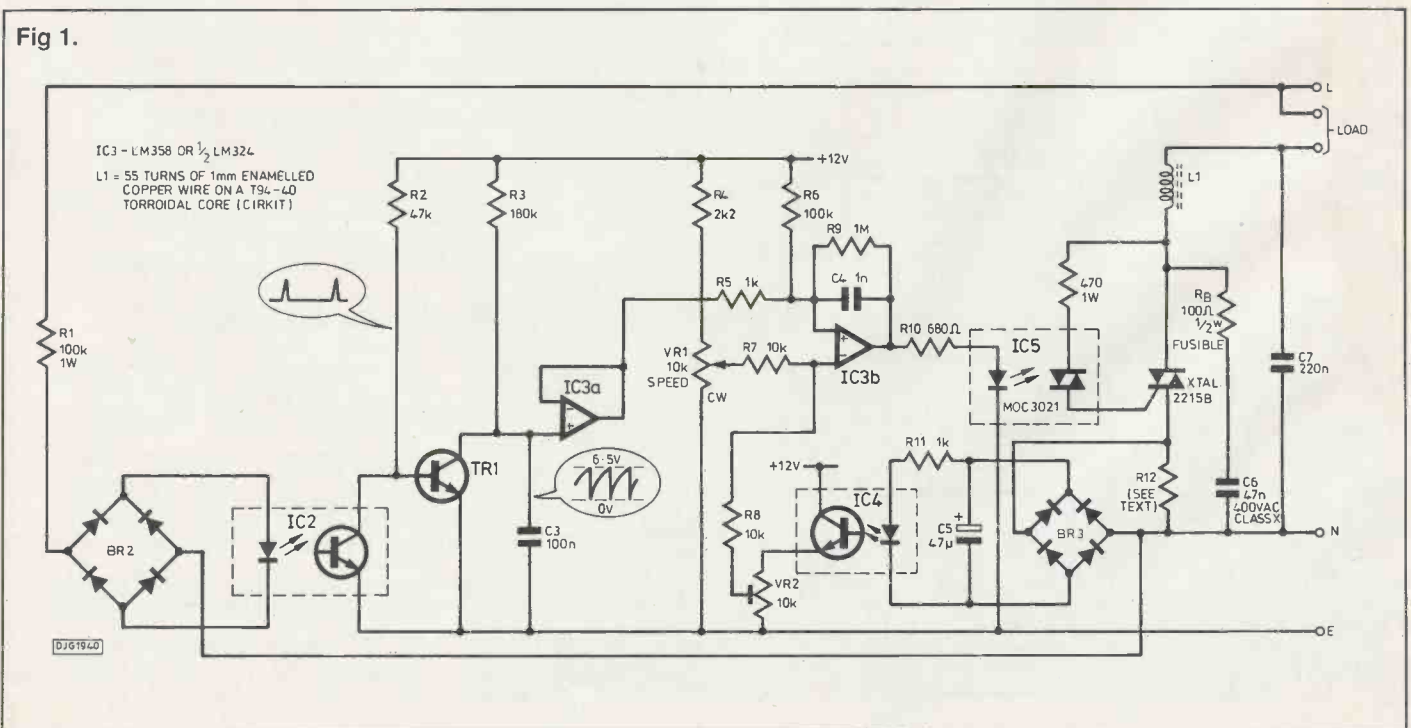

Fig 2.

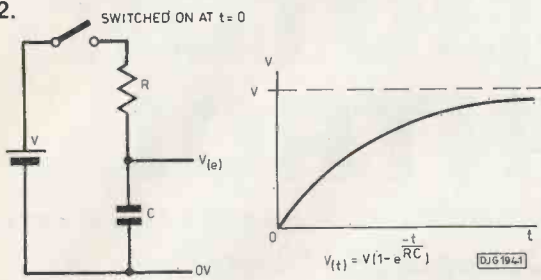
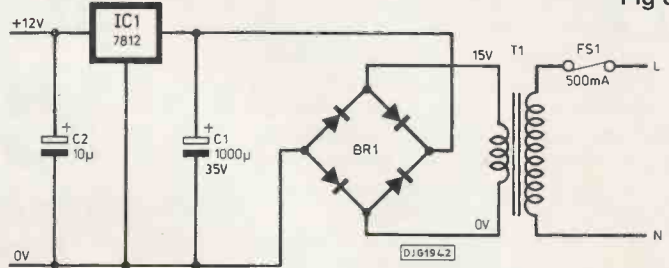

Fig 3.



current of the motor. Increases in motor current will then put more current through the opto-isolator, and apply more feedback signal. If the value of R12 is excessive the main problem will be that of too much heat dissipation.

OUTPUT STAGE

A high current triac is used to control the output. A TXAL2215B is shown in this example. It was chosen because it is an isolated tab triac rated at 400V, 15A. A similar type of triac would be equally suitable and if the heat sink is completely enclosed in an earthed or insulated case such that there is no possible access for people's fingers, etc, then an isolated tab triac is not needed.

A certain amount of output filtering is shown in this circuit, because a triac switching near the peak of the mains half-cycle can transmit a lot of interference down the mains

wiring. L1 and C7 effectively form a low-pass filter to limit this interference. C6 and R13 form a snubber network to protect the triac from spikes, and rapid changes of voltage caused by switching an inductive load. The component values shown are for example only, and may need adjustment in the light of the actual load to be used.

The only remaining part of this design is the power supply, Fig. 3. A conventional transformer, rectifier, capacitor and regulator design is used to provide a clean 12V supply for the circuit. All the control circuitry is isolated from the mains voltages, and is thus able to be controlled by external signals if necessary. The design as shown gives maximum power when the wiper of VR1 is at zero volts, and zero power when it is at the most positive end of the pot.

If an externally derived positive going control signal is to be used, an LM324 opamp could be used instead of the LM 358, and one of the remaining parts of the opamp could be

used to invert and buffer this signal.

The speed control offered by this circuit is of limited efficiency, and if really accurate speed control is desired, some sort of shaft encoder should be used to derive a speed related signal. This can then be summed with the basic speed control signal in extra circuitry, using other opamp parts.

This precise circuit has not been built and tested, though all parts of it have been used successfully in the ways indicated.

ABOUT ASK PE

Ask PE is a most-monthly column in which the most interesting readers' technical enquiries (in the opinion of the Editor) will be answered to the best of the columnist's ability. Individual queries will not be answered, even if stamped addressed envelopes are sent. Please mark envelopes clearly "ASK PE", and enclose no other correspondence because these envelopes will be forwarded straight to the columnist. **PE**

Free demonstration discs
Borland C++ • Procyon Lisp • A.I.
algorithms • Hashing routines in C
Programming the X.Client

In the UK's only news stand
magazine for developers - £1.50

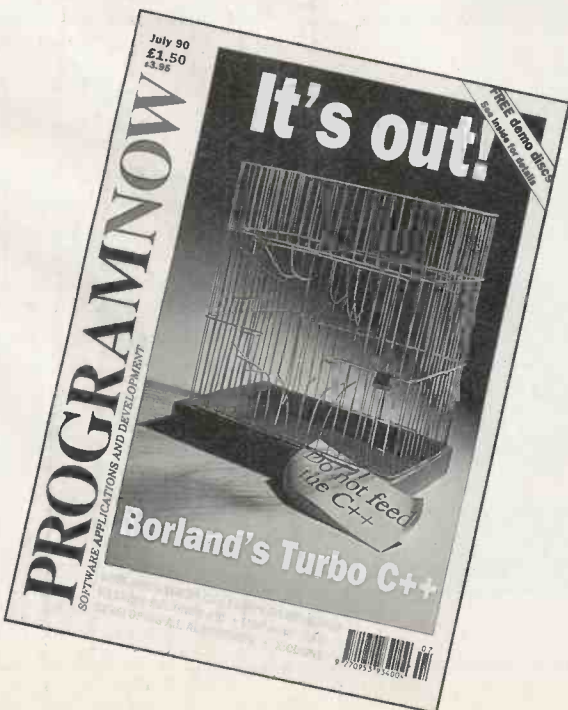

NEW

Having trouble finding
good test gear at low prices?

We have the answer!

The New **MICRO-LAB SERIES** of Audio Test Gear for the enthusiast, technician and laboratory.

They're compact, convenient and very cost effective. They're PP9 powered, portable and very easy to use.

Audio Oscillator Model P38 £64.95

5 Hz to 20 kHz in one range.
Ideal for testing amplifiers, filters speakers, etc.
Sine or triangle waves at up to 2 volts output and Square-wave or Pulse output at 5 volts fixed unusually powerful 50 ohm short-circuit proof outputs
External control of frequency, symmetry & amplitude

Distortion Analyser Model P40 £64.95

Analyse at 30, 100, 300, 1k, 3k and 10k Hz
Useable down to 0.1% distortion and 0.2 volts input
Outputs for oscilloscope and purified sinewave
Requires a companion P41 for readout and power

A F Millivoltmeter Model P41 £64.95

Wide range: 10 Hz to 2 MHz, and 1 mV to 100 V
1 M-ohm input impedance - 'scope probes can be used
AC and DC output signals for viewing, recording, control
9 x 4 SAE brings details, or send just £64.95 + £3 p&p and 15% VAT = £78.14 total each (UK) stating models required.

Output cable: add £3.50. PP9 battery: add £2.90 inc VAT
COLEBOURN ELECTRONICS, Dept. PE2, 20 Folly Lane, St. Albans, Herts, ALM3 5JT. Tel: 0727 44785

At long last the Hubble Space Telescope is in orbit. After a preliminary failure, it was launched safely; there was a further hitch in unfurling the 'solar panels', built by British Aerospace, which provide the telescope's power, but all the problems now seem to have been solved, and the outlook seems to be 'set fair'. No doubt we will have some major results in the near future.

Meanwhile, Voyager 1, which by-passed Jupiter in 1979 and Saturn in 1980, has sent back the first 'snapshot' of the Solar System, showing the Sun and various planets. Like its twin Voyager 2, it will never come back; it is leaving us permanently - and in many millions of years hence it may still be travelling between the stars. We may hope to keep track of it until about 2020, but then we are bound to lose it.

The Magellan probe is still en route for Venus, and will reach the neighbourhood of that hostile world in August. The Galileo probe continues its tortuous route for Jupiter, though it will not arrive until 1995. Finally, efforts are at present (mid-May) being made to re-activate the camera of Giotto, the spacecraft which passed through the head of Halley's Comet in 1986. If these efforts are successful, then Giotto may be sent on to rendezvous with a second comet.

THE MISSING LINK

Over the years many searches have been made for 'Brown Dwarfs' - objects which are

SPACE



WATCH

BY DR PATRICK MOORE CBE

The HST is safely in orbit and will enhance our view of the universe, Brown Dwarfs included.

not quite stars, but not quite planets. A normal star, such as the Sun, begins its career by condensing out of a cloud of gas and dust known as a nebula; as it shrinks, under the influence of gravity, it heats up, and when the central temperature reaches a certain critical value (around 10,000,000 degrees C.) nuclear reactions begin, so that the star starts to shine.

If the mass of the fledgling star is less than 8% that of the Sun, the temperature will never become high enough for nuclear reactions to be triggered off, and the body will simply glow dimly because of gravitational shrinkage. This means that it will qualify as a 'Brown Dwarf', with a surface temperature of no more than 2000 degrees. After only about a thousand million years, which is not long on the cosmical scale, it will cease to glow at all.

Because they are so dim, Brown Dwarfs are difficult to find, and until recently it had not been definitely proved that they exist. Now, however, we may have the first definite proof. At the Royal Observatory, Edinburgh, Dr. Mike Hawkins was examining plates taken with the UK Schmidt Telescope in Australia when he found objects which were extremely red, and looked very much as though they could be genuinely dim.

The first step was to measure the distances of these objects. One of them, known provisionally as MH 18, was examined and found to be no more than 68 light-years away. This means that it was very dim indeed, with a luminosity no more than 1/20,000 that of the Sun and with about 5% of the solar mass. This means that it cannot be a 'tree' star, and puts it firmly in the Brown Dwarf range.

THE JUNE SKY

Unfortunately, Austin's Comet, which I discussed last month, has failed to come up to expectations. Instead of being a brilliant object in the dawn sky, with a brilliant head and a long tail, it has been difficult to see at all without optical aid, and though it will remain on view during June it will not become brighter now.

Comets, alas, are always unpredictable. According to current theory they are very ancient objects, and there is a whole cloud of them orbiting the Sun at a distance of around one light-year (approximately 6 million million miles). When a comet is perturbed for any reason, it may 'fall in' toward the Sun, and when it enters the inner part of the Solar System we see it. Austin's Comet is probably paying its first visit - and its last, as it has been affected by the pulls of the planets and thrown into an open path, so that it will never come back.

But though it was thought to contain a great deal of 'dust', which would produce a long tail, this has not been the case, and we must agree that as a spectacle it has been a great disappointment. When we will next see a bright comet is uncertain; the last really 'great' comet was that of 1910, so that our own century has been very barren of them!

During June, Mercury is technically an evening object, but will not be seen with the naked eye from Britain. However, Venus is brilliant before dawn, in the eastern sky, and cannot be missed, because it is so much brighter than any other star or planet (at its best, it can even cast shadows). Telescopically it is now 'gibbous' - that is to say, more than half but less than full. No telescope can show its actual surface, which is always concealed by its dense cloudy atmosphere.

Mars, on the other hand, has a surface which is not veiled by cloud. It too is a morning object, and is now becoming bright, though its apparent diameter is still small. It will reach opposition next November. Of the other planets, Jupiter is still on view in the west after dark, and the three outer giants (Saturn, Uranus and Neptune) are all in Sagittarius, the Archer, so that they rise well before midnight. Saturn's rings are still wide open, and in any telescope the planet is a beautiful sight.

Uranus, which is just visible with the naked eye, lies between the two stars Mu and Lambda Sagittarii. Telescopes show it as a pale, greenish disk. Neptune, at magnitude 7.7, is below naked-eye visibility.

There are no eclipses this month, and no major meteor showers. The Moon is full on June 8, and new on the 22nd.

The starry sky during June evenings is dominated by the 'Summer Triangle' of Vega in Lyra, Deneb in Cygnus and Altair in Aquila. Look in particular for Cygnus, which is often nicknamed the Northern Cross for obvious reasons; Deneb, 70,000 times as luminous as the Sun, is its brightest star. The Milky Way runs through Cygnus, and then through Aquila before running down to the southern horizon in Sagittarius. Here we find the glorious star-clouds which hide our view of the centre of the Galaxy.

In the north-west Arcturus is prominent; later, the Square of Pegasus starts to come into view in the east. This is the best time of the year to see Antares in Scorpius (the Scorpion), the very bright, red star not far above the southern horizon. Scorpius is a splendid constellation, but unfortunately it is well south of the celestial equator, and part of it remains permanently below the British horizon.

If these observations are correct - and there seems little doubt that they are - then we have the first proof of a genuine Brown Dwarf. No doubt there are many others, and they may provide some of the 'missing mass' which we know to exist in the Galaxy and which we cannot actually see.

What is the border between a Brown Dwarf and a planet? It is difficult to say; Jupiter, for example, does not send out any light of its own, and we regard it as a planet, while MH 18, perhaps ten times as massive as Jupiter, is on the other side of the border-line. But in any case, Brown Dwarfs are fascinating objects, and they may have a great deal to tell us in the years to come. **PE**

Photos: The HST primary mirror, and the complete telescope ready for launch. Perkin-Eimer Corp, and Lockheed Missiles and Space Co. Inc supplied the photos.

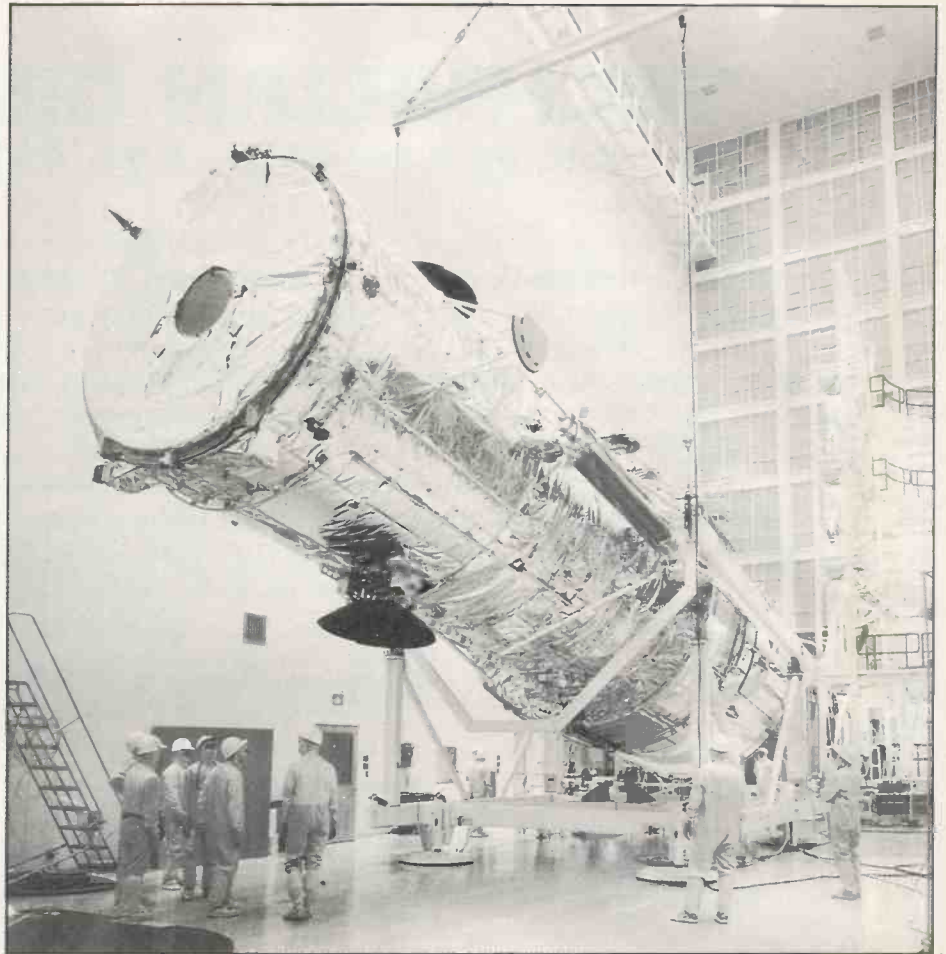
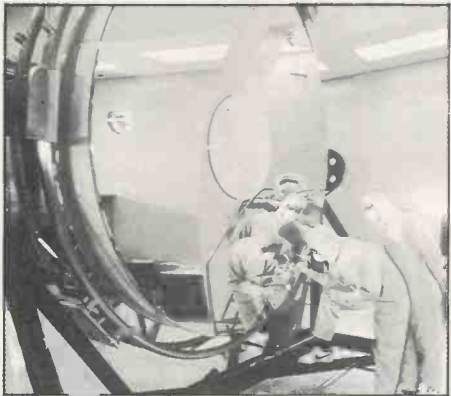

Astronomy Now

Britain's leading astronomical magazine

In the June issue:

Astronomy Now

June 1990

The Comet Austin Story

Brown Dwarf Star Discovered

Charting The Heavens With The Carlsberg Telescope

Gravitational Wave Astronomy

PLUS: Build An Innovative Telescope Mount



HUBBLE UPDATE
See page 23

☆ The Comet Austin Story ☆
 ☆ Brown Dwarf Star Discovered ☆
 Charting the Heavens ☆ Gravitational
 Wave Astronomy ☆
 Build an Innovative Telescope Mount
 ☆ ☆ ☆ ☆ ☆
 plus: News Update - The Night
 Sky - Sky Watch Down Under and
 more...

June issue on sale now - price £1.50!

Published by Intra Press - Publishers of Practical Electronics

TECHNICIAN GRADE 7

Salary £14,445 – £16,467 (inc.)

To be responsible for providing a technical service in the Microprocessor Control and Electronics section of the Department of Engineering. Duties to include responsibility for ensuring satisfactory maintenance, security and safety of areas and equipment within the section, and the development, construction, testing and maintenance of apparatus for teaching purposes. Applicants require one of the following: HNC, HND, BTEC Higher, Advanced City & Guilds or an equivalent qualification in electronics. In addition 10 years relevant experience (including training period) is required.

For further details and application form please contact Janice Garry at the above address or telephone on 081-870 2241 Ext. 315.

Closing date 15th June 1990

Wandsworth

an equal opportunity employer

All applicants are considered on the basis of their suitability for the job irrespective of disablement, race, sex or marital status.

Maplin ELECTRONICS

Are YOU looking to improve your career in Professional Sales?

We can offer an initial package of 15K+ pa with real promotional prospects to Field Management

Due to continual planned growth, MPS, which is a division of Maplin Electronics, wish to recruit a

Sales and Applications Engineer

Ideally residing in the Reading area, applicants should have a sound knowledge of electronics and preferably be qualified to Tec II or above. In addition, candidates should possess previous sales experience plus the determination to succeed. We offer a negotiable salary package plus a company car and generous fringe benefits.

To apply, either telephone for an application form or send your CV to:

**Nick Fogg, Sales Manager MPS,
Oak Road South, Benfleet, Essex SS7 2BB
Tel: (0702) 554155**

Expertise required

to assist development of a Computerised Virtual World – concept as seen on BBC 2's "Antenna" broadcast Wednesday 25th April.

**David, Barleyline Computers,
(05088) 8103. Leave message if answering machine.**

Does your company need electronics/technology minded people?

Advertise your vacancies in P.E.
Phone: 081 743 8888

We concluded last month with Investigation 4, a mosfet switch. Let's look at a variation on that theme (Figs 10 to 14 were shown last month):

Investigation 5 - a mosfet touch switch

You need: the Schmitt trigger circuit of Fig.10.

The mosfet switch circuit of Fig.13, with the 10cm wire connected to the gate (VR1 not required).

The meter is not required in either circuit.

Remove the led from the mosfet switch and re-position R4 so that it connects the collector to TR1 to the +6V line.

Remove VR1 from the Schmitt trigger.

Run a short wire from the drain of the mosfet to the 4k7 resistor (R1, Fig.10) to connect the two circuits together.

Now try touching the wire with your fingers and observe what happens to the led. You could replace the led and its resistor (R4, Fig.10) with some other load, such as a filament lamp (Module 2), a solid-state buzzer (Module 5), or a relay (Module 7).

OTHER MOSFETS

The mosfet illustrated in Fig.12 and used in the investigation is described as an *n-channel*

junction. The conductive part of the bar, the n-type region, has been narrowed or depleted, so increasing the resistance of the bar and reducing the flow of current.

Enhancement and depletion transistors with a p-channel are also manufactured. In the p-channel enhancement mosfet (Fig.16), the bar is of n-type silicon, with a region of p-type at each end. When the gate is negatively charged, electrons are repelled, creating a continuous p-type region from end to end. In the p-channel depletion mosfet (Fig.17) the bar is of p-type material. When the gate is positively charged, electrons are attracted toward it, creating a non-conducting n-type region. This restricts flow of charge carriers (holes) to a narrower region.

Vmos transistors are a special type of mosfet in which the regions of the transistor are formed in deep V-shaped grooves cut in a slice of silicon. Both n-channel and p-channel types are available. The geometry of the transistor allows a wide conducting region so that large currents can flow without overheating the transistor. This makes them suitable for high-power applications. Some can pass up to 30A, and others are rated at up to 125W. It is remarkable that such a large amount of power can be controlled by the minute electric charge accumulated by the rubbing a piece of plastic with a cloth.

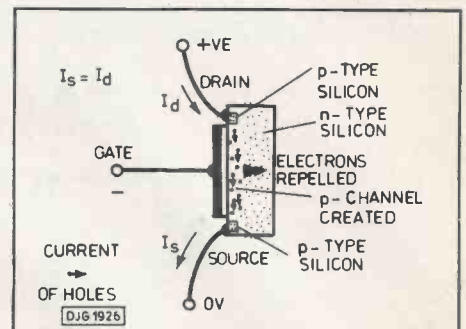
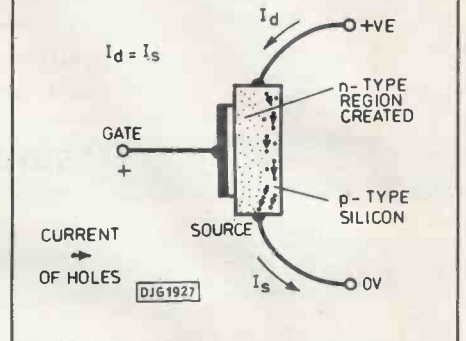

Fig 16. P-channel mosfet with gate negatively biased, and (Fig 17) with gate positively biased.



BASIC ELECTRONICS

enhancement mosfet. It is called 'n-channel' because the current flows through a channel of n-type silicon. It is called 'enhancement' because the channel is created by increasing or *enhancing* the number of negative charge carriers (electrons) in the channel. Investigation 4 showed that this is not an all-or-nothing effect. Conduction increases gradually as the gate is made more positive. The mosfet behaves like a variable resistor.

We can also make a transistor that works the other way round (Fig.15). This is an n-channel *depletion* mosfet. The bar is made entirely of n-type silicon, so it conducts freely when the gate is at zero voltage. If the gate is charge negatively, electrons are repelled from the region close to the gate. This creates a region of p-type material, through which conduction can not occur owing to the pn

Fig 15. N-channel depletion mosfet with gate negatively biased.

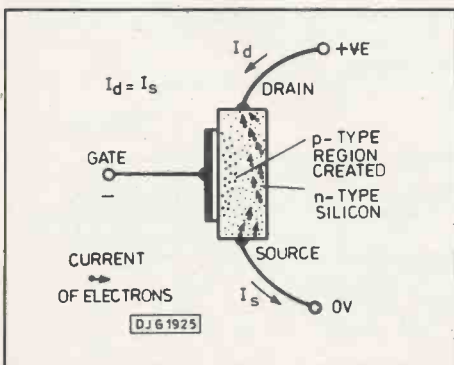

By Owen Bishop

Part 7 - more on transistors

How to score a good try on the touch-line and never be off-side for frost or fire.

Fig 18. Symbols for mosfets.

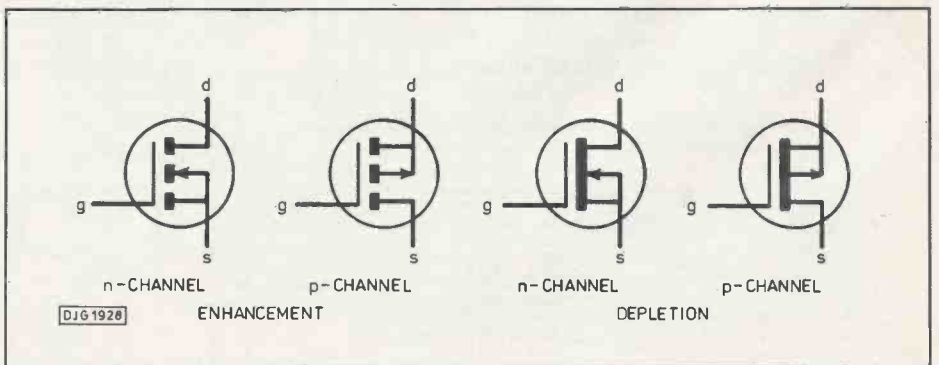

DARLINGTON PAIR

Not to be outdone, the bipolar transistors can also control a large current by the touch of a finger.

Investigation 6 - Darlington pair touch switch

You need: battery box (6V)

R1 330 ohms

LPI 6V, 0.06A filament lamp (Module 2) (or use an led and 180 ohm resistor)

TR1, TR2 ZTX300 npn transistor (2 off)

Set up the circuit of Fig.19 as in Fig.20. Investigate various ways of switching on the transistors by supplying a very small current to the base of TR1. Design a rain or 'tank full' alarm circuit. If you want to try switching larger currents, a power transistor such as a

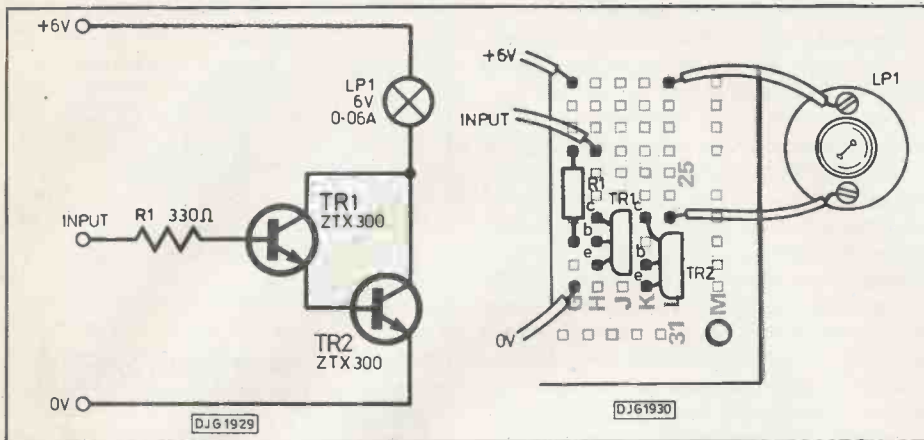

Figs 19 and 20. Circuit and layout for Investigation 6.

BD131 can be used for TR2 (it may need a heat sink).

Explain the action of the two transistors connected as a Darlington pair.

MOSFETS REPLY

As hamburger is to cheeseburger, so Darlington is to fetlington. Devices containing two mosfets connected in a way similar to the Darlington pair are marketed under the obviously but nonsensically derived name of fetlingtons. A very small change in gate potential produces a large change in the current flowing through the transistor pair.

MODULES OF THE MONTH

8 Transistor switch

This has a similar circuit to Fig.7 last month, but the protective diode is omitted because this is provided on the relay module. There is an additional transistor (TR2) which turns on an indicator. The led is connected between the collector of TR2 and the 0V rail. This is a different arrangement to that employed in the other circuits described

earlier. When TR1 is off, TR2 is on, and the voltage across the led is too small to light it. When TR1 is on, TR2 is off, and the voltage at its collector is enough to light the led. The switch supplies up to 100mA to the load. It is suitable for switching a lamp or a relay, but not the usual type of small electric motor. (Fig.21).

Parts required: R1 680 ohms; R2 27k; R3 180 ohms; D1 TIL 209 or similar led; TR1, TR2 ZTX300 npn transistors (2 off); SKT1 3-way pc socket; SKT2 2-way pc socket; stripboard 63mm x 25mm (Vero 15354).

9 Schmitt trigger switch

This has the circuit shown in Fig.9, except that the led and its resistor are omitted - Fig.22.

Parts required: R1, R3 4k7 (2 off); R2 1k, R4 100 ohms; TR1 TR2 ZTX300 npn transistor (2 off); SKT1 3-way pc socket; SKT2 2-way pc socket; stripboard 63mm x 25mm (Vero 15354).

SYSTEM OF THE MONTH

Previously we promised to improve on the fire-alarm system. The solution to the problem of intermittent action is to use a Schmitt trigger. The Schmitt trigger module takes a

lamp, a buzzer or a relay as its load. The difficulty with this is that it works the wrong way round. As temperature increases above the upper threshold, the load is switched off. This makes a good frost alarm (Fig.23) but needs modifying for use as a fire alarm. There are three approaches:

(1) If the load is a relay which switches a lamp or bell, wire the alarm device to contact 1, so that the alarm is switched on when the relay coil is off.

(2) Use a different heat sensor module, with the thermistor and resistor swapped round.

(3) Use the transistor switch as an inverter (Fig.24). A resistor of say 1k is connected as its load. Output falls from almost 6V to about 1V when the switch is on. This output is fed to the Schmitt trigger. This is another example of using a resistor to 'convert a current into a voltage'.

The system of Fig.23 is also applicable as a thermostat. The load of the trigger is a heater - a heating coil or a filament lamp. There is feedback from the heater to the sensor. The feedback is negative in the sense that rising temperature leads to the heater being turned off; falling temperature leads to the heater being turned on. The result is a stable temperature.

DISCUSSION

Investigation 5: The effects are the same as in Investigation 4, except that the switching action is more definite, due to the Schmitt trigger. Touching the wire puts the led firmly on. Prolonged contact may cause the led to stay on after the finger has been removed. Eventually the excess charge leaks away into the air and the led goes out.

Investigation 6: As soon as the base current to TR1 is enough to cause a collector current to flow, this collector current becomes the base current of TR2 and causes an even larger collector current to flow. If, for each transistor, the collector current is 100 times the base current, the collector current of TR2 is 10000 times the base current of TR1. **PE**

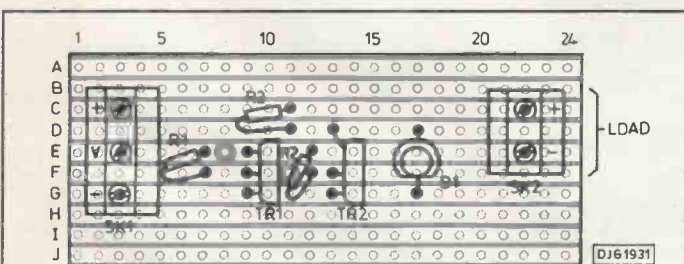

Fig 21. Module 8. Transistor switch.

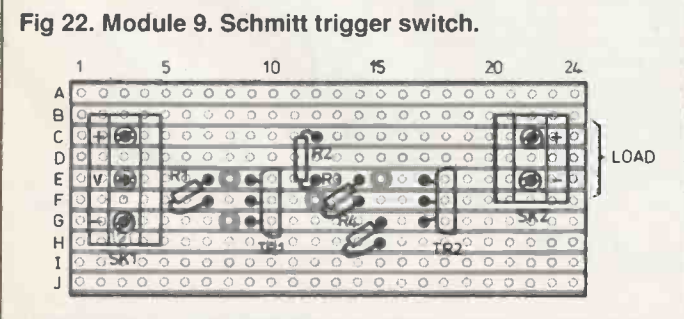

Fig 22. Module 9. Schmitt trigger switch.

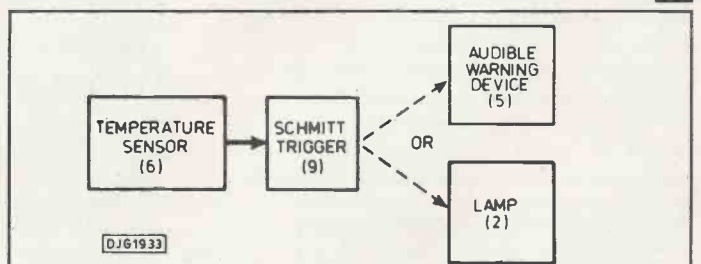

Fig 23. System of a frost alarm or thermostat.

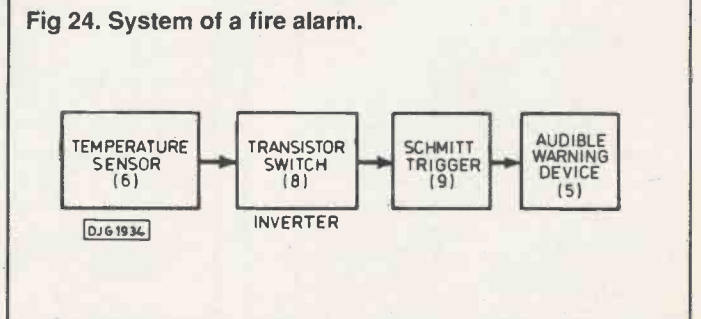

Fig 24. System of a fire alarm.

OBITUARY

We were saddened to hear of the death on March 5th 1990 of Cyril Bogod. Cyril was the founder of the British Amateur Electronics Club and its Chairman for 24 years until his death. Although I never met Cyril, I had spoken occasionally with him on the phone and was aware of the devotion he gave to the BAEC and its members. I know that he was held in great esteem by my predecessors Fred Bennett and Mike Kenward, and they both supported the club. In the latest issue of the club's newsletter is a quote from Fred (PE's founding editor) in appreciation of Cyril's efforts:

"In this materialist world where the 'every man for himself' idea is so prevalent, altruistic works shine out as brilliant beacons of hope, confirming that the spirit of generosity and mutual help is still very much a part of man's nature and will not be vanquished."

John Margetts, Secretary of the BAEC since its inception, comments that Cyril "was a kind, gentle man with a quietly determined manner, and it is due to his enthusiasm and generosity that the BAEC has been so successful and able to withstand the rigours of time. He was always ready to help beginners in electronics, particularly the young, and he achieved a great deal of success in this aim through the regular weekly meetings of the club at Penarth, where many novices graduated into knowledgeable amateurs. His passing also signifies the end of an era in the history of the BAEC."

Cyril will be sadly missed by many people and we send our commiserations to his family and to the BAEC.

Herbert Howard has assumed responsibility for the BAEC and we know that the club is in good hands. Many of you will recall that I publicised the BAEC's call for new members in PE May 90. After publication of that issue, I received the following kind letter from Herbert:

ONWARDS BAEC

Dear John,

I am writing to thank you for your enthusiastic advocacy of the BAEC on page four of PE May 90. I am sure that other members of the committee would join me in expressing our gratitude. Before your column appeared the club had already gained several new members as a result of advertisements in PE last August and again in January this year. Since your comments we have had several more joining. I know that Cyril Bogod enjoyed your support over the years, and I am glad to know that I can count on continuing support from you.

TRACK FEEDBACK

Like Cyril, I am an electronics hobbyist and have never been professionally engaged in radio or electronics (unless you count six years in the Signals Branch of the R.A.F. during the last war, when I worked on radar). Nor have I any journalistic experience; after taking a degree in Biology I taught the subject at secondary level till I retired in 1975. My interest in "wireless" started at about the time the BBC was born; I became an avid reader of Wireless World and other magazines and was soon into building 'hi-fi' amplifiers. I ran a school radio club and was responsible for all the audio-visual equipment (including constructing much of the electronics side), and when I retired I continued at the school as part time audio-visual adviser. Last year I gave that job up, so I am now able to give a good deal of my time to the affairs of the BAEC.

During the past few weeks I have spent a lot of time at Cyril's house, going through the mass of papers relating to the club, and trying to sort out all the equipment and components which Cyril had accumulated. He left all his electronic equipment and books to the club, so the committee has the job of deciding what to do with it, and that is by no means easy; it seems as though Cyril never threw anything away. I get the impression that whenever Cyril saw something that took his fancy he bought it, and very often never got round to doing anything with it. If he needed an ic or other component he bought a dozen (or a hundred)! I shall try to get some of the useful stuff into the hands of the several young beginners who have recently joined the club.

I noted in looking through the May issue of PE that you are making a special offer of a reduced subscription rate to teachers and students, and I wondered if you could consider extending this to include members of the BAEC.

Incidentally, I have been reading PE since it first came out.

Herbert Howard, B.A.E.C., 41 Thingwall Park, Fishponds, Bristol, BS16 2AJ.

Yes, certainly, we shall be very pleased to extend the special teacher/student subscription rate offer to BAEC members. The normal 12 month's subscription rate for UK readers is reduced by 10% for teachers and students. BAEC members may take advantage of this special rate by enclosing proof of

their BAEC membership status with their payment, writing to the Subscription Department at the editorial address.

Readers interested in joining the BAEC, a very worthwhile club, should write to Herbert at the address at the end of his letter.

Our Publisher, Angelo, joins me in sending our best wishes to Herbert and the BAEC. Ed.

HOBBY HAWK

Dear John,

I thought that, in your "Hobby Horse" Editorial of PE April 90, your effusive defence of electronics as a hobby was rather unfair on the anonymous critic. After all, he/she should have had the right to reply! So in view of their absence I have decided to take up the cudgel on their behalf.

To do their critique justice it would be necessary to review the whole scene and no-one can deny that things in the electronic-hobby world ain't quite what they used to be. It seems to me that the whole of the pioneering/creative spirit has dropped out of the business. It's not your fault that you do not appreciate this; how could you, when you are too young to have experienced the thrill of being 'in' on the discovery of the age. As a second generation in practical electronics you have inherited a fait accompli, the honours have all been won, the caravan has passed by. At most all you can achieve is a steady trot with a flagging horse. However, we live in a changing world and who knows what fate has in store.

I am enjoying taking PE again after a lapse of 16 years. I have a full set of issues from 1964 to 1974 (the formative years) and made a few small contributions to the articles during those years.

George Dunning, Hassocks, Sussex.

The head of the caravan has indeed passed by, but not its body which is still well attended by devotees and those who are encouraged to join along the route. There are many honours still to be won, many horizons still to be crossed. The world of electronics has yet many adventures to be explored and part of my job is to encourage people to participate in them. Although commercial designers and manufacturers are the pathfinders, the rank and file amateur hobbyists still

have much to gain from electronics, and much to offer in areas unsuited to commercial exploitation.

Having been involved in electronics, in various ways, for around three decades, I for one have found in myself an increasing addiction to electronic creativity, and refuse to believe that diy hobbies of this type are anachronisms. Comments from anonymous critics, such as those I highlighted in April, increase my determination to fight for what I believe in. Ed.

ARMAGEDDON

Dear Mr Becker,

I am writing to you once again with regard to my previous letters, and now that all of my work is completed, I do want to let you know the final results of my work.

Because of my work on the solution to the origins of the universe, I wish to tell you that the final battle for good against evil will be fought on the Earth, and at the fusion site at Culham in Oxfordshire, when they attain fusion of the plasma in the fusion chamber it shall release the power of Armageddon on the Earth, and the Apocalypse will have happened.

It will not destroy all the world, but it will serve to let mankind know that God exists, and that we are all part of his creation, and it will be the start of a new world, where we can go to his promised land if we repent of our sins.

As far as I am concerned the above information is correct, and please do keep this letter on file for future reference.

The consequences of me giving you this information, do not concern me at the moment, and as far as I am concerned I can await the results of the fusion project experiments patiently, because I do know that is all I can do. It does not concern me if I am believed or not at the moment, because I do know that I will be proved correct by the results of the events at Culham in Oxfordshire where the "JET" experiments are being conducted at the moment.

Armageddon is fully explained in the book of Revelation 16.

R.D.Caldwell, Warrington, Cheshire.

The United Kingdom Atomic Energy Authority (UKAEA) are responsible for the activities at Culham. Their spokesman at Harwell advised me that hot fusion plasma has already been achieved, lasting for 25 seconds at 8 to 10 million degrees Celsius. It is expected that a prototype fusion reactor will come into operation in the year 2000.

However, the spokesman pointed out that Nostradamus predicts that the world will end in 1996. It has to be admitted, though, that Nostradamus (1503-1566) did not have the benefit of modern computational technology to aid him with his prophecies. Ed.

PE COMPETITION RESULTS

WINNING BONANZAS!

Ten lucky winners in our April 90 competition have won a bumper bundle bonanza:

Over 550 pages of invaluable information and circuits for robotic and automation control. Under full positive Post Office feedback control we've despatched the two prize books, "*The Robot Builder's Bonanza*" and the "*Remote Control Handbook*", to the following fortunate readers:

A.J. Fletcher, Gilwern, Gwent.
J.C. Sutton, Misson, Doncaster, S.Yorks.
Roger Ingle, Great Leighs, Chelmsford, Essex.
Gerard Butler, Dun Ladghaire, Co Dublin, Ireland.
R.S. Orr, Hertford, Herts.
Gordon Rainbird, Ongar, Essex.
John Findlay, Bournemouth, Hants.
N. Thomas, Lyneham, Wilts.
Michael Drake, Callander, Perthshire.
Liz and Crystal Hanson, Bracknell, Berks,
(both names on the same form - is this what is known as double-entry book-keeping?).

Congratulations to all of you, and our grateful thanks to John Wiley and Sons Ltd, and Bernard Babani (Publishing) Ltd, respectively, for kindly supplying the books.

THE ANSWERS

We asked you who is reputed to have first used the word Robot. It was, of course, Karel Capek who coined the word to describe a person of machine-like efficiency for the 1920 play "*R.U.R.*" ("*Rossum's Universal Robots*"). Only six of you didn't know the correct answer, all believing that the honours go to Arthur C. Clarke. I gave Douglas Adams as an option in the question, but I guess you're all too familiar with his fame for "*Hitch-Hiker's Guide to the Galaxy*" to fall for that! Frank Herbert, the fourth option given, is one of my favourite SF writers, probably best known for his "*Dune*" series.

Isaac Asimov defined the First Law of Robotics to be: "*A robot may not injure a human being, or, through inaction, allow a human being to come to harm*". Every single one of you got that right! Of the optional names given, I hold in esteem Plato for being a Greek philosopher, Faraday for his research into electrical charge (the unit of capacitance is named after him), and Napier for his work in mathematics. The Ministry of Defence has numerous claims to fame!

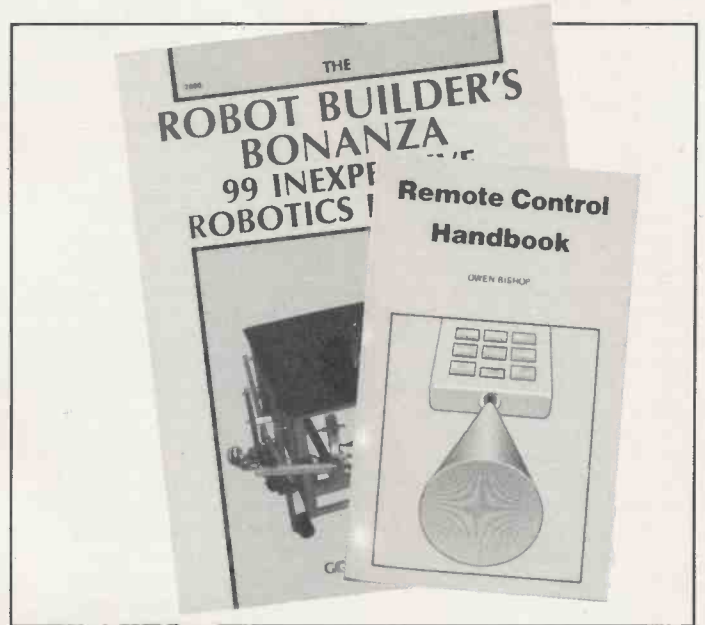

The third question produced answers that were virtually equally in favour of each of the names offered as to who was the odd one out amongst Marvin, Hal, R.Daneel, R2D2, Joe 90, and Dalek. When I set the question I had Hal in mind as the exception since I felt that the others, in a broad sense, could all be regarded as robots/automata. Hal was simply the name given to the sophisticated talking computer in Arthur C. Clarke's book/film "*2001*". Marvin was the depressed robot in the "*Hitch-Hiker's Guide*" series. R.Daneel was a robot created by Isaac Asimov, and which, as a logical detective, solved a particularly baffling murder in the book "*Caves of Steel*" (I believe), a sort of cybernetic Hercule Poirot! The film "*Star Wars*" brought fame for the robot R2D2, though I can't remember whether he was the short, fat, squeaky one, or the tall, erudite, silver one!

Perhaps, strictly speaking, Joe 90 was not an automaton, for in reality he was a puppet, used by Gerry and Sylvia Anderson in their famous tv series of the same name. (I worked for the Andersons on their earlier "*Four-Feather Falls*" puppet series, but left before the making of "*Joe 90*". Even then, about 1959 or so, they had the puppets' mouth movements electronically synchronised to the recorded speech track signals.)

I'm not sure how Dr Who would define a Dalek, but to me it epitomises the concept of a malignant robot, and so I included it in the list. Since you were all pretty equally split over the answers to this question, I allowed all your answers to be equally valid and didn't take them into account for the final draw!

I was not so lenient on Q4. Although Marvin is strongly associated with hitch-hiking and the Answer to Life (42, as some of you said), to me the endearing attribute for which I shall remember him is his acute depression! (So, too, would you be depressed if you'd been stuck in a car park for most of eternity - a fate nearly worse than being stuck in London's traffic jams.) Most of you agreed with me, and obviously sympathised with poor old Marvin.

No-one who had fully read their April 90 copy of PE should have got Q5 wrong. The answer was given in Alan Pickard's text for the Robot Car! He named the axes of robotic arm movement as pitch, roll and yaw. I'm pleased to note that most of you had, apparently, read Alan's moving words of wisdom.

ENTERTAINING ED!

I also suggested that you should write a limerick on the subject of robots. It was not a condition of the competition that you should, but was simply a means by which you could entertain me. And some of you did just that, though not as many as I had thought might do so. Perhaps electronic creativity and worse-verse creativity are not necessarily compatible attributes! But I'm sure you'll all be entertained by the odd-odes that were sent in. Here they all are:

*A robot was riding at random
With a soldering iron on a tandem.
It fixed his dry joints
And other weak points
While he consumed blackcurrent and rum.*

Liz Hanson of Bracknell, Berks, submitted that one. Need I point out the current pun? I like the rhymes of random, tandem, and-rum. I wonder what Liz consumed to come up this ditty?!

Paul J. Smith of Walworth, London SE17 obviously has a sporting eye for final indignities:

*There was a young robot from Leicester,
Who got a job as a wrestler,
Three falls and a submission,
Completely ruined his transmission,
So now he works as a cash register.*

Is Howard Barnes of Lower Shelton, Bedford suggesting that marriage and intelligence are inharmonious? :

*We built a robot, all singing and dancing,
And then put AI in the thing,
It made a mistake, once,
Got its degree, not by chance,
So we gave it a wife, how confusing.*

Malcolm Ives of Horncastle (I know it well), Lincs, might be said to take a pinker view of inter-species (!) relationships:

*There was smart robot called Floyd
Whose life was almost a void
Til one day he met
A girl called Collette
And now he's fathered an android.*

Malcolm also submitted the next one - I'll leave comments about the last line to you!

*There was a mechanical man
Controlled by some rom and some ram
But when exposed to some rays
He went into a daze
And now he's a Kylie Minogue fan.*

Eric A. Cook of Llanfrechfa, Gwent, is no stranger to me. The winner of a satellite tv receiver in one of our competitions a couple of years ago, he is a regular entrant to all our competitions. He titled his limerick "Aye, Aye, Robert" (I wonder if he is making a punned reference to Asimov's book 'I, Robot?'):

*There was a young man called Hicks
Who said "There's now't 'Bob' can't fix!"
When given repair jobs
By his boss's hob-nobs
He just passed them to his robotics!*

Eric comments that robotics should be pronounced here as Robert - Hicks!

If L.G. Wright of Bournemouth, Hants, is punning on the word 'Ed' he could find it's his days that are numbered, not those of his tabloid robot!:

*A cynical robot called Ed
Was mistakenly digital fed,
Now asked for the key
To a formula he
Recites figure tables instead.*

It's probably just as well for Gordon Rainbird of Ongar, Essex, that we don't publish full addresses:

*There once was a robot called Moss
Who was rather fond of a doss
He'd sit in the sun
Having nothing but fun;
Some might called him my boss.*

Ivan Roulson of Honiton, Devon shows signs of having already done some robot building:

*There once was a robot called Bobby
Who was part of a constructor's hobby.
His wires were gold -
But his tyres were bald
And his axes were all very sloppy.*

If I were offering prizes for the limerick entries, which I'm not, I would probably have chosen Michael Drake of Callander, Perthshire, as the winner, providing he indemnified us against libel suits!

*A certain inventor survives
Despite his companies' soars and dives.
He's known for computers
And electric commuturs
But he's really an android called Clive.*

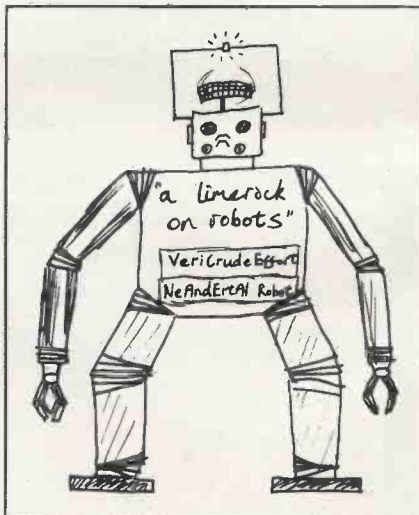

Michael Drake, determined not to duck the issue, sent in these two sketches with his limerick. I suspect I recognise the caricature as being of one of my favourite inventors.

Michael added a comment to the robot sketch, saying, "A limerick on robots (plural); is valid since this 'robot' is a system of robots combined to form a cooperative unity of functional flexibility"!

Revelling in the joys of imagination, Michael also sent in a hex code listing, commenting:

"As requested, 'a limerick on robots' (Hexadecimal, Sinclair Spectrum 1983): 22 41 20 6C 69 6D 65 72 69 63 6B 20 6F 6E 20 72 6F 62 6F 74 73 22."

I don't know Spectrum Hex but I've worked out what it says, can you? (No prizes!) Well done Michael, thanks for the entertainment.

Thanks, too, to all who sent the other limericks. We'll be having another competition for you soon, so don't forget :

PE Serves You Right!

PRACTICAL ELECTRONICS CLASSIFIED

Reach thousands of serious electronic and computer enthusiasts. Advertise in PE Classified pages: Rates 20p per word or £8.50 per single column cm (plus VAT). All classified advertisements must be pre-paid. Send your copy with the remittance (payable to Intra Press or payment by Visa or Access accepted) to: Practical Electronics, Intra House, 193 Uxbridge Road, London W12 9RA. Tel: 081-743-8888. Fax: 081-743-3062
LET PE WORK FOR YOU!

EDUCATION

FULL-TIME TRAINING COURSES

2 YEAR

BTEC NATIONAL DIPLOMA

Electronics and Communications Engineering

(TV, Computers, Programming, IT)

1 YEAR

BTEC NATIONAL CERTIFICATE

1. Electronic Equipment Servicing

(TV, Video, CCTV)

2. Computing Technology

(Microprocessors, DataComms, Interfacing)

3. Information Technology

(Telecomms, Satellite TV, Networks)

4. Software Engineering

(Assembler, BASIC, Pascal, CAD/CAM)

★ Those eligible can apply for E.T. grant support ★

★ An equal opportunities programme ★

COURSES COMMENCE

Monday 17th September 1990

LONDON ELECTRONICS COLLEGE

Dept: AA, 20 Penywern Road, London SW5 9SU. Tel: 071-373 8721

Start training now for the following courses.

- Telecomms Tech C&G 271
- Radio Amateur Licence C&G
- Microprocessor
- Introduction to Television

Send for our brochure - without obligation or telephone us on 06267 79398 (Ref: PE7/90)

Name.....

.....

Radio & Telecommunications Correspondence School, 12 Moor View Drive, Teignmouth, Devon TQ14 9UN

RETAILERS

EDINBURGH

OMNI ELECTRONICS

stock a wide range of electronic components at 174 Dalkeith Road Edinburgh EH16 5DX

Tel: 031 667 2611

Open Mon-Fri 9am-6pm

Sat. 9am-5am

NEW CATALOGUE OUT SOON

Price is just £1.50

Contact Omni Electronics now for details

Practical Electronics Classified Works!

10th May 1990

Dear Mr. Bonner,

Just a line to say that I was delighted with the response from my advert in the June Practical Electronics; the number and quality of replies exceeded my best expectations.

Yours sincerely,

M. H. C. Lewis
 Newcastle - upon - Tyne

Phone David Bonner on 081-743-8888 for details!

LONDON WEST

TECHNOMATIC LTD

Please see our display advertisement in this issue for more details!

MANCHESTER

THE ELECTRONICS SHOP

We stock a large range of electronic components, test equipment, telephone accessories, computer accessories, microphones, speakers, discolorighting, mixers, meters, stylus, so call in and have a look around.

29 Hanging Ditch, Manchester M4 3ES

Telephone: 061-834 -1185

Fax: 061-833-2969

SOUTHSEA

ELECTRONIC COMPONENTS

EVERYTHING FOR YOUR NEXT PROJECT
 THE BIGGEST DISPLAY IN THE SOUTH IS AT

FRASER ELECTRONICS

42 ELM GROVE ★ SOUTHSEA ★ HANTS

Telephone: 0705-815584

STAFFORDSHIRE

COMPONENT SOLUTIONS Ltd.

"answering your component problems"

Unit 62, Enterprise Centre, Bedford Road, Stoke-on-Trent, Staffs.,
 Tel: 0782 287038

Resistor 1/4 W 5% carbon (E12) 1p metal film 1%	3p
Resistor Pack 85 different E12 values + zero ohm link total content	1000 resistors
1000 resistors	£8.95
LEDs red/green 3/5mm	6p each. Yellow 11p
Cable ties 75mm	1p each £5.95/1,000 £49.50 per 10,000
Stepping motor 4 phase 12v 7.5 step 50 ohms	£8.95
SAA1027 stepping motor driver chip	£3.95
FM transmitter kit good quality sound	£7.94
High quality photo resist copper clad epoxy glass boards	
Dimensions	single sided double sided
3x4 inches	£0.95
1x1.07	
4x8 inches	£2.40
£2.68	
6x12 inches	£5.37
12x12 inches	£10.66

Special Offers

Computer Grade Capacitors with screw terminals 38000uf 20v £2.50
 8700uf 10v £1.95, 68000uf 15v £2.95, 10000uf 16v £1.50

7 segment Common anode led display 12mm £0.45
 LM2931A.TS.0 Low drop out 5V regulator T0220 package £0.85
 BS250 P channel MOSFET £0.45, BC559 transistor £3.95 per 100
 74LS05 hex inverter £10.00 per 100, used 8748 Microcontroller £3.50

Stereo L.W./M.W./F.M Tuner pre-amp assembly complete with volume/tone controls and tuning scale Brand new in makers carton £5.95, fully £2.50

Circuit diagram description and setting up procedure for tuner assembly described above £0.50. 5 digit 6v electromagnetic counter £1.95

Hour counter (used) 7 digit mains 240V AC 50Hz £0.95
 LCD display 16 digit 7x5 dots dot matrix £2.50
 Query keyboard 58 key good quality switches £5.00

25p for P&P per order (VAT inc.)

wide range of CMOS TTL 74HC 74F Linear transistors kits capacitors, resistors tools etc always in stock

JPG Electronics 276 Chatsworth Road Chesterfield S40 2BH
 Access orders (0246) 211202. Callers welcome

Carbon Film Resistors 1/4W E24 series 0.51R to 10MΩ	1p
100 ohm per value - 75p 1000 off in even hundreds per value - £7	
Metal Film 1/4W 10R0 to 1MΩ 5% E12 series - 2p 1% E24 series - 3p	
1/4Watt metal/carbon film E24 series 1R0 to 10MΩ - 11p	
1 Watt metal/carbon film E12 series 4R7 to 10MΩ - 5p	
BC107/8/9 - 12p BC547/8/9 - 8p BC182L 184L - 10p	
BFY50/51/52 - 20p 2N3055 - 50p TIP31A, 32A - 25p TIP41, 42 - 40p	

BANTAM head subminiature electrolytics (Mids/Volts)	
0.1/35, 0.2/25, 0.4/7.5, 3.3/16, 4.7/16 - 14p	4.7/35 - 15p
2.2/35, 4.7/25, 10/5 - 15p	4.7/35, 6/8/16 - 16p
22/16 - 20p	33/10 - 30p
	47/10 - 35p
	100/6 - 40p

Aluminium Electrolytics (Mids/Volts)	
1/50, 2.2/50, 4.7/25, 4.7/50, 10/16, 10/25, 10/50 - 5p	22/16, 22/25 - 6p
22/50, 47/16, 47/25, 47/50 - 6p	100/16, 100/25 - 7p
100/100 - 14p	220/16 - 8p
220/25, 220/50 - 10p	470/16, 470/25 - 11p
1000/25 - 18p	1000/35, 220/25 - 22p
	4700/25 - 70p

Miniature Polyester Capacitors 250V Wkg. Vertical Mounting	
01, 015, 022, 033, 047, 068 - 4p	0.1 - 5p
0.15, 0.22 - 6p	0.47 - 8p
Mylar Capacitors 100V Wkg. Vertical Mounting E12 Series	
1000p to 8200p - 3p	0.1 to 0.68 - 4p
0.1 - 5p	0.15, 0.22 - 6p
Subminiature Ceramic Plate 100V Wkg. E12 Series Vertical Mounting	
2%, 1P8 to 47P - 3p	56P to 330P - 4p
10%, 390P to 4700P - 4p	
Ceramic plate/disc E6 Series 50V 22P to .047 - 2p	
Polystyrene Capacitors 63V Wkg. E12 Series Axial Mounting	
10P to 820P - 3p	1000P to 10,000 - 4p
12,000P - 5p	
1N4148 - 2p	1N4002 - 4p
1N5404 - 14p	W01 bridge - 25p
0A91 - 8p	AA143 - 8p
W005 - 20p	1N4006 - 6p
Zener diodes E24 series 3V3 to 33V 400mW - 8p	1 watt - 12p
L.E.D.s Red, Green & Yellow 3mm & 5mm - 10p	8mm - 35p
20mm fuse 0.1A to 5A quick blow - 5p	Anti Surge - 8p
High Speed drills 0.8mm, 1.0mm, 1.3mm, 1.5mm, 2mm - 30p	
Expo Reliant drilling machines 12V d.c. with improved 3-jaw chuck 6.50	
Nicads AA - 80p	HP11 - £2.00
PP3 - £4.20	Universal Chargers - £8.50
Glass reed switches single pole make contacts - 8p	Magnets - 12p

VAT inclusive. Return postage 25p (free over £5). Lists free.

THE C.R. SUPPLY CO.,
 127 Chesterfield Road,
 Sheffield S8 0RN. Tel. 557771.

PROGRAM NOW

Software Applications and Development

The latest issue available from all good newsgroups or direct from:
 Program Now, Intra House, 193
 Uxbridge Road, London W2 4NH
 Price £1.50

TURN YOUR SURPLUS

ICS transistors etc into cash, immediate settlement. WE welcome the opportunity to quote for complete factory clearance.

Contact:
COLES-HARDING & CO.,
 103 South Brink, Wisbech, Cambs.
 ESTABLISHED 15 YEARS
 Tel: 0945 584188 - Fax: 0945 588844

CAMBRIDGE COMPUTER SCIENCE LTD

10MByte Winchester, used, 3 months Wty, £42.00 each
 5.25" Disk Drives, 80 Track DSDD £34.00 each
 5.25" drive cases, room for drive, PSU and fan £10.00 each
 Buy a case, winchester & PSU together for £64.00 set
 Small cases, to fit Half Ht 5.25" drives £10.00 each
 5.25" Disk Drives, 80 Tk DSDD Used No Wty £15.00 each
 (The £15.00 drives are sold on a strictly "as is" basis)

5.25" Disks, DSDD, 48tpi boxes of 10 £3.00/box
 50W PSU 5V 6A, 12V 2.5A, 5V 0.5A, 12V 0.5A £16.00 each
 40W PSU 5V 3.75 A, 12V 1.5A-12V 0.4A cased with on/off switch £10.00 each
 Gould PSU 0-30V @5A Limited quantity only at £45.00 each
 Dual Data lead (BBC Micro to 2 Disk Drives) £4.00 each
 Power lead (BBC Micro to Disk Drive) £2.00 each
 Dual power lead (BBC Micro to 2 Disk Drives) £4.00 each
 68000 CPUs (The first orders get 10MHz chips) £3.50 each
 Z80A CPU, CTC, P10 £1.20 each; DMA £2.00 £4.50 all 4
 74LS TTL, pick and mix, buy 10 or more for £0.12 each
 Types available: '00 '02 '04 '08 '11 '13 '15 '20 '21 '26 '27 '30 '32
 '33 '38 '42 '75 '83 '96 '107 '109 '122 '132 '136 '139 '145 '151
 '153 '157 '158 '163 '164 '166 '191 '193 '298 353'365 '670

2764 EPROMS (Ex-equipment) £1.00 each
 27128 EPROMS £2.50 each

256K Byte DRAM Modules, removed from equipment £6.00
 6116 2K Byte SRAM £1.10 each
 6264 8K Byte SRAM -15 £3.00 each -12 £3.80 each
 65256 32K Byte rams £7.00 each
 8K Byte NV ram chips £3.00 each £10.00 four
 20 pin oil low profile IC sockets £0.50 (ten) - £4.00 (100)
 40 pin oil low profile IC sockets £0.60 (ten) - £5.00 (100)

Keyboard, 100 keys on board LCD & micro if £8.00 each
 Toroidal mains transformer 12V 4A & 0.4A, 12-0-12 @0.1A & 2A, 9-0-9 @0.2A £4.00 each - £6.00 for 2 - £8.00 for 3

Video Tapes, E180 VHS £2.50 each
 Smoke detectors, small size £7.00 each
 Smoke detectors, large with escape light and pause feature £13.00 each

Prices include postage. Add 50p to orders below £5.00.
 All items new unless stated. Add 15% VAT to all prices.
 Send an SAE for our latest list or for more info.

Dept PE, 374 Milton Road, Cambridge, CB4 1SU Tel: 0223 424602 or 0831 430496 or 0831 430552
 (Mail order only, no facilities for callers)

VSA

Cooke International

DO YOU WANT USED
 SCOPES, SIGNAL GENERATORS, POWER SUPPLIES, POWER METERS, DVM'S, OSCILLATORS, ATTENUATORS, TEST EQUIPMENT.

Contact: Cooke International, Unit Four, Fordingbridge Site, Main Road, Barnham, Bognor Regis, West Sussex PO22 0EB.
 Tel: 0203 545111, Fax: 0243 524257
 Wide range of items available. Send for lists.

MICROPROCESSOR DEVELOPMENT TOOLS

EPROM Emulator £99
 Cross Assemblers £49
 Powerful Simulators £99
 EPROM Programmer £129

SMART Communications
 Telephone 081-441 3890

N.R. BARDWELL LTD

200-Signal diodes 1N4148 £1.00
 100-Rectifier diodes 1N4001 £1.00
 100-Zener diodes 5V8 400mW £1.00
 30-Assorted Diode sockets up to 40 pin £1.00
 30-Assorted Sockets/Conn. D/I, Edge, I.D.C., Header etc £1.00
 30-Transistors BC478 £1.00
 20-Minature SP/CO Slide switches £1.00
 20-Magnetic ear pins + lead and Plug £1.00
 75-Electrolytics 4.7uf 63V £1.00
 1-10 Watt stereo amplifier - 4 controls and data £2.95

Prices include VAT, postage 60p. All items new.

Many other lines in stock.
 Shop open Mon/Sat 9.30-5.30. Lists S.A.E.
 288 ABBEYDALE ROAD, SHEFFIELD S7 1FL
 TEL: (0742) 552886 FAX: (0742) 500689

30 DAYS GUARANTEE. PLEASE ADD VAT. CHECK AVAILABILITY & CARRIAGE COSTS.

MARCONI 2600S MILLIVOLTMETER AF 1MV - 300V FSD £1.25
 MARCONI 144H 10KHZ TO 72 MHZ HIGH QUALITY RF GENERATOR FROM £45
 WAYNE KERR AF GENERATOR 10HZ - 120MHZ £30
 MARCONI HF TEST SET 2603 WITH ACCESSORIES £60
 TEKTRONIX 647A DUAL TRACE SCOPE 100MHZ ALL MODS £250

SPECIAL 2002AS Marconi AM - FM signal generator 10KHZ - 72MHZ in used good condition checked and tested the superb appearance and performance will enhance any test bench £100

MARCONI GENERATOR 2015 10MHZ - 520MHZ AM FM £275
 TELEPHONE DUAL TRACE 755 SCOPE 50MHZ £250
 COSSOR SCOPE CDU150 DUAL TRACE 35MHZ £140
 SELABS SCOPE SM111 DUAL TRACE 18MHZ £120
 VARIOUS AVOS FROM £1.25
 BRIDGE MEGGERS FROM £1.50

COMPUTER FIELD

BASIC COLOUR MONITORS FROM £50
 HIGH GRADE COLOUR MONITORS VARIOUS SIZES FROM £80
 WIDE RANGE OF PRINTERS TALLY - OKI - FIT - AND OTHERS FROM £45
 SOME COLOUR PRINTERS IN SOON. TELEPHONE FOR DETAILS.
 VDUS VARIOUS CASU - NEWBURY - TEKTRONIX LYME AND OTHERS ALL TESTED £15
 S100 MOTHER BOARD 21 - CONNECTORS INCLUDING GUIDES AS NEW £15
 S100 500W POWER SUPPLY TOP VALUE OPEN £12.50
 NICELY CASED £16.50
 VARIOUS S100 CARDS MEMORY WITH 32 PLUG IN 4116 £12
 COMMS WITH SLO AND SUPPORT CHIPS £8
 FANS 3INCH & 5INCH 240V 50HZ EX EQUIPMENT CAREFULLY TESTED £7
 TWIN MITSUBISHI 3.5 720 K DRIVES CASE WITH CONTROLLER AND BUILT IN POWER SUPPLY £120
 OKI 193 PRINTER CENTRONICS INPUT HARDLY USED £120
 AMBER SWIVEL AND TILT VDUS WITH Z8 PROCESSOR STANDARD 240V INPUT 2 SERIAL PORTS - SCREEN MENU GIVES WIDE RANGE OF OPTIONS E.G. CURSOR - BAUDE - PROTOCOL - BRILLIANCE ETC. HARDLY USED £160
 232 TO TTL CON. HEADER FOR SETTING PROTOCOL. TWO 1488 AND TWO 1489 D25 WAY RIGHT ANGLE FEMALE AND CONNECTING CABLE TO YOUR SYSTEM ALL ON FIBREGLASS BOARD £12

A. WOOD. NORTH WEST. 94 WORSLEY ROAD, FARNWORTH TEL: BOLTON (0204) 71795 - OPEN 7 DAYS A WEEK -

Series X Mixer Kits

- ★ up to 1,000 inputs
- ★ 60+ 100 mm faders, pots, panels and audio switches
- ★ 6-9 echo sends
- ★ versions for recording PA, radio, disco
- ★ circuit diagrams
- ★ From £9.92

Send 40p for catalogue to: K. Tek, r.O. Box 172a, Surbiton, Surrey KT6 6HN. Tel: 01-399-3990

Z80 MICROPROCESSOR PROJECT BOARD

Bring your ideas to life with this versatile pcb. 10 by 8 inches, top quality, through hole plated, double sided, full solder resist... a dream to work with after vero. Supports: Z80, 4MHz clock, 816k EPROM, 8k SRAM, up to 512k DRAM, two RS232 & two Centronics ports, keypad, Epson LCDs, battery back-up, PSU....

£25 for bare pcb & manual by return of post, 10 day money back guarantee. Also kits of components, software & project ideas. SAE for further details.

NEW-TECH, Walker Acre House, Addington, West Yorkshire.

IS YOUR ADVERTISEMENT A TIGHT SQUEEZE?

STRECH OUT IN THE DISPLAY PAGES OF PE!

PHONE PE ON 081-743-8888

Some time this year the UK's cellular mobile radiotelephone service will have taken on its millionth customer. Relative to the country's total population of about 57 million this may not seem a lot. But compared with some other European industrialised countries it's a considerable success for the service. For example, the UK market penetration is about five times that achieved in France and Germany. The Scandinavian countries have done better, with approximately 4% market penetration relative to the UK's 1.8%, but they started about five years earlier, in 1981.

BRITISH SUCCESS

All in all the British service is seen as a great commercial success and as a model of how a public cellular system could be run. The formula for this success has been intense competition functioning under strict Government regulation. Right from the start

INDUSTRY



NOTEBOOK

PRINCELY PRICING

To most people the cellphone is a somewhat exotic appliance. It's associated with yuppies, show-offs and generally very well-heeled types. You certainly need a good income to be able to afford one. The equipment costs about £250 for a carphone or £500 for a hand-portable, though you can also get these on lease or short-term hire. Connection charge is about £60. A yearly subscription, or standing charge, is in the range £300 to £350. Finally, there is the price of the calls themselves - 25p per minute or, in the London area, 33p per minute. An average bill is perhaps in the region of £1,000 per annum.

So, despite the price competition mechanism, the mobile cellphone service is not really for the ordinary private citizen. Most of the customers are in fact business users. Here the cost can be justified by the commercial benefit to the user of being able to keep in touch while on the move. For example,

THE MEGACELLPHONE

the Government decided that the scheme should be run by two operating companies which would compete with each other for custom. As almost everyone knows, these are Cellnet and Vodafone. The Government licensed each to provide and operate its own cellular network and associated services as a separate business.

Cellnet is the trade name of Telecom Securicor Cellular Radio Ltd, a joint subsidiary of British Telecom (60%) and Securicor (40%). Vodafone is the trade name of Racal Vodafone Ltd, a wholly owned subsidiary of Racal Telecom.

The idea of the Government regulation is to make sure that the competition really works to the benefit of the public - notably in providing good service and keeping down prices. There are in fact two Government bodies involved in this. The DTI is responsible for the overall technical and commercial organisation of the service - including, for example, the frequency assignments in the 900MHz mobile radio band and the two operators' licences. Then the Office of Telecommunications (OFTEL) acts as a 'watchdog' to look after the interests of the public. It does this, for example, by enforcing the rules of competition, investigating complaints and making sure that the two network operators stick to their licences.

COMPETING CUSTOM

But although Cellnet and Vodafone are competing with each other for custom, the competition in the whole scheme is not restricted to just this system level. If it were, there would be a danger that these two operators could form a secret cartel and fix prices, to the detriment of the customer.

By Tom Ival

The great success of the British cellphone has been aided by sensible legislative controls, but is now hampered by lack of air-space.

In fact the competition extends outwards to other companies. This is the result of a clever and significant regulatory rule. A clause in the network operators' licences expressly prohibits them from selling cellphone equipment or offering air-time service directly to the customer. Instead this selling to the public has to be done through retailers called service providers. Some of them sell directly while others work through a network of dealers.

So competition is spread out among a larger number of companies than just the two network operators. This intensifies the contest for market share and the custom of the public. Market forces therefore tend to bring down prices and improve the range of choice offered to the customer.

And this is not the end. There is another level of competition - between the suppliers of the actual cellphone equipment. A dozen or more electronic equipment firms sell the appropriate products through a variety of retail outlets like phone shops, hi-fi dealers and High Street multiple stores. The great pity, though, is that the UK's electronics manufacturing industry is not benefiting here. Most of the manufacturers are foreign companies. Probably the biggest supplying the UK service are Motorola (USA) and NEC (Japan).

company representatives are reported to have taken large orders over their cellphones while travelling. A freelance actor I know is able to snap up work when away from the home telephone. Other itinerant users include vets, surveyors, servicing and repair people and members of small businesses.

INCREASING CONSTRAINTS

Even though price competition is always at work the present system is likely to remain a minority service. The network operators don't expect to be able to cope with much more than about two million subscribers in all. They are up against the physical constraints of geographical space, time and frequency spectrum.

In practical terms these constraints show up, for example, in the increasing difficulty of getting new sites for base stations around the country and in the channel congestion now causing a certain amount of difficulty in making calls through the system. According to recent OFTEL figures, customers could not connect into the network for 4.7% of the time on Vodafone and 7.3% of the time on Cellnet. Peak period congestion is higher.

The future for public mobile radiotelephone services will depend very much on how the new digital technology works out, operationally and commercially, against the established analogue engineering. Telepoint is already with us - though this has the disadvantage that you can't receive calls on your hand-portable. A pan-European digital system is being planned, while in the UK the Government has now issued licences for companies to develop and operate what are being called personal communication networks. Cost and convenience will determine the final outcome.

PE



PRACTICAL ELECTRONICS BOOK SERVICE

Here is your Editor's choice of books he thinks will be of interest to electronics and computer enthusiasts

BEGINNERS AND EARLY STARTERS

Mini-Matrix Board Projects.

R.A.Penfold. 112 pages. £2.50. Order Code BP99

Shows a selection of 20 useful and interesting circuits that can be built on a mini-matrix board of 24 holes by 10 copper strips in size - an ideal book for early experimenters.

From Atoms to Amperes.

F.A.Wilson. 160 pages. £3.50. Order Code BP254.

For the absolute beginner, clearly explaining the fundamentals behind the whole subject of electricity and electronics.

Electronic Projects for Beginners.

F.G.Rayer. 128 pages. £1.95. Order Code BP48

Specially for the newcomer to electronics who is looking for a book containing a wide range of easily made projects. Some circuits need no soldering and many others show actual component and wiring layouts.

Electronics Build and Learn

R.A.Penfold. 128 Pages. £5.95. Order Code PC 101

Combining theory and practice, the book describes a circuit demonstrator unit that is used in subsequent chapters to introduce common electronic components and circuit concepts, complete with practical experiments.

Practical Electronic Building Blocks

R.A.Penfold. There are two books -

Book 1 : 128 pages. £1.95.

Order Code BP117

Book 2 : 112 pages. £1.95.

Order Code BP118

Book 1 is about oscillators and gives circuits for a wide range, including sine, triangle, square, sawtooth and pulse waveforms and numerous others from voltage controlled to customised ic types.

Book 2 looks at amplifiers, ranging from low level discrete and opamp types to ic power amps. A selection of mixers, filters and regulators is included.

30 Solderless Breadboard Projects

R.A.Penfold. Two books each of 160

pages. Book 1 : £2.95. Order Code

BP107. Book 2 : £2.25. Order Code

BP113.

Each project is designed for building on a Verobloc breadboard and is accompanied by a description, circuit and layout diagrams and relevant constructional notes. Many of the components are common to several projects. Book 1 covers linear devices, and Book 2 covers cmos logic chips.

Beginners Guide to Building

Electronic Projects R.A.Penfold. 112

pages. £1.95. Order Code BP 227

Shows the complete beginner how to tackle the practical side of electronics and includes simple constructional projects.

SATELLITE TV

Satellite TV Installation Guide - 2nd edition John Breeds. £11.95. Order Code STV1

Full of vital information for any competent diyer who wishes to install a satellite tv antenna and obtain optimum reception quality.

An Introduction to Satellite Television

F.A.Wilson. 112 pages. £5.95. Order Code BP195

Informative answers to many of the questions about this communications revolution. The information is presented on two levels, one aimed at the complete beginner, the other at professional engineers and serious amateur enthusiasts.

TEST AND MEASUREMENT

Getting the Most from Your Multimeter

R.A.Penfold. 112 pages. £2.95. Order Code BP239

There's more to what you can do with a meter than meets the casual eye. The book covers the basics of what you can do with analogue and digital meters and discusses component and circuit testing.

Test Equipment Construction

R.A. Penfold £2.95.

Order Code BP248

Describes in detail how to construct some simple and inexpensive, but extremely useful, pieces of test equipment.

Oscilloscopes 2nd Edition

I.Hickman. £12.95. Order Code NT3

Subtitled 'How to Use Them, How They Work' the book is illustrated with diagrams and photographs and is essential reading for any one who wants to know about scopes, from first principles to practical applications.

How to Get Your Electronic Projects Working.

R.A.Penfold. 96 pages. £2.50.

Order Code BP110.

Essential reading for anyone who wants first-time success in project assembly. Covers tracing mechanical faults as well as testing for failures of active and passive components of most types.

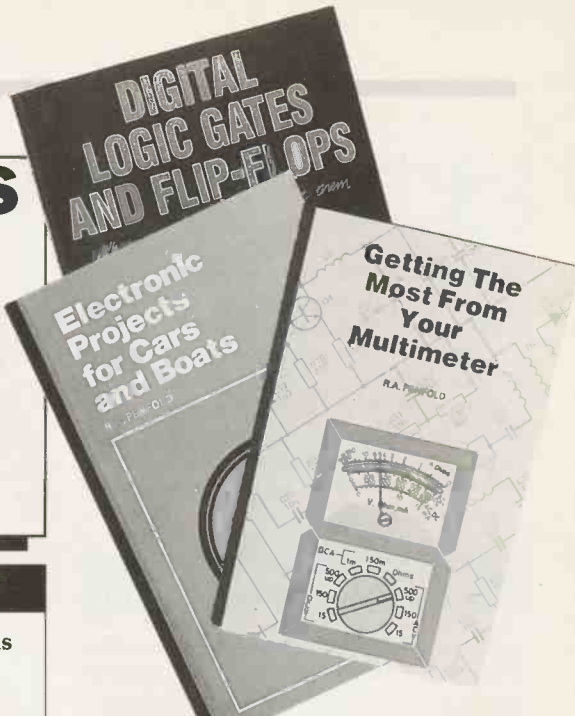

AUDIO AND MUSIC

Introducing Digital Audio

I.Sinclair. 112 pages. £5.95.

Order Code PC102

A non-mathematical introduction to the new digital technology, discussing the principles and methods involved in devices such as cd, dat and sampling.

Electronic Music Projects

R.A.Penfold. 112 pages. £2.50. Order

Code BP74

24 practical constructional projects covering fuzz, wah, sustain, reverb, phasing, tremolo etc. The text is split into four sections covering guitar, general, sound generation and accessory projects.

More Advanced Electronic Music Projects

R.A.Penfold. 96 pages. £2.95.

Order Code BP174

Complementing BP74 by covering more advanced and complex projects including flanging, chorus, ring modulation, plus a selection of drum, cymbal and gong circuits.

Computer Music Projects

R.A.Penfold. 112 pages. £2.95. Order

Code BP173

Shows how home computers can produce electronic music and covers sequencing, analogue and Midi interfacing, digital delay lines and sound generators.

Practical Midi Handbook

R.A.Penfold. 160 pages. £5.95.

Order Code PC103

A practical how-to-do-it book for musicians and enthusiasts who want to exploit the capabilities of Midi. Covers keyboards, drums, sequencers, effects, mixers, guitars, and computer music software.

Midi Projects

R.A.Penfold. 112 pages. £2.95. Order

Code BP182

Practical details of interfacing many popular home computers with Midi systems, and also covering Midi interfacing to analogue and percussion synths.

Electronic Synthesiser Construction.

R.A.Penfold. 112 pages. £2.95. Order

Code BP185.

Even relative beginners should find the monophonic synthesiser described here within their capabilities if the book is thoroughly read. Individual aspects of the synth are dealt with separately and pcb designs are shown for the main modules.

DIGITAL AND COMPUTING

A Concise Introduction to MS-DOS.
N. Kantaris. 64 pages. £2.95.
Order Code BP232

A ready-reference guide for those who need a quick insight into the essential command functions of this operating system, but who don't have the time to learn it fully.

An Introduction to Computer Peripherals

R.A. and J.W. Penfold. 80 pages.
£2.50. Order Code BP170

Covers such items as monitors, printers, disc drives, cassettes, modems, etc. explaining what they are and how to use them with your computer and with each other.

NEW! Digital Logic Gates and Flip-Flops. Ian R. Sinclair. 192 pages. £8.95. Order Code PC 105

Intelligently looks at the basic building blocks of all digital circuits and is intended for enthusiasts, students and technicians who seek to establish a firm grasp of fundamental principles.

Introduction to 6800/6802 Microprocessor Systems

R.J. Simpson and T.J. Terrell. 238 pages. £10.95. Order Code NT9

The book covers systems hardware, programming concepts and practical experimental work that will assist in understanding the 6800/6802 microprocessor, with additional information on the 6802D5E evaluation system.

An Introduction to 68000 Assembly Language.

R.A. and J.W. Penfold. 112 pages.
£2.95. Order Code BP184

Covers the fundamentals of writing programs that will vastly increase the speed of 68000 based machines such as the Commodore Amiga, Atari ST range, Apple Macintosh, etc.

Getting the Most from Your Printer
J.W. Penfold. 96 pages. £2.95.
Order Code BP181

How to use the features found on most dot-matrix printers from programs and popular wordprocessors, showing examples of what must be typed to achieve a given effect.

Micro Interfacing Circuits

R.A. Penfold. Two books, each of 112 pages.

Book 1 : £2.25. Order Code BP130.

Book 2 : £2.75. Order Code BP131

Both books include practical circuits and useful background information though pcb layouts are not included. Book 1 mainly covers computer input-output techniques. Book 2 deals primarily with practical application circuits.

An Introduction to 6502 Machine Code.

R.A. and R.W. Penfold. 112 pages.
£2.95. Order Code BP147

Covers the main principles of machine code programming on 6502-based machines such as the Vic-20, Oric-1/Atmos, Electron, BBC and Commodore 64. It assumes no previous knowledge of microprocessors or machine code and gives illustrative programming examples.

A Z-80 Workshop Manual.

E.A. Parr. 192 pages. £3.95.
Order Code BP112

A book for those who already know Basic but wish to explore machine code and assembly language programming on Z80 based computers.

Practical Digital Electronics Handbook

M. Tooley. 208 pages. £6.95.
Order Code PC 104

Nine constructional projects introduce digital circuits, logic gates, timers, microprocessors, memory and interface circuits - an essential book for anyone interested in digital devices.

DATA AND INFORMATION BOOKS

NEW! Radio and Electronics Engineer's Pocket Book - 18th Edition. Keith Brindley. 325 pages. £9.95. Order Code NT 11

An invaluable compendium of facts, figures and formulae and is indispensable to the designer, student, service engineer and all others interested in radio and electronics.

NEW! Microprocessor Pocket Book. Steve Money. 252 pages. £9.95. Order Code NT 12

Provides a wide selection of information which will be of general use to anyone involved in developing, designing or servicing, or who just wants to learn more about microprocessor systems.

NEW! Computer Engineer's Pocket Book - 2nd Edition. Michael Tooley. 224 pages. £9.95. Order Code NT 13

An invaluable compendium of facts, figures, circuits and data indispensable to designers, students, service engineers and all others interested in computer and microcomputer systems.

Op Amps

B. Dance. £7.95.

Order Code NT2

Subtitled 'Their Principles and Applications' this interesting book is written in a simple non-mathematical style and provides a source of practical circuits that use both commonplace and more sophisticated opamps.

Electronic Hobbyists Handbook

R.A. Penfold. 96 pages. £4.95. Order Code BP233

Provides a source of useful information that the amateur enthusiast is likely to need for day-to-day pursuance of hobby electronics.

Newnes Electronics Pocket Book

I.E. Parr. £9.95.

Order Code NT10

Presents all aspects of modern electronics in a readable and largely non-mathematical style, and is a good source of valuable information for enthusiasts and professional engineers alike.

Key Techniques for Circuit Design

G.C. Loveday. £6.95.

Order Code BM 101

Tackles the problems of designing circuits from scratch, introducing the concept of target specifications, the design sequence, device selection, rules of thumb, and useful equivalent circuits.

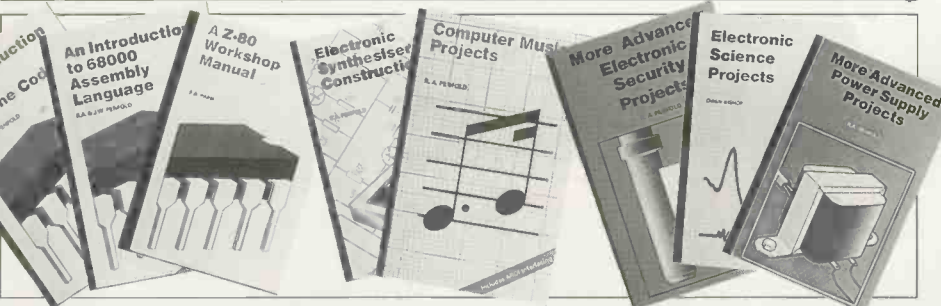

GENERAL CONSTRUCTIONAL

Electronic Science Projects.

Owen Bishop. 144 pages. £2.95. Order Code BP104

A bumper bundle of experimental projects ranging in complexity and including a colour temperature meter, electronic clock, a solid state (led display) scope, an infra-red laser, a fascinating circuit for measuring the earth's electrical field strength, and many more.

Electronic Security Devices

R.A. Penfold. 112 pages. £2.50. BP56

Full of ideas for keeping your valuables safe. The circuits include designs for light, infra-red, ultrasonic, gas, smoke, flood, door and baby sensors.

More Advanced Electronic Security Projects. R.A. Penfold. 112 pages.

£2.95. Order Code BP190

Follows on from where BP56 leaves off and describes a number of more up-to-date and sophisticated projects, such as pyro-sensors, infra-red and doppler-shift detection, fibre-optic loops, and many others.

Electronic Projects for Cars and Boats.

R.A. Penfold. 96 pages. £1.95.

Order Code BP94

15 fairly simple projects that can be used with a car and/or boat. Stripboard constructional details are included, as are explanations of the circuit theory.

Power Supply Projects

R.A. Penfold. 96 pages. £2.50.

Order Code BP76

A selection of power supply designs, including simple unregulated, fixed voltage regulated and variable voltage stabilised, ni-cad charger, voltage step-up, and inverter.

More Advanced Power Supply Projects

R.A. Penfold. 96 pages. £2.95.

Order Code BP192

Covers more advanced topics than BP76 and includes precision supplies, switch mode and computer controlled supplies, plus a selection of miscellaneous circuits.

Popular Electronic Circuits.

R.A. Penfold. 160 pages. £2.95. Order Code BP80

Containing a wide range of circuit designs for experienced constructors who are capable of producing working projects direct from a circuit diagram without specific constructional details.

HOW TO ORDER

State your order code and your name and address clearly. Enclose a cheque, PO or international money order (add 50p postage per book - £1.00 for overseas surface mail), and send to:

PE Book Service

Intra House

193 Uxbridge Road

London W12 9RA

Books are normally delivered within 10 days but please allow 28 days for delivery.

PE PCB SERVICE

IT IS EASY TO BUILD PRACTICAL ELECTRONICS PROJECTS!

Simplify your project assembly - use a ready-made printed circuit board. All are fully drilled and roller tinned. Just slot in the components as shown in the project texts, and solder them. PCBs are the professional route to project perfection.

MAIL ORDERING

Select the boards you want, and send your order to: PE PCB SERVICE, PRACTICAL ELECTRONICS, 193 UXBRIDGE ROAD, LONDON W12 9RA.

Prices include VAT and postage and packing. Add £2 per board for overseas airmail. Cheques should be made payable to Intra Press (Payments by Access and Visa also accepted). Quote the project name and PCB Code Number, and print your name and address in Block Capitals. Do not send any other correspondence with your order.

TELEPHONE ORDERS

Use your Access or Visa card and phone your order to 081-743-8888 clearly stating your name and address, card number and order details. All orders receive priority attention. Many PCBs are held in stock, so they are dispatched within a few days, but please still allow 28 days for delivery in case a PCB is temporarily out of stock.

We can only supply the PCBs listed here! Please always check the latest issue of PE before ordering.

We can also supply the photocopies of the text at £1.50 for each project part inclusive of postage and packing (overseas £2.00).

Please note that we do not supply components - they can be ordered from our advertisers!

MAR 89	CAMERA SHUTTER TIMER	187	£9.95
APR 89	PC MULTIPORT	188A/B	£20.55
MAY 89	KIRLIAN CAMERA	189A/C	£10.50
JUNE 89	SOLAR HEATING CONTROLLER	197	£7.20
	DELUXE METRONOME	198	£10.95
JULY 89	PROJECTOR SYNCHRONISER	190A	£9.50
AUG 89	EASI-BUILD - VODALEK	191	£5.50
	HAND CLAPPER	192	£6.50
SEP 89	EASI-BUILD - COMPRESSOR	193	£5.90
	FREQUENCY COUNTER-GENERATOR	194A/B	£12.50
OCT 89	EASI-BUILD VOICE-OP-SWITCH	195	£5.90
	HOME SECURITY CONTROLLER	196A/C	£19.50
DEC 89	VIDEO AGC STABILISER	199	£6.50
	ECHO STATION	200A/B	£11.50
	MINI METRONOME	201	£5.90
JAN 90	BARGRAPH TACHOMETER	202	£5.90
	EEPROM PROGRAMMER (KEYBOARD VER)	203	£14.50
FEB 90	EEPROM PROGRAMMER (SWITCH VERSION)	204	£4.90
	MODEM	205	£11.50
	MOCK STEREO	206	£4.90
MAR 90	RADIO CLOCK (TUNER AND PULSE)	207	£6.50
APR 90	RADIO CLOCK (DISPLAY DECODER)	208	£13.50
	PC/INTERFACE	209	£5.90
MAY 90	EPROM POLY-PROG (MAIN PCB)	210	£8.50
JUNE 90	EPROM POLY-PROG (TOP PCB)	211	£7.50
	MESSAGE MAKER	212	£9.50
	BAUD RATE CONVERTER	213	£4.90
	INTERMITTENT WIPER	214	£3.90
	CIRCUIT BREAKER	215	£4.90
JULY 90	MORSE DECODER	216	£9.50

JUL 87	SCOPE STORE oscilloscope add-on data storage	148	£11.94
SEP 87	GCSE TIMER UNIT - versatile variable delay	151	£5.18
OCT 87	GUITAR TO SYNTH - music interface	157A/B	£10.60
NOV 87	MIDI EXPANDER - Music Interface	159	£5.04
DEC 87	RS 232C TO MIDI	160	£6.43
JAN 88	LEGO BUGGY DRIVER	163	£6.42
FEB 88	TEACHER TALKBACK - GCSE	164	£6.36
	DC MOTOR SERVO	165	£7.53
MAR 88	APPLIANCE TIMER	166A/B	£9.38
	TEACHER LIGHTSHOW - GCSE	167A/B	£9.09
	LOGIC ANALYSER - Double-sided	168	£20.65
APR 88	LIGHT METAL EFFECTS	169	£7.10
JUNE 88	AMSTRAD ROM EXPANSION	173	£12.60
	MAINS MODEM	174	£4.90
JULY 88	VOCALS ELIMINATOR	175	£4.90
AUG 88	SPEAKING CLOCK	176	£16.75
SEPT 88	BBC MULTIPLEXER	177	£4.50
OCT 88	METAL DETECTOR	178	£6.50
DEC 88	PANNING MIXER	181	£7.80

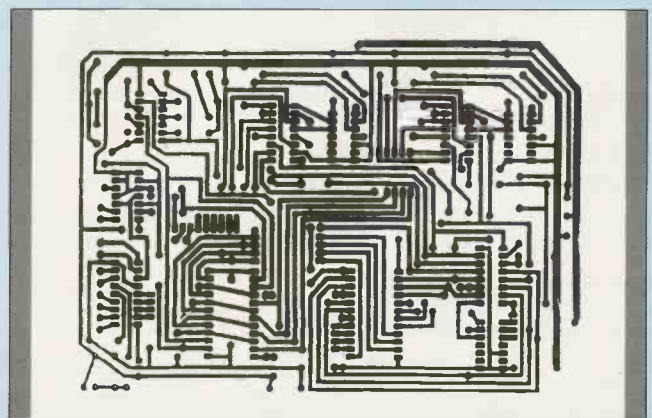

**PE PCBs are the professional route
to project perfection!**

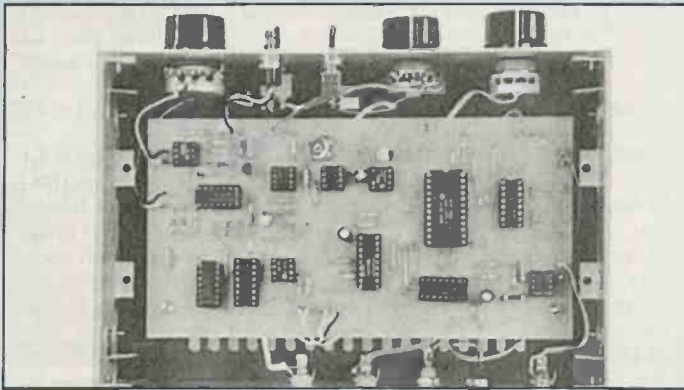

NICE AND EASY DOES IT

Building the projects published in PE is a lot easier than some of you perhaps might think. Especially when you use one of our professionally made printed circuit boards.

It's almost like painting by numbers. All the pcbs are fully drilled, and basically all you need to do is slot in the components and carefully solder them to the pcb track pads. Their places are shown in the drawings published with the project.

IDENTITIES

Component identities are usually clearly marked on them. Even if they are colour coded, like some resistors and capacitors, their values are easily worked out from component colour code charts. From time to time we publish these charts, but if you don't already have one, send a 9in x 4in stamped and self-addressed envelope to the Editorial office asking for one.

TOOLS

For many projects you only need a few simple tools - Soldering iron between 15W and 25W, with a bevelled tip. Damp sponge for keeping the tip clean. Good multicore solder of 18swg or 22swg grade. Fine nose pliers for wire shaping. Adjustable spanner or heavy pliers for tightening nuts. Miniature screwdriver for adjusting preset controls. Small wire cutters for trimming component leads. Drill and selection of bits for drilling holes in boxes. Strong magnifying glass for checking joins in close up. It's also preferable to have a multimeter for setting and checking voltages. There are some very good low cost ones available through many of our advertisers, but get one that is rated at a minimum of 20,000 ohms per volt. Many projects do not require you to have a meter, but if you are serious about electronics, you really should have one.

ASSEMBLING THE PCB

Authors will sometimes offer their own advice on the order of assembly, but as a general guide, it is usually easier to assemble parts in order of size. Start though with the integrated circuit sockets. Please use them where possible, they make life much easier than if you solder the ics themselves - with sockets you can just lift out an ic if you want.

Then insert and solder in order of resistors, diodes, presets, small capacitors, other capacitors, and finally transistors. Clip off the excess component leads after you have soldered them. Now use a magnifying glass, ideally one that you can hold to your eye, and take a good look at the joints, checking that they are satisfactorily soldered, and that no solder has spread between the pcb tracks and other joins. Be really thorough with visual checking since errors like this are the most likely reason for a circuit not working first time.

SOLDERING

Bring the tip of the iron into contact with the component lead and the pcb solder pad, then bring the end of the solder into contact with all three, feeding it in as it melts. Once sufficient solder has melted to fully surround the pad and the lead, remove the solder, and then the iron. Now allow the join to cool before touching it, otherwise the solder may set unsatisfactorily. If it does move, just reheat the join once more.

WIRING

Connecting the pcb to the various panel controls is the final assembly stage. Do this just as methodically, following the published wiring diagram. You can connect the wires to the pcb in one of three ways. The best is to insert terminal pins into the connecting holes on the pcb, and then solder wires direct to them. Or, pass the end of the wire through the pcb hole, soldering it on the other side. Alternatively, the wire can be carefully soldered direct to the pcb tracking. In all cases first strip the plastic covering off the wire, twist the strands together, and apply solder to them to keep them secure.

TESTING

Now you are ready to test and use the project as described by the author. Components can occasionally fail, but these days it is extremely uncommon, and if you have followed the instructions, been careful with your joins, and bought the parts from a good supplier, you will have the enormous satisfaction of having built an interesting and working unit. It really can be easy if you do it with care.

CHOOSE ONE NOW!

The PE PCB Service list shows all the pcbs available through PE. Look down the list and see which title takes your fancy - there must be at least one that will interest you! You will probably already have the relevant issue of PE, but even if you don't we can still help you.

BACK ISSUES

We can usually supply copies of back issues of PE up to three years old. These are £1.75 each including postage (£2.25 for overseas readers). If we no longer have the issue needed, we will be pleased to send a photocopy of the article for the project that you want to build. These are £1.00 each per issue, including postage (£1.50 to overseas readers).

OBTAINING PARTS

Some projects are available from advertising suppliers as complete kits. Otherwise, all the components listed in the text will be available from suppliers who specialise in individual components.

Occasionally a specific part may only be available from a particular supplier, if so the source will be given in the parts list. Otherwise there should be no difficulty in buying the parts. We have many good suppliers advertising in PE so have a look through their adverts - that's why they're here! Even though a part may not be listed in the adverts, a phone call or two should find a supplier who will be pleased to help. Like us, they too are in the business of encouraging you to enjoy electronics!

VARIABLE VOLTAGE TRANSFORMERS

INPUT 220/240V AC 50/60Hz OUTPUT 0-280V
 200W 0.1 amp max £24.00 p&p £3.00 (£31.05 inc VAT)
 0.5KVA 2.5 amp max £26.50 £3.75 (£34.79 inc VAT)
 1KVA 5 amp max £34.00 £4.25 (£43.99 inc VAT)
 2KVA 10 amp max £49.00 £5.50 (£52.68 inc VAT)
 3KVA 15 amp max £65.00 £6.25 (£81.94 inc VAT)
 5KVA 25 amp max £115.00
 Carriage on request



VOLTAGE CHANGING TRANSFORMER
 1250 Watt auto. Tapped 0-90V, 100, 110, 115, 120. Twice to obtain voltages between 90 and 240V. Fitted in heavy duty louvered metal case. Fused input. Price incl VAT & p&p £39.50.

FULL COMPREHENSIVE RANGE OF TRANSFORMERS-LT-ISOLATION & AUTO (110-240V Auto transfer either cased with American socket and mains lead or open frame type. Available for immediate delivery.

ULTRA VIOLET BLACK LIGHT FLUORESCENT TUBES
 4ft 40 watt £10.44 (£12.00 inc VAT) Caller only
 2ft 20 watt £7.44 + £1.25 p&p (£9.99 inc VAT)
 13in 10 watt £5.80 + 75p p&p (£7.53 inc VAT)
 12in 8 watt £4.80 + 75p p&p (£6.38 inc VAT)
 9in 6 watt £3.60 + 50p p&p (£5.12 inc VAT)
 6in 4 watt £3.60 + 50p p&p (£5.12 inc VAT)

230V AC BALLAST KIT for either 8in, 9in or 12in tubes £5.50 + 55p p&p (£6.95 inc VAT)
 For 13in tubes £6.00 + 75p p&p (£7.75 inc VAT)



400 WATT UV LAMP
 Only £34.00 + £2.50 p&p (£41.98 inc VAT)

175 WATT SELF BALLASTED BLACK LIGHT MERCURY BULBS Available with BC or ES fitting. Price incl VAT & p&p £19.84.



12 VOLT BILGE PUMPS
 Buy direct from the importers
 500 GPH 15ft head 3 amp £16.00 inc.
 1750 GPH 15ft head 9 amp £19.25 + £2.00 p&p (£25.00 inc VAT)

EPROM ERASURE KIT
 Build your own EPROM ERASURE for a fraction of the price of a make-up unit. Kit of parts less case includes 12in 8 watt 2557 Argon Tube Ballast unit pair of 8-pin leads neon indicator and switch safety microswitch and circuit £14.00 + £2.00 p&p (£18.40 inc VAT).

SUPER HY-LIGHT STROBE KIT
 Designed for Disco, Theatrical users etc. Approx 16 joules. Adjustable speed £48.00 + £2.00 p&p (£57.50 inc VAT)
 Case and reflector £22.00 + £2.00 p&p (£27.60 inc VAT)
 SAE for further details including Hy-Light and Industrial Strobe Kits.

Ample Parking Space
 Showroom open Monday/Friday

SERVICE TRADING CO

57 BRIDGMAN ROAD, CHISWICK, LONDON W4 5BB
 081-995 1560

ACCOUNT CUSTOMERS MIN. ORDER £10

WIDE RANGE OF XENON FLASHTUBES

Write/Phone your enquiries

EXTENSIVE RANGE OF DIFFERENT TYPES OF GEARED MOTORS AVAILABLE FROM STOCK

WASHING MACHINE WATER PUMP

Brand new 240V AC fan cooled can be used for a variety of purposes. Inlets 1 1/2 ins. Outlet 1 inch. Price including p&p and VAT — £10.95 or 2 for £20 including p&p and VAT.

SPECIAL OFFER AC CAPACITORS

1.5 MFD 440V £2.00 5 MFD 440V £4.00
 2 MFD 440V £2.50 5.4 MFD 280V £2.00
 4.1 MFD 440V £3.50 5 MFD 660V £3.00
 p + p 50p per unit plus VAT to be added to total.

TORIN CENTRIFUGAL BLOWER
 230V ac 2,800 RPM 0.9amp 130mm diameter impeller outlet 63 x 37mm overall size 195 x 160 x 150mm long. Price £17.50 + £2.50 p&p (£23 inc VAT)

SHADED POLE GEAR MOTORS
 In the following sizes:
 9 RPM 12 RPM 80 RPM 160 RPM 110V AC or 240V AC with capacitors (supplied). Price incl VAT & p&p £12.85

GEARED MOTORS
 71 RPM 20lb inch torque reversible 115V AC input including capacitor and transformer for 240V AC operation. Price incl VAT & p&p £23.00.

SOLID STATE EHT UNIT
 Input 230/240V AC. Output approx 15kV. Producing 10mm spark. Built-in 10 sec timer. Easily modified for 20 sec. 30 sec to continuous. Designed for boiler ignition. Dozens of uses in the field of physics and electronics. eg supplying neon or argon tubes etc. Price less case £8.50 + £1.00 p&p (£10.93 inc VAT) NMS

HEAVY DUTY MOTOR
 Crouzet 115V/230V A.C. heavy duty 1RPM motor. Anticlockwise type 82/015. Size 68mm diameter x 55mm long. Shaft 6mm diameter x 20mm long. Price inc VAT & p&p £18.40

RHEOSTAT
 50W 2 ohm 5 amp ceramic power rheostat. Price inc. VAT & p&p £10.35

MICROSWITCH
 Rye 15amp changeover lever microswitch, type S171. Brand new. Price 5 for £6.90 inc. VAT & p&p.

From stock at prices that defy competition
 C/F Blowers Program Timers
 Microswitches Synch Motors
 write/phone your enquiries

NMS = NEW MANUF SURPLUS
 R&T = RECONDITIONED AND TESTED

PROGRAMMABLE ELECTRONIC LOCK KIT

Keys could be a thing of the past with this new high security lock. Secure doors to sheds, garages, even your home or prevent the unauthorised use of computers, burglar alarms or cars. One 4-digit sequence will open the lock while incorrect entries will sound an alarm. The number of incorrect entries allowed before the alarm is triggered is selected by you. Further entries will be ignored for a time also set by you. Only the correct sequence will open the lock and switch off the alarm. The sequence may easily be changed by entering a special number and code on the supplied keyboard. Kit includes: keyboard, alarm buzzer, high quality PCB and all electronic components. Supply: 5 - 15V d.c. Wif drive our Latch Mechanism (701 150 @ £16.50) or relay directly.

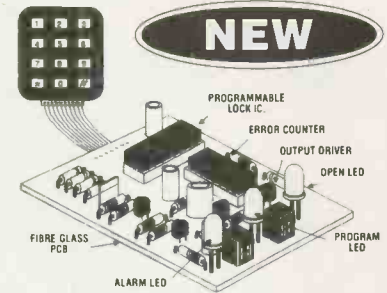

XK131 £17.35

DISCO LIGHTING KITS



DL8000K 8-way sequencer kit with built-in opto-isolated sound to light input. Only requires a box and control knob to complete. **£34.60**
 DL1000K 4-way chaser features bi-directional sequence and dimming 1kW per channel. **£21.00**
 DL21000K Uni-directional version of the above. Zero switching to reduce interference. **£11.80**
 DLA/1 (for DL & DL21000K) Optional opto input allowing audio 'beat' /light response. **80p**
 DL3000K 3-channel sound to light kit, zero voltage switching, automatic level control and built-in mic. 1kW per channel. **£17.00**

POWER STROBE KIT

Produces an intense light pulse at a variable frequency of 1 to 15Hz. Includes high quality PCB, components, connectors, 5Ws strobe tube and assembly instructions. Supply: 240V ac. Size: 80x50x45.
XK124 STROBOSCOPE KIT. £15.00

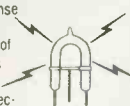

VERSATILE REMOTE CONTROL KIT



Includes all components (+transformer) for a sensitive IR receiver with 16 logic outputs (0-15V) which with suitable interface circuitry (relays, relays, etc - details supplied) can switch up to 16 items of equipment on or off remotely. Outputs may be latched to the last received code or momentary (on during transmission) by specifying the decoder IC and a 15V stabilised supply is available to power external circuits. Supply: 240V AC or 15-24V DC at 10mA. Size (exc. transformer) 9x4x2 cms. Companion transmitter is the MK18 which operates from a 9V PP3 battery and gives a range of up to 60ft. Two keyboards are available - MK9 (4-way) and MK10 (16-way).
 MK12 IR Receiver (inc transformer) **£17.00**
 MK18 Transmitter **£7.80**
 MK9 4-way Keyboard **£2.40**
 MK10 16-way Keyboard **£7.00**
 601133 Box for Transmitter. **£2.60**

VOICE RECORD/PLAYBACK KIT

This simple to construct and even simpler to operate kit will record and playback short messages or tunes. It has many uses - seatbelt or lights reminder in the car, welcome messages to visitors at home or at work, warning messages in factories and public places, in fact anywhere where a spoken message is announced and which needs to be changed from time to time. Also suitable for toys - why not convert your daughter's £8 doll to an £80 talking doll!!
 Size 76 x 60 x 15mm
 Message time 1 - 5 secs normal speed, 2 - 10 secs slow speed
XK129 £22.50

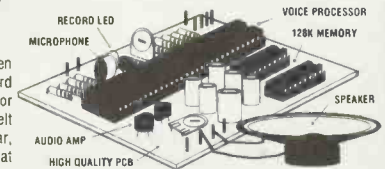

INDEX TO ADVERTISERS

A & G Electronics Ltd.....26	J.P.G. Electronics55
A.D.M. Electronics Supplies56	Keytronics.....11
Advanced Electronics Products/BIC	K. Tech55
Astronomy Now47	London Electronics College54
B.K. Electronics42	Maplin Electronics48, OBC
Barleyline Computers48	New Tech55
Bull J.24	N.R. Bardwell Ltd.55
Cambridge Computer	Number One Systems Ltd1FC
Science Ltd55	Omni Electronics54
Circuit Distribution Ltd26	Program Now55
Colebourn Electronics44	Phonosonics30
Coles Harding55	Radio and Telecommunications
Component Solutions Ltd26	Correspondence School54
Cooke International55	Scott R56
Cricklewood Electronics Ltd40	Service Trading Co62
C.R. Supply Co.55	Smart Communications55
C-Scope International Ltd40	Softmachine Distribution Ltd ...30
Davtronics30	Spiers Electronics30
Electronics Shop54	Stewart of Reading25
Eskan56	Suma Designs34
Fraser Electronics54	Technomatic Ltd.....19
Greenbank Electronics25	T.K. Electronics62
Intec (Inverclyde) Ltd.55	Virtual Reality Labs.34
J & N Bull Electrical45	Wandsworth Borough Council ..48
	A. Wood (North West)55

PLEASE MENTION PRACTICAL ELECTRONICS WHEN REPLYING TO ADVERTS

TR ELECTRONICS
 13 BOSTON RD. LONDON W7 3SJ
 TEL: 01-567 8910.
 FAX: 01-566 1916

ORDERING INFORMATION:
 All prices exclude VAT. Free P & P on orders over £50 (UK only), otherwise add £1 + VAT. Overseas P & P: Europe £3.50. Elsewhere £10. Send cheque/PO/Visa/Access No. with order. Giro No. 529314002
 LOCAL AUTHORITY AND EXPORT ORDERS WELCOME
 GOODS BY RETURN SUBJECT TO AVAILABILITY

ADVANCED ELECTRONICS PRODUCTS LTD

P.O. BOX 10, Newton Abbott, Devon. TQ12 1JP Tel: (0626) 332091 Fax: (0626) 332381

MAIL ORDER TERMS: POSTAL ORDER OR CHEQUE WITH ORDER. PLEASE ADD 75P POST AND PACKING TO ORDER VALUE AND THEN 15% VAT. IF KIT INCLUDES MAINS TRANSFORMER THEN ADD AN ADDITIONAL £2. ACCESS & VISA HOLDERS PLEASE PHONE ORDER BEFORE 4.45 PM FOR SAME DAY DESPATCH. ALL ORDERS UNDER 750 GRMS SENT BY FIRST CLASS POST. OVERNIGHT CARRIER £9.

RESISTORS	CAPACITORS	CAPACITORS	CMOS	DIODES	
Carbon Film 0.25W E12 or E24 series 1 p each (min quantity 10 per value), 80p per 100, £6.00 per 1000.	Radial Aluminium Electrolytic 20% tolerance	Disc Ceramic 5% tolerance 150Volt values in pF	4000 17p 4001 17p 4002 17p 4006 37p 4007 17p 4008 37p 4011 17p 4012 17p 4013 25p 4014 37p 4115 37p 4016 28p 4017 37p 4018 37p 4020 37p 4021 37p 4022 37p 4023 17p 4024 35p 4025 17p 4027 34p 4028 37p 4029 37p 4032 56p 4034 95p 4035 44p 4038 65p 4040 37p 4042 37p 4043 37p 4044 37p 4046 47p 4049 27p 4050 27p 4051 37p 4052 37p 4053 37p 4060 37p 4066 29p 4067 99p 4068 17p 4069 17p 4070 17p 4071 17p 4072 17p 4073 17p 4075 17p 4076 37p 4077 17p 4078 17p 4081 17p 4082 17p 4093 27p 4094 48p 4097 99p 4099 46p	4106 34p 4160 40p 4161 40p 4162 40p 4163 40p 4174 37p 4175 40p 4194 42p 4501 27p 4502 40p 4503 37p 4504 120p 4506 76p 4508 99p 4510 37p 4511 37p 4512 37p 4513 99p 4514 85p 4515 80p 4516 37p 4517 99p 4518 37p 4519 26p 4520 37p 4521 85p 4522 44p 4526 44p 4527 44p 4528 44p 4529 50p 4530 99p 4531 44p 4532 60p 4534 240p 4536 120p 4538 54p 4539 45p 4541 50p 4543 54p 4544 130p 4547 130p 4549 400p 4551 85p 4553 120p 4554 320p 4555 50p 4556 50p 4557 120p 4558 120p 4559 440p 4560 110p call sales for 4500 series above 4560	1N914 5p 1N4148 4p 1N4001 3p 1N4002/3/4/5/6 4p 1N5401 7p 1N5402/4/6/8 11p
Special Offer Mixed Pack, of 1000 Carbon Film resistors, 1R to 10M, 100 different values all separately packed and labeled only £5.90	10/16/25/35 Volt 4.7,10,22,33,47,100 12p 220,330,470 20p 1000 30p 2200 48p 3300 65p 4700 85p	10% tolerance value in pF 220,330,470,680 6p 1000,1500,2200 8p 3300,4700,6800		Zener Diodes 500 mW 2.4,2.7,3.3,3.9,4.7,5.1,5.6,6.2,6.8,8.2,10,11,12,13,15,16,18,20,22,24,27,30,33,36,39,43,47,51,56,62,66,75,82,91 All above voltages at 5p each	
Metal Film 0.25/0.5 W E96 series 10R to 1M0 4p each (min quantity 10 per value), £3.00 per 100.	50/63/ Volt 0.47,1,2.2,3.3,4.7,10 12p 22,33,47 20p 100,220 30p 470 50p 1000 90p	+80%-20% tol. value pF 4700,10000 6p 22000,47000 9p		1.3W 3.3, 3.9, 4.3, 4.7, 5.1, 5.6, 6.2, 6.8, 7.5, 8.2, 9.1, 10, 11, 12, 13, 15, 16, 18, 20, 22, 24, 27, 30, 33, 36, 39, 43, 47, 51, 56, 62, 68, 75, 82, 91. All above voltages at 16p each	
Ceramic/wire wound 4W OR1-10K 35p each 7W OR33-12K 37p each 11W OR68-10K 40p each 17W 1R-10K 44p each 5% discount on 10+, 10% on 25+ 20% on 100+	100 Volt 0.47,1,2.2,4.7 12p 10,22 20p 47 30p 100 50p	Tant. Bead resin dipped 20% tolerance value in uF 6.3 Volt 10,22 15p 47 25p		2.5W,20W & 75W versions available	
Enclosed Pre-Sets 100R-10M 20% Horizontal or Vertical 24p each. 5% discount on 10+, 10% on 25+, 20% on 100+	Ultra miniature Aluminium electrolytic radial 20% tolerance 4V 18p 220 18p 6.3 Volt 18p 22,100 18p 16 Volt 18p 10,22,47 18p 25 Volt 18p 10,22,33 18p 35 Volt 18p 4.7,10,22 18p 50 Volt 18p 0.1,0.22,0.33,0.47, 1,2.2,3.3,4.7,10	10 Volt 3.3,4.7,6.8 15p 10,15 25p 22,33,47 35p		Bridges W005 23p W02 25p W04 30p W06/08 35p 2A 200V 65p 2A 400V 72p 2A 600V 90p 6A 200V 78p 6A 400V 84p 6A 600V 99p	
Enclosed Pre-Sets 100R-10M 20% Horizontal or Vertical 24p each. 5% discount on 10+, 10% on 25+, 20% on 100+		25 Volt 1,2,2.3,3 15p 4.7,6.8 25p 10,15 35p			
20 Turr 3/4" Cermet Pots 10% tolerance 10R-2M 90p each, 5% discount on 10+, 10% on 25+, 20% on 100+		35 Volt 0.1,0.22,0.33,0.47 15p 0.68,1,2.2,3.3 20p 4.7,6.8,10 30p		Linear I.C.s call for price	

TRANSISTORS

BC107B	20p
BC108B	20p
BC109C	22p
BC184C	6p
BC212B	6p
BC239C	4p
BC307C	4p
BC548C	4p
BC558C	4p
ZTX300	17p

The above are a few examples from the 1000's of transistor types we have. We cover all ranges and types including JFET, SIPMOS, TMOS, TIP plastic & metal, FET & Darlington's.

REGULATORS

7805 5V @ 1.5A	30p
7812 12V @ 1.5A	30p
7815 15V @ 1.5A	30p
7905 -5V @ 1.5A	30p
7912 -12V @ 1.5A	30p
7915 -15V @ 1.5A	30p

KITS KITS KITS

ALL KITS ARE SUPPLIED WITH HIGH QUALITY GLASS FIBRE SILK SCREENED PCB, FULL INSTRUCTIONS, HEATSINK, SOLDER ETC. CASE NOT SUPPLIED BUT AVAILABLE.

CONSTANT CURRENT NI-CAD CHARGER Charge your NI-Cads safely, can be left on indefinitely without damage, batteries fully charged from flat in approx. 18 hours. Charge up to 12 batteries in series (except PP3). (with transformer) **£7.50**

FAST NI-CAD CHARGER Rapidly charge your NI-Cad racing pack from mains or 12Volts. Charger guarantees a full charge every time, making maximum use of your pack. (with transformer) **£10.00**

BENCH POWER SUPPLY 2.5 - 35 Volt @ 2 Amps The following spec ensures excellent value for money for this most essential of workshop equipment. Line Reg. 0.03%, Load Reg. 0.1% Ripple Rejection 70 dB, Output Res. 1.5 milliOhm, Output Noise 80uV. (with transformer) **£8.00**

10 Amp BENCH POWER SUPPLY 5 - 33 Volt Use for powering C.B./Ham Radios, or a very high powered bench power supply. Spec as 2A version above. (with transformer) **£32.00**

FM Bug, 26 x 16 x 12mm, super sensitive 500yd range 4.5-9V supplied with miniature mic & ready wound coil. **£4.50**

Telephone Bug, powered from phone line. Spec as above. **£4.00**

HUNDREDS OF KITS AVAILABLE - SEND FOR LIST

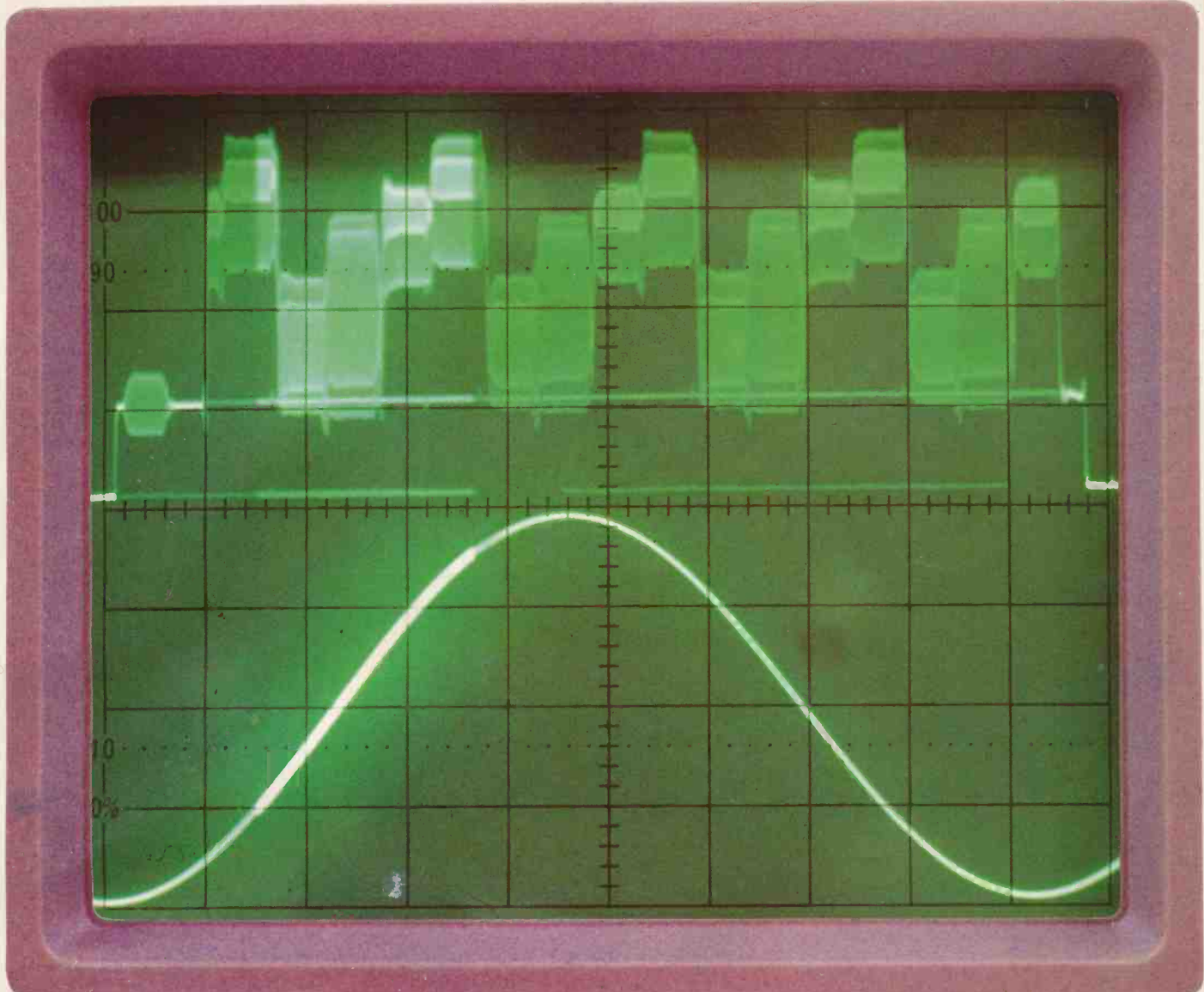

Does yours pass the screen test?

We believe ours do!!!

Precision laboratory oscilloscopes. Triple-trace 20MHz 3 channels-3 trace. XY mode allows Lissajous patterns to be produced and phase shift measured. 150mm rectangular CRT has internal graticule to eliminate parallax error. 20ns/div sweep rate makes fast signals observable. Stable triggering of both channels even with different frequencies is easy to achieve and a TV sync separator allows measurement of video signals. Algebraic operation allows the sum or difference of channel 1 and 2 to be displayed. 50mV/div output from CH 1 available to drive external instrument e.g. frequency counter. Also available, 40MHz triple trace oscilloscope. Similar to the model described above but with 12kV tube that is super bright even at the highest frequencies. This instrument also has a delayed sweep time base to provide magnified waveforms and accurate time interval measurements.

- TOA10 (20MHz Triple Scope) £334.95
- TOB10 (40MHz Triple Scope) £549.95

TEST EQUIPMENT - Choose from the extensive range featured in our new 580 page Electronics Catalogue. Available in all our shops or from WHSMITH for £2.25 or £2.75 by mail. No carriage charge if ordering Catalogue only.

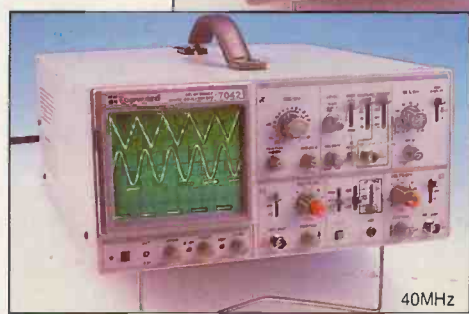
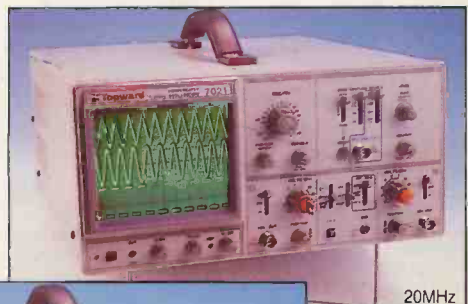

CREDIT CARD HOTLINE
0702 554161
PHONE BEFORE 5PM FOR SAME DAY DESPATCH



Maplin ELECTRONICS

P.O. BOX 3, RAYLEIGH, ESSEX, SS6 8LR.
All items subject to availability, all items will be on sale in our shops in Birmingham, Bristol, Leeds, Hammersmith, Edgware, Manchester, Nottingham, Newcastle-upon-Tyne, Reading, Southampton and Southend-on-Sea.
Add Carriage 75p. **ALL PRICES INCLUDE VAT.**

module whether it is to regard codes on its data lines as character addresses or screen control data. The E line can be regarded as the enable or clock line, and this has to be taken up and down each time a new instruction code is to be actioned.

In this morse decoder we use the module under 8-bit data control, with one screen line, shifting left by one place each time the E line is toggled. Each new character is placed at screen position eight, ie, the far right hand side. The effect is that the decoded morse messages appear to be travelling in from the right and out at the left of screen. No provision has been allowed with the decoder for recalling data that has moved off screen.

INITIALISATION GATING

The eeprom is programmed so that the set of instructions required for initialisation is stored in an area separate from the normal character decoding codes. Eeprom line A9 when high re-addresses the eeprom to the initialisation codes area. With lines A3-A8, plus A10, held low, the counter IC4a is clocked from a separate oscillator so that the eeprom progressively sends the required initialisation codes in sequence. At the end of the routine the system automatically switches itself to morse-receive mode.

IC5c and IC5d form the oscillator responsible for clocking the counter and the lcd module in the initialisation routine. The clock frequency is set by C12 and R14, though the actual frequency is largely irrelevant, providing it is within audio range.

At switch-on, C6 begins to charge via R8. Both components are connected to the clock input of the counter IC4b. When the voltage level on C6 has risen sufficiently, IC4b is triggered and its Q0 output goes high. This sets eeprom address line A9 high, so switching the eeprom's memory to the routines controlling initialisation.

Q0 is inverted by IC5f which takes the RS line low, so telling the module that any instructions coming in on the data lines D0-D7 are to be treated as control commands rather than screen data information.

The output from IC5f also controls the gate IC6. Internally, the gate consists of four separate single pole changeover switches. The block diagram is shown in Fig.4. With IC6's Select input, pin 1, held low by IC5f, the gate is switched so that inputs 2, 5, 11 and 14 are routed to outputs 4, 7, 9 and 12 respectively. Consequently, output pin 4 holds IC3 reset and momentarily resets IC4a. The oscillator is routed to the clock input of IC4a, and also to the E line.

The oscillator clocks IC4a step by step, causing the eeprom to progressively cycle through the data held as instructions for the lcd. Since the lcd is simultaneously triggered by the oscillator, it responds to these instructions, putting itself into the required operational mode referred to above. There are only eight instructions required so on the ninth count IC4b is reset by the high level

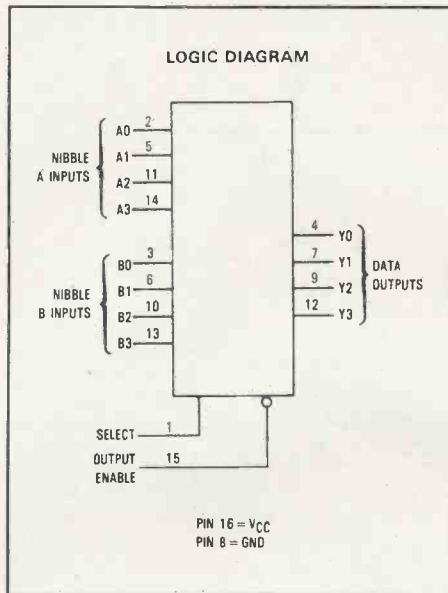

Fig 4. Logic diagram of the 74 HC157 chip used for IC6.

now on IC4a pin 14. This action terminates the initialisation sequence since IC4b Q0 is simultaneously reset to zero.

Gate IC6 automatically switches over to its other state, now routing input pins 3, 6, 10 and 13 to outputs 4, 7, 9 and 12 respectively. This condition remains stable as IC4b cannot be retriggered by the clock input because C6 will remain fully charged until the unit is switched off. It is in this stable state of IC6 that the signal routing described in the body of the text takes place.

TONE OUTPUT

You will notice that I have provided an option for sending a constant tone via C20 and R15 to an external switch, S2, and a volume control VR4. I didn't build this option into my own box, but I have placed C20 and R15 on the pcb. The intention of the option is allow for a morse practice key to be used as S2. By coupling the output of VR4 back to the signal input at C1, you can practice your morse code and see the accuracy of your keying displayed on the lcd screen.

POWER SUPPLY

The circuit requires a stabilised 5V supply. The limit of 5V must not be exceeded otherwise the eeprom, the lcd module and IC6 will die rather hurriedly. The only way you can safely run the unit from a supply greater than 5V is to use the optional regulator chip IC8. Voltages up to around 9V dc can be put into IC8 and it will then deliver a stable 5V supply to the rest of the circuit.

The lcd module additionally requires a negative voltage supply. This is generated by using the oscillator as the drive for an inverter circuit. C13-C15, D7, D8 and VR5 are the associated components. Since the negative voltage determines the lcd's screen contrast, VR5 is included to preset it to the desired level, usually at around -3V, though this will depend partly on ambient light conditions.

000	20	45	49	53	48	35	ff	ff
008	ff	ff	ff	ff	ff	ff	ff	ff
010	ff	ff	ff	ff	ff	36	ff	ff
018	ff	ff	ff	ff	ff	ff	ff	ff
020	ff	ff	ff	ff	42	26	ff	ff
028	ff	ff	ff	ff	ff	ff	ff	ff
030	ff	ff	ff	ff	ff	37	ff	ff
038	ff	ff	ff	ff	ff	ff	3B	ff
040	ff	ff	ff	44	4c	65	ff	ff
048	ff	ff	ff	ff	ff	ff	ff	ff
050	ff	ff	ff	ff	ff	ff	ff	ff
058	ff	ff	ff	ff	ff	ff	ff	ff
060	ff	ff	ff	ff	5a	ff	3f	ff
068	ff	ff	ff	ff	ff	ff	ff	ff
070	ff	ff	ff	ff	ff	38	ff	ff
078	ff	ff	ff	ff	ff	ff	ff	ff
080	ff	ff	4e	52	46	23	ff	ff
088	ff	ff	ff	ff	ff	ff	ff	ff
090	ff	ff	ff	ff	ff	2f	3c	ff
098	ff	ff	ff	ff	ff	ff	ff	ff
0A0	ff	ff	ff	ff	43	2b	ff	ff
0A8	ff	ff	ff	ff	ff	ff	ff	ff
0B0	ff	ff	ff	ff	ff	ff	ff	ff
0B8	ff	ff	ff	ff	ff	ff	ff	ff
0C0	ff	ff	ff	47	50	ff	ff	ff
0C8	ff	ff	ff	ff	ff	ff	ff	ff
0D0	ff	ff	ff	ff	ff	28	ff	ff
0D8	ff	ff	ff	ff	ff	ff	ff	ff
0E0	ff	ff	ff	ff	6f	ff	ff	ff
0E8	ff	ff	ff	ff	ff	ff	ff	ff
0F0	ff	ff	ff	ff	ff	39	27	ff
0F8	ff	ff	ff	ff	ff	ff	ff	ff
100	ff	54	41	55	56	34	ff	ff
108	ff	ff	ff	ff	ff	ff	2d	ff
110	ff	ff	ff	ff	ff	3d	ff	ff
118	ff	ff	ff	ff	ff	ff	ff	ff
120	ff	ff	ff	ff	58	ff	ff	ff
128	ff	ff	ff	ff	ff	ff	ff	ff
130	ff	ff	ff	ff	ff	ff	ff	ff
138	ff	ff	ff	ff	ff	ff	ff	ff
140	ff	ff	ff	4b	61	ff	2f	ff
148	ff	ff	ff	ff	ff	ff	ff	ff
150	ff	ff	ff	ff	ff	2b	2e	ff
158	ff	ff	ff	ff	ff	ff	ff	ff
160	ff	ff	ff	ff	51	61	21	ff
168	ff	ff	ff	ff	ff	ff	29	ff
170	ff	ff	ff	ff	ff	ff	ff	ff
178	ff	ff	ff	ff	ff	ff	ff	ff
180	ff	ff	4d	57	75	33	ff	ff
188	ff	ff	ff	ff	ff	ff	ff	ff
190	ff	ff	ff	ff	ff	ff	ff	ff
198	ff	ff	ff	ff	ff	ff	2c	ff
1A0	ff	ff	ff	ff	59	ff	ff	ff
1A8	ff	ff	ff	ff	ff	ff	ff	ff
1B0	ff	ff	ff	ff	ff	6e	ff	ff
1B8	ff	ff	ff	ff	ff	ff	ff	ff
1C0	ff	ff	ff	4f	4a	32	ff	ff
1C8	ff	ff	ff	ff	ff	ff	ff	ff
1D0	ff	ff	ff	ff	ff	ff	ff	ff
1D8	ff	ff	ff	ff	ff	ff	ff	ff
1E0	ff	ff	ff	ff	2e	31	ff	ff
1E8	ff	ff	ff	ff	ff	ff	ff	ff
1F0	ff	ff	ff	ff	ff	30	ff	ff
1F8	ff	ff	ff	ff	ff	ff	ff	ff
200	30	30	30	34	0c	01	07	88
200 to 3f8	: don't care (not used)							
400	a5	a5	a5	a5	a5	a5	a5	a5
then repeat a5 till:								
500	b0	b0	b0	b0	b0	b0	b0	b0
then repeat b0 till:								
600	30	30	30	34	0c	01	07	88

Fig 5. (E)eprom hex dump.