

Personal Computer

NEW
MS-DOS
REVIEWED

Canada \$2.75/US \$2.50/FF 18.50/FL 8.15/SFr 8.00/IR £1.23/BFr 94.00/
Lire 4,700/DKr 24.00/Nkr 14.55/DM 9.5

World May 1983 85p

BRITAIN'S LARGEST SELLING MICRO MAGAZINE



TI MOUNTS THE IBM BANDWAGON
New office micro from Texas

**NEW
MODEL**

**LOWER
COST**



Cromemco System One

MicroCentre introduce Cromemco's new System One computer, available with an integral 5 megabyte Winchester hard disk, at a new low price.

The System One supports the full range of Cromemco interface cards, including high resolution colour graphics, and software packages. The choice of operating systems includes CDOS, CP/M and CROMIX—Cromemco's answer to Unix.

Call MicroCentre for  Cromemco

MicroCentre Ltd
(Complete Micro Systems)

**Britain's independent
Cromemco importer**

**30 Dundas Street
Edinburgh EH3 6JN
Tel: 031-556 7354**

Everything you ever wanted in micros but didn't know who to ask

Digitus SYSTEMS

The 80/20 Solution

Eighty per cent of our customer needs are satisfied by matching requirements to packaged programs and machines.

Business Systems Group offers a comprehensive range of packages for both the Sophisticated User and New User.

Office Systems Group covers wordprocessing and record management needs, with single and multi-workstation systems.



Personal Systems Group helps managers and professionals with Micro Aided Management tools including: financial planning, modelling, linear programming, PERT and personal productivity aids.

Special Systems Group supplies packages to suit particular professions and industries including agencies, printers, manufacturers, distributors, dentists etc.

The Systems Groups install complete solutions, arrange training and hand hold you through to comfortable operation of your system.

The 20/80 Solution

Twenty per cent of our customers needs are satisfied by tailored design, programming, engineering and project management.

Digitus has a five-year record of fulfilling small and large microcomputing projects, e.g.

Technical Projects to take data from (1) solar heating panels (2) weighing machines and (3) oil tankers.

Administrative Projects to organise (1) 2000 bottles of urine per week (2) £1 million of barley receipts and (3) 6000 graduate applicants for 27 sites.

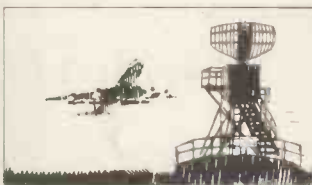

Multi-Machine Projects for (1) the complete computerisation of a City commodity broker and (2) a flight information system in an International Airport to drive 300 information receivers, staff monitors, passenger displays and flapperboards.

The Project Groups take turnkey responsibility and use as many standard software and hardware components as requirement and technical constraints allow.

Digitus PROJECTS

Digitus TRAINING

The 100% Solution

Everyone needs some education and training in micros. Digitus modular training programme provides for executives, managers, technicians, computer and office personnel.

No.		Next date
Introductory Courses		
1	Introduction to Microcomputers	Oct 10
2	Business Systems	11
3	Information Management	12
4	Management Aids	13
Skills Training		
5	Fundamentals of BASIC	May 10/11
6	Improve your BASIC	12/13
7	Wordprocessing with WordStar	May 24
8	DataStar/SuperSart MailMerge	June 29
Computer Professionals Courses		
9	Hardware for Software People	June 13
10	Operating Systems and Languages	14
11	Communications & Networks	15
12	Applications Design & Products	16
13	System & Program Generators	17
Computing Management Seminars		
14	Micro Technology & Strategy	May 17
15	Local Area Networks	May 18
16	Micro DataBase Managers	May 19

All courses include practical work and advice on microcomputers. Course fees: 1-8 £95 per day; 9-16 £125 per day + VAT, including luncheon and detailed course notes. You save £10 per day by booking more than one day's training at one time.

Request for:

- Quotation
- Response to tender
- Course booking
- Training information
- General information

Company _____

Address _____

Phone No _____

Name _____

Position _____

Requirement _____

MD

DIGITUS LTD
LADING HOUSE
10-14 BEDFORD ST
COVENT GARDEN
LONDON WC2E 9HE
Telephone (01) 379 6968
Telex 27950 Ref. 3005

CONTENTS

Vol 6 No 5 May 1983



Cover by Ian McKinnell

BENCHTESTS & REVIEWS

MICROSCRIPT 122

Intelligent Software has produced a set of related CP/M packages. Kathy Lang investigates MicroScript, the family's word processor.

SOUND ADVICE 126

Maggie Burton gets to grips with audio-visual training packs designed to teach you Pascal and CP/M.

LEARNING BY EAR 133

Steve Harris plugs in his tape recorder and tests a package that will help you make sense of Wordstar.

COMMODORE 64 136

Mike Curtis Benchtests this new colour and sound computer.



FEATURES

RELIABLE CODE 110

Programming tips from Ric Wickham.

CENTRONICS HOOK-UP 118

A J Simmonds links his Video Genie to a Tandy Lineprinter.

WHICH SPREADSHEET? 148

Mike Liardet continues his series with an evaluation of Plannercalc.



TI PROFESSIONAL 152

A new micro from Texas Instruments, tested by Robin Webster.

MICROPEN 186

Kathy Lang again — This time she examines Intelligent Software's MicroPen in her regular Database Benchtest series.



Founder Angelo Zgorelec Editor Peter Rodwell Consultant Editors David Tebbutt, Dick Pountain Deputy Editor Jane Bird Assistant Editor Maggie Burton Home Computing Editor Steve Mann Editorial Secretary Tracy Dear Art Editor Phoebe Creswell-Evans Design Assistants Richard Gadsby, Safu-Maria Gilbert Typesetters Jane Hannell, Anne Ashby Publishing Manager Fiona Collier Group Advertisement Manager John Cade Advertisement Manager Patrick Dolan Assistant Advertisement Managers Peter Goldstein, Herbert Wright Sales Executives Jan Martin, Gill Harrison, Gayle Thomson, Michael Clarke, Caroline Shepherd Micromart Gaye Collins Advertisement Assistant Priscilla Senior Group Production Manager Robert Buggs, Advertisement Production Tony Keefe Production Assistant Eva Wroblewska

PRINTER SPRINTER	119
Andrew May describes an interrupt-driven Centronics interface for the Nascom.	
MUSIC MAKER	160
Chris Jordan explains how to use the complex sound commands on the BBC Computer.	
IN SEARCH OF PERFECTION	180
Peter Rodwell is a man with a mission — the quest for the perfect operating system. Here he weighs up MS-DOS 2.	
BRAINDUMP	183
Office pedant Steve Mann gets hot under the collar about slipshod standards in computer documentation.	



A WRITER'S PARADISE	194
Jon Vogler details the pitfalls that await the newcomer to word processing.	
AN INTRODUCTION TO LISP	196
J P Bennett offers a guide to this artificial intelligence language.	

REGULARS

NEWSPRINT	100
It's that man Kewney again! All the news that's fit to print..	
MICRO CHESS	112
Tony Harrington writes about German manufacturer Hegener & Glaser.	
COMMUNICATIONS	114
Your chance to have your say.	
NUMBERS COUNT	125
Mathematical puzzles for numbers freaks.	



BANKS' STATEMENT	134
Martin's monthly musings — this time he sounds off about office automation.	
SCREENPLAY	143
Steve Mann brings you his favourite Spectrum games.	
COMPUTER ANSWERS	158
Len Warner and his team of experts are here to help you out.	
PCW SUB SET	166
Alan Tootill & Co with another batch of assembler subroutines.	
TJ'S WORKSHOP	171
Hints 'n' tips for byte-bashers everywhere.	

SUBSCRIPTIONS	176
Convincing reasons for sending us money!	
BEGINNERS START HERE	179
New to computing? This page is for you.	
PORTABLE COMPUTER WORLD	184
Dick 'Hand-held' Pountain puts Casio's new PB100 through its paces.	
DIRECT ACCESS	198
Includes Packages, ACC News, ComputerTown centres, Networks, Diary Data.	
PROGRAMS	214
Latest listings from our indefatigable readers.	
LEISURE LINES	235
J J Clessa poses another problem.	
BLUDNERS	235
Mistakes? Us?! Well, to err is human...	
BACK ISSUES	236
Just see what you've missed!	
CHIP CHAT	336
Industry gossip, scandal, things that made us laugh...	





How many hours did you lose last year?

Whatever your business or profession, in this day and age you just can't ignore the personal business computer.

And the best buy of all is the Osborne portable computer, which comes complete and ready to go with a whole range of business software to handle all the details of words, numbers and information you deal with every day.



Now, for professionals who charge their time to clients, Osborne offers a very special package. A complete Time & Cost Recording System – designed and produced by a leading UK software company, Padmede Computer Services.



The Time & Cost Recording package enables you to record and charge your time accurately and quickly – and includes an Incomplete Records system so you can produce a full set of financial accounts simply from details of postings entered onto a Transaction File.

At a mere £299 (plus VAT) it's a package you can't afford to be without.

And don't forget that at £1,375 (plus VAT) the Osborne 1 already includes SUPERCALC® for electronic spread-

sheets, WORDSTAR® for word processing, CP/M® the control program that gives you access to the world's biggest library of software options, plus CBASIC® and MBASIC® for programming.

See the Padmede System with the Osborne 1, at your local Osborne Authorised Dealer right now.

After all, time is money.

OSBORNE 1

To: Osborne Computer Corporation (UK) Ltd.,
Brochure Despatch Centre, Dept. No. 845, Hendon Road,
Sunderland SR9 9XZ. Tel: 01-247 4841.
Please send me full details of the Osborne 1.

Name _____

Address _____

Company _____

Nature of Business _____

Position Held _____

PCW/5/83



The £1,375 suggested retail price for the Osborne 1 (a registered trademark of Osborne Computer Corporation) includes a full business keyboard, built-in CRT display, two built-in double density floppy disk drives, CPU and 64 kilobytes of RAM memory, RS-232 and IEEE 488 interfaces, and the following software packages: WORDSTAR® word processing with MAILMERGE® (a trademark and a registered trademark of MicroPro International Corporation of San Rafael, California); SUPERCALC® electronic spreadsheet system (a trademark of Sorcim Corporation); CBASIC® (a registered trademark of Compuser Systems); MBASIC® (a registered trademark of Microsoft); CP/M® (a registered trademark of Digital Research); the Incomplete Records and Time & Cost Recording programs are licensed from Padmede Computer Services.

01 COMPUTERS 01-228-2207. 01 COMP

**YOU
SIMPLY
CANNOT AFFORD
TO MISS THIS OFFER**

REMEMBER! WE SPECIALISE, YOU BENEFIT



**£1,675
+ VAT.**

**FREE
80 104 COLUMN
CARD
WORTH OVER £200
UNTIL 31 MAY
ONLY**

*** DOUBLE
DENSITY OSBOURNE
(NEW STYLE) PLUS**

* A TEC FP 1500-25 Daisywheel printer (25 C.P.S. fully Wordstar compatible, with sheetfeeder + tractor option) – was retailing for over £1000 + VAT. Plus!

* A Software package of Wordstar/Mailmerge, Supercalc, C.Basic + M.Basic

PLUS! PLUS! PLUS!

A free Osborne 80/104 column card (until 31st May only). Worth over £200

Also available: Accounts, Packages, Modems, Extended Warranties on site maintenance contracts.

CALL NOW!

01 COMPUTERS

Southampton House, 192/206 York Rd, Battersea, London SW11

01-228-2207

(300 yards from Wandsworth Bridge roundabout)

PUTERS 01-228-2207. 01 COMPUTERS 01

SPECTRUM/ZX81 POWER BUFFERS

No longer suffer from lost programs due to power loss and accident. With our power supply buffer your Sinclair can continue to run for up to 1 hour* after power off, giving you plenty of time to save that vital program.

Not only that, it also suppresses power spikes to prevent those mysterious white outs, and has a red LED warning device to inform you of power on/off situation.



And all at only
£12.50 + £1.20 p&p

*On a ZX81 with a 16k RAM

MANUFACTURERS OF THE CHEAPEST INTERFACE ON THE MARKET

Cheap does not have to mean poor quality and bad manufacture! We at COBRA have proved that cheap doesn't have to mean just that. Just a look at the features that are standard will tell you that we include facilities that others may not. eg. Variable Baud rate by software control. Upper and lower case printout. Up to and including 120 ch/line, variable by software control. User programmable graphics also by software control. Plugs on back of ZX. No external power supply needed. Handshake facility as standard. And many more than just these listed.

And all this at just **£29.95p. Postage free.**

ANOTHER FIRST FROM COBRA THE COBRA INTELLIGENT RS232 INTERFACE FOR THE ZX81

Again we have done it. This time with a truly intelligent interface. With this device you can communicate between two ZX81 via an available medium, eg. telephone etc. The possibilities are endless, and with the COBRA teletype software full pages of information can be transmitted anywhere. Not only that, the price is also unbelievable.

For more information send for our brochure.

OUR PRINTER PRICES MUST BE THE BEST BARGAIN IN THIS MAGAZINE

We not only sell high quality interfaces and computer add ons. After looking at all the printers on the market we believe that you cannot beat the Micro line for quality and efficiency. This printer already sets the standards that others follow later. Bi-directional, short line seeking, 5-10 & 6.5 ch/inch, 80ch/line, upper/lower case, 8 Euro languages type faces selectable, block graphics, both RS & Centronics inputs as standard and lots more.

At only **£280 + VAT.**
Postage free.

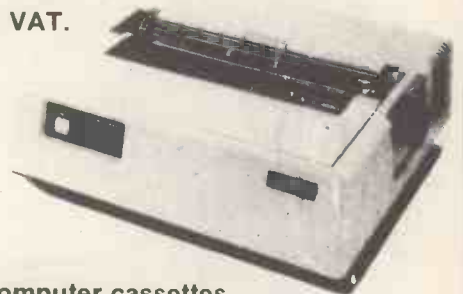

High quality computer cassettes.

We only sell the highest quality available. All cassettes are guaranteed as against most other makes.

C12 ... £0.55p C30 ... £0.60p

*Please add **£1.50** for P&P if order under **£5.00p**

COBRA TECHNOLOGY

378 Caledonian Rd, London, N1 1DY

NEW

FROM BASF

range of Floppy & Winchester disk drives, from official BASF distributors

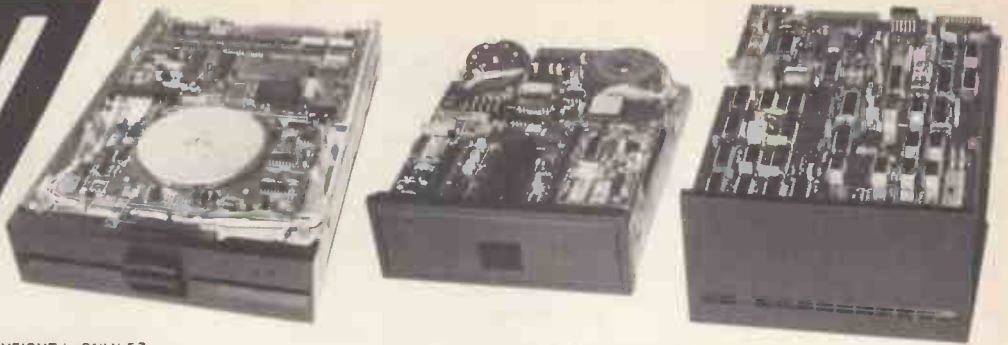

5 1/4" WINCHESTER HARD DISKS (ST-506 compatible)

- 6182 5.0 Mbyte formatted £499 + £10 Carriage + VAT = £585.35 inc.
 - 6183 7.5 Mbyte formatted £575 + £10 Carriage + VAT = £672.75 inc.
 - 6184 11.5 Mbyte formatted £650 + £10 Carriage + VAT = £759.00 inc.
 - 6185 21.0 Mbyte formatted £799 + £10 Carriage + VAT = £930.35 inc.
- Xebec S1410 HD Controller Card. £350 + £5 Carriage + VAT = £408.25 inc.
- Professional Switched Mode PSU for HD drives with cover — + 5V @ 2A, +12V @ 4.5A £125 + £5 Carriage + VAT = £149.50 inc.
- FLOPPY DISK DRIVES
- 6118-5 1/4" 96TPIDS 1 Mbyte £225 + £10 Carriage + VAT = £270.25 inc.
 - 6105-8" Slimline DS/DD direct drive, DC only 1.6 Mbyte £375 + £10 Carriage + VAT = £442.75 inc.

- HEIGHT is ONLY 57 mm (Half the height of other disk drives).
- Tech: Features — BASF 6105 8" DRIVE
- Direct drive motor eliminating need for a belt as in other drives.
 - Data storage capacity is 1.6 MByte unformatted and 1.2 MByte
 - Very quiet operation compared with other products.
 - Low heat dissipation and power consumption.
 - Fast positioning 3 m sec track-to-track.
 - Fast motor start-time.
 - Extremely reliable — MTBF of 10,000 P.O.H.
 - Disk ejector system makes disk removal easy.
 - Two status indicator lights on front panel — 'ready' and 'door lock'.
 - Industry compatible interface (Shugart).
 - No AC power is required, only +5V and +24V DC.
 - Competitively priced for OEMs.
 - Delivery normally from stock.

- Tech: Features — BASF 6118 5 1/4" DRIVE
- The 6118 flexible disk drive offers the following significant advantages.
- Two-thirds the height of the normal 5 1/4" drives but with a capacity of 1 Megabyte (unformatted).
 - Very low power consumption and heat dissipation.
 - Dust tight doors to protect disks.
 - Fast positioning (6 m sec track-to-track).
 - Ability to daisy chain up to 4 drives.
 - Auto erase and write protection facilities.
 - Status indicator light on front panel.
 - Industry compatible interface (Shugart).
 - Well proven reliability with MTBF of 10,000 P.O.H.
 - High precision positioning system: Head carriage is guided with ballbearings in precision spiral-wheel-yielding low friction and high track accuracy.

- Tech: Features — BASF 6180 5 1/4" DRIVE
- Four models to choose from — 6182 (5 Mbyte formatted), 6183 (7.5 Mbyte formatted), 6184 (11.5 Mbyte formatted), 6185 (21 Mbyte formatted).
 - Fast access time — 1.2mS, average from 61mS, average latency 8.3mS.
 - High reliability — MTBF 11,000 POH.
 - Industry standard interface.
 - Low power requirement: +12V DC @ 2.4A, +5V DC @ 0.9A.
 - Competitive prices and ex stock delivery.
 - Full 12 months warranty.

NEC

8023BE/C

WORLD'S MOST POPULAR DOT MATRIX PRINTER

New low price £320

- plus £8 carriage plus VAT = £377.20 inc.
- 100CPS print speed
 - Bi-directional logic seeking — increment mode
 - 80, 136 column
 - High resolution dot graphics — 144 x 160 dots/inch
 - proportional spacing
 - 7 x 9 dot matrix for alphanumerics & symbols
 - 8 x 8 dot matrix for character generator graphics
 - Output to printer on character by character or dot by dot basis
 - Auto reversal (up to down) of ribbon maintains clarity for long period
 - ASCII 96 characters — JIS 160 characters — character generator graphics 64 characters — European 14 characters
 - Horizontal & vertical tabbing

- Lower case descenders
- Superscript subscript, underlining
- Several character sizes & styles (Pica, elite, proportional, reduced, enlarged, enhanced etc)
- 5 unique alphabets
- Greek and Math symbols
- Adjustable tractors
- Single sheet friction feed
- Powerful programmable paper feed



The Most Advanced Low Cost Printer Outstanding Graphics, Print Quality & Performance

Stand Alone Serial Interface (to 9,600 baud) with PSU & 4K buffer

£90.00 + VAT = £109.25 inc.

LOW PROFILE PROFESSIONAL METAL CASE FOR COMPUTER SYSTEMS

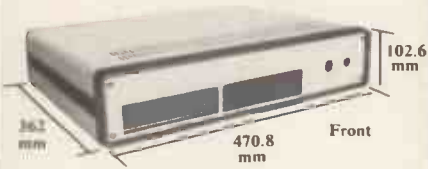

houses most single board micros, two half height 5 1/4" floppies (3/4 height floppies optional), a switch mode power supply for the complete system. The panels have cutouts for floppies, connectors and a fan (as illustrated). Thoughtfully constructed for easy accessibility. Cover and base grey/beige. Frame dark brown.

Case for 1/2 height floppies £75 + £10 P & P + VAT = £97.75

Case for 3/4 height floppies £80 + £10 P & P + VAT = £103.50

Horizontal mounting rails (set of 4) £25 + £2 P & P + VAT = £31.05



TWIN FLOPPY DISK SUBSYSTEM completely boxed with PSU



Measures only: 60mm H x 120mm W x 248mm D

Input: 220/240V 50Hz

Output: +5V @ 7A; +12V @ 3A; —5V @ 1A; —12V @ 1A;

Enough power for Single Board Micro, 2 Mini Floppies & CRT. Meets safety standards. 88 Watts.

ONLY £77 + £3 P & P + VAT = £92 inc.



New low profile professional grade case and slimline switch mode power supply for extra

- reliability! We use the latest slimline drives 3/4 or 1/2 heights!
- 5 1/4" Twin 48 TPI SS/DD 500K =£299 +£10 Carriage + VAT = £355.35 inc.
 - 5 1/4" Twin 48 TPI DS/DD 1 Mbyte =£399 + £10 Carriage + VAT = £470.35 inc.
 - 5 1/4" Twin 96 TPI DS 80 track 2 Mbyte. =£499 +£10 Carriage + VAT = £585.35 inc.
 - 5 1/4" Twin 96 TPI High Density 77 track 3.2 Mbyte (requires 8" Disk Controller Circuitry) = £799 + £10 Carriage + VAT = £930.35 inc.



for Twin 5 1/4" drives and switch mode PSU £50 + £5 P & P + VAT = £63.25 inc.

Also available separately

Box £20 + £4 + VAT = £27.60 inc. Power supply £40 + £4 + VAT = £50.60 inc.

Suitable only for 3/4 height drives (BASF, CANON, REMEX) or 1/2 height drives — please state drive size when ordering.

BARE BOX —

WORD PROCESSOR?



Yes!
One of the best!
Quick Brown Fox word processing
has more features than most other software
and runs on your VIC-20 or Commodore 64 computer. Put
yourself in league with industry standards like WORDSTAR, SCRIPTSIT,
WORDCRAFT and WORDPRO. We can supply you with a complete first-class word
processor for less than £1,000 – this includes computer, additional memory, 80 column
display monitor and a daisy-wheel typewriter which doubles as a computer printer.

It all starts with the Quick Brown Fox software at £60

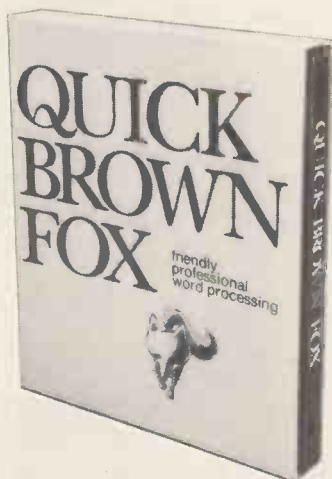

(all prices excluding VAT)

Further information from:

SPT Electronics Limited, Tollesbury, Essex, CM9 8SE, England
Telephone: Maldon (0621) 868484 – Telex: 995358

SPT Benelux B. V., Wilhelminastraat 1,3961 AG Wijk bij Duurstede, Holland
Telephone: 03435-5741

(Dealer enquiries also welcome)

SEE US ON STAND 30 AT THE INTERNATIONAL WP EXHIBITION WEMBLEY

WHO'S CUTTING THE HIDDEN COSTS OF MICROS?

SILICON VALLEY

Our present buying policy enables us to offer you some excellent value-for-money packages which give you the opportunity of making your microcomputer budget go further.

When you purchase one of the micros listed on this page you can add one of the following options most suited to your needs:

- 6 free accounts ledgers (saving between £1,500 – £3,600). Nominal, purchase, sales, invoicing, stock recording and payroll packages ready to use (CP/M and Sirius only).
- free 3-year warranty, parts and labour.
- free dot matrix or daisywheel printer (depending on system).
- free D-BASE II package (on Osborne only).
- free computer desk.



apple II E + III

OSBORNE



commodore

logica vts

NEC

PC8000

TORCH

COMPUTERS



Other packages we sell are:

Bos, Peachtree, Padmede, Systematics, Vlasak etc.,
Visicalc, Visitrend/Plot etc.,
Supercalc, Micro modeller,
Wordstar, Spellstar, Mailmerge, Select, Perfectwriter,
Easywriter, Visiword,
The Last One, D-Base II, Cardbox.

In addition Silicon Valley provides a full "Ambassador" computing service for all professional business requirements covering the whole of Central London. We have a resident Chartered Accountant who is able to advise and recommend the most suitable system tailored to your individual requirements. Come and visit us to discuss how we can help you.



SILICON VALLEY COMPUTER CENTRE

London
Suite 104/5
Hatton Square
Baldwins Gardens
London EC1N 7RJ
01-242 2803

Manchester
12 Lever Street
Piccadilly
Manchester
061-228 1686
061-792 2723

Telex 8813271 GECOMSG

The Permanent Computer Show



Sparrow 10

10 MEGABYTE REMOVABLE STORAGE SUB-SYSTEM



**“Unbelievable!” “Incredible!”
“10 Megabytes on a floppy!?”
“It had to happen...”**

These are typical comments from people who see our remarkable disc drive for the first time. But seeing is believing...

What did they see? ...

A Low Cost, High Capacity (10 MBytes), Fast (35 msec average access time, 3/6 secs start/stop), removable media, simple in design, shock resistant, contaminant resistant, small (same fit format as an 8" floppy drive), low power consumption (55 watts), integrated LSI controller, easy to interface disc drive.

Become a believer, come and see the SPARROW 10 for yourself.

Sparrow
Computer

United Kingdom: Tel: (0753) 76533

France: Tel: (33) 1 362 1010

West Germany: Tel: (49) 6121 700862

SPARROW COMPUTER UK OFFICES: 45 Ledgers Road, Slough, Berkshire, England. Telex: 847212

SPARROW COMPUTER BV, a company registered in the Netherlands with limited liability.

ATARI COMPUTERS

AM400 16K RAM Computer	129.95
A800 48K RAM Computer	329.95
A950 Interface Module	109.95
A410 Programs Recorder	42.95
CX86 Printer Cable	24.95
CX88 RS232 Cable	21.75
CD1655 Technical Users Notes	17.00
CXL4018 Pilot Language	78.29

Selection of educational, graphic games software available.



BBC MICROCOMPUTERS

BBC Micro Model A	299.95
Model A to Model B Upgrade Kit	49.95
Games Paddle	11.30
Prestel Adaptor	129.95

Selection of educational, graphic games software available.



COMMODORE MICRO COMPUTERS

Commodore VIC 20	113.00
Commodore 64	289.95

Selection of educational, graphic games software available.



CASIO POCKET COMPUTERS

FX 3600P	19.95
FX 602P	43.95
FX 700P	69.55
PC-100 Computer	43.45



SHARP PORTABLE COMPUTERS

PC 1251	69.55
CE 125	86.95
PC 1500 Colour	139.95
CE 150 Printer	124.95
CE 152	34.75
CE 153	69.56
CE 155 8K Battery	78.25
CE 158 RS232	130.45



EPSON HX-20 PORTABLE COMPUTER

Portability for programmability anywhere. Diminutive fully featured business computer, that is small and light enough to slip into a briefcase. Specifications include integrated LED screen, printer and micro-cassette, 16K RAM expandable to 32K, and its own rechargeable power supply. Ideal for people on the move.

Epson HX-20 16K 402.00



HEWLETT PACKARD

HP-32E Pre-programmed	44.26
HP-10C Programmable	47.67
HP-11C Programmable	61.29
HP-15C Advanced Program	81.72
HP-16C Programmable	81.72
HP-12C Financial	87.45
HP-41C Computer	125.37
HP-41CV Computer	176.81
Memory module	16.88
Quad memory	50.67
Extended functions	50.67
Card Reader	125.37
Printer	247.53
Digital Cassette Drive	294.21



SINCLAIR ZX COMPUTERS

Spectrum 16K	108.75
Spectrum 64K	152.25
ZX81 Computer	43.43
16K RAM	26.04
32K RAM	49.95
64K RAM	79.00
ZX Printer	52.13



SHARP MZ-80A

48K Computer	434.95
MZ-80 SFD D/Drive	285.00
MZ-80FB Dual D/Drive	529.00
CP/M-MZ-80A	64.95
MZ-80TU Assembler	44.95
MZ-8ADDZ FDOS	41.95
MZ-80AEO Expansion Unit	99.95
MZ-80AMD Master Diskette	29.95
MZ-80P4 Printer	649.00
MZ-80P5 Printer	289.95
MZ-80P6 Printer	320.00



APPLE

Apple IIe	
120K Business System:	
80 Col Card	
Disc Drive with controller	
Monitor	
Special Price	1289.00
Apple Writer II	79.95
Apple Writer IIe	P.O.A.
Quick File IIe	P.O.A.
Multiplan	155.95
Apple Dot Matrix Printer	425.00
EuroColour Card	64.95
DOS Tool Kit	39.95
Apple Plot	38.00
Business graphic	109.00
Pascal Language	139.00
Apple Logo	119.00

Apple III	
128K Computer	1995.00
256K Computer	2499.00
Profile 5 Megabyte	1599.00
Visicalc	149.00
Quick File III	52.95
Apple Writer III	116.95



BOOKS

At DEANS we stock a complete range of books for computer users. Whether you want to learn about machine-language or BASIC, games programs or business programs, we probably have the book for you.

Why don't you come in and have a look at our fine selection? If you're out of town, or can't get to Kensington, then send us an S.A.E. and well rush you our books catalogue.

Remember: it's books for learning, and it's DEANS for the best in computer books!

VDU's & MONITORS

12" Green Kaga Monitor	99.00
12" Black Kaga Monitor	99.00
12" Amber Kaga Monitor	99.00
Kaga Colour RGB	259.95
12" Green Hitachi Monitor	99.00
Sony 12" TV	229.95

PRINTERS-IMPACT

EPSON	
MX100 FT Type III	330.00
FX80 FT 160 cps	428.00
RX80 100 cps	P.O.A.
Apple Dot Matrix	425.00
SEIKOSHA	
GP100A	199.00
GP100VC	219.95
Paper Tiger	299.95

PRINTERS-DAISY WHEEL

Apple letter quality	1350.00
FEC F10	1285.00

EPSON QX-10

The QX-10: A fully integrated desktop micro-computer system that takes the hard work out of using software.

196K RAM



OLIVETTI M20 16-BIT MICRO

- Engineering
- Business
- Education
- Science

only
2395.00

or LEASE from 17.68 per week

RANK XEROX 820-II



Wordprocessing
Forecasting
Budgeting
Planning

only 2100.00 or LEASE from
£17.68 per week.

For the businessman looking for a superb business-oriented microcomputer system.

DEANS
of Kensington

191, Kensington High Street
London W8
200 Yards from High Street Kensington
Underground Station

Send orders with cheque payable to
DEANS. State goods required.
SECURICOR delivery add £6.00

Prices are subject to change without
notice. Add 15% VAT.

Tel 01-937-7896/938-1588

olivetti *USERS!*

** FULLY COMPREHENSIVE MAINTENANCE FACILITIES
(BACKED BY A TEAM OF QUALIFIED TECHNICIANS)
AT A GREATLY REDUCED COST FOR THE
FOLLOWING EQUIPMENT:—*

A5, A6

BCS 2005

BCS 2025

BCS 2030 – P SERIES & Q SERIES

BCS 3030

P 6060

P 6066

** ALSO FULLY GUARANTEED, RECONDITIONED
EQUIPMENT & PERIPHERALS FOR SALE, OR RENTAL.*

** PLUS ENORMOUS SAVINGS ON STATIONERY
FOR THE ABOVE COMPUTER EQUIPMENT.*

✂

FOR FURTHER DETAILS COMPLETE FORM BELOW OR TELEPHONE 01-228 8860

Name

Address

Telephone No.

Equipment

**LONDON MICRO SYSTEMS
Southampton House, 192-206 York Road,
Battersea SW11**

OSBORNE

AT LOW LOW PRICES !!

SPECIAL OFFER TO CLEAR STOCK OF EQUIPMENT USED ON SHORT TERM PROJECT
(MAX. USAGE 3 MONTHS)

PRICES	NEW			OUR PRICES		
SINGLE DENSITY	£1250	Qty. 1-10	£795	Qty. 11-20	£710	Qty. 21+ £620
DOUBLE DENSITY	£1395	Qty. 1-10	£945	Qty. 11-20	£860	Qty. 21+ £770
SINGLE DENSITY WITH NEW MATRIX PRINTER	£1145			SINGLE DENSITY WITH NEW DAISY WHEEL PRINTER		£1190
DOUBLE DENSITY WITH NEW MATRIX PRINTER	£1295			DOUBLE DENSITY WITH NEW DAISY WHEEL PRINTER		£1340

- ☆ WARRANTY – Full parts and labour (min. 6 months)
- ☆ SOFTWARE – CP/M Operating System C Basic M Basic Super Calc Wordstar
Comes in original packaging with manual.
- ☆ PRINTERS = Matrix – Epson MX 80. Daisy Wheel – Olivetti Praxis 30.

CONTACT TRICIA CARROLL 0276 76455 OR 76480



Delham International Limited

Princes House, High Street, Bagshot, Surrey, GU19 5AF



HERMES PRINTER 612

The PRINTER FOR Your COMPUTER

from Micro General the specialists for Printer Selection



Super Value
£1950
+vat

WORD PROCESSING & DATA PRINTING



Check out these features:

- Draft speed up to 400 cps (data mode)
- 100 cps near letter quality for word processing
- Proportional spacing selectable

A specially designed
high performance
SWISS QUALITY matrix printer

- 18 needle print head with moving Ruby guide
- 8 character sets included as standard in 4 fonts
- Tractor feed and sheet inserter/feeders available
- Epson/Centronics control codes
- Double height characters

Micro General

■ Always call for the best possible price   Access/Visa

(Dept PCW/H5) 6 The Birchwoods, Tilehurst, Reading, RG3 5UH Tel: 0734 25226

EPSON RX80 PRINTER

£99

PLUS VAT

WHEN YOU BUY YOUR OSBORNE
COMPUTER FROM 01 COMPUTERS,
THE OSBORNE SPECIALISTS. HURRY!
THIS OFFER IS OPEN ONLY
WHILE STOCKS LAST.
CALL IN NOW FOR A PERSONAL
DEMONSTRATION AND SEE OUR WIDE
RANGE OF SOFTWARE, ACCESSORIES AND
GAMES FOR THE OSBORNE 1.

**01 COMPUTERS
SOUTHAMPTON HOUSE
192-206 YORK ROAD
BATTERSEA, LONDON SW11
TEL. 01.228.2207
(300 YRDS. FROM WANDSWORTH BRIDGE)**



DEALER ENQUIRY WELCOME

TABS PEACHTREE DBASE II

Rolled into one
gives you

UNEK

A BUSINESS SOLUTION WITH A DIFFERENCE !

"Unek" offers you one of the most comprehensive suits of CPM based integrated business systems. Only with "Unek" can you customise a package to any degree without one programme change.

Using the "Unek Modifier", systems can be totally tailored or created in a matter of hours; in fact you'll wonder why you ever bothered with other software.

"UNEK" TURNS YOUR SOFTWARE NIGHTMARES INTO DREAMS

APPLICATIONS COVERED:

PRICES FROM: £225

Sales Ledger with Invoicing
Purchase Ledger
Nominal Ledger
Management Accounts
Incomplete Records
Sales Order Processing
Stock Control
Clothing Import/Export
Motor Dealers Package
Freight Forwarding Accounting

TELEPHONE 01-486 7498

SGS SOFTWARE PRODUCTS LIMITED 66 MARYLEBONE LANE,
LONDON W1

NOW AVAILABLE
UNDER 16 BIT
MS DOS

DAMS OFFICE EQUIPMENT

Not Simply a Computer Dealer



VIC 20/COMMODORE 64 IEEE 488 CARTRIDGE

The DAMS IEEE is a simple, plug-in Cartridge interface which slots into the back of your VIC/64 and links it to disk drives, language packs, printers and other peripherals. Run several VIC/64's. from one disk drive.

£49.95 + VAT.
(Price including VAT. £57.44).



'CLEAR-VIEW' ANTI-GLARE SCREEN

This exciting new product from DAMS is the answer to eye fatigue, headaches and migraine - symptoms regularly encountered by VDU operators.

up to 12" **£19.95** + VAT.
(Price inc. VAT. £22.94).
Suitable for Commodore 4032, 8032, etc. 20" and larger by special order.

13" to 20" **£24.95** + VAT.
(Price inc. VAT. £28.69).
and larger by special order.

All prices include postage and packing

VIC/COMMODORE 64 LIGHT PEN

A high-quality light pen to make the most of the vivid colour graphic displays on the VIC 20 or Commodore 64.

The DAMS light pen plugs straight into your computer with no special interface needed.



£17.35 + VAT. (Price inc. VAT. £19.95)

OR Light pen for PET 12" Screen -
£19.95 + VAT. (Price inc. VAT. £22.94)

DAMS OFFICE EQUIPMENT LTD.

GORES ROAD,
KIRKBY INDUSTRIAL ESTATE,
KIRKBY, NEAR LIVERPOOL. L33 7UA.
TEL: 051 547 2741
CREDIT CARD TELEPHONE ORDERS
WELCOME (Normal Office Hours).



VIC AID Commodore 64 version available on disk or cassette

VIC Aid is a chip which slots easily into the DAMS RAM'N ROM Board, and offers two sets of Utilities in one for the keen programmer:

Programmers Tool Kit

Gives extra commands. Auto, Number, Help, Delete, Change, Trace, Step, Light Pen, Break etc.

Machine Code Monitor

Gives Save, Memory, Display, Load, Verify etc. (similar to TIM on PET). Slots into the DAMS RAM'N ROM board or similar. If similar please state type.

£19.95 + VAT.
(Price inc. VAT. £22.94)

VIC MON Commodore 64 version available on disk or cassette

Another fine product to enhance the machine - code capabilities of the VIC. VICMON is the ultimate programming aid, incorporating: Assembler, Dissassembler, Fill, Re-Locate, Identify, Printing, Display Status Register, Display Memory with pause facility, Full Screen Assembly Edit, Software re-set from loops, Single step with variable speed etc.

Slots into the DAMS RAM'N ROM board or similar. If similar please state type.

£19.95 + VAT.
(Price inc. VAT. £22.94)

VIC 20 RAM'N ROM BOARD

Doubles the memory capacity of your basic VIC and gives you the facility to fit extra functions (VIC AID, VIC MON etc). Comes complete with specially designed cover.

Technical leaflets available on request
£22.95 + VAT.
(Price inc. VAT. £26.39)

SHOP NOW OPEN!

Visit our new computer store, 30 Dale Street, Liverpool for all your micro buys!

DEALER ENQUIRIES WELCOME

Send your business card, and receive our dealer 'fact pack' NOW!

12 months parts & labour guarantee on all products.

Please send me the following items

I enclose cheque/P.O. OR please debit my:

Access No. _____

Barclaycard No. _____

Name _____

Address _____

Tel: _____

(Prices inc. p+p)

SPECTRUM

Now from your local Spectrum dealer - the famous

NEWS from SPECTRUM

BBC

Now from SPECTRUM the outstanding BBC 'B' machine plus, Disk Drives & software see ad. opposite for details.

ATARI 800

This proven and tested micro is now **UPGRADED TO 48K RAM** and there's no increase in price either which must, make it about the best value around. See our ad. for further details.

VISCOUNT DISK DRIVES

Coming soon! a fabulous new range of Disk Drives specially selected by SPECTRUM from under £200 total suitable for most micros inc. LYNX, COL, GENIE, DRAGON etc Ask your local SPECTRUM dealer for further details.

NEW SPECTRUM MEMBERS

Check our address page! - there are many new SPECTRUM dealers throughout the UK so there's a good chance there'll be a SPECTRUM centre near you.

INTRODUCING SPECTRUM FACTS!

Next to many of our offers, you'll find a few lines tagged SPECTRUM FACTS. We pride ourselves on providing you, the customer, with a genuine service as well as super LOW prices, and we want you to know that when you buy from a SPECTRUM dealer, you'll get exactly the right micro for your needs. **SO LOOK OUT FOR YOUR SPECTRUM FACTS!**

AFTER SALES CARE

SPECTRUM service centres will ensure that should your machine 'go down' we will get it running again as quickly as possible. We also offer extended warranties at reasonable prices too! - ask your SPECTRUM HOME COMPUTER CENTRE for full details.

COMPUTER DEALERS

(or prospective Computer dealers!) If you would like to know more about becoming a SPECTRUM APPOINTED DEALER on an exclusive area basis, please write to MIKE STERN, Spectrum (UK) Ltd., Burrowfield, Welwyn Garden City, Herts.

BBC Model 'B' MICRO

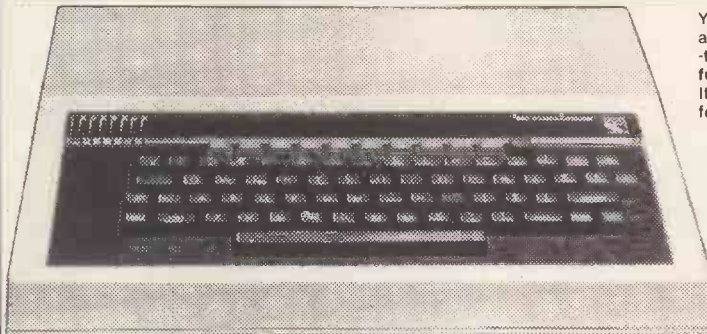

Yes, this top selling Micro system is now available from your local SPECTRUM dealer - the BBC Model 'B' offering 32K RAM plus a full back-up of peripherals & software too! It's an infinitely expandable machine, ideal for the home or business and is already widely used for educational purposes in schools - so the chances are your children may already be well familiar with its operation, which must make it the ideal choice for the home too! So if you're thinking of buying a micro you must take a look at the BBC at your local SPECTRUM dealer NOW! - but just one word of warning, initially stocks will be limited and demand is bound to be great, so please phone to check the stock position before making a journey.

BBC 'B' with Disk Interface

£470.50

BBC Disk Interface Kit

£95.00

BBC Single Disk Drive 100K

£265.00

BBC Dual Disk Drive 800K

£803.85

BBC Tape Recorder

£29.90

BBC Acorn Software Cassette

based from

£9.95

BBC Disk based software

£11.50

Spectrum LOW Price

£399.00

INC. VAT

BBC Peripherals & software in short supply - Please telephone before making a journey

MICRO PROFESSOR

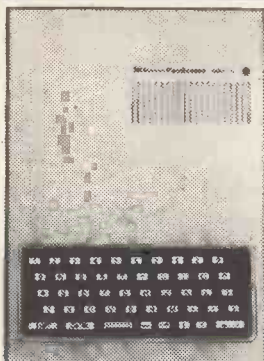

Another super new machine from the east - the superb MICRO PROFESSOR MPF-11. An extremely versatile personal computer with Apple compatibility 64K RAM & 16K ROM (includes 12K for BASIC) 6 Colours & full sound and can run on most existing Apple software. For Home, Business, Education or Games use - it's unbeatable value! So if you've always wanted an Apple but couldn't afford one take a look at the MICRO PROFESSOR at SPECTRUM NOW! it's incredible value for money.

Spectrum
LOW Price **£269.00** Inc. VAT

Optional full size 55 key, keyboard £36.25
Joysticks £14.95

Wide range of software available

ORIC-1



A superbly designed and engineered micro and great value-for-money from SPECTRUM. Offering 48K RAM Colour - (8 foreground and 8 background can be displayed at same time) High resolution graphics User definable Graphics. Full sound (6 octaves of controllable sound) Easy to use keyboard with moving keys. Standard Centronics parallel interface allows easy connection to a wide range of printers etc

Spectrum
LOW Price **£169.95** Inc. VAT

SPECTRUM FACTS

Maximum user RAM 47,870 Bytes
Text screen 28x40
High Resolution 240x200
Cassette Lead Included

The powerful and infinitely expandable

LYNX

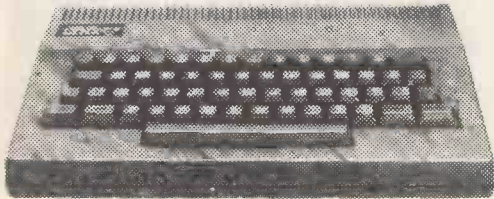

Just look at this super new LYNX Micro - an incredible 16K & 32K video ram and that's expandable up to or beyond 96K. For just £225.00 INCLUDING VAT the LYNX is exceptionally versatile. All LYNX's 'add-on' connections are standard types. The high definition colour graphics make it a top value choice for the home or office (with expansion, the LYNX can become an 80 characters-per-line word processor!) Take a look at the LYNX - a memorable bargain from SPECTRUM. But please phone to check stock position before making a journey as this machine is bound to be in great demand.

Spectrum **LOW** Price

£225.00 Inc. VAT

VISCOUNT - Teach yourself LYNX BASIC £6.95

SPECTRUM FACTS

Maximum user RAM..... 13,700 Bytes (approx)
Text Screen..... 24x30
High Resolution..... 265x248
Cassette Lead..... Included

COLOUR GENIE

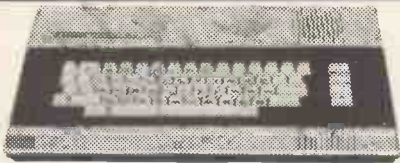

A truly reliable micro and highly recommended by SPECTRUM featuring powerful and sophisticated COLOUR GRAPHICS, allowing you to create full 8-colour Games, Diagrams and charts quickly and simply. Powerful 16KK RAM memory (expandable internally to 32K) for FULL COLOUR video games and POWERFUL COMPUTING with a full range of inexpensive accessories: 16K RAM pack, Joysticks for TV games, Light Pen, Disk Drive and a Printer. The superb Colour Genie is at SPECTRUM now - check it out and see the Genius at work!

Spectrum **LOW** Price **£224.48** Inc. VAT

COLOUR GENIE ACCESSORIES
Joysticks..... £49.49
16K RAM..... £38.50
Printer Interface..... £39.95
VISCOUNT Teach yourself Colour Genie Basic..... £6.95

SPECTRUM FACTS
Maximum user RAM..... 14,200 Bytes (approx)
Text screen..... 24x40
High Resolution..... 160x90
Cassette Lead..... Included

SINCLAIR ZX SPECTRUM

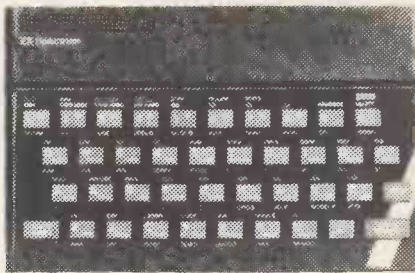

Yes, this top selling micro is now available from Spectrum in both 16K and 48K RAM. So now there's no need to send by Mail Order - just call into your local SPECTRUM dealer and pick one up. But just one word of warning: with this added availability advantage, stocks are bound to sell fast - so make it soon!

SINCLAIR ZX SPECTRUM 16K - £125.00
SINCLAIR ZX SPECTRUM 48K - £175.00

Spectrum Computer Centres have no connection whatsoever with the ZX-Spectrum Computer manufactured by Sinclair Research Ltd.

SINCLAIR ZX-81

SINCLAIR ZX £49.95
16K RAM pack £29.95
ZX Printer £59.95

Computer Bookshop INC. VAT
Software for Sinclair Computers
Bumper 7 1K ZX81 £5.95
1K Super Trio ZX81 £7.95
Labyrinth 16K ZX81 £5.95
Nightmare Park/Music 16K ZX81 £6.95
Computacalc 16K ZX81 £7.95
Personal Banking System 16K ZX81 £11.44
Space Invaders/Rescue 16K ZX81 £6.95
Breakout 16K ZX81 £5.95
Mugsy 16K ZX81 £5.95
Mergatroyds 16K ZX81 £5.95
Progmerge 16K ZX81 £5.95
Football Manager 16K ZX81 £7.95
Cassettes for ZX81 Type-10
6 Games £3.95

Junior Education £3.95
Business & Household £3.95
Skill & Judgement Games £3.95
Junior Education £3.95
Family Quiz £3.95
Type-20
Fantasy Games £4.75
Space Raiders & Bombers £4.75
Type-30
Super Programs Nos. 1-8 £4.95
Type-40
Backgammon £5.95
Flight Simulation £5.95
Type-50
English Literature 1 £6.95
English Literature 2 £6.95
Geography £6.95
History 1 £6.95
Maths. 1 £6.95



ZX-PANDA
16K RAM PACK
ONLY £24.95

OKI MICROLINE Printers

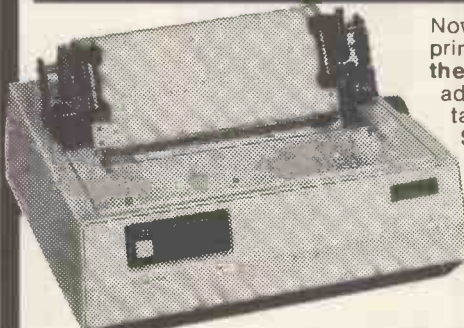

Now from SPECTRUM - this top selling range of printers renowned throughout the world for their quality and reliability. If you're thinking of adding a printer to your micro then you must take a look at the MICROLINE range at SPECTRUM - NOW! they're fantastic value-for-money especially at our SUPER LOW prices

Models Available
MICROLINE MODEL 80
MICROLINE MODEL 82A
MICROLINE MODEL 92

Check with your local SPECTRUM dealer for our SUPER LOW prices.

EPSON

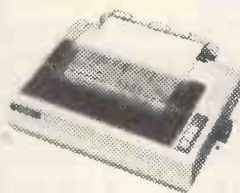

RX-80 and FX Printers now available - check with your local SPECTRUM dealer for details

SMITH CORONA



GP-100A

Now a top quality graphic printer at a price you can afford. Centronics interface connects easily with most micros.
Spectrum LOW price £229.94 Inc. VAT
Cables & Interfaces available for most micros

SMITH CORONA



Model TP-1

Microprocessor controlled, high quality daisy wheel printer at a LOW cost from SPECTRUM. Serial, Parallel or IEEE Interface.
Spectrum LOW price **£557.75** Inc. VAT

SELECTION FROM THE COMPUTER BOOKSHOP

30 Hour Basic for the BBC Micro £5.95
Let your BBC Micro Teach You to programme £6.45
BBC Micro Revealed Over the Spectrum £7.95
60 Games and Applications for the ZX Spectrum £4.95
Programming the 6502 £9.95
Programming your ZX Spectrum £6.95
ZAP Pow Boom for the Vic 20 £7.95
The ZX Spectrum Explored £5.95
Vic Innovative Computing £6.95
Mastering Machine Code on your ZX81 £7.50

BOOKS



The ZX Spectrum and how to get the most from it £5.95
Easy Programming for the ZX Spectrum £5.95
30 Programmes for the BBC Micro £4.95
CPM Handbook £11.50
Programming the Z80 £11.95
20 Best Programmes for the ZX Spectrum £5.95
Getting acquainted with your Vic 20 £8.95
Machine code and Better Basic £7.50
The Cambridge Colour Collection (Spectrum) £6.95
Vic Revealed £10.00
De RE Atari £17.00
ATARI Operating system listing £10.43

MORE SPECTRUM LOW PRICES!

SPECTRUM

A few examples from our
SOFTWARE Selection
from independent software houses

THORN EMI	
Software for ATARI	Inc. VAT
Submarine Commander	£34.44
Jumbo Jet Pilot	£34.44
Soccer	£29.84
Kickback	£29.84
Home Financial Management	£19.49
Darts	£19.49
Snooker & Billiards	£19.49
Pool	£19.49
Cribbage & Dominoes	£19.49
Cupute 4 & Revert	£14.89
Mutant Herd	£24.25
Software for Commodore	
River Rescue	£25.24
Vic Music Composer	£25.24

GEM	
Software for ZX81, Dragon and Spectrum	Inc. VAT
Monster Mine (for ZX81)	£4.95
Monster Mine (for Spectrum)	4.95
Monster Mine (for Dragon)	7.95
Space Mission (for ZX81)	£4.95
Space Mission (for Spectrum)	£4.95
Space Mission (for Dragon)	£7.95
Dragon Golf	£7.95
Dragon Character Generator	£9.95

SALAMANDER	
Games for Dragon 32	Inc. VAT
Dragon Trek	£9.95
Wizard War	£7.95
Vulcan 0	£7.95
Games Compendium DI	£7.95
Golf	£7.95

RABBIT	
Software for Commodore VIC20	Inc. VAT
Space Storm	£6.99
Ski Run	£4.99

ACCESSORIES

SANYO Colour Monitor CDD3125N £228.85

SANYO	Inc. VAT	Single part 11" x9 1/2" printer paper, box of 2,000 sheets	£13.05
SANYO 12" green monitor	£90.85	VIC Accessories from Viscount Motherboard without Buffer	£24.95
Slim 3G Cassette Recorder	£29.95	Motherboard with Buffer	£29.90
C12 Cassettes	£0.50	16K RAM Pack	£43.95
Single sided double density disks (Box of 10)	£21.25	32K RAM Pack	£66.95
Double sided, double density disks (Box of 10)	£33.81	64K RAM Pack	£114.94
Disk head cleaner	£16.10	Currah Chatterbox/Voice Synthesiser	£57.45

Now with
48K RAM
and still at the same
LOW price!

ATARI 800

Now this proven and tested machine has been upgraded to a massive 48K RAM and its still at the amazing **LOW price of £399.99** from SPECTRUM. It's an ideal Home Micro for graphics, educational and personal finance etc. use it and it will take you from learning up to a small business use. You can add printers, program recorders, disk drives and more, to expand your micro as and when you want, to suit your needs. So if you're looking for a top of the line micro you must see the ATARI 800 with 48K at SPECTRUM - NOW!



Spectrum **LOW Price**
£399.99
INC. V.A.T.

SPECTRUM FACTS

Maximum user RAM	37,899 Bytes
Text Screen	24 x 40
High Resolution	320 x 192
Cassette Lead	Needs own Recorder

ATARI 400 16K RAM



NOW ONLY £159.95
INC. VAT

BASIC cartridge extra
£39.99 inc. VAT
(£34.77 ex. VAT)

SPECTRUM FACTS

Maximum user RAM	13,323 Bytes (with basic Cartridge)
Text Screen	24 x 40
High Resolution	320 x 192
Cassette Lead	Needs own Recorder

ATARI DISK DRIVE £299.00
INC. VAT

ACCESSORIES, BOOKS & GAMES for ATARI

Accessories	INC VAT	European Countries & Caps	INC VAT
Thermal Printer	£198.95	Hangman	£14.99
16K RAM Pack	£65.00	Kingdom	£14.99
400 Keyboard	£59.95	States & Capitals	£14.99
32K RAM board (400/800)	£75.00	Touch Typing	£19.99
48K RAM board (400/800)	£99.00	Music Composer (Cartridge)	£35.99
Paddles (Pair)	£13.99	Home Entertainment (Cartridge except where stated)	
Joysticks (Pair)	£13.99	Galaxian	£29.99
I/O Cable	£12.99	Defender	£29.99
Printer Cable	£28.50	Asteroids	£29.99
Monitor Cable	£25.00	Basketball	£24.99
Thermal Paper	£4.00	Blackjack (Cassette)	£14.99
Pointmaster Joysticks	£14.95	Caverns of Mars (Disk)	£29.99
Quickshot Joysticks	£14.95	Centipede	£29.99
Keyboard for Atari 400	£00.00	Computer Chess	£24.99
Books & Manuals		Missile Command	£29.99
Wiley Manual	No VAT	PAC Man	£29.99
Basic Reference Manual	No VAT	Space Invaders	£29.99
DOS. 2 Manual	No VAT	Star Raiders	£29.99
Operating System Listing	No VAT	Cribbage & Domino	£19.95
DOS. Utilities Listing	No VAT	European Scenic Jig-saw	£19.99
Home Computer Programs - Home/Office		Programming Languages & Aids	
Word Processor (Disk)	£99.99	Assembler Editor	£39.99
Mortgage & Loan	£14.99	Atari Basic Cartridge	£39.99
Microsoft Basic (Diskette)	£59.99	Macro Assembler (Disk)	£59.99
Home Study (Cassette except where stated)		Pilot (Consumer)	£59.99
INV. to programming 1	£19.99	Pilot (Educator)	£89.99
INV. to programming 2	£22.99	Entertainer Kit (Star Raiders Missile Command & Pair Joysticks)	£69.99
INV. to programming 3	£22.99	Programmer Kit (Basic Cartridge & Manuals)	£39.99
Conversational French	£39.99		
Conversational German	£39.99		
Conversational Italian	£39.99		
Conversational Spanish	£39.99		

DRAGON



Spectrum LOW price £199.95

VISCOUNT Teach yourself Dragon Basic. £6.95

Unbelievable value from SPECTRUM! Extensive facilities include highly advanced colour graphics. Powerful standard 32K RAM (expandable to 64K Bytes). ●9 Colour 5 resolution Display ●Extended Microsoft colour BASIC (as standard) ●Advanced sound with 5 octaves - 255 tones

SPECTRUM FACTS

Maximum user RAM	29,679 Bytes
Text Screen	16x32
High Resolution	256x192
Cassette Lead	Included

JUPITER ACE

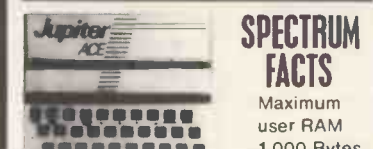

SPECTRUM FACTS

Maximum user RAM 1,000 Bytes approx.

Outstanding value-for-money! The JUPITER ACE uses easy to understand FORTH language. 3K RAM EXPANDABLE to 19K. Full moving keyboard with auto repeat and caps lock. Full sound and chunky graphics.

Spectrum LOW price £89.95

HI-TECH Software for JUPITER

Memory Stars	£5.99
Cavern Attack	£5.99
Micro Maze	£6.50
Space Battle	£4.50
Ace Invaders	£5.50
Green Cross Frog	£4.80

VIC-20

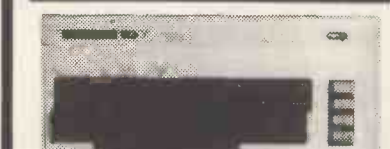

Now a top quality home/business micro for the price of a games machine

●Memory expandable to 32K ●High resolution (full PET type) graphics ●16 Screen colours and 8 border colours ●Add Disk Drive & Printer for impressive 170K Byte system ●Can act as an intelligent terminal for a larger computer.

Spectrum LOW price £139.90

COMMODORE 64

Very limited supplies of this new micro now available - please check with your local SPECTRUM dealer before making a journey.

VISCOUNT 64K RAM PACK FOR VIC-20

Unbelievable but true, now you can grade your VIC-20 from 3.5K to a massive 67 1/2K RAM. Enables you to load up to 8 games or programs at a time & still select which one you wish to use. Can be used in conjunction with other expansions to increase total memory up to 152K - using the VIC memory expansion board. The SUPER X-2 will make your VIC-20 the biggest little micro in town

Spectrum LOW price £114.94

Possibly the best value CP/M applications program for sale in the world. Probably the best way to improve productivity with your micro. Guaranteed to be the most efficient way to learn to type or to improve your typing. IANKEY.

Be honest: agree you'll benefit from IANKEY. You, your family, your staff, your students, your friends. (There's a money-back guarantee of that.)

But you will enjoy proving us right! It's new. It's the IANKEY keyboard skills package. It's from one of Britain's newest and most exciting serious software publishers. IANSYST.

ONLY £29. £25 INTRODUCTORY OFFER!

We could charge £250 to sell IANKEY to schools and colleges, but because we want people like you all over the world to benefit IANKEY is an incredible £29. - for more program than WordStar! So schools and colleges pay only £29 too. Oh well! We'll cry all the way to the bank.

Compare it with the competition at any price: Caxton's *Touch 'N' Go*, Anthony Ashpitel's *Typing Master*, Microsoft or WDS's *Typing Tutor*, *Hyper-Typer*, even old favourites like *Sight and Sound*. Feature for feature IANKEY earns a walkover. **MONEY BACK, NO RISK PURCHASE.**

Thoroughly researched

At Iansyst we have studied at length how people best learn to type. We have used this knowledge to design IANKEY and its individual lessons.

You do not need a manual to use IANKEY - instructions appear on the screen when you need them.

You get instant feedback on how well you are doing. No waiting for results.

You get proper words to type right from the beginning. No meaningless drills like "ASDF JKL;".

The exercises you type are informative. You should find them interesting. Not just a series of improving proverbs which you know anyway! Nor meaningless random words.

Screen Displays

The computer display is packed with information. It flashes the letters on a keyboard. You learn without needing to search on the keys themselves.

Those are just a few of its many features.

Recommended retail price is £29 £25 UNTIL 31.5.83

These are master card accepted.

Please specify computer and disk format.

Dealer Enquiries Welcome

Iansyst Software, (PCW1), Omnibus Building, 41 North Road, London N7 9DP. Tel (01-) 607 0187. 24 hour answering service.



Selling the outside
is one thing . . .
knowing the inside
is something else.

The PC is a very special micro. Here is a machine of technical excellence - a standard which others will be measured against. It's not surprising that such a product demands professional sales and service back-up.

Zynar is well established at the forefront of personal computing. Our network systems lead the field in Europe and the USA - our design group networked the PC even before its UK debut. We are professionals, having worked for many years in the computing and 'chip' industries.

Zynar will help you optimize the easy-to-use hardware and lead you to the best software solution: tailored, off-the-shelf, simple or sophisticated.

The PC has been worth waiting for. You will know it. IBM knows it. And we know it - inside-out.



Authorised dealer serving London & the Home Counties

Zynar Ltd (PC Systems Division)
122/3 Uxbridge High Street
Uxbridge, Middx
Tel: (0895) 59836 Telex: 896607

Please phone/send literature
Name.....
Company.....

Address.....
Tel No.....
Position.....

Application: Word processing
accounts/financial planning
general PCW1

A £480* DAISY WHEEL BARGAIN!!!

At last a daisywheel printer with a professional performance and quality at an affordable price.

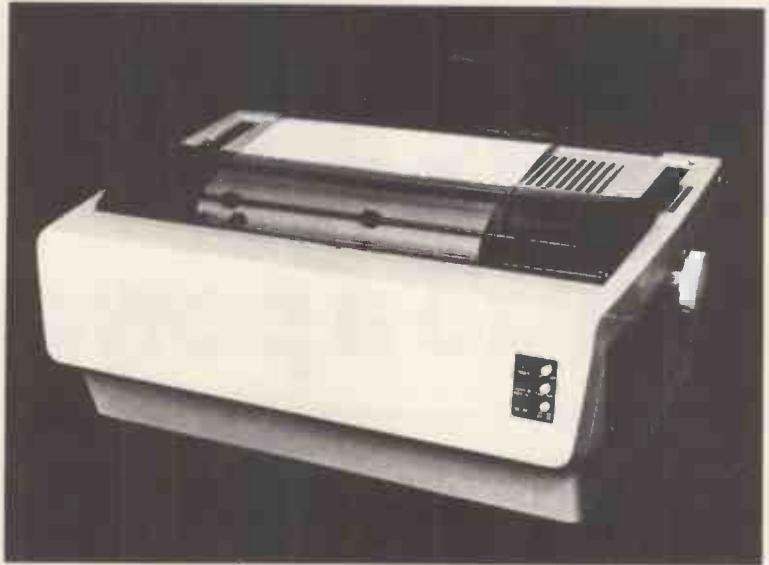

- ★ Wide 15 inch carriage.
- ★ Standard print wheels.
- ★ Standard ribbons.
- ★ Fast 25 characters per second.
- ★ Graphics commands.
- ★ Standard **Wordstar** printer.
- ★ Heavy duty mechanism.

★ Price exclude VAT and delivery

Ask about maintenance

For further details contact
JAYMAN ELECTRO DEVICES LTD
 15 ASH GROVE,
 SPRINGHEAD,
 OLDHAM.
 GREATER MANCHESTER. OL4 4RP. Tel: 061 678 0519

THE **ACT**
SIRIUS 1

MICROCOMPUTER
 (includes 128K memory, CP/M86, MS.DOS & MS BASIC 86)

plus! The EPSON MX100 Printer (136 column 100 cps)
 WORTH £500!

NATIONWIDE
 MAINTENANCE
 AVAILABLE

LOOK!

only
£2395.00*

MACHINES ALWAYS EX-STOCK



OFFICE EFFICIENCY MACHINES LTD

ENQUIRIES - CALL OUR WEST LONDON OFFICES ON 01-741 7211/2/3/4

TO ORDER YOUR MACHINE CALL OUR HOTLINE - 01-748 8404 or TELEX 263559 MICRO G



includes
 CPM OPERATING SYSTEM,
 WORDSTAR, MAILMERGE,
 SUPERCALC, M BASIC &
 C BASIC WORTH £300 FREE



To: Office Efficiency Machines Ltd.,
 1 Lochaline Street, London W6 9SJ
 Telex 263559 Micro G

- Please send me information on the
- Dealer End User
- Urgent Please phone me

Name _____

Company _____

Address _____

Telephone _____

PCWI

*WHILST OFFER LASTS

DEALERS WELCOME!

GEMIN PERFORMAN

It can do a powerful job for yo

SPECIAL LIMITED OFFER

Buy just any two programs at £19.95
and take one at £19.95
FREE!



**CASH BOOKS ACCOUNTS
PROGRAM FOR
BBC MICRO . . . £ 95.00**

New

One of the most innovative business programs on the market. Most serious accountancy packages are written and coded by professional and competent programmers. The Gemini Cashbook Accounting program was written by practising Chartered Accountants and coded by professional and competent programmers. This is a fundamental difference.

This practical program is simple to use and will replace your manual cash and bank records and by giving you instant management information, it may even put your accountant out of job!

With exceptionally exhaustive user documentation, full technical back up and product update policy this program will increase the efficiency and profitability of your business. Take a look at the information this program will provide.

- * summary of VAT information to enable you to complete your VAT returns
- * cumulative receipts and payments report analysed over the standard profit and loss and balance sheet heading.
- * option for departmental analysis of sales and purchases
- * print out of all transactions
- * journal routine for entering transfers between accounts and year end adjustment for debtors, creditors etc.
- * year end trial balance
- * profit and loss account and balance sheet.

These statements can be produced at what ever interval you require e.g. monthly, quarterly or annually.

Coming soon:- Integrated Sales + Purchase Ledgers

"... the systems worked immaculately
when tested ..."

"Mailist is a very professional piece of software ..."

(Which Micro & Software Review Feb 83)

Here's a range of software for the independent businessman that's designed to harness the power of your micro to deliver the vital information you need in all key areas of your business. A breakthrough on both price and performance, each program is fully tested and comes with all the documentation back up you need.

"Gemini's range of software is in the vanguard of the releases for 'serious' micro users ..."

(Which Micro and Software Review)



**SPREADSHEET ANALYSIS
BEEBCALC £19.95
DRAGONCALC £19.95**

New

FOR BBC AND DRAGON 32. Spreadsheet processors have proved to be important tools for using micros in business, scientific and domestic financial applications.

Without any programming knowledge at all, you may:-

- * Set up a computerised spreadsheet, with chosen row and column names.
- * Specify formulae relating any row or column to any other.
- * Enter your source data and have the results calculated.
- * Save the results on tape (or disk - BBC) for later reloading and manipulation.
- * Print the tabulated results in an elegant report format.
- * Experienced users may access saved files and write their own reporting or graphics presentation programs for the results.

Some typical applications:-

- * Small business accounting applications, e.g. profit and loss statements and cashflow projections, break-even analyses etc.
- * Investment project appraisal - anything from double glazing to oil rigs!
- * Comparing rent/lease/buy options
- * Processing the results of scientific experiments or field studies
- * Engineering calculation models
- * In fact, anything that involves repeated re-calculation of results presented in tabular or spreadsheet format.

Program Availability Chart:-

	Database	Stock Control	Mailist	Invoices & Statements	Spread sheet Analysis	Cashbook Accounting	Word processor	Home Accounts	Commercial Accounts
Sinclair Spectrum 10k or 48k	●	●	●					●	●
Dragon 32k or 64k	●				●			●	
VIC 20 (10k+)	●	●	●	●				●	●
Sinclair ZX81 (16k+)	●								
Grundyl Newbrain	●								
Texas TI99 4A	●								
Osborne 1	●								
Sharp M280A	●	●	●	●				●	●
Sharp M280K	●	●	●	●				●	●
Sharp M280B	●	●	●	●				●	●
BBC micro Model A or B 32k	●	●	●	●	●	●		●	●

IT'S NEW ACCESS SOFTWARE for business at petty cash prices.



INVOICES AND STATEMENTS . . . £19.95

Compatible with most micros. See table. Ideal for the small business. A complete suite of programs together with generated customer file for producing crisp and efficient business invoices and monthly statements on your line printer. All calculations include VAT automatically, and the program allows your own messages on the form produced. This program gives you superb presentation and saves time on one of the most tedious tasks in the office.

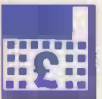

COMMERCIAL ACCOUNTS . . . £19.95

Compatible with most micros. See table. A gem of a program, all for cassette, with the following features:— Daily Journal. Credit Sales. Cash Sales. Credit Purchases. Purchases—other. Sales Ledger. Purchase Ledger. Bank Account. Year to date summary. A fully interactive program suitable for all businesses. Files can be saved and loaded and totals from one file carried forward to another on cassette. Particularly useful from a cash flow point of view, with an immediate accessibility to totals for debtors and creditors. Bank totally supported with entries for cheque numbers, credits and, of course, running balance.



MAILING LIST . . . £19.95

Compatible with most micros. See table. A superb dedicated database to allow for manipulations of names and addresses and other data. Gemini's unique 'searchkey' system gives you a further ten 'user-defined parameters' to make your own selections. Features include the facility to find a name or detail when only part of the detail is known, it will print labels in a variety of user specified formats.



DATABASE . . . £19.95

Compatible with most micros. See table. The program that everyone needs, the most valuable and versatile in your collection. Facilities include sort search, list print if required. Can be used in place of any card index application; once purchased you can write your own dedicated database to suit your particular needs with a limitless number of entries on separate cassettes.



STOCK CONTROL . . . £19.95

Compatible with most micros. See table. Dedicated software with all that's necessary to keep control of stock. This program will take the tedium out of stock control and save time and money. Routines include stock set up, user reference number, minimum stock level, financial summary, line print records, quick stock summary, add stock, delete/change record and more.



HOME ACCOUNTS . . . £19.95

Compatible with most micros. See table. Runs a complete home finance package for you with every facility necessary for keeping a track of regular and other expenses, bank account mortgage, H.P. etc. This program also allows you to plot graphically by Listograms your monthly outgoings.



WORD PROCESSOR . . . £19.95

Compatible with most micros. See table. This program features routines found in much larger and more expensive packages with a typical word length of 5-6 letters it allows for around 1000 words in memory at one time. Ideal for the user who requires a simple program to write letters on his computer. Features include, block delete, block insert, search and replace, edit text, display text and more.

Dealer/Trade enquiries invited – generous trade discounts for quantity
Special ACCESS card instant sales hotline **Tel: 03952-5165**
for GUARANTEED prompt despatch...

24 hr Ansaphone Service.

All enquiries other than credit card sales to 03952-5832

Gemini. Functional Software Specialists. 9, Salterton Road, Exmouth, Devon.

Tick the box for Program you require. Prices include V.A.T. and Package and Postage.
 Please supply the following cassette software.

Database	£19.95	<input type="checkbox"/>	ZX81 16K Database	£9.95	<input type="checkbox"/>
Stock Control	£19.95	<input type="checkbox"/>	BBC Cash Book disk or tape	£95.00	<input type="checkbox"/>
Mailing List	£19.95	<input type="checkbox"/>	BBC Disks – other titles	£23.95	<input type="checkbox"/>
Invoices and Statements	£19.95	<input type="checkbox"/>	Osborne Disk Database	£23.95	<input type="checkbox"/>
Commercial Accounts	£19.95	<input type="checkbox"/>	Word processor	£19.95	<input type="checkbox"/>
Home Accounts	£19.95	<input type="checkbox"/>	Beebcalc	£19.95	<input type="checkbox"/>
			Dragoncalc	£19.95	<input type="checkbox"/>

Name _____

Address _____

Machine Type _____

Memory Size _____

I enclose _____

Make cheques and postal orders payable to Gemini Marketing Ltd.

Diners Card Number _____

Access Number _____



Signature _____

PC 5/83

Gemini. Functional Software Specialists, 9 Salterton Road, Exmouth, Devon.



PCW/5/83

OUT NOW! 811 IDEAS FOR YOUR COMPUTER

NEW
SAME-DAY
DELIVERY
IDEAS
BOOK

In the Inmac catalogue of ideas for your computer check to see what is in the latest issue for you:

Cables, cables and more cables! How to order custom-built cables. When to use screened cables. How to choose the right EIA RS-232 extension cables for your VDU's and how to connect your Apple, Commodore, or other micros to Qume, Diablo, NEC printers. Compatible cables for connecting new peripherals to your DEC, Data General, Hewlett Packard, IBM, Osborne, Systeme and Tandy computers.

Lifetime Floppies Read about Inmac Plus — the floppy with a lifetime guarantee! Choose from our range of 100% error-free disk cartridges, flag-free disk packs,

each with a 3-year replacement guarantee.

New Ideas! Dozens of exciting new products — many never seen in Europe before now — and lots of helpful hints on getting more from your computer department.

Service and Quality — a promise you can rely on! We promise a next day delivery service of our products, a 30-day risk-FREE trial, and a 12-month trouble-free quality replacement guarantee.

Send today for your FREE catalogue with no obligation to purchase — but be warned: you will want to buy once you have read the Inmac catalogue ideas book!



FREE! IF YOU USE A COMPUTER
☎ 09285-64321/67551

Send this coupon to Dept. 104, Inmac (UK) Limited, 18 Goddard Road, Astmoor Industrial Estate, Runcorn, Cheshire WA7 1QF.

Name _____
Company _____
Address _____

24 hour tel. no.
☎ 09285-64321

VIDEO GENIE & TRS 80

EXPANSION!

NEW NEW NEW NEW

DP 1000

Disk & Printer Interface
in steel case 27x15x6 cm
Plug in and go £76.00
Includes real time clock.

48K RAM INTERNAL

48K Memory Extension, easily fitted *inside the keyboard*
unit. No Expansion Interface required. £43.50

Feature ROMs

For TRS80 Model I and Video Genie. Plug-in units fit on expansion edge connector. Compatible with expansion interfaces, using "splitter cable". Plug-in unit including one Feature ROM:

Video Genie	£29.95
TRS80	£34.50
Splitter Cable	£14.50
Feature ROMs for above	£18.95

PHONE FOR DETAILS

DP 2000

DP1000 and Canon 6106 Disk Drive
in steel case 32x15x9.5 cm
£220
(Extra drives can be connected)

Printers★★★★★

EACA
EG3085 (100cps dot matrix)
EG603 (Genie Microprinter)
BROTHER
HR1. (low cost reliable daisy wheel)

The ROM

For TRS80 (3 chip ROM) and Video Genie (remove one I.C. and plug in replacement). Alleviates key bounce. Automatic check for our Feature ROMs improves TRS80 tape loading. Personalised message on power up.
Optional lower case driver £14.95
For 2 chip ROM TRS 80's. As above but without personalised message £18.95

Computers

Genies 1 & 2 £290.00
Colour Genie £224.50

Disk Drives★★★★★

TEAC
CS50A Single 40 Track
CD50A Dual 40 Track
CS50E Single 80 Track
CD50E Dual 80 Track
CS50E Single 80 Track Dual Sided
CD50E Dual 80 Track Dual Sided

CANON 5 1/4" SLIM DISK DRIVES

	Bare drive	Single with case & PSU	Twin with case & PSU
6106 (40 TK SS)	£139	£169	£329
6108 (40 TK DS)	£169	£199	£389
120 (80 TK SS)	£189	£219	£429
220 (80 TK DS)	£229	£259	£509

fig. FORTH disk

Operating System £25.00
Discover FORTH Book by Thom Hogan £10.95

ALL PRICES ARE EXCLUSIVE OF VAT & CARRIAGE. (TELEPHONE FOR FURTHER DETAILS)

CREDIT FACILITIES AVAILABLE



GENERAL NORTHERN MICROCOMPUTERS LTD.

8 WHITWORTH ROAD, SOUTH WEST INDUSTRIAL ESTATE, PETERLEE, Co. DURHAM SR8 2JJ
TELEPHONE: PETERLEE (0783) 860314



OTHER-WORLDLY SOFTWARE **SOFTK** AT DOWN TO EARTH PRICES

Imagine a program which instantly converts
SPECTRUM BASIC into Machine Code, and transforms
the **SPECTRUM** into a micro up
to 100 times faster than a BBC Model B...

48K ZX SPECTRUM COMPILER

METEORIODS

This version has been hailed the best: 3 sizes of meteoroids, saucer, wrap-around screen, bonus ship at 10000 points, amazing explosions, rotate left/right, thrust, fire, hyperspace and shield. Full feature 'arcade' sounds and full colour. Works with Joysticks (from us at £19.50). Only £4.95 inc (16K or 48K).

SOFTIME

Amazing piece of machine code programming - produces a continuous real time clock on screen all the time - even when running/writing another program! Has alarm facility. For 16K or 48K, only £3.95.

SOFTK SPECTRUM SOFTWARE

COMPILER

Benchmarks

	BBC	SPECTRUM (BASIC)	SPECTRUM (COMPILER)
BM1	1.0s	4.8	0.15
BM2	3.1	8.7	0.09
BM3	8.2	21.1	1.10
BM4	8.7	20.4	0.99
BM5	9.1	24.0	1.11
BM6	13.9	55.3	1.91
BM7	21.4	80.7	2.14

What the SUPER C compiler does is almost magical. It turns a program written in Spectrum BASIC into a machine code equivalent. SUPER C is child's play to use - simply type in a program as usual (or load from tape) and in a few key presses SUPER C turns it instantly into a super fast machine code version. It will compile virtually any Spectrum BASIC statement, plus a few features not available to you usually, but extra thought will be required for strings and floating point. There is no program you can write in BASIC which cannot be turned into a SUPER C version. However, enhancement packages will be available in the New Year to aid string handling, floating point, and will offer a host of other features - each for a nominal cost. With SUPER C your Spectrum will run faster than with either FORTH or PASCAL - and no new language to learn! SUPER C comes complete with extensive documentation, a manual written by Tim Langdell, example programs, and all boxed in a professional library case. Less than half the price of a compiler for any comparable micro. - £14.95 inc.

48K 3D MAZENTURE

A maze program and adventure in one. Amazing 'monster chase' animation and more than a hint of dungeons and dragons. 48K only. £5.95.

THE ZOLAN ADVENTURE

A full adventure crammed into 16K! Quite astounding how extensive and engaging this program is. £4.95.

Please rush me

Mr/Mrs

Address

or for INSTANT CREDIT CARD
order 7 days a week phone:
01-930 9232.

Send cheques or POs to:
329 Croxted Road, London
SE24. Tel: 01-674 4572

SOFTK, SPECTRUM SOFTWARE

Test drive TeleVideo



TeleVideo – The Value Leader

When you're looking for a business computer, don't get caught in the hardware jam – and suffer another rush-hour in another computer showroom.

Simply take the time to try a TeleVideo for yourself and you'll discover a system that handles beautifully, powers through your paperwork, and wins every time as the cost effective solution to your business needs.

Standard software for every application

Because all TeleVideo systems run standard CP/M, you get the widest choice of 5-Star software for every application – ready made for real economy. Word processing, sales forecasting, complete ledger packages – in fact, everything you'll need to keep your business on the right road.

ive a deo

Multi-user systems for a clear growth path

As your needs grow, your TeleVideo system will grow with you – without making your original equipment redundant

That's because your initial investment becomes a part of your network.

And we have the hardware and software to make growth easier – backed by all the support you'll need from Midlectron's own fully trained dealer network.

Reliability fitted as standard

Don't think of reliability as an expensive extra. TeleVideo systems and terminals have earned their internationally recognised reputation as long-distance performers in the field.

And for regular servicing, your dealer will arrange a maintenance contract to suit you – because after all, care-free running is vital for any business.

Low-cost graphics – a Midlectron special

Only Midlectron can supply Graffix, a retro-fit option that turns a standard TeleVideo system or terminal into a professional graphics workstation.

Graffix is easy to install, transportable between systems – providing a low-cost solution to most graphics needs.

Midlectron – your first stop

We believe that once you've tried a TeleVideo for yourself, you'll be so convinced, you won't want to wait for your own system.

So Midlectron have made it easy for you. Our nationwide dealer network can put you in the driving seat fast, wherever you are. All backed by our own high levels of support, large stock investment, and fast deliveries.

For your nearest TeleVideo test centre, phone us today. And get on the road to computer efficiency tomorrow.

Systems Choice

A TeleVideo system for every application – stand-alone and multi user.

TS 803

Stand alone microcomputer system (based on the advanced design 970 terminal)

- Z80A processor (4MHz)
- 2 x 500Kbyte mini floppy disk drives
- 64K RAM
- CP/M 2.2 operating system

TS 802

Stand alone microcomputer system

- Z80A processor (4MHz)
- 2 x 500Kbyte mini floppy disk drives
- 10 Mbyte Winchester disk option (TS 802H)
- 64K RAM
- CP/M 2.2 operating system

TS 800A

Intelligent terminal

- Z80A processor (4MHz)
- 64K RAM
- For use with TeleVideo multi user service processors

TS 806/20

Service processor

- Z80A processor (4MHz)
- 20 Mbyte Winchester disk (plus 500Kbyte floppy disk back up)
- 64K RAM
- Runs MmmOST, TeleVideo's proprietary service operating system
- Supports up to 6 users

TS 816/40

Service processor

- Z80A processor (4MHz)
- 42 Mbyte Winchester disk (plus 17.2Mbyte tape cartridge back up)
- 128K RAM
- Runs MmmOST, TeleVideo's proprietary service operating system.
- Supports up to 16 users

TS 1602G

16 bit stand alone microcomputer

- 8088 processor
- 128K RAM (expandable to 256K)
- 2 x 500Kbyte mini floppy disk drives
- 10 Mbyte Winchester disk option (TS 1602GH)
- CP/M 86 operating system

Plus a wide range of TeleVideo terminals built with the same reliability and value you'd expect – and backed by Midlectron expertise and ex-stock deliveries.



Northern Office:

Midlectron House, Nottingham Road, Belper, Derby, DE5 1JQ.
Tel: (077 382) 6811 Telex: 377879.

DISTRIBUTION

No.1 for  TeleVideo®

NewBrain

**professional quality and features –
– hobby price!**

- * 40/80 character line, full screen editor.
- * Keyboard with standard key spacing and nice 'feel'.
- * 32K RAM and 29K ROM. Both expandable.
- * High resolution graphics, graph plotting, etc.
- * CP/M and networking capability.
- * Compact – will fit neatly on your desk or lab bench.
- * High quality construction.

From £234 + VAT

**SOFTWARE
Prices include VAT, P+P**

Database	£19.95
Mailist	£20.00
Home Budget	£9.95
Tycoon/Pelmanism	£9.95
Gobbler (Gollum)	£9.20
Star Trek	£9.00
Disassembler	£9.95
Life Search (Adventure)	£9.95
Pages (W/P, Window display etc.)	£35.00
Brainzap (Assembler)	£9.95
Monitor	£8.00
Diary	£10.00
Telephone	£10.00
Directory	£10.00
Orthello	£7.00

We are also developing our own software for the NewBrain. Please contact us for latest details

Software authors – if you have something good for the NewBrain please get in touch!

angela enterprises support the *NewBrain*

Personal service – evenings and weekends too! Help is just a 'phone call away! Our service starts with the sale. We are engineers and programmers – not just a sales outlet.

NewBrain Model A £234 } + VAT
Model AD (with line display) £260 } (free delivery)

130 page Beginners Guide and program tape with every machine, plus our own hints and tips from time to time.

Contact us for the latest information on hardware, software, monitors, printers, User Group, etc.

To obtain your NewBrain ring us on Stevenage (0438) 812439 (Access accepted) or send cheque/Access number to:

**HARDWARE
Prices include delivery in UK.
All with 12 month warranty (not the more usual 90 days!)**

NewBrain BATTERY MODULE £59.00 + VAT
NewBrain EPROM BOX £55.00 + VAT

SANYO or BMC Monitors
(Hi. res. 12", Green phosphor) £99.00+VAT

OKI Printers eg. 82A Please Enquire

(Other OKI models available)

EPSON FX 80 Please Enquire

SEIKOSHA GP 250X £260.00 + VAT

**FULL CP/M SYSTEM PLUS MORE
VERSATILE HARDWARE coming soon!**

Other printers – please ask.

ANGELA ENTERPRISES

4 Ninnings Lane, Rabley Heath, Welwyn, Herts. AL6 9TD

Tel. Stevenage (0438) 812439



WHEN IT COMES TO MICROCOMPUTER SOFTWARE WE WROTE THE BOOK

How do you stay up-to-the-minute with the rapidly changing world of microcomputer software? Get the Lifeboat Catalogue.

The latest innovations The new Lifeboat Catalogue is packed with the latest state-of-the-art software. And if we publish a new program after the latest catalogue has gone to press, we enclose a flash bulletin in your copy.

The greatest selection

Because Lifeboat is the world's largest publisher of microcomputer software, our catalogue offers you the greatest selection of programs for business, professional and personal use. Our more than 200 programs range from the integrated accounting and professional practice systems to office tools for book-keepers and secretaries to sophisticated tools for programmers. Included are business systems, word processors, programming languages, database management systems, application tools and advanced system utilities.

We specialise in software that runs on most small business computers. Our more than 60 media formats, including floppy disks, data cartridges, magnetic tape and disk cartridges, support well over 100 different types of computer.

Get full service We give the crucial dimension of after-sales service and full support to everything we sell.

That includes:

- An update service for software and documentation.
- Telephone, telex and mail-order services in the London office and at overseas offices in the United States, France, Switzerland, West Germany and Japan.
- Subscriptions to Lifelines,TM the monthly magazine that offers comparative reviews, tips, techniques, identified bugs and updates that keep you abreast of change.



Get it now Lifeboat now serves tens of thousands of satisfied customers with our breadth of up-to-date, fully tested, fully supported and competitively priced software.

You may not need all we offer, but we offer just what you need. After all, we wrote the book.

#1 Lifeboat Associates
World's foremost software source

Mail coupon to: Lifeboat Associates

PO Box 125, London WC2H 9LU or call 01-836 9028

Please send me a free lifeboat catalogue.

Name

Title

Company

Address

Postcode

Copyright © 1981, by Lifeboat Associates.

PCW/5/83

Lifeboat Worldwide offers you the world's largest library of software. Contact your nearest dealer of Lifeboat.

USA Lifeboat Associates 1651 Third Ave. New York NY 10028 Tel (212) 860-0300 Telex 640693 (LBSOFT NYK) TWX 710 581-2524 **JAPAN** Lifeboat Inc. OK Bldg. 5F 1-2-8 Shiba-Daimon Minato-ku Tokyo 105 Japan Tel 03-437-3901 Telex 2423296 (LBJTYO) **ENGLAND** Lifeboat Associates Ltd PO Box 125 London WC2H 9LU England Tel 01-836 9028 Telex 893709 (LBSOFTG) **SWITZERLAND** Lifeboat Associates GmbH Hinterbergstrasse Postfach 251 6330 Cham Switzerland Tel 042-36-8686 Telex 865265 (MICO CH) **WEST GERMANY** Intersoft GmbH Schlossgartenweg 5 D-8045 Ismaning W. Germany Tel 089-966-444 Telex 5213643 (ISOFT) **FRANCE** Lifeboat Associates SARL 10 Grande Rue Charles de Gaulle 92600 Asnieres France Tel 1-733-08-04 Telex 250303 (PUBLIC X PARIS)

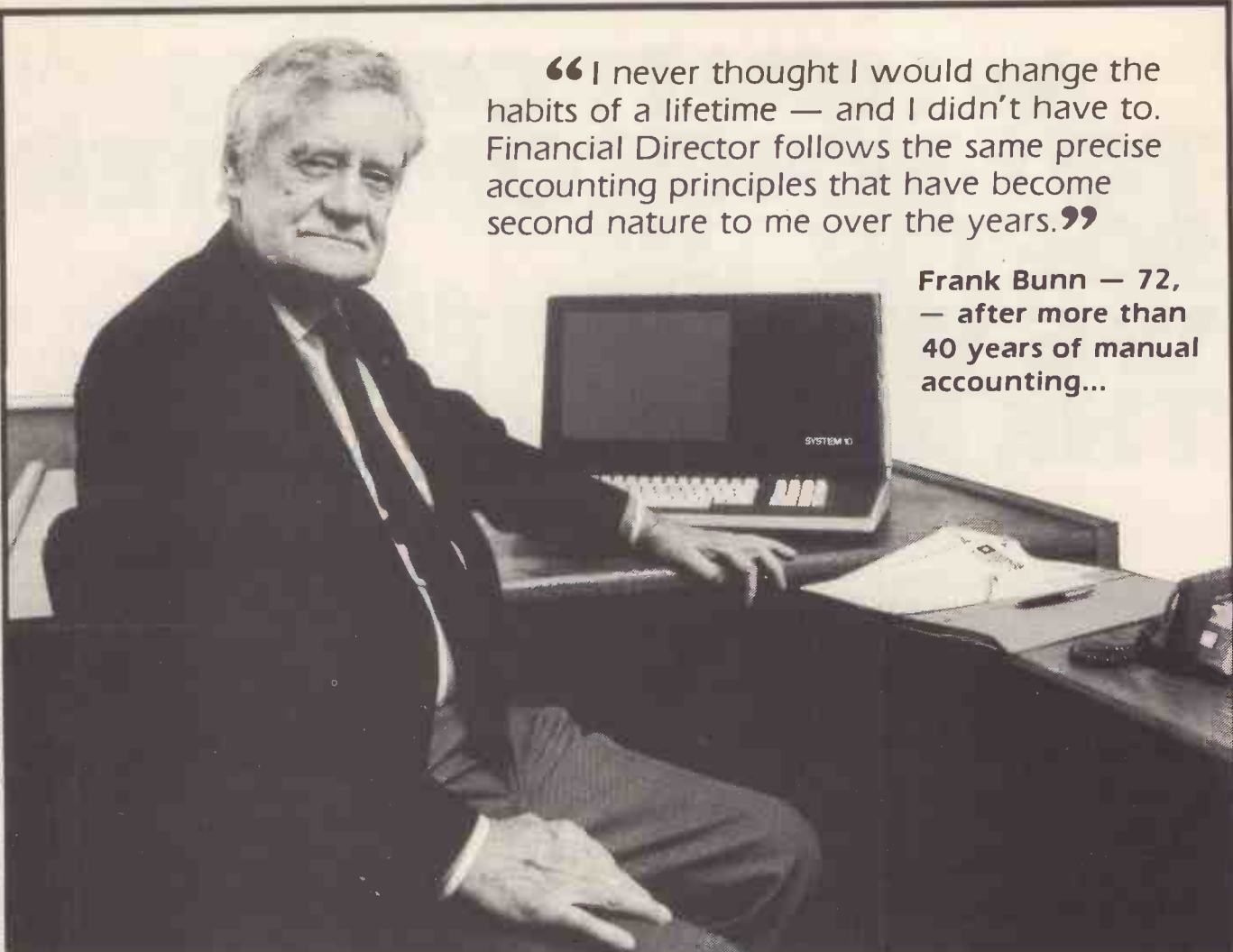

“I never thought I would change the habits of a lifetime — and I didn't have to. Financial Director follows the same precise accounting principles that have become second nature to me over the years.”

Frank Bunn — 72,
— after more than
40 years of manual
accounting...

More and more people are finding *FINANCIAL DIRECTOR* is Right for their Business

Financial Director is a complete business book-keeping and accounting software package for small and medium-sized businesses and proven in two years' field testing.

Financial Director has been designed by professional Accountants and conforms exactly to British Accounting principles with essential items such as automatic double entry and a complete audit trail which are fundamental to successful computer accounting.

Financial Director has been described as the 'accountant in a briefcase' — partly due to its unique presentation, partly because it provides the financial control skills of the professional accountant and enables the businessman to keep totally up-to-date with the progress of his business.

Financial Director works on most business micro's and is available from good computer dealers all over the country.

We recommend that you consult your accountant and implement your computer accounting system with professional assistance.

For full information and details of our training schemes and dealer network — call today.



**THE
FINANCIAL
DIRECTOR
SOFTWARE
LIMITED**

Asphalte House,
Palace Street,
London SW1E 5HS
Tel: 01-828 4377. Telex: 913001.

When it's time to stop playing games and get down to business...

Unfortunately, many of today's desk top computers are designed with too much emphasis on home use. That's fine, if you want to balance your checkbook, play "space war" or draw pictures. But when you have serious business requirements for a computer, you want one designed specifically for business.

The RAIR Business Computer is just that. A computer designed specifically for business applications, incorporating a host of features—optimised for the business environment. 8- and 16-bit microprocessors allow users to run available 8-bit—plus newer 16-bit—applications software simultaneously. And an integral high-capacity Winchester disk drive—plus provision for additional hard disk support—provides sufficient on-line storage for virtually any business application.

Advanced communications software allows the RAIR Business Computer to connect to mainframe systems and networks. And expanded RAM memory supports simultaneous access from up to four user workstations, each including an ergonomically designed, detached keyboard, high-resolution colour display, and optional workstation printer.

So if you're serious about a computer for business, call RAIR for details about our Business Computer. We're not playing games.

RAIR Limited
6-9 Upper St. Martins Lane
London WC2H 9EQ
Phone (01) 836 6921, Telex 298452

SYSTEM SPECIFICATION

Microprocessors: Concurrent 16-bit 8088 plus 8-bit 8085

RAM Memory: 256 kbytes expandable to 1024 kbytes

Integral Disk Storage: 19-Mbyte Winchester drive plus 1-Mbyte floppy drive

Storage Options: Up to 4 add-on Winchester drives plus streaming tape backup

Communications: 4 workstation ports (RS-422-compatible), plus 2 synchronous/asynchronous programmable RS-232 ports

WORKSTATIONS (up to 4)

Keyboard: Ergonomic, low-profile, 83 keys, 10 programmable function keys, 10-key numeric keypad (with cursor/editing functions)

Color Display: High-resolution, 80 characters x 25 lines, upper and lower case, 8 programmable foreground/background colors

Printer: Bidirectional, 80 characters-per-second, friction and tractor feed

SOFTWARE

Operating System: User-friendly, multi-tasking, CP/M, MP/M, PC-DOS compatible

Languages: BASIC, COBOL, Pascal

Applications: Spreadsheet, Database, Text Processing Communications

CP/M and MP/M are trademarks of Digital Research
PC-DOS is a trademark of IBM

the RAIR Business Computer.



Fourth Generation

(Fourth-Generation-Users get more)

The most advanced micro-computer; the Fourth Generation will be put onto market through a professional dealer-net. Computata is searching for these dealers and will estimate the very best on the right level.

Becoming one of the leading manufacturers in just a few years isn't just appearing out of the blue.

The philosophy underlying this development is very simple:

Computata only hires high qualified staff who design and manufacture even higher qualified products.

In many important areas Computata's know-how is on an unequalled level.

Research for new and even better products is one of the fundamentals on which Computata's continuity is built.

So is the relationship with Computata's dealers. Computata's technical and commercial reliability has become legendary already. The more astonishing it was for some competitors, that it's Computata introducing the Fourth Generation micro-computer.

It's what the professional dealer has been waiting for. From now on there is this link: Computata and the TULIP System® I; a successful combination of which you will benefit from the very start.

16 BIT = 16 BIT = Computata's TULIP System® I. With the TULIP System® I Computata introduces a high speed and one of the most powerful micro-computers

in the whole world. The appliance of the 8086 micro-processor plus the 8087 arithmetic co-processor is due to this.

The Fourth Generation is a fact now.

But not just its speed, also the fulfilment of all possible ergonomical requirements are very important.

Due to the vast keyboard with 103 clearly arranged key-tops, the TULIP System® I is very easy to operate and user-friendly.

What's more. Lots of standard software packages can be (are already)



dealers earn more.

implemented on the TULIP System® I.
 The capacity? Main memory of standard 128Kb,
 expandable upto 896Kb. Mass storage of 350Kb
 Floppy Disk as well as 5Mb removable
 Winchester Hard Disk or upto 20Mb fixed types.

As much as 8 standard aboard and software
 selectable character sets ensure high flexibility.
 Together with the colours and high resolution
 graphics it makes the TULIP System® I to be
 unique.

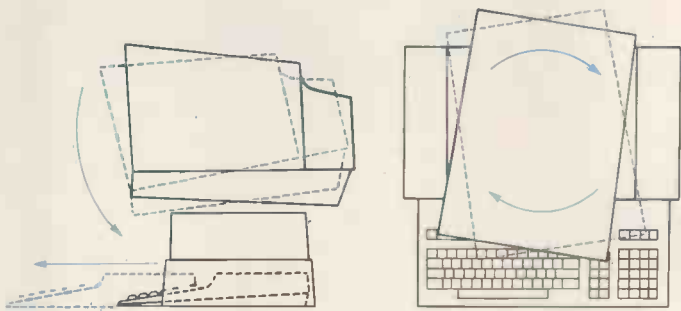

Earn more: Professional Dealers will gain in
 selling the TULIP System® I. With its extra-
 ordinary price/performance you will find a
 blooming market for the TULIP System® I. Both
 you and your clients have been waiting for this.

Dealing with CompuData's TULIP System® I
 means for you: Selling the Fourth Generation
 quality and getting a "very attractive" profit.

Yes indeed, it's worth a great deal for
 CompuData to handle with the best dealers.
 Contacting us can mean the upmost to you:
 Phone CompuData 73-422045, telex 50316 cdata
 nl or write to CompuData BV.,
 Hambakenwetering 2, 5231 DC 's-Hertogenbosch,
 The Netherlands.

We speak your language - the language of the
 Fourth Generation.

Profile of the Fourth Generation: TULIP System® I.

Specifications

Computer:
 Processor 8086, 8087 (opt)
 Clock 8 Mhz
 RAM 128-896 Kb
 Serial I/o RS-232
 Parallel I/o Centronics comp.
 Interfaces Hard-disk, tape, lightpen
 Fl. disk controller 8 inch + 5/4 inch
 Bufferd Keyboard 104 keys

Storage:
 Floppy disk dual 5 1/4 inch; 1.5 Mb
 Hard disk - fixed 5 MB, 10 Mb
 - removable 5 Mb

Display:
 Formats 80 x 25, 64 x 31, 40 x 25
 Low res. graphics 100 x 160
 High res. graphics 786 x 288 (opt)
 Colour 8
 Internat. char. sets 8 - softw. selectable

Please send me details of the dealership for
 TULIP system® I as soon as possible.

Company:

Name:

Function:

Address:

Town:

Postal Code:

Country:

Tel. no:

CompuData B.V., Hambakenwetering 2,
 5231 DC 's-Hertogenbosch, The Netherlands.
 Tel. 073 - 422045, Telex 50316 cdata nl.

Founders of the TULIP system I

PCW



Peachtree Software

The gilt-edged investment for your microcomputer



You need to be sure that the application software you choose carries the hallmark of stability and reliability and will be a sound investment for the future. It should enhance the value of the microcomputer you select to solve your business problems.

The **Peachtree Portfolio of Application Software** meets this need. The range provides for simple book-keeping (*Peachtree Basic Accounting Systems*), comprehensive accounting (*Peachtree Business Management Systems*) and integrated office automation (*Peachtree Office Productivity Systems*).

Peachtree is part of the world's largest Application Software company. We have over 20 years experience helping users of large and small computers get the full value from the computerisation of their business.

A nationwide network of independent computer retailers offers our portfolio of products on many different types of microcomputer. These companies provide the local support you want - backed up by *Peachtree*.

Major microcomputer manufacturers and distributors have made their investment in *Peachtree Software* for their computers.

They include:

IBM, DIGITAL, BRITANNIA,
RANK XEROX, PHILIPS, OSBORNE,
POSITRON, OEM, EPSON,
GRUNDY, WANG, MEMORY,
SAMURAI (distributed by Micronetworks)
SANYO and ALTOS (distributed by Logitek)

Peachtree Software is available for these machines through their own distribution networks - backed up by *Peachtree*.

THE SOFTWARE THAT WORKS FOR YOU.

Peachtree Software International Limited
43-53 Moorbridge Road, Maidenhead,
Berkshire SL6 8LT, United Kingdom
Telephone: Maidenhead (0628) 32711.
Telex 849000



A Subsidiary of Management Science America AN **MSA** COMPANY

SEND FOR THE PEACHTREE PORTFOLIO:

Clip the coupon to your card or letterhead and mail it today.



My Company: _____
My Name: _____
My Computer: _____

PCW3



The box is not always black ...

At Rair we're continually enhancing and upgrading our Black Box microcomputer range to meet the ever-changing, ever-growing needs of our customers.

That's why you'll often find our systems turning up under different names, different colours – not always black.

Our current Black Box range includes 8- and 16-bit microprocessors, that can be configured from simple

single-user floppy disk systems right up to powerful multi-user systems with Winchester hard disks and tape backup.

So next time you're choosing a microcomputer for a new application, remember to call us first.

With Rair, you can have any colour you like, including black.

RAIR

United Kingdom RAIR Limited 6-9 Upper St Martins Lane London WC2H 9EQ Telephone (01) 836 6921 Telex 298452

France RAIR Sarl 90 Avenue Champs Elysées 74008 Paris Telephone 010 331 225 4401 Telex 290177

West Germany RAIR Computer GmbH Clemensstrasse 5-7 5000 Köln 1 Telephone (0221) 219811 Telex 8881915

United States RAIR Microcomputer Corp. 4101 Burton Drive Santa Clara CA 95050 Telephone (408) 988-1790 Telex 677038

How to make work like a

First, neatly cut out the "370" label.

Now, when nobody's looking, nonchalantly tape it to your terminal, just under the "IBM," as if it really belonged there.

Then wait for your chance and quickly slip a dBASE II™ disk into your main drive.

That's it.

Your IBM Personal Computer is now ready to run a relational database system, the kind that IBM has

on their mainframes. And you're ready with more data handling power than you would have dreamt possible before dBASE II.

You'll wonder how you managed without it.

You'll find that dBASE II, because it's a relational database management system (DBMS), starts where file handling programs leave off. dBASE II handles multiple databases and simplifies everything from accounting to department staffing to monitoring rainfall on the Upper Volta.

With a word or two, you CREATE databases, APPEND new data instantly, UPDATE, MODIFY, and REPLACE fields, records and entire databases. Organize months worth of data in minutes with the built-in REPORT. Do subfield and multi-field searches, then DISPLAY some or all of the data for any condition you want to apply.

And you've just begun to tap the power of dBASE II.

Easy to look at, easy to use.

Input screens and output forms couldn't be easier — just "paint" your format on the screen



and what you see is what you'll get.

You can do automatic calculations on fields, records and databases, accurate to 10 digits.

And you can use dBASE II interactively for answers right now. Or save your instructions, then repeat everything with two words: DO Manhours, DO Project X, DO whatever has to be done.

Use dBASE II to help make your choice:

Instead of just poring over a manual, you can check out dBASE II by running it on your own system free for 30 days.

Put your micro on a mainframe.



Visit your dealer and run through a hands-on demonstration. Then buy a package and use it on your IBM PC, Sirius or CP/M computer. If you don't like it, return it and you'll get your money back, no questions asked.

But if you do that, you'll have to remove that label. Because nothing short of a mainframe works like dBASE II.

For the name of your nearest dealer, contact one of our distributors: Encotel Systems 01-686 9687. Ferrari Software 01-751 5791. Interam 01-675 5325. Pete & Pam (0706) 227011. Software Ltd 01-387 8832.

Soft Option (0476) 86017. Tamsys Windsor 56747. Xitan Systems (0703) 334711. ACT (Pulsar) 021-454 8585. Druvic International 01-226 8809.

Ashton-Tate

dBASE™



©1983 Ashton-Tate
dBASE II is a registered trademark of Ashton-Tate
CP/M is a registered trademark of Digital Research

Sinclair ZX Spectrum

**16K or 48K RAM...
full-size moving-
key keyboard...
colour and sound...
high-resolution
graphics...**

**From only
£125!**

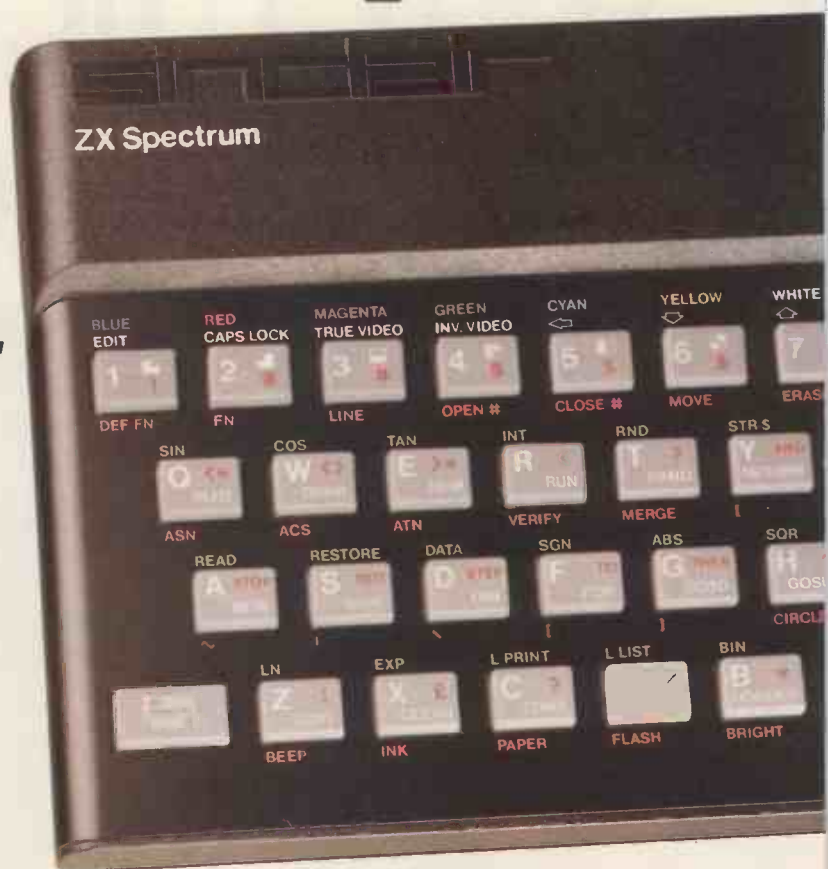

First, there was the world-beating Sinclair ZX80. The first personal computer for under £100.

Then, the ZX81. With up to 16K RAM available, and the ZX Printer. Giving more power and more flexibility. Together, they've sold over 500,000 so far, to make Sinclair world leaders in personal computing. And the ZX81 remains the ideal low-cost introduction to computing.

Now there's the ZX Spectrum! With up to 48K of RAM. A full-size moving-key keyboard. Vivid colour and sound. High-resolution graphics. And a low price that's unrivalled.

Professional power – personal computer price!

The ZX Spectrum incorporates all the proven features of the ZX81. But its new 16K BASIC ROM dramatically increases your computing power.

You have access to a range of 8 colours for foreground, background and border, together with a sound generator and high-resolution graphics.

You have the facility to support separate data files.

You have a choice of storage capacities (governed by the amount of RAM). 16K of RAM (which you can upgrade later to 48K of RAM) or a massive 48K of RAM.

Yet the price of the Spectrum 16K is an amazing £125! Even the popular 48K version costs only £175!

You may decide to begin with the 16K version. If so, you can still return it later for an upgrade. The cost? Around £60.

Ready to use today, easy to expand tomorrow

Your ZX Spectrum comes with a mains adaptor and all the necessary leads to connect to most cassette recorders and TVs (colour or black and white).

Employing Sinclair BASIC (now used in over 500,000 computers worldwide) the ZX Spectrum comes complete with two manuals which together represent a detailed course in BASIC programming. Whether you're a beginner or a competent programmer, you'll find them both of immense help. Depending on your computer experience, you'll quickly be moving into the colourful world of ZX Spectrum professional-level computing.

There's no need to stop there. The ZX Printer – available now – is fully compatible with the ZX Spectrum. And later this year there will be Microdrives for massive amounts of extra on-line storage, plus an RS232 / network interface board.



Key features of the Sinclair ZX Spectrum

- Full colour – 8 colours each for foreground, background and border, plus flashing and brightness-intensity control.
- Sound – BEEP command with variable pitch and duration.
- Massive RAM – 16K or 48K.
- Full-size moving-key keyboard – all keys at normal typewriter pitch, with repeat facility on each key.
- High-resolution – 256 dots horizontally x 192 vertically, each individually addressable for true high-resolution graphics.
- ASCII character set – with upper- and lower-case characters.
- Teletext-compatible – user software can generate 40 characters per line or other settings.
- High speed LOAD & SAVE – 16K in 100 seconds via cassette, with VERIFY & MERGE for programs and separate data files.
- Sinclair 16K extended BASIC – incorporating unique 'one-touch' keyword entry, syntax check, and report codes.

um



The ZX Printer – available now

Designed exclusively for use with the Sinclair ZX range of computers, the printer offers ZX Spectrum owners the full ASCII character set – including lower-case characters and high-resolution graphics.

A special feature is COPY which prints out exactly what is on the whole TV screen without the need for further instructions. Printing speed is 50 characters per second, with 32 characters per line and 9 lines per vertical inch.

The ZX Printer connects to the rear of your ZX Spectrum. A roll of paper (65ft long and 4in wide) is supplied, along with full instructions. Further supplies of paper are available in packs of five rolls.



The ZX Microdrive – coming soon

The new Microdrives, designed especially for the ZX Spectrum, are set to change the face of personal computing by providing mass on-line storage.

Each Microdrive can hold up to 100K bytes using a single interchangeable storage medium.

The transfer rate is 16K bytes per second, with an average access time of 3.5 seconds. And you'll be able to connect up to 8 Microdrives to your Spectrum via the ZX Expansion Module.

A remarkable breakthrough at a remarkable price. The Microdrives will be available in the early part of 1983 for around £50.



ZX Spectrum software on cassettes – available now

The Spectrum software library is growing every day. Subjects include games, education, and business/household management. Flight Simulation... Chess... Planetoids... History... Inventions... VU-CALC... VU-3D... Club Record Controller... there is something for everyone. And they all make full use of the Spectrum's colour, sound, and graphics capabilities. You'll receive a detailed catalogue with your Spectrum.

ZX Expansion Module

This module incorporates the three functions of Microdrive controller, local area network, and RS232 interface. Connect it to your Spectrum and you can control up to eight Microdrives, communicate with other computers, and drive a wide range of printers.

The potential is enormous, and the module will be available in the early part of 1983 for around £30.

sinclair

Sinclair Research Ltd, Stanhope Road, Camberley, Surrey GU15 3PS. Tel: Camberley (0276) 685311.

How to order your ZX Spectrum

BY PHONE – Access, Barclaycard or Trustcard holders can call 01-200 0200 for personal attention 24 hours a day, every day. BY FREEPOST – use the no-stamp needed coupon below. You can pay by cheque, postal order, Barclaycard,

Access or Trustcard.

EITHER WAY – please allow up to 28 days for delivery. And there's a 14-day money-back option, of course. We want you to be satisfied beyond doubt – and we have no doubt that you will be.

To: Sinclair Research, FREEPOST, Camberley, Surrey, GU15 3BR.				Order
Qty	Item	Code	Item Price £	Total £
	Sinclair ZX Spectrum – 16K RAM version	100	125.00	
	Sinclair ZX Spectrum – 48K RAM version	101	175.00	
	Sinclair ZX Printer	27	59.95	
	Printer paper (pack of 5 rolls)	16	11.95	
	Postage and packing: orders under £100	28	2.95	
	orders over £100	29	4.95	
			Total £	

Please tick if you require a VAT receipt

*I enclose a cheque/postal order payable to Sinclair Research Ltd for £ _____

*Please charge to my Access/Barclaycard/Trustcard account no. _____

*Please delete/complete as applicable _____

Signature _____

PLEASE PRINT

Name: Mr/Mrs/Miss _____

Address _____

PCW 905

FREEPOST – no stamp needed. Prices apply to UK only. Export prices on application.

ORIC Software



For the superb ORIC-1 The finest software, ORIC SOFTWARE

Fast-load action, taking ORIC's colour, graphics and sound capabilities to new frontiers. Carefully designed and selected to match ORIC's quality and quest for timeless technology.

The ever growing range includes programs for Business, Education and In-home entertainment, so whether you want a total business system or 'edge of the chair' arcade excitement, choose ORIC - The new experience in micro-software.

Part of the growing selection includes:-

FOR HOME

BACKGAMMON - CHESS
FLIGHT - ZODIAC - AIRLINE
DALLAS

FOR BUSINESS

ORIC PAY - ORICINV - ORIC STOCK - ORIC CALC -
ORIC TYPER - AUTHOR **PLUS** ORIC BASE and
ORIC FORTH languages

ORIC



Real computer software from

ORIC PRODUCTS INTERNATIONAL LTD, COWORTH PARK, LONDON ROAD, ASCOT, BERKS

JUST LAUNCHED

ORIC TREK SPACE ADVENTURE GAME

You are in command of the Federation's most powerful starship the USS Enterprise. Armed with your phasers and photon torpedoes, your task is to patrol the furthest reaches of the Galaxy, protecting Federation space against the forces of invading Klingons. Your ultimate mission is to rid the Galaxy entirely of the Klingon menace... before they destroy you. Your crew awaits you aboard the Enterprise. Starfleet Command wishes you Bon Voyage and Good Hunting!

**ORIC products available from:-
WHSMITH • DIXONS • GREENS
LASKYS • MICRO'C' • MICRO
PERIPHERALS • SPECTRUM
COMPUTERS FOR ALL
And hundreds of independent
dealers.**

Critical review?



“The 16k Oric – fighting the 16k Spectrum – is £25 cheaper. It feels a good deal more ‘professional’ than the home-appeal Sinclair. Oric’s sound is extremely versatile, and well up to the standard of the £300 or £400 BBC microcomputer made by Acorn.”

WHICH MICRO?

“Oric will soon be selling a Modem so that Prestel will become available. Owners will be able to accept telesoftware – programs loaded straight down the phone line – eventually electronic mail could come into the home by the same route, and with the addition of a tape recorder the Oric with its Modem could become a telephone answerer and message taker.”

YOUR COMPUTER

“Instead of the Spectrum’s 28 look-up single-character error reports, the Oric has 18 self-explanatory messages. If you actually want to do computing, rather than just exploring the world of off-the-shelf games programme entertainment the Oric will be a better buy.”

WHICH MICRO?

“Oric was over twice as fast as the Spectrum. Surprisingly perhaps the Oric, which initially seemed only faster when performing the simplest of calculations, has come back to beat the Spectrum by a small amount. As the problems get more complex the Oric comes into its own. One final point – in entering the benchmark tests – the Oric was certainly the easiest to handle.”

WHICH MICRO?

“One good feature of the Oric is an on-screen reminder in the top right hand corner to show that you’ve engaged all-capitals mode. So much better than the BB’s variety of lights in the corner of the keyboard. The Oric is sound, simple to get along with and offers great expansion potential.”

WHICH MICRO?

“A good speaker and built-in noises get the Oric’s sound off to a good start. Typing Zap, Ping, Shoot or Explode produces convincing arcade game noises which can easily be incorporated into any program.”

YOUR COMPUTER

“The sound commands on the Oric 1 are, for a computer of this price, very sophisticated. Three music channels, and one noise channel, mean that you can program some fairly complex sounds.”

POPULAR COMPUTING WEEKLY

“Oric is everything you hoped it would be. Alive with colour, and zapping with built-in sound effects, the Oric looks like a match for any machine now selling for less than £200.”

YOUR COMPUTER

“This slope coupled with the design of the keys makes the Oric an easy machine to touch-type on. All keys have auto-repeat and there are four keys dedicated specifically to cursor control. It is certainly easier to type on than any of Sinclair’s offerings.”

YOUR COMPUTER

“When compared to the stogginess of the Spectrum’s keyboard this is certainly an improvement. I can’t see any Orics failing through bad assembly. If only the £2400 IBM were so easy to use.”

WHICH MICRO?

“The modem is certainly unusual in a machine of this price. Together with the other peripherals, when finally available, it should make for an attractive package for a small business... surely a match for machines costing much more.”

POPULAR COMPUTING WEEKLY

ORIC-1

The Real Computer System

ORIC PRODUCTS INTERNATIONAL LTD, COWORTH PARK, LONDON ROAD, ASCOT, BERKS

available from... **WHSMITH ● DIXONS ● GREENS
LASKYS ● MICRO‘C’ ● MICRO PERIPHERALS
SPECTRUM ● COMPUTERS FOR ALL
And hundreds of independent dealers.**

SIMPLY MORE

VHA
CO1, CO3 ICL Comms
0532-747475

MOM
Condor Database
0474-57746

Biodata
Microlink-Computer
Interface
061-236 1283

B &
Housi
07

Padmede
Nominal Ledger
02514-21892

Graffcom
IBSF-W
Business Controller
01-727 5561

Comshare
Microconnect
021-704 4151

Sosoft
Tomorrows Office
0202-735656

Millhouse Designs
Comms Processor
0420-84517

M.P.
BOS Mi
01-83

M.P.S.L.
BOS Autoclerk
01-831 8811

Sapphire Systems
Stock Control
Invoicing
01-554 0582

is
gement
unting
31 0585

Pulsar
Pulsar Range
021-454 8585

UCS
027

We felt it was time we stopped telling you about ourselves and said a few words about the massive commitment which over 100 software organisations have made to the ACT Sirius 1. On these pages are just a few of more than 400 packages now available for the Sirius 1, Britain's best-selling 16-bit personal computer.

The packages range from traditional accounts programs to sophisticated computer-aided design systems and there is a whole host of software for specific industries and professions.

If you're looking for a computer solution to match your business requirements, then 'phone one of the numbers above, before you look any further. They're all convinced that the ACT Sirius 1 is the best machine of its kind in the country – and they have the software that will make it work for you. And if you don't see what you want, just clip the coupon for details of more than 400 products designed for the ACT Sirius 1.

SOFTWARE

Computing
ss. System
62449

D.L.A. Computers
Off-line telex
preparation
01-847 2331

Vuman
SymboleX-Scientific
Word Processor
061-273 3333

Praxis
Praxistock Modelling
08926-61261

Heronview
IEEE488 Driver
01-628 5423

Interdata
Telex-simulation
01-761 4135

Abtex
Micronet
Project Planning
0224-647074

obol
311

Micro Supplies
Dairy Herd
Management
0262-77115

Busisoft
Spellbinder
01-381 4337

TABS
Fast Data Entry
0264-58933

Pegasus Software
Invoicing
0536-522822

.l.
System
42796

Bristol Software
Factory
Silicon Office
0272-277135

Distincti
Coach
0937



ACT SIRIUS 1

Please send me
the Registered Product Brochure,
listing over 400 Hardware and
Software products for the ACT Sirius 1.

Name _____

Position _____

Company _____

Address _____

Telephone _____

A new star is born



pulsar

16 BIT BUSINESS SOFTWARE

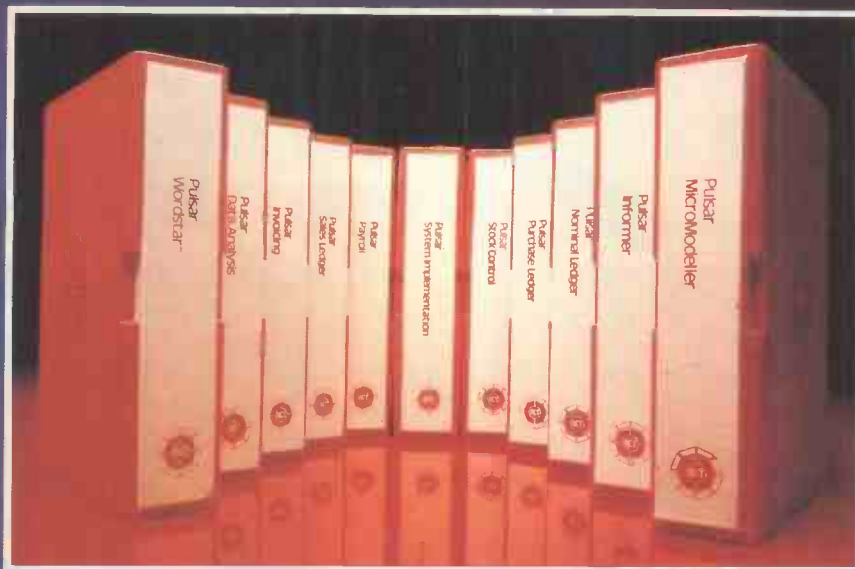

PULSAR business software is the creation of ACT – the company behind the Sirius 1 and recognised leader in 16-bit personal computing.

The new PULSAR range, developed by ACT at a cost in excess of £1 million, takes full advantage of the power and expandability of 16-bit computers.

It is inherently faster and more powerful than traditional 8-bit software.

And it is a true 16-bit range, designed and developed by ACT's own software engineers.

PULSAR offers more of all the key requirements in business software:

MORE PORTABILITY

Written throughout in machine-independent portable languages to protect your software investment.

LONGER PEDIGREE

ACT has more than 17 years experience in developing business software. Thousands of companies throughout the world use ACT packages.

GREATER INTEGRATION

All the PULSAR packages are designed to share information, avoiding duplication of files and eliminating re-entering of data.

MORE USER-FRIENDLY

ACT's unique UFO (user-friendly origination) routines allow even the inexperienced user to quickly and easily configure a PULSAR system to precise requirements.

BETTER TRAINING

Two training centres, in London and Birmingham are open to all PULSAR users.

MORE SUPPORT

A 'hot line' telephone support scheme to instantly resolve any operating queries.

PULSAR SOFTWARE CENTERS

Only PULSAR is available through the unique network of PULSAR Software Centers. These are hand-picked computer dealers who handle a range of personal computers but who specialise purely in PULSAR to meet all business needs.

THE PULSAR RANGE

Sales Ledger	£195	Informer Database	£295
Purchase Ledger	£195	Micromodeller	£595
Nominal Ledger	£195	SuperCalc™	£150
Payroll	£195	MultiPlan™	£159
Stock Control	£195	WordStar™	£295
Invoicing	£195	Select™	£295
Data Analysis	£195	MailMerge™	£95
		dBase II	£395

**AVAILABLE NOW FOR SIRIUS –
IBM PC and DEC Rainbow
coming soon.**



For more information on the new PULSAR Range clip the coupon and return to
ACT (Pulsar) Ltd
FREEPOST,
Birmingham B16 1BR
 or call
021-454 8585

Please send me further details of the new PULSAR Range.

Name _____

Position _____

Company _____

Address _____

Tel _____

SCI

™ indicates registered trade mark. Ownership details on request. ALL prices exclude VAT.

GALAXY 2 COMPUTER SYSTEM



WHATEVER REQUIREMENTS YOU HAVE



GM813 - CPU/ 64K RAM Board

- ★ 4 MHz Z80A CPU
- ★ 64K Dynamic RAM
- ★ RS232 Serial Interface
- ★ Two 8-Bit I/O Ports
- ★ 1200 Baud Cassette Interface
- ★ Extended and Page Addressing Modes

GM812 - IVC Board

- ★ 80x25 Display Format
- ★ On-board Z80A Microprocessor
- ★ Buffered Keyboard Input
- ★ Programmable Character Generator
- ★ 160x75 Pixel Graphics
- ★ Light Pen Input

GM 829 - FDC/ SASI Board

- ★ Single/Double density operation
- ★ Single/Double sided drive operation
- ★ Up to 3 mixed 3.5", 5.25" and 8" drives
- ★ Industry Standard SASI hard-disk Interface

TWO SPARE SLOTS

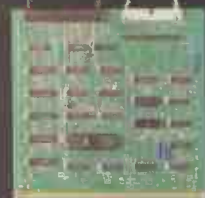
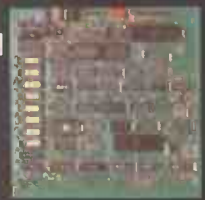

The cost-effective solution to your computer needs for only **£1,495***

For just £1,495 the Galaxy 2 provides the basic requirements for a small business system:

- **Central Processor Unit with 64K of RAM**
- **Twin disk drives (400K storage per drive)**
- **Keyboard and 12" monitor**

But unlike many other small-business systems the Galaxy System is specially designed for expansion and flexibility to meet changing requirements. It uses the world's best selling micro processor, the Z80A, and is based on industry-standard 80-Bus boards. The business system uses only 3 boards in the 5 spaces available, so extra cards can be "plugged-in" to expand the system; for example to expand the memory, or to give a colour facility, or to develop the Galaxy for the particular requirements of education, research, software development etc.

It has a CP/M operating system which gives access to the largest range of software available for any machine. In particular, Gemini can offer QUIBS; a small-business package developed especially for the Galaxy.

The Galaxy has industry-standard interfaces (parallel and serial), and Gemini Microcomputers can supply a full range of compatible hardware including a Winchester sub-system and printer.

The Galaxy offers the most cost-effective way of obtaining a basic unit which is capable of developing to meet your particular requirements; now and tomorrow.

Features include:

- Twin Z80 Processors
- 64K Dynamic RAM
- 800K Disc Based Storage
- 80 x 25 Screen Format
- Dual Printer Interfaces
- Modular Design
- Extra Disc Drives Easily Added
- Winchester Expansion Available
- Net Working System Available
- Additional Slots for 2 Cards
- 12" Green or Amber Monitor



*Price is exclusive of VAT

 Gemini Microcomputers

18 Woodside Road, Amersham, Bucks HP6 5EQ. Tel: (02403) 28321.



NEW!

Introducing the Micronix 80HD

a complete microcomputer on a single board
with 'SASI' hard disk interface

- * Z80A 4MHz CPU
- * 64K or 128K RAM on Board
- * On Board 24 x 80 VDU
- * 4K System Monitor
Sockets for further 8K EPROM
- * 4K Character Generator
Up to 64 Custom characters
- * Teletext Graphics
- * CRT Controller
- * Floppy Disk Controller for
5¼" or 8" Drives inc. High
Density 77 track 5¼" Floppies
- * Industry Standard Hard
Disk Interface (SASI)
- * 2 Channel RS232c
- * 2 Port Parallel
- * On Board Real Time Clock/
Calendar with Battery back-up
- * External I/O BUS
- * ASCII Keyboard Port
- * Disk operating system
(optional): CP/M 2.2,
CP/M 3.

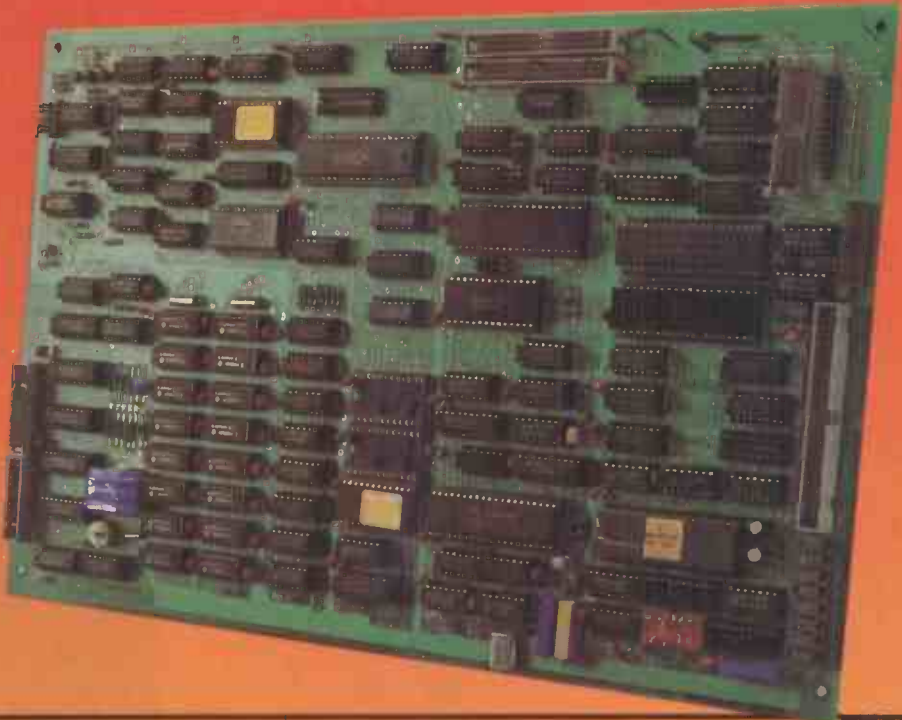

also available – for system builders

Front



Back

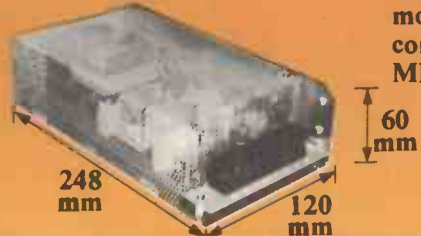

Low profile metal enclosure to house MICRONIX 80HD board, two half height 5¼" floppies (½ height floppies optional), a switch mode power supply for the complete system. The panels have cutouts for floppies, connectors and a fan (as illustrated). Thoughtfully constructed for easy accessibility. Cover and base grey/beige. Frame dark brown.

Switch mode slimline power supply model FEM 7030SS for a complete computer system enough power for MICRONIX 80HD, two mini floppies and CRT. Meets safety standards.
Input: 220/240V 50Hz.
Output: +5V @ 7A; +12V @ 3A
-5V @ 1A; -12V @ 1A
88 Watts

<p>Micronix 80HD (Please state whether 5¼" or 8" board required)</p> <p>64K £445 + £5 P & P (£15 overseas) + VAT</p> <p>128K £499 + £5 P & P (£15 overseas) + VAT</p> <p>CP/M 2.2 for Micronix 80HD £125 + VAT</p> <p>CP/M 3 for Micronix 80HD £250 + VAT</p> <p>Hard Disk utilities for Micronix 80HD £75 + VAT</p>	<p>Enclosure</p> <p>for ½ height floppies £75 + £10 P & P + VAT</p> <p>for ¾ height floppies £80 + £10 P & P + VAT</p> <p>horizontal mounting rails (set of four) £25 + £2 P & P + VAT</p> <p>Power Supply £77 + £3 P & P + VAT</p>
---	--

Although the NewBrain is conceived as a total system, the unexpanded Processor itself has a great deal to offer. It is available in two forms: Model AD, shown below, with a built-in line display; and Model A, without the line display. Both models can operate with a monitor or a television set.

MEMORY

- 24K bytes of ROM;
- 32 bytes of RAM, at least 28K of which is available to the user.

THE SCREEN DISPLAY

- 40 or 80 characters to the line – without affecting the 28K bytes of RAM at your disposal;
- 24 or 30 lines to the screen;
- well-formed characters, with true descenders;
- a full European character set;
- normal or reverse video, high resolution graphics on screen of controllable size, 256, 320, 512 or 640 horizontal resolution by 250 vertical lines;
- a facility to set up a “page” of up to 255 lines, with the screen acting as a “window” to display it;
- ability to maintain several such pages simultaneously, and to switch rapidly between them;
- text may be used on graphics screen as well as on parts of the video screen not used by graphics.

CHARACTER SET

- 512 characters, including the full ASCII set, all European accented characters, Greek and graphics symbols.

GRAPHICS

- 20 powerful graphics commands;
- all text characters usable on the graphics screen;
- variable-sized graphics screen, with the rest of the screen available for text – for versatility and to save memory.

SOFTWARE

Enhanced ANSI BASIC; screen editor (32 commands); mathematics package (10 significant figures); graphics commands.

- a very friendly screen editor – a delight to use and readily adapted to text processing;
- arithmetic to 10 significant figures;
- very controllable output formatting of numbers – invaluable for accounting, statistics, and scientific applications;
- a powerful, much enhanced BASIC;
- a very flexible operating system, which allows any data stream to be opened to any device.

INTERFACES

- two tape cassette ports built into the processor unit;
- a built-in printer interface;
- a built-in communications interface (V24/RS232);
- a video monitor interface;
- a TV interface;
- an expansion interface for NewBrain system expansion modules.

KEYBOARD

- standard typewriter pitch, action, layout and size, with editing control and graphics keys.



*CP/M IS A REGISTERED TRADE MARK OF DIGITAL RESEARCH INC.

You can get everything in the box on the

If you understand the facts and figures on the left you'll soon realise that NewBrain has to be one of the most powerful micros around.

However, if you find the box on the left a little hard to follow, don't worry.

We've got over 120 dealers nationwide who've got all the answers at their fingertips.

Either way you'll discover that NewBrain is the kind of micro that will stop the competition getting a look in.

At £269 it starts off with twice as much memory as most of its competitors and can expand to over thirty times that amount. So there's no chance of being left behind in the micro race.

It comes with a very powerful language (enhanced ANSI BASIC) and it'll take CP/M, so it'll work on the same system as similar big business micros, giving you the capacity to use an almost limitless variety of tried and tested software.

But most of all NewBrain is a machine that can expand.

It's designed to take disks, printers and memory expansion modules (up to 2M bytes) plus anything else you'd expect a professional business micro to handle.

So, whether you understand the box on the left or not, pay a visit to someone in the know on the right.

They'll answer all your questions and give you a full demonstration.

NewBrain

Grundy Business Systems Ltd., Grundy House,
Somerset Road, Teddington.

DEALER NETWORK

ALTRINCHAM PHARMACY COMPUTER SYSTEMS (061-928 0087)	GLOUCESTER MILEQUIP COMPUTERS (0452 411010)	NOTTINGHAM MICRO-C (NOTTINGHAM) (0602 412455)
BARNSTAPLE LANDKEY-NEWLAND (0271 77883) J & A CAMERAS (0271 75037)	GUILDFORD M C D LTD (0483-574659)	LASKYS (NOTTINGHAM) (0602 415150)
BEDFORD MICROPOWER BUSINESS APPLICS (0234 213571)	HAMILTON STRAIGHTLY MICRO CENTRE (03552 22517)	PETERBOROUGH LASKYS (PETERBOROUGH) (0733 313513)
BIRMINGHAM CALISTO COMPUTERS LTD (021 632 6458)	HARPENDEN CONSULTANTS IN OFFICE POWER (05827 66911)	PLYMOUTH DISKWISE LTD (0752 267000)
LASKYS (BIRMINGHAM) (021 632 6303) MICRO-C (BIRMINGHAM) (021-233 1105)	HASTINGS THE COMPUTER CENTRE (BMS) LTD (0424 439190)	PORTHCAWL TCP L (065-671 6114)
TYPEWRITER CENTRES (021 622 5385)	HEREFORD HONEYSETT COMPUTERS LTD (0432 279404)	POTTERS BAR SOFTWARE AGENTS LIMITED (0707-59669)
BISHOPS STORTFORD GEM SYSTEMS LTD (0279-52401)	HERTFORD RMR COMPUTER SERVICES (0992 56160)	PRESCOT MICROSYS LTD (051 426 7271)
BOURNE MICRO-C (LINCOLNSHIRE) (077 82 4566)	ISLE OF WIGHT VECTIS COMPUTER SERVICES (0983 528345)	PRESTON LASKYS (PRESTON) (0772 59264)
BRIGHTON LASKYS (BRIGHTON) (0273 725625)	KIDDERMINSTER MICRO-MART (0562-742142)	READING LASKYS (READING) (0734 595459)
BRISTOL ELECTROPRINT COMPUTERS (0272 292375)	KINGSTON LASKYS (KINGSTON) (01-546 1271)	RICHMOND TANTUS MICROSYSTEMS LTD (01-940 7299)
LASKYS (BRISTOL) (0272 20421) MICRO-C (BRISTOL) (0272 650501)	LEEDS MICRO-C (LEEDS) (0532 446601)	RUGBY OEM COMPUTER SYSTEMS
COLSTON COMPUTER CENTRE LTD (0272 726619)	LEICESTER MICROCELL COMPUTER SYSTEMS (0532 681366)	SANDERSTEAD J R INSTRUMENTS (01-657 7646)
BROMLEY LASKEYS (BROMLEY) (01-464 7829)	LEICESTER TILLEY COMPUTER SYSTEMS (0533-553984)	SARISBURY GREEN WENDMORE MANAGEMENT SERV LTD (04895 6318/9/0)
BUCKNELL BORDER COMPUTING & PROGRAMMING (05474 368)	LIVERPOOL LASKYS (LIVERPOOL) (051 236 2828)	SHEFFIELD T A EDUCATION LTD (0742-618539) LASKYS (SHEFFIELD) (0742 750971)
CAMBERLEY ASYST SYSTEMS CONSULTANTS LTD (0276 28397)	LONDON BEAUCHAMP COMPUTER SYSTEMS LTD (01-584 8203)	SOUTHAMPTON MICRO-C (SOUTHAMPTON) (0703-29676)
CAMBRIDGE CAMBRIDGE COMPUTER STORE (0223 65334)	LION MICRO COMPUTERS (01-580 7383)	GODWIN ELECTRICAL LTD (0703 783322)
G C C (CAMBRIDGE) LTD (0223 835330)	MICRO-C (LONDON NW1) (01-387 9275)	ST HELIER THE PROCESSOR CENTRE (JERSEY) (0534 77070)
CANTERBURY M D WRIGHT DATA SERVICES LTD (0227 69090)	TRANSAM MICROSYSTEMS LTD (01-405 5240)	DATASTREAM (JERSEY) LTD (0534-71219)
CANVEY ISLAND MERCURY MICROSYSTEMS LTD (0268-696263)	LASKYS (QUEENSWAY) (01-229 6425) LASKYS (TOTTENHAM COURT ROAD) (01-636 0845)	ST PETER PORT THE PROCESSOR CENTRE (GUERNSEY) (0481-28827)
CHALFONT ST GILES PRINTIVITY LTD (02407 4906)	LASKYS (OXFORD STREET) (01-493 4623)	STROUD THE MODEL SHOP (045 36 5920)
CHATHAM MEDWAY COMPUTERS (0634 826080)	OFFICE INSTALLATIONS LTD (01-579 6771)	SURBITON COMPUTASOLVE (01-390 2779)
CHELTENHAM COMPUTER SHACK LTD (0242 584343)	TREND VIDEO & HI-FI LTD (01-521 6146) WELBECK VIDEO (01-486 3783)	TEDDINGTON AM PROGRAMMERS LTD (01-943 2266) STAG TERMINALS LTD (01-943 0777)
CHESTER LASKYS (CHESTER) (0244 317667)	LOUGHBOROUGH DATA ONE SYSTEMS LTD (0509 37281) MICRO-C (LOUGHBOROUGH) (0509 37367)	TEIGNMOUTH QUESTEL COMPUTERS (062-672258)
COLCHESTER CAPRICORN COMPUTER CENTRE (0206 33168)	LUTON LASKYS (LUTON) (0582 38302) MICRO-C (LUTON) (0582 425079)	THORNTON HEATH CROYDON COMPUTER CENTRE (01-689 1280)
CORK C D S COMPUTING LTD (0002 23922)	MAIDENHEAD KUMA COMPUTERS LTD (0628 71778/9)	UXBRIDGE J B MICRO (0895 57908)
COVENTRY COVENTRY MICROCENTRE (0203 58942)	MAIDSTONE LASKYS (MAIDSTONE) (0622 678165)	WALTON ON THAMES PMFS (98-22895)
DARLINGTON DARLINGTON COMPUTER SHOP (0325-487478)	MANCHESTER N S C COMPUTER SHOPS LTD (061-832 2269)	KEY COMPUTER CENTRES LTD (09322-42777/8)
DERBY DOWNINGTON COMPUTERS (0332 49672)	MICRO-C (MANCHESTER) (061 834 0144)	WAREHAM GAMES & COMPUTERS (09295 51383)
DUBLIN THE E C L GROUP OF COS (0001 603497)	LASKYS (MANCHESTER) (061-832 6087) LOMAX LTD (061 832 6167)	WARRINGTON NORTHERN COMPUTERS LTD (0928 35110)
DUNFERMLINE ANDREW THOMSON (0383 724541)	MIDDLESBROUGH MICRO TECHNIC COMPUTER SYSTEMS (0642 221501/2)	WATFORD LASKYS (WATFORD) (0923 47488)
EDGWARE CITADEL PRODUCTS LTD (01-951 1848)	MILTON KEYNES MILTON KEYNES COMPUTER CENTRE (0908 668811)	WELWYN ANGELA ENTERPRISES (0438 812439)
EDINBURGH JOHN MENZIES PLC (031-225 8555) LASKYS (EDINBURGH) (031-556 2914)	NAILSEA BYTE MICRO COMPUTING CENTRE (0272 851337)	WENDOVER TARACE LTD (0296 623965)
ELSTREE ELSTREE COMPUTER CENTRE (01-953 6921)	NEW MILTON SNIPE COMPUTERS LIMITED (0425 617477)	WINDSOR CASTLE COMPUTERS (95-58118)
GILLINGHAM MEDWAY MICRO COMPUTERS LTD (0634 576764)	NEWCASTLE-UPON-TYNE MICROCORE COMPUTERS (0632 846878)	YORK LASKYS (YORK) (0904 641221)
GLASGOW VICTOR MORRIS (AUDIO VISUAL) (041 221 8958)	NEWMARKET DATA BASE (0638-667311)	

left from anyone in the box on the right.

Our spreadsheet systems But let's start with

Today, computers, micros and more importantly business planning systems are no longer considered luxuries.

They allow you to make better decisions by providing better information on budgeting, cash flow, project profitability, Acquisition Appraisal, Lease vs Purchase analysis and much more.

You stay one step ahead of your business and your business stays one step ahead of the competitors.

But which system should you buy? Surely no one system can meet the needs of all businesses?

Fortunately Comshare is not like most companies. We see the need for different systems to suit different people.

NEW USERS START HERE

PlannerCalc at £85.00* is now accepted as the first choice for people new to financial planning.

Designed for 8-bit micros, it boasts the kind of features that you'd expect to pay twice as much for. (Buy PlannerCalc's nearest rival and you'll have to.)

Unlike all other 'calc' products it allows you to enter calculations in a language you understand. Plain English.

For example:

LINE 1 SALES=100,150,175,210
LINE 2 EXPENSES=GROW 70 BY 15% FOR 4
LINE 3 NET=SALES-EXPENSES
LINE 4 CSALES=CUM SALES
COLUMN 5 YEAR=SUM OF COL 1 THRU COL 4

So it's much easier to use.

It uses the popular "spreadsheet" approach with a window that can be rolled in all directions.

Which means you can enter new figures and rules and

immediately see their effect on everything else in the model.

It comes with the best manual on the market and it's suitable for most micros with a TMCP/M 2.2 operating system, 64K of memory, giving at least 900 cells, minimum screen width of 80 characters and 2 floppy disc drives.



MUCH MORE POWER, NOT MUCH MORE MONEY

MasterPlanner is the most powerful spreadsheet system currently available with its increased matrix size, 2000-3000 cells on most 64K micros. (But at £245* it certainly isn't the most expensive.)

Consolidation of models, allows you to create separate plans for each department and then combine them into an overall company

COMSHARE DEALERS

Aberdeen
Abtext Ltd
(0224) 647074

Aldershot
EMS (UK) Ltd
(0252) 313551

Altrincham
Mercator Tech Services Ltd
(061) 941 4225

Aylesbury
Helisair Systems Ltd
(0296) 630364

Barnsley
Brook Office Supplies Ltd
(0226) 88916

Bedford
MSC Hiland Ltd
(0234) 50260

Blackburn
BEC Systems Services Ltd
(0254) 677215

TOS Bus Systems Ltd
(0254) 676915

Bradford
Comphigh
(0274) 668890

Raven Computers Ltd
(0274) 306966

Bristol
Avon Microcentre Systems Ltd
(0272) 277774

C.C.E. (Europe) Ltd.
(0454) 321088

Mercator Computer Systems Ltd
(0272) 731079

Transtec Ltd
(0272) 277462

Bury St. Edmunds
S.I.R.C.S. Ltd
(0284) 62022

Camberley
Alexander Systems Ltd
(0276) 28971

Canterbury
Kent Micro Systems
(0222) 50200

Cardiff
Bordings Computer Services Ltd
(0222) 36825

Cleveland
Bard Computer Systems Ltd
(0272) 878 157

Cranbrook
The Soft Option U.K. Ltd.
(058080) 310

Doncaster
Brisstar Computer Centre
(0302) 67135

Dublin
Transtec Ltd
(0001) 718521

Fareham
Elektronique Ltd
(0329) 230670

Glasgow
The Prospectus Partnership
(0236) 211294

Gosport
Vaunberry Ltd
(0329) 235846

Harpden
Iradion Ltd
(05827) 62421

Hastings
BMS Computer Services Ltd
(0424) 439190

Hereford
Honeysett Computers Ltd
(0432) 279404

Ipswich
Angla Microsystems
(0449) 740046

Leamington Spa
Words Ltd
(0926) 30209

Leicester
Leicester Micro Centre
(0533) 551869

Lisburn
MKW Electronic Ltd
(08462) 3184/3665

Liverpool
BEC (Liverpool) Ltd
(051) 263 5738

London
BD Computer Systems
01-435 4442

Business Information Systems
01-373 3408

Cleno Computer Systems Ltd
01-670 4202

Computer Aided Systems Ltd
01 487 3869

Computer Aided Systems Ltd
01-518 1414

Corporate Modelling Consults
01-628 4107

Daniedale Ltd
01-519 7004

DIR Computer Systems Ltd
01-439 4354

Equinox Computers Ltd
01-739 2387

Ferrari Software Ltd
01-751 5791

Jarrogate Ltd
01-671 6321

Ludhouse Computing Ltd
01-679 4321

Malmes Electronics Ltd
01-373 6607

Mayfair Business Systems Ltd
01-688 3836

MGE Systems Ltd
01-439 9617

Microtrons Telesystems Ltd
01-263 6926

P.W. Hare & Associates
01-551 1988

Archives U.K. Ltd
01-223 1688

Software Ltd
01-387 9927

Spectrum Systems Ltd
01-405 1250

Stag Terminals Ltd
01-943 0777

Stacom Ltd
01-661 2266

Sumlock Bondain Ltd
01-250 0505

Sun Business Systems Ltd
01-739 7949

Transam Computers Ltd
01-402 8137

Whispia Ltd
01-556 9151

Louth
Compu-A-Crop
(0507) 604271

Malvern
Malvern Micro Systems
(06845) 68500

Melksham
Cifer Systems Ltd
(0225) 706361

ICEN Ltd
(0225) 702133

Midhurst
Wordskill Automabon Ltd
(073081) 6641

Milton Keynes
Pericom Data Systems Ltd
(0908) 614242

Navan
S. Triple S Ltd
(046) 28472

Nottingham
Micropeople Ltd
(06074) 69117

Oxford
Choice Business Systems
(049161) 2697

Redcar
Applestop
(0642) 474707

Richmond
Tatech Computer Services
01-948 4213

Rutland
Microspec Ltd
(0572) 2528

Slough
KGB Micros Ltd
(75) 38581

Southampton
Allan Systems Ltd
(0703) 38740

St Albans
St Albans Computer Services Ltd
(0727) 77700

St Helier
The Processor Centre
(0534) 77070

Thomas & Company Ltd
(0534) 77700

West Byfleet
Fergusson Computers Ltd
(91) 41810

Weston Super-Mare
Eastern Ltd
(0934) 418346

Winchester
Modular Office Systems Ltd
(0962) 55759

Yeovil
Dale Computer Systems Ltd
(0935) 72000

Items start at £85.00. why you need one.

plan. Data transfer to word processing and other systems lets you incorporate figures in reports and output to a data base. It also has extensive formatting facilities which means you can produce reports that wouldn't look out of place in the board room.

It can store up to 25 standard reports to run when you need them. It's got full WHAT IF? analysis and direct editing of both spreadsheet and logic display.

JUST AS EASY TO USE

All this increased power doesn't mean you'll need a degree in advanced computing to understand MasterPlanner.

It works on exactly the same system as PlannerCalc and models written on PlannerCalc run without modification on MasterPlanner.

16 BIT VERSION

A new version of MasterPlanner has been specifically designed for the 16 bit micros like the Sirius 1 under TMCP/M-86 or the IBM personal using either CP/M-86 or TMMS DOS 1.1. With a vast matrix size of over 7000 cells on 128K and even more with larger memory, you'll at last be able to make the most of your micro.

ULTIMATE POWER

Fastplan is the top Comshare micro planning system.

It's file-based, allowing development of large scale models; with a staggering 18,000 cell matrix; full financial functions plus backwards iteration, file input and output; and much more. Yet, because it can be menu driven it is easy to use. For the full story, tick the Fastplan box when you return the coupon.

OVER 10 YEARS EXPERIENCE

When you invest in MasterPlanner or PlannerCalc you're not just getting the best software money can buy.



You're also getting the kind of back up and after-sales service that only a company of Comshare's track-record can guarantee.

If you'd like to know more about any product, call in at your local dealer or fill in the coupon and send it to us.

*Plus VAT and post & package.

COMSHARE

Making the computer make sense.

*CP/M and TMCP/M-86 are the registered trade marks of Digital Research Inc. Comshare Ltd., 32-34 Great Peter Street, London SW1P 2DB. Telephone: 01-222 5665.

To: Department PCW4/83 Comshare Ltd., 32-34 Gt. Peter Street, London SW1P 2DB.
Please send me:

Qty	Product	Micro	Op System	Disc Size	K	Amount £	p.
	PlannerCalc @ £99.50 (8 bit only)		CP/M 2.2	8"/5¼"			
	MasterPlanner @ £282.95		CP/M 2.2	8"/5¼"			
	MasterPlanner	IBM PC	MS DOS 1.1	8"/5¼"			
	MasterPlanner		CP/M-86	8"/5¼"			

All prices include VAT and postage & packing **TOTAL**

Please send me information about Fastplan

I enclose a cheque/postal order for £ _____ made payable to Comshare Ltd.

Please debit my Access Card No. _____ for £ _____

  Barclaycard No. _____ for £ _____

Signature _____

Name _____

Address _____

Tel. No. _____

Please allow 28 days for delivery. VAT No. 238418649. Registered No. 980406.

Comshare reserve the right not to accept any orders. Any acceptance will be subject to Comshare's terms and conditions.

ATA THE PRICE BEATERS



A Fresh new 48K Apple

Only £499
(While stocks last)

Software

PFS	£75
PFS Report	£59
DB Master 3	£139
Data Factory 3	£199
Mathemagic	£55
Graphmagic	£55
Locksmith 4.1	£65
Dos Tool Kit	£42
Apple Pascal	£149
Applewriter	£39
Applewriter II	£85
Wordstar 3.0	£155
Mailmerge	£59

Viasac Orbit Accounting Modules:
Prices on application - Please
phone for list.

Visicalc

Latest packaging
versions

Visicalc	£121
Visitrend/Plot	£149
Visidex	£149
Visifile	£159
Visischedule	£180

Disk Drives

Apple disk drives at these
incredible low prices!

With Controller	£270
Without Controller	£220

Apple III

128K	£1995
256K	£2495
Secondary Disk Drive	£240
Profile Hard Disk	£2095

Please phone for comprehensive list.

**APPLE IIe
AVAILABLE NOW
ONLY £845**
phone for details

Hitachi 12" Green Screen
Monitors Only £99 FREE

Anti-Clare
Screen

Interfaces

Parallel Printer Card	£70
Serial Printer Card	£105
Pascal Card	£105
Digitek Colour Card	£99
Z80 System (New version)	£220
80 Col System (Vldex)	£200
Soft Switch (Vldex)	£25

16K RAM Card £48
128K RAM Card £350

Epson Printers Unbeatable Value!

MX80T (Type 3) \$290
MX80F/T (Type 3) \$315
MX100F/T (Type 3) \$420
Other printer prices on
application

Accessories

Numeric Keypad	£75
Joystick (TKC)	£29
Paddles	£19
Cooling Fan	£55
10 BASF 5 1/4" Disks	£20
Listing Paper	£18
Locking Disk Box	£20

Hewlett Packard 7470A Plotter

RS 232 or HPIB

Interfaces
Outstanding Value
@ £975

Complete range
of Desktop Computers
in stock



ACT Sirius I 128K w/1.2 mb S/S Disks	£2095
ACT Sirius I 128K with 2.4 mb D/S Disks	£2549
ACT Sirius I 128K with 1.2 mb D/S Disks and 10 mb Winchester	£3995
External 10 mb Winchester Hard Disk	£2549
128K Additional Memory	£349
384K Additional Memory	£795

Software

C Basic 86	£159
Level II Cobol with forms 2	£549
Microsoft Basic Compiler	£239
Microsoft Pascal Compiler	£299
Microsoft Fortran Compiler	£299
Microsoft Cobol Compiler	£439
CP/M Programmers Kit	£169
MS 6 Dos Programmers Kit	£169
IEEE 488 Package	£169
Graphix / Bisigraf Graphics Pack	£169
ACT Pulsar Software at unbeatable prices	

commodore COMPUTERS

4016 16K	£495
4032 32K	£625
8032 32K	£799
8096 96K	£1075
Super Pet 9000	£1345

DISK DRIVES

2031 171K Single D/ Drive	£349
3040 343K Dual D/ Drive	£625
8050 950K Dual D/ Drive	£799
8250 2 mb Dual D/ Drive	£1195
9060 5 mb Hard Disk	£1795
9090 7.5 mb Hard Disk	£2245
C 28C Cassette Unit	£36

Software prices on application

IBM Software

IBM Pascal Compiler	£359
IBM Cobol Compiler	£838
IBM Fortran Compiler	£420
IBM Basic Compiler	£409
IBM Macro Assembler	£119
UCSDP - System Pascal	£749
UCSDP - System Pascal Compiler	£210
UCSDP - System Fortran 77	£749
Fortran Compiler 77	£210
CP/MC86	£287
Visicalc 256K	£159
Supercalc	£175
Time Manager	£108
Volkswriter	£146
Easywriter II	£229
Wordstar	£245
Mailmerge	£89
dBase 2	£329
Desktop Plan	£196
Graph Magic	£99
Visitrend/Plot	£189
Visidex	£166
Visifile	£156
Micro-finesse	£499

All M.P.S.I. Business
Accounting Software in stock
at unbeatable prices, please
phone for list.

Games

Championship Black Jack	£28
Microsoft adventure	£42
Deadline	£42
Zorks 1 to 3 (each)	£29

Phone us
for a
Better Deal

While
Stocks
Last

Mail Order

We accept both Access
and Barclaycard subject
to a 5% surcharge.

Telephone orders are
welcome on
01-833 0044(4 lines)

All prices plus 15% VAT
E. & O.E.



IBM PC 64K UK Spec -
240v power supply £2749

System Expansion

64K Memory Board	£277
128K Memory Board	£382
192K Memory Board	£476
256K Memory Board	£572
512K Memory Board	£980
Baby Blue	£392
Big Blue	£392

Hard Disks

5 mb Winchester	£1648
12 mb Winchester	£2197
20 mb Winchester (with tape backup)	£2699

Other Accessories

Mono Graphics Monitor	£155
Colour Monitor	£625
Colour/ Graphics Card	£340
Asynchronous Comms Card	£170
Printer adapter	£65
IBM Joysticks	£42
Light pen	£159

Phone
for
details

Delivery

Please add 1.5% to your order for UK delivery charge.
Payment accepted by cash/bankers draft/building society
cheque for immediate despatch.

All goods are normally in stock, however, please confirm before
collecting.

We are open from 9.30am to 5.00pm Mondays to Saturdays.
Credit of 30 days is available on official orders from P.C.s. Hospitals
and educational establishments, subject to a 5% surcharge.

Otherwise cheque with order. Please allow 10 days for cheque clearance.

Export orders welcome!

ata systems

4, ALBION HOUSE, 1, BACK HILL LONDON EC1

01-833 0044(4 lines) Telex 25102 Albeta G

Come in
& Take Away

Please phone for
free price list

Compatibility.



When one World beater meets another.

You're bound to recognise at least one of the beautiful products above.

Miss Dominican Republic was chosen to supremely reign as Miss World 1983. Certainly, a World beater in her own right.

Then there's the QX-10. A fully integrated Desktop Microcomputer System. A new member of the world beating Epson family.

But there's more to the functional yet stylish lines of the QX-10 (just to prove that beauty isn't only skin deep). The lightweight CPU, monitor and Keyboard units are very easy to use - even for a first time operator.

You could say that our system takes all the hard work out of using software, and once used...you probably will. What's more, when it comes to cost you'll find there's more power for your money.

Just look at these qualities.

192k upgradable to 256k RAM, Z80A CPU. RS-232C and parallel interfaces. CP/M and multifont BASIC come as standard.

The QX-10 offers an incredible graphics capability. The 80 column x 25 line display has 640 x 400 resolution and full bit image control for greater definition, 16:1 zoom and special effects. Not to mention a unique split screen facility enabling different types and graphics to be shown together. A major first for educational applications.

For even more power - simply slot in up to 5 optional interface cards for cassette, bar code reader, joysticks, sound generator, plus a universal interface card for developing your own interfaces. Clock calendar and full battery back-up complete the system.

As with all the other respected Epson products, you are assured of high quality. (We even manufacture the slim line disc drives ourselves.)

So, at last there's a desktop microcomputer system that really works together. To really work for you.

We call it compatibility. You will call it the incredible QX-10.

QX-10

**THE HUMAN COMPATIBLE
BUSINESS MICRO**

EPSON

**Extraordinary product.
Exceptional quality.**

Epson (UK) Limited, Freepost,
Wembley, Middlesex HA9 6BR.
Freefone: 2730. Telex: 8814169.

- I would like a demonstration of the QX-10.
- Please send me details and the name of my local stockist.

Name _____

Position _____

Company _____

Address _____

Tel: _____

TRS-80™ Model 16

The Multi-User Microcomputer



Tandy TRS-80 Model 16 Computer Our Most Advanced Microcomputer

The TRS-80 Model 16 is capable of 512K internal RAM and 2½ megabytes of disk storage. It has a 32/16-bit microprocessor for greatly increased speed and larger amounts of internal memory to allow more complex tasks to be accomplished with ease! In addition to the 32/16-bit main processor, the Model 16 incorporates - the Z-80 to maximise 16-bit operations. Dual Processor design permits Model 16 to use Model II software. The Model 16 features all new thin line double-sided, double-density 8-inch disk drives. Model 16 is so powerful that three people can use it at the same time - just add two low cost terminals. (Requires hard disk 384K Memory and Xenix O.S. for Multi-User).

Dual Processor Design

A second processor, a Z-80A, handles "housekeeping" chores and frees the main CPU to take full advantage of its speed and memory.

This also means that the model 16 can run software designed for our highly-respected TRS-80 Model II business computer. It also allows present Model II owners to upgrade to 16/32 bit processing - *without losing any investment in software*

The Model 16 begins as a single drive (1.25 megabyte), 128K RAM configuration. Cat. No. 26-6001 price £4299.00 inc. V.A.T.

TRS-80™ Video Data Terminal

Ideal for our multi-user Model 16, or with a modem use it to time share with information networks. Compatible with TeleVideo®, Lear Siegler® ADM-5, ADDS 25 and Hazeltine® 1410 terminals. EEPROM retains the protocol when power is off. Features user programmable keys, repeating keys, electronic bell and more. (Cat. no. 26-6050 - £699.00).

Find out more about the revolutionary TRS-80 Model 16 at the Tandy Computer Centre, store or participating Dealer near you - today!

Tandy®

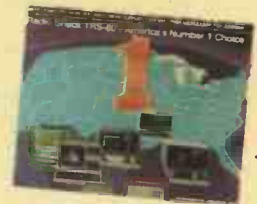

Send For Your FREE 1983 TRS-80
RSC-8 Computer Catalogue

Name

Address

Computer Marketing, Tandy Corporation (Branch UK), Tameway Tower,
Bridge Street, Walsall, West Midlands. WS1 1LA

PCW6

Any four colours can be selected at a time from the palette of 255 available.

Automatic character magnification.

Random breakdown in High voltage capacitors

5-Sep-83

0 Mean

Mean

User-defined shading patterns.

Fast block fill facilities provided.

```

100 CLEAR 200
110 DIM H(7)
120 TEXT
130 PUT 12
140 CALL "RESOLUTION", 0, 2
150 I=5
160 REM DEFINE COLOURS
170 CALL "COLOUR", 0, 0, 0, 0
180 CALL "COLOUR", 1, 6, 0, 0
190 CALL "COLOUR", 2, 250

```

Ready:

Enter week number -- 11
Enter year -- 83
Enter station number -- 1

Text in 40 character mode with 80 character mode overlaid.

Characters can be oriented in any of four directions.

'Windows' can be defined and scrolled independently.

A picture may be worth a thousand words but it still tells only half the story about graphics on the 380Z.

For a start, our standard graphics functions include point plotting, line drawing, instant block fill, block copying, offsetting, and Exclusive Or Plotting.

Then there is the important fact that our High Resolution Graphics is supported by Basic, Algol and Fortran. And since the Graphics is contained in its own 16K of RAM, every byte of user memory remains available for applications program use.

It is also worth noting that 380Z graphics are equally effective in monochrome — for 'colour' just read 'shades of grey'. Again there are 255 shades available, and there's also a very useful facility for fading up and down throughout the grey scale.

There are also the special effects — such as moving between graphics 'pages' for pseudo-animation, or the

ability to produce 'instant' graphics by drawing them with the colour 'switched' off and then 'switching' on.

Next, not only can 380Z graphics pictures be saved on and retrieved from disc, they can also be output to one of a range of popular dot matrix printers.

Remember, too, that HRG is not a third-party add-on but designed, developed, and supported by Research Machines itself as an integral part of the 380Z.

And finally, we've now implemented GINO. So for the first time this well-established, professional suite of flexible, device-independent graphics software from the CAD Centre is available on a micro.

If you are interested in graphics — for scientific, technical, and industrial research; or in secondary or higher education; or for design, engineering, or control, then you will be interested in the 380Z.

GRAPHICS MACHINE



RESEARCH MACHINES
MICROCOMPUTER SYSTEMS

RESEARCH MACHINES LTD Mill Street, Oxford OX2 0BW, Tel: (0865) 249866

There's a world of difference with...



FAST

FINANCIAL ACCOUNTING SOFTWARE from TRIDATA...

... proven business software, specially developed for the worlds largest retailer of Microcomputers, is now available on a range of machines supporting the **CP/M*, MS-DOS* & TRS-DOS*** operating systems

FAST Business Software offers the discerning businessman powerful and proven packages that can be used individually or as a comprehensive company accounting system. Designed for the first time user, both the V.D.U. screen layouts and the comprehensive manual, ensure that the transition from hand written ledgers to a computerised system is painless. Over 3,000 individual Tridata Software packages are currently in use by businesses in the U.K. providing them with cost effective solutions to their accounting and payroll problems. The FAST suite of integrated business software comprises, sales ledger with invoicing, purchase ledger, nominal ledger, stock control and payroll. Each package has been developed with the needs of the user in mind and combined with the sophisticated features contained within the programs, FAST business software is the ultimate choice for your microcomputer.



PLEASE SEND ME DETAILS ABOUT **FAST** BUSINESS SOFTWARE

NAME _____

ADDRESS _____

PCW/05/83

TEL. NO. _____

TRIDATA MICROS LTD., FREEPOST, BIRMINGHAM B5 4BR. TEL: 021-622 6085

FAST

FRASERS

Professional Micro Systems from the computer professionals

OSBORNE 1

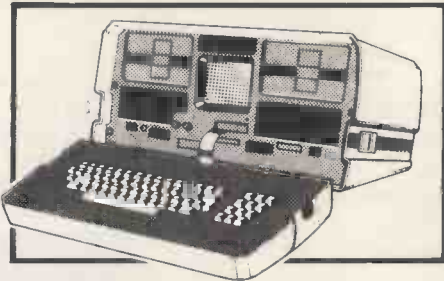

Includes £800 worth of
FREE SOFTWARE – Wordstar,
Mailmerge, Supercalc, Basic,
Disc capacities to 1.2M Byte
or Winchester

ACT SIRIUS 1



The most popular 16 BIT
system

EXACT BUSINESS SYSTEMS

SALES LEDGER
POINT SALE INVOICING
STOCK CONTROL
PURCHASE LEDGER
NOMINAL LEDGER

ALL FOR ONLY

£400 + VAT

Ex demonstration units available at giveaway prices.

91 Station Road, West Drayton, Middlesex UB7 7LT
Telephone: West Drayton 41731



SPACE CITY, Jan 83

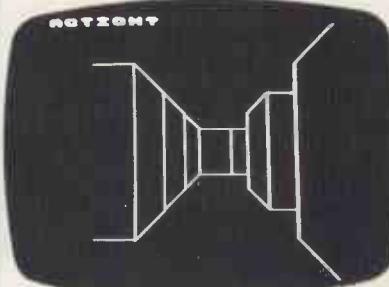

BEEBMAZE, Feb 83



WINDY FIELD, Feb 83

Screen Photographs of programs
in BEEBUG



BBC MICRO

REGISTERED REFERRAL CENTRE FOR THE BBC PROJECT

BEEBUG FOR THE BBC MICRO

BRITAIN'S LARGEST SINGLE-MICRO USER GROUP

MEMBERSHIP NOW EXCEEDS 16,000

16,000 members can't be wrong – BEEBUG provides the best support for the BBC Micro. BEEBUG Magazine – now 56 pages including new product guide supplement – devoted exclusively to the BBC Micro. Programs – Hints & Tips – Major Articles – News – Reviews – Commentary. PLUS members discount scheme with National Retailers. PLUS members Software Library. 10 Magazines a year. First Issue April 1982. Reprints of all issues available to members.

December/January Issue: Program Features: Space City (invader-type game), Breakout, Artist (Joystick painting program); Rescue (miraculously retrieves programs after bad loading or 'Bad Program' message); and Pack – a program to compact Basic programs. PLUS Disc System Review, Software reviews – including Wordwise, Book reviews, Adding Joystick interface to model A; How to access the video controller chip; and ideas for the newcomer; plus a new crop of Hints and Tips.

February Issue: Program Features: BEEBMAZE – Find your way through the random maze, guided by 3D views from inside the maze – an excellent game. FIVE-DICE – A Beeb implementation of YAHTZEE (R), a novel dice game. Also a listing of WINDY FIELD – a creation from Acornsoft, SPIROPLOT screen doodler, and a complete memory display program in a user key. Plus Machine Code Screen Dumps for the Epson and Seikosha Printers; articles on USING FILES, IDEAS ON ANIMATION (including a Rotating Cube program) an Introduction to the Use of Procedures, a Survey of Books on the BBC Micro, and a Roundup of Disc System Hints. PLUS a variety of HINTS, TIPS AND INFO, including a single VDU command to perform a SIDEWAYS SCROLL. WIN A COLOUR MONITOR, WORDWISE WORD PROCESSORS AND ACORN SOFTWARE GRAPHICS BOOKS IN OUR THIRD SOFTWARE COMPETITION.

STOP PRESS

BEEBUG has negotiated a deal with ACORN over the new 1.2 OPERATING SYSTEM ROM. BEEBUG members are offered the ROM at around half-price. See BEEBUG Feb issue for details.

SOFTWARE DETAILS

BEEBUG SOFTWARE LIBRARY

offers members a growing range of software from £3.50 per cassette. 1. Starfire (32K). 2. Moonlander (16K). 3D Noughts and Crosses (32K). 3. Shape Match (18K). Mindbender (16K). 4. Magic Eel (32K). 5. Cylon Attack (32K). 6. Astro-Tracker (32K). Utilities: 1. Disassembler (16K). Redefine (16K). Mindi Text Ed (32K). Applications: 1. Superplot (32K). 2. Masterfile (32K).

13% DISCOUNT TO MEMBERS ON THE EXCELLENT WORDWISE WORK PROCESSING PACKAGE – THIS REPRESENTS A SAVING OF OVER £5.00.

Send £1.00 for SAE for Sample

Membership: UK £5.40 for six months, £9.90 for one year.

Overseas one year only: Europe £16.00, Middle East £19.00, Americas & Africa £21.00, Other Countries £23.00.

Make cheque to BEEBUG and send to: BEEBUG Dept 6, 374 Wandsworth Rd, London SW3 4TW

For editorial material send to: The Editor, BEEBUG, PO Box 50, St. Albans, Herts AL1 2AR

THE BYTESHOPS— WHERE YOU CAN COUNT ON GETTING THE RIGHT COMPUTER.

BBC MICROCOMPUTER

PRICES EXCL. VAT

- BBC Micro Model B 347.00
 - Microwitec 14" Colour Monitor inc. 249.00
 - Cables 90.00
 - 12" Monochrome Monitor 199.00
 - Single Disk Drive 100K 369.00
 - Dual Disk Drives 200K 619.00
 - Dual d/s Disk Drives 800K 780.00
 - Torch Z80 Disk Pack inc. CP/M 95.00
 - Compatible Op. System 96K RAM 15.00
 - Disk Interface 15.00
 - Disk Cable 389.00
 - Format Disk and Doc 11.30
 - Epson MX80 FT III 3.50
 - Games Paddles 3.50
- Selection of business, educational, graphics and games software available from 3.50
- Selection of teach yourself BBC publications



EPSON HX-20 PORTABLE COMPUTER

Diminutive fully featured business computer that is small and light enough to slip into a briefcase. Specification includes integrated LCD screen, printer and microcassette; 16K RAM expandable to 32K and its own rechargeable power supply. Ideal for people on the move — data can be subsequently 'down loaded' on to a larger machine when you return to base.

402.00 ex. VAT



CROMEMCO C-10 PERSONAL COMPUTER

A full feature personal business computer system including software — for the price of a VDU. Also the entry point into the renowned Cromemco range. 1350.00 ex. VAT



- C-10 SP Personal Computer Superpak inc. Z80A Processor, 64K Memory, Single 5 1/4" 390K Byte Floppy Disk, 24 x 80 Screen, CKBA Keyboard, CP/M Compatible Operating System, plus Word Processing, Financial Planning & 32K BASIC Software 1350.00
- Additional 5 1/4" Floppy Disk Drive 510.00

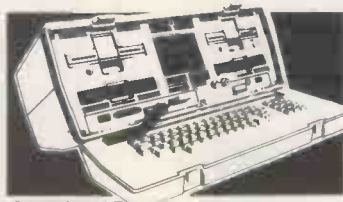

OSBORNE

Truly portable personal small computer system housed in a 'snap together' case complete with business programs, so you can start work almost anywhere. 1375 ex. VAT Double Density Version

- Osborne Portable Computer inc. Standard Software — Wordstar, Mailmerge, Supercalc, MBASIC, CBASIC, CP/M: Double Density Version inc. USDC-P System 1375.00
- Double Density Upgrade, inc. Fitting 175.00
- Screen Pack 80 Column Upgrade 225.00
- Screen Pack and Double Density Upgrade inc. Fitting 350.00
- Osborne to Epson Cable 24.00

PRINTERS — IMPACT

- Anadex DP9500A 132 Cols., 150CPS Matrix Printer with Graphics. 10, 12, 15, 16, 7 Char./In, Low Noise 1215.00
 - Anadex DP9501A 132 Cols, 150CPS Matrix Printer 10, 12.5, 13.3 Char./In, Low Noise High Density Graphics 1215.00
 - Anadex DP9620A 200CPS Printer, Low Noise, 10, 12, 15, 16.4 Char./In 100 CPS in Enhanced Mode 1295.00
 - Anadex DP9625A As 9620A Plus Double Pass Correspondence Quality Mode at 50 CPS 1450.00
 - Anadex WP6000 Dual Mode Printer 132 Cols, 150/180CPS Correspondence Quality, 200/330CPS Draft and Graphics Mode. Diablo 630 Protocol Emulation 2275.00
 - Epson MX80T/3 Tractor only 80CPS 349.00
 - Epson MX80FT/3 Friction and Tractor 389.00
 - Epson MX100FT/3 Friction and Tractor 100CPS 499.00
- Phone for new Epson model prices

PRINTERS — DAISY WHEEL

- Brother HR1 650.00
- Brother B300 458.00
- Crown Ranker — Brother 19CPS 795.00
- Diablo 620R0 25CPS 995.00
- Diablo 630R0 1895.00
- Smith Corona TP1 475.00



IBM PC

The most significant microcomputer introduction for years and already one of our best sellers. It's tremendous versatility means that it can be employed by for example, the small businessman as a stand alone desk top system, or the large corporate user as an intelligent terminal for a main frame. At The Byteshop, we can offer you the widest portfolio of IBM software and programmes plus add on's and add in's.

PRICES EXCL. VAT

- IBM PC Dual 320K Byte Disk Drives 64K Byte RAM UK Keyboard and Screen 2477.00
- IBM PC Dual 320K Byte Disk Drives 128K Byte RAM UK Keyboard and Screen 2820.00
- IBM Colour Adapter Card 216.00
- IBM Printer inc. Stand and Cable 509.00
- MICROWITEC Colour Monitor High. Res. 550.00
- KAGA Colour Monitor Med. Res. 335.00

SOFTWARE FOR THE IBM PC

- 123 Business Management Package 359.00
- BSTAM Byrom Communications Package 115.00
- CBASIC Compiler (CB86) D/R Basic Language 377.00
- CBASIC/86 Digital Research Language 204.00
- CCP/M-86 Digital Research Concurrent CP/M Operating system 248.00
- CP/M86 For IBM PC D/R Operating System 43.00
- DBASE II Ashton-Tate Database Package 435.00
- EASYFILER IUS Database Package 258.00
- EASYPLANNER IUS Financial Planning Package 161.00
- EASYSPELLER II, IUS Word Processing Package 81.00
- EASYWRITER II, IUS Word Processing Package 226.00
- FAST-GRAPH Business Graphics Package 299.00
- FLIGHT SIMULATOR Microsoft Training/ Games Package 34.00
- MAILMERGE Micro Pro Word Processing Enhancement 145.00
- MARS Sapphire Business System 395.00
- MICROSTAT Ecosoft Statistics Package 195.00
- PASCAL MT + 86 Digital Research Language 377.00
- SPELLSTAR Micro Pro Word Processing Enhancement 145.00
- SUPERCALC Sorcim Financial Planning Package 190.00
- TIM III Database Package 399.00
- WORDSTAR Micro Pro Word Processing Package 295.00
- WS + MAILMERGE Micro Pro Word Processing Package 390.00
- WS + MM + SP/S Micro Pro Word Processing Package 510.00
- WS + SPELLSTAR Micro Pro Word Processing Package 415.00

TECMAR PC MATE ADD ON'S AND ADD IN'S FOR THE IBM PC

- TECMAR Winchester Share/5 Expansion 5M. Byte, H/D with shared system adapter for up to 4 x IBM PC's inc. expansion unit 2235.00
- TECMAR First Mate, Five in one card, 64K Byte dynamic memory card c/w serial and parallel ports, clock and calendar 445.00
- TECMAR Dynamic Memory 64K Bytes 305.00
- TECMAR Dynamic Memory 256K Bytes 545.00
- TECMAR Scribe Tender with one serial and parallel cable 175.00
- TECMAR High Res. Colour Graphics 445.00
- TECMAR IEEE 488 interface 295.00
- TECMAR DADIO Digital to Analog Converter 295.00

The above is just a small selection from the 60 plus Tecmar IBM PC compatible add in's and add on's and specialist interfaces that we offer. There are data storage expansion cards; industrial, scientific and laboratory interfaces; extended input/output expansion cards; general support; communications and software utilities. Please contact us for a full listing. Our Microserve Centres in all our stores can offer full maintenance and service facilities for the IBM PC & Tecmar PC add on's.

COMART COMMUNICATOR

PRICES EXCL. VAT

Clearly the most price competitive modular computer system on the market with built-in expandability — inside and out. inc. CP/M From 1895.00 ex. VAT

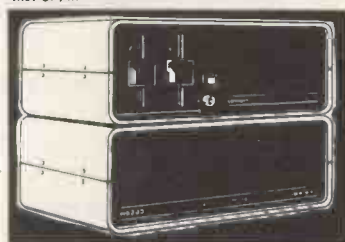

COMART COMMUNICATOR Z80A MODULAR SYSTEMS

- Comart CP100 'Communicator' Micro Computer: Z80A Processor, 64K Byte Memory, Dual 5 1/4" Floppy Diskette Drives each storing 390K Bytes of Data. Dual Serial and Parallel Ports. 10 Slot S100 Bus. CP/M Version 2 included 1895.00
- Comart CP200 as CP100 except Dual 790K Byte Diskette Drives 2195.00
- Comart CP500 as CP100 except one 790K Byte Diskette Drive and one 5" Winchester Drive having 4.8M Bytes of Formatted Data 2995.00
- Comart CP520 as CP100 except one 790K Byte Diskette Drive and one 5" Winchester Drive having 19M Bytes of Formatted Data 3995.00

COMART COMMUNICATOR 8086 MODULAR SYSTEMS

- Comart CP1100 Communicator Micro Computer: 6MHz 8086 Processor, 128K Byte Memory with Parity, Dual 5 1/4" Floppy Disk Drives each storing 390K Bytes. Dual Serial and Parallel Printer Ports. 10 Slot S100 Bus inc. CP/M86 & MS-DOS 2295.00
- Comart CP1202 As CP1100 except Dual 790K Byte Diskette Drives with 256K Byte Memory 2745.00
- Comart CP1522 As CP1202 except 1 x 790K Byte Diskette Drive and 1 x 5" Winchester Disk having 19M Bytes of Formatted Data with 256K Byte Memory 4545.00

UPGRADE KITS

Wide range of 8 to 16 bit and floppy to hard disk upgrade kits available for Communicator Systems

BYTESHOP FOR THE PROFESSIONAL

There are so many micro computers on the market that choosing the right one is far from easy. And it isn't made any easier when you find them cheek by jowl with cameras, hi-fi and a host of other electrical equipment. What you need is someone that is single minded. And that means us. Byteshops are totally dedicated to microcomputers. So, not surprisingly, we can offer you a wider range because we sell nothing else. Our prices are keener too. So are our staff. Each one is an expert who can make sure you get the computer that's exactly right for you — whether it's a home micro or a £20,000 business system.

What's more we'll freely advise you on expanding or upgrading your system as your knowledge grows or your requirements change. While our Microserve Centres offer full service and maintenance on site and at our shops. And our product support specialists are your insurance of our total commitment to after sales service. After all, we are the UK's longest established microcomputer specialists. Come and see us soon.

COMART SUBSYSTEMS

Comart CB200 Cartridge Tape Back-Up Subsystem for Hard Disk2495.00
 Comart HD520 5" x 20M Byte Hard Disk Subsystem (requires HDCONT or can be added to a CP520 or CP1520)2395
 Comart HDCONT Winchester Disk Controller for 2, 20M Byte Drives195.00
 Comart FD800 8" Floppy Single Disk Drive Subsystem; Single Sided; Single Density IBM 3740 Compatible (requires C-IFDC)995.00

COMART MULTI USER CONFIGURATIONS

Comart CP520/M CP520 Communicator System with 256K Byte Memory and 6 Serial Interfaces. Includes CP/M and MP/M114995.00
 Comart CP1525M CP1520 Communicator with a total of 512K Byte Memory and 10 Serial Interfaces. Includes CP/M86 and MP/M865995.00

S100 BOARDS

Comart CRAM64 64K Byte Dynamic RAM with Bank Select200.00
 Comart CMPU Multi-Processing Add-In Card with Z80A Slave Processor, 64K Byte Dynamic RAM 2X Serial & 1X Parallel Interface495.00
 Comart CRAM256 256K Byte Dynamic RAM with Parity, 8 and 16 Bit Data, IEEE696 Compatible. Also supports 8 Bit Bank Switching550.00
 Comart C-CPU86 8086 Processor Card, with Dual Serial and Parallel Ports. Monitor in 8K EPROM and 4K RAM300.00
 Comart C-IFDC Intelligent Diskette Drive Controller with Z80A Processor295.00
 Comart C-CPU Z80A system Processor Board Incl. 2 Serial/1 Parallel Port200.00
 Comart 4S10 4 Channel Synch/Asynch Interface Board250.00
 Comart IOP I/O Processor Board with Z80A, EPROM, RAM and C-BUS 'Off Card' Interface425.00
 Comart QUADART 4 Channel ASYNCH/SYNCH Interface Board (Requires IOP)510.00
 Comart Single Card Computer Z80A, SCC, EPROM, RAM, Serial & Parallel Ports425.00
 Dual Systems CLK24 Battery Supported Real Time Calendar Disk334.00
 Dual Systems CMEM32 32K CMOS Battery Supported Memory1350.00

CROMEMCO 68000/Z80A SUPER MICRO SYSTEMS

Cromemco CS1D2 System 1 inc. Dual 390K 5" Floppy Disks, DPU, 256KZ and 16 FDC Cards in 8 Slot S100 Card, Table Top Enclosure3730.00
 Cromemco CS1HD2E System 1 Including Single 390K 5" Floppy Disk, 5.5M Byte 5" Winchester Disk, DPU, MCU, 256MSU, 16FDC, WD126345.00
 Cromemco iCS1HD2 As System 1 except 256KZ Memory without MCU5970.00
 Cromemco CS1HD5E as CS1HD2E but with 512MSU7090.00
 Cromemco CS3D5E System 3 including Dual 1.2M Byte Floppy Disk Drives, 21 Slot Card Cage, DPU, MCU, 512MSU, 16FDC7465.00
 Cromemco CS3HD5E as CS3D5E but with 5" 5.5MB Winchester Disk and WD19330.00

CROMEMCO SOFTWARE FOR 68000/Z80A SERIES

Cromemco CRO-D Cromix (Multi-User/Multi Tasking/Unix Based Operating System)445.00
 Cromemco FOR-D Fortran '77445.00
 Cromemco PAS-D ISO Pascal445.00
 Cromemco ASM-D 68000 Macro Assembler445.00
 Cromemco STB-D 32K Structured BASIC @445.00

PRICES EXCL. VAT

Cromemco CCC-D C-Compiler @445.00
 Cromemco COB-D Cobol Compiler @445.00
 Note: All 68000 Languages (Suffix D) require Cromix (CRO-D). All Software is available on 5" or 8" Floppy Disks - Please Specify.
 @ = Availability TBA

VDU'S & MONITORS

Comart WY100 Visual Display Terminal, Green Display, 24 x 80 and Status Lines. Detached 105 Key Keyboard with Numeric Pad, Function, Cursor and Editing Controls. Swivel and Tilt Display725.00
 Comart WYSEWORD Wordstar option30.00
 Volkercraig 4404595.00
 Volkercraig 4404WS695.00
 Cromemco RGB 14LP. High Resolution Colour Monitor1395.00
 12" Green Screen Monitor99.00

BOOKS

Very wide range of computer books stocked at all shops.

DISKETTES

Byteshop 5 1/4" Single Sided, Single Density1.70ea
 Byteshop 5 1/4" Single Sided, Double Density2.13ea
 Dyson 5 1/4" Double Sided, Double Density3.90ea
 Dyson 8" Double Sided, Double Density 4.40ea
 Full range of 5 1/4" & 8" Diskettes in stock

HOME COMPUTER SOFTWARE

All Tapes Available For IBM PC, VIC, BBC, ZX81, Spectrum. Call for availability.

CP/M SOFTWARE

BASICOM Microsoft Basic Compiler272.00
 BASIC-80 Microsoft Basic Interpreter241.00
 BAZIC Micromikes Basic Language120.00
 BSTAM BYROM Software Communications Package*130.00
 BSTIMS BYROM Software Communications Package130.00
 CALCSTAR Micropro Financial Planning Electronic Spread Sheet Package90.00
 CARDBOX Caxton Store/Search System155.00
 CB80 Digital Research Basic Compiler355.00
 CB/86 D/R Basic Compiler426.00
 CBASIC Digital Research Basic Language106.00
 CBASIC/86 D/R Basic Language231.00
 CIS COBOL Microfocus COBOL Language*425.00
 COBOL-80 Microsoft COBOL Compiler516.00
 CP/M-86 DISPWR Digital Research Operating System231.00
 CP/M-86 + CBASIC 86DW Digital Research Operating System + Language430.00
 DATASTAR Micropro Database Package175.00
 DBASE II Ashton-Tate Relational Database + ZIP435.00
 FILESTAR Microsec's Disk Reformatter CP/M to IBM, DEC, Motorola and Intel Formats110.00
 FMS-80 DJR Assoc. Database/FM650.00
 FMS-81/82350.00
 FORMS 2 Microfocus Table Maker*110.00
 FORTRAN-80 Microsoft FORTRAN Compiler344.00
 GBS Bytesoft General Business System810.00
 INFOSTAR Micropro Database Reporter295.00
 ISL Bytesoft Accounting Package1110.00
 MACRO-80 Microsoft Macro Assembler137.00
 MAILMERGE Micropro Wordprocessing Enhancement to link with WORDSTAR*145.00
 MARS Sapphire Business System*395.00
 MICROSTAT Ecosoft Statistics Package*210.00
 MILESTONE Organic Software Critical* Path Package250.00
 MULTIPLAN Microsoft Financial Planning Package189.00

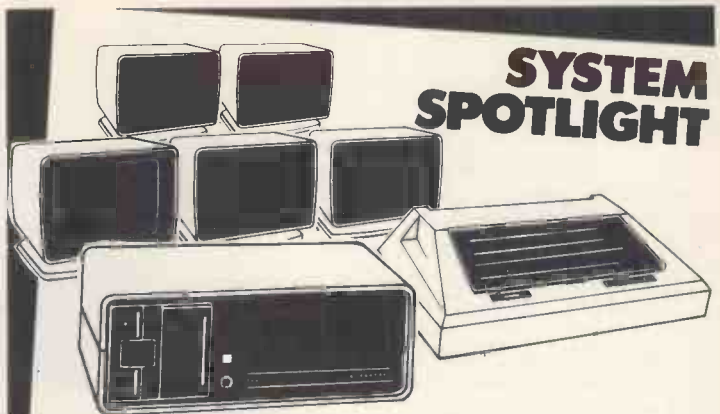

SYSTEM SPOTLIGHT

COMART CP 520MP MULTI-USER SYSTEM PACKAGE

The CP 520MP is the new top specification multi-user introduction to the renowned, expandable Comart Communicator series. This true multi-user system allows one Communicator to be shared by up to five users, each using their own dedicated Z80A Processor and 64K Byte memory, whilst sharing printer facilities and data from common disk storage. The system includes Z80A slave processor cards, 64K Byte memory per user, 1 x 5" 790K Byte Diskette Drive Plus 1 x 20 Mega Byte Winchester Hard Disc and additional interfaces and multi-processing system software. Our special system package also includes

5 x WY100 display terminals and an Anadex 9501A Dot Matrix Printer Upgrade kits are available for single user stand alone Communicator Systems to be upgraded to full Multi Processing facilities in a multi-user environment.

11,950
ex. VAT

SPECIFICATION: Comart CP520MP featuring CP520 Multi Processing Communicator System c/w 1 x Z80A main and 5 x Z80A slaves, 64K Byte main memory + 5 x 64K Bytes, 1 x 790K Byte Diskette Drive + 1 x 5" 20 Mega Byte Winchester Disk Drive, 12 Serial & 6 Parallel Interfaces, Inc. CP/M & Multi processing system software. Package includes CP520MP with 5 x WY100 Display Terminals and an Anadex 9501A Dot Matrix Printer

PASCAL/MT + D/R Pascal Language ... 248.00
 with Speed Programming Tool 355.00
 PASCAL/MT + 86 Digital Research Pascal Language for 16 Bit Systems 426.00
 PEACHTREE Basic Accounting System per module 325.00
 PEACHTREE Business Management System per module 600.00
 PERSONAL PEARL Pearl Data Base/FM ... 185.00
 PLANNERCALC Comshare Financial Planning Package 39.00
 PL/I-80 Digital Research Language* 355.00
 REPORTSTAR Micropro Reporter 210.00
 SPELLSTAR Micropro Proofreading Utility to link with WORDSTAR* 145.00
 SUPERCALC Sorcim Financial Planning/Budgeting Spread Sheet Package* 190.00
 SUPERSOFT Micropro Sort Utility 145.00
 SUPERVYZ Epic Application Control 97.00
 T/MAKER II Lifeboat Associates Financial Planning/Spread Sheet Package 195.00
 WORDSTAR Micropro Wordprocessing Package* Also available with Mailmerge and Spellstar 295.00
 WP WORKSHOP MAC Ltd Training Guide for WORDSTAR or MAILMERGE 75.00
 X BASIC Xitan Language 185.00
 X CP/M Xitan/DR Operating System 130.00
 Many Utilities, Programming Tools and Training Packages available. Also extensive range of diskette formats. Prices include configuration on machines supplied by ourselves. We are totally committed to after sales service and future support.
 *These software packages are available for both CP/M And CP/M86.

ALL PRICES EXCLUSIVE OF VAT

* Barclaycard Visa & Access cards taken in payment.
 * Shop opening hours 9 - 5.30, check individual shops for details of Saturday opening times.
 * Phone Mail Orders accepted. Please contact nearest shop for P. & Delivery Rates. Regret no C.O.D.

*Some items may be subject to a dollar surcharge if the dollar exchange rate changes more than 5 cents. Prices will be adjusted in line with the rate prevailing at the time of purchase.
 * Prices subject to change without notice E.&O.E. and are valid for the cover date life of this magazine. (May 83)
 * Whilst we carry a vast range of stock, we cannot guarantee that every advertised item will be available in each shop.
 * All goods are new and include factory warranties.
 * No refunds on opened software.
 * Orders from Government Depts. & Colleges etc. welcome.
 * Leasing & HP facilities available - apply for written details.
 * Detailed prices available on request.



BYTESHOP FOR THE BUSINESSMAN

You wouldn't go to a lawyer for medical advice, or take your tax problems to a doctor. It's just as illogical to talk computers to anyone but a computer expert.

Every Byteshop is a specialist computer store. In it you will find nothing but computers and computer people. There is nothing else to distract you. Every Byteshop can show you the very latest personal computer systems and provide solutions to both specific and specialist requirements. Word processing, production control, accounts, financial planning and colour graphics are just a few of the most popular applications.

We can also offer everything allied to micro-computers, such as stationery, diskettes, boards, ribbons for your printer, books, tapes and print wheels.

Just as important, you will have the undivided attention of a computer expert. Our staff have been trained on all our machines and peripherals and can give you sound advice and assistance, with complete impartiality.

Even if you have to travel a few extra miles it will certainly pay to come to the experts.

THE BYTESHOP

Your Specialist Computer Centre

LONDON
 The Byteshop
 324 Euston Road NW1
 Tel: 01-387 0505

BIRMINGHAM
 The Byteshop
 94-96 Hurst Street
 Tel: 021-622 7149

GLASGOW
 The Byteshop, Magnet House
 61 Waterloo Street
 Tel: 041-221 7409/8202

MANCHESTER
 The Byteshop
 11 Gateway House, Piccadilly,
 Station Approach Tel: 061-236 4737

NOTTINGHAM
 The Byteshop
 92A Upper Parliament Street
 Tel: 0602 40576

SOUTHAMPTON
 Also at XITAN Systems
 23 Cumberland Place
 Tel: 0703 334711

If you're one of those people who knows how many pecks there are to the bushel and remembers decimalisation as if it were yesterday, we've got some important news for you.

A lot has changed since your schooldays.

New maths, Venn diagrams and the decimal point have come onto the scene.

Now computers are here. And like it or not, they're here to stay.

So much so that they're now an approved part of

WHY NEWBRAIN COULD BE MORE IMPORTANT TO YOUR CHILD'S FUTURE THAN GOOD BOOKS

primary and secondary education (approved by the Department of Industry no less).

And in the future, the emphasis is going to shift more and more towards computer technology and further away from traditional schoolroom aids.

So the money you would normally have spent on a good set of encyclopaedias for your children would now be more effectively spent on one of the new breed of personal computers.

Which is why it's worth doing your homework on NewBrain.

Quite simply, it is more powerful, has more possibilities and allows for greater expansion than any other personal computer in its price range. (It costs £269.95*).

Technical Specifications

The NewBrain is a fully specified professional computer built to the highest standards of engineering and reliability. Chosen by leading OEM suppliers. Designed to facilitate easy expansion for use with the CP/M* operating system, and the addition of 5 1/4" flexible and Winchester disks, 12" green phosphor professional standard monitor, 80 cps professional quality dot matrix printer with pin addressable graphics.

Z80A cpu and COP 420M input/output micro-processors. 32K RAM expandable to 2 Mbytes. 28K ROM. Dual Cassette Ports. UHF TV port. CCITT Monitor Port. Video 40/80 Character x 25/30 lines. 256,320,512,640 x 250 Pixels. Expansion Port. V24 Bi-directional Port. V24 Printer Port. 16-character display.

Software:
Enhanced BASIC (ANSI x 3.2/78) Independent Operating System (12 device drivers). Multi Page Screen Editor (32 Control Commands). Maths (10 Significant Figures). Graphics (Absolute & Relative Plotting, Line & Arc Drawing, Shading, 20 English Language Commands).

Take its memory for a start.

It comes with 32K RAM as standard (most competitors expect you to make do with 16K).

And its 28K ROM (the computer's pre-programmed memory) means that you get software packages like screen editing, maths, BASIC and graphics built in

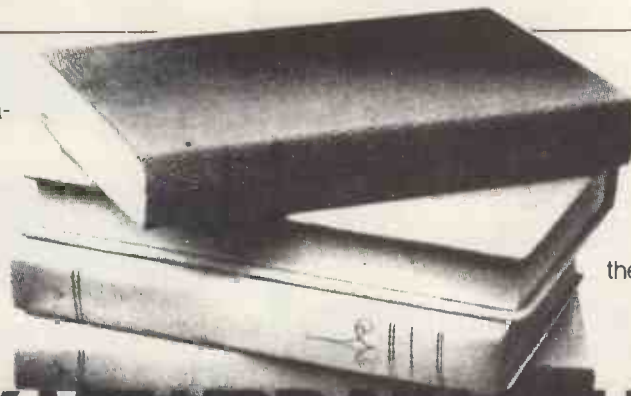

programs all available at a small extra cost.

And the list is growing. And if the kids ask you about games programs, don't worry, we've got enough of them to keep you all happy for some time to come. (Even better, get them to write their own games, that way they'll be learning at the same time).

If you think £269.95* is too much to spend on a computer for your children, you've

missed the point.

NewBrain is not a toy, it's a fully fledged business machine that can work for you at the office and at



home, take care of things on the domestic front as well as prepare you and your children for a world where the language of the computer is the language of the future.

With the NewBrain you'll receive a comprehensive instruction manual and Beginners Guide with 23 programs on cassette, as well as a complete list of all the

software and peripherals currently available.

So if you'd like to know more, simply ask for a brochure and we'll send it by return of post together with the name and address of your nearest stockist.

After all, the price of a stamp can't be too much to pay for something as important as your child's future.

© CP/M is the registered trade mark of Digital Research Inc.

*Including VAT

(the opposition usually consider these as optional extras).

Its graphics and video capabilities are second to none and its full-sized keyboard (just like the one on a typewriter) means that even the stickiest little fingers won't have any trouble getting to grips with its advanced capabilities.

As we said, when it comes to expansion, you'd have to go a long way to find a machine with the same possibilities.

With the memory expansion modules you can build all the way up to a staggering 2M bytes RAM (a figure that wouldn't look out of place on a computer costing ten times as much).

There are printers, monitors, floppy disc drives and 5 1/4" Winchester drives (don't worry if these terms seem a little unfamiliar at the moment, before long they'll be part of your everyday language).

And, of course, there's an extensive choice of optional software packages.

There are language learning programs, such as French and German vocabulary, data base programs and accounting

NEWBRAIN

M.B.A. NewBrain

20 Ashley Court, Gt. North Way, London NW4

To: M.B.A. NewBrain

20 Ashley Court, Gt. North Way, London NW4

Please send me a full colour leaflet and price list.

Name _____

Address _____

Postcode _____

What do Miss World and the new Epson printers have in common?

World Beaters. All of them.

World beating Miss Dominican Republic, below, sits with two of her counterparts. For beautiful styling that is. And a lot more besides. Which brings us neatly to the two new printers from Epson. Namely, the RX-80 and FX-80.

Faster

The RX-80 and FX-80 print at speeds of 100 and 160 characters per second, respectively.

More Value

Yet both machines are better value than their predecessors. With features like dot addressable graphics, standard Centronics compatible interface and optional RS-232C and IEEE interfaces.

The FX-80 Printer takes a lead with the addition of various extra built-in features. And we've designed the RX-80 with tractor feed for perfect alignment, and the FX-80 with both tractor and friction feed.

When you have Epson style teamed with Epson quality, your company will be well equipped for a successful and profitable future.

So now we've whet your appetite - isn't it about time you seriously considered buying one of our remarkable machines.

But act now, because with our amazing track record, there's going to be a great demand for these new world beaters.



RX-80
FX-80
PRINTING MACHINES

EPSON

**Extraordinary product.
Exceptional quality.**

Epson (UK) Limited,
Freepost, Wembley,
Middlesex HA9 6BR.
Freefone: 2730.
Telex: 8814169

- I would like a demonstration of the Epson RX-80 and FX-80 printers.
- Please send me details and the name of my local stockist.

Name _____

Position _____

Company _____

Address _____

Telephone _____

WE HAVE THE LARGEST COM FOR APPLE, IBM PC, HX20 AND

Dealer enquiries welcome from bona fide computer dealers

TRIPLE YOUR DISK ACCESS SPEED

No hardware modification required

FastDOS

Fast Disk operating system for Apple II computers
 Completely compatible with DOS disks
 Loads and saves standard DOS files
 Completely compatible with all DOS/APPLESOFT programs that access DOS through standard hooks, including FID and MUFFIN

Executes all standard DOS commands

Comparative timings:	DOS	FastDOS
Booting integer basic	13 sec	3 sec
Cataloging a 12 file disk	2 sec	1 sec
Saving a 10 sector program	8 sec	2 sec
Saving a 100 sector program	34 sec	7 sec
Loading a 100 sector program	24 sec	7 sec

Requires 48K

£19.95

VersaForm

Business Form Processor

NOW AVAILABLE FOR THE IBM PC AS WELL AS APPLE II/III & III

VersaForm required little understanding of data processing, its concepts, procedures or data storage technology. Yet it is a powerful, easy to use system which allows you to get specific paper handling jobs done without being involved with the technical data processing.

- VersaForm for Apple II £239
- Hard Disk Version for Apple II £295
- VersaForm Pascal Interface £149
- VersaForm for Apple III £299
- VersaForm for IBM PC £295

LET YOUR APPLE SPEAK FOR ITSELF!

With Street Electronics' Echo II Speech Synthesizer. Your Apple really can speak.
 Also by Street Electronics is the Echo General Purpose. - A complete stand alone unit, and The Echo Speech Module for OEM applications.

- Echo II £169
- General Purpose £249
- Speech Module for OEM £199



SO YOU THOUGHT THAT YOU COULDN'T AFFORD A PLOTTER

THEN CAME SWEET-P

AN INCOMPARABLE GRAPHIC PLOTTER AT £595

Works on all Micros with a suitable parallel interface for all your Graph Processing, Chart Processing, Engineering Graphics and Overhead Transparencies. Just take a look at this comparison with the Strobe Plotter:-

Compare	Strobe	Sweet-P	Compare	Strobe	Sweet-P
Will Paint OEM Colours	No	Yes	Interfacing	Special	Centronics
Int. Letter Size Generator	No	Yes			Parallel
Self Test	No	Yes	Size	16½x8½x3½	14x8½x3
Pause Key	No	Yes	Weight	8lbs	5½lbs
Enter Key	No	Yes	Speed	3" Sec	6" Sec
Transparencies	Yes	Yes	Res.		
Software	Yes	Yes	Steps/Inch	500	250
Plot Commands built in	None	19	Plot Area	8"x10"	8"x128"



SWEET-P SOFTWARE AVAILABLE FOR APPLE, IBM PC, OSBORNE AND XEROX 820



ADDITIONAL SOFTWARE:

- SWEET PLOT I - APPLE TUTORIAL GRAPHICS - £75 (Also for IBM PC)
- BPS - APPLE - COMPLETE BUSINESS GRAPHICS £139
- BPS - IBM PC COMPLETE GRAPHICS £265

EPSON HX-20 PORTABLE COMPUTER

THE LITTLE COMPUTER WITH THE BIG PERFORMANCE.

The HX20 is a full function, portable computer. Its standard 16KB RAM expands up to 32K bytes, or the 32KB ROM memory to 72KB. This remarkable portable computer also communicates. You can correct RS-232C and Serial Interfaces to telephone couplers and other peripherals. The full size ASC II keyboard works just like a regular typewriter. And it's complete with a built in printer, a LCD screen, and music generation via a piezo-electric speaker. Full extended Micro-soft BASIC. Time and date functions.



AND THE PRICE - AN INCREDIBLY LOW £402

MACHINE CARE - DUST COVERS

Decca RGB Monitor	£9.95	Apple II	£8.95
Sinus Keyboard	£5.95	Apple & 2 Discs	£8.95
Sinus Proc & Monitor	£10.95	Apple & 12" Monitor	£8.95
Prism Printer 580	£8.45	Apple 2 KD&12" Monitor	£9.95
Anadex 9820 Series	£8.95	Apple 2 DK&9" Monitor	£8.95
BBC Computer	£8.95	Single Disc	£3.45
IBM PC Monitor & Cover	£9.95	2 Stacked Discs	£4.45
IBM PC Keyboard	£4.95	9" Monitor	£5.95
NEC 8023B-C Printer	£8.45	Epson MX80/70	£5.95
Pat 4023/8023/8098	£9.45	Paper Tiger 445/60	£7.45
Pat 4040/8050 Disc	£8.95	MX100	£9.95
9080 Hard Disc	£8.95	Pat 4022P Printer	£5.95
Pat 4022P Printer	£5.95	Pat 8023P Printer	£7.45
Pat 8023P Printer	£7.45	Pat 8300P Printer	£8.45
Pat 8300P Printer	£8.45	Apple II	£8.95
		Apple & 2 Discs	£8.95
		Apple & 12" Monitor	£8.95
		Apple 2 KD&12" Monitor	£9.95
		Apple 2 DK&9" Monitor	£8.95
		Single Disc	£3.45
		2 Stacked Discs	£4.45
		9" Monitor	£5.95
		Epson MX80/70	£5.95
		Paper Tiger 445/60	£7.45
		MX100	£9.95
		Pat 4022P Printer	£5.95
		Pat 8023P Printer	£7.45
		Pat 8300P Printer	£8.45



THE ELITE SERIES OF DISK DRIVES FROM RANA SYSTEMS

More juice on Apple's inferiority.

Rana has an advanced write protect feature which makes it impossible to lose your information. A simple touch on the front panel's membrane switch gives you failsafe control. Apple of course only has a notch or tab, which gives you only minimal protection. With the superior Elite controller card, you can control up to four floppy disks using only one slot. With Apple's you can only use two. Of course, you can still plug into Apple's controller card, but down the line you'll want to switch to Rana's and save yourself a slot.

Elite also gives you more byte

Even our most economical model, the Elite One, gives you 14% more storage than Apple's. 163K versus Apple's 143K. With our Elite Two offering 326K and our top-of-the-line Elite Three offering a 356% storage increase at 652K. That's almost comparable to hard disk performance, all because of our high density single and double sided disks and heads.

We put our heads together to give you a superior disk drive.

We designed the Elite Three to give you near hard disk capacity with all the advantages of a minifloppy system. The double sided head operates on 80 tracks per side giving you a capacity of 652K bytes. It would take 4½ Apples to give you that.

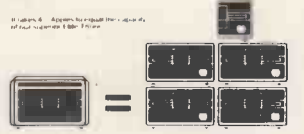

The Elite Two offers an impressive 326K bytes and 40 tracks on each side. This drive is making a real hit with users who need extra storage, but don't require top-of-the-line capacity.

- ELITE One £269
- ELITE One & Controller £349
- ELITE Two (2 x 40 Track) £419
- ELITE Two & Controller £489
- ELITE Three (2 x 80 Track) £559
- ELITE Three & Controller £629
- RANA Controller card for 4 Drives £85

Missionaire



LEARN ALL ABOUT THE STOCK MARKET AND HAVE THE TIME OF YOUR LIFE DOING IT!

Missionaire is much more than exciting, realistic game action - Missionaire is a learning tool of incomparable value - a game and a financial tutor.

- IBM PC version £69.95
- Apple II version £59.95



BINED RANGE OF PRODUCTS C/PM COMPUTERS IN THE UK!

Goods listed in this advertisement are available from our dealers throughout Europe

ANNOUNCING... **Sprinter**

RING US TODAY -
GET YOUR PRINTER
TOMORROW!

We stock the following printers:

- Tec/Itoh F10/40cps . . . £1,285
- Tech/Itoh F10/50cps. . . £1,675
- Epson MX100 F/T III . . . £499
- Epson MX82T Graphic Ptr. £369
- Epson FX80 F/TIII. . . . £438
- NEC 8023B Dot Matrix . . £349
- OKI Microline 80£199
- OKI Microline 82A£349
- OKI Microline 83A£499
- OKI Microline 84 Parallel . £799
- OKI Microline 84 H.S. Serial £891
- Olympia ESW3 with KB . £1,098
- Olympia ESW102 (RO) . . £836
- Smith Corona
TPI D/W Serial£485
- Smith Corona
TPI D/W Parallel£485
- QUME Sprint II.£1290

Dealer prices available on request

RANDOM ACCESS IN A PRINTING BUFFER?



YES!

PipeLine Random Access Printing Buffer

- Random Access printing—stores paragraphs or pictures for printing in any order—any number of times.
- FIFO Printing—conventional first-in, first-out "dumb buffer" operation.
- Bypass Printing—Lets you interrupt a long print to do a short, urgent print.
- Compression of data for efficient utilization of memory space.
- Simple erase feature to clear buffer.
- Automatic duplication capability. Prints copies without using your computer.
- Easily expandable by you, from 8K Bytes to 128K Bytes.
- Stand-alone unit—does not use up your computer's power or expansion slot space.

From £179

LPS II

Light Pen System for Apple II™ Computers

The LPS II is the only true High Resolution Light Pen System with full software Support for the Apple II. High Resolution pictures, diagrams and other graphics can be easily drawn on the screen.

LPSII FEATURES INCLUDE

- *PENTRAX Machine Language Software.
- *PENPAINTER Software system with area fill/re-fill
- *4 Complete Hi-Res Drawing Systems.
- *Menu Selection Programs.
- *Hi-Res Text Generator.

LPS II by GIBSON
LABORATORIES — £249.00

GAMES GALORE



BUY 3 - Save 15%



SPECIAL OFFER

NAME	PRICE	NAME	PRICE
High Orbit	£24.95	Cannon Ball Blitz	£24.95
Soft Porn Adventure	£19.95	Lattpak	£24.95
Cross Fire	£19.95	Lunar Leeper	£19.95
Jaw Breaker	£19.95	Sneakers	£19.95
Mission Asteroid	£13.95	Gorgan	£24.95
Mystery House	£17.95	Bandits	£21.95
Ulysses and the Golden Fleece.	£22.95	The Blade of Blackpode	£21.95
Wizard & Princess.	£22.95	Free Fall	£21.95
Marauder.	£22.95	Apple Panic	£19.95
Granston Manor.	£22.95	Pegasus	£19.95
Threshold	£27.95	Prisoner II	£22.95
Mouskattack	£22.95	Phazer Fire.	£21.95
Ultima II	£39.95	Scrabble	£24.99
Frogger.	£21.50	Gamma Goblins	£19.95
		Borg	£19.95
		Epoch	£21.95



WE ARE PLEASED TO
ANNOUNCE THAT OUR
LONDON OFFICE IS NOW AN
AUTHORISED IBM UK
PERSONAL COMPUTER
DEALER

LOOK AT THESE ITEMS FROM OUR WIDE RANGE OF PRODUCTS FOR THE IBM PC

80 Col Word Process IBM		Financial Modelling IBM	
Write On for IBM PC	99.00	1-2-3 for IBM PC	349.00
Easyspeller for IBM	125.00	Supercalc For IBM	225.00
Easywriter II For IBM	239.00	Business Forecasting Model IBM	88.00
Volkswriter IBM PC	159.00	Visicalc 256K For IBM	187.00
Wordstar For IBM	295.00		
Mailmerge For IBM	145.00	Edu Software IBM	
Superwriter For IBM (Oct 3/8)	249.00	Question	32.95
VisiWord For IBM PC	295.00	ATI Power for IBM PC DOS	59.00
		THE WORDprocessor BIBLE Tut PC	149.00
Mem Exp Cards IBM		PC Tutor	59.00
64K RAMcard for IBM PC	245.00	The Instructor for IBM PC	29.95
256K RAMcard for IBM PC	495.00	Wordtrix for IBM	22.95
192K RAMcard for IBM	287.00	Quotrix	22.95
Apparat 64K expandable RAMcard	119.00	Story Machine for IBM PC	24.95
16K upgrade for RAMcard	31.00	Facemaker for IBM PC	24.95
Vista 576K Maxicard RAMcard	395.00	Snooper Troops for IBM PC	32.95
		Snooper Troops 2 for IBM PC	32.95
Multifunction Cards IBM		Databases & DB Util IBM	
Para/RS232/Clock Card for IBM	249.00	Versaform for IBM PC	295.00
Hercules Graphics Card	495.00	Qbase for IBM PC	139.00
Assembly Language Graphics rtn	39.95	Dbase II For IBM	375.00
Quadboard 256K,Clock & I/O	695.00	Quickcode for dBase II IBM	249.00
Quadboard 64K,Clock & I/O	395.00	dUtil for dBase II IBM	69.00
Quadboard 128K,Clock & I/O	525.00	dGraph for dBase II IBM	249.00
Quadboard 192K,Clock & I/O	595.00	Easyplanner For IBM	125.00
6 Function 576K Board for PC	575.00	Easyfiler For IBM	259.80
I/O IBM-Int (2 Ser Para & GM)	195.00	PFS for IBM	84.00
		PFS Report for IBM	64.00
Graphics Hardware IBM		DB Master for IBM PC	349.00
Sweet P Plotter for IBM PC	595.00	Data Reporter for IBM PC	195.00
Versawriter Graph Tab IBM	199.00	Report Writer for IBM PC	79.00
		File-Fax for IBM PC	139.00
Firmware Devel Equip IBM		Visidex For IBM	187.00
Prom Blaster For IBM	159.00	Visifile For IBM	230.00

★ BOOKS ★

SEND NOW FOR OUR
NEW CATALOGUE
OF OVER 600
COMPUTER RELATED
BOOKS

**Our well equipped
SERVICE & REPAIR
DEPARTMENTS**

IN ROSSENDALE & LONDON ARE NOW
AVAILABLE FOR REPAIRS ON ANYONE'S
APPLE OR IBM PC

Rates are very reasonable
£10 1st 1/2 hour, £7.50 per each
subsequent 1/2 hour in
Rossendale

£12 per 1st 1/2 hour, £9 per
each subsequent 1/2 hour in
London.

Call
STEVE McCLEAN
in Rossendale (0706 227011)
or
DAVE MERCER in London
(01-769 1022)

Pete & Pam Computers

Mail Order & Distribution:
New Hall Hey Road,
Rossendale, Lancs., BB4 6JG

Phones: (0706) 227011 & 212321
Telex: 635740 Petpam G.

Norwegian Agent:
The Norwegian Software House
Oslo 5

London Retail:
103-5 Blegborough Road,
London, SW16 6DL
Phones: 01-769 1022/3/4
Telex: 923070 PRCOMP G

Telephone **47 2 64 55 77**

Prices do not include VAT please add 15% to your remittance
Postage and Packing FREE

SuperSoft®



MY PARTICULAR INTEREST IS _____

OEM, DISTRIBUTOR & DEALER ENQUIRIES INVITED

NAME _____

POSITION _____

COMPANY/ADDRESS _____

TEL: _____

END USER

DEALER

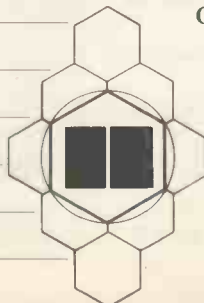

MICRO TECHNOLOGY
EUROPEAN AGENTS FOR SUPERSOFT INC.

51 THE PANTILES, TUNBRIDGE WELLS, KENT, TN25TE, ENGLAND.
TEL: 0892-45433 TELEX: 95441 MICRO-G.

Micro Technology are pleased to announce our appointment as European Agents for Supersoft Inc of Champaign, Illinois.

We shall be bringing to the European market some of the best and most advanced micro computer software, FORTRAN for CP/M, CP/M86, MS-DOS and PC-DOS on the IBM PC.

Benchmark times from Infoworld, some up to 13 times faster than IBM PC FORTRAN. The best benchmark times of any 16 bit Fortran we have seen

C, the system programmers language on all operating systems, and ADA etc. ADA the language of the future. Many more languages such as FORTH, LISP & PASCAL.

Electronic spreadsheets like SCRACHPAD probably the most advanced of the genre with Virtual memory and true consolidation. For all CP/M, CP/M 86, and MSDOS micros.

The best selling utilities: Diagnostics II to check out your system hardware, and Diskdoctor to recover data from dead or dying disks.

Watch this space for more product information, and lists of our main distributors. If you can't wait call us now on (0892) 45433

SUPERSOFT, first in software technology from MICRO TECHNOLOGY, leaders in Microcomputer Technology.

MICROTECHNOLOGY
EUROPEAN AGENTS FOR SUPERSOFT INC.

51 THE PANTILES, TUNBRIDGE WELLS, KENT TN2 5TE.
TEL: 0892-45433 TELEX: 95441 MICRO-G

The INCREDIBLE **NEW** SIRIUZ 80 only £169.87

+ VAT

- RUNS THOUSANDS OF LOW COST CP/M 80+2.2 PROGRAMS ON SIRIUS 1.
- USERS REPORT COST RECOVERED ON 1 STANDARD SOFTWARE PACKAGE ALONE.
- ALL BRITISH HARDWARE/SOFTWARE SOLVING THE 16 BIT SOFTWARE SHORTAGE.
- EXPANDED CP/M 80 COMPATIBLE OPERATING SYSTEM INCLUDED WITH EVERY SIRIUZ 80.
- MANY WELL KNOWN PROGRAMS ACTUALLY RUN FASTER THAN THEIR HIGHER PRICED 16 BIT TRANSLATIONS

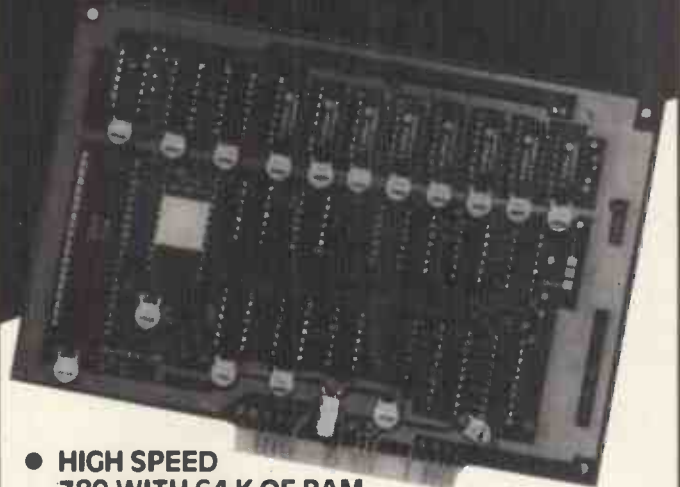

- HIGH SPEED Z80 WITH 64 K OF RAM
- SYNCHRONOUS SIRIUS INTERFACE
- EASY 5 MINUTE FITTING (FIXINGS PROVIDED)
- HIGH NOISE IMMUNITY CONSTRUCTION
- 2 YEAR HARDWARE WARRANTY
- FREE SOFTWARE UPDATES

† TM DIGITAL RESEARCH INC.

inpholink

LIMITED

FRONT STREET WEST, BEDLINGTON,
NORTHUMBERLAND NE22 5UB.
TELEPHONE: BEDLINGTON (0670) 829009/827480.

PLEASE RUSH ME _____ SIRIUZ 80 PACKAGES ON 21 DAYS APPROVAL AT £197.08 INC. VAT AND £1.50 P&P

NAME _____

ADDRESS _____

CHARGE TO MY ACCESS ACCOUNT



NO



VISA PLEASE PHONE.

DEALER ENQUIRIES INVITED.

Byrom Software

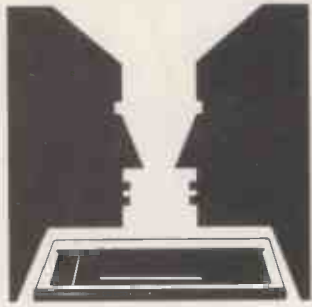

CONVERSATION PIECE

Get micro's talking to each other ... and to mainframes ... with Byrom Software's communications packages.

BSTAM

Micro to micro transmission of all CP/M* files, regardless of size.

- full wildcard expansions to send *.COM etc.
- full speed data transfer without hex conversion
- direct 9600 baud linking with UARTS, or via phone lines using modems
- reliable error detection and automatic retry

BSTMS

TTY emulation facility for communicating with remote time-sharing systems via phone lines. Osborne version available.

Terminal mode runs your computer like a TTY, and File mode lets you send and receive files to and from the Host Computer.

- interactive mode
- expand and compress programs translating binary to character files and vice versa.
- files received to and transmitted from disk

For your nearest supplier, see our main advertisement (Pages 76 and 77)



Xitan Systems Ltd. 23 Cumberland Place
Southampton SO1 2BB Tel. 0703 334711

*CP/M is a Trademark of Digital Research Inc.



LCC Lower Case Chip. Adds the full lower case set to your Apple II, complete with clip-on shift key mod. Lower case letters have true descenders. Available in most European & USA languages (please state which). **£34.00 + VAT**

LCC 8132 Epson Eprom. Provides owners of EPSON 8132 parallel card with the means to upgrade their existing card to accept conventional Apple printer card commands. Pascal & CP/M compatible. **£18.00 + VAT**

Developer. Developer speeds up the program development cycle by providing facilities to make rapid local and global changes to program text. Once installed Developer is completely transparent and does not interfere with DOS or Applesoft. **£19.95 + VAT**

Matrix Basic. Statisticians, Engineers, Scientists need MATRIX and ARRAY instructions normally found only on Main Frame computers NOW available for your Apple II. **£29.95 + VAT**

Visiplot Driver Routines. Allows users of Visiplot and an intelligent printer card such as Grappler WIZARD, Printmaster, Epson 8132, to send their graphs directly to the printer using all the features of the printer card. **£19.95 + VAT**

Tridee. The Tridee system for 3D graphics on an Apple II computer is a complete system for scientific-engineering and educational use. Useable by those with Pascal programming experience and those who wish to use it as a tool for 3D design and visualisation. Compatible with Apple FORTRAN. **£49.95 + VAT**

Supermon. Extends the facilities of the resident Apple II monitor to give several new commands to aid the machine code programmer in debugging his programs and in understanding others. **£19.95 + VAT**

Statsease. A set of seven interactive programs developed at Nottingham University using the Apple II for analysing data (up to 4000 entries) and for teaching statistics single disk with instructions. **£75.00 + VAT**
Back-up disk (can only be purchased with main disk). **£5.00 + VAT**

Visicalc Utilities. This program gives you - Visiform, enabling you to list out on your printer or VDU all the worksheet formulae, allows you to display or print those formulae too wide for Visicalc display area. Visiprint, reformat the printout of your worksheets with variable column widths, additional text headings, dates, page control and numbering. If you have a clock card, date and time are automatically included in your print-out. **£39.99 + VAT**

Omnibus. A powerful, general non parametric statistical tool, developed and tested over six years by Dr. R. Meddis, University of Technology, Loughborough. Omnibus has been written with a wide range of users in mind. It is equally suitable for undergraduates and experienced statisticians. The program is accompanied by a substantial handbook with examples to illustrate all the experimental designs within its range. **£95.00 + VAT**

Send for LCC Fact Sheets giving further details.
System Requirements: 48K Apple II or Apple //e.

LEICESTER
computer centre limited

67 Regent Road, Leicester LE1 6YF.
Tel: 0533 556268



ORIC-I 48K

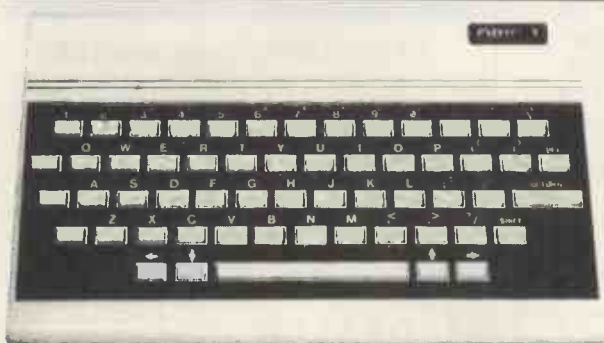

£169.95 inc. VAT

It's easy enough to buy a computer but how do you know it's the right one?

MOVIESCOPE offer you the assistance of a trained computer consultant who will be pleased to discuss and demonstrate the system that will meet your needs, and offer you full after sales advice.

Opening hours: Mon-Sat 10am-7pm
Sun 1.30-4pm

ORIC-I 48k	£169.95
LINX 48K	£224.95
COLOUR GENIE	£224.00
SPECTRUM 16K	£125.00
SPECTRUM 48K	£175.00
DRAGON 32	£198.95
COMMODORE 64	£344.99
VIC. 20	£129.95
ATARI 800	£399.99
ATARI 400	£198.95
Jupiter Ace	£89.95
Sinclair ZX 81	£49.95
TEXAS TI99/4a	£159.95

All prices inclusive of VAT

COMPREHENSIVE SELECTION OF SOFTWARE, ACCESSORIES, BOOKS AND GAMES

Moviescope service centre will ensure that should your machine 'go-down' we will get it running again as quickly as possible.

MOVIESCOPE
90 HIGH ST. BARNET. HERTS
01-449 8329

AQUA

COMPUTING LIMITED

dBASE II is the USA's leading data base package, which AQUA can offer at the special price (ex. VAT) of £375.00 while current stocks last. In addition we offer a complete supporting programming service. Get your copy of dBASE II today!

INTRODUCTORY

OFFER

£375

(excl VAT)

dBASE II

dBASE II is a registered trade mark of Ashton Tate.

We supply the latest release inclusive of a 300+ page comprehensive manual and ZIP—the dBASE II screen and print out FORM WRITER. Available for all popular Z80 (* Z80 card required) micros. On 5.25" diskettes for all machines including:

Apple II (*)	Osborne I
Televideo	North Star
Superbrain	Sanyo
Sirius I (*)	IBM PC (*)
Xerox 820/822	Galaxy

Also on SD 8" diskette (IBM format)

dBASE PACKAGES

Support packages customised to your requirements can be provided for the following applications:

- | | |
|-------------------------|------------------------|
| 1 Automatic Invoicing | 6 Stock Control |
| 2 Information Retrieval | 7 Exhibition Enquiry |
| 3 Personnel Records | 8 Mailing List |
| 4 Job Costing | 9 Production Budgeting |
| 5 Equipment Register | 10 File Indexing |

Information sheets are available on these applications. Indicate your area(s) of interest on the coupon below.

FREE - SAVE - £30

With every dBASE II purchased from AQUA before 30. 4.83, we are also providing—FREE—a copy of our program—DBFLIST.COM—The easy way of keeping track of all your dBASE II files.

The total cost inclusive of VAT & p & P is £431.25.

<input type="checkbox"/>	<input type="checkbox"/>	<input type="checkbox"/>	<input type="checkbox"/>	<input type="checkbox"/>	<input type="checkbox"/>	<input type="checkbox"/>	<input type="checkbox"/>	<input type="checkbox"/>	<input type="checkbox"/>	<input type="checkbox"/>	<input type="checkbox"/>	<input type="checkbox"/>	<input type="checkbox"/>	<input type="checkbox"/>	<input type="checkbox"/>	<input type="checkbox"/>	<input type="checkbox"/>	<input type="checkbox"/>	<input type="checkbox"/>
--------------------------	--------------------------	--------------------------	--------------------------	--------------------------	--------------------------	--------------------------	--------------------------	--------------------------	--------------------------	--------------------------	--------------------------	--------------------------	--------------------------	--------------------------	--------------------------	--------------------------	--------------------------	--------------------------	--------------------------

*Please debit my Barclaycard/Access account with
I enclose Cheque/P.O. for

£

*delete as appropriate

Name:

Address:

Machine: Sheets:

Send to AQUA Computing Ltd, 10 Barley Mow Passage
London W4 4PH (01-994 6477)

(PCW17)

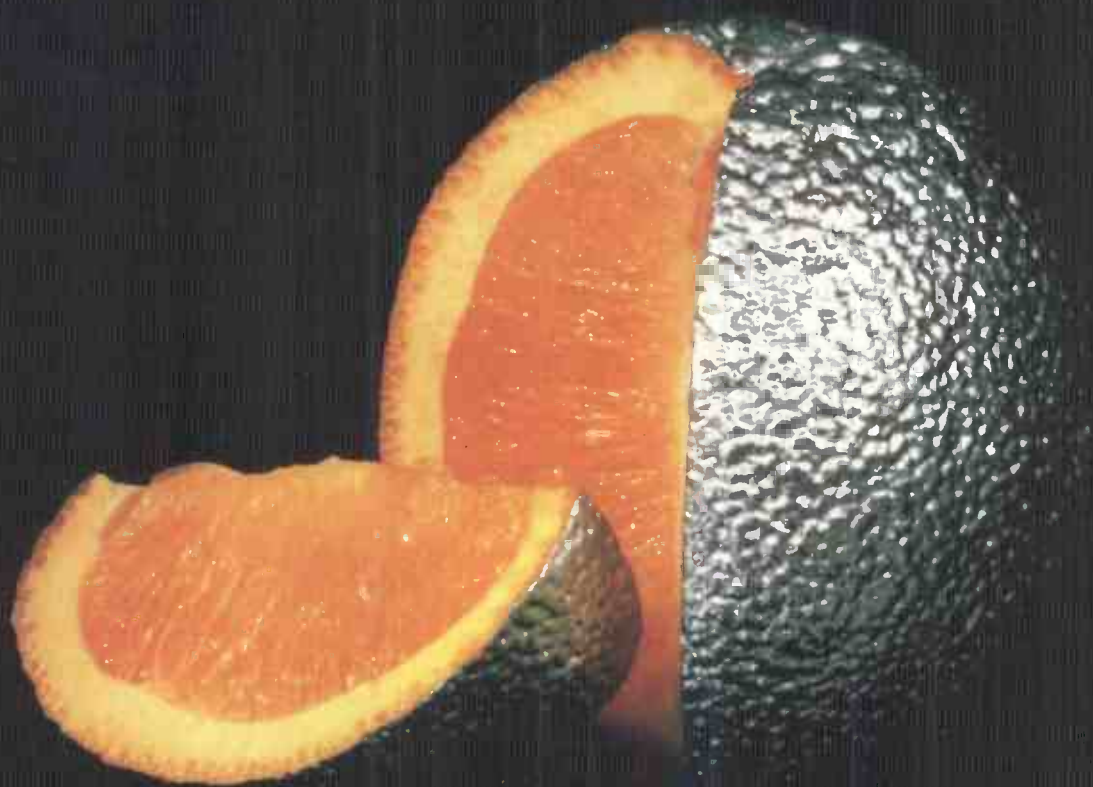

**Just about
anything
can be
improved**

Improve the productivity and profitability of your business with the Intelligence Office Automation Series.

MICROSCRIPT is an advanced text and information processing package, offering a word processor, 16 digit calculator and unique user programmable system in a single package. On screen calculation, extensive print output controls can be assembled into user designed applications packages, without previous programming experience.

MICROPLOT is a total business graphics package. It can be used to produce pie charts, bar charts, histograms, transparencies for projection and graphs from any file with the use of your microcomputer.

MICROPEN is an information entry and retrieval system. Used in conjunction with MICROSCRIPT, computer files can be created easily and automatically. Records can be stored, retrieved, printed, edited or deleted, with input and output formats designed by the user to suit individual needs.

MICRODESIGNER is a full facility computer aided design package for microcomputers. High quality drawings can be designed, edited and output to screen, printer or pen plotter, in colour, as required. It offers sophisticated screen editing functions, digitising features and general purpose shading.

Other packages in the series include Financial Modelling, Incomplete Records system and much more.

All INTELLIGENCE software features universal 8 or 16 bit system compatibility with CP/M, MP/M and UNIX operating systems, and INTELLIGENCE uses the powerful C programming language in its packages.

Contact INTELLIGENCE today for further details. Dealer, distributor and manufacturer enquiries welcomed.



INTELLIGENCE (IRL.) LTD
NAGOR HOUSE
DUNDRUM ROAD,
WINDY ARBOUR
DUBLIN 14, IRELAND
TELEPHONE 988555 988243

intelligence Software that works for you.

Please tell me more about Intelligence.

NAME _____

COMPANY _____

ADDRESS _____

£1,495*

The MIMI 802 is a supreme example of high quality British engineering. It is a truly professional microcomputer that really does meet all the criteria of a sophisticated business machine - at a price you can afford.

Our competitors expect you to make do with the basics and then buy expensive extras in order to fulfil your needs. The MIMI 802 has all the 'extras' as standard - so when you buy a MIMI you really are getting a microcomputer that will do the job from the outset.

The MIMI's operating system OS/M[†] is fully CP/M[‡] compatible so you have access to a very comprehensive range of software, extending from word processing to accounting.

During the next few months we will be announcing the availability of TROJAN - a major software innovation that totally simplifies the learning process and use of micros, and dramatically eases the creation of new applications programs. We are using it and generating applications software in record time - so we can guarantee its performance.

Don't settle for less... contact us or one of our dealers now.

Features include:

- Z80A at 4MHz
- 64K Dynamic RAM
- Integral D/S - D/D 5¼ ins floppy discs - 700Kb.
- Full RS232C and Centronics parallel ports.
- 96 Key ASCII keyboard - colour coded.
- 17 programmed function keys.
- Light pen socket.
- Elegant compact and light - 24 lbs.
- OS/M operating system - fully CP/M compatible.
- Disc format conversion facility.
- Wide range of software, utilities and languages.
- Super high resolution graphics (512 x 256 pixels).

And now with:

- Winchester disc option.
- Choice of orange or green display.

MONITOR SUPPLIED BY PHILIPS

NOW ALL OTHER MICROS ARE LESS THAN PERFECT

[†] OS/M is the trademark of Scifax Microsoftware.

[‡] CP/M is the registered trademark of Digital Research Inc.

* Monitor extra, from £142.

Some of our dealers

Anita Electronic Services
34 Musters Road West Bridgford Notts
Tel: 0602 813240
Contact: Steve Conroy

Apollo Information Systems Ltd.
13 Southend Road Grays Essex RM17 5NH
Tel: (0375) 33088
Contact: Ronald Burrell

Belmondo Research Ltd
68 Maple Road Horfield Bristol BS7 8RG
Tel: 0272 427428
Contact: Roger Banfield

Broadway Systems (BCSS) Ltd
5-7 Mariner Street Swansea W Glam Wales SA1 5BA
Tel: 0792 462279/474598 01-997 4764/0498
Contact: Philip Gittoes

City Microsystems Ltd
65 London Wall London EC2
Tel: 01-588 7272
Contact: Anthony Coulson

Computer Graphics Workshop
38 Ullet Road Sefton Park Liverpool 17
Tel: 051 733 9604
Contact: Noel Runnels-Moss

Procon Ltd
112 Albert Street Fleet Hampshire
Tel: (02514) 20991/2
Contact: Arthur Thomas



BRITISH MICRO

Penfold Works Imperial Way Watford Herts. WD2 4YY Tel: Watford (0923) 48222/43956



A Hegotron Group Company

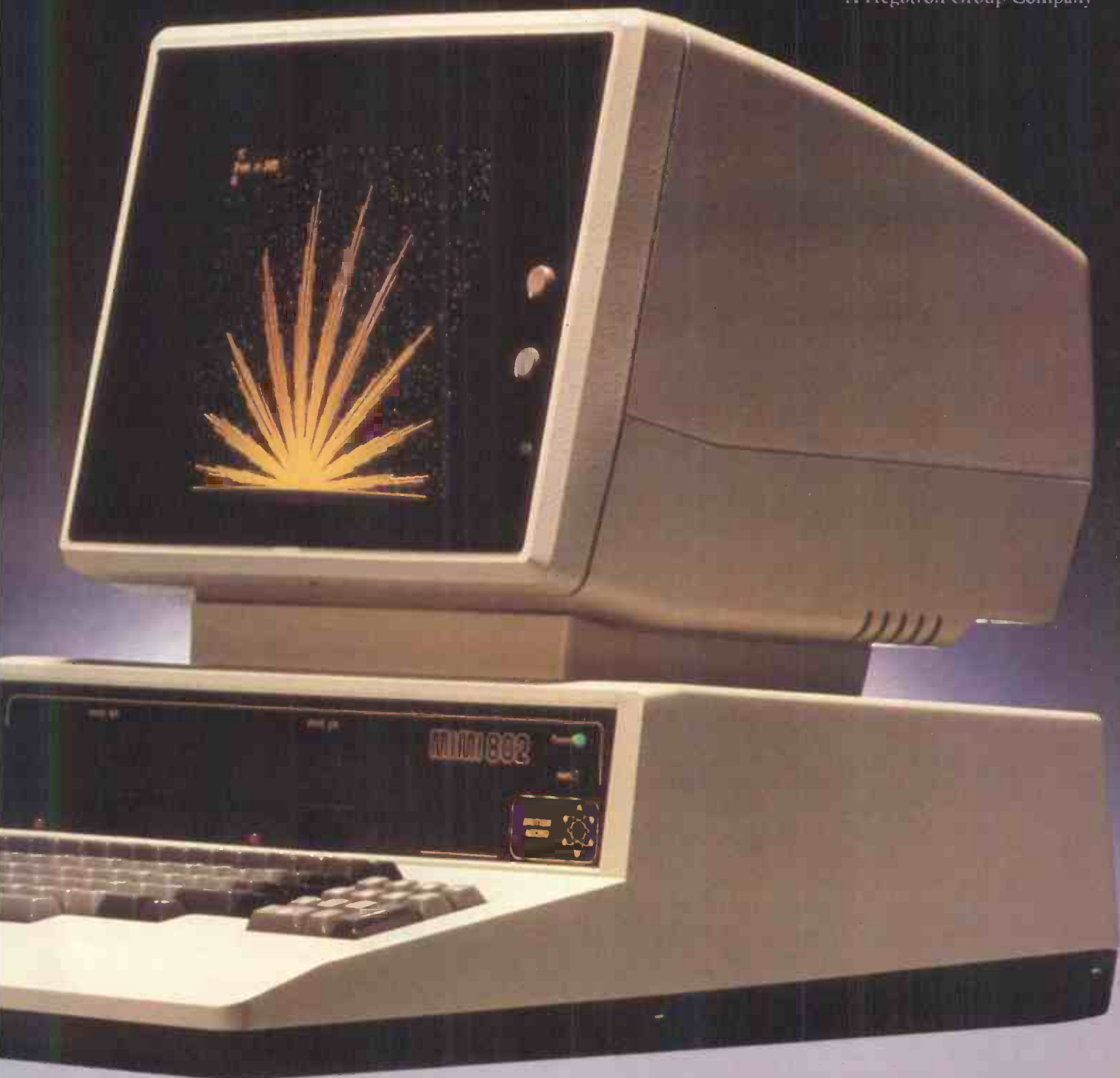

Kyle Data Services Ltd
37 High Street Ayr Scotland KA7 1LU
Tel: (0292) 285411
Contact: Alex Gardiner

Easibee Computing Ltd
133-135 High Street North East Ham London E6 1HZ
Tel: 01-471 4884
Contact: Computer Sales Director

John Elmer Office Equip
32 Victoria Road Burgess Hill Sussex
Tel: 04446 5670/5791
Contact: John Elmer

Leicester Micro Centre
59 Regent Road Leicester
Tel: 0533 551869
Contact: Ray Beresford

Malvern Micro Systems
Wych Cutting Upper Colwall Malvern Worcestershire
Tel: (06845) 68500
Contact: Barry Lewis

B & D Computing
8 Sheep St. Highworth Swindon Wilts
Tel: 0793 762449
Contact: David Wakley

Microcosm Research
26 Danbury Street London N1 8JU
Tel: 01-226 9092
Contact: Jerry Karlin

Dantre Business Systems
67 High St. Daventry Northants NN11 4BQ
Tel: 03272 77239
Contact: Mike Griffin

MIMI 802

Telex: 946024 Contact: Julie Hissey

THE BEST SELLER OF 1982



In 1982 the RICOH 1600S outsold every other comparable printer because of its speed, reliability, intelligence, flexibility and sophistication.

Because it is compatible with all known systems and software packages.

Because of the 12 month warranty that Micropute offer.

Because Micropute are a company who care, who are constantly aware of changing needs and who can fulfill any special requirements.

Not least of all, because of the price

In 1983, there will be thousands more satisfied customers.

We hope that you will be one of them.

ONLY MICROPUTE GIVE YOU SUPERCOVER

As an extra bonus Micropute Supercover will provide a 12 month on site maintenance for only £99.00 parts and labour.

**DON'T
FORGET THE
RICOH 1300S**

...a little bit slower but
every bit as clever.

Please send details of the RICOH 1600S
and 1300S

Name: _____

Position: _____

Company: _____

Address: _____

Telephone: _____

RP2



MICROPUTE

Micropute, Catherine Street, Macclesfield,
Cheshire SK11 6QY. Tel: (0625) 615384.



You too can be a good mixer

PRO PASCAL Full ISO Standard Pascal

PRO FORTRAN Full ANSI 66 Fortran

These implementations individually meet the most demanding requirements. And they can be combined together, allowing applications to take advantage of the best features of each language.

Available now for Z80 micros with CP/M or CDOS. Versions for 8086 and 68000 under development.

Prospero
LANGUAGES FOR MICROCOMPUTERS

Prospero Software Ltd. 37 Gwendolen Avenue London SW15 6EP Tel: 01-785 6848

IRVINE BUSINESS SYSTEMS LTD.

A SINGLE CARD COMPUTER FROM ONLY ★

★
£99.95
+ POST
+ VAT

BARE BOARD SEND
COST £99.95
P/P 2.00
VAT 15.24
TOTAL £117.24

ASSEMBLED & TESTED
COST £475.00
P/P 5.00
VAT 72.00
TOTAL 552.00

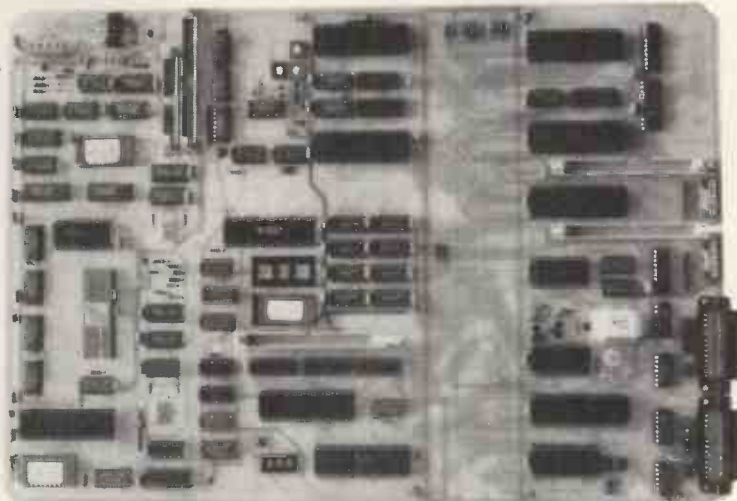

- ★ 4 MEG Z80 CPU
- ★ 64K RAM
- ★ 16K PROM
- ★ 5" & 8" DISK CONTROLLER
- ★ 80×24 VIDEO GEN
- ★ 2×SERIAL I/O
- ★ 4×PARALLEL I/O
- ★ IEEE 488 INTERFACE
- ★ KEYBOARD PORT
- ★ HARDWARE RTC
- ★ MONITOR IN PROM

THE IBS 750 S.B.C.

IRVINE BUSINESS SYSTEMS LTD, 1 MONTGOMERY PLACE, IRVINE, AYRSHIRE KA12 8PN.
0294 75000/73333

MADE IN IRVINE SCOTLAND BY IRVINE BUSINESS SYSTEMS LTD.

SEARCH NO FURTHER FOR XITAN COVERS THE

NATIONWIDE DISTRIBUTION

Xitan Systems Ltd. are long-established software distributors, maintaining close links with the principal U.S. software houses and supplying a nationwide network of approved dealers; whatever your software requirements, particularly in the professional sector, it makes sense to talk to a Xitan dealer.

SCOTLAND

GRANITE CHIPS
21 Bon Accord Street
ABERDEEN AB1 2EA
Tel: 0224 22520

BYTESHOP (GLASGOW) LTD
266 Vincent Street
GLASGOW G2
Tel: 041 221 8202

IRELAND

O & W SYSTEMS
95 Dublin Road
BELFAST
Northern Ireland
Tel: 0232 349446

NORTHERN ENGLAND

WESTERN COMPUTERS LTD
Blackpool Airport
BLACKPOOL, Lancs
Tel: 0253 404876

**ENTERPRISE SOFTWARE
PRODUCTS LTD**
40 West Street
CREWE, Cheshire
Tel: 0270 215884

**REAL-TIME COMPUTER
SYSTEMS LTD**
28-32 Mill Street
CREWE, Cheshire CW2 1AN
Tel: 0270 258142

HOLDENE
Bray House
Leicester Place
LEEDS
Tel: 0532 458439

**COMPUTER GRAPHIC
WORKSHOP**
38 Lifford Road
LIVERPOOL 17
Tel: 051 733 9604

KBS COMPUTER SERVICES
State Insurance Bldg.
14 Dale Street
LIVERPOOL L2 4TH
Tel: 051 236 8333

BYTESHOP (MANCHESTER) LTD
11 Gateway House
Piccadilly Station Approach
MANCHESTER
Tel: 061 236 4737

NSC COMPUTERS LTD
29 Hanging Ditch
MANCHESTER MA 3ES
Tel: 061 832 2269

MICROFACTOR COMPUTER SYSTEMS LTD

61 Bridge Street
MANCHESTER M3 3BQ
Tel: 061 832 2685

COMPENTIAL
118 St Anne's Road
Prestwich

MANCHESTER M25 8GJ
Tel: 061 773 8243

DATRON MICRO CENTRES
2 Abbeydale Road
SHEFFIELD
W. Yorkshire S7 4FD
Tel: 0742 585490

THOMSON COMPUTER SERVICES
55 Micklegate
YORK
N. Yorks YO1 1LF
Tel: 0904 35633

MIDLANDS

BYTESHOP (BIRMINGHAM) LTD

94 96 Hurst Street
BIRMINGHAM
West Midlands B5 4TD
Tel: 021 622 7115

CAMBRIDGE COMPUTER STORES

1 Emmanuel Street
CAMBRIDGE CB1 1NE
Tel: 0223 85334

HERALD COMPUTERS LTD

83 East Road
CAMBRIDGE
Tel: 0233 315462

BYTESHOP (NOTTINGHAM) LTD

92A Upper Parliament Street
NOTTINGHAM
Notts NG1 6LF
Tel: 0602 40576

**PLUME COMPUTER
SERVICES LTD**

11 Newark Street
LEICESTER LE1 5SB
Tel: 0533 559711

LONDON & THE SOUTH

DATAVIEW SYSTEMS LTD.
Pigeonys House
East Bay, CO1 CHESTER
Essex CO1 2XG

BABYS LTD.
191-195 Shenley Road
BOREHAMWOOD
Herts WD6 1AW
Tel: 01 953 7303

VAUNT BERRY LTD.

9 Wych Lane
Bridgemaury, GOSPORT
Hants. PO13 0SU
Tel: 0329 235846/7

SYSTEMATIC LTD
45 Woodbridge Road
GUILDFORD
Surrey GU1 4RN
Tel: 0483 572222

TELESYSTEMS
P O Box 12

GREAT MISSENDEN
Bucks HP16 9DD
Tel: 02406 5314

MICROTEK

15 Lower Brook Street
IPSWICH, Suffolk
Tel: 0473 50125

ALBION COMPUTERS
80 Great Portland Street
LONDON W1
Tel: 01 580 6787

BYTESHOP (LONDON) LTD.

324 Euston Road
LONDON NW1 3BG
Tel: 01 397 0505

HOTEL MICROSYSTEMS LTD

69 Loudoun Road
LONDON NW8 0DQ
Tel: 01 328 8737

JAROGATE LTD

197-213 Lyham Road
Brixton
LONDON SW2
Tel: 01 671 6321

OEM LTD.

1 Lochaline Street
LONDON W6 9SJ
Tel: 01 748 8404

SMALL TURNKEY SYSTEMS

31 Parolles Road
Upper Holloway
LONDON N19 3RE
Tel: 01 272 3530

TOUCHSTONE COMPUTERS LTD.

319 City Road
LONDON EC1V 1LJ
Tel: 01 278 5708

4C'S LTD

P O Box 24, 1 Avondale
MAIDENHEAD
Berks SL6 6SE
Tel: 0628 34562

ROUNDHILL COMPUTER SYSTEMS LTD

Axholme, London Road
MARLBOROUGH, Wiltshire
Tel: 0672 54675

XITAN SYSTEMS LTD

23 Cumberland Place
SOUTHAMPTON
Hants SO1 2BB
Tel: 0703 334711

LUX COMPUTER SERVICES

108 The Parade
WATFORD
Herts WD11 2AW
Tel: 0923 29513

SERVICE AND EXPERTISE

Every Xitan dealer is backed by Xitan's service and expertise, so that you can buy with confidence. Established dealers interested in becoming registered Xitan Software Dealers are invited to write or phone for full details.

N.B. Although most products are available off the shelf, not all dealers carry the complete range, and some may specialize in turnkey systems rather than retailing individual products. Also, some dealers may carry other software not supplied by Xitan.

While every effort has been made to ensure the accuracy of the information provided, Xitan are unable to accept any responsibility for errors.

SOFTWARE COUNTRY

		CPI/M-80	CPI/M-86	PC-DOS
Word Processing				
WORDSTAR	MicroPro	□	●	**
MAILMERGE	MicroPro	□	●	**
SPELLSTAR	MicroPro	□	●	**
EASYWRITER II	IUS			**
EASYSPELLER II	IUS			**
Data Bases And File Management Systems				
DATSTAR	MicroPro	□		
DBASE II	Ashton-Tate	□	●	**
EASYFILER	IUS			**
FMS-80, 81, 82	DJR Assoc	□		
INFOSTAR	MicroPro	□		
PERSONAL PEARL	Pearl Software	□		
REPORTSTAR	MicroPro	□		
RESCUE	MBS	□		
Business Systems, Financial Planning, Accounting				
CALCSTAR	MicroPro	□		
EASY PLANNER	IUS			*
MULTIPLAN	MicroSoft	□		
SAPPHIRE MARS	Sapphire Systems	□	●	
SUPERCALC	Sorcim	□	●	*
MILESTONE	Organic Software	□	●	
GBS/(General Business System)	ByteSoft	□		
ISL (Integrated Stock & Ledger)	ByteSoft	□		
Statistics				
MICROSTAT	Ecosoft	□		*
Training Packages				
HANDS-ON CP/M	MicroCal	□	●	
HANDS-ON COBOL	MicroCal	□	●	
WP WORKSHOP	MAC	□		*
FLIGHT SIMULATOR	MicroSoft	□		*
Languages				
BASIC COMPILER	MicroSoft	□		
BASIC INTERPRETER	MicroSoft	□		
BAZIC	MicroMikes	□		
CBASIC	Digital Research	□	●	
CBASIC COMPILER	Digital Research	□	●	
CIS COBOL	MicroFocus	□	●	
COBOL	MicroSoft	□		
FORTRAN	MicroSoft	□		
LEVEL II COBOL	MicroFocus	□	●	
MULISP/MUSTAR	MicroSoft	□		
MUMATH/MUSIMP	MicroSoft	□		
PASCAL/MT	Digital Research	□	●	
PASCAL/MT & SPP	Digital Research	□	●	
PL/1	Digital Research	□	●	
XBASIC	Xitan	□		

		CPI/M-80	CPI/M-86	PC-DOS
Programming Tools (Inc. Cross Assemblers)				
ACCESS MANAGER	Digital Research	□		
ANIMATOR	MicroFocus		●	
EDIT	MicroSoft	□		
BT-80	Digital Research	□		
DISPLAY MANAGER	Digital Research	□		
FORMS 2	MicroFocus		●	
LINK-80, PL1L1B	Digital Research	□		
MAC	Digital Research	□		
MACRO	MicroSoft	□		
RMAC, LINK & XREF	Digital Research	□		
SID	Digital Research	□		
SPP	Digital Research	□	●	
WORDMASTER	MicroPro	□	●	
XASM18 (1802)	Avocet	□		
XASMF8 (F8/3870)	Avocet	□		
XASM65 (6502)	Avocet	□		
XASM68 (6800/01)	Avocet	□		
XASM48 (8048/8041)	Avocet	□		
XLT86	Digital Research	□		
ZSID	Digital Research	□		
Operating Systems				
CP/M	Digital Research	□	●	
CP/M PLUS	Digital Research	□		
CP/NET & CP/NOS	Digital Research	□	●	
MP/M II	Digital Research	□	●	
CONCURRENT CPM-86 (IBM PC)	Digital Research	□	●	
Utilities				
COPYALL	MicroMikes	□		
DESPOOL	Digital Research	□		
FILESHARE	MicroFocus	□		
FILESTAR	MicroSec	□		
MUCOPY	Wheatcroft Hards	□		
SORT	Microsoft	□		
SUPERSORT	MicroPro	□		
SUPERVYZ	Epic	□		
SDISK (Silicon Disk)	Xitan	□		
Communications				
BSTAM	Byrom Software	□	●	*
BSTMS	Byrom Software	□		
Graphics				
GSX	Digital Research	□	●	
GSS- Kernel	Digital Research	□		
GSS- Plot	Digital Research	□		
GSS- 4010	Digital Research	□		
WATCH THIS SPACE				
Xitan Systems Ltd. are continually adding new software to their range: check the listing every month to keep up with exciting new developments.				

XITAN SYSTEMS

LARGE RANGE

Xitan are main U.K. distributors for Digital Research Inc., MicroPro Inc., Microsoft, Ashton-Tate, Sorcim and IUS, and suppliers of a large range of software from other leading software houses such as Byrom and Ecosoft. Most software can be supplied in a comprehensive range of formats.

Looking After our Dealers - so You Know Where to Look

TRUE 16 bit!



Olivetti M20

The new Olivetti M20 provides everything the modern businessman is likely to need in a desktop computer

* **SPEED:** fastest of 62 'Personal Computer' world' Benchmark timings. Faster than Sirius and IBM. True 16 bit data bus.

* **MEMORY EXPANSION:** 128k up to 512k RAM + SCREEN RAM

* **DISK STORAGE:** Standard 320k or 640k floppies with optional 10MG hard disk (built-in). Faster disc access

* **BUSINESS SOFTWARE;** Full Range. Integrated Accounts, Stock control, Payroll, or separate packages. Wordprocessing, Financial planning, Specific packages e.g. Solicitors' accounts, Engineering design, Numerical control etc.

* **GRAPHICS:** High resolution standard on all versions. About 3 times Apple II resolution for NO loss of user memory. Colour version available. 512x256 dots, full flexibility.

* **COMMUNICATIONS:** Programmable RS232 interface built in plus parallel printer output, IEEE 488 option. Software available for IBM etc protocols, Videotex. Extra RS232 option.

* **CP/M:** Not an ideal 16 bit operating system but optionally available. Olivetti's PCOS system is supplied as standard and is faster and more powerful. Embed system commands in Basic.

* **SERVICING:** Direct from Olivetti Service Centres.

* **FINANCE:** Lease or Rent through Olivetti Finance.

* **COMPETITIVE PRICING** (Includes PCOS and MBasic 5.2):

M20S: 128k RAM + 16 screen, Single disk, monochrome:	£1895
M20D: 160k RAM + 16k screen, Dual disk, monochrome:	£2395
M20C: 160k RAM + 32k screen, Dual disk, 8 colour:	£3262
M20H: 160k RAM, 11 MB/Hard disk, 1 Floppy, monochrome:	£4295

Brighton Computer Centre

130 Lewes Road, Brighton BN2 3LG
(0273) 688946 Mon-Sat 10am-6pm

Please send me further details of the Olivetti M20

Name

Company

Address

..... Tel.....

Application:.....



DO YOU USE CP/M? VeerPort Ltd. can help you

- Un-ERA-se a file? (UNERA)
 - Find out how CP/M allocates disk storage? (DDUMP)
 - Patch any byte on a disk? (DDUMP)
 - Test a disk for bad spots? (DTEST)
 - Recover damaged files? (DDUP+DDUMP)
 - Transfer files or programs between 2 CP/M machines (must have serial link) (FILE MOVER)
- (Soon available for CP/M 86.)

All programs are menu driven and complete with manuals.

These general disk utilities work on any single user CP/M 2.x system with any diskette size and format, and many hard disks.

Prices from £21.95 (inc. VAT).

For further details write to: VeerPort Ltd.
P.O. Box 31, Redhill RH1 6RQ.

CP/M is a trademark of Digital Research.

The Osborne Dual-Density portable business computer

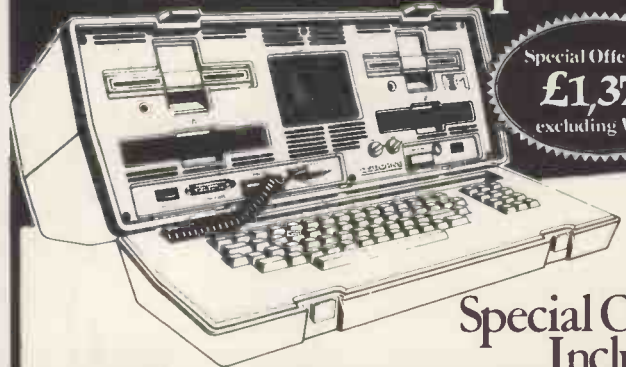

Special Offer Price
£1,375
excluding V.A.T.

Special Offer
Includes

FREE :d Base II WORTH £385

THE COMPLETE PACKAGE

- Osborne I Microcomputer • Double Density Disc Drives • Keyboard
- Monitor • RS-232/IEEE 488 PORTS • CP/M • Micro Soft Basic • C Basic
- Wordstar • Mail Merge • Supercalc • d Base II • 12 months warranty

ZAK Computers.

The total value of the software supplied free with the Osborne is £1,193, but this offer is for a very limited period only so take action now by telephoning Zak Computers Ltd., 061-872 7818 or write to Churchill House, 88/92 Talbot Road, Manchester M16 0PD. Telex: 665449.



OFFICE EFFICIENCY MACHINES LTD

1 Lochaline Street, London W6 9SJ

Tel. 01-741 7211/2/3/4

SPECIAL PROMOTION DEALS!



£2395.00

PLUS EPSON MX100 PRINTER
WORTH £500 FREE



Personal Computer



£2599.00

(OR £2895.00 INCLUDING 1
YEAR'S ON-SITE MAINTENANCE)



PORTABLE MICRO-COMPUTER

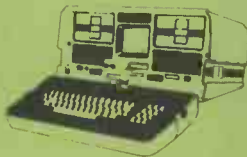

Includes
WORDSTAR, MAILMERGE,
SUPERCALC, MBASIC + CBASIC
worth £800 FREE!

£1499.00



PRAXIS ELECTRONIC PORTABLE
PRINTER/TYPEWRITER



OR ~~OSBORNE 1~~ PLUS 12" (GREEN OR AMBER) MONITOR — £1250.00

TO PLACE YOUR ORDER — CALL OUR
HOT LINE — 748 8404

Telex 263559

OEM ALSO OFFER SOME OF THE BEST
TRADE PRICES IN THE UK ON ALL THE
ABOVE MACHINES

(Prices valid while current stocks last)

To: Office Efficiency Machines Ltd.,
1 Lochaline Street, London W6 9SJ
Telex 263559 Micro G

- Please send me information on the
- Dealer End User
- Urgent Please phone me

Name _____

Company _____

Address _____

Telephone _____

OKI rules, OK!

Quality, reliability and unbeatable price performance are the hallmarks of the Oki Microline family. The only truly complete range of low-cost printers.

Exciting recent additions to the family are the Microline 92 and Microline 93 (80 and 132 column respectively). These feature NLQ print, 160 cps print speed and high resolution graphics.

With these additions the family covers the broadest possible range of capabilities. From the small but very efficient 80-column, 80 cps Microline 80, to the top-of-the-range

Microline 84. This sophisticated and professional machine offers speeds up to 200 cps, NLQ print and pin-addressable graphics.

All Microlines are made to Oki's exacting quality specifications, and all are backed by X-Data's high-level technical support capability.

Whatever your print needs, there will be an Oki printer to fit your bill. And at astonishingly low cost.



X-DATA

The authorised OKI distributor

For more information telephone Slough (0753) 72331

X-Data Limited, 750-751 Deal Avenue, Slough Trading Estate, Slough, Berks. SL1 4SH.

One card every dealer should have up his sleeve

The **PROFITLINK** card — the symbol of membership of a national accredited dealer network supplying Sapphire Systems quality software.

A fully trained and qualified dealer network who believe increased profitability can only result from supplying **quality products, quality service and quality support.**

PROFITLINK — why?

The business microcomputer user is rightly becoming more discerning in his choice of software, and is demanding quality in **product performance, dealer service and after sales support.**

Sapphire Systems believe that **PROFITLINK** will offer the dealer the incentives and support to service this healthy development more successfully.

PROFITLINK — how does it work for the dealer?

By becoming members, dealers will have the opportunity to sell Sapphire Systems proven software, including the outstanding SAPPHIRE MARS financial modelling system, across the majority of business microcomputers.

To ensure the excellence of service and support to their customers membership provides: —

- Full product and sales training
- National and local advertising support
- Sales leads
- Preferential discounts on all products
- Technical support
- National and local advertising support
- Sales leads
- Preferential discounts on all products
- Technical support

- Special offers
- Continued product development and enhancement
- Plus much, much more.

Add all these benefits together and you will see why Sapphire Systems believe **PROFITLINK** will provide **more effective sales to more satisfied and secure customers.**

PROFITLINK — how do I find out more?

Dealers — telephone the **PROFITLINK** line on 01-554-0582 or clip the coupon.

Microcomputer users — clip the coupon below for a list of dealers now joining **PROFITLINK** and more information on Sapphire Systems software.



To: Sapphire Systems Ltd, 1-3 Park Avenue, Ilford, Essex IG1 4LU. Tel: 01-554 0582
Please arrange for a **PROFITLINK** consultant to contact me Please send me more information on **PROFITLINK** I wish to attend a **PROFITLINK** dealer forum

Name _____ Position _____
Company _____
Address _____
Computer type _____
Telephone _____

Dealer User



HOW CAN YOU MAKE AN INTELLIGENT DECISION WITHOUT US?



Ten years is a long time in the computer business.

And ten years' success at the most demanding end of the business, the OEM market, says a lot about Cifer's capability.

The microcomputers and intelligent terminals we are making today have a power, a flexibility and an upwards capability which makes it unlikely they will be outgrown or outdated in the foreseeable future. And we can see further ahead than most people.

A vast range of compatible hardware gives Cifer systems functional abilities which are well beyond the scope of other equipment in the same price bracket. In fact, you could say we start where the others leave off.

And as every piece of equipment is British designed and British made, you don't have to go halfway round the world for good customer support.

Before you make the key decisions, find out about the most intelligent terminals and microcomputers in the market.

CIFER

HOW CAN YOU MAKE AN INTELLIGENT DECISION WITHOUT US?

Factory and South Western Sales
Avro Way, Bowerhill, Melksham, Wilts.
Tel: Melksham (0225) 706361.

Northern Area Sales
Tel: Nottingham (0602) 410551.

South Eastern Sales
Tel: 01 935 4437

YOU GOT THE HARD PART RIGHT. NOW FOR THE SOFT PART.

You were smart to pick IBM's Personal Computer from all the rest. You have the right hardware.

Now you have the right software, too. EasyFamily™ software from IUS is written specifically for the IBM PC. Take EasyFiler,™ for example.

EasyFiler is a stand-alone database manager which includes a text editor. Because of the text editor and a built-in report generator, you can custom design your filing and database needs. There's no need to purchase expensive, separate options, since EasyFiler includes everything you need in one package, for one price. With EasyFiler you enter, change, sort, and retrieve the exact information you want.

EasyFiler is MS/DOS based, and thus can be stored on a hard disk of up to 40 megabytes. That's not only a great increase in storage capacity, but it also allows for much faster information retrieval. EasyFiler will hold up to 10,000 individual records, with

space for 1000 characters per record.

EasyFiler has a number of features which will help you increase the power and performance of your IBM PC. It is compatible with BASIC, which means you can transfer information to or from an IBM BASIC file. EasyFiler also includes a built-in calculator, which enables you to compute data during the entry of information or during report generation. Through "Soundex," another built-in feature, you can retrieve information even if you don't know the exact spelling of a word.

EasyFiler works with other EasyFamily programs. All IUS programs have similar instructions and make full use of the IBM PC keyboard. Integration of information from one IUS program to another is easily accomplished. For instance, you can use EasyFiler with text written on EasyWriter II,™ the advanced word-processing program that gives you stand-alone wordprocessing at a PC price. Whether you're a computer expert or a novice, EasyFamily software makes your work simpler, faster and more productive. We think that's what makes it easy for you.

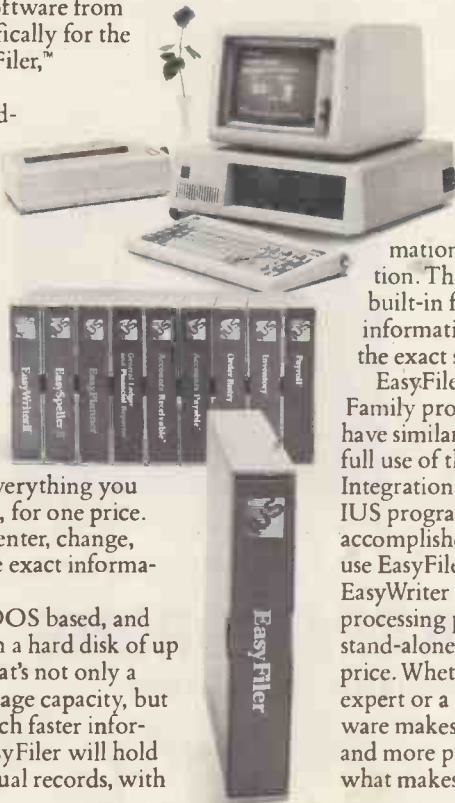

EasyWriter	EasySpeller
EasyWriter II	EasySpeller II
EasyPlanner	EasyFiler

For more information regarding EasyFiler and other IUS products, contact:

Xitan Systems, Ltd.
23 Cumberland Place
Southampton SO1 2BB
(0703) 38740

Icarus Computer Systems, Ltd.
27 Greenwood Place
London NW5 1NN
(01) 485-5574

Timon Associates
21 College Hill
London EC4
(01) 248-8720

or write
Information Unlimited Software, Inc.
2401 Marinship Way
Sausalito, CA 94965
U.S.A.



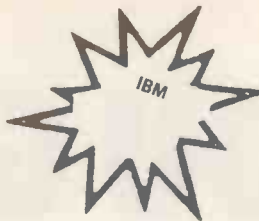

MICROCOMPUTER SALES, LEASE OR RENTAL AND OTHER SERVICES

A comprehensive rental/hire service, featuring the ACT Sirius 1, the SUPERBRAIN, BBC, ICL, APPLE & IBM range of microcomputers. **PLUS** a full range of PRINTERS & SOFTWARE.

- Short term rental available • Rental fee refundable against purchase • Very competitive costs • Plus our own low cost 24 hour maintenance service • Phone 01-458 5845 or write to our central office for details.

ACT SIRIUS 1



- THE COMPLETE BUSINESS MACHINE
- CALL FOR PRICES
- FULL SUPPORT OF THE PULSAR SOFTWARE

PRINTERS

New EPSON Type III Series



- Available for Apple, BBC, Tandy, PET NASCOM, Sorcerer & other Micros.
- MX80F/T₃ = **£310**
- MX 100 = **£425**

OTHER MODELS AVAILABLE

£175	Silentype 80-Col Graphics Printer	£460	Paper Tiger 455
£1300	Flowriter 1600 RP	£560	Paper Tiger 460
£795	ET121 KFR Olivetti Daisy Wheel printer includes parallel RS232 & IEEE 488	£725	Paper Tiger 560
£1050	QUME 35 KSR	£760	Anadex DP9500
£110	QUME Form Tractor-TEC	£795	Anadex DP9001
£1000	Starwriter 70/40	£900	Anadex DP9501
		£1200	Colour Prism 132 Printer

CP/M SOFTWARE - Available for both ACT Sirius 1 & Superbrain

LANGUAGES	STANDARD	ACCOUNTANCY
PASCAL	WORDSTAR	INCOMPLETE RECORDS
FORTRAN	MDBSIII	INTEFR ACCOUNTS
CIS-COBOL	DEII	SALES LEDGER
COBOL	MAIL MERGE	PURCHASE LEDGER
FORTRAN	DATASTAR	NOMINAL LEDGER
MBASIC	SUPERSOFT 1	INVOICING
CBASIC 86	SUPERCALC	PAYROLL
APL	MULTIPLAN	STOCK CONTROL
MPM	OASIS 16	DS
C		PULSAR SOFTWARE
MS-DOS		
CPM 86,80		



HARDWARE AVAILABLE • Call for Prices



Details of IBM & ICL range of P.C. and expansion hardware, software, ring for sales or lease or short term rentals.

For all Mail Orders, Rental Orders, Price Details or Further Information — Contact our Central Office:

MICROCOMPUTER SPACEDROME

3 WESTHOLM, HAMPSTEAD, LONDON NW11 Tel: 01:458 5845

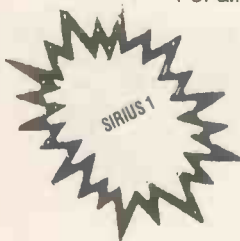

ALGOTEK

The Name in
BBC
 COMPUTERS



SPECIAL OFFER !!!
B B C Model 'B'
 word processing pack

BBC MODEL 'B'
DISK INTERFACE
WORDWISE
SMITH CORONA DIASYWHEEL PRINTER
FLOPPY DISK DRIVE
UNIQUE LOW PRICE £1119.99 carr. £15

BBC Model A	BBC Model B
£299 16K	£399 32K

TELETEX ADAPTOR	£196
DISK INTERFACE KITS	£95
PRESTEL ADAPTORS	£90

PRINTERS

MX 100 FT3	448.00
FX80	394.80
SMITH CORONA	438.00
CARR. £7.00 + VAT	



carr. £3.00

CANON BBC DISK DRIVE UNITS + VAT

Single Side	Double Sided	Double Sided
40 track	40 track	80 track
£169.00	£235.56	£283.56

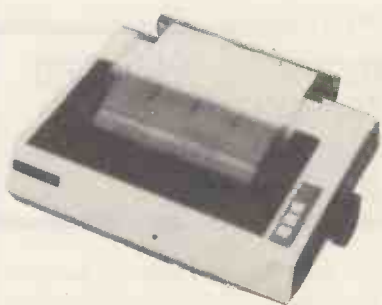

SOFTWARE FOR BBC (ALL PRICES INCLUDE VAT)

BUSINESS:
CASSETTE.
DATABASE £19.95; DISK £23.95
MAILIST £19.95; DISK £23.95
INVOICE & STATEMENT £19.95; DISK £23.95
PAYROLL £11.90; DISK £23.95
STOCK CONTROL £19.95; DISK £23.95
HOME ACCOUNTS £19.95; DISK £23.95
COMMERCIAL ACCOUNTS £19.95; DISK £23.95

WORD PRO £19.95; DISK £23.95
BEEB CALC £19.95; DISK £23.95
GAMES:
CENTIPEDE, CASS. £6.50; DISK £9.90
INVADERS, CASS. £6.50; DISK £9.90
SPACE FIGHTER, CASS. £6.50; DISK £9.90
GALAXIAN, CASS. £6.50; DISK £9.90
FRUIT MACHINE, CASS. £6.50; DISK £9.90
DROPOUT, CASS £6.50; DISK £9.90

ALGOTEK COMPUTER CO

93 WESTGATE, TRANMERE PARK, GUISELEY, LEEDS LS20 8HH.

TEL: 0943-74861

**MICRO'S COMPUTING
BUSINESS ? RESEARCH
PLEASURE**

The answer's a
**commodore
COMPUTER**

**commodore '64'
NOW IN STOCK**

L&J COMPUTERS

192 HONEYPOT LANE, QUEENSBURY, STANMORE, MIDDX HA7 1EE. 01-204 7525
THE "PET" SPECIALISTS

**We specialise in PACKAGE DEALS — from beginners to big users
you may lose out if you don't contact us before you buy!**

IF YOUR CALL IS URGENT, RING OUR HOT-LINE 01-206 0440



**NOW THE NEW 700 & 500 COMMODORE RANGE AND
8032/8096 IN NEW STYLE.**

COME AND TRY THEM AND SEE FOR YOURSELF.

- Comfortable, easy to use
- Tilt and swivel green screen
- Special function keys
- BASIC 4.0
- BASIC programs up to 64K in length
- Up to 896K RAM
- Access to CP/M programs
- IEEE-488, RS. 232C, CBM cassette
- 8 bit parallel, cartridge slot, networking
- Sound synthesis chip.

HARDWARE

CBM MICRO-COMPUTERS	16K	4016
	32K	4032
	32K	8032
	96K	8096
SUPER-PET		9000
DISK DRIVES (5.25")	2M/B	8250
	1M/B	8050
	340K	4040
	170K	2031
HARD DISKS CBM	5 M/B	9060
	7.5M/B	9090
**MATOR 23/30/60	M/B	SHARK
**MATOR BACK-UP		SHARKIVE
(**APPROX 8 WEEK DELIVERY)		
PRINTERS (MATRIX)	CBM	4022
	CBM	8023
	CENTRONIC	150
	CENTRONIC	737
(DAISY WHEEL) CBM		8300
	NEC	7730
	QUME	SPRINT

SOFTWARE

**SILICON OFFICE : WORDCRAFT : WORDPRO
D.M.S.V. : ADMINISTRATOR : DATALEX
BASIC & SUPERPAY : ACCOUNTS : VISICALC
ALL IN STOCK**

CASH BOOK

Enter daily-weekly amounts — printout and totals, weekly/monthly analysis, totals and balances. 3032, 4032 & 8032 versions from £90 to £150

STOCK TAKING for the licensing trade £240
Superb new program for 8032 £420

OUTSIDE SERVICES (For Mini-Cabs, etc.) £220
New 8032 Version at 3032 price

BITS AND PIECES

RAM/ROM FOR YOUR CBM AT ONLY £39 + VAT.
REMAINS PROGRAMMED FOR UP TO 7 DAYS
EVENT WITHOUT USING YOUR MACHINE!

For those with 3032s who want 4032s and those with 4032s who sigh for 3032s, all is not lost! HAVE BOTH, at the flick of a switch — CHIPSWITCH for £57 + ROMs for £50 (with de-glitching facility built-in).

TOOL KITS (BASIC 2 & 4), SUPERCHIPS,
...AND ALL SORTS OF OTHER CHIPS...
UPGRADE YOUR PET EVEN MORE!!

**PERSONAL SHOPPERS WELCOME
Phone & Mail Orders accepted.**

**ALL GOODS SENT SAME DAY WHEREVER POSSIBLE
LARGE S.A.E. FOR LISTS ETC.**



THIS MONTH'S BRAINWAVES FOR NEWBRAINS

PAGES - A very versatile program which offers:

1) A TEXT EDITOR

- ★ allows 20 pages of text or figures to be written
- ★ has word-rollover
- ★ retains whole lines in a buffer
- ★ allows you to duplicate lines, or part of a line
- ★ provides an easy method of changing character sets
- ★ each page is completely independent
- ★ pages can be any size you wish up to 50x80

2) A FLEXIBLE DISPLAY SYSTEM

- ★ allows each page to be displayed in any sequence you choose
- ★ display sequence will continue until stopped
- ★ the length of time each page is displayed can be individually set
- ★ a delay can be inserted to print each character s-l-o-w-l-y on the screen
- ★ interesting animated window displays easily created

3) A STORAGE SYSTEM

- ★ 'volumes' of pages may be stored on tape or disc (Grundy/CP/M)
- ★ you may compile a new 'volume' from several different sources
- ★ pages may be altered, copied or deleted

4) A PRINTOUT FACILITY

- ★ single or multiple sets of pages may be printed out
- ★ output to the printer is via the V24/RS232 port

PAGES manual & cassette 35.00

MAILIST - A superb Mailing List Program which will hold 500 entries allowing you to store names, companies, addresses, and telephone numbers. The program includes a fast alphabetical sort, a very good search facility, and will let you scroll up and down the whole list, or search for any particular name you require.

In addition to the screen display, it will print out through the RS232/V24 to a suitable printer. The print-out facilities include:-

- a) Single or sets of names
- b) With or without telephone number
- c) Screen or printer (or both)
- d) A printed list
- e) Address labels, singly or in sets

If you choose labels, then you can set the format i.e.:- column tabs, several labels side by side, and lines between each label. This program has lots more, including loading from and saving to, tape, adding new names, deleting names appending new lists, or altering existing files.

A VERY VERSATILE BUSINESS PROGRAM - CASSETTE 20.00

PAGELIST - If you already have PAGES, then this is the program you have been waiting for. It allows you to combine letters written on PAGES, with an address list written on MAILIST, and then print out a series of circulars, each with its name and address, and of course, a label. Facilities include:-
Load a PAGES volume: Load MAILIST volume plus one PAGES page:
Load printing parameters: Set up new printing parameters: Save printing parameters.

The actual printout can be arranged just the way you want it, and you can set the following parameters:

Top of form character: Lines to top of sheet: Lines to top of title: Lines to top of address: Tab to start of line: Extra tab to start of line: Extra tab to start of address: Number of first page line printed: Number of page lines printed: Blank lines after end of page.

This program is now in stock, and will be despatched immediately.

CASSETTE WITH INSTRUCTIONS 15.00

DIRECTORY - This a DATA-BASE program which can hold up to 500 files. It allows you to choose the number of files you require and then informs you of the average space available in each file. There is a very good search facility included, which allows you any combination of letters or numbrs, and when found it can be listed on to the screen or sent out to a printer. If required, the whole Data-Base can be printed out, or saved on tape.

CASSETTE 10.00

WE HAVE MANY MORE PROGRAMS, INCLUDING GAMES -
SEND STAMP FOR FULL DESCRIPTIVE LIST.

★★★STOP PRESS★★★JUST RECEIVED★★★

★★★THE FIRST HIGH RESOLUTION GRAPHICS GAME★★★

★★★FOR THE NEWBRAIN★★★"ORTHELLO"★★★ONLY 4.00★★★
OUR PROGRAMS NOW AVAILABLE FROM
ALL NEWBRAIN DEALERS.

Good original NewBrain programs always required - why not call us?

ALL THE ABOVE PRICES INCLUDE FIRST CLASS POSTAGE AND PACKING.
ALL PROGRAMS ARE IN STOCK AND SENT BY RETURN POST.

BRAINWAVE SOFTWARE LIMITED

TILBURY-JUXTA-CLARE, NR HALSTEAD, ESSEX CO9 4JT
TEL. 0787 237831

SINCLAIR OWNERS READ THIS FROM

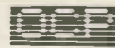

You've probably heard about MACHINE CODED PROGRAMS and thought "so what? How can they help me?"

Well now you can find out and taste the very real difference by purchasing our latest MACHINE CODED programs. These emulate features of the most modern professional computers (12 years writing machine coded programs for IBM, ICL, UNIVAC and Sinclair means we know what we're talking about).

Just read the specification and you'll see what we mean.

MACHINE CODE TEST TOOL

The ultimate professional tutor and de-bug program, we wrote this to help us write our own programs

- TEST and display machine code instructions as they're written.
- IDEAL for both the novice and the expert.
- FULLY documented with a 32 page tutorial
- HEXIDECIMAL conversion as standard.
- CHARACTER GENERATOR - of unbelievable quality

Supplied free with the Spectrum version

Available for the 16K ZX81 and 16/48K Spectrum.

SPECTRUM CHESS Dare you face The Turk

The original Turk was an eighteenth century automaton, a life-size mechanical figure resplendent in Turkish costume and seated behind a wooden cabinet on which a chess board and pieces were placed.

OCP now offer you the twentieth century equivalent of that Turk - a chess-playing computer program. The Turk challenges you to a game of chess!

MANY OPTIONS INCLUDE:

- 6 LEVELS OF DIFFICULTY
- DEMONSTRATION MODE
- BOARD EDITOR
- GAMES PRINTOUT FACILITY
- BLITZ CHESS AGAINST THE CLOCK
- TWO PLAYER MODE
- UNFINISHED GAMES CAN BE STORED
- RECOMMENDED MOVE
- FULL INSTRUCTIONS PROVIDED



ADDRESS MANAGER.....

Works on the 16K and 48K Spectrum, in 48K it will store, file, select and retrieve over 400 full addresses (over 1500 individual names). Dynamic Memory Management and compression techniques makes all this possible and there's a lot more:

- FULL SCREEN INPUT and EDITING - see it as a page as it happens with insert, delete and TAB Commands.
- MULTIPLE INDEXING - 3 way user-defined index enables you to define, catalogue, select and print entries as needed, (essential for the more sophisticated applications)
- INSTANT RESPONSE - yes, this program is very very fast.
- SUPER FRIENDLY - crash-proof, extremely easy to use and efficient in a way that BASIC can never be.

MANY USES

- AT HOME - (storing addresses, printing out Xmas Card lists etc.)
- AT WORK - for mail-order work, internal telephone directory, sorting customers into types, areas, size you choose.
- CLUBS - print-out members list, sort different categories etc.

MACHINE CODE...IT MAKES ALL THE DIFFERENCE.....

Post order to: Oxford Computer Publishing Ltd., P.O. Box 99, Oxford.

Please rush me: Address Manager at £8.95 each. Spectrum only.

Chess The Turk at £8.95 each. Spectrum only.

Machine Code Test Tool at £9.95 each.

Tick box for edition required: ZX81 Spectrum

Send cheque, postal order or ACCESS No. to above address. Or telephone order with ACCESS No. to (0753) 888866

NAME:

ADDRESS:

POSTCODE:

Available from most branches of W H SMITH and other retailers.



Available in NORTH LONDON NOW



ACT SIRIUS 1 16 BIT MICRO

with wide range of business software
Leasing facilities available

TOWN & COUNTRY COMPUTER SYSTEMS

Systems House, 489a Hertford Road, Enfield, Middx
Tel: 01-805 0903, Open until 10pm Tue, Wed, Thur & Sat until 1pm for demonstrations.

PLAY THE NUMBERS GAME WITH DIGITAL SOLUTIONS!

UNDOUBTEDLY THE MOST FLEXIBLE PROMOTION EVER – WITH A GUARANTEE OF TOTAL SUPPORT

EXAMPLE OFFER:

SIRIUS HARD DISK SYSTEM	£3995
INCLUDES OVER £1000 OF EQUIPMENT FROM OUR EXTENSIVE RANGE SUCH AS –	
PULSAR SALES	VALUE £195
PULSAR PURCHASES	£195
PULSAR NOMINAL	£195
SMITH-CORONA TP1	£485
 TOTAL	 £1070 FREE!

OTHER EXAMPLES (There are too many to list them all)

SIRIUS 1.2 Mb , 128K RAM DUAL FLOPPY £2395
INCLUDES £600 OF FREE EQUIPMENT

SIRIUS 2.4 Mb , 128K RAM DUAL FLOPPY £2895
INCLUDES £700 OF FREE EQUIPMENT

SAGE 1.3 Mb , 512K RAM DUAL FLOPPY ... £3995
INCLUDES £600 OF FREE EQUIPMENT
FREE MAINTENANCE FOR 12 MONTHS

(All other SAGE models available)

FORTUNE 5 Mb HARD DISK, 800Kb FLOPPY,
FULL WORD-PROCESSING, 256K RAM £5995
INCLUDES £1100 OF FREE EQUIPMENT

(All other FORTUNE models available)

DEC, IBM etc . . . coming soon
All cables, 48 hr delivery,
90 day warranty
installation advice etc . . . FREE . . .



PERIPHERALS AND SOFTWARE



		SELL AT
EPSON	RX-80	T.B.A.
	FX-80	T.B.A.

OKI	M80A	£235
	M82A	£379
	M83A	£535
	M84A	£949

OLIVETTI	JP-101	£320
----------	--------	------

5 OTHER MATRIX PRINTER RANGES AVAILABLE

SMITH-C	TP1	£485
	EL2000	£699

12 OTHER DAISYWHEEL RANGES AVAILABLE

PULSAR	NOMINAL	£195
	SALES	£195
	PURCHASES	£195
	PAYROLL	£195
	STOCK CONTROL	£195
	INVOICING	£195
	DATA ANALYSIS	£195
	INFORMER DBASE	£295
	MICROMODELLER	£595
	SUPERCALC	£150
	MUTLI-PLAN	£159
	WORDSTAR	£295
	SELECT	£295
	MAILMERGE	£95
	DBASE 2	£395

MOST OTHER SOFTWARE PACKAGES AVAILABLE

**ALL MACHINE UPGRADE COMPONENTS AVAILABLE.
MAINTENANCE CONTRACTS ARRANGED**

**CALL FOR A QUOTE ON PERIPHERALS & SOFTWARE WITHOUT MACHINE PURCHASE.
CALL OR WRITE TODAY:**

**DIGITAL SOLUTIONS LTD.
88 WAVENEY RD
ST. IVES
CAMBS**

HUNTINGDON (0480) 300728

or (0480) 52870

Introducing Perfect Software.™

Now, put the power of our remarkable new programs to work for you!

If you've been looking for powerful, flexible software that's also easy to use, take a close look at what we've got to offer.

An integrated product line with the state-of-the-art features and common-sense prices you're probably looking for.

Perfect Writer™

Perfect Calc™

Perfect Filer™

Perfect Speller™

Whether you're interested in one or all four of our revolutionary products, you owe it to yourself to find out what we have to offer:

Perfect Writer.

The most powerful and versatile word processing software for microcomputers available anywhere. Features include Virtual Memory, multiple editing of up to 7 files at once, dual display windows, automatic footnotes, table of contents and indexing.

Perfect Calc.

You get 17 application programs that are ready to use for

any planning and financial control task. Plus multiple editing of up to 7 files at once *and* dual display windows.

Perfect Filer.

This incredible double data base management system produces personalized standard letters and versatile sort menus for generating lists or invoices. It prints labels, envelopes and more. It can even handle accounting functions!

Perfect Speller.

Now, get a 50,000 word dictionary that checks over 4,000 words a minute. It even locates and corrects document design errors!

Take a look at what you get:

- Britain's first fully-integrated product line. Learn only one set of logical commands.
- Easy-to-use, user-friendly features that are unmatched in the industry.
- Interactive teaching disks make Perfect Software easy-to-learn.
- Available for both 8 and 16 bit micros, CP/M™ operating systems and the IBM PC.
- All programs maximize virtual memory architecture for all applications and multiple file display.
- True ASCII files for powerful communication capability.
- And lots, lots more.

Perfect Software, Inc.™

To order or find out more, contact:
Pete & Pam Computers
New Hall Hey Road
Rossendale, Lancashire BB4 6JG
Telephone: 0706 227011
Telex: 635740 PETPAM G
Transam Microsystems Limited
59/61 Theobald Road
London WC1X 8SF
Telephone: 01-405 5240/2113
Telex: 24224 (Ref. 1422)

Tamsys Limited
Pilgrim House
2-6 William Street
Windsor, Berkshire SL4 1BA
Telephone: Windsor 56747
Telex: 849462 TELFAC G

Attention Dealers/Distributors
All inquiries are invited. Contact your UK Sales Representative:

Micro Marketing International
5598 Taft Avenue
Oakland, California, USA 94616
Telephone: 415 658-5548
Telex: 171 596 AAA SCOM SUVL

OSBORNE

£995 INC. SOFTWARE

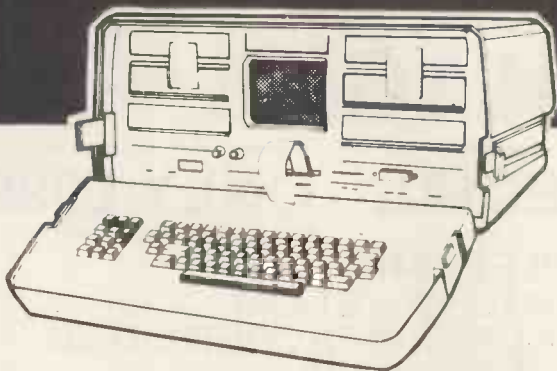

Latest Osborne Mark II

- Z80A 64K CP/M Computer
- Dual 100KB drives (upgradable)
- Typewriter keyboard + numeric pad
- Integral 52 column monitor
- Fully portable – weighs 24 lbs
- RS232/Centronics/IEEE Ports
- **Software** Wordstar/Mailmerge, C Basic – M Basic, Supercalc – CP/M

NEW LOW PRICES DEALER ENQUIRIES WELCOME

Send for list Osborne software and peripherals

All prices exclusive of VAT and delivery. Cheque with order.

Also available **Double Density Model** **£1075**

Delta Systems Limited

32 Finch Road, Douglas,
Isle of Man. Tel: 0624-27522.

BURSTING THROUGH
YOUR LETTERBOX
AT 10,000
MEGATHROBS

Phone with



No.
or send
cheque to
Same Day
Executed for
Ex-stock

P	A	S	E
PROCESS	AUTOMATION	SYSTEM	ENGINEERING

213/215 MARKET STREET
HYDE
CHESHIRE
Tel: 061 366 5935
Telex: 665843

P	A	S	E
PROCESS	AUTOMATION	SYSTEM	ENGINEERING

HARDWARE IN STOCK:

BBC 'B'	£346.95
ORIC 48K	£147.78
ATARI '400'	£134.00
ATARI '800'	£346.95
SHARP MZ80A	£475.00
JUPITER ACE	£78.22
LYNX 48K	£195.65

COLOUR GENIE	£195.20
COMMODORE VIC 20	£112.86
COMMODORE 64	£299.99
DRAGON 32	£173.86
TEXAS TI99/4	£134.74
SINCLAIR ZX81	£43.43
SINCLAIR SPECTRUM 48K	£152.17

All Machines on display at above address

★ For Software send SAE stating your computer for latest catalogue.

NOTE ★ VAT + p & p must be added to your order

WE SELL ALL PERIPHERALS FOR THE ABOVE MACHINES PLUS A REPAIR SERVICE

THE *New* APPLE II E

FROM

SIMMONS MAGEE



- 64K Expandable to 128K
- Upper & Lower Case
- Much Improved Keyboard
- Built In PAL Encoder
- Runs Apple II Software
- Eight Built-In Expansion Slots

SPECIAL ONLY £999
(VALID UNTIL 30th JUNE)

APPLE II E 64K
MONITOR III + STAND
DISK DRIVE WITH CONTROLLER
80 COLUMN CARD

YES! £999 for the above

Or Items may be purchased individually

Apple II E 64K	£645
Disk Drive + Controller	£280
Disk Drive Without	£200
80 Column Card	£70
80 Column + 64K	£150
Monitor III + Stand	£140
Multiplan Spreadsheet	£175
Quick File II E	£60
Apple Writer II E	£119
Microsoft CP/M Card	£200

PRINTERS

AT LOW, LOW PRICES

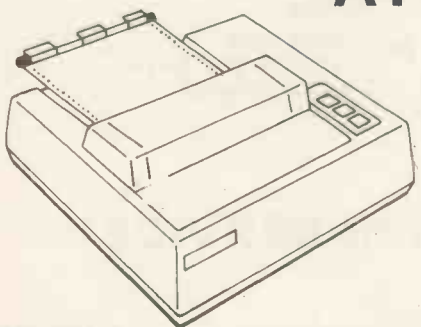

OK1

Microline 80	£215
Microline 82A	£339
Microline 83A	£539
Microline 84	£821

EPSON – TYPE III

MX 100	£405
FX 80	£418
RX 80	£280

* PRICES DO NOT INCLUDE INTERFACE CABLES

ALL PRICES EXCLUSIVE OF VAT
SHOWROOMS OPEN MON-FRI 9-5PM
SAT 9-1PM

SIMMONS MAGEE

TWICKENHAM

SIMMONS MAGEE COMPUTERS LTD. 13 YORK ST. TWICKENHAM, MIDDX. 01-891 4477

ENGLAND EXPECTS!

Nelson's message worked wonders in 1805. But communications today — are they a patch on Nelson's?



Most computers can't even talk to each other.

SEMAPHORE* changes all that. Now micro can talk to micro, micro to mini/mainframe, mini/mainframe to mini/mainframe. No fuss, no changes to hardware or system software. 2 way error-free transfers over ordinary telephone lines, for the businessman's sales figures, the engineer's designs, or the personal computer buff's games.

SEMAPHORE available for CP/M*, CP/M-86*, MSDOS* systems (SUPERBRAIN*, SIRIUS*, COMMODORE*, APPLE*, DEC* PCs, IBM* PC, ICL* PC, CIFER*, TELEVIDEO*, RAIR*...), mini/mainframes (PDP* 11, VAX*, ECLIPSE*, PRIME*, IBM 30XX, IBM 43XX...)

SEMAPHORE is the signal success of 1983. Don't turn your blind eye to it! Prices start at £125 for the CP/M version.

COMMUNICATIONS FOR MICRO, MINI & MAINFRAME

also for dumb terminals and any other RS232C device.

ALBETROS LIMITED

Frances Road Basingstoke
Hants RG21 3DA
Tel 0256 57551 Telex 858893

*Registered Trademarks

Comselekt



A SWITCH FOR COMPUTERS & PERIPHERALS....

Don't purchase another peripheral to stand idle all day. Now — with COMSELEKT — you can share existing peripherals....

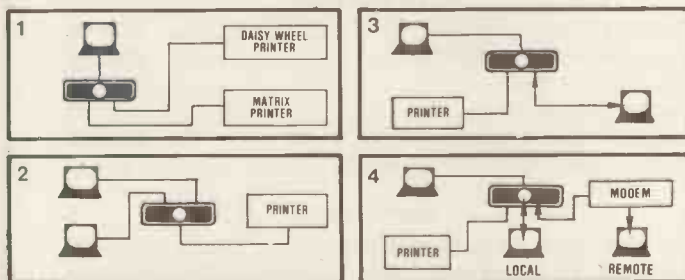

The Comselekt range allows up to 4 terminals to share the same printer

- * Compare the cost of Comselekt with buying another V.D.U., Printer etc.
- * Comselekt lets you share a peripheral with up to 4 systems at the turn of a switch.
- * Simple to connect via 25 pin 'D' type sockets on rear of unit.
- * Installed in seconds
- * Common lead with 25 way plug on each end supplied.

2 WAY £78.00 (+ VAT) 3 WAY £87.90 (+ VAT) 4 WAY £97.42 (+ VAT)

DEALER ENQUIRIES WELCOMED

Comselekt is available from reputable dealers or direct from:-

Comselekt

16 OLD PALACE ROAD,
NORWICH, NORFOLK, NR2 4JF
TEL: (0603) 667225

FREE SOFTWARE

WITH EACH ORDER OF
COMMODORE 64 £343

ALSO SUPPLIES OF
VIC-20, SPECTRUM, ORIC, DRAGON-32, ATARI
SOME WITH ABOVE OFFER — RING FOR PRICES
INFORMAST — FOR THE 64 (requires disk) £90.85

NEW 64 SOFTWARE		DRAGON 32	
MONOPOLE-64	£9.99	DRAGON TREK	£9.95
GRAVE ROBBERS	£9.99	WIZARD WAR	£7.95
SPRITE EDITOR/ CHARACTER GENERATOR	£9.99	VULCAN NOUGHTS & CROSSES	£7.95
CBM ADVENTURE PACK 1	£9.99	GOLF	£7.95
		GRAND PRIX	£7.95
VIC-20		BBC	
QUACKERS	£9.99	EDG GRAPHICS PKG	£24.95
ANNIHILATOR	£9.99	DRAGON RIDER	£7.95
ORBIS	£9.99	TANKS	£7.95
KRELL	£9.99	SUPER HANGMAN	£4.50
GALACTIC CROSSFIRE	£9.99	3D-MAZE	£4.50
FROGGER		ATLANTIS	£7.50
3K EXPANSION ONLY	£9.99	STRATO BOMBER	£7.50
SPACE STORM	£9.99		

JUST A FEW OF THE MANY TITLES AVAILABLE —
CONTACT US FOR DETAILS

PLEASE ADD 50p P&P FOR SOFTWARE —
ALL PRICES INCLUDE VAT DISCOUNTS FOR LARGE ORDERS.
SEND CHEQUE WITH ORDER TO:

TRAVEL SOFTWARE, 106 NARBONNE AVENUE, LONDON SW4
OR RING: 673 7922.

ACCESS OR VISA WELCOME.

PROGRAMMERS:
CALL US FOR TOP ROYALTIES OR
CASH FOR ORIGINAL PROGRAMMES

SIR COMPUTERS LTD — CARDIFF

Agents for Acorn, BBC and TORCH Computers



BBC Microcomputers

Model B	£399.00
BBC Model B with 1.2 OS	£399.00
Model B with disc interface	£509.00
Single 100K disc drive	£249.00
Dual 2 x 100K disc drive	£389.00
The disc manual and utilities disc are both included	
Disc interface for the BBC Micro Kit	£95.00
Fitted	£110.00
Upgrade of BBC Model A to B	£90.00

Please telephone for up to date information on Prestel, Teletext, speech synthesis, second processors, etc.

TORCH Computers

Z-80 Disc Pack for the BBC Microcomputer	£895.00
--	---------

This unit connects to the BBC Micro in the same way as a normal disc drive, but as well as offering a dual 2 x 400K disc drive for use under BBC BASIC or other languages it provides the option of using the wide range of CP/M software available for business and data processing applications. The firmware supplied with the machine allows switching between BASIC and CPN, a powerful operating system developed from CP/M 2.2.

In addition to the disc pack a second processor is supplied. This is a Z-80A with its own 64K RAM card, communicating with the 6502A in the BBC computer through the 'Tube'. Typically the speed of execution of programs under the twin-processor system is increased by up to 50% compared with a conventional single-processor computer. A third processor, the 16 bit 68000, will shortly be available.

RCHCF240	£2795.00 (ex VAT)
----------------	-------------------

This is an extension of the BBC microcomputer/Torch disc pack system, available in a single unit. The computer contains a BBC-based peripheral processor connected to the main Z-80 computer, a dual 2 x 400K disc drive as described above, a high resolution (80 character) colour monitor and a complete British Telecom approved 1200 baud modem. It is the only microcomputer which has been granted permission for direct connection to the Public Switched Telephone Network both in the U.K. and the United States.

The TORCH can communicate either directly with another TORCH or with virtually any other type of computer via Prestel. Using the Gateway facility of Prestel it is possible for the TORCH to access vast amounts of information stored by private, organisations on public database systems. The Mailbox facility of Prestel also allows the use of electronic mail.

TORCHCH240/10	As above but with a 10 MB hard disc drive
TORCHCH240/21	As above but with a 21 MB hard disc drive.

PERIPHERALS

Seikosha GP 100A Printer	£229.00
Epson MX 80 F/T type 3 Printer	£399.00
NEC PC 8023 Printer	£389.00
Kaga 12" RGB Monitor	£280.00
Sanyo 14" RGB Monitor	£270.00
High resolution 12" black/green monitor	£85.00

SOFTWARE

We currently hold in stock programs from the following suppliers: Acornsoft, A & F Software, Bug Bute, Computer Concepts, Data Base Software, Digital, Fantasia, Gemini, Golem, IJK Software, Level 9 Software, Molimerx, MP Software, Program Power, Salamander Software. Software for All Superior Software.

Unfortunately, we are unable to supply software by mail except as part of a large order. Delivery, by Interlink of any of the above items £10.00. Unless otherwise stated all prices include VAT.

**SIR Computers Ltd., 91 Whitchurch Road, Cardiff.
Telephone: (0222) 21341**

Computers for Export

Sinclair
Spectrum

Sinclair
ZX81

ORIC-1

Dragon 32

Jupiter Ace

Commodore
VIC-20



Commodore
64

Commodore
500

Commodore
700

Atari 400

Atari 800

Epson
HX-20

Plus Printers, Disc Drives, Memory Expansion, Software

Quantity discounts available

No tax charge for equipment shipped abroad

Write for our price list or call our 24hr answer phone

01-549 8229

**Galaset Ltd, 30 Bayford Road,
Littlehampton, West Sussex,
England. Telex. 8954018 Acurat G**

NAMAL
ASSOCIATES

Gatehouse,
25 Gwydir Street,
Cambridge CB1 2LG
Tel: (0223) 355404
Telex: 817445

**14" COLOR MONITOR for
BUSINESS & PERSONAL
COMPUTERS £189.00**
Video & audio inputs and 2W
audio output.

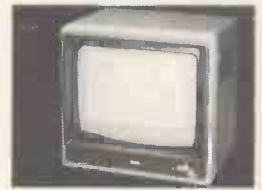

B/w monitors
with green display
9" screen—£79.00
12" screen—£85.00
(carriage £6.00 per monitor).

NAMAL SUPERTALKER

for Sinclair ZX81 £49.95
for Sinclair Spectrum £69.95
RS232 version for any computer £89.95

Products for ZX81

Ram Pack 16K £17.00
Ram Pack 64K £59.95
24 line I/O port £17.50

Products for APPLE COMPUTER

Eprom programmer card £95.00
Real Time clock card £74.00
PIA card £29.50
Parallel interface (centronic) £69.50
RS232 Serial interface card £49.95

Payments to Namal Associates.
Prices exclude V.A.T.



Newbury Data FROM

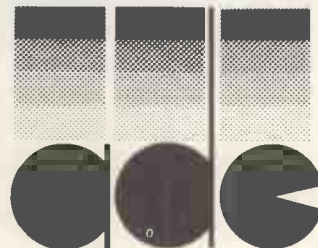

Setting the standards for matrix printing



If you're
in the market
for matrix printers
look no further than
the NDR range from
Access Data Communications.

Whatever your application, whatever your computer - micro, mini or mainframe - there's a model from the NDR 8000 series which is just right for you.

If its output you want, take a close look at the 240cps NDR 8840 - it really gets things moving. Or perhaps you're looking for a printer which will produce internal and external correspondence, reports etc. at 160 cps; the NDR 8910 will.

Irrespective of the model you choose every NDR matrix printer features electronic forms control, blank space compression, block graphics and ten different print densities. Options available include a keyboard which instantly converts a 8000 series printer into KSR mode, 2K or 16K buffers, dual colour printing and 96 character sets for all European languages.

Put simply the NDR 8000 series sets the standard for matrix printers and when you buy a NDR from Access Data one feature is always built-in - confidence.

Access Data Communications Ltd.,
Eskdale Road, Uxbridge Industrial Estate,
Uxbridge, Middlesex. UB8 2RT
Tel: (0895) 59781 (10 lines) Telex: 267336

100 FREE PROGRAMS

FROM SILICA SHOP — WITH EVERY PURCHASE OF AN

ATARI 400

800



ATARI PRICES REDUCED!

We at Silica Shop are pleased to announce some fantastic reductions in the prices of the Atari 400/800 personal computers. We believe that the Atari at its new price will become the U.K.'s most popular personal computer and have therefore set up the Silica Atari Users Club. This club already has a library of over 500 programs and with your purchase of a 400 or 800 computer we will give you the first 100 free of charge. There are also over 350 professionally written games and utility programs, some are listed below. Complete the reply coupon and we'll send you full details. Alternatively give us a ring on 01-301 1111 or 01-309 1111.

ATARI 400 with 16K **£159**

ATARI 400 with 48K **£228**

ATARI 800 with 48K **£349**

400/800 SOFTWARE & PERIPHERALS

Don't buy a T.V. game! Buy an Atari 400 personal computer and a game cartridge and that's all you'll need. Later on you can buy the Basic Programming cartridge (£35) and try your hand at programming using the easy to learn BASIC language. Or if you are interested in business applications, you can buy the Atari 800 + Disk Drive + Printer together with a selection of business packages.

Silica Shop have put together a full catalogue and price list giving details of all the peripherals as well as the extensive range of software that is now available for the Atari 400/800. The Atari is now one of the best supported personal computers. Send NOW for Silica Shop's catalogue and price list as well as details on our users club.

THE FOLLOWING IS JUST A SMALL SELECTION FROM THE RANGE OF ITEMS AVAILABLE:

ACCESSORIES Cables Cassettes Diskettes Joysticks Le Stick - Joystick Misc Supplies Paddles	Mountain Shoot Rearguard Star Flite Sunday Golf	BUSINESS Calculator Database Management Decision Maker Graph-It Invoicing Librarian Mort & Loan Anal Nominal Ledger Payroll Personal Finl Mgmt Purchase Ledger Sales Ledger Statistics 1 Stock Control Telex k 1 Visicalc Weekly Planner Word Processor	DYNACOMP Alpha Fighter Chompelo Crystals Forest Fire Intruder Alert Monarch Moonprobe Moving Maze Nominos Jigsaw Rings of The Emp Space Tilt Space Trap Stud Poker Triple Blockade	Maths-Tac-Toe Metric & Prob Solvg Mugwump Music Terms/Notatn Musical Computer My First Alphabet Number Blast Polycalc Presidents Of U.S. Quiz Master Starware Stereo 3D Graphics Three R Math Sys Video Math Flash Wordmaker	Seram States & Capitals Touch Typing	Castle Centurion Checker King Chinese Puzzle Codecracker Comedy Diskette Dice Poker Dog Daze Domination Downhill Eastern Front Galahad & Holy Grl Hickory Dickory Humpty Dumpty Jumbo Jet Lander Snooker & Billiards Submarine Commdr Super Cubes & Tilt Tournament Pool	Sleazy Adventure Solitaire Space Chase Space Trek Sultani Palace Tact Trek Terry Wizards Gold Wizards Revenge	Jawbreaker Mission Asteroid Mousekattack Threshold Ulysses/Golden Fl Wizard & Princess	PROGRAMMING AIDS from Atari Assembler Editor Dyember (APX) Microsoft Basic Pascal (APX) Pilot (Consumer) Pilot (Educator) Programming Kit
ADVENTURE INT Scott Adams Adv	AUTOMATED SIMULATIONS Crush Crumble Cmp Datestones of Ryn Dragons Eye Invasion Orlon Rescue at Rigel Ricochet Star Warrior Temple of Aoshai Upper Reaches Aps	BOOKS Basic Ref Manual Compute Atari DOS Compute BK Atari Compute Magazine De Re Atari DOS Utilities List DOS2 Manual Misc Atari Books Op System Listing Wiley Manual	EDUCATION from APX Algalcalc Atlas of Canada Cubbyholes Elementary Biology Frogmaster Hickory Dickory Inst Comptg Dem Lemonade Letterman Mapware	EDUCATION from ATARI Conv French Conv German Conv Italian Conv Spanish Energy Czar European C & Caps Hangman Invit To Prog 1/2/3 Kingdom Music Composer	ENTERTAINMENT from APX Alien Egg AntHill Atank Avalanche Babel Blackjack Casino Block Buster Block 'Em Bumper Pool	ENTERTAINMENT from ATARI Asteroids Basketball Blackjack Centipede Chess Entertainment Kit Missile Command Pac Man Space Invaders Star Raiders Super Breakout Video Easel	PERIPHERALS Cantronics Printers Disk Drive Epson Printers Program Recorder RS232 Interface Thermal Printer 16K Memory RAM 32K Memory RAM	PERSONAL INT from APX Adv Music System Banner Generator Blackjack Tutor Going To The Dogs Keyboard Organ Morse Code Tutor Personal Fitness Prg Player Piano Sketchpad	SANTA CRUZ Basics of Animation Bobs Business Display Lists Graphics Machine Kids 1 & 2 Horizontal Scrolling Master Memory Map Mini Word Processor Page Flipping Player Missile Gr Player Piano Sounds Vertical Scrolling
ON LINE SYSTEMS Crossfire Frogger	ON LINE SYSTEMS Crossfire Frogger	SILICA CLUB Over 500 programs write for details							

FOR FREE BROCHURES - TEL: 01-301 1111

For free brochures and reviews on our range of electronic products please telephone 01-301 1111. To order by telephone, just quote your name, address, credit card number, and order requirements and leave the rest to us. Post and packing is FREE OF CHARGE in the UK. Express 24 hour delivery available at an additional charge.

- **SHOP DEMONSTRATION FACILITIES** — we provide full facilities at our shop in Sidcup, Monday to Saturday 9am to 5:30pm (closing Thursday 1pm, Friday 5pm).
- **MAIL ORDER** — we are a specialist mail order company and are able to supply goods direct to your door.
- **MONEY BACK UNDERTAKING** — if you are totally unsatisfied with your purchase, you may return it to us within 15 days. On receipt of the goods in satisfactory condition we will give you a full refund.
- **PART EXCHANGE SECOND HAND MACHINES** — we offer a part exchange scheme to trade in many makes of T.V. game for personal computers.
- **COMPETITIVE PRICES** — our prices, offers and service are very competitive. We are never knowingly underpriced, and will normally match any lower price quoted by our competitors.
- **HELPFUL ADVICE** — available on the suitability of various computers.
- **AFTER SALES SERVICE** — available on all computers out of warranty.
- **VAT** — all prices quoted above include VAT at 15%.
- **CREDIT FACILITIES** — we offer credit over 12, 24 or 36 months please ask for details.

SILICA SHOP LIMITED
Dept MD0583, 1-4 The Mews, Hothelby Road, Sidcup, Kent DA14 4DX
Telephone 01-301 1111 or 01-309 1111.

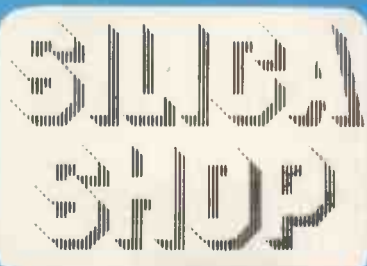

FREE LITERATURE

I am interested in purchasing an Atari 400/800 computer and would like to receive copies of your brochures and test reports as well as your price list covering all of the available Hardware and Software.

Name _____

Address _____

Postcode _____

MD0583



SYSTEMATIC BUSINESS COMPUTERS

For people with second thoughts about computing

OSBORNE

ACT SIRIUS

EPSON

LSI

DIGITAL MICROSYSTEMS

Systematic Business Computers Limited, Ambersham House,
45 Woodbridge Road, Guildford, Surrey, GU1 4RN.
Telephone: Guildford (0483) 572222

PROGRAMMERS WANTED

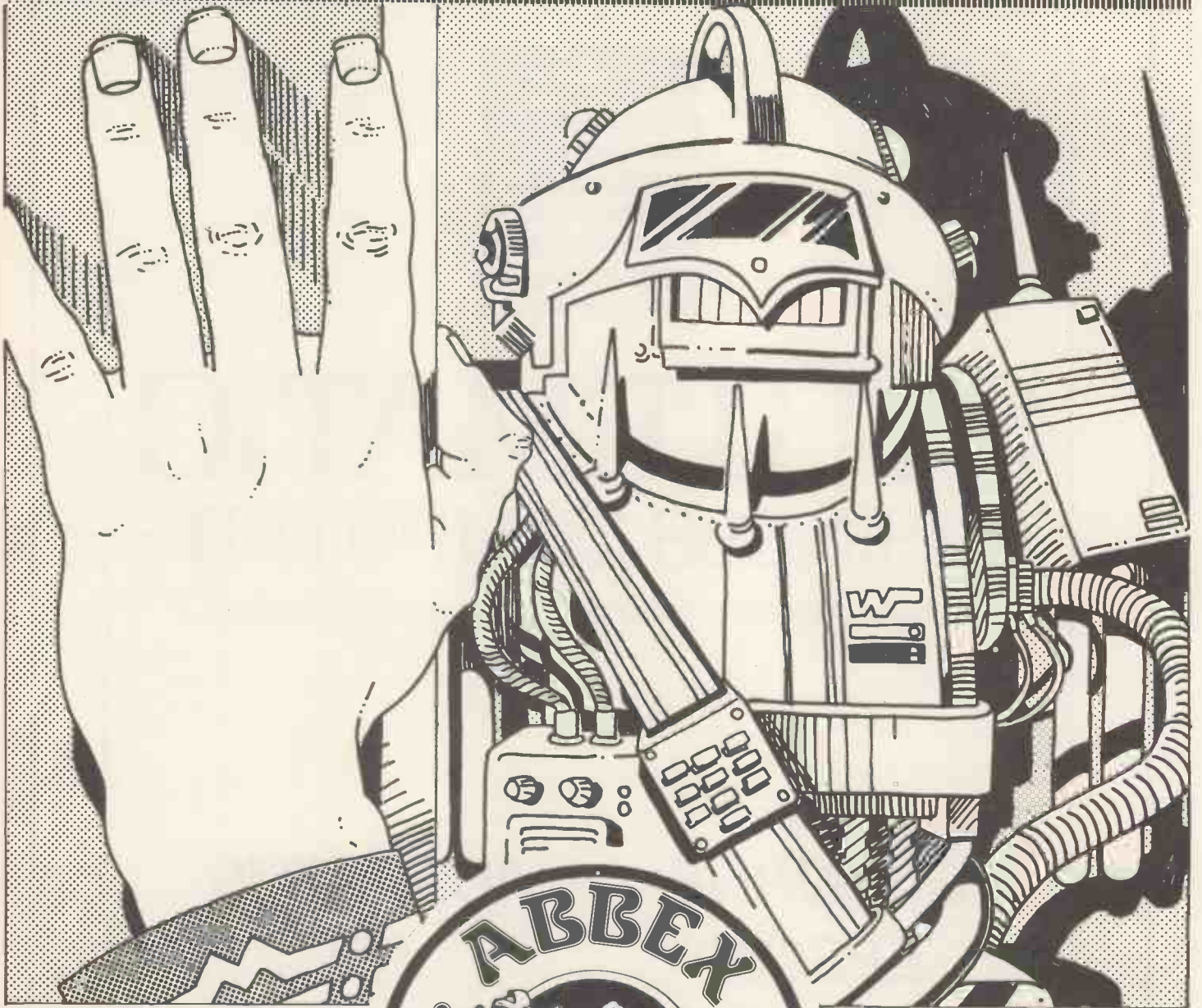

Enclosed Tape Age

Name

Address

Telephone

Are we looking for you?

AbbeX Electronics Ltd are looking for specimen programs. If you have written or are prepared to write suitable programs and would like to submit them for publication, please complete the form opposite and send it together with a sample of your work to the address below.

TAVISTOCK HOUSE 34-36 BROMHAM ROAD

BEDFORD MK40 2QD TEL:0234 213571

PCW/2

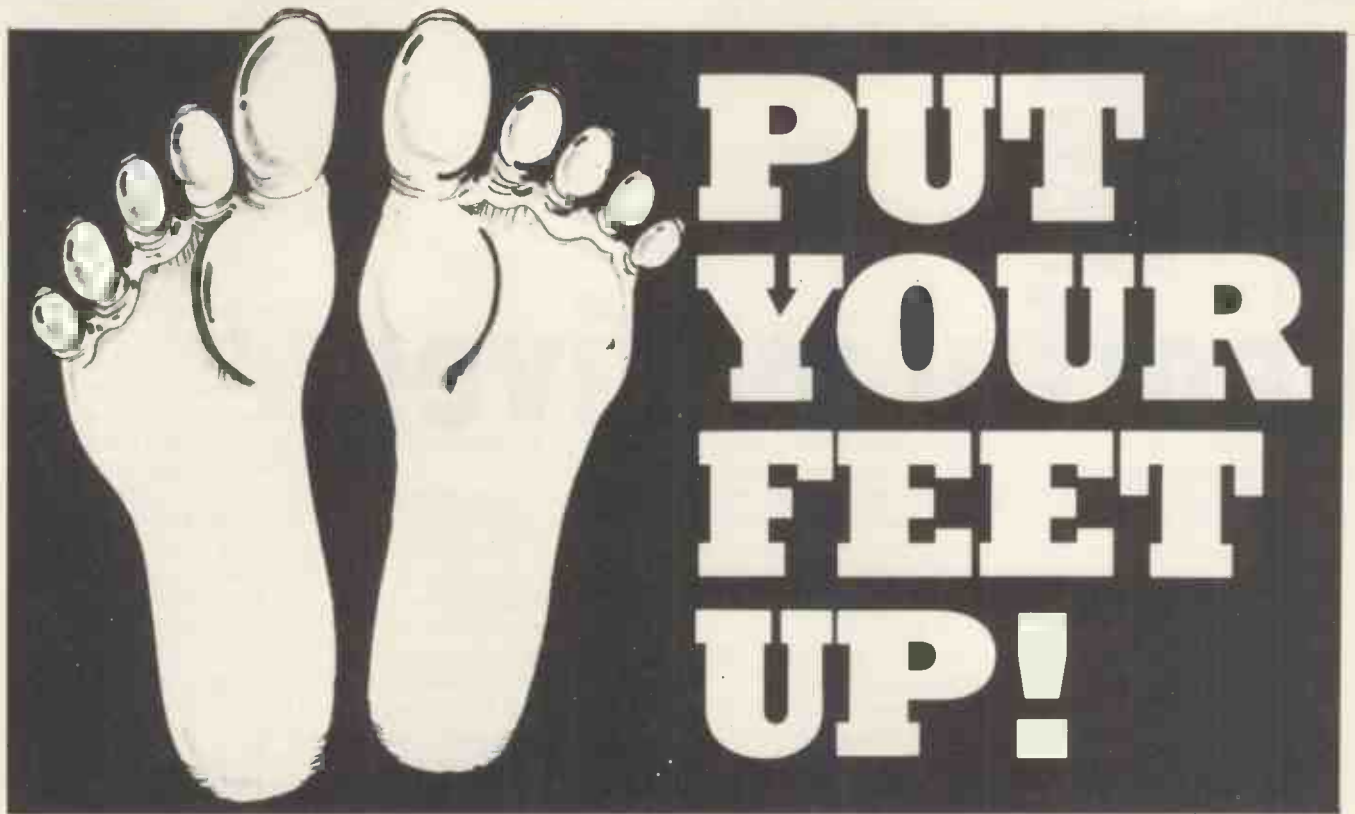

Let **STACK** make life easier for you and your VIC...

ALL VICKIT'S NOW AVAILABLE ON CARTRIDGE!!

Let us do the spade work!...

With these simple-to-use commands, HELP, AUTO, TRACE, FIND, DELETE, DUMP, OFF, RENUMBER, STEP, VICKIT 1 will take a lot of the hard work out of programming. Each time you use the programming aids of VICKIT 1 you'll save yourself a lot of time and effort!! And it'll make programming on your VIC-20 much more fun!
Available on Cartridge **£25.00** or on Eprom **£15.00**

Super Graphics!...

"Manoeuvre your spaceship (designed by you), through the meteorite storm (created by you). Beware being hit, otherwise its... ZAP!... WHOOSH!! (explosions especially designed by you!). For the most exciting colour graphics around, choose VICKIT 3. You'll get 20 easy-to-use commands to help you create your very own super graphics... and at a bargain price too!!
Available on Cartridge **£29.00** or on Eprom **£19.00**

The Best of Both Worlds!...

To give you the best value for money we've put together... ALL the programming aids of VICKIT 1 PLUS the best of the Super Graphics commands making VICKIT 2 the most economical cartridge around!!
Available on Cartridge **£35.00** or on Eprom **£25.00**

NEW LOWER PRICES!

Save ££'s with this very clever cartridge!

With the MULTI-ROM CARRIER you save the expense of buying several cartridges... simply pop your VICKIT's (or other Roms) into the empty sockets provided and soon you'll have the one cartridge with the power of FOUR!!
Only **£21.00**

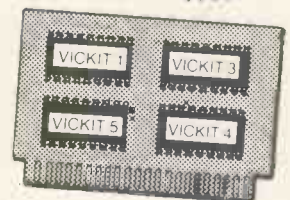

*standard size cartridge shown without covers
*supplied without roms

Hi-Speed Cassette Operations!...

Tired of waiting around for your programs to Save or Load on cassette? Now with VICKIT 4 you can SAVE, then LOAD or VERIFY all but the smallest programs at up to 7 TIMES FASTER than before. Ever wondered about Machine Code programming? Well now is your chance to give it a try!
Part of the deal with VICKIT 4 is a MACHINE CODE MONITOR and TOOLKIT.
Available on Cartridge **£29.00** or on Eprom **£19.00**

Cut through the Language Barrier!...

A superior 6502 ASSEMBLER for machine code enthusiasts to help you produce FAST-RUNNING programs. VICKIT 5 removes the tedium from machine language programming by allowing you to write your code in a special form known as 6502 Assembler Language. VICKIT 5 then performs all the laborious calculations normally associated with machine code. (Must be used with VICKIT 4)
Available on Cartridge **£29.00** or on Eprom **£19.00**

(ALL THE ABOVE PRICES EXCLUDE VAT at 15%)

MAIL THIS COUPON NOW!!

To: **Stack Computer Services Ltd., FREEPOST, Bootle, Merseyside L20 0AB.**

I am interested in your accessories for:

- VIC-20
- CBM-64
- BBC'B'
- Dragon
- Atari

Please send me your Spring '83 Catalogue.

Name _____

Address _____

Contact your local VIC-20 dealer for details

STACK

Computer Services Limited
290/298 Derby Road, Bootle, Merseyside L20 8LN.
Tel: Sales **051-933 5511** Service **051-933 3355**
Telex: **627026 (Stack-G)**



Guy Kewney delivers his monthly package of micronews.



Fearful motives

The fine, small print at the end of the most impressive micro launched last year is the astounding revelation that you cannot format diskettes on the DEC Rainbow. Nor, for that matter, can you format diskettes on the British CP/M systems sold under the name Andromeda.

This is an astounding development – it is as if Parker was to launch a new ball-point pen that would write only on Parker paper.

Not being able to format diskettes means this: you can't just buy a box of blank diskettes from the nearest shop. You have to get pre-formatted ones from your supplier.

The news wasn't released at the same time as the rest of the information, on either system. Had it been, the critics would have been full of scorn. It is possible both machines would have been dismissed as oddities.

To explain: the point of using CP/M – almost the only

point of using CP/M – is the fact that it varies very slightly from one machine to another. Thus, in theory at least, it is very easy to get exactly the program you want, because it is bound to be there, inside the CP/M canon.

There are two reasons why this doesn't mean what it should mean. It should mean that any CP/M program is yours for the asking. But in fact, since your particular CP/M machine has the "wrong" disk format, it means that the software producer has to produce a version on your diskette. And since there will be some slight changes needed, this takes him a couple of months to do.

That's the first reason you can't just buy a copy of the latest (whatever it is) program.

The second is the fact that, officially, making your own copy of the program to try it out is illegal. Naturally, this fact doesn't stop people copying other programs and trying to run them, but it does

stop them talking about how they did it.

By supplying pre-formatted blank disks, Andromeda's supplier (ITCS) hopes to prevent software copying. It also hopes to ensure that its customers use only the best quality diskettes, because they will supply only the best, under their own label. DEC says it too, has the customer's best interests in mind, and will make sure its users never suffer from grotty diskettes.

At this point most people I discussed the idea with, interrupted the conversation to do a convincing imitation of a horse laughing.

At the risk of being considered hopelessly naive, I have to admit that I believe both ITCS and DEC when they speak highly of their own motives. They really do intend to buy the best magnetic disks, and supply them to their customers. And I honestly do not doubt their sincerity.

What I doubt is whether anybody else will believe them. I think the horse-laugh will be universal.

And as for protecting software, it just won't work.

The first thing a really clever scheme for making diskettes uncopyable does is create a market for really clever programs to get round the scheme.

The second thing it does is to prevent people trying out new programs. And if they don't try them out, they don't buy them. And only a twit would pretend you can really try a program out by going into a centre for testing programs and sitting in front of a machine for an hour or so. You have to use it in your own office, feed your own data in, try to get it out again, and find out what it can't do that you can manage without, what it will do that you didn't realise you needed, and how reliable it is.

Few people who try it out buy it. Many of them might have done, if the software had been available for their machine in their local shop – but it wasn't, because the software house didn't know how to get it distributed properly.

But a lot of the ones who didn't buy it weren't going to. They didn't have the money. And they didn't like the program all that much, either.

It is easy to understand why software producers are afraid of releasing unprotected software.

But fear is a bad guide to action. Giving software houses copy protection is as much sense as giving American citizens the right to carry guns because they're afraid of being mugged. All it does is make sure that every mugger has a gun, thousands of people die each year with bullets in them, and if you walk down the streets, you are picked up as evidently either crazy, or a mugger yourself.

Both companies assure me that their policy on diskettes will not discourage sales. DEC points to the current rage and frustration amongst people who want to be dealers, just because they can't get the things until mid-April (DEC won't say what the delay is caused by, but I gather it is faulty diskettes). And ITCS points to a contract to supply 500 of its portable Zita models to YBA Kanoo group in Saudi Arabia.

All I can say in reply is that I only found out about this little detail when a friend rejected my suggestion that he seriously consider the Andromeda range, just because he had found out he couldn't buy ordinary diskettes.

And I wouldn't buy a system like that, either.

Sensible networking

Sintrom's decision to launch two circuit boards to do the job of linking microcomputers may mark the beginning of sensible networking, even though Sintrom is using the Ethernet system.

The thing that makes Sintrom's little boards different from other Ethernet-labelled products you may see advertised is that you don't have to buy a special Ethernet computer.

The boards will plug into any CP/M system using the standard \$100 cards, and providing you have enough of these lying around (three is a minimum) to make a network, it will become an Ethernet.

The cost, per machine, is around £800 extra.

However, any earlier scepticism you may have noted in this column about Ethernet as a micro solution is not dissipated by the Sintrom product. This one works, but that doesn't mean that you or I would be able to use it, any more than we would be able to buy a naked CP/M and install it on our systems.

But it does mean that software houses who want to sell software to people who have Ethernet networks, next year, can buy this and start putting the handles and starter-pedals on it.

Details on (0734) 875464.

In-flight wp

Word processing, using a four-line display only 18 letters wide, is a bit of a challenge. But the gauntlet has been

Gold Star for Comet

A month before Telecom (our old Post Office as was) was due to launch its Gold electronic mail service, and decided to postpone the announcement, a rival service has been started up by (of all people) British Leyland.

BL Systems has been running an internal electronic mail system for some time, and it isn't any secret that several people outside the company have been logging on and swapping messages.

The system is called Comet, and travel people use it a lot

(officially) and enthusiasts use it too (unofficially).

Now, they are legally entitled to do so, because the Government has approved Comet as a "value added network" for use between companies, as well as inside them.

For details of the charges and the way to join (all you need is a micro, a modem, and some suitable software) contact the company in Redditch, Worcs on (0527) 64274.



You keep your diskettes, like everybody else, in a box. The question is, how do you find the diskette you want, in a hurry? One answer is this Safer system, which hangs the envelopes up like files in a drawer, and locks them in position with a number on each, and a little card-index system at the front. That way you are forced to leave the envelope in the box, in the right order. And I know I wrote about it before, and we're so overwhelmed with stunning pix but I couldn't resist this one that MC2 sent me... contact them on 01-540 9370.

seized with the production of a word processing program for the Epson portable HX-20, called Intext, by Talbot Offset.

Talbot makes quite comprehensive claims for the system, saying that (since you can put up to 6 Kbytes into memory) the tape (rather than disk) storage of the Epson, doesn't matter. You can even drive an Epson printer direct.

The idea is not that your portable micro becomes the heart of a full-blown office system, even though there isn't anything to stop you doing this except good sense.

Instead, the text that you prepare (on the aeroplane, or in the loo) can be piped down the RS-232 cable, into a system which is better at large-scale text viewing, editing and printing.

There is also a plan to attach a portable acoustic modem, which will take its power from the Epson, and transmit the text down the phone line to the office system.

This modem, one of which is shortly going to be available from Bencom, will cost just over £200.

Intext will cost £36.00.

Details from Talbor on (0202) 519282. Bencom is on 01-940 1386.

File on BBC

The first attempt to put enormous hard-disk capacity onto a BBC microcomputer has been made by Geophysical Systems Limited, in Andover.

The word "enormous" was chosen with some care, because GSL has not exactly dithered about what size of disk to use. It has interfaced four drives, each of 85 megabytes, and says that it is prepared to supply the whole package, 340 megabytes, interface and all.

The project is just emerging from the laboratory, with the first order received very recently, so potential purchasers without some expertise should probably be cautious at this stage.

According to GSL, "a provisional filing system is currently available as a basic program providing an elementary capability for file-handling and cataloguing".

This program will be expanded by production of a

machine-code version, on permanent Eprom memory chips.

System builders who wish to join in this project at an early stage and also want to haggle about things like the local Econet network interface, and the price, should contact GSL on (0264) 58744.

Portable tape save

You can now store information in your nice portable Epson HX-20, because Bits and PCs has launched a £40 program called Deskdata, which does it.

The company describe the product as "taking the drudgery out of any card filing system" and says that it "includes mathematical functions".

However it does have its own form of drudgery: since nobody has yet invented a portable disk, this program uses the Epson's tape cartridge.

So the records are kept in memory, until they are saved to tape in sections, when memory is full.

Details from Leeds (0532) 458877.

Watch Out! Hot micros

It is hard to imagine what a thief does with a stolen computer, and were it not for the arrival of two sad announcements of such thefts, most people would agree that they aren't particularly "fenceable".

Perhaps it is hard to resell "hot" micros, but that isn't stopping some optimists. Lincoln College of Technology

reports the theft of a Commodore 8096, a disk, an Epson printer, and an oscilloscope.

Another burglary is the one at London dealer 01 Computers, where they lost eight Osborne micros, 14 printers, 17 monitors, parts of an Olivetti, and a selection of other goodies "including a two months' supply of fresh

coffee," observes an indignant Bob Rothman.

Should anybody ask your advice about the offer of a cheap Osborne, warn them that the thing will need upgrading soon, and that Osborne has the serial numbers. Then get onto Rothman and claim the "substantial reward" offered.

Expert shift

Any information you have going back to the days when there was a computer called the Exleigh Expert (which was generally admired) should now be updated.

Change the reference from Exleigh to Sord, because Sord is now seriously selling the machine itself, through 16 (at last count) dealers, rising to 40, they were hoping, by the end of March.

The list of dealers is

available from Sord at Samuel House, St Albans Street, Haymarket, London SW1Y 4SQ. Phone 01-930 4214.

Pricey tricks

Alert readers will notice a certain amount of variation in the price, as quoted in one magazine or another, of both the IBM Personal Computer, and the Apple Lisa.

Confusion on pricing on the Apple arises because the company hasn't announced a

UK price. It said "Lisa will cost \$12,000 in America," and left the rest to our imaginations.

I notice that my references last month to a £9,000 UK price have been carefully adjusted by our production team to £7,000. This is admirable optimism, totally out of keeping with either exchange rates, or Apple's past practices.

Apple has never sold things cheaper in the UK than in the US, and has made no predictions of a change in policy. At today's varying

Dragon demon

We have sad letters from two readers who sent for Dragons by mail order from one of our advertisers, but didn't get them. In order to protect the rest of you from any other crooks, please would anybody who has been ripped off let us

have full details.

The crook is NOT one of our current advertisers.

We will obviously be working with other publishers and the Computer Retailers' Association to ensure that this doesn't happen again.

rates, the price would be £8,000, and Apple is most likely to charge extra for a UK power-supply, video display, and so on, not to mention VAT

and import duties. If it sells for under £8,500, I will eat my hat, and if the price is set at £10,000, I will not even raise an eyebrow.

Confusion on the price of the IBM, however, lies in the fact that the company, like Sage, quotes a price for a system with 64 kbytes of memory and only one disk.

When you see prices like £2,400, you may have discovered somebody discounting – but check. You are going to need to spend £3,100 for a working system, and IBM doesn't like its dealers to make cut-price offers.

It really is time that the industry quoted two prices, absolutely as a matter of habit. One should be for a "minimum" box – just the processor and whatever simply can't be taken out of it (the VIC and the power supply, the Apple with no special circuitry, the Lynx with just its cables and transformer).

The other should be the cost of a system with keyboard, screen, two disks and disk operating system, 64 kbytes of memory, a printer interface, and a year's maintenance. That should be regarded as a "standard" system.

And all prices should INCLUDE VAT.

Opinionated machines

It isn't true to say that the only thing going for Olivetti and its M20 micro is the fact that its Basic interpreter ran the fastest in our PCW Benchmark summary.

The company also has going for it the fact that Clive Sinclair likes the M20.

This alone will not be enough to overcome the awful impression made by its thoroughly nasty advertisements, which show several microcomputers all purportedly and solemnly agreeing that the M20 is the best.

I prefer to think of the ads as a self-send-up, along the lines of the current Guinness campaign (that shows somebody doing a drink test of G. vs bitter, and not being able to see the pump, so not knowing that the black one is the G.) – but from talking to Olivetti, I have reluctantly come to the conclusion that they think it is a serious campaign.

The program which the machines run is nothing like the program which you may have thought you see running on them, on the TV commercial.

All the program does is to summarise Olivetti's opinion of the IBM, the Sirius, the Apple III, and the Pet, compared with the M20. "Fed with true facts, computers are impartial," remarks the advert – but the theory that opinions count as "true facts" is new to me.

Here is what Olivetti actually fed into those "impartial" machines.

First, it awarded itself 30

marks for having "true 16-bit power" rather than the 8/16-bit power of the IBM and the Sirius, which only got 20 marks. The Apple III and the Pet only got 10, because they were 8-bit. (The Olivetti, therefore, is three times as good as the Pet and Apple, when it comes to "bit-power".)

Second, it awarded itself 10 points (and the same to all the others except the Pet) for having high-resolution graphics. The Pet had graphics, so it got 5 points, but they weren't high-resolution graphics. (Only half as good.)

Then it awarded itself (and the Apple and the IBM) ten more points for having colour. Sirius and Pet only got five. (Colour is twice as good as monochrome).

Finally, it noted that the Sirius had nearly twice as much "memory" at 896 kbytes than the M20 and the IBM at just over 500 kbytes – but reckoned that the double capacity wasn't worth that much more. Probably only 30 points for Sirius as opposed to 23 points for themselves. And of course the Apple II only got 16 points, and the Pet got nearly 10 points.

They then decided that these scores should be added up, and the machines should be compared by subtracting the value, in seconds, of the Benchmark timings published in PCW.

You might be forgiven for asking why extra bits are so important, if it isn't simply that they let you plug in extra memory and run faster programs. Don't ask Olivetti. Extra bits are worth points

AND they make the machine faster. And if they give you extra memory, that's not really so much.

So the Olivetti scored 72.63 points, minus 11.5 seconds = 61.1274 points. The Sirius scored 64.93 points, less 24.8 seconds = 40.1333.

And, final absurdity, the Pet 8096 got a negative score. It scored 29.8 points, less the 34 seconds taken to run the benchmark = minus 4.20204.

The decimal points were supplied by the computer.

You might think that when the minus score came out, somebody would have twigged "Hey, this must be a measurement of nonsense, because we've just proved that having a Pet is a handicap in running programs" – but no.

I'd quite like to run a little competition for more meaningless measurements. You know, twice the area of the keyboard, divided by the number of dots on the screen, less the number of printer – sockets on the back all to the power of an arbitrary score for quality of plastic casing.

Better yet, how about this: award yourself 0.01 points for every commercially available program that runs on the M20, Olivetti. Then multiply that figure by (1.5 to the power O/S) – and O/S is calculated by taking the number of operating systems that run on your machine *and also on anybody else's*.

Then subtract something like ten points for insulting the intelligence of your customers. What! You mean that gives you a score of minus ten! oh, surely not?

the announcement it is clear that the screen can show mixed Arabic and English letters.

If only these people knew how useful a photograph would have been to illustrate this news item! And the rubbish we have to print sometimes, just because we need a few pictures on the page.

Aptec is the trade mark of Appropriate Technology, on 01-625 5575.

Window on data

The database program (stores information and digs it out again when you want it) Sequitur looks like a word-processing program (you sit in front of it, typing). It means that anybody with a Fortune 32:16 can start putting information in, without worrying whether they understand the "data structure" or "key search algorithm" or "record format". The program is now available in the UK through Tetra Data Systems of High Wycombe.

"The screen of the computer provides a 'window' into the selected file so that users can manipulate data in exactly the

Dicey downloading

The Slowloader is a cassette-based program designed to enable you to load a ZX81 program directly onto a Sinclair Spectrum.

There are not only differences between the Basic languages of the two machines, but they store their programs in a totally different way. Slowloader has such a lot to do that I asked a Sinclair enthusiast to test it out more fully than normally for this column.

His report shows that there is no simple way of overcoming the shortcomings of cheap tape recorders. Both Sinclairs whistle notes on to tape – one for dots, and another an octave higher for dashes – and have some skill at working out which note is which on replay.

But setting up a tape recorder so that the ZX81 can make sense of the whistling is a crucial and critical thing. About all you can be sure of,

when you have done it, is that the next ZX81 you find will need a different volume-control setting, or a different tape.

He therefore recommends using one channel of a very good cassette recorder for the purpose. Slowloader then loads much more easily, and gives instructions for loading the ZX81 tape, and saves them on to the same tape drive. After that, they can usually be safely saved and loaded on the ordinary battery portable.

The new version of the program is heavily altered. FAST and SLOW instructions are edited out, and the program does its best with the graphics symbols that are not common to the two machines – but even then, character codes, plotting instructions, and some of the TAB commands will have to be edited.

And obviously, PEEK and

POKE instructions have to be carefully examined and rethought. Slowloader recommends that programs which POKE to the screen be rewritten using PRINT AT.

My enthusiast friend considers that at £10 the program isn't cheap – but suggests that it could be worth the money to somebody who laboriously typed in a great many text-based programs on to an 81, and now has moved up and wants them all on the Spectrum.

"If you can see your way through a program listing and understand what it is doing, then it will probably need very little change before (or after) Slowloader has processed it. But if you can't follow it, you will probably have trouble."

Details from East London Robotics, now at No 11 Gate, Royal Albert Dock, London E6. Phone 01-474 4430.

way a secretary composes letters on a word processor," says Tetra. "Even the database commands are visual, and quickly assimilated by non-

computer professionals."

Apart from the question of what a professional non-computer might be, that leaves only the price. It can't be low, because, by press time, Tetra still hadn't told us what it was. Ask them on (0494) 45200.

Eastern Mystery

Attentive readers will have noticed advertisements for a machine called the Samurai.

One of the adverts says that you can buy it, and shows a picture of an incredible little mediaeval warrior. It may not, of course, be entirely clear to you why a half-pint Oriental person with a curved sword would make you want a

computer, but at least one notices the ad.

The other one just says that "the Samurai* home computer is coming" and adds, tersely, "*Samurai is a trademark of Samurai Worldwide Ltd."

No, they are not the same machine. No, they are not the same company. No, the deal has not been worked out between the two companies in advance. Yes, it is a terrible shame one can't buy shares in the solicitors' firms involved, isn't it? Watch this space.

Faire

The London Computer Faire is moving from its North London Poly home, to the Central Hall, Westminster.

At press time, the organisers were beside themselves with

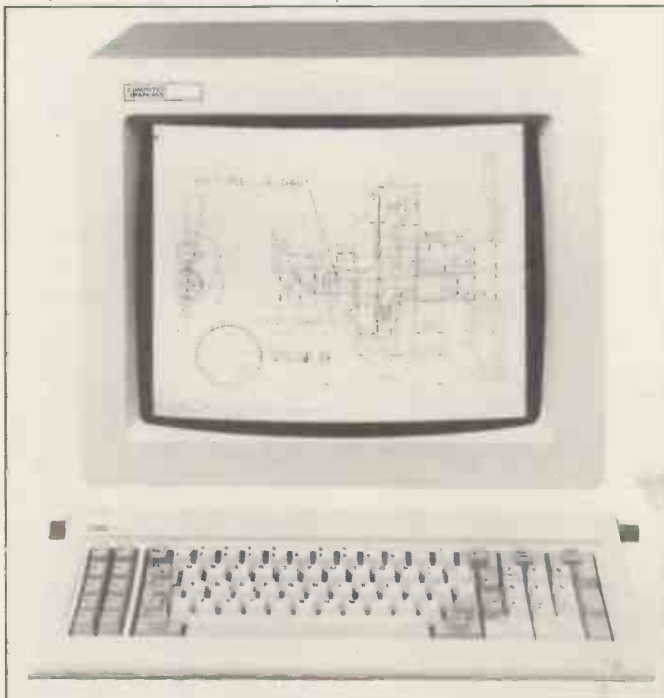

The immaculately drawn metal section shown here looks as though somebody used a Tektronix display.

They didn't: they used the Riva TK1024 graphics terminal, which can be connected to an IBM Personal Computer.

The terminal costs £4,600. That may sound expensive, but only if you've never studied a Tektronix catalogue.

Details for those who have, on (04862) 71001.

Spreadsheet taped?

Saxon Computing has a spreadsheet for the Spectrum. It is called Flexicalc.

This product "is in regular use in real planning situations," says Saxon sternly. "We shall shortly be releasing 'Consolidation' and 'Report Generator' modules, price at

£6.95 for the two – these will work with files generated by Flexicalc."

The central module costs £10. Unless you actually like file handling on audio tape, stick to that.

Details on (0401) 50697.

anxiety because the hall is "dry" and the Real Ale Bar is a tradition which they are anxious to uphold.

A new tradition, however, is the scrap computer stand, from which people can escape with keyboards, disk drives, displays, and other components or sub-systems of defunct micros.

And the normal collection of interesting hardware and software for schools, and similar purposes, will be there.

IBM net

Another network for the IBM: after Zynar's Plan 4000 that links them to Apples, Chatterbox has announced an Advanced Electronic Office Network (Aeon) which links them to its own Aeon workstation.

The network controller that the system uses has a big (40, 80 or 160 megabytes) disk store, which up to thirty different micros can all share.

The system can be expanded by adding other controllers. Details on 01-377 9341.

Oric makes friends

In four short weeks, Oric has suddenly stopped making enemies of shopkeepers, and is starting to make friends, because they are getting them.

Word is starting to reach us of software for the machine, which is "the only colour micro to sell under £100".

First package to reach me is a business package at £15 – a multi-purpose/personnel records file which "permits the mass storage and file-handling



of confidential information."

Details from Kenema Associates on (0934) 21315.

IBM opens the door

People are saying quite unkind things about IBM and its operating system, essentially trying to suggest that IBM is gradually perverting it to stop other people running their software.

It may happen one day, but don't believe it yet – there is no sign of it, whatever IBM's rivals may say.

All the signs so far are that IBM really is keeping the Personal Computer "open" by publishing all the details of software and hardware. Possibly the most telling indication is the announcement of a "hard" disk option and a bigger "XT" version of the PC.

Inside the announcement of a £4,858 system (a minimum "self-sufficient" box with 128 Kbytes, a single 360 Kbyte floppy, a 10-megabyte hard

From this pic, you can't tell that the screen is in glorious Sony Trinitron colour – but you can see that it is a nice, compact size – making it easy to read the Viewdata print on it. It is a nine-inch screen (diagonal measurement).

Sony thinks the interesting thing about it is the fact that it is being used by nearly half the Prestel customers who joined last year.

In fact the interest lies in the fact that we will soon be able to buy Sony monitors for our BBC and Commodore 64 micros (and all the rest of them) which will mean that rival tubemakers will have to sharpen up their production, too.

False economy?

Admittedly, £10,000 is a lot to pay for a TV, even one that can talk back down the phone line. So it isn't all that obvious why Homelink has decided to ask people for £10,000, and supply one.

Apparently the lure is so strong, that people will rush to invest the sum in the Nottingham Building Society.

With this TV, you can do your building society account manipulations with a Prestel system. You can also do your banking through the system, says the Homelink announcement.

But you do have to save £10,000 with the NBS first. Details on 0602 419393.

disk, keyboard, monochrome display and printer) is the encouraging extra announcement of a program transfer utility.

This does the very simple job of taking your programs from floppy disk and putting them on the hard disk. You may think it strange that one would comment on so obvious a necessity – wait till you try getting Visicalc on to an Apple hard disk.

The announcement holds nothing astounding, even though there is a new version of PC-DOS (IBM's version of MS-DOS) because IBM is under no price pressure (yet) in the UK.

In America, the new machine was coupled with a noticeable price cut, said the observers – probably because of the launch of Texas Instruments' Professional

machine.

The other new things were the use of bigger memory chips – you can put more memory actually inside the IBM box as a result – and an adaptor to connect the system to remote computers or devices. And, of course, the hard disk itself.

The facts may be simple: few people will believe it, even so. IBM has a long-nurtured reputation for deviousness, totally deserved, and this has led people to look for the worm in the apple even before the flower has been pollinated.

At the moment, the worm is said to be the operating system. IBM has "very deliberately" (according to one indignant contact inside Compaq) changed PC-DOS to prevent imitation IBMs from running software.

To prove this, my contact quoted a report in PCW which

Software giveaway

The software library of a Commodore user group called the Folklife Terminal Club, is being thrown open to any Commodore user.

This magnanimous gesture by the New York club means access to archives of 5,000 "public domain" programs, in the areas of education, business, games, utilities, and more than 25 other categories.

The software itself is FREE, but you have to buy the

diskettes on which it is stored. And there is a copying and mailing fee of £7 per diskette, which covers that.

Send your £7 to Folklife Club, Box 2222, Mt Vernon NY 10551, USA, and the first diskette you order is the Catalog Disk. That has an automatic disk cataloguing program, a listing of available software, and complete instructions.



SAVES TIME

Imagine the time, energy, and frustration you could save by boosting your Apple's speed from 1 Mhz to 3.58 Mhz. That's 3½ times faster than normal, making the Apple II Plus arguably the fastest Micro on the market.

How is it possible? It's all down to ACCELERATOR II. This new plug-in board from Pete & Pam Computers contains a 6502C Processor and 64K of memory. The board runs all native Apple II software, including programs written in Applesoft, Integer, Machine Code, Pascal, Apple Fortran 77 and Forth.

Amongst the many thousands who could benefit from ACCELERATOR II are users of Visicalc, DB Master, Micro Modeller, Multiplan Tabs, and Systematics.

SUPER FAST

In November 1982, PCW published a bumper round up of all the Benchmark Timings since PCW began. The Olivetti M20 came out top of the 'league' with an average Benchmark timing of 11.5. Running the same Benchmark test programs,

the Apple II Plus with Accelerator II averages a timing of 8.58 — that's an incredible 25% faster than the Olivetti M20.

We have reproduced some of PCW's findings, incorporating Benchmark Timings for the Apple II Plus with Accelerator II.

<u>Machine</u>	<u>BM1</u>	<u>BM2</u>	<u>BM3</u>	<u>BM4</u>	<u>BM5</u>	<u>BM6</u>	<u>BM7</u>	<u>BM8</u>	<u>Average</u>
Apple II Plus with Accelerator II	0.3	2.4	4.5	5.0	5.5	8.2	12.9	2.98	8.6
Olivetti M20	1.3	4.0	8.1	8.5	9.6	17.4	26.7	1.6	11.5
IBM Personal Computer	1.5	5.2	12.1	12.6	13.6	23.5	37.4	3.5	17.6
Osborne 01	1.4	4.4	11.7	11.6	12.3	21.9	34.9	6.1	19.9
Intertec Superbrain	1.6	5.2	14.0	13.9	14.8	26.3	43.2	5.6	21.9
Apple III	1.7	7.2	13.5	14.5	16.0	27.0	42.5	7.5	24.7
ACT Sirius 1	2.0	7.4	17.0	17.5	19.8	35.4	55.9	4.3	24.8
Xerox 820	1.7	5.5	15.5	15.1	16.2	28.9	46.1	8.0	26.1
Apple II	1.3	8.5	16.0	17.8	19.1	28.6	44.8	10.7	30.4
Commodore CBM 8032	1.7	10.0	18.4	20.3	21.9	32.4	51.0	11.9	34.3

So don't wait — start to save time now. Contact your local dealer, or call us on (0706) 212321, or, in London on 01-769 1022.

A faster, easier computing life is on its way.

— AVAILABLE NOW FROM —



Pete & Pam Computers



Head Office:
 NEW HALL HEY ROAD,
 Rossendale, Lancs. BB4 6JG
 Tel: Ross. (0706) 212321 & 227011
 Telex: 635740 PETPAM G

London Office:
 103-5 BLEGBOROUGH RD.
 London, SW16 6DL
 Tel: 01-769 1022/3/4
 Telex: 923070 PPCOMP G

featured an interview with Bill Gates, head of Microsoft. Microsoft wrote both PC-DOS and MS-DOS, and Gates was explaining the similarities.

According to the man at Compaq, the differences revealed by Gates were enormous. According to the man who interviewed Gates, he said nothing that could possibly be interpreted that way. According to other imitators, depending on their success in implementing their own versions of MS-DOS, or depending on the point they are trying to make, both points of view are correct.

What it boils down to is this. There are people who have produced machines which are sufficiently similar to the IBM that they can be sold on that similarity.

Some of those people have also "improved" both on the IBM hardware and on the MS-DOS software. Then, to show how clever they are, they have announced both total compatibility, and the improvement.

Then they load IBM approved software, and find that only 80% of it will run. Surprise, surprise. But guess whose fault it is!

Exhibitors get choosy

There is only one Comdex, and that is the exhibition in Las Vegas in the late autumn. There is another in April (26-29) which up till this year had been growing just as fast, and was just as worth attending if you had to know what was new.

This year, it has "only" 600 exhibitors in Atlanta, Georgia.

It sounds enormous, but the Spring show in every previous year has been bigger than the preceding Fall show. Last Fall, Comdex had around 1,000

VisiCalc rival gears up

Micromodeller, another "improved Visicalc" has apparently been sold to over 5,000 people in this country. It is now available on the new 16-bit machines, the ACT Sirius, the DEC Rainbow, and the IBM and Hitachi micros.

The company which sells the

Flexible character

The first reaction on seeing the £1,500 Optim Amigo or the C/WP Context, whichever name you want to give it, is to wonder where the computer is. Next you puzzle over where a second disk would go.

In fact, the computer and the second disk are here in front of you — and there is not only one computer there to see, but two, because the thing that sets this CP/M system apart from the rest is the fact that it uses a processor to drive its display, and another to run your programs.

"The unconventional thing about the Context is the incorporation of the Rockwell 6502 microcomputer (that is an ordinary 6502 chip) which enables the user to treat text like graphics on its 192000-element display screen.

This isn't quite as unusual as it sounds.

Most computers costing more than £200 — and one or two under that price — have at least a "character generator" chip — a processor which scans the main memory of the computer and turns some of it into the matrix of tiny dots that look like writing on a video-screen.

However, most character generators are merely fast, and not at all versatile. They can only display the letters stored, permanently, in them — not lines and filled areas. A processor, often slower in generating characters, has nonetheless got the extra flexibility to draw lines and shapes.

Hence the Context (or

exhibitors, so Interface Group will have to do a bit of drum-thumping. Either that, or cut exhibition prices. Nobody can afford all these exhibitions

Amigo) and its unusual graphics ability for a CP/M machine, can be made to perform quite clever tricks.

Sold by C/WP, the system includes a special version of Wordstar which takes account of some of these abilities, for no extra cost. Details on 01-630 7444.

It almost seems a shame to tuck this away — but a new sort of "character generator" has been announced as a chip, by Intel, the original microcomputer builder.

Intel has designed this to do a great deal more than display characters on a screen. First, it works fast, so that there is absolutely no need to sit in front of a terminal watching new lines gradually flicker into existence. Software designers, of course, will put their own convenience in front of ours as before — that means, pretend they are waiting for paper to move past a print-head — but there is no actual need to do so.

But more significantly, this chip is built with an awareness of the fact that most characters need not only to be displayed, but also, edited.

So it is a "co-processor" to the Intel families of processor chips, and takes all the more time-consuming tasks of text editing and display away from them.

Examples of the commands most processor chips obey would be: add registers, move memory, compare memory, perform "logic" or arithmetic, store data, and so on. This chip gets commands such as Skip, Repeat, Tab, Superscript/ Subscript, Smooth scroll, Start/ Stop — things you will recognise from the best word processors, and some that you don't normally get, even on those.

It is numbered the 82730, and you need not expect to see it inside any computer you may buy in the shops for at least a year.



each year, and obviously the picking and choosing has started.

Baby Oric

The first appearance of the 16k Oric-1 is now scheduled for late May/early June this year.

The original plan was for both 16k and 48k models to go on sale at the same time, and advertisements for mail order models went into the computer press at the end of last year. Since then Oric has had its fair share of problems:

demand for the 48k version was higher than expected — a ratio of 80:20 in favour of the bigger machine — and the 16k model ran into technical difficulties.

'The 16k unit is exactly the same design as the 48k one,' says Oric's managing director Barry Muncaster. 'We would have had no problems if the specification of a particular chip had not altered just prior to manufacture. However, it did — resulting in us having completely to change the 16k PCB, which from start-up to production has taken 12 weeks. The 16k has had to be



See 'Easy interface'

viewed from the manufacturing point of view as a totally different product. Naturally, this had caused a delay.'

Oric's policy has been to send 48k models to all 16k mail order customers, with a note to say that the machine is on extended loan and can be replaced when the 16k unit is available, or kept — subject to payment of the price difference. The company now claims to have cleared its mail order backlog, and in fact will no longer accept orders by post. The 48k version is now to be found in many High Street shops, and discussions are under way with all the major chains the consider pricing and dealer margins on the 16k model.

Steve Mann

Easy interface

Following the success of the stylish Competition-Pro joystick for the ZX Spectrum, Kempston (Micro) Electronics has announced that the joystick will now be made available for the VIC-20 and Atari 400/800. The Spectrum version is now on sale over the counter at many branches of W H Smith, and numerous software houses are developing arcade games for use with it. Competition-Pro for the Spectrum (which includes interface) is £25, and models for the VIC and Atari will set you back £16.50.

Kempston has also announced a new Centronics interface to connect the Spectrum to a whole host of popular printers. The interface will recognise LLIST and LPRINT commands, and there is also provision for special characters — condensed, expanded, etc. Supplied cased and ready to use, the interface simply plugs into any Centronics-type printer, and also includes driving software to allow up to 128 characters

per line.

This is especially good news for Spectrum owners who would like to use their computer for business applications, as Hilderbay Ltd has produced a range of business

Drunk on VICs

Commodore has announced that it will build a factory in Corby, where VIC-20s and Commodore 64s will be built. Great news: so why are all the dealers sounding so close to panic as they cheer?

The answer may lie in the Silicon Office. The appearance of a version of the Silicon Office on the ACT Sirius is a warning which many will interpret with as much alarm as a sailor would on seeing rats running down the anchor cable.

The Silicon Office is a program which combines several functions which, normally, you have to buy three or more separate programs to do. Even at £900 for the program, and considering also the limitation that it would only run on the Commodore 8096, there are a lot of them about.

On the face of it, there is nothing too surprising about the move.

There are now well over 10,000 Sirius machines in Britain, nowhere near the number of different Commodore machines (over 80,000) but more than the number of 8096s. So it is a logical move for a program that needs a lot of memory to operate in.

Also, the 8088 processor chip inside the Sirius and the MS-DOS operating system that drives it, can be found with little variation on the Digital Equipment Rainbow, the IBM PC, and several hundred other imitations of

software to be used in conjunction with Centronics-type printers.

The interface is supplied complete with connecting lead and a 12 month guarantee. Price is £45 inc VAT (but add £1 p&p). Kempston is at 180a Bedford Road, Kempston, Bedford MK42 8BL.

Steve Mann

Fruity Forth?

Forth (a language) is available on the Commodore 8000, for £180, from Kobra Micro

Marketing.

That isn't the cheapest Forth in the world, so I'm going to reproduce some of Kobra's claims for it, in the hope that it will impress people who know more about Forth than I do.

"It is," they say "a standard Forth Interest Group Forth (fig-Forth) with many extensions, including double-precision arithmetic, random numbers, IEEE control words, trigonometric functions, and a powerful string package with string-searching capabilities."

It may seem pathetic to leave it there, but either that impresses you, or it doesn't. And there's no earthly way of

those.

The company that makes the program, Bristol Software Factory, is careful not to imply any criticism of Commodore in making the announcement of its MS-DOS version.

But nothing can hide all the anxiety that Commodore dealers exude, following the launch of the 500 and 700 models in February.

For a start, Commodore barely managed to get the machines to the shows — many dealers were obliged to show cardboard cut-outs of the new models.

And at that, they could count themselves lucky, because at least they didn't have to explain why there were so many non-functional ones, nor why the integral disks were not there.

One analysis of what is happening is that the whole corporation is drunk on VICs.

Last year, Jack Tramiel (the extraordinary character who owns Commodore) actually forecast the end of the VIC, and its early replacement by the 64, before Christmas. He derided the VIC as a "games machine" and told me: "I'm very glad we had the strength to resist the games market while Apple and Atari were getting into Space Invaders — we have developed a firm background in business software, which is where the market lies."

Then he discovered that the company was about to sell its millionth VIC, and instantly sent out the cancellation

orders. All production capacity was to be put to producing home computers. Forget the business machines.

Unfortunately, the shopkeepers can't forget them. They have to have business machines to sell. They can't sell the new Commodore 500 and 700, and are having to make do with 8040s and 8096s in new boxes.

I asked a friend inside Slough what on earth was going on. He said: "Don't ask me. I'm just keeping my head down, and hoping nobody notices."

This paper had hoped to get a 700-series machine to review for this month's Benchtest. Commodore couldn't oblige, so we contacted dealers, including one who had displayed five of the things at the big Commodore exhibitions.

They had sent them all back, because they didn't work.

Commodore won't believe this, but when they first announced the damned things, back in April last year, I felt like a positive traitor as I wrote what I didn't believe. I believed that there really would be one or two machines, with 8088 chips as second "add-on processors," with Concurrent CP/M-86, just as promised, in September.

But natural caution triumphed, and I wrote that promises of "available in September" were optimistic.

Perhaps we should have asked: "Which September?"

Personal add-ons

The news that Apple will be selling Digital Memory Oscilloscopes (made by Northwest Instrument Systems) in Europe has been intriguingly disguised by Northwest's press announcement.

This told of an "agreement by which Apple will distribute the new line of Apple-compatible personal

instruments". The imagination absolutely boggled! But it turned out that the Northwest range was in engineering and manufacturing and test and service and education and physical science application, and that the first product was the memoryscope. It can be linked to an Apple, and the resulting system costs around \$5,000.

starting any explanation of why it should (or shouldn't) if it means nothing to you. Get the book.

Manhunt

Herewith the final episode in the ongoing saga of the PCW Manhunt Competition, first seen in our September 1982 issue. So overwhelming was the response to our three part puzzle that many readers who managed to ring in with the correct answer and find Brigadier Bumper Harris were disappointed in not being the first with the solution.

Well, PCW in its magnanimity decided to do something by way of compensation . . . wait for it, we ran another competition. I'm afraid we had to slightly reduce the prize money second time round, to £200, but now we are pleased to announce another winner. Congratulations go to Mr G J Blackledge of Lancashire.

Doubtless readers will be interested to know what the second puzzle was and what Mr Blackledge managed to score in the given time res-

straints. So, purely for your own amusement, here is a brief summary of the rules.

You are asked to make up a crossword in the grid shown and incorporating the letters P,C,W, as given. All words should contain at least three letters and appear in the Concise Oxford Dictionary (not the appendices). No foreign words. Colour any squares black that are to be used as

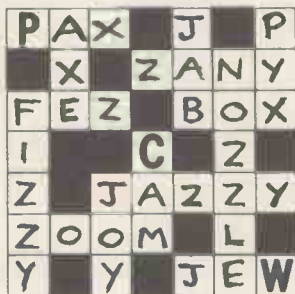

Letter	Value
Z, Q	9
X	8
J	7
V	6
Y, K	5
F, M, W, H	4
B, C, G, P	3
D, L, T, N, R	2
A, E, I, O, U, S	1

separators. No clues are necessary. Your score is then worked out from the letter values shown.

As you will see, Mr Blackledge scored an amazing 165 points using 14 words! Well done!

Liberal Topic

An unusual opportunity to tell an unusual group of people about micros: the American journal Topic is asking for 2,500-word articles for a special edition about computers "in the liberal arts". This also includes computers in education.

"Topic's readership consists of international liberal arts-faculty people in a variety of fields," says the request, adding: "Its readers are therefore highly sophisticated, but may not be acquainted with technical jargon."

Obviously, every paper that wants articles doesn't make a habit of writing to us, and if they did, we couldn't help - but this is so unusual that it seems

worth publishing the address of Thomas W Hart, Ph.D and Joseph Levenstein, Ph.D at Washington and Jefferson College, Washington, Pennsylvania 15301.

Wet electronics

I quite liked the idea of a washing machine with a computer in it, so I bought a Philips machine with "ELECTRONIC" written on the front.

It broke down, and when the engineer opened the box up, one couldn't help noticing tyhe completely traditional cogs and wheels. "Where's the electronics, then?" we asked (a bit annoyed, since it took Philips three weeks to trace the fault).

The motor, it transpires, runs at different speeds. It goes slow for wash, fast for spin. This is because there is a thyristor in the system. A thyristor is electronic. Deny that if you can.



The reason the screen and keyboard on this Canon AS100 micro look so titchy is simple: those are eight-inch diameter disk drives. Next to them, in that black strip, are two one-third height five-inch drives.

I know I'm an ungrateful wretch, but when everybody is moving to offer three-inch drives, this sort of tank with concrete foundations rather puzzles me.

I also have to report that, eighteen months after Sirius brought the Intel 8088 chip to the UK, Canon has told me that this box "is one of the first to bring fast 16-bit data processing to the microcomputer class". It has an Intel 8088 with MS-DOS as the operating system.

Somebody, tell them. (And mention that the war's over, while you're at it).

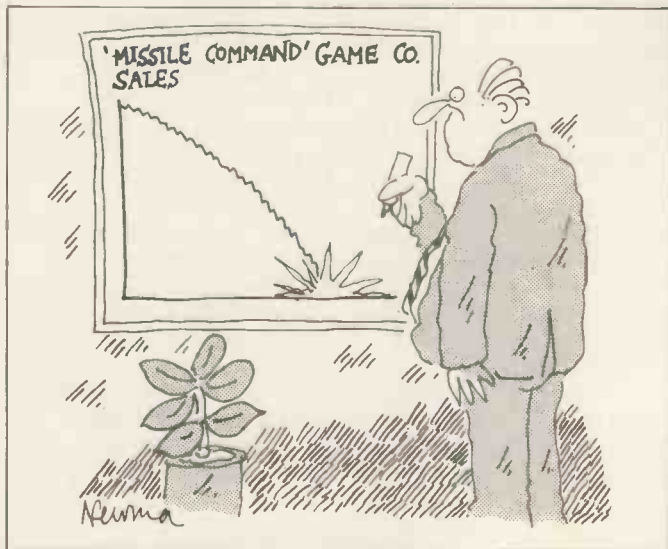

IMAGINE THE COST OF LOST DATA

through damaged Floppy Disks!
Why not protect them in a strong aluminium case, Heat Resistant Non Static, Lockable floppy Disc Storage Case. Holding up to 100 Diskettes separated with indexing dividers available for both 5¼" and 8" Floppies. Prices start at under £40 and for an introductory period* – the 5¼" case is £29.95p plus postage and packing £2.00 (orders over 5 cases postage and packing paid). Phone or send to below.

**Period ends 31st May*



SMITH SAMPLE CASES LTD

18 BETTS AVENUE, INDUSTRIAL ESTATE,
MARTLESHAM HEATH, IPSWICH IP5 7RH
TELEPHONE: IPSWICH (STD 0473) 623301
TELEX: G987703 (PREFIX SMITHCASES)

I wish to pay by cash/chequePostal Order/Access/Barclaycard

To ACCESS/BARCLAYCARD

I authorise you to debit my Access/Barclaycard



Account with the amount of £

My ACCESS/BARCLAYCARD No. is

Name (as on Access/Barclay card)

Cardholder's address

Signature

RELIABLE CODE MAKE YOUR MICRO WORK

Ric Wickham gives some pro-standard programming tips.

I am a systems programmer by profession. I have a part-share in a Video Genie which I use in my spare time to run astronomical simulations and, of course, games. My applications tend to need large volumes of fast code. In this context, 'large' means I need a shoehorn to get it into the 16k machine and 'fast' rules out the Basic interpreter. Since I only have the machine part-time I can spend a lot of time on design and coding, but when I have the machine I want to run programs, not debug them.

This has led me to a standard programming style and environment which has significantly improved the reliability of my programs, though at a slight cost in performance. The style is modular, heavily beset with conventions (mostly enforced by a macrogenerator) and compact. The ideas involved are not original, though I believe this is the first time they have been applied to micros. They come from a number of sources, notably the GIER Algol compiler of the early sixties.

Reliability

How do we ensure reliability? Firstly, by ensuring that all common programming errors are detected.

The Z80 code is very bad for this. The only hardware check is for 'overflow' which doesn't usually mean quite what I expect! Data and control stacks are muddled with no established protocol to sort them out so an extra PUSH or POP instruction can cause the next Return to transfer control to a data address; and jumping to address 0 (a typical result of leaving out a module in a multi-module program) resets the machine.

All the checks must be coded in so I use the macrogenerator. I have standard subscription macros which check bounds; a macro for calling a procedure in another module which checks that it's there; and standard multiply and divide procedures which check overflow. (So far, overflows on addition and subtraction haven't hurt!)

Secondly, by ensuring that all detected errors are reported adequately. Again, the Z80 code is unhelpful. State-of-the-art on large machines (and some small ones) is a stack print giving the names of all procedures entered with the current values of parameter variables but this implies a considerable set of conventions. To be able to make such a report, the error-handling routine must always be able to find out the state the machine was in when the error occurred; this implies that the control stack

must always be in a 'clean' state, even when processing an error (such as calling a missing procedure) which occurs halfway through updating the control stack.

Then, never lose control. In this context, 'losing control' is when the machine jumps to a random address. The best run-time system in the world is useless unless you are actually obeying it! Related to this is another point: if your program loops it should be possible to regain control without resetting the machine (if possible, without losing the state of the control stack).

What can we trade?

Nothing's free. I can do without some performance — although Basic is too slow, I don't need the ultimate in machine-code performance. I don't mind having to run all my programs through a macrogenerator before I assemble them. In fact, I welcome it since I can unload a lot of book-keeping onto the machine. Again I really don't care if no-one else can use my routines (or even read my files!). I have a fairly large set of routines in my run-time system, about 2½k. I find this no disadvantage: for small programs I don't mind using the space and my large applications are so similar that I need most of the package anyway.

Consider the fragments

Any program is built up of short sequences of instructions to perform simple operations — for instance loading a variable, adding a constant, calling a procedure, loading a formal parameter (within a routine), identifying an actual parameter (before calling a routine), and so on.

In fact, the operations I've just listed are among the most common fragments and their implementation matters more to a coding standard than anything else. Get these right and your machine will love you; get them wrong and your programs will always be bulky and/or slow and/or just plain unfriendly!

Consider loading a value. If the value is in a fixed place say at 'addr', the load only needs one instruction, eg,

```
LD HL,(ADDR)
```

whereas if the value is on the stack, 'addr' bytes above the stack pointer (as is typical for programs with recursive procedures or

dynamic space allocation) you need

```
LD IX,SP
```

```
LD L,(IX+ADDR)
```

```
LD H,(IX+ADDR+1)
```

which is not just more instructions; the instructions themselves are longer. Moral: don't keep things on stacks!

In fact, the Z80 code is very heavily biased towards fixed places for things. Given this, it makes sense to pass parameters to procedures by address: the addresses of things are constant and so can be permanently assembled into the program, so that the caller of the routine doesn't need to have any code to pass a parameter. This reduces the size of a call at the expense of a slight increase in the code required to access the parameter from inside the procedure. This must be the right way round since there's usually more than one call per procedure: so we optimise the calls.

The solution

Having covered the background, the solution is fairly straightforward.

1. All variables are statically allocated. Addresses are therefore fixed by the assembler. (Actually, they're fixed by my loader but that's a different story!)
2. All procedure calls are indirect. Calls to procedures in the run-time system, for instance the multiply routine, are all made by a CALL to fixed addresses containing jump instructions; I can therefore replace bits of the system, or move them around, without needing to change any programs that use it. Calls to 'user' procedures, that is, those in other modules of the same program, specify a 'procedure number' to a call on the Base. There is a vector of indirect addresses indexed by procedure number; this vector is used by an indirect-call procedure in the Base to find the procedure the application is actually trying to call. The vector is called GVEC and is in a fixed place, so application modules can have GVEC initialisations compiled in.
3. Parameters are passed to Base procedures in registers in a more or less ad-hoc fashion. All these procedures are wrapped in macros which remember which registers to put things in, and the values of the indirect addresses.
4. Parameters are passed to application procedures by address. Since these addresses are constant, an appropriate number of pointers are assembled in-line in the code following the call. The procedure using the

parameter value can read the addresses from a fixed area in the procedure header: it is the responsibility of the Base indirect call procedure to check that the right number of addresses have been supplied and copy them to the parameter area of the called procedure.

5. Since, from the point of view of the called routine, the parameter pointers are at fixed addresses, recursion is not possible. The procedure header therefore contains an 'entered' flag which is inspected by Base during the call to prevent recursive calls.

6. In order to keep the control stack 'clean', there must be no temporary variables on it while a call is in progress. This limits the scope of temporary variables to a single expression, which I regard as a good thing, since experience suggests that I can't remember what I've got on stack much past a dozen instructions!

Implementation

Base comes in three parts. One interprets command letters typed by the operator. This allows him to request that a module be loaded, a program run, stopped, dumped, restarted, and so forth. The second part is a set of diagnostic routines which print the current state of the program to the monitor screen. The third is a set of service routines. Some are completely general and can be called either from the application or from other parts of Base: for example, there's a routine to turn an integer into the string which represents it; and another to print the resulting string. The others can be called only from the application, because they may switch stacks from the user stack (for instance, if they have to report errors).

All Base routines are called indirectly in an ad-hoc fashion. This is supportable because all Base routines are trivial, designed to perform a single closely-specified function: the specification isn't going to change and (because the routines are indirectly-addressed) the address of the routine isn't either. Incidentally, one reason all Base routines are so simple and well-specified is that I had to prove they work by inspection because I can't use Base to test them. This is good discipline if you can stand it!

Application routines are called via an indirect procedure ICALL. ICALL is called by a restart instruction (RST 56, which happens to be spare on a non-disk Genie). It could be called by an ordinary CALL instruction but the restart is smaller. The restart is followed by a byte containing the procedure number; this is followed by a byte containing the number of bytes of parameters supplied on this call. The parameters then follow, in the form of pointers.

Thus, to print a string at MSG with procedure number PRINT:

```
RST 56
DEFB PRINT
DEFB 2 ; A pointer is two bytes
ADDR MSG ; Address of the string.
```

It's worth noting, in passing, that this sequence occupies five bytes; the standard way of printing a string on the Genie is

```
LD HL,MSG
CALL 28A7H
```

which is six bytes.

The target routine has a header which starts with a recursion flag, then contains a byte giving the number of bytes of parameters expected, space for the parameters, a byte containing the length of the name of the procedure, the name, then the code. The indirect procedure address points to the start of the header. The procedure name must contain a zero byte so a parameterless procedure with a zero-length name carries a standard overhead of four bytes.

As an example, the header for the PRINT procedure above could be as in Fig 1.

The recursion flag is -1 initially so that ICALL can say

```
INC (HL)
```

```
JR NZ, fault
```

rather than messing about loading the flag and comparing it.

Each procedure call results in three words on stack. First is the return address to the next byte after the supplied parameters in the call. Next is the address of the called routine: PRINTX in the given example. Finally, since ICALL calls the target procedure, there is on-stack a return address in the middle of ICALL. This is so that the target procedure can return simply by saying RTN, which will drop it into ICALL again at a suitable place to interpret the procedure return. This place is actually called IRTN.

The sequence of events around a call is therefore:

- calling procedure calls ICALL
- ICALL calls called procedure
- called procedure returns to IRTN
- IRTN returns to calling procedure.

How the procedures work

Base initialises GVEC to all zeros: therefore, if you try to call a routine you haven't loaded, its address will be 0 and ICALL can reject the call. There is almost no other initialisation.

ICALL is the most complex procedure. It and IRTN work in nine major steps:

1. Access GVEC to find where the target procedure is; report an error if it isn't loaded.
2. Increment the recursion flag of the target procedure and report an error if it doesn't become 0.
3. Compare the number of parameters supplied in the call with the number expected by the target procedure; report an error if they're not equal.
4. If any parameters are supplied, copy

them to the target procedure header. This is a single-instruction block move, of course.

5. Stack a pointer to the called procedure.
6. Call the first instruction of the called procedure.

When the procedure executes a RTN instruction, IRTN will

7. Unstack the procedure pointer.
8. Use the unstacked value to decrement the recursion flag.
9. Return to the original caller.

As an added bonus, both ICALL and IRTN inspect a flag in a fixed place and, if it is non-zero, print the name of the procedure being entered or from which control is returning.

The other interesting procedure is the dumper. This routine simply runs up the stack in three-word groups; for each procedure entered it prints the address of the caller (the original return address), plus the name of the procedure (from the string in the procedure header, which it finds from the stacked procedure pointer). It could also print the values of the supplied parameters, though my present version doesn't. If I ever need to implement that I'll extend the 'name' field in the procedure header to include a specification of the type of each parameter (word, byte, vector of byte, so forth). This is possible because the name is terminated by a zero byte and the total length of the field is supplied explicitly; so the supplied length can be longer than required for the name.

Frills

As I mentioned above, it is possible to set a flag in a known place, either by command to the interpreter or from within the application, which will cause ICALL and IRTN to print the name of the procedure being entered or left.

Not so much a frill, more a necessity is 'unwind'. Obviously, if you run a program and it fails, it will leave recursion flags set on a number of procedures, including the main program. Any attempt to re-run the program will therefore fail. Unwind is a procedure which can be called by an interpreter command to run up the stack unsetting the recursion markers of all the procedures that it finds. One day I'll get around to making the RUN command do it automatically when required; for the moment I invoke it manually.

Many of the routines in Base which can only be called from an application call a 'coordination' routine. (The term 'coordination' was coined for a routine in the

GOTO page 234

```
PRINTX EQU * ; Declare a local label as 'here'.
ORG GVEC+PRINT+PRINT ; put the address of this routine into
ADDR PRINTX ; the indirect call vector.
ORG PRINTX ; and continue to generate the routine
DEFB 255 ; Recursion flag.
DEFB 2 ; 2 bytes of parameters.
STRING DEFB 2 ; 2 bytes space for parameter.
DEFB 6 ; length of name of routine.
DEFM 'PRINT' ; the name itself.
DEFB 0 ; .. terminated by zero.
; The actual code for the procedure starts here; for instance
LD HL,(STRING) ; to load the address of the
parameter.
```

Fig 1

MICRO**CHESS**

A MATCH FOR BRUTE FORCE

Tony Harrington tells us why a chess computer company caused a scandal . . .

The German firm of Hegener and Glaser started out as an importer of electrical components. Its clients included firms such as Siemens, Braun and Telefunken.

All this might seem a long way from microcomputer chess, but as their company prospered, Manfred Hegener and his partner began looking around for new fields to develop. And here coincidence — which so often seems to be responsible for bringing entrepreneurs into the microcomputer chess market — took a hand.

One of the projects Hegener and Glaser opted for was to produce a new telephone. As part of the contract for the telephone project, the firm acquired the services of two programmers, Thomas Nitsche and Elmar Henne, whose hobby — you guessed it — was writing chess programs on main-frame computers. At this time (around the beginning of 1980) the first successful microchess programs were on the market.

After talking to Nitsche, Hegener and Glaser decided that there was a definite demand for a well designed chess computer. They found that their enthusiasm for pioneering in this market was not shared by the banks, but their electronics business provided them with sufficient investment capital.

By Autumn 1980 they had designed and produced 3000 units of the Mephisto portable chess computer. Within a month, orders had reached 18,000 and the production facilities had to be expanded.

In January 1982, about eighteen months after the production of the first Mephisto, the firm produced an updated version of the program, called the Mephisto II. By the end of last year, the firm reckons that total sales had reached 25,000, with 6% of these units being sold in the UK, through Competence, run by Terry Knight. A full-sized, well-finished wooden sensory board and wooden pieces were then produced as an add-on to the portable set.

The details that follow were provided by German amateur chess champion Ossi Weiner who has worked as a consultant for the firm since 1981.

By profession, Weiner is an architect, but he has played in the German Bundes League, the top German chess league, for a number of years. He has an estimated ELO rating of 2300 and has been champion of Munich three times. In 1980 together with two others he wrote a book about chess computers. This started him off as a chess journalist and a number of articles in magazines and newspapers followed.

He gave up his profession to become more involved with chess programs and artificial intelligence. In the first instance, this took the form of setting up his own

chess shop specializing in selling microcomputer chess machines. By 1980 chess computers had become very popular in Germany and the shop did well.

He decided that Hegener and Glaser had a machine with a great future in the Mephisto. He started to buy more and more of Hegener and Glaser's stock, and in the end was buying a significant proportion of the whole stock.

'Hegener came to see me and said, you are so good at selling chess computers. Don't waste your time running this shop; come and join us — so I did,' he said modestly.

Since then he has been an integral part of the Hegener and Glaser team, along with the programmer Thomas Nitsche.

From Weiner I learned that work is now well advanced on the Mephisto III, a machine which the firm hopes will break the ELO 2000 rating barrier.

According to Weiner, the Mephisto III program will continue on the same lines as the Mephisto II. He explained that the Mephisto programs are different from the majority of other chess programs on the market, in being more selective. They don't specialise in brute force calculations.

Brute force in chess programming has a very specific meaning. It means that the program looks at every possible move, no matter how idiotic or unlikely. The Mephisto program aims for a pre-selective, intelligent search, and in-depth analysis. For example, at tournament level, the Mephisto II does a four/four balanced search. In other words, it makes four brute force moves, followed by four selective moves, in its search sequence. We are talking here about an eight ply searching sequence, or four full moves for white and black.

If there are checks or forced captures involved, of course, the selective search can go deeper, even on the Mephisto II.

According to Weiner, the Mephisto II has won a number of games by playing strategically better than other chess computers, though the other side of this coin is that it has also lost tactical games to machines whose concentration on brute force paid a better tactical dividend in positions with tactical complexities.

With the Mephisto III, the brute force component of the search will be reduced to the initial two ply. From there the selective mechanism will take over up to a depth of thirteen moves on the lines.

'This posed us a problem,' Weiner said. 'How does the machine decide which is a main line?' This, he pointed out, is the creative part about designing and writing a chess program, that is, sorting out how the chess program will find out where to search

and where not to search.

The solution, Weiner said, was to have the machine distinguish between 'quiet' and 'wild' positions, and to approach the two types of position differently. Quiet positions are those where there are no immediate tactical possibilities. Wild positions, as the name suggests, are positions where a lot is going on, where pieces can be captured and attacked or checks given.

Traditionally, computers play quiet positions very badly. Machines which specialise in brute force calculation of tactical positions find themselves with no obvious move to make. What happens, as a glance at computer games listings will show, is that the machines act aimlessly. They shuffle rooks from square to square or march their castled kings from side to side. The result is like suspended animation until some human operator puts them out of their misery, or they exhaust the fifty move rule.

'What has to happen here', Weiner said, 'is that the computer attack has to have a way of recognising that this is a special type of position. It is a time not for tactics but for planning ahead. It has to devise a strategy for the game'.

Writing the algorithm which will give the machine such a capability is no easy matter. According to Weiner, the algorithm has to specify such matters as how to evaluate the relative strengths of king and queen side flanking movements, pawn structures and so forth. The result, in the Mephisto's and Roman III's case is that it now plays a very 'intuitive' game.

'The nice thing about it is that it can surprise you with its moves. Normally, if you understand chess computers you can lay money on the moves they will make and win every time. But this machine surprises even Thomas Nitsche,' he said.

The other side of the coin is that in playing more intuitively the machine has become more 'humanlike'. It will play brilliantly one day and have a totally wrong intuition the next day.

On the lower levels, there is no real improvement — perhaps even a slight weakening — by contrast with the Mephisto II and Roman II. But on the higher levels, particularly tournament level, where 19 ply searches are possible, it will play a much stronger game, Weiner says.

At the moment the programme is running on a large computer and has not yet been translated into microprocessor assembler code. It has taken and is taking a long time to de-bug, mainly because of this intuitive approach. But Weiner hopes that it will be ready for the German micro-computer tournament in Hamburg in August.



Mephisto with full-sized board

In addition to its success with the Mephisto, Hegener and Glaser scored a notable victory recently in the matter of the TV World Cup put on jointly by the BBC and German television.

Those of our readers who watched that tournament, screened every Sunday on BBC2, would have seen the Mephisto legend flash up in red on the screen from time to time. A rather complicated tale lies behind this. For while it passed relatively unnoticed in the UK, in Germany that Mephisto sign popping up on the TV screens caused more than just raised eyebrows.

Der Spiegel, the German equivalent of *Time* magazine, devoted a full page to telling its readers what an outrage this was. Advertising is unheard of on German TV. Yet here in the most blatant form was the Mephisto legend advertising, albeit indirectly, a product from Hegener and Glaser.

It came about like this. Helmut Phlegner, the German grand master, belongs to the same chess club as Ossi Weiner. Phlegner was to do the commentary for the World Cup for German television. He told Weiner that the current system for moving the pieces on to the display board was unsatisfactory and far too complicated.

It took a lot of time, and needed two cameras. This made it really expensive as well as difficult. Phlegner mentioned to Weiner that Scisys had been trying to produce a system to solve this problem but that it hadn't succeeded yet.

Weiner told Hegener and Glaser about the problem and they were interested. BBC representatives came to Munich and met Hegener and Glaser to discuss a possible development. 'We told them it was an expensive business developing a project like this,' Weiner said. 'The TV people said that they didn't mind, it costs thousands of pounds to film in any case. Go ahead and develop it,' they told us.

'We intended to develop such a system in any case. And with considerable work and effort we did come up with one.' The finished system does away with the need for cameras and with long hours of studio rehearsals, since Hegener and Glaser had the logical idea of using the chess board as if it were a terminal to input information directly to the TV screen.

The TV screen displays a chess board and simply by moving a real piece on the

real demonstration board it makes the same piece move on the television screen. Additional controls were built into the system to enable the demonstrator to highlight any square that he chose.

It was obvious that the system would save masses of TV time since no camera crews were needed at the demonstration session. But the system itself was not cheap to build. It was necessary to use a computer to interface with the display board and considerable processing power and storage was needed to drive the extremely high resolution graphics display.

(According to Weiner the interface system designed by Hegener and Glaser tells each of the million dots on the TV screen which colour to take on, at any particular moment.)

When the system was complete Hegener and Glaser took it to the TV people and here is where the problems began. They had taken it upon themselves to design a system without signing a contract. This might sound daft, but it was strictly a practical decision. As Weiner pointed out, nobody they spoke to had the authority to give them the go-ahead. 'Everyone we spoke to at the BBC or at German television thought that it was a wonderful idea but none of them could authorise money to fund the development.'

In the end the development work took four months and cost Hegener and Glaser between one hundred thousand and two hundred thousand Deutschmarks. During all this time they hadn't seen a penny on their investments. 'We weren't looking for a fortune, but we wanted some contract that would give us at least our demonstration costs back,' Weiner said.

The television people said that it was impossible, and suggested that they should be allowed to use the device during the broadcasting of the tournament, on spec as it were. 'They told us, if it's good, then we'll pay you,' Weiner said.

Obviously, that wasn't a particularly satisfying arrangement. In the end, being practical men and women, an amicable arrangement was worked out. It was agreed that Hegener and Glaser should be paid 25,000 Deutschmarks and to compensate them for their development costs the Mephisto sign would be flashed up on the screen now and then.

This somewhat unorthodox agreement.

satisfied both the TV people and Hegener and Glaser, who were alive to the publicity value of having their name broadcast to a selected interested audience, who, by the simple act of watching the chess coverage on TV, had declared themselves potential buyers of microcomputer chess sets.

None of this was to the liking of *Der Spiegel* which felt that some underhand activity must have taken place and which devoted one full page to telling its readers what a scandal this was. Weiner was most aggrieved when he mentioned this, '*Der Spiegel* made a great thing out of it. All the facts were open to the public to know from the start. We answered all their questions, fully and frankly and the net result was written up as though it was brilliant investigative journalism.' But Weiner reckoned that even the publicity provided by *Der Spiegel's* write-up did Hegener and Glaser a reasonable amount of good. 'People said Hegener and Glaser must be pretty smart if they can beat the advertising rules like this,' he said.

Just how smart they are, we will be able to judge for ourselves when Mephisto III comes onto the market later this year.

Games section

White: Mephisto II; Black: Fidelity Elite Sicilian Defence: Notes by David Levy

1	e2-e4	c7-c5
2	Nb1-c3	Nb8-c6
3	f2-f4	e7-e6
4	Ng1-f3	Ng8-f6?!

(More usual is 4...g7-g6, or 4...Ng8-e7 followed by ...d7-d5.)

5	e4-e5	Nf6-d5
6	Nc3xd5	e6xd5
7	Bf1-e2	c5-c4?!

(More to the point would be 7...d7-d6, to undouble the d-pawns.)

8...d2-d3?

(Better 8 0-0.)

8	...	c4xd3
9	Be2xd3	Bf8-c5
10	Bd3-e2	Nc6-e7
11	c2-c4?!	

(White is already embarrassed by the fact that it cannot castle K-side, because of the black bishop on c5, and now compounds this by voluntarily undoubling Black's pawns.)

11	...	d5xc4
12	Be2xc4	Qd8-b6

GOTO page 131



For travellers...



COMMUNICATIONS



PCW welcomes correspondence from its readers but we must warn that it tends to be one way! Please be as brief as possible and add 'not for publication' if your letter is to be kept private. Please note that we are unable to give advice about the purchase of computers or other hardware/software — these questions must be addressed to Len Warner (see 'Computer Answers' page). Address letters to: 'Communications,' Personal Computer World, 62 Oxford Street, London W1A 2HG.

'Annoyed'

Having just read the March 83 edition of *PCW*, I am extremely annoyed. I am a regular reader of your magazine and have been ever since I bought my first computer in 1979. Until now you have been relatively unbiased toward any particular machine, or any aspect of microcomputing.

Personally I think that the whole aspect of micros was much better before the big name electronics firms jumped on the bandwagon. All too often these companies only promote obscure standards for their own financial gain. I realise that they are in business only to make money but a lot of good ideas from smaller firms get swept aside simply because they don't have the big name or the big money. You obviously go some way to support this theory, at least that's the way I interpreted the article entitled 'Mug Trapping' on page 104. So why do you have to mention IBM no fewer than 52 times in the 7-page 'Newsprint' article and then again seven times on one page of 'Banks Statement'?

I don't buy the magazines that deal only with the ZX81 simply because I don't use a ZX81, similarly I do not intend to buy a magazine that compares every other product with IBM. It has been stated many times that micro-computing bears little resemblance to mainframe computing, so just because one firm becomes the top dog in mainframes it should not be assumed that they are going to achieve the same results with micros. I for one hope that they don't as this could well lead to stagnation in the micro field.

If I want a glossy book all about IBM then I daresay they would supply me with one, probably free of charge. I certainly would not be prepared to pay 85 pence for it

under the guise of a *PCW* cover.

Ramon Milton, Folkestone, Kent

Taking your points in order, we will always be totally unbiased towards any machine/manufacture. I can't see how anyone can describe CP/M-86 or MS-DOS as 'obscure standards'. Like it or not, Milton, small companies producing hand-crafted micros have no future in this business. It's our job to report what's happening in the industry and the European launch of the IBM is an important event, hence the coverage not only in PCW but in all other micro magazines and most serious national newspapers — Ed.

Tandy brush-off

May I be permitted through the columns of your magazine to make a comment about the treatment afforded to me by 'Tandy Corporation (UK)'?

My son has a TRS-80 Model 1 and he found that the cassette relay situated within the CPU became faulty so he duly desoldered the offending said part and we presented ourselves, with part, at a Tandy shop (not in Edinburgh) with the intention of purchasing a replacement part. We were advised that although the relay was held in stock it was not possible to sell it to us; but if we left the CPU the shop would be very happy to install the new part. We were also advised that because we had had the audacity to open up our computer (NB. Guarantee period well expired) not only would we have to pay for the part plus labour for the work, we would also be charged a sum of £5 as a penalty for opening up the CPU. We were told exactly the same story at another branch of Tandy ie, it is company

policy to make such a surcharge.

Not being able to accept that a customer should be given what would appear to be a 'brush off' I wrote to Tandy with the above story with a request as to why I could not be sold the part when we were perfectly capable of installing it. I did not even receive the courtesy of an acknowledgement. I waited a few months and wrote again, with a summary of the above, asking for a full reply to my earlier letter. I duly received a reply from the Computer Sales Controller informing me that he had no trace of my earlier letter but would I complete 'the enclosed form of indemnity' and return it along with my cheque for the part plus post, it would be sent to me. I replied immediately, by Recorded Delivery, to the effect that that was all very well; but he had still not replied to my letter. To date, no reply has been received.

I would welcome comments as to whether this is the recognised treatment given to customers by Tandy?

**Hugh J Leckie
Edinburgh**

DIY

I have a ZX81, and perhaps the adaptation I have made will be of interest to other ZX owners.

One of the ZX's faults is the lack of an 'on-off' switch, so I decided to fit one. The keyboard would also be better if the slope-angle was a little more acute. With this in mind I decided to combine a solution to both problems.

After a little thought the answer was simple, cheap, and, above all, successful. I bought a paint roller tray from a local DIY store for 70p and a switch from a car accessory shop for 60p. I cut off the support legs on the base of the paint-tray, which left a flat surface and a sloping one on the base. From the flat surface

I cut a section out for the 'power-pack' to fit into. The switch I fitted in the side of the tray. A small hole next to the switch, and another at the back, enables the power cable to enter and exit.

With the paint-tray upside-down there is now a flat, back area, with the 'power-pack' inserted and a sloping front area, with the computer on it.

All that remains is the wiring up of the switch. To this end I used a terminal-block connector, the cheap plastic type, again from a DIY shop, at a cost of only a few pence. Although this is by no means necessary it does enable easy disconnection and re-connection outside the new stand, should that ever be required.

I have used this adaptation for some time now and it is a great help with typing in a program, and it saves a lot of wear on the 'jack-plug' power point too.

It was a very simple operation to make the stand (simpler than trying to describe the process), and the result looks good too, as the tray was made of black plastic, and so matches the ZX and the whole thing cost less than £2! It also makes no difference if a 16k pack is fitted too.

**I P Finnerty
Great Sankey, Warrington**

'Twisted'

I am disappointed in you and your magazine. Before reading your March issue I was under the obviously mistaken impression that your magazine was neutral and unbiased. I am referring to your disgraceful treatment of the IBM Personal Computer. I have never read such twisted facts. I know that, like others, you suffer from the misconception that IBM is some big, bad corporation picking on poor, innocent, unsuspecting companies, but it may interest you to know that the PC is now outselling the DEC Rainbow

in the USA.

I also not that you dwell considerably on the *few* disadvantages of the system, whereas you totally ignore the many superb features of the system, like the superb quality display, the high resolution graphics, the 40k ROM, the fast processing speed, the maximum memory of over 500k, the keyboard which is a joy to use, and all the backing of the best computer company in the world. I believe that the views stated by Guy Kewney only show a total ignorance of the computer world. He is the 'mug' not the people who buy hardware and software from IBM.

P J Logan, Solihull, West Midlands

Come off it Logan, there are several 16-bit machines around with higher disk capacity, high resolution graphics and nicer keyboards selling at lower prices than the PC — Ed

Standard micros?

I wholeheartedly agree with Guy Kewney's suggestion that a potential microcomputer purchaser buys what is in the shops on the day he has the money. I am surprised therefore that *PCW* pays so much attention to yet-to-be-released 16 bit microcomputers and ignores so many microcomputers that can be bought off the shelf. Those microcomputers ignored include the Digital Equipment Corporation PDP-11 range of microcomputers and the Data General Micronova and Micro-eclipse ranges of microcomputers. I suspect that *PCW* does not regard these computers as microcomputers because they were available first in minicomputer versions. However, when I look at a 40 pin Z80 CPU and a 40 pin PDP-11/23 CPU I can't see much difference.

I am a strong believer in CP/M 80 because of the wealth of software available under it. I am a strong believer in the PDP-11 operating systems RSX-11 and RT-11 for exactly the same reason. Is so much software available for any other family of 16 bit microprocessors?

So far as not-yet-available microprocessors are concerned the ones that interest me are Digital's 16/32 bit microprocessor, the J11, and National Cash Register's 32 bit microprocessor. Both are about as powerful as the Motorola 68000 and the National Semiconductor 16032 but have a great deal more software available for them. The NCR microprocessor is particularly interesting because it offers both the NCR and IBM 370 mainframe instruction sets. Perhaps someday IBM's menu driven Small Systems Executive for the 370 will be as popular for desk top micros as CP/M 80.

Paul Mayoh, Loughborough, Leics

Big Beeb disks?

I have just received a letter from Acorn Computers Ltd, stating 'We regret that we will not be producing software to support 8in disk drives'. This is the first indication I have heard of such a decision, and is not in accordance with the published specifications for the BBC micro. Contrary to what Acorn says, the specifications do not warn against 'being subject to change'.

I have therefore written a letter to Acorn requesting a public statement answering some questions, including:

When was this decision not to support 8in disk drives taken?

As this is not in accordance with the published agreement between the BBC and Acorn Computers Ltd, has the BBC OKed it?

Why has not the public been made aware of this, and what can be done to change this decision, to the benefit of all those who want to use the BBC micro for serious applications?

I have also pointed out the problem of obtaining software in a BBC-compatible format on 5¼in disks when the BBC micro is used with the Z80 second processor, with a CP/M-compatible operating system. I have also asked if Acorn will make available a service that transfers software running under CP/M and is supplied on 8in disks in a universally accepted format to

5¼in disks in a format suitable for the BBC micro and the Z80 box.

As I know this will be of interest to many users (and especially would-be-users) of the BBC micro, I would like Acorn Computers Ltd to answer through this column, to the benefit of all readers of *PCW*.

M Christiansen, Trondheim, Norway

Well, how about it, Acorn? — Ed

Bad bugs bite back

Bug-Byte has a two-page advertisement in your March issue extolling the marvels of its games software. They may be as good as Bug-Byte describes them, but after nearly a year of trying to get one that worked, I gave up trying to find out.

I ordered 'Space Warp' in April 1982. This was the first game I had bought, so that when it did not work I thought it must be my recorder. I tried three recorders and it still did not load. I returned it, and after about two months Bug-Byte sent me a replacement. This did not load either. I returned it and waited for my money to be returned. I waited five months. In that time I wrote to Bug-Byte twice, including once to its Managing Director, without any acknowledgment from them. Finally, in January I received another copy of 'Space Warp', despite having asked for my money back. This copy did not work either!

After indicating that I would take stronger action if my money were not returned, I received a cheque from them without any covering letter or note for their really appalling service.

B Kemp, Kingswinford, W Midlands

Plagiarism

TJ's Workshop column in February '83 contained a useful contribution from Anthony Newgosh called 'Poking the MZ-80K'. Recent publications also contained similar hints. What these 'contributors' failed to reveal was the source of their

information constituted a major part of a recent paperback publication from Sigma Technical Press called *Sharp Software Techniques* by DH Trowsdale and M Turner.

Surely this is a serious copyright infringement, which is rather a grey area in computing circles. What little information I have obtained points to major loopholes in legal obligations towards software protection. Copyright laws are almost identical in Ireland to UK legislation but I am surprised nothing has been done in this area.

A simple example might prove this point. Take a popular game, say Mastermind. This program could be sold by any person without copyright infringement by simply changing one of the variable names. Is this an example of deficiencies in current legislation?

There are other areas which are cause for serious concern, namely, individuals' right of access to personal information held on numerous government departmental computers and the right to have misleading or incorrect information amended.

There may be the foundation of a series of articles on this grey area for future publications which ultimately could lead to constructive legislation.

As I do not have a legal background, these are personal reflections on this area. I also wish to point out that I have no connection whatsoever with the aforementioned publisher.

Brian Hurley, Limerick, Eire

It is equally likely that the TJ contributors discovered the POKEs for themselves by sitting down and experimenting. Perhaps authors of the above-mentioned book collected their ideas from TJ's Workshop? — Ed

Offbeat functions

John Evans' method for providing in the inverse trig functions lacking in most dialects of Basic (*Communications*, April), struck me as being far too slow for any serious application (least of all tracking satellites!). Simple application of Pythagoras' theorem quickly provides formulae for arc cos and arc

WORD PROCESSORS, TEXT EDITORS & AIDS · WORDSTAR · WORDSTAR TRAINING GUIDE · MAILMERGE · SPELLSTAR · PARAGRAB · ELECTRONIC THESAURUS · PEACH PACK · PMATE · MICROSCRIPT · MICROPEN · SPELLBINDER · TYPING TUTOR STAR-EDIT · SCRIBBLE · WORDINDEX · WORDMASTER · ZIP · NUMERICAL MODELLING SYSTEMS, OPERATIONAL RESEARCH AND STATISTICS · CALCSTAR · MULTIPLAN · MARS · MICROMODELLER · SCRATCHPAD · SUPERCALC · T/MAKER II · PLANNER CALC · MASTER PLANNER · FAST PLAN · MATHEMAGIC · MILESTONE · MICRO-STAT · OPTIMIZER · STATGRAPH · STATPACK · DATA MANAGEMENT SYSTEMS · DMS · DELTA SYSTEM · CARDBOX · dBASE II · AUTOCODE · DATA-STAR · INFOSTAR · REPORTSTAR · DATAFLOW · DATA-VIEW · FMS-80 · PERSONAL PEARL · ACCESS MANAGER · GENERAL BUSINESS APPLICATIONS · GRAFFCOM · FAST · FINANCIAL DIRECTOR · MICROMAS · D B FLEX · INCOMPLETE RECORD SYSTEM · TRIDATAFAST · MISCELLANEOUS · CATCHUM · ANALIZA · NEMESIS · DUNGEON MASTER · MILLIONAIRE · DATEBOOK · MAIL ORDER · MAILMAN · MENU MASTER · SUPPORT SERVICES · COURSES · INTERACTIVE TRAINING PROGRAMS FOR: CP/M · dBASE II · WORDSTAR · MBASIC · SUPERCALC · MULTIPLAN · I.B.M. PC · DOS · PROGRAM DEVELOPMENT AIDS · BUG & uBUG · RAIDSID · SID-86 · ZSID · DISTEL · DISILOG · PLINK · PLINK II · XLT-86 · TRANS-86 · DIAGNOSTICS · DISK DOCTOR · RECLAIM · RECOVER · DISK EDIT · UTILITIES 1 & 2 · SYSTEM CHECKER SEAL · ENCODE/DECODE · ELINK · UNLOCK DESPOOL · ZDI · BT-80 · LINK-80 · PROGRAMMERS APPRENTICE · THE LAST ONE · STRING/80 · TEX · DISPLAY MANAGER · PROGRAMMING LANGUAGES · ADA · ALGOL-60 · BASIC · S-BASIC · X-BASIC · CBASIC · CBASIC-86 · CB-80 · CIS COBOL · FORMS 2 · ANIMATOR · NEVADA COBOL · COBOL-80 · RM COBOL · FORTRAN-80 · RATFOR · LISP · MULISP · PASCAL M · PASCAL/MT · PASCAL/MT+ · SPP · PRO-PASCAL · PASCAL/Z · PASCAL B/Z · JRT PASCAL · TINY PASCAL · PL/I · TINY-C · WHITESMITH'S C · MACRO-80 · C COMPILER · MAC · PASM · SW FORT 1 · MuSIMP · CP/M · CP/M-86 · CP/M NET · SORTING PROGRAMS · M/SORT · SUPERSORT · COMMUNICATIONS SOFTWARE · BSTAM · BSTMS · RBTE-80 · TERM · TERM II · CROSSTALK · MOVE-IT · BOOKS & PUBLICATIONS · HARDWARE AND ACCESSORIES · DYSAN DISKS · HELP & ADVICE · MICROPRO BROCHURES

WORD PROCESSORS, TEXT EDITORS & AIDS · WORDSTAR · WORDSTAR TRAINING GUIDE · MAILMERGE · SPELLSTAR · PARAGRAB · ELECTRONIC THESAURUS · PEACH PACK · PMATE · MICROSCRIPT · MICROPEN · SPELLBINDER · TYPING TUTOR STAR-EDIT · SCRIBBLE · WORDINDEX · WORDMASTER · ZIP · NUMERICAL MODELLING SYSTEMS, OPERATIONAL RESEARCH AND STATISTICS · CALCSTAR · MULTIPLAN · MARS · MICROMODELLER · SCRATCHPAD · SUPERCALC · T/MAKER II · PLANNER CALC · MASTER PLANNER · FAST PLAN · MATHEMAGIC · MILESTONE · MICRO-STAT · OPTIMIZER · STATGRAPH · STATPACK · DATA MANAGEMENT SYSTEMS · DMS · DELTA SYSTEM · CARDBOX · dBASE II · AUTOCODE · DATA-STAR · INFOSTAR · REPORTSTAR · DATAFLOW · DATA-VIEW · FMS-80 · PERSONAL PEARL · ACCESS MANAGER · GENERAL BUSINESS

There's so much to choose from. But only one choice to make...

Software Limited. Simply because we've got one of the largest stocks of CP/M Software in the country. And it's available straight off-the-shelf to cover the major formats.

Our expert advice and comprehensive catalogue, make certain that the very latest Technology will

work hard for your business.

Software Limited... Because there's more to choose from, it's the only choice to make.

**01-387 8832 or
01-380 0015**

Software Limited, Duchess House,
18/19 Warren St, London W1P 5DB.
CP/M is the trademark of Digital Research.



Attractive quantity & dealer discounts available

COMMUNICATIONS

sine, and the slightly more esoteric functions of arc secant and arc cosecant are all derived from the arc tan function provided on virtually every version of Basic. These can easily be incorporated into a program using the following function definitions:

```
DEF FNACOS(X) =
ATN(SQR(1/X/X-1))
DEF FNASIN(X) =
ATN(X/SQR(1-X*X))
DEF FNASEC(X) =
ATN(SQR(X*X-1))
DEF FNACOSEC(X) =
ATN(1/SQR(X*X-1))
```

These function definitions are only valid for valid values of X, ie:

```
Arccos: 0 < X <= 1
Arcsin: 0 <= X < 1
Arcsec: X >= 1
Arccosec: X > 1
```

Note that any argument that would give an angle of $\pi/2$ gives a divide by zero error, and these cases should be checked for.

Nick Osborne
Sutton Coalfield

BM5	10.82	15.40
BM5	10.32	21.38
BM7	30.15	30.12
BM8	55.56	38.56

All times are in seconds and done over a series of days — these are the average of the times obtained. The speed of the machine is 4 MHz. I hope these are of use to you.

I now know that there is very little difference between the two languages. The BBC Basic (Z80) cost only £95 + VAT and will run on most CP/M machines. This package was purchased from M-Tec Computer Services.

One big advantage is that my son (16) can now get going on his O-level project at home and not bother with the school's BBC machine and the 10,000 other children trying to get their program done.

I would be interested to know if any other readers have had experience with this version of BBC Basic.

Ian Masters, Thetford,
Norfolk

Sandison's.

The major difficulty in using any of the usual languages (eg, Basic, Cobol, Pascal) seems to be the problem of how to represent the relationship between records in such a way as to still allow great flexibility in changing or adding to the data. For example, if I should suddenly want to add details of my great-grandfathers' sisters this should be possible without major surgery on the program. I'm not sure that a coding system like the one Mr Sandison proposes is the best approach, it tends to be too rigid and artificial, though it is not easy to improve upon if one is confined to Basic.

I would suggest that it is worthwhile taking a look at the facilities offered by Lisp. I recently bought the Lisp tape for my BBC computer and it seems to provide exactly the type of data structures needed for a family tree and lacking in Basic. I must admit that since I have not as yet been able to obtain the manual my ideas have not been tested in practice and Lisp is new territory for me despite over 10 years in D.P. However a careful reading of *LISP* by Winston & Horn (which I recommend) has made me reasonably confident in this approach.

Richard Grubb, Newark,
Notts

BBC timings

Listed are the results of the PCW Benchmark tests conducted on a Grundy 8200 using BBC Basic (Z80) and Microsoft Basic.

	M.SOFT	BBC
BM1	1.1	.84
BM2	3.9	3.80
BM3	10.27	12.34
BM4	10.04	13.57

Adopting Lisp

I was very interested by A Sandison's article on Genealogy in the April PCW.

I have often thought about producing a program for recording family history. But after turning over in my mind several different methods I eventually settled on a very very different approach to Mr

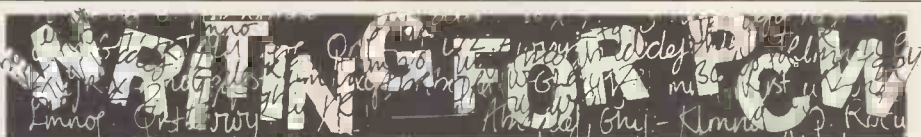
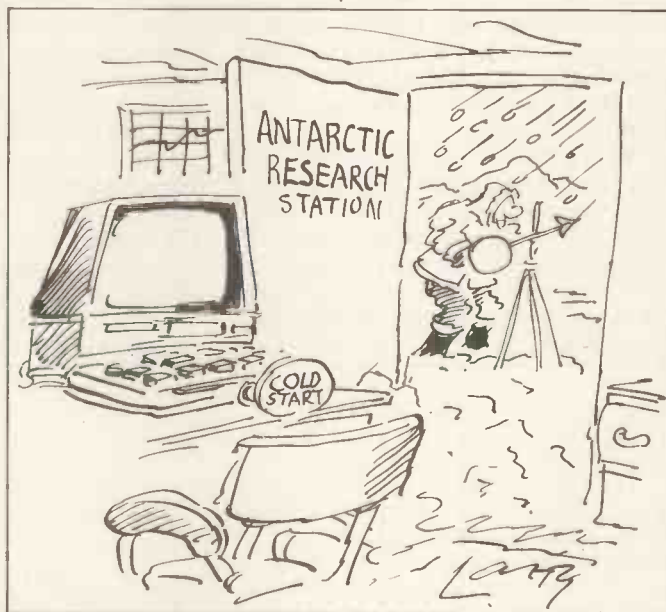

PCW welcomes approaches from would-be writers, even those who have never appeared in print before. In this game it's often those with practical experience who have important things to say so we don't mind if your prose is less than perfect — providing submissions have a sensible structure and follow a logical sequence, we can take care of the polishing.

If your article is already written, send it in — taking care to ensure that your name and address, together with a daytime phone number if possible, appears on both the covering letter and the manuscript. Manuscripts should, preferably, be typed or printed out (dot matrix output is quite acceptable) but *must* be double line-spaced with ample margins top and bottom and on each side. Make sure you keep a copy of *everything* you send us.

We can now accept articles on a limited number of disk formats: standard IBM 3740 single-sided, single-density 8in, and the following 5¼ in formats: Superbrain

SSDD 35-track; RML 380Z SSSD; Sharp MZ-80K/A DSSD, Cromemco SSSD, Nascom DSSD, Rair/ICL DSDD, SD Sales SSSD, Triton 35 track SSDD and ACT Sirius 1 (CP/M-86 or MS-DOS) single-sided. By prior arrangement we can accept stuff over the phone by modem using BSTAM at 300 baud but as we can only do this during office hours (10am to 6pm) it's not exactly a cheap way of getting your article to us! In the near future we hope to be able to accept material by The Source and Rewtel. Please note that if you want to send your article in this way, it should be as an ASCII file rather than as a 'work file' for any one type of word processor — ie, use your word processor to print the text to disk instead of to paper.

Please note that we cannot undertake to return manuscripts, diagrams and photographs, although we always try to return the latter. We can only return disks if they are accompanied by adequate postage and packaging.

If you have an idea for an article or a series, write us a letter outlining your ideas. A one- or two-page synopsis giving the proposed structure, sequence and content is what we're looking for. But before you send anything to us, take a good look through *PCW* to see what sort of articles get published and to see what style of writing we prefer (basically, avoiding pomposity at one extreme and flippancy at the other). Also take a look through the Back Issues advert to see what sort of things we have already published — no point in re-inventing the wheel.

Once you've sent off your article or proposal, please don't hassle us for a decision. We receive far more submissions than we can ever use and it takes us a while to sort through them, acknowledge receipt and give an opinion one way or the other. Please be sure to tell us if you've sent the article to another magazine — it would be very awkward indeed if the same article appeared simultaneously in two publications! Frankly, we're more likely to accept something which has been offered exclusively to us.

Finally, we do pay for published work but please be patient! Payment *normally* follows about 4-6 weeks after publication.

HARDWARE

A J Simmonds details a simple Centronics interface for Video Genie and TRS-80 Model 1 micros.

CENTRONICS HOOK-UP

I have had a Video Genie for a year now, but I have only just bought a printer (a Tandy Lineprinter VII with Centronics interface). I could not afford both an expansion interface and printer, so I decided to build an interface circuit to connect between the Video Genie expansion interface bus and the printer's Centronics port. There are interface circuits which you can buy to do this job, but the circuit is relatively simple, so I decided to build it myself and put the money I saved towards a disk drive! The circuit can also be used by a TRS-80 Model 1.

The Video Genie uses port FDH (decimal 253) for the printer, the TRS-80 Model 1 uses memory location 37E8H (decimal 14312). Normally this causes no problems for the Genie user, but for EDTASM it is a problem since EDTASM uses its own printer driver routine (not the ROM routine) and naturally expects the printer to be at

37E8H. This was done so the EDTASM could be used with both Level 1 and Level 2 Basic. It's possible to rewrite EDTASM for the Genie; the changes necessary are to replace LD A, (37E8H) with IN A, (FDH) for the printer status check, and to replace LD(37E8H), A with OUT (FDH), A to print a character. However a simpler way is to do it in hardware, by ORing the TRS-80 printer address decoding with the Video Genie printer port address decoding. The circuit is shown in Figure 1. I suggest that first you try getting the circuit to work with the LLIST and LPRINT commands, and then try adding the circuitry for EDTASM. For a TRS-80 Model 1 you only need the address decode circuitry as shown for EDTASM.

This circuit has been built and tested. It worked first time and, assuming there are no mistakes in the diagram and you check your wiring before you switch on, it should

work first time for you. Just in case you do make a wiring mistake, it's best to use IC sockets.

All chips should be low power Schottky TTL (74LS series) since they are to be powered from the interface pins to save the need for a separate power supply. In Figure 1 the chips are identified by their type, eg, 123 is a 74LS123; if there are more chips of the same type then they are numbered, eg, 30-1 and 30-2 are both 74LS30. ICs 123, 241 and 367 should be powered from pin 18 (+5v) of the Centronics connector. All other ICs should be powered from pin 19 (Vcc) of the Genie expansion bus. Pins 1, 2, 49 and 50 of the Genie expansion bus and pins 19-30 and 14-17 of the Centronics connector provide the earth and should be connected together. The Lineprinter VII only provides a Busy signal for the status, hence the other status signals (Fault, Unit Select and Out of Paper) are constant

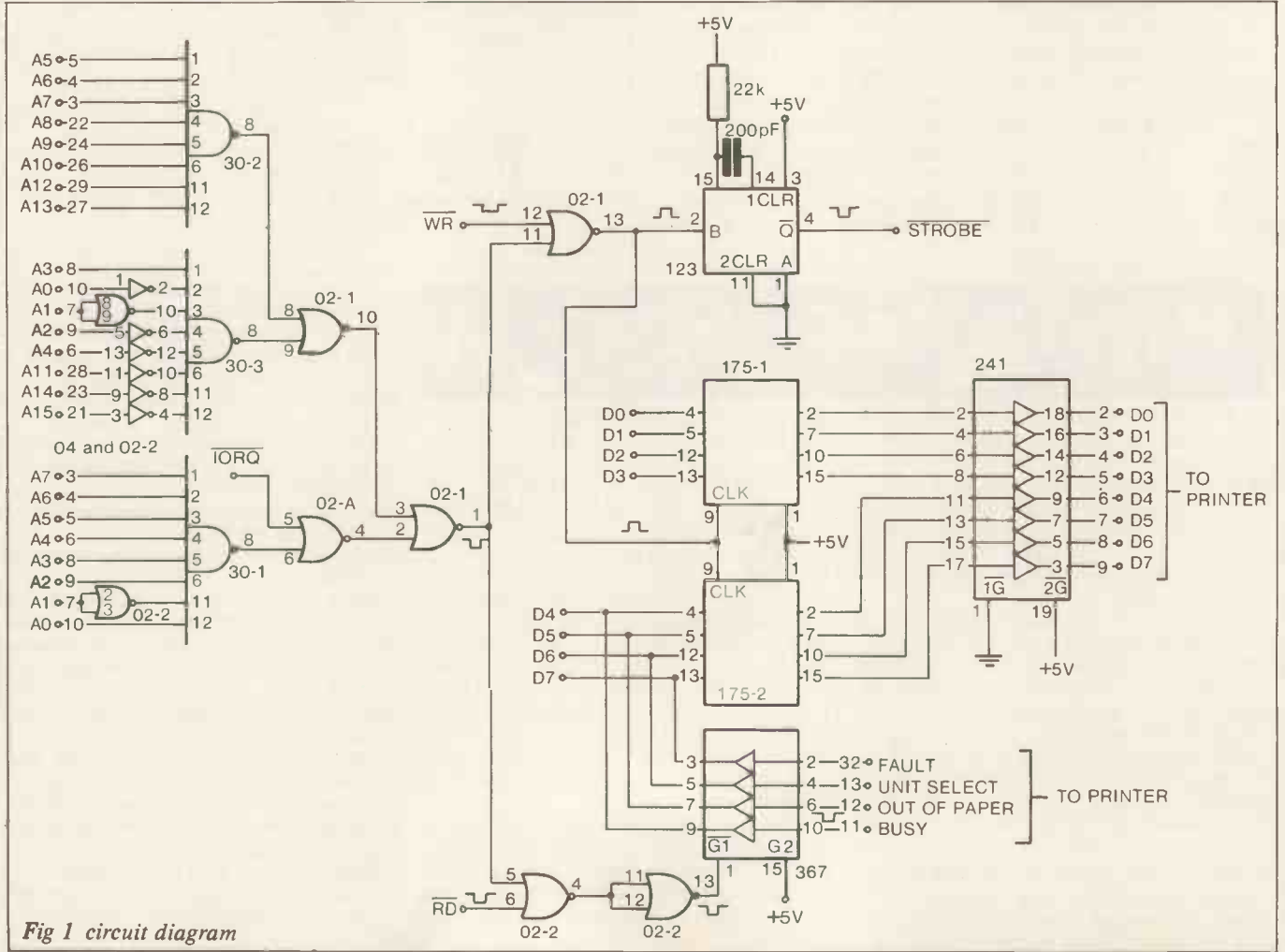

Fig 1 circuit diagram

IC	+5v	earth
04	14	7
30-1	14	7
30-2	14	7
30-3	14	7
02-1	14	7
02-2	14	7
175-1	16	8
175-2	16	8
+5v from pin 19 Genie expansion bus.		

IC	+5v	earth
123	16	8
241	20	10
367	16	8
+5v from pin 18 Centronics connector.		

Fig 1 Power connections

Printer Status	Active	Centronics Pin	Lineprinter VII
Fault Unit	low	32	high
Select	high	13	high
Out of Paper			
Busy	low	11	Busy

Fig 2

voltages. The Centronics interface is designed for reasonably long connections, so I have a 2m long cable. The Genie expansion bus on the other hand is not — I think 10 centimetres of cable is the maximum it can cope with. You will need a 36-pin AMP connector for the Centronics interface, 2m of 36 or 37-strand cable, 10cm of 50-strand cable and a 50-pin female connector for the Genie expansion bus. To connect the 50-pin connector to the cable you will need care, a vice, and perhaps right at the end a hammer!

As for the circuit description, IC 30-1

1	gnd	26	A10
2	gnd	27	A13
3	A7	28	A11
4	A6	29	A12
5	A5	30	phi
6	A4	31	pint
7	A1	32	nc
8	A3	33	nc
9	A2	34	phlda
10	A0	35	phantom
11	D5	36	halt
12	D2	37	pwait
13	nc	38	IORQ
14	D1	39	phold
15	D0	40	WR
16	D3	41	RD

Fig 3 Video Genie expansion bus

detects when port FDH is addressed (on address lines A0-A7) for a Genie printer request. ICs 30-2 and 30-3 together detect when address 37E8H is addressed (on address lines A0-A15) for an EDTASM printer request (ie, exactly as a TRS-80 Model 1). IC 123 produces a longer strobe than the WR pulse; this is necessary because the Centronics interface is slower than the Genie expansion bus (hence it can be longer). IC 175-1 and IC 175-2 hold the data byte (on D0-D7) till the printer has acknowledged (by setting Busy low) that it has received the byte. IC 241 is a buffer to stop reflections on the Centronics connector from upsetting the flip-flops in IC 175-1 and -2. IC 367 is a tri-state buffer to gate the printer status onto the data lines (D4-D7).

Naturally other ICs could be used instead, eg, a 74LS122 retriggerable monostable instead of the 74LS123 dual retriggerable monostables, two 74LS04s instead of the 74LS241, latches instead of the master-slave 74LS175s and so on. However,

17	D7	42	ccdb/
			stadbs
18	D6	43	mreq
19	VCC	44	dodbs/
			addbs
20	D4	45	ml
21	A15	46	reset
22	A8	47	rfs
23	A14	48	nmi
24	A9	49	gnd
25	nc	50	gnd

Expansion pin edge viewed from rear side:



1	strobe	19	gnd	(pair with pin 1)
2	D0	20	gnd	2
3	D1	21	gnd	3
4	D2	22	gnd	4
5	D3	23	gnd	5
6	D4	24	gnd	6
7	D5	25	gnd	7
8	D6	26	gnd	8
9	D7	27	gnd	9
10	ack	28	gnd	10
11	busy	29	gnd	11
12	out of paper	30	gnd	
13	unit select	31	nc	
14	gnd	32	fault	
15	gnd	33	nc	
16	gnd	34	nc	
17	gnd	35	nc	
18	+5v	36	test	

Fig 4 Centronics parallel connector

it is better to have a built and tested circuit to work from rather than someone's idea of what might work. I hope you have fun building this circuit, and even more out of using it.

PRINTER SPRINTER

Andrew May describes an interrupt-driven Centronics interface.

The disadvantage of running programs which send results to a printer is that a printer is considerably slower than the computer for outputting data. It is possible to obtain printer buffers to speed this up but they usually cost between £100 and £200.

The hardware and software described in this article were developed in an attempt to decrease the time spent by my Nascom computer sending data to the printer. It does this by reserving a section of memory as a buffer to store data which has been output by the computer but not yet sent to the printer. The printer interrupts the computer when it is ready for more data thereby enabling the computer to be effectively processing at the same time.

The program used is given in Listing 1. It is assembled to run in the free memory between 0C80 and 0F80 on a Nascom system and will run on any system running using either the NAS-SYS 1 or NAS-SYS 3 monitor. Memory up to 0D00 has been left free because several other programs use this as work-space.

Two pointers STRTXT and ENDTXT

store the addresses of the start and end of text within the buffer. When text is stored in the buffer the start of text pointer is incremented and when text is output to the printer the end of text pointer is incremented. If either pointer reaches the end of the buffer then it is wrapped around to the start again.

The size of the buffer can be changed by changing the values at the end of the program. At present it is set up as a 16k buffer between locations 5000 and 8FFF, this is the end of memory on a 32k system. A larger buffer means that more data can be output before the buffer is filled, an advantage if a large number of results are to be printed.

The software is divided into three main parts. The first, starting at INTLZE, initialises the PIO as an output port and sets it up to generate interrupts. It also stores the address of the output routine AOUT in the NAS-SYS output routine vector. As a result, every time a character is sent to the screen the same character is sent to the printer. The routine can be turned on

by means of the monitor 'U' command and off again by the 'N' command.

The main output routine, AOUT, stores the character to be output in the buffer. When the buffer is full a HALT instruction is executed. This causes the computer to wait until the printer is ready and can accept the next character from the buffer.

The interrupt routine, INTRPT, is executed when the printer informs the computer that it is ready for the next item of data. The routine takes the next available character from the buffer and sends it to the printer.

The Z80 processor has three interrupt modes, however the two simplest, modes 0 and I, both cause jumps to zero page memory. Since the Nascom system for which the program was written has ROM between 0000 and 07FF these modes were unusable. It was for this reason that Interrupt mode 2, the most complex, is used in the program.

When an interrupt occurs in mode 2, the interrupting device, in this case the Z80 PIO, supplies the processor with an eight bit value. The processor combines this with

Granada Computer Guides

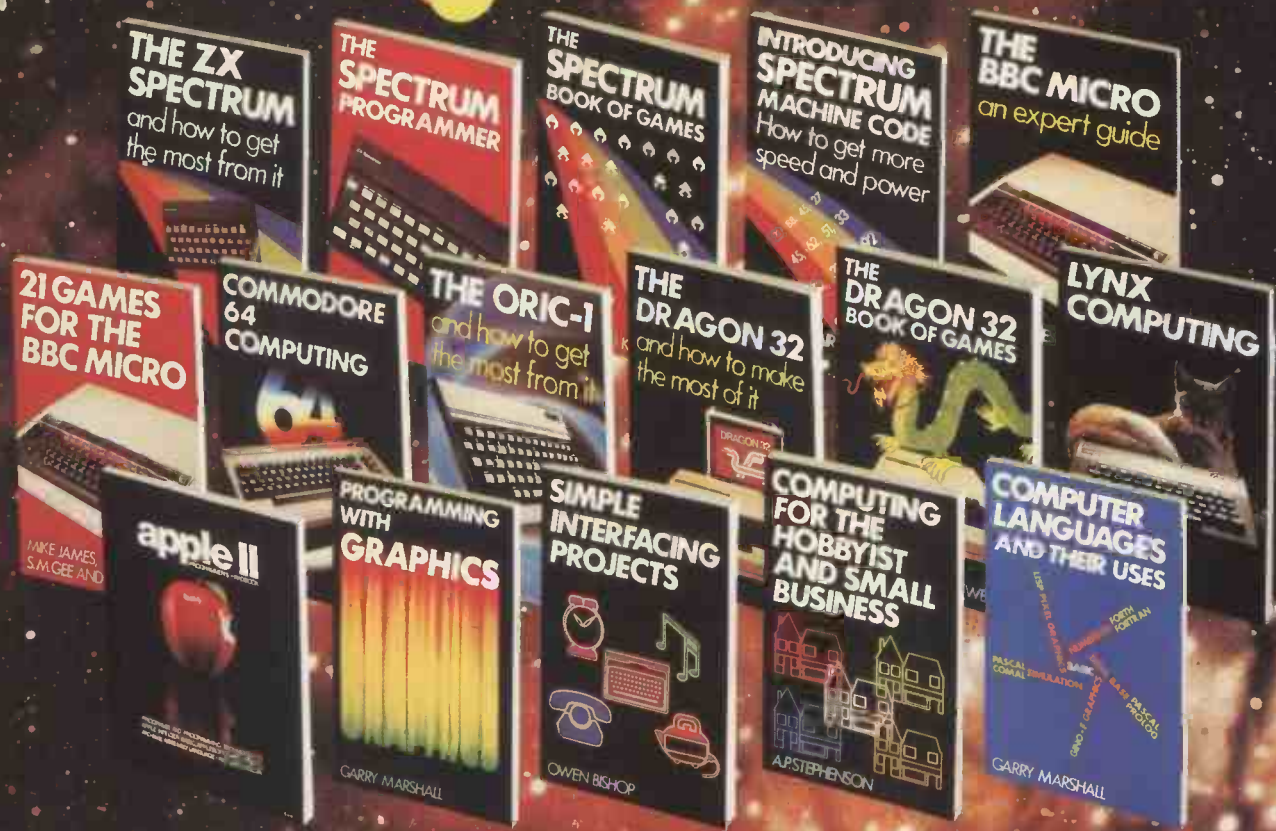

The key handbooks to your micro

THE ZX SPECTRUM

The ZX Spectrum
How to get the most out of your Spectrum. £5.95

The Spectrum Programmer
The absolute beginners guide to programming the Spectrum. £5.95

The Spectrum Book of Games
21 complete games programmes for the Spectrum. £5.95

Introducing Spectrum Machine Code
Master your Spectrum completely. £7.95

THE BBC MICRO

The BBC Micro
An expert guide to its more advanced and special features. £6.95

21 Games for the BBC Micro
Includes arcade, board and adventure games specially written. £5.95

THE COMMODORE 64

Commodore 64 Computing
A full introduction and ready reference. £5.95

THE ORIC-1

The ORIC-1
Get the most from this amazing new machine. £5.95

THE DRAGON 32

The Dragon 32
How to master the Dragon and all its facilities. £5.95

The Dragon 32 Book of Games
21 exciting games, all fully tested and crash proofed. £5.95

THE LYNX

Lynx Computing
Master the Lynx from scratch! £6.95

THE APPLE II

Apple II Programmer's Guide
The advanced programmer's guide. £10.95

Programming with Graphics
Get the best from the graphics on any machine. £5.95

Simple Interfacing Projects
Interface your machine with your domestic devices. £6.95

Computing for the Hobbyist and Small Business
A user-friendly introduction to personal computing. £6.95

Computer Languages and their Uses
A detailed guide to the advantages of other languages over BASIC. £5.95

All illustrated All available now from your local Computer store, supplier or bookshop.

GRANADA PUBLISHING

PRINTER SPURTER

an eight bit value stored in the I register and uses the resulting sixteen bit address as a pointer to find the address of the interrupt routine. Although complicated it does mean that the Z80 can service up to 128 different devices, enough for most applications. If other interrupts are to be used in the same system then their addresses should also be stored in the table.

The circuit used (fig 1) serves two purposes. It provides buffering between the PIO and the printer so if anything should go wrong the PIO is not damaged, and, by the use of a monostable it converts the hand-shaking signals used by the PIO to those required by the printer. This is necessary because the Z80 PIO provides a signal RDY which goes high when data is available on the port and goes low after that data has been read and acknowledged by the peripheral bringing the STB line low. However the printer requires that the STROBE line be brought low for at least 1 uS and then taken high again before it will read the data. The monostable provides this facility, the length of the pulse being determined by capacitor C1.

Because the 7417 buffer used has open-collector outputs it is necessary to pull the outputs high if this is not done within the printer. Use 1k resistors to the +5v supply or alternatively leave the buffers out

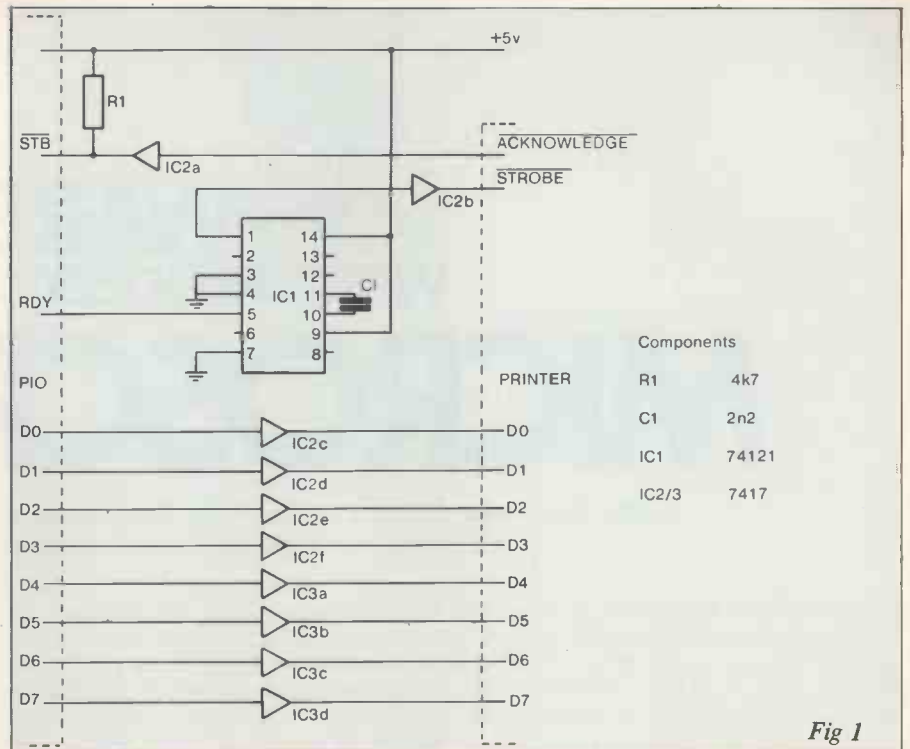

Components	
R1	4k7
C1	2n2
IC1	74121
IC2/3	7417

Fig 1

altogether since they are not absolutely essential.

Although designed for a Z80 system driving a Centronics 739 printer there is no reason why both the hardware and software should not be adapted to run on any system

with a parallel port driving a printer with a Centronics interface. On some systems not using a Z80 PIO the hardware may even be unnecessary if it is possible to program the port to produce the required signals. The effort is certainly worth while.

```

0000 0000 ;*****
0000 0001 ;# Interrupt driven #
0000 0002 ;# CENTRONICS printer #
0000 0003 ;# interface. #
0000 0004 ;#
0000 0005 ;# Andrew May 16/2/83 #
0000 0006 ;*****
0000 0007 ;
0000 0008 ;
0000 0009 ;
0000 0010 ;
0000 0011 ;
0000 0012 ;
0000 0013 ;** INITIALIZE PIO **
0000 0014 ;
0000 21 27 0D 0015 LD HL,ADUT ;Set up NAS-SYS
0003 22 78 0C 0016 LD (0C78),HL ;output vector
0006 0017 ;
0006 3E 0F 0018 LD A,0F ;PIO Port 5
0008 03 07 0019 OUT (7),A ;as output
000A 3E 87 0020 LD A,087 ;PIO interrupts
000C 03 07 0021 OUT (7),A ;enabled
000E 3E 92 0022 LD A,092 ;Lo byte of interrupt
0010 03 07 0023 OUT (7),A ;table to PIO
0012 0024 ;
0012 ED 5E 0025 IM 2 ;Set interrupt mode 2
0014 0026 ;
0014 3E 0D 0027 LD A,0D ;Hi part of interrupt
0016 ED 47 0028 LD I,A ;table to I register
0018 0029 ;
0018 2A 94 0D 0030 LD HL,(STRBUF) ;Set pointers
0018 22 8E 0D 0031 LD (STRTXT),HL ;to text in
001E 22 90 0D 0032 LD (ENDTXT),HL ;buffer space
0021 0033 ;
0021 3E 00 0034 LD A,00 ;Output a null to
0023 03 05 0035 OUT (5),A ;give first interrupt
0025 0036 ;
0025 DF 5B 0037 SCAL MRET ;Return to NAS-SYS
0027 0038 ;
0027 0039 ;
0027 0040 ;
0027 0041 ;** CHARACTER OUTPUT ROUTINE **
0027 0042 ;
0027 F3 0043 ADUT DI ;No interrupts here
0028 0044 ;
0028 F5 0045 PUSH AF ;Save registers
0029 E5 0046 PUSH HL ;Save registers
002A 05 0047 PUSH DE ;Save registers
002B 0048 ;
002B 2A 90 0D 0049 LD HL,(ENDTXT) ;Store character
002E 77 0050 LD (HL),A ;in next available
002F 23 0051 INC HL ;buffer location
0030 0052 ;
0030 ED 5B 96 0D 0053 LD DE,(ENDBUF)
0034 87 0054 OR A ;If the end
0035 ED 52 0055 SBC HL,DE ;of buffer then
0037 19 0056 ADD HL,DE ;set pointer to
0038 20 03 0057 JR NZ,ADUT1 ;start of buffer
003A 2A 94 0D 0058 LD HL,(STRBUF)
003D 0059 ;
003D ED 5B 8E 0D 0060 ADUT1 LD DE,(STRTXT)
0041 B7 0061 OR A ;If buffer is full
0042 ED 52 0062 SEC HL,DE ;then jump
0044 19 0063 ADD HL,DE
0045 28 08 0064 JR Z,ADUT2
0047 0065 ;
0047 22 90 0D 0066 LD (ENDTXT),HL ;If buffer not full
004A 0067 ;
004A 01 0068 POP DE ;Restore registers
004B E1 0069 POP HL ;Restore registers
004C F1 0070 POP AF

```

```

0D64 00 0100 NOP
0D65 23 0101 INC HL ;Point to next char
0D66 0102 ;
0D66 ED 5B 96 0D 0103 LD DE,(ENDBUF)
0D6A 87 0104 OR A ;If at the end of
0D6B ED 52 0105 SBC HL,DE ;buffer then set
0D6D 19 0106 ADD HL,DE ;to the start
0D6E 20 03 0107 JR NZ,INT1 ;of the buffer
0D70 2A 94 0D 0108 LD HL,(STRBUF)
0D73 0109 ;
0D73 ED 5B 90 0D 0110 INT1 LD DE,(ENDTXT)
0D77 87 0111 OR A ;If no more
0D78 ED 52 0112 SBC HL,DE ;text then jump
0D7A 19 0113 ADD HL,DE
0D7B 28 09 0114 JR Z,INT2
0D7D 0115 ;
0D7D 22 8E 0D 0116 LD (STRTXT),HL ;else restore pointer
0D80 0117 ;
0D80 01 0118 POP DE
0D81 E1 0119 POP HL ;restore registers
0D82 F1 0120 POP AF
0D83 0121 ;
0D83 FB 0122 EI ;Enable interrupts
0D84 ED 4D 0123 RETI ;Return
0D86 0124 ;
0D86 22 8E 0D 0125 INT2 LD (STRTXT),HL ;If no more text
0D89 0126 ;
0D89 01 0127 POP DE
0D8A E1 0128 POP HL ;restore registers
0D8B F1 0129 POP AF
0D8C 0130 ;
0D8C ED 4D 0131 RETI ;and return with
0D8E 0132 ; ;interrupts disabled
0D8E 0133 ;
0D8E 0134 ;
0D8E 0135 ;
0D8E 00 00 0136 STRTXT DEFW 0 ;Pointers
0D90 00 00 0137 ENDTXT DEFW 0 ;to text
0D92 5A 0D 0138 TABLE DEFW INTRPT ;Interrupt table
0D94 00 50 0139 STRBUF DEFW 05000 ;Start of buffer
0D96 FF 8F 0140 ENDBUF DEFW 0BFFF ;End of buffer
0D98 0141 BUFFER END
0D4D 0071 ;
0D4D FB 0072 EI ;Enable interrupts
0D4E C9 0073 RET ;Return.
0D4F 0074 ;
0D4F 22 90 0D 0075 ADUT2 LD (ENDTXT),HL ;If buffer is full
0D52 FB 0076 EI ;enable interrupts
0D53 76 0077 HALT ;Wait for interrupt
0D54 F3 0078 DI ;disable interrupts
0D55 0079 ;
0D55 01 0080 POP DE ;Restore registers
0D56 E1 0081 POP HL ;Restore registers
0D57 F1 0082 POP AF
0D58 0083 ;
0D58 FB 0084 EI ;Enable interrupts
0D59 C9 0085 RET ;Return
0D5A 0086 ;
0D5A 0087 ;
0D5A 0088 ;
0D5A 0089 ;** INTERRUPT HANDLING ROUTINE **
0D5A 0090 ;
0D5A F3 0091 INTRPT DI ;No interrupts here
0D5E 0092 ;
0D5E F5 0093 PUSH AF ;Save registers
0D5C E5 0094 PUSH HL ;Save registers
0D5D 05 0095 PUSH DE ;Save registers
0D5E 0096 ;
0D5E 2A 8E 0D 0097 LD HL,(STRTXT) ;Get next character
0D61 7E 0098 LD A,(HL) ;from buffer
0D62 03 05 0099 OUT (5),A ;Output it

```

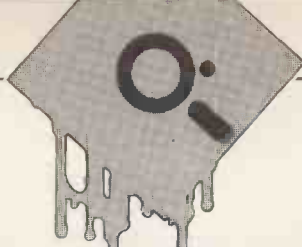

SOFTWARE
WORD PROCESSOR

MICROSCRIPT

Kathy Lang tries out an Irish package that proves a worthy competitor to the new wave of American imports.

MicroScript is the word processing member of a family of packages supplied by Intelligence (Ireland), to run under CP/M. It has been selected by DEC for inclusion in the catalogue of software for the Rainbow, running on the Z80 processor, and versions for the 8086 under both CP/M-86 and MS-DOS are, I'm told, very near completion.

MicroScript provides a large range of editing functions to create and modify text, which is displayed formatted on the screen during editing within the margins which will be used to print the document. Page formatting is handled at print time. MicroScript has a calculating facility and a powerful macro command system. It has a good many superficial resemblances to Wordstar, which also displays text within the margins which will be used at print time (in contrast to Peach Text, SpellBinder and Lexicom, the other major CP/M word processing packages, which keep editing and text formatting quite separate). Since many readers will know something about Wordstar already, I'll comment on any obvious comparisons as I describe MicroScript's facilities.

When you first run MicroScript (after it has been set up to run with your terminal and printer — more on this process anon) the screen shows a menu of options including 'Create a file' and 'Edit a file' — two separate functions, which I personally prefer to having the same command to do both. If you try to create a file using a name which already exists, MicroScript responds with 'bad file name' — better than overwriting it, but not very helpful. Once the file has been set up, MicroScript displays a blank screen for you to type your text on.

Although it is actually using a 'ruler', containing the margin positions and tabs, this is not displayed unless you request it. While you are typing, MicroScript is in 'overwrite' mode unless you alter this — that is, new characters overwrite existing text rather than being inserted. The usual 'word wrap' feature is used to stop you having to worry about line endings.

Editing

MicroScript used a 'function' approach to editing which is very similar to that used by

Wordstar, where each function, such as delete a character, move the cursor a word, etc, is carried out by one key or set of keys. (This contrasts somewhat with SpellBinder and Lexicom, which tend to have just one key for delete or move, and to vary the unit of movement — by character, word, sentence, etc.)

MicroScript provides a total of 54 instructions which the user can give to move the cursor, move text, invoke command processing (a species of macro facility which enables you to instruct the program to execute a sequence of commands as if they had been entered from the keyboard) and so on. Each of these functions is described under a sequence number in the manual and a list by number is shown in Figure 1. It depends on your implementation of MicroScript what keys are pressed to invoke these commands.

Each copy of MicroScript uses a command file in which is stored a mapping of these function numbers onto keys on the keyboard. This command file is a plain text file, so of course the user can change the mapping as often as he or she likes; this makes it very easy to personalise the program in the way best suited to individual needs. However, I thought it a pity that there was no 'default' mapping, parallel to the use of CTRL keys in WordStar, so that no one can use the manual without having to have at hand the list of commands for the particular terminal. It also makes it harder for people who regularly need to use more than one machine.

The cursor can be moved up or down a line, to the top or bottom line of the screen, to the screen 'Home' position or to the bottom right hand corner of the screen. It can be moved left or right a character or word, and to either end of the line. Movement by character or word is not circular — for instance, you can't go 'left a word' when the cursor is at the left-hand end of the line. You can move the cursor to the top of the document, but not — curiously enough — to the end; I got round this (when I remembered) by marking the last line with a unique character which I then 'found' when I came to add more text. This is made the more necessary as there is no provision for scrolling — text moves if the cursor is moved into areas which are not

currently on the screen, but text cannot be moved around the cursor. For the Wordstar devotee, there is no equivalent of CTRL-C and CTRL-R. I 'programmed' equivalents for myself using the abbreviation memories, but the scroll back was very slow as it refreshed the whole screen for each line moved.

As I said, the 'default' is to type corrections over existing text; if you want to insert, there are four ways of doing it. You can open up just enough spaces to overtype the text to be inserted, you can insert enough blank lines to make room, or you can 'elbow' the text to the right of the cursor onto the next line. You can also go into 'insert mode' in which text is always inserted rather than overtyping (this mode lasts during the editing of one paragraph or until you switch it off — and there is no 'visual clue' as to what mode you're in apart from what happens to the text itself). I had a few problems when using insert mode — it works all right within a paragraph, but at the end of a paragraph the 'blank line' between that paragraph and the next gets overwritten, and any 'part line' (such as a heading between paragraphs) gets absorbed into the text. Text can be deleted a character, a word, or a part or the whole of a line at a time, and also by marking a block of text and moving it into the 'cut buffer'. Text can also be converted from upper to lower case or the reverse — a feature I found very useful, as there is no CAPS LOCK light on our Sirius so you are often unaware you've hit CAPS LOCK by mistake.

The 'cut buffer' is part of the facilities for block movement. Text can be cut, copied, or cut leaving a blank area behind. Once in the cut buffer, text can be pasted down elsewhere, either overlaying the text already there or inserted. The cutting works on the basis of a rectangle of text, with text being moved from the top left hand corner to the bottom right hand corner of the area marked. This works fine for column movement and for whole lines, but is rather a pain for phrases or sentences which occupy less than a line (when using the technique outlined means that you lose the rest of the line) or which span line endings — you have to cut more than you need, and delete the surplus. The cut buffer cannot cope with more than 23 lines of text at a time, so if you

want to move more than that you must do it in stages.

Whole files of text can be read into MicroScript at any time — these can be just text, or commands and text intermixed. You can't however, write text out to another file directly while editing — to do this, you must store the text in the cut buffer (which is preserved across file closure), exit from the edit, edit another file and paste the contents of the buffer in the new file.

The cut buffer is a special form of internal memory. Another kind of buffer is used to store abbreviations. There are 10 permanent memories, each the size of a screen line, which are initialised in the command file and which cannot be changed within a MicroScript editing session, and another 10 volatile memories which are available for storing abbreviations during an editing session. For instance, I stored the word MicroScript while writing this review. Storage and recall each involve a single function call — one or more key-strokes, depending on how your system is set up. These memories can be used either for text or for commands or for a mixture of the two — so you can put into the memories frequently used sequences of commands to speed up the editing process.

There is a facility to FIND a string of text. To do this, you type the desired string alone on a line, place the cursor on it, and issue the FIND command. The search is always forwards, but you could of course issue a 'top of document' command first. There is a FIND and REPLACE function outside the editor — a simple global 'find and replace' invoked through the menu. However, you could easily use the abbreviation memories to store both your find and your replace strings to do a continued find and replace, with discretion as to whether to allow the replace to take place.

In addition to straightforward editing, you can also use MicroScript as a calculator. It has 10 calculator memories, to store intermediate results, and its operation is very similar to that of a simple pocket calculator with arithmetic functions. This facility could be extremely useful for work involving tables of figures included in running text.

Formatting

Text is formatted on the screen within the margins which will be used at print time. You can have word-wrap with ragged or justified margins, tabs and an indent in the ruler line. The indent works only for the first line in the paragraph, and in fact can be an outdent instead of an indent — this would be very handy for 'bulleting', where you have a list of points, each starting with an asterisk or bullet, with the left margin two places in from the bullet. The ruler used can be retrieved and altered at any time. Up to 10 rulers can be stored in ruler memories, and rulers can be saved as lines stored in the edited file.

There are some very good features here — for instance, a ruler is activated by having the cursor pass down through it. So to make sure all the text is edited using the correct rulers, all you have to do is to recall a ruler, modify it to suit your needs, and

1	Return	28	Re-format
2	Delete	29	Store ruler
3	Cursor left	30	Recall ruler
4	'' right	31	Use ruler
5	'' up	32	Underline
6	'' down	33	Underscore
7	Tab	34	Page feed
8	Push-text	35	Wipe right
9	Pull-text	36	Wipe left
10	Tab right by word	37	Delete word
11	Tab left by word	38	Goto top-left of screen
12	Delete line	39	Call merge file
13	Open line	40	Enter insert mode
14	Goto right end of line	41	Elbow line
15	Goto left end of line	42	Exit insert mode
16	Goto top of screen	43	Goto end of text on screen
17	Goto bottom of screen	44	Expand line
18	Caps convert	45	Find text
19	Lower ''	46	Store abbr.'n'
20	Cut/paste mark	47	Recall abbr.'n'
21	C/P lift-blank	48	Alt.mode 'n' on
22	C/P lift-leave	49	Alt.mode 'n' off
23	C/P lift-remove	50	Quit document
24	C/P put-overlay	51	Recall document name
25	C/P put-insert	52	Save document
26	C/P put-elbow	53	Goto top of document
27	Centre line	54	Call CMD text

Fig 1 MicroScript functions

leave it in the file — it won't be printed, and it will be acted upon next time you come to edit the file. I think this is much better than the Wordstar approach, where you need a slight 'dodge' to store a ruler properly at all, and it is only activated when you expressly request it. To format a paragraph to a ruler, you put the cursor anywhere in the paragraph and give the reformat command.

So far, so (very) good. Unfortunately, there are also some obscure features with MicroScript formatting. To start with, you can only change the right margin by changing the ruler, and the system does not recognise that a line is a ruler line while it is being edited; so to modify a ruler, you must edit it while using a ruler with a right margin equal to or greater than the right margin you want in your new ruler. To create a new ruler from scratch, you must be using a ruler which has the right margin set at 79 (the maximum which can be displayed on the screen), as a ruler must have a character in every position for the full width of the screen. I kept one ruler specifically for this — but I had to edit the command file outside MicroScript to do that, as the rulers which come with the system don't include one with the maximum width line.

Another problem is that you must have the whole of the text you want to reformat on the screen, plus the succeeding blank line, when reformatting — to reformat a long paragraph (more than 23 lines) you must do it in two bits. MicroScript is very fussy about cursor position when the reformat command is issued, when adding text at the end of a document. You must have finished the paragraph off with a blank line, when the cursor will be two lines away from the bottom of text, then move the cursor back to at least the last line of the paragraph, before issuing the reformat

command. To get round this I stored in one of the abbreviation memories a sequence consisting of two carriage returns, two cursor up commands, and the reformat — but a bit more imagination would have rendered that unnecessary, and I was using my abbreviation memories up rather quickly on command fudges. I was particularly sorry about this glitch, as finding the beginning of a paragraph is something Wordstar does not do well, and it's on the whole been much better thought out in MicroScript.

Reformatting includes right justification if that's in the ruler. There is, however, no hyphenation facility — the package doesn't even recognise word-joining hyphens as characters where lines can be split — so some of the spacing leaves a bit to be desired. But probably the worst feature is the way emphasis is treated. If you want to underline a word, you must underline the whole line; a line of hyphens is displayed on the next line, and you must then edit this line to give just the emphasis you want. But this line of hyphens is just an ordinary text line, and the hyphens, plus the character at the end of the previous line which tells MicroScript to overtype with the next line, are part of the text — so if you reformat that paragraph later you get the hyphen/underlines mixed in with the text. . .

Facilities for tables are quite good. I've already mentioned that the method of block movement is better suited to column work than to moving plain text. You can have tabs anywhere, and the indent feature could also be useful in this context — a big improvement on Wordstar's CTRL-O/G facility. It's a pity, though, that there's no provision for displaying at least the column position of the cursor on the screen — such a help when setting up tabs. The other

MICROSCRIPT

drawback comes if you have wide tables. MicroScript can't cope with text wider than the screen except by being told that the next two (or three or more) lines constitute a single, wide line, so you can't 'pan across' a 'wide' line on the screen, as there's no horizontal scrolling either. Whether this would affect you depends on your particular needs.

Pagination is handled at print time. So you can't see the page boundaries while you're editing, though you can 'view' then on the screen instead of actually printing the document. For me this is a major drawback, especially as, although there is a 'new page' command, there is no 'conditional page' break (start a new page if there are fewer than 'n' lines left to print). Headers and footers, and the positioning of the page number, are also included at printing time, as is common practice in most word processors.

Standard paragraphs and letters

Here the programming features of MicroScript come into their own. Any command which you can type into MicroScript can also be placed in a file, and read in as part of the editing process. These merged files can be 'indexed' so that you can select only a paragraph or two by dint of a unique reference. Merge files may call other merge files to a depth of seven calls. However, there is no conditional execution — unconditional jumps yes, conditional jumps no — and a range of features are made impossible by the inability to write a file while editing another. There are also no direct facilities for extracting several items from the same 'record' in a merged file; the way round this is to 'index' each item, or to use the abbreviation memories or the facilities for requesting input from the

keyboard. I felt that for slick processing of this kind you'd do better to combine with another package such as MicroPen, reviewed elsewhere in this issue. The facilities of MicroScript are I think better adapted to problems such as standard paragraph work, where the ability to string together a selection of standard paragraphs would be invaluable — far superior to Wordstar's ability to string together only complete files. As you might expect, files can also be merged at print time.

The facility to store commands in files is accomplished by giving each special symbol, such as CONTROL or ESCAPE, a 'visible equivalent' which can be edited into a file. You can also put MicroScript into a 'learn' mode, in which control functions entered at the keyboard are not acted upon but displayed in their 'visible equivalent' form — I thought this could be a very useful way to set up a control file.

Printing

A variety of features, such as emphasis and headers and footers, are acted upon at print time. The 'print menu' allows you to enter at print time definitions for such items as number of lines on the page, space between text and footer, and so on. These items include double spacing; there's no special provision for anything other than single and double spacing, but you can embed in the text instructions to the printer for special situations such as sub- and super-script, and these same provisions could be used to initiate other changes in print characteristics. These instructions are given using one of up to 22 special character variables provided for this purpose. You can ask for multiple copies from the print menu, too. But you can't print one document while editing another — not necessarily such a bad thing, as this is usually better handled by having a large printer buffer so that printing doesn't interfere with keyboard interactions.

Housekeeping

When editing a file, MicroScript keeps a copy of the old version for the time being. It only has one 'backup' file, though, so this contains the old version of the most recently edited file.

When it comes to explicit file operations, MicroScript provides the main requirements from its menu; you press F for file management and get a second menu of options, including copying, replacing and 'merging'

(which is actually copying one file and appending the second to the copy). Strangely, it doesn't provide for a 'change logged drive' facility, so all file names must be prefixed by the drive if they are not on the drive containing the programs. You can't get round this except by having a copy of the program on every data disk, as MicroScript uses several program files chained together, all of which assume that MicroScript is on the logged drive.

Software user image

I found MicroScript quite easy to use once I had had some practice — but it did take quite a bit of learning. I think someone who didn't use a word processor regularly would find it harder, especially remembering the functions and the keys which invoke them. The system uses very little prompting, too — for instance, when using the 'find' facility, you just type the string you want to find on an empty line, and press the find function key.

I've mentioned the lack of 'clues' about things such as whether you are in 'insert' or 'overtyping' mode. However, the lack of display of rulers, prompts and other system paraphernalia does mean that you see only your text on the screen, and many people will prefer that. The system of storing and retrieving rulers, abbreviations and calculations was straightforward and easy to use. I did, though, think the emphasis method very clumsy, and the way formatting treats emphasis lines is a real pig's ear — especially as the system has the clues to tell it that a line is an overtyping line.

I personally find it a real nuisance that page-breaks aren't displayed while editing, especially when there is no provision for conditional page-breaks or automatic prevention of 'widows' and 'orphans' (headings at the foot of a page or the last line of a paragraph at the top of a page). Given the philosophy of specifying page size at print time, page-breaks could not be displayed accurately during editing, which is why I prefer to be able to specify in the file — it also means you only have to set the printing parameters once for a document that uses an unusual page size or whatever.

Documentation and support

The manual was clear and simple in the main 'use of MicroScript' parts; its main disadvantages are an almost complete lack of examples, and also that it keeps quiet on some pretty important points — the problems with rulers, for instance, I found out the hard way. As is usually and regrettably the case, there is no index — which didn't help in finding my way around. The sections on setting up the terminal and other adaptations of the command file were very badly documented, and I found that quite a tough operation — I understand that much thought is currently going into making this much easier to do. Support is provided by Intelligence at an annual fee — see the Summary Box. This covers all updates, a magazine and a proper hot-line service by

Benchmarks

BM1	10
BM2	55
BM3	100
BM4	20
BM5	155
BM6	158

All timings in seconds. For an explanation of Benchmark timings, see PCW April 1981.

Summary

Package Type	Word processor with command processing; text formatting during edit.
Facilities	Editing, formatting, storage of rulers, abbreviation memories, calculator, command processor, file merge.
Ease of Use	Mixed. Few prompts, but predictable in use once basic commands learnt.
Error Messages	Few and far between.
Documentation	Clear, but not everything explained; no index; installation section inadequate (soon to be replaced).
Costs	£275 including 90-day warranty. Support contract £150 p.a. for software updates, newsletter and "hot-line" telephone support.
Supplier	Intelligence (Ireland) tel. Dublin (0001) 988555.

telephone to Dublin; training courses are available too, in London and Dublin and elsewhere if demand warrants it, but these are charged separately.

Conclusions

MicroScript is for me rather a curate's egg of a package — good in parts. Some sections of the software are excellent — such as the abbreviation memories, the ruler facilities, the calculator and the command processing and standard paragraph features. Some of these could have been made even better with a little more thought — the ability to carry out conditional execution, for instance, would make a big difference to the flexibility of the command processing. I didn't like the restrictions to 23 lines on paragraph work and block movement, and I didn't like the problems I had with insertion — especially the fact that 'insert mode' is turned off for

you without your being told. I also disliked very much the procedures for underlining and emboldening.

So how would these facilities work for the four archetypal users featured in these reviews? The author/journalist should find the editing adequate, though some features might not be quite to his or her taste; the fact that you get just your text on the screen would probably be a plus point, and an author would be likely to find features like the abbreviation memories invaluable — I did when writing this article. The ruler features were on the whole very good, but nevertheless the writer of technical reports might not find the formatting features adequate, especially aspects such as the lack of control over page layout. The manager might find the system a bit hard to learn, though perhaps he or she could be taught a simple subset. The secretary — well, that would depend on the application. Legal secretaries and the like would find the

power of the command system invaluable (though they might like it even better with conditional execution). Other office environments would be more or less suited to MicroScript depending on factors such as the value of the calculating facilities and the abbreviation memories versus the lack of control over page layout.

All in all, for a first issue the current version of MicroScript is way ahead of the first issue of most of the existing competitors — but of course they've been around a lot longer. The CP/M word processing scene has been pretty quiet for a while in terms of new issues, but it seems that MicroScript is in the vanguard of a new wave. As a European product I wish MicroScript luck, in competition with other new products such as the American package Perfect Writer (already here) and other imports promised soon including one from Ashton Tate, the authors of dBaseII.

END

NUMBERS COUNT

TRIANGULAR, TETRAHEDRAL AND FIBONACCI NUMBERS

Mike Mudge continues his series of puzzles for the maths freaks among us.

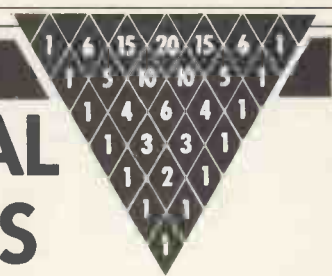

The positive integers consist of 1, 2, 3, 4, 5...; a general number in this sequence will be noted by l , m or n .

The Triangular Numbers, denoted by T_l , represent the number of identical spheres that can be packed into a complete triangular array having l rows. Thus $T_1 = 1$, $T_2 = 1 + 2 = 3$, $T_3 = 1 + 2 + 3 = 6$, and in general $T_l = 1/2 l(l + 1)$.

The Tetrahedral Numbers, denoted by t_m , represent the number of identical spheres that can be stacked in a complete triangular pyramid, or tetrahedron, having m layers — each a complete triangle. Thus $t_1 = T_1 = 1$, $t_2 = T_1 + T_2 = 1 + 3 = 4$, $t_3 = T_1 + T_2 + T_3 = 1 + 3 + 6 = 10$, and in general $t_m = 1/6 m(m + 1)(m + 2)$.

In contrast to the above numbers, which are essentially geometrical in origin, the Fibonacci Numbers, denoted by F_n , are here defined algebraically using a recurrence relation $F_{n+1} = F_n + F_{n-1}$ where $F_1 = F_2 = 1$. That is, any term in the Fibonacci sequence is obtained as the sum of the two previous terms. Thus $\{F_n\} = \{1, 1, 2, 3, 5, 8, 13, 21, \dots\}$; this sequence has so many interesting properties that it has its own publication, *The Fibonacci Quarterly*.

PROBLEM

This month's problem is in three distinct parts, which are seen to have a common logical thread.

a) Which tetrahedral numbers are also triangular numbers (eg, $T_1 = t_1 = 1$, $T_4 = t_3 = 10$)? This problem has been attributed to W Sierpinski, 1970, and others.

b) Which Fibonacci numbers are also triangular numbers (eg, $T_1 = F_1 = 1 = F_2$,

$T_2 = F_4 = 3$, $T_6 = F_8 = 21$)? This problem is due to Vern Hoggatt.

c) Which Fibonacci numbers are half the sum or difference of the cubes of two integers — eg, $1 = 1/2(1^3 + 1^3)$, $8 = 1/2(2^3 + 2^3)$, $13 = 1/2(3^3 - 1^3)$? This is closely related to the abstract problem in number theory of finding all quadratic fields of class-number 2.

Submit a program, or suite of programs, which generates answers to the above questions up to some maximum positive integer, N , whose value may be input data. All submissions should include program listings, hardware descriptions, run times and output; they will be judged for accuracy, originality and efficiency (not necessarily in that order). A prize of £10 will be awarded to the 'best' entry received within two months of the appearance of this article.

Submissions to: Mr M R Mudge BSc, FIMA, FBCS, Room 560/A, Department of Mathematics, The University of Aston in Birmingham, Gosta Green, Birmingham B4 7ET.

Note: Submissions will be returned only if suitable stamped addressed envelopes are included.

Response to the first article in this series was predictably sparse; however, the 'best' entry has been chosen as that of Robert Merson of Farnham, who combined some subtle algebraic transformations with a factoring technique to reveal: $428 = (-117091)^3 + (-111433)^3 + 2(114332)^3$
 $491 = (13584908)^3 + (13476659)^3 + 2(-13531000)^3$
 $580 = (89845)^3 + (85111)^3 + 2(-87542)^3$
 A cheque for £10 will be sent to Robin.

END



SOUND ADVICE

AUDIO~VISUAL DOCUMENTATION PACKAGES

Maggie Burton takes a preliminary look at a new way of getting the most from your micro — by using a tape recorder.

These days it seems as if anyone and everyone is holding his nose and jumping head first into the pool of computer technology. How on earth do people learn to cope with it at home and at work?

The need for universally applicable, convenient and inexpensive teaching methods is becoming more apparent as the months go by.

In businesses where whole departments (or the whole business if it is small) are being computerised, employees have to be trained somehow, and it is far safer if this is done properly. All too often a secretary is taught to use a word processor by a hurried boss or harassed colleague — and then proceeds to make mistakes, lose files, corrupt disks . . . the list goes on. Similarly, new employees, particularly young ones, need decent training if they are to perform tasks well. This applies to everything — not just computers — which can be considered a skill.

And in people's homes, too, where computers are even more on the rampage. How many homes, one wonders, have ZX81s or VIC-20s stashed in cupboards and under sofas for want of a bit of simple tuition?

It's not always easy to grasp what a manual is trying to put across — especially as the documentation is frequently the last and most hurried part of producing a computer (or software package) for consumer retail. It's also often inconvenient for people to go to evening classes and impossible to pay through the nose for expensive courses.

One way of learning a skill is to buy a packaged course. These generally consist of a cassette containing a recorded lecture (or series of short lectures) in a friendly voice, a supplementary (sometimes necessary) book and often a book or books of exercises to go with the course. Some of the computer ones come with demonstration software on floppy disks and those based on software (eg, Wordstar as reviewed by Steve Harris elsewhere in this issue) need the package to be up and running if they are to be effective.

Possibly the first area in which this type of training was applied was foreign languages (we've all heard of Lingua-Phone). Flicking through magazines in your dentist's waiting room reveals audio-course ads for guitar playing, fiction writing, typing and even self-hypnosis tapes. Sometimes these are regarded with a measure of amused scepticism but they keep selling and new ones appear from time to time.

The big disadvantage with any form of self-teaching is that it requires patience and self-discipline. It's very easy to give up or

devote less and less time to the subject, ending up finally leaving the course matter redundant and gathering dust in some dark corner of home or office. A few suppliers are now producing audio courses as a key element of their training strategy.

One company which has now applied self-training principles to a company environment is ICL. Through its Traderpoint retail outlets it is now selling a series of training packs based around audio cassettes and book courses. These cover CP/M, Wordstar (this package is actually the same as the Sound Training Wordstar pack reviewed by Steve Harris), Microsoft Basic, CIS Cobol and Pascal. An MP/M course is on the cards for the near future.

These are available either to the man in the street or to companies and will be translated into some foreign languages — namely German, French, Spanish and Italian — in future. Prices range from £50 to £105.

Most of the courses are independent of micros — although it is desirable to have a computer to hand right from the start. The CP/M 2.2 course is the exception as it is practically oriented and needs not only a version of CP/M but also a blank disk as well to be used and kept as a workdisk. Andy Street of ICL says "Wordstar is probably the most popular and CP/M comes a close second". It's easy to see what people need to learn about.

As subject matter is arranged around several cassette sessions, a more knowledgeable student can leave out the first parts of a course and get straight down to the more complex lessons. A novice can theoretically start from scratch and not be frightened by techno-jargon.

Furthermore the manuals included can adequately serve as permanent frames of reference either if something is forgotten or simply for guidance when needed.

Before I go on to make observations on the courses, I'll make it clear that my comments are initial judgements and can't be called a full review. In a later issue when I've completed the Pascal course a review will be published. I know almost nothing about Pascal. If, by the time the course is complete, I've got more than a passing familiarity with Pascal and the possibility of learning far more about actually programming using the language, then the course will be considered a fair investment.

Thus far I've listened to the introductory tapes on Pascal and CP/M and read through the manuals.

The Pascal course begins with a general introduction to high level languages. This I found interesting and informative although

it could be a little too much for a complete beginner to take in all at once. In this case it would have to be run through again, which is one of the blessings of the audio cassette training method. If you don't understand something straight away you can stop and go through it again and again at your own pace.

The wording on the tapes is very formal and the voice sounds a little terse — almost as if the chap's giving a lecture using scant notes in front of a seething crowd of drunk students. In short, he sounds nervous. And as it's the same voice for all the courses this is a bit of a disadvantage though he's friendly enough.

The book provided is well set out with plenty of space for scribbled notes in the margin (in pencil, please!) but it is mainly dependent on the cassettes — at least at first.

It provides the bare bones of the information disseminated in the course and the flesh is added to it by the voice which goes through the book step by step fleshing out the bare bones on the page. Diagrammatically presented information is used extensively, which is easier to understand than plain text.

As the tape has to be stopped occasionally so that an exercise may be performed it would be helpful if the book included boxes for recording tape positions. This would save time if one broke off after finishing an exercise when the course was resumed.

The book ends with a complete summary of Pascal syntax, error reports, debugging hints and a concise index. These are the parts which would be the most useful on a permanent basis to someone who had completed the course and progressed to writing Pascal programs. Time is also given to outlining differing versions of Pascal.

The CP/M course is set out along similar lines and includes two cassettes instead of the six provided for Pascal.

As with the Pascal course it goes into considerable detail on companies and authors involved in development of software. Once again the wording is a little 'high level' for an absolute novice. An example is a reference to 'specific machine types' and a 'de facto industry standard' in operating systems. It talks about these things before outlining what an operating system actually is. When it does get round to that it's in a lot of detail and could be hard to pick up if you didn't already have some idea.

As it's a practical course the book is mainly stocked with copious screen pictures as examples of what should be happening while CP/M is being used. It provides useful details on memory and

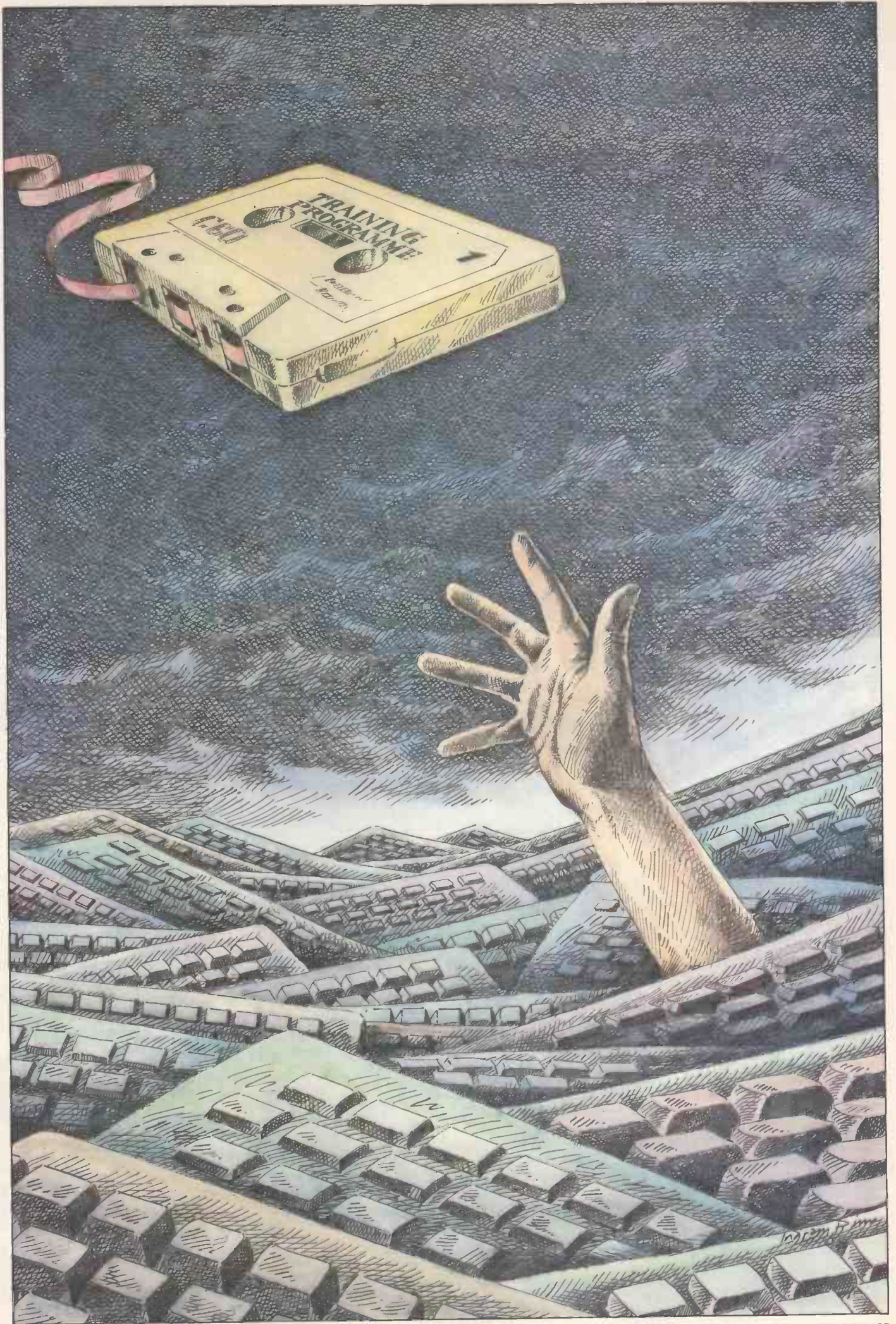

Chromasonic Hall of Fame No.18

THE 'GRAPHICS DESIGNER', OR 'PRINT & PLOT CLOT,' FAILED ART SCHOOL STUDENT. ALWAYS PLOTTING SOMETHING OR OTHER. QUITE HAPPY WITH A FEW COLOURS IN TWO DIMENSIONS, BUT IN HIS ELEMENT CHASING TURTLES ABOUT. SPENDS SPARE TIME WRITING POTENTIAL SOFTWARE FOR WALT'S NEXT LAZER-CHIP MOVIE. SEES THE WORLD THROUGH PIXEL-TINTED SPECS. REGARDS THE PAINT-BRUSH AS SOMETHING FROM THE ARK. BUT SO ARE TURTLES!



WE'LL FIT YOU OUT

AT CHROMASONIC, NO ONE IS LEFT OUT, HOWEVER BIZARRE OR ORDINARY. WE HAVE THE SOLUTION FOR EITHER. WE CAN EVEN ADVISE WHICH ONE TO BE, TO GET THE VERY BEST FROM OUR RANGE OF SYSTEMS. IF YOU CALL ON US, WE CAN FIT YOU OUT, PAINT YOU IN, PACK YOU UP AND SEND YOU OUT. TRY US. AMONG STOCKED ITEMS WE HAVE-

VIC20 NEW LOW PRICE £129

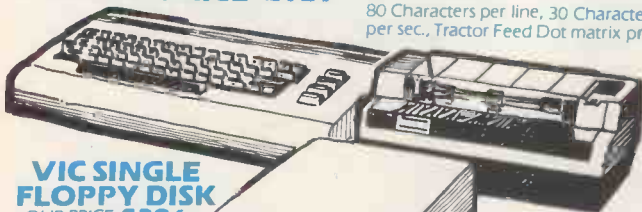

VIC SINGLE FLOPPY DISK OUR PRICE £286

174K Byte Storage
Direct interface to VIC
Compatibility with

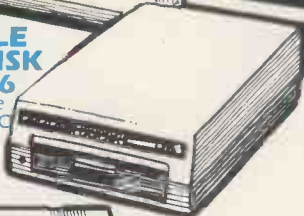

VIC CASSETTE DECK £39.00

Free cassette with 6 programs supplied



COLOUR GENIE EG 2000 PAL VERSION

- * Typewriter Keyboard
- * 8 colours
- * Extended Microsoft colour basic standard
- * 16K RAM standard expandable to 32K

* Serial and Parallel I/O Ports * CPU: Z80A/2.2 MHz
* 3 Sound Channels * 40 Columns x 24 Lines

OUR PRICE £199

BBC MODEL A & B



AUTHORISED DEALER

Full Technical Support and After-Sales Service

Large list of Software and Peripherals

ACCESSORIES FOR YOUR VIC20

- Super Expander High Resolution Cartridge £31.00
- Programmers Aid Cartridge £28.00
- Machine Code Monitor Cartridge £28.00
- BK RAM Cartridge £39.00 16K RAM Cartridge £59.00

TELEPHONE

01-2639493/5

VIC PRINTER £212.00

80 Characters per line, 30 Characters per sec., Tractor Feed Dot matrix printer.

DRAGON32

- * 9 Colours
- * 32K RAM memory as standard, expandable to 64K
- * Extended Microsoft colour basic as standard

- * Typewriter Keyboard
- * 6809E CPU
- * Advance sound feature
- * 32 Columns x 16 Lines

OUR PRICE £189



FREE 'Basic' training manual supplied



commodore

- 64K RAM
- 16-colour display
- music synthesiser
- 3-D effect

OUR PRICE **£343**

CHROMASONIC PERSONAL COMPUTERS

48 JUNCTION RD, ARCHWAY, LONDON N19 5RD Telex 22568



PCW5

I am interested in a home computer. Please send me further details

- VIC 20 DRAGON 32 COLOUR GENIE
 ADD-ONS SOFTWARE

TERMS OF BUSINESS: All prices inc 15% VAT. Delivery charged at Cost. Prices valid for cover date of this mag. Access and Barclaycard orders welcome.



Please send me "Hall of Fame Album" I enclose 75p.

NAME:

ADDRESS:

Chromasonic "Hall of Fame Album" sends 75p for your collector's Album. Start by cutting out the cartoon on this ad, one in a series of 50. We will send you the cartoon of your choice with every order, to help you build up this exclusive 1983 collection. Prize for 1st full album presented to us!!



Last year, Apple users enjoyed the advantages of over 2,500 Orbit units.

Until recently, it was only the users of Apple II and /// microcomputers who had the advantages of Orbit Business System. And that really meant something.

It meant that Apple users had a fast, flexible, easy-to-use and competitively-priced business system purpose-built to provide them with the broadest possible range of configurations, thanks to the unique combination of hardware and Orbit software products. It meant that accounting, stock control, sales invoicing, payroll and other systems were streamlined to such a degree that the performance was equivalent to that of a large mainframe computer, at a fraction of the cost.

It meant that as an Apple user's company grew, so could Orbit's system capacity. All in all, it meant that Apple users had a tremendous advantage over other microcomputer users.

Until now.

Orbit systems can now be used to complement IBM, Sirius, Victor 9000 and SAGE II microcomputers. This means that you too can benefit from the full Vlasak service which supplied over 2,500 products in the last year. Vlasak dealers provide full product and systems support, both before and after sales, personal instruction on usage, installation and servicing; and advice on up-dating your system so that it grows with your company.

Training facilities are now available for new dealers.

We shall be pleased to send you comprehensive literature on the advantages of Orbit software and how it can benefit you.

Complete the coupon and send to Vlasak Computer Systems, Vlasak House, 8 Stuart Road, High Wycombe, Bucks HP13 6AG. Tel: 0494-448633.

This year IBM, SIRIUS, VICTOR, DEC and SAGE II users can benefit too.

Orbit System — the ultimate purpose-built Accountancy Software for your microcomputer.

I would like further information on Orbit Business System

A demonstration by my local dealer

Name _____

Company _____

Address _____

Tel: No. _____

**Vlasak
Computer
Systems**

A two-minute operation turns your BBC Micro into the heart of a word processor.

VIEW is a software program from Acornsoft (the software division of Acorn Computers Ltd., who designed and built the BBC Micro) that enables you to use your BBC Micro, together with a printer, as a fully operational word processor.

View is supplied as a Rom chip that can easily be fitted to your BBC Micro by your local dealer, in a painless two-minute operation.

Then, once installed, you only have to switch on and View is operating immediately. (You can easily switch back to normal computing with a single command.)

Also included in the View package are two special books: 'Into View,' that takes you by easy stages through all the word processing commands and explains the



many ways in which View can help you, and the 'View Guide,' which provides a quick reference to all View facilities.

You'll find that View is, by any standards, a thoroughly professional system, yet still surprisingly simple for the beginner to master.

The 'Spark-Jet Printer' shown in the photograph is the ideal choice of printer for your word processing application. Extremely quiet, it offers high resolution graphics from monitor or TV. screen and is available now from dealers.

If you'd like more information, write to Acornsoft, 4a Market Hill, Cambridge CB2 3NJ.

Or, for details of your local Acornsoft dealer, phone 01-200 0200.



ACORNSOFT

SOUND ADVICE

where CP/M is loaded, diagrams on how to use STAT, PIP, SUBMIT and so on, finishing up with a glossary of terms.

ICL's courses are rather formal although they are comprehensive and would probably be better suited to the training of larger numbers of employees within a big company.

A choice which may well be preferable for individual use — either in the home or small business — would be the National Computing Centre's Business Basic course. This is definitely better than ICL's courses if you want an introduction to the principles of the computer.

It consists of one computer, a book to go with it, a book of 'application studies' and their answers, and two copies of a quick reference card which can be used to tailor the course to your own system.

A computer is really essential if you want to derive the full benefit of this course, but that is a logical requirement only if you want to learn to program. It would still teach a beginner a good deal about micros and the Basic language if they had no system.

The cassette is dependent on the book although the latter would almost suffice on its own. The tape provides a sort of friendly commentary and much of its material is contained verbatim within the book. Regular example programs are set out and con-

sidered as each part of Basic is dealt with.

Every so often you stop the tape — noting the counter number in a box provided — and read some of the book or do an exercise. A lot of pictures are provided — one of the first, incidentally, shows someone inserting a disk into a drive the wrong way — which make the book look helpful and amusing to use.

Generally I would imagine this is a fun course to do and it does go into plenty of depth — slowly. It's much more designed for the confused or simply completely innocent computer user than the more advanced ICL courses. In actuality you could learn more from ICL's product but for some individuals it might take a little longer.

The NCC only produce the one course — that outlined above. While ICL estimates it has sold a total of approximately 3,500 copies of various courses from its series, the NCC's Jill Baker says Business Basic is 'very popular' and estimates that about 20 copies are sold per month. Many of these are apparently sold to home computer users.

Although course content, accuracy and approach are all very important, with this method it is the pupil who determines the probability of success. Self-discipline is the order of the day.

Audio courses, though, are an easier

learning option than reading a book. It's a simpler matter to sit and listen to a voice telling you something than to pore over a book to find out that something yourself. In addition, although you may think most of what you've heard has gone in one ear and out through the other, it's surprising how much you can pick up without realising it.

Sound Training, ICL and the National Computing Centre are the only organisations I can discover who sell audio courses relating to computers. There may be some others. If there are, they're not making very much noise about themselves. There will probably be more springing up in future as new software appears and more companies decide to jump onto the micro bandwagon.

Meanwhile if you feel this method of learning is for you (or your employees), the National Computing Centre's Microsystems Centre supplies Business Basic — tel 01-353 0013 — and ICL courses can be discussed by contacting Andy Street on Windsor 68181 ext 179.

Prices

	exclusive of VAT
Business Basic (inc VAT)	£19.50
ICL Pascal	£105
ICL CIS Cobol	£130
ICL Microsoft Basic	£70
ICL CP/M 2.2	£50
ICL Wordstar	£50

END



continued from page 113

(Black has a clear advantage because of its domination of the a7-g1 diagonal, preventing White from castling.)

13 Qd1-c2 0-0
14 Nf3-g5 Ne7-g6

(Possibly more natural is 14...g7-g6, followed by ...Ne7-f5 and eventually ...Nf5-d4 or ...Nf5-e3, as appropriate.)

15 a2-a4 Bc5-e7?

(A serious retrograde step. 15...Bc5-e3! would be very strong, for example 16 g2-g3 d7-d5!, and if 17 Bc4xd5 Qb6-a5+. Another possibility is the immediate 15...Bc5-b4+, keeping the white king stranded in the centre and saving a tempo.)

16 a4-a5 Be7-b4+
17 Ke1-f1

(The first critical position.)

17 ... Bb4xa5?!

(Dangerous, because after White's next move Black's defence needs very accurate handling. I would have been tempted to

ignore the a5 pawn, which is vulnerable in the long term in any case, and concentrate on attempting to take advantage of the exposed situation of the white king. But computer programs are terrible materialists, and the temptation to grab a pawn is normally too much for them to resist.)

18 h2-h4!

(The best chance. White is a pawn down and its king is precariously placed, so the only hope is to take advantage of the pressure on f7 (knight and bishop) and h7 (knight and queen). Now we have the second critical position.)

18 ... h7-h6??

(There seems little wrong with 18...Qb6-b4! (threatening mate on e1) 19 Bc1-e3 d7-d5! 20 e5xd6 (or 20 Bc4xd5 Bc8-d7, with threats of ...Bd7-b5+ and ...Ra8-c8) 20...Bc8-f5 21 Qc2xf5 Qb4xc4+ 22 Kf1-g1 Ba5-b6 23 Be3xb6 a7xb6, when Black still stands better. Of course, not many chess programs would examine this 11-ply sequence, but I would have thought that a number would reject 18...h7-h6 as being too weakening. The text allows White to turn the tables, a chance which Mephisto grabs with alacrity.)

19 h4-h5! Qb6-b4
20 Bc1-e3 d7-d5

(Now this try is too late.)

21 h5xg6 h6xg5

(Everything else is inadequate, eg: (a) 21...Bc8-f5 22 Bc4-d3 Bf5xd3+ 23 Qc2xd3 h6xg5 24 g6xf7+ Rf8xf7 25 Qd3-h7+ Kg8-f8 26 Qh7-h8+ Kf8-e7 27 Qh8xa8; or (b) 21...d5xc4 22 g6xf7+ Rf8xf7 23 Ng5xf7 Kg8xf7 24 Qc2-a4, with a decisive material advantage in each case.)

22 Bc4xd5 g5xf4
23 g6xf7+ Rf8xf7
24 Be3-c5

(Threatening 25 Qc2-h7 mate.)

24 ... Qb4-b5+
25 Kf1-g1 Qb5xc5+
26 Qc2xc5 Ba5-b6

(Now all of Black's pieces are pinned: the f7 rook against its king on g8, the a7 pawn against the rook on a8, and soon the bishop on c8 against the king.)

27 Qc5xb6 a7xb6
28 Ra1xa8 g7-g5
29 R8xc8+ Kg8-g7
30 Rh1-h8

(Threat 31 Rc8-g8 mate.)

30 ... Rf7-f8
31 Rc8xf8 Kg7-g6
32 Bd5-e6 b6-b5
33 Rf8-g8 mate.

END

Word Perfect





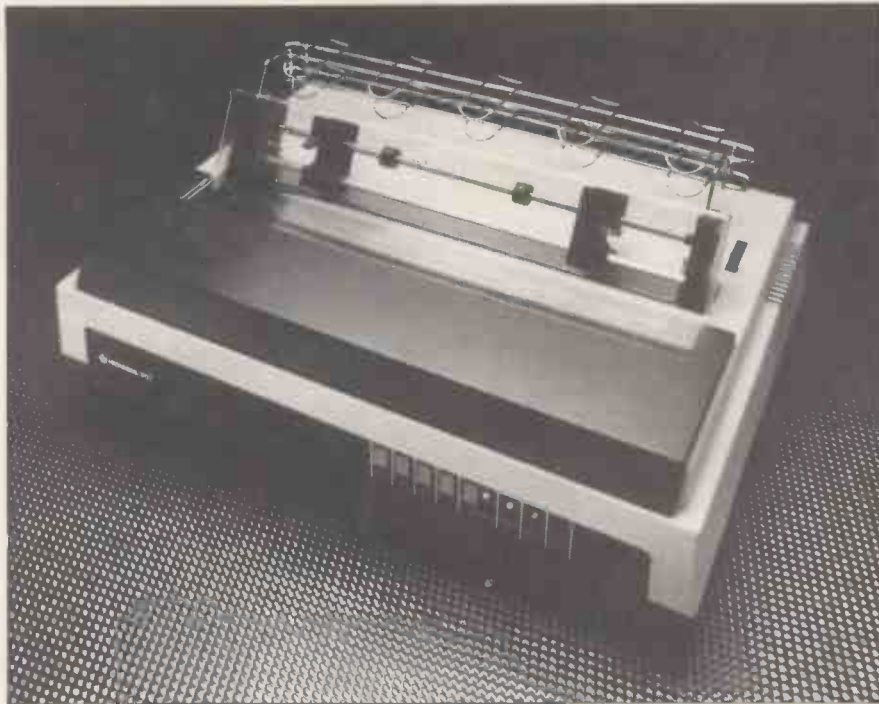

HERMES 612 THE WORLDS FIRST DAISY QUALITY MATRIX PRINTER



Now you have decided to invest in a Professional Micro, don't ignore the part of your system seen most often by those you want to impress.....You can't afford to cut corners on print quality and, at last, you don't have to. With it's many unique features and Swiss precision engineering the HERMES 612C brings you the only complete printing package available on one machine.

HOW?

BY GIVING YOU:

-  400 cps DRAFT QUALITY FOR SUPERFAST INTERNAL REPORTS
-  120 cps CRISP DAISY QUALITY FOR YOUR CORRESPONDENCE
-  AN 18 WIRE RUBY MECHANISM HEAD FOR INCREDIBLE PRECISION AND VERSATILITY
-  OVER 50 POSSIBLE CHARACTER DENSITIES AND STYLES
-  RELIABILITY SO GOOD WE ARE PREPARED TO OFFER A FULL YEARS WARRANTY

WHY NOT CONVINCENCE YOURSELF - CALL NOW

FOR YOUR FREE PRINT SAMPLE and see just how flexible a quality printer can be or get in touch with your local dealer for a complete specification.....If he can't help you we will be pleased to put you in touch with one who can, after all

You can't improve on perfection

**Micro
Peripherals Ltd**
MAIN UK TRADE DISTRIBUTOR

61 New Market Square, Basingstoke,
Hampshire, England.
Tel: Basingstoke (0256) 3232 (12 lines)
TWX: 859669 MICROP G



MICRO PERIPHERALS LTD

LEARNING BY EAR

Steve Harris plugs in his tape recorder, sits back and listens . . .

'Offputting' is one of the kinder words used to describe the manual that comes with MicroPro's Wordstar package. But it's an ill wind that blows no publisher any good, and there is no shortage of books designed to present Wordstar in a less intimidating way. Some offer a glossy, jocular approach, with the central assertion that learning is fun, and wrap the technicalities in a sugar coating of cosy chat. Others are more austere, proceeding along a very straight line of instruction to a series of exercises in producing business letters and tabular documents.

To quote from *Introduction to Wordstar* by Arthur Naiman, a writer of the word-processing-can-be-fun persuasion: 'Wordstar has just about every bell and whistle you get with any other word processing system, and then some.' The point is, of course, that to start using Wordstar you can't learn how to blow all the whistles straightaway — what you need as a beginner is something that will show you how to do on the screen what you could do on paper; and how to achieve this as painlessly as possible.

If you've got a patient and sympathetic teacher to show you everything, digging you out of the pitfalls as you go, there's no problem. If you're on your own and learning from a book, you've got to have something that either won't let you make mistakes — very improbable — or which will allow you to find your way out of them without having to read from cover to cover. But any independently produced training aid is likely to fall foul of some problems anyway because it cannot take detailed account of all the different micros that users may be learning on or of updates and refinements in the software itself.

The 'Sound Training' Wordstar instruction package aims to get new users processing words without expensive personal tuition but with a more personal and inviting approach than a written manual, and now claims to meet the needs of both Wordstar II and Wordstar III users. It is produced by Communications Projects (1 The Elms, Tillington, Hereford), which will also shortly be publishing similar packs for Mailmerge/Mailprint, Wordcraft and 'Introducing CP/M'.

The Sound Training pack is basically two audio cassettes giving a total of nearly two hours of spoken instruction with written material for back-up and reference. This comprises a manual containing work-

ing examples and a transcript of the four cassette sides, a set of 'Checklist' cards covering basics such as disk care, starting up and shutting down, and a set of 'Job Aids' cards summarising Wordstar commands. The whole lot comes in a durable spiral binder and it is designed to sell to those who want an aid to train others as well as to first-time users themselves. It costs £23 including VAT, with additional copies available at £16.68. In either case it assumes no prior knowledge of computers on the part of the trainee, but does assume familiarity with typewriting and office routines, and supposes that there will be someone to set up the computer before you start.

Once you (or the trainee) have booted the system, have a program disk in drive A and a formatted data disk in drive B, and know where the reset button is, you are ready to start listening to the tapes.

Side one offers a fear-allaying introduction — 'Don't worry, you won't break anything and you won't cause a disaster if you press the wrong button' — which instils the idea that you are 'in the driving seat' and that the tape will allow you to work at your own speed. It explains that word processing is just a way of writing, amending or editing and storing documents just as you can do on paper. This section also very simply describes the functional relationship between disk drives, screen, keyboard, printer and the computer itself without getting tangled up in the usual terminology of ROM, RAM, operating systems and programs.

Your first instruction is to key in 'WS' to load Wordstar and bring up the no-file menu on the screen.

Before discussing the contents of the menu, the tape does attempt to explain clearly that the characters you enter at this stage are instructions to the computer, not data, and to get over the concept of files and file names. However, it interrupts and confuses this with an instruction to key in H0 (help level zero), which means that Wordstar's on-screen display of commands will be suppressed when you start working on a file. This is not explained until later.

The menu — 'The list of things you can choose to do' — is quite well handled, as is the explanation of the confusingly ungrammatical shorthand term 'Editing no file' — though it would have been a good idea to have stated here that the term 'editing' includes starting a new document file as well as amending an existing document.

As an example of how the main menu works, the tape instructs you to run the STAT program to give you the number of unused bytes remaining. So, at last, you are nearly ready to start working on a document. But not quite: first, the tape has to explain the 'help level', which it has earlier told you to set at zero. With help level set at 3, Wordstar displays all menus and commands — but the tape tells you to keep it at zero because 'I've found that sometimes Wordstar provides almost too much help. . . You spend more time reading the prompts than typing text.'

Once you've opened a document file, you are required to copy-type in a 12-line piece of text from the front of the manual, which gives you something to start editing. This is all right as long as you notice that there are two spaces after each full stop and you don't make any other mistakes. Although you are told not to worry if you make mistakes, if you don't type the text in exactly as specified the subsequent instructions on editing it are likely to be confusing. It seems likely that a lot of trainees are going to call for help around this point, and it is here that the idea of replacing a teacher at your shoulder with a voice on a tape tends to fall down.

However, assuming you get the text on the screen without problems, trainees should have no trouble following the tape as it steadily runs through single-character amendment procedures. Wisely, the tape teaches you how to save and print before getting on to the further subtleties of Wordstar. This ends the second side of the tape. Side three teaches you how to format a business letter — going through scrolling, quick cursor movement, reforming and so on. Side four gets on to some of the 'bells and whistles' of Wordstar — moving blocks of text, setting margins, quick finding and other printer options.

So does Sound Training really work? If you are an experienced operator who needs a time-saving way of training others from scratch, it will probably work well and justify the cost. In this situation you, as supervisor, can explain the complications that arise — for example, the use of cursor keys and other function keys which, if provided, make Wordstar a lot easier.

In the early stages you can also clear up conceptual confusions about the nature of the operating system, programs and files. I can't help thinking, though, that setting the help level to zero straight away is a bad idea. Once a trainee understands the principles, it's a lot easier to refer to menus on the screen than to consult the Sound Training 'Job Aid' cards.

If you want to teach yourself Wordstar from scratch, the Sound Training method is less satisfactory. You'll still need some initial help and someone to turn to in case of difficulty, and you still need the written material. A well-organised book could well be a better and cheaper bet. Trying to rely on the tape alone would be a bit like trying to find your way through a complicated inner-city one-way system with only verbal instructions such as 'first left, second right', and with street names hardly mentioned; you really need a map.

END

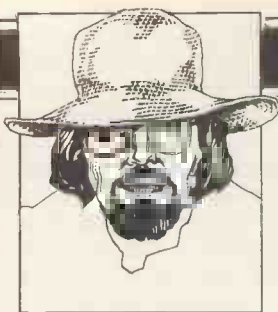

BANKS' STATEMENT

HIGH TECHNOLOGY? WE ARE NOT IMPRESSED

Martin muses on office automation, and considers eggs, baskets and Bedouins.

I have a theory. I don't for one second suppose that it is truly original, but I would claim to be the first person that I know of to have written it down, in a book I once produced.

The theory goes along the following lines: people will not accept any new development, technology or product which they can see no immediate use for or benefit from. This will be despite the fact that other people (especially the people who have developed and/or are selling the product) can see perfectly well the advantages to be gained.

A good example of this theory in action is viewdata. For those that are used to computers and computing, the use and manipulation of information and the need to gain access to vast amounts of it quickly and easily, the potential advantages of the technology are immediately apparent.

Disregarding any arguments about the specific technical capabilities of viewdata as available in this country, it has been seen that marketing it purely as a 'product' has not worked. The majority of the general public — who were expected to jump at the chance of acquiring and using this new technological wonder — have however barely risen above their normal somnolent state to give it a cursory inspection and a judgement of 'Uh?'

They have, in practice, seen little point in having vast gobs of 'information' available for which they could see no immediate or specific purpose. Only if they find an application specific to their own requirements, and only if the product — in this example viewdata — solves that applications problem, will the product as a whole then be investigated.

The same can be said of personal computers — or more specifically personal computers for use in business, commerce and the professions. I have used before the phrase that the industry has been 'bought from' rather than having to 'sell to' the marketplace, and this situation is probably about to change. In the market sector relating to business and the professions, and especially those professionals that work within large company structures, the 'selling to' is now starting, and there are some suggestions that it will not be as easy for the manufacturers of personal computers to break into this business as it has been for them to create from nothing the personal computer market *per se*.

At first sight this may appear somewhat odd; for the personal computer has already proved to be a big hit in the small business sector and the professions. Certainly it is true that the majority of purchasers have

had either a clear idea, or reasonable grounds to suspect they had an idea, of what they wanted to achieve. They were the users' who were 'buying from' the industry.

There are many, many more users of the 'small business' type yet to move towards the computer, and that total is but a flea-bite to the potential sales that exist within the walls of the large companies — the multinationals and their kin. This is the market that needs to be 'sold to'.

The majority of users, either individually or collectively, do not 'know' what they want. Oh sure, they want a computer system that will help them with their job, if only they can actually work out what it is that they do. They also, perhaps, want one for status reasons. They have trouble, however, actually identifying what it is the computer will be doing for them. Though they would possibly like one, they are not sure that they need it, or why.

Most of the rest just won't want one. They will see a computer as a threat, or as a status machine that has no relevance to them. There will be only a few (no doubt the pre-converted that have bought the likes of a Sinclair, VIC, or Dragon) who will positively want one of these new-fangled things.

For many large companies it will be worse, for they have a need to maintain, above all, some coherence in their corporate structure. Adding a new technology into the workings of the administration, financial control and product development areas of a company is a subject they will see as needing to be tackled *very* slowly.

Some estimates suggest that it could be 20 years before what we in the industry blithely refer to as 'office automation' is a normal and accepted part of a company's organisational structure.

And 20 years is a long time for some companies that are happily pinning their colours to the office automation mast to wait for their ship to come in.

There is a question here, one that goes roughly along the lines of '20 years?'. The reason the answer could be 'yes' is in the theory at the beginning of this piece. Office automation is concept built on almost infinite variation of physical implementation, and it could be many years before clear, coherent and provably workable approaches to its implementation are developed. At present, nobody really wants office automation. They have nothing against it, they just don't understand it and therefore they see no real need to have it around.

The trouble is that many of the basic

tools of office automation now exist and are being actively sold to customers. In certain applications they are already successful, particularly in the small business area where one computer is now sufficient to perform the majority of tasks required by a small company.

In larger companies they are also being successfully applied to defined applications such as word processing.

These are all just scratching the surface, however, for office automation in its fullest sense will require not just the tools but the infra-structure. It will also require the experience of failed automation attempts to provide the true definition of how, where and why it should be applied. At the moment, the industry is trying to sell farming equipment to a Bedouin. If he could learn that he could probably make a better living staying still and cultivating some land then he might buy all the farm equipment going. At the moment he sees no reason to stop being a nomad, thank you very much.

Even important elements of office automation infra-structure like local area networks fit into this picture. They are, indeed, somewhat like viewdata — everyone feels sure that they are important because they provide rapid communications facilities, but what do you communicate? How do you use the great gobs of information generated and available?

Answer these questions, and the way to apply the technology should come as a natural by-product.

But without coherent answers, it becomes questionable as to whether any or all of the tools so far produced will have any relevance in the long term. For example, personal computers as we currently know and love them — 8 or 16-bit boxes oriented towards individual man-machine interaction via such painful objects as the keyboard — may prove to be entirely the wrong type of 'tool' on which to base office automation. What if it proves to be something as yet undefined, like a speech I/O terminal connected optically to a processor that itself uses optical logic based on arithmetic to the base 4, derived from the four primary colours? I don't know — maybe somebody is working on it.

What is currently true is that several companies are beginning to pin an enormous amount of faith on office automation becoming a big market, and becoming one very soon. That in itself is a considerable act of faith, but it could be seen as being compounded by another, that their products are the right ones for such a 'market'.

BANKS' STATEMENT

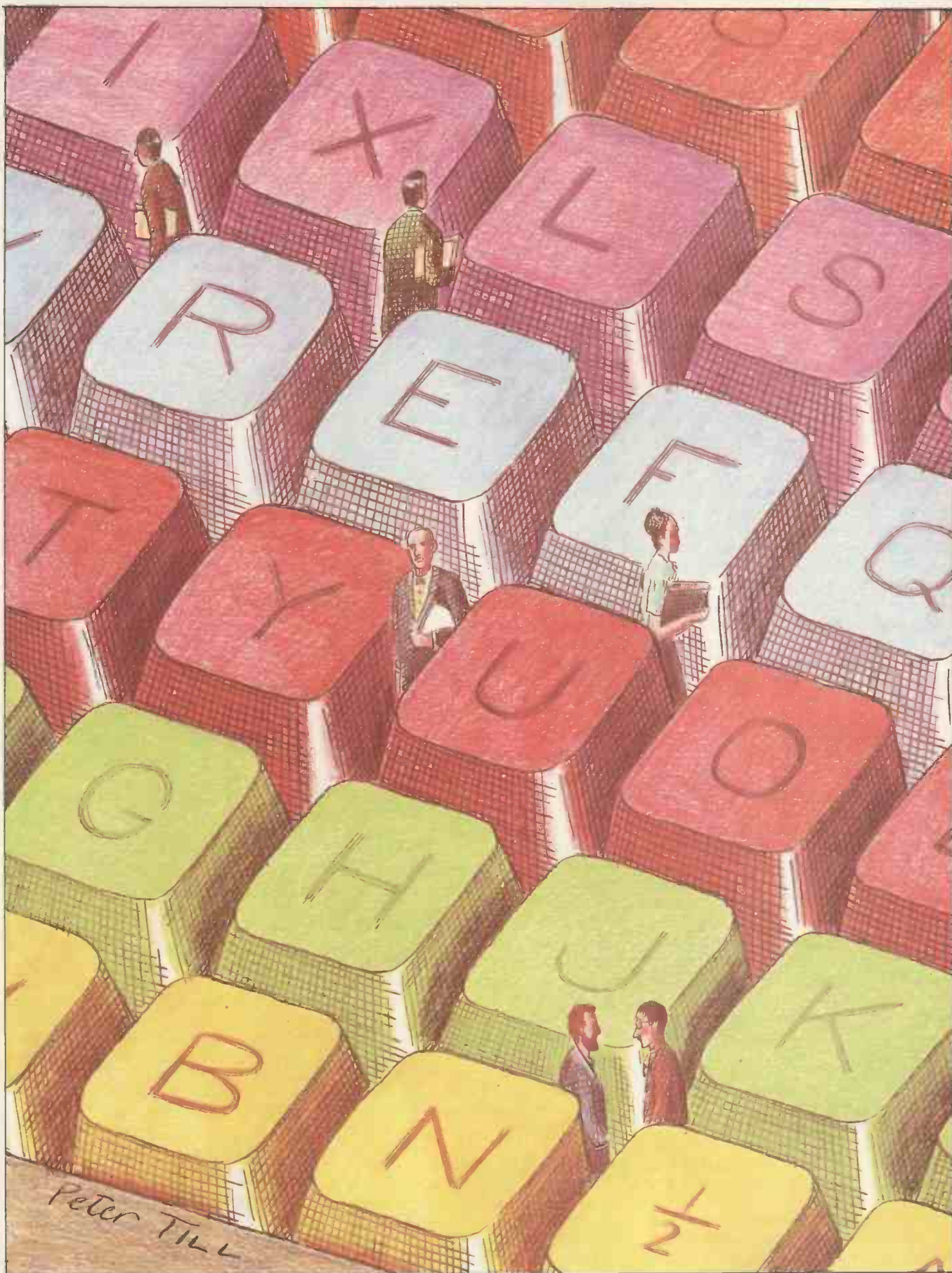

It has to be noted that one company in particular, Apple Computers, is aligning itself almost totally with the office automation market. Apple III and the revamped Apple IIe are office-oriented machines, and the new Lisa — a grand, if expensive, lady

of considerable talents — greatly enhances and expands the company's product capability in that area.

It has, however, put a lot of expensive eggs into one, as yet fairly intangible, basket. There are those in the industry who feel

that the basket is not actually there yet — or if it is it could prove to be the wrong shape to hold these particular eggs.

END

COMMODORE 64

A home computer or a small business system? Mike Curtis looks at the latest contender to the VIC-20.

The first sight of the Commodore 64 brings an immediate sense of déjà vu; it is almost identical in appearance to the very popular VIC-20, in fact some dealers have been advertising it as the VIC-64.

Viewed in this context the new Commodore machine would look to be a sure winner in the current race to put more and more memory into a small, home computer package. The price of £344.95, however would seem to exclude competition with the Sinclair Spectrum, Dragon and other similar machines and pit the new Commodore against the BBC, Newbrain and other more "serious" machines, with an educational and small business market in mind.

Commodore itself sees the machine as a low-end business machine, which can be taken home at weekends and can double as a high quality home computer, rather than the opposite. It must be borne in mind though, that a large and successful company like Commodore can afford to be flexible on prices, as when it slashed the price of the VIC-20 not so long ago. In a year or two's time when the VIC has reached its limit the price of the 64 may come down.

Hardware

The Commodore 64 comes in a large multicoloured box like the VIC, and when removed from its packaging material reveals itself in a light brown-grey case 16" by 8" and a maximum of 3" high. Most of the top is taken up by a full size qwerty keyboard. The keys are a chocolate brown colour apart from four function keys to the right of the main keyboard which are a shade lighter. This only leaves room for the Commodore 64 name at the top left and a single LED labelled "power" at the top right. The appearance is attractive and functional and clearly it is intended to blend in well with any office or home environment.

There is a separate power supply in the same type of strong plastic and the same colour as the computer.

A multitude of connectors can be found on both the right hand side and the back. On the side are the power socket next to a small on/off switch, and a pair of 9-pin sockets labelled control port 1 and control port 2 where joysticks and light-pens can be connected. At the back, reading from left to right as you look at them, are a cartridge slot, a small screw head which can be used to select the channel for the TV display, a phono-socket for the UHF TV signal, and two DIN sockets. One DIN socket carries both a composite video output to drive a monitor and an audio signal which can be plugged into a

hi-fi. The other DIN socket functions as a serial port into which can be plugged a VIC printer or a VIC disk drive. Also at the back are two edge connectors; one for the cassette interface and the other for the "user port" into which can be put various interface cartridges such as a modem or RS232. These should be familiar to any VIC or even PET user.

As usual on Commodore machines it is very easy to connect a whole range of Commodore peripherals to the 64, though other peripherals are more difficult. But it should be possible to connect, for example, a daisywheel printer via the RS232 cartridge in the user port slot. The Commodore 64 uses the same C2N cassette unit as the VIC.

Using the Commodore 64

The only thing necessary to get the Commodore 64 working is a 13 amp plug. The leads from plug to power supply and from power supply to computer are reasonably long and another long lead is provided to plug into the aerial socket of your television. The television must be tuned in to the computer's signal as usual, though this did not in my case turn out to be quite at the familiar spot of channel 36 that other machines use.

When all is working properly the screen clears to display a light blue border of about 1" surrounding a darker blue rectangle with the heading COMMODORE 64 BASIC V2 and the message that you have 38911 BASIC BYTES FREE. This to some extent makes nonsense of the claims to offer 64k of memory. Even using Assembly language the Commodore 64 can offer you only 48k of useable memory, but this is no worse than the majority of other machines; indeed it compares quite favourably with the 33080 bytes that MBasic leaves me on my 64k CP/M machine. The lettering and the cursor are in the same light blue as the border, the cursor flashes by inverting whatever is on the screen under it.

Keyboard

The keyboard is laid out almost identically to that of the VIC. At the bottom left is the Commodore key with the Commodore logo, which has several control functions; above is a key labelled RUN/STOP; there are SHIFT, SHIFT LOCK and CONTROL keys also on this side. On the right hand side are keys labelled CLR/HOME, INST/DEL and RESTORE as well as RETURN and another SHIFT; there are two cursor control keys at the

bottom right, one for up and down, the other for left and right. The letter keys carry two graphics characters on their front. The numeric keys situated along the top, carry colours except 9 and 0 which have RVS ON and RVS OFF. The four function keys on the right of the main keyboard are labelled F1 to F4 but also carry a sub-label of F5 to F8. Clearly each key has a number of different functions.

The machine powers up with the keyboard in Upper case/Graphic mode; text is displayed in upper case only, using the SHIFT key gives access to the right hand of the two graphics characters on the letter keys, but the normal shifted characters above the numerals. In this mode CONTROL can be used with numerals 1 to 8 to set the colour of characters displayed to the colour shown on the key; the colours in this main colour set are black, white, red, cyan, purple, green, blue and yellow. CONTROL and 9 will reverse the display, CONTROL AND 0 will restore it to normal.

The mode can be switched to upper/lower case by pressing the COMMODORE key and the SHIFT key together; in this mode upper and lower case characters are available from the letter keys using the SHIFT key as normal, but using the COMMODORE key instead of the SHIFT key gives access to the graphics character on the left of each letter key. The alternative set of eight colours is now available on the number keys, these being orange, brown, light red, grey 1, grey 2, light green, light blue, and grey 3. The COMMODORE and SHIFT keys will switch back to Upper/Graphic mode.

The COMMODORE key is also used when loading cassettes. The RUN/STOP key can be used to stop a Basic program while running and can be used for a warm restart in conjunction with the RESTORE key. The INST/DEL key acts as a backspace-delete or when shifted it will move text one space to the right inserting a space. The CLR/HOME key takes the cursor to the top left corner of the screen and when shifted it also clears the screen.

Editing

Full screen editing is available as standard. The two cursor keys, in conjunction with the SHIFT key which is conveniently right beside them, can be used to correct or enter text or graphics characters anywhere on the screen. When RETURN is pressed the contents of the line under the cursor are taken as input as though they had just been typed. This works even if the "line" is in fact longer than the 40 characters allowed on the screen.

The only keys which repeat are the



Photography by Ian Dobbie

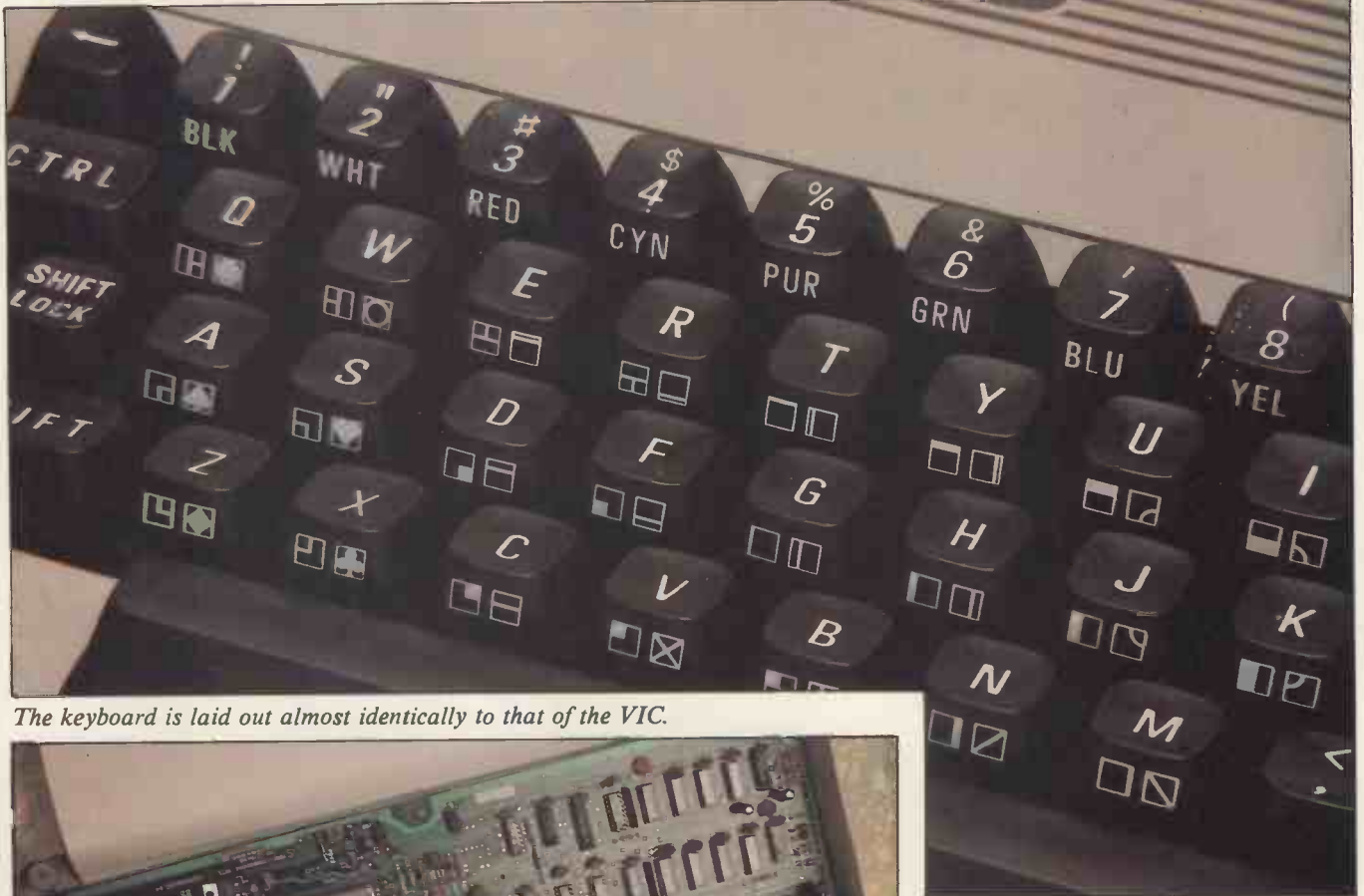

The keyboard is laid out almost identically to that of the VIC.

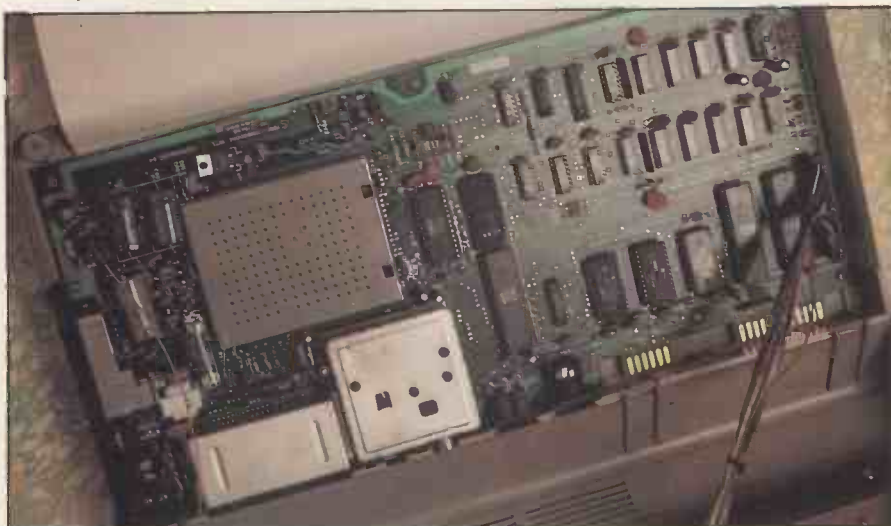

Inside the overall impression is of solid reliability.



Most of the top is taken up by a full size qwerty keyboard.

COMMODORE 64

cursor keys and SPACE. This confused me for a while, being used to auto-repeat on all keys, but I got used to it very quickly. The only snag I found was after making a change and moving the cursor back down using the RETURN key as is my habit; every line is re-entered as it is

passed including READY which is interpreted as READ Y and produces an "Out of Data" error message. The keyboard looks and feels solid and easy to use, though the keys did not "click" positively enough for my taste.

Display

The display was good with edges being quite reasonably sharp and text clear.

There are 25 rows of 40 columns, which is about the most that you can get out of a domestic television. The colours are bright and clear though I could discern a rainbow effect looking close – my television is getting a bit old though, and I have found a number of machines that give better displays when put on a more modern set. I tried the display on a black and white monitor and got a crystal sharp effect. I am surprised that there seems to be no immediate provision for an 80 column display which I would have thought at least desirable, if not necessary for serious business use.

Software

The Basic in this new machine will also come as no surprise to VIC or PET users; it is the standard Version 2 Commodore Basic which does look a bit antiquated now. Variable names can be any length, but only the first two characters are significant. Strings can be up to 255 characters. Integer variables are available using the %, but no double precision limiting real values to 9 digits (10 held internally). There are no control structures apart from FOR ... NEXT, GOTO and a simple IF ... THEN..., and no named procedures.

Input and output can be directed to any of the available ports, so giving easy control of printers, joysticks and other devices. The tape interface is quite standard for Commodore machines, though running at a different speed. It worked perfectly throughout the test. I did not have the opportunity to try the disk unit but it should work here as well as it does on the VIC.

COMMODORE 64

There are two system variables TI and TIS, that give access to a real time clock. TI contains the number of units of 1/60 sec since the machine was switched on. TIS is a 6 character string containing the time in hours, minutes and seconds. It starts at 0 but can be assigned a value to set the time. A further system variable ST contains information on input/output status which can be used to detect errors, though no details of how to do this are given in the manual.

The Benchmarks show that the 64 is in fact a little slower than the VIC but still quite reasonable compared to its main competitors. The major lack however is the almost complete absence of commands to handle the extensive graphic and sound capabilities of the machine. The only way to achieve effects is extensive use of PEEKS and POKES and although the manual goes into some detail about the various memory locations and registers which can be used for these purposes the method is very cumbersome compared to the commands available on say the BBC Micro or the Dragon.

Compatibility

The advantage of retaining the same basic language as the VIC and the PET is, of course, that the machines then become software compatible. It means that the 64 will be able to use not only the vast range of games and home programs for the VIC but also the large quantities of good business software available for the PET. The software will in general not be immediately transferable, because the PEEKS and POKES will be different, as will any USR functions or SYS calls, but it should be fairly easy for a reasonably competent home-programmer to transfer a VIC program and no doubt software to do it will become available soon. Software to make the 64 emulate a "new ROM" PET has already been announced by Commodore. A warning though that the cassette speeds are different so VIC software must be transferred via a disk.

Future add-ons

The faults with the Commodore 64 Basic will also be cleared up, for disk based systems anyway, by another new item of software called "Simon's Basic" which should be available from this April. This will give structured programming, named procedures and direct commands to handle graphics and sound. I would have preferred to see this as the standard. Other projected software includes a number of games and educational programs, obviously carried over from the VIC. But emphasis is given to a new range of software especially written for the new machine including a word-processor, a spreadsheet, a data-management package and a spelling checker as well as other languages such as UCSD Pascal, Logo, Pilot, Comal and Lisp. Even more impor-

tant is the projected Z80 add-on card which will provide the 64 with access to CP/M and unlimited software.

Other projected add-ons include RS232, IEEE and Prestel interfaces and networking capabilities. Speech synthesis is promised for this September and voice recognition for the following January. Dates may well be moveable as always in this business, but clearly the 64 will be the centre of a very sophisticated computer system with access to a very large software base.

Inside

Taking the lid off the 64 means undoing three screws at the front. Then the top comes off with the keyboard which is a separate unit. The lead on the keyboard is not quite long enough to be able to lay top and bottom side by side but it disconnects easily, as does the lead to the power LED.

Inside is a single board occupying the whole space. The processor is a 6510A, a development of the 6502 used in other Commodore machines. Memory comes in the now standard form of 8 x 64k dynamic RAM chips. There are the usual cluster of peripheral control devices and a total of 20k of ROM in three chips. The video circuitry is on its own and screened by a metal case from the rest of the machine as are some of the external connectors. The whole is surrounded by what I can only describe as a sheet of conducting cardboard. This is clearly a professional job as you would expect from a company like Commodore and the overall impression is of solid reliability.

The memory map is not given in the manual though addresses are given for the screen and various control registers. Overall there is a total of 54k of RAM which is available to the user though 16k of this is in parallel with the Basic interpreter so from Basic only 38k is left. There is 4k of ROM on top of Basic and 3k of system RAM. Unlike the Z80 and its relatives all input/output ports will appear on the main memory map so a true 64k is difficult to achieve on 6502/6510 machines.

Graphics

The graphics capabilities of the Commodore 64 are quite extensive. They represent a reasonable compromise between the speed and economy of memory of graphics characters against the convenience and quality of true bit-mapped high resolution graphics with its demands on memory.

There are three ways of using the 64's graphics. The first is by the graphics characters available from the keyboard and through the CHR\$ function; all graphics characters as well as control characters can be entered between quotes in a Basic string assignment. This makes it quick and easy to program many static pictures, such as Bar charts for example. The second way is to use POKES to play around in the video registers to give a 320 by 200 pixel resolution; this is not very easy or convenient but may be made

easier with "Simon's Basic".

The third and most interesting technique is the sprite graphics where high resolution shapes can be plotted on a 24 by 21 grid and can be made to move around the screen, enlarge and diminish through values POKEd into various sprite registers. They can be made to pass behind one another and collisions can be detected. Up to eight sprites can be active at any one time. Once again the process of defining and manipulating sprites is quite complicated from the standard Basic. The sequence that must be followed to define and use a simple sprite is first to plot the required shape on a 24 across by 21 down grid using graph paper. Each row of 24 on/off bits is interpreted as 3 bytes and the resulting 63 8-bit binary numbers converted to decimal. These 63 data values are transferred to a block of 63 bytes somewhere at the beginning of memory - the number of this block (in multiples of 63 from 0) must be POKEd to a particular register so that the sprite knows where to get its data. The starting address of the video registers is at 53248 and the number of the register is added to this base address to get the address of the register into which the appropriate values can be set.

Motion is achieved by updating the X and Y co-ordinates. The user must be able to convert between one or more '1's in an 8-bit binary pattern representing one or more sprites being manipulated into a decimal number. Collisions can be detected by PEEKing at registers and determining whether or not particular bits have been set. Sprites can be any of the 16 colours or a special multi-coloured one. One problem arises with the use of an 8-bit register to hold the X co-ordinate since this gives a maximum value of 255, whereas the screen width is 320. To move past the barrier needs the setting of the Most Significant Bit for the appropriate sprite in register 16, which effectively makes the X co-ordinate into a 9-bit number and hence up to 511. The sprites are not particularly fast when used from interpreted Basic but speed should increase when compiled Basic or Assembly code is used to give some good games effects.

The normal characters can be POKEd into the screen, which occupies 1000 bytes from 1024 in a straightforward row by row one byte per character grid, but the character codes to be POKEd are not ASCII. A parallel 1000 bytes starting at 55296 controls the colour in each character position which can be again be set by POKeing the appropriate colour code into the correct place.

Sound

The sound generation facilities are another strong feature of the Commodore 64. Again the standard Basic leaves you to set all the various features of a sound by POKeing into various registers but the facilities are excellent and the quality good.

The first thing to note is that the sound actually comes from the television set;

Wego Computers Ltd



The Sequential Switching Unit for powering up and down various devices in the correct sequence. **£75 + VAT**

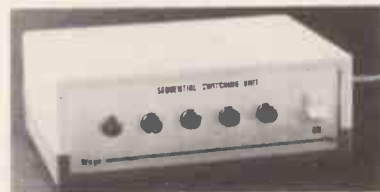

BackPack – A standby power supply that fits internally within the PET and Disk Drive. It gives at least 15 minutes to close the system down in an orderly fashion. **£140 + VAT**



The **Card Reader** is now available with an optical read head, which can also read punch cards. **from £650 + VAT**



The **TNW 1000** – an output only addressable serial interface IEEE to RS232C. **£110 + VAT**



Distributors of all Professional Software products – WordPro Plus, Power, InfoPro.

Wego Computers Ltd

22a High Street, Caterham, Surrey CR3 5UA
Tel: Caterham 49235 Telex 933660 WEGO-G

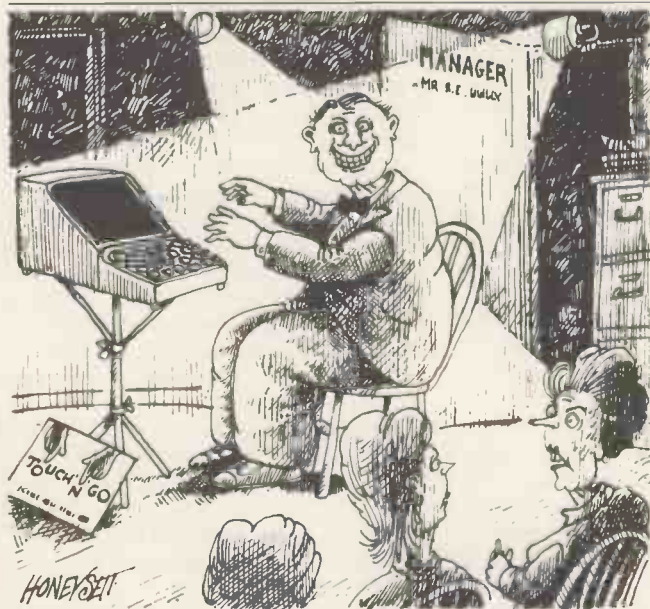

“This is the bit where he gives it all ten fingers!”

Is your high-performance computer let down by your low-performance fingers? Touch 'n' Go will change all that. In just 24 hours you can master the computer's QWERTY keyboard and its numeric keypad. Forget boring drills and meaningless hieroglyphics. Touch 'n' Go introduces real words and phrases at the earliest possible moment. The computer gives you instant feedback on your performance and can even store the results for posterity. By the end of the course you should be capable of 40 words per minute.

Why use two fingers when you have ten?

Touch 'n' Go is available from computer dealers and direct from Caxton for only £25 plus VAT. It is available in popular CP/M and MSDOS formats. Please add £1 p&p when ordering direct.



Caxton Software Ltd 10-14 Bedford Street, Covent Garden, London WC2E 9HE

ZX81-16K/DRAGON 32/BBC A+B SPECTRUM 16/48

ADVENTURE 200 (16k)

OVER 200 PLACES to explore. Written in machine code and using advanced data compression techniques it squeezes a true fixed-map adventure into just 16K – all held in ram – no extra cassette reads or books of text. Unlike a randomly generated maze type game this is a real test of your tactical skill. It starts easy but the further you progress the more dangerous and difficult the problems become as you use objects around you to overcome obstacles and evade enemies! More like a thriller than an arcade game – and you are the hero! Flexible command format allows abbreviations and multiple word lines.

Other games from Foilkade include:-

AWARI – Ancient African game of logic
FANTASTIC VOYAGE – (ZX81 16K only) Real-time simulation of micro-sub in human body. Real vascular map and fast m/code graphics.

THE FOILKADE CHALLENGE: Buy both Adventure and Awari and enter our prize competition. SAE for details.

All games £5.95 inc. 2 for £9.95 3 for £13.95

£1000 IN PRIZES

FOILKADE LTD

'PCW3', 66 LITTLEDEAN, YATE, BRISTOL BS17 4UQ

COMMODORE 64

there is no in-built loudspeaker. An audio output is available from the same connector as the video output and enables the sound to be played through an amplifier or a domestic hi-fi. It has been claimed that the sound produced by this machine is as good as some synthesisers, I think this is overstated but the quality is as good as I have heard and the range of settings available is quite staggering.

There are three voices occupying a range of registers from 54272 to 54292 inclusive. It is possible to control for each of three voices: volume (a range of 0-15), attack/decay and sustain/release, frequency, waveform, and pulse rate. Values are given in the manual to play notes over 9 octaves and in a variety of voices ranging from piano to trumpet as well as suggestions for found effects. A piano keyboard is one of the add-on units that should be available soon and that could be interesting if backed up with suitable software.

Documentation

The Commodore 64 comes with just the one 'User's' manual which purports as usual to be both a manual for the machine and an introduction to Basic (and binary arithmetic in this case). It does not really succeed but it could be worse. On balance it is much better than many Commodore manuals in the past. My main criticism is

its small size: the reader is pointed towards the 'Programmer's Reference Manual' for further information but this has to be obtained separately. There are some major omissions from the 'User's Manual', notably the only mention of the function keys is to point out how useful they could be, but nowhere does it mention how to use them! I would think that the 'Programmer's Manual' was necessary enough to warrant inclusion as standard.

To emphasise the dual nature of the Commodore 64 the manual seems to assume that many users will be attaching a disk drive so all instructions for loading and saving programs, and for the use of data files, duplicate for disks and tape.

The manual gives a number of useful examples to illustrate the use of Basic and the various facilities of the machine. Tables are included in the appendices for the video control and sound registers and clear instructions on how to POKE to the screen and the screen colour area.

Although it is quite well written the manual does seem to fall between two stools; the novice may well find some of the tables and the binary arithmetic a bit daunting and require something which takes a bit more time over their use. On the other hand a more experienced user would feel a bit restricted by the absence of the Programmer's Manual and so would need to buy it straight away.

Conclusions

The Commodore 64 is what you might

expect from a major manufacturer like Commodore: a professional high quality machine with a guaranteed large software base. There is nothing startlingly new about this machine, in some ways it is a marketing ploy like the new Apple IIE: upgrading a well-tryed and proven architecture with the most modern technology. This allows the manufacturer to launch a product which will compete on equal terms with the new machines while armed with peripheral attachments and software already available. That has to be a recipe for success. The VIC printer, joysticks, disk drives and others will all work on the 64, new sophisticated add-ons designed for this machine will be available shortly.

The machine is already proving very popular in America, and Europe has always been a better market for Commodore than for the company's major competitors so there is no doubt whatsoever that the 64 will sell well and have a major effect on the market.

It is a good machine with all the facilities that a home user would require, although I have my doubts as to its useability as a business system, but this will depend very much on the software. There are machines around now or coming soon which will overtake the Commodore 64 in specification but the 64 will have the same advantage that the VIC enjoys, namely that it along with its peripherals and software will be available in large numbers on every high street.

END

THE ONLY ORGANISATION TO ACT SOLELY ON BEHALF OF
ALL MICRO-COMPUTER USERS

THE ASSOCIATION OF MICRO-COMPUTER USERS

A NON-PROFIT MAKING ORGANISATION

GET THE STRENGTH OF THE AMU WORKING FOR YOU

GUARANTEED LOWEST U.K. PRICES FOR:
HARDWARE
SOFTWARE
SUPPLIES
MAINTENANCE
INSURANCE

COMPREHENSIVE FREE SERVICES COVERING:
SOFTWARE ADVICE AND TROUBLESHOOTING
HARDWARE ADVICE AND FEASIBILITY
GENERAL PROBLEM SOLVING
ARBITRATION FOR RETAIL GRIEVANCES
MEMBERS' EQUIPMENT-FOR-SALE REGISTER

PLUS BULK PURCHASING POWER FOR MEMBERS' VOLUME NEEDS

YOU CAN BE A SHAREHOLDER IN A POWERFUL ORGANISATION
AND HELP TO INFLUENCE THE MICRO-USERS' ENVIRONMENT

THERE ARE THREE LEVELS OF MEMBERSHIP

LEVEL ONE: HOME USERS. SUBSCRIPTION £25.00 INCLUSIVE OF ALL FEES

LEVEL TWO: BUSINESS USERS. SUBSCRIPTION £37.50 INCLUSIVE OF ALL FEES

LEVEL THREE: EDUCATIONAL USERS. SUBSCRIPTION £39.50 INCLUSIVE OF ALL FEES

Members receive a certificate and a membership card with a unique personal number ensuring that members only can ever gain access to the facilities offered by the association. There is a code of conduct which members are expected to maintain.

To: THE ASSOCIATION OF MICROCOMPUTER USERS, P.O. Box 54, Worcester, WR2 6QA. Tel: (0905) 640400

I enclose my cheque/P.O. for £ and apply for full membership at level

NAME

ADDRESS:

POST CODE TELEPHONE

EQUIPMENT USED

NOTE: PLEASE RECORD YOUR CHEQUE/P.O. NUMBER. ONLY CURRENT MICROCOMPUTER USERS ARE ELIGIBLE.
MEMBERS OF BRITISH FORCES OVERSEAS WELCOME.

Britain's finest business software for the Commodore 64

Fully featured ledgers and stock control - for less than £100 per package!

The Commodore 64 is the computer small businesses have been waiting for - inexpensive, reliable, with a large memory. Now there is Anagram business software for the 64, full-scale proven 40-column sales ledger, purchase ledger and stock control developed from existing Anagram packages for larger machines.

Anagram software uses no jargon, speaks to you in plain book-keeper's English, is extremely easy to understand. The packages for the 64 offer all the options and facilities any business is likely to need.

Sales Ledger with invoice printing - £99

Anagram Sales Ledger 64 maintains comprehensive details of each customer account on an open-item basis - each invoice remains on the account until it is paid. Handles up to 220 customer accounts, up to 20 lines per invoice, trade and settlement discounts. And you should see the reports!

Purchase Ledger with Nominal Analysis - £99

Anagram Purchase Ledger 64 is as comprehensive and full of features as the Sales Ledger, and is just as simple to use. Up to 150 supplier accounts with 50 nominals - posts invoices, credit notes and payments to each account. You can even analyse each invoice across 6 nominals plus VAT!

Easystock - £75

Easystock, like the Sales and Purchase Ledger packages for the Commodore 64, is designed to make computerisation straightforward for the businessman and his staff. Step-by-step menus ensure accurate stock records for up to 550 stock items with detailed up-to-the-minute reports.

SEND THE COUPON FOR A LEAFLET AND DETAILS OF YOUR NEAREST DEALER

Please rush me your Commodore 64 software leaflet
and the address of my nearest dealer

Name _____

Company _____

Address _____

Telephone No. _____

 **ANAGRAM SYSTEMS**
60A, Queen Street, Horsham, West Sussex RH13 5AD
Tel. (0403) 50854 58153 Telex: 877986 PCW 583

GRAPHICS

Digisolve offer high resolution fast graphics for your computer with a rapidly growing range of hardware and software.

APPLE IIE GRAPHICS

Digisolve's Apple II High Resolution Vector Graphic Processor Card quadruples the screen resolution and allows you to run powerful design and business graphics packages.

- 512 x 512 pixels resolution
- 85 characters by 64 lines of text
- 64K bytes of on board memory
- 2 pictures stored on the card not using main memory

£399.00

COLOUR GRAPHICS

Digisolve's VGP64 controller will put 512x512 pixel graphics in 8, 64 or 4096 colours on your computer. With 384K bytes of memory as standard your computer can become a powerful graphics system.

Try one on your Apple, IBM, S100, VME, Multibus or PDPII system.

8 colour	£799.00
64 colour	£899.00
4096 colour	£1599.00

INTELLIGENT GRAPHICS

With Digisolve's commitment to graphics we have introduced a cheap monochrome intelligent controller.

- RS232 or parallel
- 512x256 or 256x256
- 85x28 text with scrolling windows
- line, arc and circle drawing, board only £150.00

VDU BOARD

Just launched, the cheapest way to make an 80x24 VDU, fully scrolling operation with proper descenders.

- 19.2K Baud
- 80x24
- £160.00 @ 1+ £100.00 @ 100+ quantities

SOFTWARE

Our graphics hardware has attracted some very powerful packages with the opportunity to increase their resolution whilst gaining more memory space.

ARTISTS

We have 2D and 3D packages to take your ideas and put them onto film or video. These are already being used as advertising tools in studios.

ARCHITECTS

Scribe and Capitol are tried and tested packages to model, design and visualise buildings. These have upgraded performance with our Apple card giving increased resolution and a larger data base.

BUSINESS

Visicalc with 80 characters by 64 lines displayed on the screen.

Applewriter II pre boot giving 85x57 display, almost a full A4 page for word processing.

Digisolve



Aire & Calder Works, Cinder Lane, Castleford,
West Yorkshire WF10 1LU
Tel (0977) 513141 Telex 557661 AGRAM

Apple II and Apple IIE are the trademarks of Apple Computers Inc.

SCREENPLAY

Steve Mann selects his

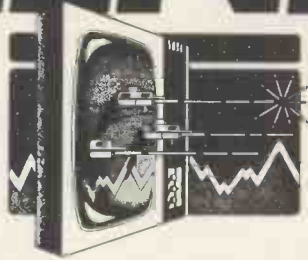

favourite Spectrum games.

Regular readers of this column will notice that there is a new name in the headline this month. There is also a considerable increase in the marks given for each game. This does not mean that I am by temperament more generous, more forgiving, sweeter-natured than Dick Olney — although this is undeniably the case — but on this occasion various factors have combined to make this review something of a special case.

When Dick was in charge of this column, he would follow a set pattern; first borrowing a machine from the relevant manufacturer, then selecting the software from among the games that are sent in for us to review. In certain cases, particularly when the machine in question was very new and little software was available, he would arrange to borrow a selection from a friendly micro retailer. This is the procedure I will be following in future months. However, this time out I am looking at software for the Spectrum — a machine I have spent a good part of the last 10 months getting to know and love. As a consequence, I

have accumulated a mass of software, and from this I have selected my favourite games.

The Spectrum situation has improved immeasurably since Dick first took a look at games for this high-selling machine; he was justifiably acerbic in his comments about some of the software that was then available — most notably the ICL range marketed under the Sinclair banner. Most Spectrum software at the time was ZX81-based, hastily updated with a few colour commands and BEEP statements, and, almost without exception, failed to do the machine's capabilities justice. Six months later, however, things have improved beyond recognition.

Sinclair machines spawn a vast number of spin-offs — the number of people who make a living producing goods solely for Clive's products must be in the thousands.

The advantages are obvious — there's a huge captive audience, and the very nature of Sinclair freaks seems to encourage the 'cottage industry' approach. This means there's lots of competition and, as a consequence, prices are kept low and choice high. For the user, this is an ideal situation — if he wants a Spectrum version of Star Trek or Scramble, he's got a choice of sometimes dozens, and it's very unlikely he'll have to pay more than five or six quid.

The games on offer here, then, are not especially new; they are all programs that I've spent a fair bit of time with. They are all professionally produced (but note my later comments on spelling and grammar), imaginative packages that are in no way inferior to some that run on the BBC or Atari — and which will cost probably three times as much. The 'Value for money' rating this month is, therefore, largely superfluous. All the games I look at here I would recommend unhesitatingly as being superb value. . . Note that, with the exception of Arcadia, all games reviewed here require the 48k Spectrum.



Game: Football Manager
Supplier: Addictive Games
Price: £5.95

Never was a company more aptly named — at least, if this particular piece of software is representative of the rest of Addictive's output. . . when I first received this game I spent the best part of a weekend playing it, and since then have returned to it more often than any other in my collection.

The object of the game is to pilot your chosen team from Division 4 through to the League Championship, on the way winning the FA Cup as often as possible. The game mirrors reality in that a good Cup run will give you greater attendances, hence more money at the gate; conversely, losing too many games cuts your income and can result in you getting the sack. You have a maximum of 16 players in your squad and can buy or sell as the situation dictates, borrowing from

the bank as necessary. You can change players' names to suit your own foibles and prejudices — which is just as well, as there's no way I'd have Kevin Keegan in any team of mine — but unfortunately your players must have names of eight letters or less, including initial, so there's no room for Kenny Dalglish. There's nothing to stop you changing a player's name to your own and leading your team to glory from the field!

On loading Football Manager for the first time you are invited to enter your name, and then choose a team from the 64 on offer. No matter which team you choose, you start the game in Division 4 — which must be particularly galling for Liverpool fans. If your favourite team is not represented, you can select any of the others and then change the name. You then select your skill level from a choice of seven, ranging from beginner to Genius. It is recommended that you start as a Beginner and increase the difficulty as you become more familiar with the game — managers of genius quality seem to suffer from an inordinate number of injuries to their players. You then have to choose your team's colours — this is not too realistic as you are restricted to black or white — and the game begins.

The truly addictive quality of this game is the remarkable way it mirrors a real football manager's problems. Each player in your squad is rated between 1 and 5 in skill; this rating affects his price in the transfer market and his cost to you

in wages. In addition, each has an energy value of 20 or less; each game played reduces this value by one, while resting the player for one game boosts his energy by 10. Your team's performance will depend on values obtained from the skill and energy ratings of the players selected, plus a morale factor — lose games and this goes down, making you more likely to lose again. This is identical to a real team's performance — teams that start losing tend to make a habit of it.

So far, the whole game is purely textual — but now the fun begins! Having selected the most suitable team for the forthcoming game (you have a dossier on your opponents' skills, morale and energy) you have to sit back, biting your nails like any real manager, while the game is played. This is done in a series of goalmouth scrambles — there's a real thrill in seeing your forwards converge on the opposing goal and a sense of uncertainty as to whether the defence clears it or the ball hits the net. Successful shots are greeted by an electronic scoreboard flashing 'GOAL!' and the match score is displayed.

It should be stressed that this is not a short game — there are 15 games in a season, plus the various rounds in the FA Cup — and to get from Division 4 to the League Championship at any of the higher skill levels is going to take you a week or two of playing every day. However, having taken Aldershot FC

SCREENPLAY

from the lower reaches of the fourth division to the top of the first, winning the FA Cup every year along the way (admittedly, only on Level 2), I can vouch for the satisfaction that can be gained from this program. Recommended

to anyone who has any interest in football — but I suspect non-sportspersons (is this non-sexist enough to get past the typesetter?) (*I'd recognise Garth Crook's bodyswerves anywhere — enthralled typesetter*) would find it somewhat

incomprehensible.

Presentation: ██████████
Addictive quality: ██████████
Use of graphics: ██████████
Value for money: ██████████



Game: Flight Simulation
Supplier: Psion/Sinclair
Price: £7.95

This program is based on a ZX81 flight simulation, but the enhancements are substantial enough to treat it as a new product in its own right.

You are presented with the view from the cockpit of a small, high-performance, twin-engined plane; the screen is split in two, with the instrumentation in the lower half and the outside world visible through the cockpit window at the top. Pressing 'm' gives you a map of the flight area, showing the two airports — 'Main' and 'Club' — a range of hills and three lakes, as well as the seven radio beacons that you lock onto for navigation.

On first attempting the simulation, the

user will probably find the instrumentation somewhat confusing — it is all too easy to go into an uncontrollable spin and plunge into the ground at a high rate of knots. But after a while you develop a sufficiently light touch on the controls. The instrumentation consists of an air-speed indicator, fuel gauge, power gauge to measure engine thrust, a digital panel which tells you which beacon you're locked onto, how far away it is and its bearing in compass degrees relative to the plane, warning signs to tell you if flaps and landing gear are up or down, a radio altimeter which gives an exact read-out of heights under 1000 feet, and the large RDF clock, which shows a diagrammatic representation of an aircraft in the centre with a digital read-out of your heading and a blip that moves around the clock's circumference and helps you align your craft correctly. Finally there's the ILS (Instrument Landing System) dial; this makes sure you are correctly lined up on the runway as you make your approach. By the time you've got this far, you'll be able to see the runway through the cockpit window; as soon as the radio altimeter hits zero, throttle back and — in theory, at least — you should taxi smoothly to a halt. To help in taxiing, there are two rudder controls; these also have some effect in

flight, although I tend to ignore them unless I'm on the ground.

As you can see, there's a lot to keep track of, and to date I have managed only a couple of complete flights — which ended with the message 'That was a bouncy landing!'. You have the option of starting from take-off, from level flight, or from the beginning or the final approach — and if you're feeling flash you can add wind effects to make things even more difficult.

It's a piece of software that you'll return to time after time — it may not match up to the IBM simulator, about which the whole world and his uncle is currently raving, but given the limitations of the Spectrum it does a fine job. It should go a long way towards restoring the somewhat tarnished image of Sinclair-label software — though I largely absolve Psion from any previous derogatory comments, as its products have always been at the very least adequate. This is considerably more than adequate; in fact, 'excellent' is the word that springs to mind.

Presentation: ██████████
Addictive quality: ██████████
Use of graphics: ██████████
Value for money: ██████████



Game: Time Gate
Supplier: Quicksilva
Price: £6.95

Time Gate is heralded as a '4D Arcade Adventure' — the fourth dimension being time. You inhabit a galaxy almost totally dominated by the Squarm — a race of 'vicious insectoid reptiles'. Mankind clings precariously to existence in the solar system. There is one functioning time-ship available — your task is to take this vessel and travel through the galaxy, going backward in time through randomly placed 'time gates' until you can reach the Squarm's home planet and destroy them before they breed and start

their loathsome galactic domination.

The program is in two parts. Part 1 describes your mission and explains the ship's controls. Quicksilva and program writer John Hollis have taken the trouble to redefine the Spectrum character set completely, but spoil it with silly mistakes — they use no apostrophes at all, and on the very first page misspell 'possible' as 'possable' — which somewhat spoils the effect. It may be unfair, but I find things like this prejudice me against the game.

Anyway, climbing off the hobby-horse and returning to Time Gate. . . The on-screen manual takes you step by step through the ship's instrumentation and explains all this clearly. You have a map of the galaxy which show your position and tells you which galactic sectors contain Squarm or planets where you can land and refuel. There's a message screen to display information from the ship's computer and a target computer which locks onto the nearest alien craft in the sector. On this panel there are also six coloured segments to give information on the extent of damage suffered by your craft's various support systems.

You play the game by moving,

Startrek-style, through the various sectors of the galaxy. Time Gates are not displayed, but your instruments will detect them if they occur in a sector you have cleared of the enemy. The computer navigates you through a Time Gate and gives you a new date, going ever backwards towards Year Zero. You can refuel and repair your ship by landing on a planet in an enemy-free sector — but once you've taken off again the planet blows up, which seems a little harsh on its inhabitants.

Once you've digested the instructions, the main game loads. There's a keyboard overlay to mark the relevant keys — very useful — and a hold button so you don't lose your place if the phone rings. The game is similar to Startrek in the searching out of the enemy, but the action is real-time, with enemy craft swooping around your cockpit. Visuals are very effective for landing and taking off and the game is undoubtedly the product of a lot of hard work. Unfortunately I found that by the time I zapped my twentieth alien I was getting seriously bored — it all seems to go on a bit too long. You can abort the mission at any time, in which case you are given a points score

— but I can't work out how this is calculated.

Full marks for design, then (if not for spelling), but I'm not convinced that this

is a game to return to very often. I'm glad I've tried it, but it won't break my heart if I never play it again.

Presentation: ██████████
Addictive quality: ██████████
Use of graphics: ██████████
Value for money: ██████████



Game: Arcadia
Supplier: Imagine
Price: £5.50

Now this really is something special. . . The bright young things at Imagine have confidently pledged themselves to the production of totally original arcade-style software for a variety of home machines — no Pac-Man rip-offs here — and I would guess that Bug-Byte (probably Imagine's closest competitor) is feeling decidedly sick at the success of Imagine's first batch of product.

First impressions of Arcadia are of a high degree of professionalism. The colourful cassette insert credits the game and graphics designers (take a bow D Lawson and M Butler), and Arcadia offers a lifetime guarantee — if one of

their games ever fails to load for any reason it will be replaced at once, totally free of charge. This is certainly a step to be encouraged. Instructions for setting up are clear and concise, and there's a touch of sly humour in that the alien beasties you are battling against belong to the Atari-an Empire. Of course, it could just be coincidence. . .

The object of the game is fairly standard zap-the-alien stuff; the alien fleets attack in waves, and there is a timer at the top of the screen. If you manage to destroy a whole fleet before the timer reaches zero, another replaces it. Conversely, if the fleet fails to destroy your ship (the Arcadia) within this time limit, it will break off the attack and a new race will home in on you.

The player has a wide choice of control keys, so it is easy to configure the keyboard to suit your particular finger-span. There is also a 'freeze' facility — any key on the top row halts execution, enabling you to break off and go and make a cup of tea.

Arcadia is very deceptive in the early stages. On playing the game for the first time it is highly unlikely you'll get past the first stage of fairly ordinary-looking alien ships. But as you get better you begin to appreciate the truly stunning graphics — there are 12 different waves

of attackers: mutant butterflies, birds, strange spinning circles, octopus-type shapes, even a mini-Centipede game at one point. If you manage to get through four levels intact, you get an extra ship (you start with five) and I am informed that there is someone out there who has reached the 53rd level; a claim I find hard to believe as the Atarian Empire is certainly no soft touch. Luckily for us cack-handed reviewers, Imagine sensibly sent along a special idiot's version of the game, which gives 99 lives instead of five — even with this enormous advantage I find I'm hard-pushed to keep up with the speed of the game. Part of the trouble is the tendency to sit back and gawp at the beauty of some of the creatures attacking you; this cassette really does show that, given sufficient imagination (sorry!), Spectrum graphics can match up to almost any other machine around.

I understand that Arcadia is now one of the top-selling Spectrum games on the market — all I can say is that it thoroughly deserves its success. Only reason it doesn't get even higher marks is that Imagine staff are big-headed enough anyway. . .

Presentation: ██████████
Addictive quality: ██████████
Use of graphics: ██████████
Value for money: ██████████



Game: The Hobbit
Supplier: Melbourne House/Sinclair
Price: £14.95

A new Melbourne House offering — and this is the one everyone's talking about. Based on the Tolkien saga, this is an adventure in which you take on the role of Bilbo and seek out the evil dragon, taking his hoarded treasure and returning it to the chest in your home. You have the added responsibility of looking after Thorin, whose survival is supposedly vital to your quest; I must admit, however, that I tend to kill him off as quickly as possible — his major activities appear to consist of telling you to hurry up and sitting down singing about gold at

every opportunity. This is a major feature of the Hobbit — described as 'animation' in the manual, what it really means is that the characters interact with each other. Even if you've merely passively waiting at a location you just know that they're off somewhere huddled in a corner, plotting. . .

This adventure has a vocabulary of over 500 words, and it is possible to chain commands in the form of, say, 'Take the axe and go through the door and kill Thorin'. You start in Bilbo's hobbit-hole, where you are visited by Gandalf the magician, who gives you a map, and away you go. . . as you'd expect there are trolls to avoid or kill, treasure to amass, etc, and in many ways it is a typical adventure.

But The Hobbit has two important differences — there are very good graphic representations of many of the locations, and there is 'English'. English is the language you use to commune with the computer. This is very sophisticated — as a bare minimum a single verb or even a compass point can be entered, but at the other end of the scale the program can cope with chained commands of the kind described above. Adverbs and adjectives can be very important and punctuation is

used in its normal form. The only limitation is length — no more than 128 characters. This allows you to be very specific — 'break all the bottles except the green one' — and it really does give the impression of holding a conversation with the computer.

Melbourne House has made moving around very easy; let's assume you're in Bilbo's house when Gandalf opens the door and goes eastward. If you want to follow him, you have a multitude of choices. If you only want to go in one of the four major compass directions, you simply press the relevant cursor key (no need to use Shift). Alternatively, you can specify movement in any direction either by spelling it out in full, abbreviating it, or using it as part of a sentence. If you know the name of the location you're heading for you can just say 'Enter Lonelands'; alternatively you can specify 'Follow Gandalf'.

This first time you reach a location the computer gives you a full description of where you are and what the place looks like, plus a list of visible exits. If you return, the description is shorter but you only have to ask and you're given a complete run-down. You can ask for help at any time, but the results are often some-

SCREENPLAY

what puzzling. On finding myself in a dark place, where I kept falling over and banging my head, I tried seeking the program's aid. Asking for help elicited the information that 'A window should be no obstacle to a thief with friends!'

The cassette comes in a large box containing a comprehensive 16-page instruc-

tion booklet and a copy of the Tolkien book. The Hobbit was written by Philip Mitchel, Veronika Megler, Alfred Milgrom and Stuart Ritchie and they, and Melbourne House, deserve a great deal of credit. I can fault it only on cost — £14.95 — but this just illustrates how well off Spectrum owners are. An Atari

user would consider that sum cheap for a good piece of software — and, after all, you *do* get a book thrown in for good measure.

Presentation: ██████████
Addictive quality: ██████████
Use of graphics: ██████████
Value for money: ██████████

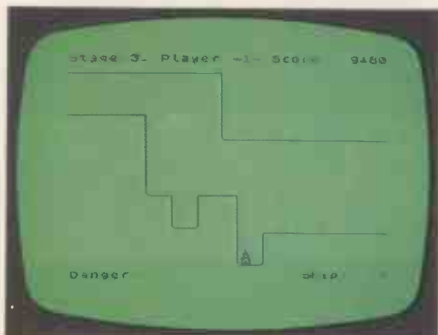

Game: Penetrator
Supplier: Melbourne House/Sinclair
Price: £5.95

Not another Scramble variant (yawn. . .). But I suppose every home should have one, and it must be admitted that as Scramble versions go this one goes a long way. Melbourne House is fast gaining a reputation for classy products, and this is no exception.

I'm sure you're all familiar with the object of this exercise — you pilot your craft over hills and through tortuous caves, dodging missiles and avoiding rocky outcrops until eventually you reach

a nuclear bomb store which has to be destroyed. To add to the hazards, there's a network of radar stations to keep tabs on your flight path — if you don't knock 'em out the missiles get more accurate and your chances of survival — slim enough at the best of times — diminish accordingly.

Written by Philip Mitchel (who also had a hand in *The Hobbit*), this game is as near as damnit impossible. The player is given every possible aid to success — there is a special training mode which allows practice of each stage independently and, more importantly (in my case at least), there's a landscape editor which allows you to customise the game to your own specifications. By reducing the number of missiles by 75 percent I managed to reach the neutron bomb store — but even after destroying this you still have to get back out again, and it sure isn't easy. I suspect it will take weeks of practice to get good enough to negotiate the whole game. I suggest designing three or four landscapes, each containing progressively more missiles (these can be saved on tape for later reloading) and trying to work your way up to completing

the whole scenario.

It takes a little while to get the feel of the controls — up and down movement is handled by the 'q' and 'a' keys and thrust and brake are available for limited periods only via the 'p' and 'o' keys. The 'p' key also doubles as a firing button for launching forward missilies — this is the bit that needs care; firing involves repeated pressing of the key and it is very easy to press too slowly, with the result that instead of obliterating your target you fly headlong into it. Any key on the bottom row activates the bomb launcher.

Penetrator is unique in its customisation feature and will astound those who like to sneer at arcade-style games played on home computers. Just load the cassette and ignore the menu of choices at the beginning; after 30 seconds or so the program will play a demonstration game. It always scores 13,000 or so, and never gets as far as the neutron bomb store, but it's fascinating to watch.

Presentation: ██████████
Addictive quality: ██████████
Use of graphics: ██████████
Value for money: ██████████



Game: Pimania
Supplier: Automata Software
Price: £10

I'm not too sure that Christian Penfold and Mel Croucher should be allowed to walk the streets; both of them are obviously warped. . .

Pimania is a game that defies description, but I guess I'll have to give it a try.

What we have here is a world where saxophones turn into hang-gliders, where red herrings swim across the bottom of the screen blowing bubbles of derision, and where snatches of music confuse, hinder and occasionally help you. Along the way you'll be greeted by a blatant appeal for cash — they promise to send

you a t-shirt, but what makes you think you can trust them? Throughout your adventures you'll be involved with the Pi-Man who'll give you presents of useful things like blackboards then next minute rob you blind.

It's a game that encourages all that is noble in the human spirit — namely naked, ravening greed. The prize is a specially designed £6000 gold and diamond sundial; whoever wins it will certainly deserve it but will undoubtedly be a gibbering lunatic by then. A couple of hours spent with this game is enough to induce dementia in the most stable of personalities — I'm having doubts about my sanity even writing about the damned thing.

Seeing as there's so much at stake, I'm not going to tell you too much — why should I help you get rich? Suffice it to say that it's an adventure, but the objects are not your run of the mill swords, magic rings and potions — oh no, here you get to pick up TV dinners, cans of worms, handfuls of valium. . .

The object is to get through the Gate of Pi, which will reward you with a place name and date. Turn up here at the appointed time and an Automata person will be there to hand over the goodies.

There are potential clues in everything — probably even in the horrendous 'disco single' on the other side of the program tape. This is 'performed' by Clair Sinclair and the Pi-Men, with instrumentation provided by the Spectrum and a Casio VC-1. I'm sure this is vitally important, but it's much too awful to listen to.

All I can say is that the Pi-Man does a mean hokey-cokey, the animation makes nonsense of the fact that the Spectrum is a slow computer, and the cassette case should carry a Government Health Warning: this game can damage your brain. Try it — you'll love it! It would appear that Automata staff are not expecting an early winner — if no one shows up on the first date set they promise to return at the same time on the same day of every year until the prize is won. You will also find yourself in competition with owners of various other machines — there are versions for the Dragon, the ZX81 and the BBC.

Presentation: ██████████
Addictive quality: ██████████
Use of graphics: ██████████
Value for money: ██████████

USED EXTENSIVELY THROUGHOUT THE ELECTRONICS INDUSTRY AND NOW AVAILABLE FOR THE FIRST TIME TO THE AMBITIOUS CONSTRUCTOR, THE R50 DIY COMPUTER FROM RADE SYSTEMS. HERE'S WHAT YOU GET...

- Z80A BASED PROCESSOR ● FULL 64K OF DYNAMIC RAM ● DUAL SERIAL PORTS ● PARALLEL PRINTER PORT
- UNLIMITED EXPANSION VIA TWO EXPANSION CONNECTORS ● FULL 4MHZ CPU ● FULL CPM SUPPORT VIA ADD-ON FLOPPY OR HARD DISC OPTION BOARDS ● USER MANUAL

PRICE INCLUDES VAT, PACKING + POSTAGE
£215
 ONLY

You can make it.

- DOZENS OF APPLICATIONS INCLUDE: ● AUTOMATION DEVICES
 ● CONTROL APPLICATIONS ● COMMUNICATIONS EQUIPMENT
 ● BUSINESS MACHINES ● WORD PROCESSORS ● GRAPHICS DISPLAYS
 ● SCIENTIFIC AND EDUCATIONAL

OPTION BOARDS INCLUDE:

- FLOPPY DISK CONTROLLER £80
 - SPRITE COLOUR GRAPHICS BOARD £99
 - R50 TECHNICAL MANUAL £6.50
- PRICES INCLUDE P+P

ALSO AVAILABLE PIO, SIO, IEEE 488 PORT, REAL TIME CLOCK, PROTOTYPING BOARD, MATHS PROCESSOR USES AMD9511, A TO D CONVERTOR, STEREO SOUND MUSIC BOARD, 192K RAM BOARD, CASSETTE INTERFACE, HARD DISC INTERFACE, CPM 2.2 AND TURBODOS AVAILABLE. INTERFACE KITS FOR ALL LEADING MICROS, PRICES ON APPLICATION.

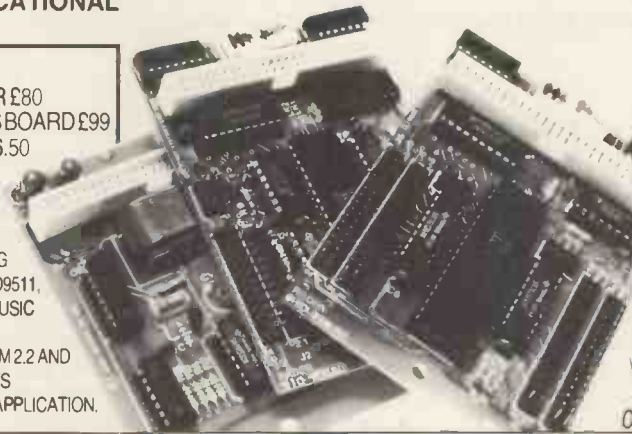

PLEASE MAKE CHEQUES/POSTAL ORDERS PAYABLE TO RADE SYSTEMS LTD.

- R50 DIY SINGLE BOARD COMPUTER £215
- FLOPPY DISC CONTROLLER £80
- SPRITE COLOUR GRAPHICS BOARD £99
- R50 TECHNICAL MANUAL £6.50
- MORE INFORMATION
- AMOUNT ENCLOSED £

NAME _____
 ADDRESS _____

 POST CODE _____

RADE SYSTEMS LTD,
 290A HIGH ROAD,
 WILLESDEN,
 LONDON
 NW10 2EU



DEALER ENQUIRIES WELCOME

APPLE USERS

BACK UP VISICALC AND ALL YOUR VISIS QUICKLY AND SIMPLY

Copy II Plus is a versatile software back-up system, capable of backing up all visis, as well as most other protected software.

Its fast — only 45 seconds for Fast Copy, less than three minutes for Bit Copy.

Its simple — menu driven for ease of use with full instructions on backing up dozens of popular programs.

Its comprehensive — it includes all the file handling and DOS utilities you will ever need.

Its priced right — at around half the cost of similar competing products.

Copy II Plus — only £35 + V.A.T.

Send cash with order, or quote your Access or Diners card number to:

Orchard Software, 17, Wigmore Street, London W.1. Telephone 01-580-5816. Dealer enquiries welcome.

**COPY II PLUS
 COPY
 COPY
 COPY**

**ORCHARD
 SOFTWARE**

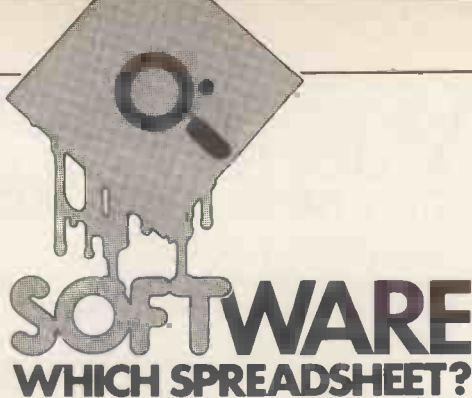

PLANNERCALC

Mike Liardet brings us the fourth article in his continuing series of everyday spreadsheet systems.

The use of 'calc' and 'plan' in spreadsheet names is currently very much in vogue, and Comshare has scored a uniquely imaginative first by giving us both in one name.

Plannercalc is one of two spreadsheet systems it is currently selling or, perhaps more accurately, giving away — the price is only £39 plus VAT. Comshare's other spreadsheet system, Masterplanner, is more sophisticated (and expensive — £245 plus VAT) and is claimed to be fully compatible with Plannercalc. In this article we shall look the gift horse in the mouth; we will consider only Plannercalc, and postpone Masterplanner until much later in the series — unless of course PCW's switchboard gets jammed by the clamour of requests to the contrary!

Comshare is a multinational company with offices throughout Europe, the US, etc. It has a lengthy track record as a time-sharing bureau and one of its specialities is in the area of financial planning. Clearly, Comshare was heavily involved in this area long before the spreadsheet was even a twinkle in the eye of its originators, Bricklin and Frankson.

Now as all/both avid readers of this series will know, one of the prime (but not the only) uses for spreadsheet systems is in the area of financial planning/modelling. Doubtless many former time-sharing users have migrated on to the more cost-effective micro and so one doesn't need to be a clairvoyant to divine the reasons for Comshare's diversification in this direction.

Apart from the above credentials, Comshare can also claim to have brought to our TV screens no lesser a personage than Ian McNaught-Davis, head of Comshare UK and also the erudite presenter on the BBC's 'Making the most of the micro' series. By one of those strange coincidences beloved by software reviewers everywhere the episode immediately prior to my writing this review (in mid-February) consisted of a short exposition from Ian McNaught-Davis on spreadsheets (no, he didn't plug

Plannercalc) followed by an interview with a consultant on the subject of tips for purchasing software packages.

Does Plannercalc match up to Mac's own excellent standard of presentation? Does it meet the exacting standards outlined by the consultant? Well, why wait in suspense for the answer? 'No, it doesn't.' Now read on to see where and why it fails.

Documentation

Alarm bells started to ring at the very first page of the manual: a short list of Plannercalc's major features (including 'quality assurance' — more on this later), followed by: 'COMSHARE. . . when time and money are not expandable, you can afford nothing less than the best'. After re-reading this several times, mentally cancelling the double negatives, realising that the poor print quality had caused me to mis-read 'expandable' where it actually says 'expendable' etc, I eventually worked out that this was actually, as one might expect, a positive statement for Comshare's services! I am not sure if the *Guinness Book of Records* has a 'Worst Slogan' section but I am sure this should be a candidate for it.

Thumbing further through the manual reveals a fairly substantial amount of documentation, about 100 pages in all, but a fairly mediocre print-quality, interspersed with occasional typographical errors (eg, 'excessive', 'in tact', 'heirarchy'), and self-congratulatory text (eg, 'A great advantage Comshare Software has over. . .') — which would be better omitted from the manual and left to the advertisements. The type size is approximately the same as that used in this article but the lines are closer together and the overall effect is that of a photocopied reproduction rather than an original. Generally my young eyes (well, relatively young anyway) managed to cope with this, but long-sighted users could find it rather a strain.

The manual is held in a ring-binder with a pouch at the front for the disks.

There is provision for opening the binder in a special way, so that it can stand freely as if it were on a bookrest. Bookrests seem to be all the rage with software manufacturers at the moment — it's a pity that my desk is always too cluttered and I have to simply sit with the manual on my knee. (When are we going to get binders that convert into frisbees, tyre levers or something I can use?)

Anyway, in this ring-binder the rings are slightly too small and the pages get snagged as you are turning them. This seems to be a common fault with ring-binders, but is especially irritating in this case, as page-turning is an all too frequently activity when using Plannercalc — it's very difficult to find your way round the manual. 'Doesn't it have an index then?' I hear you say. Well, yes it does, but occasional inaccuracies coupled with unintuitive entries make life unnecessarily hard. (For example, the index entry for 'Copy' includes page 8-13, which didn't exist in my manual. Information on wiping clear the current spreadsheet cannot be traced by 'Clear', 'Wipeout', 'Zap', etc, but is actually listed under 'Create'.)

I could list further inadequacies in the manual, but you should, by now, have got the drift. In conclusion, though, is there anything good to be said about it? Well, it is fairly substantial, occasionally illustrated, has a nice glossary and all the information you are likely to need can be found and deciphered eventually — you just have to work quite hard at it!

Getting started

My review copy of Plannercalc arrived as two 5¼ inch disks for the Apple II CP/M system. It is in fact available in a wide variety of disk formats, with facilities for the purchaser to configure it for most 80-column VDUs. It will run on CP/M systems only, unlike its big brother, Masterplanner, which also runs on CP/M-86 and MS-DOS.

The manual gives some instruction on how to set up working disks — a fairly brave attempt, as primarily this involves

using CP/M programs supplied by individual computer manufacturers, which are of course full of their own idiosyncrasies. Once the working disks have been made, the originals can be carefully locked away and the computer switched on or booted as normal, with the newly created working disks in place.

The next step is to 'install' (ie, modify) the program for your own particular VDU. You do this by running a program called, you guessed it, 'INSTALL'. The first response to this program requires some thought: 'Which Target program are you using?' The Appendix on 'INSTALL' provides no information on this whatsoever. I subsequently discovered the information on this elsewhere; it transpires that 'PCOLY.TGX' is the required response. ('Target', by the way, would appear to be the software house or Comshare subsidiary that developed Plannercalc.)

Once past this hurdle, matters become a little simpler. If you are lucky, your own VDU will be listed on a preliminary menu and all you will need to do is to make the right selection to finish the installation. Otherwise facilities exist to set up manually the information for your own VDU. This is always a painful process for any package, involving a lot of jargon and much thumbing of your VDU manual. Try and exercise some charm on your dealer and get him to do it for you! (You'll need plenty of it — at £39 retail price, he has no great margin for user training.)

Having got this far, you are at last ready to use Plannercalc — simply enter 'PC' in response to the CP/M prompt. By reading between the lines and examining the directory of all files provided with Plannercalc it is possible to deduce that 'PC' behaves like a command file, doing little more than reading in the files which actually do the 'work': 'PCOLY.TGX' — presumably a mnemonic for Plannercalc Overlay — 'PCHLP.TGX' and 'PCERR.TGX' being the files containing the text of 'help' and error messages. I mention this here, since the manual doesn't (or at least couldn't be found to, which amounts to the same thing), and I spent some considerable time discovering that all these files need to be together on the same disk for the system to be fully operational.

Plannercalc v Visicalc

Comshare's experience of a decade or more with financial planning has had a considerable influence on the design of this system. Unlike some manufacturers, who have simply come up with a revamped Visicalc, Comshare obviously has its own ideas of what the public wants. Plannercalc uses the spreadsheet approach pioneered by Visicalc, but there the resemblance ends. Instead of formulae which operate only on individual specified cells in the spreadsheet, Plannercalc's formulae operate on whole rows at a time. Not only that, but if the rows are 'named' the

names can be used in formulae, eg, 'LINE 10 PROFIT=SALES-COSTS'.

This sort of approach is obviously appealing in financial applications, but is attained only at the loss of some flexibility. For example, setting up the Benchmarks proved to be much more tricky with Plannercalc than with other spreadsheet systems. For the financial planner there is unlikely to be any problem, but other spreadsheet users, particularly those with technical or scientific applications, are likely to find Plannercalc a little bit frustrating. Comshare would appear (indirectly) to acknowledge this fact: the product is clearly labelled with 'Business Planning on a Micro'.

If I may borrow an analogy from the field of programming languages: Plannercalc is like Cobol on a spreadsheet whereas Visicalc is like Basic. This analogy extends also to the famed verbosity of Cobol — many Plannercalc formulae involve fairly lengthy typing, but tend to be more readily comprehended when reading them back afterwards.

Using Plannercalc

Having described the basic design innovations in Plannercalc, we shall move on to what it is actually like at the keyboard. Earlier on, we left off just after we had entered 'PC' to run it. After a preliminary 'copyright screen' we arrive at the spreadsheet display. Basically this consists of status information (memory space left, etc), a prompt line, a portion of the spreadsheet itself and an input line for entering formulae.

Typing 'DIRECTORY' gives a list of all models on the disk. Immediately following this, the system pauses until the Escape key is pressed. No indication is given on the screen that this key should be used and it is also difficult to track down this fact in the manual, so the immediate impression is that the system has crashed. Anyway, once we can see the models available (Plannercalc is supplied with some demonstration models) we can quickly load them from the disk using the 'RECALL' command.

Once we have a model loaded into the spreadsheet we may wish to explore it. Like most spreadsheet systems, Plannercalc provides the usual cursor move with windowing described in earlier articles. First it is necessary to press the 'execute' key, as the manual describes it. This key is defined by the installation procedure and varies for different VDUs. Eventually we track down the vital information, E (ie, a two-key hit using 'control' and 'E' keys simultaneously) is 'execute', on the Apple at any rate.

Cursor moves are achieved with ΔT , ΔV , ΔF , ΔG for up, down, left and right. If you have a keyboard nearby you can verify that these keys are arranged as four points of the compass, and their position relative to one another readily indicates their function. My only criticism of this choice of keys is that they are a little far from the 'control' key, and you need a finger span approaching that of a piano-player to be

able to do cursor moves with one hand.

It was obviously the intention of the producers of this system that attempts to move the cursor outside the confines of the present model would be signalled by a beep at the VDU. Unfortunately this did not happen consistently. Moving to the left of the first column elicited the correct response, but moving *into* the last column caused a beep. Attempts to move above the first row or below the last row produced no audible warning at all. In no cases did the system crash or do anything drastic, but the inconsistency was mildly disturbing.

It should be noted that, although it is possible to move the cursor freely around the spreadsheet, the only point in doing this is to examine different parts of it. There are no facilities for modifying the current cursor cell, as there are with Visicalc, for instance.

Modifying cells, or entering data and formulae, is achieved by using commands. The first command needed is the 'SIZE' command — you use this to specify the number of columns you will need in your model (eg, 'SIZE=13' if you want 12 month and one total column). You do not need to pre-specify the number of rows. You can also adjust the display characteristics by modifying column widths, etc.

Now for some examples of entering data and formulae:

```
LINE 4 WAGE'RATE = GROW 4
BY 8%
```

This sets the row heading for the fourth line to 'WAGE'RATE', enters a 4 in the first column, 4.32 (= $4*1.08$) in the second column, 4.67 (= $4.32*1.08$) in the third, and so on.

```
LINE 5 EXPENSES=
.5*(WAGE'RATE + 200)
```

This sets the row heading for the fifth line to 'EXPENSES', enters 102 (= $.5*(4 + 200)$) in the first column, 102.16 (= $.5*(4.32+200)$) in the second, etc.

It can be seen from the above examples that Plannercalc is vastly different from, say, Visicalc in the way that the model is set up. It would seem to be particularly easy to use for financial planning — the user does not have to wrestle with the intricacies of replication, etc — but, because the operations are predominantly designed for row upon row operations, setting up models with a more complex mathematical structure can be made more difficult. It should also be noted that text can be entered only as row or column headings and cannot be freely entered at any place in the spreadsheet, as with many other spreadsheet systems.

Other commands

We have already seen that Plannercalc commands are used for setting up the model (eg, the 'LINE' command used in the above examples) and for controlling interactions with the disk (eg, 'DIRECTORY', 'RECALL'). Other commands permit printing, clearing the spreadsheet and so on.

SoSoft

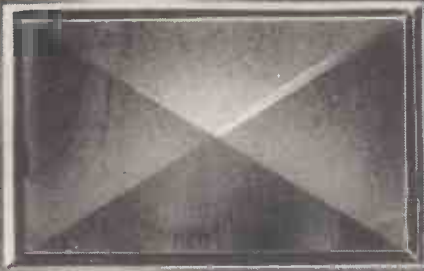

TOMORROW'S OFFICE



SOME EXISTING

SoSoft

APPLICATIONS

- Advertising Schedules
- Appointments Planning
- Bank Accounting • Bonus Schemes
- Book Keeping • Budget Control
 - Bureaux De Change
 - Commission Invoicing
- Contract Costing • Cost Ledgers
- Credit Control • Customer Files
 - Dental Records • Diary
- Equipment Leasing/Rental/HP
- Estate Agents • Estate Management
- Expense Accounting • Farm Records
 - Fleet Vehicle Management
- Index of Books • Insurance Premiums
 - Invoicing • Job Costing
 - Laboratory Data Handling
- Mailing • Manufacturing Costing
- Medical Records • Medical Research
- Membership Accounting & Records
 - Name & Address Files
- Office Administration • Parts List
- Personnel Records • Petty Cash Ledger
 - Plant/Asset Register
- Portfolio Management • Price Lists
 - Property Management
- Purchase Ledger • Records Keeping
 - Registers • Rota Planning
- Route Planning • Royalty Payments
 - Sales/Purchase Order Files
 - Seating Arrangements
- Sickness & Absence Register
 - Statistics • Stock Control
 - Test Data Storage
- Theatre Event Costing • Time Costing
 - Training Progress Reports
 - Vehicle Costing

... and your application too!

One program - One price
Thousands of uses!

Hard to believe?
Ask for a demonstration now

SoSoft

300 Ashley Road, Parkstone, Poole,
Dorset BH14 9BZ Telephone 0202 735656

PCW5

Name

Company

Type of Business

Address

Telephone No:

Existing Micro (if any)

Tell me more about Tomorrow's Office
I want to see a demonstration

Please tick

commodore

digital

ACT
sirius1

IBM

VICTOR

AND OTHERS

PLANNERCALC

One of the difficulties with using the system is that some of these commands are badly named. For example, after selecting 'PRINT' and having completed a printout we wish to return back to the normal display and continue working with the model. The screen gives no indication of how to do this. There is no quick reference card. So it's back to that manual! Eventually it transpires that we should enter 'RESULTS' to finish with printing — fairly cryptic. (Incidentally other aspects of the print facility are quite good — for example automatic formatting for reports too wide for the paper.)

Another misnomer is 'CREATE' — this actually does the opposite (ie, annihilate). In fact the best named commands are those that enable you to exit from the system and return to CP/M. The implementors have obviously put a great deal of thought into these, and have provided no fewer than five ('FINISH', 'QUIT', 'BYE', 'END' and 'STOP'), all of which have exactly the same effect! This is reminiscent of the old joke: 'The only good thing about town x is the railway station out of it.'

Conclusion

When assessing Plannercalc it is impossible to ignore the price. It is obviously going to appeal to people on a tight budget as the system is as rich in features and facilities as many of the more expensive spreadsheet systems. But, in my opinion, due to poor documentation, badly-worded screen prompts and unnecessary jargon, a user is going to take a lot longer to become proficient with Plannercalc and he must count the cost of this in his considerations.

Naturally, the low price is a poor incentive for dealers to provide anything more than 'take it or leave it' support. (After all, the price is almost in the Space Invaders category.) If you have an established relationship with a dealer than you may fare better than this; likewise if you are also simultaneously buying all the hardware to run it. In the latter case the savings pale into insignificance alongside the overall bill, anyway.

Oddly enough, if you shift your attention away from the cost considerations (which Comshare doesn't — these features prominently in all its advertisements), Plannercalc does actually have some interesting features and facilities not generally available on other spreadsheet systems. These include English-style commands and compatibility with Comshare's more sophisticated Masterplanner. If you buy it because you want this compatibility, rather than because you want to save a few quid, you will be far more likely to find long-term justification in the purchase.

Checklist

Documentation: Terrible

User-Friendliness: A useful 'help' facility, but some unintuitive command names and poor screen prompting were fairly unfriendly. Screen redrawing was rather sluggish.

Error Handling: Extensive error messages. Possible to crash the system using the 'COPY' facility.

Facilities:

Arithmetic: + - / * exponentiation and log, average, row and column sum, minimum, maximum, greater, lesser, reduce to integer and a 'row grow' operation.

Configuration: Possible to configure for both printer and VDU.

Graphics: No

Interface to other software: Compatible with Masterplanner.

Spreadsheet overlays: Not possible.

Tunrkey system: No, must use CP/M commands.

Insertions and deletions: Yes

Replication: Has a very weak 'COPY' facility, which appeared to have bugs in it.

Display flexibility: Split screens, variable column width, variable number formats.

Protected cells: No

Formula Printout: Good facility to print the 'logic' of the model

Formula Editing: Yes

Automatic/Manual Recalculation: Yes, but in manual mode it unnecessarily redraws the screen after every command.

Out of memory: Memory left permanently on display, but does not give any special notification at the actual moment it runs out of memory.

Long Jumps: Uses a 'GOTO' command.

Searching and Logic facilities: Has an 'IF-THEN' facility.

Supplier and price:

As this review was going to press, Comshare announced a considerable increase in the price of Plannercalc — it is now £85 plus VAT. Contact Comshare Ltd, 32-34 Great Peter Street, London SW1P 2DB.

Benchmark and other measurements:

Max number of columns: 128; Max number of rows: depends on number of columns; Numeric precision: 10 digits; Max column width: 30 characters.

Benchtests: Due to implementation characteristics of Plannercalc it was not possible to run fully normal Benchtests. These tests were performed on an Apple II with 2MHz Z80 processor using 56K CP/M. Refer to PCW's Feb '83 issue for more information on the tests.

Benchmark 1 — to test calculation speed and capacity: (a) not measured; (b) & (c) Recalculation time for 20 rows: 27 seconds; (d) Vertical scrolling speed: 120 seconds for 50 lines, ie, 2.4 seconds per line. Horizontal scrolling speed: 28 seconds for 13 columns, ie, 2.1 seconds per column.

Benchmark 2 — not measured.

Benchmark 3 — storage capacity was 61 13-column lines of numbers.

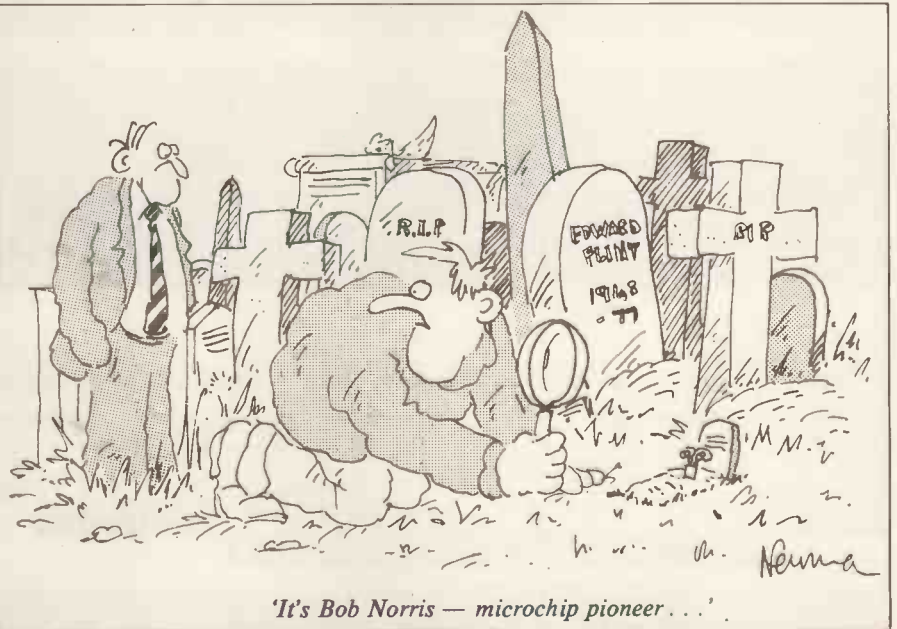

BENCHTEST

TI PROFESSIONAL

Robin Webster puts the latest IBM-compatible micro through its paces.

The profile of the new Texas Instruments Professional personal computer is surprising. It is *not* based on a TI chip, it is IBM Personal computer compatible, and it was developed by TI's Data Systems people

rather than the Home Computer division. Despite the fact that TI already has a perfectly good 16-bit chip of its own – the TI 99000 – and various other designs lounging around on R & D shelves, the

company has taken what might appear to be a self-deprecating route into the corporate microcomputer business by building its new machine around the Intel 8088. TI's perspective on the matter, though,



Photography by John Mason



The disks are set off to the right side of the casing, as with the IBM PC.



A parallel printer port is standard instead of RS232.

was that to try and counter the current software and hardware development trends would amount to financial suicide.

The Intel 8088 chip, while not the fastest or most feature-full device around, has acted as a powerful magnet, attracting significant attention from major computer manufacturers (IBM with its PC, and Digital Equipment with the Z80/8088 Rainbow), and, as a consequence, from the independent hardware/software developers as well.

In the US, where there are many publications devoted purely to what is being done with and to the IBM PC (including *PC World* - which sounds rather familiar doesn't it?) hundreds of specialised products are described each month. All sorts of weird and wonderful things which IBM in its dreams, or nightmares, never imagined could be done with its baby are on offer ridiculously low prices.

And it is this mass of already expended effort that TI is seeking to tap with the new Professional machine. But has TI managed to make it a trivial matter for a user to switch his software development work from an IBM PC to a TI Profession-

al? Is the Professional a sufficiently tempting proposition in terms of price/performance to make a potential customer seriously wonder why the IBM machine should be considered by him at all?

As a package, the TI Professional is being pitched as 'The Answer'. It comes in the usual three-part package - processor/memory unit, video display, and keyboard. It is suitably neutral in colour (off-white) to be unobtrusive in most decors. And, emphasising the drip-coffee-maker simplicity of today's machines - in terms of taking them out of the box and setting them up at least - TI states that a customer needs merely to plug the Professional in, run through the built-in diagnostics system, and, if everything is OK, begin work.

That is TI's image of a "corporate" personal computer. So, how does it perform?

Hardware

TI has tried to mirror the IBM PC, but at the same time, add something new.

From the front, the design of the main processor unit closely resembles the IBM

product. It appears to be a little wider, and may be a little lower. The disk drives are set off to the right side of the casing, as with the IBM PC, and the keyboard is attached by means of a coiled, telephone-like, cable. While the keyboard is of a different layout, it has very much the same "feel" as IBM's. The TI video display sits on top of this main unit and, although moveable in a horizontal manner (left or right), it cannot be tilted vertically. While this may cause some problems to people with badly positioned overhead lights, I didn't find any reason to dislike this omission when using the benchtest machine.

The minimum system configuration consists of: a 64K main processor unit containing a basic video controller unit; a TI monochrome (green phosphor) video display; standard TI keyboard; a parallel printer port; five internal expansion slots; and a 320K disk drive. The suggested retail price is £2,075. Larger versions can be supplied with integral 5 or 10 Mbyte Winchester disks.

The observant reader may already have spotted one surprising thing about the standard machine: the common-or-garden RS232C input/output port is missing. The parallel printer port comes standard instead. For another £185, the user can get the optional async/sync communications card, but this will take up one of those precious internal expansion slots. The board is more than just RS232 circuitry, says TI, indicating that the Professional will be able to handle TTY. IBM 3780, IBM 3270 SNA (stand-alone) and IBM 3270 BSC and SNA cluster communications protocols towards the end of the year.

A second thing about the TI machine, which isn't being openly publicised by the company, is that it can read and write disks in the IBM PC format. This would seem to suggest that you can take a 5 1/4 inch disk from an IBM PC and use it directly on the Professional - well, you should be cautious before getting over-optimistic about this.

It would be an excellent situation for TI if all the software developed on the IBM PC could suddenly be handled as if it were TI Professional software, without any

TI PROFESSIONAL

time or financial penalty to pay. Indeed, some TI dealers informed me that this transfer was possible in 95% of cases, and there was some suggestion that TI had managed to come up with sufficiently smart circuitry and/or software to deal with any problems.

Owing to the short time I had access to the TI machine, it was not possible to make controlled performance tests with IBM PC software. What's certain is that in spite of TI's underlying decision to lock into the IBM PC marketplace, hardware differences do exist. The major obstacle in the way of the "put the disk in and run it" approach is the relevant screen resolutions and video circuit design. In the case of the IBM machine, it is possible to address a total of 640 x 200 pixels. On the TI machine the pixel resolution is 720 x 300. My perspective on this is that any customer who really wants to get the TI machine simply to run IBM software is barking up the wrong tree. TI is in the process of making deals with the major independent software vendors for TI compatible products – a little research in this department should give any potential user enough confidence to make the "buy" or "don't buy" decision.

Keyboard

The Professional's keyboard doesn't really look like the IBM model – if you need a comparison, the closest would be the one offered with the Digital Equipment Rainbow – even though it is low-profile, has sculptured keys, and is attached to the system unit by means of a coiled cable. There are 97 keys in all (the Personal Computer has 83 and the DEC Rainbow has 103): 57 qwerty; 18 numeric pad; 5

cursor control, including HOME; and 12 user programmable function keys. The keys have what designers call "tactile feedback," which essentially means that you are easily able to tell when you have pressed the wretched things, instead of having the feeling that you are moving your fingers around in a bowl of jelly. All keys, except SHIFT, CNTRL (Control) and ALT (Alternate), have a repeat action when held down for more than half-a-second.

On many keyboards it can be very difficult to locate certain keys when you need them – and it is often the case that cursor control keys are buried somewhere unlikely or are only available when the keyboard is in some SHIFTed mode.

The professional has the sensible arrangement whereby the four cursor direction keys are totally separate from the main keys and arranged in an easy-to-use diamond pattern. The HOME key nestles in the middle of the diamond (this positions the cursor at the top left of the display when pressed).

As with the IBM PC, the Professional keyboard can be adjusted so that it slopes at a particular angle – between 5 and 15 degrees. Two legs on the bottom of unit can be extended or retracted by means of two inconspicuous buttons placed at the top left and top right.

A nice feature is the upper-case indicator light, a small green LED set into the CAPS LOCK key. This can help you avoid, or at least explain, those times when a character you were not expecting appears on the screen, or a particular command is rejected.

In use the Professional's keyboard doesn't ask much of the user. It is simple to comprehend, has a nice response and offers as good a selection of facilities as might be needed by a business user. 256 characters (ASCII) are generated as standard, but this can be doubled to 512

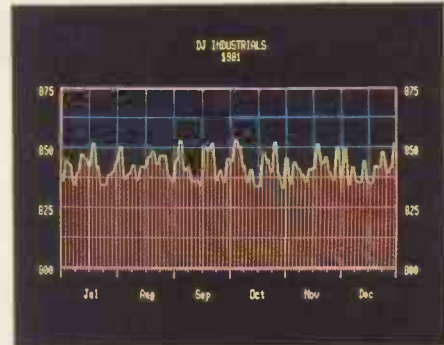

A selection of screen graphics.

characters if special scientific or foreign language characters become necessary for applications work (Occasionally, the benchtest machine would display a small heart-shaped character, but this wasn't documented anywhere.

A 12 inch monochrome (green) and 13 inch colour monitor are offered by TI on the Professional. The pixel resolution and screen format is the same on both models.

The benchtest machine was a 256K main memory unit with two 320K floppy drives and a monochrome display. Standard memory size is 64K, and 256K is the current internal limit, but expansion up to 512K will be made available later this year. The Intel 8088 cpu has been set to operate at 5 Mhz – as opposed to the 4.77 Mhz of the IBM PC.

To see what the machine could do, I ran through a couple of demo packages that TI supplies to dealers. Demo A was designed for the full colour model and made use of the machine's sound generation facilities (I sneaked into a TI dealer store to use the colour version for a brief time). Demo B was less ambitious and merely led the user through the various system features and future options.

Both demos ran under Microsoft's MS-DOS operating system, and one of the first things I noted was that the official TI operating systems instruction manual referred only to this product – CP/M-86 and the UCSD p-System were nowhere to



With all slots occupied the inside would still not be crowded.

been seen. The reason for this wasn't totally clear, but probably had to do with making the initial start-up and use of the machine as simple as possible for the customer.

Graphics

Both demos were menu-driven and used the full graphics capabilities of the display. During the section on the system components, each modular unit (system/display/keyboard) was shown in a different colour along with explanatory text. It was a useful way of explaining the role of the bits and pieces.

On choosing the section dealing with the display/colour generation capabilities, I came across one of the problems to beware of in developing graphics program routines on a colour machine and then showing them on a monochrome version. At one point, the demo attempted to show the potential customer the different kinds of graphics that can be created. There were line, bar and pie versions. On running the demo on the monochrome machine, parts of the pie chart were almost totally invisible. This turned out to be because those parts were originally given a blue colour and this did not register well on the green phosphor.

A rather impressive part of the graphics display came in the image animation section of the demo. An aircraft engine turbine was drawn by the software and then rotated to the accompaniment of a sound not unlike a turbo-prop engine. At regular intervals the program would also change the colour of the blades. It was a good example of how graphics/sound/and colour can be intermixed to great effect.

The Professional's ability to mix text and graphics on the same screen is a definite plus when compared to the IBM PC's rather less salubrious capabilities in this department.

Having raised your expectations as far as graphics are concerned, I shall now deflate them slightly. The problem in all this is that the Professional does not come with the full 720 x 300 pixel bit-mapping facility as standard – just as you have to fork out another £185 on the serial communications card, you must also buy the relevant graphics board as an optional extra.

The standard machine can only display alphanumeric characters and those jagged graphics as seen on most computers. To get into serious work you must buy either the 1-plane board (£260) which allows you to do two-colour or two monochrome shade graphics, or the 3-plane board (£450) which provides up to 8 colours (black, red, blue, magenta, green, cyan, yellow, white) or 8 colour shades.

The video display draws its power from the main system unit, via a lead plugged into the back of the main casing. If the video display power switch is left on, it is possible to turn-on or shutdown both devices by means of the single on/off switch set in the righthand side of the main unit.

As mentioned earlier, the front of the system unit looks pretty much like the

Texas Instruments Professional Computer DIAGNOSTICS Version 1.20 (C)
Copyright Texas Instruments, Inc. 1982.

Overall Unit Test	Yes No
CRT Test	Yes No
CRT Graphics Test	Yes No
Diskette Verify Test	Yes No
Diskette Read/Write Test	Yes No
Keyboard Test	Yes No
Memory Test	Yes No
Parallel Printer Test	Yes No
Communication Port(s) Test	Yes No
Display System Configuration	Yes No
Print Test Results	Yes No

Select appropriate test(s) and press ENTER ...

Fig 1

CP/M-86 Function Key Programmer for the TI PC Version 1.0

Type the Function Key you wish to program, or ESC to display the other set of keys, or Carriage Return to exit this program.

```
F1: DIR A: OD
F2: DIR B: OD
F3: STAT OD
F4: STAT
F5: STAT A: *.* OD
F6: STAT B: *.* OD
F7: PIP
F8: PIP LST:=
F9: FORMAT OD
F10: FUNCTION OD
```

Fig 2

IBM PC design, and a peek around the back of the Professional doesn't contradict that.

To the left of the unit (rear view) there is the main AC power inlet with the video power outlet set a couple of inches to the right. Just off-centre to the left is a powerful, and fairly noisy, cooling fan. TI probably opted for the high-throughput fan since the system unit has a large internal transformer supplying all the pcbs, disk drives, and the video display. Although I feel that it could have been a little less noticeable, the fan noise never really became irritating.

Moving further over to the right, there is a DIN connection for the keyboard cable set alongside the 25-pin parallel printer port. The right side of the back is given over to the five expansion slots.

Inside

The benchtest machine came with the three left-most I/O ports empty, the fourth port allocated to a 3-plane video board (even though the display was monochrome), and the fifth slot was occupied by a serial communication board.

The whole arrangement was very neat and uncluttered. Each I/O slot in the casing that was not yet filled was blanked off by means of a formed aluminium plate, held in place by an easy-to-remove screw. To get access to these screws, or other components, the main casing must be removed. TI has really made this operation very simple. Only two screws, located at the upper-left and upper-right of the back have to be undone whereupon the lid can be pulled off.

The review machine was fairly empty, but even with all slots occupied the inside would still not be overcrowded.

All five I/O slots are seated on a large motherboard about a foot square which contains the Intel 8088 chip. The motherboard lies flat on the bottom of the system unit: one end is hidden under the power supply and one of the disk drives. Simple snap-on plastic clips retain it in place. It is important to note that the TI boards are not the same design as those in the IBM PC, so don't expect to find bargains in that direction. Undoubtedly, the add-on vendors are busy making products to the TI board design specifications (see section on software).

The rugged-looking power supply is totally enclosed in a sheet metal casing. Nothing looked like it would take more than a few minutes to service, and no special tools are required.

Along with the launch of the Professional, TI has announced a new dot matrix printer called the Omni 850. This is a fairly low cost machine, about £500, with a print speed of 150 characters per second. It can print bi-directionally at 150 cps using a 9 x 9 character matrix, or it can give an enhanced print quality at 90 cps using a 15 x 9 character matrix.

Possibly its strongest recommendation is that it can reproduce the graphics images on the TI Professional's screen on a dot for dot basis by using a raster graphics technique.

The Professional can run the operating systems now expected on any corporate micro: CP/M-86, Concurrent CP/M-86, CP/M-80, MS-DOS and the portable UCSD p-System. Languages currently available under these operating systems

TI PROFESSIONAL

include Basic, Pascal, Fortran, and Cobol.

The review machine came with the MS-DOS and CP/M-86 operating systems, an MS-Basic disk and a Digital Research CBasic disk which had met some unknown fate since it was blank!

Currently, TI is supplying MS-DOS version 1.25 on the Professional and has used MS-DOS as the "example" operating system in its operating manual for the machine.

To boot the system, you can either insert the system disk in drive 'A' and switch the power on, or you can do a restart by pressing the CNTRL, ALT and DEL keys at the same time. This three-key re-boot could be criticised as being excessively cautious, but I guess it's better than finding out you've hit a one-operation reset button accidentally.

After switching on, the Professional goes through a 10 or 20 second self-test routine before actually loading disk contents into memory. The diagnostics routine is held in ROM and is linked to three coloured lights (green, yellow and red) set in the left side of the machine, as seen from the front, and which flash on and off during the test.

If everything is OK, the lights all go out at the end of the test - one or more will stay lit or not light at all if something goes awry. By noting the light activity or non-activity, it is possible to figure out what's going on.

A more detailed troubleshooting capability is made possible by inserting a TI diagnostics program disk. By doing a restart with the disk in the main drive, the user is provided with a number of test options to choose from (see Fig 1).

To use graphics commands in MS-Basic, the high-resolution graphics controller board must be installed. Once that's done, it is possible to create programs that use commands such as LINE, COLOR, PAINT, DRAW, POINT, and PALETTE, to create screen images.

The CP/M-86 disk supplied with the benchtest machine was marked "prototype version" but it nevertheless seemed to act exactly the same as CP/M-86 on other machines.

One nice facility, though, was the Function Key Programmer routine which has been tailored to the TI Professional keyboard. After booting up the system, the user can type in the word FUNCTION which loads the key programming code. (Doing this on the review machine resulted in the screen as shown by Fig 2).

This kind of feature is a great time-saver especially when you are using CP/M's somewhat cryptic command sequences.

It may be noticed that while the keyboard has 12 function keys, the CP/M-86 function routine only shows features for ten keys. This is because the F11 and F12 keys are being reserved for the communications software that will be made available in the future

For those users who want to use CP/M-80 programs on the Professional, a small company called Xedex has done it again. When the IBM PC came out, Xedex quickly brought out the Baby Blue plug-in Z80 board which turned the PC into a CP/M-80 machine. Xedex has now brought out the Baby Tex card, which does exactly the same thing. UK prices for the Baby Tex are not yet fixed.

Other than these specifics, there were no surprises in terms of how the two operating systems worked on the Professional. The benchmark programs were written in MS-Basic and gave the kind of results one would expect from a 5Mhz 8088, indicating that TI had done nothing unusual at the circuit level.

Documentation

Of the four manuals made available with the machine, only three were in their final form: the TI Professional Operating Instructions manual, the MS-DOS operating system manual, and the MS-Basic manual.

All were professionally printed in small-book format with page numbers, headings, and - most importantly - a contents index. While someone who was familiar with computers might find the Operating Instructions a little slow to inform, the first-time-ever user will welcome the attention to detail. If TI thinks there is something that must be noted carefully, a small doorkey symbol is placed in the margin next to the relevant text. The choice of subjects highlighted in this way (how to handle disks, what *not* to do if problems occur, etc) appeared to be sensible. Error messages, such as: **System Error** - 0020; or **Keyboard Error** - 0010, were generally explained in a simple manner, and MS-DOS error messages were covered at the back of the manual. Extensive use of high quality line drawings of the equipment and screen made the documentation quite pleasant to use. Naturally, the MS-DOS operating system and MS-Basic books were more comprehensive, but they still are unlikely

to scare off a user.

The CP/M-86 system documentation was not a TI version, but a collection of Digital Research generic operating manuals and photocopies of TI specific information. This was less easy to work with, but the TI-produced version should be up to the MS-DOS literature standards when it becomes available.

Potential

To try and get a real feel for the TI Professional, we should probably think less about its contact points with the IBM PC, and more about its special features.

For example, later this year TI is intending to offer a natural language interface and speech I/O facilities that can be used in database query applications and program input/output, respectively. I managed to get a look at a prototype of both products at the West Coast Computer Faire held in San Francisco during March.

Generally, I though the natural language interface worked fairly well, if slowly, when I tried to build a query about a particular airline's flight schedules.

The display screen can be split up into many (six or seven is a reasonable number) different sized windows that contain specific types of words or phrases relating to the database information.

A typical query example might be the sentence "Find me the airline with more...
GOTO page 233

Benchmark timings

Benchmark 1	1.00
Benchmark 2	4.20
Benchmark 3	9.30
Benchmark 4	9.70
Benchmark 5	10.50
Benchmark 6	19.00
Benchmark 7	29.50
Benchmark 8	31.00

All timings in seconds. For an explanation and listing of the Benchmark programs, see PCW November 1982.

Technical specifications

CPU:	Intel 8088, 5Mhz
Memory:	64K RAM, expandable up to 256K 8K ROM, expandable up to 16K
Keyboard:	97 keys (57 typewriter, 18 numeric pad, 5 cursor control, and 12 programmable special function keys). Upper/lower case character generation.
Screen:	12 inch monochrome (green phosphor) screen or 13 inch colour version. 80 cols x 25 lines display format. Both have 720 x 300, memory-mapped pixel resolution. 1-plane video board gives monochrome or two-colour generation. 3-plane video board gives 8 colours or shades.
Disks:	Standard unit comes with a single 320K, 5¼ inch drive. Options are 2 x 320K floppy drives, or one 5¼ drive plus a 5Mbyte or 10Mbyte Winchester unit.
I/O Ports:	Parallel printer port as standard. Optional Sync/Async RS-232C communications board.
Software:	MS-DOS, CP/M-86, Concurrent CP/M-86, UCSD p-System. CP/M-80 (with plug in Z80 Baby Tex board from Xedex).
Languages:	MS-Basic, C-Basic, Pascal, Fortran, Cobol as standard, but many others already on the IBM PC (Forth, for example) will probably be moved over too. A Natural Language interface for database applications is also on its way.

WINCHESTER KILLER-£895

The incredible Scorpio 6.2 Mbyte hard disk alternative from HAL Computers annihilates small capacity Winchester.

DISTINGUISHING CHARACTERISTICS

Hard disk capacity and speed with the capability of interchangeable media. Scorpio 8 eliminates the worries of head crashes, drive alignments, lost data or backup, with a new application of field proven floppy technology.

Fully Apple II compatible – DOS 3.3, Pascal 1.1 and CP/M, uses all standard Apple DOS commands. Operates on any computer with an 8 inch floppy disk interface.

HOW SCORPIO 8 IS KILLING THE SMALL WINCHESTER

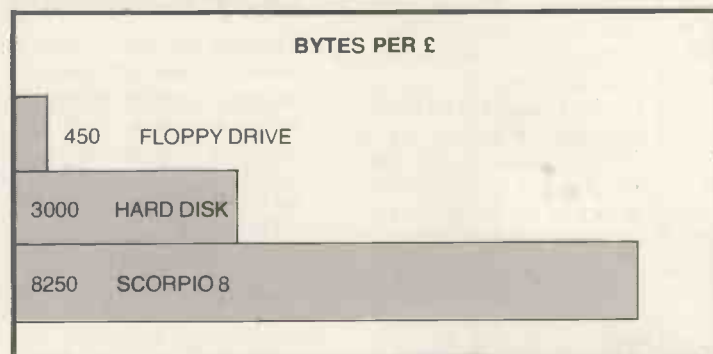
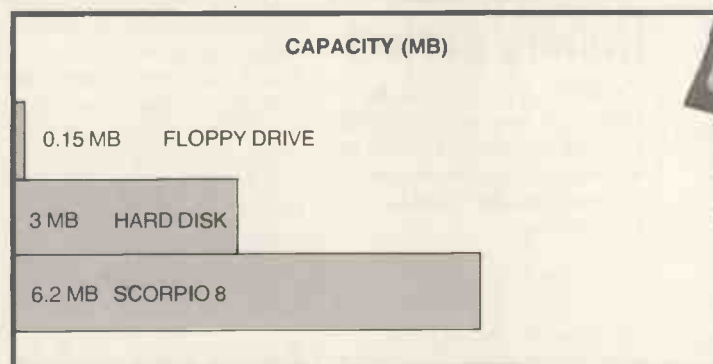

REWARDS

- Winchester capacities on floppy disks.
- Uses removeable media – a cartridge pack of five 5.25 inch diskettes each of 1.2 Mb capacity.
- High speed DMA data transfer.
- Cost effective and software compatible disk memory expansion.
- Removeable media means separate packs can be kept for different applications.
- All this from £895 complete with cabinet, power supply, interface and cables.

To claim your rewards contact us at the address shown below.

HAL
HAL Computers Limited
Invincible Road, Farnborough
Hants. GU14 7QU
Telephone (0252) 517175
Telesales (0252) 517171

COMPUTER ANSWERS

Send your queries to Len Warner, 35 St Julian's Road, St Albans, Herts.
Please note that Len cannot answer questions on an individual basis,
so please don't send an SAE with your query.



Edge wear

I use CBM 4032 and CBM 8032/96 machines with associated peripherals. With both of these I regularly use either the cassette unit or a range of dongles (PETAID, Administrator, Wordcraft, etc). I am concerned that my edge connector on the first cassette port will wear out prematurely. Can this be easily/cheaply repaired?
R A Heesterman, Sheffield

A standard edge connector, with 1/10 inch contact spacing on 1/16 inch thick circuit board, can be repaired by fixing on a strip of edge plug material. This is a moulding which slots over the edge of the PCB. It is easy to trim to length before fixing. The business end has gold-plated edge connector fingers, and the rear has formed wire tails which are soldered directly on the original contact strips to secure it. Be sparing with the solder, and clean off any excess flux to make sure it is not hiding solder splashes which might short your signals.

Timedata Ltd, 16 Hemmells, High Road, Laindon, Basildon, Essex, SS15 6ED, sells a strip meant for ZX81 (23+23 way, polarising slot position 3), as edge connector plug HZ2, price £3.50 inclusive. A 43+43 way strip, polarising slot 37, is available as RS Components stock number 468-709. Try asking your local electronics shop or TV repairer to order it for you.
LSW

Tracking down the Trackball

Could you tell me where to obtain one of the ball-type joystick controls as used on arcade video machines?

Also, where can I obtain a book on the subject of building a computer from scratch using a CPU such as the 8088 16-bit processor?
D C McGibbon, Edinburgh

The 'Trackball' joystick is of the type you describe, and is available from SBD Software, 15 Jocelyn Road, Richmond, Surrey, TW9 1BR (tel 01-948 0461). They currently list it as being available for both the Apple and the Atari.

It is probably a bit early for there to be books available on building your own 16-bit microcomputer. However, a three-part article on building your own micro based on the 8088 chip appeared recently in *Byte* magazine: 'Build the Circuit Cellar MPX-16 Computer System', by Steve Ciacia; Part 1 (November 82) page 78; Part 2 (December) page 42; Part 3 (January 83) page 54.
P L McIlmoyle

FOR the NEXT problem...

I have a problem with FOR...NEXT loops on Microsoft Basic. I know of two ways of getting a 'NEXT without FOR' error — one is not specifying a FOR before the NEXT, and another is allowing the computer to enter the loop between the FOR and the NEXT. However, I am getting this error in some third way I do not understand. It may have something to do with jumping out of other FOR...NEXT loops, which is supposed to be permissible.

J R Sampson, Bramhall, Cheshire

Jumping out of FOR loops is usually poor programming technique. The FOR loop is designed to repeat the execution of a block of statements a predetermined number of

times. If the number of repetitions cannot be determined until the loop is executing, then you should be using a different control structure. A WHILE...WEND loop may be what you need. If it is not available in your dialect of Basic then it can be built out of IF and GOTO statements.

There are two reasons why jumping out of FOR loops is allowed by Basic. One is that, in the earlier Fortran DO loop, jumping out to the 'extended range' is allowed, provided you jump back in. The other is that Basic interpreters find it difficult to stop you. When you keep leaving by jumping, you clog up Basic with dead stack entries until an error is caused. Don't do it.
LSW

History project

I'm doing a project on the history of computers. Could you tell me where I could get information on the subject?
Antonio Geada, Cashel, Co Tipperary

I am sending you a useful little booklet, which is now unfortunately out of print. Also, computer science books often have a chapter on the history of computers. You should make friends with your local librarian, who can help you build up a list of books and get them for you. Perhaps you might like to start with *The Making of the Micro: a history of the computer* by Dr Chris Evans, Gollancz 1981.
LSW

The working Spectrum

I would like to know whether if I bought a Sinclair Spectrum it could help me with my work? Also, could it ultimately be con-

nected up to a mainframe computer?
John Ives, Maldon, Essex

Obviously the Spectrum is far from the ideal business computer, but with the right software/hardware it can be quite useful. For example, an electronic spreadsheet program, such as VU-CALC or Video Software's Superplan, can be used for financial forecasting or for job costing or estimating, while a records management program like Campbell System's Masterfile can bring a card index to your fingertips and do sophisticated searching automatically. Hilderbay Ltd has concentrated on business needs and has several payroll and accounting programs available.

On the hardware side, East London Robotics Ltd offers RAM expansion to 80k, though the software suppliers have yet to take advantage of this. Cobra Technology Ltd makes an RS232 communication interface which should enable you to exchange files with a mainframe or link to a network.
James Walsh

Easy assembly

I bought the BBC micro in order to learn assembler language programming, as it has an assembler built into its Basic. Can you recommend a suitable book to help me?

J Tinsley, Manchester

Assembly Language Programming for the BBC Microcomputer, by Ian Birnbaum, published by Macmillan at £8.95, is probably the best currently available. The microprocessor used is a 6502, so any book based on that processor will help you, and there are many available — the two most popular being by Scanlon and by Leventhal.

However, in my view it is quite difficult to learn it from a book. It would be a good idea to join a local BBC user group (you can find details of local groups in *Beebug* magazine), and latch on to someone who will lead you through the beginning stages. **BEEBUG** — Independent User Group for the BBC Micro

Spectral correspondence

I run a small business and am considering buying a word processor to handle day-to-day correspondence. I already own a Sinclair Spectrum and have heard that Sinclair is working on a word processor package. Will it be sufficient for my needs, or will I need a more expensive set-up?
Mike Smith, Ilkley, W Yorks

Even with a good wp program, the Spectrum is limited by the printer quality and, until the Microdrive arrives, by the inconvenience of tapes. A correspondence quality printer would cost £300 to £500, and an RS232 interface £30. Even then, the Spectrum keyboard is hardly up to regular office typing.

If you want a relatively cheap 'real' business computer package, your best bet would be the Osborne. Because it comes complete with Wordstar, a well-established wp package, Supercalc and Basic, and because of the full-sized keyboard, double floppy disk drives and CP/M, it is much more suitable for general office duties. However, you will be paying around £1600 for a package including a printer. You must balance this cost against the improved performance, and the availability of other useful business software under CP/M.

James Walsh

Forth fills the gap

Your February answer on Spectrum Forth was very interesting. I find Basic on my ZX81 runs too slowly,

but machine code is very difficult to write and to run. Would Forth help to fill this gap? Do I have to make any chip changes to run it? Now I have a Spectrum too, I feel like experimenting with my lesser machine.
N Barrington, Timperley, Cheshire

On most micros, ZX81 included, Forth is just another machine code program on tape. You should find it solves your speed problems, and also allows you to incorporate small machine code routines quite easily. This is especially useful if you are testing hardware add-ons.

Since the February answer, I have seen three versions of Spectrum Forth advertised, at prices between £6 and £20.
LSW

Talking back

How can I get my micro to talk? I have seen fairly cheap talking clocks, so is there anything I can add to my machine to make it speak?
P Harris, London

Consumer goods with a limited vocabulary often use a speech synthesis technique based on storing a digitised speech waveform. The speech quality can be very good, but you are limited to the vocabulary supplied in the manufacturer's ROM. Another method is called phoneme or allophone synthesis, where the speech chip models the vocal tract and is driven by a series of codes for the syllables. This allows you to make up any word you like, but the quality is not so good. Two chips are available, with very similar performance, the Votrax SC-01A and the GIM SP0256.

Maplin (Rayleigh, 0702-552911) supplies the GIM SP0256 chip at £8.98, and simple kits for either VIC or ZX81 at £24.95.

William Stuart Systems (01-221 1131) supplies the Chatterbox, again using GIM, at £39 kit or £49 built. This also provides a port for a speech recognition unit.

Neither of the above has a vocabulary supplied.

Namal Associates, 25 Gwydir St, Cambridge (0223 355404) produces the Super-

talker, using the Votrax chip which allows speech inflection. I have one on my ZX81, and it has given it a whole new personality. This includes a dictionary of over 550 words plus driver routine in ROM and RAM space to extend the dictionary, or you can drive it direct with phoneme codes. The ZX81 version is £49.95, Spectrum £69.95, and RS232 for any computer £89.95.
LSW

Beeb block bug

I have a BBC Micro Model A with 32k and the 0.1 operating system. Recently I typed in a program and SAVED it on tape. When I tried to LOAD it again I was horrified to find that the computer refused to recognise the first block, and so I could not load the program at all. Is there any way that I can load back my program starting from block 0001 onwards?

TA Kayani, West Hampstead, London

The problem that you are experiencing is solely due to a bug in the 0.1 operating system. This has been cured on the series 1 operating systems. We published a 'fix' for this bug in the July issue of *Beebug*, however this does not help you recover a corrupted tape but only stops it happening in the first place. In the November *Beebug* we published a program to recover a corrupted first block. It is too long to print here so I have sent you a copy.

The long term solution is to replace your 0.1 OS by a 1.2 OS, and all BBC micro owners should be doing this now. The price is around £10 if fitted by a dealer, but *Beebug* has a special members' price of £5.85 including VAT and p&p. It is easy to fit yourself but requires a bit of care.

BEEBUG

Interface standards

I have seen references in *PCW* and other journals to an RS423 interface but have not seen any detailed des-

criptions of how this standard works and what the various lines do.

- How does RS423 compare with RS232C or V24?
 - Can an RS423 interface be connected to an RS232C modem or printer? Could an adapter be made?
 - Is RS423 likely to supersede RS232C?
 - Would there be any advantage in building an RS423 interface into my existing computers, MZ80B and Acorn Atom, neither of which have RS232C?
 - Where can one buy the necessary 5-pin sockets?
- S C Craddock, Shotley Bridge, Consett*

All these standards are designed for connecting things like teletypewriters or computers to telephone company modems, but they have been used in a simplified way for connecting computer to printer or computer to computer. There is a detailed article on this subject in *Byte*, February 1981.

Broadly speaking, RS232C and V24 are the same, but are published by different organisations. RS423 signal levels are compatible with RS232C and V24 equipment, but RS423 is suitable for driving longer cables. RS423 is also compatible with RS422, which is much more suitable for signalling in difficult conditions.

RS449, an interface standard which uses RS422 or RS423 signal levels, and the European version X21, will one day replace V24, etc, for telecoms. Peripherals manufacturers will make their own choices.

There are line driver and receiver ICs which make either interface easy but, for a printer, a Centronics interface avoids the need for extra positive and negative supply rails.

The 5-pin socket is not part of the interface standard, it is just Acorn's bizarre choice of a standard but uncommon reversible DIN audio connector for non-reversible signals. Use something else.

LSW



THE MUSIC MAKER

SOUND TECHNIQUES FOR THE BBC MICRO

How to be creative with sound on your BBC Micro: Chris Jordan explains

The BBC Microcomputer boasts an advanced sound-generating system more powerful than that fitted as standard to any other personal micro. As is often the case with innovative products, users have been slow to realise its possibilities, and creative application currently lags far behind the potential for music and sound effects that the BBC Micro offers. As evidence, witness the almost total absence of articles (except in *PCW*) on creative use of Beeb sound, as compared to an abundance on the subject of graphics. This is only partly due to the traditionally second (or even lower) place that sound takes to graphics in the league of selling-points for micros. Crash-courses in use of the **SOUND** and **ENVELOPE** statements are not the whole answer, especially since interesting sound programs can be written without using the more advanced and at first baffling features such as envelopes. The BBC Micro's sound system actually makes sound programs that do simple things like play tunes much easier to write, as well as providing more complex control options.

User options

One reviewer has stated (not in *PCW*, of course) preference for the direct method of

```
BBC Computer
Acorn DFS
BASIC
>CHAIN"MUSINT"
: C2+C2+G2E2+C2+G2E2/2
: <C2+C2+G2E2+C2+G2E2/2
: <<C2+C2+G2E2+C2+G2E2/2
: C2+C2+G2E2+C2+G2E2/2
: <<C2+C2+G2E2+C2+G2E2/2
: C2+C2+G2E2+C2+G2E2/2
: <<C2+C2+G2E2+C2+G2E2/2
: C2+C2+G2E2+C2+G2E2/2
: <<C2+C2+G2E2+C2+G2E2/2
: C2+C2+G2E2+C2+G2E2/2
: <<C2+C2+G2E2+C2+G2E2/2
: C2+C2+G2E2+C2+G2E2/2
: <<C2+C2+G2E2+C2+G2E2/2
: C2+C2+G2E2+C2+G2E2/2
: <<C2+C2+G2E2+C2+G2E2/2
: C2+C2+G2E2+C2+G2E2/2
```

Fig 1

f0	f1	f2	f3
PLAY	RECORD	REPLAY	EDIT
Pitch	Tempo	Dur.	Note
1	1.0	27	18
23 567 90 +½c			
↑ QWERTYUIOP@+-cc			
BCDEFGABCDEF GABC			

Fig 2

sound control used on the Vic 20 and Commodore 64 over the Beeb's **SOUND** and **ENVELOPE** statements. This is a cruel verdict indeed (if you take it seriously) since the Vic and 64 represent the zero option in system sound software. The user's program gets absolutely no help in using the sound generator IC, having to **POKE** unfriendly values direct to its various registers. In comparison, the Beeb provides a friendly, high-level interface that bridges the large gap between controlling the properties of a sound, and controlling the sound chip. In particular the operating system knows about the musical scale, and it handles the timing of sound events — a task which Basic is not good at, and which, from a musical point of view, is useful to take for granted. The operating system runs concurrently with the Basic program, called up at regular 10 micro second intervals to service the sound, speech, keyboard, A-D converters and software timers. This lets it produce envelopes, programmed durations and sound sequences which are initiated by **SOUND** statements but run on automatically without holding up the user's program.

Remarkably, the variety of sounds that the Beeb can make owes very little to the sound generating hardware. The Beeb uses the Texas SN76489 — a device of very modest specification and performance which is similar to those in Atari, Texas and Sharp micros. The obvious conclusion is that these machines are potentially as powerful as the Beeb in the sound department, and this is perfectly true. What makes the difference is the software that drives the chip. Interrupt-driven machine-code routines are way beyond the abilities of most users, so if the system designers don't give them the facilities, a fascinating world of creative computing remains largely barred to them.

What is needed is applications software to put this situation right. For example, how about a program that adds **SOUND** and **ENVELOPE** statements to a particular micro's Basic? All that this would demand of the machine is a typical Texas-GI type sound chip and a hardware timer that could be programmed to cause interrupts, for example the ubiquitous 6522.

Timescales

Variation of sound parameters over time is

the basis of sound synthesis, and on a more fundamental level, all music. The complete spectrum of variations runs from those that happen over periods of minutes — the domain of musical form and structure — right up to the microsecond timescales of audio waveforms, where the tone quality, or 'timbre', of sounds are determined. We can easily divide this spectrum up into bands, each containing variations of similar timescales and with related effects on the audio product. The result is a scheme that gives valuable insight into the subject of micro sound, and sound synthesis in general.

In the context of making music and sound effects with micros, three broad (and overlapping) divisions of this spectrum cover most points of interest. They are:

1. From infinitely long times up to about 100ms. This includes most of what we think of as the structures of music — from whole pieces at the low end, through movements, verses/choruses, passages, phrases, bars, and up to and including individual notes.
2. From 1 second to 1 ms. This is the realm of envelopes, vibrato, tremolo etc — variations that run within notes. We can make out their individual stages, and hear them as, actual variations in pitch, amplitude etc., but the casual listener perceives them as integrated parts of the sound's character.
3. From 50ms up to around 50µs, the upper limit of hearing. This is the frequency of the sound itself. The variations that constitute the sound waveform are responsible for the fundamental properties of timbre and amplitude. All other effects are specific variations of these parameters.

Division 1 embodies the whole point of fitting sound generators to micros — we want to be able to generate sequences of notes to make music, organise sounds for pure abstract entertainment, and produce sound effects on command to enhance games. The requirements at this level are simply the basic computational functions of a computer, sound or no. For example, the amount of RAM and availability of disk storage might determine the maximum length of a recorded composition that was to be played in real-time, but this applies just as well to the amount of stored text available in a game of adventure.

Division 2 is where creativity takes a quantum leap and where the Beeb really scores — the possibilities for different

musical 'voices', effects like chorusing, echo and ambience, and a mind-boggling diversity of abstract sound effects amounts to as much creative power per pound as many dedicated electronic instruments, including organs and synthesisers. This is the timescale where Basic begins to get left behind, and user or system machine code is needed to compute the varying pitch and amplitude values, using parameters supplied by Basic, and send them to the sound chip.

The dividing line between divisions 2 and 3 is very hazy. So far, there is only one single-chip sound IC with true control of sound waveforms, and the simple ones are confined to square, pulse and noise waveforms. However, their range of timbres can be extended by changing input parameters at a rate approaching that of the waveforms themselves, though often at high cost in terms of processor time. Update frequencies of around 50 Hz are a good compromise, and the sounds produced, although too rough and variable for music, are great for sound effects.

On the BBC Micro, this is done with the pitch envelope, which can 'scramble' the sound in different ways to yield interesting compound tones. A lucky accident means that a SOUND duration of zero can also be applied in this way, repeated by a fast Basic loop which provides a new pitch for each short (10ms) tone segment.

This article looks at some basic programming techniques which relate to timescales at the top end of division 1, controlling the duration of notes and the speed of sound sequences. This is a good starting point for those getting to grips with the BBC Micro's sound facilities, since duration control is fundamental to all musical programs. Beeb sound is well endowed with control options in this area, and many are unique to the machine.

Run this short program:

```
30 pitch%=0
40 REPEAT
50 FORinc%=3TO5
60 pitch%=pitch%+inc%
70 SOUND1, -15, pitch%*4,2
80 NEXTinc%
90 UNTILO
```

It plays a sequence of three rising major arpeggios that repeats until you hit ESC. Stop for a minute and think about what determines the tempo of the sequence. If this only takes a second, you've probably already taken one feature of Beeb sound for granted. Although the program appears free to run around the two nested loops as fast as the interpreter will take it, the note from each execution of the SOUND statement lasts for about a fifth of a second. Assuming the machine doesn't have unlimited storage for a backlog of SOUND requests, and also that it plays every one that the program generates, we conclude that the SOUND statement is being executed about five times a second, and therefore that the program runs at the correspondingly slower rate.

The operating system is what keeps the program execution in line, by the simple process of not letting Basic proceed when it asks for a sound which cannot be dealt with. This happens when a previous sound is still

```
10 REM Music Interpreter
20 REM Creative Sound on the BBC Microcomputer
30 REM Acornsoft (C) 1982
40
50 DIMtext%255,bstack%10,estack%10
60 scale$=" C D E F G A B"
70 in1%=STRING$(255," ")
80 temp%=STRING$(255," ")
90 $text%=""
100
110 ONERRORGOTO1050
120
130 REM Main Loop
140 REPEAT
150 pitch%=0:amp%=12:slur%=0
160 PRINT": ";:INPUTLINE" in1$
170 IFLEN in1$(<)0:$text%=in1$:GOTO210
180
190 REM If CR, repeat with old text
200 PRINTCHR$(11)" "$text%
210 estack%?0=0:sp%=0:oct%=1:tem%=2
220
230 REM Play complete text
240 PROCPLAY(0,LEN $text%)
250 UNTILFALSE
260
270 DEFPROCPLAY(chn%,echn%)
280 REM UNTIL chn%=echn%
290 IFchn%=echn%:ENDPROC
300 temp%=$(text%+chn%)
310 dur%=VALLEFT$(temp%, INSTR(temp%+"E", "E")-1)
320 IFdur%<1:GOTO400
330
340 REM Duration found - play note
350 chn%=chn%+LENSTR$dur%
360 SOUND1,-amp%,(pitch%+oct%*12)*4,tem%*dur%
370 IFNOTslur%THENSOUND1,0,0,0
380 amp%=12:slur%=0
390 GOTO1020
400 ch%=text%?chn%
410 IFch%(ASC"A"ORch%)ASC"G":GOTO460
420
430 REM Note name found - update pitch
440 pitch%=INSTR(scale$,CHR$ch%)
450 GOTO1010
460 symb%=INSTR("###()<>[]/^b ",CHR$ch%)
470 IFsymb%=0:PRINT"UNEXPECTED "CHR$ch%:GOTO490
480 DNSymb%GOSUB520,570,600,670,720,770,810,850
,880,920,950,980,1010
490 GOTO1010
500
510 REM " - Repeat last phrase
520 IFestack%?sp%=0:GOTO1000
530 PROCPLAY(bstack%?sp%,estack%?sp%)
540 RETURN
550
560 REM # - add one semitone
570 pitch%=pitch%+1:RETURN
580
590 REM ( - start new phrase
600 IFsp%=10:GOTO1000
610 bstack%?sp%=chn%+1
620 sp%=sp%+1
630 estack%?sp%=0
640 RETURN
650
660 REM ) - End Phrase
670 IFsp%<1THEN1000
680 sp%=sp%-1
```

THE MUSIC MAKER

```
690 estack%?sp%=chn%
700 RETURN
710
720 REM > - Increase tempo
730 IFtem%=1:GOTO1000
740 tem%=tem%-1:RETURN
750
760 REM < - Decrease Tempo
770 IFtem%=5:GOTO1000
780 tem%=tem%+1:RETURN
790
800 REM [ - Down octave
810 IFOct%=0:GOTO1000
820 oct%=oct%-1:RETURN
830
840 REM = - Slur or tie notes
850 SLUR%=-1:RETURN
860
870 REM ] - Up octave
880 IFOct%=5:GOTO1000
890 oct%=oct%+1:RETURN
900
910 REM / - Rest i.e. zero amplitude
920 amp%=0:RETURN
930
940 REM ^ - Accent
950 amp%=15:RETURN
960
970 REM b - subtract one semitone
980 pitch%=pitch%-1:RETURN
990
1000 PRINT"ILLEGAL "CHR$(chn%)
1010 chn%=chn%+1
1020 GOTO290:REM REPEAT
1030
1040 REM Error Handler
1050 IFERR=17:PRINT:GOTO140
1060 REPORT:@%=0:PRINT" at line "ERL"
```

Program 1

playing (by virtue of what is a long duration compared with program execution times), and the system's backlog capacity is already in full use. When the SOUND currently playing finishes, the OS has room to take the latest request, and Basic is allowed to run again until it hits the next SOUND statement.

By this process the sound durations control the speed of the sequence. Decreasing the value of duration (the last SOUND parameter) speeds up the sequence, and increasing it slows it down. This applies to a whole range of programs that play sequences, rhythmic patterns, tunes, in fact any program with the sole job of generating sounds in a self-timing fashion.

Program 1 is one of these, and uses only the basic SOUND parameters — amplitude, duration, and pitch — demonstrating the simplest use of SOUND in producing music. It's a Music Interpreter that plays single-voice tunes entered directly in a simple Music Composition Language (MCL) with instructions for controlling note pitch and duration, adding accents and slurs, repeating phrases etc. The Interpreter is not intended for replaying stored compositions, but rather as a compositional aid. One

almost serious use it has already been put to is copying and composing signature tunes for games.

Instruction set

The instruction set uses numbers and single characters with a very simple syntax, so that learning it involves little more than remembering the symbols. The minimum code to play a note consists of the note name (C,D,E...B and / for a rest), followed by a number that indicates duration. The note can be sharpened, flattened, accented and/or slurred by adding the appropriate symbol before the duration (before or after the note name). The note plays in the current octave, which can be moved up and down to cover the full five octave range. The actual duration of the note also depends on the tempo, which can be increased or decreased at any point. The tempo resolution is poor, due to the 50ms resolution of SOUND's duration.

Any group of instructions can be enclosed in curved brackets, and a single repeat instruction plays the last bracketed group once. A group can be repeated any number of times, but watch out for groups

that leave the octave or tempo changed — the changes will accumulate. Repeat groups can be nested up to ten deep.

Spaces are ignored and can be included to separate phrases, bars etc.

The full MCL instruction set can be seen in Fig 3.

The only rule that applies to the order of instructions for a note is that the duration comes last. Readability is improved by putting the accent and slur symbols before the note name, and the accidentals after. Similarly, octave and tempo changes are clearest if put between notes.

Here are some short examples that demonstrate use of the instructions:

A rising C major scale

```
C3 D3 E3 F3 G3 A3 B3 ]C6
```

A rising D minor scale

```
D3 E3 F3 G3 A3 Bb3 ]C# D6
```

The same, faster and an octave lower

```
> [ D3 E3 F3 G3 A3 Bb3 ]C#3 D6
```

The same, with accents and slurs

```
> [ ^=D3 =E3 =F3 G3 ^=A3  
=Bb3 ]C#3 ^D6
```

The same, played four times

```
> [ (^=D3 =E3 =F3 G3 ^=A3  
=Bb3 ]C#3 ^D6) " " "
```

The Interpreter prompts for the line of instructions to be entered (up to 255 characters long). It plays the tune as soon as RETURN is pressed to end input. To repeat the tune, press RETURN, and to stop it before the end, press ESC. Use the standard cursor-editing technique to make modifications, and hit BREAK to leave the program.

Attempts to pass the limits of octave and tempo, or to repeat an incomplete phrase, produce the message ILLEGAL X, where X is the offending symbol (< > — or "). Any unrecognised character gives the message UNEXPECTED X, where X is the character. After printing either of these messages, the interpreter carries on with the next instruction.

Playing tunes

The program is quite short, partly because there's little source decoding and syntax checking to do. The procedure PLAY contains all the interpretive works. Each call of PLAY interprets and plays a section of the source text, the start and finish positions of which are handed over as the values of its arguments. The first call asks for the whole source text to be played, but when a repeat instruction is found, PLAY is called recursively to replay the last bracketed phrase of the tune. Two stacks (bstack% and estack%) keep a record of where these phrases start and finish. Each time PLAY reaches a bracketed phrase, its limits are saved on the stack above those of enclosing phrases overwriting any previous phrase on the same level. The repeat instruction simply calls PLAY with the limit values from the top of the stack.

Procedure PLAY analyses each source character in three stages. First it tests whether the character is a number (line 320). If so, the SOUND values are worked out from the options and values already set by other instructions, and the note played (line 360). A short silent

C,D,E etc	Set pitch (in current octave)	
/	Set zero amplitude for rest	
1,2,3 etc.	Play note with this duration (using tempo)	
space	Do nothing	
±	Sharpen note	
b	Flatten note	
	Accent note	
=	Slur or tie next two notes	
}	Move up one octave	(upper limit=+3)
[Move down one octave	(lower limit=-1)
>	Increase tempo	(upper limit=+3)
<	Decrease tempo	(lower limit=-1)
(Start phrase	
)	End phrase	
"	Repeat last phrase	

Fig 3

sound separates the next note if no slur instruction has appeared. Note the fudge on line 310 that prevents the VAL function from treating the note name E as part of a number in scientific notation.

Line 410 tests whether the character is a note name, and updates the pitch if it is. The string 'scale' gives each note its correct pitch by virtue of the character's position. All remaining instructions are 450, and the mammoth ON GOSUB at line 480 selects the subroutine appropriate to the instruction.

Flushing sounds

The SOUND statement provides an alternative to specified duration, for situations where a program needs to start a sound playing, and then stop it after some undefined period of time. Duration -1 produces 'infinite' duration, whereupon the sound plays until terminated by ESC, BREAK, one of a variety of *FX commands, or a SOUND request with the flush option selected. A flushing SOUND request clears its channel of any requests that are playing or waiting, and then sounds as normal. To select flushing action, the second hex digit of the channel parameter is set to one. For example

```
SOUND &11,-15,100,5
```

produces an immediate bleep on channel 1 whatever other sounds there are playing or waiting. A short zero-amplitude sound request can be used to stop infinite duration sounds silently after a delay. The following line of Basic plays a tone that continues until any key is pressed:

```
SOUND 1,-15,100,-1:A%=GET:SOUND &11,0,0,0
```

This method is still not perfect for general application. The Basic program can kill the sound instantly on command, but it can't be sure what length will result since the infinite duration sound may have had to wait for a previous sound to finish. It might not be heard at all.

The solution is to make both requests flushing ones so they are sure to take effect immediately. While we're at it, they may as well both have infinite durations. The result is a pair of low-level commands that start and stop sounds directly - equivalent in fact to POKEing tones on and off in a Vic-type system, but with the advantage that envelopes

can be added without losing their ability to fade sounds in (in response to the 'on' SOUND) and out again (when the 'off' SOUND is sent). Here's a demonstration:

```
10 REPEAT
20 REPEAT UNTIL INKEY(-74)
30 SOUND &11,-15,100,-1:REM on
40 REPEAT UNTIL NOT INKEY(-74)
50 SOUND &11,0,0,-1:REM off
60 UNTIL FALSE
```

The tone plays while the RETURN key is held down.

A musical keyboard

This scheme of direct sound control is exactly what we need to implement a musical keyboard instrument using the Beeb's keyboard, and Program 2 is such an implementation. It uses qwerty row of keys as the white notes, and the row of number keys as the black ones, giving a range of just over two octaves. As Fig 2 shows, the keyboard is displayed on the screen with a marker showing the key being pressed. The keyboard is monophonic (single-voice) with a last-note priority system. As well as manual playing, the instrument can record from the keyboard, and play back at a different rate and/or in a different key. In edit mode, the recording can be played note-by-note, forwards or backwards, and notes can be altered, inserted or deleted. CAPS LOCK must be on when using the instrument.

The instrument has four modes, selected by the first four function keys. PLAY mode is for normal playing. In RECORD mode, the sequence of notes and rests is recorded, wiping any previous recording when the first note is played. Selecting REPLAY mode replays the last recording, even if already in REPLAY mode. The current pitch and tempo modify the replayed recording. The pitch value is the transposition in semitones, normally at zero for straight replay. The H and L keys respectively raise and lower the pitch. 'Tempo' controls the speed of replay, setting the ratio of replay to record tempo. The F key speeds up the replay, and the S key slows it down. Hitting ESC during a replay aborts it.

In EDIT mode, the position of the edit point in the recorded sequence is displayed at the right of the screen (in REPLAY and RECORD modes, this shows the number

of the last note, for reference when editing). Pressing RETURN key plays the note (or rest) at this position. The < and > keys move on and back one note respectively, playing the new note. Playing any note on the keyboard inserts it before the edit point (pressing the space bar inserts a rest) and DELETE removes the previous note or rest. The duration of any note or rest can be changed by pressing the COPY key. This sets it to the value of the current duration (displayed under REPLAY), which can be altered with the L (longer) and S (shorter) keys. The current duration is updated whenever a note is played. Attempts to move or delete past either end of the recording gives a high-pitched bleep.

Key functions

Here's a summary of the key functions:

```
f0 PLAY
f1 RECORD
f2 REPLAY
f3 EDIT
```

In PLAY, RECORD, and REPLAY modes:

```
L Lower replay pitch
H Raise replay pitch
S Slow down replay
F Speed up replay
```

In REPLAY mode:

```
ESC Abort replay
```

In EDIT mode:

```
RETURN Play note
< previous note
> next note
DELETE Delete previous note
Keyboard Insert before note
COPY Change note duration
S Shorten current duration
L Lengthen current duration
```

As the listing shows, the bulk of the program is concerned with display, and decoding and acting on command keypresses. This includes all the procedures, from line 1770 onwards. The section that handles the keyboard and sound in PLAY mode lies between lines 920 and 1030 (the keyboard is handled separately by the different modes, with the others following the same general scheme as PLAY). This is the bit we are really interested in, since it can be lifted out and used as the basis of other instruments.

The basic job of the keyboard-to-sound section can be broken down as follows:

```
REPEAT
Wait for a key depression
Derive the pitch for the note
Start the note playing
Wait for the key to be lifted
Terminate the note
UNTIL FALSE
```

This would work but suffers from the disadvantage that while a key is held down, all other keypresses are ignored. To get the last-note priority effect, the program must play the new note even if the last pressed key is still down. To check for new keys and release of the last pressed key at the same time, the set of instructions must be

THE MUSIC MAKER

repeated continuously, taking action when either of these events arise. The scheme becomes:

REPEAT

IF new key pressed

THEN Terminate last note

derive pitch

start note playing

IF last key released

THEN terminate note

UNTIL FALSE

By making the SOUND statement that plays the note a flushing one, any note already playing is automatically ended, and, as before, a silent flushing sound is used when a note finishes normally, with release of the key.

The program uses the INKEY function to communicate with the keyboard. INKEY(0) returns the ASCII code when a key is pressed, and this is converted into a pitch value by the same method used in the Music Interpreter — INSTR finds the position of the character in the data string 'keys\$'. The other end of the process uses INKEY(-ve number) to find whether the key is still down. The pitch value is converted into the code that identifies the particular key by a look-up table (kc%), and

INKEY(-code) returns FALSE if the key has been released.

The REPLAY and EDIT modes use the SOUND statement in the same low-level on-off fashion, but controlled by timing loops. An infinite-duration flushing sound starts each note, and after a timed delay, it is ended by the next one. Basic's TIME has a resolution of 10ms, so timed loops give better-resolved note lengths than does the SOUND duration facility.

Conclusion

The Music Interpreter and Keyboard Instrument clearly demonstrate an important difference between two types of sound-generating program, in which:

1. The overall program timing is governed by the sound timing.

The program is forced to wait for the current sound to complete before its next sound request will be accepted by the operating system. It runs normally between requests, but overall rate of execution is limited by the rate at which its sound requests are dealt with.

Nearly all sound-only programs, including music players and pure sound-effects

generators, are of this type. Since they have nothing to do but generate sound requests (and make attendant calculations), it doesn't really matter that they are halted for most of the time. They rely on the SOUND duration parameter and queuing system.

2. The overall sound timing is governed by the program timing.

The program runs continuously, making sound requests in response to timed events, user input etc. The program is never held up when making a sound request because it never overloads the OS. This is ensured either by program logistics (there are never enough requests of sufficient duration made in a short time), or by flushing the queues at every request (the program taking part or full control of duration as well as starting time).

Musical keyboard programs and games (applied sound-effects generators) are of this type. They use infinite duration and flushing.

David Ellis and Chris Jordan are the authors of 'Creative Sound on the BBC Microcomputer' — a forthcoming book and cassette from Acornsoft.

END

```

10 REM Recording Keyboard Instrument
20 REM Creative Sound on the BBC Microcomputer
30 REM Acornsoft (C) 1982
40
50 *KEY0a
60 *KEY1b
70 *KEY2c
80 *KEY3d
90 DIMmc% 50, kp% 25, kc% 25, mx% 4
100 DIMdur% 256, pitch% 256
110 PROCass
120 keys$="abcdLHSF, . "+CHR$127+CHR$135+CHR$13+
" "
130 keys$=keys$+CHR$9+"Q2W3ER5T6Y7UI9D0P@^[\_]"
CHR$136+CHR$139+CHR$138
140 kx%=4:ky%=14:ox%=2:oy%=4
150 px%=2:py%=8:!mx%=&1D130800
160 black$=CHR$&87+
" 2 3 5 6 7 9 0 ^ \ c"+CHR$&97
170 white$=CHR$&87+
"t Q W E R T Y U I O P @ [ _ c c"+CHR$&97
180 notes$="B C D E F G A B C D E F G A B C"
190
200 DATA0, 2, 3, 4, 5, 6, 8, 9, 10, 11, 12, 13, 14
210 DATA16, 17, 18, 19, 20, 22, 23, 24, 25, 26
220 DATA27, 28, 30
230 DATA separator
240 DATA97, 17, 50, 34, 18, 35, 52, 20, 36, 53
250 DATA69, 37, 54, 38, 39, 55, 40, 56, 72, 25
260 DATA57, 121, 41, 26, 58, 42
270
280 FORI%=0TO25:READkp%?I%:NEXT
290 READsep$
300 FORI%=0TO25:READkc%?I%:NEXTI%
310
320 ONERRORGOTO2700
330 *FX11
340 *FX4, 1
350 MODE7
360 VDU23;10, 32;0;0;0;
370 PRINTTAB(0, oy%-1)CHR$&97' CHR$&97' CHR$&97
380 PRINTTAB(ox%, oy%-2)
" f0 f1 f2 f3"
390 PRINTTAB(ox%, oy%);" PLAY ";
400 PRINT"RECORD REPLAY EDIT"
410 PRINTTAB(px%, py%)
" Pitch Tempo Dur. Note"
420 PRINTTAB(0, ky%-2);
430 VDU&97, &ODOA;&97, &ODOA;
440 VDU&97, &8D, &ODOA;&97, &8D, &ODOA;
450 VDU&97, &ODOA;
460 VDU&97, &8D, &ODOA;&97, &8D, &ODOA;

```

```

470 VDU&97, &ODOA;&97
480 PRINTTAB(kx%-2, ky%-2)STRING$(35, CHR$&FO)
490 PRINTTAB(kx%-2, ky%+6)STRING$(35, CHR$&A3)
500 PRINTTAB(kx%-2, ky%-1)STRING$(7, CHR$&B5+
CHR$8+CHR$10)
510 PRINTTAB(kx%+32, ky%-1)STRING$(7, CHR$&EA+
CHR$8+CHR$10)
520 FORI%=0TO1
530 PRINTTAB(kx%-1, ky%+I%)black$
540 PRINTTAB(kx%-1, ky%+3+I%)white$
550 NEXT
560 PRINTTAB(kx%, ky%+8)notes$
570
580 dd%=30:tr%=0:tem%=10:prev%=-1
590 pitch%?1=255:dur%?1=0:dur%?2=0
600 mode%=0:I%=0:down%=FALSE:PROCmbon
610 PROCpp:PROCpt:PROCpd:PROCpn
620 *FX15, 1
630
640 REM Main Loop
650 REPEAT
660 key%=INSTR(keys$, CHR$INKEY(0))
670 IFkey%=0:GOTO890
680 IFkey%>4:GOTO810
690 IFmode%=1:dur%?I%=0
700 PROCmboff:mode%=key%-1
710 PROCmbon
720 REM Initialise mode
730 SOUND&11, 0, 0, -1:PROCboff
740 down%=FALSE:prev%=-1
750 ONmode%+1GOTO760, 770, 780, 790
760 I%=0:PROCpn:UNTILO
770 I%=0:UNTILO
780 stop%=FALSE:I%=1:UNTILO
790 I%=1:PROCpn:dd%=dur%?1:PROCpd:UNTILO
800
810 IFkey%>14GOTO890
820 ONkey%-4GOTO830, 840, 850, 860, 870, 870, 870
870, 870
830 tr%=tr%-1:PROCpp:UNTILO
840 tr%=tr%+1:PROCpp:UNTILO
850 tem%=tem%-(tem%/(99)):PROCpt:UNTILO
860 tem%=tem%+(tem%/1):PROCpt:UNTILO
870 UNTILO
880
890 ONmode%+1GOTO920, 1060, 1240, 1380
900
910 REM Play
920 IFkey%=0:GOTO990
930 P%=key%-15
940 IFdown%:PROCboff
950 SOUND&11, -15, P%*4, -1
960 PROCbon:down%=TRUE

```

```

970 prev%=P%:C%=-kc%?P%
980 UNTILO
990 IFNOTdown%:UNTILO
1000 IFINKEY(C%):UNTILO
1010 SOUND&11,0,0,-1
1020 PROCboff:down%=FALSE
1030 prev%=-1:UNTILO
1040
1050 REM Record
1060 IFkey%=0:GOTO1150
1070 I%=I%+1:PROCpn:I%=I%-1:P%=key%-15
1080 IFdown%:PROCboff
1090 IFI% 253:PROCa:UNTILO
1100 SOUND&11,-15,P%*4,-1
1110 PROCbon:down%=TRUE
1120 dur%?I%=TIME:pitch%?I%=prev%
1130 TIME=0:I%=I%+1:prev%=P%
1140 C%=-kc%?P%:UNTILO
1150 IFNOTdown%:UNTILO
1160 IFINKEY(C%):UNTILO
1170 I%=I%+1:PROCpn:I%=I%-1
1180 SOUND&11,0,0,-1
1190 PROCboff:down%=FALSE
1200 dur%?I%=TIME:pitch%?I%=prev%
1210 TIME=0:I%=I%+1:prev%=-1:UNTILO
1220
1230 REM Replay
1240 IFstop%:UNTILO
1250 TIME=0
1260 REPEAT:IFdur%?I%=0:UNTIL1:GOTO1340
1270 PROCpn:P%=pitch%?I%
1280 IFP%() 255:GOTO1300
1290 SOUND&11,0,0,-1:GOTO1320
1300 P%=P%+tr%:SOUND&11,-15,P%*4,-1
1310 PROCboff:PROCbon:prev%=P%
1320 REPEATUNTILTIME)dur%?I%)*tem%DIV10
1330 TIME=0:PROCboff:I%=I%+1:UNTILO
1340 stop%=TRUE
1350 SOUND&11,0,0,0:UNTILO
1360
1370 REM Edit
1380 REPEAT
1390 key%=INSTR(keys$,CHR$GET):TIME=0
1400 IFkey%=0:UNTILO
1410 IFkey%<5:UNTIL1:GOTO690:REM mode change
1420 IFkey%14:GOTO1690:REM insert
1430 ONkey%-4GOTO1440,1450,1460,1450,1470,1480,
1490,1500,1520,1650
1440 dd%=dd%-(dd%() 255):PROCpd:UNTILO
1450 UNTILO
1460 dd%=dd%+(dd%() 1):PROCpd:UNTILO
1470 IFFNn(-1):GOTO1520:ELSEPROCa:UNTILO
1480 IFFNn(1):GOTO1520:ELSEPROCa:UNTILO
1490 IFFNn(-1):X%=I%:CALLdelete:UNTILO:ELSE
UNTILO
1500 IFdur%?I%=0:PROCa:ELSEdur%?I%=dd%:GOTO1520
1510
1520 IFdur%?I%=0:PROCa:UNTILO
1530 P%=pitch%?I%:dd%=dur%?I%
1540 PROCpd:TIME=0
1550 IFP%() 255:GOTO1580
1560 SOUND&11,0,0,-1
1570 REPEATUNTILTIME)dur%?I%:GOTO1610
1580 SOUND&11,-15,pitch%?I%*4,-1
1590 PROCbon:prev%=P%
1600 REPEATUNTILTIME)dur%?I%:PROCboff
1610 SOUND&11,0,0,0
1620 UNTILO
1630
1640 REM space - rest
1650 REPEATUNTILNOTINKEY(-99)
1660 P%=255:GOTO1730
1670 IFkey%=0:UNTILO
1680 REM note key
1690 P%=key%-15:C%=-kc%?P%:PROCbon
1700 SOUND&11,-15,P%*4,-1:prev%=P%
1710 REPEATUNTILNOTINKEY(C%)
1720 SOUND&11,0,0,0
1730 X%=I%:CALLinsert
1740 dur%?I%=TIME:pitch%?I%=P%
1750 PROCboff:D%=FNn(1):UNTILO
1760
1770 DEFPROCpd
1780 @%=3:PRINTTAB(px%+21,py%+1)dd%
1790 ENDPROC
1800
1810 DEFPROCpp
1820 @%=3:PRINTTAB(px%+1,py%+1)tr%
1830 ENDPROC
1840
1850 DEFPROCpt
1860 @%=&20103:PRINTTAB(px%+11,py%+1)tem%/10
1870 ENDPROC

```

```

1880
1890 DEFPROCpn
1900 @%=8:PRINTTAB(px%+25,py%+1)I%
1910 ENDPROC
1920
1930 DEFFNn(D%)
1940 IFI%=1ANDD%=-1:PROCa:=0
1950 IFdur%?I%=0ANDD%=1:PROCa:=0
1960 I%=I%+D%
1970 PROCpn:=1
1980
1990 DEFPROCa:SOUND&11,-10,149,2:ENDPROC
2000
2010 DEFPROCbon
2020 IFP% 250RPP%() 0:ENDPROC
2030 xp%=kp%?P%:row%=1-xp%MOD2
2040 PRINTTAB(kx%+xp%-1,ky%-1+row%*3);
2050 VDU&BC,&AC,&EC,8,8,8,10,10,10
2060 VDU&AD,&AC,&AE
2070 ENDPROC
2080
2090 DEFPROCboff
2100 IFprev% 250Rprev%() 0:ENDPROC
2110 xp%=kp%?prev%:row%=1-xp%MOD2
2120 PRINTTAB(kx%+xp%-1,ky%-1+row%*3);
2130 VDU32,32,32,8,8,8,10,10,10
2140 VDU32,32,32
2150 ENDPROC
2160
2170 DEFPROCmbon:LOCALI%
2180 IFmode%=10Rmode%=2:ms%=6:ELSEms%=4
2190 PRINTTAB(ox%+mx%?mode%,oy%-1);
2200 VDU&BC
2210 FORI%=1TOms%:VDU&AC:NEXT:VDU&EC
2220 PRINTTAB(ox%+mx%?mode%,oy%);
2230 VDU&B5
2240 FORI%=1TOms%:VDU9:NEXT:VDU&EA
2250 PRINTTAB(ox%+mx%?mode%,oy%+1);
2260 VDU&AD
2270 FORI%=1TOms%:VDU&AC:NEXT:VDU&AE
2280 ENDPROC
2290
2300 DEFPROCmboff:LOCALI%
2310 PRINTTAB(ox%+mx%?mode%,oy%-1);
2320 FORI%=-1TOms%:VDU32:NEXT
2330 PRINTTAB(ox%+mx%?mode%,oy%);
2340 VDU32:FORI%=1TOms%:VDU9:NEXT:VDU32
2350 PRINTTAB(ox%+mx%?mode%,oy%+1);
2360 FORI%=-1TOms%:VDU32:NEXT
2370 ENDPROC
2380
2390 DEFPROCass
2400 FORI%=0TO2STEP2:P%=mc%
2410 COPTI%
2420 .delete \ I% in X
2430 .dloop LDA dur%+1,X
2440 STA dur%,X
2450 BEQ dlout
2460 LDA pitch%+1,X
2470 STA pitch%,X
2480 INX
2490 JMP dloop
2500 .dlout RTS
2510
2520 .insert \ I% in X
2530 STX &70
2540 .sloop LDA dur%,X
2550 BEQ slout
2560 INX
2570 JMP sloop
2580 .slout INX
2590 .iloop DEX
2600 LDA dur%,X
2610 STA dur%+1,X
2620 LDA pitch%,X
2630 STA pitch%+1,X
2640 CPX &70
2650 BNE iloop
2660 RTS
2670 JNEXT
2680 ENDPROC
2690
2700 IFERR() 17:GOTO2730
2710 prev%=P%:PROCboff:PROCmbon
2720 stop%=TRUE:GOTO620
2730 ONERROROFF
2740 *FX12,0
2750 *FX4,0
2760 VDU23;10,&72;0;0;0
2770 REPORT:PRINT" at line "ERL" OK?"

```

Program 2

PCW SUBSET

Alan Tootill and David Barrow present more useful assembler-language subroutines. This is your chance to help build a library of general-purpose routines, documented to the standards we have developed together in this series. You can contribute a Datasheet, improve or develop one already printed or translate the implementation of a good idea from one processor to another. PCW will pay for those contributions that achieve Datasheet status. Contributions (for any of the popular processors) should be sent to SUB SET, PCW, 62 Oxford Street, London W1A 2HG.

STANDARDS

It is clear from the letters we get that many of today's Sub-Setters were not around in the pioneering days of 1980, when Sub Set's standards evolved. It is time then for the documentation standards, in their latest form, to be set out again:

1) The first part of the documentation, marked ":", is a label and name to identify the routine.

2) The second part, marked ";", contains a technical description, to enable the routine to be used in a system, without necessarily understanding the code:

Section 1 of the technical description gives the class of the routine. Class 1 routines

are re-entrant (usable by a part of the program interrupting another part of the program that was using it), operate correctly wherever they are located in memory, do not alter their own instructions and return unaltered all registers and flags except those declared as being used to pass information to and from the routine. Other routines are class 2.

Section 2 declares whether or not the routine is time critical.

Section 3 gives a brief description.

Section 4 gives the main actions carried out by the routine.

Section 5 lists any other routines on which the routine depends.

Section 6 gives any input/output interfaces, peripherals or local RAM areas needed.

Section 7 specifies flags, registers, 6502 zero page locations, parameters, stack or other areas assumed to have meaningful values when the routine is called.

Section 8 specifies flags, registers, 6502 zero page locations, and other areas containing results when the routine returns.

Section 9 gives the registers disturbed by use of the routine.

Section 10 gives the maximum number of bytes that could be added to the stack. This includes growth from the routine calling other routines but excludes the two bytes used by the main pro-

gram call for its return address.

Section 11 gives the number of bytes occupied by the routine.

Section 12 is optional for routines not time critical and gives the exact total or maximum number of time states.

Section 13 gives the processor or processors that will run the machine code.

3) The third part is a complete listing of the routine, with assembler mnemonics, comments and machine code.

Sixteen bytes of zero page RAM are reserved for Sub Set 6502 routines. These are referred to as MO to MF in the documentation and mnemonics and as ZZ in the machine code.

6502 ZERO-SUPPRESSED PRINT

Our first contributor this month, Andrew Watson of Stroud, is no newcomer to Sub Set. It was our remarks on zero suppression in November 1980 that prompted Andrew to send, somewhat belatedly, his Datasheet PRAY, which we, more belatedly again, pass on now. This prints out the value, held in binary in the A,Y registers, with leading zeros suppressed, using the stack,

rather than zero page memory, for working space.

It depends on your having your own routine, which is here called CHROUT, to print the character in A at the current cursor position. In the BBC Micro for example, the routine at \$FFE3 (their OSASCII) will 'print' the contents of register A on the screen.

DATASHEET

```
;; PRAY - Print the value from A,Y
;; CLASS: 1
;; TIME CRITICAL?: No
;; DESCRIPTION: Prints the binary value from A,Y as an unsigned
                decimal number with leading zeros suppressed.
;; ACTION: Push 16-bit N and get pointer to it in X
                A = $80
                REPEAT:
                PUSH A
                N = N/10, A = remainder
                UNTIL (N = 0)
                REPEAT:
                Print A as one decimal digit
                PULL A
                UNTIL (A = $80)
                Pull workspace off stack
```

```
;; SUBR DEPENDENCE: CHROUT, a subroutine to print the ASCII
                character in A
;; INTERFACES: Suitable output device (printer, VDU or whatever)
;; INPUT: Number to be printed in A (MS Byte) and Y
;; OUTPUT: The printed number, A = 0, Y undefined (could be
                corrupted by CHROUT)
;; REGS USED: A and Y
;; STACK USE: 12 maximum, 8 min + m + any stack use by CHROUT
;; LENGTH: 49
;; TIME STATES: Apprx. 44 + d * (488+execution of CHROUT) where
                d = number of digits printed
;; PROCESSOR: 6502
```

```
PRAY: PHP ;save 08
        PHA ;registers 48
        TYA ;and 98
        PHA ;get 48
        TXA ;number 8A
        PHA ;on stack 48
        TSX ;get pointer in X. 8A
        LDA #80 ;get terminator. A9 80
NXTDG: PHA ;push term. or digit. 48
        LDY #16 ;set count for 16 bits. AD 10
        SEC ;set A=$80, V=1, C=0. 38
        LDA #0 ; A9 00
        SBC #80 ; E9 80
ROLL: ROL A ;shift hi bit of N into A 2A
        CMP #10 ;and subtract 10 if C9 0A
        BCC NSUB ;required. 90 02
        SBC #10 ;( does nothing 1st loop ). E9 0A
NSUB: ROL $102,X ;rotate carry into N 3E 02 01
        ROL $103,X ;and get MS bit. 3E 03 01
        DEY ;do loop 88
        BPL ROLL ;17 times. 10 F0
        BVC NXTDG ;divide again if N not 0. 50 E6
PRDG: ORA $30 ;change digit to ASCII. 09 30
        JSR CHROUT ;and print it. 20 XX XX
        PLA ;get next digit or term 68
        BPL PRDG ;and loop if digit. 10 F8
        PLA ;restore 68
        TAX ;registers. AA
        PLA ; 68
        PLA ; 68
```

PLP	;	28
RTS	;return.	60
RET	;	C9
	; and exit.	
RSTN:	AND OC7H	E6 C7
	; Not a conditional branch;	
CP	OC7H	FE C7
	; test for RST (restart)	
JR	NZ,JPCC	20 06
	; If so,	
LD	A,D	7A
	; the required address is in	
AND	38H	E6 38
	; bits 3-5 of the opcode	
LD	H,B	60
	; H = B = zero	
LD	L,A	6F
	; L = page 0 address	
RET	;	C9
JPCC:	CP OC2H	FE C2
	; Not RST instruction; check	
JR	Z,ABCON	28 10
	; for absolute conditional	
CP	OC4H	FE C4
	; JP or CALL	
JR	Z,ABCON	28 0C
	; for absolute conditional	
CP	OC0H	FE C0
	; Not those either; finally	
JR	NZ,NOTFR	20 D4
	; check for RET cc. If not,	
CALL	CTEST	CD YY YY
	; no transfer; but if so,	
RET	NC	DD
	; test F status. If cc true,	
LD	C,RADIS	0E XX
	; treat as RET unconditional.	
JR	READR	18 AD
	; from the stack	
ABCON:	CALL CTEST	CD YY YY
	; Yes, it's JP cc / CALL cc;	
JR	C,ABS	38 AB
	; if cc true, treat as JP,	
JR	NOTFR	18 C5
	; else no control transfer.	
	; Recover saved F contents & return cc true/false in carry flag:	
CTEST:	PUSH HL	E5
	; Save pointer;	
LD	HL,AFDIS+4	21 XX 00
	; point to saved	
ADD	HL,SP	39
	; F register and	
LD	A,(HL)	7E
	; fetch into A	
POP	HL	E1
	; Restore pointer	
BIT	3,D	CB 5A
	; If condition asks for	
JR	NZ,TRUE	20 01
	; flag reset, then invert	
CPL	;	2F
	; all flags	
TRUE:	BIT 5,D	CB 6A
	; Use condition bit pattern	
JR	NZ,PRTY	20 07
	; to rotate the correct flag	
BIT	4,D	CB 62
	; into Cy	
JR	NZ,CARY	20 09
	; into Cy	
ZERO:	RLA	17
	; Z or NZ	
SIGN:	RLA	17
	; M or P	
RET	;	C9
	; return	
PRTY:	BIT 4,D	CB 62
	; into Cy	
JR	NZ,SIGN	20 FA
	; into Cy	
RRA	;	1F
	; PE or PD	
RRA	;	1F
	; rotate right	
CARY:	RRA	1F
	; C or NC	
RET	;	C9

DIVISION FOUR

The astoundingly prolific John Kerr, author also of the last Datasheet this month, has sent yet another improvement to SDIV4, the Z80 4-byte signed

integer division routine. This time it shaves one byte off the original which appeared in June 1981 and reduces the execution time from over thirteen thousand to a maximum of 8992.

KEEPING IN TOUCH

Unable to resist the challenges made occasionally in Sub Set, John Kerr of Carmyle has sent NEWPC to complement Bruce Tanner's LENGTH (March 1981).

LENGTH determines the byte length of Z80 instructions and could form the basis of a software single-step program. John's NEWPC provides us with the other essential ingredient — a routine to calculate the contents of the Program Counter

after the next instruction has been executed.

NEWPC suffers from a not inconsiderable number of relative jumps, calls and returns which John typically used to his advantage by setting the routine to test itself.

Instructions affecting the PC are tested for in the following order, with the search being stopped at (6), (8) or (9) if ED, DD or FD is not followed by a valid 'jump' byte.

	;/ STACK USE: 6	
	;/ LENGTH: 184	
	;/ PROCESSOR: Z80	
	;	
AFDIS:	EQU n1	; The number of bytes above
BCDIS:	EQU n2	; the saved registers
HLDIS:	EQU n3	; (AF,B,C,HL,IX or IY)
IXDIS:	EQU n4	; on the stack, including
IYDIS:	EQU n5	; two for CALL NEWPC.
RADIS:	EQU n6	; The total number of bytes
	;/placed on the stack by the breakpoint routine, from the	
	;/original RST n to the CALL NEWPC, including two bytes for	
	;/each of these. This is the stack displacement to the	
	;/object program 'stacktop', or return address.	
	;	
NEWPC:	PUSH HL	; Save instruction pointer
	CALL LENGTH	; & find instruction length
	POP HL	; Restore pointer to 1st byte
	LD A,(HL)	; Fetch 1st byte and
	INC HL	; point to next
	CP 18H	; If instruction is an
	JR NZ,DJ	; unconditional branch (JR),
REL:	LD B,+0	; Fetch displacement value in
	LD C,(HL)	; C and point to 1st byte of
	INC HL	; following instruction
	BIT 7,C	; Sign extend
	JR Z,POS	; displacement
	DEC B	; into B
POS:	ADD HL,B	; Add into HL to obtain
	RET	; displaced address
DJ:	CP 10H	; Not JR; test for
	JR NZ,AJ	; DJNZ instruction
	PUSH HL	; If so, fetch the saved
	LD HL,BCDIS+3	; B register contents
	ADD HL,SP	; from the stack
	LD B,(HL)	; If equal to 1, exit; else
	POP HL	; treat this as an
	DJNZ,REL	; unconditional JR;
	INC HL	; Yes, B decrements to zero,
	RET	; so no transfer of control.
AJ:	CP OC3H	; Not DJNZ; if instruction is
	JR Z,ABS	; an absolute unconditional
	CP ODDH	; JP or CALL, then new PC
	JR Z,ABS	; = 2nd & 3rd bytes of instrn
	CP OC9H	; If unconditional RET,
	LD BC,RADIS	; then read return address
	JR Z,READR	; from the stack
	CP OEDH	; If it's an ED instruction,
	JR NZ,JPHL	; there is no transfer
	LD A,(HL)	; unless it's RETI or RETN,
	AND OF7H	; which are treated
	CP 45H	; the same as
	JR NZ,NOTFR	; unconditional RET
READR:	LD H,B	; Point to
	LD L,C	; stacked
	ADD HL,SP	; address
ABS:	LD A,(HL)	; Effectively LD HL,(HL)
	INC HL	; as HL is pointing to
	LD H,(HL)	; the desired new PC
	LD L,A	;
	RET	;
JPHL:	CP OE9H	; If instruction is JP (HL),
	LD C,HLDIS	; fetch the required address
	JR Z,READR	; from the stack
	CP ODDH	; If an index instruction,
	LD C,IXDIS	; there is no transfer
	JR Z,JPI	; unless it's JP (IX)
	CP OFDH	; or JP (IY)
	LD C,IYDIS	; which are treated
	JR NZ,BRCC	; similarly to JP (HL)
JPI:	LD A,(HL)	; Fetch 2nd byte of index
	CP OE9H	; instruction; if JP,
	JR Z,READR	; read address from stack
NOTFR:	LD C,E	; No jump; add length of
	DEC C	; instruction to original
	ADD HL,B	; contents of HL.
	RET	;
BRCC:	LD D,A	; Not an index instruction;
	AND OE7H	; save 1st byte & check for
	CP 20H	; conditional branch (JR cc)
	JR NZ,RSTN	; If so,
	RES S,D	; exan. F register prior
	CALL CTEST	; to break, and if condition
	JR C,REL	; true, treat as 'JR disp';
	INC HL	; else step over displacement

DATASHEET

```

;/NEWPC - Find PC contents after next instruction is executed
;/CLASS: 2 (Not position independent; registers not saved)
;/TIME CRITICAL?: No
;/DESCRIPTION: HL points to an instruction about to be executed in
;/ 'trace' mode. NEWPC determines the address of the
;/ instruction which will be obeyed after this one.
;/ ACTION: Find the LENGTH of the current instruction. If no transfer
;/ of control will occur, add this to the original HL. Else
;/ fetch or compute the new PC. See comments for details.
;/SUBR DEPENDENCE: LENGTH - put length of instruction into E.
;/ Also local CTEST - set Cy flag if the condition
;/ specified in an instruction is satisfied by the
;/ contents of the saved F register; else clear Cy.
;/ INTERFACES: None
;/ INPUT: HL points to 1st byte of current instruction.
;/ OUTPUT: E = byte length of instruction; HL = predicted PC contents.
;/ AF,B,C,D altered.
;/ REGS USED: AF,B,C,D,E,HL

```

(1)	JR disp	18
(2)	DJNZ disp	10
(3)	JP addr	C3
(4)	CALL addr	CD
(5)	RET	C9
(6)	RETI/RETN	ED 0100 X101
(7)	JP (HL)	E9
(8)	JP (IX)	DD E9
(9)	JP (IY)	FD E9
(10)	JR cc,disp	001X X000
(11)	RST n	11XX X111
(12)	JP cc,addr	11XX X010
(13)	CALL cc,addr	11XX X100
(14)	RET cc	11XX X000

THE TIGER

The Right Product at the Right Price

The TIGER is the most unique and powerful microcomputer in its price range, exceeding the capabilities of any other micro in its class.

Designed for ease of use, convenience and to a price, TIGER will perform for a one person office, small to medium size business operations, and with its versatility and flexibility, the TIGER is ideal also for the large corporate user.

Comprehensive Software, Documentation and Support

Look at the TIGER specification. Impressive? Yes! But, all these features count for nothing unless you have reliable software, good documentation and the right level of professional support. TIGERBYTE® software includes Peachtree - one of the world's biggest and most experienced software specialists. In addition to these basic accounting and office productivity programs, TIGERBYTE® provides proven communications and graphics software. With excellent documentation and nationwide service back-up, HH provide the dealer with total product and support.

Designed for the Market

The TIGER was designed with the user in mind. Apart from its obvious aesthetically pleasing appearance and excellent use of ergonomics, the TIGER performs. The price and performance meets the



THE COMPLETE TIGER
DESKTOP SYSTEM - £2,795

needs of the smaller business but, because of its built-in modem and immediate access to Prestel, the TIGER is a powerful communications tool. Comprehensive interfacing ports mean TIGER can support advanced data communications to other terminals, minicomputers, and large corporate mainframes. With outstanding colour graphics, the TIGER is a compelling selling proposition.

HH® - The Company

The TIGER comes from a well-established British company renowned for its high quality electronics and marketing skills. We have an impressive list of clients worldwide supported by over 600 dealers in 48 countries. We'll be here tomorrow.

The Future Today and Tomorrow

The TIGER'S design is based on a combination of some of the most advanced microprocessors available, providing significantly better performance than any other micro in its price class, so it won't be obsolete tomorrow.

Invest in the Future Today

Innovation, quality and service. That's HH. We are now looking for the best 100 dealers in Britain. That could be you. Contact HH now for a dealer pack.

COMPARE THESE SPECIFICATIONS

Unique Three Processor System

Tiger's advanced pipe-lined architecture is based on the 7220, 6809 and Z80A microprocessors.

Memory: 7220: 96K RAM
Z80A: 64K RAM

Expansion bus allows virtually unlimited extra RAM, I/O devices or disk controller connection.

16K ROM provision if used without disks.
Standard 2K ROM.

6809: 2K RAM
Expansion bus allows extra RAM, I/O devices or disk controller connection.

16K ROM
256 x 4 bits parameter RAM with battery.

Disk Capacity: Two 5¼" double sided, double density, drives giving total 2.0MB.

Operating System: CP/M® Industry Standard.

Colour Graphics: 14" High resolution colour display. Dedicated 7220 processor with 96K RAM generates -

- High resolution colour 512x512 Pixels, with High Speed vector, arc and figure drawing. Features hardware Pan and Zoom, also animation.

- Text mode resolution 640x256, 80 characters x 24 lines.
 - Prestel mode 40 characters x 24 lines.
- Display writing speed 1 million pixels per second.

Features Built-in

- Modem - with auto-dial, auto-answer facility
 - Cassette Port
 - Security Switch ID Codes.
 - Reset Switch
 - Light Pen Port
 - Video Drive (TTL Level)
 - Disk Port
 - IEEE-488 Port
 - Printer Port
 - RS232
 - Network Data Link
 - Internal Loudspeaker
 - Keyboard - Expanded QWERTY, non reflective key-caps, numerical pad and cursor controls. Ten coloured definable function keys. Special ergonomic design.
 - Disk Expansion - Disk controller card, Connectors for additional two 5¼" drives and two 8" drives.
 - UHF Pal Encoder Module - option
- ® registered trade mark of Digital Research Inc.

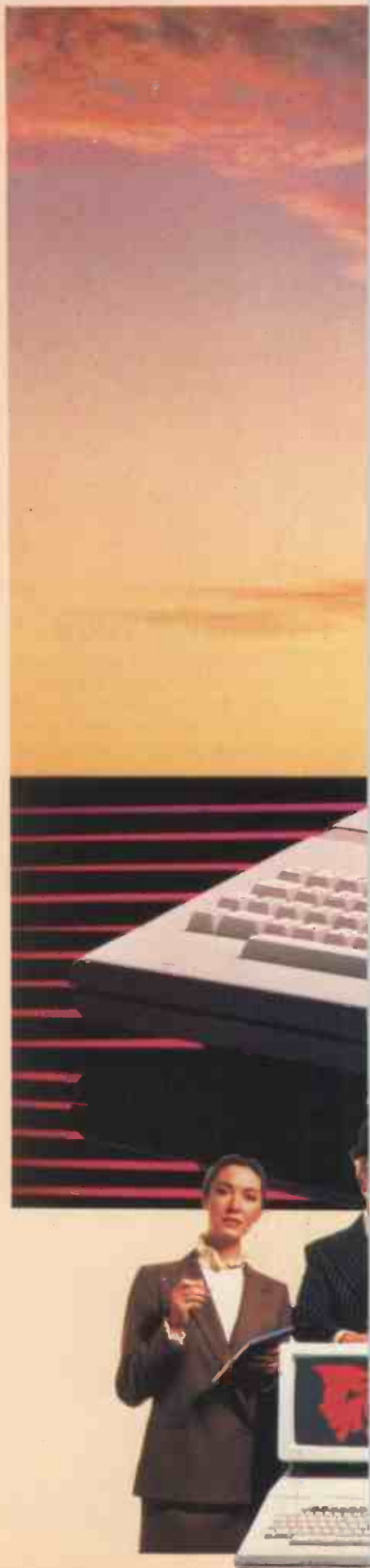

FROM

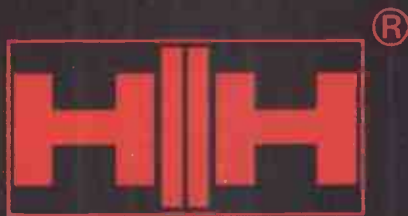

I am interested in a dealership. Please send me

full details and contact me:

Name: _____

Address: _____

Telephone No: _____

H/H Microcomputers Viking Way, Bar Hill, Cambridge CB3 8EL Telephone: Crafts Hill (0954) 81140 (16 lines)
Telex: 817515 HHELECG Telegrams: Electronic Cambridge.

PCW 5/83



COMPSOFT'S DMS – winner
of the 1982 **RITA** Awards,
'Software Product of the Year.

Now Compssoft announce
Delta – the very powerful, very
friendly database* that the
world has been waiting for.

* For micro computers with CP/M, MP/M, MSDOS or Commodore operating systems. Including IBM PC.

Compssoft Training Centre



If part of your microcomputer's job is to store information, you need Compssoft's software.

Compssoft DMS is already Britain's No. 1 record keeping program. And with 4000 users to our credit, we can honestly say we know more about information storage & retrieval than anyone else. We listen to your comments & requests and now we've produced a world first – the Delta – a true transactional database.

If you'd like to know more, we have general brochures, full technical specifications & free

guides to DMS handling a multitude of business situations from order processing, invoicing & stock recording, through to library, personnel & hospital record management.

Find out more about the database revolution. Either telephone the office or clip the coupon now.

Compssoft's Delta – taking microcomputers into the third dimension.

Compssoft Limited
Hallams Court
Shamley Green
Nr Guildford, Surrey
England GU4 8QZ
Telephone: Guildford (0483) 898545
Telex: 859210 CMPSFT



Please send me further details

Company

Contact

Address

Tel No.

TJ's WORKSHOP

Our monthly pot-pourri of hardware and software tips for the popular micros. If you have a favourite tip to pass on, send it to 'TJ's Workshop', PCW, 62 Oxford Street, London W1A 2HG. Please keep your contributions as concise as possible. We will pay £5-£30 for any tips we publish. PCW can accept no responsibility for any damage caused by using these tips, and readers should be advised that any hardware modifications may render the maker's guarantee invalid.

VIC CHARACTER BUILDER

The availability of user defined graphics on the VIC is quite well documented (TJ's Workshop January 1983 and July 1982). Basically the VIC normally looks in ROM (a 4K block from 32768 (hex 8000) to 35225 (hex 8999) for the picture of the character). By changing the value held in location 36869 (hex 9005), one of the VIC chip's control registers, it is possible to make the VIC look in another part of memory (either RAM or ROM) for this information (Table 1).

Normally each character is made up of an 8 x 8 dot matrix, but by having a 1 in bit 0 of location 36867 (hex 9003) each character is double height, being made up of an 8 x 16 matrix. In this mode each screen location is twice as big and all characters appear twice as tall (including listings,

etc). The number of rows on the screen must also be changed as 23 double height characters will not fit on the screen.

The number of rows is also kept in location 36867 so to give a screen with 15 rows of double height characters POKE 36867,31 (31 is twice the number of rows plus one). To have this number of rows the vertical centering of the screen must also be changed; this can be done with a POKE 36865,26. There is still a problem, as each character now requires twice the amount of information as for two normal characters — for example, pressing the '@' would result in a '@' being printed above an 'A'.

The way to get around this is to program the letters in the same way as user defined graphics. With normal characters this is done by defining each character with eight 8-digit binary numbers, or denary (base 10) numbers in the range 0 to 255. To

Ordinary

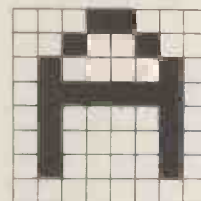

```
00011000 24
00100100 36
01000010 66
01111110 126
01000010 66
01000010 66
01000010 66
00000000 0
```

Double height

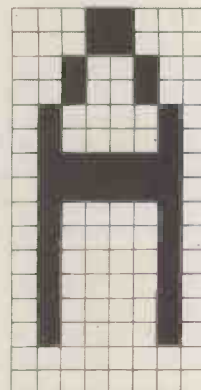

```
00011000 24
00011000 24
00100100 36
00100100 36
01000010 66
01000010 66
01111110 126
01111110 126
01000010 66
01000010 66
01000010 66
01000010 66
01000010 66
01000010 66
00000000 66
00000000 66
```

Fig 1

Value A	Value B	Value C	No Chars	Amount memory used
7168	255	28	32	512
6144	254	24	96	1536
5120	253	20	160	2560
4096	252	16	224	3584

Table 2

get double height characters 16 numbers are needed. This could be done by typing them in DATA statements, but this would take up too much memory as 16 bytes have to be reserved for every character anyway. The other way is to use the characters stored in ROM but instead of using each value once to use it twice.

This short program creates double height characters, reserving enough memory, and can be adapted to define different numbers of charac-

ters, depending on how many are needed and how much memory is available (Table 2). It will work on the unexpanded VIC, on the VIC with 3k RAM expansion or with the super expanded cartridge (in GRAPHICS 0). The screen will work normally after running the program except the computer thinks there are 23 rows although there are only 15, and you can therefore move the cursor off the bottom of the screen.

Andrew McSean

Value in	Characters	Contents of location
36869	start	
240	32768	Character ROM — upper case & full graphics
241	33792	Character ROM — upper case & graphics reversed
242	34816	Character ROM — upper & lower case with some graphics
243	35840	Character ROM — upper & lower case with graphics reversed
252	4096	Start of Basic RAM (unexpanded VIC)
253	5120	Basic RAM
254	6144	Basic RAM
255	7168	Basic RAM

(The above is an expansion of a Table in the Programmer's Reference Guide.)

Table 1

ARTISTIC AID

This program (written in Forth for the Jupiter Ace) allows you to draw your own graphics on the screen, or parts of the screen, & then store each design in the dictionary as your own 'Word'. If you then use that word the previously defined screen is drawn.

The program is fast and easy to use. After typing in the program type in : SCREEN ONE. A '?' should appear, now enter the code of a character in ASCII — if you want it repeated just keep the enter key pressed. Once

finished enter ONE to execute it.

By changing the DO LOOP limits you can define parts of the screen — eg, 9952 9824 will store the bottom four lines.

Once you have defined a screen and some parts of screens try writing one on top of the other; some good animations can be achieved. The program is useful for many graphics applications, not just games.

K P Tibbetts

```
DEFINER SCREEN
INVIS CLS 9952 9216 ( Do Loop limits)
DO
  ASCII ? I C! 300 QUERY
  LINE DUP 255 >
  IF
    DROP DUP
  ELSE
    SWAP DROP SWAP DROP DUP
  THEN
  DUP I C! C, ( Store in dictionary)
: LOOP
VIS
DOES
9952 9216 ( Do Loop Limits)
DO
  DUP C@ I C! 1+
: LOOP
```

CBM CRT CONTROL

The later versions of CBM computers, which have 12in screens differ from their predecessors by having CRT control chips which manage the operation of their VDU screens. The chip fitted is an HD46505 — in some machines, at least. This behaves as if it is equivalent to the 6845, which is often said to be the one used. The workings of the chip are controlled by 19 registers. The first, the address register, may be written to, using the instruction POKE59520,X. A value for X of zero to 17 directs attention at address 59521 to register X. Hence the following instruction POKE59521,Y will set register X to a new value Y.

Most of the registers are best left alone, as they determine matters such as the scanning frequency and screen geometry. Flexibility of these is of benefit when designing hardware, but it is hard to imagine any useful purpose in changing them during normal operation. At switch-on the chip registers are initialised from a table. In the 4000 series the values for registers 17 to 0 are held in addresses 59348 to 59331 and

entered by a subroutine starting at 58903. If, by accident or design, the critical registers become deranged the display breaks up or disappears completely. The CRT heater may even be turned off! Such disasters can quickly be averted by a call to SYS58903.

Some of the registers, however, can give useful variations. Register 6 sets the number of text lines which are displayed. This is normally 25, but any lower number has the effect of concealing later lines of text, even though they remain in the screen memory. Thus, POKE59520,6: POKE59521,0 will extinguish the display. Poking increasing numbers to 59521 will then reveal the screen again line by line. A variety of tricks can be played with register 6.

Register 1 has a similar effect in the horizontal direction. POKE59520,1: POKE59521,22 rearranges the format to give only 22 characters per line, giving a simulation of a VIC display. However, the characters are still their usual size and so the picture width is nearly halved.

Registers 12 and 13 control the address of the first character to be displayed (high byte, low byte). The 6845 has 14 address lines for controll-

ing this, but only ten of them (A0 to A9) are used for this purpose. Their relationship to the normal display RAM is logical: zero on the lines A0 to A9 causes the display to start at the usual point, 32768. Entering 1 means that the first character in the display RAM is missed and the display starts with the second character from this area. The address lines A10 and A11 are not used. The line A12 is connected to an exclusive OR gate in the path of the video signal which enables the video to be inverted or not at will, by poking 0 to 16 into register 12.

For normal display A12 is required to be high. The ability to invert the video signal is much less useful than one would have hoped: the problem is that, when inverted, all the normally blanked parts of the display become visible. These include extraneous raster area and all the frame flyback path. The highest address line, A13, is connected to pin 18 of the character generating ROM. The ROM normally fitted is a 2048 by 8 bit device, which gives the normal two CBM character sets. Space is available for two extra character sets by fitting a 4096 by 8 bit device. The 2532 PROM has the cor-

rect connections and selection between two pairs of character sets would be available under the control of A13.

Registers 10, 11, 14 and 15 are intended for the management of a cursor. As no connection is made to the cursor output signal, no use can be made of these. Registers 16 and 17 are for use with a light pen. They capture the value held on the address lines at the instant that the strobe input receives a positive-going edge. Pin 21 of the memory expansion connector J4 drives this input, via an inverter. However, pin 21 is also connected to the highest address line of the character ROM, on pin 19. This controls which of the two character sets is in use, giving the odd result that a number is latched into the light pen registers each time that the character set is shifted from upper/lower case to graphics.

Registers 0 to 11 are write-only. Registers 12 to 15 are read/write and the light pen registers, 16 and 17, are read-only. Read/write registers 14 and 15 can be used for storage, but note that registers 14, in common with registers 12 and 16, has only six working bits.

R B D Knight

BINARY CHOP

Searching string arrays for a particular value can be a very time-consuming business. This subroutine (lines 500 to 630) cuts down the search time considerably by using a technique which is sometimes called the 'binary chop'. In this method, which can only be used on arrays already sorted into ascending or descending order, we first look at the string in the middle of the array. This locates the target string in one half of the other and this half is again divided into two and the process repeated until the required string is located or we can decide it is not present. This is a far speedier method than a straightforward sequential search.

The program was written originally as a pro-

cedure for the BBC Computer but has been re-written to suit most varieties of Basic. Lines 30-150 are a short program to test the subroutine, array A\$ is filled with 676 strings of two characters each in order AA,AB...ZZ, at line 120 the user inputs a two character string and the program prints its position in the array (J%) together with the contents of this position.

The subroutine needs three parameters to be filled: ITEM\$ must hold the string for which you are searching, S% = starting subscript for the search and E% = end subscript for search. After calling the routine F=-1 if the ITEM\$ was located else F=0, and J% gives the array subscript if the search was successful.

Richard Grubb

```
10 REM SEARCH PROGRAM TO LOCATE A GIVEN
STRING IN A STRING ARRAY. THE ARRAY MUST
BE IN ASCENDING SEQUENCE.
```

```
20 :
30 DIM A$(675)
40 FOR I%=1 TO 26
50   K%=(I%-1)*26
60   FOR J%=1 TO 26
70     A$(K%)=CHR$(I%+64)+CHR$(J%+64)
80     K%=K%+1
90   NEXT
100  NEXT
110  S%=0:E%=675
120  INPUT ITEM$
130  GOSUB 500
140  PRINT J% "  "A$(J%)
150  GOTO 110
160 :
500  F=0
510  TD%=S%+(E%-S%) DIV 2
520  IF (E%-S%)>4 GOTO 590
530  I%=S%-1
540  REPEAT
550    I%=I%+1
560    IF ITEM$=A$(I%) THEN F=-1:J%=I%
570  UNTIL I%=E%
580  GOTO 630
590  IF ITEM$<A$(TD%) THEN E%=TD%:GOTO 510
600  IF ITEM$>A$(TD%) THEN S%=TD%:GOTO 510
610  J%=TD%
620  F=-1
630  RETURN
```

BBC DUMP

Here is a short routine I find useful for dumping all programs on a cassette to a printer from a BBC model A or B.

As the LIST command is not allowed from within a program I have programmed a function key to LOAD the next program above this program, to LIST it then jump back to line 80 which puts the code for function key 0 into the keyboard buffer. When the program ends the keyboard buffer is scanned by the OS and function key 0 is

executed. This is repeated until the cassette runs out or ESCAPE is pressed.

This technique can be used to execute other commands from within a program such as NEW, DELETE, etc, which are otherwise 'not allowed'. This operates under OS 0.1 and is not tube-compatible. Users with OS 1.0 upwards can replace lines 80 and 90 with *fx138,0,144.

Peter Middleton

```
5 REM CASSETTE DUMP
6 REM ~~~~~
7 REM P.Middleton, Feb 1983
10 MODE7
20 *FX6,0
30 *KEYOPAGE=&1000:MNEM:IM*LOAD""1000:ML
ISTO7:MI:BL:MI:IL:CPAGE=&E00:GOTOBO:IM
40 CLS:PRINTTAB(0,10)"BATCH PRINTER""
Load cassette and set up printer""To skip
to the next program""press <ESCAPE> the
n f0.""Press space bar when ready"
50 *FX137,1
60 WAIT=GET:CLS
70 *FX137,0
75 REM For OS1.x replace 80 and 90 with
*fx138,0,144
80 ?(&300+?&23C)=144
90 ?&23C=?&23C+1
100 END
```

POKE ERROR

There are mistakes in the article 'Pokeing the MZ-80K' by Anthony Newgrosh, TJ's Workshop of the February issue of PCW.

The filename of a program is stored from locations 4337 to 4353. Locations 4354 and 4355 are for program size. Commands are held from location 5336 to 5649. The last letter of each command has 128 added to its ASCII code. Therefore it can also be changed. For example, POKE 5405,193 will change SAVE to SAVA.

It is not true that POKE 4685, any value will make a sound on printing READY. Only

1,6,8,15,17,19... will make a sound.

For repeat on GET, POKE 10407,0 (184 is for back to normal). Cursor address cannot be changed (POKE does not work). POKE 6350,0 allows "" to be printed (POKE 6350,34 go back to normal). For example:

```
10 PRINT "He said,
";POKE
6350,0:PRINT
"Good morning!"
20 POKE 6350,34:END
```

Among screen messages, POKE 4857,17:POKE 4858,13 will not print READ but leave a blank line. If POKE 4857,13 instead, it will not even leave blank line.

Ken Chua

BBC INKEY

The machine code equivalent to INKEY on the BBC is described in the User Guide as an OSBYTE call with A=&81. If Y contains a positive number (in two's complement notation), the OSBYTE call is equivalent to INKEY with a positive parameter. The User Guide then says that if Y

contains a negative number, the call can be used to test for a specific key closure (ie, INKEY with a negative parameter), but does not make it clear that Y can contain any negative number and that it is X which must contain the negative parameter corresponding to the key to be tested for.

Glen Slade

OBSCURE 1500 CODE

The long and laborious task of learning about machine code on the Sharp PC-1500 in the absence of a manual on the subject is, perhaps, more interesting than useful, but I have turned up a few things which could be of use. Here are three of them:

ON ERROR GOTO provides a handy means of trapping and dealing with errors, but PC-1500 Basic provides no way of finding what error occurred, or where. This information is obviously vital for programs in which more than one error can occur. After some searching I have found the three relevant locations. `PEEK(&789B)` gives the error number,

while `PEEK(&78B4) * 256 + PEEK(&78B5)` returns the line number where it happened.

CALL &CD71 turns the computer off. I'm sure there must be a use for this, but I can't think of one at the moment!

When the novelty of BEEPing wears off, try this program. It provides a sound rather reminiscent of a death-ray (no relation) or a siren.

```
1 REM ABCDEFGHIJ
  KLMNOPQR
3 DATA &5A, &10, &6A,
  &10, &48, &01, &4A,
  &10, &BE, &E6, &6F,
  &62, &99, &06, &52,
  &99, &0F, &9A
5 FOR I = 1 TO 18 :
  READ A : POKE &40C9
  + I, A : NEXT I
7 END
```

Line 5 POKEs the machine code routine in line 3 into the REM in line

```
40CA 5A 10
40CC 6A 10
40CE 48 01
40D0 4A 10
40D2 BE E6 6F
40D5 62
40D6 99 06
40D8 52
40D9 99 0F
40DB 9A
L1: LSSI CYLCES
LDBI PITCH
LDGI LENGTHHI
LDFI LENGTHLO
L2: JSR BEEP
DECB
BRNZB L2
DECD
BRNZB L1
RTS
```

1 (ZX81 users will be familiar with this technique). Once this has been done lines 3 - 7 are no longer needed, and **CALL &40CA** will produce the sound. Note that the REM must be the first line in the program for this address to be correct.

For those interested, here is the assembly code:

Anyone with machine code experience should have little difficulty in understanding this.

&40CB holds the number of repetitions of the basic sound effect, and **PITCH** and **LENGTHLO** both affect its character — experiment with these.

If anyone else is experimenting with machine code on this machine I would be interested to hear from them.

Malcolm Ray

SHARP HINTS

The Sharp PC-1500 pocket computer has no instructions to position the display cursor *relative* to its current position, but location 30837 holds the cursor value. So `GCURSOR PEEK 30837`

+ n has the effect of an 'RGCURSOR n' instruction — moving the cursor n columns to the right of its current position. If n is negative, the movement is to the left. This is handy when the 'display length' of an item of output is not known in advance.

Note that if the most recent **PRINT**, **PAUSE** or **GPRINT** statement was

not terminated by a semicolon or comma, the current cursor position will be zero.

Now here's how to recover a program which you've just deleted accidentally, using 'NEW' or 'NEW 0'. The first thing to do is `POKE 16581,0` (assuming your first line number was less than 256). At this point, the **DEF** key can be used to run any suitably labelled part of the old program, but no other method of initiation will work, and the program cannot be **LIST**ed.

In order to fully restore the program, you need to know what its length

(STATUS 1) was. Add this to 16580 (40C4 hex) and convert the result to hex — say you get XXYY.

Now, `POKE 30823,&XX`
`POKE 30824,&YY`
and the program is back.

If you don't know the length, count four for each line (this takes account of the 2-byte line number, pointer byte and carriage return), two for each reserved word, and one for every other ASCII symbol in the program; finally add one to get the value of STATUS one. Or if you don't have a listing, make a guess at the program length (try to under estimate), add 16580 and **PEEK** around locations in

this vicinity until you find the byte value 255; its address is the XXYY needed above. Although this search cannot be programmed, as that would corrupt the program you're trying to retrieve, it can be speeded up considerably by the judicious use of a couple of reserve keys.

On the other hand, a suitable machine code program could be stored in the reserve of RAM, as has been done on many other machines. Does anyone out there know when Sharp plans to release the processor instruction set and monitor listing?

Kohn M Kerr

BBC WARP- AROUND

I have found the routine listed below very useful for messages produced by games programs, etc, running on the BBC microcomputer.

Use of the routine instead of the **PRINT** command will ensure that words are not split between two lines.

The routine as it stands

will accept lines of any length and will cut them down to 40 character lines. The 40 can of course be changed to 20 or 80 for the other modes.

Paul Nix

```
2000 DEF PROCno_split(A$)
2010 LOCAL L%
2015 L%=LEN(A$)
2016 IF L%+COUNT<40:PRINT A$::ENDPROC
2020 REPEAT
2050   REPEAT
2060     REPEAT
2070       L%=L%-1
2080         UNTIL L%<1 OR MID$(A$,L%,1)=" "
2090           UNTIL L%+COUNT<=40
2100             PRINTLEFT$(A$,L%-1)
2105             A$=RIGHT$(A$,LEN(A$)-L%)
2106             L%=LEN(A$)
2110             UNTIL L%<40
2120             PRINTRIGHT$(A$,L%):
2130 ENDFPROC
```

CP/M[®] GRAPHICS[™]

Your ticket to success.

Take the lead in microcomputer applications with powerful graphics software from Digital Research. CP/M and GSX are the keys to your graphic future. GSX is a logical extension of CP/M which many OEMs are adopting to standardize graphic device I/O. Computers with GSX allow your programs to take advantage of integrated graphic displays and peripherals like plotters, printers and CRT terminals. Together, CP/M and GSX deliver the same vital portability for your programs and data that has made CP/M the most accepted operating system in microcomputer history.

We also supply GSS-KERNEL[™], a library of graphic commands for drawing lines, polygons, and text according to the emerging ISO standard: GKS (Graphical Kernel System). We also offer GSS-PLOT[™], a library designed to let you create bar graphs, pie charts, histograms, and scatter plots. Both of these libraries can be linked with CBASIC[®] Compiler, Pascal/MT+,[™] PL/I and FORTRAN on 8- and 16-bit systems. When you put it all together, the Digital

Research graphics family is the most complete system you can buy for development and execution of graphic-oriented applications. Whether you're an application developer, OEM or user of microcomputers, call Digital Research for your ticket to graphic success.

Digital Research (UK) Limited, Oxford House, Oxford Street, Newbury, Berkshire, RG13 1JB. Telephone: 0635 35304.



DIGITAL RESEARCH[™]

The creators of CP/M[™]



CP/M GRAPHICS

GSS-KERNEL

GSS-PLOT

UK Distributors

Tamsys Limited
Windsor
Tel: 07535 56747

The Software
Connection Limited
Fareham
Tel: 0329 239025

Xitan Systems Limited
Southampton
Tel: 0703 334711

GSS-KERNEL and GSS-PLOT are trademarks of Graphic Software Systems, Inc. The logo, tagline and names of DRI products are either trademarks or registered trademarks of Digital Research.

LAST CHANCE!

SUBSCRIBE TO PCW NOW!

For what now seems like an eternity, the cost of an annual subscription to PCW has remained unchanged.

But times change, and we must change with them.

The price of producing PCW continues inexorably to rise. Our commitment to editorial excellence inevitably becomes more expensive. Printers and suppliers have no choice but to pass on to us the increases in their costs.

So, regrettably, from next month, the cost of subscribing to what many have said to be the world's finest micro-computing magazine will be that much greater.

Yet there is still time to avoid the increase. Provided you subscribe today.

Regardless of whether you are a new subscriber, or you wish to renew an existing subscription, sim-

ply use the coupon opposite, and make sure you get future issues of PCW at the old, low price.

Nor does it matter if your existing subscription has not yet run out. You can still benefit. Renew now, and we will add the outstanding copies onto your new subscription.

What's more, as if the opportunity to save money was not in itself sufficient incentive, there remain a few copies of the 1983 PCW Microcomputer Benchtest Special. We will send you a copy, absolutely free, immediately we receive your subscription, for as long as stocks last.

Be certain. Subscribe today. This is one offer you really cannot afford to ignore.

For the last time, here are the special offer rates for a subscription to Britain's largest selling micro-computer publication.

1 Year Subscription (U.K. only)	£11.50	In addition to 12 issues of PCW we will send you a copy of the 1983 Microcomputer Benchtest Special completely free of charge.
2 Year Subscription (U.K. only)	£19.50	(You receive 24 issues, saving yourself £3.50 off the full current subscription price. Plus you protect yourself against future increases in cover prices and postal rates which will probably amount to a saving of £5.00 over the period, plus, of course, the 1983 Microcomputer Benchtest Special.)
3 Year Subscription (U.K. only)	£29.50	(You receive 36 issues, saving yourself £5.00 off the full current subscription price. Plus you protect yourself against future increases in cover prices and postal rates which will probably amount to a saving of £7.00 over the period, plus, of course, the 1983 Microcomputer Benchtest Special.)

PLUS

We have now arranged for special 'first-of-the-press' copies to be mailed direct to subscribers which will ensure that they arrive either on the same day or one or two days in advance of national distribution in the U.K.

PLUS

Existing subscribers can take advantage of any of the offers above. Just tick the 'this is an extension subscription' box on the coupon and enclose your payment. The additional copies will be added to your existing subscription automatically. You do not have to wait until it is time to renew (by which time this offer will probably have been withdrawn). Save money by extending your subscription today!

PLUS

We have completely reorganised our Subscription Department and any problems, change of address, special requests etc. etc. will be promptly dealt with by an extremely 'user-friendly' human being should you need to write to us.

PLUS

We send subscription copies of PCW in a tough polythene wrapper. It will reach you promptly every month, unfolded and in good condition.

PLUS

You can pay for your subscription to PCW by cheque, postal order or by using Barclaycard (Visa)/American Express or Access. And you don't even need a stamp for your envelope. Use the coupon on the right.

Why do more people read PCW than any other microcomputing magazine in Europe? Subscribe today!

CHARTMAN is here!

BONSAI BRINGS YOU THE LEADING BUSINESS GRAPHICS SOFTWARE for the IBM Personal Computer.

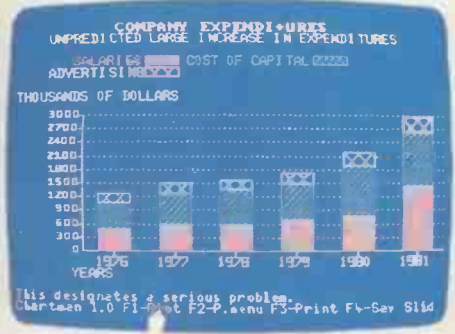
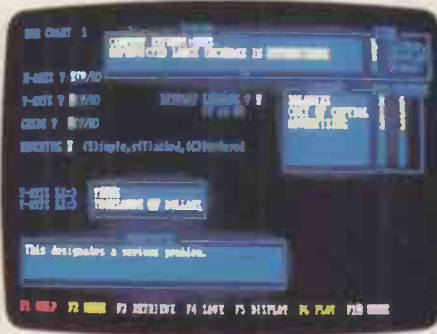

CHARTMAN brings out the messages buried in piles of data by turning columns of numbers into quickly and easily understood graphics. CHARTMAN will produce top quality horizontal and vertical Bar Charts, 2- and 3- dimensional Pie Charts, linear and logarithmic Line Charts, text pages and signs. You can display them on screen, print them on a graphics printer, and plot them onto paper or acetate transparencies.

CHARTMAN is a really easy-to-use, menu-driven program that allows you to produce presentation quality graphics immediately with little or no training. You either enter data through simple fill-in-the-blanks screen layouts, or interchange rows or columns with programs like Visicalc, MicroPlan ver 4, TK!Solver, and many others that support DIF.

CHARTMAN was designed specifically for the IBM Personal Computer to utilise its powerful features. Once charts have been created, they can be stored, then retrieved and edited later. CHARTMAN even has a slide presentation feature where charts can be saved as slides for a manually stepped or automatically timed "slide show" on the screen.

CHARTMAN I: displays everything on the screen in monochrome high resolution, prints charts on the IBM Personal Computer printer or Epson MX80 and 100 printers (all need the Epson Graftrax option), and can plot on HP7470 2-pen and HP7220 8-pen plotters. **£295**

CHARTMAN II: in addition to all the features of CHARTMAN I, CHARTMAN II can display charts in colour on RGB monitors, can print colour charts on IDS Prism colour printers, and can plot on IBM XY750 plotters. **£395**

Give Bonsai a ring, or cut the coupon, to order your copy of CHARTMAN, to receive further information, or to arrange a demonstration of CHARTMAN on the IBM Personal Computer at our London showrooms.

IBM Authorised Dealer—IBM Personal Computer

Chartman is a product of Graphic Software Inc., distributed in the UK by Bonsai Ltd.; IBM and IBM Personal Computer are trademarks of International Business Machines Corp.; HP is a trademark of Hewlett Packard Company; Visicalc and DIF are trademarks of Visicorp; MicroPlan is a trademark of Chang Labs; TK!Solver is a trademark of Software Arts; Epson and Graftrax are trademarks of Epson.

© Copyright Bonsai Ltd, 1983.



MICROCOMPUTER SYSTEMS FOR PEOPLE IN BUSINESS.

Bonsai Limited.
112-116 New Oxford Street,
London WC1A 1HJ.
(01) 580-0902.

I enclose (Tick as appropriate) Send me CHARTMAN I @ £295 (+ £5 P&P + VAT = £345)
 Send me CHARTMAN II @ £395 (+ £5 P&P + VAT = £460)
 Send further details of CHARTMAN. Please Debit my Access/Visa Account No _____
 Contact me to arrange a demonstration.

Name _____
 Company _____
 Position _____
 Address _____
 Phone _____
 Signature _____





If your printer uses your Apple[®] more than you do, you need The Bufferboard[™].

If your Apple is locked into the "PRINT" mode so much that you've taken up solitaire to kill the boredom, you need a buffer. And if your computer is the Apple II or III, the only buffer for you is The Bufferboard. Expandable to 64K of storage, The Bufferboard stores an instantaneous bucketful of print data from your computer. Then it feeds the data to your printer at its own printing rate. Your Apple is set free from driving your printer and is ready for more data from you.

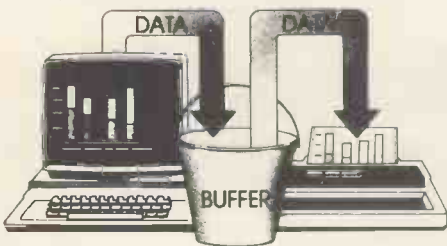

Take your existing interface— and buffer it!

Only The Bufferboard has a simple Interface-Docking System. No bulky boxes

or expensive power supplies are needed because The Bufferboard fits right into your Apple—and docks onto your existing printer interface. The result is convenient

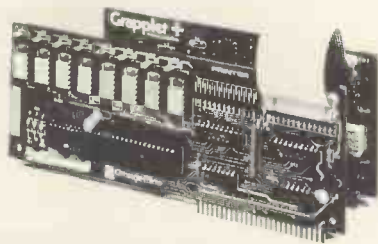

and economical buffering of most popular printer interfaces, including the Grappler +[™] interface, Epson interface, and Apple printer interface. Thirty seconds and a single hook-up are all you need to end the printer waiting game forever.

Up to 20 letter-size pages stored at a time.

The Bufferboard comes standard with 16K, and is expandable to 32K or 64K of buffering capacity with the addition of

memory chips. This "bucket" will hold up to 20 pages of a print job, allowing you freedom to use your Apple.

The Bufferboard—designed exclusively for the Apple Computer.

Specifications:

- Versions for Grappler + interface, Epson interface, Apple interface, and other popular printer interfaces
- 16K buffer standard
- Upgradeable to 32K or 64K
- Automatic memory configuration
- Automatic self test
- Includes interface docking cable.

The Bufferboard is made by Orange Micro, Inc.; the same people who brought you the popular Grappler + printer interface. Both the Grappler + and The Bufferboard are now available at your local Apple dealer.

Apple is a registered trademark of Apple, Inc. Epson is a registered trademark of Epson America, Inc.

DISTRIBUTORS:

**Pete & Pam
Computers**



Head Office:
NEW HALL HEY ROAD,
Rossendale, Lancs. BB4 6JG
Tel: Ross. (0706) 212321 & 227011
Telex: 635740 PETPAM G

London Office:
103-5 BLEGBOROUGH RD.
London, SW16 6DL
Tel: 01-769 1022/3/4
Telex: 923070 PFCOMP G

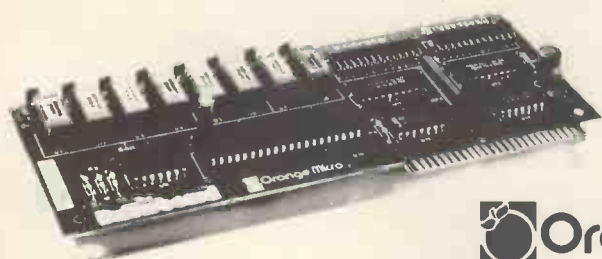

 **Orange Micro
Inc.**
TELEX: 183511 CSMA

**The
Bufferboard[™]**
For Apples and Printers

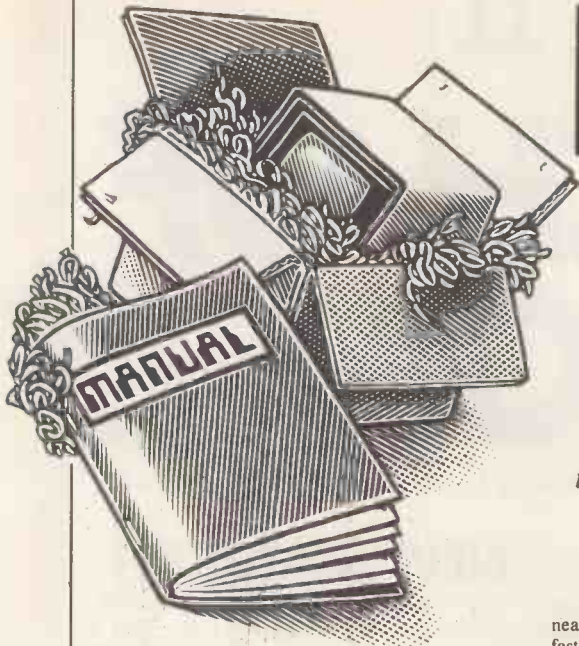

NEWCOMERS START HERE

This is our unique quick-reference guide, reprinted every month to help our readers pick their way through the most important pieces of (necessary) jargon found in PCW. While it's in no way totally comprehensive, we trust you'll find it a useful introduction. Happy microcomputing!

Welcome to the confusing world of the microcomputer. First of all, don't be fooled; there's nothing complicated about this business, it's just that we're surrounded by an immense amount of necessary jargon. Imagine if we had to continually say 'numbering system with a radix of 16 in which the letters A to F represent the values ten to 15' when instead we can simply say 'hex'. No doubt soon many of the words and phrases we are about to explain will eventually fall into common English usage. Until that time, PCW will be publishing this guide — every month.

We'll start by considering the microcomputer's functions and then examine the physical components necessary to implement these functions.

The microcomputer is capable of receiving information, processing it, storing the results or sending them elsewhere. All this information is called data and it comprises numbers, letters and special symbols which can be read by humans. Although the data is accepted and output by the computer in 'human' form, inside it's a different story — it must be held in the form of an electronic code. This code is called binary. Binary is a system of numbering which uses base 2 instead of the more familiar decimal — or, to be more accurate, denary-system of base 10. In binary notation there are only two digits — 0 and 1 — which the computer recognises as the absence or presence of an electric current. The easiest way to visualise this is to think of each binary digit (bit) as being a switch which can be either off or on. Each binary digit stands for a power of 2. The right-most digit, the least significant, is $2^0=1$, the next $2^1=2$, then $2^2=4$, $2^3=8$, $2^4=16$, $2^5=32$, $2^6=64$, $2^7=128$, $2^8=256$. So decimal 24, for example, is represented in binary as 00011000. A set of eight bits is known as a byte and, to make things easier for humans, a third system of numbering, hexadecimal or hex for short, is used as a sort of 'halfway house' between binary and denary. Hex uses numbers to base 16, with denary numbers between 9 and 16 represented by the letters A-F. The hex equivalent of a byte is obtained by giving each half a single character code: 0=0000, 1=0001, 2=0010, 3=0011, 4=0100, 5=0101 ... E=1110 and F=1111. Our example of 24 is therefore 18 in hex.

To simplify communication between computers, several standard coding systems exist, the most common being ASCII (American Standard Code for Information Interchange). This allocates a numerical code to each digit and letter. For example, the number 5 is given the ASCII code 35 hex, 53 decimal, whereas a capital A is represented by ASCII 41 hex, 65 decimal.

The computer processes data by reshuffling, performing arithmetic on, or by comparing it with other data. It's the latter function that gives a computer its apparent 'intelligence' — the ability to make decisions and to act upon them. It has to be given a set of rules in order to do this and, once again, these rules are stored in memory as bytes. The rules are called programs and while they can be input in binary or hex (machine code programming), the usual method is to have a special program which translates English or near-English into machine code. This speeds programming considerably; the

closer the programming language is to English, the faster the programming time. On the other hand, program execution speed tends to be slower.

The most common microcomputer language is Basic. Program instructions are typed in at the keyboard, to be coded and stored in the computer's memory. To run such a program the computer uses an interpreter, which is usually built into the machine's ROM (see later paragraph on this page). The interpreter picks up each Basic instruction, translates it into machine code and then feeds it to the processor for execution. It has to do this each time the same instruction has to be executed. A much faster method is to use a compiler, which accepts each instruction in turn, waits until the program has been entered, then turns each instruction into machine code before running the program. This means that each instruction has to be translated once only — consequently the speed of execution is considerably improved.

Two strange words you will hear in connection with Basic are PEEK and POKE. They give the programmer access to the memory of the machine. It's possible to read (PEEK) the contents of a byte in the computer and to modify a byte (POKE).

Moving on to hardware, this means the physical components of a computer system as opposed to software — the programs needed to make the system work.

At the heart of a microcomputer system is the central processing unit (CPU), a single microprocessor chip with supporting devices such as buffers, which 'amplify' the CPU's signals for use by other components in the system. The packaged chips are either soldered directly to a printed circuit board (PCB) or are mounted in sockets.

In some microcomputers, the entire system is mounted on a single, large PCB; in others a bus system is used, comprising a long PCB holding a number of interconnected sockets. Plugged into these are several smaller PCBs, each with a specific function — for instance, one card would hold the CPU and its support chips. The most widely-used bus system is called the S100.

The CPU needs memory in which to keep programs and data. Microcomputers generally have two types of memory. RAM (Random Access Memory) and ROM (Read Only Memory). The CPU can read information stored in RAM — and also put information into RAM. Two types of RAM exist — static and dynamic; all you really need know is that dynamic RAM uses less power and is less expensive than static, but it requires additional, complex, circuitry to make it work. Both types of RAM lose their contents when power is switched off, whereas ROM retains its contents permanently. Not surprisingly, manufacturers often store interpreters and the like in ROM. The CPU can only read the ROM's contents and cannot alter them in any way. You can buy special ROMs called PROMs (Programmable ROMs) and EPROMs (Erasable PROMs) which can be programmed using a special device; EPROMs can be erased using ultra-violet light.

Because RAM loses its contents when power is switched off, cassettes and floppy disks are used to save programs and data for later use. Audio-type tape recorders are often used by converting data to a series of

audio tones and recording them; later the computer can listen to these same tones and re-convert them into data. Various methods are used for this, so a cassette recorded by one make of computer won't necessarily work on another make. It takes a long time to record and play back information and it's difficult to locate one specific item among a whole mass of information on a cassette; therefore, to overcome these problems, floppy disks are used on more sophisticated systems.

A floppy disk is made of thin plastic, coated with a magnetic recording surface rather like that used on tape. The disk, in its protective envelope, is placed in a disk drive which rotates it and moves a read/write head across the disk's surface. The disk is divided into concentric rings called tracks, each of which is in turn subdivided into sectors. Using a program called a disk operating system, the computer keeps track of exactly where information is on the disk and it can get to any item of data by moving the head to the appropriate track and then waiting for the right sector to come round. Two methods are used to tell the computer where on a track each sector starts: soft sectoring where special signals are recorded on the surface, and hard sectoring where holes are punched through the disk around the central hole, one per sector.

Half-way between cassettes and disks is the stringy floppy — a miniature continuous loop tape cartridge, faster than a cassette but cheaper than a disk system. Hard disk systems are also available for microcomputers; they store more information than floppy disks, are more reliable and information can be transferred to and from them much more quickly.

You, the user, must be able to communicate with the computer and the generally accepted minimum for this is the visual display unit (VDU), which looks like a TV screen with a typewriter-style keyboard; sometimes these are built into the system, sometimes they're separate. If you want a written record (hard copy) of the computer's output, you'll need a printer.

The computer can send out and receive information in two forms — parallel and serial. Parallel input/output (I/O) requires a series of wires to connect the computer to another device, such as a printer, and it sends out data a byte at a time, with a separate wire carrying each bit. Serial I/O involves sending data one bit at a time along a single piece of wire, with extra bits added to tell the receiving device when a byte is about to start and when it has finished. The speed that data is transmitted is referred to as the baud rate and, very roughly, the baud rate divided by ten equals the number of bytes being sent per second.

To ensure that both receiver and transmitter link up without any electrical horrors, standards exist for serial interfaces; the most common is RS232 (or V24) while, for parallel interfaces to printers, the Centronics standard is popular.

Finally, a modem connects a computer, via a serial interface, to the telephone system, allowing two computers with modems to exchange information. A modem must be wired into the telephone system and you need British Telecom's permission; instead you could use an acoustic coupler, which has two obscene-looking rubber cups into which the handset fits, and which has no electrical connection with the phone system — British Telecom isn't so uppity about the use of these.

MS-DOS II

IN SEARCH OF PERFECTION...

Peter Rodwell continues his quest for the definitive micro operating system

Microcomputer operating systems are fast becoming something of an obsession with me. The whole point of microcomputers is that they are cheap enough to allow everyone access to computing power, especially people with no previous formal computing knowledge or experience. In particular, the busy businessman can, in theory, buy a low-cost machine which will help him to become more effective and efficient in his work. All he wants to do is to take the thing out of its box, plug it in and get down to work.

In the present state of things, he can't do this. When he switches on the computer, the first thing he comes across is the operating system — and that's where the trouble starts. To date the only operating system I have seen which even approaches a reasonable degree of user-friendliness is that of Apple's new Lisa. It's not perfect but it has gone much further along that road than any others and shows that Apple at least has a reasonable conception of the requirements of the average business user. Of course the whole effect is quite ruined by its ludicrously high price — about twice what it should be and high enough to prevent it taking off at the mass-market level which the microcomputer industry is all about.

Meanwhile the rest of the world has to make do with what it's given and for many business users this has usually meant CP/M and its derivatives. But the rise of the 16-bit micro has opened the door to new operating systems. These processors have both the power and the memory capacity to use more sophisticated operating systems — ones which are designed to make things easy for the user rather than for the programmer who wrote them. So far, the two major operating systems to emerge for 16-bit computers have been CP/M-86 from Digital Research and MS-DOS from Microsoft. I reviewed and compared these two operating systems in last November's *PCW*. At that time both systems were in their first versions and many facilities which had been promised were not available, such as the 'help' facility for CP/M-86. Both operating systems bore depressing similarities to the original CP/M (now called CP/M-80) and therefore didn't really represent much of an advance towards an operating system fit to be placed before the raw end user.

Recently, however, I was shown a pre-release version of MS-DOS 2, Microsoft's newly upgraded version of its operating system. And a rather strange mix it turns out to be: like the legendary curate's egg, it has some good (ie, user-friendly) parts but the whole system has been steered in what I consider to be a rather dubious direction.

When MS-DOS first appeared it was widely rumoured that, although it looked and behaved very much like CP/M, it was internally a Unix-like system. Unix is a minicomputer operating system designed to make life easier for the programmer. As a software development environment it's very good and has masses of sophisticated features. But it was designed to be used by computer professionals and therefore requires that its users be familiar with various computing concepts and terms. This in turn means that it is quite unsuitable for the computer-naive user who has neither the time nor the inclination to get his head round computer science. I was therefore rather disappointed to find that MS-DOS 2 had been given a much more Unix-like feel to it; when I compared CP/M-86 and MS-DOS previously, I felt that Microsoft's product was definitely the better of the two as regards its user image. Certainly Digital Research appeared not to have made any efforts at all in that direction. The new MS-DOS retains all the features of Version 1 but a whole host of new facilities have been added. It is still better than CP/M-86 as regards its user image and ease of use for basic operations but the new features are something else.

NEW FEATURES

The major addition is the provision of a 'hierarchical directory' system. This is jargon for a system which allows the user to group files together on a disk, give the group a name and perform various operations — list the directory or move files, for example — using just the group name. But it's a little more complicated than this. The directory system works in a tree-structured fashion, illustrated in Figure 1. The system starts with a 'root' directory which might, for example, contain major program files. You can then proceed to create subdirectories, each containing in turn a list of programs or data files. And these in turn can contain the names of sub-sub-directories. . . and so on.

Having moved down the tree to a particular directory, you can perform tasks on files in other directories using a pathname. As an example, suppose you are in a directory called PETER which contains a directory called FRED which in turn contains a text file called LETTER.TXT on which you wish to work. You would define the path leading to this as PETER/FRED/LETTER.TXT.

Defining pathnames is rather complex (lack of space prevents me from going into the gory details in full here) and really needs the user to maintain a sort of mental map of the disk's directory in his/her head if anything other than the simplest paths are required.

The advantage of all this may not be immediately obvious, especially when you

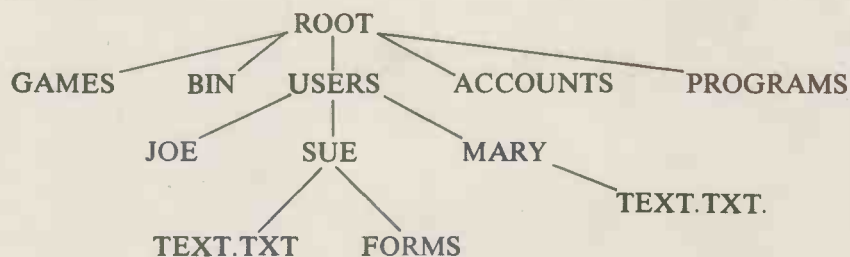

Fig 1 The hierarchical directory structure. The root directory contains directories of programs and files called GAMES, BIN, ACCOUNTS and PROGRAMS, plus a directory called USERS. USERS in turn contains directories called JOE, SUE and MARY. Both SUE and MARY have sub-directories called TEXT.TXT and SUE also has one called FORMS.

Command	Type	Purpose
BREAK	I	Turns on or off the facility for aborting a program by typing Control-C
CAT	E	Sorts and formats a disk directory
CHDIR	I	Changes the current directory in which you're working to another
CHKDSK	E	Displays and optionally fixes inconsistency in a specified directory
CIPHER	E	Encrypts and decrypts a text file, using a user-specified keyword
CLS	I	Clears the screen
COPY	I	Copies one or more files from one disk to another, renaming them if required
CTTY	I	Allows you to change the device used for input and output
DATE	I	Displays and allows you to alter/set the current date. The date and time are automatically included in directory entries.
DEL	I	Deletes specified files from a disk or directory
DIR	I	Displays the files in the current directory if used alone or in another directory if used with a pathname
DISKCOPY	E	Copies the entire contents from one disk to another, over-writing anything on the destination disk
ECHO	I	Normally the commands in a batch file are displayed on the screen as they are executed, but this can be suppressed using this command
EXIT	I	Exits the command processor of MS-DOS and returns to the previous level, if one exists
FIND	E	Searches for a specified text string within a text file or files
FOR	I	Used in batch files to allow loops to be set up
FORMAT	E	Formats the disk in a specified drive and optionally puts a copy of the operating system onto it
GOTO	I	Yes, means just what it says; one of the powerful batch file commands
IF	I	Conditional statement used in batch files
LOCATE	E	Turns '.EXE' (executable) files into binary format, giving faster-running programs and saving disk space
MKDIR	I	Creates a new directory
MORE	E	Sends output to the terminal a screenful at a time and waits for the user to hit return before displaying the next screen
PATH	I	Sets up a command path
PAUSE	I	Suspends the execution of a batch file
PRINT	E	Prints a text file on the printer while you are performing another operation
PROMPT	I	Changes the MS-DOS command prompt
RECOVER	E	Allows you to recover at least part of a file or disk containing bad sectors
REM	I	Allows you to add comments to a batch file which are displayed during execution
REN	I	Renames a file
RMDIR	I	Removes an <i>empty</i> directory from a directory structure
SET	I	A rather esoteric one, this, which allows you to set up one text string as equal to another for use in some applications programs
SHIFT	I	Allows more than 10 parameters to be passed to a batch file
SORT	E	Sorts a file alphabetically or numerically
SYS	E	Transfers the operating system (which actually consists of several files) from one disk to another
TIME	I	Displays and allows you to alter/set the time; like the date, this is added to directory entries
TYPE	I	Displays the contents of a text file on the screen
VER	I	Shows the operating system version number
VERIFY	I	Turns on/off the disk write verify facility.
VOL	I	Displays the disk volume number, if there is one

Fig 2 MS-DOS 2 commands

see how you have to specify which directory you want to work on or move to. In fact on an ordinary, single-user floppy disk system it's more of an unnecessary frill which, I suspect, most users will ignore. It comes into its own, however, on a hard disk system where, as things stand at the moment, asking for a directory listing can result in dozens of file names whizzing up the screen at a fair old rate of knots. It's also useful on multi-user systems, where every user can have his or her own directory — but as I've so often said in the past, multi-user micro systems are pretty pointless.

It's perfectly possible for a user to work with MS-DOS 2 without ever bothering with the hierarchical directory structure and I suspect that this is exactly what most end users will do. For the moment you start to use such a feature, you need to understand fully how it works and that, frankly, is something which many business users will simply not want to take the time to do.

Likewise, the 'pipe' facility may confound many first-time users to the point at which they may never use it. Pipes allow you to automatically use the output of one program as the input of another. A prime example is the SORT utility which comes with MS-DOS 2. As a simple example, you could ask for a directory listing and use SORT to sort it into alphabetical order and put the result into a text file called LIST with the command DIR : SORT >LIST. The ':' denotes a pipe which carries the output of the first command or program to the input of the next one; '>' redirects the output of a program, in this case to the file LIST. Using '>>' rather than '>' would *append* the output to the end of LIST.

SORT is one of a series of features called 'filters' which can be fed with the output of a command or program. Other filters are CIPHER, which encrypts/decrypts a text file, FIND, which will find a text string within a file and MORE, which will display text output on the screen a screenful at a time and wait while you read it.

Pipes are, I feel, easier for the computer novice to understand than the directory structure but again my hunch is that many users won't bother too much with them. Business computing is moving rapidly to the stage where a computer — to the user — ceases to be a computer and becomes a piece of office equipment to be regarded in the same light as, say, a typewriter or a photocopier; it will be purchased and used with the same attitude as are these pieces of equipment. The trend demands that suppliers sell machines which are ready to perform the desired tasks in response to very simple, easy-to-understand commands. Fortunately, MS-DOS 2 contains excellent facilities to allow the supplier to set up all operations with batch commands.

A batch command is, simply, a text file containing a list of commands. The file name must end with '.BAT' and is activated simply by typing its name as though it were a program. There's no equivalent of CP/M's SUBMIT program, which provides a batch facility but requires you to type SUBMIT ERIC to activate the batch file ERIC.

One batch file name is reserved for special use: AUTOEXEC.BAT. Any file with

SUPERBRAIN II



**-THE BEST THING
SINCE SUPERBRAIN I!**

- OFFERS:** – Basic Interpreter.
 – Full Reverse Video and True Descenders.
 – Superbly Improved Circuitry.

ALL AT REDUCED COST!

Choose From:

- THE JUNIOR (JR) WITH 350K FLOPPY DISKS
- THE QUAD DENSITY (QD) WITH 750K FLOPPY DISKS
- THE SUPER DENSITY (SD) WITH 1.5MB FLOPPY DISKS

FROM £1458

MAINTENANCE CONTRACTS
AND SOFTWARE AVAILABLE

EXCL. VAT

SUPERBRAIN CAN NOW BE CONNECTED TO HARD DISKS
FROM £2228 FOR 10MB OF EXTERNAL HARD DISK STORAGE

+ COMPUSTAR

**– LETS 255 USERS SHARE 10 OR 144MB
OF WINCHESTER DISK**

CompuStar II Terminals look and act exactly the same as Superbrain and with prices from £1125 excl. VAT low-cost multi user systems are now a reality

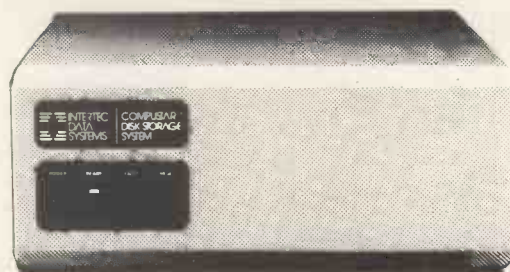

KCB
MICROS LIMITED

word processing + accountancy + financial modelling + calculation
record keeping + sales office management + accounts + payroll + graphics
engineering + communications + languages + solicitors + CAD

14 Windsor Road Slough SL1 2EJ Tel: Slough (0753) 38581/38319. Telex 23152 KMICRO
and in Scotland: Micro Change Ltd. Telfer House, 74/80 Miller Street, Glasgow Tel: 041 204 1929

IN SEARCH OF PERFECTION...

this name will automatically start to be executed when the system is turned on or reset, allowing a 'turnkey' system to be established which will automatically start running without any commands being typed in by the user at all. As an example, a file called NEWDISK.BAT could be created containing the following:

FORMAT B:

DIR B:

This would be activated by typing 'NEWDISK' and would format a blank disk in drive B and display its directory.

Up to 10 parameters can be passed to a batch file to allow you to use one batch file

to perform several tasks. Our previous example could be re-written

FORMAT %1:

DIR %1:

and activated by typing NEWDISK A or NEWDISK B, depending on which drive contained the blank disk; the '%1' would then automatically be replaced with 'A' or 'B' throughout the batch file.

A number of other new commands have been added to MS-DOS and I have listed all commands — old and new — in Figure 2. Some of these commands are internal, ie they are built into the operating system and are activated immediately you type in their names, while others are external and take the form of separate programs residing on disk.

This is really a brief overview of MS-

DOS 2 based on a morning spent at Microsoft's UK headquarters watching it being put through its paces. Obviously the first machine to benefit from it will be the IBM Personal Computer and other machines are expected to follow soon. Without wishing to boast, I'm writing this just before setting out to California for the West Coast Faire and visits to a number of companies, including Digital Research and Sirius, where, with luck and/or persuasion, I might be able to see and even pick up Sirius versions of both MS-DOS 2 and Concurrent CP/M-86, thereby getting more first-hand experience of using both in my continuing search for the perfect operating system. I don't think that either will fit this description but we're getting closer and I'll keep you posted. **END**

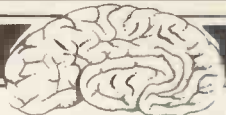

BRAINDUMP

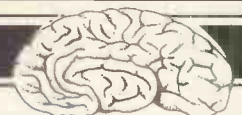

THE NEW ILLITERATES?

The English Language is fighting a losing battle against the computer industry. Steve Mann leaps to its defence. . .

Just what is it about computers that encourages illiteracy in their users? As someone who comes into contact with a wide range of computer-related products, I am now becoming resigned to the fact that, nine times out of ten, any documentation I receive will be poorly presented, will contain numerous spelling mistakes and, in general, will be of a standard that bears comparison only with the *Guardian* on an off-day.

It can be argued that this is merely a product of the times we live in. It has been said that it would be impossible to write badly in early 17th century English — the language itself was so rich in vocabulary and style that it forced its users to write well. It is undeniable that the English we speak and write today is a devalued currency; meaningless phrases like 'At this moment in time' are used as a sort of verbal shorthand by everyone from trade union leaders to television presenters and generally serve only to conceal an absence of thought. This, of course, is a general problem — just think of the number of advertisements you've seen in magazines and newspapers that feature misspellings, wrongly placed or missing apostrophes and sentences that appear to have been constructed with a random number generator. Indeed, the *Daily Mirror's* columnist Keith Waterhouse has become so disgusted at the standards prevalent in today's journalism that he has formed a society — the Association for the Abolition of Aberrant Apostrophes (AAAA for short). I am aware that I could find myself in what *Private Eye* would describe as a 'glass houses situation' here — although we do our best to catch typographical errors before *PCW* is printed, we are not always successful; and this is the case with all magazines and newspapers that have a tight production schedule. To a certain extent, this is inevitable: in the best of all possible worlds we

would have time to check, double-check and triple-check each page before it was printed; our publication schedule precludes this, however. But I would submit that this is not the case with the majority of computer-related products; typical documentation of a games cassette, for example, will consist of, at most, a couple of sheets of A4 paper or simply a cassette insert — to read and correct this is a relatively simple task.

It is all too easy to become pedantic on this subject. English is a 'living' language; style and vocabulary change from generation to generation and there are very few hard and fast rules as to what is 'right' or 'wrong' — at least in terms of grammar and construction. But one factor, surely, is of prime importance — clarity of meaning: it is here that sloppy writing and bad presentation can cause the greatest damage.

In the infancy of the microcomputer industry there was some excuse for bad presentation — products were often hastily put together in someone's home or garage, and documentation would consist of a couple of pages of typewritten notes run off on a photocopier. To a certain extent, this is still the case with a wide range of small businesses producing small quantities of original software. But the worst offenders are often those who, in theory at least, have the time and resources to do things properly. Two examples that immediately spring to mind are the documentation that accompanies Quicksilva's 'Time Gate' games cassette, and the new Lisa system from Apple. 'Time Gate' features a complete redefinition of the standard Sinclair Spectrum character set. It is obviously something that entailed a great deal of thought and effort on the part of the program writer and the company, but the effect is ruined by a complete lack of apostrophes and the misspelling of 'possible' as 'possable'. Apple, despite spending three man-millennia on

the development of Lisa, managed an elementary spelling mistake that remains on the screen for most of the time the system is in use (see March *PCW*). I find it difficult to believe that those responsible can expend so much time and effort on presenting their product to the best of their ability, yet still do not see the need to consult a dictionary.

All this, of course, does not even take into consideration the educational aspect. I am sure that many teachers would throw up their hands in horror at some of the examples to be found in software documentation. The long-term effect can only be bad for general educational standards — after all, if a child is continually confronted with a piece of documentation that is riddled with errors, the tendency will be to suppose that the mistake is, in fact, the correct way to spell or punctuate. Children can only learn by example — if you constantly present them with information that is incorrect, the chances are that they will grow up believing this information; and it's going to be that much harder for teachers to correct them.

The advent of computers forced changes to the English language — suddenly we were confronted with strange new spellings of words like 'disk' and 'program'. In most cases this served to remove any ambiguity; we now have a convenient way of distinguishing between a television programme and a computer program, a record disc and a floppy disk. It's a pity that the other legacy of the computing revolution seems to be a feeling that grammar and spelling don't really matter. I think they do — syntax is extremely important in computer languages and I can't see any reason to ignore it in English. Our native language, after all, is extremely well documented and there is a much-revised, extremely accurate user manual. It's called a dictionary — and I think we could all consult it more frequently... **END**



SHIRT POCKET CASIO

Dick Pountain takes a close look at the latest pocketable computer — the Casio PB-100

At the top end of the portable computer market all is chaos. Osborne has spawned a host of lookalikes too numerous even to remember their names. In the middle, Epson has opened up the "book sized" market and others like TI and NEC are following. But the bottom end (pricewise) of the market is still dominated by a silent struggle between two companies, Sharp and Casio. I hesitated before saying "bottom" end because in many ways these machines are in the vanguard, attacking problems of miniaturisation which their bigger rivals are for the moment avoiding by using standard micro industry parts. But if the future really does lie in a "pocket mainframe" then the technology which Sharp and Casio are putting into machines like the 1251 and the PB-100 is pioneering stuff; despite which many people will still regard them as glorified calculators.

The latest round in the war involves the almost simultaneous launch of the Sharp PC-1251 (reviewed in March) and Casio's PB-100, the subject of this review. Both machines are basically scaled down versions of previous models which, by using very Large Scale Integration, have retained all the functions of their predecessors in a much smaller, more attractive, package and at a reduced price. The PB-100 is a replacement for the fx702p which is currently being sold off at a discount to clear stocks.

Hardware

The PB-100 comes in a slim alloy and plastic case measuring 163x70x10 mm which makes it rather longer than the Sharp but equally "shirt-pocketable". Despite its extra length it has a smaller display, which holds 11 characters on a 7x5 dot matrix. At the top of the display are several small character annunciators for the different operation and angular modes and to display the number of program steps remaining.

The keyboard is completely redesigned in qwerty layout (the 702p was abcd alphabetic) and has nicely spaced keys; like the Sharp however it lacks a proper space bar, space being hidden among the other keys. The idea of single keystroke Basic reserved words is retained from the 702p; each main key has in fact four functions, the second two being obtained by entering EXTension mode. Normally shift will produce a Basic word — eg, shift A gives GOSUB — but in EXT mode one gets lower case letters which shift to

special graphics characters including some Greek letters. The equivalent of Enter or carriage return is a large key called EXE which lives in the numeric keypad. This is very convenient as it allows the PB-100 to be used as a calculator with only one hand.

The 702's CONT key is gone; now we have a STOP key which suspends program execution and EXE restarts it. The ANS key is retained which recalls to the display the result of the last calculation performed even if the power has been switched off in the meantime. MODE, shift and cursor left and right are placed in their own small pad above the main keys. Ten modes of operation are provided, namely RUN, WRT, EXT, trace on and off, print on and off, and three angular modes.

A peep inside the case (easy for once as screws are used for fastening) reveals the true achievement in integration as processor, RAM and Basic ROM are all on a single chip about half the size of a postage stamp. In addition an interesting new kind of flexible cable is used for bus connections which appears to have black plastic conductors instead of metal! Two lithium cells provide 360 hours continuous operation which translates into around two years of normal use. Next to the battery holder is space for an extension RAM module which was fitted to the test machine. The standard RAM fitted is 544

steps plus 26 memories (ie, variables), which adds up to 752 bytes since the Basic is fully tokenised. The extra RAM pack adds a further 1k to give 1568 steps and 26 memories. The memory is repartitionable using the DEFM command; one could have 94 memories (222 with RAM pack) and no program space. This is quite substantially less memory than is offered by the Sharp 1251 which comes with 3724 bytes of user memory as standard.

A glance at the Benchmark timings will show that this processor is fast for an ultra-miniature CMOS device; up to 5 times faster than the PC1251 on certain functions.

It goes without saying of course that the PB-100 is all CMOS with permanent memory and auto power off after seven



Printer cradle is in two parts and is rather fiddly.



Whole system is briefcase size.

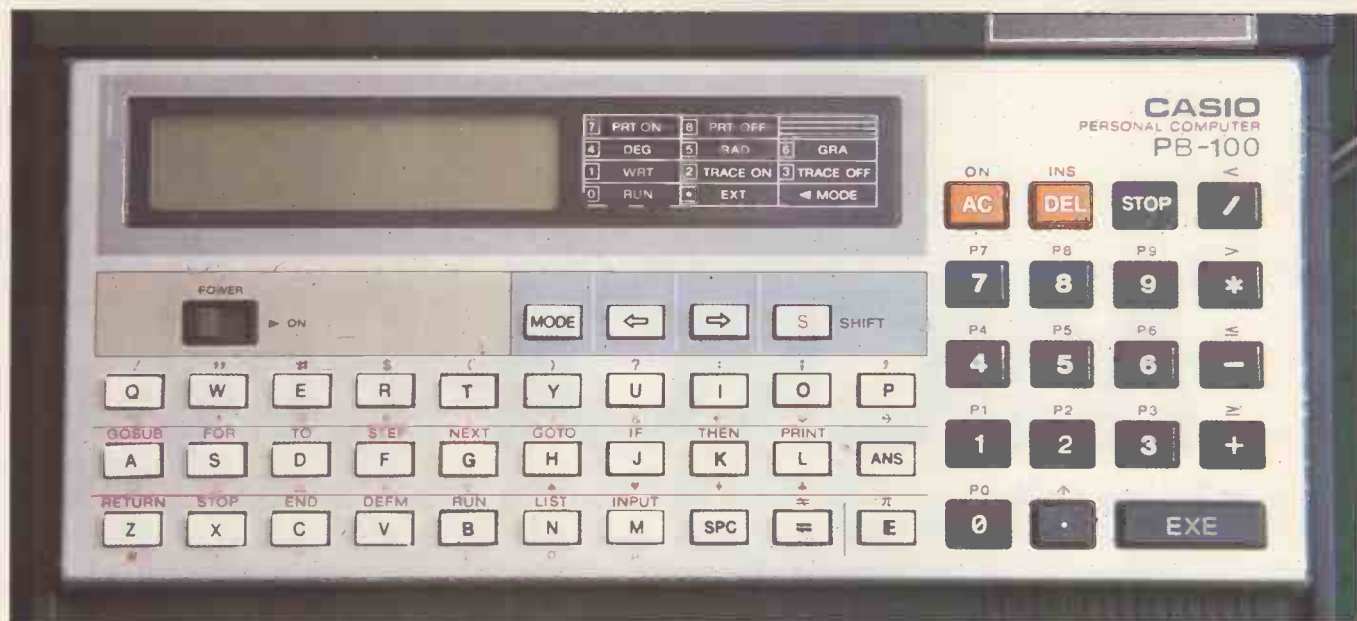

The no-frills basic model.

Benchmark timings

BM1	8
BM2	39
BM3	82
BM4	80
BM5	105
BM6	160
BM7	220
BM8	341

All timings in seconds. For a full explanation of Benchmarks see PCW November 1982.

minutes. As is now the fashion, a somewhat redundant contrast control is fitted. There is no real time clock/calendar function.

Operation

The PB-100 works very nicely indeed as a calculator due to the thought which has gone into the user interface. Chained calculations are performed exactly as they would appear on paper with the added benefit that the display can be edited using the cursor (pressing ANS once in the middle of a calculation puts the editing cursor on the display; hitting it again recalls the last result calculated). When using functions like SIN and LOG no parentheses are required around the argument which saves a lot of fiddling with shifted characters. Arithmetic is to 12 digits with 10 displayed (8 if an exponent is used); dynamic range is the usual $10^{+/-99}$. Two numeric formats are supported; fixed point scientific (selected by SET E n) or floating point (SET F n) with rounding to n digits on the display only; SET N cancels any format and the full 12 digit numbers are available internally. Scientific format (eg, 1.3456E24) is automatically selected for numbers above 10^{10} or below 10^{-3} . All the transcendental functions normal to Basic are supported but the extra statistical functions of the 702p have regrettably been abandoned; they must

be entered as a program if required.

In other respects the Basic and operating system follow closely that of the 702p; 10 program areas called P0-P9 can be selected to hold separate programs and can be saved individually or all together on tape using the optional FA-3 adaptor. The Basic offers fairly spartan but useful facilities; in particular the only string functions are MID (for extracting a substring) and VAL (string to numeric conversion) and the former only works on the special 30 character variable \$. All other string variables are limited to seven characters. The variables are allotted as A-Z or A(0) to A(25) etc; B(0) is the same variable as A(1) and so on. When using subscripted variables as arrays (they don't need to be dimensioned) it is possible for them to overlap with disastrous consequences if you don't watch out.

An irritating omission is the absence of any kind of programmable WAIT for the PRINT function; animated displays are difficult to achieve as PRINT will normally stop execution until EXE is pressed. No machine level interface via PEEK and POKE is available either.

On the plus side, the control structures are quite rich with full computed GOTO and GOSUB either to a line number or to a separate program area. Proper data files can be constructed using PUT and GET which write the contents of a single variable or a contiguous block of variables to tape.

A new thermal printer, the FP-12, is designed to go with the PB-100. It is incorporated in a cradle which holds the computer unlike the older FP-10 which hung on via a cable. The cradle is in two pieces which snap together and seems rather overcomplicated for the job it does. The printer uses 20 columns and puts out a line every second; it runs off internal rechargeable batteries but there is still a drain on the PB-100's own batteries which will last for 40 hours of continuous printing. Printing from a Basic

program is performed by selecting and deselecting print mode; there is no LPRINT statement so every print will look like:

```
300 MODE 7           (switch on print)
400 PRINT A,B,C
500 MODE 8           (switch off print)
```

though multistatement lines are permitted and will save a few bytes. MODE 7 can be selected manually from the keyboard to give hard copy for calculations.

Documentation

The PB-100 user manual is the normal flimsy affair produced by Casio but is nevertheless quite complete and better translated on average than some previous ones. However the PB comes with a sizeable paperback book as well, called 'Learn as you go' which is a useful step-by-step Basic tutorial and includes a small program library at the end. It is illustrated with cutesy cartoons in the Japanese manner and is quite readable, if slightly stilted in prose style.

Prices

Casio PB-100	£59.95
1k RAM Pack	£13.95
FA-3 Cassette adaptor	£25.95
FP-12 Thermal printer	£54.95

Conclusions

The PB-100 is one more nail in the coffin of the programmable calculator; it provides all the facilities offered by the older calculators in a smart and compact package and is much easier to program. It has a lot less memory and a less powerful Basic than the Sharp PC1251 but then it is cheaper to buy (though the gap narrows once you add in the RAM pack). It is very significantly faster than the 1251 which for applications involving long iterative computations could be crucial.

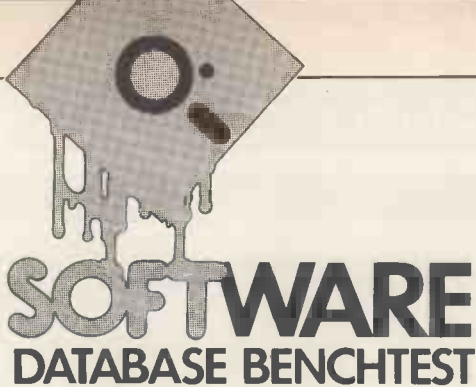

SOFTWARE DATABASE BENCHTEST

MICROPEN

Intelligent Software (Ireland) has produced a set of related CP/M packages. Here, Kathy Lang takes a look at MicroPen, a menu-driven database system. See also her review of MicroScript in this issue.

MicroPen, one member of a family of CP/M-based packages recently launched by Intelligence (Ireland), is probably the simplest and certainly the cheapest of the packages I've reviewed in this series. I thought it would be interesting to see how such a program performed against its bigger and more expensive brothers, so the major question I wanted to answer was — what do you get for £140, and is what you get enough for a serious data management application?

MicroPen is menu-driven but keeps its menus short so that they can be displayed at the top of the screen with any record currently shown. The package expects all its records to have a fixed format, with fields of fixed length. You must design just one format for each data file, but the format is extremely flexible. If you wish, you may specify a single field as the key on which the record is to be indexed; the specification of the key field is part of the input record format, but you can change it after the data file is set up if that becomes appropriate. Recall is by key field, record number or selective search. Printed reports of great variety can be used to provide circular letters, address labels, client record 'cards', what you will. There are no facilities within MicroPen for calculation (rather unusually, this is provided with Pen's sister package for word processing, MicroScript), nor for sorting. MicroPen can handle only one file at a time and doesn't provide any house-keeping facilities within the package.

Constraints

The constraints on data are shown in Figure 1. Probably the most significant constraint is the restriction to a single screenful of information — and in fact to 21 lines of the screen, as MicroPen uses the top line for instructions to the user.

File creation

The first step in creating a data file is to set up the input format. This is done not in MicroPen itself but in a word processing package. (The manual says 'such as Micro-

Script', but I used Wordstar just to prove that it is possible to use another word processing package. I didn't have any problems provided I used the non-document create option, as MicroPen dislikes format file which have the high-order bit set — and Pen does warn you about that.)

The ease of creation therefore depends on the facilities of your friendly word processor. With a good package it should be easy to 'paint-a-screen' giving any format you require. MicroPen has three conventions here. Each field is delimited by two symbols — square brackets are used unless you instruct the system differently — separated by enough character positions to hold the desired length of field. The first character within the brackets is a symbol which will be used to identify the field in report formats, and the remaining characters are spaces. The third convention concerns the first line of the format: if the file is to be indexed, this line is used to specify the key

field and the maximum number of records to be stored, otherwise it must be blank.

Apart from these conventions, the user has complete freedom as to what the rest of the format contains. So you have control over what captions are displayed and what field placing is used. A typical screen format is shown in Figure 2. Screen formats may be changed, to the extent that anything outside the square brackets may be moved at will. Fields can be renamed and also moved to different positions to some extent, provided the *sequence* and *length* of fields are maintained. The name of the key field

Max file size	disk size
Max no records	32750
Max size record	1024
Max no fields	100
Max field size	Screen width-2- caption length (if any)
Field types	Character

Fig 1 Constraints

```

:-----:-----:-----:
: Title [A ] : Initials [B ] : Surname [C ] :
:-----:-----:-----:
:Address1 [D ] : : :
:Address2 [E ] : : :
:Address3 [F ] : : :
:Address4 [G ] : : :
:-----:-----:-----:
:Advantages [H ] : : :
:Product [I ] : : :
:Container [J ] : : :
:Vouchervalue [K ] : : :
:-----:-----:-----:

```

Fig 2 Typical screen format

```

:-----:-----:-----:
: Title Mrs ] : Initials B.M. ] : Surname Pasmore ] :
:-----:-----:-----:
:Address1 1, The Brock ] : : :
:Address2 Piper's Lane ] : : :
:Address3 Haverage ] : : :
:Address4 Hampshire ] : : :
:-----:-----:-----:
:Advantages cleansing powers ] : : :
:Product Sudsy Soap Flakes ] : : :
:Container packet ] : : :
:Vouchervalue 20p ] : : :
:-----:-----:-----:

```

Fig 3 Record displayed in Fig 2 format

and the number of records to be indexed can also be changed after the data file has been set up, but only if the change is followed by the re-organise option, which takes quite a long time. Benchmark 6 shows the time for my 1000-record Benchmark data file.

Data input and updating

The format used for data entry, set up when the data file is created, is used for all interactive screen display and recall of the data. When you are adding records to the data file, or amending records which already exist, you simply use the cursor keys to move about the screen, using MicroPen as a simple screen editor. Functions are provided to move up and down by line or field and left and right by character or field. You can delete single characters or complete fields. Editing is circular — if you press the 'next field' key at the end of the last field, the cursor moves to the top of the record again. I found that a bit unnerving, especially as, like a lot of keyboard artists, I don't look at the screen all that often. When you tell MicroPen you have finished editing that record, you are given the option to make further changes, abandon the record altogether or store it as it is — all pretty obvious, you'd think, but it's surprising how few packages give you the option to correct that error you notice just as you've pressed the 'finished editing' key...

Screen display

MicroPen uses the same basic format for all interactive screen display. Figure 3 shows an example of a record displayed using the screen format given in Figure 2. You can ask to see records by number, by search, by key, or by listing all the records in the file. If you ask to look at all records, then you can have them shown either with a pause after each record, or continuously. With key display, you are asked to give the value of the key field that should be matched: an exact match is then sought. If one or more matching keys are found, MicroPen lists each key value with the associated record number (up to 20 records on the screen at a time). You can then ask to see the particular record(s) from the list. This is of course an alternative to the more common approach of allowing you to browse through all the records with a particular key. Which is better depends very much on your purpose in retrieving the record.

Printed reports

All printed reports in MicroPen are based on individual records — there are no facilities for totalling, for instance. The format of a report is dictated by a pro forma stored in a file but, unlike screen display, there may be many different report formats for each data file. These formats are created outside MicroPen by a word processor. The flexibility of the report procedure is probably the most unusual feature of MicroPen. You can include field names anywhere in the report, and surrounding text may be captions or prose. If you include field names in variable text,

```
PAGESIZE=72 STARTLINE=10 ENDLINE=65 PAGEWIDTH=78 MARGIN=10 ACROSS=1
[A [R [C,
[D,
[F,
[F,
[G.
```

January 18th 1983

Dear [A [C,

I am sure by now you will have heard of the great [H of [I. In case you have not yet had a chance to try this miracle product, I am enclosing a voucher to enable you to purchase your first [J for [K off the usual price. We look forward to having your custom for many years to come.

Yours faithfully,

L.R. Bloggs,
Marketing Manager, Sudsy Soap Powders Plc.

Fig 4 Typical report format

Mrs B.M. Pasmore,
1, The Brock,
Piper's Lane,
Haverage,
Hampshire.

January 18th 1983

Dear Mrs Pasmore,

I am sure by now you will have heard of the great cleansing powers of Sudsy Soap Flakes. In case you have not yet had a chance to try this miracle product, I am enclosing a voucher to enable you to purchase your first packet for 20p off the usual price. We look forward to having your custom for many years to come.

Yours faithfully,

L.R. Bloggs,
Marketing Manager, Sudsy Soap Powders Plc.

Fig 5 Fig 3 data printed with Fig 4 format

such as a paragraph in a letter, MicroPen reformats the paragraph to make the text fit within the specified margins. Figure 4 shows a typical 'report' consisting of a letter with some variable information, represented by the left square brackets and the letters which follow, to match with fields from the data file. Figure 5 shows how the final result would look, if this format were used to print information from the record shown in Figure 3.

In this example the text is shown printed with a 'ragged right' margin. If you have a printer which can print using 'microspace justification' (which seems to mean proportional spacing in this context) you can if you wish have the text printed flush to both margins — 'right justified' in the jargon of the word processors. Among the other printing controls are page and line size, and also 'across', a parameter which allows you to print labels which are mounted two, three or more across the page.

Selection

In addition to selecting records by number, or by key field and thence by number, you can also set up a search sequence. You can request a match on any field or all of them; if you request a match on more than one field, the requests are combined (ANDed) so that records are selected only if they satisfy all the criteria. You can select only one value from each record; that selection

may request that the value equals the test value, is not equal to, contains, does not contain, is less than, is greater than. (The last two can be used only to match numeric fields — you can specify them for any field, but they don't work for fields which contain letters.)

To allow you to make your selection, MicroPen displays the record display format on the screen, and allows you to indicate both match type and value against each field. Match type is indicated by pressing a control sequence; for instance, in the supplied version of MicroPen, CTRL-Q indicated 'contains'. Prompts are displayed on the top of the screen to remind you which control character to use but, unfortunately, there isn't room on the display format itself to print a representation of these control characters, so MicroPen uses numbers instead. These are allocated in the order the control characters appear in the prompt list, so CTRL-Q is shown in the record itself as 1, for instance. I found this rather muddling — personally I would have preferred some convention which allowed me to see displayed the character(s) I'd pressed. You could use the tailoring provisions to change this.

Tailoring

An unusual feature of MicroPen is that the user has complete control over all the prompts, as well as over the terminal and

MICROPEN

printer controls. All the instructions needed by the program are kept in a plain text file, called the command file, which can be altered by the dealer or even by the user, either with a text editor or with the REPAIR utility supplied with MicroPen. I changed mine quite a bit to make use of the function keys on our Sirius; the resulting command file is shown in Figure 6. So it would be quite easy not only to change the control sequences but also to supply prompts in other languages — presumably the EEC is the spur for this. The control sequences include all the usual cursor movement keys, a provision omitted by quite a number of the more expensive and powerful packages.

Security

MicroPen doesn't have any features to allow you to prevent unauthorised access to data. However, it does provide a 'write lock' feature to allow you to use the package in a multi-user environment. If one user has a file open for entering new records or for updating, the file is locked for writing; other users may recall records to inspect them on the screen, or to print reports, but may not add or change information.

Reliability

MicroPen takes some precautions against crashes by storing information in blocks of 4088 records per file; files are automatically linked together by the package, so users don't have to worry about this. (This also means that total file size is not restricted to the usual CP/M limit of eight Megabytes; if you wanted to, and if your disk were large enough, you could have 32,750 records each of 1024 characters!)

I didn't have any problems with lost data but I did manage to invoke the record locking feature by mistake on several occasions. For instance, when the file is first set up, if you want it to be indexed you must specify the maximum number of records it is to contain. When I tried to add an extra record to a file which already contains its maximum number of records the system stopped dead with no message; on reset, I found the file was locked against me. Unlocking is, however, a simple matter — you just invoke the 'repair' utility to reset the lock, a facility which could also be essential when several users have access to the same file. The 'repair' utility also allows you to carry out some other 'mends' which could be helpful in unusual situations.

Links with outside

MicroPen is one of a family of packages from Intelligence (Ireland); the closest in family resemblance is the word processor MicroScript (see Benchtest elsewhere in this issue), which can create the input the report format files needed by MicroPen. As MicroScript has no facilities exactly parallel to MicroPen's ability to merge structured information with running text, you would need to combine the two to get the full

features of word processing, mail-merge and simple information retrieval. At present there are no facilities to import data files into MicroPen, though a utility to do this is, I understand, in the pipeline. It shouldn't prove difficult, as MicroPen stores information in plain text, and though the format is rather unusual, it is completely predictable. I didn't have any trouble in writing a very short Basic program to convert my Bench-

mark data file, and I don't think it would have been any harder to write a similar program to convert MicroPen data to a more traditional format.

Software user image

By and large I found MicroPen very easy to use. Its basic approach is to use simple menus which appear at the top of the

```
XXXXX
3=Delete
Wait...
Enter name of database:
or press <Return> to leave system.
----- Update prohibited, database in use elsewhere. -----
] Database:
, per record
, records in the database,
0=Exit, 1=Enter, 2=Recall, 3=Recall & print, 4=Index, 5=Re-organise.
Enter name for spool-file or <Return> for hard-copy print:
Press <Escape> when data entry completed for record:
Press ^T to clear field
0=Exit, 1=Continue edit, 2=Update database,
Enter name of output format or <Return>
] Recall by: 0=Exit, 1=Record number, 2=Search, 3=List all on file.
Lengthy procedure! Press '*' to confirm or any other key to abandon :-
Enter record number (1 -
Press <Escape> when search profile complete. To set search mode: ^U=Clear
^K=Contains, ^O=Not contains, ^P=Equals, ^N=Not equals, ^L=Greater, ^J=Less
Enter record number to begin recall:
] After recall: 0=Exit, 1=Pause, 2=Continue.

Press <Space-bar> to continue, <Return> to exit & update, <Escape> to exit.
Licensed user :-
Wait while database is read/updated,
This record is deleted! Press '*' to un-delete or any other key to continue.
Now printing report...
Now leaving MicroPen ....
PAGE SIZE
STARTLINE
ENDLINE
MARGIN
PAGEWIDTH
ACROSS
Enter INDEX to search for or <Return> only to exit.
Enter reference number or <Return>
for more or '0' to exit :-
to exit, all entries now listed:-
Press <Return> to continue or <Escape> to abandon print
Total entries found for:
#.CIJWTR
27-89
32
32
0
-
-
27-74
27-75
80
9,5,4,19,13,24,27,127,20
11,15,16,17,12,10
91-93
27-31
1
20
10
0
spare
100
7
```

MicroPen (c) P. Osborn

Fig 6 Example command file

```
[ ] Database: 'B:PCWBTPEN', per record 152, records in the database, 1003
0=Exit, 1=Enter, 2=Recall, 3=Recall & print, 4=Index, 5=Re-organise.
```

'Menu' after Data File Specified

```
[ ] Recall by: 0=Exit, 1=Record number, 2=Search, 3=List all on file.
```

'Menu' after 'Recall' Specified

Fig 7 Two MicroPen 'menus'

C/WP HAS ITS WAY WITH THE DAISIES

£399 + VAT



If you want good quality print, clean and crisp as a lettuce leaf, you need a daisy wheel printer. But you pay for that quality. Or at least you did, until C/WP, which shrunk micro prices had its way with the daisies. Now, thanks to C/WP you can afford the smartest print in town.

OLIVETTI PRAXIS 30, baby of our range, not only prints superbly from your computer, but doubles as a portable electric typewriter with automatic erase ribbon and 10

character memory. It's slow (11 character a second or around 5 minutes for an A4 page), but what quality. And only £399 + VAT.

Others advertise the same printer for £480 + VAT.

The TEC STARWRITER is an even bigger bargain at just £499 + VAT. It prints bidirectionally and impeccably at 25 characters a second (just over 2 minutes a page) and responds to all the commands Wordstar throws its way. A really professional, heavy duty, thoroughly reliable daisy wheel, which has never been sold at such a low price.

For those who are only satisfied with the best, C/WP offer the QUME SPRINT 5 - the industry standard, normally sold for £1800 or more - for only £1295 + VAT. SPRINT 5 eats up your printing at 45 characters a second (about 75 seconds a page) with unbeatable quality, no fuss and not too

£1295 + VAT

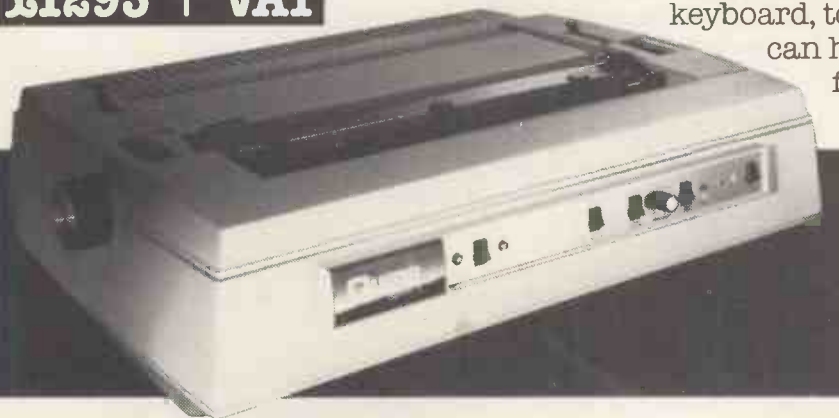

ghastly a noise. Or if you prefer a printer with a keyboard, to use as a typewriter when you want, you can have a QUME SPRINT 9/35 KSR (35 cps) for only £1045 + VAT.

£499 + VAT



Take your pick of the daisies, and remember ours bloom the whole year long. Most dealers offer you only 90 days warranty on daisy wheel printers. C/WP thinks this unacceptable. All our equipment, including daisy wheel printers has a full year's guarantee covering parts and labour.

C/WP

OUR PRICES TURN OTHERS GREEN

108 Rochester Row,
London SW1.
Telephone: 01-828 9000

MICROPEN

screen, so you always know what choices are currently open to you. Figure 7 shows two typical 'menu lines'.

As is common with menu-driven systems, on finishing a task you often have to go through several 'layers' to get back to the level at which you want to begin the next task. For instance, in the 'repair' function (which is a separate program from the main part of Pen), once you have finished unlocking a data file you then have to go through three levels of exit to get back to CP/M. Since you are most unlikely to want to carry out more than one repair function at a time, it would have been better to give the user another option after task completion, that of exiting to CP/M.

In MicroPen itself, sometimes the same problem arises and sometimes the reverse. An example of the latter occurs in the 'recall and print' option. This option involves the user giving the name of a record format file to use when printing, indicating whether a spooled print file or hard copy should be used, and selecting the method of recall. If the method chosen is recall by record number, you then specify the record number. But once that record has been processed, you are then back at the level you started from, and have to specify 'recall and print' and then all the details — such as the name of the print format file — all over again.

It would be much better to ask the user for another record number, with the *option* to return to the higher level if no more records are to be processed — especially as you can't specify a range of record numbers, just one at a time. Presumably the authors thought that most retrieval would be by selection on particular criteria rather than by record number, but it would be nice to have the option.

The other quarrel I have with the user image is over errors. There is a remarkable lack of error messages. I've mentioned the problem of trying to add too many records; another irritation was that often when I put in an invalid response I didn't get an error message, just a repeat of the prompt. For instance, when specifying the name of the data file you want to access, if you type the name of a file which doesn't exist the name is 'wiped' and the cursor repositioned at the start of the 'name' field. The mistake I'd made was obvious to me, but I'm not sure it would have been to a novice. This particular error is made harder to spot by the fact that although the data files available on the current disk are displayed, the only way to make the B drive the 'current disk' is to put the Pen command file (not the program) on every data disk, and to make B the logged drive before invoking MicroPen.

Documentation, training and support

The MicroPen manual is quite straightforward to read through, although I'd have liked more complete examples. However, the package comes with two complete sets of input format, data file and output

formats, so that wouldn't be too much of a problem. As is all too common, the manual has no index. Training for MicroPen is to be provided by Intelligence, for a fee, at locations in England as well as in Dublin. Support, which includes a 'hot-line' telephone support service, a newsletter and updates to the software, is available for an annual fee — see the next section.

Costs

The package itself costs £140, with an annual 'maintenance contract' for support and updates costing £60. The package runs on any standard CP/M system with floppy or hard disk. In addition to MicroPen itself, you would need a word processor or text editor to set up input forms. You could do this with the CP/M editor if you were familiar with it, or with your usual word processor if you have one — most people using CP/M are likely to fall into one of those groups, but it's a point to note. The package ran quite fast on those parts of the Benchmark which it could implement — the timings are given in Figure 8.

MicroPen is supplied by Intelligence (Ireland) Ltd, telephone Dublin (0001) 988555, who supplied my review copy; I'd like to thank the staff there for their help, especially the lady who answered most of my telephone queries.

Conclusions

MicroPen is basically a simple system for a simple price. If you already have word processing software, or can use the CP/M or similar editor, then the cost is £140. For that you get an easily-used package which

provides information storage, retrieval by key or by selection on the basis of one criterion per field, and flexible report printing. You also get a package which has the same approach and methods of use as its sister package, MicroScript.

There seems to be a general tendency towards 'families' of packages, each with similar user images. This has the great advantage that much of the learning from one package can be capitalised upon when learning another. A beginning has been made already by packages which use existing conventions — most notably the 'Wordstar' key conventions, used by packages such as dBaseII and Cardbox — or which allow easy transfer from one package to another to provide related facilities. The MicroPen/MicroScript set takes this approach a stage further, already available in the US (and coming over here) are packages like 1-2-3 which go further still.

To see if MicroPen is the package for you, I'd suggest taking this 'family' approach into account; if you haven't got a good word processor already, then have a look at MicroScript at the same time. However, the most important consideration will always be the features of the package itself, and here it would be worth comparing MicroPen with other packages which cost under £200, such as Pearl, Cardbox and the cheapest versions of DataPrism and Condor. (If you have a Sirius and your need is for a mailing-list/diary system, you should look at BusiPost too.) If you are looking for a simple, easy-to-use package with basic information storage and retrieval features, then MicroPen could be what you need.

END

BM1	Time to add 1 new field to each of 1000 records	na
BM2	Time to add 50 records interactively without index	scrolling time
	Time to add 50 records interactively with index	scrolling time +6 secs/record
BM3	Time to add 50 records 'in a batch'	na
BM4	Time to access 50 records from 1000 sequentially on 25-character field	4 mins 40 secs
BM5	Time to access 50 records from 1000 by index on 25-character field	2 secs/record
BM6	Time to index 1000 records on 25-character field	1 hr 20 mins
BM7	Time to sort 1000 records on 5-character field	na
BM8	Time to calculate on 1 field per record and store result in na record	
BM9	Time to total 3 fields over 1000 records	na
BM10	Time to import a file of 1000 records	as BM6*

Notes: na=Not available

*=plus time to write and run Basic program to pre-format unindexed file.

Fig 8 Benchmark times

Summary

System Type	CP/M-80 now, CP/M-86 and MS-DOS soon.
Package Type	Information management: single file, fixed length, fixed format records.
Facilities	Data entry, amendment, screen editing of data, selective recall, flexible reporting. No sorting or calculation.
Ease of Use	Simple, menu-driven, screen prompts.
Error Messages	Few, but mistakes usually fairly obvious.
Documentation	Clear manual, no index, sample files.
Costs	£140. Needs word processor editor to create input and output format files.
Supplier	Intelligence (Ireland); Dublin (0001) 988555.



LOOK WHAT "O" DID FOR OSBORNE

O-Computers has done wonders for Osborne I. We call it Super Osborne. We added refinements and lowered prices to make it the best value-for-money microcomputer you can find. For £1599 + VAT (as an introductory offer) we'll sell you our Super Osborne I with double density discs (RRP £1375) and all of Osborne's free software, a portable daisy-wheel printer (RRP £485) with cable, a 12 inch amber screen monitor (normally £110) and a built-in 80 column adaptor (estimated value £175).

WE GAVE IT 80 COLUMNS

Yes, our Super Osborne allows you to see lines of 80 characters on the screen. You can say goodbye to all that juggling with sideways scrolling that ordinary Osborne users do. Our design engineers have developed a circuit which fits inside the Osborne and provides video to British standards. You can plug any British monitor into your Super Osborne and get a rock steady message 80 columns wide.

WE GAVE IT A WINCHESTER

And while we were about our redesign, we added to the 80 column circuitry some further cleverness to allow the Super Osborne to use a CONTOUR Winchester disc. That means that when the time comes you can plug in a CONTOUR and suddenly the world is yours with up to 21 million characters of storage. A 3 million character CONTOUR, baby of the range, costs £995 + VAT.

WE MAKE YOU AN EXTRAORDINARY OFFER

Use the Osborne in your office and bask in the luxury of the CONTOUR Winchester disc's massive storage capacity. Come Friday, copy the files you need onto Osborne's new double density floppies, unplug the CONTOUR and carry your Osborne Electronic Office home for a weekend's work. Or use it with its portable electronic printer to catch up on your private correspondence.



O-COMPUTERS

A member of the C/WP Group
104-106 Rochester Row, London SW1
Telephone: 01-828 9000

Take advantage of our £1599 introductory offer. Add a 3 megabyte CONTOUR for £995, 6 megabytes for £1195, 12 megabytes for £1595, 21 megabytes for £1995. But hurry. Offer ends 1st May 1983.

BELOW. A PRINTER FOR YOUR MICROCOMPUTER.



ABOVE. AN ELECTRONIC TYPEWRITER FOR YOUR SECRETARY.

It's certainly a remarkable machine. Or should we say remarkable machines.

Because the ESW 103 KSR is not only a highly efficient printer, it's also an equally efficient 'Whisperdisc' electronic typewriter.

(One, we hasten to add, which features a wide 17" paper entry, automatic lift-off correction and proportional spacing.)

When you've finished a print-out, a

simple touch of a key and your secretary can start typing.

If you think the ESW 103 KSR costs the same as two machines you'd be wrong.

It's much nearer the price of one.

Maintenance is no problem either. Our nationwide service network will provide free 'on site' maintenance within 24 hours of your call.

The rest of the ESW range is equally impressive. Other models include the ESW 102 RO 'Whisperdisc' printer and

the new ESW 3000 50cps daisywheel printer.

For more information on the ESW range available from Intelligent Interfaces fill in the coupon below.

II INTELLIGENT INTERFACES

OFFICIAL TRADE & RETAIL DISTRIBUTORS FOR

Olympia International
Equipment to help you mind your own business

To: Intelligent Interfaces, 18 Central Chambers, Wood Street, Stratford-on-Avon, Warwickshire CV37 6JQ. Telephone: 0789 296879.
Please send me further details on: ESW 103 KSR printer/electronic typewriter ESW 102 RO 'Whisperdisc' printer ESW 3000

Name: _____

Business Address: _____

Tel. No: _____

PCW1

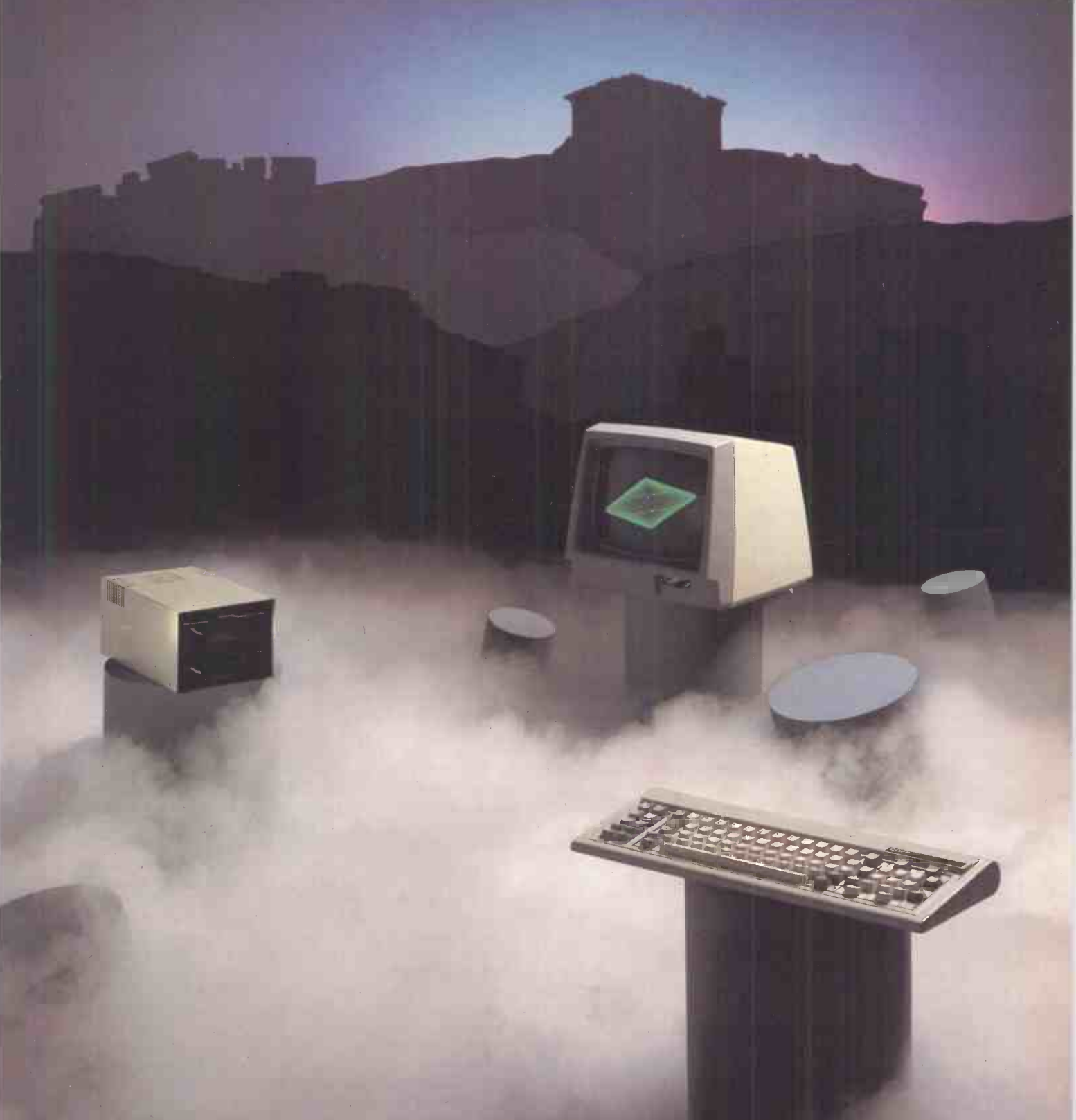

IT'S NOT ALL GREEK TO CONTEXT

Microcomputers have become part of our culture. Yet most of them expect users to communicate in cyber hieroglyphs. C/WP CONTEXT is a new type of microcomputer designed to be easier to communicate with. In fact, it's two computers in one. Computer number 1 (a Z80A with 64k RAM, if you want a little jargon) does the hard slog on your programmes – any standard CP/M programmes. Computer number 2 (a 6502 with 32k RAM) concerns itself only with talking to you – in words or pictures – on the clear 12 inch screen. You'll be delighted by the sharp speedy graphics, and the steady readable characters. And you can mix words and pictures as much as you wish. But that's not all. CONTEXT'S screen handling computer allows you to overlay one character over another, add in accents, or underlining, or bold characters, and to make your own symbols Russian, Greek, mathematical, what you will. It's certainly not all Greek to CONTEXT. And you'll enjoy the price too – computers, screen, twin disc drives, Wordstar, software all for £1495.

C/WP CONTEXT

Write or phone for details: C/WP Computers, 108, Rochester Row, London SW1 Tel.: 01-828 9000

THE REALLY VERY FRIENDLY COMPUTER

A WRITER'S PARADISE

Jon Vogler on the quest for a letter quality word processor at under £2000

For a writer the editing process used to be a tedium of red biro and frustration. The word processor, a computer with which one can edit text on a video screen until it is perfect, then print a flawless copy, is therefore the answer to a writer's prayer. Manufacturers advertise how famous thriller writers save hours producing each page. The snag, for this particular self-employed writer, was that my books sell three thousand copies, not three million, and dedicated word processors cost £5000 upwards.

Until two months ago I had never used a computer in my life. However a broken engagement recently left me time to kill, in a London office that produces educational computer cassettes. A suave, bearded individual (whose BMW outside hinted how high is the crest of the educational computing wave), remarked that one could put together a word processor for a fraction of the daunting sum mentioned above. He produced a copy of *PCW*, a magazine that I never previously knew existed, and we totalled prices to around £1500.

For three months, I followed up many adverts in the magazine but always with the same result: suppliers were full of blue sky promises but could not provide the tangible proof I wanted before blowing two months' earnings on expensive electronics. Books and articles about word processors were little help: none contained that essential element: a shopping list of specific boxes from specific suppliers, with the assurance that, when coupled together, the assembly would reproduce my flowing literary style.

It seemed that, by shopping around for best value in each individual component, I would lose the legal grip that would enable me to say to a supplier: 'You sold me this; now make it work or give me my money back'.

Two items exemplified this dilemma. A prosperous central London firm, whose staff and deep-carpeted offices seemed to double in size every time I contacted them, advertised a twenty-character-per-second, daisy-wheel printer at under £500 plus VAT. These TEC Starwriters had apparently been purchased by mighty Philips for their dedicated word processor but rejected as being too slow. It seemed fast enough for me with my small time anxiety to avoid waiting around while the machine printed a ten-page document. More important, the daisy wheel would make the print look like a typewriter; essential for editors (or friends!) who loathe the idea of corresponding with an automaton — cheaper dot matrix

printers, although faster, give the game away.

One problem: would this printer, only available with serial interface, hook up to the BBC Micro on which I had set my heart?

Disk drives caused a similar problem. The BBC's disk drives seemed either too small to store enough pages of text or too expensive at around £800 (and it seemed not actually available at the present time). However an American company, which has been in the disk business for years, was advertising drives at far more competitive prices: under £500 for 1 megabyte capacity.

At this stage, wanting to take the plunge but worried that the risks were still unacceptably high, two things happened. First I was offered a Globe Computer for under £2,000. It had a word-processing facility, a screen and two disk drives all built in. Like the BBC it would do other things than word-processing, such as keeping my small business accounts. The only extra I would need to buy was the printer. So, for an extra thousand pounds, most of the uncertainties would be removed.

At the same time however I met Dr. Colin Wormald of Eltec Computers in Bradford. Colin is a forty year old control systems engineer from Batley. He certainly did not match my stereotype of the trendy microcomputer salesman, luring rich businessmen with the hope that their children can miraculously learn the secrets of the electronic world. A year ago this scholarly, slow spoken Yorkshireman spotted that the BBC computers-in-education programme would offer rapid growth but required a more caring approach from dealers than the whizz-kids might offer. He took an agency for Acorn, which manufactures the BBC's micro, and was rewarded with the BBC agency in due course.

What attracted me about Colin was that, over the telephone, he took the trouble to explain what he thought I needed yet did not try to sell me anything. Indeed, he was actually rather difficult, explained that there was a limited number of BBC micros available with the vital 'disk interface' and he was not willing to sell me one unless I bought a disk drive from him. I explained that the BBC disk drive looked poor value and why I wanted one from the American firm. Colin rang up the firm's London agents, and then remarked dourly: 'I wouldn't buy equipment from them'. It had been admitted that, although it was true that

the American drives would operate with a BBC computer and that they had the advertised storage capacity, a substantial chunk of that storage would be used up in running them and would not be available for recording my masterpieces. Instead Colin offered me a Cumana disk drive at slightly higher price and with it the loan (but not sale due to the rules of his BBC agency) of the vital 'utilities disk' with which all disk operations have to begin.

It was his care over these enquiries which persuaded me to forget the easy option offered by the Globe and give Colin a cheque for £1,200. Inside the computer he fitted the microchip, which I had specified from Computer Concepts Ltd and which contained the essential word processing magic. Although the BBC has advertised its own package called View (and, scandalously, illustrated it on their television programme: 'Making the Most of the Micro'), I could not actually buy one yet. Not to worry, Wordwise is an excellent alternative, at the modest price of under £50.

I collected these on Christmas Eve for the most frustrating Christmas of my life! Although I managed to mend an old cassette recorder and operate with magnetic tape, I could not get the disk drive to run. Every time I telephoned Colin, he patiently told me what to do but it did not work. My wife, who works in Bradford, took the whole lot back. Colin tested it, said 'it's working fine' and returned it; still I could not make it work. When in the end I took it along myself the problem was solved in seconds: I had not been properly shutting the door on the disk drive. After that, learning to use the word processor was rapid: I was writing within ten minutes and, after two weeks and three or four articles of three thousand words, have mastered it.

Eileen, my part-time secretary, was another matter! Having spent a lifetime becoming an extremely efficient typist she was apprehensive of the unfamiliar electronic jumble and aggrieved to unlearn practices at which she had become so proficient. My preliminary reverses and frustrations with the disk drive did nothing to allay fears. However, since the system has demonstrated its sparkling results, so her enthusiasm has increased and her willingness to learn with it. She wanted to go on a proper word processor operator's course but this would be on a different make of machine.

I had planned to save the cost of a monitor by using an old black-and-white televi-



Illustration by Marting Ingley

sion set, rescued from the loft. Then my daughter emptied a cup of tea down the back of the colour telly. For two weeks the family trotted upstairs to borrow the 'acting monitor' whenever they wanted to watch 'The Professionals'. This gave valid excuse to buy a 12 inch monitor, with sharp, green letters; an improvement on the furry, grey-white characters of the old TV. Because it lacks colour my son is less likely to be playing space-invaders when I want to work.

The final and worst problem has been the printer. The London firm promised immediate delivery but actually took nearly three weeks, despite using an express delivery service. They also sent the wrong cable, (and charged £30 for it, for return of which I am still waiting) so Colin provided one (for nothing).

When at last connected the beast would only print @ signs and nothing else. With a telephone in one hand and a screwdriver in the other, I adjusted minuscule switches on a printed circuit board without success; still nothing but @@@@! It was then I really blessed the decision to go to Colin Wormald. Although he had not sold me the printer, he has spent many long evenings on it. Once he thought it was solved but after twenty lines of coherent text it printed gobbledy-gook again. 'Hand-shaking problems' he told me and lent me a dot-matrix printer while he continued the struggle.

With that, at least, I was able to print and address my daughter's wedding invitations: dotty, but otherwise up to scratch. When I apologised to Colin for the imposition on

his time, he pointed out that he has other clients with the same problem and solving it for one does for all. Also he said 'I am awfully glad to do something for you; I have just discovered that Cumana sent the 200 kilobyte disk drive and I have been over-charging you; I was terrified you would discover it before I could tell you.' (That was over a month ago and Cumana still have not delivered the right one!)

Two days ago, Colin rang me to say the printer problem was solved, except that it will not print '£' signs; does any reader know how to insert four character ASCII codes into the embedded 'define pound sign' command of 'Wordwise'?

Conclusions

Yes, it can be done and the results are sparkling.

Find a supplier who is willing to take trouble. Discuss with him what you are hoping to do and get his promise to ensure it will work in the end.

Confirm, in writing, that you buy their equipment on the understanding it will work with the other items you are going to use.

Tackle problems face-to-face, even if it means carting the equipment over to someone's office. Despite the recent advertisements, diagnosis over the telephone is still in its infancy.

Be prepared to take two or three months over the exercise.

Shopping list

One BBC 'B' Micro-computer from Eltec, 231, Manningham Lane, Bradford 8 (or any BBC agent) @	£399.00
One disk interface, fitted, @	£124.25
One WORDWISE micro-chip from Computer Concepts, 16, Wayside, Chipperfield, Herts @	£46.57
One CUMANA 400kbyte disk drive @	£569.25
One TEC Starwriter printer from C/WP, 108, Rochester Row, London SW1 @	£578.35
Various cables	£37.25
One PRINCE 12" green monitor screen	£109.54
Modifications to desk and electric sockets	£15.00
TOTAL	£1879.21
Consumables include:	
Floppy disks, each able to store about 200 pages of text @	£28.75 for 10 discs
Continuous printer paper @	£10.00 per 1000 pages
Printer ribbons, carbon or fabric	£4.75 each

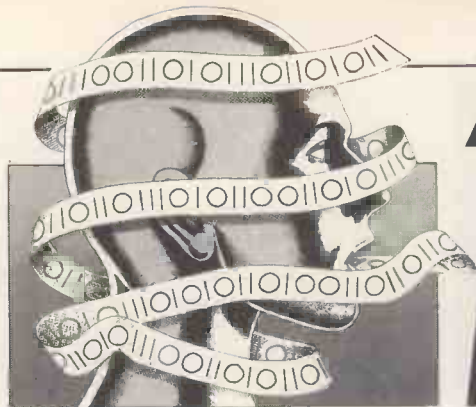

AN INTRODUCTION TO LISP

J P Bennett presents a powerful language in a readily digestible format.

In the first of two articles on Lisp I shall explain the structure and use of one of the oldest high-level programming languages. In the second article David Johnson-Davies will present and explain a large Lisp program, Eliza, which will run on most micro implementations of Lisp, mimicking the questions asked by a psychiatrist during a consultation.

Lisp is a very old language. The ideas behind the languages were first put forward by John McCarthy and his associates at Massachusetts Institute of Technology (MIT) in the late 1950's, around the time Cobol was invented, two years before Algol was thought of, eight years before the Fortran standard was published and a decade before Basic became popular. Remarkably, Lisp is now used more than ever before and has provided the basis for the new fifth generation languages, such as Logo and Prolog.

The uses of Lisp have been widespread. The best known are in artificial intelligence, of which the Eliza program to be described in the next article is an example. However the language's underlying strength in symbol handling and the ease with which Lisp programs are modified and extended, have led to its use in high precision arithmetic and algebraic manipulation, and recently to Atari's use of Lisp machines for high speed testing of new game ideas.

Lisp stands for LIST Processing language. A program consists merely of a list of functions to be evaluated. Exactly what is meant by a list will be explained later. More important first is the use of functions throughout Lisp.

We are used to functions in Basic, such as:

```
SIN (3.14159)
LOG (2.71828)
CHR$ (30)
```

We are also used to expressions such as:

```
3+2
4*3
6+5*7
```

Such expressions could however be written as functions

```
PLUS (3,2)
TIMES (4,3)
PLUS (6,TIMES(5,7))
```

This is how such expressions have to be written in Lisp. They may seem verbose, but they do have advantages. Bracketing of expression is no longer necessary. If we want the last expression above to be evaluated as:

```
(6+5)*7
```

Then we write:

```
TIMES (PLUS (6,5),7)
```

and the meaning is clear from the order of the functions.

Lisp uses a slightly different notation known as S-notation. Instead of:

```
PLUS (3,2)
```

we write:

```
(PLUS 3 2)
```

Spaces rather than commas separate items, and the first item is a function to apply to the rest of the items. Brackets go round the outside to indicate that this is a single unit; capable of evaluation on its own to yield the value 5. This strange bracketing eventually becomes familiar, but is a common source of programming errors with beginners.

The previous expressions are then written:

```
(TIMES 4 3)
```

and

```
(PLUS 6 (TIMES 5 7))
```

All the features of normal programming languages can be used as functions. For instance the Basic statement:

```
LET A = 3 (or just A = 3)
```

becomes:

```
(SETQ A 3)
```

and similarly

```
IF A < 0 THEN PRINT "NEGATIVE"
ELSE PRINT "POSITIVE"
```

becomes:

```
(COND
```

```
((LESSP A 0) (PRINT 'NEGATIVE))
```

```
(T (PRINT 'POSITIVE)))
```

The COND function is in fact slightly different, and rather more general than the Basic IF statement; it has the general form:

```
(COND
```

```
(condition1 expression1)
```

```
(condition2 expression2)
```

```
(condition expression ))
```

Each condition is evaluated in turn until one is true, and then the expression following is evaluated and returned as the result of the COND function. If no condition is true then the special value NIL, (of which more later) is returned. The conditions used above were:

```
(LESSP A 0)
```

The function LESSP returns true if its first argument is less than its second.

and

```
T
```

an item, not a function whose value is always true.

and the expressions used were
(PRINT 'NEGATIVE)

and

(PRINT 'POSITIVE) Which do the obvious

New functions are defined by using the built in function DEFUN (in some versions of Lisp called DE instead). Thus we could define the factorial function as:

```
(DEFUN FACT (N)
```

```
(COND
```

```
((EQ N 1) 1)
```

```
(T (TIMES N (FACT
```

```
(DIFFERENCE N 1))))))
```

Note the use of indentation to make the meaning clear. The function DEFUN takes any number of arguments. The first is the name of the function being defined, the second is a list of arguments (in brackets), and the rest are functions to be evaluated when the function is used. The result returned when the function is called is the value of the last expression evaluated.

This definition of FACT is recursive—it calls itself. Thus factorial 3 would be:

```
(FACT 3)
```

which is evaluated as:

```
(TIMES 3 (FACT 2))
```

which is:

```
(TIMES 3 (TIMES 2 (FACT 1)))
```

now (FACT 1) is 1 (N being now EQ to 1),

and so this becomes:

```
(TIMES 3 (TIMES 2 1))
```

ie, 6

Lisp relies heavily on recursion, since it has no looping structures, such as the FOR-NEXT or REPEAT-UNTIL of Basic, nor does it have GOTO statements, at least not in pure Lisp. If you want to do something more than once you have to do it recursively. For instance the Basic program:

```
SUM = 0
```

```
FOR I = 1 TO 10
```

```
SUM = SUM + I
```

```
NEXT
```

could be evaluated by a recursive function such as:

```
(DEFUN LOOPSUM (I)
```

```
(COND
```

```
((EQ I 10) I)
```

```
(T (PLUS I (LOOPSUM (PLUS
```

```
I 1))))))
```

and the result could be put in SUM by:

```
(SETQ SUM (LOOPSUM 1))
```

This is the second problem for beginners. Recursion is a concept that does not come easily, particularly if you are used to Basic. In practice it takes some time for novice programmers to start to appreciate its use, and then to realise that it is the most power-

ful programming tool available. Once you do get used to it you will wonder how you managed without it.

Now to return to the lists mentioned earlier. We have already seen several lists:

(PLUS 3 2)

(TIMES 4 5)

and so on. Any series of items inside brackets is a list. Thus

(A B C D)

is a list, and

((A B) (C D))

is a list of lists.

In Lisp anything that is not a list is called an atom, since unlike lists, atoms are indivisible. Let us look more closely at a simple list:

(A B C)

How is this represented in the computer? Lisp handles everything as pairs of locations in the computer's memory. Thus the list (A B C) is represented as three pairs of locations:

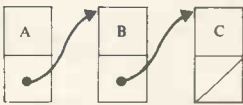

The arrows are pointers in the computer's memory. A pointer is merely the address of the location in the computer's memory being pointed to. If we draw some hypothetical computer locations we can see how the above list might be represented:

12	A	13	18
14	C	15	-1
16		17	
18	B	19	14
20		21	

Pairs of locations from 12 to 21 in the computer's memory are shown. Notice how the second field of the A pair holds the address of the B pair, and how the second field of the B pair holds the address of the C pair. The second field of the C pair is -1 to show that this is the end of the list and doesn't point anywhere. Notice how the order of A B and C in memory is unimportant, since the order in the list is all handled by pointers.

(PLUS 3 2)

is also a list and is represented as:



The symbol:



is used to mean 'end of list', and is the special atom NIL referred to earlier, ie, the address of -1 used in the previous illustration.

Practical programmers will realise that while you can fit the character A in one location, you cannot fit the characters PLUS in one location. This is indeed the case and in each of the first fields of the pairs of locations there are pointers, which point to the print names, or values, thus the

previous list is better shown as:

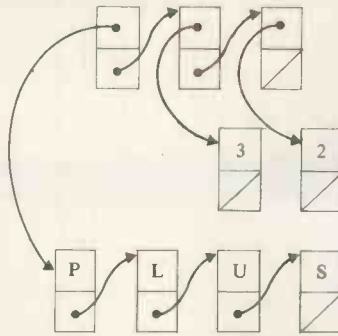

In fact Lisp needs to know whether it has a character, or a number, or a pointer in a location, and so usually a few bits are reserved in each location to show what sort of item is there. You should not make the mistake of assuming that locations in the computer's memory are equivalent to bytes. 8 bits are not enough for holding addresses, and flags etc., and so commonly LISP breaks memory up into 16 or 24 bit locations, for use. This is a mere technicality and should not worry the Lisp programmer, since such things are hidden from him.

By now the underlying uniformity of Lisp should be much more apparent. Both expressions, such as:

(PLUS 1 2)

and data, such as:

'POSITIVE

are represented as lists.

How do you go about "executing" a Lisp program? Most micro-implementations of Lisp operate in 'evaluate' mode. They usually give you a prompt, such as:

'Evaluate:'

You then type in a function to evaluate, such as:

(PLUS 3 2)

and the Lisp system will evaluate it. Evaluation consists of walking over the list representing the function and performing the functions represented. For instance here:

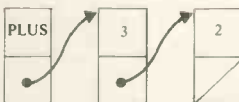

The evaluator encounters the first item PLUS and realises it requires two arguments. It gets these two arguments by following down the pointers to find 2 and 3, adds them and returns the value, typically by a reply such as:

Value is: 5

You will find lists for evaluation such as these referred to in the literature as S-expressions.

Since both programs and data have the same form, programs may be written to modify programs. Lisp provides some rather strangely named functions to manipulate lists. Consider a list FRED (SETQ FRED '(A B C D)) (Note that the ' merely means don't evaluate this list as though it were an S-expression, but set FRED up to point to it). The function CAR is used to obtain the first item in the list viz.

(CAR FRED)

will give A.

The opposite function is CDR, to give the rest of the list.

(CDR FRED)

will give (B C D).

The obscure names for these functions stand for Contents of Address Register and Contents of Data Register, and refer to the IBM 709 on which Lisp was first implemented.

Looking at our box picture:

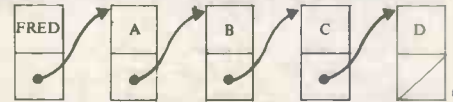

CAR gives the first location of the object referred to by FRED ie,



and CDR gives the second viz.



Assorted other functions exist to modify lists in other useful ways.

The power of Lisp comes from the way it is built up from a set of standard functions. These functions are held on a list maintained by the Lisp system, the object list or OBLIST. This initially has useful functions, such as PLUS, TIMES, CAR, CDR and so on. Every time you define a function using DEFUN it is added to this list. Running a program consists of evaluating a function you have defined, which in turn evaluates other functions you have defined on the OBLIST and so on. Thus to extend a program you just add a few functions to the OBLIST you already have and modify existing functions to evaluate them. Program development is fast, because you can test each function on the OBLIST individually before building them into the main body of routines, and also because this type of system encourages a tree-structured program, consisting of important functions evaluated as part of the main function and less important functions evaluated by the important functions and so on down to the very small functions at the bottom of the tree.

This idea of using your Lisp system, surrounded by all the functions you need, is why programmers talk of a Lisp environment and Lisp machines, rather than Lisp program. There is no one entity clearly definable as the program, merely a pool of functions on the OBLIST, all calling each other, in a way that is powerful and flexible. As you work with Lisp you too will discover the addiction for this language, common among all its users.

FURTHER READING

I would not recommend the original report by McCarthy as a good introduction to the language. The best introduction is probably *A Programmer's Introduction to Lisp* by W.D. Maurer, published by MacDonald/American Elsevier Computer Monographs, 1972.

For users with BBC micros a better book is *Lisp on the BBC Microcomputer* by Gillian Cattell and Arthur Norman, published by Acornsoft.

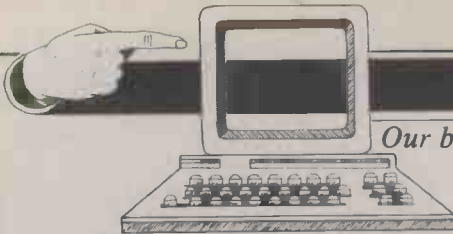

IN STORE

Our bi-monthly guide to microcomputing systems. Updates should be sent to:
Dick Olney, PCW, 62 Oxford Street, London W1A 2HG.

Machine (Price from)	Main Distributor/s (No. of Dealers)	Hardware	Software	Miscellaneous (Documentation)
ABC 26 (£4500)	AI 09237-70578(19)	64k RAM: Z80A: dual 8" F/D (2.3Mb): 12", 24 x 80 VDU: 2 x RS232 ports: 3 x P/P	CP/M: <i>MP/M Basic:</i> <i>Cobol: Fortran: Pascal.</i>	Options: 10Mb H/D £4000. BT 4/81 (S).
ABC 80 (£738)	Datormark Ltd: 97 44896	16-40k RAM: Z80A: C: 12", 16 x 40 b&w VDU: 4680 bus: IEE 488: RS232 port.	DOS Basic (16k ROM): <i>Fortran: Pascal: A:</i> <i>Multi user Basic.</i>	Colour video graphics with UHF output. Viewdata compatible. Loudspeaker. Numeric keypad. Options: dual 5 1/4" F/D (320k) £895: dual 8" F/D (2 Mb). BT 1/80. (I)
Acclaim (£3650)	Country Computers 0527 29826	64k RAM: Z80: 24x80 VDU: single 5 1/4" F/D (140k): 5 MB H/D: RS232 port. Option: P/P	CP/M: <i>Basic: Cobol:</i> <i>Fortran: Pascal</i>	Various integral H/D options up to 21Mb (£4450)
ACT Sirius 1 (£2395)	ACT 021 501 2284 (50)	128-512k RAM: 8088: dual 5 1/4" F/D (1.2M): 12", 25 x 80 VDU: 2 x RS232 ports: 2 x P/P	CP/M 86: U: Basic 86 <i>Cobol: Fortran: Pascal</i>	High res graphics. Options: 10 Mb H/D: dual 5 1/4" F/D (2.4 M) BT 2/82.(S)
Adler Alphatronic (£1895)	Adler 01-250 1717	48-64k RAM: 8085A: dual 5 1/4" F/D (1Mb): 12", 24 x 80 VDU: S/P: P/P	CP/M: <i>Basic: CBasic:</i> <i>Fortran: Cobol</i>	With 80 cps printer and dual F/D £2345 (inc CP/M). (S)
Altos ACS 800-2 £2995)	logitek: 0257 426644 (33)	64k RAM; Z80A; dual 8" F/D (1 Mb): 2 x RS232 ports: 2 P/P.	CP/M: <i>Basic: CBasic:</i> <i>Cobol.</i>	Single user. Options: DMA. Floating point processor. Phototyping board.
Altos ACS 8000- 10 (£6675)	As above.	280k RAM: Z80A: single 8" F/D (500k): 10 Mb H/D: 6 x RS232 ports: P/P: network RS422 port: DMA	CP/M: <i>MP/M: Basic:</i> <i>Cobol: Fortran: APL:</i> <i>Pascal.</i>	Multi-user/multi tasking. Up to 4 users. Options: 10 Mb: mag tape backup (S + H).
APL Signet (£1750 or £130pm)	Micro APL: 01-834 2687	64k RAM: Z80A: dual 5 1/4" F/D (380k): 2 x RS232 ports.	CP/M: <i>APL: Basic: U:</i> <i>Fortran: Cobol: Algol:</i> <i>Forth</i>	Desktop APL computer with self teaching course. (S)
Apple II (£695)	Apple (UK) 0442 60244 (200+)	16-48k, RAM: 6502: 8 I/O slot	OS: <i>Basic: Pascal:</i> <i>Fortran: Cobol: Pilot</i>	280 x 192 high resolution graphics: Option: single 5 1/4" F/D (116k) £349.
Apple III (£2496)	As above	128-256k RAM: 6502B: dual 5 1/4" F/D (286k): 12", 24x80 VDU: RS232 port: P/P.	SOS: <i>Basic: Pascal:</i>	Options: single 5 1/4" F/D (143k) £384: 5Mb H/D £2256. (E) BT 5/82
Atari 400 (£200 inc VAT)	Atari UK: Slough 33344	16k RAM: 6502: C int: cartridge slot: 24 x 40 TV int: touchpad k/b: Opt: C £50	OS (10k ROM): <i>Basic (8k ROM).</i> <i>Pilot: A:</i>	High resolution colour graphics. 4-channel sound. Four games controller/light pen sockets. BT 10/80. (I/B).
Atari 800 (£500 inc VAT)	As above.	16-48k RAM: 6502: C int: 2 x cartridge slots: 24 x 40 TV int: Opt: single 5 1/4" F/D (90k) £300: 16k RAM £65.	OS(10k ROM) Basic (8k ROM): <i>Pilot</i> <i>A: Forth: MBasic</i> (I/B).	As above. Software & RAM on cartridge modules. Up to 4 disk drives RS232C int £135: BT 10/80.
Atom (£120)	Acorn: 0223 245200 (160)	2-12k RAM: 8-16k ROM 6502: Full K/B: C int: TV int: 20 I/O lines: 1 P/P. Options: 80 col printer £199, Prestel adaptor £120.	Basic in 8k ROM: A Cass O/S: <i>Lisp:</i> <i>Forth</i>	High resolution graphics on bigger model: Single 5 1/4" F/D £297 B/ 7/80 (B)
BASF 7120 (£4400)	BASF: 01-388 4200 (12)	88k RAM: 2xZ80A: 3 x 5 1/4" F/D (480k): 12", 24 x 80 VDU: RS232 port: P/P	DOS: (OASIS) <i>Ex Basic:</i> <i>Cobol U. A: CP/M</i>	H/D available. Also 7125 with 960k F/D £4900 and 7130 with single F/D (430k) & 5Mb H/D £6300. Disk controller has own Z80A. BT 9/80
BBC Micro (£299 inc VAT)	BBC Micro Systems 0933 79300	16-32k RAM: 32k ROM 6502: C int: TV int: RS423 port: P/P: Option: single 5 1/4" F/D (100k) £230	MOS: <i>Basic A: Pascal</i> <i>Logo: Forth: Lisp</i>	Video text & second processor int. 32k model with Econet and disk interface £399. BT 1/82 (I).
Bonsai SM3000 (£1995)	Bonsai 01-580 0902	64k RAM: Z80: dual 5 1/4" F/D (700k): 12", 24x80 VDU: RS232 port: P/P	CP/M: <i>Basic: Cobol:</i> <i>Pascal: Fortran</i>	Many floppy and hard disk options. Applications software avail. from Bonsai.
Computers Lynx (£225 inc VAT)	Computers Ltd 0223 315063 (TBA)	48-192k RAM: Z80A; 24x40 TV int: C int: RS232 port	Basic	248 x 256 colour graphics (8 colour). CP/M compatible 5 1/4" F/D & printer avail soon. (B)
Canon BX-3 (£3000)	Canon 01-680-7700.	32k RAM: 6809: dual 5 1/4" F/D (640k): 28 char display: 80 cps printer: 3 x RS232 port: P/P.	OS: <i>Basic: A.</i> <i>Cobol: Pascal</i>	Fully integral unit. Extensive applications support offered on all Cannon Machines. Options: dual dual 5 1/4" F/D (640k) £1500.
Canon CX-1 (£2500)	As above.	32k RAM: 6809: dual 5 1/4" F/D (640k): 12", 24 x 80 VDU: 3 x V24 ports: P/P: light pen.	OS: <i>Basic: A: Cobol:</i> <i>Pascal</i>	Price includes installation & training. Extensive application support offered. Options: dual 8" F/D (1Mb) £3300.(S)
Canon TX-25 (£1450)	As above.	16-32k RAM: 6809: C: 20 char display: 26 col, 2.4 lps printer. Option: 2 x RS232 port.	Basic: A	Fully integral unit. Cassette is Cannon's own design (8k). Can be used with communications. (S).
Clenlo Pronto (£2825)	Clenlo Computing Systems Ltd: 01-670 4202 (TBA)	64k RAM: Z80: dual 8" F/D (1 Mb): 3 S/P: 2 P/P.	CP/M: <i>CBasic-2:</i> <i>Pearl 1: U Fortran:</i> <i>Cobol: Pascal</i>	With 2.4Mb F/D £3105. Also H/D systems with 5-20 Mb H/D & tape drive £5430.

List of Abbreviations

A Assembler	G/C Graphics card	M/A Macro assembler	S Software
BT Bench Tested	H Hardware	N/A Not available	S/P Serial port
C Cassette	H/D Hard disk	N/P Numeric pad	T/E Text editor
E Extensive	I Introductory	O/S Operating system	TBA To be announced
F/D Floppy disk	int Interface	P/P Parallel port	U Utility

Please note: Software items listed in *italic* are not included in the basic price of the equipment. All prices are *exclusive* of VAT.

IN STORE

Machine (Price from)	Main Distributor/s (No. of Dealers)	Hardware	Software	Miscellaneous (Documentation)
Cleno Table Top 525 (£1750)	As above	64k RAM: Z80 dual 5 1/4" F/D: 2xS/P	CP/M: MBasic: W/P	Wordstar & Logicalc included in price. Many options
Colour Genie (£200 inc VAT)	Lowe Electronics 0629 2430 (100+)	16-32k RAM: Z80: 16k ROM: C int: 24x40 TV int: Audio port: RS232 port: P/P	ExBasic	160x96 colour graphics. 16k RAM £30. Many options inc joysticks and light pen. F/D avail soon. (B)
Columbia PC (£2800)	Icarus 01 485 5574 (50)	128k RAM: 8088: dual 5 1/4" F/D (640k): 24x80 VDU: 2xRS232 ports: P/P: 8 expansion slots	MS-DOS: CP/M 86: Basic: Cobol: Fortran: Pascal	IBM PC compatible. With integral H/D (5 Mb) £4200 or (10 Mb) £4550 (S)
Comart Communicator (£1895)	Comart 0480 215005 (25)	64k RAM: Z80A: dual 5 1/4" F/D (780k): 2 S/P: P/P.	CP/M: MP/M Basic: Cobol: Fortran: Pascal	With 1.5 Mb F/D £2195. With 4.8 Mb H/D & 790k F/D £2995. Option: 18 Mb H/D. £3895 Also CP100 range with 8086 & 128k-1Mb RAM from £2295. Expandable to multiuser/multitasking. (S).
Commodore PET 16k, & 32k (£550, £695)	Commodore: 0753 79292 (150)	16-32k RAM: 6502: C: 12" 25x40 VDU: IEEE-488 port: Options: dual 5 1/4" F/D (343k) £695: same but (1018k) £895	O/S: Basic (in 8k ROM): Forth: Pilot: Pascal: Comal: Lisp: A	CBM 8032 with 80-col screen (32-96k) BT 12/80. £895 Field service avail. (1).
Commodore Vic 20 (£200 inc VAT)	Commodore: 0751 79292 (150)	5-32k RAM: 6502: C int: 22 x 23 TV int: S/P: P/P: Games int.	Basic	Graphics 3 tone sound generator. Will interface to PET. Option: single 5 1/4" F/D (170k). BT 9/81(S).
Commodore 500 Series (From £659)	As above	128-896k RAM: 6509: 25x40 TV int: P/P	O/S: Basic: CP/M: Pascal: Forth: Cobol: Fortran	High res. 16-colour graphics. Second processor option: Prestel facility avail.
Commodore 700 Series (From £995)	As above	128-896k RAM: 6509: 24x80 VDU: Option: dual 5 1/4" F/D (1Mb): IEEE- 488 port: RS232C port.	As above	8088 or 280 second processor option Tilt and swivel screen.
Commodore 64 (£299)	As above	64k RAM: 6509: 25x40 TV int: C int: RS232 port: P/P	Basic	Second processor option. 320x200 colour graphics. Option: Joystick: Light pen
Compucorp 625 (£6000)	Compucorp: 01-907 0198 (17)	48-60k RAM: Z80: dual 5 1/4" F/D (630k): 9". 16x80 VDU: 40 col printer: RS232 port, P/P.	Basic: A: Fortran: Pascal: U	IEEE-488 Controller and S100 int. Many applications packages avail. (E).
Compucorp 655/ 665/675/685 (from £5050)	As above	60k RAM: Z80: Up to 4x5 1/4" F/D (160k-2.4 Mb): 9", 20x80 or 12" 20x80 or 20" 60x80 VDU: 40-col printer: RS232 port	As above	Prices incl installation and training. Opt: 10-20 Mb H/D
Cromemco System Zero/DDF, System 2, System 3, System Z2H. (£1975/£3095/ £4495/£6585).	Datron: 0742 585490. Comart: 0480 215005 (25) MicroCentre: 031- 556 7354 (18)	64k RAM: Z80: dual 5 1/4" F/D (390k) on System Zero, System 2 & Z2H: dual 8" F/D (1.2 Mb) on Sys 3: 10 Mb H/D on Z2H: S/P: P/P.	CDOS: Basic: Cobol: Fortran: RPG II: Lisp: A: W/P: Multi- user Basic. Cromix. CP/M	System 2 & 3 expandable to Multi-user (max 7) Also 'D' series with 6800/ Z80A dual processor from £3620. Options: dual 8" F/D (996k): 11.2Mb H/D. BT 10/79 (E).
DAI (£595)	Data Applications (UK): 0285 2588 (7)	48k RAM: 8080: C int: 24x60 VDU int: RS232 port: over 20 industrial ints. option: dual 5 1/4" F/D £595	Basic (ROM): U	Colour graphics up to 255 x 335: 3 notes & noise generator: PAL O/P to TV: Paddle int: H maths option. (1). BT 10/80.
Diablo 3000 (£6250)	Business Computers Ltd: 01-207 3344	32k RAM: 8085: dual 8" F/D (1.3 Mb): 12", 24x80 b&w VDU: 45 cps printer.	DOS: Basic: DACL: A: U.	Selection of business packages included (S).
Digital Micro- systems DMS-3 (£3530)	Digital Microsystems 0734 343885 (14)	64k RAM: Z80A: dual 8" F/D (1.14Mb): 3xRS232 ports: 1xRS422 port: P/P.	CP/M: CBasic: Cobol: Fortran: Pascal: PL/I	Expandable to multi-user system with 10-28 Mb H/D. Extensive software avail. (S).
Digital Micro- systems DMS-4 (£4395)	As above	128-512k RAM: Z80A: single 8" F/D (500k): 11 Mb H/D: 4x RS232 ports: P/P.	CP/M: Basic-E: CBasic: Cobol: Fortran: Pascal.	Port expander to enable up to 10 workstations under M/PM. Options: 128k RAM £1295: up to 96Mb H/D. (H).
Dragon 32 (£200 inc VAT)	Dragon Data 0792 580651 (50+)	32-64k RAM: 6809E: 16x32 TV int: C int: P/P	Basic	9 colour 256x192 high resolution graphics. Option: Joysticks BT 8/82
Durango F-85 (£4995)	Comp Ancillaries: 0784 36455 (12)	64k RAM: 8085: dual 5 1/4" F/D (1 Mb): 9", 16x64 green VDU: 132 col 165 cps printer: N/P.	O/S: D Basic: CP/M: CBasic: Micro Cobol.	Up to 5 work stations: fully integrated system. Options: additional dual 5 1/4" F/D (1 Mb): 12-24 Mb H/D.(S).
Eagle II, III and IV (from £2350)	Mediatech Bus Syst 01 903 4372	64k RAM: Z80A: dual 5 1/4" F/D (768k and 1.5Mb) or single 5 1/4" F/D (784k) with 10Mb H/D: 2xRS232 ports: 2 x P/P	CP/M: CBasic: Cobol Pascal: Fortran	Many different configurations available. Full range of applications software
Epson HX20 (£402)	Epson	16-32k RAM: 32k ROM: Twin 6301 CPU: 20x4 LCD: RS232 port: Micro dot matrix printer	E Basic	Display gives 120 x 32 dot graphics. Options: TV int: micro-cassette drive: expansion module. BT 12/82
Equinox 200 (£7500)	Equinox: 01-739 2387 (N/A)	64-512k RAM: Z80: 10 Mb- 1200 Mb H/D: 6xS/P: 1 P/P.	CP/M: CBasic: Cobol: Fortran.	Multi-user MVT/FAMOS available in place of CP/M. 16-bit version (Equinox 300) £10,000. (S&H).
Fortune 32:16 (£4375)	Fortune Systems 01 938 1721	256-512k RAM: MC 68000: dual 5 1/4" F/D (800k): 12", 25x80 VDU: S/P: P/P	FOS: CP/M: Basic: Pascal: Cobol: Fortran: C	Expandable to full multi-user system. High res colour graphics
Gecas 64/2 (£3305)	Grecas Micros 01 629 3758	64k RAM: Z80A: dual 8" F/D (2.4 Mb): S100 bus.	CP/M: Cobol: Basic Pascal Fortran	Up to 4.8 Mb F/D. Expandable to multi-user/multitasking system.

List of Abbreviations

A Assembler
BT Bench Tested
C Cassette
E Extensive
F/D Floppy disk

G/C Graphics card
H Hardware
H/D Hard disk
I Introductory
Int Interface

M/A Macro assembler
N/A Not available
N/P Numeric pad
O/S Operating system
P/P Parallel port

S Software
S/P Serial port
T/E Text editor
TBA To be announced
U Utility

Please note: Software items listed in *italic* are not included in the basic price of the equipment. All prices are *exclusive* of VAT.

Three out of every four computers going into schools are BBC Micros.

Is there a lesson to be learned by every user?

As part of the current government subsidised scheme aimed at introducing micros to schools, the Department of Industry undertook a survey of machines available and made recommendations to education authorities all over the country.

The BBC Micro met their priorities exactly: it is economical yet fast and powerful, and it can justify the investment involved, through its capability to grow with the needs of the user and with the rapid changes in technology.

Teachers and education authorities agreed, and today it represents over three-quarters of all micros being ordered for schools across the country under the DOI scheme.

The BBC's choice too.

In choosing a machine to put their name to for their massive Computer Literacy Project, the BBC had the same set of priorities as the DOI. The BBC Micro is now an integral part of that project, which includes books, software, courses and a number of major television series, one of which, "Making the Most of the Micro" is now being broadcast.

All this for only £399.

The BBC Micro is light and compact. It generates high resolution colour graphics, and is capable of synthesising music and speech using its own internal speaker. The keyboard uses a conventional layout and typewriter feel.

The most sophisticated version (called

Model B) is available for only £399. (There is also a basic model available, the Model A, at £299.)

Designed to grow.

Last year the magazine "Which Micro?" said that the most attractive and exciting feature of the BBC Microcomputer was its 'enormous potential for expansion'.

This is indeed one of the features that sets it aside from the competition.

For example, as well as interface sockets to allow you to connect to a cassette recorder, and to your own television, you can also use video monitors, disc drives, printers (dot matrix and daisy wheel) and paddles for games or laboratory use.

You can also plug in ROM cartridges containing games with specialist application programs.

The Tube. A unique feature.

The Tube, which is unique to the BBC Micro, provides for the addition of a second processor via a high speed data channel. The possibilities are enormous. For example, the addition of a second

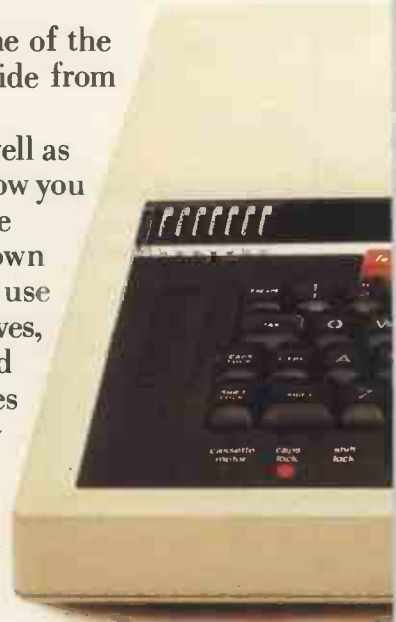

3MHz 6502 processor with 64K of RAM doubles processing speed. While a Z80 with 64K of RAM opens the door to a fully CP/M* compatible operating system, with all the benefits for business applications.

Linking up with other computers.

The BBC Micro also offers a facility of immense potential value to schools, colleges and businesses. It's called Econet® - a system which uses telephone cable to link with other BBC Micros. A number of machines can then share the use of expensive disc drive and printer facilities.

Make full use of Prestel & Teletext.

With special adaptors you will not only be able to turn your TV set into a Prestel terminal and Teletext receiver, but you can also take data and programs direct from these services. (The programs, which are known as telesoftware, are already being broadcast by BBC's Ceefax service.) This is another first for the BBC Micro.

BASIC plus.

A sophisticated version of BASIC has been chosen for the BBC Micro, which incorporates features normally found only in more advanced high level languages. However, there is also a facility allowing access through a simple command to another language - for example, PASCAL, FORTH and LISP.

*Trademark of Digital Research.



A full range of software.

Applications software for the BBC Micro already cover a very wide field. Packages covering games, education and business applications are available on cassette. All developed to the same high standards set by the hardware.

The best possible back-up.

Your BBC Micro comes with the backing of the BBC and an extensive dealer and service network.

Each approved dealer is able to offer advice and carry out expansion work and repairs.

BBC Microcomputer - Model A and Model B.
2MHz 6502A Processor.
32K ROM; 16K RAM Model A, 32K RAM Model B.
Full QWERTY keyboard with 10 user-definable function keys.
Mixed high resolution graphics and upper and lower case text.
300 baud and 1200 baud interface for standard cassette recorders.
Three-voice music synthesis with full envelope control feeding internal loudspeaker.
Interface sockets (Model B only) - RS423, for analog inputs centronics and user port.
6502, Z80, 16032 second processors.
Single and Dual Disc Drives with 100 and 800 K-bytes storage.
Teletext unit.
Speech synthesis.
Networking facility - via Acorn Econet®

How to buy your BBC Micro.

If you are a credit card holder and would like to buy a BBC Micro B, or if you would like the address of your nearest stockist, just phone 01-200 0200.

Alternatively, you can buy a Model B directly by sending off the order form below to: BBC Microcomputers, c/o Vector Marketing, Denington Estate, Wellingborough, Northants, NN8 2RL.

All orders are despatched by fully insured courier and come complete with easy to follow 500 page User Guide and Welcome cassette.



01-200 0200 credit card holders.

To BBC Microcomputers, c/o Vector Marketing, Denington Estate, Wellingborough, Northants NN8 2RL. Please send me _____ BBC Model B Microcomputers at £399 each, inc. VAT and delivery. I enclose PO/cheque payable to Acorn Computers Limited Readers A/C or charge my credit card.

Card Number _____
Amex/Diners/Visa/Access (Delete)

Name _____

Address _____

Postcode _____

Signature _____

PCW5
Registered No. 140 3810 VAT No. 215 400220

The BBC Microcomputer System.

Designed, produced and distributed by Acorn Computers Limited.

At KGB, we believe in putting pen to paper

MICROPLOT is a CP/M Graph Drawing Package

interfacing with A4 size flat bed plotters
Ideal for business and engineering applications

A comprehensive GRAPH configuration

- * axes may be user defined or automatically fixed
- * data points may be defined or suppressed
- * straight joining lines or curves, the latter from complex calculations automatically executed
- * up to eight colours available
- * up to seven broken line patterns

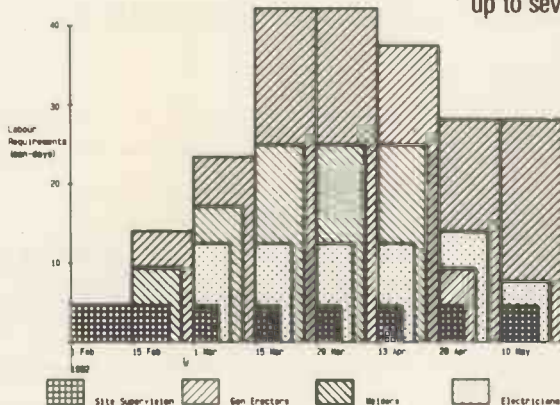
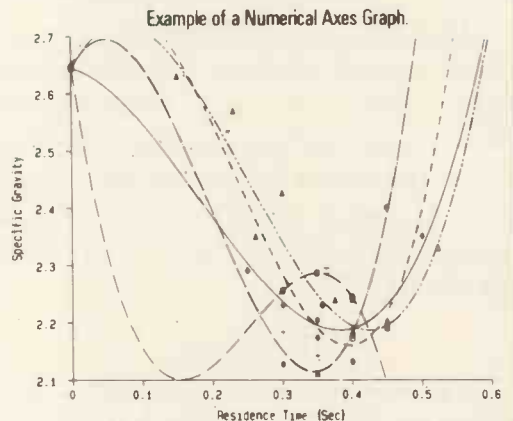

A correctly proportioned HISTOGRAM configuration

- * operates like GRAPH but structures in block format
- * various shading patterns available

A quickly drawn PIE configuration

- * created from very simple input
- * legends located in or outside boundary
- * segments can be shown withdrawn
- * various shading patterns offered
- * up to eight colours available

No screen necessary **MICROPLOT** draws on paper for reports or on film for overhead projection. Will also interface with Supercalc and Micro Modeller. Single or multi coloured plotters supplied.

Call us for literature. Ask for a demonstration.

* All three diagrams reproduced directly from Microplot.

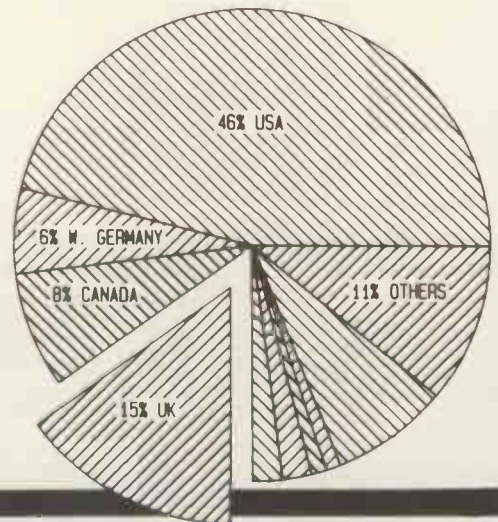

MICROPLOT – A NEW DIMENSION IN VISUAL PRESENTATION – AT ONLY £395 + VAT

KGB

MICROS LIMITED

14 Windsor Road Slough SL1 2EJ Tel: Slough (0753) 38581/38319. Telex 23152 KMICRO
and in Scotland: Micro Change Ltd. Telfer House, 74/80 Miller Street, Glasgow Tel: 041 204 1929

To KGB Micros Ltd – Please send me full details of Microplot.

Name: _____ Position: _____

Company: _____

Address: _____

Tel No: _____

IN STORE

Machine (Price from)	Main Distributor/s (No. of Dealers)	Hardware	Software	Miscellaneous (Documentation)
Gemini Multiboard (£500)	Micro Value 02403 28321(7)	64k RAM: Z80: 25 x 80 VDU int (with Z80): Option: dual 5 1/4" F/D £690.	CP/M: <i>Basic: Cobol: Pascal: Fortran: AP/L:</i>	Modular system. Other options inc ROM board & EPROM programmer. BT 2/82 (H&S).
Gemini Galaxy 2 (£1495)	As above	64k RAM: Z80A: dual 5 1/4" F/D (800k): 12", 25x80 VDU: RS232 port: P/P: C int	CPM: <i>Basic: Cobol: Fortran: Pascal: AP/L: A</i>	Options: dual 5 1/4" FD (800k): dual 8" F/D (2.4Mb)
Gimix System 68 (£2000)	SEED: 05433 78151: Windrush 0692 505189	16-64k RAM: 6800/6809: dual 5 1/4" F/D (500k): 2xRS232 ports.	OS-9: <i>Flex Basic: Pascal: A: Dis A: T/E:U</i>	With dual 8" F/D (2 Mb) £2900. Designed as development system for industrial control. (H).
Genie I (£299)	Lowe Electronics: 0629 2430 (N/A)	16k RAM: Z80: 500bps C: 16 x 64 TV int: extra C int: 1 P/P	Basic (12k ROM): <i>Pascal: A M/A: Fortran</i>	Options: single 5 1/4" F/D (184k) £220; dual 5 1/4" F/D (368k) £375 (I) Also Genie II with numeric keypad and function keys but no cassette (same price as I).
Genie III (£1900)	As above (26)	64k RAM: Z80A: dual 5 1/4" F/D (1.25 Mb): 24x80 VDU: RS232 port: P/P	NewDOS 80: <i>CP/MZ: Basic: Cobol: Fortran: Pascal</i>	System complete with business applications software, maintenance contract and choice of printer £3250 (S).
Grundyl 8200 (£1850)	M-Tech Comp Serv. 0603 870620	64-256K RAM: Z80A: dual 8" F/D (2MB): 24x80 VDU: RS232 port: P/P	CP/M: <i>Basic: Cobol: Fortran: Pascal: Forth: PL/I: Ada</i>	Various hard disk options up to 26MB
Haywood 9000 Composite (£1795)	Haywood: 01-428 0111. (TBA)	64-192k RAM: Z80A: dual 5 1/4" F/D (640k): RS232 port: P/P. 15" 28x80 VDU.	CP/M: <i>Basic: Cobol: Fortran: Pascal: W/P.</i>	Graphics avail. Expandable to 18 Mb H/D. Networking version planned (H&S)
Haywood Hinet (£7500)	As above	64k RAM: Z80A: dual 8" F/D (2Mb): 11Mb H/D: RS232 port: RS422 port: P/P. 24x80 VDU	CP/M: <i>HiNet: Basic: Cobol: Fortran: Pascal</i>	Local area network, up to 32 users. Range of H/D avail. Local disks & printers if required. Work station £2050 (H&S)
HP 75C (£728)	As above	16-24k RAM: 48k ROM: CPU: 32 char display: mag card reader	Basic	8k RAM £142. Video interface £221. Thermal printer £371. (E) BT 11/82
HP 85 (£2013)	Hewlett Packard Ltd: 0734 784774 (16)	16-32k RAM: C.P.U.: 5", 16x32 VDU: C(200k): 64 cps printer: 4 P/P. Options: dual 5 1/4" F/D (540k) £1610: full 8" F/D (2.4 Mb) £4108.	Basic (ROM)	Full dot matrix graphics. Complete range of interfaces, peripherals and application packages avail. 16k RAM £142. (S)
HP86 (£1314)	As above	80k RAM: C.P.U.: 48k ROM. Options: 12", 24x80 VDU £238: 9" 16x80 VDU £216: 5 1/4" F/D (207k) £622	ExBasic	Many expansion possibilities including CP/M module (£362), RS232 port (£289) and up to 576k user RAM. 400x240 graphics. BT 10/82 (E)
HP 125 (£2479)	As above	64k RAM: 2xZ80A: 12", 24x80 VDU 2xRS232 ports: HP-1B port. Options: dual 5 1/4" F/D (500k) £1693	CP/M: <i>Basic: Cobol: Fortran: Pascal: A</i>	Integral thermal printer £629. Also available with dual 8" F/D (2 Mb). (S). BT 3/82
IMS 5000 (£1500)	Equinox: 01-739 2387 (20)	16-56k RAM: Z80: dual 5 1/4" F/D (320k): 2xS/P: 1 P/P.	CP/M: <i>C/Basic: Cobol: Fortran.</i>	3 drives option: (S&H).
IMS 8000 (£2500)	As above	64-256k RAM: Z80: dual 8" F/D (1 Mb): 2xS/P: 1 P/P	CP/M: <i>CBasic: Cobol: Fortran: MicroCobol.</i>	Multi-user MVT/FAMOS available in place of CP/M. (S&H).
Jupiter Ace (£90 inc VAT)	Jupiter Contab,	3k RAM: 8k ROM: Z80A; 24x32 TV int: C int: loudspeaker.	Forth	Has 140 Forth words defined in ROM.
Kemitron K2000 E (£2300)	Kemitron 0244 21817 (3)	64k RAM: Z80A: single 5 1/4" F/D (150k): 12", 24x80 VDU: 2xS/P: P/P	CP/M: <i>Basic: Cobol: Fortran: Pascal: A</i>	Extensive range of support cards and industrial interfaces.
Kemitron K3000 E (£3300)	As above	64k RAM: Z80A: dual 8" F/D (2Mb): 2xS/P: P/P	CP/M: <i>MP/M: Basic: Cobol: Fortran: Pascal: A</i>	Up to four screens and four printers can be attached. Options: 10Mb H/D.
LSI M-Two (£6000)	LSI Computers 04862 23411 (20)	64-128k RAM: 8085A: dual 8" F/D (1.2 Mb): 12" 24x80 VDU: 60 cps printer	Elsie: <i>CP/M: Basic: Cobol: Fortran: Pascal: A: U</i>	Max 8 VDUs and 4 printers. Many applications packages available. Option: 10 Mb H/D £2600. (S).
LSI M-Three (£1700)	As above	64k RAM: Z80A: dual 5 1/4" F/D (350k): 12", 24x80 VDU: RS232 port: P/P	CP/M: <i>Basic: Cobol: Fortran: Pascal: A</i>	Option: Dual 8" F/D, 10 Mb H/D (E)
LSI M-four (£2175)	As above	128-256k RAM: Z80B: 8088: dual 5 1/4" or 8" F/D 3xRS232 ports: RS422 port: P/P 12" 24x80 VDU	MS-DOS: <i>CP/M-86 Basic: Cobol: Fortran: Pascal: MP/M-86</i>	Operates on either 8-bit or 16-bit applications software. Option: 10 Mb H/D
Macro 1 (£3950 or £294 pm).	Micro APL Ltd. 01-834 2687 (TBA)	64k RAM: Z80A: dual 8" F/D (1 Mb): 4xRS232 ports.	CP/M: <i>APL: U: Basic: Fortran: Cobol: Word-2star Algo: Pascal: Forth.</i>	Designed as timesharing replacement. Macro 2 with 2 Mb F/D £4750 or £334 pm.
Marinchip M9900 (£4990)	Microprocessor Eng. 0703 775482	128k RAM: 9900: dual 8" F/D (2Mb): 4xRS232 ports.	NOS: <i>Basic: Pascal: W/P: SPL: Forth: Meta</i>	Multi-user/multi-tasking OS. Options: H/D up to 120 Mb.
Micro Trainer 1 (£650)	Hewart: 0625 22030 (N/A)	16-32k RAM: 6800/6809: 10" 16x24 VDU: 2xC int: Opt: dual 5 1/4" F/D (160k) £595: 8k RAM £17.	Basic: <i>A: Pascal: PL/M: W/P</i>	SS50-based system. Graphics avail. Int card with real time clock £17. (1)
Millbank Sys 10 (£2395)	Millbank: 01-891 4691(6).	65k RAM: Z80: dual 5 1/4" F/D (700k): 12", 24x80 VDU: 2x RS232 ports: RS449 port: P/P.	CP/M: <i>Basic: Cobol: Fortran: Pascal: PLI: W/P.</i>	12-month warranty. Main-frame comm. package. Maintenance contracts. Options: 1.6 Mb F/D. 5-50 Mb H/D. (S&H)
Munroe EC8800 (£2150)	Fi-Cord Int. 061 445 7716	128k RAM: Z80A: single 5 1/4" F/D (320k): 3xRS232 ports: P/P	Munroe Multitasking System: <i>CP/M: Basic: Cobol: Fortran: Pascal</i>	High res colour graphics. Option: single 5 1/4" F/D. (320k). £495

List of Abbreviations

A Assembler	G/C Graphics card	M/A Macro assembler	S Software
BT Bench Tested	H Hardware	N/A Not available	S/P Serial port
C Cassette	H/D Hard disk	N/P Numeric pad	T/E Text editor
E Extensive	I Introductory	O/S Operating system	TBA To be announced
F/D Floppy disk	Int Interface	P/P Parallel port	U Utility

Please note: Software items listed in *italic* are not included in the basic price of the equipment. All prices are *exclusive* of VAT.

IN STORE

Machine (Price from)	Main Distributor/s (No. of Dealers)	Hardware	Software	Miscellaneous (Documentation)
Munroe OC8820 (£2990)	As above	128k RAM: Z80A: dual 5 1/4" F/D (640k): 9", 24x80 VDU: 3xRS232 ports: P/P	As above	5MB H/D avail soon. BT 4/82.
Nascom 3 (£549)	Lucas Logic 0926 59411	48-60k RAM: Z80: dual 5 1/4" F/D (700k): RS232 port: P/P.	Basic: <i>Pascal</i> : A: <i>CP/M</i> : <i>Cobol</i> <i>Fortran</i>	Options dual 5 1/4" F/D (700k) £685: 48k RAM £130.
NEC PC 8001 (£599)	IBR 0734 664111	32k RAM: Z80A: P/P Option: dual 5 1/4" F/D (326k) £699	Basic N: (24k ROM) <i>CP/M</i> : <i>Fortran</i> : <i>Cobol</i> : <i>Pascal</i> .	Colour monitor £359 (low res) or £579 (high res) both 12", 25x80 many expansion units avail. (E) BT 6/81
Newbrain Model A (£199)	Grundy: 0223 350355 (TBA)	32k-2 Mb RAM: Z80A: Nat 420: 2xC int: TV int: 2xV24 ports.	CBasic (29k ROM): A.	Graphics. Battery or mains. Options: 1/2 Mb RAM £450. Also Model AD £299. (E).
North Star Horizon (£1975)	Comart: 0480 215005. (25) Trader Comp. 01-328 3484 (60)	32-64k RAM: Z80A: dual 5 1/4" F/D (360k): 15", 24x80 VDU: 150 cps printer: 2 S/P: 1 P/P.	DOS: Basic: <i>CP/M</i> : <i>Cobol</i> : <i>Fortran</i> : <i>Pascal</i> .	Options: 5-18 Mb H/D, Multi-user.
North Star Advantage (£2195)	As above	64k RAM: Z80A: dual 5 1/4" F/D (720k): 12", 24 x 80 VDU: S/P.	GDOS: <i>CP/M</i> : <i>CBasic</i> : <i>MBasic</i> : <i>Fortran</i> : <i>Cobol</i> : <i>Pascal</i>	Price includes business graphics & demo software.
Oki if 800 (£3000)	Encotel. 01 686 9687	64k RAM: Z80A: 2k ROM: dual 5 1/4" F/D (768k): 12", 24x80 VDU: 80 col printer: loudspeaker: RS232 port: 20k ROM cartridge.	Basic: A: <i>CP/M</i> : <i>Cobol</i> : <i>Fortran</i> :	Fully integral unit. Graphics. Options: dual 5 1/4" F/D (560k): RS232 port: PP. (1). BT 10/81
Olivetti M20 (£2395)	Olivetti 01 785 6666	128k-512k RAM: Z8001: 2-8k ROM: dual 5 1/4" F/D (640k): RS232 port: P/P	Basic: <i>PCOS-A</i>	Alternative 8086 processor board to run CP/M86 & MS-DOS. Options: 11 Mb H/D (integral): printer £738. (S) B/T 9/82
Onyx C8000 (£6875)	Onyx Dist Ltd: 09066-5432 (TBA)	64k RAM: Z80: 12 Mb Cartridge: 10 Mb H/D: 4 S/P: P/P	<i>CP/M</i> : <i>MP/M Oasis</i> : <i>Unix</i> : <i>Fortran</i> : <i>Pascal</i> : <i>W/P</i>	C8001 with 128k RAM £8220. Multi-user version avail. using Oasis. (E) BT 3/81.
Oric 1 (£100 inc VAT)	Oric Products Int 0990 27641	16-48k RAM: 6502A: 28x40 TV int: C int: S/P: P/P: Loudspeaker	Basic (16k ROM): <i>Forth</i>	With 48k RAM and <i>Forth</i> on cassette £170 inc VAT. 240x200 colour graphics. Micro disk and modem avail soon. Viewdata compatible.
Osborne 1 (£1250)	Osborne 0908 615274(40)	64k RAM: Z80A: dual 5 1/4" F/D (200k): 5", 24x52 VDU: RS232 port: P/P	<i>CP/M-W/P</i> : <i>Cobol</i> <i>Fortran</i> : <i>Pascal</i> <i>CBasic</i> : <i>MBasic</i> : <i>Wordstar</i> : <i>Mailmerge</i> : <i>Supercalc</i> <i>Forth</i>	Integral system in weatherproof carrying case. Will run on battery pack. Option: dual 5 1/4" F/D (400k): BT11/81.
Oscar (£2560)	IDS Ltd: 0908 313997(30)	64k RAM: Z80: dual 5 1/4" F/D (800k): 12", 25x80 VDU: RS232 port: 1 P/P	<i>CP/M</i> : <i>Basic</i> : <i>Pascal</i> <i>Fortran</i> : <i>Cobol</i> : <i>W/P</i> : <i>A</i>	Also avail. with dual 5" F/D (1.6Mb) £2905 and 8" F/D (2Mb) £3380. Advanced video board. S&H).
Panasonic JD 800M, JD850M (£3300, £4350)	Panasonic Business Equipment: 0753 75841 (10 regional dist)	64k RAM: 8085A: 4k PROM: dual 8" F/D JD800M (500k): JD850M (2 Mb): 12", 24x80 VDU: 3xRS232 ports. P/P	<i>CP/M</i> : <i>Basic</i> : A <i>Micro-Cobol</i> .	Option: 8.4 Mb H/D £2725 (up two). BT3/80(S).
Pascal Microengine (£2295)	Pronto Electronic Systems Ltd: 01-554 6222	64k RAM: MCP 1600: 2x RS232 ports: 2 P/P.	<i>Pascal</i> .	CPU instruction set is P-code: no interpreter needed. Available with dual 8" F/D (2 Mb) £3900.
Pasca 640 (£1900)	Westrex Ltd: 01-578 0957 (TBA)	64k RAM: Z80A: dual 8" F/D (512k): 12", 24x80 VDU: RS232 port: P/P	<i>CP/M</i> : <i>Basic</i> : <i>Cobol</i> : <i>Fortran</i> : <i>Pascal</i> : A: <i>W/P</i> : <i>U</i>	Maintenance contracts avail. Option: 5-20 Mb H/D. (S) BT 5/18
Philips P2000 (£2444)	Philips Data	16-48k RAM: Z80: dual 5 1/4" E/D (140k): 12", 24x80 VDU: RS232 port.	PDOS: UCSD p-system: <i>Pascal</i> : <i>Basic</i> <i>Fortran</i> : A.	With 48k RAM, <i>Pascal</i> and <i>Basic</i> £3300: BT 12/81.(S).
Position 900 (£1950)	Position Comp. 09252 29741 (10)	64-512k RAM: 6809: 4xRS232 ports: IEEE-488 port: 1200 band C: dual 5 1/4" F/D (720k)	OS-9: <i>Basic</i> 09: <i>Pascal</i> : C: A: <i>Cobol</i> : <i>U</i> : <i>FLEX</i> <i>O/S</i>	Supports 4 users, expandable to 8. Networking allows 28 users on 7 Options dual: 5 1/4" F/D (1.4 Mb): 5-40 Mb H/D (E)
Position 9000 (£1536)	As above	64-512k RAM: 6809: 4xRS232 ports: IEEE-488 port: 1200 band C.	OS-9: <i>Basic</i> 09: <i>Pascal</i> C: A: <i>Cobol</i> : <i>U</i>	240x240 high res colour graphics. Viewdata compatible. Disk options as above. Supports 5 users. Networking allows 35 users on 7 systems (E) BT 10/82.
Prince (£3045)	Digico: 04626 78172 (50)	64k RAM: 3xZ80A: dual 5 1/4" F/D (800k): 2xRS232 port: P/P 12", 25x80 VDU	<i>CP/M</i> : <i>Basic</i> : <i>Pascal</i> : <i>Fortran</i> : <i>Cobol</i> : <i>W/P</i> : <i>A</i> : <i>T/E</i> : <i>U</i>	High res graphics. Options: single 5 1/4" F/D (400k) £600: dual 8" F/D (2 Mb) £2000 5-10Mb H/D. Rentals avail. (S).
Quantum 2000 (£2250)	Quantum Comp Sys 0532 458877	64k RAM: Z80A: dual 8" F/D (2.4Mb): 12", 24x80 VDU: C int: P/P	<i>CP/M</i> <i>Basic</i> : <i>Cobol</i> : <i>Fortran</i> : <i>Pascal</i> : A	Many expansion boards avail inc high res colour graphics. Option: 5-10Mb H/D.
Rair Black Box 3/30 (£3750)	Rair: 01-836 6921 (N/A)	64-512k RAM: 8085: dual 5 1/4" F/D (500k): 6 Mb H/D: 2xRS232 ports.	<i>CP/M</i> : <i>Basic</i> : <i>Cobol</i> : <i>Fortran</i> : M/A	64k RAM expansion £500. 256k RAM £1250. Up to 16 RS232 ports.
Research Machines 380Z (£1867)	Research Machines: 0865 249866 (N/A)	32-56k RAM: Z80A: dual 5 1/4" F/D (300k) RS232 port. P/P.	ExBasic: A: <i>T/E</i> : <i>U</i> : <i>CP/M</i> : <i>Fortran</i> : <i>Cobol</i> : <i>Algol</i> : <i>Pascal</i> .	High res colour graphics. Many possible systems. With 56k RAM & dual 8" F/D (1 Mb) £3347.
Research Machines Link 480Z (£560)	As above	32-64k RAM: Z80A: C: 2xS/P: P/P	Basic: <i>T/E</i>	High res colour graphics. Network station.

List of Abbreviations

A Assembler	G/C Graphics card	M/A Macro assembler	S Software
BT Bench Tested	H Hardware	N/A Not available	S/P Serial port
C Cassette	H/D Hard disk	N/P Numeric pad	T/E Text editor
E Extensive	I Introductory	O/S Operating system	TBA To be announced
F/D Floppy disk	Int Interface	P/P Parallel port	U Utility

Please note: Software items listed in *italic* are not included in the basic price of the equipment. All prices are *exclusive* of VAT.

Whatever your system



**I promise
to tell the truth
the whole truth
and nothing but the truth
time, after time, after time....**

DYSAN diskettes, acknowledged to be the industry leader in quality and data integrity, tested on and between the tracks to be 100% error free. When you commit your business to magnetic media, commit to DYSAN and judge the difference for yourself.



DISC PACKS AND CARTRIDGES ALSO AVAILABLE



TECHNICAL SUPPORT FROM
HAL'S ENGINEERING TEAM



QUANTITY
DISCOUNTS



FOUR HOUR ORDER
TURNROUND



EX STOCK
AVAILABILITY

Please tell me more about the
range of Dysan Media for my system.

Name

Address

Telephone No.

Computer System

Ring the Dysan hot line now on Farnborough 517171
or complete the coupon.

HAL Computers Limited
Invincible Road, Farnborough
Hants. GU147QU
Telephone (0252) 517171



Home Computer Show Manchester

April

THURSDAY 21 (12am - 7pm)
 FRIDAY 22 (10am - 6pm)
 SATURDAY 23 (10am - 6pm)

AT THE
Midland Hotel
 PETER STREET

VISIT THE COMPLETE SHOW FOR THE HOME USER AND SEE:
 A COMPLETE cross section of all hardware and software available to the home user.
 A FULL RANGE of home computers priced from £50 upwards.
 A COMPUTER ADVICE CENTRE run by independent experts for the answers to all your questions.

WIN WIN WIN TWO COMPUTERS — one for you, one for a school of your choice — to be won at each show: FREE entry form with advance tickets

ADULTS: £2.00 UNDER 8s & OAPs: FREE 25% DISCOUNT for parties of 20 or more

COMING SOON
 MAY BRIGHTON
 JUNE BIRMINGHAM

Sponsored jointly by:

Computing Today Personal Software
 Personal Computing Today
 Home Computing Weekly ZX Computing

PCW

Home Computer Show
 Please enclose SAE
 Send £1.00 Save £1.00
 Mr. Mrs. Miss
 Address
 ASP Exhibitions
 145 Charing Cross Road
 London WC2H 0EE
 01-437 1002

What do you do if your BBC Micro goes wrong?

If you value your BBC Micro and your money you can now purchase extra one and two year full guarantees direct from us or via most Acorn dealers.

If your Micro is still under warranty, just fill in the expiry date on the coupon* and the guarantee will start from that date.

We carry a full stock of parts and should your computer malfunction we will repair it within five days of receipt.

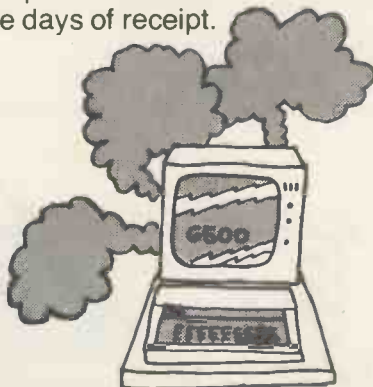

A full one year guarantee costs just £18.40
 And a full two year guarantee costs just £27.60

If your Micro is already faulty, and out of guarantee, we will repair it on receipt and issue a full years guarantee for £29.90 or a full two years guarantee for £39.10. Please state fault when sending micro.

For you and your BBC Micro's peace of mind send the coupon today

Please tick service required.

I enclose £18.40 for a full 1 years guarantee

I enclose £27.60 for a full 2 years guarantee

I enclose £29.90 for an immediate repair and a full 1 years guarantee

I enclose £39.10 for an immediate repair and a full 2 years guarantee

Surname Access Card No

Initials Make/Model A/B

Address Serial No.

..... Send remittance to:

**Cambridge Processor Services,
 25 Parsonage Street, Dept.PCW
 Cambridge CB5 8DN.**

or telephone your access card number to Madingley 210212

Warranty Expiry*
 Date / /83
 If applicable

This offer applies to mainland UK only. This guarantee does not apply to major damage caused by abuse.

IN STORE

Machine (Price from)	Main Distributor/s (No. of Dealers)	Hardware	Software	Miscellaneous (Documentation)
Sage II (£2870)	TDI 0272 742796	128-512K RAM: 68000: single 5 1/4" F/D (320k); VDU int: RS232 port: P/P	UCSD p-System: Pascal Basic: Fortran: M/A	Price includes 1 year service. With 512k RAM and dual 5 1/4" F/D (1MB) £4594 BT 2/83
SEED System 1 (£1900)	Strumech: 05433 78151 (5)	32-56k RAM: 6800: various disk options: 12", 24 x 80 VDU: RS232 port: P/P	DOS: Basic: M/A: CBasic: A: T/E	Graphics. PROM programmer Also system 19 multi-user (£3000). (E)
Sharp MZ-80K (£460-34k)	Sharp Electronics (UK) Ltd: 061-205 2333 (22)	6-48k RAM: Z80: C: 10" 24 x 40 VDU: Option: dual 5 1/4" F/D (289k) £695	Basic, A. CP/M: Pascal: Fortran: Forth	Graphics: loudspeaker. BT 10/79 (B)
Sharp MZ80A (£549)	Sharp Electronics (UK) Ltd 061 205 2333 (22)	48k RAM: Z80: 25x40 VDU: C: P/P. Options: single 5 1/4" F/D £400: dual 5 1/4" F/D £590: RS232 port	Basic: CP/M: A: Pascal: Fortran: Cobol	Expansion unit needed for disks (£100) Low res (80x50) graphics. Loudspeaker Numeric pad (B)
Sharp MZ-80B (£1095)	As above	64k RAM: Z80A: C: 9", 25 x 80 VDU: RS232 port: P/P.	Basic: A: Pascal: FDOS	High res graphics. Options: dual 5 1/4" F/D (560k) £800: 80 cps printer £415. (S)
Sharp PC1500 (£150)	As above	3-11k RAM: CPU: 16k ROM: 26 char LCD	Basic	Full system with dual cassette int. and miniature four colour plotter £375. RS232 port avail. soon. (B). BT 6/82
Sharp PC3201 (£2995)	As above CP/M: Cobol	64k RAM: Z80A: dual 5 1/4" F/D (500k); C int: 12", 25 x 80 VDU: 70 lpm printer.	DOS: U: Basic: CP/M: Cobol.	Various expansion cards avail. BT 7/81 (I&B)
Sharp PC1251 (£80)	As Above	3k RAM: 8-bit CPU: 24 char LCD	Basic (24k ROM)	Portable. Printer/cassette unit £100 BT 2/83
Sig/Net100ZS (£1299)	Shelton 01 278 6273 (5)	64k RAM: Z80A: dual 5 1/4" F/D (400k); 2xRS232 ports	CP/M: Basic: Cobol: Fortran: Pascal	Various disk options, up to 16 Mb H/D
Sinclair ZX81 (£50 inc VAT)	Sinclair: 0276 66104 (300+)	1-16k RAM: Z80A: C int: TV inb: full K/B: 44-pin expansion port.	Basic (8k ROM).	Advanced 4-chip design. Printer now avail. BT 6/81
Sinclair ZX Spectrum (£125 inc VAT)	Sinclair: 0276 685311	16-48k RAM: Z80A: 16K-ROM: T.V. int: C int	Basic	Options: 32k RAM £60. RS232 port and microdrive disks avail soon. BT 6/82
Smoke Signal Chieftan (£1800)	Windrush 0692 405189: (TBA)	32-64k RAM: 6800/6809: dual 5 1/4" F/D (500k); 2 x RS232 port.	DOS: 68/FLEX: Basic: Fortran: Cobol: A: Disc A: Pascal: U.	With dual 8" F/D (2 Mb) £2600. Designed as development system for industrial control. (H).
Sorcerer (£790)	EMG 0293 519211 (27)	48k RAM: Z80: RS232 port: L/P/P: S100 connector: 30x64 VDU int. N/P.	O/S: Basic (ROM): A: Algol: Fortran: MBasic: ExBasic: 80. Pascal: W/P.	High-resolution graphics capability: user programmable character set, Option: single 5 1/4" F/D (316k) £600 Video disk unit (1.5Mb) £1890
Sord M100 ACE (£2339)	Midas Computer Services Ltd: 07917 64686 (10)	48k RAM: Z80: 8k ROM dual 5 1/4" F/D (245k); 24 x 64 green VDU: RS232 port: N/P	O/S: Basic: A: Fortran: Pascal.	Up to 3 drives possible. Colour graphics avail. Option S100 bus. (I)
Sord M223 Mk II-V1 (£4078)	As above	64k RAM: Z80: 8k ROM: dual 5" F/D (700k); 12", 24 x 80 green VDU: RS232 ports: S100 bus: N/P	O/S: Ex Basic: CBasic: Multi-User Basic: Fortran: Cobol	Expandable to 4 Mb F/D. 32 Mb H/D, 5 screens, 2 printers. M243 with 192k RAM & 1.4 Mb F/D £5087.
SPC/I (£3140)	Digital Data: 01-573 8854	96-1056k RAM: 8085 A-2: dual 5 1/4" F/D (280k); 12", 24 x 80 VDU: 2 x RS232 ports: Option: Up to 106 Mb H/D	Mikados, Comal: Pascal: A.	Expandable to multi-user system (8 users). BT 7/80 (S).
Superbrain (£1750)	Icarus: 01-485 5574 (45)	64k RAM: 2 x Z80: dual 5 1/4" F/D (320k); 12" 25 x 80 VDU: 2 x RS232 port.	CP/M: A: Basic: Cobol: Fortran: APL: Pascal	Limited graphis, Mainframe int avail. With 676k F/D £2090, 1.5Mb £2345. With 5Mb H/D & single 338k F/D £3950. BT 8/80. (S&H)
SWTPc/09 (£3850)	SWTP Ltd 0733 234433	64k RAM: 6809: dual 5 1/4" F/D (1.5MB) 2 S/P: P/P: 12", 24 x 80 VDU	Flex O/S: Basic: A: T/E	Expandable to 768k RAM
SWTPc S/09 (£7000)	As Above	128k RAM: 6809: dual 8" F/D (2.5MB) 2 S/P: 1 P/P	Uniflex O/S: Cobol: Basic: Fortran: C. Pascal: A: Pilot: Forth.	Up to 80MB H/D. Multi-user, multi-tasking, up to 18 users
System 10 (£2995)	Millbank 01-788 1083 (TBA)	64k RAM: Z80: dual 5 1/4" F/D (700k); 12", 24 x 80 VDU: 2 x RS232 port: P/P	CR/M: Basic: Fortran: Pascal: Cobol: PL/1: W/P	12 month warranty. Maint. contracts. Applications packages avail. Choice of high level language in price. (E)
Tandberg EC10 (£3250)	Tandberg: 0532 774844 (N/A)	64k RAM: 8080 A: single 8" F/D (250k); 12" 25 x 80 VDU: 7 x RS232 ports: printer int.	CP/M: Ex Basic (24k) Multi-user Basic: Pascal: Cobol: A: U:	Up to 7 terminals. Includes V28 comms port. (S&H)
Tandy PC-2 (£179 inc VAT)	As above	3-11k RAM: CPU: 16k ROM: 26 char LCD	Basic	System with dual cassette int. and miniature four colour plotter £338 inc VAT. RS232 port avail. soon. (B)
Tandy TRS-80 Model I (£174)	Tandy: 0922 648181 (200)	16-48k RAM: Z80: C: 12", 16 x 64 VDU: RS232: P/P	Basic (12k ROM). A.	Fully expandable. Option: single 5 1/4" F/D (175k) £320 (up to 4). Many extras available. 32k RAM £260. (I)
Tandy TRS-80 Model II (£2347)	As above	64k RAM: Z80: single 8" F/D (500k) 12" 24 x 80 VDU: 2 x RS232 port: P/P	Basic M/A Fortran: Cobol 3-32 Mb H/D	Option: single 8" F/D (500k) £782 (subsequent £391, up to 4). 8-32Mb H/D
Tandy TRS 80 Model 3 (£434-£1477)	As above	See Model I Levels I and II		Fully integral unit. Up to 2 integral and 2 external 5 1/4" F/D. BT 8/81

List of Abbreviations

A Assembler
BT Bench Tested
C Cassette
E Extensive
F/D Floppy disk

G/C Graphics card
H Hardware
H/D Hard disk
I Introductory
Int Interface

M/A Macro assembler
N/A Not available
N/P Numeric pad
O/S Operating system
P/P Parallel port

S Software
S/P Serial port
T/E Text editor
TBA To be announced
U Utility

Please note: Software items listed in *italic* are not included in the basic price of the equipment. All prices are *exclusive* of VAT.

IN STORE

Machine (Price from)	Main Distributor/s (No. of Dealers)	Hardware	Software	Miscellaneous (Documentation)
Tandy TRS-80 Colour (£209)	As above	16-32k RAM: 6809; 8-16k ROM: C: 16 x 32 TV int: RS232 port.	Colour Basic.	With 16k RAM, 16k ROM & Extended Colour Basic £261 (I). BT 9/81.
Tandy TRS-80 Model 16 (£3651)	As above	128-512k RAM: Z80A 68000: dual 8" F/D (1-2Mb); P/P: 2xRS232 port.	TRSDOS: A: <i>Cobol Basic</i>	Will run all Model 11 software. System with single 5 1/4" F/D (600k) and 8Mb H/D £5911. Options: 8Mb H/D £2173 (up to four); 640x240 high res graphics: Multi-user system avail. soon. (S)
Tele Video TS800 (£3100)	Colt 01-577 2686	64k RAM: Z80A: dual 5 1/4" F/D (700k); P/P: S/P: 24x80 VDU: 80 cps printer.	CP/M: <i>Basic: Cobol: Fortran: Pascal</i>	Fully expandable to local area network with 16 users. 8 and 16 bit versions avail. and full set of application software. (S)
Terodec PBM-1000 (£4020)	Terodec: 0734 664343 (40)	80k RAM: Z80A: single 5 1/4" F/D (819k); 6Mb H/D: 2xS/P: P/P	CP/M CP/Net CBasic: <i>Fortran: Pascal: Cobol</i>	System with Okidata 80 printer: TV 1 910 VDU: W/P and various application packages £5995 (S&H)
TI 99/4A (£199 inc VAT)	TI: 0234 67466 (TBA)	16-48k RAM: 26k ROM: 9900: 2 x C int: 24 x 32, 16 colour TV int: 3 tones & noise: P/P.	OS: Basic.	12 month guarantee. Options 32k RAM: 2 x RS232: 3 x 5 1/4" F/D (92k each): Speech Synthesiser.
Torch (£12795)	Torch Comp. 0223 841000 (30)	64k RAM: Z80A: dual 5 1/4" F/D (800k); 12", 24x80 colour VDU: RS232 port: P/P: Modem	CPN: BBC Basic:	O/S is CP/M compatible. With 21MB HD and single F/D £5495. B/T 1/83
Tuscan CP/M Starter (£999)	Transam: 01-405 5240 (N/A)	24k RAM: Z80: single 5 1/4" F/D (190k); Cint: TV int: RS232 port: P/P: N/P.	CP/M: <i>Basic: Fortran: Pascal: Cobol:</i>	Options: single 5 1/4" F/D (190k) £155; single 5 1/4" F/D (370k) £285; 16k RAM £162; 3 Mb H/D £1450; 20 Mb H/D £2970 (S&H)
Tuscan Starter Kit (£299)	As above	8k RAM: Z80: Cint: 56-key K/B Options: Case £110: 5 x S100 sockets £20: TV int £3.50	8k Basic	Fully assembled version £499 BT 1/81 (H&S)
Vector MZ (£2650)	Almarc: 0602 52657 (3)	56k RAM: Z80A: dual 5 1/4" F/D (630k); 3 S/P: 2 P/P.	CP/M: <i>Basic: Algol: Cobol: Pascal: Fortran: Coral: CBasic: A.</i>	High resolution graphics. Also system B with video board & terminal £3450. (E)
Vector System 2800 (£4600)	As above	56k RAM: Z80A: dual 8" F/D (2.4 Mb): 3 S/P: 2 P/P	As above	High-res graphics. Many Options. Fully expandable to 5005 multi-user system (max 5) £5400.
VIP (£2650)	Almarc 0602 52657 (3)	64k RAM: 3k ROM: Z80B: single 5 1/4" F/D (630k); 12", 24 x 80 VDU: RS232 port, 3 x P/P	CP/M: <i>Basic: Fortran: Cobol: Pascal: A.</i>	Up to 3 additional F/D drives. Options: dual 8" F/D (2 Mb) £1063, 32 Mb H/D (TBA). (H&S). BT2/81
Windrush 6809 (£2418)	Windrush 0692 405189	56k non-volatile CMOS RAM: 6809: 2xRS232 ports: 2xP/P: dual 5 1/4" F/D (700k)	OS-9: <i>Flex: Uniflex Basic: A: PL9: SPLM: Cobol: Fortran: Pascal</i>	Designed as development system for industrial control/computer station for commercial OEM's. With dual 8" F/D (2 Mb) £2953. (E)
Xerox 820 (£1845)	Business Comp Sys 01 207 3344	64k RAM: Z80: single 5 1/4" F/D (162k); 12", 24 x 80 VDU; 2 x RS232 ports: P/P	Monitor: <i>CP/M: Basic: Cobol: Fortran: Pascal.</i>	With 8" F/D (500k) £2250. CP/M £95. BT 1/82 (S+H)
Zenith WH-11A (£2673)	Zenith Data Systems 0452 29451 (TBA)	LSI 11: 16-32k RAM: 25 x 80 VDU: S/P: P/P.	O/S: <i>Basic, Fortran: A: U.</i>	PDP 11-compat. Option: 2 x 8" F/D (1 Mb). £1717 (S&H).
Zenith Z89 £1570-£1710	As above	16-48k RAM: Z80: single 5 1/4" F/D (102k); 12" 24 x 80 b&g vdu: RS232.	<i>Basic: A: HDOS: CP/M: MBasic: CBasic: Fortran.</i>	3 x 5 1/4" F/D possible. Options: dual 8" F/D (1 Mb) £1717, 20 Mb H/D.
Zilog MCZ 1/05 (portable): MCZ 1/20A (£3250)	Thames Systems: 084421 5471 (N/A)	64k RAM: Z80: dual 8" F/D (600k); RS232 port: MCZ1/20A only 1 P/P: Option: 10 Mb H/D £7100	RIO: O/S: <i>Cobol: Basic: Fortran: Pascal: M/A: U.</i>	Available desk top or rack mounted. Debug in 3k PROM. 1/20A runs multi-user Cobol, up to 5 terminals with 40 Mb H/D. (S&H).

ACC NEWS

Rupert Steele presents his monthly round-up of news from the Amateur Computer Club.



Two important telephone-related meetings have occurred recently, one about bulletin boards and one about Prestel. But wait a minute, you say, what is a Bulletin Board? Read on...

The idea of a bulletin board is that, on the end of a phone line, there is a computer which people can talk to via a modem. The computer gives each user an identity, and they can leave messages for each other, or for a wider audience. Typically they operate at 300 baud and run unattended; there is a privileged user, or system operator, who can give special commands to help

keep the system going. Ideally, the machine should automatically re-boot in the case of power (or other) failure.

Earlier this year there was a meeting in the restaurant of Manchester Airport attended by the system operators of many of the country's bulletin boards. The meeting agreed to set up AFPAS (Association of Free Public Access Systems) as an organisation to handle proposals for common standards and inter-board liaison. Other functions for the association were to promote the distribution of public domain software, and to

promote both bulletin boards, and data communications in general.

On standards there was some progress, and from 1 May this year all bulletin board systems in the UK are expected to support the following protocol: ASCII, 7 data bits, even parity, 1 start bit, 1 stop bit, asynchronous. Optionally XON/XOFF support may be included (with timeouts to protect the board), as may a file transfer mode via the 'modem' protocol. The Secretary of AFPAS, elected at the meeting, will be Fred Brown on 421 Endike Lane, Hull HU6 8AG.

The boards that belong to the association are:

CBBS.NE (19.00 — 0.00) 0207 32447;
Bettisfield remote CP/M (13.00 — 17.00/19.00 — 23.00) 094-875 378;
Mailbox 80 Liverpool (9.00 — 17.00/19.30 — 22.00/12.30 — 22.00 weekends) 051-220 9733;
London local (22.00 — 01.00) 01-348 6518;
Forum 80 Hull (Tue/Thur 19.00 — 22.00; Sat/Sun 12:00 — 22:00) 0482-859 169;
CBBS London 01-399 2136.
The number of Mailbox 80 Liverpool may change, but the

ACC NEWS

new number will be posted on Forum-80 Hull. All of the above run at 300 baud, CCITT V21 standard.

Meanwhile, on the Prestel front, the Club Spot 800 is now up and going. The editors' conference, held in Watford at the end of February, proved to be a great success, with all the places taken; in fact we were over-subscribed, so there may well be a repeat Club Spot editors' conference elsewhere in the country.

The meeting was introduced by David Babsky, the editor of Miconet 800, and there was a session on the technicalities of editing, given by Tony Sweet of BT Prestel. There was a successful, though probably too short, 'hands-on' editing session, and then a talk by Vernon Quaintance of the ACC National Prestel Committee on the organisation of Club Spot.

The Club Spot is ultimately run by the ACC National Prestel Committee on the organisation of Club Spot.

The Club Spot is ultimately run by the ACC National Prestel Committee, which has recently been enlarged to take on representatives of the national user groups and local clubs. Representatives from BASIG, ICPUG and the Merseyside area were elected; finally our thanks are especially due to Stephen Rabagliati and IGD for providing such an excellent venue for the conference.

By the time this appears in

print, the editors will have been beaver away for some time, and there should be quite a bit of material in the Club Spot for you to look at. Club Spot 800 is of course on *8008#, part of the Miconet 800 area. If you've got Prestel (either directly or via Miconet), why don't you have a look and tell me what you think? And, of course, if you want to edit material up on Prestel, then get in touch with me about becoming an editor.

It must be over a year since the last Club was featured, but the Coventry Computing Circle looked so interesting that I thought they deserved more than a simple mention. The club, which boasts no less than 330 members, is run by Chris Baughan, of 9 Hillman House, Smithford Way, Coventry, CV1 1FZ. His phone number is 0203 25802 (evenings).

There is no membership charge for the club, the only requirement being an 'interest in computing'. The club newsletter is computerised, and lives at Mr Baughan's computer sales business. The member contribute to the contents of the newsletter by keying in their item, but it an enquiry seeking an answer, a program they've written that they wish to share, an item wanted or for sale, or anything else that they see fit.

The newsletter is printed out on request, but the computer program remembers which pages have been printed

on behalf of which members and will ensure that only items entered since the last print-out for that member will be printed out this time. The group does not, as yet, have formal meetings, though Chris says that he is able to organise these, should his members want them. The idea would be to have 'interesting people' coming to chat, rather than a more formal lecture.

The emphasis of the whole set-up is on informality, with a loosely defined free membership; the contrast with tightly formalised clubs such as OPeCC (the Oxford Personal Computer Club) is quite interesting; both organisations are very successful, despite the completely different approach to running the club.

There is a burst of activity in the Bedford and Luton area this month. A Mr D Buckingham, of 83 Neville Road, Limbury, Luton LU3 2JG (phone Luton 570125) has started 'The Dragon's Den', a new independent national user group for the Dragon microcomputer.

A Mr Stephen Betts, who was late for the Club Sport 800 Conference, having been delayed as a result of losing his shirt, is the Secretary of the Chiltern Home Computer Club (do not confuse this with the separate Chiltern Computer Club). His address is 42 Wallace Drive, Eaton Bray, Beds LU6 2DF. They are a general club, with interests in many machines, so if you live in the area why not drop him

a line for the details of the next meeting.

Mr Rowan Bird also runs a club in the same general area, but further north. He is the secretary of the Bedford Amateur Computer Club, and his address is 7a High Street, Great Barford, Beds, MK44 3LB. The club has now been running for two and a half years. They meet twice a month, on the first and third Tuesday, with a formal lecture or visit on the first Tuesday and something more informal on the third. The meetings are held at Bedford Star Rowing Club at 8pm, and the subscription is three pounds with reductions for students.

Scotland is once again the source of much computer clubbery. A Mrs Annette Johnston tells me that she is secretary of the Stonehaven Computer Club, and she lives at 7 Dunnottar Avenue, Stonehaven, Kincardineshire, Scotland, AB3 2JD. Also in these northern parts is the Scottish TRS-80 user group. The chap to contact there is Mr Dick Mackay, on 031-229 6032, and the meeting place is Mansion House Hotel, Wilton Road, West Edinburgh. Meetings are on the second Thursday of each month.

Details of the ACC and Club Spot 800 can be obtained from: Rupert Steele, St John's College, Oxford, OX1 3JP. Tel: Oxford (0865) 512811.

TRANSACTION FILE

Readers will be pleased to know that, due to our clever layout ideas, the Transaction File is up-to-date and waiting cut down considerably. Ads are accepted only on the form below for a flat fee of £2.50. Please don't specify issues as we can't oblige. Ads cannot be repeated unless separate forms are sent in. We will only accept entries from non-commercial readers. Thank you for cooperating.



- Olympia ES100 Daisywheel KSR with built-in RS232 interface and off-line keyboard, typewheels £400. Spreadsheet programme on CBM8050. Disk £15. Dallas, 28 Gordon Mans, Torrington Place, London WC1P 7HE. 01-636 2533.
- S100 — Morrows 8in controller/drive CP/M, M/Basic £400, 5Mb mini Winchester/controller CP/M £1000; Hitach 320x290 colour graphics board/software £315; CP/M 'Usergroups' disks. £4 Chamberlain Crawley (0293) 515201.
- Must clear. North Star Horizon, 56k, RAM, DS/DD drives, DOS/Basic, CP/M, £1300. Lear Siegler, ADM42 15in VDU £350, Epson MX82FT printer £275. 8k RAM boards £29. Crawley (0293) 515201.
- Apple II +. Disk and controller

- card. RAM card, TV modulator + many many programs £1200. Tel: 0279 57961.
- TRS80 Model I Level 2 16k, VDU, cassette covers original packages. £100 of s/ware including Touch Typing. All for £295 ono. Contact 01-542 7475.
- Apple II Europlus as new £400, VDU £40 write to P Waudby, methodist international house, 52 Oakfield Rd, Selly Park, Birmingham (sorry no telephone). First adequate offer secures.
- Osborne one micro with Wordstar, mailmerge, CPM, supercalc Basic complete with instruction book. Perfect working order. As new costs £1250 + VAT. Will sell for £950. No VAT. Reading 744303.
- Texas TI99/4A- only 2 months old with cassette cable and T

- Invaders bought for £250 sell for £200. 9 Rawnsley house, Manchester Road, Bradford BD5 7LE. Yorkshire after 4pm.
- Acorn Atom fully expanded + 6000 baud digital cassette, 17k eurocard, Atomcalc, wordpack ROMs, ROM selector board, Hitachi monitor. £400 will split. Cambridge 0223 355957.
- Microtan 65, Expanded Tanex. Basic, New Xbug, Tanbug V2, Toolkit, Miniboard, MPSP manuals, £110. System motherboard. 39k Tanram unused £50. Tansoft gazette 1 to 7, offers. Microtan companion £5. Fawley (0703) 891606. Hants.
- Aculab floppy tape for TRS-80 L II. Hardly used £70. HP32-E scientific calculator, mint £12. Write JS Trutwein, Flat 5, Elmslie Court,

- East Road, Maidenhead, Berks. SL6 1PN.
- TRS80 MOD 3 business system, line printer VI, 64k shuffleboard CP/M system; (current hardware cost £2300); super scriptit, VisiCalc, profile 3.2, WordStar, 50 disks crammed with software, so please Tel: 06755 2745.
- UK10 8k RAM with MONO2, software and literature. Fully working £100. CB with aerial £50. Fully working. Accept any reasonable offer for either. Tel: Richard on Potters Bar (0707) 51449.
- Acorn Atom 64k RAM, 12k ROM. F/zint, toolkit, wordpack, + books and s/ware. £220 ono. Tel Edward Crosby, Manchester 061-832 4542 office hours or 061-747 8822 eve.
- Sharp MZ80K 48k RAM in

- original packing. Manual, Sharp Basic, Space Invaders, Othello 4-D, Newsletters + computer magazine collection £320 Dartford (0322) 845579 eve.
- Osborne 1, single density drives, CP/M, Workstar/Mailmerge, Supercalc, MBasic, Diagnostic Test programs, CBasic, the lot for a bargain price of £950. in exc cond. Tel: Anthony 01-440 2403.
- Apple II Z80-card, 80-column card, CP/M system disk, the lot for £195. printer (Centronic) interface card and cable £75. Osborne 1 computer £950. Tel Anthony 01-440 2403.
- VIDEO GENIE EG3003 16k. Over £70 of s/ware with lots of games. Original manuals leads and packing £230 ono. Tel: 021-706 8640 after 6pm.

TRANSACTION FILE

£375 o.n.o. Havant (0705) 450505.

- Apple II Europlus 48k for sale. Has boxes, manuals, paddles & joystick. Much software for business & games. Green screen monitor. Any offers over £750. Tel 01-748 4202 after 6pm.
- BBC intelligent menu driven disc, by autoboosting copies itself, configures disc, easily used. Disc, program P&P £6 S.A.E. for details 24, Longdean Park, Hemel Hempstead HP3 8BZ.
- Apple II 48k Europlus, immaculate condition, manuals. Lots of programs on tape and disk. £500 o.n.o. Tel: Malcolm, Mellor 2661 ext 256.
- Commodore PET 32k Green Screen, large keyboard, cassette deck, reset switch, 4022 printer, desk, software incl. Word Processor, Games, books, manuals, cover £600. Will split 0675 81312 (Coleshill Birmingham).
- 2 Pertac FD200 5.25in drives unused £125 each. IBM selective with Aculab interface £100 ono. ICL paper tape reader £35. Westrex paper tape punch £15. Tel 021-354 8078.
- VIDEO GENIE FG3003 16k, built-in cassette, sound, editor, assembler, + and books £180 ono. Tel 0462 811591, 7 Hoo Rd, Mepershall, Beds.
- Atari 400 (48k) program recorder. Basic and manuals. 9 cartridges including Star Raiders, Defender, Asteroids, Centipede etc. + several quality games on tape. Only 3 months old £495. Maidstone 681827.
- Apple II 48k with 2 disk drives, parallel printer-card, monitor, easywriter wordprocessor, games paddles, New April 1982. £1150. Adg Widdowson, Felted School, Dunmow, Essex 0371 820231.
- VIC-20 ith cassette uid, super expander, Avengers, Joystick, intro to Basic course, covers, lots of games software and books. All worth over £270. Sell for £199 tel Atherton (08277) 2461.
- Superboard 16k RAM Cegmon new Basic 1/2/4/5/X/, Toolkit II, 32 x 48 display centronics interface, 300/600/4800 cassette 15A, PSU software manuals etc inc £135 ono. Lincoln 40621.
- Oric-1 software on cassette, Games-breakout, Lunar Lander, Nim, All Hi Res colour and sound. £5.95. Send cheque/PO to Peter Wright, Willow House, Landford Wood, Salisbury SP5 2ES.
- Colour FP Acorn ATOM (12k+12k) PSU, leads, manual under year old. Many books and magazines (Getting Acquainted, Magic Book, etc) and £50 software (Invaders, Fruit Machine, Star-Trek, etc) £195 Tel (0278) 783940.
- PET 3032, 2 cassette units, 4022 printer, all leads + keypad, tapes, soundbox, manuals, dustcover. VGC £700 ono. Also CENTRONICS 779 printer for sale. OFFERS S. Benfleet (03745) 4066 eve.
- Daisy-wheel Ricoh RPAD, 4 wheels, tractor, interface lead TRS80, 8 fabric 4 film ribbons, first offer £500, buyer collectors. Also Visicalc for TRS80 £40. 0745 582307.
- ZX81 16k leads, transformer £60, keyboard £15, character generator kit £10, printer and 6 rolls £50. The lot for £15. T158 £25 ono. G Watson, 7 Carlton Road, Boston, Lincolnshire.
- Sorcerer 52k, S100 expansion unit, dual 8in drives (1.2Mb), monitor, CP/M software includes MBasic, Fortran, Pascal/MT+, Assembler. First offer over £1200 secures. Tel Keith on Romsey 515059 after 6pm.
- Wanted original handbook for science of Cambridge MK14 computer. Grateful for any information regarding this device, such as back issues of magazines. Tel 021 708

0028. Mr Weaver.

- BBC model B as new, complete with joysticks, cassette recorder, leads, manual and software. £375 Tel Dartford (0322) 77569.
- PET 2001 16k large keyboard. Green screen, new ROM. Sound box 30+ tapes games utilities etc. CBM manual and PET revealed. Original packaging. £450. Tel Tony 01-551 0308.
- MZ-80k with Quantum Hi-Res fitted. Manuals and software. £450 ono. Tel Harrogate 872 186.
- Acorn ATOM 12k + 12k includes F.P. ROM 6522 via Word Processor ROM, games synth software, PSU. Manual leads magic book VGC £135 ono. Tel 01-446 5515 eve after 8pm.
- Wanted Acorn Atom, new keyboard + F.P. etc. and/or printer. Write conditions and prices to Danilo Mirco c/o Pachera Alberto P.O. Box 227 - 6850 Mendrisio Switzerland.
- 32k 300 series ne ROM PET (Basic-2), cassette, TV/monitor interface, digitizer pad, digital-analogue converter, toolkit, keypad, manuals, programs - Chess, Basic Tutor, music monitor, £400 ono. Tel: Bridlington 0262 603942.
- Atom 12k+21k colour VIA. Floating point, Magic book, I/O sockets, +special 4k Hi Res graphics text EPROM 5V7A PSU £100+ programs as seen £180 also cassette player £20 negotiable after 01-723 9145.
- IBM Golfball typewriter/printer. Model 731/O. Good working order. £150 ono. Tel Mottram (0457) 64064 eve.
- Tandy TRS-80 Model I level 2, VDU, Line Printer VII, manuals, cassette, books, over £100 of software, Games, Edtasm, Cross Reference. Absolute Bargain! Worth £720 £400 ono. Tel Sunderland 226754 after 5.30pm.
- TRS-80 model-1 level II 16k complete with VDU, STR-80 lead, manuals, and £70.
- TRS-80 model I level II 16k complete with VDU CTR-80 lead, manuals, and £70 worth of Arcade Games. £170 ono. Tel 449 4694. Southgate London N14. Ask for Men.
- ZX-81 +16k (Sinclair built) complete with original leads. Manual, PSU, fuller keyboard and case 2 books listings, 6 games tapes. £90.00. Tel 0777 703011, Retford, Notts.
- PC1500 PC-2 User Group start May, Fee £6. Quarterly, Programmer send programs for evaluation. S/library SAE details CH/PO membership. Hardware Diagrams, M/Map. R Erdine, 8 Blackdown Avenue, Waterthorpe, Sheffield S19 6NG. Tel 471160.
- HP41C with Quad memory module, card reader and extended functions module, with all documentation and spare cards. £300 ono. Call 01-995 8444 eve. (Might part exchange for printer, Epson or Microlin).
- Sharp MZ-80K 48k with green screen and Peeking and Poking. The MZ-80K book + extra software inc. M/C Invaders and Adventures. £280 ono. Tel (0765) 6159 after 4pm.
- TRS-80 Model I (level II) 16k numeric keypad, new ROM, with 6 books and cassette software, including Editor Assembler, and many games (worth £100+) £210 ono. Tel 01-674 0663 J Cowan.
- Sharp MZ-80k 9 months old with £100 of Kuma software including Wdpro Chess, Ohhello, adventure cost £480 offers: Tel 789 987. Also Sharp interface for Epson MX-80 FT3 printer £38.
- PET/CBM 32k new ROM with toolkit, reset key and CBM cassette deck. Commodore Assembler and PET sub-routine disk and book included + other books and

magazines. £350 ono. Worcester (0905) 51477.

- Commodore 3030 dual disk drive with PET to I.E.E.E. cable £300 ono. Also Commodore 4022 matrix printer with I.E.E.E. to I.E.E.E. cable £150 ono. Worcester (0905) 51477
- Sharp MZ-80K 48k boxed, 18 months old. Epson printer interface, and over £240 worth of software. £400 ono. Atari VCS with 6 cartridges. Brand new. £130 ono. Tel: Gloucester 66263 eve.
- Acorn ATOM system 12kRAM 12k ROM via 1.8A power supply. B+W television. 2 cassette recorders. All leads excellent condition. Books, software can split cost £400. offers? Tel 876 6780 after 6pm.
- ITT2020 motherboard with Applesoft ROMS in Apple II case with single Apple II disk drive, £650 ono. Tel 01-251 4961 eve ask for room 219.
- Sharp MZ-80K + Hi Res graphics, plenty of software including PAC-Man, Scramble 3D Maze etc. + 2 more computer languages and newsletter £350.00. Tel 01-291 1756.
- Casio FX 702P + FA2 cassette interface £65 Rustington (09062) 73094 (Sussex).
- PET 64k new ROM small keyboard with integral cassette and sound. Lots of programs included. £275 Tel Brentwood (0277) 231490.
- RML380Z 32k dual floppy disks, computalk, A/D and D/A converters, full documentation. Lots of software available on 10 diskettes. Bargain at £1,200 ono. Tel 099389 8196.
- Sharp MZ-80k 36k. As new, in box. Several programs including Chess, Space Invaders: Also 3 books and basic + toolkit £300 ono. Tel Nottingham 63451 eve.
- Micro printer 879 matrix printer with card. Suitable for Apple etc. 100 CPS Bi-directional £175 or exchange 12in green monitor, Manby Lymington 72518.
- Acorn ATOM 14k+12k includes ROSS ROM +BBC Basic via 5V3A PSU, software includes Forth+ manuals 4 months old for only £190. Tel Keith 0268 416284 (eve) only. Not Wednesday.
- TI 59 + PC100C printer. Maths utility module, mains adaptor, 25 magnetic cards. (rolls printing paper. All relevant literature. £160, post free, including VAT. Tel 0597 2283.
- Nascom 2 48k RAM professionally cased. Ext Basic, Zeap. Dis-build. Complete documentation, loads of software, tape speed 1200/2400 bits/sec, with tape recorder £300 ono. Tel 061 973 1487.
- PET 4032 Basic 4.0 cassette deck. Trendcom thermal printer, manuals, books, games. For quick sale £400, Sroczyński, Wolverley House, Station Rd, Goring, Reading. berks. Tel (0491) 872293 or write.
- TRS-80 model 1 level II 16k green screen monitor PSU. Demodulator User and Technical Manuals 8 volumes. TRS80 encyclopedia editor/, Assembler T Bug, 8 Basic lessons, graphics, several games. £250 Thanet 587548 Ramsgate.
- BBC Basic software wanted to swap, or buy (originals only). Tel Oliver on 0895 38887.
- For sale, Microtan 65 and cased ASCII keyboard, manual for V2.3 monitor. £100 ono. Tel North Cerny 429.
- Printer: Hazeltine thermal, 30 CPS, parallel interface, quiet, efficient. Large stock of paper. Interface software for Nascom: £85. Tel 021 744 5264 (B'Ham).
- Nascom-2 32k. Zeap, Nasdis, Nasdebug, Naspen, toolkit, Pascal, AY-3-8910 sound board, (Bus connection), Port-Probe, 2400/1200

cassette, software galore, numeric keypad; superbly cased with fan. All manuals: £425. Tel 021-744 5264 (B'Ham).

- Atom 12k RAM 8k ROM toolbox ROM FP ROM PSU + leads, manual +. Getting Acquainted with your Acorn Atom £200 ono. Tel 0344 882809 after 4.00pm. (Needs new keyboard - 2 keys fallen off!)
- Teletype 43ASR printer, RS232 interface, integral keyboard, friction and pin feed, roll paper holder/catcher, manuals etc. VGC £450 tel. Melbyn on 0942 812843 anytime.
- Sharp MZ-80K 48k RAM, green screen, software includes: Print at Basic, Basic, Scramble, Pacman, The Valley etc. Several books. Low Resolution Graphics. £320 ono. Tel 01-590 2880.
- Transam TUSCAN S100 with CP/M and Disk Basic. 8k RAM on board and 16k on 64k ME-3 S100 card. Twin disk drives 380k each. £1100 ono. Tel: 01-427 7742 eve. Only.
- Sharp MZ80k, excellent condition as little used. Boxed, green screen, complete with Basic tutor book, games and micro magazines. 8 months guarantee still to run. Tel: Uxbridge 52554 (Eve).
- UK101 40k, RAM, Cased blower switched 300, 600 Baud cassette, much software; All leads. For quick sale £115 ono. Tel. 08926 62540.
- Acorn system, one 3k RAM and Interface to ASCII keyboard with power supply £50 or best offer. Also keyboard for above £25. Will separate. Tel: Watford (0923) 38534 eve/w. ends.
- VIC20 with 3k RAM expander, programmer's reference guide, Innovative Computing book, plus over £50 worth of professional software. Gorf cartridge. Original packaging. £235. Tel: Great Missenden 3839, after 5pm.
- ITT 2020 48k, Apple system one disc drive DOS 3.3. Jailbreak fitted some software £700. Apple Silentype printer (new) £140 ono. Tel for further details 0977 706856.
- Apple Europlus purchase and sales Ledger Visicalc, pascal Card, Apple writer, Language Card, Graphics Tablet, Little used £1,100 ono. Tel: Richard 0733 49062 Mon-Fri.
- Acorn ATOM 12k plus 12k. Ross toolkit, EPROM, VIA, 3A15V PSU £200. Also extensive books and software available at half new price. Tel: 0342 810508 (Sussex).
- Acorn ATOM 12k RAM plus VIA. Au leads and manuals. Virtually unused. Upgrading so £130 for quick sale. Tel: 01-777 3618 eve.
- Acorn ATOM 12k RAM 12k ROM, Tool box ROM Floating Point. Loads of s/ware. VIA brand new, still in manufacturers box £250. Tel: 0292 75172 (Ayrshire).
- Atari 800 with cassette recorder and joysticks plus Basic and Star Raiders cassettes and manuals. Lost £500 at Christmas. Will swap for BBC model 'B'. Tel: 07535 62361.
- Teletype ASR33 with Tape Reader and Punch. 110 Baud ASCII, RS232 serial interface. Very good con. Including stand, service and parts manuals. £145 ono. Tel: Coggeshall (Essex), 0376 62630.
- BBC (B) S/ware: Dominoes, strip Jack Naked, interactive screen digitiser cassette for £4.95.
- Acornssoft: Monsters, Snapper, Creative Graphics, games of strategy for £4.95 each. R D Arlington (061) 799 9845. 1 Fells Grove, Worsley, Manchester.
- Apple II plus disk drive, colour card, monitor, tape. All leads, lots of s/ware inc. Visidex, Visicalc, Visiplot, games. Tel: 01-581 1455 ext 210 (day) or 01-444 5803 eve £1000 ono.

- MZ-80K 48k with EPROM board for instant Basic/Zen. Interfaced for Olivetti Praxis-35, Fortran, Basic with repeat. Excellent Word Processors along with £200+ games and utilities. £500 ono. 01-554 7114 after 7pm.
- Commodore 64. Mint condition. 1 month old. 64k 16 colours, 3 voices, with original packing and manual. Commitments cause sale. £310. Tel Sheffield (0742) 29894 (office) or 399241 (after 6pm).
- PET 3032 with 4040 disk drives, sound box, Assembler, Basic compiler. Large payroll programme, Toolkit, many games. All manuals. £900 ono. Tel Kingston (Surrey) 01-549 3233.
- Apple II computer disk drive and controller colour card, 16k RAM card. Pascal. Lots of software £895 ono. Formby 78327.
- TI-99/4A for sale. Cassette interface, 2 recorders, paddles, software including Invaders, Pac-Man, Wumpus, etc. Manual + Ti-Home and 99ER mags. worth £400+ . Yours for £240 Tel 01-205 0116 anytime (Edgware).
- Printer High speed 12Cops, 120 column, later quality Honeywell Terminat 1200, RS232C, loads of features including keyboard, £320. Tel Bishops Stortford (0279) 724211.
- Sharp MZ80A 48k + Basic interpreter, and 4 program cassettes including manual 4 months old. Very good condition £500 ono. Tel Bolton (Greater Manchester) 32537 after 6.30pm.
- Sharp MZ-80k wanted. Memory size and software not important. Must be cheap! Also disk/s and interface. Tel Peter Blackpool 0253 21832 (work) 9-5 Mon-Fri.
- Dragon text within High Resolution graphics. Load ASCII shapers from cassette. Plot/edit under cursor control. Inverse video selectable. Send £3 for listings + instructions B. Hardwick 36 Westminster Drive, Hockley, Essex.
- VIDEO GENIE EG3003 16k built-in cassette recorder. Excellent condition, leads, manuals, original box, some software, 18 months old. Little used. Any reasonable offer considered. Tel 01-603 5014.
- Nascom 32k various ROMS and games plenty of documentation uncased £200 ono. 01-550 8965.
- Epson 80 column, 140 CPS, Dot Matrix Printer boxed new. Surplus to requirements £275 ono. Tel Iver (Bucks) (0783) 651904.
- Sharp MZ80-A 48k with 40/80 column conversion, manual, programmes, books, dust cover. New at Xmas, little usage, a bargain buy at only £425. Tel Rugeley 3932 eve (STD 08894).
- Mattel Intellivision for sale, very good condition with 20 cartridges including Dungeons and Dragons, Imagi's Beauty and Beast. All for bargain price of £350 ono. Tel 01-470 4658 eve.
- VIDEO GENIE + expansion interface 48k RAM, disk control card, parallel printer outlet RS232 serial outlet and B/W monitor £400. Ono. John Berkin College Hall, Knighton Road, Leicester.
- 32k PET large keyboard, green screen, cass unit, PET RULD + prog. incl. Database £475. Tel Histon (Cambridge) (022023) 4787.
- GENIE II EG3008 16k computer, ERG3014 expander box with 48k RAM, and RS232. CENTRONICS 737 printer. Books and software (including word processor, utilities, and games). £550 ono. Tel (01) 689 3533 after 6pm.
- 32k Large keyboard NewRom PET 8k Extra ROMS, Cassette deck. 40 tapes, reset switch, lots of books etc. Everything in v. good condition. £500 ono. Tel Plumtree 06077 3418 after 4.30pm.

CTUK! CONTACTS

For further information on ComputerTown UK! see 'CTUK News' or Prestel page *800803 #

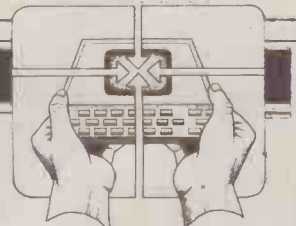

Peter J Kiff
52 Stone Road
Broadstairs
Kent CT10 1DZ

Andrew Stoneman
135 Birchdale Avenue
Newcastle-Upon-Tyne
Tyne & Wear

Christopher Bates
Ashford Main Library
Church Road
Ashford Kent

Chris Cooper
110 Church Road
Hanwell
London W7

Bill Gibbings
2 Longholme Road
Retford
Notts DN22 6TU

CTUK! CONTACTS

J M A Kilburn (Headmaster)
Shawfield Norden.
Community Middle School
Shawfield Lane
Norden
Rochdale OL12 7QR

Robin Bradbeer
Polytechnic of North London
Holloway Road
London N7

Derrick Daines
18 Cuttings Avenue
Sutton in Ashfield
Notts

Patrick Colley
52 Queensway
Caversham Park Village
Reading
Berks RG4 0SJ

Philip Joy
130 Rush Green Road
Romford
Essex

Peter Herring
Ordnance Road Library
Ordnance Road
Enfield Middx

Ted Ellerton
25 Beachdale
Winchmore Hill
London N21

David Sharp
5 Bridgenhall Road
Enfield
Middx

Rex Shipton
17 Woodlands Avenue
Eastcote
Middx

Susan Kelly
Head of Reference Services
PO Box 4
Civic Centre
Harrow
Middx

Andrew Holyer
10 Masons Road
Mannings Heath
Horsham
Sussex RH13 6JP

Derek Moody
2 Victoria Terrace
Dorchester
Dorset DT1 1LS

Pam Pollicott
South Ruislip Library
Victoria Road
South Ruislip
Middx

John Stephen Bone
2 Claremont Place
Gateshead
Tyne & Wear
NE8 1TL

Derek Knight or Bob Carter
Rayners Lane Library
Imperial Drive
Rayners Lane
Middx

Ray Skinner
62 Central Avenue
Billingham
Cleveland TS23 1LN

Brian Taylor
Tonbridge Area Library
Avebury Avenue
Tonbridge
Kent

Paul Maddison
Gardenways
Chilworth Towers
Chilworth
Southampton SO1 7JH

Peter Jarvis
c/o Health Dept
Corporation of London
Guildhall
London EC2

Vernon Gifford
111 Selhurst Road
Croydon
London SE25 6LH

Peter Stone or
Alan Strangman
Computing and Maths Dept.
The Polytechnic
Wulfruna Street
Wolverhampton WV1 1LY

Lyn Antill
1 Defoe House
Barbican
London EC2

Keith Taylor
Carter Hydraulic Work
Thornbury
Bradford BD3 8HG

Alan Hooley
21 Brammay Drive
Tottington
Bury BL8 3HS

Vernon Quaintance
50 Beatrice Avenue
Norbury
London SW16 4UN

BJ Candy
9 Oakwood Drive
Gloucester GL3 3JF

Roger Shears
18 Woodmill Lane
Bitterne Park
Southampton SO2 4PY

Chris Woodford
31 Hopley Road
Anslow Burton-On-Trent
Staffordshire

Mike Perry, Steve Collas
or Dave Lee
The Library
Ealing Road
Wembley
Middlesex HA0 4BR

Tony Cartmell
54 Foregate Street
Worcester WR1 1DX

R L Saunders
14 St Nicholas Mount
Hemel Hempstead
Herts

Brigitte Gordon
18 Purbright Crescent
New Addington
Croydon CR0 0RT

Richard Powell
22 Downham Court
South Shields
Tyne & Wear

Peter Earthy
46 High Street
Church Stretton
Shropshire SY6 6BX

Alan Sutcliffe
4 Binfield Road
Wokingham
Berks RG11 1SL

Allan Porten
14 Foxmede
Rivenhall End
Witham
Essex

E N Ryan
15 Queens Square
Eastwood
Nottingham
NG16 3BJ

NETWORK NEWS

These are all the European networks of which we're aware. Most are free — but phone them for details.

Forum-80 Hull ... (Forum-80 HQ)
Tel: 0482 859169. System operator:
Frederick Brown. International
electronic mail, library for
up/down loading software.
Forum-80 Users Group, Pet Users
section shopping list system hours,
7 days a week midnight to 8.00am,
Tues/Thurs 7.00pm to 10.00pm
Sat/Sun 1.00pm to 10.00pm.

Forum-80 London ... Tel: 01-747

3191. System operator: Leon Jay.
Electric Mail, library for
downloading. System hours:
Tues/Fri/Sun 7.00pm to 11.00pm.

Forum-80 Milton ... (TRS-80)
Users Group 80-Nett) Tel: 0908
566660. System operators: Leon
Heller and Brian Pain. Electronic
mail, library, newsletter, TRS-80
information system hours: 7 days a
week 7.00pm to 10.00pm.

Forum-80 Holland ... Operator:

Nico Karssemeyer. Tel: 01 313 512
533. Facilities: electronic mail,
program up/downloading,
shopping list. Hours, Tues-Sat
1800-0700 nightly, continuous from
1800 Sat-0700 Tues.

CBBS London ... Operator: Peter
Goldman, Tel: 01-399 2136.
Facilities: electronic mail, program
downloading. Hours: Wed
0700-0930 & 1900-2200, Fri
1900-2200, Sun 1600-2200.

Mailbox-80 Liverpool ... 051-220

9733. System operator: Peter
Toothill, Electronic mail, down-
loading TRS-80 information.
ACC ... members bulletin board,
Peter Whittle (0908 44262).
ABC-80 ... Stockholm (Sweden).
Tel: 010-468 190522.
University Research Computer ...
Sweden. Tel: 010-468 23660, guests
use password "66,66" for access.
Elfa ... Sweden 010-468 7300 706.
Tree Tradet ... Sweden 010-468
190522.

DIARY DATA

Readers are strongly advised to check details with exhibition organisers before making arrangements to avoid wasted journeys due to cancellations, printer's errors, etc.

Manchester	(Midland Hotel), Manchester Home Computer Show, Contact: ASP Exbns, 01-437 1002	22-24 April
Birmingham	(Bingley Hall), Midland Computer Show, Contact: IPC Exbns, 01-643 8040	28-30 April
London	(Bloomsbury Crest Hotel), RIBA Computer Conference, Contact: RIBA Service Ltd, 01-637 8991	10-12 May
London	(Wembley Conference Centre), Satellite and Cable TV, Contact: Online Conferences Ltd, (09274) 28211	10-12 May
Bristol	(Micro City Exbn Complex), Computers, Bus Systems « Communications Exbn, Contact: Tomorrows World Exbn Ltd (0272) 292 156	10-12 May
Southampton	(Post House), Computer Open Day Exbn, Contact: Crouchmead Communications Ltd 01-778 1102	12 May
London	(Cunard International Hotel), Computer Trade Exbn, Contact: BED Exbns Ltd 01-647 1001	17-19 May
Glasgow	(Kelvin Hall), Computer, Peripherals, « Systems Exbn, Contact: IPC Exbn Ltd 01-643 8040	17-19 May

Moore on Kuma



HX-20 Software Delights

Our Epson HX-20 authors have been prolific in the past few months and we now have nine programs including the following suite called the Desk Master Series: 1. Office Aid, 2. Wordprocessor, 3. Spread Sheet Calculator, 4. Friendly Terminal, 5. Electronic Mailbox, and 6. Decision Maker. Some of these plus other HX-20 programs are described below.

OFFICE AID turns the HX-20 into a calculator, adding up lists of figures and printing them out to 16 digit accuracy. It also has a clock/calendar facility (£29.50 plus VAT). **WORDPROCESSOR** is specifically designed for the HX-20 miniature printer with the option to go full size on a larger printer if required. It's an easy to use tool costing £29.50 plus VAT.

HOME BUDGET allows the user to keep track of mortgage, rates, credit card, rentals, heat/light, car/travel and all other kinds of personal and household expenses. Just the tool at £17.35 plus VAT to find out where all your money goes.

HORSE RACE FORECASTING is for the serious punter who wants to enhance the probability of winning. The program produces betting recommendations from data readily available in the sporting press. The HX-20's portability also means you can take it to the race course and make on the spot predictions for just £24.50 plus VAT.

COMPUTAX has been designed for financial and life assurance consultants to allow them quickly to compare clients' personal income tax liabilities and how to reduce them. An impressive tool for use in the office or in the client's home, and priced just £49.50 plus VAT.

WDPRO meets dream MAIL

It's the match of the century: WDPRO and MAILPRO. Yes, our top section Sharp wordprocessor now has a mail package to keep her company.

For £69.50, MAILPRO allows you to fill a CP/M disc with names and addresses and merge them with great ease into standard letters. It's used for mail shots and for generating mailing labels.

DIY Teach Typing Course

Using the Sharp MZ80A with its professional keyboard, you can teach yourself touch typing without tangling any keys or typing on rollers.

The software for this is called Microtype (priced £34.50 plus VAT), which places emphasis on rhythm and accuracy using the sound ability of the MZ80A to inform the student of good and bad progress.

MZ80B Statistics

Kuma is able to offer statistics packages for professional applications running on the Sharp

MZ80B under CP/M. The first package costs £95.00 plus VAT and covers such areas as calculation of descriptive statistics, t-tests, correlation and regression. There are facilities for data transformations, plotting scatter diagrams and collecting histogram data.

NewBrain Wordprocessor

At last a program has been developed to exploit the excellent touch typing keyboard of the NewBrain.

Called Tiny Word, it is the best NewBrain wordprocessor available and offers screen editing including insert and delete; screen or single line display, 16 editing commands; right justification; page numbering; margin and width control; etc. it runs on cassette used models A and AD and costs £24.50 plus VAT.

More about this and our machine use monitor and disassembler for NewBrain in our April NewBrain catalogue which is available free from Kuma on 0628 71778.

Kuma goes heavy on EM

Kuma is now heavily into electronic mail and we are fully supporting it across the full range of our hardware, e.g. Epsom, Sharp, Osborne, NewBrain and Sirius. We also have a stock of acoustic couplers. If you want advice on how to get started on EM, just call us on 0628 71778. Incidentally we are in the BL Comet Service, so if you want to leave a message for us just dial into the Kuma box.

Putting Spectrum on the Map

An educational program written for the Sharp range is now available on the 48 K Sinclair Spectrum for only £11.95 inc. VAT.

It teaches students the geography of the UK and Ireland in an entertaining series of games and tests. It is very easy to use and extremely fast in operation due to the extensive use of machine code.

High Speed Sharp

The processing speed of MZ80A and K microcomputers can be doubled from 2 MHz to 4 MHz with Kuma's new range of add-on boards.

The boards replace the standard Z80 microprocessor with the newer and more powerful Z80A, and are particularly useful for disc-based systems, especially with sample tasks like formatting discs which seem to take an eternity when you are anxious to get on. Minimal practical skill is needed to fit the boards which cost £69.50 plus VAT each.

P.S. and next month back into colour so as to alternate News with Gloss.

Kuma Computers Limited

11 York Road, Maidenhead, Berks. SL6 1SQ.
Tel: (0628) 71778/9 Telex: 849462 TELFAC KUM



PROFESSIONALS IN SOFTWARE APPLICATIONS:INTERFACING

Sirius - 1.

The best price/performance you've ever seen on a personal computer: £2395 + VAT For 128K, 1.2 Mbyte, 16 bit, available software includes:- CP/M86, MSDO, Mbasic, COBOL, PASCAL, FORTRAN. etc.

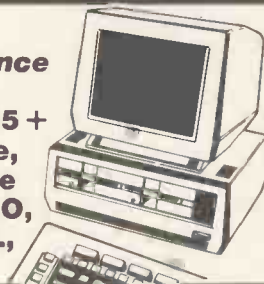

Osborne - 1: You can take it anywhere. CP/M + 64K RAM, Dual discs interfaces and Wordstar, Super Calc, Mbasic. All for £1250.00 + VAT. Ask us about additional software.



ANNOUNCING THE NEW HX20



Newbrain:

The only professional micro of this size: Phone us for immediate **FREE** delivery + SOFTWARE CATALOGUE Newbrain AD with onboard display £229. + VAT.



SHARP A + B; Computers and systems with a *Wealth of software applications programs.* "WDPRO" Wordprocessing, Database, Accounts, Mail Lists etc. Phone Now for our new Autumn 170 Program Catalogue.



SHARP ≡ KUMA ≡ SOFTWARE

Printers:

Matrix - from £380.00 + VAT.
Epson Mx 80F/T3 NEC (C.itoh)
Daisywheel - from £476.50 + VAT.
Brother 8300 Tec Star Writer

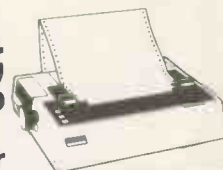

Applications:

Direct experience of office applications, phone us for advice on ledgers, stock control, payroll and word processing.

Software: the established leader for Sharp Computers.

MAIDENHEAD (0628) 71778

Kuma Computers Ltd., 11 York Road,
Maidenhead, Berks. SL6 1SQ.

Tel: (0628) 71778/9 Telex: 849462 TELFAC Kum



PLEASE SEND ME MORE DETAILS ON: Software Hardware

Sharp Osborne Name
Newbrain Sirius-1 Address

BRAIN SURGEON

Anita Electronic Services (London) Ltd are specialists in the repair and service of Superbrain I and II and associated printers including Apple silent type, Centronic, Anadex, NEC, QUME, Ricoh and Empson.

We also specialise in the repair of Commodore, Apple, Sirius, Osbourne, Alpha Tronic, and Adler computers.

We offer a fast on-sight service or alternatively repairs can be carried out at our workshops should you wish to bring in your machine.

Maintenance contracts are available at very competitive prices. Trade enquiries welcome.

For further information telephone or write to:

MR D. WILKINSON
Anita Electronic Services Ltd.,
15 Clerkenwell Close,
London E.C.1.
01-253 2444



ZX81-ZX SPECTRUM- DRAGON 32-VIC-20-BBC

The very best mail order items "over the counter"
Games, Keyboards, Serious Programs, Rams,
Books, Peripherals and much, much more!

FAST MAIL ORDER SERVICE PHONE 01-769 2887
WITH ACCESS/VISA (24hr Ansafone)
or send large S.A.E. for catalogue (state which computer)

Open 10.30 - 5.30 Tues. to Sat. (closed Mondays)
310 STREATHAM HIGH ROAD, LONDON SW16

PET HI-RES!

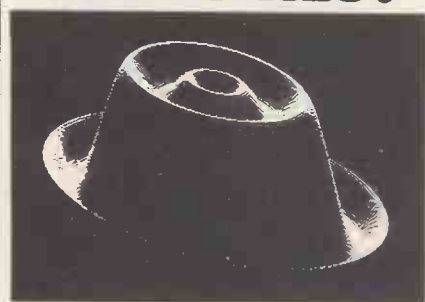

£149 plus VAT brings you 320 by 200 dot resolution on your PET/CBM screen. No soldering is necessary - SUPERSOFT graphics boards just plug in!

Three models are available: for 80-column machines specify the HR80 board; large screen 40 column machines need the HR40B board; for other machines (except very early PETs with no Rom sockets) order the HR40 board. All three boards add 8k of RAM and include GRAPHIX machine code utility software in EPROM. Over 500 boards have been installed in the UK - by schools, colleges, hospitals, research establishments, even home users - and hundreds more are being exported worldwide.

SUPERSOFT are Commodore specialists. We have a large range of software, accessories, and supplies for existing COMMODORE machines and will be supplying new machines as they are launched. Our 20 page catalogue is free to owners and users of PET/CBM machines - but here's a selection of products to whet your appetite! Add 15% VAT to all prices.

BUSICALC (FINANCIAL SPREADSHEET) £39.00
PAPERMATE PLUS (WORD PROCESSOR) £45.00

SUPERSOFT

Winchester House, Canning Road, Wealdstone, Harrow Middlesex, HA3 7SJ,
England, Telephone 01-861 1166

PROGRAMS

PCW is interested in programs written in Basic, Pascal, Forth, Logo and Comal - all of which being languages we've covered in previous issues. Please supply your programs on disk or cassette with all necessary documentation (so we've got a good idea what it's about and how much memory it uses) and, if you can, a clear listing on plain white paper.

As all programs in PCW are checked either by a referee or by one of the editorial staff, it can take some time for a program to actually appear. If you don't hear from us within two months or so, it usually means your contribution is in the referee pipeline. It's essential to ensure that your program is fully debugged before you send it in - get a friend to try it out first - and all programs we publish are paid for at a regular rate. Send contributions to: Maggie Burton PCW Programs, 62 Oxford Street, London W1A 2HG - and please enclose an SAE if you want material returned.

Program of the Month

Oric Bug Eater

by Paul Shirley

PCW's £25 Program of the Month prize goes this month to the author of the first Oric program we've received. It was well worth the hassle of looking high and low for a cable through which to list it out. Perhaps the programmer is a friend of someone at Oric Products. Perhaps he isn't but somehow he's got hold of a machine and written a program which uses most of Oric's features by March - in the absence, until recently, of a manual.

The program is an action game and seems to be a cross between Atari's Centipede and the well-known game, Worms. Basically, you have to control a creature using the arrow keys and make it eat insect eggs and parasites (the latter appear on your creature's body). At the same time

you have to avoid rocks and the wall of the screen and not crash into your own trail (the creature gets bigger the more things it eats).

The game is written to seem like a real arcade game. It uses loud sound effects and a demonstration screen giving instructions as well as a display of the top ten high scores - with a name input facility if you reach a high enough standard.

Bug-Eater is an addictive, well-presented and user friendly game. Both adults and children should get hours of fun from feeding the ever-hungry creature and, furthermore, it's enough of a challenge not to become boring after a few tries like so many other games.

```

0 REM      Paul Shirley, Feb 1983
1 REM written on 48K ORIC 1
2 GRAB
10 GOTO1000
100 REM MOVE CENTIPEDE
110 K$=KEY$: IF K$="" THEN140
120 K=ASC(K$): IF K<80R<>11 THEN140
130 DX=DX(KAND3): DY=DY(KAND3)
140 X=X+DX: Y=Y+DY: V=SCRN(X, Y) AND127
150 IFV=32 THEN T=(1+T) AND255: PLOTX(T), Y(T), 32: GOTO200
160 IFV>34 THEN GOSUB10000 'collision
165 PLAY4, 0, 1, 400
170 SC=SC+10-90*(V=34)
180 SC$=STR$(SC): SC$=RIGHT$(SC$, LEN(SC$)-1)
190 PLOT 34, 0, SC$
    
```

DRAGON 32
or
TANDY TRS-80
Colour?

Lots of programs -
lots of useful hints and information EVERY
single month in "RAINBOW", an exciting new
200-page magazine from U.S.A.

Send £2.25 (plus large 56p s.a.e.) for sample
issue to ELKAN ELECTRONICS (Dept. PCW),
FREEPOST, 11 Bury New Road, Prestwich,
Manchester M25 6LZ or telephone
061-798 7613 (24 hour service).

Printer Stands



- Handsomely crafted in 6mm tinted Perspex
- PSS model for Microline 80/82/83, Epson MX-80, Sheiksha GP100 etc. 15" x 12" x 4.5" £16.95 + VAT
- MSB monitor stand for BBC £19.95 + VAT
- PSL for Microline 84, Epson MX82 etc. 17" x 14.5" x 3.75" £19.95 + VAT
- POT Printer Output Tray for 11" fanfold paper £16.95 + VAT

Packing + Postage £3.50



CAMBRIDGE MICROELECTRONICS LTD
One Milton Road Cambridge CB4 1UY
(0223) 314814

PROGRAMS

```

195 PLAY3,1,4,SP*20+200
200 PLOTX,Y,36:H=(H+1)AND255:X(H)=X:Y(H)=Y
210 RETURN
300 REM EACH FRAME
310 FOR N=1 TO FR
320 :PX=INT(RND(1)*30+4):PY=INT(RND(1)*20+3)
330 :IFBCRN(PX,PY)=36THENPLOTX,PY,16ELSEPLOTX,PY,33
340 :FOR M=1 TO 10
345 : IF SP THEN FOR DE=-SPTO SP:NEXT
346 : REM faster than using a WAIT
350 : GOSUB100
360 :NEXT
365 :PLOT1,N/FR*26,"!" 'timeline
370 NEXT
380 RETURN
1000 CLS
1002 DIMX(255),Y(255)
1003 FORD=0TO3:READX(D),DY(D):NEXT
1004 DATA-1,0,1,0,0,1,0,-1
1010 FOR D=0TO31
1020 READ DA:POKE46080+D+8*ASC("!"),DA
1030 NEXT
1035 REM initialise screen to double height mode
1040 DATA12,30,14,7,7,14,30,12
1050 DATA21,30,51,18,19,50,31,42
1060 DATA0,0,8,13,13,31,63,63
1070 DATA12,30,63,63,63,30,18,33
1072 FOR I=0 TO 9:HI$(I)=" ORIC":HI(I)=400-20*I:NEXT
1080 REM NOW THE PLAYING LOOP
1085 POKE £26A,10 'SET KEYBOARD TOGGLES
1090 GOSUB 8000 'INSTRUCTIONS
1100 F=1:LI=3 'Frame and life counts
1102 FOR RR=1 TO 1:REM TO CLEAR OUT ALL NESTED FOR..NEXT LOOPS LATE
R
1105 POKE £26A,10
1110 REPEAT
1111 :PAPER(F-1)AND7:INKFAND7
1115 :PLAY0,0,0,0
1119 :PRINTCHR$(4);
1120 :CLS:PRINT:PRINT:PRINT:PRINT
1130 :PRINTTAB(22);CHR$(27)"JBUG-EATER FRAME "CHR$(27)"N";F
1140 :PRINTCHR$(4);
1150 IFF=1THENT$="6531653165678531853185318789:631"ELSET$="738495:6
12345900"
1151 GOSUB 4000
1152 SOUND1,2000,0:SOUND4,1,0 :SOUND2,2200,0:SOUND3,80,0 'munching
sound
1160 :GOSUB 2000 'draw borders and rocks
1170 :X=10:Y=10:T=0:H=1:PLOTX,Y,"$"
1171 :K$=KEY$:REM clear buffer
1173 :PLOT 1,0,"60"
1175 :REPEAT:K$=KEY$:UNTIL K$<>" "
1176 :IF ASC(K$)<8 OR ASC(K$)>11 THEN 1175 'is it a cursor keyPRINT
1177 :PLOT 1,0," ":PLOTX,Y," "
1178 :K=ASC(K$):DX=DX(KAND3):DY=DY(KAND3)
1180 :FR=40+F*10 'time for this frame
1190 :SP=6-F:IFSP<0THENSP=0 'speed
1191 REM set up score window black on white
1192 :PLOT32,0,0:PLOT33,0,23
1200 :GOSUB300 'run this frame
1210 :F=F+1 'next frame number
1220 UNTIL FALSE
1230 END
2000 REM DRAW BORDER
2001 CLS
2020 FOR Y=2 TO 25:PLOT2,Y,163:PLOT38,Y,163:NEXT
2030 FOR X=2 TO 38:PLOTX,2,163:PLOTX,26,163:NEXT
2200 FORR=10TO10*F
2210 X=INT(RND(1)*30+4):Y=INT(RND(1)*20+3)
2220 PLOT X,Y,163
2230 NEXT
2999 RETURN
4000 REM PLAY A TUNE~IN T$
4010 FOR L=1 TO LEN(T$)
4020 ND=ASC(MID$(T$,L,1))-47
4030 MUSIC 1,3,ND,0:MUSIC2,4,ND,0
4040 PLAY3,0,1,1600
4050 WAIT 16
4060 NEXT
4065 WAIT 100:PLAY0,0,0,0
4070 RETURN

```



BBC MODEL B (32K MODEL A) £££'s TO BE WON WITH SUPER DRAGSTER

For 1 or 2 players.
Design your DRAGSTER and race it against a friend or the computer. Too heavy - it won't move! Too clumsy - it crashes! Revving engines, crash noises, hi-score, victory tune - superb sound and graphics.
BEWARE THE SUPER DRAGSTER! What is it? Beat the computer - if you can - and find out. Great game with money prizes. Competition details with each program. Previous knowledge of dragsters not required. A winner every month - it could be you. Only £5.95.
Cheque/PO to: Bugbear, Dept PCW4, Nicholson Buildings, Templetown, South Shields, Tyne and Wear, NE33 5RZ.

VIC-20 SOFTWARE £4.00

VIC ASTEROIDS - 100% machine code, with thrust, hyperspace, multiple bolts, high score, double size screen, sound-effects, joystick options etc.

VIC INVADERS - The meanest game of Space Invaders you'll ever play. Feature packed, with double size screen, hi-res, and all the usual refinements.

ASTRO SLED - Pilot your sled through the jagged space canyon. With over 50 skill levels.

SPACE FIGHTER - A space dogfight simulator entirely in machine code. With 9 skill levels.

All programs are available on cassette for the unexpanded VIC-20, at £4.00 each (post free). Please state VIC-20 and mention PCW when ordering. For more information (with photos) send an SAE.

Excellent dealer discounts available

ARCADIA SOFTWARE

FREEPOST (no stamp required) SWANSEA, SA3 4ZZ

MICROMART

OSBORNE 1



FREE 3 YEAR ONSIGHT
BREAKDOWN GUARANTEE,
OR PRINTER OR D Base2.

COMPUTER Tel: 01-242 0024
CITY Tel: Manchester 061-228 1686



POWERFUL ISAM PACKAGE WRITTEN IN MBASIC
FOR USE WITH CP/M 86 9 & MS-DOS

18 entry points include add key, delete key, find key,
next key, previous key, get record.

Duplicate key facility, multi-file capability

Host of utilities, all menu-driven

Soak-tested by purpose-built exerciser

Only £30 inclusive of CP/M 86 diskette and documentation



43 Melrose Ave,
LONDON SW19

COLOUR and SOUND



'SIMPLY FILE' RECORDS SYSTEM
(DBMS). Select by any key. Print alphabetic
lists, mailing labels. Calculate, total, average
columns. Fast, easy, robust and VERY
versatile. DISK ONLY: £65

'SIMPLY WRITE' FAST WORD
PROCESSOR. Some £300-£400 programs
have no more facilities. Tape or disk, any
printer, 40-80 column PET. Needs 16K.
TAPE £40, DISK £45

GOTTA PET? ADDA VIC! High resolution
graphics, programmable characters, color
and sound on your PET? All this PLUS a
complete extra computer using your PET's
drives, printer etc? Under £200 including
VIC and our super PET-VIC LINK!
(Available separately)

PRICES PLUS VAT BUT INCLUDING P&P.
SEND FOR DETAILS, MORE UNUSUAL
ITEMS. GET OUR FREE 'MICROMAIL'
PET NEWSLETTERS.

SIMPLE SOFTWARE LTD.
15 HAVELOCK ROAD
BRIGHTON SUSSEX BN1 6GL
(0273) 504879



OSBORNE 1

11 COMPUTERS: Osborne specialist

We specialize: you benefit

Southampton House
192-206 York Road
Battersea, London SW11 3SA
(300 hundred yards from Wandsworth
Bridge roundabout)

upgrade your EPSON printer

MICROBUFFER

- Speeds up your print processing
- All special printer functions retained
- No software changes required
- Designed for Model II/III MX80, MX100
- Easy installation – just plug in
- Model MBS, 8k RAM, RS232C serial
- Model MBP, 16k RAM, Centronics parallel
- Ex-stock; post free in U.K. Cash with order please.
- Only £125 + VAT, total £143.75

Order from:

A>Line Computer Systems

24 Horsendale Avenue, Nuthall
Nottingham NG16 1AN
(0602) 276445

OPUS DESKING

AT LAST COMPUTER
FURNITURE MADE
BY A COMPUTER
COMPANY

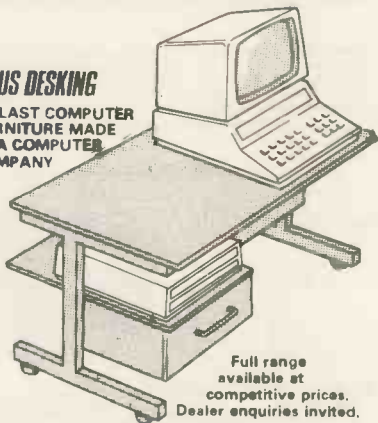

Full range
available at
competitive prices.
Dealer enquiries invited.

RAM BARGAINS

	1 OFF	25.99	100
4116.20ns	.80	.75	.68
4116.250ns	.75	.70	.55
2114.300ns	.85	.80	.75
2114.L.200ns	.95	.87	.83
4516.100us.BBC Ram	3.10	2.95	2.80
4164.200us	4.80	4.60	4.20
6116.150us C. Mos	4.20	3.95	3.50
2716.5v.450ns	2.40	2.15	2.00
2716.Triplerail	6.00		
2732-450us	3.95	3.75	3.25
2532-450us	3.95	3.75	3.25

Other IC's available. Add 50p p&p + VAT @ 15%.

ATHANA FLOPPIES

Minis with free plastic library case + hob rings.

S/S S/D	£17.95 for 10	8" DISCS	
S/S D/D	£19.95 for 10	S/S S/D	£15.50 for 10
D/S D/D	£23.50 for 10	S/S D/D	£24.50 for 10
S/S T/Track	£26.50 for 10	D/S D/D	£25.50 for 10
S/S 96 Track	£28.50 for 10		

All other discs available. Add 85p P&P + VAT @ 15%.

OPUS SUPPLIES

10 BECKENHAM GROVE
SHORTLANDS,
KENT



01-464 5040
01-464 1598

```

8000 REM INSTRUCTIONS
8005 K$=KEY$
8010 LI=9999:SC=0
8020 CLS:INK0:PAPER1
8030 PLOT 1,1,10:PLOT1,2,10
8032 SOUND1,2000,0:SOUND4,1,0 :SOUND2,2200,0:SOUND3,80,0
8040 PLOT 10,1,"Bug-Eater"
8050 PLOT 10,2,"Bug-Eater"
8055 PRINT:PRINT:PRINT:PRINT
8056 PLOT 2,22," HIT ANY KEY TO START"
8057 PLOT 1,22,12
8060 PRINT" Control the millipede"
8062 PRINT" using then arrow keys on"
8064 PRINT" the keyboard to change"
8066 PRINT" direction.
8068 PRINT
8069 IF KEYS<>" THEN 9999
8070 PRINT" Score 10 points for"
8072 PRINT" eating a ' ',like this"
8080 PLOT 32,4,"!"
8082 X=32:Y=15:K=11:T=0:H=1
8083 FOR I=13 TO 7 STEP-2.5 :PLOTX,I,"!":NEXT
8084 FOR I=1 TO 12:GOSUB 130:WAIT 10:NEXT
8085 IF KEYS<>" THEN 9999
8086 K=9:GOSUB 130:WAIT 10:GOSUB130
8088 PLOT 34,18,"!":K=10
8089 FORD= 7 TO 17 STEP3:PLOT34,D,"!":NEXT
8090 FOR I=1 TO 18:GOSUB130:WAIT 10:NEXT
8095 IF KEYS<>" THEN 9999
8100 K=8:GOSUB130:WAIT 10:GOSUB130:WAIT10
8110 PRINT:PRINT:PRINT" For bonus points eat the"
8112 PRINT" parasitic segments"
8113 WAIT 70
8114 K=11:GOSUB 130:WAIT10:GOSUB130:WAIT10
8116 K=9:PLOT 34,19,162
8118 FOR I=1 TO 4:GOSUB 130:WAIT10:NEXT
8120 K=11:PLOT 36,9,163
8130 PRINT:PRINT" Avoid rocks or your"
8132 PRINT" own trail..."
8140 FOR I=19 TO 11 STEP -1:GOSUB 130:WAIT 10:NEXT
8150 WAIT 10:EXPLODE
8152 PRINT:PRINT" You have a limited time on each frame,watch
the time line."
8180 WAIT 300:GOSUB 14000
8190 WAIT 300
9000 IF KEYS="" THEN 8000
9999 RETURN
10000 EXPLODE
10010 FOR EX=F TO 15+F:PAPEREX AND 7:WAIT 3:NEXT
10017 SOUND1,2000,0:SOUND4,1,0 :SOUND2,2200,0:SOUND3,80,0
10020 LI=LI-1
10030 IF LI<1 THEN 11000
10035 TT=T
10040 REPEAT :REM erase bug-eater
10050 :TT=(TT+1)AND255
10055 :PLOT X(TT),Y(TT)," "
10060 :X(TT)=10:Y(TT)=10
10070 UNTIL TT=H
10090 X=10:Y=10:PLOTX,Y,"$"
10100 GETD$:DX=DX(ASC(D$)AND3):DY=DY(ASC(D$)AND3) ?wait for a key p
ress
10110 RETURN
11000 REM DEAD
11002 POP:POP:POP:PULL :REM clear down stack
11004 NEXT RR:REM CLEAR DOWN ALL FOR LOOPS
11010 Z$=KEY$:REM CLEAR DOWN KBD
11020 IF SC<HI(9) THEN 11170
11030 CLS:PAPER4
11040 FOR Y=0 TO 26:PLOT 0,Y,10:NEXT
11050 PRINTCHR$(4);
11060 PRINT" Well done "
11070 PRINT:PRINT" Please enter your name"
11075 PRINT:PRINT:PRINT
11076 L=0:N$="":K$=KEY$:I$=""
11078 PRINT" ->";
11080 REPEAT
11085 :N$=N$+I$
11087 :PRINTI$;
11090 :GET I$
11100 UNTIL ASC(I$)<32
11110 PRINTCHR$(4);
    
```

If interested
in advertising
in
Micromart
please call
Gaye Collins on
01-636 6890

INSURE YOUR COMPUTER

Impact damage, Fire, Theft & Transit
Insurance for your Computer Equipment:

£1 to £1,500 cover	£8.00 pa £10 (excess)
£1,500 to £2,500	£16.00 pa £15 (excess)
£2,500 to £8,000	£16.00 pa £25 (excess)
£10,000	£20.00 pa £25 (excess)

Ask for details

KGJ Insurance Brokers
6 Hagley Road, Stourbridge
West Midlands DY8 1QG
Tel (03843) 5333/2545

PROGRAMS

```

11120 IF LEN(N$)>25 THEN N$=LEFT$(N$,25)
11130 HI(9)=SC:HI$(9)=N$:REM ADD TO BOTTOM OF HISCORES
11140 FORP=8 TO 0 STEP -1
11150 : IF HI(P)<HI(P+1) THEN GOSUB 13000
11160 NEXT
11170 GOSUB 14000 'display hiscores
11180 I=10
11190 IF KEYS<>" THEN 1090
11200 WAIT 100:I=I-1
11210 IF I>0 THEN 11190 ELSE 1090
12999 WAIT 300:GOTO1090
13000 REM SW~F
13010 T=HI(P):HI(P)=HI(P+1):HI(P+1)=T
13020 Ts=HI$(P):HI$(P)=HI$(P+1):HI$(P+1)=Ts
13030 RETURN
14000 CLS:PAPER4:INK4 'list hiscores
14010 FOR Y=0 TO 26:PLOT 1,Y,10:NEXT
14020 PRINTCHR$(4)
14030 PRINTCHR$(9);" HISCORES"
14040 FOR P=0 TO 9
14050 : PRINT
14060 : SC$=STR$(HI(P))
14070 : SC$=RIGHT$(" "+RIGHT$(SC$,LEN(SC$)-1),9)
14080 : PRINTSC$,HI$(P)
14090 NEXT
14100 FOR Y=0 TO 26:PLOT 1,Y,10:NEXT
14110 INK6
14115 PRINTCHR$(4);
14120 RETURN
    
```

Big printing for ZX Spectrum

by Robert Newman

The ZX Printer paper, inconvenient though it may be for word processing and the like, lends itself rather well to the reproduction of graphics.

Using this program can quite literally turn the ZX Printer to your advantage. It allows the printing of large characters to any line length (within reason) by turning a copy of the character set sideways, thus permitting them to be used this way on the printer. At the same time as producing them on the printer, the computer will also print the messages on the screen, making for quite an interesting display

These characters are printed eight times normal size using either the black graphic square (not the inverse space), smaller versions of the same character or any character specified by the user, including user-defined ones. 4-line messages may be printed at most (because of the width of the

paper).

Characters may be moved closer together by changing the value of the FOR...NEXT loop in line 410 from seven to six and the number of characters per line may be changed by altering the value of P\$ in line 100.

Instructions are included within the program which will run on any ZX Spectrum. If anyone simply feels like rotating their character set, the disassembled machine code is also included. This will need an assembler which produces Zilog mnemonics to run. The same effect can be produced by missing out line 620 of the program. Incidentally, it is safer and often less time-consuming if this program is saved before it is run, as it uses machine code. One mistake in the DATA statements will cause the system to crash irretrievably, in which case the program will be lost.

```

5 REM *****
10 REM *** Large printing ***
15 REM *** (c) R Newman 1983**
20 REM *****
25 CLEAR 31699
30 LET mcode=31700
35 LET cset=mcode+100
40 FOR i=mcode TO mcode+61
45 READ n:POKE i,n
50 NEXT i
55 DATA 42,178,92,17,91,0,25,229,
1,10,0,9,229,221,225,225,6,96
60 DATA 237,91,54,92,20,197,229,6,
    
```

```

8,26,119,35,19,16,250,225,229,6
65 DATA 8,197,229,6,8,175,203,6,31,
35,16,250,221,119,0,221,35,225
70 DATA 193,16,236,225,193,16,218,
201
75 RANDOMIZE USR mcode
80 REM the machine code sets up
a character set of 'sideways'
85 REM letters stored from address
mcode + 100.
90 REM *****
95 BORDER 1: PAPER 5: INK 0: CLS
100 DIM p$(4): DIM p$(4,100): DIM
    
```

MICROMART

PET PET PET PET PET

**** HI-RESOLUTION GRAPHICS ****
A high resolution graphics board that gives a 64,000 dot (320 x 200) resolution. Versions available for any dynamic ram Pet, BASIC 2.3.4, FAT40 & 80 columns. No soldering or track cutting required, supplied complete with fast GRAPHIX software in ROM and full fitting & operating instructions. £149.00

**** SUPER ROM-SELECTOR ****
A high quality printed circuit board giving 64K of utility ROM space, software selectable!!! Allows 16 x 4K ROMs/EPROMs to reside in the expansion area of your PET. One 'POME' enables any two ROMs at a time. Suitable for bank-switched software. £75.00

**** PET UPGRADES ****
WHILE-U-WAIT service! (Dynamic ram pets only.)
Memory expansion:- 8K - 32K from £59.90
16K - 32K from £48.70
8K - 16K £38.25

40 column (12" VDU only) to 80 column conversion.
40 to 80 column £89.00
40 to 80 column switchable (two machines in one!) £105.00
Full keyboard functions:- I.e. TAB,ESC,REPEAT,SCROLL up/down, define WINDOW, lower case/graphics mode & DELETE from/tocursor. All available in direct or program mode.

**** REPAIRS AND SERVICING ****
Fast and efficient repairs to all Commodore computers at reasonable prices. WHILE-U-WAIT service whenever possible.

Please add VAT to the prices shown at the current rate.

Telephone Mick Bignell for more details at:-

MICROPORT

7 Clydesdale Close,
Borehamwood, Herts. WD6 2SD.
Tel: 01-953-8385

COMPUTER CORRESPONDENCE COURSES

The course is suitable for the complete beginner, business people, teachers, and the hobbyist. The computer that is used is the DRAGON, which is ideal for teaching the many skills encompassed by the BASIC programming language.

Cost of Course
Including computer: £262.40 (incl)
Excluding computer: £89.50 (incl)
Price per Module: £8.95 (incl)

For full details write encl. SAE to:

COMPUTER CORRESPONDENCE COURSES

Churchway, West Ilsley, Nr Newbury,
Berks RG16 0AH

BDB Computer Consultants

The Lastone	£186	Winchester	from £607
Mailing List	£15	Apple Compatible 6.7MB	£1195
Stop Control	£20	MX80 MF3	£325
Disk Drives	from £145	Olivetti praxis	£399
Apple Compatible	£180	Oliv 48K	£86

Carriage and VAT extra.
Send for details

Mail order Warehouse
New Street, Cockenzie, East Lothian

OSBORNE 1

- Monitor + cable £104
- Adler/Epson/OK1 £CALL
- Olivetti ET121+RS232 £799
- OSBORNE £CALL
- Games for Osborne from £19.95

We specialise in Osborne & hold large stocks of above.
CALL FOR SUPERB PRICES

FRASER ASSOCIATES
Buckingham (02802) 6087

SOFTWARE FOR BBC MICRO & HARDWARE

Business, Domestic and Educational Software on
Cassette or Disk.
New TEAC slimline Disk Systems from £199
Memorex 5 1/4 Single S.S. Disk £1.95
C12 Cassette 39p
Send for New Brochure

MICRO-AID

Micro-Aid (PCN), 25 Fore Street,
Praze, Camborne, Cornwall.
Tel: 0209 831274

OSBORNE 1

#1 COMPUTERS: Osborne Specialist

A tec: FP1500 - 25 printer
(25 C.P.S. Daisywheel) £300.00 + V.A.T.
When you buy your Osborne from us.

Call us on

01-228 2207

MICROMART

SEARCHING FOR 'BEST PRICE'

FOUND 'BEST PRICE'... GOTO

PET	TAPE	RRP
C2N	64K	£55
CBM	64K	£299
4032	32K	£695
8032	32K	£895
8096	96K	£1195

Our own transport delivers nationwide weekly. All you need is our Best Price Quotation. Contact us Now! For Super Service.

DISK DRIVES		
2031	170K	£395
4040	343K	£695
8050	1M	£895
8250	2M	£1295
9060	5M	£1995
9090	7.5M	£2495

PRINTERS		
4022P	80COL	£395
8023	136COL	£895
8300	DAISY	£1395

VAT TO BE ADDED @ 15%
CARRIAGE — £5 PER ITEM
IF YOU KNOW WHAT YOU WANT WHY WAIT?

THESE ARE THE PRICES YOU NEED

ORCHARD COMPUTER SERVICES

Orchard House, 21 St Martins St
Wallingford, Oxon
Tel: Wallingford (0491) 35529
Open 6 days per week



BBC MICRO

also VIC, DRAGON, TANDY, etc

DEALER ENQUIRIES WELCOME

An expansion console which gives your micro the professional look. Protects your micro with room for dual disc drives or drive plus teletext adapter or second processor. All wiring out of sight within the console made of aluminium and textured sprayed in cream colour. Coming soon a bolt on extra module for extra expansion options. Yes this console will grow with you. Basic BBC console as shown £39.99 plus £4.00 P/P. Send your cheque for £43.99 or for more information enclose sae to SILENT COMPUTERS, 27 Wycombe Rd, London N17 9XN

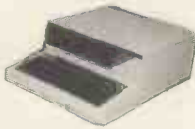

Mail order only. Viewing by arrangement.

24 hour ansaphone 801 3014

NASCOM UK101 TRS 80 All single board computers. Computer cases for your micros plus up to two disc drives with room for expansions are still available. SAE for details.

BiBi Data Computer Cassettes & 5¼" Diskettes

We manufacture computer cassettes using batch certified HM-1260 tape available in fully packaged C5, C12, C15, C20 and C15 leaderless, or we can supply custom wound lengths with or without boxes. Our 5¼" diskettes also available ssdd and dsdd.

Wholesale and Dealer enquiries welcome
Contact Nigel Boyle.
Tel: 01-223 5955, or write to:
BiBi Magnetics, Freepost, London
SW11 2BR

BiBi Magnetics Ltd, 101-105 Plough Road,
London SW11 2BJ. Telex: 917732.

PROGRAMS

```

a(4)
105 REM if you want to print more
    than 100 chars per line, you
    can increase size of p#
110 PRINT "By printing sideways
    on the ZX printer, this program
    can produce"
115 PRINT "4 lines of large characters
    with up to 100 characters per
    line."
120 PRINT "Any character with code
    32 to 127 can be printed -ie.
    anything"
125 PRINT "except user defined graphics."
130 PRINT "You can include spaces
    at the start of a line to improve
    the"
135 PRINT "layout as required."
140 PRINT "The large characters
    can be made up from i-"
145 PRINT "1)Normal sized versions
    of the same character."
150 PRINT "2)Black squares, or"
155 PRINT "3)A character of your
    choice."
160 PRINT "Choose 1,2 or 3 ":INPUT
    option
165 IF option<1 OR option>3 THEN
    GO TO 160
166 PRINT option
170 IF option <>3 THEN GO TO 190
175 PRINT "What character?": INPUT
    c#
180 IF LEN c#<>1 THEN GO TO 175
185 PRINT c#
190 PRINT "OK.Now enter your message."
200 LET max=0
210 FOR i=1 TO 4
220 INPUT ("Line ";i;"?");a#
230 IF LEN a#>max: THEN LET max=LEN a#
240 LET p#(5-i)=a#
250 PRINT a#
260 NEXT i
270 LET b2=INT (cset/256)-1
280 LET b1=cset-256*(b2+1)
290 POKE 23606,b1: POKE 23607,b2
300 REM put address of new char set
    into system variable CHARS.
310 FOR j=1 TO 4
320 IF option=2 THEN LET o#(j)="█"
330 IF option=3 THEN LET o#(j)=c#
340 NEXT j
350 REM start to do printing
360 FOR n=1 TO max
370 FOR j=1 TO 4
380 LET a(j)=cset+B*(CODE p*(j,1)-32)
390 IF option=1 THEN LET o#(j)=p*(j,1)
400 NEXT j
410 FOR j=0 TO 7
420 FOR k=1 TO 4
430 LET w=PEEK (a(k)+j)
440 IF w=0 THEN GO TO 540
450 LET t=B*(k-1)
460 LET c=128
470 IF w<c THEN GO TO 510
480 PRINT TAB t;o*(k);

```

```

490 LPRINT TAB t;o*(k);
500 LET w=w-c
510 LET t=t+1
520 LET c=c/2
530 IF w>0 THEN GO TO 470
540 NEXT k
550 PRINT : LPRINT
560 NEXT j
570 FOR j=1 TO 4
580 LET p#(j)=p*(j,2 TO 4)
590 NEXT j
600 POKE 23692,255: REM prevent
    'SCROLL?' message appearing.
610 NEXT n
620 POKE 23606,0: POKE 23607,60
630 REM restore normal char set
640 STOP

```

Disassembled machine code.

```

LD HL,(23730)
LD DE,91
ADD HL,DE
PUSH HL
LD BC,10
ADD HL,BC
PUSH HL
POP IX
POP HL
LD B,96
LD DE,(23606)
INC D
ROTAT PUSH BC
PUSH HL
LD B,B
RT1 LD A,(DE)
LD (HL),A
INC HL
INC DE
DJNZ RT1
POP HL
PUSH HL
LD B,B
RT2 PUSH BC
PUSH HL
LD B,B
XOR A
RT3 RLC (HL)
RRA
INC HL
DJNZ RT3
LD (IX+0),A
INC IX
POP HL
POP BC
DJNZ RT2
POP HL
POP BC
DJNZ ROTAT
RET
END

```

MZ-80K Mole Man

by Craig Shorland

One of the recent fads in arcade games has been for little men/animals digging through the earth shooting /avoiding monsters as they go and generally doing whatever it is that little men do to amass points in these matters.

Mole Man is one of these and I had quite a lot of fun playing it, too. The big disadvantage, though, is the 80K's silly keyboard. It

was definitely not designed with action games in mind (or touch typing, either).

The aim of the game is to shoot the black monsters (after you've dug through to them) and avoid the white monster which will shoot you if it gets half a chance. This bit is quite lethal, as you can't move when the white monster is firing and if you're in the line of fire that's hard luck. You have three

SOFTWARE

TRS-80 & VIDEO GENIE:

GENERAL LEDGER (disk only) £74.75
(Trial balance, profit & loss,
balance sheet, VAT report, banking, &
print of all records or any A/c number)

SINCLAIR:

ZX81 Pools £4.00
Spectrum Pools £4.95

COLOUR GENIE

Pools £7.95

(All prices inc. V.A.T. and P & P)

Always interested in receiving programs for above machines. 25% Royalties given.

KRICON LTD.

11 Medway, Hailsham, E. Sussex BN27 3HE
(0323) 846110

ASCII KEYBOARDS

- Parallel 7 bit TTL output
- 5v Positive Strobe
- Full ASCII character set
- 62 keys inc. ESC, CAPS, REP, DEL, TAB etc.
- Single +5v supply required
- Circuit diagram supplied
- New - Unused - Guaranteed

Cased (685 x 232 x 78mm) £34.50
Uncased (333 x 175 x 40mm) £32.20
Inclusive of VAT and Postage (UK only).

Nameworth Limited

31 Barnfield, Hemel Hempstead, Herts,
HP3 9QJ (0442-66878/48460).

MICROMART

calcsheet78

financial planning and modelling for the CBM 8032 and CBM 8096.

NOT JUST ANOTHER SPREADSHEET PROGRAM BUT A COMPREHENSIVE SUITE OF PROGRAMS.

IT WILL sense automatically if you have a 32K or 96K machine.

IT WILL create dt (TM) data transfer files which can be accessed directly, via the calcsheet78 (TM) or word processing programs (eg WordPro).

IT INCLUDES a specimen VAT spreadsheet which will calculate tax paid and received and how much tax due to or from the Customs for each quarter.

IT INCLUDES examples of invoicing and book-keeping using the spreadsheet.

Concise, comprehensive manual supplied.

All this for just £75 inc VAT (plus £1 p&p). Manual only £5 plus 50p p&p (deductible if calcsheet78 (TM) is ordered subsequently).

Also available: **USING VISICALC**, a simple guide to the world's most famous spreadsheet program (£5 plus 50p p&p).

Available soon: **VICTORY over B*A*S*I*C**, a programming manual for the VIC20 user (£2.50 plus 50p p&p if ordered now, £4 plus p&p if ordered after publication).

ESSENTIAL SOFTWARE
4 Fanshaw Avenue, Barking, Essex



COMPETITION-PRO JOYSTICK
PRECISION GAME CONTROL!

ONLY £25.00 inc. VAT
PLUS £1.00 P + P

For ZX SPECTRUM
Complete with joystick interface unit simply plug in for instant arcade action

KEMPSTON
MICRO ELECTRONICS

Dept PCW3, 180a Bedford Road, Kempston, Bedford MK42 8BL

GAMER

VIC	£129 plus VAT
DRAGON 32	£173 plus VAT
SHARP MZ80A	£433 plus VAT
ATARI 400 (16K)	£164 plus VAT
ATARI 800 (16K)	£390 plus VAT
EPSON HX20	£402 plus VAT
VIDEO GENIE (16K)	£299 plus VAT

Coming soon ORIC 1.

+ software, books, chess computers
+ Intellivision + Ace TV games
+ SF, Fantasy & Wargames

BRIGHTON 24, GLOUCESTER
TEL 0273 698424

C12/15 CASSETTES

SUITABLE FOR PROGRAMMING
DIRECT FROM MANUFACTURER,
COMPLETE WITH LABELS AND
LIBRARY CASE.
COMPETITIVE PRICES, DISCOUNTS
ON BULK PURCHASES

LEE HOLME AUDIO SERVICES LTD
MANUFACTURERS OF
HIGH QUALITY BLANK CASSETTES
350-4 LEABRIDGE ROAD, LEYTON
LONDON E10
TEL: 01-556 4748

PROGRAMS

- 80 X=X+40: IF (PEEK (X)=54) THEN X=X-40: IF (PEEK (X+40)=54) THEN GOTO 87
- 81 IF (PEEK (X)=67) THEN X=X-40: IF (PEEK (X+40)=67) THEN GOTO 87
- 82 IF PEEK (X-40)=0 THEN B6
- 83 IF PEEK (X) < > THEN 109
- 84 IF (PEEK (X)=67) THEN X=X-40
- 85 IF PEEK (X-40)=67 THEN X=X+40
- 86 POKEX-40,0
- 87 POKEX,202
- 88 GOTO 166
- 89 X=X-1: IF (PEEK (X)=63) THEN X=X+1: IF (PEEK (X-1)=63) THEN GOTO 95
- 90 IF (PEEK (X)=67) THEN X=X+1: IF (PEEK (X-1)=67) THEN GOTO 95
- 91 IF PEEK (X+1)=0 THEN 94
- 92 IF PEEK (X) < > THEN 112
- 93 IF PEEK (X)=67 THEN X=X+1
- 94 POKEX+1,0
- 95 POKEX,202
- 96 GOTO 166
- 97 X=X+1: IF (PEEK (X)=55) THEN X=X-1: IF (PEEK (X+1)=55) THEN GOTO 103
- 98 IF (PEEK (X)=67) THEN X=X-1: IF (PEEK (X+1)=67) THEN GOTO 103
- 99 IF PEEK (X-1)=0 THEN 102
- 100 IF PEEK (X) < > THEN 115
- 101 IF PEEK (X)=67 THEN X=X-1
- 102 POKEX-1,0
- 103 POKEX,202
- 104 GOTO 166
- 105 FORTH=1 TO 200: NEXT TH
- 106 FOR F=1 TO 4: POKEX,67: POKEX,208: POKEX,67: POKEX,80: POKEX,80
- 107 POKEX,4514,3:USR(68):USR(71)
- 108 NEXT F:GOTO 77
- 109 FOR F=1 TO 4: POKEX,67: POKEX,208: POKEX,67: POKEX,88: POKEX,88
- 110 POKEX,4514,3:USR(68):USR(71)
- 111 NEXT F:GOTO 86
- 112 FOR F=1 TO 4: POKEX,67: POKEX,208: POKEX,67: POKEX,69: POKEX,69
- 113 POKEX,4514,3:USR(68):USR(71)
- 114 NEXT F:GOTO 94
- 115 FOR F=1 TO 4: POKEX,67: POKEX,208: POKEX,67: POKEX,90: POKEX,90
- 116 POKEX,4514,3:USR(68):USR(71)
- 117 NEXT F:GOTO 102
- 118 DV=1:FORM=X-40 TO X-120 STEP -40: IF PEEK (M)=207 THEN 188
- 119 IF PEEK (M) < > THEN 138
- 120 POKEM,238:FOR K=1 TO 30: NEXT K: NEXT M
- 121 FORM=X-120 TO X-40 STEP 40: POKEM,0: NEXT M
- 122 GOTO 166
- 123 DV=2:FORM=X+40 TO X+120 STEP 40: IF PEEK (M)=207 THEN 188
- 124 IF PEEK (M) < > THEN 140
- 125 POKEM,238:FOR K=1 TO 30: NEXT K: NEXT M
- 126 FORM=X+120 TO X+40 STEP 40: POKEM,0: NEXT M
- 127 GOTO 166
- 128 DV=3:FORM=X-1 TO X-3 STEP -1: IF PEEK (M)=207 THEN 188
- 129 IF PEEK (M) < > THEN 142
- 130 POKEM,227:FOR K=1 TO 30: NEXT K: NEXT M
- 131 FORM=X-3 TO X-1: POKEM,0: NEXT M
- 132 GOTO 166
- 133 DV=4:FORM=X+1 TO X+3: IF PEEK (M)=207 THEN 188
- 134 IF PEEK (M) < > THEN 145
- 135 POKEM,227:FOR K=1 TO 30: NEXT K: NEXT M
- 136 FORM=X+3 TO X+1 STEP -1: POKEM,0: NEXT M
- 137 GOTO 166
- 138 FOR P=M+40 TO X-40 STEP 40: POKEP,0: NEXT P: POKEX,202
- 139 GOTO 166
- 140 FOR P=M-40 TO X+40 STEP -40: POKEP,0: NEXT P: POKEX,202
- 141 GOTO 166
- 142 FOR P=M+1 TO X-1: POKEP,0: NEXT P: POKEX,202
- 143 GOTO 166
- 144 FOR P=M-1 TO X+1 STEP -1: POKEP,0: NEXT P: POKEX,202
- 145 GOTO 166
- 146 GOTO 166
- 147 POKEX,10407,0
- 148 POKEX,U
- 149 POKED,206
- 150 GOTO 152
- 151 GOTO 219
- 152 IF N > 4 THEN 157
- 153 A=INT (RND (1)*700+53367)
- 154 IF PEEK (A) < > THEN 153
- 155 A(N)=A:POKEA,207:V(N)=1:N=N+1
- 156 FOR A=1 TO 30: POKEX,4514,3:USR(68):USR(71)
- 157 GETA\$:POKE 10407,0
- 158 IFA\$="W" THEN 72
- 159 IFA\$="T" THEN 118
- 160 IFA\$="X" THEN 80
- 161 IFA\$="B" THEN 123
- 162 IFA\$="A" THEN 89
- 163 IFA\$="F" THEN 128
- 164 IFA\$="D" THEN 97
- 165 IFA\$="H" THEN 133
- 166 POKEX,202
- 167 IF (MM=0)+(MM=3)+(MM=6) THEN 177
- 168 IF V(MM)=0 THEN 186
- 169 POKEA(MM),0
- 170 JA=INT ((A(MM)-53248)/40):IA=A(MM)-53248-JA*40
- 171 JX=INT ((X-53248)/40):IX=X-53248-JX*40
- 172 IF (IA>IX)*(PEEK (A(MM)-1)=0) THEN A(MM)=A(MM)-1
- 173 IF (IA<IX)*(PEEK (A(MM)+1)=0) THEN A(MM)=A(MM)+1

OSBORNE 1

- Monitor + cable £104
- Adler/Epson/OK1 ECALL
- Olivetti ET121+RS232 £799
- OSBORNE ECALL
- Games for Osborne from £19.95

We specialise in Osborne & hold large stocks of above. CALL FOR SUPERB PRICES

FRASER ASSOCIATES
Buckingham (02802) 6087

SPECTRUM

As stocks of most of the popular software and add-ons we offer a return of post service and an introductory offer to readers of Personal Computer News of 5% off all software ordered. Examples of discounted prices:

- THE HOBIT £14.20 PIMANIA £9.50
- BLACK CRYSTAL £7.12
- FOOTBALL MANAGER/PENETRATOR/TIMEGATE £6.60
- 3D TUNNEL/ORBITER/GROUND ATTACK/COSMIC RAIDERS £5.65

P&P 50p Free on 2 or more tapes
Send large S.A.E. for price list

IVYSOFT
91 Cleeve Drive, Ivybridge,
Devon PL21 9BS
(07554) 4088

DELFASS COMPUTERS

We are friendly people with lots of software including solicitors packages, commercial packages, adventures and rapidfire games etc.

Enquiries please write to:

22 Eastcourt Lane
Gillingham
Kent.

Every computer needs a **CHATTERBOX!**
"OK Spock, you win this time...."

SAVE ££££ ONLY £49 NEW!

for **ZX81 SPECTRUM**
NASCOM, VIC, PET, BBC, APPLE, TRS80, IBM, CRAY, ETC.
(Please state)

At last! Genuine phonetic synthesis at a sensible price. Gives your computer an *unlimited* vocabulary (nothing more to buy!). Self contained speaker/amplifier, Sinclair connector etc, **PLUS** Expansion socket for **BIG EARS** AND Monitor socket for Music Board. Full instructions, technical notes and programme examples supplied with this outstanding educational unit.

OR COMPLETE D.I.Y KIT £39
DEALER ENQUIRIES WELCOME

As seen on BBC TV "Computer Programme"

BIG EARS STOP GO LEFT RIGHT!

SPEECH INPUT FOR ANY COMPUTER

Hugely successful Speech Recognition System, complete with microphone, software and full instructions. **BUILT TESTED & GUARANTEED ONLY £49**

PLEASE STATE COMPUTER: UK101, SPECTRUM, ATOM, NASCOM2, Vic 20, Micron, ZX80/81, PET, TRS80, M280K, APPLE II, BBC MICRO

NEW: FAST MACHINE CODE FOR ZX81 SPECTRUM £7.40

ZX81/SPECTRUM MUSIC SYNTHESISER (STEREO) + 16 LINE CONTROL PORT

Play 3-part music, sound effects, drums etc. Full control of attack, decay and frequency. Input/Output lines provide control and monitor facility for Home Security, Robot Control, Model Railway etc. etc. Works with or without 16K RAM.

Add keyboard to make a live performance polyphonic synthesiser! Full Instructions/software Included.

AMAZING VALUE AT ONLY £19.50 (KIT)
Extra 23 way connectors at £2.60 **£25.50 (BUILT)**

THE COMPOSER
Music Programme for above synthesiser. Enter and play 3 part harmony. Includes demonstration tunes. **Recommended £7.40**

COLOUR MODULATOR **KIT £15**
RGB In, PALUHF out (not for ZX) **BUILT £20**

SPECIAL OFFER **I.C. £18**
SPEECH OUTPUT CHIP SX-01
Phoneme Speech Processor **DATA £0.60**

Please add VAT at 15% to all prices. Barclay/Access orders accepted by telephone. All enquiries S.A.E. please

WILLIAM STUART SYSTEMS Ltd 44 Bedford Gardens, Kensington, London W8 7EH. Tel: 01-221 1131 (sorry no callers)

PROGRAMS

If two coordinates have been entered the return key will enable a line to be drawn. If there are three or more triangles are drawn from the last point stored to all others.

A palette has been drawn at the bottom of the screen offering all the BBC's colours and the flashing cursor may be placed over one of these and future lines and shapes will be in that colour.

Pressing the delete key clears the screen but leaves the palette and shift moves the cursor to the bottom left hand corner of the screen.

Paintbox will only run on the model 'B' BBC computer and could be used as a basis for creating a more comprehensive graphics tool for this machine with comparatively little difficulty.

```

>L
10MODE2
20F=0
30C=7:CC=7
40X=600:Y=500
50PLOT70,X,Y
60N=0
70DIMA<20>
80DIMB<20>
90PROCPAL
100IF INKEY(-58)=-1 INCX=0:INCY=4:PROCMV
110IF INKEY(-42)=-1 INCX=0:INCY=-4:PROCMV
120IF INKEY(-26)=-1 INCX=-4:INCY=0:PROCMV
130IF INKEY(-122)=-1 INCX=4:INCY=0:PROCMV
140IF INKEY(-106)=-1 PROCCOL
150IF INKEY(-99)=-1 PROCDEL:PROCMK
160IF INKEY(-74)=-1 PROCDEL:PROCPAINT
170IF INKEY(-1)=-1 F=0:PLOT70,X,Y:X=10:Y=20:PLOT70,X,Y
180IF INKEY(-90)=-1 CLG:N=0:PROCPAL:PLOT70,X,Y:F=0:GCOL0,CC
190GOTO100
200DEF PROCMV
210IF F=1 GOTO 230
220PLOT70,X,Y
230X=X+INCX:Y=Y+INCY
240PLOT70,X,Y
250IF F=1 F=0
260ENDPROC
270DEF PROCMK
280IF N>19 SOUND1,-10,100,2:PROCPAINT:ENDPROC
290N=N+1
300A(N)=X:B(N)=Y
310F=1
320ENDPROC
330DEF PROCPAINT
340IF N=0 OR N=1 SOUND1,-10,100,2:ENDPROC
350IF N=2 MOVE A(N),B(N):DRAW A(N-1),B(N-1):N=0:ENDPROC
360Z=N
370N=N-1
380REPEAT
390MOVE A(Z),B(Z)
400MOVE A(N),B(N)
410N=N-1
420PLOT85,A(N),B(N)
430UNTIL N=1
440N=0
450ENDPROC
460DEF PROCDEL
470TIME=0:REPEAT:UNTIL TIME=20
    
```

TRS80 ● GENIE

Fed up with paying £10+ for a Model 1/3 game program which after a few weeks you seldom play?

Why not rent your tapes (over 150 available) for a month for under £2, all inclusive?

Send 9"x4" SAE for full details to

RENT-A-PROG

22 Heathend Road, Alsager,
Stoke-on-Trent, ST7 2SQ

PROGRAM RENTAL

BBC MICRO: Landfall + Serpent

LANDFALL: Descent simulator with full cockpit graphics. Very challenging and not for the fainthearted!

SERPENT: Eat or get eaten in this frantic maze game. Totally addictive.

Both on one tape (32K OS 0.1-1.2) £6.50

ZX SPECTRUM: Sheepwalk

SHEEPWALK? You may laugh, but it's more difficult than zapping aliens! The one you haven't seen before. **Runs 16K. £3.25**



Cheques and POs to: GT Software
8 Bull Street, Pottton, Sandy, Beds.

PROGRAMS

```

480ENDPROC
490DEF PROC PAL
500PX=100:PY=100
510MOVE PX, PY
520FOR C=1 TO 15
530MOVE PX, PY+60
540PX=PX+60
550GCOLOR, C
560PLOT85, PX, PY
570NEXT
580ENDPROC
590DEF PROC COL
600PLOT70, X, Y
610CC=POINT(X, Y)
620GCOLOR, CC
630PLOT70, X, Y
640ENDPROC
    
```

MZ-80K Terrapin

by Maurice Webb

If the MZ-80K had high resolution graphics instead of its pseudo-graphic character set, this program would be quite spectacular.

As it is, it provides an easy way of drawing simple pictures on the screen using turtle graphics principles. It's effectively a sort of 'mini-turtle', but it uses the Sharp's rather fat pixel to draw a broken line.

Using Terrapin you can draw diagonals and erase what you've done using a 'pen up' command. When moving the 'turtle' you have to specify the number of pixels by which you want to move.

It's written in SP-5025 Basic and as it is short and compact more expert readers should be able to add to it — perhaps a

routine for saving named screens or for dumping to the printer (the MZ-80K won't screen dump, remember?) could be added to it.

Terrapin should keep a few inquisitive children at bay for a while — it's easy to use — although when an instruction is expected repeated pressing of the return key will mess up the screen, which means it has to be cleared to start again or (provided the return key hasn't been pressed too many times) the cursor used to move the picture back down again.

Instructions are provided within the program.

```

10 REM *****
20 REM *** TERRAPIN ***
30 REM *** C Maurice Webb 1983 ***
40 REM *****
50 REM
60 PRINT "*****" Do require instructions ?"
70 GET Q$: IF Q$="N" THEN 100
80 IF Q$="Y" GOT0860
90 GOT070
100 PRINT "G":GOSUB340
110 N=0: X=2: Y=2: ST=0
120 GOSUB410
130 IF DR$="S" THEN 210
140 IF DR$="R" THEN AN=0: GOT0220
150 IF DR$="D" THEN AN=90: GOT0220
160 IF DR$="L" THEN AN=180: GOT0220
170 IF DR$="U" THEN AN=270: GOT0220
180 IF DR$="/" THEN 200
190 GOT0120
200 GOSUB680
210 GOSUB510
220 N=N+1: IF N=180: TA=COS(DG*AN): TB=SIN(DG*AN)
    
```

MICROMART

The SATURDAY dBASE II INTRODUCTORY COURSE

This course enables a rapid grasp to be gained of using database packages, in particular dBASE II (TM: Ashton Tate), on micros under CP/M. It is planned for those who have little or no prior knowledge of data base systems on computers, or dBASE II, and starts virtually from scratch covering:

- Introduction to Micros & CP/M
- Databases on Microcomputers
- Introduction to dBASE II
- Hands on use of dBASE II
- System design for dBASE II
- Programming in dBASE II
- Practical work on dBASE II
- Programming aids & style

Numbers are strictly limited to not more than 20 delegates. Registration is at 0900-0915, lunch 1300-1415, and conclusion at 1800. Several micros are used for hands on work including: Osborne, Sirius, Televideo, Galaxy, etc. Four lecturers are present so as to ensure that every delegate receives individual help in the practical sessions.

The next course is on Saturday JUNE 4th. Currently planned dates are for the following SATURDAYS at a West London hotel:

June	4, 18
July	2, 16, 30
September	10, 24
October	15, 29

Cost: £90 + VAT payable in advance but with scaled refunds if cancellation within specified notice periods. Cost includes course material, meals and refreshments, and a copy of Arthur Green's book: "dBASE II User's Guide". Payment by Cheque, PO, Access or VISA. Detailed explanatory leaflet available with fuller description. To make a booking or to obtain further details, telephone or write to: Steve Conlon at:

AQUA COMPUTING LTD

(Dept PW5), 10 Barley Mow Passage,
London W4 4PH

(Phone: 01-994-6477)

: GO FORTH & ★ :

Laboratory Microsystems Z-80 FORTH Version 2.0 now includes multi-tasking, editors, assemblers, utilities, good manual and games.
CP/M-8 ... £45+VAT CP/M 5" £60+VAT
CP/M-86 ... £95+VAT IBM PC or SIRIUS £95+VAT
Floating point package — includes both hardware and software support with trig. routines £95
with Z-80 FORTH above £125
Cross-compilers — ultimate FORTH tool £230
Choose target from — 6502, 8080, Z-80, 8086/8088, 68000, LSI-11, 1802 — others to come.
Additional targets £100

FORTH is available on disc, cartridge, or cassette for most machines inc. BBC, DRAGON, VIC ...

DIY FORTH kits
Installation manual £7
How to do it + model + definitions + editor
Source code listing for one processor £7
6502, 6800, 6809, 8080/Z80, 8086/8088, 9900 1802, 68000, Z8000, VAX, Apple II, LSI-11, Eclipse

FORTH books — range includes:
'Starting FORTH' by Brodie £15 inc. p+p
'Systems Guide to fig-FORTH' by Ting £25 inc. p+p
JUPITER ACE — a very nice FORTH micro ... £78+VAT



MicroProcessor Engineering Ltd
21 Hanley Road, Shirley
Southampton SO1 5AP
Tel: 0703 775482

INDEXED FILES IN BASIC !!

The LOGIX package is:

- fast! • versatile! • easy to use!
- self-tidying! • available in CBASIC or Microsoft BASIC!
- only £85+VAT!

Write or phone for details:

LOGIC PLUS 18 ST. OLAM'S CLOSE
LUTON BEDFORDSHIRE LU3 2LD

Tel: (0582)594539

JUPITER ACE ADD-ONS

Upgrade your Jupiter's memory by buying our RAMPACK. All RAMPACKS are fully tested and cased, with the 16K version expandable to 32K.

- 16K — £27 fully inclusive
- 32K — £37 fully inclusive
- 16K-32K upgrade — £14 fully inclusive

To be released soon: - 3 channel & Noise Sound Board with 16 bit I/O port (in one box!), Buffer Board, large P.S.U., 16/32 PID port, A to D's and D to A's. We are adding to this list as soon as we are able. All the above are fully cased and compatible with each other. SAE for details.

MAIL ORDER ONLY. Cheques etc. to:

ESSEX MICRO ELECTRONICS
4, Hatch Road, Brentwood, Essex CM15 9PX.

OSBORNE 1

#1 COMPUTERS: Osborne Specialist

A tec: FP1500 — 25 printer
(25 C.P.S. Daisywheel) £300.00 + V.A.T.
When you buy your Osborne from us.

Call us on

01-228 2207

MICROMART

UK 101 SOFTWARE ON TAPE

from the guy who wrote "Le Passe Temps"

- GALACTIC HITCHHIKER (8K). An adventure, all in machine code. A beauty! (£7.00)
- SUPERTREK (8K). Sail boldly through the universe, zap-ping moving Klingons in real time. Superb graphics. (£7.00)
- STARTREK (8K). The old favourite, beautifully presented. (£6.00)
- LUNAR LANDER. A real challenge. You won't get down in less than 3 hours. (£3.00)
- HANGMAN. Excellent graphics. P.E. said so! (£3.00)
- BASIC TUTOR (8x4K). The only way to learn—at the keyboard. (£12.00)
- LE PASSE-TEMPS. You NEED this, if you haven't already got it. (£3.00)
- MAD MONK (8K). It's ready at last! A machine code adventure with some truly remarkable graphics, this programme is in a class by itself. (£9.50)

These ORIGINAL PROGRAMS are compatible all 2K Monitors and are available for 16 x 48 and 32 x 43 displays (including enhanced Superboards).

HARDWARE

These kits are complete in every way. Full socketed high quality PCB, all components, switches etc. plus preformed cable assembly for easy interconnection to J1, or our MOTHERBOARD SYSTEM. Now you can add on all those extras easily. Provides eight, yet EIGHT, fully buffered J1 type sockets. (£19.50)

8K STATIC RAM BOARD (£39.50)
HI-SPEED CASSETTE INTERFACE. At last, a system that works COMPLETELY RELIABLE 4000 baud (8000 with reasonable cassette) plus software for named file handling. A delight to use. (£19.50). For software in EPROM, add £8.00.

VIDEO ENHANCEMENT. Switch selectable 16 x 48 or 32 x 48 displays without butchering your computer. (£19.50)
Monitor EPROMS re-blown to suit for just £2.50.

8K EPROM BOARD (£19.50). A 2K Extended Monitor is available in EPROM FOR £40.00 plus, coming soon, TOOLKIT in EPROM and BASIC V.

MONITOR BOARD. Plug into Monitor socket to provide switch selection of up to 4 EPROMS. (£9.50).

AVAILABLE SHORTLY: EPROM Programmer. PIA/ Sound Board. Analogue Board and something rather nice on the graphics side.

All inclusive. Please add 15% VAT. Write or phone for further details.

MERLIN MICRO SYSTEMS LTD.

93 High St., Eston, Cleveland. Tel: (0642) 454883.

EX-DEMONSTRATION COMPUTER EQUIPMENT with WARRANTY

CBM 8032 32k Computer	£685
CBM 8050 1 Meg Disk Drives	£685
CBM 4022 Dot Matrix Printer	£305
CBM 8027 Daisywheel Printer	£589
Centronics 737 Printer	£330

All Equipment is in perfect working order and is covered by warranty.

Please add 15% VAT to the above prices.

Call: LMR Microcomputers
40 Great Marlborough Street
London W1
01-434-2821

BBC Model B or A (32K) BBC

Now for something completely different

ALIEN 3D MAZE

Explore a truly 3-dimensional maze, with passages in all directions including up and down. It is a completely different maze each time, and you or the computer can choose the style and size. (Small mazes in 2 dimensions recommended for novices!)

Full sound and superb true perspective colour graphics

The aliens are after you, so avoid their clutches or shoot them as you try to find your way out of the maze before your air supply runs out.

Many features such as markers, maps, emergency supplies and a panic button with a variety of unexpected effects!

Program on cassette **WHICKHAM SYSTEMS**
SEND £5.95 14 INGLESIDE, WHICKHAM,
TYNE AND WEAR, NE16 5XY

PROGRAMS

```

230 IF N=NR THEN120
240 X=INT(X+TA+0.5):Y=INT(Y+TB+0.5)
250 IF X<2 THENX=X+1:GOTO120
260 IF X>77 THENX=X-1:GOTO120
270 IF Y<2 THENY=Y+1:GOTO120
280 IF Y>39 THENY=Y-1:GOTO120
290 IF ST=0 THEN SET X,Y
300 IF ST=1 THEN RESET X,Y
310 N=N+1:GOTO230
320 END
330 REM *** Draw border ***
340 POKE 59555,0
350 UR=53247:FORI=1TO39:POKE UR+I,67:NEXT
360 UR=UR+39:FORI=1TO820 STEP40:POKE UR+I,67:NEXT
370 UR=UR+761:FOR I=39TO1 STEP-1:POKE UR+I,67:NEXT
380 UR=UR+165:FOR I=820TO0 STEP-40:POKE UR+I,67:NEXT
390 POKE 59555,1:RETURN
400 REM *** Set/Draw ? ***
410 GOSUB510:INPUT"#####Instructions ";IN$
420 IF IN$="N"THENST=0:GOTO100
430 IF IN$="H"THENST=0:GOTO860
440 IF IN$="PU"THENST=1:POKE54048,74:GOSUB510:GOTO120
450 IF IN$="PD"THENST=0:POKE54048,67:GOSUB510:GOTO120
460 DR$=LEFT$(IN$,1):NR=VAL(MID$(IN$,2,2))
470 IF DR$="S" THENST=0:GOSUB540
480 IF(ST>1)+(ASC(IN$)=13)THEN410
490 RETURN
500 REM *** Rub-out ***
510 FORI=1TO120:POKE54127+I,0:NEXT
520 RETURN
530 REM *** Set X,Y ***
540 GOSUB510:GOSUB590
550 INPUT"#####Position X ";X:IF(X<2)+(X>77)THEN670
560 INPUT"#####Position Y ";Y:IF(Y<2)+(Y>39)THEN670
570 SET X,Y:NR=0:GOSUB630:RETURN
580 REM *** Label border ***
590 UR=53257:POKEUR,34:POKEUR+1,32:POKEUR+10,36:POKEUR+11,32:POKEUR+20,38
600 POKEUR+21,32:POKEUR+191,33:POKEUR+192,32:POKEUR+391,34:POKEUR+392,32
610 POKEUR+591,35:POKEUR+592,32:RETURN
620 REM *** Clear border ***
630 POKEUR,67:POKEUR+1,67:POKEUR+10,67:POKEUR+11,67:POKEUR+20,67:POKEUR+21,67
640 POKEUR+191,67:POKEUR+192,67:POKEUR+391,67:POKEUR+392,67:POKEUR+591,67
650 POKEUR+592,0:RETURN
660 REM *** Range error ***
670 PRINT"#####Out of range":FORI=1TO2000:NEXT:GOTO540
680 REM *** Diagonal ***
690 U$="":LR$="":LD=0:LR=0:GOSUB510
700 PRINT"#####Up/Down ";
710 GET U$
720 IF U$="U"THENUD=85:PRINT"U":GOTO750
730 IF U$="D"THENUD=68:PRINT"D":GOTO750
740 GOTO710
750 PRINT"#####Left/Right ";
760 GET L$
770 IF L$="L"THENLR=76:PRINT"L":GOTO800
780 IF L$="R"THENLR=82:PRINT"R":GOTO800
790 GOTO760
800 IF(UD=68)*(LR=82)THENAN=45:GOTO840
810 IF(UD=68)*(LR=76)THENAN=135:GOTO840
820 IF(UD=85)*(LR=76)THENAN=225:GOTO840
830 IF(UD=85)*(LR=82)THEN AN=315
840 INPUT"#####Number ";NR
850 RETURN
860 PRINT"
870 PRINT"
880 PRINT"##### The prompt Instructions requires"
890 PRINT"##### one of the following replies:"
900 PRINT:PRINT"##### Rn, Ln, Un, Dn"
910 PRINT:PRINT"##### (n=no of pixels max 99)"
920 PRINT:PRINT"##### To start at any position other than top"
930 PRINT:left give the command <S> which allows"
940 PRINT:"a new start position to be SET."
950 PRINT:PRINT"##### N gives new screen
960 PRINT"##### / allows diagonals to be drawn"
970 PRINT"##### PU gives pen-up & allows erase"
980 PRINT"##### PD gives normal pen-down"
990 PRINT"##### H for HELP"
1000 PRINT:PRINT"##### ALL COMMANDS REQUIRE <CR> TO ENTER"
1010 PRINT:PRINT"##### Press any key to start"
1020 GET T$:IF T$="" THEN1020
1030 GOTO100
1040 REM *****
1050 REM ** To convert from MZ-80K **
1060 REM **
1070 REM ** Video RAM 53248-57343 **
1080 REM ** Display code A/Z= 1/26 **
1090 REM ** 0/9 = 32/41 8/67 0/74 **
1100 REM ** 59555,0 Blanks screen **
1110 REM ** 59555,1 Restores video **
1120 REM *****

```

NEWBRAIN

PARAMETER STRING SYNTAX ERROR ERROR 110 AT 50:2

Obtain friendly messages as above with our fast and compact machine code error decoder
Available now for the NewBrain
£9.75

S.A.E. for details
J M MASON
59a High Street
Astcote, Northants NN12 8NW



HIGH STREET
COMPUTER SERVICES LTD

Enclosure for

\$100 + 2x5.25 drives.

Enclosure only: 160.00

With 12 slot, 10 MHZ \$100 (Godbout);
PSU for Winchester+floppy;
fan with filter etc: 400.00.

Board and disk drive prices
on request.

051-647 5582

PROGRAMS

MZ-80K Double Trouble

by J C Lea

Now here's a rarity! One of the very few Pascal programs we've received, this listing is an example of a game which could not be written in Basic and still run at a reasonable speed. At some stages in the game the computer has to calculate distances and directions for up to 20 creatures and five men before a move can be made. This can involve up to 300 separate computations and does not include the further work of

keeping a record of the positions of 25 sheep and working out the quickest route around a hurdle. The game itself is easy to learn, but needs a lot of skill to play well — one mistake and you're in trouble! Some people have found it very addictive. It takes up 43k in source code and 24k in compiled form which runs direct from the MZ-80K monitor.

```
0010 PROGRAM DOUBLETROUBLE;
0020 CONST TOP=#D000; SYNC=#0DA6;
0030 MONSTER=206; SHEEP=190; MAN=202;
0040 PITCH=#11A1;
0050 SOUND=#0044; SILENCE=#0047;
0060 VAR PACK:ARRAY[0..40,0..110F] OF INTEGER;
0070 FLOCK:ARRAY[0..40,0..110F] OF INTEGER;
0080 MEN:ARRAY[0..5,0..110F] OF INTEGER;
0090 LEVEL, A, F, M, ANO, FNO, MNO, Q: INTEGER;
0100 POINTS, MOVES: INTEGER;
0110 KEY: CHAR;
0120 MOVE, MMOVE: BOOLEAN;
0130 FUNCTION SIGN(X: INTEGER): INTEGER;
0140 BEGIN
0150 IF X<0 THEN SIGN:=-1
0160 ELSE IF X=0 THEN SIGN:=0
0170 ELSE SIGN:=1
0180 END;
0190 FUNCTION PMAN(X: INTEGER): INTEGER;
0200 BEGIN
0210 PMAN:=TOP+MEN[X,0]+MEN[X,1]*40;
0220 END;
0230 FUNCTION PMON: INTEGER;
0240 BEGIN
0250 PMON:=TOP+PACK[A,0]+PACK[A,1]*40;
0260 END;
0270 FUNCTION PSHEEP(X: INTEGER): INTEGER;
0280 BEGIN
0290 PSHEEP:=TOP+FLOCK[X,0]+FLOCK[X,1]*40;
0300 END;
0310 PROCEDURE NOISE(H, L, D: INTEGER);
0320 VAR X: INTEGER;
0330 BEGIN
0340 FOR X:=1 TO D DO
0350 BEGIN
0360 POKE(PITCH, H);
0370 USER(SOUND);
0380 POKE(PITCH, L);
0390 USER(SOUND);
0400 END;
0410 USER(SILENCE);
0420 END;
0430 PROCEDURE WAIT(X: INTEGER);
0440 VAR Z: INTEGER;
0450 BEGIN
0460 FOR Z:=1 TO X DO USER(SYNC);
0470 END;
0480 PROCEDURE CURSOR(H, V: INTEGER);
0490 BEGIN
0500 POKE(#1171, H); POKE(#1172, V);
0510 END;
0520 PROCEDURE SCORE;
0530 BEGIN
0540 CURSOR(6, 0);
0550 WRITE(MOVES: 5);
0560 CURSOR(32, 0);
0570 WRITE(POINTS: 5);
0580 END;
```

MICROMART



10 MEGABYTE SIRIUS
FREE CANON PLAIN PAPER COPIER or
DAISYWHEEL PRINTER, or
THREE YEAR ONSIGHT
BREAKDOWN GUARANTEE.

COMPUTER Tel: 01-242 0024
CITY Tel: Manchester 061-228 1686

BUSI OR VISI?

Whether you use your computer in an office or at home, in industry or university, BUSICALC can make it an even more powerful tool. It can handle jobs that would otherwise require a specially written program — or hours and hours of tedious paperwork. Just fill in the numbers that you know, then tell BUSICALC how to work out the others by entering simple formulae. BUSICALC can add or subtract, multiply or divide, calculate roots or powers, and perform special functions like totalling or averaging rows and columns. You can enter text on the sheet (for column headings, titles etc) and specify the number of decimal places for each calculated value — so with the help of a printer you can produce really smart reports. BUSICALC 'sheets' can be saved to disk or tape for subsequent reworking, or access by other programs. It all sounds so simple that you wonder why somebody didn't think of it before. Actually they did — we're just doing it for a quarter of the price! BUSICALC is available now for 40 and 80 column PET/CBM models and for the Commodore 64. At just £39 plus VAT (£40.50 on disk) it really is incredible value for money! Please give details of your equipment when ordering.

SUPERSOFT

Winchester House, Canning Road,
Wealdstone, Harrow, Middlesex HA3 7SJ,
England. Telephone 01-861 1166

PRINTERS FOR SHARPS

Most dot matrix and daisy wheel printers available for MZ80K & MZ80A.

Our package includes printer, cable, interface and software. Centronics for RS232, automatic conversion of Sharp codes to standard ASCII. All printer control codes can be used with BASIC. Other boards available include EPROM memory storage and programmers, ADC's etc.

Details from:-

PETERSON ELECTRONICS LTD
Academy Street
Forfar
Angus DD8 2HA
Telephone Forfar (0307) 62591

pet/vic printer.

For £79.90 (inc. VAT)

Put a ZX Printer (£59.95 from Sinclair) on your PET/VIC using the SOFTEX PRINTERFACE — costing only £19.95 plus £1 p&p.

- * Very high-resolution graphics
- * Full VIC/PET characters
- * 4 column printer with superb formatting facilities
- * Use as normal PRINT/LIST syntax

Send orders/enquiries to
SOFTEX COMPUTERS,
37 Wheaton Road, Bournemouth BH7 6LH
Telephone 0202 422028

Please state exact computer model.

THE 'BIG' SPECIAL
*** FREE ***
SPECIAL
3-year Warranty with all systems until 31st May 1983
OSBORNE
4B
microcentres ltd
Telephone (0295) 67551
North Bar, Banbury, Oxon. OX16 0TF

OSBORNE 1

01 COMPUTERS: Osborne specialist

We specialize: you benefit

Southampton House
192-206 York Road
Battersea, London SW11 3SA
(300 hundred yards from Wandsworth Bridge roundabout)

ASCII Keyboards



- Upper & Lower Case plus Control
- Low Power Consumption
- Shift & Alpha Lock
- Autorepeat (Model 777)
- Parallel Data Output
- Metal Mounting Frame
- Suitable for Tuscan, Tangerine etc.

Model KB756A	56 key	£44.50
KB710	Numeric Pad	£ 7.50
KB771	72 key	£57.50
KB777	77 key	£65.00

Accessories available include:-

Metal Case	£15.95
Edge Connector	£ 2.25
DC to DC Converter	£ 5.50

(for operation off single 5V supply)

High Performance Monitor

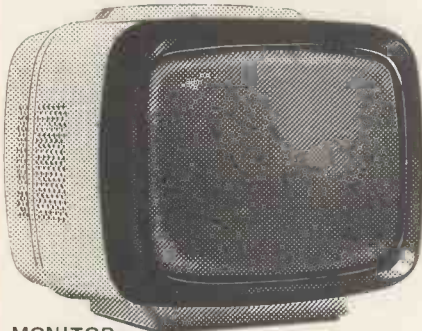

MONITOR

- 12" Green P31 Phosphor
 - MULLARD C.R.T.
 - 80 Character Line Capability
 - 24MHz Video Bandwidth
 - 240V AC Input
 - Toroidal Transformer
 - Composite Video Input
 - Ideal for Apple, B.B.C. Micro, Gemini, Nascom, Tuscan, Newbrain etc.
- MODEL 101 £89.50

NewBrain

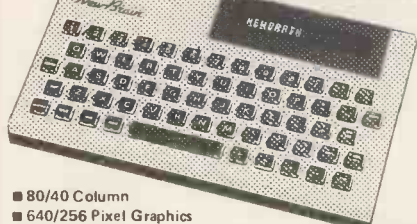

- 80/40 Column
 - 640/256 Pixel Graphics
 - 280 with 32K RAM
 - Printer Port
 - Ideal with above Monitor
 - Expansion Port for CPM, Floppies, Winchester and up to 2M Bytes RAM.
- MODEL A £229.00

ZX Spectrum Series 2-CP48 32K Memory Extension

Gives total of 48K. Simply fits internally with no soldering. Similar to competitors but only £20.95. Also if fitted by us £29.95.

U.K. Orders add 15% VAT on order total. Overseas orders add £6.50 to cover part cost postage and documentation.



FULL DATA SHEETS ON REQUEST
Citadel Products Ltd
 Dept. PCW, 50 High Street, Edgware,
 Middlesex, HA8 7EP. Tel: 01-951 1848

PROGRAMS

```

0590 PROCEDURE CHANGEMAN;
0600 BEGIN
0610 REPEAT
0620 M:=SUCC(M);
0630 IF M=6 THEN M:=1;
0640 UNTIL MENEM,11<>0;
0650 WAIT(40);
0660 END;
0670 PROCEDURE CHECKMAN;
0680 VAR X:INTEGER;
0690 BEGIN
0700 FOR X:=1 TO 5 DO
0710 BEGIN
0720 IF MEN[X,11]<>0 THEN
0730 BEGIN
0740 IF NOT (PEEK(PMAN(X),CHAR)=CHR(MAN)) THEN
0750 BEGIN
0760 MEN[X,01]:=0;
0770 MEN[X,11]:=0;
0780 MND:=PRED(MND);
0790 POINTS:=POINTS-100;
0800 END;
0810 END;
0820 END;
0830 IF (MND>0)AND(MEN[M,11]=0) THEN CHANGEMAN;
0840 END;
0850 PROCEDURE CHECKSHEEP;
0860 VAR X:INTEGER;
0870 BEGIN
0880 FOR X:=1 TO 40 DO
0890 BEGIN
0900 IF FLOCK[X,11]<>0 THEN
0910 BEGIN
0920 IF NOT (PEEK(PSHEEP(X),CHAR)=CHR(SHEEP)) THEN
0930 BEGIN
0940 FLOCK[X,01]:=0;
0950 FLOCK[X,11]:=0;
0960 FND:=PRED(FND);
0970 END;
0980 END;
0990 END;
1000 END;
1010 PROCEDURE CHECKMONSTER;
1020 BEGIN
1030 FOR A:=1 TO 40 DO
1040 BEGIN
1050 IF PACK[A,11]<>0 THEN
1060 BEGIN
1070 IF NOT (PEEK(PMON,CHAR)=CHR(MONSTER)) THEN
1080 BEGIN
1090 PACK[A,01]:=0;
1100 PACK[A,11]:=0;
1110 AND:=PRED(AND);
1120 POINTS:=POINTS+10*LEVEL;
1130 END;
1140 END;
1150 END;
1160 END;
1170 PROCEDURE NULLARRAY;
1180 VAR X,Y,Z:INTEGER;
1190 BEGIN
1200 FOR Y:=0 TO 1 DO
1210 BEGIN
1220 FOR X:=1 TO 40 DO PACK[X,Y]:=0;
1230 FOR X:=1 TO 35 DO FLOCK[X,Y]:=0;
1240 FOR X:=1 TO 5 DO MEN[X,Y]:=0;
1250 END;
1260 END;
1270 FUNCTION RAND(X,Y:INTEGER):INTEGER;
1280 VAR R:INTEGER;
1290 BEGIN
1300 REPEAT
1310 R:=RANDOM;
1320 UNTIL (R>=X) AND (R<=Y);
1330 RAND:=R;
1340 END;
1350 PROCEDURE RPLACE(H,V,H1,V1,CH:INTEGER;VAR H2,V2:INTEGER);
1360 BEGIN
1370 REPEAT
1380 H2:=RAND(H,H1);
1390 V2:=RAND(V,V1);
1400 UNTIL PEEK(TOP+H2+V2*40,CHAR)=CHR(0);
1410 POKE(TOP+H2+V2*40,CHR(CH));
1420 END;
1430 PROCEDURE HURDLE(P,L:INTEGER);
1440 VAR X,Y:INTEGER;
1450 BEGIN
1460 Y:=RAND(4,12-L DIV 2);
1470 FOR X:=Y TO Y+L DO POKE(TOP+P+X*40,163);
    
```

UK101 Programs SPRING SALE!

Tape 1: 12 games, usual price £7.00
 Tape 2: 12 games, usual price £7.00
 Tape 3: 11 games, usual price £7.00
Sale Price: All three tapes for £10.00!

Machine Code Programs:
 Pacman, Asteroids, Life, Space Invaders,
 Assembler. Usual price: £3.95 each
Sale Price: All five for £10.00!

(Please state screen size, 48x16 or 48x32)

Mr. M. Ward, 9St. Andrews Ave.
 CREWE, Cheshire, CW2 6JJ

Make the most of your Micro

- ★ Worked examples for programming Input and Output devices
- ★ Training courses in BASIC and Machine code (Assembler)
- ★ Subroutine libraries for users of CP/M and PLUTO graphics

G. Nix, B.Sc Tech Dip Ed
 11 Whitechapel St. Nottingham

PROGRAMS

```

1480 END;
1490 PROCEDURE PHURDLE;
1500 VAR X: INTEGER;
1510 BEGIN
1520 FOR X:=1 TO (12-LEVEL) DIV 3 DO
1530 BEGIN
1540 HURDLE(X*7, (5-(LEVEL-X) DIV 3)*2+1);
1550 END;
1560 END;
1570 PROCEDURE SETUP;
1580 VAR X, Y, Z: INTEGER;
1590 BEGIN
1600 WRITE(CHR(22));
1610 NULLARRAY;
1620 BEGIN
1630 FOR Z:=1 TO 300 DO
1640 BEGIN
1650 X:=RAND(30, 100)*10;
1660 NOISE(X, X+10, 20);
1670 END;
1680 END;
1690 PHURDLE;
1700 AND:=5;
1710 FOR X:=1 TO AND DO
1720 BEGIN
1730 RPLACE(1, 4, 5+LEVEL DIV 3, 20, MONSTER, PACK[X, 0], PACK[X, 1]);
1740 END;
1750 FNO:=LEVEL*2+5;
1760 FOR X:=1 TO FNO DO
1770 BEGIN
1780 RPLACE(20-LEVEL*2, 4, 19+LEVEL*2, 20, SHEEP, FLOCK[X, 0], FLOCK[X, 1]);
1790 END;
1800 FOR X:=1 TO LEVEL+18 DO
1810 BEGIN
1820 RPLACE(32, 4, 38, 20, 72, Y, Z);
1830 END;
1840 MNO:=5;
1850 FOR X:=1 TO MNO DO
1860 BEGIN
1870 RPLACE(33-LEVEL, 4, 39-LEVEL DIV 2, 20, MAN, MEN[X, 0], MEN[X, 1]);
1880 END;
1890 CURSOR(0, 0);
1900 WRITE('MOVES          LEVEL', LEVEL:2, '      SCORE')
1910 END;
1920 PROCEDURE ZAPIT(P: INTEGER);
1930 VAR H, V, P1: INTEGER;
1940 BEGIN
1950 FOR H:=-1 TO 1 DO
1960 BEGIN
1970 FOR V:=-1 TO 1 DO
1980 BEGIN
1990 P1:=P+H+V*40;
2000 POKE(P1, CHR(107));
2010 END;
2020 END;
2030 NOISE(8000, 500, 500);
2040 FOR H:=-1 TO 1 DO
2050 BEGIN
2060 FOR V:=-1 TO 1 DO POKE(P+H+V*40, CHR(0));
2070 CHECKMAN; CHECKMON; CHECKSHEEP;
2080 END;
2090 END;
2100 PROCEDURE MOVEMAN(X, Y: INTEGER);
2110 VAR H, V, P1, P2: INTEGER;
2120 BEGIN
2130 USER(SYNC);
2140 H:=MENEM, 0)+X;
2150 V:=MENEM, 1)+Y;
2160 P1:=PMAN(M);
2170 P2:=TOP+H+V*40;
2180 IF (H>-1) AND (H<40) AND (V>2) AND (V<23) THEN
2190 BEGIN
2200 IF PEEK(P1-1, CHAR)=CHR(72) THEN
2210 BEGIN
2220 IF (X=1) AND (Y=0) THEN
2230 BEGIN
2240 IF PEEK(P2, CHAR)=CHR(0) THEN
2250 BEGIN
2260 POKE(P1, CHR(72));
2270 POKE(P2, CHR(MAN));
2280 POKE(P1-1, CHR(0));
2290 MOVE:=TRUE;
2300 END;
2310 END;
2320 ELSE IF (X=-1) AND (Y=0) THEN
2330 BEGIN
2340 IF PEEK(P1-2, CHAR)=CHR(0) THEN
2350 BEGIN
2360 POKE(P1-2, CHR(72));

```

MICROMART

OSBORNE 1



FREE 3 YEAR ONSIGHT
BREAKDOWN GUARANTEE,
OR PRINTER OR D Base2.

COMPUTER Tel: 01-242 0024
CITY Tel: Manchester 061-228 1686

CBM/PET PROGRAMS

2001/3000/4000/8000/CBM 64

GAMES + TUTORIALS + UTILITIES
BUSINESS + EDUCATIONAL
HUNDREDS OF TITLES TO CHOOSE FROM
— INCLUDING SOME YOU THOUGHT HAD
GONE FOREVER — (GOT COMPU/THINK?)

SOFTWARE/FIRMWARE/ HARDWARE

ALL THE NAMES YOU KNOW, PLUS
SOME EXCITING NEW ONES.
SEND 25p STAMP(S) FOR CATALOGUE*:-

CORALSOFT
65 CECIL AVENUE, HORNCHURCH, ESSEX
RM11 2NA MAIL ORDER ONLY
Sole Distributors

Softcentre
Programs

* INCLUDES FREE VOUCHER WORTH UP TO £5



REAL-TIME CLOCK CARD

for ACORN/CONTROL UNIVERSAL SYSTEMS

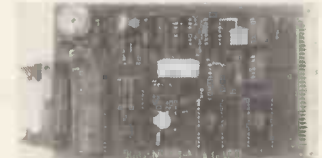

RTC/4K CMOS Memory/VIA/Acoustic
Price: £129.00 + VAT

We also stock:

- ☆ CPU CARD 6809/6502
- ☆ MEMORY CARD
- ☆ INPUT/OUTPUT CARDS
- ☆ GRAPHICS DISPLAY CONTROLLER
- ☆ VDU/PRINTERS AND EPROM PROGRAMMERS and much more!
- ☆ FDC CARD
- ☆ FLEX DOS
- ☆ CUBE SYSTEM



For details ring or write:

MICROSYSTEMS CONSULTANTS LTD
67 Dinorben Close, Fleet
Hants GU13 9SJ.

TELEPHONE: (02514) 22397

Name:

Company:

Address:

Tel:

JUPITER ACE USERS CLUB

Newsletter, software (both
games and utilities), adapter for
ZX81 add-ons.

SAE for details.

Remsoft,
18 George Street,
Brighton BN2 1RH.

THE 'BIG'

★ ★ ★ FREE ★ ★ ★
SPECIAL
3-year Warranty with all
systems until 31st May 1983

OSBORNE

4B Telephone (0295)
67551
North Bar, Banbury,
Oxon. OX16 0TF

microcentres ltd

OSBORNE 1

11 COMPUTERS: Osborne specialist
We specialize: you benefit

Southampton House
192-206 York Road
Battersea, London SW11 3SA
(300 hundred yards from Wandsworth
Bridge roundabout)

MICROMART

**northern
computers**

micro computer systems for all applications

**education
and
training
division**

location



For Educational and Training Institutions only:

Apple II, III
BBC (Free Econet Interface)
NewBrain
Green Monitors £79
Colour Monitors £199
Seikosha Printers £207
Epson Printers £289
NETWORKS
Coming soon:
Acorn Electron

we supply everything to meet the requirements of secondary schools, colleges and universities, whether it be small B.B.C. computers, Apple IIe computers, or Apple III school administration and accounting systems.

please contact: Gareth Litterer or David Horsfall
EDUCATION & TRAINING DIVISION

Northern Computers, Churchfield Road,
FRODSHAM, CHESHIRE WA6 6RD Tel: (0928) 35110



is Axon's choice for business and professional use.

For systems, software, supplies and support consult:



PO Box 12
Bentham
Lancaster
Tel: 0468 61848

AT LAST! REAL COMPUTER INSURANCE.
(MARTIN BANKS PLEASE NOTE)

EQUIP VALUE UP TO	(1) ALL RISKS X/S £10	(2) BREAK-DOWN X/S £25	COMBINED (1+2)
£1000	£12.50	£17.50	£25.00
£1500	£15.00	£37.50	£45.00
£2000	£17.50	£50.00	£60.00
£2500	£21.00	£62.50	£75.00

RATES FOR DOMESTIC AND HOBBY USE

PROFESSIONAL AND BUSINESS RATES ON APPLICATION COVERS C.P.U. AND PERIPHERALS.

DESIGNED FROM THE FLOOR UP FROM THE COMPUTER USER.

ALSO, SPECIAL SCHEME OBTAINABLE FROM US FOR REPAIR/COMPUTER ENGINEERS. SEND FOR DETAILS.

ALL OF THE ABOVE UNIQUE INSURANCE COVER, OBTAINABLE ONLY FROM US.

PETER DAVIES ASSOCIATES
INSURANCE PENSIONS FINANCE

29 DALTON STREET, CATHAYS, CARDIFF CF2 4HB (0222) 394277

PROGRAMS

```

2370     POKE (P2,CHR (MAN));
2380     POKE (P1,CHR (0));
2390     MOVE:=TRUE;
2400     END;
2410     END
2420     ELSE IF (PEEK (P2,CHAR)=CHR (0)) AND (PEEK (P2-1,CHAR)=CHR (0)) THEN
2430     BEGIN
2440     POKE (P1,CHR (0));
2450     POKE (P2,CHR (MAN));
2460     POKE (P1-1,CHR (0));
2470     POKE (P2-1,CHR (72));
2480     MOVE:=TRUE;
2490     END;
2500     END
2510     ELSE IF PEEK (P2,CHAR) = CHR (0) THEN
2520     BEGIN
2530     POKE (P1,CHR (0));
2540     POKE (P2,CHR (MAN));
2550     MOVE:=TRUE;
2560     END;
2570     END;
2580     IF MOVE=TRUE THEN
2590     BEGIN
2600     NOISE (2000,3000,200);
2610     MENEM,01:=H;MENEM,11:=V;
2620     END;
2630     END;
2640     PROCEDURE SHOWMAN;
2650     BEGIN
2660     USER (SYNC);
2670     POKE (PMAN (M),CHR (239));
2680     USER (SYNC);
2690     POKE (PMAN (M),CHR (MAN));
2700     END;
2710     PROCEDURE PRIMEBOMB;
2720     VAR H,V:INTEGER;
2730     BEGIN
2740     FOR H:=-1 TO 1 DO
2750     BEGIN
2760     FOR V:=-1 TO 1 DO
2770     BEGIN
2780     IF PEEK (PMAN (M)+H+V*40,CHAR)=CHR (72) THEN
2790     BEGIN
2800     POKE (PMAN (M)+H+V*40,CHR (71));
2810     H:=1;V:=1;
2820     NOISE (500,500,500);
2830     END;
2840     END;
2850     END;
2860     END;
2870     PROCEDURE LEAVEBOMB;
2880     BEGIN
2890     IF (PEEK (PMAN (M)-1,CHAR)=CHR (72)) AND (PEEK (PMAN (M)+1,CHAR)=CHR (0)) THEN
2900     BEGIN
2910     IF MENEM,01<39 THEN
2920     BEGIN
2930     POKE (PMAN (M),CHR (0));
2940     POKE (PMAN (M)+1,CHR (MAN));
2950     MENEM,01:=MENEM,01+1;
2960     END;
2970     END;
2980     END;
2990     PROCEDURE BETKEY;
3000     VAR KEY:CHAR;
3010     BEGIN
3020     MOVE:=FALSE;
3030     REPEAT
3040     REPEAT
3050     SHOWMAN;
3060     KEY:=INCH;
3070     IF KEY='S' THEN CHANGEMAN;
3080     IF KEY='L' THEN LEAVEBOMB;
3090     IF KEY='P' THEN PRIMEBOMB;
3100     UNTIL KEY IN 'Q','W','E','A','D','Z','X','C','!';
3110     CASE KEY OF
3120     'A':MOVEMAN (-1,0);
3130     'C':MOVEMAN (1,1);
3140     'D':MOVEMAN (1,0);
3150     'E':MOVEMAN (1,-1);
3160     'O':MOVEMAN (-1,-1);
3170     'W':MOVEMAN (0,-1);
3180     'X':MOVEMAN (0,1);
3190     'Z':MOVEMAN (-1,1);
3200     '!':Q:=1;
3210     END;
3220     UNTIL (MOVE=TRUE) OR (Q=1);
3230     END;
3240     PROCEDURE MOVESHEEP;
3250     VAR H,V,P:INTEGER;

```

RS 232/423
OLIVETTI
PRAXIS 35
INTERFACE
£72 inc.

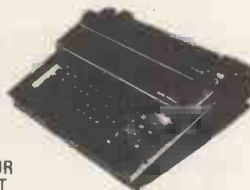

MICRO PROCESSOR CONTROLLED UNIT
Turns your Praxis 35 into a high quality (12 cps) Daisy Printer. Boxed, tested, with complete installation instructions (2 sets of 13 easy soldering joints). Great for BBC, CP/M systems etc. 300 Baud.
Also available fitted for £399 inc.

TIMTOM MICRO
9 ILTON RD
PENYLAN
CARDIFF

Also available for
Praxis 30
S.A.E. for details

NORTH
LONDON



The best selling Micro for all business needs.
Word Processing. Mailmerge. Database.
Supercalc. Systems: Support:
Excellent Prices.

WE SPECIALISE IN WORD PROCESSING

RAINBOW COMPUTERS
153 Falloden Way,
London, NW11 6LG.
01 458 2897

PROGRAMS

```

3260 BEGIN
3270 FOR F:=1 TO 35 DO
3280 BEGIN
3290 IF FLOCK(F,1)<>0 THEN
3300 BEGIN
3310 H:=FLOCK(F,0)+RAND(0,4)-2;
3320 V:=FLOCK(F,1)+RAND(0,2)-1;
3330 IF (H>0) AND (H<39) AND (V>3) AND (V<22) THEN
3340 BEGIN
3350 P:=TOP+H+V*40;
3360 IF PEEK(P,CHAR) IN [CHR(0),CHR(71)] THEN
3370 BEGIN
3380 IF PEEK(P,CHAR)=CHR(71) THEN ZAPIT(P)
3390 ELSE
3400 BEGIN
3410 POKE(P,CHR(SHEEP));
3420 POKE(PSHEEP(F),CHR(0));
3430 NOISE(500,800,25);
3440 FLOCK(F,0):=H;
3450 FLOCK(F,1):=V;
3460 END;
3470 END;
3480 END;
3490 END;
3500 END;
3510 END;
3520 PROCEDURE MAKEMONSTER(X,Y:INTEGER);
3530 VAR TEST:BOOLEAN;
3540 BEGIN
3550 TEST:=FALSE;
3560 A:=0;
3570 REPEAT
3580 A:=SUCC(A);
3590 IF PACK(A,1)=0 THEN
3600 BEGIN
3610 TEST:=TRUE;
3620 ANO:=SUCC(ANO);
3630 PACK(A,0):=X;
3640 PACK(A,1):=Y;
3650 POKE(PMON,CHR(MONSTER));
3660 END;
3670 UNTIL TEST=TRUE;
3680 END;
3690 PROCEDURE DINNER;
3700 VAR H,V,P,X,Y,Z:INTEGER;
3710 BEGIN
3720 A:=0;
3730 REPEAT
3740 A:=SUCC(A);
3750 IF PACK(A,1)<>0 THEN
3760 BEGIN
3770 P:=PMON;
3780 FOR H:=-1 TO 1 DO
3790 BEGIN
3800 FOR V:=-1 TO 1 DO
3810 BEGIN
3820 IF PEEK(P+H+V*40,CHAR) IN [CHR(MAN),CHR(SHEEP)] THEN
3830 BEGIN
3840 IF PEEK(P+H+V*40,CHAR)=CHR(MAN) THEN NOISE(500,1000,2000);
3850 FOR X:=1 TO 4 DO
3860 BEGIN
3870 Y:=5000;
3880 FOR Z:=1 TO 30 DO
3890 BEGIN
3900 Y:=Y+130;
3910 NOISE(Y,Y+100,30);
3920 END;
3930 END;
3940 MAKEMONSTER(PACK(A,0)+H,PACK(A,1)+V);
3950 V:=1;H:=1;MMOVE:=TRUE;
3960 CHECKSHEEP;CHECKMAN;
3970 END;
3980 END;
3990 END;
4000 END;
4010 UNTIL (A=40) OR (MMOVE=TRUE);
4020 END;
4030 PROCEDURE MOVEMONSTER(X,Y:INTEGER);
4040 VAR H,V,P:INTEGER;
4050 FUNCTION TEST:BOOLEAN;
4060 BEGIN
4070 TEST:=FALSE;P:=PMON+H+V*40;
4080 IF PEEK(P,CHAR) IN [CHR(0),CHR(71)] THEN TEST:=TRUE
4090 END;
4100 BEGIN
4110 H:=X;V:=Y;
4120 IF TEST=FALSE THEN
4130 BEGIN
4140 H:=0;

```

MICROMART

colour graphics

- INTERACTIVE GRAPHICS FOR RAI BLACK BOX
- 368000 PIXELS x 8 COLOURS
- CURSOR CONTROLLED
- MENU DRIVEN
- LINKS TO USER SOFTWARE
- INTERFACE TO OTHER MICROS ON REQUEST

colour monitors

- MICROVITEC MONITORS FOR BBC MICRO
- FREE DELIVERY MANCHESTER AREA

simisys computers

SIMISYS COMPUTER SYSTEMS LTD
P.O. BOX 53 WILMSLOW CHESHIRE
TEL. 0625-527422



SOFTWARE FOR THE PET AND CBM64

LEAGUE SOCCER
32K PET (New Rom) and CBM 64 £6.50
Features 92 League Teams, Promotion/Relegation, 2 Cup Competitions, Team Selection, Injuries, etc.
Guide your chosen Team to League and Cup Glory!

LONDON EXCHANGE
32K PET (New Rom) and CBM 64 £6.50
Invest your money in any of the 233 Companies-Commodities and attempt to gain a controlling interest in 16 of Britain's Major Companies!

BRIGHTON BEACH/ROULETTE
16K PET (New Rom) and CBM 64 £5.50
Make your fortune on the spin of a wheel or by hawking your Ice Cream Van around Brighton (with due regard for nude sunbathers and Marauding Elephants!)
All prices inclusive: (Please don't forget to state machine - CBM 64, Basic 3, 4, etc.) Cheques/Postal Orders to:
ASHLEY COMPUTER SERVICES
5 Garden Street, Kirkham, Preston PR4 2TU
Telephone: (0772) 686122

SPECTRUM — TRS80 LV2 VIDEO GENIE SOFTWARE

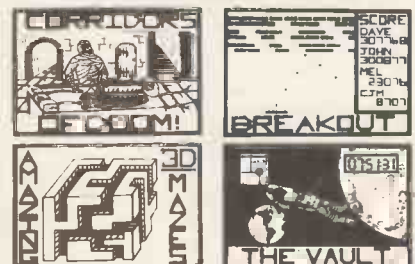

25 SUPER PROGRAMS — Machine code arcade games. Simulations, competitive games, adventures, Dungeons & Dragons, puzzles & ball games, including Breakout (the real thing — takes you through nine levels of increasing difficulty), Star Wars, Amazing 3D mazes, Gambling machine, Corridors of Doom & Trap It. All 25 on one C48 cassette. Sent by return. Post for only £8.95 inc., or send sae.

For full details.

Programmers — 25% royalties paid on original Software for the Spectrum, TRS 80 or Genie.

SPARTAN SOFTWARE (Dept. PCW)
9, COTSWOLD TERRACE,
CHIPPING NORTON, OXON.
Tel: 0608-3059

USED SUPERBRAINS
Bought and Sold
Also part exchanged against
most new 16 bit micros

INTERLEX LTD
Imperial House
Lower Teddington Road
Kingston KT1 4EP
Contact Mike Lane on
01-943 0968

'STICKY FOOT'



AN INVALUABLE HELP
TO
STOP YOUR EXPENSIVE
EQUIPMENT
CRASHING TO THE FLOOR!!

Send £2.36p to Dept BDBC 3 Market Place
Poulton-le-Fylde Lancs FY6 7AX
Allow 28 days for delivery

OSBORNE 1

#1 COMPUTERS: Osborne Specialist

A tec: FP1500 — 25 printer
(25 C.P.S. Daisywheel) £300.00 + V.A.T.
When you buy your Osborne from us.

Call us on

01-228 2207

SHARP MX80

As featured in the **March** issue

BASIC PLUS is a must for MZ80K owners.

This superb utility program offers, Numeric Pad, Key Repeat, Auto line numbering, Display Errors, Link programs, etc. On cassette with printed key labels. Still only £13.80

C.P.E. DATABASE is easily the most flexible and comprehensive database program for the MZ80K/A. It offers exceptional performance, loading data files at ten times normal speed. The powerful Calculate Search and Sort options can handle ALL types of data, even dates. It has numerous uses both at home and for business-mailing lists, stock control, in fact any card index application.

On cassette with extensive manual. **SPECIAL OFFER** at only £26.95.

C P Electronics,

51 Fairholme Road
Willington, Manchester
M20 9SA

FOOTBALL POOLS & HORSE RACING FORECASTING

FOR APPLE II, PET, TRS 80, NEWBRAIN, V. GENIE, SPECTRUM, ZX 81, MZ80K and A

These massive programs use every inch of memory to process football & horse-racing data to provide you with pools forecast results to enter on your coupon or a prediction of which horse represents the best bet. The booklets provided give step by step instructions to help you towards getting THE BIG WIN. Don't waste your money on games that soon get boring - invest now in these efficient and complex statistical analysis and sorting programs that you can use for years to come to give endless interest and entertainment. The author, Professor George is lecturer in statistical Studies and a leading authority on sporting statistics & forecasting. Have his valuable experience working for you.

FOOTBALL POOLS FORECASTING

Spectrum ZX81 £15 inc
Apple, Pet, TRS80, V. Genie, Disc, Sharp
MZ80K, (cassette only) (32K) £25 inc
BBCB Version, Newbrain, TRS80, V. Genie,
Sharp MZ80A (cassette only) (16K) £19.95 inc
Football programs can be used with
Australian and European teams

HORSE RACING

All versions £19.95 inc
except Spectrum & ZX81 £15 inc
+ £1.50 overseas

Send cheques/Postal Orders to:-

HOLLY PRODUCTS
BLACKHORNE HOUSE
DUKES LANE
GERRARDS CROSS, BUCKS SL9 7JZ

(Allow 28 days delivery - normally 7-10 days delivery)

NEW LOW PRICES

VIC-20 Computer
CASSETTE RECORDER only £118!
ATARI 400 only £40!
ATARI 400 & BASIC only £148!
ATARI 800 & BASIC only £185!
ATARI 800/48K/BASIC only £320!
DISK DRIVE only £375!
TEXAS 99/4A Computer only £278!
Commodore 64 only £152!
Commodore 64 only £312!

Software for all the above
also available.

APM
"Computers"

MAIL ORDER: (01) 647 1713
8 COSDACH AVE, WALLINGTON,
SURREY SM6 9RA

PROGRAMS

```

4150 IF (PEEK(PMON-39,CHAR)=CHR(163)) OR (PEEK(PMON+41,CHAR)=CHR(163)) THEN
4160 BEGIN
4170 V:=SIGN(PACK(A,13)-12);
4180 IF PEEK(PMON+1,CHAR) IN [CHR(0),CHR(71)] THEN
4190 BEGIN
4200 H:=1;V:=0;
4210 END;
4220 END;
4230 IF TEST=FALSE THEN
4240 BEGIN
4250 IF V=0 THEN V:=1;
4260 IF TEST=FALSE THEN
4270 BEGIN
4280 V:=0;P:=PMON;
4290 END;
4300 END;
4310 END;
4320 IF (H<>0) OR (V<>0) THEN
4330 BEGIN
4340 MMOVE:=TRUE;
4350 IF PEEK(P,CHAR)=CHR(71) THEN ZAPIT(P)
4360 ELSE
4370 BEGIN
4380 USER(SYND);
4390 POKE(PMON,CHR(0));
4400 PACK(A,0):=PACK(A,0)+H;
4410 PACK(A,13):=PACK(A,13)+V;
4420 NOISE(8000,8500,100);
4430 POKE(PMON,CHR(MONSTER));
4440 END;
4450 END;
4460 END;
4470 PROCEDURE NEARMAN;
4480 VAR H,V,D,A1,M: INTEGER;
4490 FUNCTION DIST: INTEGER;
4500 VAR H,V: INTEGER;
4510 BEGIN
4520 H:=ABS(MENCM,0)-PACK(A,0);
4530 V:=ABS(MENCM,13)-PACK(A,13);
4540 DIST:=H;
4550 IF V>H THEN DIST:=V;
4560 END;
4570 BEGIN
4580 D:=25-LEVEL-AND DIV 2;
4590 FOR A:=1 TO 40 DO
4600 BEGIN
4610 IF PACK(A,13)<>0 THEN
4620 BEGIN
4630 FOR M:= 1 TO 5 DO
4640 BEGIN
4650 IF MENCM,13<>0 THEN
4660 BEGIN
4670 IF DIST<=D THEN
4680 BEGIN
4690 IF (DIST<D) OR (RAND(0,10)<5) THEN
4700 BEGIN
4710 D:=DIST;A1:=A;
4720 H:=MENCM,0)-PACK(A,0);
4730 V:=MENCM,13)-PACK(A,13);
4740 END;
4750 END;
4760 END;
4770 END;
4780 END;
4790 END;
4800 IF D<25-LEVEL -AND DIV 2 THEN
4810 BEGIN
4820 A:=A1;
4830 MOVEMONSTER(SIGN(H),SIGN(V));
4840 END;
4850 END;
4860 PROCEDURE RANDMONSTER;
4870 VAR H,V: INTEGER;
4880 BEGIN
4890 REPEAT
4900 REPEAT
4910 A:=RAND(1,40);
4920 UNTIL PACK(A,13)<>0;
4930 H:=SIGN(30-PACK(A,0));
4940 V:=0;
4950 IF (PACK(A,13)<4) OR (PACK(A,13)>21) THEN
4960 V:=SIGN(12-PACK(A,13));
4970 MOVEMONSTER(H,V);
4980 UNTIL MMOVE=TRUE;
4990 END;
5000 PROCEDURE MONSTERTURN;
5010 BEGIN
5020 IF AND<>0 THEN
5030 BEGIN

```

OPEN HOUSE FOR COMPUTER NOVICES

Choose your time - day or evening.
Learn at your own pace on Apple, Pet or CP/M
Computers BASIC programming and
Business Packages
1 day seminar "Micro Computers for clerical
and administrative work"

Brochure from:
**MICROCOMPUTER ADVISORY
CENTRE,**

Polytechnic of the South Bank,
Borough Road, London SE1 0AA.
Tel. 01-928 8989 Ext. 2468.

MODULATORS

for



Crisp colour pictures from your Apple 11e
displayed on a domestic T.V. set. High quality
monochrome from Apple 11.

£24.99 (inc. VAT
and P&P)

Bradford Instruments Limited
UNIT D HILLAM ROAD BRADFORD BD2 1QN
TEL: BRADFORD (0274) 723866

PROGRAMS

```

5040 MMOVE:=FALSE;
5050 DINNER;
5060 IF NOT MMOVE THEN NEARMAN;
5070 IF NOT MMOVE THEN RANDMONSTER;
5080 END;
5090 END;
5100 PROCEDURE GAME;
5110 BEGIN
5120 M:=1; SETUP; MOVES:=-1;
5130 REPEAT
5140 MOVES:=MOVES+1;
5150 SCORE;
5160 GETKEY;
5170 MOVESHEEP;
5180 MONSTERTURN;
5190 IF RAND(0,LEVEL)>5 THEN MONSTERTURN;
5200 IF RAND(0,LEVEL)>8 THEN MONSTERTURN;
5210 UNTIL (MND=0) OR (AND=0) OR (Q=1);
5220 IF AND=0 THEN
5230 POINTS:=POINTS+FND*50+300+50*LEVEL-MOVES;
5240 END;
5250 PROCEDURE NEXTPAGE;
5260 VAR X:CHAR;
5270 BEGIN
5280 WRITELN;
5290 WRITELN('PRESS ANY KEY TO CONTINUE');
5300 REPEAT
5310 X:=INCH;
5320 UNTIL X<>CHR(0);
5330 WRITE(CHR(22));
5340 END;
5350 PROCEDURE INSTRUCT;
5360 BEGIN
5370 WRITE(CHR(22));
5380 WRITELN('          DOUBLETROUBLE');
5390 WRITELN;WRITELN('    ON A REMOTE ISLAND IN SCOTLAND AN');
5400 WRITELN('EXPERIMENT HAS GONE WRONG AND FIVE');
5410 WRITELN('MUTANT CREATURES HAVE ESCAPED. ');
5420 WRITELN('THESE CREATURES WERE BRED TO WITHSTAND');
5430 WRITELN('MOST FORMS OF ATTACK AND MAY ONLY BE');
5440 WRITELN('KILLED BY BLOWING THEM UP WITH A LARGE');
5450 WRITELN('QUANTITY OF HIGH EXPLOSIVE. THE ONLY');
5460 WRITE('WAY TO DO THIS IS TO ENTICE THEM TO STEP');
5470 WRITE('ON LAND MINES LAID BETWEEN THEM AND YOUR');
5480 WRITELN('FIVE MEN. ');
5490 WRITELN('THE CREATURES ARE ATTRACTED BY MOVEMENT');
5500 WRITELN('AND BY SMELL. IF ONE CATCHES A MAN IT');
5510 WRITELN('WILL EAT HIM AND THEM DIVIDE IN TWO');
5520 WRITELN('TO MAKE THINGS EVEN MORE DIFFICULT A');
5530 WRITELN('FLOCK OF SHEEP IS ALSO LOOSE AND THESE');
5540 WRITELN('TEND TO GET IN THE WAY AND GET EATEN TOO');
5550 NEXTPAGE;
5560 WRITELN('THE FOLLOWING KEYS ARE ACTIVE:');WRITELN;
5570 WRITELN('D W E   MOVE NW N NE');
5580 WRITELN('A D   MOVE W E');
5590 WRITELN('Z X C   MOVE SW S SE');WRITELN;
5600 WRITELN('S   CHANGE MAN TO MOVE');
5610 WRITELN('      (SHOWN BY FLASHING CURSOR)');
5620 WRITELN('P   PRIME BOMB');
5630 WRITELN('L   STEP BACK FROM UNPRIMED BOMB');
5640 WRITELN('TO PICK UP BOMB APPROACH IT FROM BEHIND');WRITELN;
5650 WRITELN('      QUIT');
5660 NEXTPAGE;
5670 WRITELN('CHARACTERS ARE SHOWN THUS:');WRITELN;
5680 WRITELN(CHR(99):3,' MEN ',CHR(247):3,' BOMB');
5690 WRITELN(CHR(139):3,' SHEEP ',CHR(241):3,' PRIMED BOMB');
5700 WRITELN(CHR(103):3,' CREATURES');WRITELN;
5710 WRITELN('POINTS ARE GIVEN FOR KILLING CREATURES');
5720 WRITELN('SAVING SHEEP AND NOT LOSING MEN');WRITELN;
5730 WRITELN('EACH TIME YOU KILL THE CREATURES THE');
5740 WRITELN('GAME IS MADE MORE DIFFICULT BY THERE');
5750 WRITELN('BEING MORE SHEEP AND SHORTER AND LESS');
5760 WRITELN('HURDLES. THERE ARE ALSO MORE BOMBS BUT');
5770 WRITELN('EVENTUALLY NOT AS MANY AS THE COMBINED');
5780 WRITELN('TOTAL OF MEN SHEEP AND CREATURES');WRITELN;
5790 WRITELN('THE CREATURES MOVE FASTER AND THE');
5800 WRITELN('POINTS GIVEN ARE HIGHER');
5810 NEXTPAGE;
5820 END;
5830 PROCEDURE NEWGAME;
5840 BEGIN
5850 WRITE(CHR(22));
5860 CURSOR(0,4);
5870 WRITELN('YOU REACHED LEVEL ',LEVEL);WRITELN;
5880 WRITELN('AND SCORED A TOTAL OF ',POINTS);WRITELN;
5890 WRITELN('DO YOU WANT ANOTHER GO?');
5900 REPEAT
5910 KEY:=INCH;
5920 UNTIL KEY IN ['Y','N'];

```

MICROMART



APPLE IIE or III
FREE PRINTER DOT MATRIX or
DAISY WHEEL PRINTER*

*Depends on systems size

COMPUTER Tel: 01-242 0024
CITY Tel: Manchester 061-228 1686

SCIENTIFIC SUBROUTINE LIBRARY

VOLUME 1 — STATISTICS AND FITTING FUNCTIONS

Mean, SD, normal distribution, partial expectation, Chauvenets criterion, least squares fit to polynomial and arbitrary function, repetitive least squares fits, covariance matrix, chi-squared statistic, matrix inversion, solution of simultaneous equations.

VOLUME 2 — LINEAR PROGRAMMING

Reduction of a Simplex tableau, integer programming, partial integer programming, conversational linear programming system, least cost mix problem.

VOLUME 3 — FURTHER STATISTICS

Ranking, quantiles, frequency, 2-way table, correlation coefficient, T, chi-squared and F distributions and their inverses, T test, chi-squared test, Wilcoxon test, linear and multiple regression, ANOVA 1-way and 2-way.

VOLUME 4 — TRANSFORMATIONS & SORTING ALGORITHMS

Fourier, FFT, Laplace, numerical integration and differentiation. Exchange sort, Quicksort, Shell sort, Tree sort.

Manuals including full source listings with implementation notes and documentation —

BASIC £25 per volume

PASCAL £30 per volume

Software in CP/M (8" SSSD) or DEC RT-11 (RX01) formats — £75 + VAT per volume.

CP/M TO DEC FILE TRANSFER

Software to read and write RT11 format RX01 diskettes under CP/M. Supplied on 8" SSSD diskette — £25 + VAT.

MICRO LOGIC CONSULTANTS LTD.

57, Station Rd., Southwater, Horsham, W. Sussex.

Telephone: 0403 731818

BBC CARRY CASE

Now you can carry your BBC Micro around in a rugged foam padded carry case, with nickel plated locks and hinges, and a sturdy handle. There is room to stow leads.

Price £20+£3 VAT+P&P £1

Dealer enquiries welcome

**BBC Micro Department
Computer Facilities Ltd**

Glebe House
Winterton Road
Scunthorpe
DN15 0BA
Tel. 0724 863167

SHARP MZ-80K

NEW 48K
SUPER MINOPOLY PROGRAM:

- 1) SAVE GAMES ON TAPE
- 2) ADDITIONAL CARDS, e.g. street repairs, Go to Mayfair, etc.
- 3) FASTER BOARD MOVEMENTS
- 4) OPTION OF 'KITTY' . . . etc.

The computer is now even harder to beat, with many new and improved algorithms by the author. Recommended for all AI enthusiasts.

£6.90 inc to SHARPSOFT LTD,
89-90 Paul St, London EC2A 4NE

ATTENTION ALL DRAGON 32 USERS
AND TANDY COLOR USERS!!

'Color Computer News'

Our latest magazine from the USA — full of hints, tips, ideas and software.

PLUS FREE UK SUPPLEMENT

with Dragon compatibility chart and free advisory service. Send £2.25 (plus large 50p SAE) to,

Elkan Electronics
(Dept PCW), FREEPOST, 11 Bury New Road,
Prestwich, Manchester M25 6LZ
or tel. 061-798 7613 (24 hour service)

OSBORNE 1

#1 COMPUTERS: Osborne specialist

We specialize: you benefit

Southampton House
192-206 York Road
Battersea, London SW11 3SA
(300 hundred yards from Wandsworth
Bridge roundabout)

MICROMART

BOOKS

FACULTY BOOKS
PROUDLY ANNOUNCE THEIR
AMAZING EXHIBITION OF COMPUTER BOOKS
STARTING MAY 4th FOR 6 WEEKS

AT: Middx Polytechnic HOURS
The Burroughs 10-4 Mon-Fri
Hendon LATE NIGHT
London N.W.4. Thurs to 8.30

PHONE 202-3593 FOR FURTHER INFORMATION
TUBE: HENDON CENTRAL. BUSES: 183, 143

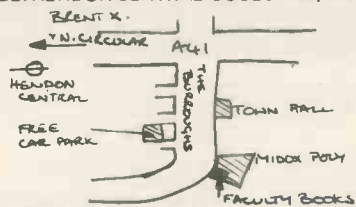

NEWBRAIN DRAGON GENIE

EDITOR adds extra commands to the machine CHANGE, FIND, GET, INSERT, DELETE, MOVE, VALUE, ORGANISE, CENTRE & RIGHT JUSTIFY TEXT.

Can be used as a word processor database or program editor, handling up to 24k on a 32k machine. The files created are in ASC11 format. Also available for DRAGON 32 & GENIE £15

RENUMBER can be used independently or in conjunction with EDITOR. All or part of a program may be renumbered with update of GOTO/GOSUB/THEN/RESUME statements. £6

MONITOR produces machine code programs on tape. Input, display, record, & test code hard copy feature. Input/output is in HEX or ASC codes. £15

Microplot

19 The Earls Croft, Cheylesmore, Coventry CV35ES
phone 0203-503038

PROGRAMMERS!

Expanding Software House requires quality programs of any type, BASIC or machine code, for Dragon, BBC, LYNX, or any other micros.

A CASH PAYMENT will be made for acceptable programs, +25% royalties. These programs will be on the market, within a month! PROGRAMMERS with promise could be offered permanent positions.

Please Contact:-

Shards Software
10 Parkvale Court
Vineway
Brentwood
Essex CM14 4OR

Or 'Phone
Brentwood (0277) 230338

BBC TRS 80 BBC TRS 80

FRENCH TUTOR (BBC B)

Odeal for O-level, home and school - it's still not too late! 3 programs teaching and testing: Vocab (+2000 words), phrases (+100 phrases), irregular verbs. True accents, graphics, sound revision sections. Also enter your own words. £10.00

BACKGAMMON (BBC B)

Excellent high-res graphics implementation of this popular strategy game. Colour and sound, tough computer opponent. £6.10

MUSICMAKER (BBC B)

Extensive and powerful music editor, + save to tape. Alphabetic notation, many instruments. Package inc. 4 demo pieces on cassette. £9.85

BBC LIGHT PEN - High quality, inc. software pack

£14.00

TRS80 JOYSTICK - Arcade-quality, self-centering Atari unit + interface + software

£14.00

FRENCH TUTOR (TRS80 Model I Level II 16K)

Huge vocab, supports accents, teaches verbs and genders. Sound + comprehensive revision sections. £10.00

OTHELLO REVERSI (TRS80 Model I Level II 16K)

Written in full machine language for superb responses, this game moves INSTANTLY. It includes an impressive graphics board and sound, with a powerful cursor control system for rapid movement entry. Play against your friends or risk your pride against the computer. Superb value for money. £4.95

All prices inc. VAT + P&P. Cheques/P.O. s to:

INSPIRATION SOFTWARE
11 Belsize Avenue, London NW3 4BL
(SAE for further details)

PROGRAMS

- 5930 END;
- 5940 BEGIN
- 5950 (M=0, C-, S-, A- *)
- 5960 INSTRUCT;
- 5970 REPEAT
- 5980 Q:=0;LEVEL:=0;POINTS:=0;
- 5990 REPEAT
- 6000 LEVEL:=SUCC(LEVEL);
- 6010 GAME;
- 6020 UNTIL (MND=0) OR (Q=1);
- 6030 NEWGAME;
- 6040 UNTIL KEY='N';
- 6050 END.

Tandy Colour Plotter Demos

by A Lovett

The Tandy CGP-115 colour plotter is a rather slow but versatile unit which can be driven by any suitable computer through a Centronics interface cable. It works well with the Acorn Atom and BBC computers. The three programs listed below were written for the Atom. 'Pattern' prints a square cross-stitched pattern, 'Sine & Cosine Waves' prints a graph of sine and cosine waves and 'Graph' draws a sales chart. Both serve to demonstrate the abilities of the little printer. Where the Atom uses PRINT\$ owners of the BBC and other computers should use PRINT CHR\$(). Mode switching on the plotter (from graphics to text and back) is done by sending ASCII codes 17 (return to text) and 18 (enter graphics) to it from the computer.

When in graphics mode the Atom requires an apostrophe after each statement, which gives a carriage return. This is not required on the BBC Computer. In all programs below the plotter is operating in graphics mode.

In graphics mode patterns, pictures and graphs can be drawn alongside text. A new range of commands is made available by this mode and these are demonstrated in the programs below. They are given using the PRINT command and a letter in inverted commas and include such facilities as pen moves, print size variation and draw commands.

No instructions are necessary for the use of these programs - they need only be keyed in and run.

```

• Graph
  5DIMB40
  10DIMA40;L=CH"l"
  15GOS.P
  20GOSUB1
  30FOR J=1 TO 12 STEP 2;
    GOSUBr ;B=VAL A ;GOS.r
  40X=VAL A ;Y=B
  45GOSUBx
  50NEXT J
  55P.$17'
  60P.$3
  70END
  500REM
  510 Q=?18*256
  520 DO Q=Q+1
  530 UNTIL ?Q=#D AND Q?3=L
  540 Q=Q+4;RETURN
  550*
  600r REM
  610r=-1
  620 DO R=R+1;A?R=Q?R
  630 UNTIL A?R=CH", " OR A?R=#D
  640 IFA?R=#D Q=Q+3
  650 Q=Q+R+1;A?R=#D;RETURN
  660*
  1000x
  1015IFJ=1;P."M"X","Y";RETURN
  
```

```

1020P."D"X","Y"
1030RETURN
180010,0
1810 75,20
1820 50,50
1830 100,100
1840 30,130
1850 75,200
2000P.$2,$18
2010P."R80,-200"
2020P."I"
2030P."X0,10,10"
2040P."HX1,25,10"
2050P."S2"
2060P."Q3"
2070P."M-10,10"
2080P."PSALE"
2090P."M10,-40"
2100P."Q0"
2110P."P 1982"
2115P."S1"
2200RETURN
  
```

Pattern

```

10P.$2
20P.$18
30X=100;Y=100
40P."M0,-350"
  
```

TELEPRINTER HANDBOOK

Now back in print at last, this book is a 'must' for anyone using one of these machines as a low-cost route to 'hard copy'. System descriptions and invaluable maintenance data for most of the popular models are provided. Fully illustrated with hundreds of line diagrams and many close-up photos of particular equipment features. (Note: interfacing with personal computers is not covered but see, for example, 'The poor man's printer', PCW Dec 1978 or 'Hard copy at a soft price', PCW May 1980).

368pp; hardbound; 246 by 184mm; second edition 1983
Price: £12.00 (£13.84 by post from RSGB)

Radio Society of Great Britain

Alma House, Cranborne Road, Potters Bar
Herts EN6 3JW Tel: Potters Bar 59015

NEWBRAIN SOFTWARE

RENUMBER £4.95
handles GOTO's, GOSUB's etc.
RENUMBER + REM REMOVER £6.95
WORD PROCESSOR £12.95
machine code allows rapid text changes
INCOME TAX £4.95
spreadsheet personal tax calculator
CURVE FIT £4.95
fits equation to your data + H1 RES plot
(least squares polynomial fit up to 10th order)

Prices include user guide, p&p
Cheques or crossed PO to
S Gaymer
16/18 Princes St, Ipswich

PROGRAMS

```

50P. "I"
100 FOR A=0 TO 200 STEP 5
105GOS. q
110P. "M"(X+A)", 100"
120P. "D300", "(Y+A)"
130P. "D"(300-A)", 300"
140P. "D"X", "(300-A)"
150P. "D"(X+A)", 100"
160NEXT A
163P. "H"
165P. $17, $3
170END
500q REM COLOUR CHANGE
510IFA/20=0 OR A/20=10 THEN P.
"C0";RETURN
520IFA/20=1 OR A/20=5 THEN P.
"C1";RETURN
530IFA/20=2 OR A/20=6 THEN P.
"C2";RETURN
540IFA/20=3 OR A/20=7 THEN P.
"C3";RETURN
550IFA/20=4 OR A/20=8 THEN P.
"C0";RETURN
560RETURN

Sine & Cosine Waves
1ST
100DIM A(2)
110P. $2
    
```

```

120P. "-----SINE AND COSINE
CURVES-----"
130P. $18
140P. "R0, -150, 240, 0"
150P. "I"
160P. "X1, -20, 10"
170P. "HX1, 20, 10"
180P. "HX0, 16, 5"
190P. "HX0, -16, 5"
200P. "C0";P. "L0"
210B=30;H=15;C=0;GOS. a
220P. "C1";P. "L3"
230B=-100;H=80;C=0;GOS. a
240P. "C2";P. "L5"
250B=100;H=80;C=1;GOS. a
260P. "C3";P. "L0"
270B=100;H=80;C=0;GOS. a
280P. "C0"
290P. "A"
300END
500a REM *DRAW CURVES*
510$A="M"
520 FOR I=-200 TO 200 STEP 4
530 *S=I/B*PI
540 IF C=0 THEN Y=x(SIN(*S)*H)
550 IF C=1 THEN Y=x(COS(*S)*H)
560P. $A, I", "Y";$A="D"
620NEXT I
    
```

TI PROFESSIONAL

continued from page 156

be scrolled both up and down and left and right. And the software is sufficiently intelligent to remove those phrases or questions that are ruled out by prior selections so that you end up with a usable query. Once you have built a query that the system can execute it tells you so by displaying the word "Executable" at the lower right-hand side of the screen. By using the return key to move a reverse video block (rather like the option boxes in Multiplan) among various main menu selections, the query can then be processed and relevant database records selected for screen display.

TI has already demonstrated the natural language interface working with the Dow Jones online retrieval service, and has indicated that there will be database specific versions on the market in the near future. Also, it will be possible to combine the natural language facility with the voice I/O capability, so making possible

some interesting program development projects.

Visicorp's version of the Xerox Smalltalk/Apple Lisa software offerings is also to be made available on the Professional. Called VisiOn, it provides the user with the ability to create "windows" on the display screen which can be edited, moved, swapped, deleted, and generally altered in some way by means of a mouse - the in-vogue micro computer companion which moves a screen cursor as it is pushed around on a desk.

Other products on the cards are two modem boards which can run at 300 bits per second or 300/1200 bps; analog interface board; a clock board; and an 8087 co-processor.

Conclusions

The TI Professional is a well made business computer system which has been designed with a specific purpose in mind - to capture a significant portion of

COMPUTER DESKING



- 30" x 24" Top
- 10" deep Storage Shelf
- Strong Metal Legs
- Easy Assembly
- Sandstone & Brown Finish

Basic Desk £42.50
Storage Shelf £5.50 VAT
Delivery & Packing £8.50

To order send cheque payable to:-

A & S Associates

Kirklands House, Kirklands Gardens, Baildon W. Yorkshire, BD17 6HP Tel (0274) 584643



HIGH RESOLUTION GRAPHICS 800 x 400 pixels

A set of BASIC subroutines offering following facilities:

Move, Draw, Circle, Arc, Textured Triangle Filling, Clear Window, Clear Screen, and 15 Different Character Sets which can be used anywhere on the screen.

Also Following Text Video Attributes: Cursor X, Y Addressing, Reverse Video, Highlighting, Underlining, and Flashing Cursor.

CP/M 86 Disk and Full User Instructions - inc VAT £50.00.

Send cash with order or SAE for further details to

Andrew Smith
13 Eastport Lane, Lewes BN7 1TL, East Sussex

MICROMART

*** For the Best Prices Ever ***
STOP & PHONE US NOW * 01-683 1181 (PBX)
We can match any price advertised



Computers:

Sharp MZ80A £434 Osborne 1 £1250
Sharp MZ80B £950 IBM PC £2662
Sirius 1 £2395

Printers:

Seikosha GP100 £225 Smith Corona TP1 ... £485
Epson FX-80 £438, MX82FT £349, MX100 £485,
OK1 80 £230, 82A £375, 83 £535, 84A £710
RICOH Flowriter TEC Starwriter F10 £1200
1600 £1550

Cables:

Standard £20 Special £35

and delivery:

Drives: 5 1/4" Top Quality Computers £15.00
SS 48 tpi £155 Printers £10.00
DS 48 tpi £185 Paper (Box) £2.00
DS 96 tpi £250 Disks (Box) £1.50

Please ring for prices.

Wide range of paper, diskettes and software available
for immediate delivery on MAIL ORDER

Ring now for help

THE MICRO-COMPUTER PROFESSIONALS

Cheques to: Croydon Micros or
20-28 Whitehorse Road, VISA ACCESS
Croydon, Surrey CR9 2HQ AMEX DINERS

Showroom open: Tuesday to Saturday 10 to 1 & 2 to 6pm
Proprietor: Frontrealm Ltd (T/A) Incorporated in England No: 1593574

BUSINESS SOFTWARE

INTEGRATED ACCOUNTS

Prepares daybooks, cash books, sales, purchase, nominal ledgers, trial balance, profit and loss accounts.
Normal price £1200.
SPECIAL OFFER £895.

PAYROLL

All valid PAYE codes are catered for. Facilities for different companies and branches. Cash analysis, payslips, P45 P60 etc. Normal price £500.
SPECIAL OFFER £395.

HARDWARE

North Star Horizon and Advantage Superbrain. All hardware and software are under warranty for 12 months.

MICROSYS LTD.

58 High Street, Prescot L34 6HQ
051-426 7271/051-430 6650



#1 COMPUTERS: Osborne Specialist

A tec: FP1500 - 25 printer
(25 C.P.S. Daisywheel) £300.00 + V.A.T.
When you buy your Osborne from us.

Call us on

01-228 2207

MICROMART

ZX81 16K SOFTWARE

Cassette 1 £4.50

METEOR STORM - how far can your starship travel through the raging meteor storm?

LIFE - the famous game where cells are born, live or die according to a few simple rules.

FIGHTER ATTACK - can you repel the invasion using your fighter and fast moving rockets.

Cassette 2 £4.50

MAZE RACE - are your reactions quick enough to get you through the maze before your time runs out.

CAPTURE - a fast moving game which will test your skill to the limits.

BREAKOUT - can you keep the ball in play long enough to breakout.

All games written in machine code for fast moving graphics. Cheques or P/O payable to:-

MG Read at

Read Micro Software

105 Julian Road, West Bridgford, Nottingham

From PROTONSOFT FOR 32K BBC

The ultimate in Star Trek type games. 40,000 different sectors of space using colour high resolution graphics for space battles, scans of the galaxy, sectors, and the full perspective view of space. Fight to the end of your strength in fast action full perspective laser battles using the best sound effects yet. Computer systems, battle systems, navigational systems etc all assist you in your constant conflict with the enemy to preserve the race of the universe. It's up to you!

Also "Master Copy" - a copy program that copies machine code and data files.

Both programs available separately with complete documentation and on a high quality computer cassette for £5.00 each plus 55p p+p.

Write to:

10 Dewery Avenue, Liverpool, L90 1LU

AT LAST, A SIMPLE A/D



for £49.95 INC VAT & P&P.

- 8-bit precision - 33K samples/sec. (max)
- Single address operation, any slot.
- Real-Time CRO diskette for APPLE II - £19 inc. extra.

Also Signal processing system available.

(Fourier Transforms, Homomorphic analysis etc, with superb graphics) £174 inc.

Sig. proc. system requires PASCAL. Details:-

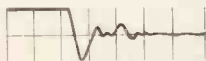

Cybernation Limited
CONSULTANTS TO INDUSTRY

PO Box 168
Hatfield
Hertfordshire AL10 9PE

Would you buy a video BLINDFOLED?



Or choose a stereo without LISTENING?

Microcomputers are even more complex - and the right one for you is harder to find. Much harder, without expert advice!

Even the cheapest are too expensive to be scrapped - and in business a mistake could cost far more than the price of the system!

For as little as £25, we will give you expert advice and help you to choose the right micro, printer, software - whatever you need.

And YOU will fix the final fee!

White Oak

Opens your eyes to the Microl
White Oak (Consultancy), Tong Lane, Whitworth,
Rochdale, LANCs. OL12 8DE.

the IBM PC microcomputer market and thereby put TI in a strong position with regard to the small business computer market. The Professional has a lot of compatible features and comes out at a few hundred dollars less than the IBM machine when standard versions are compared. Furthermore, it has a number of innovative features; the kind of software and hardware products usually found on much more expensive machines.

And maybe that's where TI has got an image problem. Users generally like to work out for themselves whether or not a particular machine suits their needs. In the case of the Professional, a user might reject the machine and buy an IBM PC on the basis that it is the original and is already supported by a monument of software and hardware. There again, the Professional may be attractive because of the future products that will be released.

And we're back to the old situation of first deciding what your needs are and then buying a system to match, and not vice-versa.

I liked the machine as long as I thought about it as a new business machine from TI - I got a little worried about it when I thought of it as an IBM PC work-alike.

Software

MS-DOS and MBasic £80
(some dealers are bundling it in free)
CP/M-86 and CBasic £195

Concurrent CP/M-86 and CBasic £250
UCSD p-System development system £550
run-time/turtlegraphics £250

Prices

Standard system: £2,075 Includes CPU, 64K RAM, 8K ROM, keyboard, 12 inch monochrome display and single 320K floppy drive. an extra £575

Colour monitor: £525
Floppy Disk Drive: £1,750
5 Mbyte Winchester: £245
Card for expansion to 128K RAM £405
Card for expansion to 192K RAM £565
Card for expansion to 256K RAM £185
Asyn/Sync comms card: UK price not fixed
Baby Tex card: Compatible UK
300 baud internal modem: modem
300/1200 modem card: prices to be advised
1-plane graphics board: £260
3-plane graphics board: £450
Model 850 printer: from £495

RELIABLE CODE

continued from page 111

George operating system that performs the timeslice function). This routine looks to see if the 'Break' key is being pressed; if so, it suspends the program. This is extremely useful for breaking into loops. The coordinator is called by ICALL and IRTN, by the multiply and divide routines, subscript calculation and indirect fetch. Between that lot, it's quite hard to accidentally write an endless loop that the Break key won't get you out of, but, for the pathologically loop-happy (me!) I also have a set of loop-construction macros covering all the normal forms of loop which call the coordinator directly.

If you really must have recursion (for instance for Pascal programs) you can achieve it at high efficiency by putting local variables in the parameter area (with their

own length byte!) and copying the parameter area 'somewhere else' (to an auxiliary stack, which could be interleaved with the control stack) if the recursion flag becomes non-zero when you increment it. On the first entry, when the flag becomes non-zero, the area contains rubbish. Of course you have to reinstate these old values when you leave the procedure.

Note that all variables remain statically allocated. (This implies that you can't have dynamic arrays.)

Note also that the copy of any given variable in a recursive nest which is 'visible' according to the Algol and Pascal scope rules is the statically allocated copy: the stacked copies are all invisible anyway. You don't need what an Algol implementor would call a 'Display Vector' to find things. (This is not strictly true of certain pro-

M & J SOFTWARE

DRAGON COMPANION BOOK £4.95
Discover 7 extra graphics modes; Take complete control of video memory mapping; Increase the processor speed (not a hardware mod); Append programs from tape; Study the workings of BASIC with the disassembler; Incorporate useful routines from BASIC in your m/c progs; Add commands to BASIC

DRAGON IMPLEMENTATION OF FORTH £15
This is a cassette based implementation and is fully documented.

FORTH LISTINGS £7
6502, 8080/280, 6809, 6800, 1802 in stock

INSTALLATION MANUAL £5
Necessary for implementing FORTH and its editor

All prices inclusive of postage and packing.
Cheques and POs made payable to

M & J SOFTWARE
34 Grays Close, Scholar Green, Stoke-on-Trent, ST7 3LU

If interested in advertising in Micromart please call Gaye Collins on 01-636 6890

cedures which are passed out of their declaration scope as parametric procedures to other procedures: you can't implement Algol 'call by name' like this.)

Note, finally, that by the time you have the extra code to administer the auxiliary stack and the rather general version of UNWIND required to be able to cope with a jump out of a procedure, you haven't

much space for program in 16k! For my applications, recursion is too much of an overhead.

By a little planning it's possible to provide an environment on TRS-80 style machines that allows sensible detection and reporting of programming errors while maintaining high space-efficiency and reasonable speed. **END**

LEISURE LINES

by J J Clessa

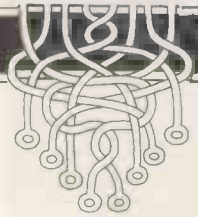

Quickie

A certain family has three children — half of the children are boys. How is this?

Prize Puzzle

Four ladies went into a post office to buy stamps.

Alice bought only 3p stamps. Betty bought only 4p stamps. Celia bought only 6p stamps and Doris bought only 8p stamps.

The total money spent by the ladies was £1.61.

The daughter got the fewest number of stamps and spent 24p.

The mother got the most stamps — she spent 72p.

Which of the four women were mother and daughter?

February Prize Puzzle

A low response — only 21 entries in all — denoting a more than average degree of difficulty.

There were several possible solutions to most of the ten parts of the problem, but we are only printing the answers submitted by the winning entrant who is Mr J E Weir of Glasgow, who also, if I'm not mistaken, has won on a previous occasion. Well, there is no rule that says you can't win twice if the luck of the draw is with you.

The winning solution was:

1 000 000 007
1 111 111 121
2 222 222 291
3 333 133 333
4 444 444 447
5 555 555 557
6 666 666 661
7 777 717 777
8 888 880 881
9 199 999 999

Congratulations, Mr. Weir, your prize should be with you by the time you read this.

BLUDNERS

Last month's review of the Oric contained a couple of mistakes — one of which Steve has owned up to; the other he insists is a typographical error. In his comments on the bug in the STR\$ command, mention was made of the Oric returning a wrong value for LEN (A\$) after A\$ had been loaded with a value using STR\$. In fact, Microsoft Basic includes the sign value each time LEN is called — this does not, however, explain the error in VAL which will have to go down as an Oric bug. In the program line to correct this, LEN was mysteriously changed to LINE — change it back and everything should work okay.



At the end of last issue's 'A look at C', we printed a wrong name for the UK agent of The Software Toolworks. System Science is the company to contact, on 01-739 0540.

could IT be the turning point of your career?

INFORMATION TECHNOLOGY: the source for economic growth into the 21st century
MSc/POSTGRADUATE DIPLOMAS

MICROPROCESSOR TECHNOLOGY & APPLICATIONS

A one-year full time course — or up to 3 years by block release — covering the design of microprocessor systems and their software, together with the applications of such systems in data communication, industrial control and robotics and related areas of management.

COMPUTING

A one-year conversion course to prepare honours graduates from Arts, Social Sciences or Business areas for careers in Information Technology. No previous

computing experience is required

Grants will normally be available to students accepted on these courses from special funds allocated by the SERC for Information Technology training.

Brighton Polytechnic

Full details about these courses and grants from:
The Registrar, Brighton Polytechnic, Moulsecomb,
Brighton BN1 4T, Tel: Brighton (0273) 893655

MICROMART

COMMODORE 64 SOFTWARE by IMPEX

BUSINESS APPLICATIONS*

80 COLUMN BOARD

EDITOR PAC

WORD PAC

FILE PAC

INQUIRE PAC

CALC-PAC

AND MORE!

HOME AND ENTERTAINMENT

BASIC TUTOR

ACCOUNT PAC

HAPPY TUTOR

BLACK JACK

SKETCH PAD

SEND LARGE SAE FOR CATALOGUE

DEALER & OVERSEAS ENQUIRIES WELCOME

IMPEX DESIGNS (UK) LIMITED,
METRO HOUSE, SECOND WAY,
WEMBLEY, MIDDX.

01-900-0999

TELEX 28604

SECOND USER EQUIPMENT BARGAINS

01-450 2417 01-450 9763

Samples of stock

IMS System £4000.00

comprising Intertec VDU, 12 flock S100

Slot card cage and power supply with ZXA.

64K dynamic RAM 2 RS232 port.

120 CPS by directional printer,

three 8" floppy disk drives with controller,

all in attractive teak finish desk.

OUR PRICE £1850.00

Zilog NCZ 10 flask, 5 systems specification as

above except not S100 bus, and CIFER VDU.

OUR PRICE £1700.00

Various other well known makes of second use

Micro Systems and Mini Systems. All at amazing

prices. Prices exclude VAT and delivery.

OSBORNE 1

DOUBLE DENSITY

PRAXIS 35+ Cent

MX80F/T III

ADLER TRD 170S DAISY

ET 121

01 Printer Cables

10 Double Density 5 1/4" SS Disks

£ask

£425

£ask

£675

£ask

£17.00

£19.00

Trade enquiries for cables welcomed

Meshurst Ltd

Tel: 01-597 3197 (Chadwell Heath)

PRICES EXCLUDE VAT & DELIVERIES

P/X CONSIDERED

ZX81 (16K) SPECTRUM (48K) STARTREK

Features an 8x8 Galaxy, Klingons and Starbases, short and long range scans, torpedoes and phasers, computer etc. PLUS normal or hyperdrive: choose your speed but watch the energy level. Galaxy Map: keep track of where you have been and whether there are any Starbases or Klingons there. Visual display of Enterprise's position and movement, and of the path of torpedoes. Messages from crew members. A user friendly long range scan. Five levels of play. And much more. Cassette with full instructions.

ZX81 £4.95

SPECTRUM £5.95 (Colour and sound too)

Gemini Software

36 Badminton Road
LEICESTER LE4 7RQ

Tel: 0533 64915

SYSTEM SCIENCE CP/M SOFTWARE

FROM SOFTWARE TOOLWORKS

C/80 Compiler Ver 2.0 £50.00
Conforms to Kernishan & Ritchie. Lacks long and floating data types. Generates .REL files. Needs 48K.

SPELL £50.00
Fast, easy to use spelling error detection program. Effective dictionary of up to 50,000 words. 48K RAM.

RATFOR £42.00
Pre-professor for FORTRAN-80. Many 'Software Tools' programs inc.

LISP/80 Interpreter £42.00
For A1 with examples. Requires 48K RAM.

TEXT-formatter £45.00
With many sophisticated features, including mail list, file inclusion, table of contents.

UVMAC-Z80 macro assembler £35.00
Generates absolute code.

COMPUTER CHEF £35.00
Recipe filer with 70 recipes, also useful for computer and keyboard training.

LABORATORY MICROSYSTEMS

Z80 FORTH Development System £45.00
Includes 90 page Manual and screens of software. Floating point version. £120

LYNX £230
Friendly overlay linking loader Fortran-80.

All of the above on 8" SSSD disc. Enquire for other formats

FOR THE OSBORNE

MYCHESS - Chess program £35.00

Pack and Crypt - file compression and encryption £30.00

MUNCHKIN and ADVENTURE each £30.00

Please send cheques or PO (add VAT + £2.00 postage)

SYSTEM SCIENCE

54 Enfield Cloisters, Fanshaw St, London N1 Tel: 01-730 0540

NEW FOR NASBUS/GEMINI The MAP V.F.C.

80 Column x 25 line screen, and Floppy disk controller on a single 8" x 8" professionally built plus in card. Fully compatible with the current range of NASBUS and GEMINI products.

FEATURES: 80 x 25 paged memory mapped screen
Flicker free display
Standard ASCII character set
128 graphic chars or inverse video
Onboard software
Video switch & keyboard port options
5 1/4" floppy disk controller

Available separately as kits or built boards

VIDEO CARD	£89 KIT	£110 BUILT
FLOPPY CONTROLLER	£95 KIT	£115 BUILT
VIDEO & FLOPPY	£165 KIT	£199 BUILT
OPTION & EXPANSION KIT	POA	

We are pleased to announce that we are supporting our new VFC with a 5 1/4" floppy disk drive system using 96 TPI, SS/DD Teac half height drives, in a slim case complete with power supply and all cables.

SINGLE DRIVE SYSTEM (500Kb)	£299 BUILT
DOUBLE DRIVE SYSTEM (1Mb)	£499 BUILT
256K RAM CARD - 64K Ver	£105 KIT £150 BUILT
(Expandable to 256K - expansion kits POA)	

SOFTWARE - We can support most systems with CP/M software - Ring for details.

ALL PRICES EXCLUDE P&P (£1.50) & VAT

MAP 80 SYSTEMS LTD

OPENING EARLY APRIL. COME AND SEE US AT OUR NEW SHOP:
CHERTSEY COMPUTER CENTRE, 1 WINDSOR STREET
CHERTSEY Tel (09328) 64663

EPSON HX-20 at

VISION STORE

NOW!

Vision Store now have in stock the fantastic Epson HX-20, the totally portable computer that slips easily into a briefcase and yet incorporates its own LCD screen, full typewriter keyboard, printer and microcassette. It runs for over 50 hours on its own power supply, which can be easily recharged overnight, for use anywhere. Come in and try the Epson HX-20 at Vision Store today.

EPSON HX-20 COMPUTER SYSTEM

HX-20 UA The HX-20 portable computer complete with integral printer and display

with transit case £411.00
without transit case £402.00

HX-20 MC-SA Optional Microcassette drive for HX-20 £75.00

HX-20 EU-SA Expansion unit for HX-20 contains 16 KB of RAM, or may be used with up to 32K ROM £80.00

HX-20 RC-SA optional ROM cartridge for HX-20 may contain 8K pre-programmed ROM (not supplied) £45.00

EPSON HX-20 ACCESSORIES

HOO-AAU Spare mains adaptor £8.50

HOO-RP Paper rolls for HX-20 pack of 5 £2.60

HOO-CR-RA Cartridge ribbons for the HX-20 (each) 1,000,000 character life £2.20

HOO-CT EPSON MC-30 Microcassette tapes £1.60

EPSON HX-20 LEADS & CABLES

702 Cable to connect an external audio cassette £5.70

714 Cable to connect an external EPSON terminal printer (serial) £15.00

716 Cable to connect 2 HX-20 computers using 8 pin RS232 sockets £15.00

717 Cable to connect 2 HX-20 computers using the High Speed serial Interface (5 pin sockets) £15.00

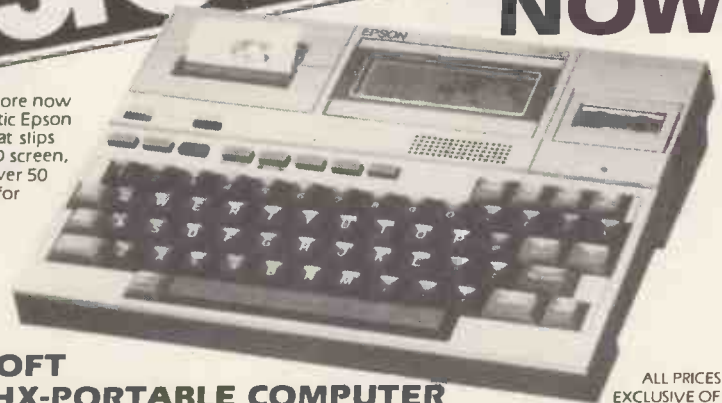

ALL PRICES ARE EXCLUSIVE OF VAT

EPSONSOFT EPSON HX-PORTABLE COMPUTER

D.I.Y.		Microcassette	Pre Programmed ROM
EPSONSOFT	A programme generator system, for the user who wishes to write data capture and data handling systems without learning BASIC	£30	£75
SIMPLICALC	A spread sheet system to create financial reports and forecasts from complex formulae	£30	£85
THE PERSONAL OFFICE	This suite of programs provides a 3 month rolling diary. A card index system, including a standard form and graphics option	£20	£75
CORRESPONDENT	A powerful word processing system, specifically designed for the HX-20, may be linked to an external printer, text files are stored on microcassette	£50	£105
MLIST	A complete mailing list system, including a selection code, complete with a link into the Correspondent system	£25	£75
SALES ORDER ENTRY SYSTEM	Allows the collection of sales orders and the downloading of a stock file from a central computer.	£40	N/A
COMMUNICATION		N/A	£30

VISION STORE

3 Eden Walk Precinct, Kingston-on-Thames, Surrey
Tel: 01-546 8974

THE MEN WHO INVENTED ME WERE
CLEVER ENOUGH TO MAKE ME THINK
IN 'FORTH' (IT'S 10 TIMES FASTER
AND 4 TIMES MORE COMPACT THAN
'BASIC').

YET THEY'RE DUMB ENOUGH TO SELL
ME FOR £89.95! ■



Richard Altwasser and Steven Vickers are the men who invented the Jupiter Ace.

After years of designing micro-computers that use BASIC (both men played a major role in creating the ZX Spectrum), they abandoned it in favour of FORTH.

FORTH is just as easy to learn as BASIC. Yet it's a faster, more compact and more structured language that educationalists and professional programmers alike prefer.

So the Jupiter Ace is the only micro-computer you can buy that is designed around FORTH.

Using it, there's little fear of accidentally 'crashing' programs halfway through and having to start all over again (a common fault with BASIC). The Jupiter Ace's comprehensive error checking sees to that.

The Jupiter Ace has a full-size keyboard, high resolution graphics, sound, floating point arithmetic, a fast, reliable cassette interface, 3K of RAM and a full 12 month warranty.

You get all that for £89.95. Plus a mains adaptor, all the leads needed to connect most cassette recorders and TV's, a software catalogue (35 cassettes available, soon to be 50), the Jupiter Ace manual and a free demonstration cassette of 5 programs

The Jupiter Ace manual is a complete introduction to personal computing and a simple-to-follow course in FORTH, from first principles to confident programming.

Plug-on 16K and 48K memory expansions are also available, at very competitive prices. (There'll be a plug-on printer interface available soon, too.)

It'll take you no time at all to realise how clever Richard and Steven were to design the Jupiter Ace around FORTH. And even less time to realise what a silly price £89.95 is to charge for it.

Technical Information

Hardware
Z80A; 8K ROM; 3K RAM.

Keyboard
40 moving keys; auto repeat; Caps Lock.

Screen
Memory mapped 32 col x 24 line flicker-free display upper and lower case ascii characters.

Graphics
High resolution 256 x 192 pixel user defined characters.

Sound
Internal loudspeaker may be programmed for entire audio spectrum.

Cassette

Programs and data in compact dictionary format may be saved, verified, loaded and merged. All tape files are named. Running at 1500 baud.

Expansion Port

Contains D.C. power rails and full Z80 Address, data and control signals. Can connect extra memory peripherals.

Editor

Allows complete editing and listing of compiled programs.

Please send cheque/postal order to:
Jupiter Cantab, 22 Foxhollow, Bar Hill,
Cambridge CB3 8EP.

Jupiter ACE

Please send me _____ Jupiter Ace microcomputers @ £89.95 (+ £3.95 p. & p.)
Tick here if you require VAT receipt

Name _____

Address _____

0060183

Available for immediate delivery. Allow 14 days for p. & p. U.K. price only (export price on request).

BACK ISSUES SERVICE

Here is a complete guide to all available back issues of *PCW*. A quick guide to their contents is shown below. Check the coupon overleaf for the issues you require.

Volume 1 No 1, 1978

The 77-68/Practical hints on kit building/Nascom 1/Charity case study/Flowcharting/Pontoon flowchart.

Volume 1 No 2 1978

Kit building Basic — first steps/Case study — a software house/PET 2001/Research machines 380Z/School computing/E78 — Europa Bus.

Volume 1 No 3, 1978

More efficient programs/Cosmac 1802/The PDP11 Part 1/Small business computing — an approach/The Z80/EPROM programmer construction.

Volume 3 No 6

June 1980

Benchtest: Tandy TRS-80 Model 11/Benchtests: Sintrom Periflex 630/48/Staff case study/Checkout: Softy Intelligent EPROM Programmer/Checkout: Exatron Stringy Floppy/Practical examples of the IEEE 48 bus use/Programs: Naming Nascom files/380Z Pictures/Fuel tank calculations — PET/PET large numerals/PET tank battle/Basic string handling.

Volume 3 No 12

December 1980

Benchtest: Microwriter/Printerfacing: Series — Part 1/Sharp PC-1211 speed-up/Programs: TRS-80 Tarot, PET Cat & Mouse, PET Rebound, MZ-80K Alligator Swamp, PET Connect, UK101 Minefield, PET Simon Benchtest: Raandn SPI

January 1981

Benchtest: Transam Tuscan/Real-time control using trains — part 1/Recover from a data tape disaster/PET Music Multi-user systems — part 1/Programs: TRS80 Four in a row, TRS80 Target Practice, PET Convoy, PET Wire, PET Maze Chase, PET Android Attack, PET Anagram

Volume 4 No 3

March 1981

Benchtest: Onyx C8002/Benchtest: Bigboard/Micro music software package/ALC circuit/Commons report/HP 43C/Programs: TRS80 Show Jumping, PET Grand Prix, PET Aircraft landing, PET Bouncy.

Volume 4 No 5

May 1981

Benchtest: Pascal 640/WP Benchtest: Magic Wand/PET colour/Low-cost digital tape system/Using calculator printers on micros/Apple music-making/Multi-user Benchtest: MVT-Famos/Programs: PET Grand Prix, PET Aircraft Landing, PET Bouncy.



Volume 4 No 7

July 1981

Benchtest: Sharp PC-3201/Multi-user Benchtest: Acorn Econet/Case study: Accident investigation on TRS-80/Zilog Z8 family/WP Benchtest: Format-80/Pascal Benchmarks: readers letters/Quicker Casio computations/Programs: ZX80 Sliding letters, UK101 Car Rally, TRS-80 Calendar, UK101 m/c code to Basic converter, PET Exam Questions, MZ-80K Designer, ZX91 Sketch Pad.



Volume 4 No 8

August 1981

Benchtest: Tandy Model III/Viewdata update/WP Benchtest: Spellbinder/Printer survey/Microholism/Programs: ZX80 Othello, Easter Sunday, Apple Mondrian, MZ-80K Duck Shoot, PET Gomoku, MZ-80K Football.



Volume 4 No 12

December 1981

Benchtest: Sharp MZ-80B Philips P2000/School network/BBC Micro inside story/'Turtle' Graphics for Apple/Forth language/Curve fitting/Calc corner: HP14C review/programs: PET Fantasy, ZX81 Battleships and cruisers.



Vol 5 No 1

January 1982

Benchtests: BBC Micro Xerox 820/Frames of Reference (new series)/ZX81 printer Checkout/Digital Drummer for PET/Calc Corner: benchmarks/Programs: MZ-80K Fortune, TRS-80 Reaction Timing, ZX80 Laybrinth, Apple Letters.



Vol 5 No 3

March 1982

Benchtests: Texas Instruments 99/4A, Hewlett-Packard 125/Choosing a Database/Comsoft DMS REVIEWED/Screenplay (new series)/Calc Corner: Hewlett-Packard Interface Loop/Programs: TRS-80 Solitaire, TRS-80 Ducks, Nascom Business Documents, MZ-80K Race Chase, ZX81 Graphplot.



Volume 5 No 4

April 1982

benchtest: Monroe OC8820/DB Benchtest: FMS-80/Checkout: Sid 1/Generating screen forms/Comal/Logo/Brain Dump-New series/Calc Corner: Casio FP-10 printer/Programs: TRS-80 Maths & Trig, PET Boot the Cat, ZX81 Resistor & Res code.



Vol 5 no 6

June 1982

Benchtests: Sharp MZ-80A/ZX Spectrum/Database Benchtest: DBMS2/West Coast Fire Report/Lisp/VIC 20 games/Calc Corner: Sharp PC1500/Programs: RML Altered Basic/VIC-20 Large Characters/BBC Breakout/VN Trailblazer/MZ-80K Next-to-Last-One/MZ-80K Tarot.



Vol 5 No 7

July 1982

Benchtests: Mimi 801/Newbrain/Database Benchtest: Silicon Office/UCSD p-System/BBC Computer-in-Depth/Apple II games/Calc Corner: T188/Programs: ZX81 Hypocycloids/BBC Character Generator/TRS-80 Truth/PET Doc/TRS-80 Screen Dump/UK101 Screen Converter/PET boxes/Atari Earth.



Vol 5 No 8

August 1982

Benchtests: Sort M23/Dragon 32/Database Benchtest: Cardbox/Preview: Sony SMC-70/UCSD p-System/RS232 Interface/Sirius graphics/NCC Show report/ZX81 Speech Checkout/Calc Corner: Casio fx602p/Programs: TRS-80 Quadrangle/UK101 Conversion of units/PET Mopup/Apple Lifespan/Apple Trees/Nascom Snail Racing/UK101 Long Multiplication & addition.

PCW SPECIALS

1983 Microcomputer Benchtest Special. 20 leading micros reviewed by the *PCW* team. Desk Top Computing £2.25.

Comprehensive guide to using micros to help you in your business.

BINDERS

Keep your copies in order with these strong, attractive yellow binders. £3.95 each (inc P&P)



Personal Computer



Vol 5 No 9
September 1982
 Benchtest: Olivetti M20/Word Processor Benchtest: Select for NEC/Database Benchtest: Aquila/Checkouts: Microwriter Revisited, E40 Data Compression/Screenplay: ZX81 Pt II/DIY Logo/P for Perfect/Beeb Colour Hi Res/RS232/Calc Corner: HP15 and I6C reviewed/programs: Video Genie Extended Basic, ZX81 Alphabetising, PET File Comparison, BBC Music Player, PET Virus, BBC Radar, PET German Game, TRS-80 Cardshuffler.

Personal Computer



Vol 5 No 10
October 1982
 Benchtests: HP-86; Positron 9000/Database Benchtest: Personal Pearl/3D Graphics for BBC Computer/Hashing Techniques/Designing your own Database/CP/M-86 v MSDOS/Clock-Calendar Card for Apple II/Calc Corner: hints for Sharp PC122/Programs: ZX81 Star Trek; PET Knockout; PET Trains.

Personal Computer



Vol 5 No 11
November 1982
 Benchtests: Canon CX-1; Hewlett Packard HP75/Database Benchtest: Condor/Apple II Clock Calendar Card Part — Algebra checking/Benchmarks summary/Bit Stik graphics for Apple/Calc Corner — HP41C, Casio fx702p programs/PCW Show report/Tiny printing on Centronics 739/Screenplay — Acorn Atom/Programs: Apple Piano; Apple Moon Module; PET Letter-writer; UK101 Logic; Atari Walls; Sharp MZ80K Area-filling; RML 380Z Restore.

Personal Computer



Volume 6 No 1
January 1983
 Benchtests: Jupiter Ace/Torch/Database Benchtest: Superfile/Warner-Orr programming techniques/Expert systems/Tokyo Data Show report/Forth Benchmarks/Digital Video/The Nearly Man — Charles Babbage/Portable Computer World — Continued Fractions/Micro Chess/Screenplay — Spectrum/Programs: VIC Connect-4/VICMon/Atari character set mover/VIC UFO/PET Forth Teacher/VIC Doppler/BBC Gomoku.

Personal Computer



Volume 6 No 2
February 1983
 Benchtest: Sage/Database Benchtest: BusiPost/Which Spreadsheet — new series/Networks — new series/Expert systems/BBC graphics revealed/Logo Turtle/Micro Chess — Fidelity's Prestige/Portable Computer World — Sharp PC1251 Benchtested/Numbers Count/Screenplay — BBC games/Programs — UK101 Vocabulary Test/PET Race Chase II/Apple Character Plotter/Variable Checker/ZX81 hex calculator/Atom Backgammon/Video Genie Aircraft Lander/Atari Flashback/MZ Text Analysis.

BACK ISSUES CENTRE

We have a complete selection of all available PCW back numbers in our flashy new Back Issues Centre in the West End of London, just half a minute's walk from Oxford Street (close to Tottenham Court Road tube station). Of course, you could order them from our excellent mail order service using the coupon below, but by visiting in person you save on postage costs. The Back Issues Centre also often has back numbers of PCW on sale which we cannot offer through the mail order service because of shortage of stock. Our receptionists will also be happy to sell you a set of binders to take your subscription. And there's a range of interesting computer books on sale as well. Drop by next time you're in the West End. We're open Monday to Friday, 10am to 6pm. The address is 14 Rathbone Place, London W1P 1DE.

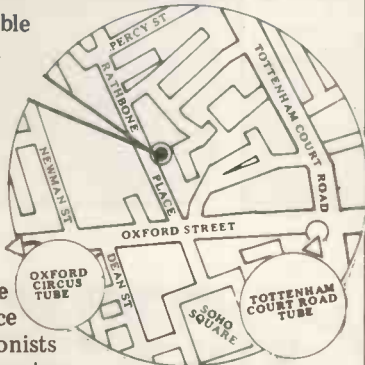

Come up and see us...
Mon-Fri
10am-6pm
Saturday
11am-6pm

Personal Computer



Volume 6 No 3
March 1983
 Benchtests: Corvus Concept, Computers Lynx/Database Benchtest: DataPrism/Which Spreadsheet? — Prophet II/IBM 9000 Instrumentation Computer/Apple Word Handler/Networks — Part II/ZX81 Graphics Module/Sharp MZ-80k Enhancements/Micro Chess — the Conchess range/Screenplay — Atari 800/Portable Computer World — hex listings for Casio fx602p and Sharp PC1211/Programs: Atari Animation/Chinese Horoscopes/PET Patience.

Personal Computer

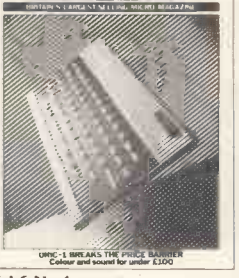

Vol 6 No 4
April 1983
 Benchtests: Oric-1, LSI M-Four/Database Benchtest: Rescue/Which Spreadsheet? — Multiplan/Networks — Part 3/Shelton Signet/A Look at C/Interfacing the BBC Micro/Screenplay — Dragon 32/Petspork compiler/Speech on the BBC/Dork program generator/Micros in dentistry/Generology — Coding family relations/Portable Computer World — Tax tables on Casio/Chess — Intelligent Software/Programs: BBC Bigprint/PET Billy/BBC Engine Failure/ZX81 Molecular Weight/1K Adventure/Beebdump/TRS-80 Word Scrambler.

CHANGE OF ADDRESS

Readers should note that all mail order subscriptions, binders and back issue enquiries must now be addressed to 55 Frith Street, London W1.

However, for personal callers only, a selection of PCW back issues, binders, micro-computing books etc can be purchased from the shop at 14 Rathbone Place, London W1.

Any one issue £1.50; all additional issues £1.00 each.
 Benchtest special £1.80. Desktop Computing £2.25.
 Binders £3.95 each. All prices include post and package.
 *Overseas orders requiring Air Mail postage add £1.00 per copy. Cheques/P.O. payable to Computing Publications Ltd,

53/55 Frith Street, London W1A 2HG Please allow up to 3 weeks for delivery and don't forget to state your name and full address with your order. Please send me the following copies of PCW. I enclose a cheque/P.O. for £. . . Please tick appropriate boxes.

Volume 1	Volume 3	Volume 4	Volume 5	Volume 6	Benchtest Special
1 <input type="checkbox"/> 2 <input type="checkbox"/>	6 <input type="checkbox"/>	1 <input type="checkbox"/> 3 <input type="checkbox"/> 5 <input type="checkbox"/> 6 <input type="checkbox"/>	1 <input type="checkbox"/> 3 <input type="checkbox"/> 4 <input type="checkbox"/> 6 <input type="checkbox"/> 7 <input type="checkbox"/>	1 <input type="checkbox"/> 2 <input type="checkbox"/>	Desk Top Computing <input type="checkbox"/>
3 <input type="checkbox"/>	12 <input type="checkbox"/>	7 <input type="checkbox"/> 8 <input type="checkbox"/> 12 <input type="checkbox"/>	8 <input type="checkbox"/> 9 <input type="checkbox"/> 10 <input type="checkbox"/> 11 <input type="checkbox"/>	3 <input type="checkbox"/> 4 <input type="checkbox"/>	Binder <input type="checkbox"/>

Name _____ Address _____

BUY THE BEST

TWILLSTAR COMPUTERS

IN STOCK



B B C

BBC MOD A 299.00
BBC MOD B 399.00

DISK DRIVES

Business Software
Educational Software
Entertainment Software



ORIC-1

THE REAL COMPUTER SYSTEM
FROM £99.95
INCL VAT

COMPUTERS
LYNX



Dragon 32

FOR ONLY
£195.00

PRINTERS

SINCLAIR SPECTRUM 16K £125.00
SINCLAIR SPECTRUM 48K £175.00

IN STOCK NOW

Dot Matrix
Epson FX 80 £395
Epson MX 100 +VAT
Seiksha GP100 A
BEST PRICES EVER

commodore COMPUTERS

Printer Cables, Leads, Disks, Stationery,
Cassettes, Ribbons, Dust Covers and
Wide Range of Software for all
Computers.

COLOUR MONITORS
14" Microvitek £250
GREEN MONITORS
Sanyo £99.00 Hitachi £99.00

**COMPUTER BOOKS & ELECTRONIC MAGAZINES
SOFTWARE, HARDWARE SUPPORT/SERVICES/RENTALS**

CALL IN FOR FURTHER DETAILS

TWILLSTAR COMPUTERS LTD

17 REGINA ROAD, SOUTHALL, MIDDX

TEL: 574-5271 (24 hours)

OPEN 10am-8pm SIX DAYS A WEEK



All about the MICRO

100s of latest books for everyone from beginners to professionals.

- Programming from Machine Code to High Level.
- Games and Graphics, techniques and programs.
- Hardware technology and design.
- Operating Systems.
- Business applications and many more
- Fast Service

Books Books Books!
Free Catalogue

Send large S.A.E. NOW!

to: Book Choice 1 Melling Road Southport
Merseyside PR9 9DU Tel: 0704 (Southport) 32230



- HP - HP -
NEWBRAIN - NEW
- ADVANTAGE - TRS 80 -
OSBORNE - COMMUNICATOR
- SIRIUS - APPLE - QUME

and we also stock a unique selection of low cost systems in our 'budget micro' department



Cambridge Computer Store

1 Emmanuel Street
Cambridge CB1 1NE
Telephone (0223) 65334/5
(closed 12.30 - 1.15 except Saturday)

SOLVE THE "WHICH MICROCOMPUTER TO BUY" PUZZLE IN SIX EASY MOVES

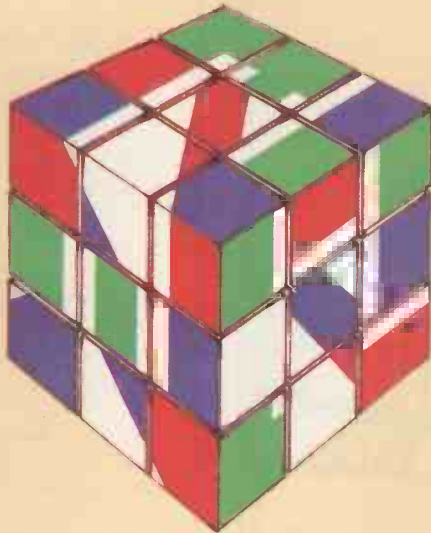

1. 16 BIT MICROPROCESSOR
2. 128K RAM
3. DUAL FLOPPY DISKS
4. 12 INCH MONOCHROME VDU
5. MSDOS OPERATING SYSTEM
6. APPROXIMATELY £1400 (EX. VAT)

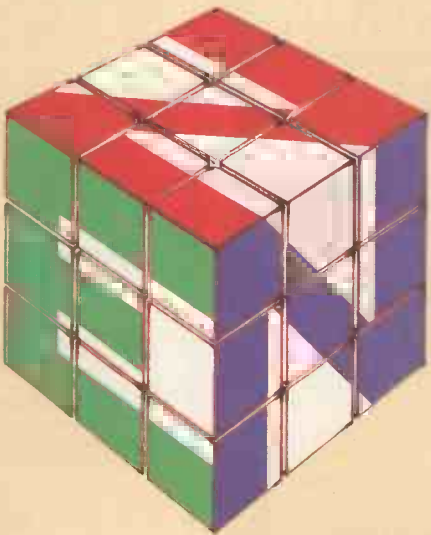

ZEN MICROCOMPUTERS LTD.

Please write for further details to:
ZEN MICROCOMPUTERS LTD, 5 ENGAINE, ORTON, LONGUEVILLE, PETERBOROUGH PE2 0QA

Name.....

Company.....

Address.....

Tel:.....

C. J. E.**Microcomputers****BBC**
SPECIALISTS

VAT included where applicable

QUALITY DISK DRIVES

Single drive 40 track single sided 1 x 100k	£180/225
Dual drive 40 track single sided 2 x 100k	£365
Dual drive 80 track double sided 2 x 400k	£799.25

All drives are cased with own PSU for reliability, and include connecting cables and utilities disk.
Delivery £4.00

SOFTWARE FOR THE BBC MICRO

MISSILE CONTROL the first implementation on the BBC Micro of the popular arcade game. (32K)	£5.00
MAZE MAN an authentic version of the popular arcade game. (32K)	£6.00
BALLOONS a highly original game that soon becomes compulsive playing. (32K)	£6.00
DISSASSEMBLER the memory dump routine includes a scrolling back in memory facility. (16K)	£5.00
MISSILE CONTROL, MAZE MAN & BALLOONS use the Keyboard or Joysticks for control	

30+ PROGRAMS FOR THE BBC MICROCOMPUTER

This Book contains program listings, with explanations & tips on using the BBC Micro
GAMES UTILITIES GRAPHICS & MUSIC
Most programs will run on Model's A & B
Edited by C.J. Evans, various Authors.
A pair of cassettes with all the programs is available.

BOOK	£5.00
BOOK & CASSETTE SET	£9.00

LEADS

The BBC Micro comes without a cassette lead

7Pin Din to 2x 3.5mm & 1x 2.5mm minijacks	£4.00
7Pin Din to 5Pin Din & 2.5mm minijack	£4.00
7Pin Din to 7Pin Din	£4.00
7Pin Din PLUGS	Two for £0.65
6Pin Din PLUGS (for RGB socket)	Two for £0.65
5Pin Din PLUGS (360° for RS232)	Two for £0.65

RS423 TO RS423 (BBC Micro to BBC Micro)	
Two metre cable	£4.00
Four metre cable	£5.00

TELEVISION/MONITOR LEADS full range available

Phono plug to Co-ax with high quality cable 3 metres	£3.00
BNC Plug to BNC Plug	£3.10
BNC Plug to Phono Plug (i.e. BBC Micro to Rediffusion TVRM)	£2.20
RGB 6PIN DIN to 6PIN DIN 1 metre	£4.00
2 metre	£5.00

PRINTER CABLES

BBC to 36 way Centronics Type connector	£17.50
BBC to 25 way D Type (for use with RS232)	£9.50
BBC to 40 way edge connector (Centronics 739)	£20.00
TORCH to 36 way Centronics Type connector	£20.00

Blank C15 and C30 Computer Cassettes

Ten for £4.50 any mix

15 Way D type Plug with Cover	£2.75
Computer graphics design pads 100 sheets	£4.00

BBC UPGRADE KITS

RAM UPGRADE (100ns)	£23.00
KIT A Printer & I/O Port	£9.50
KIT B Analogue Port	£8.00
KIT C Serial I/O & RGB	£10.00
KIT D Expansion Bus/Tube	£8.00
Full Upgrade Kit (Model A to B)	£60.00
6522 VIA (Included in Kit A)	£4.50

All components full specification

STAR DP8480 PRINTER

From £250.00 Inc VAT

80 CPS : 80/96/132 COLS
BIDIRECTIONAL LOGIC SEEKING
TRACTOR WITH FRICTION FEED

RS232 version £217.39 + £32.61 VAT = £250.00

High Res Graphics option to allow BBC Screen dumps £15.00/£20.00
(24HR SECURICOR DELIVERY FOR PRINTERS £8.00)**VAT Included where applicable**Send SAE for full Price List of our large range of accessories.
POSTAGE Add 50p per order or as stated**C. J. E.**Dept (PCW), 25 HENRY AVE, RUSTINGTON,
W. SUSSEX. BN1 6 2PA (09062) 6647**Microcomputers****Come to Kenilworth for
SHARP
OFF-THE-SHELF
RELIABILITY**

We have MZ 80 A & B and PC 1500 with Software back-up expertise to advise you on your requirements. See the advanced technology of SHARP on demonstration.

**THE LARGEST U.K.
NASCOM DEALER****Come to Kenilworth for
DRAGON
FANTASTIC VALUE FOR MONEY**

British built and designed. 32K RAM as standard. (expandable to 64K Bytes). Plus extensive facilities for colour graphics. 9 colour. 5 resolution display. Advanced sound. Prices from only £199 inc. VAT.

Full ranges of Software - tapes, cartridges, joysticks, books etc.

THE VERY POPULAR**Come to Kenilworth for
SINCLAIR
A MOST POPULAR MODEL****SINCLAIR ZX81 at £49.95
16K RAM PACK at £29.95
SINCLAIR PRINTER
at £59.95**

ZX81 1K RAM, one-touch Keyboard, complete with all connecting leads. 16K RAM pack plugs into expansion port enabling use of sophisticated ZX Software. ZX printer has full alphanumeric and graphics. 50cps, 32 characters per line.

EDUCATIONAL USES-

Our main product line - Nascom - will act as an excellent stand-alone system, optionally with High Resolution Colour Graphics and will attach to an economical Local Area Network. Ask for details of our recent installations in the educational field.

**Come to Kenilworth
THE LARGEST UK
NASCOM DEALER**

We are the largest NASCOM distributors in the U.K. and are up-to-date with all the latest hardware and software. Colour, Sound, Speech, Educational, Business, Home, or any application you have in mind.

Kit Computers with power supply, £260 excl. VAT.

Built Computers with power supply, £327.50 excl. VAT.

**Come to Kenilworth for
QUIBS
BUSINESS SYSTEMS**

An integrated Nominal, Purchase and Sales Ledger with optional invoicing and stock packages using the QUANTUM (British) with up to 2.25 M BYTE of floppy discs. Very competitive prices. But best of all friendly, professional advice on the best system.

**NASCOM
SOFTWARE
CATALOGUE**

B & L Microcomputers announce their new Software Division offering a range of high quality but inexpensive programs for the NASCOM.

Most of the programs have an educational content. The catalogue includes programs enabling owners to make the best use of the NASCOM. Send S.A.E. (9 x 6) please.

**Yes... come to Kenilworth
Business & Leisure
Micro Computers****16, The Square, Kenilworth,
Warwickshire CV8 1EB.
Telephone: (0926) 512127.**

The Home of Microcomputer Software



As you can see, this set of programs will prove to be a useful and valuable asset to any users range of software.

The CP/M TUTOR is an interactive tutorial designed to teach you all about CP/M and your computer. You need have no previous computer experience or knowledge to use this trainer.

The tutorial will run at your own speed. There are comprehensive help messages if you get stuck, as well as a question and answer session at the end of each section. If you get the answers wrong, the computer will give you a hint.

This tutorial is invaluable for anyone who wishes to understand how to make the best use of CP/M, and thus make the most of their computer.

* HELPFUL BOOKS:

We have a wide range of books, selected to support our comprehensive list of software. Four books which may interest you are:

- CP/M User Guide £11.10
- The CP/M Handbook with MP/M £12.10
- CP/M Primer £10.95
- Mastering CP/M £12.95

SUPERSOFT INC.

	Software & Manual	Manual Only
DIAGNOSTICS 1	59	12
TERM	94	9

SYNTAX SOFTWARE LTD.

CP/M TUTOR	55
------------	----

TDL SOFTWARE (Technical Design Labs)

BUSINESS BASIC	80
ZTEL (Text Editing Lang.)	35
LINKER	35

NEW PRODUCTS

For CP/M-86

ANTHONY ASHPITEL TYPING TUTORS

BASIC VERSION	50
BUSINESS VERSION	125 25

SAPPHIRE SYSTEMS LTD.

MARS	395 25
------	--------

MICROFOCUS

CIS COBOL v 4.5	425 25
FORMS 2	110 10
ANIMATOR	225 25
FILESHARE	250 20
CORAL-66	825 25
LEVEL-2 COBOL	965 40
LEVEL-2 FORMS-2	110 10
LEVEL-2 ANIMATOR	475 25

For IBM PC-DOS

MICROPRO INC.

WORDSTAR 3.0	327 50
MAIL MERGE 3.0 (requires Wordstar)	98 13
SPELLSTAR 1.2 (requires Wordstar)	163 13

ORDER INFORMATION

Most software in this advertisement is available from stock and we pride ourselves on a speedy turn-around of orders.

All prices are based on an exchange rate of \$1.53 to the £1.00 (current in Feb '83). Due to fluctuations in the exchange rate we find we have to bring out a new price list each month. Please telephone at time of ordering to confirm latest details, plus postage costs. Mail Order — Telephone Credit Card Orders — Personal Visits — Retailer and OEM Terms available.

* Free Full Descriptive Catalogue Available *

MICROCOMPUTER PRODUCTS INTERNATIONAL LTD.

ROOM PCW, 8 CAMBRIDGE HOUSE, CAMBRIDGE ROAD, BARKING, ESSEX IG11 8NT, ENGLAND Telephone: 01-591 6511 Telex: 892395

MICROFOCUS

	Software & Manual	Manual Only
CIS COBOL v 4.5	425 25	25
FORMS 2	110 10	10
ANIMATOR	225 25	25
FILESHARE	250 20	20
CORAL-66	825 25	25
LEVEL-2 COBOL	965 40	40
LEVEL-2 FORMS-2	110 10	10
LEVEL-2 ANIMATOR	475 25	25

MICRO INTEGRATION

BISYNC-80/3780	525
BISYNC-80/3780 (ASCI)	525
BISYNC-80/3270 (BSC)	525
BISYNC-80/HASP	975

MICROLOGY

FTNUMB (FORTRAN-80 RENUMBER & REFORMATTER)	50
--	----

MICROPRO INC.

WORDSTAR 3.0	327 50
MAIL MERGE 3.0 (requires Wordstar)	98 13
SPELLSTAR 1.2 (requires Wordstar)	163 13
ALL-STAR WORD PACK	471
WORDSTAR TRAINING MANUAL	24
WORD-MASTER 1.7A	98 29
TEX-WRITER 2.6	48 22
SUPER-SORT 1.6	163 29
DATASAR 1.4	229 33
CALCSTAR 1.2	196 33
ALL-STAR DATA PACK	471

APPLE VERSIONS

WORDSTAR 3.0	246 48
MAILMERGE 3.0 (requires Wordstar)	82 13
SPELLSTAR 1.2 (requires Wordstar)	128 13
DATASAR 1.101	193 33
SUPERSORT 1.8	131 29
CALCSTAR 1.2	128 33

MICROSOFT INC.

BASIC-80 5.21	242
BASIC Compiler 5.3	268
FORTRAN-80 3.44	340
COBOL-80 4.60	497
M/SORT 1.012	98
EDIT-80 2.02	85
MACRO-80 3.43	137
MULISP 2.12	137
MUMATH 2.12	170

MICROTECH EXPORTS

REFORMATTER CPM(IBM)	163 22
REFORMATTER CPM(DEC)	163 22

ORGANIC SOFTWARE

MILESTONE	263
-----------	-----

PEARL INTERNATIONAL

PERSONAL PEARL	180
PEARL-3	275

PHOENIX SOFTWARE ASSOCIATES

PLINK-Disc to disc link Loader	94 20
PASM-Macro Assembler	94 20
PEDIT-Line editor with Macros	94 20
BUG-Very powerful debug	94 20
PDEVELOP Package with all the above	252 43
PLINK-2 Overlay Link Loader	242 20

SAPPHIRE SYSTEMS LTD.

MARS	395 25
------	--------

SLOGGER SOFTWARE

DISKREV	65 13
DISKLENE	40 6
DISKORG	50 6
DISKED-2	65 8
DISKTOOLS-1 (Diskrev & Diskorg)	90 15
DISKTOOLS-2 (Disktools-1 & Disked-2)	145 19

STRUCTURED SYSTEMS (All converted to UK Standard)

SALES LEDGER	350 20
PURCHASE LEDGER	350 20
NOMINAL LEDGER	350 20
STOCK CONTROL	350 20
LETTERRIGHT	124 14
ANALYST	124 14
(File management Reporting System)	163 14
NAD (Name and Address selection system)	72 14
QSORT	72 14

ANTHONY ASHPITEL TYPING TUTORS

BASIC VERSION	50
BUSINESS VERSION	125 25

ASHTON-TATE

DBASE-II	438
----------	-----

BYROM SOFTWARE

BSTAM-Utility to link one micro-computer to another also using BSTM	124 8
BSTMS-Utility to link a micro to a mini or mainframe	147 14

CP/M USER LIBRARY

51 Volumes-Price per volume	
8" disc (one volume per disc)	5
5" disc (one volume per 2 discs)	10
5" disc (one volume per 3 discs)	15
Index	2

DECISION SYSTEMS

THE OPERATING GUIDE	45
---------------------	----

DIGITAL RESEARCH

BT-80	183 26
CBASIC v 2.08	85 18
CB-80 1.3	346 23
CP/M86	190 35
CP/M 2.2	114 26
CP/NET	141 18
DESPOOL	35 8
MAC	69 18
MP/M 1.1	153 24
MP/M 2.0	320 39
PASCAL MT+	229 26
SPEED PROGRAMMING PACKAGE	163 13
PASCAL MT+ WITH SPP	327 39
PASCAL MT+ LIB SOURCES	144
PL/1-80	350 35
SID 1.4	56 18
TEX 3.0	72 18
XLT86	105 8
ZSID 1.4	72 18

ELECTRONIC ACCOUNTING SERVICES

LINEAR & GOAL PROGRAMMING	200 10
---------------------------	--------

FOCUS COMPUTER SERVICES LTD.

PARAGRAB	95
----------	----

FOX & GELLER

QUICKSCREEN FOR DBASE-II	114 16
QUICKSCREEN FOR CBASIC/CB-80	114 16
QUICKSCREEN FOR MBASIC	114 16
QUICKCODE FOR DBASE-II	203 24

INFORMATION UNLIMITED

WHATSI (Database Management System)	80
-------------------------------------	----

KLH SYSTEMS

Spooler for CPM systems v3.0	92 8
------------------------------	------

MAGIC CIRCLE SOFTWARE

CPM SIM	157
---------	-----

MICRO-AP

SELECTOR-V 1.7	359 33
----------------	--------

MPI LTD.

FORTH	94 26
PAYROLL	500 20
SALES LEDGER	200 15
PURCHASE LEDGER	200 15
NOMINAL LEDGER	200 15
INCOMPLETE RECORDS	1200 20
MATHSPACK	120
STATSPACK	120

MEDIA AND FORMATS

Allos	A1
APPLE CP/M-80 13 Sector	RG
APPLE CP/M-80 16 Sector	RR
Blackhawk Micropolis Mod II	O2
British Micros Mimi	RK
California Computer Sys 8 in.	A1
CDS Versatile 4	O2
Columbia Data Products 8 in	A1
Comart Communicator CP50	P2
Comart Communicator CP100	P2
Comart Communicator CP200	P2
Comart Communicator CP500	P2
Compal-80	O2
CPT 8000	A1
Cromemco System 3	A1
Cromemco System 2 SD/SS	R6

Cromemco System 2 DD/SS	RX
CSSN Backup	T1
Cyler 8	A1
Datapoint 1550/2150	A1
Dec VT 180 SSDD	RV
Delta Systems	A1
Dynabyte DB8/4	A1
Exidy Sorcerer - CP/M-80	O2
Exidy Sorcerer - Exidy CP/M-80	O2
EXO	A1
Gemini Galaxy I	N1
Health H8 - H47	A1
Hewlett-Packard 125.8in	A1
IBM PC-DOS SSDD	C1
IBM PC-DOS DSDD	C2
IBM CP/M-86 SSDD	C3
IBM CP/M-86 DSDD	C4
ICL-PC	RE
iCL DRX Series	A1
ICOM 3712	A1

IMSAI VDP-80	A1
Industrial Microsystems 5000	RA
Industrial Microsystems 8000	A1
Intel MDS SD	A1
Intertec Superbrain SSDD	RK
Intertec Superbrain QD	RS
ISC Intercolor 8063/8380/8963	A1
ITT 3030 DSDD	R1
Micromail	A1
Micropolis Mod II	O2
Morrow Discus	A1
Mostek	A1
Multi-Tech 1	A1
Multi-Tech 2	C1
Micromail	C2
Micropolis Mod II	C3
Morrow Discus	C4
Mostek	RE
Nascom (Gemini Drives SSDD)	A1
Nascom (Gemini Drives DSDD)	A1

Nascom/Lucas	A1
NCR 8140/9010	RA
NNC-80	A1
NNC-80W	A1
North Star Advantage	RK
North Star Horizon SSDD	RS
North Star Horizon SSDD	A1
North Star Horizon QD (MPI CP/M)	P3
North Star Horizon QD	A1
(Other CP/M)	P2
Nylac Micropolis Mod II	O2
Osborne-I	A1
Perlec PCC 2000	O2
Rade 1000 SSDD	O2
Rade 1000 DSDD	A1
Rair Black Box	O2
Research Machines 5.25in	A1
Research Machines 8in	A1
Robotron 5"	R3
Robotron 8"	R7

SD Systems 5.25in	R3
SD Systems 8in	A1
Sharp MZ-80B	R9
Sharp PC-3201	R8
Shelton Signet	RK
Spacebyte	A1
Tarbell 8in	A1
TEL 8in	A1
Televideo DSDD	S5
Torch	NF
Toshiba T200 DSDD	S2
TRS-80 Modelli - Shuffle-board 8in	RP
TRS-80 Modelli II	RL
Vector MZ	RM
Vector Systems 2800	RE
Vector Systems B	RN
Vector VIP	A1
Xerox 820 5.25in	N3
Xerox 820 8in	A1

Eltec HOME & BUSINESS TECHNOLOGY computers

Probably the widest selection of software available by mail order.

All the top manufacturers including Acorn Soft, IJK (Sinclair), Superior Software, Bug Byte, Program Power, Hessel, Procyon.

HERE IS A SELECTION

Peeko Computer	9.95
Junior Maths Pack	6.84
Philosopher's Quest	9.95
Planetoid	9.95
Meteors	9.95
Arcadians	9.95
Swoop	7.99
Chess Model B	7.99
Space Invaders Model B The best	6.95
Atlantis — Superb fast Action 32K	6.95
Hyperdrive 32K	5.95
Stratobomber	6.95

Send SAE for full list.

HARDWARE EXPANSION

Sound pick-off module (simple to fit)	6.95
Amplifier and loudspeaker suitable for above	37.50
Light pen	34.50
X-Y digitiser	80.00

SUPER ACCESSORIES

Cover Polyester Cotton	3.97
Cover Soft PVC	4.45
Carrying Case for Computer, Cables, Cassette/ Disc Drive	55.20
Carrying Case a soft supported nylon version of above	23.00

BBC models A & B in stock: A - £299 B - £399

DISK DRIVES FOR BBC

BBC 100K Single drive (Requires discs (a))	265.00
TORCH Z80 800K Disc pack includes Z80 proc'r + 64K (b)	897.00
BBC/LVL 200K Twin Drive (a)	397.00
TEAC 200K Single Drive (a)	304.75
TEAC 400K Twin Drive (a)	569.25
TEAC 400K Single Drive (b)	396.75
TEAC 800K Twin Drive (b)	711.85
Connecting cable for TEAC drives	17.25
(a) SCOTCH Single sided discs Box of 10	28.75
(b) SCOTCH Double sided discs Box of 10	39.80

BBC UPGRADES

Full upgrade kit (fitting £31.00)	69.00
Disc interface (fitting £15.00)	109.25

The above prices are VAT inclusive. Add £1.00 p&p for orders below £100.00 and £10.00 (Securicor delivery) for orders above £100.00. Access and Barclaycard accepted on all items except BBC computers.

ELTEC COMPUTERS PCW
217 Manningham Lane, Bradford, BD8 7HH.
Tel (0274) 722512.



ACT
Sirius 1



COMMODORE 700 SERIES

BM 64

ALSO:

APPLES 

SYSTEME

SEE THE NEW SYSTEME S500. MULTI-USER, MULTI-TASKING 16BIT MICRO. VERY FAST & POWERFUL.

FOLLOW THE STAR 
NorthStar

SOFTWARE

Word-processing
Payroll
Incomplete Records
Book-keeping
Invoicing
Stock Control
Sales Ledger
Purchase Ledger
Record Keeping
Financial Packages
Time Recording
Data Base
Professional Advice Given

ACCESSORIES

Floppy Discs
Printer Ribbons
Stationery
Labels
Installation & Training
Maintenance

MATRIX PRINTERS

EPSONS 100 CPS

MX80FT-3

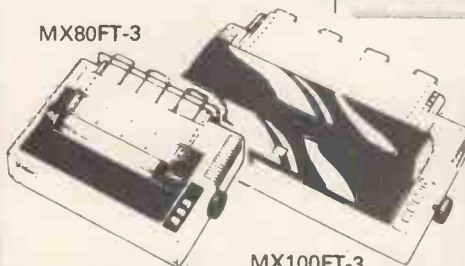

BBC COMPUTERS NOW AVAILABLE

MX100FT-3
OPTIONAL
16K BUFFER

DAISY WHEEL PRINTERS

FLOWRITER
RP 1600
60 CPS + 2K or
8K BUFFER

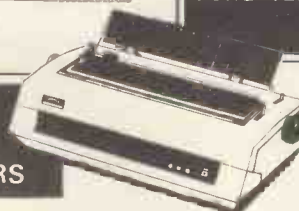

BROTHER HR-1
DAISYWHEEL PRINTER
16-20 CPS
+ 2K BUFFER

WE HAVE A CONSTANT
CHANGING RANGE OF
2nd HAND AND EX-
DEMO EQUIPMENT.
CALL US ON
01-952 0526
FOR LATEST STOCK.

BOOKS

Full range of Computer
Books on Show

**DEMONSTRATIONS
AT YOUR PLACE**

Please call for an
appointment, anytime.

DAVINCI COMPUTER SHOP

65 High Street,
Edgware, Middx.
HA8 7DD.



OPEN:
Mon-Fri 9.00-5.30
Sat 9.30-5.00
TEL: 01-952 0526



Da Vinci Computer Shop

16 K RAM PACKS FOR VIC 20

To the trade only

PLUS 80 GUARANTEE

*To beat any manufacturers price on 16K
and 24K RAM packs with full one year
guarantee.*

This offer applies to a minimum order of 10 units.

Write or phone for details to:

PLUS 80

432 GREENFORD ROAD
GREENFORD
MIDDLESEX

Tel: 575 1908.



TECHNEG CLWYD TECHNICS LTD

SPECIAL OFFER FOR MARCH/APRIL ONLY

Seikosha GP80 Printer £170 Carr £5

BBC Micro Model 'A' £261.30 Carr. £3

BBC Micro Model 'B' £348.26 Carr. £3

BBC 16K RAM Upgrade £25 + p&p £1

BBC Printer interface £10 + p&p £1

Acorn System 3 with

32K Memory £1,400 Carr. £10

Zenith Z100 16 bit

System from £2,072 Carr. £12

ALL PRICES EXCLUDE VAT

We are the Acorn Econet specialist.
Let us quote you for your system.
Education discounts available

Coach House, Kelsterton Road, Flint
Clwyd

Tel: DEESIDE 810518

3D COMPUTERS

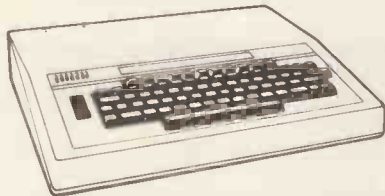

THE ACORN SPECIALISTS

BBC Micros Ex-stock

PERIPHERALS

PRINTER
COLOUR MONITOR
DISK DRIVE
TORCH Z80 DISK
CASSETTE RECORDER

NEW BRANCHES OPENING SOON:

EALING Phone 992 5855
RICKMONSWORTH 79259
MILTON KEYNES 317807

SOFTWARE

ACORNSOFT
BBC SOFT
PROGRAM POWER
BUG-BYTE
SIMON HESSEL

ADD-ONS

JOYSTICK
LIGHT PEN
GRAPHICS TABLET
TELETEXT
Z80 PROCESSOR
6502 PROCESSOR
MEMORY UPGRADE
DISK INTERFACE

BOOKS

30 HOUR BASIC
BBC BASIC
BBC MICRO REVEALED
LET YOUR BBC TEACH
LEARNING TO USE BBC
ASSEMBLY LANGUAGE

ORIC NOW IN STOCK

COMMODORE 64
NOW IN STOCK

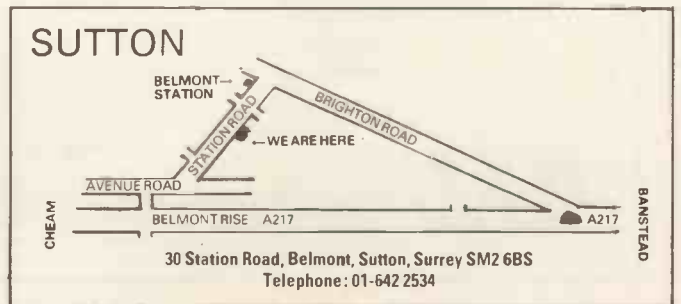
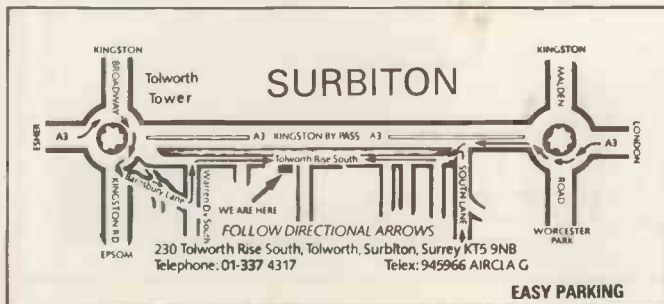



Micro Mystery...or... Micro Mastery? *Let your micro help you learn*

To use your micro well, you need a way to learn that is easy, enjoyable and economic. You will find it better to use a 'hands-on' learning system that you use on your own machine, at your own pace, and at any time. BIS-CAL (Computer Aided Learning) packages give you all these advantages and meet four key learning needs.

There are four main packages:

Hands-on CP/M Micros™ introduces the components of a micro, the concepts of information storage, handling and operating systems together with teaching the use of disk files and how to manipulate them using CP/M.

Hands-on Basic Programming™ A course on how to write effective business programs using disk files, screen formatting and printed output. No previous programming experience is required.

Hands-on CIS COBOL Programming™ To teach you all you need to know to write effective business application programs in CIS COBOL, taking advantage of all the interactive facilities.

Hands-on Level II COBOL™ A more advanced course teaching how to use Level II facilities. A major stepping stone to the industry standard COBOL for mainframe computers.

Just load the package onto your micro and begin. You will learn in the best possible way – at your own micro, in your own time.

I am interested in BIS-CAL Micro Computer Aided Learning Products. Please contact me.

I am interested in: CP/M MICROS BASIC PROGRAMMING CISCOBOL PROGRAMMING Level II COBOL *Tick as appropriate (-)*

My name is _____

Position _____

Company _____

Address _____

Telephone _____

My Micros (e.g. Apple II) _____

My Disk Format (e.g. 5 1/4" Single-sided single density, DDS 3.3) _____

My Operating System (e.g. CP/M Version 2.2) _____

BIS

CAL

Return this coupon or contact Stephen Helms at BIS, York House, 199 Westminster Bridge Road, LONDON SE1 7UT (Tel: 01-633 0866).

BIS Applied Systems

CP/M is the trademark of Digital Research Inc. CISCOBOL and Level II COBOL are trademarks of Micro Focus Ltd.

comart communicator

PROGRESS REPORT



...now the pedigree really shows

How has Comart's controlled, down to earth development strategy kept Communicator a firm favourite in the UK, and the leading candidate to reverse the tide of microcomputer imports?

New Range Additions The Communicator range has broadened to add a new 20 Megabyte 5" Winchester Hard Disk Drive System to the already well established 5 Megabyte and floppy diskette models. Another new system offers 8" floppy disk drives for compatibility of data transfer. With the associated tape and additional Winchester back up systems that adds up to eight basic models – all in the same neat, stackable, casing – all based on S100 bus construction to keep future options in memory, users, peripherals and interface requirements wide open.

New System Additions Communicator operating systems continue to broaden both in options and facilities. An improved CP/M offers enhanced diagnostics, for example, and auto boot from Hard Disk. These basic improvements are reflected in the now tried and tested Communicator multi-user MP/MI™, which also provides for full CP/M™ compatibility.

New Communications Options Communicator now offers CP/Net™ and RBTE communications protocols. Individual Communicator



Systems can now operate as intelligent information terminals, integrated with either existing mainframe or mini computer installations, or be part of a shared resource or communications network.

New Range of Terminals Find out more about Comart's new smart VDU. It's a new advanced ergonomically designed unit. It has a 105 keyset detached keyboard, soft green phosphor tilt screen, and a low profile foot. It's a perfect complement to the Communicator in both styling and performance.

Some things don't change Communicator still has Comart's established dealer network and nationwide after sales service back up, supporting thousands of Communicators already at work throughout the UK.

And in the Future? Behind all these innovations are advanced programmes of research and development. Soon Comart will be bringing you 16 bit, multi processor and distributed processing systems. This is your guarantee that Communicator will continue to keep pace as microcomputer technology progresses.

To find out more about Communicator today, call us now on 0480 215005.

Main Dealers

Birmingham The Byteshop 94/96 Hurst Street Tel 021-622 7149
Dublin Lendac Data Systems 8 Dawson Street Tel 0001 372052
Glasgow The Byteshop Magnet House 61 Waterloo Street
Tel 041-221 7409 Leeds Holdene Bray House Leicester Place
Tel 0532 459459 London The Byteshop 324 Euston Road NW1
Tel 01-387 0505 Digitus Lading House 10/14 Bedford Street Covent
Garden WC2 Tel 01-379 6968 Jarogate 197/213 Lyham Road Brixton
SW2 Tel 01-671 6321 Manchester The Byteshop 11 Gateway House
Piccadilly Station Approach Tel 061-236 4737 Nottingham
The Byteshop 92a Upper Parliament Street Tel 0602 40576
Southampton Xitan Systems 23 Cumberland Place Tel 0703 38740

A member of the Comart Group of Companies

comart
SPECIALISTS IN MICROCOMPUTERS

Comart Limited, Little End Road,
Eaton Socon, St Neots, Cambs PE19 3JG
Tel: 0480 215005 Telex: 32514 Comart G

Dealers

Aberdeen MOM Offshore Tel 0224 22863 Bedford Remdex Bradley Tel 93 68581
Cambridge Cambridge Computer Store Tel 0223 65334 Edinburgh Holdene
Microsystems Tel 001 557 4060 Glenrothes Computer Services (Scotland) Tel 0592
773710 Blackpool Western Computers Tel 0253 404676 Manchester NSC Computers
Tel 061 832 2269 Norwich Anglia Computer Centre Tel 0603 29652 Worthing Ace
Computing Services Tel 0903 35411 Middlesbrough Aztech Tel 0642 222621 Barking
Moldavia Tel 01-591 6511 Belfast Cardiac Services Co Tel 0232 625556 Wilmalaw
Holdene Tel 0625 529496 Gloucester Eurotek Consultants Tel 0208 72538
Huntingdon Westcom Tel 0480 217217 Luton M E Marketing Tel 0582 31806
Middlesex/Berks Newbury Data Recording Tel 0784 61141 Sheffield Hallam
Computer Systems Tel 0742 663125 Watford Lux Computer Services Tel 0923 29513
Aylesbury J K Wakeford Assoc. Tel 0296 27473

CP/M, MP/MI and CP/Net are all trademarks of Digital Research Inc.

NEW

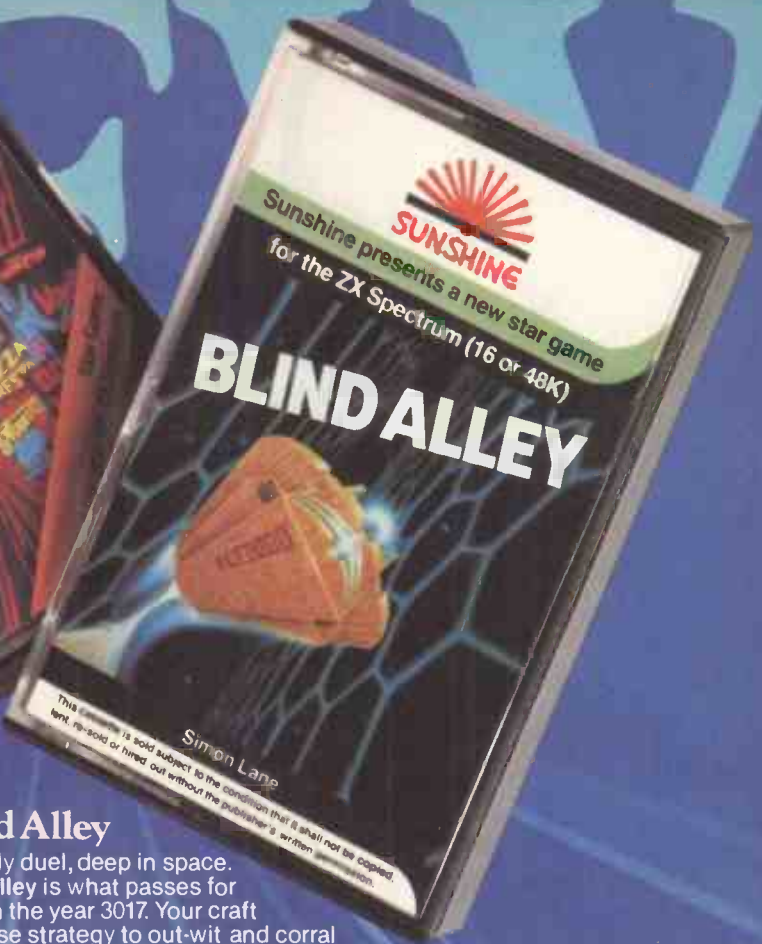
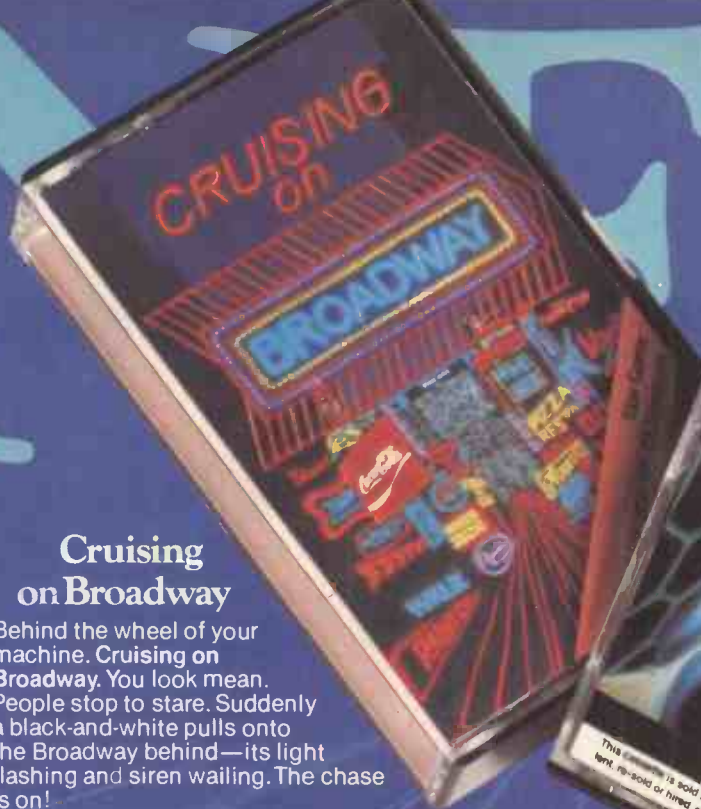

Cruising on Broadway

Behind the wheel of your machine. **Cruising on Broadway.** You look mean. People stop to stare. Suddenly a black-and-white pulls onto the Broadway behind—its light flashing and siren wailing. The chase is on!

Cruising on Broadway is a tyre-burning fast machine-code game for the 16 & 48K Spectrum. The further you can get the more difficult it becomes—cash prizes are being offered each month for the highest scores.

£4.95*

Blind Alley

A deadly duel, deep in space. **Blind Alley** is what passes for sport in the year 3017. Your craft must use strategy to out-wit and corral the opponent—in this crazy development of the pursuit games of the late 2600s. After each round in the enclosure game more players are sent against you to test your skill and agility. **Blind Alley** is the machine-code action of the future—now! For the 16 & 48K Spectrum.

£4.95

2 cassettes & 2 books from Sunshine

The Working Spectrum

(228 page book)

The first well-documented collection of serious programs for the ZX Spectrum, Programs include a Basic Renumber which can handle Gotos and Gosubs, a character dictionary, a file-handler, several utility programs and a few games. Each program is built up out of re-usable subroutines.

£5.95*

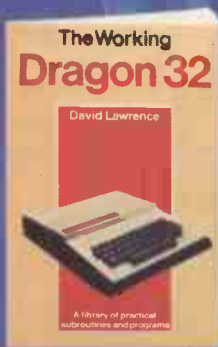
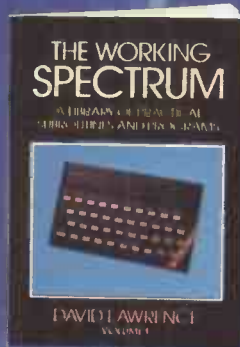

The Working Dragon 32

This is a companion volume to The Working Spectrum and includes several new features such as a Text Editor and a Music Composer and Editor. Other programs help you use the Dragon 32 as an accountant, for more advanced high resolution graphics, as a home tutor for education and for playing games. Each of the programs and subroutines is explained line by line to help develop your own programming skills.

£5.95*

*Submit your program to Sunshine and your name could be here next month.



SUNSHINE

*Available through W. H. Smith's and computer dealers.

Trade/dealer enquiries welcome.

Please send me

The Working Spectrum at £5.95 each

Cruising on Broadway at £4.95 each

The Working Dragon 32 at £5.95 each

Blind Alley at £4.95 each

I enclose a cheque/ postal order for £ _____

payable to **Sunshine Books**,
19 Whitcomb Street, London WC2 7HF.

Name _____

Address _____

Signed _____

We can normally deliver in four to five days.

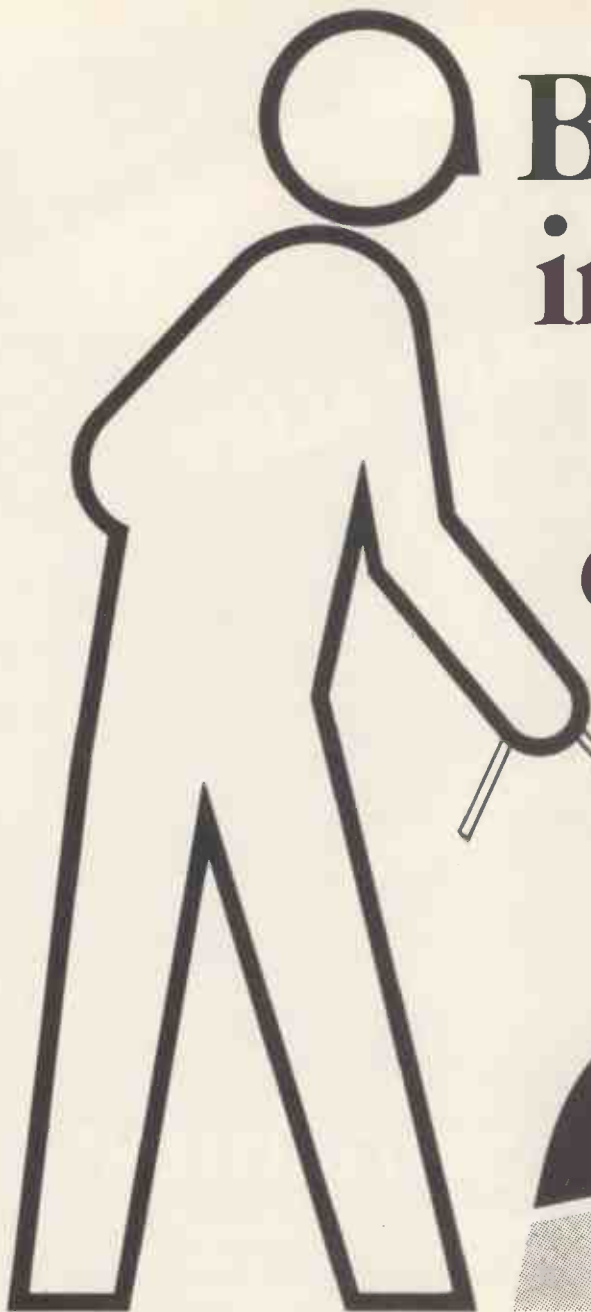

Be a lucky dog in the exciting Flexette competition.

5 great reasons to order Flexette floppy discs

1st PRIZE: MICRO COMPUTER SYSTEM

2nd PRIZES: VIDEO CASSETTE RECORDER

3rd PRIZES: PORTABLE COLOUR TV

4th PRIZES: HUNDRED DISC CAMERA
5th PRIZES: THOUSAND Copy of 'COMPUTER BLUFF' by Dr Stephen Castell.



5 more great reasons to order Flexette

- * Made by Rhône-Poulenc, one of Europe's leading manufacturers of computer media.
- * 100% certification of total disc surface to ensure error free product.
- * Cost-Quality-Performance.
 - * Surface coating that reduces headwear by 25%.
 - * A choice of 5 1/4" or 8" single or double density, single or double sided, and quad density (100 TPI).

Order Flexette now from your usual distributor, or for more information ring or write to Rhône-Poulenc Systems Ltd., High Street, Houghton Regis, Bedfordshire, LU5 5QL. Tel: Dunstable (0582) 605551.

The more you order the more chances to WIN!

Competition entry form with every pack of Flexette floppy discs you order. Check the letters on your form to see if you've won a fabulous prize.



RHÔNE-POULENC
A computer's best friend.

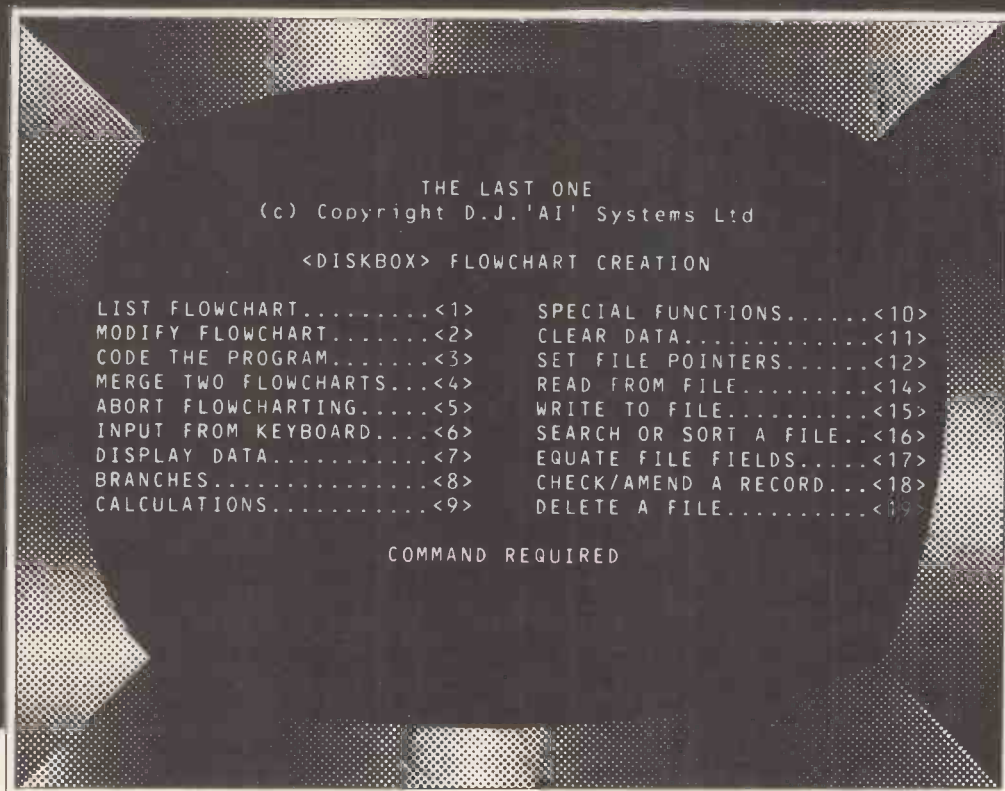

Program coding is now as easy as 1,2,3...

It's not writing programs that takes the time, it's coding them – every comma, bracket and filename has to be exactly right, just one of those obscure symbols adrift is enough to crash the biggest, toughest program in town!

How much easier it would be to say "Search that file" and "Display Fred's record" instead of having to write a dozen or more lines of faultless BASIC whenever you want to find something. Well, now you can.

The menu shown above is one of the central screen displays in **THE LAST ONE**. By combining any of the options shown it is possible to create simple or complex programs with no more than a few, carefully selected, keystrokes. **THE LAST ONE** does the rest, only asking you to answer its questions from time to time so that it can be sure that the program it is writing does exactly what you want. And all this in (more or less) plain English.

Now you can design, write, amend (and sell!) perfect customised programs without ever typing a line of code. A godsend for the business micro user, a phenomenally powerful tool for the professional programmer, a delight to all; **THE LAST ONE** allows anyone to write computer programs.

Finished programs can handle up to 15 files simultaneously (9 on the Commodore machines), they can include *any* feature found

in *any* application program you've ever seen, and they run first time – every time. Following a year of extensive field trials, **THE LAST ONE** has grown from a simple (though advanced) program generator into the one of the most powerful micro tools available. It is in use in thousands of installations around the world including banks, airlines and scientific and educational establishments as well as being available on countless small business machines.

THE LAST ONE runs on the APPLE II, the COMMODORE 4032 and 8032/96, the TRS-80 Model II (TRSDOS or CP/M), most CP/M, CPM-86 and MS-DOS machines including the IBM PC and the SIRIUS.

Whatever you use your computer for, you owe it to yourself to find out what **THE LAST ONE** can do for you – to see it in action. To order or to find out more, write to:

D.J. 'AI' Systems Ltd, Station Road, Ilminster,
Somerset, TA19 9BQ

Telephone: Ilminster (04605) 4117

THE LAST ONE™

Nominated 'SOFTWARE PRODUCT OF THE YEAR 1982', and selected as finalist in Recognition of Information Technology Achievement Awards (RITA).

Software package transforms efficiency

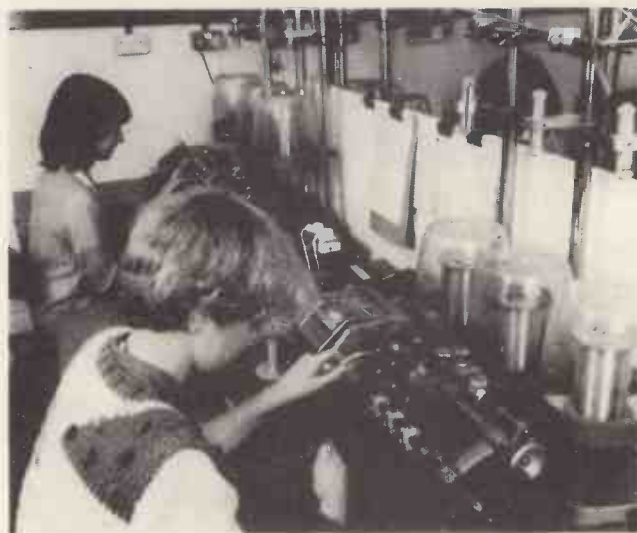

Plastics Technology of Lewes, Sussex
Manufacturers of high quality transformers

Everyone knows reliable accounting software is an asset to any business. Sadly really good packages are not so easy to find.

But Plastics Technology have got just such a package from Open Computer Services. It's easy to use and offers a comprehensive programme that can readily be updated.

Contact Open Computer Services for quality software. And don't forget, should you find a bug in one of our packages, we'll give you £100.

**Payroll now incorporates
Statutory Sick Pay module**

OPEN COMPUTER SERVICES

Aqua House Old Steine Brighton BN1 1EL
Tel. (0273) 672191 Telex 878195

MICROCOMPUTER SOFTWARE from Small Systems Engineering Ltd

CP/M 80 SOFTWARE:

BASIC 80 Microsoft's extended basic interpreter.	£230
BASIC COMPILER Compiles Basic 80 programs to machine code for speed and security.	£260
CB 80 A native code "C" compiler from Digital Research	£310
CIS COBOL An "ANSI 74" standard Cobol Compiler.	£420
CORAL 66 The high level programming language for military and industrial command and control systems.	£825
FORTRAN 80 The popular science and engineering language.	£330
PASCAL MT+ A Pascal Compiler meeting the ISO standard.	£370
PLI/80 A general purpose application programming language for developing large scale structured programs.	£325
PROPASCAL Designed for the Z80 produces relocatable machine code which is very fast and compact.	£190
DBASEII An interactive relational database management package with its own high level programming language.	£385
AUTOCODE A program generator for DBASEII.	£150
D/GRAPH Draws bar, pie, line and pie-bar charts direct from DBASEII databases.	£195
DUTIL Programming utilities for DBASEII.	£110
MICROMODELLER The number one financial modelling and forecasting program.	£525
MICROSTAT Statistical program library from Ecosoft for Basic 80.	£190
SUPERCALC Spread sheet and modelling system.	£190
BSTAM Micro to Micro communication package with CRC error checking.	£115
BSTMS Micro to mainframe intelligent terminal package.	£125
WORDSTAR The industry standard word processing package from MICROPRO.	£255
SPELLSTAR Micropro's spelling program for Wordstar.	£140
CROSS ASSEMBLERS For the following microprocessors: Motorola 6505, 6809, 6800; MOS 6502, RCA1802, INTEL 8048, 8051; National Semiconductor 400, Fairchild F8 and Zilog Z8.	£125

PC DOS

BSTAM	£115
DBASE	£430
EASY WRITER	£220
EASY SPELLER	£110
EASY FILER	£250
EASY PLANNER	£155
MICROSTAT	£190
SPELLSTAR	£140
WORDSTAR	£290

CP/M86

BSTAM	£115
CBASIC 86	£200
CIS COBOL	£420
PASCAL MT+	£370
SUPERCALC	£190

- The above software is available on disk formats to suit most popular micros.
- Small Systems manufacture second processor cards to allow the following micros to run standard CP/M 80 programs, IBM P.C., Sirius 1, Victor 9000, CBM PET.
- Descriptive sheets on the software products listed above are available on request.
- Dealer enquiries welcome.



small systems engineering ltd
2-4 Canfield Place, London NW6 3BT
Tel: 01-328 7145 Telex: 264538

**PUT A LITTLE COMPUTER
INTO YOUR LIFE
THE NEW**

**EPSON HX-20
PORTABLE COMPUTER**

from



Little computer, big power

The world has been waiting for the full-function, truly portable computer.

The Epson HX20 is that computer. Its standard 16KB RAM memory is expandable to 32KB. And the standard 32KB ROM memory can be upped to 72KB if you choose.

But this is not all there is to the HX20. It also communicates. With RS-232C and serial interfaces to connect to telephone couplers and other devices.

HX20 is easy to use. The full-size ASCII keyboard works just like your favourite typewriter.

With its built-in printer, LCD screen and music generation via piezoelectric speaker you have versatility never before found in a computer this small: and because the HX20 utilizes rechargeable nickel-cadmium batteries it will run for as long as 50 hours at a stretch.

What's more, the HX20 works on a full, extended version of microsoft BASIC.

If you would like to see the HX20 contact any Westrex office to arrange a demonstration.

Telephone: London: 01 578 0957
Birmingham: 021 554 5827
Manchester: 061 764 0324
Newcastle: 0632 326551
St. Ives: 0480 66343



Westrex Co. Ltd. Bilton Industrial Estate
Fairway Drive Greenford Middlesex UB6 8PW

AMBER 2400

- Plain Paper Printer
- 24 Columns wide
- Full upper and lower case characters
- Graphics capability
- Serial and parallel inputs as standard
- Built-in mains power supply
- Very low cost

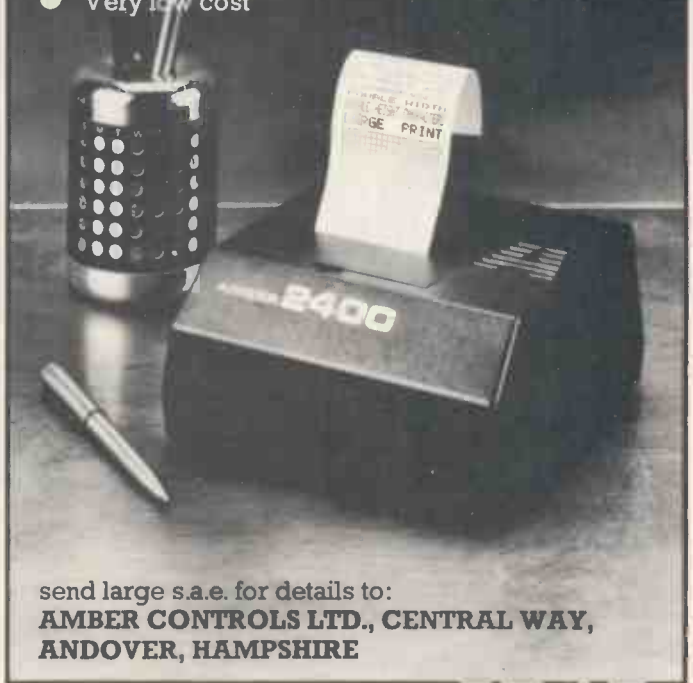

send large s.a.e. for details to:
**AMBER CONTROLS LTD., CENTRAL WAY,
ANDOVER, HAMPSHIRE**

New for APPLE II/IIe

Compare these FORTH attributes with other languages for Apple II:
Suitability — FORTH is suitable for all programming tasks, particularly games, graphics and business applications. Both novices and professionals can benefit from FORTH'S unique blend of facilities.

Productivity — FORTH programmers are more productive. Of the thousands that have changed to FORTH, many report a tenfold increase in their useful output.

Efficiency — The Metacrafts FORTH compiler produces threaded code which is very compact and which runs 10-20 times faster than BASIC and 2-5 times faster than Pascal p-code.

Extensibility — FORTH lets you design your own program control structures and data handling primitives. This means you can truly extend the language to suit your application, instead of being forced to "bend" your application to suit the language.

Simplicity — FORTH encourages a highly modular interactive style of programming which simplifies program development. This is backed up by a powerful set of tools, including a full screen editor and a debugger which allows you to test programs at the source code level.

Flexibility — Metacrafts FORTH can be configured to handle any device type, and diskettes can be generated to handle turnkey applications.

PRICE £79 includes: comprehensive user guide. FORTH 79 system, full screen editor, macro assembler, debugger, utilities. Extension word sets for double length arithmetic, strings, graphics, heap and buffer handling. Dictionary overlays. Support for 40/80 column display + printer + language card. Customer support service. Requires 48K Apple II/IIe + 1 Disk II (16 Sector).

Payment by cheque/cash with order.

Write for additional information. Dealer discounts.

Metacrafts FORTH

To: Metacrafts Ltd, 144 Crewe Road, Shavington, Crewe. Tel: (0270) 666274

Name Tel. No.

Address

Cheque No.

If you do not wish to cut out form send order separately

No1 source for software

SOFT OPTION SOFTWARE CENTRE

When you're thinking software, think Soft Option first. Chances are we'll have the right product, in the right format, on the shelf in quantity.

We despatch fast from stock. We also offer a dealer pricing system to suit individual needs with cumulative discounts available.

Finally, we *know* about software—we can give you technical support when it's needed.

So make Soft Option your first call. We'll soon become your first choice.

8 BIT **16 BIT** **16 BIT**
CP/M 80 CP/M 86 MS-DOS

and IBM PC Software



SOURCES INCLUDE:

We hold stocks of most software manufacturers including:

MICROPRO
MICROSOFT
DIGITAL RESEARCH
SORCIM
IUS
ASHTON TATE



MACHINE FORMATS INCLUDE:

Software can be made available in 8 BIT or 16 BIT formats to suit most micro-computers currently on the market including:

Superbrain
North Star Horizon
North Star Advantage
Columbia PC • IBM PC
Televideo • Apple
CP/M 8" • Rair • Sirius



PROGRAMS INCLUDE:

Our complete list of software is too long to publish and changes by the hour but here are a few examples to whet your appetite.

WORDSTAR MICROPRO's comprehensive word processing system.
PL/I-80 DIGITAL's PL/I Compiler.
BASIC-80 MICROSOFT's popular and powerful basic Interpreter. There is a Compiler too.
FORTTRAN-80 Fortran Compiler to ANSI X3.9 1966 except COMPLETE data.
SUPERCALC SORCIM's spread sheet and modelling system.
EASYFILER Data Recording System for the IBM PC from IUS.
dBASE II Relational Database Management from Ashton Tate.

RING THE SOFTLINE Grantham (0476) 860171

All products are supplied complete with full originator's documentation. Please send large s.a.e. for full details. TRADE ENQUIRIES WELCOME.



Soft option SOFTWARE CENTRE

The Soft Option (UK) Ltd. Home Farm House Colsterworth
Grantham Lincolnshire NG33 5HZ Tel: Grantham (0476) 860171

God didn't make little Green Apples...

Datalink isn't the largest dealer in the SW of England

In the same way as we all know who's responsible for nature's bounty, there's no secret about the stature of Datalink in the S.W. of England. Especially if you happen to be one of those highly professional, computer orientated blue chip and multi-national companies who are customers of ours.

And when you think that we only took three growing seasons to reach our present position it says a lot for why companies, large and small, come

to us. Things like professionalism, knowledge, service and pricing.

If you're sceptical we'll give you some names where you can check. Names that you *will* have heard of.

Let's hope we can use your company as a reference, too, before long.

And bear fruit with the rest.

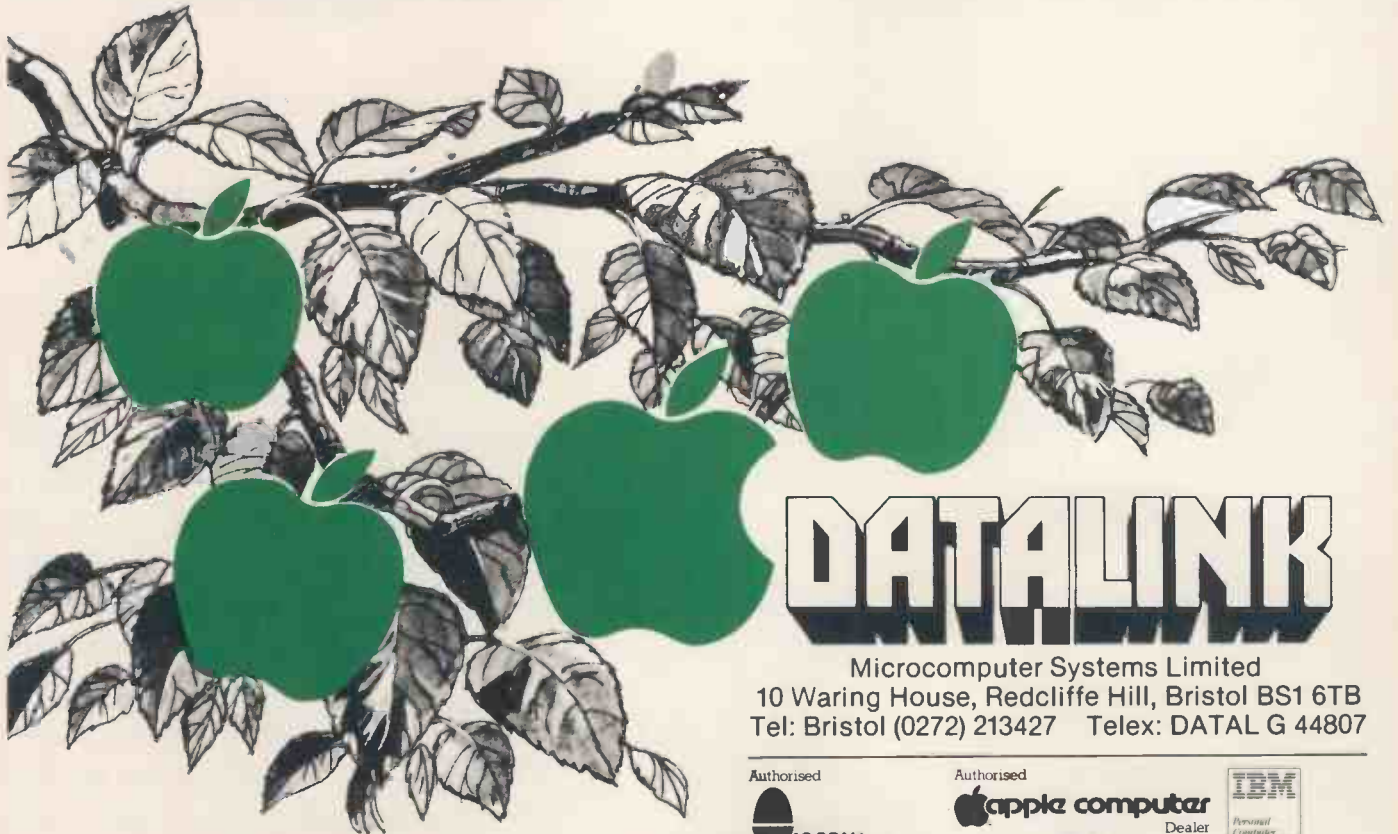

DATA LINK

Microcomputer Systems Limited
10 Waring House, Redcliffe Hill, Bristol BS1 6TB
Tel: Bristol (0272) 213427 Telex: DATAL G 44807

Authorised

 **ACORN** | BBC
COMPUTER | DEALER

Authorised

 **apple computer**
Dealer
BBC
REFERRAL CENTRE



IBM
Personal
Computer
IBM Authorised Dealer

Make Friday you



★ **Personal Computer News** is weekly, published every Friday.

★ **Personal Computer News** is only 35p.

Around a hundred pages printed on glossy paper, much of it in full colour.

Probably the best value to be found on your newsagents shelves.

★ **Personal Computer News** is edited by the largest editorial team working on any

microcomputer publication in Britain. We have individual editors working on hardware, software, peripherals, features, listings and programs – fourteen of them in all. A massive investment of talent and expertise with only one aim. To make **PCN** the finest microcomputing title in Europe.

★ Our deadlines on news and features are short.

That means we get to publish comprehensive hardware tests, software reviews, news and much else besides, weeks and weeks before monthly titles

r day of discovery.



can hope to do so.

Personal Computer News is carrying scoop reviews and tests in virtually every issue.

Whatever your particular interest in the world of microcomputing, you'll find it first in **PCN**.

★ **Personal Computer News** comes from the publishers of **Personal Computer World**.

That means you can rest assured on the quality and independence of the editorial package.

★ Every issue of **Personal Computer News**

carries a pull out 'part-work' which will gradually build into a comprehensive library on microcomputing.

In addition, you'll find free Readers' Buy and Sell ads, a totally unique programs listing section for the more popular micros, Buyers' Guides, language articles and much, much more.

★ Make Friday your day of discovery. Try **Personal Computer News**. The Complete Computing Weekly.

Home Computer - Starter Packs

THE BEST PRICE & ADVICE FOR THE BEGINNER

NEW

The exciting new personal computer from Commodore

Commodore

- ★ 64K RAM
 - ★ 16 colours, dedicated video chip
 - ★ 62 pre-defined graphics characters, 3 voices, 9 octaves. Music synthesizer, dedicated sound chip
 - ★ 40 x 25 display. 320 x 200 for high resolution
 - ★ Powerful graphics commands
 - ★ Interfaces with a complete range of peripherals
 - ★ Supports CP/M[®] and others.
- ALL FOR **★£343.85★** inc. VAT.



Printer - £230.00
Disk Drive - £299.00
Cassette Unit - £44.95

VIC 20

- STARTER PACK 1.
VIC 20 + Cassette Unit + Intro to Basic + 10 x C12 Cassettes - £195.00
- STARTER PACK 2.
VIC 20 + Floppy + Printer - £625.00

DRAGON

- ★ Britain's newest Personal Computer using the latest 6809E processor.
- ★ Full 32K Specification
- ★ Microsoft Basic, Advanced Graphics, Sound, Editing.
- ★ 9 colour display.
- ★ Professional quality keyboard
- ★ Plug-in connection for Joystick, Cassette, Printer, Games.

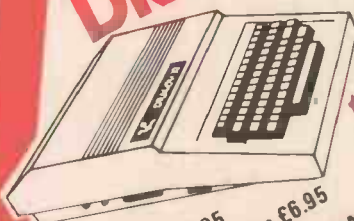

Cartridges - Ghost Attack £24.95
Octaves £19.95. Cassettes £6.95

★ DRAGON 32K - £199★

BBC

- Model B - £399
- Upgrade A to B - £95
- Disk Drive - £265
- Disk Interface £97.75 including fitting.



ALL PRICES INCLUDE VAT

ATARI

- AM400 - £159.95
- A800 - £399.00
- Recorders - £49.95
- Basic - £39.95



STARTER PACK 1.
AM400 + Cassette Deck + 10 FREE C12 Cassettes - £199

STARTER PACK 2.
AM400 + Cassette Deck + Basic - £239

NEW from ONLY £129.00

ORIC 1

- 16 Colours. Full Graphics.
- Real Sound. 16K - (June) £129.00
- 48K - £169.00

SINCLAIR



- ZX81 - £49.95
- Printer - £59.95
- 16K RAM - £29.95
- Spectrum 16K - £125.
- 48K - £175.

STARTER PACK 1.
ZX81 + 16K RAM + Printer + 10 x C12 Cassettes + 2 Rolls Paper - £146.95

STARTER PACK 2.
ZX81 + 16K RAM + 10 x C12 Cassettes - £81.95

EXPORT

Single or QUANTITY EXPORT orders welcome. NO VAT.
Experience of exports worldwide - full documentation
MONITORS, PRINTERS, SOFTWARE.
Popular prices on all popular Computers.
Send A4 S.A.E. for latest FREE Brochures & Pricelists

CASTLE ELECTRONICS

(0424) 437875

CASTLE ELECTRONICS Dept. PCW
7 CASTLE STREET, HASTINGS, E. SUSSEX.

Our Sister Company SOUTH EAST COMPUTERS, is No.1 in the South for Business Systems



THE CENTURY COMPUTER PROGRAMMING COURSE

PETER MORSE
IAN ADAMSON
BEN ANREP
BRIAN HANCOCK

The complete guide to programming in Sinclair BASIC
using ZX81 and Spectrum Microcomputers

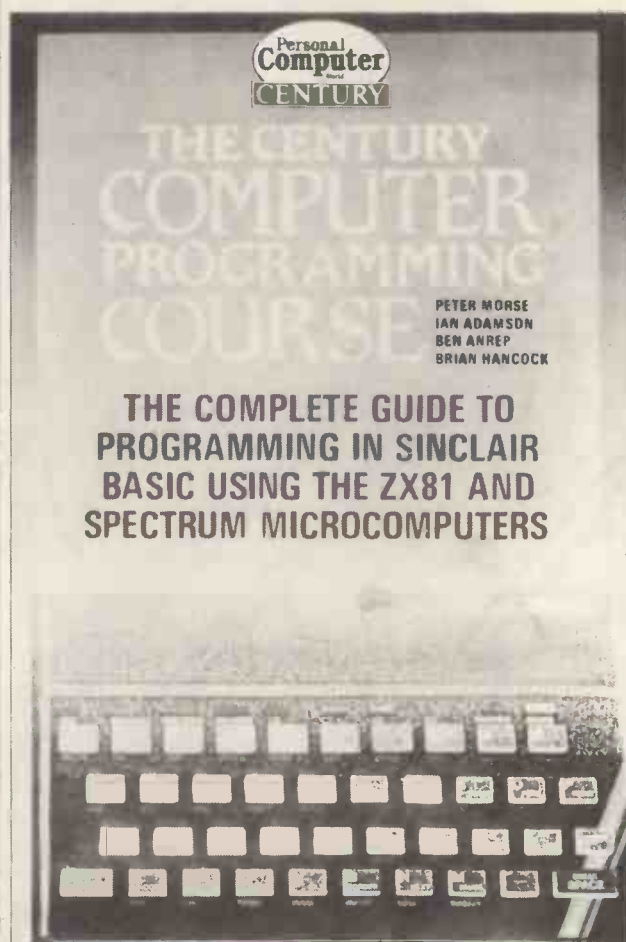

Sinclair have sold over 600,000 ZX81's and Spectrums, which means that somewhere out there are 600,000+ potential programmers.

There are enough books and collections of programs on the market to help you get beyond the user manual. **The Century Computer Programming Course** aims to transform any Sinclair owner into a serious programmer – whether they own a Spectrum or a ZX81, whether they are totally new to computing or simply have ideas in advance of their current expertise.

Beginning with the elements of BASIC syntax, **The Century Computer Programming Course** takes you right through to the creation of sophisticated applications programs. More than 500 pages and 200 programs and routines makes this a monumental project. Without it Sinclair owners are likely to remain games players for the rest of their computing lives...

*Illustrated with line drawings 544pp
£9.95 (paperback)*

Available through your local bookshop

To: Department CC8
George Philip Services Ltd
Arndale Road, Wick
Littlehampton
West Sussex BN17 7EN

Please send me copy/copies of
THE CENTURY COMPUTER
PROGRAMMING COURSE at £11.50 per
copy (post paid). (£13.50 post paid for
overseas addresses)

I enclose my cheque/postal order
for £.
(Please make your cheque/postal order
payable to George Philip)
Name
Address

.....
.....
Please allow up to 28 days for delivery



THE ACID



TEST.

D

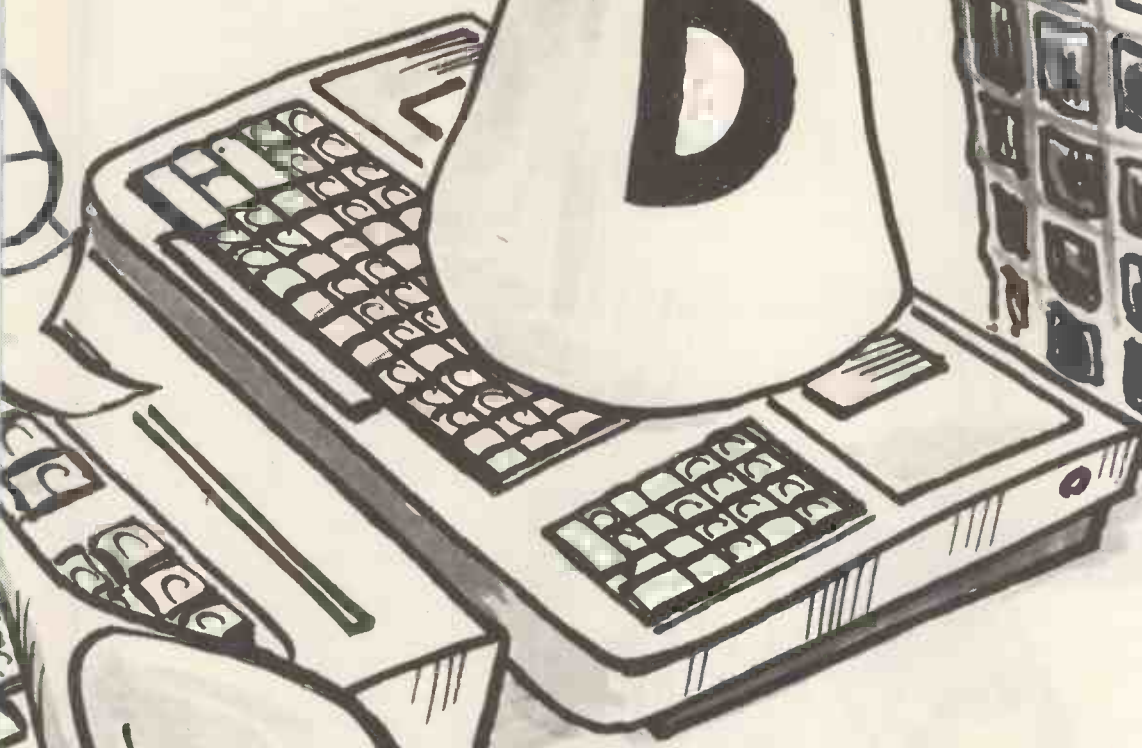

The first stage of our micro test is pretty tough. Fourteen separate procedures to check and report on.

The second stage, however, is simple torture.

We have devised eight programs which make any micro sweat. The routines gradually become more complicated.

They start with simple speed-related counting through loops, numeric calculations, variables and constants, sub-routine calls, finishing with a dimension statement. Then we test arrays and, finally, sines and logs.

We have put dozens of micros through their paces. Some are twice as fast as others, for the same price. And that's what you need to know.

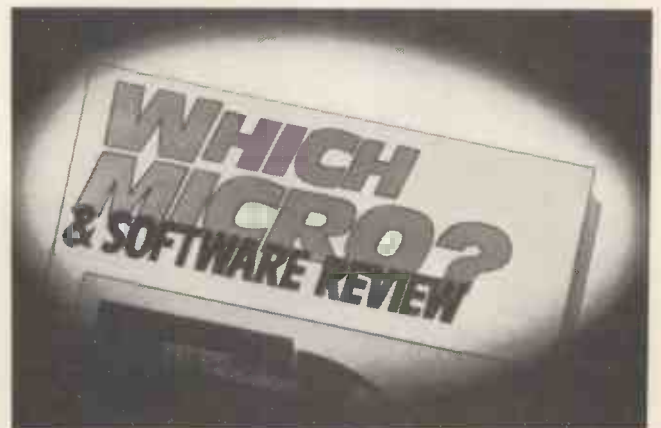

WHEN WE TEST A MICRO, IT STAYS TESTED.



MAPLIN

HARDWARE

Atari 400 with 16K RAM (AF36P) £199.95
 Atari 400 with 48K RAM (AF37S) £299.00 ★
 Atari 800 with 48K RAM (AF02C) £399.00 ★
 All above with BASIC and handbooks
 Atari Cassette Recorder (AF28F) £50.00
 Atari Disk Drive (AF06G) £299.95
 48K RAM for Atari 400 (AF44X) £99.95
 48K Upgrade for 400 (AF45Y) £99.95
 Commodore 64 (AF56L) £339.00 ★
 VIC20 (AF47B) £129.95
 16K RAM for VIC20 (AF53H) £59.95
 Commodore Cassette (AF48C) £44.95
 Commodore Disk Drive (AF50E) £299.99
 Dragon 32 (AF57M) £199.50
 Dragon Joystick (BC30H) £19.95
 Cassette Cable for Dragon (BC31J) £2.95
 Epson Printer MX80F/T (AF40T) £447.35
 MENTA (XG28F) £115.00
 Floppy Disk (YX87U) £2.50
 5 C12 Data Cassettes (AF61R) £1.99
 Joystick Controller (AC53H) £7.50
 Joysticks (Pair) (AC37S) £13.95
 Le Stick (AC45Y) £24.95
 Full details all above in MAPLIN catalogue.
 ★ Delivery next day by Datapost

SELECTED SOFTWARE

ATARI
 Attack At Ep-Cyg-4 -1E-16K-KF54J £34.95
 Baja Buggies -1C-16K-KB74R £22.95
 Candy Factory -1D-32K-KF53H £21.95
 Claim Jumper -1E-116K-KB67X £34.95
 Defender -1E-16K-KF10L £29.95
 Forth -1D-24K-YL29G £62.95
 Frogger -1C-16K-KB68Y £22.95
 Galaxian -1E-16K-KF11M £29.95
 Gorf -1E-16K-KB44X £34.95
 Hellfire Warrior -1C-32K-KF02C £27.45
 Krazy Shootout -1E-8K-BO63T £34.95
 Moon Shuttle -1C-16K-KF27Y £27.50
 Pac-Man -1E-8K-BQ71N £29.95
 Paint -1D-48K-KB22Y £29.95
 Picnic Paranoia -1E-16K-KF13P £34.95
 Preppie -1C-16K-KB07H £21.95
 Qix -1E-16K-KF16S £29.95
 SAM Speech Synth -1D-32K-KB15R £47.19
 Shamus -1E-16K-KB90X £34.95
 Softporn Adventure -1D-40K-BQ93B £20.64
 Starcross -1D-32K-KB37S £29.95
 Synassembler -1D-48K-KB83E £38.95
 Zaxxon -1C-16K-KF20W £31.50
 Zork I -1D-32K-BQ94C £29.95
 Zork II -1D-32K-BQ95D £29.95
 Zork III -1D-32K-KB31J £29.95
 3D-Supergraphics -1C-40K-BQ29G £31.95
 Plus over 280 other titles for Atari.

COMMODORE 64
 Temple Of Apshai (Part 1) -1D-BC57M £27.45
 Upper Reaches (Part 2) -1D-BC58N £13.80
 Curse Of Ra (Part 3) -1D-BC59P £13.80
 Sword Of Fergoal -1D-BC60Q £20.75
 Crush, Crumble & Chomp -1D-BC61R £20.75
 Jump Man -1D-BC62S £27.45
DRAGON
 Berserk -1E-BC32K £19.95
 Black Sanctum -1C-BC78K £7.95
 Dragon Trek -1C-BC82D £9.95
 Galax Attax -1E-BC79L £19.95
 Quest -1C-BC41U £7.95
 Wizard War -1C-BC83E £7.95
 Plus 30 other titles for Dragon
SPECTRUM
 The Hobbit (48K) -1C-BC88V £14.95
 Timegate (48K) -1C-BC89W £6.95
 Space Intruders (16K) -1C-BC90X £4.95
 Meteor Storm (16K) -1C-BC91Y £4.95
 Chess Player (48K) -1C-BC92A £6.95
 Speakeasy (48K) -1C-BC93B £4.95
VIC20
 Crush, Crumble & Chomp (+16K)
 1C-KK10L £20.75
 Datestones Of Ryn (+16K) -1C-KK13P £13.80
 Invasion Orion (+16K) -1C-KK12N £17.25
 Monster Maze -1E-KK11M £27.45
 Plattermania -1E-KK14Q £27.45
 Princess & Frog -1E-KK16S £29.95
 Rescue At Rigel (+16K) -1C-KK08J £20.75
 Ricochet (+8K) -1C-KK15R £13.80
 Sword Of Fergoal (+16K) -1C-KK09K £20.75
 Tank Arcade -1C-KH18U £11.95
 Plus 80 other titles for VIC20
 * Disk versions also available though price and memory size may be different.

MICROWRITER

The new hand-held word processor that eliminates the need for a typist. You can learn the Microwriting technique in less than an hour and produce perfectly typed text the same day.

Microwriter (AF62S) £485 + £72.75 VAT ★
 Complete Word Processor Package (Microwriter, printer and lead) (AF63T) £1,455 + £218.25 VAT ★
 Available ONLY by mail order or from WESTCLIFF shop.

★ Delivery next day by Datapost



AUTHORISED ATARI SERVICE CENTRE

Send sae now for our new software leaflet with details of all programs added since Maplin catalogue.
 Order As XH52G Issue 4.

The brilliant new colour computer

SORD M5

A superb new home computer with one of the most powerful colour video processors available. An incredible 32 sprites simultaneously and 16K of RAM dedicated to graphics alone. Powerful Z80A (3.5MHz) main processor. Three tone generators and noise generator all with envelope control like a mini-synthesiser. Complete with BASIC and superb handbooks for beginners. All this for just £189.95 (AF64U)



Maplin Electronic Supplies Ltd., Mail Order: P.O. Box 3, Rayleigh, Essex SS6 8LR. Tel. Southend (0702) 552911 (Sales). Demonstrations at our shops NOW.
 159-161 King St., Hammersmith, W6. Tel. 01-748 0926. 284, London Road, Westcliff-on-Sea, Essex. Tel. (0702) 554000. Lynton Square, Perry Barr, Birmingham. Tel. (021) 356 7292.
 All goods delivered in UK mainland carriage paid, but add 50p if total order less than £5 except catalogues. Orders including items marked ★, delivery next day by Datapost.
 Subject to availability. All prices include VAT unless shown. Prices correct at time of going to press.



If your order contains over £120 worth of computer hardware apply now for interest free credit by telephoning: Mail-order: (0702) 552911. London Shop: 01-248 0926. Birmingham Shop: 021-356 7292. Southend shop: 0702 554000 or write to P.O. Box 3, Rayleigh, Essex SS6 8LR.
 You pay 10% down, then 10% per month for a further nine months (to nearest penny).

Credit quotations on request. This offer subject to approval which can take up to 48 hours (APR = 0%).

Mapsoft full colour catalogue. Price £1 incl. post. Maplin catalogue contains full details of all hardware and lots of software. On sale now in all branches of W. H. Smith, price £1.25 or £1.50 incl. post from PO Box 3, Rayleigh, Essex.



KEY unlock the world of computing

ORIC 1



- ★ 48K user RAM
 - ★ Full graphics
 - ★ 16 colours
 - ★ Full sound
 - ★ 28 lines x 40 cols
 - ★ Centronics printer port
- £147.79**

BBC MODEL A and B



- Twin disc drives
£345
- Model A-16K
£260.00
- Model B-32K
£346.95
- ★ No. 1 educational micro
 - ★ A-32 lines x 40 cols
 - ★ B-32 lines x 80 cols

COMMODORE 64



- ★ 64K RAM - 280
 - ★ Full keyboard
 - ★ High res 320x200
 - ★ Music synthesizer
- £299.95**

Sinclair ZX SPECTRUM

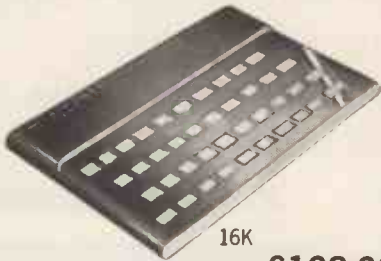

- 16K
£108.00
- 32K
£152.00

PRINTERS — Full Range

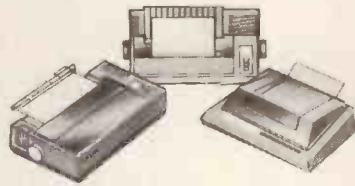

- Epson MX80 FT/3 - **£389** Nec 8023 - **£339**
 Epson MX100 - **£499** OKI Microline 80 - **£199**
 Epson RX80 - **£TBA** Seiksha GP100 - **£215**
 Epson FX80 - **£TBA** Seiksha GP250X - **£260**

COLOUR RGB MONITORS



- BMC and SANYO
- BMC 1401
— Ideal BBC A and B (400 dots)
£259.00
- Sanyo SCM 14M — Ideal BBC B (600 dots)
£399.00

NEWBRAIN — Portable



- Model A
£173.00
- Model AD
£260.00
- ★ Lowest cost CPM micro available
 - ★ Expandable to 2M RAM

DRAGON 32 — Uses 6809E



- ★ 32K RAM
 - ★ Sound
 - ★ 9 colours
 - ★ Full keyboard
- £173.40**



HAMPTON COURT **KEY** WALTON

OPEN 6 DAYS A WEEK
MON SAT 9am to 7pm (6pm SAT)

BARCLAYCARD

VISA



Buy it with Access

PRICES QUOTED EX VAT AT 15%
H.P. FACILITIES ARRANGED
MOST ITEMS CAN BE DELIVERED
24 HOURS FROM STOCK



COMPUTER CENTRES LTD

Enterprise House 44 Terrace Road
Walton-on-Thames, Surrey KT12 2SD

Telephone: Walton-on-Thames

(09322) 42777
(4 lines)

TO KEY COMPUTER CENTRES LTD.

Please send me FREE literature
(Please specify information required)

Name

Address

Post Code

At last. A range of software that's as well designed as the Dragon 32.

Six months ago, most computer users thought a Dragon was something out of an adventure game.

How times change. Nowadays, it's almost impossible to pick up a computer magazine without reading some new tribute to the Dragon 32.

THE FIRST FAMILY COMPUTER

We called it the first family computer. And we believe that much of its success derives from the fact that it has been superbly designed for the job it has to do.

Design that incorporates 32K RAM of memory at a real value-for-money price level.

Design that utilises the advanced 6809E microprocessor.

Plus a range of features that help make the world of computers accessible to first-time users. Like colour drawings. 5 octaves of music.

And plenty of power and versatility to keep up the interest as your experience increases.

SOFTWARE TO MATCH

Designing a range of software that does justice to the Dragon was a task we approached with as much care as designing the computer itself.

The results are now available - games, educational programs, hints on programming - conceived by some of the best software houses in the world, to help users get even more out of their machines.



*TV not included in price.



Graphic Animator.
A cassette that makes use of the Dragon's ability to draw on the screen. It shows you how to create simple cartoons - then bring them to life.



Personal Finance.
This cassette allows you to keep track of all the family's finances, from bills to bank statements.



Ghost Attack. On cartridge. You're in a maze, and you must find your way out. But you're not alone - you're pursued by ghosts!



Chess. A great partner to play against again and again - with one major drawback. It's very hard to beat. Test yourself against nine different levels. On cartridge.



Typing Tutor. Only a keyboard as sophisticated as the Dragon's could allow you a program like this. You use the Dragon's own keyboard to learn to type. On cassette.



Cave Hunter.
Finding the hidden gold is hard. But surviving the attacks of malevolent creatures may well prove to be impossible. Cave Hunter is on cartridge.



Dragon Selection.
A cassette of utility programs, allowing you to create your own database. Write your own tunes - or learn other language vocabularies.



Starship Chameleon. A cartridge game. You find yourself under attack by the dreaded Gabolators! Their task is to take your planet - yours is to protect it.



Computavoice.
This cassette actually enables your Dragon to speak to you. These are just some of our titles, and every month, we'll be adding more and more.

What you get out of a computer depends on what you put in. And with a Dragon 32 and Dragon software, there's enough challenge and satisfaction for anyone. But then, that's what it's designed for.

DRAGON 32
The first family computer.

New from **X-DATA**



t-stor Complete Winchester Subsystem

- fully self-contained
- single/dual disks
- up to 19MBytes
- Apple II interface standard
- DOS 3.3 or PASCAL operating software
- interface options available

X-Data's t-stor Winchester disk subsystem is designed for use with most popular micros. This free-standing, fully self-contained unit, is fitted as standard with an Apple II host interface, but others are available to order. Using IMI Winchester drives featuring special shock-absorbent mountings and extra-hard-plated media, the t-stor is supplied with disk operating software for DOS 3.3 or PASCAL. CPM will be available shortly. In the dual-drive version, each drive can be independently accessed - the second drive can be used for back-up by the user's own program.

The t-stor is supplied fully factory tested, with all necessary cables and connectors.

For more information telephone Slough (0753) 72331

X-Data Limited
750-751 Deal Avenue
Slough Trading Estate
Slough, Berks. SL1 4SH.

Here comes the **HERMIT 21**

HERMES INTELLIGENT TYPEWRITER

INTERFACES FOR THE HERMES TOPTRONIC 21 TYPEWRITER

HERMIT KSR

**UP TO
45 cps**

HERMIT MSR

- Plug on unit. (30 seconds or less to fit or remove)
- 2000 Char. Print Buffer
- RS232C Specification (TX & RX)
- Three modes of operation (normal/ set up/Ksr)
- 'WHITE-SPACE-SKIP' to increase print throughput up to 45 cps
- Printer Pause/Resume Key
- True KSR (Keyboard/send/receive) mode
- Keyboard 'SET-UP' mode to change operating parameters (non-volatile)
- Xon/Xoff, DSR/DTR, ETX/ACK handshaking protocols

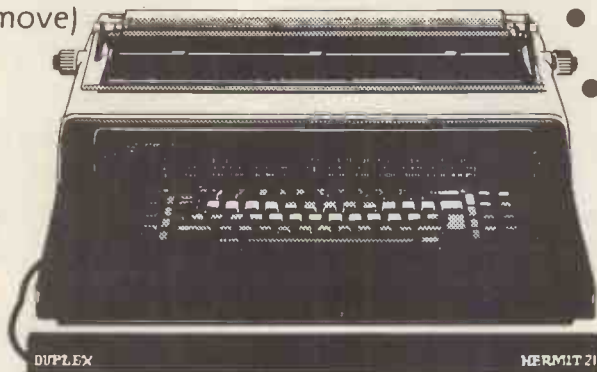

- All KSR features and
- 4000 Char. Working Memory
- Simple to use TEXT-EDITOR
- Five modes of operation. (Normal/telex/letter/ set up/Ksr)
- Battery-backup & Power-Fail-Safe.

(Protects memory contents)

- Allows HERMIT series products to be interconnected
- Special FORM-FILLING facility using multiple 'stop-codes'
- Allocate up to 100 special phrases, (paras or whole letters)
- Standard 21 features retained at all times

HERMIT 21 ADD-ONS

- HERMIT-TI: tape cassette interface unit
- HERMIT-CD: cassette deck
- HERMIT-TF: tractor feed unit
- HERMIT-PO: telex paper tape punch unit
- HERMIT-PR: telex paper tape punch reader unit
- HERMIT-AI: APPLE II RS232C converter card
- HERMIT-EI: PET microcomputer IEEE to RS232C convertor unit

**ALL PRODUCTS AVAILABLE FROM: - DUPLEX COMMUNICATIONS LTD on 0455 209131
OR DUPLEX COMMUNICATIONS (SOUTH) LTD on 0277 841011**

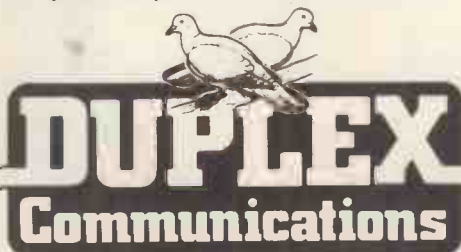
**DUPLIX**
Communications

**Dealer Enquiries
Welcome**

The Interface People

Midlands/North—2 Leire Lane, Dunton Bassett, Nr. Lutterworth, Leicestershire LE17 5JP. Tel: 0455 209131

South—52 High Street, Stock, Essex CM4 9BW. Tel: 0277 841011

Enterprise—a 16 bit from only £2300.



Data General pioneered small computers. With over 14 years' experience, over 120,000 installations worldwide, and a range of compatible systems from the micro to the super-mini — we understand the needs of the business user.

Our 16 bit Enterprise business computer has been designed as a fully compatible extension to our range. Its ease of use, range of software, level of support and competitive price make it **the** answer for small businesses and for departments of larger organisations.

**Data General
Enterprise helps
small businessmen
grow.**

Technical highlights and features

Processor 16 bit microNova

Disk capacity 716KB — 30.7MB formatted

Keyboard Typewriter style plus numeric, cursor control and special function keys

Display 80 x 25 green phosphor 12" screen

Printer 150 cps high quality dot matrix

Communications RJE/80, 3270, HASP, RS-232. Two integral programmable ports

Operating systems Enterprise/OS, MP/OS, BOS/5, M/BOS

Languages Basic, Cobol, Fortran, Pascal, MacroAssembler

Expansion Numerous interfaces, peripherals, etc.

More software. Better software

A broad range of application software packages is available to meet most requirements: accounting, word processing, financial modelling, and many others including specific 'industry' packages ensure that the Enterprise can solve **your** problems.

The software is flexible, easy to use and clear documentation is provided.

In addition, four powerful full-feature operating systems and a range of



business computer

software utilities ensure that the Enterprise is both fast and efficient, and programs may be developed using any of the well-known high level languages. Communication software enables the Enterprise to talk to other computers – both Data General and many others. Data General software is, of course, compatible throughout our range of systems.

Quality support

Support is always on tap from our network of carefully selected local dealers. Expert advice, installation, training and continued assistance are there when you need them from experienced computer professionals – all backed by one of the industry's largest and most experienced manufacturers.

Field service where you need it

Every Enterprise comes with a Data General On Site Warranty. Over 250 service staff and 15 UK service centres mean fast response.

We respond to your service call within one working day under warranty or service contract.

The computer answer

All in all, the Enterprise adds up to a great deal – more than most competitors can offer. When you look at the price you know it's a great deal. For much less than you could pay for 'just another micro'.

Data General Enterprise helps small businessmen grow.

To Enterprise Marketing, Data General Ltd., Hounslow House, 724-734 London Road, Hounslow, Middlesex TW3 1PD.

Tel. 01-572 7455.

Rush me the name of my local dealer; I want to see the Data General Enterprise in action.

Name _____

Position _____

Company address _____

Tel: _____

PCW/5/83

 **Data General**
COMPUTERS

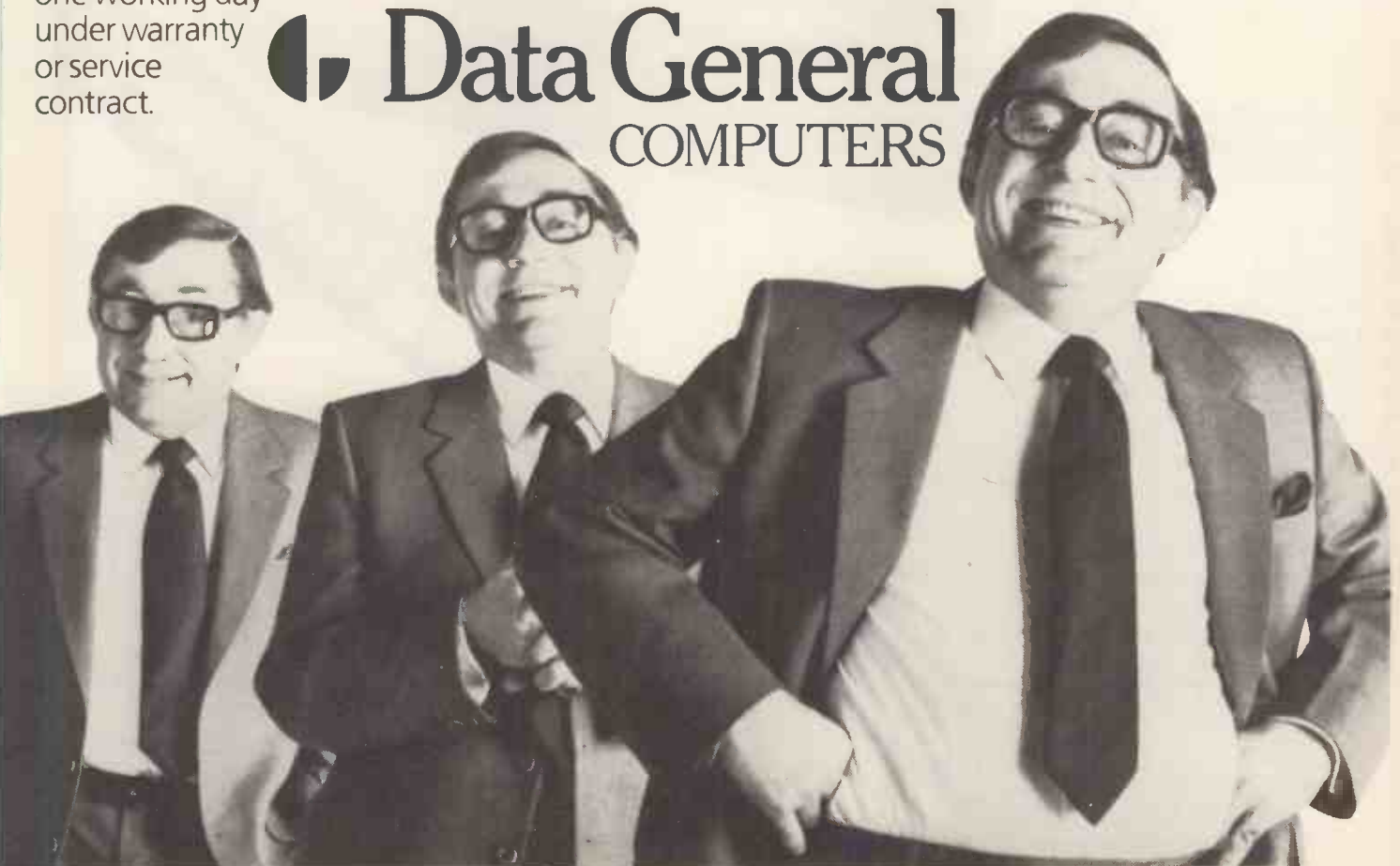

NEW FROM
HAWKE

SP8200

The new name in intelligent terminals
available ex-stock from
HAWKE COMPUTER PRODUCTS

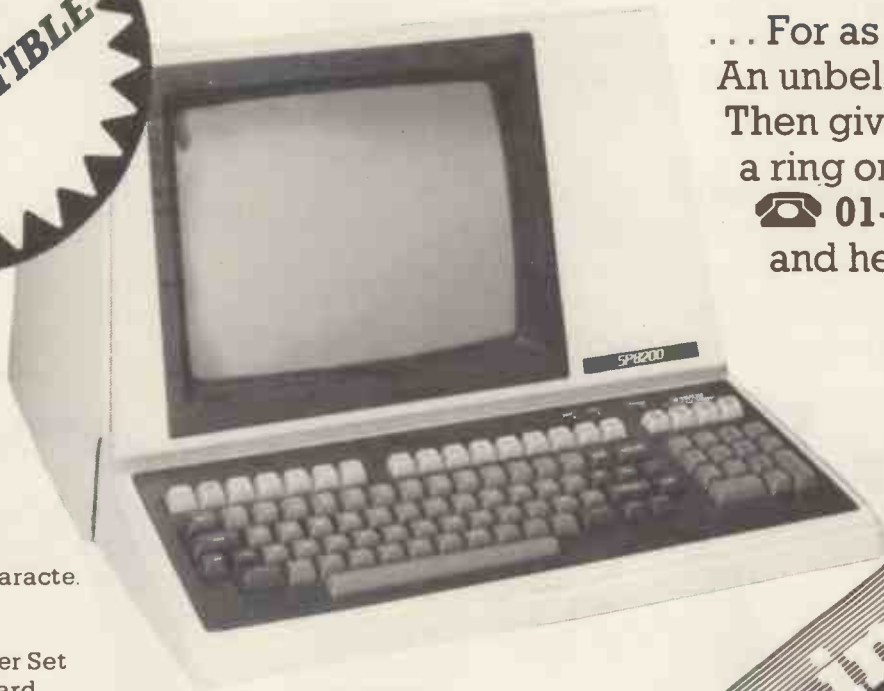

... For as little as £385!
An unbelievable price?
Then give Kevin Wilson
a ring on ...

 **01-979 7799**
and he'll confirm it!

- P4, P31 and Amber Phosphors available
- 7X9 Dot Matrix Character in 9 x 13
- 25th Status Line
- 128 ASCII Character Set
- Detachable Keyboard
- Auxiliary RS-232C Printer Port
- Typamatic Operation
- Numeric Key Cluster
- 11 Graphic Attributes
- Insert & Delete Character/Line
- Scrolling Up/Down/Fast/Slow
- 8 programmable Function Keys
- Cursor Sensing & Addressing
- Dual Intensity
- Underline/Reverse/Blinking/Blank
- Clear Character/Line/Page/All
- Tab Forward/Backward
- Optional Up to 2 pages of Memory
- Optional 20mA Current Loop

**HAWKE
COMPUTER
PRODUCTS**

Hawke Electronics Limited,
Amotex House, 45 Hanworth Road,
Sunbury on Thames, Middlesex.
Tel: 01-979 Double 7 Double 9
Telex: 923592

MIDAS S100 SYSTEMS

MIDAS 1 : From £895

MIDAS 2 : From £1,890

MIDAS 3D : From £3,100

MIDAS 86 — 16 Bit : From £3,520

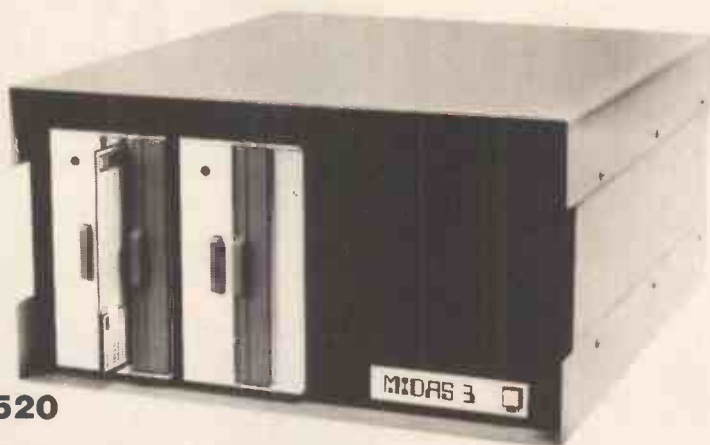

- Our versatile Z80 Microcomputers are available as standard units or custom configured to your exact specification from a comprehensive range of stocked S100 boards.
- Disc storage capacity of the MIDAS 3 can be 2M Bytes, expandable to over 80M Bytes with a Winchester Hard Disc Unit in our MIDAS 3HD range.
- MIDAS runs CP/M and MP/M. Other Software includes M-BASIC, C-BASIC, FORTRAN, COBOL, CIS-COBOL, and Word Processing.
A MIDAS 3D with 64K RAM and 2M Bytes on two 8" drives with two Serial I/O Ports and CP/M only **£3,100**
- Printers, VDUs and other peripherals stocked to give complete package system at keen prices.

BOARDS

We stock over 50 different S100 Boards all from quality manufacturers, such as Godbout, SSM, Micromation, Dual, Ithaca, Vector, S.D. Systems, Morrow, Pickles & Trout, etc.

PROCESSOR

Z80 Starter Kit
Single Board Computers
8085/8088 CPU
Z80A CPU 4MHz (4 types)
8086

EPROM

2716 EPROM (2x16K)
2708/2716/2732 Programmer

VIDEO BOARDS

24x80 I/O Drive
24x80 Memory Mapped

DISK CONTROLLERS

Single Density 5" or 8"
Double Density DMA
Floppy or Hard Controllers

RAM

Static RAM 16-64K 24 Bit addressing
Static RAM 8x64K or 16x32K RAM/
Battery Back-up
Memory Manager

I/O BOARDS

2S/2P or 4S/2P or 3P/1S etc
A/D & D/A or 12 bit
IEEE 488 Interfaces

MISCELLANEOUS

Real Time Clocks
Graphics 512x256 (b/w)
Colour Graphics 312x290
Maths Board AMD 9511
Extender Boards/Logic Probe
Motherboards 7-20 slot

MAINFRAMES

We are the sole distributor for Integrand Mainframes and Disc Enclosures, available in nine models including Desk Top and Rack Mounting, with or without provision for Disc Drives. All units totally enclosed, painted on all external surfaces and complete with power supply etc.

SOFTWARE

CP/M 1&2, MP/M, PL/1, C-Basic 2, M-Basic V5, XYBasic, Fortran 80, Cobol 80, Cis-Cobol, Pascal/Z, Pascal M/T, Forth, MAC, ZSID, Disassembler, Wordstar, Datastar, Wordmaster, Supersoft etc etc.

We are pleased to discuss your requirements and will advise you as to whether your needs can be met with one of our computers.

All of our systems are specials as they are configured to suit your specification, thus ensuring that you get what you want rather than what happens to be available.

Write or phone for a catalogue.

Unit 14, 29 Willow Lane, Mitcham, Surrey
Telephone: 01-640 6931/2/3

Computerise without compromise



The new All British QUANTUM 2000 computer system is outstanding among all the fine microcomputers now on the market. The explanation is simple. All microcomputer designers see Versatility on a high scale as their aim for the future. In the QUANTUM 2000 this ideal has actually been achieved, therefore it is demonstrably more advanced than any other.

QUANTUM 2000 offers every feature experts would look for in a new high technology 2.2 CP/M based microcomputer *plus* an

expansion potential which a few years ago would have required planning permission.

What QUANTUM means by Versatility:

1. Available with 1, 2 or 3 disk drives.
2. Disk drives can be 400K or 800K floppies OR
3. 5 or 10 meg. Winchester OR
4. A mixture of floppy and Winchester.
5. 192K of extra RAM can be added, in addition to the standard 64K.
6. If the standard Centronics plus RS232 ports are insufficient, just plugging in a board adds a few more.
7. IEEE 488? No problem! Plug in a card.
8. Other expansion cards available:
 1. REAL TIME CLOCK
 2. SPEECH SYNTHESIS
 3. NETWORKING (UP TO 32 TERMINALS)
 4. HIGH RES COLOUR
 5. A/D — D/A CONVERSION

Quantum QM 2000



Micro-Professor

THE 64K COMPUTER THAT SPANS GENERATIONS.

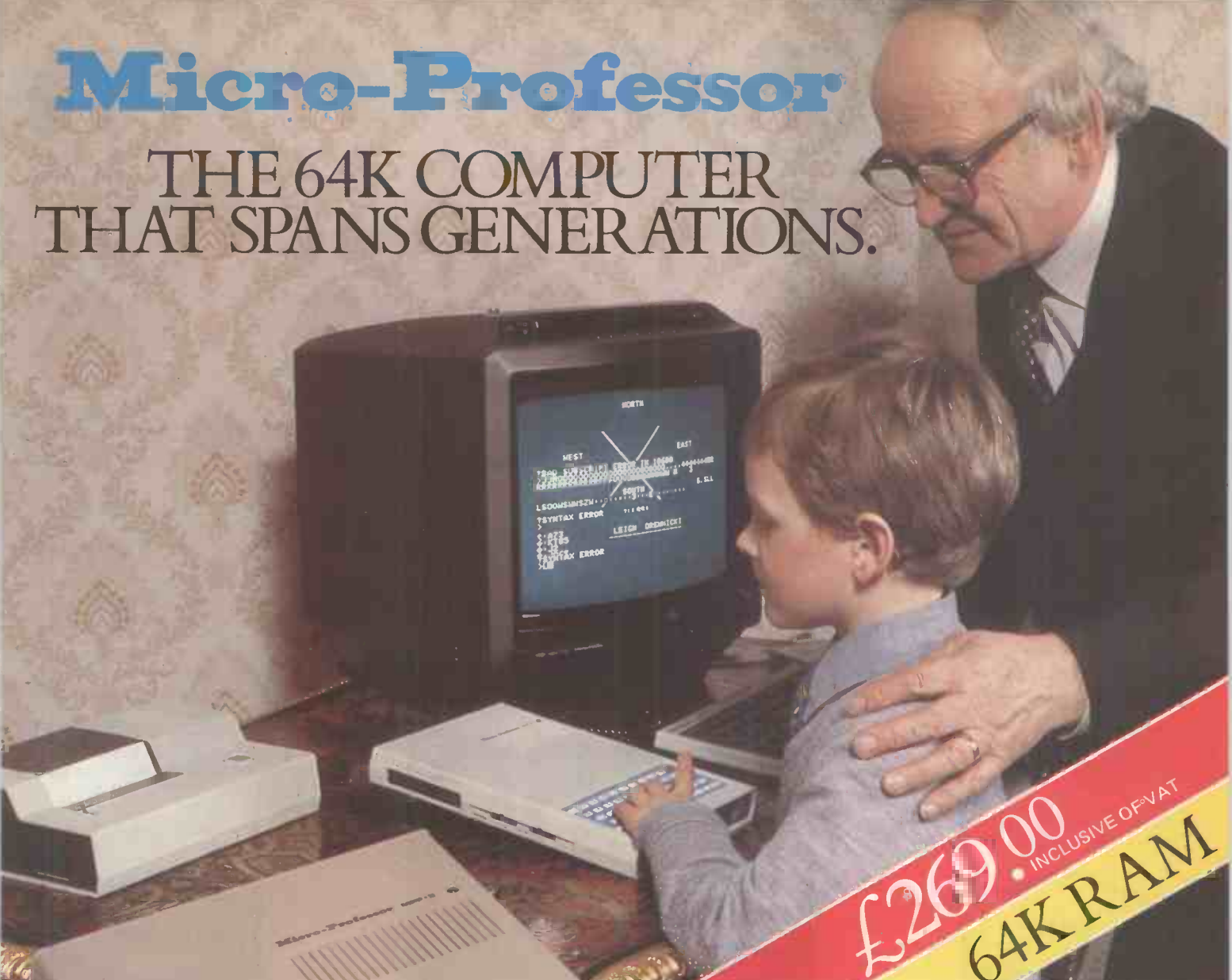

£269.00 INCLUSIVE OF VAT
64K RAM

Micro-Professor Peripherals:

- 55 Key, full-size keyboard with single stroke BASIC commands.
- Floppy Disc drive.
- Thermal or dot matrix printer.
- Joystick controls.

The complete 'family' micro-computer...

The Micro Professor is truly a family computer. With its powerful 64K RAM and 16K ROM (including 12K bytes for BASIC) it can handle the needs from the children to the office environment. Since the Micro Professor runs most of the existing APPLE II Software you will never be at a loss for home management and entertainment programmes. You and your family will also want to explore the emerging worlds of computer music, art, design and animation.

The Micro Professor can do all this and more.

In business, the Micro Professor can be a valuable tool at work with its capability to handle APPLE II Software you have access to a wide range of programmes such as accounting, payroll, job costing and inventory control, or if you have a special problem unique to your business you can write your own programmes in BASIC or go to high level languages such as PASCAL, FORTH, LOGO and PILOT.

16K ROM (includes 12K of BASIC) makes it easy.

The kids will love the excellent range of games available, 120 at present and growing all the time, plus with the knowledge that the Micro Professor is capable of handling APPLE II Software they can possibly relate to the APPLE II computer they are using at school. With its six colours plus high and low resolution graphics the Micro Professor will sustain the most enquiring mind to explore the world of computer aided design.

Apple II is a trademark of Apple Computer Inc.

Micro-Professor MPF II MASSIVE FOR A MICRO.





UCSD p-System

designed for change

Change of hardware that is, not software! This is because the UCSD p-System is the first truly portable operating system ever developed. No longer is there need to worry about 8 bits, 16 bits or even 32 bits, the p-System runs them all! Whether it's an ACT Sirius/Victor, Apple, Osborne, IBM PC, Displaywriter, DEC PC, TI, SAGE or even VAX, the same operating system and software are available. And what an operating system it is! Genuinely user friendly, it provides a superb screen editor that's addictive, a comprehensive file manager and the option of three development languages Pascal, FORTRAN 77, and BASIC.

For the software developer longevity is guaranteed because, wherever the future takes hardware, the p-System will follow,

Application

UCSD

IBM

XEROX

SAGE

APPLE



OSBORNE

ACT
SIRIUS/VICTOR

and indeed lead, because Softech Microsystems are not working on moving the p-System to new environments, there's no need! Instead they are working on new enhancements like an advanced file system, and p-Net, a portable local area network, (portable graphics utilities, assemblers, and Native Code Generators taken for granted). And like SMS so can the developer add new features and abilities to proven software.

The UCSD p-System is designed for change utilising existing procedures.

TDI are the only high volume license of the p-System in Europe, have more expertise, and can supply the complete system for all of the machines from only £375. Run time systems available too.

Make the change to the p-System. Once and for all.

**ENHANCED I.B.M. pc
VERSION AVAILABLE
for immediate delivery**

29 Alma Vale Road
Bristol BS8 2HL
TDI Limited

Dealers and educational
enquiries welcome
0272 742796

COMPUTER WAREHOUSE

THE 'ALADDIN'S' CAVE OF COMPUTER AND ELECTRONIC EQUIPMENT

HARD DISK DRIVES

Fully refurbished Diablo/DRE Series 30 2.5 mb hard disk drive for DEC RK05, NOVA, TEXAS etc.
Front load £550.00 - Top load £295.00
PSU type ME3029 for 2 drives £125.00
DRE 44A/4000A/B 10 mb 5+5 all configurations from £995.00. Call sales office for details.

5 AMP MAINS FILTERS

Cure those unnerving hang ups and data glitches caused by mains interference. Matchbox size - Up to 5 amp 240 v load. As recommended by the ZX81 newsletter. Suppression Devices SD5A £5.95.

COOLING FANS

Keep your hot parts COOL and RELIABLE with our range of BRAND NEW professional cooling fans.
ETRI 89XUOI Dim. 92 x 92 x 25 mm. Miniature 240 v equipment fan complete with finger guard. £9.95.
GOULD JB-3AR Dim. 3" x 3" x 2.5" compact very quiet running 240 v operation. NEW £6.95
BUHLER 69.11.22. 8-16 v DC micro miniature reversible fan. Uses a brushless servo motor for extremely high air flow, almost silent running and guaranteed 10,000 hr life. Measures only 62 x 62 x 22 mm. Current cost £32.00. OUR PRICE ONLY £12.95 complete with data.
MUFFIN-CENTAUR standard 4" x 4" x 1.25" fan supplied tested EX EQUIPMENT 240 v at £6.25 or 110 v at £4.95 or BRAND NEW 240 v at £10.50. 1000's of other fans Ex Stock. Call for Details. Post & Packing on all fans £1.60

DISTEL ©

The UK's FIRST free of charge, 24 hr. public access data base. Get information on 1000's of stock items and order via your computer and credit card. On line now, 300 baud. CCITT tones, full duplex, fully interactive.

DON'T MISS THOSE BARGAINS CALL NOW, IT'S FREE!
7 days per week. 24 hrs. per day
01-683 1133
8 BIT WORD - NO PARITY

COMPUTER 'CAB'

All in one quality computer cabinet with integral switched mode PSU, Mains filtering, and twin fan cooling. Originally made for the famous DEC PDP8 computer system costing thousands of pounds. Made to run 24 hours per day the PSU is fully screened and will deliver a massive +5v DC at 17 amps, +15v DC at 1 amp and -15v DC at 5 amps. The complete unit is fully enclosed with removable top lid, filtering, trip switch, 'Power' and 'Run' LEDs mounted on All front panel, rear cable entries, etc. etc. Units are in good but used condition - supplied for 240v operation complete with full circuit and tech. man. Give your system that professional finish for only £49.95 + Carr. Dim. 19" wide 16" deep 10.5" high. Useable area 16" w 10.5" h 11.5" d. Also available LESS PSU with internal dim. 19" w. 16" d. 10.5" h. £19.95. Carriage & insurance £9.50.

8" FLOPPY DISK DRIVES



Unbelievable value the DRE 7100 8" floppy disk drives utilise the finest technology to give you 100% bus compatibility with most drives available today. The only difference being our PRICE and the superb manufacturing quality!! The 7100 single sided and 7200 double sided drive accept hard or soft sectoring IBM or ANSI standard formats giving a massive 0.8 MB (7100) 1.6 MB (7200) of storage. Absolutely SHUGART, BASF, SIEMANS etc. compatible. Supplied BRAND NEW with user manual and full 90 day warranty. Carriage and insurance £9.75.
7100 Single sided £225.00 + Carr. 7200 Double sided £295 + Carr.
Optional accessories: Full technical manual £20.00 alone, £10.50 with drive. Refund of difference on drive purchase. DC and AC power connector and cable kit £8.45. 50 way IDC connector £5.50. 50 way ribbon cable £3.20 per metre.

RECHARGEABLE BATTERIES

CYCLON type D001 sealed lead acid maintenance free 2v 2.5 ah. Will deliver over 300 amps on short circuit!!! Brand new at only £2.95

VIDEO MONITORS

12" CASED. Made by the British KGM Co. Designed for continuous use as a data display station, unit is totally housed in an attractive brushed aluminium case with ON-OFF, BRIGHTNESS and CONTRAST controls mounted to one side. Much attention was given to construction and reliability of this unit with features such as, internal transformer isolated regulated DC supply, all components mounted on two fibre glass PCB boards - which hinge out for ease of service, many internal controls for linearity etc. The monitor accepts standard 75 ohm composite video signal via SO239 socket on rear panel. Bandwidth of the unit is estimated around 20 Mhz and will display most high def graphics and 132 x 24 lines. Units are secondhand and may have screen burns. However where burns exist they are only apparent when monitor is switched off. Although unguaranteed all monitors are tested prior to despatch. Dimensions approx. 14" high x 14" wide by 11" deep. Supplied complete with circuit, 240 volt AC operation. ONLY £45.00 PLUS £9.50 CARR.
24" CASED. Again made by the KGM Co with a similar spec as the 12" monitor. Originally used for large screen data display. Very compact unit in lightweight alloy case dim. 19" H x 17" D x 22" W. All silicon electronics and composite video input make an ideal unit for schools, clubs, shops etc. Supplied in a used but working condition. ONLY £55.00 PLUS £9.50 CARR. 5 INS.
14" COLOUR superb chassis monitor made by a subsidiary of the HITACHI Co. Inputs are TTL RGB with separate sync. and will plug direct into the BBC micro etc. Exceptional bandwidth with good 80 col. definition. Brand new and guaranteed. Complete with full data & circuit. 240 v AC working. Dim. 14" x 13" x 13". ONLY £199.00 PLUS £9.50 CARR.

SUPER DEAL? NO - SUPER STEAL!!

The FABULOUS 25CPS TEC Starwriter Daisy wheel printer at a fraction of its original cost. BRAND NEW AT ONLY £499 + VAT

Made to the very highest spec the TEC Starwriter FP1500-25 features a heavy duty die cast chassis and DIABLO type print mechanism giving superb registration and print quality. Micro-processor electronics offer full DIABLO/QUEME command compatibility and full control via CPM Wordstar etc. Many other features include bi directional printing, switchable 10 or 12 pitch, full width 381 mm paper handling with upto 163 characters per line, friction feed rollers for single sheet or continuous paper, Internal buffer, standard RS232 serial interface with handshake. Supplied absolutely BRAND NEW with 90 day guarantee and FREE daisy wheel and dust cover. Order NOW or contact sales office for more information. Optional extras: RS232 data cable £10.00. Tech manual £7.50. Tractor feed £120.00. Spare daisy wheel £3.00. Carriage & Ins. (UK Mainland) £10.00.

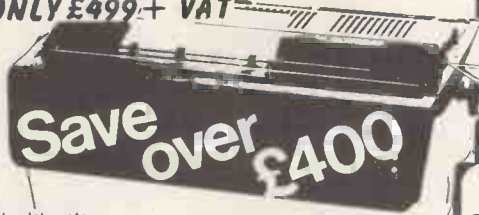

TELETYPE ASR33 I/O TERMINALS

FROM £195 + CAR + VAT
Fully fledged industry standard ASR33 data terminal. Many features including ASCII keyboard and printer for data I/O auto data detect circuitry. RS232 serial interface. 110 baud, 8 bit paper tape punch and reader for off line data preparation and ridiculously cheap and reliable data storage. Supplied in good condition and in working order.
Options: Floor stand £12.50 + VAT
KSR33 with 20ma loop interface £125.00 + Sound proof enclosure £25.00 + VAT

SOFTY 2

The amazing SOFTY 2. The complete "toolkit" for the open heart software surgeon. Copies, Displays, Emulates ROM, RAM and EPROMS of the 2516, 2532 variety. Many other features include keyboard, UHF modulator, Cassette Interface etc. Functions exceed capabilities of units costing 7 times the price! Only £169.00 pp £1.95 Data sheet on request

DATA MODEMS

Join the communications revolution with our range of EX TELECOM data modems. Made to most stringent spec and designed to operate for 24 hrs per day. Units are made to the CCITT tone spec. With RS232 i/o levels via a 25 way 'D' ski. Units are sold in a tested and working condition with data. Permission may be required for connection to PO lines.
MODEM 13A compact, async, same size as telephone base. Up to 300 baud, full duplex over 2 wires, but call mode only £75.00
MODEM 2B/C Fully fledged, up to 300 baud async, ANSWER & CALL modes, auto answer, auto switching, ideal networks etc. Just 2 wire connection to comms line. £85.00
MODEM 20-1 Compact unit for use with PRESTEL or full duplex 2 wire link. 75 baud transmit - 1200 baud receive. Auto answer. £130.00
MODEM 20-2 same as 20-1 but 75 baud receive 1200 baud transmit. £130.00
MODEM 20-3 Made for data rates up to 1200 baud in full duplex mode over 4 wire circuit or half duplex mode over 2 wires. £130.00 Carriage. 13A £4.50. 2B/C & 20 £9.50.
DATA PUMP MODEM compact unit upto 1200 baud full duplex over 4 wires or half duplex over 2 wires. BELL specification with data i/o via RS232 25 way D socket, remote test etc. 240 v operation. Supplied complete with data £65.00 carr. £4.50.

For more information or details of other types of ex stock modems contact sales office.

D.C. POWER SUPPLY SPECIALS

Experimentors PSU Ex-GPO unit all silicon electronics. Outputs give +5v @ 2 amps. +12v @ 800 ma. -12v @ 800 ma. +24v @ 350 ma. 5v @ 50 ma. floating. Dim 160 x 120 x 350 mm. All outputs fully regulated and short circuit proof. Removed from working equipment, but untested. Complete with circuit. Transformer guaranteed. Only £14.50 + £2.50 pp.
CUSTOM POWER CO555v @ 3 amp. Very compact unit dim. approx 60 x 90 x 190 mm. Semi open chassis, full crowbar overvoltage protection. Tested Ex Equipment. £11.95 + pp £1.25
FARNELL 5 Volt 40 amps. Type number G6-40A this miniature switching psu measures only 160 mm wide, 175 mm deep and 90 mm high!! Fully regulated and smoothed with over voltage protection etc. 120 or 240 volts AC input. Supplied BRAND NEW and boxed with circuit and fixing screws at a fraction of the current list price. Only £130.00 + £3.00 carr. & ins.
PERIPHERAL SYSTEM SUPPLY. Fully cased unit supplied in a Brand new or little used condition. Outputs give 5v @ 11 amps. "-4" 15-17v @ 8 amps. "-" 15-17v @ 8 amps and "+4" 24v @ 4 amps. All outputs are crowbar protected and the 5 volt output is fully regulated. Fan cooled. Supplied tested, with circuit £55.00 + £8.50 carr.
MAIN FRAME SUPPLY. A real beefy unit designed for MINI or MAINFRAME use outputs give 5 volts @ 50 amps. +12v @ 5 amps. -12v @ 10 amps. All output are fully regulated with crowbar overvoltage protection on the 5v output. Supplied with circuit and tested. Ex-Equip. 110v AC input. Only £49.95 + carr. £10.50.

66% DISCOUNT ELECTRONIC COMPONENTS & EQUIPMENT

Due to our massive bulk purchasing programme which enables us to bring you the best possible bargains, we have thousands of LC's, Transistors, Relays, Cap's, P.C.B.'s, Sub-assemblies, Switches, etc. etc surplus to our requirements. Because we don't have sufficient stocks of any one item to include in our ads, we are packing all these items into the "BARGAIN PARCEL OF A LIFETIME" Thousands of components at giveaway prices!! Guaranteed to be worth at least 3 times what you play plus we always include something from our ads, for unbeatable value!! Sold by weight.

2.5kls £4.25 + pp £1.25
10kls £10.25 + pp £2.25
5kls £5.90 + pp £1.80
20kls £17.50 + pp £4.75

ALL PRICES PLUS VAT

All prices quoted are for U.K. Mainland, paid cash with order in Pounds Sterling PLUS VAT. Minimum order value £2.00. Minimum Credit Card order £10.00. Minimum BONA FIDE account orders from Government depts, Schools, Universities and established companies £20.00 Where post and packing not indicated please ADD 80p + VAT Warehouse open Mon-Fri 9.30 - 5.30, Sat 10.15 - 5.30. We reserve the right to change prices and specifications without notice. Trade, Bulk and Export enquiries welcome.

SEMICONDUCTOR 'GRAB BAGS'

Mixed Semis amazing value contents include transistors, digital, linear, I.C.'s triacs, diodes, bridge recs, etc. etc. All devices guaranteed brand new full spec, with manufacturer's markings, fully guaranteed, 50+ £2.95 100+ £5.15
TTL 74 Series A gigantic purchase of an "across the board" range of 74 TTL series I.C.'s enables us to offer 100+ mixed "mostly TTL" grab bags at a price which two or three chips in the bag would normally cost to buy. Fully guaranteed all I.C.'s full spec. 100+ £6.90 200+ £12.30 300+ £19.50

OLIVETTI TE300 REDUCED TO CLEAR

Complete input output terminal with integral 8 hole paper tape punch and reader. Unit operates at 150 baud in standard ASCII. Ideal as a cheap printer for a MICRO etc. 120 columns, Serial data i/o. Supplied complete with data, untested, unguaranteed £65.00 + £11.50 carr.

DISPLAY ELECTRONICS

64-66 Melfort Road, Thornton Heath, Near Croydon, Surrey
01-689 7702 - 01-689 6800 Telex 27924

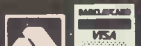

SEIKOSHA PRINTERS. FOR NAME DROPPERS EVERYWHERE.



ACORN APPLE ATARI
BBC MICRO DRAGON JUPITER
LYNX NASCOM NEWBRAIN
ORIC VIC 20/64
VIDEO GENIE
ZX 81

If you own one of these microcomputers you can get more out of it by running it with a Seikosh printer. The Seikosh range offers professional performance at a cost that's comparable with your computer – with prices from around £215 to £260 (ex VAT).

No other printers offer so much for so little. Full graphics, programmed printing (250 X) 80 col, 50 cps, on standard paper. Serial and Centronics parallel output ports enable almost all computers to be interfaced with the Seikosh range with ease. Many other advanced features, plus Seikosh's proven reliability and the nationwide support of DRG's distributor network make the Seikosh the natural choice for the microcomputer user.

Telephone these listed distributors to see one of the remarkable Seikosh Printers in action, or, if you want to know of nearer distributors, telephone the number below.

DRG

**BUSINESS
MACHINES**

THE FINEST WORLDWIDE SUPPORTED NATIONWIDE.
(Peripherals & Supplies Division) 13/14 Lynx Crescent, Winterstoke Road,
Weston-super-Mare, BS24 9DN. Telephone: (0934) 419914.

FEATURES INCLUDE:

80 col. 30 to 50 c.p.s.

Full ASCII character set

Dot addressable graphics

Programmed printing (250 X)

Expanded or double height/width printing

Standard paper + 2 copies

Self testing

9¼" x 17¼" x 5¼" dimensions

Esco Computer Facilities Limited
321 Blythswood Court, Anderston Centre, Glasgow G2
Mr Brown 041-221 0310

Northern Computers
Churchfield Road, Frodsham, Cheshire
Josephine Piff 0928-35110

Technomatic Limited
17 Burnley Road, London NW10 1ED
Mr Mehta 01-452 1500

Watford Electronics
33/35 Cardiff Road, Watford, Herts
Mr Jessa 0923-40588

HCCS
533 Durham Road, Lowfell, Gateshead
Mr Heslop 0632-821924

Oakleaf Computers
121 Dudley Road, Grantham, Lincolnshire
Mrs Jardine 0476-76994

AP Systems
90-100 Brighton Road, Surbiton, Surrey
Mr Williams 01-399 1257

Microchips
46-48 St Georges Street, Winchester, Hampshire
Mr Bennett 0962-68085

Gwent Computers
28 New Pastures, Newport, Gwent
Mr Tanswell 0633-215008

Bits and Bytes
44 Fore Street, Ilfracombe, North Devon
Mr Altass

Microstyle
29 Belvedere, Landsdown Road, Bath
Lynne Farmer 0225-334659

Leeds Computer System
60-62 Balcony, Merrion Centre, Leeds
Mr Wingfield 0937-63744

JAD Integrated Systems
21 Market Avenue, Plymouth
Mr Dollery 0752-29038

Kobra Computing
Duramark House, Farm Road, Henley-on-Thames, Oxon
Mr Rayband 01-579 5845

Computer Shack Limited
14 Pitville Street, Cheltenham
Mr Lewis 0242-584343

Sumlock Electronics
198 Deansgate, Manchester M3 3NE
Mr Moore 061-834 4233

Anglia Computers
88 St Benedicts Street, Norwich
Mr Reyzl 0603-29652

Akhter Instruments
Unit 19, Arlinghide Estate, South Road, Templefields,
Harlow, Essex
Mr Mughal 0279-412639

Eltec Services
231 Manningham Lane, Bradford BD8 7HH
Dr. W Wormald 0274-491371

Chromasonic Electronics
48 Junction Road, Archway, London
Mr Curtiss 01-236 9493

PLUTO

A BREAKTHROUGH IN COLOUR GRAPHICS

PLUTO is an intelligent, high performance colour display controller that is both compact and affordable:

Technical Profile:-

- 8" x 8" PCB
- 640 (H) x 288 (V) x 8 colours
- 16 bit Intel 8088 microprocessor
- 192 Kbytes of dual ported memory
- Fast parallel I/O interface for connection to most computers

Use PLUTO with any machine

PLUTO'S in built software gives fast access to a comprehensive command set:-

- High level software protocol.
- High speed vector drawing. (over 150,000 pixels per sec.)
- Built-in character display freely mixable with graphics.
- On-board storage of user-defined symbols.
- Complex polygon flood fill

An extended command set ROM is available providing the following functions:-

- Raster operations with rotation in multiples of 90°.
- Complex polygon colour and pattern fills.
- Circles and arcs, etc.

Prices:-

PLUTO £399 + VAT
BABY PLUTO (320 x 288) £299 + VAT
DOUBLE RES. OPTION £50 + VAT
8 MHz PROCESSOR OPT ... £50 + VAT
EXTENDED COMMAND ROM... £60 + VAT
MANUAL £6 ONLY

(OEM Discounts Available)

i research ltd.

6 Laleham Avenue · Mill Hill London NW7 3HL
Telephone: 01-959 0106

TOSHIBA DOUBLE SIDED/DOUBLE DENSITY 5 1/4" DISK DRIVES



These are high quality, very reliable, industry standard disk drives. These can be used as single sided/single density, double sided/double density or double sided/double density depending on the host computer disk interface. Compatible with most micro-computers e.g. VIDEO GENOE, ATOM, TRS 80, BBC COMPUTER, SUPER BRAIN, NASCOM etc. etc. If used as double sided/double density then the storage capacity is 500 K BYTES/DRIVE (unformatted), track density is 48 TPI and can daisy chain up to 4 drives. 90 day warranty.

One disk drive only £179 + VAT = £205.85
 Two disk drives £349 + VAT = £401.35
 Single boxed with power supply £214 + VAT = £246.10
 Dual boxed with power supply £389 + VAT = £447.35
 2 Drive Cable £15 + VAT = £17.25
 DS/DD 48 TPI diskettes £2.50 + VAT = £2.88

Double sided/double density Double Tracks 5 1/4" Disk Drives

This is the latest addition to our range of disk drives. The capacity is 1 MEGA BYTES (unformatted) per drive, the track density is 96TPI. Track to track access time is 3 msec. These are compatible with Shugart SA460 (ANSI standard interface). Compatible with BBC COMPUTER, ATOM, NASCOM and lots of other computers.

One disk drive only £239 + VAT = £279.85
 Two disk drives £469 + VAT = £539.35
 Single boxed with power supply £274 + VAT = £315.10
 Dual boxed with power supply £509 + VAT = £585.35
 DS/DD 96TPI diskettes £3.95 + VAT = £4.54 each
 Two drive cable £15 + VAT = £17.25

PROFESSIONAL MONITORS



• **GREEN MONITOR** 12" green monitors with composite and sync input. Suitable for most computers
 Hitachi MM1216 £89 + VAT = £102.35
 SM12H 18MHZ monitor £89 + VAT = £102.35
 SM12N 15MHZ monitor £69 + VAT = £79.35

• **COLOUR MONITORS** 14" colour monitors, RGB or composite and sync input.
 SCM14N Normal-res 400 dots £239 + VAT
 SCM14M Medium-res 600 dots £339 + VAT
 SCM14H High-res 800 dots £499 + VAT

KDS 7362 VDU

80 charac x 24 lines
 25th status line, RS 232C/20mA current loop interfaces, 128 displayable characters, reverse video, blink, blank, underline, half intensity, detachable keyboard with 101 keys.



AS USED WITH ICL PERSONAL COMPUTER
 Our Price £449 + VAT = £513.35

ATARI HOME COMPUTERS



ATARI 400 — £159
 ATARI 800 £399
 Prices include VAT

BBC MICROCOMPUTER

BBC Microcomputer Model B £348 + VAT = £399
 Model B + Econet Interface £389 + VAT = £446
 Model B + Disk Interface £409 + VAT = £469
 Model B + Econet + Disk interfaces £450 + VAT = £516
 Single disk drive (100K) £230 + VAT = £264
 Torch Dual Disc Drive (800K) with Z80 processor 64K of RAM and CPN operating system £779 + VAT = £895
 Parallel printer cable £12 + VAT = £103
 Games Paddles (per pair) £11 + VAT = £12.65
 Second Processor Z80 £195 + VAT = £224.25

SOFTWARE FOR BBC COMPUTER

Desk Diary (Two programmes) £8.65 + VAT = £9.95
 Algebraic manipulation package £8.65 + VAT = £9.95
 BBC Peeko Computer £8.65 + VAT = £9.95
 BBC FORTH language £14.50 + VAT = £16.67
 BBC LISP language £14.50 + VAT = £16.67
 BBC word processing package. (view) £52 + VAT = £59.80
 Printer Driver Cass £8.65 + VAT = £9.95

TEXAS INSTRUMENTS HOME COMPUTER SYSTEM



TI99/4A 16 BIT MICROPROCESSOR
 FREE CASSETTE LEAD SUPPLIED

FREE CASSETTE LEAD
 £149.95 inc VAT

TI99/4A

This microcomputer is based on TMS9900 16 bit microprocessor. It includes 16K RAM, 16 colour high resolution graphic (192x256). The screen display is 32 characters, 24 lines TI-BASIC. Full size keyboard. For Software there are about 1000 Programs to choose from. There are a lot of peripherals available e.g. Disk Drives, Disk Interface, Speech Synthesizer, Extra RAM, Additional Languages (PASCAL, TI-LOGO, ASSEMBLER). Prices: TI Home Computer £149.95; Peripheral Expansion System £149.95; Disk Controller Card £144.95; Disk Drive £199.95; Speech Synthesiser £41.95. All prices inclusive of VAT. Please send large SAE for full price list.

GUARANTEED LOWEST PRICES

We guarantee that our prices are the lowest on the market. If you can find any item advertised and in stock at less than our price we will match that price.

NEW EPSON TYPE 3 PRINTERS



NEW FX 80 PRINTER

80 column, 60 CPS, super and subscripts, auto underlining, tractor feed, 32 print fonts. Bi-directional printing, logic seeking, 9 x 9 matrix, high res. graphics, centronic parallel interface, tractor or friction paper feed. FREE 500 sheets of paper Price: £379 + VAT = £435.85

MX 100-3

136 columns, 100 CPS, all other features of MX80 plus true descenders, adjustable paper width up to 15 inches, friction or tractor feed, centronic parallel interface.
 Price: £429 + VAT = £493.35

DRAGON 32



£169 + VAT = £194.35
 INCLUDING A FREE CASS LEAD

This is a powerful new microcomputer specially designed for the family and small business use. It has 32K Bytes of Ram (expandable to 64K). 16K Byte Microsoft Colour Basic. High-res. colour graphic and very good sound features. It has full size professional keyboard and comes complete with power supply and a built-in centronic parallel printer interface. Send SAE for lists.

CASIO CALCULATORS

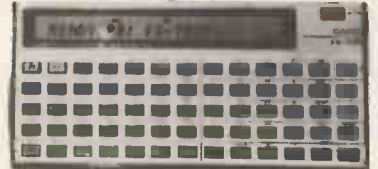

*FX-702P the casio pocket computer/calculator, basic programmer, 55 scientific functions, up to 1,680 program steps.

Special Price £61 + VAT = £69.95
 *FX-602P programmable calculator, 50 scientific function and 512 programme steps.
 Price £46 + VAT = £52.90
 *FA-2 cassette interface for FX-702 and FX-602.
 Price £16 + VAT = £18.40
 *FX-10 Mini printer for FX-702 and FX-602.
 Price £37 + VAT = £42.55
 *PB-100 pocket computer with qwerty keyboard.
 Price £39 + VAT = £44.85
 *FX700 Scientific pocket computer
 Price £47 + VAT = £54.05

SEIKOSHA GP SERIES GRAPHIC AND TEXT PRINTERS

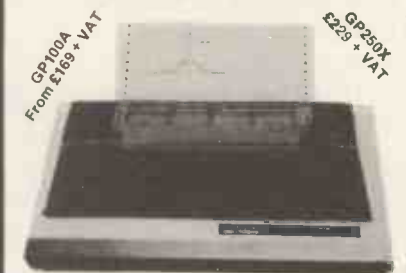

GP-100A 50CPS, 80 column Hi-res graphic line repeat function, adjustable up to 10" paper width, tractor feed, 5 x 7 dot matrix. GP-100A centronic parallel interface.
 50 CPS £189 + VAT = £217.35
 GP100A 30 CPS £169 + VAT = £194.35

GP-250X New 50 CPS, 80 column, tractor feed, true descenders, 64 user defined characters, double height and/or double width characters, 5 x 8 dot matrix, parallel and serial (RS232) interface.
 GP-250X £229 + VAT = £263.35

BYTEWRITER DAISYWHEEL PRINTER / TYPEWRITER



10, 12, 15 characters per inch switch selectable. Changeable daisywheels, 8 to 12 characters per second print speed. Centronics compatible interface internally fitted. Built in self test program. Automatic underlining, auto repeat, 12 character buffer. Lift off correction ribbon fitted. Film or carbon ribbons. Portable — carrying case supplied. Lightweight, only 21 pounds including case.
 Our special price £429 + VAT = £493.35

FAST 100 CPS NEC 8023 PRINTER

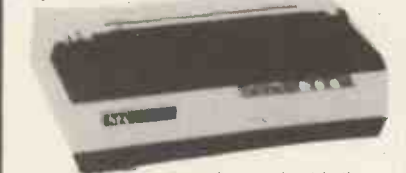

This is a high speed printer using bi-directional logic seeking operation, 7x9 matrix for alphanumerics, 8x8 for graphics and bit image printing. Programmable paper feed, original plus three copies, Greek characters and high resolution graphics. The print quality is exceptional, and the price is affordable.
 Price £299 + VAT = £343.85

AKHTER INSTRUMENTS LTD.

DEPT PCT, UNIT 19, ARLINGHYDE ESTATE, SOUTH ROAD, HARLOW, ESSEX, U.K. CM20 2BZ
 TEL: HARLOW (0279) 412639

ORDERING INFORMATION All orders which accompany a cheque or cash are CARRIAGE FREE (UK only). On all other orders a carriage charge of 3% of invoice total is applicable.

OPENING HOURS: Mon-Fri 9am-5.30pm, Sat 10am-2pm

COMDEX

EUROPE '83

Gateway to the European Computer Market

- **COMDEX/EUROPE '83** is the only computer exhibition organized exclusively for ISOs and the producers of the products they sell.
- **COMDEX/EUROPE '83** is the best way to build... expand... upgrade the distribution and sales network you need to capture your share of this dynamic growth market.
- Exhibiting at **COMDEX/EUROPE '83** is the most cost-effective way to meet with and talk to existing and potential sellers of your products and services... the professionals who will recognize the profit potential of what you offer... The professionals who know and understand local, regional and national differences.
- and how best to present your products to their end-user customers.
- And you can do it all in a business-like environment that no mass attendance end-user exhibition can offer.
- **If you manufacture, produce or offer:**
 - Computers
 - Computer Systems
 - Word processing systems
 - Peripherals
 - Magnetic media
 - Special computer furniture
 - Forms, ribbons and other supplies
 - Packaged software
 - Related services, etc.
- **And you sell your products or services through independent sales organizations (ISOs) like:**
 - Dealers
 - Systems integrators
 - Systems Houses
 - Distributors
 - Value adders
 - Computer wholesalers
 - Office machine/product dealers
 - Computer retailers/boutiques/
- departments/franchise-holders
 - Manufacturers Representatives
 - Commercial OEM's etc.
- **COMDEX/EUROPE '83** is the only computer exhibition that targets all the independent sales-organizations (ISOs) in all countries of Europe.

The Interface Group, organizers of **COMDEX/EUROPE** and other computer related conferences and exhibitions, enjoys an outstanding reputation for doing an effective job of delivering the target audience and market place to you.

COMDEX/EUROPE '83

**The RAI
Congress & Exhibition Centre
Amsterdam
The Netherlands**

October 24-27, 1983

Coupon

To: COMDEX/EUROPE, Rivierstaete, Amsteldijk 166,
1079 LH Amsterdam, The Netherlands.
Tel.: (31) 20.460.201. Telex: 12358 IFACE NL.

**Yes! I'd like more information about
COMDEX/EUROPE '83.**

- I'm interested in exhibiting
 I'm interested in attending

Company: _____

Name: _____ Title: _____

Address: _____

Postal Code/City: _____

Country: _____

Telephone: _____



Let Commodore expand your horizons.

VIC 20 is the finest home computer that money can buy.

And the better you get to know it, the more confident, adventurous and ambitious you'll become.

You'll want to take advantage of the vast range of VIC software: a superb and constantly-growing selection of programs, embracing business systems, entertainment, education and many applications in the home.

Every program in the series has been designed by experts, and chosen for its quality and value for money.

VIC business software covers a wide range of applications, including spread-sheet analysis, stock control, information handling and word-processing.

A mind-blowing range of games including Scott Adams' world-famous 'Adventure' series.

Advanced space games, including the sophisticated 'Omega Race'.

Learn subjects as diverse as English Language, programming, and biology.

And 'home' software ranges from IQ tests to Robert Carrier menus.

In addition, there is a range of VIC software, like programmers' aids and graphics packages—



to add to your understanding and enjoyment of computers and computing.

There's even a special 'VicSoft' Club for VIC 20 enthusiasts, with many advantages including special offers to club members.



VIC software will expand your horizons. And your mind.

PRICES RANGE FROM £4.99 to £24.95 INC. VAT.

 **commodore**
VIC 20

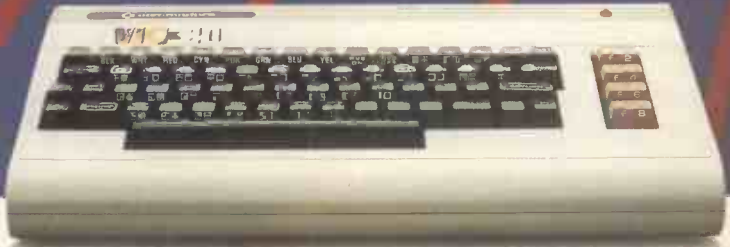

For more information, a catalogue of VIC software and details of your local retailers or dealers please phone or complete the coupon and send to:
The Commodore Information Centre,
675 Ajax Avenue, Slough, Berkshire SL1 4BG.
Telephone: Slough (0753) 79292.

Name _____
(MR./MRS./MISS)
Address _____

Postcode _____

Come to

MICROAGE ELECTRONICS

NEWSFLASH
we are now

ORIC!

hardware and
software dealers

*** BBC + Disk Interface, 800K Disk Drive, Word Processing ROM, Epson Printer, Dust covers for all units, Basic Programming Book, Cassette lead, Paper & Cable.**
Normal Price £1748.80
Our Price £1599.00
Saving £149.80 **FREE COURIER**

ACORNSOFT FOR BBC

*Snapper, *Planetoid, *Monsters, *Rocket Raid, *Meteor *Super Invaders, Philosophers Quest, Sphinx Adventure, Arcadians, Lisp Cassette, Peeko Computer, Creative Graphics Tape, Graphs and Charts Tape, Desk Diary, Arcade Action, View (on ROM) and Printer Drive Cassette.

Available on Disk.

All Acornsoft at £9.95 each, except Arcade Action (£11.90), Lisp (£16.85), View and Printer Drive (£69.90), Wordwise word Processing ROM (£46.00) +£2.00 p+p.

Only a selection of Acornsoft available.

Drawn to scale.

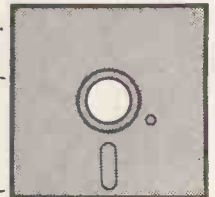
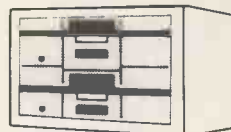

BBC compact, slimline Disk Drive.

BBC MACHINES

Model A, 32K RAM & 6522 Chip	£329.00
Model B	£399.00
Model B + Disk Interface	£494.00
BBC Dust Covers	£3.95
BBC Compatible Single Disk Drive* (100K)	£235.00
BBC Compatible Dual Disk Drive* (200K)	£389.00
BBC Dual Slimline Disk Drive* (Double Sided & Density 800K)	£799.00
Verbatim Single Sided Diskettes 10 for	£22.50
Verbatim Double Sided Diskettes 10 for	£39.95
Let us fit a disk interface in 24hrs	£95.00
RH Electronics colour light pen	£37.00

BBC MONITORS

14" RGB Microvitec Colour Monitor (as used in the BBC Computer Prog.) Including lead	£284.00
Microvitec High Res. Colour Monitor	£575.00
12" Zenith High Res. Green screen Monitor	£95.00
BNC Cable for above	£4.95
BBC Compatible Cassette Player price on application	
Blank Data Cassettes 10 for	£3.50
DIN to Jack Lead	+ £1.30 p&p £2.00
Official Joysticks per pair	+ 75p p&p £13.00
	+ £1.30 p&p

*All Drives include manual and utility Disk.

All items subject to availability.

All the products are the official versions, beware of imitations, they will invalidate your guarantee.

We accept official orders from educational establishments.

Credit card holders can phone in for express despatch.

Send large S.A.E. for lists and info pack.



PRINTERS

Acorn AP-80A now down to	£189.00
Acorn AP-100A now down to	£215.00
AP-80A Ribbons	£4.95
AP-100A Ribbons	£5.95
Brand new Epson FX 80	

Contact us for details

All printers include cable & paper	
Epson Dust Cover	£3.95
Parallel printer cable	£15.00

BOOKS

Practical Programs for BBC & Atom	£5.95
BASIC Programming on the BBC Micro	£5.95
Assembly language programming for BBC	£8.95
BBC Micro Revealed	£7.95
Creative Graphics, Graphs & Charts, LISP	all at £7.50 each
30hr. BASIC	£5.95
Let your BBC Micro teach you to program	£6.45

*** BBC Model 'B' wordprocessing pack at a low price of only £699. Save £44. Normal price £743. The Pack consists of: BBC Model 'B' GP100 Printer Cables, Cassette Player Word Processing ROM 1,000 sheets of paper. Then add the GP100A Printer at only £215. The lowest price ever.**

FREE COURIER

POSTAGE RATES

Small items such as Ribbon, books & software:— 1 item £1.00, 2 items or more All Dust Covers £1.00 p&p 50p per unit

BY COURIER TO YOUR DOOR

Large items such as Computers, Disk Drives & Monitors:— 1 item £7 2 items £10 3 or more £13

ATTENTION!!

All Lynx, Oric, BBC, Commodore 64 owners, we pay top royalties for quality software programs. Please write or phone for details.

Barclaycard and Access welcomed All prices include VAT



ALL PRICES INCLUDE VAT. FOR FURTHER DETAILS AND MAIL ORDER LIST SEND LARGE S.A.E.
Open Mon - Sat 9.15 am - 6.00 pm. Thurs 9.15 am - 1.00 pm.

MICROAGE ELECTRONICS
135 HALE LANE EDGWARE MIDDLESEX HA8 9QP
TEL: 01-959 7119 TELEX 881 3241

OPUS SUPPLIES - SPRING SAVERS

NEW TEAC DISC DRIVES

- * TEAC 55F Mini D/S 80 Track. Formatted single density 400K Byte. Double density 800K Byte. Only £229.00.
- * Case to hold 2 disc drives with power supply only. Only £29.95.
- * Ideal with BBC Micro
- * Full warranty
- * Low power consumption
- * Slimline - latest technology

8" DISC DRIVES - SHUGART COMPATIBLE

FD514 S/S Dual Density. Formatted 600K Byte. Only £149.00.
FD650 D/S Dual Density. Formatted 1.2M Byte. Only £199.

★ PERTEC ★ 90 DAY WARRANTY ★

Case to hold 2 Drives - complete with power supply & fan. Only £99.95.

'NASHVA' FLOPPY DISCS

With full 5 year Warranty. All discs have hub rings and Minis have a Free Plastic Library Case.

Minis		8" Discs	
S/S/S/D	£16.95 for 10	S/S/S/D	£17.95 for 10
S/S/D/D	£19.95 for 10	S/S/D/D	£23.95 for 10
D/S/D/D	£22.95 for 10	D/S/D/D	£24.95 for 10
S/S 80 Track	£24.95 for 10		
D/S 80 Track	£26.95 for 10		

CANON DISC DRIVES

5¼" S/S 40 track formatted single density 100K. Byte. Double density 200K. Byte. Only £129.00.
Case to hold one drive. £9.95
* Ideal with BBC Micro
* Full warranty
* Slimline design

NEW ADD ON MEMORY FOR YOUR BBC

This Board allows expansion of your memory by up to 64K of EPROM or 16K of RAM. Plugs into a spare memory expansion socket and fits inside your machine. It will take the following devices: 2716/2732/2764/6116. Each card is provided with an installation document and a demonstration cassette.

★ Only £29.95 ★

COLOUR MONITOR £99.95

Stocks are diminishing fast on this unrepeatable offer - so order now to avoid disappointment!

The VMC 22 is a 22" RGB Colour Monitor which we offer with free isolating transformers. The Monitor has a 22" Mullard 110°C CRT and for shipping purposes the CRT & Scan coil assembly are separate from the chassis. The lugs of the CRT allow it to be mounted in a standard 22" colour TV cabinet. The unit is assembled by plugging the wires from the chassis to the tube and soldering the power connector, input connector and isolating transformers. A comprehensive instruction sheet and circuit diagram are included.

NEW THE 'ORGANIZER'

At last a Desk designed for the personal computer user.

* Suitable for use with all leading micros.

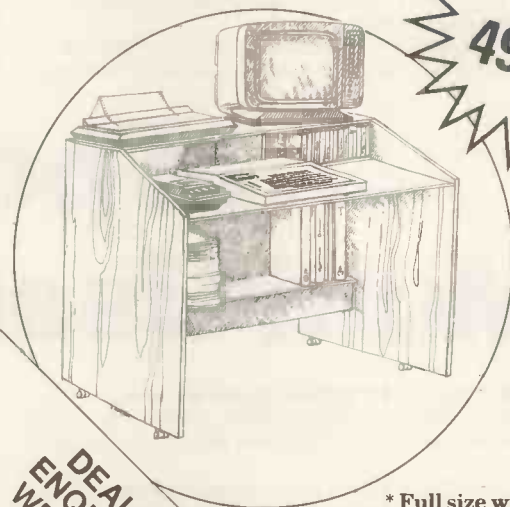

- * Teak finish
- * On casters for ease of movement
- * Self assembly
- * Top shelf, large desk top surface and bottom shelf

* Full size with ample room in front of lower shelf for you to sit comfortably

DEALER ENQUIRIES WELCOME

A DAISYWHEEL PRINTER FOR ONLY £499.00

TEC Starwriter FP 1500-25
25 CPS Friction feed
Serial Interface
Leads also available

To Order: Add Carriage at the following rates:

Monitor £10.00. Discs 85p. Memory Board 50p. Other goods £7.00. And VAT at 15% to total. Send your order to:

OPUS SUPPLIES 10 Beckenham Grove, Shortlands, Kent

Tel: 01;464 5040 or 01;464 1598

GOVERNMENT/EDUCATIONAL & OFFICIAL ORDERS WELCOME

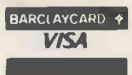

From the most powerful S-100 boards...

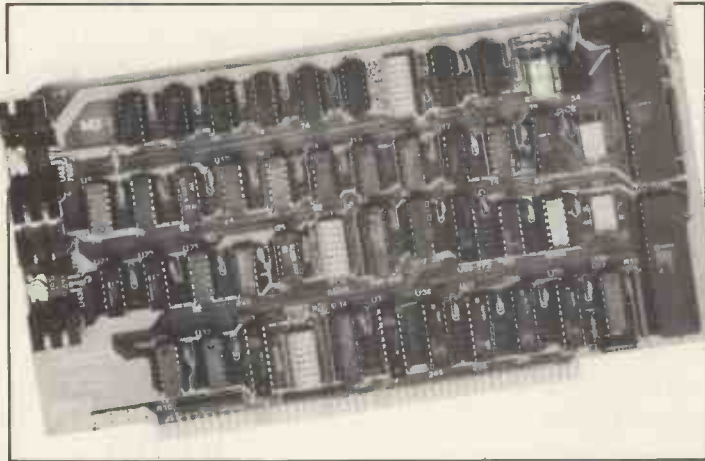

CPU 8085/8088 IEEE/S-100 board with dual processor operation, 16 MB addressing; power on jump.
CPU 68K 68000 to IEEE 696/S-100 specifications and works with 8 and/or 16 bit memory. CPU 68K also includes a socket for the optional MMU.

CPU 86/87 IEEE 696 S100 board with 8086 chip, sockets for 8087 and 80130 firmware.

CPU Z S100, 6MHz Z80 processor board.

Interfacer 1 Two RS-232C serial ports.

Interfacer 2 Three parallel ports plus RS-232C serial ports.

Interfacer 3-8 Eight RS-232C serial ports (2 sync/6 async).

Interfacer 4 Three RS-232C serial ports, one parallel port, one Centronics/Epson parallel port.

System Support 1 Clock/calendar; RAM/ROM; math processor options; RS-232C serial port interval timers and interrupt controllers.

Motherboards High performance; Shielded with active termination; 6, 12, 20, slots.

MPX 1 Multi user system front end processor with 16K on board RAM.

DISK 1 High Speed DMA floppy disk controller.

DISK 2 High Speed DMA hard disk controller for SA4000/Fujitsu F2300 interface.

DISK 3 High Speed DMA hard disk controller for SA1000/ST506 interface.

RAM 16 64Kx8 or 32Kx16 - works automatically with 8 or 16 bit systems.

RAM 17 64Kx8; ultra low power.

RAM 21 128Kx8 or 64Kx16 -works automatically with 8 or 16 bit systems.

M DRIVE The first "solid state disk drive" can increase operating speed up to 3500% , up to 4M Bytes.

DESKTOP Enclosures with shielded 20 slot motherboard, power supply, fan, dust filter, rugged all metal construction.

DUAL FLOPPY DISK SUB SYSTEM available with double sided/density drives.

... to powerful Multi-User Systems

1. Run any mix of 8 or 16 bit software at any terminal.
2. Lots of storage. 384K of RAM (expands to 1 MByte), 2.4 million (expands to 4.8 million) characters of floppy disk storage, provisions for hard disk storage.
3. Nine serial ports for terminals, printers, modems, etc.
4. Unparalleled single-user operation, as well as optional expansion from 3 users to 8 users.
5. Superior warranty. 1 year limited warranty.
6. Bundled software. System 816/C runs over 3,000 CP/M® programs, and comes with MP/M -816 , CP/M 2.2, CP/M-86, M-Drive , SuperCalc (Sorcim's powerful 16 bit spreadsheet), and dBase 11 data manager.
7. Ultra-high performance. As Interface Age said, "The (8 bit) 8085 was more than a third faster than any 8 bit micro we have tested to date...the (16 bit) 8088 (was) almost twice as quick as the indistinguishably-engineered IBM Personal Computer." You will appreciate this extraordinary level of performance when deadlines loom and time is of the essence.



Contact Comcen for more details & price list. Dealer terms available.



Authorized CompuPro Systems Center
and European Distributor.

COMCEN
TECHNOLOGY LTD

Micro-Winchesters

Desktop micro-computer with technology plus features ...

COMCEN CRYSTAL 8

- 5 Megabytes fixed Micro winchester
- 8 inch floppy disc backup
- S100 mainframe
- CP/M operating systems
- Serial terminal interface
- Serial and parallel printer interface
- Spare high speed parallel channel
- One year factory warrantee
- On-site maintenance option

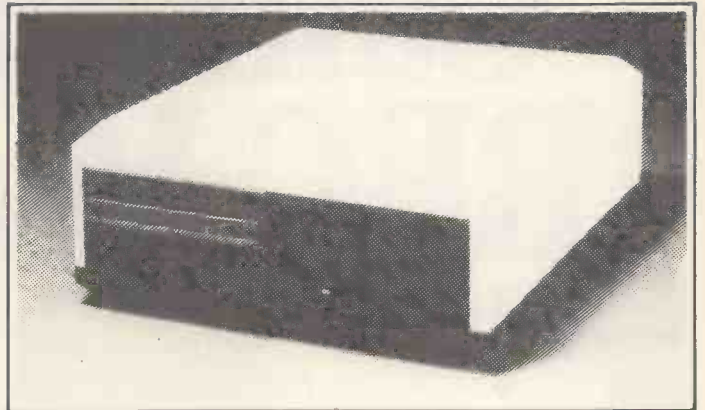

New Price £3409 (+ VAT)

New available May '83

Comcen Crystal R5

Exchangeable Winchester

COMCEN CRYSTAL R5

- 5, Megabytes exchangeable
- 5, 10, 15 or 20 Fixed
- S100 mainframe
- CP/M operating systems
- Serial terminal interface
- Serial and parallel printer interface
- Communications channel
- One year factory warrantee
- On-site maintenance option



COMCEN are EUROPEAN DISTRIBUTORS for

CompuPro™

Farbell
Electronics

SD
SYSTEMS
A SUBSIDIARY OF THE MICHIGAN GENERAL CORPORATION

45/46 WYCHTREE ST.,
MORRISTON,
SWANSEA SA6 8EX

Tel: (0792) 798337 (24 hours) 796000 (day)

COMCEN
TECHNOLOGY LTD

Cumana drives BBC Micro best!



**CUMANA DRIVES +
OWN POWER SUPPLY
=BIG PLUS FOR
BBC MICRO USERS
... JUST FOR
STARTERS**

The 'ice on the cake' is that because the Cumana Drive has its own power supply, it can be used with many other Micros when connected via the appropriate cable. Cumana supply a Drive connecting cable which has a standard 34 way edge connector plus 34 way BBC connector in the same cable length. This allows the Cumana Drive to be connected to numerous makes of micro without the need to change connecting cable. And the Japanese manufactured disk drives are quiet and utterly dependable.

**12 MONTH
FULL WARRANTY**

**£199
100K**

**£619
800K**

- | | |
|--|-------------|
| CS50A Single 40 track drive 100K | £199 |
| CD50F 2 double sided 80 Track TEAC Drives
with cabinet and power supply 800K | £619 |
| Disk formatter and instructional manual | £15 |
| Model A-B upgrade kits | £65 |

**Many other Disk Models available for BBC.
Call or write for Data Sheet.**

CUMANA LTD

Unit 1, The Pines Trading Estate, Broad Street,
GUILDFORD, Surrey GU3 3BH (0483) 503121
Telex: 859380 CUMANA

Please add VAT to all prices.

**DEALER & EDUCATIONAL ENQUIRIES WELCOME -
GENEROUS DISCOUNTS AVAILABLE**



A M ELECTRONICS

THE POWER BEHIND THE DRIVES™

Densei 6.7 Mbyte 5 1/4" Winchester ready to run

- cased with PSU + controller for Apple II and IBM PC

£1195

with host adaptor and software

- cased with PSU + controller for TRS80 Model I & III

£1195

with host adaptor and software

- bare **£600**



All prices exclusive of VAT and delivery
Delivery approximately 28 days

Office telephone 01-994 6477 9-5 pm Ansaphone Telephone 994 4470
Access telephone orders gladly accepted Dealer enquiries welcome

JUST ARRIVED
2/3 height
Apple compatible drive
£180 excl. VAT and delivery

A M Electronics 10 Barley Mow Passage Chiswick London W4 4PH

Business Management is now child's play -thanks to PIPS!



- PIPS is the simple microcomputer language of today. With PIPS you can learn to handle business accounting systems in a single day.
- PIPS has been designed for use with SORD's complete range of microcomputers. PIPS makes conventional programming obsolete.
- SORD, the fastest growing company in Japan, is one of the world's largest manufacturers of microcomputers.
- SORD offers the complete product range, from game computers to sophisticated business systems.
- Test our claim: bring your business data to our weekly PIPS Seminar and we'll help you process it in a single day - completely free of charge. Ring us now on 01-930 4214 or contact your nearest SORD dealer.

SORD

TOKYO AND NOW LONDON

SORD, Samuel House, 6 St. Albans Street, Haymarket, London SW1.
Tel: 01-930 4214. Please send further information and my invitation to a FREE 1 day PIPS seminar.

Name _____
 Position _____
 Company _____
 Address _____
 _____ Tel _____ Ext _____ PCW

London & South East Clear-View Rental & Relay Ltd., East Sussex. Tel: (0323) 898989 · Integrated Business Micro Systems Ltd., W1. Tel: 01-878 9847 · J. R. Instruments, Surrey. Tel: 01-657 1700 · Microstream, ECI. Tel: 01-251 5377 · Newman Computers Ltd., East Sussex. Tel: (08926) 64340 · Opus Systems, Staines. Tel: (0784) 57265 · Spand Commercial Services Ltd., Hythe, Kent. Tel: (0303) 65351 · South & West Apollo Administration Bureau Ltd., Penzance. Tel: (0736) 66336 · Micro Xzec Ltd., Bournemouth. Tel: (0202) 21220 · C. M. Computer Systems Ltd., Chippenham. Tel: (0249) 651341 · Micro Experience, Gloucester. Tel: (0452) 500010 · Z. R. International Ltd., Bath. Tel: (0225) 64001 · Midlands Executive Data Systems Ltd., Nottingham. Tel: (0602) 413494 · Largotim Ltd., West Midlands. Tel: (0384) 232596 · R-Mark Systems, Abingdon. Tel: (0235) 28179 · North A. R. Gerrard (Micros) Ltd., Ormskirk. Tel: (0695) 422329 · E&B Systems, Cheshire. Tel: (06065) 53722 · Grove Computing Services, Manchester. Tel: (061) 231 4727 · Scotland Admin Systems, Strathclyde. Tel: (0436) 71189.

**Quality
Computer
Media**

Disk storage Labels Paper
Ribbons Furniture
cleaning kits
Binders
Disks

**at
discount
prices**

come to Password

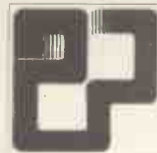

Uncertain about the disk or ribbon for your machine Call Password for online advice.

Verbatim Datalife
The industry standard.
All mini disks are double density with hub rings

5 1/4	MD525	SS	40 track	£18.95*
	MD550	DS	40 track	£24.95*
	MD577	SS	77 track	£26.95
	MD557	DS	77 track	£34.95
8	FD1500	SSSD		£22.95
	FD9000	SSSD		£28.95
	FD8000	SSDD		£29.95
	DD4001	SSDD		£34.95

* Single density compatible

All disks come with Factory guarantee 10/16/32 sectors available at the same price

BASF Disk Media
These disks are high quality at low prices

5 1/4	SSSD	£15.00
	SSDD	£19.00
	DSDD	£24.00
8	SSSD	£21.90
	SSDD	£25.90
	DSDD	£28.80
	SSSD 32 sector	£27.35



Password warning

cheap paper can damage your printer

Our stationery is superior heavyweight low dust paper We have over 30 formats to choose from Labels available on request

- ◆ One part music ruled 65gsm
2000 11 x 9 1/2 £10.95
2000 11 x 14 1/2 £12.90
2000 11 x 15 5/16 £13.50

- ◆ New mini packs for the small user
Plain 70gsm with perforated edges (72 cuts/inch gives ultra smooth edge)
Ideal for letters/forms and archive listings
1000 11 x 9 1/2 £8.36
1000 12 x 9 1/4 £8.67

UK postage and packing

Disks 8 £1.30 each pack 5 1/4 £0.95 each pack
Library cases (EGLY) £0.50 each (30) £2.60 each (60) £2.60 each Cassettes £0.95 each pack
Ribbons £0.35 each Binders £2.60 each box
Paper (1000) £2.60 each box (2000) £3.50 each box
Cleaning kit £0.50 each

Add 15% VAT to total price Cheques, Postal Orders to

Password Electronics Ltd
68 Commercial Road
Wyndham Place
Southampton
Hants SO1 0GD
Tel 0703 332130



◆ **Disk storage**

Egly	Plastic flip top	
Plastic library cases	large storage easy access	
5 1/4" holds 10 £2.00	5 1/4" holds 30	£4.35
8" holds 10 £2.20	8" holds 60 (lockable)	£18.95

◆ **Cassettes (C12)**

Manufactured especially for Micros
Bulk tested Error free operation
No more drop outs
Packaged in boxes of 10 £6.50

◆ **Professional ribbons from GEHA**

Richo RP 1600	M Strike	£3.36
NEC Spinwriter	M Strike	£3.32
Microline	Nylon	£1.32
Seikosha AP 100	Nylon	£6.25
Epson MK80	Nylon	£5.32
Commodore PET	Nylon	£5.32
Sharp CE/MZ	Nylon	£5.32
Centronics zip pack	Nylon	£2.69

We have ribbons for most popular machines

◆ **Verbatim Disk Drive Head Cleaning Kit**

Now anyone can clean heads safely and quickly
No messy fluids use as a normal disk
Cleaning Kit £6.25
Extra Disks(10) £11.50 Specify 8 or 5 1/4

◆ **Printout binders**

Width	Vinyl	Pressboard
7 1/2 - 12	£18.50	£17.20
12 1/4 - 15 1/4	£22.90	£19.50

All prices are for 10 packs. Other sizes available



HANTAREX



CTM 2000-12A9



CT 900/D-14



CTM 2000-9A9

TECHNICAL SPECIFICATIONS

CAT. NO.	TUBE	INPUT	SYNC.	BAND WIDTH	RISE/FALL	CENTRE RESOLUTION	PRICE DEL. U.K.
CTM 2000-9A9	9" 90°	COMP. VIDEO	—	18MHz	35ns	800 LINES/in	£100.50
CTM 2000-12A9	12" 90°	COMP. VIDEO	—	18MHz	35ns	800 LINES/in	£102.50
CT 2000-15B1	15" 110°	COMP. VIDEO	—	18MHz	35ns	800 LINES/in	£124.00
P31, L1 PHOSPHORS STANDARD: P4, P39 OPTIONAL EXTRA							
CT 900/D-SR-14	14"	R.G.B. LINEAR	SEP. OR COMP. POS. OR NEG.	8MHz	50ns	40 COLS. 960 CHARS.	£245.50
CT 900/D-MR-14	14"	R.G.B. LINEAR	SEP. OR COMP. POS. OR NEG.	20MHz	20ns	80 COLS. 2000 CHARS.	£378.00
CT 900/D-HR-14		T.T.L. PLUS INTENSIFIER					
INTERFACE FOR USE WITH APPLE II							£47.00

MATERIALS AND WORKMANSHIP GUARANTEED FOR 1 YEAR

HANTAREX (U.K.) LTD., UNIT 4, 95 HAYMERLE ROAD, LONDON SE15 6SA. TEL: 01-639 9343/1713 TELEX: 8952421 HANTAR G.

Business Blueprint



THE VECTOR 4

From the small business to the large multi-national, Almarc provide one of the largest selections of quality business, scientific and industrial applications software available today, including:

Wordprocessing/Mailing, Financial Modelling, Solicitors Package, Financial & Arable Management, Printers Estimating/Costing, Phototypesetting/Wordprocessing Interface, Data Base Management, Estate Agents Package, Manufacturing Software, Critical Path Analysis, Motor Trade Package, Planning Application Monitoring, Estimating, Data Logging,

Graphics Packages, Business Accounting, Accounts Receivable/Payable, Payroll, Stock Control, Invoicing, Ordering, Purchase Control, Clothing Industry Software, Network & Resource Analysis, Job Costing, Insurance Brokers.

All available on probably the most advanced, "New Generation", micro-computer system produced today.

The Vector 4, is an advanced 8/16 bit desk top computer. It allows you to take advantage of the existing 8 bit CP/M programs, while also providing 16 bit processing power. The future is built into the Vector 4, with its Z-80 and 8088 processors, 128K of main memory (expandable to 256K), 3 S-100 expansion slots and standard software facilities with high resolution graphics that are second to none. Floppy disc and hard disc systems are available.

At Almarc, we pride ourselves in our systems and our high level of customer support. We can offer back-up and training which is second to none, with 24 hour on site maintenance available in all areas.

Almarc

DATA SYSTEMS

HEAD OFFICE
Almarc Data Systems Ltd,
Great Freeman Street,
Nottingham NG3 1FR.
Tel: (0602) 62657.
Telex: 37407 Almarc/G.

Almarc Data Systems Ltd,
18A Spittal Street,
Marlow,
Bucks. SL7 1DB.
Tel: (06284) 6419.

MICRO QUESTIONS. EXPERT ANSWERS



Computer Answers, the unique magazine that solves your micro queries and problems.

Free Question and Answers service

Free Advertiser Reply service

Join the Readers Council

Benefit from the Council of Elders

Included in our regular sections this month:

- ★ **UPGRADE:** A first look at the super powerful Sage IV.
- ★ **CONNECTIONS:** How Basic plus a little circuitry can control the home.
- ★ **PROGRAMMING:** Find out what it's like to be a professional games programmer.
- ★ **INSIDE THE SYSTEM:** Get into your system with software tools.
- ★ **APPLICATIONS:** Who will produce the first micro concerto?
- ★ **BUYING AND BACKUP:** Take the backache out of programming – micro ergonomics.

THE DRAGON AND TEXAS CLINIC:
Seven pages of answers to many questions on these popular micros.

Plus sacks of readers' questions, ANSWERED

COMPUTER
Answers **OUT NOW - 75p**

From W H Smith, John Menzies and all leading newsagents.

G. W. COMPUTERS LTD

LONDON'S WEST END - NATIONWIDE OVERNITE SERVICE
 MORE PRODUCT RANGES
 PROBABLY THE WIDEST SELECTION OF NETWORKS...MICROS...
 AND PRINTERS ON DISPLAY

**** THE NEW DBMS III.7 (series III of the world's first 'task-robot-programs') ****
 **** FEATURES ****

MBasic & word-star compatible
 1400 character record sizes
 mathematical scratchpad
 record relational indexes
 translateable to any language
 User-defineable reporting
 field protection/classification
 either-or, same as, greater, smaller
 sorts 'alpha or numeric' any window

12 online file architectures
 240 fields using cross-referencing
 cross-record calculations
 'Jump-to' any record in 12 files
 User-defineable files/field words/sizes
 32000 records per filename
 20 main/200 sub fields per record
 field and record related formulae
 'Jump-to' any of 32000 records per file

random/binary/key/multiple field search
 'if-then' questioning
 file protection/password entry
 range match, not match, integer match
 sort speed 500 records per 20 seconds
 endless 'either-or' matching
 formulate/recall on selection criteria
 13 interrogation question types
 short filing output/audit trails

User-define files/field words/sizes, "sale-mail-shots"; "production-process"; "purchase/sales-analysis"; "personnel-file"

ONE OF THOUSANDS OF DIFFERENT TASKS ON WHICH THIS PROGRAM MIGHT BE EMPLOYED

DBMS'S MACROS WORK FROM THE MOMENT YOU INSERT THE 'TASK DISK' IN THE COMPUTER
 Simply design your file, give its fields your words, setup your report mask, and then enter your records. Switch to 'automatic drive' and formulate any task you wish the program to fulfill, the task is stored as a macro. Take a copy of the program on another 'task disk' and from then on, the task disk will function without a single keystroke. Think of a number of such 'task disks' such as 'stock-re-order reports'; 'stock-valuation reports'; 'analysis'; 'patient history analysis'; 'research-analysis'; 'budgetting'; 'vehicle-location control'; 'librarian analysis'; 'plus more?'

Previous issues showed examples of 'employees-short-list', 'garage stock re-order', 'sales analysis', 'librarian's list', 'hospital's patient list'. Here is an example of a 'rental recording file' and some reports it might generate.

The record may look like this:

- 1- record number (413)
- 2- client (Radio cars ltd)
- 3- date of contract (01.04.81)
- 4- date last pmt (12.02.82)
- 5- period/frequency (36/monthly)
- 7- amount of pmt (22.50)
- 8- item type (Taxi-phones)
- 9- repairs made (faulty microphone - item replaced)
- 10- cross reference (3.442!C details of full system spec and supplier)

One report might be: select??
 all records where the amount of payments are less than 50 pounds, that were taxi-phones and faults were detected. When found, pick up the cross reference code and look up that record to identify the supplier.

DBMSII (WITHOUT MACROS) AND DBMS III ARE FULLY IMPLEMENTED UNDER CPM-86 (tm) AND MS-DOS (tm) ie: <SIRIUS/VICTOR/IBM> DBMSII IS 395.00 (or 250.00 by mail order ex. training). DBMSIII is 575.00 (or 295.00 by mail order ex. training).

MICRO-COMPUTERS

G.W.L.	-G80 64K/INTFC E PORTS/K/BOARD	895.00
	-G80 V.D.U.	150.00
	-G80 DUAL D/DRIVES ENCLOSED	550.00
INTERTEC	-SUPERBRAIN 64K RAM/320K DISKS	1695.00
	-SUPERBRAIN 64K RAM/700K DISKS	2195.00
	-COMPUSTAR 64K RAM/320K DISKS	1995.00
	-COMPUSTAR 64K RAM/700K DISKS	2495.00
N'STAR	-ADVANTAGE 64K RAM/700K DISKS	£2195.00
(sic DOS)	-ADVANTAGE 64K RAM/5.3M DISKS	£3095.00
TELEVIDEO	-802 64K RAM/700K DISKS	2195.00
	-802H 64K RAM/7.3M DISKS	3750.00
	-806 64K RAM/10M DISKS	4995.00
	-816 256K/750K DISKS	£3150.00
ACT	-SIRIUS 1 128K/1.2M DISKS	£2395.00
	-SIRIUS 2 128K/2.4M DISKS	£2895.00
	-SIRIUS 3 128K/10MEG DISKS	£3995.00
VICTOR	-9000 128K/1.2M DISKS	£2395.00
IBM	-PC 64K RAM/640K DISKS	£2795.00
	-PC1 330K/640K DISKS	£3395.00
ALTO	-ACS800-2 64K RAM/1M DISKS	1995.00
	-ACS800-10 208K/10.5MEG DISKS	5495.00
NEC	-APC 128K RAM/2M DISKS	call.00
CORVUS	-CONCEPT 16 BIT PC	call.00
SANYO	-G80 64K RAM/320K DISKS	1195.00
	-G81 64K RAM NETWORKER	1350.00
ABC	-26 64K RAM/2.2M DISKS	3250.00

All computer prices include mbasic as standard
 All prices marked £ are 8/16 bit machines

SYSTEM DEALS (Our Speciality) SAVES YOU 1500.00 +

Choose any computer, any printer and 50 diskettes
 add 65.00 for cables and testing.
 add 10% warranty for 1 year (optional)
 add 110.00 for delivery & installation (optional)
 training optional extra 100.00

and get completely ****FREE****
 cpm handbook 50 basic exercises 2000 sheets paper
 DBMS III magic wand w/proc magic calc
 mbasic 80 diagnostics msort dsort
 recover auto load instant basic
 cbasic disk/games library case
 ****total value 1525.00****

Based on 8 bit hardware, 16 bit software varies!

PRINTERS

OKI	-MICROLINE 80	295.00
	-MICROLINE B2A	395.00
	-MICROLINE B3	895.00
	-MICROLINE B4	895.00
EPSON	-MX80/FT-3	425.00
	-MX100/FT-3	575.00
ANADIX	-DP 9000	895.00
	-DP 9501	1045.00
	-DP 9501 (A)	1145.00
GUME	-945 R/O	1995.00
	-955 R/O	2195.00
	-935 R/O	1495.00
NEC	-3510 R/O	1495.00
	-7710 R/O	2195.00
	-5520 KSR	2550.00
DRE	-8820	1295.00
	-8830	1695.00
TEXAS	-810	1195.00
	-825	1095.00
DIABLO	-630	1995.00
RICOH	-RP1600	1495.00
OLYMPIA	-ESW 103 14 CPS	975.00
	-ESW 300 55 CPS	1025.00

SOFTWARE

G.W.L.	-BUS V8.00 (ACCOUNTS)	275.00
	-DBMS II (DATABASE)	£395.00
	-DBMS II (BY MAIL ORDER ONLY)	£250.00
	-DBMS III (DATABASE)	£375.00
	-DBMS III (BY MAIL ORDER ONLY)	£295.00
	-FORMS/TEXT/CALC/DBMS IV	£575.00
	-SALES LEDGER	£95.00
	-PURCHASE LEDGER	£95.00
	-NOMINAL LEDGER	£95.00
	-STOCK-CONTROL	£95.00
	-ADDRESS-MAILER	£95.00
	-QASORT/QNSORT (500 RECS/14SECS)	£95.00
MICROSOFT	-MBASIC 80	£195.00
	-FORTRAN 80	295.00
	-COBOL 80	395.00
	-BASIC COMPILER	£225.00
	-MULTI-MU STAR	125.00
MICROPRO	-WORD-STAR	£295.00
	-MAIL-MERGE	£95.00
	-SPELLSTAR	125.00
	-W-STAR/M-MERGE/SP-STAR	425.00
BYROM	-BSTAM (COMMUNICATIONS)	100.00
	-BSTMS (TELE-COMMS)	100.00
DIGITAL	-CBASIC	75.00
	-PASCAL MT	225.00
	-T-MAKER	155.00
LIFEBOAT	-CIS COBOL	420.00
MFOCUS	-FORMS II	100.00
SORCIM	-SUPER CALC	195.00
PEACHTREE	-MAGIC WAND	190.00
	-MAGIC CALC	175.00
MICROSTUFF	-CROSS-TALK (TELE-COMMS)	95.00
WOOLFE	-MOVE-IT (MICRO TO MICRO)	45.00

Software formats on all micros in our hardware list
 All prices marked £ are available 8/16 bit formats

TERMS & ETC

G. W. Computers Ltd [Grama (Winter) Ltd]
 55 Bedford Court Mansions
 Bedford Avenue
 London WC1 England.
 Tel: 01-636 8210, 01-631 4818. Telex: 892031 TWC G
 Boston office telex: 94-0890

24 hour answerphones leave address for infopacks

We do not operate a reader's reply card service.
 Terms: C.W.O. or C.O.D. Prices exclude VAT.,
 but include all non-credit discounts available.
 No dealers. The above lists are not exhaustive.
 Please call in only by prior appointment.

PERIPHERALS & ACCESSORIES

CORVUS	-6 MEG HARD DISK	1950.00
	-11 MEG HARD DISK	2950.00
	-20 MEG HARD DISK	3950.00
	-MULTIPLEROR 7 STATION	695.00
	-MIRROR BACKUP CARD	695.00
INTERTEC	-COMPUSTAR 10 MEG HARD DISK	2750.00
	-CDC 96 MEG HARD DISK	7950.00
N'STAR	-16 BIT U/GRADE	395.00
	-18 MEG HARD DISK	2995.00
RODIME	-8 MEG HARD DISK	1495.00
	-12 MEG HARD DISK	1950.00
	-5MG FIXED/5MG REMOVEABLE DISK	3295.00
GENIE	-64K PRINT SPOOLER/COPPER	295.00
QUADRAM	-RS232/AUTO MODEM 1200 BAUD	450.00
BIZCOMP	-PORT EXPANDERS (4 TMMLS TO 1 PRTR)	395.00
AST	-PORT EXPANDER (SWITCHER)	95.00

NOTE CORVUS DRIVES WITH MULTIPLEPOR MAY NETWORK
 SIRIUS..SUPERBRAIN..CONCEPT..PET..VICTOR..IBM

G. W. COMPUTERS LTD

G80/86 SOFTWARE

Fully implemented on MS-DOS, CPM 2.2 and CPM 86 (tm)

Works on IBM, Sirius and Victor 9000 and all micro-computers in our price list

Requires the prior acquisition of DBMS III.7

Sale ledger (95 pounds)	Purchase ledger (95 pounds)	Nominal ledger (95 pounds)
Stock control-valuation/ re order (95 pounds)	The address mailer (95 pounds)	Quasort/Qnsort (500 records/ 15 seconds) (95 pounds)

DBMS 111.7 new switch mode facility enables you to cross up to 12 different files (32000 records per file) pre-selecting any of up to 20 fields per record/file for display/print output (240 fields) in all. One massive enquiry can pass through 384 records.

You might have two files whose records are directly related to each other, so that the first file (say containing names and addresses) refers to the second file (say financial and other information relating to the same record numbers of the first file) directly. Then you can simply select that in file 1 you are interested in just the name and telephone numbers, whereas in file 2, you are interested in the income, trading period and number of branches, information. Your enquiry can then pass through both files highlighting that information only, rather like the display below.

File 1 record 1	G.W. Computers	01-636-8210		
File 2 record 1	800,000	5 years	1	
File 1 record 2	Lloyds Bank	01-123-4567		
File 2 record 2	1000,000,000,00	100 years	500	
File 1 record 3	Selfridges	01-631-4818		
File 2 record 3	100,000,000	98 years	1	
File 1 record 4	Debenhams	01-636-1234		
File 2 record 4	120,000,000,00	50 years	50	

Actually there doesn't need to be a strict correlation between the same record numbers in different files, and you can also on just one JUMP command go to any record in any of the 32000 records in any of the twelve files and carry on cross-referencing from there onwards.

Do you see that ? Only from G.W. Computers Ltd. The database leaders.

Each module is a set of 'task disks' designed for minimal learning curve. This software derives from modules of 'DBMS III' and runs reports without your secretary having to touch a single key

Consider the advantages in these features: The user manual is contained in FIVE pages. All reports are generated by robot functions. Reliability tested (benchtest PCW June). Works in a network multi-user environment. Fast easy data entry. Files are re-organised and sorted automatically. Produced by the same people that originated 'BUSINESS', 'DBMS II', 'DB-CALC', 'AUTOLOAD AND RECOVER', 'ETC' and sold successfully over the past five years.

Also see our advertisement next page.

The G80/86 networks

Based upon one hard disk and multiplexor module the G80/86 networks feature full network sharing of data resources by adding different stations that may be as various as Sirius/Victor 9000/IBM/Superbrain/Pet/N'Star/Sanyo.

We also have a special 'spooler module' as well as software controllable port expanders and modems for output to telephones, printers, and screens so that a number of terminals may share the resources of one printer, as well as be able to send files over the telephone at any time (day/night) to both store on the hard disk and print out as well.

ONLY FROM G.W. COMPUTERS (the leaders in database).

Call us on 01-636 8210 or 01-631 4818 and leave your address for our standard 'infopacks'.

MICRO-COMPUTERS

PRINTERS

SOFTWARE

G. W. COMPUTERS LTD

LONDON'S WEST END - NATIONWIDE OVERNITE SERVICE MORE PRODUCT RANGES -
BETTER SERVICE PROBABLY THE WIDEST SELECTION OF NETWORKS...MICROS... AND
PRINTERS ON DISPLAY NATIONWIDE

FORMS/TEXT/CALC/DBMS IV

Contains the highest state of the art software available today.

ALL IN ONE PROGRAM THE DBMS IV @ 575.00

When you budget for a complete system of software you eventually end up with a host of packages like, Sales, Purchases, Nominal, Data, Text, Calc, Mailshot, Invoice, Order, Workflow, Personnel, and so on. The list is endless and the outlay several thousands of pounds.

Features: Design a form as wide as a window of 250 characters, long as needed. Cursor movements are 'left, right, up, down, delete left, delete right, tab right-left-up-down'. Paint your form as you like directly on the screen.

Text: Write a letter as you see it on the screen, edit it then simply enter P to print.

Calc: Set into the form, your data fields, "EEEEEE" and specific file-related activities, formulae and validation checks. Enter values and see the spreadsheet calculate itself.

Database: Search files for data to be inserted to fields specified. All the features of DBMS III, explained elsewhere in our ad.

Here's an example of an invoice you might design for your stationery... You could design your own spreadsheet, order form, statement, or any other kind of form that is required to fit your existing stationery.

```

INVOICE <0>EEEEEEEEEE
To <1>EEEEEEEEEEEEEE          From: G.W. Ltd
<2>EEEEEEEEEEEEEEEEEE          55 Bedford Court Mans.
<3>EEEEEEEEEEEEEEEEEE          Bedford Avenue
<4>EEEEEEEEEEEEEEEEEE          London W.C.1.
<5>EEEEEEEEEE                 Tel: 01-636 8210
Date <6>EE.EE                 Tax point <7>EE.EE
Agent <8>EEE
Quantity  Description  Cost  Tax  Total
<9>EEE   <10>EEEEEEEEEEEEEE <11>EE <12>EE <13>EEE
<14>EE   <15>EEEEEEEEEEEEEE <16>EE <17>EE <18>EEE
and so on...
Total...<19>EEEEEE          Tax...<20>EEEE
    
```

<??> items <1> to <5> internal command to request name input, and then search an address file for details.

<??> items <6> to <7> request date input and validate.

<??> item <8> request agent number and validate range.

<??> item <9> request quantity, validate range.

<??> item <10> request description, search file, accept, and calculate fields <11>, <12>, <13>. If finished Invoice then calculate fields <19> and <20>.

Now comes the more valuable facility. You can provide the 'FORM' with file-related instructions, not only to request a 'console' input for a file search against names, and stock, but after the invoice is finished the fields you have selected may be passed to related files.

eg: Send fields <0>, <1>, <6>, <7>, <11>, <12>, <13>, <19>, <20> to sales ledger.

Then send fields <9>, <10>, <11> to product analysis file.

Then send fields <0>, <1>, <7>, <19>, <20> to V.A.T. file.

Then send fields <10>, <11>, <12> <13> to Nominal ledger. Do you see?



Algray
software

ALGRAY House 33 Bradbury Street, Barnsley,
ALGRAY South Yorkshire, S70 6AQ, England



COLOUR GENIE GENIE - TRS-80 SOFTWARE

SKRAMBLE

Superb graphics, sound and action combine to make a superb action, arcade style game with an added bonus - Land your craft on level and you could win £100.
Colour Genie £8.95

GENMON

Guide your green spotlight through the Genies mind and implant thoughts directly with this machine-code monitor
Colour Genie £12.95

The Exterminator

Stage 1: Kill the birds, but they have guided missiles to help them.
Stage 2: Run out of the safe area, pick up the eggs and get back to the incinerator
Colour Genie £7.95

KONG

You may have seen Kong in the arcades, if not a giant ape has stolen your girl now you must rescue her avoiding the obstacles thrown at you
Colour Genie £8.95

V.G. - TRS-80 ONLY

Frog Race	£5.95
Exterminator	£7.96
Fortress of Evil	£7.95
Double Agent	£12.95
Air Attack	£7.95
Labyrinth of the Drogos	£7.95
Spaceship to Nowhere	£7.95
Basic Debug	£12.95
Ultipack	£12.95

OR THE LOT FOR £50.00

Double Agent

Your mission is to steal the plans. A role playing game in real time, so be prepared to fight or flee, to bluff, but do it quickly
Colour Genie £12.95

Fortress of Evil

An "adventure" that gives a 3-D view of the room. Your quest is to find the wizard and slay him. Using the objects you find along the way
Colour Genie £7.95

The Graphics Master

Release the potential of your Colour Genie with this easy to use method of using the programmable characters.
Colour Genie £7.95

COLOUR VIDEO GENIE - ONLY £224 inc. VAT
INCLUDING DELIVERY AND FREE PROGRAM

Algray
software

Algray House
33 Bradbury Street
Barnsley
South Yorkshire
S70 6AQ

Yes I would like the following software for my

.....

I enclose a cheque/P.O./Access

Name

Address

.....

.....

..... Tel. No.

IRELAND!!

NOW THE WORLD'S LEADING MICRO'S ARE AVAILABLE
AT DOWN TO EARTH PRICES!

SIRIUS 1® (1.2 MB) IRELAND'S LEADING 16 BIT MICRO **£2875.00**

SIRIUS 1® (2.4 MB) **£3475.00**

SIRIUS 1® (1.2 MB + 10 MB INTERNAL HARD DISK) **£4775.00**

IBM® PC (64K) U.S.A.'s LEADING 16 BIT MICRO **£3375.00**

IBM® PC (128K) **£3675.00**

OSBORNE 1® (THE WORLD'S LEADING PORTABLE MICRO) **£1625.00**

includes
WOROSTAR, MAILMERGE
SUPERCALC, M BASIC + C BASIC
worth £800 FREE!

PRINTERS — TEC — RICOH — EPSON — ANNADEX — FACIT — QUME, ETC.
AND WHOLE RANGE OF PERIPHERALS AND SOFTWARE!

ALSO — THE AMAZING OLIVETTI PRAXIS 35
ELECTRONIC TYPEWRITER/PRINTER
ONLY £585.00

CALL CORK (021) 888173 NOW AND
ASK FOR YOUR LOCAL AUTHORISED
MICROHOUSE DEALER — OR FILL
OUT THE RETURN SLIP FOR MORE
INFORMATION

MICROHOUSE (IRELAND) LTD.

All prices quoted are EXCLUSIVE of V.A.T.
All prices quoted in Irish pounds and subject to change without notice.

To: **Microhouse (Ireland) Ltd.,
Marian, Beaumont Lawn, Cork.**

Please send me information on

Dealer End User

Name

Company

Address

.....

.....

Telephone

The printer that thinks it's a computer!

FACT With internal microprocessor, 8K buffer store and total compatibility, the Ricoh Flowriter range has proved itself the most intelligent and reliable range of printers on the world market.

FACT Ricoh Flowriters can assume the characteristics of any popular 'intelligent' printer and plug into any hardware configuration.

FACT Ricoh Flowriters perform all your processing and printing needs while leaving the host computer free for other work.

FACT Ricoh Flowriters do all this, give you exceptional print quality, yet cost the same as ordinary daisy wheel printers!

- FEATURES**
- Internal microprocessor
 - 8K buffer under full program control
 - Includes RS232, Centronics and IEEE 488 interfaces
 - 60cps print on the RP1600, 37cps on the RP1300
 - Qume, Diablo and NEC Spinwriter wp commands-compatible
 - Auto-bidirectional and logic seeking high-speed printing
 - Graphics capability down to 1/120"

- Built-in proportional spacing tables
- Automatic margin justification, even on proportional spacing
- 128-character printwheels, wide choice of fonts
- Wide range of accessories – sheetfeeds, tractor feeds, ribbons, printwheels
- Detachable keyboard option for using Flowriter as an intelligent typewriter or KSR terminal

For intelligent printing that frees the host computer and gives you exceptional print quality and speed, find out more about the Ricoh Flowriter – the printer that **knows** it's a computer, yet costs the same as those that aren't!



The RP1600 Flowriter



The RP1300 Flowriter

Dealer Enquiries welcome.
The Ricoh/Flowriter range is only available from APTEC and their authorised dealers, backed by a nationwide service network.



**APPROPRIATE
TECHNOLOGY LTD.**
2-4 Canfield Place
London NW6 3BT
Tel: 01-625 5575/5134
Telex 264538 SSE G

The Ricoh

FLOWRITER



SAGE
COMPUTER TECHNOLOGY[®]

THE WISE MAN'S CHOICE

THE SAGE family of computers is expanding! Added to the exciting SAGE II is the new SAGE IV. Both machines provide power from the Motorola 68000 chip which is a true 16 bit processor (some even call it 32 bit) and give new levels of performance in personal computers.

With the addition of the new machine SAGE now covers the complete range of business micro-computers. Configurations now extend from memory of 128K to a massive 1 Megabyte, and storage systems from 640K to potentially 200 Megabytes of Winchester disk.

SAGE software is expanding! There is now a choice of four operating systems for the machines. The standard UCSD p-System (complete with Pascal, FORTRAN, and BASIC compilers) is now available in a multi-user form for the SAGE IV which has ports for six users.

For the user who prefers a COBOL environment MPSL now offer the BOS system (CAP Micro-Cobol) together with their large range of multi-user application software. With the implementation of RAMDISK, BOS runs twice as fast on the SAGE as any previous machine, and the list includes some sizeable mini computers!

CPM is available. What more to say except that Digital Research now give their blessing to SAGE with their CPM68K system. This comes complete with a 'C' compiler and will allow UNIX software to be compiled and run under the CPM environment.

SAGE Application software is expanding! Many of the major Apple Pascal system houses have opted for the SAGE as their development machine (remember it goes 14 times as fast as an Apple), and our software directory is getting very large, with a choice of Accounting programs, Modelling programs, Database programs, Project monitoring systems, and a host of software for specialist applications. As we say it's rather hard for anyone developing software to look away from SAGE because it makes other so-called 16 bit computers look pedestrian.

SAGE draws pictures! An interface to the PLUTO graphics system gives superb high speed, high resolution graphics in eight colours.

MicroAPL offer their MIRAGE APL system on SAGE computers, and again the SAGE delivers performance only previously found on mainframe or timesharing systems.



Every SAGE shipped is complete with ONE YEARS ON-SITE SERVICE from GCS Engineering who have over 120 field engineers, so 24 HOUR CALLOUT means just that.

SAGE is affordable! SAGE prices start at under £3000 and a typical 4 user system complete with Winchester disc AND terminals is under £7500. Wise men need to be convinced! Call your local dealer today.

TDI LIMITED, 29 ALMA VALE ROAD, BRISTOL BS8 2HL. TEL: 0272-742796

IMAGINE

a company brought into being by top professional programmers, graphic designers and software marketing specialists.

A company dedicated to the highest quality software and customer service in the world.

ARCADIA

the name of the game especially created to be the fastest, meanest, most addictive shoot 'em up game you've ever desired. Wave after wave of the most loathsome and deadly aliens billow hypnotically towards your space fighter with deadly intent. But then you have dual Plasma Disruptors and an Ion Thrust Drive haven't you? . . .

ZXSPECTRUM

(16K or 48K)
100% machine code with 12 different alien types, incredible animation and explosive effects, sound and the fastest, smoothest hi-res graphics ever!

VIC-20

(any memory size)
100% machine code with eight different alien types, smooth hi-res multicolour graphics and animation, narrow playfield and sensational sound effects. Keyboard or joystick. Game design and software by D. H. Lawson.

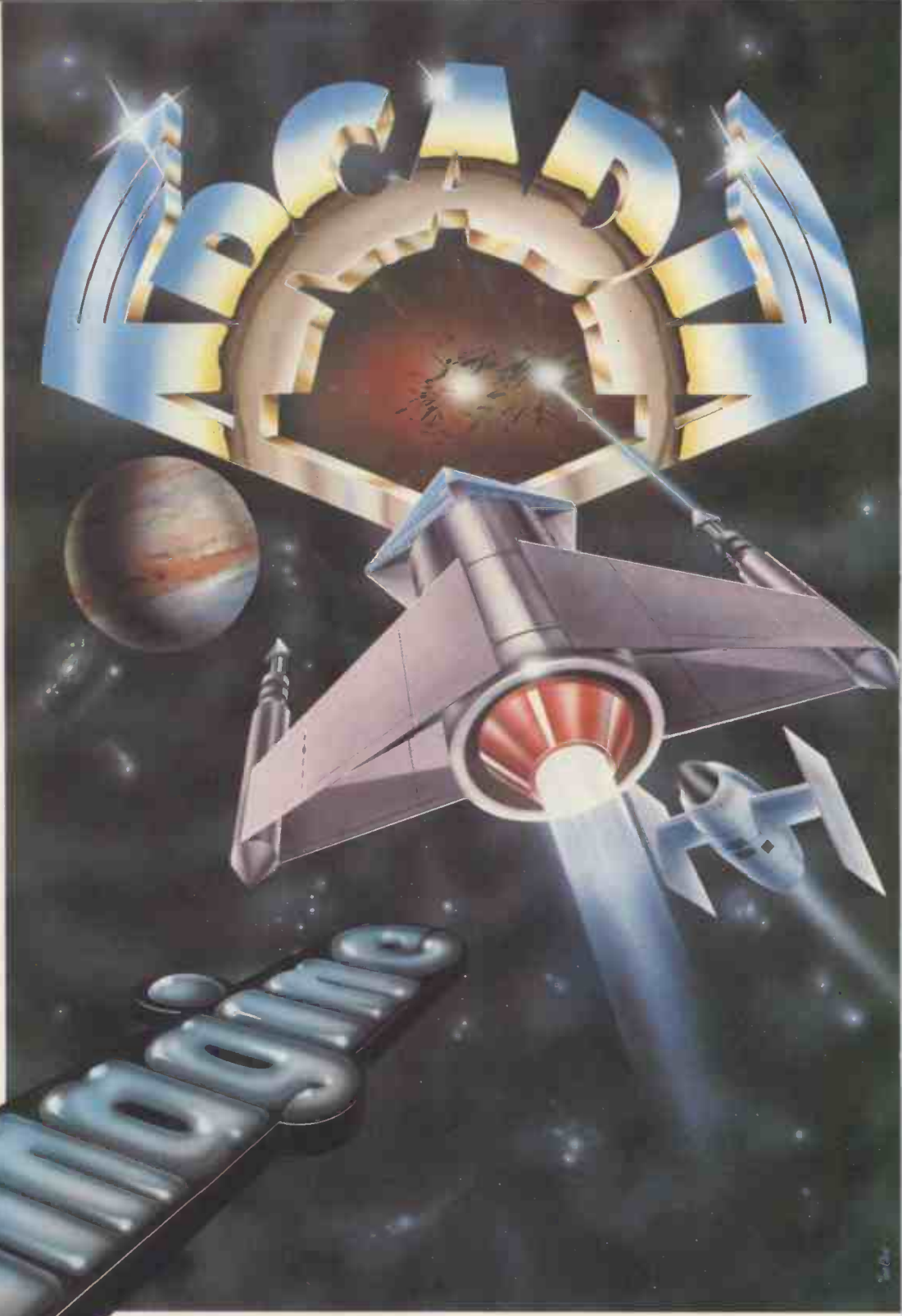

ARCADIA

For any ZXSPECTRUM or VIC-20. Just

£5.50

which includes first class postage and packing, V.A.T., and an **UNCONDITIONAL LIFETIME GUARANTEE.**

Imagine Software
Masons Buildings, Exchange Street East,
Liverpool, Merseyside L2 3PN.



SUPERFAST CREDIT CARD SALES LINE:

051 236 6849 (24hrs)



When you buy ARCADIA

you buy it for life. If an Imagine software product EVER fails to load first time simply return it to Imagine for an instant free replacement.

ALL ORDERS DISPATCHED BY FIRST CLASS POST WITHIN 24 HOURS OF RECEIPT.

Why not put a first class stamp on your order and you will receive ARCADIA within 3 days of posting.

Post coupon now to:

PCW1.

Imagine Software
Masons Buildings, Exchange Street East,
Liverpool, Merseyside L2 3PN.

Please rush me a copy of ARCADIA for (tick box):

Any ZX Spectrum Any Commodore VIC-20

*Please debit my Barclaycard/Access

I enclose Cheque/P.O. for

£ _____

*Delete as applicable

Name: _____

Address: _____



DARK STAR SYSTEMS announces . . .

SNAPSHOT TWO

The disc copy card with all the great features of SNAPSHOT, plus:

WIDER COMPATIBILITY; Works with virtually any 16K card

EASIER TO USE: Just press the trigger on the attached extension cable.
Never open your Apple's cover. Simple 1-2-3 copy procedure.
Copies most programs in 30 seconds

PEELINGS II magazine (Feb 1983) compares SNAPSHOT with Wild Card and Crack-Shot:
"Overall, with one of the supported RAM cards, SNAPSHOT is the best buy."

"The copy procedure is perhaps the easiest and clearest of the three cards."

SNAPSHOT will copy any memory-resident program that runs on the 48K Apple. SNAPSHOT uses your 16K RAM card★ to interrupt a running program and dump the entire contents of 48K and registers to an unprotected backup disc. SNAPSHOT backs up programs that baffle nibble copiers like Locksmith without any complex parameter changes or trial-and-error hassle. And SNAPSHOT is still more effective, less expensive and easier to use than its imitators.

- You have full, normal use of your other hardware and software.
- Ideal for debugging or analyzing programs.
- Freeze-frame your game! Print the graphics on your printer and resume play.
- Shooting down space invaders and the phone rings? Interrupt your game until later, or tomorrow. Save your high scores!
- Repeatedly interrupt and resume running programs.
- Faster and easier to use than nibble copiers or other copy cards.
- Full monitor capabilities to examine, modify, trace, single-step or disassemble any interrupted program.
- Suspend work with one program while you use another (for instance, interrupt word-processing a letter to look up an address in a database, then resume the letter exactly where you left off).
- Move protected programs to hard disk or 8" disk; copy several programs onto the same disk.
- List "unlistable" Basic programs; make custom modifications.
- Backups run without SNAPSHOT present; most run without 16K card.

And there's more! Write or ring for complete technical information.

PRICE; £95.00

from your local dealer or Dark Star Systems

Terms: Payment with order. Add 15% VAT. P&P included. VISA/Barclaycard and Am Ex accepted. Dealer enquiries invited. Foreign: No VAT. Add £2 postage to Europe, £7 elsewhere.

★Apple II or II+ or Franklin. One drive and Language Card/16K card required. Works with most popular cards, including Apple, Microsoft, Ramex, Digitek, MPC, RH Electronics, Orange, Franklin, etc. Other brands: specify when ordering. Graphics dump requires graphics interface card and printer.

**DARK STAR
SYSTEMS**

54 Robin Hood Way, Greenford, Middx. UB6 7QNW. Tel: 01-900 0104

When you're trying to decide on a microcomputer -
We'll spoil you with choice...

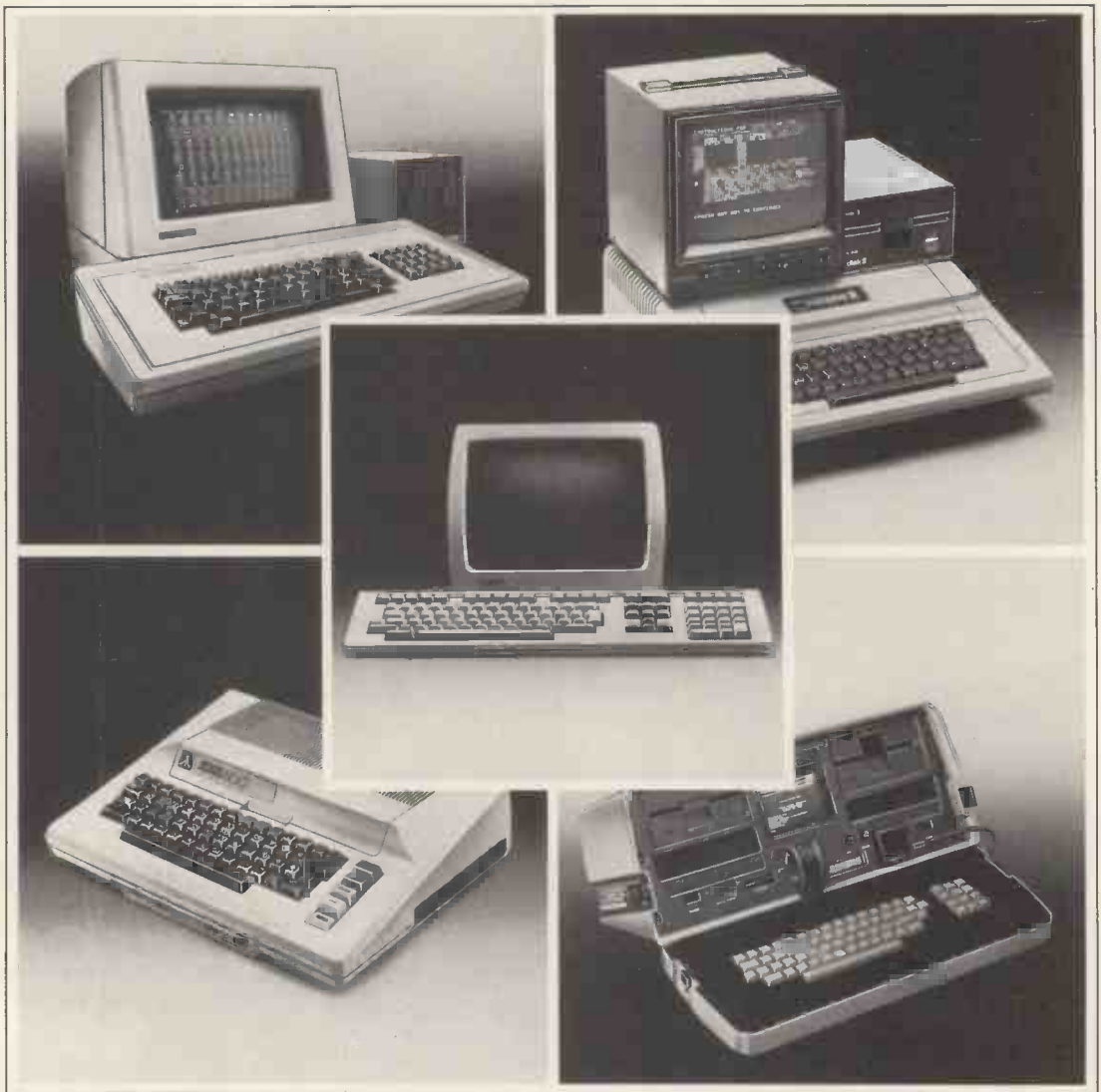

Xerox
Apple
Digital
Atari
Osborne

... & plenty of expert advice

It's not easy to choose a microcomputer. There are so many on the market today. But now The Xerox Store takes the leg work, and the uncertainty, out of making that important decision.

Now you don't have to walk the streets visiting all those different dealers and then try to compare facts. You simply visit your local Xerox Store. Here under one roof you'll find all the leading names in micros including Atari, Apple, Commodore, Digital, Hewlett Packard, Sinclair, Osborne, and of course Rank Xerox.

And we'll not only spoil you with choice but we'll also spoil you with plenty of sound, unbiased advice.

Together with our highly trained staff you can discuss your exact needs. We can show you the different systems and demonstrate precisely how they can benefit your business. You'll find our informal atmosphere provides the ideal environment to try out, test and compare our comprehensive range of micros and software.

So before you decide on that microcomputer – call in to The Xerox Store and let us show you all we have to offer.

Arrange for a free demonstration now. All your questions about these leading brands can be answered by arranging for your free demonstration so call your local Xerox Store now or telephone Freephone 2279.

LONDON 76/77 High Holborn WC1. Tel. 01-242 9596/7 • 110 Moorgate EC2. Tel. 01-588 1531/2 • 84 Piccadilly W1. Tel. 01-629 0694/5
BRISTOL Bristol & West House, Broad Quay. Tel. 0272 277828 CARDIFF South Gate House, Wood Street. Tel. 0222 40118
GLASGOW 166 Hope Street. Tel. 041-333 0495 LIVERPOOL Pearl Assurance House, Derby Square. Tel. 051-236 7512
SLOUGH 3/4 William Street. Tel. Slough 76956/7 MAKRO WHOLESALERS LTD. All locations.

The Xerox Store

The best shop around for choice

The LEEDS

COMPUTER CENTRE

For all your computer needs

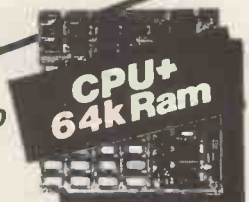

CPU £125.00
plus V.A.T.
CPU plus 64k RAM
£225.00 plus V.A.T.
64k RAM £125.00 plus V.A.T.
COMPLETE TWIN DISK SYSTEM
£675.00 plus V.A.T.
I/O Card £125.00
plus V.A.T.



MULTIBOARDS use 80-Bus and are fully Nascom compatible e.g. disks, enhanced video, Input/Output or Ram expansion.



MULTIBOARDS make computers **MULTIBOARDS** enhance:-
GEMINI, Nascom or QUANTUM
Send for full details

The QUANTUM 2000

is ideal for business applications. It can have up to THREE drives giving 2.4 megabytes of disk storage. Its expansion capabilities are almost infinite, thanks to the flexibility of Multiboard plus 80-Bus.



GEMINI GALAXY 64K 2.2 CP/M MICROCOMPUTER

A cost effective solution to the small business, educational or home user requiring a reliable Z80 based CP/M computer
From **£1450.00** plus V.A.T.

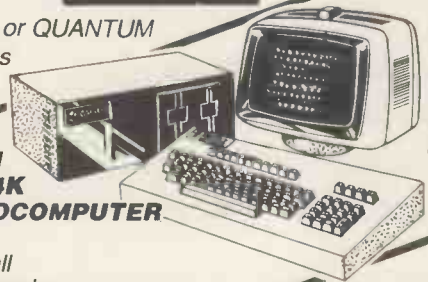

Only the new HX20 portable computer from Epson fulfils your requirements

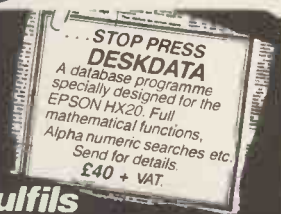

From **£402** plus VAT

The first truly portable computer with full size keyboard, built-in printer, micro cassette drive, high resolution display, rechargeable batteries give hours & hours of use and give enough power to retain memory when computer is switched off, and is only 1.7ins. thick and about A4 size.
THINK it in England, COMPUTE it over France, PRINT it in Saudi and SAVE it on your main system back in England. That's what HX20 can do for you - and it's cheaper too. For a standard desk top of roughly the same power as HX20 you could pay about twice as much - that's real value for money!

We are an official Sharp computer centre

As one of SHARP'S biggest distributors, we always have stocks. We have the expertise to advise you on interfaces and software. We developed the QUANTUM MZ80k Hi-Res which gained official SHARP approval.

- PLEASE CALL FOR LATEST PRICES.**
MZ80A with £75.00 free software **£475.00** plus V.A.T.
MZ80B with 64k plus GRAPHICS RAM **£850.00** plus V.A.T.
PC1211 **£65.00** plus V.A.T.
CE122 PRINTER **£60.00** plus V.A.T.
PC1500 **£145.00** plus V.A.T.
CE150 PLOTTER **£130.00** plus V.A.T.
QUANTUM MZ80k HI-RES **£100** plus V.A.T.

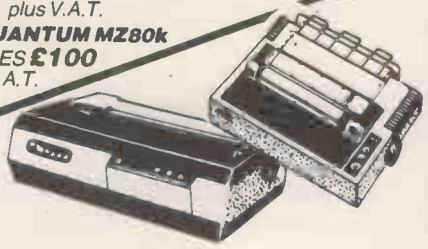

We stock the following printers:-
EPSON, SEIKOSHA,
and more important, we know how to interface them to a variety of computers.

BITS & PCS COMPUTER PRODUCTS LTD

Trading as Leeds Computer Centre.
Please call or write for full details
Leeds Computer Centre, The Balcony, 60/62 Merrion Centre, LEEDS.
Tel: 0532-458877



MICRO IRELAND (EXPORTS) LTD.

WE SUPPLY THE WORLD'S LEADING BUSINESS
MICROS TO THE WORLD'S LEADING BUSINESSES.

SIRIUS 1® (16 BIT 2 x 600K DRIVES – 128K RAM) **£2395** INCLUDING SHIPPING (W. EUROPE)

IBM® Personal Computer (128K) **£2895** INCLUDING SHIPPING (W. EUROPE)

OSBORNE 1® (DOUBLE DENSITY) **£1375** including WORDSTAR, MAILMERGE SUPERCALC, MBASIC + C BASIC worth £800 FREE
PORTABLE MICROCOMPUTER

LEON 1 PC (16 BIT – 2 x 400K DRIVES – 128K RAM) **£2195** INCLUDING SHIPPING (W. EUROPE)

APPLE – OLIVETTI M20 – SUPERBRAIN

CALL OR WRITE FOR A QUOTE ON
ALMOST ANY LEADING MICRO!

ALSO AMAZING PRICES ON A WIDE RANGE OF

- Printers
- Peripherals
- Software

To Micro Ireland Ltd.,
Marian, Beaumont Lawn, Cork.

Please send me information/quote on:

.....

Urgent

Please phone me

Name _____

Company _____

Address _____

Telephone _____

N.B. All prices quoted in UK Pounds Sterling and subject to change at any time.

ATARI 800 Home Computer
 now down in price to **£399.99** S.R.P. INC. VAT



Music Composer



Scram



Graph-it



Intro to BASIC 1



Star Raiders



European Countries



Missile Command

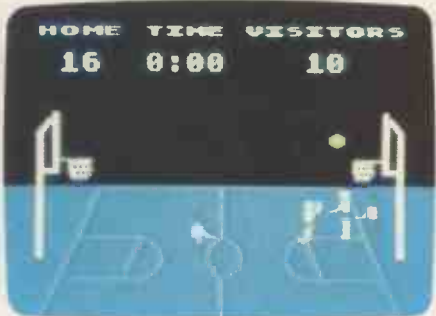

Basketball

3.7 million reasons why the Atari Home Computer is something to see. The display screen used with our computers is composed of 192 horizontal lines, each containing 320 dots. Delivering colour and luminosity instructions to each dot for a second requires 3.7 million cycles...a lot of work for the normal 6502 processor.

That's why the Atari computer has equipped its 6502 with its own electronic assistant. It's called ANTIC, and it handles all the display work, leaving the 6502 free to handle the rest. What this means to you is uncompromisingly spectacular display capabilities without loss of computer power needed to carry out the demands of your program.

That's a quality you just don't find in ordinary home computers. And it's one of the reasons some computer experts say that Atari computers are so far ahead of their time.

There's more...which is what you'd expect from Atari Language. The Atari Home Computer uses several programming languages to give the user maximum control of its extraordinary capabilities. PILOT, Microsoft BASIC and Atari BASIC are understood and spoken by the Atari computer. You'll also find our Assembler Editor cartridge indispensable for machine language programming.

Sound. An Atari computer has four sound generators, or voices, activated by a separate microchip. This leaves the principal micro-processor chips free to perform other tasks. And you can take full advantage of this capability which is designed for easy programming.

Change. Atari Home Computers have been designed to make change and expansion easy. The Atari computer has a modular operating system that can be easily replaced as new technology develops. If you need it, memory expansion requires no more than inserting additional RAM modules.* And the Atari ROM cartridge system also makes it easy to change languages. In short, your Atari computer won't become obsolete by future developments...because it already incorporates the future.

Sharing. To learn more about the amazing capabilities of Atari Home Computers, either visit your local dealer or fill in the coupon below.

THE GRAPHIC DIFFERENCE BETWEEN ATARI COMPUTERS AND ALL THE OTHERS.

*Atari 800 computer only.



Please send me a FREE brochure, price list and the address of my nearest stockist.

Name _____ PCW9
 Address _____

Atari International (UK) Inc.
 Atari House, Railway Terrace,
 Slough, Berks SL1 5BZ.
 For readers in Eire, send the
 coupon to: Omnitek Ltd,
 45 Cookstown Estate,
 Tallaght, Co. Dublin.

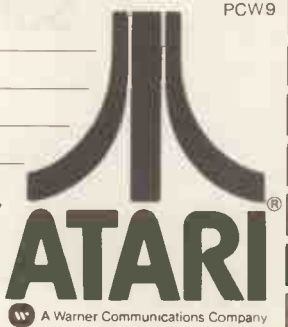

A Warner Communications Company

THE BIG SQUEEZE

It was a hot summer night and the heat was on in more ways than one. I reached over and flicked on the power. The screen went green and blinked READY. Time to get busy. Just then the phone rang.

"Andrews," it barked, "have you come up with those figures yet?"

"Take it easy," I said. "I'm on the case."

"Andrews, you won't have the fingers to *grip* a bloody case if you don't deliver the goods. Nobody messes with the firm.

"OK, OK," I whined. "Just give me 'til tomorrow morning. . ."

There was a grunt and then just the purr of a dialling tone. My hands were sweaty and it wasn't from the sweet and sour pork I'd had for lunch. I poured a shot of bourbon and rummaged for the July issue of *Personal Computer World*. There was an article on sub-routines in the January issue which might save me several hours of number-crunching. Now where was that issue?"

Ten minutes later the first pricklings of panic ran up my spine. It had vanished. If only I'd ordered a Mark III PCW Binder to keep the copies in. Already I could imagine the roaring whine of the chain saw. . . maybe they'd only take a few fingers. . .

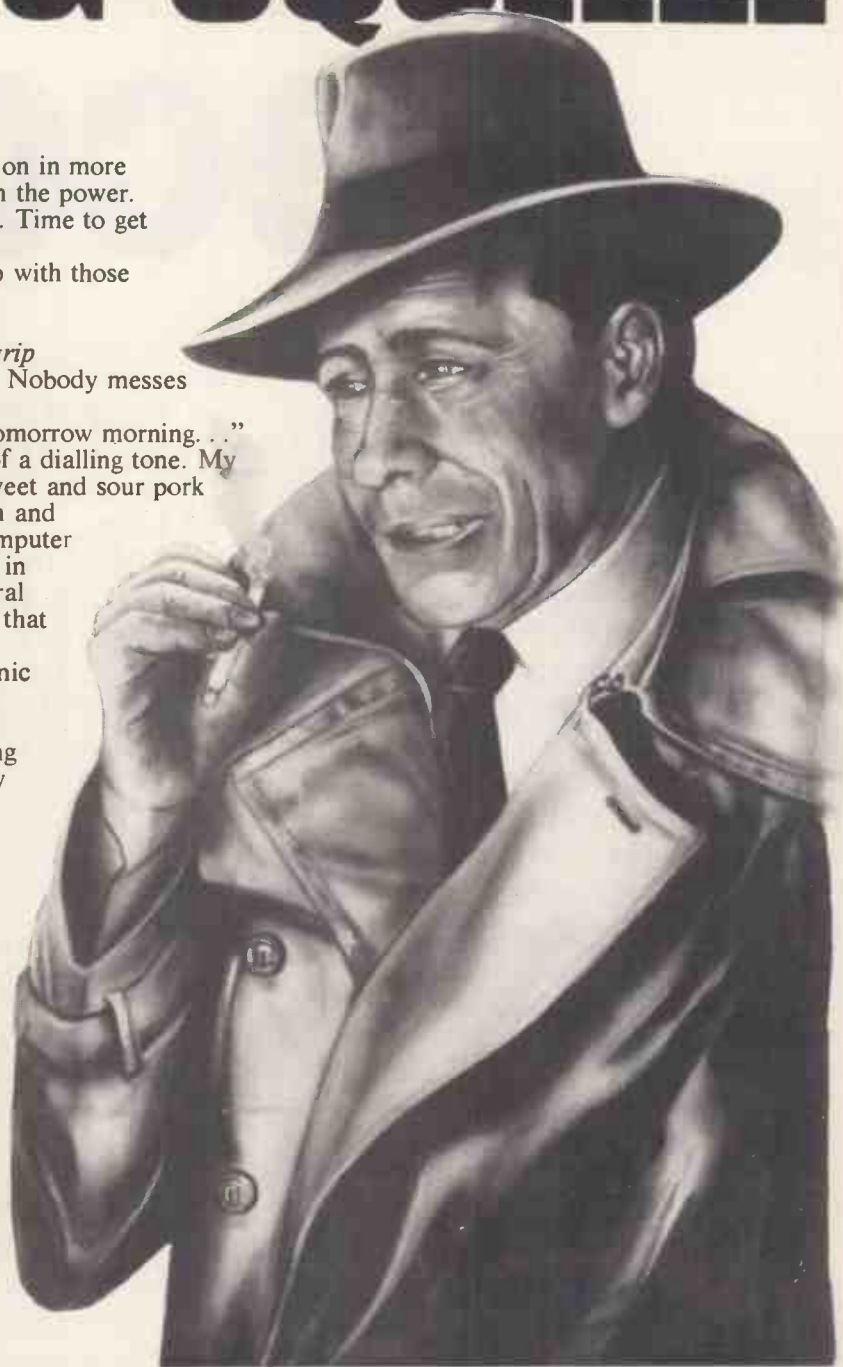

Don't get caught out. Our new Mark III PCW Binders have been especially widened and strengthened to deal with the growing size of Personal Computer World. Attractively bound with the logos of the magazine in gold on the front and spine, they keep your precious back issues of PCW in pristine condition. They also discourage other people from "borrowing" your copies and they're designed so that pages lie completely flat when opened to allow ease of reading and reference.

All in all, they represent exceptional value at £3.95 which includes all postage, VAT and handling. Use the coupon below, or, if you do not wish to deface this copy of PCW, send your order with remittance clearly written to the address indicated.

Please rush me . . . PCW Mk III binders at £3.95 each. I enclose a cheque/PO for £

Name

Address

.

.

Cheques should be made payable to *Personal Computer World*. Send this coupon to *Personal Computer World*, 53/55 Frith Street, London W1A 2MG.

The Need

SOFT is the first of the second generation of microcomputer magazines. The first to be written specifically for the microcomputer user.

Most people look to computers to perform specific tasks, whether it's the business user needing to produce a spreadsheet analysis, the archivist wishing to computerise files, or the games enthusiast looking for another Space Invaders. In every instance the solution starts not with the hardware, but with the software. Find the right software, and you've found the answer to your problems. Buy the wrong hardware, and your problems have just begun.

The logical approach to buying a computer is first to choose the program which performs the required functions and only then to decide on the hardware which will most efficiently run that program.

Clearly there is a need for a magazine which helps its readers do just that. A magazine that provides solutions, not problems. A magazine that considers the ever-increasing volume of software available and guides its readers to that which will best suit their requirements.

SOFT is that magazine.

The Publishers

Anybody can have an idea. It's making the idea work that matters. That's why at Sportscene Specialist Press we launch very few titles. Waiting until we know we will get it right.

We took Personal Computer

The first second g

World to market leadership before selling the title to VNU last Autumn. Then we launched MicroScope. Now established as the market leader, MicroScope is required reading throughout the industry. SOFT will be only our third title in this field. But it will be the first radically new approach to consumer micro magazines since PCW began it all in 1978.

The Writers

The Managing Editor of SOFT will be Dick Pountain, currently MicroScope's Software Editor, and previously Managing Editor of Personal Computer World. SOFT's Editor will be Gareth Jefferson, MicroScope's present International Editor and a man with considerable experience in editing specialist consumer magazines. The contributors will include people of the calibre of David Tebbutt, Guy Kewney, Mike Liardet, Kathy Lang and Sue Eisenbach. With SOFT they will establish a new standard in microcomputer magazine publishing.

The Concept

SOFT is committed to reviewing more software in greater depth

than any other microcomputing magazine. It will not merely make mention of the software package and documentation, it will thoroughly analyse every program in its entirety.

SOFT will certainly not ignore hardware. But hardware will be important only in so far as it influences the improvement of software.

SOFT talks not about computers, but about what computers can do. And all those involved with microcomputing, on any level, will need to read SOFT. Every month. To get the most from their computer. To keep pace with the explosively-expanding availability of software.

In short, SOFT will be the first magazine to take software seriously.

The Magazine

SOFT will be a prestige, glossy, perfect-bound A4 monthly magazine, printed on high-quality coated stock throughout. It will make extensive use of editorial colour, not only for illustrations, but also to signpost departments and clarify tabular information.

A major innovation will be the introduction of the first

st of the eneration

Special offer to PCW readers

Having published PCW for so long we feel that we know the average PCW reader rather well. And we believe that SOFT will appeal to the PCW reader even more than to the man in the street.

benchmark tests for evaluating software. A whole new series of review formats. For example one analysis of, say, a financial modelling package will be directly comparable with another.

The features will investigate all aspects of microcomputer software, from profiling the software authors, to arguing the merits and demerits of programming languages. Articulating the advantages which individual software packages have to offer. Analysing user requirements. And exploring the effectiveness of the solutions that software can provide.

But at all times SOFT will remember that computers are used by people, whether they are enthusiasts, games players, home hobbyists or business users. The editorial emphasis will always be on the human interface.

The Resource

SOFT will not confine its coverage to commercially available software. It will explain how to use languages and generate programs. And it will show how the individual can profit by creating programs to sell.

Additionally, every month SOFT will carry a continuously updated, comprehensive software directory which will be an invaluable source of reference.

Written and produced to the highest standards, utilising the best available journalists, illustrators and photographers, SOFT will be in a class of its own.

So we are offering very special terms to PCW readers who subscribe to SOFT. Return the coupon below to us by the 10th May, and we'll cut £2 off the normal annual rate of £12. Should you be dissatisfied in any way we'll refund the unused portion of your subscription.

Alternatively send us £1 and we'll rush you the first issue. Before it hits the street.

PRIORITY ORDER FORM

I would like to subscribe to SOFT for one year (12 issues)

UK £10.00

Rest of the world £23.00

I would like a sample copy of SOFT. I enclose £1.

I enclose a cheque made payable to
Sportscene Specialist Press Ltd

Please charge my American Express/
Barclaycard/Access.
(Delete where not applicable.)

Signed Account No.

Name

Address

Please send the completed form with your payment to:
SOFT, Subscriptions Department, Freeport 7, London W1E 4EZ

SOFT

LOOK! . . . FOR ALL YOUR



apple ACCESSORIES



PA

🍏 All items fully guaranteed for one year
🍏 Free postage and packing on all orders within UK

🍏 Immediate delivery
🍏 Many more items available



BUSINESS SOFTWARE	NET	INC. VAT
Access	162.00	186.30
Business Forecasting Model (Reqs. Visicalc)	69.00	79.35
Calcstar (CP/M) (80 column spread sheet)	69.00	79.35
dBase II (CP/M)	325.00	373.75
Data Star (CP/M) (powerful data entry)	122.00	140.30
Data Perfect	67.00	77.05
D.B. Master (version 3.02)	119.00	136.85
D.B. Master statistics	62.00	71.30
D.B. Master utilities (links with visi's)	62.00	71.30
Desk Top Plan II	89.10	102.35
Dutil (for dBase II)	65.00	74.75
Graphmagic (bar graphs, pie charts, etc)	59.00	67.85
Mathematic	59.00	67.85
Msort-80 (stand alone CP/M sort)	125.00	143.75
Multiplan (Microsofts superior spreadsheet)	155.00	178.25
PFS Filing system	68.00	78.20
PFS Graph	68.00	78.20
PFS Report	53.00	60.95
Omnis	195.00	224.25
Quick Code (for dBase II)	189.00	217.35
Supersort (CP/M)	99.00	113.85
The General manager (ver 2.0)	135.00	155.25
The Last One (programme generator)	185.00	212.75
Versaform (form generator in Pascal)	192.00	220.80
Visicalc	122.00	140.30
Visi - (visicalc consolidation)	19.45	22.37
Visicalc utilities	34.00	39.10
Visidex	135.00	155.25
Visifile	135.00	155.25
Visiplot	135.00	155.25
Visitrend/plot	155.00	178.25
WORD PROCESSING		
Appewriter II	72.00	82.80
Executive Secretary	149.00	171.35
Executive Speller	49.00	56.35
Format 80	195.00	224.25
List Handler (Mailer & Form Letter)	69.00	79.35
Pie Writer (40/80 columns)	87.00	100.05
Sensible Speller (new fast proof reader)	69.00	79.35
Sensible Speller (CP/M)	69.00	79.35
Screenwriter II (70 col w/out 80 col card)	75.00	86.26
Super Text 40/80	114.00	131.10
Wordstar 3.01 (CP/M) (enhanced features)	135.00	155.25

Word Handler (does not req. 80 col card)	99.00	113.85
Zardax (40/80 & inc form letter)	139.00	159.85
PRINTERS		
Epson RX-80 (100 cps tractor feed)	275.00	316.25
Epson FX-80 (160 cps & prop. spacing)	399.00	458.85
Epson MX100F T-3 (100 cps & wide carriage)	429.00	493.35
Mannesmann Tally MT120 L (160 cps)	525.00	603.75
Strobe Graphics Plotter	545.00	626.75
Nec 8023 (100 cps & prop. spacing)	339.00	389.85
Tec 1500-25 (25 cps daisy wheel)	525.00	603.75
Tec Starwriter F10-40 cps	1099.00	1263.85
PRINTER INTERFACE CARDS		
Aristocard Parallel	69.00	79.35
Aristocard Serial	75.00	86.25
Asynch Serial I/Face (771DA)	119.00	136.85
CPS Multifunction Card (inc real time clock)	119.00	136.85
Digitek Printmaster (BASIC/CPM/PASCAL)	69.00	79.35
Grappler - (Epson/Anadex/Cent/Nec)	98.00	112.70
IPB-16K (serial/parallel card & buffer)	129.00	148.35
MBP-16K (Epson 16K buffer)	96.00	110.40
Microbuffer	95.00	109.25
80 COLUMN CARDS & ACCESSORIES		
Softswitch (for Videx Videoterm)	24.95	28.69
U-Term (inc shift mod. & font editor)	127.00	146.05
Videx Enhancer II	83.00	95.45
Videx Inverse Eprom	18.45	21.22
Videx Utility Disc (inc font editor etc)	27.00	31.05
Videx Videoterm	175.00	201.25
Visicalc preboot disc (80 col with videx)	32.00	36.80
Vision-80 (incs softswitch & inverse)	185.00	212.75
MONITORS/COLOUR CARDS		
Digitek Colour Card (excellent colour on TV)	95.00	109.25
DMS R.G.B. Colour Card	89.00	102.35
Kaga 12" Green Screen	105.00	120.75
Microvitec colour monitor	275.00	316.25
Microvitec colour card (use with above)	35.00	40.25
Zenith 12" Green screen	89.00	102.35
GRAPHIC UTILITIES & MUSIC		
Arcade Machine (game designer)	42.00	48.30
Bit Stik (Robocom)	245.00	281.75

Complete Graphics System (Penguin)	65.00	74.75
Digitizer II	189.00	217.35
E-Z Draw 3.3 (excellent graphic utility)	32.00	36.80
Graforth (fast 3D utility plus music)	46.00	52.90
Graphics Magician (Penguin)	39.00	44.85
Graphic package Sublogic (detailed 3D pack)	74.75	85.96
Higher Text II (many diff fonts, sizes, cols)	25.45	29.27
Pascal Animation	41.00	47.15
Pilot Animation tools	41.00	47.15
Special Effects (Penguin)	27.00	31.05
The Artist	55.00	63.25
Versawriter (graphic digitizer)	179.00	205.85
Versawriter expansion pac 1	25.00	28.75
Zoom Grafix (similar to zoom on Bit Stik)	23.95	27.54
UTILITIES		
Aift Music System (9 voice)	65.00	97.75
Audex	18.95	21.79
Electric Duet (creates 2 part music)	21.00	24.15
Forte (4 voices & 9 octaves)	15.95	18.34
Music System (Mountain Computer 16 Voice)	211.00	242.65
S.A.M. (software automatic mouth)	75.00	86.25
Zapple Sound Effects & Music Board	56.00	64.40
UTILITIES		
Aplus (Applesoft structured Basic)	18.95	21.79
Appleguard (provides software protection)	185.00	212.75
Apple Mechanic (Beagle Brothers)	25.00	28.75
Assembly lang. Dev. (6502, Z80 or 8080)	75.00	86.25
Bag of Tricks	24.95	28.69
B.E.S.T. (Enhanced Software Tool)	23.95	27.54
Build Using (Provides 'print using' command)	23.95	27.54
Copy II Plus	35.00	40.25
Disc Doctor (CP/M disc recovery)	89.00	102.35
Disc Library (incl CP/M & Pascal)	34.95	40.19
Dos 3.3 Tool Kit	41.00	47.15
Dos Boss (modifies Dos Commands)	15.00	28.75
Edit Soft (powerful macro line editor)	19.95	22.02
Fast DOS	19.45	22.37
Global Program Line Editor (supports 80 col.)	35.50	40.83
Image Printer-Epson (flexible hi-res dump)	32.00	36.80



DIGITEK COLOURCARD

This amazing card gives high quality colour and includes a wide band modulator, simply plug in your TV or monitor. Just £95.00 + VAT.



IPB-16K SERIAL/PARALLEL INTERFACE & BUFFER

Now you need only one interface card to support both your daisywheel and dot matrix printers plus the benefits of a 16K buffer to speed things along. £129 + VAT.



STROBE GRAPHICS PLOTTER

Create superb hardcopy graphics directly from your Apple at a fraction of the cost of most other systems. A4 size or transparencies. £545.00 + VAT.



THE BIT STIK GRAPHICS SYSTEM

A large smooth tracking hemisphere with adjustable back pressure and probably the most powerful micro-computer graphics software available. £245 + VAT.



MICROVITEC 14" COLOUR MONITOR

Besides offering a crystal clear display in either text, hi-res or low-res modes. It also includes the following features. 16 text colours, b/grd colours, 80 column card compatibility. A superb colour monitor for £275.00 + VAT.



12" KAGA MONITOR

Features 24 M/Hz bandwidth, giving a very clear display, and contained in a neat Apple compatible case, green screen. £105 + VAT.

CE

0274 575973

Lisa (Assembly lang. dev. system).....	57.00	65.55
Lisa (Educational system).....	75.00	86.25
List Master (inc. smart renumbering).....	23.95	27.54
Locksmith 4.1 (bit copier for most discs).....	61.00	70.15
Merlin Macro Assembler (editor & utilities).....	42.00	48.30
Munch A Bug.....	32.00	36.00
Printographer (supports almost any printer).....	28.95	33.29
Speed Star (compiles 1200 lines per min.).....	75.00	86.25
Super Disc Copy III.....	25.00	28.75
Tasc Compiler (handles v. large programs).....	105.00	120.75
The Bug (Assembly Language debugger).....	35.00	40.25
The Inspector (disc snooper, needs 16K cd).....	35.00	40.25
The Routine Machine (mach. lang. routines).....	45.00	51.75

SYSTEM EXPANSION

16K Ramcard Digitek.....	75.00	86.25
16K Ramcard (Intelligence Research).....	55.00	63.25
32K Ramcard Saturn.....	135.00	156.25
128K Ramcard Saturn.....	299.00	343.85
128K Ramex card.....	275.00	316.25
Cool stack (holds 2 drives & monitor + fan).....	65.00	74.75
DOS upgrade kit (3.2 to 3.3).....	36.00	41.40
E-Z Port (game socket extender).....	17.00	19.55
E-Z Port II (2 game socket extenders).....	22.00	25.30
Eprom Card (holds 6).....	52.00	59.80
Keyplus Numeric Keypad.....	83.00	95.45
Lower case adapter W/shift (rev 7 +).....	34.00	39.10
Pact clip on fan.....	46.00	52.90
The Mill 6809 with Pascal speed up.....	189.00	217.35
Time Kit.....	55.00	63.25
VC-Expand/80 (up to 145K Visicalc & 80 col).....	65.00	74.75
VC-Expand Ramex (loads 136k visi in 20 sec).....	40.00	46.00
Videx Enhancer II.....	83.00	95.45
Videx Function Strip (req Enhancer II).....	49.00	56.35
VIA 6522 Card.....	59.00	67.85
Z 80 card U-micro (card only).....	73.00	83.95
Z 80 card Microsoft (New Softcard).....	199.00	228.85

LANGUAGES

Apple Pascal.....	142.00	163.30
Apple Pilot.....	80.00	92.00
Cobol 80 (CP/M).....	399.00	458.85
Forth II (Integer only).....	45.00	51.75
Fortran 80 (CP/M).....	125.00	143.75
Terrapin Logo.....	95.00	109.25
Transforth (full floating point Forth).....	75.00	86.25

Please make your order by completing the coupon and returning to us - or you can phone DAVE or SHERIDAN on 0274 575973 and your enquiry will receive a friendly and speedy response.

PACE-SOFTWARE-SUPPLIES

Rose Bank, 130 Clayton Road, Bradford BD7 2LY, West Yorks.

Please rush me the following items.

	£	p
1		
2		
3		
4		
5		
TOTAL		

I enclose my cheque made payable to PACE SOFTWARE (Export licence arranged)

Name _____
 Address _____
 Town _____
 County _____
 Postcode _____ Tel. No. _____

PCW/5/83

NEWBRAIN MICRO COMPUTER

MODEL A £234.00

MODEL AD £260.00

AT CHANNEL ISLAND PRICES

MICROVIA
 6 BELMONT ROAD
 ST. HELLIER, JERSEY
 TEL: 0534 77404

VIC, BBC, TI, DRAGON OWNERS



NO
INTERFACE
NEEDED

RX 80	£280 (£322 including VAT)
FX 80	£410 (£471.50 including VAT)
MX 100	£P.O.A.

COMPARATIVE WITH ALL MICROS

MAIL ORDER FREE DELIVERY TO YOUR DOOR BY EXPRESS COURIER	PICK UP YOURSELF PLEASE TELEPHONE (7 DAY-A-WEEK SERVICE)
---	---

HOST MICROS
 53 THE PARADE,
 BOURNE END-ON-THAMES,
 BUCKINGHAMSHIRE SL8 5SB.
 TEL: 06285 - 22780

IS IT A PRINTER? IS IT A TYPEWRITER?

SO YOU WANT A TYPEWRITER? . . . The Silver Reed EX44. Grey/Silver daisywheel typewriter Lightweight (8.5 Kg.) Portable with carrying handle and smokey coloured cover. Magic automatic correction. Goodbye forever to erasers and varnishes. Choice of 3 pitches. 10, 12, and 15 characters per inch, giving up to 165 characters per line. Any type face from the Silver Reed and IBM catalogues in any of the pitches for a really professional finish. Choice of executive quality carbon one-strike or continuous loop cloth ribbons. Half space key. Relocate key. Repeat key. 6000 character memory option for local word processing even without a computer. The price? £350+VAT. Extra memory £125+VAT.

SO YOU WANT A COMPUTER PRINTER? . . . Buy the typewriter. Buy our interface box. Push in two plugs, one into your typewriter, one into your computer. Tell your computer you have a serial printer, and that's all there is to it! Word processing, electronic spreadsheets, program listings, balance sheets and ledgers. Important documents. All letter perfect and printing out at up to 12 characters per second. Our interface has a 2000 character buffer memory. This means that you can unload your document and leave the printer to get on with it while you get on with your work. All at £450+VAT.

SO YOU'VE MISSED THE BOAT? . . . There are thousands of you out there with Silver Reed EX44 and EX55 typewriters. And you now want to connect to a computer. Buy the interface alone for £150+VAT. Plug straight in to the EX44. Slightly more complicated on the EX55 but no soldering required, and any dealer will do it for you in under half an hour, or you can do it yourself if you have a hacksaw and a screwdriver.

THE EX55 . . . A large professional typewriter/printer for the user with large volumes of printed matter. 16 characters per second print speed on a print line of up to 197 characters. Auto underline, auto-centering, etc . . . Complete and ready for use with your computer for only £800+VAT.

Complete word processing systems for under £1000!!!! Yes it's true. Epson HX-20 with EX44 and all cables, connectors and word processing software ready for immediate use. Or the Osborne I DD with Wordstar, Visicalc, and lots more and the EX44 and interface for only £1650+VAT. Ring or write today. Offer must finish soon.

Dealer enquiries welcome.

**SHADOW DATA, 189 Hanworth Road, HOUNSLOW, Middlesex TW3 3TT
01-572-7279/01-560-2784**

★ **NEWBRAIN MODEL A** ★
ELSTREE COMPUTER CENTRE £199.50

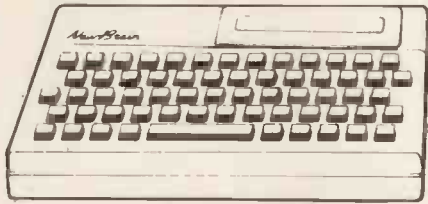

MODEL A.D.

- 80 CHARACTER DISPLAY PER LINE
- 4 CHARACTER SETS
- VERY FAST: ACCURATE KEYBOARD
- IDEAL FOR BUSINESS USE

AD £229 plus VAT £263.25
A £199 plus VAT £228.50
p&p £2.75

★ SOFTWARE JUST RELEASED. SEE LIST ASIDE.

A FULL RANGE OF PRINTERS AND MONITORS
ESPECIALLY FOR THE NEWBRAIN A & AD IN STOCK

ELSTREE COMPUTER CENTRE
32 DEACONS HILL ROAD
ELSTREE, HERTS, WD6 3HL
Tel: (01) 953 6921

OFFICE HOURS 9-6 MON-FRI.
(ALSO OPEN SUNDAY MORNING 10-12 BY APPOINTMENT ONLY)

★ TAPE RECORDER MODIFIED ESPECIALLY FOR THE
NEW BRAIN MODEL A AND AD NOW IN STOCK
£29.75+ VAT

NEWBRAIN SOFTWARE

From the software house of Elstree Computer Centre
A superb range of easy to use programmes
Purpose made and designed for the
fabulous Newbrain Computer

- Word Processor £35.00
- Database £25.50
- Invoice and credit note programme £59.50
- Invoice and credit note review £22.50
- Sales Ledger £65.00
- Stock Control £29.50
- Customer Information File £32.00
- Bank and Cash balance £29.00
- Inventory £29.50
- Mailing List £29.00
- Home Expenses £25.00
- Product Costing £22.50
- Sales Analysis £23.50
- Inventory Analysis £23.50
- Business ratios, for Investment, Sales, Turnover etc £19.50
- Calculate for Costing, Bidding (with your mark-up) £27.50
- Two programs: Mortgage repayment and property investment £21.50
- Address Book £25.00
- Business Expenses £29.50

VAT @ 15% should be added to each of the above
(include 90p P&P per program)
Phone for your nearest dealer

Send large S.A.E.
for complete range of programs
ELSTREE COMPUTER CENTRE
32 DEACONS HILL ROAD, ELSTREE, HERTS WD6 3HL
Tel: (01) 953-6921
EXPORT AND DEALER ENQUIRIES WELCOME

**BBC DEALERS
IN LEEDS**

GTM

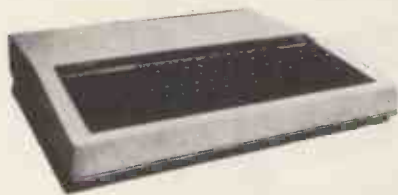

- BBC Machines**
- Model 'A' £299
 - 16K RAM 32K ROM. Full colour, high-resolution graphics (+ £7 p + p)
 - Model 'B' 32K RAM 32K ROM £399
 - 16 Colour graphics (+ £7 p + p)
 - 14" RGB Colour Monitor (as used in the BBC Computer programme) £279 (+ £9.50 courier)
 - Sanyo Colour Monitor £228.85 (+ £9.50 p + p)
 - Lead for Sanyo £8.05
 - 12" Green Monitor £95 (+ £6.50 courier)
 - BBC Joystick £13 p.pair (+ £1 p + p)

BBC Software
Monsters, Meteors, Rocket Raid, Tree of Knowledge, Philosopher's Quest,

Sphinx Adventure, Snapper, Planetoid, Arcadians, Super Invadors, Castle of Riddles. All at £9.95 (+ £1 p + p) on each item

Forth £16.85
Arcade Action £11.90 (+ £1 p + p)

GTM Software

Word Build: An educational game using colour and full graphics, sound and encouragement fully error trapped, supplied with full documentation for own word list input. Fully adaptable to any child needs (4 to any age) £5.95 (+ £1 p + p)

Smiler (phonic spelling game): aids the teacher teaching of the letter sounds and spellings. Emphasises consonant and vowel recognition £5.95 (+ £1 p + p)
If purchased together on one tape £11.00 the pair (+ £1 p + p)

Accessories for BBC Computers
Cassettes per 10 £4 (+ £1 p + p)
Verbatim single sided double density disks, box of 10 £22.50 (+ £1 p + p)

GP80 and GP100 ribbon £4.75 (+ £1 p + p)

- Printer Cable (parallel) £15 (+ £1 p + p)
- 6522 buffers £4.75 (+ £1 p + p)
- DIN to Jack cassette leads £3.50 (+ £1 p + p)
- BBC Machine dust covers £3.95 (+ £1 p + p)

Disk Drives

- BBC Disk Drive (100K) £239 (+ £4 p + p)
- GTM Single Disk Drive (100K) £224.25 (+ £4 p + p)
- BBC Double Side and Density (800K) £799 (+ £4 p + p)
- GTM 800K (manual and utility disk included) £450 (+ £4 p + p)

Printers

- Acorn GP 80A Printer £199
- Lowest ever price! (+ £4.50 p + p)
- Acorn GP 100A Printer £228 (+ £4.50 p + p)



Barclaycard and access welcomed

ALL PRICES INCLUDE VAT

GTM

NEW SHOWROOM
864 YORK ROAD, LEEDS
Tel. (0532) 647474

GENIE



GENIE

A much more . . . able computer for your money!

Get in touch with Lowe Computers at Matlock for a list of your nearest Genie specialist dealers!

able



LOWE
COMPUTERS

BLACK BEAUTY



The new T/Printer 3500 is not only black and beautiful, it's also pretty sensational in terms of sheer value for money.

And just right for the average user.

Because when you're finished using the T/Printer 3500 as a daisy wheel printer for your computer, it's ready to go right on working as an electronic typewriter. Plus it's also a genuine full KSR terminal, able to send data as well as receive. So you get triple value for your money.

Both Centronics parallel and RS-232C interfacing are built-in.

But that's only the beginning.

The T/Printer 3500 differs from other computer printers in being distinctly portable. So we include a tough ABS moulded carrying case. It's also a totally integrated unit (no separate interface boxes). You'll

find your T/Printer 3500 an ideal companion for the new generation of micro computers.

It has a few other advantages as well. Such as a Z80 microprocessor, interchangeable 100 character Olivetti daisywheels, plus a 960 character buffer and keyboard control of all functions. There's also triple pitch (10, 12 and 15 c.p.i.) so you can get up to 165 characters per line. All with an operating speed of up to 120 words per minute. And tough enough to give you years of reliable service.

If you don't need all the features of the T/Printer 3500, take a look at our budget-priced T/Printer 350. It's Centronics parallel and read-only, but is otherwise identical to the T/Printer 3500. Except in price.

The choice is yours. The T/Printer 350 costs only £475, while the T/Printer 3500 with all its features is just £535. All prices are exclusive of VAT.

DATARITE TERMINALS LTD, CALDARE HOUSE.

144-146 HIGH ROAD, CHADWELL HEATH, ESSEX RM6 6NT

TEL: 01-590 6022 01-590 1155



A RESOURCE INDUSTRIES
INTERNATIONAL COMPANY

NOW . . . FOR ZX SPECTRUM USERS EVERYWHERE

THE FULLER BOX . . .



A NEW DIMENSION IN SPECTRUM CAPABILITY

It's easy to see why the ZX Spectrum is outselling all the other small colour computers, it really is a marvel of new technology.

Equally marvellous is the new 'Fuller Box' for your Spectrum.

Sound Quality is improved enormously with the built in *Audio Amplifier* which works with all Spectrum programs. *The Sound Synthesiser* will make any sound you want to design: explosions, laser blasts, trains, birds etc. It's based on the popular G1-AY-3-8912 chip, and is supplied with a demo program.

Finally, the *Joystick Port* enables you to use any low-priced Atari/Commodore joysticks with your programs.

The Fuller Box fits neatly on to the back of your ZX Spectrum, and does not interfere with any peripherals, including the new Spectrum microdrives.

PRICE (INC. VAT)
£29.95 + 80p p&p

But the story doesn't end there! The Fuller Box has been designed to perform many other functions, and extra, expanded versions are already available.

The Fuller Orator An amazing Speech Synthesiser which can be programmed to say anything you command, using the keyboard or demo cassette. It uses the G1 SP0256 AL voice synthesiser chip; and comes complete with the Fuller Box.

£39.95 + 80p p&p (inc. VAT)

Fuller Sound Amplifier Box, including Audio Amplifier (non-expandable) **£6.95 + 80p p&p** (inc. VAT)

Fuller Orator upgrade kit - to fit inside Fuller Box **£24.95** (inc. VAT) (postage free, does not include Fuller box)

Fuller 'Master Unit' - including Orator, synthesiser, amplifier and Joystick port in Fuller Box **£54.95 + 80p p&p** (inc. VAT)

Fuller FD42 System NOW FOR ZX81 or ZX SPECTRUM



This famous, best selling product immediately converts your ZX Computer into a sturdy,

attractive and professional unit, with full size typewriter keyboard. A tough plastic case encloses the keyboard, P.C.B. and power supply. It has

42 keys including all the ZX81/Spectrum graphic characters printed on them. The full travel key switches have gold plated contacts and guaranteed life of 10⁶ operations. IT'S SO EASY TO INSTALL! You simply unscrew the ZX PCB from its case, screw it to the FD case, and plug in the keyboard. No soldering or technical knowledge required.

NOW ALL ONE PRICE! £29.95 (inc. VAT) + £2.50 p&p
16K Spectrum Expansion Module - to fit into back of Fuller case - **£24.95** (inc. VAT & p&p).

RAM Adaptor Board - enables you to fit 16K Expansion inside Fuller case - **£9.75** (inc. VAT & p&p).

Fuller

MICRO SYSTEMS

Mail to: **FULLER MICRO SYSTEMS**,
The ZX Centre, Sweeting Street, Liverpool 2.
Telephone: 051-236 6109

Fuller FDS Keyboard for the ZX81 or ZX Spectrum

Our new advanced keyboard has the same, fine specifications as the FD42 system, but with a new, re-designed case, space bar and double-sized shift and enter keys. A must for the discerning ZX81 or Spectrum user.

SPECIAL LOW PRICE £39.95 (inc. VAT) + £2.50 p&p.

Fuller ZX Spectrum Upgrade Pack

16K Spectrum owners - upgrade to 48K with a Fuller Spectrum Upgrade Pack - Complete with full assembly instructions. Model 2 or 3 only. **£34.95** (inc. VAT) p&p FREE!

COMPUTER DEALERS!

Contact us for a Special Fuller Introductory Pack. We are looking for dealers throughout the U.K.!

Please supply the following items:

ITEM	QUANTITY	PRICE	POSTAGE	TOTAL

I enclose cheque/p.o.

Or, please debit my Access/Barclaycard No. _____

Name _____

Address _____

Please send me further details. I enclose S.A.E.

PCW.5.83

Value - MicroValue - Micro

COMPUTERS

New from Gemini

Gemini Galaxy 2

- *Twin Z80A Processors
- *CP/M 2.2 Operating System
- *64K Dynamic RAM
- *800K Disk Capacity
- *80x25 Video Display
- *Serial and parallel printer interfaces
- *Cassette and light pen interfaces
- *User definable function keys
- *Numeric key pad
- *12" Monitor included

£1495
(£1719.24 inc. VAT)

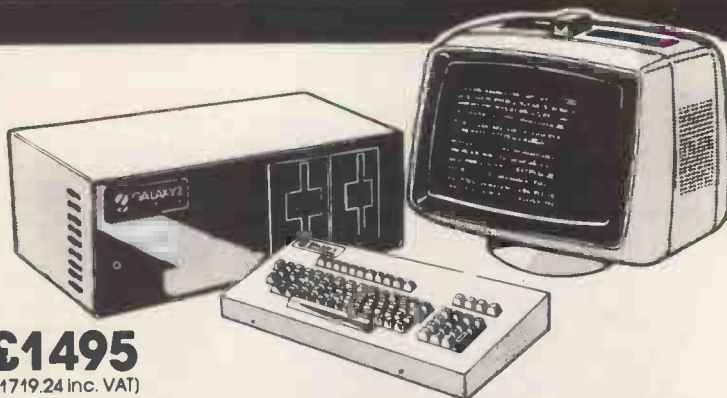

Total support for Gemini & nascom Products

nascom 3 available from MicroValue

Based around the successful Nascom 2 computer, this new system can be built up into a complete disk based system. Supplied built and tested complete with PSU, Nas-Sys 3 and Nas-Gra.

48K System

£549 (£631.35 inc. VAT)

CP/M 2.2

£100 (£115 inc. VAT)

NASCOM 2 KIT

£225 (£258.75 inc. VAT)

Built & Tested

£285 (£327.75 inc. VAT)

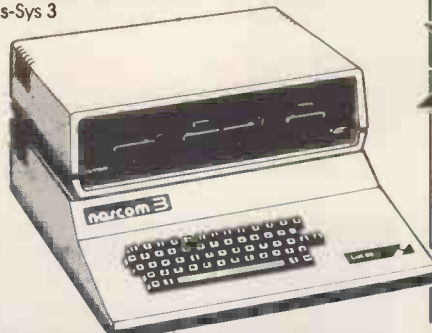

80x25 Video for nascom

£125
(£143.75 inc. VAT)

Nascom owners can now have a professional 80x25 Video display by using the Gemini G812 Intelligent Video Card with on-board Z80A. This card does not occupy system memory space and provides over 50 user controllable functions including prog character set, fully compatible with Gemini G805 and G815/809 Disk Systems. Software supplied on Gemini system disks. Built and tested.

Nascom 1 Printed Circuit

(Inc. parts list)

£25 (£28.75 inc. VAT)

GM802 64K RAM Card

£125

(£143.75 inc. VAT)

GM802K 16K RAM Kit

£80

(£92 inc. VAT)

Disk System for Gemini & nascom

GM825 Disk Drive Unit - The GM825 floppy disk housing is supplied with either one or two 5.25" single sided, double density, 96TPI high capacity Micropolis 1015F5 disk drives. These provide 400K bytes of formatted storage per drive. (Gemini QDSS format). The CP/M2.2 package available supports on-screen editing with either the normal Nascom or Gemini IVC screens, parallel or serial printers. An optional alternative to CP/M is available for Nascom owners wishing to support existing software. Called POLYDOS 4, it includes an editor and assembler and extends the Nascom BASIC to include disk commands.

Single Drive System POLYDOS 4

GM825-1S (£402.50 inc. VAT)

for Nascom (£103.50 inc. VAT)

Dual Drive System

GM825-2S (£661.25 inc. VAT)

GM809 Disk Controller Card for 8" and 5.25" drives (£143.75 inc. VAT)

CP/M2.2 Package (GM 532 for Gemini)

£90 (£103.50 inc. VAT)

GM829 for 8", 5.25" and Winchester Drives (£166.75 inc. VAT)

£145 (£166.75 inc. VAT)

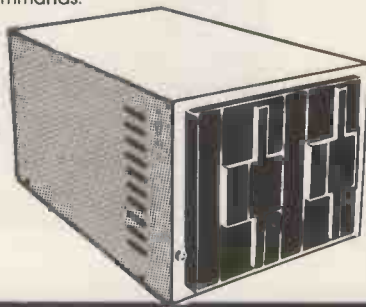

At last - a Winchester Drive for your Gemini / nascom System!

GM835 Winchester Drive Sub-system.

- *5.4 Megabyte Formatted Capacity
- *Rodime Drive
- *Industry Standard SASI interface
- *Integral Controller and power supply

£1450
(£1667.50 inc. VAT)

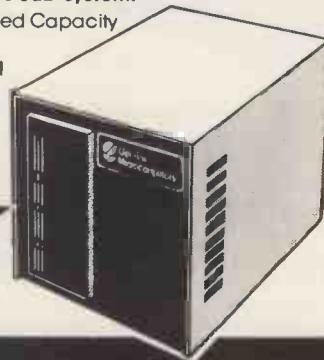

PRINTERS

Epson MX80 Type III

£348 (£399.95 inc. VAT)

Epson MX80 FT Type III

£388 (£445.95 inc. VAT)

Epson MX100 Type III

£496 (£569.95 inc. VAT)

NEC 8023A

£339 (£389.95 inc. VAT)

SEIKOSHA GP100A

£215 (£246.95 inc. VAT)

Daisy Wheel Printer:

Smith-Corona TP-1 £485 (£557.75 inc. VAT)

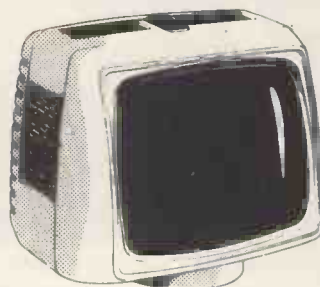
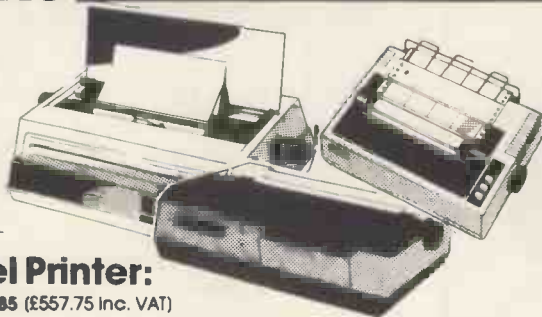

Phoenix P12 Monitor

A high quality data display monitor, ideal for all Nascom and Gemini systems. 20MHz resolution. Available in amber or green phosphor.

£110
(£126.50 inc. VAT)

Value - MicroValue - Micro

LOW COST SYSTEMS

Dragon 32

A powerful colour computer for under £200.

- ★ 32K RAM
 - ★ 6809E Microprocessor
 - ★ Extended Microsoft Colour BASIC
 - ★ 9 Colour, 5 Resolution Display
 - ★ Sound through TV 5 octaves, 255 tones
 - ★ Advanced Graphics
- Full range of Dragon software available.



£173.47
(£199.50 inc. VAT)

Sinclair ZX81

Now available through MicroValue — a real computer for less than £50!

- ★ Sinclair ZX81 Computer **£43.43** (£49.95 inc. VAT)
- ★ Sinclair ZX Printer **£52.13** (£59.95 inc. VAT)
- ★ ZX81 Learning Lab **£17.35** (£19.95 inc. VAT)
- ★ Software for Sinclair **from £3.43** (£3.95 inc. VAT)

SPECIAL OFFER
16K RAM PACK
for ZX81
£17.17 + VAT



THE NEW

SHARP MZ80A

Electronic magnificence from Sharp

Z80A C.P.U. · 48K RAM · 4K ROM · Industry standard Qwerty keyboard with numeric pad · 9" GREEN C.R.T. · 1200 baud cassette · Music and sound · Real time clock · Enhanced BASIC · Full editing facilities · Internal expansion.



£475 (£546.25 inc. VAT)

FREE SOFTWARE!

Home budget, bank reconciliation, SPACE INVADERS, STAR TREK, SCRAMBLE, bank loan calculator, mortgage calculator + 7 other games.

Educational — Geography, Maths., Spelling + 4 part BASIC tutorial.

Sinclair ZX Spectrum

Now available from MicroValue! Colour, sound and high resolution graphics from only £125

- ★ 16K ZX Spectrum Microcomputer **£108.69** (£125 incl. VAT)
- ★ 48K ZX Spectrum Microcomputer **£152.17** (£175 incl. VAT)
- ★ Sinclair ZX printer **£52.13** (£59.95 incl. VAT)



Texas TI99-4A

Colour, sound and a typewriter type keyboard for under £160

A truly expandable microcomputer system with a wide range of educational and games software.

- ★ Texas TI99-4A Microcomputer 16K **£139.08** (£159.95 incl. VAT)
- ★ Voice Synthesiser Unit **£43.43** (£49.95 incl. VAT)
- ★ Peripheral Expansion Unit **£130.39** (£149.95 incl. VAT)
- ★ Disk Drive **£278.21** (£319.95 incl. VAT)
- ★ Disk Control board (for above) **£165.70** (£189.95 incl. VAT)



ORIC 1 ORIC 1 when used with the ORIC MODEM will allow access to PRESTEL-Viewdata, which has 200,000 pages of interactive information covering sport, travel, hotel bookings, games, etc.



- ★ ORIC 1 48K Microcomputer **£147.79** (£169.95 incl. VAT)
- ★ ORIC 1 Communications Modem **£68.69** (£79.00 incl. VAT)

MICROVALUE DEALERS:

AMERSHAM, BUCKS
Amersham Computer Centre,
18 Woodside Road,
Tel: (02403) 22307

BIRMINGHAM B5
Skytronics MBM, 80 Bristol Street,
Tel: 021-622 6436

BRISTOL
Target Electronics Ltd., 16 Cherry Lane,
Tel: (0272) 421196

COLCHESTER
Emprise Electronics Ltd.,
58 East Street,
Tel: (0206) 865926

EGHAM, SURREY
Electrovalue Ltd.,
28 St. Judes Road, Englefield Green,
Tel: (07843) 3603

IPSWICH
MDW (Electronics),
47/49 Woodbridge Road East,
Tel: (0473) 78295

LONDON W2
Henry's Radio, 404 Edgware Road,
Tel: 01-402 6822

LONDON SW11
OFF Records,
Computer House, 58 Battersea Rise,
Clapham Junction,
Tel: 01-223 7730

MANCHESTER M19
EV Computing, 700 Burnage Lane,
Tel: 061-431 4866

NOTTINGHAM
Computerama, (Skytronics Ltd.)
357 Derby Road,
Tel: (0602) 781742

Telephone orders welcome



**BUY FROM THE
COMPUTER
PROFESSIONALS**

MicroValue

REAL value — from the Professionals

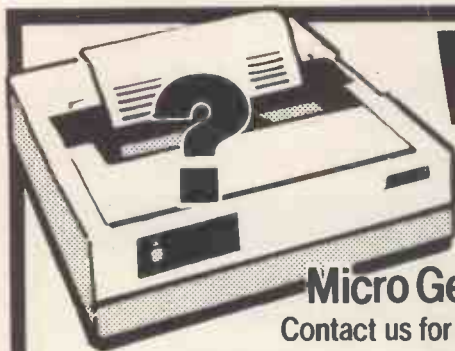

Which PRINTER FOR What COMPUTER?

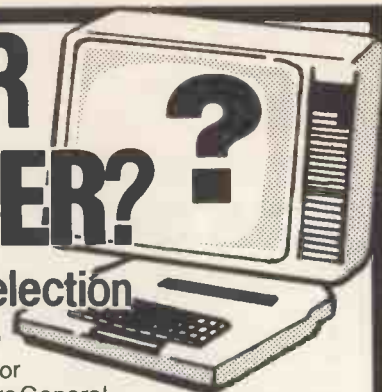

Micro General the specialists for Printer Selection
Contact us for our expert advice on all your Interfacing problems

It's not just a question of plug in and lets go. There are now over 200 different connector situations. How do you know that your computer will accept the printer of your choice? We at Micro General do not sell boxes off the shelf. As computer engineers we help you to choose and install the right printer for your computer. The advice is free and it could save you some embarrassing mistakes - Buy from us for peace of mind.

EPSON MATRIX PRINTERS

From
£298
+vat

RX80	Tractor only	
	100cps	£298+v
FX80	160cps	£438+v
MX100	100cps	
	full width	£499+v



Call for details of the
SPRINTER 32K
Buffer adaptor unit
Price from **£249+v**

**NEW
RX-80
FX-80
MODELS
NOW
AVAILABLE**

MICROLINE RANGE

From **£211+v**

Microline 80	80 cps	£211+v
Microline 82A	120 cps	£370+v
Microline 83A	120 cps	£529+v
Microline 84	200 cps	£847+v
(The M84 has High Res. Graphics plus Near Letter Quality print)		
NEW ADDITIONS TO THE MICROLINE FAMILY (All with Near Letter Quality printing and High Resolution Graphics)		
Microline 92	160 cps	£476+v
(80 cols. at 10 cpi)		
Microline 93	160 cps	
Full Width (136 cols. at 10 cpi) £688+v		

TRIUMPH-ADLER TRD 170S DAISY WHEEL PRINTER



£695
+vat

**HIGHLY RECOMMENDED
LOW COST QUALITY PRINTER**

- Amazingly quiet for the office environment.
- Serial or Parallel Interface.
- Tractor Feed & Single Sheet Feeder available.
- Character Pitch 10, 12, 15 cpi & Proportional.

**Micro
General**

■ Always call for the best possible price  Access/Visa
(Dept PCW5) 6 The Birchwoods, Tilehurst, Reading, RG3 5UH Tel: 0734 25226

BBC DEALERS IN LEEDS



BBC Machines	
Model 'A'	£299
16K RAM 32K ROM. Full colour, high-resolution graphics (+£7 p+p)	
Model 'B'	£399
32K RAM 32K ROM (+£7 p+p)	
16 Colour graphics (+£7 p+p)	
14" RGB Colour Monitor (as used in the BBC Computer programme) £279 (+£9.50 courier)	
Sanyo Colour Monitor	£228.85 (+£9.50 p+p)
Lead for Sanyo	£8.05
12" Green Monitor	£95 (+£6.50 courier)
BBC Joystick	£13 p.pair (+£1 p+p)

BBC Software
Monsters, Meteors, Rocket Raid, Tree of Knowledge, Philosopher's Quest,

Sphinx Adventure, Snapper, Planetoid, Arcadians, Super Invadors, Castle of Riddles. All at **£9.95**

(+£1 p+p) on each item

Forth £16.85
Arcade Action £11.90 (+£1 p+p)

GTM Software

Word Build: An educational game using colour and full graphics, sound and encouragement fully error trapped, supplied with full documentation for own word list input. Fully adaptable to any child needs (4 to any age) **£5.95 (+£1 p+p)**

Smiler (phonic spelling game): aids the teacher teaching of the letter sounds and spellings. Emphasises consonant and vowel recognition **£5.95 (+£1 p+p)**
If purchased together on one tape **£11.00 the pair (+£1 p+p)**

Accessories for BBC Computers

Cassettes per 10 **£4 (+£1 p+p)**
Verbatim single sided double density disks, box of 10 **£22.50**

(+£1 p+p)

GP80 and GP100 ribbon **£4.75**
(+£1 p+p)

Printer Cable (parallel)	£15
	(+£1 p+p)
6522 buffers	£4.75 (+£1 p+p)
DIN to Jack cassette leads	£3.50
	(+£1 p+p)
BBC Machine dust covers	£3.95
	(+£1 p+p)

Disk Drives

BBC Disk Drive (100K)	£239 (+£4 p+p)
GTM Single Disk Drive (100K)	£224.25 (+£4 p+p)
BBC Double Side and Density (800K)	£799 (+£4 p+p)
GTM 800K (manual and utility disk included)	£450 (+£4 p+p)

Printers

Acorn GP 80A Printer	£199
Lowest ever price!	(+£4.50 p+p)
Acorn GP 100A Printer	£228
	(+£4.50 p+p)



Barclaycard and access welcomed

ALL PRICES INCLUDE VAT

GTM

NEW SHOWROOM
864 YORK ROAD, LEEDS
Tel. (0532) 647474

DON'T MISS THIS INCREDIBLE OFFER!

50 GAMES



£9.95

YES, 50 GAMES! on cassette for all the following:

- | | | |
|-------------------|-------------------|---------------|
| GALACTIC ATTACK | MAZE EATER | SUBMARINES |
| SPACE MISSION | ORBITTER | ROCKET LAUNCH |
| LUNAR LANDER | WOTROWAY | PLANETS |
| PLASMA BOLT | FORCE FIELD | BLACK HOLE |
| STARTREK | NIM | DYNAMITE |
| RADAR LANDING | TUNNEL ESCAPE | DO YOUR SUMS |
| ATTACKER | BARREL JUMP | DERBY DASH |
| GALACTIC DOGFIGHT | CANNONBALL BATTLE | SPACE SEARCH |
| ZION ATTACK | OVERTAKE | UNIVERSE |
| IVASIVE ACTION | SITTING TARGET | RATS |
| OXO | SMASH THE WINDOWS | TANKER |
| BOGGLES | SPACE SHIP | PARACHUTE |
| "ONTON | JET FLIGHT | JETMOBILE |
| SKI JUMP | PHASER | HIGH RISE |
| HANGMAN | INTRUDER | THE FORCE |
| OLD BONES | INFERNO | EXCHANGE |
| THIN ICE | GHOSTS | |

- sinclair SPECTRUM ZX81 LYNX DRAGON ATARI VIC-30**
- apple** (ON DISC & CASSETTE)
- ACORN ATOM BBC A/B SHARP ORIC-1 NEW BRAIN**

CASCADE SOFTWARE
CASCADERS HOUSE
BARGAN'S LANE
LLANDOGO
GWENT
S. WALES
NP54PA



SUPPLY CASSETTE 50 FOR _____ COMPUTER

I enclose cheque/P.O. (

Name _____

Address _____

MAIL ORDER ONLY

ORDER NOW!

ASTROLOGY TRULY AT YOUR FINGERTIPS

USER PROMPTING PROGRAMS: merely key in birth information as requested by the computer - READ OUT (and/or PRINT OUT) what is normally the result of many hours of painstakingly tedious and complex mathematical calculations using tables, ephemeris, etc.

THE SIDEREAL TIME OF BIRTH.

THE ASCENDANT AND MIDHEAVEN in Sign, Degrees, Minutes, and Seconds for EQUAL HOUSE SYSTEM.

THE SIGNS AND POSITIONS OF THE HOUSE CUSPS in Sign, Degree, and Minutes for the PLACIDEAN SYSTEM.

THE SUN AND MOON POSITIONS in Sign, Degree, Minutes, and Seconds.

ALL THE PLANETS POSITIONS in Sign, Degrees, and Minutes. THE LUNA NODE - THE PART OF FORTUNE - THE VERTEX, AND A HOST OF OTHER BIRTHCHART INFORMATION AT THE TOUCH OF A KEY.

ZX 81

ZODIAC I ASCENDANT MC Placidus Cusp Positions £10

ZODIAC II ASPECTS + Midpoints only £8

ZX SPECTRUM 48K ZODIAC F. All on one cassette £15

DRAGON 32

ZODIAC FD. As the Zodiac F only £15

Other programs in course of preparation include: PROGRESSING THE HOROSCOPE; RECTIFICATION OF THE BIRTH TIME, etc.

STELLAR SERVICES
8 FIR TREE VALE, LEEDS LS17 7EY
Tel: (0532) 692770

MICROAGE

ELECTRONICS

BIG value in small printers

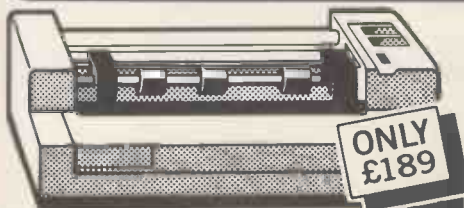

The Incredible Seikoshia AP80

The AP80 is probably the world's LOWEST COST, compact 80-column graphic dot-matrix printer available.

It can produce single and double width characters and has the ability to produce any pattern through its dot-matrix capability.

The AP80's robust construction and its unique "unihammer" make it an extremely cost effective and efficient printer.

Its features include

- 80 Cols 30 cps ● Dot Matrix Unihammer action ● 96 ASCII standard characters ● Up to 8" paper width ● Upper and lower case ● Double width printing ● Standard interface: Centronics

The Amazing Seikoshia AP100

Big brother to the AP80 the AP100 is a wider more sophisticated version of the AP80 with a full graphics capability and the ability to take standard width computer stationery, the AP100 is an ideal choice for anyone with a microcomputer.

Its features include:

- 80 cols 30 cps ● Dot Matrix Unihammer action ● 116 ASCII standard characters ● Full graphics capability ● Up to 10" paper width ● Upper and lower case ● Double width printing ● Centronics interface: Only £215.

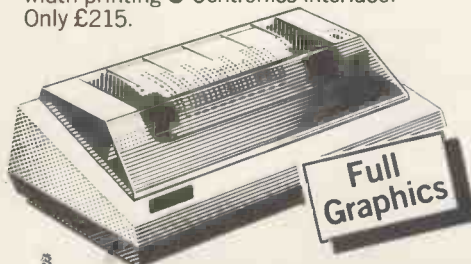

Official Orders Accepted

Free Cable + paper with printers

Accessories

- Seikoshia GP-80 Ink Ribbon £4.75 (75p p+p)
- Seikoshia GP-100 Ink Ribbon £5.75 (75p p+p)
- Dust and sound Cover £3.95 (75p p+p)

Please Rush me details of all Printers.

Name _____

Address _____

The computer I shall be using it with is: _____

PCW/5/83

MICROAGE ELECTRONICS

135 HALE LANE EDWARE MIDDLESEX HA8 9QP TEL: 01-959 7119 TELEX 881 3241

Open Mon - Sat 9.15am - 6.00pm. Thurs 9.15am - 1.00pm.

DEALER ENQUIRIES WELCOME

CALL 01-959 7119 FOR TRADE PRICES

FORTUNE 32:16™

The real world computer



With many micros, you could be forgiven for thinking they weren't actually intended to work in the real world of business. They're either incomprehensible, difficult to use, or missing something you want (usually software).

Fortune is different. Everything you need – word processing, financial modelling, database management, accounting, extensive file capacity, communications – has been beautifully executed as an integrated system.

You'll love the thoughtful human engineering that makes Fortune a joy to use. You'll benefit from professional features that are hardly the norm even in products costing thousands more. And you'll appreciate Fortune's built-in data protection which is quite unprecedented in micros.

Fortune protects your investment too, because it is easy to expand. And that's exactly what you'll want to do when you see the added control and efficiency Fortune brings to your business.

You'll soon want other users to share the computer, to run different tasks simultaneously or to access common files. All you have to do is plug in additional low-cost Fortune workstations (as these cost only £850 each, this is much more economical than having a computer for every user). With Fortune's state-of-the-art, UNIX™ based, 32/16 bit processor you have the power and speed you need.

So that you can comfortably evaluate Fortune for yourself, we have carefully selected a network of dealers to help and advise you. Like us, they are data processing professionals with years of experience in the industry.

Backing them is Tetra's single source systems service. Our support team comprises professionals in all areas of business and scientific computing. Their expertise encompasses a wide range of operating systems, programming languages and communications technologies, vital to the in-depth understanding and implementation of your applications. Similarly, hardware maintenance, throughout the UK, is provided by Tetra's own engineers whose sole responsibility is to support the Fortune range.

Processor: 32 bit MC68000. Memory: 256K to 1Mb.
Multi user/multi tasking UNIX™ system supports up to 16 users.
Languages: C, COBOL, BASIC, FORTRAN, PASCAL
Disk capacity: 1Mb Floppy, 5/10/20/40/80 Mb Winchester.
Options: communications, high resolution graphics, local networking.

The friendly multi-user computer

Tetra Data Systems Ltd
Tetra House 14-16 Temple End
High Wycombe Bucks HP13 8DR
Telephone 0494-452001/4

TETRA

SOFTWARE

ADD-ONS

FOR THE

IBM PC

 **Croydon
Micros**

HARD DISK (WINCHESTER) SYSTEMS

**FROM 5 Mbytes INTERNAL FITTING
TO ABOVE 350 Mbytes CHAINED EXTERNAL**

TAPE OR WINCHESTER CARTRIDGE BACK-UP

PRICES FROM £1,100 + V.A.T.

**HOST ADAPTORS FOR MANY MACHINES
PLUS SOFTWARE, NETWORKS & COMMUNICATIONS**

*DEALER ENQUIRIES WELCOME –
ALL CREDIT CARDS TAKEN*

★★★ NOW AVAILABLE – SPECIAL SERVICE ★★★
CP/M (8" 3740) to CP/M 86 (IBM PC)

RING NOW FOR HELP
01 - 683 1181 (PBX)

or send for details (dealers welcome) to:-

CROYDON MICROS
FREEPOST, 20-28 Whitehorse Road, Croydon, CR9 9ER

Proprietor: Frontrealm Ltd (T/A) Incorporated in England No: 1593574

COMMODORE 64

The new Commodore 64 with its in-built 64K memory, high resolution graphics, 16 colours, three dimensional effect, excellent music synthesizer, second processor and CPM capability, full range of peripherals and interfaces and compatibility with PET software is the ultimate in PERSONAL COMPUTERS with the power to perform as a true business machine.

Price £299 + VAT (Export Orders Welcome)

SINCLAIR SPECTRUM, ZX81 VIC 20, DRAGON 32, ORIC

We supply a wide range of hardware, software and accessories to both UK and overseas markets.

NETKIT II Universal Communications for the Commodore PET

Why buy an expensive terminal when you can use a CBM/PET and still be able to run normal business software.

NETKIT II is being used in many varied and diverse applications, not only as an intelligent or dumb terminal to mini or mainframe computers, but also to support CBM/PET to CBM/PET communication with shared processing and transfer of programs and data.

NETKIT II is now available for all series of CBM/PETs and is supplied with a comprehensive operation and applications manual.

Price £150 + VAT.

*Yorkshire
Microcomputers*

28 RAMSHILL ROAD SCARBOROUGH NORTH YORKSHIRE YO11 2QF
TEL: 107231 78136 TELEX: 527579

P.M.S. Developments
0432-265768

22 Tarsmill Court
Rotherwas Ind. Est.
Hereford

ZENITH 16-Bit Computer (45K) with High Resolution colour Graphics (640 by 225), 8088 and 8085 processors, 128K user ram, 2 DSDD 320KB drives, 2 Serial ports, 1 Parallel port, Disk controller supporting 4 each 8" drives and 4 each 5.25" drives, 4 slots of S-100 bus for options, Light-pen socket. Supplied with MSDOS, CP/M85 and 16-Bit Micro-soft Colour Basic with FULL GRAPHICS implementation, complete documentation including MSDOS assembler listings (7 manuals).

With 12 Month Warranty. From £2,072

8" DISK SUBSYSTEM, Capacity: 2.4MBytes, 2 Double-sided Double Density Drives in case 9" w x 10" h x 18" d with PSU, Fan, 50-way data connector, 1.5M data cable, mains cable. **Only £1,050**

ZENITH ZVM-121 12" Green screen monitors £85.00

OSBORNE I personal computer and software £1,250

OSBORNE II Double Density Disk model £1,375
Supplied with FREE 12" Green Monitor!

INTELLIGENT EPROM PROGRAMMER: 4K Buffer RS232 interface. Programs 2716, TMS 2716, TMS 2516, TMS 2508, TMS 2708, 2732, 2532, TMS 2532. Can be used with Terminal Only. Supplied with software for use under CP/M operating system. **Price: £349**

ZENITH ZVM 134 13" Colour Monitor, TTL level RGB input 20MHz bandwidth, resolution 684x480 £400
Colour WORDSTAR V3.2 (MS DOS) £240
Colour SUPERCALC (MS DOS) £175

ZENITH 2nd-user equipment at very favourable prices

OLYMPIA ESW 100/RO Daisy Printer Special Offer £495

We are unable to list all our items. If you would like details of these or more information on the above, please contact us.

Please add VAT to all prices.

FOR ALL YOUR COMPUTER SUPPLIES CONTACT

Marlowfield Ltd

Wabash Diskettes

5 1/4" SSSD £15.00 per box
8" SSSD £17.50 per box

Verbatim Diskettes

5 1/4" SSSD £17.50 per box
8" SSSD £19.50 per box

FREE Library Case with every box of Diskettes

Disk Head Cleaning Kits

5 1/4" and 8" £16.00 each

Diskette Storage Boxes

5 1/4" Storage Capacity 30/40 £17.50
5 1/4" Storage Capacity 60/80 £21.00
8" Storage Capacity 30/40 £23.00
8" Storage Capacity 60/80 £27.00

POST & PACKING IS FREE

Listing Paper

9 1/2 x 11 Plain 2000 Sheets £9.50
14 1/2 x 11 Plain 2000 Sheets £10.50

Delivery Charge £3.00 per box

Send for new price list to:

MARLOWFIELD LTD

Hesketh Bank House

7-11 Yellowhouse Lane, Southport, Merseyside
PR8 1ER Telephone (0704) 36082

HAVE YOU GOT A BBC MICRO? THEN YOU NEED:



THE NEWSLETTER OF THE INDEPENDENT NATIONAL BBC MICROCOMPUTER USERS GROUP

IN RECENT MAGAZINES:

Articles: Teletext Graphics, User Definable Characters, User Definable Keys, Sounds, *FX Telesoftware, Line Structure and Merging, Epson Screen Dump, Pixel Power, Moving Things, Manual Review, What Printer?, Seikosa Dump, Machine Code, How To Get More Colours Out Of Your BBC Micro, Circles Galore, Conversions for RGB Inputs, How To Use Joysticks, Instant Graphics, Software Protection, String, String, String, What Monitor? Speeding Up Your Programs, Computer Conversions, Questionnaire Results, Formatting, Assembler Programming On The BBC Micro, Errors? Focus On Adventure, Diskspot, Computer Programme Review, ADC Corner, Make The Most Out Of Sound, and lots, lots more.....

Programs: Labyrinth (Game), Pontoon (Game), Artillery (Game), Life (Misc.), Calendar (Misc.), Prism (Educ.), Spiral Patterns (Graphics), Bazooka (Game), 4-In-A-Row (Game), Mortgage (Misc.), Oxygen (Game), Teletext Terminal (Utility), Wordprocessor (Business), Mixer (Graphics), How Many Colours? (Graphics), Disassembler (Utility), Maths Race (Educ.), Puzzle Program (Game), TV Test Signal Generator (Utility), Alphabet Tester (Educ.), Repeat (Game), Memory Analyser (Utility), Wallball (Game), Dating (Misc.), What's The Time? (Educ.), Grand Prix (Game), Nine Dice (Game), Memory Dump (Util.) and lots, lots more.....

Regular Features: Bookreview, Letters, Hardspot, Software (we review at least 8 programs per magazine from all sources), Oddspot (a different graphical program every month), Meeting Place (where we list local user groups), Contacts (spans over 1 page of names and addresses of people who want to get in touch with other users in their area), Competitions, Printreview (we have looked at the Seikosa and Amber 2400 and give full details on how to use them with screen dump programs), Seasons (a seasonal program every month), Querspot, Special Offers (special offers and exclusive club discounts), Assembler Programming On The BBC Micro, Software Protection and lots, lots more.....

WE WON'T TRY TO PUSH LASERBUG ON YOU LIKE THE OTHERS - SEND OFF FOR A SAMPLE COPY AND YOU'LL FIND THAT LASERBUG SELLS ITSELF

Please supply me with:

A sample copy of LASERBUG @ £1.00
A 12 Month subscription to LASERBUG @ £12.00 for 12 issues of the magazine
A 6 Month subscription to LASERBUG @ £6.00 for 6 issues of the magazine
An overseas subscription to LASERBUG @ £14.00 (Surface Mail - write for details of air mail)
..... LASERBUG Dust Cover(s) @ £3.25 each
..... LASERBUG Cassette Lead(s) (Please state type(s)) @ £3.00 each

I enclose a cheque/PO for £..... made payable to LASERBUG

NAME ADDRESS

Please send the completed form to:
LASERBUG Dept. P, 10 Dawley Ride, Coinbrook, Slough, Berks. SL3 0QH.

Your Printer Best Buy!



THE BROTHER 8300
COMPUTER PRINTER
ELECTRONIC TYPEWRITER

- * Superb daisy wheel print quality.
- * Dual purpose — switch instantly from computer printing to electronic typewriter.
- * Print at up to 12 c.p.s.
- * Interchangeable daisy wheels.
- * Automatic 12 character corrections.
- * Carbon ribbon for best print quality.
- * RS232C or Centronics interface.
- * Only £385 plus VAT and carriage.



Kasad Data Services
Wych Elm House
Harlow, Essex

**KASAD
DATA**

Telephone (0279) 33231/414589



Electronequip

(Authorised BBC Dealer and Service Centre)

* THIS MONTH'S SPECIAL OFFERS

BBC1	BBC Micro Model A	299.00
BBC2	BBC Micro Model B	399.00
BBC3	BBC Model A Micro with 32K	333.50
BBC4	BBC Model A Micro 32K & VIA	339.50
BBC21	Upgrade Model A to B	99.82
BBC27	Disc Upgrade for BBC B	109.25
BBC30	14" Colour Monitor for BBC	286.25
BBC33	BMC12A 12" Black/Green Monitor	90.85
BBC36*	14" Monitor/TV. 80 columns	244.95
BBC40	Cassette Recorder for BBC	29.90
BBC41	Single 5.25" Disc Drive 100K	265.00
BBC42	Dual 5.25" Disc Drive for BBC	447.00
BBC45*	New improved Cassette for BBC	35.88
BBC48*	Dual 800K low profile disc drives	897.00
BBC49	5.25" Discs for BBC 40/80 tracks	2.20
BBC50	Epson MX80T type 3 for BBC	373.75
BBC54*	Daisy Wheel printer for BBC	558.90
BBC70	Plinth/Stowage for BBC	29.90
	Torch Colour Machine 800K floppies ex VAT	2795.00
	Torch Colour Machine Hard Disc ex. VAT	4995.00

Large stocks. Prices inclusive of VAT
All prices inclusive of postage except micros 3.00
Access and Barclaycard Welcome



Electronequip BBC

36-38 West Street Fareham Hants PO16 0JW
Tel 0329-230670

DRAGON

software+hardware

- * FLEX OPERATING SYSTEM for Dragon users. 4 drive controller card with 8k RAM for DOS, 4k ROM for DOS routines and simple stand alone commands, useable with Dragon Basic.
- * DRAGBUG MONITOR . . . £4.95. Write/edit machine code programs, debug with breakpoints, many more utilities.
- * DRAGON DISECTED . . . £4.50. Many software and hardware details for the Dragon. Double program speed in software! Using the D/A convertor, etc.
- * FAST A/D, D/A CONVERTER. 12 bit system runs at 15kHz bandwidth. Ideal for music synthesis and Digital sound recording/processing.
- * PAGED RAM CARD. Extend memory in 32k blocks, up to 512K total. Simple 'page byte' software control.
- * CP/M CARD AVAILABLE SOON! Also: 16 LINE I/O + RS232 card - EPROM Blower, etc.
- * SEND FOR full details of these and other products. Note - prices exclude VAT + 75p P&P.

OEM6809

- * WE also manufacture a range of 6809 based OEM products:
- * 6809-RMS1. Extended Eurocard with 6809 MPU, 64k DRAM, 64k EPROM, RS232 interface, PIO and monitor software. Comprehensive system BUS. Around £350.
- * FDC-RMS2. Disk Driver for 6809 card. Up to 4 D/S D/D drives, or Winchester drive. Around £200.
- * OTHER OEM 6809 products, please call or write for information.

reeve microsystems

199 Bideford Green · Linslade · Leighton
Buzzard · Beds · LU77TS · Tel 0525377909

SPECTRUM BBC DRAGON

Make the most of your microcomputer with these tested books from the Tim Hartnell *Success in the Fast Lane* computer series.

- () PROGRAMMING YOUR ZX SPECTRUM — 230 pages, 100 plus programs, Tim Hartnell and Dilwyn Jones — £6.95.
- () BEYOND SIMPLE BASIC — DELVING DEEPER INTO YOUR ZX SPECTRUM — Dilwyn Jones — £7.95.
- () 60 GAMES AND APPLICATIONS FOR THE SPECTRUM — David Harwood — £4.95.
- () CREATING ARCADE GAMES ON THE ZX SPECTRUM — Daniel Haywood — £3.95.
- () INSTANT BBC MACHINE CODE — Jeremy Ruston — tape and book, enter program in BASIC, program changes it instantly to machine code — £34.95.
- () LET YOUR BBC MICRO TEACH YOU TO PROGRAM — Tim Hartnell — £6.45.
- () THE BBC MICRO REVEALED — Jeremy Ruston — £7.95.
- () MAKING THE MOST OF YOUR DRAGON 32 — Clive Gifford — more than 150 programs, explores all the Dragon's resources — £5.95.
- () DYNAMIC GAMES FOR THE DRAGON 32 — Tim Hartnell and Robert Young — 30 great games, including Asteroid, Space Search, Reversi/Othello and Cubik's Rube — £4.95.

Interface Publications, Dept. PCW2, 44-46 Earls Court Road, London, W8 6EJ.

Please send me the books indicated above. I enclose £

Name _____

Address _____

*(reg. TM)

Sensory Chess Challenger 9



At last—a modular chess computer of really advanced specification which plays superb chess.

- ★ Programme rated by US Chess Federation at 1771 points
- ★ Accepts library of modules which further enhance basic programme
- ★ Sensory surface
- ★ Promotes pawns to any legal piece
- ★ 'Easy mode' downrates the computer's ability — ideal for learning/teaching
- ★ Very easy-to-use problem mode
- ★ Most advanced mate and draw announcements available
- ★ Comprehensive library of book openings
- ★ Can take back-up to eleven full moves
- ★ Book practice mode helps you develop your opening technique
- ★ Can advise your best move
- ★ Can play against itself
- ★ Can monitor the play of two humans
- ★ Operates on mains (transformer included) or batteries (not included)
- ★ Thinks during its opponent's playing time
- ★ The Sensory Chess Challenger 9 has been selected as a 'best buy' by numerous consumer magazines and one of the top national dailies.

Sensory Chess Challenger 9 and the full CGL range are available throughout the U.K. For details of your nearest stockist and a full Sensory 9 specification contact: Computer Games Limited, CGL House, Goldings Hill, Loughton, Essex IG10 2RR. Tel: 01-508 5600.

CGL Bringing
leisure
to life.

HAPPY MEMORIES

Part type	1 off	25-99	100 up
4116 200ns	.90	.81	.78
4116 250 ns	.70	.63	.60
4816 100ns For BBC comp	2.20	1.95	1.85
4164 200ns	3.99	3.56	3.42
2114 200ns Low power	1.15	1.00	.90
2114 450ns Low power	.95	.85	.80
4118 250ns	3.35	3.00	2.85
6116 150ns CMOS	3.35	3.00	2.85
2708 450ns	2.60	2.25	2.10
2716 450ns 5 volt	2.35	2.10	2.02
2716 450ns three rail	5.75	5.00	4.65
2732 450ns Intel type	3.50	3.15	3.00
2532 450ns Texas type	3.70	3.30	3.00
2764 250ns	4.90	4.35	4.20

Z80A-CPU	£3.95	Z80A-P10	£2.99	Z80A-CTC	£2.99
6522 PIA	£3.70	7002 A-D	£4.60	3691	£2.75
88LS120	£2.20	7805 reg	.50	7812 reg	.50

Low profile IC sockets: Pins	8	14	16	18	20	22	24	28	40
Pence	9	10	11	14	15	18	19	25	33

Soft-sectored floppy discs per 10 in plastic library case:

5 inch SSSD	£17.00	5 inch SSDD	£19.25	5 inch DSDD	£21.00
8 inch SSSD	£19.25	8 inch SSDD	£23.65	8 inch DSDD	£25.00

74LS series TTL, large stocks at low prices with DIY discounts starting at a mix of just 25 pieces. Write or 'phone for list.

Please add 50p post & packing to orders under £15 and VAT to total
Access & Visa welcome, 24hr service on (054 422) 618
Government & Educational orders welcome, £15 minimum.
Trade accounts operated, 'phone or write for details.

Happy Memories (PCW),

Gladestry, Kington, Herefordshire. HR5 3NY.

Tel: (054 422) 618 or 628

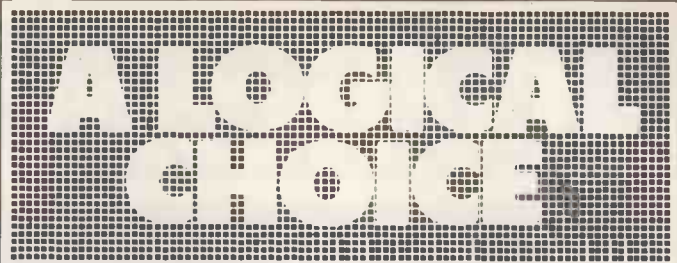

- Come on in and talk to us, we take the hard work out of choosing the right system, whether its for personal, educational or business use.
- Highly competitive prices.
- No obligation demonstration.
- 12 months parts and labour guarantee and a full after sales service back-up.
- Apple Level 1 Service Centre.
- Mail order service.
- Apple Business Systems.

THE APPLE BUSINESS CENTRE

In stock now the latest Apple IIe Microcomputer - perfect for the business user, with a full range of business software. Prices start at **£1,500** for a complete business system. For the larger business user the Apple III is also available; the complete system from **£2,500**.

THE 6809 CENTRE

We are the specialists, carrying the widest range of 6809 based Hardware and Software. Hardware products include:-
DRAGON 32 the best value home computer **£199.50**, including a wide range of Software.
POSITRON British built multi-user machine, at a very competitive price, running Flex and OS-9 Software systems prices start at **£3,400**.

S.W.T.P.C. the Industry Standard, bus-oriented, 6809 based system with full expansion capabilities. Software on Flex or Uniflex.

STIRLING 77-68 6809 based, KIT System on a range of 8" square boards, with 64K memory boards, cassette interfaces, memory mapped VDU boards, more boards under development. Design notes each **£1.00**, 64K board **£28.75**, other boards **£12.00**.

Software products include:-
FLEX SYSTEM SOFTWARE Full range always in stock, with simulators, 68000 cross assemblers, Fortran 77, all for 6809 Flex machines.

OS-9 SYSTEM SOFTWARE. With more interest in this 6809 multiuser, multitasking operating system, we are increasing our stock of programs using this system.

DYNACALC, the 6809 spreadsheet programme, at **£161**.

STYLOGRAPH, the 6809 word processing package, **£200**.

Ring us for full information and prices on our 6809 products.



The logical answer to buying computers

241 Baker St., London NW1 6XE Mail Order Hot Line 01-486 7671



DISKS DISKS DISKS

*** LOWEST PRICES - FAST DELIVERY ***
PRICE PROMISE

We will match any other lower price advertised in the current issue of PCW for single boxes in stock

5.25" DISKS - BOXES OF 10

	Price per Box (£)			QTY	AMOUNT
	1-4	5-9	10+		
VERBATIM					
MD525 S-Side/S or D Den/S- Sec (40 TR)	16.75	16.00	15.25		
MD550 D-Side/S or D Den/S- Sec (40 TR)	24.75	24.00	23.25		
MD577 S-Side/D or Q Den/S- Sec (77/80 TR)	24.00	23.10	22.20		
MD557 D-Side/D or Q Den/S- Sec (77/80 TR)	31.80	30.75	29.90		
*10 and 16 Sectors at above prices *Add £1.35 for Plastic Box					
MEMOREX					
3431 S-Side/S Den/S- Sec (40 TR)	14.50	14.00	13.50		
3481 S-Side/D Den/S- Sec (40 TR)	14.80	14.30	13.80		
3491 D-Side/D Den/S- Sec (40 TR)	19.50	18.50	17.50		
3504 S-Side/D Den/S- Sec (80 TR)	23.00	22.10	21.30		
3501 D-Side/D Den/S- Sec (80 TR)	25.00	24.00	23.00		
BASF					
1X S-Side/S Den/S- Sec	15.00	14.60	14.00		
1D S-Side/D Den/S- Sec	19.00	18.50	18.00		
2DD-Side/D Den/S- Sec	23.50	22.50	21.50		
Head cleaning kit with fluid (each)	16.30	16.00	15.70		
Library case (each)	2.10	2.00	1.90		
8" DISKS - BOXES OF 10					
FD34-1500 S-Side/S Den	17.50	16.75	16.00		
FD34-9000 S-Side/S Den 26 Sect	26.50	25.00	23.00		
FD34-8000 S-Side/S Den Unital	26.00	24.50	23.50		
FD10-4008 D-Side/D Den 8 Sect	31.00	29.00	28.00		
DD34-4001 D2TM D-Side/D Den	31.00	28.50	27.00		
*Other types available on request					
POSTAGE/PACKING (UK)					
5.25" Disks/Cleaning Kit	£1/Box (75p/Box 10+)				
8" Disks	£1.30/Box (85p/Box 10+)				
Library Case	50p/Box (35p/Box 10+)				
*Add 30p per box for 1st Class Delivery					

Total Exc. VAT	
VAT 15%	
Total Payable	

Please contact us for Quantity Discounts (10+ Boxes) and Trade Accounts. Official Orders welcomed.

Name Tel. No.

Address

Access/Barclaycard/Cheque No
If you do not wish to cut out form send order separately

34 Cannonbury Avenue, Pinner, Middx HA5 1TS
Telephone orders any time - we do the rest - 01-868 9548



Pinner Wordpro



TRIONIC

For the Attention of: All budding Computer Freaks
We Stock: Atari 400/800
Commodore Vic 20/64
Home Computers

and support these with an extensive range of utilities;
software; firmware; peripherals and add-ons.

We are probably the largest stockist of 3rd Party Atari
Software in London.

Don't take our word for granted - Come and see us for
yourselves. We are open from 10am till 8pm every day
except Sunday.

114 Station Road Harrow Middx.
Tel: 01 861 0036

Micropoint

at Laskys



APPLE IIe SYSTEM

A complete small business system. 128K memory. Colour graphics and 80 column screen.

Available separately the complete package includes:-

Apple IIe computer 64K	£842.61
Disk drive with Controller	£312.17
Monitor 3	£130.35
80 Col card + 64K memory expansion	£181.74

Total	£1466.87 + VAT
-------	-------------------

PACKAGE PRICE

£1260 +VAT

Saving £206.87 + VAT

Prices are exclusive of VAT.

The magic of the microcomputer without the mystery.

Looking for a microcomputer for home or business? Then come to Micropoint at Laskys. Used at home a micro can give endless fun to your family with games and hobbies. Or to help your children right through their education.

If you've a small business then a micro can save you time and money. It will make easy work of VAT returns, targetting, stock taking, customer information, accounting and pay rolls.

At Micropoint we have everything to help you choose the right microcomputer for you. Test

our enormous range - side by side. Or ask our experts to advise you.

As well as microcomputers we've got a very wide range of software programs that really make your micro magic. In all the popular formats.

As well as choice you get value - because we keep our prices down by buying in volume. And you get a variety of buying schemes, including Interest Free Credit*. On top of all this you get the famous Laskys Commitment which includes 14 day exchange period, a free guarantee ▲ and

service by our own network of specialist engineers. Come and see our microcomputer range.

It would work magic at home and at work.

As well as micros we have a very wide range of peripherals, accessories and programs. Disk drives, memory expansion units, cassette storage units, monitors and joysticks. Plus the widest choice in programs covering Games, Education, Household and Business.



LYNX

Compact home unit with full size keyboard. Powerful 48K memory, colour and sound. Excellent graphics, compatible with most cassette players.

£195.65
+ VAT



ATARI AM800

A home computer with full size keyboard. Big 48K memory. High resolution graphics and colour, sound. A very wide range of programs are available.

£346.09
+ VAT

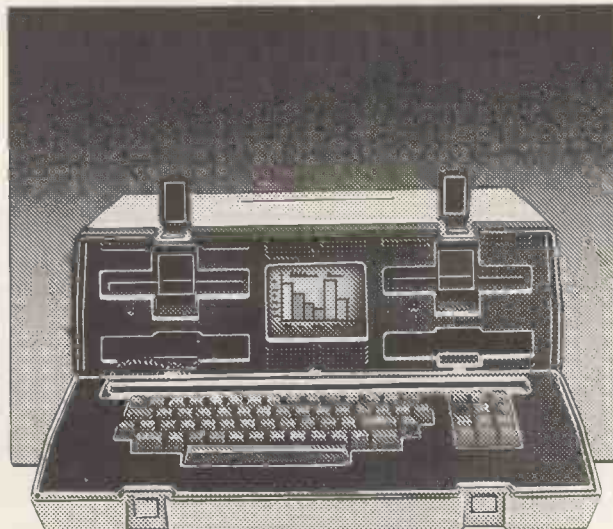

OSBORNE 1 Double Density

A portable business computer with built-in screen and two disk drives. Powerful 64K memory. Comes complete with a comprehensive business application program.

£1373.04
+ VAT

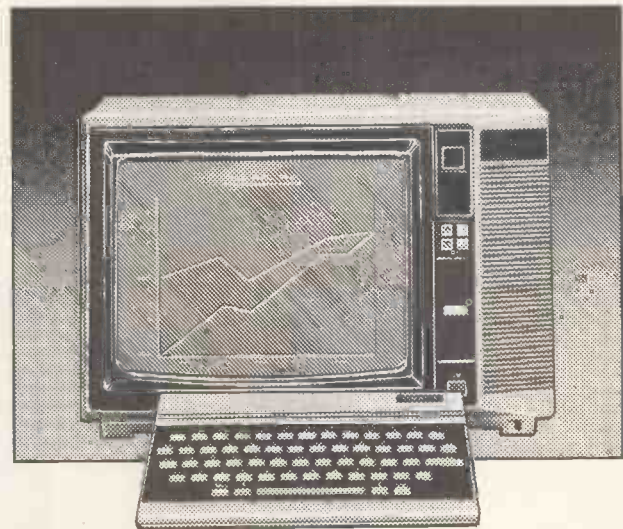

ORIC 48K

A home computer with 48K RAM. Ergonomic keyboard with 57 moving keys. 8 colours, 7 octaves of sound and a hi-fi sound output. Teletext/Viewdata compatible graphics.

£147.74
+ VAT

New at Micropoint SINCLAIR ZX SPECTRUM

Full colour and sound. High resolution graphics.
16K... **£108.60** +VAT 48K... **£147.74** +VAT
A wide range of programs and peripherals available.

Some of these models shown need a separate TV or monitor. Micropoint has a complete range of suitable models from £59.90 (B/W) or £199.90 (Colour).



▲ Computers/VDU monitors normal domestic use 2 years (business use 1 year). Programs/Peripherals normal domestic use 1 year (business use 6 months). Pre-recorded cassettes and programs will only be exchanged if proven faulty and then only for same cassette/program. All offers subject to availability. Prices are correct at time of going to press 19.8.83.

★ All credit offers subject to acceptance. Laskys Credit brokers. Please ask for written details.

A service provided in association with Unicredit Finance Ltd. Please ask for written details APR 29.0% if you pay by Bankers Order (34.5% for other methods of payment)

Full stock available at these branches:

LONDON
42 Tottenham Court Road, W1
471-3 Oxford Street, W1
7-9 Queensway, W2
ALSO OPEN SUNDAY 11 am - 7 pm
BROMLEY 22 Market Square
KINGSTON Eden Street

LUTON 192 Arndale Centre
READING Fnrar Street
MAIDSTONE 79-81 Week Street
BRIGHTON 151-2 Western Road
BRISTOL 16-20 Penn Street
GLOUCESTER 25 Eastgate Street
BIRMINGHAM 19-21 Corporation St

CHESTER 7 The Forum
MANCHESTER Amdale Centre
NEWCASTLE-UPON-TYNE
6 Northumberland St
NOTTINGHAM 1-4 Smithy Row
PETERBOROUGH Queensgate Centre
PRESTON Guildhall Arcade

SHEFFIELD 58 Leopold Street
YORK 10a Coney Street
LIVERPOOL 33 Dale Street
EDINBURGH 4 St James Centre
GLASGOW 66-70 Buchanan Street
ALSO OPEN SUNDAY 12 am - 5 pm
CARDIFF 122 Queen Street

A range of home/hobbyist computers with peripherals and programs, are available from these branches.

LONDON
257 Tottenham Court Road, W1
382 Edgware Road, W2
152 Fleet Street, EC2
Golders Green Road, NW1
COLCHESTER 13 Trinity Square
CROYDON Whitgift Centre

SLOUGH Queensmere Centre
WATFORD Charter Place
CHATHAM 8 The Pentagon
ROMFORD South Street
SOUTHEND 205-206 Churchill West
LEICESTER 45 Market Place South

NORTHAMPTON
78 Abington Street
OXFORD 16 Westgate
WOLVERHAMPTON
30 Wulfrun Way

DON'T LEAVE IT TO CHANCE !

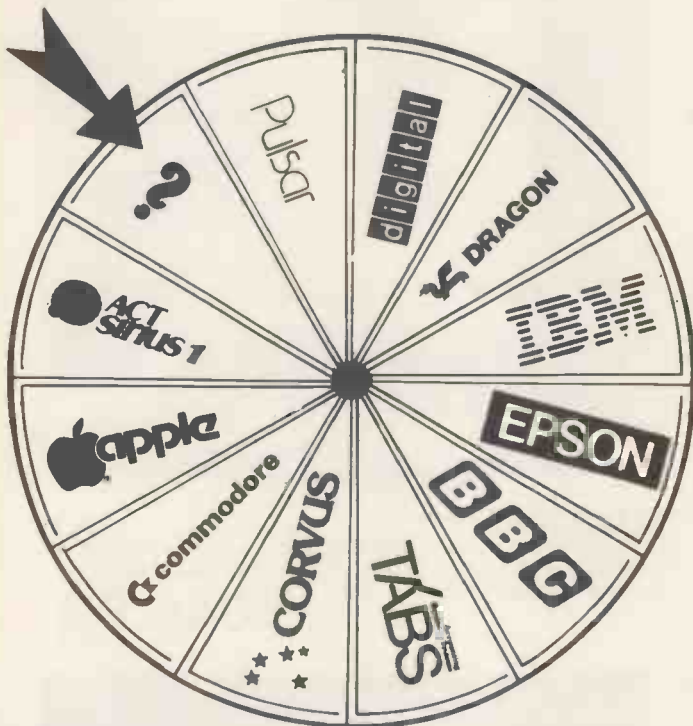

LET US TAKE THE RISKS OUT OF CHOOSING YOUR SYSTEM

- Established six years
- Professional experience
- Free consultations
- Bespoke software
- Delivery and installation
- Full after sales support
- Computer courses

Plus

Call us now for an invitation to our **Micros and the Businessman Seminars**, our special offers and details of the latest product releases. And don't forget if a software package doesn't suit we'll write something that will.

 **ozwise computers**

236 Imperial Drive, Rayners Lane, Harrow, Middlesex. Tel 01-429-1060

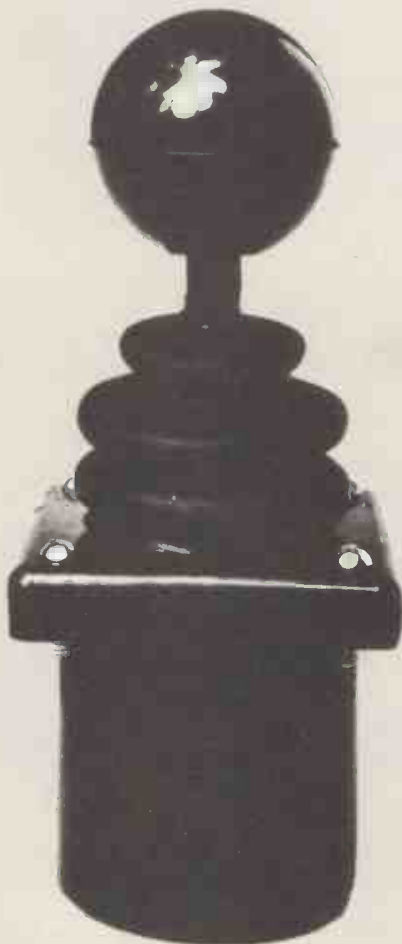

JOYSTICKS

We are specialist manufacturers and distributors of joystick controls, ranging in price from £3.00 to £1,000. 20 years experience of design and production, and high volume sales on the UK and through 8 overseas distributors allow us to offer, often from stock, or otherwise within 2 to 3 weeks, a range of standard joysticks suitable for almost any application, from a TV game to a control for earthmoving equipment.

We have 3 ranges suitable for Microcomputers

- The J1, economical dual axis carbon track controls, with or without cases, switches, and cables.
 - The JS2, high quality all metal dual controls for any standard potentiometers (and in particular for plastic film potentiometers giving life of several million cycles).
 - The JS4 unique inductively coupled contactless joystick (with life of up to 10 million cycles total noise free outputs and infinite resolution).
- In addition we frequently build 1 off special joysticks such as triple axis with 3 additional knob controls, for underwater vehicle control, or 16 function units for walking talking puppets. We also design and tool plastic or metal cases, and a wide range of accessories of all sorts including weatherproofing gaiters and bezels.

Please contact us for all your joystick requirement — prices, delivery and quality will surprise you.

We regret that we are unable to handle enquiries from individuals — please contact your dealer or write to us to ask for a dealer list.



FLIGHT LINK CONTROL LTD

UNIT 12, THE MALTINGS, TURK STREET
ALTON, HANTS.

Telephone: Alton (0420) 87241 Telex: 858623 Telbur G

SHARP

PC 1251 POCKET COMPUTER

WITH OPTIONAL

CE 125

PRINTER/MICRO CASSETTE RECORDER

NEW

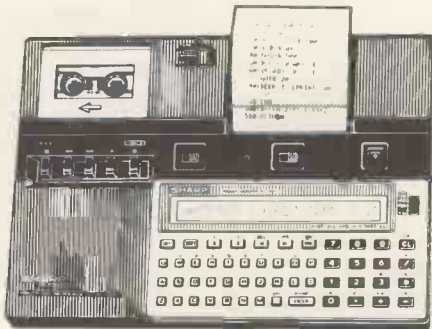

PC 1251 £79.95 inc. VAT **CE 125** £99.95 inc. VAT

P.P. & Ins. £5.00 for PC1251 on its own or with CE 125 two or more units - FREE

ALSO AVAILABLE

PC 1500 and accessories. Phone for prices

Access and Barclaycard welcome

WEST COAST PERSONAL COMPUTERS

47 HYLE STREET, AYR HA7 1RS
TELEPHONE (0292) 285082

LOW PRICE HIGH QUALITY SOFTWARE FOR COMMODORE 32K PET AND 64 PURCHASE AND SALES CONTROL £80 + VAT

Runs both purchase and sales ledgers with optional calculation of VAT from the gross or net amount, analysis by accounting period, 'due for payment' report, totals for net VAT and gross, etc.

INVOICE PRINT £80 + VAT

Prints invoices on your own stationery laid out according to your own instructions. This programme is an optional add-on to be used in conjunction with 'purchase and sales control'.

STOCK CONTROL £60 + VAT

Keeps detailed stock records including stock location, re-order level, quantity on order, cost and selling prices and stock valuation.

NOMINAL LEDGER £60 + VAT

Produces trial balance and up to 20 reports in addition to profit and loss and balance sheet. This programme is intended for use on its own, but it can read files set-up by our purchase and sales control and stock control programmes.

INTEGRATED ACCOUNTING SYSTEMS FROM £400 + VAT

Write or phone for details and complete software list.

**ELECTRONIC AIDS
(TEWKESBURY) LTD**

Mythe Crest, The Mythe, Tewkesbury
Gloucestershire GL20 6EB
Tel: 0386 831020/0684 294003

Micromail

List now includes **NEW Apple II E**

Mail Order Items

Inc VAT
and
Net carriage

Apple II E 64K	625.00	722.00
Apple Disk + Controller	275.00	319.00
Apple Disk without Controller	199.00	229.00
Micro-Sci Disk A40 + Controller	275.00	319.00
Micro-Sci Disk A40 without Controller	199.00	299.00
Apple Monitor III	120.00	142.00
Zenith 12" Monitor	69.00	84.00
Apple 80 Column Card II E	60.00	70.00
Apple 80 Column Card II E + 64K Expander	145.00	167.00
Bit 3 Full View 80 Column Card	175.00	205.00
Business Graphics	85.00	100.00
Language Card	75.00	90.00
Applewriter II	65.00	75.00
CCS Synchronous Serial Interface	75.00	87.00
TV Modulator	11.50	13.00
Eurocolor Card	60.00	72.00
Dos 3.3 Toolkit	35.00	42.00
Mountain Hardware Rompkus Card	85.00	100.00
Epson Printers	Call for prices	
Apple Interface for Epson	75.00	86.00

NEW SOFTWARE (ON CASSETTE)

DRAGON

Dragon Magic No. 1 — 12 BASIC programs including BRICKOUT, 3-D EFFECT and useful household programs that start where the manual leaves off **6.04 6.95**

Dragon Magic No. 2 — 10 more advanced programs in electronic magazine format to take you deeper into basic programming including PSYCHIC TEST, VALLEY BOMBER, etc. **6.04 6.95**

Dragon Wordprocessor (EDITEXT) (for Dragon 32 + Printer) **11.96 13.75**

BBC MICRO (MODEL B)
Twin Joysticks (true analogue) (uses analogue port) **13.00 16.00**

Vogon Attack (with super graphics) + Shuttle Lander, Towers of Hanoi, Robot Battle and Four in a Row **6.04 6.95**

BBC Games Tape 2 — includes: Death Castle, Adventure Maze, Battleships, Mastermind, Rat Shoot, Number Invaders and Computer Hangman **6.04 6.95**
7 Educational games for 6-10 yr olds **5.17 5.95**

SPECTRUM
9 Educational Programs for 4-7 yr olds **5.17 5.95**

RESEARCH MACHINES
Single Joystick for RM 480Z **9.57 11.00**



Cash with order

**MICROMAIL LTD., P.O. BOX 34 (DEPT. CT),
Leighton Buzzard LU7 8SJ
Telephone: (0525) 376600
Barclaycard/Access accepted.**

Adding high resolution colour graphics to your Nascom or Gemini system need not cost more than £199.

Introducing the new **Microvector MV256** adding a high Resolution Colour Graphics capability to your **NASCOM** or **GEMINI** computer system.

- ★ High resolution display. 256 x 256 x 4 planes (16 colours).
- ★ 32k of display memory with flicker-free update (Outside of the host computers memory address space).
- ★ Non-interlaced 50Hz CCIR 625 line display format.
- ★ High Quality PAL UHF output with intercarrier sound facility.
- ★ Composite B/W video 75 ohm output (16 grey levels).
- ★ Red, Blue & Green video 75 ohm outputs (sync. mixed on each) available on MV256B only.
- ★ Audio & light pen inputs.

The **MV256** uses the **Thomson EF9365** graphics display processor to provide high level graphics functions in hardware.

- ★ Ultra fast vector and character generation give full animation capability (typ 800 000 pixels/sec. max 1300 000 pixels/sec).
- ★ Selectable line types (continuous, dotted, dashed, dotted-dashed).
- ★ 96 ASCII character set. Programmable character sizes and orientations.
- ★ Rectangle fill, clear screen and scan screen operations.
- ★ Host computer access to display memory via registers.
- ★ Comprehensive display status information.
- ★ Light pen control.
- ★ NMI interrupt generation (on board link option).

MV256A **£199** + VAT MV256B **£220** + VAT

Both the **MV256A** and **MV256B** are supplied built and tested with comprehensive documentation and programming examples. Postage & Packing free.

Colour Video monitor 10 inch 0.6 mm pitch tube 9MHz bandwidth, suitable for use with MV256B. Also has PAL decoder enabling direct connection to domestic video recorder.

Arfon Light pen, Plug in, compatible with Micro Vector board.

£199 + VAT & CARR.

£50 + VAT

Cable Accessories available.

For further information please contact

CLIMAX COMPUTERS LTD

17a Broad Street, South Molton, Devon. Tel: (07695) 2314

SOFTWARE

ORIC-1

LYNX

JUPITER ACE

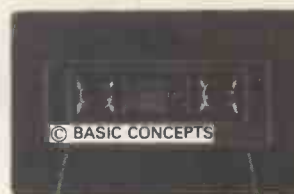

SOFTWARE

COLOUR GENIE

SPECTRUM

DRAGON

TEACH YOURSELF BASIC

ORIC-1

LYNX

COLOUR GENIE

SPECTRUM

DRAGON

BBC 'B' COMING SOON

TEACH YOURSELF GRAPHICS

ORIC-1

COLOUR GENIE

DRAGON

LEARN FORTH

JUPITER ACE

HAPPY LANDINGS

ORIC-1

LYNX

COLOUR GENIE

SPECTRUM

DRAGON

* WATCH THIS SPACE FOR NEW SOFTWARE COMING SOON *

ALL CASSETTES £6.95 + 30p pack & post

BASIC CONCEPTS

PO BOX 46

0372 - 378694

LEATHERHEAD

SURREY

KT22 7XF

DEALER ENQUIRIES WELCOME

COMPUTASOLVE LTD.

8 CENTRAL PARADE, ST. MARKS HILL, SURBITON, SURREY KT6 4PJ TEL: 01-390-5135

MINER (NEWBRAIN)

EARTHQUAKES... PIRATES... REVOLTING WORKERS...

All this and much more in "MINER" for the NEWBRAIN micro.

The aim is to make a million pounds in fourteen weeks, by mining ore, and transporting it from the dark continent to civilisation. A superb game for one player versus the computer, hours of nail-biting enjoyment guaranteed.

£8.50 inc. V.A.T. & P&P

SPACE TRADER (NEWBRAIN)

"ONE SMALL STEP FOR MAN... ONE GIANT LEAP FOR MANKIND"

Come up from that coal mine and take a leap into space with our second great game for the NEWBRAIN. Another game of skill from the same author as MINER... it's different but just as good.

You must hire space shuttles to trade between the five planets of the Star System PGIG. If you can prove your worth you might even be admitted to the exalted Federation of Space Traders!!

£8.50 inc. V.A.T. & P&P

D-R-A-F-T-M-A-T-E (BBC MODEL "B")

OUR FIRST OFFERING FOR THE BBC MICRO... AND WHAT A STUNNER!!

DRAFTMATE allows ANYONE to draw pictures on the BBC without any knowledge whatsoever of BBC Basic. Pictures can be dumped directly to a printer, or saved on tape for later modification and use. Optional use of joysticks adds a further dimension to a truly amazing piece of software. You really need to see it running to fully appreciate its versatility... word just cannot do it justice.

£9.95 inc. V.A.T. & P&P

NEWBRAIN Models "A" & "AD", ORIC-1, ZX SPECTRUM, DRAGON, BBC Model B, ATARI Models 400 & 800 all available from stock.



Trade Enquiries Welcome

— NEW FROM —

MICROTEK

Estimating Package for Contractors

Prepares tenders, costings, Bill of quantities, Schedule of Rates, and Bonus schedule. Can be used by Builders, Plumbers, Electricians etc.

Uses a CP/M computer with digitizer. It prepares tenders and costings from plans. It also uses the digitizer for data entry.

The tender will take into account all the preliminaries, overheads, discounts and profits.

The system is exceptionally easy to use and modify. It saves a huge amount of time for the busy contractor.

YET ANOTHER PACKAGE FROM

MICROTEK Ltd.

15 Lower Brook St. Ipswich Suffolk IP4 1AQ
tel. Ipswich (0473) 50152/52466



DON'T MISS THIS INCREDIBLE OFFER! 50 GAMES

£9.95



YES, 50 GAMES! on cassette for all the following:

GALACTIC ATTACK	MAZE EATER	SUBMARINES
SPACE MISSION	ORBITTER	ROCKET LAUNCH
LUNAR LANDER	MOTORWAY	PLANETS
PLASMA BOLT	FORCE FIELD	BLACK HOLE
STARTREK	NIM	DYNAMITE
RADAR LANDING	TUNNEL ESCAPE	DO YOUR SUMS
ATTACKER	BARREL JUMP	DERBY DASH
GALACTIC DOGFIGHT	CANNONBALL BATTLE	SPACE SEARCH
ZION ATTACK	OVERTAKE	UNIVERSE
IVASIVE ACTION	SITTING TARGET	RATS
OKO	SMASH THE WINDOWS	TANKER
BOGGLES	SPACE SHIP	PARACHUTE
PONTOON	JET FLIGHT	JETMOBILE
SKI JUMP	PHASER	HIGH RISE
HANGMAN	INTRUDER	THE FORCE
OLD BONES	INFERNO	EXCHANGE
THIN ICE	GHOSTS	

Sinclair SPECTRUM

Apple (ON DISC & CASSETTE)

ACORN-ATOM

BBC

DRAGON

ATARI VIC20

SHARP

ORIC-1

NEW BRAIN

ZX81 LYNX



POSTAGE FREE TO U.K.
ORDER DIRECT TO:

U.T.S.
P.O. Box 96
HARROGATE
NORTH YORKSHIRE
HG3 2UZ

PLEASE SEND ME _____
CHEQUE ENCLOSED, VALUE _____
NAME _____
ADDRESS _____
POSTCODE _____ G/226

**cut &
post
now**

Beeb Pen

THE WORDPROCESSOR FOR THE BBC MACHINE

THIS IS A SPECIALLY WRITTEN, FULL WORD PROCESSING PACKAGE FOR THE BBC MACHINE (MODEL B OR MODEL A, EXPANDED). NO EFFORT HAS BEEN SPARED TO BRING YOU THE FULL FACILITIES OF A WORDPROCESSOR ON YOUR BEEB. THE PACKAGE CONTAINS MANY FEATURES, INCLUDING . . .

- ☆ FULL ON SCREEN EDITING
- ☆ LINE LENGTHS UPTO 255

- ☆ RIGHT AND LEFT JUSTIFICATION
- ☆ MANY, MANY MORE !!

NORMAL PRICE £44.85

(SPECIAL INTRODUCTORY PRICE FOR ORDERS RECEIVED BEFORE JUNE £39.10).

AVAILABLE ON DISC OR EPROM (PLEASE STATE).

SPECIAL OFFER 12" ZENITH GREEN SCREEN MONITOR £86.25
WHEN ORDER WITH BEEB PEN.

ALSO AVAILABLE WITH DETAILS ON REQUEST

STUDENT RECORD PACKAGE FOR CP/M £276

GENERAL PURPOSE DATA BASE FOR CP/M £276

'C.A.L.' PROGRAMS FOR THE BEEB.

GAMES FOR THE BEEB.

ALL PRICES INCLUDE P+P, V.A.T. - MAIL ORDER ONLY

Braintech

81 RYDAL CRESCENT, PERIVALE, MIDDLESEX, UB6 8DZ. Tel: 01-997 8986



OTHER-WORLDFLY SOFTWARE **SOFTK** AT DOWN TO EARTH PRICES

Imagine a program which instantly converts
SPECTRUM BASIC into Machine Code, and transforms
the SPECTRUM into a micro up
to 100 times faster than a BBC Model B...

48K ZX SPECTRUM COMPILER

METEOROIDS

This version has been hailed the best: 3 sizes of meteoroids, saucer, wrap-around screen, bonus ship at 10000 points, amazing explosions, rotate left/right, thrust, fire, hyperspace and shield. Full feature 'arcade' sounds and full colour. Works with Joysticks (from us at £19.50). Only £4.95 inc (16K or 48K).

SOFTIME

Amazing piece of machine code programming - produces a continuous real time clock on screen all the time - even when running/writing another program! Has alarm facility. For 16K or 48K, only £3.95.

SOFTK SPECTRUM SOFTWARE

COMPILER

Benchmarks

BBC	SPECTRUM (BASIC)	SPECTRUM (COMPILER)
BM1 1.0s	4.8	0.15
BM2 3.1	8.7	0.09
BM3 8.2	21.1	1.10
BM4 8.7	20.4	0.99
BM5 9.1	24.0	1.11
BM6 13.9	55.3	1.91
BM7 21.4	80.7	2.14

What the SUPER C compiler does is almost magical. It turns a program written in Spectrum BASIC into a machine code equivalent. SUPER C is child's play to use - simply type in a program as usual (or load from tape) and in a few key presses SUPER C turns it instantly into a super fast machine code version. It will compile virtually any Spectrum BASIC statement, plus a few features not available to you usually, but extra thought will be required for strings and floating point. There is no program you can write in BASIC which cannot be turned into a SUPER C version. However, enhancement packages will be available in the New Year to aid string handling, floating point, and will offer a host of other features - each for a nominal cost. With SUPER C your Spectrum will run faster than with either FORTH or PASCAL - and no new language to learn! SUPER C comes complete with extensive documentation, a manual written by Tim Langdell, example programs, and all boxed in a professional library case. Less than half the price of a compiler for any comparable micro, - £14.95 inc.

48K 30 MAZENTURE

A maze program and adventure in one. Amazing 'monster chase' animation and more than a hint of dungeons and dragons. 48K only, £5.95.

THE ZOLAN ADVENTURE

A full adventure crammed into 16K! Quite astounding how extensive and engaging this program is. £4.95.

Please rush me

Mr/Mrs

Address

or for INSTANT CREDIT CARD order 7 days a week phone: 01-930 9232.

Send cheques or POs to:
329 Croxted Road, London SE24. Tel: 01-674 4572

SOFTK, SPECTRUM SOFTWARE

THE HR1 THE FINEST PRINTER/TYPEWRITERS MONEY CAN BUY.

Only £650 + VAT



The HR1

Bi-directional - 17 CPS - some features as below, but without keyboard and lift off facility.

Compatible with

SHARP
OSBORNE
APPLE II
APPLE III
TELEVIDEO
TANDY
BBC
MIMI
TEXAS 30/30
PET
HEWLETT PACKARD
SUPERBRAIN
SIRIUS
XEROX
IBM

In fact most computers!

THE CROWN RANIER ONLY £795 + VAT

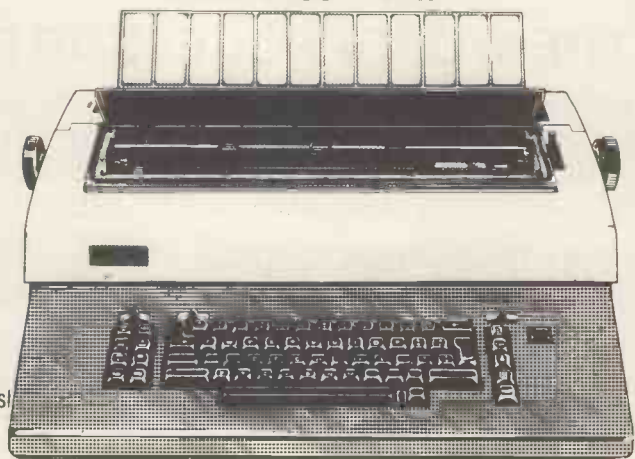

CROWN RANIER - The leader of all interfaced daisy wheel printer/typewriters: Here's why:

The unbeatable Crown Ranier is the only heavy duty daisy wheel printer/typewriter which runs on a linear motor - no belts or cables to break, stretch or wear - and uses the IBM ribbon and lift off correctors. The reliability has become legend in these days of expensive electronic typewriter breakdowns.

CENTRONIC - IEEE - RS232 INTERFACES - No external boxes - interchangeable daisywheels - variable pitch - three free daisy wheels - automatic whole line correction - easily copes with standard printed forms - 195,000 characters per ribbon (at least twice the average character length) - standard lift off correctors - a printer/typewriter at the flick of a switch.

Perfection as a typewriter (now used by local authorities and multi-nationals), perfection as a printer.

Beware of lightweight, low cost machines - these can never give long term reliable service. THIS MACHINE WILL!! The professional machine.

Ask you local computer or office equipment dealer for further information. EX STOCK DELIVERY.

SOLE UK DISTRIBUTOR. TRADE ENQUIRIES INVITED



CROWN BUSINESS CENTRE

56-58 SOUTH ST., EASTBOURNE,
SUSSEX. (0323) 639983.

Linsac's ZX Companion series has received excellent press reviews:

"Far and away the best" — *Your Computer*

Thoughtfully written, detailed and illustrated with meaningful programs ... outstandingly useful" — *EZUG*

'The Spectrum Games Companion' is the latest addition to the series and is aimed at the games player and programmer alike. Twenty-one games designed specifically for the ZX Spectrum are included, with clear instructions on entry and play. Each program is explained fully with complete details on how it is designed and written. Introductory chapters show how to set up and use the Spectrum and how to create your own games. Later sections cover number games, word games, board games, simulation games, dice games, card games and grid games. If you want to enjoy your ZX Spectrum and learn its secrets at the same time then this is the book for you!

Bob Maunder is co-author of 'The ZX80 Companion' and author of 'The ZX81 Companion'. He is a Senior Lecturer in Computer Science at Teesside Polytechnic, holds an MSc degree in Computer Science, and is a Member of the British Computer Society.

The Spectrum Games Companion is available from good book shops, or send £5.95 to:

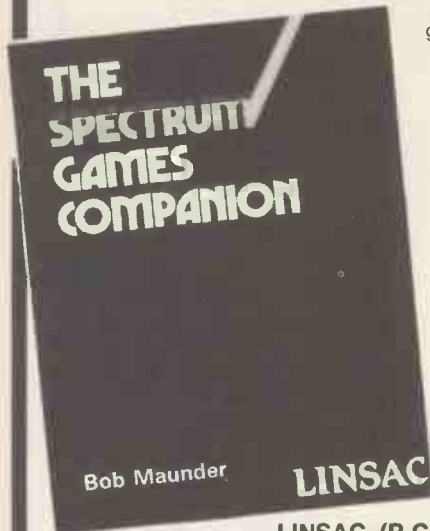

ONLY
£5.95

LINSAC, (P.C.W.) 68 Barker Road,
Middlesbrough, Cleveland TS5 5ES

Postage is free within the U.K. —

add £1 for Europe or £2.50 outside Europe.

ISBN 0 907211 02 X

EXTRAS FOR THE BBC

Unique Hardware & Software

Guaranteed Available Now

HARDWARE

"MEDPROM-B" EPROM programmer
With Machine Code software, User Port Connection,
Programs 2516/2716/2532/2732, Software EPROM
Safety Features. **£79.00**

Also available for 2764/27128 using EX1 Adaptor Unit **£19.75**

"MEDCLOCK" real time calendar/clock,
battery operated user port connection **£29.50**

SOFTWARE

"MEDITOR-B" free format text file gen/editor
including: "MEDMAIL-B" mailshot label printer
Professional Word Processor. Features enable Edit,
Save, Compose and Append Text with Single Key
Letter Commands. **£ 9.50**

"MEDMON-B" machine code monitor
20 Commands: Disassemble, Memchange, Break-
points, Search, Relocate, Offset, etc. Invaluable for
Program Development and to reveal the Machine
Operating System. **£ 9.95**

"MEDMON" also available in EPROM for use with all
versions of O.S. **£17.00**

All prices include p & p. Please add VAT.

Microtrol Engineering Design Ltd.,
Dept. Y, 640 Melton Road, Thurmaston,
Leicester LE4 8BB. Tel: 0533 704492.

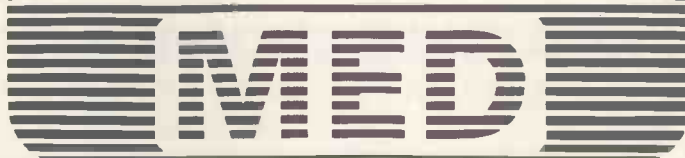

BBC Spectrum nascom

GIANT ADVENTURE GAMES

- 1) COLOSSAL ADVENTURE:** The classic mainframe game "Adventure" with all the original treasures & creatures + 70 extra rooms.
- 2) ADVENTURE QUEST:** Through forest, desert, mountains, caves, water, fire, moorland and swamp on an epic quest vs Tyranny.
- 3) DUNGEON ADVENTURE:** The vast dungeons of the Demon Lord have survived His fall. Can you get to their treasures first?

Every Level 9 adventure has over 200 individually described locations and is packed with puzzles — a game can easily take months to complete. Only sophisticated compression techniques can squeeze so much in! Each game needs 32K and costs £9.90

BBC FORTH, FORTH TOOLKIT

- "r q FORTH" runs on 16K or 32K BBC micros and costs £15. It:
- * follows the FORTH-79 STANDARD and has fig-FORTH facilities;
 - * provides 260 FORTH words;
 - * is infinitely extensible;
 - * has a full-screen editor;
 - * allows full use of the M.O.S.;
 - * permits use of all graphic modes, even 0-2 (just!);
 - * provides recursion easily;
 - * runs faster than BBC BASIC;
 - * needs no added hardware;
 - * includes a 70 page technical manual and a summary card;
 - * has hundreds of users.
- Level 9 Computing are pleased to announce a new toolkit for "r q FORTH" on 32K BBC micros. It costs only £10 and adds the following facilities to FORTH:
- * a 6502 assembler, providing machine-code within FORTH;
 - * turtle graphics, giving you easy-to-use colour graphics;
 - * decompiler routines, allowing the versatile examination of your compiled FORTH Programs;
 - * the full double-number set;
 - * an example FORTH program: and demonstrations of graphics;
 - * other useful routines.

nascom	Asteroids	m/c,g £7.90
Extension Basic	Galaxy Invaders	m/c,g £5.90
Adds 30 new keywords to BASIC	Missile Defence	m/c,g £7.90
Compression Assembler 2	Super Gulp	eb,g £4.90
Small Source + high speed	5-games cassette	misc £5.90
	(FULL RANGE IN CATALOGUE)	

ALL PRICES INCLUDE P & P AND VAT. All programs are in stock and will be sent within 2 days of receipt. Please send order or SAE for catalogue, describing your micro, to:

LEVEL 9 COMPUTING

Dept W, 229 Hughenden Road, High Wycombe, Bucks. HP13 5PG

TOP VALUE AND LOWER PRICES AT

LOMAX NEW COMPUTER CENTRE

(Est 1927)

The BBC Microcomputer System MODEL B	£399	SHARP MZ80A	£499
(cassette lead £4.50)		(incl £75.00 of FREE software)	
BBC COLOUR MONITOR	£287	NEW LYNX - 48	£225
SINCLAIR ZX-81	£48.00	ORIC - 1 48K NOW AVAILABLE	£167.95
SINCLAIR 16K RAM Pack	£29.95	GENIE 2000 (COLOUR)	£225
PACKAGE PRICE (Save £5.00)	£73.90	NEW BRAIN Model A	£205
JUPITER ACE	£89.95	NEW BRAIN Model AD	£242
Free Post & insurance on above items		ATARI 800	£375
PRINTERS SEIKOSHA GP 100A ...	£215	ATARI 400	£189
EPSON MX 80 FT Type III	£375	DRAGON 32	£198
MONITORS from	£79.95	SOFTWARE AVAILABLE FOR ACORN (BBC) ATARI, DRAGON, BUG-BYTE, RABBIT, COMMODORE, UK	
CASSETTE RECORDERS from	£29.95	Send S.A.E. for our Computer News Sheet For Insurance & Postal charges ADD £5 for Hardware £1 for Software	
ACORN/ST MONSTERS, ARCADIANs, SUPER INVADERS SNAPPERS, METEORS plus many more £9.95 each		For MAIL ORDER Phone your ACCESS / VISA on our HOT LINE 061-832 6345 or send cheque P.O. Payable to LOMAX LTD for IMMEDIATE ATTENTION NO EXTRA CHARGE ON CREDIT CARDS	

LOMAX (Computer Division)
8 EXCHANGE ST (St Anns Sq) MANCHESTER M2 7HL

MEMORY & GRAPHICS BOARDS FOR THE ACT SIRIUS 1

Designed & Manufactured in Britain to the Highest Standards – at Remarkably Low Prices

MEMORY BOARD available in two versions

- 256K (R.R.P. £399) **£279**
- 128K expandable to 256K (R.R.P. £285) **£199**

GRAPHICS BOARD

- 128K Bytes of RAM + graphics routines in ROM (R.R.P. £399) **£279**

Graphics Features include:-

- CHARACTER LOAD AND PRINT
- AREA FILL WITH USER DEFINED PATTERNS
- AREA DELETE
- RELOCATABLE SCREEN ORIGIN
- RAPID PLOTTING OF POLYGONS, CIRCLES, ARCS AND ELLIPSES
- CHOICE OF FULL AND BROKEN LINES AND RAY LINES
- ROTATION IN STEPS OF 1°
- FULL SCREEN DUMP

ALL PRICES EXCLUSIVE OF VAT

DEALER ENQUIRIES INVITED

MAGUS COMPUTER SYSTEMS LTD

SOPWORTH MANOR, SOPWORTH, CHIPPENHAM, WILTS SN14 6PS
TELEPHONE: 045 423 231 & 022 122 3576

At last the easy way to show your business information using an ACT 128K Sirius computer.

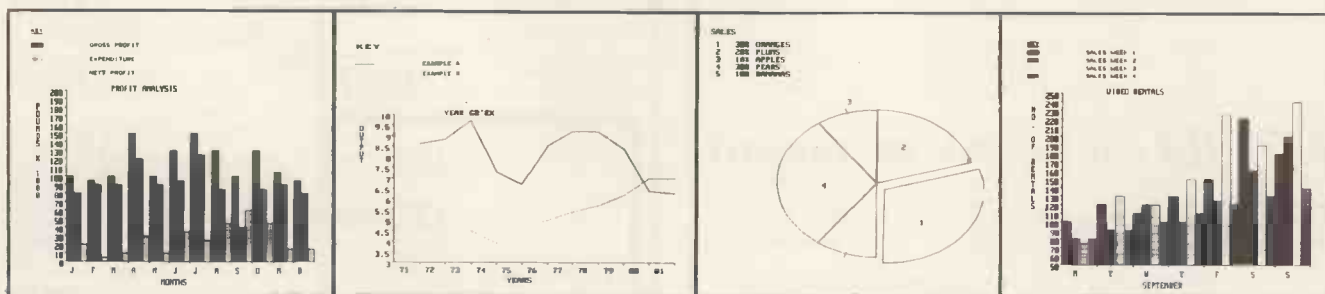

Graphs, histograms and pie charts are of great help in showing weekly/monthly/yearly data, report and survey information, accounting, stock control and sales figures. The program links with Supercalc and User programs.

A new program designed for an ACT 256K Sirius 1 computer links with Multiplan MSDOS, Supercalc and User programs.

128K boards available at only £285.

A new graphics package from Georgetown Computer Services - Specially designed for any business large or small.

Phone Roy Smith on Didcot (0235) 817927 for more information.

How to increase the size of your memory.

Anyone with even a limited knowledge of home computers will instantly recognise the very large advantages of owning a Lynx.

And anyone who truly understands the considerable differences between home computers is likely to have spotted The Lynx a mile off.

With 48K of memory to start with, The Lynx far outweighs the majority of home computers on the market.

And it is precisely that size of memory which makes The Lynx a superior animal in its field.

What's more, 48K of memory is not the end of its capacity, but merely the beginning.

Your Lynx can grow. To 96K, to 128K, or to 192K. All inboard.

All of a sudden your Lynx home computer has assumed the size of memory usually associated with business machines.

Its increased capacity will mean you can have an impressive word processor.

Disk drives and printers, mono or colour monitors can be added on.

With an serial port, your Lynx home computer is compatible with a wide range of other manufacturers' equipment.

And CP/M® compatibility opens the door to a comprehensive selection of business software.

Furthermore, your Lynx home computer has high resolution colour graphics.

In other words, you are free to draw in all 8 colours anywhere on the screen.

For the full story about The Lynx home computer, call in at your nearest Laskys or Spectrum Computer Centre.

®CP/M is the registered trade mark of Digital Research Inc.

COMPUTERS
LYNX



EPSON HX-20 SOFTWARE from MST

MST PORTABLE FILING SYSTEM (DATABASE) £25 inclusive of postage and VAT

Away from the office? Need immediate access to records? Load them on your HX-20 and TAKE THEM WITH YOU! Choose your own "card" headings, THEN sort them, search them, add to them, delete them, print them, browse them, SAVE THEM.

Alphabetical or Numeric sorts on ALL HEADINGS. TOTAL of numeric fields over user-selected record range.

TIME and DATE INDEXED printouts or records. Total flexibility at your fingertips - at home, in the car, on the train - ANYWHERE! 16k version, or 32k for SUPERCAPACITY. Complete the order form NOW, and state the version required.

MST PORTABLE STOCK CONTROL £25 inclusive of postage and VAT

Portable computerized stock control system. 800 stock items on a single microcassette tape. Time indexed Stock Lists, Reorder Reports, and Stock Evaluation reports over userselected range of items.

Add/Issue option ensures accurate records and instant stock evaluation by item and over user-selected range of items.

Integral printer gives record of deleted items, stock issued or added, etc.

ADD to this the elegant file change system and powerful Search Description facility and you have the ideal stock check mechanism for supermarkets, magazine stores, commodity stores of all kinds.

Thousands of stock items can be stored, evaluated and monitored by this FULLY PORTABLE SYSTEM.

I authorize you to debit by ACCESS Account with the amount £

ACCESS CARD NUMBER

NAME SIGNATURE

ADDRESS

DATE

OR you can PHONE your ACCESS order to 0626-832617 NOW!

OR you can send your CASH/CHEQUE/POSTAL ORDER with order to

MST CONSULTANTS, DEPT PCW, NEWTON ROAD, BOVEY TRACEY, DEVON TQ13 9BB



Knights guarantee lowest prices on Sharp & Atari

DEAL A36+2 £419 SHARP MZ-80A, 36 programs + BASIC & PASCAL languages.

DEAL A40+3 £439 MZ-80A, 40 programs + BASIC, PASCAL & FORTH languages.

DEAL A40+4 £449 MZ-80A, 40 programs + 4 languages - BASIC, PASCAL, FORTH & KNIGHTS EXPERT MACHINE CODE.

DEAL A113+4 £475 MZ-80A with 4 languages - BASIC, PASCAL, FORTH, and MACHINE CODE + 113 programs.

DEAL B3 £747 MZ-80B 76K total memory, BASIC, MACHINE CODE & ASSEMBLER.

DEAL B3+75 £859 MZ-80B with BASIC, MACHINE CODE, ASSEMBLER & 16 DIGIT DOUBLE PRECISION BASIC + 75 programs.

DEAL P5+KA1 £363 complete SHARP P5 printer system with all cables, character generator, interface card for MZ-80A or K + KNIGHT COMMANDER.

DEAL P6+KA1 £418 MZ-80K or A P6 printer system + KNIGHT COMMANDER.

DEAL MZ-80FD+A1 £657 complete MZ-80A or K dual floppy system with Master Disk, manuals, card & cables + KNIGHTS EXPERT MACHINE CODE.

DEAL MZ-80A SYSTEM £1575 complete A system, micro, dual disks, printer, expansion unit, all cards, cables, manuals, 4 languages + 150 programs.

DEAL MZ-80A SYSTEM + 152 £1750 A system as above + disk programs for 2000 item STOCK CONTROL & 2000 name MAILING LIST.

DEAL MZ-80B SYSTEM £1899 complete B system, micro, printer, dual disks, BASIC, MACHINE CODE, ASSEMBLER + 70 programs.

DEAL MZ-80B SYSTEM + 73 £2050 B system as above + 3 DISK PROGRAMS - STOCK 2000, MAIL LIST 2000, & DATA PROCESSING.

ATARI 400 £138 26K memory + 61 programs.

ATARI 800 £299 with 58K memory + 61 programs.

ATARI 810 DISK UNIT £259 with 61 programs.

BASIC CARTRIDGE for above ATARI 400 9 ATARI 800 micros £33.90.

All prices exclude V.A.T. but include 48hr U.K. Securicor delivery.
No surcharge on ACCESS or VISA.

This is our 9th year of selling Sharp without ever having charged to repair a Sharp product.

Ring or write for our newsletter & software catalogue which details our 600 programs.

Scandinavian versions of our Sharp software are available at LASSEN-KNIGHT, STRANDGADE 22, 1401 Copenhagen K.

Knights Computers

108 Rosemount Place, Aberdeen Tel: 0224 630526

VicOdden's of London Bridge

New Home Micro Centre now open at

6 LONDON BRIDGE WALK LONDON S.E.1 Tel: 01-403 1988

NOW IN STOCK

**ORIC ● DRAGON ● LYNX
COMMODORE 64 ● ATARI 800
and more!**

Plus a wide range of
SOFTWARE—all at super
LOW prices.







We are SPECTRUM members and can supply all the items featured in the SPECTRUM advertisement in this issue, if not out of stock, over the counter or via our mail order service. Please phone for further details.

WE ARE HERE



ENGLISH SOFTWARE

WE MAKE CONCEPT REALITY!

-  concept evaluation
-  creative development
-  program assistance
-  multi-system formatting
-  6 month development plans

If you write videogame programs in 16K machine for Apple,* Atari,* IBM, PC, Commodore 64, NEC or any other major system, learn how to make your concept **reality!**

The English Software Company

IN THE USA

P.O. BOX 3185
REDONDO BEACH
CALIFORNIA
90277
(213) 372 3440

IN UNITED KINGDOM & EUROPE

50 NEWTON STREET
PICCADILLY
MANCHESTER M12EA
ENGLAND
(061) 236 7259



Please include all documentation with demo submissions

ENGLISH SOFTWARE
MAKING CONCEPT REALITY!

Watford
COMPUTER
PLUS



Turn to Computer Plus

Official **BBC** Referral Centre

SPECIAL PRICE PRINTERS! (LIMITED PERIOD)

EPSON — the most popular printer in the world.

MX 100F/TIII £425

★★ The new FX80 at £375 ★★

SEIKOSHA — low cost, high quality printer. GP100A £189, GP250X £239

MONITORS — 12" Sanyo £69, 12" Kaga RGB £259, 14" Microvitec £269

SOFTWARE — Acornsoft, BBC, Bugbyte, etc. Computer Concept's

WORDWISE word processor (£39) on demonstration (reviewed Beebug Dec. 82)

PLUS — BBC models A and B, disc drives, upgrade kits, joysticks, accessories, books, magazines, etc. *All prices exclusive of VAT*

Computer Plus

47, Queens Road, Watford. Telephone WATFORD 33927

LONDON COMPUTER CENTRE



ACT Sirius 1

1.2 Mb Disk Storage £2395
2.4 Mb Disk Storage £2895

Now available
Z 80 CP/M Add-on board
to run all CP/M 8 bit or
16 bit software

NEW

**Sirius
Hard Disk 10 Mb
Available Now! £3995**

Wordstar Magic Wand Spellbinder
Spellstar D Base II T/Maker Calcstar
Milestone Datastar Microstar
Fortran Cobol Pascal or any CP/M
software

NEW



EPSON QX10

the revolutionary
small Business
Computer

CP/M 2.2
196K RAM
£1730

TELE-VIDEO SINGLE-USER TO MULTI-USER



Sales



Invoice



Purchasing

806/816

Word Processing

Payroll

Nominal



CP/M Software

Wordstar **£195**
Spellstar **£130**
Grammatik **£65**
Foot Note **£75**
CPM/IBM **£99**
CPM/DEC **£99**
T Maker II **£150**
D Base II **£395**
Autocode **£120**
Milestone **£195**
Task **£195**

NEW

EPSON FX-80
160 CPS

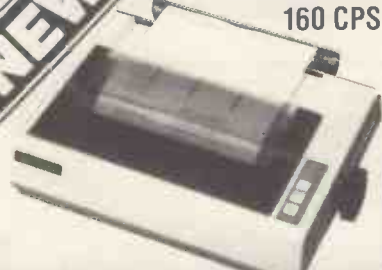

EPSON HX20
the Portable
Computer £402



NEW

**New Superbrain 2
from £1595**
Dedicated Wordstar Keypad



**AUTO SHEET
FEEDER £580**
New! 12" Wide
Automatic
Sheet Feeder
fits all below



NEW

AUTHORISED TANDY DEALER
11 Mb Hard Disk model 11/16
runs CP/M & TRS DOS £1895

Model 16
128K
from £3129

Model II
with TRS DOS
and CPM at
no extra charge
from **£1995**

Model III
16K **£599**
48K **£649**
48K with 2 disk
drives **£1395**



**DAISY WHEEL
PRINTERS
LETTER QUALITY
PRINTING.**



FLOWRITER RP 1600 60 CPS
£1500.

TEC 40. 40 CPS
JAPANESE DIABLO 630 uses Diablo
Daisy Wheel & Ribbons **£1135.**
TEC F1500 25 CPS **£590**



MacCombo

System 1.5 £1695 complete
Televideo 950 type terminal,
1.5 Mb Disk Storage
4 RS2343, Centronics Port.
CP/M 2.2 Z80A (4Mhz)

OPTIONS: Additional 2 Drives =
3Mb Storage 10Mb Hard Disk.
8" Drives Available.

HARD DISKS

for Superbrain,
TRS 80 Model II, Apple

Model 6 6 Mb Formatted **£1595**
Model 12 11.5 Mb Formatted **£1895**
* Specially designed Hybrid
heavy duty power supply
* Data Error Recovery



All prices are Exclusive of VAT and Delivery. Dealer Enquiries invited on all Products.
Large range of CPM Software available. Please phone for Prices.

Demonstrations on all models.

43 GRAFTON WAY, LONDON W1P 5LA (Opposite Maples)
OPENING HOURS: 11-7 MON-FRI 12-4 SAT Tel: 388 6991/2
24 hour answer phone: 01-388 5721



CYBER 3 ROBOT

£650 plus VAT

The Cyber 3 robot has been developed for the educational and light industrial market. It has been designed to meet the requirements for a robot which will emulate, in behaviour and physical attributes, larger industrial robots.

Constructed in black satin anodised aluminium and driven by stepping motors. The arm can access 350 degrees, with a reach of 50 cm and a lift of 250 gm.

Now featuring FORTH driven software; increasingly recognised as the robot language for simplicity and ease of use. Free FORTH compiler provided.

The Speakeasy

A low cost speech synthesizer complete with VOTRAX speech output chip, unlimited vocabulary, power supply, speaker and case all for only **£89** plus VAT; p&i: £2.50.



For further information contact:

CYBER ROBOTICS LTD
61 Ditton Walk, Cambridge.
Tel: CAMBRIDGE (0223) 210675.

FOR BBC MICROCOMPUTER

Software

FORTH ROM & documentation **£34.72 + VAT**
Manual (for newcomers to FORTH) ... **£6.75**
STATISTICS PACKAGE **£19.75 + VAT**
(on 5¼" Disc)

Hardware & Accessories

TORCH drives & operating system ... **£780.00 + VAT**
Printers, drives etc (please phone for quote)

FOR EPSON HX20

Software

FORTH ROM + documentation **£34.72 + VAT**
(Manual available shortly)

Hardware & Accessories

EXPANSION UNIT, USV Interface etc
..... Please phone for quote

COMING SOON FOR BBC MICRO

FORTH FLOATING POINT EXTENSION (ROM)
COMPUTER AIDED LEARNING PACKAGE

OTHER MACHINES:

Dragon 32, Colon Genie, Apple, SWTPc

H.C.C.S. Associates

533 Durham Road, Low Fell
Gateshead, Tyne & Wear NE9 5EY
Tel: (0632) 821924



PROGRAMS FOR THE DRAGON 32

SULTAN'S MAZE by Christopher Hunt.

Enter the 3D Maze in search of the Sultan's jewels, but beware, your strength may run out, or, you may come face to face with the Mad Guardian. A multi-difficulty game with fantastic graphics and sound.

Price £7.95

EDUQUIZ I by Peter Chase.

Three great educational quiz games. Bet on the answer of your choice and be a winner! Eduquiz makes learning fun! On this tape, improve your knowledge of . . . Geography, Inventors and their inventions and the Kings and Queens of Great Britain.

Price £9.95

EDUQUIZ II by Peter Chase.

Three more subjects in the Eduquiz series. This tape helps you learn about . . . Writers, Painters and Musicians.

Price £9.95

FUNMATHS I by Peter Chase.

Improve your maths while you play these five great games! In Number Race you must beat the computer, or a friend, to exactly 100 by eating the numbers. Maths Maze asks questions as you work your way around the maze. Chemist is a game of ratios, where you mix two chemicals, trying not to get blown up! Dragon exercises your skill at expressing coordinates - you have to find the Dragon, hidden in a grid. Last, but no means least, Simon tests your memory for tunes/colours/numbers.

Price £9.95

GEMPACK IV by W.E. MacGowan.

Two great machine code games, with full colour graphics. In Sea Harrier you must land your plane on the aircraft carrier, after dispersing the clouds with chemical bombs, but don't hit the ship! In Sub Chase you must depth charge the wolf pack without being sunk. Both with 4 levels of play from easy to kamakaze!

Price £7.95

ALIEN BLITZ by Peter Chase.

Your craft is running low on fuel and you must land! You have to use your bombs to clear a space amongst the skyscrapers, but beware of craters! A superb multi-level action game for the Dragon, with superb sound and graphics.

Price £7.95

LYNX PROGRAMS

Please write or phone for details. All available by mail order from:

GEM SOFTWARE

UNIT D, THE MALTINGS, SAWBRIDGEWORTH, HERTS.

Telephone: (0279) 723567

TRADE ENQUIRIES WELCOME - PLEASE RING FOR DEALER PACK

LONDON COMPUTER CENTRE

8/16 Bit Software with Support

The comprehensive range includes
Wordstar **£235** D Base II **£325**
Supercalc **£125**

Word processing

SPELLBINDER, Magic Wand, Spellstar,
Proofreader, Grammatik.

Financial Planning

Calcstar, Multiplan, Plannercalc.

D Base Corner

Autocode, Quickcode, D Base Window, D Names.

Languages

Basic 80, Basic Compiler, Fortron, Cobal,
Cis Cobal, Pascal.

Communications

Bstam, Crosstalk, Move It.

Utilities

Sid, Z Sid, Mac . . . and lots and lots more.

Formats

Superbrain, Tele-video, Sanyo, Epson,
Northstar 8" SD, Osborne, Sirius, IBM, Dec.

All prices are exclusive of VAT

For the LCC Software Price List

Tel: 01-388 6991

Software



43 GRAFTON WAY, LONDON W1P 5LA (Opposite Maples)
OPENING HOURS: 11-7 MON-FRI 12-4 SAT Tel: 388 6991/2
24 hour answer phone: 01-388 5721

AT THESE PRICES YOU CAN SWITCH OVER TO A PROFESSIONAL VIDEO MONITOR

PHONE FOR LATEST LOW PRICES

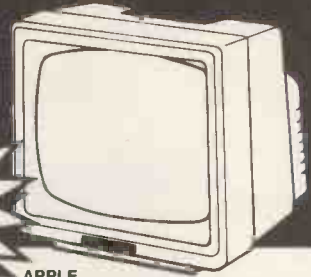

There is a Kaga monitor suitable for use with your system, be it an Apple, Commodore, BBC Acorn, Osborne, Tandy, NEC, Sharp or any other popular micro.

MONITORS

■ High-res. 12" B/W inc. Cable	£86
■ High-res. 12" Green inc. Cable	£96
■ High-res. 12" Amber inc. Cable	£112
■ 12" RGB Colour Monitor (med. res.)	£225
■ 12" RGB Colour Monitor (high res.)	£275
■ 12" RGB Colour Monitor (super high res.)	£350
■ Apple II or IIE RGB Card + Cable (pls. specify)	£75
■ RGB Cable for Apple III/IMP P/C/BBC (pls. specify)	£9

EPSON PRINTERS

FX80 Printer	£375
MX100 Type III Printer	420
RS232 Interface	30
RS232 Interface with 2K Buffer	53
Serial Interface Type III	60
IEEE - 488 Parallel Interface	37
Apple Interface (Non-Graphics) + Cable	49
Apple Interface (Graphics) + Cable	57
TRS80 Interface	22
Ribbon for MX80/82 Series	5
Ribbon for MX100 Series	9

CENTRONICS PRINTERS

SPECIAL OFFER 737-2 Parallel (Brand new, sealed and boxed without warranty)	215
---	-----

737-2 Parallel (with warranty)	299
1 Cartridge Ribbon for 150/152	4
1 Zippack Ribbon for 737/739	3

PRINTER INTERFACE CARDS

Centronics parallel printer interface (inc. cable)	69
--	----

ANADEX PRINTERS

DP9000A/DP9001A/DP9500A/DP9501A - Serial/Parallel	995
Graphics Printers (pls. specify model)	1065
DP9620A Serial/Parallel (Graphics)	13
Ribbon for DP9000/9500 Series	

PRINTER INTERFACE CARDS

Parallel Interface card with graphics dump firmware (inc. cable)	69
Anadex parallel printer interface card with screen dump firmware (inc. cable)	128

WALTERS PRINTER - BRITISH MADE

120 - Parallel	310
----------------	-----

INTEGREX COLOUR PRINTERS

CX80 Colour-Parallel	707
Apple II Interface Card	88
CX80 Colour - RS232 Serial	767
CX80 Colour - IEEE	755
CX80 Colour - RS232 3.7K Buffer	830

SMITH CORONA DAISY WHEEL PRINTERS

TP1 Daisy Wheel Printer - Parallel	400
TP1 Daisy Wheel Printer - Serial	400
IEEE Interface Box for TP1	67

APPLE INTERFACE CARDS AND ACCESSORIES

MC 8-Slot Expansion Chassis	396
Clock Calendar Card	149
Ramex 128K Memory Card	245
Ramex 16K Memory Card	64
Videx 80 Column Card	200
Omnivision 80-col Display Card	180
SUP'R Terminal Card	185

PRINTER INTERFACE CARDS

Printer installation kit for Apple II or III (pls. specify)	87
CCS Serial Printer Card for Apple II	113
CPS Multifunction Card for Apple II	140
CPS Printer Cable for Apple II (pls. specify)	16

DEMONSTRATION/TRANSIT CASE

For Apple + 2 disc Drives	55
---------------------------	----

Terms of business: Cash/cheque/POS with order
P&P: Interface cards and ribbons - per unit £1. Printers, monitors and cases - per unit £6
VAT: All prices are exclusive of VAT. Please add 15% to the total cost including P&P. Goods damaged in transit will be replaced FOC.

Please send me the following goods:

707	_____
88	_____
767	_____
755	_____
830	_____

Total (inc. P&P) _____ 15% VAT _____
 I enclose cash/cheques/POS for sum of _____

Name _____
 Address _____

PCW/5/83

AIMGRAM

Aimgram Ltd 31 Roman Gardens
 Kings Langley Herts WD4 8LG Tel: Kings Langley

(09277) 68211

POSTAGE & PACKING FREE IN THE U.K.

CDS

DIRECT MAIL

COMMODORE 64

74 PORTLAND ROAD, SOUTH NORWOOD, LONDON SE25

- * COMMODORE 64 **£299.00** inc. VAT!
- * DISK DRIVE 1541 **£269.00** inc. VAT!
- * VIC GRAPHIC PRINTER **£199.00** inc. VAT!
- * CASSETTE DECK **£39.99** + VAT!

- EASY SCRIPT Disk (64 word processor) **£75.00**
- CALC RESULT Disk (64 spread sheet) **£108.00**
- PAL 64 Disk (Assembly language) **£78.00**
- POWER Disk (Programmers aid) **£78.00**

- COMMODORE 64 SOFTWARE CASSETTES
- MONOPOLE **£9.99**
- ALIEN PANIC
- CAVERN RUN
- KRAZY KONG
- PAKACUDA
- CENTROPODS

COMING SOON!
 DEFENDER 64, NIM
 AND MANY MORE



TELEPHONE OUR HOTLINE
01-656 8941

CHEQUES PAYABLE TO CDS LTD

THE TEXAS PROGRAM BOOK

Vince Apps

35 programs for games, home and business use with the TI 99/4A £5.95

Written for the home user these games are both fun and educational.

Now you can enter a 3D maze, run a horse race, and even help a Penguin to save it's eggs. You can test your skills with anagrams, do metric conversions and run your own filing system and home accounts.

Available through bookshops everywhere or cheque or p.o.

Orders to

PHOENIX PUBLISHING ASSOC

14 VERNON ROAD BUSHEY
HERTS WD2 2JL

Price £5.95 plus 50p post.

NAME.....
ADDRESS.....
.....
.....post code.....

AT LAST

COMPUTER BONANZA!

COMPUTERS
AT UNBEATABLE PRICES



EPSON HX20

Portable Computer	All prices + VAT
With carry case	£385.00
Without carry case	£380.00
Micro-cassette Drive	£71.50
1 Year Guarantee Parts and Labour.	



All prices + VAT	
ACT SIRIUS 1 128K with 1.2mb S/S Disks	£2025
ACT SIRIUS 1 128K with 2.4mb D/S Disks	£2525
ACT SIRIUS 1 128K with 1.2mb D/S Disks and 10mb Winchester	£3975
10mb Hard Disk	£2525
128K Extra Memory	£340
384K Extra Memory	£775



90 Days Guarantee Parts and Labour.
Add £3.00 to delivery charge for system.

Payment by Cheque, Access, Visa etc.
All prices Apply to 31st March 1983.



IMMEDIATE DELIVERY.

Shipments throughout UK by TNT. We can export to most countries in the world. Please phone for Access or Visa buying details.

Micro-Spares

We cannot and will not be beaten on Price!

Note our change of address
104-106 Hanover Street, Edinburgh EH2 1DR
031-226 3345

APPLE ADVENTURES — £13.95 ALL INC!

TRADE ENQUIRIES WELCOME
ADVENTURE SERIES NO 1

THE WHITE BARROWS — Program approximately 8K

Somewhere amid this maze of burial chambers lurks an Evil Sorcerer whom you need to trap. Trouble is, he's protected by Trolls, Dwarves, Serpents and the occasional Dragon or two! Your magic staff will block the tunnel to prevent him escaping... unless, that is, he outwits you.

A real brain twister, White Barrows requires both brains and brawn from its players. It's no good just hacking your way through the Barrows and hoping to fall over the Sorcerer. Eventually you'll meet a Dragon — and they don't hack easily! You'll need all your cunning and strength to survive this one for long.

CONQUERING EVEREST — Program approximately 11k

So, you think climbing mountains is all about scrambling over rocks? This superb piece of programming will soon change all that!

You are in charge of an expedition comprising 18 climbers, 34 Sherpas and 40 Porters. There is food, tents and equipment for all, including the oxygen you'll need as you near the summit. Trouble is, it all starts at the BOTTOM of the mountain and you have to get it all to the TOP! Each route upward must be forced and any camp you make must be properly supplied, otherwise the expedition members will retreat down the mountain.

The monsters in this game are avalanches, starvation, storms and worst of all, bad planning! A real thinking man's adventure, Everest will test your skill and forward planning to the limit.

TWO MASSIVE ADVENTURES ON ONE DISC FOR JUST £13.95 ALL INCLUSIVE!

ADVENTURE SERIES NO 2

CELLS & SERPENTS — Approximately 11K

More monsters than you ever thought could fit behind your keyboard. Wander the hills in search of gold and glory but be very, very careful where you tread!! There are things here that make your wildest nightmares look like Julie Andrews. Fancy meeting a Mind Flyer for example? Or shaking hands with an Asmodeus maybe? (You'll only do that once!) Treasure is here to be found... the hard way!

See how good you really are at Adventure with this practically unsurvivable fantasy. Not for the faint of heart or the slow of sword.

STOCKMARKET — Approximately 11K

There are other ways of making money than bashing Troils on the head. Try this one for a change. Contend with a fluctuating economy, tax investigations, bullish opponents, impatient bank managers and consortium takeovers as you try to make your first million.

It is decidedly difficult and definitely compulsive. A must for all those aspiring financial wizards, both young and old. Easy to play but harder to beat than a Dragon. Up to six players can join in too.

BOTH GAMES ON ONE DISC FOR £13.95 ALL INCLUSIVE!



Fill in the coupon and return it to: ASP Software,
145 Charing Cross Road, London WC2H 0EE.

Please send me . . . tape(s) — (delete as necessary)
of for (state which version required).
I enclose my cheque/Postal Order/International Money Order
(delete as necessary) for: (made payable to ASP Ltd)
OR Debit my Access/Barclaycard (delete as necessary)





Please use BLOCK CAPITALS

Name (Mr/Mrs/Miss)

Address

Signature

Date

Please allow 28 days for delivery



CRYSTAL RESEARCH LTD

XTAL BASIC 3

A Z80 based Interpreter. Disc and Cassette versions including CP/M are available now or in the near future.

FEATURES

- Has over 110 Commands and Functions and is user extendable.
- Xtal BASIC 3** incorporates its own editor that is independent of VDU or terminal being used but appears to have the facilities of the most sophisticated direct screen editing, in brief the editor contains the following:
Lines of 127 characters (can be extended up to 254)
Full on screen editing, up, down, left, right.
Auto insertion of lines.
HOME CURSOR, CLEAR SCREEN, DELETE LEFT, DELETE RIGHT, INSERT CHARACTER, ERASE WHOLELINE, ERASE TO END OF SCREEN, PRINT SCREEN CONTENTS TO PRINTER, and ABANDON LINE. A LINE EDIT MODE IS INCLUDED AS STANDARD.
- Variables can be of any length. First five characters used to distinguish one variable from another. Multi-dim arrays, string arrays and integer arrays.
- Full Tape and Disc file handling.
- 32 standard error messages and traps. Ability to trap **BREAK KEYS**. Error table is extendable.
- Possible to run programs larger than memory capacity.
- Special features allow transfers of programs from machine to machine.
- Xtal BASIC 3** is designed to be compatible with most available BASICS and a program is supplied for many BASIC to BASIC conversions.
- The manual, consisting of over 100 pages, includes full description of the BASIC, sample programs, useful Machine Code Subroutines in Xtal BASIC 3, examples of extra commands and functions.
- SIZE 12K to 14K** depending on the System.
- Available on **Cassette** and/or **Disc**. Please contact Crystal Research Ltd., for availability on your particular machine.
- On Cassette **£40.00 + VAT** On Disc **£60.00 + VAT**
OEM and Manufacturers are invited to contact Crystal Research Ltd., for licence details.

Open 0930-1200 1300-1730 except Saturday & Sunday
40 Magdalene Road, Torquay,
Devon, England Tel: 0803 27890
Access and Barclaycard



SINCLAIR AND ORIC COMPUTERS

UK prices are shown first. The bracketed prices are export prices which include insured air-mail postage to all the countries of Europe including Norway, Sweden, Finland and Denmark. For overseas customers outside Europe an extra £5 postage per item is charged. Oric 1 48K computer £147 (£158). zx81 £43.43 (£52). zx printer £52.13 (£61). zx spectrum £108.70 (£129). zx spectrum 48K £152 (£172). 32K memory upgrade for 16K spectrum (issue 2 only) £44 (£45). zx microdrive n/a (n/a). zxs232 n/a (n/a). 5 printer rolls £10.43 (£16). zx81 ram packs:- 16K £26.04 (£28), 64K £49 (£51).

DRAGON 32 £173

COMMODORE COMPUTERS

Commodore 64 £299. Vic 20 £130. Kit to allow the use of an ordinary mono cassette recorder with the Vic 20 and the Commodore 64 £6. Commodore cassette recorder for these computers £36.50. Super expander high resolution cartridge £27.95. We stock most accessories.

BBC MICROCOMPUTERS

A Model £260. B Model £347.

GENIE COMPUTERS

New colour Genie £179. cassette recorder £25, 16K ram card £33. Light pen £15. Accessories for Genie 1 and Genie 2:- EG3014 32K £189. Disc drives single £199, dual £369. Double density convertor £72. High resolution graphics £82. Printer interface £36.

UK101 AND SUPERBOARD

32 x 48 display expansion kits UK101 £9, Series 1 Superboard £14, 32K memory expansion board £60. Cegmon £22.50. Word processor prog £10. Centronics interface kit £10. Cased disc drives with DOS single £275, double £415. Stand alone floppy disc controller £85.

ORIC-1 48K COMPUTER £147.78



PRINTERS

Low cost Daisy Wheels - Smith Corona TP1 £418, Brother HR1 £520. Olivetti Praxis 30 Byewriter: the latest miracle, a combined daisy wheel printer and electric typewriter for only £418. Epson FX80 £387. Epson MX 100/3 £425. Oki Microline 80 £199. Oki Microline 82A £343. Oki Microline 83A £467. Oki Microline 84 £684. Oki Microline 92 £437. Oki Microline 93 £599.

5V POWER KITS

Fully stabilized 5V computer and TTL power kits. 1.5A £7.83, 3A £12.17, 6A £20.87.

SHARP COMPUTERS

We can supply Epson printers to run direct from the MZ80A and MZ80K (i/o box not needed) for £72 plus printer price. We also specialize in interfacing printers to the MZ80K, MZ80A and MZ80B both with and without the i/o box.

Postage £1 on Sinclair products (UK), £3.50 on other computers, £4.50 on printers and 50p on other orders. Please add VAT to all prices. Official credit and overseas orders welcome.

SWANLEY ELECTRONICS

Dept PCW, 32 Goldsel Road, Swanley
Kent BR8 8EZ

Tel Swanley (0322) 64851

GREAT BRITISH SOFTWARE OFFER

£50 FREE SOFTWARE WITH EACH MODEL AD

NEW BRAIN PURCHASED AT

£299 (including VAT) (ADD £3 SECURICOR DELIVERY)

Order Code	Title	Price	Avail-able	Order Code	Title	Price	Avail-able	Order Code	Title	Price	Avail-able	
GAMES				HOME APPLICATIONS				UTILITIES				
BS 001	WORMS	9.95	NOW	BS 002	DIARY	12.50	NOW	BS 006	PAGES WORD PROCESSOR	42.00	NOW	
CS 001	MINER	10.00	NOW	BS 003	DIRECTORY	12.50	NOW	EC 003	WORD PROCESSOR	42.00	NOW	
DW 001	SUPAWARI/FOURSQUARE	10.00	NOW	BS 004	TELEPHONE	12.50	NOW	EC 004	DATABASE	31.50	NOW	
DW 002	THE ORACLE	10.00	NOW	EC 001	HOME EXPENSES	23.95	NOW	GB 013	GRUNDY DATABASE	31.50	SOON	
DW 003	BATTLESHIPS/THE TRIAD GAME/BIORHYTHM ANALYSIS	10.00	NOW	EC 002	ADDRESS BOOK	29.95	NOW	KC 016	FILE MANAGER	27.00	NOW	
DW 004	HANGMAN	10.00	NOW	GB 006	HOME BUDGET	12.00	NOW	KC 017	TINY WORD WORDPROCESSOR	29.00	NOW	
DW 005	JUNIOR HANGMAN	10.00	NOW	GB 007	PERSONAL INFORMATION MANAGEMENT SYSTEM	55.00	SOON	KC 018	DISASM/DISASSEMBLER	17.00	NOW	
DW 006	WORDFIND	10.00	NOW	GB 008	FREEZER/BIRTHDAYS	7.00	SOON	KC 019	MCMON MACHINE CODE MONITOR	17.00	NOW	
DW 007	JUNIOR WORDFIND	10.00	NOW	GB 009	FRENCH VOCABULARY	7.00	SOON		BUSINESS APPLICATIONS			
DW 008	MINI WORDFIND/MINI HANGMAN	10.00	NOW	GB 010	GERMAN VOCABULARY	7.00	SOON	BS 007	PRICE LIST	12.50	NOW	
DW 009	MASTERFIND	10.00	NOW	GB 011	INCOME TAX	TBA	MAY	EC 005	INVOICE & CREDIT NOTE	If bought together deduct 69.95	NOW	
DW 010	ANTONYMS + SYNONYMS/MINI SPELLING TEST	10.00	NOW	GB 012	PERSONAL INVESTMENT MANAGER	TBA	MAY	EC 006	INVOICE & CREDIT NOTE REVIEW	£12.50 from total	27.50	NOW
GB 001	TYCOON/PELMANISM	12.00	NOW	KC 007	CARD INDEX	35.00	NOW	EC 007	SALES LEDGER	76.00	NOW	
GB 002	QUADRAX/SPACE BATTLE	12.00	SOON	KC 008	KINGS & QUEENS QUIZ	17.00	NOW	EC 008	STOCK CONTROL	38.00	NOW	
GB 003	OTHELLO/BLACKJACK	TBA	MAY	KC 009	FRENCH VOCABULARY + DATABASE	10.00	NOW	EC 009	CUSTOMER INFORMATION FILE	38.00	NOW	
GB 004	ORAFTS/BACKGAMMON	TBA	MAY	KC 010	FRENCH VERB + DATABASE	10.00	NOW	EC 010	BANK & CASH BALANCE	34.00	NOW	
GB 005	CHESS	TBA	MAY	KC 011	FRENCH CONJUGATE	10.00	NOW	EC 011	INVENTORY	35.00	NOW	
KC 001	GOBLER	10.00	NOW	KC 012	FREEZER CONTROL	13.00	NOW	EC 012	MAILING LIST	34.00	NOW	
KC 002	STARTREK	10.00	NOW	KC 013	HORSE RACE FORECAST	29.00	NOW	EC 013	PRODUCT COSTING	27.50	NOW	
KC 003	BOUNCER	10.00	NOW	KC 014	FOOTBALL FORECAST	29.00	NOW	EC 014	SALES ANALYSIS	78.50	NOW	
KC 004	GLOCK HIM IN	10.00	NOW	KC 015	MCD MULTIPLE CHOICE OBJECTIVE QUESTIONS	10.00	NOW	EC 015	INVENTORY ANALYSIS	28.50	NOW	
KC 005	MASTERMIND	10.00	NOW		UTILITIES			EC 016	BUSINESS RATIO: for investment, sales, turnover etc.	23.50	NOW	
KC 006	COMMODITY TRADER II	10.00	NOW	BS 005	WORD WORKER	29.95	NOW	EC 017	CALCULATE FOR COSTING, BIDDING (with mark-up)	32.50	NOW	
								EC 018	TWO PROGRAMS - Mortgage repmts + prop. invment	25.50	NOW	
								EC 014	MONTHLY ACCOUNTS (Inn VAT)	31.50	SOON	
								KC 020	AGRICULTURAL FIELD COSTING	35.00	NOW	
								KC 021	DENTISTS NHS SCHEDULE	35.00	NOW	

MAIL ORDERS: ADD 50p P&P EACH CASSETTE



SOFTWARE AGENTS LTD

(ALL PRICES INCLUDE VAT)
10 Eastfield Parade
Forbes Avenue, Potters Bar
Herts. EN6 5ND
Potters Bar (0707) 59404

Executive Software Club

Choose software the easy way —
Try it first!

- ★ Try software for two weeks before deciding whether to purchase.
- ★ If you buy, the rental is entirely free of charge — *you can't lose!*
- ★ Huge catalogue of the best software available. Examples include dBase II, Micromodeller, Microplanner, Wordstar, Format 80, Visicalc, Multiplan etc.
- ★ Hardware currently supported: Apple IIe, Apple II, Sirius 1, IBM PC, Victor 9000 and most CP/M Formats.
- ★ Membership of the Executive Software Club costs just £30.00 p.a.
- ★ Large range of hardware also available on short or long-term rent — including the amazing Epson HX20 portable micro.
- ★ Write or telephone for free catalogue.

Call us now — 01-739 5889

The Executive Software Club
350/356 Old Street, London EC1Y 9DI

PRINTER BONANZA!

EPSON

PRINTERS AT UNBEATABLE PRICES



MX 80 FT III

Total Price
Product discontinued by EPSON,
none available in UK

MX 82 FT III

Product discontinued by EPSON

MX 100 FT III

£399 + £59.85 VAT **£458.85**

Interfaces to any machine supplied — please ask for price
STOP FLASH: The new FX80FT £385 + VAT. EPSON's new 160 CPS Printer that beats the MX80 hands down.
STOP FLASH: N.E.C. 8023 £307.00 + VAT



All printers carry a 1 Year Guarantee and come with paper. Shipment is by TNT Overnight Express to your door — Please add £7 + VAT carriage.

Payment by Cheque, Access, Visa etc.
All prices Apply to 31st March 1983.



Shipments throughout UK. We can export to most countries in the world.

Please phone for Access or Visa buying details.

STOP FLASH: N.E.C. 8023 £307.00 + VAT

IMMEDIATE DELIVERY.

Micro-Spares

We cannot and will not be beaten on Price!

Note our change of address
104-106 Hanover Street, Edinburgh EH2 1DR
031-226 3345

THE

VALLEY

© ASP LTD 1982



What are you... Barbarian or Wizard?

Choose your character type carefully... Barbarians recover quickly but their magic doesn't come easily. A Wizard? Slow on the draw and slow to mature...but live long enough and grow wise enough and your lightning bolts are almost unstoppable...

The Valley is a real-time game of adventure and survival. You may choose one of five character types to be your personal 'extension of self' to battle and pit your wits against a number of monsters. Find treasure, fight a Thunder-Lizard in the arid deserts of the Valley, conquer a Kraken in the lakes surrounding the dread Temples of Y'Nagoth or cauterise a Wraith in the Black Tower. In fact, live out the fantasies you've only dared dream about. **BUT BEWARE...** more die than live to tell the tale.

You've read the program (Computing Today — April '82 ... Now buy the tape. Tape versions (£11.45 each inc P&P and VAT) available for: ZX Spectrum (48K), Atari 400 and 800 (32K) Dragon, Tandy TRS-80 Model 1 Level 2, BBC Model A and B, Sharp MZ-80A, Sharp MZ-80K (18K), VIC-20 (with 16K RAM pack) and PET (New ROM, 16K RAM minimum). Disc version (£13.95 each inc P&P and VAT) available for: Apple II (DOS 3.3), Sharp MZ-80A, Sharp MZ-80K and PET 8032 (8050 drives). Full instructions are included with the game, but if you want more detail on the program, a 16 page reprint of the original 'Computing Today' article is available at £1.95 all inclusive.

Fill in the coupon and return it to:

ASP Software,
ASP Ltd,
145 Charing Cross Road,
London WC2H 0EE

and become one
of the many to play...
The Valley...

Please send me the following versions of
The Valley Tape @£11.45 all
inclusive of P&P and VAT.
Disc @£13.95 all inclusive of
P&P and VAT.

Please use **BLOCK CAPITALS**

NAME(Mr/Mrs/Miss)

ADDRESS

POSTCODE

Signature

Date

Please allow 21 days for delivery

TRADE ENQUIRIES WELCOME

**DRAGON AND VIC A
VERSIONS NOW
AVAILABLE!**

ADVERTISERS INDEX

Angela Enterprises	30	Datalink	255	Jayman Electro Services	23	Prospero Software	75
Albetros Ltd	93	DJ AI Systems Ltd	251	Jupiter Cantab	237	Personal Computer News	256/257
Akhtar Instruments	200/201	Digital Research	175	A & G Knight	336	Quantum	272
Acorn Soft	278	Dark Star Systems	299	KGB Micros	182,202	RMS Ltd	323
Audio Computers	IBC	Davinci Computer Shop	244	Kent Microsystems	247	Rhône Poulenc	250
Aqua Computing	69	DRG Peripherals	276	Kasad Data Services	323	Rair	33,37
Ashton Tate	38/39	Datarite	314	Keyboard Hire Ltd	247	Rade	147
Amber	253	DRG Business Machines	277	Key Computer Centre	263	Research Machines	57
Act Computers	44/45/46/47	Data General	268/269	Kuma	213	Response Marketing	295,303
Access Data, Communications	95	Digitus Ltd	1	Linsack	333	Swanley Electronics	342
Acorn Peripherals	130	Digisolve	142	Level 9 Computing	333	Sirton Computers	271
AM Electronics	287	Duplex Communications	262	Lowmax	333	Soft Option	254
Atari	304	Deans of Kensington	12	Lifeboat Associates	31	Stirling Micro Systems	325
Almarc Data Systems	289	Death Valley Computers	141	London Micro Systems	5,13,17	Small Systems Engineering Ltd	252
Apple Takeaway	54	Delta Systems Ltd	91	London Computer Centre	339	Software Ltd	116
Algray	294	Displays Electronics	275	Lazerbug	322	Systematic Business Computers	97
Aimgram	340	Datastream	309	Lasky's	326/327	Sinclair Research Ltd	40/41
Apple Orchard	22	Dragon Data	264/265	Leicester Computer Centre	68	Silicon Valley	9
Anagram Systems	142	Digital Solutions	88/89	L&J Computers	86	Sir Computers	94
Abbox Electronics Ltd	98	Dams Business Computers	17	Lowe Electronics	312/313	Sunshine Books	249
Algotek Computer Company Ltd	85	Delham International Ltd	14	Magus Computer Systems	334	Shadow Data (Feitchcrest)	310
Appropriate Technology	296	Emap	260/261	Med	333	SPT Electronics Ltd	8
Argus Specialist Publications	206,291,341,343	Eltec	244	Microvalue	316/317	Softek	332
Business & Leisure Microcomputers	242	Elstree Computer Centre	332	Maplin	262	Silica Shop	96
Brighton Computer Centre	78	Electroniquequip	323	Microcomputer Products	243	Sord Computers	287
Beebug	59	Epson	55,63	Micro Marketing International	90	Simmons Magee Computers Ltd	92
Bits & PC's	302	Electronic Aids	329	Microage Electronics	282,319	System Science	236
BIS Applied Systems	246	EDC Photonic	291	Map 80 Systems	236	Sirtel	273
Brainwave Software	87	Executive Software Club	343	Microcentre	236	Spectrum	18/19/20/21
British Micro	72/73	Fuller Micro Systems	315	Microtek	331	Sapphire Systems	81
Basic Concepts	330	Flight Link Control Ltd	319	Micro General	14,318	SGS Software	16
Book Choice	240	Fraser's	59	Micro Pute	74	Stage One Computers	150
Bonsai	177	Foilcade Ltd	140	Microtechnology	66/67	Stack Computers	321
Bunch Books	306/307	Financial Director Software Ltd	32	Metacrafts Ltd	253	Sparrow Computer	10
Binders	305	Grama Ltd	292/293	Moviescope Ltd	69	Smith's Sample Cases	109
CJE Microcomputers	242	Gradepoll Ltd	331	Midelectron	28/29	Trionic Ltd	325
Comptodata	34/35	Gemini Marketing	24/25	Microperipherals	132	TDI Ltd	274,297
Cambridge Processor Services Ltd	206	Gemini Books	120	Marlowfield Ltd	322	Tridata Micros	58
C/WP	189,191,193	Gemini Microcomputers	48	Micromail Ltd	329	Techneg-Clwyd Technics Ltd	245
Century Books	259	Grundy Business Systems	50/51	Micro Computer Space Drome	84	3D Computers	245
Computer Answers	290	General Northern Micro	27	MBA	62	Technomatic	70
Commodore	280/281	GTMLtd	311,318	Microspares	341,343	Tandy	56
Crown Business Centre Ltd	332	George Town	334	MST Consultants	336	Town & Country	87
Comart	60/61,248	Gemini Electronics	337	Namal Associates Ltd	95	Travel Software	93
Castle Electronics	258	Gem Software	339	Open Computer Services	252	Twilstar Computers	240
Caxton Software	140	Hal Computers Ltd	157,205	Opus Supplies	283	UTS	319
Comshare	52/53	Happy Memories	325	Oric Products International	42/43	Vision Store	95,236
Chimax Computers	330	H. Electronics	168/169	Oxford Computer Publishing	87	Vincelord Ltd	7,49
Computa Solve	330	Hawke Electronics	270	Office Efficiency Machines	23,79	Veerport	78
Cifer	82	HCCS	339	Osborne Computers	4	Viasar Electronics	129
Comcen Technology Ltd	284/285	Host Micros	309	Ozwise Computers	325	Vicodden	337
Chromasonic Electronics	128	Hantarex (UK) Ltd	288	Pinner Word Processor	325	Westrex	253
Cavendish Data Systems	340	Intelligent Intafaces	192	Pase	91	Watford Electronics	11
Crystal Research	342	Inpholink Ltd	67	Peachtree Software	36	West Computers Ltd	140
Computer Plus	337	IO Research Ltd	277	Pace	308/309	West Coast Personal Computers	329
Cumana	286	Ian Litterick Associates	147	Plus 80 Ltd	245	Xitan Systems	68,76/77
Comsoft	170	Information Unlimited Software	83	PMS Developments	322	X-Data	80,266
Croydon Micros Ltd	305	Intelligence Ireland Ltd	71	Pedro Computer Services	331	Xerox Store	300/301
Cyber Robotics	339	Inmac UK	26	Password Electronics	288	Yorkshire Microcomputers	322
Comselekt	93	Irvine Business Systems Ltd	75	Pete & Pam Computers	64/65,105,178	Zen Microcomputers Ltd	241
Cambridge Computer Store	240	Interface	279,320,323	Potter's Bar Computers	342	Zak Computers	78
Computer Games	324	Imagine Software	298	Phoenix Publishing Associates	341	Zynar	22
Cobra Technology	6			Personal Computers Ltd	OBC		
Camputers	335						

Parents can be so insensitive. A photo published recently in *Home Computing Weekly* as part of a profile on a software house is captioned 'Hugh Jarse prepares a program for dispatch to a mail order customer'. Perhaps this inauspicious name is actually a jibe by the company's employees at the expense of *HC Weekly* hacks. . . An observant soul in *PCW's* office recently drew the Editor's attention (a difficult task indeed) to a review of the Sharp MZ-80B in March 1983 *MicroIndecision*. This features a photo of the MZ-80A. What's even worse is the contents page, which refers to a review of the MX-80B. Which machine are they reviewing? . . . The Oric-1 appears, according to the company's silly brochure, to be able to run VIC software. Basically, if you look at a certain photo of two kids playing with the machine, you will notice that the screen shows a Pacman look-alike — VICmen. The Oric is even



limiting itself in the picture to 23 columns. How can Oric possibly claim there is 'no comparable competition' to their micro on the one hand, while on the other using another micro's software to advertise it? . . . And still on our latest hobbyhorse — that of simulated screen displays — we hear that the Advertising Standards Authority has brought all the might of the tepid sponge to bear by censoring Sinclair for its orange screen display in the Spectrum leaflet. Perhaps they read *PCW* too (sound of frantic nail-polishing, self-applause, etc) . . . And now the latest computer craze — skinfeld callipers. We'll refrain from saying any more because we're too shocked, but in the wake of *Fat is a*

Feminist Issue and anorexia nervosa, as well as Anna Ford's morning callisthenics, comes a keep fit program, **HELP**. You'll stay flabby while your Apple II sheds pounds of lipomatous flesh and replaces it with rippling muscle. . . *PCW's* wastebins have been absolutely clogged recently with boring press releases about Statutory Sick Pay packages. It seems that every small software house in the country has decided it is the only one to have thought of the ideas. And as the SSP system is a singularly stupid one in the first place, it's hardly news to learn that people are trying to lessen already appalling amounts of time-wasting bureaucratic paperwork by computerising it — and therefore (in many

cases) producing twice the amount of paper produced by a manual system. . . Cabin cleaners on flight PA125 on 16 March from Heathrow to San Francisco were amazed at the unusual number of copiously filled airtick bags dotted about the plane. The explanation for this lies neither in the bumpy ride nor the awful swill Pan Am distributed in place of food. Neither was it the large amounts of booze consumed in an airborne bacchanalia by the many micro industry figures on their way to the West Coast Faire. No, the blame for the cleaners' extra workload rests on the traumatic sight of Guy Kewney dressed in a sleeveless pink vest waving his armpits in people's faces. . . Finally, for those who are really 'in the know' (hard luck if you aren't), here's a naughty little puzzler for you. Who accompanied the Queen on a tour of Silicon Valley recently? Her Majesty, of course. . .

896 K BYTES WITH PARITY

AVAILABLE ON:

- VICTOR 9000
- SIRIUS I

AND SOON:

- IBM P.C.

ONE OFF END USER PRICES:

- 128K CARTRIDGE — £199 + VAT
- 384K CARTRIDGE — £384 + VAT*
- 778K CARTRIDGE — £774 + VAT*

*Normal Dealer Margin 25% available on approved accounts

THE NEW 3/4 MEGABYTE MEMORY CARTRIDGE IS HERE:

- Manufactured in the U.K.
- Full one year warranty
- Over the counter exchange
- Upgradable and uses only one expansion slot
- Parity error detection

IT'S ALL YOURS!

SEE US AT THE COMPUTER FAIR
10th-12th JUNE AT EARLS COURT IN
LONDON

STL

SOLIDISK TECHNOLOGY LIMITED

COMPUTERS PERIPHERALS MICROPROCESSOR DEDICATED SYSTEMS
Tel: (0702) 618146/613081 Trade Name: AUDIO COMPUTERS

VICTOR 9000
 SIRIUS I
 IBM P.C.

SOLIDISK TECHNOLOGY LIMITED
 87 Bournemouth Park Road, Southendon Sea, Essex. SS5 2JJ

Item	Qty	Price Inc VAT	Total
128K Memory Cartridge		£228.85	
384K Memory Cartridge		£441.60	
778K Memory Cartridge		£1.00	£ 1.00
Post and packing			
Please charge my Access, Barclay account: TOTAL £			
NAME			
ADDRESS			

*Please detach/complete as applicable P.O. payable to: SOLIDISK TECHNOLOGY LTD for: £

The chosen one.

Personal Computers

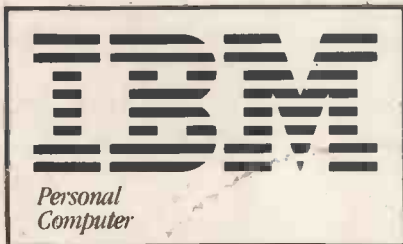

IBM Authorised Dealer

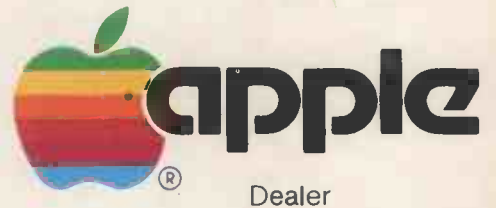

We are very pleased to announce that we have been chosen by three of the best companies to bring you their personal computer products. They think we are pretty good — why not come and see for yourself?

Personal Computers Limited, 218 & 220/226 Bishopsgate, London EC2M 4JS Tel. 01 377 1200