



**ELECTRONICS
TODAY INTERNATIONAL**

TOMORROW'S TECHNOLOGY TODAY

PLAY LASER TAG

FREE DISK
AC Circuit simulation
program plus
comprehensive suite of
PC diagnostics

**Make a
computer
controlled
laser gun game**

**I/O ports for an
Amstrad PCW**

PLUS

- *Remote mains controller for your PC*
- *Remote garage door opener*
- *ETI single board PC compatible computer*
- *Shed alarm*

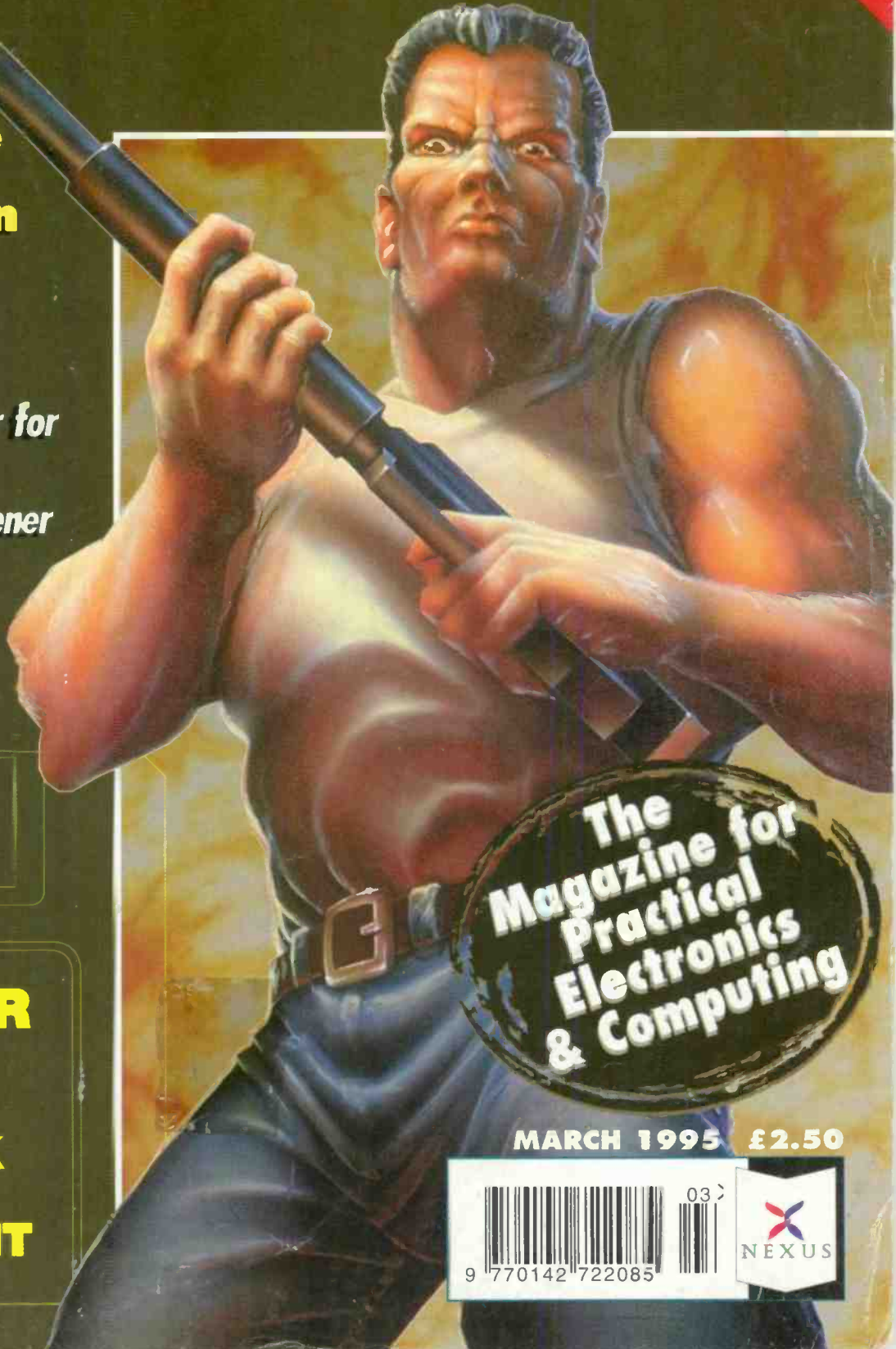

**The
Magazine for
Practical
Electronics
& Computing**

**NO COVER
DISK**

**THEN ASK
YOUR
NEWSAGENT**

MARCH 1995 £2.50



03 >



Take the

Quickroute

to successful PCB & Schematic Design

from
£99.00



Design PCB's and Schematics quickly

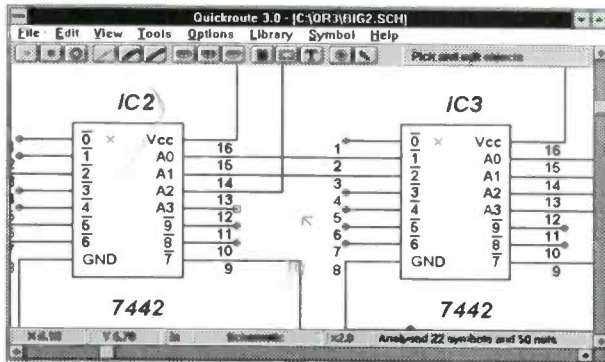

After schematic capture, components can be re-arranged prior to manual or automatic routing.

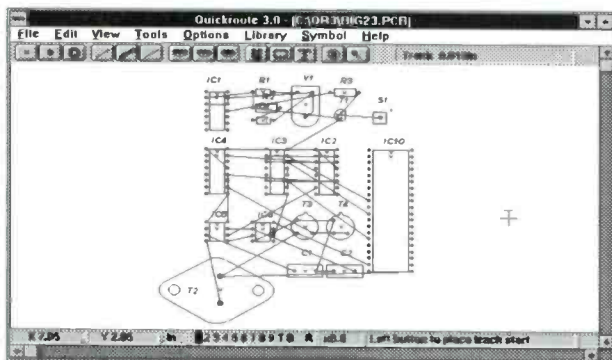

	Auto Router Max Layers	Schematic Capture	Gerber & NC-Drill	Design Size K nodes
DESIGNER	2 Standard	None	None	10
DESIGNER+	2 Medium	None	Export	20
PRO	8 Fast	Standard	Export	30
PRO+	8 Fast	Advanced	Export/ Import*	40

*PRO+ can import Gerber files

All versions include an auto-router.

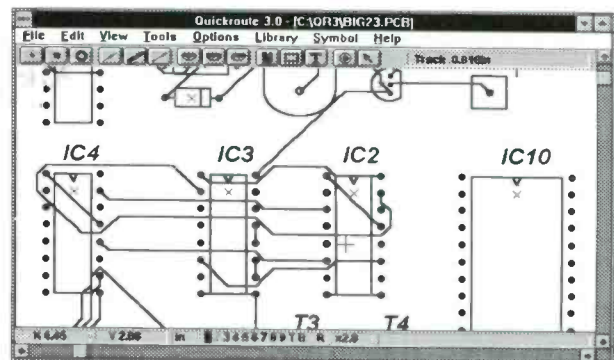

Telephone or FAX POWERware on 061 449 7101

POWERware, 14 Ley Lane,
Marple Bridge, Stockport,
SK6 5DD, UK.

Quickroute 3.0 for Windows 3.1
DESIGNER £99.00 **DESIGNER+** £149.00
PRO £199.00 **PRO+** £299.00
 All prices exclude post & packing, and V.A.T.

**DEMO
DISK
Available**

Contents



Make a game of Laser Tag 18

The first part of a new ETI project designed by Robin Abbot to build a computer controlled laser tag game system, a very sophisticated interactive game for several players that rivals those used commercially



Garden Shed Alarm 42

From Tim Parker comes a very useful project for a burglar alarm system which can be installed in your garden shed, workshop, garage or greenhouse.

The ETI 80188 Single Board Computer 50

We continue with part three of the project to construct a very powerful single board computer which uses a processor of the same family as that used in a PC and which can therefore directly run software which has been developed on the PC.

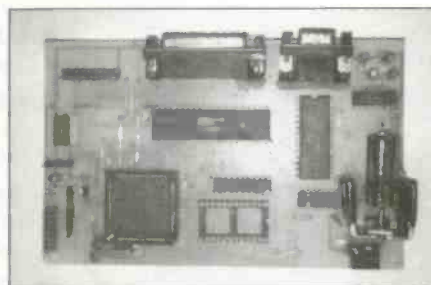

ETI Cover Disk & PC Clinic 30

A look at how to use this month's cover disk. How to do linear AC circuit analysis with Aciran V1.4 for Windows, Plus, solving some PC problems with the collection of diagnostic software.

A computer controlled SMART mains control system 32

A computer controlled SMART mains control system - Part two of the project designed by Dr Pei An which allows a PC to control up to 93 different mains devices using signals actually transmitted through the mains power cable.

PCW I/O Port 39

This parallel I/O port project by Jason Sharpe should appeal to anyone who has an old Amstrad PCW computer lying around and would like to use it as a control system.

The Raydor 60

Part two of the project to build the automatic garage door opening system which has been designed and patented by Pat Alley, and which forms an interesting project for the more mechanically inclined reader.

Regulars

- News and event diary 6
- Practically speaking 68
- PCB foils 70
- Open Forum 74

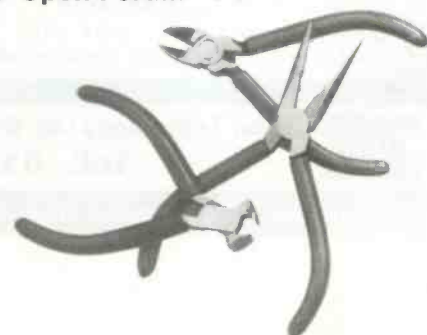

& Features & Projects

Walking Robots 12

A look at how to design robots which can walk across uneven terrains, and an introduction to the First ETI Amateur Robot Competition which will be held in London in January 1996

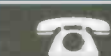
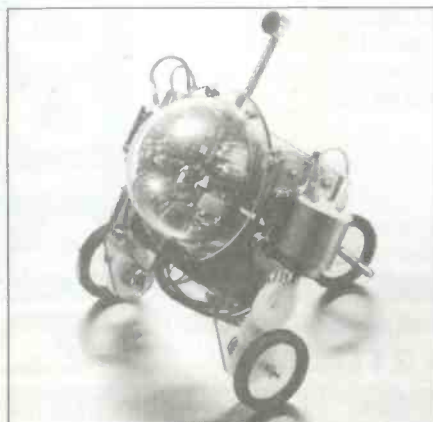

SUBSCRIPTION
& BACK ISSUES
HOTLINE
0737 768611

Subscribe & Save

Phone the hotline and take advantage of our special offer detailed on page 69

Pico Releases PC Potential

Pico's Virtual Instrumentation enable you to use your computer as a variety of useful test and measurement instruments or as an advanced data logger.

Hardware and software are supplied together as a package - no more worries about incompatibility or complex set-up procedures. Unlike traditional 'plug in' data acquisition cards, they simply plug into the PC's parallel or serial port, making them ideal for use with portable PC's.

Call for your Guide on 'Virtual Instrumentation'.

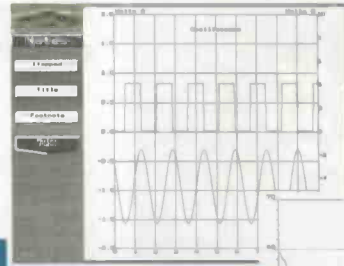

PicoScope
'Virtual instrument' software.

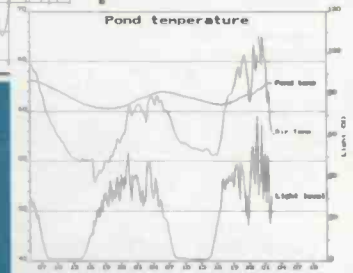

PicoLog
Advanced data logging software.

NEW SLA-16 Logic Analyser

Pocket sized 16 channel Logic Analyser



- Connects to PC serial port.
- High Speed -up to 50MHz sampling.
- Internal and external clock modes.
- 8K Trace Buffer.

SLA-16
with software, power supply and cables £ 219

NEW ADC-100 Virtual Instrument

Dual Channel 12 bit resolution



- Digital Storage Scope
- Spectrum Analyser
- Frequency Meter
- Chart Recorder
- Data Logger
- Voltmeter

The ADC-100 offers both a high sampling rate (100kHz) and a high resolution. It is ideal as a general purpose test instrument either in the lab or in the field. Flexible input ranges ($\pm 200\text{mV}$ to $\pm 20\text{V}$) allows the unit to connect directly to a wide variety of signals.

ADC-100 with PicoScope £199
with PicoScope & PicoLog £209

ADC-10

1 Channel 8 bit

- Lowest cost
- Up to 22kHz sampling
- 0-5V input range

The ADC-10 gives your computer a single channel of analog input. Simply plug into the parallel port and your ready to go.

ADC-10 with PicoScope £49
PicoScope & PicoLog £59

Carriage UK free, Overseas £9
Oscilloscope Probes (x1, x10) £10
Existing ADC 10/11/12/100 users can add PicoLog for £25

ADC-11

11 Channel 10 bit

- Digital output
- Up to 18kHz sampling
- 0-2.5V input range

The ADC-11 provides 11 channels of analog input in a case slightly larger than a matchbox. It is ideal for portable data logging using a "notebook" computer.

ADC-11 with PicoScope £85
PicoScope & PicoLog £95

ADC-12

1 Channel 12 bit

- High resolution
- Up to 17kHz sampling
- 0-5V input range

The ADC-12 is similar to the ADC-10 but offers an improved 12 bit (1 part in 4096) resolution compared to the ADC-10's 8 bit (1 part in 256).

ADC-12 with PicoScope £85
PicoScope & PicoLog £95



ADC-10 Simply plug into the parallel port and your ready to go.

ADC-16

8 Channel 16 bit+sign

- Highest resolution
- 2Hz sampling - 16bit
- $\pm 2.5\text{V}$ input range

The ADC-16 has the highest resolution of the range, it is capable of detecting signal changes as small as $40\ \mu\text{V}$. Pairs of input channels can be used differentially to reject noise. Connects to serial port.

ADC-16 with PicoLog £115

PICO TECHNOLOGY



Pico Technology Ltd. Broadway House, 149-151 St Neots Rd, Hardwick, Cambridge. CB3 7QJ
Tel: 01954 - 211716 Fax: 01954 - 211880



Phone or FAX for sales, ordering information, data sheets, technical support. All prices exclusive of VAT

A4 DTP MONITORS Brand new, 300 DPI. Complete with diagram but no interface details. (so you will have to work it out!) Bargain at just £12.99 each!!!

OPD MONITORS 9" mono monitor, fully cased complete with raster board, switched mode psu etc. CGA/TTL input (15way D), IEC mains. £15.99 ref DEC23. Price including kit to convert to composite monitor for CCTV use etc is £21.99 ref DEC24

LOW COST LASER NIGHT SIGHT just £79!!!
Cheaper version of our £245 Cyclops model, works ok in low light levels or in complete darkness with the built in Laser. ref 95/79 (please allow about 1 month delivery for these due to import difficulties)

PC CONTROLLED 4 CHANNEL TIMER Control (on/off times etc) up to 4 items (BA 240v each) with this kit. Complete with software, relays, PCB etc. £25.99 Ref 95/26

LOW COST RADAR DETECTOR Built and tested pocket radar detector. Ideal for picking up speed traps etc. Why pay £70 or more? ours is just £24.99 ref 95/25

COMPLETE PC 300 WATT UPS SYSTEM Top of the range UPS system providing protection for your computer system and valuable software against mains power fluctuations and cuts. New and boxed, UK made Provides up to 5 mins running time in the event of complete power failure to allow you to save your system down correctly. SALE PRICE just £118.00.

RACAL MODEM BONANZA! 1 Racal MPS1223 1200/75 modem, telephone lead, mains lead, manual and comms software, the cheapest you onto the net all this for just £13 ref DEC13.

HOW LOW ARE YOUR FLOPPIES? 3.5" (1.44) unbranded. We have sold 100,000+ so ok! Pack of 50 £24.99 ref DEC16

BRITISH TELECOMM SOLID METERS SA9083 These are 'returns' so they may have faults but look ok. Complete with new leads and leather case. Price for two meters & 1 case is £10 ref DEC89.

6mw LASER POINTER. Supplied in kit form, complete with power adjuster, 1.5mw, and beam divergence adjuster. Runs on 2 AAA batteries. Produces thin red beam ideal for fovis, gun sights, experiments etc. Cheapest in the UK! just £39.95 ref DEC49

SHOP WOBBLERS! Small assemblies designed to take D size batteries and 'wobble' cardboard model signs about in shop windows! £3.99 Ref SEP42

RADIO PAGER Brand new, UK made pocket pagers clearance price is just £4.99 each 100x40x15mm packed with bits! Ref SEP5.

BULL TENS UNIT Fully built and tested TENS (Transcutaneous Electrical Nerve Stimulation) unit, complete with electrodes and full instructions, TENS is used for the relief of pain etc in up to 70% of sufferers. Drug free pain relief, safe and easy to use, can be used in conjunction with analgesics etc. £49 Ref TEN1

STEREO MICROSCOPE 155X195MM, up to 600mm high, so items up to 10" will fit under lens. Rack and pinion focusing, 6 interchangeable rotating object lenses, interchangeable eye pieces, & scaled eyepiece for accurate measuring etc. Powerful low voltage illumination system with green filter and variable intensity, 100mm black/white + ground glass stage plate, 70mm swivel mirror, adjustable eyepieces (both focus and width). Magnification range 4.6-100.8x, field of view 39-2.4mm. Price is £299 for complete setup. Ref 95/300.

3D 35MM CAMERA SYSTEM Complete kit to convert a standard 35mm camera into a 3D version, enable you to take 3D colour slides with your own camera! Kit contains a prism assembly for the front of your existing lens, a sample 3D slide, a 3D slide viewer and 2 different lens mounts 49mm and 52mm, (other sizes available from photo shops at about £3 ea) all you need is standard slide film. Price for the complete kit is £29.99 ref 95/30.

COMPUTER RS232 TERMINALS. (LIBERTY) Excellent quality modem units, (like wyse 50, s) 2RS232, 20 function keys, 50 thru to 38,400 baud, menu driven port, screen, cursor, and keyboard setup menus (18 menus), £29 Ref NOV4.

OMRON TEMPERATURE CONTROLLERS (E6C2). Brand new controllers, adjustable from -50 deg C to +1,200 deg C using graduated dial, 2% accuracy, thermocouple input, long life relay output, 3A 240v o/p contacts. Perfect for exactly controlling a temperature. Normal trade £50+, ours £15. Ref E5C2.

ELECTRIC MOTOR BONANZA! 110x60mm. Brand new precision, cap start (or spin to start), virtually silent and features a moving outer case that acts as a fly wheel. Because of their unusual design we think that 2 of these in a tube with some homemade fan blades could form the basis for a wind tunnel etc. Clearance prices! just £4.99 FOR A PAIR! (note these will have to be wired in series for 240v operation Ref NOV1.

MOTOR NO 2 BARGAIN 110x90mm. Similar to the above motor but more suitable for mounting vertically (ie turntable etc). Again you will have to wire 2 in series for 240v use. Bargain price is just £4.99 FOR A PAIR!! Ref NOV3.

OMRON ELECTRONIC INTERVAL TIMERS.

Miniature adjustable timers, 4 pole o/o output 3A 240v,
HY1230S, 12VDC adjustable from 0-30 secs. £9.99
HY1210M, 12VDC adjustable from 0-10 mins. £9.99
HY1260M, 12VDC adjustable from 0-60 mins. £9.99
HY2460M, 24VAC adjustable from 0-60 mins. £5.99
HY241S, 24VAC adjustable from 0-1 secs. £5.99
HY2460S, 24VAC adjustable from 0-60 secs. £5.99
HY243H, 24VAC adjustable from 0-3 hours. £8.99
HY2401S, 240v adjustable from 0-1 secs. £9.99
HY2405S, 240v adjustable from 0-5 secs. £9.99
HY24060m, 240v adjustable from 0-60 mins. £12.99

PC PAL VGA TO TV CONVERTER Converts a colour TV into a basic VGA screen. Complete with built in psu, lead and s/ware. £49.95. Ideal for laptops or a cheap upgrade.

EMERGENCY LIGHTING UNIT Complete unit with 2 double bulb floodlights, built in charger and auto switch. Fully cased. 6v 8AH lead acid req'd. (secondhand) £4 ref MAG4P11.

GUIDED MISSILE WIRE. 4,200 metre reel of ultra thin 4 core insulated cable, 28lbs breaking strain, less than 1mm thick! Ideal alarms, intercoms, fishing, dolls house's etc. £14.99 ref MAG15P5

300v PANEL METER 70X60X50MM, AC, 90 degree scale. Good quality meter. £5.99 ref MAG 6P14. Ideal for monitoring mains etc.

ASTEC SWITCHED MODE PSU BM41012 Gives +5 @ 3.75A, +12 @ 1.5A, -12 @ .4A, 230/110, cased, BM41012. £5.99 ref AUG6P3.

TORRODIAL TX 30-0-30 480VA. Perfect for Mosfet amplifiers etc. 120mm dia 55mm thick. £18.99 ref APR19.

AUTO SUNCHARGER 155x300mm solar panel with diode and 3 metre lead fitted with a digar plug. 12v 2watt. £9.99 ea ref AUG10P3.

FLOPPY DISCS DSDD Top quality 5.25" discs, these have been written to once and are unused. Pack of 20 is £4 ref AUG4P1.

ECLATRON FLASH TUBE As used in police car flashing lights etc, full spec supplied, 60-100 flashes a min. £9.99 ref APR10P5.

24v AC 96WATT Cased power supply. New. £13.99 ref APR14.

MILITARY SPEC GEIGER COUNTERS Unused anstraightfrom Her majesty's forces. £50 ref MAG 50P3.

STETHOSCOPE Fully functioning stethoscope, ideal for listening to hearts, pipes, motors etc. £6 ref MAR6P6.

OUTDOOR SOLAR PATH LIGHT Captures sunlight during the day and automatically switches on a built in lamp at dusk. Complete with sealed lead acid battery etc. £19.99 ref MAR20P1.

ALARM VERSION Of above unit comes with built in alarm and pir to detect intruders. Good value at just £24.99 ref MAR25P4.

CARETAKER VOLUMETRIC Alarm, will cover the whole of the ground floor against forced entry. Includes mains power supply and integral battery backup. Powerful internal sounder, will take external bell if req'd. Retail £150+, ours? £49.99 ref MAR50P1.

TELEPHONE CABLE White 6 core 100m reel complete with a pack of 100 dials. Ideal 'phone extns etc. £7.99 ref MAR8P3.

MICRODRIVE STRIPPER Small cased tape drives ideal for stripping. Lots of useful goodies including a smart case, and lots of components. £2 each ref JUN2P3.

SOLAR POWER LAB SPECIAL You get TWO 6"x6" 6v 130mA solar cells, 4 LEDs, wire, buzzer, switch plus 1 relay motor. Superb value kit just £5.99 REF. MAG6P8

SOLID STATE RELAYS Will switch 25A mains. Input 3.5-26v DC 57x43x21mm with terminal screws £3.99 REF MAG4P10

300DPI A4 DTP MONITOR Brand new but shop soiled so hence bargain price! TTL/ECL inputs, 15" landscape, 1200x1664 pixel complete with circuit diag to help you interface with your projects. JUST £14.99. REF JUN15P2.

BUGGING TAPE RECORDER Small voice activated recorder, uses micro cassette complete with headphones. £28.99 ref MAR29P1.

ULTRAMINI BUG MIC 6mmx3.5mm made by AKG. 5-12v electret condenser. Cost £12 ea, Ours? just four for £9.99 REF MAG10P2.

RGB/CGA/EGA/TL COLOUR MONITORS 12" in good condition. Back anodised metal case. £79 each REF JUN79

ANSWER PHONES Returns with 2 faults, we give you the bits for 1 fault, you have to find the other yourself. BT Response 200's £18 ea REF MAG18P1. PSU £5 ref MAG5P12.

SWITCHED MODE PSU ex equip, 60w +5v @ 5A, -5v @ 5A, +12v @ 2A, -12v @ 5A 120/220v cased 245x88x55mm IEC input socket £6.99 REF MAG7P1

PLUG IN PSU 9V 200mA DC £2.99 each REF MAG3P9

PLUG IN ACORN PSU 19v AC 14w. £2.99 REF MAG3P10

POWER SUPPLY fully cased with mains and o/p leads 17v DC 900mA output. Bargain price £5.99 ref MAG6P9

ACORN ARCHIEDES PSU +5v @ 4.4A, on/off sw uncased, selectable mains input, 145x100x45mm £7 REF MAG7P2

GEIGER COUNTER KIT Low cost professional twin tube, complete with PCB and components. Now only £19 REF AUG19.

9v DC POWER SUPPLY Standard plug in type 150ma 9v DC with lead and DC power plug. price for two is £2.99 ref AUG3P4.

AA NICAD PACK encapsulated pack of 8 AA nicad batteries (tagged) ex equip, 55x32x32mm. £3 a pack. REF MAG3P11

13.8V 1.9A psu cased with leads. Just £9.99 REF MAG10P3

PC MODEM CARDS. These are high spec plug in cards made for the Amstrad laptop computers. 2400 baud dial up unit complete with leads. Clearance price is £5 REF: MAG5P1

INFRA RED REMOTE CONTROLLERS Originally made for hi spec satellite equipment but perfect for all sorts of remote control projects. Our clearance price is just £2 REF: MAG2

200 WATT INVERTER Converts 10-15v DC into either 110v or 240v AC. Fully cased 115x36x156mm, complete with heavy duty power lead, digar plug, AC outlet socket. Auto over/acid shutdown, auto short circuit shut down, auto input over voltage shutdown, auto input under voltage shut down (with audible alarm), auto temp control, unit shuts down if overheated and sounds audible alarm. Fused reversed polarity protected. output frequency within 2%, voltage within 10%. A extremely well built unit at an excellent price. Just £64.99 ref AUG6S.

UNIVERSAL SPEED CONTROLLER KIT Designed by us for the C5 motor but ok for any 12v motor up to 30A. Complete with PCB etc. A heat sink may be required. £17.00 REF: MAG17

MAINS CABLE PRECUT black 2 core 2 metre lengths ideal for repairs, projects etc. 50 metres for £1.99 ref AUG2P7.

COMPUTER COMMUNICATIONS PACK Kit contains 100m of 6 core cable, 100 cable clips, 2 line drivers with RS232 interfaces and all connectors etc. Ideal low cost method of communicating between PCs over a long distance. Complete kit £8.99.

MINICYCLOPS PIR 52x62x40mm runs on PP3 battery complete with shrill sounder. Cheap protection at only £5.99 ref MAR6P4.

ELECTRIC MOTOR KIT Comprehensive educational kit! Includes all you need to build an electric motor. £9.99 ref MAR10P4.

VIDEO SENDER UNIT. Transmits both audio and video signals from either a video camera, video recorder, TV or Computer etc to any standard TV set in a 100' range! (tune TV to a spare channel) 12v DC op. Price is £15 REF: MAG15 12v psu is £5 extra REF: MAG5P2

SOME OF OUR PRODUCTS MAY BE UNLICENSEABLE IN THE UK

BULL ELECTRICAL

250 PORTLAND ROAD HOVE SUSSEX

BN3 5QT (ESTABLISHED 50 YEARS)

MAIL ORDER TERMS: CASH PO OR CHEQUE

WITH ORDER PLUS £3.00 POST PLUS VAT.

PLEASE ALLOW 7-10 DAYS FOR DELIVERY

TELEPHONE ORDERS WELCOME

TEL: 01273 203500

FAX: 01273 323077

WEA

***FM CORDLESS MICROPHONE** Small hand held unit with a 500' range! 2 transmit power levels. Reqs PP3 9v battery. Tuneable to any FM receiver. Price is £15 REF: MAG15P1

LOW COST WALKIE TALKIES Pair of battery operated units with a range of about 200'. Ideal for garden use or as an educational toy. Price is £8 a pair REF: MAG 8P1 2x PP3 req'd.

***MINIATURE RADIO TRANSCEIVERS** A pair of walkie talkies with a range of up to 2km in open country. Units measure 22.5x2x155mm. Including cases and earpieces. 2xPP3 req'd. £30.00 pr. REF: MAG30

COMPOSITE VIDEO KIT. Converts composite video into separate H sync, V sync, and video. 12v DC. £8.00 REF: MAG8P2.

LQ3600 PRINTER ASSEMBLIES Made by Amstrad they are entire mechanical printer assemblies including printhead, stepper motors etc etc In fact everything bar the case and electronics, a good stripper £5 REF: MAG5P3 or 2 for £8 REF: MAG8P3

LED PACK of 100 standard red 5m leds £5 REF MAG5P4

UNIVERSAL PC POWER SUPPLY complete with flyleads, switch, fan etc. Two types available 150w at £15 REF: MAG15P2 (23x23x23mm) and 200w at £20 REF: MAG20P3 (23x23x23mm)

***FM TRANSMITTER** housed in a standard working 13A adapter! the bug runs directly off the mains so lasts forever why pay £700? or prices £26 REF: MAG26 Transmits to any FM radio.

***FM BUG KIT** New design with PCB embedded coil for extra stability. Works to any FM radio. 9v battery req'd. £5 REF: MAG5P5

***FM BUG BUILT AND TESTED** superior design to kit. Supplied to detective agencies. 9v battery req'd. £14 REF: MAG14

TALKING COINBOX STRIPPER originally made to retail at £79 each, these units are designed to convert an ordinary phone into a payphone. The units have the locks missing and sometimes broken hinges. However they can be adapted for their original use or used for something else?? Price is just £3 REF: MAG3P1

TOP QUALITY SPEAKERS Made for HI FI televisions these are 10 watt 4R Jap made 4" round with large shielded magnets. Good quality. £2 each REF: MAG2P4 or 4 for £6 REF: MAG6P2

TWEETERS 2" diameter good quality tweeter 140R (ok with the above speaker) 2 for £2 REF: MAG2P5 or 4 for £3 REF: MAG3P4

AT KEYBOARDS Made by Apricot these quality keyboards need just a small mod to run on any AT, they work perfectly but you will have to put up with 1 or 2 foreign keycaps! Price £6 REF: MAG6P3

HEADPHONES Ex Virgin Atlantic. 8 pairs for £2 REF: MAG2P8

DCS PACKS Microsoft version 3.3 or higher complete with all manuals or price just £5 REF: MAG5P8 Worth it just for the very comprehensive manual 5.25" only.

DCS PACK Microsoft version 5 Original software but no manuals hence only £5.99. 3.5" only.

PIR DETECTOR Made by famous UK alarm manufacturer these are hi spec, long range internal units. 12v operation. Slight marks on case and unboxed (although brand new) £8 REF: MAG8P5

MOBILE CAR PHONE £5.99 Well almost complete in car phone excluding the box of electronics normally hidden under seat. Can be made to illuminate with 12v also has built in light sensor so display only illuminates when dark. Totally convincing! REF: MAG6P6

ALARM BEACONS Zenon strobe made to mount on an external bell box but could be used for caravans etc. 12v operation. Just connect up and it flashes regularly! REF: MAG6P11

6"X12" AMORPHOUS SOLAR PANEL 12v 155x310mm 130mA. Bargain price just £5.99 ea REF MAG6P12.

FIBRE OPTIC CABLE BUMPER PACK 10 metres for £4.99 ref MAG5P13 ideal for experimenters! 30 m for £12.99 ref MAG13P1

HEATSINKS (finned) TO220, designed to mount vertically on a pcb 50x40x25mm you can have a pack of 4 for £1 ref JUN1P11.

INFRARED LASER NIGHT SCOPES
Image intensifier complete with hand grip attachment with built in adjustable laser lamp for zero light conditions. Supplied with Pentax 42mm camera mount and normal eye piece. 1.6kg. uses 1xPP3, 3xAAA's. Please allow us about 1 month for delivery on this product due to import problems! £245+Vat

NEW HIGH POWER LASERS
15mW, Helium neon, 3 switchable wavelengths. 63um, 1.15um, 3.39um (2 of them are infrared) 500:1 polarizer built in so good for holography. Supplied complete with mains power supply, 790x65mm. Use with EXTREME CAUTION AND QUALIFIED GUIDANCE. £349+Vat

WE BUY SURPLUS STOCK FOR CASH

1995 100 PAGE CATALOGUE NOW AVAILABLE, 45P STAMP OR FREE WITH ORDER.

3FT X 1FT 10WATT SOLAR PANELS

14.5v/700mA
£44.95

(PLUS £2.00 SPECIAL PACKAGING CHARGE)

TOP QUALITY AMORPHOUS SILICON CELLS HAVE ALMOST A TIMELESS LIFESPAN WITH AN INFINITE NUMBER OF POSSIBLE APPLICATIONS, SOME OF WHICH MAY BE CAR BATTERY CHARGING, FOR USE ON BOATS OR CARAVANS, OR ANYWHERE A PORTABLE 12V SUPPLY IS REQUIRED.

PORTABLE RADIATION DETECTOR

WITH NEW COMPUTER INTERFACE.
£59.00

A Hand held personal Gamma and X Ray detector. This unit contains two Geiger Tubes, has a 4 digit LCD display with a Piezo speaker, giving an audio visual indication. The unit detects high energy electromagnetic quanta with an energy from 30K eV to over 1.2M eV and a measuring range of 5-9999 UR/h or 10-99990 Nr/h. Supplied complete with handbook. Ref. NOV18.

New 486 based SBC with integral Data Acquisition System

This single board computer system from Advanced Modular Computers Ltd. is intended for embedded industrial applications. The PC-425 single board computer comes with 32 lines of I/O and will interface to a PC, Opto MUX, Pro Mux, Micro DAC and uMac systems. An eight-position opto isolated module rack mounted on the board will accept both digital and analogue I/O modules from Octagon, Opto 22, and Greyhill. The digital and analogue I/O may be expanded to 40 lines.

PC/104 interface allows up to three of these expansion modules to be mounted on the PC-425. Memory comprises 256Kbytes of flash for booting (DOS 5.0) and up to 512 Kbytes of flash EPROM for executable programmes can be inserted. On-Board dynamic RAM is expandable from 0 to 4Mbytes.

The board has all the features of a typical PC, including serial and parallel ports, watchdog timer, LCD interface and floppy disk controller. The operating temperature range is -25 to +75 degrees Centigrade. Up to 32 systems can be connected in a single network, with the capability of controlling 32,768 points using an on-board repeater.

For further information contact AMC of Slough on 0753 530660.

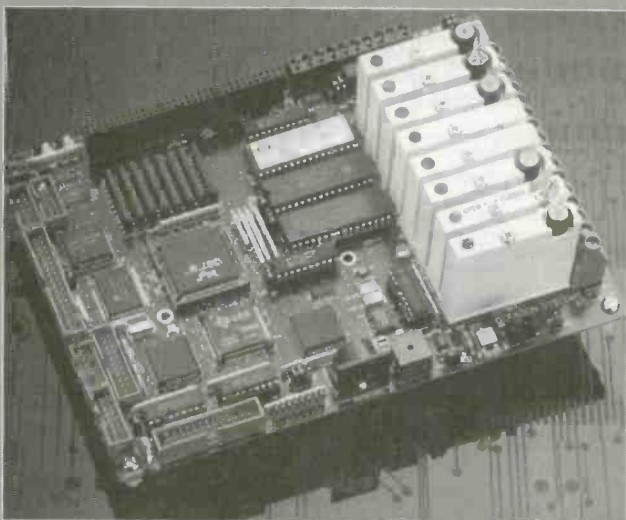

New 12-function lightweight cycle computer

With the new 12-function compact lightweight cycle computer from Maplin Electronics, the cyclist can easily see how



far and how fast he has cycled. He can also use the cycle computer to pace himself on a long journey. The function displays are grouped into Basic, Advanced, and Professional levels so that the riders have easy access to as much or as little information as is required. This allows the computer to satisfy the needs of the newcomer or professional alike and keep pace as the rider's skill increases. The handlebar mounting allows easy removal of the main unit for security and use away from the cycle. It is supplied complete with handlebar mounting, speed sensor with spoke mounting magnet, long life lithium battery and full instructions.

The 12 function cycle computer is available from Maplin Electronics and is priced at £16.99, for further details contact Maplin on 0702 554161.

Automatic gate systems

Woking based Gate-A-Mation Ltd has developed a new fully electronic automatic gate system which should be of considerable interest to any security conscious company. It can be regarded as the car park equivalent of the familiar entryphone system used in most modern blocks of flats. As such, it enables security to keep a close check on all vehicles entering and leaving the premises.



For further information contact Gate-A-Mation Ltd, of Woking on 0483 747373.

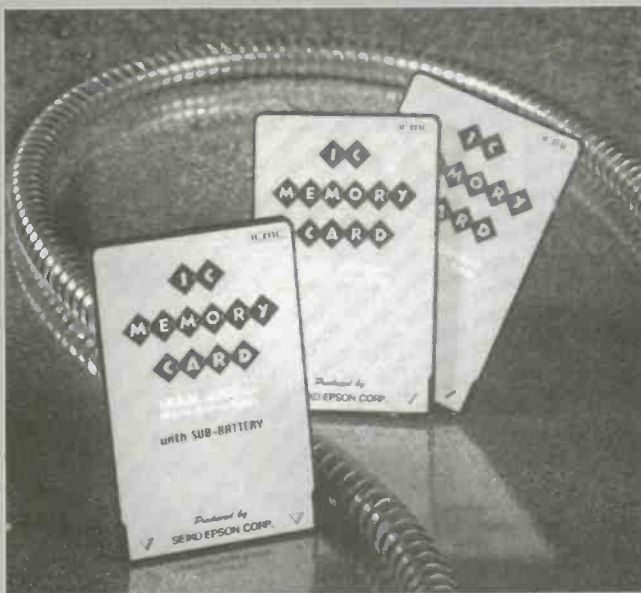

Very low power 4Mb PCMCIA card.

Epson has just launched a new ultra-low power 4Mbyte PCMCIA memory card featuring fast access times. This card, the WWB40/ES20, has a current consumption of just 250microamps. and access times down to 200nS. It is a low voltage (3V) SRAM card featuring a proprietary ASIC based system for the control of the I/O and power functions. The card can be provided with or without a second battery, allowing users to change battery without loss of data and with or without attribute memory. Compatible with Jeida ver4.1 and PCMCIA ver 2.0 standards, the 68-pin, 8/16 bit card measures 85mm x 54mm x 3mm, to conform with PCMCIA Type I requirements.

As well as SRAM, DRAM, OTPROM, Mask ROM, EEPROM and Flash cards, Epson also offers combination and custom cards. A Flash/SRAM combination option allowing users to integrate program code and memory expansion onto one card, thus using only a single card slot, is available and offers low standby current. 2Kb EEPROM Attribute memory and a second battery for SRAM. Custom cards, which can be half-size, or combination cards, are also available.

For further details contact Epson of Hemel Hempstead on 0442 227331.

New DSP software tools.

NEC Electronics has announced a new suite of software development tools for its uPD7701X family of high performance 16 bit fixed floating point digital signal processors. The Atair tools, which significantly reduce overall system development time, run on IBM compatible PCs under Windows 3.1.

The new suite consists of four basic software products: the Workbench multi-tasking environment is used in conjunction with other members of the suite and undertakes many of the time-consuming procedures. The

Debugger performs integrated in circuit emulation, while the Simulator uses a graphical user interface to verify the processor function without a hardware requirement.

NEC's uPD7701X devices have a 30ns instruction cycle time and a 3-stage pipeline enabling 33MIPS performance. Their architecture and powerful instruction set allow them to carry out up to eight operations in parallel, making them one of the fastest general DSPs available.

For further information about NEC DSPs and development software contact NEC in Milton Keynes on 0908 691133.



TOMORROW'S TECHNOLOGY UPDATE

Smartcards

New applications for smartcards are cropping up almost daily. The French have recently made some major commitments to the use of smartcard technology in financial applications and for the storage of personal medical information. In the UK, smartcards are also being used in customer loyalty schemes such as the one being run by Shell and the credit card company, Visa, have also announced the development of a smart credit card.

British Telecom have announced that they are to start installing smartcard phones as a replacement for their existing phonenumber phoneboxes. BT have also made it clear in their announcement that they expect their smartcard phones to also be used in conjunction with various financial smartcards. Expect to see the first smartcard phoneboxes within the next twelve months.

The London Transport smartcard project has been very successful and is now being expanded with the availability of the Farecard rechargeable ticket which will allow users to prepay for tickets and then use them as and when required. A move which takes this project one step closer towards using the card as a general purpose cashless payment card.

The Royal National Institute for the Blind has also taken an interest in smartcard technology and has published a report on smartcards and disabled people. The RNIB sees smartcard technology as a means of offering a lot of advantages to the disabled. Smartcards are not only easier to use than cash but they can also be used to inform various systems that the user is disabled (it can be used to increase display size and brightness, give audio feedback, summon human assistance, etc).

If you want to find out more about smartcard applications then why not visit SMARTCARD - The International Smartcard Exhibition and Conference, to be held between the 14th and 16th of February at Olympia, London. For further information on this event ring 01733 394304

Communications satellites

Following the feature on electronics in space it is nice to be able to report that on the 21st of November 1994 a Martin Marietta Atlas IIA rocket blasted off from the Kennedy Spacecentre carrying the Orion I communications satellite - the first European sourced satellite to be purchased by an American company, thus proving that, in some areas, European space technology is on a par with that of the USA.

The Orion I satellite is designed to provide transatlantic and local low cost, high capacity, business communications

services for the USA and Europe, catering for such diverse areas as business television, data transfer and electronic news gathering. It is a highly innovative design and is, in fact,

the world's first all solid state Ku-band repeater with each one of the 34 Ku-band channels using solid state amplifiers. It also features very advanced and high performance antennas made from Kevlar composite and manufactured using shaped, dual skin, laser etched grid technology, a European first.

The \$227million design, build, and launch contract for the Orion I was given to the Anglo/French company Matra Marconi Space and the satellite was built and designed at its facilities in Stevenage and Bristol. After launch, the satellite will be controlled and monitored from a specially built spacecraft control centre in Stevenage. This centre will control the satellite during the launch and early orbit phase of the mission with commands being relayed from the centre to the satellite using the Telstar network of ground stations.

Matra Marconi Space is now the recognised leader of the space industry in Europe and has successfully launched a whole series of commercial, national and defence satellites, including the UK's military SKYNET satellites, the French military TELECOM satellites and two NATO satellites. The company is also involved in Spacelab, in the HOTOL launcher project and in the construction of Earth observation satellites such as SPOT and HELIOS as well as many other European Space Agency projects.

Matra Marconi Space is the first fully integrated European space technology company and now employs over 4,300 people and operates from five major sites, three in the UK and two in France. They have a turnover in excess of \$1 billion and an order book of over \$1.5 billion.

Electronic Nose

Applications for the electronic nose are rapidly expanding. Systems are now being evaluated in areas as wide ranging as food, cosmetic, environmental and plastic industries. Customs are looking at the technology as a means of detecting drugs and identifying people who have been handling drugs. Meanwhile, a team at Manchester University have used this technology to build the world's first electronic truffle detector. Looks like it could be the end of the road for sniffer dogs and truffle hunting pigs.

Part of the reason why these new applications are being developed lies in recent improvements in the neural network system which provides the electronic nose with its intelligence.

Multipurpose LCD clock and timer

Maplin Electronics have just launched a new multipurpose LCD digital clock and timer which boasts a host of functions, making it ideal for use at home, in the office, on the sports field or in the car.

The dual time zone capability means that it can display both local time and continental time and is therefore particularly useful for business persons travelling abroad or those in contact with customers overseas.

The chronograph (stop watch) facility can time events to the nearest one hundredth of a second and up to a duration of 10 hours. Four memories are available for storing lap times, which can be recalled when the chronograph is



stopped. The pacer facility emits audible beeps at a rate from 60 to 240 beeps per minute for setting paces, oar strokes, exercises, etc.

The LCD digital clock timer costs £9.99 and is available from Maplin Electronics, for further details contact Maplin on 0702 554161.

The 2001 embedded PC

The 2001 embedded PC from Slough-based AMC is a half-sized CPU card that combines all the most eagerly sought after features in embedded designs, plus the ability to add mission-specific capabilities. It is designed as a single board solution, with expansion through a PC-104 interface, or through the ISA bus.

The 2001 can be used stand alone, or in a passive backplane system.

The 2001 is a very flexible product, with the ability to choose various processors (from the 386SX to the 486SLC2) and add or remove most features so that users only pay for what they need.

The list of key features is impressive, including a Cyrix 486SLC2-66 processor, a flat panel display interface, SCSIII, a PC-104 interface, optional RS-485, optional bootable 3Mbyte FLASH drive and an incredible 140,000 hour mean

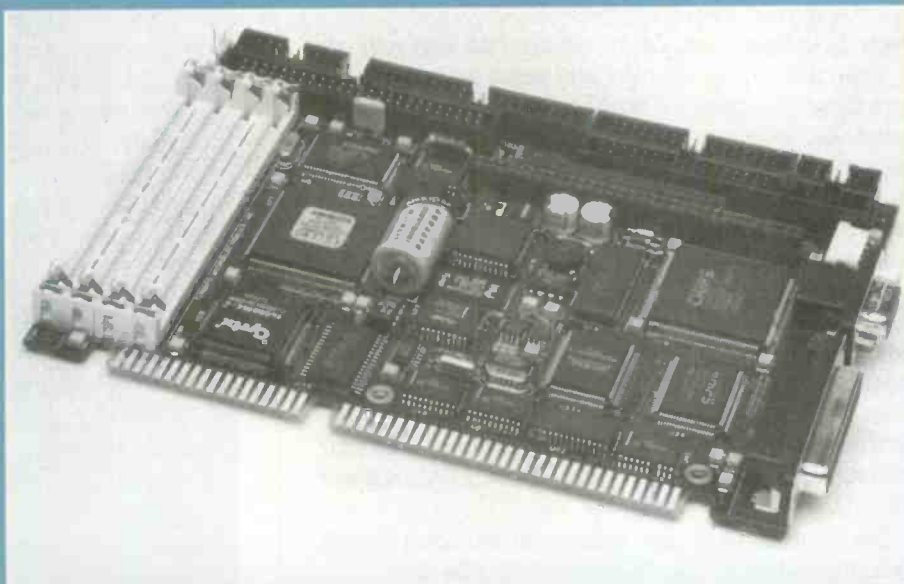

time between failure rate.

The PC-104 interface allows the addition of various features such as networking, fax/modems, data acquisition, PCMCIA, etc from a wide range of vendors. The on-board video controller drives both flat panel or CRT based displays. System parameters may be stored in EEPROM removing any worries about BIOS settings being dependent on battery condition.

For more information contact AMC on 0753 580660.

Event Diary

- 29 Jan - 1st Feb European Light Show Exhibition, Earls Court, London. Tel 01952 290905
- 7-9 Feb ISDN User - Integrated Communications Exhibition, Olympia, London. Tel: 01733 394304
- 14-16 Feb SMARTCARD - The International Smartcard Exhibition and Conference, Olympia, London. Tel:01733 394304
- 1-2 March Electronic Books International, Wembley Centre, London. Tel: 0171 976 0405
- 7-9 March Computers in Libraries, Wembley Centre, London. Tel: 0171 9766405
- 16-19 March Computer Shopper Show, NEC, Birmingham. Tel: 0181 742 2826
- 9-11 April European Computer Trade Show, Business Design Centre, London. Tel: 0181 7422828
- 22 April International Marconi Day exhibition station at Puckpool Park Wireless Museum, IOW. Tel: 01933 567665

If you are organising an event which you would like to have included in this section, please send full details to: ETI, Nexus House, Boundary Way, Hemel Hempstead, Herts HP2 7ST. Clearly mark your envelope Event Diary.

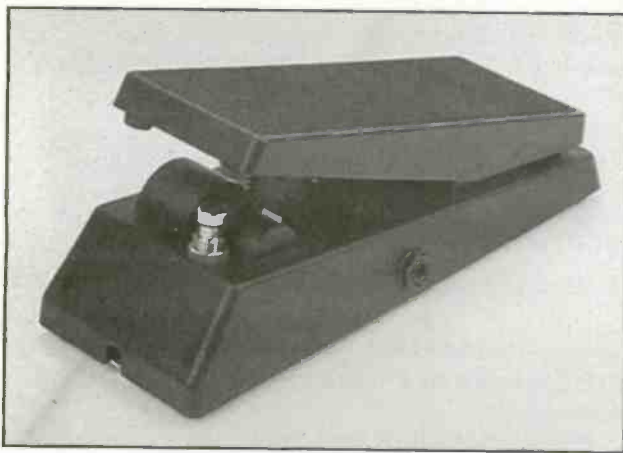

New Maplin Wah Wah Pedal Kit

Maplin Electronics have just launched a new wah-wah pedal kit which should prove popular and which has a number of advantages over previous designs. These include adjustable resonance, which determines the subtlety of the effect and adjustable range used for electric guitars; in fact, on any electronic musical instruments such as keyboards and electric violins. The circuit also features a compander that reduces noise in the circuit and improves the harmonic output content, which makes for a very warm sound.

The Wah Wah acts as a kind of tone boost control, and moving the pedal adjusts the frequency point at which the boost occurs. Rhythm or lead guitar is usually used with the device. When playing rhythm, the pedal is moved in time with the 'strum' and when playing lead, extra expressive abilities become available, enabling almost 'infinite sustain' without screaming feedback.

The complete kit is easily assembled and costs £34.99. For further details contact Maplin on 0702 554161.

VMEbus PCMCIA carrier

Arcom-Control Systems has added a two slot PCMCIA carrier for Type I, II or III cards to its VMEbus range - a board which provides a flexible foundation for the construction of rugged data loggers and industrial instrumentation.

Supported by PhoenixCARD Manager Plus software and backed by a range of PC compatible 486 or 386 processors, the board allows users to install, run and upgrade standard DOS and Windows applications in harsh or remote field and factory locations with great ease and with total compatibility with office PCs. The board's dual slots accept any form of PCMCIA card and give great flexibility of configuration allowing users to combine, for example, storage devices such as solid state or rotating disks with communications links via fax modems or LAN interfaces.

The software interchangeability this board creates between office PCs and target systems provides new levels of flexibility for designers of data acquisition and datalogging systems. With some 300 suppliers supporting the PCMCIA standard, users can choose from hundreds of plug-in options including Flash EPROM, SRAM and ATA disk storage devices, as well as a fast expanding choice of communications and I/O functions. All three PCMCIA card thicknesses, from 3.3mm to 10.5mm, are accepted.

Designated the VPCMCIA, the 6U board design is based around the powerful Cirrus Logic CL-PD6720 controller and is optimised to give system builders and OEMs considerable flexibility. Features include a 128K EPROM socket for local storage of configuration data, a DC power distribution architecture supporting both 5 and 3.3 volt cards, comprehensive interrupt support, hot insertion capability, on-board buzzer and/or speaker connection and protection against electrostatic discharge from the front panel and card

entry positions. Extra logic circuitry on the card allows Arcom VMEbus systems to support up to two carrier cards, or four PCMCIA slots in any VMEbus system. Each PCMCIA socket has five programmable memory windows of up to 16MBytes in size and two programmable I/O windows. The board may be accessed as a VMEbus slave.

The VPCMCIA board costs £595 and further details can be obtained from Arcom Control Systems Ltd of Cambridge on 0223 411200.

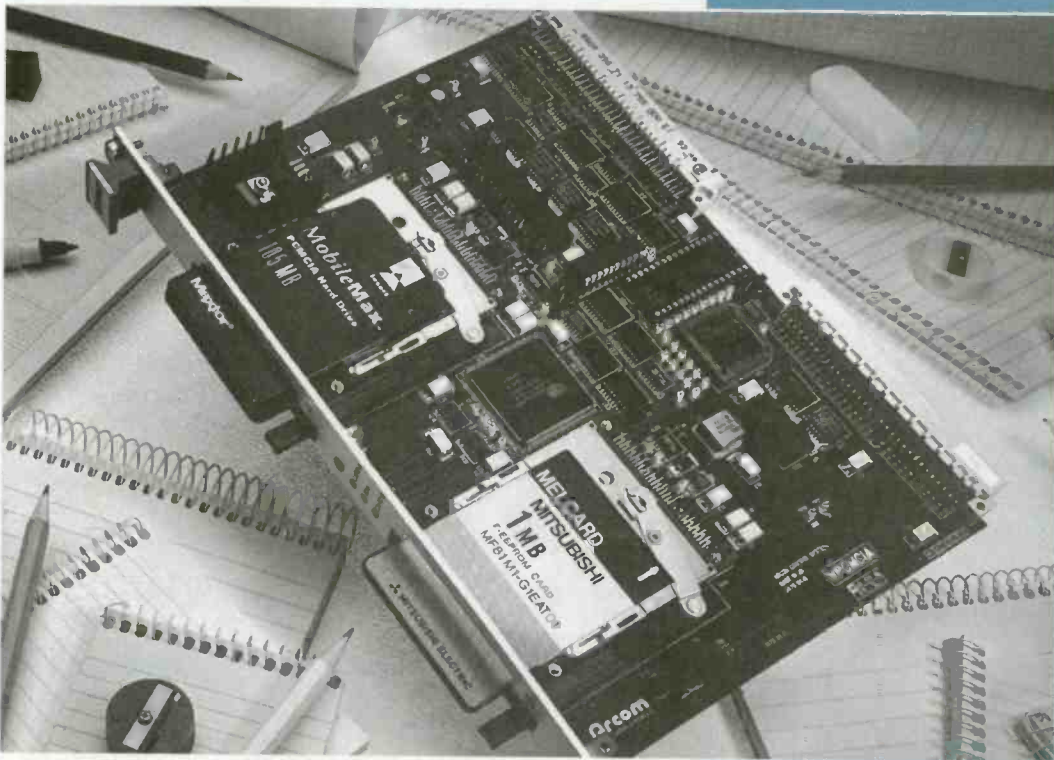



**8 CAVANS WAY,
BINLEY INDUSTRIAL ESTATE,
COVENTRY CV3 2SF
Tel: 0203 650702
Fax: 0203 650773
Mobile: 0860 400683**

(Premises situated close to Eastern-by-pass in Coventry with easy access to M1, M6, M40, M42, M45 and M69)

OSCILLOSCOPES

Gould OS3000 - 30MHz Dual ch.....	£250
Gould 4035 - 20MHz Digital storage.....	£600
Gould 4050 - 35MHz Digital storage.....	£750
Gould 5110 - 100MHz Intelligent oscilloscope.....	£950
Gould OS4000, OS4200, OS4020, OS245.....	from £125
Hewlett Packard 1740A, 1741A, 17744A, 100MHz dual ch.....	from £350
Hewlett Packard 1707A, 1707B - 75MHz 2ch.....	from £275
Hewlett Packard 54201A - 300MHz Digitizing.....	£1950
Hewlett Packard 54504A - 400MHz Digitizing.....	£3950
Hitachi V422 - 40MHz Dual channel.....	£300
Hitachi V212 20MHz Dual Channel.....	£175
Nicolet 3091 - LF D.S.O.....	£1100
Philips PM 3315 - 60MHz - D.S.O.....	£750
Tektronix 2213 - 60MHz Dual Channel.....	£425
Tektronix 2246 100MHz-4 channel.....	(as new) £995
Tektronix 2215 60MHz dual trace.....	£450
Tektronix 2235 Dual trace 100MHz (portable).....	£800
Tektronix 2335 Dual trace 100MHz (portable).....	£750
Tektronix 2225 - 50MHz dual ch.....	£450
Tektronix 465/465B - 100MHz dual ch.....	from £350
Tektronix 7313, 7603, 7613, 7623, 7633, 100MHz 4 ch.....	from £300
Tektronix 7704 - 250MHz 4 ch.....	from £650
Tektronix 7844 - Fitted with 7A42, 7B80, 7B85 Plug-Ins.....	£1500
Tektronix 7904 - 500MHz.....	from £850
Tektronix 468 - 100MHz Digital Storage.....	£800
Phillips 3206, 3211, 3212, 3217, 3226, 3240 3243, 3244, 3261, 3262 (2ch + 4ch).....	from £125 to £350
Philips PM 3295A - 400MHz Dual Channel.....	£2250
Philips PM 3296 - 350MHz Dual Channel.....	£1950
Philips PM 3208 - 20MHz Dual Channel.....	£200
Telequipment D68 - 50MHz Dual Channel.....	£200

Other scopes available too

SPECTRUM ANALYSERS

Hewlett Packard 3580A - -5Hz-50KHz.....	£995
Hewlett Packard 8590A - 10KHz - 1.5GHz - (as new).....	£4300
Hewlett Packard 182T with 8559A (10MHz - 21GHz).....	£3750
Hewlett Packard 4953 Protocol analyser.....	£2500
Hewlett Packard 8561A - 6.5GHz.....	£12,000
Hewlett Packard 3585A 20Hz - 40MHz.....	£3750
Hewlett Packard 3561A Dynamic Signal Analyser.....	£3500
HP 3582A - 25KHz Analyser, dual channel.....	£2500
HP8754A - Network analyser 4-1300MHz.....	£3500
Marconi 2370 - 110MHz.....	£995
Marconi 2371 - 304Hz - 200MHz.....	£1250
Rohde & Schwarz - SWOB 5 Polyskop 0.1 - 1300MHz.....	£2750

MISCELLANEOUS

Anritsu MG642A Pulse Pattern Generator.....	£1500
Avo VCM 163 Valve Characteristic Meter.....	£400
Ballantine 323 True RMS Voltmeter.....	£350
Datalab DL 1080 Programmable Transient Recorder.....	£350
Farnell RB 1030-35 Electronic load 1Kw.....	£450
Farnell 2081 R/F Power meter.....	POA
Farnell TSV 70 MkII Power Supply (70V-5A or 35V-10A).....	£200
Ferroglyph RTS-2 Audio Test Set with ATU 1.....	£500
Fluke 8010A/8012A/8050A Digital multimeters - from.....	£125
Fluke 5101A AC/DC Calibrator.....	£3500
Fluke 5101B AC/DC Calibrator.....	£6500
Fluke 5220A Transconductance Amplifier (20A).....	£3000
General Rad 1658 LCR Digibrldge.....	£250
Gould TA 600 - Thermal Array Recorder.....	£400
Helden 1107 - 30V-10A Programmable Power Supply (IEEE).....	£650
Hewlett Packard 334A - Distortion Analyser.....	£250
Hewlett Packard 436A Power meter +8481A sensor.....	£950
Hewlett Packard 3437A System voltmeter.....	£350
Hewlett Packard 3456A Digital voltmeter.....	£850
Hewlett Packard 3760/3761 Data gen + error detector.....	each £300
Hewlett Packard 3762/3763 Data gen + error detector.....	each £350
Hewlett Packard 3777A Channel selector.....	£250

Hewlett Packard 4193A Vector impedance meter.....	£3250
Hewlett Packard 5420A Digital Signal Analyser.....	£350
Hewlett Packard 5423A Structural Dynamics Analyser.....	£350
Hewlett Packard 54470B Digital Filter.....	£100
Hewlett Packard 54410A Analogue/Digital Converter.....	£100
Hewlett Packard 6632A System Power Supply.....	£450
Hewlett Packard 7402 Recorder with 17401A x 2 plug-ins.....	£300
Hewlett Packard 8011A Pulse gen. 0.1Hz-20MHz.....	£500
Hewlett Packard 8406A Frequency comb. generator.....	£500
Hewlett Packard 8443A Tracking gen/counter with 1EEE.....	£300/400
Hewlett Packard 8444A Tracking Generator.....	£750
Hewlett Packard 8620C Sweep oscillator mainframe.....	£400
Hewlett Packard 8750A Storage normaliser.....	£375
Hewlett Packard 3438A Digital multimeter.....	£200
Hewlett Packard 6181C D.C. current source.....	£150
Hewlett Packard 59501B HP.1B isolated D/A power supply programmer.....	£150
Hewlett Packard 3711A/3712A/3791B/3793B Microwave Link Analyser	£3500
Hewlett Packard 8901B - Modulation analyser AM/FM (150KHz - 1300MHz).....	£3750
Hewlett Packard 8903B - Audio Analyser (20Hz - 100KHz).....	£2750
Hewlett Packard 5316A Universal Counter HP1B.....	£550
Hewlett Packard 5316B Universal Counter HP1B.....	£775
Hewlett packard 5385A Frequency Counter - 1GHz - (HP1B) with OPTS 001/003/004/005.....	£995
Hewlett Packard 1630G Logic Analyser (65 channel).....	£850
Hewlett Packard 8657B 2060MHz synthesised signal generator	(as new) £8250
Hewlett Packard 3779C Primary Multiplex Analyser.....	£1000
Hewlett Packard 6623A Triple output system power supply.....	£1950
Hewlett Packard 6624A Quad output system power supply.....	£2250
Hewlett Packard 35677A "S" Parameter Test Set.....	£1250
Hewlett Packard 6453A Power supply 15v-200A.....	£1250
Hewlett Packard 4261A LCR Meter.....	£400
Hewlett Packard 4271B LCR Meter.....	£900
Hewlett Packard 3764A (Opt 002) Digital Transmission Analyser.....	£3500
Hewlett Packard 3586A Selective level meter.....	£1750
Hewlett Packard 8656A 990 MHz synthesised sig. gen.....	£1500
Hewlett packard 3488A HP - 1B switch control.....	£500
International Light - IL 1700 Research Radiometer with Erythermal Sensor Head.....	£1250
Krohn-Hite 2200 Lin/Log Sweep Generator.....	£995
Krohn-Hite 4024A Oscillator.....	£250
Krohn-Hite 6500 Phase Meter.....	£250
Leader LCR 745G LCR Meter.....	(as new) £1150
Lyons PG73N/PG75/PG28/PG Pulse generator.....	from £225
Marconi 2432A 500MHz digital freq. meter.....	£200
Marconi 2337A Automatic dist. meter.....	£150
Marconi 2356 20MHz level oscillator.....	£300
Marconi 2306 Programmable interface.....	£450
Marconi 2830 Multiplex tester.....	£1000
Marconi 2831 Channel access switch.....	£400
Multicore "Vapourette" Bench Top Vapour Phase SMD Soldering Machine (New + Unused).....	£650
Philips 5390 1GHz R/F Synthesised signal gen.....	£1250
Philips PM 5167 10MHz function gen.....	£400
Racal Dana 202 Logic analyser + 68000 disassembler.....	£250
Racal Dana 9242D Programmable PSU 25V-2A.....	£300

**MANY MORE ITEMS AVAILABLE - SEND LARGE
S.A.E. FOR LIST OF EQUIPMENT
ALL EQUIPMENT IS USED - WITH 30 DAYS
GUARANTEE.
PLEASE CHECK FOR AVAILABILITY BEFORE
ORDERING - CARRIAGE & VAT TO BE ADDED TO
ALL GOODS**

ROBOTS

which can walk

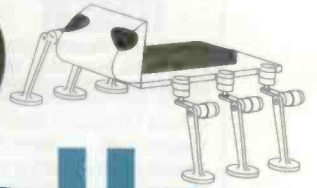

Creating a robot which can walk across an unknown terrain is one of the great challenges facing the designers of such systems. Here, we look at some of the problems and some of the solutions

Nearly all the great science fiction robots of the cinema have walked. Most have been anthropomorphic 'metal men' such as C3PO in Star Wars, others such as Huey, Louey, and Duey in Silent Running have simply used walking as a means of locomotion. However, most of the current generation of robots to be found in factories and laboratories are either static or move using wheels. Why then does science fiction put such emphasis on walking robots?

The answer to this question is that besides the obvious dramatic impact of an anthropomorphic robot, walking is a more efficient form of locomotion when faced with an uneven terrain full of obstacles. One would probably not attempt to drive a car across a field strewn with large numbers of boulders of different sizes, but one could walk across it, climbing over the boulders where necessary.

This means that if we want to have mobile robots which can operate in an uneven terrain then it is probably best to design a system which can walk rather than one which uses wheels. Given this conclusion, it is hardly surprising to discover that NASA has replaced the wheeled 'rover' of lunar exploration days with a walking robot for future unmanned planetary exploration projects.

Indeed, walking planetary exploration robots are already being tested out.

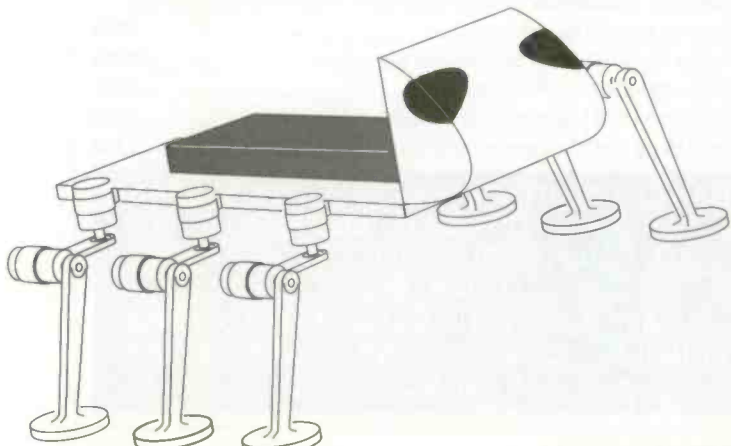

The Dante project is a good example, where NASA are experimenting with the use of a walking robot to explore an active volcano in Antarctica. The walking robot used in this project is still undergoing refinements that will overcome limitations that were brought to light in earlier tests, but it already demonstrates the kind of use to which walking robots will be put, to working and exploring extremely harsh environmental conditions, both on Earth and on the planets of our solar system.

Two feet, four feet, or more?

The first thing that we need to do when thinking about the design of a practical walking robot is to abandon any idea of building a bipedal system that mimics the human being. Building such a robot is not impossible but very complex because of the constant need to readjust the robot's centre of gravity and balance while it is walking or even just standing still; without such fine readjustment it will fall over. To demonstrate this, notice that it is virtually impossible to stand completely still, the body will continually make small side to side or back and forwards movements to restore balance.

Of course when designing a bipedal robot, one could lower the centre of gravity by putting a lot of weight in the feet, but this would make it difficult to actually lift the legs off the ground since this would again raise the centre of gravity to a point where instability would occur. The result of this approach is that one would end up with a robot that shuffled along rather like the walking robots sold in toy shops.

A robot with three legs would be stable in a stationary position but would become totally unstable when one leg is lifted in order to move it forward. The only solution to this instability would be to have two of the legs used for locomotion and the third used to counterbalance the instability resulting from movement of the other two. This type of approach is used by birds, kangaroos, some lizards and, millions of years ago, many species of dinosaur. In all these species, a tail is used as a counterbalancing third leg.

A four-legged robot will have far greater stability than a two-legged one. For a start, the centre of gravity is lower and the four legs, assuming they are located at the four corners of a robot body, will prevent it actually falling over whilst it is standing still. However, if one of the four legs is lifted in order to move it forward as part of a walking sequence then it once again becomes potentially unstable.

The only way to overcome this instability is to monitor the system's stability and then make small adjustments in the position of the three legs still on the ground so that the centre of

gravity is shifted away from the lifted leg and stability is restored. If you look at a four-legged animal like a dog you can see how it moves its body and tail to perform the movement of the centre of gravity away from any lifted leg.

A five-legged system is another possibility that would be more stable than a four-legged system. Apart from the starfish family there are no five-legged organisms in nature. But in many four-legged animals the tail performs the same function as a leg; just think of how a monkey uses its tail.

We finally come to systems with six legs. If we look at nature we find that there are more species on this planet with six legs than there are with four, or two, or indeed any other number of legs. These six-legged species are the insect and they provide us with a perfect model of an easy to build walking system, one where instability is no longer a serious problem. An insect walks by lifting a leg and moving it forward, then swinging the rest of the body forward in order to follow it some of the way. With only one leg off the ground at a time it still has five legs on the ground and is thus perfectly stable at all times, even with three legs off the ground it can still be completely stable.

This means that if we are building a walking robot then the easiest design to implement is one with six legs. With six legs there is no need to design into the system all the fine adjustments of position which are necessary in order to achieve stability during walking. All that the design needs are fairly simple leg movement actuators and a controller which can move the legs in the correct manner and the correct sequence. In fact, if we look at most of the practical walking robots which have been built in various labs around the world, then we find that the vast majority of them are six-legged, or so-called 'insectoid robots' - robots which vary in size from just a few centimetres to several metres long, and which can be used for a wide range of different uses, from planetary exploration to military applications.

Insectoid robots

A great deal of development work has gone into the design of different insectoid robots. Indeed, at Massachusetts Institute of Technology there is a specialist 'insect lab' which is dedicated

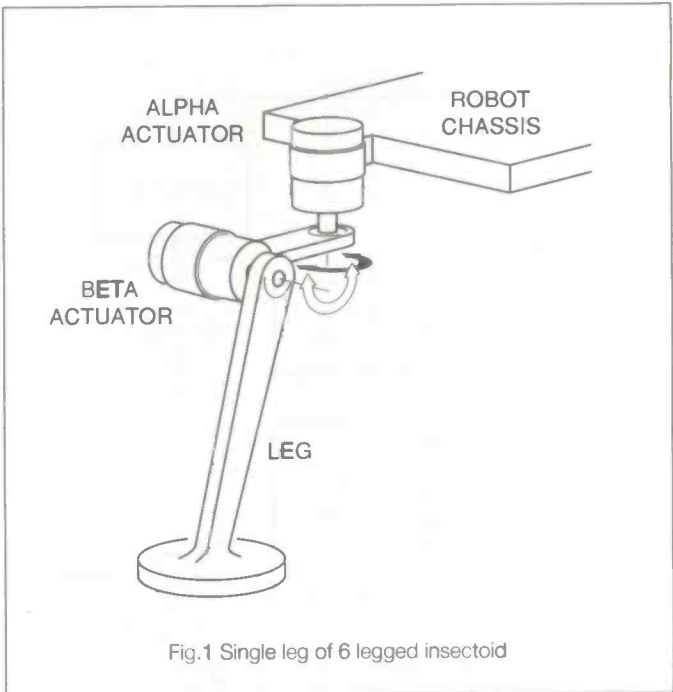

Fig.1 Single leg of 6 legged insectoid

to designing and developing such six-legged autonomous walking robots. For the rest of this article we will look at some of the design concepts which have been developed by Rodney Brooks and his team at MIT.

One great advantage of an insectoid robot design is that it is modular, six identical single legs joined as pairs to make three identical pairs of left and right legs, which in turn are joined together to make a single insectoid. The legs have to be capable of swivelling forward and backwards and of being lifted up and down. This means that each of the six identical legs requires two actuators; one, the Beta Motor, lifts the leg up and down, and the other, the Alpha Motor, swivels it forward and backward (see Fig.1.).

The two actuators are in fact servo motor systems of some sort (the exact mechanics employed are up to the designer, but at ETI we have built a perfectly serviceable walking robot using commercial radio control servo motors as the actuators and pulse width proportional servos are, in general, a lot easier to use in this type of application - they only require a single I/O line between processor and servo, thus cutting down on electronics and wiring complexity). The virtue of such servo motors is that they are easily connected to a microprocessor I/O port and their position accurately controlled using very simple software.

The MIT robots are built to a design philosophy known as 'subsumption architecture'. This does not employ the traditional analytical approach to the design of robotic systems but instead uses a network of processors and hardware which is capable of developing simple behaviour patterns. This is a strictly hierarchical system and no behaviour will be added to the system until the lower levels of subsumption are up and running. Thus the walking robot must be able to stand before it can walk, walk before it can climb stairs and so on.

In keeping with this philosophy, each leg on the MIT insectoids has its own processor, it is an independent unit and communicates with a higher level processor simply by transferring a couple of values. It is up to each leg processor to accurately control the movements of that specific leg's motors in response to commands from the higher processor and to inform that higher level processor when the action has been executed.

The basic MIT insectoid thus has a total of twelve actuators

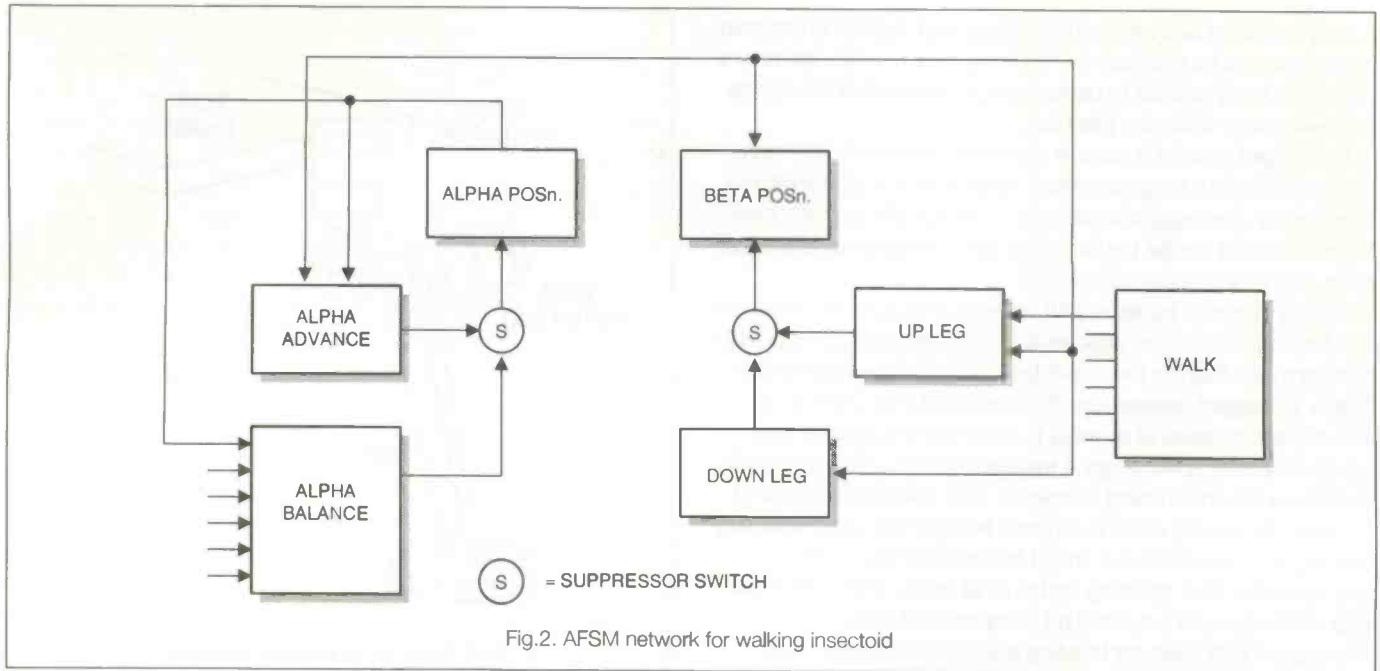

and seven processors; that is one main processor and one processor and two actuators for each leg. Each of these processors runs software which is configured as a number of Augmented Finite State Machines, or AFSMs. Each basic leg processor is running five AFSMs and the main processor two AFSMs, making 32 AFSMs in total. It is the interaction between this network of AFSMs that is used to generate simple walking behaviour.

Walking with six legs

Robot system developers have traditionally looked upon the creation of a walking robot as something that poses considerable technical difficulties. Indeed if we were to use a standard analytic approach then writing the control software for such a robot would indeed be a difficult task. But, thanks to Rodney Brook's subsumption philosophy a lot of the complexity is removed and can in fact be automatically generated by the system and it is a philosophy which is, to a very large degree, independent from the hardware design.

To examine how the system works we need to look at the various subsumption layers, starting with the lowest and simplest, making the robot stand up. Each leg processor has two AFSMs which control the actuators; these are known as the AlphaPos AFSM and the BetaPos AFSM. A number sent to one of these AFSMs will cause the related servo motor to turn to the vertical or lateral position that equates to that number. So at the lowest level of subsumption we can get the robot to stand up by using the supervisor processor to transmit to all the AlphaPos and BetaPos AFSMs the appropriate leg position

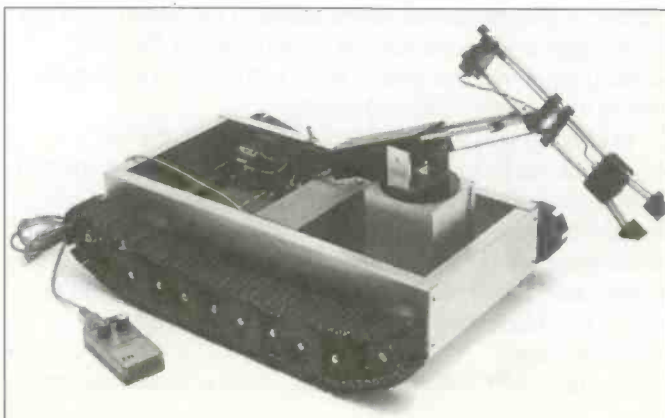

values to get the system to stand up.

The result of this is that all the servo motors will move to the correct position and the insectoid's legs will be correctly positioned in order to make it stand up. However, this needs to be done carefully and in the correct sequence otherwise there is a danger that the robot will simply fall over. Legs should be moved to a zero starting position first, then all moved together in the correct sequence thus ensuring that the robot stands up in an even and organised manner.

Once the robot has been made to stand, we can then add the next subsumption layer, the layer which performs the basic walking control. By basic walking we mean walking forward at a set speed and in a straight line over a level floor free from obstructions. For a six-legged insectoid, basic walking means that when any five legs are touching the ground, a sixth leg is raised. To move forward a small amount the insectoid merely swings all the legs touching the ground to the rear by a few degrees. The raised leg is then swung forward and placed on the ground, when this leg touches the ground another is raised and once more all the legs swung a few degrees to the rear.

This process continues until all six legs have been raised and is then repeated as the insectoid moves forward. It may seem rather slow and cumbersome and indeed, there are a great many different walking sequences which are used by insects, but all rely on the same basic principle; the legs which are on the ground swing back, whilst those which are raised swing forward.

A very common insect leg movement sequence is known as the alternating tripod gait, if the legs on the right side of the body are labelled R and those on the left L, and are numbered from 1 to 3 with leg 1 being at the front of the insectoid then two alternating sets of tripods are used. These two sets are R1, L2, R3, and L1, R2, L3. In walking using this gait, an insect will leave one tripod set on the ground and lift all the legs of the other tripod set. The body is then swung forward, the raised legs moved forward, set on the ground and the other tripod set legs raised, the body swung forward, and so on.

The insectoid control software

The most important components of the basic walking subsumption layer are located in the control processor; a global controller AFSM called Alpha Balance and a walking sequence master module called Walk. Each leg processor is running a

network of five AFSMs which govern leg movement by both Alpha and Beta actuators.

The AFSMs used in the MIT subsumption based insectoids communicate with each other by passing values that represent either commands or status reports from other AFSMs. This is particularly important in the Alpha Balance AFSM which is designed to receive continual reports on the position of each leg and then generate the Alpha actuator swivel commands that are responsible for the insectoid actually moving forward.

The position of each leg is represented by a number that can be either positive or negative. The position has a value of zero when the leg is at 90degrees to the body, a negative value when it is pointing to the rear of the body and a positive value when it is pointing forward; the greater the value the more the leg is rotated away from the 90degree position. The function of Alpha Balance is to add all these values together and produce an average leg value, if the sum is negative then the average leg points backward and if it is positive then the average leg points forward. When an insectoid moves it swings a leg, or legs, to the front. This leg or legs then send a positive value/values back to the Alpha Balance, the result being that the average leg value will become more positive. This upsets the balance of the system so, to restore it, Alpha Balance sends a counterbalancing negative value to the remaining legs which are on the ground and this negative signal causes them to swivel to the rear, thus restoring the balance. In other words, what Alpha Balance tries to do is ensure that the average leg value is around zero.

In a basic insectoid, all that the Walk AFSM does is generate the walk sequence. It has no feedback and its output is simply an on/off signal to the network of leg control AFSMs running in the leg processor and it will probably generate just a single sequence pattern at a standard walking speed. However, higher subsumption layers will use the Walk AFSM to generate different kinds of walking pattern that will allow the insectoid to move at different speeds, to walk backwards or turn corners.

The leg processor software

Each leg processor thus has three connections to the main control processor. There is the command line coming from the Walk AFSM and the Input and output to the Alpha Balance

AFSM. In addition, the leg processor has a connection which drives the Alpha actuator and another which drives the Beta actuator. In practice, there will also be other connections to limit switches and some form of leg force, or foot down, sensors. The interconnections between the five leg processor AFSMs and also between them and the two controller AFSMs are shown in Fig.2. Note that, in addition to the AlphaPos and BetaPos AFSMs used in the standing subsumption level, there are three new ones; Alpha Advance, Up Leg, and Down Leg. The suppresser switches will prevent the system trying to move past the design limits and perhaps damaging itself. The best way of describing the leg processor AFSMs, how they function individually and how they interact with each other, is to try and go through what happens when a leg movement is initiated. Leg movement initiation comes via a command line from the higher level Walk AFSM and which is connected to the leg processor Up Leg AFSM. The activation of Up Leg by this command now starts off a sequence of co-ordinated events. The first is that Up Leg sends a negative value to BetaPos, thereby activating the beta actuator and raising the leg. Normally, BetaPos will be sent a positive value by the Down Leg AFSM, thereby keeping the leg firmly on the ground, but the signal from Up Leg counteracts this and thus initiates the desired leg movement.

When the leg has been raised to the desired level the BetaPos AFSM will send a completed action signal to three other AFSMs in the network. These are Up Leg, Down Leg, and Alpha Advance and this completion signal thus initiates three simultaneous actions. The signal to Alpha Advance generates a strongly positive signal which is sent to the AlphaPos AFSM thereby causing the Alpha actuator to swing the leg forward. At the same time the completion signal from BetaPos to Up Leg causes it to cancel the negative value being sent to BetaPos and the same completion signal to Down Leg reactivates its positive signal to BetaPos. The result of these two actions is that the leg is replaced firmly on the ground, but in a new position since it has been swung forward by the Alpha actuator. The above system will walk in a reasonable manner but it has one weakness, it will only walk on totally flat and even ground. This is because the BetaPos AFSM is designed to raise and

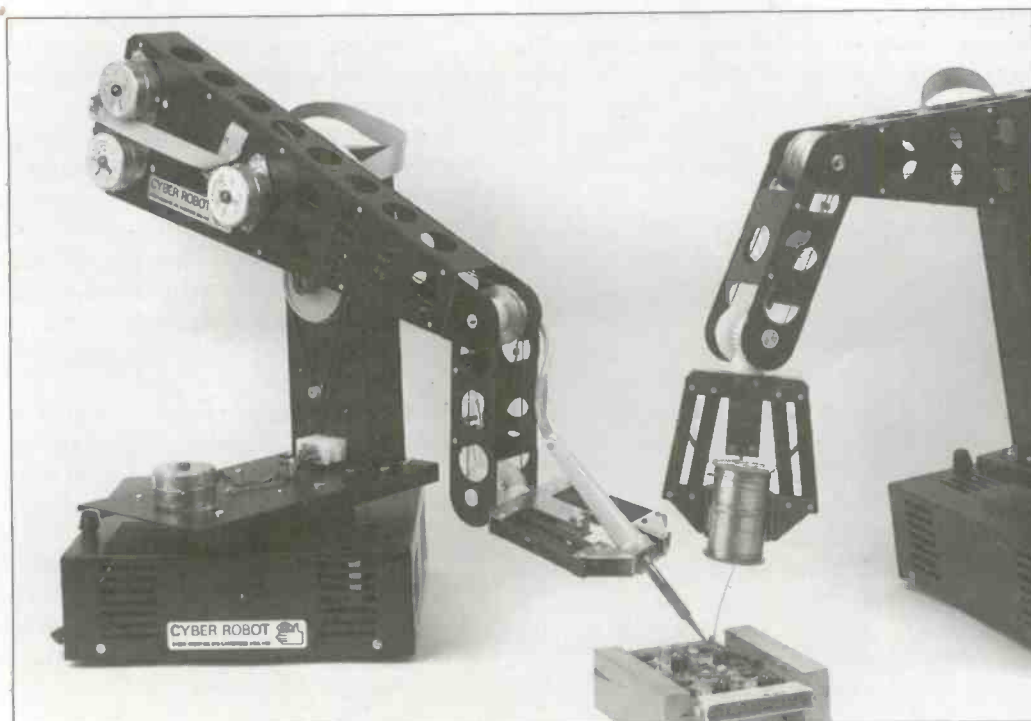

lower the leg to preset positions. If the ground is uneven, then the leg may meet the ground before it is lowered to the preset position, or it may not reach the ground at all. In either case, it will upset the ability of the system to walk, perhaps catastrophically. The solution is to add another level to the system by adding another AFSM that communicates with BetaPos and tells it when the leg has touched the ground, as opposed to using the preset position. This builds into the system a degree of compliance which allows the insectoid to cope with walking on uneven terrains. The system can be designed to sense when the leg has touched the ground using either force sensors on each robot foot or by measuring the amount of force applied by the Beta actuator.

Similar sensors can be built into the system to tell another new AFSM attached to AlphaPos that the raised leg when it is being swung forward has hit something and therefore either needs to be raised higher or if this does not work then the higher level of subsumption needs to be activated to get the insectoid to avoid the obstruction.

Higher levels of subsumption can be added which will enable the system to use sensors such as whiskers or infra-red/ultrasonic rangefinders that will be able to detect obstacles in front of the insectoid before they are hit by a leg and thus enable the system to take the necessary evasive action. Conversely, the sensors could be used to detect something which will attract the insectoid.

Subsumption architecture is an interesting technique for

building autonomous robots that are capable of displaying complex behavioural patterns. In theory, it should be possible to go on adding new layers to the system ad infinitum, but this is only in theory, in practice systems have only been built with just a few layers, and indeed there may be some practical limit to the number of layers which can be used.

Going further

The above described technique is just one of many that can be used to create a robot that will move about by walking rather than with the aid of wheels. It is a very primitive system and will need considerable refinement, as well as the addition of further subsumption layers, before it will do more than just stagger across the floor in a very ungainly fashion.

However, the aim of this article is not to provide a complete set of instructions for building a walking robot but to simply point readers who might be considering building an entry for the First ETI Amateur Robot Competition in the right direction. So come on readers, let's see what you can do, let's show the world that anything NASA can do, ETI readers can also do.

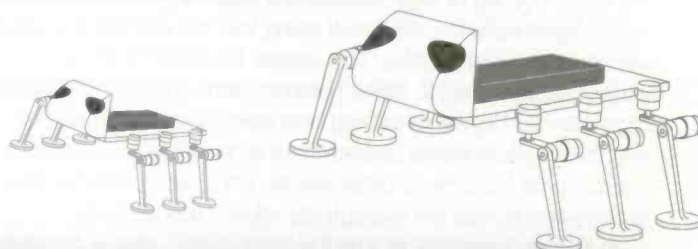

The First Electronics Today International Amateur Robot Competition

A competition which is provisionally scheduled to take place at the Model Engineering Exhibition in January 1996, the competition is to find a walking robot which can, in the shortest time, traverse a course that will include slopes, stairs, and numerous different obstacles. The course area will be 10 metres square. The robot will start from one corner of the course area and will be expected to retrieve an empty standard aluminium soft drinks can located at the opposite diagonal corner of the course area and bring it back to the starting position.

The robot must be completely autonomous with no connection or communication of any sort with any external computer or individual. It must therefore contain its own processor and its own power source.

The robot will be expected to walk over obstacles less than 5cms high, and locate and go around any that are higher. Stairs will have a rise height of 5cms and a tread depth of 10cms, no slope will be greater than 20degrees.

Each leg must be lifted clear of the floor at some stage whilst walking on level ground (no using wheels on the end of each leg!) and at no time can all the legs be lifted off the floor for more than two seconds (hopping is allowed but no flying).

The dimensions of the robot must be such that at maximum leg extension it will fit within a 50cm cube. It can have between one and ten legs and at no time, while traversing the course, must the main body of the robot touch the ground, although it can do so before starting the course and after completing the course.

The competition is open to any amateur robot builder or group of robot builders. It is scheduled to be held at the Model Engineers Exhibition in London during the first week of January 1996.

More details about the course design, the judging and, of course, the prizes, will be published over the coming months in ETI. Judging by initial interest in commercial sponsorship, we hope that prizes will be quite substantial. We are also expecting to have considerable media coverage of the event.

To help readers with the early stages of planning and designing an entry, we will be publishing further articles on subjects which should be of assistance and will also be arranging for various manufacturers to supply specialist items which will be needed by robot builders.

If you are interested in entering a robot for this competition then could you please write to us as soon as possible at ETI giving your name, address and contact phone number, plus a few details about yourself or your group. This information will help us to plan the event. Preliminary entry notification should be sent to: ETI, Robot Competition, ASP, Boundary Way, Hemel Hempstead, Herts HP2 7ST.



Surplus always wanted for cash!

THE ORIGINAL SURPLUS WONDERLAND!

THIS MONTH'S SELECTION FROM OUR VAST EVER CHANGING STOCKS

Surplus always wanted for cash!

LOW COST PC's - ALL EXPANDABLE - ALL PC COMPATIBLE

SPECIAL BUY AT 286

40Mb HD + 3Mb Ram



LIMITED QUANTITY only of these 12Mhz HI GRADE 286 systems Made in the USA to an industrial specification, the system was designed for total reliability. The compact case houses the motherboard, PSU and EGA video card with single 5 1/4" 1.2 Mb floppy disk drive & integral 40Mb hard disk drive to the front. Real time clock with battery backup is provided as standard. Supplied in good used condition complete with enhanced keyboard, 640k + 2Mb RAM, DOS 4.01 and 90 DAY Full Guarantee. Ready to Run!
Order as HIGRADE 286 **ONLY £149.00 (E)**
CALL FOR QTY DISCOUNTS

Optional Fitted extras: VGA graphics card	£29.00
1.4Mb 3 1/2" floppy disk drive (instead of 1.2 Mb)	£32.95
NE2000 Ethernet (thick, thin or twisted) network card	£49.00

PC SCOOP COMPLETE COLOUR SYSTEM ONLY £99.00



A massive bulk purchase enables us to bring you a COMPLETE ready to run colour PC system at an unheard of price! The Display Electronics PC99 system comprises of fully compatible and expandable XT PC with 256k of RAM, 5 1/4" 360k floppy disk drive, 12" CGA colour monitor, standard 84 key keyboard, MS DOS and all connecting cables - just plug in and go! Ideal students, schools or anybody wishing to learn the world of PC's on an ultra low budget. Don't miss this opportunity. Fully guaranteed for 90 Days.

Order as PC99COL	£99.00 (E)
Optional Fitted extras: 640k RAM	£29.00
2nd floppy drive, specify 5 1/4" 360k or 3 1/2" 720k	£29.95

Above prices for PC99 offer ONLY.

SPECIAL OFFER

Computer Controlled Laser Video Disk Player

One of the most amazing surplus deals that we ever been able to offer you! The Philips VP410 LaserVision player, in as new condition, unit features full computer control. Plays standard 12" LaserVision disks with startling visual and audio quality in two channel stereo or mono. When controlled by a computer, it may also be used as a versatile high quality storage / retrieval medium. It will play back either LaserVision CAV (active play) or CLV (Long Play) discs (which covers most types of commercially available video discs). Some of the many features of this incredible machine are:

- BS-232 INTERFACE
- BNC-SCART INTERFACE
- R+W WIRED REMOTE CONTROL
- RGB/COMPOSITE VIDEO OUTPUT
- PAL/RGB DECODER
- FAST RANDOM ACCESS

SPECIAL PURCHASE Only £399.00 (F)

19" RACK CABINETS Superb quality 6 foot 40U Virtually New, Ultra Smart Less than Half Price!



Top quality 19" rack cabinets made in UK by Optima Enclosures Ltd. Units feature designer, smoked acrylic lockable front door, full height lockable half louvered back door and removable side panels. Fully adjustable internal fixing struts, ready punched for any configuration of equipment mounting plus ready mounted integral 12 way 13 amp socket switched mains distribution strip make these racks some of the most versatile we have ever sold. Racks may be stacked side by side and therefore require only two side panels to stand singly or in bays.

Overall dimensions are: 77-1/2" H x 32-1/2" D x 22" W. Order as:
OPT Rack 1 Complete with removable side panels. £335.00 (G)
OPT Rack 2 Rack, Less side panels £225.00 (G)

Over 1000 racks in all sizes 19" 22" & 24" 3 to 44 U. Available from stock!! Call with your requirements.

TOUCH SCREEN SYSTEM

The ultimate in 'Touch Screen Technology' made by the experts - MicroTouch - but sold at a price below cost!! System consists of a flat translucent glass laminated panel measuring 29.5 x 23.5 cm connected to a PCB with on board sophisticated electronics. From the board comes a standard serial RS232 or TTL output. The output continuously gives simple serial data containing positional X & Y co-ordinates as to where a finger is touching the panel - as the finger moves, the data instantly changes. The X & Y information is given at an incredible matrix resolution of 1024 x 1024 positions over the screen size!!! So, no position, however small falls detection. A host of available translation software enables direct connection to a PC for a myriad of applications including: control panels, pointing devices, POS systems, controllers for the disabled or computer un-trained etc etc Imagine using your finger in 'Windows' instead of a mouse!! (A driver is indeed available!) The applications for this amazing product are only limited by your imagination!! Supplied as a complete system including Controller, Power Supply and Data at an incredible price of only: **£145.00 (B)**
RFE. Full Software Support Available - Fully Guaranteed

LOW COST RAM & CPU'S

INTEL 'ABOVE' Memory Expansion Board. Full length PC-XT and PC-AT compatible card with 2 Mbytes of memory on board. Card is fully selectable for Expanded or Extended (286 processor and above) memory. Full data and driver disk supplied. In good used condition fully tested and guaranteed. **£59.95 (A1)**
Half length 8 bit memory upgrade cards for PC AT XT expands memory either 256k or 512k in 64k steps. May also be used to fill in RAM above 640k DOS limit. Complete with data.
Order as: XT RAM UC. 256k. £32.95 or 512k £38.95 (A1)
1 MB x 9 SIMM 9 chip 120ns only £19.50 (A1)
1 MB x 9 SIMM 3 chip 80 ns only £23.50 (A1)
1 MB x 9 SIMM 9 chip 80 ns only £22.50 (A1)
4 MB 70ns 72 pin simm module only £89.00 (A1)
SPECIAL INTEL 486-DX33 CPU few only £79.99 (A1)

NO BREAK UNINTERRUPTIBLE PSU'S

Brand new and boxed 230 volts 1 KVA uninterruptible power supply system from Densel. Model MUD 1085-AHBH. Complete with sealed lead acid batteries in matching case. Approx time from interrupt is 15 minutes. Complete with full manual. **£575.00 (E)**
EMERSON ACCUCARD UPS, brand new 8 Bit half length PC compatible card for all IBM XT/AT compatibles. Card provides DC power to all internal system components in the event of power supply failure. The Accusaver software provided uses only 6k of base RAM and automatically copies all system, expanded and video memory to the hard disk in the event of loss of power. When power is returned the machine is returned to the exact status when the power failed!! The unit features full self diagnostics on boot and is supplied brand new, with full, easy fitting instructions and manual. Normally £189.00 NOW! **£69.00** or 2 for **£120 (E)**

FLOPPY DISK DRIVES 3.5" - 8"

5.25" from £22.95 - 3.5" from £24.95

Massive purchases of standard 5.25" and 3.5" drives enables us to present prime product at industry beating low prices! All units (unless stated) are BRAND NEW or removed from often brand new equipment and are fully tested, aligned and shipped to you with a 90 day guarantee and operate from standard voltages and are of standard size. All are IBM-PC compatible (if 3.5" supported on your PC).

3.5" Panasonic JU363/4 720k or equivalent	£24.95 (B)
3.5" Mitsubishi MF355C-L. 1.4 Meg. Laptops only*	£36.95 (B)
3.5" Mitsubishi MF355C-D. 1.4 Meg. Non laptop	£29.95 (B)
5.25" Teac FD-55GFR 1.2 Meg	£29.95 (B)
5.25" BRAND NEW Mitsubishi MF501B 360K	£22.95 (B)
* Data cable included in price.	
Shugart 800/801 B SS refurbished & tested	£195.00 (E)
Shugart 851 B double sided refurbished & tested	£250.00 (E)
Mitsubishi M2894-63 B double sided NEW	£275.00 (E)
Mitsubishi M2896-63-02U B DS slimline NEW	£285.00 (E)

Dual 8" drives with 2 mbyte capacity housed in a smart case with built in power supply. Ideal as exterior drives! **£499.00 (F)**

HARD DISK DRIVES

End of line purchase scoop! Brand new NEC D2246 8" 85 Mbyte of hard disk storage! Full industry standard SMD Interface. Ultra hi speed data transfer and access time, replaces Fujitsu equivalent model. Complete with manual. Only **£299.00 (E)**

3.5" FUJII FK-309-26 20mb MFM I/F RFE	£59.95 (C)
3.5" CONNER CP3024 20 mb IDE I/F (or equiv) RFE	£69.95 (C)
3.5" CONNER CP3044 40mb IDE I/F (or equiv) RFE	£89.00 (C)
3.5" RODIME RQ3057S 45mb SCSI I/F (Mac & Acorn)	£99.00 (C)
5.25" MINISCRIBE 3425 20mb MFM I/F (or equiv.) RFE	£49.95 (C)
5.25" SEAGATE ST-238R 30 mb RLL I/F Refurb	£69.95 (C)
5.25" CDC 94205-51 40mb HH MFM I/F RFE tested	£69.95 (C)
8" FUJITSU M2322K 160mb SMD I/F RFE tested	£195.00 (E)

Hard disc controllers for MFM, IDE, SCSI, RLL etc. from £16.95

THE AMAZING TELEBOX

Converts your colour monitor into a QUALITY COLOUR TV!!



TV SOUND & VIDEO TUNER!

The TELEBOX consists of an attractive fully cased mains powered unit, containing all electronics ready to plug into a host of video monitors made by makers such as MICROVITEC, ATARI, SANYO, SONY, COMMODORE, PHILIPS, TATUNG, AMSTRAD etc. The composite video output will also plug directly into most video recorders, allowing reception of TV channels not normally receivable on most television receivers* (TELEBOX MB). Push button controls on the front panel allow reception of 8 fully tuneable 'off air' UHF colour television channels. TELEBOX MB covers virtually all television frequencies VHF and UHF including the HYPERBAND as used by most cable TV operators. A composite video output is located on the rear panel for direct connection to most makes of monitor or desktop video systems. For complete compatibility - even for monitors without sound - an integral 4 watt audio amplifier and low level Hi Fi audio output are provided as standard.

TELEBOX ST for composite video Input type monitors	£34.95
TELEBOX STL as ST but with integral speaker	£37.50
TELEBOX MB Multiband VHF-UHF-Cable- Hyperband tuner	£69.95

For overseas PAL versions state 5.5 or 6mhz sound specification.
*For cable / hyperband reception Telebox MB should be connected to cable type service. Shipping code on all Teleboxes is (B)

FANS & BLOWERS

MITSUBISHI MMF-D6D12DL 60 x 25 mm 12v DC	£4.95 10 / £42
MITSUBISHI MMF-09B12DH 92 x 25 mm 12v DC	£5.95 10 / £53
PANCAKE 12-3.5 92 x 18 mm 12v DC	£7.95 10 / £69
EX-EQUIP 120 x 38mm AC fans - tested specify 110 or 240 v	£6.95
EX-EQUIP 80 x 38mm AC fans - tested specify 110 or 240 v	£5.95
VERO rack mount 1U x 19" fan tray specify 110 or 240v	£45.95 (E)
IMHOF B26 1900 rack mnt 3 x 19" Blower 110/240v NEW	£79.95

Shipping on all fans (A). Blowers (B). 50,000 Fans Ex Stock CALL

IC's - TRANSISTORS - DIODES

OBsolete - SHORT SUPPLY - BULK

5,000,000 items EX STOCK

For MAJOR SAVINGS - SAE or CALL FOR LATEST LIST

Issue 13 of Display News now available - send large SAE - PACKED with bargains!



LONDON SHOP
Open Mon - Sat 9:00 - 5:30
215 Whitehorse Lane
South Norwood
On 68A Bus Route
N. Thornton Heath &
Selhurst Park SR Rail Stations

ALL MAIL & OFFICES
Open Mon-Fri 9:00-5:30
Dept ETI. 32 Bliggin Way
Upper Norwood
LONDON SE19 3XF

DISTEL The Original
FREE On line Database
Info on 1000's of items
V21, V22, V22 BIS
0181 679 1888

ALL ENQUIRIES
0181 679 4414
FAX 0181 679 1927

All prices for UK Mainland. UK customers add 17.5% VAT to TOTAL order amount. Minimum order £10. Bona Fide account orders accepted from Government, Schools, Universities and Local Authorities - minimum account order £50. Cheques over £100 are subject to 10 working days clearance. Cash charges (A)=£3.00, (A1)=£4.00, (B)=£5.50, (C)=£8.50, (D)=£12.00, (E)=£15.00, (F)=£18.00, (G)=CALL. Allow approx 6 days for shipping - faster Call. Scotland surcharge CALL. All goods supplied to our Standard Conditions of Sale and unless stated guaranteed for 90 days. All guarantees on a return to base basis. All rights reserved to change prices / specifications without prior notice. Orders subject to stock. Discounts for volume. Top CASH prices paid for surplus goods. All trademarks etc acknowledged. © Display Electronics 1995. E & O.E. 1/11

Light Gun Game

Most large towns and cities now have at least one Laser Gun arena. They are usually very popular with young people and, judging by the queues and the prices charged, must be very lucrative! This project is an attempt to achieve a similar type of game for the home constructor

Having built this project, all you need to provide is a large arena with obstacles, flashing lights, sound and carbon dioxide smoke and you're set up for hordes of enthusiastic youth and enormous profits ... alternatively, you can play it just for fun in any hall or preferably outside in a common, wood, football field etc.

The light guns consist of a belt pack which is worn around the waist with the gun wired into the belt pack. The guns fire infra-red pulses and have a detector at the front and back of the belt pack. You achieve a 'kill' by hitting an opponent with the infra-red shot from the gun. The guns have a range of about 5m in daylight and considerably better at night - with careful aiming we found ranges up to 30m.

The project consists of the light guns, team bases, and an optional central 'renewal' unit. At the simplest, two guns can be built for a two player game, more guns and team bases can be added for team games and, if the central unit is built, then a variety of game types can be played, the game duration can be set, and each player has an individual score at the end of the game. This article explains the construction and use of the light guns; subsequent articles detail the bases and central unit.

For team games the players are split into two teams - the packs are painted red or green to divide the teams. The packs have LEDs which are of the same colour as the pack so that the team colour of each player is easily visible at night. Each team may have up to 15 players and a base which they attempt to defend against the other team. The bases each have Xenon

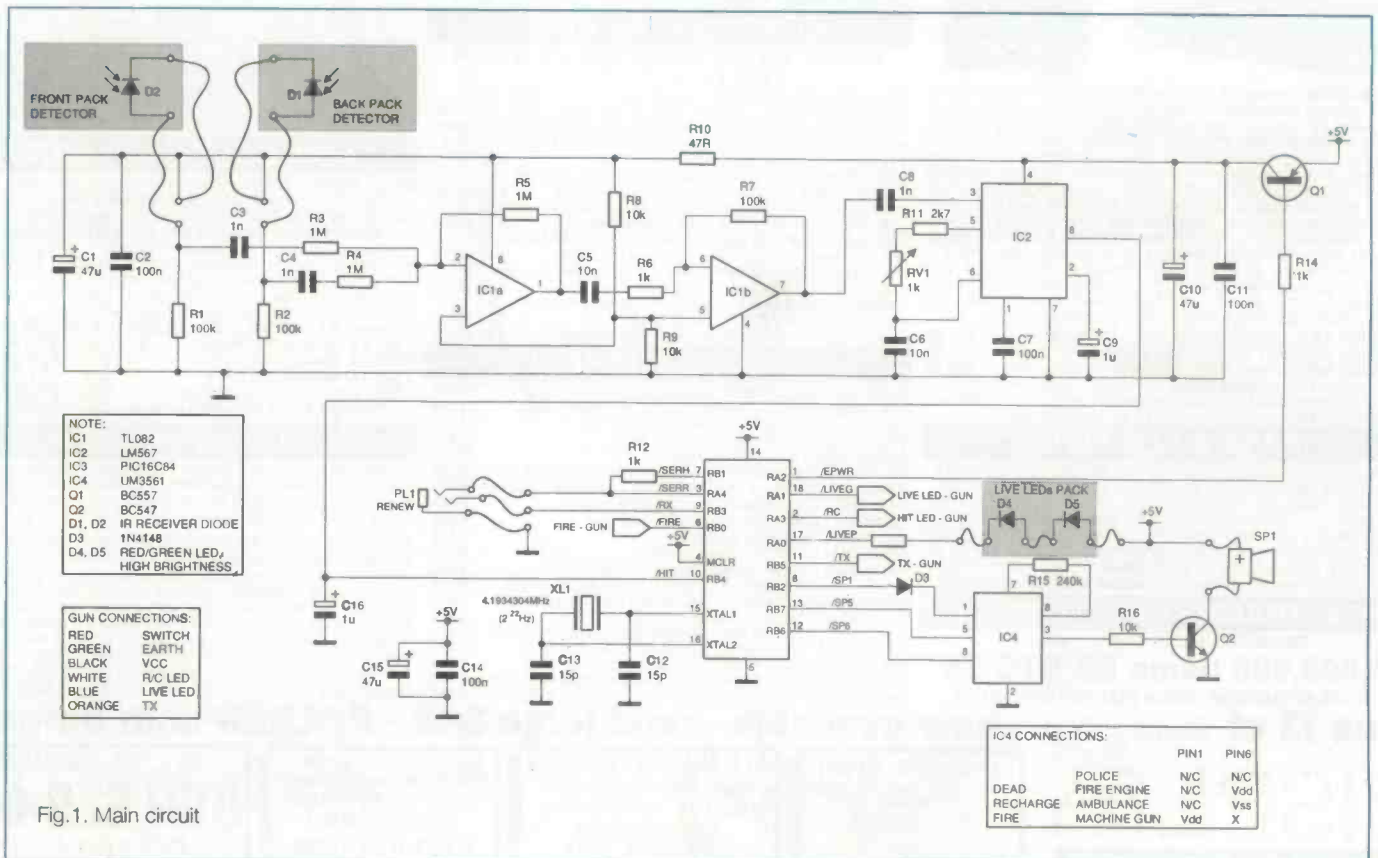

Fig. 1. Main circuit

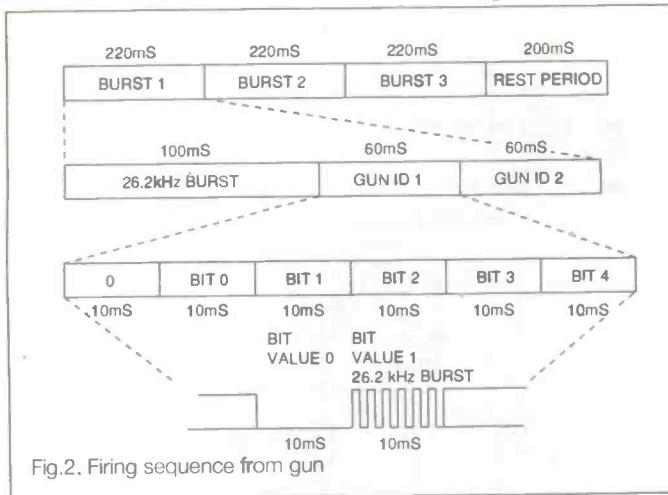

Fig.2. Firing sequence from gun

warning lights and a siren which are triggered if a member of the opposing team succeeds in hitting the base. The construction, operation and use of the bases will be explained in a later article.

Light gun features

The gun itself has a fire trigger switch, two LEDs for the information of the user, the infra-red LEDs which 'fire' at other players and the batteries and the battery recharging socket. The first gun LED is the live LED and comes on when the player is 'live', the other is the hit LED used to give information about being hit.

The pack has a case at the front containing the main light gun circuitry, and a small plastic box at the back. There is an LED and a sensor in the front case and in the back box. The LEDs inform other players about the team and the status of this player, while the sensors detect when the gun has been hit. The front case also contains a 3.5mm stereo jack socket (the

'renewal socket') which is used to renew the player when all lives have been lost.

Renewing the player

The player is 'renewed' to restore him to life. The light gun may be operated in one of two modes, depending on whether a central renewal station is in use.

The first mode is the simple mode where the gun is renewed by inserting a simple 3.5mm stereo jack plug with all its connections shorted into the renewal socket. In this mode the gun has 4 lives and 16 shots per life when it has been renewed. There is no time limit on the game except that imposed by the organisers. Players may be divided into red and green teams and aim to set off each other's bases - in this case, base hits are used to score each team. Alternatively, a solo game may be played without bases where the number of renewals may be used for individual player scores.

The second mode is normal mode where a central renewal station is used. In this mode, the game type is selected at the central renewal station and guns renewed by inserting the renewal lead from the central station. Each game offers a different number of lives and shots per life. Team games or solo games with or without bases are selectable. The game duration is set at the central station and the guns will all die simultaneously at the end of the game. In addition to this, the



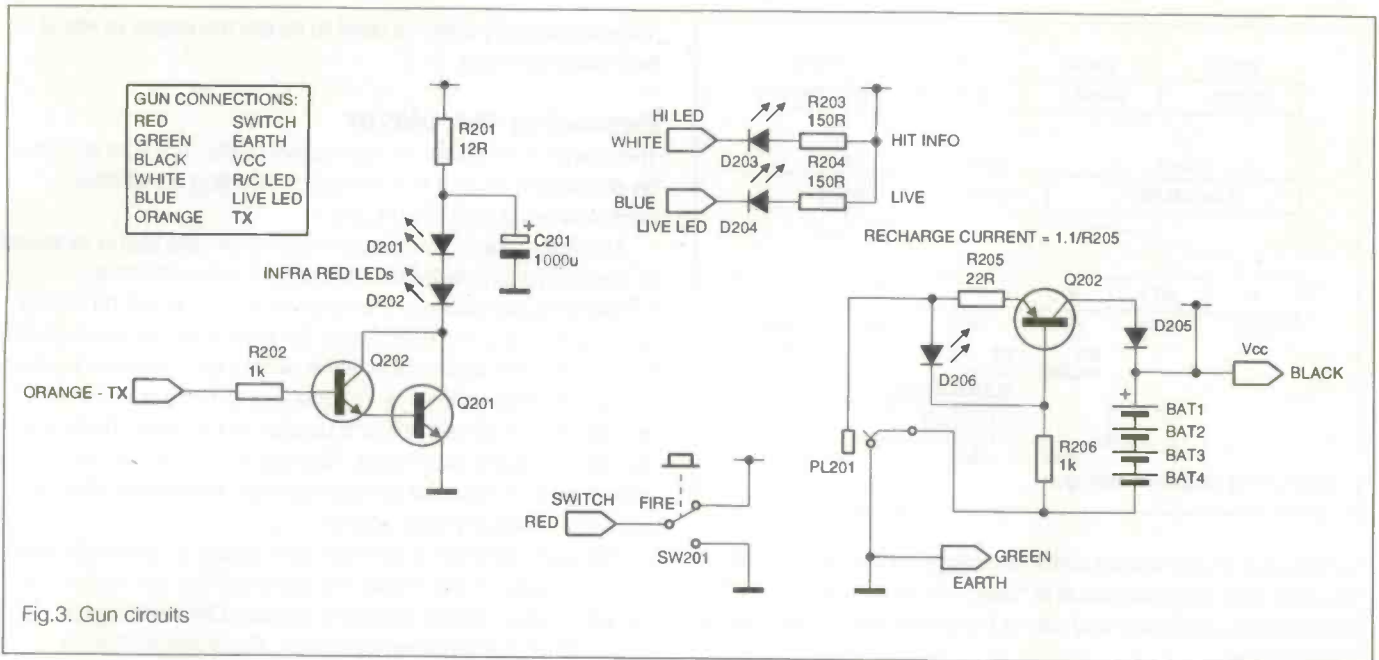

Fig.3. Gun circuits

guns may be programmed with a warrior mode which only allows certain users to hit the bases. The various games that can be played will be described in the later article on the central.

When the gun is first powered up it is in the 'dead' state, all LEDs are turned off and the gun cannot be fired. The gun is renewed either by inserting a shorted 3.5mm stereo jack plug in simple mode, or by inserting the renewal lead from the central in normal mode.

For a 4 second period after renewal, the gun cannot be fired and the pack cannot be hit. During this period, the hit LED illuminates and the pack LEDs are switched off and the pack makes the sound of an ambulance. This allows the player time to get away safely from the renewal station without being shot.

Firing and shots

Once renewed, the gun is 'live'. The LEDs at the front and back of the belt pack illuminate together with the live LED on the gun. The gun may be fired by pulling the trigger. Whilst firing, the gun cannot be hit.

The player has a limited number of shots per life. If these are used up then the player immediately loses all remaining lives and the gun returns to the dead state. When there are three or less shots left, the gun live LED flashes to warn the player.

Being hit

The sensors at the front and back of the pack detect the infra red signal from a gun. If the pack is hit then the player loses a life.

For the first four seconds after being hit the pack makes a siren sound and the live LEDs and pack LEDs go out. During this period, no shots may be fired and the pack cannot be hit again. This is the 'protected period'. For a further four seconds after the protected period, the pack makes a sweep sound and the live LED and pack LEDs flash rapidly, the gun cannot be fired but the pack can be hit again. During this second period the player is a 'sitting duck'; the flashing LEDs make it very clear to other players that the sitting duck is an easy target.

The hit LED on the gun illuminates during both four-second periods after the gun has been hit to further warn the player that he cannot fire. The gun also has a 'revenge' shot - for a period of one second after being hit, the player can fire one shot to get the player who has just shot him - if he is quick enough to see him!

When only one life is left, the gun live LED flashes to warn the player. Once all the lives, or all the shots, have been used up the player is 'dead'. The pack and gun LEDs go out and the gun must be renewed before the player can re-enter the game.

Other Features

The gun has rechargeable batteries and may be recharged from any 10-15V DC power source. Several guns can be recharged simultaneously; each gun needs about 80mA from the recharging power source. The gun is recharged by inserting a 3.5mm mono jack plug into the recharging socket on the gun. The plug should have the tip as negative, and the ring as positive; note this is the opposite to normal power supplies.

To change the gun into simple mode, the fire trigger is held down whilst the recharging plug is withdrawn from the gun - the hit LED illuminates. Normal mode is entered by leaving the fire trigger released whilst the recharging plug is withdrawn - the gun live LED illuminates. The gun will stay in the mode set until the recharging plug is inserted again.

If the gun is not used for a period of about four minutes - if the player is not hit and if the gun is not fired or renewed - then the gun goes into sleep mode. In sleep mode, all LEDs and internal circuits are turned off and the power consumption of

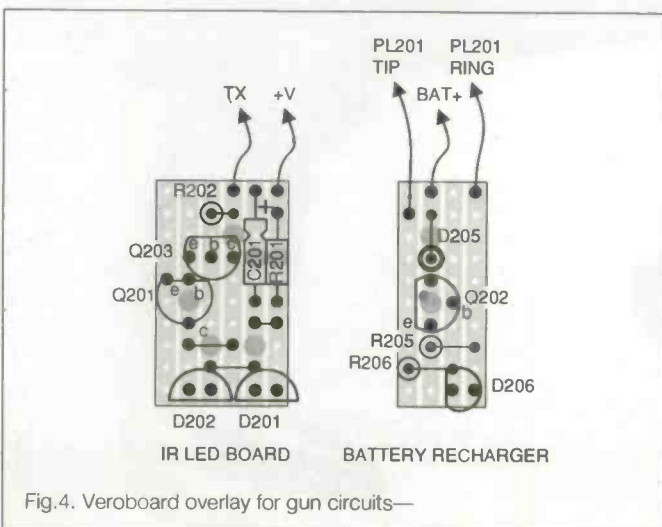

Fig.4. Veroboard overlay for gun circuits—

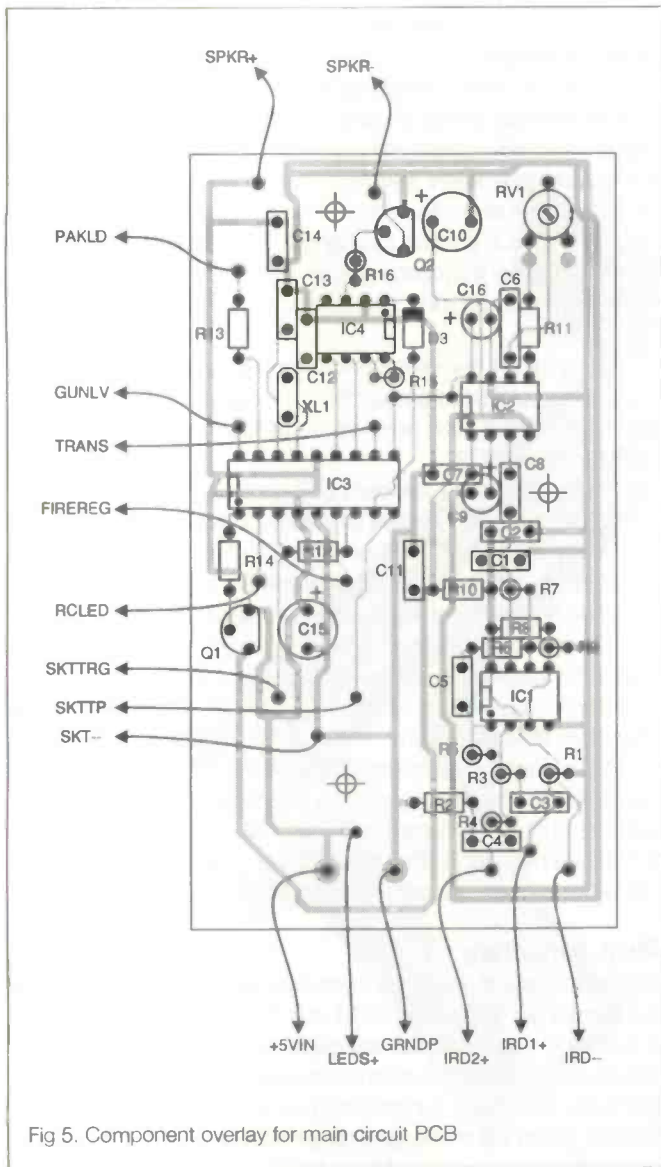

Fig 5. Component overlay for main circuit PCB

the gun drops to about 40uA; the gun cannot be fired or renewed. Pressing the fire switch wakes the gun up, after which it is in the dead state and may be renewed as normal. This means that the gun does not need an on-off switch.

Each gun has its own identity which may be programmed from the central. The gun identity is held in EEPROM and is not lost if the power is disconnected when the batteries are recharged. The gun identity is used from the central to report scores for each player at the end of the game and is used by the bases to identify which player hit them. The gun identity is not used in simple mode.

Operation of the circuit

The circuitry of the gun is split into two parts. The main circuitry is held in the case on the front of the belt, the gun holds the infra-red LEDs, the batteries and the battery charging circuitry.

Main Circuit

The main circuit is shown in figure 1.

It won't come as any surprise that functionality of this complexity in an affordable and compact unit can only be achieved by using a microprocessor. In this case most of the functions are contained within a microcontroller - the PIC16C84, IC3. This device contains 1K of program store, a real time clock, an interrupt handler, two general purpose I/O ports, and 64 bytes of EEPROM data store.

The real time clock is used to keep time in the gun. The clock is set up to generate interrupts at a 1/16th of a second rate and these interrupts are used to measure the game time, operate the hit timers and enter sleep mode after a 255 second period of inactivity. The main interrupt input is used to detect the operation of the fire trigger and to bring the gun out of sleep mode. The EEPROM data memory is used to store the gun ID reliably and is held over power down to the chip.

The PIC uses a crystal for timing. This is more costly than other oscillator types but offers temperature stability and accuracy which is required for serial communication to the central renewal unit. The oscillator frequency is 4.194303MHz which is divided by 2^{18} to give an exact 1/16 second timer interrupt internally. The outputs of the PIC are used to drive the main gun functions.

Communication with the central renewal unit is through a serial link on socket PL1. The tip of the socket is used to transmit information directly from the renewal unit to the PIC. The central ring of the socket is used to request and acknowledge transmission and to transmit information from the gun to the central. The gun transmits its own identity and the number of lives left to the central at a rate of about 1000 bits/S. The central transmits an 8 byte packet to the gun, including information on game type and duration, at a rate of about 10500 bits/S. The central also uses a different packet type to program the gun identity. R12 is needed for the operation of the serial protocol which is described in more detail in the later article on the renewal unit. Whilst passing information to and from the central, the gun LEDs show successful renewal.

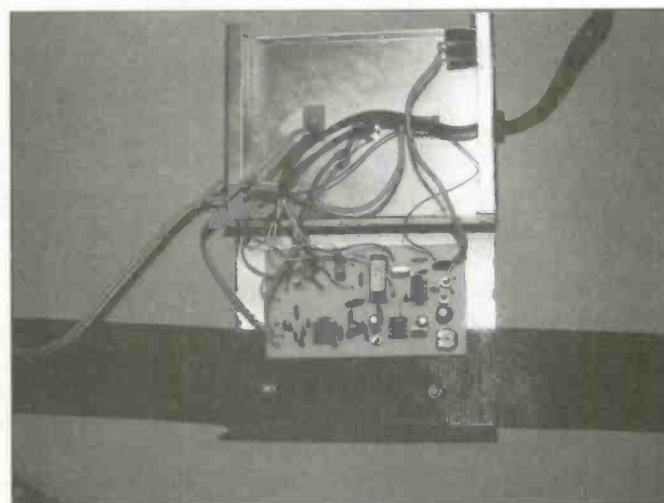
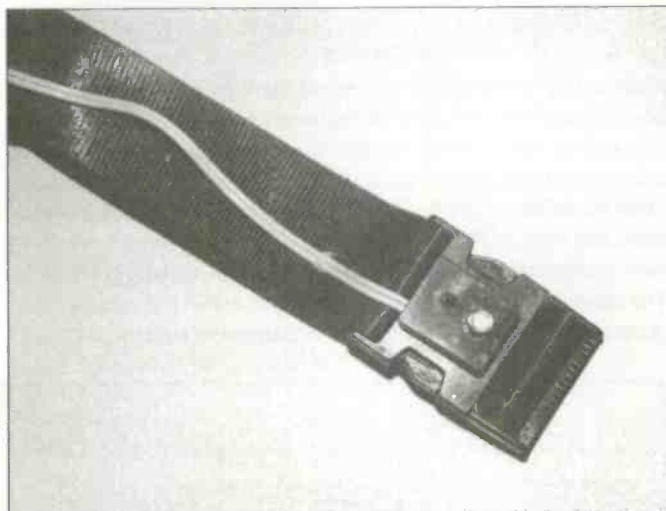

In simple mode, the shorting of the socket tip to ground directly renews the gun.

The 20mA current drive capability of each output pin can drive LEDs directly; there are three LED drives, one for the front and back pack LEDs, one for the gun live LED, and one for the gun hit LED. The PIC also directly generates the 26.2KHz square wave used for the infra-red LEDs when firing; this output is on pin 11.

The sound chip, IC4, is powered directly from the PIC, as its power consumption is only 5mA. The output of the sound chip is buffered by TR2 to drive a speaker or sounder. This must have 64ohm or greater voice coil resistance. The sound chip is connected to generate three sound types: a machine gun noise which is used for firing, a fire engine noise which is used for the protected period and an ambulance noise which is used during the sitting duck period.

Output RA2 on pin 1 of the PIC is used to switch TR1. TR1 is used to switch power to the infra-red receiver circuitry, so that in sleep mode all unused functions are powered down minimising battery drain.

All guns have an identity, which is a number from 1 to 15, and a colour - red or green. Thus guns may have identities such as red 12 or green 6. Internally, the gun ID is held as a 5 bit number, the bottom 4 bits are the gun number and the top bit is the colour - red is 0 and green is 1. Thus, red 12 has code 0CHex and green 6 has code 16Hex.

The gun fires using a 26KHz square wave from two infra-red LEDs; this is generated in software in the PIC. The firing stream is a 100mS burst of square wave followed by the gun identity which is transmitted in serial form as a low start bit followed by the 5 bit identity in binary form - LSB first. Each bit is 10mS long and is sent as a burst of 26KHz if the bit is 1, and no pulses at all (the Infra-red LEDs are turned off) for a 0. The ID is repeated once to make 12 bits. The whole sequence of 100mS burst followed by two identity transmissions is repeated three times to make up a total 660mS burst. A 200mS gap during which no other functions operate is left following the gun transmission to allow the internal PLL to recover so that the gun won't detect its own transmission. The whole sequence is illustrated in figure 2. The identity fired by the gun is only used within the bases; the guns use the presence of the 26KHz signal to indicate a hit as

reliable detection of the identity is not possible at extensive ranges.

The IR pre-amp is made up from dual CMOS op-amp IC1. The IR detector diodes D1 and D2 operate in the reverse biased mode and their outputs are passed through capacitors C3 and C4 to remove ambient infra-red effects. The signals are added by IC1a which is configured as unity gain inverting amplifier. The output of IC1a is passed through R6 and C5 which roll off unwanted lower frequency signals. The second stage formed by IC1b has a gain of 20dB and its output is passed to the PLL tone decoder.

As the circuit operates from 5Vdc the non-inverting inputs of IC1 are connected to the junction of R8 and R9 which is at supply/2. All switching noise from the PIC is effectively filtered by R10, C1 and C2.

The PLL, IC2, is a standard 567 tone decoder which is connected to detect signals of 26KHz. The centre frequency of the PLL is set by R11, VR1 and C6. C6 must be a high stability polyester or polystyrene capacitor to ensure minimum change of frequency over a wide temperature range. The filter components are chosen to provide a fairly slow detection of the signal (approx. 5mS), and the output is further filtered by C16 and the pull-up resistor on input RB4 of the PIC. This minimises the risk of false detection.

The current consumption of the gun is about 50mA when live, 150mA when firing and 1mA when dead. In sleep mode, total consumption drops to around 40uA. This gives typically 6 to 8 hours play per recharge, and consumption in sleep mode will be lower than the self discharge rate of the Ni-Cd batteries.

Gun circuitry

Figure 3 shows the circuitry contained within the gun. The infra-red diodes are driven by TR201 and TR203 and are driven with a current of 100mA. C201 sharpens the edges of the waveform. The Ni-Cd batteries are held in the gun and are recharged at 50mA by the simple constant current source formed around TR202. When the recharging plug is inserted into PL201, the batteries are disconnected from the main circuitry. The renewal mode is selected by the PIC when the recharge plug is removed. It detects the state of the fire switch as the program starts running to choose normal or simple renewal mode.

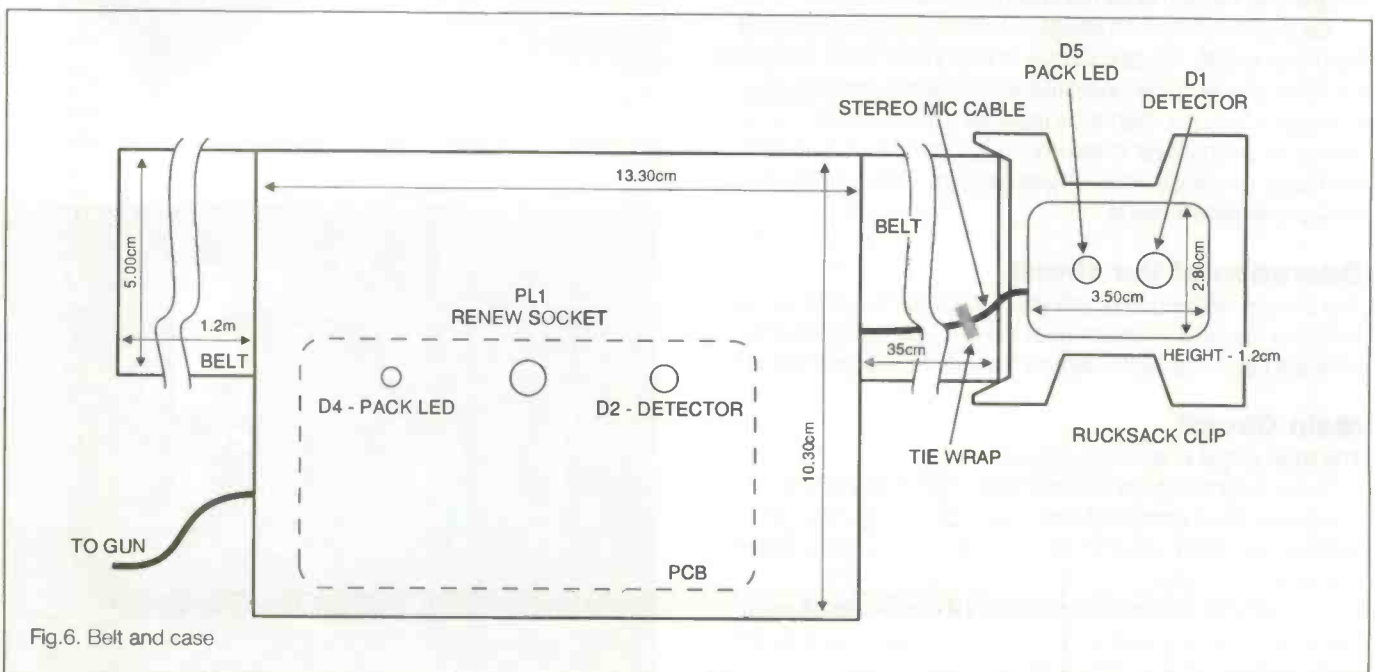

Fig.6. Belt and case

CONSTRUCTION

Obtaining components

Undoubtedly the most difficult item will be the gun itself. We were lucky enough to find a box full of old Sinclair Spectrum light guns in a Greenweld sale for £5 for a carrier bag full! Greenweld and some other surplus suppliers may still have stocks of these guns which are almost perfect for this application. Originally we had some success with modified water pistols but abandoned this idea when we found the Spectrum guns. Whatever is used, the most difficult aspect will be fitting the fire switch into a modified gun, the Spectrum guns had a change-over micro-switch which was re-used.

The case at the front of the pack is aluminium; we used Maplin's AB10 case. This front case must be metal and earthed as the receiver is very susceptible to noise. The small case at the rear of the pack which is glued to the rucksack clip is a plastic potting box.

The belt is 2' wide black nylon webbing. We eventually bought 25m at 50p/m from a tent repairer. Yacht chandlers are much more expensive and it is almost impossible to buy a car seat belt for safety reasons. The belt is held on to the player with a rucksack clip, which can be bought from camping shops for around £1.25 each.

If you buy all the parts for the gun individually and brand new, then it will cost around £30 for all electronic and mechanical parts. However, if you are building in quantity, then it becomes worth shopping around, using surplus suppliers and asking suppliers to give quantity discount. We have built 14

guns in total, the first four were prototypes which cost about £25 each, the remainder we managed to build for less than £15 each.

The most important issue to bear in mind when building the gun is mechanical robustness. The light guns are going to be worn by players who will be running around a play area with obstacles and the guns will suffer strong shaking and vibration which will soon cause failure of poorly made connections.

All nuts and bolts **must** be secured with shake-proof washers. Most items in the light gun are glued in place except the main circuit board. We found that by far the best glue was silicone rubber sealant. This is cheap, sticky when wet, dries fast and is very strong but flexible when dry. Despite this, glued items can still be prised apart without damage if necessary. We used Superglue to secure the red filters to the cases and to glue the photo diodes to the filter, as it has the advantage of being transparent. Secure loose wires with silicone rubber.

We found that if you build several guns in parallel at the same time, then it is possible to complete five guns in about twice as long as the time taken to complete one gun. It is also definitely much easier (and saves the sanity) to build a large quantity of guns with a team of builders rather than just one!

As in most electronics projects, the most difficult part of the construction is mechanical; the electronic circuitry in the project is straightforward. The table at the end of this article shows the complete component list for the project.

The construction of the gun is shown in photo 1, the physical construction of the gun will be very dependent on the gun case used. The two gun circuits - the battery recharger and the infra-red LED driver are too small to justify PCB construction, so veroboard is used. Figure 4 shows the veroboard overlay for the



Fig.7. Front panel graphics

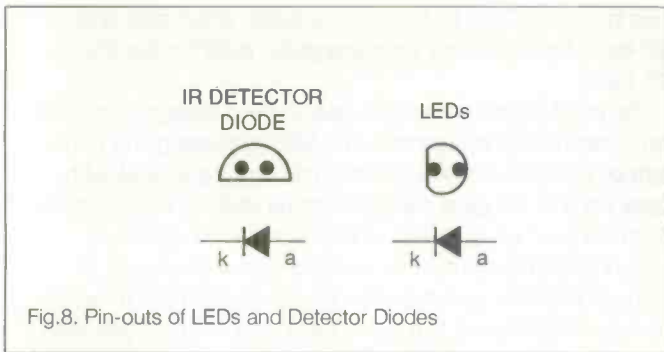

Fig.8. Pin-outs of LEDs and Detector Diodes

two circuits. This can be photocopied and glued directly to the board. The grey squares are track breaks, thick black lines are wire links and black circles are PCB pins; the other components are shown on the layout. Figure 8 shows the pin out of the infra-red LEDs. Note that C201 is glued directly to the gun case and wired to the infra-red driver board. The batteries are glued into the gun case using silicone rubber. The gun and hit LEDs are mounted by the leads, one lead is melted into the case plastic, the other to a small piece of veroboard holding R203 and R204 which is then soldered to the fire switch. The cable from the gun to the case is 6 way; the colour codes for the cable we used are shown in figure 3.

Test the gun and recharge the batteries as shown below before wiring the gun to the main case. Test the infra-red driver and battery recharge circuits before gluing them into the case. The infra-red driver circuit is glued to a spacer to place the infra-red LEDs on the main axis of the gun. LED D206 is mounted through the case so that it can be seen from outside the gun and is Superglued in place.

The main circuit board in the gun is shown in figure 5. Insert resistors R1 to R16 first, follow with diode D3, sockets for IC1 to IC4, printed circuit board pins and finally the capacitors, crystal, and variable resistor. Note that IC4 is the opposite way round on the board to ICs 1 to 3. There is one link - J2. Don't insert the ICs yet.

The front case is shown open in photo 2, it should be drilled and then painted, either red or green dependent on the team. The belt is held by two bolts and is glued to the base of the case so that when the belt is worn with the case at the front the belt is at the top of the case. Figure 6 shows the measurements for the belt. The belt is clamped firmly by the case when it is screwed shut. There are three supports for the PCB, hold it with M3 bolts and shake-proof washers and use 5mm spacers.

The front panel graphic is shown in figure 7. We found a cheap way of producing the graphics was to laser print the image in mirror form directly on to overhead transparency film, and to Superglue it to the case. The renew socket is fitted centrally into the case, the pack LED and the detector diode are fitted on either side of the socket. The LED in the front case is glued into place, or a chrome LED holder may be used. The detector diode is glued to a small piece of red filter material which is glued to the case. Figure 8 shows the pin out of the LEDs and detector diode. The renew socket should be fitted after the graphic as it holds the film to the case. Use a high power iron to solder the socket ring to the socket. The speaker is glued directly to the case. It is very important that the wires to the speaker and the speaker itself are kept away from the input circuitry on the PCB, because the input circuit will pick up signals from the speaker wiring and the player will suffer spurious hits.

The rucksack clip fixed end is fitted to the shorter end of the belt. Fold about 5cm of the belt through the clip and either glue

it back on itself or, better still, sew it. Fit the rear LED into the rear case with a chrome LED holder and fix the detector diode in the same way as the front detector. Use stereo screened microphone cable to wire the rear detector and LED to the front case. The cathode of the detector and LED should be connected to the screen of the cable. You may want to test the complete circuit before gluing the rear case to the rucksack clip using silicone rubber. The cable is held to the belt using tie-wrap, self-locking cable grips. Connect the speaker, pack LEDs, detector diodes and renew socket to the main PCB. Leave the case open.

Set-up and Testing

The gun should be tested first. Break one of the battery links and insert an ammeter. An external supply of 10 to 15v DC should be used. A 3.5mm mono jack plug is used with the tip connected to negative supply. D206 should light and the current measured to the battery should be about 50mA. Leave for 14 to 16 hours to recharge the batteries.

Insert a plug into the recharge socket to isolate the supply from the gun. Wire the gun to the front case, a self-gripping cable grommet must be used as there will be high stresses on the cable during play.

Remove the recharge plug and check that there is +5v DC between pins 5 and 14 of IC3. Short the LED connections on IC3 to ground one by one (pins 2, 17 and 18) and check that the LEDs illuminate. Short pin 8 of IC3 to +5v and the speaker should emit a police siren sound. Insert the recharge plug and then insert ICs 1 to 4. Note that IC4 is the opposite orientation to the other ICs.

Press the fire trigger and pull out the recharge plug. The hit LED should illuminate to show that simple recharge mode is in use. Take a 3.5mm plug with all the connections shorted and insert it into the renew socket, remove it, the speaker will emit the renew tone for four seconds, and then the gun will be live. Now short both halves of the case and ensure that the PCB is bolted in place before adjusting the PLL. Measure the frequency on pin 5 of IC2 and adjust to 25.2KHz with VR1 (without a frequency meter, then adjust for maximum range of detection with the aid of another gun). We found that it may be necessary to increase R11 to 3K3 with some 567 devices to enable correct adjustment. Note that this frequency is (correctly) about 1KHz lower than the transmitted frequency from the PIC.

With the aid of another gun check all the functions. Insert an ammeter again and check that after roughly four minutes all functions of the gun cease and current consumption drops to around 40uA. Pressing the fire trigger will return current consumption to around 1mA before the next renew or sleep period. Screw the case shut, bolt the gun shell together and the gun is ready for use.

Playing the game

We found teams of around four to six were most successful in team games; individual games from two to ten players are also successful. The renewal station (either the central renewal unit, or, in simple mode, a shorted 3.5mm stereo plug attached to a length of string) should be placed at a central location. If used, the bases should be placed equidistant from the renewal station. We found lightly wooded areas to be by far the best areas to play the game and dusk, or a moonlit night, to be the best conditions for play when the range is greatest and the pack LEDs are most visible. Players must be firmly dissuaded from covering the detectors with clothing or their hands! 15 minutes for a game (the default from the central) is about right.

Main Circuit

Gun Circuit

Capacitors

- C1,10,15 47uF Electrolytic
- C2,7,11,14 100nF Ceramic
- C3,4,8 1nF Ceramic
- C5 10nF Ceramic
- C6 10nF Polyester
- C9,16 1uF Electrolytic
- C12,13 15pF Ceramic

Semiconductors

- D1,2 IR Receiver diode
- D3 1N4148
- D4,5 HE, 5mm Red/Green LED, High Bri.
- IC1 TL082
- IC2 LM567
- IC3 PIC 16C84
- IC4 UM3561
- TR1 BC557
- TR2 BC547

Resistors

- R1,2,7 100K 1% Metal Oxide
- R3,4,5 1M 1% Metal Oxide
- R6,12,14 1K1% Metal Oxide
- R8,9,16 10K1% Metal Oxide
- R10 47R 1% Metal Oxide
- R11 2K71% Metal Oxide
- R13 68R1% Metal Oxide
- R15 240K1% Metal Oxide
- VR1 1K variable resistor horizontal

Miscellaneous

- XL1 4.193MHz crystal
- PL1 Stereo Jack Skt, 3.5mm
- SP1 Sounder, >64ohm
- Cable 1 Twin Mic Cable
- Clip 1 Rucksack clip
- Belt 1 Webbing Belt, 5x135cm
- Case 1 Aly Case, Maplin - AB10
- Case 2 Potting box, Min
- Vero Board
- Tie wraps
- M3 Bolts
- M3 Nuts
- M3 Shakeproof washers
- Red filter
- PCB

Capacitors

- C201 1000uF Electrolytic Axial 10V

Semiconductors

- D201,202 IR LED 5mm
- D203 Orange LED 5mm
- D204 Red/Green LED 5mm
- D205 1N4001
- D206 Red LED 3mm
- TR201,203 BC547
- TR202 BC557

Resistors

- R201 12R1% Metal Oxide
- R202,206 1K1% Metal Oxide
- R203,204 150R1% Metal Oxide
- R205 22R1% Metal Oxide

Miscellaneous

- PL201 3.5mm Mono Jack Socket
- BAT 1-4 Battery
- Vero Board 1.5"x1.5"
- Cable 6-way



EXPRESS COMPONENTS

MAINS IONIZER KIT. Very useful kit that increases the flow of negative ions, helps clear cigarette smoke, dust, pollen etc. Helps reduce stress and respiratory problems. £15. kit, £20 built.

COMBINATION LOCK. Electronic 9 key combination lock suitable for alarms, cars, houses etc, easily programmable. Includes mains 2A relay o/p. 9v operation. £10 kit, £14 built.

VARIABLE POWER SUPPLY. Stabilized, short circuit protected. Gives 3-30v DC at 2.5A, ideal for workshop or laboratory. £14 kit, £18 built. 24VAC required.

LEAD ACID CHARGER. Two automatic charging rates (fast and slow), visual indication of battery state. Ideal for alarm systems, emergency lighting, battery projects etc. £12 kit, £16 built.

PHONE LINE RECORDER. Device that connects to the 'phone line and activates a cassette recorder when the handset is lifted. Ideal for recording 'phone conversations etc!. £8 kit, £12 built.

ROBOT VOICE. Turns your voice into a robot voice! answer the phone with a different voice!. £9 kit, £13 built.

PHONE BUG DETECTOR. This device will warn you if somebody is eavesdropping on your 'phone line. £6 kit £9 built.

PHONE BUG. Small bug powered by the telephone line. Only transmits when the phone is used. Popular surveillance product. £8 kit, £12 built.

STROBE LIGHT. Bright strobe light with an adjustable frequency of 1-60hz. (a lot faster than conventional strobes!) £16 kit, £20 built.

4W FM TRANSMITTER. 3 RF stages, audio preamp. 12-18vDC. Medium powered bug £20 kit, £28 built.

3 CHANNEL LIGHT CHASER. 3x 800w output, speed and direction controls, can be used with 12 led's (supplied) or TRIACS for mains lights (also supplied). 9-15v DC. £17 kit, £23 built.

25W FM TRANSMITTER. 4 stage, a preamp will be required. (Our preamp below is suitable) £79 built. (no kits).

SOUND EFFECTS GENERATOR. Produces any thing from bird chips to sirens! add sounds to all sorts of things £9 kit £13 built.

FM/AM SCANNER. Well not quite, you have to turn the knob yourself but you will hear things on this radio (even TV) that you would not hear on an ordinary radio! A receiver that covers 50-160MHz both AM and FM. Built in 5w amplifier. £15 kit, £20 built.

CAR ALARM SYSTEM. Works on vibration and/or voltage drop from door etc being opened. Entry and exit delays plus adjustable alarm duration. Low cost protection! £12 kit, £16 built.

15W FM TRANSMITTER. 4 stage, high power bug. You will need a preamp for this (see our preamp below which is ok) £69 built. (no kits).

1W FM TRANSMITTER. 2 stage including preamp and mic. Good general purpose bug. 8-30VDC. £12 kit, £16 built.

50 IC's for £1.50
Nice mix of chips at a bargain price!

CERAMIC CAPACITOR PACK
Good mixed pack of 100 capacitors for just £1.00

ELECTROLYTIC PACK 1
100 small mixed electrolytic capacitors just £1.00

ELECTROLYTIC PACK 2
50 larger electrolytic mixed capacitors

RESISTOR PACK NO 1
250 low wattage resistors, ideal for most projects etc. Just £1.00

RESISTOR PACK NO 2
Hi wattage pack, good selection of mixed wattages and values 50 in all, bargain price just £1.00

PRESET PACK
Nice selection of 25 mixed preset pots for just another £1!

RELAY PACK NO 1
6 mixed relays for £1, that's just 17p each.

CONNECTOR PACK
10 different connectors, again for £1

FUSE PACK NO 1
40 mixed 20mm fuses, ideal for repairs etc, or just to stock up the spares box! Just £1.00

FUSE PACK NO 2
30 mixed 1.25" fuses again ideal for spares etc. Just £1.00

WIRE PACK
25 Metres of insulated wire for just £1.00, good for projects etc.

SLEEVING PACK
100 assorted pieces of sleeving for connectors etc. Yours for just £1.00

DIODE PACK
100 assorted diodes for just £1.00

LED PACK
20 light emitting diodes for £1.00

TRANSISTOR PACK
50 mixed transistors, another bargain at £1.00

BUZZER PACK
10 things that make a noise for just £1.00!

POT PACK
10 pots for £1, (5 different types) a snip at £1.00

DISPLAYS
10 seven segment displays for £1.00

ORDER 10 PACKS OR MORE AND CHOOSE ONE FREE PACK!!

FREE COMPONENT CATALOGUE WITH EVERY ORDER!!

99p Post

BULK PACKS

PREAMP MIXER. 3 channel input, independent level and tone controls. Ideal for use with the hi power FM transmitters. £15 kit, £19 built.

TREMBLER ALARM. Designed for bikes etc, adjustable sensitivity, preset alarm time, auto reset. Could be adapted for all sorts of "borrowable" things £12 kit, £16 built.

ULTRASONIC RADAR. A project that can be used as a movement detector in an enclosed space. Range about 10 metres, 12vDC. Good basis for car, shed, caravan alarm etc. £14 kit, £19 built.

PHONE CALL RELAY. Very useful kit that incorporates a relay that operates when the phone rings. Can be used to operate more bells, signalling lights etc. Good for noisy environments or if you have your headphones on! £10 kit, £14 built.

PORTABLE ALARM SYSTEM. Small 9v alarm system based on a mercury switch. The alarm continues to sound until disabled by the owner. Buzzer included. £11 kit £15 built.

800W MUSIC TO LIGHT EFFECT. Add rhythm to your music with this simple sound to light kit. £8 kit, £12 built.

MOSQUITO REPELLER. Modern way to keep the midges away! Runs for

about a month on one 1.5v battery. Frequency is set to drive away mosquitos etc. £7 kit, £11 built.

3 CHANNEL SOUND TO LIGHT. Can be used anywhere as no connection is made to hi fi. Separate sensitivity controls for each channel, 1,200W power handling. Microphone included. £14 kit, £19 built.

MINI METAL DETECTOR. Detects pipes, wires etc up to 20cm deep. Useful before you drill those holes! £8 kit, £12 built.

0-5 MINUTE TIMER. Simple time switch adjustable from 0-5 mins, will switch 2A mains load. 12v op. Ideal for laboratory, photographic projects etc. £7 kit, £11 built.

7 WATT III FI AMPLIFIER. Useful, powerful amplifier 20hz-15hz, 12-18vdc. Good for intercoms, audio systems, car etc. £7 kit £11 built.

INCAR SOUND TO LIGHT. Put some atmosphere in your car with this kit. Each channel has 6 led's that create a beautiful lighting effect! £10 kit, £14 built.

VOX SWITCH. This is a sound activated switch, ideal for use on transmitters, CB's, tape recorders etc. Adjustable sensitivity, built in delay. Mic input. £7 kit, £11 built.

KITS 'N MODULES

LIQUID LEVEL DETECTOR. Useful item, can be used to detect fluid levels in watertanks, baths, ponds fishtanks etc. Could also be used as rain alarm with an easily constructed sensor. £5 kit, £9 built.

FM TRANSMITTER. Mini FM transmitter 2 transistor, comes with FET miniature mic and is tuneable from 63 to 130MHZ. £7 kit, £11 built.

FUNCTION GENERATOR. Generates sinusoidal, saw tooth and square waveforms from 20hz up to 20khz. Separate level controls for each waveform. 24vac. £15 kit, £20 built.

5 WATT SIREN. Powerful siren kit with an impressive 5 watts output. Ideal for alarms etc. £6 kit £10 built.

TELEPHONE AMPLIFIER. Very sensitive amplifier which using a 'phone pickup coil (supplied) will let you fol-

low a telephone conversation without holding the handset to your ear! £11 kit £15 built.

SWITCH PACK
10 switches for just £1.00

12v FLOURESCENT. A useful kit that will enable you to light large flourescent tubes from your car battery etc. 9v mains transformer required. £8 kit, £12 built.

KNOB PACK
10 knobs for just £1.00

REMEMBER! YOUR FREE COPY OF OUR CUT PRICE COMPONENTS CATALOGUE SENT WITH EVERY ORDER!!!

How to place your order.....
By phone.....0273 771156
By FAX.....0273 206875
By Post...PO box 517 Hove Sussex BN3 5QZ
Payment by ACCESS, VISA, CHEQUE OR POSTAL ORDER.
Cheques and postal orders should be payable to Express Components.
ALL PRICES ARE SUBJECT TO 99p POST AND VAT. Some of our products may be unlicensable for use in the UK (particularly the FM transmitters.)

POWER AMPLIFIER MODULES-TURNABLES-DIMMERS-LOUDSPEAKERS-19 INCH STEREO RACK AMPLIFIERS

* PRICES INCLUDE V.A.T. * PROMPT DELIVERIES * FRIENDLY SERVICE * LARGE (A4) S.A.E. 60p STAMPED FOR CATALOGUE *

OMP MOS-FET POWER AMPLIFIERS
HIGH POWER, TWO CHANNEL 19 INCH RACK

THOUSANDS PURCHASED BY PROFESSIONAL USERS



THE RENOWNED MXF SERIES OF POWER AMPLIFIERS
FOUR MODELS:- MXF200 (100W + 100W) MXF400 (200W + 200W)
MXF600 (300W + 300W) MXF900 (450W + 450W)
ALL POWER RATINGS R.M.S. INTO 4 OHMS, BOTH CHANNELS DRIVEN

FEATURES: ★ Independent power supplies with two toroidal transformers ★ Twin L.E.D. Vu meters ★ Level controls ★ Illuminated on/off switch ★ XLR connectors ★ Standard 775mV inputs ★ Open and short circuit proof ★ Latest Mos-Fets for stress free power delivery into virtually any load ★ High slew rate ★ Very low distortion ★ Aluminium cases ★ MXF600 & MXF900 fan cooled with D.C. loudspeaker and thermal protection.

USED THE WORLD OVER IN CLUBS, PUBS, CINEMAS, DISCOS ETC.

SIZES:- MXF200 W19"xH3 1/2" (2U)xD11"
MXF400 W19"xH5 1/4" (3U)xD12"
MXF600 W19"xH5 1/4" (3U)xD13"
MXF900 W19"xH5 1/4" (3U)xD14 1/2"

PRICES:- MXF200 £175.00 MXF400 £233.85
MXF600 £329.00 MXF900 £449.15
SPECIALIST CARRIER DEL. £12.50 EACH



OMP X03 STEREO 3-WAY ACTIVE CROSS-OVER



Advanced 3-Way Stereo Active Cross-Over, housed in a 19" x 1U case. Each channel has three level controls: bass, mid & top. The removable front fascia allows access to the programmable DIL switches to adjust the cross-over frequency: Bass-Mid 250/500/800Hz, Mid-Top 1.8/3.5/5KHz, all at 24dB per octave. Bass invert switches on each bass channel. Nominal 775mV Input/output. Fully compatible with OMP rack amplifier and modules.

Price £117.44 + £5.00 P&P

STEREO DISCO MIXER SDJ3400SE ★ ECHO & SOUND EFFECTS ★

STEREO DISCO MIXER with 2 x 7 band L & R graphic equalisers with bar graph LED Vu meters. **MANY OUTSTANDING FEATURES:-** Including Echo with repeat & speed control, DJ Mic with talk-over switch, 6 Channels with individual faders plus cross fade, Cue Headphone Monitor, 8 Sound Effects. Useful combination of the following inputs:- 3 turntables (mag), 3 mics, 5 Line for CD, Tape, Video etc.



Price £144.99 + £5.00 P&P

SIZE: 482 x 240 x 120mm

PIEZO ELECTRIC TWEETERS - MOTOROLA

Join the Piezo revolution! The low dynamic mass (no voice coil) of a Piezo tweeter produces an improved transient response with a lower distortion level than ordinary dynamic tweeters. As a crossover is not required these units can be added to existing speaker systems of up to 100 watts (more if two are put in series). **FREE EXPLANATORY LEAFLETS ARE SUPPLIED WITH EACH TWEETER.**

TYPE 'A' (KSN1036A) 3" round with protective wire mesh. Ideal for bookshelf and medium sized Hi-Fi speakers. Price £4.90 + 50p P&P.

TYPE 'B' (KSN1005A) 3 1/2" super horn for general purpose speakers, disco and P.A. systems etc. Price £5.99 + 50p P&P.

TYPE 'C' (KSN1016A) 2" x 5" wide dispersion horn for quality Hi-Fi systems and quality discos etc. Price £6.99 + 50p P&P.

TYPE 'D' (KSN1025A) 2" x 6" wide dispersion horn. Upper frequency response retained extending down to mid-range (2KHz). Suitable for high quality Hi-Fi systems and quality discos. Price £9.99 + 50p P&P.

TYPE 'E' (KSN1038A) 3 1/4" horn tweeter with attractive silver finish trim. Suitable for Hi-Fi monitor systems etc. Price £5.99 + 50p P&P.

LEVEL CONTROL Combines, on a recessed mounting plate, level control and cabinet input jack socket. 85x85mm. Price £4.10 + 50p P&P.

ibf FLIGHT CASED LOUDSPEAKERS

A new range of quality loudspeakers, designed to take advantage of the latest speaker technology and enclosure designs. Both models utilize studio quality 12" cast aluminium loudspeakers with factory fitted grilles, wide dispersion constant directivity horns, extruded aluminium corner protection and steel ball corners, complemented with heavy duty black covering. The enclosures are fitted as standard with top hats for optional loudspeaker stands.



POWER RATINGS QUOTED IN WATTS RMS FOR EACH CABINET
FREQUENCY RESPONSE FULL RANGE 45Hz - 20KHz

ibf FC 12-100WATTS (100dB) PRICE £159.00 PER PAIR
ibf FC 12-200WATTS (100dB) PRICE £175.00 PER PAIR

SPECIALIST CARRIER DEL. £12.50 PER PAIR

OPTIONAL STANDS PRICE PER PAIR £49.00
Delivery £6.00 per pair

IN-CAR STEREO BOOSTER AMPS

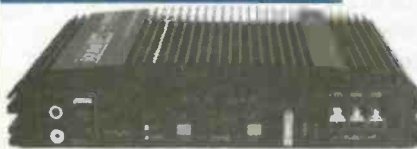

PRICES: 150W £49.99 250W £99.99
400W £109.95 P&P £2.00 EACH

THREE SUPERB HIGH POWER CAR STEREO BOOSTER AMPLIFIERS

150 WATTS (75 - 75) Stereo, 150W Bridged Mono
250 WATTS (125 + 125) Stereo, 250W Bridged Mono
400 WATTS (200 + 200) Stereo, 400W Bridged Mono
ALL POWERS INTO 4 OHMS
Features:
★ Stereo, bridgable mono ★ Choice of high & low level inputs ★ L & R level controls ★ Remote on-off ★ Speaker & thermal protection.

OMP MOS-FET POWER AMPLIFIER MODULES SUPPLIED READY BUILT AND TESTED.

These modules now enjoy a world-wide reputation for quality, reliability and performance at a realistic price. Four models are available to suit the needs of the professional and hobby market i.e. Industry, Leisure, Instrumental and Hi-Fi etc. When comparing prices, NOTE that all models include toroidal power supply, integral heat sink, glass fibre P.C.B. and drive circuits to power a compatible Vu meter. All models are open and short circuit proof.

THOUSANDS OF MODULES PURCHASED BY PROFESSIONAL USERS



OMP/MF 100 Mos-Fet Output power 110 watts
R.M.S. into 4 ohms, frequency response 1Hz - 100KHz
-3dB, Damping Factor > 300, Slew Rate 45V/uS,
T.H.D. typical 0.002%, Input Sensitivity 500mV, S.N.R.
-110 dB. Size 300 x 123 x 60mm.
PRICE £40.85 + £3.50 P&P

OMP/MF 200 Mos-Fet Output power 200 watts
R.M.S. into 4 ohms, frequency response 1Hz - 100KHz
-3dB, Damping Factor > 300, Slew Rate 50V/uS,
T.H.D. typical 0.001%, Input Sensitivity 500mV, S.N.R.
-110 dB. Size 300 x 155 x 100mm.
PRICE £64.35 + £4.00 P&P

OMP/MF 300 Mos-Fet Output power 300 watts
R.M.S. into 4 ohms, frequency response 1Hz - 100KHz
-3dB, Damping Factor > 300, Slew Rate 75V/uS,
T.H.D. typical 0.001%, Input Sensitivity 500mV, S.N.R.
-110 dB. Size 330 x 175 x 100mm.
PRICE £81.75 + £5.00 P&P

OMP/MF 450 Mos-Fet Output power 450 watts
R.M.S. into 4 ohms, frequency response 1Hz - 100KHz
-3dB, Damping Factor > 300, Slew Rate 75V/uS,
T.H.D. typical 0.001%, Input Sensitivity 500mV, S.N.R.
-110 dB, Fan Cooled, D.C. Loudspeaker Protection, 2
Second Anti-Thump Delay. Size 385 x 210 x 105mm.
PRICE £132.85 + £5.00 P&P

OMP/MF 1000 Mos-Fet Output power 1000 watts
R.M.S. into 2 ohms, 725 watts R.M.S. into 4 ohms,
frequency response 1Hz - 100KHz -3dB, Damping
Factor > 300, Slew Rate 75V/uS, T.H.D. typical
0.002%, Input Sensitivity 500mV, S.N.R. -110 dB, Fan
Cooled, D.C. Loudspeaker Protection, 2
Second Anti-Thump Delay. Size 422 x 300 x 125mm.
PRICE £259.00 + £12.00 P&P

NOTE: MOS-FET MODULES ARE AVAILABLE IN TWO VERSIONS:
STANDARD - INPUT SENS 500mV, BAND WIDTH 100KHz.
PEC (PROFESSIONAL EQUIPMENT COMPATIBLE) - INPUT SENS
775mV, BAND WIDTH 50KHz. ORDER STANDARD OR PEC.

LOUDSPEAKERS



LARGE SELECTION OF SPECIALIST LOUDSPEAKERS AVAILABLE, INCLUDING CABINET FITTINGS, SPEAKER GRILLES, CROSS-OVERS AND HIGH POWER, HIGH FREQUENCY BULLETS AND HORNS, LARGE (A4) S.A.E. (60p STAMPED) FOR COMPLETE LIST.

McKenzie and Fane Loudspeakers are also available.

EMINENCE:- INSTRUMENTS, P.A., DISCO, ETC

ALL EMINENCE UNITS 8 OHMS IMPEDANCE
8" 100 WATT R.M.S. WEB-100 GEN. PURPOSE, LEAD GUITAR, EXCELLENT MID, DISCO. RES. FREQ. 72Hz, FREQ. RESP. TO 4KHz, SENS 97dB. **PRICE £32.71 + £2.00 P&P**
10" 100 WATT R.M.S. ME10-100 GUITAR, VOCAL, KEYBOARD, DISCO, EXCELLENT MID. RES. FREQ. 71Hz, FREQ. RESP. TO 7KHz, SENS 97dB. **PRICE £33.74 + £2.50 P&P**
10" 200 WATT R.M.S. ME10-200 GUITAR, KEYB'D, DISCO, VOCAL, EXCELLENT HIGH POWER MID. RES. FREQ. 55Hz, FREQ. RESP. TO 3.5KHz, SENS 99dB. **PRICE £43.47 + £2.50 P&P**
12" 100 WATT R.M.S. ME12-100L GEN. PURPOSE, LEAD GUITAR, DISCO, STAGE MONITOR. RES. FREQ. 49Hz, FREQ. RESP. TO 6KHz, SENS 100dB. **PRICE £35.64 + £3.50 P&P**
12" 100 WATT R.M.S. ME12-100LT (TWIN CONE) WIDE RESPONSE, P.A., VOCAL, STAGE MONITOR. RES. FREQ. 42Hz, FREQ. RESP. TO 10KHz, SENS 98dB. **PRICE £36.87 + £3.50 P&P**
12" 200 WATT R.M.S. ME12-200 GEN. PURPOSE, GUITAR, DISCO, VOCAL, EXCELLENT MID. RES. FREQ. 58Hz, FREQ. RESP. TO 6KHz, SENS 98dB. **PRICE £46.71 + £3.50 P&P**
12" 300 WATT R.M.S. ME12-300GP HIGH POWER BASS, LEAD GUITAR, KEYBOARD, DISCO ETC. RES. FREQ. 47Hz, FREQ. RESP. TO 5KHz, SENS 103dB. **PRICE £70.19 + £3.50 P&P**
15" 200 WATT R.M.S. ME15-200 GEN. PURPOSE BASS, INCLUDING BASS GUITAR. RES. FREQ. 46Hz, FREQ. RESP. TO 5KHz, SENS 99dB. **PRICE £50.72 + £4.00 P&P**
15" 300 WATT R.M.S. ME15-300 HIGH POWER BASS, INCLUDING BASS GUITAR. RES. FREQ. 39Hz, FREQ. RESP. TO 3KHz, SENS 103dB. **PRICE £73.34 + £4.00 P&P**

EARBENDERS:- HI-FI, STUDIO, IN-CAR, ETC

ALL EARBENDER UNITS 8 OHMS (Except EB8-50 & EB10-50 which are dual impedance tapped @ 4 & 8 ohms)
BASS, SINGLE CONE, HIGH COMPLIANCE, ROLLED SURROUND
8" 50watt EB8-50 DUAL IMPEDANCE, TAPPED 4/8 OHM BASS, HI-FI, IN-CAR. **PRICE £8.90 + £2.00 P&P**
10" 50WATT EB10-50 DUAL IMPEDANCE, TAPPED 4/8 OHM BASS, HI-FI, IN-CAR. **PRICE £13.65 + £2.50 P&P**
10" 100WATT EB10-100 BASS, HI-FI, STUDIO. **PRICE £30.39 + £3.50 P&P**
RES. FREQ. 35Hz, FREQ. RESP. TO 3KHz, SENS 96dB.
12" 100WATT EB12-100 BASS, STUDIO, HI-FI, EXCELLENT DISCO. **PRICE £42.12 + £3.50 P&P**
RES. FREQ. 26Hz, FREQ. RESP. TO 3 KHz, SENS 93dB.
FULL RANGE TWIN CONE, HIGH COMPLIANCE, ROLLED SURROUND
5 1/4" 60WATT EB5-60TC (TWIN CONE) HI-FI, MULTI-ARRAY DISCO ETC. RES. FREQ. 63Hz, FREQ. RESP. TO 20KHz, SENS 92dB. **PRICE £9.99 + £1.50 P&P**
6 1/2" 60WATT EB6-60TC (TWIN CONE) HI-FI, MULTI-ARRAY DISCO ETC. RES. FREQ. 38Hz, FREQ. RESP. TO 20KHz, SENS 94dB. **PRICE £10.99 + 1.50 P&P**
8" 60WATT EB8-60TC (TWIN CONE) HI-FI, MULTI-ARRAY DISCO ETC. RES. FREQ. 40Hz, FREQ. RESP. TO 18KHz, SENS 89dB. **PRICE £12.99 + £1.50 P&P**
10" 60WATT EB10-60TC (TWIN CONE) HI-FI, MULTI ARRAY DISCO ETC. RES. FREQ. 35Hz, FREQ. RESP. TO 12KHz, SENS 98dB. **PRICE £16.49 + £2.00 P&P**

TRANSMITTER HOBBY KITS

PROVEN TRANSMITTER DESIGNS INCLUDING GLASS FIBRE PRINTED CIRCUIT BOARD AND HIGH QUALITY COMPONENTS COMPLETE WITH CIRCUIT AND INSTRUCTIONS
3W TRANSMITTER 80-108MHz, VARICAP CONTROLLED PROFESSIONAL PERFORMANCE, RANGE UP TO 3 MILES, SIZE 38 x 123mm. SUPPLY 12V @ 0.5AMP. **PRICE £14.85 + £1.00 P&P**
FM MICRO TRANSMITTER 100-108MHz, VARICAP TUNED, COMPLETE WITH VERY SENS FET MIC, RANGE 100-300m, SIZE 56 x 46mm. SUPPLY 9V BATTERY. **PRICE £8.80 + £1.00 P&P**



PHOTO: 3W FM TRANSMITTER



POSTAL CHARGES PER ORDER £1.00 MINIMUM. OFFICIAL ORDERS FROM SCHOOLS, COLLEGES, GOVT. BODIES, P.L.C.s ETC. PRICES INCLUSIVE OF V.A.T. SALES COUNTER, VISA AND ACCESS ACCEPTED BY POST, PHONE OR FAX.



B.K. ELECTRONICS

UNITS 1 & 5 COMET WAY, SOUTHEND-ON-SEA, ESSEX, SS2 6TR.
Tel.: 0702 - 527572 Fax.: 0702 - 420243

Cover Disk

The FREE cover disk supplied with this copy of ETI includes an AC circuit simulation programme which will run on any PC under Windows 3.0, and a comprehensive collection of PC diagnostic programmes which will help the user to locate and solve a whole range of different problems on any PC AT, from 286 to Pentium

Linear AC Circuits Analysis with ACIRAN V1.4 for Windows

The following is a brief introduction to this very versatile and comprehensive programme. It is a shareware programme which means that readers who intend to use it are expected to complete the registration form that is supplied as a text file on the disk and return it, together with the registration fee, to the authors. A full version of the printed manual and the latest version of the software will be supplied to all registered users.

ACIRAN is a Linear AC Circuit Analysis Program designed to ease small signal AC analysis of active and passive circuits. ACIRAN can handle Resistors, Capacitors, Inductors, Transformers(Ideal), FETs, Transistors, Operational Amplifiers, Transmission Lines, and Voltage Controlled Current Sources.

To save time and ease design, a number of FET, Op-amp and Transistor model parameters have been supplied. More complex models can be built up using passive components and Voltage Controlled Current sources.

Installation

ACIRAN V1.4 was created using the Turbo Pascal for Windows Compiler (V 1.5) and is able to support co-processors. If your machine has a floating point chip, it is detected by ACIRAN and used for all calculations. If you do not have a co-processor, it is simulated by software. ACIRAN will run under Windows 3.0 or 3.1 in Standard or Extended mode. It requires a minimum 286 system with at least 1Mbyte of RAM.

Some of the files on the disk are compressed. You must run the install program first to unpack these to your working disk/directory. Select Run from the Program Manager and enter a:install (or whatever drive you are installing from). If you are in DOS, switch to the drive containing AFW and type win install.

Getting Started

The programme offers a conventional Windows type display which conforms to standard Windows command structure. The main menu offers the following selection:

File Edit Config Data Analyse Results Graph Help

File provides the following sub-menu:

New - is used to enter a new circuit description to ACIRAN and as it clears any previous circuit from memory you should save any

data that you have in memory first. You will be given a warning first.

Open - allows you to load a previously saved circuit for analysis or modification. Circuits are expected to have extension .CIR or .CTS (automatically appended by ACIRAN). You will be presented with a Filebox. Use the cursor keys or mouse to highlight the file you wish to load and then press return or click the OK button.

Save - allows you to save your circuit description to disk. If you are entering a large circuit then you should save it periodically.

Save_As - allows you to save your circuit under a new name, perhaps to save a different version. Save_As will be called the first time a circuit is saved as it will not have an existing filename.

Printer SetUp - will allow you to configure your printer, e.g. select landscape or portrait mode.

Exit - will exit from ACIRAN and take you back to Windows. Any circuit description held in memory will be lost, so make sure you have saved any data that you want to keep. ACIRAN will give a warning if you have not saved your circuit and have made changes.

Going back to the main menu:

Edit - allows you to make changes to the circuit description such as adding or deleting components and changing component values. Edit has its own sub-menu which will be described later.

Config - allows you to set up certain flags and to request additional circuit parameters such as impedance and return loss. This information is stored along with the circuit details in the files. The Config dialog box will be described later.

NetList - allows you to inspect your circuit description by listing the components, their values and circuit connections. You can send the data to a printer by selecting Print from the system menu of the Netlist Window.

Analyse - instructs ACIRAN to analyse the circuit in memory. Logarithmic and Linear frequency sweeps are allowed. ACIRAN can also carry out Monte-Carlo analysis if component tolerances have been entered.

Results - offers the choice to Display or File. To view the results, select Display; to obtain a hard copy of these results, the Print option should be selected from the system menu of the Results Window. Results can also be stored in a text file for later use.

Graph - will plot various parameters such as Gain or phase against frequency. A hard copy can be obtained by selecting Print from the menu.

Learning to use ACIRAN

To enter a circuit, select New and enter a circuit name. This is for your benefit only and appears in listings.

Next you will see a dialog box of component types; use the normal selection methods to choose a component type. If the component type is Fet, Op amp or Transistor you will be asked if you wish to load model parameters from disk. If you select to do so, you will be presented with another file selection box to choose the component model. A number of examples are included on the disk, and they provide a good way of learning ACIRAN. However, let's first look at how to enter one from the keyboard.

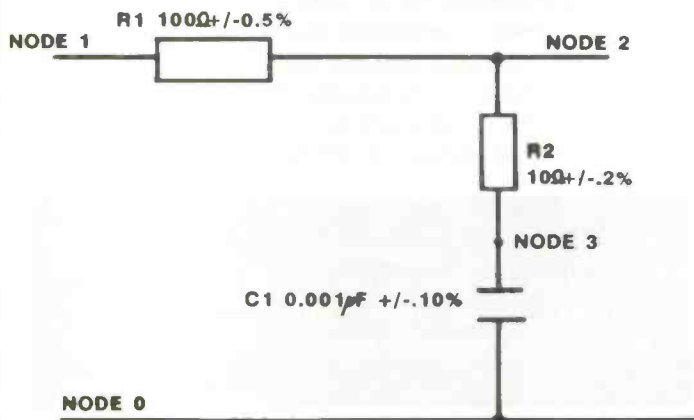

The circuit is shown below:

To enter this circuit first select New from the File Menu.

- Enter the circuit description 'RC Filter' <cr>.
- When the Select component box is displayed, choose a resistor, and a form will appear on the screen. You will be asked for the component identifier; enter 'R1' and press <TAB>. (Up to 5 characters can be entered for the component identifier).
- You will now move to the next input field. You will then be asked for the value of R1. Enter 100 <TAB>.
- You will then be asked for the tolerance in %. Enter 0.5 <TAB>. (The leading zero is essential).
- Next you will be asked 'From Node'. Enter 1 <TAB>, and then 'To node', Enter 2 <TAB>.

The convention in ACIRAN is that the INPUT NODE is ALWAYS 1 and the GROUND NODE is ALWAYS 0. The OUTPUT NODE is variable (more about this later).

- Once you have completed the form you must press enter or click the OK button to exit and save your data.
- If you press Cancel, the data will be ignored. You can move around the input form changing the information, using the edit keys, until you are happy with what you have entered. Previously entered data is presented and can be accepted by entering <cr>.
- Enter component R2 in the same way. It is not important which way round the passive component is connected.
- To enter C1 select Capacitor and, for the value, enter 0.001u. The 'u' or 'U' at the end tell ACIRAN that the value is in micro farads. A number of multiplier options are allowed and upper or lower case can be interchanged in all cases except 'M' and 'm'.

The multipliers accepted by ACIRAN are:

'G' or 'g'	Giga = x1E9
'M'	Mega = x1E6
'K' or 'k'	Kilo = x1E3
'm'	milli = x1E-3
'U' or 'u'	micro = x1E-6

'N' or 'n' nano = x1E-9

'P' or 'p' pico = x1E-12

These multipliers can be entered in a number of formats, e.g. 1k2, 1K2, 1.2K, 1200, 12e2, 12E2 and 1.2e3 are all acceptable and identical.

- Now that the circuit has been entered click Cancel in response to next component and you will be asked for the Output node.

If you press <cr> without entering any data ACIRAN will assign the highest node used to the output node. In this circuit this is not the case and you must enter 2 <cr>.

It is advisable to save your work and so as soon as the main menu returns press Alt-F for File then Alt-S for Save, or use the mouse. When asked for a file name enter any valid filename, but remember to omit any file extension.

You can check your circuit configuration by selecting NetList. The circuit listing is displayed. You can scroll through it using the scroll bar on the left of the window, or by pressing the up/down arrow keys or PageUp and PageDn keys. To Print the data, select Print from the windows system menu. This allows one to check that the circuit connections are correct.

Running the analysis

The circuit to be analysed can either be entered directly or loaded from disk. At the start of Analysis a frequency input form will appear and you must complete at least the first three entries. You

Installing programmes from the ETI Cover disk.

In order to get all the programmes onto this disk, it has been necessary to compress the files into self-extracting archives.

The programs are:

16550PRG	-	Serial I/O test utility
ACIRAN	-	A linear AC circuit simulation program
ÇACHETST	-	A PC cache memory test utility
PCUTILS	-	A collection of PC diagnostic utilities

To unzip these to a hard drive we suggest the following:

Create a directory on the hard drive to hold the files

e.g. MD PCUTILS

Change to the directory created

e.g. CD PCUTILS

Place this disk in your floppy drive

Type the name of the self-extractor, including the path to the floppy drive

e.g. A:PCUTILS

The files will now be extracted to the current directory

Please note all the programmes on this disk are shareware, if you intend to use any one or more of them regularly then you must fill in the appropriate registration order form/s and send it to the address given on the form together with the requested registration fee.

can select Log or Linear sweep from the Config box, the default is Log. For the moment leave it as Log. Now enter the start frequency. Enter 100k and press <TAB>. Enter End frequency 100M (note capital 'M' for Megahertz). Finally, enter the number of frequency steps, 10 <cr>.

Leave the default number of passes as 1. Remember to press return or click OK once you are satisfied with the input data. If, however, you enter a number of Passes > 1 then ACIRAN will analyse your circuit that number of times, and on each pass it will vary the component values within the tolerance limits you specified for each component.

ACIRAN will now analyse your circuit from 100 kilohertz to 100 megahertz in 10 logarithmic steps. The Sweep mode selected will remain in force in future analysis unless you specifically change it. During Analysis the frequency sweep mode and range are displayed and a counter shows the percentage of the analysis completed. You can abort the run by pressing Escape or clicking on the Cancel button. In either case, you will get a message when the analysis is over. NOTE: Due to the numerically intensive nature of this program there may be a few seconds delay between the user aborting the run and ACIRAN recognising the abort message as it only checks the message queue once during each frequency pass.

Select Results to see a table of results. Only Gain, Phase and Time Delay are shown by default; to see impedance or return loss you must check the boxes in the Config dialog box. To print, select Print from system menu.

Close the Results window, or minimise it. Select Graph and choose Magnitude. If your printer has graphics capability you can obtain hard copies by selecting Print from the menu of the Graph Window use the mouse or press Alt + P.

For details on how to configure ACIRAN edit circuits and other aspects of using this programme, see the manual contained on the disk. This can be read by virtually any wordprocessor which can then be used to print it out. Also supplied on the disk are a number of examples of ACIRAN models. For further information on these, look at the documentation supplied on the disk or the printed version supplied to registered users.

ACIRAN for Windows Registration

ACIRAN is a shareware program and if you intend to use it regularly then there is a registration fee of £65.00. Registered users will receive the latest version of this program and a full printed manual. The software can be supplied on either 5.25" or 3.5" floppy disk and for shipping outside the U.K. there is an additional charge of £1.50 (All payments MUST be in Pounds Sterling)

Please send your completed order form (there is a copy stored as a text file on the disk) to:
ACIRAN Software Systems, 29 Duncryne Place,
Bishopbriggs, Glasgow, Scotland G64 2DP.

This month's PC Clinic is devoted to a description of the useful range of shareware PC utilities which are included on the FREE cover disk included with this issue of ETI, utility programmes which will help you to track down some of the more common, as well as some of the more obscure, faults which PC users can encounter.

There are three files of utility programmes included on this disk; they are:

- 16550PRG - Serial I/O test utility
- CACHETST - A PC cache memory test utility
- PCUTILS - A collection of PC diagnostic utilities

16550PRG - Serial I/O test utility

16550 is a shareware program designed to allow the 'unlocking' of the internal FIFO buffer present in the UART chip of the same name. The program will scan all four COM ports (COM1: - COM4:) available on the PC and report the presence (if any) of the 16550 UART. The user may optionally set the various parameters necessary to utilise this buffered mode of operation.

Program operation

The 16550 UART initially powers up in a non-FIFO state. This makes the UART software-compatible with the 16450 and the older 8250. In most cases, the communications software doesn't know the difference. At least until the data comes in faster than the program can process it!

The 16550 program goes in and 'unlocks' the FIFO capabilities in the UART and, even in a buffered state, the 16550 still looks like the 16450 to older programs! If buffering occurs, then the data is held, and subsequently read out at a relaxed pace automatically, providing full compatibility with older software, yet giving the high-speed protection of a data buffer!

PC

Program parameters

The 16550 automatically detects a 16550 UART and provides control for the COM port address, enabling and disabling of the FIFO, and the settings for a special interrupt based upon the number of characters being held in the FIFO buffer.

Executing the program without specifying any parameters results in a scan of all COM ports and reports the presence of a 16550 UART in each. If the user knows that a 16550 device exists, additional parameters may be specified to access the FIFO. These parameters are as follows:

COMn - Tells the 16550 program to use COM port n, where n indicates ports 1 through 4. Any value outside of this range results in an error. NOTE: A COM port MUST be specified when setting the UART!

? - Echoes a brief help text on the screen. No action is taken.

/f - Enables the 16550 internal buffers.

/r - Disables the 16550 internal buffers and resets the UART to the 8250/16450 compatibility mode.

/tn - Allows the adjustment of the FIFO-full interrupt. n specifies the number of characters allowed in the buffer before an interrupt occurs. The values for n are 1,4,8 and 14. NOTE: this is a very sensitive setting! For normal operation with old communications software, this parameter should not be used!

The program defaults to FIFO disabled, and a /f parameter of

1. If the command line parameters are valid, the program will verify that a 16550 UART is present and that the parameters have been set. Unless another program that recognises a 16550 UART is executed, the UART should remain in the current state.

Registering

If you find that this program is useful and saves you some time and headaches, the author would appreciate a \$5.00 (US) suggested donation. The author's address is: Brent Turner, P.O. Box 3612, Fullerton, CA, 92634-3612.

CACHETST A PC cache memory test utility

This program is designed to help a user evaluate the impacts of a cache, or the changes to an existing cache, on a drive's performance. Furthermore, with users increasingly using caches during a variety of tasks, it is important to find the optimal cache settings given the task at hand. Whereas a word processor might make heavy usage of sequential files, a database might make heavy usage of random access files. With this in mind, the memory requirements, sectors cached, write delays and so forth have many possible variations.

By default, Cache Test creates a 10,000 record sequential file using 32 byte records and then a 10,000 record random access file that again uses 32 byte record lengths. Note, even if the default is changed, any sample string length will be increased by two bytes by the addition of a CR/LF. You may want to compensate accordingly if you wish to be exact in your

measurements. The sample record size indicator displays the TRUE sample string size.

This program uses BIOS to do all of its reads and writes, so any hardware or software cache should be able to get some good "hits." In attempt to flush caches during the test, files are frequently opened and closed.

All of the times that this program writes are the result of subtracting the beginning time from the ending time. Nothing fancy, so the values are relatively accurate. Note, if you do some maths to compute access times per record, you will run into the age-old problem of significant digits. This program only accounts for one decimal location (0.1). As such, if you try to take the timings out to 1/100th of a second, the resulting error factor can be quite high.

Remember, if an outcome is in doubt, use a larger sample size! That is to say, increase the number of bytes that are written to the disk. The other alternative is to increase the number of sample passes. You'll notice that results begin to stabilise with file sizes of 5000 records, 32 bytes, and 5 passes.

This program is released as shareware. Its price is \$5 for each concurrently used copy. The author's address is: George Spafford, 3001 LakeShore Drive, #329 St. Joseph, MI 49085. Data: (616) 468-5026 Queued Access BBS 14.4Kb USR Dual HST FIDOnet: 1:2340/0 NEC/NC Site. Sysop: Tim Akright

PCUTILS - PC Hardware Utilities

There are 25 of these PC hardware related utilities; they are as follows:

- AT_CLOCK.ZIP Corrects for AT CMOS clock time slippage
- AT_SETUP.INF Information on the AT 'SETUP' utility
- AT_SLOW.ZIP Slow ATs down to 4.77 for games and such
- AT_SLOW3.ZIP Use high-res timer to slow down 80286/80386
- ATCLOCK.ZIP Use hardware clock instead of DOS for time/date
- ATDRTABL.ZIP Displays AT hard disk drive table
- ATFMT.ASM Disk format program for AT (MASM source)
- ATIM.ZIP Precision program timing for AT
- ATNUDG2.ZIP Nudge AT realtime clock daily to correct time
- ATROMUTL.ZIP AT ROM BIOS and hard disk table utilities
- CMOS14.ZIP CMOS v1.4: Saves/restores CMOS to/from file
- CMOSER11.ZIP 386/286 enhanced CMOS setup program
- CMOSRAM.ZIP Save AT/386/486 CMOS data to file and restore
- HTMU.ZIP Read/modify AT ROM drv types to burn new EPROM
- KBDR.ZIP Swaps control & cap lock keys on IBM AT & PS/2
- KBMAP.ASM Remap AT keyboard keys
- KEYBOARD.ZIP Kbd*.com, utilities to re-map selected keys on
- ROM2.ZIP Save AT and 386 CMOS data to file and restore
- SETTD.C Set DOS time/date from realtime clock
- SETUP21.ZIP Setup program which modifies CMOS RAM
- SPEEDKEY.ZIP Resident program to speed keyboard input
- SWPKEYAT.ZIP Swap escape and tilde keys on AT keyboard

- TAD.ZIP Set AT real-time-clock from DOS date & time
- VIEWCMOS.ZIP Display contents of AT CMOS RAM, w/C source
- XKB.ZIP Set AT keyboard repeat rate & delay, w/C source

Note that some of these utilities will only work on 286 systems. Others will only work on 386/486 based systems. A lot of these utilities are related to the CMOS RAM, and they will be of particular use in diagnosing problems with older systems.

To use any of the above diagnostic routines you will first of all have to un-zip them using the version of PKUNZIP included on the disk

IMPORTANT NOTICE: All the software included on the ETI cover disk is distributed as is, with no warranty. The authors have made reasonable attempts to ascertain their performance but cannot guarantee that they will work in every instance. Neither the authors, Electronics Today International or anyone associated with ETI are responsible for any damages or loss of data resulting from the use of this program.

The shareware version of these programs may be freely distributed as long as all files are included in the package. The registered version may not be copied or duplicated.

clinic

SMART MAINS CONTROL SYSTEM

Part two of Dr Pei An's SMART mains control system which allows a computer to control up to 93 different mains devices using signals actually transmitted through the mains power cable

Last month we looked at the principles employed in the design of this system which allows up to 93 individual mains switches to be controlled by a personal computer. We showed how the system can be described as 'smart' because the mains switches are not controlled by any control wires connected directly to the computer.

The control commands which tell the mains switches to turn on or off are generated by a computer-based controller and transmitted through the existing mains lines in a building. The switches detect the message and carry out corresponding actions. The schematic of the system is shown in Figure 1.

This system has a huge advantage over the conventional system. In the conventional system, each mains switch has to be controlled by separate wires for controlling the on and off of the switches. This requires investment as well as effort to install the wiring in the building. Once the wiring is installed, the switches cannot be moved freely. However, the SMART mains control system solves all these problems

Construction

The controller and switches are constructed on single-sided print circuit boards. The full size copper foil pattern is given at the end of the magazine and component layout are shown in Figures 3 and 4.

Before soldering the components on the board, check the PC board for unwanted links or cuts on the copper tracks. Small components should be mounted on the board before the larger components. The mains transformer T2 for the controller is not mounted on the board at this stage. Instead, two wires are soldered at the points of secondary outputs of the transformer (as shown in Figures 3 and 4). This is for testing the controller and the switches with low voltages. When mounting the bridge rectifier, the electrolytic capacitors, the 7805 5V regulator and the transient voltage protection diode D1, care must be taken on the polarity. Refer to Figure 11 for details on the tank coil T1. The former has six pins, arranged with three on each side. Pins 5 and 6 are LIVE connectors to the mains and are on the same side as the A042 stamp on the body. If in doubt where these pins are, check for continuity with a multimeter. Insert T1 into the PCB with Pins 4, 5 and 6 close to C1 and C2 position. This component must be fitted correctly. It is suggested that IC sockets are used for all the ICs. The controller and the switches are finally placed in proper plastic boxes. Suggested arrangements

for the controller and the switch are given in Figures 6 and 7. The mains cables protruding through the wall of the boxes must be fastened by proper cable glands (see Figures 6 and 7). The mains cable for the controller should be for 5A rating or higher and the mains plugs for the controller must be fitted with a 5A fuse. The switches are designed for controlling a mains appliance up to 5A (1200 W). Therefore, a 5A mains cable or higher should be used and the mains plug and the socket of the switches should be fitted with 5A fuses. It is good practice to stick some safety labels on the controller box and the switches. The labels should warn people that the devices are connected to the 240V mains and the maximum rating is 5A. If you use the devices in other mains wiring configurations, please make sure that your mains connections meet the standard of electrical connections.

Testing

CAUTION

It must be pointed out that this mains control system is connected directly to 240V AC and therefore danger exists to the constructors. Physical contact with the mains can be lethal and every precaution must be taken to prevent this from happening. If constructors have any doubts, please ask advice from competent electricians.

After soldering, a careful inspection must be conducted to check all the soldering joints to make sure there are no shorts, especially in the area where 240V AC is present (The high voltage area on the PCB board is marked by a dotted box in Figures 3 and 4). Testing of the controller and the switch are slightly different. Firstly the testing procedures of the controller are described. Testing is performed in four stages:

Stage 1: Testing the power supplies

When testing the controller the first time, an external 12V AC or 17V DC is used to power the board via the two wires soldered to the secondary outputs of the transformer (see Figures 3 and 4). After the final checking, the Centronic connector can be connected to the computer using the printer lead and power can be connected to the controller. The first step of testing is to measure the voltage of the power supply at various points of the circuit. The voltage at the positive output of the bridge rectifier is measured first, which should be

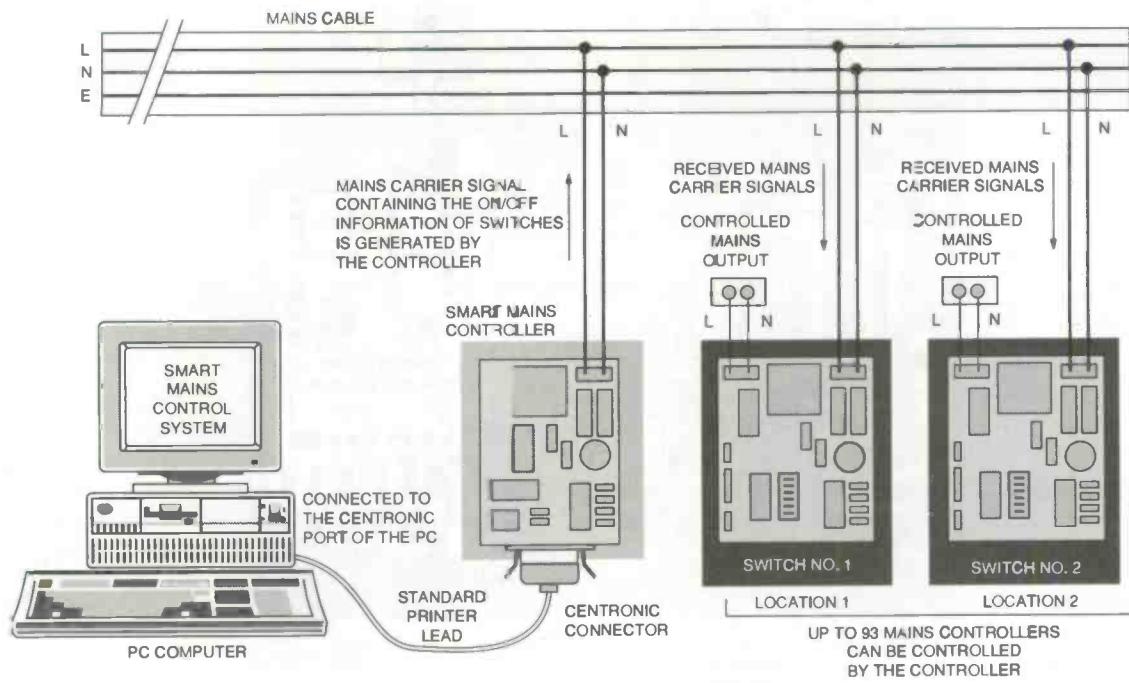

Fig. 1 Smart mains controller block diagram

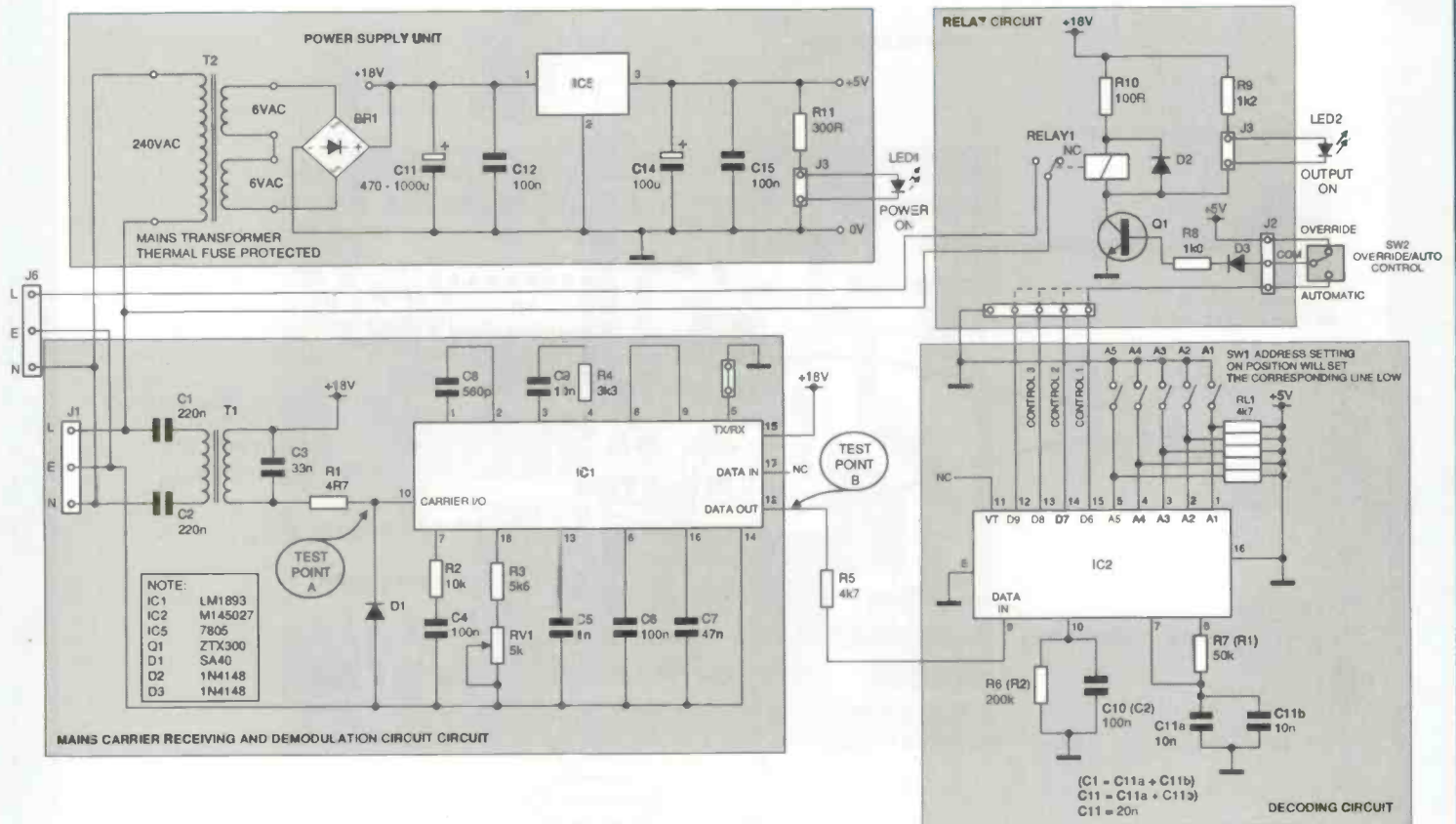

Fig. 2 Smart mains controller circuit diagram

consistent with the input power supply voltage. The voltage at Pin 15 of IC should be the same as the voltage measured above. The voltages at Pin 16 of the encoder IC and Pin 14 of 74LS164 should be +5V.

Stage 2: Testing opto-isolator and encoder circuits

Run the sample program and load a data into the shift register. Then use a logic probe or a voltmeter to measure the voltage level of the outputs of the shift register. This should be consistent with the data sent out from the computer. Next, use an oscilloscope to see the waveform of the encoded signal output from the encoder IC and the signal input to the mains carrier IC (Test Point B). The waveform should reconcile with the encoding format as explained above. The above testing requires no adjustment at all. If all the components are OK and properly located in position, the circuit should work straight away.

Stage 3: Preliminary testing of the mains carrier circuit

Testing of the mains carrier circuit is the major task and involves some minor adjustments. Firstly, turn the slug in T1 anticlockwise until it levels with the top of the can. Connect the oscilloscope to the Carrier I/O (Test Point A, Pin 10 of IC1). By adjusting the TIME knob of the oscilloscope, an oscillogram showing two sinusoid waves should appear on the CRT (see Figure 8a). If not, adjust RV1 clockwise or anti-clockwise. These two sine waves are slightly different in wavelength and in amplitude. The wave with a longer wavelength (lower frequency) is the carrier frequency representing logic 1; the wave with a shorter wavelength (higher frequency) is the one representing logic low. With a trimming tool, adjust RV1 for the longer wavelengths of the sine waves to be about 8.1 μ s (corresponding to 123 KHz). The other sine wave will automatically have a wavelength of 7.9 μ s.

Stage 4: Final testing

The two temporary wires on the PCB board can be removed, the mains transformer is mounted on the board and the mains lead is connected to the terminal J1. During the final testing, the controller is connected to the mains supply. Therefore it is

suggested that the circuit board should be properly mounted inside the plastic case. This will prevent the operator from accidentally touching the active area of the PCB board. However, caution must be taken in the final testing stage.

Plug the controller into a mains socket and use the oscilloscope to see the waveform of the test point A. The oscillograph observed in the above stage should appear on the CRT. Now use a trimming tool to screw down the slug in T1 slowly and observe the oscillograph on the CRT. The amplitudes of the two sine waves both change. Adjust until the two sine waves have the same amplitude and both reach the maximum. This procedure is illustrated in Figures 8(c) and 8(d). The SMART controller now is ready to operate.

Stage 1: Testing power supplies

When testing the switch the first time, an external 12V AC or 17V DC is used to power the board via the two wires soldered to the secondary outputs of the transformer. After a final checking of the circuit board, power can be connected to the controller. The first step of testing is to measure the voltage of the power supply at various points of the circuit. The voltage at the positive output of the bridge rectifier is measured first, which should be consistent with the input power supply voltage. The voltage at Pin 15 of IC1 should be the same voltage as measured above. Next the voltages at Pin 16 of the decoder is checked, which should be +5V.

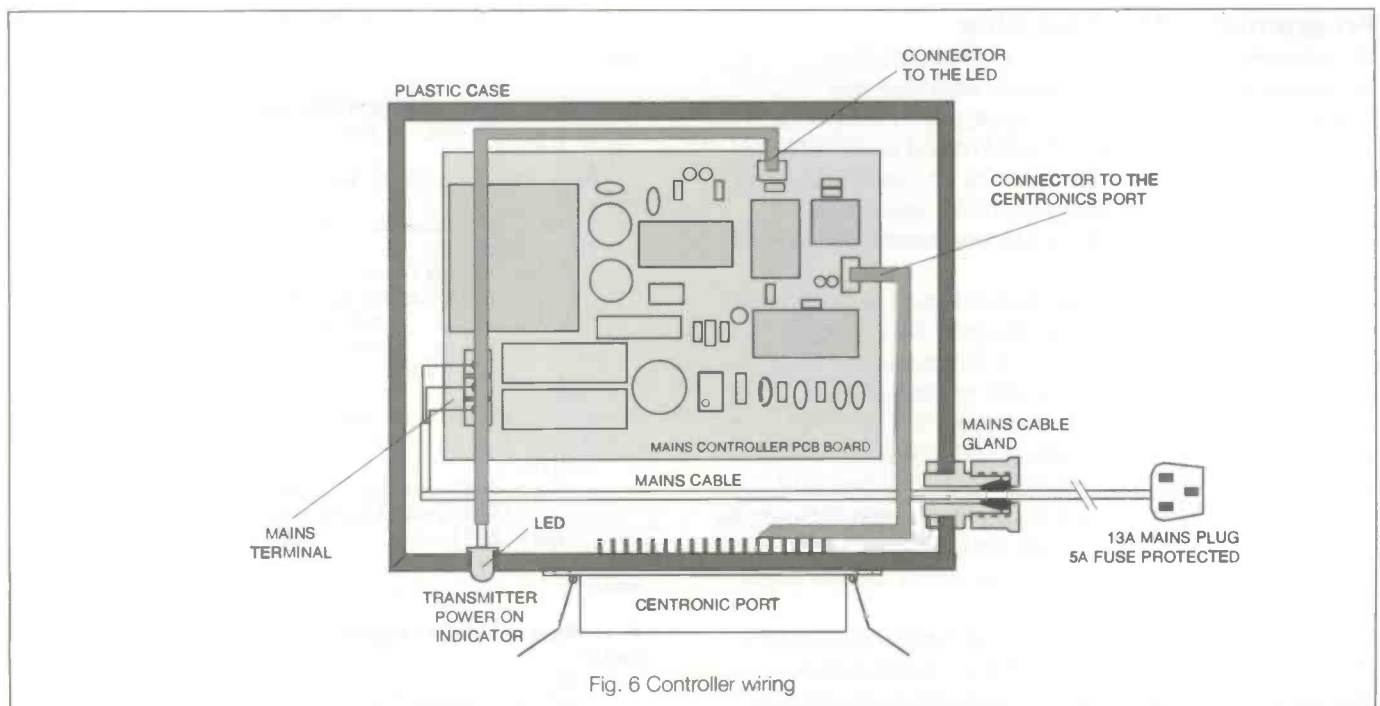
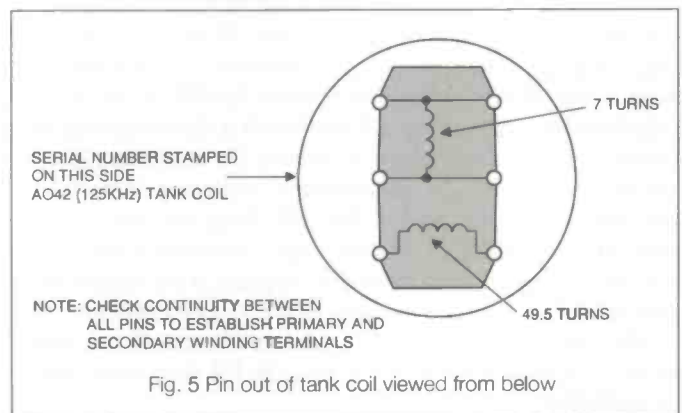

Stage 2: Testing the relay circuit

By connecting the COM of J2 to the OVERRIDE, the relay should be energised and LED2 should be on. If this works, it means that the relay circuit is working fine.

Stage 3: Testing the mains carrier circuit

Leaving the jumper J5 unconnected will set the mains carrier IC to the transmit mode. This is used to align the central frequency of the switch to the controller. The procedure is identical to that described in the testing Stage 3 of the controller.

Stage 4: Final testing of the switches

After the alignment, the mains transformer can be mounted on the PCB board and the mains leads are connected to the controller board for the final testing. During the final testing the switch will be connected to the mains lines. Therefore, it is suggested that the circuit board should be properly mounted inside the plastic case.

Plug the SMART controller into the mains socket and run the sample program. (When running the program, input the address to be 1 or above.) Set the address of the SMART switch (SW1) to the same number and connect J5 using a jumper. Plug the SMART switch into another mains socket and use the oscilloscope to observe the waveform at Test Point A. By adjusting the control knobs of the oscilloscope, the received mains carrier signal can be observed. Screw down the slug in T1 carefully until the maximum carrier signal is reached. Now connect the oscilloscope to the Test Point B on the circuit board which is the output of the mains carrier IC. A waveform of serial digital data should be observed on the CRT. If not, re-adjust the RV1 again. If the oscilloscope is a dual-trace one, the waveform of the output of the encoder in the controller and the waveform of the input to the decoder IC in the switch can be displayed at the same time on the CRT. These two waveforms should be exactly the same! If the relay is switched to the automatic mode, we can also hear the clicks of the relay when energised and released. The ON/OFF LED (LED2) will flash.

After the testing, the switch is ready to operate. Plug a table lamp into the mains socket on the switch; the lamp is now fully controlled by the computer.

Programming the controller

The controller is able to interface with any I/O cards of computers, provided that the cards at least have two independent outputs. The current application utilises PC's Centronic ports (printer ports). The DATA and the CONTROL lines are connected to the DB 0 and DB 1 of the DATA port of the Centronic port, respectively. On the 36-way female Centronic-type connector, those two lines correspond to Pin 2 and Pin 3 of the connector.

It is useful to give a brief introduction to the Centronic port at this point. The port originally was designed for connecting printers to the computer. However, it can be used for much wider applications. The Centronic port consists of three separate I/O ports, namely, the DATA port, the CONTROL port and the STATUS port. The DATA and CONTROL ports are output ports. The STATUS port is an input port. The DATA port transfers the actual data during the communication between the computer and the external devices; the CONTROL port is a handshake port by which the computer issues controls to the

external devices; the STATUS is another handshake port from which the computer reads the information issued by the devices. A PC can support up to 3 Centronic ports which are

labelled LPT1, LPT2 and LPT3. For the purpose of explaining how to control the Centronic port, let us consider LPT1. The I/O addresses of the DATA, CONTROL and STATUS are 888, 890, 889 decimal, respectively. To send data to the DATA port of the LPT1, the follow commands can be used:

```
In Turbo Pascal: PORT[888]:=X
In BASIC:       OUT 888, X
```

In which x is the decimal value of the data to be sent. To read data from the STATUS port the following commands can be used:

```
In Turbo Pascal: Y:=PORT[889]
In BASIC:       Y=INP(889)
```

In which y is the decimal value of the data received.

The control software for the SMART controller is described below: Firstly the 8-bit data which contains the 5-bit (D0 to D4) address and 3-bit (D5 to D7) control lines is chopped into bit form. Then the MSB of the data is sent to DB0 of the DATA port. Next, a low-to-high-then-low pulse is issued by the DB1 of the DATA port. This will latch the bit to the shift register. The above procedure is repeated seven times to send the rest of the data bits to the shift register.

A sample program written in Turbo Pascal 6 is listed below. When running the program, it first asks users to input the address of the switch to be controlled and then the time period of OFF and ON of the switch. After this, the program will make the selected switch to switch on and off according the specified time periods.

List of the SMART MAINS CONTROLLER control program

```
program smart_controller;
uses
  dos, crt;
var
  address,i,j,swaddress:integer;
  weight:array[1..12] of integer;
  delaytime,lighttime:real;

Procedure bit_weight;
begin
  weight[1]:=1;
  for i:=2 to 12 do weight[i]:=weight[i-1]*2;
end;

Procedure send_address(address:integer);
{send the address to the 74LS164 shift register}
var
  sw:array[1..12] of byte;
begin
  for i:=12 downto 1 do
    begin
      sw[i]:=0;
      if address>=weight[i] then begin
        address:=address-weight[i];
        sw[i]:=1;
      end;
    end;
  {load sw values into the 164 registers}
  for i:=12 downto 1 do
    begin
      port[888]:=sw[i]; delay(1);
      port[888]:=sw[i]+2; delay(1);
      port[888]:=0; delay(1);
    end;
end;

Procedure intialization;
begin
  clrscr;
  writeln('SMART MAINS CONTROL');
```

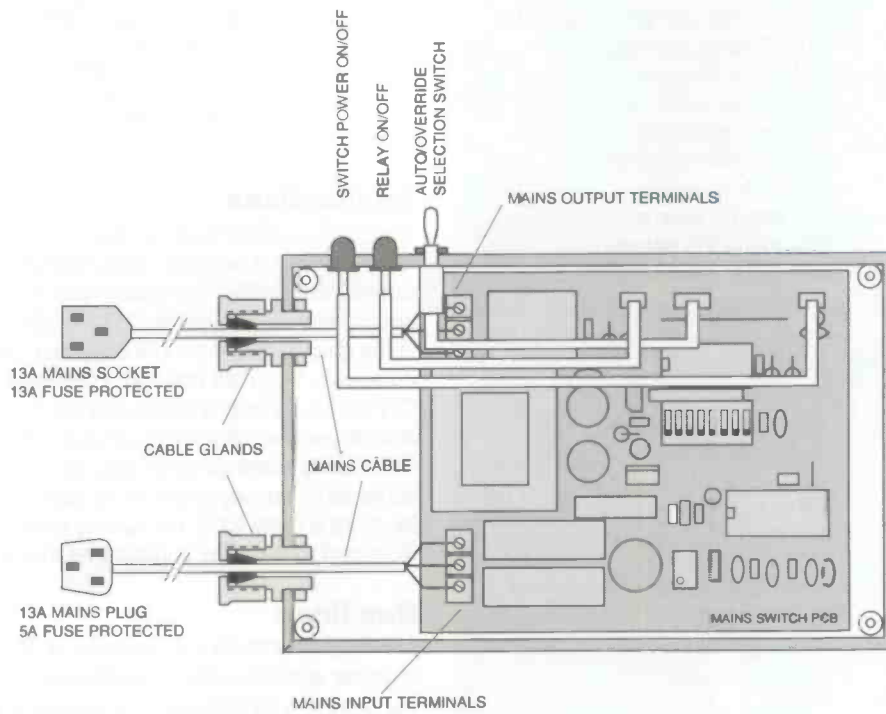
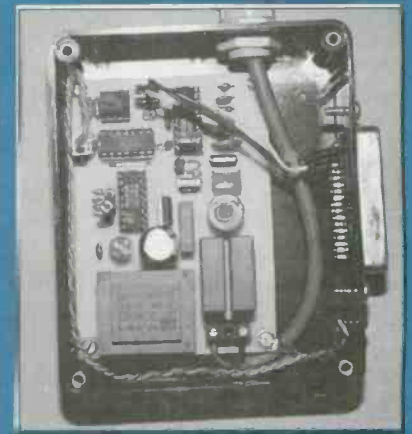
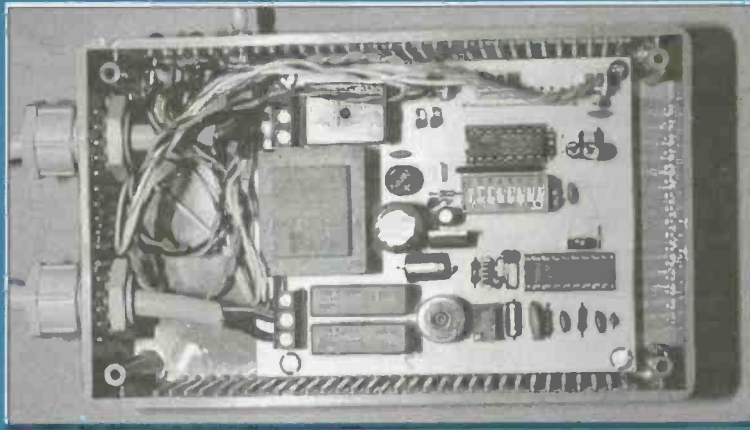
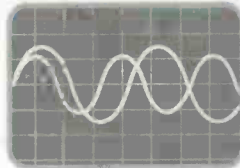

Fig. 7 Switch unit wiring



(a) The waveforms of the encoded data (Test Point B)



(c) The amplitudes of the two sin waves differ. Tank coil needs adjustment

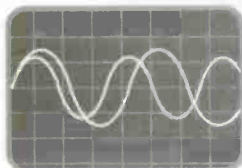

(b) The waveforms of the modulated mains carrier signal (Test Point A)

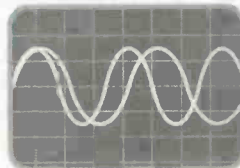

(d) Adjust the tank coil for the amplitudes of the sin waves to be the same

Fig. 8 Test waveforms



**SMART MAINS CONTROLLER
(TRANSMITTER)****Resistors****(All resistors are 0.25W, 1% metal film resistors)**

- R1 4R7
- R2 10K
- R3 5K6
- R4 3K3
- R5 50K
- R6 100K
- R7,R8 1K0
- R9,R10 100R
- R11,R12 4K7
- R13 390R
- RV1 Vertical 18-turn enclosed cermet, 5K

Capacitors

- C1,C2 IS CAP 220nF, 250V AC
- C3 IS CAP 33nF, 250V AC
- C4,C6,C12 100nF/50V ceramic
- C5 1nF/50V ceramic
- C7 47nF/50V polylayer
- C8 560pF/50V 1% polysty
- C9 10nF/50V ceramic
- C10a 4n7/50V 1% polysty
- C10b 330pF/50V 1% polysty
- C11 470uF/25V electrolytic

Semiconductors

- IC1 LM1893N mains carrier transceiver IC (UF50E)
- IC2 M145026 encoder IC (UJ49D)
- IC3 74LS164 8-bit shift register
- IC4 ILD74 dual opto-isolator IC (YY62S)
- IC5 7805 +5V voltage regulator
- D1 Zener SA40A (QY71N)
- LED1 5mm red LED
- BR1 1A bridge rectifier

Others

- J1 3 way PCB terminal block
- J2 3 way PCB connector set
- J3 2 way PCB connector set
- T1 Thermally protected mains transformer, 240V primary, 2 6V AC secondary (RS 196-741)
- T2 Tank coil, AO42YUK (FT56K)
- PCB PCB board for the controller
Spacers PCB spacer sets for the PCB board (4 off)
- LKs Links on the PCB board, 0.6 mm diameter tinned copper wire
- IC sockets Various IC sockets for the ICs
- Cable gland

Optional

- J4 Centronic 36-Pin female connector
- Mains cable 5A mains cable (2 meters)
- Mains plug 5A fused mains plug
- Box Box for the controller (120 mm * 100 mm * 40 mm)

Note that the code numbers in the brackets are the stock numbers in Maplin Electronics catalogue, or otherwise stated in other catalogues.

```
writeln('SMART MAINS CONTROL');
write('Input the address of the SMART
switch: '); readln(swaddress);
write('Input the delay period (second):
'); readln(delaytime);
write('Input the light on period
(second): '); readln(lighttime);
end;
```

Main Program

```
begin
  initialization;
  bit_weight;
  repeat
    send_address(swaddress+32); {place the
      chopped bit on DATA line, DB0 of
      the DATA port}
    delay(round(lighttime*1000)); {CLOCK
      line, DB1 of the DATA port is made
      high}
    send_address(swaddress+0); {Clock Line,
      DB1 of the DATA port is made low
      again}
    delay(round(delaytime*1000));
  until keypressed;
end.
```

Applications

The present system can control up to 93 switches with each having a unique address. Switches set at the same address will operate identically. The system can be used in numerous applications. For example, lights in different rooms of a house, in the garage and even in the garden can be controlled by a computer. You may develop a software to control the ON and OFF of the lights at a touch of a key in your bedroom. You may also develop a software to program these lights to go ON and OFF during evenings when you are not at home. There are some other novelty applications associated with light decoration (such as a party light) and energy saving systems. I will be delighted to hear any suggestions from readers.

Buy lines

The PCB boards for the controller and switches are available together with the software written on 3.5 floppy diskette, from the author. A kit consisting of one controller and one switch is available from the author at a price of £75 including P&P. The assembled and test system is also available from the author. Please phone or fax the author on 061-272-8279 for information on any of the above. The tank coil, the mains carrier IC and D1 are available from Maplin Electronics. Their stock numbers are shown in the Parts List.

PIC Development & Support

Beginners Guide to the Microchip PIC - £19.95 (no VAT)
 PIC Project Board (for all 18 pin PIC's) - £24.95 + VAT
 PIC Project Software Pack (5 projects) - £14.95 + VAT
 PIC Soft - ready made software routines & programs
 PIC Training Workshops - Microchip Approved
 PIC Consultancy
 Add £1.50 postage. Send A4 SAE for catalogue.
 Cheque with order to:-

Bluebird Electronics
 Clayshore House, 150 High Street
 Worton, Deizes. SN10 5SE
 Tel/Fax 01380 725110

AMSTRAD PCW 8256/512

8 Bit Input and Output Port

For readers using the Amstrad PCW 8256/512 computer, Jason Sharp has designed a simple eight bit I/O port which will allow experimenters to use this venerable computer system to control a wide range of devices

Using a computer to control devices in the real world is probably one of the most interesting aspects of computing. This can easily be achieved by using a parallel I/O port. The project presented here is a simple I/O port, with 8 binary inputs and 8 binary outputs.

Ins and Outs of the PCW

At the heart of the PCW is the popular Z80 processor. Connections to most of its pins are available via the 50 way edge connector at the rear of the machine. The pin assignments are shown in fig.1.

The Z80 has separate I/O and memory address spaces. When the Z80 is required to access I/O locations the /IOREQ line is taken low. When accessing a memory location /MEMRQ is taken low.

/WR is taken low to show the processor wishes to write to a port or memory. /RD is taken low when a read is being performed.

The Z80 can address 65,536 ports. Normally only ports 0 to 255 are used. Some of these ports are used internally by the PCW, as shown in fig.2. If we wish to add an I/O device we must select a port that is not used. Port 160 (A0 for those who prefer hex!) was chosen for this project.

Circuit Description

The circuit diagram for the I/O port is shown in fig.3

When the Z80 wants to access port 160, address lines A0 to A7 will hold 10100000 (binary). /IOREQ will also be low. IC1 is an 8 bit comparator. When these conditions are met, the output (pin 19) goes low.

When a location is written to, the data only remains on the bus for a fraction of a second. IC3 is an octal D-type latch. When /WR and pin 19 of IC1 both go low, the output of the NOR gate, IC1a, also goes high. The rising edge of this signal causes the data to be latched to the outputs.

A tri-state buffer is used to isolate the inputs from the data bus. When the port is to be read the output of IC2c goes low. This allows the states of the inputs onto the data bus to be read by the processor. IC4 is a bi-directional buffer, wired to work in only one direction. It was used instead of a one way device as it has a bus structured pin out, simplifying and producing a neater circuit board design.

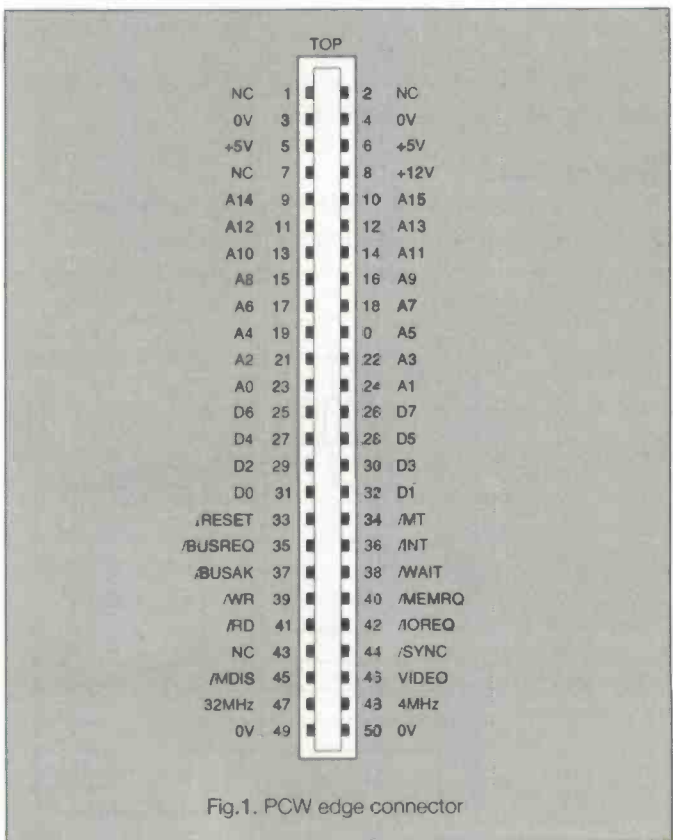

Fig.1. PCW edge connector

PORT	USAGE
0 - 127	DISC CONTROLLER
128 - 223	UNUSED
224 - 231	RESERVED
232 - 239	UNUSED
240 - 243	BANK SWITCHING
244	INTERRUPT COUNTER
245 - 246	SETS ROLLER RAM ADDRESS
247	SCREEN CONTROL
248	PRINTER CONTROL
252 - 253	PRINTER CONTROL
254 - 255	PROBABLY UNUSED

Fig.2. Port assignment data

Construction

Construction of the circuit is quite straightforward if the PCB shown in fig.4 is used. Take care not to bridge any tracks when soldering, as some are quite close. Start with the low profile components and finish with the taller components. When finished, check the board for solder bridges, etc. The 74HC devices are CMOS so take the appropriate precautions when handling them.

The I/O board can be connected to the PCW using a piece of 50 way ribbon cable. This should be terminated at one end with a 50 way IDC edge connector, and with a 50 way IDC connector at the other. The cable should be less than 50cm long or ringing may cause erratic behaviour.

Testing and Use

Plug the unit into the PCW and switch on. If the computer fails to boot or anything unusual happens, unplug the circuit and check for shorts, etc. When the computer is loaded with CP/M, run BASIC and type in listing 1.

Fig.4 shows a suitable test circuit. When used with Listing 1, switching the switches will cause the corresponding LED to be switched on or off (an expensive light switch!). Listing 2 should produce a 'bouncing light' display.

Data is output from BASIC using OUT 160,(value). Data is input using INP(160), eg. A=INP(160).

Applications

So what can this device be used for apart from producing a bouncing light? It can be used to drive relays, motors,

indicators, sense light levels or temperatures and much more. Below are some circuit ideas.

Note that the PCW's internal power supply is used to power the interface. The Amstrad technical manual does not state the current rating of this supply. Therefore an external 5v power supply should be used to power external devices (especially motors and relays). This can be done by connecting the 0V output of the PCW to the 0V output of the external power supply.

If switches are to be connected to the input they may need debouncing. The circuit shown in fig 5.a will perform this task. To save on hardware costs, switches can be de-bounced using software. Read the input twice (a delay will be required between each reading if writing in Assembler). Compare the two inputs. If they are different, the switch may be bouncing. Keep reading the input until the two values are the same. If looking for very quick activations from BASIC, the de-bounce circuit is recommended.

Individual bits of the input can be checked by ANDing the value read from the input with the bit you wish to check. For example, if you want to see if bit 3 is set AND the input with 4 (i.e.. 0000100 binary). The result will be zero if that input is low. Otherwise it will be 4.

Inputs and outputs can be isolated from other circuitry by using opto couplers. Fig 5b shows the basic set-up. The exact values required will depend on the application and type of opto-coupler used.

Fig.6 shows a simple motor driver with direction control. Using this circuit a 'buggy' could be built. The more

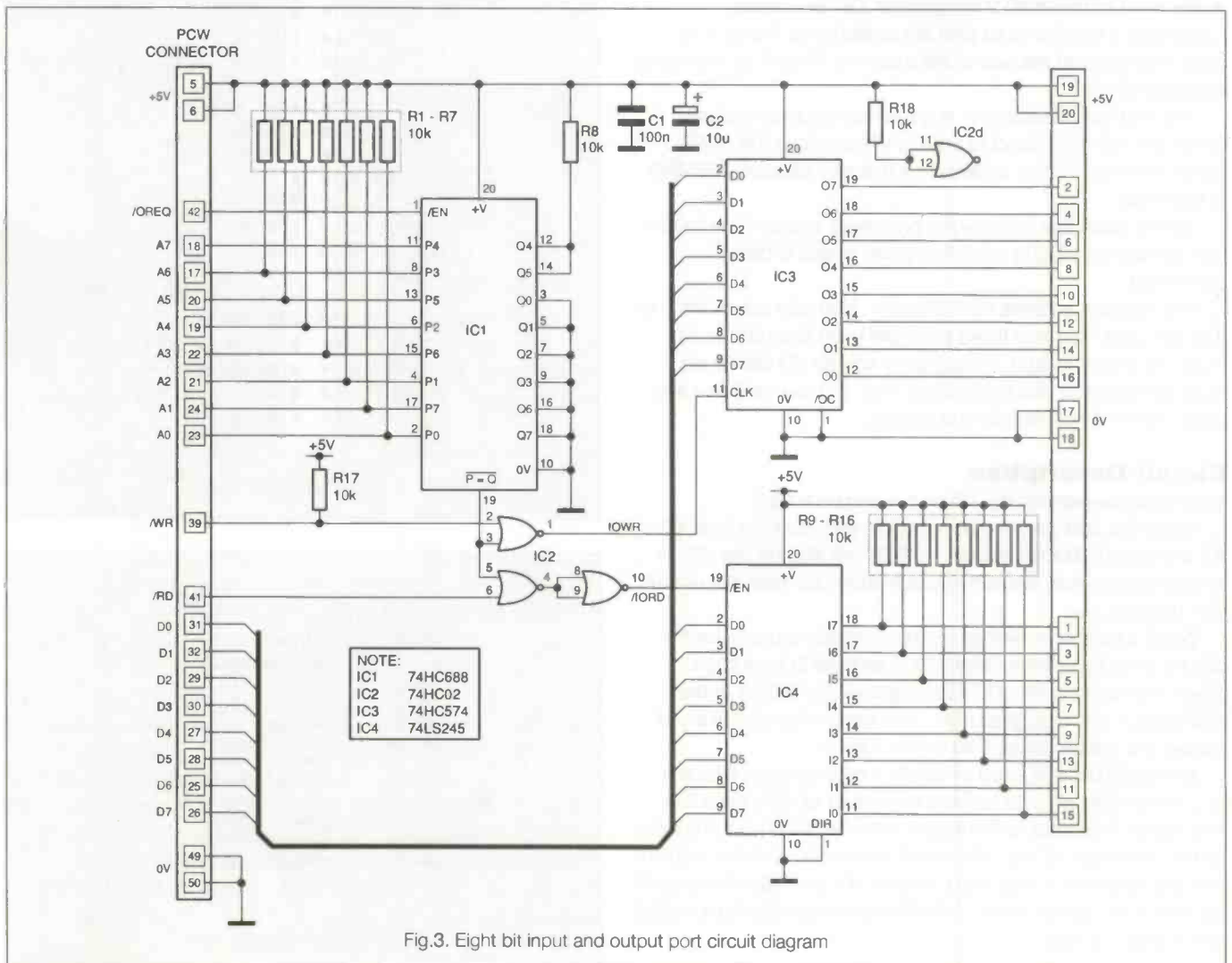

Fig.3. Eight bit input and output port circuit diagram

PARTS LIST

Resistors

- R1-R18 10K

Capacitors

- C1 0.1uF decoupling
- C2 10uF 16V Tantalum

Semiconductors

- IC1 74HC688
- IC2 74HC02
- IC3 74HC574
- IC4 74LS245

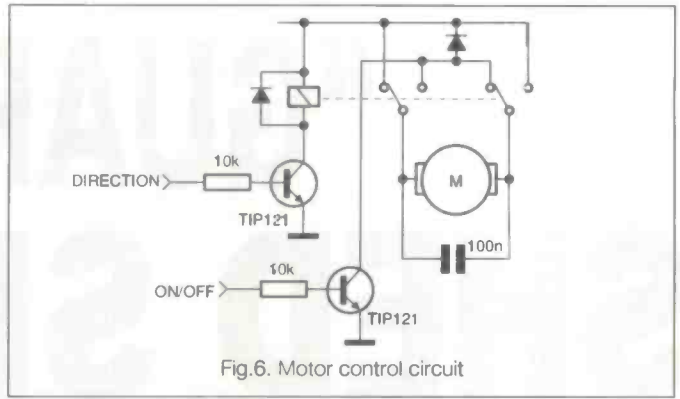

Fig.6. Motor control circuit

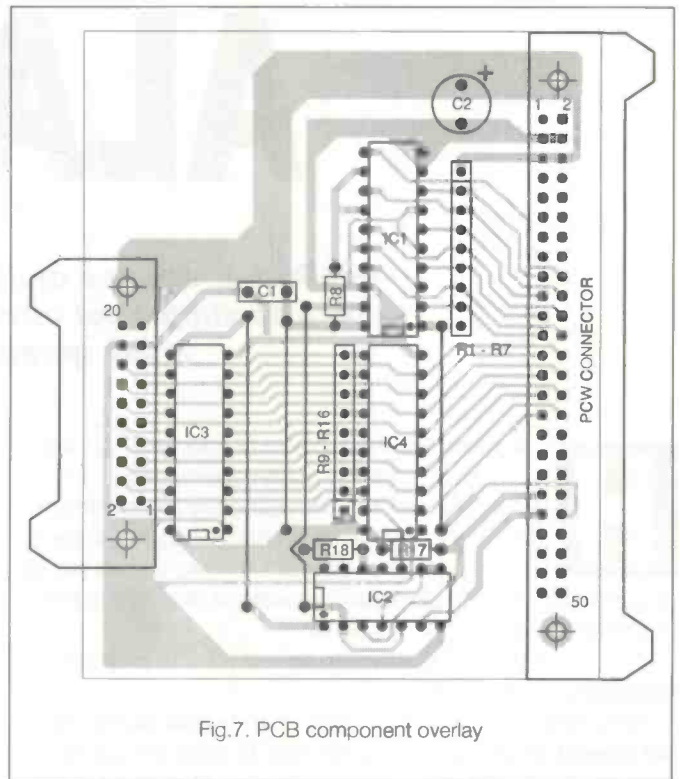

Fig.7. PCB component overlay

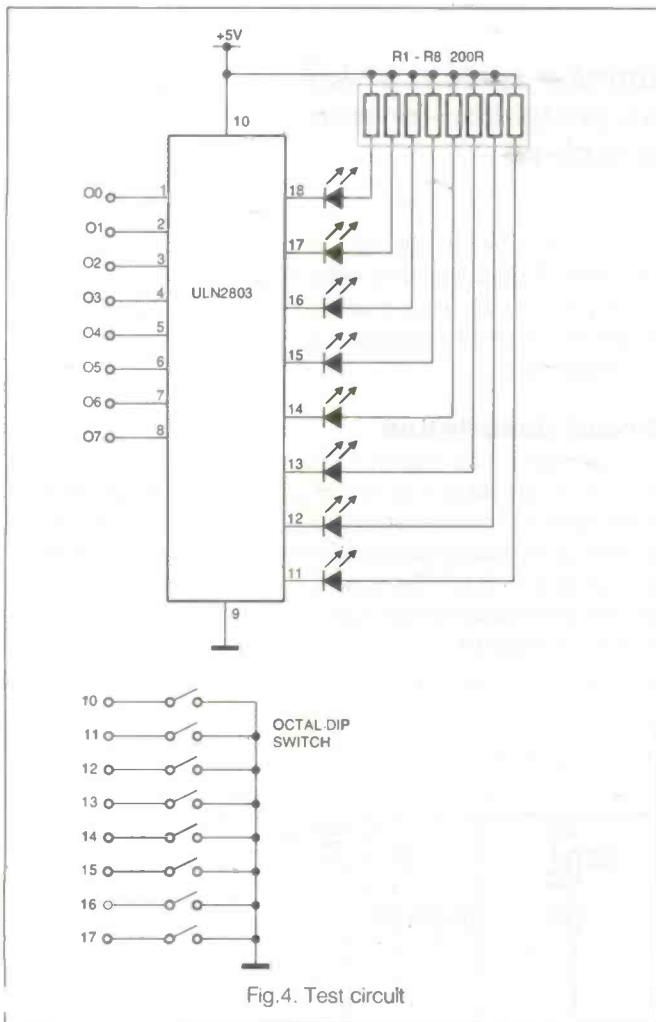

Fig.4. Test circuit

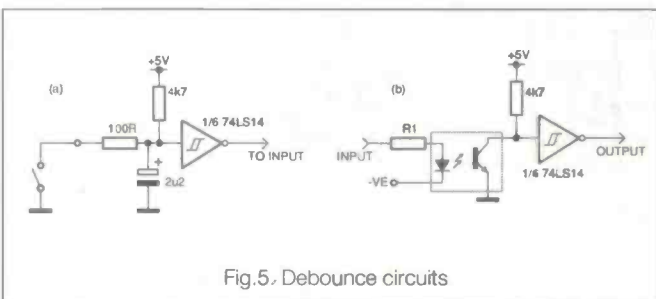

Fig.5. Debounce circuits

sophisticated technical LEGO has small motors. Sometimes opto-encoder discs are included. These can be used to sense if the motor is moving or if it has stalled. A solenoid and pen could be added for drawing. Microswitches could be fitted to enable collision detection. The buggy could be used as an educational aid. The I/O port can be accessed from DR LOGO using the following commands,

```
.out 160 value
and
.in 160
```

Using with other Z-80 based systems

Although originally designed for the Amstrad PCW, this project can be easily connected to most Z-80 based systems. Just connect the data, address, and signal lines of the board to the appropriate pins on the target system. The board is accessed by reading and writing to port 160. If several boards are required, they can be mapped to different ports by changing the states of the 'Qn' pins (see circuit diagram). The board is enabled when each Q pin is at the same logic level as its corresponding P pin (i.e.. Q1=P1,Q2=p2,...,Q7=P7). For example, to map the board to port 161, Q7 (IC1 pin 18) must be tied high.

"GUARDEN" SHED SECURITY ALARM

Tim Parker offers a multi-function system which provides simple yet effective protection for your shed, garage or lock-up

How much are the contents of your shed, garage or lock-up worth? Chances are it's quite a lot when you add it all up, especially if it got stolen and you realise the cost of replacing it at today's prices. Most crimes of this sort are carried out by opportunists and it could be only a matter of time before the "it'll never happen to me" happens!

This security alarm should help safeguard your property from being the next in line.

One thing should be made quite clear; burglar alarms do not prevent break-ins but they can help to deter the culprit from attacking what might otherwise be easy pickings by sounding a loud alarm, not only to disorientate and warn off the attacker but also to draw the attention of possible passers-by.

It has a built-in exit buzzer, fault indication and the ability to detect shock vibration, torch beam illumination and door or window movement, each of which may either be adjusted or disabled if any of the particular functions aren't required for your purposes.

Circuit description

The complete circuit diagram for the shed alarm is shown in Figure 1. As simple as it is, the versatility of the design offers a multitude of selectable features, only one of which must be decided upon during construction - and that's only whether or not you want to fit C7! Because there's a certain amount of interaction between various parts of the circuit, it is best to explain it in sections.

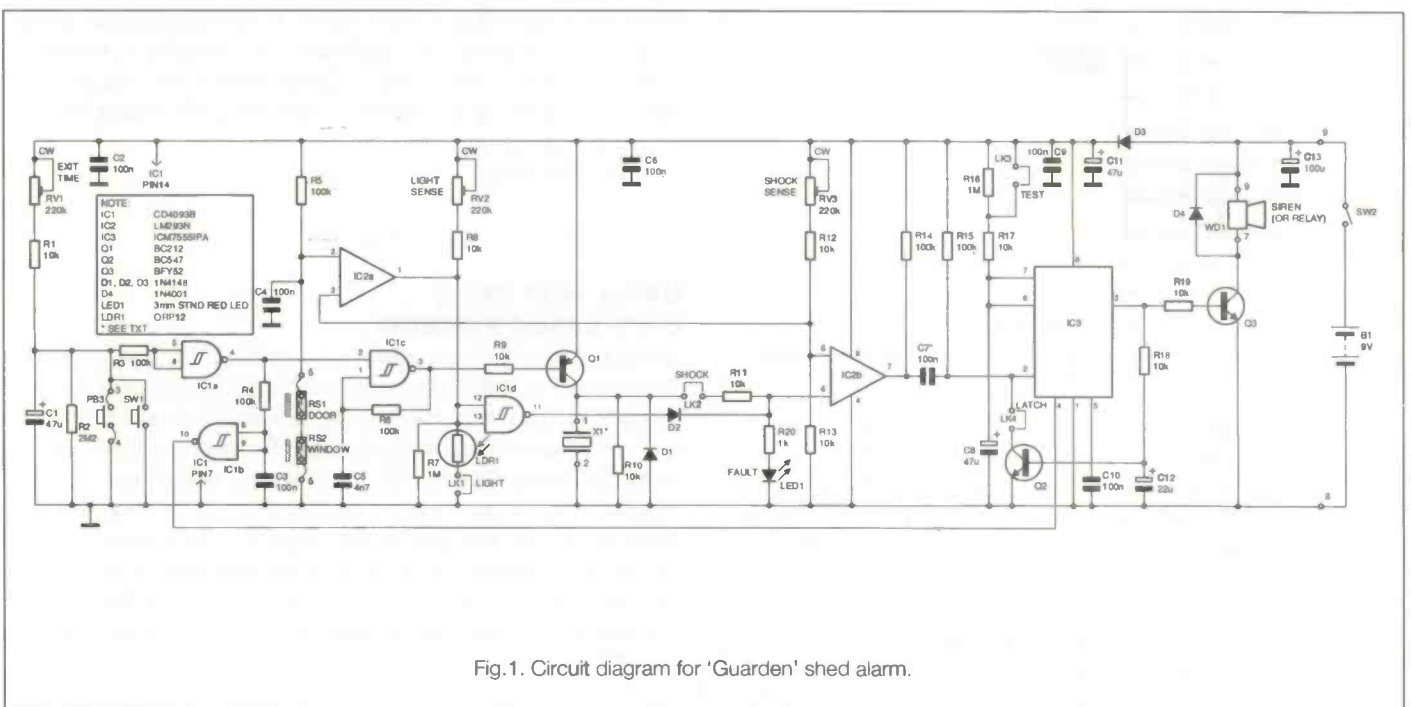

Fig.1. Circuit diagram for 'Garden' shed alarm.

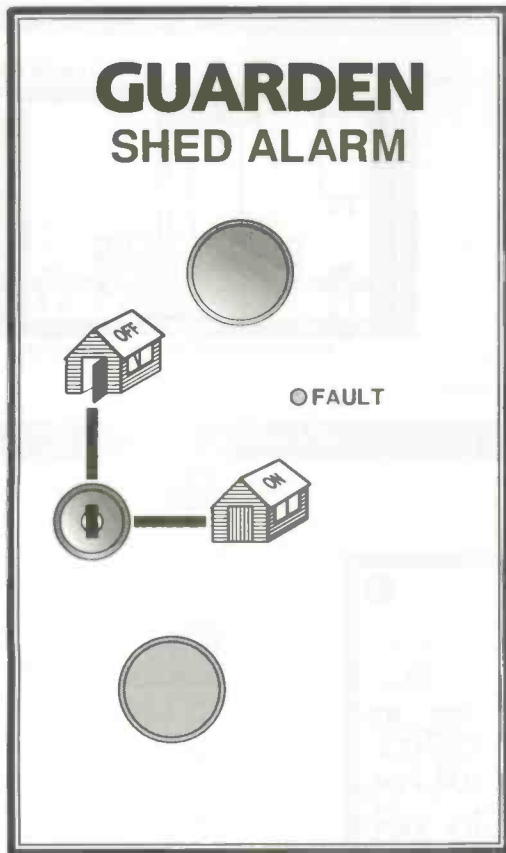

Fig.6. Front panel layout suggestion

Exit timer/buzzer

The exit timer and buzzer circuits are based around IC1a, IC1c, Q1 and X1, with their associated components. When power is first applied via keyswitch SW2, capacitor C1 will be discharged, and the voltage on its positive side will slowly increase from zero to a maximum of almost the positive rail - depending on the setting of VR1. This rising voltage is fed via R3 to the input (pins 5 & 6) of an inverter formed by IC1a and, whilst C1 is charging, the output at pin 4 will be high. This is used to enable the oscillator based around IC1c, C5 and R6. Note that only Schmitt trigger devices can be made to oscillate using a single gate in this manner - normal NAND gates will not work. The squarewave output at pin 3 of IC1c is used via R9 to drive the base of transistor Q1, which is configured as a common emitter open collector switch and, in turn, drives the piezo transducer X1. It is possible to drive these types of transducers directly from the output of CMOS devices such as IC1 but, because X1 serves two functions, this method is impractical in the design here.

At DC levels, X1 appears as an open circuit to the collector of Q1, so resistor R10 is included across X1 to draw current from the collector of Q1 - without it, Q1 won't conduct and so no sound would be produced by the transducer. With the shock sensor enable link LK2 fitted, the fault indicator LED1 will glow dimly while the exit buzzer is sounding, due to the pulses being fed to it through R11. This is not a fault, it is done intentionally so that LED1 gives a low light level output to indicate that the exit timer is running and a high brightness to indicate a fault warning. The lower light level is obviously not available if LK2 is not fitted.

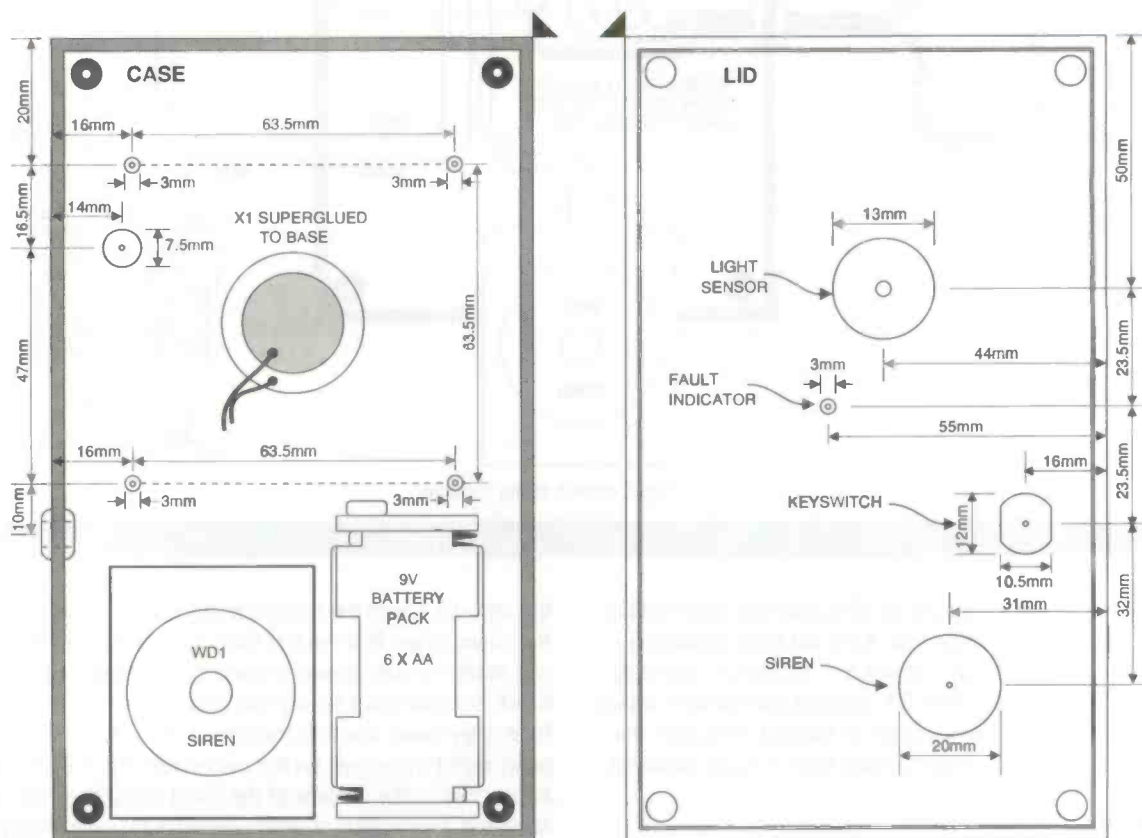

Fig.3. Drilling details for case and lid

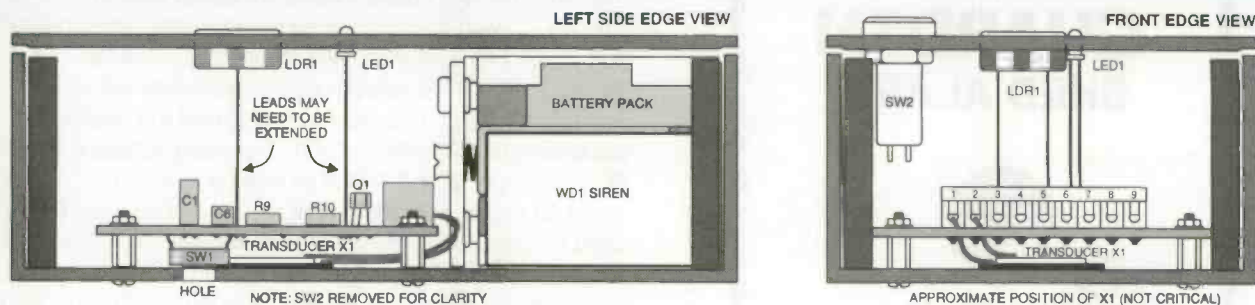

Fig. 4. Fixing positions inside case

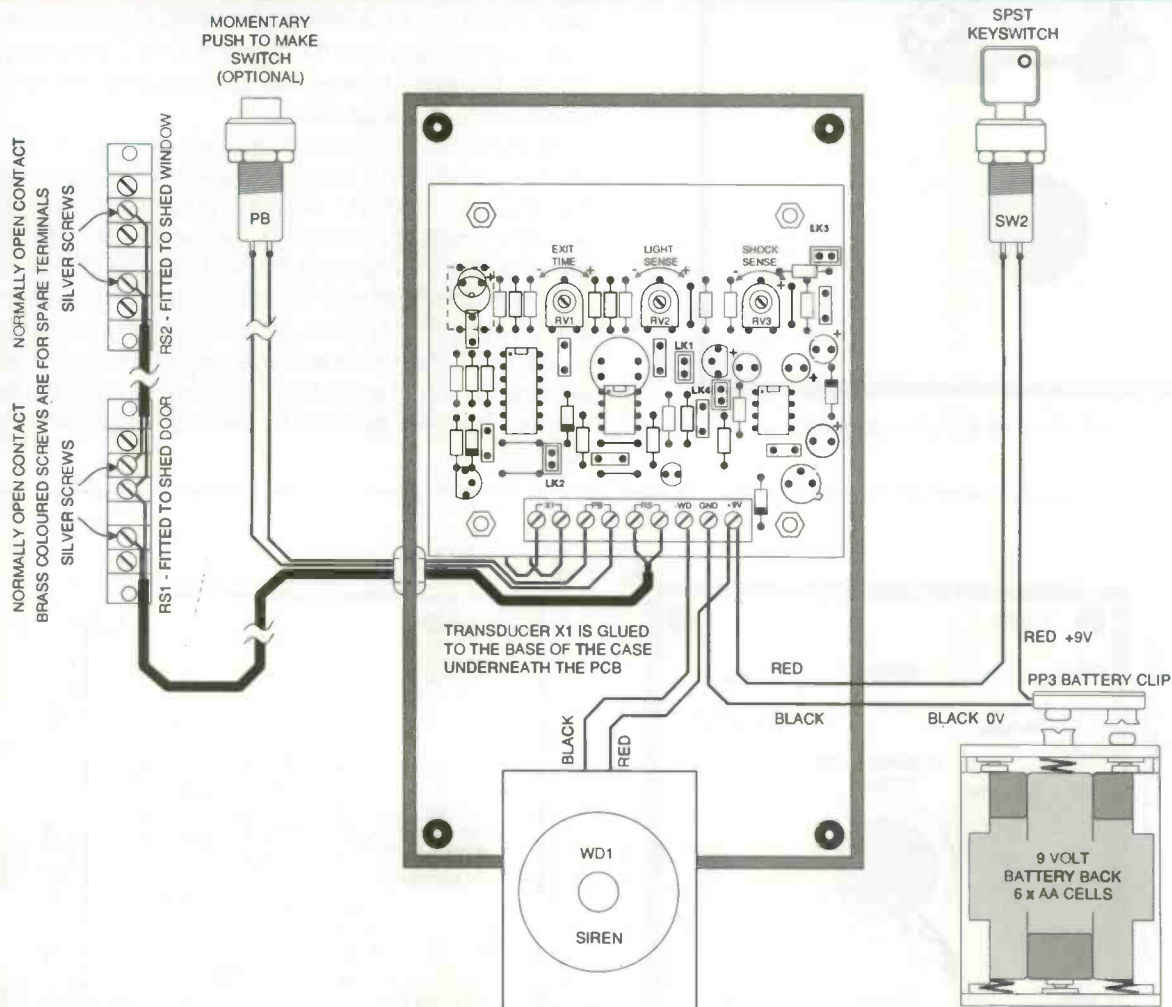

Fig. 5. How it all fits together

When the voltage at the inputs to IC1a reaches about 2/3 of the supply voltage, pin 4 will go low, IC1c will stop oscillating - leaving its output at pin 3 high, Q1 will turn off and X1 will stop sounding. The charge current for C1 is adjustable via VR1, which results in a corresponding adjustment of the exit time, with the values shown this gives a range typically from 1 to 20 seconds.

Entry timer

Most domestic burglar alarms sound a low volume entry buzzer as soon as the entrance door is opened, but this principle cannot be practically applied in our application, because the shed alarm is intended for use in somewhat confined areas. If

the intruder heard the buzzer as soon as the door was opened, the chances are that the first thing to go would be the whole alarm unit itself! For this reason there is no designated entry timer fitted, but that's not to say that provisions haven't been made for it; they have, through the use of SW1. This is a small tactile push switch mounted on the underside of the PCB and made accessible to the outside of the shed through a 'tiny' hole in the shed wall, the location of which should only be known by the owner.

Pressing SW1 will activate the EXIT timer and disable the alarm during this period, which should be set to allow sufficient time to enter the shed and turn off the alarm with the keyswitch. Where the use of SW1 is impractical, the optional push button

PB1 can be fitted to a remote location, again known only by the owner; pressing this will have the same effect. Alternatively, if you don't mind the noise for a few seconds, you could simply allow the alarm to sound as you open the shed door, before turning it off with the keyswitch.

Door and window sensors

Reed switches RS1 and RS2 are standard surface-mounting security fittings with normally open contacts and, although only two are shown in the drawing, many more can be added by connecting them all in series. These are fitted to the outer frames of the door and window and a magnet (usually supplied with them) fitted to the actual opening light and door themselves, such that they are in close proximity of, and in parallel with, the reed switch when the door or window is closed. In this way, as the door or window is opened, so the contacts inside the reed switch open, and vice versa.

IC2 is a dual comparator which has open collector outputs. IC2a performs a simple inverting function. If the voltage on pin 2 rises above that on pin 3 the output on pin 1 will be pulled low (OV). If the potential on pin 2 falls below that on pin 3 the output will effectively go open circuit or "float". Depending on the setting of VR3 pin 3 of IC2a is held somewhere between about 4% and 50% of the supply voltage - 0.4V to 4.5V with a 9V supply. The voltage itself is unimportant so long as pin 2 can swing above and below it by more than a few millivolts - the input offset voltage of the comparators.

When the window and door are closed, RS1 and RS2 will also be closed. This will hold pin 2 of IC2a at 0V. The output at pin 1 will therefore "float" and have negligible effect on the inputs of IC1d to which it is connected. If either the door or window are opened the 0V continuity will be removed and pin 2

will be pulled up to the supply voltage via resistor R5 and pin 1 will go low, taking with it the inputs to IC1d. The resulting high output of IC1d (pin 11) is fed via D2 to the alarm triggering input (pin 6) of IC1b in order to sound the alarm.

Capacitor C4 is used to debounce the reed switches if the occupants turn on the alarm, but don't exit the shed until after the exit time has elapsed (see ALARM TRIGGER).

Light sensor

There were a number of beneficial factors which influenced the addition of a light sensor in the design of the shed alarm. What if you don't have a window to protect using the method above and the would-be thief suspected the door to be alarmed, so decided to remove a roof panel to gain access (this is not just some far fetched idea, it happens more often than you may realise)? With the door closed, it would be dark inside - even during the daytime, in which case the inrush of light would trigger the alarm. If the attack were to take place at night, it's going to remain dark (ish) inside even with the roof panel removed, but the chances are our intruder is going to need some kind of illumination (a torch, matches or cigarette lighter) in order to see what's worth taking and this will activate the alarm once sufficient light is detected, whether directly from the source or reflected off any suitable surface.

The light sensing element LDR1 is an ORP12 - Light Dependent Resistor (LDR). This device has a very high resistance in total darkness - well in excess of 1M Ω , but this resistance falls quite substantially when exposed to light, being typically 10k Ω - 20k Ω in average (cloudy) daylight and can be as low as only 30 Ω in bright sunlight. It forms part of the potential divider chain based around VR2, R8, R7 and LDR1 itself and is connected to the input of inverter IC1d (pins 12 & 13).

NOTE: SW1 IS MOUNTED ON THE UNDERSIDE

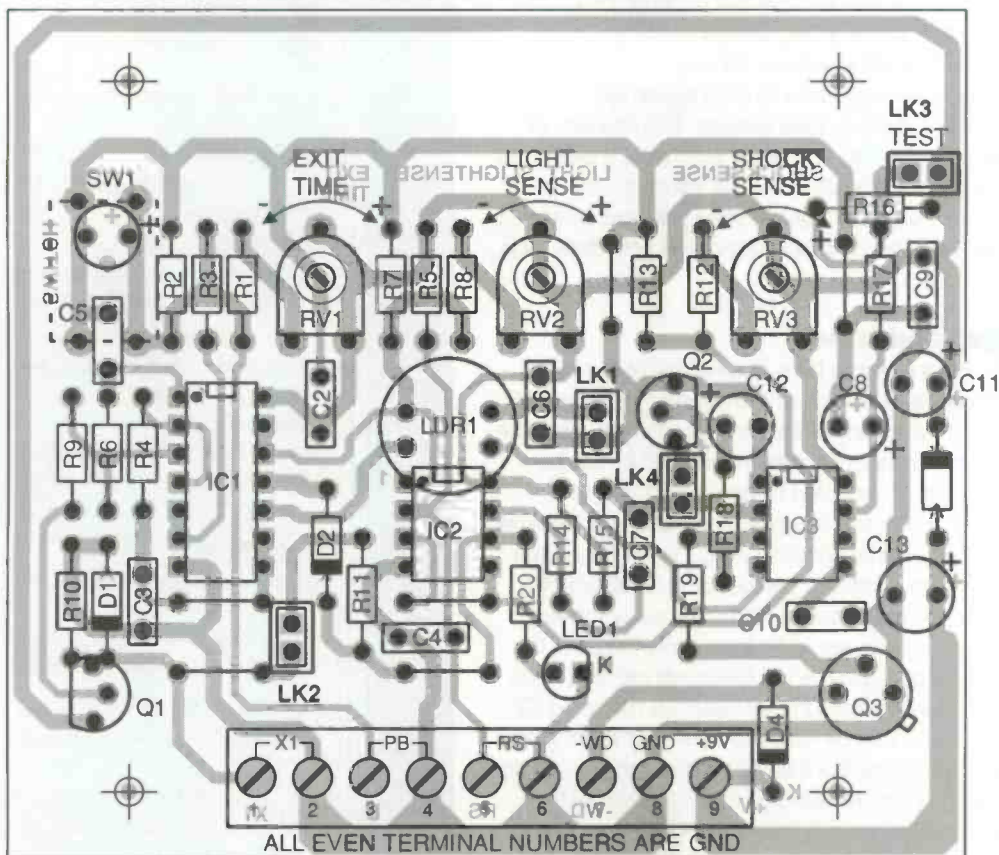

Fig.2. PCB component layout

Under dark conditions, the high resistance of LDR1 results in a voltage greater than 2/3 of the supply at the inputs to IC1d, the output on pin 11 will be low and so too will be the anode of D2. Since D2 allows only positive voltages through to the alarm triggering circuit, the output of IC1d has no effect in this state. As the light level increases, the resistance of LDR1 decreases, thereby reducing the voltage at the inputs of IC1d. Once this reaches a point below 1/3 of the supply, pin 11 will go high, D1 will conduct and apply this voltage to the triggering circuit and thus set off the alarm. The amount of illumination required to trigger the alarm is adjustable via the sensitivity control VR2. If the light sensing feature of the alarm is not required, jumper link LK1 can be opened to disconnect LDR1 without having to remove it from the circuit.

Shock vibration sensor

As mentioned earlier, the piezo transducer X1 performs two functions, one is the exit buzzer and the other is here, as the sensing element for shock vibrations. X1 is an un-housed (open) transducer which, although it will work in free air as a resonator (though not very loud), in order to operate reliably as a shock sensor, it must be hard glued (using super glue) to the case of the alarm, which in turn must be secured very firmly to a reasonably resonant section of the shed structure. In this way, the shock vibrations produced by (say) the door being attacked with a crowbar, or a window being smashed will be transmitted through the shed structure to the case of the alarm and be detected by X1, setting off the siren.

When X1 receives shock vibrations, it produces output pulses with an amplitude relative to the intensity of the vibrations. This output level can be quite high. Indeed, when tapped lightly with just the tip of a fingernail, the output pulse can easily peak above 10V. These pulses are fed to the alarm triggering circuit via resistor R11. Diode D1 is connected in parallel with X1 to prevent the negative half cycle of the pulses reaching IC2b, as this causes erratic operation of the comparator function - resulting in false alarms.

The operation of IC2b is identical to IC2a explained previously in the doors and windows section. The intensity of the shock vibration required to trigger the alarm is adjustable via the shock sensitivity control VR3. When set correctly, the alarm should be quite immune to 'normal' vibrations caused by strong winds, flapping roof felt, hanging or rubbing tree branches, pets and birds etc.

Alarm trigger and timer

After signal processing of some form or other, all of the alarm sensors result in a positive voltage at the inverting input (pin 6) of comparator IC2b. When any of the sensors are activated, the output of IC2b - which is normally held high by R14 - will be pulled low. This is then AC coupled by capacitor C7 and provides a low-going pulse to the trigger input of the alarm timer IC3. The reason for AC signal coupling via C7 is to ensure that the alarm timer can turn off after a pre-determined length of time, even if the sensor which caused it (or any other for that matter) is still active, such as would be the case if the door or window were forced open and the would-be intruder fled once the alarm sounded, leaving them in that state. By replacing C7 with a wire link the alarm can be made to sound for as long as any of the sensors are active, but this will have a significant drain on the batteries if left un-acknowledged for any length of time.

There is an advantage and a possible disadvantage of having C7 fitted. The advantage concerns the use of the exit timer. If the shed door is open before the alarm is switched on or is

COMPONENTS LIST FOR DTE "GUARDEN" SHED SECURITY ALARM

RESISTORS

- R1, 8 to 13, 17, 18 10k Ω (9 off)
- R2 2M Ω (1 off)
- R3 to 6, 14 100k Ω (6 off)
- R5 15
- R7, 16 1M Ω (2 off)
- R19 4K7 (1 off)
- R20 1K Ω (1 off)

Total 20 resistors

POTENTIOMETERS

- VR1, 2, 3 220K Ω horizontal preset (3 off)
- Total 3 presets

CAPACITORS

- C1, 8, 11, 12 47 μ F/16V radial electrolytic (4 off)
- C2, 3, 4, 6, 7 100nF ceramic - 5mm pitch (7 off)
- C9, 10
- C5 4n7 ceramic - 5mm pitch
- C13 100 μ F/16V radial electrolytic

Total 13 capacitors

SEMICONDUCTORS

- D1, 2, 3 1N4148 silicon signal diode (3 off)
- D4 1N4001 1 amp silicon rectifier diode
- IC1 CD4C93B quad 2-input nand Schmitt trigger
- IC2 LM393N dual low-power comparator
- IC3 ICM7555IPA low-power CMOS timer
- LED1 3mm standard red light emitting diode
- Q1 BC212 PNP silicon transistor
- Q2 BC547 NPN silicon transistor
- Q3 BFY52 NPN silicon transistor

Total 11 semiconductors

HARDWARE & MISCELLANEOUS

- B1 9V battery back - 2 x 3 "AA" cells
- PP3 size battery clip to suit B1
- CASE ABS plastic box 150 x 90 x 45 (internal)
- GROMMET 6.5mm (internal) PVC grommet
- LK1 to LK4 2-PIN PCB pin header (4 off)

Jumper links for above (4 off)

- PB1 Panel mounting N/O push button *
- RS1, RS2 N.O. surface mount reed switch with magnet
- SW1 12mm PCB mounting tactile button switch
- SW2 Miniature panel mounting keyswitch

TERMINALS

- 9-way (3 x 3-way) PCB terminal block
- WD1 Two-tone single piezo electric siren
- X1 27mm 1.8KHz open piezo transducer
- twin "figure 8" 7/0.2 flex (10 metres)
- M3 fixing hardware (screws, nuts, washers)

PCB DTE "GUARDEN" SHED ALARM BOARD
(ring 0283-542229 for details)

* Optional - not required for main unit

opened during the exit time, then although the fault indicator LED1 will be brightly lit, the exit time can be allowed to elapse and the alarm will go into the armed state but will not sound the siren, nor will activating any of the other sensors with the fault indicator lit. The occupants will still be allowed to exit the shed and close the door behind them, which will extinguish the fault indicator, but should the door now be opened again the alarm will sound. Note that this feature only applies if the door is open before or during the exit time, and only then if C7 is fitted. The possible disadvantage is that once triggered, the alarm will time out and turn off as normal but if, after this time, any of the sensors are still active, the alarm will show a fault and will not be allowed to sound again until the fault is rectified - even if a different sensor is now activated.

Alarm timer

As mentioned, the alarm timing function is carried out by IC3, which is a low power CMOS version of the 555 timer, configured in its monostable mode. Once a low-going trigger pulse is applied to pin 2, C8 is allowed to charge up at a rate determined by R16 and R17. The output at pin 3 will go high, turning on transistor Q3 via R19, sounding the siren. Diode D4 protects Q3 from back emf produced by the siren or any other inductive load such as a relay connected to the output terminals. When the voltage on pin 6 reaches 2/3 of the supply, C8 is discharged into pin 7 and the output on pin 3 turns off (low).

The timing period for the high output is set by R16, R17 and C8. With the given values, the timer should run for about 30 seconds. Experience has shown, however, that this time period can vary quite substantially depending on which manufacturer's version of the IC is used, so these values should serve as reference only. For testing purposes, jumper link LK3 can be inserted to short out R16; this shortens the timing period to about 1 second and is useful for checking the operation of the alarm during setting up.

Transistor Q2 is also turned on by the output of IC3 - via R18. If jumper link LK4 is fitted, once triggered, the collector of Q2 will hold pin 2 of IC3 low, and the output will remain in the high state indefinitely - even after the time period has expired, and irrespective of the state of the fault indicator (pin 7 of IC2b). Again, experience has also shown that not all versions of the CMOS 555 have this facility, some of them will turn off after the time period even with pin 2 held low; this will obviously render the latching function non-effective, a point to bear in mind when selecting this device.

The reset input (pin 4) of IC3 is connected to the output of IC1b, which prevents the alarm sounding during the exit time. Whilst pin 4 of IC3 is low the output remains low and the IC will not respond to any signals at pin 2. At the start of the exit time period, pin 4 of IC1a goes high, C3 is charged rapidly via R4 and pin 10 goes low. At the end of the exit time, pin 4 of IC1a goes low, but the corresponding high output at pin 10 is delayed slightly as C3 is discharged by IC1a through R4. This slight delay - which is only a few milliseconds - is required if the shock sensor feature is enabled by inserting jumper link LK2, because of the electromechanical properties of the transducer X1. If IC3 was enabled immediately after the exit buzzer ceased, the self resonance of X1 would produce enough output to be detectable as a shock vibration and would trigger IC2b, which would obviously set off the alarm. Delaying the release of the reset signal therefore allows sufficient time for X1 to settle to its normal operating level before the alarm circuit is enabled.

Capacitors C2, C6, C9, C11 and C13 decouple the supply

at various points throughout the circuit. Diode D3 ensures that any heavy duty current stages produced by the load across the output do not interfere with the operation of the lower current parts of the circuit.

Construction

Before you solder any components to the PCB, it's a good idea to use the board as a template for the 5 hole positions in the base of the case, even though full drilling details are given in Figure 3, this will make it much easier to obtain the precise hole position for SW1. Although not strictly necessary, a hole of about 10mm can be drilled underneath X1 to give a slight increase in volume to the exit buzzer, but remember to do it before you super glue it in place - it'll be too late afterwards!

The complete PCB component layout is shown in Figure 2. Assembly should be reasonably straight forward; start with the low profile components, building up to the highest ones, leaving SW1, LDR1 and LED1 until last. There are seven wire links on the board; don't overlook the one underneath LDR1 just above IC2. Ensure the correct orientation of all the polarised components - electrolytic capacitors, all three transistors and the three ICs. Take special care not to touch the pins when handling IC1 and IC3, and use an earthed soldering iron tip where possible - these CMOS devices can be destroyed by static charge which builds up on the human body. If in doubt, solder IC sockets to the board first and insert the ICs when the assembly is complete. Before soldering LDR1 and LED1, turn the PCB over and carefully solder SW2 to the underside in the position shown dotted on the layout.

The only awkward component is LDR1; the mounting height for this will depend on the depth of the case you intend to use, but should fit almost flush with the outside of the lid when it's fitted. You may even find that you have to extend the leads slightly. The easiest way to fit LDR1 is to 'kink' the lead and solder it into the board slightly higher than required so as to protrude through the lid. In this way, once the PCB is finally fitted and the lid is in place, it can be pushed back into position without the risk of forcing the pads off the back of the PCB. A similar situation occurs with the fault indicator LED1 but, since this can protrude through the front of the case by a variable amount, positioning should cause no real problems.

Once the board is completed, don't fix it into the case if you intend to use the entry timer switch SW1, as you will need to have access behind the PCB to drill the hole in the shed for it.

Be careful when drilling the hole for the keyswitch SW2. This is a 'snug' fit between the top of the siren and the bottom of the terminal block on the edge of the PCB, and you could experience problems with long-barrelled version if the hole is slightly out of line. The hole for the grommet should be close to the bottom of the case so that the wires passing through it don't end up jammed between it and the keyswitch. Finally, the hole above the siren is just to let the noise out and can, if desired, be covered from the inside of the lid with a small piece of loudspeaker fabric (just to make it look nice).

Next month...

we will continue this project with a look at installation and testing.

POWERFUL SCHEMATIC CAPTURE, PCB DESIGN AND AUTOROUTING ALL FOR JUST £395...

PROPAK AR for DOS provides all the features you need to create complex PCB designs quickly and easily. Draw the circuit diagram using the powerful facilities of ISIS DESIGNER+ and then netlist into ARES AUTOROUTE for placement, autorouting and tidy up. Advanced real time design rule checks guarantee that the final PCB will correspond exactly with the schematic thus saving you from costly layout errors and time consuming debugging.

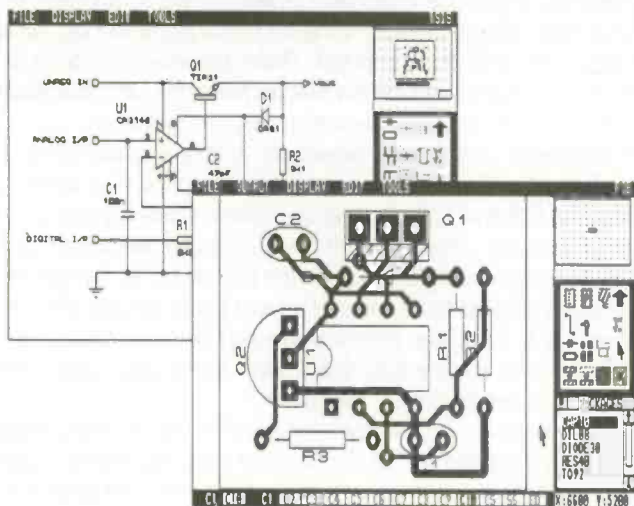

- Attractive, easy to use graphical interface.
- Object oriented schematic editor with automatic wire routing, dot placement and mouse driven place/edit/move/delete.
- Netlist generation for most popular CAD software.
- Bill of Materials and Electrical Rules Check reports.
- Two schemes for hierarchical design.
- Automatic component annotation and packaging.
- Comprehensive device libraries and package libraries including both through hole and SMT parts.
- User definable snap grids (imperial and metric) and Real Time Snap to deal with tricky SMT spacings.
- Manual route editing features include Auto Track Necking, Topological editing and Curved tracks.
- Autorouting for single, double and multi-layer boards.
- Non autorouting PROPAK is available for just £250 if you do not need or want the router.
- Full connectivity and design rule checking.
- Power plane generator with thermal relief necking.
- Graphics support to 800x600 Super VGA.
- Output to dot matrix and laser printers, HP and Houston plotters, Postscript devices, Gerber and Excellon NC machines plus DXF and other DTP file formats.

CADPAK

Two Programs for the Price of One

ISIS SUPERSKETCH

A superb schematic drawing program for DOS offering Wire Autorouting, Auto Dot Placement, full component libraries, export to DTP and much more.

**Only
£79**

Exceptionally easy and quick to use. For example, you can place a wire with just two mouse clicks - the wire autorouter does the rest.

PCB II

High performance yet easy to use manual PCB layout package. Many advanced features including curved tracks, auto track necking, DXF export, Gerber and NC file generation, Gerber viewing and more.

Alan Chadwick writing in ETI (January 94) concluded...
"At £79 I thought this was an excellent buy."

ISIS ILLUSTRATOR

Schematic Drawing for Windows

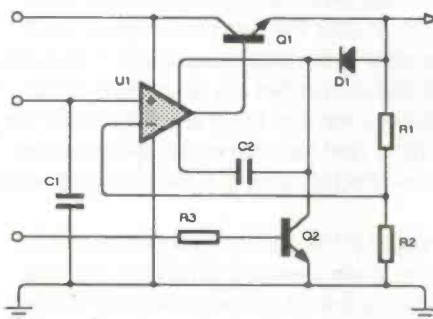

**From
£99**

Running under Windows 3.1, ISIS ILLUSTRATOR lets you create presentation quality schematic drawings like you see in the magazines. Furthermore, when the drawing is done, transferring it to another document is just a matter of pasting it through the Clipboard.

Now used by a number of prominent technical authors to illustrate their latest books and magazine articles.

labcenter
E l e c t r o n i c s



WE HAVE MOVED - NOTE NEW ADDRESS

Call us today on 0756 753440 or fax 0756 752857 for a demo pack - state DOS or Windows. Multi-copy and educational discounts available.

Prices exclude p&p (£5 for U.K.) and VAT. All manufacturers' trademarks acknowledged.

53-55 Main St, Grassington, North Yorks. BD23 5AA.



Chelmer Valve Company

*For High Quality
Audio Valves*

We offer below a selection of our CVC PREMIUM range of audio valves. These CVC BRAND valves are from selected world wide sources, processed in our special facility to provide low noise/hum/microphony PRE-AMP valves and Power Valves burnt-in for improved stability and reliability. Use this sheet as your order form. If you require matched pairs, quads or octets etc. Please allow £1.00 extra per valve for this service and mark alongside the valve type number 'M2, M4, M8' etc as required.

	UNIT PRICE	QTY.	TOTAL PRICE		UNIT PRICE	QTY.	TOTAL PRICE
PRE-AMP VALVES				RECTIFIERS			
ECC81	5.00			EZ80	4.00		
ECC82	4.00			EZ81	4.25		
ECC83	5.00			GZ32	5.00		
ECC85	4.00			GZ33	5.00		
ECC88	5.00			GZ34	5.00		
ECF82	5.00			GZ37	5.00		
ECL82	5.00			5U4G	5.00		
ECL86	5.00			5V4G	4.00		
EF86	4.00			5Z4G	3.50		
E80F (GOLD PIN)	9.00			SOCKETS			
E81CC (GOLD PIN)	6.00			B9A (state chassis or PCB)	1.60		
E82CC (GOLD PIN)	6.00			B9A Gold Pltd (State Chassis or PCB)	3.50		
E83CC (GOLD PIN)	6.00			OCTAL (State Chassis or PCB)	1.75		
E88CC (GOLD PIN)	7.00			OCTAL Gold Pltd (State Chas or PCB)	4.20		
6SL7GT	4.00			4 PIN #For 2A3, 811A etc)	3.00		
6SN7GT	4.20			4 PIN #FOR 211 & 845)	11.00		
6922	5.00			4 PIN Gold Pltd (For 211, 845)	15.00		
7025	6.00			7 PIN #For 6C33CB)	4.50		
POWER VALVES				Screening Can (For ECC83 etc)	2.00		
EL34/6CA7	7.50			MATCHING CHARGES			
EL84/6BQ5	4.00			POST & PACKING (UK)			3.00
EL84/7189A	5.10			TOTAL EXC. VAT			
KT66	9.20			VAT @ 171/2% (UK & EEC)			
KT77	12.00			TOTAL TO PAY			£
KT88	12.50			Please make CHEQUES payable to			
KT88 (Gold Special)	19.50			'CHELMER VALVE COMPANY or pay by			
2A3 (State 4 Pin or Octal)	14.00			ACCESS/MASTER CARD/VISA, give details:			
211	22.00			<input type="text"/> <input type="text"/> <input type="text"/> <input type="text"/> <input type="text"/> <input type="text"/> <input type="text"/> <input type="text"/> <input type="text"/> <input type="text"/> <input type="text"/> <input type="text"/> <input type="text"/> <input type="text"/> <input type="text"/> <input type="text"/> <input type="text"/> <input type="text"/> <input type="text"/> <input type="text"/>			
300B	50.50			Signature			
6C33C-B	36.00			Expiry Date			
6L6GC	6.50			Name			
6L6WGC/5881	8.00			Address			
6V6GT	5.00					
6080	14.00					
6146B	10.20					
6336A	40.00					
6550A	11.00					
6550A(S)	13.50					
7581A	11.00					
811A	9.50					
845	29.90					
TOTAL CARRIED FORWARD Post Code			

Valve amplifiers sound better still with CVC PREMIUM valves!

The ETI 80188 single board Computer

A powerful and highly versatile 16bit processor system designed by Richard Grodzik for which software can be developed directly on any IBM PC, this month we continue our look at programming the board.

PART 3

Last month we took an initial look at programming the 80188 SBC, and showed how this versatile board can be used for a wide range of applications. Part of this versatility can be attributed to the fact that it is software compatible with the family of processor chips used in the IBM PC. This means that software can be directly developed and tested on the PC and then downloaded onto the 80188 SBC, thereby making software development for the SBC much easier and quicker. It also means that software can be developed using the enormous range of software development tools which are available on the PC.

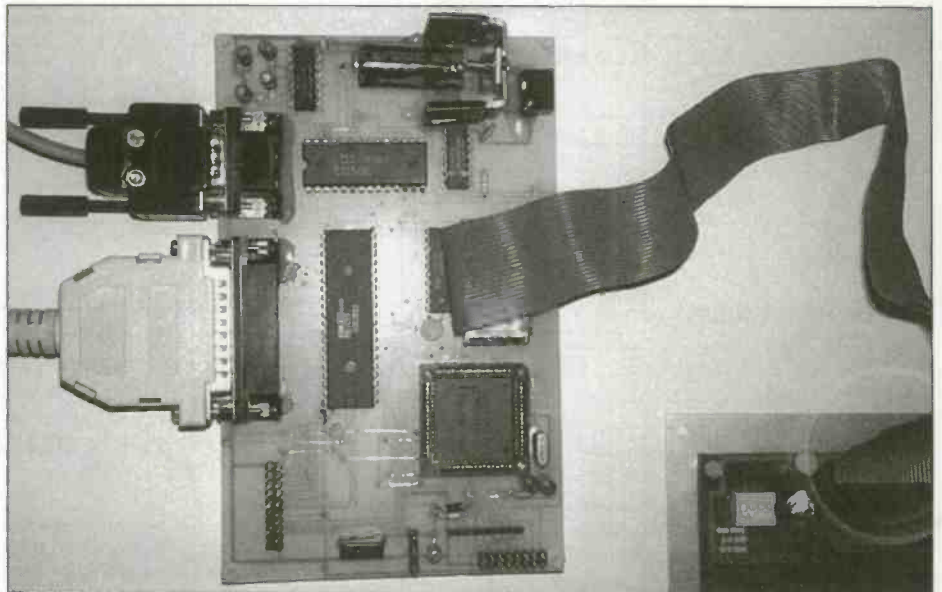

Serial Communications

Inter-communication between two computers is effectively achieved over an asynchronous RS232 link. The 80188 SBC and the P.C. both must execute communications software simultaneously to enable serial data to pass in either direction. The following chapter details the software necessary for the 80188 SBC and the P.C.

The 8251 USART is capable of both synchronous and asynchronous serial data communication. The 80188 SBC uses the asynchronous communication format on which the industry standard RS232 communication protocol is based. Therefore all programming details of the 8251 will be confined to the asynchronous mode.

Programming the 8251

Following a reset operation, the 8251 must be loaded with a control word (MODE) which initialises the 8251 to support the desired communications protocol regarding speed of transmission and word length. Control words written to the 8251 after the MODE instruction will load the COMMAND instruction. To return to the MODE instruction, the master reset bit in the command instruction word can be set to initiate an internal reset operation which automatically places the 8251 back into the MODE instruction format. Alternatively, a power-up reset or system hardware reset will achieve the same result. The C/D input line of the 8251 (pin 12), connected to the Ao system address line, is raised high whenever a control word

(MODE or COMMAND) is written the 8251. It is also high whenever a status read is performed. The base address of the 8251 (0C00H) in the 80188 system IO Map is reserved for the reading/writing of data for the 8251, (C/D input line low). Address 0C01H is therefore the MODE/COMMAND/STATUS address of the USART.

Once programmed, the 8251 performs as a UART (universal asynchronous receiver/transmitter) and is ready for communications. The command instruction controls the operation of the 8251. It cannot begin transmission until the TXenable bit is set in the command instruction and it has received a CTS (clear to send) logic low input. Likewise, the 8251 cannot begin reception of data until the RXenable bit is set in the command register. The following two programs demonstrate serial asynchronous transmission and reception of data using polled operation to determine the status of the UART. For transmission, the TxRDy flag is polled. This flag signals that the transmitter buffer is empty (a character has been transmitted) and that the buffer is ready to accept another character. For reception, the RxRDy flag is polled. This flag signals that the receive buffer contains a received character and is ready to be read by the CPU.

The logic level of the RxRDy output pin follows the logic level of the RxRDy status bit, and therefore this pin may be connected to the interrupt structure of the CPU, so that whenever a character is received and this pin is raised logic high, an interrupt service routine will execute to read the received character. The logic level of the TxRDy output pin similarly follows the logic level of the TxRDy status bit, but on condition that the CTS pin is low and the TxEN bit of the command instruction has been set. The TxRDy output pin is raised logic high and can also be used to generate an interrupt; the service routine loading a new character to the transmitter buffer.

```
; PTXD.ASM
```

```
CODE SEGMENT
```

```
ASSUME CS:CODE
```

```
ORG 0
```

```
ORG 0400H
```

```
CLI
```

```
MOV SP,0FFH ;INITIALISE STACK  
; POINTER
```

```
MOV DX,0FFA2H ;SELECT LMCS 0000-00FFH  
; 8155 RAM
```

```
MOV AX,038H
```

```
OUT DX,AX
```

```
MOV DX,0FFA4H ;PACS REGISTER ADDRESS
```

```
MOV AX,0F8H ;CONFIGURE PCS0 CHIP
```

```
SELECT TO START
```

```
;ADDRESS 0C00H
```

```
OUT DX,AX
```

```
MOV DX,0FFA8H ;MPCS REGISTER ADDRESS
```

```
MOV AX,081B8H
```

```
OUT DX,AX
```

```
;MAIN PROGRAM STARTS
```

```
CALL TIMER
```

```
CALL USART_INITIALISE
```

```
MOV BL,030H ;OUTPUT ASCII '0'
```

```
CYCLE:CALL TRANSMIT
```

```
JMP CYCLE
```

```
TRANSMIT PROC NEAR
```

```
MOV AL,BL ;DATA
```

```
ADD BL,+1 ;TRANSMIT NEXT ASCII
```

```
CHARACTER
```

```
MOV DX,0C00H
```

```
OUT DX,AL
```

```
NOTR:MOV DX,0C01H ;STATUS
```

```
IN AX,DX
```

```
AND AL,1
```

```
CMP AL,1
```

```
JNZ NOTR
```

```
MOV CX,01FFH ;DELAY
```

```
DEL5:LOOP DEL5
```

```
RET
```

```
TRANSMIT ENDP
```

```
TIMER PROC NEAR
```

```
MOV DI,0105H ;8155 TIMER ADDRESS HIGH  
; BYTE
```

```
MOV AL,040H ;SQUARE WAVE OUTPUT
```

```
MOV [DI],AL
```

```
MOV DI,0104H ;8155 TIMER ADDRESS LOW  
; BYTE
```

```
MOV AL,9 ;DIVIDE BY 9
```

```
MOV [DI],AL
```

```
MOV DI,0100H ;8155 COMMAND ADDRESS
```

```
MOV AL,0C3H ;START 8155 TIMER
```

```
MOV [DI],AL
```

```
RET
```

```
TIMER ENDP
```

```
USART_INITIALISE PROC NEAR
```

```
;USART INITIALISATION FOR TRANSMISSION
```

```
;AT 9600 BAUD
```

```
;1 STOP BIT,8 DATA BITS,NO PARITY
```

```
;USART ADDRESS 0C01H=COMMAND,0C00H=DATA
```

```
MOV AL,04FH
```

```
MOV DX,0C01H
```

```
OUT DX,AL
```

```
MOV AL,3
```

```
MOV DX,0C01H
```

```
OUT DX,AL
```

```
RET
```

```
USART_INITIALISE ENDP
```

```
ORG 07F0H
```

```
JMP 0FFC0H:0000
```

```
ORG 0800H
```

```
ENDS
```

```
END
```

The 8251 requires two clock signals - the system clock applied to the CK input is derived from the master crystal frequency which is divided by two to produce a frequency of 5.5296 Mhz at the CLK OUT pin of the 80188.

The clock feeding the Rxc and Txc has to be an exact multiple of the required baud rate - in this case 9600 baud. The 8155 contains a 12 bit timer which is used to provide the Txc and Rxc signals. The CLK OUT signal is fed to this timer which is programmed by procedure TIMER to provide a divide by 9 function. The resulting frequency of 614.4 KHz after a further division by 64 by the USART results in a transmit and receive baud rate of 9600.

Procedure USART_INITIALISE programs the 8251 for the RS232 protocol - 1 stop bit, 8 data bits, no parity. See diagrams for details of programming for other protocols.

Chip select of the 8251 is performed by the PCS0 line of the 80188. The 80188 can generate several chip selects (PCS0 - PCS6) which are active for seven contiguous blocks of 128 bytes above a programmed base address. The PACS register defines the start address of the peripheral select block - in this case 0C00H. The MPCS register selects the size of block located in IO space (2K). The following peripheral chip selects will therefore be active for the following address ranges:

```
PCS0=0C00-0C7F
PCS1=0C80-0CFF
PCS2=0D00-0D7F
PCS3=0E00-0E7F etc.
```

Receiving Data

Again, the mode and command bytes are written to the command register at address 0C01H. The RXRDY bit is set and the status register is polled to indicate when a byte has been received.

```
;RXD.ASM
PAGE ,132
CODE SEGMENT
ASSUME CS:CODE
ORG 0
ORG 0400H
MOV SP,0FFH ;INITIALISE STACK POINTER
MOV DX,0FFA2H ;SELECT LMCS 0000-00FFH
;8155 RAM
MOV AX,038H ;038H
OUT DX,AX
MOV DX,0FFA4H ;CONFIGURE PCS0 CHIP
;SELECT TO 0C00H
MOV AX,0F8H
OUT DX,AX
MOV DX,0FFA8H
MOV AX,081B8H
OUT DX,AX
CALL TIMER ;INITIALISE 8155'S
;TIMER
CALL USART_INITIALISE ;INITIALISE 8251 FOR
;9600 BAUD
;8 DATA BITS,1 STOP
```

```
;BIT,NO PARITY
;MAIN PROGRAM
CYCLE:
NOTR:MOV DX,0C01H ;POLL USART STATUS
;REGISTER
IN AX,DX
AND AL,2
CMP AL,2
JNZ NOTR ;IF BYTE
;RECEIVED,CONTINUE
MOV DX,0C00H
IN AX,DX ;GET DATA
MOV DI,0102H ;SEND BYTE TO PORT B
MOV [DI],AL
JMP CYCLE ;REPEAT FOREVER
TIMER PROC NEAR
MOV DI,0105H ;TIMER HIGH BYTE
MOV AL,040H ;SQUARE WAVE OUTPUT
MOV [DI],AL ;PORT B OUTPUT
MOV DI,0104H ;TIMER LOW BYTE
MOV AL,9 ;DIVIDE BY 9
MOV [DI],AL
MOV DI,0100H ;8155 COMMAND REGISTER
MOV AL,0C3H ;START TIMER
MOV [DI],AL
RET
TIMER ENDP
USART_INITIALISE PROC NEAR
MOV AL,04FH
MOV DX,0C01H
OUT DX,AL
MOV AL,4
MOV DX,0C01H
OUT DX,AL
RET
USART_INITIALISE ENDP
ORG 07F0H ;RESET VECTOR AT FFFF0H
JMP 0FFC0H:0000 ;START EXECUTING AT
;0FFFC0H
ORG 0800H ;FILE SIZE = 2048 (2
Kbytes)
CODE ENDS
END
```

Programming for Interrupts

The 80188 has the same basic software interrupt structure as the 8088 processor. Up to 256 interrupt pointers can be generated which define the start address (CS:IP) of the interrupt

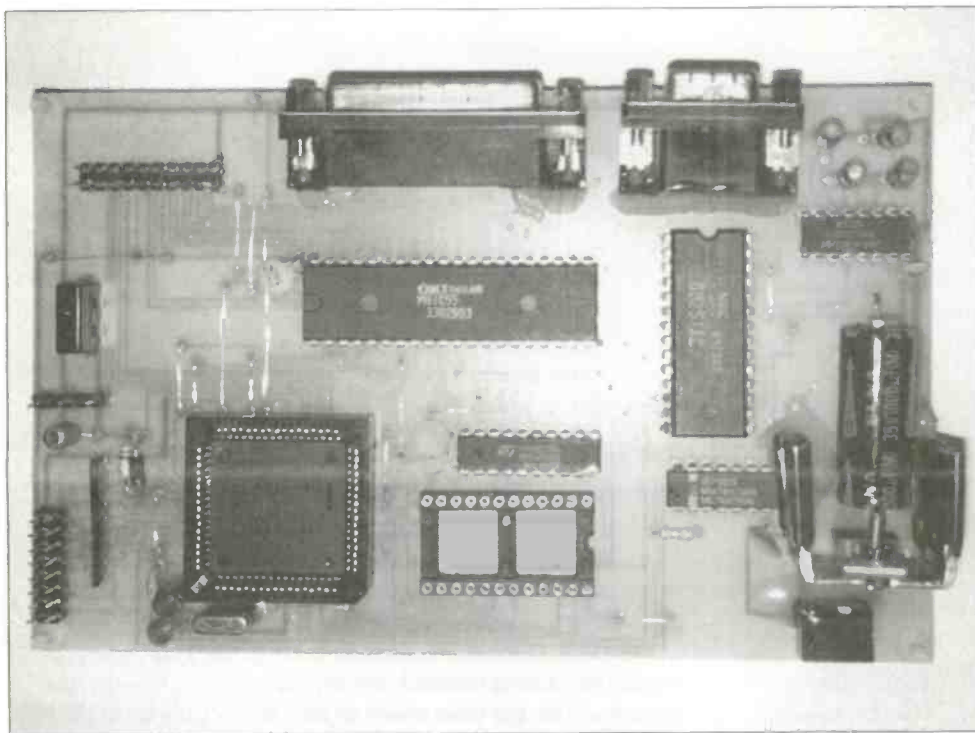

CS:IP doubleword points to the starting address of the interrupt service routine. Once the interrupt has been serviced, an IRET instruction will pop the CS and IP doubleword and the flag register from the stack and normal sequential program execution will continue from the point of interrupt.

Using hardware Interrupts

The following program demonstrates how the 80188 system is programmed to activate the INT0 line. Procedure INITIALISE programs the 80188's

internal registers as follows:

- The mask register (address FF28H) enables type 12 interrupts. To enable other interrupts, the

following mask bytes are written to this register:

service routine. The 80188 SBC has an area of RAM internal to the 8155, from address 0000 to 00FFH which can contain the interrupt pointers required by the system's software. Although this area of memory is also shared by the memory stack, it should be sufficient to include several interrupt pointers.

The 80188 interrupt system responds to the same software generated interrupts as does the 8088 processor. These include TYPE 0, divide overflow, TYPE 1, single step and TYPE 2 NMI. In addition, the 80188 will generate internal interrupt vectors (pointers) when interrupt lines INT0, INT1, INT2 or INT3 are asserted high. For example, an INT0 interrupt will generate addresses 30H and 32H - and cause the IP and Code segment register values at these locations in RAM, to be loaded, defining the start address of the interrupt service routine to be executed for that interrupt.

Software Interrupts

Any interrupt service routine can be program generated by means of a software INT instruction. It has the general form:

INT TYPE No.

For example, a type 17 pointer will generate vectors 44H and 46H (17 x 4) and (17 x 4)+2; these address locations in RAM will contain the IP:CS address information of a service interrupt routine. Whenever a software interrupt is executed, the following occurs:

- The flag register is pushed on stack.
- The trap flag and the interrupt flag (IF) is cleared to disable other maskable interrupts and disable single-stepping.
- The CS register is pushed on stack.
- The address of the interrupt vector is calculated - the 80188's hardware does this automatically by multiplying the interrupt type by 4.
- The CS base address of the interrupt service routine is loaded from the vector table into the CS register.
- The IP register is pushed onto stack.
- The IP offset of the interrupt service routine is loaded from the vector table into the IP.
- In summary, after an INT instruction has been executed, the

```
Type 13      INT1 =DDH
Type 14      INT2 =BDH
Type 15      INT3 =7DH
```

INT0 control register (address FF38H), is programmed for level or edge (040H) interrupts. Control register for other interrupt sources are:

```
INT1 FF3AH
INT2 FF3CH
INT3 FF3EH
```

Again, loading 040H for edge and 050H for level interrupts. Procedure VECTOR loads the IP offset and the CS value of the interrupt service routine (ISR) into the vector table at address 30H and 32H.

Finally, the STI instruction enables the interrupt structure. A high level transition at the INT0 pin will cause the program to vector to the interrupt service routine and 55H will appear on port B output lines. To enable further interrupts after the IRET instruction, the end of interrupt register at location FF22H must be loaded with word 0800FH. This register is common for all interrupt sources.

```
;INT0.ASM
                                PAGE ,132
CODE SEGMENT
ASSUME CS:CODE,DS:CODE
ORG 0
ORG 0400H

CLI                               ;DISABLE INTERRUPT
MOV SP,0FFH
MOV DX,0FFA2H                     ;CONFIGURE LCS 00-0FFH
```

```

MOV AX,038H      ;038H
OUT DX,AX
;MAIN PROGRAM
CALL VECTOR
CALL INITIALISE
STI              ;ENABLE INTERRUPT
                ;WAIT FOR INTERRUPT AT
                INTO PIN 45
HLT              ;STOP

```

```

;TYPE
;12
MOV AX,0800FH
OUT DX,AX
IRET            ;RETURN FROM INTERRUPT
ORG 07F0H
JMP 0FFC0:0000
ORG 0800H
CODE ENDS
END

```

```

VECTOR PROC NEAR
C_S EQU 0FF80H      ;BASE ADDRESS
                    OF EPROM
INT_TYPE EQU 12
INT0 = INT_TYPE *4 ;ADDRESS 30H
MOV AX,OFFSET ISR  ;LOAD ADDRESS
                    OF INTERRUPT
                    ;ROUTINE
MOV DI,INT0        ;INT0
                    INTERRUPT
                    VECTOR TABLE
MOV [DI],AX        ;ADDRESS 030H
                    = IP OFFSET
MOV AX,C_S
MOV DI,INT0+2      ;ADDRESS 032H
                    = CODE
                    SEGMENT
MOV [DI],AX
RET
VECTOR ENDP

```

```

INITIALISE PROC NEAR
MOV DX,0FF28H      ;MASK REGISTER ,ENABLE
                    INTO
MOV AX,000EDH
OUT DX,AL
MOV DX,0FF38H      ;INT0 CONTROL REGISTER
MOV AL,050h        ;040h ;EDGE
                    INTERRUPT
OUT DX,AL
MOV DI,0100H       ;PORT A,B OUTPUT
MOV AL,03
MOV [DI],AL
RET
INITIALISE ENDP
ISR:                ;INTERRUPT SERVICE
                    ROUTINE
CLI                ;DISABLE INTERRUPT
MOV DI,0102H       ;SEND 55H TO PORT B
MOV AL,055H
MOV [DI],AL
MOV DX,0FF22H      ;EOI REGISTER NON
                    SPECIFIC EOI VECTOR

```

Using the timer to generate waveforms

The following example demonstrates how the 80188's timers may be programmed to generate waveforms of any duty cycle. In this case, a square wave is generated by timer one and is presented to timer1 out output pin. Two registers - MAXA and MAXB define the maximum count value of the timer; when maximum count is reached, the logic level on the timer output pin is inverted, the timer resets to zero and counts up to MAXB value, whereupon the logic level on the output pin once again inverts, and so on. Since each incrementation of the timer takes .72 uS (System clock frequency/8), the width of the mark/space of the resultant waveform is directly proportional to values programmed into MAXA and MAXB registers.

```

;TIMER1.ASM (100HZ)
;CONNECT TIMER IN 1 (PIN 21) TO +5V
;100HZ SQUARE WAVE PRODUCED AT TIMER OUT 1
(PIN 23)
CODE SEGMENT
ASSUME CS:CODE
ORG 0
ORG 0400H
TIMERMODE EQU 0FF5EH ;TIMER 1 CONTROL
                    REGISTER
COUNTER EQU 0FF58H   ;16 BIT COUNT
                    REGISTER
MAXCOUNTA EQU 0FF5AH ;MAX COUNT
                    REGISTER A
MAXCOUNTB EQU 0FF5CH ;MAX COUNT
                    REGISTER B
SQUAREWAVE = 0C003H
MAXA = 01B00H        ;MAX COUNT VALUE
                    A
MAXB = 01B00H        ;MAX COUNT VALUE
                    B
CLI                  ;DISABLE
                    INTERRUPTS

```

```

MOV DX,MAXCOUNTA      ;LOAD MAX COUNT
                        REGISTERS
MOV AX,MAXA
OUT DX,AX

MOV DX,MAXCOUNTB
MOV AX,MAXB
OUT DX,AX

MOV DX,TIMERMODE      ;PROGRAM TIMER 1
                        CONTROL REGISTER
MOV AX,SQUAREWAVE     ;FOR SQUARE WAVE
                        OUTPUT

OUT DX,AX

HLT                    ;STOP

ORG 07F0H
JMP 0FFC0:0000

ORG 0800H
CODE ENDS
END

```

```

MOV AL,0E3H           ;9600 baud,8 data bits,1
                        stop bit, no parity
MOV DX,00             ;COM1
MOV AH,00             ;BIOS call-serial
                        communications
INT 014H

```

```

NEXT:
MOV AH,1              ;Test for received
                        character
INT 16H
JNZ FINISH

```

```

MOV DX,COM1
hsk: IN AL,DX
      TEST AL,01      ;Byte received?
      JZ hsk          ;No

```

```

SUB DX,+05            ;COM1 port address
IN AL,DX              ;Fetch data byte

```

```

MOV BX,index
MOV BYTE PTR DS:ACQUIRED_DATA[BX],AL ;Write

```

```

byte
CALL WRITE

```

```

JMP NEXT

```

```

FINISH:
MOV BX,FILE_HAND     ;Close file
MOV AH,03EH          ;DOS function call-3EH
INT 021H

```

Streaming data to the Hard Disk

Data logging by the 80188 SBC can be achieved by uploading the acquired data to the PC via the RS232 serial link. The following program allows serial data received at the COM1 terminal to be written to disk in real time. A file 'UP' is created which contains the captured data. Pressing the enter key will cause exit to DOS.

The executable file is assembled via the A86 assembler and results in a DOS COM file, which will run on any PC.

```

;DATAIN.ASM
CODE SEGMENT
ASSUME CS:CODE,DS:CODE

```

```

ORG 100h

```

```

INDEX      DW 0
FILENAME   DB
'C:\8088\ASM\UP',0 ;Filename
FILE_HAND  DW 0
ACQUIRED_DATA DB 1 DUP(0)

```

```

COM1 EQU 03FDH      ;Serial port
                        address

```

```

START:
LEA DX,FILENAME     ;Create file
MOV CX,00h
MOV AH,03CH         ;DOS function
                        call 3CH

```

```

INT 021H
MOV FILE_HAND,AX    ;Open file

```

```

MOV AH,04CH ;Return to
DOS
INT 021H

```

```

WRITE PROC NEAR
PUSH CX

```

```

MOV BX,FILE_HAND   ;Write buffer contents
                        to file 'UP' MOV
CX,1                ;Write byte to file
LEA DX,ACQUIRED_DATA
MOV AH,040H        ;DOS function call-40H
INT 021H

```

```

POP CX
RET
WRITE ENDP

```

```

CODE ENDS
END START

```

```

LEA DX,FILENAME
MOV AL,1            ;Write only
MOV AH,03DH        ;DOS function call-3DH
INT 021H

```

```

;Configure
communications
protocol

```

Next Month...

we will continue be looking at the first of the 80188 SBC add-on boards.

A SAMPLING OSCILLOSCOPE AND LOGIC ANALYSER

IN AN AFFORDABLE PORTABLE PACKAGE

- 10 Mega samples per second single channel DSO
- 1MHz analogue bandwidth
- 0.2v-50v input range
- Various Triggering options
- 10 Mega samples per second 8 channel logic analyser
- 5v TTL/4.5-15v CMOS logic level inputs
- Crisp, clear LCD screen
- Zoom and Scroll facilities (selected ranges only)
- Battery or mains adapter powered
- 12 Months Warranty (Built version only)
- "Get you working" service (kits only)

The Miniscope



MINISCOPE KIT £139
MINISCOPE BUILT £179
MAINS PSU £6.00 P&P £6.00
PLEASE ADD VAT AT 17.5%

Write or phone for a free Information Pack to

AUDON

AUDON ELECTRONICS

36 Attenborough Lane, Chilwell, Nottingham NG9 5JW 0602 259737

High quality stepping motor kits (all including stepping motors) Comstep independent control of 2 stepping motors by PC (Via the parallel port) with 2 motors and software. £67.00 ready built. £99.00
Software support and 4 digital inputs kit £27.00
power interface 4A kit £36.00
power interface 8A kit £46.00
Stepper kit 4 (manual control) includes 200 step stepping motor and control circuit £23.00
We are now stocking a range of stepping motors and kits to drive them please ask for the stepping motor data sheet for full information.
Inverter toroidal transformers 225VA 10.5-0-10.5 primary 0-260-265 secondary £29.95
LEDs 3mm or 5mm red or green 7p each
yellow 11p each
cable ties 1p each £5.95 per 1000
£49.50 per 10,000
High quality photo resist copper clad epoxy glass boards
Dimensions single sided double sided
3x4 inches £1.09 £1.23
4x8 inches £2.75 £2.99
6x12 inches £6.20 -
12x12 inches £12.25 -
Rechargeable Batteries
AA (HP7) £0.99
AA 700mAh £1.75
C 2AH with solder tags £3.60
D 4AH with solder tags £4.95
1/2AA with solder tags £1.55
C (HP11) 1.8AH £2.20
D (HP2) 1.2AH £2.60
Sub C with solder tags £2.50
Standard charger charges 4 AA cells in 5 hours or 4Cs or Ds in 12-14 hours + 1xPP3 (1, 2, 3 or 4 cells may be charged at a time) £5.95
High power charger as above but charges the Cs and Ds in 5 hours AAs Cs and Ds must be charged in 2s or 4s
Nickel Metal Hydride AA cells high capacity with no memory. £3.50
100mAh £3.50
1200mAh £3.75
Special offers please check for availability
42x 16mm dia 1.2v batteries £1.45
stick of 4 171mmx16mm dia with red & black leads 4.8v £5.95
Computer grade capacitors with screw terminals 8700uf 10v £1.95, 6800uf 15v £2.95, 1000uf 16v £1.50, 5800uf 60v £4.95
LM337K TO3 case variable regulator £1.95 £1.44
100+ CaAs FET low leakage current S8873 £12.95 each £9.95 10+ £7.95 100+
BS250 P channel mosfet £0.45, BC559 transistor £3.95 per 100
74LS05 hex inverter £10.00 per 100, used 8748 Microcontroller £3.50
SL952 UHF Limiting amplifier LC 16 surface mounting package with data sheet £1.95
AM27S02 £1.25 each 90p 100+, CD4007UB 10p 100+, 6p 1000+
Sinclair light gun terminated with a jack plug and PP3 clip gives a signal when pointed at 50hz flickering light with output wave form chart £3.95
DC-DC converter Reliability model V12P5 12v in 5v

200ma out 300v input to output isolation with data £4.95 each or pack of 10 £39.50
Hour counter used 7 digit 240v ac 50Hz £1.45
QWERTY keyboard 58 key good quality switches new kit £6.00
Airpax AB2903-C large stepping motor 14v 7.5' step 270hm 68mm dia body 6.3mm shaft £8.95 or £200.00 for a box of 30
Polyester capacitors box type 22.5mm lead pitch 0.9uf 250vdc 18p each 14p 100+ 9p 1000+ 1uf 250vdc 20p each, 15p 100+, 10p 1000+ 3.3uf 100vdc 30p each, 20p 100+, 15p 1000+ 1uf 50v bipolar electrolytic axial leads 15p each, 7.5p 1000+
0.22uf 250v polyester axial leads 15p each, 7.5p 100+ Polypropylene 1uf 400vdc (Wima MKP10) 27.5mm pitch
32x29x17mm case 75p each 60p 100+
Philips 123 series solid aluminium axial leads 33uf 10v & 2.2uf 40p each, 25p 100+
Philips 108 series long life 22uf 63v axial 30p each 15p 1000+
Multilayer AVX ceramic capacitors all 5mm pitch 100v 100pf, 150pf, 220pf, 1000pf (10n) 10p each, 5p 100+, 3.5p 1000+
500pf compression trimmer 60p
40 uf 370vac motor start capacitor (dielectrol type containing no pcb's) £5.95 or £49.50 for 10
Solid carbon resistors very low inductance ideal for RF circuits
27ohm 2W, 68ohm 2W 25p each 15p each 100+ we have a range of 0.25w 0.5w 1w and 2w solid carbon resistors please send SAE for list
P.C. 400W PSU (Intel part 201035 001) with standard motherboard and 5 disk drive connectors, fan and mains inlet/outlet connectors on back and switch on the side (top for tower case) dims
212x49x149mm excluding switch £26.50 each
£138.00 for 6
MX180 Digital multimeter 17 ranges 100vdc 750vac 2Mohm 200mA transistor Hfe 9v and 1/5v battery test £12.95
AMD 27256-3 Eproms £2.00 each, £1.25 100+
DIP switch 3PC0 12 pin (ERG SDC-3-023) 60p each 40p 100+
Disk drive boxes for 5.25 disk drive with room for a power supply light grey plastic 67x268x247mm £7.95 or £49.50 for 10
Hand held ultrasonic remote control £3.95
CV2486 gas relay 30 x 10mm dia with 3 wire terminals will also work as a neon light 20p each or £7.50 per 100
All products advertised as new and unused unless otherwise stated. Wide range of CMOS TTL 74HC 74F Linear Transistors kits rechargeable batteries capacitors tools etc. always in stock. Please add £1.95 towards P&P vat included in all prices

JPG ELECTRONICS

ETI 276-278 Chatsworth Road,
Chesterfield S40 2BH
Access Visa Orders (01246) 211202
Callers Welcome

Seetrax CAE / Ranger / PCB Design

Ranger 1 / £100

Schematic capture linked to PCB.
Parts and wiring list entry.
Outline (footprint) library editor.
Manual board layout.
Full design rule checker.
Black annotation (linked to schematic)
Power, memory and signal autorouter, £50.

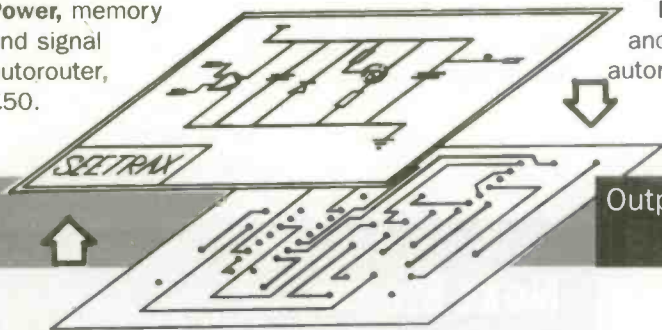

Ranger 2 / £599

All the features of the Ranger 1, plus,
Gate and pin swapping (linked to the schematic).
Track highlighting.
Auto track necking.
Copper flood fill.
Power planes (heat relief and anti-pads).

Rip-up and retry autorouter.

Outputs to:

8/9 and 24 pin dot-matrix printers.
HP Desk/Laser Jet, Canon BJet, Postscript (R3 only)
HP-GL, Houston Instruments plotters.
Gerber photoplotters.
NC Drill Excellon, Sieb and Meyer.
AutoCAD DXF.

Ranger 3 / £3500

All the features of the Ranger 2, plus,
UNIX or Dos versions.
1 Micron resolutions and angles to 1/10th degree.
Hierarchical or flat schematic.
Unlimited design size.
Any-shaped pad.
Split power planes.
Optional on line DCR.
100% rip-up and retry, push and shove autorouter.

Seetrax CAE / Hinton Daubnay House / Broadway Lane / Lovedean / Hampshire / PO8 0SG.

Call 0705 591037 or fax 0705 599036 for further information / demo packs.

All systems upward compatible. Trade deals available. All trademarks acknowledged.

Is your PCB design package not quite as "professional" as you thought? Substantial trade-in discounts still available.

Board Capture

Schematic Capture Design Tool

- Direct netlist link to BoardMaker2
- Forward annotation with part values
- Full undo/redo facility (50 operations)
- Single-sheet, multi-paged and hierarchical designs
- Smooth scrolling
- Intelligent wires (automatic junctions)
- Dynamic connectivity information
- Automatic on-line annotation
- Integrated on-the-fly library editor
- Context sensitive editing
- Extensive component-based power control
- Back annotation from BoardMaker2

£395

Board Maker

BoardMaker1 - Entry level

- PCB and schematic drafting
- Easy and intuitive to use
- Surface mount and metric support
- 90, 45 and curved track corners
- Ground plane fill
- Copper highlight and clearance checking

£95

BoardMaker2 - Advanced level

- All the features of BoardMaker1
- Full netlist support- BoardCapture, OrCad, Schema, Tango, CadStar
- Full Design Rule Checking both mechanical and electrical
- Top down modification from the schematic
- Component renumber with back annotation
- Report generator- Database ASCII, BOM
- Thermal power plane support with full DRC

£395

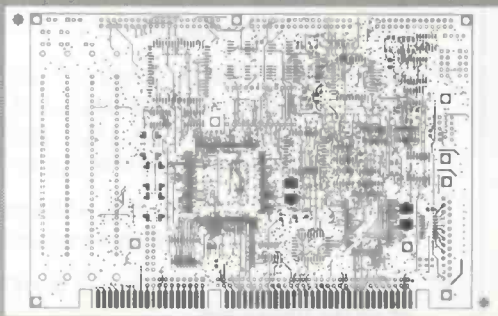
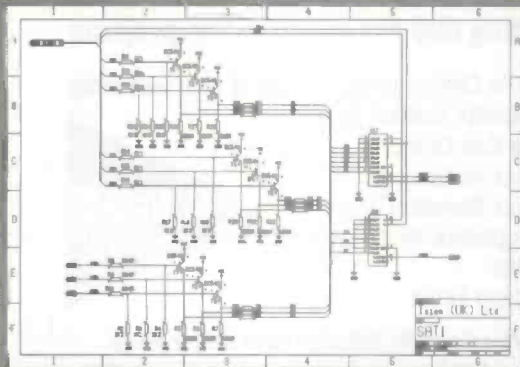

Board Router

Gridless re-entrant autorouter

- Simultaneous multi-layer routing
- SMD and analogue support
- Full interrupt, resume, pan and zoom while routing

£200

Output drivers - Included as standard

- Printers - 9 & 24 pin Dot matrix, HPLaserjet and PostScript
- Penplotters - HP, Graphtec & Houston
- Photoplotters - All Gerber 3X00 and 4X00
- Excellon NC Drill and Annotated drill drawings (BM2)

For further information contact
Tsien (UK) Limited
 Aylesby House
 Wenny Road, Chatteris
 Cambridge, PE16 6UT
 Tel 01354 695959
 Fax 01354 695957

E-mail Sales@tsien.demon.co.uk

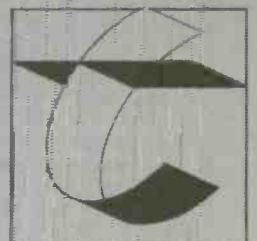

tsien



PCB Designer

For Windows 3.1
Runs on any PC running
Windows in standard or
enhanced mode
with 2MB
RAM

Only
£49
All
Inclusive

- ✓ Produce *Single* or *Double* sided PCBs.
- ✓ Print out to *any Windows supported* printer.
- ✓ *Toolbar* for rapid access to commonly used components.
- ✓ Helpful prompts on screen as you work.
- ✓ Pads sizes fully customisable.
- ✓ No charges for technical support.
- ✓ Snap-to grid sizes 0.1", 0.05" 0.025" and unrestricted.
- ✓ SMT pads and other pad shapes.
- ✓ Positive reviews by Robert Penfold and Paul Stenning, copies available on request.

Phone (0432) 355 414 (Access and Visa welcome)

Niche Software

22 Tavistock Drive, Belmont, Hereford, HR2 7XN.

Please Note: Since PCB designer is so easy to use, and to keep costs down, PCB Designer has an On-Line manual, in Windows Help format. A FREE tutorial is also supplied.

WINTER 1994/5 CATALOGUE



The Winter 94/95 edition has 280 pages packed with over 4000 products and now with news and features including two full construction projects

- ▶ New additions to Cirkit's unique range of kits, including:
 - Infra-red Remote Control System
 - Combustible Gas Detector
 - Mains Carrier Audio Link
 - Mains Carrier Remote Control
 - Electrical Appliance Watt Meter
 - Breath Tester
 - TV Audio/Video Tuner

£1.95
+ 30p p&p

- ▶ Two feature projects, fully detailed articles for Hi-Fi quality Infra-red Cordless Headphones and 'Chiptester' a logic IC tester with full PC software, with full construction kits available for both
- ▶ Many more additions throughout the catalogue including mobile phone batteries and chargers, low cost thermometers, timers, ICs, LEDs, test equipment, books, opto couplers and much more
- ▶ 280 pages, 26 sections, over 4000 products from some of the worlds finest manufactures and suppliers
- ▶ Available from 20th October at most large newsagents or direct from Cirkit
- ▶ **Send for your copy today!**

FANTASTIC SAVINGS ON METERS AND MORE !!!

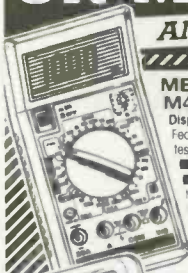

**METEX 4 1/2 DIGIT DMM
M4630** ■ 3D Range 4 1/2 Digit
Display 17mm ■ 0.05% Accuracy.
Features: ■ 5 range capacitance
test ■ 5 ohms ranges to 20M
■ Transistor and Diode Test
■ Continuity LED and buzzer ■ Data
hold switch ■ 5-ranges AC/DC Volts
■ AC/DC current to 20 Amps
■ With leads,
batteries,
instructions
and hard case
£49.95



TL34 ■ 3 1/2 Range ■ 3 1/2
digit 24mm Large Display
Features: ■ 5 Capacitance ranges
■ 6 - resistance ranges to 20M ohm
■ Diode and transistor test ■ 5 AC/DC
volts ranges Basic 0.5% accuracy.
■ 5 ranges AC/DC current to 20Amps
■ With leads,
battery and
instructions.
£27.95

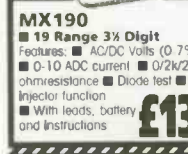

MX190
■ 19 Range 3 1/2 Digit
Features: ■ AC/DC Volts (0.7%)
■ 0-10 ADC current ■ 0/2k/2MEG
ohmresistance ■ Diode test ■ Signal
injector function
■ With leads, battery
and instructions
£13.95

Full details send for instruments
Info pack (SAE 36p UK) Ref: TG

ALL PRICES INCLUDE VAT

TEST METERS	
Satellite Finder	£29.95
■ Easy to use kit	
Professional Satellite	£89.95
F/S meter	£67.95
LCR Meter ■ 3 1/2 Digit ■ 7 Cap ■ 6	
Inductance ■ 7 resistance ranges	£62.95
Capacitance Meter ■ 3 1/2 Digit	
■ 9 ranges ■ 18mm LCD display	£62.95
Digital Lux Meter	£62.95
■ 3 ranges ■ 3 1/2 digit LCD ■ Data hold	
output terminal	£62.95
Sound Level Meter	£46.95
■ 40 to 120 db ■ Two ranges	
Analogue Clamp Meter	£32.95
■ 0/300 amps ■ AC 5 ranges ■ 0/750	
VAC 0/75v DC ■ 0/200 K OHM	£32.95
Digital Clamp Meter	£51.95
■ 3 1/2 Digit ■ 11 ranges incl temperature	
■ Data hold etc	£56.95
AC/DC Current Clamp	£51.95
■ 0/2000 amps AC/DC two ranges for	
use with Dmm's	£51.95
Temperature Measurement	£41.95
■ Dual input 3 1/2 Digit °C/°F with	
thermocouple (X)	£41.95
BENCH INSTRUMENTS	
Digital LED Capacitance autorange	£93.00
bench meter 0.1%	
LCR bridge	£126.00
7 Digit frequency counter	£87.00
10KHz to 200MHz	
POWER SUPPLIES	
Single meter *twin meter	
0/24v dc 0/30amps	£174.00
0/24v dc 0/50amps	£188.00
0/30v dc 0/3 amps	*£140.00
Twin version	*£260.00
5-15v dc 0/4 amps	£52.95
0/30v DC 0/24 Amps	
digital display	£99.95
SIGNAL SOURCES 220/240v AC	
6 Range RF Gen 100 KHZ to 150 MHz	£122.00
(350MHz Harmonics)	
5- range Audio Gen 10Hz to 1 MHz	£119.00
Sine/square	
0.5Hz to 500KHz Function Gen	
Sine/Sq/Triang	£124.00

ALL PRICES INCLUDE VAT
OPEN 6 DAYS A WEEK

HENRY'S
AUDIO ELECTRONICS
(Reg. Prop. Cubegate Ltd)

404 Edgware Rd, London W2 1ED
Tel: 071-724 3564/071-258 1831
Fax: 071-724 0322
Discounts for quantity and education



Cirkit

Cirkit Distribution Ltd

Park Lane · Broxbourne · Hertfordshire · EN10 7NQ
Telephone (0992) 448899 · Fax (0992) 471314

EASY-PC, Schematic and PCB CAD

Over 18,000 Installations
in 80 Countries World-wide!

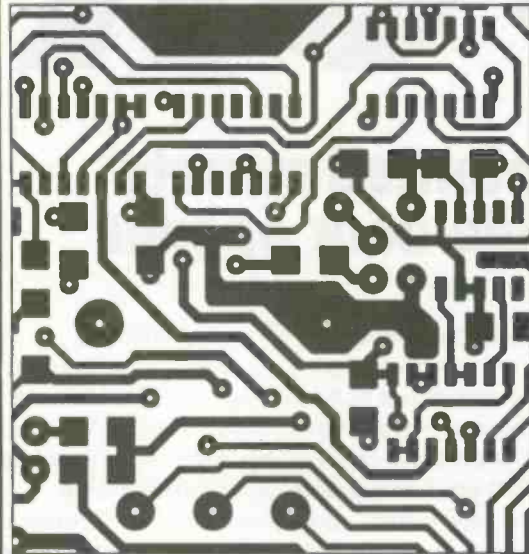

- Runs on:- PC/XT/AT/286/386/486 with Hercules, CGA, EGA or VGA display and many DOS emulations.
- Design:- Single sided, Double sided and Multi-layer (8) boards.
- Provides full Surface Mount support.
- Standard output includes Dot Matrix / Laser / Ink-jet Printer, Pen Plotter, Photo-plotter and N.C. Drill.
- Tech Support - free.
- Superbly easy to use.

Still Only £98.00!

Plus P&P+VAT

BRITISH DESIGN

AWARD

1989

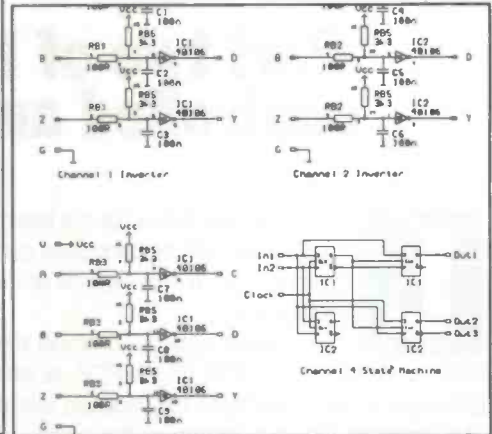

Options:-500 piece Surface Mount Symbol Library £48,
1000 piece Symbol Library £38, Gerber Import facility £98.

Electronic Designs Right First Time?

See us on Stand A107 at ICAT 95 (CAD/CAM) Show, NEC 7-9 March

New! ELECTRO-MAGNETIC Layout Simulation ONLY £495

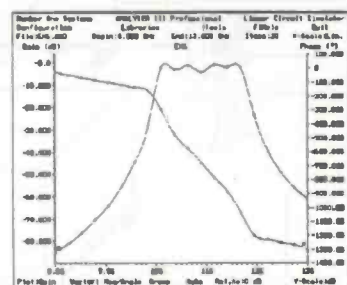
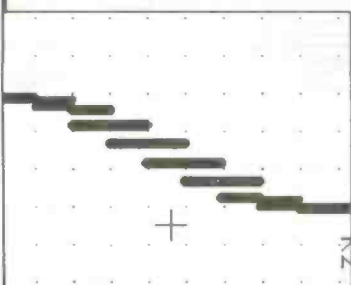
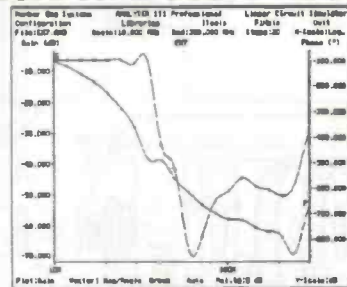
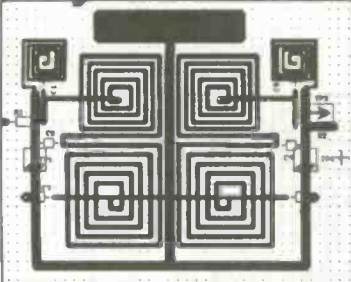

Affordable Electronics CAD

LAYAN: Electro-magnetic Layout Simulator. Links to EASY-PC Professional XM and ANALYSER III Professional.	£495.00
EASY-PC Professional: Schematic Capture and PCB CAD. Links to ANALYSER III and PULSAR.	From £195.00
PULSAR: Digital Circuit Simulator	From £98.00
ANALYSER III: Linear Analogue Circuit Simulator	From £98.00
Z-MATCH for Windows: Smith Chart based problem solving program for R.F. Engineers	£245.00
FILTECH: Active and Passive Filter design	£145.00
EASY-PC: Entry level PCB and Schematic CAD	£98.00
<i>Prices exclude P&P and VAT.</i>	

For full information, please write, phone or fax:-

Number One Systems

UK/EEC: Ref. ETI, HARDING WAY, ST.IVES, CAMBS., ENGLAND, PE17 4WR.

Telephone UK: 01480 461778 (7 lines) Fax: 01480 494042

USA: Ref. ETI, 1795 Granger Avenue, Los Altos, CA 94024

Telephone/Fax: (415) 968 9306

International +44 1480 461778

MASTERCARD, VISA, DELTA, SWITCH Welcome.

- TECHNICAL SUPPORT FREE FOR LIFE
- PROGRAMS NOT COPY PROTECTED.
- SPECIAL PRICES FOR EDUCATION.

RAYDOR

Part two of Pat Alley's patented remote controlled automatic garage door opener

Last month we looked at the basic mechanics of the Raydor remote controlled garage door opener. This month we look at the controlling electronics

The mains fused at 2 amps at the plug and a back-up 3amp thermal FS1 on the PCB, is fed straight to the primary of a 15-0-15V 50VA fully isolated transformer and relay RLC contacts, timed to switch off the control box light three minutes after the door closes. The centre tap of the transformer secondary is connected to mains earth, as is the motor body. The low 30VAC is fully rectified into +15V and -15V (but not smoothed) relative to mains earth. This is used to power the motor forward or in reverse when relay contacts RLA or RLB

are closed respectively. FS2 and FS3 protect both the transformer secondary winding and RLA/RLB contacts against simultaneous operation of RLA/RLB. High spikes of back emf from the motor are limited to 68V by the paralleled VDR across the motor. The electronic circuit 0V line is meanwhile connected to the -15V line which allows diode D2 to sample the full +30VDC alternating current, which is smoothed by C1 to about 40VDC and fed by a resistor chain to two voltage comparators IC4a and IC4b. These comparators act as motor overload detectors. Should the voltage fall to a value preset by VR1 on door opening (or VR2 on door closing), the respective comparator outputs a low. D1 rectifies only 15VAC and C2 smoothes it to about +21VDC which is used for the relay coil

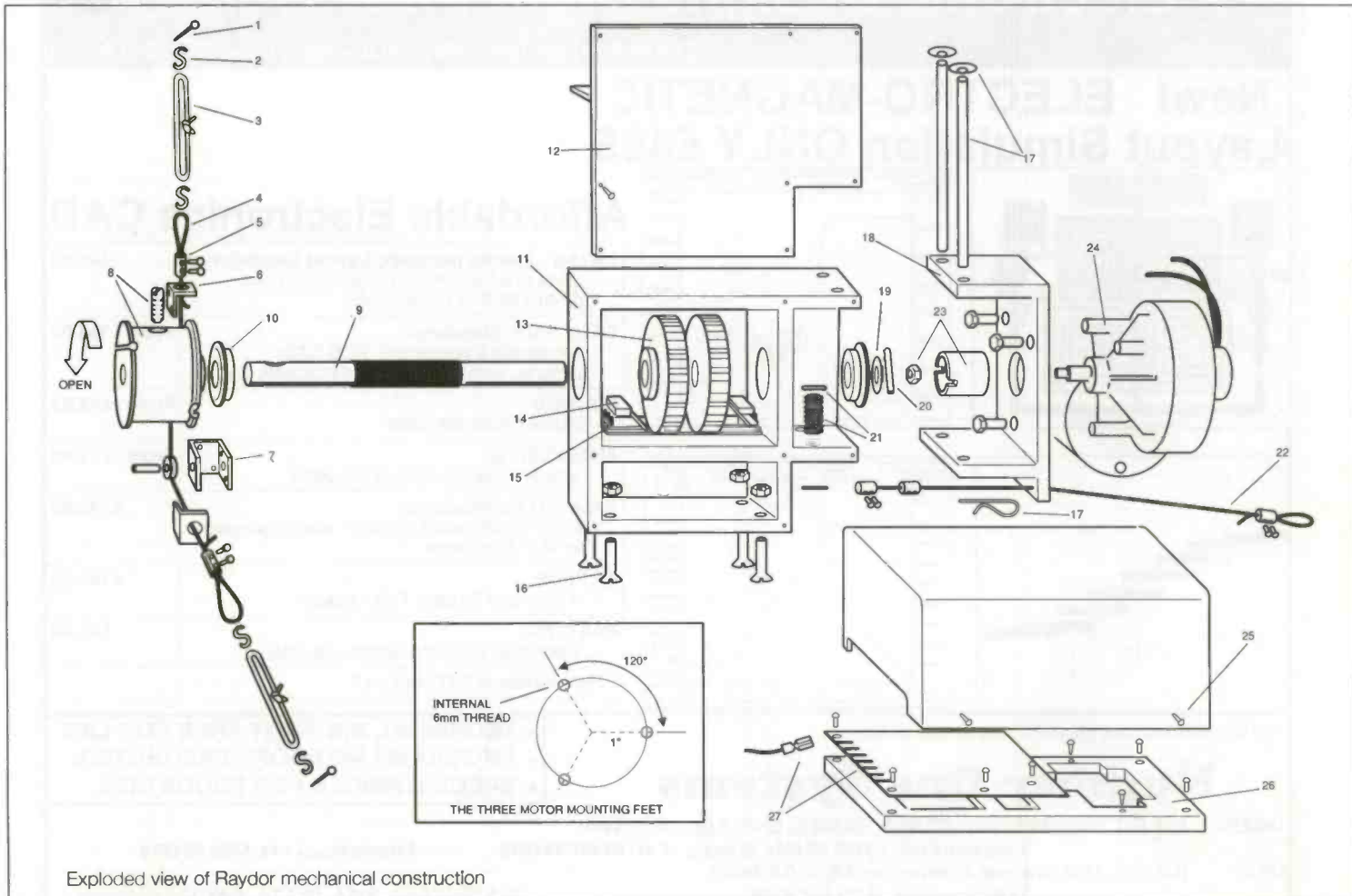

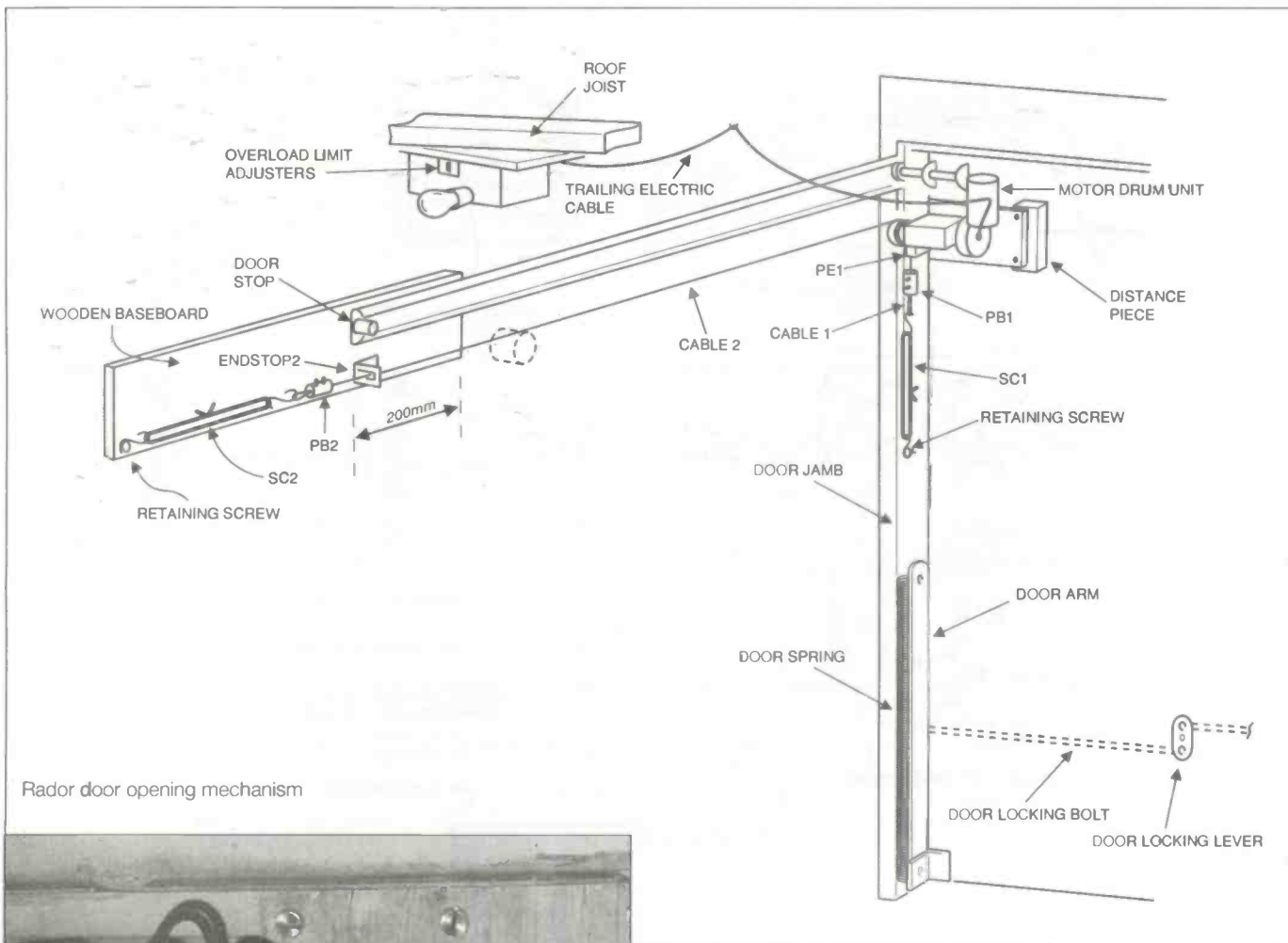

Rador door opening mechanism

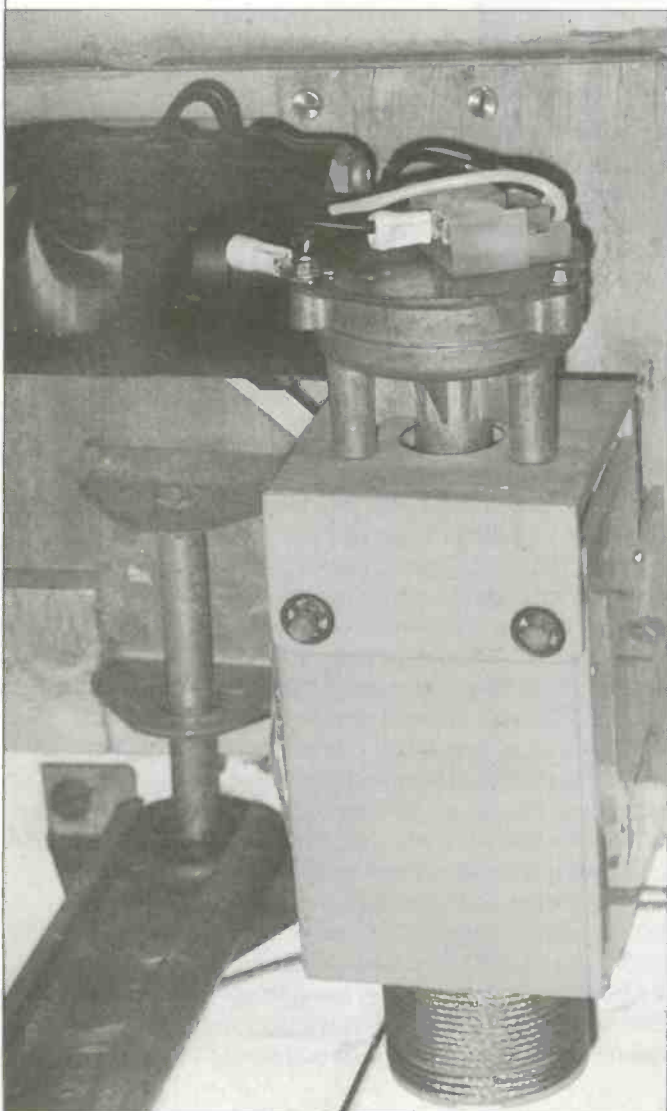

circuits and for powering the radio receiver, Q1, ZD1, R1, R2, C3, and C4 regulate and smooth the voltage for the ICs to about 8.1V.

The four gates of IC1 are configured as an alternate action switch (A/S) with IC1b controlling the up-line or opening phase of the door and IC1a the down line or closing phase of the door. C10 ensures that IC1a outputs a high when the mains is first switched on. The A/S can be triggered from the press switch SW1, or the radio transmitter via its receiver. On triggering the A/S, IC1b outputs a high which charges the down-line timing capacitor C13 (when IC1a was high it charged the up-line capacitor C12) and charges timer capacitor C14 which, via IC2a, Q5 and RLC, switches on the mains light. Meanwhile, 'slugging' components R14/C11 introduce a 1 second delay before IC2b outputs a high which, via microswitch MS2, switches on Q2 causing the RLA1 contact to close and run the motor forward to open the door. On commencing to open, the mechanical disc nuts (DNs) move axially and MS1 contacts close which is incidental. When the door reaches the fully open position, MS2 is operated by DN2. This physically interrupts power to Q2 and thus RLA de-energises to stop the motor.

Meanwhile on the way open various exigencies could occur requiring the door to be stopped immediately (e.g. door in jeopardy of hitting obstruction). The user could anticipate this by sending a normal trigger signal via SW1 or the remote radio transmitter. This will operate the A/S, sending IC1b low, D7 and R13 will discharge C11 quickly and Q2 will switch off, causing RLA1 contacts to open and switch off the motor. Alternatively, if the door should hit the obstruction, the motor current will increase rapidly as it begins to stall and the voltage on C1 will drop rapidly such that IC4b will output a low, IC3d will output a

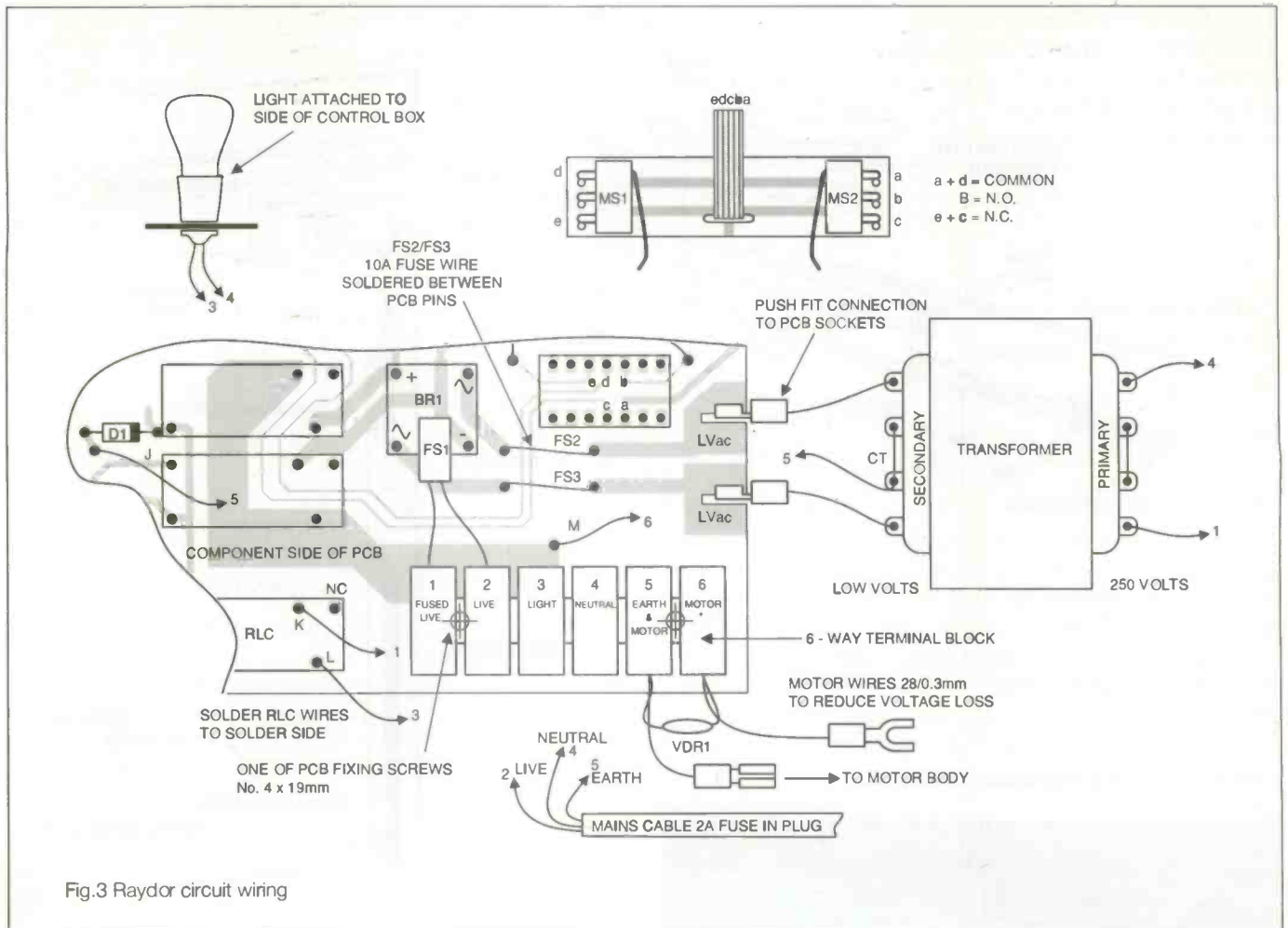

Fig.3 Raydor circuit wiring

high and, via slugging components R9/C7, IC2c will output a high within 1/10 second and trigger the A/S to stop the motor. In all the above cases, subsequent re-triggering of the A/S will cause the motor to restart.

Once the door is opened it can be triggered closed, this time IC1a outputting a high. Simultaneously, two actions occur which are features of this circuit. The first action is that IC2d goes high, Q3 switches on and supplies only holding current to RLB which is insufficient to energise RLB. The second action (which can only ever happen when the door is fully open) is that IC3a outputs a high, Q4 switches on and augments the current to RLB sufficient to energise it, causing the motor to run in reverse to close the door. As the DNs start to travel, MS2 is released, causing IC3a to output a low and Q4 switches off, leaving only the holding current from Q3 to maintain RLB energised (it will be appreciated that a relay needs less current to remain energised than it takes to energise it). Normally the door will run to the closed position where DN1 will operate MS1 to open its contacts, physically interrupting power to Q3 which de-energises RLB and stops the motor. Also, once the door begins to run closed and IC1b outputs a low, C14 will begin to discharge and, three minutes later, Q5 will switch off and RLC1 opens to switch off the light.

Meanwhile, during the closing cycle, similar exigencies as before may occur to necessitate prompt re-opening of the door (a better proposition than simply stopping it). Once again, the user can anticipate it by initiating a normal trigger signal or, if the door hits the obstruction, it will occur automatically via the closing overload circuit IC4a, IC3b and IC2c. In either case, the A/S will operate causing IC1a to output a low which via IC2d and Q3 will quickly de-energise RLB to stop the motor.

Simultaneously, IC1b will output a high but, due to the slugging components R4/C11, RLA does not energise for 1 second and this prevents immediate reversal of motor rotation which may otherwise cause both electrical and mechanical damage. The door now runs open (but can be stopped once again as previously described) until, when fully open, MS2 is operated by DN2. Thus, it will be appreciated that, in spite of fully automatic door operation and safety devices, the user never loses overriding control.

Finally, if for some reason during operation the safety features failed (e.g. the motor stalled) or the drive was lost between motor and the door (e.g. the cable broke, unwound etc. leaving the motor to run all the time you were away on holiday!), C12 or C13 would discharge as appropriate within about 25 seconds resulting in power being removed from the motor. It may be of interest to note that, given a low impedance power output such as a car battery, windscreen wiper motors can develop a power approaching 1hp. Fortunately, with Raydor, maximum power is curtailed to 50 watts (all the transformer can output) and 7 amps (due to the relatively high output impedance of the transformer secondary) which the motor, transformer and BR1 can easily sustain for 25 seconds. In a destruction test carried out, the motor remained cold and could withstand being permanently stalled. The transformer got quite warm but could no doubt also sustain a permanently stalled motor. However, BR1 reached a temperature exceeding 150°C after 5 minutes and went short circuit. This is the reason for the 85°C thermal fuse FS1 being fitted in close contact with BR1 so that, if all else fails, FS1 will blow early thus disconnecting the mains voltage and source of the heat.

CONSTRUCTIONAL DETAILS PCB and soldered components

With regard to the main PCB supplied and the screen printed component overlay, ignore R7. A dashed line indicates a shorting wire. A modification needed to be carried out on the PCB is to cut the track as shown between R5 and D4 and then with a short length of insulated wire join the two points both marked X i.e. D4 to D3 and C5 as per the circuit diagram.

Solder in the shortest components first. This means starting with all the resistors and finishing with the relays. Ensure you get the polarity correct for the electrolytic capacitors and BR1. Solder in the pins for FS2 and FS3, wrap 10amp fusewire round them then solder to the pins. Finally solder the four short wires J - M to the PCB as shown in fig. 3. Note that the only parts of the PCB carrying mains voltage are the two RLC contacts.

Once all the components have been soldered in, fit the PCB into position onto its integral base standoffs, ensuring minimum clearance from the side of the lid and that the overload limit pots VR1 and VR2 align with the lid cut-outs. Hold the PCB down with a finger, remove the lid and mark the integral base plate standoffs coincident with the 5 PCB holes. Drill 1.5mm pilot holes and screw the board down onto the control box base plate using three No.2 x 8mm self-tapping screws. Now screw down the 6-way terminal block with two No.4 x 19mm screws. Drill 3mm holes and screw down the transformer using two No. 6 x 19mm self-tapping screws.

Transformer

The transformer supplied has both primary (mains) and secondary (low voltage) connections on one side which should face toward the rear of the base plate away from the PCB. The four top primary connections and four bottom secondary connections are well marked but, for those unfamiliar with the conventions, the two inner tags in both cases should be soldered together with a short lead as shown in fig.3 and, in the case of the secondary windings, both of the two inner tags constitute the centre tap. For those who supply their own transformer, ensure the primary connections face away from the PCB as shown in fig.3.

Wiring details

In all cases, normal 7/0.2mm equipment wire can be used except for the 3-core mains cable from the plug (fused to 2 amps) and the two 3 metre long 28/0.3mm motor connecting wires. Fig.2 shows all the wiring connections to the 6-way terminal block, each wire annotated with a number e.g. that from D1 is connected to terminal block No.5. The two 15vac connections are plugged into the rear PCB sockets and being unpolarised, can be connected either way round. A crimping tool is best used to connect the 7/0.2mm equipment wire to a PCB connector and the 28/0.3mm motor wires to their spade grips but, if one is not available, then use ordinary pliers. The lightbulb holder is fitted into the control box lid hole. The 3 amp

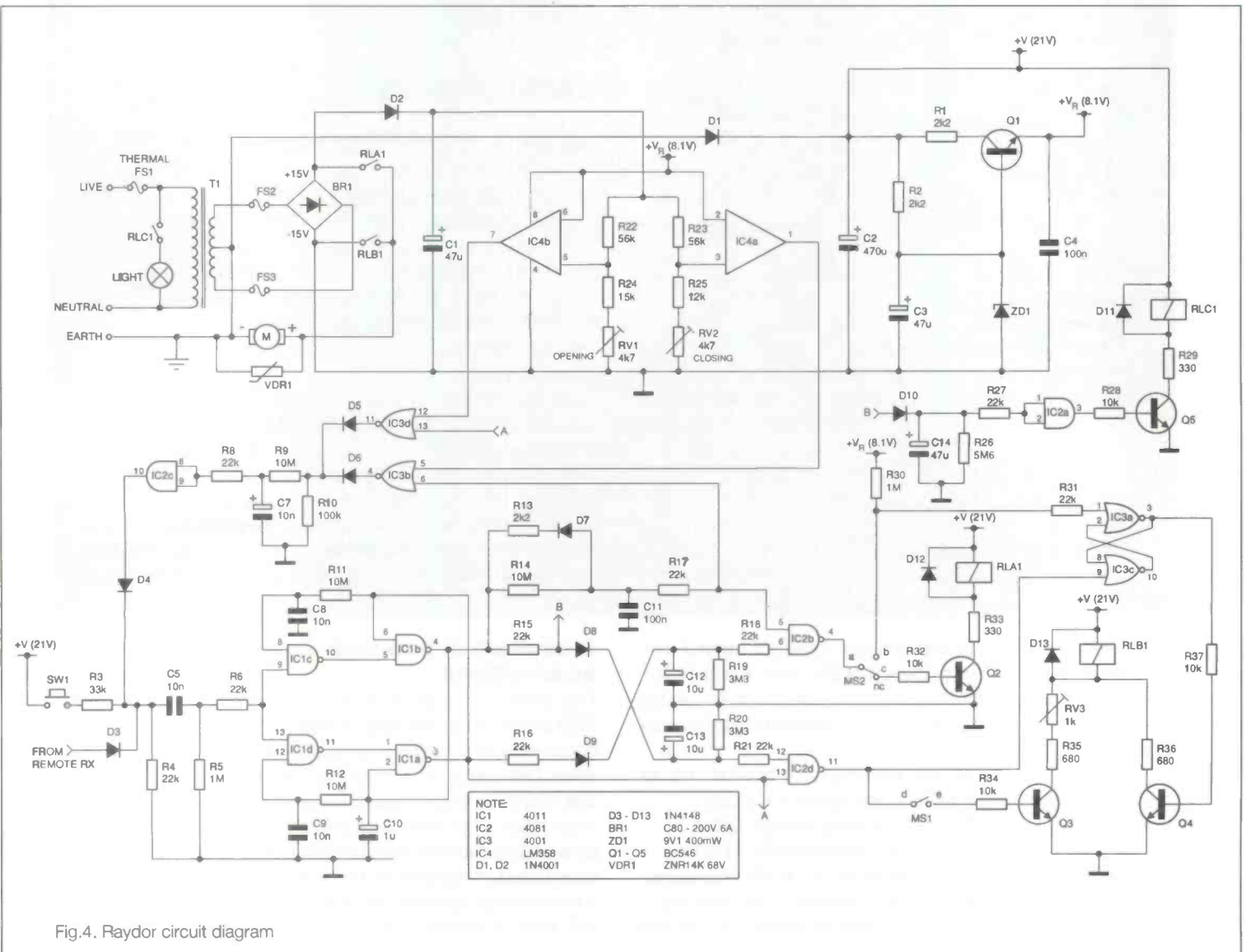

Fig.4. Raydor circuit diagram

Electronic components list for Raydor

RESISTORS all 1/4W, 5%

- R1 - 2K2
- R2 - 2K2
- R3 - 33K
- R4 - 22K
- R5 - 1M
- R6 - 22K
- R7 - NOT USED
- VCR8 - 22K
- R9 - 10M
- F10 - 100K
- F11 - 10M
- R12 - 10M
- R13 - 2K2
- R14 - 10M
- R15 - 22K
- R16 - 22K
- R17 - 22K
- R18 - 22K
- R19 - 3M3
- R20 - 3M3
- R21 - 22K
- R22 - 56K
- R23 - 56K
- R24 - 15K
- R25 - 12K
- R26 - 5M6
- R27 - 22K
- R28 - 10K
- R29 - 330
- R30 - 1M
- R31 - 22K

- R32 - 10K
- R33 - 330
- R34 - 10K
- R35 - 680
- R36 - 680
- R37 - 10K

- VR1 - 4K7
- VR2 - 4K7
- VR3 - 1K

CAPACITORS

- C1 - 47 μ F/50V ELECTROLYTIC
- C2 - 470 μ F/25V ELECTROLYTIC
- C3 - 47 μ F/16V ELECTROLYTIC
- C4 - 100n/25V ELECTROLYTIC
- C5 - 10n
- C6 - NOT USED/SHORTED
- C7 - 10n
- C8 - 10n
- C9 - 10n
- C10 - 1 μ F/16V ELECTROLYTIC
- C11 - 100n/16V ELECTROLYTIC
- C12 - 10 μ F/16V ELECTROLYTIC
- C13 - 10 μ F/16V ELECTROLYTIC
- C14 - 47 μ F/16V ELECTROLYTIC

SEMI-CONDUCTORS

- IC1 - 4011
- IC2 - 4081
- IC3 - 4001
- IC4 - LM358
- D1, D2 - IN 4000
- D3 - D13 - IN 4148
- BR1 - C80-200V 6AMP
- ZD1 - GV1 400mW
- Q1 - Q5 - BC546
- VDR1 - 2NR 14K 68V

MISCELLANEOUS

- SW1 - PRESS TO MAKE (BELL PUSH TYPE)
- 6 WAY TERMINAL BLOCK 5 AMP
- DIL SOCKETS - 14 PIN X 4 8 PIN X 1
- IDC TRANSITION CONNECTOR - 14 WAY
- 5-WAY RIBBON CABLE - 3 METRES
- PCB PINS - 4 PLUS 10 AMP FUSEWIRE FOR FS2 & FS3
- FUSE FS1 - 3 AMP THERMAL FUSE 85°C
- EQUIPMENT WIRE 7/0.2mm - 10 metres
- T & E CLAMPS X 2
- RELAYS RLA1}
- RLA2} G2L
- RLA3} 1N/O - 10 AMP CONTACTS

TRANSFORMER: 15 - 0 - 15V 50VA

The mechanical components detailed last month can be obtained directly from the author: Mr P H Alley, Squirrel Leap, Hagley Road, Fleet, Hants GU13 8LH. (Tel: 01252 621505)

thermal fuse FS1 is connected between terminals 1 and 2 with its insulated body laid flat on the top of BR1 (with a spot heat sink compound if available to enhance conductivity). For added safety, enclose the two leads of FS1 in insulated sleeving since they carry mains voltage.

Finally, fit the lid to the base, ensuring it is a good fit onto its base, if necessary filing away any high spots, the plastic urethane being easily drilled, filed or sandpapered. Drill four 1.5mm pilot holes, two either side, then screw the lid to the base using four No.2 x 12mm self-tapping screws. The mains lead, the two motor leads and ribbon cable can be taken out through the rear hole in the lid which may be enlarged as required.

Microswitch pcb and ribbon cable connections

First divide the copper side of the 76mm x 20mm microswitch PCB into six equal sections as shown dotted in fig.3, using a hobby knife and steel rule to isolate each section one from the other. Drill a series of 1.5mm holes the width of the ribbon cable then drill at an angle to join them all to form a slot. Drill three 1mm holes, 2mm from each end then solder in the six PCB pins. Laying each microswitch flat on the insulated side of the board, solder their tags to the pins. The levers of the microswitches can later be gently contoured for reliable contact with their respective DNs (disc nuts). For identification purposes

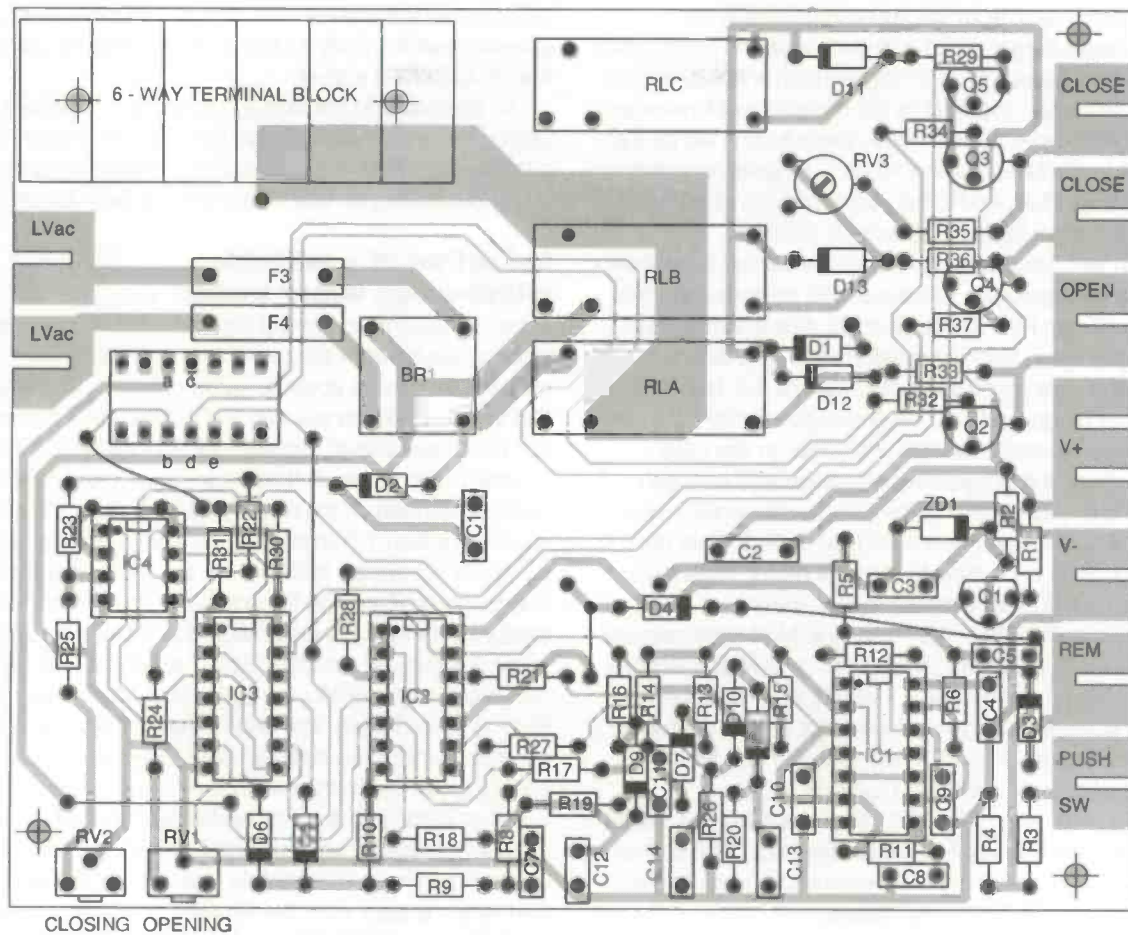

Fig.5.PCB component overlay

the connections of the microswitches are annotated a - e in fig.3 to correspond with the circuit diagram.

Care is needed when assembling the ribbon cable to its IDC connector. This is best done by placing the IDC connector base in its DIL socket, aligning the ribbon cable with the appropriate connectors then pressing the top down firmly. Next, polarise the IDC connector by cutting off pin 1 and placing a spot of glue in its corresponding DIL socket 1. Now identify each wire at the other end of the cable which also doubles as a continuity check. Drill a hole or slot in the rear of the drum unit, push the ribbon cable through then through the microswitch PCB slot and solder each lead to its appropriate copper strip.

Re-confirm continuity between each switch tag and its appropriate IDC pin ensuring isolation one from the other, noting of course that there is a switch continuity between C (common) and NC of the microswitch when the lever is not pressed and between C and NO when it is pressed. Place some glue along the PCB slot to act as a strain relief then, after wiping clean the copper side of the PCB, press down onto the double-sided adhesive strip. Wind the disc nuts to the centre, remove the protection paper from the double-sided adhesive then carefully position the microswitch PCB and press down.

For those who wish, the IDC connector and its DIL socket can be dispensed with and the ribbon cable soldered direct to the PCB.

This will mean that the drum unit and control box are joined together by the ribbon cable but this does not make installation of Raydor any more difficult. Also, if desired, the microswitch PCB can be screwed or bolted down but drilling suitable holes in the main frame is difficult unless the microswitch assembly is reversed and placed in front of the disc nuts, in which case remember to reverse the positions of MS1 and MS2. MS2 is always the one nearest the motor.

BENCH TEST

To save time, it is advisable to carry out a bench test before installation begins. Simply connect the drum unit to the control box and push switch SW1 to the PCB sockets marked PUSH SW and V+. Remove the drum unit lid, wind the DNs close together away from MS1 and place a rubber band around MS1 so that its lever remains depressed. Press push switch momentarily and make sure the motor rotates in the door opening direction i.e. clockwise viewed from the motor. After a few seconds, press push switch again and ensure the motor stops. Now remove the rubber band from MS1 and ensure that the motor does not restart. Press push switch to restart the motor. After a few seconds, depress MS2 with your finger to stop the motor. Keeping MS2 depressed press push switch ensuring the motor runs in reverse then release MS2.

After a few seconds, press MS1 momentarily to stop the motor. After a few seconds, press push switch and allow the motor to run until it finally stops of its own accord after about 25 seconds. Now wind DN1 and DN2 about 15mm apart then, using two fingers to prevent them rotating, press push switch to start motor and this time allow DN2 to operate MS2. On the reverse closing cycle press push switch to check the stop/reverse feature.

Repeat as necessary and finally check that the light extinguishes three minutes after MS1 is operated. I do not advise checking the overload feature on the bench.

Selection of relay rib

For those using their own relays, choose a 6v - 12v relay for RLB and carry out tests to determine the limits of energisation and holding currents, including VR3 of appropriate resistance to

trim RLB current in situ. (It will be understood that if, for example, a normal trigger signal is given to stop the motor when the door opening the output of IC1a goes high and R35 should ensure that the current supplied by Q3 is insufficient to energise RLB. Should R35 prove to be too low, the outcome will be that the motor will immediately reverse when IC1a goes high and since momentarily RLA and RLB contacts may be closed at the same time then either FS2 or FS3 or both will blow.

The bench test described in the previous section is designed to avoid the relays operating simultaneously by employing the rubber band to keep MS1 contacts open, thus ensuring RLB cannot energise when SW1 is pressed to stop the motor. If now the rubber band is removed within 25 seconds (i.e. before C13 has time to discharge) and RLB does energise (indicated by the motor running in reverse) then R35 is too low. In this case remove the power and progressively increase VR3 between repeated tests employing the rubber band (or keep MS1 lever depressed with your finger) until such time as RLB does not energise when SW1 is pressed to stop the motor. Note this VR3 setting (call it X). Now increase VR3 to maximum. Subsequently with the "door" fully open (i.e. MS2 is depressed), repeatedly press SW1 whilst reducing VR3 until RLB energises reliably to run the motor in reverse (call this Y). A suitable final setting for VR3 would be halfway between X and Y, so long as the difference between X and Y is significant. If not, then a change in value of R35 and/or R36 is called for.

Note that, in the case of the G2L relays supplied, the values of R35 and R36 are the result of exhaustive tests. VR3 should be set to 0 ohms (i.e. max anti-clockwise) and on no occasion so far has it ever needed to be increased.

Main PCB socket connections

These are all located along the free end of the main PCB. The two leads of the push switch SW1, located in the garage, are connected across the sockets marked PUSH SW and +V. The remote radio receiver is powered from socket marked -V (0V) and the socket marked V+ (+21V). If the receiver has an isolated relay output then its two signal leads are connected as for the push switch above (each socket can take two connections back to back). If the receiver has a CMOS or transistorised output of around +9V referenced to 0V then its one signal output lead is connected to the socket marked REM (remote).

The other sockets marked UP and DOWN are for test purposes and troubleshooting where, for example, a technician may want to simply run the door in one direction or another unencumbered by the automatics. Should you wish to use these at any time, a small modification will be required consisting of soldering a short wire to the ZD1/C3/R2 connection on the copper side of the PCB. Place a PCB connector, protected by an insulated plastic boot, on the other end of the wire. This short wire is hidden under the board. To make use of it, first remove the plug from the mains, pull the shorting wire out with a hook, slide the insulating boot off its connector and plug into the socket marked V-. Power is switched on and since the Zener and C3 are now shorted out, Q1 output is 0V and therefore all ICs rendered inoperative.

To run the door open - Connect SW1 to sockets marked V- and UP. The motor will now run forward whilst SW1 is kept depressed (i.e. the UP socket is connected on the PCB to Q3 collector and closing SW1 simply shorts the Q2 collector - emitter junctions).

To run the door down - Place a shorting connection across the two DOWN sockets and transfer SW1 lead from UP to DOWN. The motor will run in reverse whilst SW1 is kept depressed (the shorting connector, which simply connects the

collectors of Q3 and Q4, can be left in so that running the door up and down is merely a case of transferring the SW1 lead from the UP to DOWN socket).

An alternative to the above is to use a 12V battery. First, unplug the control box positive lead from the motor, then connect the 12V battery (1 amp hour upwards) across the motor depending on which direction you wish to run the motor.

Selection of a suitable windscreen wiper motor

There are several sources of second-hand windscreen wiper motors, varying from the removal of one from a car you, a family member or friend is about to scrap or one from a scrapyards. Get the smallest one you can find - it shouldn't cost more than £5. The motor should rotate about 40 - 70 RPM offload at around 1 amp or less in the normal direction of rotation (DOR) and should rotate in the reverse DOR at about the same speed at no more than 1.5 amps. For those who wish to purchase the drum unit but supply their own windscreen wiper motor, ensure that the three 6mm bolt fixing feet are spaced according to fig. 1 (bottom centre) of the previous article. As already stated, this spacing is virtually standard for all car windscreen wiper motors. Also most output shafts are about 10 - 15mm long with either a 6mm or 8mm thread. The end of the simple drive block you construct, should be screwed onto the shaft and the free end should extend no more than 28mm from the inside surface of the pivot frame (if it does exceed 28mm you will have to use spacers under the motor's fixing feet). The free end of the drive block should have diametrically opposed slots which can be filed to just greater than the diameter of the drum shaft drive pin (1/8" diameter Selok pin) and about the same depth.

Although the 50 watt transformer used in Raydor hardly begins to utilise the tremendous torque of which a windscreen wiper motor is capable, it makes sense to use the normal DOR (i.e. polarity) for opening the door (which needs more torque than for closing). One reason for this is because not all wiper motor armatures are neutrally wound (i.e. consume approximately the same current in both DORs) and another is that the worm and gear may be cut so as to transmit torque more efficiently in the normal DOR it was designed for. If it is found that with normal polarity the shaft rotates anti-clockwise as viewed from the motor then use this DOR for opening the door. In such a case there will be the small advantage of height clearance in fitting the motor/drum unit to the right-hand side of the door where the cables will come off the top of the drum.

WARNING

Be aware that if the Raydor circuit is powered from the mains then the 0V line of the electronic circuit is -15V below mains earth. For this reason an oscilloscope should not be used to check circuit operation unless suitable precautions are taken to prevent heavy low voltage do current flow through the oscilloscope ground lead which will blow FS2/FS3.

System 200 device programmer

SYSTEM:
Programs 24, 26 32 pin EPROMs, EEPROMs, FLASH and Emulators as standard, quickly, reliably and at low cost. Expandable to cover virtually any programmable part including serial E2, PALS, CALS, EPLD's and microcontrollers from all manufacturers.

DESIGN:
Not a plug-in card, but connects to the PC serial or parallel port. It comes complete with powerful yet

easy to control software, cable and manual

SUPPORT:
UK design, manufacture and support. Same day dispatch, 12 month warranty and 10 day money back guarantee.



ASK FOR OUR FREE INFORMATION PACK.

Contact us all over Europe:
Germany, 089 4602071
Norway, 0702 17850.
Italy, 02 92 10 3554.
France, (1) 69 30 13 79.
Sweden, 08 73E 5360.

Also from Electrospeed UK

mcp

Park Road Centre, Malmesbury,
Wiltshire, SN16 0BX. (uk)
Tel: 0666 825146. Fax: 0666 825141

WE HAVE THE WIDEST CHOICE OF USED OSCILLOSCOPES IN THE COUNTRY

TEKTRONIX 7000 SERIES OSCILLOSCOPES
Available from £200 - PLUG-INS SOLD SEPARATELY

TEKTRONIX 2245A 4 Channel 100MHz Cursor etc	£1000
TEKTRONIX 2245A 4 Channel 100MHz Cursor Voltmeter etc	£1250
TEKTRONIX 475 Dual Trace 200MHz Delay Sweep	£500
TEKTRONIX 465 Dual Trace 100MHz Delay Sweep	£400
TEKTRONIX SC504 Dual Trace 80MHz in TMS03B	£500
WATSU S5571C 4 Channel 100MHz Delay Sweep with DM	£800
TRIO 2100 4 Channel 100MHz Delay Sweep	£800
TRIO CS2070 4 Channel 100MHz Delay Sweep	£800
TEKTRONIX 2215 Dual Trace 60MHz Delay Sweep	£450
KIKUSUI COS509TM 3 Channel 60MHz Delay Sweep	£800
HITACHI V550F Dual Trace 60MHz Delay Sweep	£350
PHILIPS PM3217 Dual Trace 50MHz Delay Sweep	£400
GOULD OS300 Dual Trace 80MHz Delay Sweep	£380
TRIO CS1566A Dual Trace 20MHz	£200
GOULD OS250B Dual Trace 15MHz	£125
HITACHI V6045 2 Channel 40 MSa Digital Storage Cursors	£1100
LE CROY 9400 Dual Trace 125MHz Digital Storage	£2000
GOULD OS4000 Dual Trace 10MHz Digital Storage	£380

THIS IS JUST A SAMPLE - MANY OTHERS AVAILABLE

HEWLETT PACKARD 1740A OSCILLOSCOPES
100MHz Dual Trace, Delay Sweep For Only £350

MARCONI 2018 Synthesised AM/FM Sig Gen 80kHz-520MHz	£700
M.P. 5540B Sig. Gen. 50kHz-1024MHz	£1000
H.P. 2820C Swiss Oscillator with 8245A 5.801Hz AGHz	£400
SYSTRON DONNER 1702 Synth. AM/FM Sig Gen 100kHz-1GHz	£500
RACAL 9081 Synthesised Sig Gen 5-520MHz	£800
FARNELL SS0250 Synthesised AM/FM Sig 10MHz-520MHz	£400
MARCONI TF2014 AM/FM Sig. Gen. 10kHz-510MHz	£380
MARCONI TF2015 With Synchronizer TF2171 (back box)	£380
MARCONI TF2016 FM Sig. Gen. 10kHz-110MHz	£380
MARCONI TF2018 With Synchronizer 2173 (back box)	£370
PHILIPS P 5326 AM/FM Sig. Gen. 100kHz-110MHz	£380
MARCONI TF2002B AM/FM Sig. Gen. 10kHz-88MHz with Dig. Sync	£110
H.P. SMITH ANTENNA type 12-652-4	£200
RACAL INSTRUMENT RECORDER type Store 4DN	£300
M.P. 3575A Gain Phase Meter 1Hz-13MHz	£400
MARCONI TF2337 Automatic Distortion Meter	£200
SAVROSA Automatic Modulation Meter type 252B	£125
RACAL 9104 RF Power Meter 1MHz-1GHz 10mW-300W	£400
RACAL 9100 Absorption Wattmeter 1.5MHz-520MHz 300mW	£300
TEKTRONIX CP5250 Trip. Output PSU 2x20 VO-5A Var, 5V2A Fnd	£225
TEKTRONIX CPG250 Function Gen. 0-2Hz-2MHz Sine/Sqr/Tri etc	£255
TEKTRONIC CDM250 Digital Multimeter 3 1/2 digit LED	£180

SPECTRUM ANALYSERS

H.P. 853 with 8550A 0.81-21GHz	£4500
H.P. 3580A LED 0.5MHz-50MHz	£1000
POLARAD 841-1 10MHz-18GHz	£1500
ANCO AC281 with AC211 1700MHz	£1500
H.P. 182 with 8558B 100kHz-1500MHz	£1500
H.P. 141T with 8554B & 8552B 500kHz-1250MHz	£9200
H.P. 141T with 8553B & 8552A 1kHz-110MHz	£800
MARCONI TF2270 30kHz-110MHz	£1000
H.P. 8443 Tracking Generators Available from	£300
H.P. 141T Main Frames Only, Good Tubes	£700

H.P. 3456A 6 digit DC/True RMS AC/Rms HP1B	£600
EIPIDANA 351D Microwave Frequency Counter 20Hz-18GHz	£300
H.P. 5541 Frequency Counter 50kHz-1.5GHz LED	£300
MARCONI 2435 Digital Frequency Meter 2GHz	£400
RACAL 1998 Freq. Counter 1.5GHz (options GP1B & High Stab)	£300
RACAL 1991 Universal Counter/Timer 100MHz 9 digit	£150
MARCONI 2437 Universal Counter/Timer DC - 100MHz 8 digit	£175
MARCONI 2431A Frequency Counter 10Hz-200MHz 8 digit	£150
MARCONI 2430A Frequency Counter 10Hz-520MHz 9 digit	£300
RACAL 9918 Frequency Counter 10Hz-520MHz 9 digit	£200
RACAL 9913 Frequency Meter 10Hz-520MHz 8 digit	£125
RACAL 9901 Universal Counter/Timer DC-50MHz 6 digit	£100
RACAL 9901 Frequency Meter 10Hz-120MHz 7 digit	£100
DATRON 1051A 6.5 digit Autocal Multimeter True RMS AC/Current	£750
H.P. 3490A 5 digit Multimeter AC/DC/Ohms	£200
H.P. 3435A 3.5 digit Multimeter AC/DC/Ohms/Current LED	£100
PHILIPS FM25A Multi Function DMM 3.5-8.5 digit GPIB/BEE	£400
SOLARTRON 7150 6.5-8.5 digit DMM with IEEE	£200
SOLARTRON 7045 4.5 digit Multimeter Volts/Amps/Ohms	£80
WAYNE KERR B905 Automatic Precision Bridge 0.05%	£880
MARCONI TF2700 Universal Bridge Battery Operated	from £150
MARCONI TF132A Universal LCR Bridge 0.1%	£125
HEATHKIT IB RLC Bridge	£80
BRADLEY 192 Oscilloscope Calibrator	£800
WILTRON 560 Scaler Network Analyser with Detectors	£1000
H.P. 5025A Signature Analyser	£350
FARNELL HQ3100 0-30V, 0-100A Metre	£300
FARNELL TV570 100µV 70V 5A/5V 10A Metre	£200
FARNELL 83010 30V, 10A Variable	£100
FARNELL L300 0-30V, 0.5A Metre	£125
MARCONI (WR1) TF214 0-30V 1A, 0-15V 2A, 0-7.5V 4A Metre	£30
H.P. 6518A 0-30V, 0-5mA Metre	£150
BRANDENBURG 472H PSU ±0-20V	£300
FEEDBACK FG600 Sine/Sqr/Tri 0-01Hz-100kHz	£60
LYONS PG371A Pulse Gen. FRF 1Hz-20MHz 100V	£500
FARNELL PG101 Pulse Gen. 100nSec 10MHz (1 Sec 1Hz)	£75
LINDON LA1 Mk 2B Audio Analyser	£700
UNADIM EP501 Audio Analyser	£380
PHILIPS PM518 Colour TV Pattern Generator	£1250
RAFORD LD04 Low Distortion Oscillator	£400
RAFORD LDM52 Low Distortion Measuring Set	£880
MARCONI TF215 Attenuator DC-1GHz	£100
MARCONI TF836B Audio Power Meter Sine	£250
H.P. 16300 Logic Analyser 43ch	£750
H.P. 8405A Vector Voltmeter 1-1000MHz 8mm	£300

NEW EQUIPMENT

HAMEG OSCILLOSCOPE HM1005 Triple Trace 100MHz	
APOLLO 10 100MHz Counter Timer Ratio/Period/Time etc	£947
HAMEG OSCILLOSCOPE HM624 Dual Trace 60MHz Delay Sweep	£355
HAMEG OSCILLOSCOPE HM303 Dual Trace 30MHz Comp. tester	£392
HAMEG OSCILLOSCOPE HM205-3 Dual Trace 20MHz Digital Storage	£553

All other models available - all oscilloscopes supplied with 2 probes

BLACK STAR EQUIPMENT (P&P all units £5)

APOLLO 10 100MHz Counter Timer Ratio/Period/Time etc	£222
H.P. 100 100MHz (as above with more functions)	£225
METEOR 100 FREQUENCY COUNTER 100MHz	£119
METEOR 600 FREQUENCY COUNTER 600MHz	£145
METEOR 1000 FREQUENCY COUNTER 1GHz	£189
JUPITOR 800 FUNCTION GEN. 0.1Hz-500kHz Sine/Sqr/Tri	£119
ORION COLOUR BAR GENERATOR PAL/TV/Video	£229

All other Black Star equipment available

OSCILLOSCOPE PROBES Switched X1 X10 (P&P £3)

Used Equipment - Guaranteed. Manuals supplied if possible. This is a VERY SMALL SAMPLE OF STOCK. SAE or telephone for lists. Please check availability before ordering. CARRIAGE all units £16. VAT to be added to Total of Goods and Carriage.

STEWART OF READING

110 WYKEHAM ROAD, READING, BERKS RG6 1PL
Tel: 0734 268041 Fax: 0734 351696 Callers welcome 9am to 5.30pm MON-FRI (UNTIL 5pm THURS)

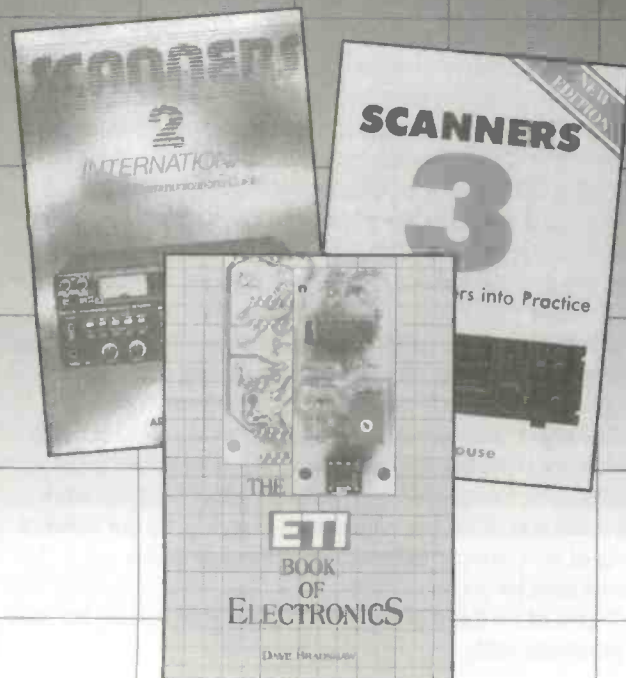

Scanners 2. International

Comprehensive information on the use of VHF and UHF communication bands. This book gives details on how to construct accessories to improve the performance of scanning equipment and is International in its scope.

Scanners 3 - Putting Scanners into Practice

Now in its 4th edition, this Scanners has seen the largest number of changes and additions, to the point of a virtual rewrite. More detailed frequency listings, actual frequencies used by coastal stations, airfields and the emergency services. A so, for the first time a section on HF bands.

ETI Book of Electronics

An introduction to electronics that clearly explains the theory and principles involved. Each chapter includes a project to make. Projects include a loudspeaker divider, continuity tester, mini-amplifier, a burglar alarm and more.

Scanners 2 International	0 85242 924 X	£9.95	<input type="checkbox"/>
Scanners 3 - A complete update	1 85486 106 9	£9.95	<input type="checkbox"/>
ETI Book of Electronics	0 85242 928 2	£10.95	<input type="checkbox"/>

P&P + 10% minimum £1 (UK only) Overseas + 20%

Telephone orders (0797) 366905

I enclose my remittance of..... Please make cheque payable to Bailey Distribution and send to the address below:

Please charge my Mastercard/Visa

Expiry Date..... Signature.....

Name.....

Address.....

Post code.....

Complete details and return to Bailey Distribution,
Learoyd Road, Mounfield Rd Ind. Estate, New Romney, Kent, TN28 8XU.

Practically SPEAKING

BY TERRY BALBIRNIE

Tools of the trade

This month and next, we shall look at some of the tools which are needed by the electronics hobbyist. Soldering equipment is not included because this has already been discussed in previous parts of the series

Some amateurs try to avoid buying special tools and rely on those found lying around or in the car toolbox. Others buy dozens of items which they will rarely use. Only a few special tools are really needed and they cost very little. Before proceeding, it should be stressed that the first requirement is a pair of safety goggles. Whenever working with materials where pieces could fly into the eyes, these must be worn.

A bit screwy

Some small screwdrivers will be needed for inserting and removing fixings in cases, tightening grub screws in control knobs and similar jobs. For low-volume amateur use, cheap ones will be adequate - you need pay no more than 60p each. Buy a minimum of two flat-blade screwdrivers, one with a 3mm blade and one a little larger - say, 5mm. You will also need two or three small crosspoint screwdrivers. Do not try to make do without these by jamming a flat blade into a crosspoint head. Either it will chew up the head, damage the screwdriver or will not grip properly. Worse, it may jump out of the head and scratch the surface or injure your hand. If you decide to buy a set of screwdrivers, ask yourself if you are likely to need all the styles and sizes.

Cut up

Side cutters are used to snip off lengths of wire. They are also used to cut excess component lead from the soldered joints on a circuit panel. This is an area where a good quality box-jointed tool is worth paying for. Cheap ones blunt quickly and tend to loosen and fall apart. It is not necessary to buy the best quality - expect to pay up to £10. A cutting length of about 130mm will be found useful.

A variation of the side cutter is the end (top) cutter. These are held perpendicular to the surface. End cutters are more useful than side cutters when working in confined spaces.

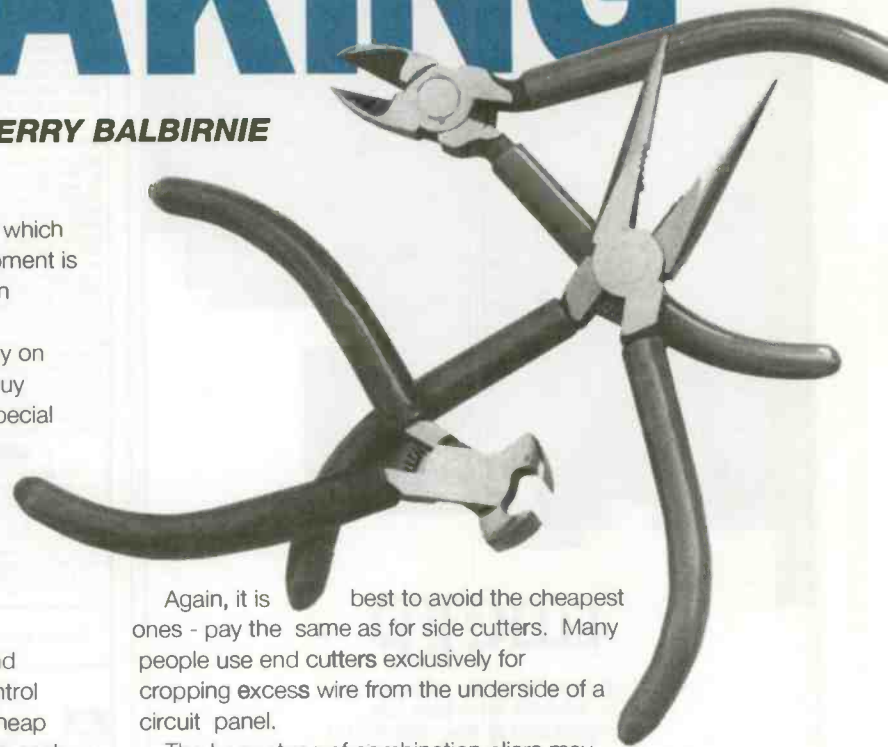

Again, it is best to avoid the cheapest ones - pay the same as for side cutters. Many people use end cutters exclusively for cropping excess wire from the underside of a circuit panel.

The heavy type of combination pliers may be occasionally useful but the snipe nose variety will be found handier for light electronics work. These serve several purposes. They may be used to grip components or pieces of wire while they are being manipulated into place. Pliers may also be used for bending end leads, component tags, etc. It is better to use pliers for this type of job rather than using the fingers - they give a tighter bend and a more professional-looking finish. Pliers are also useful as a heat shunt when soldering heat-sensitive components into position. If they are used to grip the lead between the component and the soldering iron, they will conduct the heat away and prevent damage.

Every electronics hobbyist needs a pair of wire strippers. These are needed to remove the insulation from a piece of wire. Do not rely on using pliers, side cutters or - worse still - scissors or teeth! The danger is that if the wire is of the stranded type, some of the copper conductors will be lost. This means that the wire will end up with a lower current-carrying capacity than before. If the wire is of the single strand type, a small nick is often made in the wire. This may not be noticed but, sooner or later, the wire will break at that point. Wire strippers avoid this problem.

There are various types of wire strippers - those which need an adjustment for the wire size and those that do not. The "single-action" type is particularly useful. These may seem clumsy and it is not always possible to manoeuvre them into difficult positions but they work well. The wire is simply placed in position and the handles squeezed. The tool grips the work then cuts and strips the insulation. If possible, try out different types of wire stripper before buying the one which seems best for you.

That's all for this month. Next time we shall pursue our look at workshop tools.

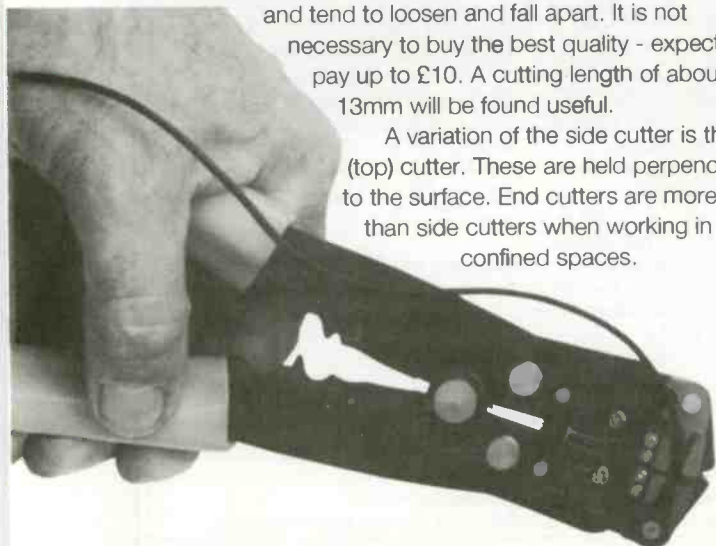

EQT LTD STEVENAGE

Professional Sub-Contract Manufacturing & Suppliers to the Electronics Industry

- Do you have a requirement for any of the following services:
- PCB Assembly (Conventional and Surface Mount)
 - Wave & Hand Soldering
 - Complete Equipment Manufacture
 - Device Programming from hand written shits or PC 3 1/2" disc
 - Cable Harness Assembly/loom Manufacture
 - Card Cage and Module Wiring
 - Full Inspection
 - Product Design/Consultation
 - Full Procurement Service
 - PCB Test & "Burn in" Facilities
 - Enclosure Design & Manufacture
 - PCB Artwork Manufacture
 - Circuits Drawn Professionally
 - Kit Procurement & Supply
 - Component Sales
 - Refurbishment a speciality
 - Top Quality Work at Reasonable Rates

Phone Tracey on (0438) 360406 or fax details of your requirements to us on (0438) 352742
EQT LTD, Cromer House, Caxton way, STEVENAGE, HERTS, SG1 2DF

OMNI ELECTRONICS

174 Dalkeith Road, Edinburgh EH16 5DX • 031 667 2611

- The supplier to use if you're looking for -**
- ★ **A WIDE RANGE OF COMPONENTS AIMED AT THE HOBBYIST** ★
 - ★ **COMPETITIVE VAT INCLUSIVE PRICES** ★
 - ★ **MAIL ORDER - generally by RETURN OF POST** ★
 - ★ **FRIENDLY SERVICE** ★



Open: Monday-Thursday 9.15-6.00
Friday 9.15-5.00 Saturday 9.30-5.00



The EM31 - 80C31/80C320 Module

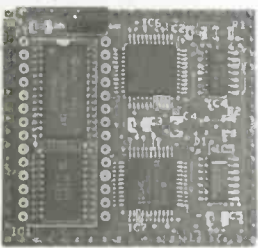

Small, Practical & Sensibly Priced
EPROM to 64k, 32k RAM under EPROM

24 Digital I/O lines

72 pin Connector mounts module directly to Target PCB

Small (1.8" Sq.) Multilayer PCB with full Ground Plane.

CPU - an 80C31 running up to 16MHz or the Dallas 80C320 up to 25MHz. (Equivalent to a 62MHz 80C31)

£49.95 falling with Quantity.

Our catalogue lists modules based on the 64180, 80C552, 80C188, 6800 processors, and a wide range of peripheral modules, A/D, D/A, Serial, Opto, Relay etc. with Power Supplies, Backplanes & Cases. Request your Copy today

Devantech Ltd
INDUSTRIAL ELECTRONIC SYSTEMS

TEL: 0379 644285
FAX: 0379 650482

★ ★ FOR SALE ★ ★

DEFENCE & AEROSPACE INDUSTRY ELECTRONIC EQUIPMENT & COMPONENTS ALL HIGH QUALITY SURPLUS MANY SPECIALS. WE STOCK 1000 + ITEMS & IF WE DON'T STOCK IT WE MAY BE ABLE TO GET IT FOR YOU

PLEASE WRITE OR PHONE FOR LISTS OR REQUIREMENTS

MAYFLOWER ELECTRONICS
48 BRENDON ROAD,
WATCHET, SOMERSET, TA23 0HT
TEL (0984) 631825 FAX (0984) 634245

THIS IS AN OPPORTUNITY NOT TO BE MISSED

Stop

Look

Listen

Have you experienced the frustration of waiting at the newsagents only to discover your favourite magazine has sold out? By subscribing you can receive every issue hot off the press with guaranteed free delivery*.

Plus, remember you will not be affected by any future price increases throughout the duration of your subscription.

One call does it all! In fact nothing could be simpler, phone our subscription hotline quoting your VISA / ACCESS details, or complete the coupon below and establish your collection of Electronics Today International, the magazine that's better than ever.

Please commence my subscription from theissue.
(Quote Subscription No. if extending/renewing.....)
I enclose my cheque/P.O. for £..... made payable to NEXUS
or, debit my Access/Visa account:



Electronics Today International Subscription Rates

1Yr UK £25.80 Europe and Eire £32.70 Sterling O/Seas £33.90 US \$ Dollars \$56

Signature.....
Card Expiry.....
Name.....
Address.....
Post Code.....

Please send this coupon to:
Argus Subscription Services, Queensway House, 2 Queensway, Redhill, Surrey, RH1 1QS.
Please tick this box if you do not wish to receive information from any other companies which may be of interest to you.

Keep ahead of the pack,
with our fantastic subscription offer.
Subscription Hotline
01737 768611

*UK Only

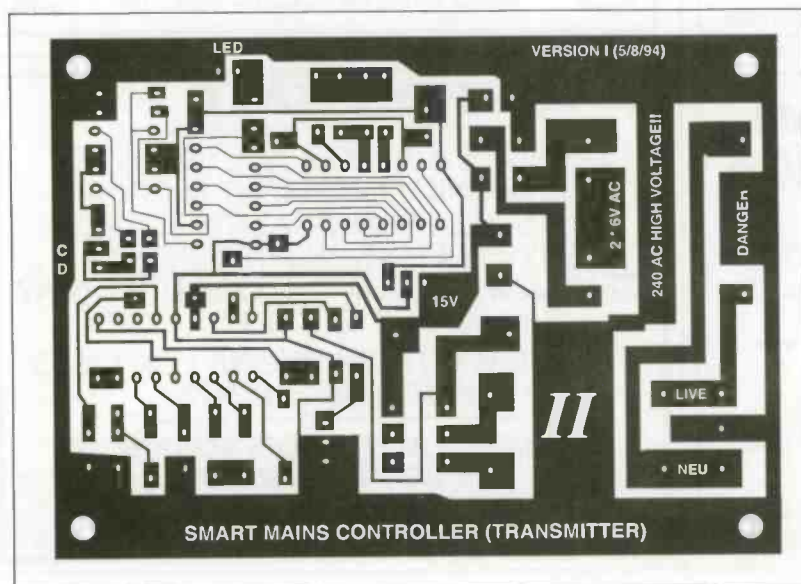

Smart Mains Control

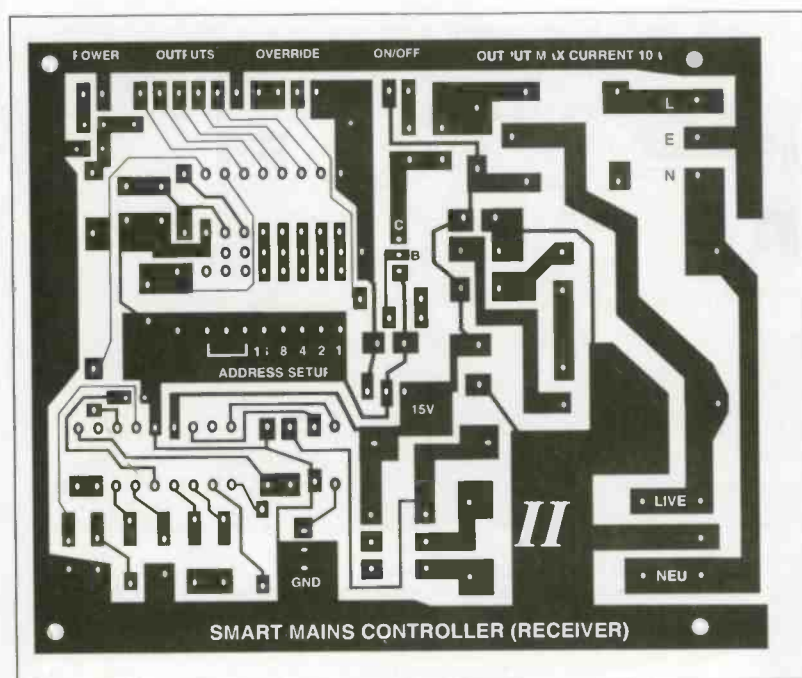

Smart Mains Control

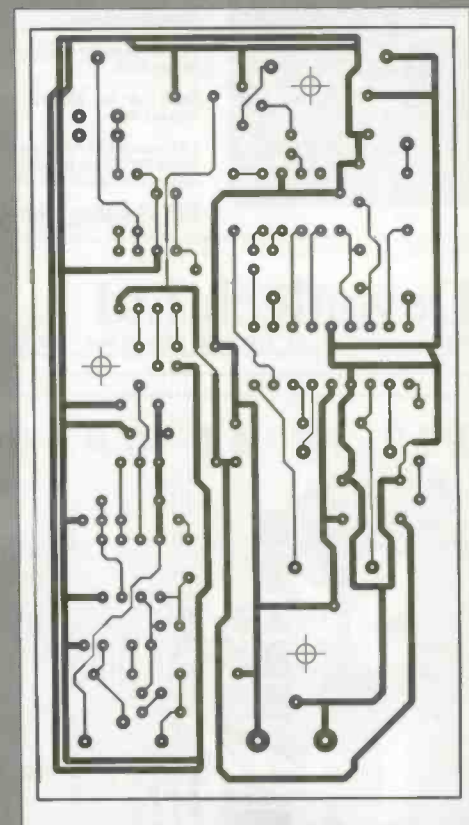

Laser Tag

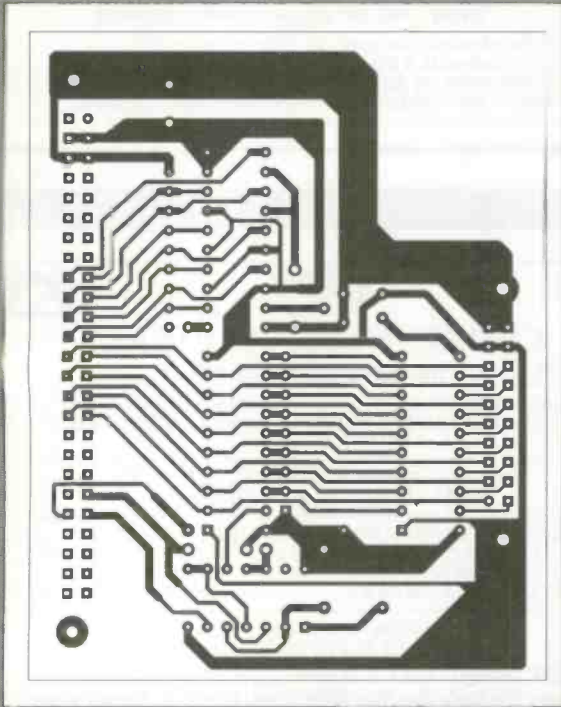

PCW I/O Port

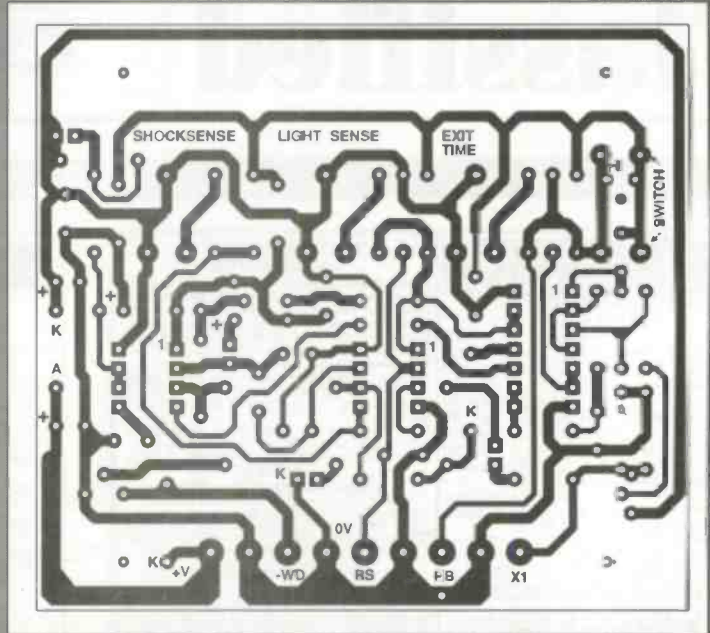

Garden Shed Alarm

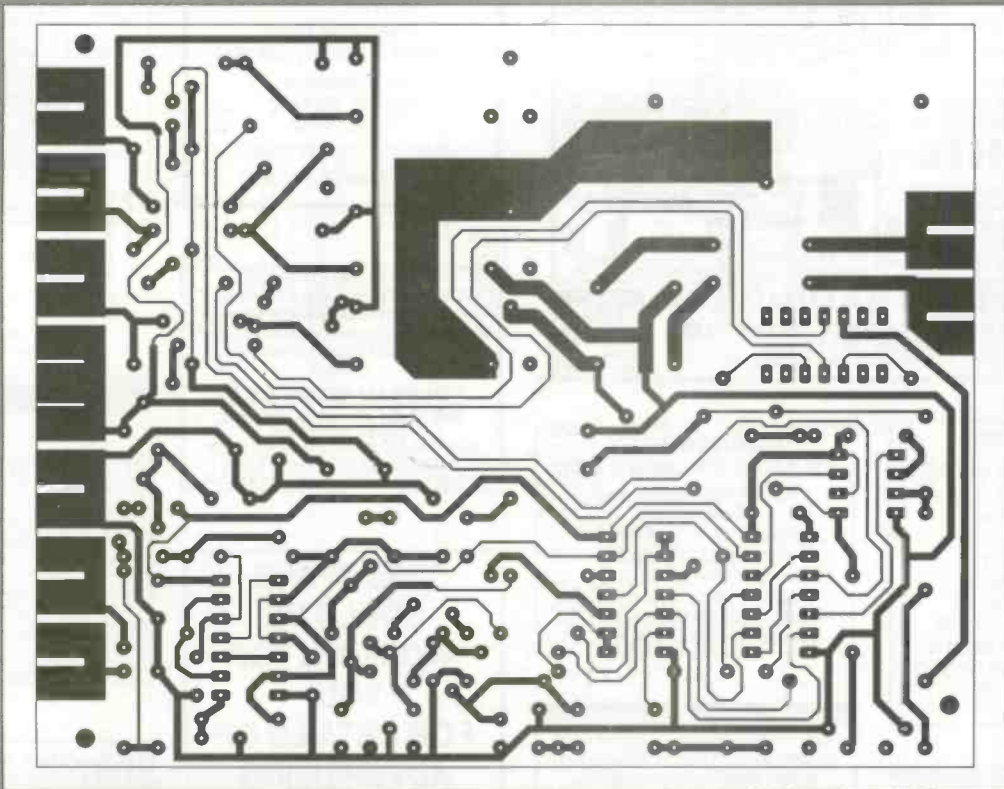

Raydor

ETI

Classified



James Gale
01442 66551

Send your requirements to:
ETI Classified Department, Nexus, Nexus House,
Boundary Way, Hemel Hempstead, HP2 7ST
Lineage: 70p per word (+ VAT) (minimum 15 words)
Semi display: (minimum 2.5cms)
£9.50 + VAT per single column centimetre



Ring for information on series bookings/discounts.
All advertisements in this section must be prepaid.
Advertisements are accepted subject to the terms and conditions
printed on the advertisement rate card (available on request).

FOR SALE

VARIABLE VOLTAGE TRANSFORMERS

INPUT 220/240V AC 50/60
OUTPUT 0-260V

	Price	P&P
0.5KVA 2.5 amp max	£31.90	£6.00
	£44.53 inc VAT	
1KVA 5 amp max	£41.15	£7.00
	£56.58 inc VAT	
2KVA 10 amp max	£59.40	£8.50
	£79.78 inc VAT	
3KVA 15 amp max	£78.65	£8.50
	£102.40 inc VAT	
5KVA 25 amp max	£139.15	

(Plus Carriage)

Buy direct from the Importers. Keenest prices in the country
COMPREHENSIVE RANGE OF TRANSFORMERS—IT-ISOLATION & AUTO
(110-240V Auto transfer either cased with American socket and mains lead or open frame type. Available for immediate delivery.

WIDE RANGE OF XENON FLASH TUBES

Write/Phone your enquiries

ULTRA VIOLET BLACK LIGHT FLOUORESCENT TUBES

4ft 40 watt £14.00 (callers only)	(£16.45 inc VAT)
2ft 20 watt £9.00 (callers only)	(£10.58 inc VAT)
12in 8 watt £4.80 + 75p p&p	(£5.52 inc VAT)
9in 8 watt £3.95 + 50p p&p	(£5.24 inc VAT)
6in 4 watt £3.95 + 50p p&p	(£5.24 inc VAT)

230V AC BALLAST KIT

For either 6in, 9in or 12in tubes £8.05 + £1.40 p&p (£9.75 inc VAT)

The above Tubes are suitable for Fored Bank Note detection, security marking etc.
Other Wave Lengths of U.V. TUBE available please telephone your enquiries.

400 WATT UV LAMP

Only £38.00 + £4.00 p&p £49.35 inc VAT
160 WATT SELF BALLASTED BLACK LIGHT MERCURY BULB
Available with BC or ES fitting, price inc VAT & p&p and VAT £25.55



12V D.C. BILGE PUMPS

500 GPH 15ft head 3 amp £19.98
1750 GPH 15ft head 9 amp £34.55
Also now available: 24V D.C. 1750 GPH 15ft head 5 amp £35.55. All designed to be used submerged. PRICES INCLUDE P&P & VAT

SUPER MY-LIGHT STROBE KIT

Designed for Disco, Theatrical use etc.
Approx 16 joules Adjustable speed £50.00 + £3.00 p&p (£52.28 inc VAT)
Case and reflector £24.00 + £3.00 p&p (£31.73 inc VAT).
SAE for further details including My-Light and industrial Strobe Kits.

SERVICE TRADING CO

57 BRIDGMAN ROAD, CHISWICK, LONDON W4 5BB

FAX 081 995 0549 081-995 1560
ACCOUNT CUSTOMERS MIN. ORDER £10



Showroom open Monday/Friday

Ample Parking Space

SWC SCIENTIFIC WIRE COMPANY

ENAMELLED COPPER WIRE
TINNED WIRE SILVER
PLATED COPPER WIRE
SOLDER EUREKA WIRE
NICKEL CHROME WIRE.
BRASS WIRE LI TZ WIRE
BIFILAR WIRE MANGANIN
WIRE TEFZEL WIRE NICKEL
SAE BRINGS LIST 18 RAVEN
RD LONDON E18 1HW
FAX 081 559 1114

P.C. I/O CARD Manual 24 pages detailing I/O port addresses parallel, serial and joystick port data. Ideal for inputting and outputting data to and from a P.C. £3.20. E W Lofthouse, 155 Main Street, Scholes, Leeds LS15 4DP. Tel: 0274 390011.

"BOFFINS SPECIAL" - UNIQUE OFFER

Surplus Precision Medical Unit, internally in excellent condition. Designed primarily to eject a precise controllable amount of fluid from a medical syringe (latter not supplied). Contains the following removable components: Dual Micro Processor Boards and EPROMS. Escap Precision 12V DC Motor with 300:1 Gear Box and optical encoder coupled to a precision threaded drive mechanism. Mains supply with 6 x 1.5V Ni-Cad A.A. cells back-up. L.C.D. Digital read-out 17mm high with legends. Audible warning.

These are sold for the dismantling of the exceptional quality components. regret no Circuits available. Ridiculously low price: £20.00 + £4.00 p&p (£28.20 incl VAT)

3.5 KVA ISOLATION TRANSFORMER

New Manufacturers surplus mounted in a solid metal enclosure with a surface mounted MK Residual Current Circuit Breaker. Internally fused 240V AC Input and Output. External SHA, Ground Point. Ideal for work bench isolation etc. Size Width 44cm Depth 44cm Height Incl. RCD 47cm. Weight 60 Kilos.
Price EX-WAREHOUSE £120.00 + VAT.

240V AC CENTRIFUGAL BLOWER

New Manuf. Surplus Skeleton Blower suitable for mounting inside an enclosure to cool equipment. Overall size 130x110x85mm. Outlet 80x35mm. Impeller 60mm dia x 60mm long. £14.10 incl. P&P & VAT

SEWING MACHINE MOTOR

Brand new 220/240V AC/DC SEW-TRIC 2 lead Brush Motor. Size L 100mm x W 70mm x W.55mm. Spindle, 1/4in. dia x 1in. long. £14.10 incl. P&P & VAT

GEARED MOTORS

71 RPM 20lb inch torque reversible 115V AC input including capacitor and transformer for 240V AC operation. Price inc VAT & p&p £27.73

SOLID STATE EHT UNIT

Input 230/240V AC. Output approx 15KV. Producing 10mm spark. Built-in 10 sec timer. Easily modified for 20 sec, 30 sec to continuous. Designed for boiler ignition. Dozens of uses in the field of physics and electronics, eg supplying neon or argon tubes etc. Price less case £8.50 + £2.40 p&p (£12.81 inc VAT) NMS

EPROM ERASURE KIT

Build your own EPROM ERASURE for a fraction of the price of a made-up unit kit of parts less case includes 12in 8 watt 2537 Angst Tube Ballast unit, pair of bi-pin leads, neon indicator, on/off switch, safety microswitch and circuit £16.00 + £2.00 p&p (£19.98 inc VAT)

WASHING MACHINE WATER PUMP

Brand new 240V AC, fan cooled. Can be used for a variety of purposes. Inlet 1 1/2 in. outlet 1 in. dia. Price includes p&p & VAT. £11.20 each or 2 for £20.50 inclusive.

MICROSWITCH

Pye 15 amp changeover lever microswitch, type S171 Brand new price 5 for £7.05 inc VAT & p&p

COOKE INTERNATIONAL

SUPPLIER OF QUALITY USED TEST INSTRUMENTS

ANALYSERS, BRIDGES, CALIBRATORS, VOLTMETERS, GENERATORS, OSCILLOSCOPES, POWER METERS. ETC ALWAYS AVAILABLE

ORIGINAL SERVICE MANUALS FOR SALE
COPY SERVICE ALSO AVAILABLE

EXPORT, TRADE AND U.K. ENQUIRIES WELCOME
SEND LARGE S.A.E. FOR LISTS OF EQUIPMENT AND MANUALS
ALL PRICES EXCLUDE VAT AND CARRIAGE
DISCOUNT FOR BULK ORDERS SHIPPING ARRANGED

OPEN MONDAY TO FRIDAY 9AM - 5PM
COOKE INTERNATIONAL

ELECTRONIC TEST & MEASURING INSTRUMENTS
Unit Four, Fordingbridge Site, Main Road, Barnham, Bognor Regis, West Sussex, PO22 0EB Tel (+ 44) 0243 545111/2 Fax + 44) 0243 542457

LIVERPOOL

PROGRESSIVE RADIO

87/93 Dale Street
Tel: 051 236 0982 051 236 0154

47 Whitechapel
Tel: 051 236 5489
Liverpool 2

'THE ELECTRONICS SPECIALISTS'
Open: Tues-Sat 9.30-5.30

LEN COOKE ENTERPRISES

For the best value in Used Electronic Test Instruments

We buy, sell and service oscilloscopes, signal generators, frequency counters, spectrum Analysers, Power meters, logic testers, etc. Spare parts available for most Textronix scopes.

Tel: 081-813-9946
Fax: 081-574-2339
Mobile: 0374 759984

Main order address: Unit 5, Southall Enterprise Centre, Bridge Road, Southall, Middx. UB2 4AI

We engineer what we buy, we support what we sell.

TURN YOUR SURPLUS TRANSISTORS, ICS ETC INTO CASH immediate settlement.

We also welcome the opportunity to quote for complete factory clearance

Contact:

COLES-HARDING & CO.

Unit 58, Queens Road, Wisbech, Cambs PE13 7PQ
BUYERS OF SURPLUS INVENTORY
ESTABLISHED OVER 20 YEARS
Tel: 01945 584188 Fax: 01945 475216

NEWMARKET TRANSFORMERS LTD

Main Order Transformer Specialists.

Toroidal and Laminated Transformers, 3VA to 1kVA.

Fast delivery. Competitive prices. Quality guaranteed.
Phone: Michael Dornan on 0638 662989 for Immediate Quote

PROJECTS FOR IBM-PC & LAPTOP PCS

Controlled by Printer or RS232 ports
Versatile 24-line I/O card, Data logging system sound sampler/playback, EPROM emulator, Stepper motor board (+A/D+I/O ports), 8031 development system. Z80 and 80535 single board computers, etc.

INNOVATIVE INTERFACING

58 Lamport Court, Manchester M1 7EQ U.K. Phone/Answer/Fax: 061-272-8279

THIS SPACE
COULD BE
WORKING FOR
YOU!

FOR DETAILS OF
ADVERTISING
RATES CALL
JAMES ON
01442 66551

SOFTWARE

SCIENTIFIC SHAREWARE

Discover the true wealth of PD & shareware for the PC. Since 1982 PDSL have supplied the best and latest programs covering all interests Business, Leisure, Engineering, CAD, DTP, Maths, Stats, Chemistry, Education, Electronics, Ham Radio, Esoteric, Medical, Retracting, Programming & Languages, Tools, Utilities, WP, Editors, Comm. Special applications, Esoteric, Novelties, Astronomy & hundreds more. All software can be provided on Floppy disc or CD ROM.

Whatever your interest we probably have it. Send today for our PC Shareware reference guide. It runs to more than 250,000 words and is probably the most comprehensive catalogue currently available. Send £2.50 (voucher provided refundable on first order) or phone/fax using Access/Visa/MC to:
PDSL, Wiscombe House, Beacon Rd, Crowborough, East Sussex, TN6 1UL Tel 0892 663298 Fax 0892 66473

ASTRA Desk Top Accounting™

Overture - Invoicing, Sales, Purchases, Nominal, VAT, etc
Premier - plus Stock, Jobs, EPDS, Barcodes, Serial No. etc
Professional - plus Multi-Currency/Depos/Locations etc

S&S Systems Ltd, Bretton Court, Manor Road, Wales
Sheffield, S31 8PD, UK (software distributors and Apple dealers)
Tel: (01939) 773999 • Fax: (01939) 773645 • Int Code: 1444 1991

Open Forum

Ten years ago robots were all the rage and there was much discussion about them taking over the more menial jobs in manufacturing and service industries. New car factories were being built at the time, full of robot welding lines that could do the job better and quicker than any human. A great deal of press and TV coverage was given to events such as the Micromouse robot competition.

There were several companies manufacturing kits which allowed enthusiasts to build mobile robots and robot arms. There were even a couple of magazines devoted to practical robot building, plus quite a stack of books on the subject; even ETI carried a build your own robot project.

Then suddenly all interest seemed to disappear, the magazines ceased publication, the companies went out of business and the press were no longer bothered about robotics. It is difficult to say why this happened, though it was probably the result of media overkill. Too much hype for a subject which failed to deliver what the media and the enthusiast wanted.

The science fiction image of robots, the metal men, turned out to be in reality just rather sophisticated but otherwise boring pieces of factory automation.

But just because the media and the general public lost interest in robotics that does not mean to say that all research and development in robotics also ceased. Indeed, quite the opposite. Now in the mid 1990s we are beginning to see renewed popular interest in the subject.

The press and TV are once again curious to see what the designers of metal monsters are up to. Enthusiasts tired of playing with their personal computers are also rediscovering the intellectual challenge that is robotics. The only difference is that this time the robot developers have a lot more to show.

Robots of today are not just building cars, they are carrying out surgical operations. Neither are they blindly bumping their way around a maze; instead, six-legged metal insects are purposefully scuttling around labs, robot fish are swimming in a giant test tank and robot security men are guarding buildings and warehouses.

The robots that are being designed today are not the clunking metal men of films, but the explorers of distant planets and ocean bottoms, mankind's helpers for the future. This may all sound over-optimistic, and fanciful, but the technology behind both robotics and machine intelligence is advancing in leaps and bounds. Who knows what might be possible in another decade?

However, although both robotics and machine intelligence studies are advancing rapidly, they are still areas where big research and development funds are not always essential and where the individual researcher, perhaps even a knowledgeable amateur, can still make a major breakthrough.

This brings me to the main point, the fact that this magazine is breaking new ground with our proposals for the First ETI Amateur Robot Competition which will be held in London in January 1996. This may seem like a long way off but we want to give potential competitors plenty of time in which to work on good designs for what will be a difficult competition.

But do not be deterred from taking part simply because it is going to be difficult, we do not want this to be a competition where winning is all important, we want it to be one where taking part is the important thing. A competition where, hopefully, all the participants will learn from each other as well as from taking part, and where these new ideas can be applied in building better entries for the following year's competition.

Nick Hampshire, Editor of ETI.



EDITORIAL

Editor *Nick Hampshire*

Sub Editor *Eamonn Percival*

Editorial Assistant *Wendy Butler*

CREATIVE

Designer *Nadia Ahdout/Jeff Hamblin*

Technical Illustration *John Puczynski*

Photography *Manny Cefai*

ADVERTISEMENT SALES

Display Sales

Eric Thompson

Advertisement Copy Control

Marie Quilter

Classified Sales

James Gale

MANAGEMENT

Managing Director

Terry Pattison

Circulation & Promotions Manager

Debra Stupple

Production Manager

Tony Dowdeswell

Group Editor

Stuart Cooke

Group Advertisement Manager

Claire Jenkinson



Next Month...

In the April 1995 issue of ETI we will be continuing our laser tag game project and Neil Birtles will be showing how to construct the light gun base unit. We will also be looking at the first of Richard Grodzik's add-on boards for his 80188 single board computer project.

If you have ever fancied the idea of building a computer controlled 'turtle', then the next issue of ETI has a project for such a robot which has been designed by Dr Pei An. From Richard Tanfield there is a design for a versatile Ni-Cad battery charger, and from Douglas Clarkeson there is an interesting project on the measurement of light.

We will also be examining the world's smallest computer programmable in Basic, the Parallax Stamp. Furthermore we will be describing the first of a series of applications projects based around this very useful little device.

Next month's Tomorrow's Technology feature will examine the current and future use of electronics in the film industry. PC Clinic will look at audio adapters and the FREE cover disk will contain more useful software for the electronics and computer experimenter.

ETI is normally published on the first Friday in the month preceding the cover date. The contents of this publication including all articles, plans, drawings and programs and all copyright and all other intellectual property rights therein belong to Nexus Special Interests. All rights conferred by the Law of Copyright and other intellectual property rights and by virtue of international copyright conventions are specifically reserved to Nexus Special Interests and reproduction requires the prior written consent of the company ©1990 Nexus Special Interests. All reasonable care is taken in the preparation of the magazine contents, but the publishers cannot be held legally responsible for errors. Where mistakes do occur, a correction will normally be published as soon as possible afterwards. All prices and data contained in advertisements are accepted by us in good faith as correct at the time of going to press. Neither the advertisers nor the publishers can be held responsible, however, for any variations affecting price or availability which may occur after the publication has closed for press.

Subscription rates-UK £23.40 Europe £30.30 Sterling Overseas £31.50 US Dollars Overseas \$62.00

Published by Nexus Special Interests, Nexus House, Boundary Way, Hemel Hempstead HP2 7ST. Telephone (0442) 66551. UK newstrade distribution by SM Distribution Ltd, 6 Leigham Court Road, London SW16 2PG. Telephone 081-667 8111. Overseas and non-newstrade sales by Magazine Sales Department, Argus House, Boundary Way, Hemel Hempstead, HP2 7ST. Telephone (0442) 66551. Subscriptions by Nexus Subscription Services, ETI, Queensway House, 2 Queensway, Redhill, Surrey RH1 1QS. Telephone (0737) 768611.

US subscriptions by Wise Owl Worldwide Publications, 4314 West 238th Street, Torrance, CA90505 USA. For Visa/Mastercard orders in USA - Telephone (310) 375 6258 Fax (310) 375 0548. Pacific Time: 9am-9pm Weekdays. 10am-6pm Weekends. Typesetting and origination by Ebony, Liskeard, Cornwall. Printed by Wiltshire Ltd. Bristol.



Nexus House, Boundary Way,
Hemel Hempstead HP2 7ST
Telephone (0442) 66551
Fax (0442) 66998

“Electronics Workbench
is the best simulator to
design and verify circuits.”

Gordon MacDonald
Production Engineer Technician

Electronics Workbench is a highly productive bench where you design and verify circuits in a fraction of the time. Connections are always perfect. Wires route themselves. And the simulated components and test instruments work just like the real thing.

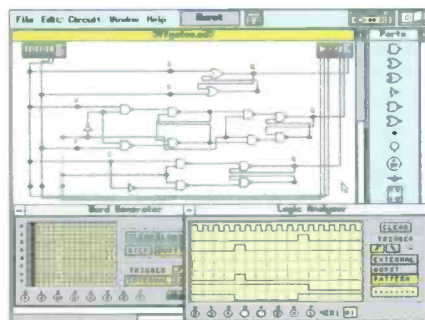

Digital Module: Analyzing a logic circuit.

It's faster than building with actual components because you change connections and component values instantly. And since the simulated components are free, you don't need to replace burnt-out parts or keep an extensive inventory. The result: You save precious time and money. Guaranteed!

The standard for simplicity and power for over six years, Electronics Workbench is the most popular tool of its kind. It has gained worldwide acclaim as the ideal complement to any test bench. Fact: Over 90% of our customers recommend it to their friends and colleagues.

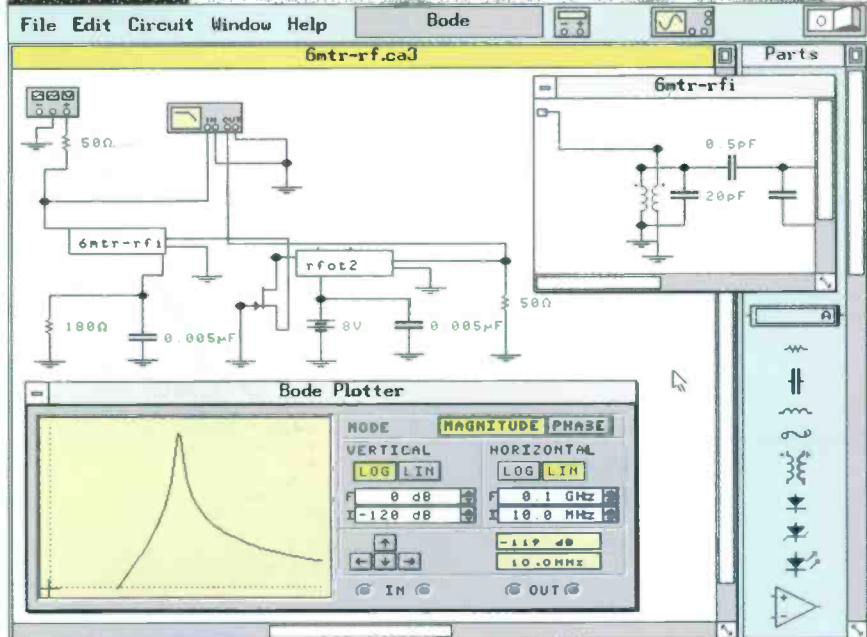
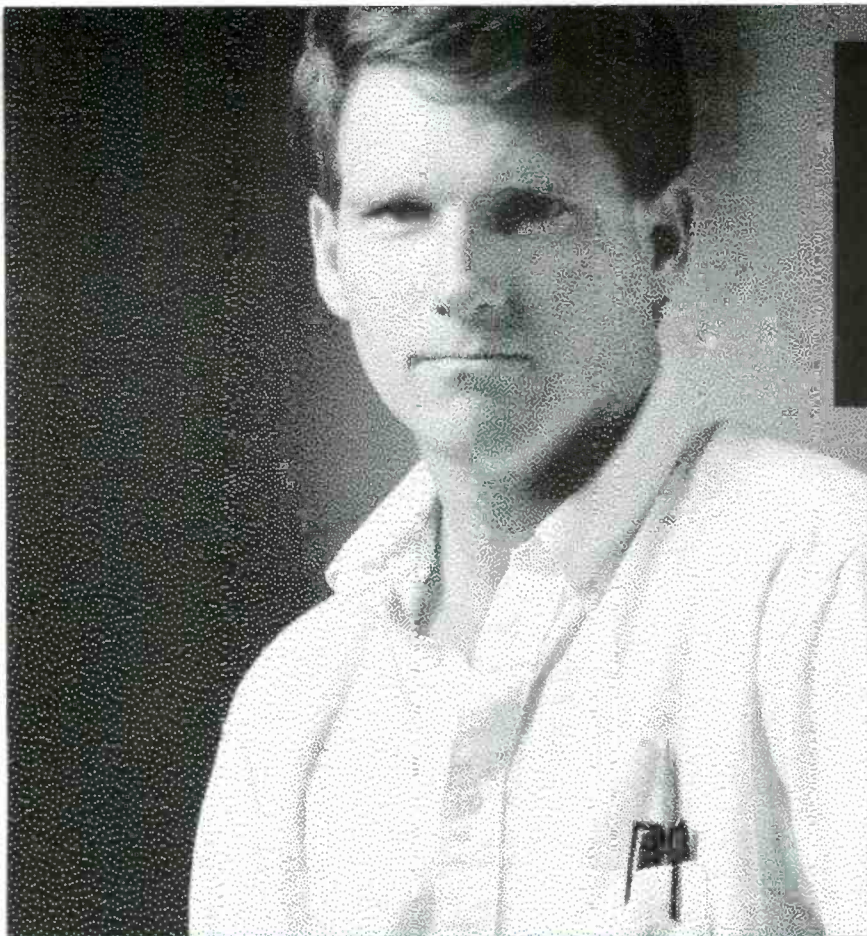

Analog Module: Tuning an RF front end.

Electronics Workbench®

The electronics lab in a computer™

Call: 44 0203 233216

Robinson Marshall (Europe) PLC
Nadella Building, Progress Close, Leofric Business Park, Coventry, Warwickshire CV3 2TF
FAX: (44) 0203 233210

*30-day money-back guarantee.

Shipping charges - UK £4.99. All prices are plus V.A.T.
All trademarks are the property of their respective owners.

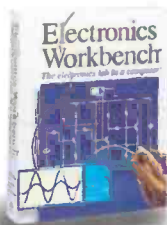

Just £199*
For DOS, Windows or Mac Version.



NEW

FULL COLOUR GUIDE TO ELECTRONIC PRODUCTS

Sept 1994–Aug 1995

Maplin



BS 5750
Part 2 1987

Level B:
Quality Assurance
RS12750

Order your copy of the New MAPLIN Catalogue on sale NOW!
Pick up a copy from any branch of WHSMITH, branches of John Menzies in Scotland ONLY, Eason & Son in N. Ireland ONLY, and Maplin stores nationwide for just £3.45 or post this coupon now to receive your copy for just £3.95 inc. p&p. If you live outside the U.K. send £7.30 or 18 IRCs for Airmail in Europe (including Republic of Ireland); £6.50 or 16 IRCs for surface mail outside Europe; or £12.30 or 30 IRCs for Airmail outside Europe.
I enclose £3.95/£7.30/£6.50/£12.30 (delete as applicable).

Name
Address
Post Code
Send to Maplin Electronics,
P.O. Box 3, Rayleigh,
Essex, England
SS6 8LR
EHS

Over 800 colour packed pages
with hundreds of Brand New
Products at Super Low Prices.

**OUT OF
THIS WORLD
ONLY**

£3.45

Available from all branches of WHSMITH, John Menzies in Scotland ONLY, Eason & Son in N. Ireland ONLY, and Maplin stores nationwide. The Maplin Electronics 1995 Catalogue – **OUT OF THIS WORLD**