



2013 Price List

**Material Handling,
Healthcare, Cleanroom, Lab**



Material Handling, Healthcare & Cleanroom Equipment

- Table of Contents -

Detailed contents listing at the start of each individual section.

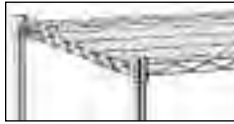

Shelving / Retail Display5-86



Wall Shelves87-96



Cleanroom / Lab Equipment97-110



Healthcare111-126



Electronics127-140



Tables141-176



Sinks / Floor Troughs177-218

Warranty Information2

Terms & Conditions3

SpecFAB® Custom Fabrications219-222

Alphanumeric Price Index223-256

How to order:

EAGLE'S Customer Service Center

Committed to customer service and customer satisfaction along with quality products.

Toll Free: 1-800-637-5100

Phone: (302) 653-3000

Fax: (302) 653-2065

Email: customerservice@eaglegrp.com

VISIT US ON THE WEB

To find an EAGLE representative, dealer or service center in your area go to

www.eaglegrp.com

STOCK STATUS IS INDICATED BY:

MTS (•) - make-to-stock items with shipment same day or next day.

MTO () - make-to-order items.

LOOK!

FOR THESE EMBLEMS

Located to the right of or below each appropriate product title and/or product subtitle:

see spec sheet **EG01.00** - catalog spec sheet reference (available online www.eaglegrp.com)



- approved by the National Sanitation Foundation



- approved by Underwriters Laboratories for U.S.A. ONLY

NFPA-96 - Meets the standards of the National Fire Protection Association, Bulletin #96

REGISTERED TRADEMARKS OF EAGLE MHC® - a division of EAGLE GROUP

Add-A-Shelf®, adjusTable®, EAGLEbrite®, EAGLEgard®, FLEX-MASTER®, Floor Trak®, LIFESTOR®, MasterSeal®, Master Trak®, MICROGARD®, Quad-Adjust®, QuadPLUS®, QuadTruss®, Quik-Set®, Redi-Pak®, SPEC AIR®, SpecFAB®, SPEC-MASTER®, Snap-n-Slide®, Sterile-Eze®, uni-lok®, Valu-Gard®, VALU-MASTER®, and WALSTOR®.

TRADEMARKS OF EAGLE MHC® - a division of EAGLE GROUP

Lok-n-Fold™, Shelf Select™, and STAND-OUTS™.

WARRANTY INFORMATION

EAGLE Shelving Warranty

EAGLE MHC® warrants that goods supplied hereunder manufactured by EAGLE MHC® will be free from defects in material and workmanship at the time they leave our factory. Upon factory inspection, we guarantee to replace any shelf that is defective for a period of up to one year from the date of original installation, not to exceed 18 months from date of shipment from EAGLE, provided that it has been properly installed and maintained. If a shelf proves to be defective, or not in conformity with the specification, customers are entitled only to replacement of such unit. Under no circumstances will we be liable for any claims for labor or subsequent damage.

To the original owner, EAGLE GROUP warrants against rust formation over more than 5% of the shelving surface as stated below following original date of installation:

	WARRANTY	DRY STORAGE	COOLER STORAGE
Chrome	1-year warranty	✓	-
EAGLEbrite®	3-year warranty	✓	-
VALU-MASTER® and Valu-Gard®	5-year warranty	✓	✓
EAGLEgard® (with MICROGARD®)	15-year warranty	✓	✓
Stainless Steel	15-year warranty	✓	✓
QuadPLUS®	*	✓	✓
* Polymer Shelf Mats have a lifetime warranty against rust and corrosion.			
* Wire Truss Frames, based on finish, have same warranty duration as outlined above.			
LIFESTOR® (with MICROGARD®)	**	✓	✓
** 1-year manufacturer's warranty on all component parts.			
** Lifetime limited warranty against rust or corrosion on stainless steel posts and stainless steel rails (3-year warranty on zinc with clear epoxy).			

EAGLE wire shelving must be cleaned with soft cloths and mild detergents. Using harsh detergents, abrasive materials, scrapers or stiff brushes will void this warranty, as will physical damage, rupturing the coating or sustained exposure to corrosive substances and vapors. Warranty applies only when shelves have been continuously used within a temperature range from -20°F to +120°F, with intermittent exposure up to +200°F for VALU-MASTER® or EAGLEgard® epoxy finishes, and up to +175°F for chrome or EAGLEbrite® zinc finishes.

In the event of a warranty claim, an EAGLE GROUP representative will examine the installation and determine return or repair disposition. Repairs will be handled by the initial owner. Returns, including disassembly and subsequent reassembly, become the responsibility of the initial owner. Replacements will be shipped prepaid FOB the nearest distribution point.

There are no warranties which extend beyond these warranties. All other expressed or implied warranties, including those of merchantability or fitness for a particular purpose, which exceed the warranties stated above, are disclaimed by EAGLE MHC® and excluded from this agreement. No employee or agent of ours has any authority to make any representation or warranty which exceeds the warranties stated above.

NO EAGLE EQUIPMENT MAY BE RETURNED EXCEPT UPON WRITTEN AUTHORIZATION FROM EAGLE MHC®.
SEE PAGE 3 FOR TERMS & CONDITIONS.

* * *

EAGLE Worktable and Sink Warranty

EAGLE MHC® warrants that goods supplied hereunder manufactured by EAGLE MHC® will be free from defects in material and workmanship at the time they leave our factory.

Within a period of one year from the date of original installation of the equipment, not to exceed 18 months from date of shipment from EAGLE, EAGLE MHC®, will replace, without charge, any defective parts or component material upon demonstration to its satisfaction that a breach of warranty did not exist. Under no circumstances will we be liable for any claims for labor or subsequent damage.

There are no warranties which extend beyond these warranties. All other expressed or implied warranties, including those of merchantability or fitness for a particular purpose, which exceed the warranties stated above, are disclaimed by EAGLE MHC® and excluded from this agreement. No employee or agent of ours has any authority to make any representation or warranty which exceeds the warranties stated above.

NO EAGLE EQUIPMENT MAY BE RETURNED EXCEPT UPON WRITTEN AUTHORIZATION FROM EAGLE MHC®.
SEE PAGE 3 FOR TERMS & CONDITIONS.

* * *

EAGLE Surgical Case Carts

EAGLE MHC® warrants that goods supplied hereunder manufactured by EAGLE MHC® will be free from defects in material and workmanship at the time they leave our factory.

Within a period of three years from the date of shipment from EAGLE, EAGLE MHC® will replace, without charge, any defective parts or component material upon demonstration to its satisfaction that a breach of warranty did not exist. Under no circumstances will we be liable for any claims for labor or subsequent damage.

There are no warranties which extend beyond these warranties. All other expressed or implied warranties, including those of merchantability or fitness for a particular purpose, which exceed the warranties stated above, are disclaimed by EAGLE MHC® and excluded from this agreement. No employee or agent of ours has any authority to make any representation or warranty which exceeds the warranties stated above.

NO EAGLE EQUIPMENT MAY BE RETURNED EXCEPT UPON WRITTEN AUTHORIZATION FROM EAGLE MHC®.
SEE PAGE 3 FOR TERMS & CONDITIONS.

EAGLE Material Handling, Healthcare & Cleanroom Equipment (MHC®) is a division of EAGLE GROUP.
(formerly known as Metal Masters)

- Terms and Conditions -

Prices

All merchandise will be billed at our current published list prices in effect at the time of shipment.

Performance

All shipping promises are made with the expectation that shipment will go forward as specified. However, fulfillment is always subject to availability of material and to conditions affecting shipment that are beyond our control. EAGLE MHC® shall not be held liable for any delay in performance due to reasons beyond our control.

Shortage

All claims for shortage must be brought to our attention within five (5) business days from date merchandise is received. Please be certain that you receive the number of packages signed for.

Cancellations

Cancellations are not accepted on orders in transit or on custom items. Standard orders already in process that are cancelled may be subject to a 20% restocking charge.

Returns

Custom and modified standard equipment is non-returnable.

Authorization:

- ✓ Previously written approval from EAGLE MHC®'s Customer Service is mandatory on all returns.
- ✓ Return authorization must be requested within 60 days from date of shipment.
- ✓ Authorized return shipments, in which merchandise is not defective and orders have been properly filled, must be shipped prepaid and properly packaged to prevent merchandise damage.
- ✓ Each return authorization number (*located on the upper right hand corner of the form*) must be written on the outside of each carton returned to EAGLE MHC®.

Restocking

- ✓ Restocking and equipment repair fees for merchandise damaged during return shipment to EAGLE MHC® will be withheld from issued credit.
- ✓ Returns of made-to-stock merchandise are subject to a 30% restocking fee.

Restocking (continued):

- ✓ Returns of made-to-order merchandise are subject to a 50% restocking fee.
- ✓ \$75 net minimum on merchandise returns.

Prints & Drawings

All prints and drawings submitted with orders are accepted as a final approval in the custom order process. Errors that arise due to incorrect submittals are the responsibility of the customer. There are no cancellations on custom orders.

Damages

EAGLE MHC®'s responsibility ceases immediately upon our retaining receipt of pickup from our dock by the transportation company, unless the merchandise is refused by the consignee. If a container shows rough handling, do not give the carrier a clear delivery receipt and inspect the merchandise immediately. Upon finding damage while unpacking the product, call the carrier without further unpacking, ask for an inspection, and follow through by filing a claim.

Order Approval

All orders are subject to final approval by EAGLE MHC®'s home office. Acceptance and/or performance shall be at all times subject to the approval of EAGLE MHC®'s Credit Department. Minimum order \$50.00 net.

Terms

Discount and discount date are clearly marked at the bottom of each invoice should you be entitled to any discount, subject to current status of your account.

FOB

All shipments are shipped from FOB point "collect" unless otherwise specified. All orders shipped prepaid and add will receive a 20% administrative surcharge added to the freight charge. Orders shipped UPS from manufacturing point will not receive FOB distribution point rates.

UPS

All UPS shipments will be charged a minimum of \$25.00.

- MONETARY VALUES ARE BASED ON U.S. CURRENCY. -

IMPORTANT NOTICE:

Due to the continuing cost fluctuations of stainless steel and other materials, we at EAGLE MHC® reserve the right to modify our price lists by charging dealer discounts and/or imposing a surcharge.



OTHERS' WIRE SHELVES COMPARED TO EAGLE GROUP'S...

(18" x 60" shelves shown)

EAGLE GROUP's shelves...

...incorporate more perimeter and interior serpentine trusses and mat continuity support wires than any competitive shelves.

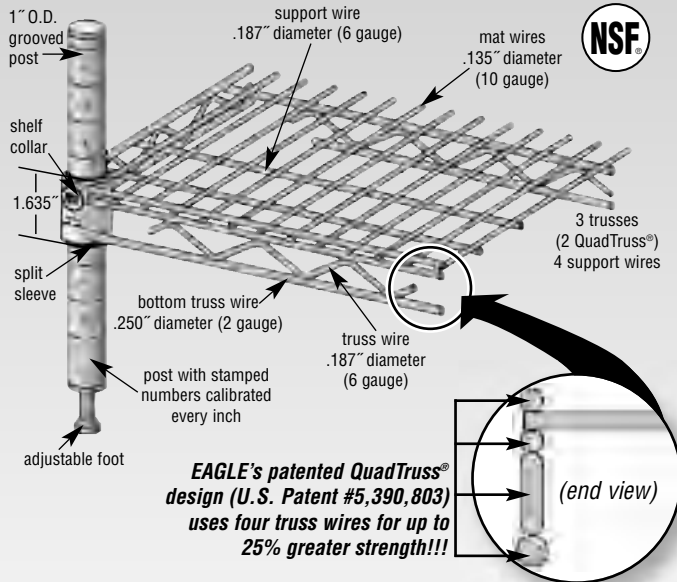

Metro and most imported shelves...

...incorporate both perimeter and interior serpentine trusses and mat continuity support wires, but fewer than EAGLE GROUP's.

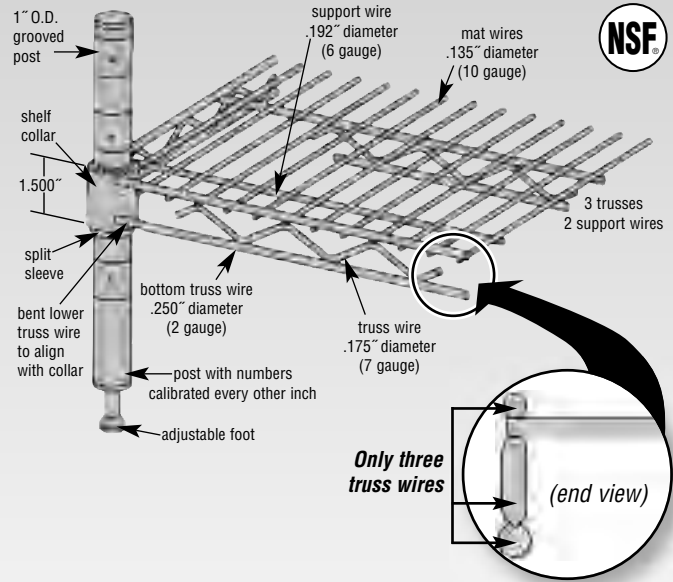

Eagle Group has the strongest wire shelf in the industry—no matter how you stack it!

SHELF AND POST FINISHES AVAILABLE

Stainless Steel Finish—OUR BEST!

Stainless Steel

- NSF-listed for all environments.
- Type 304 stainless steel.

NOTE: Stainless steel shelving is electropolished.

15-YEAR LIMITED WARRANTY

EAGLEgard® Hybrid Epoxy

Zinc Chloride
Clear Chromate
MasterSeal® Sealer
Blue Green (translucent)
- hybrid epoxy with MICROGARD®*

- NSF-listed for all environments.
- Zinc chloride plating followed by clear chromate plating with MasterSeal® Sealer and a hybrid epoxy final coat.

15-YEAR LIMITED WARRANTY

Valu-Gard® Green Epoxy

Phosphate Conversion Coating
MasterSeal® Sealer
Green (opaque)
- hybrid metallic epoxy

- NSF-listed for wet or dry storage environments.
- Phosphate conversion coating followed by green hybrid epoxy coating.

5-YEAR LIMITED WARRANTY

VALU-MASTER® Gray Epoxy

Phosphate Conversion Coating
MasterSeal® Sealer
Pewter Gray Epoxy

- NSF-listed for wet or dry storage environments.
- Phosphate conversion coating followed by metallic gray epoxy coating.

5-YEAR LIMITED WARRANTY

Chrome Finish

Bright Nickel
Chrome
Air-dry Lacquer

- NSF-listed for dry storage environments.
- Bright nickel plating followed by chrome plating.

NOTE: Optional clear hybrid epoxy, NSF-listed for all environments, is available.

1-YEAR LIMITED WARRANTY

EAGLEbrite® Zinc

Zinc chloride
Clear Chromate
MasterSeal® Sealer

- NSF-listed for dry storage environments.
- Bright zinc chloride plating followed by clear chromate plating with MasterSeal® sealer for improved rust protection.

NOTE: Wire shelves feature MasterSeal® Sealer. NSF-listed for all environments.

3-YEAR LIMITED WARRANTY

* MICROGARD®...

...is an antimicrobial agent which contains built-in protection to retard the growth of a broad range of bacteria, mold and mildew on shelf surface that causes stains, odors and degradation.

...combines inorganic antimicrobial silver ions with a patented delivery system. The silver ions react with bacteria in three ways:

1) suffocates the cell, 2) stops the cell reproduction system, and 3) stops the cell from growing.

...is standard on all EAGLEgard® shelving.

Shelving / Retail Display

Accessories/Components

Casters	11, 12, 58, 71, 75
Casting for Leveling Feet	45
Collar Plug	45
Dividers	46, 59
Enclosure Panels	26
Foot Plates	45
Glides	45
Inlays	58
Label Holders	22, 38
Ledges	47, 59, 76
Leveling Feet.....	45
Post Cap	45
Post Clamp	45
Retaining Clamp	45
Rods & Tabs	26, 45
“S” Hooks	45
Split Sleeves	45
More Accessories and Components.....	10-12, 45-52

Add-A-Shelf® and Accessories19-20

Cantilever Shelving System Wall Mount82-86

Carts

Angled Shelf/ Visual Merchandising Carts	31-32
Black Polymer Utility Cart.....	32
Cart Covers	30
Hardwood Top Demo & Wine Carts ..	62
Mobile Platform Carts.....	32
Polymer Utility Carts.....	32, 78
Utility Carts	22, 27-28
Stem Caster Carts.....	29
Wire Basket Utility Carts	24

Dolly Frames / Dolly Trucks

Aluminum Truck Dollies	37
Dolly Frames.....	38
Dolly Trucks	33

LIFESTOR® Polymer Shelving

Accessories/Components	75-77
Add-On Units	73
Dunnage Racks.....	78
Floor-Trak® Storage Systems	79
Shelving / Posts	74-75
Starter Units	72
Utility Carts	78
Overhead Track Storage Systems	80-81

Posts10, 20, 59

QuadPLUS® Starter Units and Polymer Shelf Mats8-9

Quik-Set® Solid Shelving68-71

Racks and Platforms

Dunnage Racks	35-37
Platforms	34
Polymer Dunnage Racks.....	36
Tank Racks/Accessories	43

Redi-Pak®

Utility Carts	22
Wire Shelving Units	21

Retail Display Shelving and Accessories

Accessories/Components	58-60
Decorative Shelves	57
Front Case Merchandise Shelving.....	61
Garment Racks/Accessories	34
Gondola Shelving/Accessories	64-66
Pot/Pan Rack/Accessories	63
Retail Display Workstations	62
Secure Display Merchandiser	63
Soft Goods Display	61
Wire Display Shelving/ Accessories	66-67

Security Units and Accessories39-42

Shelves / Shelving Units

Adjustable Wire Shelving • Add-A-Shelf®	19-20
• Quad-Adjust®	7-8
Cantilever Shelves.....	10
Dunnage Shelf; Starter Units	36
Four/Five-Shelf Add-On Units	16, 18
Four/Five-Shelf Starter Units	8, 15, 17
Hybrid Shelves	23-24
Reverse Mat Shelves/ Label Holders	22
Seismic Shelves/Posts	14
Slanted Shelves	46
Sliding Shelves	50
Solid Shelves/Accessories	13
Triangle Shelf	24
Wire Basket Shelves	24
Wire Shelves.....	6

Tables44

Track Systems

Floor Track Storage Systems	55-56, 79
Overhead Track Storage Systems.....	53-54, 80-81

Wine Shelves and Components25-26

Workstations

Modular Desks/Workstations	43
Retail Display Workstations	62

For the
“Wall Shelves” section,
go to pages 87–96.



Wire Shelves

see spec sheet **EG01.00**

WEIGHT CAPACITIES:

- Shelves up to 48" (1219mm): 800 lb. (363 kg).
- 54"-72" (1372-1829mm) shelves: 600 lb. (272 kg) - evenly distributed static load.

Note: Shelving units should not exceed 2400 lbs. (1089 kg) per set of four posts.

- 24"-48" (610-1219mm) lengths: Four per box.
- 54"-72" (1372-1829mm) lengths: Two per box.
- Four pairs of split sleeves per shelf.

PACKAGING:

Freight class is 70.0.

(•) MTS (made to stock) / () MTO (made to order)



(Patent #5,390,803)

Patented QuadTruss® Design

makes shelves up to 25% stronger and provides a retaining ledge for increased strength and product retention.

	length		weight		cu ft	EAGLEbrite®		chrome		Valu-Master®		Valu-Gard®		EAGLEgard®		stainless	
	in.	mm	lb.	kg		model #	list	model #	list	model #	list	model #	list	model #	list	model #	list
14" width (356mm)	24"	610	6	2.7	0.5	1424Z •	46	1424C •	53	1424V •	54	1424VG •	54	1424E •	62	1424S •	186
	30"	762	7	3.2	0.5	1430Z •	48	1430C •	55	1430V •	57	1430VG •	57	1430E •	65	1430S •	188
	36"	914	8	3.6	0.5	1436Z •	52	1436C •	59	1436V •	61	1436VG •	61	1436E •	67	1436S •	190
	42"	1067	9	4.1	0.7	1442Z •	61	1442C •	67	1442V •	68	1442VG •	68	1442E •	78	1442S •	234
	48"	1219	10	4.5	0.7	1448Z •	61	1448C •	67	1448V •	70	1448VG •	70	1448E •	78	1448S •	234
	54"	1372	12	5.5	0.9	1454Z •	63	1454C •	70	1454V •	77	1454VG •	77	1454E •	87	1454S •	286
	60"	1524	14	6.4	0.9	1460Z •	72	1460C •	77	1460V •	80	1460VG •	80	1460E •	89	1460S •	296
	72"	1829	17	7.7	1.1	1472Z •	82	1472C •	89	1472V •	94	1472VG •	94	1472E •	103	1472S •	335
18" width (457mm)	24"	610	7	3.2	0.7	1824Z •	57	1824C •	59	1824V •	61	1824VG •	61	1824E •	70	1824S •	228
	30"	762	8	3.6	0.7	1830Z •	59	1830C •	60	1830V •	66	1830VG •	66	1830E •	73	1830S •	232
	36"	914	9	4.1	0.7	1836Z •	61	1836C •	62	1836V •	68	1836VG •	68	1836E •	76	1836S •	234
	42"	1067	11	5.0	0.9	1842Z •	70	1842C •	74	1842V •	76	1842VG •	76	1842E •	91	1842S •	279
	48"	1219	12	5.5	0.9	1848Z •	70	1848C •	74	1848V •	81	1848VG •	81	1848E •	91	1848S •	279
	54"	1372	15	6.8	1.2	1854Z •	82	1854C •	87	1854V •	98	1854VG •	98	1854E •	108	1854S •	355
	60"	1524	17	7.7	1.2	1860Z •	82	1860C •	87	1860V •	99	1860VG •	99	1860E •	108	1860S •	355
	72"	1829	20	9.1	1.3	1872Z •	98	1872C •	104	1872V •	113	1872VG •	113	1872E •	125	1872S •	422
21" width (533mm)	24"	610	8	3.6	0.7	2124Z •	63	2124C •	68	2124V •	69	2124VG •	69	2124E •	80	2124S •	264
	30"	762	9	4.1	0.7	2130Z •	65	2130C •	70	2130V •	74	2130VG •	74	2130E •	82	2130S •	267
	36"	914	11	5.0	0.8	2136Z •	67	2136C •	73	2136V •	76	2136VG •	76	2136E •	86	2136S •	269
	42"	1067	12	5.5	1.1	2142Z •	77	2142C •	85	2142V •	88	2142VG •	88	2142E •	101	2142S •	311
	48"	1219	14	6.4	1.1	2148Z •	77	2148C •	85	2148V •	89	2148VG •	89	2148E •	101	2148S •	311
	54"	1372	16	7.3	1.3	2154Z •	94	2154C •	100	2154V •	105	2154VG •	105	2154E •	118	2154S •	414
	60"	1524	18	8.2	1.3	2160Z •	94	2160C •	100	2160V •	107	2160VG •	107	2160E •	118	2160S •	414
	72"	1829	24	10.9	1.4	2172Z •	113	2172C •	119	2172V •	130	2172VG •	130	2172E •	144	2172S •	490
24" width (610mm)	24"	610	9	4.1	0.8	2424Z •	67	2424C •	72	2424V •	75	2424VG •	75	2424E •	88	2424S •	285
	30"	762	11	5.0	0.8	2430Z •	69	2430C •	75	2430V •	80	2430VG •	80	2430E •	90	2430S •	287
	36"	914	13	5.9	0.8	2436Z •	72	2436C •	77	2436V •	82	2436VG •	82	2436E •	92	2436S •	291
	42"	1067	15	6.8	1.2	2442Z •	86	2442C •	92	2442V •	99	2442VG •	99	2442E •	113	2442S •	352
	48"	1219	16	7.3	1.2	2448Z •	86	2448C •	92	2448V •	103	2448VG •	103	2448E •	113	2448S •	352
	54"	1372	19	8.6	1.5	2454Z •	105	2454C •	110	2454V •	115	2454VG •	115	2454E •	134	2454S •	430
	60"	1524	21	9.5	1.5	2460Z •	105	2460C •	110	2460V •	121	2460VG •	121	2460E •	134	2460S •	430
	72"	1829	26	11.8	1.6	2472Z •	120	2472C •	130	2472V •	141	2472VG •	141	2472E •	157	2472S •	537
30" width (762mm)	30"	762	16	7.3	1.0	3030Z •	87	3030C •	100	3030V •	102	3030VG •	102	3030E •	119	3030S •	339
	36"	914	17	7.7	1.0	3036Z •	99	3036C •	113	3036V •	116	3036VG •	116	3036E •	137	3036S •	385
	48"	1219	20	9.1	1.5	3048Z •	113	3048C •	130	3048V •	134	3048VG •	134	3048E •	156	3048S •	448
	60"	1524	25	11.4	1.8	3060Z •	127	3060C •	143	3060V •	149	3060VG •	149	3060E •	178	3060S •	498
	72"	1829	30	13.6	2.3	3072Z •	153	3072C •	172	3072V •	179	3072VG •	179	3072E •	214	3072S •	604
36" width (914mm)	36"	914	21	9.5	1.3	3636Z •	107	3636C •	126	3636V •	127	3636VG •	127	3636E •	153	3636S •	430
	48"	1219	26	11.8	1.9	3648Z •	128	3648C •	145	3648V •	151	3648VG •	151	3648E •	178	3648S •	506
	60"	1524	34	15.4	2.3	3660Z •	147	3660C •	169	3660V •	173	3660VG •	173	3660E •	209	3660S •	590
	72"	1829	43	19.5	2.8	3672Z •	178	3672C •	197	3672V •	210	3672VG •	210	3672E •	246	3672S •	703



Catalog Section 1

Quad-Adjust® Wire Shelving

see spec sheet **EG01.14**



PATENTED!
(patent #7,992,731)

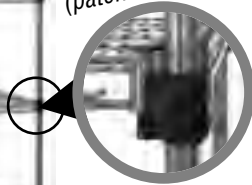

Each shelf corner fits in collar mounted to split sleeve



(Patent #5,390,803)

Patented QuadTruss® Design

makes shelves up to 25% stronger and provides a retaining ledge for increased strength and product retention.

FEATURES:

- Shelves feature special interlocking corners that fit in collars mounted to split sleeves, allowing addition or removal of a shelf without the need to disassemble the entire shelf unit.
- Tapered split sleeves create a positive lock that becomes stronger as the load increases.
- Posts (page 10) are numbered in increments of 1" (25mm) to ensure fast and level assembly.
- Leveling feet are provided to help compensate for uneven floor surfaces.
- Shelves utilize patented QuadTruss® design: the mat wires are sandwiched between two top truss wires, adding significant strength and distributing the entire load without stress and strain on the welds.

Note: To create a mobile shelf unit, top and bottom shelves must be standard shelves (page 6).

Quad-Adjust® shelves assembled with posts (see page 10 for posts)

Weight capacities and packaging are the same as that of Wire Shelves (page 6).

Freight class is 70.0.

(•) MTS (made to stock) / () MTO (made to order)

HOW TO ASSEMBLE:



1. Snap split sleeves onto post over number of your choice.



2. Attach Quad-Adjust® collar onto split sleeves.



3. Slide shelf into slots in collar to complete.

Quad-Adjust® Shelves

	length		weight		cu ft	EAGLEbrite®		chrome		VALU-MASTER®		Valu-Gard®		EAGLEgard®		stainless steel	
	in.	mm	lb.	kg		model #	list	model #	list	model #	list	model #	list	model #	list	model #	list
14" width (356mm)	24"	610	6	2.7	0.5	QA1424Z	81	QA1424C	89	QA1424V	86	QA1424VG	86	QA1424E	99	QA1424S	255
	30"	762	7	3.2	0.5	QA1430Z	86	QA1430C	92	QA1430V	90	QA1430VG	90	QA1430E	102	QA1430S	258
	36"	914	8	3.6	0.5	QA1436Z	88	QA1436C	94	QA1436V	96	QA1436VG	96	QA1436E	105	QA1436S	259
	42"	1067	9	4.1	0.7	QA1442Z	94	QA1442C	104	QA1442V	107	QA1442VG	107	QA1442E	115	QA1442S	309
	48"	1219	10	4.6	0.7	QA1448Z	99	QA1448C	106	QA1448V	110	QA1448VG	110	QA1448E	121	QA1448S	310
	54"	1372	12	5.5	0.9	QA1454Z	105	QA1454C	110	QA1454V	112	QA1454VG	112	QA1454E	125	QA1454S	379
	60"	1524	14	6.4	0.9	QA1460Z	110	QA1460C	115	QA1460V	125	QA1460VG	125	QA1460E	130	QA1460S	389
72"	1829	17	7.7	1.1	QA1472Z	124	QA1472C	130	QA1472V	133	QA1472VG	133	QA1472E	144	QA1472S	435	
18" width (457mm)	24"	610	7	3.2	0.7	QA1824Z	93	QA1824C	94	QA1824V	93	QA1824VG	93	QA1824E	110	QA1824S	307
	30"	762	8	3.6	0.7	QA1830Z	95	QA1830C	98	QA1830V	103	QA1830VG	103	QA1830E	111	QA1830S	309
	36"	914	9	4.1	0.7	QA1836Z	99	QA1836C	• 100	QA1836V	• 108	QA1836VG	• 108	QA1836E	• 114	QA1836S	312
	42"	1067	11	5.0	0.9	QA1842Z	106	QA1842C	110	QA1842V	116	QA1842VG	116	QA1842E	130	QA1842S	364
	48"	1219	12	5.5	0.9	QA1848Z	110	QA1848C	112	QA1848V	• 125	QA1848VG	• 125	QA1848E	• 133	QA1848S	368
	54"	1372	15	6.8	1.2	QA1854Z	121	QA1854C	125	QA1854V	133	QA1854VG	133	QA1854E	147	QA1854S	455
	60"	1524	17	7.7	1.2	QA1860Z	124	QA1860C	128	QA1860V	• 139	QA1860VG	• 139	QA1860E	• 152	QA1860S	461
72"	1829	20	9.1	1.3	QA1872Z	139	QA1872C	145	QA1872V	162	QA1872VG	162	QA1872E	169	QA1872S	541	
21" width (533mm)	24"	610	8	3.6	0.8	QA2124Z	100	QA2124C	106	QA2124V	102	QA2124VG	102	QA2124E	121	QA2124S	349
	30"	762	9	4.1	0.8	QA2130Z	102	QA2130C	110	QA2130V	110	QA2130VG	110	QA2130E	124	QA2130S	353
	36"	914	11	5.0	0.8	QA2136Z	105	QA2136C	111	QA2136V	121	QA2136VG	121	QA2136E	126	QA2136S	356
	42"	1067	12	5.5	1.1	QA2142Z	112	QA2142C	122	QA2142V	128	QA2142VG	128	QA2142E	139	QA2142S	404
	48"	1219	14	6.4	1.1	QA2148Z	115	QA2148C	125	QA2148V	133	QA2148VG	133	QA2148E	141	QA2148S	407
	54"	1372	16	7.3	1.3	QA2154Z	133	QA2154C	138	QA2154V	143	QA2154VG	143	QA2154E	159	QA2154S	527
	60"	1524	18	8.2	1.3	QA2160Z	134	QA2160C	140	QA2160V	145	QA2160VG	145	QA2160E	163	QA2160S	530
72"	1829	24	10.9	1.4	QA2172Z	158	QA2172C	164	QA2172V	176	QA2172VG	176	QA2172E	193	QA2172S	623	
24" width (610mm)	24"	610	9	4.1	0.8	QA2424Z	105	QA2424C	110	QA2424V	111	QA2424VG	111	QA2424E	129	QA2424S	376
	30"	762	11	5.0	0.8	QA2430Z	107	QA2430C	112	QA2430V	121	QA2430VG	121	QA2430E	131	QA2430S	378
	36"	914	13	5.9	0.8	QA2436Z	110	QA2436C	115	QA2436V	• 126	QA2436VG	• 126	QA2436E	• 134	QA2436S	382
	42"	1067	15	6.8	1.2	QA2442Z	124	QA2442C	131	QA2442V	136	QA2442VG	136	QA2442E	154	QA2442S	452
	48"	1219	16	7.3	1.2	QA2448Z	126	QA2448C	• 134	QA2448V	• 146	QA2448VG	• 146	QA2448E	• 158	QA2448S	454
	54"	1372	19	8.6	1.5	QA2454Z	144	QA2454C	151	QA2454V	160	QA2454VG	160	QA2454E	177	QA2454S	549
	60"	1524	21	9.5	1.5	QA2460Z	146	QA2460C	153	QA2460V	• 169	QA2460VG	• 169	QA2460E	• 180	QA2460S	552
72"	1829	26	11.8	1.6	QA2472Z	165	QA2472C	176	QA2472V	195	QA2472VG	195	QA2472E	206	QA2472S	681	

Note: MICROGARD® antimicrobial protection standard on all EAGLEgard® shelving.



100 Industrial Boulevard, Clayton, DE 19938-8903 U.S.A.
Phone: 800-637-5100 or 302-653-3000. Fax: 302-653-2065
http://www.eaglegrp.com

Quad-Adjust® Wire Shelving (continued)

Freight class is 70.0.

see spec sheet **EG01.14**

(*) MTS (made to stock) / () MTO (made to order)

Quad-Adjust® Reverse Mat Shelves

	length		weight		cu ft	EAGLEbrite®		chrome		VALU-MASTER®		Valu-Gard®		EAGLEgard®		stainless steel	
	in.	mm	lb.	kg		model #	list	model #	list	model #	list	model #	list	model #	list	model #	list
14" (356mm)	24"	610	6	2.7	0.5	QAR1424Z	88	QAR1424C	94	QAR1424V	91	QAR1424VG	91	QAR1424E	105	QAR1424S	270
	36"	914	8	3.6	0.5	QAR1436Z	93	QAR1436C	101	QAR1436V	103	QAR1436VG	103	QAR1436E	111	QAR1436S	275
	48"	1219	10	4.6	0.7	QAR1448Z	101	QAR1448C	112	QAR1448V	116	QAR1448VG	116	QAR1448E	129	QAR1448S	331
18" (457mm)	24"	610	7	3.2	0.7	QAR1824Z	99	QAR1824C	100	QAR1824V	102	QAR1824VG	102	QAR1824E	116	QAR1824S	326
	36"	914	9	4.1	0.7	QAR1836Z	105	QAR1836C	106	QAR1836V	114	QAR1836VG	114	QAR1836E	122	QAR1836S	333
	48"	1219	12	5.5	0.9	QAR1848Z	116	QAR1848C	120	QAR1848V	132	QAR1848VG	132	QAR1848E	141	QAR1848S	391
21" (533mm)	24"	610	8	3.6	0.7	QAR2124Z	103	QAR2124C	104	QAR2124V	108	QAR2124VG	108	QAR2124E	123	QAR2124S	335
	36"	914	11	5.0	0.8	QAR2136Z	111	QAR2136C	119	QAR2136V	129	QAR2136VG	129	QAR2136E	133	QAR2136S	377
	48"	1219	14	6.4	1.1	QAR2148Z	124	QAR2148C	132	QAR2148V	141	QAR2148VG	141	QAR2148E	151	QAR2148S	433
24" (610mm)	24"	610	9	4.1	0.8	QAR2424Z	112	QAR2424C	116	QAR2424V	118	QAR2424VG	118	QAR2424E	137	QAR2424S	400
	36"	914	13	5.9	0.8	QAR2436Z	118	QAR2436C	124	QAR2436V	133	QAR2436VG	133	QAR2436E	142	QAR2436S	407
	48"	1219	16	7.3	1.2	QAR2448Z	133	QAR2448C	142	QAR2448V	157	QAR2448VG	157	QAR2448E	167	QAR2448S	482

Note: MICROGARD® antimicrobial protection standard on all EAGLEgard® shelving.

Quad-Adjust® 4-Tier Starter Units — Convenient easy-to-order starter unit kits.

see product announcement **EG8115M**



Consists of (2) standard wire shelves, (2) Quad-Adjust® shelves (patent #7,992,731), and (4) 74" (1880mm) posts.

	length		weight		cu ft	EAGLEbrite®		chrome		VALU-MASTER®		Valu-Gard®		EAGLEgard®		stainless steel	
	in.	mm	lb.	kg		model #	list	model #	list	model #	list	model #	list	model #	list	model #	list
18" width (457mm)	36"	914	65	40	2.7	F2QA2-74-1836Z	412	F2QA2-74-1836C	424	F2QA2-74-1836V	456	F2QA2-74-1836VG	456	F2QA2-74-1836E	496	F2QA2-74-1836S	1380
	48"	1219	78	36	3.6	F2QA2-74-1848Z	452	F2QA2-74-1848C	472	F2QA2-74-1848V	516	F2QA2-74-1848VG	516	F2QA2-74-1848E	564	F2QA2-74-1848S	1582
	60"	1524	102	46	4.3	F2QA2-74-1860Z	504	F2QA2-74-1860C	530	F2QA2-74-1860V	580	F2QA2-74-1860VG	580	F2QA2-74-1860E	636	F2QA2-74-1860S	1920
	72"	1819	117	53	5.1	F2QA2-74-1872Z	566	F2QA2-74-1872C	598	F2QA2-74-1872V	654	F2QA2-74-1872VG	654	F2QA2-74-1872E	704	F2QA2-74-1872S	2214
24" width (610mm)	36"	914	81	37	3.6	F2QA2-74-2436Z	456	F2QA2-74-2436C	484	F2QA2-74-2436V	520	F2QA2-74-2436VG	520	F2QA2-74-2436E	568	F2QA2-74-2436S	1138
	48"	1219	98	45	4.6	F2QA2-74-2448Z	516	F2QA2-74-2448C	552	F2QA2-74-2448V	602	F2QA2-74-2448VG	602	F2QA2-74-2448E	658	F2QA2-74-2448S	1308
	60"	1524	122	55	5.7	F2QA2-74-2460Z	594	F2QA2-74-2460C	626	F2QA2-74-2460V	684	F2QA2-74-2460VG	684	F2QA2-74-2460E	744	F2QA2-74-2460S	1508
	72"	1819	149	68	6.9	F2QA2-74-2472Z	662	F2QA2-74-2472C	712	F2QA2-74-2472V	776	F2QA2-74-2472VG	776	F2QA2-74-2472E	842	F2QA2-74-2472S	1774

Note: MICROGARD® antimicrobial protection standard on all EAGLEgard® shelving.

NEW QuadPLUS® 5-Tier Starter Units — Convenient easy-to-order starter unit kits.

Consists of: (1) Standard collar truss frame with louvered QuadPLUS® blue shelf mats; (3) Quad-Adjust® collar truss frames with louvered QuadPLUS® blue shelf mats; (1) Standard collar truss frame with solid QuadPLUS® blue shelf mats; and (4) 74" (1880mm) posts. Mobile units feature 5" (127mm) resilient swivel stem casters—two with brake.

	length		...with Valu-Master® epoxy finish*				...with chrome finish*			
	in.	mm	STATIONARY		MOBILE		STATIONARY		MOBILE	
			model #	list	model #	list	model #	list	model #	list
18" width (457mm)	36"	914	QPSU1836V-B5-74	617	QPMU1836V-B5-74	735	QPSU1836C-B5-74	585	QPMU1836C-B5-74	703
	48"	1219	QPSU1848V-B5-74	718	QPMU1848V-B5-74	936	QPSU1848C-B5-74	598	QPMU1848C-B5-74	716
	60"	1524	QPSU1860V-B5-74	835	QPMU1860V-B5-74	953	QPSU1860C-B5-74	793	QPMU1860C-B5-74	911
21" width (533mm)	36"	914	QPSU2136V-B5-74	673	QPMU2136V-B5-74	791	QPSU2136C-B5-74	641	QPMU2136C-B5-74	759
	48"	1219	QPSU2148V-B5-74	773	QPMU2148V-B5-74	891	QPSU2148C-B5-74	736	QPMU2148C-B5-74	854
	60"	1524	QPSU2160V-B5-74	892	QPMU2160V-B5-74	1010	QPSU2160C-B5-74	850	QPMU2160C-B5-74	968
24" width (610mm)	36"	914	QPSU2436V-B5-74	726	QPMU2436V-B5-74	844	QPSU2436C-B5-74	689	QPMU2436C-B5-74	807
	48"	1219	QPSU2448V-B5-74	862	QPMU2448V-B5-74	980	QPSU2448C-B5-74	820	QPMU2448C-B5-74	938
	60"	1524	QPSU2460V-B5-74	1001	QPMU2460V-B5-74	1119	QPSU2460C-B5-74	954	QPMU2460C-B5-74	1072

Optional QuadPLUS® Dividers — 8" (203mm) height.

length	w/chrome		w/Valu-Master®			
	in.	mm	model #	list	model #	list
18"	457	QPSD18-C	65	QPSD18-V	66	
21"	533	QPSD21-C	66	QPSD21-V	67	
24"	610	QPSD24-C	70	QPSD24-V	71	



Catalog Section 1

QuadPLUS® Polymer Shelf Mats...

see product announcement **EG8147M**

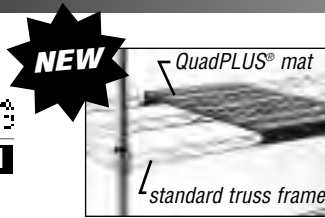

FEATURES

- Blue* polymer louvered or solid shelf mats.
- MICROGARD® antimicrobial protection standard on mats.
- Easy assembly—no tools required!

Note: Shelf mats also fit on wire shelves (pages 6 & 7).

Note: Packaging is the same as that of Wire Shelves (page 6).

...with Standard Wire Truss Frame...

						...with Valu-Master® gray epoxy finish*				...with chrome finish*			
	length		weight		cu	w/louvered mats		w/solid mats		w/louvered mats		w/solid mats	
	in.	mm	lb.	kg	ft	model #	list	model #	list	model #	list	model #	list
18" width (457mm)	24"	610	7	3.2	0.7	QPF-1824V-BL	87	QPF-1824V-BS	92	QPF-1824C-BL	83	QPF-1824C-BS	87
	30"	762	8	3.6	0.7	QPF-1830V-BL	92	QPF-1830V-BS	97	QPF-1830C-BL	87	QPF-1830C-BS	92
	36"	914	10	4.5	0.7	QPF-1836V-BL	92	QPF-1836V-BS	97	QPF-1836C-BL	87	QPF-1836C-BS	92
	42"	1067	11	5.0	0.9	QPF-1842V-BL	110	QPF-1842V-BS	117	QPF-1842C-BL	105	QPF-1842C-BS	111
	48"	1219	12	5.4	0.9	QPF-1848V-BL	110	QPF-1848V-BS	117	QPF-1848C-BL	105	QPF-1848C-BS	111
	54"	1372	15	6.8	1.2	QPF-1854V-BL	131	QPF-1854V-BS	138	QPF-1854C-BL	124	QPF-1854C-BS	131
	60"	1524	17	7.7	1.2	QPF-1860V-BL	131	QPF-1860V-BS	138	QPF-1860C-BL	124	QPF-1860C-BS	131
21" width (533mm)	72"	1829	20	9.0	1.3	QPF-1872V-BL	149	QPF-1872V-BS	157	QPF-1872C-BL	142	QPF-1872C-BS	149
	24"	610	8	3.6	0.7	QPF-2124V-BL	99	QPF-2124V-BS	104	QPF-2124C-BL	94	QPF-2124C-BS	99
	30"	762	9	4.1	0.7	QPF-2130V-BL	102	QPF-2130V-BS	107	QPF-2130C-BL	97	QPF-2130C-BS	102
	36"	914	11	5.0	0.8	QPF-2136V-BL	102	QPF-2136V-BS	107	QPF-2136C-BL	97	QPF-2136C-BS	102
	42"	1067	13	5.9	1.1	QPF-2142V-BL	120	QPF-2142V-BS	126	QPF-2142C-BL	114	QPF-2142C-BS	120
	48"	1219	14	6.4	1.1	QPF-2148V-BL	120	QPF-2148V-BS	126	QPF-2148C-BL	114	QPF-2148C-BS	120
	54"	1372	16	7.3	1.3	QPF-2154V-BL	141	QPF-2154V-BS	149	QPF-2154C-BL	134	QPF-2154C-BS	142
24" width (610mm)	60"	1524	18	8.2	1.3	QPF-2160V-BL	141	QPF-2160V-BS	149	QPF-2160C-BL	134	QPF-2160C-BS	142
	72"	1829	23	10.4	1.4	QPF-2172V-BL	172	QPF-2172V-BS	182	QPF-2172C-BL	163	QPF-2172C-BS	173
	24"	610	10	4.5	0.8	QPF-2424V-BL	109	QPF-2424V-BS	116	QPF-2424C-BL	104	QPF-2424C-BS	110
	30"	762	11	5.0	0.8	QPF-2430V-BL	111	QPF-2430V-BS	118	QPF-2430C-BL	105	QPF-2430C-BS	112
	36"	914	13	5.9	0.8	QPF-2436V-BL	111	QPF-2436V-BS	118	QPF-2436C-BL	105	QPF-2436C-BS	112
	42"	1067	15	6.8	1.2	QPF-2442V-BL	136	QPF-2442V-BS	142	QPF-2442C-BL	129	QPF-2442C-BS	135
	48"	1219	16	7.3	1.2	QPF-2448V-BL	136	QPF-2448V-BS	142	QPF-2448C-BL	129	QPF-2448C-BS	135
	54"	1372	19	8.6	1.5	QPF-2454V-BL	161	QPF-2454V-BS	169	QPF-2454C-BL	153	QPF-2454C-BS	161
	60"	1524	21	9.5	1.5	QPF-2460V-BL	161	QPF-2460V-BS	169	QPF-2460C-BL	153	QPF-2460C-BS	161
	72"	1829	25	11.3	1.6	QPF-2472V-BL	188	QPF-2472V-BS	198	QPF-2472C-BL	179	QPF-2472C-BS	188

...with Quad-Adjust® Truss Frame...

						...with Valu-Master® gray epoxy finish*				...with chrome finish*			
	length		weight		cu	w/louvered mats		w/solid mats		w/louvered mats		w/solid mats	
	in.	mm	lb.	kg	ft	model #	list	model #	list	model #	list	model #	list
18" width (457mm)	24"	610	7	3.2	0.7	QPF-QA1824V-BL	102	QPF-QA1824V-BS	108	QPF-QA1824C-BL	98	QPF-QA1824C-BS	102
	30"	762	8	3.6	0.7	QPF-QA1830V-BL	108	QPF-QA1830V-BS	114	QPF-QA1830C-BL	102	QPF-QA1830C-BS	108
	36"	914	10	4.5	0.7	QPF-QA1836V-BL	108	QPF-QA1836V-BS	114	QPF-QA1836C-BL	102	QPF-QA1836C-BS	108
	42"	1067	11	5.0	0.9	QPF-QA1842V-BL	129	QPF-QA1842V-BS	138	QPF-QA1842C-BL	124	QPF-QA1842C-BS	131
	48"	1219	12	5.4	0.9	QPF-QA1848V-BL	129	QPF-QA1848V-BS	138	QPF-QA1848C-BL	124	QPF-QA1848C-BS	131
	54"	1372	15	6.8	1.2	QPF-QA1854V-BL	154	QPF-QA1854V-BS	162	QPF-QA1854C-BL	146	QPF-QA1854C-BS	154
	60"	1524	17	7.7	1.2	QPF-QA1860V-BL	154	QPF-QA1860V-BS	162	QPF-QA1860C-BL	146	QPF-QA1860C-BS	154
21" width (533mm)	72"	1829	20	9.0	1.3	QPF-QA1872V-BL	175	QPF-QA1872V-BS	185	QPF-QA1872C-BL	167	QPF-QA1872C-BS	175
	24"	610	8	3.6	0.7	QPF-QA2124V-BL	116	QPF-QA2124V-BS	122	QPF-QA2124C-BL	111	QPF-QA2124C-BS	116
	30"	762	9	4.1	0.7	QPF-QA2130V-BL	120	QPF-QA2130V-BS	126	QPF-QA2130C-BL	114	QPF-QA2130C-BS	120
	36"	914	11	5.0	0.8	QPF-QA2136V-BL	120	QPF-QA2136V-BS	126	QPF-QA2136C-BL	114	QPF-QA2136C-BS	120
	42"	1067	13	5.9	1.1	QPF-QA2142V-BL	141	QPF-QA2142V-BS	148	QPF-QA2142C-BL	134	QPF-QA2142C-BS	141
	48"	1219	14	6.4	1.1	QPF-QA2148V-BL	141	QPF-QA2148V-BS	148	QPF-QA2148C-BL	134	QPF-QA2148C-BS	141
	54"	1372	16	7.3	1.3	QPF-QA2154V-BL	166	QPF-QA2154V-BS	175	QPF-QA2154C-BL	158	QPF-QA2154C-BS	167
24" width (610mm)	60"	1524	18	8.2	1.3	QPF-QA2160V-BL	166	QPF-QA2160V-BS	175	QPF-QA2160C-BL	158	QPF-QA2160C-BS	167
	72"	1829	23	10.4	1.4	QPF-QA2172V-BL	202	QPF-QA2172V-BS	214	QPF-QA2172C-BL	192	QPF-QA2172C-BS	204
	24"	610	10	4.5	0.8	QPF-QA2424V-BL	128	QPF-QA2424V-BS	136	QPF-QA2424C-BL	122	QPF-QA2424C-BS	129
	30"	762	11	5.0	0.8	QPF-QA2430V-BL	131	QPF-QA2430V-BS	139	QPF-QA2430C-BL	124	QPF-QA2430C-BS	132
	36"	914	13	5.9	0.8	QPF-QA2436V-BL	131	QPF-QA2436V-BS	139	QPF-QA2436C-BL	124	QPF-QA2436C-BS	132
	42"	1067	15	6.8	1.2	QPF-QA2442V-BL	160	QPF-QA2442V-BS	167	QPF-QA2442C-BL	152	QPF-QA2442C-BS	159
	48"	1219	16	7.3	1.2	QPF-QA2448V-BL	160	QPF-QA2448V-BS	167	QPF-QA2448C-BL	152	QPF-QA2448C-BS	159
	54"	1372	19	8.6	1.5	QPF-QA2454V-BL	189	QPF-QA2454V-BS	199	QPF-QA2454C-BL	180	QPF-QA2454C-BS	189
	60"	1524	21	9.5	1.5	QPF-QA2460V-BL	189	QPF-QA2460V-BS	199	QPF-QA2460C-BL	180	QPF-QA2460C-BS	189
	72"	1829	25	11.3	1.6	QPF-QA2472V-BL	221	QPF-QA2472V-BS	233	QPF-QA2472C-BL	211	QPF-QA2472C-BS	221

*Available with green polymer mats and truss frames coated with EAGLEgard® green epoxy (w/MICROGARD®) or Valu-Gard® green epoxy finish—see EG8153M.



100 Industrial Boulevard, Clayton, DE 19938-8903 U.S.A.
Phone: 800-637-5100 or 302-653-3000. Fax: 302-653-2065
<http://www.eaglegrp.com>

Posts

see spec sheets **EG01.00** **EG01.01** **EG01.11A** **EG01.14**

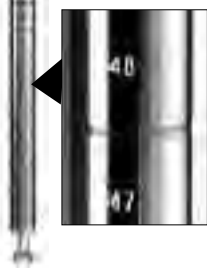

Posts are numbered on vertical 1" (25mm) increments to help ensure fast and level assembly.

- Height includes leveling bolt and cap.
- EAGLEbrite® posts feature air-dry lacquer and can be used for walk-in coolers.

FEATURES:

Notes: For special length post, apply price at next higher length plus a cutting charge of **\$11.00 list per post.**

See page 11 for appropriate stem casters.

Freight class is 50.0.

(•) MTS (made to stock) / () MTO (made to order)

For Stationary Applications

height		cu	weight		EAGLEbrite®		chrome		Valu-Gard®		VALU-MASTER®		EAGLEgard®		stainless steel	
in.	mm	ft	lb.	kg	model #	list	model #	list	model #	list	model #	list	model #	list	model #	list
7"	178	0.1	1.0	0.5	P7-Z •	10	P7-C	11	P7-VG	12	P7-V	12	P7-E •	14	P7-S	29
14"	356	0.1	1.0	0.5	P14-Z •	12	P14-C •	13	P14-VG	14	P14-V	14	P14-E •	15	P14-S	31
18"	457	0.1	1.5	0.7	P18-Z •	14	P18-C •	15	P18-VG	16	P18-V	16	P18-E	22	P18-S •	44
33"	838	0.1	2.0	0.9	P33-Z •	15	P33-C •	16	P33-VG •	18	P33-V •	18	P33-E •	23	P33-S •	51
54"	1372	0.1	3.0	1.4	P54-Z •	21	P54-C •	22	P54-VG •	23	P54-V •	23	P54-E •	24	P54-S •	57
63"	1600	0.3	3.5	1.8	P63-Z •	22	P63-C •	23	P63-VG •	24	P63-V •	24	P63-E •	27	P63-S •	64
74"	1880	0.5	4.0	1.8	P74-Z •	23	P74-C •	25	P74-VG •	26	P74-V •	26	P74-E •	29	P74-S •	72
86"	2184	0.8	5.0	2.3	P86-Z •	28	P86-C •	30	P86-VG •	30	P86-V •	30	P86-E •	34	P86-S •	82
96"	2438	0.9	6.0	2.7	n/a		P96-C •*	35	n/a		n/a		n/a		P96-S •*	92

* 96" (2438mm) posts are NOT to be used on units less than 24" (610mm) front-to-back. Recommend using in conjunction with foot plates to affix to floor, and with post clamps where applicable.

For Mobile Applications

height		cu	weight		EAGLEbrite®		chrome		Valu-Gard®		VALU-MASTER®		EAGLEgard®		stainless steel	
in.	mm	ft	lb.	kg	model #	list	model #	list	model #	list	model #	list	model #	list	model #	list
7"	178	0.1	1.0	0.5	CP7-Z	10	CP7-C	11	CP7-VG	12	CP7-V	12	CP7-E	14	CP7-S	29
14"	356	0.1	1.0	0.5	CP14-Z	12	CP14-C	13	CP14-VG	14	CP14-V	14	CP14-E	15	CP14-S	31
18"	457	0.1	1.5	0.7	CP18-Z	14	CP18-C	15	CP18-VG	16	CP18-V	16	CP18-E	22	CP18-S	44
33"	838	0.1	2.0	0.9	CP33-Z •	15	CP33-C •	16	CP33-VG •	18	CP33-V	18	CP33-E	23	CP33-S •	51
54"	1372	0.1	3.0	1.4	CP54-Z •	21	CP54-C •	22	CP54-VG	23	CP54-V	23	CP54-E	24	CP54-S	57
63"	1600	0.3	3.5	1.8	CP63-Z •	22	CP63-C •	23	CP63-VG •	24	CP63-V •	24	CP63-E •	27	CP63-S •	64
74"	1880	0.5	4.0	1.8	CP74-Z •	23	CP74-C •	25	CP74-VG •	26	CP74-V •	26	CP74-E •	29	CP74-S •	72
86"	2184	0.8	5.0	2.3	CP86-Z •	28	CP86-C •	30	CP86-VG •	30	CP86-V	30	CP86-E •	34	CP86-S	82

Cantilever Shelves

see spec sheet **EG01.03E**



- 1" (25mm) wraparound ledge.
- 12" (305mm) wide shelves.

FEATURES:

NOTE: When ordering back posts, confirm with customer service, the correct post height to accommodate these shelves.

Freight class is 70.0.

(•) MTS (made to stock) / () MTO (made to order)

length		weight		cubic	chrome		stainless steel	
in.	mm	lb.	kg	feet	model #	list	model #	list
24"	610	5	2.3	0.5	CS1224-C	57	CS1224-S	182
30"	762	5	2.3	0.8	CS1230-C	61	CS1230-S	198
36"	914	6	2.7	0.8	CS1236-C	63	CS1236-S	207
42"	1067	7	3.2	0.9	CS1242-C	70	CS1242-S	219
48"	1219	8	3.6	1.0	CS1248-C •	73	CS1248-S	230
54"	1372	9	4.1	1.1	CS1254-C	79	CS1254-S	244
60"	1524	10	4.5	1.3	CS1260-C •	85	CS1260-S	269

Ideal for adding extra storage above an existing shelving unit.

Packaged two per box.



Catalog Section 1

Stem Casters

see spec sheet **EG01.05A**

Note: Decorative stem casters also available (see page 58).
Conductive stem casters available (see page 136).
These casters cannot be used with Master Trak®.

FEATURES:

- Use with posts.
- Donut bumpers.
- Swivel casters have a temperature rating of -15°F.

Freight class is 65.0.

(•) MTS (made to stock) / () MTO (made to order)

Cart-Washable Casters

- Features stainless steel boot, swivel stem, sealed precision bearings, and polyurethane wheels.

type	capacity		wheel diameter		wheel face		weight		cubic feet	model #	list
	lbs.	kg	in.	mm	in.	mm	lbs.	kg			
stem/swivel	300	136.1	5"	127	1¼"	32	2.0	0.9	0.1	A222152	126
stem/brake	300	136.1	5"	127	1¼"	32	2.0	0.9	0.1	A222153	138



Add mobility to your stationary unit.

resilient

Resilient

type	wheel diameter		wheel face		weight		cu ft	zinc				stainless steel			
	in.	mm	in.	mm	lbs.	kg		capacity		model #	list	capacity		model #	list
stem/swivel	4"	102	1"	25	1.1	0.5	0.1	125	56.7			CSS4-125•	22		
stem/swivel	5"	127	1"	25	2.0	0.9	0.1	125	56.7	CSS5-125•	24	n/a	n/a	n/a	n/a
stem/swivel	5"	127	1¼"	32	2.5	1.2	0.1	300	136.1	CSS5-300•	27	200	90.7	CSS5S-200	131
stem/brake	5"	127	1¼"	32	2.8	1.3	0.1	300	136.1	CSB5-300•	32	200	90.7	CSB5S-200	144
stem/rigid ▼	5"	127	1¼"	32	3.5	1.6	0.1	300	136.1	CSR5-300•	30	200	90.7	CSR5S-200	126

Polyurethane

type	capacity		wheel diameter		wheel face		weight		cu ft	nickel plated		stainless steel	
	lbs.	kg	in.	mm	in.	mm	lbs.	kg		model #	list	model #	list
stem/swivel	300	136.1	5"	127	1¼"	32	2.5	1.2	0.1	CSS5P-300•	44	CSS5PS-300•	137
stem/brake	300	136.1	5"	127	1¼"	32	2.8	1.3	0.1	CSB5P-300•	48	CSB5PS-300•	151
stem/rigid ▼	300	136.1	5"	127	1¼"	32	3.5	1.6	0.1	CSR5P-300•	49	CSR5PS-300	126



(nickel plated) swivel stem caster with polyurethane tread

Polymer Casters

- Corrosion-resistant stainless steel axle, zinc plated stem, polymer horn, and 5" (127mm) diameter polyurethane wheel.

type	type of bearing	capacity		wheel diameter		wheel face		weight		cu ft	model #	list
		lbs.	kg	in.	mm	in.	mm	lbs.	kg			
stem/swivel	delrin	250	113.4	5"	127	1¼"	32	2.0	0.9	0.1	CPSS5-250•	71
stem/brake	delrin	250	113.4	5"	127	1¼"	32	2.0	0.9	0.1	CPSB5-250•	87



▼ Channel Frames for Rigid Stem Casters

Please note: Shelf width must be known when ordering rigid stem casters in order to ship appropriate channel frame to lock rigid casters.

shelf width		weight		cubic feet	model #	list
in.	mm	lbs.	kg			
14"	356	1.5	0.7	0.1	A201706	14
18"	457	2.0	0.9	0.1	A201007	19
21"	533	2.5	1.1	0.1	A201008	24
24"	610	2.8	1.3	0.1	A201009	24
30"	762	3.5	1.6	0.1	A204795	26
36"	914	4.0	1.8	0.1	A207562	27



channel frame for rigid stem casters

Replacement Donut Bumpers for Stem Casters

description	model #	list
3½" (89mm) diameter	A200019•	7
5" (127mm) diameter, with swivel center	A213261•	12



donut bumper

Plate Casters

see spec sheet **EG01.05B**

Freight class is 65.0.

(•) MTS (made to stock) / () MTO (made to order)

Polymer - Polyurethane tread.

type	capacity		wheel diameter		wheel face		weight		model #	list
	lbs.	kg	in.	mm	in.	mm	lbs.	kg		
stem	250	90.7	5"	127	1 1/4"	32	2.8	1.3	PCPS5-250	55
lock	250	90.7	5"	127	1 1/4"	32	2.8	1.3	PCPL5-250	69



Resilient

type	capacity		wheel diameter		wheel face		weight		cu ft	EAGLEbrite® zinc	
	lbs.	kg	in.	mm	in.	mm	lbs.	kg		model #	list
swivel	200	90.7	5"	127	1 1/4"	29	2.8	1.3	0.5	CPS5-200	35
brake	200	90.7	5"	127	1 1/4"	29	2.8	1.3	0.5	CPB5-200	39
rigid	200	90.7	5"	127	1 1/4"	29	2.8	1.3	0.5	CPR5-200	39
swivel	250	90.7	5"	127	1 1/4"	32	3.0	1.4	0.5	CPS5-250 •	45
brake	250	90.7	5"	127	1 1/4"	32	3.0	1.4	0.5	CPB5-250	48
rigid	250	90.7	5"	127	1 1/4"	32	3.0	1.4	0.5	CPR5-250	48
swivel	500	226.8	6"	152	2"	51	9.0	4.1	0.5	CPS6-500	67
brake	500	226.8	6"	152	2"	51	9.0	4.1	0.5	CPB6-500	75
rigid	500	226.8	6"	152	2"	51	9.0	4.1	0.5	CPR6-500	67



Polyurethane

type	capacity		wheel diameter		wheel face		weight		cu ft	EAGLEbrite® zinc	
	lbs.	kg	in.	mm	in.	mm	lbs.	kg		model #	list
swivel	300	136.1	5"	127	1 1/4"	32	3.0	1.4	0.5	CPS5P-300 •	39
brake	300	136.1	5"	127	1 1/4"	32	3.0	1.4	0.5	CPB5P-300 •	43
rigid	300	136.1	5"	127	1 1/4"	32	3.0	1.4	0.5	CPR5P-300	40
swivel	500	226.8	5"	127	2"	51	8.0	3.6	0.5	CPS5P-500 •	79
brake	500	226.8	5"	127	2"	51	8.0	3.6	0.5	CPB5P-500 •	90
rigid	500	226.8	5"	127	2"	51	8.0	3.6	0.5	CPR5P-500	90
swivel	600	272.1	6"	152	2"	51	9.0	4.1	0.5	CPS6P-600 •	87
brake	600	272.1	6"	152	2"	51	9.0	4.1	0.5	CPB6P-600 •	99
rigid	600	272.1	6"	152	2"	51	9.0	4.1	0.5	CPR6P-600	99
swivel	700	317.5	8"	203	2"	51	10.5	4.8	1.0	CPS8P-700	99
brake	700	317.5	8"	203	2"	51	10.5	4.8	1.0	CPB8P-700	110
rigid	700	317.5	8"	203	2"	51	10.5	4.8	1.0	CPR8P-700	110



with brake

Swivel/Lock Casters - Polyurethane tread.

type	capacity		wheel diameter		wheel face		weight		cu ft	EAGLEbrite® zinc	
	lbs.	kg	in.	mm	in.	mm	lbs.	kg		model #	list
swivel/lock	800	362.9	6"	152	2"	51	9.0	4.1	1.0	CPL6Z-800	164
swivel	800	362.9	6"	152	2"	51	9.0	4.1	1.0	CPS6Z-800	68
rigid	800	362.9	6"	152	2"	51	9.0	4.1	1.0	CPR6Z-800	64
brake	800	362.9	6"	152	2"	51	9.0	4.1	1.0	CPB6Z-800	81
swivel/lock	900	408.2	8"	203	2"	51	10.0	4.8	1.0	CPL8Z-900	170
swivel	900	408.2	8"	203	2"	51	10.0	4.8	1.0	CPS8Z-900	77
rigid	900	408.2	8"	203	2"	51	10.0	4.8	1.0	CPR8Z-900	70
brake	900	408.2	8"	203	2"	51	10.0	4.8	1.0	CPB8Z-900	89



Stainless Steel Pressure Washable Casters - Polyurethane tread.

type	capacity		wheel diameter		wheel face		weight		cu ft	stainless steel	
	lbs.	kg	in.	mm	in.	mm	lbs.	kg		model #	list
swivel/lock	300	136.1	5"	127	1 1/4"	32	3.0	1.4	0.5	CPCM5S-300	146
swivel	300	136.1	5"	127	1 1/4"	32	3.0	1.4	0.5	CPS5S-300	130
brake	300	136.1	5"	127	1 1/4"	32	3.0	1.4	0.5	CPB5S-300	142



with brake

Catalog Section 1

Solid Shelves

see spec sheet **EG01.01**

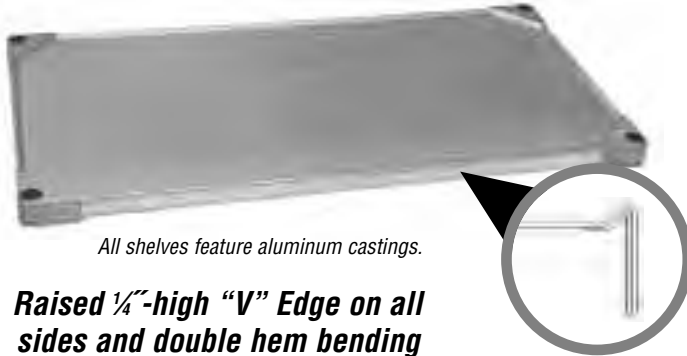

All shelves feature aluminum castings.

Raised 1/4"-high "V" Edge on all sides and double hem bending provides quality and strength!

side view of solid shelf, showing raised "V" edge

WEIGHT CAPACITY:

- Shelves up to 48" (1219mm): 600 lb. (272 kg).
- 54"-72" (1372-1829mm) shelves: 400 lb. (181 kg) - evenly distributed static load.

PACKAGING:

- 24"-48" (610-1219mm) lengths: Four per box.
- 54"-72" (1372-1829mm) lengths: Two per box.
- Four pairs of split sleeves per shelf.

All items can be shipped UPS.

Note: For cleanroom applications add prefix "CR" to stainless steel model number. **Example: CRSS1424S.**

Freight class is 70.0.

(•) MTS (made to stock) / () MTO (made to order)

	length		weight		cu ft	galvanized		VALU-MASTER®		Valu-Gard®		stainless	
	in.	mm	lb.	kg		model #	list	model #	list	model #	list	model #	list
14" width (356mm)	24"	610	10	4.5	0.5	SS1424G	129	SS1424V	141	SS1424VG	141	SS1424S	215
	30"	762	12	5.5	0.5	SS1430G	131	SS1430V	144	SS1430VG	144	SS1430S	223
	36"	914	14	6.4	0.5	SS1436G	138	SS1436V	149	SS1436VG	149	SS1436S •	223
	42"	1067	15	6.8	0.7	SS1442G	141	SS1442V	156	SS1442VG	156	SS1442S	268
	48"	1219	17	7.7	0.7	SS1448G	143	SS1448V	158	SS1448VG	158	SS1448S •	268
	54"	1372	20	9.1	0.9	SS1454G	155	SS1454V	171	SS1454VG	171	SS1454S	292
	60"	1524	22	10.0	0.9	SS1460G	156	SS1460V	177	SS1460VG	177	SS1460S •	320
72"	1829	26	11.8	1.1	SS1472G	163	SS1472V	186	SS1472VG	186	SS1472S	372	
18" width (457mm)	24"	610	11	5.0	0.7	SS1824G	128	SS1824V	144	SS1824VG	144	SS1824S •	244
	30"	762	14	6.4	0.7	SS1830G	134	SS1830V	147	SS1830VG	147	SS1830S •	249
	36"	914	16	7.3	0.7	SS1836G •	137	SS1836V	154	SS1836VG	154	SS1836S •	249
	42"	1067	18	8.2	0.9	SS1842G	145	SS1842V	160	SS1842VG	160	SS1842S	306
	48"	1219	20	9.1	0.9	SS1848G •	147	SS1848V •	163	SS1848VG	163	SS1848S •	306
	54"	1372	22	10.0	1.2	SS1854G	159	SS1854V	177	SS1854VG	177	SS1854S	346
	60"	1524	24	10.9	1.2	SS1860G •	162	SS1860V	180	SS1860VG	180	SS1860S •	366
72"	1829	28	12.7	1.3	SS1872G	169	SS1872V	192	SS1872VG	192	SS1872S •	440	
21" width (533mm)	24"	610	13	5.9	0.7	SS2124G	138	SS2124V	153	SS2124VG	153	SS2124S	272
	30"	762	15	6.8	0.7	SS2130G	141	SS2130V	157	SS2130VG	157	SS2130S	278
	36"	914	18	8.2	0.8	SS2136G	151	SS2136V	166	SS2136VG	166	SS2136S •	278
	42"	1067	21	9.5	1.1	SS2142G	154	SS2142V	171	SS2142VG	171	SS2142S	349
	48"	1219	23	10.5	1.1	SS2148G	158	SS2148V	175	SS2148VG	175	SS2148S	349
	54"	1372	25	11.4	1.3	SS2154G	170	SS2154V	191	SS2154VG	191	SS2154S	363
	60"	1524	28	12.7	1.3	SS2160G	170	SS2160V	193	SS2160VG	193	SS2160S	428
72"	1829	30	13.6	1.4	SS2172G	185	SS2172V	255	SS2172VG	255	SS2172S	466	
24" width (610mm)	24"	610	15	6.8	0.8	SS2424G •	139	SS2424V	154	SS2424VG	154	SS2424S •	294
	30"	762	17	7.7	0.8	SS2430G	143	SS2430V	157	SS2430VG	157	SS2430S	300
	36"	914	19	8.6	0.8	SS2436G •	152	SS2436V •	167	SS2436VG	167	SS2436S •	300
	42"	1067	23	10.5	1.0	SS2442G	157	SS2442V	176	SS2442VG	176	SS2442S •	365
	48"	1219	24	10.9	1.2	SS2448G •	162	SS2448V	179	SS2448VG	179	SS2448S •	365
	54"	1372	27	12.3	1.5	SS2454G	175	SS2454V	194	SS2454VG	194	SS2454S	410
	60"	1524	31	14.1	1.5	SS2460G •	179	SS2460V	201	SS2460VG	201	SS2460S •	430
72"	1829	33	15.0	1.6	SS2472G •	190	SS2472V	218	SS2472VG	218	SS2472S •	504	

Solid Shelf Joining Clamp

see spec sheet **EG01.03D**



model # **list per pair**

A203078 26

Note: Two required per shelf.

FEATURES:

- Clamp and two additional posts create various shelving add-on configurations.
- Joins shelves end-to-end, back-to-back, or at right angles.

(•) MTS (made to stock) / () MTO (made to order)



100 Industrial Boulevard, Clayton, DE 19938-8903 U.S.A.
 Phone: 800-637-5100 or 302-653-3000. Fax: 302-653-2065
<http://www.eaglegrp.com>

Seismic Shelving

see spec sheet **EG01.27**

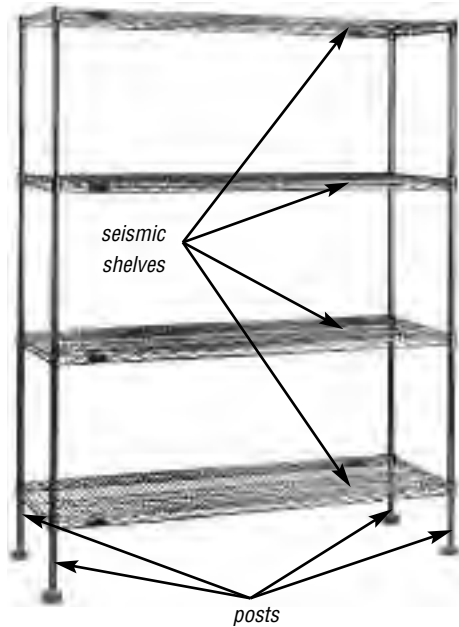

Designed to withstand earthquakes without labor-intensive sway braces.

- 24"-48" (610-1219mm) lengths: Four per box.
- 54"-60" (1372-1524mm) lengths: Two per box.
- Four pairs of aluminum split sleeves per shelf.

PACKAGING:

Note: Shelves and posts sold separately.

Freight class is 70.0.

(•) MTS (made to stock) / () MTO (made to order)



(Patent #5,390,803)

Patented QuadTruss® Design makes shelves up to 25% stronger and provides a retaining ledge for increased strength and product retention.

Shelves

	length		weight		cu ft	EAGLEbrite®		chrome	
	in.	mm	lb.	kg		model #	list	model #	list
18" width (457mm)	24"	610	7	3.2	0.7	SA1824Z	74	SA1824C	81
	30"	762	9	4.1	0.7	SA1830Z	81	SA1830C	91
	36"	914	10	4.5	0.7	SA1836Z	88	SA1836C	96
	42"	1067	12	5.4	0.9	SA1842Z	96	SA1842C	104
	48"	1219	13	5.8	0.9	SA1848Z	105	SA1848C	113
	54"	1372	14	6.4	1.2	SA1854Z	119	SA1854C	129
21" width (533mm)	60"	1524	18	8.2	1.2	SA1860Z	120	SA1860C	132
	24"	610	8	3.6	0.7	SA2124Z	82	SA2124C	90
	30"	762	10	4.5	0.7	SA2130Z	90	SA2130C	101
	36"	914	12	5.4	0.8	SA2136Z	98	SA2136C	110
	42"	1067	13	5.8	1.1	SA2142Z	107	SA2142C	120
	48"	1219	15	6.8	1.1	SA2148Z	113	SA2148C	134
24" width (610mm)	54"	1372	17	7.7	1.3	SA2154Z	130	SA2154C	143
	60"	1524	19	8.6	1.3	SA2160Z	139	SA2160C	147
	24"	610	9	4.1	0.8	SA2424Z	90	SA2424C	99
	30"	762	12	5.4	0.8	SA2430Z	100	SA2430C	104
	36"	914	14	6.4	0.8	SA2436Z	102	SA2436C	112
	42"	1067	16	7.3	1.0	SA2442Z	112	SA2442C	125
	48"	1219	17	7.7	1.2	SA2448Z	120	SA2448C	136
	54"	1372	18	8.2	1.5	SA2454Z	138	SA2454C	152
	60"	1524	22	10.0	1.5	SA2460Z	146	SA2460C	162

Approved by the California Office of Statewide Health Planning and Development.



Note: OSHPD ongoing evaluation may affect EAGLE GROUP's approve/pre-approve status. Consult factory.

Posts for Seismic Shelving

see spec sheet **EG01.27**

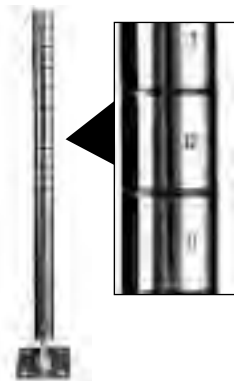

Posts are numbered on vertical 1" (25mm) increments to help ensure fast and level assembly.

- Four staked posts required; per unit.
- Foot plates standard with each post.

FEATURES:

Freight class is 50.0.

(•) MTS (made to stock) / () MTO (made to order)

post height	weight		cu ft	EAGLEbrite®		chrome		
	in.	mm		lb.	kg	model #	list	model #
54"	1372	3.0	1.4	0.003	SAP54-Z	28	SAP54-C	30
63"	1600	3.5	1.6	0.008	SAP63-Z	29	SAP63-C	34
72"	1829	4.0	1.8	0.014	SAP72-Z	30	SAP72-C	35

Catalog Section 1

Four-Shelf Starter Units

see spec sheet **EG01.25**

- Four shelves.
- Four posts (same finish as shelves).
- Shipped knocked-down.

INCLUDES:

Note: 54" (1372mm) shelves available (see page 6).

Freight class is 70.0.

(*) MTS (made to stock) / () MTO (made to order)



EAGLEgard® finish standard with MICROGARD® protection.

See bottom of page 4 for details.



(Patent #5,390,803)

Patented QuadTruss® Design makes shelves up to 25% stronger and provides a retaining ledge for increased strength and product retention.

Models with 63" (1600mm) Height

	length		weight		cu ft	EAGLEbrite®		chrome		VALU-MASTER®		Valu-Gard®		EAGLEgard®		stainless	
	in.	mm	lb.	kg		model #	list	model #	list	model #	list	model #	list	model #	list	model #	list
18" width (457mm)	24"	610	42	19	1.8	S4-63-1824Z • 316	S4-63-1824C • 328	S4-63-1824V • 340	S4-63-1824VG • 340	S4-63-1824E • 388	S4-63-1824S • 1168						
	30"	762	47	21	2.2	S4-63-1830Z • 324	S4-63-1830C • 332	S4-63-1830V • 360	S4-63-1830VG • 360	S4-63-1830E • 400	S4-63-1830S • 1184						
	36"	914	53	24	2.6	S4-63-1836Z • 332	S4-63-1836C • 340	S4-63-1836V • 368	S4-63-1836VG • 368	S4-63-1836E • 412	S4-63-1836S • 1192						
	42"	1067	57	26	3.0	S4-63-1842Z • 368	S4-63-1842C • 388	S4-63-1842V • 400	S4-63-1842VG • 400	S4-63-1842E • 472	S4-63-1842S • 1372						
	48"	1219	63	29	3.5	S4-63-1848Z • 368	S4-63-1848C • 388	S4-63-1848V • 420	S4-63-1848VG • 420	S4-63-1848E • 472	S4-63-1848S • 1372						
	60"	1524	82	37	4.2	S4-63-1860Z • 416	S4-63-1860C • 440	S4-63-1860V • 492	S4-63-1860VG • 492	S4-63-1860E • 540	S4-63-1860S • 1676						
72"	1829	94	43	5.0	S4-63-1872Z • 480	S4-63-1872C • 508	S4-63-1872V • 548	S4-63-1872VG • 548	S4-63-1872E • 608	S4-63-1872S • 1944							
21" width (533mm)	24"	610	46	21	2.1	S4-63-2124Z • 340	S4-63-2124C • 364	S4-63-2124V • 372	S4-63-2124VG • 372	S4-63-2124E • 428	S4-63-2124S • 1312						
	30"	762	52	24	2.6	S4-63-2130Z • 348	S4-63-2130C • 372	S4-63-2130V • 392	S4-63-2130VG • 392	S4-63-2130E • 436	S4-63-2130S • 1324						
	36"	914	59	27	3.0	S4-63-2136Z • 356	S4-63-2136C • 384	S4-63-2136V • 400	S4-63-2136VG • 400	S4-63-2136E • 452	S4-63-2136S • 1332						
	42"	1067	65	30	3.5	S4-63-2142Z • 396	S4-63-2142C • 432	S4-63-2142V • 448	S4-63-2142VG • 448	S4-63-2142E • 512	S4-63-2142S • 1500						
	48"	1219	71	32	4.0	S4-63-2148Z • 396	S4-63-2148C • 432	S4-63-2148V • 452	S4-63-2148VG • 452	S4-63-2148E • 512	S4-63-2148S • 1500						
	60"	1524	88	40	5.0	S4-63-2160Z • 416	S4-63-2160C • 492	S4-63-2160V • 524	S4-63-2160VG • 524	S4-63-2160E • 580	S4-63-2160S • 1912						
72"	1829	98	45	7.8	S4-63-2172Z • 480	S4-63-2172C • 568	S4-63-2172V • 616	S4-63-2172VG • 616	S4-63-2172E • 684	S4-63-2172S • 2216							
24" width (610mm)	24"	610	50	23	2.4	S4-63-2424Z • 356	S4-63-2424C • 380	S4-63-2424V • 396	S4-63-2424VG • 396	S4-63-2424E • 460	S4-63-2424S • 1396						
	30"	762	57	26	2.9	S4-63-2430Z • 364	S4-63-2430C • 392	S4-63-2430V • 416	S4-63-2430VG • 416	S4-63-2430E • 468	S4-63-2430S • 1404						
	36"	914	65	30	3.5	S4-63-2436Z • 376	S4-63-2436C • 400	S4-63-2436V • 424	S4-63-2436VG • 424	S4-63-2436E • 476	S4-63-2436S • 1420						
	42"	1067	72	33	3.6	S4-63-2442Z • 432	S4-63-2442C • 460	S4-63-2442V • 492	S4-63-2442VG • 492	S4-63-2442E • 560	S4-63-2442S • 1664						
	48"	1219	79	36	4.5	S4-63-2448Z • 432	S4-63-2448C • 460	S4-63-2448V • 508	S4-63-2448VG • 508	S4-63-2448E • 560	S4-63-2448S • 1664						
	60"	1524	98	45	5.6	S4-63-2460Z • 508	S4-63-2460C • 532	S4-63-2460V • 580	S4-63-2460VG • 580	S4-63-2460E • 644	S4-63-2460S • 1976						
72"	1829	120	55	6.8	S4-63-2472Z • 568	S4-63-2472C • 612	S4-63-2472V • 660	S4-63-2472VG • 660	S4-63-2472E • 736	S4-63-2472S • 2404							

Models with 74" (1880mm) Height

	length		weight		cu ft	EAGLEbrite®		chrome		VALU-MASTER®		Valu-Gard®		EAGLEgard®		stainless	
	in.	mm	lb.	kg		model #	list	model #	list	model #	list	model #	list	model #	list	model #	list
18" width (457mm)	24"	610	51	23	1.9	S4-74-1824Z • 320	S4-74-1824C • 336	S4-74-1824V • 348	S4-74-1824VG • 348	S4-74-1824E • 396	S4-74-1824S • 1200						
	30"	762	58	26	2.3	S4-74-1830Z • 328	S4-74-1830C • 340	S4-74-1830V • 368	S4-74-1830VG • 368	S4-74-1830E • 408	S4-74-1830S • 1216						
	36"	914	65	30	2.7	S4-74-1836Z • 336	S4-74-1836C • 348	S4-74-1836V • 376	S4-74-1836VG • 376	S4-74-1836E • 420	S4-74-1836S • 1224						
	42"	1067	70	32	3.1	S4-74-1842Z • 372	S4-74-1842C • 396	S4-74-1842V • 408	S4-74-1842VG • 408	S4-74-1842E • 480	S4-74-1842S • 1404						
	48"	1219	78	36	3.6	S4-74-1848Z • 372	S4-74-1848C • 396	S4-74-1848V • 428	S4-74-1848VG • 428	S4-74-1848E • 480	S4-74-1848S • 1404						
	60"	1524	102	46	4.3	S4-74-1860Z • 420	S4-74-1860C • 448	S4-74-1860V • 500	S4-74-1860VG • 500	S4-74-1860E • 548	S4-74-1860S • 1708						
72"	1829	117	53	5.1	S4-74-1872Z • 484	S4-74-1872C • 516	S4-74-1872V • 556	S4-74-1872VG • 556	S4-74-1872E • 616	S4-74-1872S • 1976							
21" width (533mm)	24"	610	57	26	2.2	S4-74-2124Z • 344	S4-74-2124C • 372	S4-74-2124V • 380	S4-74-2124VG • 380	S4-74-2124E • 436	S4-74-2124S • 1344						
	30"	762	64	29	2.7	S4-74-2130Z • 352	S4-74-2130C • 380	S4-74-2130V • 400	S4-74-2130VG • 400	S4-74-2130E • 444	S4-74-2130S • 1356						
	36"	914	73	33	3.1	S4-74-2136Z • 360	S4-74-2136C • 392	S4-74-2136V • 408	S4-74-2136VG • 408	S4-74-2136E • 460	S4-74-2136S • 1364						
	42"	1067	81	37	3.6	S4-74-2142Z • 400	S4-74-2142C • 440	S4-74-2142V • 456	S4-74-2142VG • 456	S4-74-2142E • 520	S4-74-2142S • 1532						
	48"	1219	88	40	4.1	S4-74-2148Z • 400	S4-74-2148C • 440	S4-74-2148V • 460	S4-74-2148VG • 460	S4-74-2148E • 520	S4-74-2148S • 1532						
	60"	1524	109	50	5.1	S4-74-2160Z • 420	S4-74-2160C • 500	S4-74-2160V • 532	S4-74-2160VG • 532	S4-74-2160E • 588	S4-74-2160S • 1944						
72"	1829	122	55	7.7	S4-74-2172Z • 484	S4-74-2172C • 576	S4-74-2172V • 624	S4-74-2172VG • 624	S4-74-2172E • 692	S4-74-2172S • 2248							
24" width (610mm)	24"	610	62	28	2.5	S4-74-2424Z • 360	S4-74-2424C • 388	S4-74-2424V • 404	S4-74-2424VG • 404	S4-74-2424E • 468	S4-74-2424S • 1428						
	30"	762	71	32	3.0	S4-74-2430Z • 368	S4-74-2430C • 400	S4-74-2430V • 424	S4-74-2430VG • 424	S4-74-2430E • 476	S4-74-2430S • 1436						
	36"	914	81	37	3.6	S4-74-2436Z • 380	S4-74-2436C • 408	S4-74-2436V • 432	S4-74-2436VG • 432	S4-74-2436E • 484	S4-74-2436S • 1452						
	42"	1067	89	40	3.7	S4-74-2442Z • 436	S4-74-2442C • 468	S4-74-2442V • 500	S4-74-2442VG • 500	S4-74-2442E • 568	S4-74-2442S • 1696						
	48"	1219	98	45	4.6	S4-74-2448Z • 436	S4-74-2448C • 468	S4-74-2448V • 516	S4-74-2448VG • 516	S4-74-2448E • 568	S4-74-2448S • 1696						
	60"	1524	122	55	5.7	S4-74-2460Z • 512	S4-74-2460C • 540	S4-74-2460V • 588	S4-74-2460VG • 588	S4-74-2460E • 652	S4-74-2460S • 2008						
72"	1829	149	68	6.9	S4-74-2472Z • 572	S4-74-2472C • 620	S4-74-2472V • 668	S4-74-2472VG • 668	S4-74-2472E • 744	S4-74-2472S • 2436							



100 Industrial Boulevard, Clayton, DE 19938-8903 U.S.A.
 Phone: 800-637-5100 or 302-653-3000. Fax: 302-653-2065
<http://www.eaglegrp.com>

Four-Shelf Add-On Units

see spec sheet **EG01.25**



EAGLEgard® finish standard
with **MICROGARD®** protection.
See bottom of page 4 for details.

- Four shelves.
- Two posts (same finish as shelves).
- Two "S" hooks per shelf.
- Shipped knocked-down.

INCLUDES:

Note: 54" (1372mm) shelves available see page 6.

Freight class is 70.0.

(•) MTS (made to stock) / () MTO (made to order)



(Patent #5,390,803)

Patented QuadTruss® Design
makes shelves up to 25% stronger and
provides a retaining ledge for increased
strength and product retention.

Models with 63" (1600mm) Height

	length		weight		cu ft	EAGLEbrite®		chrome		VALU-MASTER®		Valu-Gard®		EAGLEgard®		stainless	
	in.	mm	lb.	kg		model #	list	model #	list	model #	list	model #	list	model #	list	model #	list
18" width (457mm)	24"	610	35	16	1.8	A4-63-1824Z •	296	A4-63-1824C •	306	A4-63-1824V •	316	A4-63-1824VG •	316	A4-63-1824E •	358	A4-63-1824S •	1064
	30"	762	40	18	2.2	A4-63-1830Z •	304	A4-63-1830C •	310	A4-63-1830V •	336	A4-63-1830VG •	336	A4-63-1830E •	370	A4-63-1830S •	1080
	36"	914	46	21	2.6	A4-63-1836Z •	312	A4-63-1836C •	318	A4-63-1836V •	344	A4-63-1836VG •	344	A4-63-1836E •	382	A4-63-1836S •	1088
	42"	1067	50	23	3.0	A4-63-1842Z •	348	A4-63-1842C •	366	A4-63-1842V •	376	A4-63-1842VG •	376	A4-63-1842E •	442	A4-63-1842S •	1268
	48"	1219	56	25	3.5	A4-63-1848Z •	348	A4-63-1848C •	366	A4-63-1848V •	396	A4-63-1848VG •	396	A4-63-1848E •	442	A4-63-1848S •	1268
	60"	1524	75	34	4.2	A4-63-1860Z •	396	A4-63-1860C •	418	A4-63-1860V •	468	A4-63-1860VG •	468	A4-63-1860E •	510	A4-63-1860S •	1572
72"	1829	87	40	5.0	A4-63-1872Z •	460	A4-63-1872C •	486	A4-63-1872V •	524	A4-63-1872VG •	524	A4-63-1872E •	578	A4-63-1872S •	1840	
21" width (533mm)	24"	610	39	18	2.1	A4-63-2124Z •	320	A4-63-2124C •	342	A4-63-2124V •	348	A4-63-2124VG •	348	A4-63-2124E •	398	A4-63-2124S •	1208
	30"	762	45	21	2.6	A4-63-2130Z •	328	A4-63-2130C •	350	A4-63-2130V •	368	A4-63-2130VG •	368	A4-63-2130E •	406	A4-63-2130S •	1220
	36"	914	52	24	3.0	A4-63-2136Z •	336	A4-63-2136C •	362	A4-63-2136V •	376	A4-63-2136VG •	376	A4-63-2136E •	422	A4-63-2136S •	1228
	42"	1067	58	26	3.5	A4-63-2142Z •	376	A4-63-2142C •	410	A4-63-2142V •	424	A4-63-2142VG •	424	A4-63-2142E •	482	A4-63-2142S •	1396
	48"	1219	64	29	4.0	A4-63-2148Z •	376	A4-63-2148C •	410	A4-63-2148V •	428	A4-63-2148VG •	428	A4-63-2148E •	482	A4-63-2148S •	1396
	60"	1524	81	37	5.0	A4-63-2160Z •	396	A4-63-2160C •	470	A4-63-2160V •	500	A4-63-2160VG •	500	A4-63-2160E •	550	A4-63-2160S •	1808
72"	1829	92	42	7.8	A4-63-2172Z •	460	A4-63-2172C •	546	A4-63-2172V •	592	A4-63-2172VG •	592	A4-63-2172E •	654	A4-63-2172S •	2112	
24" width (610mm)	24"	610	43	20	2.4	A4-63-2424Z •	336	A4-63-2424C •	358	A4-63-2424V •	372	A4-63-2424VG •	372	A4-63-2424E •	430	A4-63-2424S •	1292
	30"	762	50	23	2.9	A4-63-2430Z •	344	A4-63-2430C •	370	A4-63-2430V •	392	A4-63-2430VG •	392	A4-63-2430E •	438	A4-63-2430S •	1300
	36"	914	58	26	3.5	A4-63-2436Z •	356	A4-63-2436C •	378	A4-63-2436V •	400	A4-63-2436VG •	400	A4-63-2436E •	446	A4-63-2436S •	1316
	42"	1067	65	30	3.6	A4-63-2442Z •	412	A4-63-2442C •	438	A4-63-2442V •	468	A4-63-2442VG •	468	A4-63-2442E •	530	A4-63-2442S •	1560
	48"	1219	72	33	4.5	A4-63-2448Z •	412	A4-63-2448C •	438	A4-63-2448V •	484	A4-63-2448VG •	484	A4-63-2448E •	530	A4-63-2448S •	1560
	60"	1524	91	41	5.6	A4-63-2460Z •	488	A4-63-2460C •	510	A4-63-2460V •	556	A4-63-2460VG •	556	A4-63-2460E •	614	A4-63-2460S •	1872
72"	1829	113	51	6.8	A4-63-2472Z •	548	A4-63-2472C •	590	A4-63-2472V •	636	A4-63-2472VG •	636	A4-63-2472E •	706	A4-63-2472S •	2300	

Models with 74" (1880mm) Height

	length		weight		cu ft	EAGLEbrite®		chrome		VALU-MASTER®		Valu-Gard®		EAGLEgard®		stainless	
	in.	mm	lb.	kg		model #	list	model #	list	model #	list	model #	list	model #	list	model #	list
18" width (457mm)	24"	610	43	20	1.9	A4-74-1824Z •	298	A4-74-1824C •	310	A4-74-1824V •	320	A4-74-1824VG •	320	A4-74-1824E •	362	A4-74-1824S •	1080
	30"	762	50	23	2.3	A4-74-1830Z •	306	A4-74-1830C •	314	A4-74-1830V •	340	A4-74-1830VG •	340	A4-74-1830E •	374	A4-74-1830S •	1096
	36"	914	57	26	2.7	A4-74-1836Z •	314	A4-74-1836C •	322	A4-74-1836V •	348	A4-74-1836VG •	348	A4-74-1836E •	386	A4-74-1836S •	1104
	42"	1067	62	28	3.1	A4-74-1842Z •	350	A4-74-1842C •	370	A4-74-1842V •	380	A4-74-1842VG •	380	A4-74-1842E •	446	A4-74-1842S •	1284
	48"	1219	70	32	3.6	A4-74-1848Z •	350	A4-74-1848C •	370	A4-74-1848V •	400	A4-74-1848VG •	400	A4-74-1848E •	446	A4-74-1848S •	1284
	60"	1524	93	42	4.3	A4-74-1860Z •	398	A4-74-1860C •	422	A4-74-1860V •	472	A4-74-1860VG •	472	A4-74-1860E •	514	A4-74-1860S •	1588
72"	1829	108	49	5.1	A4-74-1872Z •	462	A4-74-1872C •	490	A4-74-1872V •	528	A4-74-1872VG •	528	A4-74-1872E •	582	A4-74-1872S •	1856	
21" width (533mm)	24"	610	48	22	2.2	A4-74-2124Z •	322	A4-74-2124C •	346	A4-74-2124V •	352	A4-74-2124VG •	352	A4-74-2124E •	402	A4-74-2124S •	1224
	30"	762	56	26	2.7	A4-74-2130Z •	330	A4-74-2130C •	354	A4-74-2130V •	372	A4-74-2130VG •	372	A4-74-2130E •	410	A4-74-2130S •	1236
	36"	914	65	30	3.1	A4-74-2136Z •	338	A4-74-2136C •	366	A4-74-2136V •	380	A4-74-2136VG •	380	A4-74-2136E •	426	A4-74-2136S •	1244
	42"	1067	73	33	3.6	A4-74-2142Z •	378	A4-74-2142C •	414	A4-74-2142V •	428	A4-74-2142VG •	428	A4-74-2142E •	486	A4-74-2142S •	1412
	48"	1219	80	36	4.1	A4-74-2148Z •	378	A4-74-2148C •	414	A4-74-2148V •	432	A4-74-2148VG •	432	A4-74-2148E •	486	A4-74-2148S •	1412
	60"	1524	101	46	5.1	A4-74-2160Z •	398	A4-74-2160C •	474	A4-74-2160V •	504	A4-74-2160VG •	504	A4-74-2160E •	554	A4-74-2160S •	1824
72"	1829	113	51	7.7	A4-74-2172Z •	462	A4-74-2172C •	550	A4-74-2172V •	596	A4-74-2172VG •	596	A4-74-2172E •	658	A4-74-2172S •	2128	
24" width (610mm)	24"	610	53	24	2.5	A4-74-2424Z •	338	A4-74-2424C •	362	A4-74-2424V •	376	A4-74-2424VG •	376	A4-74-2424E •	434	A4-74-2424S •	1308
	30"	762	62	28	3.0	A4-74-2430Z •	346	A4-74-2430C •	374	A4-74-2430V •	396	A4-74-2430VG •	396	A4-74-2430E •	442	A4-74-2430S •	1316
	36"	914	73	33	3.6	A4-74-2436Z •	358	A4-74-2436C •	382	A4-74-2436V •	404	A4-74-2436VG •	404	A4-74-2436E •	450	A4-74-2436S •	1332
	42"	1067	81	37	3.7	A4-74-2442Z •	414	A4-74-2442C •	442	A4-74-2442V •	472	A4-74-2442VG •	472	A4-74-2442E •	534	A4-74-2442S •	1576
	48"	1219	90	41	4.6	A4-74-2448Z •	414	A4-74-2448C •	442	A4-74-2448V •	488	A4-74-2448VG •	488	A4-74-2448E •	534	A4-74-2448S •	1576
	60"	1524	113	51	5.7	A4-74-2460Z •	490	A4-74-2460C •	514	A4-74-2460V •	560	A4-74-2460VG •	560	A4-74-2460E •	618	A4-74-2460S •	1888
72"	1829	141	64	6.9	A4-74-2472Z •	550	A4-74-2472C •	594	A4-74-2472V •	640	A4-74-2472VG •	640	A4-74-2472E •	710	A4-74-2472S •	2316	

Catalog Section 1

Five-Shelf Starter Units

see spec sheet **EG01.25**



EAGLEgard® finish standard
with **MICROGARD®** protection.
See bottom of page 4 for details.

- Five wire shelves.
- Four posts (*same finish as shelves*).
- Shipped knocked-down.

INCLUDES:

Note: 54" (1372mm) shelves available see page 6.

Freight class is 70.0.

(•) MTS (*made to stock*) / () MTO (*made to order*)



Patented QuadTruss® Design
makes shelves up to 25% stronger and
provides a retaining ledge for increased
strength and product retention.

Models with 74" (1880mm) Height

	length		weight		cu ft	EAGLEbrite®		chrome		VALU-MASTER®		Valu-Gard®		EAGLEgard®		stainless	
	in.	mm	lb.	kg		model #	list	model #	list	model #	list	model #	list	model #	list	model #	list
18" width (457mm)	24"	610	51	23	1.9	S5-74-1824Z • 377	S5-74-1824C • 395	S5-74-1824V • 409	S5-74-1824VG • 409	S5-74-1824E • 466	S5-74-1824S • 1428						
	30"	762	58	26	2.3	S5-74-1830Z • 387	S5-74-1830C • 400	S5-74-1830V • 434	S5-74-1830VG • 434	S5-74-1830E • 481	S5-74-1830S • 1448						
	36"	914	65	30	2.7	S5-74-1836Z • 397	S5-74-1836C • 410	S5-74-1836V • 444	S5-74-1836VG • 444	S5-74-1836E • 496	S5-74-1836S • 1458						
	42"	1067	70	32	3.1	S5-74-1842Z • 442	S5-74-1842C • 470	S5-74-1842V • 484	S5-74-1842VG • 484	S5-74-1842E • 571	S5-74-1842S • 1683						
	48"	1219	78	36	3.6	S5-74-1848Z • 442	S5-74-1848C • 470	S5-74-1848V • 509	S5-74-1848VG • 509	S5-74-1848E • 571	S5-74-1848S • 1683						
	60"	1524	102	46	4.3	S5-74-1860Z • 502	S5-74-1860C • 535	S5-74-1860V • 599	S5-74-1860VG • 599	S5-74-1860E • 656	S5-74-1860S • 2063						
21" width (533mm)	24"	610	57	26	2.2	S5-74-2124Z • 407	S5-74-2124C • 440	S5-74-2124V • 449	S5-74-2124VG • 449	S5-74-2124E • 516	S5-74-2124S • 1608						
	30"	762	64	29	2.7	S5-74-2130Z • 417	S5-74-2130C • 450	S5-74-2130V • 474	S5-74-2130VG • 474	S5-74-2130E • 526	S5-74-2130S • 1623						
	36"	914	73	33	3.1	S5-74-2136Z • 427	S5-74-2136C • 465	S5-74-2136V • 484	S5-74-2136VG • 484	S5-74-2136E • 546	S5-74-2136S • 1633						
	42"	1067	81	37	3.6	S5-74-2142Z • 477	S5-74-2142C • 525	S5-74-2142V • 544	S5-74-2142VG • 544	S5-74-2142E • 621	S5-74-2142S • 1843						
	48"	1219	88	40	4.1	S5-74-2148Z • 477	S5-74-2148C • 525	S5-74-2148V • 549	S5-74-2148VG • 549	S5-74-2148E • 621	S5-74-2148S • 1843						
	60"	1524	109	50	5.1	S5-74-2160Z • 502	S5-74-2160C • 600	S5-74-2160V • 639	S5-74-2160VG • 639	S5-74-2160E • 706	S5-74-2160S • 2358						
24" width (610mm)	24"	610	62	28	2.5	S5-74-2424Z • 427	S5-74-2424C • 460	S5-74-2424V • 479	S5-74-2424VG • 479	S5-74-2424E • 556	S5-74-2424S • 1713						
	30"	762	71	32	3.0	S5-74-2430Z • 437	S5-74-2430C • 475	S5-74-2430V • 504	S5-74-2430VG • 504	S5-74-2430E • 566	S5-74-2430S • 1723						
	36"	914	81	37	3.6	S5-74-2436Z • 452	S5-74-2436C • 485	S5-74-2436V • 514	S5-74-2436VG • 514	S5-74-2436E • 576	S5-74-2436S • 1743						
	42"	1067	89	40	3.7	S5-74-2442Z • 522	S5-74-2442C • 560	S5-74-2442V • 599	S5-74-2442VG • 599	S5-74-2442E • 681	S5-74-2442S • 2048						
	48"	1219	98	45	4.6	S5-74-2448Z • 522	S5-74-2448C • 560	S5-74-2448V • 619	S5-74-2448VG • 619	S5-74-2448E • 681	S5-74-2448S • 2048						
	60"	1524	122	55	5.7	S5-74-2460Z • 617	S5-74-2460C • 650	S5-74-2460V • 709	S5-74-2460VG • 709	S5-74-2460E • 786	S5-74-2460S • 2438						
72"	1829	149	68	6.9	S5-74-2472Z • 692	S5-74-2472C • 750	S5-74-2472V • 809	S5-74-2472VG • 809	S5-74-2472E • 901	S5-74-2472S • 2973							

Models with 86" (2184mm) Height

	length		weight		cu ft	EAGLEbrite®		chrome		VALU-MASTER®		Valu-Gard®		EAGLEgard®		stainless	
	in.	mm	lb.	kg		model #	list	model #	list	model #	list	model #	list	model #	list	model #	list
18" width (457mm)	24"	610	55	25	3.9	S5-86-1824Z • 397	S5-86-1824C • 415	S5-86-1824V • 425	S5-86-1824VG • 425	S5-86-1824E • 486	S5-86-1824S • 1468						
	30"	762	60	27	3.9	S5-86-1830Z • 407	S5-86-1830C • 420	S5-86-1830V • 450	S5-86-1830VG • 450	S5-86-1830E • 501	S5-86-1830S • 1488						
	36"	914	65	30	3.9	S5-86-1836Z • 417	S5-86-1836C • 430	S5-86-1836V • 460	S5-86-1836VG • 460	S5-86-1836E • 516	S5-86-1836S • 1498						
	42"	1067	75	34	4.9	S5-86-1842Z • 462	S5-86-1842C • 490	S5-86-1842V • 500	S5-86-1842VG • 500	S5-86-1842E • 591	S5-86-1842S • 1723						
	48"	1219	80	36	4.9	S5-86-1848Z • 462	S5-86-1848C • 490	S5-86-1848V • 525	S5-86-1848VG • 525	S5-86-1848E • 591	S5-86-1848S • 1723						
	60"	1524	105	48	6.4	S5-86-1860Z • 522	S5-86-1860C • 555	S5-86-1860V • 615	S5-86-1860VG • 615	S5-86-1860E • 676	S5-86-1860S • 2103						
21" width (533mm)	24"	610	60	27	3.9	S5-86-2124Z • 427	S5-86-2124C • 460	S5-86-2124V • 465	S5-86-2124VG • 465	S5-86-2124E • 536	S5-86-2124S • 1648						
	30"	762	65	30	3.9	S5-86-2130Z • 437	S5-86-2130C • 470	S5-86-2130V • 490	S5-86-2130VG • 490	S5-86-2130E • 546	S5-86-2130S • 1663						
	36"	914	75	34	4.4	S5-86-2136Z • 447	S5-86-2136C • 485	S5-86-2136V • 500	S5-86-2136VG • 500	S5-86-2136E • 566	S5-86-2136S • 1673						
	42"	1067	80	36	5.9	S5-86-2142Z • 497	S5-86-2142C • 545	S5-86-2142V • 560	S5-86-2142VG • 560	S5-86-2142E • 641	S5-86-2142S • 1883						
	48"	1219	90	41	5.9	S5-86-2148Z • 497	S5-86-2148C • 545	S5-86-2148V • 565	S5-86-2148VG • 565	S5-86-2148E • 641	S5-86-2148S • 1883						
	60"	1524	110	50	6.9	S5-86-2160Z • 522	S5-86-2160C • 620	S5-86-2160V • 655	S5-86-2160VG • 655	S5-86-2160E • 726	S5-86-2160S • 2398						
24" width (610mm)	24"	610	65	30	4.4	S5-86-2424Z • 447	S5-86-2424C • 480	S5-86-2424V • 495	S5-86-2424VG • 495	S5-86-2424E • 576	S5-86-2424S • 1753						
	30"	762	75	34	4.4	S5-86-2430Z • 457	S5-86-2430C • 495	S5-86-2430V • 520	S5-86-2430VG • 520	S5-86-2430E • 586	S5-86-2430S • 1763						
	36"	914	85	39	4.4	S5-86-2436Z • 472	S5-86-2436C • 505	S5-86-2436V • 530	S5-86-2436VG • 530	S5-86-2436E • 596	S5-86-2436S • 1783						
	42"	1067	95	43	6.4	S5-86-2442Z • 542	S5-86-2442C • 580	S5-86-2442V • 615	S5-86-2442VG • 615	S5-86-2442E • 701	S5-86-2442S • 2088						
	48"	1219	100	45	6.4	S5-86-2448Z • 542	S5-86-2448C • 580	S5-86-2448V • 635	S5-86-2448VG • 635	S5-86-2448E • 701	S5-86-2448S • 2088						
	60"	1524	125	57	7.9	S5-86-2460Z • 637	S5-86-2460C • 670	S5-86-2460V • 725	S5-86-2460VG • 725	S5-86-2460E • 806	S5-86-2460S • 2478						
72"	1829	150	68	9.4	S5-86-2472Z • 712	S5-86-2472C • 770	S5-86-2472V • 825	S5-86-2472VG • 825	S5-86-2472E • 921	S5-86-2472S • 3013							



100 Industrial Boulevard, Clayton, DE 19938-8903 U.S.A.
Phone: 800-637-5100 or 302-653-3000. Fax: 302-653-2065
<http://www.eaglegrp.com>

Five-Shelf Add-On Units ⁴⁵⁻⁶⁰ ₁₋₃

see spec sheet **EG01.25**



EAGLEgard® finish standard with MICROGARD® protection.
See bottom of page 4 for details.

- Five wire shelves.
- Two posts (same finish as shelves).
- Two "S" hooks per shelf.
- Shipped knocked-down.

INCLUDES:

Note: 54" (1372mm) shelves available see page 6.

Freight class is 70.0.

(*) MTS (made to stock) / () MTO (made to order)



(Patent #5,390,803)

Patented QuadTruss® Design makes shelves up to 25% stronger and provides a retaining ledge for increased strength and product retention.

Models with 74" (1880mm) Height

	length		weight		cu ft	EAGLEbrite®		chrome		VALU-MASTER®		Valu-Gard®		EAGLEgard®		stainless	
	in.	mm	lb.	kg		model #	list	model #	list	model #	list	model #	list	model #	list	model #	list
18" width (457mm)	24"	610	43	20	1.9	A5-74-1824Z • 361	A5-74-1824C • 375	A5-74-1824V • 387	A5-74-1824VG • 387	A5-74-1824E • 440	A5-74-1824S • 1316						
	30"	762	50	23	2.3	A5-74-1830Z • 371	A5-74-1830C • 380	A5-74-1830V • 412	A5-74-1830VG • 412	A5-74-1830E • 455	A5-74-1830S • 1336						
	36"	914	57	26	2.7	A5-74-1836Z • 381	A5-74-1836C • 390	A5-74-1836V • 422	A5-74-1836VG • 422	A5-74-1836E • 470	A5-74-1836S • 1346						
	42"	1067	62	28	3.1	A5-74-1842Z • 426	A5-74-1842C • 450	A5-74-1842V • 462	A5-74-1842VG • 462	A5-74-1842E • 545	A5-74-1842S • 1571						
	48"	1219	80	36	3.6	A5-74-1848Z • 426	A5-74-1848C • 450	A5-74-1848V • 487	A5-74-1848VG • 487	A5-74-1848E • 545	A5-74-1848S • 1571						
	60"	1524	93	42	4.3	A5-74-1860Z • 486	A5-74-1860C • 515	A5-74-1860V • 577	A5-74-1860VG • 577	A5-74-1860E • 630	A5-74-1860S • 1951						
21" width (533mm)	24"	610	48	22	2.2	A5-74-2124Z • 391	A5-74-2124C • 420	A5-74-2124V • 429	A5-74-2124VG • 429	A5-74-2124E • 490	A5-74-2124S • 1496						
	30"	762	56	26	2.7	A5-74-2130Z • 401	A5-74-2130C • 430	A5-74-2130V • 454	A5-74-2130VG • 454	A5-74-2130E • 500	A5-74-2130S • 1511						
	36"	914	65	30	3.1	A5-74-2136Z • 411	A5-74-2136C • 445	A5-74-2136V • 464	A5-74-2136VG • 464	A5-74-2136E • 520	A5-74-2136S • 1521						
	42"	1067	73	33	3.6	A5-74-2142Z • 461	A5-74-2142C • 505	A5-74-2142V • 524	A5-74-2142VG • 524	A5-74-2142E • 595	A5-74-2142S • 1731						
	48"	1219	80	36	4.1	A5-74-2148Z • 461	A5-74-2148C • 505	A5-74-2148V • 529	A5-74-2148VG • 529	A5-74-2148E • 595	A5-74-2148S • 1731						
	60"	1524	101	46	5.1	A5-74-2160Z • 486	A5-74-2160C • 580	A5-74-2160V • 619	A5-74-2160VG • 619	A5-74-2160E • 680	A5-74-2160S • 2246						
24" width (610mm)	24"	610	53	24	2.5	A5-74-2424Z • 411	A5-74-2424C • 440	A5-74-2424V • 459	A5-74-2424VG • 459	A5-74-2424E • 530	A5-74-2424S • 1601						
	30"	762	62	28	3.0	A5-74-2430Z • 421	A5-74-2430C • 455	A5-74-2430V • 484	A5-74-2430VG • 484	A5-74-2430E • 540	A5-74-2430S • 1611						
	36"	914	73	33	3.6	A5-74-2436Z • 436	A5-74-2436C • 465	A5-74-2436V • 494	A5-74-2436VG • 494	A5-74-2436E • 550	A5-74-2436S • 1631						
	42"	1067	81	37	3.7	A5-74-2442Z • 506	A5-74-2442C • 540	A5-74-2442V • 579	A5-74-2442VG • 579	A5-74-2442E • 655	A5-74-2442S • 1936						
	48"	1219	90	41	4.6	A5-74-2448Z • 506	A5-74-2448C • 540	A5-74-2448V • 599	A5-74-2448VG • 599	A5-74-2448E • 655	A5-74-2448S • 1936						
	60"	1524	113	51	5.7	A5-74-2460Z • 601	A5-74-2460C • 630	A5-74-2460V • 689	A5-74-2460VG • 689	A5-74-2460E • 760	A5-74-2460S • 2326						
	72"	1829	141	64	6.9	A5-74-2472Z • 676	A5-74-2472C • 730	A5-74-2472V • 789	A5-74-2472VG • 789	A5-74-2472E • 875	A5-74-2472S • 2861						

Models with 86" (2184mm) Height

	length		weight		cu ft	EAGLEbrite®		chrome		VALU-MASTER®		Valu-Gard®		EAGLEgard®		stainless	
	in.	mm	lb.	kg		model #	list	model #	list	model #	list	model #	list	model #	list	model #	list
18" width (457mm)	24"	610	45	20	3.7	A5-86-1824Z • 371	A5-86-1824C • 385	A5-86-1824V • 395	A5-86-1824VG • 395	A5-86-1824E • 450	A5-86-1824S • 1336						
	30"	762	51	23	3.7	A5-86-1830Z • 381	A5-86-1830C • 390	A5-86-1830V • 420	A5-86-1830VG • 420	A5-86-1830E • 465	A5-86-1830S • 1356						
	36"	914	56	25	3.7	A5-86-1836Z • 391	A5-86-1836C • 400	A5-86-1836V • 430	A5-86-1836VG • 430	A5-86-1836E • 480	A5-86-1836S • 1366						
	42"	1067	66	30	4.7	A5-86-1842Z • 436	A5-86-1842C • 460	A5-86-1842V • 470	A5-86-1842VG • 470	A5-86-1842E • 555	A5-86-1842S • 1591						
	48"	1219	71	32	4.7	A5-86-1848Z • 436	A5-86-1848C • 460	A5-86-1848V • 495	A5-86-1848VG • 495	A5-86-1848E • 555	A5-86-1848S • 1591						
	60"	1524	96	44	6.2	A5-86-1860Z • 496	A5-86-1860C • 525	A5-86-1860V • 585	A5-86-1860VG • 585	A5-86-1860E • 640	A5-86-1860S • 1971						
21" width (533mm)	24"	610	51	23	3.7	A5-86-2124Z • 401	A5-86-2124C • 430	A5-86-2124V • 437	A5-86-2124VG • 437	A5-86-2124E • 500	A5-86-2124S • 1516						
	30"	762	56	25	3.7	A5-86-2130Z • 411	A5-86-2130C • 440	A5-86-2130V • 462	A5-86-2130VG • 462	A5-86-2130E • 510	A5-86-2130S • 1531						
	36"	914	66	30	4.2	A5-86-2136Z • 421	A5-86-2136C • 455	A5-86-2136V • 472	A5-86-2136VG • 472	A5-86-2136E • 530	A5-86-2136S • 1541						
	42"	1067	71	32	5.7	A5-86-2142Z • 471	A5-86-2142C • 515	A5-86-2142V • 532	A5-86-2142VG • 532	A5-86-2142E • 605	A5-86-2142S • 1751						
	48"	1219	81	37	6.7	A5-86-2148Z • 471	A5-86-2148C • 515	A5-86-2148V • 537	A5-86-2148VG • 537	A5-86-2148E • 605	A5-86-2148S • 1751						
	60"	1524	101	46	5.7	A5-86-2160Z • 496	A5-86-2160C • 590	A5-86-2160V • 627	A5-86-2160VG • 627	A5-86-2160E • 690	A5-86-2160S • 2266						
24" width (610mm)	24"	610	56	25	4.2	A5-86-2424Z • 421	A5-86-2424C • 450	A5-86-2424V • 467	A5-86-2424VG • 467	A5-86-2424E • 540	A5-86-2424S • 1621						
	30"	762	66	30	4.2	A5-86-2430Z • 431	A5-86-2430C • 465	A5-86-2430V • 492	A5-86-2430VG • 492	A5-86-2430E • 550	A5-86-2430S • 1631						
	36"	914	76	35	4.2	A5-86-2436Z • 446	A5-86-2436C • 475	A5-86-2436V • 502	A5-86-2436VG • 502	A5-86-2436E • 560	A5-86-2436S • 1651						
	42"	1067	86	39	6.2	A5-86-2442Z • 516	A5-86-2442C • 550	A5-86-2442V • 587	A5-86-2442VG • 587	A5-86-2442E • 665	A5-86-2442S • 1956						
	48"	1219	91	41	6.2	A5-86-2448Z • 516	A5-86-2448C • 550	A5-86-2448V • 607	A5-86-2448VG • 607	A5-86-2448E • 665	A5-86-2448S • 1956						
	60"	1524	116	53	7.7	A5-86-2460Z • 611	A5-86-2460C • 640	A5-86-2460V • 697	A5-86-2460VG • 697	A5-86-2460E • 770	A5-86-2460S • 2346						
	72"	1829	141	64	9.2	A5-86-2472Z • 686	A5-86-2472C • 740	A5-86-2472V • 797	A5-86-2472VG • 797	A5-86-2472E • 885	A5-86-2472S • 2881						

Catalog Section 1

Add-A-Shelf®

see spec sheet **EG01.11A**

WEIGHT CAPACITY:

- 300 lb. (136.1 kg); per shelf.
- using an evenly distributed load.

Note: Top and bottom shelves of unit must be standard shelves. Post are sold separately.

(For Chrome finish, see page 6;
for black, red, or white epoxy, see page 57).

- Use Add-A-Shelf® shelves for intermediate shelves. Add-A-Shelf® is not recommended for mobile applications.

WARNING:

Freight class is 70.0.

(*) MTS (made to stock) / () MTO (made to order)



Add-A-Shelf® Collars

allows addition or removal of shelf without breaking down the entire unit.

description	model #	list
set of four	A208891	9

- One set of four included with each shelf.
 - Must be used with split sleeves.
- To order: Model # **PLASTIC SPLIT SLEEVES**, list (per set of four): \$5.



(Patent #5,390,803)

Patented QuadTruss® Design makes shelves up to 25% stronger and provides a retaining ledge for increased strength and product retention.

Add-A-Shelf® Adjustable Shelves - Patent # 5,884,567

	length		weight		cu ft	EAGLEbrite®		chrome		black		red		white	
	in.	mm	lb.	kg		model #	list	model #	list	model #	list	model #	list	model #	list
14" width (356mm)	36"	914	8	3.6	0.5	A1436Z	60	A1436C •	65	A1436BL •	66	A1436R	66	A1436W	66
	48"	1219	10	4.5	0.7	A1448Z	67	A1448C •	74	A1448BL	75	A1448R	75	A1448W	75
18" width (457mm)	36"	914	9	4.1	0.7	A1836Z	66	A1836C •	67	A1836BL	68	A1836R	68	A1836W	68
	48"	1219	12	5.5	0.9	A1848Z	77	A1848C •	80	A1848BL	81	A1848R	81	A1848W	81
	60"	1524	15	6.8	1.0	A1860Z	90	A1860C	94	A1860BL	95	A1860R	95	A1860W	95
21" width (533mm)	36"	914	11	5.0	0.8	A2136Z	74	A2136C	79	A2136BL	80	A2136R	80	A2136W	80
	48"	1219	14	6.4	1.1	A2148Z	85	A2148C	91	A2148BL	92	A2148R	92	A2148W	92
	60"	1524	17	7.7	1.3	A2160Z	101	A2160C	112	A2160BL	113	A2160R	113	A2160W	113
24" width (610mm)	36"	914	13	5.9	0.8	A2436Z	78	A2436C •	85	A2436BL	86	A2436R	86	A2436W	86
	48"	1219	16	7.3	1.2	A2448Z	92	A2448C •	100	A2448BL	101	A2448R	101	A2448W	101
	60"	1524	21	9.5	1.5	A2460Z	112	A2460C •	127	A2460BL	128	A2460R	128	A2460W	128

PACKAGING:

- 36" and 48" lengths: Four per box.
- 60" lengths: Two per box.
- Four pairs split sleeves per shelf.
- Four-pack collars per shelf.

Add-A-Shelf® Reverse Mat Shelves - Patent # 5,884,567

	length		weight		cu ft	EAGLEbrite®		chrome		black		red		white	
	in.	mm	lb.	kg		model #	list	model #	list	model #	list	model #	list	model #	list
14" width (356mm)	36"	914	8	3.6	0.5	D1436Z	62	D1436C	67	D1436BL	68	D1436R	68	D1436W	68
	48"	1219	10	4.5	0.7	D1448Z	69	D1448C	76	D1448BL	77	D1448R	77	D1448W	77
18" width (457mm)	36"	914	9	4.1	0.7	D1836Z	68	D1836C	69	D1836BL	70	D1836R	70	D1836W	70
	48"	1219	12	5.5	0.9	D1848Z	79	D1848C	82	D1848BL	83	D1848R	83	D1848W	83
21" width (533mm)	36"	914	11	5.0	0.8	D2136Z	76	D2136C	81	D2136BL	82	D2136R	82	D2136W	82
	48"	1219	14	6.4	1.1	D2148Z	87	D2148C	94	D2148BL	95	D2148R	95	D2148W	95
24" width (610mm)	36"	914	13	5.9	0.8	D2436Z	80	D2436C	87	D2436BL	88	D2436R	88	D2436W	88
	48"	1219	16	7.3	1.2	D2448Z	95	D2448C	102	D2448BL	103	D2448R	103	D2448W	103



HOW TO ASSEMBLE: Add-A-Shelf® Collar

Numerically calibrated grooved posts, tapered plastic split sleeves and shelf collars combine to make shelving assembly a **SIMPLE 3 STEP EXERCISE:**



1. Snap split sleeves onto post over the number of your choice.

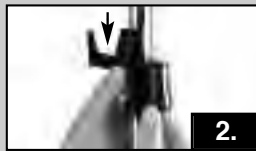

2. Slide collar over split sleeves. When together, a positive lock is created without the use of tools.

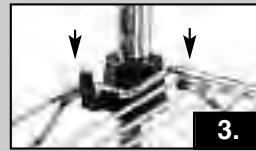

3. Place shelf over collar to complete.



Add-A-Shelf® as a merchandise display unit



100 Industrial Boulevard, Clayton, DE 19938-8903 U.S.A.
Phone: 800-637-5100 or 302-653-3000. Fax: 302-653-2065
http://www.eaglegrp.com

Posts for Add-A-Shelf®

see spec sheet **EG01.11A**

Freight class is 50.0.

(•) MTS (made to stock) / () MTO (made to order)



post height	weight		cu ft	EAGLEbrite®		chrome		black		red		white		
	in.	mm		lb.	kg	model #	list	model #	list	model #	list	model #	list	
7"	178		0.8	0.4	0.1	P7-Z • 10	P7-C	11	P7-BL	12	P7-R	12	P7-W	12
14"	356		1.0	0.5	0.1	P14-Z • 12	P14-C • 13		P14-BL • 14		P14-R	14	P14-W	14
33"	838		2.0	0.9	0.1	P33-Z • 15	P33-C • 16		P33-BL • 18		P33-R	18	P33-W	18
54"	1372		3.0	1.4	0.1	P54-Z • 21	P54-C • 22		P54-BL • 23		P54-R	23	P54-W	23
63"	1600		3.5	1.8	0.3	P63-Z • 22	P63-C • 23		P63-BL • 24		P63-R	24	P63-W	24
74"	1880		4.0	1.8	0.5	P74-Z • 23	P74-C • 25		P74-BL • 26		P74-R	26	P74-W	26
86"	2184		5.0	2.3	0.8	P86-Z • 28	P86-C • 30		P86-BL • 31		P86-R	31	P86-W	31

Add-A-Shelf® Post Clamps

see spec sheet **EG01.11A**

Freight class is 70.0.

(•) MTS (made to stock) / () MTO (made to order)



zinc		black epoxy	
model #	list	model #	list
ADD-A-CLAMP	8	ADD-A-CLAMP-BL	10

Add-A-Shelf® Starter Units

see spec sheet **EG01.11B**

- Front edge of shelf can be lowered 4" (102mm) to create slanted shelf.

FEATURES:

Note: Top and bottom shelves of unit must be standard shelves.

- Use Add-A-Shelf® shelves for intermediate shelves. Add-A-Shelf® is not recommended for mobile applications.

WARNING:

Freight class is 70.0.

(•) MTS (made to stock) / () MTO (made to order)



KIT INCLUDES:

- Two standard shelves.
- Two Add-A-Shelf® shelves.
- Four Redi-Pak® posts.
- Four bags of split sleeves.
- Two bags of Add-A-Shelf® collars.

**ALL IN ONE BOX
LOWERING SHIPPING COST!**



(Patent #5,390,803)

Patented QuadTruss® Design makes shelves up to 25% stronger and provides a retaining ledge for increased strength and product retention.

	Units with 63" (1600mm) Posts						Units with 74" (1880mm) Posts			
	length		chrome		black epoxy		chrome		black epoxy	
	in.	mm	model #	list	model #	list	model #	list	model #	list
14" width (356mm)	36"	914	RS4-63-A1436C	461	RS4-63-A1436BL	466	RS4-74-A1436C	490	RS4-74-A1436BL	495
	48"	1219	RS4-63-A1448C	491	RS4-63-A1448BL	496	RS4-74-A1448C	520	RS4-74-A1448BL	525
18" width (457mm)	36"	914	RS4-63-A1836C	492	RS4-63-A1836BL	497	RS4-74-A1836C	523	RS4-74-A1836BL	528
	48"	1219	RS4-63-A1848C	532	RS4-63-A1848BL	537	RS4-74-A1848C	562	RS4-74-A1848BL	568
21" width (533mm)	36"	914	RS4-63-A2136C	506	RS4-63-A2136BL	511	RS4-74-A2136C	537	RS4-74-A2136BL	542
	48"	1219	RS4-63-A2148C	558	RS4-63-A2148BL	564	RS4-74-A2148C	588	RS4-74-A2148BL	594
24" width (610mm)	36"	914	RS4-63-A2436C	537	RS4-63-A2436BL	542	RS4-74-A2436C	566	RS4-74-A2436BL	572
	48"	1219	RS4-63-A2448C	613	RS4-63-A2448BL	619	RS4-74-A2448C	642	RS4-74-A2448BL	648

Catalog Section 1

Redi-Pak® Wire Shelving Units

see spec sheet **EG01.26**



Redi-Pak



Packed and shipped in one box.

**SAVES UP TO 50%
ON SHIPPING COSTS!**

4-SHELF UNITS:

- Four wire shelves.
- Four two-piece posts.

5-SHELF UNITS:

- Five wire shelves.
- Four two-piece posts.

Can be shipped UPS.

Freight class is 70.0.

(•) MTS (made to stock) / () MTO (made to order)



(Patent #5,390,803)

Patented QuadTruss® Design

makes shelves up to 25% stronger and provides a retaining ledge for increased strength and product retention.

4-Shelf Units, 63" (1600mm) Height

	length		weight		cu ft	EAGLEbrite®		chrome		VALU-MASTER®		Valu-Gard®		EAGLEgard®	
	in.	mm	lb.	kg		model #	list	model #	list	model #	list	model #	list	model #	list
18" width (457mm)	36"	914	52	23.6	2.8	1836Z63	398	1836C63	423	1836V63	455	1836VG63	455	1836E63	514
	48"	1219	64	29.0	3.6	1848Z63	448	1848C63	481	1848V63	518	1848VG63	518	1848E63	590
	60"	1524	84	38.1	4.8	1860Z63	528	1860C63	545	1860V63	588	1860VG63	588	1860E63	673
24" width (610mm)	36"	914	68	30.8	3.2	2436Z63	454	2436C63	493	2436V63	531	2436VG63	531	2436E63	595
	48"	1219	80	36.3	4.8	2448Z63	521	2448C63	569	2448V63	611	2448VG63	611	2448E63	703
	60"	1524	100	45.4	6.0	2460Z63	610	2460C63	661	2460V63	710	2460VG63	710	2460E63	798

4-Shelf Units, 74" (1880mm) Height

	length		weight		cu ft	EAGLEbrite®		chrome		VALU-MASTER®		Valu-Gard®		EAGLEgard®	
	in.	mm	lb.	kg		model #	list	model #	list	model #	list	model #	list	model #	list
18" width (457mm)	36"	914	52	23.6	2.8	1836Z74	405	1836C74	431	1836V74	464	1836VG74	464	1836E74	516
	48"	1219	74	33.6	3.6	1848Z74	468	1848C74	499	1848V74	537	1848VG74	537	1848E74	608
	60"	1524	84	38.1	4.8	1860Z74	528	1860C74	558	1860V74	601	1860VG74	601	1860E74	714
24" width (610mm)	36"	914	68	30.8	3.2	2436Z74	469	2436C74	502	2436V74	540	2436VG74	540	2436E74	607
	48"	1219	80	36.3	4.8	2448Z74	545	2448C74	585	2448V74	629	2448VG74	629	2448E74	727
	60"	1524	100	45.4	6.0	2460Z74	634	2460C74	678	2460V74	730	2460VG74	730	2460E74	821

5-Shelf Units, 63" (1600mm) Height

	length		weight		cu ft	EAGLEbrite®		chrome		VALU-MASTER®		Valu-Gard®		EAGLEgard®	
	in.	mm	lb.	kg		model #	list	model #	list	model #	list	model #	list	model #	list
18" width (457mm)	36"	914	61	27.7	3.5	1836Z63-5	479	1836C63-5	510	1836V63-5	548	1836VG63-5	548	1836E63-5	611
	48"	1219	76	34.5	4.5	1848Z63-5	548	1848C63-5	582	1848V63-5	627	1848VG63-5	627	1848E63-5	718
	60"	1524	101	45.8	6.0	1860Z63-5	598	1860C63-5	669	1860V63-5	720	1860VG63-5	720	1860E63-5	826
24" width (610mm)	36"	914	81	36.7	4.0	2436Z63-5	558	2436C63-5	602	2436V63-5	645	2436VG63-5	645	2436E63-5	726
	48"	1219	96	43.6	6.0	2448Z63-5	644	2448C63-5	706	2448V63-5	758	2448VG63-5	758	2448E63-5	789
	60"	1524	121	54.9	7.5	2460Z63-5	753	2460C63-5	799	2460V63-5	861	2460VG63-5	861	2460E63-5	975

5-Shelf Units, 74" (1880mm) Height

	length		weight		cu ft	EAGLEbrite®		chrome		VALU-MASTER®		Valu-Gard®		EAGLEgard®	
	in.	mm	lb.	kg		model #	list	model #	list	model #	list	model #	list	model #	list
18" width (457mm)	36"	914	61	27.7	3.5	1836Z74-5	480	1836C74-5	529	1836V74-5	569	1836VG74-5	569	1836E74-5	642
	48"	1219	76	34.5	4.5	1848Z74-5	565	1848C74-5	608	1848V74-5	657	1848VG74-5	657	1848E74-5	746
	60"	1524	101	45.8	6.0	1860Z74-5	608	1860C74-5	693	1860V74-5	745	1860VG74-5	745	1860E74-5	858
24" width (610mm)	36"	914	81	36.7	4.0	2436Z74-5	575	2436C74-5	626	2436V74-5	672	2436VG74-5	672	2436E74-5	755
	48"	1219	96	43.6	6.0	2448Z74-5	666	2448C74-5	725	2448V74-5	781	2448VG74-5	781	2448E74-5	893
	60"	1524	121	54.9	7.5	2460Z74-5	774	2460C74-5	821	2460V74-5	881	2460VG74-5	881	2460E74-5	1004



100 Industrial Boulevard, Clayton, DE 19938-8903 U.S.A.
Phone: 800-637-5100 or 302-653-3000. Fax: 302-653-2065
<http://www.eaglegrp.com>

Redi-Pak® Utility Carts

see spec sheet **EG01.10**

Redi-Pak



Packed and shipped in one box.

**SAVES UP TO 50%
ON SHIPPING COSTS!**



**Easy handling
and inventory
tracking!**

WEIGHT CAPACITY:

- Medium-duty 500 lb. (227 kg).

INCLUDES:

- 36½" (927mm) height.
- One handle.
- Two posts.
- Four resilient 4" (102mm) casters with donut bumpers.
- Either two or three chrome shelves with built-in 1" (25mm) ledge on three sides.

Can be shipped UPS.

Freight class is 70.0.

(•) MTS (made to stock) / () MTO (made to order)

2-Shelf Unit

3-Shelf Unit

width	length		cubic feet	weight		model #	list	weight		model #	list
	in.	mm		lb.	kg			lbs.	kg		
18" (457mm)	36"	914	3.0	38	17.2	U2-1836C-RP	322	45	20.4	U3-1836C-RP	389



(Patent #5,390,803)

Reverse Mat Shelves

see spec sheet **EG01.03E**

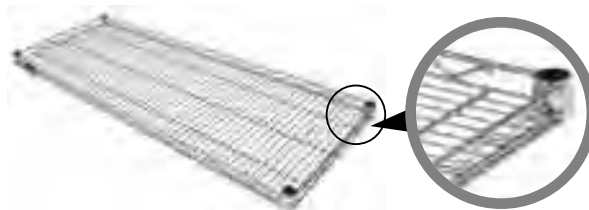

**Shelves have
built-in ledges
which prevent
contents from
falling off!**

WEIGHT CAPACITY:

- 250 lb. (113 kg); per shelf.

Freight class is 70.0.

(•) MTS (made to stock) / () MTO (made to order)



(Patent #5,390,803)

Patented QuadTruss® Design makes shelves up to 25% stronger and provides a retaining ledge for increased strength and product retention.

	length		weight		cu ft	EAGLEbrite®		chrome		black		red		white	
	in.	mm	lb.	kg		model #	list	model #	list	model #	list	model #	list	model #	list
14" width (356mm)	36"	914	7	3.2	0.5	RM1436Z	54	RM1436C	61	RM1436BL	62	RM1436R	62	RM1436W	62
	48"	1219	10	4.5	0.7	RM1448Z	63	RM1448C	69	RM1448BL	70	RM1448R	70	RM1448W	70
18" width (457mm)	36"	914	9	4.1	0.7	RM1836Z	63	RM1836C	63	RM1836BL	64	RM1836R	64	RM1836W	64
	48"	1219	11	4.9	0.9	RM1848Z	73	RM1848C	76	RM1848BL	77	RM1848R	77	RM1848W	77
21" width (533mm)	36"	914	11	4.9	0.8	RM2136Z	69	RM2136C	75	RM2136BL	76	RM2136R	76	RM2136W	76
	48"	1219	13	5.9	1.1	RM2148Z	79	RM2148C	87	RM2148BL	88	RM2148R	88	RM2148W	88
24" width (610mm)	24"	610	9	4.1	0.8	RM2424Z	69	RM2424C	74	RM2424BL	75	RM2424R	75	RM2424W	75
	36"	914	12	5.4	0.8	RM2436Z	74	RM2436C	79	RM2436BL	80	RM2436R	80	RM2436W	80
	48"	1219	15	6.8	1.2	RM2448Z	88	RM2448C	95	RM2448BL	96	RM2448R	96	RM2448W	96

Label Holders for Reverse Mat Shelves

see spec sheet **EG01.03E**



length	fits shelf size		model #	list	
	in.	mm			in.
3¼"	83		all	A225494	6
13"	330	18"	457	A225512	9
19"	483	24"	610	A225513	11
25"	635	30"	762	A225514	13
31"	787	36"	914	A225515	23
43"	1092	48"	1219	A225516	25
45"	1143	48"	1219	A225517	43
55"	1397	60"	1524	A225518	45
67"	1702	72"	1829	A225519	47

FEATURES:

- Clear plastic.
- Snaps onto shelf edge.
- Provides easy identification of shelf contents or section.
- Holds 1¼" (32mm) high labels.

Note: These also work on standard shelves.

Freight class is 70.0.

(•) MTS (made to stock) / () MTO (made to order)

Catalog Section 1

Hybrid Shelves

see spec sheet **EG01.46**



four-post system with hybrid shelves

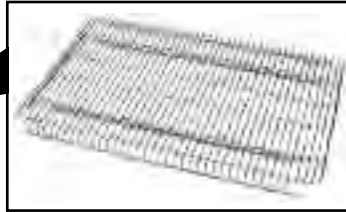

hybrid shelf

Additional Side-to-Side Partitions for Optional Center Stop Assemblies

length	EAGLEbrite®		
	in.	mm	list
30"	762	A219390	40
36"	914	A219391	62
42"	1067	A219392	67
48"	1219	A219393	72

- Shelves mount over two crossbraces of a four-post high-density system.
- Available for new systems or can be retrofitted to existing systems.
- Can be mixed or matched with solid metal shelves as required.
- Load tested to 250 lbs. (113.4 kg).
- Open-wire construction.

FEATURES:

PACKAGING:

- 24"-48" (610-1219mm) lengths: Four per box.

Freight class is 70.0.

(•) MTS (made to stock) / () MTO (made to order)



front-to-back ledge

side-to-side partition

Optional Center Stop Assemblies

- For Standard Four-Post Series only.
- Comes with one side-to-side partition that interlocks with two front-to-back ledges to form an "H".

Standard Four-Post Series

	length		EAGLEbrite®		VALU-MASTER®		stainless steel		EAGLEbrite®		VALU-MASTER®		stainless steel	
	in.	mm	model #	list	model #	list	model #	list	model #	list	model #	list	model #	list
12" width (305mm)	24"	610	SP1224Z	48	SP1224V	52	SP1224S	81	SPD1224-Z	64	SPD1224-V	68	SPD1224-S	110
	36"	914	SP1236Z	53	SP1236V	57	SP1236S	114	SPD1236-Z	69	SPD1236-V	77	SPD1236-S	153
	42"	1067	SP1242Z	56	SP1242V	67	SP1242S	125	SPD1242-Z	75	SPD1242-V	90	SPD1242-S	166
	48"	1219	SP1248Z	68	SP1248V	70	SP1248S	128	SPD1248-Z	91	SPD1248-V	94	SPD1248-S	170
15" width (381mm)	30"	762	SP1530Z	52	SP1530V	54	SP1530S	88	SPD1530-Z	90	SPD1530-V	94	SPD1530-S	116
	36"	914	SP1536Z	57	SP1536V	61	SP1536S	120	SPD1536-Z	113	SPD1536-V	119	SPD1536-S	160
	42"	1067	SP1542Z	67	SP1542V	70	SP1542S	130	SPD1542-Z	119	SPD1542-V	126	SPD1542-S	173
	48"	1219	SP1548Z	70	SP1548V	74	SP1548S	134	SPD1548-Z	125	SPD1548-V	131	SPD1548-S	179
16" width (406mm)	30"	762	SP1630Z	55	SP1630V	57	SP1630S	89	SPD1630-Z	93	SPD1630-V	98	SPD1630-S	118
	36"	914	SP1636Z	61	SP1636V	64	SP1636S	104	SPD1636-Z	116	SPD1636-V	122	SPD1636-S	139
	42"	1067	SP1642Z	69	SP1642V	73	SP1642S	122	SPD1642-Z	121	SPD1642-V	128	SPD1642-S	163
	48"	1219	SP1648Z	74	SP1648V	77	SP1648S	136	SPD1648-Z	128	SPD1648-V	134	SPD1648-S	181
18" width (457mm)	30"	762	SP1830Z	56	SP1830V	59	SP1830S	98	SPD1830-Z	94	SPD1830-V	99	SPD1830-S	130
	36"	914	SP1836Z	62	SP1836V	66	SP1836S	115	SPD1836-Z	118	SPD1836-V	125	SPD1836-S	155
	42"	1067	SP1842Z	69	SP1842V	73	SP1842S	134	SPD1842-Z	121	SPD1842-V	131	SPD1842-S	179
	48"	1219	SP1848Z	74	SP1848V	77	SP1848S	151	SPD1848-Z	129	SPD1848-V	136	SPD1848-S	201
21" width (533mm)	30"	762	SP2130Z	61	SP2130V	64	SP2130S	108	SPD2130-Z	98	SPD2130-V	103	SPD2130-S	144
	36"	914	SP2136Z	67	SP2136V	70	SP2136S	128	SPD2136-Z	121	SPD2136-V	128	SPD2136-S	170
	42"	1067	SP2142Z	73	SP2142V	76	SP2142S	146	SPD2142-Z	128	SPD2142-V	134	SPD2142-S	196
	48"	1219	SP2148Z	78	SP2148V	81	SP2148S	165	SPD2148-Z	132	SPD2148-V	139	SPD2148-S	220
24" width (610mm)	30"	762	SP2430Z	69	SP2430V	73	SP2430S	141	SPD2430-Z	103	SPD2430-V	108	SPD2430-S	189
	36"	914	SP2436Z	70	SP2436V	74	SP2436S	165	SPD2436-Z	127	SPD2436-V	133	SPD2436-S	220
	42"	1067	SP2442Z	86	SP2442V	90	SP2442S	192	SPD2442-Z	131	SPD2442-V	138	SPD2442-S	257
	48"	1219	SP2448Z	89	SP2448V	93	SP2448S	213	SPD2448-Z	137	SPD2448-V	143	SPD2448-S	285
30" width (762mm)	30"	762	SP3030Z	81	SP3030V	88	SP3030S	166	SPD3030-Z	112	SPD3030-V	118	SPD3030-S	221
	36"	914	SP3036Z	86	SP3036V	90	SP3036S	193	SPD3036-Z	136	SPD3036-V	142	SPD3036-S	258
	42"	1067	SP3042Z	98	SP3042V	102	SP3042S	225	SPD3042-Z	141	SPD3042-V	149	SPD3042-S	300
	48"	1219	SP3048Z	105	SP3048V	111	SP3048S	249	SPD3048-Z	146	SPD3048-V	155	SPD3048-S	334
32" width (813mm)	36"	914	SP3236Z	92	SP3236V	96	SP3236S	195	SPD3236-Z	160	SPD3236-V	169	SPD3236-S	261
	42"	1067	SP3242Z	106	SP3242V	112	SP3242S	195	SPD3242-Z	166	SPD3242-V	175	SPD3242-S	261
	48"	1219	SP3248Z	113	SP3248V	119	SP3248S	255	SPD3248-Z	171	SPD3248-V	180	SPD3248-S	338
36" width (914mm)	36"	914	SP3636Z	102	SP3636V	108	SP3636S	254	SPD3636-Z	165	SPD3636-V	173	SPD3636-S	337
	42"	1067	SP3642Z	111	SP3642V	116	SP3642S	292	SPD3642-Z	171	SPD3642-V	180	SPD3642-S	388
	48"	1219	SP3648Z	116	SP3648V	124	SP3648S	331	SPD3648-Z	177	SPD3648-V	186	SPD3648-S	440



100 Industrial Boulevard, Clayton, DE 19938-8903 U.S.A.
 Phone: 800-637-5100 or 302-653-3000. Fax: 302-653-2065
<http://www.eaglegrp.com>

Hybrid Shelves (Cont.)

see spec sheet **EG01.46**

Freight class is 70.0.

(•) MTS (made to stock) / () MTO (made to order)

Case Work Series

	length		EAGLEbrite®		VALU-MASTER®		stainless steel			length		EAGLEbrite®		VALU-MASTER®		stainless steel	
	in.	mm	model #	list	model #	list	model #	list		in.	mm	model #	list	model #	list	model #	list
12" width (305mm)	28"	711	SPL1224Z	48	SPL1224V	52	SPL1224S	81	21" width (533mm)	28"	711	SPL2130Z	61	SPL2130V	64	SPL2130S	108
	34"	864	SPL1236Z	53	SPL1236V	57	SPL1236S	114		34"	864	SPL2136Z	67	SPL2136V	70	SPL2136S	128
	40"	1016	SPL1242Z	56	SPL1242V	67	SPL1242S	125		40"	1016	SPL2142Z	73	SPL2142V	76	SPL2142S	146
	46"	1168	SPL1248Z	68	SPL1248V	70	SPL1248S	128		46"	1168	SPL2148Z	78	SPL2148V	81	SPL2148S	165
15" width (381mm)	28"	711	SPL1530Z	52	SPL1530V	54	SPL1530S	88	24" width (610mm)	28"	711	SPL2430Z	69	SPL2430V	73	SPL2430S	141
	34"	864	SPL1536Z	57	SPL1536V	61	SPL1536S	120		34"	864	SPL2436Z	70	SPL2436V	74	SPL2436S	165
	40"	1016	SPL1542Z	67	SPL1542V	70	SPL1542S	130		40"	1016	SPL2442Z	86	SPL2442V	90	SPL2442S	192
	46"	1168	SPL1548Z	70	SPL1548V	74	SPL1548S	134		46"	1168	SPL2448Z	89	SPL2448V	93	SPL2448S	213
16" width (406mm)	28"	711	SPL1630Z	55	SPL1630V	57	SPL1630S	89	30" width (762mm)	28"	711	SPL3030Z	81	SPL3030V	88	SPL3030S	166
	34"	864	SPL1636Z	61	SPL1636V	64	SPL1636S	104		34"	864	SPL3036Z	86	SPL3036V	90	SPL3036S	193
	40"	1016	SPL1642Z	69	SPL1642V	73	SPL1642S	122		40"	1016	SPL3042Z	98	SPL3042V	102	SPL3042S	225
	46"	1168	SPL1648Z	74	SPL1648V	77	SPL1648S	136		46"	1168	SPL3048Z	105	SPL3048V	111	SPL3048S	249
18" width (457mm)	28"	711	SPL1830Z	56	SPL1830V	59	SPL1830S	98	32" width (813mm)	34"	864	SPL3236Z	92	SPL3236V	96	SPL3236S	195
	34"	864	SPL1836Z	62	SPL1836V	66	SPL1836S	115		40"	1016	SPL3242Z	106	SPL3242V	112	SPL3242S	195
	40"	1016	SPL1842Z	69	SPL1842V	73	SPL1842S	134		46"	1168	SPL3248Z	113	SPL3248V	119	SPL3248S	255
	46"	1168	SPL1848Z	74	SPL1848V	77	SPL1848S	151		36" width (914mm)	34"	864	SPL3636Z	102	SPL3636V	108	SPL3636S
								40"	1016		SPL3642Z	111	SPL3642V	116	SPL3642S	292	
									46"	1168	SPL3648Z	116	SPL3648V	124	SPL3648S	331	

Wire Basket Utility Carts

product announcement **EG01.35**



description

1 chrome basket shelf, 1 chrome standard shelf
2 chrome basket shelves

FEATURES:

- Includes four 4" (102mm) swivel stem casters with bumpers and two push handles.
- 36½" (927mm) overall cart height.

Freight class is 70.0.

(•) MTS (made to stock) / () MTO (made to order)

description	weight		model #	list
	lbs.	kg		
1 chrome basket shelf, 1 chrome standard shelf	31	14.1	WBC1836C-1B1W	325
2 chrome basket shelves	32	14.5	WBC1836C-2B	286

Wire Basket Shelf

see spec sheet **EG01.03E**



400-lb. (181.4 kg)
weight capacity!

FEATURES:

- Chrome-plated.
- For use with standard shelving posts.
- 4¼" (107mm) depth.

Freight class is 70.0.

(•) MTS (made to stock) / () MTO (made to order)

width	length	weight		chrome		
		in	mm	lbs.	kg	model #
18" (457mm)	36"	914	10	4.5	WBS1836C	93

Triangle Shelf

see spec sheet **EG01.03E**



FEATURES:

- Attached to standard posts (sold separately —see pages 10 and 20), can be a freestanding unit.
- Or added onto standard 18" wide wire shelving (page 6) via "S" hooks.

Freight class is 70.0.

(•) MTS (made to stock) / () MTO (made to order)

width	weight		chrome		black epoxy	
	lbs.	kg	model #	list	model #	list
18" (457mm)	16	7.3	TR18C	43	TR18BL	48

WINE SHELVES

Convert your existing shelving unit by adding cradle wine shelves onto standard posts.

Cradle Wine Shelves

see spec sheet **EG01.20**

Freight class is 70.0.

(•) MTS (made to stock) / () MTO (made to order)



Each bottle is "cradled" by heavy gauge wire to avoid movement.

	length		weight		cu ft	capacity (750ml bottles)	chrome		black epoxy	
	in.	mm	lb.	kg			model #	list	model #	list
14" width (356mm)	36"	914	7	3.2	1.0	9	W1436C •	113	W1436BL	113
	48"	1219	9	4.1	1.3	12	W1448C •	128	W1448BL	128

Bulk Wine Shelf Units

see spec sheet **EG01.24**



Largest capacity offered in the industry; bottles are stored in bulk.

- Each compartment is adjustable for bottle diameter.
- Holds one dozen bottles per compartment.
- Bottles are retained with removable dividers, back panels and end panels.
- Panels are chrome plated.
- 74" (1880mm) height.

FEATURES:

Note: Not for mobile applications.

Freight class is 70.0.

(•) MTS (made to stock) / () MTO (made to order)

	length		weight		cu ft	capacity (750ml bottles)	chrome		black epoxy	
	in.	mm	lb.	kg			model #	list	model #	list
14" width (356mm)	36"	914	140	63.5	5	180	BW1436C	1958	BW1436BL	1958
	48"	1219	160	72.5	9	240	BW1448C	2505	BW1448BL	2305

Bulk Wine Shelf Units with Security Doors

	length		weight		cu ft	capacity (750ml bottles)	chrome		black epoxy	
	in.	mm	lb.	kg			model #	list	model #	list
14" width (356mm)	36"	914	183	83.0	5	180	BW1436C-SC	2968	BW1436BL-SC	2968
	48"	1219	205	93.0	9	240	BW1448C-SC	3496	BW1448BL-SC	3216

Wine Glass Racks

see spec sheet **EG01.03E**

FEATURES:

- Fits onto underside of existing wire shelves or wire overshelves.
- 18" & 24" (457 & 610mm) lengths available.
- No hardware or tools required for installation.

Freight class is 70.0.

(•) MTS (made to stock) / () MTO (made to order)



length	zinc		chrome			
	in.	mm	model #	list ea	model #	list ea
18"	457	WGR18-Z	33	WGR18-C	36	
24"	610	WGR24-Z	37	WGR24-C	40	

SHELVING CONFIGURATIONS FOR WINE STORAGE

Created with standard shelving by adding a series of rods, tabs and enclosure panels.

Enclosure Panels

see spec sheet **EG01.03A**

**Helps secure shelf contents,
enclosing the back and sides of unit.**

INCLUDES: • Four retaining clamps.

Freight class is 70.0.

(•) MTS (made to stock) / () MTO (made to order)

Note: These do not work with corner castings of solid shelves.
Recommended for use with wire shelves only.

shelf	panel width		post height		weight		cubic feet	chrome		stainless	
	in.	mm	in.	mm	lb.	kg		model #	list	model #	list
18" width (457mm)	14"	356	54"	1372	6	2.7	1.5	E1854-C	63	E1854-S	140
	14"	356	63"	1600	7	3.2	1.8	E1863-C •	66	E1863-S	149
	14"	356	74"	1880	8	3.6	2.0	E1874-C •	72	E1874-S	177
	14"	356	86"	2184	9	4.1	2.3	E1886-C	130	E1886-S	181
24" width (610mm)	20"	233	54"	1372	9	4.1	2.1	E2454-C	74	E2454-S	169
	20"	233	63"	1600	10	4.5	2.3	E2463-C •	79	E2463-S	185
	20"	233	74"	1880	11	5.0	2.6	E2474-C •	82	E2474-S	202
	20"	233	86"	2184	12	5.4	2.8	E2486-C	145	E2486-S	213



CONSULT THESE TABLES FOR NUMBER OF PANELS REQUIRED:

Panels sold individually. Consult charts below for number of panels needed.

For the Back of Unit	shelf length		54" (1372mm) post ht.	63" (1600mm) post ht.	74" (1880mm) post ht.	86" (2184mm) post ht.
	in.	mm	—panel(s) required	—panel(s) required	—panel(s) required	—panel(s) required
	30"	762	(1) E2454	(1) E2463	(1) E2474	(1) E2486
	36"	914	(2) E1854	(2) E1863	(2) E1874	(2) E1886
	42"	1067	(1) E1854	(1) E1863	(1) E1874	(1) E1886
			(1) E2454	(1) E2463	(1) E2474	(1) E2486
	48"	1092	(2) E2454	(2) E2463	(2) E2474	(2) E2486
			(2) E1854	(2) E1863	(2) E1874	(2) E1886
	54"	1372	(1) E2454	(1) E2463	(1) E2474	(1) E2486
			(2) E1854	(2) E1863	(2) E1874	(2) E1886
	60"	1524	(2) E2454	(2) E2463	(2) E2474	(2) E2486
			(1) E1854	(1) E1863	(1) E1874	(1) E1886
	72"	1829	(3) E2454	(3) E2463	(3) E2474	(3) E2486

For Each End	shelf width		54" (1372mm) post ht.	63" (1600mm) post ht.	74" (1880mm) post ht.	86" (2184mm) post ht.
	in.	mm	—panel(s) required	—panel(s) required	—panel(s) required	—panel(s) required
	18"	457	(1) E1854	(1) E1863	(1) E1874	(1) E1886
	21"	533	(1) E1854	(1) E1863	(1) E1874	(1) E1886
	24"	610	(1) E2454	(1) E2463	(1) E2474	(1) E2486
	30"	762	(1) E2454	(1) E2463	(1) E2474	(1) E2486
	36"	914	(2) E1854	(2) E1863	(2) E1874	(1) E1886

Clip for Solid Shelves (ONLY)

see spec sheet **EG01.03A**

model #	list
A204318	1

Rods and Tabs

see spec sheet **EG01.03D**



chrome		stainless steel	
model #	list ea	model #	list ea
R54-C	10	R54-S	33
R63-C •	11	R63-S	36
R74-C •	12	R74-S	41
R86-C •	14	R86-S	44

FEATURES:

- Used to enclose backs or sides of shelving units to prevent contents from falling.
- Also used to partition shelving units by positioning rods interior to shelves.
- Model number indicates height.
- Each rod comes with four tabs.

Freight class is 70.0.

(•) MTS (made to stock) / () MTO (made to order)

Catalog Section 1

A highly flexible and maneuverable transport product which can be configured in either wire or solid shelves, or a combination of both.

Medium Duty Utility Carts

see spec sheet **EG01.10**



(Patent #5,390,803)

Patented QuadTruss® Design makes shelves up to 25% stronger and provides a retaining ledge for increased strength and product retention.

WEIGHT CAPACITY: • 500 lb. (227 kg) maximum.

INCLUDES:

- Two chrome handles.
- Four resilient rubber casters.
- 18" wide carts have 4" (102mm) casters.
- 21" and 24" carts have 5" (127mm) casters.

Note: For conductive use, order aluminum split sleeves or plastic conductive split sleeves (page 45), and optional grounding cable or anti-static drag chain (page 128).

LIFESTOR® Utility Carts available (see page 78).

See page 28 for optional stainless steel handles.

Freight class is 70.0.

(•) MTS (made to stock) / () MTO (made to order)

2-Shelf Units

	width	length		cu ft	weight		EAGLEbrite®		chrome		stainless steel		
		in.	mm		lbs.	kg	model #	list	model #	list	model #	list	
40" height* (1016mm) including casters	18" (457mm)	24"	610	2.5	32	14.5	EU2-1824Z •	276	EU2-1824C •	279	EU2-1824S	689	
		30"	762	2.5	35	15.8	EU2-1830Z •	284	EU2-1830C •	286	EU2-1830S	747	
		36"	914	2.5	38	17.2	EU2-1836Z •	288	EU2-1836C •	291	EU2-1836S	788	
	21" (533mm)	36"	914	2.9	42	19.1	EU2-2136Z •	314	EU2-2136C •	327	EU2-2136S	880	
		24" (610mm)	36"	914	2.9	45	20.4	EU2-2436Z •	327	EU2-2436C •	337	EU2-2436S	929

* Stainless steel cart are 40" (1016mm) height. Chrome carts 37 1/4" (959mm) height including casters.

3-Shelf Units

	width	length		cu ft	weight		EAGLEbrite®		chrome		stainless steel		
		in.	mm		lbs.	kg	model #	list	model #	list	model #	list	
40" height* (1016mm) including casters	18" (457mm)	24"	610	2.5	37	16.7	EU3-1824Z •	337	EU3-1824C •	342	EU3-1824S	881	
		30"	762	2.5	41	18.5	EU3-1830Z •	348	EU3-1830C •	352	EU3-1830S	969	
		36"	914	2.5	45	20.4	EU3-1836Z •	356	EU3-1836C •	359	EU3-1836S	1029	
	21" (533mm)	36"	914	2.9	48	21.8	EU3-2136Z •	388	EU3-2136C •	405	EU3-2136S	1153	
		24" (610mm)	36"	914	2.9	58	26.3	EU3-2436Z •	404	EU3-2436C •	422	EU3-2436S	1229

* Stainless steel cart are 40" (1016mm) height. Chrome carts 37 1/4" (959mm) height including casters.

Utility Carts with Solid Shelf

see spec sheet **EG01.10**



(Patent #5,390,803)

Patented QuadTruss® Design makes shelves up to 25% stronger and provides a retaining ledge for increased strength and product retention.

INCLUDES:

- Two chrome handles.
- Four casters.
- Two chrome finish open-wire shelves.
- One stainless steel solid shelf.

Note: For conductive use, order aluminum split sleeves or plastic conductive split sleeves (page 45), and optional grounding cable or anti-static drag chain (page 128).

LIFESTOR® Utility Carts available (see page 78).

See page 28 for optional stainless steel handles.

Freight class is 70.0.

(•) MTS (made to stock) / () MTO (made to order)

	width	length		caster diameter		weight		cu ft	model #	list
		in.	mm	in.	mm	lbs.	kg			
37 1/4" height (959mm)	18" (457mm)	24"	610	4"	102	36	16.3	2.5	EU3-1824CS	490
		30"	762	4"	102	39	17.7	2.5	EU3-1830CS	508
		36"	914	4"	102	42	19.1	2.5	EU3-1836CS	533
including casters	21" (533mm)	36"	914	5"	127	65	29.5	2.9	U3-2136CS	581
		24" (610mm)	36"	914	5"	127	71	32.2	3.3	U3-2436CS



Heavy Duty Utility Carts

see spec sheet **EG01.10**

WEIGHT CAPACITY:

- 800 lb. (363 kg) maximum.



(Patent #5,390,803)

Patented QuadTruss® Design
makes shelves up to 25% stronger and provides a retaining ledge for increased strength and product retention.

INCLUDES:

- Two handles (see below)—one on each end.
- Four 5" (127mm) resilient rubber swivel casters.

Note: Carts can be made conductive with the use of aluminum split sleeves or plastic conductive split sleeves (page 45), and optional grounding cable or anti-static drag chain (page 128).

LIFESTOR® Utility Carts available (see page 78).

Freight class is 70.0.

(•) MTS (made to stock) / () MTO (made to order)

2-Shelf Units

	length	cu	weight		EAGLEbrite®		chrome		stainless steel			
			in.	mm	ft	lbs.	kg	model #	list	model #	list	model #
40" height* (1016mm) including casters	18" width (457mm)	36"	914	2.5	38	17.2	U2-1836Z •	314	U2-1836C •	318	U2-1836S	856
		42"	1067	2.9	41	18.5	U2-1842Z •	330	U2-1842C •	337	U2-1842S	946
	21" width (533mm)	36"	914	2.9	42	19.1	U2-2136Z •	330	U2-2136C •	343	U2-2136S	929
		42"	1067	3.4	44	20.0	U2-2142Z •	348	U2-2142C •	362	U2-2142S	1018
		48"	1219	3.9	48	21.8	U2-2148Z •	353	U2-2148C •	366	U2-2148S	1018
	24" width (610mm)	36"	914	3.3	46	20.9	U2-2436Z •	343	U2-2436C •	356	U2-2436S	979
		42"	1067	3.9	50	22.7	U2-2442Z •	366	U2-2442C •	382	U2-2442S	1105
		48"	1219	4.4	52	23.6	U2-2448Z •	372	U2-2448C •	389	U2-2448S	1105
		60"	1524	5.5	62	28.1	U2-2460Z •	415	U2-2460C •	425	U2-2460S	1266

* Stainless steel cart are 40" (1016mm) height. Chrome carts 37" (959mm) height including casters.

3-Shelf Units

	length	cu	weight		EAGLEbrite®		chrome		stainless steel			
			in.	mm	ft	lbs.	kg	model #	list	model #	list	model #
40" height* (1016mm) including casters	18" width (457mm)	36"	914	2.5	48	21.8	U3-1836Z •	379	U3-1836C •	385	U3-1836S	1098
		42"	1067	2.9	52	23.6	U3-1842Z •	403	U3-1842C •	416	U3-1842S	1234
	21" width (533mm)	36"	914	2.9	53	24.0	U3-2136Z •	402	U3-2136C •	423	U3-2136S	1207
		42"	1067	3.4	56	25.4	U3-2142Z •	427	U3-2142C •	449	U3-2142S	1339
		48"	1219	3.9	62	28.1	U3-2148Z •	435	U3-2148C •	457	U3-2148S	1339
	24" width (610mm)	36"	914	3.3	59	26.8	U3-2436Z •	422	U3-2436C •	438	U3-2436S	1279
		42"	1067	3.9	65	29.5	U3-2442Z •	456	U3-2442C •	480	U3-2442S	1467
		48"	1219	4.4	68	30.8	U3-2448Z •	464	U3-2448C •	489	U3-2448S	1467
		60"	1524	5.5	83	37.6	U3-2460Z •	528	U3-2460C •	543	U3-2460S	1710

* Stainless steel cart are 40" (1016mm) height. Chrome carts 37" (959mm) height including casters.

Handles for Utility Carts

see spec sheets **EG01.03B** **EG04.07**

Note: Electropolished Utility Hands for cleanroom applications.

Freight class is 70.0.

(•) MTS (made to stock) / () MTO (made to order)



width	weight	cubic	chrome*		stainless steel**		electropolished**				
			in.	mm	lbs.	kg	feet	model #	list	model #	list
18"	4.0	0.9	457	1.8	0.9	UH18-C •	41	UH18-S	106	EPUH18-S	132
21"	4.2	0.9	533	1.9	0.9	UH21-C •	42	UH21-S	107	EPUH21-S	134
24"	4.5	0.9	610	2.1	0.9	UH24-C •	42	UH24-S	110	EPUH24-S	137

*31½" (800mm) height without casters
**33¾" (848mm) height without casters

Stem Caster Carts

see spec sheet **EG01.07**

Freight class is 70.0.

(•) MTS (made to stock) / () MTO (made to order)



INCLUDES:

- Four 63" (1600mm) posts.
- Four shelves.
- Plastic split sleeves.
- Donut bumpers.
- Indicated 5" x 1 1/4" (127 x 32mm) casters.
- 68" (1727mm) overall height.
- Fast assembly without the use of tools.
- Shipped knocked-down.

Note: Carts can be made conductive with the use of aluminum split sleeves or plastic conductive split sleeves (page 45), and optional grounding cable or anti-static drag chain (page 128).



(Patent #5,390,803)

Patented QuadTruss® Design

makes shelves up to 25% stronger and provides a retaining ledge for increased strength and product retention.

		weight		cu ft	caster type	wheel tread	EAGLEbrite®		chrome		
		lbs.	kg				model #	list	model #	list	
18" width (457mm)	36" length (914mm)				swivel	resilient	CC1836Z-S	• 465	CC1836C-S	• 469	
					swivel	poly	CC1836Z-SP	• 534	CC1836C-SP	• 539	
		58	26.3	2.6	swivel/brake	resilient	CC1836Z-SB	• 476	CC1836C-SB	• 480	
					swivel/brake	poly	CC1836Z-SBP	• 545	CC1836C-SBP	• 552	
					swivel/rigid	resilient	CC1836Z-SR	• 488	CC1836C-SR	• 502	
				swivel/rigid	poly	CC1836Z-SRP	• 546	CC1836C-SRP	• 564		
	48" length (1219mm)					swivel	resilient	CC1848Z-S	• 469	CC1848C-S	• 513
					swivel	poly	CC1848Z-SP	• 539	CC1848C-SP	• 584	
		70	31.7	3.5	swivel/brake	resilient	CC1848Z-SB	• 526	CC1848C-SB	• 541	
					swivel/brake	poly	CC1848Z-SBP	• 596	CC1848C-SBP	• 610	
					swivel/rigid	resilient	CC1848Z-SR	• 530	CC1848C-SR	• 556	
				swivel/rigid	poly	CC1848Z-SRP	• 590	CC1848C-SRP	• 618		
	60" length (1524mm)					swivel	resilient	CC1860Z-S	• 567	CC1860C-S	• 584
					swivel	poly	CC1860Z-SP	• 636	CC1860C-SP	• 654	
		86	39.0	4.4	swivel/brake	resilient	CC1860Z-SB	• 581	CC1860C-SB	• 596	
				swivel/brake	poly	CC1860Z-SBP	• 652	CC1860C-SBP	• 666		
				swivel/rigid	resilient	CC1860Z-SR	• 582	CC1860C-SR	• 608		
			swivel/rigid	poly	CC1860Z-SRP	• 644	CC1860C-SRP	• 669			
21" width (533mm)	36" length (914mm)				swivel	resilient	CC2136Z-S	• 499	CC2136C-S	• 524	
					swivel	poly	CC2136Z-SP	• 567	CC2136C-SP	• 593	
		67	30.4	3.0	swivel/brake	resilient	CC2136Z-SB	• 511	CC2136C-SB	• 537	
					swivel/brake	poly	CC2136Z-SBP	• 581	CC2136C-SBP	• 605	
					swivel/rigid	resilient	CC2136Z-SR	• 515	CC2136C-SR	• 553	
				swivel/rigid	poly	CC2136Z-SRP	• 577	CC2136C-SRP	• 614		
	48" length (1219mm)					swivel	resilient	CC2148Z-S	• 543	CC2148C-S	• 574
					swivel	poly	CC2148Z-SP	• 613	CC2148C-SP	• 643	
		79	35.8	4.0	swivel/brake	resilient	CC2148Z-SB	• 556	CC2148C-SB	• 586	
					swivel/brake	poly	CC2148Z-SBP	• 626	CC2148C-SBP	• 656	
					swivel/rigid	resilient	CC2148Z-SR	• 559	CC2148C-SR	• 602	
				swivel/rigid	poly	CC2148Z-SRP	• 620	CC2148C-SRP	• 662		
	60" length (1524mm)					swivel	resilient	CC2160Z-S	• 613	CC2160C-S	• 636
					swivel	poly	CC2160Z-SP	• 681	CC2160C-SP	• 708	
		96	43.5	5.0	swivel/brake	resilient	CC2160Z-SB	• 626	CC2160C-SB	• 652	
				swivel/brake	poly	CC2160Z-SBP	• 695	CC2160C-SBP	• 720		
				swivel/rigid	resilient	CC2160Z-SR	• 631	CC2160C-SR	• 665		
			swivel/rigid	poly	CC2160Z-SRP	• 694	CC2160C-SRP	• 724			
24" width (610mm)	36" length (914mm)				swivel	resilient	CC2436Z-S	• 519	CC2436C-S	• 543	
					swivel	poly	CC2436Z-SP	• 589	CC2436C-SP	• 613	
		74	33.5	3.5	swivel/brake	resilient	CC2436Z-SB	• 532	CC2436C-SB	• 556	
					swivel/brake	poly	CC2436Z-SBP	• 601	CC2436C-SBP	• 626	
					swivel/rigid	resilient	CC2436Z-SR	• 538	CC2436C-SR	• 568	
				swivel/rigid	poly	CC2436Z-SRP	• 598	CC2436C-SRP	• 629		
	48" length (1219mm)					swivel	resilient	CC2448Z-S	• 579	CC2448C-S	• 607
					swivel	poly	CC2448Z-SP	• 647	CC2448C-SP	• 677	
		90	40.8	4.5	swivel/brake	resilient	CC2448Z-SB	• 591	CC2448C-SB	• 621	
					swivel/brake	poly	CC2448Z-SBP	• 632	CC2448C-SBP	• 691	
					swivel/rigid	resilient	CC2448Z-SR	• 595	CC2448C-SR	• 635	
				swivel/rigid	poly	CC2448Z-SRP	• 657	CC2448C-SRP	• 698		
	60" length (1524mm)					swivel	resilient	CC2460Z-S	• 663	CC2460C-S	• 681
					swivel	poly	CC2460Z-SP	• 733	CC2460C-SP	• 752	
		110	49.9	5.6	swivel/brake	resilient	CC2460Z-SB	• 674	CC2460C-SB	• 695	
				swivel/brake	poly	CC2460Z-SBP	• 744	CC2460C-SBP	• 764		
				swivel/rigid	resilient	CC2460Z-SR	• 678	CC2460C-SR	• 711		
			swivel/rigid	poly	CC2460Z-SRP	• 740	CC2460C-SRP	• 774			



Cart Covers

see spec sheet **EG01.09**

**Meets J.C.A.H. standards
for transporting clean linen!**



cart cover
enveloping entire cart/truck

cart cover with panel folded back for
easy shelf accessibility

**Light weight,
easy to handle!**

FEATURES:

- Top corners are reinforced.
- Choice of white coated, white uncoated, or transparent vinyl.
- Coated cart covers available in powder blue (suffix "PB") and light green (suffix "LG"). Example: CVC-63-1836PB. Other colors available—consult factory.
- Covers are nonreturnable.

Note: Cart covers to fit Security Units (pages 40-41) available.

To order cart cover for Stationary or Mobile Security Unit, add suffix "-S" to end of model number (ex: CV-63-2436-S) and add 20% to list price.

To order cart cover for Dolly Truck Security Unit, add suffix "-D" to end of model number (ex: CV-63-2436-D) and add 20% to list price.

NEW Double-Flap option available. \$20 upcharge.

To order, add suffix "-DF" to model number (ex: CV-63-2436-DF).

Black electrostatic discharge (ESD) cart covers also available—see page 136.

Freight class is 70.0.

(•) MTS (made to stock) / () MTO (made to order)

					White Coated Nylon*				White Uncoated Polyester				Transparent**									
	length		post height		weight		cu ft	zipper		velcro		zipper		zipper								
	in.	mm	in.	mm	lbs.	kg		model #	list	model #	list	model #	list	model #	list							
18" width (457mm)	36"	914	54"	1372	3	1.4	1	CZC-54-1836	223	CVC-54-1836	231	CZ-54-1836	129	CV-54-1836	142	CZ-54-1836-T	287					
			63"	1600				CZC-63-1836	227	CVC-63-1836	239	CZ-63-1836	137	CV-63-1836	146	CZ-63-1836-T	287					
	48"	1219	54"	1372	4	1.8	1	CZC-54-1848	231	CVC-54-1848	243	CZ-54-1848	144	CV-54-1848	153	CZ-54-1848-T	292					
			63"	1600				CZC-63-1848	238	CVC-63-1848	246	CZ-63-1848	145	CV-63-1848	156	CZ-63-1848-T	292					
21" width (533mm)	60"	1524	54"	1372	5	2.3	1	CZC-54-1860	251	CVC-54-1860	259	CZ-54-1860	149	CV-54-1860	158	CZ-54-1860-T	302					
			63"	1600				CZC-63-1860	255	CVC-63-1860	264	CZ-63-1860	151	CV-63-1860	160	CZ-63-1860-T	322					
	48"	1219	54"	1372	4	1.8	1	CZC-54-2148	257	CVC-54-2148	268	CZ-54-2148	167	CV-54-2148	177	CZ-54-2148-T	319					
			63"	1600				CZC-63-2148	268	CVC-63-2148	280	CZ-63-2148	184	CV-63-2148	193	CZ-63-2148-T	339					
74"			1880	CZC-74-2148				272	CVC-74-2148	282	CZ-74-2148	210	CV-74-2148	221	CZ-74-2148-T	357						
54"			1372	CZC-54-2160				295	CVC-54-2160	303	CZ-54-2160	174	CV-54-2160	187	CZ-54-2160-T	354						
60"	1524	63"	1600	5	2.3	1	CZC-63-2160	300	CVC-63-2160	310	CZ-63-2160	193	CV-63-2160	202	CZ-63-2160-T	376						
		74"	1880				CZC-74-2160	304	CVC-74-2160	315	CZ-74-2160	225	CV-74-2160	231	CZ-74-2160-T	396						
		24" width (610mm)	24"				610	54"	1372	3	1.4	1	CZC-54-2424	272	CVC-54-2424	273	CZ-54-2424	305	CV-54-2424	202	CZ-54-2424-T	307
								63"	1600				CZC-63-2424	276	CVC-63-2424	284	CZ-63-2424	316	CV-63-2424	242	CZ-63-2424-T	307
36"	914		54"	1372	3	1.4	1	CZC-54-2436	227	CVC-54-2436	239	CZ-54-2436	148	CV-54-2436	157	CZ-54-2436-T	312					
			63"	1600				CZC-63-2436	239	CVC-63-2436	251	CZ-63-2436	153	CV-63-2436	164	CZ-63-2436-T	312					
		74"	1880	CZC-74-2436				245	CVC-74-2436	256	CZ-74-2436	187	CV-74-2436	192	CZ-74-2436-T	380						
		86"	2184	CZC-86-2436				266	CVC-86-2436	284	CZ-86-2436	233	CV-86-2436	238	CZ-86-2436-T	401						
48"	1219	54"	1372	4	1.8	1	CZC-54-2448	270	CVC-54-2448	281	CZ-54-2448	160	CV-54-2448	172	CZ-54-2448-T	329						
		63"	1600				CZC-63-2448	282	CVC-63-2448	295	CZ-63-2448	189	CV-63-2448	200	CZ-63-2448-T	329						
		74"	1880				CZC-74-2448	288	CVC-74-2448	298	CZ-74-2448	204	CV-74-2448	218	CZ-74-2448-T	339						
		86"	2184				CZC-86-2448	332	CVC-86-2448	341	CZ-86-2448	248	CV-86-2448	256	CZ-86-2448-T	422						
60"	1524	54"	1372	5	2.3	1	CZC-54-2460	302	CVC-54-2460	312	CZ-54-2460	215	CV-54-2460	225	CZ-54-2460-T	360						
		63"	1600				CZC-63-2460	307	CVC-63-2460	319	CZ-63-2460	223	CV-63-2460	231	CZ-63-2460-T	360						
		74"	1880				CZC-74-2460	312	CVC-74-2460	322	CZ-74-2460	253	CV-74-2460	263	CZ-74-2460-T	439						
		86"	2184				CZC-86-2460	360	CVC-86-2460	360	CZ-86-2460	295	CV-86-2460	304	CZ-86-2460-T	462						
72"	1829	54"	1372	6	2.7	1	CZC-54-2472	307	CVC-54-2472	319	CZ-54-2472	221	CV-54-2472	229	CZ-54-2472-T	403						
		63"	1600				CZC-63-2472	313	CVC-63-2472	326	CZ-63-2472	238	CV-63-2472	246	CZ-63-2472-T	411						
		74"	1880				CZC-74-2472	321	CVC-74-2472	329	CZ-74-2472	259	CV-74-2472	270	CZ-74-2472-T	452						
		86"	2184				CZC-86-2472	377	CVC-86-2472	372	CZ-86-2472	310	CV-86-2472	319	CZ-86-2472-T	475						

* White-coated nylon covers are fire-retardant; ** Entire cover is transparent except for the seams. Transparent covers with velcro available at same price.

Helps keep equipment clean on shelf carts and shelf trucks.

Catalog Section 1

Angled Shelf/ Visual Merchandising Carts

see spec sheet **EG01.44**



visual merchandising cart
with optional shelf dividers

**Ideal for displaying
POINT-OF-SALE
or SPECIAL SALE ITEMS.**

FEATURES:

- 72" (1829mm) height.
- 3/4" (83mm) upturn at front
- 1/4" (32mm) downturn at rear.
- Shelves are reversible.
- Units available in 2' to 5' lengths (610 to 1524mm).

WEIGHT CAPACITY:

- 300 lbs. (136.1 kg) per shelf.

INCLUDES:

- Four shelves adjust on 1" (25mm) vertical increments and the 0°-30° slope of each shelf.
- Four posts.
- Four 5" x 1 1/4" (127 x 32mm) resilient swivel casters, two with brake.
- Additional caster sizes are available.
- Standard wire shelves (page 6) can be used.

Note: To order red or white epoxy finish, add suffix "R" (red) or "W" (white). **Example: M1836R.** Priced same as black epoxy.

Additional shelves and wire dividers available as options.

Freight class is 70.0.

(•) MTS (made to stock) / () MTO (made to order)

length		weight		cu	EAGLEbrite®		chrome		black		VALU-MASTER®		Valu-Gard®	
in.	mm	lb.	kg	ft	model #	list	model #	list	model #	list	model #	list	model #	list
24"	610	52	23.6	3.6	M1824Z-4	552	M1824C-4	619	M1824BL-4	630	M1824V-4	630	M1824VG-4	630
36"	914	60	27.2	4.4	M1836Z-4 •	578	M1836C-4	636	M1836BL-4	645	M1836V-4	645	M1836VG-4	645
48"	1219	68	30.8	5.8	M1848Z-4 •	641	M1848C-4	663	M1848BL-4	691	M1848V-4	691	M1848VG-4	691
60"	1524	76	34.5	7.3	M1860Z-4 •	686	M1860C-4	708	M1860BL-4	731	M1860V-4	731	M1860VG-4	731



Additional Angled Shelves for Angled Shelf / Visual Merchandising Carts - Hanger rails included.

length		weight		cu	EAGLEbrite®		chrome		black		VALU-MASTER®		Valu-Gard®	
in.	mm	lb.	kg	ft	model #	list	model #	list	model #	list	model #	list	model #	list
24"	610	4	1.8	2.2	M1824Z	87	M1824C	102	M1824BL	107	M1824V	107	M1824VG	107
36"	914	9	4.1	2.5	M1836Z	93	M1836C	106	M1836BL	111	M1836V	111	M1836VG	111
48"	1219	12	5.5	2.8	M1848Z	108	M1848C	113	M1848BL	120	M1848V	120	M1848VG	120
60"	1524	17	7.7	3.1	M1860Z	120	M1860C	125	M1860BL	130	M1860V	130	M1860VG	130

Note: If purchased as component piece for unit assembly, two 3-sided truss frames must be ordered (see page 32).



Shelf Dividers for Angled Shelf / Visual Merchandising Carts - 4 1/2" (114mm) height.

length		weight		cu	chrome		black		VALU-MASTER®		Valu-Gard®	
in.	mm	lb.	kg	ft	model #	list	model #	list	model #	list	model #	list
18"	457	1.0	0.5	0.6	M18C	36	M18BL	38	M18V	38	M18VG	38

Front-to-Back Hanger Rail for Angled Shelf / Visual Merchandising Carts

length		weight		cu	EAGLEbrite®		chrome		black		VALU-MASTER®		Valu-Gard®	
in.	mm	lb.	kg	ft	model #	list	model #	list	model #	list	model #	list	model #	list
18"	457	0.7	0.3	2.0	WR18-Z	14	WR18-C	16	WR18-BL	16	WR18-V	21	WR18-VG	21

Side-to-Side Hanger Rails for Angled Shelf / Visual Merchandising Carts

length		weight		cu	EAGLEbrite®		chrome		black		VALU-MASTER®		Valu-Gard®	
in.	mm	lb.	kg	ft	model #	list	model #	list	model #	list	model #	list	model #	list
24"	610	1.5	0.7	0.3	LR24-Z	21	LR24-C	25	LR24-BL	27	LR24-V	27	LR24-VG	27
36"	914	1.9	0.9	0.6	LR36-Z	22	LR36-C	29	LR36-BL	33	LR36-V	33	LR36-VG	33
48"	1219	2.1	1.0	0.7	LR48-Z	23	LR48-C	36	LR48-BL	38	LR48-V	38	LR48-VG	38
60"	1524	2.5	1.1	0.8	LR60-Z	25	LR60-C	41	LR60-BL	42	LR60-V	42	LR60-VG	42



...Merchandising Carts (Cont.)

see spec sheet **EG01.44**

Freight class is 70.0.

(•) MTS (made to stock) / () MTO (made to order)



three-sided truss snare
18" (457mm) front-to-back.



four-sided truss snare
18" (457mm) front-to-back.

3-Sided Truss Frame for Angled Shelf/Visual Merchandising Cart

length		weight		cu ft	EAGLEbrite®		chrome		black		VALU-MASTER®		Valu-Gard®	
in.	mm	lb.	kg		model #	list	model #	list	model #	list	model #	list	model #	list
36"	914	3.5	1.6	2	3TF1836-Z	29	3TF1836-C	31	3TF1836-BL	34	3TF1836-V	34	3TF1836-VG	34
48"	1219	4.0	1.8	3	3TF1848-Z	31	3TF1848-C	36	3TF1848-BL	39	3TF1848-V	39	3TF1848-VG	39
60"	1524	4.5	2.0	4	3TF1860-Z	35	3TF1860-C	39	3TF1860-BL	43	3TF1860-V	43	3TF1860-VG	43

4-Sided Truss Frame for Angled Shelf/Visual Merchandising Carts

length		weight		cu ft	EAGLEbrite®		chrome		black		VALU-MASTER®		Valu-Gard®	
in.	mm	lb.	kg		model #	list	model #	list	model #	list	model #	list	model #	list
36"	914	3.5	1.6	2	4TF1836-Z	48	4TF1836-C	52	4TF1836-BL	57	4TF1836-V	57	4TF1836-VG	57
48"	1219	4.0	1.8	3	4TF1848-Z	52	4TF1848-C	59	4TF1848-BL	62	4TF1848-V	62	4TF1848-VG	62
60"	1524	4.5	2.0	4	4TF1860-Z	55	4TF1860-C	65	4TF1860-BL	69	4TF1860-V	69	4TF1860-VG	69

Mobile Platform Carts

see spec sheet **EG60.36**

- Heavy duty all-aluminum construction.
- 1½" x 2¾" (38 x 70mm) square tubing.
- 5" (127mm) casters—two swivel with brake and two rigid.

FEATURES:

Freight class is 70.0.

(•) MTS (made to stock) / () MTO (made to order)



Lifetime guarantee against rust and corrosion!

5-year guarantee against workmanship and material defects!

overall dimensions			deck size		weight capacity		model #	list	
width	depth	height	width	depth	lbs.	kg			
in.	mm	mm	in.	mm					
20"	37¼"	42"	508	959	1067	1200	544.3	1202	626
20"	49¼"	42"	508	1264	1067	1200	544.3	1203	690
20"	61¼"	42"	508	1569	1067	1200	544.3	1212	803

Black Polymer Utility Cart

see spec sheet **EG01.06**

WEIGHT CAPACITY: • 200 lb. (90.7 kg).

- Four 4" (102mm) diameter swivel casters, two with brake.
- Stylish brushed aluminum uprights.

FEATURES:

Freight class is 70.0.

(•) MTS (made to stock) / () MTO (made to order)



Utilizes three heavy duty black polymer shelves and utility handles!

height		width	length		weight		model #	list	
in.	mm		in.	mm	lbs.	kg			
37¼"	(959mm)	18¾"	(473mm)	33¾"	854	30	13.6	EU3-2030-P	667

Catalog Section 1

Dolly Trucks

see spec sheet **EG01.08**



FEATURES:

- Fast assembly without tools.
- Open wire construction.
- Shipped knocked-down.

INCLUDES:

- Four shelves.
- Four posts.
- Plastic split sleeves.
- Four designated 5" x 1 1/4" (127 x 32mm) casters.
- Aluminum truck dolly with wraparound bumper.

Freight class is 70.0.

(•) MTS (made to stock) / () MTO (made to order)



(Patent #5,390,803)

Patented QuadTruss® Design
makes shelves up to 25% stronger and provides a retaining ledge for increased strength and product retention.

		shelf dimensions		weight		cu ft	caster type	wheel tread	with EAGLEbrite® shelf unit		with chrome shelf unit		
		in.	mm	lbs.	kg				model #	list	model #	list	
69" height (1753mm)	23 3/4" width (603mm)	40 1/8" length (1038mm)	18" x 36"	457 x 914	72	32.7	4.2	swivel	resilient	DT1836-ZS	864	DT1836-CS	892
			swivel	poly	DT1836-ZSP	837	DT1836-CSP	864					
		52 1/8" length (1343mm)	18" x 48"	457 x 1219	86	39.0	5.6	swivel	resilient	DT1836-ZSB	872	DT1836-CSB	899
								swivel/brake	resilient	DT1836-ZSBP	847	DT1836-CSBP	872
		64 1/8" length (1648mm)	18" x 36"	457 x 914	100	45.4	6.8	swivel	resilient	DT1848-ZS	931	DT1848-CS	968
								swivel	poly	DT1848-ZSP	904	DT1848-CSP	940
	52 1/8" length (1343mm)	18" x 48"	457 x 1219	86	39.0	5.6	swivel/brake	resilient	DT1848-ZSB	938	DT1848-CSB	976	
							swivel/brake	poly	DT1848-ZSBP	912	DT1848-CSBP	948	
	26 3/4" width (680mm)	40 1/8" length (1038mm)	21" x 36"	533 x 914	82	37.2	4.8	swivel	resilient	DT1860-ZS	1016	DT1860-CS	1054
								swivel	poly	DT1860-ZSP	990	DT1860-CSP	1027
		52 1/8" length (1343mm)	21" x 48"	533 x 1219	98	44.5	6.4	swivel/brake	resilient	DT1860-ZSB	1024	DT1860-CSB	1060
								swivel/brake	poly	DT1860-ZSBP	996	DT1860-CSBP	1034
64 1/8" length (1648mm)		21" x 60"	533 x 1524	114	51.7	7.9	swivel	resilient	DT2136-ZS	912	DT2136-CS	959	
							swivel	poly	DT2136-ZSP	889	DT2136-CSP	933	
52 1/8" length (1343mm)	21" x 48"	533 x 1219	98	44.5	6.4	swivel/brake	resilient	DT2136-ZSB	919	DT2136-CSB	968		
						swivel/brake	poly	DT2136-ZSBP	895	DT2136-CSBP	940		
29 3/4" width (756mm)	40 1/8" length (1038mm)	24" x 36"	610 x 914	90	40.8	5.6	swivel	resilient	DT2148-ZS	979	DT2148-CS	1030	
							swivel	poly	DT2148-ZSP	954	DT2148-CSP	1005	
	52 1/8" length (1343mm)	24" x 48"	610 x 1219	112	50.8	7.2	swivel/brake	resilient	DT2148-ZSB	987	DT2148-CSB	1038	
							swivel/brake	poly	DT2148-ZSBP	961	DT2148-CSBP	1013	
	64 1/8" length (1648mm)	24" x 60"	610 x 1524	134	60.8	8.9	swivel	resilient	DT2160-ZS	1077	DT2160-CS	1119	
							swivel	poly	DT2160-ZSP	1053	DT2160-CSP	1094	
52 1/8" length (1343mm)	24" x 48"	610 x 1219	112	50.8	7.2	swivel/brake	resilient	DT2160-ZSB	1085	DT2160-CSB	1127		
						swivel/brake	poly	DT2160-ZSBP	1059	DT2160-CSBP	1137		
29 3/4" width (756mm)	40 1/8" length (1038mm)	24" x 36"	610 x 914	90	40.8	5.6	swivel	resilient	DT2436-ZS	929	DT2436-CS	971	
							swivel	poly	DT2436-ZSP	903	DT2436-CSP	944	
	52 1/8" length (1343mm)	24" x 48"	610 x 1219	112	50.8	7.2	swivel/brake	resilient	DT2436-ZSB	937	DT2436-CSB	979	
							swivel/brake	poly	DT2436-ZSBP	911	DT2436-CSBP	954	
	64 1/8" length (1648mm)	24" x 60"	610 x 1524	134	60.8	8.9	swivel	resilient	DT2448-ZS	1013	DT2448-CS	1066	
							swivel	poly	DT2448-ZSP	987	DT2448-CSP	1038	
52 1/8" length (1343mm)	24" x 48"	610 x 1219	112	50.8	7.2	swivel/brake	resilient	DT2448-ZSB	1021	DT2448-CSB	1072		
						swivel/brake	poly	DT2448-ZSBP	993	DT2448-CSBP	1046		
64 1/8" length (1648mm)	24" x 60"	610 x 1524	134	60.8	8.9	swivel	resilient	DT2460-ZS	1124	DT2460-CS	1165		
						swivel	poly	DT2460-ZSP	1098	DT2460-CSP	1141		
52 1/8" length (1343mm)	24" x 48"	610 x 1219	112	50.8	7.2	swivel/brake	resilient	DT2460-ZSB	1133	DT2460-CSB	1172		
						swivel/brake	poly	DT2460-ZSBP	1105	DT2460-CSBP	1147		



100 Industrial Boulevard, Clayton, DE 19938-8903 U.S.A.
Phone: 800-637-5100 or 302-653-3000. Fax: 302-653-2065
<http://www.eaglegrp.com>

Garment Racks



model #
GRS1836C

see spec sheet **EG01.28**



(Patent #5,390,803)

INCLUDES:

- Four chrome post with adjustable feet.
- Two wire chrome plated shelves.
- 74" (1880mm) height on stationary units.
- 80" (3032mm) height on mobile units.
- Mobile racks four 5" (127mm) polyurethane tread casters, with rubber donut bumper.

Freight class is 70.0.

(•) MTS (made to stock) / () MTO (made to order)

Patented QuadTruss® Design

makes shelves up to 25% stronger and provides a retaining ledge for increased strength and product retention.

Convenient storage of coats, uniforms, or garments.

	length		weight		cu	description	STATIONARY		MOBILE	
	in.	mm	lbs.	kg			model #	list	model #	list
18" width (457mm)	36"	914	48	21.8	2.2	unit as shown	GR1836C	296	UR1836C	468
	36"	914	64	29.0	2.2	same, plus 1 solid shelf	GRS1836C	409	URS1836C	615
	48"	1219	52	23.6	2.6	unit as shown	GR1848C	322	UR1848C	502
	48"	1219	72	32.7	2.6	same, plus 1 solid shelf	GRS1848C	449	URS1848C	674
	60"	1524	58	26.3	3.2	unit as shown	GR1860C	362	UR1860C	542
	60"	1524	82	37.2	3.2	same, plus 1 solid shelf	GRS1860C	515	URS1860C	772

Optional Wire Shelves

	length		weight		cu	model #	list
	in.	mm	lbs.	kg			
18" width (457mm)	36"	914	9	4.1	0.7	1836C •	62
	48"	1219	12	5.5	0.9	1848C •	74
	60"	1524	17	7.7	1.2	1860C •	87

Replacement Coat Hanger Tubes

	length		weight		cubic	model #	list
	in.	mm	lbs.	kg			
24"	610	1.5	0.7	0.1	CH24	35	
30"	762	1.7	0.8	0.1	CH30	37	
36"	914	2.2	1.0	0.1	CH36	39	
42"	1067	2.7	1.2	0.1	CH42	40	
48"	1219	3.2	1.5	0.1	CH48 •	41	
54"	1372	3.5	1.6	0.2	CH54	44	
60"	1524	3.8	1.7	0.2	CH60	47	



Optional Hangers

description	weight		cu	chrome	
	lbs.	kg		model #	list
open loop hanger	0.4	0.2	0.3	OLH-C •	12
closed loop hanger	0.4	0.2	0.3	CLH-C	12



Platforms

see spec sheet **EG01.13**



600 lbs. weight capacity

FEATURES:

- Open-wire construction for improved air circulation, minimizing dust.

Freight class is 70.0.

(•) MTS (made to stock) / () MTO (made to order)



(Patent #5,390,803)

Patented QuadTruss® Design

makes shelves up to 25% stronger and provides a retaining ledge for increased strength and product retention.

		length		weight		cu	EAGLEbrite®		chrome		EAGLEgard®	
		in.	mm	lbs.	kg		model #	list	model #	list	model #	list
14" height (356mm)	18" width (457mm)	24"	610	10	4.5	0.7	PF1824-Z •	106	PF1824-C •	112	PF1824-E •	133
		30"	762	11	5.0	0.7	PF1830-Z •	107	PF1830-C •	113	PF1830-E •	136
		36"	914	13	5.9	0.7	PF1836-Z •	110	PF1836-C •	115	PF1836-E •	139
	21" width (533mm)	24"	610	12	5.4	0.7	PF2124-Z •	112	PF2124-C •	122	PF2124-E •	143
		30"	762	13	5.9	0.7	PF2130-Z •	114	PF2130-C •	125	PF2130-E •	145
		36"	914	14	6.4	0.8	PF2136-Z •	116	PF2136-C •	127	PF2136-E •	147
	24" width (610mm)	24"	610	13	5.9	0.8	PF2424-Z •	116	PF2424-C •	126	PF2424-E •	151
		30"	762	15	6.8	0.8	PF2430-Z •	119	PF2430-C •	129	PF2430-E •	153
		36"	914	17	7.7	0.8	PF2436-Z •	121	PF2436-C •	131	PF2436-E •	155

Catalog Section 1

Dunnage Shelves

see spec sheet **EG01.13**



Improves your system's weight-bearing capacity.

FEATURES:

- Four-sided frame with center supports.
- Removable heavy duty $\frac{3}{16}$ " (8mm)-diameter wire mat assembly.

Note: All weights and cubic feet are approximate.

Freight class is 70.0.

(•) MTS (made to stock) / () MTO (made to order)

	length		weight		cu ft	chrome		EAGLEgard®		stainless steel	
	in.	mm	lbs.	kg		model #	list	model #	list	model #	list
18" width (457mm)	24"	610	14	6.4	0.6	DS1824-C	144	DS1824-E	182	n/a	n/a
	30"	762	18	8.2	0.7	DS1830-C	159	DS1830-E	193	n/a	n/a
	36"	914	21	9.5	0.8	DS1836-C	169	DS1836-E	205	DS1836-S	530
	48"	1219	28	12.7	1.1	DS1848-C	196	DS1848-E •	241	DS1848-S	644
	60"	1524	33	15.0	1.3	DS1860-C	228	DS1860-E •	272	DS1860-S	758
21" width (533mm)	24"	610	15	6.8	0.6	DS2124-C	162	DS2124-E	199	n/a	n/a
	30"	762	19	8.6	0.8	DS2130-C	167	DS2130-E	207	n/a	n/a
	36"	914	22	10.0	0.9	DS2136-C	178	DS2136-E	218	n/a	n/a
	48"	1219	28	12.7	1.2	DS2148-C	203	DS2148-E	248	n/a	n/a
	60"	1524	34	15.4	1.5	DS2160-C	232	DS2160-E	294	n/a	n/a
24" width (610mm)	24"	610	16	7.3	0.8	DS2424-C	157	DS2424-E	192	n/a	n/a
	30"	762	20	9.0	0.9	DS2430-C	172	DS2430-E	207	n/a	n/a
	36"	914	24	10.9	1.1	DS2436-C	186	DS2436-E	223	DS2436-S	579
	48"	1219	30	13.6	1.4	DS2448-C	209	DS2448-E •	255	DS2448-S	698
	60"	1524	37	16.8	1.8	DS2460-C	248	DS2460-E •	300	DS2460-S	838

Dunnage Racks

see spec sheet **EG01.13**



Store large items off the floor!

Snag-free wire surface.

WEIGHT CAPACITY:

- Up to 36" long: 1600 lbs. (635 kg).
- 48" long: 1300 lbs. (590 kg).
- 60" long: 1000 lbs. (454 kg).
- static load equally distributed.

Note: All weights and cubic feet are approximate.

Freight class is 70.0.

(•) MTS (made to stock) / () MTO (made to order)

	length		weight		cu ft	chrome		EAGLEgard®		stainless steel		
	in.	mm	lbs.	kg		model #	list	model #	list	model #	list	
14" overall height (356mm)	18" width (457mm)	24"	610	21	9.5	0.5	DR1824-C	233	DR1824-E	272	n/a	n/a
		30"	762	24	10.9	1.0	DR1830-C	247	DR1830-E	291	n/a	n/a
		36"	914	31	14.1	1.6	DR1836-C	263	DR1836-E	308	DR1836-S	672
		48"	1219	37	16.8	2.2	DR1848-C	311	DR1848-E •	369	DR1848-S	895
		60"	1524	43	19.5	3.0	DR1860-C	385	DR1860-E	408	n/a	n/a
	21" width (533mm)	24"	610	24	10.9	0.8	DR2124-C	242	DR2124-E	288	n/a	n/a
		30"	762	27	12.2	2.0	DR2130-C	260	DR2130-E	308	n/a	n/a
		36"	914	33	15.0	2.0	DR2136-C	278	DR2136-E	327	n/a	n/a
		48"	1219	39	17.6	2.9	DR2148-C	330	DR2148-E	386	n/a	n/a
		60"	1524	45	20.4	3.3	DR2160-C	375	DR2160-E	423	n/a	n/a
	24" width (610mm)	24"	610	27	12.2	1.4	DR2424-C	248	DR2424-E	294	n/a	n/a
		30"	762	30	13.6	1.8	DR2430-C	267	DR2430-E	310	n/a	n/a
		36"	914	35	15.9	2.1	DR2436-C •	285	DR2436-E •	335	DR2436-S	770
		48"	1219	41	18.6	2.8	DR2448-C •	336	DR2448-E •	396	DR2448-S	980
		60"	1524	47	21.3	3.5	DR2460-C	388	DR2460-E	446	n/a	n/a



100 Industrial Boulevard, Clayton, DE 19938-8903 U.S.A.
 Phone: 800-637-5100 or 302-653-3000. Fax: 302-653-2065
<http://www.eaglegrp.com>

Mobile Dunnage Racks

see spec sheet **EG01.13** WEIGHT CAPACITY:



INCLUDES:

- 800 lbs. (363 kg).
- equally distributed on the top surface.
- Four 5" swivel polyurethane tread casters, two with brakes.
- 3-sided frame with 1" (25mm)-square tubing.
- Snag-free wire surface.

Note: All weights and cubic feet are approximate.

Freight class is 70.0.

(•) MTS (made to stock) / () MTO (made to order)

		length		weight		cu ft	chrome		EAGLEgard®		stainless steel	
		in.	mm	lbs.	kg		model #	list	model #	list	model #	list
14" overall height (356mm)	18" width (457mm)	24"	610	33	15.0	1.0	MDR1824-C	523	MDR1824-E	602	n/a	n/a
		30"	762	36	16.3	2.3	MDR1830-C	534	MDR1830-E	614	n/a	n/a
		36"	914	43	19.5	2.3	MDR1836-C	574	MDR1836-E	642	MDR1836-S	1066
		48"	1219	49	22.2	3.0	MDR1848-C	624	MDR1848-E	731	MDR1848-S	1260
		60"	1524	55	24.9	4.5	MDR1860-C	635	MDR1860-E	740	n/a	n/a
	21" width (533mm)	24"	610	36	16.3	3.1	MDR2124-C	538	MDR2124-E	619	n/a	n/a
		30"	762	39	17.6	3.3	MDR2130-C	542	MDR2130-E	628	n/a	n/a
		36"	914	45	20.4	3.0	MDR2136-C	555	MDR2136-E	642	n/a	n/a
		48"	1219	51	23.1	4.0	MDR2148-C	605	MDR2148-E	704	n/a	n/a
	24" width (610mm)	60"	1524	57	25.9	5.0	MDR2160-C	654	MDR2160-E	743	n/a	n/a
		24"	610	40	18.1	3.0	MDR2424-C	541	MDR2424-E	626	n/a	n/a
		30"	762	42	19.1	3.0	MDR2430-C	546	MDR2430-E	632	n/a	n/a
36"		914	47	21.3	3.0	MDR2436-C	591	MDR2436-E	663	MDR2436-S	1137	
48"		1219	53	24.0	4.0	MDR2448-C	644	MDR2448-E	730	MDR2448-S	1342	
		60"	1524	63	28.6	5.0	MDR2460-C	669	MDR2460-E	780	n/a	n/a

Polymer Dunnage Racks

see spec sheet **EG01.17**

Durable polyethylene construction prevents corrosion and rust.



FEATURES:

- No assembly required.

Freight class is 70.0.

(•) MTS (made to stock) / () MTO (made to order)

	width		length		weight		cubic feet	capacity		color	model #	list
	in.	mm	in.	mm	lbs.	kg		lbs.	kg			
12" height (305mm)	22"	559	36"	914	18	8.2	5.5	2000	907	black	PD3622	289
	22"	559	48"	1219	24	10.9	7.3	3000	1361	black	PD4822	349
	22"	559	60"	1524	28	12.7	9.2	3000	1361	black	PD6022	401
	36"	914	48"	1219	35	15.9	14.5	3500	1588	black	PD4836	384

Starter Units with Dunnage Shelf

see spec sheet **EG01.19**

Heavy duty dunnage shelf improves the units overall weight-bearing capacity.



FEATURES:

- Tapered split sleeves create a positive lock that becomes stronger as the load increases.
- 74" (1880mm) posts numbered in increments of 1" (25mm) to ensure fast and level assembly.

Freight class is 70.0.

(•) MTS (made to stock) / () MTO (made to order)

Stationary

width x length		zinc		chrome		EAGLEgard®	
in.	mm	model #	list	model #	list	model #	list
24" x 48"	610 x 1219	DS4-P74-2448Z	665	DS4-P74-2448C	763	DS4-P74-2448E	780

Mobile

width x length		zinc		chrome		EAGLEgard®	
in.	mm	model #	list	model #	list	model #	list
24" x 48"	610 x 1219	DS4-CP74-2448Z	762	DS4-CP74-2448C	861	DS4-CP74-2448E	877



Note: Mobile models feature 5" resilient swivel casters with bumpers.

Catalog Section 1

Aluminum Dunnage Racks

see spec sheet **EG01.17**



- 1½" (38mm) square tubing.
- Plastic feet.

FEATURES:

Freight class is 70.0.

(•) MTS (made to stock) / () MTO (made to order)

	length		weight		cubic feet	weight capacity		number of lats	RACKS WITH 8" (203mm) HEIGHT		RACKS WITH 12" (305mm) HEIGHT	
	in.	mm	lbs.	kg		lbs.	kg		model #	list	model #	list
20" width (508mm)	36"	914	10	4.5	6.8	2000	907	4	WDR203608-A •	241	WDR203612-A •	241
	48"	1219	14	6.4	8.9	2000	907	4	WDR204808-A •	280	WDR204812-A •	280
	60"	1524	18	8.2	11.0	1500	680	4	WDR206008-A •	315	WDR206012-A •	315
24" width (610mm)	36"	914	12	5.4	8.0	2000	907	5	WDR243608-A •	272	WDR243612-A •	272
	48"	1219	16	7.3	10.5	2000	907	5	WDR244808-A •	306	WDR244812-A •	306
	60"	1524	20	9.1	13.1	1500	680	5	WDR246008-A •	353	WDR246012-A •	353

Nesting Dunnage Racks

see spec sheet **EG01.17**



FEATURES:

- All-aluminum construction.

Freight class is 70.0.

(•) MTS (made to stock) / () MTO (made to order)

Racks are stackable, saving space when not in use.

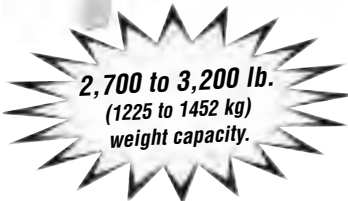

2,700 to 3,200 lb.
(1225 to 1452 kg)
weight capacity.

		length		weight		cubic feet	weight capacity		model #	list
		in.	mm	lbs.	kg		lbs.	kg		
12" height (305mm)	18" width (457mm)	24"	610	8	3.6	3.0	3200	1452	NDR182412-A	231
		36"	914	10	4.5	4.5	3200	1452	NDR183612-A	266
		48"	1219	12	5.4	6.0	2700	1225	NDR184812-A	297
	20" width (508mm)	24"	610	8	3.6	3.4	3200	1452	NDR202412-A	231
		36"	914	10	4.5	5.1	3200	1452	NDR203612-A	266
		48"	1219	12	5.4	6.7	2700	1225	NDR204812-A	297
	24" width (610mm)	24"	610	9	4.1	4.0	3200	1452	NDR242412-A	273
		36"	914	11	5.0	6.0	3200	1452	NDR243612-A	304
		48"	1219	14	6.4	8.0	2700	1225	NDR244812-A	353

Aluminum Truck Dollies

see spec sheet **EG01.03B**



INCLUDES:

- Four designated 5" x 1¼" (127 x 32mm) casters with poly tread.
- Wraparound bumpers.

Freight class is 70.0.

(•) MTS (made to stock) / () MTO (made to order)

	length		weight		cubic feet	caster type	caster load rate (each)		model #	list
	in.	mm	lbs.	kg			lbs.	kg		
29¾" width (756mm)	52"	1343	41	18.6	6.3	swivel	300	136.1	TD2448-SP	519
	52"	1343	44	20.0	6.3	swivel/brake	300	136.1	TD2448-BSP	1068
	64"	1648	48	21.8	7.6	swivel	300	136.1	TD2460-SP	545
	64"	1648	50	22.7	7.6	swivel/brake	300	136.1	TD2460-BSP	1074



Dolly Frames with Wraparound Bumper

see spec sheet **EG01.03B**



dolly frames
with wraparound bumper

- If ordering casters list dolly frame and caster model numbers separately.
- Holes are prepunched for use with plate casters on page 12.

ORDERING:

Freight class is 70.0.

(•) MTS (made to stock) / () MTO (made to order)

	Aluminum					Chrome Plated Steel						
	length		weight		cu	model #	list	weight		cu	model #	list
	in.	mm	lbs.	kg	ft			lbs.	kg	ft		
23³/₄" width (603mm)	40 ¹ / ₂ "	1038	14	6.4	1.6	DF1836-A	307	16	7.3	1.6	DF1836-C	464
	46 ¹ / ₂ "	1191	16	7.3	1.9	DF1842-A	322	18	8.2	1.9	DF1842-C	487
	52 ¹ / ₂ "	1343	18	8.2	2.1	DF1848-A	333	20	9.1	2.1	DF1848-C	502
	64 ¹ / ₂ "	1648	21	9.6	2.6	DF1860-A	366	23	10.4	2.6	DF1860-C	555
	76 ¹ / ₂ "	1953	23	10.4	2.9	DF1872-A	426	25	11.3	2.9	DF1872-C	643
26³/₄" width (680mm)	40 ¹ / ₂ "	1038	17	7.7	1.8	DF2136-A	331	19	8.6	1.8	DF2136-C	498
	46 ¹ / ₂ "	1191	19	8.6	2.1	DF2142-A	342	21	9.6	2.1	DF2142-C	515
	52 ¹ / ₂ "	1343	21	9.6	2.4	DF2148-A	357	24	10.9	2.4	DF2148-C	538
	64 ¹ / ₂ "	1648	23	10.4	2.9	DF2160-A	384	23	11.8	2.9	DF2160-C	578
	76 ¹ / ₂ "	1953	25	11.3	3.5	DF2172-A	403	28	12.7	3.5	DF2172-C	610
29³/₄" width (756mm)	40 ¹ / ₂ "	1038	21	9.6	2.1	DF2436-A	324	23	10.4	2.1	DF2436-C	490
	46 ¹ / ₂ "	1191	26	11.8	2.4	DF2442-A	340	29	13.2	2.4	DF2442-C	513
	52 ¹ / ₂ "	1343	29	13.2	3.9	DF2448-A	353	32	14.5	3.9	DF2448-C	533
	64 ¹ / ₂ "	1648	31	14.1	4.2	DF2460-A	384	34	15.4	4.2	DF2460-C	578
	76 ¹ / ₂ "	1953	39	17.7	4.5	DF2472-A	449	42	19.1	4.5	DF2472-C	677

Plastic Label Holders

see spec sheet **EG01.03D**



gray plastic label holder

black plastic label holder

clear plastic label holder

FEATURES:

- Snaps onto shelf edge.
- Provides easy identification of shelf contents or section.
- Holds 1" to 1¹/₄" (25 to 32mm) high labels.

Freight class is 70.0.

(•) MTS (made to stock) / () MTO (made to order)

length		fits shelf size		gray		black		clear	
in.	mm	in.	mm	model #	list	model #	list	model #	list
3"	76	all	all	A204331*	4	A206216 *	4	A208746	4
13"	330	18"	457	A206196	7	A206217	7	A208747	7
19"	483	24"	610	A206197	9	A206218	9	A208749	9
25"	635	30"	762	A206198	10	A206219	10	A208750	10
31"	787	36"	914	A206199	11	A206220	11	A208751 •	11
33"	838	36"	914	A213096	11	A227763	11	A227764	11
37"	940	42"	1067	A223747	12	A223748	12	A223749	12
43"	1092	48"	1219	A206200	13	A206221	13	A208752	13
45"	1143	48"	1219	A212494	16	A225208	16	A217621	16
55"	1397	60"	1524	A206201	19	A226222	19	A208753	19
67"	1702	72"	1829	A227842	25	A227841	25	A222144	25

* Actual length: 3³/₄" (83mm)



Security Modules

see spec sheet **EG01.16**



shown with hinged door
(shown mounted to shelf unit
sold separately)



shown with flip-up door
(shown mounted to shelf unit
sold separately)

- End panels.
- Rear panel.
- Door(s).
- Fits in between two wire shelves spaced 20" (508mm) apart.

INCLUDES:

Note: Shelving units sold separately—see pages 15 and 17.

Freight class is 70.0.

(•) MTS (made to stock) / () MTO (made to order)

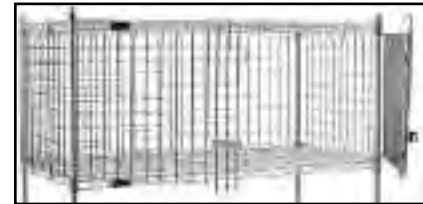

Converts portion of shelf unit into a lockable enclosed security unit, adding versatility to shelf unit. More than one module can be added to unit, depending on unit's overall height.

Hinged Doors

	length		weight		EAGLEbrite® zinc		chrome		EAGLE-Gard®		stainless steel	
	in.	mm	lb.	kg	model #	list	model #	list	model #	list	model #	list
18" width (457mm)	30"	762	20	9.0	SECM1830Z	332	SECM1830C	434	SECM1830E	457	SECM1830S	1173
	36"	914	23	10.4	SECM1836Z	338	SECM1836C	439	SECM1836E	463	SECM1836S	1195
	48"	1219	27	12.2	SECM1848Z	360	SECM1848C	466	SECM1848E	491	SECM1848S	1278
	60"	1524	32	14.5	SECM1860Z	363	SECM1860C	524	SECM1860E	551	SECM1860S	1285
21" width (533mm)	30"	762	21	9.5	SECM2130Z	337	SECM2130C	438	SECM2130E	462	SECM2130S	1191
	36"	914	24	10.9	SECM2136Z	345	SECM2136C	446	SECM2136E	469	SECM2136S	1216
	48"	1219	29	13.2	SECM2148Z	369	SECM2148C	475	SECM2148E	501	SECM2148S	1309
	60"	1524	33	15.0	SECM2160Z	374	SECM2160C	531	SECM2160E	559	SECM2160S	1322
24" width (610mm)	30"	762	24	10.9	SECM2430Z	343	SECM2430C	445	SECM2430E	468	SECM2430S	1210
	36"	914	27	12.2	SECM2436Z	354	SECM2436C	475	SECM2436E	501	SECM2436S	1253
	48"	1219	31	14.1	SECM2448Z	377	SECM2448C	539	SECM2448E	568	SECM2448S	1338
	60"	1524	35	15.9	SECM2460Z	400	SECM2460C	604	SECM2460E	635	SECM2460S	1425

Flip-Up Door

	length		weight		EAGLEbrite® zinc		chrome		EAGLE-Gard®		stainless steel	
	in.	mm	lb.	kg	model #	list	model #	list	model #	list	model #	list
18" width (457mm)	30"	762	24	10.9	SECM1830FZ	390	SECM1830FC	464	SECM1830FE	490	SECM1830FS	1370
	36"	914	29	13.2	SECM1836FZ	395	SECM1836FC	469	SECM1836FE	494	SECM1836FS	1390
	48"	1219	34	15.4	SECM1848FZ	412	SECM1848FC	492	SECM1848FE	518	SECM1848FS	1458
	60"	1524	39	17.6	SECM1860FZ	416	SECM1860FC	492	SECM1860FE	560	SECM1860FS	1467
21" width (533mm)	30"	762	26	11.8	SECM2130FZ	394	SECM2130FC	469	SECM2130FE	494	SECM2130FS	1387
	36"	914	30	13.6	SECM2136FZ	401	SECM2136FC	475	SECM2136FE	501	SECM2136FS	1408
	48"	1219	35	15.9	SECM2148FZ	426	SECM2148FC	502	SECM2148FE	528	SECM2148FS	1484
	60"	1524	40	18.1	SECM2160FZ	431	SECM2160FC	540	SECM2160FE	569	SECM2160FS	1499
24" width (610mm)	30"	762	28	12.7	SECM2430FZ	399	SECM2430FC	473	SECM2430FE	498	SECM2430FS	1402
	36"	914	32	14.5	SECM2436FZ	408	SECM2436FC	498	SECM2436FE	525	SECM2436FS	1438
	48"	1219	38	17.2	SECM2448FZ	427	SECM2448FC	548	SECM2448FE	576	SECM2448FS	1509
	60"	1524	43	19.5	SECM2460FZ	447	SECM2460FC	596	SECM2460FE	628	SECM2460FS	1580



FULL-SIZE SECURITY UNITS

Safely store and transport costly materials and items subject to pilferage.

Full-Size Stationary Security Units

see spec sheet **EG01.22**

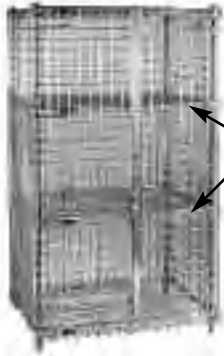

additional center shelves
(see page 41)



(Patent #5,390,803)

Patented QuadTruss® Design

makes shelves up to 25% stronger and provides a retaining ledge for increased strength and product retention.

FEATURES:

- 2" x 2" (51 x 51mm) mesh.
- Shipped knocked-down.

Note: See page 30 for optional cart covers available. Doors on front and rear of unit available. To order, add suffix "-2D" (ex: SC2436S-2D). **20% upcharge.**

Freight class is 70.0.

(•) MTS (made to stock) / () MTO (made to order)

		length		weight		cu ft	chrome		EAGLEgard®		stainless steel	
		in.	mm	lbs.	kg		model #	list	model #	list	model #	list
67" overall height (1702mm)	17 1/4" width (438mm)	33 1/4"	845	114	51.7	5	SC1430	968	SC1430E	971	SC1430S	2293
		39 1/4"	997	123	55.8	5	SC1436 •	1075	SC1436E	1079	SC1436S	2547
		51 1/4"	1302	141	64.0	9	SC1448 •	1337	SC1448E	1354	SC1448S	3102
		63 1/4"	1607	159	72.1	10	SC1460	1481	SC1460E	1466	SC1460S	3233
	27 1/4" width (692mm)	33 1/4"	845	123	55.8	9	SC2430	1033	SC2430E	1262	SC2430S	2860
		39 1/4"	997	145	65.8	9	SC2436 •	1147	SC2436E •	1402	SC2436S	3177
		51 1/4"	1302	171	77.6	13	SC2448 •	1429	SC2448E •	1742	SC2448S	3868
		63 1/4"	1607	197	89.4	15	SC2460 •	1549	SC2460E	1891	SC2460S	4006
	33 1/4" width (845mm)	33 1/4"	845	145	65.8	15	SC3030	1298	SC3030E	1542	SC3030S	3573
		39 1/4"	997	163	73.9	13	SC3036	1441	SC3036E	1713	SC3036S	3970
		51 1/4"	1302	181	82.1	15	SC3048	1795	SC3048E	2240	SC3048S	4837
		63 1/4"	1607	207	93.9	18	SC3060 •	1937	SC3060E	2408	SC3060S	5007

Full-Size Mobile Security Units

see spec sheet **EG01.22**

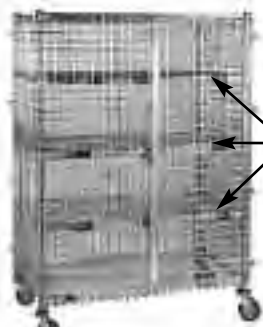

additional center shelves
(see page 41)



(Patent #5,390,803)

Patented QuadTruss® Design

makes shelves up to 25% stronger and provides a retaining ledge for increased strength and product retention.

FEATURES:

- Four swivel 5" x 1 1/4" (127 x 32mm) stem casters with polyurethane tread, two with brake.
- 2" x 2" (51 x 51mm) mesh.
- Shipped knocked-down.

Note: All stainless steel mobile security units come with stainless steel casters with polyurethane tread. See page 11 for other stem casters available. See page 30 for optional cart covers available. Doors on front and rear of unit available. To order, add suffix "-2D" (ex: CSC2430-2D). **20% upcharge.**

Freight class is 70.0.

(•) MTS (made to stock) / () MTO (made to order)

		length		weight		cu ft	chrome		EAGLEgard®		stainless steel	
		in.	mm	lbs.	kg		model #	list	model #	list	model #	list
69" overall height (1753mm)	27 1/4" width (692mm)	33 1/4"	845	135	61.2	9	CSC2430	1213	CSC2430E	1440	CSC2430S	2860
		39 1/4"	997	161	73.0	9	CSC2436 •	1348	CSC2436E •	1600	CSC2436S	3177
		51 1/4"	1302	185	83.9	13	CSC2448 •	1629	CSC2448E •	1945	CSC2448S	3869
		63 1/4"	1607	204	92.5	15	CSC2460 •	1752	CSC2460E	2092	CSC2460S	4006
	33 1/4" width (845mm)	33 1/4"	845	161	73.0	15	CSC3030	1533	CSC3030E	1846	CSC3030S	3573
		39 1/4"	997	179	87.2	13	CSC3036	1703	CSC3036E	2052	CSC3036S	3970
		51 1/4"	1302	203	92.1	15	CSC3048	2054	CSC3048E •	2491	CSC3048S	4837
		63 1/4"	1607	221	100.2	18	CSC3060 •	2208	CSC3060E	2681	CSC3060S	5007



Catalog Section 1

Full-Size Dolly Truck Security Units

see spec sheet **EG01.22**

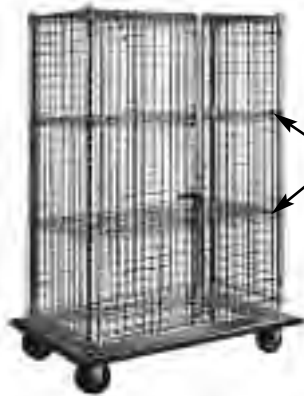

optional center shelves



(Patent #5,390,803)

Patented QuadTruss® Design

makes shelves up to 25% stronger and provides a retaining ledge for increased strength and product retention.

- Dolly with wraparound bumper.
- 2" x 2" (51x 51mm) mesh.
- Four swivel 5" x 1 1/4" (127 x 32mm) poly plate casters, two with brakes.
- Shipped knocked down.

INCLUDES:

Note: See page 12 for optional plate casters.
See page 30 for optional cart covers available.
Doors on front and rear of unit available. To order, add suffix "-2D" (ex: DTSC2448-2D). **20% upcharge.**

Freight class is 70.0.

(*) MTS (made to stock) / () MTO (made to order)

		length		weight		cu ft	chrome shelf unit with aluminum dolly		EAGLEgard® shelf unit with aluminum dolly		stainless steel shelf unit with stainless steel dolly	
		in.	mm	lbs.	kg		model #	list	model #	list	model #	list
69" overall height (1753mm)	29 3/4" width (756mm)	34 7/8"	886	161	73.0	7.3	DTSC2430	1457	DTSC2430E	2525	DTSC2430S	4702
		40 7/8"	1038	177	80.3	10.7	DTSC2436	1619	DTSC2436E	2805	DTSC2436S	5224
		52 7/8"	1343	214	97.1	18.5	DTSC2448	1920	DTSC2448E	3339	DTSC2448S	6200
		64 7/8"	1648	245	111.1	22.9	DTSC2460	2063	DTSC2460E	3682	DTSC2460S	6365

Optional Posts for Full-Size Security Units

post height in.	mm	weight		cu ft	chrome		EAGLEgard®		stainless steel	
		lbs.	kg		model #	list	model #	list	model #	list
74"	1880	4	1.8	0.5	SP74-CS	29	SP74-ES	35	SP74-SS	76
86"	2184	5	2.3	0.8	SP86-CS	36	SP86-ES	39	SP86-SS	87

Optional Shelves for Full-Size Security Units

	Wire Shelves					Optional Quad-Adjust® Shelves											
	Must be installed when assembling unit.					For use as intermediate shelves only.											
	length		weight		cu ft	chrome		EAGLEgard®		stainless steel		chrome		EAGLEgard®		stainless steel	
in.	mm	lbs.	kg	model #		list	model #	list	model #	list	model #	list	model #	list	model #	list	
14" width* (356mm)	30"	762	7	3.2	0.5	1430C •	55	1430E •	65	1430S	188	n/a	n/a	n/a	n/a	n/a	
	36"	914	8	3.6	0.5	1436C •	59	1436E •	67	1436S •	190	QA1436C	94	QA1436E	105	QA1436S	259
	48"	1219	10	4.5	0.7	1448C •	67	1448E •	78	1448S •	234	QA1448C	106	QA1448E	121	QA1448S	310
	60"	1524	14	6.4	0.9	1460C •	77	1460E •	89	1460S •	296	QA1460C	115	QA1460E	130	QA1460S	389
24" width (610mm)	30"	762	11	5.0	0.8	2430C •	75	2430E •	90	2430S •	287	n/a	n/a	n/a	n/a	n/a	
	36"	914	13	5.9	0.8	2436C •	77	2436E •	92	2436S •	291	QA2436C	115	QA2436E	134	QA2436S	382
	48"	1219	16	7.3	1.2	2448C •	92	2448E •	113	2448S •	352	QA2448C	134	QA2448E	158	QA2448S	454
	60"	1524	21	9.5	1.5	2460C •	110	2460E •	134	2460S •	430	QA2460C	153	QA2460E	180	QA2460S	552
30" width* (762mm)	30"	762	16	7.3	1.0	3030C	100	3030E	119	3030S	339						
	36"	914	17	7.7	1.0	3036C •	113	3036E •	137	3036S •	385						
	48"	1219	20	9.1	1.5	3048C •	130	3048E •	156	3048S •	448						
	60"	1524	25	11.4	1.8	3060C •	143	3060E •	178	3060S •	498						

* 14" and 30" widths (356 and 762mm) do not fit Full-Size Dolly Truck Security Units.

Ordering Full Size Security Units Assembled:

- Security carts shipped assembled, add \$350 to list price and add suffix "-A".
Example: SC1460E-A.
- For assembled unit with center shelves installed (evenly spaced), indicate number of center shelves wanted by adding a number before the "A" in suffix "-A".
- For **example**, suffix "-1A" indicates assembled unit with one center shelf, suffix "-2A" indicates assembled unit with two center shelves, and so on.
Example: SC1460E-2A.
- **PRICING:** add \$350 to list price of security unit, and add list price of each applicable center shelf to be added.



100 Industrial Boulevard, Clayton, DE 19938-8903 U.S.A.
Phone: 800-637-5100 or 302-653-3000. Fax: 302-653-2065
http://www.eaglegrp.com

Mini Security Units

see spec sheet **EG01.22**



(Patent #5,390,803)

Patented QuadTruss® Design makes shelves up to 25% stronger and provides a retaining ledge for increased strength and product retention.

- Stationary chrome plated units.
- 40" (1016mm) height.
- Shipped knocked down.

FEATURES:

Freight class is 70.0.

(•) MTS (made to stock) / () MTO (made to order)

	length		weight		cubic feet	model #	list
	in.	mm	lbs.	kg			
16" width (406mm)	38"	965	88	39.9	8.6	MSC1436•	926
	50"	1270	104	47.2	9.6	MSC1448	1185
26" width (660mm)	38"	965	100	45.4	9.2	MSC2436*	962
	50"	1270	114	51.7	10.6	MSC2448*	1229

* Optional stem casters (page 11) available only for these models.

Optional Shelves for Mini Security Units

- With chrome plated finish.

	length		weight		cubic feet	model #	list
	in.	mm	lbs.	kg			
14" width (356mm)	36"	914	8	3.6	0.5	1436C•	59
	48"	1219	10	4.5	0.7	1448C•	67
24" width (610mm)	36"	914	13	6.0	0.8	2436C•	77
	48"	1219	16	7.3	1.2	2448C•	92



Optional Add-A-Shelf® Adjustable Shelves for All Security Units

see spec sheet **EG01.22**



optional Add-A-Shelf® being added to security unit

WEIGHT CAPACITY: • 300 lb. (136.1 kg) per shelf.

Note: Top and bottom shelves of unit must be standard shelves—see page 41.

WARNING: • Use Add-A-Shelf® shelves for intermediate shelves.

FEATURES: • Chrome finish.

Freight class is 70.0.

(•) MTS (made to stock) / () MTO (made to order)



(Patent #5,390,803)

Patented QuadTruss® Design makes shelves up to 25% stronger and provides a retaining ledge for increased strength and product retention.

Just a quick note...



GET FREE DOWNLOADS

- Spec Sheet • Product Instructions •
- Special Flyers • Brochures •

www.eaglegrp.com

	length		weight		cubic feet	model #	list
	in.	mm	lbs.	kg			
14" width (356mm)	36"	914	8	3.6	0.5	A1436C•	65
	48"	1219	10	4.6	0.7	A1448C•	74
24" width (610mm)	36"	914	13	5.9	0.8	A2436C•	85
	48"	1219	16	7.3	1.2	A2448C•	100
	60"	1524	21	9.5	1.5	A2460C•	127



Catalog Section 1

Tank Racks

see spec sheet **EG01.31**

FEATURES:

- All models chrome-plated.
- Two styles available.

Freight class is 70.0.

(•) MTS (made to stock) / () MTO (made to order)



style "B" tank rack with optional drip pan shown



style "A" tank rack with optional drip pan shown

Style "A" – 33" (838mm) height

Includes:

- One dunnage mat with frame.
- One 3-sided frame.
- Four 33" (838mm) posts.
- Cable assembly.

Style "B" – 74" (1880mm) height

Includes:

- One dunnage mat with frame.
- One 3-sided frame.
- Four 74" (1880mm) posts.
- Cable assembly.
- Two standard shelves.

	length		weight		cu	model #	list	weight		cu	model #	list
	in.	mm	lb.	kg	ft			lb.	kg	ft		
24" width (610mm)	30"	762	40	18.1	0.2	STR2430A	427	68	30.8	0.3	STR2430B	652
	48"	1219	50	22.7	0.3	STR2448A	511	88	39.9	0.4	STR2448B	790

Optional Drip Pans for Tank Racks

- Stainless steel.



	length		weight		cu	model #	list
	in.	mm	lb.	kg	ft		
24" width (610mm)	30"	762	8	3.6	0.2	DP30	227
	48"	1219	12	5.4	0.3	DP48	258

Optional Cylinder Retainer for Tank Racks

- Chrome-plated.
- Cylinders are secured to retainer to further prevent damage.

	width		weight		cu	model #	list
	in.	mm	lb.	kg	ft		
24"	610	7	3.2	0.3	CRR24-C	107	



Modular Desks / Workstations

see spec sheet **EG01.02**



FEATURES:

- Heavy gauge type 304 stainless steel.
- Two chrome cantilever open-wire shelves.
- 16 gauge 1" (25mm) diameter chrome-plated posts with exclusive MasterSeal® coating.
- Rear grid panel constructed of chrome
- Three-sided 1" (25mm) channel frame.
- Leveling feet.

Note: Optional keyboard drawer available. To order add suffix "**-K**" to model number (example: **MD2448-K**) and **\$297** to list price.

Freight class is 70.0.

(•) MTS (made to stock) / () MTO (made to order)

	length		weight		cubic	model #	list
	in.	mm	lb.	kg	feet		
24" width (610mm)	36"	914	78	35.3	1.0	MD2436	1174
	48"	1219	85	38.6	1.0	MD2448	1272

Optional Keyboard Station

- Mounts under tabletop.
- 20½" wide x 11½" deep (521 x 292mm).

weight		cubic	stainless steel	
lbs.	kg	feet	model #	list
6.0	2.7	0.35	KBD-1/SS	297



adjuSTable® Work Surface Systems

see spec sheet **EG10.09**

CUSTOMIZABLE WORK SURFACE CONFIGURATIONS TO MEET YOUR NEEDS!



basic unit



1-tier unit



2-tier unit

adjuSTable®

- Unit can be expanded and customized by adding optional shelving accessories (pages 45-50).
- Custom configurations available, including alternate finishes and solid shelving. Contact factory to configure your custom workstation.
- Optional drawers available (see pages 170-173).

CUSTOM:

Freight class is 70.0.

(•) MTS (made to stock) / () MTO (made to order)



(Patent #5,390,803)

Patented QuadTruss® Design makes shelves up to 25% stronger and provides a retaining ledge for increased strength and product retention.

Additional wire undershelves, solid stainless steel undershelves, chrome wire overshelves, or solid stainless steel overshelves make the possibilities almost unlimited.

		Basic Units				1-tier Units				2-tier Units											
	length	cu	weight		16/304		14/304		weight	16/304		14/304		weight	16/304		14/304				
	in.	mm	ft	lbs.	kg	model #	list	model #		list	lbs.	kg	model #		list	model #	list	model #	list		
24" width (610mm)	36"	914	4.5	65	29.5	T2436EBW	791	T2436EW	867	73	33.1	T2436EBW-1	985	T2436EW-1	1060	81	36.7	T2436EBW-2	1080	T2436EW-2	1157
	48"	1219	5.7	81	36.7	T2448EBW	860	T2448EW	996	91	41.3	T2448EBW-1	1104	T2448EW-1	1207	101	45.8	T2448EBW-2	1218	T2448EW-2	1322
	60"	1524	7.1	99	44.9	T2460EBW	1006	T2460EW	1145	113	51.3	T2460EBW-1	1246	T2460EW-1	1364	127	57.6	T2460EBW-2	1370	T2460EW-2	1489
30" width (762mm)	36"	914	4.5	75	34.0	T3036EBW	877	T3036EW	982	83	37.6	T3036EBW-1	1070	T3036EW-1	1179	91	41.3	T3036EBW-2	1164	T3036EW-2	1274
	48"	1219	5.7	94	42.6	T3048EBW	989	T3048EW	1128	104	47.2	T3048EBW-1	1201	T3048EW-1	1335	114	51.7	T3048EBW-2	1313	T3048EW-2	1455
	60"	1524	7.1	115	52.2	T3060EBW	1145	T3060EW	1303	129	58.5	T3060EBW-1	1364	T3060EW-1	1525	143	64.9	T3060EBW-2	1488	T3060EW-2	1651

CONSISTS OF:

- Stainless steel table top/work surface with hat channel supports.
- Four 33" (838mm) chrome posts.
- Two chrome wire undershelves.*

CONSISTS OF:

- Stainless steel table top/work surface with hat channel supports.
- Two 54" (1372mm) rear chrome posts.
- Two 33" (838mm) front chrome posts.
- Two 21" (533mm) front chrome posts for overshelf.
- One 14" (356mm) wide chrome wire overshelf.
- Two chrome wire undershelves.*

CONSISTS OF:

- Stainless steel table top/work surface with hat channel supports.
- Two 63" (1600mm) rear chrome posts.
- Two 33" (838mm) front chrome posts.
- Two 29" (737mm) front chrome posts for overshelves.
- Two 14" (356mm) wide chrome wire overshelves.
- Two chrome wire undershelves.*

*18" (457mm) wide undershelves used for 24" (610mm) wide tables; 24" (610mm) wide undershelves used for 30" (762mm) wide tables.

Optional Keyboard Stations

- 20½" wide x 11½" deep (521 x 292mm).

		Table Mount		Wire Mount				
weight	cubic	stainless steel		chrome		stainless steel		
		model #	list	model #	list	model #	list	
6.0	2.7	0.35	KBD-1/SS	297	KBD-2•	182	KBD-2/SS	370



table mount keyboard station



wire mount keyboard station

Post Clamp for 1-tier and 2-tier Units

- Attaches 3" x 3" (76 x 76mm) grid panel (see enclosure panels on page 26 and wall mats on page 88) onto AdjuSTable® systems with overshelves.
- Chrome-plated collar with ¼-20 weld stud, chrome acorn nut and heavy gauge clamp.

model #	list each
A210098	5



Catalog Section 1

Shelving Components / Accessories

see spec sheets **EG01.03A** **EG01.03D**

Freight class is 70.0.

(•) MTS (made to stock) / () MTO (made to order)

Collar Plug

- Fills shelf corner openings where posts have been eliminated by use of "S" hooks.
- Packed four per bag.

model #	list
COLLAR PLUG	5
<i>(set of four)</i>	



Post Cap

- Fills post end openings at top of shelving unit.

model #	list ea
POST CAP	1



Post Clamps

- Provides maximum strength when shelving units are connected by clamping posts securely together.



chrome		black epoxy	
model #	list ea	model #	list ea
POST CLAMP	7	A214169	8

Retaining Clamp

- Chrome-plated.
- For use with enclosure panels (page 26) in conjunction with wire shelf.

model #	list ea
RETAINING CLAMP	4



Glides

- Fits under leveling bolt to protect floors from abrasion.

model #	list ea
GLIDES	2



Foot Plates

- These allow unit to be bolted to the floor.
- Can be used without bolts when a wider foot is desired for more stability.



triangular



square



"space-saving" square

Aluminum Split Sleeves

- For conductive, over-the-road or high-temperature installations.
- Set of four.

with zinc rings		with stainless rings	
model #	list	model #	list
A208909 •	15	A208908 •	25



aluminum split sleeves and ring



Plastic Split Sleeves

- Four included with each shelf.
- High-temperature-resistant ABS plastic create a positive lock that becomes stronger as the load increases.

model #	list
PLASTIC SPLIT SLEEVES	5
<i>(set of four)</i>	



Plastic Conductive Split Sleeves

- Packed four per bag.

model #	list
A219236	10



Casting

- Stabilizes leveling foot.

model #	list ea
A203568	2

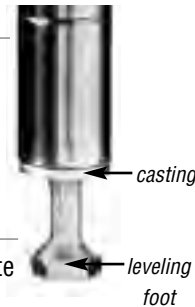

casting

leveling foot

Leveling Foot

- Use these to accommodate for uneven floors.

model #	list ea
LEVELING FOOT	1

Security "S" Hooks

- Discourages separation of adjoined shelf units.
- Hardware included.

model #	list ea
S-HOOKS-SK	8

"S" Hooks

- Join individual shelving units in a number of combinations using "S" hooks.
- Joins end-to-end, back-to-back, or at right angles.
- Two hooks required per connection.

model #	list ea
A200012 •	3



Rods and Tabs

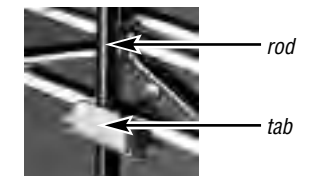

rod

tab

chrome		stainless steel	
model #	list ea	model #	list ea
R54-C	10	R54-S	33
R63-C •	11	R63-S	36
R74-C •	12	R74-S	41
R86-C •	14	R86-S	44

Dividers

see spec sheet **EG01.03A**

FEATURES:

- 8" high (203mm) dividers keep shelf contents organized.

Freight class is 70.0.

(•) MTS (made to stock) / () MTO (made to order)

Solid Shelving Dividers

length		cubic	weight		chrome		stainless steel	
in.	mm	feet	lb.	kg	model #	list	model #	list
14"	356	0.6	1.0	0.5	SSD14-C	22	SSD14-S	65
18"	457	0.6	1.3	0.6	SSD18-C	25	SSD18-S	67
21"	533	0.8	1.5	0.7	SSD21-C	27	SSD21-S	79
24"	610	1.0	1.8	0.8	SSD24-C •	30	SSD24-S	81
30"	762	1.2	2.3	1.0	SSD30-C	41	SSD30-S	100
36"	914	1.4	3.0	1.4	SSD36-C	51	SSD36-S	118



Wire Shelving Dividers

length		cubic	weight		chrome		VALU-MASTER®		Valu-Gard®		EAGLEgard®		stainless	
in.	mm	feet	lb.	kg	model #	list	model #	list	model #	list	model #	list	model #	list
14"	356	0.6	1.0	0.5	SD14-C •	22	SD14-V	23	SD14-VG	23	SD14-E	24	SD14-S	56
18"	457	0.6	1.0	0.5	SD18-C	25	SD18-V	26	SD18-VG	26	SD18-E	27	SD18-S	64
21"	533	0.8	2.0	0.9	SD21-C •	27	SD21-V	28	SD21-VG	28	SD21-E	30	SD21-S	72
24"	610	1.0	2.0	0.9	SD24-C •	31	SD24-V	34	SD24-VG	34	SD24-E	37	SD24-S •	78
30"	762	1.2	2.0	0.9	SD30-C	37	SD30-V	38	SD30-VG	38	n/a	n/a	SD30-S	95
36"	914	1.4	3.0	1.4	SD36-C	43	SD36-V	46	SD36-VG	46	n/a	n/a	SD36-S	115

Slanted Shelves

see spec sheet **EG01.03E**

FEATURES:

- Shipped knocked-down.

Freight class is 70.0.

(•) MTS (made to stock) / () MTO (made to order)

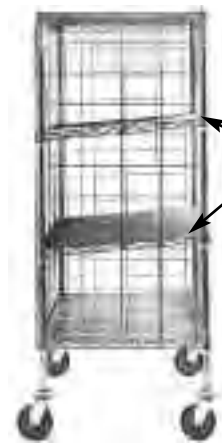

Increased visibility allows easy access to shelf contents.

optional slanted shelves



(Patent #5,390,803)

Patented QuadTruss® Design

makes shelves up to 25% stronger and provides a retaining ledge for increased strength and product retention.

	length		weight		cubic feet	EAGLEbrite®		chrome		EAGLEgard®	
	in.	mm	lb.	kg		model #	list	model #	list	model #	list
21" width (533mm)	36"	914	11	5.0	0.8	SL2136Z	92	SL2136C	102	SL2136E	120
	48"	1219	14	6.4	1.1	SL2148Z	120	SL2148C	132	SL2148E	159
	60"	1524	18	8.2	1.1	SL2160Z	129	SL2160C	142	SL2160E	185
24" width (610mm)	36"	914	13	5.9	0.8	SL2436Z	114	SL2436C	127	SL2436E	152
	48"	1219	16	7.3	1.2	SL2448Z	133	SL2448C	147	SL2448E	179
	60"	1524	21	9.5	1.5	SL2460Z	144	SL2460C	156	SL2460E	190

Stationary Wire Wall Mounts

see spec sheet **EG02.12**

END UNIT:

- One single shelf support and mounting plate.

MID UNIT:

- One double shelf support and mounting plate.

Freight class is 70.0.

(•) MTS (made to stock) / () MTO (made to order)



end unit

Designed for fixed application

Note: Shelves (page 6) sold separately.

End Units*										Mid Units								
length		cu ft	weight**		chrome		Valu-Gard®		stainless**		weight** lbs. kg	chrome		Valu-Gard®		stainless**		
in.	mm		ft	lbs.	kg	model #	list	model #	list	model #		list	model #	list	model #	list	model #	list
14"	356	0.5	6	2.7	WB14-C •	39	WB14-VG •	39	WB14-S •	86	8	3.6	DWB14-C •	59	DWB14-VG	59	DWB14-S	128
18"	457	0.5	8	3.6	WB18-C •	40	WB18-VG •	40	WB18-S •	89	10	4.5	DWB18-C •	61	DWB18-VG	61	DWB18-S	136
21"	533	0.7	10	4.5	WB21-C •	40	WB21-VG	40	WB21-S	93	12	5.5	DWB21-C	62	DWB21-VG	62	DWB21-S	139
24"	610	0.7	12	5.5	WB24-C •	41	WB24-VG	41	WB24-S •	96	14	6.4	DWB24-C •	63	DWB24-VG	63	DWB24-S	143

*End Units priced per piece; **For stainless steel units, add 1 lb. (0.5 kg) weight.

Catalog Section 1

Ledges

see spec sheet **EG01.03A**

FEATURES:

- Prevents contents from falling off unit.
- Easily attaches without the use of tools.

Freight class is 70.0.

(•) MTS (made to stock) / () MTO (made to order)

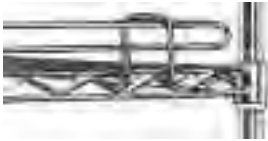

1"-high (25mm) ledge
for wire shelving



4"-high (102mm) ledge
for wire shelving

Solid Shelving Ledges

1"-high (25mm) Ledges *

4"-high (102mm) Ledges

length in.	mm	cu ft	weight		chrome		stainless steel		weight lb.	kg	chrome		stainless steel	
			lb.	kg	model #	list	model #	list			model #	list	model #	list
14"	356	0.2	0.2	0.1	SL14-1C	16	SL14-1S	34	0.8	0.4	SL14-4C	22	SL14-4S	41
18"	457	0.3	0.3	0.1	SL18-1C	18	SL18-1S	36	0.9	0.4	SL18-4C	23	SL18-4S	43
21"	533	0.3	0.4	0.2	SL21-1C	19	SL21-1S	39	1.0	0.5	SL21-4C	24	SL21-4S	48
24"	610	0.3	0.5	0.2	SL24-1C	22	SL24-1S	44	1.2	0.6	SL24-4C	25	SL24-4S	55
30"	762	0.5	0.7	0.3	SL30-1C	26	SL30-1S	53	1.4	0.6	SL30-4C	29	SL30-4S	64
36"	914	0.6	0.9	0.4	SL36-1C	28	SL36-1S	62	1.6	0.7	SL36-4C	33	SL36-4S	76
42"	1067	0.6	1.1	0.5	SL42-1C	29	SL42-1S	67	1.8	0.8	SL42-4C	35	SL42-4S	82
48"	1092	0.7	1.3	0.6	SL48-1C	33	SL48-1S	78	2.0	0.9	SL48-4C	40	SL48-4S	207
54"	1372	0.8	1.5	0.7	SL54-1C	35	SL54-1S	86	2.2	1.0	SL54-4C	41	SL54-4S	214
60"	1524	0.8	1.7	0.8	SL60-1C	36	SL60-1S	90	2.4	1.1	SL60-4C	42	SL60-4S	222
72"	1829	1.0	2.1	1.0	SL72-1C	40	SL72-1S	101	2.6	1.2	SL72-4C	49	SL72-4S	226

* When installed, actual height of ledge is 1½" (38mm).

Wire Shelving 1"-high (25mm) Ledges *

length in.	mm	cu ft	weight		chrome		VALU-MASTER®		Valu-Gard®		stainless	
			lb.	kg	model #	list	model #	list	model #	list	model #	list
14"	356	0.2	0.2	0.1	L14-1C	12	L14-1V	13	L14-1VG	13	L14-1S	21
18"	457	0.3	0.3	0.1	L18-1C	13	L18-1V	14	L18-1VG	14	L18-1S	23
21"	533	0.3	0.4	0.2	L21-1C	14	L21-1V	15	L21-1VG	15	L21-1S	25
24"	610	0.3	0.5	0.2	L24-1C •	15	L24-1V	16	L24-1VG	16	L24-1S	27
30"	762	0.5	0.7	0.3	L30-1C	18	L30-1V	19	L30-1VG	19	L30-1S	37
36"	914	0.6	0.9	0.4	L36-1C	22	L36-1V	23	L36-1VG	23	L36-1S	41
42"	1067	0.6	1.1	0.5	L42-1C	23	L42-1V	24	L42-1VG	24	L42-1S	46
48"	1092	0.7	1.3	0.6	L48-1C •	24	L48-1V	25	L48-1VG	25	L48-1S	46
54"	1372	0.8	1.5	0.7	L54-1C •	26	L54-1V	27	L54-1VG	27	L54-1S	57
60"	1524	0.8	1.7	0.8	L60-1C •	26	L60-1V	28	L60-1VG	28	L60-1S	57
72"	1829	1.0	2.1	1.0	L72-1C	27	L72-1V	29	L72-1VG	29	L72-1S	64

* When installed, actual height of ledge is 1½" (38mm).

Wire Shelving 4"-high (102mm) Ledges

length in.	mm	cu ft	weight		chrome		VALU-MASTER®		Valu-Gard®		EAGLEgard®		stainless	
			lb.	kg	model #	list	model #	list	model #	list	model #	list	model #	list
14"	356	0.2	0.8	0.4	L14-4C •	16	L14-4V	18	L14-4VG	18	L14-4E	19	L14-4S	36
18"	457	0.3	0.9	0.4	L18-4C •	18	L18-4V	19	L18-4VG	19	L18-4E	23	L18-4S •	40
21"	533	0.3	1.0	0.5	L21-4C •	19	L21-4V	21	L21-4VG	21	L21-4E	24	L21-4S	46
24"	610	0.3	1.2	0.6	L24-4C •	22	L24-4V	23	L24-4VG	23	L24-4E	25	L24-4S •	48
30"	762	0.5	1.4	0.6	L30-4C •	25	L30-4V	26	L30-4VG	26	L30-4E	29	L30-4S	60
36"	914	0.6	1.6	0.7	L36-4C •	27	L36-4V	28	L36-4VG	28	L36-4E	31	L36-4S •	70
42"	1067	0.6	1.8	0.8	L42-4C •	33	L42-4V	35	L42-4VG	35	L42-4E	39	L42-4S	89
48"	1092	0.7	2.0	0.9	L48-4C •	33	L48-4V	36	L48-4VG	36	L48-4E	39	L48-4S	89
54"	1372	0.8	2.2	1.0	L54-4C	36	L54-4V	38	L54-4VG	38	L54-4E	42	L54-4S	102
60"	1524	0.8	2.4	1.1	L60-4C •	36	L60-4V	39	L60-4VG	39	L60-4E	42	L60-4S	102
72"	1829	1.0	2.6	1.2	L72-4C •	43	L72-4V	46	L72-4VG	46	L72-4E	51	L72-4S •	128



Slide Systems

see spec sheet **EG01.03C**

LOAD CAPACITY: • Up to 35 lbs. (15.9 kg).

FEATURES: • Easily attaches without the use of tools.

Freight class is 70.0.

(•) MTS (made to stock) / () MTO (made to order)



slide system with tote boxes

Clever way to improve space efficiency.



fits shelf width	adaptable tote boxes	width x length x depth	weight lbs.	kg	cubic feet	model #	list
24" (610mm)	TB1022-3, TB1022-6	21 1/2" x 14" x 10 1/4" (683 x 356 x 260mm)	5.0	2.3	2.0	TS1421	100
24" (610mm)	TB1722-3, TB1722-6, TB1722-9	21 1/2" x 20" x 10 1/4" (683 x 508 x 260mm)	7.5	3.4	3.8	TS2021 •	104
21" (533mm)	TB1016-3, TB1016-6	17 1/2" x 14" x 10 1/4" (543 x 356 x 260mm)	4.0	1.8	1.8	TS1417	99
21" (533mm)	TB1722-3*, TB1722-6*, TB1722-9*	17 1/2" x 25 1/2" x 10 1/4" (543 x 797 x 260mm)	5.0	2.3	4.0	TS2517	103

* Fits TS2517 sideways

Tote Boxes for Slide Systems

see spec sheet **EG01.03C**

FEATURES: • Dividable up to 1 1/8" (29mm) square compartments.
• Injection molded from high-density polyethylene material.

Note: Also available in molded fiberglass (see page 49).

Freight class is 70.0.

(•) MTS (made to stock) / () MTO (made to order)

ESD Tote Boxes and Accessories also available! See pages 133 and 134.



TB1016 & TB1722 series



TB1022 series

fits slide system	width x length x depth inches	mm	weight lbs.	kg	cubic feet	color	model #	list
TS1417	10 1/2" x 16 1/2" x 3 1/2"	276 x 419 x 89	1.0	0.5	0.4	gray	TB1016-3	30
TS1417	10 1/2" x 16 1/2" x 6"	276 x 419 x 152	1.5	0.7	0.8	gray	TB1016-6	33
TS2021, TS2517	17 1/2" x 22 1/2" x 3"	444 x 572 x 76	2.3	1.0	0.8	gray	TB1722-3 *	49
TS2021, TS2517	17 1/2" x 22 1/2" x 6"	444 x 572 x 152	3.5	1.6	1.5	gray	TB1722-6 ••	57
TS2021, TS2517	17 1/2" x 22 1/2" x 8"	444 x 572 x 203	4.0	1.8	3.0	gray	TB1722-9 *	68
TS1421, TS2517	11" x 22 1/2" x 3"	279 x 572 x 76	1.5	0.7	0.6	white	TB1022-3	36
TS1421, TS2517	11" x 22 1/2" x 5 3/4"	279 x 572 x 146	2.0	0.9	1.1	white	TB1022-6	42

* Fits TS2517 sideways

Tote Box Dividers and Covers

fits tote box	color	Long Dividers			Short Dividers			Covers	
		model #	list	max. # accepted	model #	list	max. # accepted	model #	list
TB1016-3	gray	A217766	4	7	A217760	4	11	A217765	28
TB1016-6	gray	A203841	5	7	A203843	4	11	A217765	28
TB1722-3	gray	A217763	4	11	A217764	4	15	A217638	35
TB1722-6	gray	A203842	5	11	A203844	6	15	A217638	35
TB1722-9	gray	A203845	7	11	A203846	6	15	A217638	35
TB1022-3	white	A203838	4	7	A203839	4	15	A203874	30
TB1022-6	white	A217759	5	7	A217791	4	15	A203874	30



cover (for TB1016 and TB1722 tote boxes)



dividers

Catalog Section 1

Card Holders for Tote Boxes

see spec sheet **EG01.03C**



FEATURES:

- Clear vinyl.

Freight class is 70.0.

(•) MTS (made to stock) / () MTO (made to order)

holds labels		model #	list
in.	mm		
2" x 8"	51 x 203	CH28	8
3" x 5"	76 x 127	CH35	9
5" x 8"	127 x 203	CH58	10

Molded Fiberglass Boxes and Trays

see spec sheet **EG01.03C**



assorted molded fiberglass boxes and trays

Boxes are stackable for maximum storage efficiency!

FEATURES:

- Made of thermoset polyester composite material.
- Flame and chemical resistant.

Freight class is 70.0.

(•) MTS (made to stock) / () MTO (made to order)

description	bottom inside dimensions length x width x depth		top outside dimensions length x width x height		cu ft	model #	list
	in.	mm	in.	mm			
tray	24 $\frac{3}{4}$ " x 16 $\frac{1}{4}$ " x 1"	619 x 413 x 25	25 $\frac{1}{4}$ " x 17 $\frac{1}{4}$ " x 1 $\frac{1}{2}$ "	654 x 454 x 29	0.1	A208505	72
stacking box	23 $\frac{3}{4}$ " x 15 $\frac{1}{4}$ " x 2 $\frac{1}{4}$ "	606 x 403 x 73	25 $\frac{1}{4}$ " x 17 $\frac{1}{4}$ " x 3"	654 x 451 x 76	0.6	A208506	96
stacking box	23 $\frac{3}{4}$ " x 15 $\frac{1}{4}$ " x 4 $\frac{1}{2}$ "	606 x 403 x 114	25 $\frac{1}{4}$ " x 17 $\frac{1}{4}$ " x 4 $\frac{1}{2}$ "	654 x 451 x 114	1.0	A208507	88
stacking box	23 $\frac{3}{4}$ " x 15 $\frac{1}{4}$ " x 5 $\frac{1}{4}$ "	606 x 403 x 146	25 $\frac{1}{4}$ " x 17 $\frac{1}{4}$ " x 6"	654 x 451 x 152	1.3	A208508	85
lid	—	—	25 $\frac{1}{4}$ " x 17 $\frac{1}{4}$ "	654 x 451	—	A208513*	51

* Model #A208513 lid fits models A208506, A208507, and A208508 stacking boxes.

Storage Baskets

see spec sheet **EG01.03E**

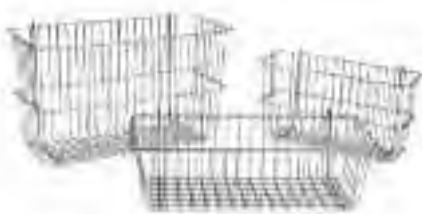

FEATURES:

- Chrome-plated.
- Easily attaches to hanger rail or side of wire shelf.

Freight class is 70.0.

(•) MTS (made to stock) / () MTO (made to order)

width x length x height in.	width x length x height mm	weight		cubic feet	model #	list
		lbs.	kg			
13 $\frac{3}{4}$ " x 5" x 7"	340 x 127 x 178	9	4.1	0.4	A216650	36
17 $\frac{1}{2}$ " x 7 $\frac{1}{2}$ " x 5"	441 x 191 x 127	7	3.2	0.6	A216651	39
17 $\frac{1}{2}$ " x 7 $\frac{1}{2}$ " x 10"	441 x 191 x 254	11	5.0	1.0	A216652	53

File Basket

see spec sheet **EG01.03E**



Ideal for organizing standard-sized file folders.

FEATURES:

- Chrome-plated.
- Fits all widths.

Freight class is 70.0.

(•) MTS (made to stock) / () MTO (made to order)

width x length x height in.		width x length x height mm		weight		cubic feet	model #	list
				lbs.	kg			
2 $\frac{1}{2}$ " x 12 $\frac{1}{2}$ " x 8 $\frac{3}{4}$ "		67 x 324 x 222		2	0.9	0.3	A216649	43

Sliding Shelf

see spec sheet **EG01.03E**



width x length		weight		chrome	
in	mm	lbs.	kg	model #	list
18" x 36"	457 x 914	9	4.1	SLS1836C	77

FEATURES:

- Chrome-plated.
- For use with standard 1" (25mm)-diameter posts—on wire shelf or solid shelf units.

Freight class is 70.0.

(•) MTS (made to stock) / () MTO (made to order)

Tray Slides

see spec sheet **EG01.03C**

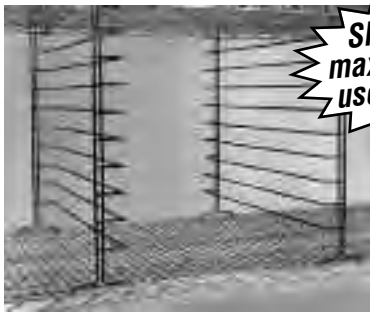

Slides help maximize your use of space!

50-lb. weight capacity per slide.

FEATURES:

- 1¾" (45mm) spacing, 22" (559mm) height.
- Sold as a set of two.
- 18" or 24" (457 or 610mm) wide applications.
- Can be used with tote boxes on page 48.

Freight class is 70.0.

(•) MTS (made to stock) / () MTO (made to order)

Standard
Holds 9 trays.

Heavy Duty
Holds 11 trays. Features panel assembly welded to the back of slides

width	cu ft	weight		chrome		EAGLEgard®		weight lbs.	kg	chrome		EAGLEgard®	
		lbs.	kg	model #	list	model #	list			model #	list	model #	list
17½" (435mm)	2.3	9	4.1	TS18-C	81	TS18-E	96	12	5.4	HDT18-C	192	HDT18-E	213
23½" (587mm)	3.0	11	5.0	TS24-C	86	TS24-E	101	15	6.8	HDT24-C	211	HDT24-E	235

Adjustable Undershelf Slides

see spec sheet **EG01.03C**



adjustable undershelf slides with tote box

FEATURES:

- Stainless steel.
- Accommodates any tote box side-to-side dimension.
- Sold as a set.

Freight class is 70.0.

(•) MTS (made to stock) / () MTO (made to order)

description	weight		model #	list
	lbs.	kg		
slides for 18" (457mm) wide shelf	3	1.4	US18-S	56
slides for 21" (533mm) wide shelf	3	1.4	US21-S	61
slides for 24" (610mm) wide shelf	3	1.4	US24-S	64
slides for 30" (762mm) wide shelf	4	1.8	US30-S	67
slides with side-to-side mount, for 24" (610mm) wide shelf	3	1.4	USS24-S	125
slides with side-to-side mount, for 30" (762mm) wide shelf	4	1.8	USS30-S	151

Tote Boxes for Adjustable Undershelf Slides

width x length x depth		weight		cubic feet	model #		list
in.	mm	lbs.	kg		model #	list	
17½" x 22½" x 3"	446 x 568 x 76	2	0.9	0.8	TB1722-3	49	
17½" x 22½" x 6"	446 x 568 x 152	3	1.4	1.4	TB1722-6•	57	
17½" x 22½" x 8"	446 x 568 x 203	4	1.8	2.3	TB1722-9	68	

One-Piece Slides

see spec sheet **EG01.03C**



one-piece slide with tote box

FEATURES:

- Easily attaches to shelf.

Freight class is 70.0.

(•) MTS (made to stock) / () MTO (made to order)

Helps prevent shelf clutter!

Tote Box for One-Piece Slides

width x length x depth		weight		cubic feet	model #		list
in.	mm	lbs.	kg		model #	list	
17½" x 22½" x 6"	446 x 568 x 152	3.5	1.6	1.5	TB1722-6•	57	

Catalog Section 1

Post Extension Kit and Components

see spec sheet **EG01.03D**

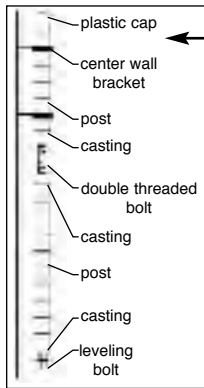

Post Extension Kit

description	model #	list
consists of components listed below, set of four	4PEK	61

Components

item	model #	list
double-threaded bolt	A200868	2
wall bracket	B201023	9
casting	A207351	5

FEATURES:

- Screw posts together with double-threaded bolt and extra foot casting.

Note: DO NOT attempt to use any higher combinations than P54 and P86 maximum, 140" (3556mm) total. Any combinations higher than 86" (2184mm) must be attached to walls using wall bracket on post adjacent to wall. Place units only against wall, not in center of room.

(•) MTS (made to stock) / () MTO (made to order)

3-Sided Double Truss Frames

see spec sheet **EG01.03B**

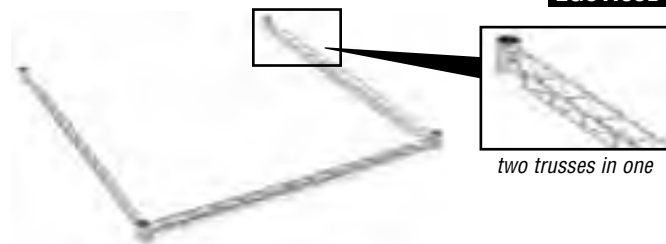

Note: See page 52 for 3-Sided Channel Frames.

Freight class is 70.0.

(•) MTS (made to stock) / () MTO (made to order)

Improves support and stability!

	length		weight		cu ft	chrome		EAGLEgard®		stainless steel	
	in.	mm	lbs.	kg		model #	list	model #	list	model #	list
18" width (457mm)	24"	610	5	2.2	0.7	DTF1824-C	67	DTF1824-E	75	DTF1824-S	205
	30"	762	6	2.7	0.7	DTF1830-C	68	DTF1830-E	77	DTF1830-S	211
	36"	914	6	2.7	0.7	DTF1836-C	69	DTF1836-E	80	DTF1836-S	216
	42"	1067	7	3.2	0.8	DTF1842-C	70	DTF1842-E	81	DTF1842-S	222
	48"	1219	7	3.2	0.8	DTF1848-C	73	DTF1848-E	82	DTF1848-S	227
	60"	1524	8	3.6	1.0	DTF1860-C	82	DTF1860-E	96	DTF1860-S	261
	72"	1829	9	4.1	1.4	DTF1872-C	92	DTF1872-E	107	DTF1872-S	289
21" width (533mm)	24"	610	5	2.2	0.8	DTF2124-C	69	DTF2124-E	79	DTF2124-S	208
	30"	762	6	2.7	0.8	DTF2130-C	70	DTF2130-E	80	DTF2130-S	211
	36"	914	6	2.7	0.8	DTF2136-C	73	DTF2136-E	82	DTF2136-S	215
	42"	1067	7	3.2	0.9	DTF2142-C	75	DTF2142-E	89	DTF2142-S	229
	48"	1219	8	3.6	0.9	DTF2148-C	76	DTF2148-E	90	DTF2148-S	232
	60"	1524	8	3.6	1.1	DTF2160-C	91	DTF2160-E	106	DTF2160-S	269
	72"	1829	10	4.5	1.4	DTF2172-C	119	DTF2172-E	141	DTF2172-S	295
24" width (610mm)	24"	610	6	2.7	1.5	DTF2424-C	69	DTF2424-E	80	DTF2424-S	209
	30"	762	7	3.2	1.5	DTF2430-C	70	DTF2430-E	81	DTF2430-S	215
	36"	914	7	3.2	1.5	DTF2436-C	74	DTF2436-E	87	DTF2436-S	224
	42"	1067	8	3.6	2.0	DTF2442-C	75	DTF2442-E	89	DTF2442-S	230
	48"	1219	9	4.1	2.5	DTF2448-C	77	DTF2448-E	92	DTF2448-S	233
	60"	1524	10	4.5	2.5	DTF2460-C	92	DTF2460-E	107	DTF2460-S	272
	72"	1829	11	5.0	2.7	DTF2472-C	119	DTF2472-E	141	DTF2472-S	411
30" width (762mm)	36"	914	7	3.2	2.0	DTF3036-C	85	DTF3036-E	100	DTF3036-S	275
	48"	1219	9	4.1	2.5	DTF3048-C	91	DTF3048-E	106	DTF3048-S	289
	60"	1524	10	4.5	2.5	DTF3060-C	100	DTF3060-E	116	DTF3060-S	333
	72"	1829	11	5.0	2.7	DTF3072-C	127	DTF3072-E	152	DTF3072-S	366
36" width (914mm)	36"	914	7	3.2	2.5	DTF3636-C	99	DTF3636-E	113	DTF3636-S	285
	48"	1219	9	4.1	2.7	DTF3648-C	104	DTF3648-E	119	DTF3648-S	294
	60"	1524	10	4.5	2.7	DTF3660-C	114	DTF3660-E	130	DTF3660-S	337
	72"	1829	11	5.0	3.0	DTF3672-C	143	DTF3672-E	166	DTF3672-S	372



100 Industrial Boulevard, Clayton, DE 19938-8903 U.S.A.
 Phone: 800-637-5100 or 302-653-3000. Fax: 302-653-2065
<http://www.eaglegrp.com>

3-Sided Channel Frames

see spec sheet **EG01.03B**

Freight class is 70.0.

(•) MTS (made to stock) / () MTO (made to order)



	length		weight		cu ft	chrome		EAGLEgard®		stainless steel	
	in.	mm	lbs.	kg		model #	list	model #	list	model #	list
18" width (457mm)	24"	610	5	2.2	0.7	CF1824-C	90	CF1824-E	106	CF1824-S	233
	30"	762	6	2.7	0.7	CF1830-C	94	CF1830-E	112	CF1830-S	244
	36"	914	6	2.7	0.7	CF1836-C	95	CF1836-E	113	CF1836-S	254
	42"	1067	7	3.2	0.8	CF1842-C	99	CF1842-E	116	CF1842-S	256
	48"	1219	7	3.2	0.8	CF1848-C	100	CF1848-E	118	CF1848-S	260
	60"	1524	8	3.6	1.0	CF1860-C	111	CF1860-E	132	CF1860-S	298
	72"	1829	9	4.1	1.4	CF1872-C	125	CF1872-E	151	CF1872-S	328
21" width (533mm)	24"	610	5	2.2	0.8	CF2124-C	92	CF2124-E	108	CF2124-S	237
	30"	762	6	2.7	0.8	CF2130-C	95	CF2130-E	113	CF2130-S	244
	36"	914	6	2.7	0.8	CF2136-C	99	CF2136-E	116	CF2136-S	249
	42"	1067	7	3.2	0.9	CF2142-C	102	CF2142-E	120	CF2142-S	260
	48"	1219	8	3.6	0.9	CF2148-C	103	CF2148-E	121	CF2148-S	262
	60"	1524	8	3.6	1.1	CF2160-C	119	CF2160-E	143	CF2160-S	308
	72"	1829	10	4.5	1.4	CF2172-C	166	CF2172-E	201	CF2172-S	339
24" width (610mm)	24"	610	6	2.7	1.5	CF2424-C	95	CF2424-E	113	CF2424-S	244
	30"	762	7	3.2	1.5	CF2430-C	99	CF2430-E	116	CF2430-S	255
	36"	914	7	3.2	1.5	CF2436-C	102	CF2436-E	120	CF2436-S	260
	42"	1067	8	3.6	2.0	CF2442-C	103	CF2442-E	121	CF2442-S	269
	48"	1219	9	4.1	2.5	CF2448-C•	104	CF2448-E•	125	CF2448-S	272
	60"	1524	10	4.5	2.5	CF2460-C•	125	CF2460-E•	151	CF2460-S	318
	72"	1829	11	5.0	2.7	CF2472-C	173	CF2472-E	207	CF2472-S	349
30" width (762mm)	36"	914	7	3.2	2.0	CF3036-C	106	CF3036-E	129	CF3036-S	318
	48"	1219	9	4.1	2.5	CF3048-C	110	CF3048-E	132	CF3048-S	328
	60"	1524	10	4.5	2.5	CF3060-C	175	CF3060-E	160	CF3060-S	379
	72"	1829	11	5.0	2.7	CF3072-C	185	CF3072-E	224	CF3072-S	418
36" width (914mm)	36"	914	7	3.2	2.5	CF3636-C	115	CF3636-E	140	CF3636-S	325
	48"	1219	9	4.1	2.7	CF3648-C	119	CF3648-E	143	CF3648-S	338
	60"	1524	10	4.5	2.7	n/a	n/a	CF3660-E	172	CF3660-S	387
	72"	1829	11	5.0	3.0	n/a	n/a	CF3672-E	242	CF3672-S	429

Handles for Caster Carts

see spec sheet **EG01.03B**



Push Handles

Easily slips over posts.

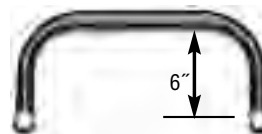

Extended Push Handles

Designed to prevent damage to knuckles.

FEATURES:

- Fits unit widths only.

width		weight		cubic feet	chrome		stainless steel		cubic feet	chrome		stainless steel	
in.	mm	lbs.	kg		model #	list	model #	list		model #	list	model #	list
14"	356	1.7	0.8	0.1	PH14-C	26	PH14-S	70	0.2	EH14-C	30	EH14-S	101
18"	457	1.9	0.9	0.1	PH18-C•	29	PH18-S	80	0.3	EH18-C	38	EH18-S	122
21"	533	2.1	1.0	0.1	PH21-C	30	PH21-S	88	0.3	EH21-C	39	EH21-S	127
24"	610	2.3	1.1	0.2	PH24-C•	30	PH24-S	95	0.4	EH24-C	39	EH24-S	136
30"	762	2.6	1.2	0.3	PH30-C	38	PH30-S	104	0.5	EH30-C	47	EH30-S	142
36"	914	3.0	1.4	0.3	PH36-C	43	PH36-S	110	0.5	EH36-C	57	EH36-S	154

Note: Stainless steel models include electropolished finish.

Catalog Section 1



patented
QuadTruss
design
(Patent #5,390,803)

Patented QuadTruss® Design makes shelves up to 25% stronger and provides a retaining ledge for increased strength and product retention.



UNIQUE ROLLER DESIGN

- Patent #5,680,942.
- Makes moving mobile units easy.
- Eliminates binding due to uneven floors.
- Rollers also support track.



SHELVES

sold separately (see page 6) are available in EAGLEbrite® zinc, chrome, VALU-MASTER® pewter gray epoxy, EAGLEgard® green epoxy, and stainless steel finish.

Maximum shelf length should not exceed 60" (1524mm).

Master Trak® Overhead Track High-Density Storage System

Note: Master Trak® not recommended for use in carpeted areas.

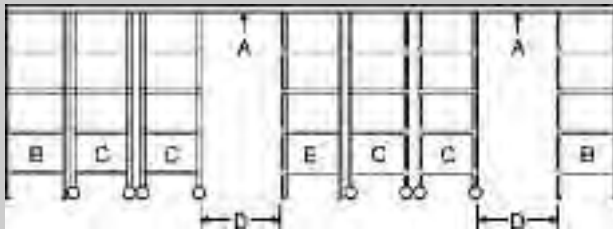

Components

Shelves sold separately (see page 6).

- A** front & rear overhead tracks
- B** stationary end units
- C** mobile units
- D** open aisle—30" to 36" (762 to 914mm) is recommended
- E** stationary mid unit (optional—use same model # as stationary end unit kit)

Stationary End / Intermediate Unit Kits

see spec sheet **EG01.18**

- Posts.
- Hardware necessary for connecting stationary end units to track.
- One kit is required for each end unit.
- End units must be anchored to the floor to prevent movement.
- Priced per kit.

Note: Shelves sold separately see page 6.

Freight class is 70.0.

(•) MTS (made to stock) / () MTO (made to order)

74" (1880mm) Posts

86" (2184mm) Posts

weight		cu	EAGLEbrite®		chrome		EAGLEgard®		weight		cu	EAGLEbrite®		chrome		EAGLEgard®	
lbs.	kg	ft	model #	list	model #	list	model #	list	lbs.	kg	ft	model #	list	model #	list	model #	list
17	7.7	0.1	EP74-Z•	175	EP74-C•	188	EP74-E•	205	21	9.5	0.1	EP86-Z	182	EP86-C	198	EP86-E	219



100 Industrial Boulevard, Clayton, DE 19938-8903 U.S.A.
Phone: 800-637-5100 or 302-653-3000. Fax: 302-653-2065
<http://www.eaglegrp.com>

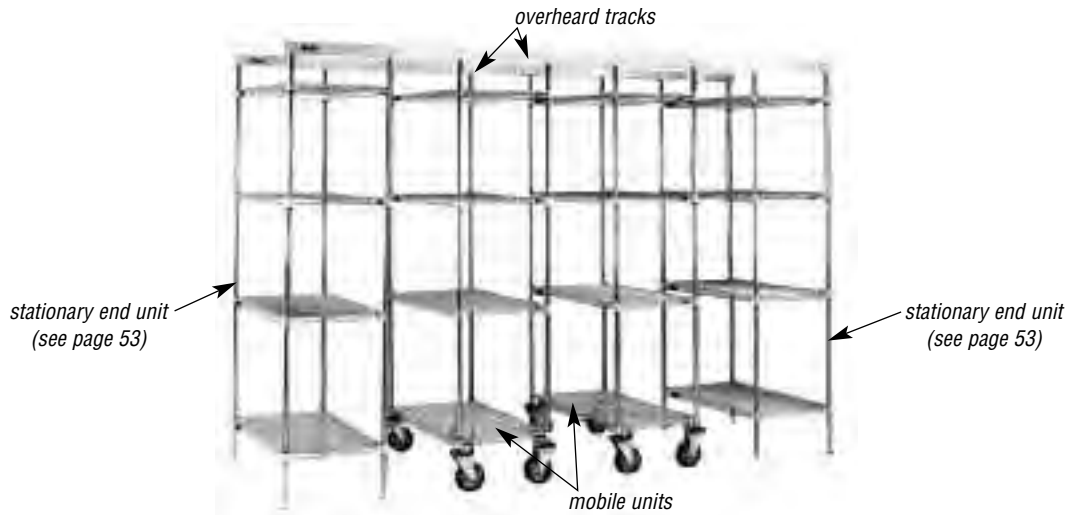

(Shelves shown are sold separately—see page 6)

Master Trak® Mobile Unit Kits

see spec sheet **EG01.18**

WEIGHT CAPACITY: | • 900 lbs. (408 kg).

Note: Shelves sold separately see page 6.

- Posts.
- Casters are 5" x 1½" (127 x 38mm) polymer.
- All parts and necessary hardware.
- One kit is required for each mobile unit.
- Priced per kit.

Freight class is 70.0.

(•) MTS (made to stock) / () MTO (made to order)

74" (1880mm) Height*

86" (2184mm) Height*

width		cu	weight		EAGLEbrite®		chrome		EAGLEgard®		weight		EAGLEbrite®		chrome		EAGLEgard®	
in.	mm		lbs.	kg	model #	list	model #	list	model #	list	lbs.	kg	model #	list	model #	list	model #	list
18"	457	0.1	33	15.0	MUK18-Z	385	MUK18-C•	427	MUK18-E	713	37	16.8	MUK18-Z86	399	MUK18-C86	443	MUK18-E86	724
21"	533	0.1	34	15.4	MUK21-Z	398	MUK21-C	438	MUK21-E	723	38	17.2	MUK21-Z86	415	MUK21-C86	456	MUK21-E86	743
24"	610	0.1	35	15.9	MUK24-Z	402	MUK24-C•	445	MUK24-E•	734	39	17.6	MUK24-Z86	421	MUK24-C86	464	MUK24-E86	761
30"	762	0.1	35	15.9	MUK30-Z	410	MUK30-C	456	MUK30-E	755	39	17.6	MUK30-Z86	427	MUK30-C86	474	MUK30-E86	781
36"	914	0.1	36	16.3	MUK36-Z	420	MUK36-C	476	MUK36-E	776	40	18.1	MUK36-Z86	434	MUK36-C86	497	MUK36-E86	800

* Casters are included in post height.

Master Trak® Overhead Track Kits

see spec sheet **EG01.18**

PACKAGING: | • Kits 13' (3962mm) and longer are wood-crated.

- All necessary sections of front and rear tracks for assembling track lengths of 6' to 21' (1829 to 6401mm), plus all hardware.

Note: Any kits 9' (2743mm) or longer include two or more front and rear track sections, with joiner pieces and all hardware. A mid-stationary unit is recommended on lengths of over 30' (9144mm).

Freight class is 70.0.

(•) MTS (made to stock) / () MTO (made to order)

length	weight	cu		
ft. mm	lbs. kg	ft	model #	list
6' 1829	18 8.2	1.8	OHT-6	420
7' 2134	21 9.5	2.1	OHT-7	467
8' 2438	24 10.9	2.4	OHT-8	703
9' 2743	27 12.2	2.7	OHT-9	764
10' 3048	30 13.6	3.0	OHT-10	828

length	weight	cu		
ft. mm	lbs. kg	ft	model #	list
11' 3353	33 15.0	3.3	OHT-11	891
12' 3658	36 16.3	3.6	OHT-12	954
13' 3962	39 17.7	3.9	OHT-13	1013
14' 4267	42 19.1	4.2	OHT-14	1071
15' 4572	45 20.4	4.5	OHT-15	1301

length	weight	cu		
ft. mm	lbs. kg	ft	model #	list
16' 4877	48 21.8	4.8	OHT-16	1364
17' 5181	51 23.1	5.1	OHT-17•	1426
18' 5486	54 24.5	5.4	OHT-18	1488
19' 5791	57 25.9	5.7	OHT-19	1548
20' 6096	60 27.2	6.0	OHT-20	1608
21' 6401	63 28.6	6.3	OHT-21	1667

Catalog Section 1

Single-Deep Floor-Trak® High-Density Storage System

see spec sheet **EG01.39**

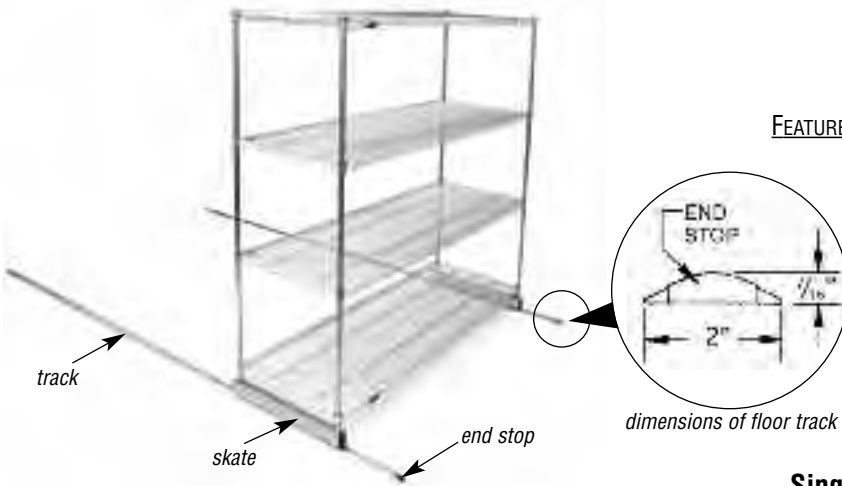

single deep unit shown assembled with wire starter unit

FEATURES:

- Non-corrosive track constructed of anodized aluminum.
- The system is ADA-compliant. NSF approved.
- Simple and easy to install.
- Easy to add on additional units.
- Open construction allows for the use of cart covers when required.
- Industrial-type, hardened steel bearings allow loaded units to glide effortlessly over the track.

Note: Unit will tilt if not loaded properly.
LOAD BOTTOM FIRST!

Freight class is 70.0.

(•) MTS (made to stock) / () MTO (made to order)

Single-Deep Skate Kits

- Two skates.
- All necessary parts and hardware.
- One kit is required for each mobile unit.
- Skates are aircraft-quality aluminum with stainless steel inserts and hardened steel ball bearings.
- Weight capacity of 2000 lbs (907.2 kg) per mobile section.

Note: Shelves (page 6) and posts (page 10) sold separately.

width		weight		cu	model #	list
in.	mm	lbs.	kg	ft		
18"	457	6	2.7	0.09	SDSK-18	543
21"	533	7	3.2	0.11	SDSK-21	563
24"	610	7	3.2	0.23	SDSK-24	586
30"	762	8	3.6	0.15	SDSK-30	655
36"	914	10	4.5	0.18	SDSK-36	866

Bumper Brackets for use with Floor-Trak® Skate Kits

Stainless steel. Set of four.

model #	list
SDSKATB-S	190

...sold individually

Hardware included.

model #	list
SKATB-S	64



Optional Shim Kits

Accommodates uneven floors.

model #	list
912991	145

Optional Foot Brake Kit

Mounts onto frontmost skate.

model #	list
MFBK-S	91

Single-Deep Floor Track Kits

- Pair of aluminum tracks with plastic end stops.
- All hardware included.

Note: Not recommended to piece tracks together. Order length needed.
Custom lengths available. Consult factory.

length		weight		cu	model #	list
ft.	mm	lbs.	kg	ft		
6'	1829	5	2.3	0.06	SDFT-6	552
7'	2134	5	2.3	0.07	SDFT-7	626
8'	2438	6	2.7	0.08	SDFT-8	699
9'	2743	7	3.2	0.09	SDFT-9	774
10'	3048	8	3.6	0.10	SDFT-10	847
11'	3353	8	3.6	0.11	SDFT-11	920
12'	3658	9	4.1	0.12	SDFT-12	994
13'	3962	10	4.5	0.13	SDFT-13	1069
14'	4267	11	5.0	0.14	SDFT-14	1143
15'	4572	11	5.0	0.15	SDFT-15	1216
16'	4877	12	5.4	0.16	SDFT-16	1292
17'	5181	13	5.8	0.17	SDFT-17	1365
18'	5486	14	6.4	0.18	SDFT-18	1439
19'	5791	14	6.4	0.19	SDFT-19	1511
20'	6096	15	6.8	0.20	SDFT-20	1587
21'	6401	16	7.3	0.21	SDFT-21	1661
22'	6706	17	7.7	0.21	SDFT-22	1701
23'	7010	18	8.2	0.21	SDFT-23	1726
24'	7315	19	8.6	0.21	SDFT-24	1796
25'	7620	20	9.0	0.21	SDFT-25	1867
26'	7925	21	9.5	0.21	SDFT-26	1937
27'	8230	22	10.0	0.21	SDFT-27	2007
28'	8534	23	10.4	0.21	SDFT-28	2078
29'	8839	24	10.9	0.21	SDFT-29	2148
30'	9144	25	11.3	0.21	SDFT-30	2220



Double-Deep Floor-Trak® High-Density Storage System

see spec sheet **EG01.39**

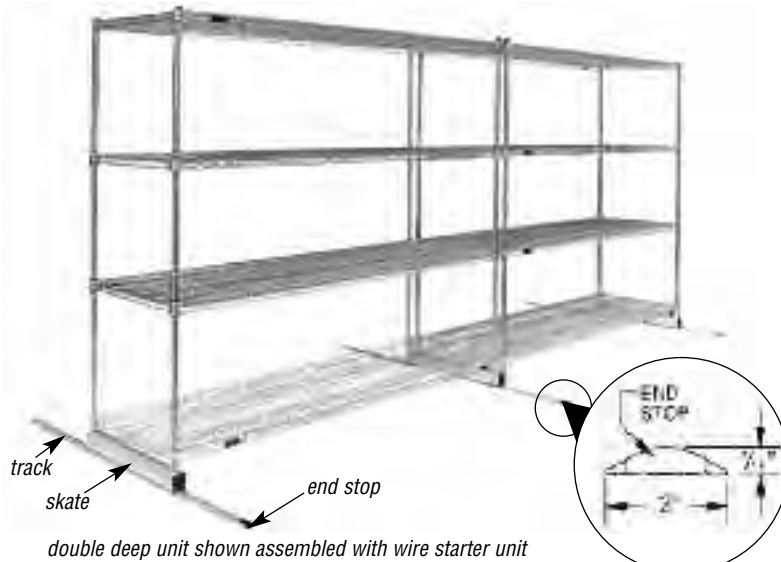

double deep unit shown assembled with wire starter unit

dimensions of floor track

Double-Deep Skate Kits

- Three skates.
- All necessary parts and hardware.
- One kit is required for each mobile unit.
- Skates are aircraft-quality aluminum with stainless steel inserts and hardened steel ball bearings.
- Weight capacity of 1500 lbs (680.4 kg) per mobile section —3000 lbs. (1361 kg) at middle skate.

Note: Shelves (see page 6) and posts sold separately (see page 10).

width		weight		cu	model #	list
in.	mm	lbs.	kg	ft		
18"	457	10	4.5	0.14	DDSK-18	987
21"	533	11	5.0	0.16	DDSK-21	1015
24"	610	12	5.4	0.18	DDSK-24	1053
30"	762	14	6.4	0.23	DDSK-30	1153
36"	914	16	7.3	0.27	DDSK-36	1470

Optional Shim Kits

Accommodates uneven floors.

model #	list
912991	145

Optional Foot Brake Kit

Mounts onto frontmost skate.

model #	list
MFBK-S	91

Inside Posts for Double-Deep Units

- Each double-deep unit requires a set of four 'inside' posts (listed below) along with four standard stationary posts.

Note: See page 10 for standard stationary posts and wire shelves (sold separately, see page 6).

Sets of four 74" (1880mm) posts

weight	cu	EAGLEbrite®		chrome		EAGLEgard®		
		model #	list	model #	list	model #	list	
17	7.7	0.1	TEP74-Z	140	TEP74-C	158	TEP74-E	170

Sets of four 86" (2184mm) posts

weight	cu	EAGLEbrite®		chrome		EAGLEgard®		
		model #	list	model #	list	model #	list	
21	9.5	0.1	TEP86-Z	164	TEP86-C	176	TEP86-E	189

IMPORTANT: Maximum post height per skate size: 18"-, 21"-, and 24"-wide skates on 74" post height or less; 30"- and 36"-wide skates on 86" post height or less.

Freight class is 70.0.

(•) MTS (made to stock) / () MTO (made to order)

Note: Unit will tilt if not loaded properly.
LOAD BOTTOM FIRST!

Double-Deep Floor Track Kits

- Three aluminum tracks with plastic end stops.
- All hardware included.

Note: Not recommended to piece tracks together. Order length needed.

Custom lengths available. Consult factory.

Double-deep units should not exceed depths of 10' (3048mm).

length		weight		cu	model #	list
ft.	mm	lbs.	kg	ft		
6'	1829	7	3.2	0.09	DDFT-6	827
7'	2134	8	3.6	0.11	DDFT-7	938
8'	2438	9	4.1	0.12	DDFT-8	1048
9'	2743	10	4.5	0.14	DDFT-9	1159
10'	3048	13	5.8	0.16	DDFT-10	1271
11'	3353	14	6.4	0.17	DDFT-11	1381
12'	3658	15	6.8	0.18	DDFT-12	1493
13'	3962	16	7.3	0.20	DDFT-13	1603
14'	4267	16	7.3	0.21	DDFT-14	1715
15'	4572	17	7.7	0.23	DDFT-15	1825
16'	4877	18	8.2	0.24	DDFT-16	1935
17'	5181	19	8.6	0.26	DDFT-17	2047
18'	5486	21	9.5	0.27	DDFT-18	2158
19'	5791	22	10.0	0.29	DDFT-19	2269
20'	6096	23	10.4	0.30	DDFT-20	2380
21'	6401	24	10.9	0.32	DDFT-21	2491
22'	6706	25	11.3	0.32	DDFT-22	2557
23'	7010	26	11.8	0.32	DDFT-23	2588
24'	7315	27	12.2	0.32	DDFT-24	2694
25'	7620	28	12.7	0.32	DDFT-25	2800
26'	7925	29	13.2	0.32	DDFT-26	2906
27'	8230	30	13.6	0.32	DDFT-27	3011
28'	8534	31	14.1	0.32	DDFT-28	3118
29'	8839	32	14.5	0.32	DDFT-29	3224
30'	9144	33	15.0	0.32	DDFT-30	3329

Bumper Brackets for use with Floor-Trak® Skate Kits

Stainless steel. Set of six.

model #	list
DDSKATB-S	259

...sold individually

Hardware included.

model #	list
SKATB-S	64



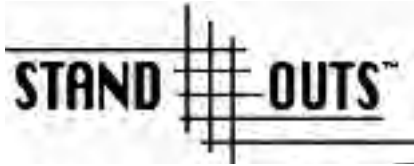

Show-off your merchandise when you use our wire display shelving units in various configurations highlighted by our brilliant finishes.

- Open wire grid shelf allows maximum merchandise visibility.
- Easy to assemble.
- Shelf spacing adjusts in seconds.
- Choose from our custom and standard colors.

Decorative Shelves

see spec sheet **EG01.34A**



(Patent #5,390,803)

Patented QuadTruss® Design

makes shelves up to 25% stronger and provides a retaining ledge for increased strength and product retention.

INCLUDES:

- Four plastic split sleeves per shelf ordered, packaged four per bag.
- Black sleeves except white shelves.
- White shelves come with white sleeves.

Note: To order custom decorative colors, add suffix "BM" (black matte), "L" (lilac), "M" (maroon), "SV" (silver vein), "SA" (sapphire), "SG" (smoked glass), "T" (teal), "GV" (gold vein), "CV" (copper vein), or "RU" (ruby) to the desired shelf size model number when ordering. **Call for custom decorative color pricing.**

Freight class is 70.0.

(•) MTS (made to stock) / () MTO (made to order)

	length		weight		cubic feet	red		white		black	
	in.	mm	lbs.	kg		model #	list	model #	list	model #	list
14" width (356mm)	24"	610	6	2.9	0.5	1424R •	54	1424W •	54	1424BL •	54
	30"	762	7	3.2	0.5	1430R	57	1430W	57	1430BL	57
	36"	914	8	3.6	0.5	1436R	61	1436W	61	1436BL •	61
	42"	1067	9	3.9	0.7	1442R	68	1442W	68	1442BL	68
	48"	1219	10	4.4	0.7	1448R	70	1448W	70	1448BL •	70
	54"	1372	12	5.4	0.9	1454R	77	1454W	77	1454BL •	77
	60"	1524	14	6.4	0.9	1460R	80	1460W	80	1460BL •	80
72"	1829	17	7.7	1.1	1472R	94	1472W	94	1472BL •	94	
18" width (457mm)	24"	610	7	3.2	0.7	1824R	61	1824W	61	1824BL	61
	30"	762	8	3.6	0.7	1830R	66	1830W •	66	1830BL •	66
	36"	914	9	3.9	0.7	1836R	68	1836W	68	1836BL •	68
	42"	1067	11	5.0	0.9	1842R	76	1842W	76	1842BL •	76
	48"	1219	12	5.4	0.9	1848R	81	1848W	81	1848BL	81
	54"	1372	15	6.8	1.2	1854R	98	1854W	98	1854BL •	98
	60"	1524	17	7.7	1.2	1860R	99	1860W	99	1860BL •	99
72"	1829	20	9.1	1.3	1872R	113	1872W	113	1872BL	113	
21" width (533mm)	24"	610	8	3.7	0.7	2124R	69	2124W	69	2124BL	69
	30"	762	9	4.1	0.7	2130R	74	2130W	74	2130BL •	74
	36"	914	11	5.0	0.8	2136R	76	2136W	76	2136BL	76
	42"	1067	12	5.4	1.1	2142R	88	2142W	88	2142BL •	88
	48"	1219	14	6.4	1.1	2148R	89	2148W	89	2148BL	89
	54"	1372	16	7.3	1.3	2154R	105	2154W	105	2154BL	105
	60"	1524	18	8.2	1.3	2160R	107	2160W	107	2160BL	107
72"	1829	24	10.9	1.4	2172R	130	2172W	130	2172BL •	130	
24" width (610mm)	24"	610	9	4.1	0.8	2424R	75	2424W	75	2424BL	75
	30"	762	11	5.0	0.8	2430R •	80	2430W	80	2430BL •	80
	36"	914	13	5.9	0.8	2436R	82	2436W	82	2436BL	82
	42"	1067	15	6.8	1.2	2442R	99	2442W	99	2442BL •	99
	48"	1219	16	7.3	1.2	2448R	103	2448W	103	2448BL	103
	54"	1372	19	8.6	1.5	2454R	115	2454W	115	2454BL •	115
	60"	1524	21	9.5	1.5	2460R	121	2460W	121	2460BL •	121
72"	1829	26	11.8	1.6	2472R	141	2472W	141	2472BL	141	



STAND-OUTS™ Decorative Shelving Accessories

see spec sheet **EG01.34A** **EG01.34B**

Freight class is 70.0.

(•) MTS (made to stock) / () MTO (made to order)

Decorative Casters

- For use with Stationary Posts (page 59).

type	wheel diameter		weight		cubic feet	model #	list
	in.	mm	lbs.	kg			
swivel	2"	51	0.4	0.2	0.03	A208903 •	9
swivel/brake	2"	51	0.4	0.2	0.03	A208904 •	10
swivel	4"	102	0.7	0.3	0.03	A208905 •	22
swivel/brake	4"	102	0.8	0.4	0.03	A208906 •	28



#A208904

Decorative Foot Plate

diameter		model #	list
in.	mm		
2"	51	A204942	5



Inlays

- Fits between posts and levels with top of shelf edge.



Black and White
Reversible. Priced per inlay. 1/8"-thick.

Clear *
Priced per pack of four. 1/32"-thick.

	length		weight**		cu ft	model #	list	model #	list
	in.	mm	lbs.	kg					
14" width (356mm)	30"	762	1.0	0.5	0.2	DSI-1430	46	CSI-1430	73
	36"	914	1.0	0.5	0.2	DSI-1436	49	CSI-1436	77
	48"	1219	1.0	0.5	0.2	DSI-1448	57	CSI-1448 •	93
	60"	1524	1.0	0.5	0.2	DSI-1460	60	CSI-1460	130
18" width (457mm)	36"	914	1.0	0.5	0.2	DSI-1836	56	CSI-1836 •	80
	48"	1219	1.0	0.5	0.2	DSI-1848	64	CSI-1848	95
	60"	1524	1.0	0.5	0.2	DSI-1860	66	CSI-1860	112
	72"	1829	1.0	0.5	0.2	DSI-1872	69	CSI-1872	128
21" width (533mm)	36"	914	1.1	0.5	0.2	DSI-2136	62	CSI-2136	86
	48"	1219	1.2	0.5	0.3	DSI-2148	66	CSI-2148	100
	60"	1524	1.3	0.5	0.3	DSI-2160	69	CSI-2160	114
	72"	1829	1.4	0.5	0.3	DSI-2172	72	CSI-2172	130
24" width (610mm)	24"	610	1.0	0.5	0.2	DSI-2424	53	CSI-2424	74
	30"	762	1.0	0.5	0.3	DSI-2430	58	CSI-2430	85
	36"	914	1.0	0.5	0.3	DSI-2436	64	CSI-2436	89
	48"	1219	1.1	0.5	0.3	DSI-2448	74	CSI-2448	104
	54"	1372	1.3	0.6	0.3	DSI-2454	78	CSI-2454	115
	60"	1524	1.4	0.6	0.3	DSI-2460	82	CSI-2460	131
	72"	1829	1.8	0.8	0.3	DSI-2472	87	CSI-2472	143
30" width (762mm)	60"	1524	2.0	0.9	0.3	DSI-3060	91	CSI-3060	206
	72"	1829	2.5	1.1	0.3	DSI-3072	96	CSI-3072	209

* Actual width of CSI Inlays is minus 1/4" (32mm).

** Weight shown per inlay.

Display Arms

- For everything from pots to purses; perfect for 'quick-pick' items.
- Easily attaches to standard posts.

length	weight	EAGLEbrite®		red		white		black		chrome			
		in.	mm	lbs.	kg	model #	list	model #	list	model #	list		
6"	25	20	9	DA6-Z	15	DA6-R	16	DA6-W	16	DA6-BL	16	DA6-C	15



Posts

see spec sheet **EG01.34A**

Freight class is 50.0.

(•) MTS (made to stock) / () MTO (made to order)



					For Stationary Applications				For Mobile Applications			
height		weight		cu	Model #				Model #			
in.	mm	lbs.	kg	ft	red	white	black	list	red	white	black	list
7"	178	0.8	0.4	0.1	P7-R	P7-W	P7-BL	12	CP7-R	CP7-W	CP7-BL	12
14"	356	1.0	0.5	0.1	P14-R	P14-W	P14-BL •	14	CP14-R	CP14-W	CP14-BL	14
33"	838	2.0	0.9	0.1	P33-R	P33-W	P33-BL •	18	CP33-R	CP33-W	CP33-BL	18
54"	1372	3.0	1.4	0.1	P54-R	P54-W	P54-BL •	23	CP54-R	CP54-W	CP54-BL •	23
63"	1600	3.5	1.8	0.3	P63-R	P63-W	P63-BL •	24	CP63-R	CP63-W	CP63-BL	24
74"	1880	4.0	1.8	0.5	P74-R	P74-W	P74-BL •	26	CP74-R	CP74-W	CP74-BL •	26
86"	2184	5.0	2.3	0.8	P86-R	P86-W	P86-BL •	31	CP86-R	CP86-W	CP86-BL	31

Ledges

see spec sheet **EG01.34A**

Freight class is 70.0.

(•) MTS (made to stock) / () MTO (made to order)

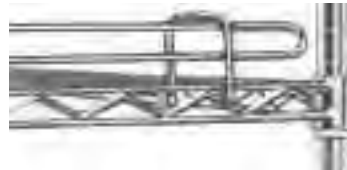

					1" (25mm) Ledges*				4" (102mm) Ledges					
length		cu	weight		Model numbers				weight		Model numbers			
in.	mm	ft	lbs.	kg	red	white	black	list	lbs.	kg	red	white	black	list
14"	356	0.2	0.2	0.1	L14-1R	L14-1W	L14-1BL	13	0.8	0.4	L14-4R	L14-4W	L14-4BL	13
18"	457	0.3	0.3	0.1	L18-1R	L18-1W	L18-1BL	14	0.9	0.4	L18-4R	L18-4W	L18-4BL	14
21"	533	0.3	0.4	0.2	L21-1R	L21-1W	L21-1BL	15	1.0	0.5	L21-4R	L21-4W	L21-4BL	15
24"	610	0.3	0.5	0.2	L24-1R	L24-1W	L24-1BL	16	1.2	0.6	L24-4R	L24-4W	L24-4BL	16
30"	762	0.5	0.7	0.3	L30-1R	L30-1W	L30-1BL	19	1.4	0.6	L30-4R	L30-4W	L30-4BL	19
36"	914	0.6	0.9	0.4	L36-1R	L36-1W	L36-1BL	23	1.6	0.7	L36-4R	L36-4W	L36-4BL •	23
42"	1067	0.6	1.1	0.5	L42-1R	L42-1W	L42-1BL	24	1.8	0.8	L42-4R	L42-4W	L42-4BL	24
48"	1219	0.7	1.3	0.6	L48-1R	L48-1W	L48-1BL	25	2.0	0.9	L48-4R	L48-4W	L48-4BL •	25
54"	1372	0.8	1.5	0.7	L54-1R	L54-1W	L54-1BL	27	2.2	1.0	L54-4R	L54-4W	L54-4BL	27
60"	1524	0.8	1.7	0.8	L60-1R	L60-1W	L60-1BL	28	2.4	1.1	L60-4R	L60-4W	L60-4BL	28
72"	1829	1.0	2.1	1.0	L72-1R	L72-1W	L72-1BL	29	2.6	1.2	L72-4R	L72-4W	L72-4BL	29

* When installed, actual height of ledge is 1½" (38mm).

Shelf Dividers

see spec sheet **EG01.34A**

Freight class is 70.0.

(•) MTS (made to stock) / () MTO (made to order)



Organize shelf contents with these snap-on dividers!

length		weight		cubic	red		white		black	
in.	mm	lbs.	kg	feet	model #	list	model #	list	model #	list
14"	356	1.0	0.5	0.6	SD14-R	23	SD14-W	23	SD14-BL	23
18"	457	1.3	0.6	0.6	SD18-R	26	SD18-W	26	SD18-BL	26
21"	533	1.5	0.7	0.8	SD21-R	28	SD21-W	28	SD21-BL	28
24"	610	1.8	0.8	1.0	SD24-R	34	SD24-W	34	SD24-BL	34
30"	762	2.2	1.0	1.2	SD30-R	38	SD30-W	38	SD30-BL	38
36"	914	2.7	1.2	1.4	SD36-R	46	SD36-W	46	SD36-BL	46

Cantilever Shelves

see spec sheet **EG01.34B**



Ideal for adding extra storage above an existing shelving unit.

Packaged two per box.

FEATURES:

- 1" (25mm) wraparound ledge.
- 12" (305mm) wide shelves.

NOTE: When ordering back posts, confirm with customer service, the correct post height to accommodate these shelves.

Freight class is 70.0.

(•) MTS (made to stock) / () MTO (made to order)

	length		weight		cu	red		white		black	
	in.	mm	lbs.	kg	ft	model #	list	model #	list	model #	list
12" width (305mm)	24"	610	4	1.8	0.5	CS1224-R	59	CS1224-W	59	CS1224-BL	59
	30"	762	5	2.3	0.8	CS1230-R	63	CS1230-W	63	CS1230-BL	63
	36"	914	6	2.7	0.8	CS1236-R	65	CS1236-W	65	CS1236-BL	65
	42"	1067	7	3.2	0.9	CS1242-R	72	CS1242-W	72	CS1242-BL	72
	48"	1219	8	3.6	1.0	CS1248-R	75	CS1248-W	75	CS1248-BL	75
	54"	1371	8	3.6	1.0	CS1254-R	81	CS1254-W	81	CS1254-BL	81
	60"	1524	9	4.1	1.0	CS1260-R	87	CS1260-W	87	CS1260-BL	87

Etagere Top

see spec sheet **EG01.34B**



FEATURES:

- Decorative top fits 24" (610mm) long shelving.

Freight class is 70.0.

(•) MTS (made to stock) / () MTO (made to order)

	length		weight		cu	red		white		black		chrome	
	in.	mm	lbs.	kg	ft	model #	list	model #	list	model #	list	model #	list
24"	305		1.5	0.7	1.3	ET24-R	27	ET24-W	27	ET24-BL	27	ET24-C	26

Hanger Rails

see spec sheet **EG01.34B**

Freight class is 70.0.

(•) MTS (made to stock) / () MTO (made to order)

Front-to-Back

width	weight		cu	red		white		black		chrome		
	in.	mm		lbs.	kg	model #	list	model #	list	model #	list	
14"	356	1.0	0.5	0.2	WR14-R	19	WR14-W	19	WR14-BL	19	WR14-C	18
18"	457	1.1	0.5	0.3	WR18-R	20	WR18-W	20	WR18-BL	16	WR18-C	16
24"	610	1.5	0.7	0.3	WR24-R	23	WR24-W	23	WR24-BL	23	WR24-C	22
30"	762	1.7	0.8	0.5	WR30-R	25	WR30-W	25	WR30-BL	25	WR30-C	24
36"	914	1.9	0.9	0.6	WR36-R	26	WR36-W	26	WR36-BL	26	WR36-C	25



Left-to-Right

width	weight		cu	red		white		black		chrome		
	in.	mm		lbs.	kg	model #	list	model #	list	model #	list	
24"	610	1.5	0.7	0.3	LR24-R	27	LR24-W	27	LR24-BL	27	LR24-C	25
30"	762	1.7	0.8	0.5	LR30-R	30	LR30-W	30	LR30-BL	30	LR30-C	27
36"	914	1.9	0.9	0.6	LR36-R	33	LR36-W	33	LR36-BL	33	LR36-C	29
42"	1067	2.0	0.9	0.6	LR42-R	35	LR42-W	35	LR42-BL	35	LR42-C	33
48"	1092	2.1	1.0	0.7	LR48-R	38	LR48-W	38	LR48-BL	38	LR48-C	36
54"	1372	2.3	1.0	0.8	LR54-R	40	LR54-W	40	LR54-BL	40	LR54-C	38
60"	1524	2.5	1.1	0.8	LR60-R	42	LR60-W	42	LR60-BL	42	LR60-C	41
66"	1676	2.7	1.2	0.9	LR66-R	46	LR66-W	46	LR66-BL	46	LR66-C	42
72"	1829	2.9	1.3	1.0	LR72-R	54	LR72-W	54	LR72-BL	54	LR72-C	49

Catalog Section 1

Hooks

see spec sheet **EG01.34B**

Freight class is 70.0.

(•) MTS (made to stock) / () MTO (made to order)

These snap-on hooks are heavy-gauge mild steel.

length x width x height in. mm		weight lbs. kg		cu ft	description	black model # list		chrome model # list	
1 1/4" x 4 1/4" x 3/8"	32 x 108 x 10	0.3	0.1	0.1	small snap hook	SH-BL	12	SH-C	12
2 1/4" x 4 1/4" x 3/8"	57 x 108 x 10	0.3	0.1	0.1	large snap hook	LH-BL	15	LH-C	15
2 1/4" x 4 1/4" x 3/8"	57 x 108 x 10	0.3	0.1	0.1	large double hook	LDH-BL	26	LDH-C	26

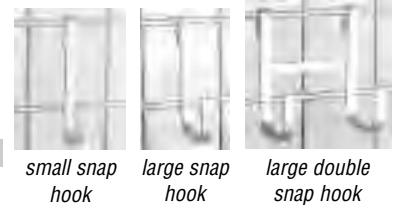

Front Case Merchandise Shelving

see product announcement **EG8105**

FEATURES:

- 14" (356mm) standard height.
- Set of four split sleeves per shelf.

Freight class is 70.0.

(•) MTS (made to stock) / () MTO (made to order)



Note: To order unit with decorative casters, add suffix "-DC" to model number (example: FCM1448V-DC) and \$21. To order unit with 18" (457mm)-high posts, add suffix "-18" to model number (example: HDFCM1424C-18). For units with cantilever oversheaf, add \$6. For units with two standard shelves, add \$12.

Units with 12" (305mm)-wide Cantilever Oversheaf

width (356mm)	length		chrome		black		red		VALU-MASTER®		Valu-Gard®		white	
	in.	mm	model #	list	model #	list	model #	list	model #	list	model #	list	model #	list
14"	24"	610	FCM1424C	210	FCM1424BL	214	FCM1424R	214	FCM1424V	214	FCM1424VG	214	FCM1424W	214
	30"	762	FCM1430C	222	FCM1430BL	226	FCM1430R	226	FCM1430V	226	FCM1430VG	226	FCM1430W	226
	36"	914	FCM1436C	234	FCM1436BL	238	FCM1436R	238	FCM1436V	238	FCM1436VG	238	FCM1436W	238
	42"	1067	FCM1442C	258	FCM1442BL	262	FCM1442R	262	FCM1442V	262	FCM1442VG	262	FCM1442W	262
	48"	1219	FCM1448C	262	FCM1448BL	266	FCM1448R	266	FCM1448V	266	FCM1448VG	266	FCM1448W	266
	54"	1372	FCM1454C	273	FCM1454BL	277	FCM1454R	277	FCM1454V	277	FCM1454VG	277	FCM1454W	277
	60"	1524	FCM1460C	289	FCM1460BL	293	FCM1460R	293	FCM1460V	293	FCM1460VG	293	FCM1460W	293

Units with Two Standard Shelves

width (356mm)	length		chrome		black		red		VALU-MASTER®		Valu-Gard®		white	
	in.	mm	model #	list	model #	list	model #	list	model #	list	model #	list	model #	list
14"	24"	610	HDFCM1424C	189	HDFCM1424BL	193	HDFCM1424R	193	HDFCM1424V	193	HDFCM1424VG	193	HDFCM1424W	193
	30"	762	HDFCM1430C	198	HDFCM1430BL	202	HDFCM1430R	202	HDFCM1430V	202	HDFCM1430VG	202	HDFCM1430W	202
	36"	914	HDFCM1436C	208	HDFCM1436BL	212	HDFCM1436R	212	HDFCM1436V	212	HDFCM1436VG	212	HDFCM1436W	212
	42"	1067	HDFCM1442C	230	HDFCM1442BL	234	HDFCM1442R	234	HDFCM1442V	234	HDFCM1442VG	234	HDFCM1442W	234
	48"	1219	HDFCM1448C	234	HDFCM1448BL	238	HDFCM1448R	238	HDFCM1448V	238	HDFCM1448VG	238	HDFCM1448W	238
	54"	1372	HDFCM1454C	244	HDFCM1454BL	248	HDFCM1454R	248	HDFCM1454V	248	HDFCM1454VG	248	HDFCM1454W	248
	60"	1524	HDFCM1460C	258	HDFCM1460BL	262	HDFCM1460R	262	HDFCM1460V	262	HDFCM1460VG	262	HDFCM1460W	262

Soft Goods Display

see product announcement **EG8084**



shown with optional hooks

INCLUDES:

- Standard adjustable feet.
- Standard color is red.
- Three shelves.
- Display arm.
- Two hanger rails.
- Two etagere tops used for signage.

Freight class is 70.0.

(•) MTS (made to stock) / () MTO (made to order)

Note: Options include the finish of your choice (see page 57 for custom colors and suffix codes), additional shelves and hooks, hanger tube, and decorative casters.

height	width	length		weight		cubic feet	model # list	
		in.	mm	lbs.	kg		model #	list
64" (1626mm)	24" (610mm)	24"	610	49	22.2	3	SDG2424R	403



Retail Display Workstation

see product announcement **EG8082**



retail display workstation shown with optional accessories

Available accessories:

(see pages 58-61)

- Hanger rails
- Display arms
- Ledges
- Dividers
- Wire grids panels
- Display hooks

Available options:

- Additional wood tabletop choices.
- Laminate top in lieu of wood.
- Your custom logo displayed on wood caps.
- European-style corners on wood caps.

CONSULT FACTORY.

FEATURES:

- 63" (1600mm) high freestanding rear shelf unit.
- 34" (864mm) high table, both capped with a hardwood finish.

SHELVES FEATURES:

- Four 14" (356mm) wide chrome shelves and posts.

TABLE FEATURES:

- Two 18" (457mm) wide chrome wire undershelves and posts.

Freight class is 70.0.

(•) MTS (made to stock) / () MTO (made to order)

width	length		weight		cu ft	model #	list
	in.	mm	lbs.	kg			
36" (914mm)	50"	1270	110	49.9	6	RDW48CB	3076

Hardwood Top Wine Cart

see spec sheet **EG01.48**



(Patent #5,390,803)

INCLUDES:

- 1 1/4" (45mm) thick hardwood butcher block top.
- Two chrome wine racks that can hold up to 18 bottles of wine.
- Chrome wire shelf for storage.

Freight class is 70.0.

(•) MTS (made to stock) / () MTO (made to order)

width	length		weight		cu ft	model #	list
	in.	mm	lbs.	kg			
18" (457mm)	40"	1016	69	31.3	7.7	WR1840C	1110

Smooth rolling casters for easy mobility.

Hardwood Top Demo Carts

see product announcement **EG8181**



INCLUDES:

- 1 1/4" (45mm) thick hardwood butcher block top.
- Two wire undershelves, Valu-Master® gray finish.
- 5" (127mm)-diameter decorative casters with donut bumpers.

Note: Available accessories include laminate top in lieu of wood, wire basket, and utility hooks.

Options include the finish of your choice (see page 57 for custom colors and suffix codes).

Freight class is 70.0.

(•) MTS (made to stock) / () MTO (made to order)

height	width	length		weight		cubic feet	model #	list
		in.	mm	lbs.	kg			
34" (864mm)	24" (610mm)	36"	914	61	27.7	4.0	DC2436V	1220
		48"	1219	73	33.1	5.0	DC2448V	1270
		60"	1524	91	41.3	6.0	DC2460V	1421

Catalog Section 1

Pot / Pan Rack

see product announcement **EG8085**



Designed for displaying items such as cookware, while allowing plenty of tabletop room for other display.

pot/pan rack shown with additional bracket

- 33" (838mm) high.
- Chrome plated.
- Overall bracket length is 10" (254mm).
- Base is screwed into bottom of post.
- Entire assembly screws onto tabletop.
- Threaded stud welded into middle of 12" (305mm) square heavy gauge mild steel base.
- Three display brackets with 8" (203mm) hexagon pad welded onto each bracket.

FEATURES:

Note: Options include the finish of your choice (see page 57 for custom colors and suffix codes), specified post height and additional brackets.

Freight class is 70.0.

(•) MTS (made to stock) / () MTO (made to order)

width	length in. mm	weight lbs. kg	cu ft	model #	list
12" (305mm)	12" 305	15 6.8	1.2	A210115	91

Optional Freestanding Base for Pot / Pan Rack

- Chrome.
- 22" x 30" (559 x 762mm).
- Available as an option to mounting.

model #	list
A210109	39



Additional Bracket for Pot / Pan Rack

- Chrome.

model #	list
A210075	20



bracket

Secure Display Merchandiser

see product announcement **EG8083**



secure display merchandiser shown with optional accessories

- Posts and shelves are chrome plated.
- Mylar inlay for top shelf.
- Four 2 3/8" (60mm) decorative casters.

FEATURES:

Freight class is 70.0.

(•) MTS (made to stock) / () MTO (made to order)

height	width	length in. mm	weight lbs. kg	cubic feet	model #	list
40" (1016mm)	14" (356mm)	36" 914	90 40.8	9	SDM1436C	1189

Options for Secure Display Merchandiser

description	model #	list
center wire shelf	A1436C •	65
polymer top	SDM1436C-P	116
natural wood top	SDM1436C-W	93
laminated top	SDM1436C-L	372
wall grid panel / sign holder	SDMB36-C	202

STAND-OUTS™ Gondola Wire Shelving

see spec sheet **EG01.33**



STAND SOLD SEPARATELY!

Manufacturers' ID numbers

1-Kent	4-Madix/Lozier
2-Universal Nolin	5-Royston
3-Streater	6-PermaSteel

- Use on all major shelving fixtures (see "Manufacturers' ID numbers" box).
- Pair of shelf brackets notched to securely hold the display shelf in place. Brackets can be positioned horizontally or slanted.
- Available in 3' and 4' (914 and 1219mm) lengths.
- Available in 18", 21", and 24" (457, 533, and 508mm) depths.
- Choose from custom and standard colors.

FEATURES:

Steps to follow when ordering:

- 1) **Determine decorative color of gondola shelf.** For standard colors, refer to chart (below). For custom colors, add suffix below to the desired model number when ordering:

BM (black matte), **L** (lilac), **M** (maroon),
SV (silver vein), **SA** (sapphire), **SG** (smoked glass),
T (teal), **GV** (gold vein), **CV** (copper vein), **RU** (ruby)
Call factory for pricing.

- 2) **Determine correct brackets.** Refer to the "Manufacturers' ID numbers" table (left) and add the corresponding ID number to the end of the desired gondola shelf model number when ordering. **Example: Model #HG1836BL-3** indicates an 18" x 36" (457 x 914mm) gondola shelf with black epoxy finish and brackets that fit a gondola made by Streater.

Freight class is 70.0.

(•) MTS (made to stock) / () MTO (made to order)

Gondola Shelves - Patent # 6,345,795

- Price includes shelf with standard color and pair of shelf brackets.

	length		weight		cu	red		white		black		chrome	
	in.	mm	lbs.	kg		ft	model #	list	model #	list	model #	list	model #
18" width (457mm)	36"	914	12	5.8	0.7	HG1836R	89	HG1836W	89	HG1836BL	89	HG1836C	87
	48"	1219	15	6.8	0.9	HG1848R	103	HG1848W	103	HG1848BL	103	HG1848C	101
21" width (533mm)	36"	914	14	6.4	0.8	HG2136R	94	HG2136W	94	HG2136BL	94	HG2136C	92
	48"	1219	17	7.7	1.1	HG2148R	109	HG2148W	109	HG2148BL	109	HG2148C	106
24" width (610mm)	36"	914	16	7.3	0.8	HG2436R	102	HG2436W	102	HG2436BL	102	HG2436C	99
	48"	1219	19	8.6	1.2	HG2448R	116	HG2448W	116	HG2448BL	116	HG2448C	112



gondola shelf and bracket

Replacement Brackets - Patent # D 435,787

- Sold in pairs.
- Order replacement brackets to utilize standard shelves in different gondola systems.

length	weight	cu	Kent		U. Nolin		Streater		Madix/Lozier		Royston		PermaSteel			
			in.	mm	lbs.	kg	ft	model #	list	model #	list	model #	list	model #	list	
18"	457	4.8	2.2	1.0	HGK18	30	HGU18	30	HGS18	30	HGML18	30	HGR18	30	HGP18	30
21"	533	5.3	2.4	1.0	HGK21	35	HGU21	35	HGS21	35	HGML21	35	HGR21	35	HGP21	35
24"	610	5.8	2.6	1.0	HGK24	40	HGU24	40	HGS24	40	HGML24	40	HGR24	40	HGP24	40

Wall Standards

- Use for mounting directly to walls instead of gondolas, if desired.
- Sold and priced individually.
- 12 gauge zinc plated mild steel.

Note: Shelving used only with Universal Nolin (suffix "-2") will fit wall standards.

height	weight	cu	Kent		U. Nolin		Streater		Madix/Lozier		Royston		PermaSteel	
			in.	mm	lbs.	kg	ft	model #	list	model #	list	model #	list	model #
24"	610	3.0	1.4	0.1	NUR24	26								
36"	914	4.5	2.0	0.1	NUR36	28								
48"	1219	6.0	2.7	0.1	NUR48	29								

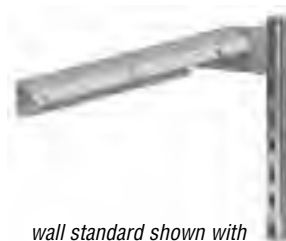

wall standard shown with Universal Nolin gondola bracket

Catalog Section 1

Freestanding Gondola Inset Adjustable Wire Shelving

see spec sheet **EG01.32**

FEATURES:

- These units can stand side-by-side on gondolas without size interference, giving shelf contents a cleaner, more efficient appearance.
- Easy assembly — no tools required.

Two Wire Shelves (top and bottom)

Featuring patented QuadTruss® Design, making shelves up to 25% stronger. Shelves consist of a top mat assembly using 10 gauge mat wires spaced on 7/8" (22mm) centers and welded to full length 6 gauge serpentine trusses.



gondola inset adjustable wire shelving unit used with gondola



(Patent #5,390,803)

Two Add-A-Shelf® Center Shelves

300 lb. (136.1 kg) capacity. Shelves can be added or removed without disassembling the entire shelf unit. Add-A-Shelf® Reverse Mat Shelves, featuring a built-in ledge, available as an alternative. See below.

STAND SOLD SEPARATELY!

Note: For posts, see page 59, for collars and split sleeves see page 66.

Freight class is 70.0.

(•) MTS (made to stock) / () MTO (made to order)

Gondola Inset Wire Shelves*

	length		weight		EAGLEbrite®		chrome		black		red		white	
	in.	mm	lb.	kg	model #	list	model #	list	model #	list	model #	list	model #	list
14" width (356mm)	35 1/2"	902	8	3.6	G1436Z	55	G1436C	63	G1436BL	66	G1436R	66	G1436W	66
	47 1/2"	1207	10	4.6	G1448Z	65	G1448C	73	G1448BL	77	G1448R	77	G1448W	77
18" width (457mm)	35 1/2"	902	9	4.1	G1836Z	66	G1836C	70	G1836BL	74	G1836R	74	G1836W	74
	47 1/2"	1207	12	5.5	G1848Z	78	G1848C	86	G1848BL	90	G1848R	90	G1848W	90
21" width (533mm)	35 1/2"	902	11	5.0	G2136Z	73	G2136C	81	G2136BL	86	G2136R	86	G2136W	86
	47 1/2"	1207	14	6.4	G2148Z	85	G2148C	95	G2148BL	98	G2148R	98	G2148W	98
24" width (610mm)	35 1/2"	902	13	5.9	G2436Z	79	G2436C	87	G2436BL	90	G2436R	90	G2436W	90
	47 1/2"	1207	16	7.3	G2448Z	94	G2448C	104	G2448BL	108	G2448R	108	G2448W	108

*These shelves are designed specifically for use with gondolas. They are 1/2" (13mm) shorter than our regular wire shelving.

Add-A-Shelf® for Gondola Inset Wire Shelving - Patented # 5,884,567

- To specify finish, add suffix **Z** (EAGLEbrite® zinc), **C** (chrome), **BL** (black), **R** (red), or **W** (white) to model number when ordering. For example: **A1448W** indicates a white Add-A-Shelf® shelf.



Add-A-Shelf® Shelves

Add-A-Shelf® Reverse Mat Shelves

	length**		weight		model #	List prices					model #	List prices				
	in.	mm	lb.	kg		EAGLEbrite®	chrome	black	red	white		EAGLEbrite®	chrome	black	red	white
14" width (356mm)	36"	914	8	3.6	A1436	60	65	66	66	66	D1436	62	67	68	68	68
	48"	1219	10	4.6	A1448	67	74	75	75	75	D1448	69	76	77	77	77
18" width (457mm)	36"	914	9	4.1	A1836	66	67	68	68	68	D1836	68	69	70	70	70
	48"	1219	12	5.5	A1848	77	80	81	81	81	D1848	79	82	83	83	83
21" width (533mm)	36"	914	11	5.0	A2136	74	79	80	80	80	D2136	76	81	82	82	82
	48"	1219	14	6.4	A2148	85	91	92	92	92	D2148	87	94	95	95	95
24" width (610mm)	36"	914	13	5.9	A2436	78	85	86	86	86	D2436	80	87	88	88	88
	48"	1219	16	7.3	A2448	92	100	101	101	101	D2448	95	102	103	103	103

** Dimensions are nominal



100 Industrial Boulevard, Clayton, DE 19938-8903 U.S.A.
 Phone: 800-637-5100 or 302-653-3000. Fax: 302-653-2065
 http://www.eaglegrp.com

Posts for Gondola Inset Wire Shelving

see spec sheet **EG01.32**

Freight class is 50.0.

(•) MTS (made to stock) / () MTO (made to order)

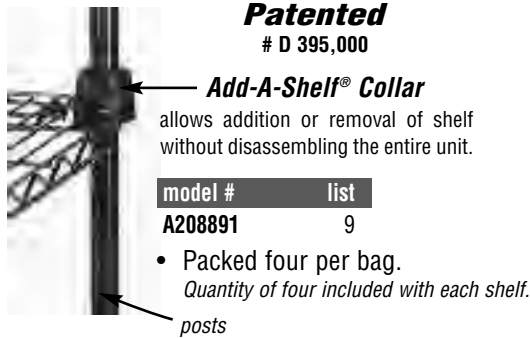

Split Sleeves

description	model #	list
plastic split sleeves for all shelves, set of four	PLASTIC SPLIT SLEEVES	5



height in.	mm	weight		EAGLEbrite®		chrome		black		red		white	
		lb.	kg	model #	list	model #	list	model #	list	model #	list	model #	list
14"	356	1.0	0.5	P14-Z •	12	P14-C •	13	P14-BL •	14	P14-R	14	P14-W	14
33"	838	2.0	0.9	P33-Z •	15	P33-C •	16	P33-BL •	18	P33-R	18	P33-W	18
54"	1372	3.0	1.4	P54-Z •	21	P54-C •	22	P54-BL •	23	P54-R	23	P54-W	23
63"	1600	3.5	1.6	P63-Z •	22	P63-C •	23	P63-BL •	24	P63-R	24	P63-W	24
74"	1880	4.0	1.8	P74-Z •	23	P74-C •	25	P74-BL •	26	P74-R	26	P74-W	26
86"	2184	5.0	2.3	P86-Z •	28	P86-C •	30	P86-BL •	31	P86-R	31	P86-W	31

Wire Display Shelving

see spec sheet **EG01.21** WEIGHT CAPACITY:



STAND SOLD SEPARATELY!

MasterSeal® coating
for improved rust protection.

Manufacturers' ID numbers

1-Kent	4-Madix/Lozier
2-Universal Nolin	5-Royston
3-Streater	6-PermaSteel

- Heavy-duty shelves can hold up to 40 lbs. (18 kg) per linear foot.
- EAGLEbrite® zinc finish with MasterSeal® coating.
- Used primarily for gondolas.
- Designed for use on all major shelving fixtures such as Kent, Madix/Lozier, Royston, Streater, Universal Nolin, and PermaSteel.
- One-piece shelf bracket, tier notched to securely hold the display shelf in place.
- Brackets can be positioned horizontally or slanted.
- Shelving can be displayed using the 1" or 3" (25 or 76mm) integral fence by simply rotating the shelf 180°.
- Available in 3' and 4' (914 and 1219mm) lengths.

FEATURES:

Freight class is 70.0.

(•) MTS (made to stock) / () MTO (made to order)

	width		weight		cu ft	model #	list
	in.	mm	lbs.	kg			
36" length (914mm)	10"	254	10	4.5	0.5	81036	80
	12"	309	11	5.0	0.7	81236	86
	14"	356	11	5.0	0.7	81436	89
	16"	406	12	5.5	0.7	81636	92
	18"	457	12	5.5	0.7	81836	101
	20"	508	13	5.9	0.7	82036	107
48" length (1219mm)	10"	254	12	5.5	0.7	81048	85
	12"	309	13	5.9	0.7	81248	94
	14"	356	14	6.4	0.9	81448	100
	16"	406	15	6.8	0.9	81648	102
	18"	457	16	7.3	1.1	81848	108
	20"	508	17	7.7	1.1	82048	112

Note: Price includes shelf & brackets.

Steps to follow when ordering:

- Find your shelving system supplier in "Manufacturers' ID Numbers" table at middle of this page.
- Determine correct brackets. Add the corresponding ID number to the end of the desired display shelf model number when ordering. **Example: Model #810365** indicates a 10" x 36" (254 x 914mm) display shelf with brackets that fit a shelving fixture made by Royston.

Catalog Section 1

Wire Display Shelving Accessories

see spec sheet **EG01.21**

Freight class is 70.0.

(•) MTS (made to stock) / () MTO (made to order)

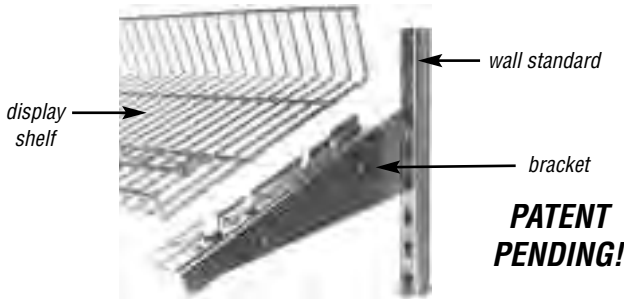

wall standard shown with display shelf and Universal Nolin bracket



Replacement Brackets

- Sold in pairs.
- Order replacement brackets to utilize standard shelves in different gondola systems.

length		weight		cu	Kent		U. Nolin		Streater		Madix/Lozier		Royston		PermaSteel	
in.	mm	lbs.	kg	ft	model #	list	model #	list	model #	list	model #	list	model #	list	model #	list
10"	254	2.6	1.2	0.6	K10	40	U10	40	S10	40	ML10	40	R10	40	P10	40
12"	309	3.2	1.5	0.6	K12	43	U12	43	S12	43	ML12	43	R12	43	P12	43
14"	356	3.7	1.7	0.6	K14	47	U14	47	S14	47	ML14	47	R14	47	P14	47
16"	406	4.3	2.0	0.6	K16	52	U16	52	S16	52	ML16	52	R16	52	P16	52
18"	457	4.8	2.2	0.6	K18	54	U18	54	S18	54	ML18	54	R18	54	P18	54
20"	508	5.3	2.4	0.6	K20	57	U20	57	S20	57	ML20	57	R20	57	P20	57

Dividers / Ends

length		weight		cu	model # list	
in.	mm	lbs.	kg	ft	model #	list
10"	254	0.5	0.2	0.3	D10	29
12"	309	0.6	0.3	0.4	D12	31
14"	356	0.7	0.3	0.4	D14	34
16"	406	0.8	0.4	0.7	D16	35
18"	457	0.9	0.4	0.7	D18	37
20"	508	1.0	0.5	1.0	D20	42



Wall Standards

- Use for mounting directly to walls.
- Sold and priced individually.
- Order shelving with ID#2 (*Universal Nolin* – see chart below) for use with wall standards.

height		weight		cu	model # list	
in.	mm	lbs.	kg	ft	model #	list
24"	610	3.0	1.4	0.1	NUR24	26
36"	914	4.5	2.0	0.1	NUR36	28
48"	1219	6.0	2.7	0.1	NUR48	29

Manufacturers' I.D. Numbers

Match your bracket to one of these drawings to determine manufacturer's I.D. number.

(Note: Bracket diagrams are not to scale - for reference purposes only)



1 - Kent



2 - Universal Nolin



3 - Streater

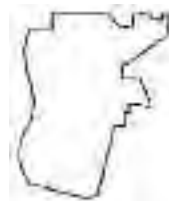

4 - Madix/Lozier



5 - Royston

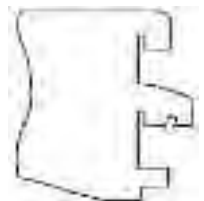

6 - PermaSteel

Quik-Set® Flat Solid Shelves

see spec sheet **EG01.23**



FEATURES:

- Heavy duty.
- All sides of shelves are constructed with a 2" (51mm) downturn and marine edge.
- Each corner is fitted with a heavy-duty aluminum casting to accept a split sleeve.
- No tools are required for assembly.

Freight class is 70.0.

(•) MTS (made to stock) / () MTO (made to order)

Stainless Steel

	length		cu ft	14 gauge				16 gauge			
	weight			weight		weight		weight			
	in.	mm		lb.	kg	model #	list	lb.	kg	model #	list
18" width (457mm)	36"	914	0.8	24	10.9	SHDS1836SF	414	19	8.6	HDS1836SF	396
	42"	1067	0.9	26	11.8	SHDS1842SF	460	21	9.5	HDS1842SF	430
	48"	1219	1.0	29	13.2	SHDS1848SF	501	24	10.9	HDS1848SF	465
	54"	1372	1.1	33	15.0	SHDS1854SF	545	27	12.2	HDS1854SF	508
	60"	1524	1.3	36	16.3	SHDS1860SF	588	29	13.2	HDS1860SF	555
24" width (610mm)	36"	914	1.0	35	15.9	SHDS2436SF	537	28	12.7	HDS2436SF	492
	42"	1067	1.2	39	17.6	SHDS2442SF	589	32	14.5	HDS2442SF	555
	48"	1219	1.3	43	19.5	SHDS2448SF	661	36	16.3	HDS2448SF	601
	54"	1372	1.5	48	21.8	SHDS2454SF	714	41	18.6	HDS2454SF	655
	60"	1524	1.7	55	24.9	SHDS2460SF	765	47	21.3	HDS2460SF	703

VALU-MASTER® Gray Epoxy

	length		cu ft	14 gauge				16 gauge			
	weight			weight		weight		weight			
	in.	mm		lb.	kg	model #	list	lb.	kg	model #	list
18" width (457mm)	36"	914	0.8	24	10.9	SHDS1836VF	211	19	8.6	HDS1836VF	204
	42"	1067	0.9	26	11.8	SHDS1842VF	224	21	9.5	HDS1842VF	214
	48"	1219	1.0	29	13.2	SHDS1848VF	231	24	10.9	HDS1848VF	221
	54"	1372	1.1	33	15.0	SHDS1854VF	247	27	12.2	HDS1854VF	222
	60"	1524	1.3	36	16.3	SHDS1860VF	259	29	13.2	HDS1860VF	244
24" width (610mm)	36"	914	1.0	35	15.9	SHDS2436VF	229	28	12.7	HDS2436VF	219
	42"	1067	1.2	39	17.6	SHDS2442VF	240	32	14.5	HDS2442VF	228
	48"	1219	1.3	43	19.5	SHDS2448VF	248	36	16.3	HDS2448VF	236
	54"	1372	1.5	48	21.8	SHDS2454VF	271	41	18.6	HDS2454VF	255
	60"	1524	1.7	55	24.9	SHDS2460VF	279	47	21.3	HDS2460VF	265

Valu-Gard® Green Epoxy

	length		cu ft	14 gauge				16 gauge			
	weight			weight		weight		weight			
	in.	mm		lb.	kg	model #	list	lb.	kg	model #	list
18" width (457mm)	36"	914	0.8	24	10.9	SHDS1836VGF	211	19	8.6	HDS1836VGF	204
	42"	1067	0.9	26	11.8	SHDS1842VGF	224	21	9.5	HDS1842VGF	214
	48"	1219	1.0	29	13.2	SHDS1848VGF	231	24	10.9	HDS1848VGF	221
	54"	1372	1.1	33	15.0	SHDS1854VGF	247	27	12.2	HDS1854VGF	222
	60"	1524	1.3	36	16.3	SHDS1860VGF	259	29	13.2	HDS1860VGF	244
24" width (610mm)	36"	914	1.0	35	15.9	SHDS2436VGF	229	28	12.7	HDS2436VGF	219
	42"	1067	1.2	39	17.6	SHDS2442VGF	240	32	14.5	HDS2442VGF	228
	48"	1219	1.3	43	19.5	SHDS2448VGF	248	36	16.3	HDS2448VGF	236
	54"	1372	1.5	48	21.8	SHDS2454VGF	271	41	18.6	HDS2454VGF	255
	60"	1524	1.7	55	24.9	SHDS2460VGF	279	47	21.3	HDS2460VGF	265

Catalog Section 1

Quik-Set® Embossed Solid Shelves

see spec sheet **EG01.23**

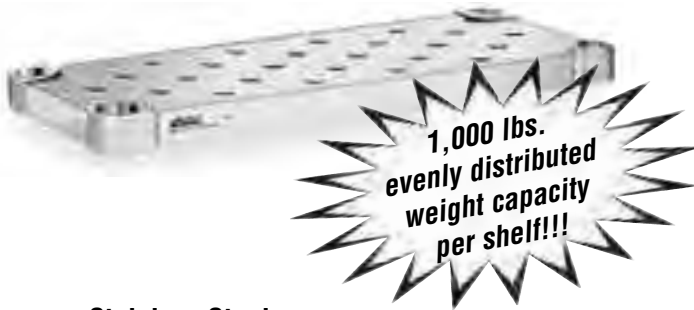

- Heavy duty.
- Constructed with a 2" (51mm) downturn and marine edge.
- Each corner is fitted with a heavy-duty aluminum casting to accept a split sleeve.
- Top of shelf is die stamped with a 1" (25mm) diameter drawn impression to provide a raised area for air circulation.
- Each emboss is on 3" (76mm) centers for the width and 3" (76mm) centers for the length.

FEATURES:

Freight class is 70.0.

(*) MTS (made to stock) / () MTO (made to order)

Stainless Steel

	length		cu ft	14 gauge				16 gauge			
	weight			weight		weight		weight			
	in.	mm		lb.	kg	model #	list	lb.	kg	model #	list
18" width (457mm)	36"	914	0.8	24	10.9	SHDS1836SE	451	19	8.6	HDS1836SE	438
	42"	1067	0.9	26	11.8	SHDS1842SE	501	21	9.5	HDS1842SE	485
	48"	1219	1.0	29	13.2	SHDS1848SE	544	24	10.9	HDS1848SE	531
	54"	1372	1.1	33	15.0	SHDS1854SE	584	27	12.2	HDS1854SE	555
	60"	1524	1.3	36	16.3	SHDS1860SE	624	29	13.2	HDS1860SE	582
24" width (610mm)	36"	914	1.0	35	15.9	SHDS2436SE	563	28	12.7	HDS2436SE	524
	42"	1067	1.2	39	17.6	SHDS2442SE	579	32	14.5	HDS2442SE	570
	48"	1219	1.3	43	19.5	SHDS2448SE	627	36	16.3	HDS2448SE	604
	54"	1372	1.5	48	21.8	SHDS2454SE	704	41	18.6	HDS2454SE	672
	60"	1524	1.7	55	24.9	SHDS2460SE	780	47	21.3	HDS2460SE	720

VALU-MASTER® Gray Epoxy

	length		cu ft	14 gauge				16 gauge			
	weight			weight		weight		weight			
	in.	mm		lb.	kg	model #	list	lb.	kg	model #	list
18" width (457mm)	36"	914	0.8	24	10.9	SHDS1836VE	219	19	8.6	HDS1836VE	209
	42"	1067	0.9	26	11.8	SHDS1842VE	229	21	9.5	HDS1842VE	220
	48"	1219	1.0	29	13.2	SHDS1848VE	234	24	10.9	HDS1848VE	224
	54"	1372	1.1	33	15.0	SHDS1854VE	253	27	12.2	HDS1854VE	242
	60"	1524	1.3	36	16.3	SHDS1860VE	262	29	13.2	HDS1860VE	248
24" width (610mm)	36"	914	1.0	35	15.9	SHDS2436VE	233	28	12.7	HDS2436VE	224
	42"	1067	1.2	39	17.6	SHDS2442VE	244	32	14.5	HDS2442VE	232
	48"	1219	1.3	43	19.5	SHDS2448VE	253	36	16.3	HDS2448VE	241
	54"	1372	1.5	48	21.8	SHDS2454VE	274	41	18.6	HDS2454VE	261
	60"	1524	1.7	55	24.9	SHDS2460VE	286	47	21.3	HDS2460VE	269

Valu-Gard® Green Epoxy

	length		cu ft	14 gauge				16 gauge			
	weight			weight		weight		weight			
	in.	mm		lb.	kg	model #	list	lb.	kg	model #	list
18" width (457mm)	36"	914	0.8	24	10.9	SHDS1836VGE	219	19	8.6	HDS1836VGE	209
	42"	1067	0.9	26	11.8	SHDS1842VGE	229	21	9.5	HDS1842VGE	220
	48"	1219	1.0	29	13.2	SHDS1848VGE	234	24	10.9	HDS1848VGE	224
	54"	1372	1.1	33	15.0	SHDS1854VGE	253	27	12.2	HDS1854VGE	242
	60"	1524	1.3	36	16.3	SHDS1860VGE	262	29	13.2	HDS1860VGE	248
24" width (610mm)	36"	914	1.0	35	15.9	SHDS2436VGE	233	28	12.7	HDS2436VGE	224
	42"	1067	1.2	39	17.6	SHDS2442VGE	244	32	14.5	HDS2442VGE	232
	48"	1219	1.3	43	19.5	SHDS2448VGE	253	36	16.3	HDS2448VGE	241
	54"	1372	1.5	48	21.8	SHDS2454VGE	274	41	18.6	HDS2454VGE	261
	60"	1524	1.7	55	24.9	SHDS2460VGE	286	47	21.3	HDS2460VGE	269



Quik-Set® Louvered Solid Shelves

see spec sheet **EG01.23**



FEATURES:

- Heavy duty.
- Shelves are constructed with a 2" (51mm) downturn and marine edge.
- Each corner is fitted with a heavy-duty aluminum casting to accept a split sleeve.
- Top of shelf is die stamped with a 2¾" x ½" (70 x 13mm) opening with a ¼" (2mm) drawn depression around the opening to provide reinforcement.
- Each opening is on 3" (76mm) centers for the width and 3" (76mm) centers for the length.

Freight class is 70.0.

(•) MTS (made to stock) / () MTO (made to order)

Stainless Steel

	length		cu ft	14 gauge				16 gauge			
				weight				weight			
	in.	mm		lb.	kg	model #	list	lb.	kg	model #	list
18" width (457mm)	36"	914	0.8	24	10.9	SHDS1836SL	451	17	7.7	HDS1836SL	438
	42"	1067	0.9	26	11.8	SHDS1842SL	501	19	8.6	HDS1842SL	485
	48"	1219	1.0	29	13.2	SHDS1848SL	544	22	10.0	HDS1848SL	531
	54"	1372	1.1	33	15.0	SHDS1854SL	584	25	11.3	HDS1854SL	555
	60"	1524	1.3	36	16.3	SHDS1860SL	624	27	12.2	HDS1860SL	582
24" width (610mm)	36"	914	1.0	35	15.9	SHDS2436SL	563	26	11.8	HDS2436SL	524
	42"	1067	1.2	39	17.6	SHDS2442SL	579	30	13.6	HDS2442SL	570
	48"	1219	1.3	43	19.5	SHDS2448SL	627	34	15.4	HDS2448SL	621
	54"	1372	1.5	48	21.8	SHDS2454SL	704	39	17.6	HDS2454SL	672
	60"	1524	1.7	55	24.9	SHDS2460SL	780	45	20.4	HDS2460SL	720

VALU-MASTER® Gray Epoxy

	length		cu ft	14 gauge				16 gauge			
				weight				weight			
	in.	mm		lb.	kg	model #	list	lb.	kg	model #	list
18" width (457mm)	36"	914	0.8	22	10.4	SHDS1836VL	221	17	7.7	HDS1836VL	210
	42"	1067	0.9	24	10.9	SHDS1842VL	231	19	8.6	HDS1842VL	222
	48"	1219	1.0	27	12.2	SHDS1848VL	239	22	10.0	HDS1848VL	228
	54"	1372	1.1	31	14.5	SHDS1854VL	243	25	11.3	HDS1854VL	237
	60"	1524	1.3	34	15.4	SHDS1860VL	266	27	12.2	HDS1860VL	245
24" width (610mm)	36"	914	1.0	33	15.0	SHDS2436VL	236	26	11.8	HDS2436VL	225
	42"	1067	1.2	37	16.8	SHDS2442VL	246	30	13.6	HDS2442VL	234
	48"	1219	1.3	41	18.6	SHDS2448VL	257	34	15.4	HDS2448VL	243
	54"	1372	1.5	47	21.3	SHDS2454VL	279	39	17.6	HDS2454VL	266
	60"	1524	1.7	53	24.0	SHDS2460VL	289	45	20.4	HDS2460VL	272

Valu-Gard® Green Epoxy

	length		cu ft	14 gauge				16 gauge			
				weight				weight			
	in.	mm		lb.	kg	model #	list	lb.	kg	model #	list
18" width (457mm)	36"	914	0.8	22	10.4	SHDS1836VGL	221	17	7.7	HDS1836VGL	210
	42"	1067	0.9	24	10.9	SHDS1842VGL	231	19	8.6	HDS1842VGL	222
	48"	1219	1.0	27	12.2	SHDS1848VGL	239	22	10.0	HDS1848VGL	228
	54"	1372	1.1	31	14.5	SHDS1854VGL	243	25	11.3	HDS1854VGL	237
	60"	1524	1.3	34	15.4	SHDS1860VGL	266	27	12.2	HDS1860VGL	245
24" width (610mm)	36"	914	1.0	33	15.0	SHDS2436VGL	236	26	11.8	HDS2436VGL	225
	42"	1067	1.2	37	16.8	SHDS2442VGL	246	30	13.6	HDS2442VGL	234
	48"	1219	1.3	41	18.6	SHDS2448VGL	257	34	15.4	HDS2448VGL	243
	54"	1372	1.5	47	21.3	SHDS2454VGL	279	39	17.6	HDS2454VGL	266
	60"	1524	1.7	53	24.0	SHDS2460VGL	289	45	20.4	HDS2460VGL	272

Catalog Section 1

Quik-Set® Solid Shelving Accessories

see spec sheet **EG01.23A**

Freight class is 50.0.

(•) MTS (made to stock) / () MTO (made to order)

Posts

- 1½" (42mm) diameter.
- Grooved in 2" (51mm) increments.

height		weight		cubic feet	VALU-MASTER®		Valu-Gard®		stainless steel	
in.	mm	lb.	kg		model #	list	model #	list	model #	list
14"	356	1.0	0.5	0.2	HDSP14-V	19	HDSP14-VG	19	HDSP14-S	51
33"	838	2.0	0.9	0.2	HDSP33-V	24	HDSP33-VG	24	HDSP33-S	70
54"	1372	3.0	1.4	0.2	HDSP54-V	28	HDSP54-VG	28	HDSP54-S	74
63"	1600	3.5	1.8	0.2	HDSP63-V	30	HDSP63-VG	30	HDSP63-S	86
74"	1880	4.0	1.8	0.2	HDSP74-V	35	HDSP74-VG	35	HDSP74-S	98
86"	2184	6.0	2.7	0.2	HDSP86-V	37	HDSP86-VG	37	HDSP86-S	108



Caster Posts

- 1½" (42mm) diameter.
- Grooved in 2" (51mm) increments.

height		weight		cubic feet	VALU-MASTER®		Valu-Gard®		stainless steel	
in.	mm	lb.	kg		model #	list	model #	list	model #	list
14"	356	1.0	0.5	0.2	HDSCP14-V	19	HDSCP14-VG	19	HDSCP14-S	51
33"	838	2.0	0.9	0.2	HDSCP33-V	24	HDSCP33-VG	24	HDSCP33-S	70
54"	1372	3.0	1.4	0.2	HDSCP54-V	28	HDSCP54-VG	28	HDSCP54-S	74
63"	1600	3.5	1.8	0.2	HDSCP63-V	30	HDSCP63-VG	30	HDSCP63-S	86
74"	1880	4.0	1.8	0.2	HDSCP74-V	35	HDSCP74-VG	35	HDSCP74-S	98
86"	2184	6.0	2.7	0.2	HDSCP86-V	37	HDSCP86-VG	37	HDSCP86-S	108



Adjustable Foot

- Adjust from minimum height of 1½" to maximum height of 2½" (38 to 64mm).

weight		model #	list
lb.	kg		
0.25	0.1	301036	9



Post Cap

- Black plastic cap fits inside 1½" (32mm) diameter post.

weight		model #	list
lb.	kg		
0.25	0.1	330010	4

Castors

see spec sheet **EG01.23A**

FEATURES:

- 5" (127mm) diameter.
- Set of four (two swivel, two with brake).

Freight class is 65.0.

(•) MTS (made to stock) / () MTO (made to order)



Polymer Cart Washable with Polymer Tread

weight capacity per caster		model #	list per set
lbs.	kg		
250	113.4	CAHW4-SB •	539

Zinc with Rubber Tread

weight capacity per caster		model #	list per set
lbs.	kg		
250	113.4	CAHP4-SB •	434



LIFESTOR® Polymer Shelving

LIFESTOR® Starter Units

see spec sheet **EG01.12A**



shelving made of removable shelf sections which are dishwasher safe.



INCLUDES:

- Four posts.
- Four shelves.
- Combination of stainless steel or zinc posts, rails, high density green polymer shelving sections and fittings provide a heavy duty unit that is virtually non-corrosive.

Freight class is 70.0.

(•) MTS (made to stock) / () MTO (made to order)

Featuring MICROGARD®

an antimicrobial agent which contains built-in protection to retard the growth of a broad range of bacteria, mold and mildew on shelf surface that causes stains, odors and degradation.

Standard on all LIFESTOR® Shelving.

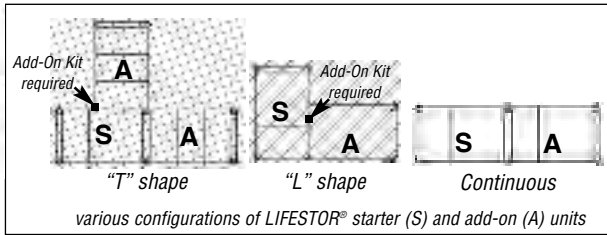

63" (1600mm)-High Starter Units — With 63" (1600mm) high posts.

	length		weight		cu ft	stainless steel				EAGLEbrite®			
						w/ 4 Solid Shelves		w/ 4 Louvered Shelves		w/ 4 Solid Shelves		w/ 4 Louvered Shelves	
	in.	mm	lb.	kg		model #	list	model #	list	model #	list	model #	list
18" width (457mm)	24"	610	42	19.1	3.6	S4-63S-S1824PM	696	S4-63S-L1824PM	640	S4-63Z-S1824PM	620	S4-63Z-L1824PM	576
	30"	762	52	23.6	4.5	S4-63S-S1830PM	708	S4-63S-L1830PM	672	S4-63Z-S1830PM	636	S4-63Z-L1830PM	584
	36"	914	60	27.2	5.6	S4-63S-S1836PM	744	S4-63S-L1836PM	720	S4-63Z-S1836PM	656	S4-63Z-L1836PM	600
	42"	1067	65	29.5	5.8	S4-63S-S1842PM	808	S4-63S-L1842PM	5904	S4-63Z-S1842PM	724	S4-63Z-L1842PM	676
	48"	1219	70	31.8	6.0	S4-63S-S1848PM	856	S4-63S-L1848PM	784	S4-63Z-S1848PM	732	S4-63Z-L1848PM	684
	54"	1372	78	35.4	6.8	S4-63S-S1854PM	952	S4-63S-L1854PM	848	S4-63Z-S1854PM	828	S4-63Z-L1854PM	760
23" width (584mm)	60"	1524	86	39.0	7.6	S4-63S-S1860PM	1036	S4-63S-L1860PM	860	S4-63Z-S1860PM	840	S4-63Z-L1860PM	776
	24"	610	48	21.8	4.4	S4-63S-S2324PM	740	S4-63S-L2324PM	740	S4-63Z-S2324PM	720	S4-63Z-L2324PM	668
	30"	762	60	27.2	5.6	S4-63S-S2330PM	840	S4-63S-L2330PM	748	S4-63Z-S2330PM	728	S4-63Z-L2330PM	676
	36"	914	70	31.8	6.0	S4-63S-S2336PM	876	S4-63S-L2336PM	760	S4-63Z-S2336PM	740	S4-63Z-L2336PM	688
	42"	1067	76	34.5	6.5	S4-63S-S2342PM	964	S4-63S-L2342PM	884	S4-63Z-S2342PM	864	S4-63Z-L2342PM	792
	48"	1219	82	37.2	7.2	S4-63S-S2348PM	1008	S4-63S-L2348PM	900	S4-63Z-S2348PM	880	S4-63Z-L2348PM	804
	54"	1372	94	42.6	8.4	S4-63S-S2354PM	1088	S4-63S-L2354PM	1000	S4-63Z-S2354PM	980	S4-63Z-L2354PM	896
	60"	1524	102	46.3	9.6	S4-63S-S2360PM	1104	S4-63S-L2360PM	1012	S4-63Z-S2360PM	992	S4-63Z-L2360PM	844

74" (1880mm)-High Starter Units — With 74" (1880mm) high posts.

	length		weight		cu ft	stainless steel				EAGLEbrite®			
						w/ 4 Solid Shelves		w/ 4 Louvered Shelves		w/ 4 Solid Shelves		w/ 4 Louvered Shelves	
	in.	mm	lb.	kg		model #	list	model #	list	model #	list	model #	list
18" width (457mm)	24"	610	44	20.0	4.0	S4-74S-S1824PM	724	S4-74S-L1824PM	668	S4-74Z-S1824PM	640	S4-74Z-L1824PM	596
	30"	762	54	24.5	4.9	S4-74S-S1830PM	736	S4-74S-L1830PM	700	S4-74Z-S1830PM	656	S4-74Z-L1830PM	604
	36"	914	62	28.1	6.0	S4-74S-S1836PM	772	S4-74S-L1836PM	748	S4-74Z-S1836PM	676	S4-74Z-L1836PM	620
	42"	1067	67	30.4	6.2	S4-74S-S1842PM	836	S4-74S-L1842PM	5932	S4-74Z-S1842PM	744	S4-74Z-L1842PM	696
	48"	1219	72	32.7	6.4	S4-74S-S1848PM	884	S4-74S-L1848PM	812	S4-74Z-S1848PM	752	S4-74Z-L1848PM	704
	54"	1372	80	36.3	7.2	S4-74S-S1854PM	980	S4-74S-L1854PM	876	S4-74Z-S1854PM	848	S4-74Z-L1854PM	780
23" width (584mm)	60"	1524	88	39.9	8.0	S4-74S-S1860PM	1064	S4-74S-L1860PM	888	S4-74Z-S1860PM	860	S4-74Z-L1860PM	796
	24"	610	50	22.7	5.0	S4-74S-S2324PM	768	S4-74S-L2324PM	768	S4-74Z-S2324PM	740	S4-74Z-L2324PM	688
	30"	762	62	28.1	6.0	S4-74S-S2330PM	868	S4-74S-L2330PM	776	S4-74Z-S2330PM	748	S4-74Z-L2330PM	696
	36"	914	72	32.7	6.4	S4-74S-S2336PM	904	S4-74S-L2336PM	788	S4-74Z-S2336PM	760	S4-74Z-L2336PM	708
	42"	1067	76	34.5	7.0	S4-74S-S2342PM	992	S4-74S-L2342PM	912	S4-74Z-S2342PM	884	S4-74Z-L2342PM	812
	48"	1219	84	38.1	7.6	S4-74S-S2348PM	1036	S4-74S-L2348PM	928	S4-74Z-S2348PM	900	S4-74Z-L2348PM	824
	54"	1372	96	43.6	9.0	S4-74S-S2354PM	1116	S4-74S-L2354PM	1028	S4-74Z-S2354PM	1000	S4-74Z-L2354PM	916
	60"	1524	106	48.1	10.5	S4-74S-S2360PM	1132	S4-74S-L2360PM	1040	S4-74Z-S2360PM	1012	S4-74Z-L2360PM	864



Catalog Section 1

LIFESTOR® Add-On Units

see spec sheet **EG01.12B**



**400 lbs.
per shelf
weight capacity**

- Two posts.
- Four shelves.
- Combination of stainless steel or zinc posts, rails, high density green polymer shelving sections and fittings provide a heavy duty unit that is virtually non-corrosive.

INCLUDES:

Freight class is 70.0.

(•) MTS (made to stock) / () MTO (made to order)

Featuring MICROGARD®

an antimicrobial agent which contains built-in protection to retard the growth of a broad range of bacteria, mold and mildew on shelf surface that causes stains, odors and degradation.

Standard on all LIFESTOR® Shelving.

63" (1600mm)-High Add-On Units — With 63" (1600mm) high posts.

	length		weight		cu ft	stainless steel				EAGLEbrite®			
						w/ 4 Solid Shelves		w/ 4 Louvered Shelves		w/ 4 Solid Shelves		w/ 4 Louvered Shelves	
	in.	mm	lb.	kg		model #	list	model #	list	model #	list	model #	list
18" width (457mm)	24"	610	35	15.9	2.8	A4-63S-S1824PM	608	A4-63S-L1824PM	552	A4-63Z-S1824PM	562	A4-63Z-L1824PM	498
	30"	762	45	20.4	3.7	A4-63S-S1830PM	620	A4-63S-L1830PM	584	A4-63Z-S1830PM	542	A4-63Z-L1830PM	506
	36"	914	53	24.0	4.8	A4-63S-S1836PM	656	A4-63S-L1836PM	632	A4-63Z-S1836PM	558	A4-63Z-L1836PM	522
	42"	1067	58	26.3	5.0	A4-63S-S1842PM	720	A4-63S-L1842PM	5816	A4-63Z-S1842PM	578	A4-63Z-L1842PM	598
	48"	1219	63	28.6	5.2	A4-63S-S1848PM	768	A4-63S-L1848PM	696	A4-63Z-S1848PM	646	A4-63Z-L1848PM	606
	54"	1372	71	32.7	6.0	A4-63S-S1854PM	864	A4-63S-L1854PM	760	A4-63Z-S1854PM	654	A4-63Z-L1854PM	682
23" width (584mm)	24"	610	41	18.6	3.6	A4-63S-S2324PM	652	A4-63S-L2324PM	652	A4-63Z-S2324PM	762	A4-63Z-L2324PM	590
	30"	762	53	24.0	4.8	A4-63S-S2330PM	752	A4-63S-L2330PM	660	A4-63Z-S2330PM	642	A4-63Z-L2330PM	598
	36"	914	63	28.6	5.2	A4-63S-S2336PM	788	A4-63S-L2336PM	672	A4-63Z-S2336PM	650	A4-63Z-L2336PM	610
	42"	1067	70	31.8	6.1	A4-63S-S2342PM	876	A4-63S-L2342PM	796	A4-63Z-S2342PM	662	A4-63Z-L2342PM	714
	48"	1219	75	34.0	6.4	A4-63S-S2348PM	920	A4-63S-L2348PM	812	A4-63Z-S2348PM	786	A4-63Z-L2348PM	726
	54"	1372	87	39.5	7.6	A4-63S-S2354PM	1000	A4-63S-L2354PM	912	A4-63Z-S2354PM	802	A4-63Z-L2354PM	818
60"	1524	95	43.1	8.4	A4-63S-S2360PM	1016	A4-63S-L2360PM	924	A4-63Z-S2360PM	902	A4-63Z-L2360PM	766	

74" (1880mm)-High Add-On Units — With 74" (1880mm) high posts.

	length		weight		cu ft	stainless steel				EAGLEbrite®			
						w/ 4 Solid Shelves		w/ 4 Louvered Shelves		w/ 4 Solid Shelves		w/ 4 Louvered Shelves	
	in.	mm	lb.	kg		model #	list	model #	list	model #	list	model #	list
18" width (457mm)	24"	610	37	16.7	3.0	A4-74S-S1824PM	622	A4-74S-L1824PM	566	A4-74Z-S1824PM	552	A4-74Z-L1824PM	508
	30"	762	47	21.3	3.9	A4-74S-S1830PM	634	A4-74S-L1830PM	598	A4-74Z-S1830PM	568	A4-74Z-L1830PM	516
	36"	914	55	24.9	5.0	A4-74S-S1836PM	670	A4-74S-L1836PM	646	A4-74Z-S1836PM	588	A4-74Z-L1836PM	532
	42"	1067	60	27.2	5.2	A4-74S-S1842PM	734	A4-74S-L1842PM	5830	A4-74Z-S1842PM	656	A4-74Z-L1842PM	608
	48"	1219	65	29.4	5.4	A4-74S-S1848PM	782	A4-74S-L1848PM	710	A4-74Z-S1848PM	664	A4-74Z-L1848PM	616
	54"	1372	73	33.1	6.2	A4-74S-S1854PM	878	A4-74S-L1854PM	774	A4-74Z-S1854PM	760	A4-74Z-L1854PM	692
60"	1524	80	36.3	7.0	A4-74S-S1860PM	962	A4-74S-L1860PM	786	A4-74Z-S1860PM	772	A4-74Z-L1860PM	708	
23" width (584mm)	24"	610	43	19.5	4.0	A4-74S-S2324PM	666	A4-74S-L2324PM	666	A4-74Z-S2324PM	652	A4-74Z-L2324PM	600
	30"	762	55	24.9	5.0	A4-74S-S2330PM	766	A4-74S-L2330PM	674	A4-74Z-S2330PM	660	A4-74Z-L2330PM	608
	36"	991	65	29.4	5.4	A4-74S-S2336PM	802	A4-74S-L2336PM	686	A4-74Z-S2336PM	672	A4-74Z-L2336PM	620
	42"	1067	68	30.8	6.5	A4-74S-S2342PM	890	A4-74S-L2342PM	810	A4-74Z-S2342PM	796	A4-74Z-L2342PM	724
	48"	1219	77	34.9	7.6	A4-74S-S2348PM	934	A4-74S-L2348PM	826	A4-74Z-S2348PM	812	A4-74Z-L2348PM	736
	54"	1372	89	40.3	8.0	A4-74S-S2354PM	1014	A4-74S-L2354PM	926	A4-74Z-S2354PM	912	A4-74Z-L2354PM	828
60"	1524	98	44.5	8.3	A4-74S-S2360PM	1030	A4-74S-L2360PM	938	A4-74Z-S2360PM	924	A4-74Z-L2360PM	776	



100 Industrial Boulevard, Clayton, DE 19938-8903 U.S.A.
Phone: 800-637-5100 or 302-653-3000. Fax: 302-653-2065
<http://www.eaglegrp.com>

LIFESTOR® Shelving

see spec sheet **EG01.12C**



assembled LIFESTOR® stationary unit
(see page 75 for posts)

**400 lbs.
per shelf
weight
capacity**



assembled LIFESTOR® mobile unit
(see page 75 for posts)

- Rails.
- Side braces.
- Four connector kits.
- Combination of stainless steel or zinc posts, rails, high density green polymer shelving sections and fittings provide a heavy duty unit that is virtually non-corrosive.

INCLUDES:

Freight class is 70.0.

(*) MTS (made to stock) / () MTO (made to order)

Featuring MICROGARD®

an antimicrobial agent which contains built-in protection to retard the growth of a broad range of bacteria, mold and mildew on shelf surface that causes stains, odors and degradation.

Standard on all LIFESTOR® Shelving.

Shelves for Stationary Applications – Front-to-back side braces are polymer for stationary use.

	length*		weight		cu ft	shelves w/ stainless steel rails				shelves w/ EAGLEbrite® zinc rails			
						Solid Shelves		Louvered Shelves		Solid Shelves		Louvered Shelves	
	in.	mm	lb.	kg		model #	list	model #	list	model #	list	model #	list
18" width (457mm)	24"	610	7.0	3.2	0.5	S1824PSM	130	L1824PSM	116	S1824PZM	116	L1824PZM	105
	30"	762	8.5	3.9	0.7	S1830PSM	133	L1830PSM	124	S1830PZM	120	L1830PZM	107
	36"	914	10.0	4.5	0.9	S1836PSM	142	L1836PSM •	136	S1836PZM	125	L1836PZM •	111
	42"	1067	11.5	5.2	1.1	S1842PSM	158	L1842PSM •	143	S1842PZM	142	L1842PZM •	130
	48"	1219	13.0	5.9	1.3	S1848PSM •	170	L1848PSM •	152	S1848PZM •	144	L1848PZM •	132
	54"	1372	14.5	6.6	1.5	S1854PSM	194	L1854PSM •	168	S1854PZM	168	L1854PZM •	151
60"	1524	16.0	7.3	1.7	S1860PSM	215	L1860PSM •	171	S1860PZM •	171	L1860PZM •	155	
23" width (584mm)	24"	610	8.5	3.9	0.7	S2324PSM	141	L2324PSM	141	S2324PZM	141	L2324PZM	128
	30"	762	10.0	4.5	0.9	S2330PSM •	166	L2330PSM	143	S2330PZM	143	L2330PZM	130
	36"	914	11.5	4.8	1.1	S2336PSM	175	L2336PSM •	146	S2336PZM	146	L2336PZM •	133
	42"	1067	13.0	5.9	1.3	S2342PSM •	197	L2342PSM •	177	S2342PZM	177	L2342PZM •	159
	48"	1219	14.5	6.6	1.5	S2348PSM •	208	L2348PSM •	181	S2348PZM •	181	L2348PZM •	162
	54"	1372	16.0	7.3	1.7	S2354PSM	228	L2354PSM •	206	S2354PZM	206	L2354PZM •	185
60"	1524	17.5	7.9	1.9	S2360PSM •	232	L2360PSM •	209	S2360PZM	209	L2360PZM •	172	

Shelves for Mobile Applications – Finish of front-to-back side braces match finish of side-to-side rails. Rails enhance stability.

	length*		weight		cu ft	shelves w/ stainless steel rails				shelves w/ EAGLEbrite® zinc rails			
						Solid Shelves		Louvered Shelves		Solid Shelves		Louvered Shelves	
	in.	mm	lb.	kg		model #	list	model #	list	model #	list	model #	list
18" width (457mm)	24"	610	7.0	3.2	0.5	S1824PSM-M	195	L1824PSM-M	181	S1824PZM-M	175	L1824PZM-M	164
	30"	762	8.5	3.9	0.7	S1830PSM-M	216	L1830PSM-M	206	S1830PZM-M	188	L1830PZM-M	175
	36"	914	10.0	4.5	0.9	S1836PSM-M	241	L1836PSM-M	234	S1836PZM-M	207	L1836PZM-M	194
	42"	1067	11.5	5.2	1.1	S1842PSM-M	266	L1842PSM-M	251	S1842PZM-M	234	L1842PZM-M	222
	48"	1219	13.0	5.9	1.3	S1848PSM-M	285	L1848PSM-M	266	S1848PZM-M	241	L1848PZM-M	229
	54"	1372	14.5	6.6	1.5	S1854PSM-M	320	L1854PSM-M	294	S1854PZM-M	275	L1854PZM-M	258
60"	1524	16.0	7.3	1.7	S1860PSM-M	359	L1860PSM-M	314	S1860PZM-M	286	L1860PZM-M	269	
23" width (584mm)	24"	610	8.5	3.9	0.7	S2324PSM-M	221	L2324PSM-M	206	S2324PZM-M	199	L2324PZM-M	186
	30"	762	10.0	4.5	0.9	S2330PSM-M	248	L2330PSM-M	227	S2330PZM-M	210	L2330PZM-M	197
	36"	914	11.5	4.8	1.1	S2336PSM-M	273	L2336PSM-M	245	S2336PZM-M	230	L2336PZM-M	216
	42"	1067	13.0	5.9	1.3	S2342PSM-M	305	L2342PSM-M	285	S2342PZM-M	269	L2342PZM-M	251
	48"	1219	14.5	6.6	1.5	S2348PSM-M	323	L2348PSM-M	296	S2348PZM-M	278	L2348PZM-M	258
	54"	1372	16.0	7.3	1.7	S2354PSM-M	353	L2354PSM-M	332	S2354PZM-M	313	L2354PZM-M	293
60"	1524	17.5	7.9	1.9	S2360PSM-M	375	L2360PSM-M	353	S2360PZM-M	324	L2360PZM-M	301	

* Shelves up to 48" (1219mm) long hold 400 lbs. (181.4 kg). Shelves over 48" (1219mm) hold 300 lbs. (136.1 kg).

Catalog Section 1

LIFESTOR® Shelving (continued)

see spec sheet **EG01.12C**

Freight class is 70.0.

(•) MTS (made to stock) / () MTO (made to order)

Posts...

- Constructed of stainless steel or zinc plated mild steel with a clear antimicrobial epoxy coating.
- 1¼" (32mm) outside diameter, grooved at 2" (51mm) increments for easy assembly.
- Post cap included.

			...For Stationary use*				...For Mobile use**					
height in.	weight		cu ft	stainless		EAGLEbrite®		stainless		EAGLEbrite®		
	mm	lbs.		kg	model #	list	model #	list	model #	list	model #	list
14"	356	1.0	0.5	0.2	PP14-S	26	PP14-Z	25	CPP14-S•	26	CPP14-Z	25
33"	383	2.0	0.9	0.4	PP33-S•	37	PP33-Z•	29	CPP33-S	37	CPP33-Z	35
54"	1372	3.0	1.4	0.4	PP54-S	39	PP54-Z	36	CPP54-S	39	CPP54-Z	36
63"	1600	3.5	1.6	0.4	PP63-S•	44	PP63-Z•	39	CPP63-S•	44	CPP63-Z•	39
74"	1880	4.0	1.8	0.5	PP74-S•	51	PP74-Z•	44	CPP74-S•	51	CPP74-Z•	44
86"	2184	5.0	2.3	0.5	PP86-S•	59	PP86-Z	51	CPP86-S•	59	CPP86-Z	51

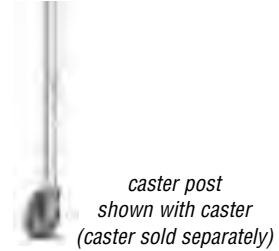

* Stationary posts include adjustable feet.

** Stainless steel or zinc side braces are required for mobile use – two per shelf.

LIFESTOR® Shelving Components

see spec sheet **EG01.12C**

Freight class is 50.0.

(•) MTS (made to stock) / () MTO (made to order)

Casters

- For use with #CPP caster posts, and not for LIFESTOR® Dunnage Racks, page 78.

Note: Stainless steel or zinc side braces are required for use with casters. Two braces per shelf are required.

IMPORTANT: Not for cart-wash use.



Shelf Sections

- Green polymer.
- Features MICROGARD® protection.

caster description	weight		cubic feet	model #	list
	lbs.	kg			
5" (127mm) dia. swivel heavy-duty 250 lb. (113 kg) cap. - urethane	3.0	1.4	0.1	A205340•	69
same as above with brake	3.5	1.6	0.1	A205341•	72
5" (127mm) rotary bumper, each	1.0	0.5	0.1	A205342	15

shelf width in.	mm	weight		cu ft	solid		louvered	
		lbs.	kg		model #	list	model #	list
18"	457	1.9	0.9	0.4	A216242	16	A216244	15
23"	584	2.4	1.1	0.4	A216243	26	A216245	23

Replacement Side Braces (front-to-back)...

- Two per shelf required.

...For Stationary use

shelf width in.	mm	cu ft	weight		polymer	
			lbs.	kg	model #	list
18"	457	0.2	0.8	0.4	A216246	9
23"	584	0.2	1.0	0.5	A216247	11

...For Mobile use

shelf width in.	mm	cu ft	zinc				stainless			
			weight		model #	list	weight		model #	list
lbs.	kg	lbs.	kg	lbs.			kg			
18"	457	0.2	1.2	0.5	A211331•	19	1.2	0.5	A216240	23
23"	584	0.2	1.5	0.7	A211332•	30	1.5	0.7	A216241•	33



Featuring MICROGARD®

an antimicrobial agent which contains built-in protection to retard the growth of a broad range of bacteria, mold and mildew on shelf surface that causes stains, odors and degradation.

Standard on all LIFESTOR® Shelving.



100 Industrial Boulevard, Clayton, DE 19938-8903 U.S.A.
 Phone: 800-637-5100 or 302-653-3000. Fax: 302-653-2065
<http://www.eaglegrp.com>

LIFESTOR® Shelving Components

see spec sheet **EG01.12C**



Rails (side-to-side)

- Constructed of stainless steel or zinc plated mild steel with a clear antimicrobial epoxy coating.
- Each end fits securely into a lug.

fits shelf length		actual rail length		weight		stainless steel		EAGLEbrite®	
in.	mm	in.	mm	lbs.	kg	model #	list	model #	list
24"	610	18 ³ / ₁₆ "	478	1.4	0.6	A215051	33	A215152	29
30"	762	24 ³ / ₁₆ "	631	1.8	0.8	A215052	41	A215153	34
36"	914	30 ³ / ₁₆ "	783	2.1	0.9	A215053	49	A215154	41
42"	1067	36 ³ / ₁₆ "	935	2.5	1.1	A215054	54	A215155	46
48"	1219	42 ³ / ₁₆ "	1087	2.8	1.3	A215055	57	A215156	48
54"	1372	48 ³ / ₁₆ "	1240	3.2	1.5	A215056	63	A215157	54
60"	1392	54 ³ / ₁₆ "	1392	3.5	1.6	A215057	72	A215158	57

"L" or "T" Add-On Kits

- Consist of "U" connector and notched shelf section.
- Features MICROGARD® protection.
- For add-on units, see page 73.

louvered shelf section with notch

shelf width		weight		cu	solid		louvered	
in.	mm	lbs.	kg	ft	model #	list	model #	list
18"	457	2.0	0.9	0.4	18-SM	40	18-LM	34
23"	584	2.5	1.1	0.4	23-SM	40	23-LM	34

"U" connector

Freight class is 70.0.

(•) MTS (made to stock) / () MTO (made to order)

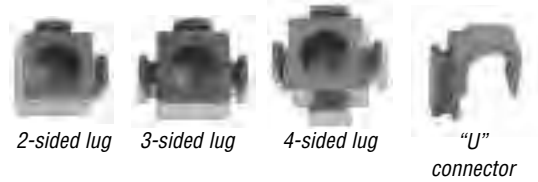

Connectors

description	weight		cu ft	model #	list
	lbs.	kg			
2-sided lug	0.4	0.2	.04	A208137	10
3-sided lug	0.4	0.2	.04	A208138	10
4-sided lug	0.4	0.2	.04	A208139	10
"U" Connector	0.2	0.1	.04	A208140	11



Miscellaneous

description	model #	list
split sleeve *	A208141	4
adjustable foot	A208143	8
cap	A208144	4

*Split sleeve must be ordered as a separate component.

LIFESTOR® Shelving Accessories

see spec sheet **EG01.12D**

Ledges

- Ledges snap over post without tools.
- Valu-Gard® green epoxy finish.
- Consult factory for other finishes.

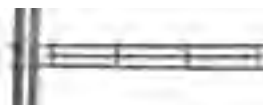

length		weight		1" (25mm)		4" (102mm)	
in.	mm	lbs.	kg	model #	list	model #	list
*18"	457	0.5	0.2	LSL18-1VG	23	LSL18-4VG	25
*23"	584	0.6	0.3	LSL23-1VG	25	LSL23-4VG	27
24"	610	0.6	0.3	LSL24-1VG	25	LSL24-4VG	27
30"	762	0.7	0.3	LSL30-1VG	27	LSL30-4VG	29
36"	914	0.8	0.4	LSL36-1VG	38	LSL36-4VG	42
42"	1067	0.8	0.4	LSL42-1VG	40	LSL42-4VG	43
48"	1219	0.9	0.4	LSL48-1VG	42	LSL48-4VG	44
54"	1372	1.2	0.5	LSL54-1VG	46	LSL54-4VG	52
60"	1524	1.4	0.5	LSL60-1VG	51	LSL60-4VG	57

* Front-to-back. All other lengths are used side-to-side.

Freight class is 70.0.

(•) MTS (made to stock) / () MTO (made to order)

Dividers

- 8" (203mm).
- Dividers snap onto shelf via two 16 gauge stainless steel clips.
- Valu-Gard® green epoxy finish.
- Consult factory for other finishes.



width		weight		model #	list
in.	mm	lbs.	kg		
18"	457	1.3	0.6	LSD18-VG	15
23"	584	1.8	0.8	LSD23-VG	19

Catalog Section 1

LIFESTOR® Shelving Accessories

see spec sheet **EG01.12D**

Freight class is 70.0.

(•) MTS (made to stock) / () MTO (made to order)

Enclosure Panels

- 3" (76mm) grid.
- Panels attach to shelf via six 14 gauge stainless steel clips.
- A flat blade screwdriver is required for installation.
- Valu-Gard® green epoxy finish.
- Consult factory for other finishes.

width		for 54" (1372mm) post height		for 63" (1600mm) post height		for 74" (1880mm) post height	
in.	mm	model #	list	model #	list	model #	list
12"	305	LSE1254-VG	72	LSE1263-VG	75	LSE1274-VG	86
18"	457	LSE1854-VG	78	LSE1863-VG	89	LSE1874-VG	92

Ordering requirements for Enclosure Panels:

- Panels for 63" (1600mm) posts used as example below.

shelf width		enclosure panel	
in.	mm	model #	qty
18"	457	LSE1263-VG	1
23"	584	LSE1863-VG	1

shelf length		enclosure panel	
in.	mm	model #	qty
24"	610	LSE1263-VG	1
30"	762	LSE1863-VG	1
36"	914	LSE1263-VG	2
42"	1067	LSE1863-VG	2
48"	1219	LSE1863-VG	2
54"	1372	LSE1263-VG	4
60"	1524	LSE1863-VG	3

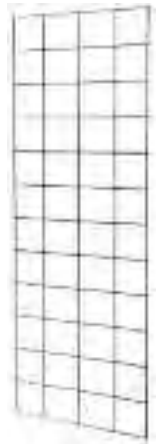

Tote Slide Systems

- Only available for 23" (584mm) wide shelves.
- System is suspended from the unit's rails via four shelf slide clips (sold separately).
- Load capacity up to 35 lbs. (15.9 kg).

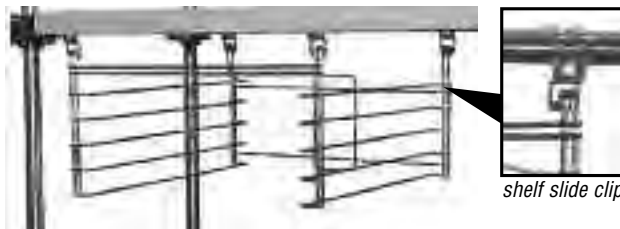

shelf slide clip

width x length x depth		weight		cubic	model #	list
in.	mm	lbs.	kg	feet		
14" x 21 1/2" x 10 1/4"	356 x 683 x 260	5.0	2.3	2.0	TS1421	100
20" x 21 1/2" x 10 1/4"	508 x 683 x 260	7.5	3.4	3.8	TS2021•	104

Shelf Slide Clips for Tote Slide Systems

- Set of four.

weight		cubic	model #	list
lbs.	kg	feet		
0.5	0.2	0.1	SSC	51

Wall Brackets

- **LIFESTOR® can now be mounted to the wall!**
- Each bracket consists of one single shelf support and one mounting plate.
- Valu-Gard® green epoxy finish.

for shelf width		weight		cubic		model #	list per pair
in.	mm	lbs.	kg	feet	feet		
18"	457	10	4.5	0.5		LWB18-VG	68
23"	584	14	6.4	0.7		LWB23-VG	78



**Go Green.
Go Eagle.**

Look for the tag
on the bar code



LIFESTOR® Dunnage Racks

see spec sheet **EG01.13**



stationary dunnage rack with louvered shelves



mobile dunnage rack with louvered shelves

Featuring MICROGARD®

an antimicrobial agent which contains built-in protection to retard the growth of a broad range of bacteria, mold and mildew on shelf surface that causes stains, odors and degradation.

Standard on all LIFESTOR® Shelving.

Stationary Racks: 1,000 lbs. (454 kg).

Mobile Racks: 800 lbs. (363 kg).

WEIGHT CAPACITY:

MOBILE FEATURES:

- Four 5" (127mm) diameter heavy duty swivel casters with rubber tread, two with brakes.

STATIONARY FEATURES:

- Stainless steel bullet feet.

BOTH FEATURES:

- 1½" (41mm) diameter stainless steel legs.
- 1¼" (32mm) diameter stainless steel crossbracing on all four sides.
- 14" (356mm) height.

Freight class is 70.0.

(•) MTS (made to stock) / () MTO (made to order)

	Stationary			Mobile							
	size		cu ft	w/ Solid Shelves		w/ Louvered Shelves		w/ Solid Shelves		w/ Louvered Shelves	
	in.	mm		model #	list	model #	list	model #	list	model #	list
18" width (457mm)	32"	813	2.0	DR-S1832PSM	429	DR-L1832PSM	426	MDR-S1832PSM	586	MDR-L1832PSM	581
	41"	1041	2.6	DR-S1841PSM	467	DR-L1841PSM	462	MDR-S1841PSM	637	MDR-L1841PSM	621
	50"	1270	3.1	DR-S1850PSM	503	DR-L1850PSM	498	MDR-S1850PSM	686	MDR-L1850PSM	680
23" width (584mm)	32"	813	2.0	DR-S2332PSM	449	DR-L2332PSM	440	MDR-S2332PSM	607	MDR-L2332PSM	601
	41"	1041	2.6	DR-S2341PSM	494	DR-L2341PSM	482	MDR-S2341PSM	663	MDR-L2341PSM	653
	50"	1270	3.1	DR-S2350PSM	538	DR-L2350PSM	525	MDR-S2350PSM	720	MDR-L2350PSM	705

LIFESTOR® Utility Carts

see spec sheet **EG01.41**



Allows for removal or adjustment of shelves without disassembling entire cart.

- Green polymer shelving sections are non-corrosive, dishwasher-safe.
- Easy to assemble in minutes—only one person required.
- All units feature three tiers.
- Heavy duty 5" (127mm) diameter swivel casters with rotary bumper, two with brake.

FEATURES:

Freight class is 70.0.

(•) MTS (made to stock) / () MTO (made to order)

Featuring MICROGARD®

an antimicrobial agent which contains built-in protection to retard the growth of a broad range of bacteria, mold and mildew on shelf surface that causes stains, odors and degradation.

Standard on all LIFESTOR® Shelving.

	Stainless Steel Finish						EAGLEbrite® Zinc Finish			
	shelf size		w/ solid shelves		w/ louvered shelves		w/ solid shelves		w/ louvered shelves	
	in.	mm	model #	list	model #	list	model #	list	model #	list
18" width (457mm)	36"	914	U3-S1836PSM	1106	U3-L1836PSM	1086	U3-S1836PZM	874	U3-L1836PZM	853
	48"	1219	U3-S1848PSM	1225	U3-L1848PSM	1196	U3-S1848PZM	1044	U3-L1848PZM	956
23" width (584mm)	36"	914	U3-S2336PSM	1219	U3-L2336PSM	1168	U3-S2336PZM	956	U3-L2336PZM	906
	48"	1219	U3-S2348PSM	1380	U3-L2348PSM	1309	U3-S2348PZM	1086	U3-L2348PZM	1013

Catalog Section 1

Floor-Trak® Storage System designed for LIFESTOR® Polymer Shelving

see spec sheet **EG01.40**

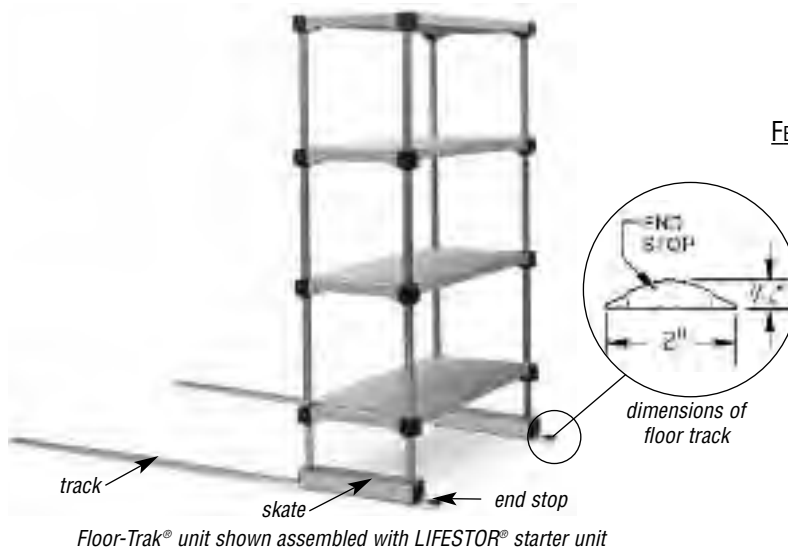

Floor-Trak® unit shown assembled with LIFESTOR® starter unit

- Non-corrosive tracks constructed of anodized aluminum.
- System is ADA-compliant.
- Simple and easy to install.
- Easy to add on additional tracks and units.
- Open construction allows for the use of cart covers when required.
- Industrial-type, hardened steel bearings allow loaded units to glide effortlessly over the track.
- Single-deep only.

FEATURES:

Note: LIFESTOR® shelves and posts sold separately (see pages 74 & 75—not for use with LIFESTOR® starter units).

Unit will tilt if not loaded properly.
LOAD BOTTOM FIRST!

Freight class is 70.0.

(•) MTS (made to stock) / () MTO (made to order)

Featuring MICROGARD®

an antimicrobial agent which contains built-in protection to retard the growth of a broad range of bacteria, mold and mildew on shelf surface that causes stains, odors and degradation.

Standard on all LIFESTOR® Shelving.

Floor-Trak® Kits

- A pair of aluminum tracks with end stops.
- All hardware and assembly instructions included.

Note: Not recommended to piece tracks together. Order length needed. Custom lengths available. Consult factory.

width		weight		cu	model #	list
ft.	mm	lbs.	kg			
6'	1829	5	2.3	0.06	SDFT-6	552
7'	2134	5	2.3	0.07	SDFT-7	626
8'	2438	6	2.7	0.08	SDFT-8	699
9'	2743	7	3.2	0.09	SDFT-9	774
10'	3048	8	3.6	0.10	SDFT-10	847
11'	3353	8	3.6	0.11	SDFT-11	920
12'	3658	9	4.1	0.12	SDFT-12	994
13'	3962	10	4.5	0.13	SDFT-13	1069
14'	4267	11	5.0	0.14	SDFT-14	1143
15'	4572	11	5.0	0.15	SDFT-15	1216
16'	4877	12	5.4	0.16	SDFT-16	1292
17'	5181	13	5.8	0.17	SDFT-17	1365
18'	5486	14	6.4	0.18	SDFT-18	1439
19'	5791	14	6.4	0.19	SDFT-19	1511
20'	6096	15	6.8	0.20	SDFT-20	1587
21'	6401	16	7.3	0.21	SDFT-21	1661

Skate Kits

- Two skates and all necessary parts and hardware.
- Skates are aircraft-quality aluminum with stainless steel inserts and hardened steel ball bearings.
- One kit is required for each mobile unit.

Note: Skate kits require the use of one of the post kits listed in chart below.

width		weight		cu	model #	list
in.	mm	lbs.	kg			
18"	457	6	2.7	0.09	LSDSK-18	562
23"	584	7	3.2	0.23	LSDSK-23	605

Post Kits for use with Floor-Trak® Skate Kits

- Required for use with Skate Kits.
- Each kit includes four 16 gauge type 304 posts and hardware.

post height		weight		stainless steel	
in.	mm	lbs.	kg	model #	list
63"	1600	17	7.7	TLEP63-S	486
74"	1880	20	9.0	TLEP74-S	510

Bumper Brackets for Floor-Trak® Skate Kits...

Stainless steel. Set of four.

model #	list
SDSKATB-S	190

...sold individually Hardware included.

model #	list
SKATB-S	64



Optional Shim Kits

Accommodates uneven floors.

model #	list
912991	145

Optional Foot Brake Kit

Mounts onto frontmost skate.

model #	list
MFBK-S	91



100 Industrial Boulevard, Clayton, DE 19938-8903 U.S.A.
Phone: 800-637-5100 or 302-653-3000. Fax: 302-653-2065
<http://www.eaglegrp.com>

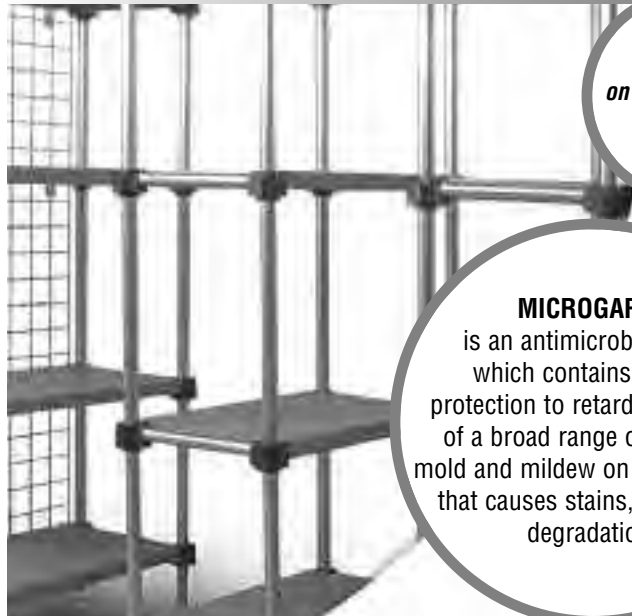

Standard on all LIFESTOR® Shelving.

MICROGARD® is an antimicrobial agent which contains built-in protection to retard the growth of a broad range of bacteria, mold and mildew on shelf surface that causes stains, odors and degradation.

Features:

- Removable shelf mats are dishwasher-safe for sanitation.
- Quick and easy assembly.
- All units include hardware necessary for connecting units to overhead track.
- Optional ledges, dividers and enclosure panels available. See pages 76 and 77.
- Posts on all units are 74" (1880mm) and grooved in 1" (25mm) increments. Shelves sold separately (see page 74).
- Recommended aisle widths are 30" - 36" (762 - 914mm). However, larger items stored within the system may require an aisle width over 36" (914mm)

Freight class is 70.0.

LIFESTOR® Master Trak®

Overhead Track Polymer Storage System

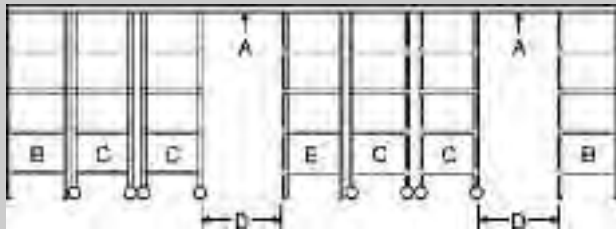

Components

Shelves sold separately (see page 74).

- A** front & rear overhead tracks
- B** stationary end units
- C** mobile units
- D** open aisle—30" to 36" (762 to 914mm) is recommended
- E** stationary mid unit (optional—use same model # as stationary end unit kit)

Stationary Units

see spec sheet **EG01.30**

- Positioned on each end, and also serve as a mid unit.
- The width of the end-stationary units and mid-stationary units should be the same or bigger than the width of the mobile units.
- Stationary units must be bolted to the floor.
- A maximum of three mobile units and 36" (914mm) aisle space is allowed before a mid unit is necessary.
- Four 16 gauge type 304 posts, stainless steel footplates, and hardware.

Note: End-stationary units and mid-stationary units must have a minimum of four shelves.

post height		weight		stainless steel	
in.	mm	lbs.	kg	model #	list
74"	1880	17	7.7	LEP74-S	662

Freight class is 50.0.

(•) MTS (made to stock) / () MTO (made to order)

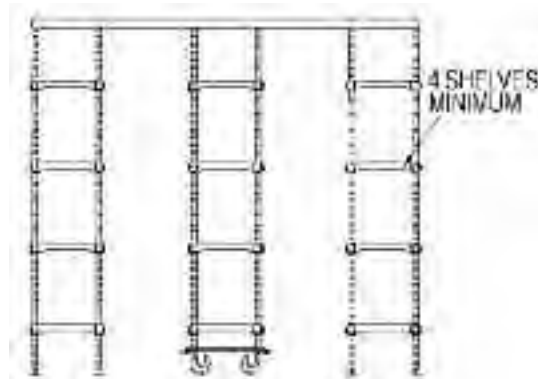

front view



Catalog Section 1

Mobile Unit Kits

see spec sheet **EG01.30**

- One 14 gauge stainless steel dolly frame.
- Four 5" (127mm) rigid poly casters
- Four 1" (25mm) thick gray PVC corner bumpers.
- Four 16 gauge type 304 stainless steel posts.
- Hardware.

Note: Mobile units require stainless steel or zinc side braces, not polymer (see page 75).

	length		weight		model #	list
	in.	mm	lbs.	kg		
18" width (457mm)	36"	914	54	24.5	LMUK1836-S	1329
	42"	1067	57	25.9	LMUK1842-S	1347
	48"	1219	60	27.2	LMUK1848-S	1364
	54"	1372	62	28.1	LMUK1854-S	1389
	60"	1524	64	29.0	LMUK1860-S	1412
23" width (584mm)	36"	914	62	28.1	LMUK2336-S	1351
	42"	1067	63	28.6	LMUK2342-S	1368
	48"	1219	64	29.0	LMUK2348-S	1385
	54"	1372	66	29.9	LMUK2354-S	1406
	60"	1524	68	30.8	LMUK2360-S	1480

Overhead Track Units

see spec sheet **EG01.30**

- Front and rear 2" x 2" x 1/4" (51 x 51 x 6mm) aluminum channels for lengths up to 9' (2743mm).
- Any unit 10' (3048mm) or longer will have multiple track sections.
- Each section will be joined with a 2" x 2" (51 x 51mm) 14 gauge stainless steel connector and hardware to join tracks.

length		weight		model #	list	length		weight		model #	list
ft.	mm	lbs.	kg			ft.	mm	lbs.	kg		
6'	1829	18	8.2	LOHT-6	249	14'	4267	42	19.1	LOHT-14	615
7'	2134	21	9.5	LOHT-7	253	15'	4572	45	20.4	LOHT-15	658
8'	2438	24	10.9	LOHT-8	265	16'	4877	48	21.8	LOHT-16	697
9'	2743	27	12.2	LOHT-9	291	17'	5181	51	23.1	LOHT-17	736
10'	3048	30	13.6	LOHT-10	318	18'	5486	54	24.5	LOHT-18	762
11'	3353	33	15.0	LOHT-11	519	19'	5791	57	25.9	LOHT-19	987
12'	3658	36	16.3	LOHT-12	572	20'	6096	60	27.2	LOHT-20	1028
13'	3962	39	17.6	LOHT-13	594	21'	6401	63	28.6	LOHT-21	1072

Freight class is 70.0.

(•) MTS (made to stock) / () MTO (made to order)

Featuring MICROGARD®

an antimicrobial agent which contains built-in protection to retard the growth of a broad range of bacteria, mold and mildew on shelf surface that causes stains, odors and degradation.

Standard on all LIFESTOR® Shelving.

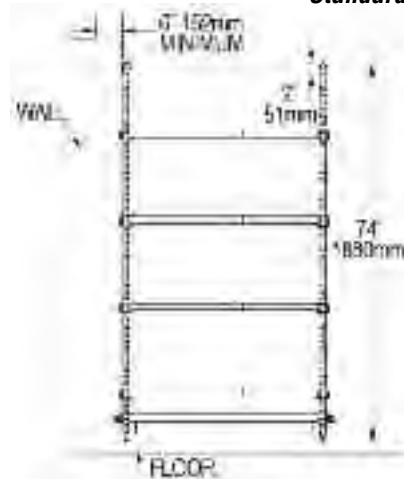

side view

Freight class is 70.0.

(•) MTS (made to stock) / () MTO (made to order)

Featuring MICROGARD®

an antimicrobial agent which contains built-in protection to retard the growth of a broad range of bacteria, mold and mildew on shelf surface that causes stains, odors and degradation.

Standard on all LIFESTOR® Shelving.

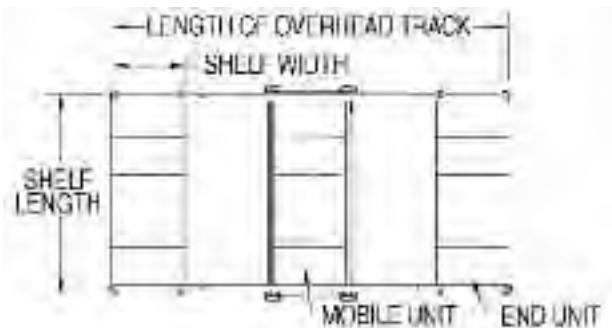

top view

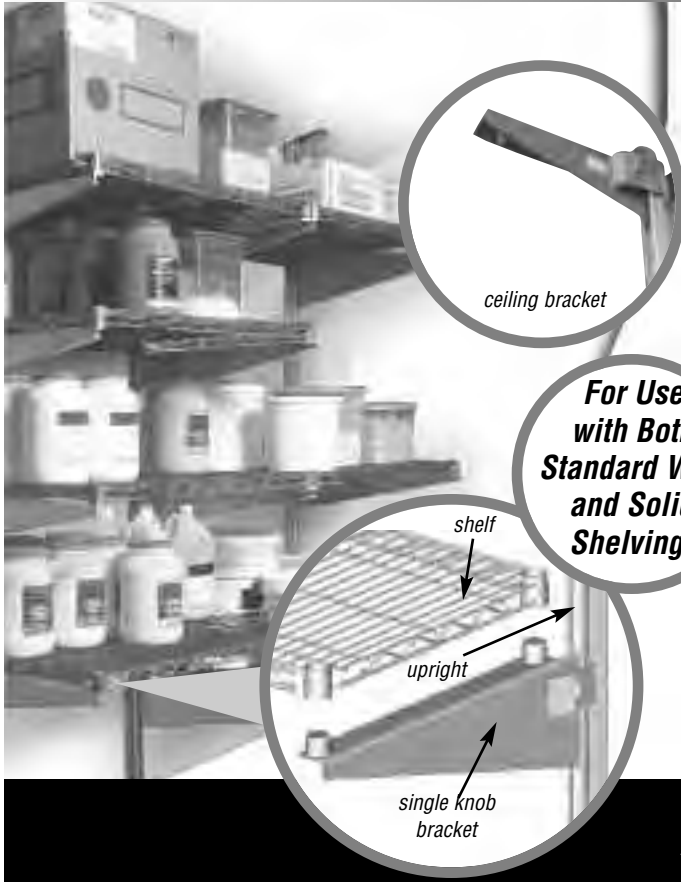

**For Use
with Both
Standard Wire
and Solid
Shelving!**

Weight Capacities					
Allowable Bracket Loading (per bracket)				Shelf Load Capacity (per shelf) Shelves not included.	
bracket length in.	mm	maximum load recommended lb.	kg	shelf description	weight capacity lb. kg
14"	356	540	244.9	Shelves 24" to 48" (610 to 1219mm) long	800 362.8
18"	457	465	210.9		
21"	533	395	179.2	Shelves 54" to 72" (1372 to 1829mm) long	600 272.2
24"	610	360	163.3		

Features:

- Requires no post supports to get in the way, making shelf loading and unloading easier.
- 100% usable shelving surface, from section to section, wall to wall, and front to back.
- Floor is unobstructed.
- Infinite height adjustability, no slots or keyholes to line up for leveling.
- Heavy-duty, rugged construction.
- Cantilever shelving components are listed on pages 82 through 86.

Freight class is 70.0.

Cantilever Shelving Systems

Standard Uprights

see spec sheet **EG01.45A**



**For wall-mounted
storage.**

- 14 gauge.
- Continuously seam-welded.
- Rust and corrosion resistant.

FEATURES:

Note: Prices do not include ceiling brackets.

Freight class is 70.0.

(•) MTS (made to stock) / () MTO (made to order)

		Gray Epoxy				Stainless Steel				Aluminum										
height in.	mm	cu ft	weight		REGULAR		NSF		weight lb.	kg	REGULAR		NSF							
			lb.	kg	model #	list	model #	list			model #	list	model #	list						
12"	305	0.02	1	0.5	MMU-1	23	MMNSU-1	26	1	0.5	MMUSS-1	78	MMNSUSS-1	82	1	0.5	MMU/A-1	23	MMNSU/A-1	26
24"	610	0.04	3	1.4	MMU-2	41	MMNSU-2	43	3	1.4	MMUSS-2	142	MMNSUSS-2	148	2	0.9	MMU/A-2	41	MMNSU/A-2	43
36"	914	0.06	4	1.8	MMU-3	66	MMNSU-3	69	4	1.8	MMUSS-3	213	MMNSUSS-3	225	2	0.9	MMU/A-3	66	MMNSU/A-3	69
48"	1219	0.08	6	2.7	MMU-4	77	MMNSU-4	82	5	2.3	MMUSS-4	284	MMNSUSS-4	297	3	1.4	MMU/A-4	77	MMNSU/A-4	82
60"	1524	0.10	7	3.2	MMU-5	97	MMNSU-5	103	7	3.2	MMUSS-5	356	MMNSUSS-5	375	4	1.8	MMU/A-5	97	MMNSU/A-5	103
72"	1829	0.13	9	4.1	MMU-6	116	MMNSU-6	125	8	3.6	MMUSS-6	425	MMNSUSS-6	442	4	1.8	MMU/A-6	116	MMNSU/A-6	125
84"	2134	0.15	10	4.5	MMU-7	137	MMNSU-7	146	9	4.1	MMUSS-7	494	MMNSUSS-7	516	5	2.3	MMU/A-7	137	MMNSU/A-7	146
96"	2438	0.17	11	5.0	MMU-8	157	MMNSU-8	170	11	5.0	MMUSS-8	563	MMNSUSS-8	591	6	2.7	MMU/A-8	157	MMNSU/A-8	170
108"	2743	0.19	13	5.8	MMU-9	177	MMNSU-9	193	12	5.4	MMUSS-9	632	MMNSUSS-9	664	7	3.2	MMU/A-9	177	MMNSU/A-9	193
120"	3048	0.21	14	6.4	MMU-10	198	MMNSU-10	213	13	5.8	MMUSS-10	701	MMNSUSS-10	738	7	3.2	MMU/A-10	198	MMNSU/A-10	213
144"	3658	0.23	17	7.7	MMU-12	243	MMNSU-12	262	16	7.3	MMUSS-12	843	MMNSUSS-12	886	9	4.1	MMU/A-12	243	MMNSU/A-12	262
156"	3962	0.25	20	9.0	MMU-14	285	n/a	n/a	-	-	n/a	n/a	n/a	n/a	10	4.5	MMU/A-14	285	MMNSU/A-14	305
168"	4267	0.30	23	10.4	MMU-16	324	n/a	n/a	-	-	n/a	n/a	n/a	n/a	12	5.4	MMU/A-16	324	MMNSU/A-16	349

Catalog Section 1

Back-To-Back Uprights — Floor-To-Ceiling

see spec sheet **EG01.45A**

FEATURES:

- Attaches to floor and ceiling.
- Two uprights are bolted or welded back-to-back.

Note: Prices do not include ceiling brackets.



For center room storage.

Freight class is 70.0.

(*) MTS (made to stock) / () MTO (made to order)

		Gray Epoxy				Stainless Steel				Aluminum								
height in.	cu mm	weight ft	REGULAR		NSF		weight lb.	kg	REGULAR		NSF		weight lb.	kg	REGULAR			
			model #	list	model #	list			model #	list	model #	list			model #	list		
48"	1219	0.29	11	5.0	MMBB/FC-4	164	MMNSBB/FC-4	178	11	5.0	MMBBSS/FC-4	548	MMNSBBSS/FC-4	629	11	5.0	MMBB/FC/A-4	164
60"	1524	0.37	14	6.4	MMBB/FC-5	205	MMNSBB/FC-5	220	24	10.9	MMBBSS/FC-5	689	MMNSBBSS/FC-5	791	14	6.4	MMBB/FC/A-5	205
72"	1829	0.44	17	7.7	MMBB/FC-6	246	MMNSBB/FC-6	266	28	12.7	MMBBSS/FC-6	818	MMNSBBSS/FC-6	941	17	7.7	MMBB/FC/A-6	246
84"	2134	0.51	20	9.0	MMBB/FC-7	289	MMNSBB/FC-7	313	33	15.0	MMBBSS/FC-7	954	MMNSBBSS/FC-7	1098	20	9.0	MMBB/FC/A-7	289
96"	2438	0.59	23	10.4	MMBB/FC-8	333	MMNSBB/FC-8	361	38	17.2	MMBBSS/FC-8	1088	MMNSBBSS/FC-8	1251	23	10.4	MMBB/FC/A-8	333
108"	2743	0.66	26	11.8	MMBB/FC-9	375	MMNSBB/FC-9	406	42	19.1	MMBBSS/FC-9	1225	MMNSBBSS/FC-9	1407	26	11.8	MMBB/FC/A-9	375
120"	3048	0.73	29	13.2	MMBB/FC-10	519	MMNSBB/FC-10	453	47	21.3	MMBBSS/FC-10	1361	MMNSBBSS/FC-10	1565	29	13.2	MMBB/FC/A-10	519
144"	3658	0.88	34	15.4	MMBB/FC-12	534	MMNSBB/FC-12	561	57	25.9	MMBBSS/FC-12	1634	MMNSBBSS/FC-12	1880	34	15.4	MMBB/FC/A-12	534

Heavy-Duty Back-To-Back Uprights — Floor-To-Ceiling

see spec sheet **EG01.45C**

FEATURES:

- Double-faced unitized uprights.
- Attaches to floor and ceiling.
- Two uprights are bolted or welded back-to-back.

Note: Prices do not include ceiling brackets.



For center room storage.

Freight class is 70.0.

(*) MTS (made to stock) / () MTO (made to order)

		Gray Epoxy				Stainless Steel				Aluminum								
height in.	cu mm	weight ft	REGULAR		NSF		weight lb.	kg	REGULAR		NSF		weight lb.	kg	REGULAR			
			model #	list	model #	list			model #	list	model #	list			model #	list		
48"	1219	0.29	20	9.0	MMBB-4	291	MMNSBB-4	330	11	5.0	MMBBSS-4	673	MMNSBBSS-4	772	14	6.4	MMBB/A-4	295
60"	1524	0.37	25	11.3	MMBB-5	343	MMNSBB-5	396	24	10.9	MMBBSS-5	846	MMNSBBSS-5	973	17	7.7	MMBB/A-5	334
72"	1829	0.44	30	13.6	MMBB-6	412	MMNSBB-6	473	28	12.7	MMBBSS-6	1020	MMNSBBSS-6	1171	21	9.5	MMBB/A-6	399
84"	2134	0.51	35	15.9	MMBB-7	481	MMNSBB-7	552	33	15.0	MMBBSS-7	1190	MMNSBBSS-7	1363	24	10.9	MMBB/A-7	469
96"	2438	0.59	40	18.1	MMBB-8	552	MMNSBB-8	630	38	17.2	MMBBSS-8	1359	MMNSBBSS-8	1558	28	12.7	MMBB/A-8	534
108"	2743	0.66	45	20.4	MMBB-9	621	MMNSBB-9	707	42	19.1	MMBBSS-9	1528	MMNSBBSS-9	1754	31	14.1	MMBB/A-9	603
120"	3048	0.73	50	22.7	MMBB-10	690	MMNSBB-10	790	47	21.3	MMBBSS-10	1697	MMNSBBSS-10	1949	34	15.4	MMBB/A-10	668
144"	3658	0.88	60	27.2	MMBB-12	825	MMNSBB-12	946	57	25.9	MMBBSS-12	2045	MMNSBBSS-12	2335	41	18.6	MMBB/A-12	803

Ceiling Brackets for Standard and Back-To-Back Uprights

see spec sheet **EG01.45B**

Note: Required for all installations.

Freight class is 70.0.

(*) MTS (made to stock) / () MTO (made to order)



		Gray Epoxy				Stainless Steel				Aluminum			
description	REGULAR		NSF		REGULAR		NSF		REGULAR		NSF		
	model #	list	model #	list	model #	list	model #	list	model #	list	model #	list	
left	MMCB-6-L	21	MMNSCB-6-L	21	MMCBSS-6-L	51	MMNSCBSS-6-L	53	MMCB/A6-L	33	MMNSCB/A6-L	33	
right	MMCB-6-R	21	MMNSCB-6-R	21	MMCBSS-6-R	51	MMNSCBSS-6-R	53	MMCB/A6-R	33	MMNSCB/A6-R	33	



Heavy Duty Crossbraces

see spec sheet **EG01.45C**

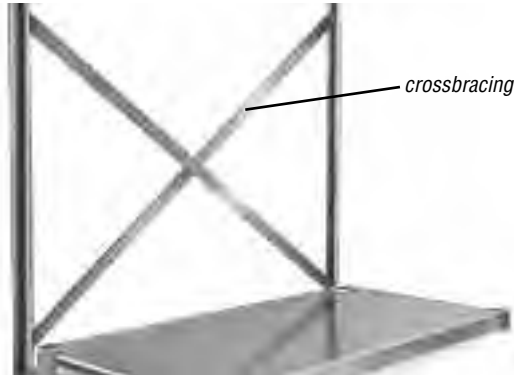

crossbracing

- Adds to stability of unit.
- 1" (25mm) wide 7-gauge steel.

FEATURES:

Freight class is 70.0.

(•) MTS (made to stock) / () MTO (made to order)

fits shelf length		crossbrace length		Gray Epoxy				Nickel				
in.	mm	in.	mm	weight		model #		weight		model #		list
				lb.	kg			lb.	kg			
36"	914	48"	1219	2	0.9	MMXB-48	22	2	0.9	MMXB-N-48	57	
48"	1219	60"	1524	3	1.4	MMXB-60	26	3	1.4	MMXB-N-60	69	
60"	1524	72"	1829	4	1.8	MMXB-72	30	4	1.8	MMXB-N-72	82	
72"	1829	84"	2134	5	2.3	MMXB-84	35	5	2.3	MMXB-N-84	96	

Single Knob Brackets

see spec sheet **EG01.45B**



right single knob bracket

- With flange on top left or right, these brackets support single shelf or end of shelf run.

FEATURES:

Freight class is 70.0.

(•) MTS (made to stock) / () MTO (made to order)

Left Single Knob Brackets

Gray Epoxy				Stainless Steel				Aluminum												
length		cu		weight		REGULAR		NSF		weight		REGULAR		NSF						
in.	mm	ft	lb.	kg	model #	list	model #	list	model #	list	lb.	kg	model #	list	model #	list				
14"	356	0.09	2	0.9	MMB-K-14-L	57	MMNSB-K-14-L	63	2	0.9	MMBSS-K-14-L	123	MMNSBSS-K-14-L	133	1	0.5	MMB-K/A-14-L	66	MMNSB-K/A-14-L	70
18"	457	0.12	3	1.4	MMB-K-18-L	70	MMNSB-K-18-L	77	2	0.9	MMBSS-K-18-L	171	MMNSBSS-K-18-L	178	1	0.5	MMB-K/A-18-L	74	MMNSB-K/A-18-L	81
21"	533	0.15	3	1.4	MMB-K-21-L	78	MMNSB-K-21-L	88	3	1.4	MMBSS-K-21-L	204	MMNSBSS-K-21-L	215	1	0.5	MMB-K/A-21-L	82	MMNSB-K/A-21-L	92
24"	610	0.17	3	1.4	MMB-K-24-L	88	MMNSB-K-24-L	95	3	1.4	MMBSS-K-24-L	221	MMNSBSS-K-24-L	231	2	0.9	MMB-K/A-24-L	95	MMNSB-K/A-24-L	103

Right Single Knob Brackets

Gray Epoxy				Stainless Steel				Aluminum												
length		cu		weight		REGULAR		NSF		weight		REGULAR		NSF						
in.	mm	ft	lb.	kg	model #	list	model #	list	model #	list	lb.	kg	model #	list	model #	list				
14"	356	0.09	2	0.9	MMB-K-14-R	57	MMNSB-K-14-R	63	2	0.9	MMBSS-K-14-R	123	MMNSBSS-K-14-R	133	1	0.5	MMB-K/A-14-R	66	MMNSB-K/A-14-R	70
18"	457	0.12	3	1.4	MMB-K-18-R	70	MMNSB-K-18-R	77	2	0.9	MMBSS-K-18-R	171	MMNSBSS-K-18-R	178	1	0.5	MMB-K/A-18-R	74	MMNSB-K/A-18-R	81
21"	533	0.15	3	1.4	MMB-K-21-R	78	MMNSB-K-21-R	88	3	1.4	MMBSS-K-21-R	204	MMNSBSS-K-21-R	215	1	0.5	MMB-K/A-21-R	82	MMNSB-K/A-21-R	92
24"	610	0.17	3	1.4	MMB-K-24-R	88	MMNSB-K-24-R	95	3	1.4	MMBSS-K-24-R	221	MMNSBSS-K-24-R	231	2	0.9	MMB-K/A-24-R	95	MMNSB-K/A-24-R	103

Double Knob Brackets

see spec sheet **EG01.45B**



For use with wire or solid shelving

- With flanges on top left and right, these brackets support two adjoining wire or solid shelves on a common upright.

FEATURES:

Freight class is 70.0.

(•) MTS (made to stock) / () MTO (made to order)

Gray Epoxy				Stainless Steel				Aluminum												
length		cu		weight		REGULAR		NSF		weight		REGULAR		NSF						
in.	mm	ft	lb.	kg	model #	list	model #	list	model #	list	lb.	kg	model #	list	model #	list				
14"	356	0.19	3	1.4	MMDB-K-14	99	MMNSDB-K-14	98	3	1.4	MMDBSS-K-14	171	MMNSDBSS-K-14	185	1	0.5	MMDB-K/A-14	98	MMNSDB-K/A-14	108
18"	457	0.25	4	1.8	MMDB-K-18	116	MMNSDB-K-18	128	3	1.4	MMDBSS-K-18	245	MMNSDBSS-K-18	259	2	0.9	MMDB-K/A-18	128	MMNSDB-K/A-18	140
21"	533	0.29	4	1.8	MMDB-K-21	128	MMNSDB-K-21	142	4	1.8	MMDBSS-K-21	293	MMNSDBSS-K-21	309	2	0.9	MMDB-K/A-21	137	MMNSDB-K/A-21	151
24"	610	0.33	5	2.3	MMDB-K-24	132	MMNSDB-K-24	145	4	1.8	MMDBSS-K-24	319	MMNSDBSS-K-24	329	2	0.9	MMDB-K/A-24	144	MMNSDB-K/A-24	160

Catalog Section 1

Optional Single Foot Brackets with Knobs

see spec sheet **EG01.45B**



For use with wire and solid shelving

- Serves as a base for bottom shelf.
- Left brackets and right brackets available.
- 9 7/8" (238mm) height.

FEATURES:

Freight class is 70.0.

(•) MTS (made to stock) / () MTO (made to order)

Left Single Foot Brackets with Knobs

		Gray Epoxy						Stainless Steel						
length		cu	weight		REGULAR		NSF		weight		REGULAR		NSF	
in.	mm	ft	lb.	kg	model #	list	model #	list	lb.	kg	model #	list	model #	list
14"	356	0.13	4	1.8	MMFB-K-14-L	96	MMNSFB-K-14-L	104	4	1.8	MMFBSSK-149-L	282	MMNSFBSSK-149-L	324
18"	457	0.17	5	2.3	MMFB-K-18-L	115	MMNSFB-K-18-L	126	6	2.7	MMFBSSK-189-L	373	MMNSFBSSK-189-L	427
21"	533	0.19	6	2.7	MMFB-K-21-L	130	MMNSFB-K-21-L	144	-	-	n/a	n/a	n/a	n/a
24"	610	0.21	6	2.7	MMFB-K-24-L	142	MMNSFB-K-24-L	157	7	3.2	MMFBSSK-249-L	481	MMNSFBSSK-249-L	551

Right Single Foot Brackets with Knobs

		Gray Epoxy						Stainless Steel						
length		cu	weight		REGULAR		NSF		weight		REGULAR		NSF	
in.	mm	ft	lb.	kg	model #	list	model #	list	lb.	kg	model #	list	model #	list
14"	356	0.13	4	1.8	MMFB-K-14-R	96	MMNSFB-K-14-R	104	4	1.8	MMFBSSK-149-R	282	MMNSFBSSK-149-R	324
18"	457	0.17	5	2.3	MMFB-K-18-R	115	MMNSFB-K-18-R	126	6	2.7	MMFBSSK-189-R	373	MMNSFBSSK-189-R	427
21"	533	0.19	6	2.7	MMFB-K-21-R	130	MMNSFB-K-21-R	144	-	-	n/a	n/a	n/a	n/a
24"	610	0.21	6	2.7	MMFB-K-24-R	142	MMNSFB-K-24-R	157	7	3.2	MMFBSSK-249-R	481	MMNSFBSSK-249-R	551

Optional Double Foot Brackets with Knobs

see spec sheet **EG01.45B**



- For use with wire or solid shelving.
- Serves as a base for adjoining two bottom shelves.
- 9 7/8" (238mm) height.

FEATURES:

Freight class is 70.0.

(•) MTS (made to stock) / () MTO (made to order)

		Gray Epoxy						Stainless Steel						
length		cu	weight		REGULAR		NSF		weight		REGULAR		NSF	
in.	mm	ft	lb.	kg	model #	list	model #	list	lb.	kg	model #	list	model #	list
14"	356	0.26	4	1.8	MMDFB-K-14	156	MMNSDFB-K-14	171	5	2.3	MMDFBSSK-149	323	MMNSDFBSSK-149	372
18"	457	0.33	5	2.3	MMDFB-K-18	201	MMNSDFB-K-18	223	7	3.2	MMDFBSSK-189	411	MMNSDFBSSK-189	475
21"	533	0.39	6	2.7	MMDFB-K-21	222	MMNSDFB-K-21	243	-	-	n/a	n/a	n/a	n/a
24"	610	0.42	7	3.2	MMDFB-K-24	229	MMNSDFB-K-24	253	8	3.6	MMDFBSSK-249	548	MMNSDFBSSK-249	632

Heavy Duty Single Knob "C" Brackets

see spec sheet **EG01.45C**



- For dynamic loads.
- For use with wire or solid shelving.

FEATURES:

Freight class is 70.0.

(•) MTS (made to stock) / () MTO (made to order)

Left Single Knob Brackets

Gray Epoxy					Stainless Steel					Aluminum										
length		weight		REGULAR		NSF		weight		REGULAR		NSF		weight		REGULAR		NSF		
in.	mm	ft	lb.	kg	model #	list	model #	list	lb.	kg	model #	list	model #	list	lb.	kg	model #	list	model #	list
18"	457	0.12	3	1.4	MMBC-K-18-L 61		MMNSBC-K-18-L 66		2	0.9	MMBCSS-K-18-L 112		MMNSBCSS-K-18-L 118		1	0.5	MMBC-K/A-18-L 57		MMNSBC-K/A-18-L 61	
21"	533	0.15	3	1.4	MMBC-K-21-L 69		MMNSBC-K-21-L 74		3	1.4	MMBCSS-K-21-L 139		MMNSBCSS-K-21-L 152		1	0.5	MMBC-K/A-21-L 66		MMNSBC-K/A-21-L 69	
24"	610	0.17	3	1.4	MMBC-K-24-L 78		MMNSBC-K-24-L 82		3	1.4	MMBCSS-K-24-L 165		MMNSBCSS-K-24-L 178		2	0.9	MMBC-K/A-24-L 69		MMNSBC-K/A-24-L 74	

Right Single Knob Brackets

Gray Epoxy					Stainless Steel					Aluminum										
length		weight		REGULAR		NSF		weight		REGULAR		NSF		weight		REGULAR		NSF		
in.	mm	ft	lb.	kg	model #	list	model #	list	lb.	kg	model #	list	model #	list	lb.	kg	model #	list	model #	list
18"	457	0.12	3	1.4	MMBC-K-18-R 61		MMNSBC-K-18-R 66		2	0.9	MMBCSS-K-18-R 112		MMNSBCSS-K-18-R 118		1	0.5	MMBC-K/A-18-R 57		MMNSBC-K/A-18-R 61	
21"	533	0.15	3	1.4	MMBC-K-21-R 69		MMNSBC-K-21-R 74		3	1.4	MMBCSS-K-21-R 139		MMNSBCSS-K-21-R 152		1	0.5	MMBC-K/A-21-R 66		MMNSBC-K/A-21-R 69	
24"	610	0.17	3	1.4	MMBC-K-24-R 78		MMNSBC-K-24-R 82		3	1.4	MMBCSS-K-24-R 165		MMNSBCSS-K-24-R 178		2	0.9	MMBC-K/A-24-R 69		MMNSBC-K/A-24-R 74	

Heavy Duty Double Knob "C" Brackets

see spec sheet **EG01.45C**



- For dynamic loads.
- With flanges on top left and right, these brackets support two adjoining wire or solid shelves on a common upright.

FEATURES:

Freight class is 70.0.

(•) MTS (made to stock) / () MTO (made to order)

Gray Epoxy					Stainless Steel					Aluminum										
length		weight		REGULAR		NSF		weight		REGULAR		NSF		weight		REGULAR		NSF		
in.	mm	ft	lb.	kg	model #	list	model #	list	lb.	kg	model #	list	model #	list	lb.	kg	model #	list	model #	list
18"	457	0.25	4	1.8	MMDBC-K-18 99		MMNSDBC-K-18 108		3	1.4	MMDBCSS-K-18 169		MMNSDBCSS-K-18 178		2	0.9	MMDBC-K/A-18 91		MMNSDBC-K/A-18 99	
21"	533	0.29	4	1.8	MMDBC-K-21 112		MMNSDBC-K-21 122		4	1.8	MMDBCSS-K-21 195		MMNSDBCSS-K-21 208		2	0.9	MMDBC-K/A-21 104		MMNSDBC-K/A-21 108	
24"	610	0.33	5	2.3	MMDBC-K-24 118		MMNSDBC-K-24 126		4	1.8	MMDBCSS-K-24 218		MMNSDBCSS-K-24 234		2	0.9	MMDBC-K/A-24 112		MMNSDBC-K/A-24 112	

Wall Shelves

Adjustable Post Wire Wall Mounts

Sold as Components.....	95
Sold as Prepackaged Units.....	94

Snap-n-Slide®

Wall Shelves.....	90
Wire Wall Shelves.....	91

Wall Shelves

Piggyback Wall Mounted Shelf Kits.....	92
Shelves with Removable Hooks.....	93
Single Bar Pot Racks.....	93
Stationary Wire Wall Mounts.....	95

Tab Lock Shelves.....	91
Wall Mounted Shelves.....	92
Wall Mounted Shelves with Marine Counter Edge.....	94
Wire Wall Shelf Kits.....	91

WALSTOR® Modular Wall System.....88

WALSTOR® Modular Wall System Accessories.....89

WALSTOR® Modular Wall System

Convert wasted wall space into a productive and organized work area.

Imagine the possibilities!

- Maximize space.
- Keep every thing within easy reach, without taking up valuable floor space.
- Organize room effectively and efficiently with total flexibility.
- Sway-resistant design locks individual shelves firmly into place uneven loads safely on the system.
- Positioned anywhere on a wall, regardless of stud position.

To learn more about WalStor®, see pages 88 and 89.



Single Shelf Kit

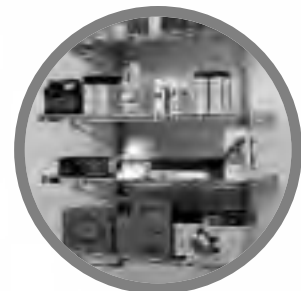

Double Shelf Kit
(with extra shelves)

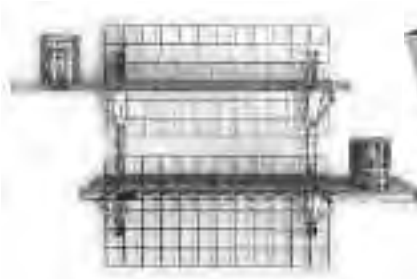

**WalStor® system
shown demonstrating
an uneven load capability.**

Modular Wall System

see spec sheet **EG02.00A**

Wall Mats

- 3" x 3" (76 x 76mm) zinc-plated grids.
- Required only for hanging accessories.

	length		weight		cubic feet	model #	list
	height in.	mm	lbs.	kg			
18" (457mm)	36"	914	9	4.1	0.2	WM1836 • 78	
	48"	1219	11	5.0	0.3	WM1848 • 102	
	60"	1524	14	6.4	0.3	WM1860	118
24" (609mm)	48"	1219	13	5.8	0.3	WM2448 • 119	
	72"	1828	19	8.6	0.5	WM2472	137
	84"	2133	22	9.9	0.6	WM2484	164
	96"	2438	25	11.3	0.7	WM2496	173
33" (838mm)	54"	1372	22	9.9	0.5	WM3354	200
48" (1219mm)	48"	1219	19	8.6	0.7	WM4848	194

Vertical Wall Uprights

- Zinc-plated finish.
- Sold in pairs.

height in.	mm	weight		cu ft	model #	list
		lbs.	kg			
12"	305	2	0.9	0.2	PR12VU • 45	
30"	762	4	1.8	0.4	PR30VU • 74	
45"	1143	5	2.3	0.5	PR45VU • 92	

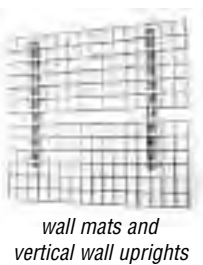

Wire Shelf Brackets

- Zinc-plated finish.
 - Sold in pairs.
- (Note: Must be ordered with Vertical Wall Uprights)

depth in.	mm	weight		cubic feet	model #	list
		lbs.	kg			
14"	356	3	1.5	0.1	PR14B • 100	
18"	457	4	2.0	0.1	PR18B • 107	
21"	533	4	2.0	0.1	PR21B	111
24"	610	5	2.0	0.1	PR24B	143



Note: WalStor® must be mounted to a solid surface or studs in a wall. User needs to determine installation materials and methods suitable to hold and support the WalStor® system.

Freight class is 70.0.

(•) MTS (made to stock) / () MTO (made to order)

Single Shelf Kits

- One EAGLEbrite® shelf.
- One wall mat.
- One pair of 30" (762mm) vertical wall uprights.
- One pair of 18" (457mm) wire shelf brackets.



	shelf and wall mat size		weight		cu ft	model #	list
	in.	mm	lbs.	kg			
18" width (457mm)	36"	914	35	15.9	3.5	WAL-1-1836	328
	48"	1219	36	16.3	4.5	WAL-1-1848	363

Double Shelf Kits

- Two EAGLEbrite® shelves.
- Two wall mats.
- One pair of 45" (1143mm) vertical wall uprights.
- Two pairs of 18" (457mm) wire shelf brackets.

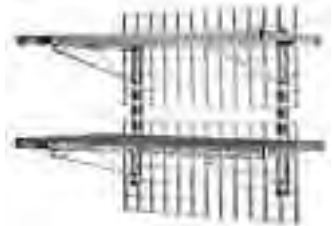

	shelf dimensions		weight		cubic feet	model #	list
	in.	mm	lbs.	kg			
18" width (457mm)	36"	914	41	18.6	2.0	WAL-2-1836	600
	48"	1219	49	22.2	2.4	WAL-2-1848	670

Wall Grid Shelving - see spec sheet **EG02.00C**

width x length		weight		cubic feet	chrome		Valu-Gard®		EAGLEbrite®	
in.	mm	lbs.	kg		model #	list	model #	list	model #	list
14" x 30"	356 x 762	7	3.2	3.1	1430WGS-C	111	1430WGS-VG	115	1430WGS-Z	103
14" x 36"	356 x 914	9	4.1	3.6	1436WGS-C	116	1436WGS-VG	120	1436WGS-Z	108
18" x 30"	457 x 762	9	4.1	3.7	1830WGS-C	119	1830WGS-VG	123	1830WGS-Z	111
18" x 36"	457 x 914	12	5.4	4.5	1836WGS-C	124	1836WGS-VG	128	1836WGS-Z	114
18" x 48"	457 x 1219	15	6.8	6.0	1848WGS-C	143	1848WGS-VG • 147		1848WGS-Z	132

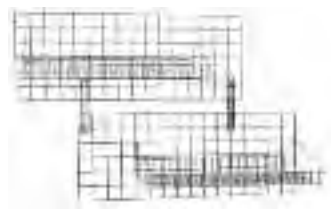

Catalog Section 2



Custom configurations allow you to personalize your WalStor® system for merchandise displays or over-the-workstation storage. Engineered with the idea that a perfect storage system adapts easily to individual requirements.

Modular Wall System Accessories

see spec sheet **EG02.00B**

Freight class is 70.0.

(•) MTS (made to stock) / () MTO (made to order)



WalStor® system with optional accessories shown

shelf collar plugs ▶
Model #: **COLLAR PLUG**
(4 per shelf required)



utensil rack ▶
Model #: **SCOOP10-VG**. List: \$57
5" depth x 10-1/2" length (127 x 267mm),
2 lbs., 0.5 cu. ft. ValuGuard® epoxy finish.



small
snap
hook** ▶



large
snap
hook** ▶



utensil
hook** ▶



large
double
hook** ▶



**book
holder** ▶



**light duty
utility
shelf** ▶



**grid
shelf** ▶



**triangle
shelf** ▶



**towel
rack** ▶



**spice
rack** ▶



merchandising
display hook** ▶



Vertical uprights for display shelf

See page 66 for display shelves.
Specify Universal Nolin (manufacturer ID #2).
Requires a pair of DSS (display shelf standards).

**large
bin** ▶



**small
bin** ▶



**hanging
file
holder** ▶



**plastic
bin
holder** ▶



**grid panel
wall bracket** ▶



**1/2-size
pan
holder** ▶



**drop
basket** ▶



**wire
basket** ▶



**grid
panel
basket** ▶



description	length x width x height		weight		cu ft	model #	list	description	length x width x height		weight		cu ft	model #	list
	in.	mm	lbs.	kg					in.	mm	lbs.	kg			
1/2 size pan holder	12" x 8" x 3"	305 x 203 x 76	1.0	0.5	0.2	PH3RD	49	merch. dspl hook	12" x 3"	304 x 76	0.2	0.1	0.1	MDH-12**	22
book holder	3" x 12" x 10"	76 x 305 x 254	2.0	0.9	0.2	BH-1	141	plastic bin dividers	10 1/2" x 5"	276 x 127	2.0	0.9	0.1	A204237	19
vertical uprights	2" x 8 1/4"	51 x 222	2.0	0.9	0.3	DSS	96	plastic bin holder	4" x 2"	102 x 51	0.3	0.1	0.4	PBH •	36
drop basket (for 18" wire shelf)	22" x 18" x 11"	559 x 457 x 280	3.0	1.4	0.3	DB	106	small plastic bin	10 1/2" x 5 1/2" x 5"	276 x 140 x 127	0.75	0.3	0.2	A203877 *	16
grid shelf	16 3/4" x 16 3/4"	426 x 426	4.0	1.8	0.6	GS17	139	small snap hook	1 1/4" x 4 1/4" x 3 3/8"	32 x 127 x 76	0.3	0.1	0.1	SH ** •	4
hanging file holder	12" x 8" x 3"	305 x 203 x 76	1.0	0.5	0.2	HFH	48	spice rack	14" x 2"	356 x 51	1.0	0.5	0.1	SR14	61
large double hook	2 1/4" x 4 1/4" x 3 3/8"	57 x 108 x 3	0.3	0.1	0.1	LDH** •	9	spice rack	24" x 2"	610 x 51	1.5	0.7	0.2	SR24	65
large plastic bin	10 1/2" x 11" x 5"	276 x 280 x 127	1.0	0.5	0.3	A203879 *	22	towel rack	10 1/2" x 5" x 3.5"	267 x 127 x 76	1.0	0.5	0.3	TR10	48
large snap hook	2 1/4" x 4 1/4" x 3 3/8"	57 x 108 x 3	0.3	0.1	0.1	LH ** •	7	utensil hook	2 1/2" x 2"	64 x 51	0.3	0.1	0.1	UH ** •	11
lt. duty utility shelf	11 1/4" x 8" x 3 1/2"	286 x 203 x 89	2.0	0.9	0.2	LDUS12	59	wire basket	13 3/8" x 5" x 7"	340 x 127 x 178	0.5	0.2	0.2	WB •	32
merch. dspl hook	4" x 3"	101 x 76	0.2	0.1	0.1	MDH-4**	13	2-deck can rack	8 1/2" x 13" x 14"	219 x 330 x 356	1.0	0.5	0.1	CR2D	160
merch. dspl hook	6" x 3"	152 x 76	0.2	0.1	0.1	MDH-6**	14	4-deck can rack	8 1/2" x 8 1/2" x 28 1/2"	210 x 216 x 724	3.0	1.3	1.2	CR4D	178
merch. dspl hook	8" x 3"	203 x 76	0.2	0.1	0.1	MDH-8**	19	wall bracket	3" x 4" x 4"	76 x 102 x 102	0.2	0.1	0.1	GPWB	21
merch. dspl hook	10" x 3"	254 x 76	0.2	0.1	0.1	MDH-10**	20	triangle shelf	24" x 24"	610 x 610	3.6	1.6	0.5	GPS24-C	69
								grid panel basket	15" x 24"	381 x 610	2.8	1.2	0.4	GBP15-C	77

*A203877 requires (1) PBH. A203879 requires (2) PBH. **All hooks are heavy gauge chrome-plated.



100 Industrial Boulevard, Clayton, DE 19938-8903 U.S.A.
Phone: 800-637-5100 or 302-653-3000. Fax: 302-653-2065
http://www.eaglegrp.com

Snap-n-Slide® Wall Shelves

see spec sheet **EG02.01**



- Brackets can be mounted to wall studs – no wall backing required.
- 1½" (38mm) upturn on rear and ends.
- Heavy gauge stainless steel construction.
- No tools required to attach shelf to wall brackets.

FEATURES:

Freight class is 70.0.

(•) MTS (made to stock) / () MTO (made to order)

Optional Dividers for Snap-n-Slide® Wall Shelves

- 4" (102mm) height.

description	model #	list
for 12" (305mm) shelving	358114	37
for 15" (381mm) shelving	358115	39



12" (305mm) wide Snap-n-Slide® Shelves with Rolled Front Edge

length in. mm	weight		wt. capacity*		cu ft	16 gauge type 430		16 gauge type 304		14 gauge type 304	
	lbs.	kg	lbs.	kg		model #	list	model #	list	model #	list
24" 610	12	5.4	90	40.8	0.7	SWS1224-16/4 •	227	SWS1224-16/3 •	273	SWS1224-14/3	289
36" 915	14	6.4	135	61.2	1.1	SWS1236-16/4 •	245	SWS1236-16/3 •	345	SWS1236-14/3 •	369
48" 1219	17	7.7	180	81.6	1.4	SWS1248-16/4 •	302	SWS1248-16/3 •	382	SWS1248-14/3 •	411
60" 1524	23	10.4	225	102.1	1.8	SWS1260-16/4 •	321	SWS1260-16/3 •	418	SWS1260-14/3	445
72" 1829	25	11.3	270	122.5	2.1	SWS1272-16/4 •	397	SWS1272-16/3 •	514	SWS1272-14/3	562

15" (381mm) wide Snap-n-Slide® Shelves with Rolled Front Edge

length in. mm	weight		wt. capacity*		cu ft	16 gauge type 430		16 gauge type 304		14 gauge type 304	
	lbs.	kg	lbs.	kg		model #	list	model #	list	model #	list
24" 610	15	6.8	90	40.8	1.1	SWS1524-16/4	245	SWS1524-16/3	298	SWS1524-14/3	325
36" 915	17	7.7	135	61.2	1.7	SWS1536-16/4 •	253	SWS1536-16/3 •	355	SWS1536-14/3	401
48" 1219	21	9.5	180	81.6	2.2	SWS1548-16/4 •	305	SWS1548-16/3 •	433	SWS1548-14/3	488
60" 1524	28	12.7	225	102.1	2.7	SWS1560-16/4 •	331	SWS1560-16/3 •	475	SWS1560-14/3	503
72" 1829	30	13.6	270	122.5	3.3	SWS1572-16/4	404	SWS1572-16/3	592	SWS1572-14/3	669

15" (381mm) wide Snap-n-Slide® Shelves with "V" Marine Front Edge 14 gauge

length in. mm	weight		wt. capacity*		cu ft	14 gauge type 304		14 gauge type 316	
	lbs.	kg	lbs.	kg		model #	list	model #	list
24" 610	15	6.8	90	40.8	1.1	SWS1524-14/304-VMAR	422	SWS1524-14/316-VMAR	470
36" 915	17	7.7	135	61.2	1.7	SWS1536-14/304-VMAR	442	SWS1536-14/316-VMAR	545
48" 1219	21	9.5	180	81.6	2.2	SWS1548-14/304-VMAR	575	SWS1548-14/316-VMAR	676
60" 1524	28	12.7	225	102.1	2.7	SWS1560-14/304-VMAR	638	SWS1560-14/316-VMAR	761
72" 1829	30	13.6	270	122.5	3.3	SWS1572-14/304-VMAR	755	SWS1572-14/316-VMAR	893

15" (381mm) wide Snap-n-Slide® Shelves with "V" Marine Front Edge 16 gauge

length in. mm	weight		wt. capacity*		cu ft	16 gauge type 430		16 gauge type 304	
	lbs.	kg	lbs.	kg		model #	list	model #	list
24" 610	15	6.8	90	40.8	1.1	SWS1524-16/430-VMAR	369	SWS1524-16/304-VMAR	414
36" 915	17	7.7	135	61.2	1.7	SWS1536-16/430-VMAR	399	SWS1536-16/304-VMAR	461
48" 1219	21	9.5	180	81.6	2.2	SWS1548-16/430-VMAR	471	SWS1548-16/304-VMAR	551
60" 1524	28	12.7	225	102.1	2.7	SWS1560-16/430-VMAR	506	SWS1560-16/304-VMAR	604
72" 1829	30	13.6	270	122.5	3.3	SWS1572-16/430-VMAR	596	SWS1572-16/304-VMAR	709

* Weight capacities pertain to evenly distributed weight.

Catalog Section 2

Snap-n-Slide® Wire Wall Shelves

see spec sheet **EG02.02**



- Wire design allows for air circulation.
- Brackets can be mounted to studs with no backing required.

FEATURES:

Note: See page 90 for solid Snap-n-Slide® Wall Shelves.

Freight class is 70.0.

(•) MTS (made to stock) / () MTO (made to order)

	length		weight		weight *		cu ft	chrome		VALU-MASTER®		Valu-Gard®		EAGLEgard®	
	in.	mm	lbs.	kg	lbs.	kg		model #	list	model #	list	model #	list	model #	list
12" width (305mm)	24"	610	5	2.3	70	31.8	0.7	SNSW1224C	104	SNSW1224V	109	SNSW1224VG	109	SNSW1224E	122
	36"	915	7	3.2	105	47.6	1.1	SNSW1236C	137	SNSW1236V	145	SNSW1236VG	145	SNSW1236E	158
	48"	1219	9	4.1	140	63.5	1.4	SNSW1248C	171	SNSW1248V	180	SNSW1248VG	180	SNSW1248E	192
	60"	1524	11	5.0	175	79.5	1.8	SNSW1260C	186	SNSW1260V	195	SNSW1260VG	195	SNSW1260E	210
	72"	1829	14	6.4	210	95.3	2.1	SNSW1272C	238	SNSW1272V	251	SNSW1272VG	251	SNSW1272E	262

* Weight capacity pertains to evenly distributed weight.

Wire Wall Shelf Kits

see spec sheet **EG02.04**



- One wire shelf.
- Two stationary wire wall mounts.

INCLUDES:

Freight class is 70.0.

(•) MTS (made to stock) / () MTO (made to order)

	length		weight		chrome		VALU-MASTER®		Valu-Gard®	
	in.	mm	lb.	kg	model #	list	model #	list	model #	list
14" width (356mm)	36"	914	12	5.4	GWB1436C	107	GWB1436V	109	GWB1436VG	109
	48"	1219	14	6.4	GWB1448C	120	GWB1448V	123	GWB1448VG	123
18" width (457mm)	36"	914	14	6.4	GWB1836C	114	GWB1836V	123	GWB1836VG	123
	48"	1219	17	7.7	GWB1848C	127	GWB1848V	139	GWB1848VG	139

Tab Lock Shelves

see spec sheet **EG02.09**



- 16 gauge, type 430 stainless steel.
- 1½" (38mm) roll on front.
- 1½" (38mm) upturn on rear and ends.
- Tab lock for easy assembly.
- Die-formed stainless steel mounting brackets.
- Not available in other widths.
- 60" (1524mm) length max.

FEATURES:

Freight class is 70.0.

(•) MTS (made to stock) / () MTO (made to order)

	length		weight		cubic feet	model #	
	in.	mm	lbs.	kg		list	list
10" width (254mm)	24"	610	10	4.5	0.6	WS1024TL	• 189
	36"	915	12	5.4	0.9	WS1036TL	• 201
	48"	1219	15	6.8	1.3	WS1048TL	• 230
	60"	1524	20	9.0	1.6	WS1060TL	• 260
12" width (305mm)	24"	610	12	5.4	0.6	WS1224TL	• 202
	36"	915	14	6.4	0.9	WS1236TL	• 219
	48"	1219	17	7.7	1.3	WS1248TL	• 248
	60"	1524	23	10.4	1.6	WS1260TL	• 277



Wall Mounted Shelves

see spec sheet **EG02.05**



Die-formed stainless steel mounting brackets are stud-welded to shelf.

- 1½" (38mm) roll on front.
- 1½" (38mm) upturn on rear and ends.

FEATURES:

Note: 15" and 18" (381 and 457mm) wide shelves available. To order, replace "12" in model number with a "15" or "18" indicating desired shelf width (example: **WS1548-16/3**). For 15" (381mm) wide shelves, **add 15% to list price** of 12" (305mm) wide models. For 18" wide shelves, **add 30% to list price** of 12" (305mm) shelves.

Freight class is 70.0.

(•) MTS (made to stock) / () MTO (made to order)

	length		weight		cubic feet	16 gauge, type 430		16 gauge, type 304		14 gauge, type 304	
	in.	mm	lbs.	kg		model #	list	model #	list	model #	list
10" width (254mm)	24"	610	10	4.5	0.5	WS1024-16/4	432	WS1024-16/3	506	WS1024-14/3	558
	36"	915	12	5.4	0.7	WS1036-16/4 •	465	WS1036-16/3	572	WS1036-14/3	630
	48"	1219	15	6.8	0.9	WS1048-16/4 •	469	WS1048-16/3	609	WS1048-14/3	667
	60"	1524	20	9.0	1.2	WS1060-16/4 •	502	WS1060-16/3	673	WS1060-14/3	738
	72"	1829	22	10.0	1.4	WS1072-16/4 •	535	WS1072-16/3	735	WS1072-14/3	806
	84"	2133	24	10.9	1.7	WS1084-16/4	563	WS1084-16/3	797	WS1084-14/3	873
	96"	2438	29	13.2	1.9	WS1096-16/4	653	WS1096-16/3	920	WS1096-14/3	1011
	108"	2743	32	14.5	2.1	WS10108-16/4	710	WS10108-16/3	1008	WS10108-14/3	1110
120"	3048	34	15.4	2.3	WS10120-16/4	744	WS10120-16/3	1138	WS10120-14/3	1252	
12" width (305mm)	24"	610	12	5.4	0.6	WS1224-16/4 •	465	WS1224-16/3 •	541	WS1224-14/3	596
	36"	915	14	6.4	0.9	WS1236-16/4 •	499	WS1236-16/3 •	607	WS1236-14/3	666
	48"	1219	17	7.7	1.1	WS1248-16/4 •	511	WS1248-16/3 •	651	WS1248-14/3	716
	60"	1524	23	10.4	1.4	WS1260-16/4 •	544	WS1260-16/3 •	718	WS1260-14/3	788
	72"	1829	25	11.3	1.7	WS1272-16/4 •	581	WS1272-16/3 •	785	WS1272-14/3 •	861
	84"	2133	28	12.7	2.0	WS1284-16/4 •	616	WS1284-16/3 •	852	WS1284-14/3	937
	96"	2438	31	14.1	2.2	WS1296-16/4 •	722	WS1296-16/3 •	932	WS1296-14/3	1024
	108"	2743	36	16.3	2.5	WS12108-16/4	789	WS12108-16/3	1093	WS12108-14/3	1199
120"	3048	39	17.6	2.8	WS12120-16/4	823	WS12120-16/3	1155	WS12120-14/3	1271	

Piggyback Wall Mounted Shelf Kits

see spec sheet **EG02.13**

PATENTED!
(patent #8,025,163 B2)



Additional Brackets (pair)

18" (457mm) width. Chrome.

FEATURES:

- Brackets can be mounted to studs – no wall backing required.
- Freedom to move the shelves left or right.
- Wire design allows for air circulation.
- 18" (457mm) width.
- No tools required to attach shelf to wall brackets.

Freight class is 70.0.

(•) MTS (made to stock) / () MTO (made to order)

	weight		description	model #	list
	lbs.	kg			
three-tier	7.3	3.3	SSW18B3-C	85	
five-tier	10.8	4.9	SSW18B5-C	101	

Three-Tier Units – Includes one pair of 23¾" (606mm)-high brackets.

shelf width x length in. mm	Units with One Chrome Shelf				Units with Two Chrome Shelves				Units with Three Chrome Shelves				chrome			
	weight		model #	list	weight		model #	list	weight		model #	list	weight		model #	list
lbs.	kg	lbs.			kg	lbs.			kg	lbs.			kg	lbs.		
18" x 24" 457 x 610	12	5.4	S1-3B-SSW1824C	107	17	7.7	S2-3B-SSW1824C	164	22	10.0	S3-3B-SSW1824C	220	5	2.3	SSW1824C	57
18" x 30" 457 x 762	13	5.9	S1-3B-SSW1830C	121	19	8.6	S2-3B-SSW1830C	189	25	11.3	S3-3B-SSW1830C	256	6	2.7	SSW1830C	70
18" x 36" 457 x 914	14	6.4	S1-3B-SSW1836C	128	21	9.5	S2-3B-SSW1836C	203	28	12.7	S3-3B-SSW1836C	279	7	3.2	SSW1836C	78
18" x 42" 457 x 1067	16	7.3	S1-3B-SSW1842C	140	24	10.9	S2-3B-SSW1842C	231	33	15.0	S3-3B-SSW1842C	322	9	4.1	SSW1842C	94
18" x 48" 457 x 1219	17	7.7	S1-3B-SSW1848C	147	27	12.2	S2-3B-SSW1848C	243	37	16.8	S3-3B-SSW1848C	338	10	4.5	SSW1848C	99
18" x 60" 457 x 1524	22	10.0	S1-3B-SSW1860C	172	37	16.8	S2-3B-SSW1860C	293	51	23.1	S3-3B-SSW1860C	413	15	6.8	SSW1860C	125

Five-Tier Units – Includes one pair of 33¾" (860mm)-high brackets.

shelf width x length in. mm	Units with Three Chrome Shelf				Units with Four Chrome Shelves				Units with Five Chrome Shelves				chrome			
	weight		model #	list	weight		model #	list	weight		model #	list	weight		model #	list
lbs.	kg	lbs.			kg	lbs.			kg	lbs.			kg	lbs.		
18" x 24" 457 x 610	19	8.6	S3-5B-SSW1824C	239	22	10.0	S4-5B-SSW1824C	294	29	13.2	S5-5B-SSW1824C	349	5	2.3	SSW1824C	57
18" x 30" 457 x 762	22	10.0	S3-5B-SSW1830C	275	28	12.7	S4-5B-SSW1830C	344	34	15.4	S5-5B-SSW1830C	412	6	2.7	SSW1830C	70
18" x 36" 457 x 914	25	11.3	S3-5B-SSW1836C	298	32	14.5	S4-5B-SSW1836C	373	39	17.6	S5-5B-SSW1836C	449	7	3.2	SSW1836C	78
18" x 42" 457 x 1067	30	13.6	S3-5B-SSW1842C	339	38	17.2	S4-5B-SSW1842C	431	47	21.3	S5-5B-SSW1842C	521	9	4.1	SSW1842C	94
18" x 48" 457 x 1219	34	15.4	S3-5B-SSW1848C	357	44	20.0	S4-5B-SSW1848C	453	54	24.5	S5-5B-SSW1848C	548	10	4.5	SSW1848C	99
18" x 60" 457 x 1524	49	22.2	S3-5B-SSW1860C	432	64	29.0	S4-5B-SSW1860C	553	79	35.8	S5-5B-SSW1860C	673	15	6.8	SSW1860C	125



Catalog Section 2

Shelves with Removable Hooks

see spec sheet **EG02.06**



- 16 gauge type 430 shelf with type 304 stainless steel pot rack.
- 1½" (38mm) roll on front.
- 1½" (38mm) upturn on rear and ends.
- Furnished with one double-prong hook per foot.

FEATURES:

Freight class is 70.0.

(•) MTS (made to stock) / () MTO (made to order)

10" (254mm) Wide Shelves						12" (305mm) Wide Shelves					
length		weight		cu	model #	list	weight		cu	model #	list
in.	mm	lbs.	kg	ft			lbs.	kg	ft		
36"	914	12	5.4	1.0	WSP1036	786	15	6.8	1.1	WSP1236	815
48"	1219	23	10.4	1.3	WSP1048	803	29	13.2	1.5	WSP1248 •	845
60"	1524	37	16.8	1.6	WSP1060	838	43	19.5	1.8	WSP1260 •	884
72"	1829	51	23.1	1.9	WSP1072	867	57	25.9	2.2	WSP1272 •	919
84"	2134	65	29.5	2.2	WSP1084	909	71	32.2	2.6	WSP1284	971
96"	2438	79	35.8	2.5	WSP1096	972	85	38.6	2.9	WSP1296	992
108"	2743	93	42.2	2.8	WSP10108	1276	99	44.9	3.3	WSP12108	1356
120"	3048	107	48.5	3.1	WSP10120	1305	113	51.3	3.6	WSP12120	1387
132"	3353	121	54.9	3.4	WSP10132	1382	127	57.6	4.0	WSP12132	1459
144"	3658	135	61.2	3.7	WSP10144	1413	141	64.0	4.4	WSP12144	1486



Additional Hook for Shelves with Removable Hooks

- Stainless steel.

weight	cu	list
lbs. kg	ft	model # ea.
0.2 0.1	0.1	300696 25

15" (381mm) Wide Shelves						18" (457mm) Wide Shelves					
length		weight		cu	model #	list	weight		cu	model #	list
in.	mm	lbs.	kg	ft			lbs.	kg	ft		
36"	914	21	9.5	1.3	WSP1536	1066	27	12.2	1.6	WSP1836	1276
48"	1219	35	15.9	1.8	WSP1548	1088	41	18.6	2.2	WSP1848	1297
60"	1524	49	22.2	2.3	WSP1560	1239	55	24.9	2.7	WSP1860	1365
72"	1829	63	28.6	2.7	WSP1572	1343	69	31.3	3.2	WSP1872	1461
84"	2134	77	34.9	3.2	WSP1584	1539	83	37.6	3.7	WSP1884	1585
96"	2438	91	41.3	3.6	WSP1596	1612	97	44.0	4.3	WSP1896	1678
108"	2743	105	47.6	4.0	WSP15108	1751	111	50.3	4.8	WSP18108	2040
120"	3048	119	54.0	4.5	WSP15120	1779	125	56.7	5.3	WSP18120	2071
132"	3353	133	60.3	4.9	WSP15132	1911	139	63.1	5.9	WSP18132	2110
144"	3658	147	66.7	5.4	WSP15144	1944	153	69.4	6.4	WSP18144	2143

Single Bar Utility Racks



- One-piece flat 3/16" (5mm)-thick solid bar.
- 2" (51mm)-wide.
- Furnished with one double-prong hook per foot.

FEATURES:

Freight class is 70.0.

(•) MTS (made to stock) / () MTO (made to order)



Additional Hook for Single Bar Utility Racks

- Stainless steel.

weight	cu	list
lbs. kg	ft	model # ea.
0.2 0.1	0.1	300696 25

length	ALUMINUM				STAINLESS STEEL					
	in.	mm	lbs.	kg	model #	list	weight	model #	list	
24"	610	5	2.3	SBPR-24-A	391	9	4.1	SBPR-24-S	521	
36"	915	6	2.7	SBPR-36-A	411	12	5.4	SBPR-36-S	548	
48"	1219	7	3.2	SBPR-48-A	424	15	6.8	SBPR-48-S	563	
8½" width (216mm)	60"	1524	9	4.1	SBPR-60-A	435	18	8.2	SBPR-60-S	580
	72"	1829	11	5.0	SBPR-72-A	449	21	9.5	SBPR-72-S	598
	84"	2134	13	5.9	SBPR-84-A	460	25	11.3	SBPR-84-S	613
	96"	2438	15	6.8	SBPR-96-A	507	29	13.2	SBPR-96-S	675
	108"	2743	17	7.7	SBPR-108-A	558	34	15.4	SBPR-108-S	740
120"	3048	20	9.0	SBPR-120-A	605	39	17.6	SBPR-120-S	807	



Wall Mounted Shelves with Marine Counter Edge

see spec sheet **EG02.10**



- 24" (610mm) length.
- Made of highly polished heavy gauge type 430 stainless steel.
- Marine counter edge in front that prevents microwave from sliding off.
- Hole with grommet at center rear for wiring.

FEATURES:

Freight class is 70.0.

(•) MTS (made to stock) / () MTO (made to order)

width		weight		cubic feet	model #	list
in.	mm	lbs.	kg			
18"	457	17	7.7	4.8	MWS1824 •	461
24"	610	23	10.4	4.8	MWS2424 •	525

Adjustable Post Wire Wall Mounts Sold as Prepackaged Units

see spec sheet **EG02.11**

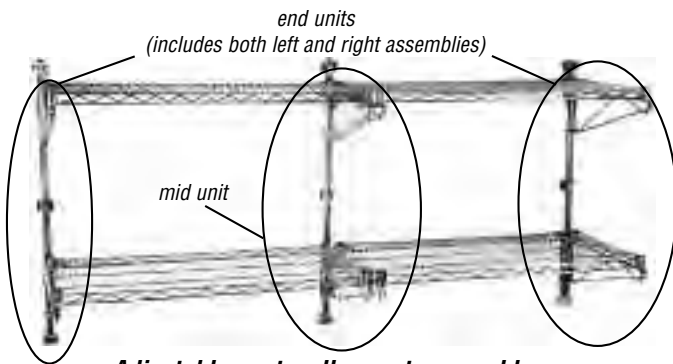

Adjustable post wall mounts are sold as prepackaged end and mid units, or sold as components (see page 95). The prepackaged units contain all needed components except shelves and wall bolts. Wall bolts must be selected according to wall type.

END UNITS.

- Two posts, single shelf brackets, post supports.
- Number of shelf brackets depends on the height of the posts.
 - 14" (356mm) posts: one row of brackets.
 - 33" (838mm) posts: two rows of brackets
 - ...and so on.

MID UNITS

- One post, double shelf brackets, post supports.
- Number of shelf brackets corresponds to post height the same as end units.

FEATURES:

- One shelf long, order only one end unit.
- Two shelves long, order one end and one mid unit.
- Three shelves long, order one end and two mid units. And so on.

ORDERING:

Freight class is 70.0.

(•) MTS (made to stock) / () MTO (made to order)

Note: Shelves (page 6) and accessories (pages 46 & 47) are sold separately.

Prepackaged End Units

Prepackaged Mid Units

	post height		# of shelves	cu ft	weight*		chrome		Valu-Gard®		stainless steel		chrome		Valu-Gard®		stainless steel	
	in.	mm			lbs.	kg	model #	list	model #	list	model #	list	model #	list	model #	list	model #	list
	14" width (356mm)	14"			356	1	0.6	7	3.2	PWE14-1C	174	PWE14-1VG	174	PWE14-1S	487	PWM14-1C	112	PWM14-1VG
	33"	838	2	0.7	14	6.4	PWE14-2C	282	PWE14-2VG	282	PWE14-2S	864	PWM14-2C	191	PWM14-2VG	191	PWM14-2S	568
	54"	1372	3	0.7	22	10.0	PWE14-3C	391	PWE14-3VG	391	PWE14-3S	1110	PWM14-3C	269	PWM14-3VG	269	PWM14-3S	757
	63"	1600	4	0.7	28	13.0	PWE14-4C	472	PWE14-4VG	472	PWE14-4S	1361	PWM14-4C	333	PWM14-4VG	333	PWM14-4S	949
18" width (457mm)	14"	356	1	0.6	8	3.6	PWE18-1C	176	PWE18-1VG	176	PWE18-1S	503	PWM18-1C	114	PWM18-1VG	114	PWM18-1S	324
	33"	838	2	0.6	15	6.8	PWE18-2C	282	PWE18-2VG	282	PWE18-2S	901	PWM18-2C	192	PWM18-2VG	192	PWM18-2S	592
	54"	1372	3	0.7	23	10.0	PWE18-3C	393	PWE18-3VG	393	PWE18-3S	1162	PWM18-3C	273	PWM18-3VG	273	PWM18-3S	784
	63"	1600	4	0.7	29	13.0	PWE18-4C	474	PWE18-4VG	474	PWE18-4S	1432	PWM18-4C	336	PWM18-4VG	336	PWM18-4S	980
21" width (533mm)	14"	356	1	0.7	9	4.1	PWE21-1C	179	PWE21-1VG	179	PWE21-1S	506	PWM21-1C	118	PWM21-1VG	118	PWM21-1S	329
	33"	838	2	0.8	16	7.3	PWE21-2C	291	PWE21-2VG	291	PWE21-2S	907	PWM21-2C	203	PWM21-2VG	203	PWM21-2S	598
	54"	1372	3	0.9	25	11.0	PWE21-3C	406	PWE21-3VG	406	PWE21-3S	1170	PWM21-3C	285	PWM21-3VG	285	PWM21-3S	796
	63"	1600	4	0.9	32	15.0	PWE21-4C	493	PWE21-4VG	493	PWE21-4S	1432	PWM21-4C	356	PWM21-4VG	356	PWM21-4S	913
24" width (610mm)	14"	356	1	0.7	10	4.5	PWE24-1C	179	PWE24-1VG	179	PWE24-1S	516	PWM24-1C	119	PWM24-1VG	119	PWM24-1S	328
	33"	838	2	0.8	17	7.7	PWE24-2C	294	PWE24-2VG	294	PWE24-2S	926	PWM24-2C	203	PWM24-2VG	203	PWM24-2S	600
	54"	1372	3	0.9	26	12.0	PWE24-3C	411	PWE24-3VG	411	PWE24-3S	1197	PWM24-3C	288	PWM24-3VG	288	PWM24-3S	806
	63"	1600	4	0.9	34	16.0	PWE24-4C	498	PWE24-4VG	498	PWE24-4S	1479	PWM24-4C	358	PWM24-4VG	358	PWM24-4S	1016

* For stainless steel units, add 1 lb. (0.5 kg) weight.



Catalog Section 2

Adjustable Post Wire Wall Mounts Sold as Components

see spec sheet **EG02.11**

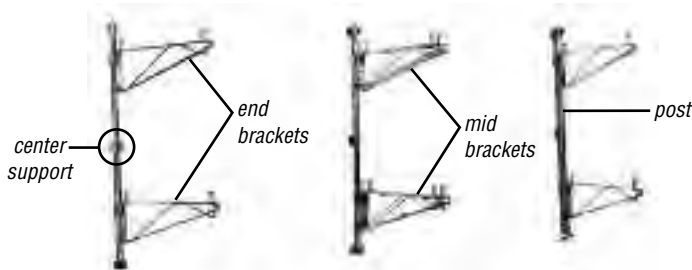

brackets used in conjunction with posts and center supports

- Designed to allow inter-mixing of shelf widths or customizing of units to fit specification needs.
- All components priced individually.

FEATURES:

Freight class is 70.0.

(•) MTS (made to stock) / () MTO (made to order)

End Brackets

length in. mm	weight		cu ft	chrome		Valu-Gard®		stainless steel	
	lbs.	kg		model #	list	model #	list	model #	list
14" 356	3	1.4	0.5	PWB14C • 42	PWB14VG • 42	PWB14S • 136			
18" 457	4	1.8	0.6	PWB18C • 43	PWB18VG • 43	PWB18S 139			
21" 533	5	2.3	1.0	PWB21C • 44	PWB21VG 44	PWB21S 147			
24" 610	6	2.7	1.0	PWB24C • 46	PWB24VG 46	PWB24S • 151			

Note: Must be used with posts to mount to the wall.

Posts

height in. mm	weight		cu ft	chrome		Valu-Gard®		stainless steel	
	lbs.	kg		model #	list	model #	list	model #	list
14" 356	2	0.9	0.1	PW14C • 48	PW14VG • 48	PW14S 139			
33" 838	3	1.4	0.1	PW33C • 62	PW33VG • 62	PW33S 222			
54" 1372	5	2.3	0.1	PW54C • 77	PW54VG 77	PW54S 226			
63" 1524	6	2.7	0.2	PW63C 79	PW63VG 79	PW63S 231			

Mid Brackets

length in. mm	weight		cu ft	chrome		Valu-Gard®		stainless steel	
	lbs.	kg		model #	list	model #	list	model #	list
14" 356	6	2.7	0.5	PDWB14C • 66	PDWB14VG • 66	PDWB14S 207			
18" 457	8	3.6	0.6	PDWB18C • 68	PDWB18VG 68	PDWB18S 214			
21" 533	10	4.5	1.0	PDWB21C • 71	PDWB21VG 71	PDWB21S 222			
24" 610	12	5.4	1.0	PDWB24C 73	PDWB24VG 73	PDWB24S 226			

Note: Must be used with posts to mount to the wall.

Center Support for Posts

weight lbs. kg	cu ft	chrome		Valu-Gard®		stainless steel	
		model #	list	model #	list	model #	list
1	0.5	A203059	11	A218017	11	A207016	41

Note: Must be used in conjunction with post.

Stationary Wire Wall Mounts

see spec sheet **EG02.12**



stationary wall mount with shelf support and mounting plate

Designed for fixed application where vertical adjustment is not required.

END UNIT:

- One single shelf support and mounting plate.

MID UNIT:

- One double shelf support and mounting plate.

Freight class is 70.0.

(•) MTS (made to stock) / () MTO (made to order)

End Units*										Mid Units						
length in. mm	cu ft	weight**		chrome		Valu-Gard®		stainless**		weight** lbs. kg	chrome		Valu-Gard®		stainless**	
		lbs.	kg	model #	list	model #	list	model #	list		model #	list	model #	list		
14" 356	0.5	6	2.7	WB14-C • 42	WB14-VG • 43	WB14-S • 101	8	3.6	DWB14-C • 63	DWB14-VG 64	DWB14-S 151					
18" 457	0.5	8	3.6	WB18-C • 43	WB18-VG • 44	WB18-S • 105	10	4.5	DWB18-C • 65	DWB18-VG 66	DWB18-S 161					
21" 533	0.7	10	4.5	WB21-C • 43	WB21-VG 44	WB21-S 108	12	5.5	DWB21-C 65	DWB21-VG 66	DWB21-S 164					
24" 610	0.7	12	5.5	WB24-C • 44	WB24-VG 45	WB24-S • 112	14	6.4	DWB24-C • 66	DWB24-VG 67	DWB24-S 171					

*End Units priced per piece; **For stainless steel units, add 1 lb. (0.5 kg) weight.



100 Industrial Boulevard, Clayton, DE 19938-8903 U.S.A.
Phone: 800-637-5100 or 302-653-3000. Fax: 302-653-2065
http://www.eaglegrp.com

Wall Mounted Drop Tables/Shelves

see product announcement **EG8134**

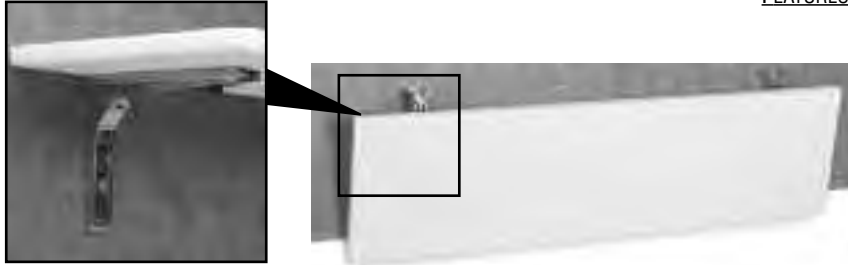

drop bracket shown in raised-up position

poly drop table/shelf mounted onto wall —shown in dropped-down position

- 3/4" (19mm) thick shelf.
- Pair of chrome-plated drop brackets.
- Weight capacity of 80 lbs. (36.3 kg).

FEATURES:

Freight class is 70.0.

(•) MTS (made to stock) / () MTO (made to order)

width		length		weight		Poly *		Richlite® **				16/3 Stainless Steel			
in.	mm	in.	mm	lb.	kg	model #	list	lb.	kg	model #	list	lb.	kg	model #	list
10"	254	24"	610	7	3.2	DSP-1024	229	7	3.2	DSR-1024	346	11	5.0	DSS-1024	269
10"	254	30"	762	9	4.1	DSP-1030	239	9	4.1	DSR-1030	395	13	5.9	DSS-1030	274
10"	254	36"	914	11	5.0	DSP-1036	253	11	5.0	DSR-1036	447	15	6.8	DSS-1036	286
12"	305	24"	610	8	3.6	DSP-1224	236	8	3.6	DSR-1224	375	12	5.4	DSS-1224	271
12"	305	30"	762	10	4.5	DSP-1230	248	10	4.5	DSR-1230	377	14	6.4	DSS-1230	285
12"	305	36"	914	12	5.4	DSP-1236	264	12	5.4	DSR-1236	508	16	7.3	DSS-1236	294

* Poly tables/shelves can withstand hot items up to 180°F without discoloration.

** Richlite® tables/shelves can withstand hot items up to 350°F without discoloration.

Wall Cabinets

see spec sheet **EG02.07**



wall cabinet with hinged doors



wall cabinet with sliding doors

- Heavy gauge stainless steel.
- Back is recessed with full-length concealed mounting plate for easy installation.
- Fixed center shelf.
- Hinged doors provided with lift-off pin hinges.
- 15" (381mm) width. 28" (711mm) overall height.

FEATURES:

Freight class is 100.0.

(•) MTS (made to stock) / () MTO (made to order)

length		weight		cubic	Open Front		Hinged Doors		Sliding Doors	
in.	mm	lbs.	kg	feet	model #	list	model #	list	model #	list
24"	610	95	43.1	13.5	WCO-24	3128	WCH-24	4245	WCS-24	3539
30"	762	115	52.2	17.3	WCO-30	3132	WCH-30	4704	WCS-30	4312
36"	914	125	56.7	18.0	WCO-36	3248	WCH-36	4786	WCS-36	4445
42"	1067	145	65.8	18.2	—	—	WCH-42	5029	WCS-42	4467
48"	1219	165	74.8	18.3	WCO-48	3741	WCH-48	5185	WCS-48	4870
54"	1372	180	81.6	25.4	—	—	WCH-54	5301	WCS-54	4960
60"	1524	195	88.5	22.6	WCO-60	4094	WCH-60	5945	WCS-60	5632
66"	1676	210	95.3	30.6	—	—	WCH-66	5988	—	—
72"	1829	225	102.0	26.8	WCO-72	4584	WCH-72	6660	WCS-72	6307
84"	2134	255	115.7	38.5	WCO-84	4344	WCH-84	6849	WCS-84	6470
90"	2286	267	121.1	41.7	—	—	WCH-90	7237	WCS-90	6852
96"	2438	260	117.9	35.2	WCO-96	5133	WCH-96*	7461	WCS-96*	7064
120"	3048	360	163.3	55.8	—	—	—	—	WCS-120	8512

* Features two pairs of doors.



Cleanroom / Lab Equipment

Accessories/Components

Hangers & Hanger Bar Kits101
 Posts, Electropolished101
 Polymer Stem Casters102
 Replacement Garment Hanger Tubes ..102
 Vibration Dampening Casters102

adjuSTable® Work Surface Systems

adjuSTable® Work Surface Systems ..106

Cantilevered Overhead System.....107
 Wire Overshelf System.....108

Freestanding Gowning Racks

with Hanger Rail.....98
 with Wire Shelving Components99

Workstations

Workstations104
 Mobile Computer Workstations104

More Cleanroom/Lab Equipment

Shoe Racks105
 Roll Bag Dispensers.....106
 Vertical Storage Cabinets105
 Cleanroom Tables.....109
 Stainless Steel Countertops110
 Wall Mounted Gowning Racks100
 Gowning Benches.....103

Wall Mounted Stainless Steel Tables

see spec sheet **EG8107**



table featuring backplash with box marine counter edge



- 14-gauge brackets with hole for electrical wire run.
- Wall mounted for environments with frequent wash downs.
- Available in same configuration as a standard worktable (pages 144-155).
- 200 lb. (90.7 kg) weight capacity.
- Options available include integral sink bowls, drawers, end splashes, and latex sound deadening.

FEATURES:

Freight class is 70.0.

(•) MTS (made to stock) / () MTO (made to order)

Tables with 16 gauge type 304 stainless steel tabletops available! See page 141.

14 Gauge Type 304 Stainless Steel Tabletop with Rolled Edge

	length		no. of brackets	WITH FLAT TOP		WITH 1-1/2" UPTURN		WITH 4-1/2" BACKSPLASH	
	in.	mm		model #	list	model #	list	model #	list
30" width (762mm)	48"	1219	3	WT3048SE	776	UWT3048SE	913	WT3048SE-BS	970
	60"	1524	3	WT3060SE	886	UWT3060SE	1042	WT3060SE-BS	1108
	72"	1829	4	WT3072SE	1036	UWT3072SE	1219	WT3072SE-BS	1295

14 Gauge Type 304 Stainless Steel Tabletop with Box Marine Counter Edge

	length		no. of brackets	WITH FLAT TOP		WITH 1-1/2" UPTURN		WITH 4-1/2" BACKSPLASH	
	in.	mm		model #	list	model #	list	model #	list
30" width (762mm)	48"	1219	3	WT3048SEM	1090	UWT3048SEM	1282	WT3048SEM-BS	1363
	60"	1524	3	WT3060SEM	1162	UWT3060SEM	1367	WT3060SEM-BS	1453
	72"	1829	4	WT3072SEM	1312	UWT3072SEM	1544	WT3072SEM-BS	1640

Optional table edges available:

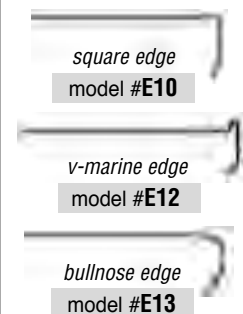

Sterilizer Trays

Features include:

- Heavy gauge type 304 stainless steel with electropolish finish.
- Handles seamlessly blended with cover.
- Perforated bottom.
- Safety edges.
- Customized to fit your needs.

EAGLE's SpecFAB® Division provides a way to short-cut the design and fabrication process. To learn more about SpecFAB®, visit us at www.eaglegrp.com. Just another way you can **Profit From The EAGLE Advantage®**.



Freestanding Gowning Racks with Hanger Rail

see spec sheet **EG04.01A**



shown with single gowning rack – freestanding for non-removable hangers

shown with double gowning rack – freestanding for removable hangers

shown with cantilevered gowning rack – freestanding for removable hangers

- Stainless steel construction offers a non-contaminating surface that eliminates particle shedding.
- Electropolished models feature electrochemically passivated surfaces for the most demanding requirements.
- 75" (1905mm) height.
- Hanger slots are standard 3" (76mm) centers, but other center configurations are available.

FEATURES:

Note: Prices do not include hangers. See page 101 for optional hangers. All models use open loop hangers.

Freight class is 70.0.

(•) MTS (made to stock) / () MTO (made to order)

Designed for efficient storage of garments in the cleanroom.

Single Rack Models

							for Non-Removable Hangers				for Removable Hangers			
	length		weight		cu	number of hanger slots	stainless steel		electropolished		stainless steel		electropolished	
	in.	mm	lbs.	kg	ft		model #	list	model #	list	model #	list	model #	list
24" width (610mm)	48"	1219	40	18.1	15.0	15	S2448-SGRN	2427	EP2448-SGRN	2762	S2448-SGRR	2104	EP2448-SGRR	2444
	60"	1524	45	20.4	15.0	19	S2460-SGRN	2481	EP2460-SGRN	2992	S2460-SGRR	2146	EP2460-SGRR	2651
	72"	1829	50	22.7	15.0	23	S2472-SGRN	2521	EP2472-SGRN	3097	S2472-SGRR	2202	EP2472-SGRR	2769
	84"	2134	55	24.9	17.5	27	S2484-SGRN	2703	EP2484-SGRN	3269	S2484-SGRR	2365	EP2484-SGRR	2925

Double Rack Models

							for Non-Removable Hangers				for Removable Hangers			
	length		weight		cu	number of hanger slots	stainless steel		electropolished		stainless steel		electropolished	
	in.	mm	lbs.	kg	ft		model #	list	model #	list	model #	list	model #	list
24" width (610mm)	48"	1219	59	26.7	15.0	32	S2448-DGRN	3631	EP2448-DGRN	4316	S2448-DGRR	3293	EP2448-DGRR	3855
	60"	1524	68	30.8	15.0	40	S2460-DGRN	3778	EP2460-DGRN	4606	S2460-DGRR	3491	EP2460-DGRR	4112
	72"	1829	77	34.9	15.0	48	S2472-DGRN	3943	EP2472-DGRN	4898	S2472-DGRR	3604	EP2472-DGRR	4373
	84"	2134	86	39.0	17.5	56	S2484-DGRN	4116	EP2484-DGRN	5072	S2484-DGRR	3779	EP2484-DGRR	4528

Cantilevered Rack Models

							for Non-Removable Hangers				for Removable Hangers			
	length		weight		cu	number of hanger slots	stainless steel		electropolished		stainless steel		electropolished	
	in.	mm	lbs.	kg	ft		model #	list	model #	list	model #	list	model #	list
24" width (610mm)	48"	1219	45	20.4	15.0	16	S2448-CGRN	2427	EP2448-CGRN	2762	S2448-CGRR	2104	EP2448-CGRR	2444
	60"	1524	50	22.7	15.0	20	S2460-CGRN	2481	EP2460-CGRN	2992	S2460-CGRR	2146	EP2460-CGRR	2651
	72"	1829	55	24.9	15.0	24	S2472-CGRN	2521	EP2472-CGRN	3097	S2472-CGRR	2202	EP2472-CGRR	2769
	84"	2134	60	27.2	17.5	28	S2484-CGRN	2702	EP2484-CGRN	3269	S2484-CGRR	2365	EP2484-CGRR	2925

Catalog Section 4

EAGLE offers gowning racks that incorporate wire shelving components with specially designed gown storage options. They offer a more economical rack option in less demanding environments in chrome plated steel as well as electropolished stainless steel models.

Freestanding Gowning Racks with Wire Shelving Components

see spec sheet **EG04.01B**

- 86" (2184mm) height.
- Wire shelf features QuadTruss® Design. Patent #5,390,803.

FEATURES:

Note: See each model for spacing centers.

Freight class is 70.0.

(•) MTS (made to stock) / () MTO (made to order)

with Hanger Slots

- Hanger slots on standard 2½" (64mm) centers.
- Custom spacing available.
- Prices do not include hangers – see page 101 for optional hangers.

	length		weight		cubic feet	number of hanger slots	electropolished		chrome	
	in.	mm	lbs.	kg			model #	list	model #	list
24"	48"	1219	30	13.6	5.4	17	EP2448-GR	1151	C2448-GR	504
width	60"	1524	37	16.8	6.5	22	EP2460-GR	1375	C2460-GR	569
(610mm)	72"	1829	40	18.1	7.0	27	EP2472-GR	1610	C2472-GR	648



Optional Keeper Bars for above Gowning Racks

- Makes hangers non-removable.

length in.	mm	number of hanger slots	electropolished		chrome	
			model #	list	model #	list
48"	1219	17	KB48-EP	71	KB48-C	61
60"	1524	22	KB60-EP	79	KB60-C	68
72"	1829	27	KB72-EP	87	KB72-C	75

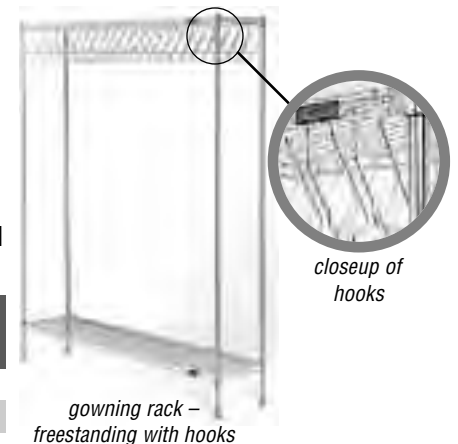

with Hooks

- Hooks welded on all four shelf sides are spaced on 1½" (38mm) centers and are staggered 1" (25mm) vertically hook-to-hook for ease of access.

	length		weight		cubic feet	number of hooks	electropolished		chrome	
	in.	mm	lbs.	kg			model #	list	model #	list
14"	48"	1219	56	25.4	5.4	72	EP1448-GRH	2280	C1448-GRH	1194
width	60"	1524	68	30.8	6.5	88	EP1460-GRH	2725	C1460-GRH	1244
(356mm)	72"	1829	80	36.3	7.0	104	EP1472-GRH	3320	C1472-GRH	1492

with Hanger Tube

- 1" (25mm) diameter tubular bar which easily mounts to underside of wire shelf.
- Facilitates laminar flow.
- See page 102 for replacement garment hanger tubes.

	length		weight		cubic feet	stainless steel		chrome	
	in.	mm	lbs.	kg		model #	list	model #	list
24"	48"	1219	27	12.2	5.4	S2448-GRT	875	C2448-GRT	348
width	60"	1524	34	15.4	6.5	S2460-GRT	955	C2460-GRT	377
(610mm)	72"	1829	37	16.7	7.0	S2472-GRT	1058	C2472-GRT	426

Convenient for storage of lab coats, uniforms and garments.



Wall Mounted Gowning Racks

see spec sheet **EG04.08**

When space management is critical, EAGLE offers three wall mounted options for garment storage.

- Open wire top shelf for laminar flow. Features QuadTruss® Design. Patent #5,390,803.
- Economical models are available in chrome plated steel, in addition to electropolished stainless steel.
- Hangers are not included.

FEATURES:

Note: See page 101 for optional hangers available.

Freight class is 70.0.

(•) MTS (made to stock) / () MTO (made to order)

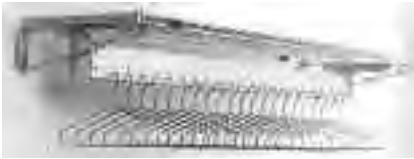

gowning rack – wall mounted with optional hangers

with Hanger Slots

- Hanger slots on 2½" (64mm) centers.
- Prices do not include hangers.

	length		weight		cubic feet	number of hanger slots	electropolished		chrome	
	in.	mm	lbs.	kg			model #	list	model #	list
24"	48"	1219	19	8.6	1.4	17	EP2448-WGR	908	C2448-WGR	387
width (610mm)	60"	1524	24	10.9	1.7	22	EP2460-WGR	1108	C2460-WGR	468
	72"	1829	29	13.2	2.0	27	EP2472-WGR	1331	C2472-WGR	539

Optional Keeper Bars for above Gowning Racks

- Makes hangers non-removable.

length in.	mm	number of hanger slots	electropolished		chrome	
			model #	list	model #	list
48"	1219	17	KB48-EP	71	KB48-C	61
60"	1524	22	KB60-EP	79	KB60-C	68
72"	1829	27	KB72-EP	87	KB72-C	75



gowning rack – wall mounted with hooks

with Hooks

- Hooks welded on 1½" (38mm) centers.

	length		weight		cubic feet	number of hooks	electropolished		chrome	
	in.	mm	lbs.	kg			model #	list	model #	list
14"	48"	1219	21	9.5	1.4	30	EP1448-WGRH	1179	C1448-WGRH	543
width (356mm)	60"	1524	27	12.2	1.7	38	EP1460-WGRH	1406	C1460-WGRH	626
	72"	1829	31	14.1	2.0	46	EP1472-WGRH	1690	C1472-WGRH	761



wall mounted tubular gowning rack

with Hanger Tube

- See page 102 for replacement garment hanger tubes.

	length		weight		cubic feet	electropolished		chrome	
	in.	mm	lbs.	kg		model #	list	model #	list
18"	48"	1219	17	7.7	1.4	S1848-WGRT	487	C1848-WGRT	203
width (457mm)	60"	1524	22	10.0	1.7	S1860-WGRT	559	C1860-WGRT	218
	72"	1829	27	12.2	2.0	S1872-WGRT	652	C1872-WGRT	234

Accessories

Hangers

see spec sheet **EG04.06**

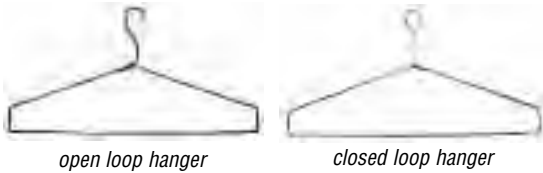

open loop hanger

closed loop hanger

Note: For freestanding or wall mounted gowning racks, removable or non-removable models (pages 98-100).

Freight class is 70.0.

(•) MTS (made to stock) / () MTO (made to order)

Open Loop Hangers

Closed Loop Hangers

weight		cubic		chrome		stainless steel		electropolished		chrome		stainless steel		electropolished	
lbs.	kg	feet		model #	list	model #	list	model #	list	model #	list	model #	list	model #	list
0.4	0.2	0.3		OLH-C •	12	OLH-S •	18	OLH-EP	20	CLH-C	12	CLH-S	18	CLH-EP	20

2-Piece Hangers

- Use with non-removable hanger models.
- Top component is affixed to the gowning rack, while the bottom component is removable for convenient mounting of the garment.
- These hangers discourage removal from the gowning area.



weight		cubic		chrome		stainless steel		electropolished	
lbs.	kg	feet		model #	list	model #	list	model #	list
0.5	0.2	0.3		TPH-C	41	TPH-S	48	TPH-EP	55

Hanger Bar Kits

see spec sheet **EG04.06**

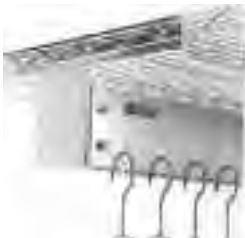

Note: For freestanding or wall mounted gowning racks, removable or non-removable models (pages 98-100).

- For use with 2-piece and open loop hangers.
- Retrofits existing shelving into freestanding or wall mounted gowning racks.
- 24" (610mm) wide shelves only.
- Hanger slots on standard 2½" (64mm) centers.
- Custom spacing available.
- Prices do not include hangers.

FEATURES:

Freight class is 70.0.

(•) MTS (made to stock) / () MTO (made to order)

length		weight		cu	number of hanger slots	electropolished		stainless steel		chrome	
in.	mm	lbs.	kg	ft		model #	list	model #	list	model #	list
48"	1219	7.0	3.2	0.8	17	HBK-48EP	318	HBK-48S	264	HBK-48C	219
60"	1524	9.5	4.3	1.2	22	HBK-60EP	354	HBK-60S	294	HBK-60C	252
72"	1829	12.0	5.4	1.6	27	HBK-72EP	372	HBK-72S	326	HBK-72C	279

Electropolished Posts

see spec sheet **EG04.07**

Freight class is 50.0.

(•) MTS (made to stock) / () MTO (made to order)



Posts come standard with electropolished foot plates.

post height		weight		cu	...Stationary		...Mobile	
in.	mm	lbs.	kg	ft	model #	list	model #	list
33"	383	2.0	0.9	0.4	P33-EPS	60	CP33-EPS	60
54"	1372	3.0	1.4	0.4	P54-EPS	80	CP54-EPS	80
63"	1600	3.5	1.6	0.4	P63-EPS	86	CP63-EPS	86
74"	1880	4.0	1.8	0.5	P74-EPS	97	CP74-EPS	97
86"	2184	5.0	2.3	0.5	P86-EPS	106	CP86-EPS	106



Replacement Garment Hanger Tubes

see spec sheet **EG04.07**



**Weight Capacity:
50 lbs.**

garment hanger tube

length		weight		cubic		chrome		stainless steel	
in.	mm	lbs.	kg	feet	model #	list	model #	list	
24"	610	1.5	0.7	0.1	CH24	35	CH24-S	76	
30"	762	1.7	0.8	0.1	CH30	37	CH30-S	78	
36"	914	2.2	1.0	0.1	CH36	39	CH36-S	80	
42"	1067	2.7	1.2	0.1	CH42	40	CH42-S	84	
48"	1219	3.2	1.5	0.1	CH48 •	41	CH48-S	86	
54"	1372	3.5	1.6	0.2	CH54	44	CH54-S	97	
60"	1524	3.8	1.7	0.2	CH60	47	CH60-S	105	
72"	1929	4.7	2.1	0.2	CH72	49	CH72-S	109	

Note: Mounts onto 18" and 24" (457 and 610mm) wide shelves only.

For freestanding or wall mounted gowning racks with hanger tubes (pages 98-100).

Freight class is 50.0.

(•) MTS (made to stock) / () MTO (made to order)

Vibration Dampening Casters

see spec sheet **EG04.07**

Where vibration dampening is important, these unique 50A shore hardness "Softie™" casters reduce vibration transfer for work in process.

type	capacity		wheel diameter		wheel face		weight		cu	zinc	
	lbs.	kg	in.	mm	in.	mm	lbs.	kg		model #	list
stem/swivel	180	81.6	5"	127	1 3/8"	35	2.0	0.9	0.1	SCSS5-180 •	38
stem/brake	180	81.6	5"	127	1 3/8"	35	2.5	1.1	0.1	SCSB5-180	41
stem/rigid*	180	81.6	5"	127	1 3/8"	35	2.8	1.3	0.1	SCSR5-180	38

* Channel frames for rigid stem casters available. See page 11.

Note: For use with mobile posts (see page 101).

Freight class is 65.0.

(•) MTS (made to stock) / () MTO (made to order)



"Softie™" caster

Replacement Caster Wheels

- Retrofit your existing casters.

Fits	model #	list
5" (127mm) casters	SCW-180	12



Polymer Stem Casters

see spec sheets **EG01.05** **EG04.07**



These casters offer total corrosion resistance.

- Stainless steel axle.
- Zinc-plated stem.
- Polymer horn.
- Polyurethane wheel.

FEATURES:

Note: For use with mobile posts (see page 101).

Freight class is 65.0.

(•) MTS (made to stock) / () MTO (made to order)

type	type of bearing	capacity		wheel diameter		wheel face		weight		cu	model #	list
		lbs.	kg	in.	mm	in.	mm	lbs.	kg			
stem/swivel	delrin	250	113.4	5"	127	1 1/4"	32	2.0	0.9	0.1	CPSS5-250 •	71
stem/brake	delrin	250	113.4	5"	127	1 1/4"	32	2.0	0.9	0.1	CPSB5-250 •	87

Catalog Section 4

Gowning Benches

see spec sheet **EG04.03**

Solid

- 14 gauge type 304 stainless steel seat.
- Front and rear feature a rolled edge, with ends turned down at 90°.
- Shipped knocked-down.
- 17" (432mm) overall height.

FEATURES:

- Flanged stainless foot plates for convenient attachment to the floor.
- Available in brushed finish 304 stainless steel or electropolished finish.

Freight class is 70.0.

(•) MTS (made to stock) / () MTO (made to order)

Hold up to 500 lbs.!

	length		weight		cubic feet	electropolished		stainless steel	
	in.	mm	lbs.	kg		model #	list	model #	list
9" width (229mm)	36"	914	26	11.8	5.8	CRB0936EP	1141	CRB0936	931
	48"	1219	32	14.5	8.2	CRB0948EP	1201	CRB0948	978
	60"	1524	39	17.6	11.0	CRB0960EP	1344	CRB0960	1045
	72"	1829	46	20.9	14.6	CRB0972EP	1455	CRB0972	1135
12" width (305mm)	36"	914	30	13.6	2.0	CRB1236EP	1205	CRB1236 •	993
	48"	1219	40	18.1	3.0	CRB1248EP	1267	CRB1248 •	1044
	60"	1524	50	22.7	3.6	CRB1260EP	1391	CRB1260 •	1091
	72"	1829	60	27.2	4.3	CRB1272EP*	1503	CRB1272* •	1184
	84"	2134	70	31.8	5.2	CRB1284EP*	1554	CRB1284*	1233

* Comes with six legs.



Wire

- Four (4) 18" (457mm) legs with foot plates.
- One (1) three-sided channel frame.
- One (1) wire shelf.

	length		weight		cubic feet	chrome		stainless steel	
	in.	mm	lbs.	kg		model #	list	model #	list
14" width (356mm)	36"	914	15	6.8	0.5	W1436-GBC	247	W1436-GBS	742
	48"	1219	19	8.6	0.7	W1448-GBC	273	W1448-GBS	824
	60"	1524	25	11.3	0.9	W1460-GBC	297	W1460-GBS	860
	72"	1829	30	13.6	1.1	W1472-GBC	311	W1472-GBS	912

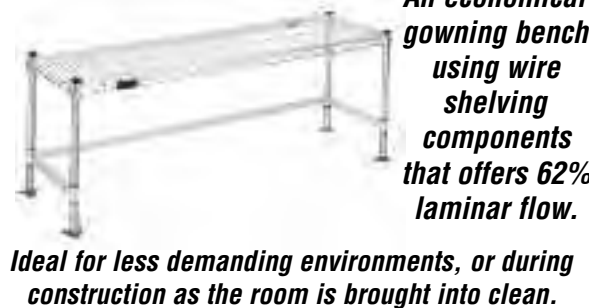

Gowning Benches with Standard Undersheff...

- Designated seat, legs, foot plates, and one wire undersheff (additional wire undersheffs and dividers are optional).
- 72" (1829mm) units have six legs.
- Standard undersheff for all 72" (1829mm) units consists of two #1436S wire shelves with S-hooks.
- All wire undersheffs are 14" (356mm) wide.
- 19" (483mm) overall height.

Seats hold up to 500 lbs.!

...with Perforated Seat

3 1/2" (89mm) perforated on one inch center.

	length		weight		cubic feet	electropolished		stainless steel	
	in.	mm	lbs.	kg		model #	list	model #	list
18" width (457mm)	36"	914	38	17.2	4.4	PCRB1836EP	1877	PCRB1836	1592
	48"	1219	43	19.5	5.7	PCRB1848EP	1977	PCRB1848	1677
	60"	1524	49	22.0	7.1	PCRB1860EP	2176	PCRB1860	1778
	72"	1829	55	24.9	8.5	PCRB1872EP	2348	PCRB1872	1919



gowning bench with standard undersheff and perforated seat, shown with additional undersheff and dividers

...with Solid Seat

	length		weight		cubic feet	electropolished		stainless steel	
	in.	mm	lbs.	kg		model #	list	model #	list
18" width (457mm)	36"	914	38	17.2	4.4	CRB1836EP	1666	CRB1836	1381
	48"	1219	43	19.5	5.7	CRB1848EP	1753	CRB1848	1455
	60"	1524	49	22.0	7.1	CRB1860EP	1927	CRB1860	1539
	72"	1829	55	25.0	8.5	CRB1872EP	2080	CRB1872	1665

Options for Gowning Benches with Undersheff

Dividers — 4" high.

model	list
SD14-4S	50

Additional Undersheffs*

model	list
1436S •	190
1448S •	234
1460S •	296

* For 72" (1829mm) long gowning benches, two #1436S undersheffs are required.



Workstations

see spec sheet **EG04.10**



basic wire workstation

wire top workstation with two overshelves

WEIGHT CAPACITY:

- Up to 800 lb. (363kg) load-bearing capacity.

FEATURES:

- Mobile units come with four 5" (127mm) poly stem casters (two with brake).
- Wire units offer 62% laminar flow.
- All units have standard working height of 33" (838mm).

Freight class is 70.0.

(•) MTS (made to stock) / () MTO (made to order)

Basic Wire Units

Stationary Units

Mobile Units

	length		cu		weight		chrome		stainless steel		weight		chrome		stainless steel	
	in.	mm	ft	lbs.	kg	model #	list	model #	list	lbs.	kg	model #	list	model #	list	
24" width (610mm)	36"	914	3.0	21	9.5	WS2436C	226	WS2436S	838	29	13.2	MWS2436C	521	MWS2436S	1158	
	48"	1219	3.8	28	12.7	WS2448C	257	WS2448S	914	36	16.3	MWS2448C	551	MWS2448S	1235	

Wire Top Units with Two Overshelves

Stationary Units

Mobile Units

	length		cu		weight		chrome		stainless steel		weight		chrome		stainless steel	
	in.	mm	ft	lbs.	kg	model #	list	model #	list	lbs.	kg	model #	list	model #	list	
24" width (610mm)	36"	914	4.4	34	15.4	WS2436WT	349	WS2436WT-S	1311	42	19.1	MWS2436WT	648	MWS2436WT-S	1543	
	48"	1219	5.5	41	18.6	WS2448WT	403	WS2448WT-S	1344	56	25.4	MWS2448WT	697	MWS2448WT-S	1665	

Optional Keyboard Stations for Workstations

- 20½" wide x 11½" deep (521 x 292mm).
- Works on 24" (610mm) wide shelves.



chrome keyboard station shown

weight		cubic	chrome		stainless steel	
lbs.	kg	feet	model #	list	model #	list
6.0	2.7	0.35	KBD-2•	182	KBD-2/SS	370

Mobile Computer Workstations

see spec sheet **EG01.04**



with optional mouse shelf

Optional Mouse Shelf

width x length		cu		weight		model #	
in.	mm	ft	lbs.	kg	model #	list	
7" x 7"	178 x 178	0.1	2.0	0.9	MS-C	11	

FEATURES:

- 5" (127mm) casters—two with brake.
- Cantilevered shelf, undershelf, keyboard drawer.
- 38¾" (981mm) working height.
- 53¾" (1362mm) overall height.

Note: Call factory for information on other casters available.

Freight class is 70.0.

(•) MTS (made to stock) / () MTO (made to order)

	width**	length		weight		cu		with Resilient-Tread Casters		w/Polyurethane-Tread Casters			
		in.	mm	lbs.	kg	ft	chrome model #	*list	stainless steel model #	*list	chrome model #	*list	stainless steel model #
24" (610mm)	24"	610	40	18.1	3.7	MCWS2424C	• 522	MCWS2424S	1087	MCWS2424C-P	590	MCWS2424S-P	1111
30" (762mm)	30"	762	56	25.4	4.5	MCWS3030C	572	MCWS3030S	1136	MCWS3030C-P	640	MCWS3030S-P	1161

* List prices do not include cost of mouse shelf.

** 24" x 24" (610 x 610mm) units feature 14" x 24" (357 x 610mm) undershelf, 30" x 30" (762 x 762mm) units feature 18" x 30" (457 x 762mm) undershelf.

Catalog Section 4

Shoe Racks

see spec sheet **EG04.09**



(Patent #5,390,803)

Wire shelves offer the optimum combination of laminar flow and ventilation for the storage of cleanroom shoes.

FEATURES:

- Rods & tabs run through the shelves to create the cubbies for each pair of shoes.
- Shoe racks may be configured in chrome plated as well as electropolished stainless steel.
- Foot plates are included for fastening to the floor.
- 86" (2184mm) post height.

Note: Optional snap-on plastic label holders are available for identification of each cubby.

Freight class is 70.0.

(•) MTS (made to stock) / () MTO (made to order)

	length*		weight		cu ft	# of cubbies	cubby size		chrome		stainless steel	
	in.	mm	lbs.	kg			width x height	width	height	model #	list	model #
14" width (356mm)	60"	1524	190	86.2	15	60	10" x 6½"	254 x 165	SR1460C	1456	SR1460S	4073
	72"	1829	220	99.8	18	80	9" x 6½"	229 x 165	SR1472C	1611	SR1472S	4905

*Available in any shelf length. For information on shelf lengths, see "Wire Shelves," page 6.

Vertical Storage Cabinets

see spec sheet **EG04.11**



vertical storage cabinet with flat top

FEATURES:

- 18 gauge type 430 stainless steel cabinet body.
- Shelves adjustable on 4" (102mm) vertical centers.
- Double pan 20 gauge stainless steel hinged doors.
- Transverse rod handles featuring keyed locks.

Note: Factory-installed 5" (127mm) plate casters with brake available. To order, add suffix **"-CPB5"** (example: **VSC2436-3-CPB5**) and **\$292 list** (set of four).

Freight class is 92.5.

(•) MTS (made to stock) / () MTO (made to order)

Optional Additional Shelves for Vertical Storage Cabinets

Freight class is 70.0

description	weight		cu ft	model #	list
	lbs.	kg			
fits 36" (914mm) long cabinets	25	11.3	1.5	VSC36	171
fits 48" (1219mm) long cabinets	30	13.6	2.0	VSC48	192

with Flat Top

width x length x height in. mm	cu ft	wt. cap. per shelf		UNITS WITH 3 SHELVES				UNITS WITH 4 SHELVES			
		lbs.	kg	weight		model #	list	weight		model #	list
24" x 36" x 72" 610 x 914 x 1829	53	150	68.0	413	187.3	VSC2436-3	4722	416	188.7	VSC2436-4	4945
24" x 48" x 72" 610 x 1219 x 1829	68	200	90.7	485	220.2	VSC2448-3	5396	490	222.3	VSC2448-4	5642

with Slanted Top

width x length x height in. mm	cu ft	wt. cap. per shelf		UNITS WITH 3 SHELVES				UNITS WITH 4 SHELVES			
		lbs.	kg	weight		model #	list	weight		model #	list
24" x 36" x 78½" 610 x 914 x 1994	53	150	68.0	416	188.7	VSCS2436-3	4722	419	190.1	VSCS2436-4	4945
24" x 48" x 78½" 610 x 1219 x 1994	68	200	90.7	488	221.4	VSCS2448-3	5396	495	223.6	VSCS2448-4	5642



Roll Bag Dispensers

see spec sheet **EG04.00**

An effective means for dispensing rolls of bags, film, or tube stock. An easy way to establish protocol by avoiding inadvertent mixing of non-compatible chemicals.

- Two 14" x 48" (356 x 1219mm) wire shelves.
- Eight removable dispensing bars.
- One 3-sided channel frame.
- Four 74" (1829mm) posts with 30" (762mm) outrigger feet for stability.
- Dispensing bars are adjustable on 1" (25mm) increments.
- Custom sizes available.

FEATURES:

Freight class is 70.0.

(•) MTS (made to stock) / () MTO (made to order)



Not recommended on casters.

width x length*		weight		cu	chrome		stainless steel	
in.	mm	lbs.	kg	ft	model #	list	model #	list
14" x 48"	356 x 1219	79	35.8	2.3	BD1448C	1516	BD1448S	2262

* 30" (762mm) wide units available for mobile applications. Call factory for more information.

Replacement Outrigger Base Extensions for Roll Bag Dispensers

front-to-back depth		weight		cu	chrome		stainless steel	
in.	mm	lbs.	kg	ft	model #	list	model #	list
30"	762	4	1.8	0.5	C30-PBB	143	S30-PBB	308

adjuSTable® Work Surface Systems

see spec sheet **EG04.04A**

- Four 33" (838mm) posts and your choice of base combination.
- Tabletops on all models feature hat channels underneath for added strength.

FEATURES:

Freight class is 70.0.

(•) MTS (made to stock) / () MTO (made to order)



with H-frame base and wire shelf



with C-frame base and wire shelf

EAGLE's adjuSTable® system allows you to create work surfaces in the configuration of your choice.

	length		weight*		cu ft	AC Series		AS Series		AP Series*		AEP Series		APEP Series	
	in.	mm	lb.	kg		model #	list	model #	list	model #	list	model #	list	model #	list
24" width (610mm)	36"	914	65	29.5	4.5	AC2436T	748	AS2436T	1126	AP2436T	1414	AEP2436T	1357	APEP2436T	1646
	48"	1219	81	36.7	5.7	AC2448T	875	AS2448T	1300	AP2448T	1591	AEP2448T	1627	APEP2448T	1918
	60"	1524	97	44.0	7.1	AC2460T	987	AS2460T	1507	AP2460T	1798	AEP2460T	1978	APEP2460T	2268
	72"	1829	113	51.3	8.5	AC2472T	1075	AS2472T	1714	AP2472T	2006	AEP2472T	2225	APEP2472T	2512
30" width (762mm)	36"	914	75	34.0	4.5	AC3036T	816	AS3036T	1282	AP3036T	1571	AEP3036T	1754	APEP3036T	2044
	48"	1219	94	42.6	5.7	AC3048T	967	AS3048T	1493	AP3048T	1786	AEP3048T	2039	APEP3048T	2331
	60"	1524	113	51.3	7.1	AC3060T	1095	AS3060T	1713	AP3060T	2005	AEP3060T	2260	APEP3060T	2551
	72"	1829	132	59.9	8.5	AC3072T	1194	AS3072T	1999	AP3072T	2288	AEP3072T	2570	APEP3072T	2866
36" width (914mm)	36"	914	85	38.6	5.6	AC3636T	1028	AS3636T	1488	AP3636T	1777	AEP3636T	1955	APEP3636T	2170
	48"	1219	108	49.0	7.1	AC3648T	1174	AS3648T	1796	AP3648T	2086	AEP3648T	2304	APEP3648T	2556
	60"	1524	131	59.4	8.9	AC3660T	1286	AS3660T	2067	AP3660T	2358	AEP3660T	2664	APEP3660T	2960
	72"	1829	154	69.9	10.6	AC3672T	1430	AS3672T	2362	AP3672T	2512	AEP3672T	2987	APEP3672T	3286

* Note: For perforated tops, laminar air flow is 23-25% depending on size.

1) Select work surface (from chart above).

Prefixes in chart:

- "AC" - 16 gauge type 304 brushed stainless top with chrome base
- "AS" - 16 gauge type 304 brushed stainless top with stainless base
- * "AP" - 14 gauge type 304 brushed stainless top with 3/4" (19mm) perforations on 1" (25mm) centers with stainless base.
- * "AEP" - Electropolished solid top with stainless base.
- "APEP" - Electropolished perforated top with stainless base.

2) Select base combination.

Must be specified with your choice of work surface.

Base combination is included in table price.

Choose from the following combinations:

- Base with two C-frames
- Base with two H-frames
- Base with one C-frame and one wire shelf
- Base with one H-frame and one wire shelf

For wire mount keyboard stations see page 107.

Catalog Section 4

adjuSTable® Work Surface Systems with Cantilevered Overhead System

see spec sheet **EG04.04B**

Allows you to create work surfaces of your choice with cantilevered overhead or wire overshelf systems. Tabletops on all models feature hat channels underneath for added strength.

Work surface of your choice is combined with two 33" (838mm) front posts, two 63" (1600mm) rear posts, two cantilevered wire overshelves, and your choice of base combination.

1) Select work surface.

Prefixes in chart below:

“OAC” – 16 gauge type 304 brushed stainless top, with chrome base and chrome overshelves.

“OAS” – 16 gauge type 304 brushed stainless top, with stainless base and stainless overshelves.

* “OAP” – 14 gauge type 304 brushed stainless top with ¼" (19mm) perforations on 1" (25mm) centers, with stainless base and stainless overshelves.

“OAEP” – 14 gauge type 304 electropolished solid top, with stainless base and stainless overshelves.

* “OAPEP” – 14 gauge type 304 electropolished perforated top, with stainless base and stainless overshelves.



shown with two C-frame bases

	length		weight*		cu ft	OAC Series		OAS Series		OAP Series*		OAEP Series		OAPEP Series*	
	in.	mm	lb.	kg		model #	list	model #	list	model #	list	model #	list	model #	list
24"	36"	914	65	29.5	4.4	OAC2436T-2	891	OAS2436T-2	1549	OAP2436T-2	1781	OAEP2436T-2	1840	OAPEP2436T-2	2071
width (610mm)	48"	1219	81	36.7	5.7	OAC2448T-2	1026	OAS2448T-2	1772	OAP2448T-2	2062	OAEP2448T-2	2097	OAPEP2448T-2	2389
	60"	1524	97	44.0	7.0	OAC2460T-2	1163	OAS2460T-2	2056	OAP2460T-2	2347	OAEP2460T-2	2529	OAPEP2460T-2	2819
30"	36"	914	75	34.0	4.4	OAC3036T-2	948	OAS3036T-2	1707	OAP3036T-2	1996	OAEP3036T-2	2180	OAPEP3036T-2	2469
width (762mm)	48"	1219	94	42.6	5.7	OAC3048T-2	1118	OAS3048T-2	1966	OAP3048T-2	2256	OAEP3048T-2	2508	OAPEP3048T-2	2801
	60"	1524	113	51.3	7.0	OAC3060T-2	1269	OAS3060T-2	2265	OAP3060T-2	2556	OAEP3060T-2	2808	OAPEP3060T-2	3099
36"	36"	914	85	38.6	5.0	OAC3636T-2	1157	OAS3636T-2	1910	OAP3636T-2	2202	OAEP3636T-2	2379	OAPEP3636T-2	2595
width (914mm)	48"	1219	108	49.0	7.0	OAC3648T-2	1323	OAS3648T-2	2267	OAP3648T-2	2557	OAEP3648T-2	2773	OAPEP3648T-2	3026
	60"	1524	131	59.4	9.0	OAC3660T-2	1446	OAS3660T-2	2615	OAP3660T-2	2906	OAEP3660T-2	3212	OAPEP3660T-2	3508

* Note: For perforated tops, laminar air flow is 23-25% depending on size.

2) Select base combination.

Base combination is included in table price.

Must be specified with your choice of work surface.

Choose from the following combinations:

- Base with two C-frames
- Base with two H-frames
- Base with one C-frame and one wire shelf
- Base with one H-frame and one wire shelf

Contact factory for custom workstation.

Optional Keyboard Stations for adjuSTable® Work Surface Systems 20½" wide x 11½" deep (521 x 292mm).

		Table Mount		Wire Mount				
weight lbs.	kg	cubic feet	stainless steel		chrome		stainless steel	
			model #	list	model #	list	model #	list
6.0	2.7	0.35	KBD-1/SS	297	KBD-2•	182	KBD-2/SS	370



table mount keyboard station



wire mount keyboard station for tables on page 104

adjuSTable® Work Surface Systems with Wire Overshelf System

see spec sheet **EG04.04C**

- FEATURES: • 34½" (876mm) working height.
- Freight class is 70.0.
- (•) MTS (made to stock) / () MTO (made to order)

Allows you to create work surfaces of your choice with cantilevered overhead or wire overshelf systems. Tabletops on all models feature hat channels underneath for added strength.

Work surface of your choice is combined with two 33" (838mm) front posts, two 63" (1600mm) rear posts, two wire overshelves, two 29" (737mm) front posts for wire overshelves, and your choice of base combination.



1) Select work surface.

Prefixes in the chart below:

- "WOAC" – 16 gauge type 304 brushed stainless top, with chrome base and chrome overshelves.
- "WOAS" – 16 gauge type 304 brushed stainless top, with stainless base and stainless overshelves.
- * "WOAP" – 14 gauge type 304 brushed stainless top with ¾" (19mm) perforations on 1" (25mm) centers, with stainless base and stainless overshelves.
- "WOAEP" – 14 gauge type 304 electropolished solid top, with stainless base and stainless overshelves.
- * "WOAPEP" – 14 gauge type 304 electropolished perforated top, with stainless base and stainless overshelves.

	length		weight		cu ft	WOAC Series		WOAS Series		WOAP Series*		WOAEP Series		WOAPEP* Series	
	in.	mm	lb.	kg		model #	list	model #	list	model #	list	model #	list	model #	list
24" width (610mm)	36"	914	65	29.5	4.4	WOAC2436T-2	942	WOAS2436T-2	1632	WOAP2436T-2	1864	WOAEP2436T-2	1922	WOAPEP2436T-2	2152
	48"	1219	81	36.7	5.7	WOAC2448T-2	1073	WOAS2448T-2	1896	WOAP2448T-2	2184	WOAEP2448T-2	2222	WOAPEP2448T-2	2512
	60"	1524	97	44.0	7.0	WOAC2460T-2	1205	WOAS2460T-2	2225	WOAP2460T-2	2517	WOAEP2460T-2	2697	WOAPEP2460T-2	2989
30" width (762mm)	36"	914	75	34.0	4.4	WOAC3036T-2	997	WOAS3036T-2	1789	WOAP3036T-2	2013	WOAEP3036T-2	2261	WOAPEP3036T-2	2551
	48"	1219	94	42.6	5.7	WOAC3048T-2	1164	WOAS3048T-2	2091	WOAP3048T-2	2380	WOAEP3048T-2	2634	WOAPEP3048T-2	2924
	60"	1524	113	51.3	7.0	WOAC3060T-2	1310	WOAS3060T-2	2434	WOAP3060T-2	2724	WOAEP3060T-2	2979	WOAPEP3060T-2	3267
36" width (914mm)	36"	914	85	38.6	5.0	WOAC3636T-2	1209	WOAS3636T-2	1993	WOAP3636T-2	2282	WOAEP3636T-2	2461	WOAPEP3636T-2	2677
	48"	1219	108	49.0	7.0	WOAC3648T-2	1369	WOAS3648T-2	2390	WOAP3648T-2	2679	WOAEP3648T-2	2898	WOAPEP3648T-2	3152
	60"	1524	131	59.4	9.0	WOAC3660T-2	1487	WOAS3660T-2	2787	WOAP3660T-2	3074	WOAEP3660T-2	3382	WOAPEP3660T-2	3678

* Note: For perforated tops, laminar air flow is 23-25% depending on size.

2) Select base combination.

Base combination is included in table price. Must be specified with your choice of work surface. Choose from the following combinations:

- Base with two C-frames
- Base with two H-frames
- Base with one C-frame and one wire shelf
- Base with one H-frame and one wire shelf

Contact factory for custom configurations.

Optional Utility Drawers for adjuSTable® Work Surface Systems

Stainless steel construction. Enclosed assembly comes complete with housing, drawer, drawer pan, and drawer front. Guides and rollers included.

length x width x height in. mm	cu ft	with Pull Flange and Full Front				Enclosed Assembly			
		weight lbs.	kg	part #	list	weight lbs.	kg	part #	list
20" x 20" x 5" 508 x 508 x 127	3.0	25	11.3	501571•	374	35	15.9	501572•	681



model #501571
utility drawer



model #501572
enclosed assembly

Catalog Section 4

Cleanroom Tables

see spec sheet **EG04.02**

There are two steps in ordering a cleanroom table:

- Step 1) Choose a tabletop.
 - Step 2) Choose a base frame.
- Each order must be specified.

FEATURES:

- Available with solid or perforated tops.
- Brushed or electropolished finish.
- Perforated tops allow for 40% laminar flow, depending on size.
- All tops are 14 gauge type 304 stainless.
- Shipped knocked down, reducing freight costs and the potential for freight damage.

Freight class is 70.0.

(•) MTS (made to stock) / () MTO (made to order)

STEP 1: Select Cleanroom Tabletops – Alcohol-Wiped and Cleanroom-Bagged

Prefixes in chart below:

- “CRT” – Brushed stainless solid top.
- “CRPT” – Brushed stainless perforated top (3/4" dia. holes on 1" center).
- “SEP” – Electropolished solid top.
- “EPCRT” – Electropolished perforated top (3/4" dia. holes on 1" center).

	length		weight*		cu ft	CRT Series*		CRPT Series		SEP Series*		EPCRT Series	
	in.	mm	lb.	kg		model #	list	model #	list	model #	list	model #	list
24" width (610mm)	24"	610	30	13.6	2.9	CRT2424T	1194	CRPT2424T	1361	SEP2424T	1713	EPCRT2424T	1635
	36"	914	40	18.1	3.5	CRT2436T	1326	CRPT2436T	1602	SEP2436T	1904	EPCRT2436T	1921
	48"	1219	50	22.7	4.6	CRT2448T	1385	CRPT2448T	1872	SEP2448T	2384	EPCRT2448T	2395
	60"	1524	58	26.3	5.7	CRT2460T	1441	CRPT2460T	2022	SEP2460T	2564	EPCRT2460T	2585
	72"	1829	76	34.5	6.9	CRT2472T	1637	CRPT2472T	2590	SEP2472T	3172	EPCRT2472T	3190
	84"	2134	80	36.3	7.9	CRT2484T	1978	CRPT2484T	2870	SEP2484T	3633	EPCRT2484T	3661
	96"	2438	101	45.8	9.1	CRT2496T	2112	CRPT2496T	3733	SEP2496T	4348	EPCRT2496T	4373
30" width (762mm)	30"	762	32	14.5	2.9	CRT3030T	1212	CRPT3030T	1414	n/a	n/a	n/a	n/a
	36"	914	42	19.1	3.5	CRT3036T	1347	CRPT3036T	1665	SEP3036T	2147	EPCRT3036T	2162
	48"	1219	55	24.9	4.6	CRT3048T	1399	CRPT3048T	1932	SEP3048T	2492	EPCRT3048T	2504
	60"	1524	66	29.9	5.7	CRT3060T	1596	CRPT3060T	2089	SEP3060T	2793	EPCRT3060T	2812
	72"	1829	79	35.8	6.9	CRT3072T	1736	CRPT3072T	2597	SEP3072T	3228	EPCRT3072T	3240
	84"	2134	91	41.3	7.9	CRT3084T	2057	CRPT3084T	3097	SEP3084T	3743	EPCRT3084T	3761
	96"	2438	112	50.8	9.1	CRT3096T	2198	CRPT3096T	3826	SEP3096T	4466	EPCRT3096T	4498
36" width (914mm)	36"	914	50	22.7	4.4	CRT3636T	1396	CRPT3636T	1749	SEP3636T	2225	EPCRT3636T	2365
	48"	1219	63	28.6	5.5	CRT3648T	1468	CRPT3648T	1989	SEP3648T	2622	EPCRT3648T	2791
	60"	1524	75	34.0	6.8	CRT3660T	1858	CRPT3660T	2311	SEP3660T	3023	EPCRT3660T	3225
	72"	1829	90	40.8	8.1	CRT3672T	2016	CRPT3672T	2614	SEP3672T	3336	EPCRT3672T	3558
	84"	2134	106	48.1	9.5	CRT3684T	2151	CRPT3684T	3123	n/a	n/a	n/a	n/a
	96"	2438	125	56.7	10.8	CRT3696T	2359	CRPT3696T	3923	n/a	n/a	n/a	n/a

* For CRT and SEP Series, add 10 lbs. to weight.



with perforated top and H-frame base



with solid top and C-frame base

STEP 2: Select Cleanroom Table Base Frame

The following options are included in the table price (above). Must be specified with your choice of tabletop.

- For CRT and CRPT Series tables only:**
 - Knocked down stainless steel H-frame
 - Knocked down stainless steel C-frame
- For SEP and EPCRT Series tables only:**
 - Knocked down electropolished H-frame
 - Knocked down electropolished C-frame

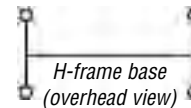

Optional Base Frames available for Cleanroom Tables

The following options are not included in the table price.

Contact Customer Service for pricing.

- For CRT and CRPT Series tables only:**
 - Solid stainless steel undershelf.
 - Perforated stainless steel undershelf.
 - Welded construction H-frame.
 - Welded construction C-frame.
- For SEP and EPCRT Series tables only:**
 - Solid undershelf electropolished.
 - Perforated undershelf electropolished.



Stainless Steel Cleaner & Polish

- Cleans and polishes in one step.
- Does not streak or leave fingerprints.
- Leaves a protective invisible coating.

weight		model #	list
oz.	kg		
15	0.4	004026	16



100 Industrial Boulevard, Clayton, DE 19938-8903 U.S.A.
 Phone: 800-637-5100 or 302-653-3000. Fax: 302-653-2065
<http://www.eaglegrp.com>

Stainless Steel Countertops

see spec sheet **EG04.12**

...with
**Stainless Steel
Hat Channels**

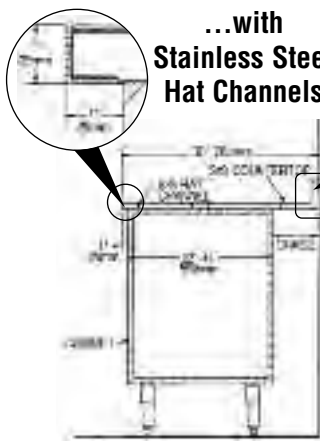

countertop with hat channels
(shown adjoined to cabinet)

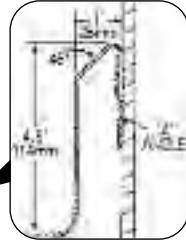

standard
backsplash
with 45° return
and z-clip

...with
**Marine-Grade
Plywood**

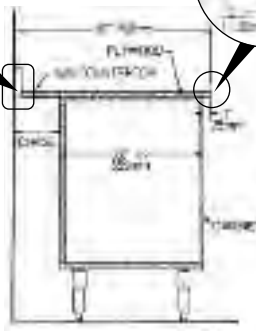

countertop with plywood
(shown adjoined to cabinet)

- Countertops for cabinet base (by others) are 16 gauge type 304 stainless steel with a #4 finish.
- All countertops are 30" (762mm) front-to-back and include 4½" x 1" (114 x 25mm) backsplash with 45° return and z-clip.
- Custom configurations also available. Consult factory.

COUNTERTOP EDGES AVAILABLE:

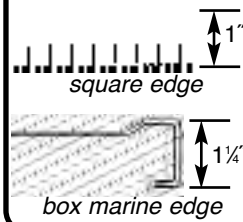

Countertops with Stainless Steel Hat Channels

length in.	mm	with square edge		with box marine edge		with square edge		with box marine edge	
		model #	list	model #	list	model #	list	model #	list
24"	610	CTC3024-SQ	1126	CTC3024-BM	1126	CTW3024-SQ	1113	CTW3024-BM	1113
30"	762	CTC3030-SQ	1149	CTC3030-BM	1149	CTW3030-SQ	1137	CTW3030-BM	1137
36"	914	CTC3036-SQ	1174	CTC3036-BM	1174	CTW3036-SQ	1161	CTW3036-BM	1161
42"	1067	CTC3042-SQ	1226	CTC3042-BM	1226	CTW3042-SQ	1213	CTW3042-BM	1213
48"	1219	CTC3048-SQ	1279	CTC3048-BM	1279	CTW3048-SQ	1266	CTW3048-BM	1266
54"	1372	CTC3054-SQ	1333	CTC3054-BM	1333	CTW3054-SQ	1319	CTW3054-BM	1319
60"	1524	CTC3060-SQ	1387	CTC3060-BM	1387	CTW3060-SQ	1372	CTW3060-BM	1372
66"	1676	CTC3066-SQ	1440	CTC3066-BM	1440	CTW3066-SQ	1425	CTW3066-BM	1425
72"	1829	CTC3072-SQ	1584	CTC3072-BM	1584	CTW3072-SQ	1478	CTW3072-BM	1478
78"	1981	CTC3078-SQ	1638	CTC3078-BM	1638	CTW3078-SQ	1530	CTW3078-BM	1530
84"	2134	CTC3084-SQ	1694	CTC3084-BM	1694	CTW3084-SQ	1584	CTW3084-BM	1584
90"	2286	CTC3090-SQ	1752	CTC3090-BM	1752	CTW3090-SQ	1636	CTW3090-BM	1636
96"	2438	CTC3096-SQ	1803	CTC3096-BM	1803	CTW3096-SQ	1690	CTW3096-BM	1690
102"	2591	CTC30102-SQ	1859	CTC30102-BM	1859	CTW30102-SQ	1833	CTW30102-BM	1833
108"	2743	CTC30108-SQ	1914	CTC30108-BM	1914	CTW30108-SQ	1977	CTW30108-BM	1977
114"	2896	CTC30114-SQ	1968	CTC30114-BM	1968	CTW30114-SQ	2030	CTW30114-BM	2030
120"	3048	CTC30120-SQ	2023	CTC30120-BM	2023	CTW30120-SQ	2084	CTW30120-BM	2084
126"	3200	CTC30126-SQ	2078	CTC30126-BM	2078	CTW30126-SQ	2136	CTW30126-BM	2136
132"	3353	CTC30132-SQ	2133	CTC30132-BM	2133	CTW30132-SQ	2188	CTW30132-BM	2188
138"	3505	CTC30138-SQ	2188	CTC30138-BM	2188	CTW30138-SQ	2241	CTW30138-BM	2241
144"	3658	CTC30144-SQ	2243	CTC30144-BM	2243	CTW30144-SQ	2294	CTW30144-BM	2294

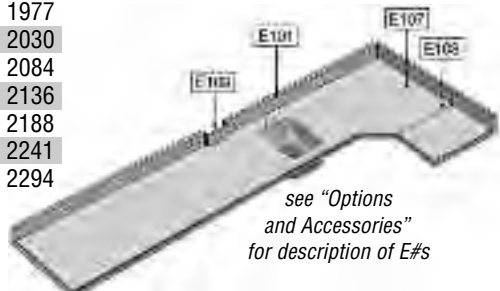

see "Options
and Accessories"
for description of E#s

Options and Accessories

model #	description	list
E101	10" (254mm) high backsplash, per linear foot	52
E107	90° corner	1230
E108	Welded field joint	240
E109	Cutout for pipes, columns	601
E37	NSF sprayed-on latex sound deadening - up to 12' (3658mm)	646
E37A	Latex sound deadening, for each additional ft.	51
Type 316 S/S	Add per countertop/item	45%

Optional Drawn Bowl Sinks with Faucet & Basket Drain

model #	description	list
E20	14" x 10" x 9½" (356 x 254 x 241mm)	972
E21	16" x 14" x 9½" (406 x 356 x 241mm)	1022
E22	20" x 16" x 8" (508 x 406 x 203mm)	1090
E23	20" x 16" x 14" (508 x 406 x 356mm)	1208
E24	20" x 18" x 14" (508 x 457 x 356mm)	1325
E24A	20" x 20" x 14" (508 x 508 x 356mm)	1334
E25	24" x 24" x 14" (610 x 610 x 356mm)	1806

Exchange Carts

EC Series112
 ECD Series112
 ECD7/ECE7 Series115
 ECDS Series113
 ECDT Series114
 ECE Series112
 ECES Series113
 ECET Series115
 ECS Series113
 ECT Series114

Carts

Basket119
 Catheter Procedure120
 Inhalation Therapy118
 Linen118
 Mail118
 Patient Article Carts/Accessories116
 Stainless Steel Case122
 Sterile Wrap121
 Suture117
 Wire Basket Utility119

Steril-Eze® Surgical Case Carts

Closed121
 Open120
 Open Wire121

More Healthcare

Cart Covers124
 Double-Sided Bin-Holder Rails126
 Foot Stools117
 Instrument Tables123
 Mobile Garment Racks123
 Plate Casters116
 Stainless Steel Overlays126
 Storage Bins125
 Surgical Scrub Sinks119



Shower Benches

Teak wood slats offer superior water resistance, and can withstand heat, moisture and mold.

FEATURES:

- Seat is made of full-length 1½"-thick x 3½"-wide (29 x 89mm) Burmese teak wood slats, featuring finished top edges, spaced for drainage.
- Wall-mounted model includes 11-gauge stainless steel drop brackets, allowing the bench to be folded down when not in use.
- Options available include lengths from 24" to 36" (610 to 914mm), towel ring, soap/shower basket.



Freight class is 70.0.

(•) MTS (made to stock) / () MTO (made to order)

Consult factory for pricing.

description	width		length		model #
	in.	mm	in.	mm	
wall mount, stainless brackets	16"	762	30"	762	SB1630W
floor mount, stainless base	16"	762	30"	762	SB1630-S
floor mount, teak wood base	16"	762	30"	762	SB1630-T



Exchange Carts

see spec sheet **EG05.09A**

Meets all requirements for supply exchange in any healthcare environment.



(Patent #5,390,803)

Patented QuadTruss® Design

makes shelves up to 25% stronger and provides a retaining ledge for increased strength and product retention.

- Chrome-plated posts are grooved and are numbered on one-inch increments, enabling shelving to be adjusted up and down.
- Open-wire construction reduces dust and contamination build-up.
- Five chrome-plated wire shelves.
- With various shelving configurations, caster styles, accessory packages, and a number of sizes, these carts are the ultimate in versatility!

FEATURES:

Freight class is 70.0.

(•) MTS (made to stock) / () MTO (made to order)



#EC2160C

EC Series

5" (127mm) resilient stem casters (two with brake). Six plastic label holders. 69" (1753mm) overall height.

shelf width x length		weight		cubic	model #	list
in.	mm	lbs.	kg	feet		
21" x 48"	533 x 1219	93	42.2	6.3	EC2148C	609
21" x 60"	533 x 1524	114	51.7	7.3	EC2160C	681
24" x 48"	610 x 1219	106	48.1	6.8	EC2448C	657
24" x 60"	610 x 1524	131	59.4	8.3	EC2460C	741



#ECD2448C

ECD Series

6" (152mm) polyurethane casters (two with brake). Chrome dolly frame with wraparound bumper. 6" (152mm) deep tote boxes with dividers. Shelf dividers. Six plastic label holders. One slide assembly. 70" (1778mm) overall height.

shelf width x length		weight		cubic	# of tote	# of shelf	model #	list
in.	mm	lbs.	kg	feet	boxes	dividers		
21" x 48"	533 x 1219	123	55.8	9.9	2	2	ECD2148C	1849
21" x 60"	533 x 1524	146	66.2	12.2	2	3	ECD2160C	1938
24" x 48"	610 x 1219	163	73.9	19.6	2	2	ECD2448C	1911
24" x 60"	610 x 1524	188	85.3	19.6	2	3	ECD2460C	2030



#ECE2448C

ECE Series

8" (203mm) polyurethane casters (two with brake). Chrome dolly frame with wraparound bumper. Side and back enclosure panels. Slide assemblies. 6" (152mm) deep tote boxes with box dividers. Shelf dividers. 12 plastic label holders. 72" (1829mm) overall height.

shelf width x length		weight		cubic	# of tote	# of shelf	# of super	model #	list
in.	mm	lbs.	kg	feet	boxes	dividers	slides		
21" x 48"	533 x 1219	160	72.6	20.3	2	4	1	ECE2148C	2241
21" x 60"	533 x 1524	185	83.9	25.2	4	6	2	ECE2160C	2638
24" x 48"	610 x 1219	178	80.7	23.5	2	4	1	ECE2448C	2305
24" x 60"	610 x 1524	203	92.1	34.8	4	6	2	ECE2460C	2739

Catalog Section 5

Exchange Carts

see spec sheet **EG05.09A** **EG05.09B**

Meets all requirements for supply exchange in any healthcare environment.



(Patent #5,390,803)

Patented QuadTruss® Design

makes shelves up to 25% stronger and provides a retaining ledge for increased strength and product retention.

FEATURES:

- Chrome-plated posts are grooved and are numbered on one-inch increments, enabling shelving to be adjusted up and down.
- Open-wire construction reduces dust and contamination build-up.
- Four chrome-plated wire shelves.
- With various shelving configurations, caster styles, accessory packages, and a number of sizes, these carts are the ultimate in versatility!

Freight class is 70.0.

(•) MTS (made to stock) / () MTO (made to order)

ECS Series

5" (127mm) resilient stem casters (two with brake). One stainless steel solid shelf. Six plastic label holders. 69" (1753mm) overall height.

shelf width x length		weight		cubic	model #	list
in.	mm	lbs.	kg	feet		
21" x 48"	533 x 1219	158	71.6	6.3	ECS2148C	779
21" x 60"	533 x 1524	183	83.0	7.3	ECS2160C	877
24" x 48"	610 x 1219	173	78.5	6.8	ECS2448C	829
24" x 60"	610 x 1524	193	87.5	8.3	ECS2460C	945



#ECS2160C

ECDS Series

6" (152mm) polyurethane casters (two with brake). One stainless steel solid shelf. Chrome dolly frame with wraparound bumper. One slide assembly. 6" (152mm) deep tote boxes with box dividers. Shelf dividers. Six plastic label holders. 70" (1778mm) overall height.

shelf width x length		weight		cubic	# of tote	# of shelf	model #	list
in.	mm	lbs.	kg	feet	boxes	dividers		
21" x 48"	533 x 1219	185	83.9	15.8	2	2	ECDS2148C	2020
21" x 60"	533 x 1524	200	90.7	19.2	2	3	ECDS2160C	2156
24" x 48"	610 x 1219	192	87.1	15.8	2	2	ECDS2448C	2061
24" x 60"	610 x 1524	218	98.9	19.2	2	3	ECDS2460C	2234



#ECDS2160C

ECES Series

8" (203mm) polyurethane casters (two with brake). One stainless steel solid shelf. Chrome dolly frame with wraparound bumper. Side and back enclosure panels. Slide assemblies. 6" (152mm) deep tote boxes with box dividers. Shelf dividers. 12 plastic label holders. 72" (1829mm) overall height.

shelf width x length		weight		cubic	# of tote	# of shelf	# of super	model #	list
in.	mm	lbs.	kg	feet	boxes	dividers	slides		
21" x 48"	533 x 1219	160	72.6	20.3	2	4	1	ECES2148C	2377
21" x 60"	533 x 1524	185	83.9	25.2	4	6	2	ECES2160C	2639
24" x 48"	610 x 1219	178	80.7	23.5	2	4	1	ECES2448C	2432
24" x 60"	610 x 1524	203	92.1	34.8	4	6	2	ECES2460C	2807



#ECES2160C



Exchange Carts

see spec sheet **EG05.09B EG05.09C**



(Patent #5,390,803)

Patented QuadTruss® Design
makes shelves up to 25% stronger and provides a retaining ledge for increased strength and product retention.

FEATURES:

- Chrome-plated posts are grooved and are numbered on one-inch increments, enabling shelving to be adjusted up and down.
- Open-wire construction reduces dust and contamination build-up.
- Four chrome-plated wire shelves.
- Choice of chrome-plated wire or stainless steel solid fifth shelf.

Meets all requirements for supply exchange in any healthcare environment.

With various shelving configurations, caster styles, accessory packages, and a number of sizes, these exchange carts are the ultimate in versatility.



#ECT2160C

ECT Series

5" (127mm) resilient stem casters (two with brake). One slide assembly. Two 6" (152mm) deep tote boxes with box dividers. Six plastic label holders. 69" (1753mm) overall height.

shelf width x length		weight		cubic feet	# of tote boxes	shelves	model #	list
in.	mm	lbs.	kg					
21" x 60"	533 x 1524	166	75.3	11.6	2	5-wire	ECT2160C	890
21" x 60"	533 x 1524	191	86.6	11.6	2	4-wire, 1-solid	ECTS2160C	1089
24" x 60"	610 x 1524	181	82.1	11.6	2	5-wire	ECT2460C	953
24" x 60"	610 x 1524	206	93.4	11.6	2	4-wire, 1-solid	ECTS2460C	1156



#ECDTS2160C

ECDT Series

6" (152mm) polyurethane casters (two with brake). Chrome dolly frame with wraparound bumper. Three slide assemblies. Six tote boxes with box dividers. Three shelf dividers. Six plastic label holders. 70" (1778mm) overall height.

shelf width x length		weight		cu ft	tote boxes			shelves	model #	list
in.	mm	lbs.	kg		3" (76mm)	6" (152mm)	9" (229mm)			
21" x 60"	533 x 1524	231	104.7	26.6	1	4	1	5-wire	ECDT2160C	2375
21" x 60"	533 x 1524	241	109.3	26.6	1	4	1	4-wire, 1-solid	ECDS2160C	2574
24" x 60"	610 x 1524	246	111.6	26.6	1	4	1	5-wire	ECDT2460C	2454
24" x 60"	610 x 1524	256	116.1	26.6	1	4	1	4-wire, 1-solid	ECDS2460C	2657

Catalog Section 5

Exchange Carts — ECET Series

see spec sheet **EG05.09C**



(Patent #5,390,803)

Patented QuadTruss® Design makes shelves up to 25% stronger and provides a retaining ledge for increased strength and product retention.

FEATURES:

- Chrome-plated posts are grooved and are numbered on one-inch increments, enabling shelving to be adjusted up and down.
- Open-wire construction reduces dust and contamination build-up.
- Four chrome-plated wire shelves.
- Choice of chrome-plated wire or stainless steel solid fifth shelf.

Meets all requirements for supply exchange in any healthcare environment.

With various shelving configurations, caster styles, accessory packages, and a number of sizes, these exchange carts are the ultimate in versatility.



ECET Series

6" (152mm) polyurethane casters (two with brake). Chrome dolly frame with wraparound bumper. Side and back enclosure panels. Three slide assemblies. Six tote boxes with box dividers. 12 plastic label holders. 72" (1829mm) overall height.

shelf width x length in. mm	weight lbs. kg	cu ft	tote boxes 3" (76mm)	tote boxes 6" (152mm)	tote boxes 9" (229mm)	shelves	model #	list
21" x 60" 533 x 1524	250 113.4	29.6	1	4	1	5-wire	ECET2160C	2647
21" x 60" 533 x 1524	260 117.9	29.6	1	4	1	4-wire, 1-solid	ECETS2160C	2843
24" x 60" 610 x 1524	262 118.8	29.6	1	4	1	5-wire	ECET2460C	2707
24" x 60" 610 x 1524	272 123.4	29.6	1	4	1	4-wire, 1-solid	ECETS2460C	2909

ECD7/ECE7 Series

8" (203mm) polyurethane casters (two with brake). Choice of three shelf dividers or side and back enclosure panels. Three slide assemblies. Seven tote boxes with snap on card holders and box dividers. 12 plastic label holders. Chrome dolly frame with wraparound bumper. 72" (1829mm) overall height.



shelf width x length in. mm	weight lbs. kg	cu ft	tote boxes 3" (76mm)	tote boxes 6" (152mm)	shelves	other	model #	list
24" x 60" 610 x 1524	226 102.5	19.6	2	5	5-wire	shelf dividers	ECD72460C	2613
24" x 60" 610 x 1524	236 107.0	19.6	2	5	4-wire, 1-solid	shelf dividers	ECD7S2460C	2818
24" x 60" 610 x 1524	250 113.4	28.8	2	5	5-wire	enclosure panels	ECE72460C	2871
24" x 60" 610 x 1524	260 117.9	28.8	2	5	4-wire, 1-solid	enclosure panels	ECE7S2460C	3075



Patient Article Carts

see spec sheet **EG05.10**

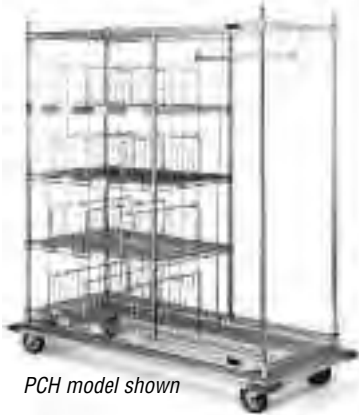

PCH model shown

- 48" (1219mm) long models come with eight dividers and 12 bin markers.
- 60" (1524mm) long models come with 12 dividers and 16 bin markers.
- 24" (610mm) long coat hanger tube and 12 rods.

FEATURES:

Freight class is 92.5.

(•) MTS (made to stock) / () MTO (made to order)

	length		weight		cu ft	intermediate shelf length		style	model #	list
	in.	mm	lbs.	kg		in.	mm			
24" width (610mm)	48"	1219	103	46.7	13.6	24"	610	standard	PC2448-C	1064
	60"	1524	126	57.2	18.2	36"	914	standard	PC2460-C	1238
	48"	1219	166	75.8	24.8	24"	610	heavy duty	PCH2448-C	1267
	60"	1524	188	85.3	25.4	36"	914	heavy duty	PCH2460-C	1391

Patient Article Cart Covers - Freight class 70.0

shelf width x length		post height		weight		cu ft	uncoated w/zipper		coated w/zipper	
in.	mm	in.	mm	lbs.	kg		model #	list	model #	list
24" x 48"	610 x 1219	63"	1600	4	1.8	0.5	CZ-63-2448	189	CZC-63-2448	282
24" x 60"	610 x 1524	63"	1600	5	2.3	0.6	CZ-63-2460	223	CZC-63-2460	307

Accessories for Patient Article Carts - Freight class 70.0

description	weight		cubic feet	model #	list
	lbs.	kg			
8" (203mm) divider	1.8	0.8	0.5	SD24-C	30
rod (includes 4 fastening tabs)	0.5	0.2	0.4	R63-C	11
plastic label holder	—	—	—	A204331	4
24" x 24" (610 x 610mm) chrome shelf	9.5	4.3	0.8	2424C	72
24" x 36" (610 x 914mm) chrome shelf	13.6	6.2	0.8	2436C	77

Polyurethane Plate Casters

see spec sheet **EG01.05B**

Freight class is 65.0.

(•) MTS (made to stock) / () MTO (made to order)

type	capacity		wheel diameter		wheel face		weight		cu ft	EAGLEbrite® zinc	
	lbs.	kg	in.	mm	in.	mm	lbs.	kg		model #	list
swivel	600	272.1	6"	152	2"	51	9.0	4.1	0.5	CPS6P-600 •	87
brake	600	272.1	6"	152	2"	51	9.0	4.1	0.5	CPB6P-600 •	99
rigid	600	272.1	6"	152	2"	51	9.0	4.1	0.5	CPR6P-600	99
swivel	700	317.5	8"	203	2"	51	10.5	4.8	1.0	CPS8P-700	99
brake	700	317.5	8"	203	2"	51	10.5	4.8	1.0	CPB8P-700	110
rigid	700	317.5	8"	203	2"	51	10.5	4.8	1.0	CPR8P-700	110



with brake

Catalog Section 5

Suture Carts

see spec sheet **EG05.08**



- 18" (457mm) width.
- Four or five specially designed, adjustable slanted shelves for quick and easy access to sutures.
- Shelves adjust up to 30° slant.
- Open-wire construction.
- All models include three dividers per shelf.
- 5" (127mm) casters, two of which have brakes, are chrome-plated with polyurethane tread.
- All components are chrome-plated.

FEATURES:

Freight class is 70.0.

(•) MTS (made to stock) / () MTO (made to order)

4-Shelf Units

	length		post height		weight		cu		
	in.	mm	in.	mm	lbs.	kg	ft	model #	list
18" width (457mm)	36"	914	54"	1372	62	28.1	2.5	SCH1836C-4	885
	48"	1219	54"	1372	66	29.9	3.5	SCH1848C-4	888

Options for Suture Carts - Freight class is 30.0.
Customize your unit to suit any application.

length	weight	cubic					
in.	mm	lbs.	kg	feet	description	model #	list
36"	914	3	1.4	1.0	3 shelf add-on	SCH1836C	90
48"	1219	5	2.3	1.8	4 shelf add-on	SCH1848C	102
18"	457	1	0.5	0.3	divider	M18C •	36

5-Shelf Units

	length		post height		weight		cu		
	in.	mm	in.	mm	lbs.	kg	ft	model #	list
18" width (457mm)	36"	914	63"	1600	73	33.1	3.5	SCH1836C-5	1059
	48"	1219	63"	1600	81	36.7	5.3	SCH1848C-5	1116

Suture Cart Covers

Models below are with a zipper. For cart covers with velcro, see page 30.

shelf width x length	post height	weight	cu	uncoated		coated				
				in.	mm	in.	mm	lbs.	kg	ft
18" x 36"	457 x 914	54"	1372	3	1.4	0.8	CZ-54-1836	129	CZC-54-1836	223
18" x 48"	457 x 1219	54"	1372	4	1.8	0.9	CZ-54-1848	144	CZC-54-1848	231
18" x 36"	457 x 914	63"	1600	3	1.4	0.8	CZ-63-1836	137	CZC-63-1836	227
18" x 48"	457 x 1219	63"	1600	4	1.8	0.9	CZ-63-1848	145	CZC-63-1848	238

Foot Stools

see spec sheet **EG05.04**



**300-lb.
Weight capacity!**

FEATURES:

- Single-step foot stool.
- All-welded construction.
- Flared legs with rubber tips.
- Non-slip rubber mat.
- Chrome or stainless steel finish.

Freight class is 85.0.

(•) MTS (made to stock) / () MTO (made to order)

width x length x height	weight	cubic					
in.	mm	lbs.	kg	feet	finish	model #	list
11 1/2" x 14 1/4" x 9"	289 x 362 x 229	8	3.6	1.0	stainless steel	SFS16S	264
11 1/2" x 14 1/4" x 9"	289 x 362 x 229	10	4.5	1.0	chrome	SFS14C	106



100 Industrial Boulevard, Clayton, DE 19938-8903 U.S.A.
Phone: 800-637-5100 or 302-653-3000. Fax: 302-653-2065
<http://www.eaglegrp.com>

Linen Carts

see spec sheet **EG05.02**



STANDARD FEATURES:

- Four chrome-plated wire shelves.
- One solid stainless steel shelf.
- Chrome-plated 63" (1600mm) posts.
- 5" (127mm) resilient stem casters (two with brake).
- Donut bumpers.

HEAVY DUTY FEATURES:

- Four chrome-plated wire shelves.
- One solid stainless steel shelf.
- Chrome-plated dolly frame with wraparound bumper.
- 6" (152mm) polyurethane casters (two with brake).
- Side and back enclosure panels.
- Chrome plated posts, aluminum split sleeves.
- Locking hardware.

Freight class is 70.0.

(•) MTS (made to stock) / () MTO (made to order)

Heavy Duty Linen Cart

*width x length in. mm	weight lbs. kg	cubic feet	model #	list
24" x 60" 610 x 1524	240 108.9	29	LCD2460C	2362

* Shelf width x length. Dolly is 29 1/4" width x 64 1/4" length (756 x 1648mm).

Standard Duty Linen Cart

*width x length in. mm	weight lbs. kg	cubic feet	model #	list
24" x 60" 610 x 1524	190 86.2	8.3	LC2460C	946

* Shelf width x length. Dolly is 29 1/4" width x 64 1/4" length (756 x 1648mm).

Mail Cart

see spec sheet **EG05.04**



**Designed to handle
internal/external mail
distribution.**

FEATURES:

- 5" (127mm) swivel casters on front.
- 10" (254mm) rigid roller-bearing casters on rear.
- Nickel-chrome finished.
- 1" (25mm) tubular frame.
- 11" (279mm) height top basket for files.
- 7" (178mm) height bottom basket for boxes.

Freight class is 70.0.

(•) MTS (made to stock) / () MTO (made to order)

overall width x length x height in. mm	weight lbs. kg	cubic feet	model #	list
28" x 47" x 38 1/2" 711 x 1194 x 978	60 27.2	6.0	MC-1	951

Inhalation Therapy Cart

see spec sheet **EG05.12**



(Patent #5,390,803)

Patented QuadTruss® Design

makes shelves up to 25% stronger and provides a retaining ledge for increased strength and product retention.

FEATURES:

- Bottom shelf, handles and trussed frames are chrome plated.
- Cylinder racks are 5/16" (8mm) in diameter with 4 1/2" x 4 1/2" (114 x 114mm) openings for gas cylinders.
- Racks accommodate twelve D or E cylinders and are plastisol coated.
- Cart design conforms to NFPA-99.
- Aluminum split sleeves and four UL recognized 5" (127mm) conductive casters.

Freight class is 70.0.

(•) MTS (made to stock) / () MTO (made to order)

width x length x height in. mm	weight lbs. kg	cubic feet	model #	list
20" x 27" x 31 1/2" 508 x 686 x 1016	41 19	3.5	GCC1•	612

Catalog Section 5



Surgical Scrub Sinks

see product announcement **EG8178**



#SHS2424-1D



ADA-compliant

#SHS2424-1W-ADA

- 16 gauge type 304 stainless steel.
- Removable front access panel.
- 4" (102mm)-high backsplash.
- Square edge on front and sides.
- Sink bowl with deep slope basin.
- Temperature control mixing valve.
- Z-clips for wall mounting.
- Includes stainless steel flat strainer drain, tail piece, and p-trap.
- Includes flexible stainless steel supply hoses.

FEATURES:

Freight class is 85.0.

(•) MTS (made to stock) / () MTO (made to order)

description	model #	list
wall-mount unit with deck mount faucet	SHS2424-1D	3845
ADA wall-mount unit with splash-mount electronic faucet for hands-free operation	SHS2424-1W-ADA	3382

Basket Carts

see spec sheet **EG05.04**



Collapsible X-frame is ideal for mail, pharmacy, lab, medical records and other small tasks.

FEATURES:

- Maneuvers easily and quietly on 3" (76mm) swivel casters with rubber tread.
- Tubular, chrome plated frame.
- Poly-coated wire baskets and basket support.

Freight class is 70.0.

(•) MTS (made to stock) / () MTO (made to order)

width x length x height in. mm	weight lbs. kg	cubic feet	description	model #	list
18" x 26" x 37" 457 x 661 x 940	26 11.8	12.0	cart with (2) 6" baskets	BC18	580
18" x 26" x 37" 457 x 661 x 940	27 12.2	12.0	cart with (1) 6" and (1) 12" basket	BC18-1	603

Baskets for Basket Carts - Poly-coated white wire baskets.

width x length x height in. mm	weight lbs. kg	cubic feet	model #	list
14¼" x 24½" x 6" 362 x 620 x 152	5.5 2.5	1.8	A203895	66
14¼" x 24½" x 12" 362 x 620 x 305	6.5 3.0	2.8	A203929	89

Wire Basket Utility Carts

product announcement **EG01.35**



- Includes swivel stem casters with bumpers and two push handles.
- 36½" (927mm) overall cart height.

FEATURES:

Freight class is 70.0.

(•) MTS (made to stock) / () MTO (made to order)

description	weight lbs. kg	model #	list
1 chrome basket shelf, 1 chrome standard shelf	31 14.1	WBC1836C-1B1W	325
2 chrome basket shelves	32 14.5	WBC1836C-2B	286



Catheter Procedure Carts

see spec sheet **EG05.03**

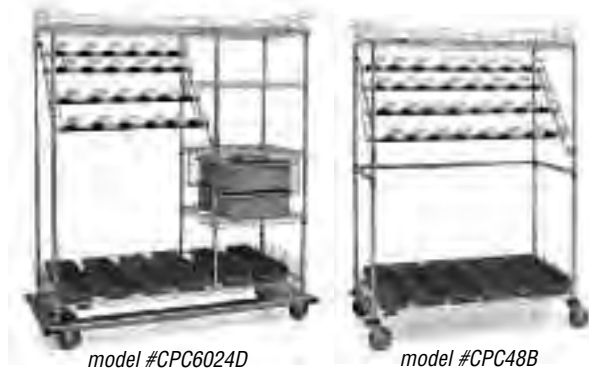

Capable of holding a variety of sizes and styles of catheter packages.

FEATURES:

- All components are adjustable.
- Support bars are readily removable.
- Hooks, boxes, slides, bins, and wire ledges included with appropriate models.
- 5" (127mm) swivel casters with polyurethane tread, two with brakes.
- 73" (1854mm) height.

Freight class is 70.0.

(•) MTS (made to stock) / () MTO (made to order)



(Patent #5,390,803)

Patented QuadTruss® Design

makes shelves up to 25% stronger and provides a retaining ledge for increased strength and product retention.

Combination-Style Carts with 36" (914mm) Side Shelves and four 24" (610mm) Bars

	length		weight		cubic feet	# of hooks included	maximum # of hooks per bar	max. # of boxes	tote slides	super bins	ledges	model #	list
	in.	mm	lbs.	kg									
24" width (610mm)	60"	1524	146	66.2	15.0	16	5	N/A	N/A	N/A	N/A	CPC6036	1653
	60"	1524	174	78.9	17.8	16	5	2	1	6	6	CPC6036D	2162

Combination-Style Carts with 24" (610mm) Side Shelves and four 36" (914mm) Bars

	length		weight		cubic feet	# of hooks included	maximum # of hooks per bar	max. # of boxes	tote slides	super bins	ledges	model #	list
	in.	mm	lbs.	kg									
24" width (610mm)	60"	1524	149	67.6	9.8	24	9	N/A	N/A	N/A	N/A	CPC6024	1772
	60"	1524	162	73.5	18.6	24	9	2	1	6	6	CPC6024D	2251

Bulk Storage Carts with four 48" (1219mm) Bars

	length		weight		cubic feet	# of hooks included	maximum # of hooks per bar	max. # of boxes	tote slides	super bins	ledges	model #	list
24" (610mm) width	in.	mm	lbs.	kg									
48"	1219	82	37.2	8.7	32	13	N/A	N/A	6	6	CPC48B	1745	

Bulk Storage Carts with four 60" (1524mm) Bars

	length		weight		cubic feet	# of hooks included	maximum # of hooks per bar	max. # of boxes	tote slides	super bins	ledges	model #	list
24" (610mm) width	in.	mm	lbs.	kg									
60"	1524	101	45.8	7.4	40	17	N/A	N/A	6	6	CPC60B	1929	

Steril-Eze® Open Surgical Case Carts

see spec sheet **EG05.15**



FEATURES:

- Adjustable shelves.
- All type 304 stainless steel.
- Hemmed safety edges.

Freight class is 92.5.

(•) MTS (made to stock) / () MTO (made to order)

width x length x height in.	width x length x height mm	weight lbs.	weight kg	cu ft	description	model #	list
24" x 36" x 36"	610 x 914 x 914	89	40.4	3.8	open surgical case cart	OSCC2436	1643
24" x 48" x 36"	610 x 1219 x 914	118	53.5	3.8	open surgical case cart	OSCC2448	1748
12" x 20" x 4"	305 x 508 x 102	6	2.7	4.9	optional drawer	A204178	212



Catalog Section 5

Steril-Eze® Open Wire Surgical Case Carts

see spec sheet **EG05.17**



Patented QuadTruss® Design
(Patent #5,390,803)

Patented QuadTruss® Design
makes shelves up to 25% stronger and provides a retaining ledge for increased strength and product retention.

- Wire shelves.
- Tote boxes & slides.
- Enclosure panels.
- Stainless steel finish.

FEATURES:

Freight class is 70.0.

(•) MTS (made to stock) / () MTO (made to order)

width x length x height		weight		description	model #	list
in.	mm	lbs.	kg			
24" x 24" x 54"	610 x 610 x 1372	88	39.9	4 wire shelves, 1 tote box	OCC2424S	2363
24" x 48" x 54"	610 x 1219 x 1372	130	59.0	4 wire shelves, 2 tote boxes	OCC2448S	2848

Sterile Wrap Carts

see spec sheet **EG05.05**



- Chrome bottom shelf.
- Channel frame - chrome.
- Post material are chrome.

FEATURES:

Freight class is 70.0.

(•) MTS (made to stock) / () MTO (made to order)

width x length x height		weight		cubic feet	model #	list
in.	mm	lbs.	kg			
24" x 48" x 68"	610 x 1219 x 1727	83	37.6	7.6	SWC2448C	1087
24" x 60" x 68"	610 x 1524 x 1727	94	42.6	8.3	SWC2460C	1169

Sterile Wrap Cart Covers

shelf width x length		post height		weight		cu ft	uncoated		coated	
in.	mm	in.	mm	lbs.	kg		model #	list	model #	list
24" x 48"	610 x 1219	63"	1600	4	1.8	0.4	CZ-63-2448	189	CZC-63-2448	282
24" x 48"	610 x 1219	63"	1600	4	1.8	0.4	CV-63-2448	200	CVC-63-2448	295
24" x 60"	610 x 1524	63"	1600	5	2.3	0.4	CZ-63-2460	223	CZC-63-2460	307
24" x 60"	610 x 1524	63"	1600	5	2.3	0.4	CV-63-2460	231	CVC-63-2460	319

Additional Support Bars

Freight class is 50.0.

length		weight		cu ft	model #	list
in.	mm	lbs.	kg			
48"	1219	2.7	1.2	0.1	SB48	59
60"	1524	3.4	1.5	0.2	SB60	68

NOTE: In model numbers, "Z" stands for zipper and "V" for velcro enclosures

Steril-Eze® Closed Surgical Case Carts

see spec sheets **EG05.13** **EG05.14**



horizontal...



...vertical

Call factory for pricing.

- Accessibility of an open cart.
- Pull-out center shelf for easier access to instruments.

FEATURES:

Freight class is 92.5.

(•) MTS (made to stock) / () MTO (made to order)

width x length x height		weight		cubic feet	description	model #
in.	mm	lbs.	kg			
24" x 36" x 36"	610 x 914 x 914	181	82.1	18.0	horizontal cart	CSCC2436
24" x 48" x 36"	610 x 1219 x 914	272	123.4	24.0	horizontal cart	CSCC2448
23" x 27" x 54"	686 x 584 x 1372	190	86.2	26.6	vertical cart	CSCC2327



100 Industrial Boulevard, Clayton, DE 19938-8903 U.S.A.
Phone: 800-637-5100 or 302-653-3000. Fax: 302-653-2065
<http://www.eaglegrp.com>

Stainless Steel Closed Case Carts

see spec sheet **EG05.18**



single-wide case carts

double-wide case cart

FEATURES:

- Sloped bottom panel for drainage, bumpers, 3" x 5" (76 x 127mm) document holder, and push handle.
- Type 304 stainless steel construction.
- Slots at 3" (76mm) intervals accept shelves and drawers.
- Carts offered in single or double width.

Note: Units with 8½" x 11" (216 x 279mm) card holders available. To order, replace suffix "-DS" with "-DL" (example: CSCC2633-DL).

Freight class is 92.5.

(•) MTS (made to stock) / () MTO (made to order)

Contact Factory For Pricing.

STEP 1: Select cart body.

Single-Width Carts

overall width x length x height* in. mm	inner width x length in. mm	interior slots	WITH CARD HOLDER** model #	WITH CARD HOLDER** & SECURITY TAB model #
27½" x 32½" x 39" 702 x 829 x 991	24¾" x 32½" 614 x 827	7	CSCC2633-DS	CSCC2633-DSST
27½" x 32½" x 54" 702 x 829 x 1372	24¾" x 32½" 614 x 827	12	CSCC2648-DS	CSCC2648-DSST

Double-Width Carts

overall width x length x height* in. mm	inner width x length in. mm	with center post	WITH CARD HOLDER** model #	WITH CARD HOLDER** & SECURITY TAB model #
27½" x 55" x 39" 702 x 1397 x 991	24¾" x 48¼" 614 x 1226	no	CSCC4933-DS	CSCC4933-DSST
27½" x 55" x 39" 702 x 1397 x 991	24¾" x 48¼" 614 x 1226	yes	CSCC4933M-DS	CSCC4933M-DSST

* Heights include 5" (127mm) -diameter casters. See Step 2 below for casters.

** Standard 3" x 5" (76 x 127mm) card holder. To order unit with 8½" x 11" (216 x 279mm) card holder, replace "-DS" in model number with "-DL". Ex: CSCC2633-DL. All card holders are welded on.

STEP 2: Select set of four casters.

Add suffix at end of cart model number. Example: CSCC2633-DS-1.

description	CHROME add suffix	STAINLESS add suffix
5"-diameter—(4) swivel	-1	-6
6"-diameter—(4) swivel	-2	-7A
5"-diameter—(3) swivel, (1) swivel lock	-3	-7
6"-diameter—(2) swivel, (2) swivel brake	-4	-8
6"-diameter—(1) swivel, (2) swivel brake, (1) swivel lock	-5	-9

STEP 3: Select internal components.

Stainless Steel Shelves

description	FOR SINGLE-WIDE CARTS model #	FOR DOUBLE-WIDE CARTS model #
perforated shelf	502954	502955
wire shelf	503077	503078

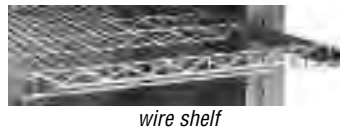

wire shelf

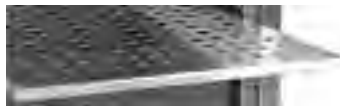

perforated shelf

Shelf/Drawer Bearer Package

Stainless steel brackets designed to mount shelves and drawers inside cart. Not included with shelf, must be ordered with shelf or drawer to mount. Drawers supplied by others.

description	model #
pair of brackets	502951



Stainless Steel Cleaner & Polish



- Cleans and polishes in one step.
- Does not streak or leave fingerprints.
- Leaves a protective invisible coating.

weight oz. kg	model #	list
15 0.4	004026	16



Catalog Section 5

Mobile Garment Racks

see spec sheet **EG01.28**



model #
UR1836C

Convenient storage or transportation of lab coats, uniforms, or garments.

- Top shelf for hats or flat items.
- Bottom shelf (*shelves*) for drying shoes or boots.
- 74" (1880mm) height on stationary units,
- 80" (2032mm) height on mobile units.
- 5" (127mm) polyurethane tread casters.

FEATURES:

Freight class is 70.0.

(•) MTS (*made to stock*) / () MTO (*made to order*)

width x length x height in. mm	weight lbs. kg	cubic feet	description	model #	list
18" x 36" x 80" 457 x 914 x 2032	48 21.8	2.2	unit as shown	UR1836C	468
18" x 36" x 80" 457 x 914 x 2032	64 29.0	2.2	same, plus 1 solid shelf	URS1836C	615
18" x 48" x 80" 457 x 1219 x 2032	52 23.6	2.6	unit as shown	UR1848C	502
18" x 48" x 80" 457 x 1219 x 2032	72 32.7	2.6	same, plus 1 solid shelf	URS1848C	674
18" x 60" x 80" 457 x 1524 x 2032	58 26.3	3.2	unit as shown	UR1860C	542
18" x 60" x 80" 457 x 1524 x 2032	82 37.2	3.2	same, plus 1 solid shelf	URS1860C	772

Optional Wire Shelves

width x length in. mm	weight lbs. kg	cubic feet	model #	list
18" x 36" 457 x 914	9 4.1	0.7	1836C	62
18" x 48" 457 x 1219	12 5.5	0.9	1848C	74
18" x 60" 457 x 1524	17 7.7	1.2	1860C	87

Optional Open Loop Hangers

weight lbs. kg	cubic feet	chrome model #	list	stainless steel model #	list	electropolished model #	list
0.4 0.2	0.3	OLH-C •	12	OLH-S •	18	OLH-EP	20

Optional Closed Loop Hangers

weight lbs. kg	cubic feet	chrome model #	list	stainless steel model #	list	electropolished model #	list
0.4 0.2	0.3	CLH-C	12	CLH-S	18	CLH-EP	20

Replacement Coat Hanger Tubes

Freight class is 50.0.

length in. mm	weight lbs. kg	cubic feet	model #	list
24" 610	1.5 0.7	0.1	CH24	35
30" 762	1.7 0.8	0.1	CH30	37
36" 914	2.2 1.0	0.1	CH36	39
42" 1067	2.7 1.2	0.1	CH42	40
48" 1219	3.2 1.5	0.1	CH48	41
54" 1372	3.5 1.6	0.2	CH54	44
60" 1524	3.8 1.7	0.2	CH60	47

Instrument Tables

see spec sheet **EG05.01**



with undershelf

All Welded Assembly.

- Top surface, undershelf, and legs are heavy gauge type 304 stainless steel.
- Edges of the top are safety hemmed.
- 1" (25mm) diameter tubular legs with 4" (102mm) diameter swivel casters.
- 34" (864mm) overall height.

FEATURES:

Freight class is 70.0.

(•) MTS (*made to stock*) / () MTO (*made to order*)

width x length in. mm	weight lbs. kg	cu ft	with H-frame model #	list	with undershelf model #	list
16" x 20" 406 x 508	25 11.3	6.3	ITT1620	1045	ITU1620	986
16" x 30" 406 x 762	30 13.6	9.5	ITT1630	1071	ITU1630	1027
18" x 34" 457 x 864	33 15.0	12.1	ITT1834	1079	ITU1834	1044
20" x 36" 508 x 914	36 16.3	14.2	ITT2036	1101	ITU2036	1089
20" x 48" 508 x 1219	47 21.3	18.9	ITT2048	1137	ITU2048	1152
24" x 36" 610 x 914	39 17.7	17.0	ITT2436	1121	ITU2436	1126
24" x 46" 610 x 1168	50 22.7	21.8	ITT2446	1154	ITU2446	1190
24" x 58" 610 x 1473	59 26.8	37.4	ITT2458	1196	ITU2458	1263



Cart Covers

see spec sheet **EG01.09**



cart cover enveloping entire cart/truck



cart cover with panel folded back for easy shelf accessibility

- Top corners are reinforced.
- Choice of white coated, white uncoated, or transparent vinyl.
- Coated cart covers available in powder blue (suffix "PB") and light green (suffix "LG"). Example: CVC-63-1836PB
- Covers are nonreturnable.

FEATURES:

Note: Black electrostatic discharge (ESD) cart covers also available—see page 136.

NEW Double-Flap option available. \$21 upcharge.
To order, add suffix "-DF" to model number
(ex: CV-63-2436-DF).

Freight class is 70.0.

(•) MTS (made to stock) / () MTO (made to order)

**Light weight,
easy to handle!**

**Meets J.C.A.H. standards
for transporting clean linen!**

				White Coated Nylon*				White Uncoated Polyester				Transparent**					
	length		post height	weight		cu	zipper		velcro		zipper		zipper				
	in.	mm	in.	mm	lbs.		kg	ft	model #	list	model #	list	model #	list	model #	list	
18" width (457mm)	36"	914	54"	1372	3	1.4	1	CZC-54-1836	223	CVC-54-1836	231	CZ-54-1836	129	CV-54-1836	142	CZ-54-1836-T	287
			63"	1600				CZC-63-1836	227	CVC-63-1836	239	CZ-63-1836	137	CV-63-1836	146	CZ-63-1836-T	287
	48"	1219	54"	1372	4	1.8	1	CZC-54-1848	231	CVC-54-1848	243	CZ-54-1848	144	CV-54-1848	153	CZ-54-1848-T	292
			63"	1600				CZC-63-1848	238	CVC-63-1848	246	CZ-63-1848	145	CV-63-1848	156	CZ-63-1848-T	292
21" width (533mm)	60"	1524	54"	1372	5	2.3	1	CZC-54-1860	251	CVC-54-1860	259	CZ-54-1860	149	CV-54-1860	158	CZ-54-1860-T	302
			63"	1600				CZC-63-1860	255	CVC-63-1860	264	CZ-63-1860	151	CV-63-1860	160	CZ-63-1860-T	322
	48"	1219	54"	1372				CZC-54-2148	257	CVC-54-2148	268	CZ-54-2148	167	CV-54-2148	177	CZ-54-2148-T	319
			63"	1600	4	1.8	1	CZC-63-2148	268	CVC-63-2148	280	CZ-63-2148	184	CV-63-2148	193	CZ-63-2148-T	339
		74"	1880				CZC-74-2148	272	CVC-74-2148	282	CZ-74-2148	210	CV-74-2148	221	CZ-74-2148-T	357	
60"	1524	54"	1372				CZC-54-2160	295	CVC-54-2160	303	CZ-54-2160	174	CV-54-2160	187	CZ-54-2160-T	354	
		63"	1600	5	2.3	1	CZC-63-2160	300	CVC-63-2160	310	CZ-63-2160	193	CV-63-2160	202	CZ-63-2160-T	376	
		74"	1880				CZC-74-2160	304	CVC-74-2160	315	CZ-74-2160	225	CV-74-2160	231	CZ-74-2160-T	396	
24" width (610mm)	24"	610	54"	1372	3	1.4	1	CZC-54-2424	272	CVC-54-2424	273	CZ-54-2424	305	CV-54-2424	202	CZ-54-2424-T	307
			63"	1600				CZC-63-2424	276	CVC-63-2424	284	CZ-63-2424	316	CV-63-2424	242	CZ-63-2424-T	307
	36"	914	54"	1372				CZC-54-2436	227	CVC-54-2436	239	CZ-54-2436	148	CV-54-2436	157	CZ-54-2436-T	312
			63"	1600	3	1.4	1	CZC-63-2436	239	CVC-63-2436	251	CZ-63-2436	153	CV-63-2436	164	CZ-63-2436-T	312
			74"	1880				CZC-74-2436	245	CVC-74-2436	256	CZ-74-2436	187	CV-74-2436	192	CZ-74-2436-T	380
	48"	1219	54"	1372				CZC-54-2448	270	CVC-54-2448	281	CZ-54-2448	160	CV-54-2448	172	CZ-54-2448-T	329
			63"	1600	4	1.8	1	CZC-63-2448	282	CVC-63-2448	295	CZ-63-2448	189	CV-63-2448	200	CZ-63-2448-T	329
			74"	1880				CZC-74-2448	288	CVC-74-2448	298	CZ-74-2448	204	CV-74-2448	218	CZ-74-2448-T	339
	60"	1524	54"	1372				CZC-54-2460	302	CVC-54-2460	312	CZ-54-2460	215	CV-54-2460	225	CZ-54-2460-T	360
			63"	1600	5	2.3	1	CZC-63-2460	307	CVC-63-2460	319	CZ-63-2460	223	CV-63-2460	231	CZ-63-2460-T	360
			74"	1880				CZC-74-2460	312	CVC-74-2460	322	CZ-74-2460	253	CV-74-2460	263	CZ-74-2460-T	439
	72"	1829	54"	1372				CZC-54-2472	307	CVC-54-2472	319	CZ-54-2472	221	CV-54-2472	229	CZ-54-2472-T	403
		63"	1600	6	2.7	1	CZC-63-2472	313	CVC-63-2472	326	CZ-63-2472	238	CV-63-2472	246	CZ-63-2472-T	411	
		74"	1880				CZC-74-2472	321	CVC-74-2472	329	CZ-74-2472	259	CV-74-2472	270	CZ-74-2472-T	452	
	86"	2184				CZC-86-2472	377	CVC-86-2472	372	CZ-86-2472	310	CV-86-2472	319	CZ-86-2472-T	475		

* White-coated nylon covers are fire-retardant; ** Entire cover is transparent except for the seams. Transparent covers with velcro available at same price.

Helps keep equipment clean on shelf carts and shelf trucks.

Catalog Section 5

Storage Bins

see spec sheet **EG05.07**

Freight class is 70.0.

(•) MTS (made to stock) / () MTO (made to order)

The perfect solution to organizing or storing small, easy-to-lose items. Lightweight but durable.

Exchange Bins

Available in three sizes.

color	length x width x height		weight		cubic	carton	model #	list
	in.	mm	lbs.	kg	feet	quantity		each
blue	18" x 4 1/4" x 4"	457 x 105 x 102	8	3.6	0.2	12	A203885	6
blue	18" x 6 1/4" x 4"	457 x 168 x 102	12	5.5	0.3	12	A203887	8
blue	23 1/2" x 6 1/4" x 4"	600 x 168 x 102	8	3.6	0.4	6	A203889	13



Dividers for Exchange Bins

Note: Shipped in cartons only.

color	length x height		weight		cubic	carton	model #	list per
	in.	mm	lbs.	kg	feet	quantity		ctn.
black	4 1/4" x 4"	105 x 102	1	0.5	—	24	A204235	19
black	6 1/4" x 4"	168 x 102	2	0.9	—	24	A204236	24

Supply Bins

Available in four sizes.

color	length x width x height		weight		cubic	carton	model #	list
	in.	mm	lbs.	kg	feet	quantity		each
blue	10 1/2" x 5 1/2" x 5"	276 x 140 x 127	12	5.5	0.2	12	A203877	13
blue	10 1/2" x 11" x 5"	276 x 280 x 127	9	4.1	0.4	6	A203879	19
blue	14 1/4" x 8 1/4" x 7"	374 x 210 x 178	22	10.0	0.6	12	A203881	21
blue	14 1/4" x 16 1/2" x 7"	374 x 419 x 178	18	8.1	1.0	6	A203883	28



Dividers for Supply Bins

Note: Shipped in cartons only.

color	length x height		weight		cubic	carton	model #	list per
	in.	mm	lbs.	kg	feet	quantity		ctn.
black	10 1/2" x 5"	276 x 127	2	0.9	—	6	A204237	21
black	14 1/4" x 7"	374 x 178	3	1.4	—	6	A204238	25

Stock Bin

These stackable bins are built for heavy-duty use.

color	length x width x height		weight		cubic	carton	model #	list
	in.	mm	lbs.	kg	feet	quantity		each
beige	17 1/2" x 8 1/2" x 4"	454 x 216 x 102	21	9.5	0.8	6	A203891	29



Divider for Stock Bin

Note: Shipped in cartons only.

color	length x height		weight		cubic	carton	model #	list
	in.	mm	lbs.	kg	feet	quantity		each
black	8 1/2" x 4"	216 x 102	1	0.5	—	6	A204239	15

Bulk Supply Tub

Durable. Perfect for transporting or storing larger items.

color	length x width x height		weight		cubic	carton	model #	list
	in.	mm	lbs.	kg	feet	quantity		each
gray	24 1/2" x 19" x 9 1/2"	622 x 483 x 241	20	9.1	2.8	6	A203893	57



Stainless Steel Overlays

see product announcement **EG8177**

width x length *		model#	list
in.	mm		
24" x 24"	610 x 610	353761	385
24" x 30"	610 x 762	353762	405
24" x 36"	610 x 914	353763	431
24" x 48"	610 x 1219	353764	480
24" x 51"	610 x 1295	353765	506
24" x 60"	610 x 1524	353766	593
24" x 72"	610 x 1829	353767	653
24" x 96"	610 x 2438	353768	804
30" x 30"	762 x 762	353770	428
30" x 36"	762 x 914	353771	463
30" x 48"	762 x 1219	353772	522
30" x 51"	762 x 1295	353773	544
30" x 60"	762 x 1524	353774	648
30" x 72"	762 x 1829	353775	705
30" x 96"	762 x 2438	353776	873
36" x 72"	914 x 1829	362659	1028



overlay fitted onto tabletop

FEATURES:

- For process tables.
- Economical upgrade to existing work surface, with no fasteners required.
- 20 gauge type 304 stainless steel construction with satin finish.
- Liquid adhesive could be used per application.
- Durable finish allowing easy cleanup.
- Hemmed safety edge on all four sides.
- Corners are welded and polished.
- Custom sizes and material gauges are available.

Freight class is 88.0.

(•) MTS (made to stock) / () MTO (made to order)



* inside measurements

Double-Sided Bin-Holder Rails

see product announcement **EG8152M**

NOW PATENTED!
(patent #8,141,724 B2)



shown assembled as a cart
(*bins sold separately)



Assembly — numerically calibrated grooved posts, tapered plastic split sleeves and rail collars combine to make shelving assembly a simple two-step exercise:

- 1) snap the split sleeves onto a post over the number of your choice
- 2) slide a rail collar over the split sleeves. A positive lock between rail bin and post is created without the use of any tools.

BIN-HOLDER RAILS:

- Bin-holder rails are sold as an accessory or purchased with posts as a kit.
- EAGLEbrite® zinc or chrome plated.
- Bins attach to both sides of rail - no tools required.

BIN-HOLDER RAIL CARTS:

- Carts consist of four bin-holder rails and four 63" posts with casters.
- Posts are numbered in increments of 1" (25mm) to ensure fast and level assembly.

Freight class is 70.0.

(•) MTS (made to stock) / () MTO (made to order)



Bin holder rails can also be used on EAGLE Floor-Trak® units

*For additional information on Floor-Trak® Systems, refer to spec sheet EG01.39 or visit us on-line, www.eaglegrp.com.

Bin-Holder Rails

Bin-Holder Rail Carts

	length		weight		Zinc		Chrome		weight	Zinc		Chrome			
	in.	mm	lbs.	kg	model #	list	model#	list		lbs.	kg	model #	list	model#	list
	24" width (610mm)	36"	914	11.0	5.0	DBH2436Z	151	DBH2436C		209	64	29.0	DBHC2436Z-4	939	DBHC2436C-4
	42"	1067	12.5	5.7	DBH2442Z	208	DBH2442C	212	70	31.8	DBHC2442Z-4	1003	DBHC2442C-4	1003	
	48"	1219	14.0	6.4	DBH2448Z	220	DBH2448C	243	76	34.5	DBHC2448Z-4	1036	DBHC2448C-4	1126	
	54"	1372	15.5	7.0	DBH2454Z	225	DBH2454C	247	82	37.2	DBHC2454Z-4	1057	DBHC2454C-4	1143	
	60"	1524	17.0	7.7	DBH2460Z	239	DBH2460C	267	88	39.9	DBHC2460Z-4	1114	DBHC2460C-4	1220	
30" width (762mm)	36"	914	12.5	5.7	DBH3036Z	206	DBH3036C	229	70	31.8	DBHC3036Z-4	985	DBHC3036C-4	1070	
	42"	1067	14.0	6.4	DBH3042Z	211	DBH3042C	238	76	34.5	DBHC3042Z-4	1005	DBHC3042C-4	1104	
	48"	1219	15.5	7.0	DBH3048Z	239	DBH3048C	269	82	37.2	DBHC3048Z-4	1113	DBHC3048C-4	1232	
	54"	1372	17.0	7.7	DBH3054Z	244	DBH3054C	281	88	39.9	DBHC3054Z-4	1134	DBHC3054C-4	1279	
	60"	1524	18.5	8.4	DBH3060Z	264	DBH3060C	316	94	42.6	DBHC3060Z-4	1212	DBHC3060C-4	1420	



Accessories

Card Holders	134
Conductive Bins and Dividers	135
Conductive Casters	136
Dividers for ESD Tote Boxes	134
ESD Cart Covers	136
ESD Tote Boxes & Accessories	133
Molded Fiberglass ESD Boxes and Tray	135
Split Sleeves	137
Vibration Dampening Casters	136

adjusTable®

Extras	139
with Cantilever Overhead System ..	137
with Wire Overshelf System	138

Carts

Burn-In Carts.....	130
Electronic Tray.....	128
Electronic Vibration Dampening	128
Gravity Flow Line Feed	129

More Electronics

All-Welded Units with Solid Tray Racks	130
Benchside Tote Box Carriers	133
Double-Sided Bin-Holder Rails	140
Mobile Computer Workstation.....	131
Reel Shelves	131
Stencil Shelf	130
Tote Box Carriers.....	132



Electronic Tray Carts

see spec sheet **EG07.05**

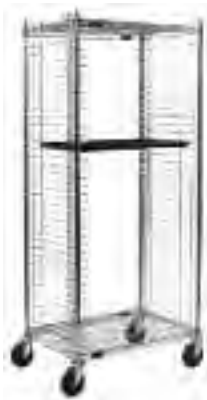

Trays sold separately.
See page 135 for
Molded Fiberglass Trays.

- Knock-down units.
- EAGLEbrite® zinc-plated wire shelves.
- Chrome posts.
- Aluminum split sleeves.
- End-load and side-load racks offer a practical and economical method of transporting or storing 17½" x 25¼" (454 x 654mm) product on trays.
- Units require no tools for assembly.
- 5" (127mm) diameter resilient swivel casters, two with brake.
- Units can be made conductive by adding drag chain or ESD cable.

FEATURES:

Freight class is 70.0.

(•) MTS (made to stock) / () MTO (made to order)

description	overall dimensions width x length x height		weight		cu ft	sliding space		full size pan capacity	model #	list
	in.	mm	lbs.	kg		in.	mm			
end load	30" x 21" x 67½"	762 x 533 x 1711	65	29.5	15.0	1½"	38	38	WTRE38-Z •	499
end load	30" x 21" x 67½"	762 x 533 x 1711	74	33.6	15.0	3"	76	20	WTRE20-Z •	495
side load	21" x 30" x 67½"	533 x 762 x 1711	65	29.5	15.0	1½"	38	38	WTRS38-Z •	499
side load	21" x 30" x 67½"	533 x 762 x 1711	74	33.6	15.0	3"	76	20	WTRS20-Z •	495

Electronic Vibration Dampening Tray Carts

see spec sheet **EG07.04**



Engineered to provide maximum benefit in three key areas: vibration transfer, ESD safe, and cost.

electronic vibration dampening tray cart (half size)

Trays sold separately.
See page 135
for Molded
Fiberglass Trays.

- Polyurethane 50 shore A casters dramatically reduce vibration transfer.
- Standard caster configuration features two swivel and two with brake.
- Carts are made ESD safe with the use of aluminum split sleeves and optional grounding device.
- EAGLEbrite® zinc-plated wire shelves.
- Product safety is ensured with front and back locks on all models.

FEATURES:

Freight class is 70.0.

(•) MTS (made to stock) / () MTO (made to order)

description	overall dimensions width x length x height		weight		cu ft	sliding space		full size pan capacity	model #	list
	in.	mm	lbs.	kg		in.	mm			
end load, half height	31¼" x 21¼" x 49½"	807 x 543 x 1254	80	36.3	15.0	1¾"	45	20	ETCE20-Z	809
end load, full height	31¼" x 21¼" x 62½"	807 x 543 x 1584	97	44.0	15.0	1¾"	45	30	ETCE30-Z *	914
side load, half height	21¼" x 31¼" x 49½"	543 x 807 x 1254	80	36.3	15.0	1¾"	45	20	ETCS20-Z	809
side load, full height	21¼" x 31¼" x 62½"	543 x 807 x 1584	97	44.0	15.0	1¾"	45	30	ETCS30-Z *	914

* Half-height carts include two ergonomically positioned push handles.

Options for Electronic Tray Carts and Vibration Dampening Tray Carts

Optional ESD Grounding Cable

- Provides greater dependability on mobile units.
- Replaces conductive casters when used with conductive split sleeves.
- Easily installed.

model #	list
GC-16	22



Optional Anti-Static Drag Chain

- 16" (406mm) long.
- Used for conductive applications.
- Clips into shelf.

model #	list
DC16-S •	21



Catalog Section 7

Gravity Flow Line Feed Carts

see spec sheet **EG07.03**



Offers the ergonomic advantage of an angled shelf along with added visibility in the storage bins.

- Standard model includes three EAGLEbrite® zinc-plated angled shelves, four posts, four casters (*two with brake*), one 3-sided truss, and one 4-sided truss.
- Flexibility to adjust shelves on 1" (25mm) vertical increments and the slope of each shelf.
- Open-wire construction for high visibility of merchandise.
- Chrome posts.
- 5" x 1 1/4" (127 x 32mm) standard resilient swivel casters, two with brake — each with a weight capacity of 300 lbs. (136.1 kg).
- Mobile units are 69" (1753mm) height, including casters.
- Stationary units are 63" (1600mm) height.

FEATURES:

Note: Additional shelves available as options. Additional caster sizes available.

Freight class is 70.0.

(•) MTS (*made to stock*) / () MTO (*made to order*)

length			weight		cubic	Stationary		Mobile	
in.	mm	lbs.	kg	feet	EAGLEbrite®		EAGLEbrite®		
					model #	list	model #	list	
36"	914	93	42.2	6	SM3636Z-3	592	M3636Z-3	692	
48"	1219	114	51.7	8	SM3648Z-3	664	M3648Z-3	764	
60"	1524	144	65.3	10	SM3660Z-3	819	M3660Z-3	900	

Replacement/Additional Components for Gravity Flow Line Feed Carts:

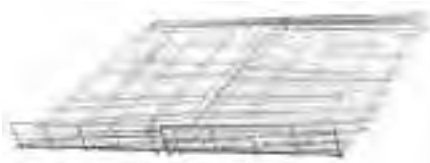

Angled Shelves

- Hanger rails included.

length			weight		cubic	EAGLEbrite®	
in.	mm	lbs.	kg	feet	model #	list	
36"	914	26	11.8	5	M3636Z	166	
48"	1219	32	14.5	7	M3648Z	180	
60"	1524	40	18.1	9	M3660Z	215	



Side-to-Side Hanger Rails...

length			weight		cubic	EAGLEbrite®	
in.	mm	lbs.	kg	feet	model #	list	
36"	914	3	1.4	1.5	A215543	30	
48"	1219	4	1.8	2.0	A215544	34	
60"	1524	5	2.3	2.5	A215546	36	

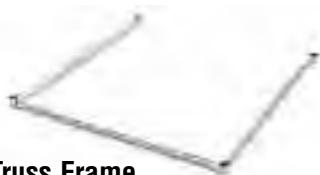

3-Sided Truss Frame

- 36" (914mm) wide.

length			weight		cubic	EAGLEbrite®	
in.	mm	lbs.	kg	feet	model #	list	
36"	914	7	3.2	2	A215538	36	
48"	1219	10	4.5	3	A215539	47	
60"	1524	12	5.4	4	A215541	51	

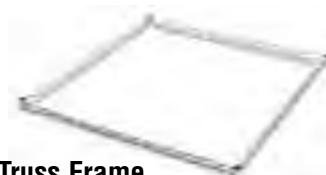

4-Sided Truss Frame

- 36" (914mm) wide.

length			weight		cubic	EAGLEbrite®	
in.	mm	lbs.	kg	feet	model #	list	
36"	914	9	4.1	2	A215532	54	
48"	1219	12	5.4	3	A215534	65	
60"	1524	15	6.8	4	A215536	74	



Burn-In Carts

see spec sheet **EG07.07**



A simple testing and preparation station for electronic products.

FEATURES:

- For transporting products to and from testing areas.
- Choice of chrome or EAGLEbrite® zinc finish.
- 69" (1753mm) high.
- Casters are resilient swivel 5" (127mm) diameter and include donut bumpers.
- Standard power harness is designed to be used on four-shelf unit as shown.

Freight class is 70.0.

(•) MTS (made to stock) / () MTO (made to order)

width x length in. mm	weight lbs. kg	cubic feet	chrome model # list	zinc model # list
28" x 64" 711 x 1626	114 51.7	6.0	BIC 3633	BIC-Z 3611



(Patent #5,390,803)

Replacement Power Harness Nine outlets each. NEMA 5-15P plug.

description	weight		cubic feet	model # list	
	lbs.	kg		model #	list
one strip w/cord & plug	2	0.9	0.7	MHPH	746
four strips wired to one cord & plug	8	3.6	2.8	MHPH-4	1410

Patented QuadTruss® Design makes shelves up to 25% stronger and provides a retaining ledge for increased strength and product retention.

All-Welded Units with Solid Tray Racks

see spec sheet **EG07.00**



Holds 10" x 26" pans.

FEATURES:

- All-welded aluminum frame construction.
- Frame and supports are 1" (25mm) square aluminum tubing.
- Tray slides are 1 1/2" (48mm) wide with two raised beads to minimize friction.
- 5" (127mm) casters.

Freight class is 70.0.

(•) MTS (made to stock) / () MTO (made to order)

description	overall dimensions width x length x height in. mm		weight lbs. kg		cu ft	sliding space in. mm		full size pan capacity	model #	list		
	width	length	height	width		length						
front load	20 1/2"	26"	69 1/4"	518	660	1759	47	21.3	21.0	2" 51	30	OUR-1830-2/W • 1004
side load	28 1/2"	20"	69 1/4"	724	457	1759	32	14.5	25.2	2" 51	30	OUR-2630-2/W 965

Aluminum Tray

description	dimensions		model #	list
	in.	mm		
solid, 18 gauge	17 3/4"	25 3/4"	SP1826-18 • 25	



Stencil Shelf

see spec sheet **EG07.08**



The stencil shelf may be used with any combination of posts and casters that best meets your requirements.

FEATURES:

- EAGLEbrite® zinc finish.
- One bottom and one top partitioned shelf.
- One ST1836Z-13 is required for each tier desired.
- Each unit has (15) 2" (51mm) partitions.

Note: Stationary unit can be made conductive with the use of optional aluminum split sleeves (page 137).

Mobile unit may be made conductive with the use of optional aluminum split sleeves (page 137) and an optional drag chain (page 128).

Freight class is 70.0.

(•) MTS (made to stock) / () MTO (made to order)

#ST1836Z-13 includes two shelves.

two tiers of stencil shelves shown in mobile unit configuration

width x length in. mm	weight lbs. kg	cu ft	capacity	model #	list
18" x 36" 457 x 914	18 8.2	5.0	holds (15) stencils	ST1836Z-13	226



Catalog Section 7

Mobile Computer Workstations

see spec sheet **EG01.04**



with optional mouse shelf



(Patent #5,390,803)

Patented QuadTruss® Design

makes shelves up to 25% stronger and provides a retaining ledge for increased strength and product retention.

- 5" (127mm) casters—two with brake.
- Cantilevered shelf, undershelf, keyboard drawer.
- 38 $\frac{3}{8}$ " (981mm) working height.
- 53 $\frac{3}{8}$ " (1362mm) overall height.

FEATURES:

Note: See page 136 for other casters available.

Freight class is 70.0.

(•) MTS (made to stock) / () MTO (made to order)

width**	length		weight		cu ft	with Resilient-Tread Casters		w/Polyurethane-Tread Casters					
	in.	mm	lbs.	kg		chrome model #	stainless steel model #	chrome model #	stainless steel model #	chrome *list	stainless steel *list		
24" (610mm)	24"	610	40	18.1	3.7	MCWS2424C •	522	MCWS2424S	1087	MCWS2424C-P	590	MCWS2424S-P	1111
30" (762mm)	30"	762	56	25.4	4.5	MCWS3030C	572	MCWS3030S	1136	MCWS3030C-P	640	MCWS3030S-P	1161

* List prices do not include cost of mouse shelf.

** 24" x 24" (610 x 610mm) units feature 14" x 24" (357 x 610mm) undershelf, 30" x 30" (762 x 762mm) units feature 18" x 30" (457 x 762mm) undershelf.

Optional Mouse Shelf for Mobile Computer Workstation

width x length		cu ft	weight		model #	list
in.	mm		lbs.	kg		
7" x 7"	178 x 178	0.1	2.0	0.9	MS-C	11



Reel Shelves

see spec sheet **EG07.06**

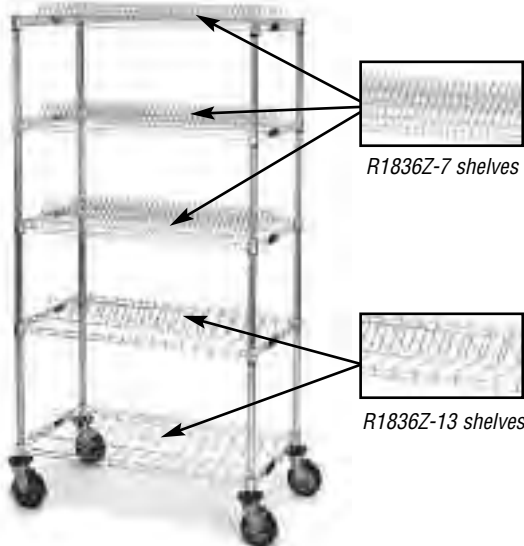

R1836Z-7 shelves

R1836Z-13 shelves

- EAGLEbrite® zinc plated finish with MasterSeal®, 9-gauge wire for the mat, and 6-gauge wire for the cradle and trusses.
- R1836-7 has a $\frac{3}{4}$ " (19mm) open space for each reel.
- R1836-13 has a 2" (51mm) open space for each reel.
- The reel shelves may be used with any combination of posts and casters that best meets your requirements.

FEATURES:

Freight class is 70.0.

(•) MTS (made to stock) / () MTO (made to order)

The perfect solution to store and transport surface mount reels.

width x length	weight	cubic	capacity	model #	list
in. mm	lbs. kg	feet			
18" x 36" 457 x 914	10 4.5	5.0	holds (78) 7"-diameter reels	R1836Z-7	108
18" x 36" 457 x 914	9 4.1	5.0	holds (15) 13"-diameter reels or 15"-diameter reels	R1836Z-13	100

reel shelves shown in mobile unit configuration - posts and casters sold separately (see pages 10 & 11)



Tote Box Carriers

see spec sheet **EG07.01**

The ideal way to transport totes, trays, and other containers.

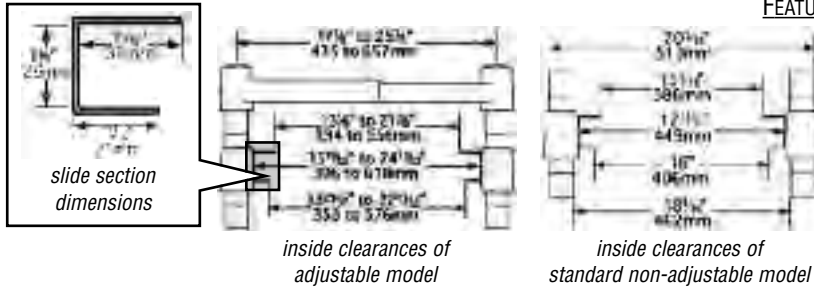

FEATURES:

- Three sets of tote box slides.
- Two brake and two swivel casters, resilient or polymer.
- 68" (1727mm) height, includes casters
- 63" (1600mm) 16-gauge chrome-plated posts.
- 26" (660mm) length from front to back.

Note: See pages 133 and 134 for tote boxes and tote box accessories.

Note: To order units with aluminum split sleeves in place of standard plastic split sleeves, add suffix "-ESD". Example: TBC1-R-ESD

Freight class is 70.0.

(•) MTS (made to stock) / () MTO (made to order)

One-Bay

- Adjustable or standard.
- Comes with three single slide sets.

width x length		weight		cubic feet	caster type	description	model #	list
in.	mm	lbs.	kg					
26" x 22 1/2"	660 x 575	55	24.9	3.5	resilient	1 section, non-adjustable	TBC1-R *	524
		55	24.9	3.5	poly	1 section, non-adjustable	TBC1-P *	621
26" x 20"	660 x 524	55	24.9	3.5	resilient	1 section, adjustable	TBC-R	687
		to 26" x 29"	to 660 x 746	55	24.9	3.5	poly	1 section, adjustable

* For Non-Adjustable units, applicable tote boxes are #TB3030XL, TB3060XL, TB3080XL, and TB3120XL (page 133).

Two-Bay

- Comes with three single slide sets and three double slides.

width x length		weight		cubic feet	caster type	description	model #	list
in.	mm	lbs.	kg					
26" x 41 1/4"	660 x 1060	112	50.8	9	resilient	2 section, non-adjustable	TBC2-R *	743
26" x 41 1/4"	660 x 1060	112	50.8	9	poly	2 section, non-adjustable	TBC2-P *	804

* For Non-Adjustable units, applicable tote boxes are #TB3030XL, TB3060XL, TB3080XL, and TB3120XL (page 133).

Three-Bay

- Comes with three single slide sets and six double slides.

width x length		weight		cubic feet	caster type	description	model #	list
in.	mm	lbs.	kg					
26" x 60 1/2"	660 x 1546	168	76.2	12	resilient	3 section, non-adjustable	TBC3-R *	963
26" x 60 1/2"	660 x 1546	168	76.2	12	poly	3 section, non-adjustable	TBC3-P *	1025

* For Non-Adjustable units, applicable tote boxes are #TB3030XL, TB3060XL, TB3080XL, and TB3120XL (page 133).

Tote Box Slides for Tote Box Carriers

- Made of 16 gauge chrome plated steel with a channel opening of 1 1/8" (29mm).

type	weight		cubic feet	model #	list
	lbs.	kg			
single slides (sold in pairs)	1.5	0.7	0.5	TBC-S •	76 per pair
double slide (sold individually)	3.0	1.4	0.5	TBC-SD	71 each

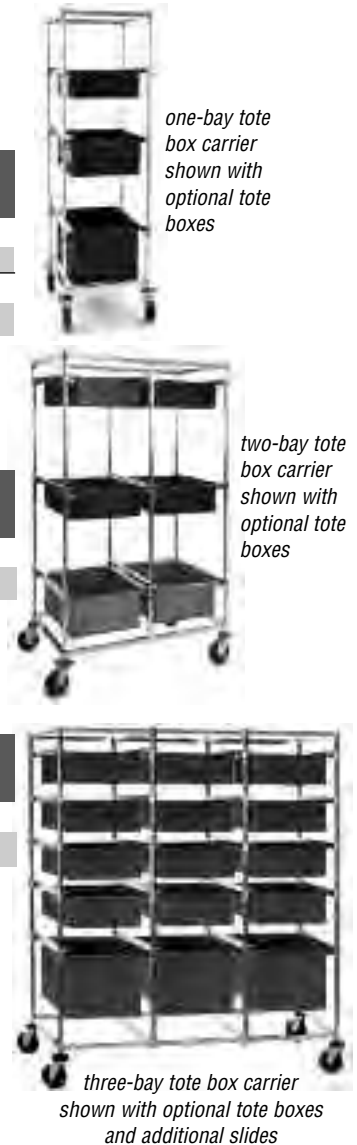

Catalog Section 7

Benchside Tote Box Carriers

see spec sheet **EG07.02**

- Angled wire shelf with 3½" (89mm) upturn.
- Wire undershelf.
- Posts joined to 5" (127mm)-diameter swivel casters with resilient tread—two with brake.
- All shelves and posts are zinc-plated.

FEATURES:

Note: For static dissipation, add aluminum split sleeves (page 137) and drag chain (page 128).

Variable shelf angle is ergonomically sensitive to repetitive pick-and-place activity.

Freight class is 70.0.

(•) MTS (made to stock) / () MTO (made to order)



benchside tote box carrier shown with optional tote boxes

width x length		height		weight		cubic	caster type	model #	list
in.	mm	in.	mm	lbs.	kg	feet			
18" x 24"	457 x 610	(rear)	39"	991	50	22.7	3.3	1824BTZ	309
		(front)	30"	762					
18" x 36"	457 x 914	(rear)	39"	991	55	24.9	4.5	1836BTZ	334
		(front)	30"	762					
18" x 48"	457 x 1219	(rear)	39"	991	60	27.2	6.0	1848BTZ	353
		(front)	30"	762					
18" x 60"	457 x 1524	(rear)	39"	991	65	29.5	7.5	1860BTZ	372
		(front)	30"	762					

Optional ESD Tote Boxes & Tote Box Accessories

see spec sheet **EG07.09**

Freight class is 70.0.

(•) MTS (made to stock) / () MTO (made to order)



assorted divider tote boxes

ESD Tote Boxes

- Made of conductive material.
- Fits tote box carriers (page 132).
- Containers can be divided into compartments by length and/or width.
- Dividers are on 1¼" (32mm) centers.

dimensions of outside top length x width x height			weight		cu	max. divider slots		model #	list		
in.	mm	mm	lbs.	kg	ft	long	short				
						in.	mm	in.	mm		
10.8" x 8.5" x 3.5"	274 x 216 x 89		0.7	0.3	0.2	5"	127	7"	178	TB1035XL	24
10.8" x 8.5" x 5.0"	274 x 216 x 127		0.9	0.4	0.3	5"	127	7"	178	TB1050XL	27
16.5" x 10.9" x 3.5"	419 x 277 x 89		1.2	0.5	0.4	7"	178	11"	279	TB2035XL	28
16.5" x 10.9" x 6.0"	419 x 277 x 152		1.6	0.7	0.6	7"	178	11"	279	TB2060XL	39
16.5" x 10.9" x 8.0"	419 x 277 x 203		2.0	0.9	0.8	7"	178	11"	279	TB2080XL	44
22.4" x 17.4" x 3.0"	567 x 442 x 76		1.8	0.8	0.7	11"	279	15"	381	TB3030XL *	68
22.4" x 17.4" x 6.0"	567 x 442 x 152		3.5	1.6	1.3	11"	279	15"	381	TB3060XL *	71
22.4" x 17.4" x 8.0"	567 x 442 x 203		4.1	1.9	1.8	11"	279	15"	381	TB3080XL *	86
22.4" x 17.4" x 12.0"	567 x 442 x 305		6.0	2.7	1.7	11"	279	15"	381	TB3120XL *	119

* Only the TB3000 series tote boxes fit non-adjustable tote box carriers (page 132).

ESD Snap-On Tote Box Covers

Conductive. Black.

Protect the contents of your divider box with these hi-density injection molded covers.

for container model	weight		cubic	model #	list
	lbs.	kg	feet		
TB1000 Series	0.2	0.1	0.1	CTB1000-XL	18
TB2000 Series	0.5	0.2	0.1	CTB2000-XL	33
TB3000 Series	1.2	0.5	0.3	CTB3000-XL	53



For ESD Tote Box Dividers and Card Holders, see page 134.



ESD Tote Box Accessories (continued)

see spec sheet **EG07.09**

Dividers

Freight class is 70.0.

(•) MTS (made to stock) / () MTO (made to order)



Conductive. These injection molded dividers compartmentalize width and length of box interior to prevent part movement.

fits tote box	Long Dividers			Short Dividers		
	model #	list	max. # accepted	model #	list	max. # accepted
TB1035XL	DL1035-XL	4	5	DS1035-XL	3	7
TB1050XL	DL1050-XL	5	5	DS1050-XL	4	7
TB2035XL	DL2035-XL	5	7	DS2035-XL	4	11
TB2060XL	DL2060-XL	7	7	DS2060-XL	6	11
TB2080XL	DL2080-XL	9	7	DS2080-XL	7	11
TB3030XL	DL3030-XL	7	11	DS3030-XL	5	15
TB3060XL	DL3060-XL	8	11	DS3060-XL	6	15
TB3080XL	DL3080-XL	9	11	DS3080-XL	7	15
TB3120XL	DL3120-XL	25	11	DS3120-XL	21	15

Card Holders for ESD Tote Boxes



- Static dissipative.
- Transparent blue vinyl material.
- Easily snaps onto TB3000 Series divider boxes (page 133).

FEATURES:

Freight class is 70.0.

(•) MTS (made to stock) / () MTO (made to order)

holds labels		model #	list
in.	mm		
2" x 8"	51 x 203	CH28S	9
3" x 5"	76 x 127	CH35S	11
5" x 8"	127 x 203	CH58S	12

Go Green. Go ECO-Built™ by EAGLE.

For institutions concerned about meeting their own green standards, buying Eco-Built™ is simply the right thing to do.

Look for the ECO-Built™ tag on the bar code ➔



Catalog Section 7

Molded Fiberglass ESD Boxes and Tray

see spec sheet **EG07.10**

Freight class is 70.0.

(•) MTS (made to stock) / () MTO (made to order)



molded fiberglass ESD boxes and trays

Molded Fiberglass ESD Boxes

- Made of thermoset polyester composite material.
- Flame and chemical resistant.

These black ESD boxes are stackable for maximum storage efficiency.

description	inside length x width		outside length x width		depth		cu ft	model #	list
	in.	mm	in.	mm	in.	mm			
stacking box	24 1/4"	619	25 3/4"	654	3"	76	0.6	A208510	59
stacking box	24 1/4"	619	25 3/4"	654	4 1/2"	114	1.0	A208511	65
stacking box	24 1/4"	619	25 3/4"	654	6"	152	1.3	A208512	73
lid	24 1/4"	619	25 3/4"	654	—	—	—	A208514 *	46

*Model #A208514 lid fits all stacking boxes listed in chart.

Molded Fiberglass ESD Tray

- Made of thermoset polyester composite material.
- Flame and chemical resistant.

description	inside length x width		outside length x width		depth		cu ft	model #	list
	in.	mm	in.	mm	in.	mm			
black	24 1/4"	619	25 3/4"	654	1 1/2"	29	0.1	A208509	60

Note: Model #A208509 cannot be used safely in a lab oven. Do not heat.

Conductive Bins and Dividers

see spec sheet **EG07.11**

- Molded with a carbon-filled copolymer polypropylene material which protects sensitive electronic components from typical electromagnetic interference (EMI).

FEATURES:

Freight class is 70.0.

(•) MTS (made to stock) / () MTO (made to order)

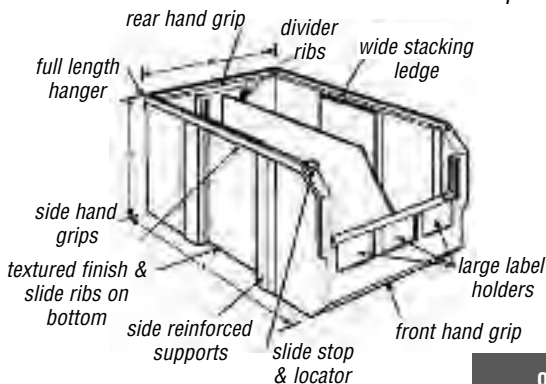

Ultra-strong stackable containers are ideal for storage and transportation of electronic components and parts, assemblies, and loaded circuit boards.



assorted conductive bins

bins with dividers

overall dimensions			weight*	cu*	carton	Bins		Dividers		
width	length	height				model #	list	model #	list	
in.	mm	mm	lbs.	kg	quantity	each	each	each		
4 1/4"	105	114	0.5	0.2	0.7	48	A208336	6	A208348	8
4 1/4"	105	138	0.5	0.2	0.8	48	A208337	6	A208349	9
4 1/4"	105	191	0.5	0.2	1.0	48	A208338	8	A208350	12
5 1/2"	138	279	0.5	0.2	0.6	12	A208339	20	A208351	18
5 1/2"	138	343	1.0	0.5	0.5	12	A208340	21	A208352	18
11"	279	279	1.5	0.7	0.5	8	A208341	27	A208353	18
8 1/4"	210	279	1.5	0.7	0.5	8	A208342	28	A208354	29
8 1/4"	210	375	1.5	0.7	1.1	8	A208343	30	A208355	35
16 1/2"	419	375	3.0	1.4	1.8	6	A208344	54	A208356	35
11"	279	406	2.5	1.1	1.3	4	A208345	57	A208357	42
11"	279	457	2.8	1.2	1.7	4	A208346	65	A208358	48
16 1/2"	419	457	4.0	1.8	2.6	4	A208347	87	A208359	48

* Total carton



100 Industrial Boulevard, Clayton, DE 19938-8903 U.S.A.
 Phone: 800-637-5100 or 302-653-3000. Fax: 302-653-2065
<http://www.eaglegrp.com>

ESD Cart Covers

see spec sheet **EG07.12**

Controls electrostatic discharge while protecting contents from moisture and contamination.



**Black outside,
Green inside.**

FEATURES:

- Controls electrostatic discharge while protecting contents from moisture and contamination.
- All cart covers have a flap on one side.
- "ETC" model cart covers have both side and end flaps for side or end load.
- Comes with brass zipper and paperwork pouch.
- ESD cart covers are waterproof, tear-resistant, antibacterial and flame retardant.

Freight class is 70.0.

(•) MTS (made to stock) / () MTO (made to order)

shelf width x length		post height		weight		cubic	model #	list
in.	mm	in.	mm	lbs.	kg	feet		
18" x 36"	457 x 914	63"	1600	3	1.4	2.5	CZ-63-1836-ESD	407
18" x 48"	457 x 1219	63"	1600	4	1.8	2.5	CZ-63-1848-ESD	456
24" x 24"	610 x 610	63"	1600	3	1.4	2.5	CZ-63-2424-ESD	407
24" x 36"	610 x 914	63"	1600	3	1.4	2.5	CZ-63-2436-ESD	425
24" x 48"	610 x 1219	63"	1600	4	1.8	2.5	CZ-63-2448-ESD	493
24" x 60"	610 x 1524	63"	1600	5	2.3	2.5	CZ-63-2460-ESD	533
fits #ETCE20-Z (page 128)		49"	1245	3	1.4	2.5	CZ-49-ETC	416
fits #ETCS20-Z (page 128)								
fits #ETCE30-Z (page 128)		63"	1600	4	1.8	2.5	CZ-63-ETC	470
fits #ETCS30-Z (page 128)								

Vibration Dampening Casters

see spec sheets **EG01.05A EG07.12**

Where vibration dampening is important, these unique 50A shore hardness "Softie™" casters reduce vibration transfer for work in process.

Note: These casters can be substituted for resilient casters in Electronic Tray Carts (page 128), where vibration dampening is important. **Add \$30 to WTR cart model number list prices.**

Freight class is 65.0.

(•) MTS (made to stock) / () MTO (made to order)

type	capacity		wheel diameter		wheel face		weight		cu	zinc	
	lbs.	kg	in.	mm	in.	mm	lbs.	kg	ft	model #	list
stem/swivel	180	81.6	5"	127	1 1/4"	35	2.0	0.9	0.1	SCSS5-180 •	38
stem/brake	180	81.6	5"	127	1 1/4"	35	2.5	1.1	0.1	SCSB5-180	41
stem/rigid*	180	81.6	5"	127	1 1/4"	35	2.8	1.3	0.1	SCSR5-180	38

* Channel frames for rigid stem casters available. See page 11.



"Softie™" caster

Replacement Caster Wheels for Vibration Dampening Casters

- Retrofit your existing casters.

Fits	model #	list
5" (127mm) casters	SCW-180	12



Conductive Casters

see spec sheets **EG01.05A EG07.12**

FEATURES:

- Meets federal specification FF-C-88C regarding conductivity.

Freight class is 65.0.

(•) MTS (made to stock) / () MTO (made to order)

type	capacity		wheel diameter		wheel face		weight		cu	zinc	
	lbs.	kg	in.	mm	in.	mm	lbs.	kg	ft	model #	list
stem/swivel	200	90.7	5"	127	1 1/4"	32	2.5	1.2	0.1	CSS5-CC •	56
stem/brake	200	90.7	5"	127	1 1/4"	32	2.8	1.3	0.1	CSB5-CC •	62
stem/rigid*	200	90.7	5"	127	1 1/4"	32	3.5	1.6	0.1	CSR5-CC	64

* Channel frames for rigid stem casters available. See page 11.



Catalog Section 7

Split Sleeves

see spec sheets **EG01.03D** **EG07.12**

Freight class is 70.0.

(•) MTS (made to stock) / () MTO (made to order)

Aluminum Split Sleeves

- For conductive, over the road or high-temperature installations.
- Set of four.



aluminum split sleeves and ring

with zinc rings		with stainless rings	
model #	list	model #	list
A208909 •	15	A208908 •	25

Plastic Conductive Split Sleeves

- Packed four per bag.



model #	list
A219236	11

adjustable® with Cantilevered Overhead System

see spec sheet **EG07.13A**

FEATURES:

- 34½" (876mm) working height.
- Tabletops on all models feature hat channels underneath for added strength.

Freight class is 70.0.

(•) MTS (made to stock) / () MTO (made to order)

Allows you to create work surfaces of your choice with cantilevered overhead system.



adjustable® with overhead cantilevered system shown with H-frame & wire undershelf base, and optional bin holder, reel holder, and bench power center

Work surface of your choice is combined with two 33" (838mm) front posts, two 63" (1600mm) rear posts, two cantilevered overshelves, and your choice of base combination.

1) Select work surface.

- "OAC" – 16 gauge type 304 brushed stainless top, with chrome base and chrome overshelves.
- "OAS" – 16 gauge type 304 brushed stainless top, with stainless base and stainless overshelves.

	length		weight		cubic feet	OAC Series		OAS Series	
	in.	mm	lb.	kg		model #	list	model #	list
24" width (610mm)	36"	914	65	29.5	4.4	OAC2436T-2	891	OAS2436T-2	1549
	48"	1219	81	36.7	5.7	OAC2448T-2	1026	OAS2448T-2	1772
	60"	1524	97	44.0	7.0	OAC2460T-2	1163	OAS2460T-2	2056
30" width (762mm)	36"	914	75	34.0	4.4	OAC3036T-2	948	OAS3036T-2	1707
	48"	1219	94	42.6	5.7	OAC3048T-2	1118	OAS3048T-2	1966
	60"	1524	113	51.3	7.0	OAC3060T-2	1269	OAS3060T-2	2265
36" width (914mm)	36"	914	85	38.6	5.0	OAC3636T-2	1157	OAS3636T-2	1910
	48"	1219	108	49.0	7.0	OAC3648T-2	1323	OAS3648T-2	2267
	60"	1524	131	59.4	9.0	OAC3660T-2	1446	OAS3660T-2	2615

2) Select base combination.

Base combination is included in table price. Must be specified with your choice of work surface.

Choose from the following combinations:

- Base with two C-frames
- Base with one C-frame and one wire shelf
- Base with two H-frames
- Base with one H-frame and one wire shelf

Consult factory for custom configurations.



**adjuSTable®
with Wire Overshelf System**

see spec sheet **EG07.13A**

FEATURES:

- 34½" (876mm) working height.
- Tabletops on all models feature hat channels underneath for added strength.

Freight class is 70.0.

(•) MTS (made to stock) / () MTO (made to order)

**Allows you to create work surfaces of your choice
with wire overshelf systems.**

Work surface of your choice is combined with two 33" (838mm) front posts, two 63" (1600mm) rear posts, two wire overshelves, two 29" (737mm) front posts for wire overshelves, and your choice of base combination.



adjuSTable® with wire overshelf system shown with C-frame bases

1) Select work surface.

"WOAC" – 16 gauge type 304 brushed stainless top with chrome base

"WOAS" – 16 gauge type 304 brushed stainless top with stainless base

	length		weight		cubic feet	OAC Series		OAS Series	
	in.	mm	lb.	kg		model #	list	model #	list
24" width (610mm)	36"	914	65	29.5	4.4	WOAC2436T-2	942	WOAS2436T-2	1632
	48"	1219	81	36.7	5.7	WOAC2448T-2	1073	WOAS2448T-2	1896
	60"	1524	97	44.0	7.0	WOAC2460T-2	1205	WOAS2460T-2	2225
30" width (762mm)	36"	914	75	34.0	4.4	WOAC3036T-2	997	WOAS3036T-2	1789
	48"	1219	94	42.6	5.7	WOAC3048T-2	1164	WOAS3048T-2	2091
	60"	1524	113	51.3	7.0	WOAC3060T-2	1310	WOAS3060T-2	2434
36" width (914mm)	36"	914	85	38.6	5.0	WOAC3636T-2	1209	WOAS3636T-2	1993
	48"	1219	108	49.0	7.0	WOAC3648T-2	1369	WOAS3648T-2	2390
	60"	1524	131	59.4	9.0	WOAC3660T-2	1487	WOAS3660T-2	2787

2) Select base combination.

Base combination is included in table price.

Must be specified with your choice of work surface.

Choose from the following combinations:

- Base with two C-frames
- Base with one C-frame and one wire shelf
- Base with two H-frames
- Base with one H-frame and one wire shelf

Consult factory for custom configurations.

Go Green. Go ECO-Built™ by EAGLE.

For institutions concerned about meeting their own green standards, buying Eco-Built™ is simply the right thing to do.

Look for the ECO-Built™ tag on the bar code



Catalog Section 7

**Extras for adjusTable®
with Overhead Systems**

Freight class is 70.0.

(•) MTS (made to stock) / () MTO (made to order)

see spec sheet **EG07.13B**

Bin Holders

- Accommodates supply and conductive bins.
- Constructed of 1½" x ½" (41 x 13mm) 12-gauge mild steel, angle-welded to two conical collars for support.
- Shipped with two plastic split sleeves for attachment to posts.

workstation length		weight		cu ft	bin capacity		model #	list
in.	mm	lbs.	kg		in.	mm		
36"	914	3.0	1.4	0.1	33"	838	BH36C	30
48"	1219	4.0	1.8	0.1	45"	1143	BH48C •	32
60"	1524	4.5	2.0	0.3	57"	1448	BH60C •	34



Chrome-plated bin holders allow you to sort, store and separate supplies.

Reel Holders

- Constructed of 1¼" x 1¼" x 3" (32 x 32 x 76mm) chrome-plated 14-gauge "C" channel, welded to a conical collar.
- Shipped with plastic split sleeves for attachment to posts.
- Rod is constructed of ⅝" (16mm) diameter 16 gauge stainless steel tubing.
- Tubing is held within rod holders with removable 1½" (38mm) long zinc-plated hairpin cotter clips.

workstation length		weight		cu ft	reel capacity		model #	list
in.	mm	lbs.	kg		in.	mm		
36"	914	3.0	1.4	0.1	31"	787	RH36-C	68
48"	1219	4.0	1.8	0.1	42"	1067	RH48-C	71
60"	1524	4.5	2.0	0.3	54"	1372	RH60-C	73



Chrome-plated reel holders allow you to sort and store wire and labels.

Bench Power Centers

- UL-approved 115-volt, 20-amp power strip comes complete with mounting hardware and 6' (1829mm) cord.
- Cleat included to secure power cord when not in use.

workstation length		weight		cu ft	outlet capacity		model #	list
in.	mm	lbs.	kg		115V - 20A			
36"	914	10	4.5	0.1	5		BPC36C	316
48"	1219	15	6.8	0.1	7		BPC48C	319
60"	1524	20	9.0	0.3	9		BPC60C	323



See page 170-173 for optional utility drawers.

Stainless Steel Cleaner & Polish



FEATURES:

- Cleans and polishes in one step.
- Does not streak or leave fingerprints.
- Leaves a protective invisible coating.

(•) MTS (made to stock) / () MTO (made to order)

weight		model #	list
oz.	kg		
15	0.4	004026	16



Double-Sided Bin-Holder Rails

see product announcement **EG8152M**

NOW PATENTED!
(patent #8,141,724 B2)

- Bin-holder rails are sold as an accessory or purchased with posts as a kit.
- EAGLEbrite® zinc or chrome plated.
- Bins attach to both sides of rail – no tools required.

BIN-HOLDER RAILS:

- Carts consist of four bin-holder rails and four 63" (1600mm) posts with casters.
- Posts are numbered in increments of 1" (25mm) to ensure fast and level assembly.
- Assembly — numerically calibrated grooved posts, tapered plastic split sleeves and rail collars combine to make shelving assembly a simple two-step exercise:

- 1) snap the split sleeves onto a post over the number of your choice; and
- 2) slide a rail collar over the split sleeves. A positive lock between rail bin and post is created without the use of any tools.

BIN-HOLDER RAIL CARTS:



shown assembled as a cart
(bins sold separately)



bin holder rail
(bins sold separately)

Freight class is 70.0.

(•) MTS (made to stock) / () MTO (made to order)

Bin-Holder Rails

	length		weight		Zinc		Chrome	
	in.	mm	lbs.	kg	model #	list	model#	list
24" width (610mm)	36"	914	11.0	5.0	DBH2436Z	151	DBH2436C	209
	42"	1067	12.5	5.7	DBH2442Z	208	DBH2442C	212
	48"	1219	14.0	6.4	DBH2448Z	220	DBH2448C	243
	54"	1372	15.5	7.0	DBH2454Z	225	DBH2454C	247
	60"	1524	17.0	7.7	DBH2460Z	239	DBH2460C	267
30" width (762mm)	36"	914	12.5	5.7	DBH3036Z	206	DBH3036C	229
	42"	1067	14.0	6.4	DBH3042Z	211	DBH3042C	238
	48"	1219	15.5	7.0	DBH3048Z	239	DBH3048C	269
	54"	1372	17.0	7.7	DBH3054Z	244	DBH3054C	281
	60"	1524	18.5	8.4	DBH3060Z	264	DBH3060C	316



Bin holder rails can also be used on Eagle Floor-Trak® units

For additional information on Floor-Trak® Systems, refer to spec sheet EG01.39, or visit us online at www.eaglegrp.com

Bin-Holder Rail Carts

	length		weight		Zinc		Chrome	
	in.	mm	lbs.	kg	model #	list	model#	list
24" width (610mm)	36"	914	64	29.0	DBHC2436Z-4	939	DBHC2436C-4	990
	42"	1067	70	31.8	DBHC2442Z-4	1003	DBHC2442C-4	1003
	48"	1219	76	34.5	DBHC2448Z-4	1036	DBHC2448C-4	1126
	54"	1372	82	37.2	DBHC2454Z-4	1057	DBHC2454C-4	1143
	60"	1524	88	39.9	DBHC2460Z-4	1114	DBHC2460C-4	1220
30" width (762mm)	36"	914	70	31.8	DBHC3036Z-4	985	DBHC3036C-4	1070
	42"	1067	76	34.5	DBHC3042Z-4	1005	DBHC3042C-4	1104
	48"	1219	82	37.2	DBHC3048Z-4	1113	DBHC3048C-4	1232
	54"	1372	88	39.9	DBHC3054Z-4	1134	DBHC3054C-4	1279
	60"	1524	94	42.6	DBHC3060Z-4	1212	DBHC3060C-4	1420

Accessories/Components

Casters156-157, 163
 More Accessories
 and Components156, 158,
 167, 169

Custom Options176

Drawers170-173

Hardwood Worktables157

Overshelves / Table Mounted

Flex-Master® Adjustable.....165-167
 Microwave169
 Non-Adjustable / All-Welded.....168

SPEC-MASTER®

Enclosed Worktables
 with Backsplash161
 with Flat Top159
 with Upturn160

Specialty Tables

adjuSTable® Work Surface Systems162
 Folding Tables164

Stands

Mobile Utility Stands.....164
 Mobile with Undershef.....164
 Stationary Utility Stands163

Utility Tool Racks174-175

Wall Cabinets167

Worktables w/Stainless Steel Top

with Backsplash and
 Tubular Base154-155
 with Backsplash and
 Undershef Base152-153
 with Flat Top and
 Tubular Base146-147
 with Flat Top and
 Undershef Base144-145
 with Upturn and
 Tubular Base150-151
 with Upturn and
 Undershef Base148-149
 Filler Tables158
 Knock Down Worktables
 with Cabinet Kit158

For Wall Shelves, see page 87.

Wall Mounted Stainless Steel Tables

see spec sheet **EG8107**

Facilitates
 small rolling
 cabinets which
 can be moved
 in and out.

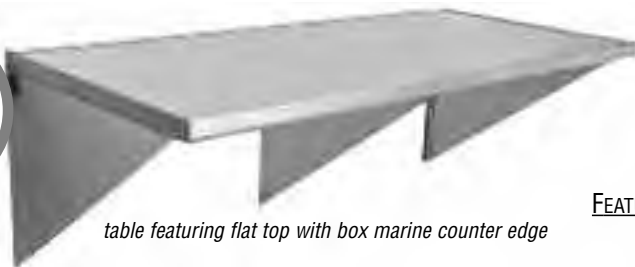

table featuring flat top with box marine counter edge

FEATURES:

- Tabletop available in 16- or 14-gauge stainless steel.
- 14-gauge brackets with hole for electrical wire run.
- Wall mounted for environments with frequent wash downs.
- Available in same configuration as a standard worktable (pages 144-155).
- 200 lb. (90.7 kg) weight capacity.
- Options available include integral sink bowls, drawers, end splashes, and latex sound deadening.

Freight class is 70.0.

(•) MTS (made to stock) / () MTO (made to order)

Tables with Flat Top

	length		no. of brackets	16/304 TABLETOP WITH ROLLED EDGE		14/304 TABLETOP WITH ROLLED EDGE		14/304 TABLETOP WITH BOX MARINE COUNTER EDGE	
	in.	mm		model #	list	model #	list	model #	list
30" width (762mm)	48"	1219	3	WT3048SEB	548	WT3048SE	776	WT3048SEM	1090
	60"	1524	3	WT3060SEB	642	WT3060SE	886	WT3060SEM	1162
	72"	1829	4	WT3072SEB	720	WT3072SE	1036	WT3072SEM	1312

Tables with 1½" Upturn

	length		no. of brackets	model #		list		model #		list	
	in.	mm		model #	list	model #	list	model #	list		
30" width (762mm)	48"	1219	3	UWT3048SEB	645	UWT3048SE	913	UWT3048SEM	1282		
	60"	1524	3	UWT3060SEB	755	UWT3060SE	1042	UWT3060SEM	1367		
	72"	1829	4	UWT3072SEB	847	UWT3072SE	1219	UWT3072SEM	1544		

Tables with 4½" Backsplash

	length		no. of brackets	model #		list		model #		list	
	in.	mm		model #	list	model #	list	model #	list		
30" width (762mm)	48"	1219	3	WT3048SEB-BS	685	WT3048SE-BS	970	WT3048SEM-BS	1363		
	60"	1524	3	WT3060SEB-BS	803	WT3060SE-BS	1108	WT3060SEM-BS	1453		
	72"	1829	4	WT3072SEB-BS	900	WT3072SE-BS	1295	WT3072SEM-BS	1640		

Optional table edges available:

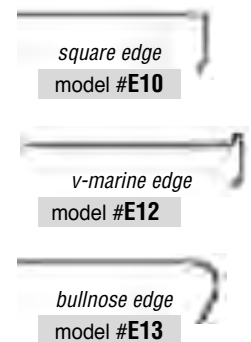

SPEC-MASTER® Marine Series

14 gauge, type 304 stainless steel tabletop.
Features a marine counter edge to prevent spillage.

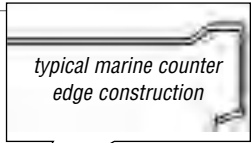

**WITH
FLAT TOP AND
UNDERSHELF...**
See page 144-145



**WITH
FLAT TOP AND
TUBULAR BASE...**
See page 146-147



**WITH
4½" (267MM)
BACKSPLASH AND
UNDERSHELF...**
See page 152-153



**WITH
4½" (267MM)
BACKSPLASH AND
TUBULAR BASE...**
See page 154-155

EM, SEM, GTEM, and STEM series

SPEC-MASTER® Series

14 gauge, type 304 stainless steel tabletop.



**WITH
FLAT TOP AND
UNDERSHELF...**
See page 144-145



**WITH
UPTURN AND
UNDERSHELF...**
See page 148-149



**WITH
BACKSPLASH AND
UNDERSHELF...**
See page 152-153



**WITH
FLAT TOP AND
TUBULAR BASE...**
See page 146-147



**WITH
UPTURN AND
TUBULAR BASE...**
See page 150-151



**WITH
BACKSPLASH AND
TUBULAR BASE...**
See page 154-155

E, SE, GTE, and STE series

Deluxe Series

16 gauge, type 304 stainless steel table top.

typical rolled edge construction



**WITH
FLAT TOP AND
UNDERSHELF...**

See page 144-145



**WITH
UPTURN AND
UNDERSHELF...**

See page 148-149



**WITH
BACKSPLASH AND
UNDERSHELF...**

See page 152-153



**WITH
FLAT TOP AND
TUBULAR BASE...**

See page 146-147



**WITH
UPTURN AND
TUBULAR BASE...**

See page 150-151



**WITH
BACKSPLASH AND
TUBULAR BASE...**

See page 154-155

EB, SEB, GTEB, and STEB series

Budget Series

16 gauge, type 430 stainless steel table top.

typical rolled edge construction



**WITH
FLAT TOP AND
UNDERSHELF...**

See page 144-145



**WITH
UPTURN AND
UNDERSHELF...**

See page 148-149



**WITH
BACKSPLASH AND
UNDERSHELF...**

See page 152-153



**WITH
FLAT TOP AND
TUBULAR BASE...**

See page 146-147



**WITH
UPTURN AND
TUBULAR BASE...**

See page 150-151



**WITH
BACKSPLASH AND
TUBULAR BASE...**

See page 154-155

B, SB, GTB, and STB series

Worktables with Stainless Steel Flat Top & Galvanized Legs/Undershelf

see spec sheets **EG10.40A** **EG10.40B** **EG10.40C** **EG10.40D**

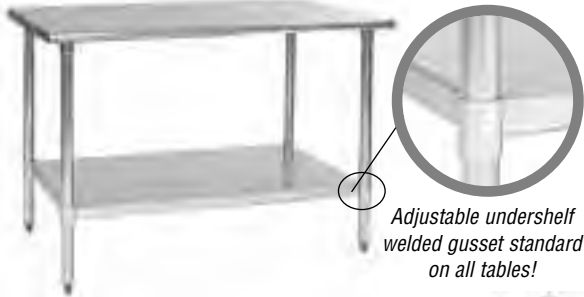

Adjustable undershelf welded gusset standard on all tables!

FEATURES:



(Patent #5,165,349)

- 1½" (41mm) diameter legs and adjustable undershelf are heavy gauge galvanized steel.
- Heavy gauge polished stainless steel top.
- Offers worktables with a rolled edge on front and rear, with ends turned 90°, except SPEC-MASTER® Marine edge.
- 35½" - 36½" (892 - 918mm) adjustable working height.

Note: All shipping weights and cubic feet are approximate.

NSF sprayed-on latex sound deadening available. To order, add \$646 to list price and suffix "-SD". Example: T2424B-SD.

Optional fixed undershelf available in place of standard adjustable undershelf. To order, add 10% to list price, and "-F" to end of suffix. Example: T2424B-F.

Freight class is 70.0.

For FLEX-MASTER® overshelf kits, see pages 167.

For drawer kits, see page 173.



See page 156 for optional casters available.

(•) MTS (made to stock) / () MTO (made to order)

	length		# of legs	weight		cu ft	BUDGET 16/430 top		DELUXE 16/304 top		*SPEC-MASTER® 14/304 top		* ▼ Marine 14/304 top	
	in.	mm		lbs.	kg		model #	list	model #	list	model #	list	model #	list
24" width (610mm)	24"	610	4	40	18.1	3.5	T2424B •	655	T2424EB	722	T2424E	758	T2424EM	1266
	30"	762	4	45	20.4	3.8	T2430B •	710	T2430EB	787	T2430E	839	T2430EM	1357
	36"	914	4	50	22.7	4.4	T2436B •	771	T2436EB	846	T2436E	899	T2436EM	1416
	48"	1219	4	60	27.2	5.7	T2448B •	786	T2448EB	861	T2448E	914	T2448EM	1439
	60"	1524	4	70	31.8	7.1	T2460B •	829	T2460EB	933	T2460E	1002	T2460EM	1523
	72"	1829	4	80	36.3	8.5	T2472B •	887	T2472EB	1011	T2472E	1086	T2472EM	1616
	84"	2134	4	90	40.8	11.2	T2484B •	1131	T2484EB	1446	T2484E	1479	T2484EM	1973
	96"	2438	6	100	45.4	11.2	T2496B •	1287	T2496EB	1549	T2496E	1588	T2496EM	2086
	108"	2743	6	110	49.9	14.0	T24108B	2094	T24108EB	2238	T24108E	2192	T24108EM	2738
	120"	3048	6	120	54.4	14.0	T24120B	2154	T24120EB	2302	T24120E	2413	T24120EM	2802
30" width (762mm)	132"	3353	8	130	59.0	16.8	T24132B	2165	T24132EB	2344	T24132E	2540	T24132EM	3006
	144"	3658	8	140	63.5	16.8	T24144B	2167	T24144EB	2413	T24144E	2549	T24144EM	3070
	30"	762	4	46	20.9	3.8	T3030B •	730	T3030EB	815	T3030E	867	T3030EM	1387
	36"	914	4	52	23.6	4.4	T3036B •	788	T3036EB	875	T3036E	926	T3036EM	1451
	48"	1219	4	64	29.0	5.7	T3048B •	800	T3048EB •	901	T3048E	963	T3048EM	1489
	60"	1524	4	76	34.5	7.1	T3060B •	875	T3060EB •	991	T3060E	1061	T3060EM	1596
	72"	1829	4	84	38.1	8.5	T3072B •	951	T3072EB •	1086	T3072E	1162	T3072EM	1702
	84"	2134	4	96	43.6	11.2	T3084B •	1187	T3084EB	1468	T3084E	1561	T3084EM	2060
	96"	2438	6	108	49.0	11.2	T3096B •	1374	T3096EB	1601	T3096E	1705	T3096EM	2203
	108"	2743	6	120	54.4	14.0	T30108B	2114	T30108EB	2371	T30108E	2496	T30108EM	2946
36" width (914mm)	120"	3048	6	132	59.9	14.0	T30120B	2185	T30120EB	2441	T30120E	2563	T30120EM	3011
	132"	3353	8	144	65.3	16.8	T30132B	2294	T30132EB	2575	T30132E	2647	T30132EM	3188
	144"	3658	8	156	70.8	16.8	T30144B	2363	T30144EB	2594	T30144E	2793	T30144EM	3256
	48"	1219	4	70	31.8	7.0	T3648B	997	T3648EB	1097	T3648E	1130	T3648EM	1790
	60"	1524	4	82	37.2	8.8	T3660B	1123	T3660EB	1230	T3660E	1266	T3660EM	1929
	72"	1829	4	96	43.6	10.5	T3672B	1228	T3672EB	1335	T3672E	1380	T3672EM	2055
	84"	2134	4	108	49.0	12.2	T3684B	1689	T3684EB	1813	T3684E	1848	T3684EM	2478
	96"	2438	6	120	54.4	13.9	T3696B	1795	T3696EB	1922	T3696E	1976	T3696EM	2597
	108"	2743	6	132	59.9	17.3	T36108B	2552	T36108EB	2846	T36108E	2914	T36108EM	3404
	120"	3048	6	144	65.3	17.3	T36120B	2610	T36120EB	2914	T36120E	2982	T36120EM	3471
48" width (1219mm)	132"	3353	8	156	70.8	20.7	T36132B	2675	T36132EB	3011	T36132E	3114	T36132EM	3676
	144"	3658	8	168	76.2	20.7	T36144B	2822	T36144EB	3076	T36144E	3275	T36144EM	3747
	48"	1219	4	124	56.2	9.3	n/a	n/a	n/a	n/a	T4848E	2635	T4848EM	3512
	60"	1524	4	146	66.2	14.0	n/a	n/a	n/a	n/a	T4860E	2946	T4860EM	3823
	72"	1829	6	171	77.6	14.0	n/a	n/a	n/a	n/a	T4872E	3199	T4872EM	4078
	84"	2134	8	197	89.4	18.7	n/a	n/a	n/a	n/a	T4884E	4343	T4884EM	5218
	96"	2438	8	241	109.3	18.7	n/a	n/a	n/a	n/a	T4896E	4593	T4896EM	5471
	108"	2743	8	278	126.1	23.3	n/a	n/a	n/a	n/a	T48108E	6872	T48108EM	7755
	120"	3048	8	316	143.3	23.3	n/a	n/a	n/a	n/a	T48120E	6951	T48120EM	7818
	132"	3353	10	353	160.1	27.9	n/a	n/a	n/a	n/a	T48132E	7551	T48132EM	8420
144"	3658	10	391	177.4	27.9	n/a	n/a	n/a	n/a	T48144E	7605	T48144EM	8488	

* On SPEC-MASTER® and SPEC-MASTER® Marine tables, increase stated weight by 10%. ▼ SPEC-MASTER® Marine tables feature a marine counter edge to prevent spillage.



Catalog Section 10

Worktables with Stainless Steel Flat Top & Stainless Steel Legs/Undershelf

see spec sheets **EG10.41A** **EG10.41B** **EG10.41C** **EG10.41D**



(Patent #5,165,349)



See page 156 for optional casters available.

- 1 5/8" (41mm) diameter legs and adjustable undershelf are heavy gauge stainless steel.
- Heavy gauge polished stainless steel top.
- Offers worktables with a rolled edge on front and rear, with ends turned 90°, except SPEC-MASTER® Marine.
- 35 1/2" - 36 1/2" (892 - 918mm) adjustable working height.

FEATURES:

Note: All shipping weights and cubic feet are approximate.

NSF sprayed-on latex sound deadening available. To order, add \$646 to list price and suffix "-SD". Example: T2424SB-SD.

For FLEX-MASTER® overshelf kits, see pages 167.

For drawer kits, see page 173.

Freight class is 70.0.

(•) MTS (made to stock) / () MTO (made to order)

	length		# of legs	weight		cu ft	BUDGET 16/430 top		DELUXE 16/304 top		*SPEC-MASTER® 14/304 top		* ▼ Marine 14/304 top		
	in.	mm		lbs.	kg		model #	list	model #	list	model #	list	model #	list	
24" width (610mm)	24"	610	4	40	18.1	3.5	T2424SB	920	T2424SEB •	981	T2424SE	1058	T2424SEM	1581	
	30"	762	4	45	20.4	3.8	T2430SB	1002	T2430SEB	1080	T2430SE	1174	T2430SEM	1696	
	36"	914	4	50	22.7	4.4	T2436SB •	1059	T2436SEB •	1139	T2436SE	1234	T2436SEM	1755	
	48"	1219	4	60	27.2	5.7	T2448SB	1089	T2448SEB •	1180	T2448SE •	1287	T2448SEM	1810	
	60"	1524	4	70	31.8	7.1	T2460SB	1176	T2460SEB	1284	T2460SE	1402	T2460SEM	1926	
	72"	1829	4	80	36.3	8.5	T2472SB	1262	T2472SEB	1386	T2472SE	1520	T2472SEM	2044	
	84"	2134	4	90	40.8	11.2	T2484SB	1559	T2484SEB	1906	T2484SE	2079	T2484SEM	2521	
	96"	2438	6	100	45.4	11.2	T2496SB	1673	T2496SEB	2040	T2496SE	2228	T2496SEM	2667	
	108"	2743	6	110	49.9	14.0	T24108SB	2716	T24108SEB	2832	T24108SE	3189	T24108SEM	3445	
	120"	3048	6	120	54.4	14.0	T24120SB	2780	T24120SEB	3007	T24120SE	3254	T24120SEM	3511	
	132"	3353	8	130	59.0	16.8	T24132SB	2841	T24132SEB	3093	T24132SE	3362	T24132SEM	3786	
	144"	3658	8	140	63.5	16.8	T24144SB	2991	T24144SEB	3156	T24144SE	3527	T24144SEM	3852	
	30" width (762mm)	30"	762	4	46	20.9	3.8	T3030SB •	1043	T3030SEB •	1148	T3030SE	1244	T3030SEM	1767
		36"	914	4	52	23.6	4.4	T3036SB •	1115	T3036SEB •	1205	T3036SE	1307	T3036SEM	1828
48"		1219	4	64	29.0	5.7	T3048SB •	1160	T3048SEB •	1266	T3048SE •	1385	T3048SEM	1902	
60"		1524	4	76	34.5	7.1	T3060SB •	1269	T3060SEB •	1396	T3060SE •	1523	T3060SEM	2045	
72"		1829	4	84	38.1	8.5	T3072SB •	1375	T3072SEB •	1520	T3072SE •	1668	T3072SEM	2260	
84"		2134	4	96	43.6	11.2	T3084SB	1615	T3084SEB	1991	T3084SE •	2170	T3084SEM	2610	
96"		2438	6	108	49.0	11.2	T3096SB •	1811	T3096SEB •	2202	T3096SE •	2404	T3096SEM	2715	
108"		2743	6	120	54.4	14.0	T30108SB	2881	T30108SEB	3145	T30108SE	3407	T30108SEM	3727	
120"		3048	6	132	59.9	14.0	T30120SB	2947	T30120SEB	3213	T30120SE	3476	T30120SEM	3793	
132"		3353	8	144	65.3	16.8	T30132SB	3131	T30132SEB	3434	T30132SE	3730	T30132SEM	4043	
36" width (914mm)	144"	3658	8	156	70.8	16.8	T30144SB	3197	T30144SEB	3504	T30144SE	3798	T30144SEM	4111	
	48"	1219	4	70	31.8	7.0	T3648SB	1338	T3648SEB	1493	T3648SE	1581	T3648SEM	2221	
	60"	1524	4	82	37.2	8.8	T3660SB	1481	T3660SEB	1638	T3660SE	1740	T3660SEM	2388	
	72"	1829	4	96	43.6	10.5	T3672SB	1620	T3672SEB	1789	T3672SE	1901	T3672SEM	2560	
	84"	2134	4	108	49.0	12.2	T3684SB	2239	T3684SEB	2431	T3684SE	2574	T3684SEM	3123	
	96"	2438	6	120	54.4	13.9	T3696SB	2414	T3696SEB	2606	T3696SE	2767	T3696SEM	3315	
	108"	2743	6	132	59.9	17.3	T36108SB	3429	T36108SEB	3736	T36108SE	3960	T36108SEM	4296	
	120"	3048	6	144	65.3	17.3	T36120SB	3498	T36120SEB	3803	T36120SE	4028	T36120SEM	4359	
48" width (1219mm)	132"	3353	8	156	70.8	20.7	T36132SB	3620	T36132SEB	3964	T36132SE	4330	T36132SEM	4657	
	144"	3658	8	168	76.2	20.7	T36144SB	3790	T36144SEB	4146	T36144SE	4396	T36144SEM	4726	
	48"	1219	4	124	56.2	9.3	n/a	n/a	n/a	n/a	T4848SE	3055	T4848SEM	3934	
	60"	1524	4	146	66.2	14.0	n/a	n/a	n/a	n/a	T4860SE	3379	T4860SEM	4262	
	72"	1829	6	171	77.6	14.0	n/a	n/a	n/a	n/a	T4872SE	3691	T4872SEM	4573	
	84"	2134	8	197	89.4	18.7	n/a	n/a	n/a	n/a	T4884SE	4990	T4884SEM	5869	
	96"	2438	8	241	109.3	18.7	n/a	n/a	n/a	n/a	T4896SE	5386	T4896SEM	6267	
48" width (1219mm)	108"	2743	8	278	126.1	23.3	n/a	n/a	n/a	n/a	T48108SE	7854	T48108SEM	8738	
	120"	3048	8	316	143.3	23.3	n/a	n/a	n/a	n/a	T48120SE	7922	T48120SEM	8802	
	132"	3353	10	353	160.1	27.9	n/a	n/a	n/a	n/a	T48132SE	8518	T48132SEM	9396	
	144"	3658	10	391	177.4	27.9	n/a	n/a	n/a	n/a	T48144SE	8582	T48144SEM	9463	

* SPEC-MASTER® and SPEC-MASTER® Marine tables feature all stainless steel construction. Increase stated weight by 10%.

▼ SPEC-MASTER® Marine tables feature a marine counter edge to prevent spillage.



100 Industrial Boulevard, Clayton, DE 19938-8903 U.S.A.
 Phone: 800-637-5100 or 302-653-3000. Fax: 302-653-2065
<http://www.eaglegrp.com>

Worktables with Stainless Steel Flat Top & Galvanized Tubular Base

see spec sheets **EG10.42A** **EG10.42B** **EG10.42C** **EG10.42D**

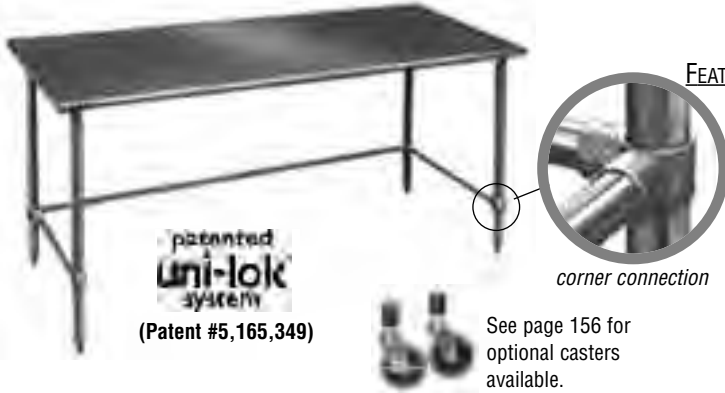

- Tubular base.
- 1½" (41mm)-diameter legs and 1¼" (32mm)-diameter crossbracing are heavy gauge galvanized steel.
- Heavy gauge polished stainless steel top.
- Offers worktables with a rolled edge on front and rear, with ends turned 90°, except SPEC-MASTER® Marine.
- 35½" - 36½" (892 - 918mm) adjustable working height.

Note: All shipping weights and cubic feet are approximate.
NSF sprayed-on latex sound deadening available. To order, add \$646 to list price and suffix "-SD". Example: T2424GTB-SD.

For FLEX-MASTER® overshelf kits, see pages 167.

For drawer kits, see page 173.

Freight class is 70.0.

(•) MTS (made to stock) / () MTO (made to order)

	length		# of legs	weight		cu ft	BUDGET 16/430 top		DELUXE 16/304 top		*SPEC-MASTER® 14/304 top		* ▼ Marine 14/304 top	
	in.	mm		lbs.	kg		model #	list	model #	list	model #	list	model #	list
24" width (610mm)	24"	610	4	40	18.1	3.5	T2424GTB	765	T2424GTB	836	T2424GTE	869	T2424GTEM	1381
	30"	762	4	45	20.4	3.8	T2430GTB	821	T2430GTB	901	T2430GTE	952	T2430GTEM	1466
	36"	914	4	50	22.7	4.4	T2436GTB	880	T2436GTB	961	T2436GTE	1011	T2436GTEM	1529
	48"	1219	4	60	27.2	5.7	T2448GTB	894	T2448GTB	974	T2448GTE	1031	T2448GTEM	1554
	60"	1524	4	70	31.8	7.1	T2460GTB	939	T2460GTB	1046	T2460GTE	1112	T2460GTEM	1638
	72"	1829	4	80	36.3	8.5	T2472GTB	998	T2472GTB	1125	T2472GTE	1196	T2472GTEM	1734
	84"	2134	4	90	40.8	11.2	T2484GTB	1241	T2484GTB	1561	T2484GTE	1595	T2484GTEM	2088
	96"	2438	6	100	45.4	11.2	T2496GTB	1396	T2496GTB	1665	T2496GTE	1698	T2496GTEM	2198
	108"	2743	6	110	49.9	14.0	T24108GTB	2131	T24108GTB	2345	T24108GTE	2580	T24108GTEM	2851
	120"	3048	6	120	54.4	14.0	T24120GTB	2207	T24120GTB	2410	T24120GTE	2590	T24120GTEM	2914
132"	3353	8	130	59.0	16.8	T24132GTB	2261	T24132GTB	2459	T24132GTE	2643	T24132GTEM	3118	
144"	3658	8	140	63.5	16.8	T24144GTB	2270	T24144GTB	2524	T24144GTE	2652	T24144GTEM	3184	
30" width (762mm)	30"	762	4	47	21.3	3.8	T3030GTB	841	T3030GTB	928	T3030GTE	981	T3030GTEM	1503
	36"	914	4	53	24.0	4.4	T3036GTB	898	T3036GTB	991	T3036GTE	1040	T3036GTEM	1562
	48"	1219	4	65	29.5	5.7	T3048GTB	912	T3048GTB •	1012	T3048GTE	1077	T3048GTEM	1602
	60"	1524	4	77	34.9	7.1	T3060GTB	986	T3060GTB •	1104	T3060GTE	1178	T3060GTEM	1710
	72"	1829	4	89	40.4	8.5	T3072GTB	1058	T3072GTB •	1196	T3072GTE	1276	T3072GTEM	1816
	84"	2134	4	101	45.8	11.2	T3084GTB	1295	T3084GTB	1582	T3084GTE	1671	T3084GTEM	2173
	96"	2438	6	113	51.3	11.2	T3096GTB	1485	T3096GTB	1712	T3096GTE	1820	T3096GTEM	2318
	108"	2743	6	125	56.7	14.0	T30108GTB	2229	T30108GTB	2481	T30108GTE	2606	T30108GTEM	3057
	120"	3048	6	137	62.1	14.0	T30120GTB	2294	T30120GTB	2551	T30120GTE	2675	T30120GTEM	3126
	132"	3353	8	149	67.6	16.8	T30132GTB	2334	T30132GTB	2616	T30132GTE	2758	T30132GTEM	3301
144"	3658	8	161	73.0	16.8	T30144GTB	2469	T30144GTB	2764	T30144GTE	2905	T30144GTEM	3369	
36" width (914mm)	48"	1219	4	73	33.1	7.0	T3648GTB	1109	T3648GTB	1209	T3648GTE	1381	T3648GTEM	1902
	60"	1524	4	87	39.5	8.8	T3660GTB	1234	T3660GTB	1341	T3660GTE	1385	T3660GTEM	2040
	72"	1829	4	101	45.8	10.5	T3672GTB	1338	T3672GTB	1446	T3672GTE	1493	T3672GTEM	2170
	84"	2134	4	115	52.2	12.2	T3684GTB	1797	T3684GTB	1926	T3684GTE	1977	T3684GTEM	2594
	96"	2438	6	129	58.5	13.9	T3696GTB	1884	T3696GTB	2034	T3696GTE	2089	T3696GTEM	2714
	108"	2743	6	143	64.9	17.3	T36108GTB	2581	T36108GTB	2875	T36108GTE	3028	T36108GTEM	3519
	120"	3048	6	157	71.2	17.3	T36120GTB	2723	T36120GTB	3028	T36120GTE	3097	T36120GTEM	3586
	132"	3353	8	171	77.6	20.7	T36132GTB	2781	T36132GTB	3121	T36132GTE	3226	T36132GTEM	3793
144"	3658	8	185	83.9	20.7	T36144GTB	2931	T36144GTB	3281	T36144GTE	3292	T36144GTEM	3862	
48" width (1219mm)	48"	1219	4	87	39.5	9.3	n/a	n/a	n/a	n/a	T4848GTE	2745	T4848GTEM	3604
	60"	1524	4	101	45.8	14.0	n/a	n/a	n/a	n/a	T4860GTE	3061	T4860GTEM	3934
	72"	1829	6	115	52.2	14.0	n/a	n/a	n/a	n/a	T4872GTE	3313	T4872GTEM	4267
	84"	2134	8	120	54.4	18.7	n/a	n/a	n/a	n/a	T4884GTE	4457	T4884GTEM	5329
	96"	2438	8	143	64.9	18.7	n/a	n/a	n/a	n/a	T4896GTE	4701	T4896GTEM	5584
	108"	2743	8	157	71.2	23.3	n/a	n/a	n/a	n/a	T48108GTE	6981	T48108GTEM	7863
	120"	3048	8	171	77.6	23.3	n/a	n/a	n/a	n/a	T48120GTE	7059	T48120GTEM	7931
	132"	3353	10	185	83.9	27.9	n/a	n/a	n/a	n/a	T48132GTE	7664	T48132GTEM	8529
144"	3658	10	199	90.3	27.9	n/a	n/a	n/a	n/a	T48144GTE	7727	T48144GTEM	8595	

* On SPEC-MASTER® and SPEC-MASTER® Marine tables, increase stated weight by 10%. ▼ SPEC-MASTER® Marine tables feature a marine counter edge to prevent spillage.



Catalog Section 10

Worktables with Stainless Steel Flat Top & Stainless Steel Tubular Base

see spec sheets **EG10.43A EG10.43B EG10.43C EG10.43D**



FEATURES:

- Tubular base.
- 1½" (41mm)-diameter legs and 1¼" (32mm)-diameter crossbracing are heavy gauge stainless steel.
- Heavy gauge polished stainless steel top.
- Offers worktables with a rolled edge on front and rear, with ends turned 90°, except SPEC-MASTER® Marine.
- 35½" - 36½" (892 - 918mm) adjustable working height.

Note: All shipping weights and cubic feet are approximate.

NSF sprayed-on latex sound deadening available. To order, add **\$646 to list price** and suffix **"-SD"**. Example: **T2424STB-SD**.

For FLEX-MASTER® overshelf kits, see pages 167.

For drawer kits, see page 173.

Freight class is 70.0.

(•) MTS (made to stock) / () MTO (made to order)

	length		# of legs	weight		cu ft	BUDGET 16/430 top		DELUXE 16/304 top		*SPEC-MASTER® 14/304 top		* ▼ Marine 14/304 top	
	in.	mm		lbs.	kg		model #	list	model #	list	model #	list	model #	list
24" width (610mm)	24"	610	4	40	18.1	3.5	T2424STB	1028	T2424STEB	1093	T2424STE	1171	T2424STEM	1694
	30"	762	4	45	20.4	3.8	T2430STB	1112	T2430STEB	1194	T2430STE	1287	T2430STEM	1810
	36"	914	4	50	22.7	4.4	T2436STB	1170	T2436STEB	1254	T2436STE	1347	T2436STEM	1871
	48"	1219	4	60	27.2	5.7	T2448STB	1197	T2448STEB	1294	T2448STE	1400	T2448STEM	1821
	60"	1524	4	70	31.8	7.1	T2460STB	1284	T2460STEB	1396	T2460STE	1516	T2460STEM	2039
	72"	1829	4	80	36.3	8.5	T2472STB	1373	T2472STEB	1502	T2472STE	1635	T2472STEM	2161
	84"	2134	4	90	40.8	11.2	T2484STB	1666	T2484STEB	2023	T2484STE	2188	T2484STEM	2634
	96"	2438	6	100	45.4	11.2	T2496STB	1785	T2496STEB	2157	T2496STE	2338	T2496STEM	2836
	108"	2743	6	110	49.9	14.0	T24108STB	2742	T24108STEB	3052	T24108STE	3305	T24108STEM	3554
	120"	3048	6	120	54.4	14.0	T24120STB	2888	T24120STEB	3120	T24120STE	3366	T24120STEM	3623
30" width (762mm)	132"	3353	8	130	59.0	16.8	T24132STB	2949	T24132STEB	3203	T24132STE	3473	T24132STEM	3895
	144"	3658	8	140	63.5	16.8	T24144STB	3012	T24144STEB	3269	T24144STE	3539	T24144STEM	3963
	30"	762	4	47	21.3	3.8	T3030STB	1166	T3030STEB	1260	T3030STE	1359	T3030STEM	1881
	36"	914	4	53	24.0	4.4	T3036STB	1225	T3036STEB	1318	T3036STE	1420	T3036STEM	1941
	48"	1219	4	65	29.5	5.7	T3048STB	1271	T3048STEB •	1381	T3048STE •	1500	T3048STEM	2020
	60"	1524	4	77	34.9	7.1	T3060STB	1381	T3060STEB •	1508	T3060STE •	1649	T3060STEM	2162
	72"	1829	4	89	40.4	8.5	T3072STB	1486	T3072STEB •	1635	T3072STE •	1782	T3072STEM	2374
	84"	2134	4	101	45.8	11.2	T3084STB	1730	T3084STEB	2106	T3084STE	2284	T3084STEM	2727
	96"	2438	6	113	51.3	11.2	T3096STB	1919	T3096STEB	2316	T3096STE	2521	T3096STEM	2827
	108"	2743	6	125	56.7	14.0	T30108STB	2991	T30108STEB	3258	T30108STE	3520	T30108STEM	3841
36" width (914mm)	120"	3048	6	137	62.1	14.0	T30120STB	3057	T30120STEB	3327	T30120STE	3587	T30120STEM	3905
	132"	3353	8	149	67.6	16.8	T30132STB	3147	T30132STEB	3445	T30132STE	3735	T30132STEM	4160
	144"	3658	8	161	73.0	16.8	T30144STB	3306	T30144STEB	3613	T30144STE	3911	T30144STEM	4227
	48"	1219	4	73	33.1	7.0	T3648STB	1451	T3648STEB	1608	T3648STE	1694	T3648STEM	2333
	60"	1524	4	87	39.5	8.8	T3660STB	1590	T3660STEB	1752	T3660STE	1855	T3660STEM	2503
	72"	1829	4	101	45.8	10.5	T3672STB	1732	T3672STEB	1901	T3672STE	2019	T3672STEM	2674
	84"	2134	4	115	52.2	12.2	T3684STB	2351	T3684STEB	2538	T3684STE	2684	T3684STEM	3238
	96"	2438	6	129	58.5	13.9	T3696STB	2523	T3696STEB	2723	T3696STE	2878	T3696STEM	3432
	108"	2743	6	143	64.9	17.3	T36108STB	3441	T36108STEB	3810	T36108STE	4071	T36108STEM	4407
	120"	3048	6	157	71.2	17.3	T36120STB	3606	T36120STEB	3921	T36120STE	4140	T36120STEM	4472
48" width (1219mm)	132"	3353	8	171	77.6	20.7	T36132STB	3726	T36132STEB	4140	T36132STE	4309	T36132STEM	4766
	144"	3658	8	185	83.9	20.7	T36144STB	3790	T36144STEB	4261	T36144STE	4513	T36144STEM	4837
	48"	1219	4	87	39.5	9.3	n/a	n/a	n/a	n/a	T4848STE	3285	T4848STEM	4045
	60"	1524	4	101	45.8	14.0	n/a	n/a	n/a	n/a	T4860STE	3490	T4860STEM	4376
	72"	1829	6	115	52.2	14.0	n/a	n/a	n/a	n/a	T4872STE	3801	T4872STEM	4680
	84"	2134	8	120	54.4	18.7	n/a	n/a	n/a	n/a	T4884STE	5108	T4884STEM	5981
	96"	2438	8	143	64.9	18.7	n/a	n/a	n/a	n/a	T4896STE	5496	T4896STEM	6374
	108"	2743	8	157	71.2	23.3	n/a	n/a	n/a	n/a	T48108STE	7978	T48108STEM	8845
	120"	3048	8	171	77.6	23.3	n/a	n/a	n/a	n/a	T48120STE	8033	T48120STEM	8909
	132"	3353	10	185	83.9	27.9	n/a	n/a	n/a	n/a	T48132STE	8640	T48132STEM	9508
144"	3658	10	199	90.3	27.9	n/a	n/a	n/a	n/a	T48144STE	8708	T48144STEM	9571	

* SPEC-MASTER® and SPEC-MASTER® Marine tables feature all stainless steel construction. Increase stated weight by 10%.

▼ SPEC-MASTER® Marine tables feature a marine counter edge to prevent spillage.



100 Industrial Boulevard, Clayton, DE 19938-8903 U.S.A.
 Phone: 800-637-5100 or 302-653-3000. Fax: 302-653-2065
<http://www.eaglegrp.com>

Worktables with Stainless Steel Top, Upturn & Galvanized Legs/Undershelf

see spec sheets **EG10.02A EG10.02B EG10.02C**



adjustable undershelf welded gusset

NOW STANDARD!

FEATURES:



(Patent #5,165,349)

- 1½" (38mm) upturn at the rear of the table.
- 1½" (41mm)-diameter legs and adjustable undershelf are heavy gauge galvanized steel.
- Heavy gauge polished stainless steel top.
- 35½" - 36½" (892 - 918mm) adjustable working height.

Note: All shipping weights and cubic feet are approximate.

NSF sprayed-on latex sound deadening available. To order, add \$646 to list price and suffix "-SD". Example: UT2424B-SD.

Optional fixed undershelf available in place of standard adjustable undershelf. To order, add 10% to list price, and "-F" to end of suffix. Example: UT2424EB-F.

For FLEX-MASTER® overshelf kits, see page 167.

For drawer kits, see page 173.

Freight class is 70.0.

(•) MTS (made to stock) / () MTO (made to order)



See page 156 for optional casters available.

	length		# of legs	weight		cu ft	BUDGET 16/430 top		DELUXE 16/304 top		*SPEC-MASTER® 14/304 top	
	in.	mm		lbs.	kg		model #	list	model #	list	model #	list
24" width (610mm)	24"	610	4	40	18.1	3.5	UT2424B	741	UT2424EB	813	UT2424E	846
	30"	762	4	45	20.4	3.8	UT2430B •	799	UT2430EB	875	UT2430E	928
	36"	914	4	50	22.7	4.4	UT2436B •	854	UT2436EB	934	UT2436E	991
	48"	1219	4	60	27.2	5.7	UT2448B •	868	UT2448EB	952	UT2448E	1008
	60"	1524	4	70	31.8	7.1	UT2460B •	919	UT2460EB	1023	UT2460E	1091
	72"	1829	4	80	36.3	8.5	UT2472B •	976	UT2472EB	1100	UT2472E	1174
	84"	2134	4	90	40.8	11.2	UT2484B	1216	UT2484EB	1542	UT2484E	1573
	96"	2438	6	100	45.4	11.2	UT2496B	1375	UT2496EB	1642	UT2496E	1676
	108"	2743	6	110	49.9	14.0	UT24108B	2174	UT24108EB	2256	UT24108E	2370
	120"	3048	6	120	54.4	14.0	UT24120B	2219	UT24120EB	2391	UT24120E	2508
30" width (762mm)	132"	3353	8	130	59.0	16.8	UT24132B	2240	UT24132EB	2437	UT24132E	2641
	144"	3658	8	140	63.5	16.8	UT24144B	2253	UT24144EB	2576	UT24144E	2722
	30"	762	4	50	22.7	3.8	UT3030B •	819	UT3030EB	906	UT3030E	955
	36"	914	4	55	24.9	4.4	UT3036B •	875	UT3036EB	967	UT3036E	1015
	48"	1219	4	65	29.5	5.7	UT3048B •	887	UT3048EB	990	UT3048E	1051
	60"	1524	4	75	34.0	7.1	UT3060B •	962	UT3060EB	1086	UT3060E	1154
36" width (914mm)	72"	1829	4	85	38.6	8.5	UT3072B •	1036	UT3072EB	1174	UT3072E	1254
	84"	2134	4	95	43.1	11.2	UT3084B	1274	UT3084EB	1559	UT3084E	1653
	96"	2438	6	105	47.6	11.2	UT3096B •	1461	UT3096EB	1693	UT3096E	1795
	108"	2743	6	115	52.2	14.0	UT30108B	2202	UT30108EB	2460	UT30108E	2586
	120"	3048	6	125	56.7	14.0	UT30120B	2267	UT30120EB	2531	UT30120E	2654
	132"	3353	8	135	61.2	16.8	UT30132B	2380	UT30132EB	2600	UT30132E	2735
	144"	3658	8	145	65.8	16.8	UT30144B	2448	UT30144EB	2664	UT30144E	2799
	48"	1219	4	75	34.0	7.0	UT3648B	1086	UT3648EB	1190	UT3648E	1223
36" width (914mm)	60"	1524	4	85	38.6	8.8	UT3660B	1211	UT3660EB	1318	UT3660E	1359
	72"	1829	4	95	43.1	10.5	UT3672B	1316	UT3672EB	1427	UT3672E	1468
	84"	2134	4	105	47.6	12.2	UT3684B	1776	UT3684EB	1901	UT3684E	1956
	96"	2438	6	115	52.2	13.9	UT3696B	1881	UT3696EB	2011	UT3696E	2066
	108"	2743	6	125	56.7	17.3	UT36108B	2636	UT36108EB	2833	UT36108E	2922
	120"	3048	6	135	61.2	17.3	UT36120B	2703	UT36120EB	3007	UT36120E	3073
	132"	3353	8	145	65.8	20.7	UT36132B	2760	UT36132EB	3098	UT36132E	3204
	144"	3658	8	155	70.3	20.7	UT36144B	2910	UT36144EB	3166	UT36144E	3271

* On SPEC-MASTER® tables, increase stated weight by 10%.



Catalog Section 10

Worktables with Stainless Steel Top Upturn & Stainless Steel Legs/Undershelf

see spec sheets **EG10.48A** **EG10.48B** **EG10.48C**



(Patent #5,165,349)



See page 156 for optional casters available.

FEATURES:

- 1½" (38mm) upturn at the rear of the table.
- 1½" (41mm)-diameter legs and adjustable undershelf are heavy gauge stainless steel.
- Heavy gauge polished stainless steel top.
- 35½" - 36½" (892 - 918mm) adjustable working height.

Note: All shipping weights and cubic feet are approximate.

NSF sprayed-on latex sound deadening available. To order, add **\$646 to list price** and suffix **"-SD"**. Example: **UT2424SB-SD**.

For FLEX-MASTER® overshelf kits, see pages 167.

For drawer kits, see page 173.

Freight class is 70.0.

(•) MTS (made to stock) / () MTO (made to order)

	length		# of legs	weight		cu ft	BUDGET 16/430 top		DELUXE 16/304 top		*SPEC-MASTER® 14/304 top	
	in.	mm		lbs.	kg		model #	list	model #	list	model #	list
24" width (610mm)	24"	610	4	40	18.1	3.5	UT2424SB	1010	UT2424SEB	1070	UT2424SE	1149
	30"	762	4	45	20.4	3.8	UT2430SB	1090	UT2430SEB	1169	UT2430SE	1265
	36"	914	4	50	22.7	4.4	UT2436SB	1148	UT2436SEB	1233	UT2436SE	1326
	48"	1219	4	60	27.2	5.7	UT2448SB	1178	UT2448SEB	1272	UT2448SE	1380
	60"	1524	4	70	31.8	7.1	UT2460SB	1262	UT2460SEB	1373	UT2460SE	1498
	72"	1829	4	80	36.3	8.5	UT2472SB	1347	UT2472SEB	1473	UT2472SE	1613
	84"	2134	4	90	40.8	11.2	UT2484SB	1644	UT2484SEB	1999	UT2484SE	2169
	96"	2438	6	100	45.4	11.2	UT2496SB	1762	UT2496SEB	2128	UT2496SE	2316
	108"	2743	6	110	49.9	14.0	UT24108SB	2802	UT24108SEB	3028	UT24108SE	3275
	120"	3048	6	120	54.4	14.0	UT24120SB	2866	UT24120SEB	3097	UT24120SE	3342
30" width (762mm)	132"	3353	8	130	59.0	16.8	UT24132SB	2927	UT24132SEB	3274	UT24132SE	3447
	144"	3658	8	140	63.5	16.8	UT24144SB	3079	UT24144SEB	3340	UT24144SE	3620
	30"	762	4	50	22.7	3.8	UT3030SB	1145	UT3030SEB	1236	UT3030SE	1335
	36"	914	4	55	24.9	4.4	UT3036SB	1202	UT3036SEB	1299	UT3036SE	1393
	48"	1219	4	65	29.5	5.7	UT3048SB	1246	UT3048SEB	1359	UT3048SE	1472
	60"	1524	4	75	34.0	7.1	UT3060SB	1356	UT3060SEB	1487	UT3060SE	1616
	72"	1829	4	85	38.6	8.5	UT3072SB	1466	UT3072SEB	1613	UT3072SE	1760
	84"	2134	4	95	43.1	11.2	UT3084SB	1708	UT3084SEB	2081	UT3084SE	2260
	96"	2438	6	105	47.6	11.2	UT3096SB	1897	UT3096SEB	2298	UT3096SE	2496
	108"	2743	6	115	52.2	14.0	UT30108SB	2971	UT30108SEB	3236	UT30108SE	3501
36" width (914mm)	120"	3048	6	125	56.7	14.0	UT30120SB	3037	UT30120SEB	3302	UT30120SE	3568
	132"	3353	8	135	61.2	16.8	UT30132SB	3128	UT30132SEB	3420	UT30132SE	3820
	144"	3658	8	145	65.8	16.8	UT30144SB	3190	UT30144SEB	3589	UT30144SE	3891
	48"	1219	4	75	34.0	7.0	UT3648SB	1425	UT3648SEB	1582	UT3648SE	1669
	60"	1524	4	85	38.6	8.8	UT3660SB	1567	UT3660SEB	1734	UT3660SE	1832
	72"	1829	4	95	43.1	10.5	UT3672SB	1711	UT3672SEB	1881	UT3672SE	1992
	84"	2134	4	105	47.6	12.2	UT3684SB	2326	UT3684SEB	2521	UT3684SE	2666
	96"	2438	6	115	52.2	13.9	UT3696SB	2501	UT3696SEB	2696	UT3696SE	2863
	108"	2743	6	125	56.7	17.3	UT36108SB	3516	UT36108SEB	3716	UT36108SE	4051
	120"	3048	6	135	61.2	17.3	UT36120SB	3585	UT36120SEB	3895	UT36120SE	4120
132"	3353	8	145	65.8	20.7	UT36132SB	3811	UT36132SEB	4054	UT36132SE	4290	
144"	3658	8	155	70.3	20.7	UT36144SB	3884	UT36144SEB	4241	UT36144SE	4488	

* On SPEC-MASTER® tables, increase stated weight by 10%. All stainless steel construction.



100 Industrial Boulevard, Clayton, DE 19938-8903 U.S.A.
 Phone: 800-637-5100 or 302-653-3000. Fax: 302-653-2065
<http://www.eaglegrp.com>

Worktables with Stainless Steel Top, Upturn & Galvanized Tubular Base

see spec sheets **EG10.03A** **EG10.03B** **EG10.03C**



FEATURES:

- 1½" (38mm) upturn at the rear of the table.
- Tubular base.
- 1½" (41mm)-diameter legs and 1¼" (32mm)-diameter crossbracing are heavy gauge galvanized steel.
- Heavy gauge polished stainless steel top.
- 35½" - 36⅝" (892 - 918mm) adjustable working height.

Note: All shipping weights and cubic feet are approximate.
 NSF sprayed-on latex sound deadening available. To order, add \$646 to list price and suffix "-SD". Example: UT2424GTB-SD.
 For FLEX-MASTER® overshelf kits, see pages 167.
 For drawer kits, see page 173.

Freight class is 70.0.

(*) MTS (made to stock) / () MTO (made to order)

See page 156 for optional casters available.

	length		# of legs	weight		cu ft	BUDGET 16/430 top		DELUXE 16/304 top		*SPEC-MASTER® 14/304 top	
	in.	mm		lbs.	kg		model #	list	model #	list	model #	list
24" width (610mm)	24"	610	4	40	18.1	3.5	UT2424GTB	851	UT2424GTB	927	UT2424GTE	1044
	30"	762	4	45	20.4	3.8	UT2430GTB	908	UT2430GTB	990	UT2430GTE	1091
	36"	914	4	50	22.7	4.4	UT2436GTB	967	UT2436GTB	1048	UT2436GTE	1109
	48"	1219	4	60	27.2	5.7	UT2448GTB	980	UT2448GTB	1063	UT2448GTE	1163
	60"	1524	4	70	31.8	7.1	UT2460GTB	1026	UT2460GTB	1137	UT2460GTE	1201
	72"	1829	4	80	36.3	8.5	UT2472GTB	1087	UT2472GTB	1218	UT2472GTE	1287
	84"	2134	4	90	40.8	11.2	UT2484GTB	1327	UT2484GTB	1653	UT2484GTE	1687
	96"	2438	6	100	45.4	11.2	UT2496GTB	1486	UT2496GTB	1755	UT2496GTE	1790
	108"	2743	6	110	49.9	14.0	UT24108GTB	2219	UT24108GTB	2369	UT24108GTE	2478
	120"	3048	6	120	54.4	14.0	UT24120GTB	2354	UT24120GTB	2504	UT24120GTE	2616
30" width (762mm)	132"	3353	8	130	59.0	16.8	UT24132GTB	2359	UT24132GTB	2544	UT24132GTE	2675
	144"	3658	8	140	63.5	16.8	UT24144GTB	2367	UT24144GTB	2609	UT24144GTE	2740
	30"	762	4	50	22.7	3.8	UT3030GTB	927	UT3030GTB	1019	UT3030GTE	1070
	36"	914	4	53	24.0	4.4	UT3036GTB	986	UT3036GTB	1080	UT3036GTE	1130
	48"	1219	4	57	25.9	5.7	UT3048GTB	998	UT3048GTB	1102	UT3048GTE	1168
	60"	1524	4	67	30.4	7.1	UT3060GTB	1072	UT3060GTB	1196	UT3060GTE	1266
	72"	1829	4	77	34.9	8.5	UT3072GTB	1145	UT3072GTB	1287	UT3072GTE	1366
	84"	2134	4	87	39.5	11.2	UT3084GTB	1385	UT3084GTB	1670	UT3084GTE	1767
	96"	2438	6	97	44.0	11.2	UT3096GTB	1571	UT3096GTB	1805	UT3096GTE	1908
	108"	2743	6	107	48.5	14.0	UT30108GTB	2252	UT30108GTB	2576	UT30108GTE	2696
36" width (914mm)	120"	3048	6	117	53.1	14.0	UT30120GTB	2374	UT30120GTB	2643	UT30120GTE	2767
	132"	3353	8	127	57.6	16.8	UT30132GTB	2424	UT30132GTB	2710	UT30132GTE	2930
	144"	3658	8	137	62.1	16.8	UT30144GTB	2488	UT30144GTB	2776	UT30144GTE	3003
	48"	1219	4	61	27.7	7.0	UT3648GTB	1195	UT3648GTB	1302	UT3648GTE	1335
	60"	1524	4	73	33.1	8.8	UT3660GTB	1322	UT3660GTB	1434	UT3660GTE	1470
	72"	1829	4	85	38.6	10.5	UT3672GTB	1425	UT3672GTB	1542	UT3672GTE	1582
	84"	2134	4	97	44.0	12.2	UT3684GTB	1889	UT3684GTB	2019	UT3684GTE	2067
	96"	2438	6	109	49.4	13.9	UT3696GTB	1991	UT3696GTB	2124	UT3696GTE	2180
	108"	2743	6	121	54.9	17.3	UT36108GTB	2746	UT36108GTB	2965	UT36108GTE	3031
	120"	3048	6	133	60.3	17.3	UT36120GTB	2812	UT36120GTB	3120	UT36120GTE	3188
132"	3353	8	145	65.8	20.7	UT36132GTB	2867	UT36132GTB	3210	UT36132GTE	3314	
144"	3658	8	157	71.2	20.7	UT36144GTB	2932	UT36144GTB	3278	UT36144GTE	3379	

* On SPEC-MASTER® tables, increase stated weight by 10%.



Catalog Section 10

Worktables with Stainless Steel Top, Uprn & Stainless Steel Tubular Base

see spec sheets **EG10.49A** **EG10.49B** **EG10.49C**



FEATURES:

- 1½" (38mm) upturn at the rear of the table.
- Tubular base.
- 1½" (41mm)-diameter legs and 1¼" (32mm)-diameter crossbracing are heavy gauge stainless steel.
- Heavy gauge polished stainless steel top.
- 35½" - 36½" (892 - 918mm) adjustable working height.

Note: All shipping weights and cubic feet are approximate.

NSF sprayed-on latex sound deadening available. To order, add \$646 to list price and suffix "-SD". Example: UT2424STB-SD.

For FLEX-MASTER® overshelf kits, see pages 167.

For drawer kits, see page 173.

Freight class is 70.0.

(•) MTS (made to stock) / () MTO (made to order)

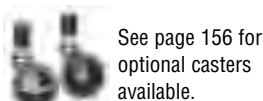

See page 156 for optional casters available.

	length		# of legs	weight		cu ft	BUDGET 16/430 top		DELUXE 16/304 top		*SPEC-MASTER® 14/304 top	
	in.	mm		lbs.	kg		model #	list	model #	list	model #	list
24" width (610mm)	24"	610	4	40	18.1	3.5	UT2424STB	1136	UT2424STEB	1181	UT2424STE	1260
	30"	762	4	45	20.4	3.8	UT2430STB	1199	UT2430STEB	1284	UT2430STE	1380
	36"	914	4	50	22.7	4.4	UT2436STB	1260	UT2436STEB	1343	UT2436STE	1439
	48"	1219	4	60	27.2	5.7	UT2448STB	1286	UT2448STEB	1386	UT2448STE	1493
	60"	1524	4	70	31.8	7.1	UT2460STB	1373	UT2460STEB	1487	UT2460STE	1609
	72"	1829	4	80	36.3	8.5	UT2472STB	1460	UT2472STEB	1589	UT2472STE	1726
	84"	2134	4	90	40.8	11.2	UT2484STB	1756	UT2484STEB	2111	UT2484STE	2280
	96"	2438	6	100	45.4	11.2	UT2496STB	1870	UT2496STEB	2246	UT2496STE	2434
	108"	2743	6	110	49.9	14.0	UT24108STB	2829	UT24108STEB	3055	UT24108STE	3389
	120"	3048	6	120	54.4	14.0	UT24120STB	2975	UT24120STEB	3210	UT24120STE	3460
	132"	3353	8	130	59.0	16.8	UT24132STB	3036	UT24132STEB	3291	UT24132STE	3558
144"	3658	8	140	63.5	16.8	UT24144STB	3039	UT24144STEB	3359	UT24144STE	3733	
30" width (762mm)	30"	762	4	50	22.7	3.8	UT3030STB	1257	UT3030STEB	1353	UT3030STE	1446
	36"	914	4	53	24.0	4.4	UT3036STB	1315	UT3036STEB	1413	UT3036STE	1507
	48"	1219	4	57	25.9	5.7	UT3048STB	1359	UT3048STEB	1470	UT3048STE	1588
	60"	1524	4	67	30.4	7.1	UT3060STB	1467	UT3060STEB	1601	UT3060STE	1734
	72"	1829	4	77	34.9	8.5	UT3072STB	1572	UT3072STEB	1726	UT3072STE	1874
	84"	2134	4	87	39.5	11.2	UT3084STB	1816	UT3084STEB	2197	UT3084STE	2374
	96"	2438	6	97	44.0	11.2	UT3096STB	2006	UT3096STEB	2407	UT3096STE	2606
	108"	2743	6	107	48.5	14.0	UT30108STB	2994	UT30108STEB	3348	UT30108STE	3612
	120"	3048	6	117	53.1	14.0	UT30120STB	3145	UT30120STEB	3416	UT30120STE	3676
	132"	3353	8	127	57.6	16.8	UT30132STB	3232	UT30132STEB	3532	UT30132STE	3934
	144"	3658	8	137	62.1	16.8	UT30144STB	3300	UT30144STEB	3704	UT30144STE	4002
36" width (914mm)	48"	1219	4	61	27.7	7.0	UT3648STB	1533	UT3648STEB	1696	UT3648STE	1787
	60"	1524	4	73	33.1	8.8	UT3660STB	1679	UT3660STEB	1843	UT3660STE	1945
	72"	1829	4	85	38.6	10.5	UT3672STB	1822	UT3672STEB	1992	UT3672STE	2107
	84"	2134	4	97	44.0	12.2	UT3684STB	2437	UT3684STEB	2634	UT3684STE	2776
	96"	2438	6	109	49.4	13.9	UT3696STB	2609	UT3696STEB	2811	UT3696STE	2972
	108"	2743	6	121	54.9	17.3	UT36108STB	3524	UT36108STEB	3828	UT36108STE	4164
	120"	3048	6	133	60.3	17.3	UT36120STB	3694	UT36120STEB	4007	UT36120STE	4232
	132"	3353	8	145	65.8	20.7	UT36132STB	3808	UT36132STEB	4161	UT36132STE	4382
	144"	3658	8	157	71.2	20.7	UT36144STB	3875	UT36144STEB	4353	UT36144STE	4471

* On SPEC-MASTER® tables, increase stated weight by 10%.
SPEC-MASTER® tables feature all stainless steel construction.



Worktables with Stainless Steel Top, Backsplash & Galvanized Legs/Undershelf

see spec sheets **EG10.44A** **EG10.44B** **EG10.44C** **EG10.44D**



adjustable undershelf welded gusset
NOW STANDARD!

FEATURES:

- 4½" (114mm) backsplash at the rear of the table.
- 1½" (41mm)-diameter legs and adjustable undershelf are heavy gauge galvanized steel.
- Heavy gauge polished stainless steel top.
- SPEC-MASTER® Marine series worktables feature a marine counter edge on front and both ends.
- 35½" - 36½" (892 - 918mm) adjustable working height.

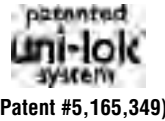

Note: All shipping weights and cubic feet are approximate.

Optional 10½" (267mm) backsplash available for SPEC-MASTER® Marine series worktables. To order, add 10% to list price and replace suffix "-BS" with suffix "-10BS".

Example: T2424EM-10BS.

NSF sprayed-on latex sound deadening available. To order, add \$646 to list price and suffix "-SD". Example: T2424B-BS-SD.

Optional fixed undershelf available in place of standard adjustable undershelf. To order, add 10% to list price, and "-F" to end of suffix. Example: T3048EM-BS-F.

For optional power strips (only for tables with backsplash), see pages 156.

For FLEX-MASTER® overshelf kits, see pages 167.

For drawer kits, see page 173.



See page 156 for optional casters available.

Freight class is 70.0.

(•) MTS (made to stock) / () MTO (made to order)

	length		# of legs	weight		cu ft	BUDGET 16/430 top		DELUXE 16/304 top		*SPEC-MASTER® 14/304 top		* ▼ Marine 14/304 top	
	in.	mm		lbs.	kg		model #	list	model #	list	model #	list	model #	list
24" width (610mm)	24"	610	4	43	19.5	3.5	T2424B-BS	900	T2424EB-BS	982	T2424E-BS	1007	T2424EM-BS	1692
	30"	762	4	48	21.8	3.8	T2430B-BS •	962	T2430EB-BS	1061	T2430E-BS	1093	T2430EM-BS	1834
	36"	914	4	53	24.0	4.4	T2436B-BS •	1018	T2436EB-BS	1122	T2436E-BS	1153	T2436EM-BS	1841
	48"	1219	4	63	28.6	5.7	T2448B-BS •	1025	T2448EB-BS	1147	T2448E-BS	1180	T2448EM-BS	1926
	60"	1524	4	73	33.1	7.1	T2460B-BS •	1094	T2460EB-BS	1230	T2460E-BS	1266	T2460EM-BS	1961
	72"	1829	4	85	38.6	8.5	T2472B-BS •	1157	T2472EB-BS	1312	T2472E-BS	1359	T2472EM-BS	2053
	84"	2134	4	97	44.0	11.2	T2484B-BS	1419	T2484EB-BS	1670	T2484E-BS	1728	T2484EM-BS	2418
	96"	2438	6	114	51.7	11.2	T2496B-BS	1584	T2496EB-BS	1803	T2496E-BS	1843	T2496EM-BS	2536
	108"	2743	6	142	64.4	14.0	T24108B-BS	2385	T24108EB-BS	2554	T24108E-BS	2639	T24108EM-BS	3214
	120"	3048	6	154	69.9	14.0	T24120B-BS	2448	T24120EB-BS	2612	T24120E-BS	2696	T24120EM-BS	3377
30" width (762mm)	132"	3353	8	166	75.3	16.8	T24132B-BS	2508	T24132EB-BS	2614	T24132E-BS	2762	T24132EM-BS	3491
	144"	3658	8	178	80.7	16.8	T24144B-BS	2643	T24144EB-BS	2819	T24144E-BS	2911	T24144EM-BS	3558
	30"	762	4	50	22.7	3.8	T3030B-BS •	980	T3030EB-BS	1093	T3030E-BS	1125	T3030EM-BS	1799
	36"	914	4	53	24.0	4.4	T3036B-BS •	1039	T3036EB-BS	1153	T3036E-BS	1184	T3036EM-BS	1810
	48"	1219	4	70	31.8	5.7	T3048B-BS •	1057	T3048EB-BS	1190	T3048E-BS	1229	T3048EM-BS	1976
	60"	1524	4	81	36.7	7.1	T3060B-BS •	1134	T3060EB-BS	1287	T3060E-BS	1332	T3060EM-BS	2092
	72"	1829	4	94	42.6	8.5	T3072B-BS •	1210	T3072EB-BS	1389	T3072E-BS	1439	T3072EM-BS	2139
	84"	2134	4	108	49.0	11.2	T3084B-BS	1485	T3084EB-BS	1748	T3084E-BS	1810	T3084EM-BS	2582
	96"	2438	6	130	59.0	11.2	T3096B-BS •	1679	T3096EB-BS	1896	T3096E-BS	1963	T3096EM-BS	2743
	108"	2743	6	150	68.0	14.0	T30108B-BS	2514	T30108EB-BS	2684	T30108E-BS	2776	T30108EM-BS	3436
36" width (914mm)	120"	3048	6	170	77.1	14.0	T30120B-BS	2581	T30120EB-BS	2755	T30120E-BS	2844	T30120EM-BS	3501
	132"	3353	8	188	85.3	16.8	T30132B-BS	2733	T30132EB-BS	2914	T30132E-BS	3020	T30132EM-BS	3687
	144"	3658	8	207	93.9	16.8	T30144B-BS	2797	T30144EB-BS	2982	T30144E-BS	3088	T30144EM-BS	3749
	48"	1219	4	77	34.9	7.0	T3648B-BS	1374	T3648EB-BS	1432	T3648E-BS	1473	T3648EM-BS	2235
	60"	1524	4	90	40.8	8.8	T3660B-BS	1488	T3660EB-BS	1638	T3660E-BS	1694	T3660EM-BS	2376
	72"	1829	4	106	48.1	10.5	T3672B-BS	1579	T3672EB-BS	1751	T3672E-BS	1813	T3672EM-BS	2507
	84"	2134	4	123	55.8	12.2	T3684B-BS	1865	T3684EB-BS	2049	T3684E-BS	2124	T3684EM-BS	2947
	96"	2438	6	132	59.9	13.9	T3696B-BS	2097	T3696EB-BS	2306	T3696E-BS	2387	T3696EM-BS	3068
	108"	2743	6	169	76.7	17.3	T36108B-BS	2965	T36108EB-BS	3149	T36108E-BS	3256	T36108EM-BS	3911
	120"	3048	6	192	87.1	17.3	T36120B-BS	3030	T36120EB-BS	3216	T36120E-BS	3324	T36120EM-BS	3976
132"	3353	8	216	98.0	20.7	T36132B-BS	3113	T36132EB-BS	3311	T36132E-BS	3527	T36132EM-BS	4197	
144"	3658	8	239	108.4	20.7	T36144B-BS	3178	T36144EB-BS	3476	T36144E-BS	3600	T36144EM-BS	4262	

* On SPEC-MASTER® and SPEC-MASTER® Marine tables, increase stated weight by 10%.

▼ SPEC-MASTER® Marine tables feature a marine counter edge to prevent spillage.



Catalog Section 10

Worktables with Stainless Steel Top, Backsplash & Stainless Steel Legs/Undershelf

see spec sheets **EG10.45A** **EG10.45B** **EG10.45C** **EG10.45D**



FEATURES:



(Patent #5,165,349)

- 4½" (114mm) backsplash at the rear of the table.
- 1½" (41mm)-diameter legs and adjustable undershelf are heavy gauge stainless steel.
- Heavy gauge polished stainless steel top.
- SPEC-MASTER® Marine series worktables feature a marine counter edge on front and both ends.
- 35½" - 36½" (892 - 918mm) adjustable working height.

Note: All shipping weights and cubic feet are approximate.

Optional 10½" (267mm) backsplash available for SPEC-MASTER® Marine series worktables. To order, add 10% to list price and replace suffix "-BS" with suffix "-10BS".

Example: T2424SEM-10BS.

NSF sprayed-on latex sound deadening available. To order, add \$646 to list price and suffix "-SD". Example: T2424SB-BS-SD.

For FLEX-MASTER® overshelf kits, see page 167.

For drawer kits, see page 173.

For optional power strips (only for tables with backsplash), see pages 156.



See page 156 for optional casters available.

Freight class is 70.0.

(•) MTS (made to stock) / () MTO (made to order)

	length		# of legs	weight		cu ft	BUDGET 16/430 top		DELUXE 16/304 top		*SPEC-MASTER® 14/304 top		* ▼ Marine 14/304 top	
	in.	mm		lbs.	kg		model #	list	model #	list	model #	list	model #	list
24" width (610mm)	24"	610	4	43	19.5	3.5	T2424SB-BS	1236	T2424SEB-BS	1288	T2424SE-BS	1361	T2424SEM-BS	1991
	30"	762	4	48	21.8	3.8	T2430SB-BS	1332	T2430SEB-BS	1387	T2430SE-BS	1480	T2430SEM-BS	2107
	36"	914	4	53	24.0	4.4	T2436SB-BS	1389	T2436SEB-BS •	1451	T2436SE-BS	1573	T2436SEM-BS	2169
	48"	1219	4	63	28.6	5.7	T2448SB-BS	1419	T2448SEB-BS •	1502	T2448SE-BS •	1608	T2448SEM-BS	2225
	60"	1524	4	73	33.1	7.1	T2460SB-BS	1504	T2460SEB-BS	1613	T2460SE-BS •	1728	T2460SEM-BS	2337
	72"	1829	4	85	38.6	8.5	T2472SB-BS	1593	T2472SEB-BS	1726	T2472SE-BS	1854	T2472SEM-BS	2454
	84"	2134	4	97	44.0	11.2	T2484SB-BS	1889	T2484SEB-BS	2214	T2484SE-BS	2374	T2484SEM-BS	2930
	96"	2438	6	114	51.7	11.2	T2496SB-BS	2002	T2496SEB-BS	2359	T2496SE-BS	2532	T2496SEM-BS	3075
	108"	2743	6	142	64.4	14.0	T24108SB-BS	2844	T24108SEB-BS	3287	T24108SE-BS	3527	T24108SEM-BS	3864
	120"	3048	6	154	69.9	14.0	T24120SB-BS	3108	T24120SEB-BS	3352	T24120SE-BS	3589	T24120SEM-BS	3926
132"	3353	8	166	75.3	16.8	T24132SB-BS	3164	T24132SEB-BS	3548	T24132SE-BS	3702	T24132SEM-BS	4195	
144"	3658	8	178	80.7	16.8	T24144SB-BS	3324	T24144SEB-BS	3615	T24144SE-BS	3882	T24144SEM-BS	4262	
30" width (762mm)	30"	762	4	50	22.7	3.8	T3030SB-BS •	1388	T3030SEB-BS	1456	T3030SE-BS	1555	T3030SEM-BS	2178
	36"	914	4	53	24.0	4.4	T3036SB-BS	1447	T3036SEB-BS •	1516	T3036SE-BS	1615	T3036SEM-BS	2239
	48"	1219	4	70	31.8	5.7	T3048SB-BS	1493	T3048SEB-BS •	1584	T3048SE-BS •	1698	T3048SEM-BS	2315
	60"	1524	4	81	36.7	7.1	T3060SB-BS	1600	T3060SEB-BS •	1724	T3060SE-BS •	1848	T3060SEM-BS	2458
	72"	1829	4	94	42.6	8.5	T3072SB-BS •	1699	T3072SEB-BS •	1857	T3072SE-BS •	2000	T3072SEM-BS	2599
	84"	2134	4	108	49.0	11.2	T3084SB-BS	1947	T3084SEB-BS	2298	T3084SE-BS	2465	T3084SEM-BS	3023
	96"	2438	6	130	59.0	11.2	T3096SB-BS	2140	T3096SEB-BS •	2521	T3096SE-BS	2713	T3096SEM-BS	3248
	108"	2743	6	150	68.0	14.0	T30108SB-BS	3211	T30108SEB-BS	3484	T30108SE-BS	3745	T30108SEM-BS	4140
	120"	3048	6	170	77.1	14.0	T30120SB-BS	3278	T30120SEB-BS	3553	T30120SE-BS	3814	T30120SEM-BS	4207
	132"	3353	8	188	85.3	16.8	T30132SB-BS	3461	T30132SEB-BS	3793	T30132SE-BS	4084	T30132SEM-BS	4459
144"	3658	8	207	93.9	16.8	T30144SB-BS	3526	T30144SEB-BS	3862	T30144SE-BS	4149	T30144SEM-BS	4529	
36" width (914mm)	48"	1219	4	77	34.9	7.0	T3648SB-BS	1666	T3648SEB-BS	1860	T3648SE-BS	1999	T3648SEM-BS	2637
	60"	1524	4	90	40.8	8.8	T3660SB-BS	1811	T3660SEB-BS	2100	T3660SE-BS	2253	T3660SEM-BS	2803
	72"	1829	4	106	48.1	10.5	T3672SB-BS	1955	T3672SEB-BS	2252	T3672SE-BS	2415	T3672SEM-BS	2974
	84"	2134	4	123	55.8	12.2	T3684SB-BS	2568	T3684SEB-BS	2678	T3684SE-BS	2878	T3684SEM-BS	3540
	96"	2438	6	132	59.9	13.9	T3696SB-BS	2741	T3696SEB-BS	2866	T3696SE-BS	3084	T3696SEM-BS	3733
	108"	2743	6	169	76.7	17.3	T36108SB-BS	3760	T36108SEB-BS	4066	T36108SE-BS	4370	T36108SEM-BS	4699
	120"	3048	6	192	87.1	17.3	T36120SB-BS	3826	T36120SEB-BS	4131	T36120SE-BS	4439	T36120SEM-BS	4767
	132"	3353	8	216	98.0	20.7	T36132SB-BS	4055	T36132SEB-BS	4288	T36132SE-BS	4614	T36132SEM-BS	5069
144"	3658	8	239	108.4	20.7	T36144SB-BS	4127	T36144SEB-BS	4355	T36144SE-BS	4821	T36144SEM-BS	5139	

* SPEC-MASTER® and SPEC-MASTER® Marine tables feature all stainless steel construction. Increase stated weight by 10%.

▼ SPEC-MASTER® Marine tables feature a marine counter edge to prevent spillage.



100 Industrial Boulevard, Clayton, DE 19938-8903 U.S.A.
 Phone: 800-637-5100 or 302-653-3000. Fax: 302-653-2065
<http://www.eaglegrp.com>

Worktables with Stainless Steel Top, Backsplash & Galvanized Tubular Base

see spec sheets **EG10.46A** **EG10.46B** **EG10.46C** **EG10.46D**



- 4½" (114mm) backsplash at the rear of the table.
- Tubular base.
- 1½" (41mm)-diameter legs and 1¼" (32mm)-diameter crossbracing are heavy gauge galvanized steel.
- Heavy gauge polished stainless steel top.
- SPEC-MASTER® Marine series worktables feature a marine counter edge on front and both ends.
- 35½" - 36½" (892 - 918mm) adjustable working height.

FEATURES:

Note: All shipping weights and cubic feet are approximate.

Optional 10½" (267mm) backsplash available for SPEC-MASTER® Marine series worktables. To order, add 10% to list price and replace suffix "-BS" with suffix "-10BS".

Example: T2424GTEM-10BS.

NSF sprayed-on latex sound deadening available. To order, add \$646 to list price and suffix "-SD". **Example:** T2424GTB-BS-SD.

For optional power strips (only for tables with backsplash), see pages 156.

For FLEX-MASTER® overshelf kits, see pages 167.

For drawer kits, see page 173.



See page 156 for optional casters available.

Freight class is 70.0.

(•) MTS (made to stock) / () MTO (made to order)

	length		# of legs	weight		cu ft	BUDGET 16/430 top		DELUXE 16/304 top		*SPEC-MASTER® 14/304 top		* ▼ Marine 14/304 top	
	in.	mm		lbs.	kg		model #	list	model #	list	model #	list	model #	list
24" width (610mm)	24"	610	4	41	18.6	3.5	T2424GTB-BS	1012	T2424GTB-BS	1094	T2424GTE-BS	1121	T2424GTEM-BS	1855
	30"	762	4	46	20.9	3.8	T2430GTB-BS	1071	T2430GTB-BS	1178	T2430GTE-BS	1203	T2430GTEM-BS	1951
	36"	914	4	51	23.1	4.4	T2436GTB-BS	1132	T2436GTB-BS	1236	T2436GTE-BS	1265	T2436GTEM-BS	2009
	48"	1219	4	61	27.7	5.7	T2448GTB-BS	1134	T2448GTB-BS	1257	T2448GTE-BS	1294	T2448GTEM-BS	2039
	60"	1524	4	71	32.2	7.1	T2460GTB-BS	1205	T2460GTB-BS	1341	T2460GTE-BS	1381	T2460GTEM-BS	2128
	72"	1829	4	81	36.7	8.5	T2472GTB-BS	1267	T2472GTB-BS	1427	T2472GTE-BS	1470	T2472GTEM-BS	2228
	84"	2134	4	91	41.3	11.2	T2484GTB-BS	1528	T2484GTB-BS	1788	T2484GTE-BS	1842	T2484GTEM-BS	2604
	96"	2438	6	101	45.8	11.2	T2496GTB-BS	1693	T2496GTB-BS	1898	T2496GTE-BS	1959	T2496GTEM-BS	2727
	108"	2743	6	111	50.3	14.0	T24108GTB-BS	2424	T24108GTB-BS	2590	T24108GTE-BS	2677	T24108GTEM-BS	3430
	120"	3048	6	121	54.9	14.0	T24120GTB-BS	2558	T24120GTB-BS	2729	T24120GTE-BS	2811	T24120GTEM-BS	3488
30" width (762mm)	132"	3353	8	131	59.4	16.8	T24132GTB-BS	2612	T24132GTB-BS	2785	T24132GTE-BS	2871	T24132GTEM-BS	3711
	144"	3658	8	141	64.0	16.8	T24144GTB-BS	2675	T24144GTB-BS	2866	T24144GTE-BS	2937	T24144GTEM-BS	3775
	30"	762	4	51	23.1	3.8	T3030GTB-BS	1090	T3030GTB-BS	1203	T3030GTE-BS	1236	T3030GTEM-BS	1978
	36"	914	4	56	25.4	4.4	T3036GTB-BS	1148	T3036GTB-BS	1265	T3036GTE-BS	1299	T3036GTEM-BS	2039
	48"	1219	4	66	29.9	5.7	T3048GTB-BS	1163	T3048GTB-BS	1302	T3048GTE-BS	1339	T3048GTEM-BS	2089
	60"	1524	4	76	34.5	7.1	T3060GTB-BS	1243	T3060GTB-BS	1400	T3060GTE-BS	1443	T3060GTEM-BS	2202
	72"	1829	4	86	39.0	8.5	T3072GTB-BS	1320	T3072GTB-BS	1505	T3072GTE-BS	1554	T3072GTEM-BS	2316
	84"	2134	4	96	43.6	11.2	T3084GTB-BS	1597	T3084GTB-BS	1860	T3084GTE-BS	1925	T3084GTEM-BS	2695
	96"	2438	6	106	48.1	11.2	T3096GTB-BS	1788	T3096GTB-BS	2008	T3096GTE-BS	2073	T3096GTEM-BS	2863
	108"	2743	6	116	52.6	14.0	T30108GTB-BS	2627	T30108GTB-BS	2722	T30108GTE-BS	2888	T30108GTEM-BS	3651
36" width (914mm)	120"	3048	6	126	57.2	14.0	T30120GTB-BS	2688	T30120GTB-BS	2870	T30120GTE-BS	2955	T30120GTEM-BS	3715
	132"	3353	8	136	61.7	16.8	T30132GTB-BS	2841	T30132GTB-BS	2944	T30132GTE-BS	3042	T30132GTEM-BS	3905
	144"	3658	8	146	66.2	16.8	T30144GTB-BS	2914	T30144GTB-BS	3010	T30144GTE-BS	3109	T30144GTEM-BS	3976
	48"	1219	4	71	32.1	7.0	T3648GTB-BS	1485	T3648GTB-BS	1544	T3648GTE-BS	1589	T3648GTEM-BS	2409
	60"	1524	4	81	36.7	8.8	T3660GTB-BS	1600	T3660GTB-BS	1752	T3660GTE-BS	1807	T3660GTEM-BS	2556
	72"	1829	4	91	41.3	10.5	T3672GTB-BS	1636	T3672GTB-BS	1861	T3672GTE-BS	1926	T3672GTEM-BS	2694
	84"	2134	4	101	45.8	12.2	T3684GTB-BS	1975	T3684GTB-BS	2168	T3684GTE-BS	2239	T3684GTEM-BS	3146
	96"	2438	6	111	50.3	13.9	T3696GTB-BS	2136	T3696GTB-BS	2415	T3696GTE-BS	2501	T3696GTEM-BS	3273
	108"	2743	6	121	54.9	17.3	T36108GTB-BS	2987	T36108GTB-BS	3170	T36108GTE-BS	3369	T36108GTEM-BS	4138
	120"	3048	6	131	59.4	17.3	T36120GTB-BS	3139	T36120GTB-BS	3332	T36120GTE-BS	3437	T36120GTEM-BS	4205
132"	3353	8	141	64.0	20.7	T36132GTB-BS	3222	T36132GTB-BS	3419	T36132GTE-BS	3539	T36132GTEM-BS	4432	
144"	3658	8	151	68.5	20.7	T36144GTB-BS	3282	T36144GTB-BS	3486	T36144GTE-BS	3604	T36144GTEM-BS	4498	

* On SPEC-MASTER® and SPEC-MASTER® Marine tables, increase stated weight by 10%.

▼ SPEC-MASTER® Marine tables feature a marine counter edge to prevent spillage.

Catalog Section 10

Worktables with Stainless Steel Top, Backsplash & Stainless Steel Tubular Base

see spec sheets **EG10.47A** **EG10.47B** **EG10.47C** **EG10.47D**

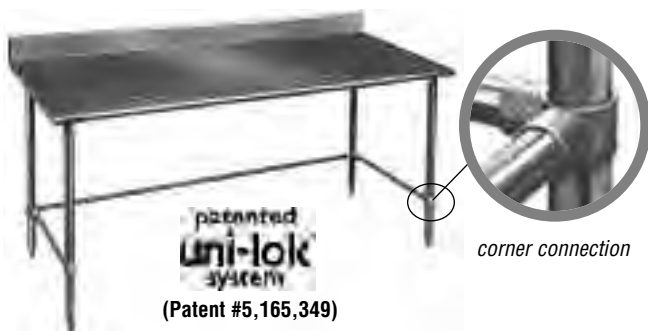

FEATURES:

- 4½" (114mm) backsplash at the rear of the table.
- Tubular base.
- 1½" (41mm)-diameter legs and 1¼" (32mm)-diameter crossbracing are heavy gauge stainless steel.
- Heavy gauge polished stainless steel top.
- SPEC-MASTER® Marine series worktables feature a marine counter edge on front and both ends.
- 35½" - 36½" (892 - 918mm) adjustable working height.

Note: All shipping weights and cubic feet are approximate.

Optional 10½" (267mm) backsplash available for SPEC-MASTER® Marine series worktables. To order, add 10% to list price and replace suffix "-BS" with suffix "-10BS".

Example: T2424STEM-10BS.

NSF sprayed-on latex sound deadening available. To order, add \$646 to list price and suffix "-SD". Example: T2424STB-BS-SD.

For optional power strips (only for tables with backsplash), see pages 156.

For FLEX-MASTER® overshelf kits, see pages 167.

For drawer kits, see page 173.



See page 156 for optional casters available.

Freight class is 70.0.

(*) MTS (made to stock) / () MTO (made to order)

	length		# of legs	weight		cu ft	BUDGET 16/430 top		DELUXE 16/304 top		*SPEC-MASTER® 14/304 top		* ▼ Marine 14/304 top	
	in.	mm		lbs.	kg		model #	list	model #	list	model #	list	model #	list
24" width (610mm)	24"	610	4	41	18.6	3.5	T2424STB-BS	1345	T2424STEB-BS	1402	T2424STE-BS	1472	T2424STEM-BS	2106
	30"	762	4	46	20.9	3.8	T2430STB-BS	1441	T2430STEB-BS	1503	T2430STE-BS	1596	T2430STEM-BS	2224
	36"	914	4	51	23.1	4.4	T2436STB-BS	1500	T2436STEB-BS	1562	T2436STE-BS	1657	T2436STEM-BS	2282
	48"	1219	4	61	27.7	5.7	T2448STB-BS	1528	T2448STEB-BS	1613	T2448STE-BS	1719	T2448STEM-BS	2334
	60"	1524	4	71	32.2	7.1	T2460STB-BS	1612	T2460STEB-BS	1726	T2460STE-BS	1842	T2460STEM-BS	2453
	72"	1829	4	81	36.7	8.5	T2472STB-BS	1703	T2472STEB-BS	1840	T2472STE-BS	1966	T2472STEM-BS	2570
	84"	2134	4	91	41.3	11.2	T2484STB-BS	1995	T2484STEB-BS	2328	T2484STE-BS	2488	T2484STEM-BS	3042
	96"	2438	6	101	45.8	11.2	T2496STB-BS	2111	T2496STEB-BS	2468	T2496STE-BS	2645	T2496STEM-BS	3190
	108"	2743	6	111	50.3	14.0	T24108STB-BS	3065	T24108STEB-BS	3300	T24108STE-BS	3532	T24108STEM-BS	3972
	120"	3048	6	121	54.9	14.0	T24120STB-BS	3219	T24120STEB-BS	3465	T24120STE-BS	3704	T24120STEM-BS	4040
30" width (762mm)	132"	3353	8	131	59.4	16.8	T24132STB-BS	3271	T24132STEB-BS	3556	T24132STE-BS	3818	T24132STEM-BS	4310
	144"	3658	8	141	64.0	16.8	T24144STB-BS	3334	T24144STEB-BS	3730	T24144STE-BS	3882	T24144STEM-BS	4378
	30"	762	4	51	23.1	3.8	T3030STB-BS	1499	T3030STEB-BS	1569	T3030STE-BS	1668	T3030STEM-BS	2292
	36"	914	4	56	25.4	4.4	T3036STB-BS	1558	T3036STEB-BS	1630	T3036STE-BS	1732	T3036STEM-BS	2356
	48"	1219	4	66	29.9	5.7	T3048STB-BS	1601	T3048STEB-BS	1697	T3048STE-BS	1823	T3048STEM-BS	2433
	60"	1524	4	76	34.5	7.1	T3060STB-BS	1710	T3060STEB-BS	1837	T3060STE-BS	1965	T3060STEM-BS	2496
	72"	1829	4	86	39.0	8.5	T3072STB-BS	1816	T3072STEB-BS	1973	T3072STE-BS	2112	T3072STEM-BS	2715
	84"	2134	4	96	43.6	11.2	T3084STB-BS	2057	T3084STEB-BS	2407	T3084STE-BS	2580	T3084STEM-BS	3138
	96"	2438	6	106	48.1	11.2	T3096STB-BS	2252	T3096STEB-BS	2634	T3096STE-BS	2822	T3096STEM-BS	3364
	108"	2743	6	116	52.6	14.0	T30108STB-BS	3324	T30108STEB-BS	3555	T30108STE-BS	3858	T30108STEM-BS	4256
36" width (914mm)	120"	3048	6	126	57.2	14.0	T30120STB-BS	3390	T30120STEB-BS	3596	T30120STE-BS	3929	T30120STEM-BS	4324
	132"	3353	8	136	61.7	16.8	T30132STB-BS	3470	T30132STEB-BS	3905	T30132STE-BS	4197	T30132STEM-BS	4574
	144"	3658	8	146	66.2	16.8	T30144STB-BS	3530	T30144STEB-BS	3976	T30144STE-BS	4263	T30144STEM-BS	4643
	48"	1219	4	71	32.1	7.0	T3648STB-BS	1776	T3648STEB-BS	1976	T3648STE-BS	2111	T3648STEM-BS	2519
	60"	1524	4	81	36.7	8.8	T3660STB-BS	1919	T3660STEB-BS	2210	T3660STE-BS	2368	T3660STEM-BS	2829
	72"	1829	4	91	41.3	10.5	T3672STB-BS	2060	T3672STEB-BS	2365	T3672STE-BS	2533	T3672STEM-BS	3089
	84"	2134	4	101	45.8	12.2	T3684STB-BS	2676	T3684STEB-BS	2793	T3684STE-BS	2995	T3684STEM-BS	3655
	96"	2438	6	111	50.3	13.9	T3696STB-BS	2855	T3696STEB-BS	2980	T3696STE-BS	3198	T3696STEM-BS	3847
	108"	2743	6	121	54.9	17.3	T36108STB-BS	3871	T36108STEB-BS	4059	T36108STE-BS	4484	T36108STEM-BS	4816
	120"	3048	6	131	59.4	17.3	T36120STB-BS	3937	T36120STEB-BS	4247	T36120STE-BS	4549	T36120STEM-BS	4882
132"	3353	8	141	64.0	20.7	T36132STB-BS	4044	T36132STEB-BS	4403	T36132STE-BS	4868	T36132STEM-BS	5180	
144"	3658	8	151	68.5	20.7	T36144STB-BS	4108	T36144STEB-BS	4466	T36144STE-BS	4941	T36144STEM-BS	5249	

* SPEC-MASTER® and SPEC-MASTER® Marine tables feature all stainless steel construction. Increase stated weight by 10%.

▼ SPEC-MASTER® Marine tables feature a marine counter edge to prevent spillage.



100 Industrial Boulevard, Clayton, DE 19938-8903 U.S.A.
 Phone: 800-637-5100 or 302-653-3000. Fax: 302-653-2065
<http://www.eaglegrp.com>

Optional LIFESTOR® Undershelves for Stainless Steel Worktables

see spec sheet **EG10.53**

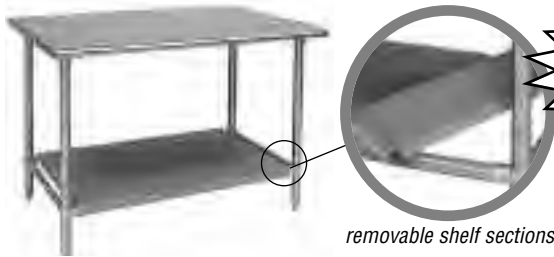

The ONLY machine washable undershelf in the market today!



(Patent #5,165,349)

FEATURES:

- Solid polymer shelf sections available for tubular-base tables only.
- Dishwasher-safe and non-corrosive.
- Four-sided adjustable stainless steel bracing

Note: Undershelves work with any tubular series worktable at time of order and cannot retrofit in field due to leg spacing. Recommended for use with stationary tables only. To order undershelves, add suffix “-L1” to worktable model number. **Example: T2484STB-L1.** See chart below for pricing.

Freight class is 70.0.

(•) MTS (made to stock) / () MTO (made to order)

For 24" (610mm) wide worktables

worktable length	LIFESTOR® undershelf	worktable length	LIFESTOR® undershelf
in. mm	list	in. mm	list
24" 610	100	84" 2134	246
30" 762	116	96" 2438	360
36" 914	138	108" 2743	397
48" 1219	161	120" 3048	406
60" 1524	200	132" 3353	441
72" 1829	225	144" 3658	481

For 30" (762mm) wide worktables

worktable length	LIFESTOR® undershelf	worktable length	LIFESTOR® undershelf
in. mm	list	in. mm	list
30" 762	132	96" 2438	431
36" 914	160	108" 2743	484
48" 1219	179	120" 3048	493
60" 1524	243	132" 3353	527
72" 1829	274	144" 3658	584
84" 2134	303		

Featuring MICROGARD® an antimicrobial agent which contains built-in protection to retard the growth of a broad range of bacteria, mold and mildew on shelf surface that causes stains, odors and degradation. **Standard on all LIFESTOR® Shelving.**

Optional Power Strips for Stainless Steel Worktables with Backsplash

length	number of outlets	model #	list
in. mm			
24" 610	8	PS2408	173
36" 914	12	PS3612	189
48" 1219	16	PS4816	195
60" 1524	20	PS6020	242



FEATURES:

- Brushed aluminum finish.
- 15' (4572mm) cord and plug.
- Reset button.
- Toggle ON-OFF switch.
- Mounts via pair of stainless steel clips—no tools required.

Optional Casters

see spec sheet **EG10.59**

description	wt. cap. per caster		model #	list
	lbs.	kg		
Zinc with Resilient Tread				
4" (102mm) dia., set of four (two swivel, two w/brake)	115	52.2	CA4-SB•	378
4" (102mm) dia., set of six (three swivel, three w/brake)	115	52.2	CA6-SB•	566
4" (102mm) dia., set of eight (four swivel, four w/brake)	115	52.2	CA8-SB•	756
Zinc with Poly Tread				
5" (127mm) dia., set of four (two swivel, two w/brake)	200	90.7	CAH4-SB•	502
5" (127mm) dia., set of six (three swivel, three w/brake)	200	90.7	CAH6-SB•	752
5" (127mm) dia., set of eight (four swivel, four w/brake)	200	90.7	CAH8-SB•	752
Polymer Cart Washable with Polymer Tread				
5" (127mm) dia., set of four (two swivel, two w/brake)	250	113.4	CAHW4-SB•	539
5" (127mm) dia., set of six (three swivel, three w/brake)	250	113.4	CAHW6-SB•	809
5" (127mm) dia., set of eight (four swivel, four w/brake)	250	113.4	CAHW8-SB•	1077

Note: To determine set of casters applicable, see “# of legs” column in Worktables charts (pages 144-155).

Freight class is 65.0.

(•) MTS (made to stock) / () MTO (made to order)



Catalog Section 10

Hardwood Worktables

see spec sheet **EG10.10**

- 1¼" (44mm) hardwood tops.
- With flat top or with 4" (102mm) covered backsplash and end splashes.
- Shipped knocked down.

FEATURES:

Note: All shipping weights and cubic feet are approximate.
For optional drawer assemblies, see page 172.



hardwood table with flat top and undershelf...

...with flat top and tubular base...

...with backsplash and undershelf...

...with backsplash and tubular base

Freight class is 55.0.

(•) MTS (made to stock) / () MTO (made to order)

Flat Top Hardwood Worktables...

	...with Adjustable Undershelf								...with Tubular Base						
	length		cu ft	weight		galvanized legs & undershelf		stainless steel legs and undershelf		weight		galvanized tubular base		stainless steel tubular base	
	in.	mm		lbs.	kg	model #	list	model #	list	lbs.	kg	model #	list	model #	list
24" width (610mm)	48"	1219	5.3	94	42.6	MT2448B	840	MT2448S	1011	92	41.7	MT2448GT	746	MT2448ST	952
	60"	1524	6.6	118	53.5	MT2460B	942	MT2460S	1147	117	53.1	MT2460GT	826	MT2460ST	1066
	72"	1829	8.0	141	64.0	MT2472B	1045	MT2472S	1282	138	62.6	MT2472GT	905	MT2472ST	1185
	96"	2438	10.7	189	85.7	MT2496B	1481	MT2496S	1789	182	82.6	MT2496GT	1299	MT2496ST	1480
30" width (762mm)	48"	1219	6.7	141	64.0	MT3048B	927	MT3048S	1147	139	63.1	MT3048GT	838	MT3048ST	1089
	60"	1524	8.3	147	66.7	MT3060B	1054	MT3060S	1314	145	65.8	MT3060GT	941	MT3060ST	1242
	72"	1829	9.9	177	80.3	MT3072B	1178	MT3072S	1482	174	77.8	MT3072GT	1042	MT3072ST	1390
	96"	2438	13.2	235	106.6	MT3096B	1689	MT3096S	2066	230	104.3	MT3096GT	1501	MT3096ST	1943

Hardwood Worktables with Backsplash & End Splashes...

	...with Adjustable Undershelf								...with Tubular Base						
	length		cu ft	weight		galvanized legs & undershelf		stainless steel legs and undershelf		weight		galvanized tubular base		stainless steel tubular base	
	in.	mm		lbs.	kg	model #	list	model #	list	lbs.	kg	model #	list	model #	list
30" width (762mm)	60"	1524	9.8	149	67.6	MT3060B-BS	1853	MT3060S-BS	2399	147	66.7	MT3060GT-BS	1733	MT3060ST-BS	2275
	72"	1829	11.7	180	81.6	MT3072B-BS	2228	MT3072S-BS	2742	177	80.3	MT3072GT-BS	2082	MT3072ST-BS	2671
	96"	2438	15.5	240	108.9	MT3096B-BS	3047	MT3096S-BS	3628	235	106.6	MT3096GT-BS	2855	MT3096ST-BS	3436

Optional Casters for Hardwood Worktables



zinc casters

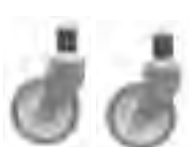

cart washable casters

description	Zinc with Resilient Tread				Zinc with Poly Tread				Polymer Cart Washable with Polymer Tread			
	wt. cap. per caster		list per set	model #	wt. cap. per caster		list per set	model #	wt. cap. per caster		list per set	model #
	lbs.	kg			lbs.	kg			lbs.	kg		
4" (102mm) dia., set of 4 (2 swivel, 2 w/brake)	115	52.2	CA4-SB	378	n/a	n/a	n/a	n/a	n/a	n/a	n/a	n/a
4" (102mm) dia., set of 6 (3 swivel, 3 w/brake)	115	52.2	CA6-SB	566	n/a	n/a	n/a	n/a	n/a	n/a	n/a	n/a
5" (127mm) dia., set of 4 (2 swivel, 2 w/brake)	200	90.7	CAH4-SB	502	250	113.4	CAHP4-SB	434	250	113.4	CAHW4-SB	539
5" (127mm) dia., set of 6 (3 swivel, 3 w/brake)	200	90.7	CAH6-SB	752	250	113.4	CAHP6-SB	652	250	113.4	CAHW6-SB	809



Knock Down Worktables with Cabinet Kit 

see spec sheet **EG10.36**



- Type 430 stainless steel tabletop and side panels.
- Tabletop is 30" (762mm) with 4½" (114mm) high backsplash.
- Stainless steel side panels and front doors with open rear.
- Easy assembly via machine screws and threaded inserts.

FEATURES:

Freight class is 70.0.

(•) MTS (made to stock) / () MTO (made to order)



(Patent #5,165,349)

	length		cubic feet	weight		...with Hinged Doors		...with Sliding Doors	
	in.	mm		lbs.	kg	model #	list	model #	list
30" width (914mm)	36"	914	4.4	52	23.6	T3036BA-BS-HGD	1511	T3036BA-BS-SLD	1663
	48"	1219	5.4	66	29.9	T3048BA-BS-HGD	1613	T3048BA-BS-SLD	1776
	60"	1524	7.1	79	35.8	T3060BA-BS-HGD	1730	T3060BA-BS-SLD	1901

Filler Tables 

see spec sheet **EG10.51**



Note: Filler tables are not designed to stand alone or to hold heavy equipment loads. Application and safe installation are the responsibility of the end user.

FEATURES:

- Standard flanged feet adds stability to 12" and 15" (305 and 381mm) long tables.
- 18" (457mm) feature bullet feet.
- 1½" (38mm) upturn.
- Stainless steel legs crossbraced front-to-back and side-to-side.

Freight class is 70.0.

(•) MTS (made to stock) / () MTO (made to order)



(Patent #5,165,349)

	length		cubic feet	weight *		Deluxe 16 gauge type 304 stainless steel top.		SPEC-MASTER® * 14 gauge type 304 stainless steel top.	
	in.	mm		lbs.	kg	model #	list	model #	list
24" width (610mm)	12"	305	2.9	30	13.6	UT2412STEB	745	UT2412STE	810
	15"	381	2.9	34	15.4	UT2415STEB	763	UT2415STE	829
	18"	457	2.9	36	16.3	UT2418STEB •	797	UT2418STE	866
30" width (762mm)	12"	305	2.9	34	15.4	UT3012STEB	805	UT3012STE	875
	15"	381	2.9	36	16.3	UT3015STEB •	823	UT3015STE	894
	18"	457	2.9	40	18.1	UT3018STEB •	868	UT3018STE	944
36" width (914mm)	12"	305	3.5	37	16.8	UT3612STEB	858	UT3612STE	932
	15"	381	3.5	40	18.1	UT3615STEB	884	UT3615STE	960
	18"	457	3.5	45	20.4	UT3618STEB	919	UT3618STE	998

* Add 10% weight for SPEC-MASTER®.

Worktable Stabilizer Bar (pair)

see spec sheet **EG10.59**



model #	list
WTS30	167

FEATURES:

- Fits standard 30" and 36" (762 and 914mm) width worktables.
- Heavy 12 gauge steel angle and gussets.
- Valu-Master® epoxy coated.

Freight class is 70.0.

(•) MTS (made to stock) / () MTO (made to order)



Catalog Section 10

SPEC-MASTER® Enclosed Worktables with Flat Top

see spec sheet **EG10.30**



patented
uni-lok
system
(Patent #5,165,349)

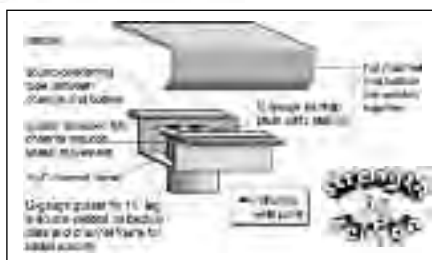

FEATURES:

- All-welded cabinet.
- Top mechanically polished to satin finish.
- Sound-deadened between top and frame.
- 1 1/8" (42mm) diameter type 304 stainless legs.
- 1" (25mm) adjustable feet.
- 1 1/2" (38mm) sanitary rolled rim on front and back with square edge on ends for flush fit.

Note: Full length fixed center shelf available. To order full width, add 20% to list price and suffix "-FCS". To order two-thirds width, add 20% to list price and suffix "-CS". Example: OB2436SE-CS.

To order table with 4" (102mm) casters, add suffix "-CA" and add to list price \$378 (for tables with four legs) or \$566 (for tables with six legs). Example: OB2436SE-CA.

To order table with 5" (127mm) casters, add suffix "-CAH" and add to list price \$502 (for tables with four legs) or \$752 (for tables with six legs). Example: OB2436SE-CAH.

NSF sprayed-on latex sound deadening available. To order, add \$646 to list price and suffix "-SD". Example: OB2436SE-SD.

For enhanced utility, add overselves from page 168.

Freight class is 125.0.

(•) MTS (made to stock) / () MTO (made to order)

				with Open Front				with Sliding Doors*				with Hinged Doors*				
	length		# of legs	cu ft	weight		model #	list	weight		model #	list	weight		model #	list
	in.	mm			lbs.	kg			lbs.	kg			lbs.	kg		
24" width (610mm)	36"	914	4	36	132	59.9	OB2436SE	2244	138	62.6	CB2436SE	2864	138	62.6	CBH2436SE	3510
	48"	1219	4	49	160	72.6	OB2448SE	2330	170	77.1	CB2448SE	3203	170	77.1	CBH2448SE	3675
	60"	1524	4	63	200	90.7	OB2460SE	2493	212	96.2	CB2460SE	3442	212	96.2	CBH2460SE	3919
	72"	1829	4	72	240	108.9	OB2472SE	2657	254	115.2	CB2472SE	3691	254	115.2	CBH2472SE	4159
	84"	2134	6	83	281	127.5	OB2484SE	2891	299	135.6	CB2484SE**	4220	299	135.6	CBH2484SE**	4679
	96"	2438	6	95	322	146.1	OB2496SE	3038	339	153.8	CB2496SE**	4558	339	153.8	CBH2496SE**	5019
	120"	3048	6	105	366	166.0	OB24120SE	3601	384	174.2	CB24120SE**	5266	384	174.2	CBH24120SE**	5724
30" width (762mm)	36"	914	4	36	136	61.7	OB3036SE	2369	142	64.4	CB3036SE	2992	142	64.4	CBH3036SE	3628
	48"	1219	4	49	166	75.3	OB3048SE	2452	173	78.5	CB3048SE•	3324	173	78.5	CBH3048SE	3794
	60"	1524	4	63	199	90.3	OB3060SE	2636	219	99.3	CB3060SE•	3587	219	99.3	CBH3060SE	4061
	72"	1829	4	72	248	112.5	OB3072SE	2823	261	118.4	CB3072SE•	3854	261	118.4	CBH3072SE	4325
	84"	2134	6	83	294	133.4	OB3084SE	3016	312	141.5	CB3084SE**	4336	312	141.5	CBH3084SE**	4801
	96"	2438	6	95	340	154.2	OB3096SE	3329	350	158.8	CB3096SE**	4749	350	158.8	CBH3096SE**	5209
	120"	3048	6	105	432	196.0	OB30120SE	3829	450	204.1	CB30120SE**	5493	450	204.1	CBH30120SE**	5946

* 20 gauge stainless steel doors. To order optional door locks, add suffix "-L" and \$163 list price; ** Tables 84" (2134mm) and longer have two sets of doors.

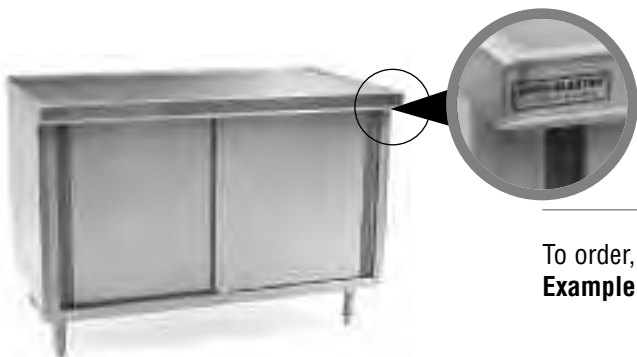

SPEC-MASTER® Marine Counter Edge Cabinets

To order, add 20% to list price and add "M" after "SE" in model number. Example: OB2436SEM.

see spec sheet **EG10.33A**



SPEC-MASTER® Enclosed Worktables with Upturn

see spec sheet **EG10.31**



patented
uni-lok
system
(Patent #5,165,349)

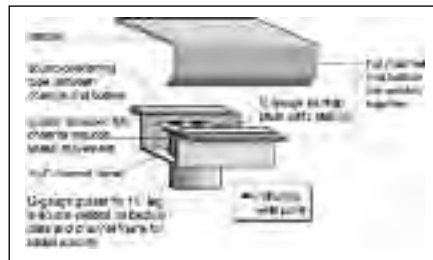

- All-welded cabinet.
- Top mechanically polished to satin finish.
- Top is 14 gauge type 304 stainless steel reinforced with a full length "hat" channel support.
- Body is heavy gauge type 430 stainless steel.
- Sound-deadened between top and frame.
- 1½" (42mm) diameter type 304 stainless legs.
- 1" (25mm) adjustable feet.
- 1½" (38mm) sanitary rolled rim on front, 1½" (38mm) rear upturn, and square edge on ends for flush fit.

FEATURES:

Note: Full length fixed center shelf available. To order full width, **add 20% to list price** and suffix **"-FCS"**. To order two-thirds width, **add 20% to list price** and suffix **"-CS"**. **Example: UOB2436SE-CS.**

To order table with 4" (102mm) casters, add suffix **"-CA"** and **add to list price \$378** (for tables with four legs) or **\$566** (for tables with six legs).

Example: UOB3036SE-CA.

To order table with 5" (127mm) casters, add suffix **"-CAH"** and **add to list price \$502** (for tables with four legs) or **\$752** (for tables with six legs).

Example: UOB3036SE-CAH.

NSF sprayed-on latex sound deadening available.

To order, **add \$646 to list price** and suffix **"-SD"**.

Example: UOB3036SE-SD.

For enhanced utility, add overselves from page 168.

Freight class is 125.0.

(*) MTS (made to stock) / () MTO (made to order)

					with Open Front				with Sliding Doors*				with Hinged Doors*			
	length		# of legs	cu ft	weight		model #	list	weight		model #	list	weight		model #	list
	in.	mm			lbs.	kg			lbs.	kg			lbs.	kg		
24" width (610mm)	36"	914	4	36	132	59.9	UOB2436SE	2244	138	62.6	UCB2436SE	2864	138	62.6	UCBH2436SE	3510
	48"	1219	4	49	160	72.6	UOB2448SE	2330	170	77.1	UCB2448SE	3203	170	77.1	UCBH2448SE	3675
	60"	1524	4	63	200	90.7	UOB2460SE	2493	212	96.2	UCB2460SE	3442	212	96.2	UCBH2460SE	3919
	72"	1829	4	72	240	108.9	UOB2472SE	2657	254	115.2	UCB2472SE	3691	254	115.2	UCBH2472SE	4159
	84"	2134	6	83	281	127.5	UOB2484SE	2891	299	135.6	UCB2484SE**	4220	299	135.6	UCBH2484SE**	4679
	96"	2438	6	95	322	146.1	UOB2496SE	3038	339	153.8	UCB2496SE**	4558	339	153.8	UCBH2496SE**	5019
30" width (762mm)	120"	3048	6	105	366	166.0	UOB24120SE	3601	384	174.2	UCB24120SE**	5266	384	174.2	UCBH24120SE**	5724
	36"	914	4	36	136	61.7	UOB3036SE	2369	142	64.4	UCB3036SE	2992	142	64.4	UCBH3036SE	3628
	48"	1219	4	49	166	75.3	UOB3048SE	2452	173	78.5	UCB3048SE•	3324	173	78.5	UCBH3048SE	3794
	60"	1524	4	63	199	90.3	UOB3060SE	2636	219	99.3	UCB3060SE•	3587	219	99.3	UCBH3060SE	4061
	72"	1829	4	72	248	112.5	UOB3072SE	2820	261	118.4	UCB3072SE•	3854	261	118.4	UCBH3072SE	4325
	84"	2134	6	83	294	133.4	UOB3084SE	3016	312	141.5	UCB3084SE**	4336	312	141.5	UCBH3084SE**	4801
	96"	2438	6	95	340	154.2	UOB3096SE	3329	350	158.8	UCB3096SE**	4749	350	158.8	UCBH3096SE**	5209
	120"	3048	6	105	432	196.0	UOB30120SE	3829	450	204.1	UCB30120SE**	5493	450	204.1	UCBH30120SE**	5946

* 20 gauge stainless steel doors. To order optional door locks, add suffix **"-L"** and \$163 list price; ** Tables 84" (2134mm) and longer have two sets of doors.

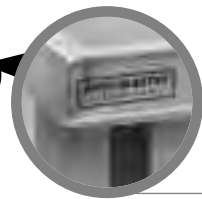

SPEC-MASTER® Marine Counter Edge Cabinets

To order, **add 20% to list price** and add **"M"** after **"SE"** in model number.
Example: UOB2436SEM.

see spec sheet **EG10.33B**



Catalog Section 10

SPEC-MASTER® Enclosed Worktables with Backsplash

see spec sheet **EG10.32**



FEATURES:

- All-welded cabinet.
- Top mechanically polished to satin finish.
- Top is 14 gauge type 304 stainless steel reinforced with a full length "hat" channel support.
- Body is heavy gauge type 430 stainless steel.
- Sound-deadened between top and frame.
- 1 1/8" (42mm) diameter type 304 stainless legs.
- 1" (25mm) adjustable stainless steel feet.
- 1 1/2" (38mm) sanitary rolled rim on front, 4 1/2" (114mm) backsplash on rear, and square edge on ends for flush fit.

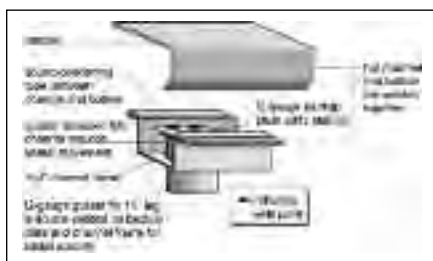

Note: Full length fixed center shelf available. To order full width, add 20% to list price and suffix "-FCS". To order two-thirds width, add 20% to list price and suffix "-CS". Example: **OB2436SE-BS-CS**.

To order table with 4" (102mm) casters, add suffix "-CA" and add to list price \$378 (for tables with four legs) or \$566 (for tables with six legs). Example: **OB3036SE-BS-CA**.

To order table with 5" (127mm) casters, add suffix "-CAH" and add to list price \$502 (for tables with four legs) or \$752 (for tables with six legs). Example: **OB3036SE-BS-CAH**.

NSF sprayed-on latex sound deadening available. To order, add \$646 to list price and suffix "-SD". Example: **OB3036SE-BS-SD**.

For enhanced utility, add overselves from page 168.

Freight class is 125.0.

(•) MTS (made to stock) / () MTO (made to order)

	length in. mm	# of legs	cu ft	with Open Front		with Sliding Doors*		with Hinged Doors*							
				weight lbs. kg	model #	list	weight lbs. kg	model #	list	weight lbs. kg	model #	list			
24" width (610mm)	36" 914	4	36	133	60.3	OB2436SE-BS	2269	139	63.1	CB2436SE-BS	3011	139	63.1	CBH2436SE-BS	3535
	48" 1219	4	49	161	73.0	OB2448SE-BS	2353	171	77.6	CB2448SE-BS	3226	171	77.6	CBH2448SE-BS	3700
	60" 1524	4	63	202	91.6	OB2460SE-BS	2522	214	97.1	CB2460SE-BS	3475	214	97.1	CBH2460SE-BS	3945
	72" 1829	4	72	243	110.2	OB2472SE-BS	2695	256	116.1	CB2472SE-BS	3730	256	116.1	CBH2472SE-BS	4197
	84" 2134	6	83	284	128.8	OB2484SE-BS	2934	304	137.9	CB2484SE-BS**	4260	304	137.9	CBH2484SE-BS**	4724
	96" 2438	6	95	326	147.9	OB2496SE-BS	3085	343	155.6	CB2496SE-BS**	4603	343	155.6	CBH2496SE-BS**	5070
120" 3048	6	105	390	176.9	OB24120SE-BS	3662	390	176.9	CB24120SE-BS**	5326	390	176.9	CBH24120SE-BS**	5781	
30" width (762mm)	36" 914	4	36	137	62.1	OB3036SE-BS	2467	143	64.9	CB3036SE-BS	3110	143	64.9	CBH3036SE-BS	3653
	48" 1219	4	49	167	75.8	OB3048SE-BS	2474	174	78.9	CB3048SE-BS•	3345	174	78.9	CBH3048SE-BS	3818
	60" 1524	4	63	201	91.2	OB3060SE-BS	2764	221	100.2	CB3060SE-BS•	3622	221	100.2	CBH3060SE-BS	4087
	72" 1829	4	72	251	113.9	OB3072SE-BS	2859	264	119.8	CB3072SE-BS•	3890	264	119.8	CBH3072SE-BS	4358
	84" 2134	6	83	299	135.6	OB3084SE-BS	3056	319	144.7	CB3084SE-BS**	4378	319	144.7	CBH3084SE-BS**	4845
	96" 2438	6	95	344	156.0	OB3096SE-BS	3376	355	161.0	CB3096SE-BS**	4793	355	161.0	CBH3096SE-BS**	5570
120" 3048	6	105	438	198.7	OB30120SE-BS	3889	458	207.8	CB30120SE-BS**	5552	458	207.8	CBH30120SE-BS**	6005	

* 20 gauge stainless steel doors. To order optional door locks, add suffix "-L" and \$163 list price; ** Tables 84" (2134mm) and longer have two sets of doors.

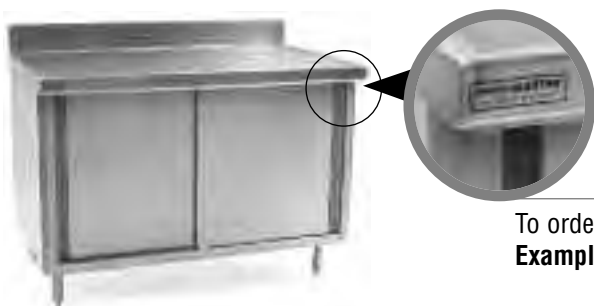

SPEC-MASTER® Marine Counter Edge Cabinets

To order, add 20% to list price and add "M" after "SE" in model number. Example: **OB2436SEM-BS**.

see spec sheet **EG10.33C**



adjustable® Work Surface Systems

see spec sheet **EG10.09**



- Unit can be further expanded and customized by adding optional shelving accessories (pages 45-50).
- Custom configurations available, including alternate finishes and solid shelving. Contact factory to configure your custom workstation.
- Optional drawers available (see pages 170-173).

CUSTOM:

Note: For Post Clamps for 1-tier and 2-tier unit, see page 44.

For Keyboard stations, see page 44.

Freight class is 70.0.

(•) MTS (made to stock) / () MTO (made to order)

adjustable®

Additional wire undershelves, solid stainless steel undershelves, chrome wire overshelves, or solid stainless steel overshelves make the possibilities almost unlimited.



Patented QuadTruss® Design makes shelves up to 25% stronger and provides a retaining ledge for increased strength and product retention.

Basic Units

	length		cu ft	weight		16/304		14/304	
	in.	mm		lbs.	kg	model #	list	model #	list
24" width (610mm)	36"	914	4.5	65	29.5	T2436EBW	791	T2436EW	867
	48"	1219	5.7	81	36.7	T2448EBW	860	T2448EW	996
	60"	1524	7.1	99	44.9	T2460EBW	1006	T2460EW	1145
30" width (762mm)	36"	914	4.5	75	34.0	T3036EBW	877	T3036EW	982
	48"	1219	5.7	94	42.6	T3048EBW	989	T3048EW	1128
	60"	1524	7.1	115	52.2	T3060EBW	1145	T3060EW	1303

CONSISTS OF:

- Stainless steel table top/work surface with hat channel supports.
- Four 33" (838mm) chrome posts.
- Two chrome wire undershelves.*

1-tier Units

	length		cu ft	weight		16/304		14/304	
	in.	mm		lbs.	kg	model #	list	model #	list
24" width (610mm)	36"	914	4.5	73	33.1	T2436EBW-1	985	T2436EW-1	1060
	48"	1219	5.7	91	41.3	T2448EBW-1	1104	T2448EW-1	1207
	60"	1524	7.1	113	51.3	T2460EBW-1	1246	T2460EW-1	1364
30" width (762mm)	36"	914	4.5	83	37.6	T3036EBW-1	1070	T3036EW-1	1179
	48"	1219	5.7	104	47.2	T3048EBW-1	1201	T3048EW-1	1335
	60"	1524	7.1	129	58.5	T3060EBW-1	1364	T3060EW-1	1525

CONSISTS OF:

- Stainless steel table top/work surface with hat channel supports.
- Two 54" (1372mm) rear chrome posts.
- Two 33" (838mm) front chrome posts.
- Two 21" (533mm) front chrome posts for overshelf.
- One 14" (356mm) wide chrome wire overshelf.
- Two chrome wire undershelves.*

2-tier Units

	length		cu ft	weight		16/304		14/304	
	in.	mm		lbs.	kg	model #	list	model #	list
24" width (610mm)	36"	914	4.5	81	36.7	T2436EBW-2	1080	T2436EW-2	1157
	48"	1219	5.7	101	45.8	T2448EBW-2	1218	T2448EW-2	1322
	60"	1524	7.1	127	57.6	T2460EBW-2	1370	T2460EW-2	1489
30" width (762mm)	36"	914	4.5	91	41.3	T3036EBW-2	1164	T3036EW-2	1274
	48"	1219	5.7	114	51.7	T3048EBW-2	1313	T3048EW-2	1455
	60"	1524	7.1	143	64.9	T3060EBW-2	1488	T3060EW-2	1651

CONSISTS OF:

- Stainless steel table top/work surface with hat channel supports.
- Two 63" (1600mm) rear chrome posts.
- Two 33" (838mm) front chrome posts.
- Two 29" (737mm) front chrome posts for overshelves.
- Two 14" (356mm) wide chrome wire overshelves.
- Two chrome wire undershelves.*

* 18" (457mm) wide undershelves used for 24" (610mm) wide tables; 24" (610mm) wide undershelves used for 30" (762mm) wide tables.



Catalog Section 10

Utility Stands

see spec sheet **EG10.26A**



FEATURES:

- Highly polished 16 gauge, type 304 stainless steel flat top.
- Adjustable undershelf or adjustable crossbracing.
- 24" (610mm) working height.

WEIGHT CAPACITIES:

- 600 lb. (272.2 kg) weight capacity of top.
- 150 lb. (68.0 kg) weight capacity of undershelf.
- evenly distributed static load.

Freight class is 70.0.

(•) MTS (made to stock) / () MTO (made to order)



(Patent #5,165,349)

width	length		weight		cubic feet	...with Undershelf		...with Tubular Base					
	in.	mm	lbs.	kg		galvanized legs model #	list	stainless steel legs model #	list	galvanized legs model #	list	stainless steel legs model #	list
24" (610mm)	24"	610	42	19.1	3.5	MS2424	• 799	MS2424S	971	TMS2424	799	TMS2424S	971
	24"	610	47	21.3	3.8	MS3024	• 833	MS3024S	1018	TMS3024	833	TMS3024S	1018
30" (762mm)	30"	762	49	22.2	3.8	MS3030	• 928	MS3030S	1155	TMS3030	928	TMS3030S	1155
	36"	914	51	23.1	4.0	MS3036	• 953	MS3036S	1174	TMS3036	953	TMS3036S	1174
36" (914mm)	36"	914	53	24.0	4.2	MS3636	999	MS3636S	1229	TMS3636	999	TMS3636S	1229

Optional Utensil Rack for Utility Stands

- Stainless steel.
- 54" (1371mm) height.

weight lbs.	kg	cubic feet	add to model #	unit list
23	10.4	5.3	UR-501	648

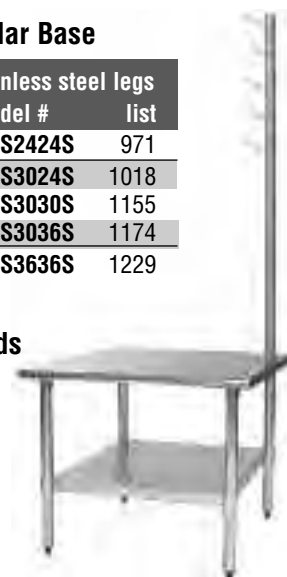

utility stand with undershelf and optional utensil rack

Optional Casters for Utility Stands

description	wt. cap. per caster		model #		list
	lbs.	kg	model #	list	
4" (102mm) dia., set of four (two swivel, two w/brake)	115	52.2	CA4-SB	• 378	
4" (102mm) dia., set of six (three swivel, three w/brake)	115	52.2	CA6-SB	• 566	
5" (127mm) dia., set of four (two swivel, two w/brake)	200	90.7	CAH4-SB	• 502	
5" (127mm) dia., set of six (three swivel, three w/brake)	200	90.7	CAH6-SB	• 752	



caster



caster with brake

NEW Stainless Steel Cleaner & Polish

weight oz.	kg	model #	list
15	0.4	004026	16



FEATURES:

- Cleans and polishes in one step.
- Does not streak or leave fingerprints.
- Leaves a protective invisible coating.

(•) MTS (made to stock) / () MTO (made to order)



100 Industrial Boulevard, Clayton, DE 19938-8903 U.S.A.
 Phone: 800-637-5100 or 302-653-3000. Fax: 302-653-2065
 http://www.eaglegrp.com

Mobile Utility Stands

see spec sheet **EG10.26B**



patented
uni-lok
system
(Patent #5,165,349)

- 34" (864mm) working height.
- 14 gauge type 304 stainless steel top with no-drip marine counter edge.
- Stainless steel crossbracing on three sides.
- Four 4" (102mm) casters (two with brakes).
- Pan rack slide holds six 18" x 26" (457 x 660mm) pans.
- 400 lb. (181.4 kg) total weight capacity (top and slides) - evenly distributed static load.

FEATURES:

Freight class is 70.0.

(•) MTS (made to stock) / () MTO (made to order)

	length		weight		cubic feet	galvanized		stainless steel	
	in.	mm	lbs.	kg		model #	list	model #	list
30" width (762mm)	30"	762	55	24.9	3.8	MMT3030G	2043	MMT3030S •	2280
	36"	914	60	27.2	4.1	MMT3036G	2090	MMT3036S	2347

Mobile Utility Stand with Undershef

see spec sheet **EG10.26B**



patented
uni-lok
system
(Patent #5,165,349)

- Top is 14 gauge type 304 stainless steel with no-drip marine counter edge.
- Stainless steel undershef.
- Two 4" (102mm) casters with brake.

FEATURES:

Freight class is 70.0.

(•) MTS (made to stock) / () MTO (made to order)

	length		weight		cubic feet	model #	list
	width	in.	mm	lbs.			
24" (610mm)	30"	762	47	21.3	3.8	MET2430S •	1782

Stainless Steel Lok-n-Fold™ Tables

see spec sheet **EG10.57**



with removable undershef

- Heavy gauge type 430 stainless steel top.
- Folding legs constructed of heavy gauge painted mild steel.
- Locking dimples, a safety mechanism, ensure legs are locked in place.
- 30% (784mm) non-adjustable height.

FEATURES:

Freight class is 70.0.

(•) MTS (made to stock) / () MTO (made to order)

	length		weight capacity		cu ft	WITH OPEN BASE				WITH REMOVABLE GALVANIZED UNDERSHELF				WITH REMOVABLE STAINLESS STEEL UNDERSHELF			
	in.	mm	lbs.	kg		weight		model #	list	weight		model #	list	weight		model #	list
						lbs.	kg			lbs.	kg			lbs.	kg		
24" width (610mm)	48"	1219	360	163.3	6.0	44	20.0	T2448F	582	61	27.7	T2448F-US	702	61	27.7	T2448F-USS	762
	60"	1524	450	204.1	7.5	48	21.8	T2460F	614	65	29.5	T2460F-US	758	65	29.5	T2460F-USS	828
	72"	1829	540	244.9	8.9	52	23.6	T2472F	700	70	31.8	T2472F-US	804	70	31.8	T2472F-USS	889
30" width (762mm)	48"	1219	450	204.1	7.4	46	20.9	T3048F	639	63	28.6	T3048F-US	722	63	28.6	T3048F-USS	777
	60"	1524	562	254.9	9.2	50	22.7	T3060F	685	69	31.3	T3060F-US	779	69	31.3	T3060F-USS	842
	72"	1829	675	306.2	11.0	56	25.4	T3072F	726	75	34.0	T3072F-US	830	75	34.0	T3072F-USS	906

Catalog Section 10

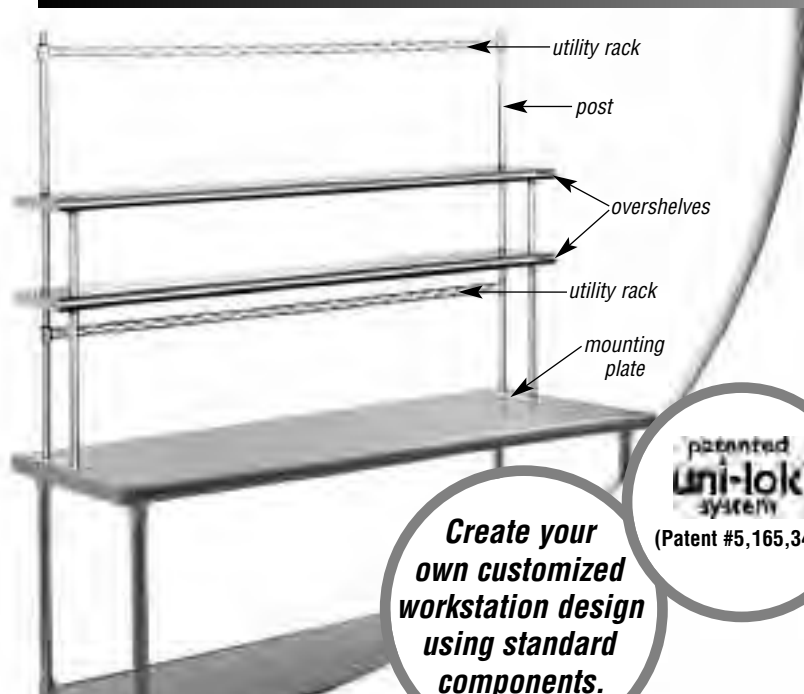

Features:

- Any table can be customized with overshelves of the same length.
- System can easily be changed or expanded as needed.
- Tables are caster-capable for workstation mobility.
- Overshelves' height adjustable in 1" (25mm) increments for flexible and accurate placement.
- 10" and 12" (254 and 305mm) shelf widths can be intermixed on same posts.
- Split sleeve.
- Tapered collar for easy assembly.
- Overshelves shipped knocked-down.
- All shipping weights and cubic feet are approximate.

Freight class is 70.0.

FLEX-MASTER® Overshelf System

Continued on page 166 & 167

Overshelves

see spec sheet **EG10.08**

- 14 gauge, type 304 shelves available upon request.
- Priced per shelf.

FEATURES:

Freight class is 70.0.

(•) MTS (made to stock) / () MTO (made to order)



	length		weight		cubic feet	16/430		16/304	
	in.	mm	lbs.	kg		model #	list ea	model #	list ea
10" width (254mm)	30"	762	10.1	4.6	0.5	411030	300	421030	328
	36"	915	12.1	5.5	0.6	411036	304	421036	338
	48"	1219	13.1	6.0	0.8	411048	328	421048	372
	60"	1524	15.2	6.9	1.0	411060 •	357	421060 •	419
	72"	1829	17.2	7.8	1.2	411072 •	405	421072	467
	84"	2133	19.3	8.8	1.5	411084	452	421084	514
	96"	2438	21.3	9.7	1.7	411096 •	498	421096	581
	108"	2743	23.4	10.6	1.9	411010	540	421010	624
	120"	3048	25.4	11.5	2.1	411012	582	421012	664
	132"	3353	27.4	12.5	2.3	411013	631	421013	713
144"	3658	29.4	13.4	2.5	411014	676	421014	775	
12" width (305mm)	30"	762	11.1	5.1	0.6	411230	304	421230	338
	36"	915	12.3	5.6	0.8	411236 •	318	421236	377
	48"	1219	14.8	6.7	1.0	411248 •	346	421248 •	395
	60"	1524	17.2	7.8	1.3	411260 •	371	421260 •	439
	72"	1829	19.7	9.1	1.5	411272 •	426	421272 •	497
	84"	2133	22.1	10.0	1.8	411284	474	421284	558
	96"	2438	24.6	11.2	2.0	411296 •	513	421296	623
	108"	2743	27.0	12.3	2.3	411210	571	421210	669
	120"	3048	29.5	13.4	2.5	411212	636	421212	718
	132"	3353	31.5	14.3	2.7	411213	681	421213	764
144"	3658	33.5	15.2	2.9	411214	726	421214	809	



Posts - FLEX-MASTER® Overshelf System

see spec sheet **EG10.08**

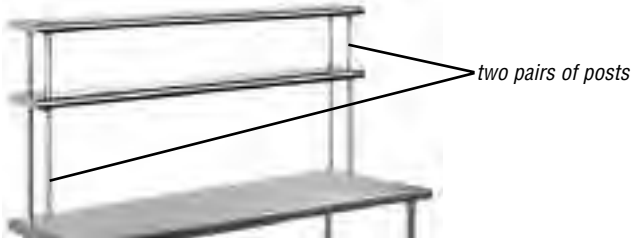

- Sold in pairs.
- Each pair includes mounting plate.
- For 30" to 72" (762 to 1829mm) shelves: two pairs.
- For 84" to 120" (2134 to 3048mm) shelves: three pairs required.
- For 132" and 144" (3353 and 3658mm) shelves: four pairs required.

ORDERING:

Freight class is 50.0.

(•) MTS (made to stock) / () MTO (made to order)

height		weight		cubic feet	chrome		stainless steel	
in.	mm	lbs.	kg		model #	list	model #	list
18"	457	1.7	0.8	0.1	418202 •	131	418002 •	152
30"	762	2.4	1.1	0.2	430202 •	143	430002 •	195
48"	1219	5.6	2.5	0.2	448202 •	174	448002 •	257

Utility Racks

see spec sheet **EG10.08**



FEATURES:

- Chrome plated.

Freight class is 50.0.

(•) MTS (made to stock) / () MTO (made to order)

for overshelf length						for overshelf length							
in.	mm	lbs.	kg	cubic feet	model #	list	in.	mm	lbs.	kg	cubic feet	model #	list
30"	762	1.7	0.8	0.2	PRT30-C	68	84"	2133	4.1	1.9	0.4	PRT84-C *	140
36"	915	1.9	0.9	0.2	PRT36-C	80	96"	2438	4.9	2.2	0.4	PRT96-C * •	164
48"	1219	2.1	1.0	0.2	PRT48-C •	87	108"	2743	5.6	2.5	0.5	PRT108-C*	166
60"	1524	2.5	1.1	0.3	PRT60-C •	102	120"	3048	6.2	2.8	0.5	PRT120-C*	172
72"	1829	2.9	1.3	0.4	PRT72-C •	120	132"	3353	6.9	3.1	0.6	PRT132-C**	186
							144"	3658	7.6	3.5	0.6	PRT144-C**	202

* Utility racks 84" to 120" (2133 to 3048mm) come in two pieces.

**132" and 144" (3353 and 3658mm) racks come in three pieces.

Mounting Plate

see spec sheet **EG10.08**



model #	list each
311915	23

FEATURES:

- Aluminum.
- Designed to accommodate both 10" and 12" (254 and 305mm) wide shelves.

Freight class is 70.0.

(•) MTS (made to stock) / () MTO (made to order)

Double-Prong Hook

see spec sheet **EG10.08**

weight lbs.	kg	cubic feet	model #	list each
0.2	0.1	0.1	300696	25



FEATURES:

- Stainless steel.
- Slips over utility racks.
- 2¼" (57mm) prongs.

Freight class is 70.0.

(•) MTS (made to stock) / () MTO (made to order)

Catalog Section 10

FLEX-MASTER® Kits for All Stainless Steel Worktables

see spec sheet **EG10.08**

Kit A

description	for Budget tables* add to list	for all other tables add to list
fits 36" (914mm) long worktables	1252	1370
fits 48" (1219mm) long worktables	1324	1422
fits 60" (1524mm) long worktables	1404	1540
fits 72" (1829mm) long worktables	1552	1694

* Note: Kits for "Budget" worktables include 16 gauge type 430 shelves and stainless steel posts.

Kit B

description	for Budget tables* add to list	for all other tables add to list
fits 36" (914mm) long worktables	1026	1144
fits 48" (1219mm) long worktables	1082	1180
fits 60" (1524mm) long worktables	1132	1268
fits 72" (1829mm) long worktables	1242	1384

* Note: Kits for "Budget" worktables include 16 gauge type 430 shelves and stainless steel posts.

Kit A
INCLUDES:

- Two 12" (305mm) wide 16 gauge type 304 shelves.
 - Two 30" (762mm) stainless steel front posts.
 - Two 48" (1219mm) stainless steel rear posts.
 - Two chrome utility racks.
- To order, add suffix "-FM-PL" to model number.
Example: T3060SE-FM-PL.

Tabletops are predrilled for rear mounting of posts and shelves.

Kit B
INCLUDES:

- Two 12" (305mm) wide 16 gauge type 304 shelves.
 - Four 30" (762mm) stainless steel posts.
- To order, add suffix "-FM" to model number.
Example: T3060SE-FM.

Freight class is 70.0.

(•) MTS (made to stock) / () MTO (made to order)

Stainless Steel Bins

see spec sheet **EG10.59**



width x length x height		weight		cubic	model #		list
in.	mm	lbs.	kg	feet			
6½" x 5½" x 6"	165 x 140 x 152	1.5	0.7	0.1	SB-1		276

FEATURES:

- Designed for either overshef or wall shelf applications.
- 22 gauge stainless steel with fully covered deep-drawn construction, complete with label holders.
- Removable bin must be allowed 7¼" (197mm) space and slides on stainless steel angle supports secured to underside of shelf.

Note: Shipping weight and cubic feet are approximate.

Freight class is 85.0.

(•) MTS (made to stock) / () MTO (made to order)

Wall Cabinets

see spec sheet **EG02.07**

length	weight	cu	Open Front		Hinged Doors		Sliding Doors	
			model #	list	model #	list	model #	list
24"	610	95 43.1 13.5	WCO-24	3128	WCH-24	4245	WCS-24	3539
30"	762	115 52.2 17.3	WCO-30	3132	WCH-30	4704	WCS-30	4312
36"	914	125 56.7 18.0	WCO-36	3248	WCH-36	4786	WCS-36	4445
42"	1067	145 65.8 18.2	-	-	WCH-42	5029	WCS-42	4467
48"	1219	165 74.8 18.3	WCO-48	3741	WCH-48	5185	WCS-48	4870
54"	1372	180 81.6 25.4	-	-	WCH-54	5301	WCS-54	4960
60"	1524	195 88.5 22.6	WCO-60	4094	WCH-60	5945	WCS-60	5632
66"	1676	210 95.3 30.6	-	-	WCH-66	5988	-	-
72"	1829	225 102.0 26.8	WCO-72	4584	WCH-72	6660	WCS-72	6307
84"	2134	255 115.7 38.5	WCO-84	4344	WCH-84*	6849	WCS-84*	6470
90"	2286	267 121.1 41.7	-	-	WCH-90*	7237	WCS-90*	6852
96"	2438	260 117.9 35.2	WCO-96	5133	WCH-96*	7461	WCS-96*	7064
120"	3048	360 163.3 55.8	-	-	-	-	WCS-120*	8512

* Features two pairs of doors.

FEATURES:

- Heavy gauge stainless steel.
- Back is recessed with full-length concealed mounting plate for easy installation.
- Fixed center shelf.
- Hinged doors provided with lift-off pin hinges.
- 15" (381mm) width. 28" (711mm) overall height.

Freight class is 100.0.

(•) MTS (made to stock) / () MTO (made to order)



wall cabinet with hinged doors



100 Industrial Boulevard, Clayton, DE 19938-8903 U.S.A.
Phone: 800-637-5100 or 302-653-3000. Fax: 302-653-2065
http://www.eaglegrp.com

Overshelves, Non-Adjustable

see spec sheet **EG10.28**

- Mounted on four stainless steel, 1" (25mm) diameter tubular base legs.
- Special width shelves available.

FEATURES:

Note: Recommended that overshelves be ordered when ordering tables. Specify choice of centered or rear-mounted on table. Otherwise, table must be field-drilled for mounting overshelves.



single deck overshelf



double deck overshelf

Freight class is 70.0.

(•) MTS (made to stock) / () MTO (made to order)

Optional heat lamp brackets available. Standard 12" (305mm) shorter than overshelf. To order, add suffix "-HLB" to model number (example: **OS1236-16/4-HLB**) and \$193 per pair. Two pairs required for lengths 84" (2133mm) and over.

Single Deck Overshelves, Non-Adjustable - Shipped knocked-down.

	length		# of legs	weight		cu ft	16 gauge, type 430		16 gauge, type 304		14 gauge, type 304	
	in.	mm		lbs.	kg		model #	list	model #	list	model #	list
10" width (254mm)	36"	915	4	15	6.8	0.9	OS1036-16/4	545	OS1036-16/3	659	OS1036-14/3	729
	48"	1219	4	19	8.6	1.3	OS1048-16/4	580	OS1048-16/3	721	OS1048-14/3	801
	60"	1524	4	24	10.9	1.6	OS1060-16/4	616	OS1060-16/3	791	OS1060-14/3	879
	72"	1829	4	29	13.2	1.9	OS1072-16/4	659	OS1072-16/3	864	OS1072-14/3	958
	84"	2133	6	34	15.4	2.2	OS1084-16/4	697	OS1084-16/3	932	OS1084-14/3	1035
	96"	2438	6	37	16.8	2.5	OS1096-16/4	852	OS1096-16/3	1110	OS1096-14/3	1234
	108"	2743	6	38	17.2	2.8	OS10108-16/4	873	OS10108-16/3	1143	OS10108-14/3	1266
	120"	3048	6	39	17.6	3.1	OS10120-16/4	905	OS10120-16/3	1239	OS10120-14/3	1380
	132"	3353	8	42	19.1	3.7	OS10132-16/4	947	OS10132-16/3	1315	OS10132-14/3	1463
144"	3658	8	46	20.9	4.2	OS10144-16/4	982	OS10144-16/3	1382	OS10144-14/3	1537	
12" width (305mm)	36"	915	4	16	7.3	0.9	OS1236-16/4	577	OS1236-16/3	688	OS1236-14/3	764
	48"	1219	4	20	9.0	1.3	OS1248-16/4	611	OS1248-16/3	755	OS1248-14/3	839
	60"	1524	4	25	11.3	1.6	OS1260-16/4	653	OS1260-16/3	827	OS1260-14/3	920
	72"	1829	4	30	13.6	1.9	OS1272-16/4	698	OS1272-16/3	905	OS1272-14/3	1006
	84"	2133	6	35	15.9	2.2	OS1284-16/4	742	OS1284-16/3	978	OS1284-14/3	1089
	96"	2438	6	38	17.2	2.5	OS1296-16/4	905	OS1296-16/3	1179	OS1296-14/3	1312
	108"	2743	6	39	17.6	2.5	OS12108-16/4	962	OS12108-16/3	1266	OS12108-14/3	1410
	120"	3048	6	40	18.1	3.1	OS12120-16/4	995	OS12120-16/3	1332	OS12120-14/3	1479
	132"	3353	8	43	19.5	3.7	OS12132-16/4	1052	OS12132-16/3	1422	OS12132-14/3	1582
144"	3658	8	47	21.3	4.2	OS12144-16/4	1085	OS12144-16/3	1488	OS12144-14/3	1652	

Double Deck Overshelves, Non-Adjustable - All welded construction, shipped assembled.

	length		# of legs	weight		cu ft	16 gauge, type 430		16 gauge, type 304		14 gauge, type 304	
	in.	mm		lbs.	kg		model #	list	model #	list	model #	list
10" width (254mm)	36"	915	4	31	14.1	8.6	DOS1036-16/4	1070	DOS1036-16/3	1198	DOS1036-14/3	1318
	48"	1219	4	39	17.6	11.4	DOS1048-16/4	1104	DOS1048-16/3	1260	DOS1048-14/3	1388
	60"	1524	4	48	21.8	14.2	DOS1060-16/4	1187	DOS1060-16/3	1375	DOS1060-14/3	1513
	72"	1829	4	59	26.8	17.0	DOS1072-16/4	1260	DOS1072-16/3	1487	DOS1072-14/3	1633
	84"	2134	6	69	31.3	19.8	DOS1084-16/4	1334	DOS1084-16/3	1591	DOS1084-14/3	1751
	96"	2438	6	75	34.0	22.6	DOS1096-16/4	1629	DOS1096-16/3	1925	DOS1096-14/3	2118
	108"	2743	6	77	34.9	25.4	DOS10108-16/4	1744	DOS10108-16/3	2079	DOS10108-14/3	2285
	120"	3048	6	79	35.8	28.2	DOS10120-16/4	1780	DOS10120-16/3	2144	DOS10120-14/3	2358
	132"	3353	8	85	38.6	35.8	DOS10132-16/4	1898	DOS10132-16/3	2301	DOS10132-14/3	2531
144"	3658	8	92	41.7	41.8	DOS10144-16/4	1932	DOS10144-16/3	2360	DOS10144-14/3	2597	
12" width (305mm)	36"	915	4	32	14.5	8.6	DOS1236-16/4	1131	DOS1236-16/3	1259	DOS1236-14/3	1461
	48"	1219	4	40	18.1	11.4	DOS1248-16/4	1163	DOS1248-16/3	1355	DOS1248-14/3	1568
	60"	1524	4	48	21.8	14.2	DOS1260-16/4	1254	DOS1260-16/3	1455	DOS1260-14/3	1687
	72"	1829	4	60	27.2	17.0	DOS1272-16/4	1343	DOS1272-16/3	1559	DOS1272-14/3	1812
	84"	2134	6	70	31.8	19.8	DOS1284-16/4	1429	DOS1284-16/3	1708	DOS1284-14/3	1947
	96"	2438	6	76	34.5	22.6	DOS1296-16/4	1736	DOS1296-16/3	2022	DOS1296-14/3	2157
	108"	2743	6	78	35.4	25.4	DOS12108-16/4	1879	DOS12108-16/3	2108	DOS12108-14/3	2318
	120"	3048	6	80	36.3	28.3	DOS12120-16/4	1914	DOS12120-16/3	2213	DOS12120-14/3	2436
	132"	3353	8	87	39.5	35.9	DOS12132-16/4	2055	DOS12132-16/3	2460	DOS12132-14/3	2707
144"	3658	8	95	43.1	42.0	DOS12144-16/4	2088	DOS12144-16/3	2527	DOS12144-14/3	2778	



Catalog Section 10

Extra Undershelves

see spec sheet **EG10.59**



- For tables with uni-lok® hat channel frame.
- Designed for storage of shorter, smaller items under worktable where only one undershelf might not suffice.
- Available in galvanized or stainless steel.

FEATURES:

Note: When ordering an extra or replacement undershelf, please order per the size of your tabletop. Please note the "for table size" column in chart.

Freight class is 70.0.

(•) MTS (made to stock) / () MTO (made to order)

	for table size *		weight			cu ft	galvanized (adjustable)		stainless steel (adjustable)			
	length in.	length mm	lbs.	kg	ft		model #	list	model #	list	model #	list
24" width (610mm)	24"	610	15	6.6	1.6	2424GADJUS	168	2424SADJUS-18/4	375	2424SADJUS-18/3	412	
	30"	762	18	8.2	1.9	2430GADJUS	200	2430SADJUS-18/4	411	2430SADJUS-18/3	451	
	36"	915	21	9.6	2.3	2436GADJUS	204	2436SADJUS-18/4	433	2436SADJUS-18/3	473	
	48"	1219	27	12.2	3.0	2448GADJUS	213	2448SADJUS-18/4	475	2448SADJUS-18/3	520	
	60"	1524	33	15.0	3.7	2460GADJUS	220	2460SADJUS-18/4	535	2460SADJUS-18/3	584	
	72"	1829	39	17.6	4.5	2472GADJUS	223	2472SADJUS-18/4	599	2472SADJUS-18/3	657	
	84"	2134	45	20.4	5.2	2484GADJUS	225	2484SADJUS-18/4	668	2484SADJUS-18/3	729	
	96"	2438	51	23.1	5.9	2496GADJUS	239	2496SADJUS-18/4	720	2496SADJUS-18/3	788	
	108"	2743	57	25.9	6.6	24108GADJUS	248	24108SADJUS-18/4	821	24108SADJUS-18/3	890	
	120"	3048	63	28.6	7.3	24120GADJUS	267	24120SADJUS-18/4	826	24120SADJUS-18/3	899	
	132"	3353	69	31.3	8.1	24132GADJUS	298	24132SADJUS-18/4	882	24132SADJUS-18/3	961	
	144"	3658	75	34.0	8.8	24144GADJUS	330	24144SADJUS-18/4	1046	24144SADJUS-18/3	1134	
	30" width (762mm)	24"	610	17	7.5	1.9	3024GADJUS	174	3024SADJUS-18/4	438	3024SADJUS-18/3	477
		30"	762	21	9.5	2.4	3030GADJUS	213	3030SADJUS-18/4	470	3030SADJUS-18/3	515
36"		915	24	10.7	2.8	3036GADJUS	215	3036SADJUS-18/4	498	3036SADJUS-18/3	543	
48"		1219	30	13.6	3.7	3048GADJUS	220	3048SADJUS-18/4	542	3048SADJUS-18/3	595	
60"		1524	36	16.3	4.6	3060GADJUS	225	3060SADJUS-18/4	621	3060SADJUS-18/3	680	
72"		1829	42	19.1	5.5	3072GADJUS	239	3072SADJUS-18/4	694	3072SADJUS-18/3	759	
84"		2134	48	21.8	6.4	3084GADJUS	246	3084SADJUS-18/4	769	3084SADJUS-18/3	840	
96"		2438	54	24.5	7.3	3096GADJUS	248	3096SADJUS-18/4	854	3096SADJUS-18/3	934	
108"		2743	60	27.2	8.2	30108GADJUS	284	30108SADJUS-18/4	943	30108SADJUS-18/3	1052	
120"		3048	66	29.9	9.0	30120GADJUS	302	30120SADJUS-18/4	1048	30120SADJUS-18/3	1110	
132"		3353	72	32.7	9.9	30132GADJUS	325	30132SADJUS-18/4	1161	30132SADJUS-18/3	1223	
144"		3658	78	35.4	10.8	30144GADJUS	359	30144SADJUS-18/4	1257	30144SADJUS-18/3	1366	

* Undershelves for 30" (762mm) wide tables listed above also fit 36" (915mm) wide tables.

Table Mounted Microwave Shelves

see spec sheet **EG10.25**



- 16 gauge type 304 stainless steel.
- 24" x 24" (610 x 610mm) microwave area.
- 16 1/2" (422mm) clearance above tabletop.
- Six stainless steel posts.

FEATURES:

Freight class is 70.0.

(•) MTS (made to stock) / () MTO (made to order)

	length		weight		cu ft	Left Side		Right Side		Center				
	in.	mm	lbs.	kg		model #	list	model #	list	weight lbs.	weight kg	cu ft	model #	list
	12" width (305mm)	60"	1524	30	13.6	1.9	MOS1260L	1020	MOS1260R	1020	32	14.5	2.1	MOS1260C
72"		1829	35	15.9	2.4	MOS1272L	1156	MOS1272R	1156	38	17.2	2.6	MOS1272C	1293
84"		2133	40	18.1	3.0	MOS1284L	1251	MOS1284R	1251	43	19.5	3.2	MOS1284C	1385
96"		2438	45	20.4	3.4	MOS1296L	1385	MOS1296R	1385	48	21.8	3.7	MOS1296C	1443



100 Industrial Boulevard, Clayton, DE 19938-8903 U.S.A.
 Phone: 800-637-5100 or 302-653-3000. Fax: 302-653-2065
<http://www.eaglegrp.com>

Drawers

- For stainless steel and hardwood tables.
- Type 430 stainless steel.

Note: To specify drawer assemblies for hardwood tables (page 157), you must order model #605500 mounting kit (at no additional charge) along with drawer selected.

To specify drawer assemblies for custom equipment (fabricated through SpecFAB®) which requires angle frame construction, you must order model #605499 (at no additional charge) mounting kit along with drawer selected.

Drawer Capacity Per Table

Drawers can be centered, left or right.

Holes are predrilled for 20" x 20" drawers only.

table length in. mm	15" x 20" (381 x 508mm) drawer capacity per table	20" x 20" (508 x 508mm) drawer capacity per table
24" 610	0	0
30" 762	1 centered	0
36" 914	1 centered	1 centered
48" 1219	1 centered; or 1 left & 1 right	1 centered
60" 1524	1 centered; or 1 left & 1 right	1 centered; or 1 left & 1 right
72" 1829	3 (1 centered, 1 left, 1 right)	1 centered; or 1 left & 1 right
84" 2134	4	1 centered; or 1 left & 1 right
96" 2438	4 (2 left, 2 right)	2 (1 left, 1 right)
108" 2743	4 (2 left, 2 right)	4 (2 left, 2 right)
120" 3048	4 (2 left, 2 right)	4 (2 left, 2 right)
132" 3353	6 (3 left, 3 right)	4 (2 left, 2 right)
144" 3658	6 (3 left, 3 right)	4 (2 left, 2 right)

Drawers with Polymer Slides

see spec sheet **EG10.13A**



- 1/2" (13mm) thick polycarbonate grooved friction slides.
- To specify drawer assemblies for tabletops with box marine edge, you must order model #607297 mounting kit along with drawer selected.

FEATURES:

Note: For use on standard worktables only, not for equipment using angle frame construction.

No locks are available for these drawers.

Freight class is 85.0.

(•) MTS (made to stock) / () MTO (made to order)

width x length x height in. mm	cu ft	weight		For ALL 24" STANDARD tables				For ALL 30" & 36" STANDARD tables				For 36" tables with FRAMING specified AT 30 1/8" CENTER LINES			
		lbs.	kg	model #	list	weight lbs. kg	model #	list	weight lbs. kg	model #	list				
20" x 15" x 5" 508 x 381 x 127	1.4	13	5.8	502976*	• 169	13	5.8	503007*	• 169	13	5.8	503011*	• 169		
20" x 20" x 5" 508 x 508 x 127	1.4	13	5.8	502975**	• 200	13	5.8	503006	• 200	13	5.8	503010	• 200		

* Tables must be field drilled for mounting; ** #502975 will protrude past tabletop width.

Drawers with Pull Flange

see spec sheet **EG10.13A**



- Includes full-extension zinc-plated steel slides with rubber stops.

FEATURES:

Note: No locks are available for these drawers.

Freight class is 85.0.

(•) MTS (made to stock) / () MTO (made to order)

width x length x height in. mm	weight lbs. kg	cubic feet	model #	list
20" x 15" x 5" 508 x 381 x 127	13 5.8	1.4	502941*	• 230
20" x 20" x 5" 508 x 508 x 127	13 5.8	1.4	500772	• 265

* Tables must be field drilled for mounting.

Catalog Section 10

Drawers with Pull Flange & Full Front

see spec sheet **EG10.13A**



- Includes full-extension zinc-plated steel slides with rubber stops.
- Hemmed safety pull handle.

FEATURES:

Note: No locks are available for these drawers.

Freight class is 85.0.

(•) MTS (made to stock) / () MTO (made to order)

width x length x height		weight		cubic	model #	list
in.	mm	lbs.	kg	feet		
20" x 15" x 5"	508 x 381 x 127	25	11.3	3.0	502942* •	342
20" x 20" x 5"	508 x 508 x 127	25	11.3	3.0	501571 •	374

* Tables must be field drilled for mounting.

Tier Drawers - Regular

see spec sheet **EG10.13B**



tier drawer



tier drawer with legs

- Heavy gauge type 430 stainless steel cabinet with three roller-track drawers.
- With or without legs.
- Guides.
- Full-extension zinc-plated steel slides.
- Stainless steel drawer.
- Hemmed safety pull handle on each drawer.

FEATURES:

Note: All shipping weights and cubic feet are approximate.

Freight class is 85.0.

(•) MTS (made to stock) / () MTO (made to order)

width x length x height		description	weight		cubic	model #	list
inches	mm		lbs.	kg	feet		
22½" x 24" x 22"	572 x 610 x 559	3 drawers, nylon feet	75	34.0	9.8	TD3 •	2304
22½" x 24" x 34½"	572 x 610 x 876	3 drawers, with legs	78	35.4	9.8	TD3L	2600

NSF-Approved Tier Drawers

see spec sheet **EG10.13B**



model #NTD3L
with NSF-certified drawer

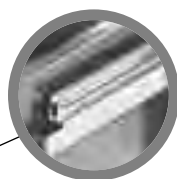

removable NSF
drawer slide

- Utilizes totally removable drawer slides certified by the National Sanitation Foundation.
- Otherwise, design and features are the same as tier drawers mentioned above.
- Hemmed safety pull handle on each drawer.

FEATURES:

Notes: These drawers can be integrated into a table.

Model #NTD3I. \$3334 list.

Optional Pan Replacement available.

Model #608120. \$126 list.

Freight class is 85.0.

(•) MTS (made to stock) / () MTO (made to order)

width x length x height		description	weight		cubic	model #	list
inches	mm		lbs.	kg	feet		
22½" x 24" x 22"	572 x 610 x 559	3 drawers, nylon feet	75	34.0	9.8	NTD3	2468
22½" x 24" x 34½"	572 x 610 x 876	3 drawers, with legs	78	35.4	9.8	NTD3L	2604



Drawer Assemblies

see spec sheet **EG10.13B**



enclosed drawer assembly



SPEC-MASTER® heavy duty drawer assembly

For Stainless Steel and Hardwood Tables!

FEATURES:

- Removable drawer pan.

Note: All shipping weights and cubic feet are approximate. Lock available. **\$163 list.** To order, add suffix “-L”. **Example: 502972-L.**

To determine number of drawers per table, see chart on page 170.

Freight class is 85.0.

(•) MTS (made to stock) / () MTO (made to order)

Enclosed Assemblies

Type 430 stainless steel, front with hemmed safety pull handle, and full-extension zinc-plated steel slides.

SPEC-MASTER® Heavy Duty Assemblies

Type 304 stainless steel, insulated front and self-closing drawer slides that fully extend from housing. **THESE ASSEMBLIES ARE STACKABLE!!**

width x length x height		cu ft	weight		model #		list		OPTIONAL PAN REPLACEMENT		weight		OPTIONAL PAN REPLACEMENT		
in.	mm		lbs.	kg			model #	list	model #	list	lbs.	kg	model #	list	model #
20" x 15" x 5"	508 x 381 x 127	3.0	35	15.9	502943 •	655	608115	181	40	18.1	502972 •	1058	608117	220	
20" x 20" x 5"	508 x 508 x 127	3.0	35	15.9	501572 •	681	608118 **	191	40	18.1	502971 •	1094	606826	228	

* Tables must be field drilled for mounting.

** Pan replacement #608118 does NOT fit drawer assembly #501572 with optional lock (#501572-L). Drawer assembly #501572-L only accepts pan replacement #608119, list \$256.

Drawer Assemblies With NSF-Approved Slides

see spec sheet **EG10.13B**

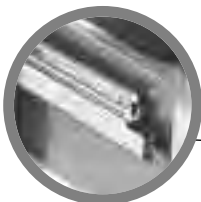

removable NSF drawer slide



#502946 or 502947 drawer assembly

FEATURES:

- Type 430 stainless steel.
- Utilizes a totally removable drawer slide, making it easy to clean for complete sanitation.
- Requires no tools.
- All-stainless steel housing, frame, drawer front complete with full-length front pull flange, and removable drawer pan with large radius corners.
- Hemmed safety pull handle.

Note: To determine number of drawers per table, see chart on page 170. Optional lock available. **\$163 list.** To order, add suffix “-L”. **Example: 502946-L.**

Freight class is 85.0.

(•) MTS (made to stock) / () MTO (made to order)

width x length x height		weight		cubic feet	model #		list		OPTIONAL PAN REPLACEMENT	
in.	mm	lbs.	kg				model #	list	model #	list
20" x 15" x 5"	508 x 381 x 127	35	15.9	3.0	502947 •	673	608115	181	608115	181
20" x 20" x 5"	508 x 508 x 127	35	15.9	3.0	502946 •	706	608116 **	181	608116 **	181

* Tables must be field drilled for mounting.

** Pan replacement #608116 does NOT fit drawer assembly #502946 with optional lock (#502946-L). Drawer assembly #502946-L only accepts pan replacement #608119, list \$256.

Catalog Section 10

Polymer Drawers

see spec sheet **EG10.13A**

FEATURES:

- Made of heavy gauge polymer.
- With pull flange and built-in drawer stop.

Freight class is 85.0.

(•) MTS (made to stock) / () MTO (made to order)



width x length x depth		weight		cubic feet	model #	list
in.	mm	lbs.	kg			
13 7/8" x 19" x 3"	352 x 483 x 76	9	4.1	1.4	502948	272
13 7/8" x 19" x 6"	352 x 483 x 152	13	5.8	3.0	502949	326
13 7/8" x 19" x 9"	352 x 483 x 229	18	8.2	4.5	502950	384

Drawer Kits for All Stainless Steel Worktables

see spec sheet **EG10.13A**

Freight class is 70.0.

(•) MTS (made to stock) / () MTO (made to order)

description	add * suffix #	add to list
20" x 20" x 5" (508 x 508 x 127mm) enclosed drawer assembly (#501572)	-D1	681
20" x 20" x 5" (508 x 508 x 127mm) drawer with pull flange and full front (#501571)	-D2	375
20" x 20" x 5" (508 x 508 x 127mm) drawer with pull flange (#500772)	-D3	265

* Example: T3060SB-D3



ECO-Built™ is an important part of The EAGLE Advantage.

The numbers don't lie. EAGLE's efforts to consume less, emit less and conserve more are beginning to bear fruit. The tree to the left shows just some of what we now accomplish each year.

Look for the ECO-Built™ tag on the bar code.



Table Mounted Utility Tool Racks

see spec sheet **EG10.12**



- Furnished with 1 1/2" (41mm) stainless steel tubular supports extending through table top and fastened securely to adjustable undershelf.
- Racks are triple-bar type made of 3/8" x 2" (5 x 51mm), aluminum or type 304 stainless steel bars bolted together and fitted with one two-prong sliding hook per foot.

FEATURES:

NOTE: All shipping weights and cubic feet are approximate. Worktables with Utility Tool Rack not recommended for use with casters.

Freight class is 70.0.

(•) MTS (made to stock) / () MTO (made to order)

fits table length	Aluminum					Stainless Steel							
	in.	mm	in.	mm	weight lbs. kg	cu ft	model #	list	weight lbs. kg	cu ft	model #	list	
36"	914	28"	711	38	17.2	1.7	TM36APR	874	50	22.7	1.7	TM36PR	1045
48"	1219	40"	1016	42	19.1	1.9	TM48APR	908	57	25.9	1.9	TM48PR	1104
60"	1524	52"	1321	46	20.9	1.9	TM60APR	940	64	29.0	1.9	TM60PR	1163
72"	1829	64"	1626	50	22.7	1.9	TM72APR	984	70	31.8	1.9	TM72PR •	1224
84"	2134	76"	1930	54	24.5	1.9	TM84APR	1173	77	34.9	1.9	TM84PR	1447
96"	2438	88"	2235	58	26.3	2.1	TM96APR	1209	83	37.6	2.1	TM96PR	1507
108"	2743	100"	2540	62	28.1	2.3	TM108APR *	1467	89	40.4	2.3	TM108PR *	1822
120"	3048	112"	2845	66	29.9	2.5	TM120APR *	1511	95	43.1	2.5	TM120PR *	1898
132"	3353	124"	3150	71	32.2	2.8	TM132APR *	1556	102	46.3	2.8	TM132PR *	1992
144"	3658	136"	3454	76	34.5	3.1	TM144APR *	1607	109	49.4	3.1	TM144PR *	2030

* These racks include center tubular support.

Optional Adjustable Shelves for Table Mounted Pan/Pot Racks

12" (305mm) wide. 16 gauge, type 304 stainless steel.

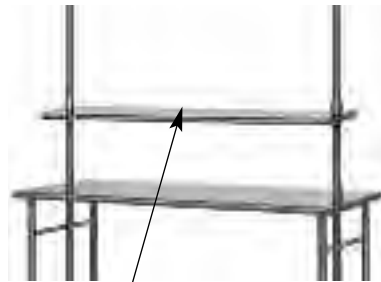

optional adjustable shelf for table mounted pot/pan racks

shelf length	weight	cubic		
in.	mm	lbs.	kg	feet
36"	914	16	7.3	0.9
48"	1219	20	9.0	1.3
60"	1524	25	11.3	1.6
72"	1829	30	13.6	1.9
84"	2134	35	15.9	2.2
96"	2438	39	17.6	2.5
108"	2743	41	18.6	3.1
120"	3048	45	20.4	3.6
132"	3353	49	22.2	4.1
144"	3658	53	24.0	4.7

Single Bar Pot Racks

	ALUMINUM					STAINLESS STEEL				
	length in.	mm	weight lbs.	kg	model #	list	weight lbs.	kg	model #	list
8 1/2" width (216mm)	24"	610	5	2.3	SBPR-24-A	391	9	4.1	SBPR-24-S	521
	36"	915	6	2.7	SBPR-36-A	411	12	5.4	SBPR-36-S	548
	48"	1219	7	3.2	SBPR-48-A	424	15	6.8	SBPR-48-S	563
	60"	1524	9	4.1	SBPR-60-A	435	18	8.2	SBPR-60-S	580
	72"	1829	11	5.0	SBPR-72-A	449	21	9.5	SBPR-72-S	598
	84"	2134	13	5.9	SBPR-84-A	460	25	11.3	SBPR-84-S	613
	96"	2438	15	6.8	SBPR-96-A	507	29	13.2	SBPR-96-S	675
	108"	2743	17	7.7	SBPR-108-A	558	34	15.4	SBPR-108-S	740
120"	3048	20	9.0	SBPR-120-A	605	39	17.6	SBPR-120-S	807	

FEATURES:

- One-piece flat 3/8" (5mm)-thick solid bar.
- 2" (51mm)-wide.
- Includes one two-prong pot hook per foot.

Freight class is 70.0.

(•) MTS (made to stock) / () MTO (made to order)



single bar pot rack



pot hook

Additional Hook for Single Bar Pot Racks

- Stainless steel.

weight lbs.	kg	cu ft	model #	list ea.
0.2	0.1	0.1	300696	25

Catalog Section 10

Ceiling Mounted Utility Tool Racks

see spec sheet **EG10.12**



- Furnished with chain hangers for ceiling suspension.
- Racks are triple-bar type made of 3/16" x 2" (5 x 51mm), aluminum or type 304 stainless steel bars bolted together, and fitted with one two-prong sliding hook per foot.

FEATURES:

Note: All shipping weights and cubic feet are approximate.

Freight class is 70.0.

(•) MTS (made to stock) / () MTO (made to order)

rack length		Aluminum					Stainless Steel				
in.	mm	weight lbs.	weight kg	cu ft	model #	list	weight lbs.	weight kg	cu ft	model #	list
28"	711	28	12.7	0.7	CM36APR	703	41	18.6	0.7	CM36PR	899
40"	1016	32	14.5	0.9	CM48APR •	739	48	21.8	0.9	CM48PR •	939
52"	1321	36	16.3	1.2	CM60APR •	772	54	24.5	1.2	CM60PR •	1002
64"	1626	40	18.1	1.6	CM72APR •	816	60	27.2	1.6	CM72PR •	1060
76"	1930	44	20.0	1.9	CM84APR	1010	67	30.4	1.8	CM84PR	1290
88"	2235	48	21.8	2.1	CM96APR	1042	74	33.6	2.1	CM96PR	1347
100"	2540	53	24.0	2.5	CM108APR	1219	81	36.7	2.5	CM108PR	1697
112"	2845	58	26.3	2.9	CM120APR	1233	87	39.5	2.9	CM120PR	1790
124"	3150	63	28.6	3.3	CM132APR	1298	94	42.6	3.3	CM132PR	1814
136"	3454	68	30.8	3.7	CM144APR	1324	101	45.8	3.7	CM144PR	2070

Wall Mounted Utility Tool Racks

see spec sheet **EG10.12**



- Racks are double-bar type made of 3/16" x 2" (5 x 51mm), aluminum or type 304 stainless steel bars bolted together, and fitted with one two-prong sliding hook per foot.
- Stainless steel brackets.

FEATURES:

Freight class is 70.0.

(•) MTS (made to stock) / () MTO (made to order)

rack length		Aluminum					Stainless Steel				
in.	mm	weight lbs.	weight kg	cu ft	model #	list	weight lbs.	weight kg	cu ft	model #	list
36"	914	13	5.8	1.0	WM36APR •	254	18	8.2	1.0	WM36PR •	293
48"	1219	15	6.8	1.2	WM48APR •	265	22	10.0	1.2	WM48PR •	353
60"	1524	17	7.7	1.4	WM60APR •	303	26	11.8	1.4	WM60PR •	377
72"	1829	19	8.6	1.8	WM72APR •	388	29	13.2	1.8	WM72PR •	480
84"	2134	21	9.5	2.0	WM84APR •	408	33	15.0	2.0	WM84PR •	521
96"	2438	23	10.4	2.3	WM96APR •	501	37	16.8	2.3	WM96PR •	740
108"	2743	25	11.3	2.6	WM108APR	604	41	18.6	2.6	WM108PR	830
120"	3048	28	12.7	2.9	WM120APR	612	45	20.4	2.9	WM120PR	879
132"	3353	31	14.1	3.2	WM132APR	709	50	22.7	3.3	WM132PR	893
144"	3658	34	15.4	3.5	WM144APR	761	55	24.9	3.5	WM144PR	1122

Corner Guards

see spec sheet **EG10.14**

- Adheres to corner of adjacent wall(s).
- Heavy gauge stainless steel.
- Adhesive tape backing.

height		2" x 2" Inner Corner Guards		2" x 2" Outer Corner Guards	
in.	mm	model #	list	model #	list
36"	914	CG-I-36	102	CG-O-36	102
48"	1219	CG-I-48	119	CG-O-48	119
60"	1524	CG-I-60	135	CG-O-60	135
72"	1829	CG-I-72	149	CG-O-72	149



- Options / Accessories / Replacements -

see spec sheet **EG10.50**

Please allow six to eight weeks shipping cycle for custom fabrication after receipt of approved drawings. Add 10% upcharge to expedite 4-week shipping cycle.

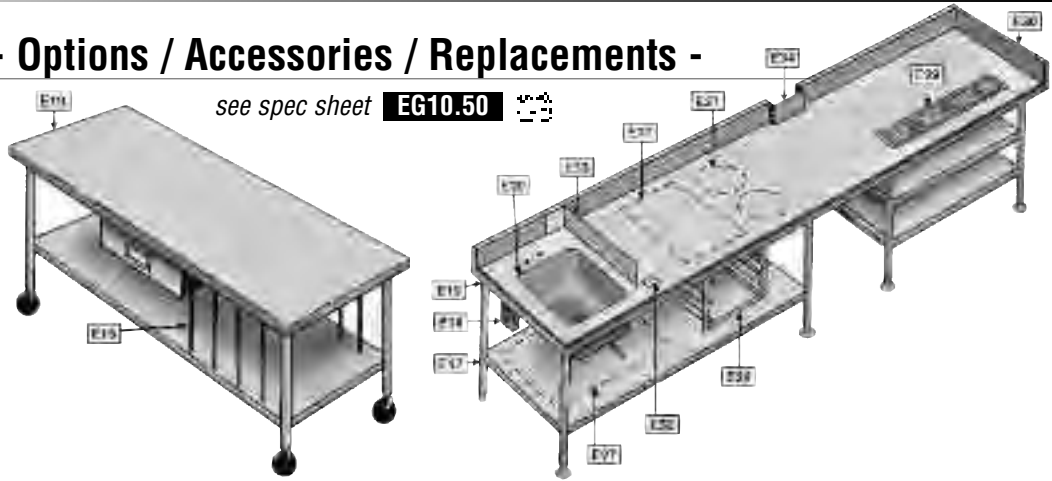

model #	description	unit	list	model #	description	unit	list
E10	Square edge table - front and/or rear	per table	201	300720	Lever drains - 1.5" I.P.S. (38mm)	each	220
E11	Marine counter edge	per table	434	300721	Lever drains - 2" I.P.S. (51mm)	each	220
E12	"V" type marine edge	per table	434	300722	Lever drains - 2" I.P.S. (51mm) with overflow	each	452
E13	Bullnose edge	per table	412	341189 ***	Twist handle drains - 1.5" I.P.S. (38mm)	each	232
E15	Vertical tray dividers - 4-section assembly, 3" on centers	each	641	336002 ***	Twist handle drains - 2" I.P.S. (51mm)	each	232
300698	Casters - 4" (102mm)-diameter with brake	each	99	341190 ***	Twist handle drains - 2" I.P.S. (51mm) with overflow	each	525
300699	Casters - 4" (102mm)-diameter without brake	each	94	E27	Top cutout - square or round (Specify location)	each	272
317635	Casters - 5" (127mm)-diameter with brake	each	128	E28	Angle slides for pans, up to six pairs Specify location and pan size.	set	562
317636	Casters - 5" (127mm)-diameter without brake	each	128	E29	Urn trough, 4.5" wide x 1.25" deep (114 x 32mm) with 1.5" (38mm) drain, complete with louvered grate. (Length must be maximum of 6" shorter than table. Specify location.)	lin. ft	137
313835	Stainless steel flanged bullet feet	each	25	E30	End splash — per end (Specify end), all heights	each	296
300692	Bullet feet - stainless steel	each	17	E31	1.5" (38mm) rear upturn for undershelf	table	119
301036	Bullet feet - white metal	each	9	E32	Can opener hole with under table support (Specify location)		193
300293	Bullet feet - plastic	each	2	E33	Sink splashes — single thickness 4" tall (102mm)	each	306
E17	Special height legs	per table	151	E34	Column cutout (Send floor plan/sketch)	each	633
E18 *	Duplex receptacle and mounting plate (under table)	each	380	NOT PICTURED			
E18.1 *	Duplex receptacle in splash (requires at least 6"-high splash)	each	367	model #	description	unit	list
E18.2 *	Pedestal duplex receptacle (top of table or overshelf)	each	424	606329	Scrap chute, 6" (152mm)-diameter	each	214
E19	Stainless steel gussets	each	33	606331	Knife rack (fits rolled rim, poly, and square edge tables)	each	310
E20	Sinks — complete with faucet and basket drain (Specify location)	each	1024	E35	16 gauge s/s apron in front of sinks or cutouts	lin. ft	149
E21	- 10" x 14" x 9.5" bowl (254 x 356 x 241mm)	each	1075	E36	Fully welded - top, undershelf & legs	each	479
E22 **	- 14" x 16" x 9.5" bowl (356 x 406 x 241mm)	each	1147	E36A	Welded base only - undershelf & legs	each	322
E23 **	- 16" x 20" x 8" bowl (406 x 508 x 203mm)	each	1272	E37	NSF sprayed-on sound deadening up to 12' (3658mm)	table	646
E24 **	- 16" x 20" x 14" bowl (406 x 508 x 356mm)	each	1395	E37A	- for each additional foot	lin. ft	51
E24A **	- 18" x 20" x 14" bowl (457 x 508 x 356mm)	each	1395	E38-6****	Cantilever mount up to 6' (1829mm) - add to wall shelf price	each	375
E25	- 20" x 20" x 14" (508 x 508 x 356mm)	each	1404	E38-12****	Cantilever mount up to 12' (3658mm) - add to wall shelf price	each	561
E25	- 24" x 24" x 14" (610 x 610 x 356mm)	each	1901	E39	Enclosed backsplash	lin. ft	80
E25	for 36" (914mm)-wide tables	each	1901				
313304	T&S faucet upgrade - deck mount 4" (102mm) centers	each	569				

* For GFI receptacle, add "-GFI" to E number (example: E18.1-GFI) and \$38 to list price.
 ** These sink bowls will not fit in a table any less than 30" (762mm) wide.
 *** Optional twist drain brackets available for use with twist handle drains.
 **** Applicable to wall mount shelves and pot racks.

Optional Sinks Built Into Tables – Standard Locations

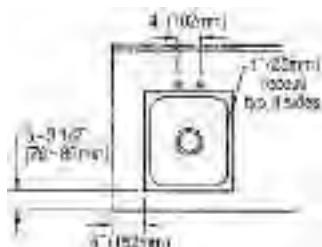

sink on left/right side of table

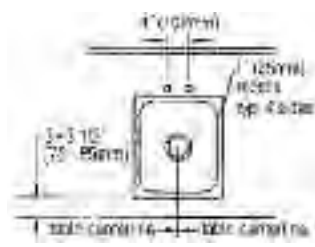

sink on center of table

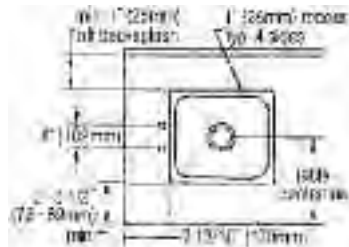

sink with faucet on end of table

Optional Table Edges

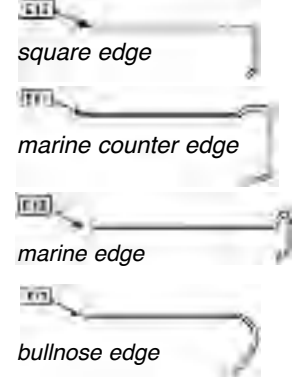

Accessories/Replacements

Hand Sinks	189-191
All Other Sinks.....	193, 210-213

Custom Options210

412, 414, and 314 Series Sinks

One-Compartment	194
Two-Compartment	195
Three-Compartment	196
Four-Compartment	197

Counter Drop-In Sinks207

Floor Drains/Troughs214-216

Hand Sinks.....178-192

Accessories	189-191
Electronic.....	181-182
HFL-5000 Handwashing System.....	178
Physically Challenged / ADA	185
With Waste Receptacle	188

Specialty Sinks

314 Series Corner	205
310 / 312 Series Specialty Use.....	206
Lavatory	192
Mop Sink	206
Mop Sink Storage Cabinet	209

SPEC-MASTER® FN Series Heavy Duty Sinks

One-Compartment	198
Two-Compartment	199
Three-Compartment	200
Four-Compartment	201
FFN Series Flush Front	204
Specialty Use/Parts Cleaning.....	205

Undermount Sink Bowls ..208-209

Utility Sinks202-204

EAGLE HAND SINKS WITH MICROGARD® Antimicrobial Protection.

**THE
INDUSTRY'S
CLEAN
LEADER.**

NOW HERE'S A GREAT IDEA:

making your handwashing stations more convenient and accessible by integrating them into your work sequence. What better way to attain more frequent handwashing. Let the industry's clean leader help by giving you the widest range of hand sink choices – many available with exclusive MICROGARD® Antimicrobial Protection. More models, configurations and accessories mean more design options for you... so you'll have more efficient work areas along with improved hygiene.

For all the details on how EAGLE hand sinks add up to better sanitation, visit www.eaglegrp.com.



Stainless Steel Fabricated Sinks

see spec sheets **EG20.14** **EG20.15**

- 14"-deep (356mm) bowls with 3/4" (19mm) radius corners.
- 9 1/2" (241mm)-high backsplash with 1" (25mm) upturn and tile edge.

FEATURES:

Freight class is 100.0.

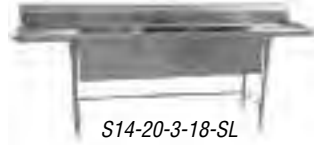

S14 Series

Stainless steel legs, crossbracing, gussets and bullet feet.

S16 Series

Galvanized legs, crossbracing and gussets, and plastic bullet feet.

# of bowls	drainboard length		# of drbds	overall length		14 gauge type 304 stainless steel construction		16 gauge type 304 stainless steel construction	
	in.	mm		in.	mm	model #	list	model #	list
1	n/a		0	29"	737	S14-20-1-SL	1538	S16-20-1	1354
2	18"	457	1	67 1/2"	1715	S14-20-2-18R-SL	2671	S16-20-2-18R	2351
	18"	457	1	67 1/2"	1715	S14-20-2-18L-SL	2671	S16-20-2-18L	2351
2	18"	457	2	81"	2057	S14-20-2-18-SL	2811	S16-20-2-18	2474
	18"	457	1	89 1/2"	2273	S14-20-3-18R-SL	3524	S16-20-3-18R	3100
2	18"	457	1	89 1/2"	2273	S14-20-3-18L-SL	3524	S16-20-3-18L	3100
	18"	457	2	103"	2616	S14-20-3-18-SL	3708	S16-20-3-18	3263
3	24"	610	1	95 1/2"	2426	S14-20-3-24R-SL	3674	S16-20-3-24R	3234
	24"	610	1	95 1/2"	2426	S14-20-3-24L-SL	3674	S16-20-3-24L	3234
3	24"	610	2	115"	2921	S14-20-3-24-SL	3869	S16-20-3-24	3404
	18"	457	2	103"	2616	S14-28-3-18-SL *	4698	S16-28-3-18 *	4131

* #S14-28-3-18-SL and #S16-28-3-18 sinks feature 20" x 28" (508 x 711mm) sink bowls.

HFL-5000 Touch-Free Handwashing Systems

see spec sheet **EG20.55**

- EAGLE hand sink with MICROGARD® antimicrobial protection.
- Kimberly-Clark touchless towel dispenser. EAGLE part #377454. Use Kleenex #50606 or Scott #02000 towel roll.
- T&S electronic eye faucet, splash mounted with battery-saving hydro-generator power source. A LEED-friendly combination with the flow of water creating its own power source. EAGLE part #369865.
- Purell/LTX hand sanitizing dispenser. EAGLE part #377455.
- Gojo/LTX hand soap dispenser. EAGLE part #377456.
- Wire glove rack for Elara single service gloves. EAGLE part #352855.
- Tucel soft bristle white nail brush. Model #1832. EAGLE part #348602



Optional MICROGARD® for Hand Sinks!

(See pages 179-188 for applicable hand sinks.)

- MICROGARD® is an antimicrobial agent which contains built-in protection to retard the growth of a broad range of bacteria, mold and mildew on the surface that cause stains, odors and degradation.
- MICROGARD® combines inorganic antimicrobial silver ions with a patented delivery system. The patented delivery system triggers the release of silver ions which react with bacteria in three ways:
 - 1) Suffocates the cell.
 - 2) Stops the cell reproduction system.
 - 3) Stops the cell from growing.
- MICROGARD® is a second line of defense. In keeping with good hygiene practices, clean this product as usual. The protection will not wash out, while organic bactericides may.**
- MICROGARD® is applied onto top and underside of sink deck, backsplash, and inside & outside of sink bowl (excludes faucets, drains, towel/soap dispensers, waste receptacle, skirt, pedal valves, and nail brush holder).

* MICROGARD® does not protect users or others against bacteria, viruses, germs or other disease organisms. Always clean this product thoroughly after each use.

** Note: To clean, use mild soap and water, rinse, and wipe entire surface dry. Soft non-abrasive cleaners may be used when necessary. Strong abrasive cleaners will scratch and dull the surface.

description of hand sink included	model #	list
with waste receptacle	HFL-5000	3788
with skirt (no waste receptacle)	HFL-5000-S	3638
with waste receptacle and end splashes	HFL-5000-LRS	4224



Catalog Section 20

Traditional Hand Sinks

see spec sheet **EG20.40**

MICROGARD®

an antimicrobial agent which contains built-in protection to retard the growth of a broad range of bacteria, mold and mildew on shelf surface that causes stains, odors and degradation.

- All sinks are wall mountable.
- Deep-drawn seamless design.
- Positive drain, included on all models.
- All type 304 stainless steel.
- Splash mount gooseneck faucet included on all models except HSA-10.

FEATURES:

Freight class is 85.0.

(•) MTS (made to stock) / () MTO (made to order)

Cleanest sinks in the industry!

HSA-10* •		list:	486
	bowl size:	9¼" x 13½" x 6¼" (248 x 343 x 173mm)	
	overall size:	14¼" x 18¾" x 12¼" (376 x 480 x 324mm)	
	weight:	10 lbs. (4.5 kg)	
	cubic feet:	2.8	
MICROGARD® available: To order, add suffix "-MG" to model # / add \$110 to list price.		includes:	4" (102mm) centerline faucet holes, basket drain.

HSA-10-FAW •		list:	765
	bowl size:	9¼" x 13½" x 6¼" (248 x 343 x 173mm)	
	overall size:	14¼" x 18¾" x 12¼" (376 x 480 x 324mm)	
	weight:	14 lbs. (6.4 kg)	
	cubic feet:	2.8	
MICROGARD® available: To order, add suffix "-MG" to model # / add \$110 to list price.		includes:	Faucet with wrist handles, p-trap, tail piece, basket drain.

HSA-10-F •		list:	569
	bowl size:	9¼" x 13½" x 6¼" (248 x 343 x 173mm)	
	overall size:	14¼" x 18¾" x 12¼" (376 x 480 x 324mm)	
	weight:	12 lbs. (5.2 kg)	
	cubic feet:	2.8	
MICROGARD® available: To order, add suffix "-MG" to model # / add \$110 to list price.		includes:	Faucet, basket drain.

HSA-10-FL •		list:	813
	bowl size:	10" x 14" x 5" (254 x 356 x 127mm)	
	overall size:	14¼" x 18¾" x 12¼" (376 x 480 x 318mm)	
	weight:	15 lbs. (6.6 kg)	
	cubic feet:	2.8	
		includes:	Faucet, polymer lever drain.

HSA-10-FA •		list:	601
	bowl size:	9¼" x 13½" x 6¼" (248 x 343 x 173mm)	
	overall size:	14¼" x 18¾" x 12¼" (376 x 480 x 324mm)	
	weight:	14 lbs. (6.4 kg)	
	cubic feet:	2.8	
MICROGARD® available: To order, add suffix "-MG" to model # / add \$110 to list price.		includes:	Faucet, p-trap, tail piece, basket drain.

HSA-10-FO •		list:	674
	bowl size:	10" x 14" x 5" (254 x 356 x 127mm)	
	overall size:	14¼" x 18¾" x 12¼" (376 x 480 x 318mm)	
	weight:	13 lbs. (5.6 kg)	
	cubic feet:	2.8	
		includes:	Faucet, polymer lever drain w/overflow.

* To order hand sink with no faucet holes, add suffix "-NH" to model number (example: HSA-10-NH). \$142 upcharge.



100 Industrial Boulevard, Clayton, DE 19938-8903 U.S.A.
Phone: 800-637-5100 or 302-653-3000. Fax: 302-653-2065
http://www.eaglegrp.com

Hand Sinks with Standard Towel Dispenser and/or Soap Dispenser

see spec sheets **EG20.05** **EG20.41**

MICROGARD®

an antimicrobial agent which contains built-in protection to retard the growth of a broad range of bacteria, mold and mildew on shelf surface that causes stains, odors and degradation.

- Deep-drawn positive drain and splash mount gooseneck faucet included on all models.
- All 304 series stainless steel, including towel dispenser.
- Soap dispenser on all models holds 16 ounces.
- Towel dispenser holds 4" x 10" (102 x 254mm) C-fold disposable paper towels.

FEATURES:

Freight class is 85.0.

(•) MTS (made to stock) / () MTO (made to order)

HSA-10-FDP		list: 1197
	bowl size:	9 3/4" x 13 1/2" x 6 3/4" (248 x 343 x 173mm)
	overall size:	14 3/4" x 19 1/4" x 28 3/4" (376 x 489 x 718mm)
	weight:	27 lbs. (12.2 kg)
	cubic feet:	6.2
MICROGARD® available: To order, add suffix "-MG" to model # / add \$110 to list price.		includes: Faucet, towel dispenser, soap dispenser, basket drain.

HSA-10-FODP		list: 1470
	bowl size:	10" x 14" x 5" (254 x 356 x 127mm)
	overall size:	14 3/4" x 19 1/4" x 28" (376 x 489 x 711mm)
	weight:	27 lbs. (12.2 kg)
	cubic feet:	6.2
MICROGARD® available: To order, add suffix "-MG" to model # / add \$110 to list price.		includes: Faucet, towel dispenser, soap dispenser, polymer lever drain w/overflow.

HSA-10-FDPS		list: 1828
	bowl size:	9 3/4" x 13 1/2" x 6 3/4" (248 x 343 x 173mm)
	overall size:	14 3/4" x 19 1/4" x 30" (376 x 489 x 762mm)
	weight:	34 lbs. (15.4 kg)
	cubic feet:	6.2
MICROGARD® available: To order, add suffix "-MG" to model # / add \$110 to list price.		includes: Faucet, towel dispenser, soap dispenser, skirt, basket drain.

HSA-10-F-DS*		list: 749
	bowl size:	9 3/4" x 13 1/2" x 6 1/2" (248 x 343 x 165mm)
	overall size:	14 1/16" x 18 1/8" x 12 3/4" (376 x 480 x 324mm)
	weight:	12 lbs. (5.2 kg)
	cubic feet:	2.8
<i>(see page 187 for #HSAN-10-F-DS)</i>		MICROGARD® available: To order, add suffix "-MG" to model # / add \$110 to list price.
MICROGARD® available: To order, add suffix "-MG" to model # / add \$110 to list price.		includes: Faucet, deck-mount soap dispenser, basket drain.

HSA-10-FLDP		list: 1437
	bowl size:	10" x 14" x 5" (254 x 356 x 127mm)
	overall size:	14 3/4" x 19 1/4" x 28" (376 x 489 x 711mm)
	weight:	27 lbs. (12.2 kg)
	cubic feet:	6.2
MICROGARD® available: To order, add suffix "-MG" to model # / add \$110 to list price.		includes: Faucet, towel dispenser, soap dispenser, polymer lever drain.

HSA-10-FWLDP-LRS		list: 1940
	bowl size:	10" x 14" x 5" (254 x 356 x 127mm)
	overall size:	14 3/4" x 19 1/4" x 28" (376 x 489 x 711mm)
	weight:	27 lbs. (12.2 kg)
	cubic feet:	6.2
MICROGARD® available: To order, add suffix "-MG" to model # / add \$110 to list price.		includes: Faucet with wrist handles, towel dispenser, soap dispenser, basket drain, p-trap, tail piece, and side splashes.

* Overall height does not include soap dispenser bottle. See page 187 for "Space-Saver" hand sink with deck-mount soap dispenser.

Catalog Section 20

Electronic Eye Hand Sinks - AC POWER

see spec sheet **EG20.42**

Note: For regulating water temperature, Temperature Adjustment Valve (see page 190) is required.

MICROGARD®

an antimicrobial agent which contains built-in protection to retard the growth of a broad range of bacteria, mold and mildew on shelf surface that causes stains, odors and degradation.

- Electronic “eye” sensor beam activates water flow and adjusts from 3” to 12” (76 to 305mm).
- Requires 120-volt, 15-amp electricity.
- 120-volt AC adapter.
- Splash mount gooseneck spout.
- Lever or basket drain.
- Y-Inlet Non-Adjustable Mixing Valve.

FEATURES:

Freight class is 85.0.

(•) MTS (made to stock) / () MTO (made to order)

HSA-10-FE*•		list: 2070
	bowl size:	9¼" x 13½" x 6¼" (248 x 343 x 173mm)
	overall size:	14¾" x 18¾" x 12¾" (376 x 480 x 324mm)
	weight:	14 lbs. (6.3 kg)
	cubic feet:	2.8
MICROGARD® available: To order, add suffix “-MG” to model # / add \$110 to list price.		includes: Spout, electronic eye, and basket drain.

HSA-10-FDPE*		list: 2963
	bowl size:	9¼" x 13½" x 6¼" (248 x 343 x 173mm)
	overall size:	14¾" x 19¼" x 28¼" (376 x 489 x 718mm)
	weight:	27 lbs. (12.2 kg)
	cubic feet:	6.2
MICROGARD® available: To order, add suffix “-MG” to model # / add \$110 to list price.		includes: Spout, electronic eye, soap dispenser, towel dispenser, and basket drain.

HSA-10-FOE		list: 2176
	bowl size:	10" x 14" x 5" (254 x 356 x 127mm)
	overall size:	14¾" x 18¾" x 12½" (376 x 480 x 318mm)
	weight:	13 lbs. (5.7 kg)
	cubic feet:	2.8
		includes: Spout, electronic eye, and polymer lever drain with overflow.

HSA-10-FODPE		list: 2975
	bowl size:	10" x 14" x 5" (254 x 356 x 127mm)
	overall size:	14¾" x 19¼" x 28" (376 x 489 x 711mm)
	weight:	27 lbs. (12.2 kg)
	cubic feet:	6.2
		includes: Spout, electronic eye, soap dispenser, towel dispenser, and polymer lever drain with overflow.

HSA-10-FA-PE		list: 2756
	bowl size:	9¼" x 13½" x 6¼" (248 x 343 x 173mm)
	overall size:	14¾" x 18¾" x 40¼" (376 x 480 x 1036mm)
	weight:	28 lbs. (12.7 kg)
	cubic feet:	5.9
MICROGARD® available: To order, add suffix “-MG” to model # / add \$110 to list price.		includes: Spout, electronic eye, soap dispenser, P-trap, tail piece, and basket drain.

HSA-10-FDPEE		list: 3246
	bowl size:	9¼" x 13½" x 6¼" (248 x 343 x 173mm)
	overall size:	14¾" x 19¼" x 31¼" (376 x 489 x 794mm)
	weight:	29 lbs. (13.2 kg)
	cubic feet:	6.2
MICROGARD® available: To order, add suffix “-MG” to model # / add \$110 to list price.		includes: Spout, electronic eye, towel dispenser, electronic soap dispenser, and basket drain.

* Optional waste receptacle available for models HSA-10-FE, HSA-10-FDPE, and HSA-10-FDPEE. See page 191.



100 Industrial Boulevard, Clayton, DE 19938-8903 U.S.A.
Phone: 800-637-5100 or 302-653-3000. Fax: 302-653-2065
<http://www.eaglegrp.com>

Electronic Hand Sinks - Battery Power

see spec sheets **EG20.07** **EG20.49**

MICROGARD®

an antimicrobial agent which contains built-in protection to retard the growth of a broad range of bacteria, mold and mildew on shelf surface that causes stains, odors and degradation.

- Battery-powered electronic-eye faucet which operates on four "AA" batteries (included).
- Y-Inlet Non-Adjustable Mixing Valve.
- "Low battery" indicator light.

FEATURES:

Freight class is 85.0.

(•) MTS (made to stock) / () MTO (made to order)

HSA-10-FDPEE-B-T		list: 4555
	bowl size:	9¼" x 13½" x 6¾" (248 x 343 x 173mm)
	overall size:	14¾" x 19¼" x 47½" (376 x 489 x 1207mm)
	weight:	46 lbs. (20.9 kg)
	cubic feet:	6.2
MICROGARD® available: To order, add suffix "-MG" to model # / add \$110 to list price.		includes: Battery-powered electronic eye faucet, towel dispenser, electronic soap dispenser, waste receptacle & skirt, and basket drain.

HSAP-14-ADA-FE-B		list: 4542
	bowl size:	16" x 14" x 5" (406 x 356 x 127mm)
	overall size:	24" x 22" x 24½" (610 x 559 x 623mm)
	weight:	15 lbs. (6.8 kg)
	cubic feet:	6.2
MICROGARD® available: To order, add suffix "-MG" to model # / add \$110 to list price.		includes: Battery-powered electronic eye faucet, basket drain, c-fold towel dispenser in front, deck-mount soap dispenser, skirt.

HSA-10-FE-B-DS*		list: 2572
	bowl size:	9¼" x 13½" x 6¾" (248 x 343 x 173mm)
	overall size:	14¼" x 18" x 12¼" (376 x 480 x 324mm)
	weight:	12 lbs. (5.2 kg)
	cubic feet:	2.8
MICROGARD® available: To order, add suffix "-MG" to model # / add \$110 to list price.		includes: Battery-powered electronic eye faucet, deck-mount soap dispenser, basket drain.

HSA-10-FE-B-NB-MG		list: 2622
	bowl size:	9¼" x 13½" x 6¾" (248 x 343 x 173mm)
	overall size:	14¼" x 18" x 12¼" (376 x 480 x 324mm)
	weight:	12 lbs. (5.2 kg)
	cubic feet:	2.8
MICROGARD® Standard		includes: Battery-powered electronic eye faucet, splash-mount nail brush holder, nail brush, MICROGARD®, basket drain.

HSAN-10-FE-B-DS*		list: 2881
	bowl size:	13½" x 9¼" x 6¾" (343 x 248 x 171mm)
	overall size:	17¼" x 12¼" x 14¼" (457 x 308 x 362mm)
	weight:	12 lbs. (5.2 kg)
	cubic feet:	2.8
MICROGARD® available: To order, add suffix "-MG" to model # / add \$110 to list price.		includes: Battery-powered electronic eye faucet, deck-mount soap dispenser, basket drain.

HSA-10-FE-B-T-NB-MG		list: 3231
	bowl size:	9¼" x 13½" x 6¾" (248 x 343 x 173mm)
	overall size:	14¼" x 18" x 29" (376 x 480 x 740mm)
	weight:	29 lbs. (13.1 kg)
	cubic feet:	3.2
MICROGARD® Standard		includes: Battery-powered electronic eye faucet, splash-mount nail brush holder, nail brush, MICROGARD®, waste receptacle & skirt, basket drain.

* Overall height does not include soap dispenser globe.

Catalog Section 20

Miscellaneous Hand Sinks

see spec sheets **EG20.21** **EG20.44**

Freight class is 85.0.

(•) MTS (made to stock) / () MTO (made to order)

MICROGARD®

an antimicrobial agent which contains built-in protection to retard the growth of a broad range of bacteria, mold and mildew on shelf surface that causes stains, odors and degradation.

HSA-10-FA-P•		list: 1258
 <p>with Foot Valve Operation</p>	bowl size:	9¼" x 13½" x 6¼" (248 x 343 x 173mm)
	overall size:	14¾" x 18¾" x 39¼" (376 x 480 x 997mm)
	weight:	32 lbs. (14.5 kg)
	cubic feet:	5.9
MICROGARD® available: To order, add suffix "-MG" to model # / add \$110 to list price.		includes: Spout, foot pedal valves, P-trap, tail piece, basket drain.

HSA-10-FA-1P•		list: 1258
 <p>with Foot Valve Operation</p>	bowl size:	9¼" x 13½" x 6¼" (248 x 343 x 173mm)
	overall size:	14¾" x 18¾" x 39¼" (376 x 480 x 997mm)
	weight:	32 lbs. (14.5 kg)
	cubic feet:	5.9
MICROGARD® available: To order, add suffix "-MG" to model # / add \$110 to list price.		includes: Spout, single foot pedal valve, P-trap, tail piece, basket drain.

HSA-10-FK*•		list: 1233
 <p>with Knee Valve Operation</p>	bowl size:	9¼" x 13½" x 6¼" (248 x 343 x 173mm)
	overall size:	14¾" x 18¾" x 17½" (376 x 480 x 445mm)
	weight:	27 lbs. (12.2 kg)
	cubic feet:	3.1
MICROGARD® available: To order, add suffix "-MG" to model # / add \$110 to list price.		includes: Spout, knee pedals, skirt, and basket drain.

HSA-10-FKP		list: 2202
 <p>single knee pedal valve</p>	bowl size:	9¼" x 13½" x 6¼" (248 x 343 x 173mm)
	overall size:	14¾" x 18¾" x 17½" (376 x 480 x 445mm)
	weight:	27 lbs. (12.2 kg)
	cubic feet:	3.1
MICROGARD® available: To order, add suffix "-MG" to model # / add \$110 to list price.		includes: Spout, single pedal knee valve, skirt, basket drain.

HSA-10-1FK*•		list: 1233
 <p>with Knee Valve Operation</p>	bowl size:	9¼" x 13½" x 6¼" (248 x 343 x 173mm)
	overall size:	14¾" x 18¾" x 17½" (376 x 480 x 445mm)
	weight:	27 lbs. (12.2 kg)
	cubic feet:	3.1
MICROGARD® available: To order, add suffix "-MG" to model # / add \$110 to list price.		includes: Spout, single knee pedal, skirt, and basket drain.

HSA-10-FDPK*		list: 1889
 <p>with Knee Valve Operation</p>	bowl size:	9¼" x 13½" x 6¼" (248 x 343 x 173mm)
	overall size:	14¾" x 19¼" x 33" (376 x 489 x 838mm)
	weight:	38 lbs. (17.2 kg)
	cubic feet:	6.2
MICROGARD® available: To order, add suffix "-MG" to model # / add \$110 to list price.		includes: Spout, knee pedals, skirt, soap dispenser, towel dispenser, basket drain.

HSA-10-FW•		list: 657
 <p>with Standard Wrist Handles</p>	bowl size:	9¼" x 13½" x 6¼" (248 x 343 x 173mm)
	overall size:	14¾" x 18¾" x 12¼" (376 x 480 x 324mm)
	weight:	14 lbs. (6.4 kg)
	cubic feet:	2.8
MICROGARD® available: To order, add suffix "-MG" to model # / add \$110 to list price.		includes: Faucet with wrist handles, basket drain.

* Overall height does not include skirt and knee valves.



100 Industrial Boulevard, Clayton, DE 19938-8903 U.S.A.
Phone: 800-637-5100 or 302-653-3000. Fax: 302-653-2065
<http://www.eaglegrp.com>

Miscellaneous Hand Sinks

see spec sheet **EG20.31**

Freight class is 85.0.

(•) MTS (made to stock) / () MTO (made to order)

MICROGARD®

an antimicrobial agent which contains built-in protection to retard the growth of a broad range of bacteria, mold and mildew on shelf surface that causes stains, odors and degradation.

HSA-10-FAW •		list: 765
	bowl size:	9¼" x 13½" x 6¼" (248 x 343 x 173mm)
	overall size:	14¾" x 18⅞" x 12¾" (376 x 480 x 324mm)
	weight:	14 lbs. (6.4 kg)
	cubic feet:	2.8
MICROGARD® available: To order, add suffix "-MG" to model # / add \$110 to list price.		includes: Faucet with wrist handles, P-trap, tail piece, basket drain.

HSA-10-FTWS		list: 898
	bowl size:	9¼" x 13½" x 6¼" (248 x 343 x 173mm)
	overall size:	14¾" x 18⅞" x 12¾" (376 x 480 x 324mm)
	weight:	20 lbs. (9.0 kg)
	cubic feet:	3.1
MICROGARD® available: To order, add suffix "-MG" to model # / add \$110 to list price.		includes: Faucet, tubular wall brackets, basket drain.

Hand Wash Sinks

see spec sheet **EG20.47**



Model # HWC-E



Model # HWB-E

- Type 304 stainless steel all-welded construction.
- 1½" (38mm) bull nose front edge.
- Hinged door with pull handle and magnetic catch.
- Pump-action soap dispenser on rear deck.
- Built-in front-loading C-fold towel dispenser located in front of sink bowl.
- Deck-mounted faucet.
- Basket drain.
- Crumb cup.

FEATURES:

Freight class is 85.0.

(•) MTS (made to stock) / () MTO (made to order)

Space-Saver Models

- Wall-mountable.
- Furnished with Z-clips to secure to wall.

bowl size		overall size		weight		WITH STANDARD FAUCET		WITH T&S FAUCET	
width	length x depth	width	length x height	lbs.	kg	model #	list	model #	list
in.	mm	in.	mm						
9¼"	11½" x 6"	16⅞"	14" x 21¼"	28	12.7	HWC-E	2282	HWC-T	2491
	235 x 292 x 152		421 x 356 x 540						

Drop-In Models

bowl size		overall size		cutout dimensions		weight		WITH STANDARD FAUCET		WITH T&S FAUCET	
width	length x depth	width	length x height	width	length	lbs.	kg	model #	list	model #	list
in.	mm	in.	mm	in.	mm						
9¼"	11½" x 6"	17½"	16⅞" x 17¼"	16"	14⅞"	29	13.2	HWB-E	2387	HWB-T	2594
	235 x 292 x 152		445 x 419 x 438		406 x 378						

Catalog Section 20

Physically Challenged Hand Sinks

see spec sheet **EG20.45**

Designed for unique applications!

FEATURES: • Standard with faucet and basket drain.

Freight class is 85.0.

(•) MTS (made to stock) / () MTO (made to order)

HSAP-14-FW•		list: 1637
	bowl size:	16" x 14" x 5" (406 x 356 x 127mm)
	overall size:	24½" x 19" x 16½" (613 x 483 x 419mm)
	weight:	15 lbs. (6.8 kg)
	cubic feet:	3.7
includes: Faucet, basket drain, and wall brackets.		

HSAP-14-ADA-FE-B		list: 4542
	bowl size:	16" x 14" x 5" (406 x 356 x 127mm)
	overall size:	24" x 22" x 24½" (610 x 559 x 623mm)
	weight:	15 lbs. (6.8 kg)
	cubic feet:	6.2
includes: Battery-powered electronic eye splash-mount faucet, c-fold towel dispenser in front, deck mount soap dispenser, skirt, basket drain.		

HSAP-14-ADA-FW		list: 3885
	bowl size:	16" x 14" x 5" (406 x 356 x 127mm)
	overall size:	24" x 22" x 24½" (610 x 559 x 623mm)
	weight:	15 lbs. (6.8 kg)
	cubic feet:	6.2
includes: Splash-mount faucet w/wrist handles, mixer valve, c-fold towel dispenser in front, deck mount soap dispenser, skirt, basket drain.		

EAGLE introduces...



ELECTROPOLISHED FINISH

(Consult factory for applicable models and availability)

- Increased resistance to corrosion.
- Improved surface finish.
- Deburring.
- Reduced product adhesion.
- Ease of cleaning.
- Attractive appearance.

To order, add suffix "-EP"
(Example: HSA-10-F-EP).
Add \$140 to list price of hand sink, except for pedestal sinks (add \$200).

Portable Hand Sinks

see product announcement **EG8120**

- Stainless steel cabinet with lockable door.
- Stainless steel top features "v"-marine edge and rear backsplash.
- 5-gallon fresh water tank, 7-gallon soiled water tank.
- 4" (102mm) swivel casters—two with brake.
- Towel rack and trash chute included.
- NEMA 5-15 plug & cord.

Sinks with Stainless* Steel Sink Bowl

Overall dimensions:
24"W x 26"L x 44¾"H
(610 x 660 x 1136mm)

Sinks with Designer** Acrylic Water Plate

Overall dimensions:
24"W x 26"L x 44¾"H
(610 x 660 x 1122mm)

description	weight***		model #	list	weight***		model #	list
	lbs.	kg			lbs.	kg		
cold water only	110	49.9	PHS-S-C	4835	155	70.3	PHS-A-C	6103
hot & cold water	110	49.9	PHS-S-H	5969	155	70.3	PHS-A-H	7237

* Features 14" x 16" x 5" (356 x 406 x 127mm) stainless steel sink bowl with deck-mount faucet.

** Features 12½" x 16" (32 x 406mm) polycarbonate water plate which drains into a stainless steel trough, and deck-mount faucet.

*** Weights shown reflect empty tanks.



portable hand sink with stainless steel sink bowl



portable hand sink with acrylic water plate

Notes: NEW Optional Poly Cutting Board available. 3/4"-thick. Green color. Model #376509, list \$175.

2- and 3-bowl hand sinks available through SpecFAB®.

Freight class is 85.0.

(•) MTS (made to stock) / () MTO (made to order)



100 Industrial Boulevard, Clayton, DE 19938-8903 U.S.A.
Phone: 800-637-5100 or 302-653-3000. Fax: 302-653-2065
http://www.eaglegrp.com

Hand Sinks with Side Splashes

see spec sheet **EG20.56**

- FEATURES: • Standard with faucet and basket drain.

Freight class is 85.0.

(•) MTS (made to stock) / () MTO (made to order)

HSA-10-F-LRS •		list: 1005
	bowl size:	9¼" x 13½" x 6¼" (248 x 343 x 173mm)
	overall size:	14¾" x 18¾" x 12¼" (376 x 480 x 324mm)
	weight:	14 lbs. (6.4 kg)
	cubic feet:	3.9
	includes:	Faucet, basket drain, and side splashes.

HSAN-10-F-LRS •		list: 1112
	bowl size:	13½" x 9¼" x 6¼" (343 x 248 x 173mm)
	overall size:	18" x 12" x 14¼" (457 x 305 x 362mm)
	weight:	13 lbs. (5.9 kg)
	cubic feet:	2.8
	includes:	12" (305mm) side-to-side, faucet, basket drain, and side splashes.

HSA-10-FTWS-LRS		list: 1334
	bowl size:	9¼" x 13½" x 6¼" (248 x 343 x 173mm)
	overall size:	14¾" x 18¾" x 12¼" (376 x 480 x 324mm)
	weight:	21 lbs. (9.5 kg)
	cubic feet:	3.5
	includes:	Faucet, tubular wall brackets, basket drain, and side splashes.

HSA-10-FDPE-LRS		list: 3399
	bowl size:	9¼" x 13½" x 6¼" (248 x 343 x 173mm)
	overall size:	14¾" x 19¼" x 28¼" (376 x 489 x 718mm)
	weight:	31 lbs. (14.1 kg)
	cubic feet:	2.8
	includes:	Spout with electronic eye, towel dispenser, soap dispenser, basket drain, and side splashes.

Go Green. Go ECO-Built™ by EAGLE.

The advantages may be invisible. But when you see the tag you'll know the product you purchase has been produced in the EAGLE plant, under the principles that drive the ECO-Built™ program.

For institutions concerned about meeting their own green standards, buying ECO-Built™ is simply the right thing to do.

Look for the ECO-Built™ tag on the bar code 



Catalog Section 20

Space-Saver Series Hand Sinks

see spec sheets **EG20.05** **EG20.43**

MICROGARD®

an antimicrobial agent which contains built-in protection to retard the growth of a broad range of bacteria, mold and mildew on shelf surface that causes stains, odors and degradation.

FEATURES: • Standard with faucet and basket drain.

Freight class is 85.0.

(•) MTS (made to stock) / () MTO (made to order)

HSAN-10-F•		list:	676
	bowl size:	13½" x 9¼" x 6¼" (343 x 248 x 171mm)	
	overall size:	18" x 12" x 14¼" (457 x 305 x 362mm)	
	weight:	12 lbs. (5.2 kg)	
	cubic feet:	2.8	
<p>Only 12" (305mm) side-to-side to maximum space efficiency.</p>		includes:	Splash mount faucet, basket drain.
<p>MICROGARD® available: To order, add suffix "-MG" to model # / add \$110 to list price.</p>			

HSAND-10-F•		list:	564
	bowl size:	13½" x 9¼" x 6¼" (343 x 248 x 171mm)	
	overall size:	19⅞" x 12" x 14¼" (498 x 305 x 362mm)	
	weight:	12 lbs. (5.2 kg)	
	cubic feet:	2.8	
<p>Only 12" (305mm) side-to-side to maximum space efficiency.</p>		includes:	Deck mount faucet, basket drain.

HSANT-FS		list:	799
	bowl size:	13½" x 9¼" x 6¼" (343 x 248 x 171mm)	
	overall size:	18" x 12" x 26½" (457 x 305 x 673mm)	
	weight:	13 lbs. (5.8 kg)	
	cubic feet:	3.5	
<p>19½" (495mm) Backsplash and Skirt</p>		includes:	Faucet, 19½" (495mm) high backsplash, basket drain.

HSAN-10-F-DS*		list:	864
	bowl size:	13½" x 9¼" x 6¼" (343 x 248 x 165mm)	
	overall size:	17⅞" x 12" x 14¼" (457 x 308 x 362mm)	
	weight:	12 lbs., 5.2 kg	
	cubic feet:	2.8	
		includes:	Faucet, deck-mount soap dispenser, basket drain.

* Overall height does not include soap dispenser globe.

NEW **Stainless Steel Cleaner & Polish**

- Cleans and polishes in one step.
- Does not streak or leave fingerprints.
- Leaves a protective invisible coating.

weight		model #	list
oz.	kg		
15	0.4	004026	16

EAGLE introduces...

ELECTROPOLISHED FINISH
(Consult factory for applicable models and availability)

- Increased resistance to corrosion.
- Improved surface finish.
- Deburring.
- Reduced product adhesion.
- Ease of cleaning.
- Attractive appearance.

To order, add suffix "-EP"
(Example: HSA-10-F-EP).
Add \$140 to list price of hand sink, except for pedestal sinks (add \$200).



Special Purpose Hand Sinks

see spec sheets **EG20.20** **EG20.36** **EG20.37** **EG20.48**

Hand Sink with Deck Mount Faucet

HSAD-10-F		list: 525
	bowl size:	9¼" x 13½" x 6¾" (249 x 343 x 171mm)
	overall size:	16½" x 18¾" x 12¼" (419 x 479 x 324mm)
	weight:	14 lbs. (6.4 kg)
	cubic feet:	2.6
	includes:	Faucet and basket drain.

FEATURES: • Standard with faucet and basket drain.

Freight class is 85.0.

(•) MTS (made to stock) / () MTO (made to order)

Designed for unique applications!

MICROGARD®

an antimicrobial agent which contains built-in protection to retard the growth of a broad range of bacteria, mold and mildew on shelf surface that causes stains, odors and degradation.

Economical Hand Sink

- Faucet is deck mounted gooseneck.

HSAE-10-FA		list: 633
	bowl size:	10" x 14" x 5" (254 x 356 x 127mm)
	overall size:	15" x 16¾" x 9" (381 x 425 x 229mm)
	weight:	10 lbs. (4.5 kg)
	cubic feet:	1.3
includes:	Faucet, p-trap, tail piece, basket drain, wall brackets, 4" (102mm) high backsplash.	

Hand Sink with Waste Receptacle-Patent protected

- U.S. Patent #5,732,422.
- Faucet is splash mounted gooseneck.

HSA-10-FDP-T		list: 1745
	bowl size:	9¼" x 13½" x 6¾" (248 x 343 x 173mm)
	overall size:	14¼" x 19¼" x 44¾" (376 x 480 x 1133mm)
	weight:	46 lbs. (20.9 kg)
	cubic feet:	9.3
MICROGARD® available:	To order, add suffix "-MG" to model # / add \$110 to list price.	includes: Faucet, basket drain, soap dispenser, towel dispenser, waste skirt, and waste receptacle.

Hand Sink with 8" (203mm) Centerline Faucet Holes

- Accommodates splash-mount faucet with 8" (203mm) centerline.

HSA-10-8		list: 471
	bowl size:	9¼" x 13½" x 6¾" (248 x 343 x 173mm)
	overall size:	14¼" x 18¾" x 12¼" (376 x 480 x 324mm)
	weight:	10 lbs. (4.5 kg)
	cubic feet:	2.8
MICROGARD® available:	To order, add suffix "-MG" to model # / add \$110 to list price.	includes: 8" (203mm) centerline faucet holes (no faucet), basket drain

Hand Sink with 8" (203mm) Centerline Faucet

- Faucet is splash mounted gooseneck.

HSA-10-8F		list: 605
	bowl size:	9¼" x 13½" x 6¾" (248 x 343 x 173mm)
	overall size:	14¼" x 18¾" x 12¼" (376 x 480 x 324mm)
	weight:	12 lbs. (5.2 kg)
	cubic feet:	2.8
MICROGARD® available:	To order, add suffix "-MG" to model # / add \$110 to list price.	includes: Faucet on 8" (203mm) center, basket drain.

Catalog Section 20

Hand Sink Accessories -Faucets & Valves

see spec sheet **EG20.52A**



Standard Faucets

- With 4" (102mm) center, except #313075.

description	model #	list
splash mounted, gooseneck spout	303987	158
wrist handles for faucet #303987	307120	99
splash mounted with wrist handles, gooseneck spout	306495	327
deck mounted, gooseneck spout, 1/4-turn handles	302004	173
deck mounted, 8" (203mm) spout, 1/4-turn handles	301248	156
drinking bubbler	318495	551
splash mounted, gooseneck spout, 8" (203mm) center	313075	153

T&S splash mounted faucet with wrist handles



T&S Extra Heavy Duty Faucets

- Top quality faucets.

OUR BEST

description	model #	list
splash mounted, gooseneck spout	306134	508
splash mounted, wrist handles, gooseneck spout	313305	506

Faucet-Mount Emergency Eyewash Units

- Fits in place of standard aerator on spout.

description	model #	list
pull valve activation, includes two dust covers, chrome finish	326272	447
rotate to activate, polished stainless finish, "eye-pod" design	377563	894

IMPORTANT NOTE: If anti-scald valve (see below) is needed, order #373848 only.

Anti-Scald Valve for Faucet-Mount Emergency Eyewash Units

- This is the only anti-scald valve to be used with faucet-mount emergency eyewash units (above).
- Meets ANSI Z358.1 and ASSE 1071 standards.

description	model #	list
1/2" (13mm) NPT, 65 - 95°F	373848	2019

FEATURES:

- All faucets below feature 4" (102mm) centers, except where noted.

Note: Faucets listed are lead-free AB1953-compliant.

Can be shipped UPS.

(•) MTS (made to stock) / () MTO (made to order)

Repair Kit for Standard Faucets

- For faucets #303987, 302004, and 301248 only.

description	model #	list
hot/cold ceramic cartridge	368421	28

NEW Short 90° for Splash Mount Faucets

description	model #	list
set of two, 1/2" NPT female x male	376740	52

Spouts/Spout Assemblies

description	model #	list
splash-mount replacement gooseneck for knee/foot valve-operated models	312162	318

Battery-Powered Electronic-Eye Faucet

- Used as a replacement to sinks on page 181 (by adding suffix "-B"), or as a replacement faucet for sinks on page 182 via the model number below.

description	model #	list
Splash mount. Comes with 6-volt battery and built-in low-battery indicator	326014	1488
Upgrade: T&S electric-eye faucet, splash-mtd with battery and AC adapter for dual operation. With AC adapter plugged in, faucet automatically switches to AC power to conserve battery	356128	1592

Shut-Off Valve

- Antibacterial surface.
- Screws onto faucet aerator.
- Polished chrome finish.

description	model #	list
shut-off push bar	349921	66

Anti-Scald Valve

- Automatic shutdown with either hot or cold water failure.
- ASSE 1016 and 1017 listed.

IMPORTANT: Not for use with Faucet-Mount Emergency Eyewash Units.

description	model #	list
1/2" (13mm) NPT, 100 - 145°F	326696	595



Hand Sink Accessories - Valves

see spec sheet **EG20.52A**

Can be shipped UPS.

(*) MTS (made to stock) / () MTO (made to order)

Temperature Adjustment Valve ("Mixing Valve")

- For hand sinks with AC-powered electronic faucet or hand sinks with single pedal valves.
- Cast brass body.
- 3/8" (10mm) all connections.



description	model #	list
built-in check valves to prevent backflow and adjustment screw valves to mix hot and cold	326015	103

Non-Adjustable Y-Inlet Mixing Valve

- For electronic hand sinks and hand sinks with single pedal valves only.
- "Y" shaped single-piece component. Chrome-plated brass body.



description	model #	list
Male connections; threads are 3/8"-24 UNEF	342938	30

Tempering Valve

- Maximum output of 120°F.
- Maximum pressure of 150 psi.
- ASSE 1016 and 1070 listed.



description	model #	list
thermoplastic body, 3/8" (10mm) male compression fittings, 80°F-120°F, 0.5-2.5 gpm, built-in check valve	375612	321



single foot pedal valve



double foot pedal valve



knee pedal valve

Pedal Valves

description	DOUBLE PEDALS		SINGLE PEDALS	
	model #	list	model #	list
foot pedal valve, floor mount	300604	354	355994	354
knee pedal valve	313481	474	351738	474

Hand Sink Accessories - Miscellaneous

see spec sheet **EG20.52B**

Can be shipped UPS.

(*) MTS (made to stock) / () MTO (made to order)



#318496
towel dispenser



#DP-10 towel dispenser



#388454 towel dispenser

Towel/Soap Dispensers

description	model #	list
type 304 with conventional soap dispenser	DP-10 *●	779
type 304 stainless, with electric eye soap dispenser	DP-20 *	1620
type 304 stainless, wall mounted	318496	272
break-resistant plastic, touchless, wall mounted	377454	194

* Fits all HSA hand sinks except Space Saver models.

Hand Sanitizing Dispenser

description	model #	list
Purell/LTX, wall mounted	377455	249



hand sanitizing dispenser

Plumbing

description	model #	list
tail piece, nickel-plated	300791	15
P-trap, nickel-plated	300789	86



tail piece



P-trap



conventional soap dispenser



soap dispenser with electric eye



deck mount soap dispenser

Soap Dispensers

description	model #	list
soap dispenser, conventional, 12-oz	300602	29
soap dispenser, wall mounted with electric eye	377456	249
soap dispenser, deck-mount, 16-oz	324074	114

nail brush

nail brush holder

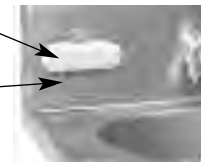

Nail Brush and Nail Brush Holder

- To order nail brush and nail brush holder, add suffix "-NB" to hand sink model number. **Example: HSA-10-F-NB .**

description	model #	list each
infectious-control nail brush made of FDA-approved material, splash-mount stainless steel nail brush holder	add suffix "-NB"	105

Catalog Section 20

Hand Sink Accessories - Miscellaneous

see spec sheet **EG20.52B**

Can be shipped UPS.

(•) MTS (made to stock) / () MTO (made to order)

Waste Receptacle

- U.S. Patent #5,732,422.
- 20 gauge stainless steel.
- Removable.
- Comes with skirt.
- Must be factory installed.

Note: To order, add suffix “-T” to hand sink model number.

Example: HSA-10-F-T.

PATENTED DESIGN



HSA-10-FDP-T
hand sink with waste receptacle

for models:	model #	list
HSA-10; HSA-10-F; HSA-10-FA; HSA-10-FDP; HSA-10-FE; HSA-10-FDPE; HSA-10-FDPEE; and HSA-10-FW	add suffix “-T”	589

Electropolished Finish

(Consult factory for applicable models and availability.)



- Increased resistance to corrosion.
- Improved surface finish.
- Deburring.
- Reduced product adhesion.
- Ease of cleaning.
- Attractive appearance.

To order, add suffix “-EP”

(Example: HSA-10-F-EP)

Add \$140 to list price of hand sink, except pedestal sinks (add \$200).

End Splashes...

- Type 304 stainless steel.

Note: Will not work with Space Saver Hand Sinks (page 187) that have faucets with wrist handles.

...Factory-installed

Notes: To order, add suffix “-LS” (left end splash), “-RS” (right end splash), or “-LRS” (both end splashes). **Example:** HSA-10-F-LRS.

MICROGARD® cannot be put on hand sinks with end splashes.



hand sink with optional end splashes

descriptions	model #	list
left end splash only	add suffix “-LS”	219
right end splash only	add suffix “-RS”	219
left and right end splash	add suffix “-LRS”	436

...for Field-installation

descriptions	model #	list each
one self-adhesive side splash, can be used for right or left application	HSA-SSK •	139
same as above, but fits only on Physically Challenged sinks (page 185)	HSAP-SSK	169



pair of end splashes for field installation



polymer lever drain

Wall Brackets

- 14 gauge type 304 stainless steel.

descriptions	model #	list
side mounting, one pair, does not fit Space Saver models	606396 •	204



wall bracket

Skirt Assembly

- Type 304 stainless steel.

fits models:	model #	list
HSA-10; HSA-10-F; HSA-10-FA; HSA-10-FDP; HSA-10-FE; HSA-10-FDPE; HSA-10-FDPEE; and HSA-10-FW.	606215 •	460
HSAN-10-F	607560	326



Drains

description	maximum flow rate		model #	list
	gallons per minute	gallons per hour		
polymer lever drain fits 3½" (89mm) diameter holes	11	660	319931	74
overflow assembly for lever drain #319931 (above)	-	-	319932	34
1½" (38mm) drain assembly, fits 2" (51mm) dia. hole	12	720	300886	12
mini crumb cup for 1½" (38mm) drain	-	-	300966	5
s/s basket drain assembly fits 3½" (89mm) diameter holes w/crumb cups	18	1080	300287	20
cast metal lever drain with overflow assembly, with 7¼" (185mm) long lever, fits 3½" (89mm) diameter holes	-	-	347771	209



Hot Water Heater

see spec sheet **EG20.52B**



with TANKLESS WATER HEATER

99% EFFICIENT!
Flow switch activates heater only on demand—no standby heat loss.

No temperature/pressure relief valve needed (check local codes), reducing installation cost.

applicable hand sinks include:	add suffix #	list each
HSA-10; HSA-10-F; HSA-10-FA; HSA-10-FDP; HSA-10-FE; HSA-10-FDPE; HSA-10-FDPEE; HSA-10-FW; HSA-10-FA-P; and HSAD-10-F.	“-WH”	2170

FEATURES:

- For EAGLE hand sinks with 10" x 14" (254 x 356mm) rounded bowl.
- Stainless steel pedestal base features notches for electrical wiring and front access panel.
- Unit comes equipped with an energy-saving tankless water heater. 120V 29A electricity. 0.5 GPM. 150 PSI maximum operating pressure (minimum 25 PSI).
- Water is heated instantaneously when faucet is on.
- To order, add suffix “-WH” to model number and add **\$2170 to list price** of hand sink.
Example: HSA-10-FDPEE-WH

Note: Must be field-wired.

Freight class is 70.0.

(•) MTS (made to stock) / () MTO (made to order)

Lavatory Sinks

see spec sheet **EG20.12**

Replacements for Lavatory Sinks

description	to fit process sink model #	model #	list
splash mount spout	P1916, P1916FE, W1916	300600	179
drain assembly	P1916, P1916FE, W1916,	300287	20
temperature adjustment valve, or “mixing valve”	P1916FE	326015	103

FEATURES:

- A marine edge.
- Type 304 stainless steel sink bowl.
- Gooseneck spout.
- Soap dispenser.
- Basket drain.
- Wall mount and pedestal models available.

Freight class is 85.0.

(•) MTS (made to stock) / () MTO (made to order)

W1916-FA •		list: 1396
	bowl size:	15¼" x 19¼" x 8⅞" (400 x 500 x 225mm)
	overall size:	23" x 24⅝" (584 x 618mm)
	shipping wt:	35 lbs., 15.9 kg
	cubic feet:	1.6
includes: Gooseneck faucet, soap dispenser, basket drain.		
<i>wall mounted</i>		

P1916 •		list: 2353
	bowl size:	15¼" x 19¼" x 8⅞" (400 x 500 x 225mm)
	overall size:	23" x 24⅝" (571 x 618mm)
	shipping wt:	48 lbs., 21.8 kg
	cubic feet:	1.6
includes: Gooseneck spout, soap dispenser, pedestal with foot valves, basket drain.		
<i>pedestal mounted, foot pedal valve</i>		

W1916		list: 2673
	bowl size:	15¼" x 19¼" x 8⅞" (400 x 500 x 225mm)
	overall size:	23" x 24⅝" (571 x 618mm)
	shipping wt:	43 lbs., 19.5 kg
	cubic feet:	1.6
includes: Gooseneck spout, soap dispenser, knee valves, basket drain.		
<i>wall mounted, knee valve operation</i>		

P1916FE		list: 3151
	bowl size:	15¼" x 19¼" x 8⅞" (400 x 500 x 225mm)
	overall size:	23" x 24⅝" (571 x 618mm)
	shipping wt:	48 lbs., 21.8 kg
	cubic feet:	1.6
includes: Gooseneck spout with electronic-eye operation, soap dispenser, pedestal, basket drain.		
<i>pedestal mounted, electronic-eye operation</i>		

Euro-style edging on front and sides.

Sink Kits for 314, 412, and 414 Series Sinks

see spec sheet **EG20.51A**

Standard Sink Kit components:

- Stainless steel gussets
- Stainless steel crossbraced legs
- Stainless steel feet
- T&S faucet #313293

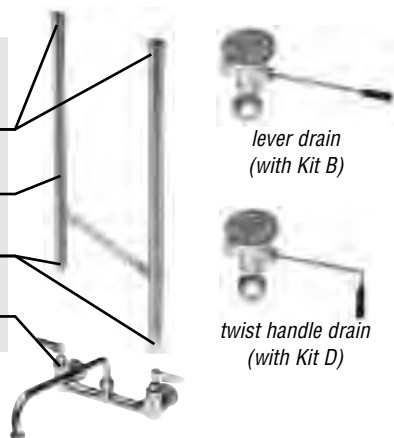

Kit A

- Add suffix “-CLF” to sink model number.

description	add to list price
1 faucet	1112
2 faucets	1683

Kit B

- Standard sink kit components plus lever drain. Add suffix “-CLFD” to sink model number.

description	add to list price
1 faucet	1112
2 faucets	1683
per lever drain	220

Kit C

- Standard sink kit components plus lever drain with overflow. Add suffix “-CLFDO” to sink model number.

description	add to list price
1 faucet	1112
2 faucets	1683
per lever drain with overflow	452

Kit D

- Standard sink kit components plus twist handle drain and twist handle bracket. Add suffix “-CLFDT” to sink model number.

description	add to list price
1 faucet	1112
2 faucets	1683
per twist handle drain	232

Kit E

- Standard sink kit components plus twist handle drain with overflow and twist handle bracket. Add suffix “-CLFDOT” to sink model number.

description	add to list price
1 faucet	1112
2 faucets	1683
per twist handle drain with overflow	525

412, 414, and 314 Series Sinks Deep Drawn Construction

- Deep drawn seamless covered corner sink bowls of all units have a generous radius and are rectangular for maximum capacity.
- Legs are galvanized, 1½” (41mm) diameter and welded adjacent to sink bowl for maximum stability and support.
- Crossbraced front-to-back with 1” (25mm) diameter galvanized tubing.
- Leg gussets are welded to a die-cut heavy-gauge reinforcing plate.
- 9½” (241mm) standard backsplash includes 1” (25mm) upturn and tile edge for easy installation and feathering to wall/splash surface.
- Basket-type waste drains are included to fit sink bowl’s 3½” (89mm) opening and feature 1½” (38mm) outlet.
- 30” and 36” (762 and 914mm) drainboards available upon request.

Note: Stainless steel legs with front-to-back crossbracing available (does not include stainless steel feet).

To order, add \$341 to list price and suffix “-SL” to model number (example: 414-16-1-SL).

To order stainless steel legs and gussets, add \$473 to list price and suffix “-SLG” to model number (example: 414-16-1-SLG).

Left-to-right crossbracing available.

For galvanized, add 5% to list price and suffix “-CBG” to model number.

For stainless steel (does not include stainless steel legs), add 10% to list price and suffix “-CBS” to model number (example: 414-16-1-CBS).

Twist drain brackets available.

Works in conjunction with optional twist handle drains (not included – see page 212). To order, add \$28 per compartment to list price and suffix “-TB” to model number. Example: 414-16-1-TB.

For overflow hole (does not include drain), add \$41 per compartment to list price and suffix “-OF” to model number (example: 414-16-1-OF).

Sink accessories, see pages 210-213.

All shipping weights and cubic feet are approximate.

ALL SINKS SHIPPED FULLY CRATED.

Freight class is 150.0.

412, 414, and 314 Series Sinks
One-Compartment Sinks

see spec sheets **EG20.03** **EG20.23** **EG20.27**

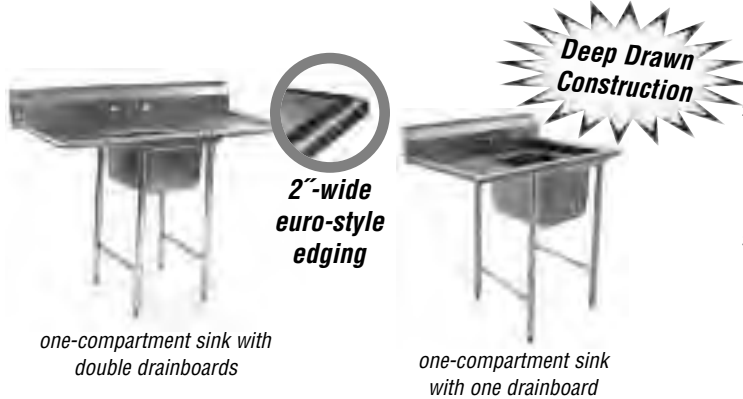

Deep Drawn Construction

- All heavy gauge type 430 construction.
- 10½" (267mm) deep sink bowl.
- 44" (1118mm) overall height.

412 SERIES:

- 14" (356mm) deep heavy gauge type 304 sink bowl with type 430 drainboards, and backsplash.
- 44" (1118mm) overall height.

414 SERIES:

- All heavy gauge type 304 construction.
- 14" (356mm) deep sink bowl.
- 44" (1118mm) overall height.

314 SERIES:

Freight class is 150.0.

(•) MTS (made to stock) / () MTO (made to order)

One Compartment, No Drainboards

bowl size		drainboard		weight		cu	overall size		GOOD		BETTER		BEST		
width x length		length				ft	width x length		412 Series		414 Series		314 Series		
in. mm		in. mm		lbs. kg			in. mm		- see spec sheet - EG20.03		- see spec sheet - EG20.23		- see spec sheet - EG20.27		
in.	mm	in.	mm	lbs.	kg	ft	in.	mm	model #	list	model #	list	model #	list	
20"	508	-	-	40	18.1	10.5	27½"	23¾"	699 x 591	412-16-1•	1589	414-16-1•	1828	314-16-1•	2067
24"	610	-	-	45	20.4	10.0	31¾"	25½"	807 x 648	n/a	n/a	414-18-1•	2140	314-18-1	2393
22"	559	-	-	55	24.9	14.5	29¾"	29¾"	756 x 749	n/a	n/a	414-22-1•	2275	314-22-1	2406
24"	610	-	-	60	27.2	16.5	31¾"	31¾"	807 x 800	412-24-1•	2124	414-24-1•	2308	314-24-1	2570

One Compartment, One Drainboard (right or left)

bowl size		drainboard		weight		cu	overall size		GOOD		BETTER		BEST		
width x length		length				ft	width x length		412 Series		414 Series		314 Series		
in. mm		in. mm		lbs. kg			in. mm		- see spec sheet - EG20.03		- see spec sheet - EG20.23		- see spec sheet - EG20.27		
in.	mm	in.	mm	lbs.	kg	ft	in.	mm	model #	list	model #	list	model #	list	
20"	508	18"	457	59	26.8	18.1	27½"	38½"	699 x 987	412-16-1-18R or L•	2230	414-16-1-18R or L•	2504	314-16-1-18R or L	2776
		24"	610	65	29.5	19.5	27½"	44½"	699 x 1140	412-16-1-24R or L	2248	414-16-1-24R or L•	2535	314-16-1-24R or L•	2810
24"	610	18"	457	64	29.0	22.0	31¾"	40¾"	807 x 1035	n/a	n/a	414-18-1-18R or L	2901	314-18-1-18R or L	3191
		24"	610	70	31.8	22.9	31¾"	46¾"	807 x 1188	n/a	n/a	414-18-1-24R or L	2922	314-18-1-24R or L	3213
22"	559	18"	457	74	33.6	23.0	29¾"	45"	756 x 1143	n/a	n/a	414-22-1-18R or L	3169	314-22-1-18R or L	3284
		24"	610	80	36.3	26.0	29¾"	51"	756 x 1295	n/a	n/a	414-22-1-24R or L	3190	314-22-1-24R or L	3306
24"	610	18"	457	79	35.8	25.0	31¾"	46¾"	807 x 1188	412-24-1-18R or L	3018	414-24-1-18R or L	3326	314-24-1-18R or L	3620
		24"	610	85	38.6	28.6	31¾"	52¾"	787 x 1340	412-24-1-24R or L	3079	414-24-1-24R or L•	3361	314-24-1-24R or L	3673

One Compartment, Double Drainboards

bowl size		drainboard		weight		cu	overall size		GOOD		BETTER		BEST		
width x length		length				ft	width x length		412 Series		414 Series		314 Series		
in. mm		in. mm		lbs. kg			in. mm		- see spec sheet - EG20.03		- see spec sheet - EG20.23		- see spec sheet - EG20.27		
in.	mm	in.	mm	lbs.	kg	ft	in.	mm	model #	list	model #	list	model #	list	
20"	508	18"	457	78	35.4	25.7	27½"	54½"	699 x 1384	412-16-1-18•	2365	414-16-1-18	2622	314-16-1-18	2901
		24"	610	90	40.8	30.8	27½"	66½"	699 x 1689	412-16-1-24	2371	414-16-1-24	2707	314-16-1-24	2989
24"	610	18"	457	83	37.6	29.6	31¾"	56"	807 x 1422	n/a	n/a	414-18-1-18	2995	314-18-1-18	3291
		24"	610	95	43.1	38.1	31¾"	68"	807 x 1727	n/a	n/a	414-18-1-24	3023	314-18-1-24	3319
22"	559	18"	457	93	42.2	30.3	29¾"	60¾"	756 x 1537	n/a	n/a	414-22-1-18	3279	314-22-1-18	3394
		24"	610	105	47.6	37.1	29¾"	72½"	756 x 1842	n/a	n/a	414-22-1-24	3307	314-22-1-24	3422
24"	610	18"	457	98	44.5	32.5	31¾"	62"	807 x 1575	412-24-1-18	3214	414-24-1-18	3462	314-24-1-18	3704
		24"	610	110	49.9	40.6	31¾"	74"	807 x 1880	412-24-1-24	3279	414-24-1-24	3514	314-24-1-24	3836



Catalog Section 20

412, 414, and 314 Series Sinks Two-Compartment Sinks

see spec sheets **EG20.03** **EG20.24** **EG20.28**

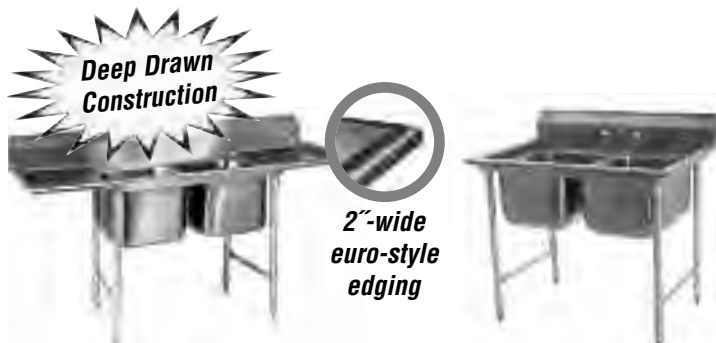

two-compartment sink with double drainboards

two-compartment sink with no drainboards

- All heavy gauge type 430 construction.
- 10½" (267mm) deep sink bowls.
- 44" (1118mm) overall height.

412 SERIES:

- 14" (356mm) deep heavy gauge type 304 sink bowl with type 430 drainboards, and backsplash.
- 44" (1118mm) overall height.

414 SERIES:

- All heavy gauge type 304 construction.
- 14" (356mm) deep sink bowls.
- 44" (1118mm) overall height.

314 SERIES:

Freight class is 150.0.

(•) MTS (made to stock) / () MTO (made to order)

Two Compartments, No Drainboards

bowl size		drainboard length		weight		cu ft	overall size		GOOD 412 Series - see spec sheet - EG20.03		BETTER 414 Series - see spec sheet - EG20.24		BEST 314 Series - see spec sheet - EG20.28		
width	length	in.	mm	in.	mm		lbs.	kg	width	length	model #	list	model #	list	model #
20" x 16"	508 x 406	-	-	64	29.0	18.1	27½" x 41"	699 x 1041	412-16-2 •	2174	414-16-2 •	2503	314-16-2 •	2775	
24" x 18"	610 x 457	-	-	75	33.8	24.0	31¼" x 45½"	807 x 1156	n/a	n/a	414-18-2 •	2880	314-18-2	3327	
22" x 22"	559 x 559	-	-	80	36.3	25.8	29¾" x 53½"	756 x 1359	n/a	n/a	414-22-2	3143	314-22-2	3427	
24" x 24"	610 x 610	-	-	90	40.8	29.6	31¼" x 57½"	807 x 1461	412-24-2	3197	414-24-2 •	3473	314-24-2 •	3946	

Two Compartments, One Drainboard (right or left)

bowl size		drainboard length		weight		cu ft	overall size		GOOD 412 Series - see spec sheet - EG20.03		BETTER 414 Series - see spec sheet - EG20.24		BEST 314 Series - see spec sheet - EG20.28		
width	length	in.	mm	in.	mm		lbs.	kg	width	length	model #	list	model #	list	model #
20" x 16"	508 x 406	18"	457	83	37.6	25.7	27½" x 56½"	699 x 1438	412-16-2-18R or L •	2882	414-16-2-18R or L •	3312	314-16-2-18R or L	3623	
		24"	610	89	40.4	28.3	27½" x 62½"	699 x 1591	412-16-2-24R or L	2911	414-16-2-24R or L •	3363	314-16-2-24R or L	3830	
24" x 18"	610 x 457	18"	457	94	42.6	33.0	31¼" x 60½"	807 x 1543	n/a	n/a	414-18-2-18R or L	3868	314-18-2-18R or L	4359	
		24"	610	100	45.4	35.0	31¼" x 66½"	807 x 1696	n/a	n/a	414-18-2-24R or L	3892	314-18-2-24R or L	4384	
22" x 22"	559 x 559	18"	457	99	44.9	34.0	29¾" x 69"	756 x 1753	n/a	n/a	414-22-2-18R or L	4305	314-22-2-18R or L	4571	
		24"	610	105	47.6	37.1	29¾" x 75"	756 x 1905	n/a	n/a	414-22-2-24R or L	4329	314-22-2-24R or L	4595	
24" x 24"	610 x 610	18"	457	109	49.4	38.0	31¼" x 72½"	807 x 1847	412-24-2-18R or L	4289	414-24-2-18R or L	4672	314-24-2-18R or L	5077	
		24"	610	115	52.2	41.6	31¼" x 78½"	807 x 2000	412-24-2-24R or L	4376	414-24-2-24R or L •	4774	314-24-2-24R or L	5415	

Two Compartments, Double Drainboards

bowl size		drainboard length		weight		cu ft	overall size		GOOD 412 Series - see spec sheet - EG20.03		BETTER 414 Series - see spec sheet - EG20.24		BEST 314 Series - see spec sheet - EG20.28		
width	length	in.	mm	in.	mm		lbs.	kg	width	length	model #	list	model #	list	model #
20" x 16"	508 x 406	18"	457	102	46.3	32.8	27½" x 72½"	699 x 1848	412-16-2-18 •	2977	414-16-2-18 •	3441	314-16-2-18	3911	
		24"	610	114	51.7	38.5	27½" x 84½"	660 x 2140	412-16-2-24	3024	414-16-2-24 •	3504	314-16-2-24	3977	
24" x 18"	610 x 457	18"	457	113	51.3	43.8	31¼" x 76"	807 x 1930	n/a	n/a	414-18-2-18	3984	314-18-2-18	4481	
		24"	610	125	56.7	48.7	31¼" x 88"	807 x 2235	n/a	n/a	414-18-2-24	4028	314-18-2-24	4528	
22" x 22"	559 x 559	18"	457	118	53.5	42.0	29¾" x 84½"	756 x 2146	n/a	n/a	414-22-2-18	4441	314-22-2-18	4707	
		24"	610	130	59.0	48.5	29¾" x 96½"	756 x 2451	n/a	n/a	414-22-2-24	4493	314-22-2-24	4757	
24" x 24"	610 x 610	18"	457	128	58.1	47.0	31¼" x 88"	807 x 2235	412-24-2-18	4438	414-24-2-18	4827	314-24-2-18	5288	
		24"	610	140	63.5	53.6	31¼" x 100"	807 x 2540	412-24-2-24	4529	414-24-2-24 •	4977	314-24-2-24	5521	



100 Industrial Boulevard, Clayton, DE 19938-8903 U.S.A.
Phone: 800-637-5100 or 302-653-3000. Fax: 302-653-2065
<http://www.eaglegrp.com>

412, 414, and 314 Series Sinks Three-Compartment Sinks

see spec sheets **EG20.03** **EG20.25** **EG20.29**

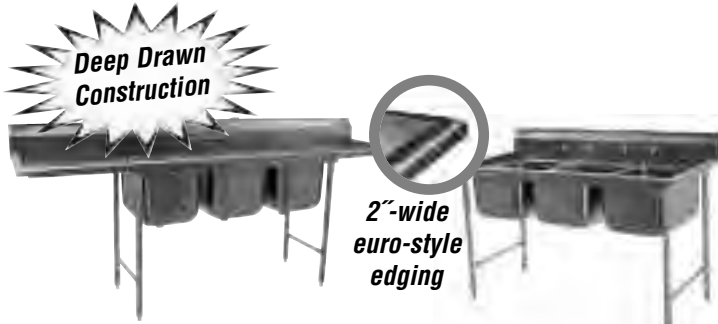

three-compartment sink with double drainboards (faucet not included)

three-compartment sink with no drainboards

- All heavy gauge type 430 construction.
- 10½" (267mm) deep sink bowls.
- 44" (1118mm) overall height.

412 SERIES:

- 14" (356mm) deep heavy gauge type 304 sink bowls with type 430 drainboards, and backsplash.
- 44" (1118mm) overall height.

414 SERIES:

- All heavy gauge type 304 construction.
- 14" (356mm) deep sink bowls.
- 44" (1118mm) overall height.

314 SERIES:

Freight class is 150.0.

(•) MTS (made to stock) / () MTO (made to order)

Three Compartments, No Drainboards

bowl size width x length in. mm		drainboard length in. mm		weight lbs. kg		cu ft	overall size width x length in. mm		GOOD 412 Series - see spec sheet - EG20.03 model # list		BETTER 414 Series - see spec sheet - EG20.25 model # list		BEST 314 Series - see spec sheet - EG20.29 model # list	
20" x 16"	508 x 406	-	-	85	38.6	25.7	27½" x 58¾"	699 x 1492	412-16-3 •	2757	414-16-3 •	3034	314-16-3 •	3471
24" x 18"	610 x 457	-	-	114	51.7	33.0	31¼" x 65½"	807 x 1664	n/a	n/a	414-18-3 ••	3749	314-18-3 *	4392
22" x 22"	559 x 559	-	-	120	54.4	37.1	29¾" x 77½"	756 x 1969	n/a	n/a	414-22-3 *	4166	314-22-3 *	4600
24" x 24"	610 x 610	-	-	125	56.7	41.5	31¼" x 83½"	807 x 2121	412-24-3 *	4188	414-24-3 ••	4547	314-24-3 *	5128

* Features two sets of faucet holes.

Three Compartments, One Drainboard (right or left)

bowl size width x length in. mm		drainboard length in. mm		weight lbs. kg		cu ft	overall size width x length in. mm		GOOD 412 Series - see spec sheet - EG20.03 model # list		BETTER 414 Series - see spec sheet - EG20.25 model # list		BEST 314 Series - see spec sheet - EG20.29 model # list	
20" x 16"	508 x 406	18"	457	104	47.2	33.3	27½" x 74¾"	699 x 1889	412-16-3-18R or L •	2913	414-16-3-18R or L •	3838	314-16-3-18R or L	4661
		24"	610	110	49.9	35.8	27½" x 80¾"	699 x 2042	412-16-3-24R or L •	2943	414-16-3-24R or L	3867	314-16-3-24R or L	4692
24" x 18"	610 x 457	18"	457	133	60.3	42.0	31¼" x 80¾"	807 x 2051	n/a	n/a	414-18-3-18R or L*	4821	314-18-3-18R or L*	5511
		24"	610	139	63.1	68.0	31¼" x 86¾"	807 x 2203	n/a	n/a	414-18-3-24R or L*	4840	314-18-3-24R or L*	5530
22" x 22"	559 x 559	18"	457	139	63.1	45.0	29¾" x 93"	756 x 2362	n/a	n/a	414-22-3-18R or L*	5425	314-22-3-18R or L*	5840
		24"	610	145	65.8	48.4	29¾" x 99"	756 x 2515	n/a	n/a	414-22-3-24R or L*	5445	314-22-3-24R or L*	5863
24" x 24"	610 x 610	18"	457	144	65.3	50.0	31¼" x 98¾"	807 x 2508	412-24-3-18R or L*	5470	414-24-3-18R or L*	5995	314-24-3-18R or L*	6555
		24"	610	150	68.0	54.6	31¼" x 104¾"	807 x 2661	412-24-3-24R or L*	5582	414-24-3-24R or L*•	6079	314-24-3-24R or L*	6829

* Features two sets of faucet holes.

Three Compartments, Double Drainboards

bowl size width x length in. mm		drainboard length in. mm		weight lbs. kg		cu ft	overall size width x length in. mm		GOOD 412 Series - see spec sheet - EG20.03 model # list		BETTER 414 Series - see spec sheet - EG20.25 model # list		BEST 314 Series - see spec sheet - EG20.29 model # list	
20" x 16"	508 x 406	18"	457	123	55.8	40.9	27½" x 90"	699 x 2286	412-16-3-18 •	3015	414-16-3-18 •	3942	314-16-3-18 •	4774
		24"	610	135	61.2	46.0	27½" x 102"	699 x 2591	412-16-3-24 •	3067	414-16-3-24 •	4002	314-16-3-24 •	4841
24" x 18"	610 x 457	18"	457	152	68.9	50.5	31¼" x 96"	807 x 2438	n/a	n/a	414-18-3-18 ••	4946	314-18-3-18 ••	5644
		24"	610	164	74.4	57.0	31¼" x 108"	807 x 2743	n/a	n/a	414-18-3-24 ••	5069	314-18-3-24 ••	5769
22" x 22"	559 x 559	18"	457	158	71.6	54.0	29¾" x 108¾"	756 x 2756	n/a	n/a	414-22-3-18 ••	5573	314-22-3-18 *	5986
		24"	610	170	77.1	59.6	29¾" x 120½"	756 x 3061	n/a	n/a	414-22-3-24 ••	5716	314-22-3-24 ••	6129
24" x 24"	610 x 610	18"	457	163	73.9	60.0	31¼" x 114"	807 x 2896	412-24-3-18 *	5593	414-24-3-18 ••	5999	314-24-3-18 *	6497
		24"	610	175	79.4	65.2	31¼" x 126"	807 x 3200	412-24-3-24 ••	5707	414-24-3-24 ••	6264	314-24-3-24 *	7023

* Features two sets of faucet holes.

Catalog Section 20

414 and 314 Series Sinks Four-Compartment Sinks

see spec sheets **EG20.26** **EG20.30**



four-compartment sink
with double drainboards

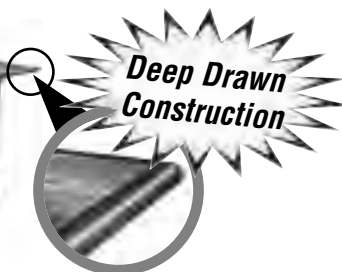

2"-wide
euro-style edging

- 14" (356mm) deep heavy gauge type 304 sink bowls with type 430 drainboards, and backsplash.
- 44" (1118mm) overall height.
- Two sets of faucet holes.

414 SERIES:

- All heavy gauge type 304 construction.
- 14" (356mm) deep sink bowls.
- 44" (1118mm) overall height.
- Two sets of faucet holes.

314 SERIES:

Freight class is 150.0.

(•) MTS (made to stock) / () MTO (made to order)

Four Compartments, No Drainboards

bowl size width x length		drainboard length		weight		cu ft	overall size width x length		BETTER 414 Series - see spec sheet - EG20.26		BEST 314 Series - see spec sheet - EG20.30	
in.	mm	in.	mm	lbs.	kg		in.	mm	model #	list	model #	list
20" x 16"	508 x 406	n/a	n/a	125	56.7	33.3	27½" x 76½"	699 x 1943	414-16-4	4096	314-16-4	4906
24" x 18"	610 x 457	n/a	n/a	135	61.2	48.4	31¾" x 85½"	807 x 2172	414-18-4	4734	314-18-4	5573
24" x 24"	610 x 610	n/a	n/a	153	69.4	55.6	31¾" x 109½"	807 x 2783	414-24-4	5836	314-24-4	6728

Four Compartments, One Drainboard (right or left)

bowl size width x length		drainboard length		weight		cu ft	overall size width x length		BETTER 414 Series - see spec sheet - EG20.26		BEST 314 Series - see spec sheet - EG20.30	
in.	mm	in.	mm	lbs.	kg		in.	mm	model #	list	model #	list
20" x 16"	508 x 406	18"	457	144	65.3	41.0	27½" x 92½"	699 x 2340	414-16-4-18R or L	4978	314-16-4-18R or L	5833
		24"	610	150	68.0	43.4	27½" x 98½"	699 x 2492	414-16-4-24R or L	5010	314-16-4-24R or L	5868
24" x 18"	610 x 457	18"	457	154	69.9	49.0	31¾" x 100½"	807 x 2559	414-18-4-18R or L	5978	314-18-4-18R or L	6853
		24"	610	160	72.6	59.6	31¾" x 106½"	807 x 2711	414-18-4-24R or L	6132	314-18-4-24R or L	6875
24" x 24"	610 x 610	18"	457	172	78.0	61.0	31¾" x 124½"	807 x 3169	414-24-4-18R or L	7171	314-24-4-18R or L	8291
		24"	610	178	80.7	67.7	31¾" x 130½"	807 x 3321	414-24-4-24R or L	7715	314-24-4-24R or L	8697

Four Compartments, Double Drainboards

bowl size width x length		drainboard length		weight		cu ft	overall size width x length		BETTER 414 Series - see spec sheet - EG20.26		BEST 314 Series - see spec sheet - EG20.30	
in.	mm	in.	mm	lbs.	kg		in.	mm	model #	list	model #	list
20" x 16"	508 x 406	18"	457	163	73.9	48.5	27½" x 107½"	699 x 2737	414-16-4-18 •	5184	314-16-4-18	6045
		24"	610	175	79.5	53.6	27½" x 119½"	699 x 3042	414-16-4-24	5262	314-16-4-24	6129
24" x 18"	610 x 457	18"	457	173	78.5	65.0	31¾" x 116"	807 x 2946	414-18-4-18	6075	314-18-4-18	6976
		24"	610	185	83.9	70.9	31¾" x 128"	807 x 3251	414-18-4-24	6146	314-18-4-24	7054
24" x 24"	610 x 610	18"	457	191	86.6	73.0	31¾" x 140"	807 x 3556	414-24-4-18	7546	314-24-4-18	8466
		24"	610	203	92.1	79.7	31¾" x 152"	807 x 3861	414-24-4-24 •	7890	314-24-4-24	8877

Stainless Steel Cleaner & Polish



weight		model #	
oz.	kg		list
15	0.4	004026	16



FEATURES:

- Cleans and polishes in one step.
- Does not streak or leave fingerprints.
- Leaves a protective invisible coating.

(•) MTS (made to stock) / () MTO (made to order)



100 Industrial Boulevard, Clayton, DE 19938-8903 U.S.A.
Phone: 800-637-5100 or 302-653-3000. Fax: 302-653-2065
<http://www.eaglegrp.com>

SPEC-MASTER® FN Series Coved Corner Sinks One-Compartment Sinks

see spec sheet **EG20.32**



- 14 gauge type 304 18-8 stainless steel.
- All bowls are 14" (356mm) deep and have 5/8" (16mm) radius corners, both vertical and horizontal.
- Stainless steel gussets, feet, legs and crossbracing.
- Adjustable crossbracing front-to-back and side-to-side for increased stability.
- 9 1/2" (241mm) standard backsplash includes 1" (25mm) upturn and tile edge.
- Basket-type waste drains are included to fit sink bowl's 3 1/2" (89mm) opening and feature 1 1/2" (38mm) outlet.
- 30" and 36" (762 and 914mm) drainboards* available upon request.

FEATURES:

* On sinks with drainboard(s) 30" and 36", legs are under the outer end of the drainboard(s).

Note: All shipping weights and cubic feet are approximate. **ALL SINKS SHIPPED FULLY CRATED.**

For sink accessories, see pages 212-213.

For sink kits, see page 211.

Freight class is 150.0.

(•) MTS (made to stock) / () MTO (made to order)

Notes: Twist drain bracket available.

Works in conjunction with optional twist handle drain (not included – see page 212). To order, add \$28 per compartment to list price and suffix "-TB" to model number (example: FN2016-1-14/3-TB).

For overflow hole (does not include drain), add \$41 per compartment to list price and suffix "-OF" to model number (example: FN2016-1-14/3-OF).

One Compartment, No Drainboards

bowl size width x length in. mm		drainboard length in. mm		weight lbs. kg		cubic feet	overall size width x length in. mm		model #	list
20" x 16"	508 x 406	–	–	55	24.9	10.1	27" x 21"	686 x 533	FN2016-1-14/3	2742
20" x 18"	508 x 457	–	–	58	26.3	11.9	27" x 23"	686 x 584	FN2018-1-14/3 •	3089
20" x 20"	508 x 508	–	–	60	27.2	12.9	27" x 25"	686 x 635	FN2020-1-14/3	3089
24" x 24"	610 x 610	–	–	69	31.2	17.8	31" x 29"	787 x 737	FN2424-1-14/3	3308
28" x 20"	711 x 508	–	–	79	35.8	16.7	35" x 25"	889 x 635	FN2820-1-14/3	3648



One Compartment, One Drainboard (right or left)

bowl size width x length in. mm		drainboard length in. mm		weight lbs. kg		cubic feet	overall size width x length in. mm		model #	list
20" x 16"	508 x 406	18"	457	74	30.8	18.7	27" x 37 1/2"	686 x 953	FN2016-1-18R or L-14/3	2919
		24"	610	80	33.1	21.5	27" x 43 1/2"	686 x 1105	FN2016-1-24R or L-14/3	2968
20" x 18"	508 x 457	18"	457	76	34.4	20.3	27" x 39 1/2"	686 x 1003	FN2018-1-18R or L-14/3	3201
		24"	610	81	36.7	22.4	27" x 45 1/2"	686 x 1156	FN2018-1-24R or L-14/3	3256
20" x 20"	508 x 508	24"	610	85	37.2	23.4	27" x 47 1/2"	686 x 1207	FN2020-1-24R or L-14/3	3256
24" x 24"	610 x 610	24"	610	88	37.6	30.5	31" x 51 1/2"	787 x 1308	FN2424-1-24R or L-14/3	3724
28" x 20"	711 x 508	24"	610	104	43.1	30.2	35" x 47 1/2"	889 x 1207	FN2820-1-24R or L-14/3	3805



One Compartment, Double Drainboards

bowl size width x length in. mm		drainboard length in. mm		weight lbs. kg		cubic feet	overall size width x length in. mm		model #	list
20" x 16"	508 x 406	18"	457	93	37.6	26.3	27" x 54"	686 x 1372	FN2016-1-18-14/3	3033
		24"	610	105	42.1	32.0	27" x 66"	686 x 1676	FN2016-1-24-14/3	3153
20" x 18"	508 x 457	18"	457	96	43.5	28.7	27" x 56"	686 x 1422	FN2018-1-18-14/3	3331
		24"	610	106	48.1	32.9	27" x 68"	686 x 1727	FN2018-1-24-14/3	3436
20" x 20"	508 x 508	24"	610	110	48.5	33.9	27" x 70"	686 x 1778	FN2020-1-24-14/3	3436
24" x 24"	610 x 610	24"	610	119	49.0	43.9	31" x 74"	787 x 1880	FN2424-1-24-14/3	3941
28" x 20"	711 x 508	24"	610	129	55.3	43.8	35" x 70"	889 x 1778	FN2820-1-24-14/3	3980



Catalog Section 20

**SPEC-MASTER® FN Series Coved Corner Sinks
Two-Compartment Sinks**

see spec sheet **EG20.33**



(faucet not included)

Notes: Twist drain brackets available.

Works in conjunction with optional twist handle drains (not included – see page 212). To order, add \$28 per compartment to list price and suffix “-TB” to model number (example: FN2032-2-14/3-TB).

For overflow hole (does not include drain), add \$41 per compartment to list price and suffix “-OF” to model number (example: FN2032-2-14/3-OF).

- 14 gauge type 304 18-8 stainless steel.
- All bowls are 14” (356mm) deep and have 3/8” (16mm) radius corners, both vertical and horizontal.
- Stainless steel gussets, feet, legs and crossbracing.
- Adjustable crossbracing front-to-back and side-to-side for increased stability.
- 9 1/2” (241mm) standard backsplash includes 1” (25mm) upturn and tile edge.
- Basket-type waste drains are included to fit sink bowl’s 3 1/2” (89mm) opening and feature 1 1/2” (38mm) outlet.
- 30” and 36” (762 and 914mm) drainboards* available upon request.

FEATURES:

* On sinks with drainboard(s) 30” and 36”, legs are under the outer end of the drainboard(s).

Note: All shipping weights and cubic feet are approximate. **ALL SINKS SHIPPED FULLY CRATED.**

For sink accessories, see pages 212-213.

For sink kits, see page 211.

Freight class is 150.0.

(•) MTS (made to stock) / () MTO (made to order)

Two Compartments, No Drainboards

bowl size width x length in. mm		drainboard length in. mm		weight lbs. kg		cubic feet	overall size width x length in. mm		model #	list
20" x 16"	508 x 406	-	-	77	34.9	20.4	27" x 39"	686 x 991	FN2032-2-14/3	3667
20" x 18"	508 x 457	-	-	82	37.2	22.4	27" x 43"	686 x 1092	FN2036-2-14/3	4026
20" x 20"	508 x 508	-	-	86	39.0	23.9	27" x 47"	686 x 1194	FN2040-2-14/3	4026
24" x 24"	610 x 610	-	-	91	41.3	32.2	31" x 55"	787 x 1397	FN2448-2-14/3	4788
28" x 20"	711 x 508	-	-	96	43.6	31.3	35" x 47"	889 x 1194	FN2840-2-14/3	4796



Two Compartments, One Drainboard (right or left)

bowl size width x length in. mm		drainboard length in. mm		weight lbs. kg		cubic feet	overall size width x length in. mm		model #	list
20" x 16"	508 x 406	18"	457	96	43.6	28.2	27" x 55 1/2"	686 x 1410	FN2032-2-18R or L-14/3	3941
		24"	610	102	46.3	31.1	27" x 61 1/2"	686 x 1562	FN2032-2-24R or L-14/3	4009
20" x 18"	508 x 457	18"	457	101	45.8	30.6	27" x 59 1/2"	686 x 1511	FN2036-2-18R or L-14/3	4458
		24"	610	107	48.5	33.1	27" x 65 1/2"	686 x 1664	FN2036-2-24R or L-14/3	4513
20" x 20"	508 x 508	24"	610	111	50.3	35.0	27" x 69 1/2"	686 x 1763	FN2040-2-24R or L-14/3	4513
24" x 24"	610 x 610	24"	610	116	52.6	45.0	31" x 77 1/2"	787 x 1969	FN2448-2-24R or L-14/3	5429
28" x 20"	711 x 508	24"	610	121	54.9	45.0	35" x 69 1/2"	889 x 1763	FN2840-2-24R or L-14/3	5429



Two Compartments, Double Drainboards

bowl size width x length in. mm		drainboard length in. mm		weight lbs. kg		cubic feet	overall size width x length in. mm		model #	list
20" x 16"	508 x 406	18"	457	115	52.2	36.0	27" x 72"	686 x 1829	FN2032-2-18-14/3	4078
		24"	610	127	57.6	41.8	27" x 84"	686 x 2134	FN2032-2-24-14/3	4177
20" x 18"	508 x 457	18"	457	120	54.4	39.4	27" x 76"	686 x 1930	FN2036-2-18-14/3 •	4240
		24"	610	132	59.9	43.8	27" x 88"	686 x 2235	FN2036-2-24-14/3	4678
20" x 20"	508 x 508	24"	610	136	61.7	45.7	27" x 92"	686 x 2337	FN2040-2-24-14/3	4678
24" x 24"	610 x 610	24"	610	141	64.0	58.4	31" x 100"	787 x 2540	FN2448-2-24-14/3	5623
28" x 20"	711 x 508	24"	610	146	66.2	58.8	35" x 92"	889 x 2337	FN2840-2-24-14/3	5661



100 Industrial Boulevard, Clayton, DE 19938-8903 U.S.A.
Phone: 800-637-5100 or 302-653-3000. Fax: 302-653-2065
http://www.eaglegrp.com

SPEC-MASTER® FN Series Coved Corner Sinks Three-Compartment Sinks

see spec sheet **EG20.34**



(faucets not included)



- 14 gauge type 304 18-8 stainless steel.
- All bowls are 14" (356mm) deep and have 5/8" (16mm) radius corners, both vertical and horizontal.
- Stainless steel gussets, feet, legs and crossbracing.
- Adjustable crossbracing front-to-back and side-to-side for increased stability.
- 9 1/2" (241mm) standard backsplash includes 1" (25mm) upturn and tile edge.
- Basket-type waste drains are included to fit sink bowls' 3 1/2" (89mm) opening and feature 1 1/2" (38mm) outlet.
- 30" and 36" (762 and 914mm) drainboards* available upon request.

FEATURES:

* On sinks with drainboard(s) 30" and 36", legs are under the outer end of the drainboard(s).

Note: All shipping weights and cubic feet are approximate.
ALL SINKS SHIPPED FULLY CRATED.
For sink accessories, see pages 212-213.
For sink kits, see page 211.

Freight class is 150.0.

(•) MTS (made to stock) / () MTO (made to order)

Notes: Twist drain brackets available.

Works in conjunction with optional twist handle drains (not included – see page 212). To order, add \$28 per compartment to list price and suffix “-TB” to model number (example: FN2048-3-14/3-TB).

For overflow hole (does not include drain), add \$41 per compartment to list price and suffix “-OF” to model number (example: FN2048-3-14/3-OF).

Three Compartments, No Drainboards

bowl size width x length in. mm		drainboard length in. mm		weight lbs. kg		cubic feet	overall size width x length in. mm		model #	list
20" x 16"	508 x 406	–	–	99	44.9	29.2	27" x 57"	686 x 1448	FN2048-3-14/3	4533
20" x 18"	508 x 457	–	–	102	46.3	32.1	27" x 63"	686 x 1600	FN2054-3-14/3 *	5182
20" x 20"	508 x 508	–	–	114	51.7	35.0	27" x 69"	686 x 1753	FN2060-3-14/3 *	5182
24" x 24"	610 x 610	–	–	127	57.6	46.7	31" x 81"	787 x 2057	FN2472-3-14/3 *	6028
28" x 20"	711 x 508	–	–	130	59.0	45.0	35" x 69"	889 x 1753	FN2860-3-14/3 *	6208



* Features two sets of faucet holes.

Three Compartments, One Drainboard (right or left)

bowl size width x length in. mm		drainboard length in. mm		weight lbs. kg		cubic feet	overall size width x length in. mm		model #	list
20" x 16"	508 x 406	18"	457	118	53.5	36.9	27" x 73 1/2"	686 x 1867	FN2048-3-18R or L-14/3	4722
		24"	610	124	56.2	39.9	27" x 79 1/2"	686 x 2019	FN2048-3-24R or L-14/3	4770
20" x 18"	508 x 457	18"	457	121	54.9	40.4	27" x 79 1/2"	686 x 2019	FN2054-3-18R or L-14/3 *	5569
		24"	610	127	57.6	42.8	27" x 85 1/2"	686 x 2172	FN2054-3-24R or L-14/3 *	5607
20" x 20"	508 x 508	24"	610	139	63.1	45.7	27" x 91 1/2"	686 x 2324	FN2060-3-24R or L-14/3 *	5607
		24"	610	152	68.9	59.5	31" x 103 1/2"	787 x 2629	FN2472-3-24R or L-14/3 *	6816
28" x 20"	711 x 508	24"	610	155	70.3	58.8	35" x 91 1/2"	889 x 2324	FN2860-3-24R or L-14/3 *	6940



* Features two sets of faucet holes.

Three Compartments, Double Drainboards

bowl size width x length in. mm		drainboard length in. mm		weight lbs. kg		cubic feet	overall size width x length in. mm		model #	list
20" x 16"	508 x 406	18"	457	137	61.7	44.7	27" x 90"	686 x 2286	FN2048-3-18-14/3	4838
		24"	610	149	67.6	50.6	27" x 102"	686 x 2591	FN2048-3-24-14/3	4936
20" x 18"	508 x 457	18"	457	140	63.5	49.1	27" x 96"	686 x 2438	FN2054-3-18-14/3 •	5698
		24"	610	158	71.6	53.5	27" x 108"	686 x 2743	FN2054-3-24-14/3 *	5864
20" x 20"	508 x 508	24"	610	164	74.4	56.4	27" x 114"	686 x 2896	FN2060-3-24-14/3 *	5864
		24"	610	177	80.3	72.8	31" x 126"	787 x 3200	FN2472-3-24-14/3 *	6996
28" x 20"	711 x 508	24"	610	180	81.6	72.5	35" x 114"	889 x 2896	FN2860-3-24-14/3 *	7181



* Features two sets of faucet holes.

Catalog Section 20

SPEC-MASTER® FN Series Coved Corner Sinks Four-Compartment Sinks

see spec sheet **EG20.35**



all sinks two sets of faucets holes



- 14 gauge type 304 18-8 stainless steel.
- All bowls are 14" (356mm) deep and have 5/8" (16mm) radius corners, both vertical and horizontal.
- Stainless steel gussets, feet, legs and crossbracing.
- Adjustable crossbracing front-to-back and side-to-side for increased stability.
- 9 1/2" (241mm) standard backsplash includes 1" (25mm) upturn and tile edge.
- Basket-type waste drains are included to fit sink bowls' 3 1/2" (89mm) opening and feature 1 1/2" (38mm) outlet.
- 30" and 36" (762 and 914mm) drainboards* available upon request.

FEATURES:

* On sinks with drainboard(s) 30" and 36", legs are under the outer end of the drainboard(s).

Notes: Twist drain brackets available.

Works in conjunction with optional twist handle drains (not included – see page 212). To order, add \$28 per compartment to list price and suffix "-TB" to model number (example: FN2064-4-14/3-TB).

For overflow hole (does not include drain), add \$41 per compartment to list price and suffix "-OF" to model number (example: FN2064-4-14/3-OF).

Note: All shipping weights and cubic feet are approximate.

ALL SINKS SHIPPED FULLY CRATED.

For sink accessories, see pages 212-213.

For sink kits, see page 211.

Freight class is 150.0.

(•) MTS (made to stock) / () MTO (made to order)

Four Compartments, No Drainboards

bowl size width x length in. mm		drainboard length in. mm		weight lbs. kg		cubic feet	overall size width x length in. mm		model #	list
20" x 16"	508 x 406	–	–	121	54.9	35.4	27" x 75"	686 x 1905	FN2064-4-14/3	5797
20" x 18"	508 x 457	–	–	132	59.9	39.0	27" x 83"	686 x 2108	FN2072-4-14/3	6512
20" x 20"	508 x 508	–	–	142	64.4	42.7	27" x 91"	686 x 2311	FN2080-4-14/3	6512
24" x 24"	610 x 610	–	–	163	73.9	57.1	31" x 107"	787 x 2718	FN2496-4-14/3	7493
28" x 20"	711 x 508	–	–	170	77.1	54.9	35" x 91"	889 x 2311	FN2880-4-14/3	7925



Four Compartments, One Drainboard (right or left)

bowl size width x length in. mm		drainboard length in. mm		weight lbs. kg		cubic feet	overall size width x length in. mm		model #	list
20" x 16"	508 x 406	18"	457	140	63.5	45.7	27" x 91 1/2"	686 x 2324	FN2064-4-18R or L-14/3	5839
		24"	610	146	66.2	48.6	27" x 97 1/2"	686 x 2477	FN2064-4-24R or L-14/3	5892
20" x 18"	508 x 457	18"	457	151	68.5	50.1	27" x 99 1/2"	686 x 2527	FN2072-4-18R or L-14/3	6892
		24"	610	157	71.2	52.5	27" x 105 1/2"	686 x 2680	FN2072-4-24R or L-14/3	6931
20" x 20"	508 x 508	24"	610	167	75.8	56.4	27" x 113 1/2"	686 x 2883	FN2080-4-24R or L-14/3	6931
		24"	610	188	85.3	68.5	31" x 129 1/2"	787 x 3289	FN2496-4-24R or L-14/3	8200
28" x 20"	711 x 508	24"	610	195	88.5	67.7	35" x 113 1/2"	889 x 2883	FN2880-4-24R or L-14/3	8431



Four Compartments, Double Drainboards

bowl size width x length in. mm		drainboard length in. mm		weight lbs. kg		cubic feet	overall size width x length in. mm		model #	list
20" x 16"	508 x 406	18"	457	159	72.1	53.5	27" x 108"	686 x 2743	FN2064-4-18-14/3	6054
		24"	610	171	77.6	55.4	27" x 120"	686 x 3048	FN2064-4-24-14/3	6167
20" x 18"	508 x 457	18"	457	170	77.1	54.9	27" x 116"	686 x 2646	FN2072-4-18-14/3 •	7065
		24"	610	182	82.6	59.0	27" x 128"	686 x 3251	FN2072-4-24-14/3	7132
20" x 20"	508 x 508	24"	610	192	87.1	62.6	27" x 136"	686 x 3454	FN2080-4-24-14/3	7132
		24"	610	213	96.6	81.4	31" x 152"	787 x 3861	FN2496-4-24-14/3	8429
28" x 20"	711 x 508	24"	610	220	99.8	110.2	35" x 136"	889 x 3454	FN2880-4-24-14/3	8673



100 Industrial Boulevard, Clayton, DE 19938-8903 U.S.A.
Phone: 800-637-5100 or 302-653-3000. Fax: 302-653-2065
<http://www.eaglegrp.com>

Utility Sinks One- and Two-Compartment Sinks

see spec sheets **EG20.13A** **EG20.13B**



Note: Overflow hole available (does not include drain). To order, add \$41 per compartment to list price and suffix “-OF” to model number (example: 1818-1-16/3-OF).

For detachable drainboards, see page 204.

For NSF-approved utility sinks, add 35% to list price and add prefix “N-” to model number. Example: N-2460-2-16/3.

- For numerous applications when NSF construction is not required.
- Square-corner construction.
- 8” (203mm) backsplash.
- Adjustable bullet feet.
- Heavy gauge stainless steel.
- 304 and 430 series construction available.
- Sink compartments are 13 3/8” (340mm) deep.
- Legs are 1 1/8” (41mm) diameter galvanized tubing and are located directly under sink compartments for maximum stability and weight support.

FEATURES:

Freight class is 150.0.

(•) MTS (made to stock) / () MTO (made to order)

One Compartment, No Drainboards

bowl size width x length in. mm		drainboard length in. mm		weight lbs. kg		cubic feet	overall size width x length in. mm		type 430 stainless steel		type 304 stainless steel	
in.	mm	in.	mm	lbs.	kg		in.	mm	model #	list	model #	list
18" x 18"	457 x 457	n/a	n/a	53	24.0	0.9	22" x 19"	559 x 492	1818-1-16/4 •	898	1818-1-16/3	1047
18" x 24"	457 x 610	-	-	56	25.4	11.6	22" x 25"	559 x 645	1824-1-16/4	904	1824-1-16/3	1095
21" x 18"	533 x 457	-	-	56	25.4	10.5	25" x 19"	635 x 492	2118-1-16/4 •	894	2118-1-16/3	1074
21" x 24"	533 x 610	-	-	59	26.8	13.1	25" x 25"	635 x 645	2124-1-16/4 •	925	2124-1-16/3	1126
21" x 36"	533 x 914	-	-	65	29.5	18.1	25" x 37"	635 x 949	2136-1-16/4	996	2136-1-16/3	1251
24" x 24"	610 x 610	-	-	60	27.2	14.6	28" x 25"	711 x 645	2424-1-16/4 •	963	2424-1-16/3	1181
24" x 36"	610 x 914	-	-	68	30.8	20.2	28" x 37"	711 x 949	2436-1-16/4 •	1025	2436-1-16/3	1310

One Compartment, Double Drainboards

bowl size width x length in. mm		drainboard length in. mm		weight lbs. kg		cubic feet	overall size width x length in. mm		type 430 stainless steel		type 304 stainless steel	
in.	mm	in.	mm	lbs.	kg		in.	mm	model #	list	model #	list
21" x 24"	533 x 610	18"	457	99	44.9	28.3	25" x 60"	635 x 1530	2124-1-18-16/4	1991	2124-1-18-16/3	2428
24" x 24"	610 x 610	24"	610	108	49.0	37.1	28" x 72"	711 x 1835	2424-1-24-16/4	2142	2424-1-24-16/3	2509

Two Compartments, No Drainboards

bowl size width x length in. mm		drainboard length in. mm		weight lbs. kg		cubic feet	overall size width x length in. mm		type 430 stainless steel		type 304 stainless steel	
in.	mm	in.	mm	lbs.	kg		in.	mm	model #	list	model #	list
18" x 18"	457 x 457	-	-	75	34.0	16.1	22" x 37"	559 x 949	1836-2-16/4 •	1211	1836-2-16/3	1480
18" x 24"	457 x 610	-	-	80	36.3	20.6	22" x 49"	559 x 1254	1848-2-16/4	1269	1848-2-16/3	1595
21" x 18"	533 x 457	-	-	80	36.3	18.1	25" x 37"	635 x 949	2136-2-16/4 •	1239	2136-2-16/3	1524
21" x 24"	533 x 610	-	-	85	38.6	23.2	25" x 49"	635 x 1254	2148-2-16/4	1253	2148-2-16/3	1609
24" x 24"	610 x 610	-	-	89	40.4	25.8	28" x 49"	711 x 1254	2448-2-16/4 •	1374	2448-2-16/3	1710
24" x 30"	610 x 762	-	-	95	43.1	31.5	28" x 61"	711 x 1559	2460-2-16/4	1703	2460-2-16/3	1963

Two Compartments, Double Drainboards

bowl size width x length in. mm		drainboard length in. mm		weight lbs. kg		cubic feet	overall size width x length in. mm		type 430 stainless steel		type 304 stainless steel	
in.	mm	in.	mm	lbs.	kg		in.	mm	model #	list	model #	list
21" x 18"	533 x 457	18"	457	120	3048	33.3	25" x 72"	635 x 1835	2136-2-18-16/4	2455	2136-2-18-16/3	2989
24" x 24"	610 x 610	24"	610	139	3531	48.4	28" x 96"	711 x 2445	2448-2-24-16/4	2556	2448-2-24-16/3	3069

Catalog Section 20

Utility Sinks Three- and Four-Compartment Sinks

see spec sheets **EG20.13C** **EG20.13D**



Note: Overflow hole available (*does not include drain*). To order, add \$41 per compartment to list price and suffix “-OF” to model number (example: 1836-3-16/3-OF).

For detachable drainboards, see page 204.

For NSF-approved utility sinks, add 35% to list price and add prefix “N-” to model number. Example: N-1836-3-16/3.

Freight class is 150.0.

(•) MTS (*made to stock*) / () MTO (*made to order*)

Three Compartments, No Drainboards

bowl size		drainboard		weight		cubic feet	overall size		type 430 stainless steel		type 304 stainless steel	
width in.	length mm	length in.	length mm	lbs.	kg		width in.	length mm	model #	list	model #	list
18" x 12"	457 x 305	-	-	79	35.8	16.1	22" x 37 3/8"	559 x 949	1836-3-16/4•	1396	1836-3-16/3	1697
18" x 16"	457 x 406	-	-	90	40.8	20.6	22" x 49 3/8"	559 x 1254	1848-3-16/4	1455	1848-3-16/3	1802
18" x 18"	457 x 457	-	-	97	44.0	22.8	22" x 55 3/8"	559 x 1407	1854-3-16/4•	1653	1854-3-16/3	1967
21" x 12"	533 x 305	-	-	85	38.6	18.1	25" x 37 3/8"	635 x 949	2136-3-16/4•	1431	2136-3-16/3	1752
21" x 16"	533 x 406	-	-	87	39.5	23.2	25" x 49 3/8"	635 x 1254	2148-3-16/4•	1493	2148-3-16/3	1860
21" x 18"	533 x 457	-	-	100	45.4	25.7	25" x 55 3/8"	635 x 1407	2154-3-16/4•	1659	2154-3-16/3	2021
21" x 20"	533 x 508	-	-	110	49.9	28.3	25" x 61 3/8"	635 x 1559	2160-3-16/4*	1715	2160-3-16/3*	2100
24" x 16"	610 x 406	-	-	92	41.7	25.8	28" x 49 3/8"	711 x 1254	2448-3-16/4	1569	2448-3-16/3	1945
24" x 20"	610 x 508	-	-	115	52.2	31.5	28" x 61 3/8"	711 x 1559	2460-3-16/4*	1814	2460-3-16/3*	2182
24" x 24"	610 x 610	-	-	125	56.7	37.1	28" x 73 3/8"	711 x 1864	2472-3-16/4**	1858	2472-3-16/3*	2309

* Features two sets of faucet holes.

Three Compartments, Double Drainboards

bowl size		drainboard		weight		cubic feet	overall size		type 430 stainless steel		type 304 stainless steel	
width in.	length mm	length in.	length mm	lbs.	kg		width in.	length mm	model #	list	model #	list
21" x 12"	533 x 305	18"	457	125	56.7	33.3	25" x 72 1/4"	635 x 1835	2136-3-18-16/4	2508	2136-3-18-16/3	2966
21" x 16"	533 x 406	18"	457	127	57.6	38.4	25" x 84 1/4"	635 x 2140	2148-3-18-16/4	2590	2148-3-18-16/3	3194
21" x 18"	533 x 457	18"	457	140	63.5	40.9	25" x 90 1/4"	635 x 2292	2154-3-18-16/4	2830	2154-3-18-16/3	3393
24" x 24"	610 x 610	24"	610	175	79.4	59.6	28" x 120 1/4"	711 x 3054	2472-3-24-16/4*	3053	2472-3-24-16/3*	3888

* Features two sets of faucet holes.

Four Compartments, No Drainboards - (All sinks feature two sets of faucet holes.)

bowl size		drainboard		weight		cubic feet	overall size		type 430 stainless steel		type 304 stainless steel	
width in.	length mm	length in.	length mm	lbs.	kg		width in.	length mm	model #	list	model #	list
18" x 18"	457 x 457	-	-	110	49.9	29.5	22" x 73 3/8"	559 x 1864	1872-4-16/4	1902	1872-4-16/3	2370
21" x 18"	533 x 457	-	-	115	52.2	33.3	25" x 73 3/8"	635 x 1864	2172-4-16/4	1991	2172-4-16/3	2407
24" x 18"	610 x 457	-	-	125	56.7	37.1	28" x 73 3/8"	711 x 1864	2472-4-16/4	2046	2472-4-16/3	2519

Four Compartments, Double Drainboards - (All sinks feature two sets of faucet holes.)

bowl size		drainboard		weight		cubic feet	overall size		type 430 stainless steel		type 304 stainless steel	
width in.	length mm	length in.	length mm	lbs.	kg		width in.	length mm	model #	list	model #	list
21" x 18"	533 x 457	18"	457	155	70.3	48.5	25" x 108 1/4"	635 x 2750	2172-4-18-16/4	3138	2172-4-18-16/3	3662



100 Industrial Boulevard, Clayton, DE 19938-8903 U.S.A.
Phone: 800-637-5100 or 302-653-3000. Fax: 302-653-2065
<http://www.eaglegrp.com>

Detachable Drainboards for Utility Sinks

see spec sheet **EG20.13E**

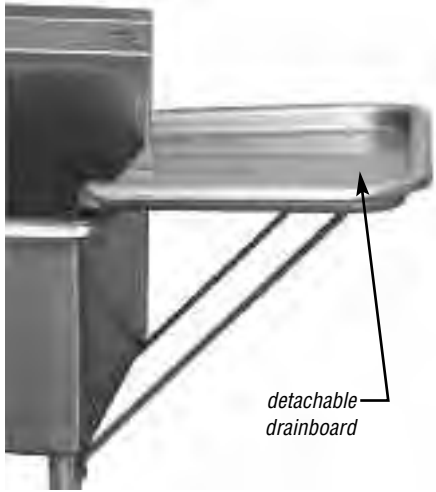

Drainboards will not work on NSF utility sinks!

- Unique die-stamped rolled rim construction.
- All drainboards are fully reversible, allowing for left- or right-hand operation.
- “Easy clip-on installation” utilizes two support brackets that bolt to sink gussets.
- Available in 430 or 304 series stainless steel.
- Drainboards 30” (762mm) long are furnished with legs.

FEATURES:

Freight class is 70.0.

(•) MTS (made to stock) / () MTO (made to order)

width (front-to-back) x length (side-to-side)		weight		cu	16 gauge type 430 stainless steel		16 gauge type 304 stainless steel	
in.	mm	lbs.	kg	ft	model #	list	model #	list
18" x 18"	457 x 457	19	8.6	1.8	18x18 RRDEDB •	252	18x18 RRDEDB-16/3	422
18" x 24"	457 x 610	23	10.4	1.9	18x24 RRDEDB •	267	18x24 RRDEDB-16/3	444
18" x 30"	457 x 762	27	12.2	2.8	18x30 RRDEDB	455	18x30 RRDEDB-16/3	496
21" x 18"	533 x 457	20	9.0	1.8	21x18 RRDEDB •	252	21x18 RRDEDB-16/3	422
21" x 24"	533 x 610	24	10.9	2.1	21x24 RRDEDB •	271	21x24 RRDEDB-16/3	444
21" x 30"	533 x 762	28	12.7	2.5	21x30 RRDEDB	508	21x30 RRDEDB-16/3	534
24" x 18"	610 x 457	21	9.5	2.3	24x18 RRDEDB •	260	24x18 RRDEDB-16/3	416
24" x 24"	610 x 610	25	11.3	2.4	24x24 RRDEDB •	281	24x24 RRDEDB-16/3	458
24" x 30"	610 x 762	29	13.2	2.7	24x30 RRDEDB	498	24x30 RRDEDB-16/3	525

SPEC-MASTER® FFN Series Flush Front Sinks

see spec sheet **EG20.54**



- Full front and 10” (254mm) high backsplash are 14 gauge stainless steel.
- 14 gauge double drainboards, rolled rims and sink bowl partitions.
- 1” (25mm) downturn at rear.
- Sink compartments feature ¼” (19mm) coved inside radii.
- Basket-type waste drain fits 3½” (89mm) opening and features 1½” (38mm) outlet.
- Legs are located directly under sink bowls.
- All-welded base constructed of 1½” (41mm) diameter tubular stainless steel.
- Adjustable stainless steel bullet feet.
- 14” (356mm) water level and swirl-away drainage.

FEATURES:

Freight class is 150.0.

(•) MTS (made to stock) / () MTO (made to order)

bowl size width x length		drainboard length		overall size width x length		model #	list	overall size width x length		model #	list
in.	mm	in.	mm	in.	mm			in.	mm		
27" x 18"	686 x 457	24"	610	30½" x 85½"	775 x 2216	FFN2736-2-24-14/3	12941	30½" x 105¼"	775 x 2673	FFN2754-3-24-14/3	15610
27" x 18"	686 x 457	30"	762	30½" x 97½"	775 x 2480	FFN2736-2-30-14/3	14484	30½" x 117¼"	775 x 2978	FFN2754-3-30-14/3	17391
27" x 20"	686 x 508	24"	610	30½" x 89½"	775 x 2318	FFN2740-2-24-14/3	13537	30½" x 111¼"	775 x 2826	FFN2760-3-24-14/3	16503
27" x 20"	686 x 508	30"	762	30½" x 101½"	775 x 2581	FFN2740-2-30-14/3	15073	30½" x 123¼"	775 x 3131	FFN2760-3-30-14/3	18285
27" x 24"	686 x 610	24"	610	30½" x 97½"	775 x 2521	FFN2748-2-24-14/3	14722	30½" x 123¼"	775 x 3131	FFN2772-3-24-14/3	18285
27" x 24"	686 x 610	30"	762	30½" x 109½"	775 x 2785	FFN2748-2-30-14/3	16265	30½" x 135¼"	775 x 3435	FFN2772-3-30-14/3	20061
27" x 30"	686 x 762	24"	610	30½" x 109½"	775 x 2826	FFN2760-2-24-14/3	16503	30½" x 141¼"	775 x 3588	FFN2790-3-24-14/3	20954
27" x 30"	686 x 762	30"	762	30½" x 121½"	775 x 3089	FFN2760-2-30-14/3	18040	30½" x 153¼"	775 x 3893	FFN2790-3-30-14/3	22735

* Three-Compartment sinks feature two sets of faucet holes.

Catalog Section 20

SPEC-MASTER® Specialty Use/Parts Cleaning Sinks

see spec sheet **EG20.38**



FEATURES:

- All bowls have 14" depth (356mm), 5/8" (16mm) radius corners.
- 14 gauge type 304 18-8 stainless steel construction.
- Available with one, two, or no drainboards.

Note: All shipping weights and cubic feet are approximate.

Freight class is 150.0.

(•) MTS (made to stock) / () MTO (made to order)

Two Compartments

inside bowl dimensions width x length in. mm		overall dimensions width x length in. mm		drain boards	weight lbs. kg		cu ft	model #	list
14" x 32"	356 x 813	37" x 37"	902 x 940	none	155	70.3	23	SFN2832-2-14/3	4664
14" x 32"	356 x 813	37" x 53½"	902 x 1359	one 18" (457mm) R or L	175	79.3	26	SFN2832-2-18R or L-14/3	5249
14" x 32"	356 x 813	37" x 70"	902 x 1778	two 18" (457mm) R & L	200	90.7	46	SFN2832-2-18-14/3	5746

Three Compartments

inside bowl dimensions width x length in. mm		overall dimensions width x length in. mm		drain boards	weight lbs. kg		cu ft	model #	list
two 14" x 32" (356 x 813mm) bowls, & one 20" x 30" (508 x 762mm) bowl		37" x 59"	902 x 1499	none	164	74.4	36	SFN3052-3-14/3	5978
		37" x 75½"	902 x 1918	one 18" (457mm) R or L	192	87.1	47	SFN3052-3-18R or L-14/3	6470
		37" x 92"	902 x 2337	two 18" (457mm) R & L	210	95.3	58	SFN3052-3-18-14/3	6636
three 32" x 14" (813 x 356mm) bowls		39" x 51"	991 x 1265	none	160	72.6	32	SFN3242-3-14/3	6230
		39" x 67½"	991 x 1715	one 18" (457mm) R or L	175	79.4	45	SFN3242-3-18R or L-14/3	6422
		39" x 84"	991 x 2134	two 18" (457mm) R & L	200	90.7	56	SFN3242-3-18-14/3	6652

314 Series Corner Sinks

see spec sheet **EG20.09**



all sinks have two sets of faucet holes

FEATURES:

- Deep-drawn, heavy gauge type 304 construction.
- Poly cutting board/sink cover.

Note: All shipping weights and cubic feet are approximate.
ALL UNITS SHIPPED FULLY CRATED.

Twist drain brackets available.

Works in conjunction with optional twist handle drains (not included - see page 212). To order, add **\$28 per compartment to list price** and suffix **"-TB"** to model number. Example: **C314-10-3-12-TB**.

Freight class is 150.0.

(•) MTS (made to stock) / () MTO (made to order)

no. bowls	bowl size width x length x depth	drain boards	overall size width x length	shipping weight	cu ft	model #	list
3	10" x 14" x 10" (254 x 355 x 254mm)	two 12" (305mm)	39" x 43" (991 x 1092mm)	80 lbs. (36.3 kg)	27	C314-10-3-12	4743
3	16" x 20" x 14" (406 x 508 x 356mm)	two 18" (457mm)	57¼" x 59¼" (1454 x 1518mm)	140 lbs. (63.5 kg)	65	C314-16-3-18 •	6240
3	22" x 22" x 14" (558 x 558 x 356mm)	two 18" (457mm)	69" x 69" (1753 x 1753mm)	175 lbs. (79.4 kg)	87	C314-22-3-18	6769
3	24" x 24" x 14" (610 x 610 x 356mm)	two 24" (610mm)	79" x 79" (2007 x 2007mm)	200 lbs. (90.7 kg)	108	C314-24-3-24	7315



100 Industrial Boulevard, Clayton, DE 19938-8903 U.S.A.
Phone: 800-637-5100 or 302-653-3000. Fax: 302-653-2065
http://www.eaglegrp.com

310 and 312 Series Specialty Use Sinks

see spec sheet **EG20.19**

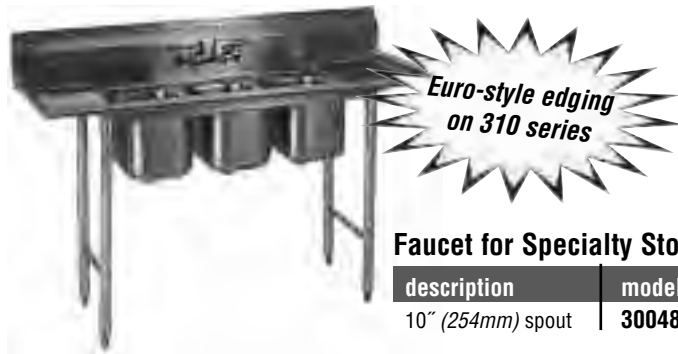

Faucet for Specialty Store Sinks

description	model #	list
10" (254mm) spout	300489	126

- Heavy gauge type 304 construction.
- Sink bowls are deep-drawn, except where noted.
- 9½" (241mm) backsplash includes 1" (25mm) upturn and tile edge for easy installation and feathering to wall/splash surface.

FEATURES:

Note: All shipping weights and cubic feet are approximate.

Twist drain brackets available.

Works in conjunction with optional twist handle drains (not included – see page 212). To order, add **\$28 per compartment to list price** and suffix “-TB” to model number (example: **310-10-3-12-TB**).

Freight class is 150.0.

(•) MTS (made to stock) / () MTO (made to order)

310 Series

no. bowls	bowl size width x length x depth	drain boards	overall size width x length	shipping weight	cu ft	model #	list
3	14" x 10" x 9½" (355 x 254 x 247mm)	two 12" (305mm)	21" x 60" (533 x 1524mm)	71 lbs. (32.2 kg)	23	310-10-3-12 •	2827
3	14" x 10" x 9½" (355 x 254 x 247mm)	two 18" (457mm)	21" x 72" (533 x 1829mm)	78 lbs. (35.4 kg)	27	310-10-3-18 •	2899
3	14" x 10" x 9½" (355 x 254 x 247mm)	two 24" (610mm)	21" x 84" (533 x 2134mm)	87 lbs. (39.5 kg)	32	310-10-3-24	2954

312 Series

no. bowls	bowl size width x length x depth	drain boards	overall size width x length	shipping weight	cu ft	model #	list
3	20" x 12" x 12" (508 x 305 x 305mm)	two 12" (305mm)	27" x 66" (686 x 1676mm)	89 lbs. (40.4 kg)	22	312-12-3-12 ••	2999
3	14" x 16" x 12" (356 x 406 x 305mm)	two 12" (305mm)	23" x 72" (584 x 1829mm)	105 lbs. (47.6 kg)	46	312-14-3-12 •	3213

* #312-12-3-12 features fabricated sink bowls.

Mop Sinks

see spec sheet **EG20.01**



- 304 18-8 stainless steel construction.
- Sink bowl is heavy gauge with deep-drawn covered corners.
- Drain with flat strainer plate.

FEATURES:

Note: See page 209 for Mop Storage Cabinet. See page 210 for optional Utility Shelves with Mop Hangers.

Freight class is 85.0.

(•) MTS (made to stock) / () MTO (made to order)

bowl size width x length in mm		cu ft	21½" x 24¾" x 15½" O.A. SIZE *				25½" x 32¾" x 19½" O.A. SIZE **			
			sh. weight lbs. kg		model # list		sh. weight lbs. kg		model # list	
16" x 20"	406 x 508	8.4	35	15.8	F1916 •	1396	53	24.0	F1916-12	1446
20" x 28"	508 x 711	11.9	68	30.8	F2820	1597	86	39.0	F2820-12	1774

* Includes 3¼" high backsplash. 12½" deck height. 8" bowl depth.

** Includes 3¼" high backsplash. 16½" deck height. 12" bowl depth.

Optional Accessories for Mop Sink

description	weight		model #	list
	lbs.	kg		
3-pole mop holder	4	1.8	312688	179
4-pole mop holder	4.5	2.0	321561 •	261
30" (762mm) hose & wall mounted bracket	8	3.6	312689	171
service faucet (comes with vacuum breaker)	11	5.0	312690	500

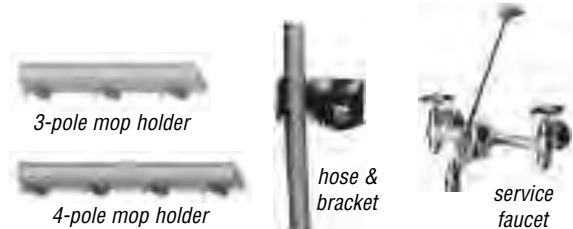

Catalog Section 20

Countertop Drop-In Self Rim Design Sinks

see spec sheet **EG20.39** FEATURES:

All weights and cubic feet are approximate.

Faucet holes are punched on 4" (102mm) centers. To order sinks with faucet holes punched on 8" (203mm) centers, add \$155 to list price and add suffix "-8CL" (example: SR18-24-13.5-3-8CL). Faucets sold separately for "-8CL" sinks. See page 210.

Deck mount Electronic Eye Faucets available. For One-Compartment sinks only. To order, add suffix "-FE" to model #. Example: SR10-14-5-1-FE. Consult factory for list price.

deck mount electronic-eye faucet

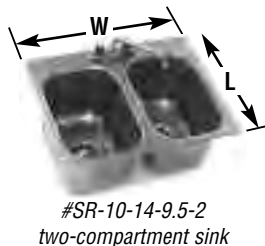

- 304 series stainless steel.
- Faucet and basket drain.

Freight class is 85.0.

(•) MTS (made to stock) / () MTO (made to order)

Not NSF approved for warewashing and/or food preparation operations. Not intended for NSF installation into stainless steel work surface. Please consult factory if need arises.

See page 210 for all replacement and optional faucets available, and for the NEW Bottom Mount Kit.



One Compartment – Furnished with #302004 faucet with gooseneck spout, except where noted. See page 210 for other available faucets.

inside bowl dimensions width x length x depth		overall width x length		TOP MOUNT cutout width x length		BOTTOM MOUNT cutout*		weight lbs. kg	cu ft	model #	list	
in.	mm	in.	mm	in.	mm	in.	mm					
14" x 10" x 5"	356 x 254 x 127	19" x 12 1/2"	483 x 324	17 1/2" x 11 1/4"	448 x 286	14 1/2" x 10 1/2"	372 x 270	10	4.5	0.7	SR10-14-5-1•▲	407
14" x 10" x 9 1/2"	356 x 254 x 241	18 1/2" x 12 3/4"	480 x 324	17 1/2" x 11 1/4"	445 x 286	14 1/2" x 11"	378 x 279	12	5.4	1.4	SR10-14-9.5-1•	504
14" x 12" x 9 1/2"	356 x 305 x 241	19" x 14 1/2"	483 x 375	17 1/2" x 13 1/4"	448 x 337	14 1/2" x 12 1/2"	372 x 321	14	6.4	1.7	SR12-14-9.5-1•▲	659
10" x 14" x 5"	254 x 356 x 127	15" x 16 1/4"	381 x 426	13 1/2" x 15 1/4"	346 x 387	10 1/2" x 14 1/4"	270 x 372	10	4.5	0.8	SR14-10-5-1▲	407
10" x 14" x 5"	254 x 356 x 127	15" x 16 1/4"	381 x 426	13 1/2" x 15 1/4"	346 x 387	n/a	n/a	12	5.4	0.8	SRU14-10-5-1**▲	866
10" x 14" x 9 1/2"	254 x 356 x 241	15" x 16 1/4"	381 x 422	13 1/2" x 15 1/4"	346 x 384	11" x 14 1/4"	279 x 378	12	5.4	1.6	SR14-10-9.5-1	657
12" x 14" x 9 1/2"	305 x 356 x 241	17" x 16 1/4"	432 x 426	15 1/2" x 15 1/4"	397 x 387	12 1/2" x 14 1/4"	321 x 372	14	6.4	1.8	SR14-12-9.5-1▲	640
16" x 14" x 9 1/2"	406 x 356 x 241	21" x 16 1/4"	533 x 425	19 1/2" x 15 1/4"	499 x 387	16 1/2" x 14 1/4"	422 x 372	23	10.4	2.1	SR14-16-9.5-1•▲	788
14" x 16" x 9 1/2"	356 x 406 x 241	19" x 18 1/4"	483 x 476	17 1/2" x 17 1/4"	448 x 448	14 1/2" x 16 1/4"	372 x 422	23	10.4	2.1	SR16-14-9.5-1▲	788
20" x 16" x 8"	508 x 406 x 203	24 1/4" x 18 1/2"	629 x 470	23 3/4" x 17"	594 x 432	20 1/4" x 16 1/4"	527 x 426	26	11.8	2.2	SR16-19-8-1	674
20" x 16" x 13 1/2"	508 x 406 x 343	24 1/4" x 18 1/2"	629 x 470	23 3/4" x 17"	594 x 432	20 1/4" x 16 1/4"	527 x 426	28	12.7	3.9	SR16-19-13.5-1	845
24" x 18" x 13 1/2"	610 x 457 x 343	28 3/4" x 20 1/2"	730 x 521	27 3/4" x 19"	695 x 483	24 1/4" x 18 1/4"	629 x 476	32	14.5	4.9	SR18-24-13.5-1	788
16" x 20" x 8"	406 x 508 x 203	20 3/4" x 22 1/2"	527 x 572	19 1/2" x 21"	492 x 533	16 1/4" x 20 1/4"	426 x 527	24	10.9	2.3	SR19-16-8-1■•	788
16" x 20" x 13 1/2"	406 x 508 x 343	20 3/4" x 22 1/2"	527 x 572	19 1/2" x 21"	492 x 533	16 1/4" x 20 1/4"	426 x 527	25	11.3	3.9	SR19-16-13.5-1■•	845
12" x 20" x 6 1/2"	305 x 508 x 165	17" x 22 1/4"	432 x 578	15 1/2" x 21 1/4"	397 x 540	12 1/2" x 20 1/4"	321 x 524	28	12.7	1.6	SR20-12-6.5-1▲	852
22" x 22" x 13 1/2"	559 x 559 x 343	27" x 24 1/4"	686 x 629	25 1/2" x 23 1/4"	651 x 591	22 1/2" x 22 1/4"	575 x 575	34	15.4	5.5	SR22-22-13.5-1■	1056
18" x 24" x 13 1/2"	457 x 610 x 343	22 3/4" x 26 1/2"	578 x 673	21 1/2" x 25"	543 x 635	18 1/4" x 24 1/4"	476 x 629	32	14.5	5.0	SR24-18-13.5-1	788
24" x 24" x 13 1/2"	610 x 610 x 343	28 3/4" x 26 1/2"	730 x 673	27 3/4" x 25"	695 x 635	24 1/4" x 24 1/4"	627 x 627	36	16.3	6.4	SR24-24-13.5-1	1077

* See page 210 for Bottom Mount Kit; ** #SRU14-10-5-1 features an upturn on sides and rear; ■ These sinks utilize #300490 faucet with 12" (305mm) swivel spout; ▲ 20 gauge stainless steel. All others constructed of 18 gauge stainless steel.

Two Compartment – Furnished with #300490 faucet with 12" (203mm) spout, except where noted. See page 210 for other available faucets.

inside bowl dimensions width x length x depth		overall width x length		TOP MOUNT cutout width x length		BOTTOM MOUNT cutout*		weight lbs. kg	cu ft	model #	list	
in.	mm	in.	mm	in.	mm	in.	mm					
14" x 10" x 9 1/2"	356 x 254 x 241	18 1/2" x 24 1/4"	480 x 629	17 1/2" x 23 1/4"	445 x 591	14 1/2" x 23"	378 x 584	25	11.3	2.8	SR10-14-9.5-2■•	978
14" x 12" x 9 1/2"	356 x 305 x 241	19" x 28 1/4"	483 x 730	17 1/2" x 27 1/4"	448 x 692	14 1/2" x 26 1/4"	372 x 676	27	12.2	3.2	SR12-14-9.5-2▲	1042
16" x 14" x 9 1/2"	406 x 356 x 241	21" x 32 1/2"	525 x 832	19 1/2" x 31 1/4"	499 x 794	16 1/2" x 30 1/4"	422 x 778	42	19.1	4.0	SR14-16-9.5-2▲	1191
20" x 16" x 8"	508 x 406 x 203	24 1/4" x 36 1/4"	527 x 921	23 3/4" x 34 1/4"	594 x 883	20 1/4" x 34 1/2"	527 x 876	48	21.8	4.3	SR16-19-8-2	1401
20" x 16" x 13 1/2"	508 x 406 x 343	24 1/4" x 36 1/4"	527 x 921	23 3/4" x 34 1/4"	594 x 883	20 1/4" x 34 1/2"	527 x 876	52	23.6	7.5	SR16-19-13.5-2•	1472
24" x 18" x 13 1/2"	610 x 457 x 343	28 3/4" x 40 1/4"	578 x 1022	27 3/4" x 38 3/4"	695 x 984	24 1/4" x 38 1/2"	629 x 978	56	24.9	9.7	SR18-24-13.5-2	1687
22" x 22" x 13 1/2"	559 x 559 x 343	27" x 48 1/4"	686 x 1238	25 1/2" x 47 1/4"	651 x 1200	22 1/2" x 46 1/4"	575 x 1184	57	25.9	10.7	SR22-22-13.5-2	1875
24" x 24" x 13 1/2"	610 x 610 x 343	28 3/4" x 52 1/2"	730 x 1324	27 3/4" x 50 1/2"	695 x 1286	24 1/4" x 50 1/2"	629 x 1280	64	29.0	12.5	SR24-24-13.5-2	2277

* See page 210 for Bottom Mount Kit; ■ Model #SR10-14-9.5-2 utilizes #301248 faucet with 8" (203mm) swivel spout; ▲ 20 gauge stainless steel. All others constructed of 18 gauge stainless steel.

Three Compartment – Furnished with #300490 faucet with 12" (305mm) spout, except where noted. See page 210 for other available faucets.

inside bowl dimensions width x length x depth		overall width x length		TOP MOUNT cutout width x length		BOTTOM MOUNT cutout*		weight lbs. kg	cu ft	model #	list	
in.	mm	in.	mm	in.	mm	in.	mm					
14" x 10" x 9 1/2"	356 x 254 x 241	18 1/2" x 36 1/4"	480 x 933	17 1/2" x 35 1/4"	445 x 895	14 1/2" x 35"	378 x 889	37	16.8	4.1	SR10-14-9.5-3•	1410
14" x 12" x 9 1/2"	356 x 305 x 241	19" x 42 1/4"	483 x 1086	17 1/2" x 41 1/4"	448 x 1031	14 1/2" x 40 1/4"	372 x 1032	39	17.6	4.7	SR12-14-9.5-3▲	1655
16" x 14" x 9 1/2"	406 x 356 x 241	21" x 48 1/4"	533 x 1238	19 1/2" x 47 1/4"	498 x 1200	16 1/2" x 46 1/4"	422 x 1184	66	29.9	6.0	SR14-16-9.5-3•▲	1675
20" x 16" x 8"	508 x 406 x 203	24 1/4" x 54"	629 x 1372	23 3/4" x 52 1/2"	594 x 1334	20 1/4" x 52 1/4"	527 x 1327	72	32.7	6.3	SR16-19-8-3	1823
20" x 16" x 13 1/2"	508 x 406 x 343	24 1/4" x 54"	629 x 1372	23 3/4" x 52 1/2"	594 x 1334	20 1/4" x 52 1/4"	527 x 1327	77	34.9	10.9	SR16-19-13.5-3•	1930
24" x 18" x 13 1/2"	610 x 457 x 343	28 3/4" x 60"	730 x 1524	27 3/4" x 58 1/2"	695 x 1486	24 1/4" x 58 1/4"	629 x 1480	82	37.2	14.1	SR18-24-13.5-3■	2342

* See page 210 for Bottom Mount Kit; ■ These sinks utilize #301440 faucet with 14" (356mm) swivel spout; ▲ 20 gauge stainless steel. All others constructed of 18 gauge stainless steel.



100 Industrial Boulevard, Clayton, DE 19938-8903 U.S.A.
Phone: 800-637-5100 or 302-653-3000. Fax: 302-653-2065
http://www.eaglegrp.com

Undermount Sink Bowls with Drawn Bowl

see spec sheet **EG20.18**

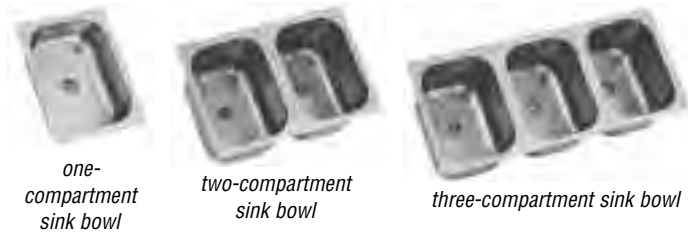

one-compartment sink bowl

two-compartment sink bowl

three-compartment sink bowl

- For NSF-approved welded fabrication.
- Deep-drawn seamless bowls.
- Type 304 stainless steel construction.
- Bowls are provided with drain holes only.

FEATURES:

Note: All shipping weights and cubic feet are approximate.

Freight class is 85.0.

(•) MTS (made to stock) / () MTO (made to order)

One Compartment

inside bowl dimensions width x length x depth in. mm		overall dimensions width x length in. mm		gauge	drain hole in. mm		weight lbs. kg		cu ft	model #	list
14" x 10" x 5"	356 x 254 x 127	16" x 12"	406 x 305		20	3 1/2"	89	9			
14" x 10" x 9 1/2"	356 x 254 x 241	16" x 12"	406 x 305	18	3 1/2"	89	11	5.0	1.4	FDI-10-14-9.5-1	336
14" x 12" x 9 1/2"	356 x 305 x 241	16" x 14"	406 x 356	20	3 1/2"	89	13	5.8	2.4	FDI-12-14-9.5-1	351
20" x 12" x 6 1/2"	508 x 305 x 165	22" x 14"	559 x 356	20	2"	51	14	6.4	2.6	FDI-12-20-6.5-1	367
16" x 14" x 6"	406 x 356 x 152	18" x 16"	457 x 406	20	3 1/2"	89	14	6.4	2.5	FDI-14-16-6-1	375
16" x 14" x 9 1/2"	406 x 356 x 241	18" x 16"	457 x 406	20	3 1/2"	89	14	6.4	2.3	FDI-14-16-9.5-1	386
19 3/4" x 15 3/8" x 8"	502 x 391 x 203	21 3/4" x 17 3/8"	552 x 441	20	2"	51	15	6.8	2.6	FDI-15.38-19.75-8-1	389
20" x 16" x 8"	508 x 406 x 203	21 3/4" x 18"	552 x 457	18	3 1/2"	89	23	10.4	3.7	FDI-16-19-8-1	472
20" x 16" x 13 1/2"	508 x 406 x 343	21 3/4" x 18"	552 x 457	18	3 1/2"	89	25	11.3	3.7	FDI-16-19-13.5-1	477
24" x 18" x 13 1/2"	610 x 457 x 343	26" x 20"	660 x 508	18	3 1/2"	89	37	16.8	8.6	FDI-18-24-13.5-1	578
20" x 20" x 5"	508 x 508 x 127	22" x 22"	559 x 559	20	3 1/2"	89	19	8.6	1.5	FDI-20-20-5-1	370
22" x 22" x 13 1/2"	559 x 559 x 343	24" x 24"	610 x 610	18	3 1/2"	89	39	17.6	7.3	FDI-22-22-13.5-1	674
24" x 24" x 13 1/2"	610 x 610 x 343	26" x 26"	660 x 660	18	3 1/2"	89	41	18.6	8.3	FDI-24-24-13.5-1	703

Two Compartment

inside bowl dimensions width x length x depth in. mm		overall dimensions width x length in. mm		gauge	drain hole in. mm		weight lbs. kg		cu ft	model #	list
14" x 10" x 9 1/2"	356 x 254 x 241	16" x 24"	406 x 610		18	3 1/2"	89	19			
14" x 12" x 9 1/2"	356 x 305 x 241	16" x 28"	406 x 711	20	3 1/2"	89	21	9.5	4.5	FDI-12-14-9.5-2	697
16" x 14" x 9 1/2"	406 x 356 x 241	18" x 32"	457 x 813	20	3 1/2"	89	25	11.3	6.2	FDI-14-16-9.5-2	751
20" x 16" x 8"	508 x 406 x 203	21 3/4" x 36"	552 x 914	18	3 1/2"	89	43	19.5	5.1	FDI-16-19-8-2	913
20" x 16" x 13 1/2"	508 x 406 x 343	21 3/4" x 36"	552 x 914	18	3 1/2"	89	50	22.7	7.6	FDI-16-19-13.5-2	939
24" x 18" x 13 1/2"	610 x 457 x 343	26" x 40"	660 x 1016	18	3 1/2"	89	73	33.1	15.7	FDI-18-24-13.5-2	1097
22" x 22" x 13 1/2"	559 x 559 x 343	24" x 48"	610 x 1219	18	3 1/2"	89	75	34.0	12.6	FDI-22-22-13.5-2	1301
24" x 24" x 13 1/2"	610 x 610 x 343	26" x 52"	660 x 1321	18	3 1/2"	89	81	36.7	15.0	FDI-24-24-13.5-2	1356

Three Compartment

inside bowl dimensions width x length x depth in. mm		overall dimensions width x length in. mm		gauge	drain hole in. mm		weight lbs. kg		cu ft	model #	list
14" x 10" x 9 1/2"	356 x 254 x 241	16" x 36"	406 x 914		18	3 1/2"	89	27			
14" x 12" x 9 1/2"	356 x 305 x 241	16" x 42"	406 x 1067	20	3 1/2"	89	30	13.6	5.3	FDI-12-14-9.5-3	975
16" x 14" x 9 1/2"	406 x 356 x 241	18" x 48"	457 x 1219	20	3 1/2"	89	36	16.3	7.2	FDI-14-16-9.5-3	1094
20" x 16" x 8"	508 x 406 x 203	21 3/4" x 54"	552 x 1372	18	3 1/2"	89	63	28.6	11.3	FDI-16-19-8-3	1318
20" x 16" x 13 1/2"	508 x 406 x 343	21 3/4" x 54"	552 x 1372	18	3 1/2"	89	75	34.0	15.9	FDI-16-19-13.5-3	1375
24" x 18" x 13 1/2"	610 x 457 x 343	26" x 60"	660 x 1524	18	3 1/2"	89	101	45.8	21.8	FDI-18-24-13.5-3	1593
22" x 22" x 13 1/2"	559 x 559 x 343	24" x 72"	610 x 1829	18	3 1/2"	89	113	51.3	19.8	FDI-22-22-13.5-3	1807
24" x 24" x 13 1/2"	610 x 610 x 343	26" x 78"	660 x 1981	18	3 1/2"	89	123	55.8	21.8	FDI-24-24-13.5-3	1884

Catalog Section 20

Undermount Sink Bowls with Drawn Bowl (cont.)

see spec sheet **EG20.18**



Four Compartment

inside bowl dimensions width x length x depth in. mm		overall dimensions width x length in. mm		gauge	drain hole in. mm		weight lbs. kg		cu ft	model #	list
14" x 10" x 9½"	356 x 254 x 241	16" x 48"	406 x 1219	18	3½"	89	35	15.9	6.0	FDI-10-14-9.5-4	1161
14" x 12" x 9½"	356 x 305 x 241	16" x 56"	406 x 1422	20	3½"	89	39	17.6	7.2	FDI-12-14-9.5-4	1297
16" x 14" x 9½"	406 x 356 x 241	18" x 64"	457 x 1626	20	3½"	89	47	21.3	9.7	FDI-14-16-9.5-4	1346
20" x 16" x 8"	508 x 406 x 203	21¾" x 72"	552 x 1829	18	3½"	89	83	37.6	16.9	FDI-16-19-8-4	1593
20" x 16" x 13½"	508 x 406 x 343	21¾" x 72"	552 x 1829	18	3½"	89	100	45.4	14.8	FDI-16-19-13.5-4	1644
24" x 18" x 13½"	610 x 457 x 343	26" x 80"	660 x 3032	18	3½"	89	129	58.5	28.4	FDI-18-24-13.5-4	1874
22" x 22" x 13½"	559 x 559 x 343	24" x 96"	610 x 2438	18	3½"	89	151	68.6	23.5	FDI-22-22-13.5-4	2192
24" x 24" x 13½"	610 x 610 x 343	26" x 104"	660 x 2642	18	3½"	89	163	73.9	28.5	FDI-24-24-13.5-4	2281

FEATURES:

- For NSF-approved welded fabrication.
- Deep-drawn seamless bowls.
- Type 304 stainless steel construction.
- Bowls are provided with drain holes only.

Note: All shipping weights and cubic feet are approximate.

Freight class is 85.0.

(•) MTS (made to stock) / () MTO (made to order)

Undermount Sink Bowls with Fabricated Wall

see spec sheet **EG20.16**

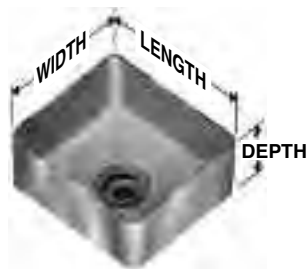

Bowls are tapered to allow for 60% nesting, which facilitates shipping and storage.

FEATURES:

- For NSF-approved welded fabrication.
- Type 304 18-8 stainless steel construction.
- ⅝" (16mm) radius corners.
- 3½" (89mm) drain hole with sump.
- Swirl away drainage.

Freight class is 85.0.

(•) MTS (made to stock) / () MTO (made to order)

inside bowl dimensions (W x L x D) in. mm			gauge	weight lbs. kg		cu ft	model #	list
9" x 12" x 6"	229 x 305 x 152	16	6	2.7	0.4	FNWNF-9-12-6-1	623	
9" x 14" x 8"	229 x 356 x 203	16	8	3.6	0.5	FNWNF-9-14-8-1	660	
12" x 14" x 8"	305 x 356 x 203	16	11	5.0	0.8	FNWNF-12-14-8-1	680	
14" x 16" x 8"	356 x 406 x 203	16	12	5.4	1.0	FNWNF-14-16-8-1	713	
18" x 18" x 10"	457 x 457 x 254	14	24	10.9	1.9	FNWNF-18-18-10-1	637	
18" x 18" x 12"	457 x 457 x 305	14	27	12.2	2.3	FNWNF-18-18-12-1	646	
20" x 20" x 10"	508 x 508 x 254	14	25	11.3	2.3	FNWNF-20-20-10-1	674	
20" x 20" x 12"	508 x 508 x 305	14	29	13.2	2.8	FNWNF-20-20-12-1	709	
20" x 20" x 14"	508 x 508 x 356	14	32	14.5	3.2	FNWNF-20-20-14-1	747	
20" x 27" x 6"	508 x 686 x 432	14	20	9.0	1.5	FNWNF-20-27-6-1	637	
20½" x 20½" x 5"	521 x 521 x 127	14	18	8.2	1.2	FNWNF-20.5-20.5-5-1	574	
20½" x 20½" x 8"	521 x 521 x 203	14	24	10.9	1.9	FNWNF-20.5-20.5-8-1	630	
24" x 24" x 12"	610 x 610 x 305	14	38	17.2	4.0	FNWNF-24-24-12-1	788	
24" x 24" x 14"	610 x 610 x 356	14	42	19.1	4.7	FNWNF-24-24-14-1	828	



mop storage cabinet
(mop not included)

Mop Sink Storage Cabinet

see product announcement **EG8104**

width x length x height in. mm	cubic feet	model #	list
22¼" x 25" x 84¼"	565 x 635 x 2140	39.0	F1916-VSCS 5190

FEATURES:

- Heavy gauge type 430 stainless steel construction.
- 12" (305mm)-wide center shelf.
- Double-pan 20 gauge stainless steel hinged doors.
- Transverse rod handles featuring keyed locks.
- Top is slanted at a 15° angle.
- Sides are louvered along top for ventilation.
- Holds two mops.

Freight class is 125.0.

(•) MTS (made to stock) / () MTO (made to order)

Note: Optional upgrade to type 300 stainless steel cabinet available. To order, add 15% to list price and suffix "-SE" to model number (example: F1916-VSCS-SE).



100 Industrial Boulevard, Clayton, DE 19938-8903 U.S.A.
Phone: 800-637-5100 or 302-653-3000. Fax: 302-653-2065
<http://www.eaglegrp.com>

Utility Shelves with Mop Hangers

see spec sheet **EG20.02**

width x length		model #	list
in.	mm		
8" x 24"	203 x 610	US0824-16/3*	559
8" x 36"	203 x 914	US0836-16/3	642
8" x 48"	203 x 1219	US0848-16/3	812



FEATURES:

- 16 gauge type 304 stainless steel.
- Mop hangers. Flat hooks.
- Hangers and hooks are riveted to front of shelf.

Note: Faucets listed are lead-free AB1953-compliant.

Freight class is 70.0.

(*) MTS (made to stock) / () MTO (made to order)

Options for Countertop Drop-In Sinks

see spec sheet **EG20.39**

Deck Mount Faucets...

description	...Standard		...T&S	
	model #	list	model #	list
gooseneck faucet, 4" (102mm) center, for single bowls	302004	173	313308	415
8" (203mm) spout, 4" (102mm) center, for single and double bowls	301248	156	313306	400
8" (203mm) spout, 4" (102mm) center, for single and double bowls, with spray arm	-	-	377430	462
8" (203mm) spout, 8" (203mm) center, for single and double bowls, with spray arm	-	-	303560	462
12" (305mm) spout, 4" (102mm) center, for triple bowls	300490	165	313303 *	414
12" (305mm) spout, 8" (203mm) center, for triple bowls, with spray arm	-	-	303561 *	522
14" (356mm) spout, 4" (102mm) center, for triple bowls	301440	180	313307 *	415
14" (356mm) spout, 8" (203mm) center, for triple bowls, with spray arm	-	-	303562	520



#302004 faucet



#303560 faucet

* Faucets with spray arm require special faucet holes.

NEW Bottom-Mount Kit — One kit per one-compartment sinks, two kits per two-compartment sink, three kits per three-compartment sink.

description	model #	list
8 undermount clips per kit	362188	77



undermount clip

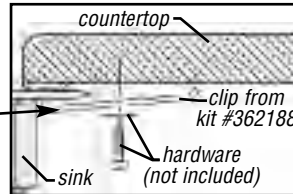

Custom Sink Modifications

see spec sheet **EG20.50**

model #	description	list
E30	End splash - per end, all heights	296
E40	Provision for sink heater	168
E41	Disposal provision package—collar	696
E41A	Disposal provision package—cone	696
E43	Stand pipe with corner guard, available only on FN-style and utility sinks	210
E44	Faucet hole revision - adding or moving	157
E45	Trough installed in drainboard - up to 30" (762mm) long	854
E46	Rubber scrap block installed	341
E101A	Turn down backsplash - per sink, includes Z-clips	230

Not Pictured

model #	description	list
E37	NSF sprayed-on latex sound deadening - up to 12' (3658mm)	646
E37A	- for each additional foot	51
E38-6*	Cantilever mount up to 6' (1829mm) - add to wall shelf price	375
E38-12*	Cantilever mount up to 12' (3658mm) - add to wall shelf price	561
E39	Enclosed backsplash	80/lin. ft.
E47	Sink cover holders, sized for stainless steel or poly (includes upper and lower track)	641/slot
E48	Stainless steel apron, to cover sink bowls - 2 or 3 compartment	1027
E48A	- for each additional compartment over 3	171
E49	s/s undershelf under drainboards - up to 24" (610mm) w/short legs	552
E49A	- for each additional foot over 24" (610mm)	242
E50	Provision for water pump	1439
E51	Optional size drainboard	318/lin. ft.
E52	High backsplash up to 13" (330mm)	165/lin. ft.
E53	High backsplash up to 18" (457mm)	1295/lin. ft.
E54	Working height revision	280/sink
E55	Drainboard corner turn	1295/ea.
E56	overflow hole	41

* Applicable to wall mount shelves and pot racks.

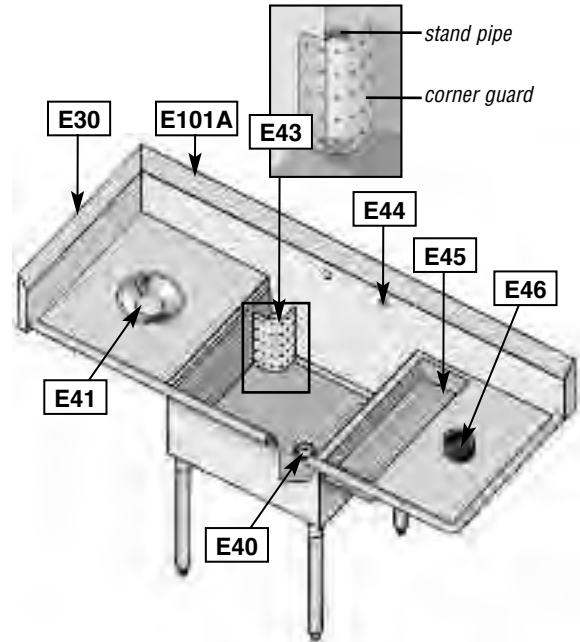

Catalog Section 20

Sink Accessories/Replacements

see spec sheet **EG20.51A**

Can be shipped UPS.

(•) MTS (made to stock) / () MTO (made to order)

Sink Kits for SPEC-MASTER® FN Series Sinks

- Includes T&S faucet #313293.



lever drain (with sink kits B)



lever drain with overflow (with sink kits C)



Kit A

- Add suffix “-F” to sink model number.

description	add to list price
1 faucet	571
2 faucets	1142

Kit B

- T&S faucet plus lever drain. Add suffix “-FD” to sink model number.

description	add to list price
1 faucet	571
2 faucets	1142
per lever drain	220

Kit C

- T&S faucet plus lever drain with overflow. Add suffix “-FDO” to sink model number.

description	add to list price
1 faucet	571
2 faucets	1142
per lever drain with overflow	452

Kit D

- T&S faucet plus twist handle drain and twist handle bracket. Add suffix “-FDT” to sink model number.

description	add to list price
1 faucet	571
2 faucets	1142
per twist handle drain	232

Kit E

- T&S faucet plus twist handle drain with overflow and twist handle bracket. Add suffix “-FDOT” to sink model number.

description	add to list price
1 faucet	571
2 faucets	1142
per twist handle drain with overflow	525

Plumbing Components

description	model #	list each
P-trap, nickel-plated	300789	86
tail piece for 1.5" (38.1mm) IPS connection, nickel-plated	300791	15
anti-siphon vacuum breaker	313832	167
backflow preventer	313834	195

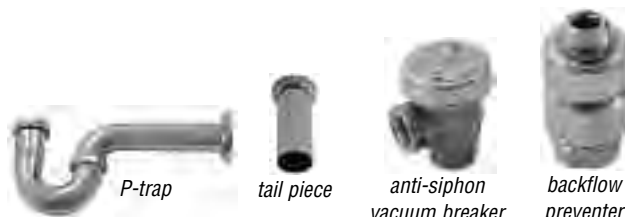

Sink Accessories/Replacements

see spec sheet **EG20.51A**

Can be shipped UPS.

(•) MTS (made to stock) / () MTO (made to order)

Sink Covers...

For 412, 414, 314, and Spec-Master® FN Series Sinks only.

fits sink bowl size	Polyboard		Stainless Steel	
	model #	list	model #	list
14" x 10" (356 x 254mm)	313207	127	321555	158
16" x 20" (483 x 508mm)	351584	144	351585	179
20" x 18" (508 x 457mm)	335377	148	346175	189
20" x 20" (508 x 508mm)	326267	151	305428	185
22" x 22" (559 x 559mm)	313204	156	321557	200
24" x 18" (610 x 457mm)	326268	152	326270	194
24" x 24" (610 x 610mm)	313205	168	321558	245
28" x 20" (711 x 508mm)	326269	167	326271	197

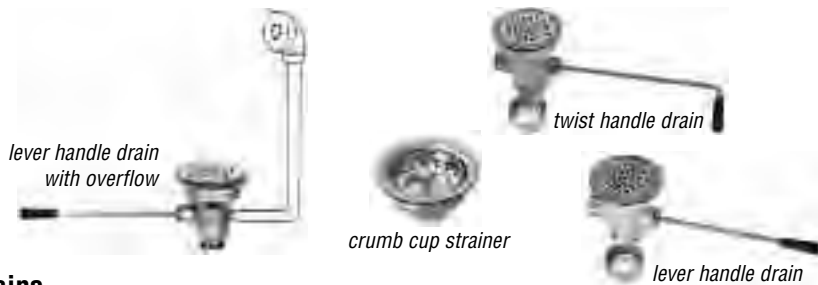

Drains

description	max. flow rate		model #	list
	gal. per minute	gal. per hour		
lever handle drain with 1.5" or 2" (38 or 51mm) NPS connection	27	1620	300720	220
lever handle drain with 2" (51mm) NPS connection	32	1920	300721	220
lever handle drain with 2" (51mm) NPS connection and overflow	32	1920	300722	452
twist handle drain with 1.5" or 2" (38 or 51mm) NPS connection	27	1620	341189 *	232
twist handle drain with 2" (51mm) NPS connection	32	1920	336002 *	232
twist handle drain with 2" (51mm) NPS connection and overflow	32	1920	341190 *	525
nickel-plated brass rotary drain with 1.5" or 2" (38 or 51mm) NPS connection	40	2400	369653	374
crumb cup strainer with 1.5" (38mm) outlet	18	1080	300287	20

* Twist handle bracket, for use with twist handle drain, should be ordered as sink option "TB" at time of sink order —or see Sink Kits on page 193 (for 314, 412, or 414 Series sinks) or page 211 (for FN Series sinks).

Control Bracket

description	model #	list each
3" x 5" (76 x 127mm), extra heavy duty	309796	66

Note: Requires custom mounting.



Leg Components

description	model #	list each
19" (483mm) stainless steel leg	300315	30
for utility sinks		
stainless steel bullet feet	300692	17
stainless steel flanged bullet feet	313835	25
plastic bullet feet	300293	2

Sink Accessories/Replacements

see spec sheet **EG20.51B**

T&S Extra Heavy Duty Faucets

- Top-of-the-line, T&S quality products.
- Splash mounted with 8" (203mm) centers.

description	model #	list
8" (203mm) spout	313920	557
10" (254mm) spout	340380	568
12" (305mm) spout	313293	571
14" (356mm) spout	313294	576

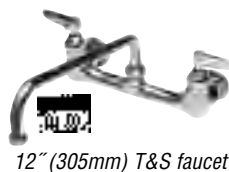

OUR BEST

T&S Extra Heavy Duty Faucet with Wrist Handles

- Top-of-the-line T&S quality.
- Deck mounted with 4" (102mm) centers.
- 4" (102mm) long wrist handles and rigid gooseneck spout.



description	model #	list
extra heavy duty	313304	569

Catalog Section 20

Sink Accessories/Replacements

see spec sheet **EG20.51B**

Standard Faucets

- 8" (203mm) centers.
- Splash mounted

description	model #	list
8" (203mm) spout, standard	313918	208
12" (305mm) spout, standard	300716	214
14" (356mm) spout, standard	300804	219
16" (406mm) spout, standard	313919	220
12" (305mm) spout, heavy duty	301001	514
14" (356mm) spout, heavy duty	301002	520
19" (489mm) double-jointed spout	301003	577
gooseneck, 8" (203mm) center	313075	153

Standard Faucets with Wrist Handles

- Deck mounted with 4" (102mm) centers.
- 4" (102mm) long wrist handles and gooseneck spout.

description	model #	list
standard, rigid gooseneck spout	301005	294
heavy duty, swivel gooseneck spout	301004	479

Prerinse Units and Components

Standard

description	model #	list
splash mounted spray unit	300719	1065
deck mounted spray unit	300718	1061
faucet add-on with 12" (305mm) spout	301189	282
wall bracket	301190	71
prerinse hose, 36" (914mm) length	313116	202
prerinse spray valve assembly for spray units #300718 and 300719	313323	174

T&S Extra Heavy Duty - Top-of-the-line. **OUR BEST**

description	model #	list
splash mounted spray unit with wall bracket	313296	1394
deck mounted spray unit with wall bracket	313295	1312
faucet add-on with 12" (305mm) spout for use with #313296 faucet	313297	347

Note: Faucets listed are lead-free AB1953-compliant.

Can be shipped UPS.

(•) MTS (made to stock) / () MTO (made to order)



19" (483mm)
double-jointed spout faucet



12" (305mm)
heavy duty faucet

Repair Kits for Standard Faucets

description	for faucets #	model #	list
hot/cold stems, handles, seats, bonnet nuts, O-rings	313918, 313919	304146	95
hot/cold ceramic cartridge	300716, 300804	368421	28



standard
wrist handle faucet



splash mounted
prerinse spray unit

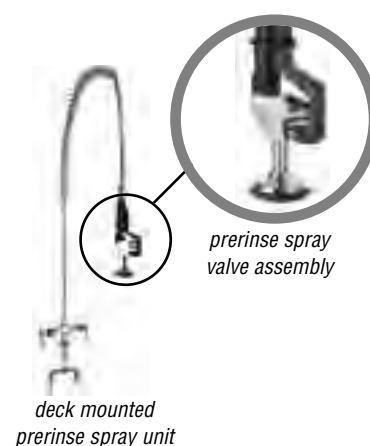

deck mounted
prerinse spray unit



prerinse wall bracket



prerinse faucet add-on

The EAGLE Advantage

Can be summed up in two concise points:

Price/Value leadership and Value-Added Service. EAGLE is committed to providing you the highest quality products while maintaining the competitiveness necessary in today's market.

Visit us at www.eaglegrp.com



100 Industrial Boulevard, Clayton, DE 19938-8903 U.S.A.
Phone: 800-637-5100 or 302-653-3000. Fax: 302-653-2065
<http://www.eaglegrp.com>

Floor Troughs

see spec sheet **EG25.00**



floor trough with subway-style grating

(see chart below for dimensions A through F)

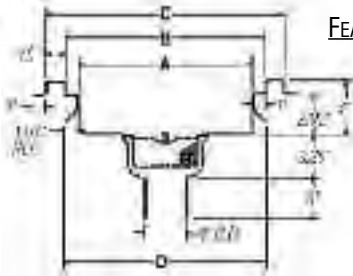

FEATURES:

- Built-in pitch towards drain ensures complete drainage.
- Secured with anchor straps.
- Stainless steel drain accommodates up to a 4" (102mm) diameter pipe, and removable perforated stainless steel basket.
- Stainless steel subway-style grating or fiberglass grating.

Note: Custom sizes available. Contact factory for pricing.

Gray Fiberglass Grating available.
To order add suffix "G" to model #.
Example FT-1218-FGG.

Freight class is 85.0.

(•) MTS (made to stock) / () MTO (made to order)

Yellow Fiberglass Grating

Note: Wide T-Bar Fiberglass Grating* available (for fiberglass only). ADA-compliant! Wider T-bar width provides a more solid walking area, and prevents objects from falling through. Resistant to corrosion, skid, fire, chipping and cracking. To order, add 5% to list price and suffix "ADA". **Example: FT-1224-FG-ADA.**

* Please note: Wide T-Bar "ADA" option is available only for troughs with fiberglass grating, not for troughs with stainless steel grating.

12" (305mm) WIDE TROUGHES	15" (381mm) WIDE TROUGHES	18" (457mm) WIDE TROUGHES	24" (610mm) WIDE TROUGHES
dimension A: 7" (178mm)	dimension A: 10" (254mm)	dimension A: 13" (330mm)	dimension A: 19" (483mm)
dimension B: 9" (229mm)	dimension B: 12" (305mm)	dimension B: 15" (381mm)	dimension B: 21" (533mm)
dimension C: 12" (305mm)	dimension C: 15" (381mm)	dimension C: 18" (457mm)	dimension C: 24" (610mm)
dimension D: 9.25" (235mm)	dimension D: 12.25" (311mm)	dimension D: 15.25" (387mm)	dimension D: 21.25" (540mm)

dimension E in. mm	dimension F in. mm	model #	list	model #	list	model #	list	model #	list
18" 457	15" 381	FT-1218-FG	1813	n/a	n/a	n/a	n/a	n/a	n/a
24" 610	21" 533	FT-1224-FG	1966	FT-1524-FG	2005	FT-1824-FG	2154	FT-2424-FG	2305
30" 762	27" 686	FT-1230-FG	2157	FT-1530-FG	2178	FT-1830-FG	2377	FT-2430-FG	2597
36" 914	33" 838	FT-1236-FG	2260	FT-1536-FG	2280	FT-1836-FG	2547	FT-2436-FG •	2800
48" 1219	45" 1143	FT-1248-FG	2594	FT-1548-FG	2626	FT-1848-FG	2949	FT-2448-FG	3288
60" 1524	57" 1448	FT-1260-FG	2809	FT-1560-FG	2932	FT-1860-FG	3294	FT-2460-FG	3769
72" 1829	69" 1753	FT-1272-FG	3173	FT-1572-FG	3236	FT-1872-FG	3681	FT-2472-FG	3803
84" 2134	81" 2057	FT-1284-FG	3471	FT-1584-FG	3569	FT-1884-FG	4110	FT-2484-FG	4738
96" 2438	93" 2362	FT-1296-FG	3789	FT-1596-FG	3852	FT-1896-FG	4488	FT-2496-FG	5185
120" 3048	117" 2972	FT-12120-FG	4420	FT-15120-FG	4663	FT-18120-FG	5437	FT-24120-FG	6306

Subway-Style Stainless Steel Grating

12" (305mm) WIDE TROUGHES	15" (381mm) WIDE TROUGHES	18" (457mm) WIDE TROUGHES	24" (610mm) WIDE TROUGHES
dimension A: 7" (178mm)	dimension A: 10" (254mm)	dimension A: 13" (330mm)	dimension A: 19" (483mm)
dimension B: 9" (229mm)	dimension B: 12" (305mm)	dimension B: 15" (381mm)	dimension B: 21" (533mm)
dimension C: 12" (305mm)	dimension C: 15" (381mm)	dimension C: 18" (457mm)	dimension C: 24" (610mm)
dimension D: 9.25" (235mm)	dimension D: 12.25" (311mm)	dimension D: 15.25" (387mm)	dimension D: 21.25" (540mm)

dimension E in. mm	dimension F in. mm	model #	list	model #	list	model #	list	model #	list
18" 457	15" 381	FT-1218-SG	2520	n/a	n/a	n/a	n/a	n/a	n/a
24" 610	21" 533	FT-1224-SG •	2643	FT-1524-SG	2811	FT-1824-SG •	2973	FT-2424-SG	3599
30" 762	27" 686	FT-1230-SG	2725	FT-1530-SG	2878	FT-1830-SG	3138	FT-2430-SG	3748
36" 914	33" 838	FT-1236-SG •	2808	FT-1536-SG	3270	FT-1836-SG •	3305	FT-2436-SG •	4273
48" 1219	45" 1143	FT-1248-SG •	3470	FT-1548-SG	3980	FT-1848-SG	3929	FT-2448-SG	4948
60" 1524	57" 1448	FT-1260-SG	4162	FT-1560-SG	4661	FT-1860-SG	4848	FT-2460-SG	5548
72" 1829	69" 1753	FT-1272-SG	4782	FT-1572-SG	5360	FT-1872-SG	5307	FT-2472-SG	6448
84" 2134	81" 2057	FT-1284-SG	5620	FT-1584-SG	6061	FT-1884-SG	6445	FT-2484-SG	7048
96" 2438	93" 2362	FT-1296-SG	5782	FT-1596-SG	6718	FT-1896-SG	6610	FT-2496-SG	7798
120" 3048	117" 2972	FT-12120-SG	7601	FT-15120-SG	8182	FT-18120-SG	8760	FT-24120-SG	9446

Anti-splash Floor Troughs

see spec sheet **EG25.01**



**Patent #
D519,618 S**

"Anti-splash" design assures complete drainage while preventing splashing back onto the floor.

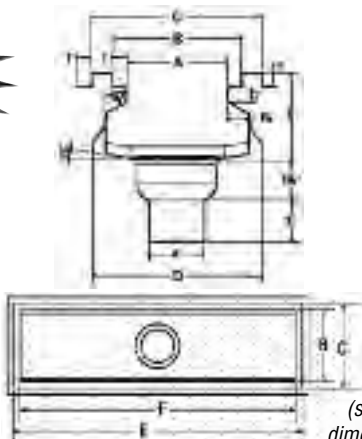

(see chart below for dimensions A through F)

- Built-in pitch towards drain ensures complete drainage.
- Secured with anchor straps.
- Stainless steel drain accommodates up to a 4" (102mm) diameter pipe, and removable perforated stainless steel basket.
- Stainless steel subway-style grating or fiberglass grating.

FEATURES:

Note: Custom sizes available. Contact factory for pricing.

Gray Fiberglass Grating available.
To order add suffix "G" to model #.
Example ASFT-1218-FGG.

Freight class is 85.0.

(•) MTS (made to stock) / () MTO (made to order)

Yellow Fiberglass Grating

Note: Wide T-Bar* Fiberglass Grating available. ADA-compliant! Wider T-bar width provides a more solid walking area, and prevents objects from falling through. Resistant to corrosion, skid, fire, chipping and cracking. To order, **add 5% to list price** and suffix **"-ADA"**. **Example: ASFT-1218-FG-ADA.**

* Please note: Wide T-Bar "ADA" option is available only for troughs with fiberglass grating, not for troughs with stainless steel grating.

12" (305mm) WIDE TROUGHES	15" (381mm) WIDE TROUGHES	18" (457mm) WIDE TROUGHES	24" (610mm) WIDE TROUGHES
dimension A: 7" (178mm)	dimension A: 10" (254mm)	dimension A: 13" (330mm)	dimension A: 19" (483mm)
dimension B: 9" (229mm)	dimension B: 12" (305mm)	dimension B: 15" (381mm)	dimension B: 21" (533mm)
dimension C: 12" (305mm)	dimension C: 15" (381mm)	dimension C: 18" (457mm)	dimension C: 24" (610mm)
dimension D: 11.25" (286mm)	dimension D: 14.25" (362mm)	dimension D: 17.25" (438mm)	dimension D: 23.25" (591mm)

dimension E in.	dimension F mm	dimension E in.	dimension F mm	model #	list	model #	list	model #	list	model #	list
18"	457	15"	381	ASFT-1218-FG	2036	n/a	n/a	n/a	n/a	n/a	n/a
24"	610	21"	533	ASFT-1224-FG	2209	ASFT-1524-FG	2253	ASFT-1824-FG	2419	ASFT-2424-FG	2590
30"	762	27"	686	ASFT-1230-FG	2425	ASFT-1530-FG	2445	ASFT-1830-FG	2671	ASFT-2430-FG	2920
36"	914	33"	838	ASFT-1236-FG	2539	ASFT-1536-FG	2561	ASFT-1836-FG	2861	ASFT-2436-FG	3147
48"	1219	45"	1143	ASFT-1248-FG	2914	ASFT-1548-FG	2949	ASFT-1848-FG	3314	ASFT-2448-FG	3695
60"	1524	57"	1448	ASFT-1260-FG	3155	ASFT-1560-FG	3297	ASFT-1860-FG	3700	ASFT-2460-FG	4233
72"	1829	69"	1753	ASFT-1272-FG	3566	ASFT-1572-FG	3637	ASFT-1872-FG	4135	ASFT-2472-FG	4275
84"	2134	81"	2057	ASFT-1284-FG	3902	ASFT-1584-FG	4009	ASFT-1884-FG	4620	ASFT-2484-FG	5325
96"	2438	93"	2362	ASFT-1296-FG	4257	ASFT-1596-FG	4329	ASFT-1896-FG	5042	ASFT-2496-FG	5824
120"	3048	117"	2972	ASFT-12120-FG	4968	ASFT-15120-FG	5239	ASFT-18120-FG	6107	ASFT-24120-FG	6731

Subway-Style Stainless Steel Grating

12" (305mm) WIDE TROUGHES	15" (381mm) WIDE TROUGHES	18" (457mm) WIDE TROUGHES	24" (610mm) WIDE TROUGHES
dimension A: 7" (178mm)	dimension A: 10" (254mm)	dimension A: 13" (330mm)	dimension A: 19" (483mm)
dimension B: 9" (229mm)	dimension B: 12" (305mm)	dimension B: 15" (381mm)	dimension B: 21" (533mm)
dimension C: 12" (305mm)	dimension C: 15" (381mm)	dimension C: 18" (457mm)	dimension C: 24" (610mm)
dimension D: 11.25" (286mm)	dimension D: 14.25" (362mm)	dimension D: 17.25" (438mm)	dimension D: 23.25" (591mm)

dimension E in.	dimension F mm	dimension E in.	dimension F mm	model #	list	model #	list	model #	list	model #	list
18"	457	15"	381	ASFT-1218-SG	2822	n/a	n/a	n/a	n/a	n/a	n/a
24"	610	21"	533	ASFT-1224-SG	2836	ASFT-1524-SG	2743	ASFT-1824-SG	3166	ASFT-2424-SG	3791
30"	762	27"	686	ASFT-1230-SG	2965	ASFT-1530-SG	3047	ASFT-1830-SG	3378	ASFT-2430-SG	4392
36"	914	33"	838	ASFT-1236-SG	3096	ASFT-1536-SG	3543	ASFT-1836-SG	3593	ASFT-2436-SG	4561
48"	1219	45"	1143	ASFT-1248-SG	3854	ASFT-1548-SG	4263	ASFT-1848-SG	4311	ASFT-2448-SG	5333
60"	1524	57"	1448	ASFT-1260-SG	4641	ASFT-1560-SG	4712	ASFT-1860-SG	5329	ASFT-2460-SG	6028
72"	1829	69"	1753	ASFT-1272-SG	5358	ASFT-1572-SG	5762	ASFT-1872-SG	5885	ASFT-2472-SG	7025
84"	2134	81"	2057	ASFT-1284-SG	6291	ASFT-1584-SG	6555	ASFT-1884-SG	7118	ASFT-2484-SG	7720
96"	2438	93"	2362	ASFT-1296-SG	6552	ASFT-1596-SG	7228	ASFT-1896-SG	7378	ASFT-2496-SG	8565
120"	3048	117"	2972	ASFT-12120-SG	8561	ASFT-15120-SG	8990	ASFT-18120-SG	9718	ASFT-24120-SG	10407



100 Industrial Boulevard, Clayton, DE 19938-8903 U.S.A.
Phone: 800-637-5100 or 302-653-3000. Fax: 302-653-2065
<http://www.eaglegrp.com>

Replacement Subway-Style Grating for Floor Troughs and Drains

see spec sheet **EG25.02**

Stainless Steel Grating

- Constructed of 3/16" x 1" (5 x 25mm) vertically positioned bars, spaced 1" (25mm) apart to allow ease of drainage.
- 13/16" (21mm) clearance between bars prevents casters on mobile equipment from wedging in grate.
- Two 5/16" (8mm) rods, set 2 1/4" (57mm) in from each edge, are welded to the bars to eliminate swaying.
- Standard on floor troughs.
- Sizes available fit floor drains up to 24" (610mm) wide.
- Grates 12" and 15" (305 and 381mm) wide feature three rods.
- Grates 21" (533mm) wide feature five rods.

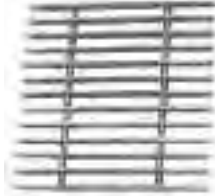

for floor trough widths		grate width x length		model #	list each
in.	mm	in.	mm		
12"	305	9" x 7 1/2"	229 x 191	341169	348
12"	305	9" x 9"	229 x 229	341117	444
12"	305	9" x 12"	229 x 305	341123	484
15"	381	12" x 9"	305 x 229	340992	529
15"	381	12" x 12"	305 x 305	331006	571
18"	457	15" x 6"	381 x 154	341330	490
18"	457	15" x 7 1/2"	381 x 191	341110	521
18"	457	15" x 9"	381 x 229	341113	559
18"	457	15" x 12"	381 x 305	336992	610
18"	457	15" x 15"	381 x 381	345934	663
24"	610	21" x 9"	533 x 229	341109	632
24"	610	21" x 11"	533 x 279	351572	677
24"	610	21" x 12"	533 x 305	336976	698

Freight class is 85.0.

(•) MTS (made to stock) / () MTO (made to order)

Wide "T" Bar Fiberglass Grating — ADA-compliant!

- Conforms with the Americans with Disabilities Act for use with the physically handicapped.
- Provides a more solid walking area than traditional "T" bar shape, and prevents objects from falling through grating.
- Corrosion-, skid- and fire-resistant.
- High strength, low thermal conductivity.
- Resistant to chipping and cracking.
- Temperature rating of 250°F.



Fiberglass Grating

- Constructed of 1" (25mm) high yellow or gray polyester material with a non-slip grit on top surface.
- Tapered "I" beam construction for ease of cleaning and draining.
- Temperature rating of 250°F.
- Other sizes available—consult factory.



GRAY OR YELLOW

for floor trough widths		grate width x length		Gray	
in.	mm	in.	mm	model #	list ea
12"	305	9" x 9"	229 x 229	370000	135
12"	305	9" x 12"	229 x 305	370001	165
12"	305	9" x 15"	229 x 381	370002	179
15"	381	12" x 9"	305 x 229	370003	142
15"	381	12" x 12"	305 x 305	370004	173
18"	457	15" x 9"	381 x 229	370005	181
18"	457	15" x 12"	381 x 305	370006	225
18"	457	15" x 15"	381 x 381	370007	279
24"	610	21" x 9"	533 x 229	370008	229
24"	610	21" x 12"	533 x 305	370009	289

for floor trough widths		grate width x length		Yellow		Gray	
in.	mm	in.	mm	model #	list ea	model #	list ea
12"	305	9" x 9"	229 x 229	362648	106	374015	115
12"	305	9" x 12"	229 x 305	362647	127	374018	138
12"	305	9" x 15"	229 x 381	373030	135	374021	146
15"	381	12" x 9"	305 x 229	362650	106	374044	115
15"	381	12" x 12"	305 x 305	362649	127	374047	138
18"	457	15" x 9"	381 x 229	362652	137	374073	148
18"	457	15" x 12"	381 x 305	362651	166	374076	180
18"	457	15" x 15"	381 x 381	373206	206	374079	224
24"	610	21" x 9"	533 x 229	362654	167	374102	181
24"	610	21" x 12"	533 x 305	362653	209	374105	227

Floor Drains

see spec sheet **EG25.00**



description	width x length in. mm	model #	list
with yellow fiberglass grating	12" x 12" 305 x 305	FD-FG	1443
with subway-style grating	12" x 12" 305 x 305	FD-SG	1922

Note: Floor opening = 11 1/2" x 11 1/2" (292 x 292)

FEATURES:

- Perforated waste cup can be inverted to double as a bee hive strainer.
- Yellow fiberglass grating or subway-style stainless steel grating.

Note: Gray Fiberglass Grating available. To order add suffix "G" to model #. Example FD-FGG.

Freight class is 85.0.

(•) MTS (made to stock) / () MTO (made to order)



SpecFAB® Custom Fabrications

Shelf Select™221
Shelf Select™ for Retail222
The SpecFAB® Division220





EAGLE's SpecFAB® Division fills the gap between standard equipment and high-cost, highly customized equipment. Depending on the custom need, configurations can be designed from pre-fab pieces by using existing components, or designed completely from scratch to match exacting consultant and architect's plans and details. This flexibility means custom equipment can be delivered faster and at a lower cost directly to the job site.

Frequently Asked Questions about Project Quotations:

How do I request a Quote?

- Standard or modified product using listed 'E' numbers from the catalog:
 - Email requests to the Customer Service Representative for your geographical area or custserv@eaglegrp.com
 - Telephone (800) 441-8440 and ask for the Customer Service Representative for your city and state.
 - Fax (302) 653-2065
 - Eagle Group, ATTN: Customer Service, 100 Industrial Blvd., Clayton, DE 19938
- Custom products not found in the catalog:
 - Email requests to quotes@eaglegrp.com
 - Fax (302) 653-2065
 - Eagle Group, ATTN: Project Quotations, 100 Industrial Blvd., Clayton, DE 19938

What to include with your request?

- Your Name and Dealer Name
- Projected Installation Date and Timeline
- Job or Project Name
- Consultant Name when Applicable
- Required Date for Quote
- Plans and Specs related to the Project
- Bid Date for Project
- Special Considerations

How long will it take to process my request for a custom quote?

- Typical lead time of 72 hours for most new incoming projects.
- Large scale projects will carry longer lead times. Please be sure to communicate required bid dates.

How can I find out the status of my custom quote request?

- Customer Service - The Customer Service representative for your area can access information regarding the status of your request via email or call (800) 441-8440.
- SpecFAB® Customer Service.
- SpecFAB® Quote Coordinator - call (800) 441-8440 and ask for the Quote Coordinator, Christina Martin, ext. 2784.
- Outgoing email signatures for quotes sent from SpecFAB® highlight the primary points of contact.

Frequently Asked Questions about Project Submittals:

How do I get a Submittal Drawing?

- Submit a purchase order for the project with plans and specifications if not previously provided to the Quotations Department.
- Provide a letter of intent for the project.
- Request quote drawings via quotes@eaglegrp.com.
- Shelf Select™ requests through quotes@eaglegrp.com.

How long will it take to receive drawings?

- Typical requests for drawings are addressed within 72-hours.
- Large scale projects will carry longer lead times. Please be sure to communicate required bid dates.
- To contact Project Submittals regarding your drawings, contact the Submittals Coordinator, Bruce Moffett at bmoffett@eaglegrp.com or (800) 441-8440, ext. 3158.
- Outgoing email signatures for drawings sent from SpecFAB® highlight the primary points of contact.

Shelf Select™ for Retail

A No-Cost Design & Layout Service for Retail Shelving by



Typical Shelf Select™ applications include retail display, floral display, department stores, and point-of-purchase items.

Provide Us With:

- Dimensions of display or storage space available.
- Number of shelves per unit.
- Post heights.
- Indicate stationary, mobile or high density shelving.
- Any additional specific or pertinent display or storage requirements.

And We'll Provide You With:

- **Plan View**
Shelving system layout makes the most efficient utilization of your space available.
- **Perspective View**
Illustrates the proposed equipment assembled in the available space.
- **Quote**
Includes model numbers, net prices and shipping weights for all components in specified job.

For more information about Shelf Select™ for Retail, request the Shelf Select™ service announcement EG8200

Simply

Email: quotes@eaglegrp.com

Fax: 302-653-2065

in your order and our trained staff will begin planning, layout and quotation upon receipt.

A completed Shelf Select™ custom layout and quotation will be mailed, emailed or faxed back to you within 48 hours.

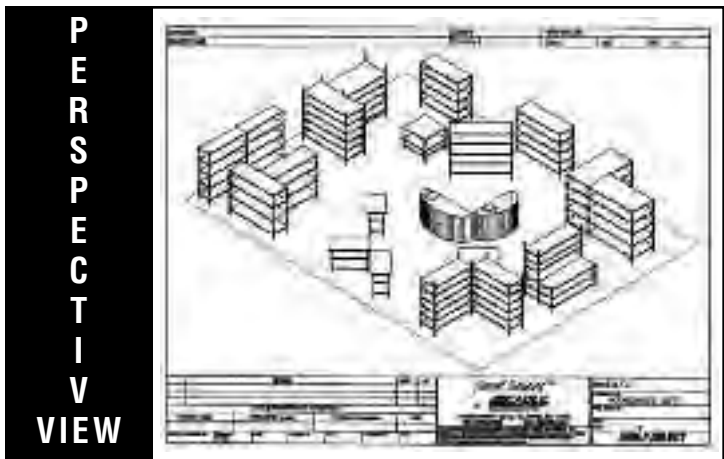
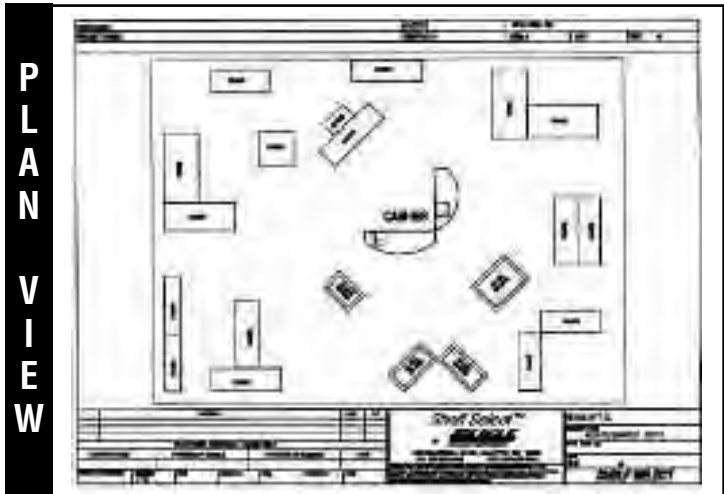

FINAL OUTCOME!