

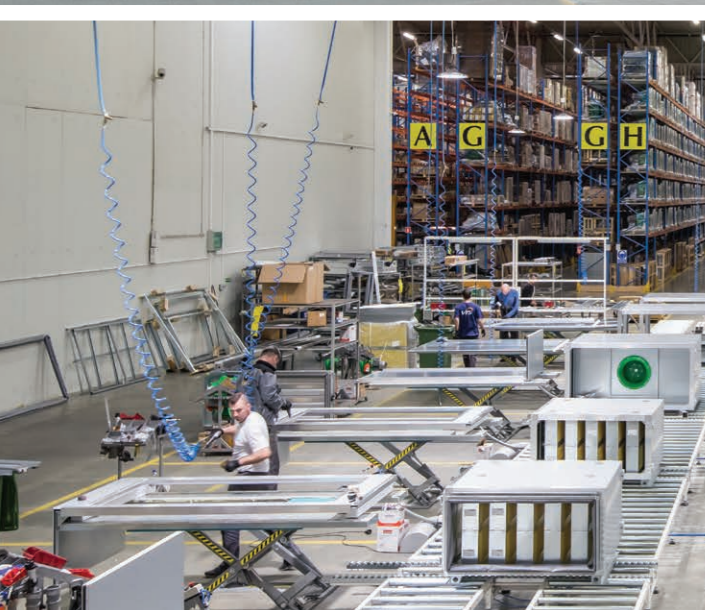

ventus

PRO
2022





 **01**
VTS Group



VTS GROUP – is a manufacturer of technically advanced HVAC equipment, combining innovative technologies in the field of research&development, production and logistics.

OUR MISSION

AHU#1

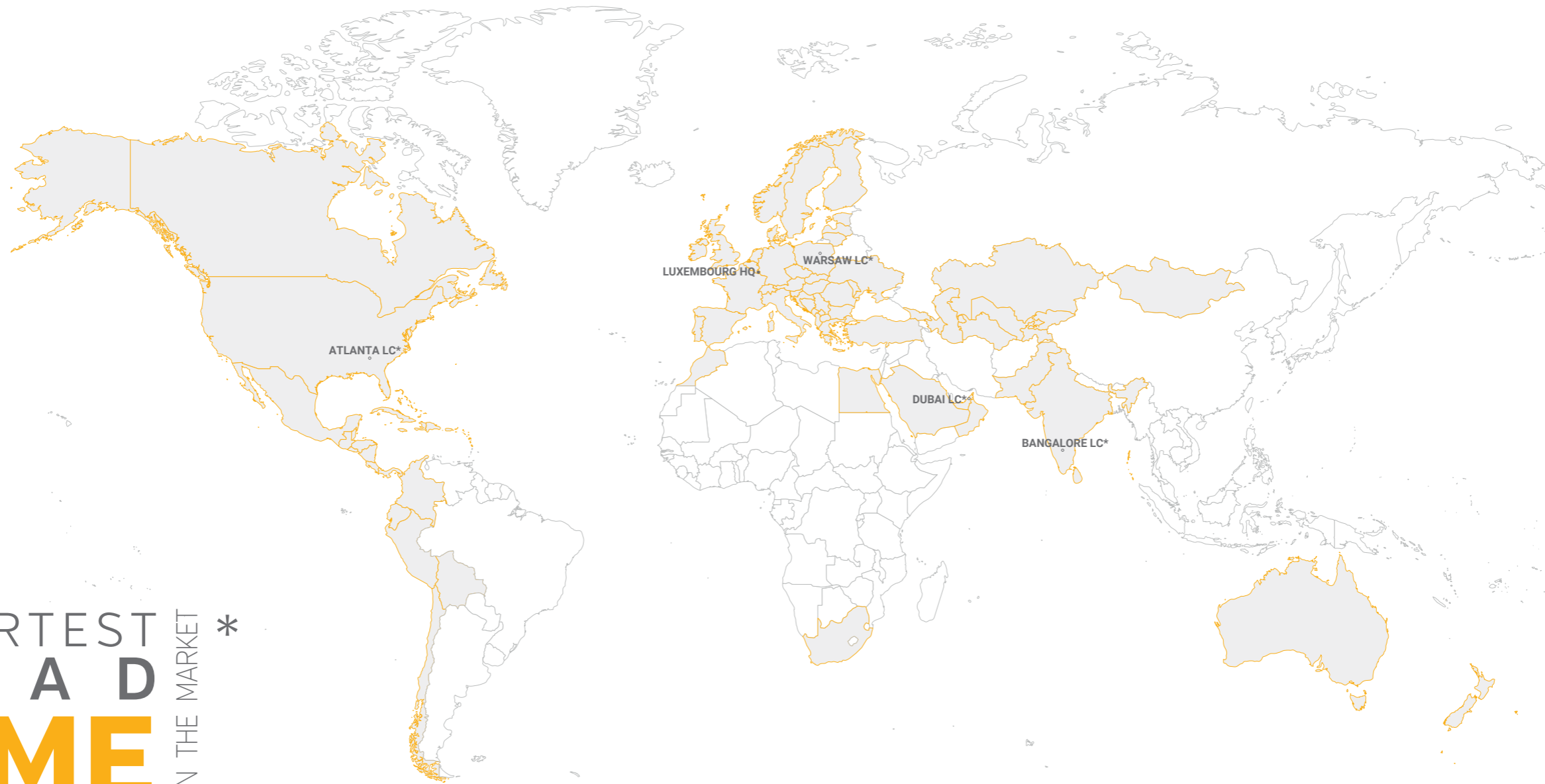

SHORTEST
LEAD
TIME ON THE MARKET *

* Logistics center





3 PILLARS OF SUCCESS

Constantly highest quality of products. Best prices on the market. Shortest lead time. These 3 pillars of marketing policy allows VTS to be always one step head, wherever in the world.

Following the best practices of the branch, VTS has created a network of 4 efficiently running production and logistic centers (**Atlanta, Dubai, Warsaw, Bangalore**), enable to ensure the shortest lead time on the market, wherever in the world.

Large-scale production of repetitive units allows VTS to offer them at **the most competitive price, simultaneously keeping their highest possible quality**

Multistage quality control system allows VTS to offer **2 years warranty.**

SHORTEST
LEAD
TIME ON THE MARKET



\$ COMPETITIVE
PRICE

150 000
UNITS
SOLD ANNUALLY

Q BEST
QUALITY

2 YEARS WARRANTY
FOR EACH
UNIT





VENTUS PRO

PRODUCT RANGE



| Series | PVS | PVS PO | PVS HY |
|----------------------------------|--|--|---|
| Typical applications | Clean rooms, laboratories, operating theaters, hospitals, pharmaceutical industry, food industry, chemical industry, electronics industry, swimming pools. | Swimming pools and places where dehumidification is necessary | Hospitals, clean room, laboratories, pharmaceutical facilities |
| Air flow range | 1 000 - 125 000 m ³ /h | 2 500 - 30 000 m ³ /h | 2 400 - 10 000 m ³ /h |
| Number of available sizes | 71 | 15 | 7 |
| Controls | <ul style="list-style-type: none"> » Plug&Play standard » Availability of industrial controllers | <ul style="list-style-type: none"> » Plug&Play standard » Availability of industrial controllers | <ul style="list-style-type: none"> » Plug&Play standard » Availability of industrial controllers |
| Important data | <ul style="list-style-type: none"> » EN 1886 Casing Classes: T2, TB2, F9, L1, D1 » Panel: 60mm high density rock wool » Galvanized, Stainless, Epoxy Inner & Outside sheet » EPA, HEPA, ULPA and electrostatic high efficiency filters | <ul style="list-style-type: none"> » Pool surface area: 61 - 732 m² » Dehumidification capacity: 18 - 212 kg/h » Cooling capacity: 13,5 - 154 kW | <ul style="list-style-type: none"> » Humidifier capacity: 15 - 90 kg/h » Refrigerant: R410A » Filters: Coarse 80% [G4] / ePM2,5 65% [F7] / ePM1 80% [F9] |



02

VENTUS PRO - PVS

CERTIFICATIONS

VTS Group air handling units meet all the comfort needs of every building with its custome design and high flexibility. Production is carried out in accordance with EN 1886 and EN13053 standards in production facilities holding ISO-9001, ISO-14001 and OHSAS-18001 certificates.

VENTUS PRO - PVS series air handling units have been approved by Eurovent.



VENTUS PRO - PVS SERIES AIR HANDLING UNITS

The casing of the VENTUS PRO - PVS AHUs is made of a steel or aluminum frame, to which "sandwich" panels made of rock wool, covered with a metal sheet on both sides, are attached. Air Handling Units are available in 71 sizes covering a flow range from 1 000 – 125 000 m³/h. A wide range of options and accessories are available. Units are manufactured in modular sections, which are easy to handling and installation.

- » 1 000 – 125 000 m³/h air flow
- » 60 mm standart panel thickness
- » 0,8 mm % 1,0 mm sheet thickness
- » Galvanized, stainless, epoxy inner & outside sheet
- » Steel & aluminum profile
- » Different & special production options



QUALITY AND STANDARTS

VENTUSPRO - PVS series air handling units optimize the indoor air quality by controlling the temperature and humidity. With flexible and environmentally friendly performance, it provides high energy savings as well as comfort.

- » 71 sizes in total
- » Flexible and multidirectional production options
- » High quality and efficiency
- » Eurovent approved performance guarantee
- » Designed in accordance with EN 1886 and EN 13053 standards

MECHANICAL PERFORMANCES ACCORDING TO EN1886 NORMS

| Brand | Range | Heat Transfer Calss | Thermal Bridge Factor | Filter Bypass Leakage | Casing Tightness -400 / + 700 pa | Mechanical Strength Class of the Casing |
|-------|------------------|---------------------|-----------------------|-----------------------|----------------------------------|---|
| VTS | VENTUS PRO - PVS | T2 | TB2 | F9 | L1 | D1 |

* Performance values certified by Eurovent

CASING ACCOUSTICAL PERFORMANCES

| HZ | 125 | 250 | 500 | 1000 | 2000 | 4000 | 8000 |
|----|-----|-----|-----|------|------|------|------|
| dB | 14 | 28 | 26 | 31 | 22 | 27 | 42 |

* Performance values certified by Eurovent

CERTIFICATE
N° 22.05.007

Air Handling Unit / Centrales de traitement d'air
Range Name / Nom de Gamme :
VENTUS PRO PVS

Granted on May 10, 2022 - Date 1ère admission 10 mai 2022

This document is valid at the date of issue - Check the current validity on:
Document valable à la date d'émission - Vérifier la validité en cours sur :
www.eurovent-certification.com

Participant/Titulaire
VTS sp. z o.o.
Al. Grunwaldzka 472
A 80-309 Gdansk, Poland

This product performance certificate is issued by Eurovent Certita Certification according to the certification rules. *Ce certificat de performance produit est délivré par Eurovent Certita Certification dans les conditions fixées par le référentiel.*

ECP AHU - « Air Handling Unit » in force at established date. *ECP AHU - « Centrales de traitement d'air » en vigueur à date d'émission.*

Pursuant to the decision notified by Eurovent Certita Certification, the right to use the mark ECP shall be granted to the beneficiary company for the above range in the conditions defined by the certification program mentioned. *En vertu de la décision notifiée par Eurovent Certita Certification, le droit d'usage de la marque ECP est accordé à la société qui en est bénéficiaire pour la gamme visée ci-dessus, dans les conditions définies par le programme de certification mentionné.*

Unless withdrawn or suspended, this certificate remains valid as long as the requirements for the certification program framework are met. The validity of this certificate is to be verified on www.eurovent-certification.com. *Sauf retrait ou suspension, ce certificat demeure valide tant que les conditions du référentiel du programme de certification sont respectées. La validité du certificat est à vérifier sur le site Internet www.eurovent-certification.com.*

THIS CERTIFICATE HAS BEEN ISSUED ON 10/05/2022
THIS CERTIFICATE IS VALID UNTIL 30/11/2022 *CE CERTIFICAT A ETE EMIS LE 10/05/2022
CE CERTIFICAT EST VALIDE JUSQU'AU 30/11/2022*

Paris, 10 mai 2022

MANAGING BOARD MEMBER / MEMBRE DIRECTOIRE

cofrac Organisme accrédité n° 5-0517
Certification Produits et Services selon la norme NF EN ISO/CEI 17065:2012
Permis d'exercice sur application de l'Accréditation PS-0517 Produits and Services Certification according to NF EN ISO/CEI 17065:2012
Scope available on www.cofrac.fr
COFRAC est signataire des accords MIA d'EA et MIA d'AF
COFRAC is signatory of EA MIA and AF MIA.
List of EA members is available on www.cofrac.fr/ea
List of AF members is available on www.cofrac.fr/af

1/2

Eurovent Certita Certification SAS au capital de 100 000 € - 48-50 rue de la Victoire 75009 Paris - FRANCE
Tel. : +33 (0)1 75 44 71 71 - 513 133 637 RCS Paris - SIRET 513 133 637 000 35 - TVA FR 59513133637
SOURCE: TEMPLATE_ECP_RANGE_REV1



SPECIFICATIONS

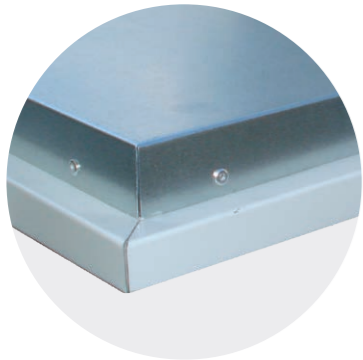

PROFILE & PANEL

- » 60 mm standard product
- » VPRO-ST / 1,2 mm steel profile
- » VPRO-AL / 1,8 mm aluminum profile
- » 0,8-1,0 mm inner & outside sheet
- » EPDM tightness joint
- » Polyamide corner piece

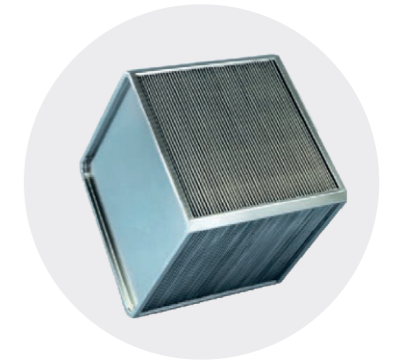

HEAT RECOVERY

- » Plate, rotary, run-around or heat-pipe options
- » Different coating options for comfort and hygiene
- » Bypass damper

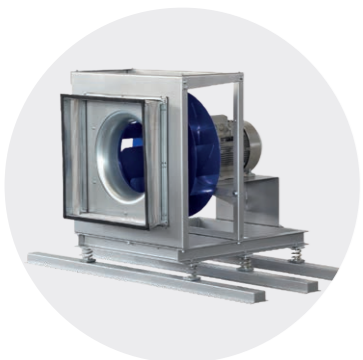

FAN & MOTOR

- » Complies with AMCA performance and sound criteria
- » PLUG, EC, Belt pulley,
- » IE3 & IE4 electric motors
- » Complies with ATEX (an option)

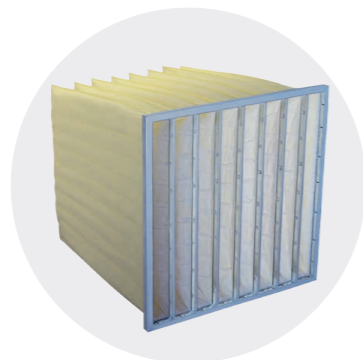

FILTER

- » Complies with ISO 16890
- » Filters: Coarse 80% (G4) / ePM2,5 65% (F7) / ePM1 80% (F9) level precise filtering
- » Filters: carbon, metal, electrostatic, EPA and HEPA



AIR DAMPER

- » Aluminum structure
- » PVC gear mechanism
- » EPDM tightness joint
- » Opposite & parallel wing



SILENCER

- » Double skinned
- » Galvanized & stainless sheet
- » Filled with high density rock wool
- » Rounded air inlet and outlet edges



COIL

- » Eurovent certified
- » Wide variety and combination
- » Different coating options for comfort and hygiene
- » Complies with DX / VRF



COMPONENTS

PROFILE & PANEL



- » Outer panel sheets are resistant to corrosive conditions with electrostatic powder painted, UV protected special PVC coating.
- » Inner surface sheets are 110 gr/m² or 275 gr/m² galvanized, stainless, epoxy or painted. Panel insulation is made with 60 mm 70 kg/m³ or 110 kg/m³ rock wool.
- » Central interior surfaces are designed without any indent or protrusion.

AIR DAMPER



- » The air dampers are made of high quality 6063 (AlMgSi0.5) extruded aluminum and have airfoil blades. The wings are covered with EPDM seals that provide the highest level of sealing when closed.
- » Dampers are installed in accordance with EN 1751 standards to ensure perfect air flow and prevent condensation.

COIL



- » Coils are selected according to the type of fluid. The battery tubes can be copper or steel, fins aluminum, copper or steel. Coating (epoxy, hydrophilic, etc.) options are available for corrosive environments.
- » All coils are tested at 20 bar pressure. There are stainless steel drain pans and PVC based drop eliminators.

FAN & MOTOR

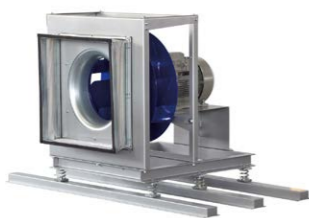

- » Fans are selected by taking into account the high efficiency, minimum energy consumption and low noise level to meet the air flow and total static pressure.
- » Depending on the area of use, the following are available:
 - impellers with forward or backward curved blades,
 - direct or belt drive,
 - PLUG or DIDW fan,
 - EC or AC motors,
- » All fans and motors can be ATEX certified EXPROOF feature
- » Fan motors are totally enclosed fan-cooled (TEFC), IP-55/56 protected and Class F insulated. Operating characteristics of motors are in accordance with IEC 60034-1 & IEC 60085. In accordance with our company standards, minimum IE3 class electric motors are used in our air handling units.



FILTER



A wide range of filters is available:

- » Coarse filters - panel or metal
 - G1 (50% ≤ Am ≤ 65%)
 - G2 (65% ≤ Am ≤ 80%)
 - G3 (80% ≤ Am ≤ 90%)
 - G4 (90% ≤ Am)
- » Medium filters - panel or pocket
 - M5 (40% ≤ Em ≤ 60%)
 - M6 (60% ≤ Em ≤ 80%)
- » Fine panel or pocket filters
 - F7 (80% ≤ Em ≤ 90%); 0.4 μm - 35%
 - F8 (90% ≤ Em ≤ 95%); 0.4 μm - 55%
 - F9 (95% ≤ Em); 0.4 μm - 70%
- » Efficient filters - EPA
 - E10 (≥85%)
 - E11 (≥95%)
 - E12 (≥99.5%)
- » High Efficient filters - HEPA
 - H13 (≥99.95%)
 - H14 (≥99.995%)
- » Ultra Low Penetration filters - ULPA
 - U15 (≥99.999 5%)
 - U16 (≥99.999 95%)
 - U17 (≥99.999 995%)

SILENCER

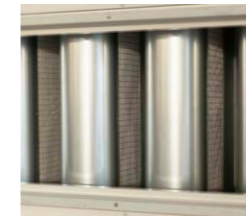

- » Optionally, silencers are placed at the entrance and exit of the air handling unit.
- » The surfaces of the silencer elements on the air inlet and outlet sides are rounded to reduce the noise created by the air flow.

ROTARY HEAT WHEEL

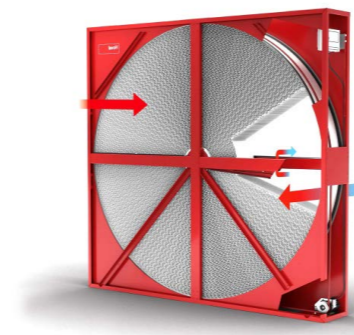

Design and application

- » Rotor is made of aluminum waves with shaft suspended on bearings, installed in steel housing.
- » Rotor filling – two layers of alternately winded aluminium foil – one flat, the other – corrugated – making small ducts for the air.
- » Purge zone reducing the cross-contamination effect of contaminated exhaust air to supply to absolute minimum.
- » Set of gaskets installed both on the wheel outer edge and bar separating supply from exhaust air being an additional protection against crosscontamination.
- » Rotary heat wheel recovers sensible heat from return air to supply, which passes the unit in opposite direction. The process enables heat recovery in winter time, same as cool recovery in summer.
- » Humidity recovery from return to supply in case the rotor pad temperature is lower than dew point of return air – typically during winter season.
- » The frame is usually made of galvanized steel. The rotor blades are made of aluminum material. Can be coated with epoxy for corrosive air condisitons.

Specification

- » Efficiency is between 60%-85%.
- » Rotor drive system with smooth revolutions control enabling to maintain highest recovery efficiency and to adjust degree of recovery performance.

PLATE CROSS-FLOW EXCHANGER

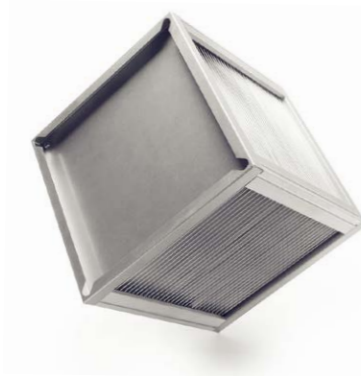

Design and application

- » Recuperator made of crosswise stamped aluminum plates, between which supply and exhaust air passes alternately in counterflow arrangement.
- » As standard, the recuperator is equipped with by-pass damper, enabling its securing against frosting and heat recovery capacity regulation.
- » The recuperator provides sensible heat recovery for warmer air to the colder one. For winter season – recovery of heat from return air to supply. For summer – recovery of chill from return air to supply.

Specification

- » Energy recovery with very high separation of supply and exhaust air streams (99.9%).
- » Heat recovery with temperature efficiency up to 76% depending on the amount of air flowing through it
- » Plates can be epoxy coated or made of stainless steel.
- » It can work in the range from -30°C to 90°C.
- » The exchanger is equipped with a condensate pan, which is made of stainless steel

RUN-AROUND COILS SYSTEM

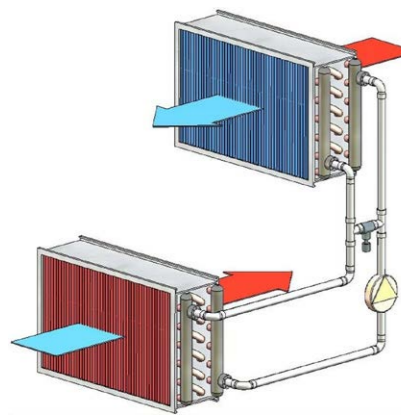

Design and application

- » Set of two water coils – one in supply, the other one in exhaust airstream.
- » The coil in return airstream recovers the heat (cooler) and passes it to the coil in the supply air (heater) by means of heat-transfer fluid (water-glycol mixture). In case of chill recovery, entire process is reversed.
- » System applied for supply and exhaust air handling units installed remotely to each other.
- » There is a circulation pump and balance tank in the circuit. A stainless double inclined condensation pan is used on the exhaust side.

Specification

- » Indirect Energy recovery (sensible heat) at 100% supply and exhaust airstreams separation.
- » Max heat-transfer fluid operation pressure: 1,6 MPa=16 bar (tested 21 bar).
- » Max glycol concentration: 50%.

HEAT-PIPE

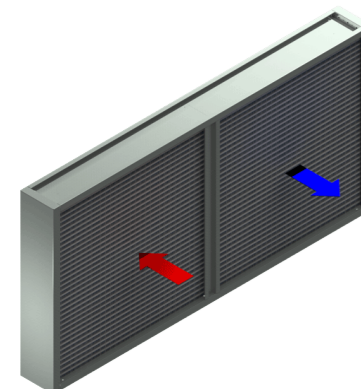

Design and application

- » Two exchangers (evaporator and condenser) connected in one closed thermodynamic system filled with refrigerant. One exchanger on the fresh air side and the other on the exhaust air side.
- » A device uses a two-phase, closed cycle to transfer heat, with the evaporation of the working fluid in the evaporator and its subsequent condensation in the condenser.
- » The heat pipe is a very efficient passive device used to transfer energy. Heat pipes let high efficient transfer at minimum temperature differences, simple structure, and easy control, and no required moving parts like a pump or compressor.
- » A heat pipe heat exchanger is utilized as an efficient air-to-air heat recovery device in both commercial and industrial applications.

Specification

- » Efficiency is between 40-60%.
- » Closed loop system
- » Unidirectional winter or summer recovery.

CONTROL PANEL

- » Both: the MCC (Micro Control Center) power panel and the DDC (Direct Digital Controller) power supply and control panel are offered.
- » The panel can be built into the AHU also as Plug & Play version (MCC & DDC) or delivered as an external power supply or power supply and control switchboard.
- » General control - temperature and humidity control for simple applications. It includes: an electronic control panel, duct temperature and humidity sensors, valve actuators, and damper actuators. Frequency converters (AC motors) can be added if required.
- » Precise control - an advanced microprocessor control system with software specially designed for the needs is used. Flow rate, temperature, humidity, filter contamination, pressure difference between spaces, etc. The location and device information can be controlled by a microprocessor.
- » The control system can be integrated with the building management system (BMS).



THE CONTROL SYSTEM CAN MANAGE THE FOLLOWING FUNCTIONS

- » Automatic selection of cooling and heating.
- » Humidity control (humidity, enthalpy).
- » Comfort enhancement or dehumidification control with the after heater.
- » The desired air flow can be adjusted according to the operating altitude and temperature.
- » Adjusting the aspirator flow according to the actual fan flow rate at the desired positive or negative pressure ratio.
- » Cleaning mode input on the controller that automatically increases the flow for fast cleaning of the room.
- » Programming of seven days of the week with 4 different daily programs (temperature, flow rate, on-off).
- » Daily, weekly work-stop time can be adjusted.
- » Flow temperature limit control (comfort temperature, condensation start temperature).
- » It can be integrated into the building automation system with all known communication languages (Modbus, BACnet, Lon-ECHOLON, LAN TCP / IP, SNMP) with an additional hardware.
- » All similar devices can be communicated as a network.
- » The control of the fans can be done parametrically, thermostatic, continuously, gradually or proportionally.



HYGIENIC AIR HANDLING UNIT

VTS Group hygienic air handling units are special devices designed to be used in hospital and clean room applications that require sensitive and sterile conditions. It can be used in operating theaters, clean rooms, pharmaceutical and chemical industry, food industry and special industrial applications where hygiene conditions are required. Hygienic air handling units are used in the health and food sector to prevent bacterias and viruses from entering the sterile environment, to create clean air that the environment needs, and to provide a positive and negative pressure balance suitable for the purpose of the sterile environment.



GENERAL FEATURES

- » Devices delivered in Plug & Play standard. With built-in power and control circuit (MCC & DDC).
- » All of the components are in a structure that does not allow the formation of a microbiological environment.
- » All connections and dampers are leakproof and of a standard to prevent condensation.
- » The panels are designed to minimize condensation (T2-TB2).
- » Internal surfaces are designed with stainless (304SS & 316SS) antibacterial structure without any indentation or protrusion. It does not accumulate dirt and dust.
- » It has a structure that prevents uninterrupted and water accumulation with the correct drainage design.
- » It is produced in a way that the hygiene structure will not deteriorate during the transportation and commissioning phase.

- ✓ EN 1886
- ✓ VDI 6022
- ✓ VDI 3803
- ✓ DIN 1946
- ✓ EN 13053

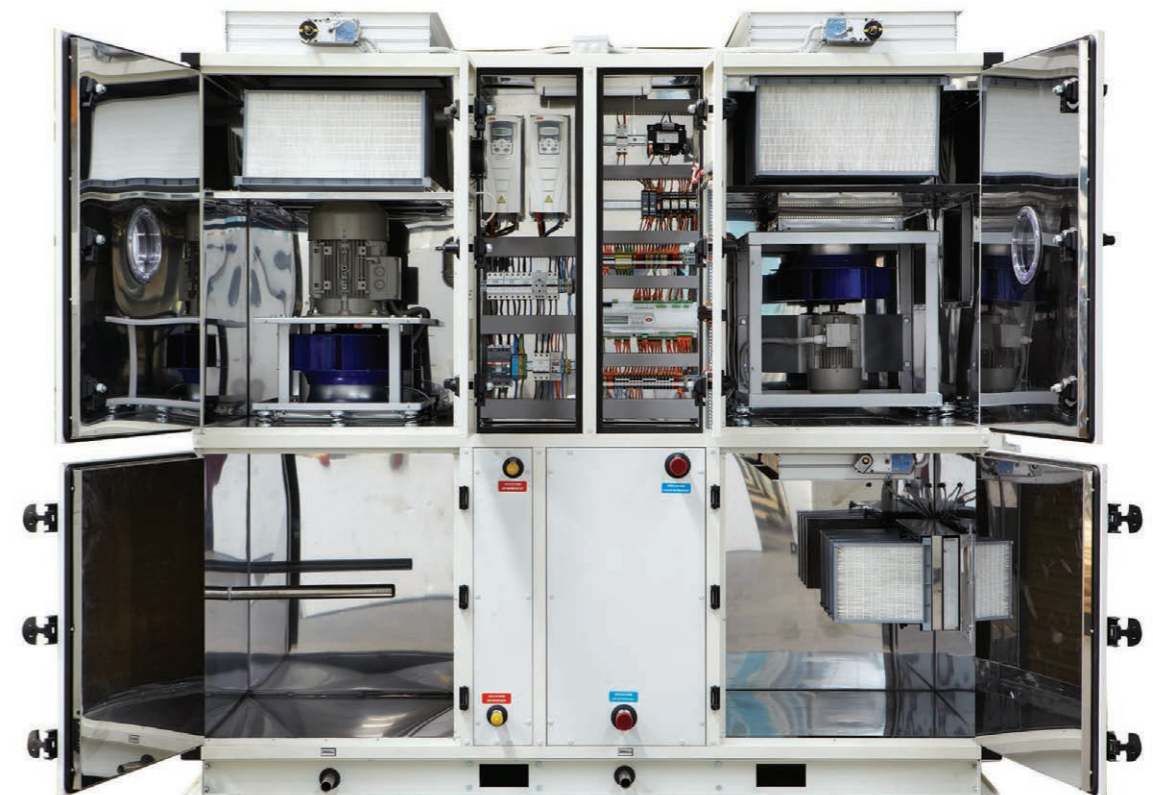

Hygienic air handling units can be also produced with different designs and components.



TECHNICAL DATA

| VENTUS PRO | Unit inner section | | Cross section | Nominal air flow rate | Max air flow rate |
|------------|--------------------|------|---------------|-----------------------|-------------------|
| | G | Y | | | |
| | mm | mm | | | |
| PVS 3x6 | 620 | 350 | 0,22 | 1719 | 2734 |
| PVS 4.5x6 | 620 | 465 | 0,29 | 2283 | 3633 |
| PVS 6x6 | 620 | 620 | 0,38 | 3044 | 4843 |
| PVS 6x9 | 930 | 620 | 0,58 | 4567 | 7265 |
| PVS 6x12 | 1240 | 620 | 0,77 | 6089 | 9687 |
| PVS 9x9 | 930 | 930 | 0,86 | 6850 | 10898 |
| PVS 9x12 | 1240 | 930 | 1,15 | 9133 | 14530 |
| PVS 9x15 | 1550 | 930 | 1,44 | 11417 | 18163 |
| PVS 12x12 | 1240 | 1240 | 1,54 | 12178 | 19374 |
| PVS 12x15 | 1550 | 1240 | 1,92 | 15222 | 24217 |
| PVS 12x18 | 1860 | 1240 | 2,31 | 18267 | 29061 |
| PVS 15x15 | 1550 | 1550 | 2,40 | 19028 | 30272 |
| PVS 15x18 | 1860 | 1550 | 2,88 | 22833 | 36326 |
| PVS 15x21 | 2170 | 1550 | 3,36 | 26639 | 42380 |
| PVS 18x18 | 1860 | 1860 | 3,46 | 27400 | 43591 |
| PVS 18x21 | 2170 | 1860 | 4,04 | 31967 | 50856 |
| PVS 21x21 | 2170 | 2170 | 4,71 | 37294 | 59332 |
| PVS 24x24 | 2480 | 2480 | 6,15 | 48711 | 77495 |
| PVS 27x27 | 2790 | 2790 | 7,78 | 61650 | 98080 |
| PVS 31x31 | 3100 | 3100 | 9,61 | 76111 | 121086 |
| PVS 34x34 | 3410 | 3410 | 11,63 | 92095 | 146514 |
| PVS 37x37 | 3720 | 3720 | 13,84 | 109600 | 174364 |
| PVS 21x40 | 4030 | 2170 | 8,75 | 69261 | 110188 |
| PVS 21x43 | 4340 | 2170 | 9,42 | 74589 | 118664 |
| PVS 24x46 | 4650 | 2480 | 11,53 | 91333 | 145303 |

NOTEBOOK

SAMPLE UNIT CONFIGURATIONS

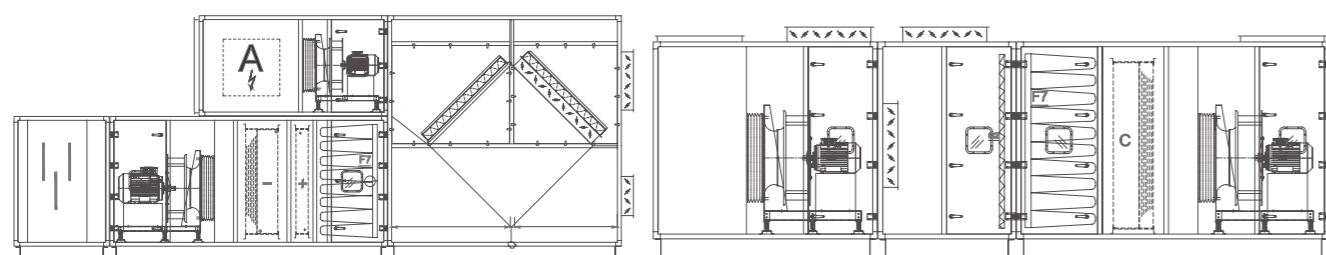



03

VENTUS PRO
- PVS PO pool
dehumidification
unit

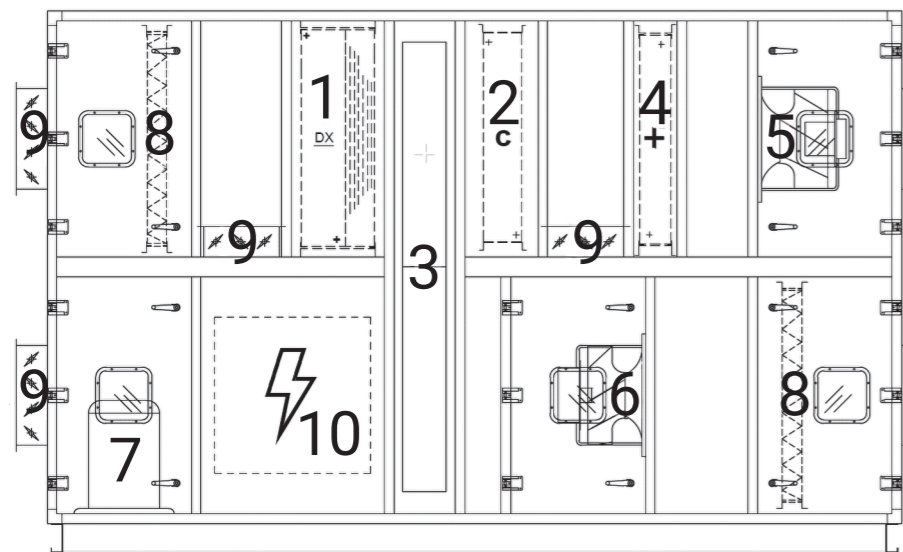

1. Direct Expansion
2. Condanser
3. Heat Pipe
4. Hot Water
5. Supply Fan
6. Exhaust Fan
7. Compressor
8. Filter
9. Damper
10. Control Panel

A version with a pre-heater is available.

PVS PO pool dehumidifiaction units are designed for indoor swimming pools and places where dehumidification is necessary. According to VDI 2089 standards the relative humidity inside the indoor pool spaces should be between 40% and 64%. If relative humidity is out of this range the formation and proliferation of microorganisms such as bacteria, virus and fungi in the environment is increased. In addition to this, the condensated chlorinated water leads to corrosion on metal and wood surfaces. This unfavourable conditions are only overcome by dehumidification and keeping relative humidity between healthy climate conditions.

COMPRESSOR WORKING AREA

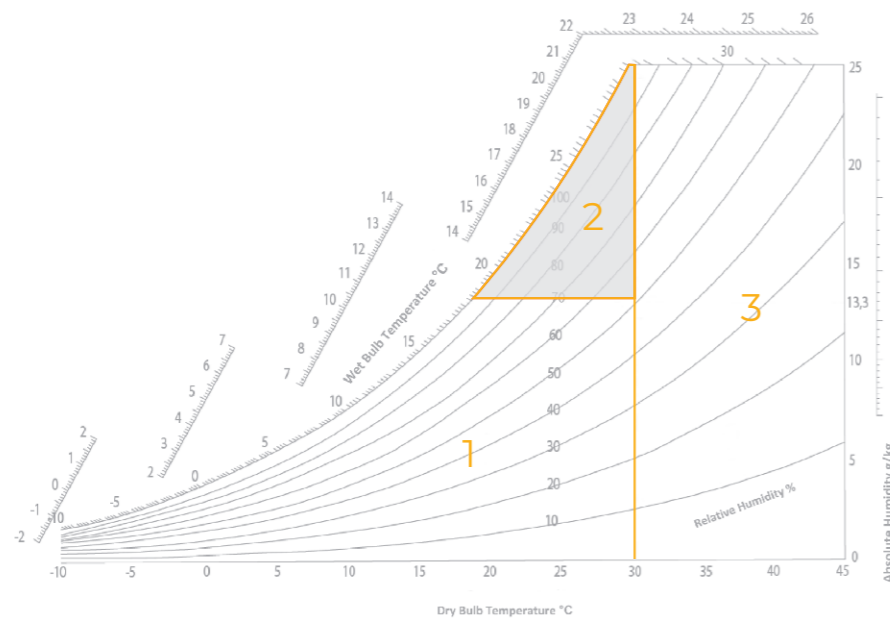

- » High efficiency with external air absolute humidity and air flow control
- » Minimum energy consumption and operating cost with mechanical cooling
- » Plate heat recovery options
- » Automatic adjustment of fresh air rate according to need

| PVS PO AC | | PVS PO 25 | PVS PO 30 | PVS PO 36 | PVS PO 50 | PVS PO 60 | PVS PO 70 | PVS PO 80 | PVS PO 100 | PVS PO 120 | PVS PO 150 | PVS PO 180 | PVS PO 200 | PVS PO 230 | PVS PO 250 | PVS PO 300 |
|-------------------------------|-------------------|-----------|-----------|-----------|-----------|-----------|-----------|-----------|------------|------------|------------|------------|------------|------------|------------|------------|
| Pool Surface Area | m ² | 61 | 73 | 88 | 122 | 146 | 171 | 195 | 244 | 293 | 366 | 439 | 488 | 562 | 610 | 732 |
| Dehumidification Capacity | kg/h | 18 | 21 | 25 | 35 | 42 | 50 | 57 | 71 | 85 | 106 | 127 | 142 | 163 | 177 | 212 |
| Air Flow | m ³ /h | 2500 | 3000 | 3600 | 5000 | 6000 | 7000 | 8000 | 10000 | 12000 | 15000 | 18000 | 20000 | 23000 | 25000 | 30000 |
| Cooling Capacity | kW | 13,5 | 14,5 | 18,2 | 24 | 29 | 35 | 39 | 47 | 58 | 70 | 80 | 90 | 110 | 124 | 154 |
| Hot Water Capacity (90-70 °C) | kW | 26 | 30 | 36 | 48 | 57 | 63 | 78 | 96 | 113 | 147 | 162 | 185 | 222 | 233 | 279 |
| Compressor Type (R407C) | | Scroll | | | | | | | | | | | | | | |
| Compressor Quantity | adet | 1 | 1 | 1 | 2 | 2 | 1 | 2 | 2 | 2 | 2 | 3 | 3 | 3 | 2 | 2 |
| Compressor Power | kW | 4,5 | 4,1 | 5,7 | 6,4 | 8,3 | 10,3 | 10,4 | 13,4 | 17 | 20,4 | 22,7 | 25 | 30 | 33,4 | 41,8 |
| Supply Fan External Pressure | Pa | 300 | | | | | | | | | | | | | | |
| Exhaust Fan External Pressure | Pa | 300 | | | | | | | | | | | | | | |
| Supply Fan Motor Power | kW | 1,1 | 1,1 | 1,1 | 1,5 | 2,2 | 2,2 | 3 | 3 | 3 | 4 | 7,5 | 7,5 | 7,5 | 7,5 | 11 |
| Exhaust Fan Motor Power | kW | 0,75 | 0,75 | 0,75 | 1,1 | 1,5 | 2,2 | 2,2 | 4 | 4 | 4 | 5,5 | 7,5 | 7,5 | 7,5 | 7,5 |

Pool Dehumidification Units;

- Designed for 30°C DB and 54% RH comfort, -3°C and 90% outdoor weather conditions.
- Dehumidification capacity is calculated according to the 8,5g / kg (dry air) value of the blowing air.

| PVS PO EC | | PVS PO 25 | PVS PO 30 | PVS PO 36 | PVS PO 50 | PVS PO 60 | PVS PO 70 | PVS PO 80 | PVS PO 100 | PVS PO 120 | PVS PO 150 | PVS PO 180 | PVS PO 200 | PVS PO 230 | PVS PO 250 | PVS PO 300 |
|-------------------------------|-------------------|-----------|-----------|-----------|-----------|-----------|-----------|-----------|------------|------------|------------|------------|------------|------------|------------|------------|
| Pool Surface Area | m ² | 61 | 73 | 88 | 122 | 146 | 171 | 195 | 244 | 293 | 366 | 439 | 488 | 562 | 610 | 732 |
| Dehumidification Capacity | kg/h | 18 | 21 | 25 | 35 | 42 | 50 | 57 | 71 | 85 | 106 | 127 | 142 | 163 | 177 | 212 |
| Air Flow | m ³ /h | 2500 | 3000 | 3600 | 5000 | 6000 | 7000 | 8000 | 10000 | 12000 | 15000 | 18000 | 20000 | 23000 | 25000 | 30000 |
| Cooling Capacity | kW | 13,5 | 14,5 | 18,2 | 24 | 29 | 35 | 39 | 47 | 58 | 70 | 80 | 90 | 110 | 124 | 154 |
| Hot Water Capacity (90-70 °C) | kW | 26 | 30 | 36 | 48 | 57 | 63 | 78 | 96 | 113 | 147 | 162 | 185 | 222 | 233 | 279 |
| Compressor Type (R407C) | | Scroll | | | | | | | | | | | | | | |
| Compressor Quantity | adet | 1 | 1 | 1 | 2 | 2 | 1 | 2 | 2 | 2 | 2 | 3 | 3 | 3 | 2 | 2 |
| Compressor Power | kW | 4,5 | 4,1 | 5,7 | 6,4 | 8,3 | 10,3 | 10,4 | 13,4 | 17,0 | 20,4 | 22,7 | 25,0 | 30,0 | 33,4 | 41,8 |
| Supply Fan External Pressure | Pa | 300 | | | | | | | | | | | | | | |
| Exhaust Fan External Pressure | Pa | 300 | | | | | | | | | | | | | | |
| Supply Fan Motor Power | kW | 1,05 | 1,20 | 1,20 | 2,95 | 2,50 | 2,50 | 2,90 | 3,40 | 3,30 | 5,00 | 6,90 | 6,90 | 6,60 | 11,40 | 10,00 |
| Exhaust Fan Motor Power | kW | 0,75 | 1,20 | 1,20 | 1,80 | 2,95 | 2,50 | 2,50 | 2,90 | 3,45 | 5,00 | 5,80 | 5,80 | 6,90 | 6,60 | 10,00 |

Pool Dehumidification Units;

- Designed for 30°C DB and 54% RH comfort, -3°C and 90% outdoor weather conditions.
- Dehumidification capacity is calculated according to the 8,5g / kg (dry air) value of the blowing air.

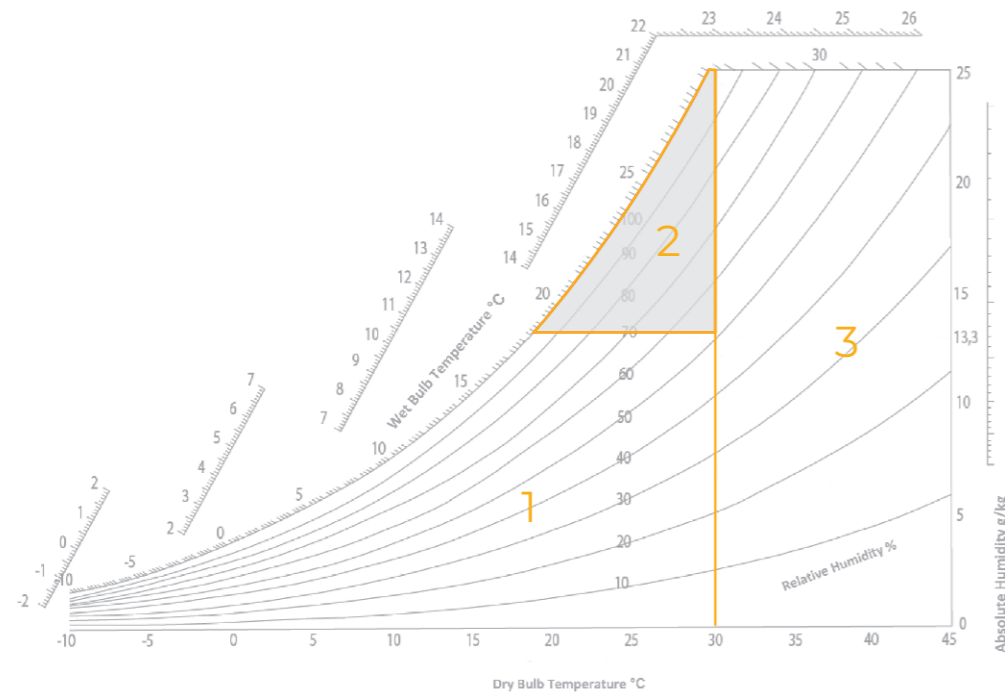

1- LOW OUTDOOR AIR TEMPERATURE AND LOW OUTDOOR ABSOLUTE HUMIDITY

- » Outdoor absolute humidity value is lower than 13,3 gr/kg.
- » Outdoor dry bulb temperature is lower than 30°C.
- » 1st operation mode is active.
- » Bypass damper is active
- » Compressors are off.
- » Dehumidification process with fresh air mixture.
- » Heating process with heat-pipe, if needed hot water heater gets activated as well.

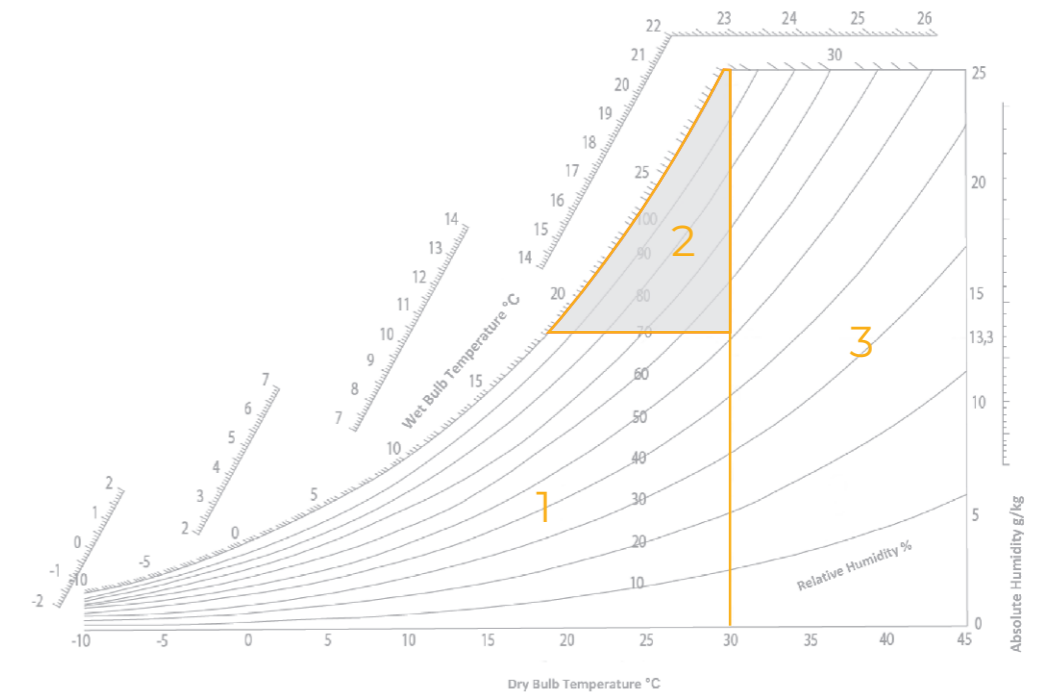
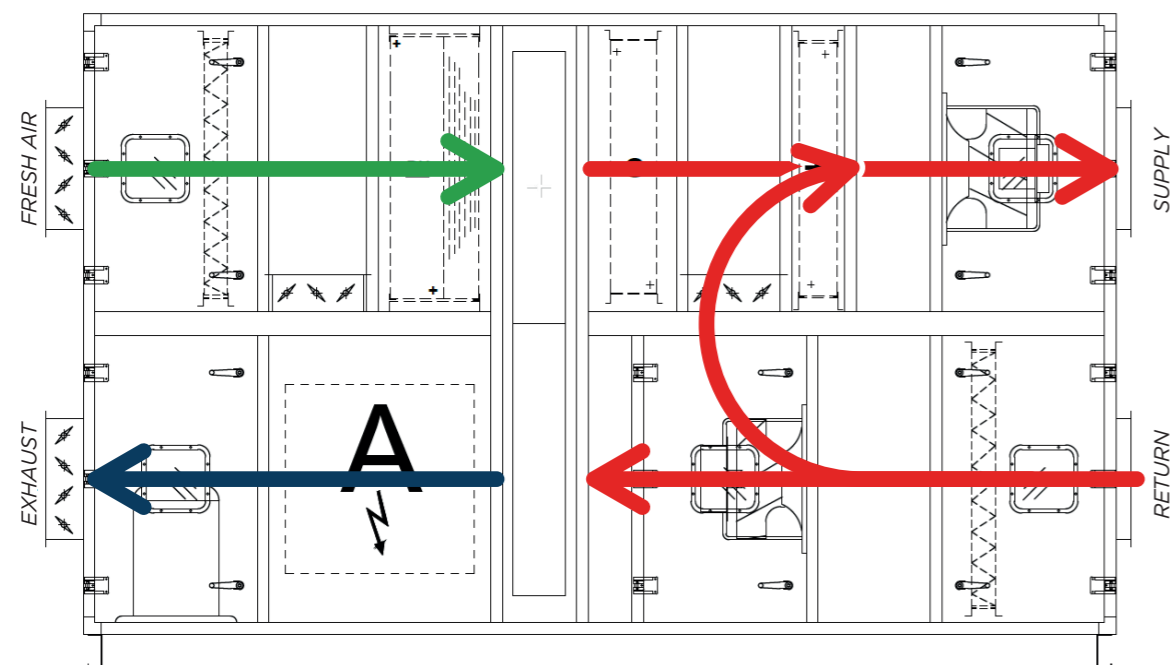

2- LOW OUTDOOR AIR TEMPERATURE AND HIGH OUTDOOR ABSOLUTE HUMIDITY

- » Outdoor absolute humidity value is higher than 13,3 gr/kg.
- » Outdoor dry bulb temperature is lower than 30°C.
- » 2nd operation mode is active.
- » Proportional mixing damper is active.
- » Compressors are on.
- » Dehumidification process with cooling and condensation of fresh air mixture.

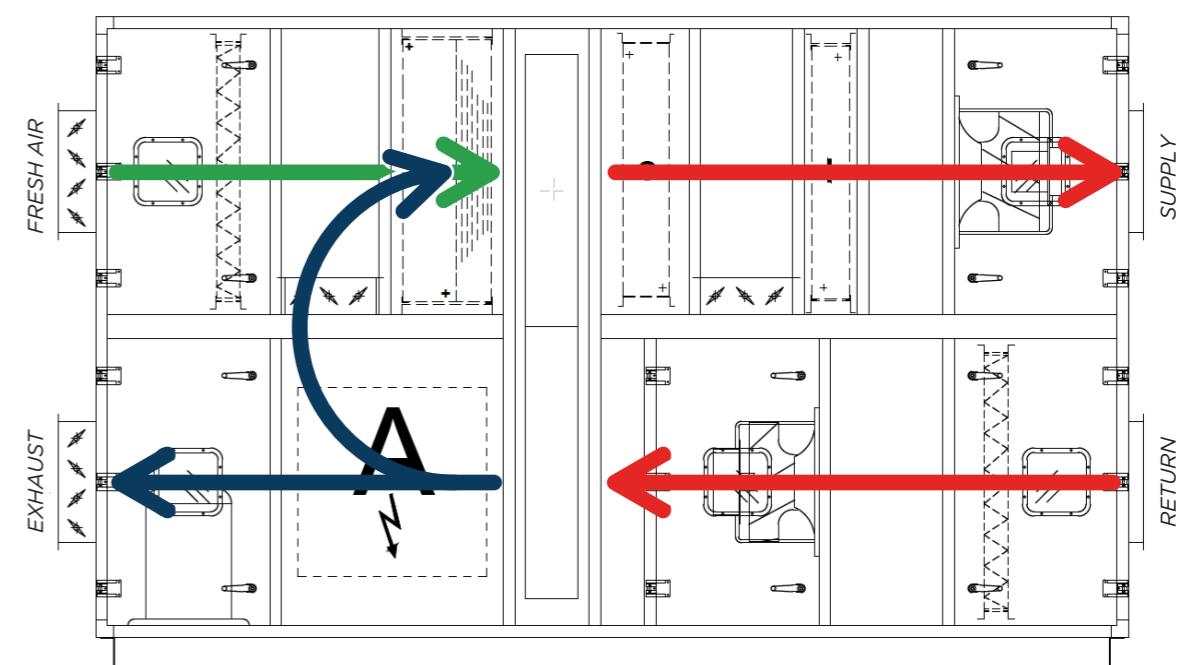

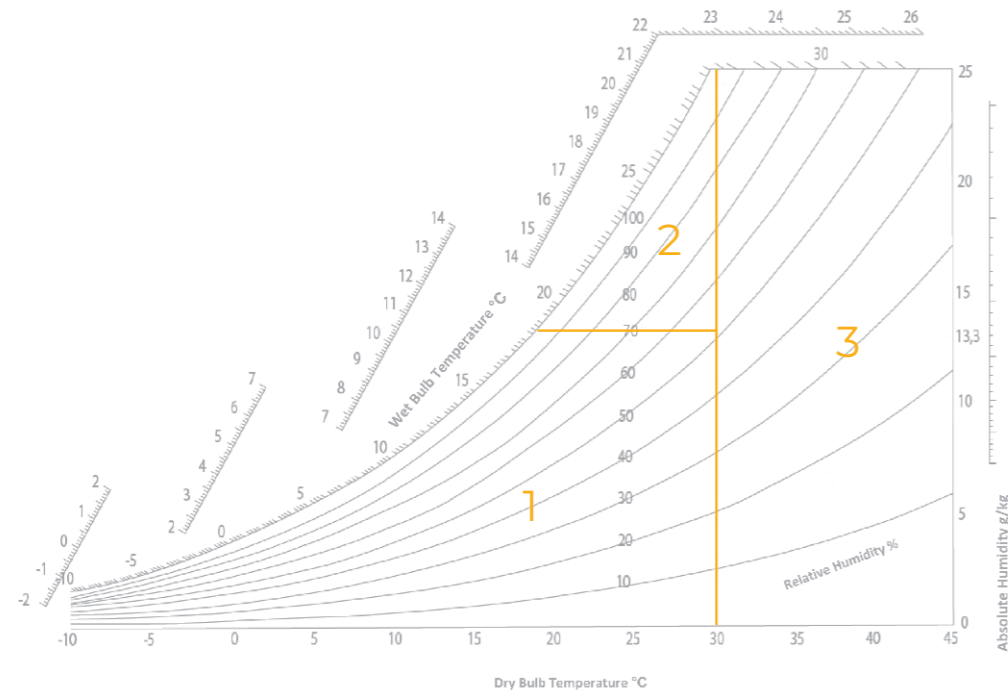

3- HIGH OUTDOOR AIR TEMPERATURE AND LOW OUTDOOR ABSOLUTE HUMIDITY

- » Outdoor absolute humidity value is lower than 13,3 gr/kg.
- » Outdoor dry bulb temperature is higher than 30°C.
- » 3rd operation mode is active.
- » Bypass damper and proportional mixing damper is deactive.
- » Compressors are off.

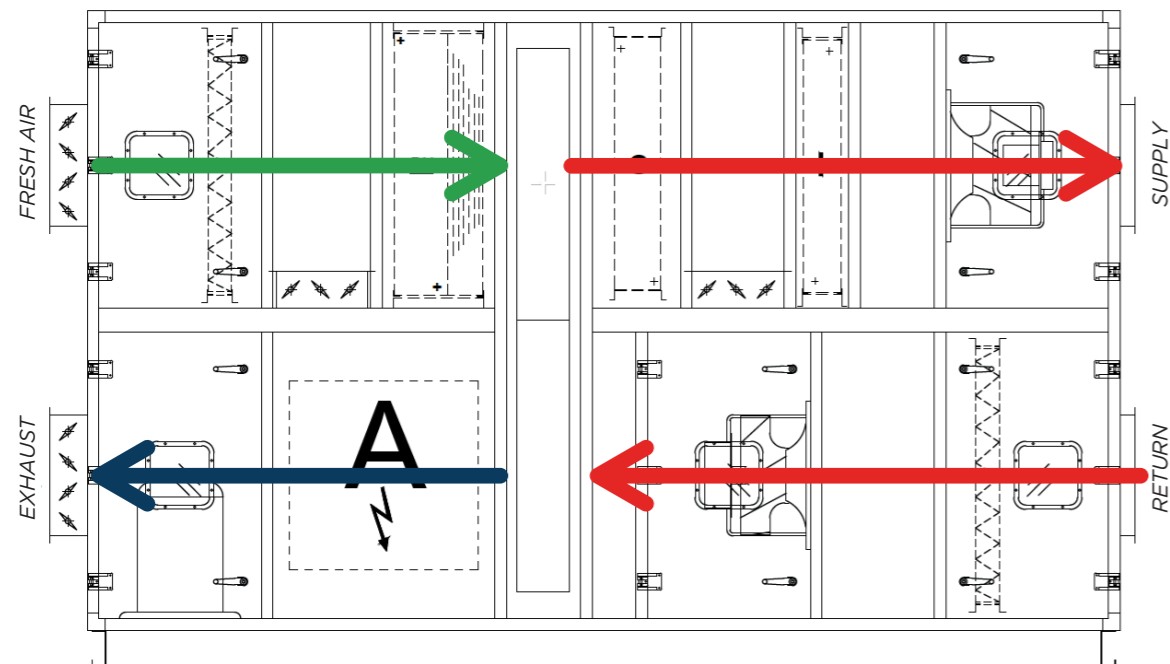

SPECIFICATIONS

- » High efficient with different operation scenarios depending on the outdoor and indoor air absolute humidity and temperature.
- » Minimum energy consumption and operating cost.
- » Fully automatic operation with internal automation system.
- » Automatic adjustment of fresh air ratio according to need.
- » High efficient heat pipe heat recovery system to minimize energy consumption and operating costs.
- » When the absolute humidity is low, the amount of fresh air can be automatically adjusted by proportionally operated dampers and the dehumidification can be done automatically with fresh air without starting the compressors.
- » Air flow adjustment and realtime constant air flow function with supply and exhaust plug fans.
- » High efficient cooling circuit with scroll type hermetic compressors.
- » Low pressure and high efficient coil in copper tube/ aluminum fin type.
- » Epoxy coated interior surface and coils.

CONTROL PANEL

- » Automatic switching between fresh air and dehumidification functions
- » On/off function with external signal
- » Constant pressure or constant flow control
- » Switching between automatic or manual modes
- » Night mode operation function
- » Supply air temperature upper-lower limit function
- » Filter contamination information function
- » Calendar function
- » Communication: ModBus or BacNet
- » Audible and visual alarm function



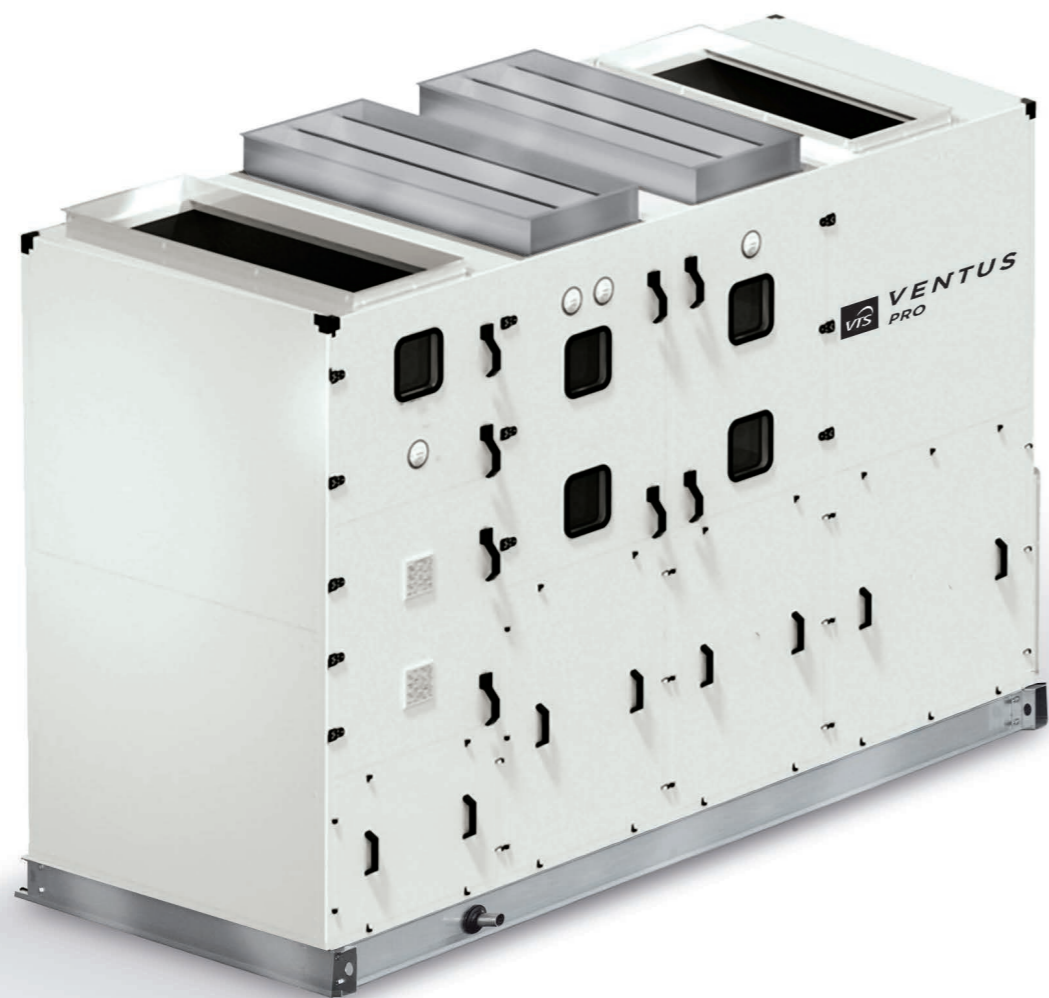

04

VENTUS PRO
- PVS HY
package hygienic
air handling unit

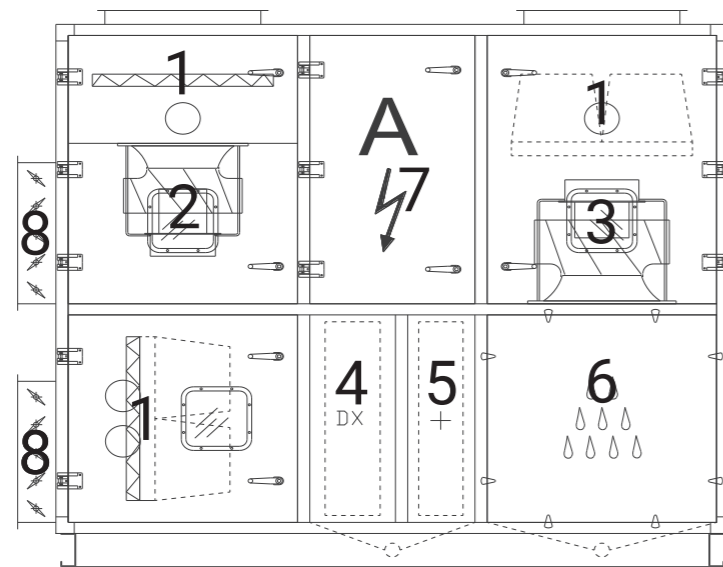
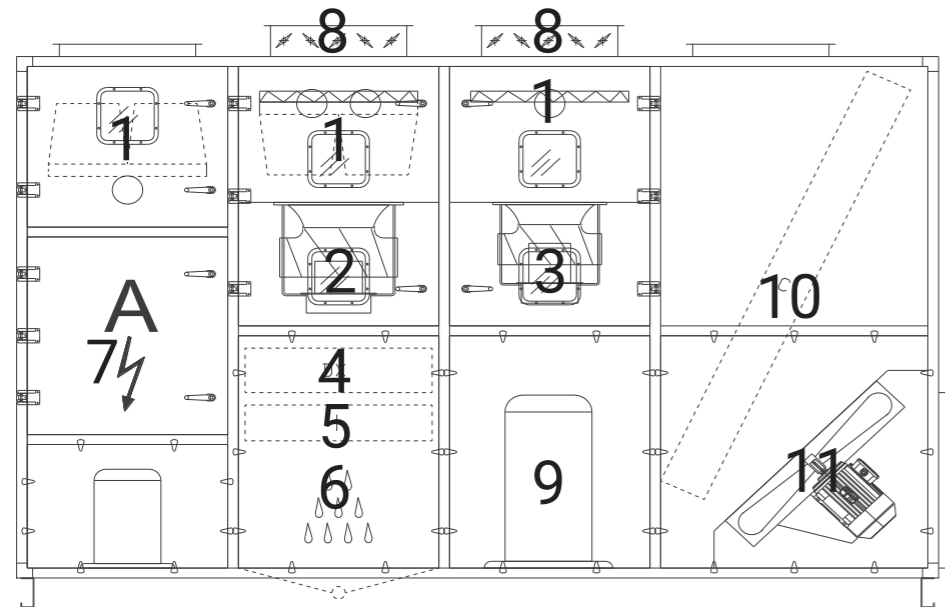

- 1. Filter
- 2. Supply Fan
- 3. Exhaust Fan
- 4. Direct Expansion
- 5. Hot Water Coil
- 6. Steam Humidifier
- 7. Control Panel
- 8. Damper
- 9. Compressor
- 10. Condenser Coil
- 11. Condenser Fan

VENTUS PRO - PVS HY package hygienic air handling units are special devices designed to be used in hospital and clean room applications that require sensitive and sterile conditions. It can be used in operating theaters, clean rooms, pharmaceutical and chemical industry, food industry and special industrial applications where hygiene conditions are required. VENTUS PRO - PVS HY package hygienic air handling units are used in the health and food sector to prevent bacteria and viruses from entering the sterile environment, to create clean air that the environment needs, and to provide a positive and negative pressure balance in accordance with the purpose of the sterile environment. Packaged hygienic air handling units designed as modular compact are produced in 2 different types as standard, in the range of 2400 - 10.000 m³/h.

| PVS HY C | | PVS HY C24 | PVS HY C36 | PVS HY C48 | PVS HY C60 | PVS HY C72 | PVS HY C84 | PVS HY C100 |
|---|-------------------|--------------|------------|------------|------------|------------|------------|-------------|
| Air Flow | m ³ /h | 2 400 | 3 600 | 4 800 | 6 000 | 7 200 | 8 400 | 10 000 |
| Exhaust External Static Pressure | Pa | 495 | 330 | 580 | 420 | 655 | 740 | 440 |
| Supply External Static Pressure | Pa | 1090 | 900 | 990 | 940 | 1270 | 1115 | 1030 |
| Total Current | A | 18 | 21 | 32 | 39 | 41 | 52 | 60 |
| Total Power | kW | 10 | 12 | 19 | 23 | 24 | 30 | 35 |
| Power Supply | V / Hz / ~ | 380 / 50 / 3 | | | | | | |
| Cooling Capacity | kW | 27,8 | 40,7 | 56,81 | 73,7 | 79,6 | 94,6 | 123,1 |
| Hot Water Capacity (90 - 70°C) | kW | 32,3 | 53,0 | 67,3 | 83,6 | 100,7 | 114,0 | 139,2 |
| Humidifier Capacity | kg/h | 15 | 30 | 40 | 50 | 60 | 75 | 90 |
| Compressor Type | - | SCROLL | | | | | | |
| Compressor Quantity | n | 2 | | | | | | |
| Refrigerant | - | R410A | | | | | | |
| Filters | - | G4 / F7 / F9 | | | | | | |

Designed for summer: 37°C - 38.5% Rh / Winter: 0°C - 80% Rh conditions.

| PVS HY | | PVS HY 24 | PVS HY 36 | PVS HY 48 | PVS HY 60 | PVS HY 72 | PVS HY 84 | PVS HY 100 |
|---|-------------------|--------------|-----------|-----------|-----------|-----------|-----------|------------|
| Air Flow | m ³ /h | 2 400 | 3 600 | 4 800 | 6 000 | 7 200 | 8 400 | 10 000 |
| Exhaust External Static Pressure | Pa | 495 | 330 | 580 | 420 | 655 | 740 | 440 |
| Supply External Static Pressure | Pa | 1090 | 900 | 990 | 940 | 1270 | 1115 | 1030 |
| Total Current | A | 6 | 6 | 7 | 9 | 12 | 13 | 14 |
| Total Power | kW | 3 | 3 | 5 | 6 | 8 | 9 | 9 |
| Power Supply | V / Hz / ~ | 380 / 50 / 3 | | | | | | |
| Cooling Capacity | kW | 27,8 | 40,7 | 56,81 | 73,7 | 79,6 | 94,6 | 123,1 |
| Hot Water Capacity (90 - 70°C) | kW | 32,3 | 53,0 | 67,3 | 83,6 | 100,7 | 114,0 | 139,2 |
| Humidifier Capacity | kg/h | 15 | 30 | 40 | 50 | 60 | 75 | 90 |
| Refrigerant | - | R410A | | | | | | |
| Filters | - | G4 / F7 / F9 | | | | | | |

Designed for summer: 37°C - 38.5% Rh / Winter: 0°C - 80% Rh conditions.

SPECIFICATIONS

1. 7 different volume and capacity,
2. Low pressure and high efficient coil in copper tube / aluminum fin type,
3. High efficient EC plug fan,
4. Stainless inner surface,
5. 60 mm rock wool for heat and sound insulation,
6. Environmentally friendly R410A gas,
7. High efficient scroll compressor and condenser fans,
8. Plug & Play.

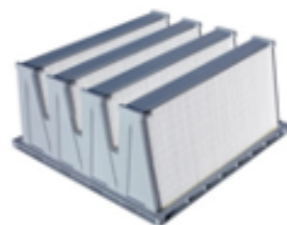

1. Humidity control (humidity, enthalpy),
2. Heating and cooling control,
3. Increasing comfort or dehumidification control with the after heater,
4. To detect the pollution of all filters used separately and to generate alarm information,
5. Constant flow rate and pressure function,
6. Programming of seven days of the week (temperature, flow rate, on-off),
7. Blow temperature limit control (comfort temperature, condensation initial temperature),
8. It can be integrated into the Building Management System with all known communication languages (Modbus, BACnet, Lon-ECHLON, LAN TCP / IP, SNMP) with an additional hardware.
9. With an additional hardware, the whole system can be connected to a central computer, managed, and accessible from the Internet,
10. It is possible to see and change all parameters with the terminal on it,
11. All similar devices can be communicated as a network,
12. Operation and configuration parameters can be encrypted,
13. Audible and visual alarm information is given,
14. Daily, weekly work-stop time can be adjusted,
15. When the device configuration changes, a new configuration can be easily defined parametrically (adding humidifier, valve-damper control changes, dehumidification, changing the fan control type, etc.),
16. Temperature control can be done parametrically, proportional, proportional + integral or proportional + integral + derivative.
17. All kind of alarms information are kept in memory (differential pressure switches, thermal, sensor, emergency stop, etc.).



PVS HY C DIMENSIONS

| PVS HY C | | L | W | H | A | B | C | F |
|------------|----|------|------|------|------|-----|-----|------|
| 24 | mm | 3000 | 835 | 2060 | 660 | 410 | 610 | 2310 |
| 36 | mm | 3000 | 1145 | 2060 | 970 | 410 | 610 | 2310 |
| 48 | mm | 3350 | 1455 | 2110 | 1280 | 510 | 710 | 2360 |
| 60 | mm | 3450 | 1455 | 2110 | 1280 | 510 | 710 | 2360 |
| 72 | mm | 3450 | 1765 | 2310 | 1590 | 510 | 710 | 2560 |
| 84 | mm | 3450 | 1765 | 2310 | 1590 | 510 | 710 | 2560 |
| 100 | mm | 4200 | 2075 | 2360 | 1900 | 710 | 710 | 2610 |

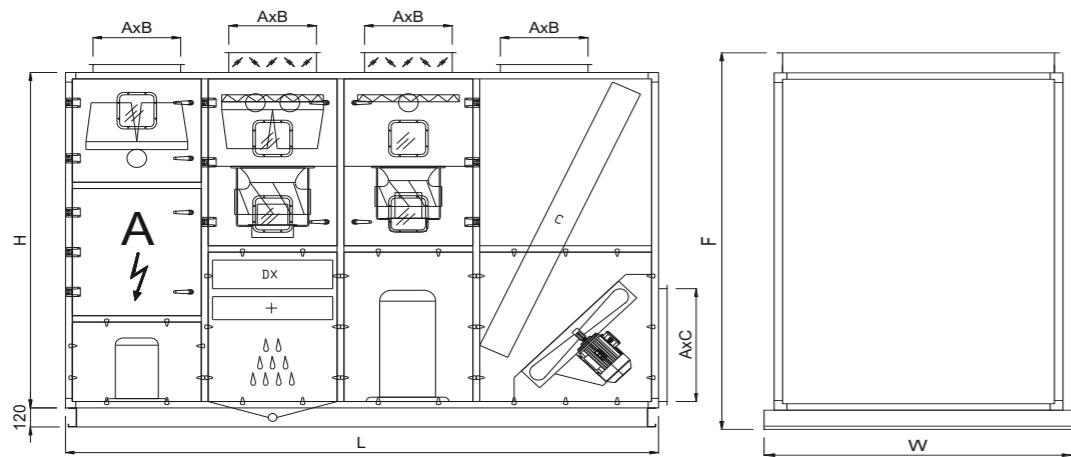

PVS HY DIMENSIONS

| PVS HY | | L | W | H | A | B | C |
|------------|----|------|------|------|------|-----|------|
| 24 | mm | 2000 | 835 | 1750 | 660 | 410 | 1920 |
| 36 | mm | 2000 | 1145 | 1750 | 970 | 410 | 1920 |
| 48 | mm | 2200 | 1455 | 1840 | 1280 | 510 | 2010 |
| 60 | mm | 2200 | 1455 | 1840 | 1280 | 510 | 2010 |
| 72 | mm | 2200 | 1765 | 1970 | 1590 | 510 | 2140 |
| 84 | mm | 2200 | 1765 | 1970 | 1590 | 510 | 2140 |
| 100 | mm | 2640 | 2075 | 2370 | 1900 | 710 | 2540 |

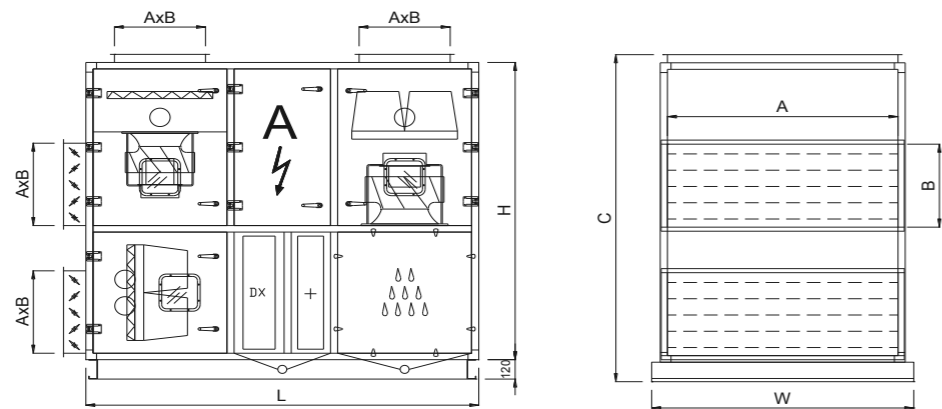

NOTEBOOK



05

FVS
Fancoil Units



FVS SERIES FANCOIL UNITS

FVS FCU is designed as a ceiling concealed hydronic water duct fan coil unit. It has modern appearance, compact structure, low noise and large cooling (and optionally heating) capacity. A fan coil unit (FCU) contains a fan which draws the air in a space into the unit then blows it over a cold or hot coil. The air comes out of the FCU either chilled or warmer than before. Air filters at the FCU inlet catch contamination from drawn air. The FCU is not designed to handle fresh air. They are used in buildings where multiple small spaces require individual control. Usually they are applicable in hospitals, business centers, hotels, residences, shopping centres. Concealed ceiling type fan coils are produced in 2 types as standard and high pressure.

FVS-DL series is designed for standard ESP fancoil

- » FVS-DL are produced in 13 models with 2 pipes (cooler or heater) and 4 pipes (cooler and heater).

FVS-YB series is designed for high pressure fancoil

- » FVS-YB is produced in 5 models with 2 pipes (cooler or heater) and 4 pipes (cooler and heater).

MODERN AND ENERGY SAVING DESIGN

- » Low energy consumption
- » High comfort of use
- » Low noise level
- » Compact and original design
- » Easy assembly
- » Electronic control option

TECHNICAL SPECIFICATIONS

CASE

A galvanized steel sheet is used in fan coil units of the FVS FCU series. The case structure is designed in such a way as to be very durable and resistant to deformation, and prevent the occurrence of vibrations.

The condensation tray is used in all 2-pipe and 4-pipe models. PE insulation is used in the condensation tray and on the outer surface of the main housing after the cooler to prevent condensation. The applied insulation also reduces the level of sound generated by the fan, what ensures quiet operation of the whole device.

FANS

As a standard, radial fans with static and dynamic balance, maximum efficiency and optimum sound level with 3-speed directly coupled motors are used.

COIL

Copper pipe - aluminum fins and brass collector battery with low pressure losses are used as standard. In addition, the battery is positioned at an angle of 45° to the blowing direction in order to obtain maximum efficiency from the device.

FILTER

Through to specially designed slides, anti-bacterial filters are used, which can be removed and installed and can also be washed.

ACCESSORIES

Heating coil for 4-pipe fancoil. Wall mounted analog thermostat. Wall mounted digital thermostat.

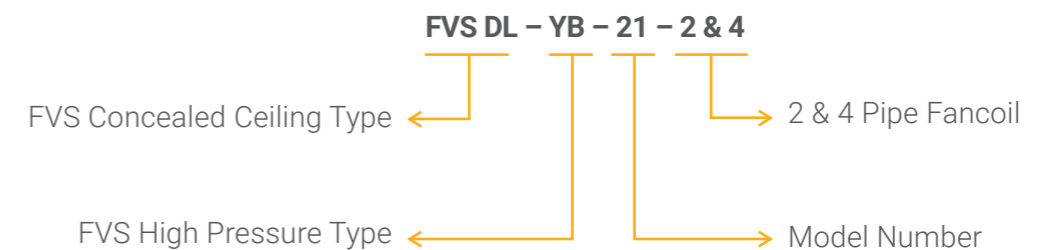
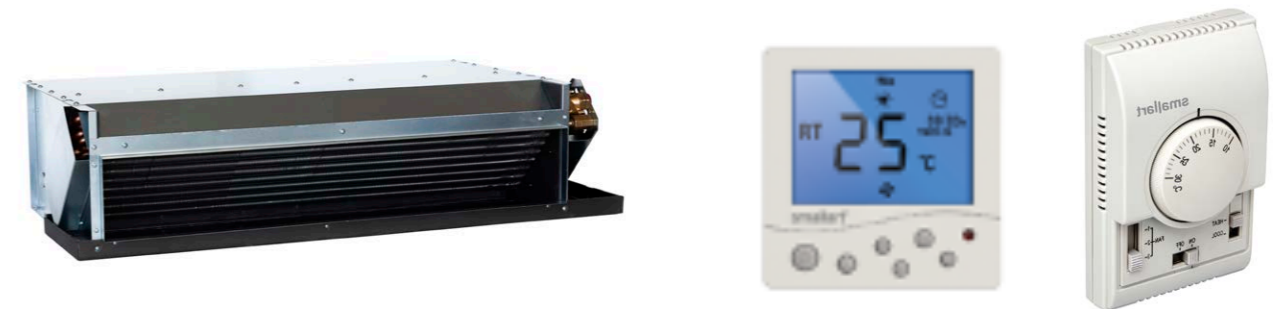



TECHNICAL SPECIFICATIONS

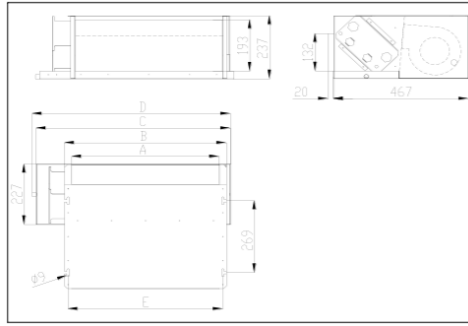

FVS-DL-21-102

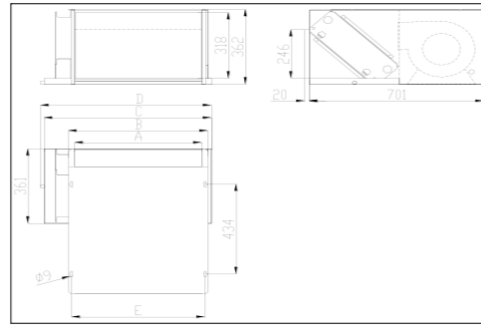

FVS-42...82 YB - FVS 44...84 YB

NOTEBOOK

| MODEL | 7-12°C | 90-70°C | AIR FLOW (m³/h) | WATER INLET-OUTLET (inc) | WATER INLET-OUTLET (inc) | DRAIN (inc) | ABSOLUTE MOTOR POWER (Watt) | MAX. CURRENT (A) | 2 Pipe Weight (Kg) | 4 Pipe Weight (Kg) | DIMENSION | | | | |
|------------|---------------|---------------|-----------------|--------------------------|--------------------------|-------------|-----------------------------|------------------|--------------------|--------------------|-----------|--------|--------|--------|--------|
| | CAPACITY (kW) | CAPACITY (kW) | | | | | | | | | A (mm) | B (mm) | C (mm) | D (mm) | E (mm) |
| FVS-DL-21 | 2,1 | 6,3 | 350 | 3/4"-3/4" | 1/2"-1/2" | 3/4" | 54 Watt | 0,28 A | 14,1 | 15,9 | 480 | 530 | 642 | 672 | 505 |
| FVS-DL-23 | 2,3 | 6,9 | 400 | 3/4"-3/4" | 1/2"-1/2" | 3/4" | 56 Watt | 0,28 A | 14,1 | 15,9 | 480 | 530 | 642 | 672 | 505 |
| FVS-DL-26 | 2,6 | 8 | 485 | 3/4"-3/4" | 1/2"-1/2" | 3/4" | 57 Watt | 0,35 A | 14,7 | 16,5 | 480 | 530 | 642 | 672 | 505 |
| FVS-DL-29 | 2,9 | 8,7 | 490 | 3/4"-3/4" | 1/2"-1/2" | 3/4" | 63 Watt | 0,35 A | 15,1 | 17 | 480 | 530 | 642 | 672 | 505 |
| FVS-DL-37 | 3,7 | 11,2 | 670 | 3/4"-3/4" | 1/2"-1/2" | 3/4" | 66 Watt | 0,35 A | 20,7 | 23,3 | 830 | 880 | 992 | 1022 | 855 |
| FVS-DL-42 | 4,1 | 12,5 | 780 | 3/4"-3/4" | 1/2"-1/2" | 3/4" | 70 Watt | 0,35 A | 20,7 | 23,3 | 830 | 880 | 992 | 1022 | 855 |
| FVS-DL-49 | 4,9 | 14,7 | 900 | 3/4"-3/4" | 1/2"-1/2" | 3/4" | 86 Watt | 0,5 A | 21,1 | 23,8 | 830 | 880 | 992 | 1022 | 855 |
| FVS-DL-51 | 5,1 | 15,4 | 960 | 3/4"-3/4" | 1/2"-1/2" | 3/4" | 90 Watt | 0,5 A | 21,1 | 23,8 | 830 | 880 | 992 | 1022 | 855 |
| FVS-DL-58 | 5,8 | 16,9 | 940 | 3/4"-3/4" | 1/2"-1/2" | 3/4" | 92 Watt | 0,5 A | 21,9 | 24,8 | 910 | 960 | 1072 | 1102 | 935 |
| FVS-DL-65 | 6,5 | 19,2 | 1170 | 3/4"-3/4" | 1/2"-1/2" | 3/4" | 123 Watt | 0,63 A | 32,8 | 36,5 | 1310 | 1360 | 1472 | 1502 | 1335 |
| FVS-DL-76 | 7,6 | 22,6 | 1470 | 3/4"-3/4" | 1/2"-1/2" | 3/4" | 128 Watt | 0,85 A | 33,8 | 37,5 | 1310 | 1360 | 1472 | 1502 | 1335 |
| FVS-DL-89 | 8,9 | 26,5 | 1570 | 3/4"-3/4" | 1/2"-1/2" | 3/4" | 132 Watt | 0,7 A | 39,4 | 43,2 | 1660 | 1710 | 1822 | 1852 | 1685 |
| FVS-DL-102 | 10,2 | 30,7 | 1920 | 3/4"-3/4" | 1/2"-1/2" | 3/4" | 170 Watt | 1,00 A | 40,2 | 44 | 1660 | 1710 | 1822 | 1852 | 1685 |
| FVS-42 YB | 6,75 | 20,59 | 1360 | 1"-1" | - | 3/4" | 1 X 150 Watt | 1 x 1.6 A | 28 | - | 510 | 560 | 672 | 702 | 535 |
| FVS-52 YB | 9,42 | 33,4 | 2450 | 1"-1" | - | 3/4" | 2 X 150 Watt | 2 x 1.6 A | 40 | - | 710 | 760 | 872 | 902 | 735 |
| FVS-62 YB | 12,2 | 38,97 | 2670 | 1"-1" | - | 3/4" | 2 X 150 Watt | 2 x 1.6 A | 44 | - | 910 | 960 | 1072 | 1102 | 935 |
| FVS-72 YB | 14,32 | 42,79 | 2768 | 1"-1" | - | 3/4" | 2 X 150 Watt | 2 x 1.6 A | 48 | - | 1110 | 1160 | 1272 | 1302 | 1135 |
| FVS-82 YB | 19,61 | 58,28 | 3930 | 1"-1" | - | 3/4" | 3 x 150 Watt | 3 x 1.6 A | 52 | - | 1310 | 1360 | 1472 | 1502 | 1335 |
| FVS-44 YB | 6,6 | 8,74 | 1310 | 1"-1" | 1/2"-1/2" | 3/4" | 1 x 150 Watt | 1 x 1.6 A | - | 29 | 510 | 560 | 672 | 702 | 535 |
| FVS-54 YB | 8,99 | 13,27 | 2262 | 1"-1" | 1/2"-1/2" | 3/4" | 2 X 150 Watt | 2 x 1.6 A | - | 41 | 710 | 760 | 872 | 902 | 735 |
| FVS-64 YB | 11,76 | 16,06 | 2510 | 1"-1" | 1/2"-1/2" | 3/4" | 2 X 150 Watt | 2 x 1.6 A | - | 45 | 910 | 960 | 1072 | 1102 | 935 |
| FVS-74 YB | 14 | 18,38 | 2670 | 1"-1" | 1/2"-1/2" | 3/4" | 2 X 150 Watt | 2 x 1.6 A | - | 50 | 1110 | 1160 | 1272 | 1302 | 1135 |
| FVS-84 YB | 19,12 | 24,33 | 3765 | 1"-1" | 1/2"-1/2" | 3/4" | 3 x 150 Watt | 3 x 1.6 A | - | 54 | 1310 | 1360 | 1472 | 1502 | 1335 |

All values in the capacity table are calculated according to the High Fan speed.



VTS Group S.A.

20, rue de l'Industrie
L-8399 Windhof, Luxembourg
tel: +352 20 60 22 41
e-mail: contact@vtsgroup.lu

Due to continuous improvement of the products, VTS reserves right to implement modifications.
Some of technical data and descriptions may vary from the actual products specification.
Before placing the order, please, confirm all technical specification with VTS sales representative.

www.vtsgroup.com