



LASERCORE™

QUALITY TO THE CORE

MAJOR FIBER AND CO₂ LASER CUTTING SYSTEMS

2021 CATALOG
REV. #2

 **SuperFlash**[®]
COMPRESSED GAS EQUIPMENT

A WORD FROM THE CEO

For the last 60 years, SuperFlash brand flashback arrestors, gas mixers, quick connectors, manifolds, heating solutions, and other compressed gas equipment have protected and served millions of compressed gas users and welders in more than 100 countries. LaserCore is unique because it provides distributors with another item that end-users want- it's a product that will create sales for distributors and it's backed by our family business customer service. With laser cutting sweeping the metal working industry, LaserCore is the destination for nozzles, ceramics, and holders. Don't forget to visit our website for updates, and additional product information.

Thank you,
V. E. Marquard-Schultz, Esq.



PHOENIX | ARIZONA
WESTLAKE | OHIO
ONTARIO | CANADA
ORLANDO | FLORIDA



LASERCORE™

QUALITY TO THE CORE

MAJOR FIBER AND CO₂ LASER CUTTING SYSTEMS

NOZZLES

- Precise dimensions that guarantee repeatable, consistent performance at the work piece
- Engineered to ensure geometric tolerances to provide improved gas flow
- Manufactured with high quality materials for lifelong durability

CERAMICS & HOLDERS

- Made with materials resistant to high temperatures
- OEM Compatibility Guaranteed
- Consistent quality ensures optimal process backed by a satisfaction guarantee

OPTICS

- Full range of replacement protective windows diameter size 19 to 140 available
- Protection from back spatter and debris
- Anti-reflective coatings resulting in even less thermal distortion and longer lens life

GAS FILTERS

- Can be installed in existing gas pipelines and is immediately ready-to-operate
- User-friendly design for simple cartridge change without disassembly
- Wide range of applications including technical gases

SERVICE

- A reliable partner: Shipping ▪ Service ▪ Stock ▪ Phone Support
- Local stock: Florida ▪ Ohio ▪ Arizona ▪ Canada
- Same-day shipping for in-stock items
- Training with industry experts on the latest products and technology

LaserCore™ is your destination for nozzles, ceramics, and holders. We provide high quality products and customer service with low cost for Major Fiber or CO₂ Laser Cutting Systems.

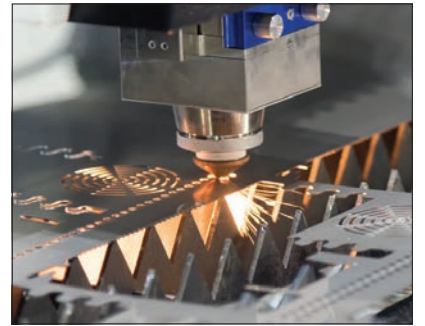
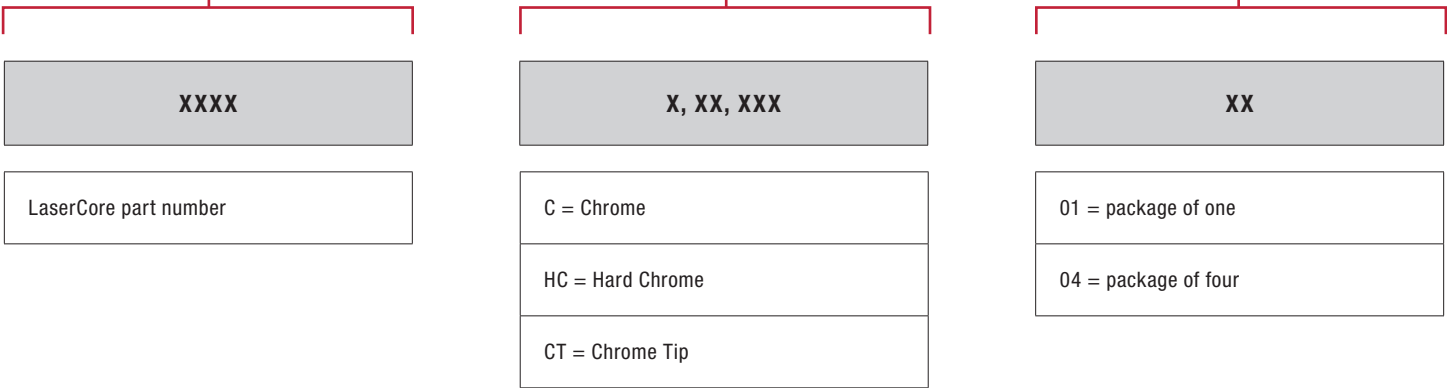

TABLE OF CONTENTS

XX

10	20	30 1000-4999	30 5000-9999	40	50	60	70 2000	70 3000	70 3000	70 4000	70 5000	70 6000	70 7000	70 8000	70 9000	80 1000-4999	80 5000-9999	90
TRUMPF	AMADA	MITSUBISHI	CINCINNATI	MAZAK	BYSTRONIC	PRECITEC	BLM	DURMA	HAAS	HK LASER	HAN'S LASER	LVD	MESSER	PENTA	SALVAGININI	PRIMA	RAYTOOLS	OPTICS
PG. 01	PG. 09	PG. 15	PG. 20	PG. 21	PG. 34	PG. 41	PG. 49	PG. 52	PG. 53	PG. 54	PG. 55	PG. 56	PG. 59	PG. 60	PG. 61	PG. 63	PG. 70	PG. 73

10 - 1121 - C - 04





POS	LASERCORE	OEM	DESCRIPTION
1	10-1001-01	092405 - 280408 - P0494-752-00001	ORIG. NOZZLE HOLDER KT M1.5" KN
2	10-1002-01	936678 - 913966/00-WO	CERAMIC NOZZLE HOLDER

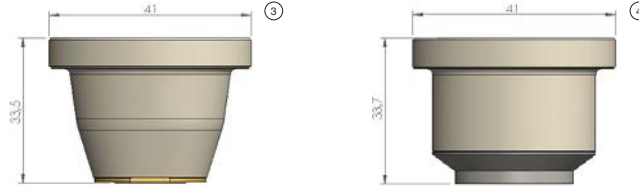

POS	LASERCORE	OEM	DESCRIPTION
3	10-1003-01	1755673	CERAMIC NOZZLE HOLDER AUTOCHANGER
	10-1004-01	1349171	CERAMIC NOZZLE HOLDER
4	10-1005-01	1906032	NOZZLE HOLDER COOL LINE M12

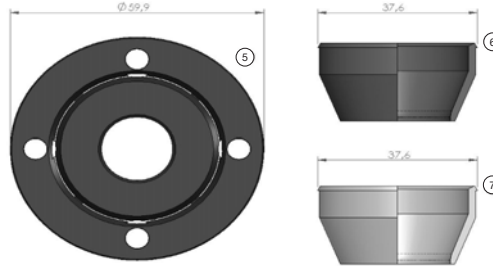

POS	LASERCORE	OEM	DESCRIPTION
5	10-1006-01	234485	BREAK-AWAY
6	10-1007-01	256153-955826	COVER - BLACK
7	10-1008-01	256153-955826	PTFE COVER - WHITE

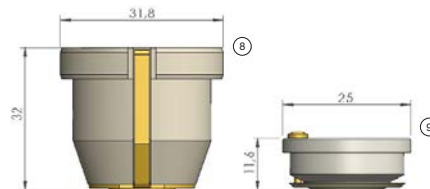

POS	LASERCORE	OEM	DESCRIPTION
8	10-1009-01	254493-260432	CERAMIC NOZZLE HOLDER
9	10-1010-01	258809, 243839, 247894	CERAMIC NOZZLE HOLDER
	10-1011-01	258809	ORIGINAL CERAMIC NOZZLE HOLDER

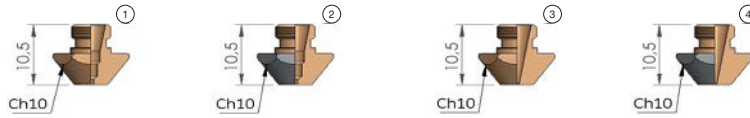

POS	LASERCORE	OEM	DESCRIPTION
1	10-1101-04	135420-1354230	NOZZLE Ø 0.8 EBD
	10-1102-04	212334	NOZZLE Ø 1.0 EBD
2	10-1121-C-04	135420-1354230	NOZZLE Ø 0.8 EBD CP
	10-1122-C-04	212334	NOZZLE Ø 1.0 EBD CP
3	10-1201-04		NOZZLE Ø 0.8 EBD HD
	10-1202-04		NOZZLE Ø 1.0 EBD HD
	10-1203-04	1479581	NOZZLE Ø 1.2 EBD HD
	10-1204-04	216199	NOZZLE Ø 1.4 EBD HD
	10-1205-04	225213	NOZZLE Ø 1.7 EBD HD
	10-1206-04	1487009	NOZZLE Ø 2.0 EBD HD
	10-1207-04	126156	NOZZLE Ø 2.3 EBD HD
	10-1208-04		NOZZLE Ø 2.5 EBD HD
	10-1209-04		NOZZLE Ø 2.7 EBD HD
4	10-1221-C-04		NOZZLE Ø 0.8 EBD HD CP
	10-1222-C-04		NOZZLE Ø 1.0 EBD HD CP
	10-1223-C-04	1479581	NOZZLE Ø 1.2 EBD HD CP
	10-1224-C-04	216199	NOZZLE Ø 1.4 EBD HD CP
	10-1225-C-04	225213	NOZZLE Ø 1.7 EBD HD CP
	10-1226-C-04	1487009	NOZZLE Ø 2.0 EBD HD CP
	10-1227-C-04	126156	NOZZLE Ø 2.3 EBD HD CP
	10-1228-C-04		NOZZLE Ø 2.5 EBD HD CP
	10-1229-C-04		NOZZLE Ø 2.7 EBD HD CP



POS	LASERCORE	OEM	DESCRIPTION
5	10-1300-04	226939	NOZZLE 1.0
	10-1301-04		NOZZLE 1.4
	10-1302-04		NOZZLE 1.7
6	10-1320-C-04	226939	NOZZLE 1.0 CP
	10-1321-C-04		NOZZLE 1.4 CP
	10-1322-C-04		NOZZLE 1.7 CP



POS	LASERCORE	OEM	DESCRIPTION
7	10-1400-04		NOZZLE Ø 1.0 HD
	10-1401-04		NOZZLE Ø 1.4 HD
	10-1402-04		NOZZLE Ø 1.7 HD
8	10-1420-C-04		NOZZLE Ø 1.0 HD CP
	10-1421-C-04		NOZZLE Ø 1.4 HD CP
	10-1422-C-04		NOZZLE Ø 1.7 HD CP



POS	LASERCORE	OEM	DESCRIPTION
9	10-1500-04	135320	NOZZLE Ø 1.0 HD
	10-1501-04		NOZZLE Ø 1.20 HD
	10-1502-04	135318	NOZZLE Ø 1.4 HD
	10-1503-04	126157	NOZZLE Ø 1.7 HD
10	10-1520-C-04	135320	NOZZLE Ø 1.0 HD CP
	10-1521-C-04		NOZZLE Ø 1.2 HD CP
	10-1522-C-04	135318	NOZZLE Ø 1.4 HD CP
	10-1523-C-04	126157	NOZZLE Ø 1.7 HD CP

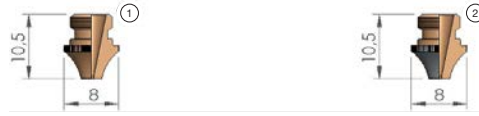

POS	LASERCORE	OEM	DESCRIPTION
1	10-1600-04	913799	NOZZLE Ø 0.8 EBF HD
	10-1601-04	913800	NOZZLE Ø 1.0 EBF HD
	10-1602-04	1487034	NOZZLE Ø 1.2 EBF HD
	10-1603-04	913801	NOZZLE Ø 1.4 EBF HD
	10-1604-04	937988	NOZZLE Ø 1.7 EBF HD
	10-1605-04		NOZZLE Ø 2.0 EBF HD
	10-1606-04	937989	NOZZLE Ø 2.3 EBF HD
2	10-1620-C-04	913799	NOZZLE Ø 0.8 EBF HD CP
	10-1621-C-04	913800	NOZZLE Ø 1.0 EBF HD CP
	10-1622-C-04	1487034	NOZZLE Ø 1.2 EBF HD CP
	10-1623-C-04	913801	NOZZLE Ø 1.4 EBF HD CP
	10-1624-C-04	937988	NOZZLE Ø 1.7 EBF HD CP
	10-1625-C-04		NOZZLE Ø 2.0 EBF HD CP
	10-1626-C-04	937989	NOZZLE Ø 2.3 EBF HD CP

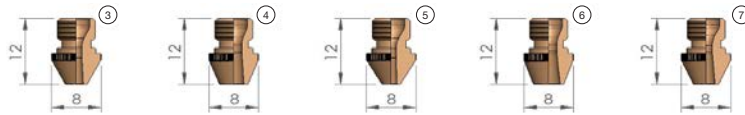

POS	LASERCORE	OEM	DESCRIPTION
3	10-1700-04	2241407	NOZZLE Ø 1,8 EBC X12
4	10-1701-04	2085524	NOZZLE Ø 2,6 EBC X20
5	10-1702-04	2241406	NOZZLE Ø 1,6 EBC X31
6	10-1703-04	2241524	NOZZLE Ø 2,6 EBC X35
7	10-1704-04	2241409	NOZZLE Ø 2,0 EBC X40

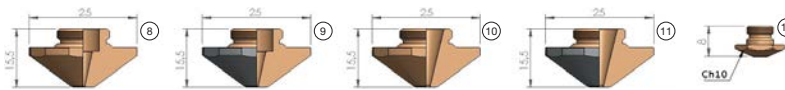

POS	LASERCORE	OEM	DESCRIPTION
8	10-1800-04	1324858	NOZZLE Ø 0.8 EAA
	10-1801-04	1324860	NOZZLE Ø 1.0 EAA
	10-1802-04	1324861	NOZZLE Ø 1.2 EAA
	10-1803-04	1324863	NOZZLE Ø 1.4 EAA
	10-1804-04	1324864	NOZZLE Ø 1.7 EAA
10	10-1805-04	1324865	NOZZLE Ø 2.0 EAA
	10-1806-04	1324866	NOZZLE Ø 2.3 EAA
	10-1807-04	1324867	NOZZLE Ø 2.7 EAA
9	10-1900-HC-04	1324858	NOZZLE Ø 0.8 EAA SPECIAL CP
	10-1901-HC-04	1324860	NOZZLE Ø 1.0 EAA SPECIAL CP
	10-1902-HC-04	1324861	NOZZLE Ø 1.2 EAA SPECIAL CP
	10-1903-HC-04	1324863	NOZZLE Ø 1.4 EAA SPECIAL CP
	10-1904-HC-04	1324864	NOZZLE Ø 1.7 EAA SPECIAL CP
11	10-1905-HC-04	1324865	NOZZLE Ø 2.0 EAA SPECIAL CP
	10-1906-HC-04	1324866	NOZZLE Ø 2.3 EAA SPECIAL CP
	10-1907-HC-04	1324867	NOZZLE Ø 2.7 EAA SPECIAL CP
9	10-2000-C-04	1324858	NOZZLE Ø 0.8 EAA CP
	10-2001-C-04	1324860	NOZZLE Ø 1.0 EAA CP
	10-2002-C-04	1324861	NOZZLE Ø 1.2 EAA CP
	10-2003-C-04	1324863	NOZZLE Ø 1.4 EAA CP
	10-2004-C-04	1324864	NOZZLE Ø 1.7 EAA CP
11	10-2005-C-04	1324865	NOZZLE Ø 2.0 EAA CP
	10-2006-C-04	1324866	NOZZLE Ø 2.3 EAA CP
	10-2007-C-04	1324867	NOZZLE Ø 2.7 EAA CP
12	10-2100-04	1589610	NOZZLE Ø 2.0 BLOW OFF EBM

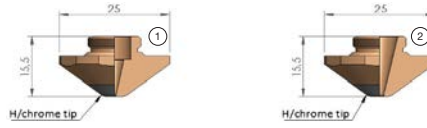

POS	LASERCORE	OEM	DESCRIPTION
1	10-2200-CT-04		NOZZLE Ø 0.8 EAA CP
	10-2201-CT-04		NOZZLE Ø 1.0 EAA CP
	10-2202-CT-04		NOZZLE Ø 1.2 EAA CP
	10-2203-CT-04		NOZZLE Ø 1.4 EAA CP
	10-2204-CT-04		NOZZLE Ø 1.7 EAA CP
2	10-2205-CT-04		NOZZLE Ø 2.0 EAA CP
	10-2206-CT-04		NOZZLE Ø 2.3 EAA CP
	10-2207-CT-04		NOZZLE Ø 2.7 EAA CP



POS	LASERCORE	OEM	DESCRIPTION
3	10-2300-04	1373324	NOZZLE Ø 0.8 EAB
	10-2301-04	1373325	NOZZLE Ø 1.0 EAB
	10-2302-04	1373326	NOZZLE Ø 1.2 EAB
	10-2303-04	1373327	NOZZLE Ø 1.4 EAB
	10-2304-04	1373328	NOZZLE Ø 1.7 EAB
4	10-2305-04	1373329	NOZZLE Ø 2.0 EAB
	10-2306-04	1373330	NOZZLE Ø 2.3 EAB
	10-2307-04	1373331	NOZZLE Ø 2.7 EAB



POS	LASERCORE	OEM	DESCRIPTION
5	10-2320-CT-04	1373324	NOZZLE Ø 0.8 EAB CP
	10-2321-CT-04	1373325	NOZZLE Ø 1.0 EAB CP
	10-2322-CT-04	1373326	NOZZLE Ø 1.2 EAB CP
	10-2323-CT-04	1373327	NOZZLE Ø 1.4 EAB CP
	10-2324-CT-04	1373328	NOZZLE Ø 1.7 EAB CP
6	10-2325-CT-04	1373329	NOZZLE Ø 2.0 EAB CP
	10-2326-CT-04	1373330	NOZZLE Ø 2.3 EAB CP
	10-2327-CT-04	1373331	NOZZLE Ø 2.7 EAB CP

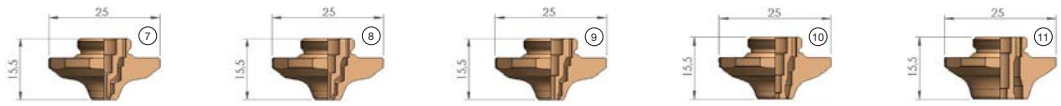

POS	LASERCORE	OEM	DESCRIPTION
7	10-2500-04	2059462	DOUBLE NOZZLE EAU Ø 2.5
8	10-2501-04	2060001	DOUBLE NOZZLE EAU Ø 3.0
9	10-2502-04	2060004	DOUBLE NOZZLE EAU Ø 4.0
10	10-2503-04	2060025	DOUBLE NOZZLE EAU Ø 6.0
11	10-2504-04	2253595	DOUBLE NOZZLE EAU Ø 10.0

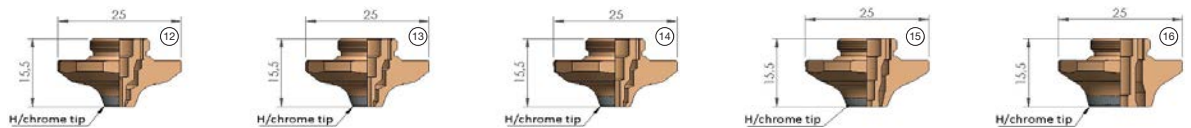

POS	LASERCORE	OEM	DESCRIPTION
12	10-2600-CT-04		DOUBLE NOZZLE EAU Ø 2.5 CP
13	10-2601-CT-04		DOUBLE NOZZLE EAU Ø 3.0 CP
14	10-2602-CT-04		DOUBLE NOZZLE EAU Ø 4.0 CP
15	10-2603-CT-04		DOUBLE NOZZLE EAU Ø 6.0 CP
16	10-2604-CT-04		DOUBLE NOZZLE EAU Ø 10.0 CP



LaserCore is not affiliated with the named manufacturers. Reference to machines, parts, descriptions, and model numbers are for convenience in verifying compatibility only. All parts are made by or for LaserCore and are not made by the referenced manufactures (unless expressly indicated). All other trademarks are the properties of their respective owners.

oxyfuelsafety.com • (888) 327-7306
28825 RANNEY PARKWAY, CLEVELAND, OH 44145
PN LC101-0920



POS	LASERCORE	OEM	DESCRIPTION
1	10-2700-04	1579549	DOUBLE NOZZLE EAK Ø 2.5
	10-2701-04	1579556	DOUBLE NOZZLE EAK Ø 3.0
2	10-2702-04	1835747	DOUBLE NOZZLE EAK Ø 4.0

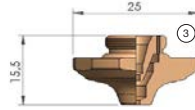

POS	LASERCORE	OEM	DESCRIPTION
3	10-2710-04	1664569	DOUBLE NOZZLE EAN Ø 1.7
	10-2711-04	1664602	DOUBLE NOZZLE EAN Ø 2.0
	10-2712-04	1664625	DOUBLE NOZZLE EAN Ø 2.5

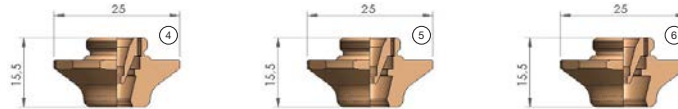

POS	LASERCORE	OEM	DESCRIPTION
4	10-2720-04	1809091	DOUBLE NOZZLE EAQ Ø 6.0
5	10-2721-04	1809421	DOUBLE NOZZLE EAQ Ø 7.5
6	10-2722-04	1886199	DOUBLE NOZZLE EAQ Ø 9.5

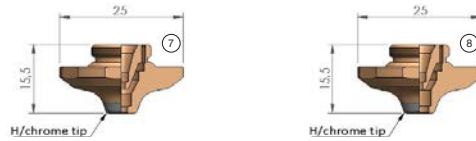

POS	LASERCORE	OEM	DESCRIPTION
7	10-2800-CT-04	1579549	DOUBLE NOZZLE EAK Ø 2.5 CP
	10-2801-CT-04	1579556	DOUBLE NOZZLE EAK Ø 3.0 CP
8	10-2802-CT-04	1835747	DOUBLE NOZZLE EAK Ø 4.0 CP

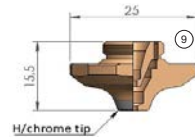

POS	LASERCORE	OEM	DESCRIPTION
9	10-2810-CT-04	1664569	DOUBLE NOZZLE EAN Ø 1.7 CP
	10-2811-CT-04	1664602	DOUBLE NOZZLE EAN Ø 2.0 CP
	10-2812-CT-04	1664625	DOUBLE NOZZLE EAN Ø 2.5 CP

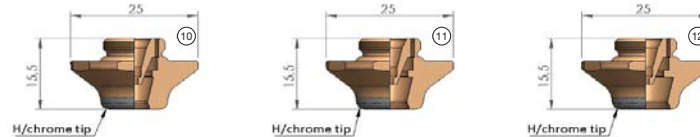

POS	LASERCORE	OEM	DESCRIPTION
10	10-2820-CT-04	1809091	DOUBLE NOZZLE EAQ Ø 6.0 CP
11	10-2821-CT-04	1809421	DOUBLE NOZZLE EAQ Ø 7.5 CP
12	10-2822-CT-04	1886199	DOUBLE NOZZLE EAQ Ø 9.5 CP



POS	LASERCORE	OEM	DESCRIPTION
1	10-2900-04	1851641	NOZZLE ECP Ø 0.8
	10-2901-04	1851587	NOZZLE ECP Ø 1.0
	10-2902-04	1851588	NOZZLE ECP Ø 1.2
	10-2903-04	1851618	NOZZLE ECP Ø 1.4
	10-2904-04	1851619	NOZZLE ECP Ø 1.7
	10-2905-04	1851620	NOZZLE ECP Ø 2.0
	10-2906-04	1851651	NOZZLE ECP Ø 2.3
	10-2907-04	1851652	NOZZLE ECP Ø 2.7
2	10-2920-CT-04	1851641	NOZZLE ECP Ø 0.8 CP
	10-2921-CT-04	1851587	NOZZLE ECP Ø 1.0 CP
	10-2922-CT-04	1851588	NOZZLE ECP Ø 1.2 CP
	10-2923-CT-04	1851618	NOZZLE ECP Ø 1.4 CP
	10-2924-CT-04	1851619	NOZZLE ECP Ø 1.7 CP
	10-2925-CT-04	1851620	NOZZLE ECP Ø 2.0 CP
	10-2926-CT-04	1851651	NOZZLE ECP Ø 2.3 CP
10-2927-CT-04	1851652	NOZZLE ECP Ø 2.7 CP	

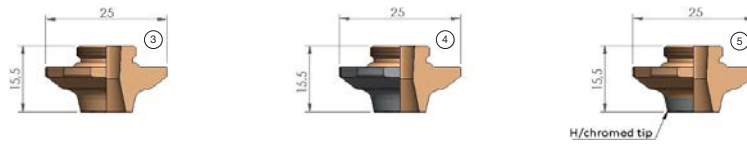

POS	LASERCORE	OEM	DESCRIPTION
3	10-3000-04	1633046	NOZZLE EAC Ø 5.3
	10-3001-04	1633046	NOZZLE EAC Ø 5.3
4	10-3010-C-04	1633046	NOZZLE EAC Ø 5.3 CP
	10-3011-C-04	1633046	NOZZLE EAC Ø 5.3 CP
5	10-3020-CT-04	1633046	NOZZLE EAC Ø 5.3 CP
	10-3021-CT-04	1633046	NOZZLE EAC Ø 5.3 CP

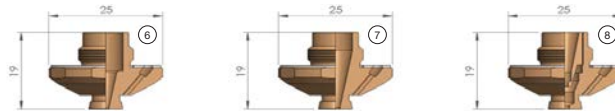

POS	LASERCORE	OEM	DESCRIPTION
6	10-3100-04	1879940	NOZZLE EGL Ø 1.4
	10-3101-04	1879951	NOZZLE EGL Ø 1.7
7	10-3102-04	1879952	NOZZLE EGL Ø 2.0
	10-3103-04	1879953	NOZZLE EGL Ø 2.3
8	10-3110-04		DOUBLE NOZZLE EGL Ø 2.0
	10-3111-04		DOUBLE NOZZLE EGL Ø 2.5
	10-3112-04		DOUBLE NOZZLE EGL Ø 3.0
	10-3113-04		DOUBLE NOZZLE EGL Ø 4.0

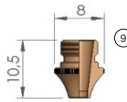

POS	LASERCORE	OEM	DESCRIPTION
9	10-3200-04	1546809	NOZZLE SLIM EBH Ø 2,7

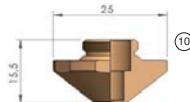

POS	LASERCORE	OEM	DESCRIPTION
10	10-3300-04	1637264	NOZZLE ZAA-01
	10-3301-04	1637264	NOZZLE ZAA-01

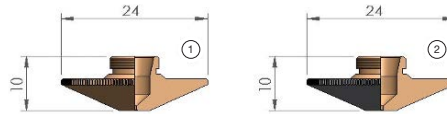

POS	LASERCORE	OEM	DESCRIPTION
1	10-3400-04	124561-237499	NOZZLE Ø 0.8 ECE
	10-3401-04	124562-237498	NOZZLE Ø 1.0 ECE
	10-3402-04	966809	NOZZLE Ø 1.2 ECE
	10-3403-04		NOZZLE Ø 1.4 ECE
	10-3404-04	237500	NOZZLE Ø 1.5 ECE
	10-3405-04		NOZZLE Ø 1.7 ECE
	10-3406-04	237503-1253211	NOZZLE Ø 2.0 ECE
	10-3407-04	124564	NOZZLE Ø 2.3 ECE
	10-3408-04	237504	NOZZLE Ø 3.0 ECE
2	10-3500-C-04	352280	NOZZLE Ø 0.8 ECE CP
	10-3501-C-04	352281	NOZZLE Ø 1.0 ECE CP
	10-3502-C-04	352282	NOZZLE Ø 1.2 ECE CP
	10-3503-C-04		NOZZLE Ø 1.4 ECE CP
	10-3504-C-04	352288	NOZZLE Ø 1.5 ECE CP
	10-3505-C-04		NOZZLE Ø 1.7 ECE CP
	10-3506-C-04		NOZZLE Ø 2.0 ECE CP
	10-3507-C-04	124564	NOZZLE Ø 2.3 ECE CP
	10-3508-C-04		NOZZLE Ø 3.0 ECE CP



POS	LASERCORE	OEM	DESCRIPTION
3	10-3600-04	237497	NOZZLE Ø 1.4 HD ECE
4	10-3700-C-04	352283	NOZZLE Ø 1.4 HD ECE CP



POS	LASERCORE	OEM	DESCRIPTION
5	10-3800-04	237497/S	NOZZLE Ø 1.4 ECE HD
	10-3801-04	237501	NOZZLE Ø 1.7 ECE HD
	10-3802-04	237502	NOZZLE Ø 2.0 ECE HD
	10-3803-04	126933	NOZZLE Ø 2.3 ECE HD
	10-3804-04		NOZZLE Ø 2.5 ECE HD
	10-3805-04	942742	NOZZLE Ø 2.7 ECE HD
	10-3806-04		NOZZLE Ø 3.0 ECE HD
6	10-3900-C-04		NOZZLE Ø 1.4 ECE HD CP
	10-3901-C-04	352284	NOZZLE Ø 1.7 ECE HD CP
	10-3902-C-04	237502	NOZZLE Ø 2.0 ECE HD CP
	10-3903-C-04	352285	NOZZLE Ø 2.3 ECE HD CP
	10-3904-C-04		NOZZLE Ø 2.5 ECE HD CP
	10-3905-C-04	352286	NOZZLE Ø 2.7 ECE HD CP
10-3906-C-04		NOZZLE Ø 3.0 ECE HD CP	

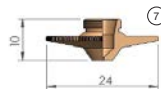

POS	LASERCORE	OEM	DESCRIPTION
7	10-4000-04	215780	NOZZLE Ø 0.8
	10-4001-04	87658	NOZZLE Ø 1.0



POS	LASERCORE	OEM	DESCRIPTION
1	10-4002-04	88894	NOZZLE Ø 1.4 HD
	10-4003-04	217867	NOZZLE Ø 1.7 HD
2	10-4100-C-04		NOZZLE Ø 0.8 CP
	10-4101-C-04		NOZZLE Ø 1.0 CP

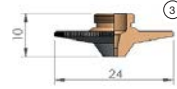

POS	LASERCORE	OEM	DESCRIPTION
3	10-4102-C-04		NOZZLE Ø 1.4 HD CP
	10-4103-C-04		NOZZLE Ø 1.7 HD CP



POS	LASERCORE	OEM	DESCRIPTION
4	10-4200-04	1277773	NOZZLE Ø 0.8
	10-4201-04	1277771	NOZZLE Ø 1.0
	10-4202-04	1277774	NOZZLE Ø 1.2
	10-4203-04	1277776	NOZZLE Ø 1.4
	10-4204-04	1277779	NOZZLE Ø 1.7
	10-4205-04	1277780	NOZZLE Ø 2.0
	10-4206-04	1277781	NOZZLE Ø 2.3
	10-4207-04	1277782	NOZZLE Ø 2.7
5	10-4220-C-04		NOZZLE Ø 0.8 CP
	10-4221-C-04		NOZZLE Ø 1.0 CP
	10-4222-C-04		NOZZLE Ø 1.2 CP
	10-4223-C-04		NOZZLE Ø 1.4 CP
	10-4224-C-04		NOZZLE Ø 1.7 CP
	10-4225-C-04		NOZZLE Ø 2.0 CP
	10-4226-C-04		NOZZLE Ø 2.3 CP
10-4227-C-04		NOZZLE Ø 2.7 CP	



POS	LASERCORE	OEM	DESCRIPTION
6	10-4400-04	1774018	NOZZLE EFL Ø 1.4
	10-4401-04	1838745	NOZZLE EFL Ø 1.7
7	10-4402-04	1774020	NOZZLE EFL Ø 2.0
	10-4403-04	1774092	NOZZLE EFL Ø 2.3

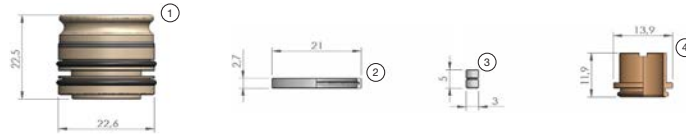

POS	LASERCORE	OEM	DESCRIPTION
1	20-1000-01	71712350	NOZZLE HOLDER PLUG-IN with INNER
	20-1001-01	71712350	NOZZLE HOLDER PLUG-IN
4	20-1002-01	71716438-71798350	INNER FOR PLUG-IN
2	20-1003-01	71712340	PTFE COLLAR WITH GROOVE
3	20-1004-01	71712344	LOCATING PIN

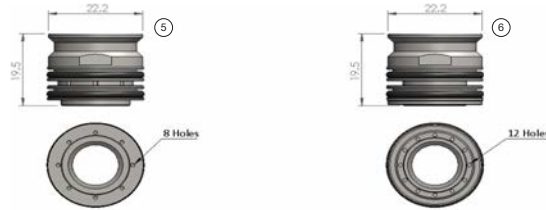

POS	LASERCORE	OEM	DESCRIPTION
5	20-1005-01	71502036	NOZZLE ADAPTOR WITH 8 HOLES
6	20-1006-01	71502036	NOZZLE ADAPTOR WITH 12 HOLES



POS	LASERCORE	OEM	DESCRIPTION
7	20-1007-01		DISC HEAD PROTECTION CERAMIC Ø 22
8	20-1008-01	71341614	DISC HEAD PROTECTION VESPEL Ø 21
	20-1009-01	71341614	DISK HEAD PROTECTION Ø 21 PLASTIC



POS	LASERCORE	OEM	DESCRIPTION
9	20-1010-01	71341630	SENSOR CABLE
10	20-1011-01	71398965	SENSOR CABLE HS 15

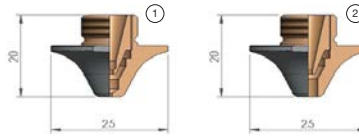

POS	LASERCORE	OEM	DESCRIPTION
1	20-1100-C-04		DOUBLE NOZZLE Ø D1.2E CP ECO CUT
	20-1101-C-04	71518550-71461029-71502038	DOUBLE NOZZLE Ø D1.4E CP ECO CUT
	20-1102-C-04		DOUBLE NOZZLE Ø D1.7E CP ECO CUT
	20-1103-C-04		DOUBLE NOZZLE Ø D2.0E CP ECO CUT
	20-1104-C-04	71516789-71501059	DOUBLE NOZZLE Ø D2.5E CP ECO CUT
	20-1105-C-04		DOUBLE NOZZLE Ø D3.0E CP ECO CUT
	20-1106-C-04	71516790-71501060	DOUBLE NOZZLE Ø D4.0E CP ECO CUT
2	20-1110-C-04	71501093	DOUBLE NOZZLE Ø D4.0 AL CP

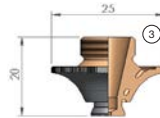

POS	LASERCORE	OEM	DESCRIPTION
3	20-1200-C-04		NOZZLE Ø S1.2W CP WACS
	20-1201-C-04		NOZZLE Ø S1.4W CP WACS



POS	LASERCORE	OEM	DESCRIPTION
4	20-1300-C-04		NOZZLE Ø S0.8E CP ECO CUT
	20-1301-C-04	71566685	NOZZLE Ø S1.0E CP ECO CUT
	20-1302-C-04	71502037-71461028-71566686-71369812	NOZZLE Ø S1.2E CP ECO CUT
	20-1303-C-04		NOZZLE Ø S1.5E CP ECO CUT
	20-1304-C-04		NOZZLE Ø S2.0E CP ECO CUT
	20-1305-C-04		NOZZLE Ø S2.5E CP ECO CUT
	20-1306-C-04		NOZZLE Ø S3.0E CP ECO CUT
5	20-1310-C-04		NOZZLE Ø S1.4 CP ECO CUT
	20-1311-C-04	71501056 - 71712720	NOZZLE Ø S1.5 CP ECO CUT
	20-1312-C-04		NOZZLE Ø S1.7 CP ECO CUT
	20-1313-C-04	71501057-71555124	NOZZLE Ø S2.0 CP ECO CUT
	20-1314-C-04		NOZZLE Ø S2.3 CP ECO CUT
	20-1315-C-04		NOZZLE Ø S2.5 CP ECO CUT
	20-1316-C-04	71516788-71501058	NOZZLE Ø S3.0 CP ECO CUT
	20-1317-C-04		NOZZLE Ø S4.0 CP ECO CUT

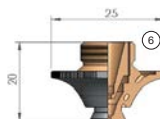

POS	LASERCORE	OEM	DESCRIPTION
6	20-1400-C-04		DOUBLE NOZZLE Ø D1.4W CP WACS
	20-1401-C-04		DOUBLE NOZZLE Ø D1.7W CP WACS
	20-1402-C-04		DOUBLE NOZZLE Ø D2.0W CP WACS
	20-1403-C-04	71712335	DOUBLE NOZZLE Ø D2.5W CP WACS
	20-1404-C-04		DOUBLE NOZZLE Ø D3.0W CP WACS
	20-1405-C-04		DOUBLE NOZZLE Ø D3.5W CP WACS
	20-1406-C-04	71712336 - 71461158	DOUBLE NOZZLE Ø D4.0W CP WACS
	20-1407-C-04		DOUBLE NOZZLE Ø D4.5W CP WACS
	20-1408-C-04		DOUBLE NOZZLE Ø D5.0W CP WACS

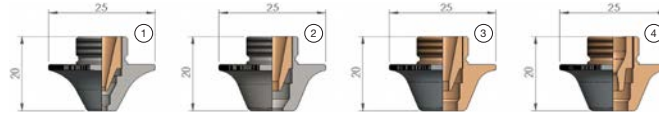

POS	LASERCORE	OEM	DESCRIPTION
1	20-1500-HC-04		DOUBLE NOZZLE Ø D2.5CC SPECIAL CP FOR CLEAN CUT
	20-1501-HC-04	71341728 - 71555121	DOUBLE NOZZLE Ø D4.0CC SPECIAL CP FOR CLEAN CUT
2	20-1502-HC-04		DOUBLE NOZZLE Ø D5.0CC SPECIAL CP FOR CLEAN CUT
	20-1503-HC-04		DOUBLE NOZZLE Ø D6.0CC SPECIAL CP FOR CLEAN CUT
	20-1504-HC-04	71341729 - 71712721	DOUBLE NOZZLE Ø D7.0CC SPECIAL CP FOR CLEAN CUT
3	20-1520-C-04	71501092 - 71563458	DOUBLE NOZZLE Ø 7.0 AL CC CP
4	20-1540-C-04	71712692	DOUBLE NOZZLE Ø 7.0SC CP SILKY CUT

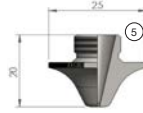

POS	LASERCORE	OEM	DESCRIPTION
5	20-1600-HC-04		NOZZLE Ø S1.5CC SPECIAL CP FOR CLEAN CUT
	20-1601-HC-04	71502043	NOZZLE Ø S2.0CC SPECIAL CP FOR CLEAN CUT
	20-1602-HC-04		NOZZLE Ø S2.5CC SPECIAL CP FOR CLEAN CUT
	20-1603-HC-04	71502044	NOZZLE Ø S3.0CC SPECIAL CP FOR CLEAN CUT



POS	LASERCORE	OEM	DESCRIPTION
6	20-1700-C-04		DOUBLE NOZZLE Ø D1.5F CP
	20-1701-C-04	71570022	DOUBLE NOZZLE Ø D2.0F CP
	20-1702-C-04		DOUBLE NOZZLE Ø D2.5F CP
	20-1703-C-04		DOUBLE NOZZLE Ø D4.0F CP
7	20-1720-CT-04		DOUBLE NOZZLE Ø D1.5F CP
	20-1721-CT-04		DOUBLE NOZZLE Ø D2.0F CP
	20-1722-CT-04		DOUBLE NOZZLE Ø D2.5F CP
	20-1723-CT-04		DOUBLE NOZZLE Ø D4.0F CP

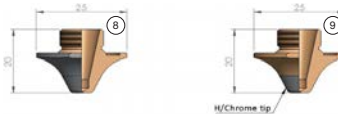

POS	LASERCORE	OEM	DESCRIPTION
8	20-1800-C-04		NOZZLE Ø S0.8 FE CP
	20-1801-C-04	71570021, S1.0FE	NOZZLE Ø S1.0 FE CP
	20-1802-C-04	71570020, S1.2FE	NOZZLE Ø S1.2 FE CP
	20-1803-C-04		NOZZLE Ø S1.4 FE CP
9	20-1820-CT-04		NOZZLE Ø S0.8 FE CP
	20-1821-CT-04	71570021, S1.0FE	NOZZLE Ø S1.0 FE CP
	20-1822-CT-04	71570020, S1.2FE	NOZZLE Ø S1.2 FE CP
	20-1823-CT-04		NOZZLE Ø S1.4 FE CP



POS	LASERCORE	OEM	DESCRIPTION
10	20-1900-CT-04		NOZZLE Ø S0.8 FE FIBER CP
	20-1901-CT-04	71570030	NOZZLE Ø S1.0 FE FIBER CP
	20-1902-CT-04	71570023	NOZZLE Ø S1.2 FE FIBER CP
	20-1903-CT-04		NOZZLE Ø S1.4 FE FIBER CP
	20-1904-CT-04		NOZZLE Ø S1.7 FE FIBER CP
	20-1905-CT-04		NOZZLE Ø S2.0 FE FIBER CP
11	20-1910-CT-04	71568227	DOUBLE NOZZLE Ø D1.2 FE FIBER CP
	20-1911-CT-04		DOUBLE NOZZLE Ø D1.5 FE FIBER CP



POS	LASERCORE	OEM	DESCRIPTION
1	20-2000-C-04	71599667	DOUBLE NOZZLE Ø10 CP
2	20-2001-C-04	71599668	DOUBLE NOZZLE Ø12 CP



POS	LASERCORE	OEM	DESCRIPTION
3	20-2020-CT-04	71599667	DOUBLE NOZZLE Ø10 CP
4	20-2021-CT-04	71599668	DOUBLE NOZZLE Ø12 CP



POS	LASERCORE	OEM	DESCRIPTION
5	20-2100-C-04		NOZZLE Ø S0.8 CP W/CONCAVE
	20-2101-C-04		NOZZLE Ø S1.0 CP W/CONCAVE
	20-2102-C-04		NOZZLE Ø S1.2 CP W/CONCAVE
6	20-2110-C-04		DOUBLE NOZZLE Ø D1.4 CP W/CONCAVE

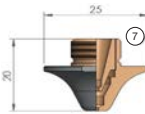

POS	LASERCORE	OEM	DESCRIPTION
7	20-2200-C-04	1572361	DOUBLE NOZZLE Ø D1.2 CP
	20-2201-C-04	71369813, 71502038, 71341779, 71518550	DOUBLE NOZZLE Ø D1.4 CP
	20-2202-C-04	1572361, 71518548, 1572380	DOUBLE NOZZLE Ø D1.7 CP
	20-2203-C-04	1572361	DOUBLE NOZZLE Ø D2.0 CP
	20-2204-C-04	71501059, 71515394, 71516789, 1576398	DOUBLE NOZZLE Ø D2.5 CP
	20-2205-C-04	1572361	DOUBLE NOZZLE Ø D3.0 CP
	20-2206-C-04	71501060, 71515395, 1576399	DOUBLE NOZZLE Ø D4.0 CP
	20-2207-C-04		DOUBLE NOZZLE Ø D4.0 CP INNER D2.0
	20-2208-C-04	1572361	DOUBLE NOZZLE Ø D5.0 CP
20-2209-C-04		DOUBLE NOZZLE Ø D6.0 CP	

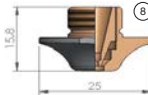

POS	LASERCORE	OEM	DESCRIPTION
8	20-2300-C-04		DOUBLE NOZZLE SHORT Ø D4,0 CP
	20-2301-C-04		DOUBLE NOZZLE SHORT Ø D5,0 CP
	20-2302-C-04		DOUBLE NOZZLE SHORT Ø D6,0 CP

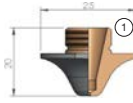

POS	LASERCORE	OEM	DESCRIPTION
1	20-2400-C-04	1572362, 71563584	NOZZLE Ø 0.8 CP
	20-2401-C-04	1572367A, 71563585	NOZZLE Ø 1.0 CP
	20-2402-C-04	71369812, 71461028, 71341778	NOZZLE Ø 1.2 CP
	20-2403-C-04	1572362	NOZZLE Ø 1.4 CP
	20-2404-C-04	1572362, 1572368B	NOZZLE Ø 1.5 CP
	20-2405-C-04	1572362	NOZZLE Ø 1.7 CP
	20-2406-C-04	71515392, 71369815	NOZZLE Ø 2.0 CP
	20-2407-C-04		NOZZLE Ø 2.5 CP
	20-2408-C-04	71515393, 1576112	NOZZLE Ø 3.0 CP
	20-2409-C-04	1572362	NOZZLE Ø 4.0 CP

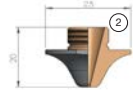

POS	LASERCORE	OEM	DESCRIPTION
2	20-2500-C-04		NOZZLE Ø 0.8 CP
	20-2501-C-04		NOZZLE Ø 1.0 CP
	20-2502-C-04		NOZZLE Ø 1.2 CP
	20-2503-C-04		NOZZLE Ø 1.4 CP
	20-2504-C-04		NOZZLE Ø 1.5 CP
	20-2505-C-04		NOZZLE Ø 1.7 CP
	20-2506-C-04		NOZZLE Ø 2.0 CP
	20-2507-C-04		NOZZLE Ø 2.3 CP
	20-2508-C-04		NOZZLE Ø 3.0 CP

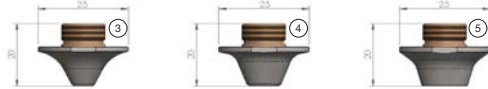

POS	LASERCORE	OEM	DESCRIPTION
3	20-2600-C-04		DOUBLE NOZZLE Ø2.5 CP - SS
	20-2601-C-04		DOUBLE NOZZLE Ø3.0 CP - SS
	20-2602-C-04		DOUBLE NOZZLE Ø4.0 CP - SS
4	20-2603-C-04		DOUBLE NOZZLE Ø6.0 CP - SS
5	20-2604-C-04		DOUBLE NOZZLE Ø10.0 CP - SS

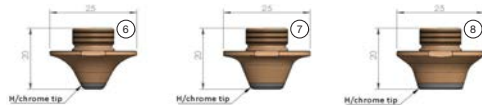

POS	LASERCORE	OEM	DESCRIPTION
6	20-2700-CT-04		DOUBLE NOZZLE Ø2.5 CP - SS
	20-2701-CT-04		DOUBLE NOZZLE Ø3.0 CP - SS
	20-2702-CT-04		DOUBLE NOZZLE Ø4.0 CP - SS
7	20-2703-CT-04		DOUBLE NOZZLE Ø6.0 CP - SS
8	20-2704-CT-04		DOUBLE NOZZLE Ø10.0 CP - SS



POS	LASERCORE	OEM	DESCRIPTION
9	20-2800-C-04		NOZZLE Ø 0.8 CP
	20-2801-C-04	1664545U	NOZZLE Ø 1.0 CP
	20-2802-C-04	1664545U	NOZZLE Ø 1.25 CP
	20-2803-C-04	1664545U	NOZZLE Ø 1.5 CP
	20-2804-C-04	1664545U	NOZZLE Ø 1.75 CP
10	20-2805-C-04	1664644U-71341610	NOZZLE Ø 2.0 CP
	20-2806-C-04	1664545U	NOZZLE Ø 2.5 CP
	20-2807-C-04	1664645U-71360142	NOZZLE Ø 3.0 CP
	20-2808-C-04		NOZZLE Ø 4.0 CP

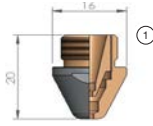

POS	LASERCORE	OEM	DESCRIPTION
1	20-2900-C-04	1669864/7134162	DOUBLE NOZZLE Ø D1.0 CP
	20-2901-C-04	1669864/7134162	DOUBLE NOZZLE Ø D1.2 CP
	20-2902-C-04	1669864/7134162	DOUBLE NOZZLE Ø D1.4 CP
	20-2903-C-04	1669864/7134162	DOUBLE NOZZLE Ø D1.5 CP
	20-2904-C-04	1669864/7134162	DOUBLE NOZZLE Ø D1.8 CP
	20-2905-C-04	1669864/7134162	DOUBLE NOZZLE Ø D2.0 CP
	20-2906-C-04	1669864/7134162/ 41341680/71341772	DOUBLE NOZZLE Ø D2.5 CP
	20-2907-C-04	1669864/7134163	DOUBLE NOZZLE Ø D3.0 CP
	20-2908-C-04	1669864/7134162	DOUBLE NOZZLE Ø D3.5 CP
	20-2909-C-04		DOUBLE NOZZLE Ø D3.8 CP
	20-2910-C-04	1669795/71341681	DOUBLE NOZZLE Ø D4.0 CP

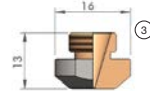
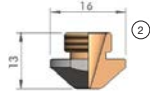

POS	LASERCORE	OEM	DESCRIPTION
2	20-3000-C-04	62094006	NOZZLE Ø 1.0 CP
	20-3001-C-04	62094006	NOZZLE Ø 1.25 CP
	20-3002-C-04	62094006, 1507610	NOZZLE Ø 1.5 CP
	20-3003-C-04	62094006	NOZZLE Ø 1.75 CP
	20-3004-C-04	62094006, 1507611	NOZZLE Ø 2.0 CP
	20-3005-C-04	62094006	NOZZLE Ø 2.5 CP
3	20-3006-C-04	62094008, 71102007	NOZZLE Ø 3.0 CP
	20-3100-C-04	62094005	NOZZLE Ø 1.0 CP
	20-3101-C-04	62094005	NOZZLE Ø 1.25 CP
	20-3102-C-04	62094005, 71341515	NOZZLE Ø 1.5 CP
	20-3103-C-04	62094005, 71341515-1.75	NOZZLE Ø 1.75 CP
	20-3104-C-04	62094005, 71102006	NOZZLE Ø 2.0 CP
	20-3105-C-04	62094005	NOZZLE Ø 2.5 CP
		20-3106-C-04	62094005, 71341515-3.0

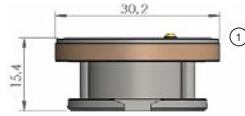

POS	LASERCORE	OEM	DESCRIPTION
1	30-1000-01	BQ980D311G02	EX NOZZLE HOLDER STAINLESS STEEL



POS	LASERCORE	OEM	DESCRIPTION
2	30-1002-01	BQ980D311G02	MITSUBISHI® O RING FOR NOZZLE

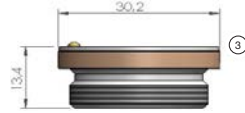

POS	LASERCORE	OEM	DESCRIPTION
3	30-1003-01	P0594-860-00001 - 71800010	NOZZLE HOLDER IT HP2" MZP/MEL

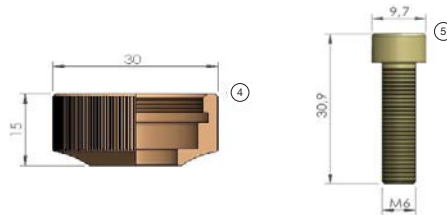

POS	LASERCORE	OEM	DESCRIPTION
4	30-1004-01	71800026 - BQ933D94H01	NOZZLE NUT
5	30-1005-01	71800008 - L2490A005	SAFETY SCREW

NON-NOZZLES

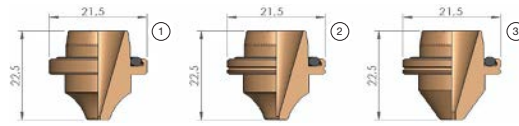

POS	LASERCORE	OEM	DESCRIPTION
1	30-1100-04	BQ983D150-H01	mitsubishi® EX NOZZLE Ø 1.0 with o-ring
	30-1102-04	BQ983D314-H01	mitsubishi® EX NOZZLE Ø 1.4 with o-ring
2	30-1101-04	BQ983D151-H01	mitsubishi® EX NOZZLE Ø 1.2 with o-ring
	30-1104-04	BQ983D152-H01	mitsubishi® EX NOZZLE Ø 1.7 with o-ring

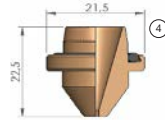

POS	LASERCORE	OEM	DESCRIPTION
4	30-1103-04	BQ983D153-H01	mitsubishi® EX NOZZLE Ø 1.5 with o-ring
	30-1105-04	BQ983D153-H02	mitsubishi® EX NOZZLE Ø 2.0 with o-ring
	30-1106-04	BQ983D153-H03	mitsubishi® EX NOZZLE Ø 2.5 with o-ring
	30-1107-04	BQ983D153-H04	mitsubishi® EX NOZZLE Ø 3.0 with o-ring
	30-1108-04	BQ983D153-H05	mitsubishi® EX NOZZLE Ø 3.5 with o-ring

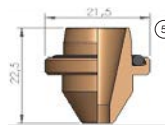

POS	LASERCORE	OEM	DESCRIPTION
5	30-1109-04		mitsubishi® EX NOZZLE Ø 4.0 with o-ring
	30-1110-04		mitsubishi® EX NOZZLE Ø 5.0 with o-ring
	30-1111-04		mitsubishi® EX NOZZLE Ø 6.0 with o-ring

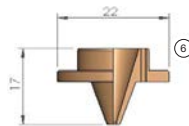

POS	LASERCORE	OEM	DESCRIPTION
6	30-1200-04	W270	mitsubishi® INNER NOZZLE Ø 1.3 - 8 HOLES
	30-1201-04	71800023 - BQ943D156H01 - W270-1.5	mitsubishi® INNER NOZZLE Ø 1.5 - 8 HOLES
	30-1202-04		mitsubishi® INNER NOZZLE Ø 2.0 - 8 HOLES
	30-1203-04	71800024 - BQ943D156H03 - W515	mitsubishi® INNER NOZZLE Ø 1.5 - 24 HOLES
	30-1204-04		mitsubishi® INNER NOZZLE Ø 2.0 - 24 HOLES

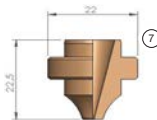

POS	LASERCORE	OEM	DESCRIPTION
7	30-1300-04	BQ933D283H01 - 71800016A0	mitsubishi® NOZZLE S10 Ø 1.0
	30-1302-04		mitsubishi® NOZZLE S14 Ø 1.4

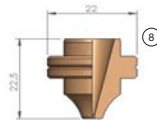

POS	LASERCORE	OEM	DESCRIPTION
8	30-1301-04	BQ943D269H01-W18Q93326901- 71800017	mitsubishi® NOZZLE S12 Ø 1.2

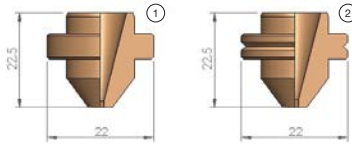

POS	LASERCORE	OEM	DESCRIPTION
1	30-1303-04	BQ943D157H01 - 71800018	MITSUBISHI® NOZZLE S15 Ø 1.5
	30-1305-04	71800019 - BQ943D157H02	MITSUBISHI® NOZZLE S20 Ø 2.0
	30-1306-04		MITSUBISHI® NOZZLE S25 Ø 2.5
	30-1307-04		MITSUBISHI® NOZZLE S30 Ø 3.0
	30-1308-04		MITSUBISHI® NOZZLE S35 Ø 3.5
	30-1304-04		MITSUBISHI® NOZZLE S17 Ø 1.7
2	30-1309-04	W18Q93302701	MITSUBISHI® NOZZLE S17 Ø 1.7

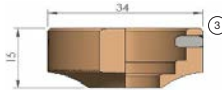

POS	LASERCORE	OEM	DESCRIPTION
3	30-1451-01	BQ980D328G01	MITSUBISHI® EX OUTER NOZZLE FOR NOZZLE

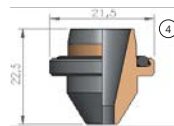

POS	LASERCORE	OEM	DESCRIPTION
4	30-1520-C-04		MITSUBISHI® EX NOZZLE Ø 4.0 with o-ring CP
	30-1521-C-04		MITSUBISHI® EX NOZZLE Ø 5.0 with o-ring CP
	30-1522-C-04		MITSUBISHI® EX NOZZLE Ø 6.0 with o-ring CP

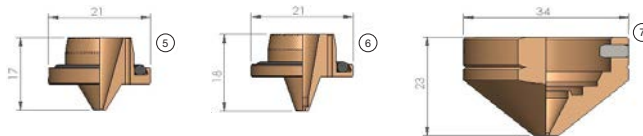

POS	LASERCORE	OEM	DESCRIPTION
5	30-1600-04		MITSUBISHI® EX INNER NOZZLE Ø 1.5-3 holes with o-ring
	30-1601-04		MITSUBISHI® EX INNER NOZZLE Ø 2.0-3 holes with o-ring
	30-1602-04		MITSUBISHI® EX INNER NOZZLE Ø 1.5-4 holes with o-ring
	30-1603-04		MITSUBISHI® EX INNER NOZZLE Ø 2.0-4 holes with o-ring
	30-1604-04		MITSUBISHI® EX INNER NOZZLE Ø 1.5-6 holes with o-ring
	30-1605-04		MITSUBISHI® EX INNER NOZZLE Ø 2.0-6 holes with o-ring
	30-1606-04	BQ983D206H03	MITSUBISHI® EX INNER NOZZLE Ø 1.5 - 8 holes with o-ring
	30-1607-04		MITSUBISHI® EX INNER NOZZLE Ø 2.0-8 holes with o-ring
	30-1608-04		MITSUBISHI® EX INNER NOZZLE Ø 2.5-8 holes with o-ring
	30-1609-04	BQ983D206H04	MITSUBISHI® EX INNER NOZZLE Ø 1.5 - 24 holes with o-ring
	30-1610-04		MITSUBISHI® EX INNER NOZZLE Ø 2.0-24 holes with o-ring
6	30-1611-04		MITSUBISHI® EX INNER NOZZLE Ø 2.5-24 holes with o-ring
	30-1615-04		MITSUBISHI® EX INNER NOZZLE M01 Ø 1.5 - 4 holes with o-ring
7	30-1616-04		MITSUBISHI® EX INNER NOZZLE M01 Ø 2.0 - 4 holes with o-ring
	30-1650-04		MITSUBISHI® EX OUTER NOZZLE Ø 1,5 WITH INNER WALL
	30-1651-04		MITSUBISHI® EX OUTER NOZZLE Ø 2,0 WITH INNER WALL
	30-1652-04		MITSUBISHI® EX OUTER NOZZLE Ø 2,5 WITH INNER WALL
	30-1653-04		MITSUBISHI® EX OUTER NOZZLE Ø 3,0 WITH INNER WALL
	30-1654-04		MITSUBISHI® EX OUTER NOZZLE Ø 3.5 WITH INNER WALL
	30-1655-04	BQ980D434G01	MITSUBISHI® EX OUTER NOZZLE Ø 4.0 WITH INNER WALL



POS	LASERCORE	OEM	DESCRIPTION
1	30-2100-04	71800016-BQ943D897H01-W18Q94389701	AMADA® - MITSUBISHI® HV NOZZLE Ø 1.0
2	30-2200-04	W18Q93309101	AMADA® - MITSUBISHI® HV NOZZLE Ø 2.5
	30-2201-04	W18Q93309102	AMADA® - MITSUBISHI® HV NOZZLE Ø 3.0

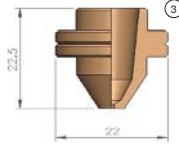

POS	LASERCORE	OEM	DESCRIPTION
3	30-2300-04		MITSUBISHI® NOZZLE Ø 1.0
	30-2301-04		MITSUBISHI® NOZZLE Ø 1.2
	30-2302-04		MITSUBISHI® NOZZLE Ø 1.5
	30-2303-04		MITSUBISHI® NOZZLE Ø 1.7
	30-2304-04		MITSUBISHI® NOZZLE Ø 2.0
	30-2305-04		MITSUBISHI® NOZZLE Ø 2.5

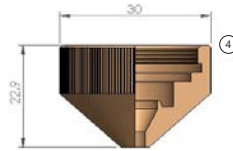

POS	LASERCORE	OEM	DESCRIPTION
4	30-2450-04	71800027-BQ933D221H04-P0593-8600001	MITSUBISHI® OUTER NOZZLE WITH INNER WALL

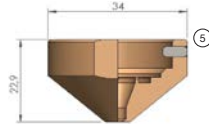

POS	LASERCORE	OEM	DESCRIPTION
5	30-2550-04		MITSUBISHI® EX OUTER NOZZLE Ø 3.0 MM

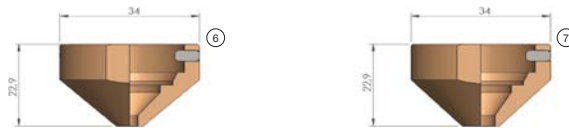

POS	LASERCORE	OEM	DESCRIPTION
6	30-2650-04	BQ980D442G03	MITSUBISHI® EX OUTER NOZZLE Ø 4.0 MM
7	30-2750-04	BQ980D442G01	MITSUBISHI® EX OUTER NOZZLE Ø 7.0 MM

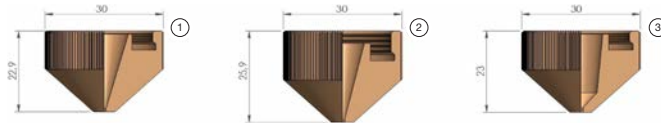

POS	LASERCORE	OEM	DESCRIPTION
1	30-2800-04	W1626	mitsubishi® NOZZLE Ø 1.0
	30-2801-04	W1627	mitsubishi® NOZZLE Ø 1.2
	30-2802-04		mitsubishi® NOZZLE Ø 1.4
	30-2803-04	W1628	mitsubishi® NOZZLE Ø 1.5
	30-2804-04	W1661	mitsubishi® NOZZLE Ø 1.7
	30-2805-04	W1629	mitsubishi® NOZZLE Ø 2.0
	30-2806-04	W1630	mitsubishi® NOZZLE Ø 2.5
	30-2807-04	W1664	mitsubishi® NOZZLE Ø 3.0
	30-2808-04	W1665	mitsubishi® NOZZLE Ø 3.5
	30-2809-04	W1666	mitsubishi® NOZZLE Ø 4.0
	30-2810-04	W1662	mitsubishi® NOZZLE Ø 4.5
2	30-2811-04	W1663	mitsubishi® NOZZLE Ø 5.0
	30-2900-04	W1249	mitsubishi® SHIELD NOZZLE Ø 1.0
	30-2901-04	W1256	mitsubishi® SHIELD NOZZLE Ø 1.2
	30-2902-04	W1250	mitsubishi® SHIELD NOZZLE Ø 1.5
	30-2903-04	W1251	mitsubishi® SHIELD NOZZLE Ø 2.0
	30-2904-04	W1252	mitsubishi® SHIELD NOZZLE Ø 2.5
	30-2905-04	W1253	mitsubishi® SHIELD NOZZLE Ø 3.0
3	30-2906-04	W1254	mitsubishi® SHIELD NOZZLE Ø 3.5
	30-2907-04	W1255	mitsubishi® SHIELD NOZZLE Ø 4.0
	30-3000-04	W1626B	mitsubishi® NOZZLE Ø 1.0 LOW PRESSURE
	30-3001-04	W1627B	mitsubishi® NOZZLE Ø 1.2 LOW PRESSURE
	30-3002-04	W1628B	mitsubishi® NOZZLE Ø 1.5 LOW PRESSURE
	30-3003-04	W1629B	mitsubishi® NOZZLE Ø 2.0 LOW PRESSURE
	30-3004-04	W1630B	mitsubishi® NOZZLE Ø 2.5 LOW PRESSURE
	W1664B	mitsubishi® NOZZLE Ø 3.0 LOW PRESSURE	
	W1665B	mitsubishi® NOZZLE Ø 3.5 LOW PRESSURE	
	W1666B	mitsubishi® NOZZLE Ø 4.0 LOW PRESSURE	



POS	LASERCORE	OEM	DESCRIPTION
4	30-3100-04	NCW1626C	NOZZLE Ø 1.0 NARROW CONE
	30-3101-04	NCW1627C	NOZZLE Ø 1.2 NARROW CONE
	30-3102-04	NCW1629C	NOZZLE Ø 2.0 NARROW CONE
	30-3103-04	NCW1630C	NOZZLE Ø 2.5 NARROW CONE

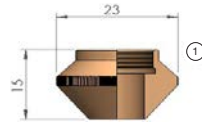

POS	LASERCORE	OEM	DESCRIPTION
1	30-5000-01	923021	TIP RETAINER NUT

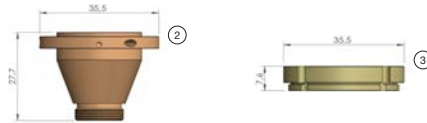

POS	LASERCORE	OEM	DESCRIPTION
2	30-5001-01	923258	TIP RETAINER
3	30-5002-01	923259	INSULATOR RING

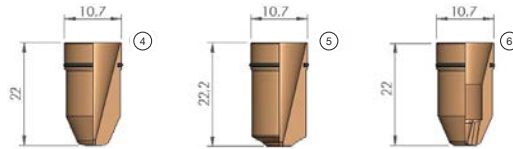

POS	LASERCORE	OEM	DESCRIPTION	
4	30-5100-04	924635	NOZZLE Ø 1.0 WITH O-RING	
	30-5101-04		NOZZLE Ø 1.2 WITH O-RING	
	30-5102-04		NOZZLE Ø 1.3 WITH O-RING	
	30-5103-04		NOZZLE Ø 1.4 WITH O-RING	
	30-5104-04		909660	NOZZLE Ø 1.5 WITH O-RING
	30-5105-04		910315	NOZZLE Ø 2.0 WITH O-RING
	30-5106-04		924638, 913191	NOZZLE Ø 2.5 WITH O-RING
5	30-5107-04	924634	NOZZLE Ø 3.0 WITH O-RING	
	30-5200-04	924636, 913188	NOZZLE Ø 1.5 WITH O-RING	
6	30-5201-04	924637, 913190	NOZZLE Ø 2.0 WITH O-RING	
	30-5300-04	923013	SHOWER NOZZLE Ø 1.0 WITH O-RING	
	30-5301-04	923014	SHOWER NOZZLE Ø 1.5 WITH O-RING	
	30-5302-04	910315-S	SHOWER NOZZLE Ø 2,0 WITH O-RING	

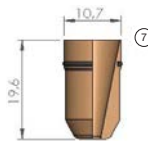

POS	LASERCORE	OEM	DESCRIPTION
7	30-5400-04	924635	NOZZLE W/O-RING Ø 3.15

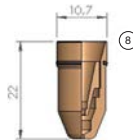

POS	LASERCORE	OEM	DESCRIPTION
8	30-5500-04	913026	DOUBLE NOZZLE W/O-RING Ø 1.0
	30-5501-04		DOUBLE NOZZLE W/O-RING Ø 1.2
	30-5502-04		DOUBLE NOZZLE W/O-RING Ø 1.5
	30-5503-04		DOUBLE NOZZLE W/O-RING Ø 2.0
	30-5504-04		DOUBLE NOZZLE W/O-RING Ø 2.5

NON-NOZZLES & NOZZLES

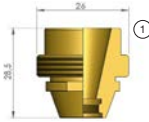

POS	LASERCORE	OEM	DESCRIPTION
1	40-1000-01	46603350510	NOZZLE ADAPTER BODY



POS	LASERCORE	OEM	DESCRIPTION
2	40-1001-01	46602350080	STYLUS FOOT H9 BRASS
3	40-1002-01		STYLUS FOOT H9 BRASS

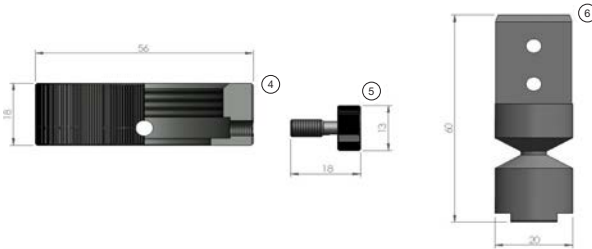

POS	LASERCORE	OEM	DESCRIPTION
4	40-1003-01	46683300930	RING
5	40-1004-01	46683300032	BOLT M5 x.05
6	40-1005-01	36682300280	ALUMINIUM BREAK-AWAY BAR L60 - M8

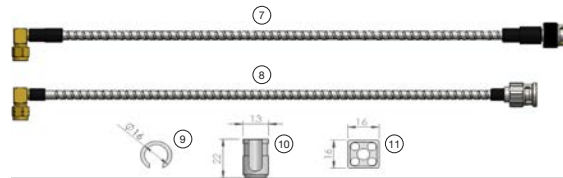

POS	LASERCORE	OEM	DESCRIPTION
7	40-1006-01	46683301980	CONNECTING CABLE FOR SENSOR HEAD
8	40-1007-01	46683301330	CONNECTING CABLE FOR SENSOR HEAD 33cm
9	40-1008-01	46683301870, 46683301920	COVER CLIPS PTFE
10	40-1009-01	46683301860, 46683301910	CONNECTOR COVER FOR CABLE PTFE
11	40-1010-01	46683301851	CONNECTOR COVER PTFE

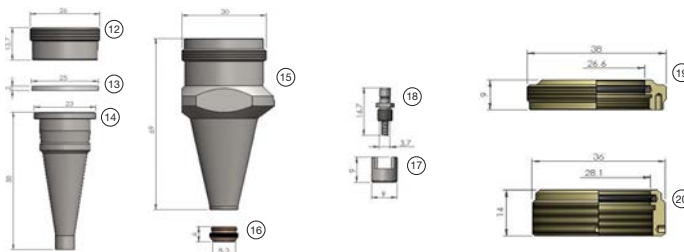

POS	LASERCORE	OEM	DESCRIPTION
12	40-1011-01	46713330940	TORCH INNER TOP
13	40-1012-01	46713330960	WASHER FOR CONE
14	40-1013-01	46713330930	INNER SENSOR CONE
15	40-1014-01	46713331240	SENSOR CONE
16	40-1015-01	46713300321-P0352-311-00001	VESPEL NUT - SPACE GEAR
17	40-1016-01	46713330951	CONNECTOR CAP
18	40-1017-01	46713331111	CONNECTOR
19	40-1018-01	P0492-702-00001-29100021-P0492-702-00002	INSULATING RING - plastic
20	40-1019-01	46713330920	INSULATION RING

NON-NOZZLES

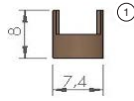

POS	LASERCORE	OEM	DESCRIPTION
1	40-1020-01	46713300390	INSULATOR COLLAR

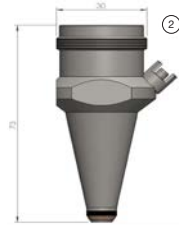

POS	LASERCORE	OEM	DESCRIPTION
2	40-1021-01		COMPLETE HEAD



POS	LASERCORE	OEM	DESCRIPTION
3	40-1022-01	281386 P0360-155-00500	ELECTRODE CABLE



POS	LASERCORE	OEM	DESCRIPTION
4	40-1023-01	46743300181	CONNECTING CABLE FOR SENSOR HEAD

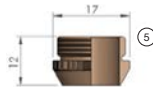

POS	LASERCORE	OEM	DESCRIPTION
5	40-1024-01	46713331280	NUT

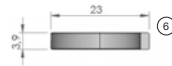

POS	LASERCORE	OEM	DESCRIPTION
6	40-1025-01	46143312180	CERAMIC RING 23x4



POS	LASERCORE	OEM	DESCRIPTION
7	40-1026-01	46143308290	DOWNSIDE CABLE OF PREAMP BUILT IN TYPE

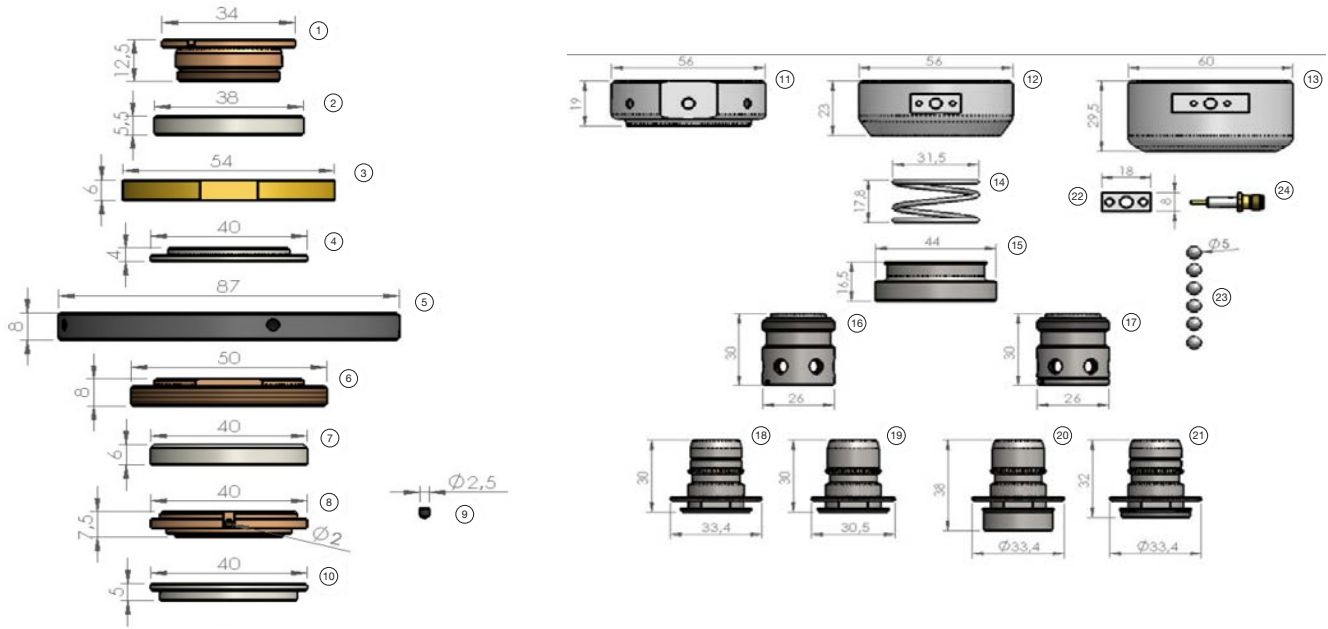

POS	LASERCORE	OEM	DESCRIPTION
1	40-7000-01	46143300280	H.G RETAINER NUT
2	40-7001-01	46143300270	SPACER PTFE 38x5,5
	40-7002-01	46143300270	SPACER CERAMIC 38x5,5
	40-7003-01	46143312100	SPACER PPS 38x5,5
3	40-7004-01	46143300320	BRASS NUT 56mm
	40-7005-01	46143300260	SPACER PTFE 40x4
4	40-7006-01	46143300260	SPACER CERAMIC 40x4
	40-7007-01	46143312130	SPACER PPS 40x4
	40-7008-01	36143300332	H.G. RING ALUMINIUM
6	40-7009-01	46143300290	H.G RETAINER NUT M50
	40-7010-01	46143304440	SPACER PTFE 40x6
	40-7011-01	46143304440	SPACER CERAMIC 40x6
7	40-7012-01	46143312170	SPACER PPS 40x6
	40-7013-01	46143307421	H.G. RETAINER NUT
	40-7014-01	46683301180	H.G. SCREW HEX DRIVE
10	40-7015-01	46143300240	SPACER PTFE 40x5
	40-7016-01	46143300240	SPACER CERAMIC 40x5
	40-7017-01	46143312120	SPACER PPS 40x5
11	40-7018-01	36143303242	H.G. BODY
12	40-7019-01	36143307980	H.G. ALUMINIUM BODY
13	40-7020-01	36143310550	H.G. ALUMINIUM BODY
14	40-7021-01	46143300220	H.G. SPRING
15	40-7022-01	46143308000	H.G. RETAINER SPRING STEEL
16	40-7023-01	36143304400, 36143304401	H.G. COUPLER
17	40-7024-01	36143310530	H.G. COUPLER
18	40-7025-01	36143310522	H.G. NOZZLE HOLDER LARGE
19	40-7026-01	36143304420	H.G. NOZZLE HOLDER
20	40-7027-01	36143310740	H.G. NOZZLE HOLDER LONG
21	40-7028-01		H.G. NOZZLE HOLDER
22	40-7029-01	46143308170	H.G. SPACER FOR CONNECTOR ALUMINIUM
23	40-7030-01	46143300230	H.G. KIT BALL - 6 PCS
24	40-7031-01	46143308190	H.G. CONNECTOR

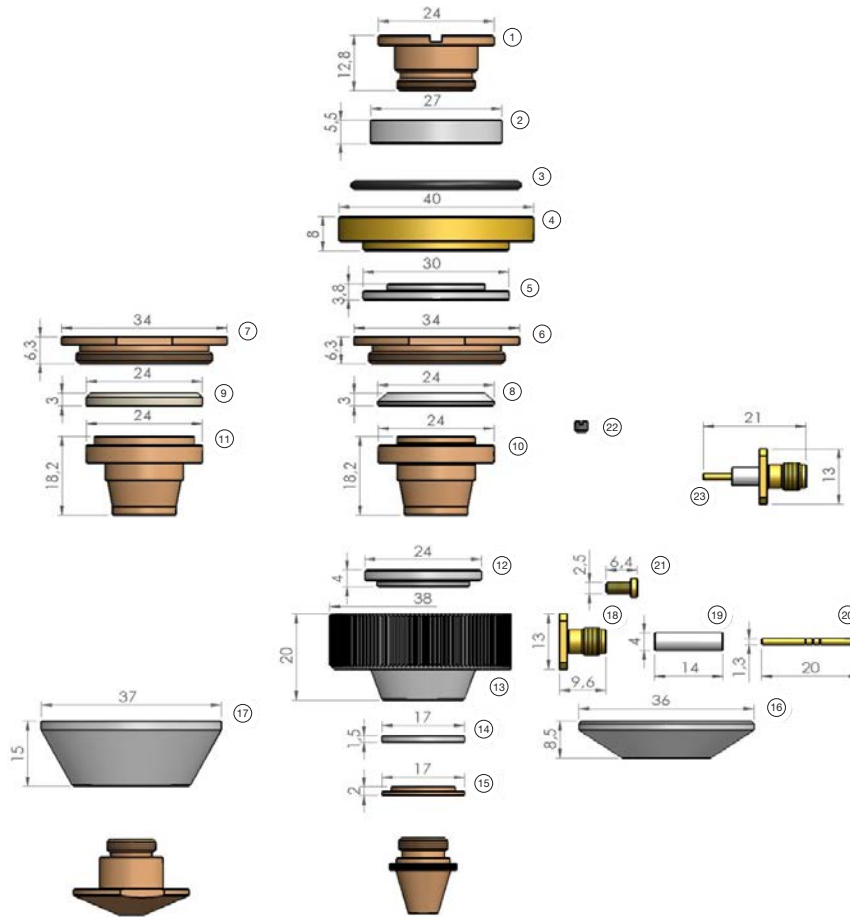

POS	LASERCORE	OEM	DESCRIPTION
1	40-8000-01	46683301110	NOZZLE HOLDER
2	40-8001-01	46683301080, 46683302081	SPACER PTFE 27X5,5
	40-8002-01	46683301080, 46683302081	SPECIAL SPACER 27X5.5 - PEEK
	40-8003-01	46683301080, 46683302081	CERAMIC SPACER 27x5.5
3	40-8004-01	J2600S03200	O'RING EXTERNAL BASE - RUBBER
4	40-8005-01	46683301070	BRASS BASE
	40-8006-01	46683301090	SPACER PTFE 30X4
5	40-8007-01	46683301090	SPECIAL SPACER 30X4 - PEEK
	40-8008-01	46683301090	CERAMIC SPACER 30x4
	40-8009-01	46683301100	COPPER NUT
7	40-8010-01	46773300510	COPPER RING SUPPORT
	40-8011-01	46683301120	PTFE SPACER 24x3
	40-8012-01	46683301120	SPECIAL SPACER 24x3 - PLASTIC
	40-8013-01	46683301120	CERAMIC SPACER 24x3
9	40-8014-01	46773300710	CERAMIC SPACER 24x3
	40-8015-01	46773300710	CERAMIC SPACER 24x3
	40-8016-01	46683300850	COPPER NOZZLE HOLDER
11	40-8017-01	46773300720, 46773300721	COPPER NOZZLE HOLDER
	40-8018-01	46683301130	SPACER PTFE 24X4
12	40-8019-01	46683301130	SPECIAL SPACER 24X4 - PLASTIC
	40-8020-01	46683301130	CERAMIC SPACER 24X4
13	40-8021-01	46683301140	ALUMINIUM BODY
14	40-8022-01	46683301150	SPACER PTFE 17X1,5
	40-8023-01	46683301160	COPPER RING
16	40-8024-01	46683301930	PTFE PROTECTION
	40-8025-01	46683301930P	SPECIAL PROTECTION - PLASTIC
17	40-8026-01	46683301841	INSULATOR PTFE H15
18	40-8027-01		CONNECTOR
19	40-8028-01		CONNECTING PTFE PIPE
20	40-8029-01	46683301170	CONTACT
21	40-8030-01	46683300000	SCREW (4PCS)
22	40-8031-01	46683301180	SCREW FOR CONTACT SLOTTED HEAD
23	40-8032-01	46683301171	CONNECTOR ASSEMBLY

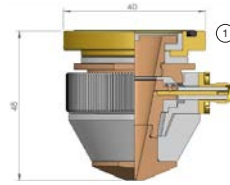

POS	LASERCORE	OEM	DESCRIPTION
1	40-8040-01		HEAD W/PTFE SPACER
	40-8041-01		HEAD W/LONG LIFE SPACER
	40-8042-01		HEAD W/CERAMIC SPACER

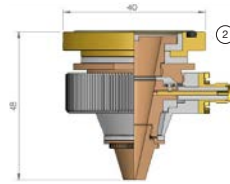

POS	LASERCORE	OEM	DESCRIPTION
2	40-8050-01		HEAD W/PTFE SPACER
	40-8051-01		HEAD W/LONG LIFE SPACER
	40-8052-01		HEAD W/CERAMIC SPACER

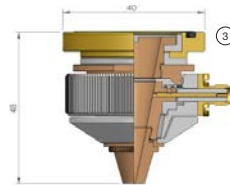

POS	LASERCORE	OEM	DESCRIPTION
3	40-8060-01		HEAD W/PTFE SPACER
	40-8061-01		HEAD W/LONG LIFE SPACER
	40-8062-01		HEAD W/CERAMIC SPACER

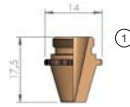

POS	LASERCORE	OEM	DESCRIPTION
1	40-1100-04	46603350508	NOZZLE Ø 0.8
	40-1101-04	46603350511	NOZZLE Ø 1.0
	40-1102-04	46603350512	NOZZLE Ø 1.2
	40-1103-04	4660335052B	NOZZLE Ø 1.5
	40-1104-04	46603350517	NOZZLE Ø 1.7
	40-1105-04	46603350517-1.8	NOZZLE Ø 1.8
	40-1106-04	4660335052C	NOZZLE Ø 2.0
	40-1107-04	46603350522-2.2	NOZZLE Ø 2.2
	40-1108-04	46603350525	NOZZLE Ø 2.5
	40-1109-04	46603350530	NOZZLE Ø 3.0
	40-1110-04	46603350530-3,5 Q660335052F	NOZZLE Ø 3.5
	40-1111-04	46603350530-4.0	NOZZLE Ø 4.0
	40-1112-04	46603350530-4.5	NOZZLE Ø 4.5
	40-1113-04	46603350530-5.0	NOZZLE Ø 5.0

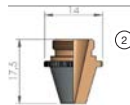

POS	LASERCORE	OEM	DESCRIPTION
2	40-1120-C-04	46603350508	NOZZLE Ø 0.8 CP
	40-1121-C-04	46603350511	NOZZLE Ø 1.0 CP
	40-1122-C-04	46603350512	NOZZLE Ø 1.2 CP
	40-1123-C-04	4660335052B	NOZZLE Ø 1.5 CP
	40-1124-C-04	46603350517	NOZZLE Ø 1.7 CP
	40-1125-C-04	46603350517-1.8	NOZZLE Ø 1.8 CP
	40-1126-C-04	4660335052C	NOZZLE Ø 2.0 CP
	40-1127-C-04	46603350522-2.2	NOZZLE Ø 2.2 CP
	40-1128-C-04	46603350525	NOZZLE Ø 2.5 CP
	40-1129-C-04	46603350530	NOZZLE Ø 3.0 CP
	40-1130-C-04	46603350530-3,5 Q660335052F	NOZZLE Ø 3.5 CP
	40-1131-C-04	46603350530-4.0	NOZZLE Ø 4.0 CP
	40-1132-C-04	46603350530-4.5	NOZZLE Ø 4.5 CP
	40-1133-C-04	46603350530-5.0	NOZZLE Ø 5.0 CP

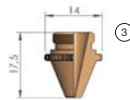

POS	LASERCORE	OEM	DESCRIPTION
3	40-1200-04	46603350521-0,8	NOZZLE Ø 0.8
	40-1201-04	46603350521-1,0	NOZZLE Ø 1.0
	40-1202-04	46603350521-1,2	NOZZLE Ø 1.2
	40-1203-04	46603350520-1,5	NOZZLE Ø 1.5
	40-1204-04	46603350521-1,7	NOZZLE Ø 1.7
	40-1205-04	46603350522-2,0	NOZZLE Ø 2.0
	40-1206-04	46603350522-2,5	NOZZLE Ø 2.5
	40-1207-04	46683301281-2,5	NOZZLE Ø 3.0

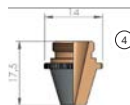

POS	LASERCORE	OEM	DESCRIPTION
4	40-1220-C-04	46603350521-0,8	NOZZLE Ø 0.8 CP
	40-1221-C-04	46603350521-1,0	NOZZLE Ø 0.8 CP
	40-1222-C-04	46603350521-1,2	NOZZLE Ø 1.2 CP
	40-1223-C-04	46603350520-1,5	NOZZLE Ø 1.5 CP
	40-1224-C-04	46603350521-1,7	NOZZLE Ø 1.7 CP
	40-1225-C-04	46603350522-2,0	NOZZLE Ø 2.0 CP
	40-1226-C-04	46603350522-2,5	NOZZLE Ø 2.5 CP
	40-1227-C-04	46683301281-2,5	NOZZLE Ø 3.0 CP

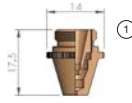

POS	LASERCORE	OEM	DESCRIPTION
1	40-1300-04		DOUBLE NOZZLE Ø 1.0
	40-1301-04		DOUBLE NOZZLE Ø 1.2
	40-1302-04		DOUBLE NOZZLE Ø 1.5
	40-1303-04		DOUBLE NOZZLE Ø 1.7
	40-1304-04		DOUBLE NOZZLE Ø 1.8
	40-1305-04		DOUBLE NOZZLE Ø 2.0
	40-1306-04		DOUBLE NOZZLE Ø 2.0
	40-1307-04		DOUBLE NOZZLE Ø 2.5
	40-1308-04		DOUBLE NOZZLE Ø 3.0

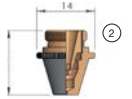

POS	LASERCORE	OEM	DESCRIPTION
2	40-1320-C-04		DOUBLE NOZZLE Ø 1.0 CP
	40-1321-C-04		DOUBLE NOZZLE Ø 1.2 CP
	40-1322-C-04		DOUBLE NOZZLE Ø 1.5 CP
	40-1323-C-04		DOUBLE NOZZLE Ø 1.7 CP
	40-1324-C-04		DOUBLE NOZZLE Ø 1.8 CP
	40-1325-C-04		DOUBLE NOZZLE Ø 2.0 CP
	40-1326-C-04		DOUBLE NOZZLE Ø 2.2 CP
	40-1327-C-04		DOUBLE NOZZLE Ø 2.5 CP
	40-1328-C-04		DOUBLE NOZZLE Ø 3.0 CP

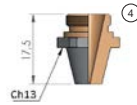
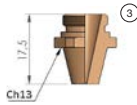

POS	LASERCORE	OEM	DESCRIPTION
3	40-1400-04		HEXAGONAL NOZZLE Ø 0.8
	40-1401-04		HEXAGONAL NOZZLE Ø 1.0
	40-1402-04		HEXAGONAL NOZZLE Ø 1.2
	40-1403-04		HEXAGONAL NOZZLE Ø 1.5
	40-1404-04		HEXAGONAL NOZZLE Ø 1.7
	40-1405-04		HEXAGONAL NOZZLE Ø 1.8
	40-1406-04		HEXAGONAL NOZZLE Ø 2.0
	40-1407-04		HEXAGONAL NOZZLE Ø 2.2
	40-1408-04		HEXAGONAL NOZZLE Ø 2.5
	40-1409-04		HEXAGONAL NOZZLE Ø 3.0
	40-1410-04		HEXAGONAL NOZZLE Ø 3.5
4	40-1411-04		HEXAGONAL NOZZLE Ø 4.0
	40-1420-C-04		HEXAGONAL NOZZLE Ø 0.8 CP
	40-1421-C-04		HEXAGONAL NOZZLE Ø 1.0 CP
	40-1422-C-04		HEXAGONAL NOZZLE Ø 1.2 CP
	40-1423-C-04		HEXAGONAL NOZZLE Ø 1.5 CP
	40-1424-C-04		HEXAGONAL NOZZLE Ø 1.7 CP
	40-1425-C-04		HEXAGONAL NOZZLE Ø 1.8 CP
	40-1426-C-04		HEXAGONAL NOZZLE Ø 2.0 CP
	40-1427-C-04		HEXAGONAL NOZZLE Ø 2.2 CP
	40-1428-C-04		HEXAGONAL NOZZLE Ø 2.5 CP
	40-1429-C-04		HEXAGONAL NOZZLE Ø 3.0 CP
40-1430-C-04		HEXAGONAL NOZZLE Ø 3.5 CP	
40-1431-C-04		HEXAGONAL NOZZLE Ø 4.0 CP	

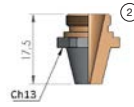
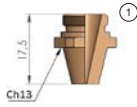

POS	LASERCORE	OEM	DESCRIPTION
1	40-1500-04		HEXAGONAL DOUBLE NOZZLE Ø 1.2
	40-1501-04		HEXAGONAL DOUBLE NOZZLE Ø 1.5
	40-1502-04		HEXAGONAL DOUBLE NOZZLE Ø 1.8
	40-1503-04		HEXAGONAL DOUBLE NOZZLE Ø 2.0
	40-1504-04		HEXAGONAL DOUBLE NOZZLE Ø 2.2
	40-1505-04		HEXAGONAL DOUBLE NOZZLE Ø 2.5
2	40-1506-04		HEXAGONAL DOUBLE NOZZLE Ø 3.0
	40-1520-C-04		HEXAGONAL DOUBLE NOZZLE Ø 1.2 CP
	40-1521-C-04		HEXAGONAL DOUBLE NOZZLE Ø 1.5 CP
	40-1522-C-04		HEXAGONAL DOUBLE NOZZLE Ø 1.8 CP
	40-1523-C-04		HEXAGONAL DOUBLE NOZZLE Ø 2.0 CP
	40-1524-C-04		HEXAGONAL DOUBLE NOZZLE Ø 2.2 CP
	40-1525-C-04		HEXAGONAL DOUBLE NOZZLE Ø 2.5 CP
40-1526-C-04		HEXAGONAL DOUBLE NOZZLE Ø 3.0 CP	

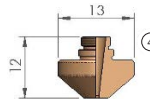
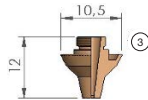

POS	LASERCORE	OEM	DESCRIPTION
3	40-1600-04	46713300290-10	NOZZLE 3D Ø 1.0
	40-1601-04	Q6713330410 / 46713300290-12	NOZZLE 3D Ø 1.2
	40-1602-04	46713300290-15 / P0352-381-00015	NOZZLE 3D Ø 1.5
	40-1603-04		NOZZLE 3D Ø 1.8
	40-1604-04	46713300280 / P0352-382-00020	NOZZLE 3D Ø 2.0
	40-1605-04	46713300280-25	NOZZLE 3D Ø 2.5
	40-1606-04	46713300280-30 / 46713300430	NOZZLE 3D Ø 3.0
4	40-1607-04	46713300280-35	NOZZLE 3D Ø 3.5
	40-1700-04		NOZZLE 2D Ø 1.0
	40-1701-04	46713300310	NOZZLE 2D Ø 1.2
	40-1702-04	P0352-386-00015	NOZZLE 2D Ø 1.5
	40-1703-04		NOZZLE 2D Ø 1.8
	40-1704-04	46713300300 / P0352-387-00020	NOZZLE 2D Ø 2.0
	40-1705-04	46713300300-25	NOZZLE 2D Ø 2.5
40-1706-04	46713300300-30	NOZZLE 2D Ø 3.0	

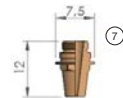
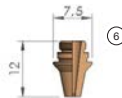
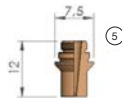

POS	LASERCORE	OEM	DESCRIPTION
5	40-1800-04	281005-P0352-323-00010	NOZZLE Ø1.0 ZK
	40-1801-04	281034-P0352-324-00012	NOZZLE Ø1.2 ZK
	40-1802-04	281013-P0352-325-00015	NOZZLE Ø1.5 ZK
	40-1803-04	280899-P0352-326-00018	NOZZLE Ø1.8 ZK
	40-1804-04	350044.3-P0352-327-00020	NOZZLE Ø2.0 ZK
	40-1805-04	P0352-328-00025	NOZZLE Ø2.5 ZK
6	40-1900-04	281006-P0352-333-00010	NOZZLE Ø1.0 KK
	40-1901-04	281030-P0352-334-00012	NOZZLE Ø1.2 KK
	40-1902-04	281031-P0352-335-00015	NOZZLE Ø1.5 KK
	40-1903-04	280898-P0352-336-00018	NOZZLE Ø1.8 KK
7	40-1904-04	P0352.336.00020	NOZZLE Ø2.0 KK
	40-2000-04		NOZZLE DE M1.5 KS 1.0 HEX
	40-2001-04		NOZZLE DE M1.5 KS 1.2 HEX
	40-2002-04	P0491-1001-00015	NOZZLE DE M1.5 KS 1.5 HEX
40-2003-04	P0491-1002-00020	NOZZLE DE M1.5 KS 2.0 HEX	

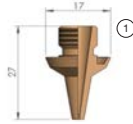

POS	LASERCORE	OEM	DESCRIPTION
1	40-2100-04		NOZZLE 3D Ø1,0
	40-2101-04	46713331320	NOZZLE 3D Ø1,2
	40-2102-04	46713331310	NOZZLE 3D Ø1,5
	40-2103-04		NOZZLE 3D Ø1,8
	40-2104-04	46713331300	NOZZLE 3D Ø2,0
	40-2110-04	46713331330	NOZZLE 3D Ø2,5
	40-2111-04	46713331290	NOZZLE 3D Ø3,0
	40-2112-04		NOZZLE 3D Ø3,5

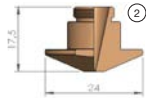

POS	LASERCORE	OEM	DESCRIPTION
2	40-2200-04		NOZZLE Ø 1.0
	40-2201-04		NOZZLE Ø 1.2
	40-2202-04	46683301950	NOZZLE Ø 1.5
	40-2203-04	46683301821	NOZZLE Ø 2.0
	40-2204-04	46683301960	NOZZLE Ø 2.5
	40-2205-04	46683301970	NOZZLE Ø 3.0
	40-2206-04		NOZZLE Ø 3.5
	40-2207-04		NOZZLE Ø 4.0
	40-2208-04		NOZZLE Ø 4.5

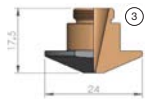

POS	LASERCORE	OEM	DESCRIPTION
3	40-2220-C-04		NOZZLE Ø 1.0 CP
	40-2221-C-04		NOZZLE Ø 1.2 CP
	40-2222-C-04	46683301950	NOZZLE Ø 1.5 CP
	40-2223-C-04	46683301821	NOZZLE Ø 2.0 CP
	40-2224-C-04	46683301960	NOZZLE Ø 2.5 CP
	40-2225-C-04	46683301970	NOZZLE Ø 3.0 CP
	40-2226-C-04		NOZZLE Ø 3.5 CP
	40-2227-C-04		NOZZLE Ø 4.0 CP
	40-2228-C-04		NOZZLE Ø 4.5 CP

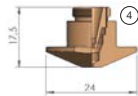

POS	LASERCORE	OEM	DESCRIPTION
4	40-2300-04		DOUBLE NOZZLE Ø 1.0
	40-2301-04		DOUBLE NOZZLE Ø 1.2
	40-2302-04	46683302420	DOUBLE NOZZLE Ø 1.5
	40-2303-04		DOUBLE NOZZLE Ø 1.8
	40-2304-04	46683302430	DOUBLE NOZZLE Ø 2.0
	40-2305-04	46683302440	DOUBLE NOZZLE Ø 2.5
5	40-2306-04	46683302450	DOUBLE NOZZLE Ø 3,0
	40-2320-C-04		DOUBLE NOZZLE Ø 1.0 CP
	40-2321-C-04		DOUBLE NOZZLE Ø 1.2 CP
	40-2322-C-04	46683302420	DOUBLE NOZZLE Ø 1.5 CP
	40-2323-C-04		DOUBLE NOZZLE Ø 1.8 CP
	40-2324-C-04	46683302430	DOUBLE NOZZLE Ø 2.0 CP
	40-2325-C-04	46683302440	DOUBLE NOZZLE Ø 2.5 CP
40-2326-C-04	46683302440	DOUBLE NOZZLE Ø 3.0 CP	

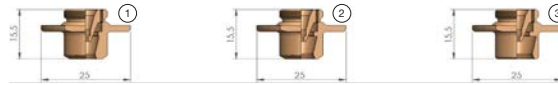

POS	LASERCORE	OEM	DESCRIPTION
1	40-2400-04	Q6283300030	DOUBLE NOZZLE SMOOTH Ø 6.0
2	40-2401-04	Q6283300020	DOUBLE NOZZLE SMOOTH Ø 7.5
3	40-2402-04	Q6283300010	DOUBLE NOZZLE SMOOTH Ø 9.5

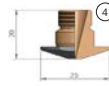

POS	LASERCORE	OEM	DESCRIPTION
4	40-2500-C-04		NOZZLE Ø 0.8 CP
	40-2501-C-04		NOZZLE Ø 1.0 CP
	40-2502-C-04	46143304470	NOZZLE Ø 1.2 CP
	40-2503-C-04	46143304450	NOZZLE Ø 1.5 CP
	40-2504-C-04		NOZZLE Ø 1.8 CP
	40-2505-C-04	46143304460	NOZZLE Ø 2.0 CP
	40-2506-C-04	46143304480	NOZZLE Ø 2.5 CP
	40-2507-C-04	46143304490	NOZZLE Ø 3.0 CP
	40-2508-C-04	46143304500	NOZZLE Ø 3.5 CP
	40-2509-C-04	46143304510	NOZZLE Ø 4.0 CP

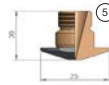

POS	LASERCORE	OEM	DESCRIPTION
5	40-2600-C-04		DOUBLE NOZZLE Ø 1.2 CP
	40-2601-C-04	46143306450	DOUBLE NOZZLE Ø 1.5 CP
	40-2602-C-04	46143306460	DOUBLE NOZZLE Ø 2.0 CP
	40-2603-C-04	46143306480	DOUBLE NOZZLE Ø 2.5 CP
	40-2604-C-04	46143306490	DOUBLE NOZZLE Ø 3.0 CP
	40-2605-C-04	46143306500	DOUBLE NOZZLE Ø 3.5 CP
	40-2606-C-04		DOUBLE NOZZLE Ø 4.0 CP



POS	LASERCORE	OEM	DESCRIPTION
6	40-2700-C-04		NOZZLE SLIM Ø 0.8 CP
	40-2701-C-04		NOZZLE SLIM Ø 1.0 CP
	40-2702-C-04	46143310343	NOZZLE SLIM Ø 1.2 CP
	40-2703-C-04	46143310353	NOZZLE SLIM Ø 1.5 CP
	40-2704-C-04		NOZZLE SLIM Ø 1.8 CP
	40-2705-C-04	46143310363	NOZZLE SLIM Ø 2.0 CP
	40-2706-C-04		NOZZLE SLIM Ø 2.2 CP
	40-2707-C-04	46143310373	NOZZLE SLIM Ø 2.5 CP
	40-2708-C-04	46143310383	NOZZLE SLIM Ø 3.0 CP
	40-2709-C-04	46143310393	NOZZLE SLIM Ø 3.5 CP
	40-2710-C-04	46143310403	NOZZLE SLIM Ø 4.0 CP

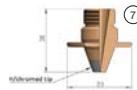

POS	LASERCORE	OEM	DESCRIPTION
7	40-2800-CT-04		NOZZLE SLIM Ø 0.8 CP
	40-2801-CT-04		NOZZLE SLIM Ø 1.0 CP
	40-2802-CT-04	46143310343	NOZZLE SLIM Ø 1.2 CP
	40-2803-CT-04	46143310353	NOZZLE SLIM Ø 1.5 CP
	40-2804-CT-04		NOZZLE SLIM Ø 1.8 CP
	40-2805-CT-04	46143310363	NOZZLE SLIM Ø 2.0 CP
	40-2806-CT-04		NOZZLE SLIM Ø 2.2 CP
	40-2807-CT-04	46143310373	NOZZLE SLIM Ø 2.5 CP
	40-2808-CT-04	46143310383	NOZZLE SLIM Ø 3.0 CP
	40-2809-CT-04	46143310393	NOZZLE SLIM Ø 3.5 CP
	40-2810-CT-04	46143310402	NOZZLE SLIM Ø 4.0 CP

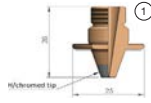

POS	LASERCORE	OEM	DESCRIPTION
1	40-2900-C-04		DOUBLE NOZZLE SLIM Ø 0.8 CP
	40-2901-C-04		DOUBLE NOZZLE SLIM Ø 1.0 CP
	40-2902-C-04		DOUBLE NOZZLE SLIM Ø 1.2 CP
	40-2903-C-04	36143311500	DOUBLE NOZZLE SLIM Ø 1.5 CP
	40-2904-C-04		DOUBLE NOZZLE SLIM Ø 1.8 CP
	40-2905-C-04	36143311510	DOUBLE NOZZLE SLIM Ø 2.0 CP
	40-2906-C-04		DOUBLE NOZZLE SLIM Ø 2.2 CP
	40-2907-C-04	36143311520	DOUBLE NOZZLE SLIM Ø 2.5 CP
	40-2908-C-04	36143311530	DOUBLE NOZZLE SLIM Ø 3.0 CP
	40-2909-C-04	36143312380	DOUBLE NOZZLE SLIM Ø 3.5 CP
	40-2910-C-04	36143312390	DOUBLE NOZZLE SLIM Ø 4.0 CP
	40-2911-C-04		DOUBLE NOZZLE SLIM Ø 4.5 CP
	40-2912-C-04		DOUBLE NOZZLE SLIM Ø 5.0 CP

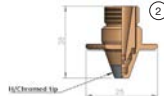

POS	LASERCORE	OEM	DESCRIPTION
2	40-3000-CT-04		DOUBLE NOZZLE SLIM Ø 0.8 CP
	40-3001-CT-04		DOUBLE NOZZLE SLIM Ø 1.0 CP
	40-3002-CT-04		DOUBLE NOZZLE SLIM Ø 1.2 CP
	40-3003-CT-04	36143311500	DOUBLE NOZZLE SLIM Ø 1.5 CP
	40-3004-CT-04		DOUBLE NOZZLE SLIM Ø 1.8 CP
	40-3005-CT-04	36143311510	DOUBLE NOZZLE SLIM Ø 2.0 CP
	40-3006-CT-04		DOUBLE NOZZLE SLIM Ø 2.2 CP
	40-3007-CT-04	36143311520	DOUBLE NOZZLE SLIM Ø 2.5 CP
	40-3008-CT-04	36143311530	DOUBLE NOZZLE SLIM Ø 3.0 CP
	40-3009-CT-04	36143312380	DOUBLE NOZZLE SLIM Ø 3.5 CP
	40-3010-CT-04	36143312390	DOUBLE NOZZLE SLIM Ø 4.0 CP
	40-3011-CT-04		DOUBLE NOZZLE SLIM Ø 4.5 CP
	40-3012-CT-04		DOUBLE NOZZLE SLIM Ø 5.0 CP

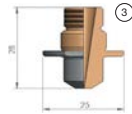

POS	LASERCORE	OEM	DESCRIPTION
3	40-3100-C-04		NOZZLE PENCIL Ø 0.8 CP
	40-3101-C-04	6283301190	NOZZLE PENCIL Ø 1.0 CP
	40-3102-C-04	36143312220	NOZZLE PENCIL Ø 1.2 CP
	40-3103-C-04	36143312230	NOZZLE PENCIL Ø 1.5 CP
	40-3104-C-04	Q6143300060	NOZZLE PENCIL Ø 1.8 CP
	40-3105-C-04	36143312240	NOZZLE PENCIL Ø 2.0 CP
	40-3106-C-04		NOZZLE PENCIL Ø 2.2 CP
	40-3107-C-04	36143312250	NOZZLE PENCIL Ø 2.5 CP
	40-3108-C-04	36143312260	NOZZLE PENCIL Ø 3.0 CP
	40-3109-C-04	36143312270	NOZZLE PENCIL Ø 3.5 CP
	40-3110-C-04	36143312280	NOZZLE PENCIL Ø 4.0 CP
	40-3111-C-04	6143355590	NOZZLE PENCIL Ø 4.5 CP
	40-3112-C-04	6283301030	NOZZLE PENCIL Ø 5.0 CP
	40-3113-C-04	6143355600	NOZZLE PENCIL Ø 5.5 CP

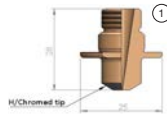

POS	LASERCORE	OEM	DESCRIPTION
1	40-3200-CT-04		NOZZLE PENCIL Ø 0.8 CP
	40-3201-CT-04	6283301190	NOZZLE PENCIL Ø 1.0 CP
	40-3202-CT-04	36143312220	NOZZLE PENCIL Ø 1.2 CP
	40-3203-CT-04	36143312230	NOZZLE PENCIL Ø 1.5 CP
	40-3204-CT-04	Q6143300060	NOZZLE PENCIL Ø 1.8 CP
	40-3205-CT-04	36143312240	NOZZLE PENCIL Ø 2.0 CP
	40-3206-CT-04		NOZZLE PENCIL Ø 2.2 CP
	40-3207-CT-04	36143312250	NOZZLE PENCIL Ø 2.5 CP
	40-3208-CT-04	36143312260	NOZZLE PENCIL Ø 3.0 CP
	40-3209-CT-04	36143312270	NOZZLE PENCIL Ø 3.5 CP
	40-3210-CT-04	36143312280	NOZZLE PENCIL Ø 4.0 CP
	40-3211-CT-04	6143355590	NOZZLE PENCIL Ø 4.5 CP
	40-3212-CT-04	6283301030	NOZZLE PENCIL Ø 5.0 CP
	40-3213-CT-04	6143355600	NOZZLE PENCIL Ø 5.5 CP

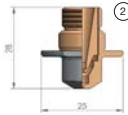

POS	LASERCORE	OEM	DESCRIPTION
2	40-3300-C-04		DOUBLE NOZZLE PENCIL Ø 0.8 CP
	40-3301-C-04		DOUBLE NOZZLE PENCIL Ø 1.0 CP
	40-3302-C-04	Q6143300080	DOUBLE NOZZLE PENCIL Ø 1.2 CP
	40-3303-C-04	36143312300	DOUBLE NOZZLE PENCIL Ø 1.5 CP
	40-3304-C-04	36143312310	DOUBLE NOZZLE PENCIL Ø 1.8 CP
	40-3305-C-04	36143312311	DOUBLE NOZZLE PENCIL Ø 2.0 CP
	40-3306-C-04		DOUBLE NOZZLE PENCIL Ø 2.2 CP
	40-3307-C-04	36143312320	DOUBLE NOZZLE PENCIL Ø 2.5 CP
	40-3308-C-04	36143312330	DOUBLE NOZZLE PENCIL Ø 3.0 CP
	40-3309-C-04	36143312340	DOUBLE NOZZLE PENCIL Ø 3.5 CP
	40-3310-C-04	36143312350	DOUBLE NOZZLE PENCIL Ø 4.0 CP
	40-3311-C-04	Q6143312360	DOUBLE NOZZLE PENCIL Ø 4.5 CP
	40-3312-C-04	Q6143312370	DOUBLE NOZZLE PENCIL Ø 5.0 CP

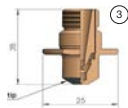

POS	LASERCORE	OEM	DESCRIPTION
3	40-3400-CT-04		DOUBLE NOZZLE PENCIL Ø 0.8 CP
	40-3401-CT-04		DOUBLE NOZZLE PENCIL Ø 1.0 CP
	40-3402-CT-04	Q6143300080	DOUBLE NOZZLE PENCIL Ø 1.2 CP
	40-3403-CT-04	36143312300	DOUBLE NOZZLE PENCIL Ø 1.5 CP
	40-3404-CT-04	36143312310	DOUBLE NOZZLE PENCIL Ø 1.8 CP
	40-3405-CT-04	36143312311	DOUBLE NOZZLE PENCIL Ø 2.0 CP
	40-3406-CT-04		DOUBLE NOZZLE PENCIL Ø 2.2 CP
	40-3407-CT-04	36143312320	DOUBLE NOZZLE PENCIL Ø 2.5 CP
	40-3408-CT-04	36143312330	DOUBLE NOZZLE PENCIL Ø 3.0 CP
	40-3409-CT-04	36143312340	DOUBLE NOZZLE PENCIL Ø 3.5 CP
	40-3410-CT-04	36143312350	DOUBLE NOZZLE PENCIL Ø 4.0 CP
	40-3411-CT-04	Q6143312360	DOUBLE NOZZLE PENCIL Ø 4.5 CP
	40-3412-CT-04	Q6143312370	DOUBLE NOZZLE PENCIL Ø 5.0 CP



POS	LASERCORE	OEM	DESCRIPTION
1	40-3500-C-04		DOUBLE NOZZLE PENCIL SUS Ø 4.0 - inner Ø1,2
	40-3501-C-04	6143355360	DOUBLE NOZZLE PENCIL SUS Ø 4.0 - inner Ø1,4
	40-3502-C-04	6143355370	DOUBLE NOZZLE PENCIL SUS Ø 4.0 - inner Ø1,8
	40-3503-C-04	6283301050	DOUBLE NOZZLE PENCIL SUS Ø 4.5 - inner Ø1,2
	40-3504-C-04	6283301200	DOUBLE NOZZLE PENCIL SUS Ø 5.0 - inner Ø1,2
	40-3505-C-04	6283301210	DOUBLE NOZZLE PENCIL SUS Ø 5.5 - inner Ø1,2
	40-3506-C-04	6283301840	DOUBLE NOZZLE PENCIL SUS Ø 5.5 - inner Ø2,0
2	40-3600-CT-04		DOUBLE NOZZLE PENCIL SUS Ø 4.0 - inner Ø1,2
	40-3601-CT-04	6143355360	DOUBLE NOZZLE PENCIL SUS Ø 4.0 - inner Ø1,4
	40-3602-CT-04	6143355370	DOUBLE NOZZLE PENCIL SUS Ø 4.0 - inner Ø1,8
	40-3603-CT-04	6283301050	DOUBLE NOZZLE PENCIL SUS Ø 4.5 - inner Ø1,2
	40-3604-CT-04	6283301200	DOUBLE NOZZLE PENCIL SUS Ø 5.0 - inner Ø1,2
	40-3605-CT-04	6283301210	DOUBLE NOZZLE PENCIL SUS Ø 5.5 - inner Ø1,2
	40-3606-CT-04	6283301840	DOUBLE NOZZLE PENCIL SUS Ø 5.5 - inner Ø2,0

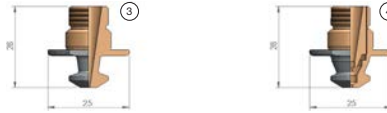

POS	LASERCORE	OEM	DESCRIPTION
3	40-3700-C-04	6283301790	NOZZLE PENCIL Ø 1.0HP CP
	40-3701-C-04	6283301800	NOZZLE PENCIL Ø 1.2HP CP
	40-3702-C-04	6283301810	NOZZLE PENCIL Ø 1.5HP CP
4	40-3710-C-04	6283301820	DOUBLE NOZZLE PENCIL Ø 1.5HP CP

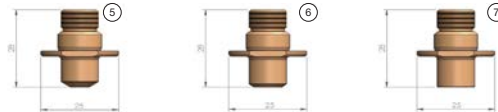

POS	LASERCORE	OEM	DESCRIPTION
5	40-3800-04		DOUBLE NOZZLE Ø 2.5 - SS
	40-3801-04		DOUBLE NOZZLE Ø 3.0 - SS
	40-3802-04		DOUBLE NOZZLE Ø 4.0 - SS
6	40-3803-04		DOUBLE NOZZLE Ø 6.0 - SS
7	40-3804-04		DOUBLE NOZZLE Ø 10.0 - SS

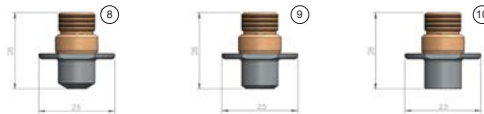

POS	LASERCORE	OEM	DESCRIPTION
8	40-3900-HC-04		DOUBLE NOZZLE Ø 2.5 SPECIAL CP - SS
	40-3901-HC-04		DOUBLE NOZZLE Ø 3.0 SPECIAL CP - SS
	40-3902-HC-04		DOUBLE NOZZLE Ø 4.0 SPECIAL CP - SS
9	40-3903-HC-04		DOUBLE NOZZLE Ø 6.0 SPECIAL CP - SS
10	40-3904-HC-04		DOUBLE NOZZLE Ø 10.0 SPECIAL CP - SS

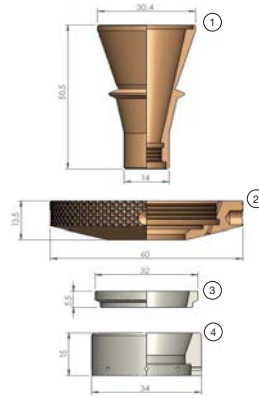

POS	LASERCORE	OEM	DESCRIPTION
1	50-1000-01	2-10837	NOZZLE BODY
2	50-1001-01	3-13110	COPPER SHIELD
3	50-1002-01	3-13113	INSULATING RING
4	50-1003-01	3-13422	INSULATING RING WITH HOLES

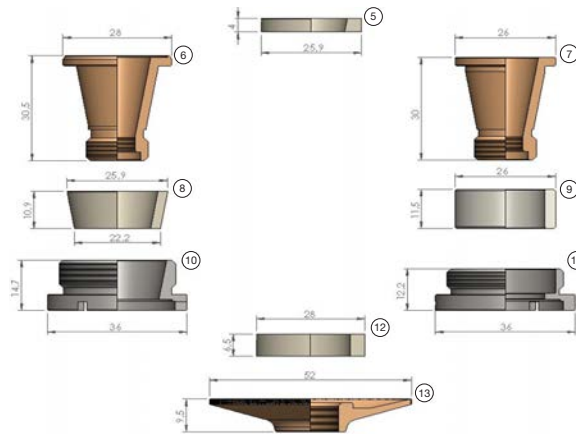

POS	LASERCORE	OEM	DESCRIPTION
5	50-1004-01	4-01642	CERAMIC INSULATING DISC
	50-1005-01	4-01642	CERAMIC INSULATING DISC NEW VERSION
6	50-1006-01	2-08701	NOZZLE BODY
7	50-1007-01	10032930	NOZZLE BODY
8	50-1008-01	4-01959	CERAMIC CONE
	50-1009-01	4-01959	CERAMIC CONE - NEW VERSION
9	50-1010-01	10032838	CERAMIC INSULATING RING
10	50-1011-01	3-11071	FASTENING NUT
11	50-1012-01	10032839	FASTENING NUT
12	50-1013-01	4-09010	CERAMIC INSULATING RING
13	50-1014-01	2-08700	SIGNBOARD

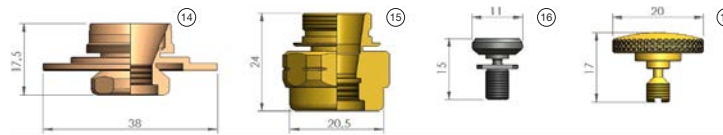

POS	LASERCORE	OEM	DESCRIPTION
14	50-1015-01	10051133	ADAPTER mSB
15	50-1016-01	10064099	NOZZLE BODY
16	50-1017-01	3-09001	SCREW FOR CROSS-JET
17	50-1018-01	4-03136	KNURLED SCREW - BRASS

NON-NOZZLES

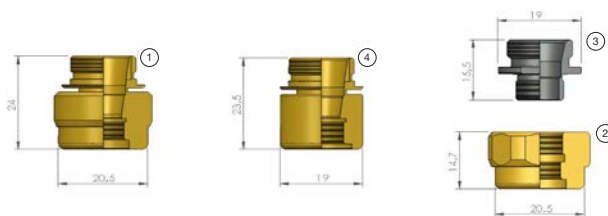

POS	LASERCORE	OEM	DESCRIPTION
1	50-1019-01		NOZZLE BODY
2	50-1020-01	10071494	NOZZLE BODY
3	50-1021-01	10075057	COUPLING
4	50-1022-01		NOZZLE BODY

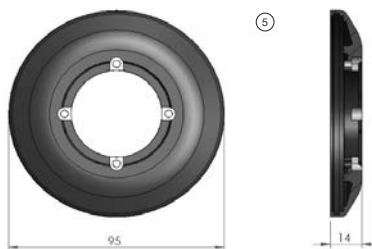

POS	LASERCORE	OEM	DESCRIPTION
5	50-1023-01	2-03243	FRONT PLATE

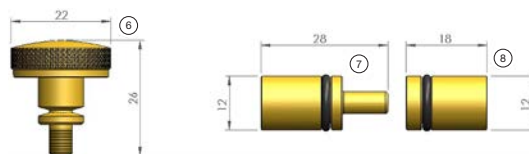

POS	LASERCORE	OEM	DESCRIPTION
6	50-1024-04	4-04976	KNURLED SCREW
7	50-1025-04	7023207	MALE WATER CONNECTOR
8	50-1026-04	7023208	FEMALE WATER CONNECTOR
7 + 8	50-1027-04	7023207, 7023208	WATER CONNECTOR MALE + FEMALE



POS	LASERCORE	OEM	DESCRIPTION
9	50-1028-01		CL SIGNBOARD

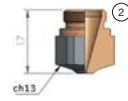
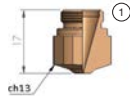

POS	LASERCORE	OEM	DESCRIPTION
1	50-1100-04	3-04277 HK08	NOZZLE Ø 0.8 HD
	50-1101-04	3-01910 HK10	NOZZLE Ø 1.0 HD
	50-1102-04	3-01911 HK12	NOZZLE Ø 1.25 HD
	50-1103-04	3-01912 HK15	NOZZLE Ø 1.5 HD
	50-1104-04	3-01913 HK17	NOZZLE Ø 1.75 HD
2	50-1120-C-04	3-04277 HK08	NOZZLE Ø 0.8 HD CP
	50-1121-C-04	3-01910 HK10	NOZZLE Ø 1.0 HD CP
	50-1122-C-04	3-01911 HK12	NOZZLE Ø 1.25 HD CP
	50-1123-C-04	3-01912 HK15	NOZZLE Ø 1.5 HD CP
	50-1124-C-04	3-01913 HK17	NOZZLE Ø 1.75 HD CP

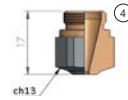
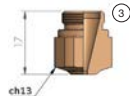

POS	LASERCORE	OEM	DESCRIPTION
3	50-1300-04	3-01914 HK20	NOZZLE Ø 2.0 HD
	50-1301-04	3-03854 HK25	NOZZLE Ø 2.5 HD
	50-1302-04	3-06112 HK30	NOZZLE Ø 3.0 HD
	50-1303-04	HK35	NOZZLE Ø 3.5 HD
	50-1304-04	HK40	NOZZLE Ø 4.0 HD
4	50-1320-C-04	3-01914 HK20	NOZZLE Ø 2.0 HD CP
	50-1321-C-04	3-03854 HK25	NOZZLE Ø 2.5 HD CP
	50-1322-C-04	3-06112 HK30	NOZZLE Ø 3.0 HD CP
	50-1323-C-04	HK35	NOZZLE Ø 3.5 HD CP
	50-1324-C-04	HK40	NOZZLE Ø 4.0 HD CP

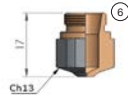
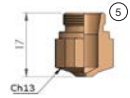

POS	LASERCORE	OEM	DESCRIPTION
5	50-1500-04	3-04273 K08	NOZZLE Ø 0.8
	50-1501-04	3-01905 K10	NOZZLE Ø 1.0
	50-1502-04	3-01906 K12	NOZZLE Ø 1.25
	50-1503-04	3-01907 K15	NOZZLE Ø 1.5
	50-1504-04	3-01908 K17	NOZZLE Ø 1.75
	50-1505-04	3-01909 K20	NOZZLE Ø 2.0
	50-1506-04	3-04274 K25	NOZZLE Ø 2.5
6	50-1507-04	3-04275 K30	NOZZLE Ø 3.0
	50-1520-C-04	3-04273 K08	NOZZLE Ø 0.8 CP
	50-1521-C-04	3-01905 K10	NOZZLE Ø 1.0 CP
	50-1522-C-04	3-01906 K12	NOZZLE Ø 1.25 CP
	50-1523-C-04	3-01907 K15	NOZZLE Ø 1.5 CP
	50-1524-C-04	3-01908 K17	NOZZLE Ø 1.75 CP
	50-1525-C-04	3-01909 K20	NOZZLE Ø 2.0 CP
50-1526-C-04	3-04274 K25	NOZZLE Ø 2.5 CP	
50-1527-C-04	3-04275 K30	NOZZLE Ø 3.0 CP	

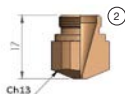
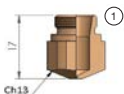

POS	LASERCORE	OEM	DESCRIPTION
2	50-1600-04	3-01910 HK10	NOZZLE Ø 1.0
	50-1601-04	3-01911 HK12	NOZZLE Ø 1.25
	50-1602-04	3-01912 HK15	NOZZLE Ø 1.5
	50-1603-04	3-01913 HK17	NOZZLE Ø 1.75
	50-1604-04	3-01914 HK20	NOZZLE Ø 2.0
1	50-1700-04	3-04273 K08	NOZZLE Ø 0.8
	50-1701-04	3-01905 K10	NOZZLE Ø 1.0
	50-1702-04	3-01906 K12	NOZZLE Ø 1.25
	50-1703-04	3-01907 K15	NOZZLE Ø 1.5
	50-1704-04	3-01908 K17	NOZZLE Ø 1.75
	50-1705-04	3-01909 K20	NOZZLE Ø 2.0

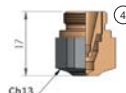
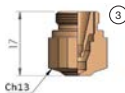

POS	LASERCORE	OEM	DESCRIPTION
3	50-1800-04	3-16058 NK10 - 15	DOUBLE NOZZLE Ø 1.0
	50-1801-04	3-16059 NK12- 15	DOUBLE NOZZLE Ø 1.25
	50-1802-04	3-16060 NK15- 15	DOUBLE NOZZLE Ø 1.5
	50-1803-04	3-14317 NK17 - 15	DOUBLE NOZZLE Ø 1.75
	50-1804-04	3-14318 NK20 - 15	DOUBLE NOZZLE Ø 2.0
	50-1805-04	3-14319 NK25 - 15	DOUBLE NOZZLE Ø 2.5
	50-1806-04	3-16256 NK25 - 20	DOUBLE NOZZLE Ø 2.5
	50-1807-04	3-16061 NK30 - 17	DOUBLE NOZZLE Ø 3.0
	50-1808-04	3-16257 NK30 - 20	DOUBLE NOZZLE Ø 3.0
	50-1809-04	NK35-30	DOUBLE NOZZLE Ø 3.5
4	50-1820-C-04	3-16058 NK10 - 15	DOUBLE NOZZLE Ø 1.0 CP
	50-1821-C-04	3-16059 NK12- 15	DOUBLE NOZZLE Ø 1.25 CP
	50-1822-C-04	3-16060 NK15- 15	DOUBLE NOZZLE Ø 1.5CP
	50-1823-C-04	3-14317 NK17 - 15	DOUBLE NOZZLE Ø 1.75 CP
	50-1824-C-04	3-14318 NK20 - 15	DOUBLE NOZZLE Ø 2.0 CP
	50-1825-C-04	3-14319 NK25 - 15	DOUBLE NOZZLE Ø 2.5 CP
	50-1826-C-04	3-16256 NK25 - 20	DOUBLE NOZZLE Ø 2.5 CP
	50-1827-C-04	3-16061 NK30 - 17	DOUBLE NOZZLE Ø 3.0 CP
	50-1828-C-04	3-16257 NK30 - 20	DOUBLE NOZZLE Ø 3.0 CP
	50-1829-C-04	NK35-30	DOUBLE NOZZLE Ø 3.5 CP

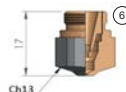
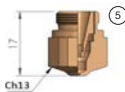

POS	LASERCORE	OEM	DESCRIPTION
5	50-2000-04	3-16058 NK10 - 15	DOUBLE NOZZLE Ø 1.0
	50-2001-04	3-16059 NK12 - 15	DOUBLE NOZZLE Ø 1.25
	50-2002-04	3-16060 NK15 - 15	DOUBLE NOZZLE Ø 1.5
	50-2003-04	3-14317 NK17 - 15	DOUBLE NOZZLE Ø 1.75
6	50-2020-C-04	3-16058 NK10 - 15	DOUBLE NOZZLE Ø 1.0 CP
	50-2021-C-04	3-16059 NK12 - 15	DOUBLE NOZZLE Ø 1.25 CP
	50-2022-C-04	3-16060 NK15 - 15	DOUBLE NOZZLE Ø 1.5 CP
	50-2023-C-04	3-14317 NK17 - 15	DOUBLE NOZZLE Ø 1.75 CP

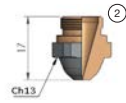
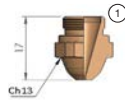

POS	LASERCORE	OEM	DESCRIPTION
1	50-2100-04	3-04275 H08	NOZZLE Ø 0.8 HD
	50-2101-04	3-01899 H10	NOZZLE Ø 1.0 HD
	50-2102-04	3-01900 H12	NOZZLE Ø 1.25 HD
	50-2103-04	3-01901 H15	NOZZLE Ø 1.5 HD
	50-2104-04	3-01902 H17	NOZZLE Ø 1.75 HD
	50-2105-04	3-01903 H20	NOZZLE Ø 2.0 HD
	50-2106-04	3-04276 H25	NOZZLE Ø 2.5 HD
	50-2107-04	H30	NOZZLE Ø 3.0 HD
2	50-2120-C-04	3-04275 H08	NOZZLE Ø 0.8 HD CP
	50-2121-C-04	3-01899 H10	NOZZLE Ø 1.0 HD CP
	50-2122-C-04	3-01900 H12	NOZZLE Ø 1.25 HD CP
	50-2123-C-04	3-01901 H15	NOZZLE Ø 1.5 HD CP
	50-2124-C-04	3-01902 H17	NOZZLE Ø 1.75 HD CP
	50-2125-C-04	3-01903 H20	NOZZLE Ø 2.0 HD CP
	50-2126-C-04	3-04276 H25	NOZZLE Ø 2.5 HD CP
	50-2127-C-04	H30	NOZZLE Ø 3.0 HD CP

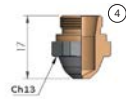
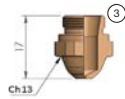

POS	LASERCORE	OEM	DESCRIPTION
3	50-2200-04	3-04271 08	NOZZLE Ø 0.8
	50-2201-04	3-01894 10	NOZZLE Ø 1.0
	50-2202-04	3-01895 12	NOZZLE Ø 1.25
	50-2203-04	3-01896 15	NOZZLE Ø 1.5
	50-2204-04	3-01897 17	NOZZLE Ø 1.75
	50-2205-04	3-01898 20	NOZZLE Ø 2.0
	50-2206-04	3-04272 25	NOZZLE Ø 2.5
4	50-2220-C-04	3-04271 08	NOZZLE Ø 0.8 CP
	50-2221-C-04	3-01894 10	NOZZLE Ø 1.0 CP
	50-2222-C-04	3-01895 12	NOZZLE Ø 1.25 CP
	50-2223-C-04	3-01896 15	NOZZLE Ø 1.5 CP
	50-2224-C-04	3-01897 17	NOZZLE Ø 1.75 CP
	50-2225-C-04	3-01898 20	NOZZLE Ø 2.0 CP
50-2226-C-04	3-04272 25	NOZZLE Ø 2.5 CP	

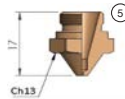

POS	LASERCORE	OEM	DESCRIPTION
5	50-2300-04	3-04271 08	NOZZLE Ø 0.8
	50-2301-04	3-01894 10	NOZZLE Ø 1.0
	50-2302-04	3-01895 12	NOZZLE Ø 1.25
	50-2303-04	3-01896 15	NOZZLE Ø 1.5
	50-2304-04	3-01897 17	NOZZLE Ø 1.75
	50-2305-04	3-01898 20	NOZZLE Ø 2.0

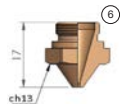

POS	LASERCORE	OEM	DESCRIPTION
6	50-2400-04	3-01899 H10	NOZZLE Ø 1.0 HD
	50-2401-04	3-01900 H12	NOZZLE Ø 1.25 HD
	50-2402-04	3-01901 H15	NOZZLE Ø 1.5 HD
	50-2403-04	3-01902 H17	NOZZLE Ø 1.75 HD
	50-2404-04	3-01903 H20	NOZZLE Ø 2.0 HD



POS	LASERCORE	OEM	DESCRIPTION
1	50-2500-04	N10-15	DOUBLE NOZZLE Ø 1.0
	50-2501-04	N12-15	DOUBLE NOZZLE Ø 1.25
	50-2502-04	N15-15	DOUBLE NOZZLE Ø 1.5
	50-2503-04	N17-15	DOUBLE NOZZLE Ø 1.75
	50-2504-04	N20-15	DOUBLE NOZZLE Ø 2.0
	50-2505-04	N25-15	DOUBLE NOZZLE Ø 2.5
	50-2506-04	N25-20	DOUBLE NOZZLE Ø 2.5
	50-2507-04	N30-17	DOUBLE NOZZLE Ø 3.0
	50-2508-04	N30-20	DOUBLE NOZZLE Ø 3.0
2	50-2520-C-04	N10-15	DOUBLE NOZZLE Ø 1.0 CP
	50-2521-C-04	N12-15	DOUBLE NOZZLE Ø 1.25 CP
	50-2522-C-04	N15-15	DOUBLE NOZZLE Ø 1.5 CP
	50-2523-C-04	N17-15	DOUBLE NOZZLE Ø 1.75 CP
	50-2524-C-04	N20-15	DOUBLE NOZZLE Ø 2.0 CP
	50-2525-C-04	N25-15	DOUBLE NOZZLE Ø 2.5 CP
	50-2526-C-04	N25-20	DOUBLE NOZZLE Ø 2.5 CP
	50-2527-C-04	N30-17	DOUBLE NOZZLE Ø 3.0 CP
	50-2528-C-04	N30-20	DOUBLE NOZZLE Ø 3.0 CP



POS	LASERCORE	OEM	DESCRIPTION
3	50-3000-04	10048529 HK08	NOZZLE Ø 0.8
	50-3001-04	10035266 HK10	NOZZLE Ø 1.0
	50-3002-04	10035267 HK12	NOZZLE Ø 1.2
	50-3003-04	10035268 HK15	NOZZLE Ø 1.5
	50-3004-04	10035269 HK17	NOZZLE Ø 1.75
	50-3005-04	10035270 HK20	NOZZLE Ø 2.0
	50-3006-04	10035271, HK25	NOZZLE Ø 2.5
	50-3007-04	10035272 HK30	NOZZLE Ø 3.0
	50-3008-04	10049744 HK35	NOZZLE Ø 3.5
4	50-3100-04	10049747 NK10-15	DOUBLE NOZZLE Ø 1.0
	50-3101-04	10035275 NK12-15	DOUBLE NOZZLE Ø 1.2
	50-3102-04	10035278 NK15-15	DOUBLE NOZZLE Ø 1.5
	50-3103-04	10035290 NK17-15	DOUBLE NOZZLE Ø 1.75
	50-3104-04	10035292 NK20-15	DOUBLE NOZZLE Ø 2.0
	50-3105-04	10035294 NK25-15	DOUBLE NOZZLE Ø 2.5
	50-3106-04	10035296 NK25-20	DOUBLE NOZZLE Ø 2.5
	50-3107-04	10035298 NK30-17	DOUBLE NOZZLE Ø 3.5
	50-3108-04	10035301 NK30-20	DOUBLE NOZZLE Ø 3.0
	50-3109-04	10035303 NK35-30	DOUBLE NOZZLE Ø 3.5
	50-3110-04	10068496 NK35-17	DOUBLE NOZZLE Ø 3.5
50-3111-04	10068496 NK40-17	DOUBLE NOZZLE Ø 4.0	

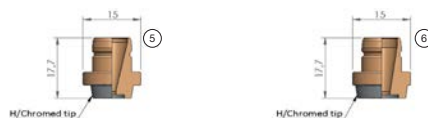

POS	LASERCORE	OEM	DESCRIPTION
5	50-3200-CT-04	10084700	NOZZLE Ø2.0 F20 DW
	50-3201-CT-04	10084701	NOZZLE Ø2.5 F25 DW
	50-3202-CT-04	10066333	NOZZLE Ø3.0 F30 DW
	50-3203-CT-04	10066332, 10090091	NOZZLE Ø3.5 F35 DW
6	50-3204-CT-04	10068494, 10090092	NOZZLE Ø5.0 F50 DW
	50-3205-CT-04	10066331	NOZZLE Ø4.0 F40 DW
	50-3206-CT-04	10066330	NOZZLE Ø4.5 F45 DW
	50-3207-CT-04	10086053	NOZZLE Ø5.5 F55 DW
	50-3208-CT-04	10086069	NOZZLE Ø6.0 F60 DW



POS	LASERCORE	OEM	DESCRIPTION
1	50-3300-CT-04	10089806	NOZZLE Ø2.0 F20
	50-3301-CT-04	10089805	NOZZLE Ø2.5 F25
	50-3302-CT-04	10089803	NOZZLE Ø3.0 F30
	50-3303-CT-04	10090089	NOZZLE Ø3.5 F35
2	50-3304-CT-04	10089802	NOZZLE Ø4.0 F40
	50-3305-CT-04	10089800	NOZZLE Ø4.5 F45
	50-3306-CT-04	10090090	NOZZLE Ø5.0 F50
	50-3307-CT-04	10089799	NOZZLE Ø5.5 F55
	50-3308-CT-04	10089798	NOZZLE Ø6.0 F60

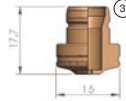

POS	LASERCORE	OEM	DESCRIPTION
3	50-3400-04	10039202	NOZZLE Ø 2.0



POS	LASERCORE	OEM	DESCRIPTION
1	60-1000-01	281330, P0571-260-00001, 6930281330	ORIGINAL NOZZLE HOLDER KT B2"
	60-1001-01	P0571-1051-00001, 6930281333	ORIGINAL NOZZLE HOLDER KT B2" CON
	60-1002-01	P0571-1051-00001, 6930281333	NOZZLE HOLDER KT B2" CON



POS	LASERCORE	OEM	DESCRIPTION
2	60-1100-04	281590-P0591-569-00008	NOZZLE Ø 0.8
	60-1101-04	281331-P0591-561-00010	NOZZLE Ø 1.0
	60-1102-04	281351-P0591-562-00012	NOZZLE Ø 1.2
	60-1103-04	281352-P0591-563-00015	NOZZLE Ø 1.5
	60-1104-04		NOZZLE Ø 1.7
	60-1105-04	281353-P0591-564-00018	NOZZLE Ø 1.8
	60-1106-04	281354-P591-565-00020	NOZZLE Ø 2.0
	60-1107-04		NOZZLE Ø 2.3
	60-1108-04	281591-P0591-566-00025	NOZZLE Ø 2.5
	60-1109-04		NOZZLE Ø 2.7
	60-1110-04		NOZZLE Ø 3.0
3	60-1200-C-04	281590-P0591-569-00008	NOZZLE Ø 0.8 CP
	60-1201-C-04	281331-P0591-561-00010	NOZZLE Ø 1.0 CP
	60-1202-C-04	281351-P0591-562-00012	NOZZLE Ø 1.2 CP
	60-1203-C-04	281352-P0591-563-00015	NOZZLE Ø 1.5 CP
	60-1204-C-04		NOZZLE Ø 1.7 CP
	60-1205-C-04	281353-P0591-564-00018	NOZZLE Ø 1.8 CP
	60-1206-C-04	281354-P591-565-00020	NOZZLE Ø 2.0 CP
	60-1207-C-04		NOZZLE Ø 2.3 CP
	60-1208-C-04	281591-P0591-566-00025	NOZZLE Ø 2.5 CP
	60-1209-C-04		NOZZLE Ø 2.7 CP
60-1210-C-04		NOZZLE Ø 3.0 CP	

NON-NOZZLES
& NOZZLES



POS	LASERCORE	OEM	DESCRIPTION
1	60-1300-04		NOZZLE Ø 0.8 HD
	60-1301-04	281548-P0591-571-00010-29100233	NOZZLE Ø 1.0 HD
	60-1302-04	281549-P0591-572-00012-29100234	NOZZLE Ø 1.2 HD
	60-1303-04		NOZZLE Ø 1.4 HD
	60-1304-04	281463-P0591-573-00015-29100235	NOZZLE Ø 1.5 HD
	60-1305-04	P0591-574-00018	NOZZLE Ø 1.8 HD
	60-1306-04	281550-P0591-575-00020	NOZZLE Ø 2.0 HD
	60-1307-04		NOZZLE Ø 2.3 HD
	60-1308-04	281551-P0591-576-00025	NOZZLE Ø 2.5 HD
	60-1309-04		NOZZLE Ø 2.75 HD
	60-1310-04		NOZZLE Ø 3.0 HD
	60-1311-04		NOZZLE Ø 3.2 HD
	60-1312-04		NOZZLE Ø 3.5 HD
	60-1313-04		NOZZLE Ø 4.0 HD
	60-1314-04		NOZZLE Ø 4.5 HD
	60-1315-04		NOZZLE Ø 5.0 HD
2	60-1400-C-04		NOZZLE Ø 0.8 HD CP
	60-1401-C-04	281548-P0591-571-00010	NOZZLE Ø 1.0 HD CP
	60-1402-C-04	281549-P0591-572-00012	NOZZLE Ø 1.2 HD CP
	60-1403-C-04		NOZZLE Ø 1.4 HD CP
	60-1404-C-04	281463-P0591-573-00015	NOZZLE Ø 1.5 HD CP
	60-1405-C-04	P0591-574-00018	NOZZLE Ø 1.8 HD CP
	60-1406-C-04	281550-P0591-575-00020	NOZZLE Ø 2.0 HD CP
	60-1407-C-04		NOZZLE Ø 2.3 HD CP
	60-1408-C-04	281551-P0591-576-00025	NOZZLE Ø 2.5 HD CP
	60-1409-C-04		NOZZLE Ø 2.75 HD CP
	60-1410-C-04		NOZZLE Ø 3.0 HD CP
	60-1411-C-04		NOZZLE Ø 3.2 HD CP
	60-1412-C-04		NOZZLE Ø 3.5 HD CP
	60-1413-C-04		NOZZLE Ø 4.0 HD CP
	60-1414-C-04		NOZZLE Ø 4.5 HD CP
	60-1415-C-04		NOZZLE Ø 5.0 HD CP

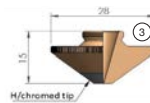

POS	LASERCORE	OEM	DESCRIPTION
3	60-1500-CT-04		NOZZLE Ø 0.8 HD CP
	60-1501-CT-04		NOZZLE Ø 1.0 HD CP
	60-1502-CT-04		NOZZLE Ø 1.2 HD CP
	60-1503-CT-04		NOZZLE Ø 1.4 HD CP
	60-1504-CT-04		NOZZLE Ø 1.5 HD CP
	60-1505-CT-04		NOZZLE Ø 1.8 HD CP
	60-1506-CT-04		NOZZLE Ø 2.0 HD CP
	60-1507-CT-04		NOZZLE Ø 2.3 HD CP
	60-1508-CT-04		NOZZLE Ø 2.5 HD CP
	60-1509-CT-04		NOZZLE Ø 2.75 HD CP
	60-1510-CT-04		NOZZLE Ø 3.0 HD CP
	60-1511-CT-04		NOZZLE Ø 3.2 HD CP
	60-1512-CT-04		NOZZLE Ø 3.5 HD CP
	60-1513-CT-04		NOZZLE Ø 4.0 HD CP
	60-1514-CT-04		NOZZLE Ø 4.5 HD CP
	60-1515-CT-04		NOZZLE Ø 5.0 HD CP

42 • NOZZLES



POS	LASERCORE	OEM	DESCRIPTION
1	60-1600-04		DOUBLE NOZZLE Ø 0.8
	60-1601-04	P0591-002-00010	DOUBLE NOZZLE Ø 1.0
	60-1602-04	P0591-002-00012	DOUBLE NOZZLE Ø 1.2
	60-1603-04		DOUBLE NOZZLE Ø 1.4
	60-1604-04	P0591-002-00015	DOUBLE NOZZLE Ø 1.5
	60-1605-04	P0591-002-00018	DOUBLE NOZZLE Ø 1.8
	60-1606-04	P0591-002-00020	DOUBLE NOZZLE Ø 2.0
	60-1607-04	P0591-002-00023	DOUBLE NOZZLE Ø 2.3
	60-1608-04	P0591-002-00025	DOUBLE NOZZLE Ø 2.5
	60-1609-04		DOUBLE NOZZLE Ø 2.7
	60-1610-04	P0591-002-00030	DOUBLE NOZZLE Ø 3.0
	60-1611-04	P0591-002-00035	DOUBLE NOZZLE Ø 3.5
	60-1612-04	P0591-002-00040	DOUBLE NOZZLE Ø 4.0
	60-1613-04		DOUBLE NOZZLE Ø 4.5
60-1614-04		DOUBLE NOZZLE Ø 5.0	
2	60-1700-C-04		DOUBLE NOZZLE Ø 0.8 CP
	60-1701-C-04		DOUBLE NOZZLE Ø 1.0 CP
	60-1702-C-04		DOUBLE NOZZLE Ø 1.2 CP
	60-1703-C-04		DOUBLE NOZZLE Ø 1.4 CP
	60-1704-C-04		DOUBLE NOZZLE Ø 1.5 CP
	60-1705-C-04		DOUBLE NOZZLE Ø 1.8 CP
	60-1706-C-04		DOUBLE NOZZLE Ø 2.0 CP
	60-1707-C-04		DOUBLE NOZZLE Ø 2.3 CP
	60-1708-C-04		DOUBLE NOZZLE Ø 2.5 CP
	60-1709-C-04		DOUBLE NOZZLE Ø 2.7 CP
	60-1710-C-04		DOUBLE NOZZLE Ø 3.0 CP
	60-1711-C-04		DOUBLE NOZZLE Ø 3.5 CP
	60-1712-C-04		DOUBLE NOZZLE Ø 4.0 CP
	60-1713-C-04		DOUBLE NOZZLE Ø 4.5 CP
60-1714-C-04		DOUBLE NOZZLE Ø 5.0 CP	

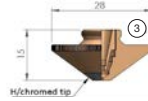

POS	LASERCORE	OEM	DESCRIPTION
3	60-1800-CT-04		DOUBLE NOZZLE Ø 0.8 CP
	60-1801-CT-04		DOUBLE NOZZLE Ø 1.0 CP
	60-1802-CT-04		DOUBLE NOZZLE Ø 1.2 CP
	60-1803-CT-04		DOUBLE NOZZLE Ø 1.4 CP
	60-1804-CT-04		DOUBLE NOZZLE Ø 1.5 CP
	60-1805-CT-04		DOUBLE NOZZLE Ø 1.8 CP
	60-1806-CT-04		DOUBLE NOZZLE Ø 2.0 CP
	60-1807-CT-04		DOUBLE NOZZLE Ø 2.3 CP
	60-1808-CT-04		DOUBLE NOZZLE Ø 2.5 CP
	60-1809-CT-04		DOUBLE NOZZLE Ø 2.7 CP
	60-1810-CT-04		DOUBLE NOZZLE Ø 3.0 CP
	60-1811-CT-04		DOUBLE NOZZLE Ø 3.5 CP
	60-1812-CT-04		DOUBLE NOZZLE Ø 4.0 CP
	60-1813-CT-04		DOUBLE NOZZLE Ø 4.5 CP
60-1814-CT-04		DOUBLE NOZZLE Ø 5.0 CP	

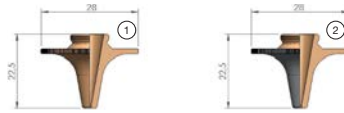

POS	LASERCORE	OEM	DESCRIPTION
1	60-1900-04	P0578-0411-00010	NOZZLE RADIUS LONG Ø 1.0
	60-1901-04	P0578-0412-00012	NOZZLE RADIUS LONG Ø 1.2
	60-1902-04	P0578-0413-00015 / 6930300039	NOZZLE RADIUS LONG Ø 1.5
	60-1903-04	P0578-0414-00018	NOZZLE RADIUS LONG Ø 1.8
	60-1904-04	P0578-0415-00020 / 6930300040	NOZZLE RADIUS LONG Ø 2.0
	60-1905-04	P0578-0417-00025	NOZZLE RADIUS LONG Ø 2.5
2	60-2000-C-04		NOZZLE RADIUS LONG Ø 1.0 CP
	60-2001-C-04		NOZZLE RADIUS LONG Ø 1.2 CP
	60-2002-C-04		NOZZLE RADIUS LONG Ø 1.5 CP
	60-2003-C-04		NOZZLE RADIUS LONG Ø 1.8 CP
	60-2004-C-04		NOZZLE RADIUS LONG Ø 2.0 CP
	60-2005-C-04		NOZZLE RADIUS LONG Ø 2.5 CP



POS	LASERCORE	OEM	DESCRIPTION
3	60-2100-04	6930250001	DOUBLE NOZZLE Ø 0.8
	60-2101-04	6930250002	DOUBLE NOZZLE Ø 1.0
	60-2102-04	6930250003	DOUBLE NOZZLE Ø 1.2
	60-2103-04	6930250004	DOUBLE NOZZLE Ø 1.5
	60-2104-04		DOUBLE NOZZLE Ø 1.8
4	60-2200-C-04		DOUBLE NOZZLE Ø 0.8 CP
	60-2201-C-04		DOUBLE NOZZLE Ø 1.0 CP
	60-2202-C-04		DOUBLE NOZZLE Ø 1.2 CP
	60-2203-C-04		DOUBLE NOZZLE Ø 1.5 CP
	60-2204-C-04		DOUBLE NOZZLE Ø 1.8 CP



POS	LASERCORE	OEM	DESCRIPTION
5	60-2300-04		NOZZLE Ø 0.8
	60-2301-04		NOZZLE Ø 1.0
	60-2302-04		NOZZLE Ø 1.2
	60-2303-04		NOZZLE Ø 1.5
6	60-2320-C-04		NOZZLE Ø 0.8 CP
	60-2321-C-04		NOZZLE Ø 1.0 CP
	60-2322-C-04		NOZZLE Ø 1.2 CP
	60-2323-C-04		NOZZLE Ø 1.5 CP



POS	LASERCORE	OEM	DESCRIPTION
7	60-2400-04		NOZZLE Ø 0.8
	60-2401-04		NOZZLE Ø 1.0
	60-2402-04		NOZZLE Ø 1.2
	60-2403-04	P0591-1049-00015	NOZZLE Ø 1.5
	60-2404-04	P0591-1050-00018	NOZZLE Ø 1.8
	60-2405-04		NOZZLE Ø 2.0
8	60-2420-C-04		NOZZLE Ø 0.8 CP
	60-2421-C-04		NOZZLE Ø 1.0 CP
	60-2422-C-04		NOZZLE Ø 1.2 CP
	60-2423-C-04		NOZZLE Ø 1.5 CP
	60-2424-C-04		NOZZLE Ø 1.8 CP
	60-2425-C-04		NOZZLE Ø 2.0 CP

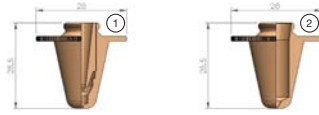

POS	LASERCORE	OEM	DESCRIPTION
1	60-2500-04		DOUBLE NOZZLE Ø 1.0
	60-2501-04		DOUBLE NOZZLE Ø 1.2
	60-2502-04		DOUBLE NOZZLE Ø 1.5
	60-2503-04		DOUBLE NOZZLE Ø 1.8
	60-2504-04		DOUBLE NOZZLE Ø 2.0
	60-2505-04		DOUBLE NOZZLE Ø 2.3
	60-2506-04		DOUBLE NOZZLE Ø 2.5
	60-2507-04		DOUBLE NOZZLE Ø 3.0
	60-2508-04		DOUBLE NOZZLE Ø 3.5
2	60-2600-04	P0573-563-00010	NOZZLE Ø 1.0
	60-2601-04	P0573-563-00012	NOZZLE Ø 1.2
	60-2602-04	P0573-563-00015	NOZZLE Ø 1.5
	60-2603-04		NOZZLE Ø 1.8
	60-2604-04	P0573-563-00020	NOZZLE Ø 2.0
	60-2605-04	P0573-563-00025	NOZZLE Ø 2.5
	60-2606-04		NOZZLE Ø 3.0



POS	LASERCORE	OEM	DESCRIPTION
3	60-2700-04		NOZZLE Ø 1.0 HD
	60-2701-04		NOZZLE Ø 1.2 HD
	60-2702-04		NOZZLE Ø 1.5 HD
	60-2703-04		NOZZLE Ø 2.0 HD
	60-2704-04		NOZZLE Ø 2.5 HD
	60-2705-04		NOZZLE Ø 3.0 HD
	60-2706-04		NOZZLE Ø 3.5 HD
	60-2707-04		NOZZLE Ø 4.0 HD
	60-2708-04		NOZZLE Ø 4.5 HD
60-2709-04		NOZZLE Ø 5.0 HD	
4	60-2720-C-04		NOZZLE Ø 1.0 HD CP
	60-2721-C-04		NOZZLE Ø 1.2 HD CP
	60-2722-C-04		NOZZLE Ø 1.5 HD CP
	60-2723-C-04		NOZZLE Ø 2.0 HD CP
	60-2724-C-04		NOZZLE Ø 2.5 HD CP
	60-2725-C-04		NOZZLE Ø 3.0 HD CP
	60-2726-C-04		NOZZLE Ø 3.5 HD CP
	60-2727-C-04		NOZZLE Ø 4.0 HD CP
	60-2728-C-04		NOZZLE Ø 4.5 HD CP
	60-2729-C-04		NOZZLE Ø 5.0 HD CP



POS	LASERCORE	OEM	DESCRIPTION
5	60-2800-04		NOZZLE Ø 1.5 HD
	60-2801-04		NOZZLE Ø 2.0 HD
	60-2802-04		NOZZLE Ø 2.5 HD
6	60-2820-C-04		NOZZLE Ø 1.5 HD CP
	60-2821-C-04		NOZZLE Ø 2.0 HD CP
	60-2822-C-04		NOZZLE Ø 2.5 HD CP

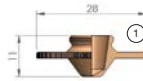

POS	LASERCORE	OEM	DESCRIPTION
1	60-2900-04	281340/P0571-281-00010	NOZZLE Ø 1.0
	60-2901-04	281341/P0571-282-00012	NOZZLE Ø 1.2
	60-2902-04	281342/P0571-283-00015	NOZZLE Ø 1.5
	60-2903-04	281342/P0571-284-00018	NOZZLE Ø 1.8
	60-2904-04	281343/P0571-285-00020	NOZZLE Ø 2.0
	60-2905-04	281344/P0571-286-00025	NOZZLE Ø 2.5

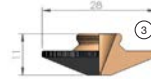
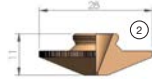

POS	LASERCORE	OEM	DESCRIPTION
2	60-3000-04	281559/P0571-291-00010	NOZZLE Ø 1.0
	60-3001-04	P0571-292-00012	NOZZLE Ø 1.2
	60-3002-04	281570/P0571-293-00015	NOZZLE Ø 1.5
	60-3003-04		NOZZLE Ø 1.8
	60-3004-04	281571/P0571-295-00020	NOZZLE Ø 2.0
	60-3005-04	281572/P0571-297-00025	NOZZLE Ø 2.5
	60-3006-04	281572/P0571-297-00025	NOZZLE Ø 3.0
3	60-3020-C-04		NOZZLE Ø 1.0 CP
	60-3021-C-04		NOZZLE Ø 1.2 CP
	60-3022-C-04		NOZZLE Ø 1.5 CP
	60-3023-C-04		NOZZLE Ø 1.8 CP
	60-3024-C-04		NOZZLE Ø 2.0 CP
	60-3025-C-04		NOZZLE Ø 2.5 CP
	60-3026-C-04		NOZZLE Ø 3.0 CP

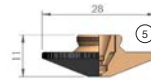
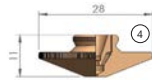

POS	LASERCORE	OEM	DESCRIPTION
4	60-3100-04		DOUBLE NOZZLE Ø 1.0
	60-3101-04		DOUBLE NOZZLE Ø 1.2
	60-3102-04		DOUBLE NOZZLE Ø 1.4
	60-3103-04		DOUBLE NOZZLE Ø 1.5
	60-3104-04		DOUBLE NOZZLE Ø 1.8
	60-3105-04		DOUBLE NOZZLE Ø 2.0
	60-3106-04		DOUBLE NOZZLE Ø 2.5
	60-3107-04		DOUBLE NOZZLE Ø 3.0
5	60-3108-04		DOUBLE NOZZLE Ø 3.5
	60-3120-C-04		DOUBLE NOZZLE Ø 1.0 CP
	60-3121-C-04		DOUBLE NOZZLE Ø 1.2 CP
	60-3122-C-04		DOUBLE NOZZLE Ø 1.4 CP
	60-3123-C-04		DOUBLE NOZZLE Ø 1.5 CP
	60-3124-C-04		DOUBLE NOZZLE Ø 1.8 CP
	60-3125-C-04		DOUBLE NOZZLE Ø 2.0 CP
	60-3126-C-04		DOUBLE NOZZLE Ø 2.5 CP
60-3127-C-04		DOUBLE NOZZLE Ø 3.0 CP	
60-3128-C-04		DOUBLE NOZZLE Ø 3.5 CP	

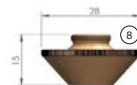
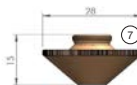
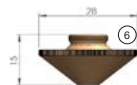

POS	LASERCORE	OEM	DESCRIPTION
6	60-3200-04		DOUBLE NOZZLE Ø 2.5 - SS
	60-3201-04		DOUBLE NOZZLE Ø 3.0 - SS
	60-3202-04		DOUBLE NOZZLE Ø 4.0 - SS
7	60-3203-04		DOUBLE NOZZLE Ø 6.0 - SS
8	60-3204-04		DOUBLE NOZZLE Ø 10.0 - SS

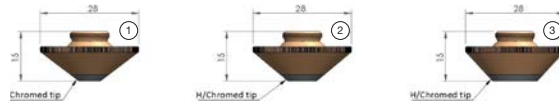

POS	LASERCORE	OEM	DESCRIPTION
1	60-3220-CT-04		DOUBLE NOZZLE Ø 2.5 CP - SS
	60-3221-CT-04		DOUBLE NOZZLE Ø 3.0 CP - SS
	60-3222-CT-04		DOUBLE NOZZLE Ø 4.0 CP - SS
2	60-3223-CT-04		DOUBLE NOZZLE Ø 6.0 CP - SS
	60-3224-CT-04		DOUBLE NOZZLE Ø 10.0 CP - SS



POS	LASERCORE	OEM	DESCRIPTION
4	60-3300-04		NOZZLE Ø 0.8
	60-3301-04	280551-P0494-853-00010	NOZZLE Ø 1.0
	60-3302-04	280552-P0494-854-00012	NOZZLE Ø 1.2
	60-3303-04	280553-P0494-855-00015	NOZZLE Ø 1.5
	60-3304-04	280554-P0494-856-00017	NOZZLE Ø 1.7
	60-3305-04	280555-P0494-857-00020	NOZZLE Ø 2.0
	60-3306-04		NOZZLE Ø 2.3
	60-3307-04		NOZZLE Ø 2.5
	60-3308-04		NOZZLE Ø 3.0
	60-3309-04		NOZZLE Ø 4.0
5	60-3400-04	280943-P0494-787-00010	NOZZLE Ø 1.0
	60-3401-04	280942-P0494-788-00012	NOZZLE Ø 1.2
	60-3402-04	280941-P0494-789-00015	NOZZLE Ø 1.5
	60-3403-04		NOZZLE Ø 1.8
	60-3404-04		NOZZLE Ø 2.0

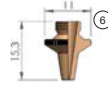

POS	LASERCORE	OEM	DESCRIPTION
6	60-3500-04		NOZZLE Ø 1.0
	60-3501-04	P0787-482-00012	NOZZLE Ø 1.2
	60-3502-04	P0787-483-00015	NOZZLE Ø 1.5
	60-3503-04		NOZZLE Ø 1.7
	60-3504-04	P0787-1001-00020	NOZZLE Ø 2.0
	60-3505-04		NOZZLE Ø 2.5



POS	LASERCORE	OEM	DESCRIPTION
7	60-3600-04	280013, P0492-441-00008, W222	NOZZLE Ø 0.8
	60-3601-04	280014, P0492-442-00010, W223	NOZZLE Ø 1.0
	60-3602-04	280015, P0492-443-00012, W228	NOZZLE Ø 1.2
	60-3603-04	280016, P0492-444-00015, W224	NOZZLE Ø 1.5
	60-3604-04	P0492-447-00018	NOZZLE Ø 1.8
	60-3605-04	280937, P0492-445-00020, W225	NOZZLE Ø 2.0
	60-3606-04	P0492-448-00023	NOZZLE Ø 2.3
	60-3607-04	281791, P0492-446-00025, W226	NOZZLE Ø 2.5
	60-3608-04		NOZZLE Ø 3.0
	8	60-3620-C-04	280013, P0492-441-00008, W222
60-3621-C-04		280014, P0492-442-00010, W223	NOZZLE Ø 1.0 CP
60-3622-C-04		280015, P0492-443-00012, W228	NOZZLE Ø 1.2 CP
60-3623-C-04		280016, P0492-444-00015, W224	NOZZLE Ø 1.5 CP
60-3624-C-04		P0492-447-00018	NOZZLE Ø 1.8 CP
60-3625-C-04		280937, P0492-445-00020, W225	NOZZLE Ø 2.0 CP
60-3632-C-04		P0492-448-00023	NOZZLE Ø 2.3 CP
60-3633-C-04		281791, P0492-446-00025, W226	NOZZLE Ø 2.5 CP
60-3634-C-04			NOZZLE Ø 3.0 CP



POS	LASERCORE	OEM	DESCRIPTION
1	60-3700-04	281813, P0589-424-00008	NOZZLE Ø 0.8
	60-3701-04	281789, P0589-426-00010	NOZZLE Ø 1.0
	60-3702-04	281561, 778550	NOZZLE Ø 1.2
	60-3703-04	281814, 149957	NOZZLE Ø 1.5
	60-3704-04	P0589-428-00020	NOZZLE Ø 2.0
2	60-3720-C-04	281813, P0589-424-00008	NOZZLE Ø 0.8 CP
	60-3721-C-04	281789, P0589-426-00010	NOZZLE Ø 1.0 CP
	60-3722-C-04	281561, 778550	NOZZLE Ø 1.2 CP
	60-3723-C-04	281814, 149957	NOZZLE Ø 1.5 CP
	60-3724-C-04	P0589-428-00020	NOZZLE Ø 2.0 CP



POS	LASERCORE	OEM	DESCRIPTION
1	70-2001-01	6930003224/00	NOZZLE HOLDER

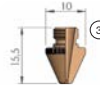

POS	LASERCORE	OEM	DESCRIPTION
2	70-2100-04	455054	NOZZLE Ø 1.0
	70-2101-04	455034	NOZZLE Ø 1.5
	70-2102-04	455024	NOZZLE Ø 1.8
	70-2103-04	455014	NOZZLE Ø 2.0
	70-2104-04	C50762A	NOZZLE Ø 2.5
	70-2105-04	455044	NOZZLE Ø 1.2
3	70-2200-04	6930250031/00	NOZZLE Ø 1.0 TCL
	70-2201-04	6930250032/00	NOZZLE Ø 1.2 TCL
	70-2202-04	6930250033/00	NOZZLE Ø 1.5 TCL
	70-2203-04	6930250034/00	NOZZLE Ø 1.8 TCL
	70-2204-04	6930250035/00	NOZZLE Ø 2.0 TCL
	70-2205-04	6930250043/00	NOZZLE Ø 2.3 TCL
	70-2206-04	6930250036/00	NOZZLE Ø 2.5 TCL
70-2207-04	6930250044/00	NOZZLE Ø 3.0 TCL	

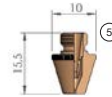
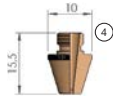

POS	LASERCORE	OEM	DESCRIPTION
4	70-2300-04	6930250862	NOZZLE Ø 1.0 KNL
	70-2301-04	6930250863	NOZZLE Ø 1.2 KNL
	70-2302-04	6930250835	NOZZLE Ø 1.5 KNL
	70-2303-04	6930250864	NOZZLE Ø 1.8 KNL
	70-2304-04	6930250836	NOZZLE Ø 2.0 KNL
	70-2305-04		NOZZLE Ø 2.3 KNL
	70-2306-04	6930250865	NOZZLE Ø 2.5 KNL
5	70-2307-04	6930250866	NOZZLE Ø 3.0 KNL
	70-2400-04	6930250857	DOUBLE NOZZLE Ø 1.0 KNL
	70-2401-04	6930250858	DOUBLE NOZZLE Ø 1.2 KNL
	70-2402-04	6930250837	DOUBLE NOZZLE Ø 1.5 KNL
	70-2403-04	6930250859	DOUBLE NOZZLE Ø 1.8 KNL
	70-2404-04	6930250838	DOUBLE NOZZLE Ø 2.0 KNL
	70-2405-04		DOUBLE NOZZLE Ø 2.3 KNL
	70-2406-04	6930250860	DOUBLE NOZZLE Ø 2.5 KNL
	70-2407-04	6930250861	DOUBLE NOZZLE Ø 3.0 KNL

NOZZLES



POS	LASERCORE	OEM	DESCRIPTION
1	70-2500-04	6930250800/00	NOZZLE SCB Ø 1.0
	70-2501-04	6930250801/00	NOZZLE SCB Ø 1.2
	70-2502-04	6930250802/00	NOZZLE SCB Ø 1.5
	70-2503-04	6930250803/00	NOZZLE SCB Ø 1.8
	70-2504-04	6930250804/00	NOZZLE SCB Ø 2.0
	70-2505-04	6930250805/00	NOZZLE SCB Ø 2.3
	70-2506-04	6930250806/00	NOZZLE SCB Ø 2.5
	70-2507-04	6930250807/00	NOZZLE SCB Ø 3.0
	70-2508-04	6930250808/00	NOZZLE SCB Ø 3.5
	70-2509-04	6930250809/00	NOZZLE SCB Ø 4.0
2	70-2520-HC-04	6930250800/00	NOZZLE SCB Ø 1.0 SPECIAL CP
	70-2521-HC-04	6930250801/00	NOZZLE SCB Ø 1.2 SPECIAL CP
	70-2522-HC-04	6930250802/00	NOZZLE SCB Ø 1.5 SPECIAL CP
	70-2523-HC-04	6930250803/00	NOZZLE SCB Ø 1.8 SPECIAL CP
	70-2524-HC-04	6930250804/00	NOZZLE SCB Ø 2.0 SPECIAL CP
	70-2525-HC-04	6930250805/00	NOZZLE SCB Ø 2.3 SPECIAL CP
	70-2526-HC-04	6930250806/00	NOZZLE SCB Ø 2.5 SPECIAL CP
	70-2527-HC-01	6930250807/00	NOZZLE SCB Ø 3.0 SPECIAL CP
	70-2528-HC-01	6930250808/00	NOZZLE SCB Ø 3.5 SPECIAL CP
	70-2529-HC-01	6930250809/00	NOZZLE SCB Ø 4.0 SPECIAL CP

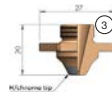

POS	LASERCORE	OEM	DESCRIPTION
3	70-2540-CT-04	6930250800/00	NOZZLE SCB Ø 1.0 CP
	70-2541-CT-04	6930250801/00	NOZZLE SCB Ø 1.2 CP
	70-2542-CT-04	6930250802/00	NOZZLE SCB Ø 1.5 CP
	70-2543-CT-04	6930250803/00	NOZZLE SCB Ø 1.8 CP
	70-2544-CT-04	6930250804/00	NOZZLE SCB Ø 2.0 CP
	70-2545-CT-04	6930250805/00	NOZZLE SCB Ø 2.3 CP
	70-2546-CT-04	6930250806/00	NOZZLE SCB Ø 2.5 CP
	70-2547-CT-04	6930250807/00	NOZZLE SCB Ø 3.0 CP
	70-2548-CT-04	6930250808/00	NOZZLE SCB Ø 3.5 CP
	70-2549-CT-04	6930250809/00	NOZZLE SCB Ø 4.0 CP



POS	LASERCORE	OEM	DESCRIPTION
4	70-2600-04	6930250810/00	DOUBLE NOZZLE D3F Ø 1.0
	70-2601-04	6930250811/00	DOUBLE NOZZLE D3F Ø 1.2
	70-2602-04	6930250812/00	DOUBLE NOZZLE D3F Ø 1.5
	70-2603-04	6930250813/00	DOUBLE NOZZLE D3F Ø 1.8
	70-2604-04	6930250814/00	DOUBLE NOZZLE D3F Ø 2.0
	70-2605-04	6930250815/00	DOUBLE NOZZLE D3F Ø 2.3
	70-2606-04	6930250816/00	DOUBLE NOZZLE D3F Ø 2.5
	70-2607-04	6930250817/00	DOUBLE NOZZLE D3F Ø 3.0
	70-2608-04	6930250818/00	DOUBLE NOZZLE D3F Ø 3.5
	5	70-2620-HC-04	6930250810/00
70-2621-HC-04		6930250811/00	DOUBLE NOZZLE D3F Ø 1.2 SPECIAL CP
70-2622-HC-04		6930250812/00	DOUBLE NOZZLE D3F Ø 1.5 SPECIAL CP
70-2623-HC-04		6930250813/00	DOUBLE NOZZLE D3F Ø 1.8 SPECIAL CP
70-2624-HC-04		6930250814/00	DOUBLE NOZZLE D3F Ø 2.0 SPECIAL CP
70-2625-HC-04		6930250815/00	DOUBLE NOZZLE D3F Ø 2.3 SPECIAL CP
70-2626-HC-04		6930250816/00	DOUBLE NOZZLE D3F Ø 2.5 SPECIAL CP
70-2627-HC-04		6930250817/00	DOUBLE NOZZLE D3F Ø 3.0 SPECIAL CP
70-2628-HC-04		6930250818/00	DOUBLE NOZZLE D3F Ø 3.5 SPECIAL CP

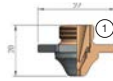

POS	LASERCORE	OEM	DESCRIPTION
1	70-2629-HC-04	6930250840	DOUBLE NOZZLE ACB Ø 2.5 SPECIAL CP
	70-2630-HC-04	6930250839	DOUBLE NOZZLE ACB Ø 4.0 SPECIAL CP

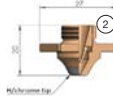

POS	LASERCORE	OEM	DESCRIPTION
2	70-2640-CT-04	6930250810/00	DOUBLE NOZZLE D3F Ø 1.0 CP
	70-2641-CT-04	6930250811/00	DOUBLE NOZZLE D3F Ø 1.2 CP
	70-2642-CT-04	6930250812/00	DOUBLE NOZZLE D3F Ø 1.5 CP
	70-2643-CT-04	6930250813/00	DOUBLE NOZZLE D3F Ø 1.8 CP
	70-2644-CT-04	6930250814/00	DOUBLE NOZZLE D3F Ø 2.0 CP
	70-2645-CT-04	6930250815/00	DOUBLE NOZZLE D3F Ø 2.3 CP
	70-2646-CT-04	6930250816/00	DOUBLE NOZZLE D3F Ø 2.5 CP
	70-2647-CT-04	6930250817/00	DOUBLE NOZZLE D3F Ø 3.0 CP
	70-2648-CT-04	6930250818/00	DOUBLE NOZZLE D3F Ø 3.5 CP

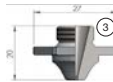

POS	LASERCORE	OEM	DESCRIPTION
3	70-2701-HC-04	6930250821/00	NOZZLE NCB Ø 1.8 SPECIAL CP
	70-2702-HC-04	6930250822/00	NOZZLE NCB Ø 2.0 SPECIAL CP
	70-2703-HC-04	6930250823/00	NOZZLE NCB Ø 2.3 SPECIAL CP
	70-2704-HC-04	6930250824/00	NOZZLE NCB Ø 2.5 SPECIAL CP
	70-2705-HC-04	6930250825/00	NOZZLE NCB Ø 3.0 SPECIAL CP
	70-2706-HC-04	6930250826/00	NOZZLE NCB Ø 3.5 SPECIAL CP
	70-2707-HC-04	6930250827/00	NOZZLE NCB Ø 4.0 SPECIAL CP
	70-2720-HC-04	6930250820/00	NOZZLE NCB Ø 1.5 SPECIAL CP

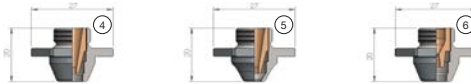

POS	LASERCORE	OEM	DESCRIPTION
4	70-2800-HC-04	6930250819	DOUBLE NOZZLE NCB Ø 7.0 SPECIAL CP
5	70-2801-HC-04	6930250841	DOUBLE NOZZLE NCB Ø 5.0 SPECIAL CP
6	70-2802-HC-04		DOUBLE NOZZLE QCB Ø 7.0 SPECIAL CP

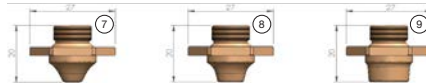

POS	LASERCORE	OEM	DESCRIPTION
7	70-2900-01		DOUBLE NOZZLE Ø 2.5 - SS
	70-2901-01		DOUBLE NOZZLE Ø 3.0 - SS
	70-2902-01		DOUBLE NOZZLE Ø 4.0 - SS
8	70-2903-01		DOUBLE NOZZLE Ø 6.0 - SS
9	70-2904-01		DOUBLE NOZZLE Ø 10.0 - SS

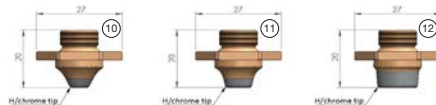

POS	LASERCORE	OEM	DESCRIPTION
10	70-2920-CT-01		DOUBLE NOZZLE Ø 2.5 CP - SS
	70-2921-CT-01		DOUBLE NOZZLE Ø 3.0 CP - SS
	70-2922-CT-01		DOUBLE NOZZLE Ø 4.0 CP - SS
11	70-2923-CT-01		DOUBLE NOZZLE Ø 6.0 CP - SS
12	70-2924-CT-01		DOUBLE NOZZLE Ø 10.0 CP - SS



POS	LASERCORE	OEM	DESCRIPTION
1	70-3100-04		NOZZLE Ø 1.2
	70-3101-04		NOZZLE Ø 1.5
	70-3102-04		NOZZLE Ø 1.8
	70-3103-04		NOZZLE Ø 2.0
	70-3104-04		NOZZLE Ø 2.5
	70-3105-04		NOZZLE Ø 3.0
2	70-3106-04		NOZZLE Ø 4.0
	70-3200-04		DOUBLE NOZZLE Ø 1.2
	70-3201-04		DOUBLE NOZZLE Ø 1.5
	70-3202-04		DOUBLE NOZZLE Ø 1.8
	70-3203-04		DOUBLE NOZZLE Ø 2.0
	70-3204-04		DOUBLE NOZZLE Ø 2.5
	70-3205-04		DOUBLE NOZZLE Ø 3.0
70-3206-04		DOUBLE NOZZLE Ø 3.5	
70-3207-04		DOUBLE NOZZLE Ø 4.0	

NON-NOZZLES

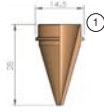

POS	LASERCORE	OEM	DESCRIPTION
1	70-3300-04		NOZZLE Ø 0.5
	70-3301-04		NOZZLE Ø 1.0



POS	LASERCORE	OEM	DESCRIPTION
1	70-4000-01	HCH-S01201	CERAMIC NOZZLE HOLDER

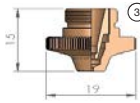
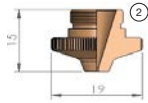

POS	LASERCORE	OEM	DESCRIPTION
2	70-4100-04	NP08, MX-0988	NOZZLE N Ø 0.8
	70-4101-04	NP10, MX-0989	NOZZLE N Ø 1.0
	70-4102-04	NP12, MX-0990	NOZZLE N Ø 1.2
	70-4103-04	NP15, MX-0991	NOZZLE N Ø 1.5
	70-4104-04	NP18, MX-0993	NOZZLE N Ø 1.8
	70-4105-04	NP20, MX-0992	NOZZLE N Ø 2.0
	70-4106-04	NP25, MX-0994	NOZZLE N Ø 2.5
	70-4107-04	NP30, MX-0995	NOZZLE N Ø 3.0
3	70-4200-04	TP10	DOUBLE NOZZLE N Ø 1.0
	70-4201-04	TP15, HCH-TP1515	DOUBLE NOZZLE N Ø 1.5
	70-4202-04	TP20, HCH-TP1520	DOUBLE NOZZLE N Ø 2.0
	70-4203-04	TP25, HCH-TP1525	DOUBLE NOZZLE N Ø 2.5
	70-4204-04	TP30, HCH-TP2030	DOUBLE NOZZLE N Ø 3.0
	70-4205-04		DOUBLE NOZZLE N Ø 4.0

NOZZLES



POS	LASERCORE	OEM	DESCRIPTION
1	70-5020-C-04		DOUBLE NOZZLE Ø 1.2 CP
	70-5021-C-04		DOUBLE NOZZLE Ø 1.4 CP
	70-5022-C-04		DOUBLE NOZZLE Ø 1.6 CP
	70-5023-C-04		DOUBLE NOZZLE Ø 1.8 CP
	70-5024-C-04		DOUBLE NOZZLE Ø 2.0 CP
	70-5025-C-04		DOUBLE NOZZLE Ø 3.0 CP
	70-5026-C-04		DOUBLE NOZZLE Ø 4.0 CP
	70-5027-C-04		DOUBLE NOZZLE Ø 5.0 CP
2	70-5040-CT-04		DOUBLE NOZZLE Ø 1.2 CP
	70-5041-CT-04		DOUBLE NOZZLE Ø 1.4 CP
	70-5042-CT-04		DOUBLE NOZZLE Ø 1.6 CP
	70-5043-CT-04		DOUBLE NOZZLE Ø 1.8 CP
	70-5044-CT-04		DOUBLE NOZZLE Ø 2.0 CP
	70-5045-CT-04		DOUBLE NOZZLE Ø 3.0 CP
	70-5046-CT-04		DOUBLE NOZZLE Ø 4.0 CP
70-5047-CT-04		DOUBLE NOZZLE Ø 5.0 CP	



POS	LASERCORE	OEM	DESCRIPTION
1	70-6000-01	281146-P0380-211-00001-29100033	ORIG. NOZ. HOLDER IT M1.5" DZ - ALUMINUM
	70-6001-01	281146-P0380-211-00001-29100033	NOZ. HOLDER IT M1.5" DZ - ALUMINUM
2	70-6002-01	P0497-68871	ORIG. NOZ. HOLDER KT M1.5"D _{XN} - CERAMIC

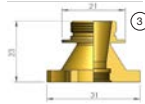

POS	LASERCORE	OEM	DESCRIPTION
3	70-6003-01	M000079093	ADAPTER AUTO CHANGE

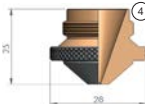

POS	LASERCORE	OEM	DESCRIPTION
4	70-6027-C-04	D5241857-Z000000540B	NOZZLE Ø 3.0 HD - CONICAL CP
	70-6028-C-04	D5241877-Z000000564B	NOZZLE Ø 3.5 HD - CONICAL CP
	70-6029-C-04	D5241878-Z000000565B	NOZZLE Ø 4.0 HD - CONICAL CP
	70-6030-C-04	D5242531-Z000000566B	NOZZLE Ø 4.5 HD - CONICAL CP
	70-6031-C-04	D5242535-Z000000567B	NOZZLE Ø 5.0 HD - CONICAL CP
	70-6032-C-04	D5242536-Z000000568B	NOZZLE Ø 6.0 HD - CONICAL CP

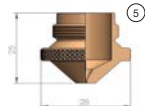

POS	LASERCORE	OEM	DESCRIPTION
5	70-6100-04	D5241993	NOZZLE Ø 0.8 - CYLINDRICAL
	70-6101-04	D7945470	NOZZLE Ø 1.0 - CYLINDRICAL
	70-6102-04	D5241982	NOZZLE Ø 1.2 - CYLINDRICAL
	70-6103-04	D7945434	NOZZLE Ø 1.5 - CYLINDRICAL
	70-6104-04	D7945452	NOZZLE Ø 2.0 - CYLINDRICAL
	70-6105-04	D7945517	NOZZLE Ø 2.5 - CYLINDRICAL
	70-6106-04		NOZZLE Ø 3.0 - CYLINDRICAL

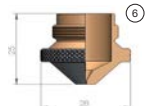

POS	LASERCORE	OEM	DESCRIPTION
6	70-6120-C-04	D5241993	NOZZLE Ø 0.8 - CYLINDRICAL CP
	70-6121-C-04	D7945470	NOZZLE Ø 1.0 - CYLINDRICAL CP
	70-6122-C-04	D5241982	NOZZLE Ø 1.2 - CYLINDRICAL CP
	70-6123-C-04	D7945434	NOZZLE Ø 1.5 - CYLINDRICAL CP
	70-6124-C-04	D7945452	NOZZLE Ø 2.0 - CYLINDRICAL CP
	70-6125-C-04	D7945517	NOZZLE Ø 2.5 - CYLINDRICAL CP
	70-6126-C-04		NOZZLE Ø 3.0 - CYLINDRICAL CP

NOZZLES

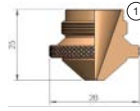

POS	LASERCORE	OEM	DESCRIPTION
1	70-6200-04	D5241863	NOZZLE Ø 1.0 HD - CONICAL
	70-6201-04		NOZZLE Ø 1.2 HD - CONICAL
	70-6202-04	D5241862	NOZZLE Ø 1.5 HD - CONICAL
	70-6203-04	D5242512	NOZZLE Ø 1.7 HD - CONICAL
	70-6204-04	D5241855	NOZZLE Ø 2.0 HD - CONICAL
	70-6205-04	D5242513-Z000000539D	NOZZLE Ø 2.3 HD - CONICAL
	70-6206-04	D5241856-Z000000563B	NOZZLE Ø 2.5 HD - CONICAL
	70-6207-04	D5241857-Z000000540B	NOZZLE Ø 3.0 HD - CONICAL
	70-6208-04	D5241877-Z000000564B	NOZZLE Ø 3.5 HD - CONICAL
	70-6209-04	D5241878-Z000000565B	NOZZLE Ø 4.0 HD - CONICAL
	70-6210-04	D5242531-Z000000566B	NOZZLE Ø 4.5 HD - CONICAL
	70-6211-04	D5242535-Z000000567B	NOZZLE Ø 5.0 HD - CONICAL
70-6212-04	D5242536-Z000000568B	NOZZLE Ø 6.0 HD - CONICAL	

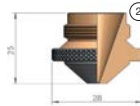

POS	LASERCORE	OEM	DESCRIPTION
2	70-6220-C-04	D5241863	NOZZLE Ø 1.0 HD - CONICAL CP
	70-6221-C-04		NOZZLE Ø 1.2 HD - CONICAL CP
	70-6222-C-04	D5241862	NOZZLE Ø 1.5 HD - CONICAL CP
	70-6223-C-04	D5242512	NOZZLE Ø 1.7 HD - CONICAL CP
	70-6224-C-04	D5241855	NOZZLE Ø 2.0 HD - CONICAL CP
	70-6225-C-04	D5242513-Z000000539D	NOZZLE Ø 2.3 HD - CONICAL CP
	70-6226-C-04	D5241856-Z000000563B	NOZZLE Ø 2.5 HD - CONICAL CP

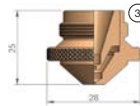

POS	LASERCORE	OEM	DESCRIPTION
3	70-6300-04		DOUBLE NOZZLE Ø 1.2
	70-6301-04	29100304	DOUBLE NOZZLE Ø 1.5
	70-6302-04	29100307	DOUBLE NOZZLE Ø 2.0
	70-6303-04	29100305	DOUBLE NOZZLE Ø 2.5
	70-6304-04	29100306	DOUBLE NOZZLE Ø 3.0
	70-6305-04		DOUBLE NOZZLE Ø 3.5
	70-6306-04		DOUBLE NOZZLE Ø 4.0

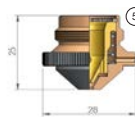
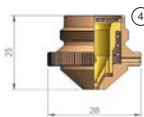

POS	LASERCORE	OEM	DESCRIPTION
4	70-6400-04	G8040180	DOUBLE NOZZLE W/SPRING Ø 2.5 INNER Ø 1.3
	70-6401-04	G8040181	DOUBLE NOZZLE W/SPRING Ø 2.5 INNER Ø 1.5
	70-6402-04	G8040182	DOUBLE NOZZLE W/SPRING Ø 3.0 INNER Ø 2.0
	70-6403-04	G8040183	DOUBLE NOZZLE W/SPRING Ø 3.0 INNER Ø 1.3
	70-6404-04	G8040184	DOUBLE NOZZLE W/SPRING Ø 3.0 INNER Ø 1.5
5	70-6406-C-04	G8040181	DOUBLE NOZZLE W/SPRING Ø 2.5 INNER Ø 1.5 CP
	70-6407-C-04	G8040182	DOUBLE NOZZLE W/SPRING Ø 3.0 INNER Ø 2.0 CP
	70-6408-C-04	G8040183	DOUBLE NOZZLE W/SPRING Ø 3.0 INNER Ø 1.3 CP
	70-6409-C-04	G8040184	DOUBLE NOZZLE W/SPRING Ø 3.0 INNER Ø 1.5 CP
70-6420-C-04	G8040180	DOUBLE NOZZLE W/SPRING Ø 2.5 INNER Ø 1.3 CP	

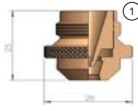

POS	LASERCORE	OEM	DESCRIPTION
1	70-6500-04		DOUBLE NOZZLE Ø 7,5 EAQ

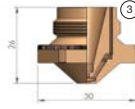
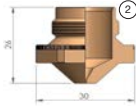

POS	LASERCORE	OEM	DESCRIPTION
2	70-6600-04		NOZZLE Ø 0.8 - CYLINDRICAL FIBER nozzle changer
	70-6601-04		NOZZLE Ø 1.0 - CYLINDRICAL FIBER nozzle changer
	70-6602-04	M000074272	NOZZLE Ø 1.2 - CYLINDRICAL FIBER nozzle changer
	70-6603-04		NOZZLE Ø 1.5 - CYLINDRICAL FIBER nozzle changer
	70-6604-04		NOZZLE Ø 2.0 - CYLINDRICAL FIBER nozzle changer
	70-6605-04		NOZZLE Ø 2.5 - CYLINDRICAL FIBER nozzle changer
	70-6606-04		NOZZLE Ø 3.0 - CYLINDRICAL FIBER nozzle changer
3	70-6700-04		DOUBLE NOZZLE Ø 1.2 FIBER nozzle changer
	70-6701-04	(A000040929)	DOUBLE NOZZLE Ø 1.5 FIBER nozzle changer
	70-6702-04	A000042360 - (A000040931)	DOUBLE NOZZLE Ø 2.0 FIBER nozzle changer
	70-6703-04	A000042361 - (A000040933)	DOUBLE NOZZLE Ø 2.5 FIBER nozzle changer
	70-6704-04		DOUBLE NOZZLE Ø 3.0 FIBER nozzle changer
	70-6705-04		DOUBLE NOZZLE Ø 3.5 FIBER nozzle changer
	70-6706-04		DOUBLE NOZZLE Ø 4.0 FIBER nozzle changer
70-6707-04		DOUBLE NOZZLE Ø 5.0 FIBER nozzle changer	

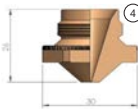

POS	LASERCORE	OEM	DESCRIPTION
4	70-6800-04		NOZZLE Ø 1.0 - CONIC FIBER nozzle changer
	70-6801-04		NOZZLE Ø 1.2 - CONIC FIBER nozzle changer
	70-6802-04		NOZZLE Ø 1.5 - CONIC FIBER nozzle changer
	70-6803-04		NOZZLE Ø 1.7 - CONIC FIBER nozzle changer
	70-6804-04		NOZZLE Ø 2.0 - CONIC FIBER nozzle changer
	70-6805-04		NOZZLE Ø 2.3 - CONIC FIBER nozzle changer
	70-6806-04		NOZZLE Ø 2.5 - CONIC FIBER nozzle changer
	70-6807-04		NOZZLE Ø 2.7 - CONIC FIBER nozzle changer
	70-6808-04		NOZZLE Ø 3,0 - CONIC FIBER nozzle changer
	70-6809-04		NOZZLE Ø 3,5 - CONIC FIBER nozzle changer
	70-6810-04		NOZZLE Ø 4,0 - CONIC FIBER nozzle changer

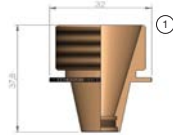

POS	LASERCORE	OEM	DESCRIPTION
1	70-7000-01		NOZZLE ADAPTOR

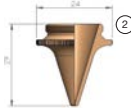

POS	LASERCORE	OEM	DESCRIPTION
2	70-7100-04		NOZZLE FLF Ø 0.8
	70-7101-04		NOZZLE FLF Ø 1.0
	70-7102-04		NOZZLE FLF Ø 1.2
	70-7103-04		NOZZLE FLF Ø 1.4
	70-7104-04		NOZZLE FLF Ø 1.7
	70-7105-04		NOZZLE FLF Ø 2.0
	70-7106-04		NOZZLE FLF Ø 2.5
	70-7107-04		NOZZLE FLF Ø 3.0

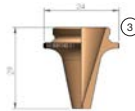

POS	LASERCORE	OEM	DESCRIPTION
3	70-7200-04	G0.0000.230	NOZZLE FLS Ø 0.8
	70-7201-04	G0.0000.231	NOZZLE FLS Ø 1.0
	70-7202-04	G0.0000.232	NOZZLE FLS Ø 1.2
	70-7203-04	G0.0000.233	NOZZLE FLS Ø 1.4
	70-7204-04	G0.0000.234	NOZZLE FLS Ø 1.7
	70-7205-04	G0.0000.235	NOZZLE FLS Ø 2.0
	70-7206-04	G0.0000.236	NOZZLE FLS Ø 2.5
	70-7207-04	G0.0000.237	NOZZLE FLS Ø 3.0
	70-7208-04	G0.0000.673	NOZZLE FLS Ø 3.5
	70-7209-04	G0.0000.674	NOZZLE FLS Ø 4.0
	70-7210-04		NOZZLE FLS Ø 5.0

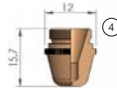

POS	LASERCORE	OEM	DESCRIPTION
4	70-7300-04		NOZZLE Ø 0.8
	70-7301-04		NOZZLE Ø 1.0
	70-7302-04		NOZZLE Ø 1.2
	70-7303-04		NOZZLE Ø 1.4
	70-7304-04		NOZZLE Ø 1.6
	70-7305-04		NOZZLE Ø 1.8
	70-7306-04		NOZZLE Ø 2.0
	70-7307-04		NOZZLE Ø 2.2
	70-7308-04		NOZZLE Ø 2.4
	70-7309-04		NOZZLE Ø 3.0

NOZZLES

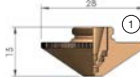

POS	LASERCORE	OEM	DESCRIPTION
1	70-8100-04	10.03.11.09.001	DOUBLE NOZZLE Ø 1.0
	70-8101-04	10.03.11.09.002	DOUBLE NOZZLE Ø 1.25
	70-8102-04	10.03.11.09.003	DOUBLE NOZZLE Ø 1.5
	70-8103-04	10.03.11.09.005	DOUBLE NOZZLE Ø 2.0
	70-8104-04	10.03.11.09.006	DOUBLE NOZZLE Ø 2.5
	70-8105-04	10.03.11.09.007	DOUBLE NOZZLE Ø 3.0
	70-8106-04	10.03.11.09.008	DOUBLE NOZZLE Ø 3.5
	70-8107-04	10.03.11.09.021	DOUBLE NOZZLE Ø 4.0
	70-8108-04	10.03.11.09.022	DOUBLE NOZZLE Ø 4.5

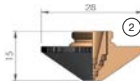

POS	LASERCORE	OEM	DESCRIPTION
2	70-8120-C-04		DOUBLE NOZZLE Ø 1.0 CP
	70-8121-C-04		DOUBLE NOZZLE Ø 1.25 CP
	70-8122-C-04		DOUBLE NOZZLE Ø 1.5 CP
	70-8123-C-04		DOUBLE NOZZLE Ø 2.0 CP
	70-8124-C-04		DOUBLE NOZZLE Ø 2.5 CP
	70-8125-C-04		DOUBLE NOZZLE Ø 3.0 CP
	70-8126-C-04		DOUBLE NOZZLE Ø 3.5 CP
	70-8127-C-04		DOUBLE NOZZLE Ø 4.0 CP
	70-8128-C-04		DOUBLE NOZZLE Ø 4.5 CP

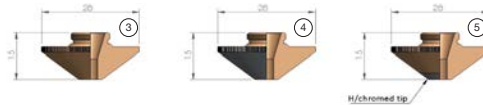

POS	LASERCORE	OEM	DESCRIPTION
3	70-8200-04	10.03.11.09.015	NOZZLE Ø 4.0 HD LARGE HEAD
	70-8201-04	10.03.11.09.016	NOZZLE Ø 4.5 HD LARGE HEAD
	70-8202-04	10.03.11.09.030	NOZZLE Ø 5.0 HD LARGE HEAD
4	70-8220-C-04		NOZZLE Ø 4.0 HD LARGE HEAD CP
	70-8221-C-04		NOZZLE Ø 4.5 HD LARGE HEAD CP
	70-8222-C-04		NOZZLE Ø 5.0 HD LARGE HEAD CP
5	70-8243-CT-04		NOZZLE Ø 4.0 HD LARGE HEAD CP
	70-8244-CT-04		NOZZLE Ø 4.5 HD LARGE HEAD CP
	70-8245-CT-04		NOZZLE Ø 5.0 HD LARGE HEAD CP

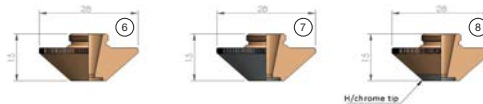

POS	LASERCORE	OEM	DESCRIPTION
6	70-8300-04	10.03.11.05.083	NOZZLE Ø 3.5 BOOSTER CUT
	70-8301-04	10.03.11.05.084	NOZZLE Ø 5.0 BOOSTER CUT
	70-8302-04		NOZZLE Ø 6.0 BOOSTER CUT
7	70-8320-C-04		NOZZLE Ø 3.5 BOOSTER CUT CP
	70-8321-C-04		NOZZLE Ø 5.0 BOOSTER CUT CP
	70-8322-C-04		NOZZLE Ø 6.0 BOOSTER CUT CP
8	70-8343-CT-04		NOZZLE Ø 3.5 BOOSTER CUT CP
	70-8344-CT-04		NOZZLE Ø 5.0 BOOSTER CUT CP
	70-8345-CT-04		NOZZLE Ø 6.0 BOOSTER CUT CP



POS	LASERCORE	OEM	DESCRIPTION
9	70-8400-04	10.03.11.11.004	DOUBLE NOZZLE Ø 5.0 HQ
10	70-8420-C-04		DOUBLE NOZZLE Ø 5.0 HQ CP

NOZZLES



LaserCore is not affiliated with the named manufacturers. Reference to machines, parts, descriptions, and model numbers are for convenience in verifying compatibility only. All parts are made by or for LaserCore and are not made by the referenced manufactures (unless expressly indicated). All other trademarks are the properties of their respective owners.

oxyfuelsafety.com ▪ (888) 327-7306
28825 RANNEY PARKWAY, CLEVELAND, OH 44145
PN LC101-0920

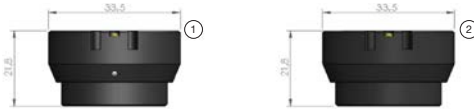

POS	LASERCORE	OEM	DESCRIPTION
1	70-9000-01		ALUMINUM AUTOMATIC NOZZLE HOLDER WITH BUSH
2	70-9001-01	281146-P0380-211-00001-29100033	NOZ. HOLDER IT M1.5" DZ - ALUMINUM

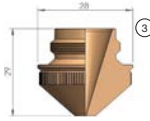

POS	LASERCORE	OEM	DESCRIPTION
3	70-9100-04	3164010046	NOZZLE Ø 1.00
	70-9101-04	3164010045	NOZZLE Ø 1.25
	70-9102-04	3164010044	NOZZLE Ø 1.50
	70-9103-04	3164010043	NOZZLE Ø 1.75
	70-9104-04	3164010042	NOZZLE Ø 2.00
	70-9105-04	3164010041	NOZZLE Ø 2.25
	70-9106-04	3164010040	NOZZLE Ø 2.50
	70-9107-04	3164010039	NOZZLE Ø 2.75
	70-9108-04	3164010038	NOZZLE Ø 3.00
70-9109-04		NOZZLE Ø 3.50	

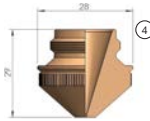

POS	LASERCORE	OEM	DESCRIPTION
4	70-9200-04	3164010166	NOZZLE Ø 1.00
	70-9201-04	3164010165	NOZZLE Ø 1.25
	70-9202-04	3164010164	NOZZLE Ø 1.50
	70-9203-04	3164010168	NOZZLE Ø 1.75
	70-9204-04	3164010163	NOZZLE Ø 2.00
	70-9205-04	3164010169	NOZZLE Ø 2.25
	70-9206-04	3164010162	NOZZLE Ø 2.50
	70-9207-04	3164010170	NOZZLE Ø 2.75
	70-9208-04	3164010161	NOZZLE Ø 3.00
70-9209-04	3164010167	NOZZLE Ø 3.50	

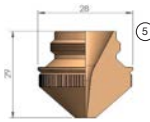

POS	LASERCORE	OEM	DESCRIPTION
5	70-9300-04	3164010181	NOZZLE Ø 1.00
	70-9301-04	3164010182	NOZZLE Ø 1.25
	70-9302-04	3164010183	NOZZLE Ø 1.50
	70-9303-04	3164010198	NOZZLE Ø 1.75
	70-9304-04	3164010184	NOZZLE Ø 2.00
	70-9305-04	3164010199	NOZZLE Ø 2.25
	70-9306-04	3164010185	NOZZLE Ø 2.50
	70-9307-04	3164010200	NOZZLE Ø 2.75
	70-9308-04	3164010186	NOZZLE Ø 3.00
70-9309-04	3164010187	NOZZLE Ø 3.50	

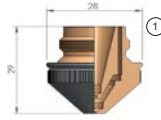

POS	LASERCORE	OEM	DESCRIPTION
1	70-9400-04		DOUBLE NOZZLE Ø 1.0
	70-9401-04		DOUBLE NOZZLE Ø 1.25
	70-9402-04		DOUBLE NOZZLE Ø 1.5
	70-9403-04		DOUBLE NOZZLE Ø 1.75
	70-9404-04		DOUBLE NOZZLE Ø 2.0
	70-9405-04		DOUBLE NOZZLE Ø 2.25
	70-9406-04		DOUBLE NOZZLE Ø 2.5
	70-9407-04		DOUBLE NOZZLE Ø 2.7
	70-9408-04		DOUBLE NOZZLE Ø 3.0

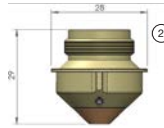

POS	LASERCORE	OEM	DESCRIPTION
2	70-9500-04	3164010188	NOZZLE Ø1,00 FOR AUTOMATIC CHANGE
	70-9501-04	3164010189	NOZZLE Ø1,25 FOR AUTOMATIC CHANGE
	70-9502-04	3164010190	NOZZLE Ø1,50 FOR AUTOMATIC CHANGE
	70-9503-04	3164010195	NOZZLE Ø1,75 FOR AUTOMATIC CHANGE
	70-9504-04	3164010191	NOZZLE Ø2,00 FOR AUTOMATIC CHANGE
	70-9505-04	3164010196	NOZZLE Ø2,25 FOR AUTOMATIC CHANGE
	70-9506-04	3164010192	NOZZLE Ø2,50 FOR AUTOMATIC CHANGE
	70-9507-04	3164010197	NOZZLE Ø2,75 FOR AUTOMATIC CHANGE
	70-9508-04	3164010193	NOZZLE Ø3,00 FOR AUTOMATIC CHANGE
	70-9509-04	3164010194	NOZZLE Ø3,50 FOR AUTOMATIC CHANGE



POS	LASERCORE	OEM	DESCRIPTION
1	80-1000-01	480.73.107	INSULATING RING-PLASTIC - HEAD 5" - ID 10
2	80-1001-01		INSULATING RING-PLASTIC - HEAD 7.5" - ID 11

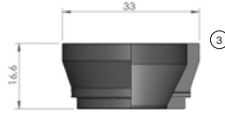

POS	LASERCORE	OEM	DESCRIPTION
3	80-1002-01	LW6.59.121	SENSOR INSULTAOR



POS	LASERCORE	OEM	DESCRIPTION
4	80-1003-01		ELECTRODE CABLE 150 mm
	80-1004-01		ELECTRODE CABLE 230 mm
	80-1005-01		ELECTRODE CABLE 350 mm

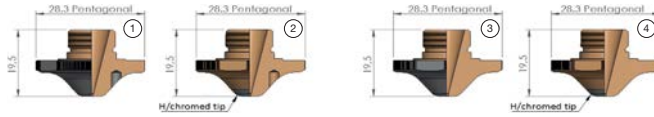

POS	LASERCORE	OEM	DESCRIPTION
1	80-1100-C-04	LW6.1G.660	NOZZLE PENT Ø 0.8 CP
	80-1101-C-04	LW6.1G.661	NOZZLE PENT Ø 1.0 CP
	80-1102-C-04	LW6.1G.662	NOZZLE PENT Ø 1.25 CP
	80-1103-C-04	LW6.1G.663	NOZZLE PENT Ø 1.5 CP
	80-1104-C-04	LW6.1G.664	NOZZLE PENT Ø 1.75 CP
	80-1105-C-04	LW6.1G.665	NOZZLE PENT Ø 2.0 CP
	80-1106-C-04	LW6.1G.667	NOZZLE PENT Ø 2.5 CP
	80-1107-C-04	LW6.1G.669	NOZZLE PENT Ø 3.0 CP
	80-1108-C-04	LW6.1G.670	NOZZLE PENT Ø 3.5 CP
	80-1109-C-04	LW6.1G.666	NOZZLE PENT Ø 2.25 CP
2	80-1110-C-04	LW6.1G.668	NOZZLE PENT Ø 2.75 CP
	80-1120-CT-04	LW6.1G.660	NOZZLE PENT Ø 0.8 CP
	80-1121-CT-04	LW6.1G.661	NOZZLE PENT Ø 1.0 CP
	80-1122-CT-04	LW6.1G.662	NOZZLE PENT Ø 1.25 CP
	80-1123-CT-04	LW6.1G.663	NOZZLE PENT Ø 1.5 CP
	80-1124-CT-04	LW6.1G.664	NOZZLE PENT Ø 1.75 CP
	80-1125-CT-04	LW6.1G.665	NOZZLE PENT Ø 2.0 CP
	80-1126-CT-04	LW6.1G.667	NOZZLE PENT Ø 2.5 CP
	80-1127-CT-04	LW6.1G.669	NOZZLE PENT Ø 3.0 CP
	80-1128-CT-04	LW6.1G.670	NOZZLE PENT Ø 3.5 CP
3	80-1129-CT-04	LW6.1G.666	NOZZLE PENT Ø 2.25 CP
	80-1130-CT-04	LW6.1G.668	NOZZLE PENT Ø 2.75 CP
	80-1200-C-04	LW6.1G.103	NOZZLE PENT Ø 1.5 CP
	80-1201-C-04	LW6.1G.105	NOZZLE PENT Ø 2.0 CP
4	80-1202-C-04	LW6.1G.107	NOZZLE PENT Ø 2.5 CP
	80-1203-C-04	LW6.1G.109	NOZZLE PENT Ø 3.0 CP
	80-1220-CT-04	LW6.1G.103	NOZZLE PENT Ø 1.5 CP
4	80-1221-CT-04	LW6.1G.105	NOZZLE PENT Ø 2.0 CP
	80-1222-CT-04	LW6.1G.107	NOZZLE PENT Ø 2.5 CP
	80-1223-CT-04	LW6.1G.109	NOZZLE PENT Ø 3.0 CP



POS	LASERCORE	OEM	DESCRIPTION
5	80-1300-C-04	LW6.1G.302	DOUBLE NOZZLE PENT Ø 1.25 CP
	80-1301-C-04	LW6.1G.303	DOUBLE NOZZLE PENT Ø 1.5 CP
	80-1302-C-04	LW6.1G.304	DOUBLE NOZZLE PENT Ø 1.75 CP
	80-1303-C-04	LW6.1G.305	DOUBLE NOZZLE PENT Ø 2.0 CP
	80-1304-C-04	LW6.1G.307	DOUBLE NOZZLE PENT Ø 2.5 CP
	80-1305-C-04	LW6.1G.204	DOUBLE NOZZLE PENT Ø 2.5 CP
	80-1306-C-04	LW6.1G.309	DOUBLE NOZZLE PENT Ø 3.0 CP
	80-1307-C-04	LW6.1G.206	DOUBLE NOZZLE PENT Ø 3.0 CP
	80-1308-C-04	LW6.1G.207	DOUBLE NOZZLE PENT Ø 3.5 CP
	6	80-1320-CT-04	LW6.1G.302
80-1321-CT-04		LW6.1G.303	DOUBLE NOZZLE PENT Ø 1.5 CP
80-1322-CT-04		LW6.1G.304	DOUBLE NOZZLE PENT Ø 1.75 CP
80-1323-CT-04		LW6.1G.305	DOUBLE NOZZLE PENT Ø 2.0 CP
80-1324-CT-04		LW6.1G.307	DOUBLE NOZZLE PENT Ø 2.5 CP
80-1325-CT-04		LW6.1E.204	DOUBLE NOZZLE PENT Ø 2.5 CP
80-1326-CT-04		LW6.1G.309	DOUBLE NOZZLE PENT Ø 3.0 CP
80-1327-CT-04		LW6.1E.206	DOUBLE NOZZLE PENT Ø 3.0 CP
80-1328-CT-04		LW6.1E.207	DOUBLE NOZZLE PENT Ø 3.5 CP

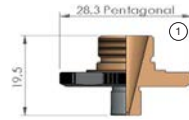

POS	LASERCORE	OEM	DESCRIPTION
1	80-1400-C-04	LW6.1G.699	NOZZLE PENT Ø 1.5 CP
	80-1401-C-04	LW6.1G.700	NOZZLE PENT Ø 2.0 CP
	80-1402-C-04	LW6.1G.701	NOZZLE PENT Ø 2.5 CP
	80-1403-C-04	LW6.1G.702	NOZZLE PENT Ø 3.0 CP



POS	LASERCORE	OEM	DESCRIPTION
2	80-1500-C-04	LW6.1G.200	DOUBLE NOZZLE PENT Ø 3.0
	80-1501-C-04	LW6.1G.201	DOUBLE NOZZLE PENT Ø 3.5
	80-1502-C-04	LW6.1G.202	DOUBLE NOZZLE PENT Ø 4.0
3	80-1600-C-04	LW6.1G.203	DOUBLE NOZZLE PENT Ø 5.0
4	80-1700-C-04	LW6.1G.204	DOUBLE NOZZLE PENT Ø 7.0



POS	LASERCORE	OEM	DESCRIPTION
5	80-1705-C-04	LW6.1G.685	DOUBLE NOZZLE PENT Ø 2.0 CP
	80-1800-C-04	LW6.1G.680	DOUBLE NOZZLE PENT Ø 0.8 CP
	80-1801-C-04	LW6.1G.681	DOUBLE NOZZLE PENT Ø 1.0 CP
	80-1802-C-04	LW6.1G.682	DOUBLE NOZZLE PENT Ø 1.25 CP
	80-1803-C-04	LW6.1G.683	DOUBLE NOZZLE PENT Ø 1.5 CP
	80-1804-C-04	LW6.1G.684	DOUBLE NOZZLE PENT Ø 1.75 CP
	80-1806-C-04	LW6.1G.686	DOUBLE NOZZLE PENT Ø 2.25 CP
	80-1807-C-04	LW6.1G.687	DOUBLE NOZZLE PENT Ø 2.5 CP
	80-1808-C-04	LW6.1G.688	DOUBLE NOZZLE PENT Ø 2.75 CP
6	80-1809-C-04	LW6.1G.689	DOUBLE NOZZLE PENT Ø 3.0 CP
	80-1820-CT-04	LW6.1G.680	DOUBLE NOZZLE PENT Ø 0.8 CP
	80-1821-CT-04	LW6.1G.681	DOUBLE NOZZLE PENT Ø 1.0 CP
	80-1822-CT-04	LW6.1G.682	DOUBLE NOZZLE PENT Ø 1.25 CP
	80-1823-CT-04	LW6.1G.683	DOUBLE NOZZLE PENT Ø 1.5 CP
	80-1824-CT-04	LW6.1G.684	DOUBLE NOZZLE PENT Ø 1.75 CP
	80-1825-CT-04	LW6.1G.685	DOUBLE NOZZLE PENT Ø 2.0 CP
	80-1826-CT-04	LW6.1G.686	DOUBLE NOZZLE PENT Ø 2.25 CP
	80-1827-CT-04	LW6.1G.687	DOUBLE NOZZLE PENT Ø 2.5 CP
	80-1828-CT-04	LW6.1G.688	DOUBLE NOZZLE PENT Ø 2.75 CP
80-1829-CT-04	LW6.1G.689	DOUBLE NOZZLE PENT Ø 3.0 CP	

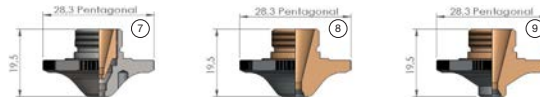

POS	LASERCORE	OEM	DESCRIPTION
7	80-1900-C-04	LW6.1G.800	DOUBLE NOZZLE PENT Ø 3.0
	80-1901-C-04	LW6.1G.801	DOUBLE NOZZLE PENT Ø 3.5
	80-1902-C-04	LW6.1G.802	DOUBLE NOZZLE PENT Ø 4.0
	80-1903-C-04	LW6.1G.803	DOUBLE NOZZLE PENT Ø 5.0
	80-1904-C-04	LW6.1G.804	DOUBLE NOZZLE PENT Ø 7.0
8	80-2000-C-04	LW6.1G.522a	NOZZLE PENT Ø 3.0 CP
9	80-2100-C-04	LW6.1G.524	NOZZLE PENT Ø 3.0 CP



POS	LASERCORE	OEM	DESCRIPTION
1	80-2200-04		NOZZLE Ø 0.8
	80-2201-04		NOZZLE Ø 1.0
	80-2202-04		NOZZLE Ø 1.2
	80-2203-04	LW6.1E.111	NOZZLE Ø 1.5
	80-2204-04	LW6.1E.112	NOZZLE Ø 2.0
	80-2205-04	LW6.1E.113	NOZZLE Ø 2.5
	80-2206-04	LW6.1E.114	NOZZLE Ø 3.0
2	80-2220-C-04		NOZZLE Ø 0.8 CP
	80-2221-C-04		NOZZLE Ø 1.0 CP
	80-2222-C-04		NOZZLE Ø 1.2 CP
	80-2223-C-04	LW6.1E.111	NOZZLE Ø 1.5 CP
	80-2224-C-04	LW6.1E.112	NOZZLE Ø 2.0 CP
	80-2225-C-04	LW6.1E.113	NOZZLE Ø 2.5 CP
	80-2226-C-04	LW6.1E.114	NOZZLE Ø 3.0 CP

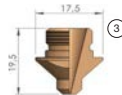

POS	LASERCORE	OEM	DESCRIPTION
3	80-2300-04	750.42.559	NOZZLE Ø 0,3
	80-2301-04		NOZZLE Ø 1,0
	80-2302-04	750.42.550	NOZZLE Ø 1,5
	80-2303-04	750.42.551	NOZZLE Ø 2,0
	80-2304-04	750.42.552	NOZZLE Ø 2,5
	80-2305-04	750.42.553	NOZZLE Ø 3,0

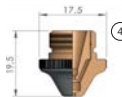

POS	LASERCORE	OEM	DESCRIPTION
4	80-2400-C-04	520.17.111	DOUBLE NOZZLE Ø 1,5 CP
	80-2401-C-04	520.17.114	DOUBLE NOZZLE Ø 2,0 CP
	80-2402-C-04	750.43.560	DOUBLE NOZZLE Ø 2,5 CP
	80-2403-C-04	520.17.561	DOUBLE NOZZLE Ø 3,0 CP
	80-2404-C-04	520.17.562	DOUBLE NOZZLE Ø 3,5 CP



POS	LASERCORE	OEM	DESCRIPTION
5	80-2500-04		NOZZLE Ø 1.0
	80-2501-04		NOZZLE Ø 1.2
	80-2502-04	LW6.1G.500-LW6.1G.600	NOZZLE Ø 1.5
	80-2503-04	LW6.1G.501-LW6.1G.601	NOZZLE Ø 2.0
	80-2504-04	LW6.1G.502-LW6.1G.602	NOZZLE Ø 2.5
	80-2505-04	LW6.1G.503-LW6.1G.603	NOZZLE Ø 3.0
6	80-2520-C-04		NOZZLE Ø 1.0 CP
	80-2521-C-04		NOZZLE Ø 1.2 CP
	80-2522-C-04	LW6.1G.500-LW6.1G.600	NOZZLE Ø 1.5 CP
	80-2523-C-04	LW6.1G.501-LW6.1G.601	NOZZLE Ø 2.0 CP
	80-2524-C-04	LW6.1G.502-LW6.1G.602	NOZZLE Ø 2.5 CP
	80-2525-C-04	LW6.1G.503-LW6.1G.603	NOZZLE Ø 3.0 CP

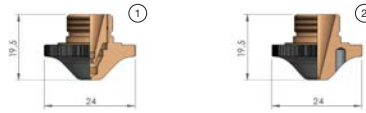

POS	LASERCORE	OEM	DESCRIPTION
1	80-2600-C-04	1.06E+11	DOUBLE NOZZLE Ø 0.8 CP
	80-2601-C-04	1.06E+11	DOUBLE NOZZLE Ø 1.0 CP
	80-2602-C-04	1.06E+11	DOUBLE NOZZLE Ø 1.25 CP
	80-2603-C-04	1.06E+11	DOUBLE NOZZLE Ø 1.5 CP
	80-2604-C-04	1.06E+11	DOUBLE NOZZLE Ø 1.75 CP
	80-2605-C-04	1.06E+11	DOUBLE NOZZLE Ø 2.0 CP
	80-2606-C-04	1.06E+11	DOUBLE NOZZLE Ø 2.5 CP
	80-2607-C-04	1.06E+11	DOUBLE NOZZLE Ø 3.0 CP
2	80-2700-C-04	LW6.1G.604	NOZZLE Ø 1.5 CP
	80-2701-C-04		NOZZLE Ø 1.75 CP
	80-2702-C-04	LW6.1G.605	NOZZLE Ø 2.0 CP
	80-2703-C-04	LW6.1G.606	NOZZLE Ø 2.5 CP
	80-2704-C-04	LW6.1G.607	NOZZLE Ø 3.0 CP

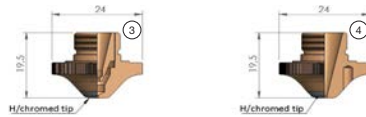

POS	LASERCORE	OEM	DESCRIPTION
3	80-2800-CT-04	1.06E+11	DOUBLE NOZZLE Ø 0.8 CP
	80-2801-CT-04	1.06E+11	DOUBLE NOZZLE Ø 1.0 CP
	80-2802-CT-04	1.06E+11	DOUBLE NOZZLE Ø 1.25 CP
	80-2803-CT-04	1.06E+11	DOUBLE NOZZLE Ø 1.5 CP
	80-2804-CT-04	1.06E+11	DOUBLE NOZZLE Ø 1.75 CP
	80-2805-CT-04	1.06E+11	DOUBLE NOZZLE Ø 2.0 CP
	80-2806-CT-04	1.06E+11	DOUBLE NOZZLE Ø 2.5 CP
	80-2807-CT-04	1.06E+11	DOUBLE NOZZLE Ø 3.0 CP
4	80-2900-CT-04	LW6.1G.604	NOZZLE Ø 1.5 CP
	80-2901-CT-04		NOZZLE Ø 1.75 CP
	80-2902-CT-04	LW6.1G.605	NOZZLE Ø 2.0 CP
	80-2903-CT-04	LW6.1G.606	NOZZLE Ø 2.5 CP
	80-2904-CT-04	LW6.1G.607	NOZZLE Ø 3.0 CP



POS	LASERCORE	OEM	DESCRIPTION
5	80-3000-C-04	LW6.1G.633	NOZZLE PENT Ø 1.5 CP
	80-3001-C-04	LW6.1G.635	NOZZLE PENT Ø 2.0 CP
	80-3002-C-04	LW6.1G.637	NOZZLE PENT Ø 2.5 CP
6	80-3100-C-04	LW6.1G.643	DOUBLE NOZZLE PENT Ø 1.5 CP
	80-3101-C-04	LW6.1G.645	DOUBLE NOZZLE PENT Ø 2.0 CP
	80-3102-C-04	LW6.1G.647	DOUBLE NOZZLE PENT Ø 2.5 CP

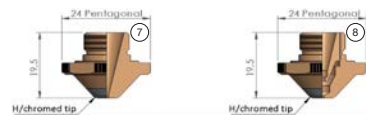

POS	LASERCORE	OEM	DESCRIPTION
7	80-3200-CT-04	LW6.1G.633	NOZZLE PENT Ø 1.5 CP
	80-3201-CT-04	LW6.1G.635	NOZZLE PENT Ø 2.0 CP
	80-3202-CT-04	LW6.1G.637	NOZZLE PENT Ø 2.5 CP
8	80-3300-CT-04	LW6.1G.643	DOUBLE NOZZLE PENT Ø 1.5 CP
	80-3301-CT-04	LW6.1G.645	DOUBLE NOZZLE PENT Ø 2.0 CP
	80-3302-CT-04	LW6.1G.647	DOUBLE NOZZLE PENT Ø 2.5 CP

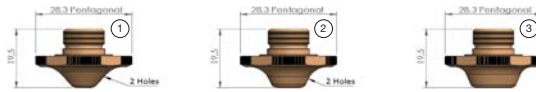

POS	LASERCORE	OEM	DESCRIPTION
1	80-3400-04		DOUBLE NOZZLE PENT Ø 2.5 - SS
	80-3401-04		DOUBLE NOZZLE PENT Ø 3.0 - SS
	80-3402-04		DOUBLE NOZZLE PENT Ø 4.0 - SS
2	80-3500-04		DOUBLE NOZZLE PENT Ø 6.0 - SS
3	80-3600-04		DOUBLE NOZZLE PENT Ø 10.0 - SS

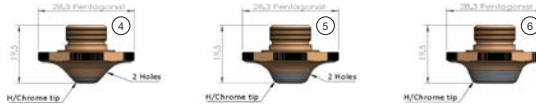

POS	LASERCORE	OEM	DESCRIPTION
4	80-3700-CT-04		DOUBLE NOZZLE PENT Ø 2.5 CP - SS
	80-3701-CT-04		DOUBLE NOZZLE PENT Ø 3.0 CP - SS
	80-3702-CT-04		DOUBLE NOZZLE PENT Ø 4.0 CP - SS
5	80-3800-CT-04		DOUBLE NOZZLE PENT Ø 6.0 CP - SS
6	80-3900-CT-04		DOUBLE NOZZLE PENT Ø 10.0 CP - SS

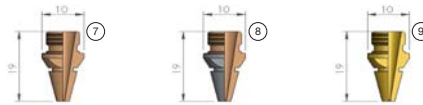

POS	LASERCORE	OEM	DESCRIPTION
7	80-4000-04		NOZZLE Ø 1.0 CONICAL
	80-4001-04		NOZZLE Ø 1.2 CONICAL
	80-4002-04		NOZZLE Ø 1.5 CONICAL
	80-4003-04		NOZZLE Ø 1.7 CONICAL
	80-4004-04		NOZZLE Ø 2.0 CONICAL
	80-4005-04		NOZZLE Ø 2.5 CONICAL
	80-4006-04		NOZZLE Ø 3.0 CONICAL
8	80-4020-C-04		NOZZLE Ø 1.0 CP
	80-4021-C-04		NOZZLE Ø 1.2 CP
	80-4022-C-04	485.73.431	NOZZLE Ø 1.5 CP
	80-4023-C-04		NOZZLE Ø 1.7 CP
	80-4024-C-04	485.73.433	NOZZLE Ø 2.0 CP
	80-4025-C-04		NOZZLE Ø 2.5 CP
	80-4026-C-04		NOZZLE Ø 3.0 CP
9	80-4040-04	485.73.331	NOZZLE Ø 1.5 BRASS
	80-4041-04	485.73.333	NOZZLE Ø 2.0 BRASS
	80-4042-04	485.73.334	NOZZLE Ø 2.5 BRASS

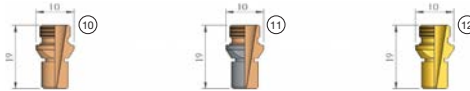

POS	LASERCORE	OEM	DESCRIPTION
10	80-4100-04		NOZZLE Ø 1.0
	80-4101-04		NOZZLE Ø 1.2
	80-4102-04		NOZZLE Ø 1.5
	80-4103-04		NOZZLE Ø 1.7
	80-4104-04		NOZZLE Ø 2.0
	80-4105-04		NOZZLE Ø 2.5
	80-4106-04		NOZZLE Ø 3.0
11	80-4120-C-04		NOZZLE Ø 1.0 CP
	80-4121-C-04		NOZZLE Ø 1.2 CP
	80-4122-C-04	485.73.421	NOZZLE Ø 1.5 CP
	80-4123-C-04		NOZZLE Ø 1.7 CP
	80-4124-C-04	485.73.422	NOZZLE Ø 2.0 CP
	80-4125-C-04	485.73.423	NOZZLE Ø 2.5 CP
	80-4126-C-04	485.73.424	NOZZLE Ø 3.0 CP
12	80-4140-04		NOZZLE Ø 1.0 BRASS
	80-4141-04	485.73.321	NOZZLE Ø 1.5 BRASS
	80-4142-04	485.73.322	NOZZLE Ø 2.0 BRASS
	80-4143-04	485.73.323	NOZZLE Ø 2.5 BRASS
	80-4144-04	485.73.324	NOZZLE Ø 3.0 BRASS

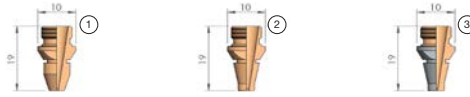

POS	LASERCORE	OEM	DESCRIPTION
1	80-4200-04		NOZZLE Ø 1.0
	80-4201-04		NOZZLE Ø 1.2
	80-4202-04		NOZZLE Ø 1.5
	80-4203-04		NOZZLE Ø 1.7
	80-4204-04		NOZZLE Ø 2.0
	80-4205-04		NOZZLE Ø 2.5
	80-4206-04		NOZZLE Ø 3.0
2	80-4300-04		NOZZLE Ø 1.5
	80-4301-04		NOZZLE Ø 2.0
	80-4302-04		NOZZLE Ø 2.5
	80-4303-04		NOZZLE Ø 3.0
3	80-4320-C-04	485.73.451	NOZZLE Ø 1.5 CP
	80-4321-C-04	485.73.452	NOZZLE Ø 2.0 CP
	80-4322-C-04	485.73.453	NOZZLE Ø 2.5 CP
	80-4323-C-04		NOZZLE Ø 3.0 CP



POS	LASERCORE	OEM	DESCRIPTION
4	80-4400-04		NOZZLE Ø 0.3 BRASS
5	80-4500-04		NOZZLE Ø 0.3 BRASS
6	80-4600-04		NOZZLE Ø 0.3
7	80-4700-C-04	485.73.455	NOZZLE Ø 0.3 CP

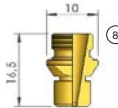

POS	LASERCORE	OEM	DESCRIPTION
8	80-4800-04	490.1N.301	NOZZLE Ø 2.0 BRASS
	80-4801-04	490.1N.302	NOZZLE Ø 2.5 BRASS
	80-4802-04		NOZZLE Ø 3.0 BRASS

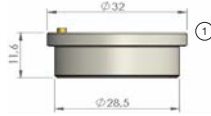

POS	LASERCORE	OEM	DESCRIPTION
1	80-5000-01		CERAMIC NOZZLE HOLDER

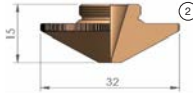

POS	LASERCORE	OEM	DESCRIPTION
2	80-6000-04	120GJT0508	NOZZLE Ø 0.8
	80-6001-04	120GJT0510	NOZZLE Ø 1.0
	80-6002-04	120GJT0512	NOZZLE Ø 1.2
	80-6003-04		NOZZLE Ø 1.4
	80-6004-04	120GJT0515	NOZZLE Ø 1.5
	80-6005-04		NOZZLE Ø 1.8
	80-6006-04	120GJT0520	NOZZLE Ø 2.0
	80-6007-04		NOZZLE Ø 2.3
	80-6008-04	120GJT0525	NOZZLE Ø 2.5
	80-6009-04		NOZZLE Ø 2.75
	80-6010-04	120GJT0630	NOZZLE Ø 3.0
	80-6011-04		NOZZLE Ø 3.2
	80-6012-04	120GJT0635	NOZZLE Ø 3.5
	80-6013-04	120GJT0540	NOZZLE Ø 4.0
	80-6014-04	120GJT0545	NOZZLE Ø 4.5
	80-6015-04	120GJT0550	NOZZLE Ø 5.0
80-6016-04		NOZZLE Ø 6.0	

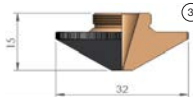

POS	LASERCORE	OEM	DESCRIPTION
3	80-6020-C-04		NOZZLE Ø 0.8 CP
	80-6021-C-04		NOZZLE Ø 1.0 CP
	80-6022-C-04		NOZZLE Ø 1.2 CP
	80-6023-C-04		NOZZLE Ø 1.4 CP
	80-6024-C-04		NOZZLE Ø 1.5 CP
	80-6025-C-04		NOZZLE Ø 1.8 CP
	80-6026-C-04		NOZZLE Ø 2.0 CP
	80-6027-C-04		NOZZLE Ø 2.3 CP
	80-6028-C-04		NOZZLE Ø 2.5 CP
	80-6029-C-04		NOZZLE Ø 2.75 CP
	80-6030-C-04		NOZZLE Ø 3.0 CP
	80-6031-C-04		NOZZLE Ø 3.2 CP
	80-6032-C-04		NOZZLE Ø 3.5 CP
	80-6033-C-04		NOZZLE Ø 4.0 CP
	80-6034-C-04		NOZZLE Ø 4.5 CP
	80-6035-C-04		NOZZLE Ø 5.0 CP
80-6036-C-04		NOZZLE Ø 6.0 CP	

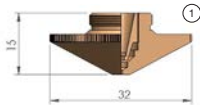

POS	LASERCORE	OEM	DESCRIPTION
1	80-6100-04		DOUBLE NOZZLE Ø 0.8
	80-6101-04		DOUBLE NOZZLE Ø 1.0
	80-6102-04		DOUBLE NOZZLE Ø 1.2
	80-6103-04		DOUBLE NOZZLE Ø 1.4
	80-6104-04		DOUBLE NOZZLE Ø 1.5
	80-6105-04		DOUBLE NOZZLE Ø 1.8
	80-6106-04		DOUBLE NOZZLE Ø 2.0
	80-6107-04		DOUBLE NOZZLE Ø 2.3
	80-6108-04		DOUBLE NOZZLE Ø 2.5
	80-6109-04		DOUBLE NOZZLE Ø 2.7
	80-6110-04		DOUBLE NOZZLE Ø 3.0
	80-6111-04		DOUBLE NOZZLE Ø 3.5
	80-6112-04		DOUBLE NOZZLE Ø 4.0
	80-6113-04		DOUBLE NOZZLE Ø 4.5
	80-6114-04		DOUBLE NOZZLE Ø 5.0
80-6115-04		DOUBLE NOZZLE Ø 6.0	



POS	LASERCORE	OEM	DESCRIPTION
2	80-6120-C-04	120GJT0608	DOUBLE NOZZLE Ø 0.8 CP
	80-6121-C-04	120GJT0610	DOUBLE NOZZLE Ø 1.0 CP
	80-6122-C-04	120GJT0612	DOUBLE NOZZLE Ø 1.2 CP
	80-6123-C-04		DOUBLE NOZZLE Ø 1.4 CP
	80-6124-C-04	120GJT0615	DOUBLE NOZZLE Ø 1.5 CP
	80-6125-C-04		DOUBLE NOZZLE Ø 1.8 CP
	80-6126-C-04	120GJT0620	DOUBLE NOZZLE Ø 2.0 CP
	80-6127-C-04		DOUBLE NOZZLE Ø 2.3 CP
	80-6128-C-04	120GJT0625	DOUBLE NOZZLE Ø 2.5 CP
	80-6129-C-04		DOUBLE NOZZLE Ø 2.7 CP
	80-6130-C-04	120GJT0630	DOUBLE NOZZLE Ø 3.0 CP
	80-6131-C-04	120GJT0635	DOUBLE NOZZLE Ø 3.5 CP
	80-6132-C-04	120GJT0640	DOUBLE NOZZLE Ø 4.0 CP
	80-6133-C-04	120GJT0645	DOUBLE NOZZLE Ø 4.5 CP
	80-6134-C-04	120GJT0650	DOUBLE NOZZLE Ø 5.0 CP
80-6135-C-04		DOUBLE NOZZLE Ø 6.0 CP	

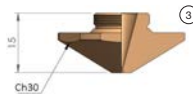

POS	LASERCORE	OEM	DESCRIPTION
3	80-6200-04		NOZZLE Ø 0.8
	80-6201-04		NOZZLE Ø 1.0
	80-6202-04		NOZZLE Ø 1.2
	80-6203-04		NOZZLE Ø 1.4
	80-6204-04		NOZZLE Ø 1.5
	80-6205-04		NOZZLE Ø 1.8
	80-6206-04		NOZZLE Ø 2.0
	80-6207-04		NOZZLE Ø 2.5
	80-6208-04		NOZZLE Ø 3.0
	80-6209-04		NOZZLE Ø 3.5
	80-6210-04		NOZZLE Ø 4.0
	80-6211-04		NOZZLE Ø 4.5
	80-6212-04		NOZZLE Ø 5.0



POS	LASERCORE	OEM	DESCRIPTION
1	80-6220-C-04		NOZZLE Ø 0.8 CP
	80-6221-C-04		NOZZLE Ø 1.0 CP
	80-6222-C-04		NOZZLE Ø 1.2 CP
	80-6223-C-04		NOZZLE Ø 1.4 CP
	80-6224-C-04		NOZZLE Ø 1.5 CP
	80-6225-C-04		NOZZLE Ø 1.8 CP
	80-6226-C-04		NOZZLE Ø 2.0 CP
	80-6227-C-04		NOZZLE Ø 2.5 CP
	80-6228-C-04		NOZZLE Ø 3.0 CP
	80-6229-C-04		NOZZLE Ø 3.5 CP
	80-6230-C-04		NOZZLE Ø 4.0 CP
	80-6231-C-04		NOZZLE Ø 4.5 CP
	80-6232-C-04		NOZZLE Ø 5.0 CP



POS	LASERCORE	OEM	DESCRIPTION
2	80-6300-04		DOUBLE NOZZLE Ø 0.8
	80-6301-04		DOUBLE NOZZLE Ø 1.0
	80-6302-04		DOUBLE NOZZLE Ø 1.2
	80-6304-04		DOUBLE NOZZLE Ø 1.4
	80-6305-04		DOUBLE NOZZLE Ø 1.5
	80-6306-04		DOUBLE NOZZLE Ø 1.8
	80-6307-04		DOUBLE NOZZLE Ø 2.0
	80-6308-04		DOUBLE NOZZLE Ø 2.5
	80-6309-04		DOUBLE NOZZLE Ø 3.0
	80-6310-04		DOUBLE NOZZLE Ø 3.5
	80-6311-04		DOUBLE NOZZLE Ø 4.0
	80-6312-04		DOUBLE NOZZLE Ø 4.5
	80-6313-04		DOUBLE NOZZLE Ø 5.0



POS	LASERCORE	OEM	DESCRIPTION
3	80-6320-C-04		DOUBLE NOZZLE Ø 0.8 CP
	80-6321-C-04		DOUBLE NOZZLE Ø 1.0 CP
	80-6322-C-04		DOUBLE NOZZLE Ø 1.2 CP
	80-6324-C-04		DOUBLE NOZZLE Ø 1.4 CP
	80-6325-C-04		DOUBLE NOZZLE Ø 1.5 CP
	80-6326-C-04		DOUBLE NOZZLE Ø 1.8 CP
	80-6327-C-04		DOUBLE NOZZLE Ø 2.0 CP
	80-6328-C-04		DOUBLE NOZZLE Ø 2.5 CP
	80-6329-C-04		DOUBLE NOZZLE Ø 3.0 CP
	80-6330-C-04		DOUBLE NOZZLE Ø 3.5 CP
	80-6331-C-04		DOUBLE NOZZLE Ø 4.0 CP
	80-6332-C-04		DOUBLE NOZZLE Ø 4.5 CP
	80-6333-C-04		DOUBLE NOZZLE Ø 5.0 CP

LASERCORE	DESCRIPTION	DIAMETER	THICKNESS	AR COATING
90-1930-01	Protective Window 19x3 900-1100 nm	19.00	3.00	900-1100 nm
90-1903-01	Protective Window 19x3 1030-1080 nm	19.00	3.00	1030-1080 nm
90-2682-01	Protective Window 26.8x2 1064/1070 nm	26.80	2.00	1064/1070 nm
90-2702-01	Protective Window 27x2 900-1080 nm	27.00	2.00	900-1080 nm
90-2720-01	Protective Window 27x2 1064/1070 nm	27.00	2.00	1064/1070 nm
90-2700-01	Protective Window 27x2 900-1100 nm	27.00	2.00	900-1100 nm
90-3001-01	Protective Window 30x1.5 900-1080 nm	30.00	1.50	900-1080 nm
90-3016-01	Protective Window 30x1.6 900-1100 nm	30.00	1.60	900-1100 nm
90-3802-01	Protective Window 38x2 1064/1070 nm	38.00	2.00	1064/1070 nm
90-3803-01	Protective Window 38x3 1064/1070 nm	38.00	3.00	1064/1070 nm
90-3902-01	Protective Window 39x2 1070 nm	39.00	2.00	1070 nm
90-5001-01	Protective Window 50x1.5 1064/1070 nm	50.00	1.50	1064/1070 nm
90-5020-01	Protective Window 50x2 900-1100 nm	50.00	2.00	900-1100 nm
90-5022-01	Protective Window 50x2 1064/1070 nm	50.00	2.00	1064/1070 nm
90-5023-01	Protective Window 50x2 1030-1090 nm	50.00	2.00	1030-1090 nm
90-5003-01	Protective Window 50x3 1030-1090 nm	50.00	3.00	1030-1090 nm
90-5030-01	Protective Window 50x3 900-1100 nm	50.00	3.00	900-1100 nm
90-5515-01	Protective Window 55x1.5 uncoated	55.00	1.50	uncoated
90-5516-01	Protective Window 55x1.5 900-1090 nm	55.00	1.50	900-1090 nm
90-5518-01	Protective Window 55x1.5 900-1090 nm	55.00	1.50	900-1090 nm
90-5519-01	Protective Window 55x1.5 1064/1070 nm	55.00	1.50	1064/1070 nm
90-6003-01	Protective Window 60x3 1064/1070 nm	60.00	3.00	1064/1070 nm
90-2152-01	Protective Window 21.5x2 900-1080 nm	21.50	2.00	900-1080 nm
90-2235-01	Protective Window 22.35x4 900-1080 nm	22.35	4.00	900-1080 nm
90-2405-01	Protective Window 24x5 1030-1090 nm	24.00	5.00	1030-1090 nm
90-2541-01	Protective Window 25.4x1.5 900-1080 nm	25.40	1.50	900-1080 nm
90-2544-01	Protective Window 25.4x4 900-1080 nm	25.40	4.00	900-1080 nm
90-2794-01	Protective Window 27.9x4.1 900-1080 nm	27.90	4.10	900-1080 nm
90-3015-01	Protective Window 30x1.5 900-1080 nm	30.00	1.50	900-1080 nm
90-3005-01	Protective Window 30x5 900-1080 nm	30.00	5.00	900-1080 nm
90-3050-01	Protective Window 30x5 900-1080 nm	30.00	5.00	900-1080 nm
90-3206-01	Protective Window 32x6.35 1025-1080 nm	32.00	6.35	1025-1080 nm
90-3331-01	Protective Window 33.3x1.5 900-1080 nm	33.30	1.50	900-1080 nm
90-3403-01	Protective Window 34x3 900-1080 nm	34.00	3.00	900-1080 nm
90-3430-01	Protective Window 34x3 900-1080 nm	34.00	3.00	900-1080 nm
90-3405-01	Protective Window 34x5 1030-1070 nm	34.00	5.00	1030-1070 nm
90-3501-01	Protective Window 35x1.5 900-1080 nm	35.00	1.50	900-1080 nm
90-3605-01	Protective Window 36x5 900-1080 nm	36.00	5.00	900-1080 nm
90-3650-01	Protective Window 36x5 900-1080 nm	36.00	5.00	900-1080 nm
90-3707-01	Protective Window 37x7 900-1080 nm	37.00	7.00	900-1080 nm
90-3770-01	Protective Window 37x7 900-1080 nm	37.00	7.00	900-1080 nm
90-3807-01	Protective Window 38x7 900-1080 nm	38.00	7.00	900-1080 nm
90-3815-01	Protective Window 38.1x5 900-1080 nm	38.10	5.00	900-1080 nm
90-4107-01	Protective Window 41x7 900-1080 nm	41.00	7.00	900-1080 nm
90-4209-01	Protective Window 42x9 1025-1080 nm	42.00	9.00	1025-1080 nm
90-4503-01	Protective Window 45x3 900-1090 nm	45.00	3.00	900-1090 nm
90-5021-01	Protective Window 50x2 900-1080 nm	50.00	2.00	900-1080 nm
90-5081-01	Protective Window 50.8x1 900-1080 nm	50.80	1.00	900-1080 nm
90-5517-01	Protective Window 55x1.5 1025-1080 nm	55.00	1.50	1025-1080 nm
90-9603-01	Protective Window 96x3 1030-1090 nm	96.00	3.00	1030-1090 nm
90-1130-01	Protective Window 113x3 1030-1090 nm	113.00	3.00	1030-1090 nm
90-1340-01	Protective Window 134x3 1030-1090 nm	134.00	3.00	1030-1090 nm
90-1343-01	Protective Window 134x3 1030-1090 nm	134.00	3.00	1030-1090 nm
90-1400-01	Protective Window 140x4 1030-1090 nm	140.00	4.00	1030-1090 nm

LASERCORE™

 **SuperFlash®**
COMPRESSED GAS EQUIPMENT