

SERVICE MANUAL



EX542/EX612/EX615/EX540/EX762/EX540I/EX542I/
ES523ST/EW533ST

Date	Revise Version	Description
2009.07.08	V1.0	Initial Issue
2009.10.13	V2.0	Add EX540/EX762
2009.12.16	V3.0	Add EX540I/EX542I
2010.02.07	V4.0	Add ES523ST/EW533ST; Modify "Defect specification table" in Chapter 4;

Copyright Feb, 2010. All Rights Reserved. P/N: 36.8FJ01G001

SI: *Asina*

TSE: *Asina*

Check: *Aliek*

Approved: *Aliek*

Preface

This manual is applied to EX542/EX612/EX615/EX540/EX762/EX540I/EX542I/ES523ST/ EW533ST projection system. The manual gives you a brief description of basic technical information to help in service and maintain the product.

Your customers will appreciate the quick response time when you immediately identify problems that occur with our products. We expect your customers will appreciate the service that you offer them.

This manual is for technicians and people who have an electronic background. Please send the product back to the distributor for repairing and do not attempt to do anything that is complex or is not mentioned in the troubleshooting.

Notice: The information found in this manual is subject to change without prior notice. Any subsequent changes made to the data herein will be incorporated in future edition.

EX542/EX612/EX615/EX540/EX762/EX540I/EX542I/ES523ST/EW533ST Service Manual

Copyright Feb. 2010

All Rights Reserved

Manual Version 4.0

EX542/EX612/EX615/EX540/EX762/EX540I/EX542I /ES523ST/ EW533ST Comparison List

Parts	EX540	EX542	EX540I	EX542I	EW533ST	ES523ST	EX615	EX612	EX762
USER'S GUIDE	36.8FB01G001	36.8EF01G001		36.8FR01G001	36.8HA01G001		36.8EF01G001	36.8FK01G001	36.8FB01G001
LAMP DRIVER MODULE	70.8FJ05GR01						70.8EF38GR01		70.8FB21GR01
LVPS	75.8CT02G001						75.8CT01G001		75.8FB01GP01
BLOWER	49.8CS01G002						49.8EF04G001		49.8FB01G001
OPTICAL ENGINE MODULE	70.8FJ06GR01		70.8FJ30GR01		70.8HA18GR01	70.8GZ16GR01	70.8EF40GR01	70.8FK03GR01	70.8FB22GR01
MAIN BOARD MODULE	70.8FR05GR01	70.8FJ03GR01	70.8FR24GR01	70.8FJ27GR01	80.8HA01G001	80.8GZ01G001	70.8EF43GR01	80.8FK01G001	70.8FB24GR01
DMD CHIP	48.8EZ01G001	48.8CQ01G001	48.8EZ01G001	48.8CQ01G003	48.8EJ01G001	48.8EH01G001	48.8CQ01G001		48.8CQ01G003
FAN	49.88T01G001						49.8EF03G001		
THERMAL SWITH	43.8EF17G001						43.8EG17G001		43.8FB17G001
IO COVER MODULE	70.8FJ04GR01		70.8FJ28GR01		70.8HA20GR01	70.8GZ17GR01	70.8EF44GR01	70.8FK02GR01	70.8EF44GR01
SPEAKER	49.8EF01G001				49.8GZ01G001		49.87K01G201		49.8EM01G011
DAUGHTER BOARD	80.8EF06G002				80.8GZ06G001		80.8EF06G003		80.8EF06G002
LAN MODULE BOARD	80.8EF07G001				NA				80.8EF07G001
REMOTE CONTROL	45.8EF01G001					45.8GZ01G001	45.8EF02G001		45.8EF01G001
COLOR WHEEL MODULE	70.8EF41GR01		70.8FJ29GR01		70.8FB23GR01		70.8EF41GR01		70.8FB23GR01

Table of Content

Chapter 1 Introduction

Highlight	1-1
Compatible Mode	1-3

Chapter 2 Disassembly Process

Equipment Needed & Product Overview	2-1
Disassemble Lamp Cover Module	2-2
Disassemble Lamp Module	2-2
Disassemble Focus Ring	2-3
Disassemble Top Cover Module	2-3
Disassemble Keypad Board Module and Zoom Ring	2-4
Disassemble Top Shielding	2-5
Disassemble Main Board Module	2-5
Disassemble Daughter Board and Lan Module Board	2-8
Disassemble Engine Module	2-9
Disassemble Color Wheel Module	2-9
Disassemble DMD Chip and DMD Board	2-10
Disassemble Rod Module	2-10
Disassemble System Fan Module and Thermal Switch	2-11
Disassemble Speakers	2-12
Disassemble Blower	2-13
Disassemble Front IR Module	2-14
Disassemble LVPS Module and Interlock Switch	2-14
Disassemble Lamp Driver Module	2-15
Disassemble Security Bar Cap	2-15
Disassemble Bottom Shielding	2-16

	Disassemble IO Cover	2-17
	Rod Adjustment	2-18
	Re-write Lamp Usage Hour	2-19
Chapter 3	Troubleshooting	
	LED Lighting Message	3-1
	Main Procedure	3-2
Chapter 4	Function Test & Alignment Procedure	
	Test Equipment Needed	4-1
	Service Mode	4-1
	OSD Reset	4-1
	Test Condition	4-2
	Test Inspection Procedure	4-4
	PC MODE	4-5
	Video Performance	4-8
	ADC Calibration	4-11
	Optical Performance Measure	4-13
	Network Function Test (For EX542/EX615/EX540/EX762/EX540I/EX542I)	4-15
	Others	4-18
Chapter 5	Firmware Upgrade	
	Section 1: System Firmware Upgrade (For EX540/EX542/EX612/EX615/EX762/EX540I/EX542I)	5-1
	Equipment Needed	5-1
	DLP Composer Lite Setup Procedure	5-2
	Setup Procedure	5-4

USB Driver Upgrade Procedure	5-4
Firmware Upgrade Procedure	5-5
Section 2: System Firmware Upgrade (For ES523ST/EW533ST)	5-8
DLP Composer Lite Setup Procedure	5-9
Setup Procedure	5-9
Firmware Upgrade Procedure	5-9
Section 3: 8051 Firmware Upgrade Procedure	5-13
Equipment Needed	5-13
NLINK Setup Procedure	5-14
Manley USB Driver Upgrade Procedure	5-16
8051 Firmware Upgrade Procedure	5-18
Section 4: Network Firmware Upgrade Procedure (For EX542/EX615/EX540/EX762/EX540I/EX542I)	5-20
Equipment Needed	5-20
Write Down Projector IP	5-21
Network Setting	5-22
PC Hardware Link	5-23

Chapter 6 EDID Upgrade

EDID Introduction	6-1
Equipment Needed (For EX542/EX615/EX540/EX762/EX540I/EX542I)	6-2
Setup Procedure (VGA) (For EX542/EX615/EX540/EX762/EX540I/EX542I)	6-3
EDID Key-In Procedure (VGA-1 & VGA-2) (For EX542/EX615/EX540/EX762/EX540I/EX542I)	6-3

Equipment Needed (for ES523ST/EW533ST)	6-6
Setup Procedure (VGA) (for ES523ST/EW533ST)	6-7
EDID Key-In Procedure (for ES523ST/EW533ST)	6-7
Setup Procedure (HDMI) (For EX542/EX615/EX540/EX762/EX540I/EX542I)	6-10
EDID Key-In Procedure (HDMI) (For EX542/EX615/EX540/EX762/EX540I/EX542I)	6-10

Appendix A

Exploded Image	I
----------------	---

Appendix B

Serial Number System Definition	I
PCBA Code Definition	II

Introduction

1-1 Highlight

No	Item	Description
1	Technology	<ul style="list-style-type: none"> ● 0.55" XGA 2xLVDS SERIES 450 DMD DC3 (for EX542/EX612/EX615/EX762/EX542I/EX540/EX540I) ● 0.55" SVGA, S450, Dark Chip 3 (for ES523ST) ● 0.65" WXGA, S450, Dark Chip 3 (for EW533ST)
2	Dimension (W x D x H)	<ul style="list-style-type: none"> ● 324 x 234 x 97 mm
3	Weight	<ul style="list-style-type: none"> ● 6.3-6.4 lbs (for EX542/EX612/EX615/EX540/EX540I/EX542I) ● <6.7 lbs (for EX762) ● 6.5 lbs (for ES523ST/EW533ST)
4	Power Supply	<ul style="list-style-type: none"> ● Auto-ranging: 100V~ 240V ± 10%, 50~ 60Hz
5	Keystone Correction	<ul style="list-style-type: none"> ● +/-40 degree (TI spec.)
6	Resolution	<ul style="list-style-type: none"> ● Native Resolution: 1024 x 768 (for EX542/EX612/EX615/EX762/EX542I/ EX540/EX540I) ● Native Resolution: 800x600 (for ES523ST) ● Native Resolution: 1280x800 (for EW533ST)
7	Power consumption	<ul style="list-style-type: none"> ● Full Mode:(Typ)338W,(Max)372W @ac 110V ● ECO mode:(Typ)285W,(Max)314W @ac 110V (for EX762) ● Full Mode:(Typ)231W,(Max)255W @ac 110V ● ECO Mode:(Typ)212W,(Max)233W @ac 110V (for EX540/EX542) ● Full Mode:(Typ)298W,(Max)328W @ac 110V ● ECO Mode:(Typ)247W,(Max)272W @ac 110V (for EX615/EX612) ● Full Mode:(Typ)233W,(Max)255W @ac 110V ● ECO Mode:(Typ)207W,(Max)230W @ac 110V (for EX540I/EX542I) ● Full Mode: (Typ) 230W, (Max) 255W @ 110VAC ● ECO Mode:(Typ) 212W, (Max) 233W @ 110VAC (for ES523ST/EW533ST)

No	Item	Description
8	Throw ratio	<ul style="list-style-type: none"> • 1.95~ 2.15 @60"(Distance/Width) (for EX612/EX615) • 1.6~ 1.92 @60"(Distance/Width) (for EX540/EX542/EX762/EX540I/EX542I) • 0.72 (Distance/Width) (for EW533ST) • 0.9 (Distance/Width) (for ES523ST)
9	Projection lens	<ul style="list-style-type: none"> • YM25, F# 2.4~ 2.66, f= 18.2~ 21.8 mm @60" (for EX542/EX762/EX540/EX540I/EX542I) • YM09X/FPL30, F# 2.41~ 2.55 @60", f= 21.8 ~ 24 mm @60" (for EX612/EX615) • YM43, F# 2.55, f= 10.19 mm (for ES523ST/ EW533ST)
10	Lamp life	<ul style="list-style-type: none"> • 2000 Hours, 50% Survival Rate (Standard-Mode) (for EX540/EX542/EX762) • 2500 Hours, 50% Survival Rate (Standard-Mode) (for EX615/EX612) • 3000 Hours,50% Survival Rate(Standard-Mode) (for EX540I/EX542I/ ES523ST/EW533ST) • 4000 Hours, 50% Survival Rate (ECO-Mode) (for EX542/EX540/EX615/EX612) • 3000 Hours, 50% Survival Rate (ECO-Mode) (for EX762) • 4500 Hours,50% Survival Rate(ECO-Mode) (for EX540I/EX542I/ ES523ST/EW533ST)
11	Offset	<ul style="list-style-type: none"> • 115% ± 5% (for EX540/EX542/EX612/EX615/EX762/EX540I/EX542I) • 112.4%±5% (for ES523ST/EW533ST)
12	Video compatibility	<ul style="list-style-type: none"> • NTSC: NTSC M 3.58 MHz, 4.43 MHz • PAL: PAL B/D/G/H/I/M/N, 4.43 MHz • SECAM: SECAM B/D/G/K/K1/L, 4.25/4.4 MHz • Component: 480i/p, 576i/p, 720p (50/60Hz), 1080i/p (50/60Hz) (for EX540/EX542/EX612/EX615/EX762/EX540I/EX542I) • Component: 480i/p, 576i/p, 720p(50/60Hz), 1080i(50/60Hz), 1080P(50/60Hz) (for ES523ST/EW533ST)
13	Aspect ratio	<ul style="list-style-type: none"> • 4:3, 16:9 I, 16:9 II, NATIVE, AUTO (for EX540/EX542/EX612/EX615/EX762/EX540I/EX542I) • 4:3, 16:9, 16:10, Native, Auto (for ES523ST/EW533ST)
14	Lamp	<ul style="list-style-type: none"> • 180 W OSRAM Lamp E20.8 elliptic (for EX540/ EX542/EX540I/ EX542I/ ES523ST/EW533ST) • 230 W OSRAM Lamp E20.8 elliptic (for EX615/EX612) • 280 W OSRAM Lamp E20.8 elliptic (for EX762)
15	Color Wheel	<ul style="list-style-type: none"> • 5 Segments; RGBYW; Filter Diameter 40 mm • R76Y32G78W98B76 • 2x, 7200 RPM

No	Item	Description
16	System Controller	<ul style="list-style-type: none"> • DDP2430(for EX540/EX542/EX615/EX612) • DDP2431(for EX762 for EX540I/EX542I/ ES523ST/EW533ST)
17	Input Connections	<ul style="list-style-type: none"> • VGA-in: VGA in 1 (wireless dongle, YPbPr) VGA in 2 (SCART, YPbPr) (for EX540/EX542/EX612/EX615/EX762/EX540I/EX542I) • VGA-in: VGA-in x 1 (RGB) (for ES523ST/EW533ST) • Composite: RCA x 1 (for EX540/EX542/EX612/EX615/EX762/EX540I/EX542I) • Composite video: Composite Video x 1 (for ES523ST/ EW533ST) • S-video: Mini-DIN 4 pin x 1 • RCA Audio in: RCA Audio in x 2 (R & L) (for ES523ST/ EW533ST) • Audio-in (Green coded port): <ul style="list-style-type: none"> • Audio-in 1 only (Daughter Board) (for EX612) • Audio-in 1, 2, 3 (Daughter Board) (for EX542/EX615/EX540/EX762/EX540I/EX542I) • HDMI: HDMI v1.3 (HDCP) (for EX542/EX615/EX540/EX762/EX540I/EX542I/ES523ST/ EW533ST) • Audio-in connectivity grouping (for EX542/EX615/EX540/EX762/EX540I/EX542I) <ul style="list-style-type: none"> • VGA-in1 -> Audio in1 • VGA-in2 -> Audio in2 • Composite/S-Vidoe -> Audio in3
18	Temperature	<ul style="list-style-type: none"> • Operating (Full-power-mode): 5~ 40 °C • Non-operation (storage): -10°C~ 60°C
19	Altitude	<ul style="list-style-type: none"> • For EX540/EX542/EX612/EX615/EX762/EX540I/EX542I: <ul style="list-style-type: none"> • Operating: <ul style="list-style-type: none"> 0 ~ 2,500 ft, for 5°C~ 40°C 2500 ft ~ 5,000 ft, for 5°C~ 35°C 5,000 ft ~ 10,000 ft, for 5°C~ 30°C • For ES523ST/ EW533ST: <ul style="list-style-type: none"> • Operating: <ul style="list-style-type: none"> 0 ~ 2,500 ft, for 5°C~ 40°C 2500 ft ~ 5,000 ft, for 5°C~ 30°C 5,000 ft ~ 10,000 ft, for 5°C~ 25°C

1-2 Compatible Mode

Computer Compatibility (Analog)

Compatibility	Resolution	V-Sync [Hz]	H-Sync [KHz]
VGA	640 x 350	70	31.5
	640 x 350	85	37.9
	640 x 400	85	37.9
	640 x 480	60	31.5
	640 x 480	72	37.9
	640 x 480	75	37.5
	640 x 480	85	43.3
	720 x 400	70	31.5
	720 x 400	85	37.9
SVGA	800 x 600	56	35.2
	800 x 600	60	37.9
	800 x 600	72	48.1
	800 x 600	75	46.9
	800 x 600	85	53.7
XGA	1024 x 768	60	48.4
	1024 x 768	70	56.5
	1024 x 768	75	60
	1024 x 768	85	68.7
WXGA	1280 x 768	60	47.8
SXGA	1152 x 864	60	53.5
	1152 x 864	70	63.8
	1152 x 864	75	67.5
	1152 x 864	85	77.1
	1280 x 1024	60	63.98
	1280 x 1024	75	79.98
	1280 x 1024	85	91.1
	1280 x 960	60	60.0
WXGA	1280 x 800	60	49.68
SXGA+	1400 x 1050	60	63.98
UXGA	1600 x 1200	60	75
MAC LC 13"	640 x 480	66.66	34.98
MAC II 13"	640 x 480	66.68	35
MAC 16"	832 x 624	75	49.725

Compatibility	Resolution	V-Sync [Hz]	H-Sync [KHz]
MAC 19"	1024 x 768	75	60.24
MAC	1152 x 870	75	68.68
MAC G4	640 x 480	60	31.35
i Mac DV	1024 x 768	75	60
i Mac DV	1152 x 870	75	68.49
i Mac DV	1280 x 960	75	75

Computer Compatibility (Digital)

Compatibility	Resolution	V-Sync [Hz]	H-Sync [KHz]
VGA	640 x 350	70	31.5
	640 x 350	85	37.9
	640 x 400	85	37.9
	640 x 480	60	31.5
	640 x 480	72	37.9
	640 x 480	75	37.5
	640 x 480	85	43.3
	720 x 400	70	31.5
	720 x 400	85	37.9
SVGA	800 x 600	56	35.2
	800 x 600	60	37.9
	800 x 600	72	48.1
	800 x 600	75	46.9
	800 x 600	85	53.7
XGA	1024 x 768	60	48.4
	1024 x 768	70	56.5
	1024 x 768	75	60
	1024 x 768	85	68.7
WXGA	1280 x 768	60, 75, 85	47.8
	1280 x 800	60	49.64

Compatibility	Resolution	V-Sync [Hz]	H-Sync [KHz]
SXGA	1152 x 864	60	53.5
	1152 x 864	70	63.8
	1152 x 864	75	67.5
	1152 x 864	85	77.1
	1280 x 1024	60	63.98
	1280 x 1024	75	79.98
	1280 x 1024	85	91.1
SXGA+	1400 x 1050	60	63.98
UXGA	1600 x 1200	60	75

Note: If the Computer Compatibility supportive signal is different from User's Manual, please refer to User's Manual.

Disassembly Process

2-1 Equipment Needed & Product Overview

1. Screw Bit (+): 105
2. Screw Bit (+): 107
3. Screw Bit (-): 107
4. Hex Sleeves 5 mm
5. Tweezers
6. Projector

** Before you start: This process is protective level II. Operators should wear electrostatic chains.*

** Note: - If you need to replace the Main Board, you have to record the Lamp Usage Hour.*

- The disassembly process for EX542/EX612/EX615/EX540/EX762/EX540I/EX542I/ES523ST/EW533ST is the same , we take EX615 as an example here.



2-2 Disassemble Lamp Cover Module

1. Loosen 2 screws (as red circle) on the Lamp Cover.
2. Disassemble the Lamp Cover Module.



2-3 Disassemble Lamp Module

1. Loosen 2 screws (as red circle) on the Lamp Module.
2. Take off the Lamp Module.



2-4 Disassemble Focus Ring

1. Rotate the Focus Ring clockwise until you cannot rotate any more (as red arrow direction).
2. Pull out the Focus Ring.

Note: - When you assemble the Focus Ring, ensure the 3 card slot (as green square) placed in the 3 double-screw bolt (as yellow circle) properly, and the Focus Ring can be well adjusted.

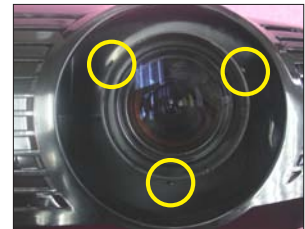

2-5 Disassemble Top Cover Module

1. Unscrew 2 screws (as red circle) from the Bottom Cover.
2. Press two sides of the projector as the blue arrows point.
3. Remove the Top Cover Module.



Note: - When you remove the Top Cover, take care the connector (as yellow square) of FPC cable which connect Main Board and Keypad Board Module, then unplug it from Keypad Board Module.

- Avoid damaging by pulling keypad FPC cable.

- Make sure the FPC cable plug into the correct ports when assembling it.

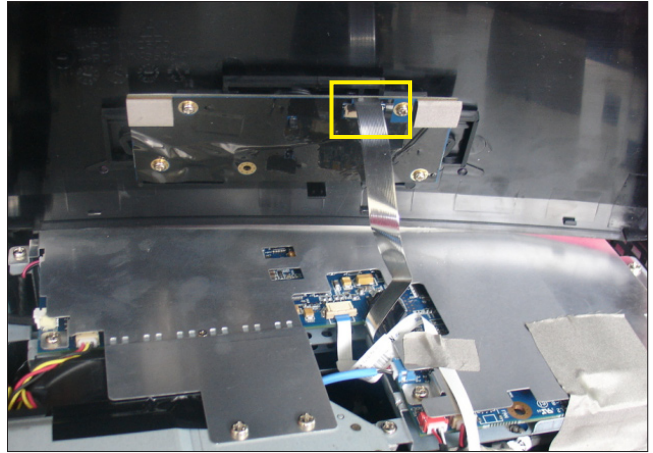

2-6 Disassemble Keypad Board Module and Zoom Ring

1. Unscrew 4 screws (as blue circle) to disassemble the Keypad Board Module from the Top Cover Module.
2. Separate the Keypad from the Top Cover Module.
3. Unscrew 3 screws (as red circle) to disassemble the Zoom Ring.

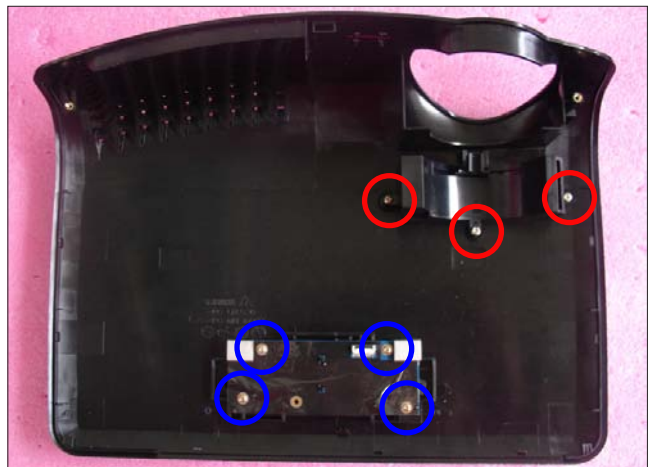

Keypad Board



Keypad



Zoom Ring

2-7 Disassemble Top Shielding

1. Tear off 2 EMI tapes (as green square).
2. Unscrew 12 screws (as red circle).
3. Disassemble the Top Shielding.

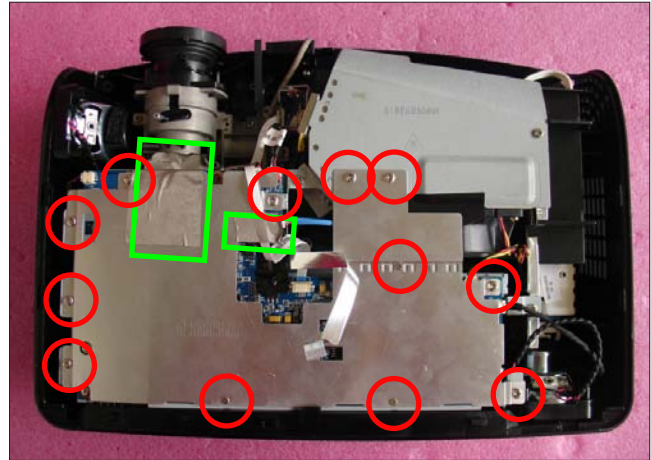

Top Shielding



2-8 Disassemble Main Board Module

1. Unplug 1 connector (as green square) to remove the FPC cable.
2. Unplug 8 connectors (as yellow square).
3. Unscrew 5 screws (as red circle) from the Main Board Module.

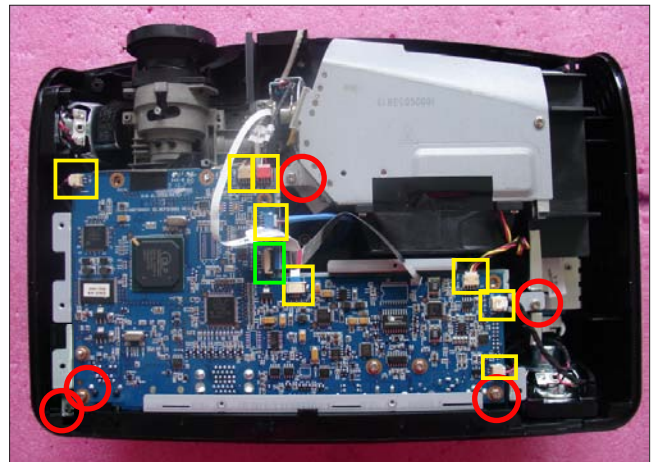

FPC cable

4. Unscrew 1 screw (as blue circle) from the IO Cover.
5. Unscrew 8 hex screws (as green circle) from the IO Cover.
6. Unplug 1 connector (as orange square).

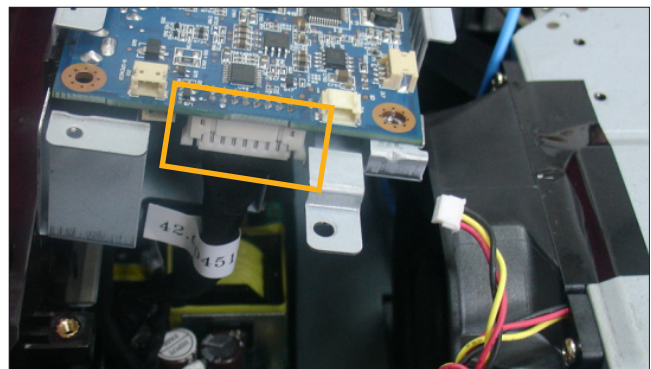

7. Separate the Main Board Module and Main Board Shielding.



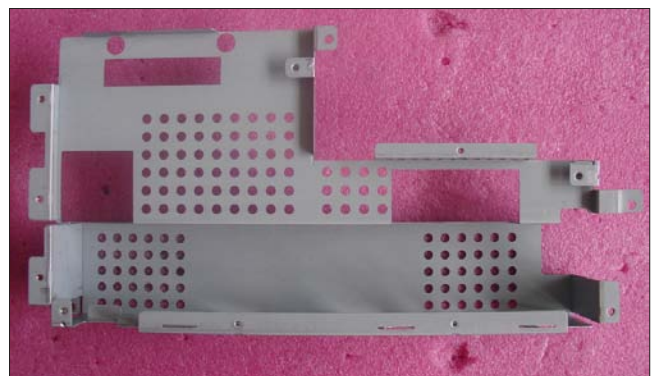
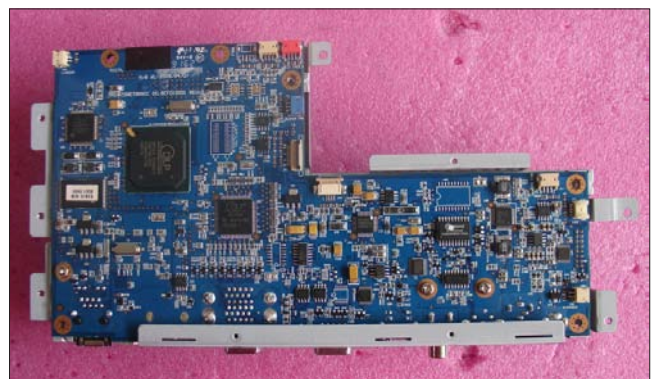

Note: - Make sure cables plug into the correct ports when assembling the unit.

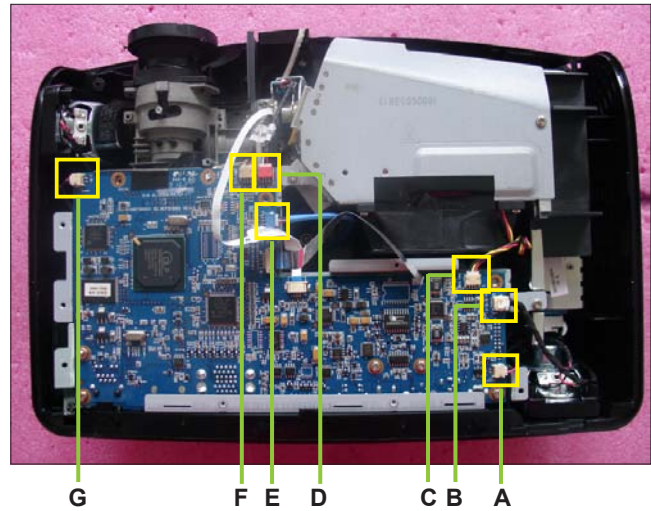

Main Board Shielding

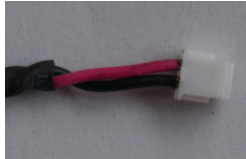
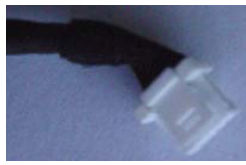
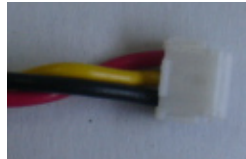
Please refer to the table as below for details of each connector.

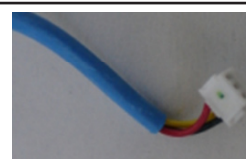

Item	Male Connector on Main Board	The key feature	Figure
A & G	Speaker	Compose of Red/Black Wire and Black wire tube (2 pin)	
B	Lamp Driver	Black wire tube (5 pin)	
C	System Fan	Compose of Red/Yellow/Black Wire (3 pin)	
D	Photo Sensor	Compose of Red/Black/White Wire and Black wire tube (3 pin)	
E	Blower	Compose of Black/Yellow/Red Wire and Blue wire tube (3 pin)	
F	IR	Compose of Black/Yellow/Red Wire and Gray wire tube (3 pin)	

2-9 Disassemble Daughter Board and Lan Module Board

1. Unscrew 2 screws (as green circle) to disassemble the Daughter Board.
2. Unscrew 1 screw (as red circle) to disassemble the Lan Module Board.

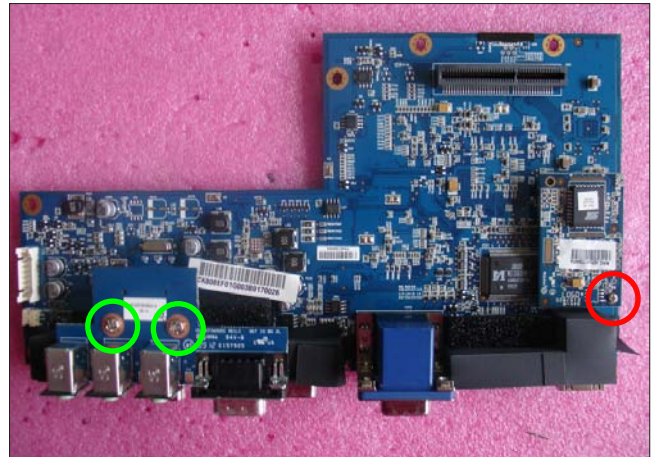

Daughter Board



Lan Module Board

3. Unscrew 3 hex screws (as yellow circle) from the Main Board Module.



2-10 Disassemble Engine Module

1. Tear off the black mylar (as green square).
2. Unscrew 4 screws (as yellow circle) to disassemble the Engine Module.

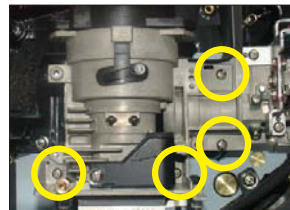
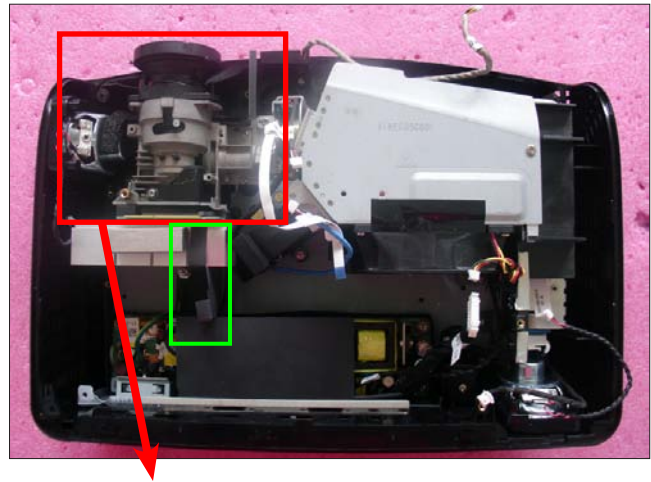

2-11 Disassemble Color Wheel Module

1. Unscrew 2 screws (as red circle) to disassemble the Color Wheel Module.
2. Unscrew 1 hex screw (as green circle).
3. Unscrew 1 screw (as blue circle) to disassemble the Photo Sensor Board from the Color Wheel Module.

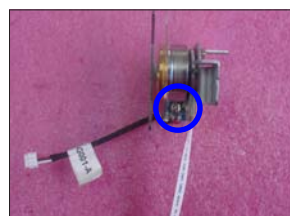
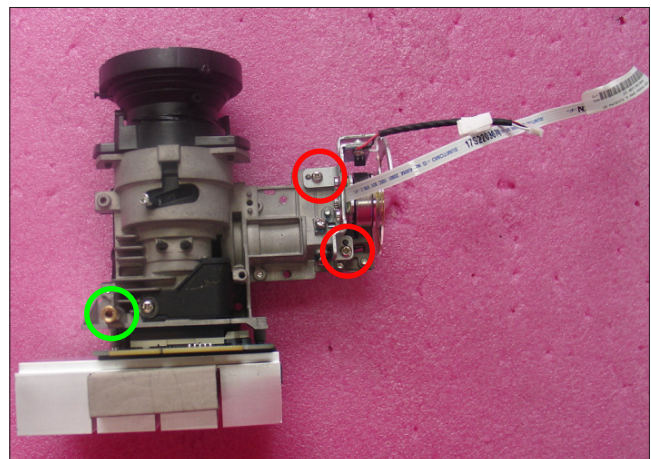

Note: - Avoid touching the glass parts of color wheel.

2-12 Disassemble DMD Chip and DMD Board

1. Unscrew 2 screws (as red circle) to disassemble the Heat Sink and DMD Module.
2. Rotate the screw (as yellow circle) clockwise to disassemble the DMD Board and DMD Chip.

Note: - Avoid touching the DMD Chip when you disassemble it.

- Found that the DMD Chip has scrapes or dirt use of a magnifying glass, you may use an electrostatic ion gun to clean it.

- Pay attention to the fixed position when assembling the DMD Chip.

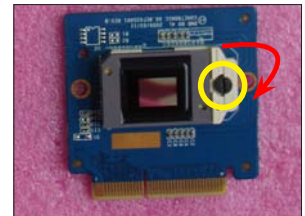
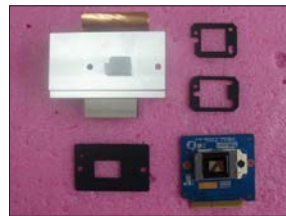
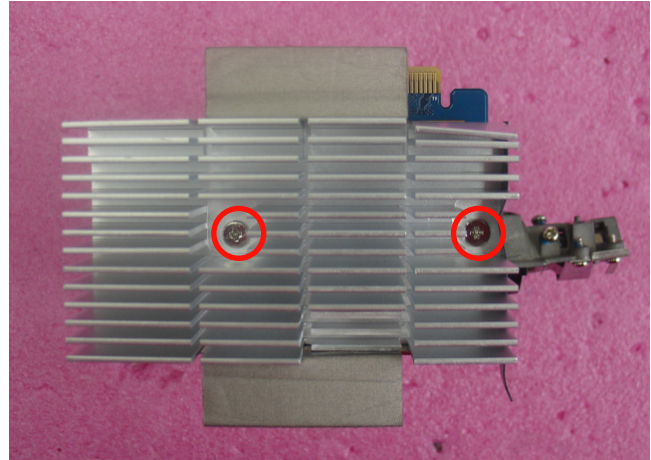

2-13 Disassemble Rod Module

1. Unscrew 2 screws (as green circle) to take off the Rod Spring.
2. Unscrew 1 screw (as yellow circle) to take off the Rod Cover.
3. Remove the Rod.

Note: - Avoid touching the Rod when you disassemble or assemble it.

- Please notice the Rod Module's direction when you assemble it (as picture A shown).

- Ensure left edge of Rod Module contact with the Engine base's blocks.

- Rod Spring must hook in the position as picture B shown.

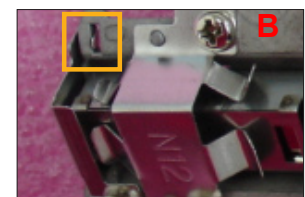
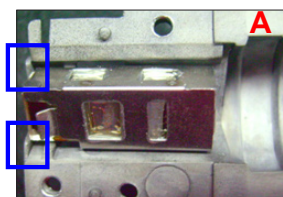
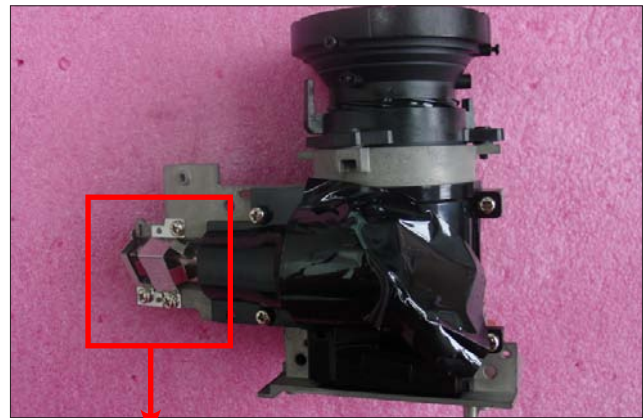

2-14 Disassemble System Fan Module and Thermal Switch

1. Tear off the black tape (as yellow square).
2. Unscrew 4 screws (as red circle) to disassemble the System Fan Module.
3. Unscrew 1 screw (as blue circle) and unplug 1 connector (as green square) to disassemble the Thermal Switch.

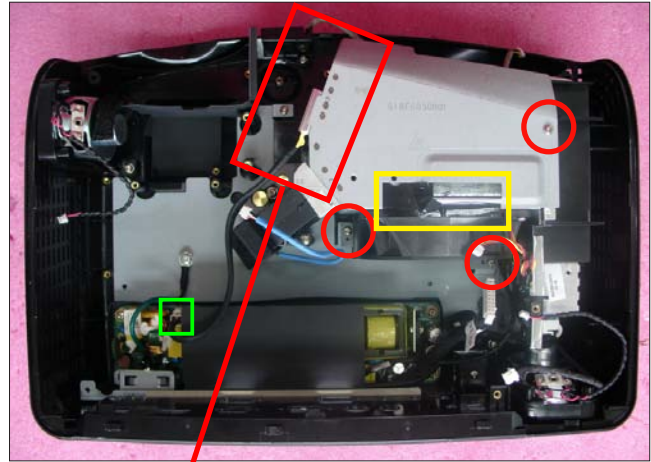

Thermal Switch

4. Unscrew 4 screws (as green circle) to separate Fan and Fan Shielding.



Fan Shielding

Note: - Take the Fan Module as the right gesture.



the right gesture



the wrong gesture

2-15 Disassemble Speakers

1. Unscrew 4 screws (as yellow circle) to disassemble the two Speakers.

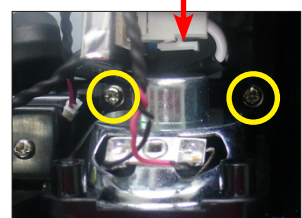
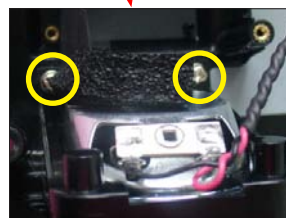
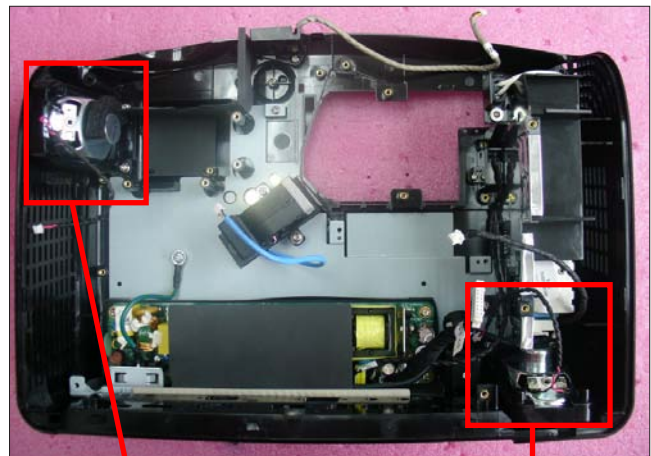

2. Unscrew 4 screws (as red circle) to separate the Speaker Holder and Speaker.

(Same procedure for the other Speaker)



2-16 Disassemble Blower

1. Unscrew 2 screws (as red circle) to disassemble the Blower Module.
2. Separate Blower and Blower Rubber.

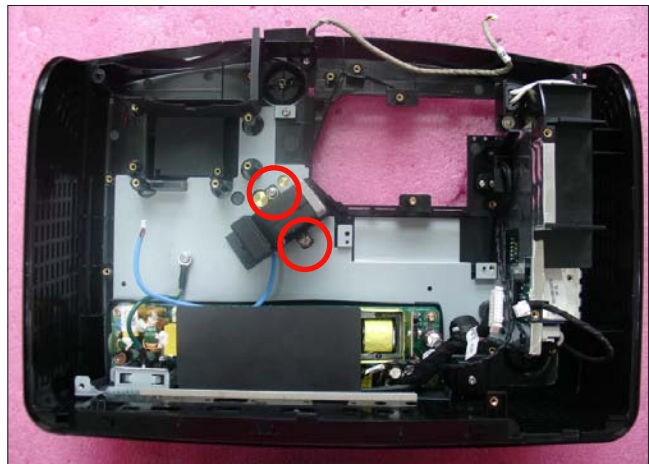

2-17 Disassemble Front IR Module

1. Unscrew 1 screw (as red circle) to disassemble the Front IR Module.
2. Unfasten 2 tenons (as yellow square) to separate the IR Board and IR Holder.

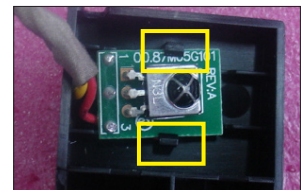
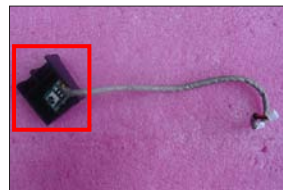
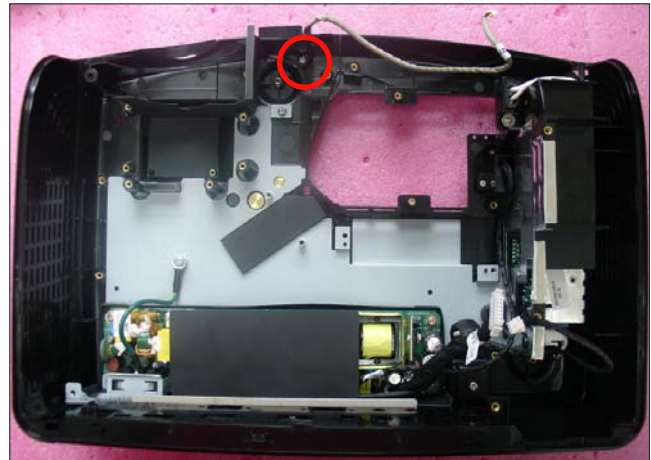

2-18 Disassemble LVPS Module and Interlock Switch

1. Unscrew 6 screws (as yellow circle).
2. Unplug 1 connector (as blue square).
3. Disassemble the LVPS Module, the AC Inlet Bracket and Mylar.
4. Unscrew 1 screw (as green circle).

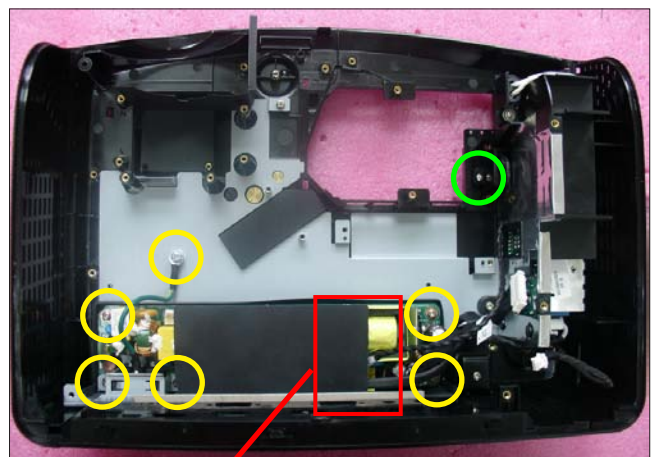

AC Inlet Bracket

5. Unplug 2 connectors (as green square).
6. Disassemble the Interlock Switch and the cable from the LVPS Module.

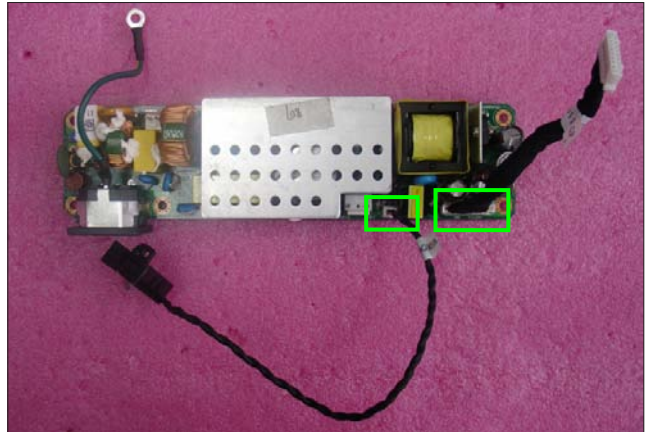

2-19 Disassemble Lamp Driver Module

1. Unscrew 1 screw (as red circle) to disassemble the Lamp Driver Module.
2. Unplug 3 connectors (as yellow square).

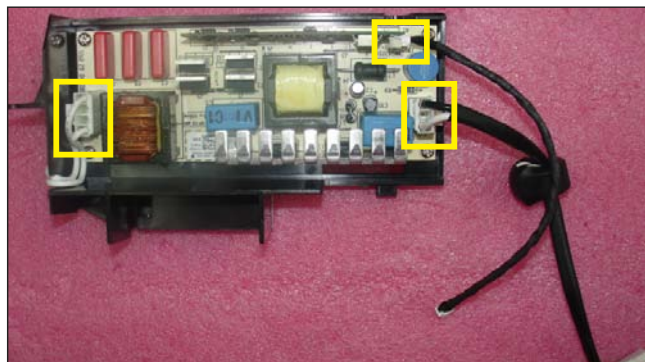
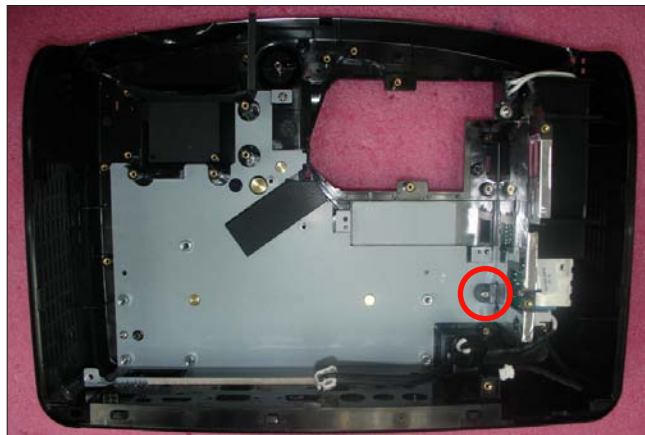

3. Separate the Lamp Driver Module and Lamp Driver Holder.

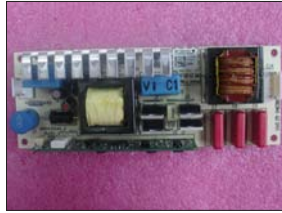

Lamp Driver Holder



2-20 Disassemble Security Bar Cap

1. Unscrew 1 screw (as red circle) to disassemble the Security Bar Cap and Security Bar.

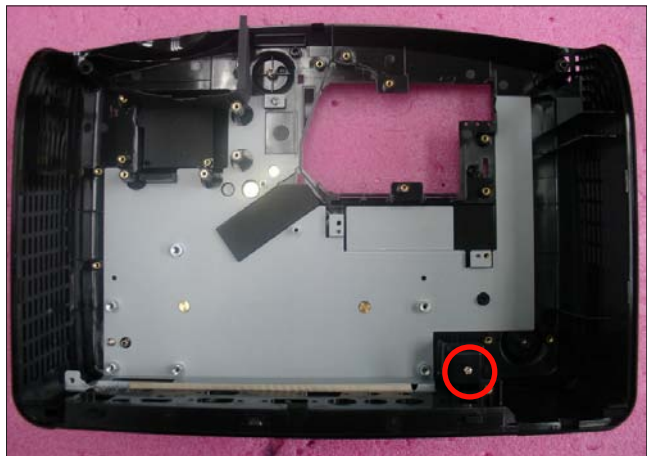

2-21 Disassemble Bottom Shielding

1. Unscrew 2 screws (as red cricle) to disassemble the Bottom Shielding.

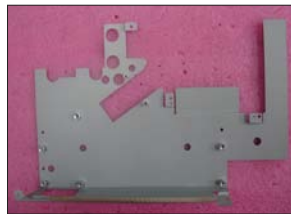
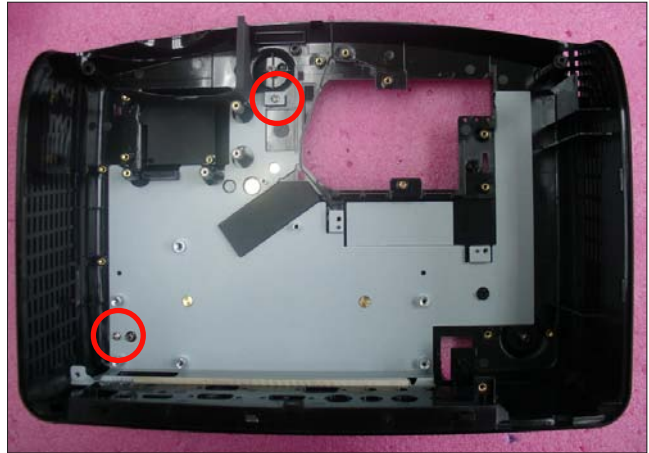

2-22 Disassemble IO Cover

1. Unfasten 2 tenons (as green square).
2. Remove the IO Cover.

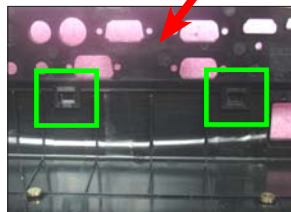
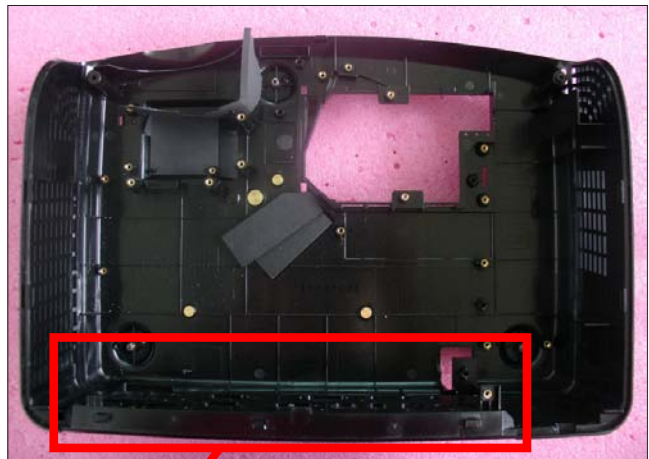

2-23 Rod Adjustment

1. Environment Adjustment

- The distance between the engine and the screen is 1.95 M.
- This process should be done at a dark environment (under 10 Lux).

2. Procedure Adjustment

- Change the screen to "white screen".
- Adjust the screws by using the rod on the engine module to readjust the image.

("screw 1" should be adjusted first, and then "screw 2". Adjust until the yellowish or bluish parts disappeared.)

3. Abnormal image inspection

- It should not have any abnormal color at the rim of the image by estimating through the eyes.

Note: - To avoid over adjusting the rod.

- After the operation, please use the glue to fix the screws.

- Please use Z type driver to adjust Rod screw 1.

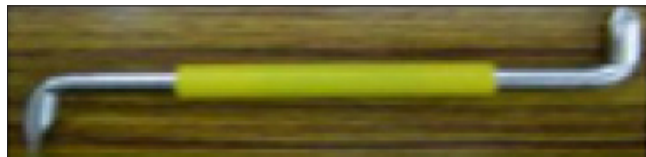
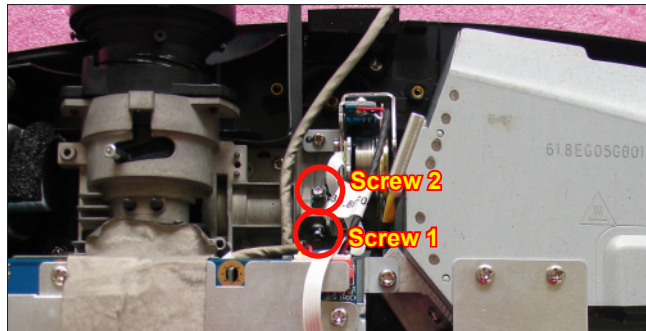
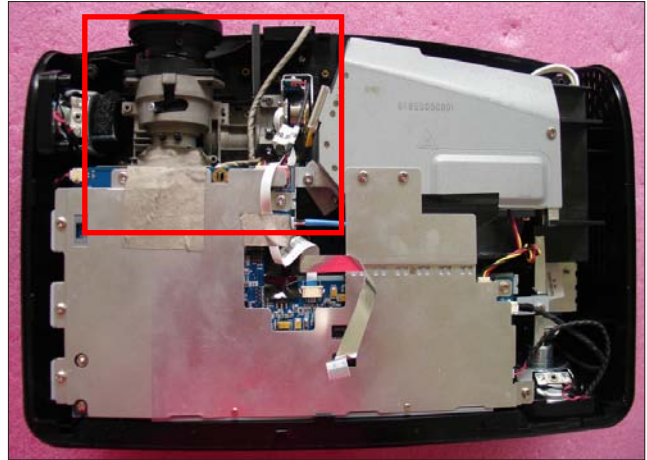

Z type driver

2-24 Re-write Lamp Usage Hour

1. Get into Service Mode

- Press "Power", "Left", "Left" and "Menu" buttons sequentially to get into Service Mode.

2. Re-write Lamp Hours (Normal)

- Use "up" or "down" buttons to select "Lamp Hours (Normal)", then use "left" or "right" buttons to re-write the Lamp Hours.

3. Re-write Lamp Hours (ECO)

- The way of re-write "Lamp Hours (ECO)" is the same as "Lamp Hours (Normal)".

4. Exit Service Mode





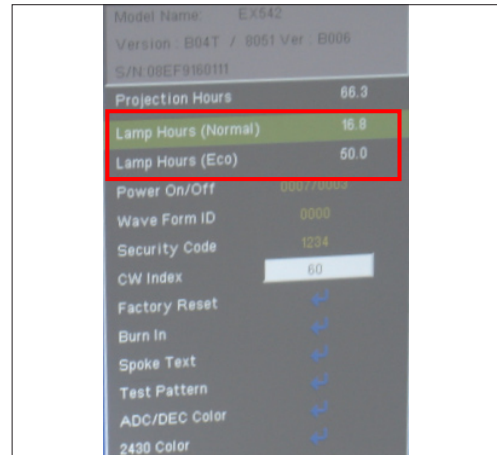









- Use "up" or "down" buttons to select "Exit", then press "Enter" to exit the Service Mode.

*Note: left key = decrease lamp hour
right key =increase lamp hour*



Troubleshooting

3-1 LED Lighting Message

Message	ON/STANDBY LED (Amber/Green)	Temp LED (Red)	Lamp LED (Red)
Standby State (Input power cord)	 (Amber)		
Power on (Warming)	Flashing (Green)		
Power on and Lamp lighting	 (Green)		
Power off (Cooling)	Flashing (Green)		
Error (Lamp failed)	Flashing (Amber)		 (Red)
Error (Fan failed)	Flashing (Amber)	Flashing (Red)	
Error (Over Temp.)	Flashing (Amber)	 (Red)	

Note:  Steady light  No light



3-2 Main Procedure

No	Symptom	Procedure
1	No Power	<ul style="list-style-type: none"> - Ensure the Power Cord and AC Power Outlet are securely connected - Ensure all connectors are securely connected and aren't broken - Check LVPS - Check Lamp Driver - Check Main Board
2	Auto Shut Down	<ul style="list-style-type: none"> - Check LED status <ul style="list-style-type: none"> a. Lamp Fail: ON/STANDBY LED (flashes amber); Lamp LED (lights red) <ul style="list-style-type: none"> - Check Lamp - Check Lamp Driver - Check Main Board - Check Color Wheel - Check Photo Sensor - Check whether Wireless status of OSD Menu is on (connect VGA1- IN port with VGA source) b. Over Temp.: ON/STANDBY LED (flashes amber); Temp LED (lights red) <ul style="list-style-type: none"> - Check Thermal Switch - Check Fan - Check Main Board c. Fan Fail: ON/STANDBY LED (flashes amber); Temp LED (Flashes red) <ul style="list-style-type: none"> - Check Fan - Check Main Board

No	Symptom	Procedure
3	No Light On	<ul style="list-style-type: none"> - Ensure all connectors are securely connected and aren't broken - Check Lamp Cover, Interrupt Switch - Check Lamp Module - Check Lamp Driver - Check LVPS - Check Main Board - Check Color Wheel - Check Photo Sensor Board
4	No Image	<ul style="list-style-type: none"> - Ensure the Signal Cable and Source work (If you connect multiple sources at the same time, use the "Source" button switch) - Ensure all connectors are securely connected and aren't broken - Check Main Board - Check DMD Board - Check DMD Chip - Check Color Wheel - Check Engine Module
5	Mechanical Noise	<ul style="list-style-type: none"> - Check Color Wheel - Check Fan Module
6	Line Bar/Line Defect	<ul style="list-style-type: none"> - Check whether the Main Board and the DMD Board are assembled properly - Check Main Board - Check DMD Board - Check DMD Chip

No	Symptom	Procedure
7	Image Flicker	<ul style="list-style-type: none"> - Do "Reset (All data)" of the OSD Menu - Ensure that the signal cables and source are work as well - Check Lamp Driver and waveform - Check Lamp Module - Check Color Wheel - Check Photo Sensor and clean Photo Sensor - Check DMD Board - Check Main Board
8	Color Abnormal	<ul style="list-style-type: none"> - Do "Reset (All data)" of the OSD Menu - Adjust Color Wheel Index - Check Main Board - Check DMD Board - Check Color Wheel
9	Poor Uniformity/ Shadow	<ul style="list-style-type: none"> - Ensure the projection screen without dirt - Ensure the projection lens is clean - Ensure the Brightness is within spec. - Check rod alignment - Check Engine Module
10	Dead Pixel/Dust (Out of spec.)	<ul style="list-style-type: none"> - Ensure the projection screen without dirt - Ensure the projection lens is clean - Clean DMD Chip and Engine Module - Check DMD Chip - Check Engine Module
11	Garbage Image	<ul style="list-style-type: none"> - Ensure that the signal cables and source work as well - Check Main Board - Check DMD Board

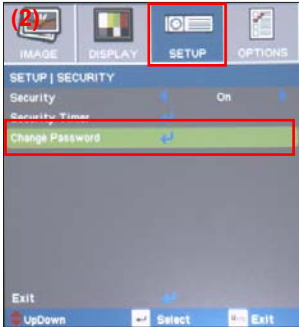
No	Symptom	Procedure
12	Remote Controller/Control Panel Failed	<ul style="list-style-type: none"> - Remote Controller <ul style="list-style-type: none"> a. Check Battery b. Check Remote Controller c. Check IR Sensor Board d. Check Main Board - Control Panel <ul style="list-style-type: none"> a. Check FPC b. Check Keypad c. Check Main Board
13	Function Abnormal	<ul style="list-style-type: none"> - Do "Reset (All data)" of the OSD Menu - Check Main Board - Check DMD Board
14	Audio Abnormal	<ul style="list-style-type: none"> - Ensure that the signal cables and source are work as well - Ensure that your Projector is not in "Mute" mode - Check the interior Speakers of the projector - Check the exterior Speaker that you are using - Check Main Board - Check Daughter Board
15	Network Fail (for EX542/EX615/EX540/EX762/EX540I/EX542I)	<ul style="list-style-type: none"> - Ensure you have set up the right IP address and the connection is OK (Network green LED should light up) - Check Lan Module Board - Check Main Board

No	Symptom	Procedure
16	Forgetting Password (Administrator Password)	<p>- If you forget the Password, please do the following steps to get the Universal Password:</p> <ol style="list-style-type: none"> (1) When you turn on the projector, the message "Enter Security Code" appears. Please Input the "Current Security Code 8642" by Remote Control, then press "Enter". (2) Press "Menu" button, select "Setup", "Change Password", then press "Enter" button. The message "Enter Security Code" appears again, repeat step (1). (3) The message "Enter New Security Code" appears. Input a 4-digits code (letters and/or numbers) that you define. (4) To confirm, key in the password again. The "Security Code change successfully" appear on the screen. <div style="display: flex; justify-content: space-around; align-items: flex-start;"> <div style="text-align: center;"> <p>(1)</p>  </div> <div style="text-align: center;"> <p>(2)</p>  </div> </div> <div style="text-align: center; margin-top: 20px;"> <p>(3)</p>  </div>
17	3D Image Abnormal (for EX762/EX540I/EX542I/ES523ST/EW533ST)	<ul style="list-style-type: none"> - Ensure the using 3D glasses is good and you must face the projection. - Ensure the signal source is 3D format. - Ensure the 3D function of projector OSD is on and 3D sync invert is on. - Check main board.

Function Test & Alignment Procedure

4-1 Test Equipment Needed

- IBM PC with XGA resolution
- DVD player with Multi-system, equipped "Component", "S-Video", "Composite" and "HDMI".
- HDTV Source (720P,1080P,1080i)
- Minolta CL-100
- Quantum Data 802B or CHROMA2327 (Color Video Signal & Pattern Generator)

4-2 Service Mode

- EX542/EX612/EX615/EX540/EX762/EX540I/EX542I/ES523ST/EW533ST have two kinds of Service Mode, use different ways to get into each Service Mode:
 1. Turn on the projector
 2. (1) Press "Power", "Left", "Left" and "Menu" buttons sequentially to get into Service Mode 1.
(2) Press "Power", "Up", "Down" and "Menu" button sequentially to get into Service Mode 2.
(3) Select "Exit" to leave the Service Mode after confirming the configuration.

4-3 OSD Reset

- After final QC step, we have to erase all saved change again and restore the OSD default setting. The following actions will allow you to erase all end-users' settings and restore the default setting:
 1. Please get into OSD menu.
 2. Execute "Reset" function.

4-4 Test Condition

- Circumstance brightness: Dark room less than 10.0 lux.
- Inspection distance: 1.8 m~2.5 m functional inspection.
- Screen size: 60 inches diagonal.
- After repairing each unit, a Run-in test is necessary (refer to the below table).

Symptom	Run-in Time
Normal repair	2 hours
NFF	4 hours
Auto shutdown	6 hours

- Get into Burn-In Mode

* Cycle setting is based on the defect symptoms. ie: If it is NFF, the run-in time is 4 hours. You have to set the lamp on for 50 min. and lamp off for 10 min for 4 cycles.

Press Power > Left > Left > Menu to get into service mode 1	
Choose Burn-In Test > enter	
Lamp On (Mins)	Press right key to adjust the time (50)
Lamp Off (Mins)	Press right key to adjust the time (10)
Burn in cycle	Press right key to adjust the cycle
After setting up the time, choose "Enter to Burn-In" and press Enter button	

Screen Defects (While replacing DMD Chip, DMD Board and Main Board)

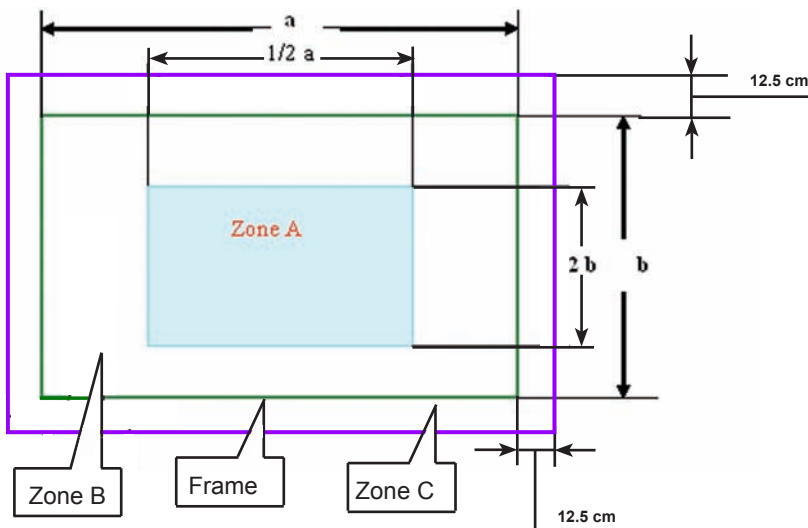

< Figure: Zone A, Zone B & Frame(as green line) Definition, Active area=Zone A+ Zone B >

4-5 Defect specification table

For EX762/EX542I/ES523ST

Order	Symptom	Pattern	Criteria
1	Bright pixel (dots)	Gray 10 pattern	A+B=0
2	Dark pixel(dots)	White pattern	A+B≤4
3	Unstable pixel (dots)	Any pattern	A+B=0
4	Adjacent dark pixel (dots)	Any pattern	A+B=0
5	Dark blemish (Dirty)	Blue 60 pattern	A+B≤2 (diameter <1/2 inch)
6	Bright blemish (Dirty)	Gray 10 pattern	A+B≤2 (diameter <1/2 inch)
7	Bright dots on frame	Gray 10 pattern	≤1

For EX542/EX612/EX615/EX540/EX540I

Order	Symptom	Pattern	Criteria
1	Bright pixel (dots)	Any pattern	A+B=0
2	Dark pixel(dots)	Any pattern	A+B≤4
3	Unstable pixel (dots)	Any pattern	A+B=0
4	Adjacent dark pixel (dots)	Any pattern	A+B=0
5	Dark blemish (Dirty)	Blue 60 pattern	A+B≤4 (diameter <1 inch)
6	Bright blemish (Dirty)	Gray 10 pattern	A+B≤4 (diameter <1 inch)
7	Bright dots on frame	Any pattern	≤1

For EW533ST

Order	Symptom	Pattern	Criteria
1	Bright pixel (dots)	Gray 10 pattern	A+B=0
2	Dark pixel(dots)	White pattern	A+B≤7
3	Unstable pixel (dots)	Any pattern	A+B=0
4	Adjacent dark pixel (dots)	Any pattern	A+B=0
5	Dark blemish (Dirty)	Blue 60 pattern	A+B≤4 (diameter <1 inch)
6	Bright blemish (Dirty)	Gray 10 pattern	A+B≤4 (diameter <1 inch)
7	Bright dots on frame	Gray 10 pattern	≤1

4-6 Test Inspection Procedure

Update	Change parts						
	Main Board	Firmware	Color Wheel	Lamp Module	Engine Module	Lan Module	Blower
Version Update	v	v				v	
Color Wheel Index	v		v				
ADC Calibration (RGB/ Video Calibration)	v						
Reset lamp hour				v			
OSD Reset	v	v					
EDID	v						
Re-write Lamp Hour Usage	v						
Rod adjustment					v		
Factory RPM Save	v						v

Note: - If Color appears abnormal after changing Main Board/Color Wheel Module, please do Color Wheel index adjustment.

- After changing parts, check the information above.

4-7 PC MODE

Note: - When getting into function test, adjust the zoom ring and focus ring to guarantee the image maximum and clearest, then start to test.

- Test signal: analog 1024 x 768 (for EX542/EX612/EX615/EX762/EX542I/EX540I/EX540I)
- analog 800 x 600 @60Hz (for ES523ST)
- analog 1280 x 800 @60HZ (for EW533ST)
- The defect specification for EX762/EX542I/ES523ST is the same, we take EX762 for example here, others model please refer to 4-5 for details.

1. Frequency and tracking boundary

Procedure

- Test equipment: video generator
- Test signal: analog 1024 x 768@60Hz
- Test Pattern: General-1 or Master
- Check and see if the image sharpness is well performed.
- If not, re-adjust by the following steps:
 - (1) Select "Frequency" function to adjust the total pixel number of pixel clock in one line period.
 - (2) Select "Tracking" function and use right or left arrow key to adjust the value to minimize video flicker.
- Adjust Resync or Frequency/Tracking/H. Position/V. Position to the inner screen.

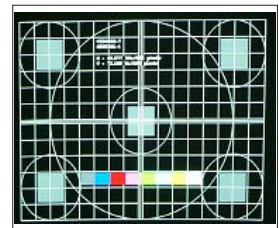

General-1

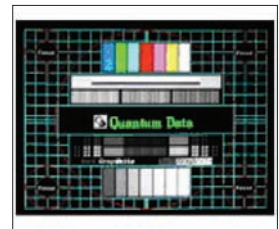

Master

Inspection item

- Eliminate visual wavy noise by Resync, Frequency or Tracking selection.
- Check if there is noise on the screen.
- Horizontal and vertical position of the video should be adjustable to the screen frame.

Criteria

- If there is noise on the screen, the product is considered as failure product.
- If there is noise on the screen, use auto or manual "frequency" function or "tracking" function to adjust the screen.

- The PC mode functionally sure be workable include support format with frequency and auto detected functional will be workable.

2. Bright pixel

Procedure

- Test equipment: video generator.
- Test signal: analog 1024x768@60Hz.
- Test Pattern: Gray 10

Inspection item

- Bright pixel check.

Criteria

- Bright pixel is unacceptable under gray 10 pattern.

Please refer to the figure in 4-4 Test Condition for Frame and Active area.

Note: The defect criteria follows TI specification.



Gray 10

3. Dark pixel

Procedure

- Test equipment: video generator.
- Test signal: analog 1024x768@60Hz.
- Test Pattern: White pattern

Inspection item

- Dark pixels check.
- White pattern (IRE=100)
- Adjacent dark pixel.

Criteria

- The number of the dead pixels should be less or equal to 4 pixels.

- Adjacent pixel with each other is unacceptable.

Note: The defect criteria follows TI specification.



White pattern

4. Bright Blemish

Procedure

- Test equipment: video generator
- Test signal: 1024x768 @60Hz
- Test Pattern: Gray 10

Inspection item

- Bright blemish check
- The bright blemish should be less or equal to 2 under gray 10 pattern.
- Ref. Defect specification table

Criteria



Gray 10

5. Dark Blemish

Procedure

- Test equipment: video generator
- Test signal: 1024x768 @60Hz
- Test Pattern: Blue 60

Inspection item

- Dark blemish check
- The dark blemish should be less or equal to 2 under blue 60 pattern.
- Ref. Defect specification table

Criteria



Blue 60

6. Focus test

Procedure

- Test equipment: video generator.
- Test signal: analog 1024 x 768@60Hz
- Test Pattern: full screen or MEME Sony

Inspection item

- Focus check
- From screen 2.38 Mvia visual to check the focus, look at the entire screen, focus shall be clear, crisp, and sharp over the entire surface of the display pattern.(Blur word on one of the corner after adjustment is acceptable. However, the word should at least be recognizable.)

Criteria



Full screen

7. Color performance

Procedure	<ul style="list-style-type: none"> - Test equipment: video generator. - Test signal: 720p, 1080i, 1080p - Test Pattern: Master, 64 gray RGBW or SMPTE bar <p>* Please refer to 4-2 to get into service mode 1. Use 720p & 1080p signal, master pattern to do HDTV test. Color cannot discolor to purple and blue.</p>
Inspection item	<ul style="list-style-type: none"> - Check if each color level is well-functioned. - Color saturation
Criteria	<ul style="list-style-type: none"> - Screen appears normal. It should not have any abnormal condition, such as lines appear on the screen and so on. - Color appears normal. - It is unacceptable to have few lines flashing. - RGBW should all appear normal on the screen and sort from R-G-B-W. - Color levels should be sufficient and normal. (The unidentified color levels on both left and right sides should not over 4 color levels.) - Gray level should not have abnormal color or heavy lines. - If color appears abnormal, please get into service mode 1 to do color wheel index adjustment.

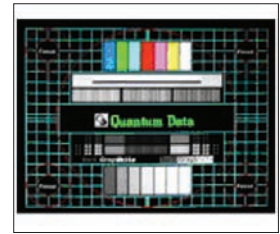

Master



64 gray RGBW

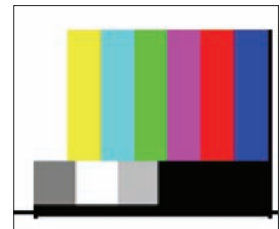

SMPTE BAR

4-8 Video Performance

1. CVBS

Procedure	<ul style="list-style-type: none"> - Test equipment: DVD player - Test signal: CVBS
Inspection item	<ul style="list-style-type: none"> - Video performance test



Motion video

- Inspection Distance - 1.8 M ~2.5 M
- Criteria
- Check any abnormal color, line distortion or any noise on the screen.
 - Check the sound from speakers.
 - Check whether "freeze" and "mute" are normal.
 - Press "V Keystone" on remote controller, check whether keystone function is normal.

2. S-Video

- Procedure
- Test equipment: DVD player
 - Test signal: S-Video
- Inspection item - Video performance test
- Inspection Distance - 1.8 M ~2.5 M
- Criteria
- Check any abnormal color, line distortion or any noise on the screen.
 - Check the sound from speakers.
 - Check whether "freeze" and "mute" are normal.
 - Press "V Keystone" on remote controller, check whether keystone function is normal.

3. HDTV/Component

- Procedure
- Test equipment: DVD player
 - Test signal: Ycbcr/YPbPr
- Inspection item - HDTV performance test
- Inspection Distance - 1.8 M ~2.5 M
- Criteria
- Check any abnormal color, line distortion or any noise on the screen.
 - Check the sound from speakers.
 - Check whether "freeze" and "mute" are normal.
 - Press "V Keystone" on remote controller, check whether keystone function is normal.

4. HDMI Test (not for EX612)

Procedure	<ul style="list-style-type: none">- Test equipment: DVD Player with HDMI output.- Test signal: 720p, 1080p, 1080i
Inspection item	<ul style="list-style-type: none">- HDMI performance test.
Inspection Distance	<ul style="list-style-type: none">- 1.8 M ~2.5 M.
Criteria	<ul style="list-style-type: none">- Ensure the image is well performed and the color can not discolor.- Check whether "mute" is normal.

5. Audio Test

Procedure	<ul style="list-style-type: none">- Test equipment: DVD Player- Test signal: CVBS
Inspection item	<ul style="list-style-type: none">- Audio performance test
Inspection Distance	<ul style="list-style-type: none">- 1.8 M ~2.5 M
Criteria	<ul style="list-style-type: none">- Check the sound from speakers- Plug Audio cable into Audio in 1 port, check whether "Volume" is normal.- Plug Audio cable into Audio Out port, check whether the outboard speaker's "Volume" is normal.- Adjust the volume to "5→ 10" by using the remote controller.- Check the sound from speakers.- Check whether the "mute" is normal. <p>Note: EX542/EX615/EX540/EX762/EX540I/EX542I have 3 Audio.</p> <p>In ports for different input signals. To test each Audio In port, make sure input its correspondent signal.</p>

6. 3D Test

Procedure	- Test equipment: DVD Player - Test signal: 1280X720@120Hz (HQFS format CD)
Inspection item	- 3D test
Inspection Distance	- < 6M
Criteria	- The image should not appear noise, flicker,

4-9 ADC Calibration

1. Video Calibration

Procedure	- Test equipment: video generator - Once Main Board is changed, video calibration should be done as well. (1) Test signal: 480i (2) Test Pattern: SMPTE BAR - Note (1) Calibration pattern should be in full screen mode. (2) Please refer to 4-2 Guide to get into service mode 1 and choose "ADC calibration". (3) Choose and get into "Video Calibration", press "Enter" button to execute "Video Calibration". When the message "Success" appears, it means "Video Calibration" is OK. Choose "Menu" or "Exit" to leave service mode 1.
Check pattern	- Test signal: 576p, 720p, 1080i - Test pattern: Master * After finishing Video adjustment, check Master pattern.
Inspection item	- Color saturation
Criteria	- There should not have any lack of SMPTE BAR. - The screen appears normal, it shouldn't appear any abnormal condition, such as lines and so on. - It is unacceptable that the color appears abnormal and flashing.



SMPTE BAR

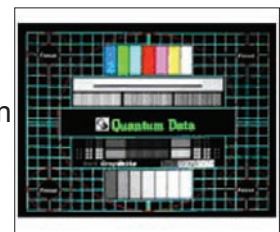

Master

2. RGB Calibration

Procedure

- Test equipment: video generator
- Once Main Board is changed, RGB calibration should be done as well.
 - (1) Test signal: 1024 x 768@60Hz
 - (2) Test Pattern: White/Black
- Note
 - (1) Calibration pattern should be in full screen mode.
 - (2) Please refer to 4-2 Guide to get into service mode 1 and choose "RGB calibration".
 - (3) Choose and get into "Video Calibration", press "Enter" button to execute "RGB Calibration". When the message "Success" appears, it means "RGB Calibration" is OK. Choose "Menu" or "Exit" to leave service mode 1.

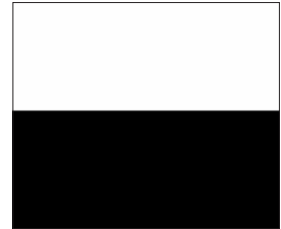

White/Black

Check pattern

- Test signal: 1024 x 768@60Hz
- Test pattern: 64 grey RGBW
 - * After finishing RGB adjustment, check 64 gray RGBW pattern.



64 gray RGBW

Inspection item

- Color saturation

Criteria

- There should not have any lack of 64 gray RGBW pattern.
- The screen appears normal, it shouldn't appear any abnormal condition, such as lines and so on.
- The color should appear normal and sort in right order, it is unacceptable that the color appears abnormal and flashing.
- Color levels should be sufficient and normal. (the unidentified color levels on both left and right sides should not over 8 color levels.)

4-10 Optical Performance Measure

Inspection Condition
- Environment luminance: 10.0 Lux
- Product must be warmed up for 5 minutes
- Distances from the screen: 1.95 M
- Screen Size: 60 inches diagonal

1. Test equipment

Procedure	- Press "Power→ Left→ Left→ Menu" to get into service mode 1. - Select "Spoke Test"
-----------	--

2. Brightness

Procedure	- Full white pattern - Use CL100 to measure brightness values of P1~P9. - Follow the brightness formula to calculate brightness values. ☀ Brightness Formula Avg. (P1~P9)*1.1m ²
Criteria	• 1000 ANSI lumen (for EX542/EX540/EX540I/EX542I/ES523ST/ EW533ST) • 1400 ANSI lumen (for EX612/EX615/EX762)

3. Full On/Full Off Contrast

- Procedure
- Full white pattern & Full black pattern
 - Use CL100 to measure brightness values of full white pattern P5 & full black pattern B5
 - Follow Contrast formula to calculate contrast values.

☀ Contrast Formula

$$P5/B5$$

Note: P5=center of white image

B5 = the center of black image.

- Criteria
- 1600:1 (for EX540/EX542/EX612/EX615/EX762/EX540I/EX542I)
 - 1750:1 (for ES523ST/EW533ST)

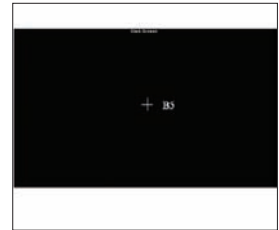

Full black pattern

4. Uniformity

- Procedure
- Full white pattern
 - Use CL100 to measure brightness values of P1~P9 (see image: Full white).
 - Follow the Uniformity formula to calculate average values.

☀ Uniformity Formula

$$\text{JBMA Uniformity} = \text{Avg. (P1, P3, P7, P9)} / P5 \times 100\%$$

- Criteria
- 70%

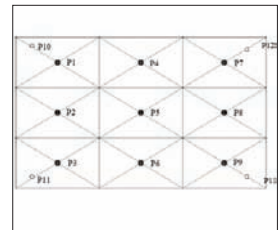

Full white pattern

4-11 Network Function Test

For EX540/EX542/EX615/EX762/EX540I/EX542I

1. Write Down Projector IP

(1) Turn on the Projector, then press "Menu" button to get into OSD Mode.

- Use "right" button to select "SETUP".
- Use "down" button to remove the light mark to "RS232", then press "Enter" button to select "Network", press "Enter" button.



(2) Select "Network", press "Enter" button.



(3) Remove the light mark to "DHCP", then press "Enter" button to select "Off", press "Enter" button.

- The IP address will be shown on screen.
- Write down the IP address: 192.168.0.100.
- Ensure the IP address, Subnet Mask, Gateway and DNS are right as the the picture shown.

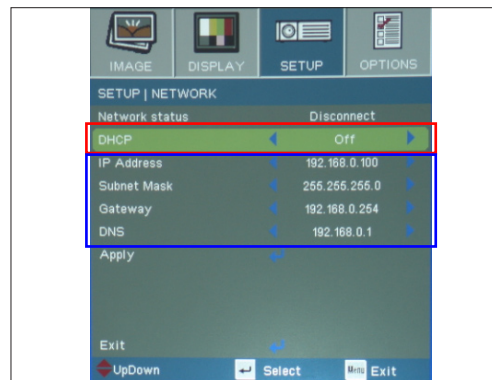

2. Network Setting

(1) Open the "Local area connection", choose "properties".

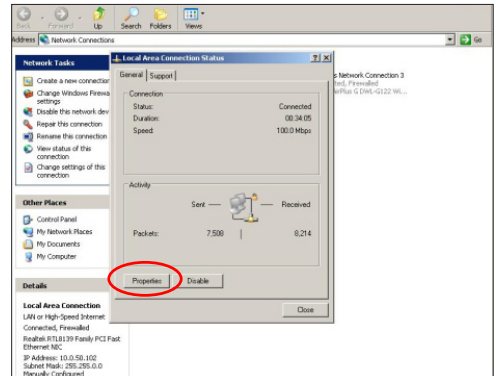

(2) Select "Internet protocol (TCP/IP)", then click "Properties".

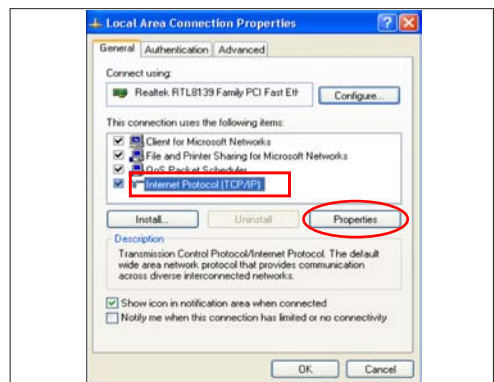

(3) Modify the IP address to 192.168.0.101, and modify Subnet mask to 255.255.255.0.

Note: - The HOST ID (192.168.0.XXX) of PC IP address must be different from the projector IP address written down in step 1 of 4-10.

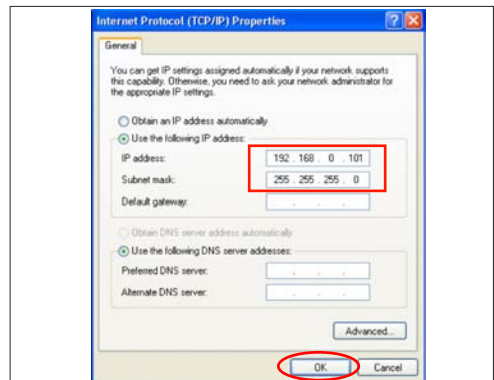

(4) Click "OK".

(5) Click "Close" to quit the setting screen.

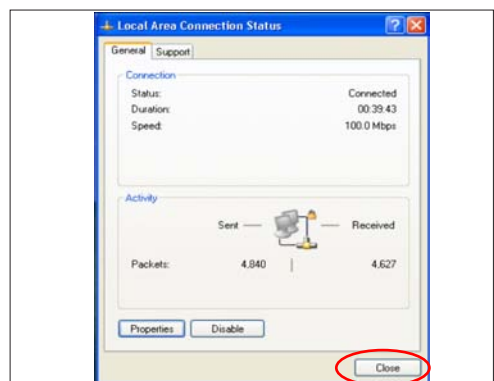

3. Read Projector Information

- (1) Connect the PC and the Projector with LAN Cable.
- (2) Execute "Internet Explorer".
- (3) Visit the IP address: "http://192.168.0.100".
 - Key in "User Name: Administrator" and "Password: administrator", click "Login" to get into Projector Web Server.
- (4) Projector information will be shown on the screen.
 - Please check whether each item's function is OK.

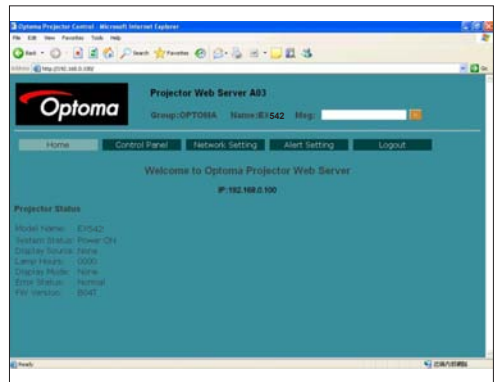
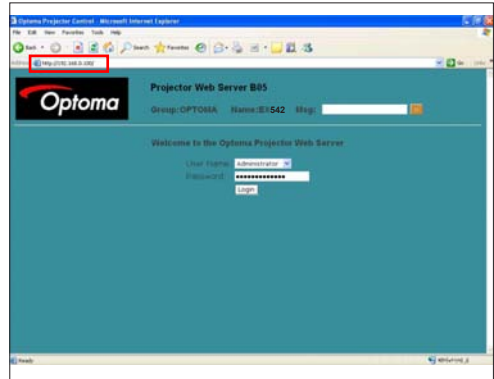

4-12 Others

1. Function Inspection

- Keypad button - All keypad buttons must operate smoothly.
- General - All OSD functions must be checked for functionality. When OSD menu is displayed, there shall be no visible peaking, ringing, streaking, or smearing artifacts on the screen.
- Factory Default - The factory settings (with appropriate centering, size, geometry distortion, etc.) shall be displayed upon "Recall" is selected from OSD.
- Display Size - All preset modes shall expand to full screen size using OSD Horizontal and Vertical Size controls.
- Display Data Channel (DDC) - The purpose of the DDC test is to verify the DDC1/DDC2B operation of the projector and to verify Plug & Play function.
- Acoustic - High pitch sound from cooling fan and color wheel is unacceptable.

2. Check points for exterior and print pattern

Check item	Check point
Text & Pattern	Missing letters & pattern or blurry prints are unacceptable.
Exterior	Dirt, scrape, water ripples and uneven color are unacceptable.
Focus ring&Zoom ring	Focus ring&Zoom ring is functioning smoothly.
Logo	Missing logo, missing prints and blurry prints are unacceptable
Screw	All screws sure be fixed and in right type.
Pedestal	Well-functioned
Lamp Cover	It should be locked in the correct place.
Plastic Parts	All plastic parts can not be broken and damaged.
Safety or warning label	All safety and warning labels should be visible, including all contents.
Connector	All interface connectors should be complete and workable.

Firmware Upgrade

Section 1: System Firmware Upgrade (For EX540/EX542/EX612/EX615/EX762/EX540I/EX542I)

5-1-1 Equipment Needed

**Software: (DDP 2430-USB/EX540/EX542/EX612/EX615;
DDP 2431-USB/EX762/EX540I/EX542I)**

- DLP Composer Lite 9.2
- Firmware (*.img)
- Library file (library file has to put in PC and set right path in 5-1-5 step 3)

Hardware:

- Projector
- Power Cord: 42.50115G001
- Mini USB Cable: 42.00286G101
- PC or Laptop

Note: The FW upgrade procedure for EX612/EX615/EX542/EX540/EX762/EX540I/EX542I is the same ,we take EX542 as an example here.



5-1-2 DLP Composer Lite Setup Procedure

1. Choose "DLP Composer Lite V9.2 Setup" Program.

2. Click "Next".

3. Read "License Agreement".

- Choose "I accept and agree to be bound by all the terms and conditions of this License Agreement".

- Click "Next".

4. Click "Next".

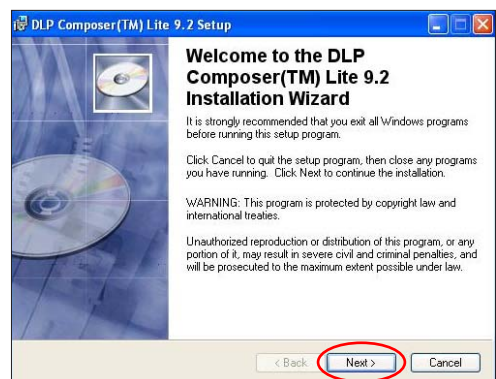

5. Click "Next".

6. Click "Next".

7. The program is executing "installing" status.

8. Click "Finish".

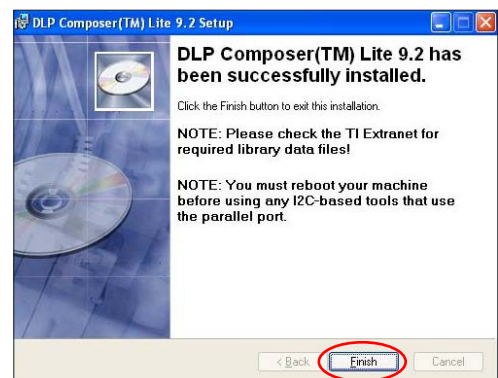
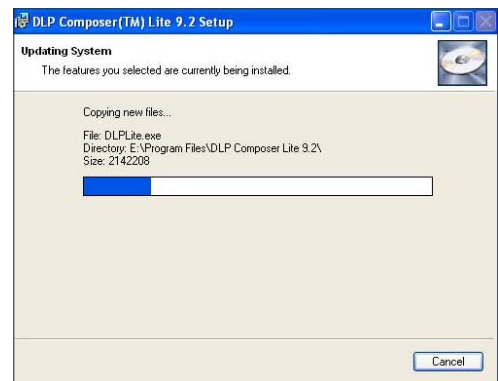
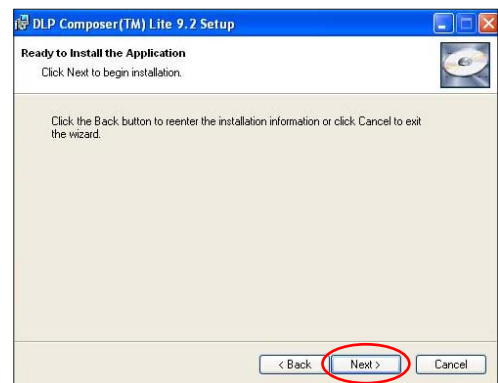
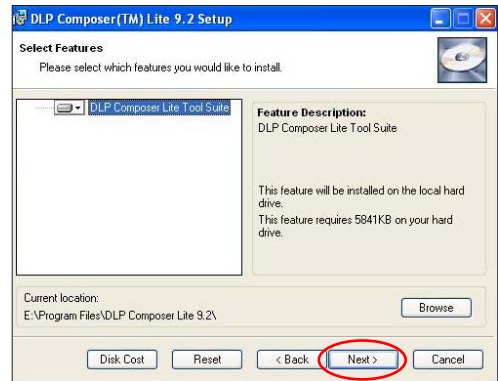

5-1-3 Setup Procedure

1. Set up

- Hold on "MENU" and "POWER" buttons and plug in the power cord.
- The ON/STANDBY LED will be flashing green.
- Release "MENU" and "POWER" buttons.
- Connect projector with USB cable.

Note: - The system fan and the lamp will not operate.



5-1-4 USB Driver Upgrade Procedure

1. Execute Program

- (1) Connect projector with PC by USB cable.
- (2) "Found New Hardware Wizard" picture will appear on the screen.
- (3) Select "Install the software automatically (Recommended)".
- (4) Click "Next".
- (5) Searching picture, please wait for several seconds.

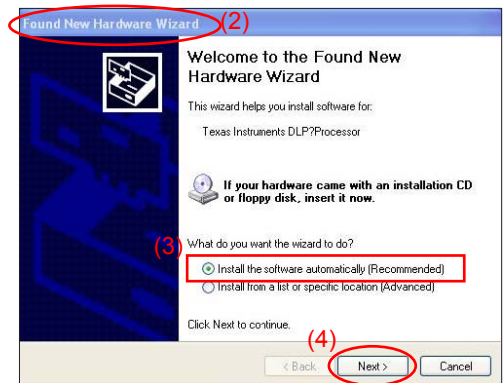

(6) Click "Finish", then the USB driver has been installed successfully.

Note: - If you have installed the USB driver, there is no need to perform this action.



5-1-5 Firmware Upgrade Procedure

1. Execute the "DLP Composer™ Lite 9.2" file.



2. Click "Edit" and "Perferences".

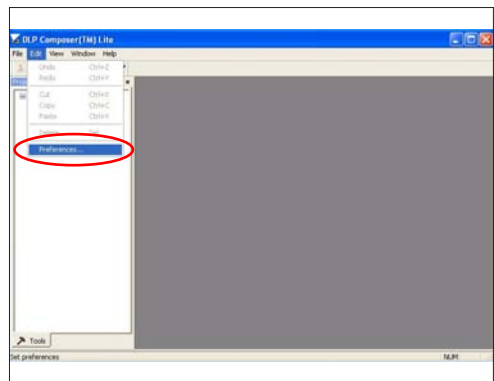

3. Click "Library".

- Click the "Browse" and navigate to the directory where you put the DLP Composer installation files in.
- Click "Library v9.2" folder.
- Click "OK".

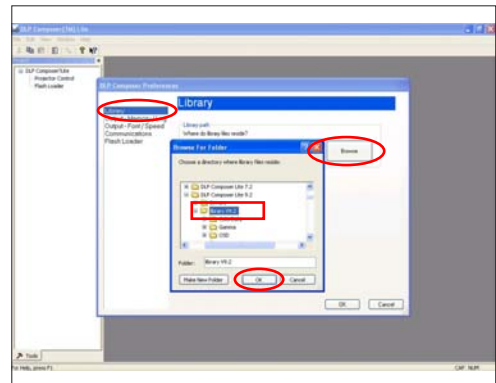

4. Click "Communications".

- Select "USB".
- Click "OK".

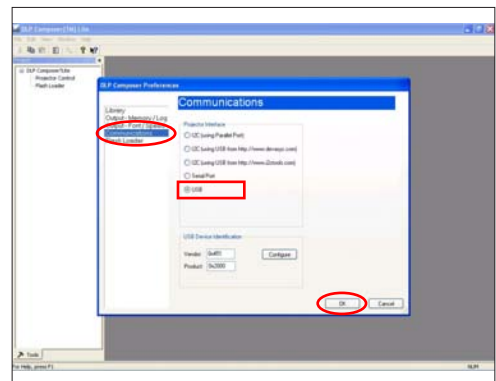

5. Choose "Flash Loader".

- Click "Browse" to search the firmware file (*.img).
- Click "Open".

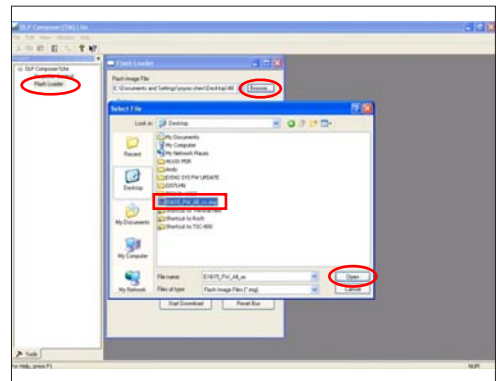

6. Select "Skip Boot Loader Area".
(select "32KB").

- Click "Reset Bus" to erase the flash memory.

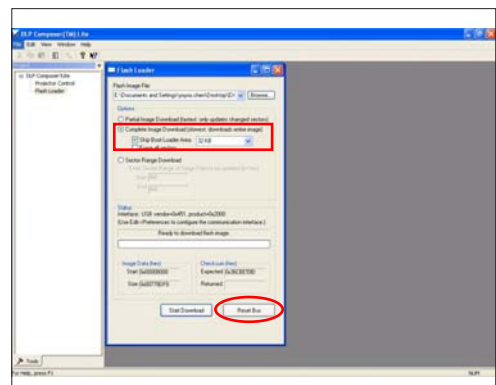

7. If the FW is ready, click "Start Download" to execute the firmware upgrade.

- Click "Yes".

8. Proceeding Picture.

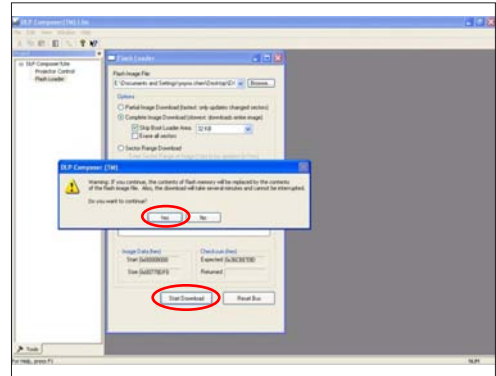

9. It takes about several minutes, the firmware upgrade process is finished, "Download completed" will appear on the screen.

- The projector will automatically turn on.
 - Unplug USB cable.

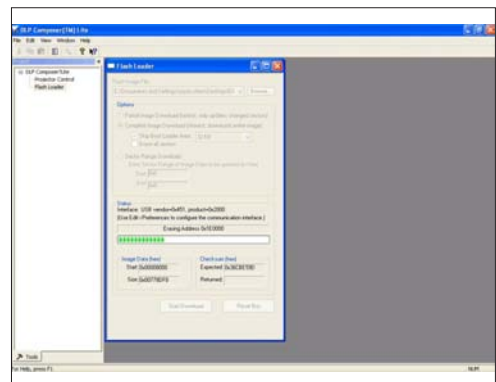

10. Check FW version.

- Get into the service mode to check the firmware version.

(To get into service mode, please press "Power", "Left", "Left" and "Menu" buttons sequentially.)

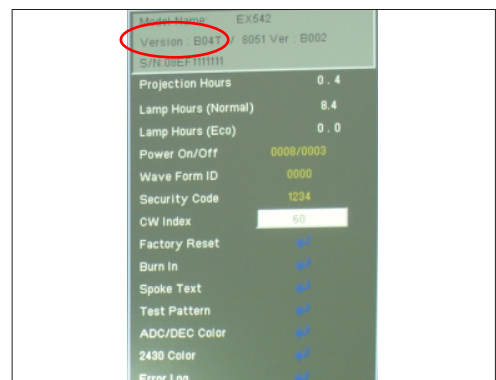
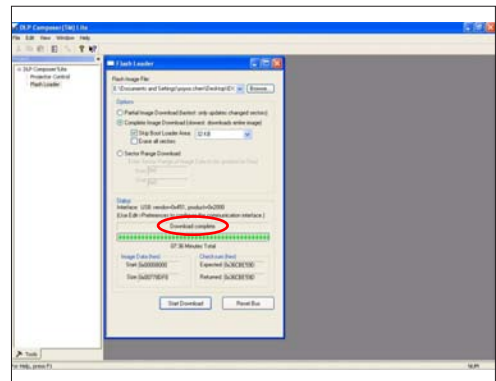

Section 2: System Firmware Upgrade (For ES523ST/EW533ST)

5-2-1 Equipment Needed

Software: DDP 2431-RS232

- DLP Composer Lite 9.2
- Firmware (*.img)
- Library file (library file has to put in PC and set right path in 5-1-5 step 3)

Hardware:

- Projector
- Power Cord: 42.50115G001
- RS232 Cable: 42.00272G002
- PC or Laptop

Note: The FW upgrade procedure for EW533ST is the same ,we take ES523ST as an example here.



5-2-2 DLP Composer Lite Setup Procedure

Note: "DLP Composer Lite V9.2 Setup" Program refer to 5-1-2 for details.

5-2-3 Setup Procedure

1. Set up

- Plug in Power and RS232 cable in the PC, the ON/STANDBY LED will display green.
- Hold the "Menu" then press "Power" button about 5 seconds then release these two buttons.

Note: - The system fan and the lamp will not operate.



5-2-4 Firmware Upgrade Procedure

1. Execute the "DLP Composer™ Lite 9.2" file.



2. Click "Edit" and "Perferences".

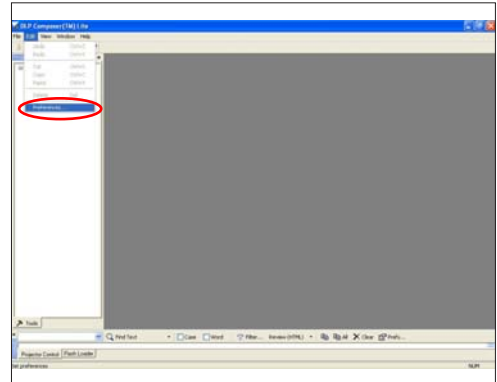

3. Click "Library".

- Click the "Browse" and navigate to the directory where you put the DLP Composer installation files in.
- Click "ES523ST Library" folder.
- Click "OK".

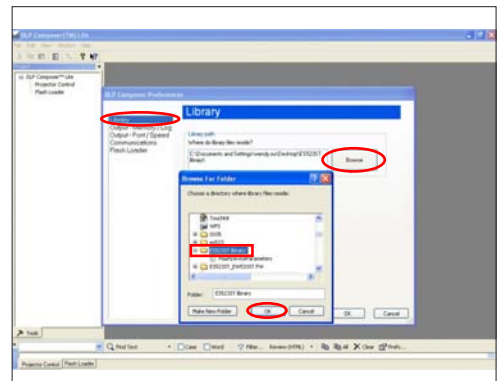

4. Click "Communications".

- Select "Serial Port".
- Choose "COM1".
- Click "OK".

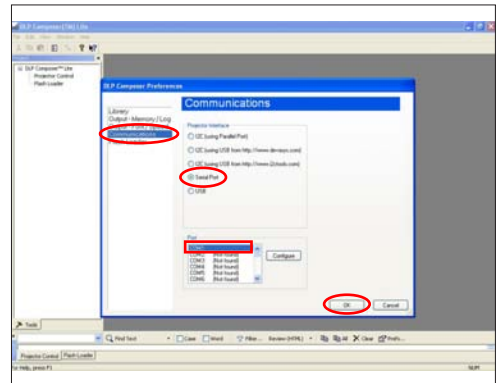

5. "Serial Port Configuration" picture will appear on the screen.

- Make sure the settings are as below:
 - (1) In "Baud Rate" item, select "115200".
 - (2) In "Data Bits" item, select "8".
 - (3) In "Stop Bits" item, select "1".

- (4) In "Parity" item, select "None".
 - (5) In "RTS" item, select "Disable".
 - (6) In "CTS" item, select "Disable".
 - (7) Key in "2000" into "Read" and "Write" items of "Timeouts (in milliseconds)".
- Click "OK".

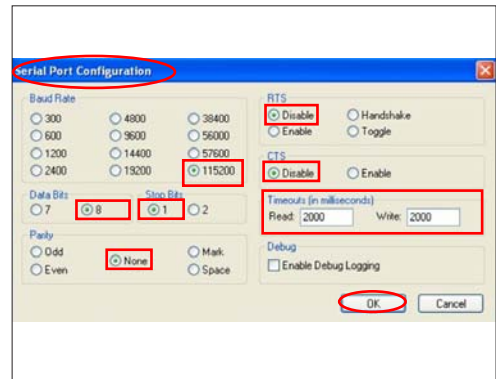

6. Click "OK".

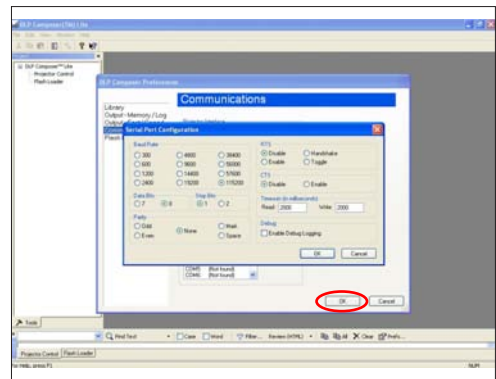

7. Choose "Flash Loader".

- Click "Browse" to search the firmware file (*.img).
- Click "Open".

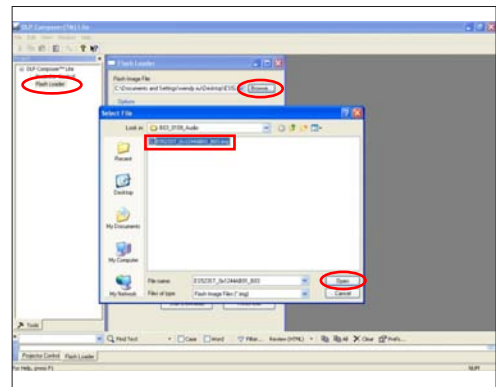

8. Select "Skip Boot Loader Area".
(select "32KB").

- Click "Reset Bus" to erase the flash memory.

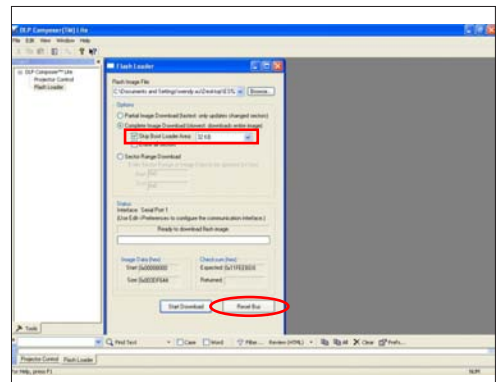

9. If the FW is ready, click "Start Download" to execute the firmware upgrade.

- Click "Yes".

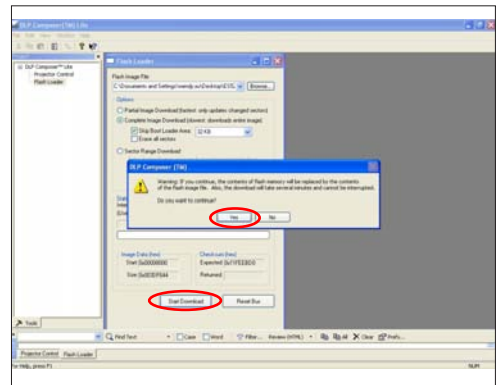

10. Proceeding Picture.

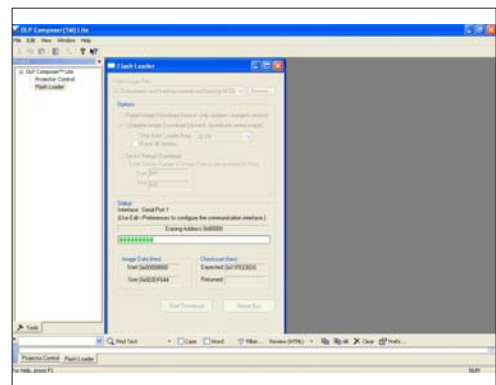

11. It takes about several minutes, the firmware upgrade process is finished, "Download completed" will appear on the screen.

- The projector will automatically turn on.

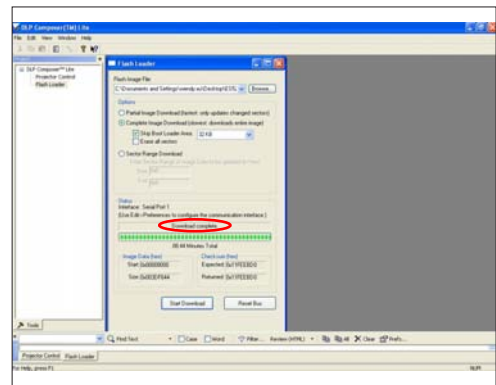

12. Check FW version.

- Get into the service mode to check the firmware version.

(To get into service mode, please press "Power", "Left", "Left" and "Menu" buttons sequentially.)

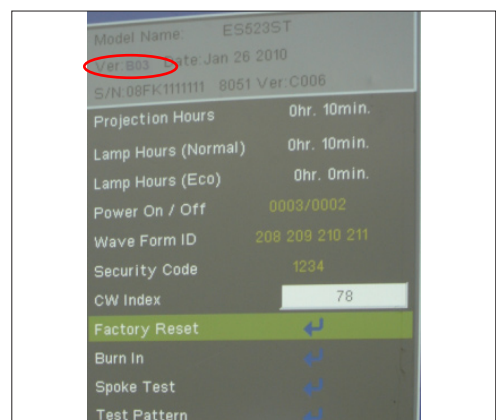

Section 3: 8051 Firmware Upgrade Procedure

5-3-1 Equipment Needed

Software: (DDP 2430-USB/EX540/EX542/EX612/EX615;

DDP 2431-USB/EX762/EX540I/EX542I/ES523ST/EW533ST)

- Setup_NLINK_en
- Manley USB Driver_NLINK
- EX542/EX612/EX615_8051_xxx.hex
- EX540_8051_xxx.hex
- EX762_8051_xxx.hex
- EX540I/EX542I_8051_xxx.hex
- ES523ST/EW533ST_8051_xxx.hex

Hardware:

- Projector
- Power Cord: 42.50115G001
- Mini USB Cable
- NLINK Cable 2
- NLINK Fixture
- PC or Laptop

Note: - The 8051 FW upgrade procedure for EX615/EX612/EX542/EX540/EX762/EX540I/EX542I/ES523ST/EW533ST is the same, we take EX542 as an example here.

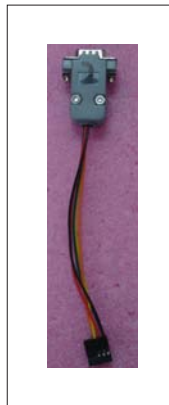

5-3-2 NLINK Setup Procedure

1. Choose "setup_NLINK_en.exe" program.

2. Click "Next".

3. Click "Next".

4. Click "Next".

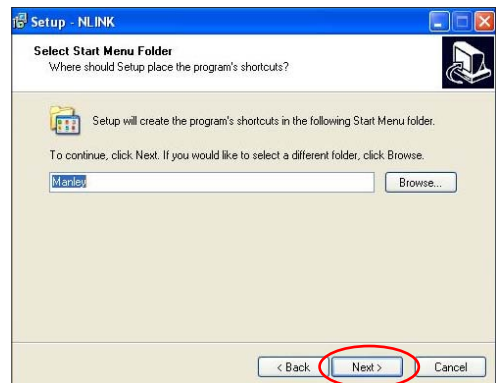
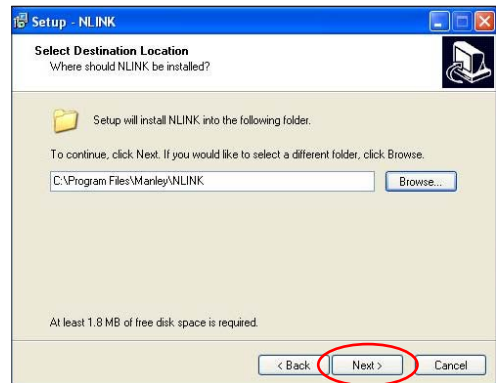

5. Click "Next".

- Select the additional task that you may create a desktop icon.

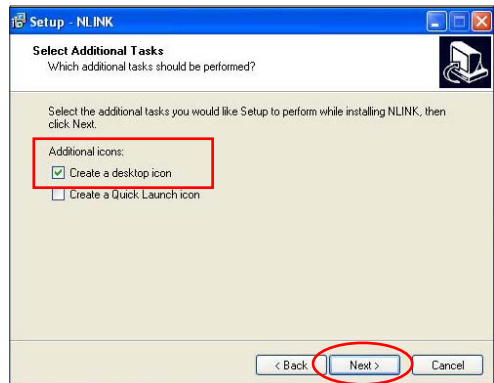

6. Click "Install" to begin installing NLINK Procedure.

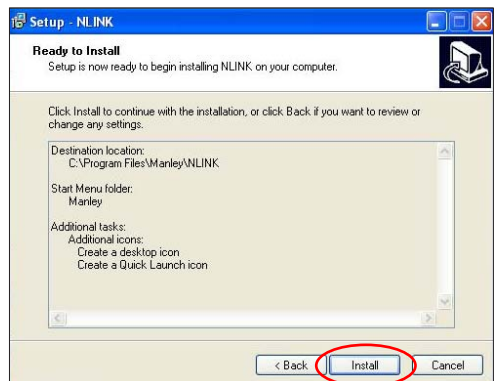

7. Click "Finish".

- Complete the NLINK setup.

8. "MCU Choose" picture will appear on the screen.

- Close the picture.

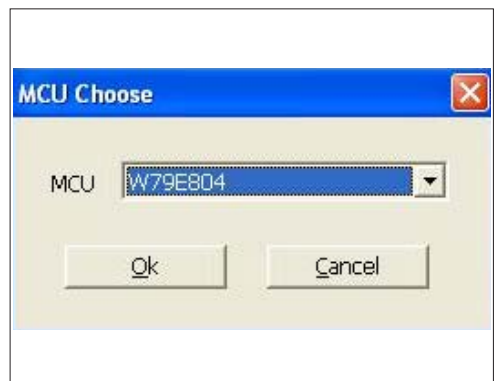

5-3-3 Manley USB Driver Upgrade Procedure

1. Set up

- Plug in the power cord, the power LED will light on red.
- Connect VGA-1 Port of projector with NLINK Fixture.
- Connect NLINK Fixture with PC by USB cable.



2. Execute Program

(1) "Found New Hardware Wizard" picture will appear on the screen.

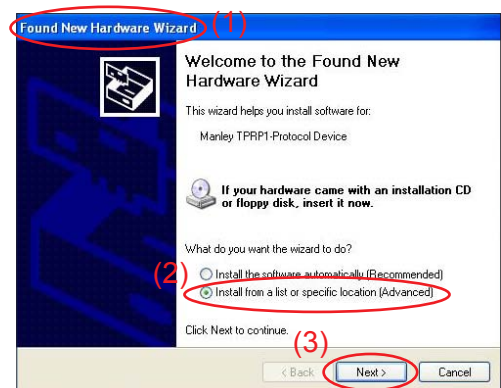

(2) Select "Install from a list or specific location (Advanced)".

(3) Click "Next".

(4) Select "Include this location in the search", then click "Browse".

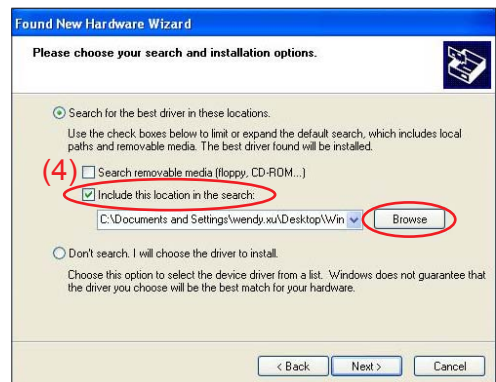

(5) "Browse For Folder" picture will appear on the screen.

(6) Select "TPRP1" folder in the "Manley USB Driver_N-Link" folder, then click "OK".

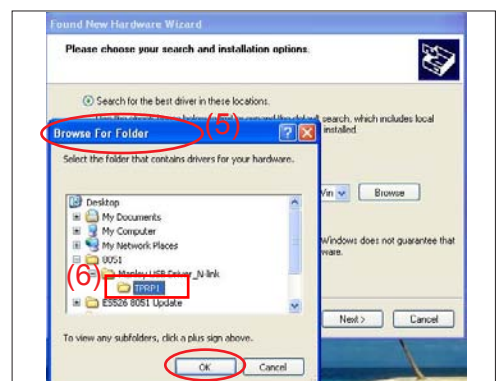

(7) Click "Next".

(8) Click "Continue Anyway".

(9) Click "Finish".

- "Manley TPRP1-Protocol Emulator" will appear on the picture.
- Complete the USB Driver Upgrade Procedure.

Note: - If "Found New Hardware Wizard" picture appear again, repeat step 2 to install USB Driver.

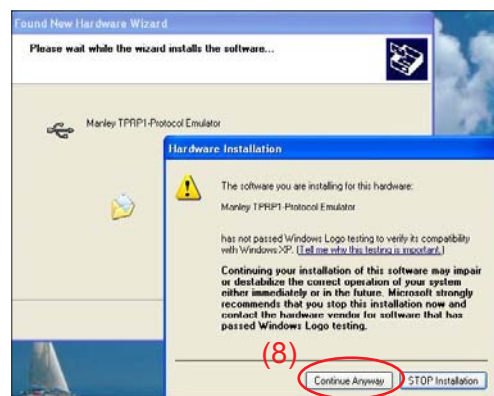
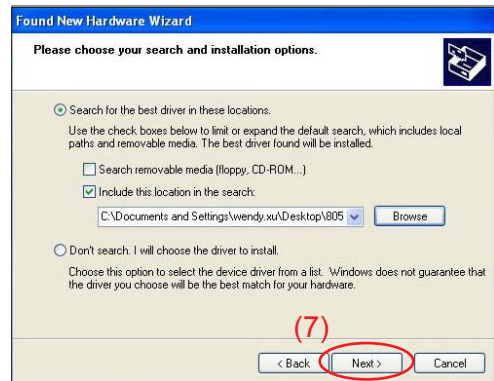

5-3-4 8051 Firmware Upgrade Procedure

1. Execute 8051 FW Program

- Double click "NLINK V1.2" to execute NLINK program.

Note: - When we execute NLINK program, the power LED and Fixture LED flash red.

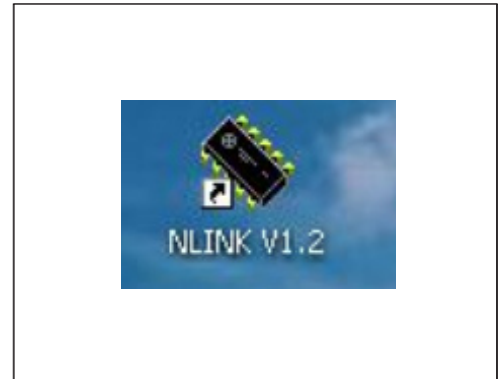

2. Choose the right type of MCU

- "MCU Choose" picture will appear on the screen, select "W79E804".
- Click "OK".

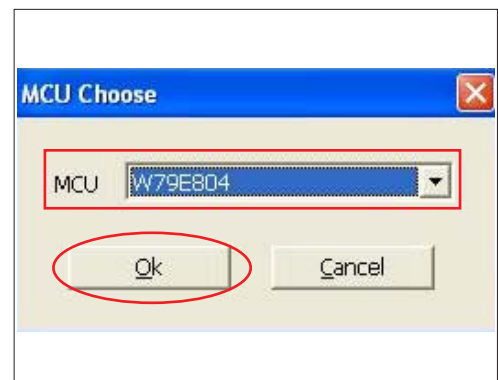

3. Choose 8051 file (*.hex)

- "Manley Nlink" picture will appear on the screen.
- Ensure "MCU" is the one you chose in the last step (as green square).
- Click "Open".
- Select the 8051 file where you put the file in, then click "Open".

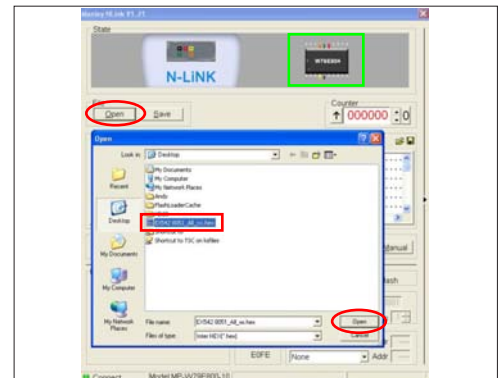

4. Program settings

- Ensure NLINK Fixture and PC are securely connected: the indicator lights on green, and the state is "Connect" (as blue square).
- Select "4MHz-20MHz Crystal" (as green square).
- Click "Erase/Write(W)" to execute 8051 FW upgrade.

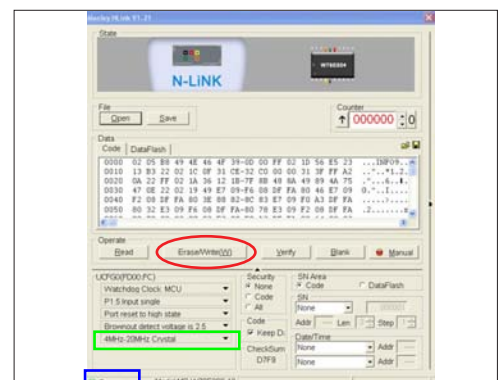

5. Finish

- When 8051 FW upgrade process is finished, "Write Chip success" will be shown.

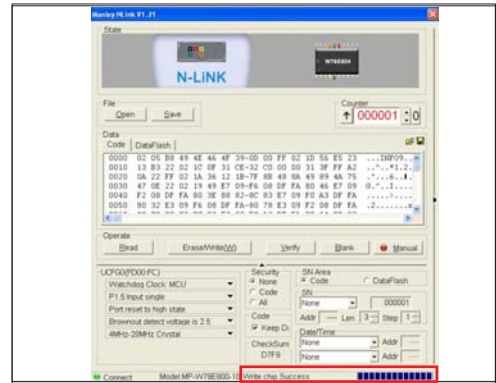

6. Check 8051 FW version

- Turn on the unit and get into the service mode to check the 8051 FW version.

(To get into service mode, please press "Power", "Left", "Left" and "Menu" buttons sequentially.)

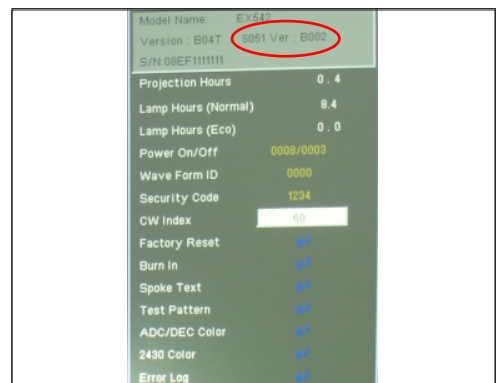

Section 4: Network Firmware Upgrade Procedure (for EX542/EX615/EX540/EX762/EX540I/EX542I)

5-4-1 Equipment Needed

Software:

- EX542_LAN Module FW_xxx.bin (*.bin)

Hardware:

- Projector
- Power Cord: 42.50115G001
- LAN Cable
- PC

Note: The Network FW Upgrade Procedure for EX615/EX542/EX540/EX762/EX540I/EX542I is the same, we take EX542 as an example here.



5-4-2 Write Down Projector IP

1. Plug in power cord to the projector and plug in LAN cable to the PC.



2. Turn on the projector, then press "Menu" button to get into OSD menu.

- Use "right" button to select "SETUP".

- Use "down" button to remove the light mark to "RS232", then press "Enter" button to select "Network", press "Enter" button.

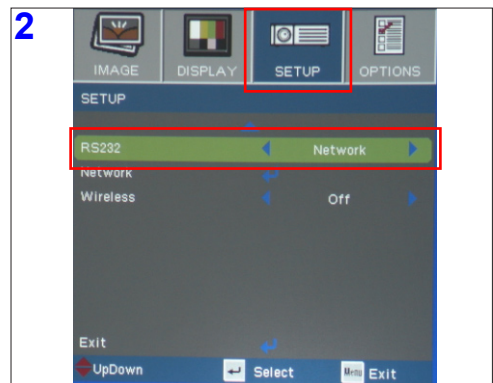

3. Select "Network", press "Enter" button.

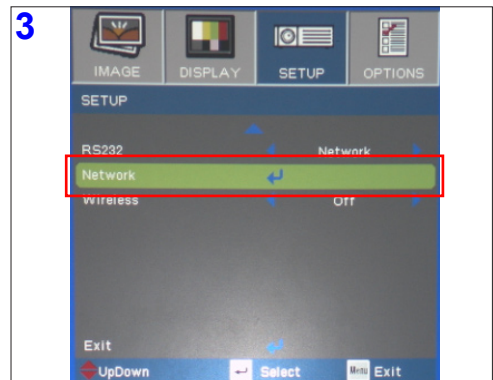

4. Remove the light mark to "DHCP", then press "Enter" button to select "Off", press "Enter" button.

- The IP address will be shown on screen.

- Write down the IP address: 192.168.0.100.

- Ensure the IP address, Subnet Mask, Gateway and DNS are right as the the picture 4 shown.

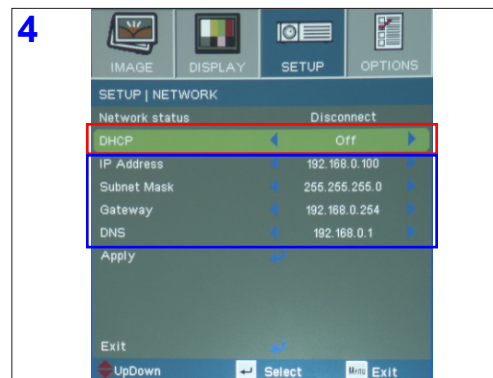

5-4-3 Network Setting

1. Double click the "Local area connection", choose "Properties".
2. Select "Internet protocol (TCP/IP)", then click "Properties".

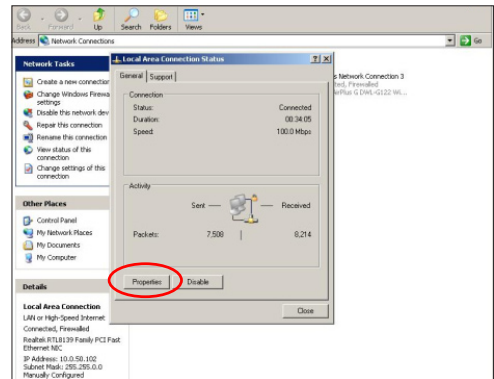

3. Modify the IP address to 192.168.0.101, and modify Subnet mask to 255.255.255.0.

Note: - The HOST ID (192.168.0.XXX) of PC IP address must be different from the projector IP address written down in step 4 of 5-3-2.

4. Click "OK".

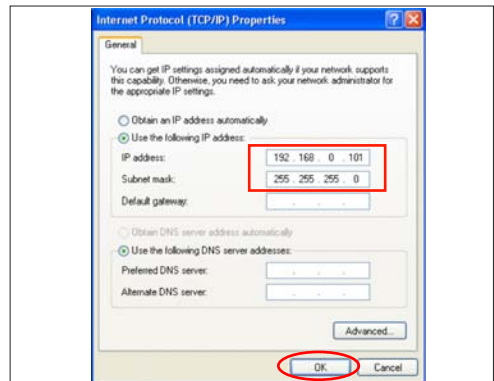
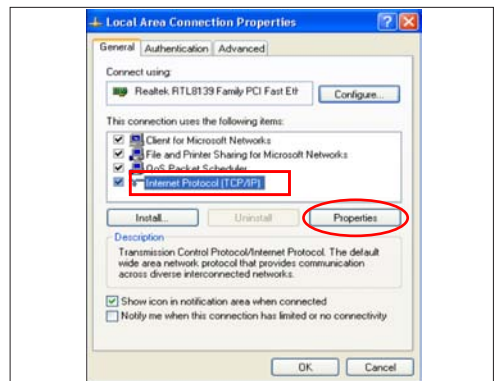

5. Click "Close" to quit the setting screen.

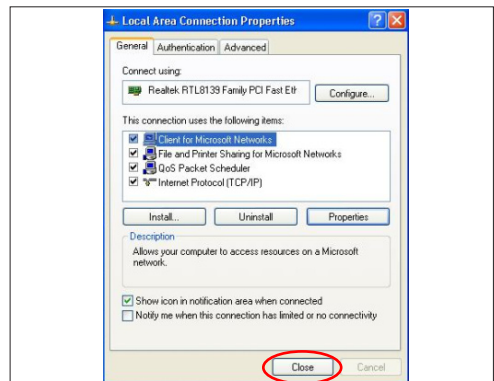

5-4-4 PC Hardware Link

1. Execute "Internet Explorer".



2. Visit "http:// 192.168.0.100/tgi/fu.tgi" to get into Firmware Update screen.

Note: - The format of address is "IP address/tgi/fu.tgi".

- Click "Continue".

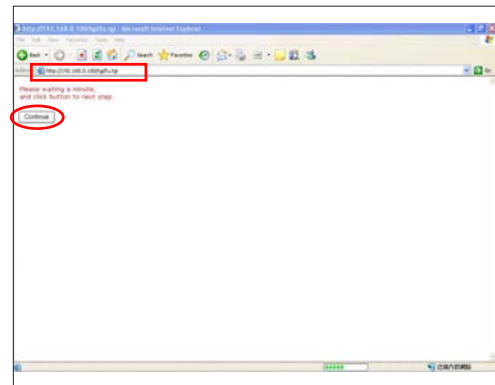

3. "Firmware Update" image will appear on the screen.

- Click "Browse" button to select the Network FW file (*.bin) which you saved.

- Click "Open".

- Click "Update" to start updating.

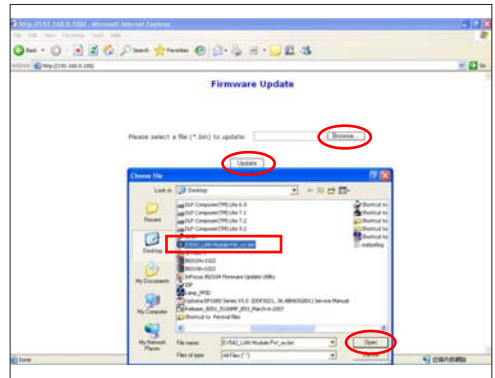

4. Firmware Upgrade procedure.

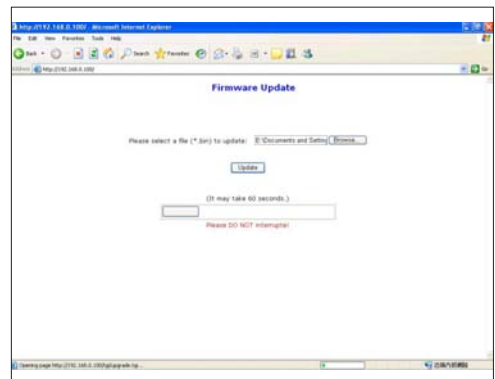

5. Click "Re Login".

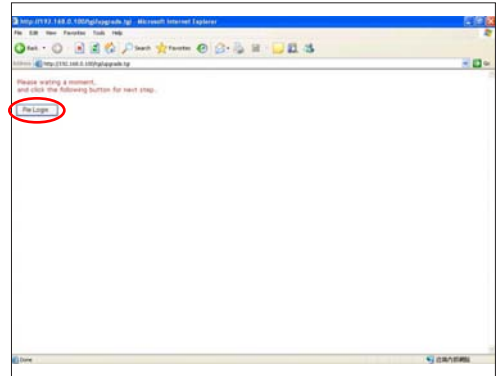

6. Firmware upgrade procedure completes.

- The projector Network FW version will appear.

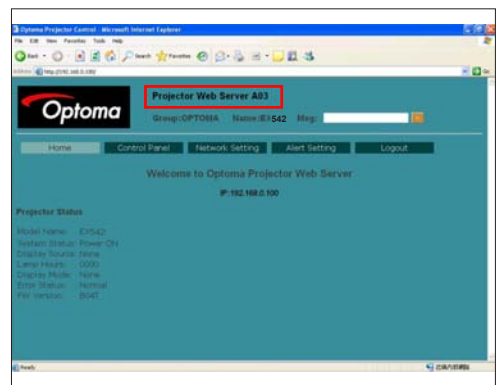

EDID Upgrade

6-1 EDID Introduction

Extended Display Identification Data is a VESA standard data format that contains basic information about a display device and its capabilities, including vendor information, maximum image size, color characteristics, factory pre-set timings, frequency range limits, and character strings for the monitor name and serial number.

The information is stored in the display and is used to communicate with the system through a Display Data Channel (DDC), which sits between the display device and the PC graphics adapter. The system uses this information for configuration purposes, so the monitor and system can work together.

Note: - If a display device has digital input ports, like DVI or HDMI, but without EDID in its Main Board, the display device will show no image while the input source is digital signal.

- The EDID Upgrade procedure for EX615/EX612/EX542/EX540/EX762/EX540I/EX542I is the same, we take EX542 as an example here.

- The EDID Upgrade procedure for ES523ST/EW533ST is the same, we take ES523ST as an example here.

6-2 Equipment Needed (for EX542/EX615/EX540/EX762/EX540I/EX542I)

Software

- EDID Program
- EDID File (*.ini)

Hardware

- Projector
- Power Cord for Projector (42.53506G002)
- VGA Cable (42.87305G102)
- HDMI(M) to DVI(F) Adapter (42.82B13G001)
- DVI Cable (42.83N06G001)
- Generic Fixture (80.00001.001) for EDID Key-in (Fixture: JP3 must be closed)
- RS-232 9 Pin Cable (pin to pin, F-M) (42.83C07G001)
- Power Adapter (47.57803G001)
- Monitor
- PC

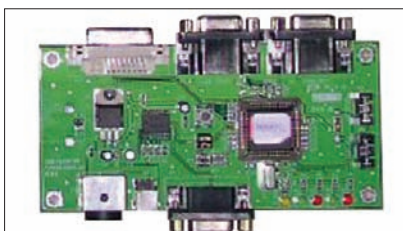

6-3 Setup Procedure (VGA) (for EX542/EX615/EX540/ EX762/EX540I/EX542I)

1. Connect all ports
 - (1) Connect P1 of fixture with COM Port of PC/Laptop by RS232 Cable.
 - (2) Connect P3 of fixture with VGA-1 Port of projector by VGA Cable 1.
 - (3) Connect P4 of fixture with VGA-2 Port of projector by VGA Cable 2.
 - (4) Plug Power Adapter to JP1 of fixture.
 - (5) Power on fixture.
 - (6) Plug Power Cord to projector.

Note: -You must confirm that the JP3 is closed in all procedure.

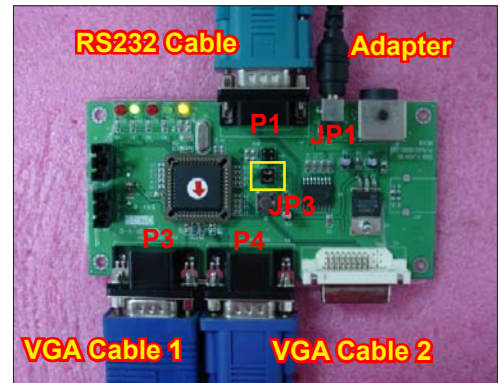

6-4 EDID Key-In Procedure (VGA-1 & VGA-2) (for EX542/EX615/EX540/ EX762/EX540I/EX542I)

1. Execute EDID Program
 - Double click "EDID" to execute EDID program.



2. Process

- (1) Select the COM Port which you are using.
- (2) Click "Model".
- (3) Select the EDID file (*.ini).
- (4) Click "Open".
- (5) Key in the Serial Number into the Barcode blank space.
- (6) In "Write Source Select" item, select "VGA-A" and "VGA-B".
- (7) Click "Program".

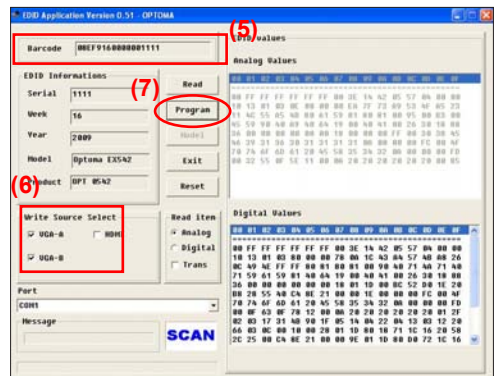
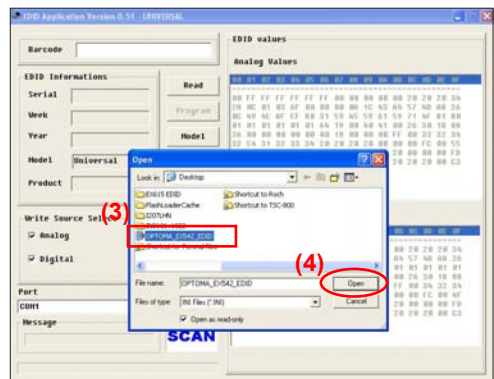
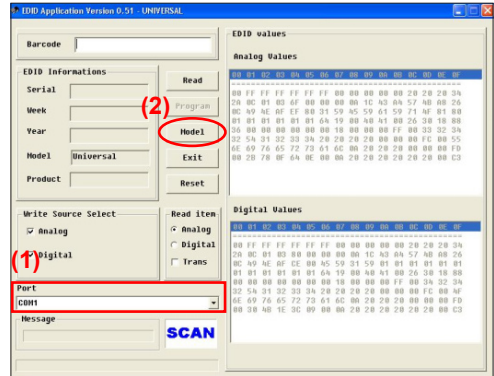

3. Change the cable to VGA-A

- When the message "Please change the cable to VGA-A" appears on the screen, click "OK".

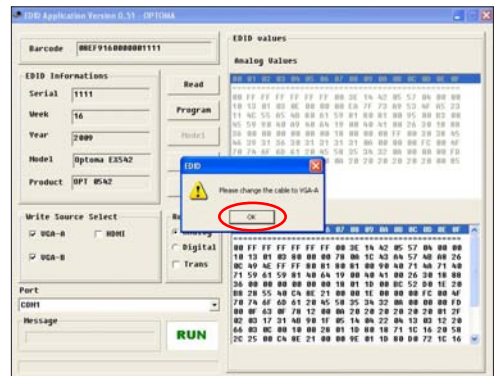

4. Change the cable to VGA-B

- When the message "Please change the cable to VGA-B" appears on the screen, click "OK".

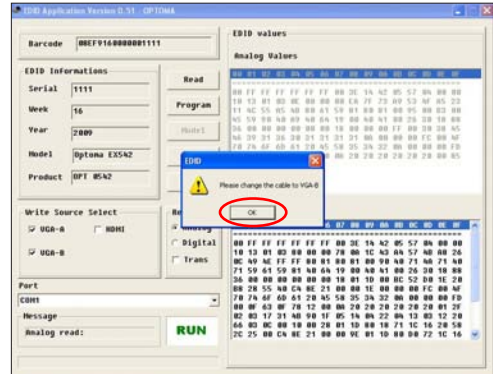

5. When the EDID program is completed, a message "OK" will appear on the screen.

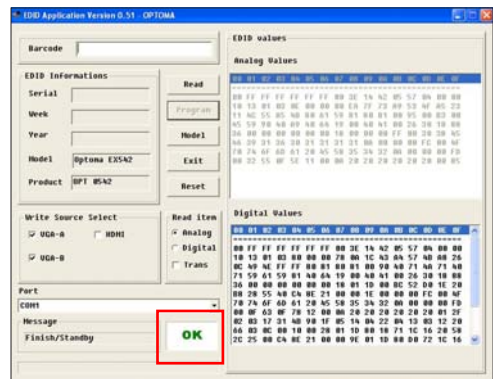

6. Read EDID "VGA-A&VGA-B" information

- In "Read item", select "Analog" and "Trans", then click the "Read".

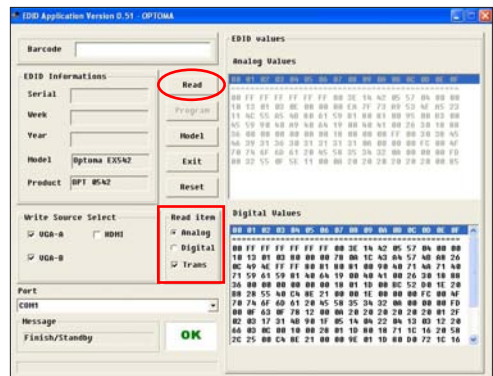

7. EDID information will show the result.

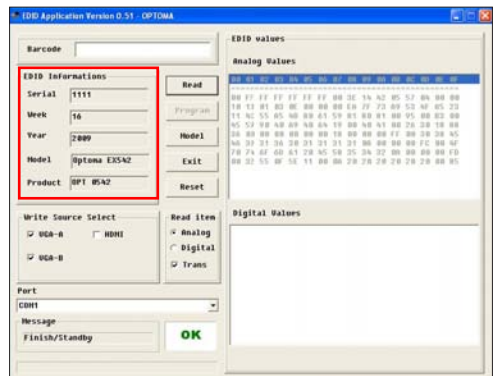

6-5 Equipment Needed (for ES523ST/EW533ST)

Software

- EDID Program
- EDID File (*.ini)

Hardware

- Projector
- Power Cord for Projector (42.53506G002)
- VGA Cable (42.87305G102)
- Generic Fixture (80.00001.001) for EDID Key-in (Fixture: JP3 must be closed)
- RS-232 9 Pin Cable (pin to pin, F-M) (42.83C07G001)
- Power Adapter (47.57803G001)
- Monitor
- PC

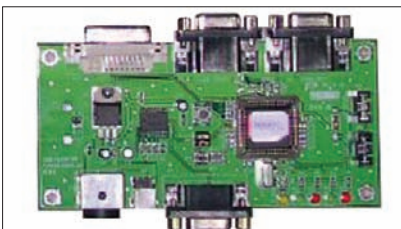

6-6 Setup Procedure (VGA) (for ES523ST/EW533ST)

1. Connect all ports
 - (1) Connect P1 of fixture with COM Port of PC/Laptop by RS232 Cable.
 - (2) Connect P3 of fixture with VGA-IN Port of projector by VGA Cable.
 - (3) Plug Power Adapter to JP1 of fixture.
 - (5) Power on fixture.
 - (6) Plug Power Cord to projector.

Note: -You must confirm that the JP3 is closed in all procedure.

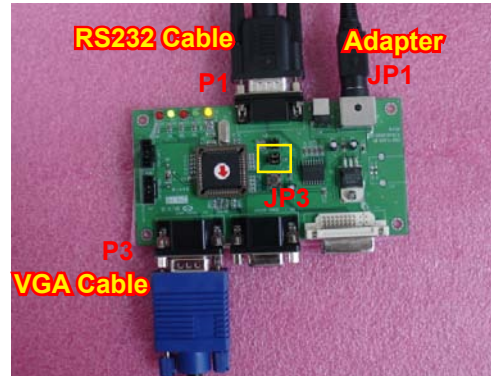

6-7 EDID Key-In Procedure (VGA-1 & VGA-2) (for ES523ST/EW533ST)

1. Execute EDID Program
 - Double click "EDID" to execute EDID program.

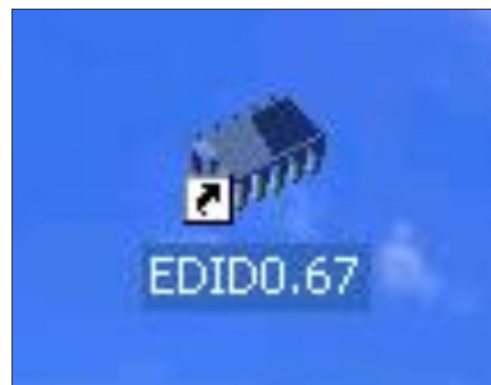

2. Process

- (1) Select the COM Port which you are using.
- (2) Click "Model".
- (3) Select the EDID file (*.ini).
- (4) Click "Open".
- (5) Key in the Serial Number into the Barcode blank space.
- (6) In "Write Source Select" item, select "VGA".
- (7) Click "Program".

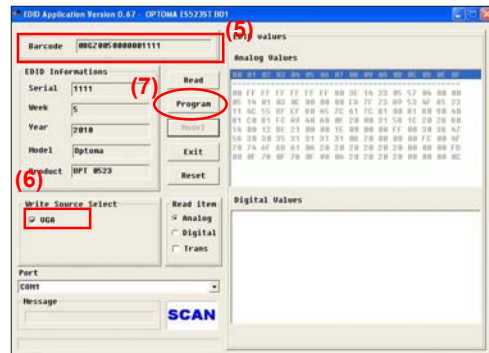
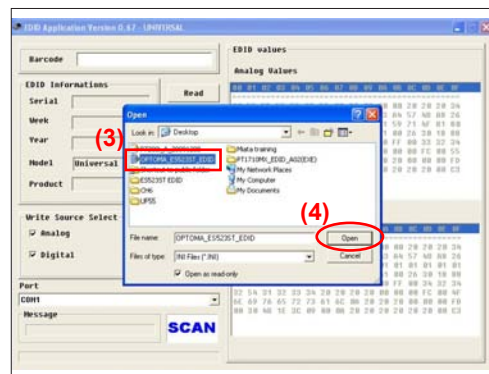
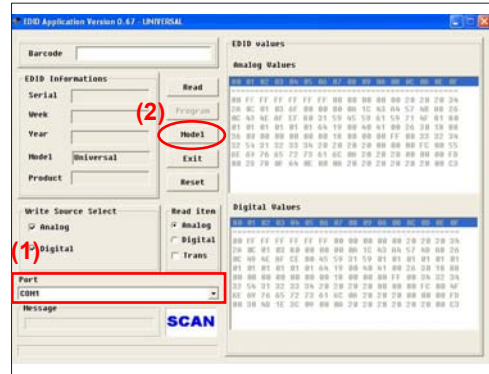

3. Change the cable to VGA

- When the message "Please change the cable to VGA" appears on the screen, click "OK".

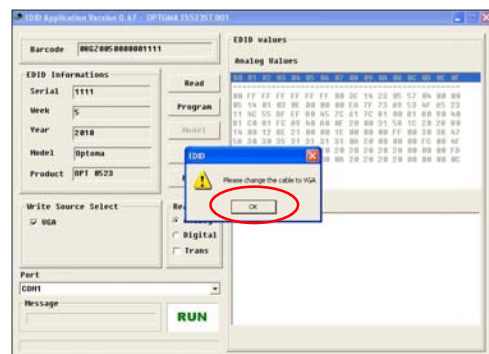

4. When the EDID program is completed, a message "OK" will appear on the screen.

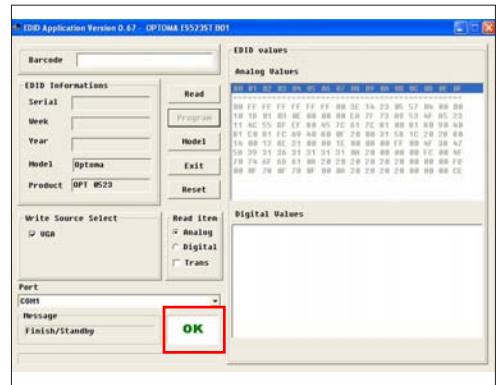

5. Read EDID "VGA" information

- In "Read item", select "Analog" and "Trans", then click the "Read".

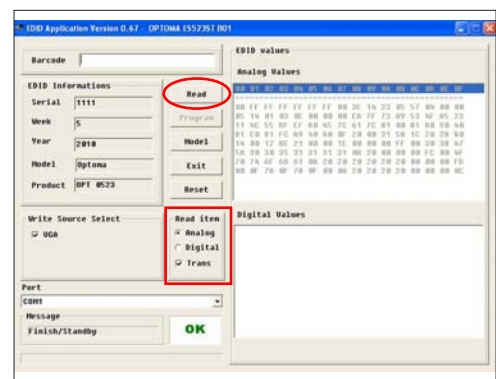

6. EDID information will show the result.

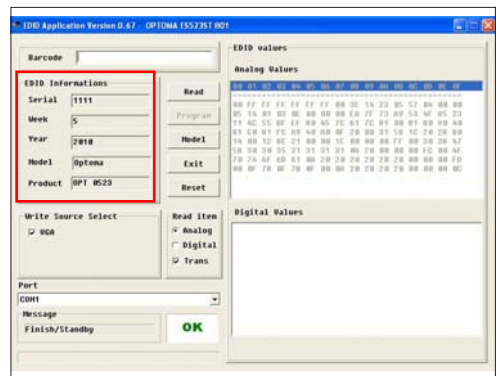

6-8 Setup Procedure (HDMI) (for EX542/EX615/EX540/ EX762/EX540I/EX542I)

1. Connect all ports
 - (1) Connect P1 of fixture with COM Port of PC/Laptop by RS232 Cable.
 - (2) Connect P5 of fixture with HDMI Port of projector by DVI Cable.
 - (3) Plug Power Adapter to JP1 of fixture.
 - (4) Power on fixture.
 - (5) Plug Power Cord to projector.

Note: You must confirm that the JP3 is closed in all procedure.

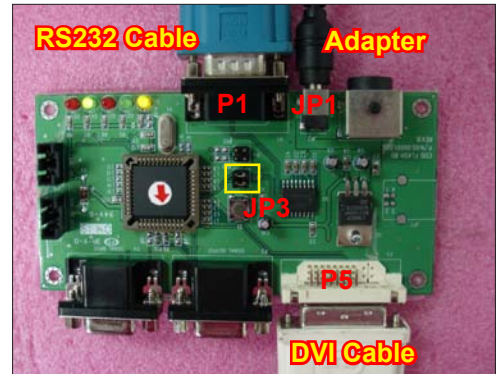

6-9 EDID Key-In Procedure (HDMI) (for EX542/EX615/EX540/ EX762/EX540I/EX542I)

1. Execute EDID Program
 - Double click "EDID" to execute EDID program.



2. Process

(1) Select the COM Port which you are using.

(2) Click "Model".

(3) Select the EDID file (*.ini).

(4) Click "Open".

(5) Key in the Serial Number into the Barcode blank space.

(6) In "Write Source Select" item, select "HDMI".

(7) Click "Program".

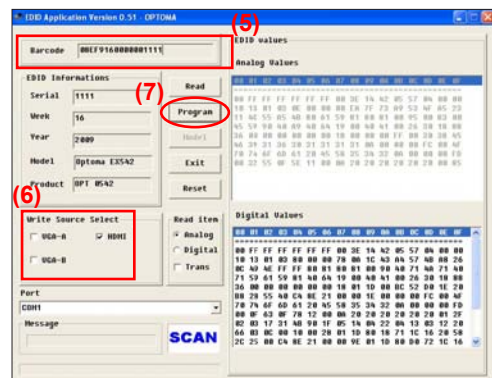
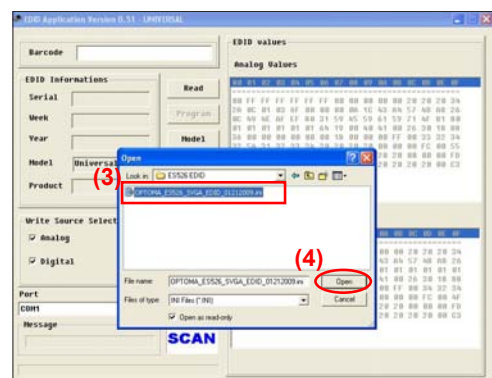
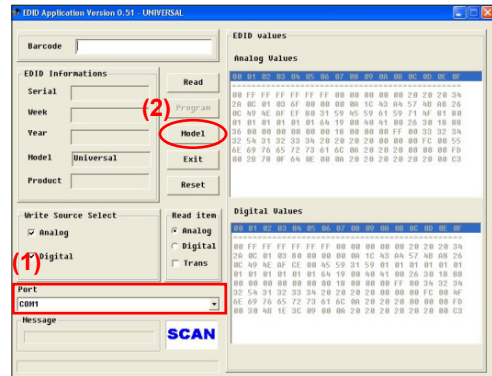

3. Change the cable to HDMI

- When the message "Please change the cable to HDMI" appears on the screen, click "OK".

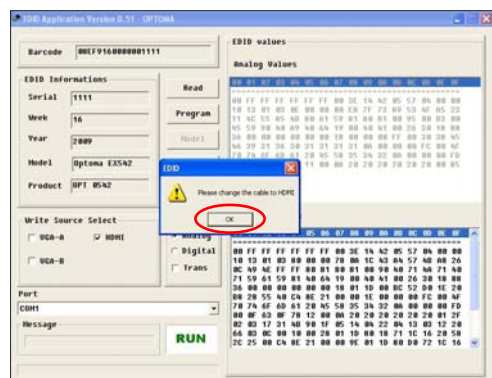

4. When the EDID program is completed, a message "OK" will appear on the screen.

5. Read EDID "HDMI" information

- In "Read item", select "Digital" and "Trans", then click the "Read".

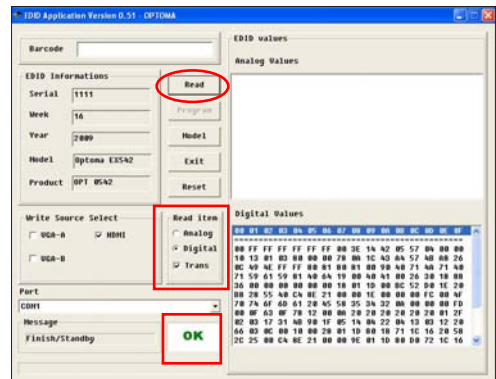

6. EDID information will show the result.

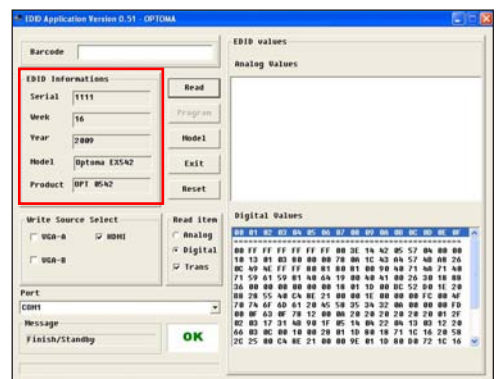

Appendix A (Exploded Image)

Note: This chapter is only designed to show the exploded image of the projector. For updated part numbers, please refer to RSPL report.

D.C.

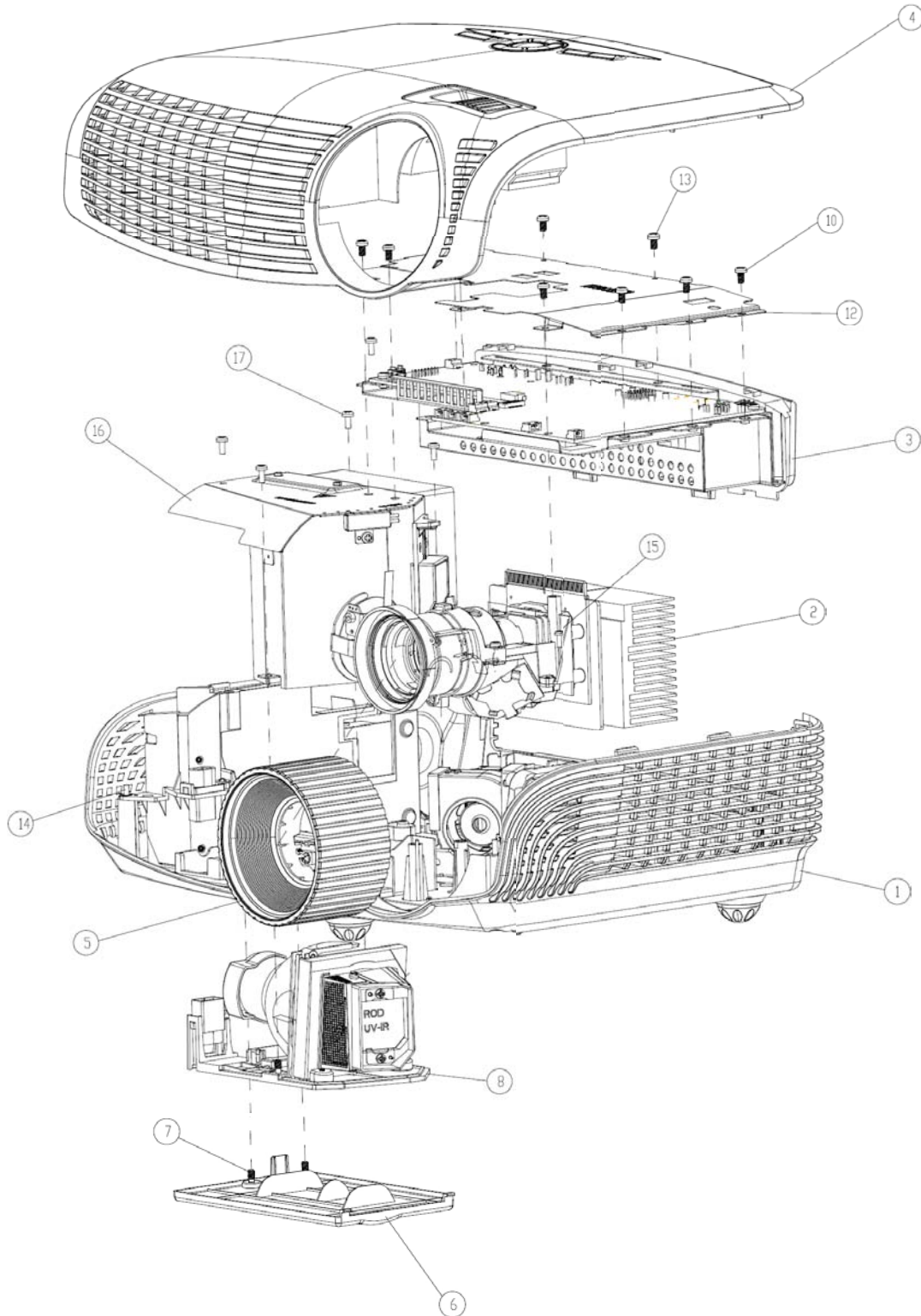

Item	P/N	Description	Parts Supply
1	70.8EF11G001	EX612 ASSY BOTTOM HOUSING MODULE	
2	70.8EF01G001	ASSY OPTICAL ENGINE MODULE EX612	
3	70.8EF08G001	MAIN BOARD ASSEMBLY EX612	
4	70.8EF06G001	TOP COVER AND ZOOM RING ASSY EX612	
5	51.8EF02G001	FOCUS RING EX612 (FOR YM09)	
	70.8EF45GR01	ASSY LAMP COVER BLACK EX615 (SERVICE)	V
6	51.8EG03G011	LAMP COVER BLACK EX615	
7	61.00018G002	LOCK SCREW PAN MECH M3*8.5-3.5 BLACK	
8	SP.8EF01GC01	LAMP MODULE FOR PROJECTOR EX542	V
8	SP.8EG01GC01	LAMP MODULE FOR PROJECTOR EX615/EX612	V
9	41.83M06G001	EMI TAPE W30*L70mm	
10	85.1A123G050	SCREW PAN MECH M3*5 Ni	
11	85.00823G080	HEX SCREW M3*H8*L5.3,BRASS	
12	61.8EG03G001	TOP SHIELDING HD20	
13	85.0A122G030	SCREW DOUBLE FLAT MECH M2*3Ni	
14	85.1A323G080	SCREW PAN MECH M3*8 BLACK "GREEN"	
15	85.1A526G060	SCREW PAN MECH M2.6*6 Ni NYLOK	
16	70.8EG17G001	ASSY 8525 FAN SHIELDING MODULE HD20	
17	85.1A123G060	SCREW PAN MECH M3*6 Ni	

Assy TOP COVER MODULE

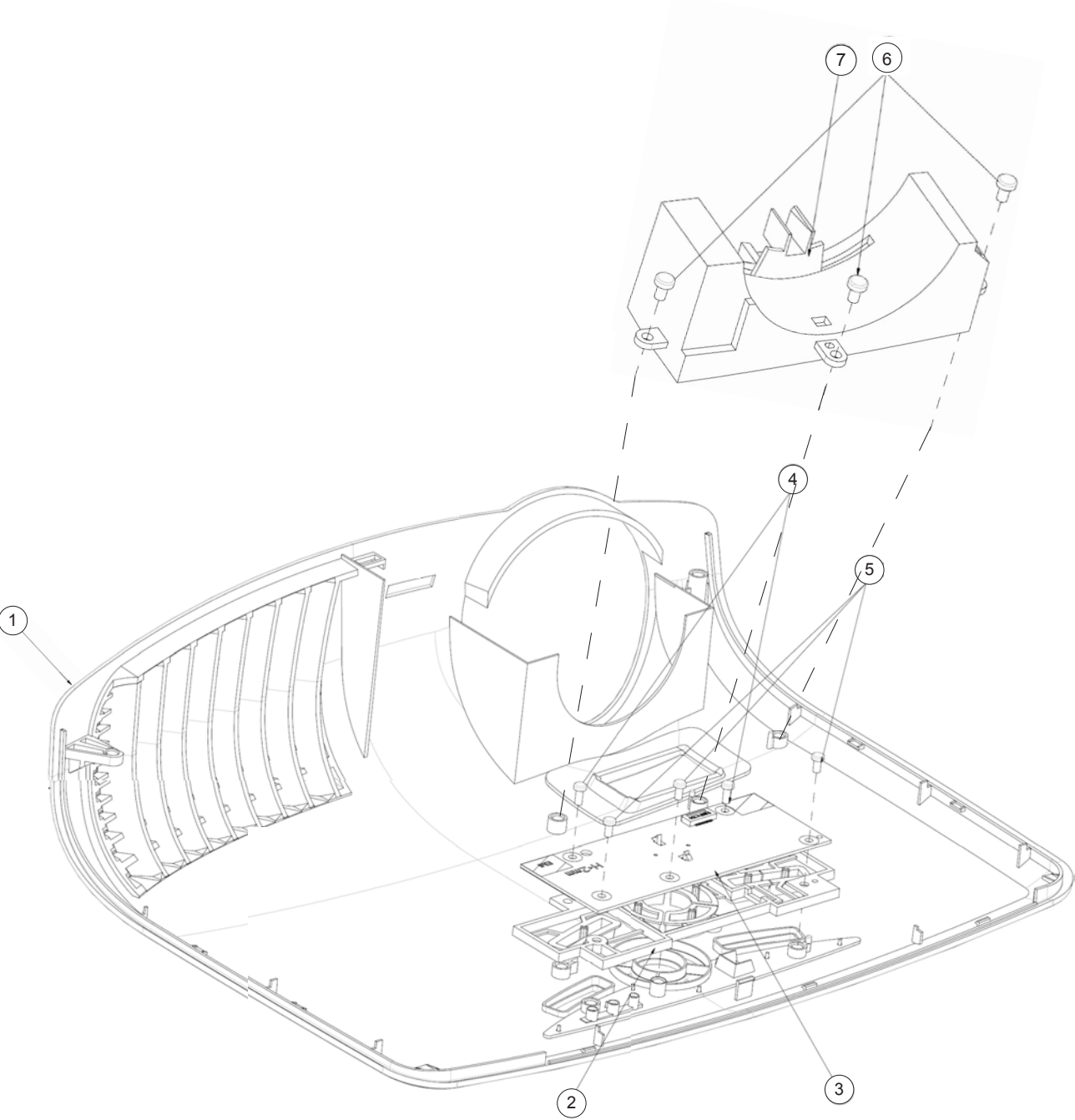

Item	P/N	Description	Parts Supply
1	75.8EF01G002	TOP COVER ASSEMBLY EX615	V
2	51.8EG14G011	KEYPAD PLATE ENTER EX612	
3	80.8EF03G001	PCBA KEY PAD BOARD FOR EX615	V
4	85.1A123G050	SCREW PAN MECH M3*5 Ni	
5	85.1A123G050	SCREW PAN MECH M3*5 Ni	
6	85.41BA6G060	FLAT SCERW M2.6*6 Flat Thickness1.1mm	
7	51.8EG11G001	ZOOM RING DUST COVER HD20	

ASSY BOTTOM COVER MODULE

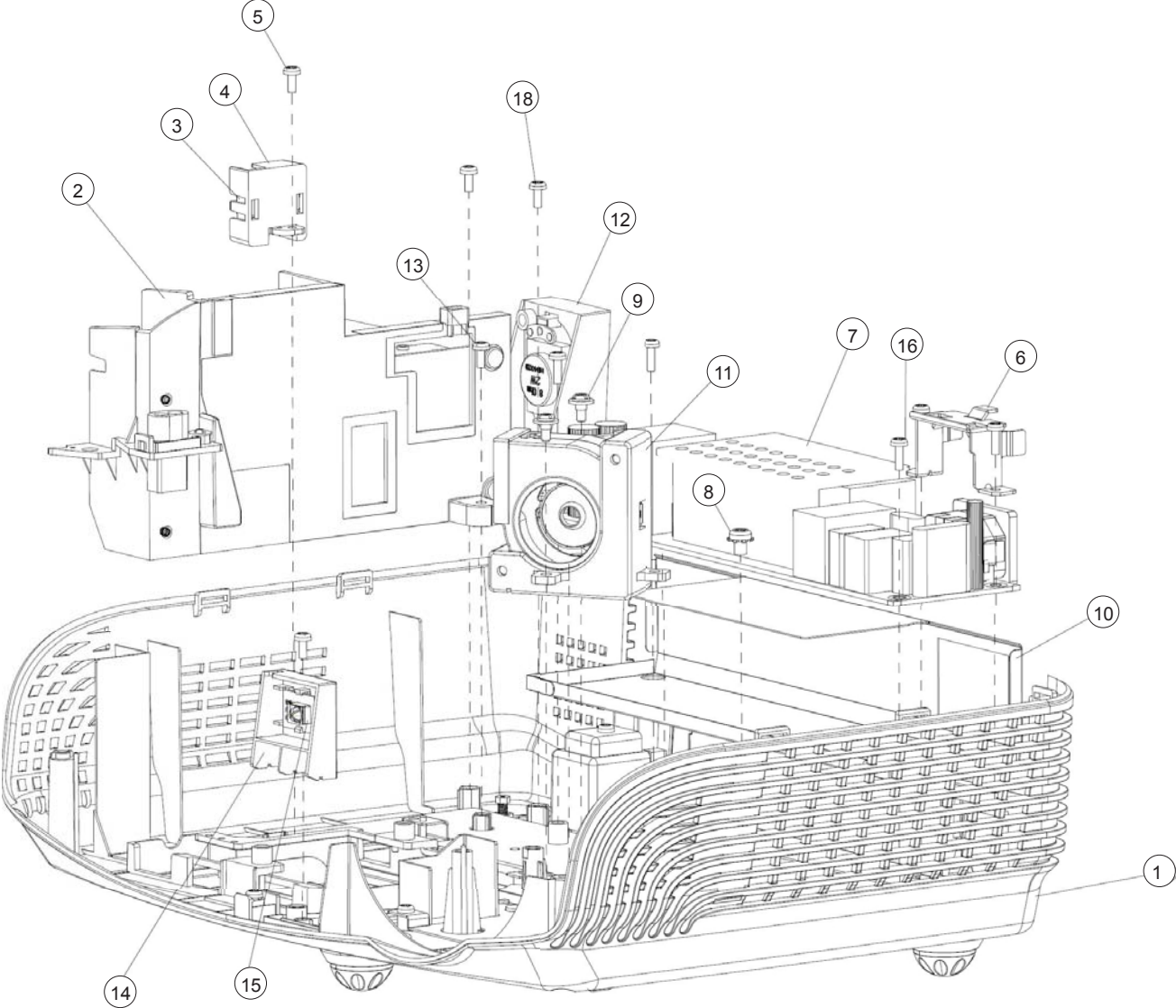

Item	P/N	Description	Parts Supply
	70.8EF37GR01	ASSY BOTTOM COVER MODULE FOR EX615 (SERVICE)	V
1	51.8EG01G011	BOTTOM COVER MN3600H BLACK EX612	
	70.8EJ01GR01	ASSY OSRAM LAMP DRIVER 230W FOR EX542 (SERVICE)	V
	70.8EF38GR01	ASSY OSRAM LAMP DRIVER 230W FOR EX615 (SERVICE)	V
2	75.8BW01G002	ASSY OSRAM LAMP DRIVER O3 MID 230W (Gen5_Panyu+E20.8)	
3	75.8AA04G001	BUY ASSY INTERLOCK SWITCH 1409X	
4	51.89W18G001	LIMIT SWITCH HOLDER PC MN3600H BLACK TDP-SP1	
5	85.WA126G060	SCREW PAN HEAD TAP M2.6*6	
6	61.88T19G001	AC INLET BRACKET FOR X1160E	
7	75.8CT02G001	ASSY MATRITEK 180/200W LVPS FOR HORUS (EX542)	V
7	75.8CT01G001	ASSY MATRITEK 230W LVPS FOR HORUS	V
8	85.1C224G051	SCREW PAN MECH M4*5 COLOR W/TOOTH WASHER Cr3+	
9	61.87340G001	STAND OFF M3*4L D8.0 2100MP	
10	51.8EG20G001	230W LVPS MYLAR PC T=0.43 HD20	
11	70.8EG14G001	ASSY 4520 BLOWER MODULE HD20	
12	70.8EF10G001	EX612 2W SPEAKER HOLDER ASSY	
13	85.WA123G060	SCREW PAN TAP M3*6 Ni	
14	51.8EG05G001	IR FRONT BOTTOM HOLDER MN3600H BLACK	
15	80.87Z04G001	PCBA IR SENSOR BD HD80	
16	85.1F123G060	SCREW PAN MECH W/SF M3*6 Ni GREEN	
17	42.00451G011	W.A. 16P 90mm LVPS TO MAIN BD UL1007 P1266	
18	85.1F123G060	SCREW PAN MECH W/SF M3*6 Ni GREEN	
19	42.81G01G001	CABLE W.A. 2P #20 160mm LAPS TO BALLAST PD120	
20	51.8EG27G001	REAR SPEAK MYLAR HD20	
21	51.8EF06G001	AIR STOP MYLAR EX615	
22	51.8EG31G001	FRON LEFT LIGHT LEAK MYLAR HD20	

ASSY MAIN BOARD AND IO BOARD MODULE

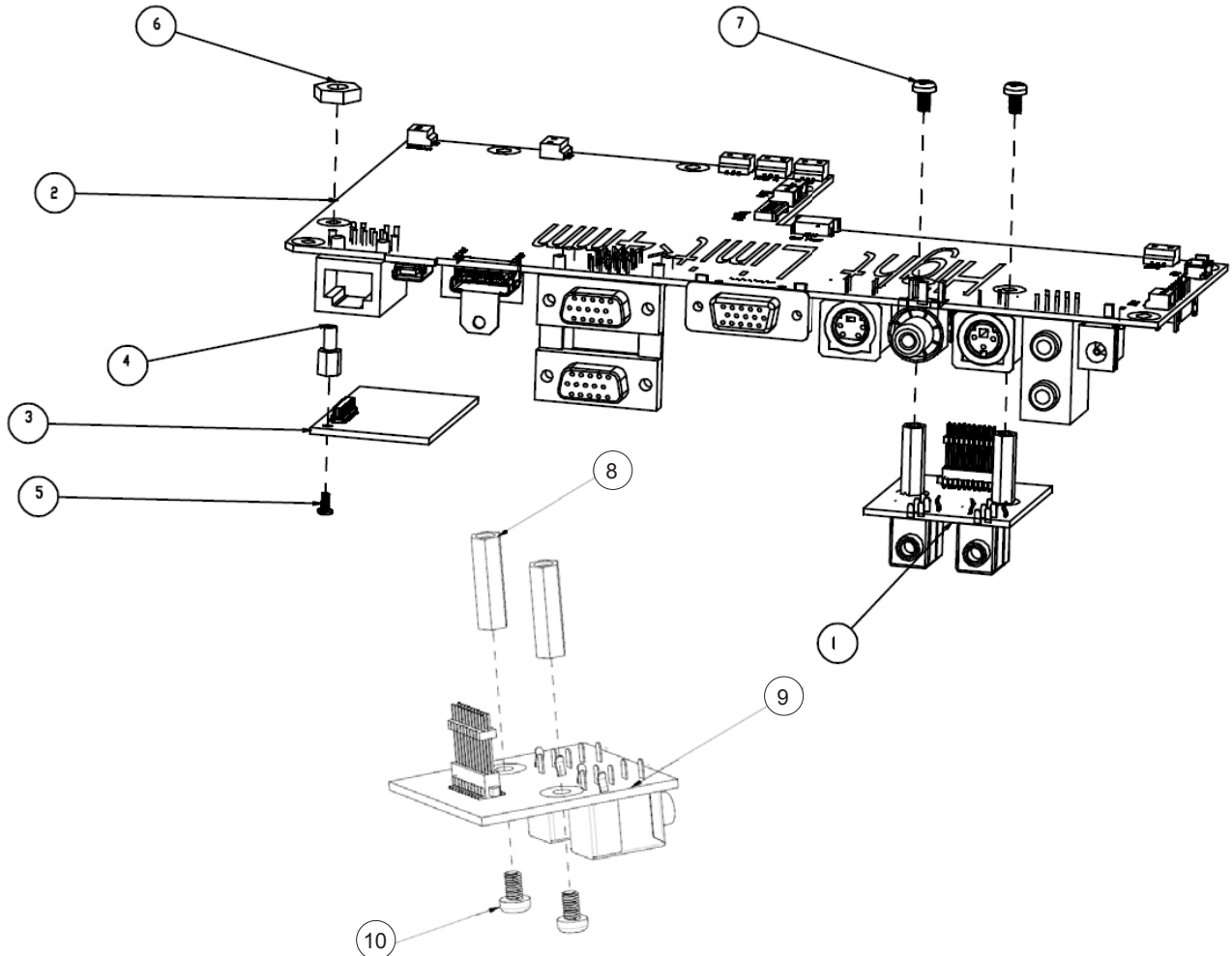

Item	P/N	Description	Parts Supply
1	70.8EF09G001	IO BOARD ASSEMBLE EX612	
	70.8EJ03GR01	ASSY PCBA MAIN BOARD FOR EX542 (SERVICE)	V
	80.8FK01G001	PCBA MAIN BD FOR EX612	V
	70.8EF43GR01	ASSY PCBA MAIN BOARD FOR EX615 (SERVICE)	V
2	80.8EF01G003	PCBA MAIN BD FOR EX615	
3	80.8EF07G001	PCBA LAN MODULE BD FOR EX615/EX542	V
4	61.00080G001	STAND OFF H=6.0 M2/M3*L6 Sn EP910	
5	85.1A122G040	SCREW PAN MECH M2*4 Ni	
6	86.0A123G024	HEX NUT M3*5.5*0.5P L2.4 Ni	
7	85.1A123G050	SCREW PAN MECH M3*5 Ni	
8	61.83N19G001	HEX SPACER M3 H=17mm L=5mm AL PD726	
9	80.8EF06G003	PCBA DAUGHTER BD FOR EX612	V
9	80.8EF06G002	PCBA DAUGHTER BOARD FOR EX615/EX542	V
10	85.1A123G050	SCREW PAN MECH M3*5 Ni	

ASSY MAIN BOARD MODULE

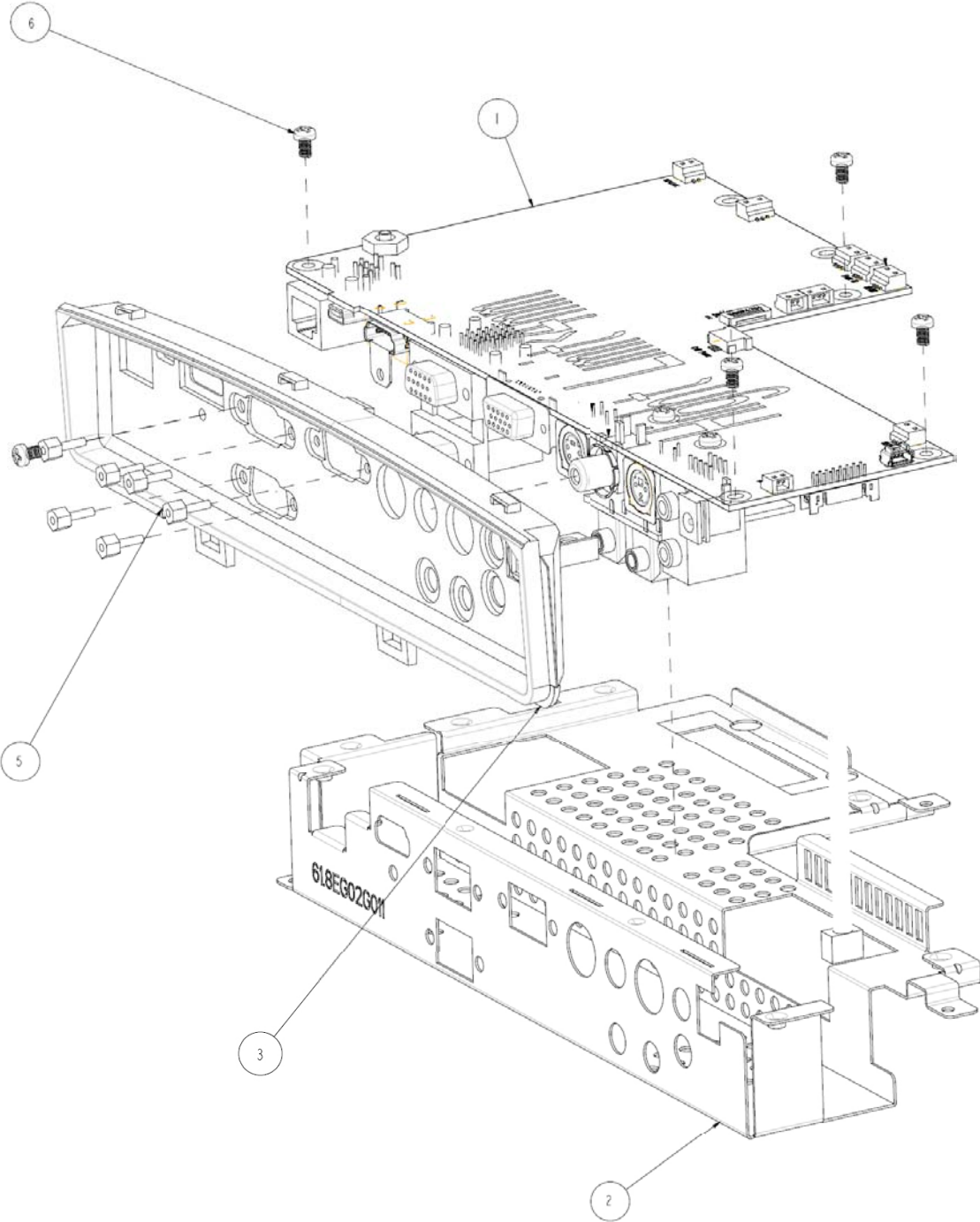

Item	P/N	Description	Parts Supply
1	70.8EF26G001	MAIN BOARD IO BOARD ASSY EX612	
2	61.8EG02G011	MAIN BOARD SHIELDING EX612	
	70.8EJ04GR01	ASSY IO COVER MODULE FOR EX542 (SERVICE)	V
	70.8FK02GR01	ASSY IO COVER MODULE FOR EX612 (SERVICE)	V
	70.8EF44GR01	ASSY IO COVER MODULE FOR EX615 (SERVICE)	V
3	51.8EG10G011	IO COVER EX612	
4	41.86R01G001	ADUIO I/O PORT EMI GASKET W13*H1*L13mm diameter 6.5mm	
5	85.005AGG408	SCREW HEX I/O #4-40 H4*L8 NI NYLOK	
6	85.1A123G050	SCREW PAN MECH M3*5 Ni	
7	51.8EF04G001	MAIN BOARD MYLAR EX542	
8	52.8EF02G001	MAIN BOARD SPONGE EX615	
9	52.8EF04G001	MAIN BOARD SPONGE 20mm EX615	
10	41.85Y04G002	EMI GASKET (S-VIDEO & S-VIDEO) W18*H0.35*L17 mm	

ASSY OPTICAL ENGINE MODULE

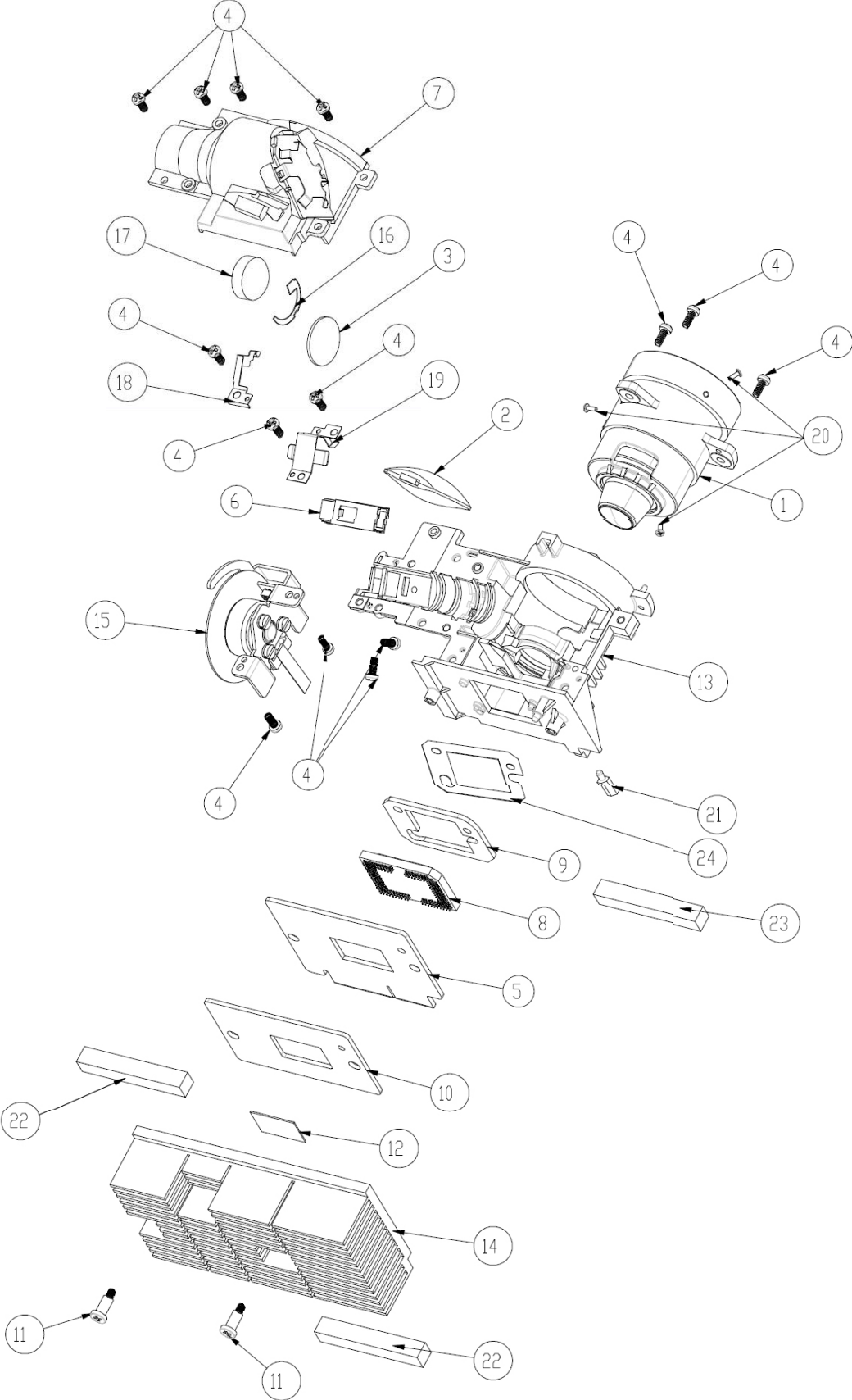

Item	P/N	Description	Parts Supply
1	23.8BA01G001	PROJECTION LENS YM25	
2	70.8EG18G001	ASSY RELAY MODULE HD20	
	70.8EJ02GR01	ASSY OPTICAL ENGINE MODULE EX542 (SERVICE)	V
	70.8FK03GR01	ASSY OPTICAL ENGINE MODULE EX612 (SERVICE)	V
	70.8EF40GR01	ASSY OPTICAL ENGINE MODULE EX615 (SERVICE)	V
3	23.8AH20G011	YO CONDENSER 1 FOR A15W	
4	85.1A526G060	SCREW PAN MECH M2.6*6 Ni NYLOK	
5	80.8EF02G001	PCBA DMD BD FOR X15-II XGA	V
	70.8EF42GR01	ASSY ROD MODULE EX615 (SERVICE)	V
6	70.8EF36G001	ASSY ROD MODULE EX615	
7	70.8CP10G001	ASSY ENGINE BOTTOM COVER Z15	
8	48.8CQ01G001	0.55" XGA 2xLVDS SERIES 450 DMD -8 TI 1076-603cB	V
9	52.8CP01G011	DMD RUBBER EX615	
10	52.8CP02G001	DMD BOARD RUBBER X1161	
11	85.4A826G118	STEP SCREW FOR TYPEX DMD M2.6*11.8mm, X15	
12	52.8CP04G001	S450 0.55" XGA/SVGA DMD thermal pad, FUJIPO-LY, Sarcon XR-HE, 18.4x12.5x0.5 mm	
13	70.8CP11G001	ASSY ENGINE BASE Z15	
14	61.8EF02G001	DMD HEATSINK AL6063 EX615	
15	70.8EF03G001	ASSY COLOR WHEEL MODULE EX612	
16	61.8EF03G001	CONDENSER LIGHT STOP EX615	
17	23.8AH20G012	YO CONDENSER 2 FOR A15W	
18	61.88N13G002	ROD COVER NEW SUS301 X15	
19	61.88N12G001	ROD SPRING SUS301,X15	
20	85.WA321G040	SCREW PAN TAP M1.7*4 BLACK	
21	85.00823G080	HEX SCREW M3*H8*L5.3,BRASS	
22	41.83C01G001	EMI GASKET W13*H15*L40	
23	41.8BV01G001	EMI GASKET W6*H13*L40	
24	61.8EF01G001	DMD MASK EX615	

ASSY COLOR WHEEL MODULE

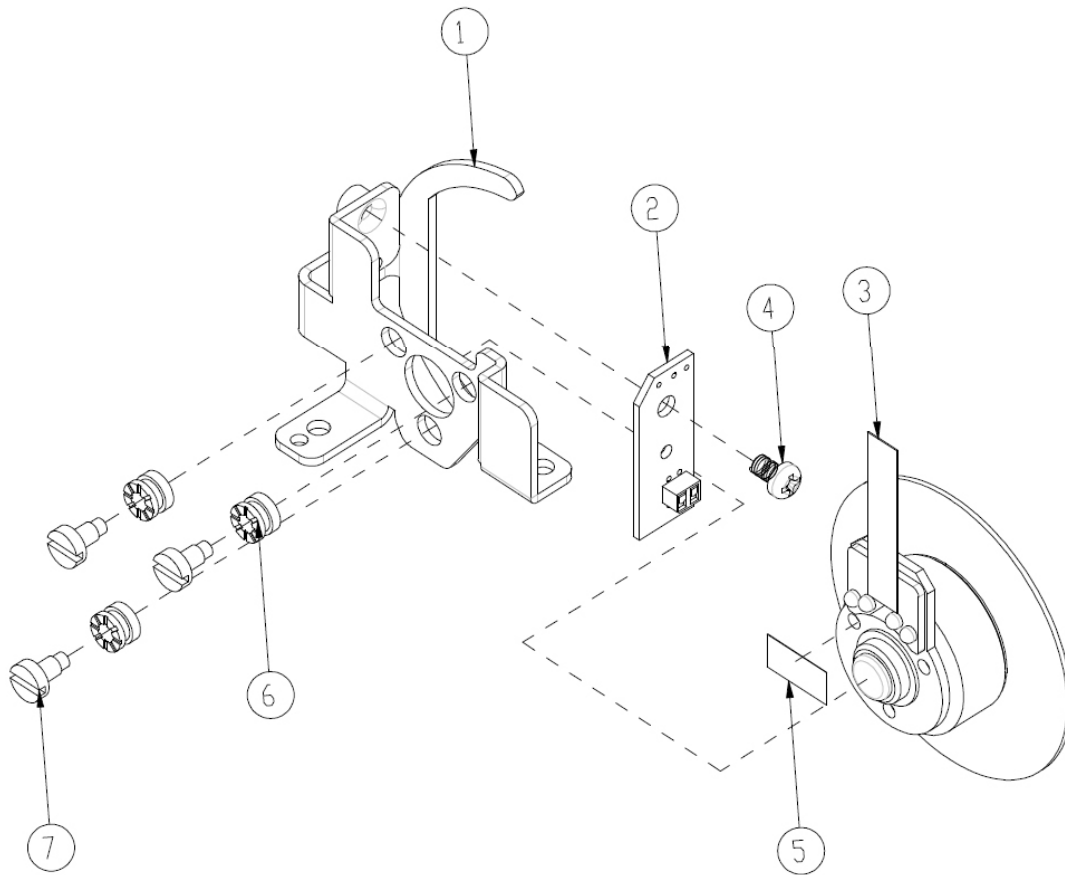

Item	P/N	Description	Parts Supply
	70.8EF41GR01	ASSY COLOR WHEEL MODULE EX615 (SERVICE)	V
1	61.8CP03G001	CW BRACKET SECC X1161	
2	80.8EF04G001	PCBA PHOTO SENSOR BOARD FOR EX615	V
3	23.8EF19G101	YO 5S R76Y32G78W98B76 CW (WITH FTZS MOTOR)	
4	85.1A126G040	SCREW PAN MECH M2.6*4 Ni	
5	51.82Y29G001	TAPE 3M J350 10*5mm FOR COLOR WHEEL DP715	
6	52.83615G001	COLOR WHEEL DISC RUBBER, EzPro755	
7	61.83628G001	COLOR WHEEL SHOULDER SCREW, EzPro755	

ASSY BLOWER MODULE

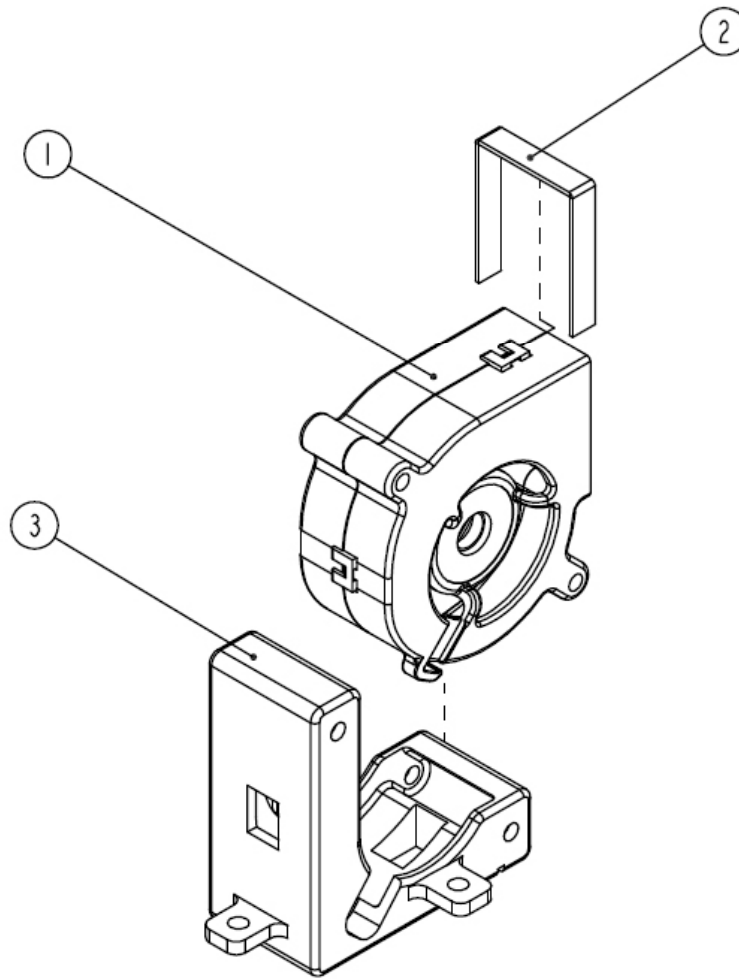

Item	P/N	Description	Parts Supply
1	49.8EF04G001	SUNON 45*20mm GB1245PKVX-8 F-TYPE BLOWER (EX542)	V
1	49.8EF04G001	SUNON 45*20mm GB1245PKVX-8 F-TYPE BLOWER (EX612/EX615)	V
2	52.89T01G001	BLOWER AIR TIGHT F12 H5350	
3	52.82G08G001	BLOWER 4520 RUBBER EP7190	

ASSY FAN SHIELDING MODULE

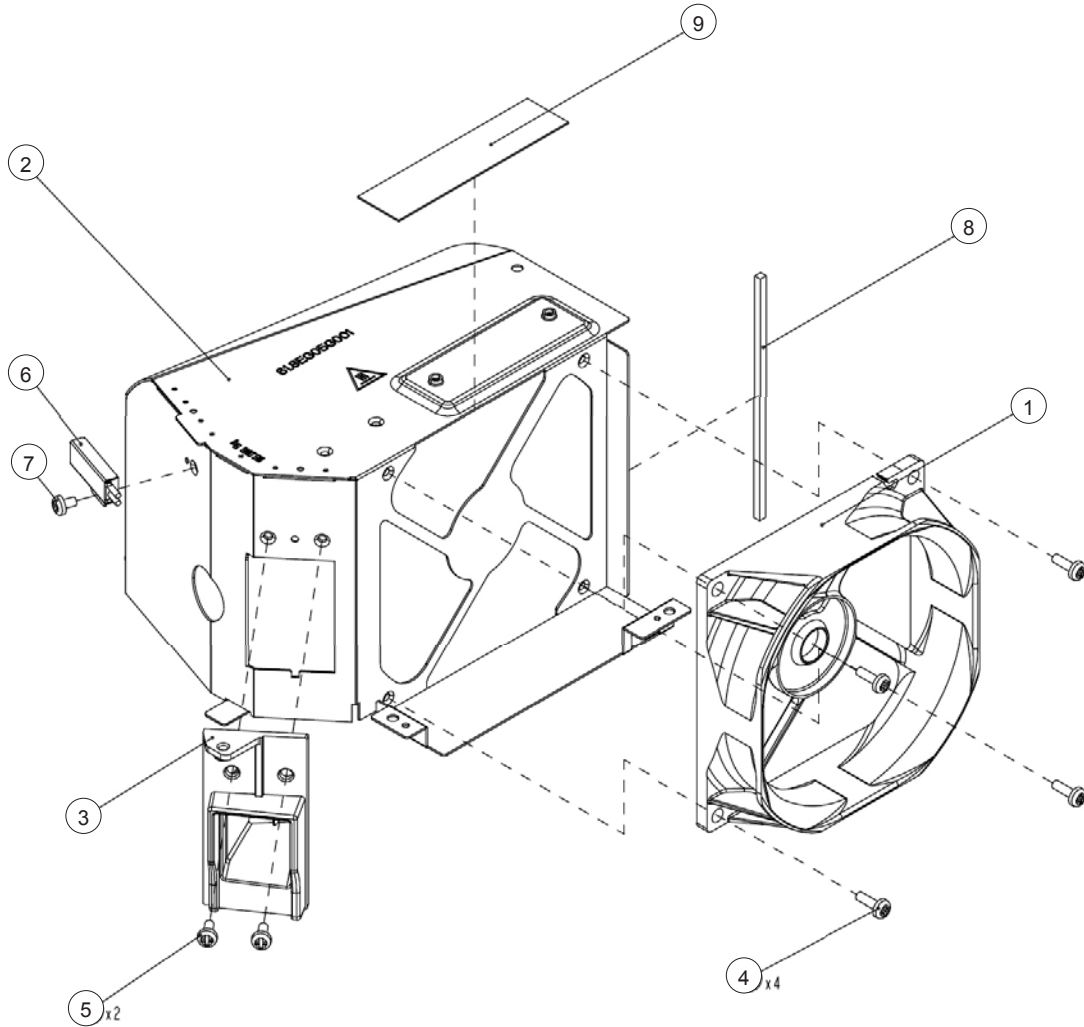

Item	P/N	Description	Parts Supply
1	49.88T01G001	SUNON, KDE1207PKV1-A 70*70*20mm AXIAL FAN (EX542)	V
1	49.8EF03G001	SUNON KDE1285PTV1 AXIAL FAN-LOW COST (EX612/EX615)	V
2	61.8EG05G001	8525 FAN SHIELDING HD20	
3	61.8EG11G001	LAMP BLOWER DUCT HD20	
4	85.1A123G080	PAN SCREW M3*8 FOR YM-64 FRONT CELL&SP	
5	85.1A123G060	SCREW PAN MECH M3*6 NI	
6	43.8EF17G001	THERMAL SWITCH WITH BRACKET (KLIXON YS11) EX542 85C (EX542)	V
6	43.8EG17G001	THERMAL SWITCH WITH BRACKET (KLIXON YS11) HD20 100C (EX612/EX615)	V
7	85.1A123G040	SCREW PAN MECH M3*4 Ni	
8	51.81540G001	TAPE 3M J350 17*60mm	
9	41.8EF01G001	EMI GASKET W5*H4*L80m	

A.K.

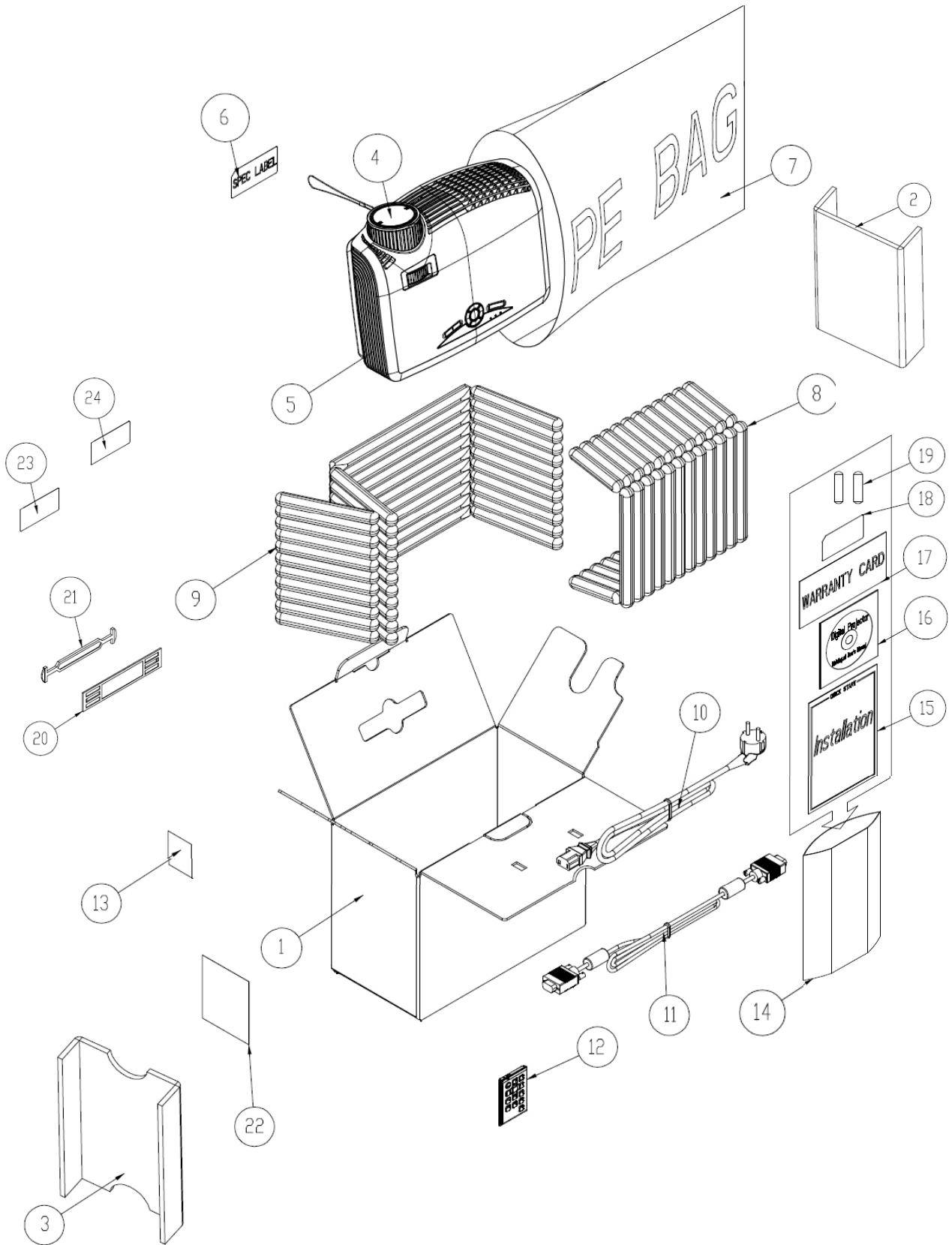

Item	P/N	Description	Parts Supply
1	55.8EG01G011	CARTON OUTSIDE BOX AB FLUTE EX615	V
2	55.8EG02G001	PARTITION PAPER RIGHT HD20	
3	55.8EG03G001	PARTITION PAPER LEFT HD20	
4	70.8EG01G001	LENS CAP ASSEMBLY HD20	
5	DC.8EF01G001	D.C. EX615	
6	35.86301G001	SPEC LABEL BLANK PD120	
7	51.00093G002	PE BAG 400*520*0.07mm FOR OPTOMA	
8	56.8EG01G001	AIR BAG BOTTOM HD20	
9	56.8EG02G001	AIR BAG TOP HD20	
10	42.50112G001	CABLE POWER CORD 1830mm SP-023+IS14 EUR. GREEN	
11	42.00200G005	CABLE VGA 15P 1.8M BLK EP739	
	45.8EF02G001	REMOTE CONTROLER OF EX612 WITHOUT LASER	V
12	45.8EF01G001	REMOTE CONTROL OF Z15II WITH LASER	V
13	57.00001G001	PACK SIO2 DRIER 20g	
14	51.00027G003	PE BAG ZIPPER 33cm*25cm SIZE GREEN FOR OPTOMA	
15	36.8EF02G001	QUICK START CARD MULTILINGUAL OPTOMA EX542/EX612/EX615	
	36.8FK01G001	USER'S GUIDE MULTILINGUAL (CD) OPTOMA EX612	V
16	36.8EF01G001	USER'S GUIDE MULTILINGUAL (CD) OPTOMA EX542/EX615	V
17	36.00012G002	WARRANTY CARD 3 YEARS, USA FOR OPTOMA LPP SERIES	
18	36.00018G001	EXTENDED WARRANTY ; REGISTRATION FORM,USA FOR LPP SERIES	
19	46.80S01G101	BATTERY #7 1.5V NOVACELL	
20	51.00200G001	HANDLE BAR 2. PE HD70	
21	51.00201G001	HANDLE BAR 1.PE HD70	
22	35.82001G111	AK LABEL 3"*3" BLANK	
23	35.00040G001	LABEL 30mm, GREEN	
24	35.52302G091	LABEL CARTON 108*92 BLANK	

Appendix B

I. Serial Number System Definition

Serial Number Format for Projector (take EX542 as example)

Q **8FJ** **9** **15** **AAAAA** **C** **0001**

① ② ③ ④ ⑤ ⑥ ⑦

- ① : Q = Optoma
- ② : 8FJ = Project Code
- ③ : 9 = Last number of the manufacture year (ex: 2009 = 9)
- ④ : 15 = week of the manufacture year (ex: the fifteenth week of the year = 15)
- ⑤ : AAAAA = not-defined
- ⑥ : C = Manufacture factory (TW or China)
- ⑦ : 0001 = Serial Code

EX: Q8FJ915AAAAAC0001

This label "Q8FJ915AAAAAC0001" represents the serial number for EX542. It is produced at CPC on fifteenth of 2009. Its serial code is 0001.

II. PCBA Code Definition

PCBA Code for Projector

A **B** **XXXXXXXXXX** **C** **XXX** **EEEE**

① ② ③ ④ ⑤ ⑥

- ① : ID
- ② : Vendor Code
- ③ : P/N
- ④ : Revision
- ⑤ : Date Code
- ⑥ : S/N