



NITROGEN PAC

SPRINKLER CORROSION INHIBITING SYSTEM

SC SERIES

INSTALLATION, COMMISSIONING, AND MAINTENANCE MANUAL

Serial Number _____

Date of Installation _____ Date of Commissioning _____



UNITED Fire Systems

Division of UNITED Fire Protection Corporation

1 Mark Road

Kenilworth, NJ USA 07033

908-688-0300

www.unitedfiresystems.net

Manual Part Number 30-NPSICM-000

Revision 4.00

May 2019

(THIS SURFACE DELIBERATELY LEFT BLANK)

INDEX

Section	Description	Page
	INDEX	
	List Of Figures	iv
	List Of Tables	iv
	List Of Abbreviations	v
	Safety Information	vi
	Foreword	viii
	Limited Warranty	ix
1.	GENERAL INFORMATION	
1.1	Glossary	1
1.2	System Purpose	2
1.3	Functional Description	3
1.4	Component Descriptions	4
1.4.1	SC Series Assembly	4
1.4.1.1	Compressor	5
1.4.1.2	Refrigerated Dryer	5
1.4.1.3	Nitrogen Generator Cabinet	5
1.4.1.4	Nitrogen Receiver	6
1.4.2	Purge Vent Assemblies Model PVA	6
1.4.2.1	Model PVA-3	6
1.4.2.2	P/N 31-100020-101 Optional Muffler Assembly for Model PVA-3	6
1.4.2.3	Model PVA-2	6
1.4.3	N ₂ Purity Analyzer – Hand-Held Model NA-1	8
1.4.4	Air Maintenance Device Model AMD-1	8
1.4.5	Optional True Advanced Purge System Model TAP-G2	9
1.4.6	Optional Corrosion Monitor Assembly Model CMA-1	9
2.	EQUIPMENT SELECTION	
2.1	Introduction	10
2.2	Basis for Equipment Selection	10
2.3	Steps to Follow	10
2.4	Information To Be Obtained During Survey	11
2.5	Information To Be Derived From Survey	12
2.6	Choosing The Proper NITROGEN-PAC™ SC Series Unit	12
2.6.1	SC Series Unit Initial-Fill With Air	12
2.6.2	Maximum Number Of Risers	12
2.6.3	Maximum Volume Of All Risers	13
2.6.4	Determination of Pipe Volume	13
2.6.5	Supervisory Pressure	13
2.6.6	Maximum Volume Of Single Largest Riser	13
2.7	Example 1	14
2.8	Example 2	14
2.9	Example 3	15
2.10	Additional Equipment	16
2.10.1	Air Maintenance Device (Model AMD-1)	16
2.10.2	Purge Vent Assembly (PVA)	16
2.10.3	(Optional) Muffler Assembly for Model PVA-3 (P/N 31-100020-101)	16
2.10.4	Hand-Held Nitrogen Purity Analyzer Model NA-1	16
2.10.5	(Optional) True Advanced Purge (Model TAP-G2-115-1)	16
2.10.6	(Optional) Corrosion Monitor Assembly (Model CMA-1)	16
2.11	Bill Of Materials	17

2	EQUIPMENT SELECTION (continued)	
2.12	Additional Survey Items	17
2.12.1	Are Sprinkler Systems NEW or EXISTING?	17
2.12.2	Are Sprinkler Systems Equipped with Quick-Opening Devices (Dry Accelerators)?	17
3.	INSTALLATION	
3.1	Unpacking	18
3.2	SC Location	18
3.2.1	Engineering Drawings (if available)	18
3.2.2	Proximity	18
3.2.3	Weight	18
3.2.4	Noise	19
3.2.5	Temperature	19
3.2.6	Clearance	19
3.3	Placement	19
3.4	Installation Kit	20
3.5	Pipe and Fittings	21
3.6	System Arrangements	21
3.6.1	Type I Arrangements	21
3.6.2	Type II Arrangements	23
3.7	Air Maintenance Device Model AMD-1	24
3.7.1	Location	25
3.7.2	Inlet	25
3.7.3	Outlet	25
3.7.4	Final Connection	25
3.8	Drain	25
3.8.1	Drain Piping	25
3.8.2	Condensate Pump (Installer Provided Option)	25
3.8.3	Oil / Water Separator (Installer Provided Option)	25
3.9	Electrical Installation	26
3.9.1	Codes	26
3.9.2	Personnel	26
3.9.3	Electrical Disconnect Switch	26
3.9.4	Wiring	26
3.9.5	Power for Accessories	27
3.10	Purge Vent Assembly Model PVA	27
3.10.1	Location	29
3.10.2	Sprinkler Piping	29
3.10.3	Connection to VERTICAL Branch Line	29
3.10.4	Connection to HORIZONTAL Branch Line	29
3.10.5	Muffler Assembly for Model PVA-3 (UFS Provided Option)	29
3.10.6	True Advanced Purge System	29
3.11	N ₂ Purity Analyzer – Hand-Held Model NA-1	29
3.12	Corrosion Monitor Assembly	29
3.12.1	Location	31
3.12.2	Sprinkler Piping	31
3.12.3	VERTICAL Installation	31
3.12.4	HORIZONTAL Installation	31
3.12.5	Wiring Instructions	32
4.	COMMISSIONING	
4.1	Preliminary	35
4.2	Startup	35
4.3	30 Minute Initial Fill	35
4.4	Purging	35

4	COMMISSIONING (continued)	
4.5	Final Acceptance	37
	Valve Positions	38
	Form UFS-602 - Commissioning Worksheet and Checklist	39
5.	MAINTENANCE	
5.1	Monthly Inspection	44
5.1.1	Objective	44
5.1.2	Personnel	44
5.1.3	Instructions	44
5.2	Annual Maintenance	45
5.2.1	Objective	45
5.2.2	Personnel	45
5.2.3	Instructions	45
5.3	Specific Procedures	45
5.3.1	Inspection and Maintenance of Refrigerated Dryer	45
5.3.2	Use of Model NA-1 Nitrogen Purity Analyzer to Measure Nitrogen Purity at SC Series Nitrogen Generator Cabinet	45
5.3.3	Use of Model NA-1 Nitrogen Purity Analyzer to Measure Nitrogen Purity at Model PVA Purge Vent Assembly	45
5.3.4	Replacement of Compressor Intake Filter Assembly	45
5.3.5	Condensate Pump (Installer Provided Option)	45
5.3.6	Examination and Cleaning of Automatic Float Drains in SC Series Nitrogen Generator Cabinet	46
5.3.7	Replacement of Coalescing and Particulate Filter Elements in SC Series Nitrogen Generator Cabinet	46
5.3.8	Replacement of Batteries in Model NA-1 Nitrogen Purity Analyzer	46
5.3.9	Replacement of Sensor in Model NA-1 Nitrogen Purity Analyzer	46
5.3.10	Drainage of Accumulated Water at Model PVA Purge Vent Assembly	46
5.3.11	Replacement of Strainer at Model PVA Purge Vent Assembly	47
5.4	Maintenance Parts	48
	Form UFS-603 - Monthly Inspection Checklist	49
	Form UFS-604 - Annual Maintenance Checklist	51
6	TROUBLESHOOTING	54

	APPENDICES	
A	Refrigerated Dryer	
B	Coalescing and Particulate Filters	
C	N ₂ Purity Analyzer – Hand-Held Model NA-1	
D	Air Maintenance Device Model AMD-1	

LIST OF FIGURES

Figure No.	Description	Page
1	Functional Description and General Arrangement	3
2	SC Series Assembly	4
3	Purge Vent Assembly Model PVA	7
4	P/N 31-100020-101 Optional Muffler Assembly for Model PVA-3	7
5	N ₂ Purity Analyzer – Hand-Held Model NA-1	8
6	Air Maintenance Device Model AMD-1	8
7	True Advanced Purge System Model TAP-G2	9
8	Corrosion Monitor Assembly Model CMA-1	9
9	Form UFS-1001	10
10	Assembly of Installation Kit	20
11	Type I NITROGEN-PAC™ SC Arrangement	22
12	Type II NITROGEN-PAC™ SC Arrangement	23
13	Air Maintenance Device Model AMD-1 - Installation	24
14	Purge Vent Assembly Model PVA – Dimensions and Installation in Vertical Branch Line	28
15	Purge Vent Assembly Model PVA – Installation in Horizontal Branch Line	28
16	Installation – Corrosion Monitor Assembly Model CMA-1	30
17	Corrosion Signal Connection	32
18	Typical Installation Showing Valve Locations and Numbers	34
19	Positions – Valves 1, 2, and 3	38
20	Model PVA Purge Vent Assembly	47

LIST OF TABLES

Table No.	Description	Page
1	Information To Be Obtained During Survey	11
2	Information To Be Derived From Survey	12
3	Maximum Limits - NITROGEN-PAC™ SC Series Units	12
4	Gallons Per Foot Of Pipe Based On Nominal Pipe Size And Pipe Schedule	13
5	Purge Vent Assemblies	16
6	Bill Of Materials	17
7	NITROGEN-PAC™ SC Series – Dimensions and Weight	19
8	Piping Limitations	21
9	NITROGEN-PAC™ SC Series – Electrical Specifications	26
10	Wire Sizes	27
11	PVAs for Use with NITROGEN-PAC™ SC Series Systems	27
12	Valve Numbers and Purposes	35
13	Quick Reference Valve Position Table	38
14	Maintenance Parts	48

LIST OF ABBREVIATIONS

The following is an explanation of abbreviations used in this manual.

MEASUREMENT UNITS		
ABBREVIATION	UNIT	PARAMETER BEING MEASURED
A	Amperes	Electric current
°F	Degrees Fahrenheit	Temperature
Hz	Hertz	Frequency (cycles per second)
in	Inches	Length
lbs.	Pounds	Weight
PSI	Pounds per Square Inch	Pressure (reference not specified)
PSIG	Pounds per Square Inch, Gauge	Pressure (referenced to normal atmospheric pressure)
VAC	Volts, Alternating Current	Electrical voltage (electromotive force)
v/v	Volume / Volume	Concentration expressed as a ratio of volumes

OTHER MEASUREMENT TERMS	
ABBREVIATION	MEANING
H	Height
L	Length
W	Width

NITROGEN-PAC™ EQUIPMENT	
ABBREVIATION	MEANING
AMD	Air Maintenance Device
NA	Nitrogen Analyzer
PVA	Purge Vent Assembly
SC	“Self-Contained” (refers to self-contained NITROGEN-PAC™ SC Series assemblies)
TAP	True Advanced Purge device

MISCELLANEOUS TERMS	
ABBREVIATION	MEANING
MIC	Microbiologically Influenced Corrosion
N ₂	Nitrogen (2 represents two atoms of nitrogen in a naturally-occurring diatomic molecule)
NFPA	National Fire Protection Association
NPT	National Pipe Thread - Tapered
Sch.	Schedule (refers to standard expression of pipe wall thickness)

SAFETY INFORMATION

This manual contains safety information that is important to know and understand. This information is provided for the safety of installers, operators, and users of the UNITED Fire Systems **NITROGEN-PAC™** equipment. Carefully read, understand, and follow instructions identified by these symbols.



The use of the word “DANGER” identifies an immediate hazard with a likelihood of death or serious personal injury if instructions, including recommended precautions, are not followed.



The use of the word “WARNING” identifies the presence of hazards or unsafe practices that could result in death, personal injury, or serious property damage if instructions, including recommended precautions, are not followed.



The use of the word “CAUTION” identifies possible hazards or unsafe practices that could result in personal injury or property damage if instructions, including recommended precautions, are not followed.



The use of the word “IMPORTANT” identifies special instructions, not related to hazards that should be followed.

IMPORTANT NOTICES TO INSTALLERS AND USERS

This manual must be read thoroughly and completely understood before installation and operation of UNITED Fire Systems **NITROGEN-PAC™** equipment. All appropriate safety standards for handling of gases as determined by local or national laws and regulations should be followed at all times.



WARNING

Do not operate unit if damage occurred during shipping, handling, or use. Contact UNITED Fire Systems immediately. Failure to do so could result in death, personal injury, or serious property damage.

General Safety Information



IMPORTANT

Read all of the safety information in this manual before operating this equipment. Use of the equipment in a manner not specified within this manual may impair the protection provided by the UNITED Fire Systems **NITROGEN-PAC™** equipment and could result in an unplanned release of pressure, which may cause serious injury or damage. Only competent personnel, who have been trained, qualified, and approved by UNITED Fire Systems should perform commissioning, servicing, and repair procedures.

When handling, installing, or operating this equipment, personnel must employ safe engineering practices and observe all related local regulations, health, and safety procedures, and legal requirements for safety.

Ensure that the equipment is depressurized and electrically isolated before carrying out any of the scheduled maintenance instructions specified in this manual.

Nitrogen is not a poisonous gas. However, in a concentrated form, there is a risk of asphyxiation. The SC unit produces both a flow of nitrogen and a flow of oxygen enriched air which quickly disperses in the atmosphere. However, do not directly inhale the output gas from the outlet pipe.

NITROGEN-PAC™ SC Series equipment is classified as non-hazardous for transportation purposes and as non-flammable for fire regulations. This equipment is for indoor use only. Do not operate outdoors.

Specific procedures must be followed for maintenance of the **NITROGEN-PAC™** SC system and the equipment to which the unit is connected. Appropriate labels must be continuously displayed in all areas where personnel might be exposed to a nitrogen atmosphere.

FOREWORD

This manual is written for those who install, operate and maintain UNITED Fire Systems **NITROGEN-PAC™** SC Series sprinkler corrosion inhibiting systems. The manual contains installation, operation, and maintenance information for these assemblies.



IMPORTANT

UNITED Fire Systems assumes no responsibility for the installation, operation, or maintenance of any systems other than those addressed in this manual. The data contained in this manual is for information purposes only. UNITED Fire Systems believes this data to be accurate at the time of publication, but the data is published and presented without any guarantee or warranty whatsoever. UNITED Fire Systems disclaims any liability for any use that may be made of the data and information contained in this manual by any and all parties.



IMPORTANT

UNITED Fire Systems **NITROGEN-PAC™** SC Series sprinkler corrosion inhibiting systems are a vital part of the fire protection of any facility where these units are installed. Life safety and property protection depends on continuing proper operation of these assemblies. The owner of the **NITROGEN-PAC™** SC Series equipment is responsible for its condition and continued proper operation. UNITED Fire Systems strongly recommends that all owners of **NITROGEN-PAC™** SC Series systems engage the services of qualified, trained fire protection professionals to design, install, commission, and maintain the equipment.

UNITED Fire Systems **NITROGEN-PAC™** SC Series sprinkler corrosion inhibiting systems are to be installed and maintained by qualified, trained personnel in accordance with:

- This Installation, Operation, and Maintenance Manual P/N 30-NPSICM-000.
- National Fire Protection Association No. 13, “Standard for the Installation of Sprinkler Systems.”
- National Fire Protection Association No. 25, “Standard for the Inspection, Testing, and Maintenance of Water-Based Fire Protection Systems.”
- National Fire Protection Association No. 70, “National Electrical Code®”.

Any questions on the information in this manual should be addressed to:

UNITED Fire Systems
Division of United Fire Protection Corporation
1 Mark Road
Kenilworth, NJ USA 07033
908-688-0300
www.unitedfiresystems.net

LIMITED WARRANTY NITROGEN-PAC™

What Does This Warranty Cover?

This warranty covers all manufacturing defects in material and workmanship in all equipment supplied for new **NITROGEN-PAC™** sprinkler corrosion inhibiting systems.

How Long Does The Coverage Last?

This warranty lasts for eighteen (18) months from the date of shipment to the original purchaser.

What Will UNITED Fire Systems Do?

UNITED Fire Systems will repair, replace, or refund the purchase price of, at its option, any defective **NITROGEN-PAC™** equipment at no charge.

What Does This Warranty Not Cover?

Equipment that has NOT been commissioned by UNITED Fire Systems or a trained distributor is not covered under this warranty. Equipment that is not properly installed and maintained per UNITED Fire Systems manual P/N 30-NPSICM-000 is not covered. Equipment that has been repaired or tampered with not in accordance with the instructions in manual P/N 30-NPSICM-000 is not covered. This warranty does not cover ordinary maintenance in accordance with manual P/N 30-NPSICM-000. Any problem that is caused by abuse, misuse, or an act of God (such as a flood) is not covered. Transportation and shipping charges to return product to UNITED Fire Systems or for UNITED Fire Systems to ship repaired or replacement product are not covered. Also, consequential and incidental damages are not recoverable under this warranty. Some states do not allow the exclusion or limitation of incidental or consequential damages, so the above limitation or exclusion may not apply.

How Do You Obtain Service?

In order to be eligible for service under this warranty, your equipment must have been commissioned by UNITED Fire Systems or a trained distributor. If something goes wrong with your **NITROGEN-PAC™**, contact:

UNITED Fire Systems
Division of UNITED Fire Protection Corporation
1 Mark Road
Kenilworth, NJ USA 07033
908-688-0300
www.unitedfiresystems.net

= OR =

Your
Trained
Distributor

Is This The Entire Warranty?

This limited warranty is the entire warranty given by UNITED Fire Systems to the purchaser of **NITROGEN-PAC™** equipment. There are no other warranties expressed or implied, beyond those required by law.

How Do State and Federal Laws Apply?

This warranty gives you specific legal rights per Federal law. You may also have other rights which vary from state to state.

1. GENERAL INFORMATION

- 1.1. GLOSSARY.** All glossary terms are defined in reference to their use in this manual. Refer to this glossary for definitions of unfamiliar terms encountered when reading and using this manual.
- 1.1.1. Air.** Air is the naturally occurring gas making up Earth's atmosphere. Air consists of a mixture of gases, of which two predominate (see the glossary terms Nitrogen and Oxygen).
- 1.1.2. Coalescing Filter.** The coalescing filter used in the **NITROGEN-PAC™** SC Series Assembly is located in the nitrogen generator cabinet. This filter separates oil from the dried compressed air, avoiding contamination of the separator membrane.
- 1.1.3. Compressed Air.** Compressed air refers to the output of the **NITROGEN-PAC™** compressor. This air has NOT been conditioned for entry into the nitrogen generator cabinet. The compressed air requires drying by the refrigerated dryer before entering the nitrogen generator cabinet.
- 1.1.4. Pressure Dew Point.** The temperature at which the water in a compressed gas at given pressure condenses into liquid water at the same rate at which it evaporates. At temperatures below the pressure dew point, liquid water will leave the gas. At temperatures above the pressure dew point, liquid water will be taken up by the gas.
- 1.1.5. Dried Compressed Air.** Dried compressed air refers to the output of the **NITROGEN-PAC™** SC refrigerated dryer. This compressed air has been conditioned for entry into the nitrogen generator cabinet.
- 1.1.6. Microbiologically Influenced Corrosion (MIC).** Microbiologically influenced corrosion (also known as MIC) occurs inside steel dry and preaction sprinkler pipes in the presence of certain microbes. This form of corrosion causes thinning of pipe walls, possibly leading to failure under water pressure. Pinhole leaks can occur, leading to water damage. Roughening of the internal pipe surface leads to unpredictable hydraulics, impairing the effectiveness of the sprinkler system. The tubercles formed by the microbes can loosen, clogging sprinkler heads and impairing or preventing the discharge of water onto a fire. MIC microbes can be aerobic, growing in the presence of oxygen, or anaerobic, not needing oxygen but growing in the presence of water. Prevention of MIC results in longer life and better functionality of the sprinkler system. MIC can be inhibited by using nitrogen to displace oxygen and dry out the inside of the pipe.
- 1.1.7. Nitrogen (N₂).** Nitrogen is a naturally occurring diatomic gas present in Earth's atmosphere at a concentration of approximately 78% (v/v). All references to "nitrogen" in this manual are the output from the nitrogen outlet of the SC Series assembly. This outlet delivers gas that is at least 98 percent (v/v) nitrogen, at a pressure dew point of approximately -40°F. The pressure dew point of nitrogen is much lower than of compressed air, making nitrogen much more effective at drying out the inside of a sprinkler pipe.
- 1.1.8. Oxidation Corrosion.** Oxidation corrosion (also known as rust) occurs inside steel dry and preaction sprinkler pipes in the presence of oxygen and water. This form of corrosion causes thinning of pipe walls, possibly leading to failure under water pressure. Pinhole leaks can occur, leading to water damage. Roughening of the internal pipe surface leads to unpredictable hydraulics, impairing the effectiveness of the sprinkler system. Loose rust particles can clog sprinkler heads, impairing or preventing the discharge of water onto a fire. Prevention of oxidation corrosion results in longer life and better functionality of the sprinkler system. Oxidation corrosion can be inhibited by using nitrogen to displace oxygen and dry out the inside of the pipe.
- 1.1.9. Oxygen (O₂).** Oxygen is a naturally occurring diatomic gas present in Earth's atmosphere at a concentration of approximately 21% (v/v). Oxygen is discharged from the nitrogen generator cabinet after being separated from dried compressed air by the separator membrane.
- 1.1.10. Particulate Filter.** The particulate filter used in the **NITROGEN-PAC™** SC is located in the nitrogen generator cabinet. This filter separates particulate matter from the dried compressed air stream, avoiding contamination of the separator membrane.

- 1.1.11. Purging.** Because of its low dew point, the nitrogen introduced into the sprinkler piping by the **NITROGEN-PAC™** system absorbs liquid water. To ensure complete drying of the pipe interior, saturated nitrogen within the pipe must be replaced by dry nitrogen. Purging ensures that this process occurs.
- 1.1.12. Separator Membrane.** When dried compressed air is supplied to the separator membrane in the **NITROGEN-PAC™** SC nitrogen generator cabinet, the smaller oxygen and other gas molecules permeate through the walls of hollow fiber membranes. The larger nitrogen molecules flow through the fibers and exit through the ends of the fibers.
- 1.2. SYSTEM PURPOSE.** The UNITED Fire Systems **NITROGEN-PAC™** SC Series Sprinkler Corrosion Inhibiting System is a fully integrated nitrogen generating system designed to introduce high-purity nitrogen into preaction or dry sprinkler piping. **NITROGEN-PAC™** replaces the existing air compressor, providing the necessary supervisory pressure in the form of nitrogen instead of air. **NITROGEN-PAC™** occupies minimal space, operates quietly, and can be installed near the sprinkler system riser(s).

The interior of preaction and dry sprinkler piping is subject to corrosion, which can lead to clogged sprinkler heads, leaks, and pipe failure. This corrosion can be of two distinct types. Oxidation corrosion takes place in the presence of oxygen, and is accelerated by the presence of water. Microbiologically influenced corrosion (MIC) takes place in the presence of certain microbes that attack metal, again in the presence of water and in many cases oxygen. Reducing the damaging effects of corrosion is best accomplished by greatly reducing or eliminating the amount of water and oxygen left in the pipe. Ordinary air compressors used to provide supervisory pressure keep the oxygen concentration inside the pipe the same as normal air – ideal for oxidation corrosion to take place. Ordinary compressors also do not dry the air – residual water from system testing remains in low points, and moist air can actually increase standing water within pipes from condensation. The introduction of high-purity dry nitrogen with a low dew point reduces or eliminates these two problems. The interior of the pipe remains dry, with very little oxygen remaining to attack the metal.



Rapid release of nitrogen gas into an enclosed space displaces oxygen and can cause an asphyxiation hazard. Inhalation of nitrogen in increased concentration can result in unconsciousness and asphyxiation without warning. All areas containing nitrogen system equipment **MUST** be adequately ventilated. All nitrogen gas leaks discovered during installation, commissioning, and maintenance of **NITROGEN-PAC™** nitrogen generating equipment **MUST** be corrected promptly. Failure to comply can result in death or serious personal injury.

1.3. **FUNCTIONAL DESCRIPTION.** Refer to Figure 1.

Figure 1
Functional Description and General Arrangement

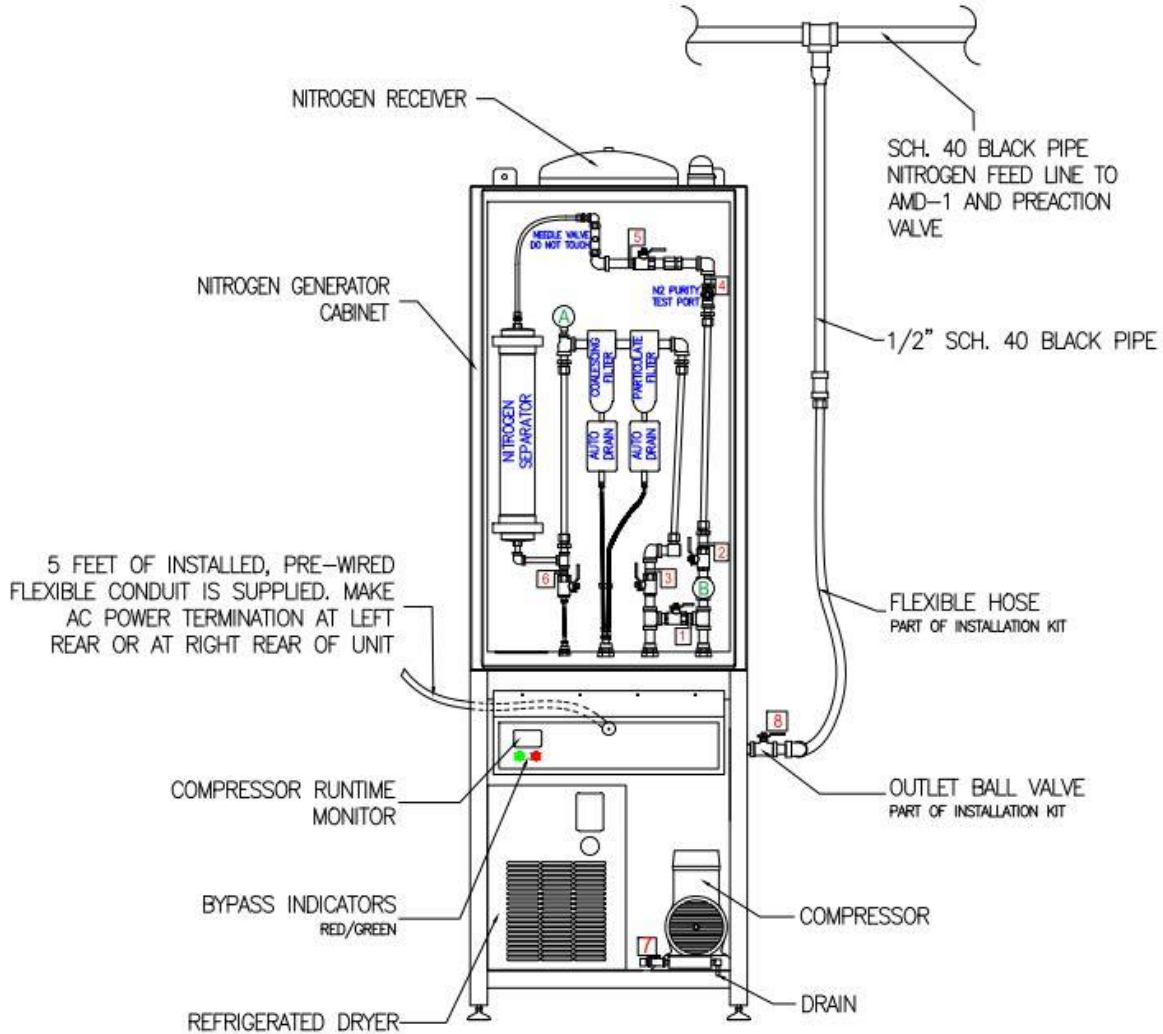

- A. The compressor compresses atmospheric air for entry into the refrigerated dryer.
- B. Dried compressed air leaves the refrigerated dryer and enters the nitrogen generator cabinet.
- C. Coalescing and particulate filters in the nitrogen generator cabinet remove oil and particulate matter from the dried compressed air.
- D. The nitrogen separator membrane in the nitrogen generator cabinet separates oxygen from the dried compressed air. The 98% pure nitrogen is piped to the nitrogen receiver. The separated oxygen is vented to the interior of the cabinet, and openings in the cabinet release this oxygen back into the atmosphere.
- E. The nitrogen receiver stores nitrogen for use in the sprinkler piping.
- F. Nitrogen is provided to the sprinkler system valve trim through an air maintenance device (not shown).
- G. Air is gradually displaced by nitrogen as air leaves through the purge vent assembly.
- H. Even when 98% pure nitrogen is established in the sprinkler pipe, purging can continue to allow the dry nitrogen to remove the water.

1.4. COMPONENT DESCRIPTIONS.

1.4.1. SC Series Assemblies. Refer to Figures 1 and 2.

Figure 2
SC Series Assembly



- 1.4.1.1. Compressor.** The compressor provides air for 30 minute initial fill of dry or preaction sprinkler piping per NFPA 13, and supplies compressed air for the production of nitrogen.
- 1.4.1.2. Refrigerated Dryer.** The refrigerated dryer removes moisture from compressed air from the compressor, creating dried compressed air suitable for the operating characteristics of the separator membrane within the nitrogen generator cabinet. Drying the compressed air is also important for generating nitrogen with a dew point low enough for effective drying of the inside of the sprinkler pipe.
- 1.4.1.3. Nitrogen Generator Cabinet.** The nitrogen generator cabinet is the heart of the **NITROGEN-PAC™** system. The cabinet contains the membrane that separates nitrogen from compressed air. Also included are coalescing and particulate filters which prolong the life of the membrane, and valves for operation of the system.
- 1.4.1.3.1. Particulate and Coalescing Filters.** The particulate and coalescing filters are factory installed inside the nitrogen generator cabinet. Each filter has a rugged cast aluminum housing and a filter element constructed with a stainless steel support core and high performance filter media, pre-assembled into each housing. Filter element replacement is simple. Compressed air enters the inlet port of the filter and passes through the single filter element. In the coalescing filter, air flows from the inside to the outside of the element. In the particulate filter, air flows from the outside of the element to the inside. Clean air exits the opposite side of the filter.
- 1.4.1.3.2. Membrane Technology.** A membrane is a selective barrier, allowing gases to move through the membrane at different rates. A helium-filled balloon is an example of a membrane - helium passes through pores in the balloon over time, causing the balloon to deflate. The membrane separator used in the nitrogen generator cabinet work on a similar principle, involving the permeation of gases through a polymer membrane fiber. The membrane separator contains thousands of fibers installed into a housing shell which is made from ABS plastic. Dried compressed air is fed into the separator, forcing the gas down the bores of the hollow fibers. Nitrogen molecules can't pass quickly through the fibers, so they concentrate as they travel down the length of the separator and exit the separator under pressure. Oxygen and other gas molecules quickly permeate through the wall of the hollow fibers and exit through a different port.
- 1.4.1.3.3. Runtime Monitor.** The runtime monitor is a digital display on the front of the control cabinet. The monitor tracks the hours and minutes of compressor run time. This information can be used to evaluate the amount of leakage present in the sprinkler system.
- 1.4.1.3.4. Bypass Valves and Indicators.** Valves accessible when the nitrogen generator cabinet cover is open allow bypassing of the filters and membrane. This facilitates the initial fill of the sprinkler system piping with compressed air, as required by NFPA 13. Green and red visual indicators on the front of the control cabinet show the status of the valves. Green indicates the system is in Normal mode, supplying nitrogen to the sprinkler system piping. Flashing Red indicates the system is in Bypass mode, supplying compressed air to the sprinkler system piping for initial fill or air only for sprinkler supervision if nitrogen is temporarily not available. An additional flashing red beacon on the top of the unit also indicates Bypass mode.



WARNING

The nitrogen generator cabinet creates a 30% to 40% oxygen concentration exhaust that may present a flammability hazard. Ensure the SC Series assembly is NOT located in an area where an oxygen-enriched atmosphere will be a hazard. Failure to comply with this warning can result in increased risk from fire, including death, serious personal injury, and property damage.



IMPORTANT

Adequate ventilation is important for the SC unit. While natural ventilation or existing openings may be adequate, consideration should be given to providing additional ventilation when locating the unit in a closet or other small space. A louvered door or 1-1/2 inch gap between the door and floor should be sufficient. Check with the owner and local codes before modifying any door.

- 1.4.1.4. Nitrogen Receiver.** The nitrogen receiver is a steel tank for receiving and storing nitrogen from the nitrogen generator cabinet. The receiver is attached to the back of the cabinet.
- 1.4.2. Purge Vent Assemblies Model PVA.** This device purges gas from the interior of the sprinkler pipe, allowing the **NITROGEN-PAC™** system to replace air with nitrogen, and also allowing nitrogen to remove liquid water from inside the pipe. This assembly should be connected to the sprinkler piping in the vicinity of the inspector's test connection. A float valve prevents the escape of water when the sprinkler valve opens and the sprinkler piping fills with water. A fixed orifice regulates the amount of gas leaving the pipe. A union facilitates installation and positioning. A strainer helps prevent blockage of the orifice. A drain plug allows occasional removal of accumulated liquid water.
- 1.4.2.1. Model PVA-3.** Model PVA-3 serves as a connection point for an N₂ Purity Analyzer – Hand-Held Model NA-1 to assess the percentage of nitrogen in the pipe manually.
- 1.4.2.2. P/N 31-100020-101 Optional Muffler Assembly for Model PVA-3.** The optional Muffler Assembly P/N 31-100020-101 easily attaches to the outlet of the Model PVA-3 Purge Vent Assembly. The muffler should provide approximately 15 dB noise reduction at the location of the PVA. The muffler is easily removed for attachment of the Model NA-1 N₂ Purity Analyzer – Hand-Held.
- 1.4.2.3. Model PVA-2.** Model PVA-2 permits connection of flexible tubing that directs samples of the gas within the pipe to a UNITED Fire Systems True Advanced Purge (TAP) device. The TAP device automatically displays the percentage of nitrogen present in the sprinkler pipe, and also automates the initial purge / maintenance purge process. See separate TAP Installation, Commissioning, and Maintenance Manual for details on installation of the True Advanced Purge (TAP) device. (NOTE: The TAP device is equipped with mufflers so there is no need for P/N 31-100020-101.)

Figure 3
Purge Vent Assembly Model PVA
(PVA-3 shown)

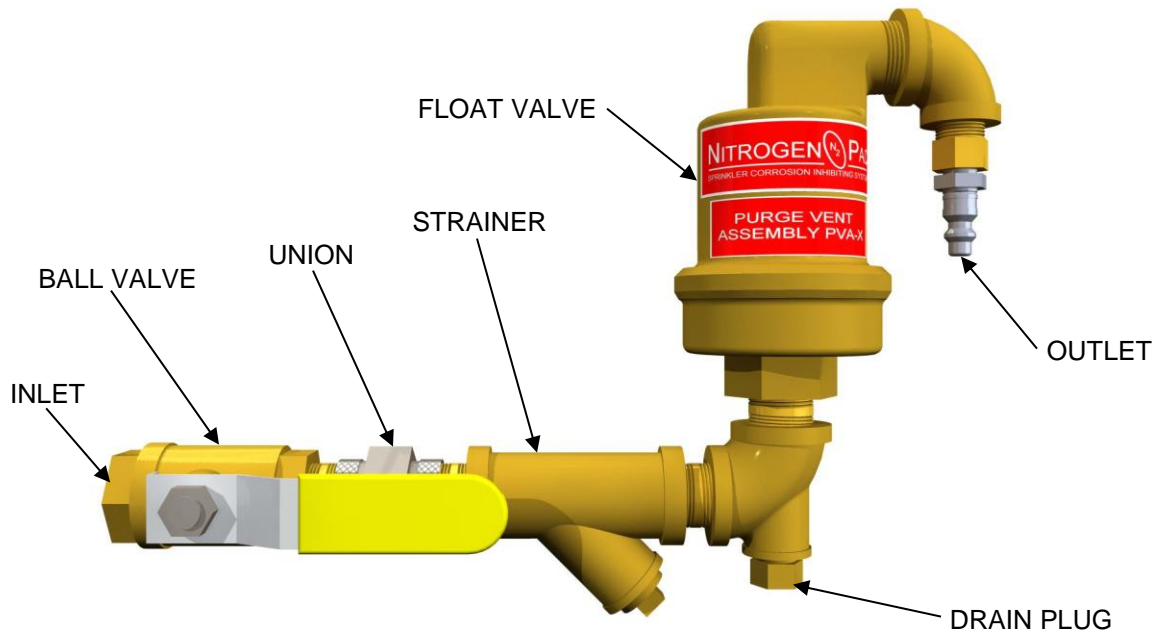
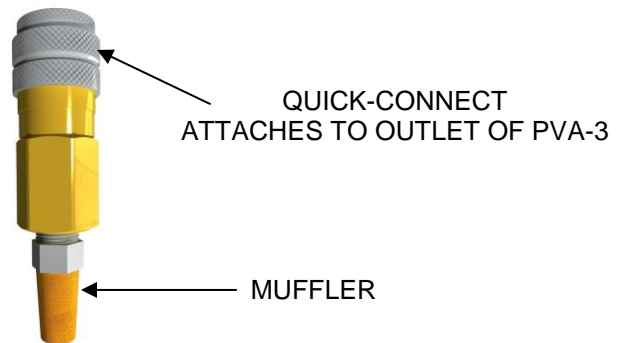

Figure 4
P/N 31-10020-101 Optional PVA Muffler Assembly
(For use with Purge Vent Assembly Model PVA-3)



- 1.4.3. N₂ Purity Analyzer – Hand-Held Model NA-1.** (Figure 5) The N₂ purity analyzer is a hand held device designed to permit manual monitoring of the percent nitrogen at either a **NITROGEN-PAC™** purge vent Model PVA-3 or at the system’s nitrogen generator cabinet. Occasional monitoring at the nitrogen generator cabinet provides assurance that the generator is performing as intended. Monitoring at the system’s purge vent(s) provides assurance that 98% nitrogen is present, and air has been expelled. The Model NA-1 analyzer is hand-held, battery operated, and contains a large 3-digit display directly reading the percent nitrogen when attached to a sampling point. The analyzer is equipped with a length of flexible tubing and half of a quick-connect, compatible with both the sampling point in the nitrogen generator cabinet and on the purge vent(s).

Figure 5
N₂ Purity Analyzer – Hand-Held Model NA-1



- 1.4.4. Air Maintenance Device Model AMD-1.** (Figure 6) The air maintenance device is designed to automatically regulate and maintain the flow of nitrogen from a **NITROGEN-PAC™** system into dry or preaction sprinkler pipe. The nitrogen pressure flows through a regulator so that upon activation of a sprinkler head, the nitrogen pressure will not interfere with the operation of the sprinkler valve or lengthen the time until the piping fills with water. Shutoff and bypass ball valves are provided to permit initial fill of the pipe with air, in accordance with the NFPA 13 mandated time requirement of 30 minutes or less. A “Y” strainer protects the regulator from particulate matter.

Figure 6
Air Maintenance Device Model AMD-1



- 1.4.5. **Optional True Advanced Purge System Model TAP-G2.** (Figure 7) The True Advanced Purge unit is designed to automatically purge air from within a dry-pipe or preaction sprinkler system and replace the air with 98% nitrogen from a NITROGEN-PAC™ sprinkler corrosion inhibiting system. The system also automatically samples, analyzes, and displays the percentage of nitrogen within the pipe.

Figure 7
True Advanced Purge System Model TAP-G2



- 1.4.6. **Optional Corrosion Monitor Assembly Model CMA-1.** (Figure 8) The corrosion monitor assembly is designed for monitoring the possible corrosion inside of a wet or dry sprinkler system piping. The assembly consists of a corrosion probe in a chamber, a pressure switch, an isolation valve, and a drain valve. The corrosion probe keeps pressure from reaching the pressure switch. When corrosion perforates the probe, sprinkler system pressure reaches the pressure switch, actuating a signal and providing early warning of possible corrosion inside the piping. The isolation valve allows replacement of the corrosion probe without depressurizing the entire system, and the drain valve safely vents pressure from the probe chamber.

Figure 8
Corrosion Monitor Assembly Model CMA-1



2. EQUIPMENT SELECTION

2.1 Introduction. This section outlines the steps to properly select the equipment for a UNITED Fire Systems **NITROGEN-PAC™** SC Series sprinkler corrosion inhibiting system. The entire section should be reviewed and understood by system designers and installers. Proper equipment selection will result in the longest possible system life, fewest number of facility interruptions such as water leaks, pipe ruptures, inadvertent valve trips, and spurious low air signals, and the lowest possible cost for initial equipment, commissioning, operation (especially run time), and ongoing maintenance and repairs.

2.2 Basis for Equipment Selection. Equipment for SC Series sprinkler corrosion inhibiting systems is based on the relevant portions of NFPA 13, *Standard for the Installation of Sprinkler Systems*, NFPA 25, *Standard for the Inspection, Testing, and Maintenance of Water-Based Fire Protection Systems*, and the industry-standard target of 98% minimum purity nitrogen in each sprinkler system.

2.3 Steps to Follow.

2.3.1 Read, understand, and follow the instructions in this manual.

2.3.2 Perform a survey of the sprinkler system(s) to be supplied with nitrogen. Form UFS-1001 (see Figure 9) can be used as an aid to surveying and recording the information needed. This form is available from UNITED Fire Systems in printable format for easy field use, and also in Excel format for automatic selection of proper equipment.

2.3.3 Use survey information to choose proper SC Series nitrogen generator unit(s) to be supplied and all other components needed for a complete system.

Figure 9
Form UFS-1001

UNITED FIRE SYSTEMS		UNITED FIRE SYSTEMS 1 MARK ROAD, KENILWORTH, NJ 07033 USA 908-688-0300 -- www.unitedfiresystems.com		NITROGEN-PAC™						
NITROGEN-PAC™ SC SERIES EQUIPMENT SELECTION GUIDE UFS-1001 REV 4.01 - APR 2019 - PAGE 1 OF 2										
INSTRUCTIONS										
1. Become familiar with Section 2 of SC Series Installation, Commissioning, and Maintenance Manual P/N 30-NPSICM-000. 2. Perform survey of sprinkler system(s) to be protected by a NITROGEN-PAC™ SC Series sprinkler corrosion inhibiting system. 3. Items in BLUE boxes should be filled in by person performing survey. 4. Items on both pages in RED boxes automatically fill based on entered survey information. 5. Maximum allowable supervisory pressure is 40 PSIG.										
NITROGEN-PAC SC UNIT LIMITATIONS = AND = AUTOMATIC UNIT SELECTION										
FOR INITIAL-FILL WITH AIR (IF REQUIRED)			FOR NITROGEN							
SINGLE LARGEST RISER - GALLONS		GENERATION CAPACITY - MAXIMUM CAPACITY		UNIT MODEL NUMBER						
MAXIMUM NUMBER OF RISERS	UP TO 20 PSI	OVER 20 TO 40 PSI	OF ALL RISERS - GALLONS							
3 RISERS	600 GALLONS	300 GALLONS	800 GALLONS		MODEL SC-1S					
5 RISERS	600 GALLONS	300 GALLONS	1200 GALLONS		MODEL SC-1M					
3 RISERS	950 GALLONS	475 GALLONS	1600 GALLONS		MODEL SC-2M					
5 RISERS	950 GALLONS	475 GALLONS	4000 GALLONS		MODEL SC-2L					
STEP 1 - INITIAL-FILL WITH AIR CLICK HERE TO CLEAR STEP 1 - INITIAL-FILL WITH AIR SELECTION										
IS NITROGEN-PAC SYSTEM REQUIRED TO PERFORM INITIAL-FILL FUNCTION? NO										
STEP 2 - PIPE VOLUME CALCULATOR CLICK HERE TO CLEAR STEP 2 - PIPE VOLUME CALCULATOR ENTRIES										
SCHEDULE 40 PIPE		NOMINAL PIPE SIZE		1/2"	3/4"	1"	1-1/4"	1-1/2"	2"	
		GALLONS PER FOOT		0.016	0.028	0.045	0.078	0.106	0.175	
		ENTER FEET OF PIPE								
		ENTER INCHES OF PIPE								
		PIPE VOLUME (GALLONS)								
		NOMINAL PIPE SIZE		2-1/2"	3"	4"	5"	6"	8"	
		GALLONS PER FOOT		0.249	0.384	0.662	1.040	1.501	2.599	
		ENTER FEET OF PIPE								
		ENTER INCHES OF PIPE								
		PIPE VOLUME (GALLONS)								
SCHEDULE 10 PIPE		NOMINAL PIPE SIZE		2"	2-1/2"	3"	4"	5"	6"	8"
		GALLONS PER FOOT		0.190	0.284	0.434	0.741	1.098	1.649	2.777
		ENTER FEET OF PIPE								
		ENTER INCHES OF PIPE								
		PIPE VOLUME								
TOTAL PIPE VOLUME IN GALLONS - TRANSFER TO STEP 3										
STEP 3 - INDIVIDUAL RISER INFORMATION		CLICK HERE TO CLEAR STEP 3 - INDIVIDUAL RISER INFORMATION								
RISER #	PIPE VOLUME (GALLONS)	SUPERVISORY PRESSURE (PSIG)	NUMBER OF RISERS IN SYSTEM =							
1			CAPACITY IN GALLONS OF SINGLE LARGEST RISER =							
2			CAPACITY IN GALLONS OF ALL RISERS =							
3			HIGHEST VALUE OF SUPERVISORY PRESSURE =							
4										
5										
!! IMPORTANT !! MAXIMUM GALLON VALUES ARE BASED ON SPRINKLER PIPING LEAKAGE NOT EXCEEDING NFPA 13 ACCEPTANCE REQUIREMENT OF MAXIMUM 1-1/2 PSIG IN 24 HOURS STARTING AT 40 PSIG. UNITED FIRE SYSTEMS RECOMMENDS PERFORMING LEAKAGE TEST, AND CORRECTING EXCESS LEAKAGE, BEFORE DESIGNING, INSTALLING, AND COMMISSIONING A NITROGEN-PAC™ SYSTEM.										

UNITED FIRE SYSTEMS		UNITED FIRE SYSTEMS 1 MARK ROAD, KENILWORTH, NJ 07033 USA 908-688-0300 -- www.unitedfiresystems.com		NITROGEN-PAC™	
NITROGEN-PAC™ SC SERIES EQUIPMENT SELECTION GUIDE UFS-1001 REV 4.01 - APR 2019 - PAGE 2 OF 2					
STEP 4 - AUTOMATIC BILL OF MATERIALS					
UFS P/N	DESCRIPTION	QUANTITY	DATA SHEET		
STEP 5 - ADDITIONAL EQUIPMENT CLICK HERE TO CLEAR STEP 5 - ADDITIONAL EQUIPMENT					
RISER #	HAZARD DESCRIPTION	AIR MAINTENANCE DEVICE	TRUE ADVANCED PURGE	CORROSION MONITOR ASSEMBLY	
1					
2					
3					
4					
5					
STEP 6 - OPTIONAL EQUIPMENT CLICK HERE TO CLEAR STEP 6 - OPTIONAL EQUIPMENT					
UFS P/N	DESCRIPTION	QUANTITY	DATA SHEET		
31-100020-101	MUFFLER ASSEMBLY FOR PVA-3				UFS-314A
33-000003-050	QTY. (50) FEET OF CONNECTION TUBING FOR TAP				UFS-317A
33-000006-000	CONNECTOR, TUBE x TUBE				UFS-317A
STEP 7 - OTHER SURVEY QUESTIONS CLICK HERE TO CLEAR STEP 7 - OTHER SURVEY QUESTIONS					
ARE SPRINKLER SYSTEM(S) NEW OR EXISTING?					
ARE SPRINKLER SYSTEM(S) EQUIPPED WITH QUICK-OPENING DEVICES (DRY ACCELERATORS)?					
STEP 8 - CUSTOMER INFORMATION CLICK HERE TO CLEAR STEP 8 - CUSTOMER INFORMATION					
CUSTOMER:		PROJECT NAME:			
ADDRESS 1:		ADDRESS 2:			
CITY:		STATE:			
ZIP:		CONTACT:			
PHONE:		EMAIL:			

2.4 Information To Be Obtained During Survey. See Tables 1 and 2.

Table 1
Information To Be Obtained During Survey

Item No.	Item	Explanation
1	Is the nitrogen system required to provide the system initial-fill with air in the NFPA 13 required 30 minutes?	<p>If the answer is “YES”, then the SC Series unit compressor must be sized to provide a sufficient air quantity for the volume of the largest protected sprinkler riser AND a sufficient air quantity to supply nitrogen for the volume of all protected sprinkler risers.</p> <p>If the answer is “NO”, then the SC Series unit compressor must be sized to provide a sufficient air quantity to supply nitrogen for the volume of all protected sprinkler risers. An existing or new air compressor, separate from the SC Series unit, must be provided to supply a sufficient air quantity for the largest protected sprinkler riser.</p>
2	What is the number of sprinkler risers to be protected with nitrogen by one (1) SC Series unit?	One (1) SC Series unit can protect from one (1) to five (5) risers. More than five (5) risers require the use of multiple SC Series units or a NITROGEN-PAC™ M Series system.
3	What is the volume (in gallons) of each sprinkler riser?	The volume of each sprinkler riser is a fundamental item in determining the required SC Series unit with sufficient capacity to supply nitrogen and, if desired, initial-fill air.
4	What is the supervisory pressure (in PSIG) required by each sprinkler riser?	The maximum supervisory pressure supplied by any SC Series unit is 40 PSIG.
5	Are sprinkler system(s) NEW or EXISTING ?	<p>If answer is NEW, the likelihood of significant gas pressure leakage is low. The maximum leakage is 1-1/2 PSIG in 24 hours starting at 40 PSIG.</p> <p>If answer is EXISTING, the likelihood of significant gas pressure leakage is much higher than new systems. To ensure the minimum compressor run time and lengthen compressor life, leaks should be corrected until total leakage is at or below 1-1/2 PSIG in 24 hours starting at 40 PSIG.</p>
6	Are the sprinkler system(s) equipped with quick-opening devices (dry accelerators)?	<p>If answer is YES, consideration must be given to the action of the dry accelerator during purging. To avoid inadvertent sprinkler valve tripping, it may be necessary to replace the dry accelerator with a new device, or close the inlet valve to the dry accelerator during purging.</p> <p>NOTE: Closing the dry accelerator inlet valve may result in lengthened time for water to reach the most remote sprinkler head(s). Ensure that the AHJ and the owner are in agreement regarding closing the dry accelerator inlet valve</p> <p>If answer is NO, no additional consideration is needed.</p>

2.5 Information To Be Derived From Survey. See Table 2.

Table 2
Information To Be Derived From Survey

Item No.	Item	Explanation
7	What is the volume of all risers (in gallons)?	Derive this number by adding the riser volumes from Item 3 (see Table 1) together. The total volume of all risers to be protected is used to determine which SC Series unit will produce the proper amount of nitrogen for all the risers.
8	What is the volume of the single largest riser (in gallons)?	The volume of the single largest riser is used to determine which SC Series unit can supply enough air for the NFPA 13 required 30-minute initial fill.

2.6 Choosing The Proper NITROGEN-PAC™ SC Series Unit. Refer to Table 3. Four (4) different SC Series units are available. Each has its own maximum limits. The selected SC Series unit must meet or exceed all applicable limits determined by the survey.

Table 3
Maximum Limits – NITROGEN-PAC™ SC Series Units

A	B	C	D	E
IF ITEM 1 IS YES, USE A, B, C, AND D				
IF ITEM 1 IS NO, USE A AND B				
SEE ITEM 2	SEE ITEM 7	SEE ITEMS 4 AND 8		
		SINGLE LARGEST RISER (IN GALLONS)		
MAXIMUM NUMBER OF RISERS	MAXIMUM VOLUME OF ALL RISERS (IN GALLONS)	UP TO 20 PSIG SUPERVISORY PRESSURE	UP TO 40 PSIG SUPERVISORY PRESSURE	NITROGEN-PAC™ SC SERIES MODEL NUMBER
3	800	600	300	Model SC-1S
5	1200	600	300	Model SC-1M
3	1600	950	475	Model SC-2M
5	4000	950	475	Model SC-2L

2.6.1 SC Series Unit Initial-Fill With Air. This answer (YES or NO) was determined by survey item 1 (see Table 1). Refer to Table 3.

- a. If the answer is **NO**, then only the limits in Columns **A** and **B** need to be satisfied. Proceed to **2.6.2**.
- b. If the answer is **YES**, then the limits in Columns **A**, **B**, and either C or D need to be satisfied. Proceed to **2.6.2**.

2.6.2 Maximum Number Of Risers. This number was determined by survey item 2 (see Table 1). Refer to Table 3, column **A**.

- a. If the number of risers is 1, 2, or 3, then any of the four (4) SC Series units can be used. Proceed to **2.6.3**.
- b. If the number of risers is 4 or 5, then either the Model SC-1M or Model SC-2L must be chosen. Proceed to **2.6.3**.
- c. If the number of risers is six (6) or more, then consider the use of two (2) or more SC Series units, or a **NITROGEN-PAC™** M Series system.

2.6.3 Maximum Volume Of All Risers. This number was determined by survey item 7 (see Table 2). Refer to Table 3, column B.

- a. When the SC unit is NOT required to provide initial-fill with air (see 2.6.1 a), then:
 - 1. Use an SC-1S unit to provide nitrogen for up to 900 gallons maximum volume of up to 3 risers.
 - 2. Use an SC-1M unit to provide nitrogen for up to 1200 gallons maximum volume of up to 5 risers.
 - 3. Use an SC-2M unit to provide nitrogen for up to 1600 gallons maximum volume of up to 3 risers.
 - 4. Use an SC-2L unit to provide nitrogen for up to 4000 gallons maximum volume of up to 5 risers.
 - 5. If the total volume is more than 4000 gallons, then consider the use of two (2) or more SC Series unit or a **NITROGEN-PAC™** M Series system.
- b. When the SC unit IS required to provide initial-fill with air (see 2.6.1 b), then proceed to 2.6.4.

2.6.4 Determination of Pipe Volume. Determining the actual volume (in gallons) of each riser is necessary for proper SC unit selection. One of several methods may be used:

- a. Examine the system layout drawings for completed pipe volume calculations.
- b. Examine the system hydraulic calculation results for completed pipe volume calculations.
- c. Use the system layout drawings to do a “takeoff” of the sizes and lengths of all piping connected to each riser.
- d. As is typical for existing systems, layout drawings and hydraulic calculations may not be available. The last remaining alternative is to do a field survey of all system piping, by size and length.
 - 1. Determine accessible pipe lengths with a tape measure.
 - 2. When pipe is not directly accessible (such as pipe that is hung overhead, above ceilings, or buried in walls), attempt to estimate lengths by “pacing off” each segment.



IMPORTANT

The pipe volume is a fundamental parameter that **MUST** be determined. If a relatively “inaccurate” method of determining length (such as “pacing off” must be used, make sure that the pipe volume is not underestimated. Underestimating the pipe volume can result in:

- 1. Not meeting the 30-minute initial-fill requirement.
- 2. Greatly extended compressor run time, and shortened compressor life.
- 3. Not reaching or maintaining 98% nitrogen purity in the piping.
- 4. Not maintaining minimum pipe pressure, resulting in unwanted “low air” signals.

WHEN IN DOUBT, OVERESTIMATE!

Table 4

GALLONS PER FOOT OF PIPE BASED ON NOMINAL PIPE SIZE AND PIPE SCHEDULE											
Nominal Pipe Size	1/2”	3/4”	1”	1-1/4”	1-1/2”	2”	2-1/2”	3”	4”	6”	8”
Schedule 40 Pipe	0.016	0.028	0.045	0.078	0.106	0.175	0.249	0.384	0.662	1.501	2.599
Schedule 10 Pipe						0.190	0.284	0.434	0.741	1.649	2.777

2.6.5 Supervisory Pressure. This number was determined by survey item 4 (see Table 1).

- a. Refer to Table 3, column C if the supervisory pressure is 20 PSIG or less.
- b. Refer to Table 3, column D if the supervisory pressure is over 20 PSIG (up to a maximum of 40 PSIG).

2.6.6 Maximum Volume Of Single Largest Riser. This number was determined by survey item 8 (see Table 2). Choose the SC unit model which does not exceed the limits in Columns A and B, and the volume of the single largest riser does not exceed the value in Column C or Column D (see 2.6.4)

2.7 Example 1

2.7.1 Is system required to provide initial-fill with air? **YES.**

2.7.2 How many risers is the system required to protect? **2.**

2.7.3 What is the capacity in gallons of Riser 1?

- **4" Sch. 10 pipe: 124.5 feet** X 0.741 gallons per foot = 92.255 round to **93 gallons.**
- **3" Sch. 10 pipe: 80 feet** X 0.434 gallons per foot = 34.720 round to **33 gallons.**
- **2" Sch. 10 pipe: 240.75 feet** X 0.190 gallons per foot = 45.743 round to **46 gallons.**
- **3/4" Sch. 40 pipe: 146 feet** X 0.028 gallons per foot = 4.088 round to **5 gallons.**
 - **TOTAL = 177 gallons.**

2.7.4 What is the capacity in gallons of Riser 2?

- **8" Sch. 10 pipe: 75.5 feet** X 2.777 gallons per foot = 209.432 round to **210 gallons.**
- **4" Sch. 10 pipe: 160.5 feet** X 0.741 gallons per foot = 118.931 round to **119 gallons.**
- **2-1/2" Sch. 10 pipe: 665 feet** X 0.284 gallons per foot = 188.86 round to **189 gallons.**
- **3/4" Sch. 40 pipe: 276.25 feet** X 0.028 gallons per foot = 7.735 round to **8 gallons.**
 - **TOTAL = 526 gallons.**

2.7.5 What is the capacity in gallons of the single largest riser? **526 gallons (Riser 2).**

2.7.6 What is the capacity in gallons of all risers? $177 + 526 =$ **703 gallons.**

2.7.7 What is the highest required supervisory pressure? **18 PSIG.**

2.7.8 Which NITROGEN-PAC SC unit is required? Since the SC unit is required to perform initial-fill with air, the values in **columns A, B C, and D of Table 3** must all be satisfied.

- a. Column A – Since the example has **2 risers**, any of the four SC units satisfy this requirement.
- b. Column B – Since the example has a capacity of all risers of **703 gallons**, any of the four SC units satisfy this requirement.
- c. Columns C or D – Since the example has a required supervisory pressure of **18 PSIG**, Column C is applicable, and since the capacity of the single largest riser is **526 gallons**, SC Series Model SC-1S may be chosen. (NOTE – If desired, any SC Series model with a greater capacity may also be chosen.)

2.8 Example 2

2.8.1 Is system required to provide initial-fill with air? **NO.**

2.8.2 How many risers is the system required to protect? **4.**

2.8.3 What is the capacity in gallons of Riser 1?

- **4" Sch. 10 pipe: 124.5 feet** X 0.741 gallons per foot = 92.255 round to **93 gallons.**
- **3" Sch. 10 pipe: 80 feet** X 0.434 gallons per foot = 34.720 round to **33 gallons.**
- **2" Sch. 10 pipe: 240.75 feet** X 0.190 gallons per foot = 45.743 round to **46 gallons.**
- **3/4" Sch. 40 pipe: 146 feet** X 0.028 gallons per foot = 4.088 round to **5 gallons.**
 - **TOTAL = 177 gallons.**

2.8.4 What is the capacity in gallons of Riser 2?

- **8" Sch. 10 pipe: 75.5 feet** X 2.777 gallons per foot = 209.432 round to **210 gallons.**
- **4" Sch. 10 pipe: 160.5 feet** X 0.741 gallons per foot = 118.931 round to **119 gallons.**
- **2-1/2" Sch. 10 pipe: 665 feet** X 0.284 gallons per foot = 188.86 round to **189 gallons.**
- **3/4" Sch. 40 pipe: 276.25 feet** X 0.028 gallons per foot = 7.735 round to **8 gallons.**
 - **TOTAL = 526 gallons.**

2.8.5 What is the capacity in gallons of Riser 3?

- **8" Sch. 10 pipe: 75.5 feet** X 2.777 gallons per foot = 209.432 round to **210 gallons.**
- **4" Sch. 10 pipe: 160.5 feet** X 0.741 gallons per foot = 118.931 round to **119 gallons.**
- **2-1/2" Sch. 10 pipe: 665 feet** X 0.284 gallons per foot = 188.86 round to **189 gallons.**
- **3/4" Sch. 40 pipe: 276.25 feet** X 0.028 gallons per foot = 7.735 round to **8 gallons.**
 - **TOTAL = 526 gallons.**

2.8.6 What is the capacity in gallons of Riser 4?

- **8" Sch. 10 pipe: 75.5 feet** X 2.777 gallons per foot = 209.432 round to **210 gallons.**
- **4" Sch. 10 pipe: 160.5 feet** X 0.741 gallons per foot = 118.931 round to **119 gallons.**

- **2-1/2" Sch. 10 pipe: 665 feet** X 0.284 gallons per foot = 188.86 round to **189 gallons.**
- **3/4" Sch. 40 pipe: 276.25 feet** X 0.028 gallons per foot = 7.735 round to **8 gallons.**
 - **TOTAL = 526 gallons.**

2.8.7 What is the capacity in gallons of the single largest riser? **526 gallons (Riser 2).**

2.8.8 What is the capacity in gallons of all risers? $177 + 526 =$ **703 gallons.**

2.8.9 What is the highest required supervisory pressure? **18 PSIG.**

2.8.10 Which NITROGEN-PAC SC unit is required?

2.7.8.1 Since the SC unit is required to perform initial-fill with air, the values in **columns A, B C, and D of Table 3** must all be satisfied.

- a. Column A – Since the example has **2 risers**, any of the four SC units satisfy this requirement.
- b. Column B – Since the example has a capacity of all risers of **703 gallons**, any of the four SC units satisfy this requirement.
- c. Columns C or D – Since the example has a required supervisory pressure of **18 PSIG**, Column C is applicable, and since the capacity of the single largest riser is **526 gallons**, SC Series Model SC-1S may be chosen. (NOTE – If desired, any SC Series model with a greater capacity may also be chosen.)

2.9 Example 3

2.9.1 Is system required to provide initial-fill with air? **YES.**

2.9.2 How many risers is the system required to protect? **5.**

2.9.3 What is the capacity in gallons of Riser 1?

- **2-1/2" Sch. 40 pipe: 195 feet** X 0.249 gallons per foot = 48.555 round to **49 gallons.**
- **2" Sch. 40 pipe: 375 feet** X 0.175 gallons per foot = 65.625 round to **66 gallons.**
- **3/4" Sch. 40 pipe: 410 feet** X 0.028 gallons per foot = 11.48 round to **12 gallons.**
 - **TOTAL = 127 gallons.**

2.9.4 What is the capacity in gallons of Riser 2?

- **3" Sch. 40 pipe: 275 feet** X 0.384 gallons per foot = 105.6 round to **106 gallons.**
- **2-1/2" Sch. 40 pipe: 197 feet** X 0.249 gallons per foot = 49.053 round to **50 gallons.**
- **3/4" Sch. 40 pipe: 862 feet** X 0.028 gallons per foot = 24.136 round to **25 gallons.**
 - **TOTAL = 181 gallons.**

2.9.5 What is the capacity in gallons of Riser 3?

- **3" Sch. 40 pipe: 650 feet** X 0.384 gallons per foot = 249.6 round to **250 gallons.**
- **2" Sch. 40 pipe: 455 feet** X 0.175 gallons per foot = 79.625 round to **80 gallons.**
- **3/4" Sch. 40 pipe: 380 feet** X 0.028 gallons per foot = 10.640 gallons round to **11 gallons.**
 - **TOTAL = 341 gallons.**

2.9.6 What is the capacity in gallons of Riser 4?

- **4" Sch. 40 pipe: 90 feet** X 0.662 gallons per foot = 59.580 round to **60 gallons.**
- **2-1/2" Sch. 40 pipe: 210 feet** X 0.249 gallons per foot = 52.29 round to **53 gallons.**
- **2" Sch. 40 pipe: 675 feet** X 0.175 gallons per foot = 118.125 round to **119 gallons.**
- **3/4" Sch. 40 pipe: 378 feet** X 0.028 gallons per foot = 10.584 round to **11 gallons.**
 - **TOTAL = 243 gallons.**

2.9.7 What is the capacity in gallons of Riser 5?

- **1-1/2" Sch. 40 pipe: 220 feet** X 0.106 gallons per foot = 23.32 rounds to **24 gallons.**
- **3/4" Sch. 40 pipe: 177 feet** X 0.028 gallons per foot = 4.956 round to **5 gallons.**
 - **TOTAL = 29 gallons.**

2.9.8 What is the capacity in gallons of the single largest riser? **341 gallons (Riser 3).**

2.9.9 What is the capacity in gallons of all risers? $127 + 181 + 341 + 243 + 29 =$ **921 gallons.**

2.9.10 What is the highest required supervisory pressure? **25 PSIG.**

2.9.11 Which NITROGEN-PAC SC unit is required?

2.9.11.1 Since the SC unit is required to perform initial-fill with air, the values in **columns A, B C, and D of Table 3** must all be satisfied.

- a. Column A – Since the example has **5 risers**, only the Model SC-1M or the SC-2L will satisfy the requirement.
- b. Column B – Since the example has a capacity of all risers of **921 gallons**, either the Model SC-1M or the SC-2L will satisfy the requirement.

- c. Columns C or D – Since the example has a required supervisory pressure of **25 PSIG**, Column D is applicable, and since the capacity of the single largest riser is **341 gallons**, SC Series Model SC-2L must be chosen.

2.10 Additional Equipment.

2.10.1 Air Maintenance Device (Model AMD-1). If existing sprinkler systems have air maintenance devices already installed, such devices may be re-used. It is recommended that each of these devices be thoroughly inspected and tested for proper operation and absence of internal corrosion and debris before re-use. If sprinkler systems are new, or existing devices require replacement, use qty. (1) Model AMD-1 per sprinkler riser.

2.10.2 Purge Vent Assembly (PVA). Each sprinkler system requires the installation of a purge vent assembly (PVA) to permit replacement of air within each system with nitrogen. The purge vent assembly includes a manual shutoff valve and an automatic float valve to prevent water discharge when the sprinkler system fills with water. Each model of PVA includes the proper orifice for purging and the proper outlet connection for the nitrogen purity monitoring method chosen. Choose the proper model of purge vent assembly (PVA) per **Table 5**.

**Table 5
Purge Vent Assemblies**

Model	Description	Outlet Connection
PVA-2	For use on systems with True Advanced Purge Device – see 2.10.3 .	Push-on tubing
PVA-3	For use on systems with Hand-Held Nitrogen Purity Analyzer - see 2.10.4 .	Male quick-connect
(PVA-1)	DO NOT use Model PVA-1 Purge Vent Assembly on NITROGEN-PAC™ SC Series systems. The orifice in this assembly is intended for use with NITROGEN-PAC M Series systems only.	

2.10.3 [Optional] Muffler Assembly for Model PVA-3 (P/N 31-100020-101). If Model PVA-3 Purge Vent Assemblies are installed in locations where occasional gas discharge noise is considered objectionable, a muffler assembly (P/N 31-100020-101) may be installed. The muffler assembly consists of a sintered bronze muffler and a female quick-connect that mates to the male quick-connect on the PVA-3. The muffler assembly may be removed to attach the hand-held nitrogen purity analyzer (Model NA-1) to the PVA-3 outlet.

2.10.4 Hand-Held Nitrogen Purity Analyzer Model NA-1. The hand-held nitrogen purity analyzer Model NA-1 is used to manually measure nitrogen purity at each PVA-3 and at the nitrogen purity port within the SC Series nitrogen generator cabinet.

2.10.5 [Optional] True Advanced Purge (Model TAP-G2-115-1).

- a. TAP Device.** The True Advanced Purge (TAP) Device automatically measures the nitrogen purity in the sprinkler piping, and also automatically controls the required purge cycle. Choose one (1) TAP device per sprinkler riser where such automation is desired. NOTE: Choose Model PVA-2 Purge Vent Assembly for use with each TAP device.
- b. Connection Tubing.** The TAP device inlet is connected to the outlet of the Model PVA-2 Purge Vent Assembly with plenum-rated polyethylene tubing. The device is shipped with twenty (20) feet of suitable tubing. Additional fifty (50) foot lengths of tubing (P/N 33-000003-050) are available.
- c. Connector, Tube x Tube.** Connector P/N 33-000006-000 is used to connect individual lengths of tubing together.

2.10.6 [Optional] Corrosion Monitor Assembly (Model CMA-1). The optional corrosion monitor assembly Model CMA-1 may be installed to provide a signal when internal corrosion has occurred inside the sprinkler pipe.

2.11 Bill Of Materials. To aid in ordering, use the Bill Of Materials in **Table 6** to choose the correct system components.

Table 6
Bill Of Materials

UFS Model Number	Description	Qty.	Notes
SC-1S-115-1	NITROGEN-PAC SC Unit, Model SC-1S		
SC-1M-115-1	NITROGEN-PAC SC Unit, Model SC-1M		
SC-2M-115-1	NITROGEN-PAC SC Unit, Model SC-2M		
SC-2L-115-1	NITROGEN-PAC SC Unit, Model SC-2L		
AMD-1	Air / Nitrogen Maintenance Device		1 per sprinkler riser
PVA-2	Purge Vent Assembly, for use with TAP Device		1 per sprinkler riser
PVA-3	Purge Vent Assembly, for Manual Nitrogen Purity Checking		
31-100020-101	Muffler Assembly, for Model PVA-3		Optional
NA-1	Hand-held Nitrogen Purity Analyzer		1 per system
TAP-G2-115-1	True Advanced Purge device		1 per sprinkler riser
33-000003-050	TAP Connection Tubing, 50 foot length		Optional
33-000006-000	Connector, Tubing x Tubing		Optional
CMA-1	Corrosion Monitor Assembly		Optional

2.12 Additional Survey Items.

2.12.1 Are Sprinkler Systems NEW or EXISTING? If the answer is EXISTING, it should be understood that existing sprinkler systems typically have large leakage rates. NFPA 25 permits a maximum leakage rate of 3 PSIG in 2 hours starting at 40 PSIG. To avoid excessive NITROGEN-PAC™ SC Series compressor run time and possible premature compressor failure / replacement, leaks should be corrected until the measured leakage rate does not exceed 1-1/2 PSIG in 24 hours starting at 40 PSIG.

2.12.2 Are Sprinkler Systems Equipped with Quick-Opening Devices (Dry Accelerators)? Dry accelerators are used on some sprinkler systems to ensure that water is delivered to the farthest sprinkler head in an acceptable period of time. Dry accelerators combined with natural pipe leakage and deliberate purging to increase nitrogen concentration can lead to unwanted dry-pipe valve trips. To avoid valve trips during purging:

- a. Ensure that the dry accelerator device is functioning properly. Consider replacing an existing dry accelerator with a new unit if the device has been in service for an extended period of time.
- b. Reduce natural leakage to as near-zero as possible. Special attention should be paid to existing systems, as natural leakage tends to increase as systems age.
- c. If necessary, close the dry accelerator inlet valve during purging. **NOTE!!** Closing the dry accelerator inlet valve may lengthen the time for water to reach the furthest sprinkler head. Ensure that the system end user and the Authority Having Jurisdiction (AHJ) are aware of the consequences of closing the valve during purging, and consider this acceptable. (It should NOT be necessary to keep the dry accelerator inlet valve closed once the nitrogen purity reaches 98%, and the manual PVA purge valve or the TAP device automatic purge valve are closed.)

3. INSTALLATION



Rapid release of nitrogen gas into an enclosed space displaces oxygen and can cause an asphyxiation hazard. Inhalation of nitrogen in increased concentration can result in unconsciousness and asphyxiation without warning. All areas containing nitrogen system equipment **MUST** be adequately ventilated. All nitrogen gas leaks discovered during installation, commissioning, and maintenance of SC Series nitrogen generating equipment **MUST** be corrected promptly. Failure to comply can result in death or serious personal injury.



IMPORTANT

The installation of the **NITROGEN-PAC™** SC Sprinkler Corrosion Inhibiting System **MUST** be in accordance with this manual. Read this manual in its entirety **BEFORE** beginning installation of the **NITROGEN-PAC™** SC. Understand and follow all instructions provided in this manual.

3.1. Unpacking. Check shipment of the UNITED Fire Systems **NITROGEN-PAC™** SC Series packaging and equipment for damage. If there is any damage or missing parts, the transportation company's agent should make a notation to the effect on the Bill of Lading. Claims should be settled directly with the transportation company. Verify that all parts were received in the shipment as ordered. Contact UNITED Fire Systems immediately if there are any missing parts or discrepancies.



CAUTION

Understand and follow all safety recommendations when moving heavy pieces of equipment. Equipment may be easily tipped over when moving. Failure to use caution can result in equipment damage and personal injury.



IMPORTANT

During unpacking and installation of the **NITROGEN-PAC™** SC, **DO NOT** tip the refrigerated dryer on its side, or turn it upside-down.

3.2. SC Location. Due consideration must be given to all of the following considerations when locating equipment.

3.2.1 Engineering Drawings (if available). If a survey was conducted, and engineering drawings prepared, locate all equipment per these drawings.

3.2.2 Proximity. The **NITROGEN-PAC™** SC unit should be installed in reasonably close proximity to the system riser(s) being protected. The most logical location is in the same sprinkler room as the riser(s). If necessary, the SC unit may be installed remotely. Documentation and signage should be clear to identify which equipment in remote locations is connected together.

3.2.3 Weight. Refer to Table 7 for the weight of the **NITROGEN-PAC™** SC unit. Ensure that the mounting surface is capable of supporting the weight, with a clear safety margin. Consult a structural engineer as necessary to verify suitability of locations.

3.2.4. Noise. **NITROGEN-PAC™** SC units emit noise when the compressor or the refrigerated dryer are running. Such noise is normal and is part of regular system operation. Evaluate all options for SC unit location so that normal noise is not disruptive to building occupants or facility operations. Relocation of the SC unit after installation will probably be complex and expensive.

3.2.5. Temperature. The **NITROGEN-PAC™** SC shall be installed in a location with a minimum temperature of +40 degrees F and a maximum temperature of +122°F. Provide heating or cooling as necessary to keep the **NITROGEN-PAC™** SC unit within these temperature limits.

3.2.6. Clearance. Sufficient clearance should be available after installation for maintenance operations to take place on equipment. Leave at least (3) feet of clearance in front for personnel to access equipment for maintenance. Leave at least (8) inches on each side to permit proper airflow. The nitrogen generator cabinet is equipped with a hinged door. Allow sufficient clearance for the door to be swung completely open.



WARNING

The **NITROGEN-PAC™** SC creates a 30% to 40% oxygen concentration exhaust that may present a flammability hazard. Ensure the **NITROGEN-PAC™** SC is NOT located in an area where an oxygen-enriched atmosphere will be a hazard. Failure to comply with this warning can result in increased risk from fire, including death, serious personal injury and property damage.



IMPORTANT

Adequate ventilation is important for the **NITROGEN-PAC™** SC. While natural ventilation or existing openings may be adequate, consideration should be given to providing additional ventilation when locating the SC in a closet or other small space. A louvered door or 1-1/2 inch gap between the door and floor should be sufficient. Check with the owner and local codes before modifying any door.

3.3. Placement. The **NITROGEN-PAC™** SC does not require fastening to the floor surface. The weight of the assembly is sufficient to hold it in place. If the assembly is properly leveled, movement should not occur. The assembly is equipped with four (4) leveling feet. After placing the unit in the intended location, use the leveling feet to level the unit both front-to-back and side-to-side.

Table 7
NITROGEN-PAC™ SC – Dimensions and Weight

Model No.	Height (H) inches	Width (W) inches	Depth (D) inches	Unit Weight Lbs.	Shipping Weight Lbs.
All Models	74	24	21.5	385	Approx. 450

3.4. Installation Kit. The installation kit packed with the SC contains:

- Qty. (1) outlet port ball valve assembly
- Qty. (1) outlet hose
- Qty. (1) valve identification flag

Refer to Figure 10.

- Remove and discard plastic plug from SC outlet port.
- Attach outlet port ball valve assembly to SC outlet port. Orient as shown in Figure 10.
- Affix valve identification flag near outlet port ball valve.
- Retain the outlet hose for connection of nitrogen piping to outlet.

Figure 10
Assembly of Installation Kit

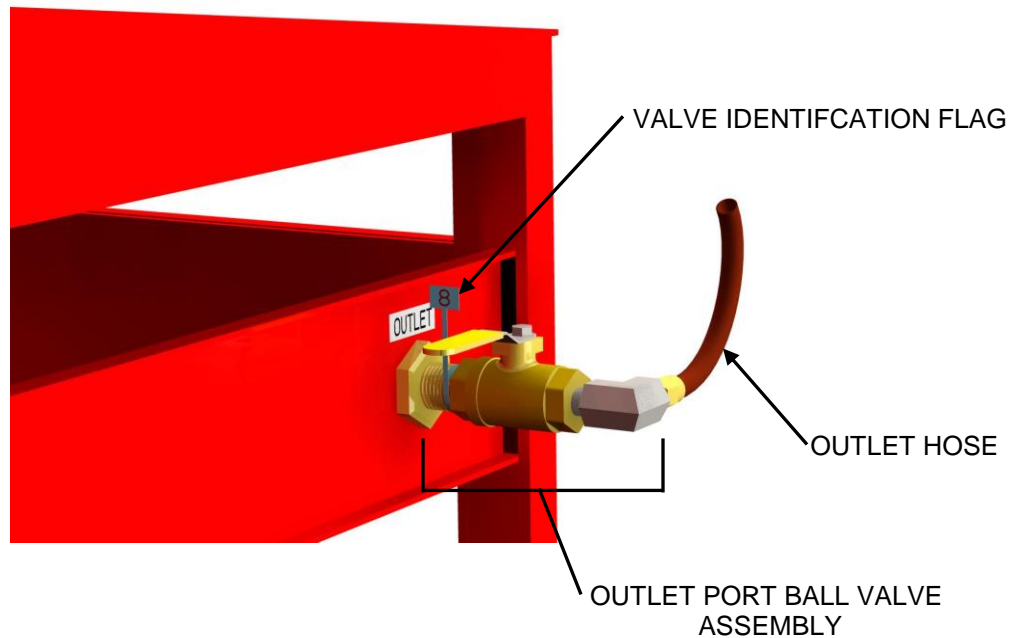

IMPORTANT

DO NOT omit the outlet hose. The hose minimizes compressor motor vibration from reaching the nitrogen piping.

3.5. Pipe and Fittings. All piping should be Sch. 40 black steel. All fittings should be Class 150 black threaded. Galvanized pipe is not recommended. All pipe should be securely fastened in a workmanlike manner. Limit the pipe lengths between the SC unit and AMD(s) to those in Table 8.

**Table 8
 Piping Limitations**

SINGLE RISER SYSTEM		
CHOOSE ONE OPTION	Pipe Size (NPT)	Maximum Length – All Pipe (feet)
OPTION 1	Supply Pipe from SC to AMD = 1/2 inch	300
OPTION 2	Supply Pipe from SC to AMD = 3/4 inch	600

MULTIPLE RISER SYSTEMS		
CHOOSE ONE OPTION	Pipe Size (NPT)	Maximum Length – All Pipe (feet)
OPTION 1	Supply Pipe from SC to Branch Lines = 1/2 inch	300
	Branch Pipes from Supply Pipe to AMDs = 1/2 inch	
OPTION 2	Supply Pipe from SC to Branch Lines = 3/4 inch	600
	Branch Pipes from Supply Pipe to AMDs = 1/2 inch	

NOTE: On multiple riser systems, branch pipes from supply pipe to AMDs should be as short as possible.

3.6. System Arrangements. Various system arrangements may be used for specific sprinkler system requirements.

3.6.1. Type I Arrangements. See Figure 11. Type I arrangements use the compressor built-in to the SC unit for nitrogen generation as well as for 30-minute initial-fill as required by NFPA 13, and have no additional external compressor. Type I arrangements can be used for single-riser systems, or multiple-riser systems up to the maximum recommended number for the model of SC unit chosen. See Section 2, Table 3 for the maximum recommended number of risers for each SC model.



IMPORTANT

Type I arrangements are **NOT RECOMMENDED** for use with dry-pipe sprinkler systems. Use Type I arrangements for preaction sprinkler systems only. Further information is provided in Section 3.6.2 – Type II Arrangements.

Figure 11
Type I NITROGEN-PAC™ SC Arrangement

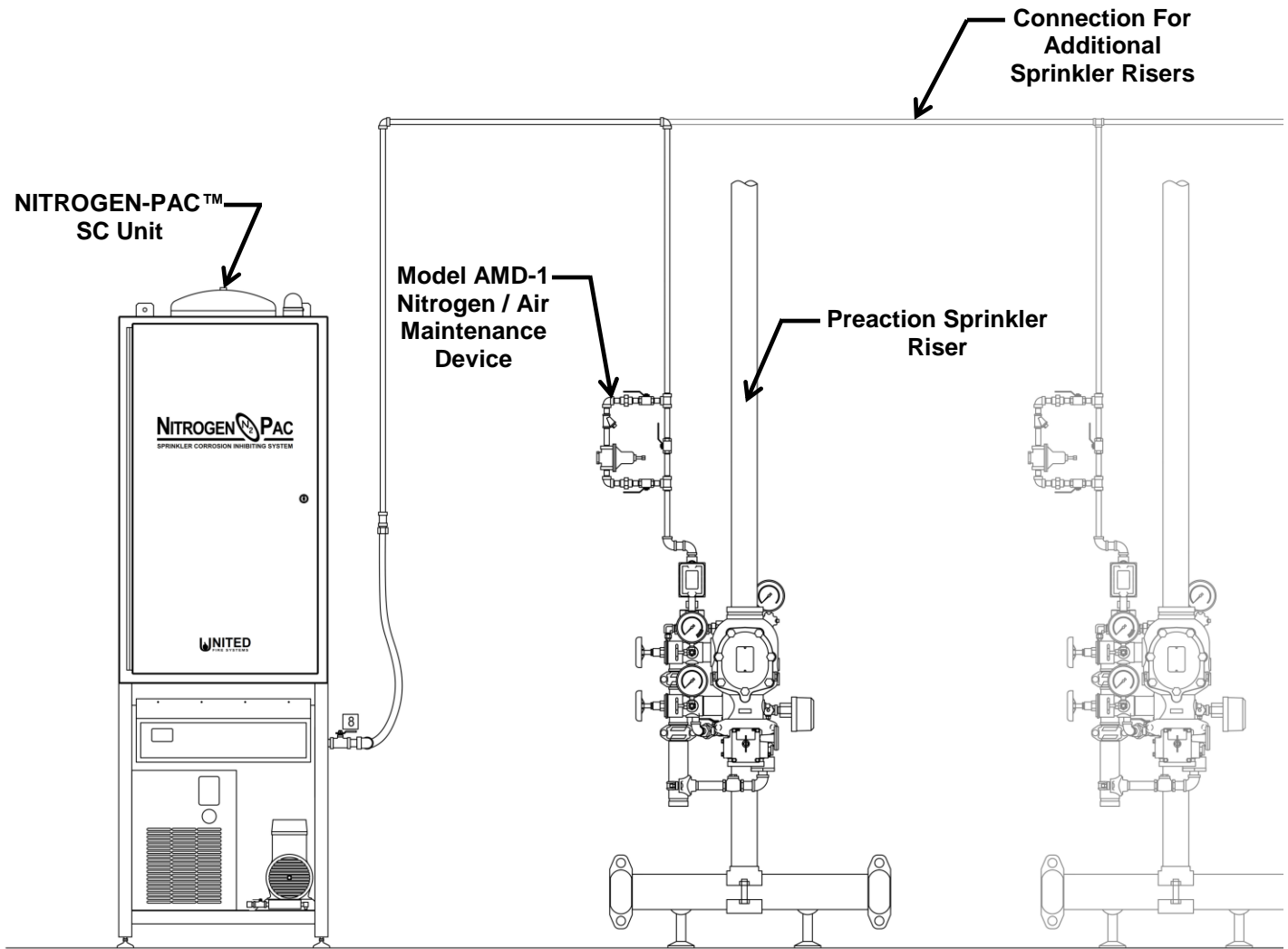

3.6.2 Type II Arrangements. See Figure 12. Type II arrangements use an additional external air compressor to provide 30-minute initial air fill and also can provide a backup pressure source to avoid inadvertent tripping of dry-pipe systems in the event of excessive leakage or nitrogen system failure. Type II arrangements can be used for single-riser systems, or multiple-riser systems up to the maximum recommended number for the model of SC unit chosen. See Section 2, Table 3 for the maximum recommended number of risers for each SC model.

3.6.2.1 Check Valves. Installer-supplied check valves shall be used to separate the NITROGEN-PAC SC pressure source from the additional air compressor pressure source. Check valves should be brass, rated for minimum 500 PSIG at 70° F, have a minimum opening pressure of 1 PSIG, and be spring-loaded to permit mounting in any configuration. An acceptable check valve is McMaster-Carr 7768K14 (1/2" NPT female x female) or McMaster-Carr 7768K41 (3/4" NPT female x female).

3.6.2.2 Type II Systems With Preaction Sprinkler Risers Only. For Type II arrangements with preaction sprinkler risers only, the additional external air compressor is meant for 30-minute initial air fill. The additional Model AMD-1 nitrogen / air maintenance device shown in the external air compressor outlet piping is not required.

3.6.2.3 Type II Systems That Include Dry-Pipe Sprinkler Risers. For Type II arrangements that include dry-pipe sprinkler risers, the Model AMD-1 nitrogen / air maintenance device in the external air compressor outlet pipe permits adjustment of this pressure source to provide automatic backup that can avoid inadvertent actuation of dry-pipe systems in the event of excessive leakage or nitrogen system failure.

Figure 12
Type II NITROGEN-PAC™ SC Arrangement

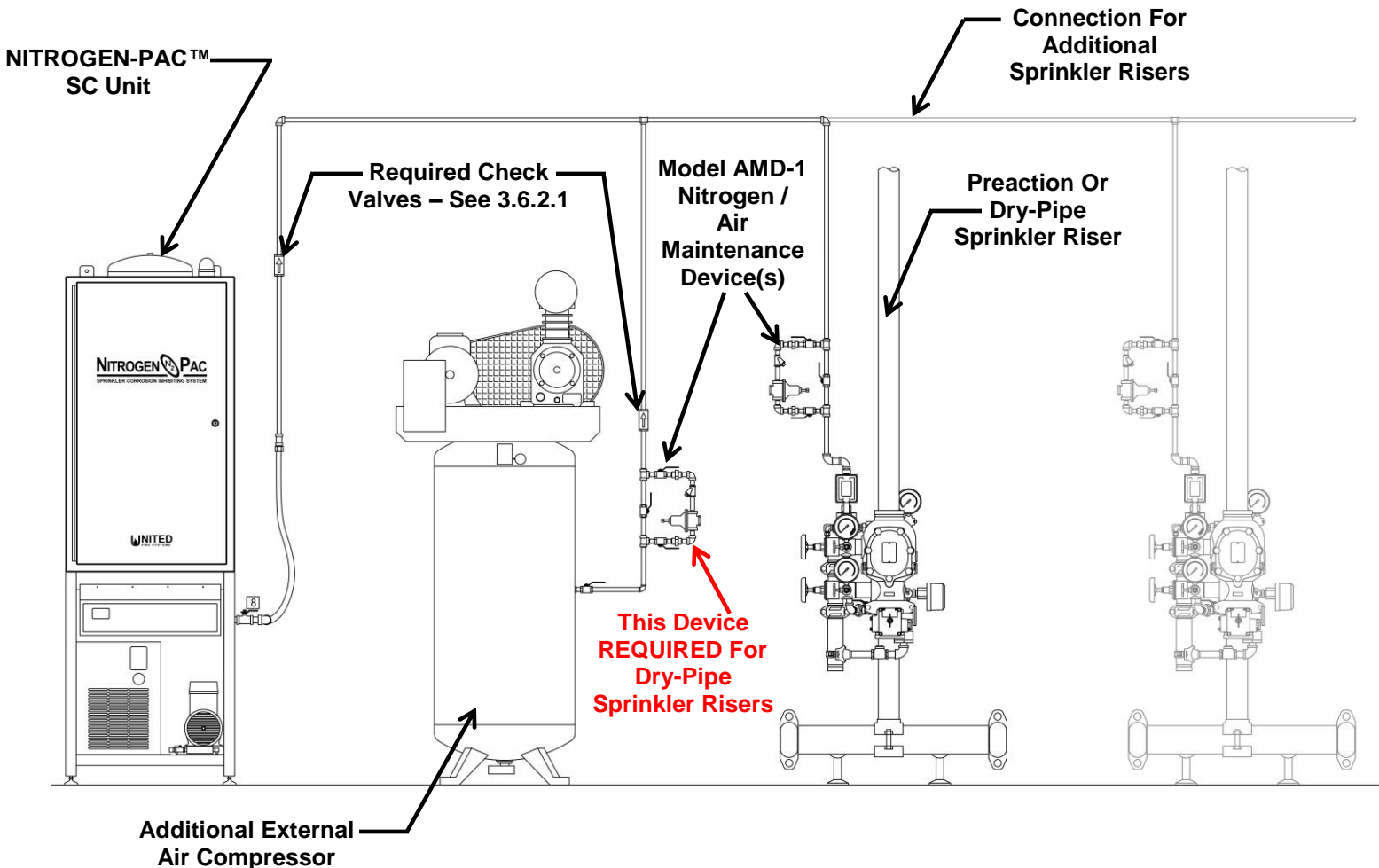

3.6.2.4 Adjustment of Model AMD-1 Connected To External Air Compressor (Backup AMD). Adjust the setting of this AMD to be BELOW but close to the low air supervisory switch setting of the dry-pipe valve. The setting of this AMD should also be as high as possible ABOVE the pressure where the dry-pipe valve trips. Each system installation requires examination based on the brand and model of dry-pipe valve, and the supplied water pressure. Example:

- Recommended normal supervisory pressure = **40 PSI**. (This is the setting of the AMD-1 at the valve trim.)
- Low air switch setting = **28 PSI**. (This setting allows normal variations in supervisory pressure to be “ridden out” without sending a low air supervisory signal.)
- Setting of Backup AMD = **26 PSI**. (This setting should provide a low air signal, but prevent the dry-pipe valve from tripping.)
- Dry-pipe valve trip setting = As low as practical below 26 PSI.

3.7 Air Maintenance Device Model AMD-1. Refer to Figure 13.

Figure 13
Air Maintenance Device Model AMD-1 - Installation

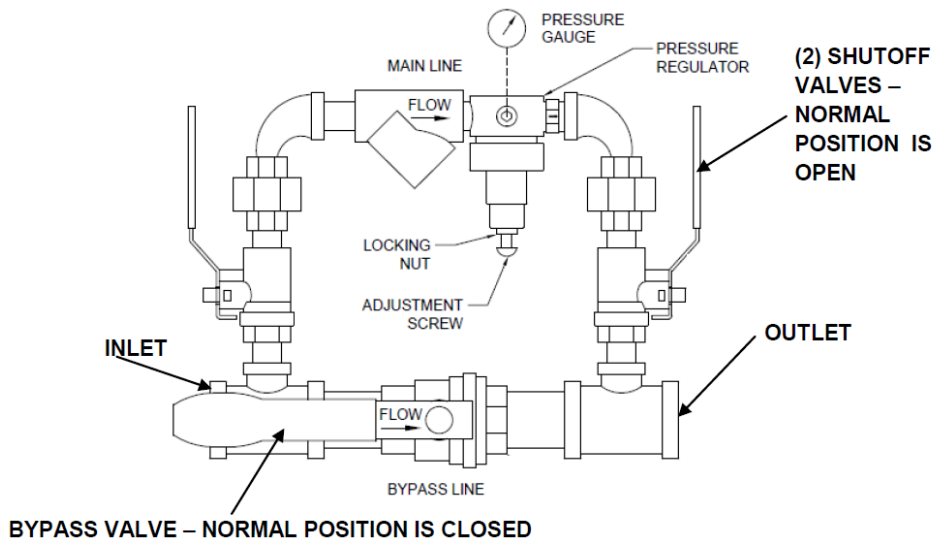

IMPORTANT

An Air Maintenance Device **MUST** be used between the outlet of the SC and the sprinkler valve.

- 3.7.1. Location.** Air maintenance device(s) should be installed in convenient close proximity to each sprinkler valve receiving nitrogen. UNITED Fire Systems strongly recommends that each valve / riser have its own air maintenance device.
- 3.7.2. Inlet.** Piping from the SC connects to the inlet port of the AMD-1. The inlet port is 3/4 inch NPT female. See Section 3.5 for pipe and fittings.
- 3.7.3. Outlet.** Piping from the outlet port of the Air Maintenance Device connects to the trim of the sprinkler valve receiving nitrogen. The outlet port is 3/4 inch NPT female. See Section 3.5 for pipe and fittings.
- 3.7.4. Final Connection.** Refer to Figure 10. The nitrogen feed line is connected to the SC with the outlet hose supplied within the Installation Kit.
- Connect the NPT male end of the outlet hose to the previously installed nitrogen feed line.
 - Connect the female swivel end of the outlet hose to the elbow on the outlet port ball valve assembly previously attached to the SC.



IMPORTANT

DO NOT omit the outlet hose. The hose minimizes compressor motor vibration from reaching the nitrogen piping.

3.8. Drain

- 3.8.1. Drain Piping.** All points on the SC requiring drainage are connected to one point. Install drain piping from **NITROGEN-PAC™** SC drain connection to an appropriate drain location. Refer to Figure 1 for location of drain connection. Drain run may be pipe or tubing. Consult with relevant authorities having jurisdiction, local codes, or building owner for approved materials and discharge location.
- 3.8.2. Condensate Pump (Installer provided option).** A condensate pump may be needed if drain is above the SC drain outlet, or if drain is some distance from the SC installation location. UNITED Fire Systems does not supply condensate pumps. It is recommended that this drain be run to a building drain or an environmentally-approved condensate collection / disposal system.
- 3.8.3. Oil / Water Separator (Installer provided option).** If run to a building drain, environmental regulations may require installation of an oil / water separator.



IMPORTANT

Local regulations may require the installation of an oil / water separator in condensate drain piping. Verify local requirements before completing installation. UNITED Fire Systems does not supply oil / water separators.

3.9. Electrical Installation.



DANGER
RISK OF ELECTROCUTION

Voltages and currents associated with **NITROGEN-PAC™** equipment are **LETHAL**. Follow all instructions provided. Work involving power **MUST** be performed **ONLY** by qualified individuals. All required precautions to prevent contact with live electrical conductors and equipment **MUST** be taken. Failure to comply with these instructions is an immediate hazard with a likelihood of death or serious personal injury!

Table 9
NITROGEN-PAC™ SC – Electrical Specifications

Model No.	Current (A)	Voltage (VAC)	Frequency (Hz)	Phase
SC-1S	12.9	115	60	1
SC-1M				
SC-2M	16.3			
SC-2L				

- 3.9.1 Codes.** All wiring and wiring methods shall be in strict compliance with NEC and local codes.
- 3.9.2 Personnel.** All wiring shall be performed by a licensed electrician.
- 3.9.3 Electrical Disconnect Switch.** For safety and convenience during maintenance, UNITED Fire Systems recommends the installation of a dedicated electrical disconnect switch for each unit. The disconnect switch should not be more than 50 ft. from the unit location; the disconnect switch cannot be higher than 6 ft. 7 in. above the floor or working platform, unless located adjacent to the equipment it supplies [NEC 404.8(A)]. All disconnect switches must conform to nationally recognized standards and meet all applicable certification requirements. These include, but are not limited to: NFPA 70–National Electrical Code (NEC), Underwriters Laboratories (UL), or other Nationally Recognized Testing Laboratory (NRTL).
- 3.9.4 Wiring.** (See Table 10) Run 115 VAC 60 Hz single-phase 3-conductor (HOT, NEUTRAL, GROUND) power to junction box in close proximity to SC. Connect pre-wired flexible conduit to junction box. Connect hot (BLACK), neutral (WHITE), and ground (GREEN) conductors in flexible conduit to incoming 115 VAC 60 Hz single phase power. Do NOT activate power circuit until instructed to do so during commissioning (see Section 4).

**Table 10
 Wire Sizes**

115 VAC POWER – WIRE SIZES

**IT IS IMPORTANT THAT WIRE OF SUFFICIENT SIZE IS INSTALLED FOR THE POWER SUPPLYING THIS UNIT.
 USE THE TABLE BELOW TO DETERMINE THE MINIMUM WIRE GAUGE TO USE.**

TABLE – MINIMUM WIRE SIZES FOR NITROGEN-PAC SC 115 VAC POWER	
LENGTH OF WIRE RUN FROM CIRCUIT BREAKER PANELBOARD TO UNIT	MINIMUM WIRE SIZE (AWG)
Less than 25 feet	12 gauge minimum
Over 25 feet up to 50 feet	10 gauge minimum
Over 50 feet up to 100 feet	8 gauge minimum
Over 100 feet	See Note 1

Note 1 – Over 100 feet, use latest edition of NEC to determine ampacity of conductors to deliver 11 amps minimum at no less than 115 VAC (maximum 4% voltage drop from nominal 120 VAC) under full load.



IMPORTANT

Failure to install wire of adequate size as shown in the above table will result in compressor motor overheat and shutdown. Motor and compressor life will be significantly shortened.

3.9.5. Power for Accessories. UNITED Fire Systems does NOT recommend that power for accessories such as a condensate pump be taken from the terminal strip inside the **NITROGEN-PAC™** SC control enclosure. Provide such power separately.

3.10. Purge Vent Assembly Model PVA. See Table 11. The choice of the proper PVA to use is based on the intended method of nitrogen percentage measurement at the device.

**Table 11
 PVAs for Use with NITROGEN-PAC™ SC Series Systems**

Model Number	Orifice Size (inch dia.)	Connection Point Type	Nitrogen Measurement Method
PVA-2	0.016	Push-To-Connect Fitting for Tubing	True Advanced Purge (TAP) Device
PVA-3	0.010	Quick-Connect, Male	Model NA-1 Nitrogen Purity Analyzer – Hand-Held

NOTE: Model PVA-3 can be equipped with an optional UFS provided muffler P/N 31-100020-101. TAP devices include mufflers as standard equipment.

Figure 14
Purge Vent Assembly Model PVA - Dimensions and Installation in Vertical Branch Line

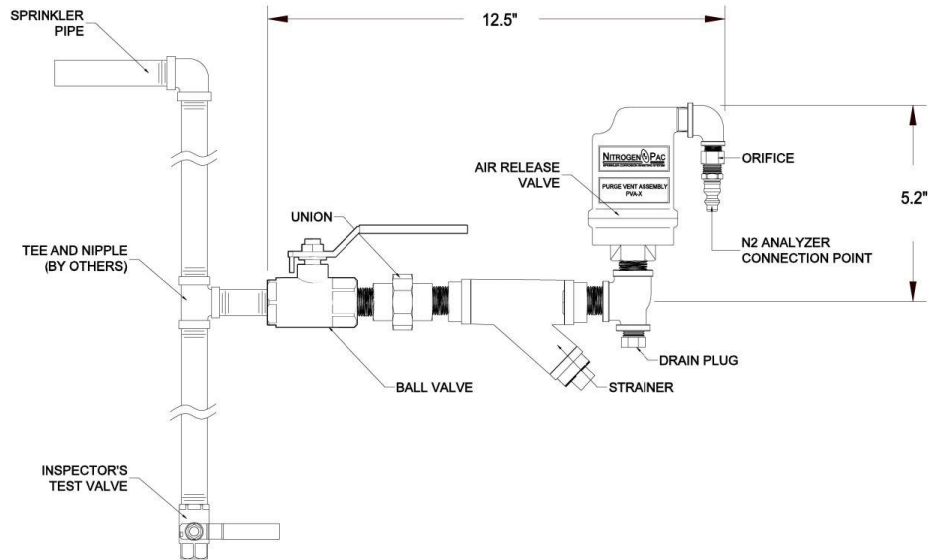
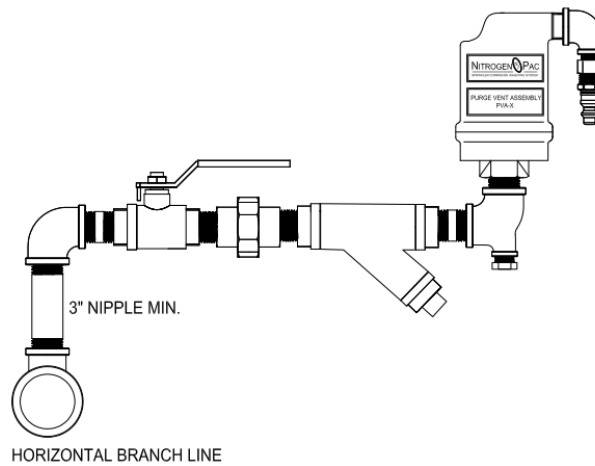

Figure 15
Purge Vent Assembly Model PVA - Installation in Horizontal Branch Line





IMPORTANT

DO NOT disassemble Purge Vent Assembly to install! The union (see Figure 14) may be used to facilitate installation.

3.10.1 Location. Determine location to install the Purge Vent Assembly. The assembly should be located near the inspector's test valve or at an accessible remote branch line end point.

3.10.2. Sprinkler Piping. Confirm that sprinkler piping system is NOT pressurized.



CAUTION

Failure to confirm that the sprinkler piping is NOT pressurized could result in personal injury and / or property damage.

3.10.3. Connection to VERTICAL Branch Line. Refer to Figure 14. Install tee and nipple in vertical branch line as shown. Position the tee with the outlet horizontal, as indicated. Attach Purge Vent Assembly to nipple. It is acceptable to install additional pipe and elbows before the assembly to accommodate proper installation. The assembly **MUST** be installed vertically as shown for float valve to function properly. Use union to facilitate installation and proper assembly positioning. Ball valve should remain closed until commissioning.

3.10.4 Connection to HORIZONTAL Branch Line. Refer to Figure 15. Install tee and nipple in horizontal branch line, as shown. Position the tee with the outlet vertical, as indicated. Install a 3 inch minimum pipe length nipple into the tee before the elbow, as shown. Attach Purge Vent Assembly to nipple. It is acceptable to install additional pipe and elbows before the assembly to accommodate proper installation. The assembly **MUST** be installed vertically as shown for float valve to function properly. Use union to facilitate installation and proper assembly positioning. Ball valve should remain closed until commissioning.

3.10.5 Optional Muffler Assembly for Model PVA-3. Assemble the female quick-connect on the Muffler Assembly to the outlet male quick-connect on the Purge Vent Assembly Model PVA-3.

3.10.6 True Advance Purge System (UNITED Fire System Provided Option). The True Advanced Purge Model TAP-G2 may be installed to automatically purge air from within a dry-pipe or preaction sprinkler system and replace the air with 98% nitrogen from a **NITROGEN-PAC™** sprinkler corrosion inhibiting system; see Table 11 in section 3.10 for selecting a compatible PVA model. Refer to TAP Manual (UFS P/N: 33-TG2MAN-000)

3.11 N₂ Purity Analyzer – Hand-Held Model NA-1. To use this device:

- Unpack pre-assembled analyzer and connection hose assembly.
- Press ON button to ensure unit powers up.
- Store unit in clean and dry permanent storage location with included instruction manual.

3.12 Corrosion Monitor Assembly. Refer to Figure 16. The choice of proper CMA installation is based on the orientation of the pipe at the intended assembly location. Model CMA-1 can be installed horizontally in a vertical riser or branch line; and can be installed horizontally or vertically in a horizontal Sprinkler Main or branch line.

Figure 16
Installation: Corrosion Monitor Assembly Model CMA-1

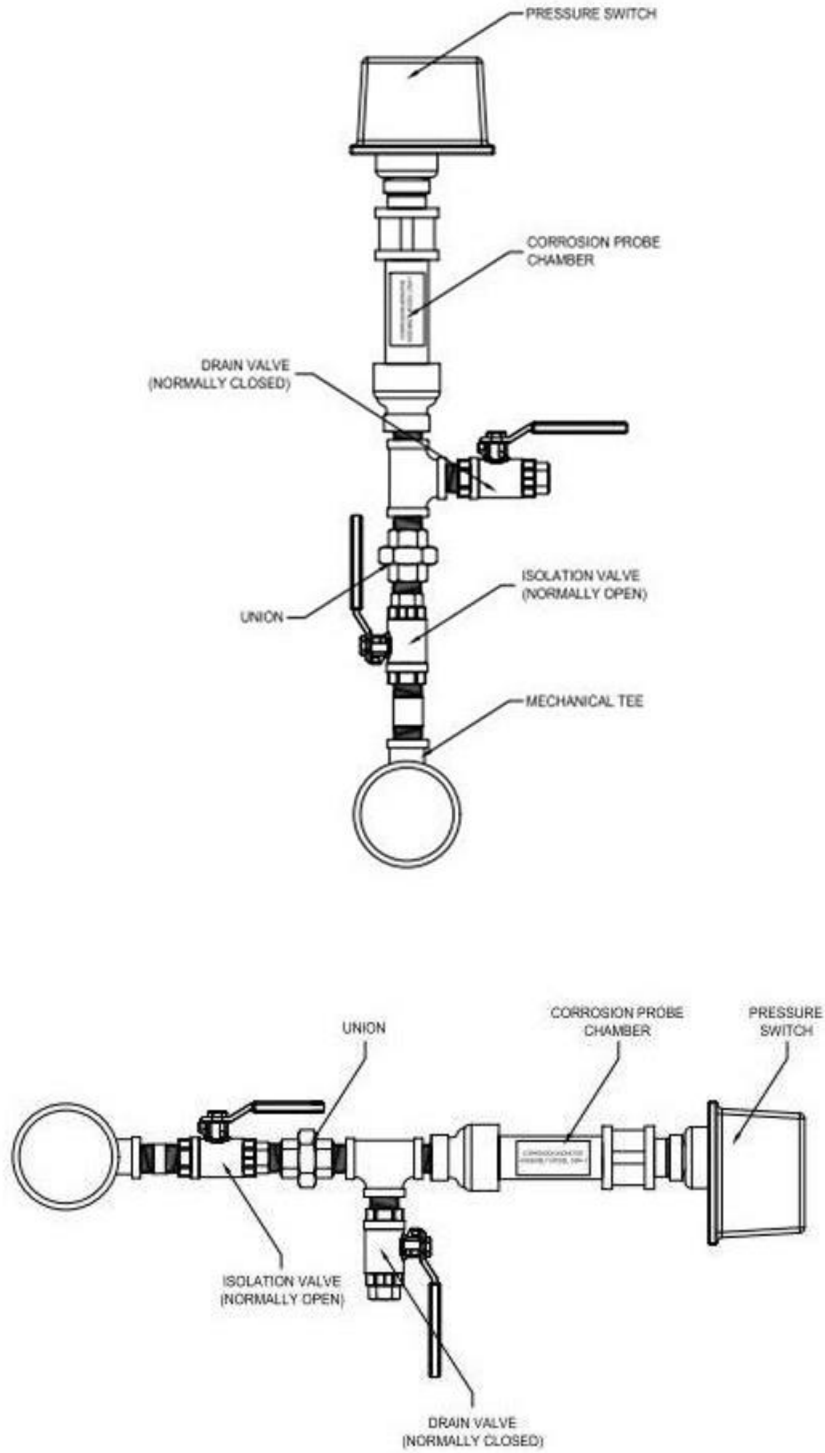



IMPORTANT

DO NOT disassemble Corrosion Monitor Assembly to install! The union (see Figure 16) may be used to facilitate installation.

3.12.1 Location. Refer to Section 3.12. Determine location to install the Corrosion Monitor Assembly. The assembly should be located at an accessible installation outlet.

3.12.2 Sprinkler Piping. Confirm that sprinkler piping system is NOT pressurized



CAUTION

Failure to confirm that the sprinkler piping is NOT pressurized could result in personal injury and / or property damage.

3.12.3 VERTICAL Installation. Refer to Figure 16. Install tee and nipple as shown. Position the tee with the outlet vertical, as indicated. Attach Corrosion Monitor Assembly to nipple. It is acceptable to install additional pipe and elbows before the assembly to accommodate proper installation. The assembly **MUST** be installed as shown for drain valve to function properly. Use union to facilitate installation and proper assembly positioning. Isolation ball valve should remain closed until commissioning. Follow instructions provided with replacement probe kit (UFS P/N: 30-500013-100) when replacement is required.

3.12.4 HORIZONTAL Installation. Refer to Figure 16. Install tee and nipple, as shown. Position the tee with the outlet horizontal, as indicated. Install a pipe nipple into the tee before the elbow, as shown. Attach Corrosion Monitor Assembly to nipple. It is acceptable to install additional pipe and elbows before the assembly to accommodate proper installation. The assembly **MUST** be installed as shown for drain valve to function properly. Use union to facilitate installation and proper assembly positioning. Isolation ball valve should remain closed until commissioning. Follow instructions provided with replacement probe kit (UFS P/N: 30-500013-100) when replacement is required.

Figure 17
Corrosion Signal Connection

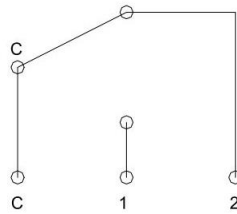

TERMINAL (shown above with no pressure applied)

- 1: Open with no pressure applied. Closes upon detection of pressure. Use for corrosion indication
- 2: Closed with no pressure applied



DANGER



Failure to follow **WIRING INSTRUCTIONS** correctly can result in **ELECTROCUTION!**

3.12.5 Wiring Instructions. Refer to Figure 17

- Remove cover by removing tamper resistant screw.
- Run wires through an approved conduit connector and affix the connector on the device. Two knockouts are provided on the pressure switch for 1/2" conduit. Individual switch compartments and ground screws are suitable for dissimilar voltage.
- Connect the wires to the appropriate terminal connections shown in Figure 17. Switch contacts are SPDT; 10 Amps @ 125/250 VAC, 2 Amps @ 30 VDC.

4. COMMISSIONING. The process of system commissioning is important for achieving satisfactory results.



The **NITROGEN-PAC™** SC must be installed in an adequately ventilated area. The SC creates a 30% to 40% oxygen stream which may pose a flammability problem in an oxygen-sensitive environment. Ensure the area surrounding the SC is adequately ventilated. Failure to do so creates an increased flammability hazard that can lead to serious property damage, serious injury, or death.



Rapid release of nitrogen gas into an enclosed space displaces oxygen and can cause an asphyxiation hazard. Inhalation of nitrogen in increased concentration can result in unconsciousness and asphyxiation without warning. All areas containing nitrogen system equipment **MUST** be adequately ventilated. All nitrogen gas leaks discovered during installation, commissioning, and maintenance of **NITROGEN-PAC™** SC Series nitrogen generating equipment **MUST** be corrected promptly. Failure to comply can result in death or serious personal injury.



Prior to commissioning the **NITROGEN-PAC™** SC Series nitrogen generating system, the owner, sprinkler contractor, or other sprinkler service professional shall inspect and test the sprinkler piping to establish that maximum leakage is within the allowable limit set by NFPA Standard 13. **THIS LEAKAGE RATE IS MAXIMUM 1-1/2 PSIG LOSS IN 24 HOURS STARTING AT 40 PSIG.** If excessive leakage exists, correct leaks and re-test. Nitrogen generating systems do not reverse pipe corrosion, stop leaks, or overcome excessive leakage.



The needle valve in the SC nitrogen generator cabinet is adjusted at the factory for the production of 98% nitrogen by the generator, and requires no further field adjustments. **DO NOT DISTURB THE SETTING OF THIS NEEDLE VALVE!** Moving the needle valve can render the generator incapable of producing 98% nitrogen. Proper re-adjustment of the needle valve requires training and instrumentation. At any time, if it appears that the **NITROGEN-PAC™** SC unit is not generating 98% nitrogen, contact UNITED Fire Systems for assistance.

- UNITED Fire Systems recommends that the technician performing the commissioning become thoroughly familiar with this entire manual, as well as the actual installation, before beginning the process.
- Follow the steps as indicated.
- Each valve in the system is identified by number. See Figure 16 for valve locations and numbers, and Table 12 for valve purposes. Each valve has a blue flag marker with the number. Look for and identify all valves before proceeding.
- Temperature fluctuations can affect nitrogen purity readings. The temperature at the SC unit's location and at the system PVAs should be as stable as possible to provide maximum assurance of nitrogen purity measurement accuracy.
- Use a copy of the Commissioning Worksheet / Checklist during the procedure to record all values as indicated and steps followed.
- Open and close all valves *carefully* and *slowly*.

Figure 18
Typical Installation
Showing Valve Locations and Numbers

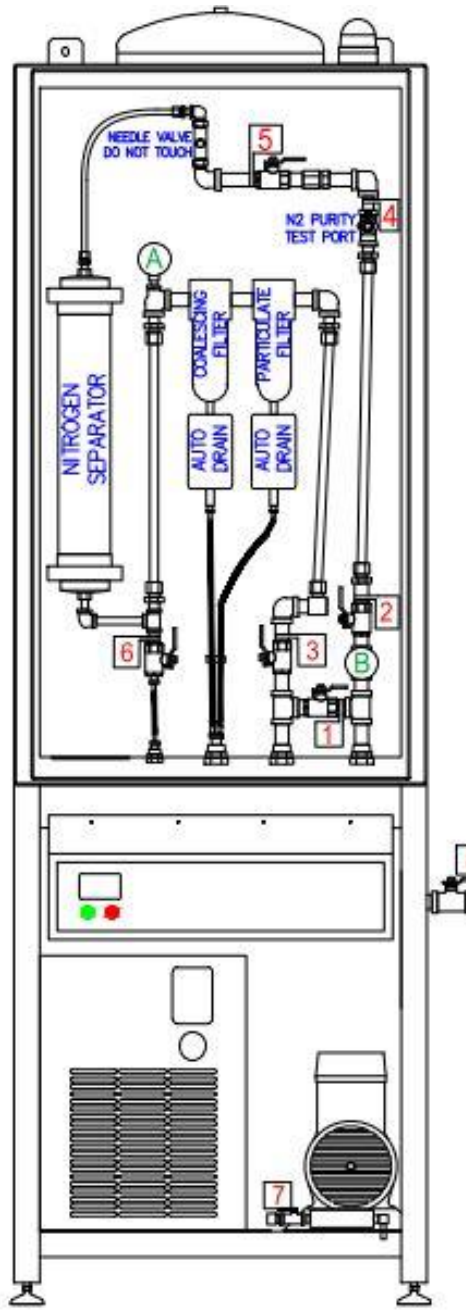

Table 12
Valve Numbers and Purposes

Valve Number	Name	NORMAL Position
1	Bypass Valve	CLOSED
2	Nitrogen Isolation Valve	OPEN
3	Inlet Valve	OPEN
4	Test Port Valve	CLOSED
5	Shutoff Valve	OPEN
6	Vent Valve	CLOSED
7	Drain Valve	CLOSED
8	Outlet Valve	OPEN



IMPORTANT

See Figure 19 on Page 38. The handle on Valve **2** does NOT follow “ordinary” valve convention.
 Valve **2** is OPEN when the handle is perpendicular to the pipe.
 Valve **2** is CLOSED when the handle is parallel to the pipe.
 DO NOT have Valve **1** open when Valves **2** and **3** are open!



IMPORTANT

If True Advanced Purge (TAP) devices are installed, refer to separate TAP Installation, Commissioning, and Maintenance Manual for details on installation and commissioning of these devices prior to commissioning the **NITROGEN-PAC™** SC system.



IMPORTANT

Temperature fluctuations can affect nitrogen purity readings. Differences between readings taken at different times may be due to changes in temperature at the SC Series unit and at the reading location. Differences between readings should not be immediately interpreted as a system fault.

4.1. Preliminary.

Step	Procedure
Preliminary 1	Prepare copy of Commissioning Worksheet / Checklist for use during procedure.
Preliminary 2	Verify that electrical connection to NITROGEN-PAC™ SC is complete in accordance with this manual.
Preliminary 3	Verify that all piping connections are complete in accordance with this manual.
Preliminary 4	Turn off water supply to sprinkler valve.
Preliminary 5	Ensure that all valves in Table 12 are in the NORMAL position, all PVA valves are CLOSED, and all AMD-1 valves are CLOSED.
SYSTEM IS NOW READY FOR STARTUP – PROCEED TO STARTUP 1	

4.2. Startup.

Step	Procedure
Startup 1	Operate panelboard circuit breaker and/or recommended disconnect switch to ON. Compressor should start.
Startup 2	Operate switch on refrigerated dryer to ON. Refrigerated dryer should start.
Startup 3	Verify all valves are in NORMAL position (see Table 12). Gauge A should begin to indicate pressure.
SYSTEM IS READY FOR 30 MINUTE INITIAL FILL – PROCEED TO INITIAL FILL 1.	

4.3. 30 Minute Initial Fill.

Step	Procedure
Initial Fill 1	Carefully CLOSE Valves 2 and 3 and OPEN Valve 1 . RED Bypass visual indicator should be ON.
Initial Fill 2	OPEN AMD-1 Inlet Valve(s). AMD-1 pressure gauge(s) should indicate pressure.
Initial Fill 3	Adjust AMD-1 regulator(s) to indicate gage pressure approximately 5-10% above minimum pressure required by valve pressure switch. Examples: <ul style="list-style-type: none"> • If valve pressure switch operates at 13 PSI, adjust AMD-1 regulator so that gauge indicates approximately 15 PSI. • If valve pressure switch operates at 40 PSI, adjust AMD-1 regulator so that gauge indicates approximately 44 PSI. IN NO CASE should regulator be adjusted for pressure higher than can be handled by sprinkler valve.
Initial Fill 4	CLOSE AMD-1 Inlet Valve(s).
Initial Fill 5	OPEN AMD-1 Bypass Valve(s).
Initial Fill 6	After 30 minutes or less, supervisory pressure should be reached. Valve pressure switch should be satisfied. Signal indicating low pressure should not be present when control unit is reset. If supervisory pressure is NOT reached in 30 minutes or less, troubleshoot sprinkler system for leaks. If supervisory pressure still cannot be reached, contact UNITED Fire Systems.
SYSTEM IS READY FOR PURGING – PROCEED TO PURGE 1.	

4.4. Purging. The system is now filled with air. It is necessary to purge the air and replace it with 98% nitrogen. This process will take a period of time (3 to 14+ days) to accomplish.

Step	Procedure
Purge 1	CLOSE Valve 1 and OPEN Valves 2 and 3 . After a short period, GREEN Normal visual indicator should be ON.
Purge 2	CLOSE AMD-1 Bypass Valve(s).
Purge 3	OPEN AMD-1 Inlet and Outlet Valve(s).
Purge 4	OPEN valve on PVA. If SC is supplying N ₂ to multiple risers, open valves on no more than one (1) PVA at one time.
Purge 5	Check to ensure all valves are in NORMAL position (see Quick Reference Valve Position Table).
Purge 6	If installer provided drain condensate pump has been installed, ensure that pump power is connected to separate power source, and is NOT connected to SC unit power terminal strip. Also ensure that pump discharge is run to an appropriate drain location, and pump functions as intended.
Purge 7	Switch Nitrogen Analyzer (NA-1) ON. Calibrate if needed – see Appendix C.
Purge 8	Attach NA-1 to N ₂ Purity Test Port in nitrogen generator cabinet.
Purge 9	<i>Carefully</i> open Valve 4 . Hissing will be heard from holes on NA-1.
Purge 10	Examine reading on NA-1. <ul style="list-style-type: none"> • If reading is 98% N₂ or more, record reading on commissioning form, close Valve 4, and proceed to Purge 11. • If reading is below 98% N₂, adjustment of needle valve may be necessary. Contact UNITED Fire Systems before proceeding!
Purge 11	Record N ₂ purity percentage at each PVA using NA-1 Nitrogen Analyzer or True Advanced Purge (TAP) device.
Purge 12	Measure and record values on all system gages: <ul style="list-style-type: none"> • Gauge A (on inlet side of membrane) in nitrogen generator cabinet • Gauge B (on outlet side of membrane) in nitrogen generator cabinet • Gauge(s) on AMD-1s
SYSTEM IS NOW ON PURGE. N₂ CONCENTRATION IN SPRINKLER SYSTEM PIPE SHOULD BEGIN TO INCREASE. PROCEED TO FINAL ACCEPTANCE 1.	

4.5. Final Acceptance.

Step	Procedure
Final Acceptance 1	After approximately 2 weeks, return to site.
Final Acceptance 2	Measure and record N ₂ purity percentage at nitrogen generator cabinet test port using NA-1 Nitrogen Analyzer.
Final Acceptance 3	If nitrogen percentage at nitrogen generator cabinet test port is below 98%, needle valve may require adjustment. Contact UNITED Fire Systems before proceeding!
Final Acceptance 4	Measure and record nitrogen percentage at each PVA-3 using NA-1 Nitrogen Analyzer or True Advanced Purge (TAP) device.
Final Acceptance 5	If nitrogen percentage at any PVA-3 is less than 98%, purge is not complete. Return every 2 days and re-measure. Nitrogen percentage should be increasing between visits.
Final Acceptance 6	If nitrogen percentage is not increasing, or does not reach 98%, troubleshoot sprinkler system for leaks.
Final Acceptance 7	When nitrogen percentage at each PVA reaches 98%, system commissioning is complete. Record hours and minutes displayed on Runtime Monitor. System can be turned over to customer.
SYSTEM IS NOW IN SERVICE.	

Table 13
Quick-Reference Valve Position Table

QUICK REFERENCE VALVE POSITION TABLE							
VALVE	A	B	C	D	E	F	G
	NORMAL	BYPASS	PURGE	FILTER SERVICE	N ₂ PURITY AT TEST PORT	N ₂ PURITY AT PVAs	DRAIN
1	Closed	Open	Closed	Closed	Closed	Closed	Closed
2	Open	Closed	Open	Closed	Open	Open	Closed
3	Open	Closed	Open	Closed	Open	Open	Closed
4	Closed	Closed	Closed	Closed	Open	Closed	Closed
5	Open	Open	Open	Closed	Open	Open	Closed
6	Closed	Closed	Closed	Open	Closed	Closed	Open
7	Closed	Closed	Closed	Closed	Closed	Closed	Open
8	Open	Open	Open	Closed	Open	Open	Closed
AMD VALVES							
AMD-1 Inlet(s)	Open	Closed	Open	Open	Open	Open	Open
AMD-1 Outlet(s)	Open	Closed	Open	Open	Open	Open	Open
AMD-1 Bypass(es)	Closed	Open	Closed	Closed	Closed	Closed	Closed
PVA INLET VALVE(S)							
PVA-3 Inlet Valve(s) with NA-1	Closed	Closed	Open	Closed	Closed	Open	Closed
PVA-2 Inlet Valve(s) with TAP	Open	Open	Open	Open	Open	Open	Closed
TAP = True Advanced Purge device. Leave PVA inlet valve OPEN unless draining water at PVA location. TAP device will be in control of purging.							

NOTES

- A** = NORMAL – system is providing nitrogen into preaction sprinkler system(s).
- B** = BYPASS – compressed air is routed to preaction sprinkler system(s) for initial fill (max. 30 minutes) per NFPA 13, or to put sprinkler system on air if nitrogen is not available
- C** = PURGE – system(s) are purging air out of sprinkler piping, replacing air with nitrogen.
- D** = FILTER SERVICE – filter elements in SC cabinet filters are to be replaced.
- E** = N₂ PURITY AT TEST PORT – nitrogen purity at SC cabinet is to be checked with NA-1 hand-held meter.
- F** = N₂ PURITY AT PVAs – nitrogen purity at PVAs is to be checked with NA-1 hand-held meter or TAP device.
- G** = DRAIN – draining accumulated moisture from SC.

Figure 19
Positions
Valves 1, 2, and 3

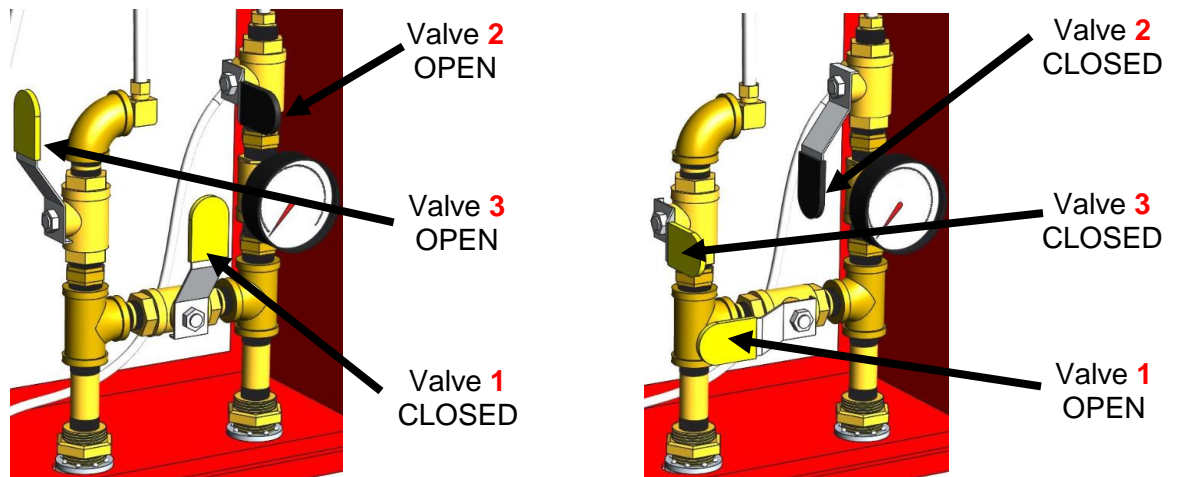

System Condition – NORMAL
 Supplying NITROGEN To Sprinkler System
GREEN Visual Indicator ON
RED Visual Indicator OFF

System Condition – BYPASS (Initial Fill)
 Supplying AIR To Sprinkler System
RED Visual Indicator ON
GREEN Visual Indicator OFF



**COMMISSIONING WORKSHEET AND CHECKLIST
 NITROGEN-PAC SC SERIES SYSTEM
 UFS-602 REVISION 1.03 – PAGE 1 OF 5**



DATE	
-------------	--

LOCATION INFORMATION	
User	
Address 1	
Address 2	
City, State, Zip	
System	

SPRINKLER SYSTEM INFORMATION			
NO. OF RISERS		SYSTEM GALLONS	

NITROGEN-PAC™ SC UNIT SERIAL NUMBER	
TRUE ADVANCED PURGE™ SERIAL NUMBER #1	
TRUE ADVANCED PURGE™ SERIAL NUMBER #2	
TRUE ADVANCED PURGE™ SERIAL NUMBER #3	
TRUE ADVANCED PURGE™ SERIAL NUMBER #4	
TRUE ADVANCED PURGE™ SERIAL NUMBER #5	

PRELIMINARY	OK	NOT OK
Are all electrical connections complete?		
Are all piping connections complete?		
Is the water supply to the sprinkler valve (s) off?		
Are all nitrogen generator valves in NORMAL position (see Quick Reference Valve Position Table), all PVA valves CLOSED , and all AMD-1 valves CLOSED ?		

STARTUP	OK	NOT OK
Has the panelboard circuit breaker and/or disconnect switch been turned ON , and has the compressor started?		
Has the switch on the refrigerated dryer been turned ON , and has the refrigerated dryer started?		
Has Gauge A begun to indicate pressure?		



**COMMISSIONING WORKSHEET AND CHECKLIST
 NITROGEN-PAC SC SERIES SYSTEM
 UFS-602 REVISION 1.03 – PAGE 2 OF 5**



30 MINUTE INITIAL FILL	OK	NOT OK
Have Valves 2 and 3 been <i>carefully</i> closed and Valve 1 been <i>carefully</i> opened?		
Is the RED Bypass visual indicator ON ?		
Have the AMD-1 inlet valve(s) been OPENED ?		
Have the AMD-1 regulator(s) been properly adjusted?		
Has the AMD-1 inlet valve(s) been CLOSED ?		
Are AMD-1 bypass valve(s) OPEN ?		
Is the sprinkler system(s) beginning to fill with air?		
Did the sprinkler system(s) reach supervisory pressure in 30 minutes or less?		
If the sprinkler system(s) did not reach supervisory pressure in 30 minutes or less, has the sprinkler system(s) been checked for leaks and have leaks been corrected?		

MANUAL PURGING (FOR SYSTEMS WITH PVA-3)	OK	NOT OK
Has Valve 1 been closed, and have Valves 2 and 3 been OPENED ?		
Is the GREEN Normal visual indicator ON ?		
Have the AMD-1 bypass valves been CLOSED , and have the AMD-1 inlet / outlet valve(s) been OPENED ?		
Has the valve on no more than one (1) PVA been OPENED ?		
Have all valves been checked to ensure they are in the NORMAL position per the Quick Reference Valve Position Table?		
If provided, is the condensate pump properly installed and does it function as intended?		

AUTOMATIC PURGING (FOR SYSTEMS WITH TRUE ADVANCED PURGE™)	OK	NOT OK
Has Valve 1 been closed, and have Valves 2 and 3 been opened?		
Is the GREEN Normal visual indicator ON?		
Have the AMD-1 bypass valve(s) been closed, and have the AMD-1 inlet / outlet valve(s) been opened?		
Have all the inlet valves on the PVAs been opened?		
Has no more than one (1) TAP been put into Initial Purge Mode?		
Have all valves been checked to ensure they are in normal position per the Quick Reference Valve Position Table?		
If provided, is the condensate pump properly installed and does it function as intended?		



**COMMISSIONING WORKSHEET AND CHECKLIST
 NITROGEN-PAC SC SERIES SYSTEM
 UFS-602 REVISION 1.03 – PAGE 3 OF 5**



STARTUP (Continued)					
Have all nitrogen purity values been measured and recorded?					
SC Cabinet Test Port	%	PVA or TAP #1	%	PVA or TAP #2	%
PVA or TAP #3	%	PVA or TAP #4	%	PVA or TAP #5	%

PROPER GAUGE READINGS – GAUGES A and B							
Model No.	Gauge	Proper Gauge Reading		Model No.	Gauge	Proper Gauge Reading	
		Minimum	Maximum			Minimum	Maximum
SC-1	A	0	100	SC-2	A	0	100
	B	75	95		B	55	75
Have the values on all system gauges been recorded?		Gauge A	PSIG	Gauge B	PSIG	AMD Gauge #1	PSIG
AMD Gauge #2	PSIG	AMD Gauge #3	PSIG	AMD Gauge #4	PSIG	AMD Gauge #5	PSIG

TIME ON RUNTIME MONITOR:	HOURS / MINUTES
NOTE: Initial time will NOT be zero. Indicated time includes factory test run time and commissioning run time.	

FINAL ACCEPTANCE					
Have all nitrogen purity values been measured and recorded?					
SC Cabinet Test Port	%	PVA or TAP #1	%	PVA or TAP #2	%
PVA or TAP #3	%	PVA or TAP #4	%	PVA or TAP #5	%

PROPER GAUGE READINGS – GAUGES A and B							
Model No.	Gauge	Proper Gauge Reading		Model No.	Gauge	Proper Gauge Reading	
		Minimum	Maximum			Minimum	Maximum
SC-1	A	0	100	SC-2	A	0	100
	B	75	95		B	55	75
Have the values on all system gauges been recorded?		Gauge A	PSIG	Gauge B	PSIG	AMD Gauge #1	PSIG
AMD Gauge #2	PSIG	AMD Gauge #3	PSIG	AMD Gauge #4	PSIG	AMD Gauge #5	PSIG

TIME ON RUNTIME MONITOR:	HOURS / MINUTES
NOTE: Initial time will NOT be zero. Indicated time includes factory test run time and commissioning run time.	



**COMMISSIONING WORKSHEET AND CHECKLIST
 NITROGEN-PAC SC SERIES SYSTEM
 UFS-602 REVISION 1.03 – PAGE 5 OF 5**



QUICK REFERENCE VALVE POSITION TABLE

	A	B	C	D	E	F	G
VALVE	NORMAL	BYPASS	PURGE	FILTER SERVICE	N ₂ PURITY AT TEST PORT	N ₂ PURITY AT PVAs	DRAIN
1	Closed	Open	Closed	Closed	Closed	Closed	Closed
2	Open	Closed	Open	Closed	Open	Open	Closed
3	Open	Closed	Open	Closed	Open	Open	Closed
4	Closed	Closed	Closed	Closed	Open	Closed	Closed
5	Open	Open	Open	Closed	Open	Open	Closed
6	Closed	Closed	Closed	Open	Closed	Closed	Open
7	Closed	Closed	Closed	Closed	Closed	Closed	Open
8	Open	Open	Open	Closed	Open	Open	Closed
AMD VALVES							
AMD-1 Inlet(s)	Open	Closed	Open	Open	Open	Open	Open
AMD-1 Outlet(s)	Open	Closed	Open	Open	Open	Open	Open
AMD-1 Bypass(es)	Closed	Open	Closed	Closed	Closed	Closed	Closed
PVA INLET VALVE(S)							
PVA-3 Inlet Valve(s) with NA-1	Closed	Closed	Open	Closed	Closed	Open	Closed
PVA-2 Inlet Valve(s) with TAP	Open	Open	Open	Open	Open	Open	Closed
TAP = True Advanced Purge device. Leave PVA inlet valve open unless draining water at PVA location. See manual 30-NPSICM-000 for more information.							

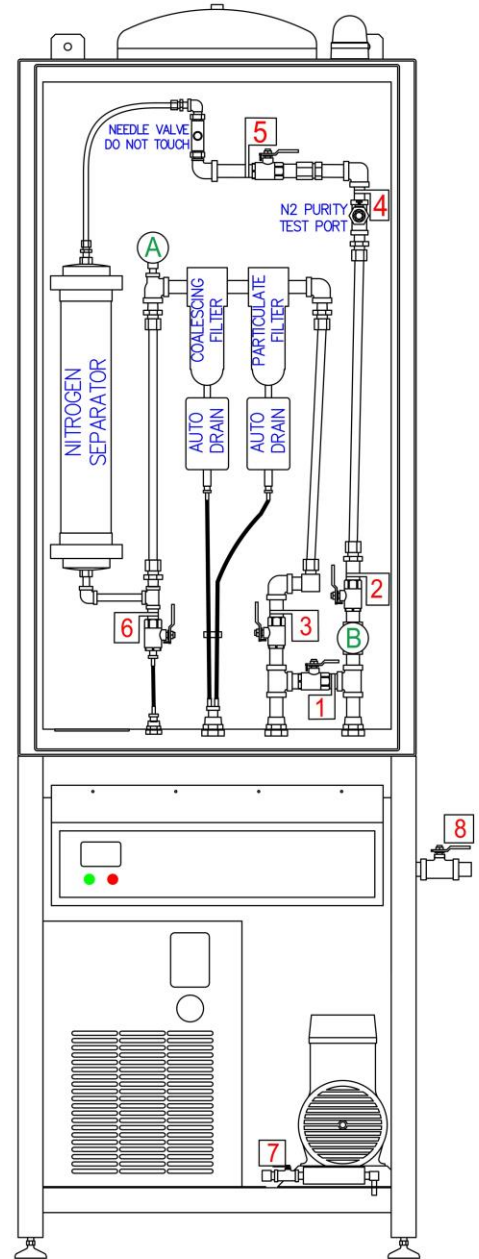

- A** = NORMAL – system is providing nitrogen into preaction sprinkler system(s).
- B** = BYPASS – compressed air is routed to preaction sprinkler system(s) for initial fill (max. 30 minutes) per NFPA 13, or to put sprinkler system on air if nitrogen is not available.
- C** = PURGE – system(s) are purging air out of sprinkler piping, replacing air with nitrogen.
- D** = FILTER SERVICE – filter elements in SC cabinet filters are to be replaced.
- E** = N₂ PURITY AT TEST PORT – nitrogen purity at SC cabinet is to be checked with NA-1 hand-held meter.
- F** = N₂ PURITY AT PVAs – nitrogen purity at PVAs is to be checked with NA-1 hand-held meter or TAP
- G** = DRAIN – draining accumulated moisture from SC and PVAs.

5. MAINTENANCE



Rapid release of nitrogen gas into an enclosed space displaces oxygen and can cause an asphyxiation hazard. Inhalation of nitrogen in increased concentration can result in unconsciousness and asphyxiation without warning. All areas containing nitrogen system equipment **MUST** be adequately ventilated. All nitrogen gas leaks discovered during installation, commissioning, and maintenance of SC Series nitrogen generating equipment **MUST** be corrected promptly. Failure to comply can result in death or serious personal injury.



The needle valve in the SC nitrogen generator cabinet is adjusted at the factory for the production of 98+% nitrogen by the generator, and requires no further field adjustments. **DO NOT DISTURB THE SETTING OF THIS NEEDLE VALVE!** Moving the needle valve can render the generator incapable of producing 98% nitrogen. Proper re-adjustment of the needle valve requires training and instrumentation. At any time, if it appears that the **NITROGEN-PAC™** SC unit is not generating 98% nitrogen, contact UNITED Fire Systems for assistance.



All valves should always be opened and closed *carefully and slowly*.

5.1 Monthly Inspection.

- 5.1.1 Objective.** Monthly inspection helps assure that the **NITROGEN-PAC™** SC system continues to be in good working order. This inspection involves visual checks of system and valve status, as well as measurement of the nitrogen output of the generator and the nitrogen percentage in the sprinkler pipe.
- 5.1.2 Personnel.** This inspection can be performed by individuals generally familiar with the system and its installation. UNITED Fire Systems recommends that individuals performing monthly inspections become familiar with the contents of this manual. Read, understand, and follow all safety information in this manual, indicated by the words DANGER, WARNING, and CAUTION, and all information indicated by the word IMPORTANT.

Look for the  symbol. This indicates specific safety information and other important information which should be read, understood, and followed.

- 5.1.3 Instructions.** See Form UFS-604 on the following pages for the steps to follow when performing monthly inspection. If any of the inspection steps indicate a NOT OK condition, refer to this manual for instructions to rectify the condition.



Temperature fluctuations can affect nitrogen purity readings. Differences between readings taken at different times may be due to changes in temperature at the SC Series unit and at the reading location. Differences between readings should not be immediately interpreted as a system fault.

5.2 Annual Maintenance.

5.2.1 Objective. Annual maintenance helps keep the **NITROGEN-PAC™** SC system in satisfactory condition. This maintenance involves testing various components of the system, as well as replacement of key elements.

5.2.2 Personnel. UNITED Fire Systems strongly recommends that trained, experienced fire protection technicians perform this maintenance. Personnel should be thoroughly familiar with all details of system operation and maintenance, as well as the sprinkler equipment that the SC system is connected to. Read, understand, and follow all safety information in this manual, indicated by the words DANGER, WARNING, and CAUTION, and all information indicated by the word IMPORTANT.



Look for the  symbol. This indicates specific safety information and other important information which should be read, understood, and followed.

5.2.3 Instructions. See Form UFS-603 for the steps to follow when performing annual maintenance. This form also indicates the replacement parts that should be on hand to properly perform the maintenance procedure. Specific procedural instructions are shown below in Section 5.3.

5.3 Specific Procedures

5.3.1 Inspection and Maintenance of Refrigerated Dryer. Refer to Appendix A of this manual.

5.3.2 Use of Model NA-1 Nitrogen Purity Analyzer to Measure Nitrogen Purity at SC Series Nitrogen Generator Cabinet.

- Open SC Series nitrogen generator cabinet door.
- Switch Model NA-1 Nitrogen Purity Analyzer ON. Calibrate if needed – see Appendix C.
- Attach female quick-connect on analyzer to male quick-connect on N₂ Purity Test Port in nitrogen generator cabinet.
- *Carefully* open Valve 4. Hissing will be heard from holes on NA-1.
- Record reading from analyzer on inspection or commissioning form.
- Close Valve 4.
- Detach female quick-connect on analyzer from male quick-connect on N₂ Purity Test Port.

5.3.3 Use of Model NA-1 Nitrogen Purity Analyzer to Measure Nitrogen Purity at Model PVA Purge Vent Assembly.

- Switch Model NA-1 Nitrogen Purity Analyzer ON. Calibrate if needed – see Appendix C.
- If muffler assembly P/N 31-100020-101 is attached to outlet of Model PVA Purge Vent Assembly, detach female quick connect on muffler assembly from male quick-connect on outlet of purge vent assembly. Retain muffler assembly for re-attachment.
- Attach female quick-connect on analyzer to male quick-connect on outlet of Model PVA Purge Vent Assembly.
- If PVA ball valve is not already open for purging, *carefully* open valve. Hissing will be heard from holes on NA-1.
- Record reading from analyzer on inspection or commissioning form.
- Position purge vent assembly ball valve in original position.
- Detach female quick-connect on analyzer from male quick-connect on outlet of purge vent assembly.
- Re-attach female quick-connect on muffler assembly (if previously detached) to male quick-connect on outlet of purge vent assembly.

5.3.4 Replacement of Compressor Intake Filter Assemblies

- Check that Gauge B reads 55 to 95 PSI so that compressor does not run during procedure
- Remove existing filter assemblies by unscrewing (no tools required – filters are hand-tight).
- Replace with new filter assemblies by screwing on hand-tight. DO NOT USE TOOLS TO TIGHTEN FILTERS.

5.3.5 Condensate Pump (Installer provided option). Condensate pumps are not supplied by UNITED Fire Systems. Instructions provided with pump at installation should be followed.

5.3.6 Examination and Cleaning of Automatic Float Drains in SC Series Nitrogen Generator Cabinet

- Refer to Quick Reference Valve Position Table Column **D** – Filter Service. Position valves as shown. CAREFULLY allow pressure to bleed off.
- Disconnect drain tubing from push-to-connect fitting at drain port of cabinet by lifting disconnect ring and gently pulling tubing out.
- Hold knurled ring at top of float drain. Unscrew bottom of float drain.
- Clean screens and floats as needed. If new screens or floats are needed, see 5.4 – Maintenance Parts.
- Re-assemble float drains.
- If desired, perform maintenance on filter elements per 5.3.7.
- Re-insert drain tubing into push-to-connect fitting at drain port.
- When re-starting SC, check connections for leaks. Correct as necessary.

5.3.7 Replacement of Coalescing and Particulate Filter Elements in SC Series Nitrogen Generator Cabinet

- Refer to Quick Reference Valve Position Table Column **D** – Filter Service. Position valves as shown. CAREFULLY allow pressure to bleed off.
- Disconnect drain tubing from push-to-connect fitting at drain port of cabinet by lifting disconnecting ring and gently pulling tubing out.
- NOTE – Appendix B provides further information on filters.
- Unscrew filter bowls from filter bodies. Note relative positions of filter bowls – BOWLS MUST NOT BE INTERCHANGED AT RE-ASSEMBLY.
- Remove used filter elements. Replace with new filter elements – see 5.4 – Maintenance Parts.
- Re-attach filter bowls to filter bodies. Ensure proper bowl is attached to proper filter body, and do not interchange.
- If desired, perform maintenance on automatic float drains per 5.3.1.
- Re-insert drain tubing into push-to-connect fitting at drain port.
- When re-starting SC, check connections for leaks. Correct as necessary.

5.3.8 Replacement of Batteries in Model NA-1 Nitrogen Purity Analyzer. Refer to Appendix C of this manual.

5.3.9 Replacement of Sensor in Model NA-1 Nitrogen Purity Analyzer. Refer to Appendix C of this manual.

5.3.10 Drainage of Accumulated Water at Model PVA Purge Vent Assembly. Residual water can accumulate at PVAs, possibly blocking purge flow. Periodic removal of this residual water permits purging to take place with no obstruction.



IMPORTANT

To prevent inadvertent operation of sprinkler valve or actuation of low air signal, ALWAYS close PVA ball valve BEFORE removing drain plug or strainer retainer.

Figure 20
Model PVA Purge Vent Assembly

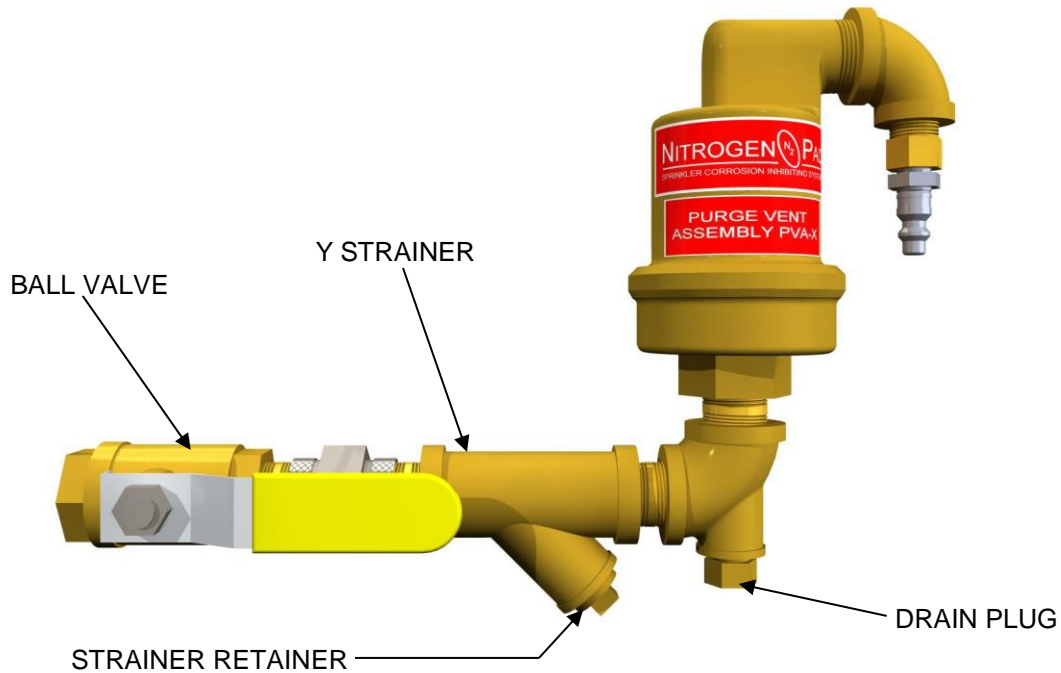

- Refer to Figure 20.
- If open, CLOSE PVA ball valve.
- Hold PVA so that torque applied to drain plug does not move PVA.
- With suitable wrench, remove drain plug.
- Allow sufficient time for accumulated water to drain.
- Apply Teflon tape to male threads of drain plug. (Recommended tape = Hercules Megatape or similar; 1/2 inch wide x 3.5 mils thick.)
- Replace drain plug, tightening with suitable wrench.
- If TAP device is installed, open ball valve.
- If TAP device is not installed, open ball valve only if purging is required.

5.3.11 Replacement of Strainer at Model PVA Purge Vent Assembly

- A clogged strainer may inhibit purging. Replace strainer when clogged.
- Refer to Figure 20.
- If open, CLOSE PVA ball valve.
- Hold PVA so that torque applied to drain plug does not move PVA.
- Apply suitable wrench to HEX on strainer retainer. Do not remove square plug.
- Remove strainer retainer and retain.
- Examine rubber seal on strainer retainer. If damaged during removal, leakage may occur.
- Remove old strainer.
- Insert new strainer – ensure strainer remains fully inserted.
- Tighten strainer retainer wrench-tight.
- If TAP device is installed, open ball valve.
- If TAP device is not installed, open ball valve only if purging is required.

5.4 Maintenance Parts

**Table 14
Maintenance Parts**

Description	UFS P/N
Intake Filter, Compressor	00-100005-558
Element, Particulate/Coalescing Filter	30-500002-101
Screen, Float Drain	30-500003-101
Float, Float Drain	30-500003-102
Screen, Strainer, PVA	30-500003-301
Element, Sensing, NA-1	30-500005-001
Battery, NA-1	Not available through UFS – source locally



**MONTHLY INSPECTION CHECKLIST
 NITROGEN-PAC SC SERIES SYSTEM
 UFS-603 REVISION 1.03 – PAGE 1 OF 2**



DATE	
-------------	--

LOCATION INFORMATION	
User	
Address 1	
Address 2	
City, State, Zip	
System	

NITROGEN-PAC™ SC UNIT SERIAL NUMBER	
--	--

STEP	PROCEDURE	OK	NOT OK
1	Is the GREEN visual indicator for SYSTEM NORMAL on?		
2	Has the message on the front panel of the Refrigerated Dryer been checked? NOTE: NORMAL indications are On , On_ , On: , On: , or ESA . Any other message indicates the need for further maintenance and / or repair. See UFS manual 30-NPSICM-000 Appendix A.		
3	Has Drain Valve 7 been opened, allowing any condensate to drain, and the valve then closed?		
4	Are all valves at the SC in the NORMAL position per the Quick Reference Valve Position Table?		
5	Are all the valves at all AMDs in their proper position?		
6	Are the inlet valves at all PVAs in their proper position?		
7	If owned by customer, is the NA-1 Nitrogen Analyzer located in its proper storage location, is the location still clean and dry, and does the device power up?		
8	Have all nitrogen purity values, pressures on all system gauges, and the time on the Runtime Monitor been recorded below?		

NITROGEN PURITY VALUES					
SC Cabinet Test Port	%	PVA or TAP #1	%	PVA or TAP #2	%
PVA or TAP #3	%	PVA or TAP #4	%	PVA or TAP #5	%

PRESSURES ON SYSTEM GAUGES							
Model No.	Gauge	Proper Gauge Reading		Model No.	Gauge	Proper Gauge Reading	
		Minimum	Maximum			Minimum	Maximum
SC-1	A	0	100	SC-2	A	0	100
	B	75	95		B	55	75
Have the values on all system gauges been recorded?		Gauge A	PSIG	Gauge B	PSIG	AMD Gauge #1	PSIG
AMD Gauge #2	PSIG	AMD Gauge #3	PSIG	AMD Gauge #4	PSIG	AMD Gauge #5	PSIG

	PRINT NAME	SIGNATURE	DATE
INSPECTOR			



**MONTHLY INSPECTION CHECKLIST
 NITROGEN-PAC SC SERIES SYSTEM
 UFS-603 REVISION 1.03 – PAGE 2 OF 2**



QUICK REFERENCE VALVE POSITION TABLE

	A	B	C	D	E	F	G
VALVE	NORMAL	BYPASS	PURGE	FILTER SERVICE	N ₂ PURITY AT TEST PORT	N ₂ PURITY AT PVAs	DRAIN
1	Closed	Open	Closed	Closed	Closed	Closed	Closed
2	Open	Closed	Open	Closed	Open	Open	Closed
3	Open	Closed	Open	Closed	Open	Open	Closed
4	Closed	Closed	Closed	Closed	Open	Closed	Closed
5	Open	Open	Open	Closed	Open	Open	Closed
6	Closed	Closed	Closed	Open	Closed	Closed	Open
7	Closed	Closed	Closed	Closed	Closed	Closed	Open
8	Open	Open	Open	Closed	Open	Open	Closed
AMD VALVES							
AMD-1 Inlet(s)	Open	Closed	Open	Open	Open	Open	Open
AMD-1 Outlet(s)	Open	Closed	Open	Open	Open	Open	Open
AMD-1 Bypass(es)	Closed	Open	Closed	Closed	Closed	Closed	Closed
PVA INLET VALVE(S)							
PVA-3 Inlet Valve(s) with NA-1	Closed	Closed	Open	Closed	Closed	Open	Closed
PVA-2 Inlet Valve(s) with TAP	Open	Open	Open	Open	Open	Open	Closed
TAP = True Advanced Purge device. Leave PVA inlet valve open unless draining water at PVA location. See manual 30-NPSICM-000 for more information.							

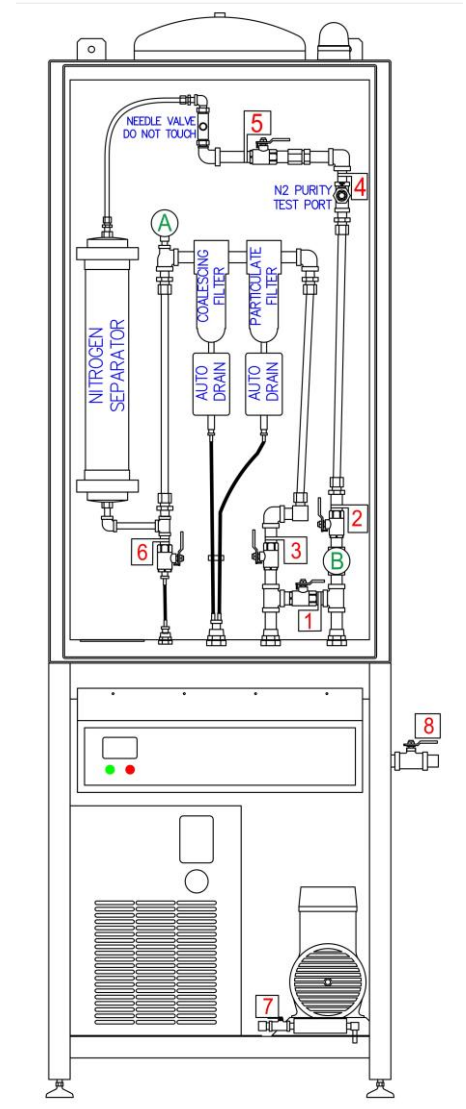

- A** = NORMAL – system is providing nitrogen into preaction sprinkler system(s).
- B** = BYPASS – compressed air is routed to preaction sprinkler system(s) for initial fill (max. 30 minutes) per NFPA 13, or to put sprinkler system on air if nitrogen is not available.
- C** = PURGE – system(s) are purging air out of sprinkler piping, replacing air with nitrogen.
- D** = FILTER SERVICE – filter elements in SC cabinet filters are to be replaced.
- E** = N₂ PURITY AT TEST PORT – nitrogen purity at SC cabinet is to be checked with NA-1 hand-held meter.
- F** = N₂ PURITY AT PVAs – nitrogen purity at PVAs is to be checked with NA-1 hand-held meter or TAP
- G** = DRAIN – draining accumulated moisture from SC and PVAs.







**ANNUAL MAINTENANCE CHECKLIST
 NITROGEN-PAC SC SERIES SYSTEM
 UFS-604 REVISION 1.04 – PAGE 1 OF 3**



DATE	
-------------	--

LOCATION INFORMATION	
User	
Address 1	
Address 2	
City, State, Zip	
System	

NITROGEN-PAC™ SC UNIT SERIAL NUMBER	
--	--

STEP	PROCEDURE	OK	NOT OK
1	Is the GREEN visual indicator for SYSTEM NORMAL on?		
2	Has the message on the front panel of the Refrigerated Dryer been checked? NOTE: NORMAL indications are  ,  ,  ,  , or  . Any other message indicates the need for further maintenance and / or repair. See UFS manual 30-NPSICM-000 Appendix A.		
3	Has the refrigerated dryer condenser been examined through the slots on the rear, and has the condenser been carefully cleaned with compressed air if dirty?		
4	Are the refrigerated dryer inlet and outlet connections properly affixed and tight?		
5	Is the SC nitrogen outlet hose present, secure and in good condition?		
6	Are all valves at the SC in the NORMAL position per the Quick Reference Valve Position Table?		
7	Has Valve 1 been opened, and Valves 2 and 3 closed, and is the GREEN visual indicator off and the RED visual indicator on? When the valves are returned to NORMAL, do the visual indicators return to normal?		
8	Is the condensate drain connected to a hose or piping leading to a proper drain?		
9	If present, is the condensate pump properly connected and in good working order?		
10	Has drain valve 7 been opened long enough to permit condensate to drain, and then closed?		
11	Have the compressor intake filters been replaced?		
12	Have the float drains at the coalescing and particulate filters been examined and cleaned if necessary?		
13	Have the filter elements in the coalescing and particulate filters been replaced?		
14	Is all nitrogen piping secure and tight?		



**ANNUAL MAINTENANCE CHECKLIST
 NITROGEN-PAC SC SERIES SYSTEM
 UFS-604 REVISION 1.04 – PAGE 2 OF 3**



STEP	PROCEDURE	OK	NOT OK
15	Are all the valves at all AMDs in their proper position?		
16	Are the inlet valves at all PVAs in their proper position?		
17	Has residual water (if present) been drained from each PVA? (CAUTION: Close inlet valve at PVA before attempting water drainage, to prevent inadvertent sprinkler valve operation.)		
18	If owned by customer, is the NA-1 Nitrogen Analyzer located in its proper storage location, is the location still clean and dry, have the batteries been replaced, and has the device been tested?		
19	Have all nitrogen purity values, pressures on all system gauges, and the time on the Runtime Monitor been recorded below?		

NITROGEN PURITY VALUES					
SC Cabinet Test Port	%	PVA or TAP #1	%	PVA or TAP #2	%
PVA or TAP #3	%	PVA or TAP #4	%	PVA or TAP #5	%

PRESSURES ON SYSTEM GAUGES							
Model No.	Gauge	Proper Gauge Reading		Model No.	Gauge	Proper Gauge Reading	
		Minimum	Maximum			Minimum	Maximum
SC-1	A	0	100	SC-2	A	0	100
	B	75	95		B	55	75
Have the values on all system gauges been recorded?		Gauge A	PSIG	Gauge B	PSIG	AMD Gauge #1	PSIG
AMD Gauge #2	PSIG	AMD Gauge #3	PSIG	AMD Gauge #4	PSIG	AMD Gauge #5	PSIG

18	Have all valves been left in NORMAL position?		
----	---	--	--

REPLACEMENT PARTS REQUIRED AT ANNUAL MAINTENANCE		
Quantity	UFS P/N	Description
2	30-500002-101	Element, Particulate and Coalescing Filter
2	00-100005-555	Intake Filter, Compressor
2	N / A	(If owned by customer) Battery, AA Alkaline, for NA-1 Nitrogen Analyzer

OPTIONAL REPLACEMENT PARTS FOR ANNUAL MAINTENANCE			
UFS P/N	Description	Quantity Replaced	Quantity Not Replaced
30-500003-101	Screen, Float Drain		
30-500003-102	Float, Float Drain		
30-500003-301	Screen, Strainer, PVA		
30-500005-001	Element, Sensing, NA-1		

COMPLETION SIGNATURES			
	PRINT NAME	SIGNATURE	DATE
INSPECTOR			
CUSTOMER			



**ANNUAL MAINTENANCE CHECKLIST
 NITROGEN-PAC SC SERIES SYSTEM
 UFS-604 REVISION 1.04 – PAGE 3 OF 3**



QUICK REFERENCE VALVE POSITION TABLE

	A	B	C	D	E	F	G
VALVE	NORMAL	BYPASS	PURGE	FILTER SERVICE	N ₂ PURITY AT TEST PORT	N ₂ PURITY AT PVAs	DRAIN
1	Closed	Open	Closed	Closed	Closed	Closed	Closed
2	Open	Closed	Open	Closed	Open	Open	Closed
3	Open	Closed	Open	Closed	Open	Open	Closed
4	Closed	Closed	Closed	Closed	Open	Closed	Closed
5	Open	Open	Open	Closed	Open	Open	Closed
6	Closed	Closed	Closed	Open	Closed	Closed	Open
7	Closed	Closed	Closed	Closed	Closed	Closed	Open
8	Open	Open	Open	Closed	Open	Open	Closed
AMD VALVES							
AMD-1 Inlet(s)	Open	Closed	Open	Open	Open	Open	Open
AMD-1 Outlet(s)	Open	Closed	Open	Open	Open	Open	Open
AMD-1 Bypass(es)	Closed	Open	Closed	Closed	Closed	Closed	Closed
PVA INLET VALVE(S)							
PVA-3 Inlet Valve(s) with NA-1	Closed	Closed	Open	Closed	Closed	Open	Closed
PVA-2 Inlet Valve(s) with TAP	Open	Open	Open	Open	Open	Open	Closed
TAP = True Advanced Purge device. Leave PVA inlet valve open unless draining water at PVA location. See manual 30-NPSICM-000 for more information.							

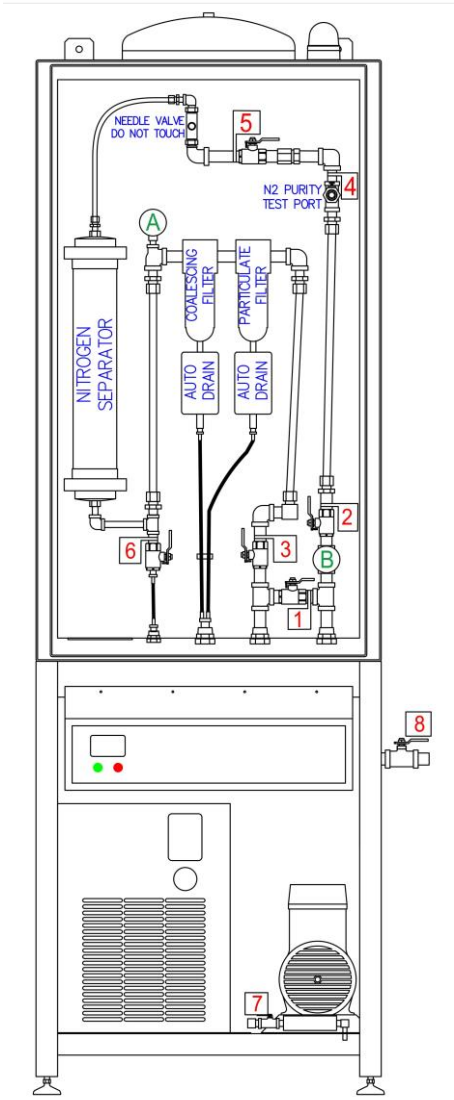

- A = NORMAL** – system is providing nitrogen into preaction sprinkler system(s).
- B = BYPASS** – compressed air is routed to preaction sprinkler system(s) for initial fill (max. 30 minutes) per NFPA 13, or to put sprinkler system on air if nitrogen is not available.
- C = PURGE** – system(s) are purging air out of sprinkler piping, replacing air with nitrogen.
- D = FILTER SERVICE** – filter elements in SC cabinet filters are to be replaced.
- E = N₂ PURITY AT TEST PORT** – nitrogen purity at SC cabinet is to be checked with NA-1 hand-held meter.
- F = N₂ PURITY AT PVAs** – nitrogen purity at PVAs is to be checked with NA-1 hand-held meter or TAP
- G = DRAIN** – draining accumulated moisture from SC and PVAs.

6. TROUBLESHOOTING



IMPORTANT

All troubleshooting is to be performed by qualified personnel. . Be aware of pressurized system components as some of the troubleshooting procedures require system components to be pressurized. **Failure to do so can result in system damage and/or personal injury.**

SYMPTOM	INDICATION(S)	PROBLEM	SOLUTION	MANUAL REFERENCE
Compressor does not run	Green "SYSTEM NORMAL" indicator is OFF	Power is OFF	Check circuit breaker and any required motor disconnect device.	
	Green "SYSTEM NORMAL" indicator is ON	Possible compressor overheating	Allow compressor to cool	
Refrigerated dryer does not run	Panel on front of dryer is blank.	Refrigerated dryer not receiving power	Check seating of refrigerated dryer power plug in receptacle on rear of control cabinet.	
Nitrogen purity in sprinkler system not increasing	Red "SYSTEM BYPASSED" indicator is ON	SC unit is in Bypass mode	Verify position of Valves 1, 2, and 3 - restore to Nitrogen position.	See Figure 19
	Green "SYSTEM NORMAL" indicator is ON	SC unit may not be producing nitrogen	Check nitrogen purity at test port using NA-1 meter	See 5.3.2
	SC unit is producing 98% nitrogen when checked with NA-1 meter	Valve on PVA is CLOSED	Open valve	See 4.4
		PVA assembly has been flooded with water	Drain PVA assembly	See 5.3.10
		Strainer at PVA is clogged	Replace strainer	See 5.3.11
SC unit not producing 98% nitrogen when checked with NA-1 meter	Contact UNITED Fire Systems			

SYMPTOM	INDICATION(S)	PROBLEM	SOLUTION	MANUAL REFERENCE
Excessive compressor runtime (more than 2-1/2 hours per day) during purging	During purging, the SC compressor is supplying air to make nitrogen for purging. Runtime during purging will be much greater during purging, and “excessive” runtime is normal. Air compressor runtime should be assessed after purging is complete.			
Excessive compressor runtime (more than 2-1/2 hours per day) after purging	Runtime indicator indicates more than 2-1/2 hours of runtime in a 24 hour period.	Compressor intake filters are clogged	Replace intake filters.	See 5.3.4
		Particulate and / or condensing filters are clogged	Replace filter elements	See 5.3.7
		Leakage in piping between SC outlet and AMD	Repair all leaks.	
		Leakage at AMD	Repair all leaks.	
		Excessive leakage in sprinkler piping	Repair leaks until leakage is minimized	See 2.12.1
		SC regulator drift	When compressor is running, check Gauge A for reading of 100 PSI.	If Gauge A reading is too low, contact UNITED Fire Systems
Low air signal	Control panel monitoring sprinkler valve indicates SUPERVISORY – LOW AIR condition	AMD valves not properly positioned	Position AMD ball valves properly	See Table 13
		AMD regulator not properly adjusted	Adjust AMD regulator to correspond with required supervisory pressure	See Appendix D
		Compressor is not able to “keep up”	See “Excessive compressor runtime (more than 2-1/2 hours per day) after purging” above	
High air signal	Control panel monitoring sprinkler valve indicates SUPERVISORY – HIGH AIR condition	AMD regulator not properly adjusted	Adjust AMD regulator to correspond with required supervisory pressure	See Appendix D
Inadvertent dry-pipe valve tripping during purging		Presence of quick-opening device (dry accelerator)	See 2.12.1 for information on dealing with the presence of a quick-opening device (dry accelerator)	

APPENDIX A - SC SERIES MANUAL
INGERSOLL-RAND DIRECT EXPANSION COMPRESSED AIR DRYER
OPERATOR'S MANUAL - MODEL D12IN-A (60Hz; NPT)



CONTENTS

1. GENERAL INFORMATION

1.1 Functional Description	3
1.2 Safe Use of the Dryer	3

2. INSTALLATION

2.1 Acceptance and Transportation	4
2.2 Installation Site	4
2.3 Installation	4

3. START UP

3.1 Control Panel	5
3.1.1 Keys function	6
3.1.2 Condensate discharge Parameters	
Programming	6
3.1.3 Anomaly Warning	7
3.1.4 Remote signalling Alarm	7
3.2 Before Start Up	8
3.3 Start Up	8

4. MAINTENANCE, TROUBLESHOOTING AND DISMANTLING

4.1 Maintenance	8
4.2 Troubleshooting	8
4.3 Dismantling	10

ATTACHMENTS TO THIS MANUAL

A) Refrigerant Circuit	21
B) Electric Circuit Diagram	22
C) Technical Data Sheet	24
D) Correction Factors	25
E) Dryer Dimensions	26
F) Basic Spare Parts	28

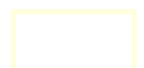

INTRODUCTION

This manual is an integral part of the dryer you bought, and must remain with the machine even if this will be resold.











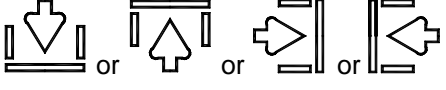
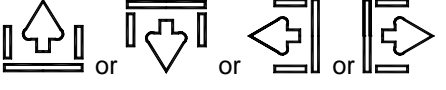

It is highly recommended that the qualified*personnel for installation maintenance and/or control will fully comply with the contents of this manual and the prevention and safety rules in force in the country where the system will be used. In this way, not only the usage of the machine will be rational, but also the service will result cost effective.

In case your dryer will present any kind of problem, please contact your local authorized Ingersoll Rand distributor.

Please note that, when necessary, the use of original spare parts will ensure efficiency and long duration to your dryer.

Due to the continuous technological evolution, Ingersoll Rand reserves the right to modify the specifications contained in this manual without giving previous notice.

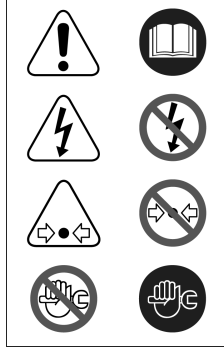
SYMBOLS AND LABELS USED IN THE MANUAL AND ON THE DRYER

	Air inlet.		Air outlet.
	Read the Operators manual before attempt to start up the machine and to perform any service operation on the dryer.		Pay particular attention to components or systems under pressure.
	Pay particular attention to the indications preceded by these symbols.		Pay particular attention to hot surfaces.
	Installation, maintenance, and/or control operations preceded by these symbols must be performed exclusively by qualified personnel*.		Pay particular attention to the risk of electric shock.
	Condensate drain point.		Rotation direction of the fan.
	Pay particular attention to the risk of moving parts	CAUTION	- RISK OF ELECTRIC SHOCK; DISCONNECT FROM SUPPLY SOURCE BEFORE SERVICING
	Attention: Before performing any maintenance operation on this machine, do not forget to disconnect the electric supply, to completely discharge air pressure, and to refer to the Operators manual	CAUTION	- MOVING PART; DO NOT OPERATE WITH PANEL REMOVED
		CAUTION	- HOT PART; DO NOT OPERATE WITH PANEL REMOVED
			ATTENZIONE ATTENTION IMPORTANTE ACHTUNG OGNI SETTIMANA ONCE A WEEK TOUTES LES SEMAINES CADA SEMANA WOCHENTLICH
		IL CONDENSATORE VA PULITO CON UN GETTO DI ARIA COMPRESSA. THE CONDENSER MUST BE CLEANED BY BLOWING OUT WITH AIR. NETTOYER LE CONDENSEUR AVEC UN JET D'AIR COMPRIME'. LIMPIAR EL CONDENSATOR CON AIRE COMPRIMIDO. DEN KONDENSATOR MIT EINEM DRUCKLUFTSTRAHL REINIGEN.	

* Qualified personnel must be trained and certified in accordance with local laws and regulations.

WARRANTY

The Company warrants that the equipment manufactured by it and delivered hereunder will be free of defects in material and workmanship for a period of twelve months from the date of placing the Equipment in operation or eighteen months from the date of shipment from the factory, whichever shall first occur. The Purchaser shall be obligated to promptly report any failure to conform to this warranty, in writing to the Company in said period, whereupon the Company shall, at its option, correct such nonconformity, by suitable repair to such equipment or, furnish a replacement part F.O.B. point of shipment, provided the Purchaser has stored, installed, maintained and operated such Equipment in accordance with good industry practices and has complied with specific recommendations of the Company. Accessories or equipment furnished by the Company, but manufactured by others, shall carry whatever warranty the manufacturers have conveyed to the Company and which can be passed on to the Purchaser. The Company shall not be liable for any repairs, replacements, or adjustments to the Equipment or any costs of labor performed by the Purchaser or others without Company's prior written approval.

The effects of corrosion, erosion and normal wear and tear are specifically excluded. Performance warranties are limited to those specifically stated within the Company's proposal. Unless responsibility for meeting such performance warranties are limited to specified tests, the Company's obligation shall be to correct in the manner and for the period of time provided above.

THE COMPANY MAKES NO OTHER WARRANTY OR REPRESENTATION OF ANY KIND WHATSOEVER, EXPRESSED OR IMPLIED, EXCEPT THAT OF TITLE, AND ALL IMPLIED WARRANTIES OF MERCHANTABILITY AND FITNESS FOR A PARTICULAR PURPOSE, ARE HERBY DISCLAIMED.

Correction by the Company of nonconformities whether patent or latent, in the manner and for the period of time provided above, shall constitute fulfillment of all liabilities of the Company for such nonconformities whether based on contract, warranty negligence, indemnity, strict liability or otherwise with respect to or arising out of such Equipment.

The Purchaser shall not operate Equipment which is considered to be defective, without first notifying the Company in writing of its intention to do so. Any such use of Equipment will be at Purchaser's sole risk and liability.

Note that this is Ingersoll Rand standard warranty. Any warranty in force at the time of purchase of the equipment or negotiated as part of the purchase order may take precedence over this warranty.

1. GENERAL INFORMATION

1.1 FUNCTIONAL DESCRIPTION

Ingersoll Rand refrigerated air dryers remove moisture from compressed air. Moisture is detrimental to pneumatically operated appliances, controls, instruments, machinery and tools.

Compressed air enters the patented aluminum heat exchanger where it is cooled down to the dew point temperature in two different stages: In the first air/air sector compressed inlet air is cooled thanks to the colder compressed air coming out counterflow from the condensate separator. In the second refrigerant / air sector, compressed air temperature is further lowered to the dew point temperature. During this two stages almost all the oil and water vapours contained in compressed air are condensed to liquid and successively be separated from the compressed air in the condensate separator and drained out by the automatic drain. At this point the obtained cold air re-enters counterflow the initial air / air exchanger and it is reheated by the inlet hot air with the consequence of energy recovering and also reduction of the relative humidity contained in the outflowing air.

This dryer can be easily installed into various pneumatic systems in which dry air is required or desired. Please refer to Start up chapter for complete operating details.

The dryer comes provided with all the control, safety and adjustment devices, therefore no auxiliary devices are needed.

A system overload not exceeding the maximum operative limits can worsen the operational performance of the dryer (high dew point), but it will not affect its safety.

The electric diagram (attachment B) shows the minimum protection degree IP 42.

Improper grounding can result in electrical shock and can cause severe injury or death.

This product must be connected to a grounded, metallic, permanent wiring system or an equipment-grounding terminal or lead on the product.

All grounding must be performed by a qualified electrician and comply with national and local electrical codes. In the event of an electrical short circuit, grounding reduces the risk of electric shock by providing an escape wire for the electric current.

Ground must be established with a bare grounding wire sized according to the voltage and minimum branch circuit requirements.

Ensure good bare metal contact at all grounding connection points, and ensure all connections are clean and tight.

Check grounding connections after initial installation and periodically thereafter to ensure good contact and continuity has been maintained.

Check with a qualified electrician or service technician if the grounding instructions are not completely understood, or if in doubt as to whether the product is properly grounded.



1.2 USE OF THE MACHINE IN SAFE CONDITIONS

This system has been designed and manufactured in compliance with the European safety directive in force and UL/ULC, therefore any installation, use and maintenance operations must be performed respecting the instructions contained in this manual.

Because an air dryer is pressurized and contains rotating parts, the same precautions should be observed as with any piece of machinery of this type where carelessness in operation or maintenance could be hazardous to personnel. In addition to obvious safety rules that should be followed with this type of machinery, safety precautions as listed below must be observed.



1. Only qualified personnel shall be permitted to adjust, perform maintenance or repair this air dryer.
2. Read all instructions completely before operating unit.
3. Pull main electrical disconnect switch and disconnect any separate control lines, if used, before attempting to work or perform maintenance on the unit.
4. Do not attempt to service any part while machine is in an operational mode.
5. Do not attempt to remove any parts without first relieving the entire air system of pressure.
6. Do not attempt to remove any part of the refrigeration system without removing and containing refrigerant in accordance with the EPA and local regulations.
7. Do not operate the dryer at pressures in excess of its rating.
8. Do not operate the dryer without guards, shields and screen in place.
9. Inspect unit daily to observe and correct any unsafe operating conditions.

2. INSTALLATION

2.1 ACCEPTANCE, UNPACKING AND HANDLING

Upon receiving your Ingersoll Rand air dryer, please inspect the unit closely. If rough handling is detected, please note it on your delivery receipt, especially if the dryer will not be uncrated immediately. Obtaining the delivery person's signed agreement to any noted damages will facilitate any insurance claims by the customer.

It is mandatory to keep the dryer always in vertical position, as indicated by the symbols present on the packaging. For handling, use devices having sufficient capacity for the weight of the machine.

Remove the packaging after having positioned the dryer in the installation site. Dispose the various packaging materials in compliance with the relevant rules locally in force.

If not in use, the dryer can be stored in its packaging in a dust free and protected site between 32°F (0°C) and 120 °F (50 °C), and a specific humidity not exceeding 90 %. Should the stocking time exceed 12 months, please contact your local Ingersoll Rand authorized distributor.

Under no circumstances should any person attempt to lift heavy objects without proper lifting equipment (i.e., crane, hoist, slings or fork truck). Lifting any unit without proper lifting equipment, may cause serious injury. Use fork lift channels where provided.

2.2 INSTALLATION SITE

While preparing a proper site for the installation of the dryer, please take into account the following requirements



- The machine must be protected from atmospheric agents and not directly exposed to sun light.
- A seating base flat and capable to hold the weight of the machine.
- Ambient temperature complying with the nominal data of the dryer.
- The dryer should be located in a clean area, without forced air draft that can affect the fan control system.
- Make sure to leave sufficient clearance (20 inches, 500 mm) around the dryer in order to allow an adequate cooling of the machine and for maintenance and/or control operations.

The incoming air must be free from smoke or flammable vapours which could lead to explosion or fire risks.

2.3 INSTALLATION

Before attempting any installation operation, make sure that



- **No parts of the air system are under pressure.**
- **No parts of the system are electrically powered.**
- **Tubing to be connected to the dryer are free of impurities.**
- **All interconnecting piping has been tightened.**

After having verified the points listed above, you can proceed to the installation of the machine.

1. Connect the dryer to the compressed air lines. If not already existing, we suggest to install a by-pass allowing to isolate the machine from the plant, thus to facilitate eventual maintenance operations.
2. Perform the electrical connection in accordance with any local laws and regulations after reviewing the dryer electrical specifications and wiring diagram.
3. Check the condensate drainage assembly, and connect the drain flexible hose to the draining line, keeping in mind that **the condensate separated by the dryer may contain oil, therefore, in order to dispose of it in compliance with the local rules in force, we suggest installing a water-oil separator having adequate capacity.**
4. Power the dryer after having checked that the nominal voltage and line frequency are constant and matching the nominal values of the machine. **The user must provide the installation with an adequate line protection and a ground terminal complying with the electrical rules locally in force.**



In order to optimise the use of the dryer, we suggest to place it in such a way that all the control instruments of the machine will result easily visible.

A suitably sized prefilter must be installed before the dryer. Failure to install and maintain a proper prefilter will void the dryer warranty. The rating for this filter must be at least 10 micron.

3. START UP

Ensure that the dryer is by-passed, or there is no load on the cooler.

Switch on the main electrical isolation switch (if present). The control panel will show the message OFF, indicating that the line and control voltages are available.

Start sequence

The dryer will initially start by pressing the local ON/OFF button for 1 second. The start sequence will progress only if there are no active alarms. The compressor motor will start AFTER 120 SECONDS. The fan motor will start simultaneously with the compressor for D300-360IN models, after 30 seconds for smaller models.

Stop sequence

The dryer can be stopped locally from the control panel. After having pressed the ON/OFF switch for 1 second, the compressor and the fan motor keep on running for further 10 seconds in order to re-balance the internal pressures. The dryer can be also stopped due to an alarm or energy saving condition (ESA or ES2). Any alarm will de-energize the compressor, fan motor can still running, it depends on the type of alarm (see Display indications chapter). If the shutdown is due to an alarm, a message will blink on display indicating the reason for the shutdown. Energy saving condition (ESA or ES2) occurs when the dew point stands below the set value for a long time in order to save energy and avoid heat exchanger freezing. This situation can happen when ambient temperature is low and there is no compressed air load.

Variable speed fan control

A patented microprocessor allows to adjust dryer's cooling capacity by changing the fan motor speed. If the dew point is greater than the set value, the fan speed is increased, if the dew point is smaller than the set value, the fan velocity is decreased. The range can be from 0 to 100% and the higher is the fan speed, the faster the fan LED blinks, you can read the exact value by pressing the UP button. If the velocity is 100% you will read FL (Full Load). Under load standard condition the fan speed is usually at 100%, if there is no load the fan velocity can oscillate between 0 and 20%.

In models D300-360IN, in order to adjust the greater dryer's cooling capacity, a hot gas by-pass valve cooperates with the variable speed system.

3.1 CONTROL PANEL

The dryers are provided with an electronic control system. All adjustments and resets can be performed by means of the digital panel located on the front of the dryer.

The control panel is composed of 5 keys (ON/OFF, TEST, SET, DOWN and UP) and a 3 digit display, with three signalling LEDs indicated by icons (PIC 1)

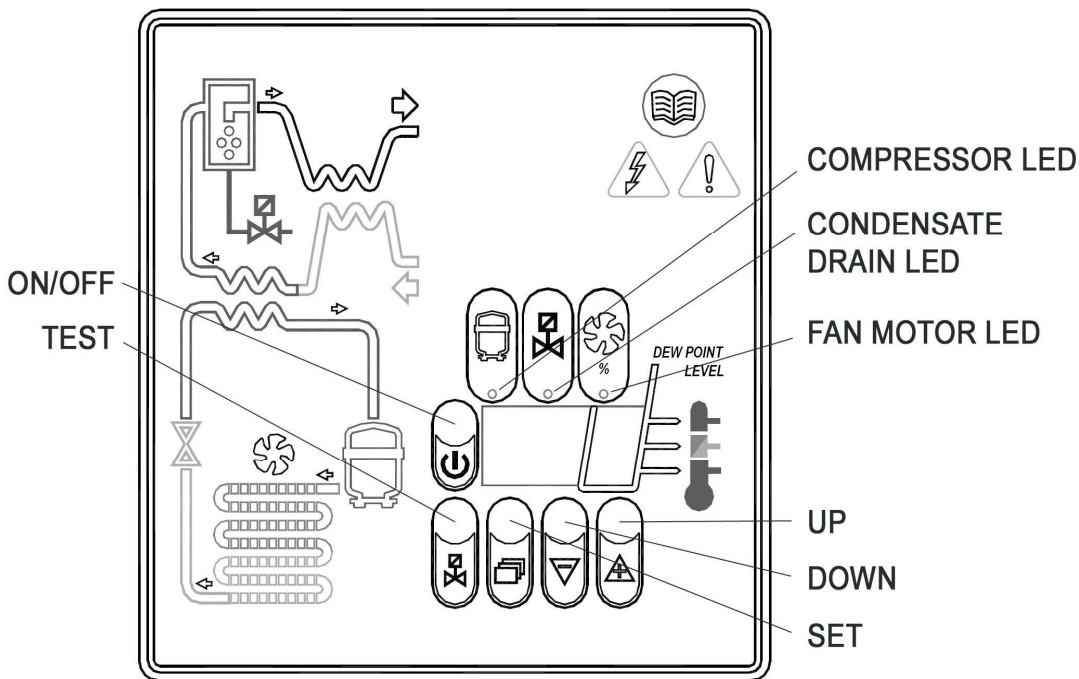

PIC. 1

DISPLAY VISUALIZATION AND SIGNALLING LEDES

DISPLAY	DESCRIPTION
	the unit is ON with low load
	the unit is ON with normal load
	the unit is ON with normal-high load
	the unit is ON with high load

LED	STATUS	DESCRIPTION
	ON	Compressor energized
	Blinking	Programming mode activated
	ON	Condensate drain energized
	ON	Speed of the fan = 100%
	Blinking	Speed of the fan < 100%
	OFF	Fan not running

3.1.1 KEYS FUNCTION

TEST: When pushed for 3 sec. during normal operation, it activates the condensate drain.

SET: When pushed and released during normal operation, it displays the dew point set value (decimal).
When pushed for 10 seconds, it allows to enter the C8 and C9 condensate drain parameters programming menu (see relevant table).
When pushed after having set new configuration values, it stores the applied modifications.

 **DOWN:** When pushed while setting the drain set point, it decreases the displayed value of one unit per second, during the first 10 seconds, than of one unit every 0,1 sec.
When pushed for 10 seconds during normal operation, it starts an automatic test cycle of the controller.

UP: When pushed while setting the drain set point, it increases the displayed value of one unit per second, during the first 10 seconds, than of one unit every 0,1 sec.



ON / OFF: Pushed for 1 second, it activates or deactivates the dryer. When the dryer is deactivated, the display shows OFF.

NOTE: when the controller is in the OFF position, some parts of the dryer may still be energized. Therefore, for safety purposes, disconnect the electrical power before performing any operation on the machine.

3.1.2 CONDENSATE DISCHARGE PARAMETERS PROGRAMMING



Push the SET key for 10 seconds to enter the parameters configuration menu: the display will show in sequence the set point value, the code of the first modifiable parameter (C8) and its value). Only if strictly necessary, use the UP and/or DOWN keys to change the displayed parameter value. Press the SET key to store the previously changed parameter value or to browse the parameters without changing them.
15 seconds after the last performed operation, the controller will return automatically to the normal operation mode.

	PARAMETER	DESCRIPTION	RANGE	DEFAULT SET VALUE		
	C8	Delay between condensate discharges	1 ÷ 999 (min)	1		
	C9	Time required for condensate discharge	1 ÷ 999 (sec)	D12-144IN-A	D180IN-A	D300-360IN-A
				1	2	3

NOTE: Changes entered for timing values will be effective only after exiting the programming, while changes to other variables will be immediately effective.

Please remember that eventual changes to the configuration parameters of the machine could negatively affect its efficiency. Thus, changes have to be performed by a person familiar with the operation of the dryer.

WARNING FOR USER:

IT'S FORBIDDEN TO ATTEMPT TO MODIFY THE OTHER CONFIGURATION PARAMETERS OF THE ELECTRONIC CONTROLLER WITHOUT AUTHORIZATION AND COLLABORATION OF INGERSOLL RAND'S AUTHORIZED DISTRIBUTOR.

3.1.3 DISPLAY INDICATIONS

The controller is capable of recognizing certain types of anomalies in the drying circuit. In such cases, a message will blink on the display, alternated to the current dew point value.

MESSAGE (BLINKING)	CAUSE	OUTPUTS	ACTIONS
HtA	High dew point value (delayed alarm)	Alarm output ON Refrig. Compressor output OFF Fan output ON Drain cycle standard	Resettable by switching off the dryer. If problem persists call your local Ingersoll Rand distributor.
Ht2	Very high dew point value (immediate alarm)		
LtA	Low dew point value	Alarm output ON Refrig. Compressor output OFF Fan output OFF Drain cycle standard	Automatic reset when dew point returns to preset range. If problem persists call your local Ingersoll Rand distributor.
PF1	Interruption or short circuit on the PTC probe input line	Alarm output ON Refrig. Compressor output OFF Fan output OFF Drain cycle standard	Resettable by switching off the dryer. May require replacing the faulty probe. If problem persists call your local Ingersoll Rand distributor.
ESA	The automatic Energy saving mode activated due to low load	Alarm output OFF Refrig. Compressor output OFF Fan output OFF Drain cycle standard	No action necessary. Automatic Reset
ES2			
ASt	Activated after repeated alarms	Alarm output ON Refrig. Compressor output OFF Fan output ON Drain cycle standard	Call your local Ingersoll Rand distributor.

Note: PF1 has priority on all other messages.

3.1.4 REMOTE SIGNALING ALARM

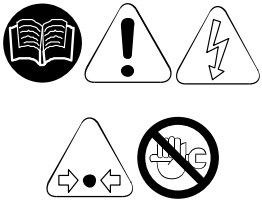

The dryer control board is equipped with a dry contact for a remote alarm signal. This is normally open contact: when an alarm is detected, this contact is closed. Proceed as follows to activate a remote alarm output:

1. The User must review the diagram below.
2. Disconnect the dryer from electrical power supply, remove cover and left side panel.
3. Connect the alarm circuit to the terminal blocks (See PIC.2).
4. Replace cover, left side panel and reconnect power.

Alarm Output relays electric features:
Max. 250VAC / 3A – AC 15 (Amp. Inductive)

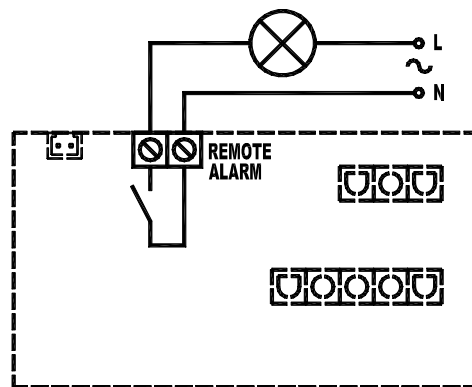

PIC.2

The activation of the above function is at the User's discretion. The User will purchase all necessary installation material. Any operation which needs access to the dryer must be carried out by qualified personnel.

3.2 BEFORE START UP



Before starting the machine, make sure that all operating parameters correspond to the nominal data. The dryer is supplied already tested and preset for normal operation, and it doesn't require any calibration. Nevertheless, it's necessary to check the operating performances during the first working hours.

3.3 START UP

The operations specified below must be performed after the first start up and at each start up after a prolonged inactive period of time due to maintenance operations, or any other reason.



1. Make sure that all instructions contained in chapters INSTALLATION SITE and INSTALLATION have been observed.
2. Ensure dryer by-pass is open and air inlet/outlet valves closed. (if existing).
3. Activate power supply and press the ON/OFF switch on the control panel for at least 1 second. (note there is a 2 minute delay before the dryer will start after the dryer is turned on).
4. Wait 5 to 10 minutes until machine has achieved its standard operating parameters.
5. Slowly open the air outlet valve and successively open the air inlet valve.
6. If existent, close the air by-pass valve.
7. Check if the condensate drain is working properly.
8. Check if all connecting pipes are properly tightened and fixed.

Before disconnecting the dryer from electrical power supply, use ON/OFF switch to stop the dryer. Otherwise wait 10 minutes before switching the dryer on again, in order to allow freon pressure to rebalance.

4. MAINTENANCE, TROUBLESHOOTING AND DECOMMISSIONING

4.1 MAINTENANCE

Before attempting any maintenance operation, make sure that:



1. **No parts of the system are under pressure.**
2. **No parts of the system are electrically powered.**

→ WEEKLY OR EVERY 40 HOURS OF OPERATION

- Verify the temperature on the control panel display is acceptable.
- Visually check if the condensate is drained regularly.

→ MONTHLY OR EVERY 200 HOURS OF OPERATION

- Clean the condenser with compressed air, taking care not to damage the condenser fins..
- At the end of the above mentioned operations, check if the dryer is working properly.
- Check the condition of any filters installed with the dryer. Replace elements as needed.

→ YEARLY OR EVERY 2000 HOURS OF OPERATION

- Check if the flexible tube used for condensate drainage is damaged and replace it if necessary.
- Check if all connecting pipes are properly tightened and fixed.
- At the end of the above mentioned operations, check if the dryer is working properly.

4.2 TROUBLESHOOTING

NOTE: FOLLOWING BEHAVIORS ARE NORMAL CHARACTERISTIC OF OPERATION AND NOT TROUBLES



- Variable speed of the fan.
- Display of message ESA and ES2 in case of operation without load or low load.
- A 2 minute delay for dryer to start after pressing the on/off switch.



Troubleshooting and eventual control and/or maintenance operations must be performed by qualified personnel.

For maintaining the refrigerating circuit of the machine, contact a refrigeration engineer.

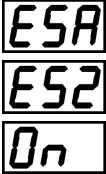
TROUBLE	DISPLAY	POSSIBLE CAUSE	REMEDY	
WATER IN THE SYSTEM	Control panel display is blank	No power in the line.	Restore the power in the line.	
		Problems with cabling.	Check cabling; if the trouble persists, replace it.	
		Problems with the electronic control board.	Check the electronic control board; if the trouble persists, replace it.	
	OFF	The dryer is off.	Turn it on by pressing the ON/OFF switch for 1 second.	
	On	Dryer in stand-by.	Wait 2 minutes after the dryer is switched on.	
		Compressed air inlet/outlet inverted.	Check if the compressed air inlet/outlet is connected properly.	
		The flow rate and/or temperature of the air entering the dryer are higher than the nominal values.	Restore the nominal conditions.	
		The ambient temperature is higher than the nominal values.	Restore the nominal conditions.	
		The condenser is dirty.	Clean the condenser.	
		Condensate drain is not functioning.	Clean the condensate drainage system pre-filter. (Pic.3)	
			Replace the coil of the drainage solenoid valve if burned.	
			Clean or replace the drainage solenoid valve if clogged/jammed.	
			Check the C8 and C9 parameters of the electronic control board; if the trouble persists, replace it.	
		The temperature control probe is positioned improperly or faulty.	Check the probe; if the trouble persists, replace it.	
	HtA	Problems with cabling or with the electronic control board.	Check the cabling and the electronic control board, if the trouble persists, replace them.	
			Activation of compressor's internal thermal protection.	Wait one hour and check again. If the fault persists: stop dryer and call your local Ingersoll Rand distributor.
		Problems with the electrical components of the compressor.	Check the electrical components of the compressor.	
		Defective compressor.	Replace the compressor.	
		The flow rate and/or temperature of the air entering the dryer are higher than the nominal values.	Restore the nominal conditions.	
		The ambient temperature is higher than the nominal values.	Restore the nominal conditions.	
		Ht2	The condenser is dirty.	Clean the condenser.
			The temperature control probe is positioned improperly or faulty.	Check the probe; if the trouble persists, replace it.
		LEA	Fan pressure switch defective or burned out (if present).	Turn off the dryer and call your local Ingersoll Rand distributor.
			High pressure switch defective or burned out (if present).	Turn off the dryer and call your local Ingersoll Rand distributor.
			Gas leakage in the refrigerating circuit.	Turn off the dryer and call your local Ingersoll Rand distributor.
			Defective fan.	Replace the fan.
			Protection fuse burned out (if present).	Replace the fuse.
	ESA		The temperature control probe is positioned improperly or faulty.	Check the probe; if the trouble persists, replace it.
		ES2	Gas leakage in the refrigerating circuit without load.	Turn off the dryer and call your local Ingersoll Rand distributor.
	PF1		The temperature control probe is positioned improperly or faulty.	Check the probe; if the trouble persists, replace it.
ASL		Series of alarms very close to each other.	Call your local Ingersoll Rand distributor.	

TROUBLE	DISPLAY	POSSIBLE CAUSE	REMEDY
LOW PRESSURE IN THE LINE		Ice formation in the evaporator.	Check the probe; if the trouble persists, replace it.
			Check the electronic control board; if the trouble persists, replace it.
			Contact our Service Centre to check the gas charge.
		Clog.	Check if the compressed air inlet/outlet is connected properly.
			Check if the connecting tubing is clogged; in case proceed accordingly.
			Check if any valves are closed.
			Check the condition of any filter.
		Air flows continuously through the condensate drainage.	Drainage solenoid valve jammed, clean or replace it.
			Verify the condensate drainage times set on the electronic control board (C8 and C9).
			Check the signal from the control board: if it is continuous, replace the control board.

IMPORTANT:

The temperature control probe is extremely delicate. Do not remove the probe from its position. In case of any kind of problem, please contact your local Ingersoll Rand distributor

Pic.3

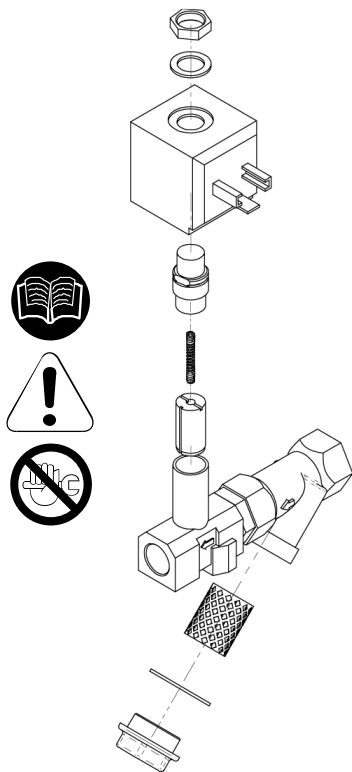

Cleaning of the drain solenoid valve

4.3 DECOMMISSIONING

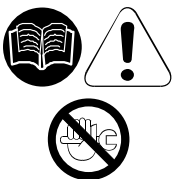

In case of necessity, decommission the machine and the relevant packaging **in compliance with the rules locally in force.**

Pay particular attention to the refrigerant, as it contains part of the refrigerating compressor lubricating oil.

Always contact a waste disposal and recycling facility.

ATTACHMENTS TO THIS MANUAL

Legend

Pos.	DESCRIPTION
1A1	Electronic Controller
1B1	Drain solenoid valve coil
1M1	Refrigerant compressor
1M2	Fan Motor
1P1	High pressure Switch
1P2	Fan pressure Switch
1Q1	Compressor circuit breaker
1Q2	Fan circuit breaker
1S1	Main power switch
1S2	Plug
1T1	Transformer
1V1	Solenoid drain Valve
CB	Compressor box
CBL	Cables
CND	Condenser
CNV	Fan capacitor
CPL	Capillary tube
EB	Electrical box
ED	10 micron filter element
EH	0.01 micron filter element
EP	1 micron filter element
EQ	5 micron filter element
EVA	Evaporator
F1 – F2	Fuses
FD	Air filter 10 micron
FF	Filter dryer
FH	Air filter 0.01 micron
FP	Air filter 1 micron
FQ	Air filter 5 micron
FR	Drain screen
FV	Fan motor fuse
G	Grid
IM	Moisture indicator
K1	Contactator switch
K2	Fan contactor switch
PCP	Thermal protection
PR	Air-air heat exchanger
PSC	Air-air heat exchanger (D__IT)
RBF	Tap with strainer
RR	Rotalock cock
RT1	Temperature probes
SC	Heat exchanger base
SCO	Condensate separator
SLI	Liquid separator
SSC	Condensate drain
STC	Control panel cover
TEMP	Time setter
TH	Thermostat
TLT	Remote cont. Thermostat
VB	By-pass hot gas valve
VE	Expansion valve
VNR	One way valves with strainer
VT	Fan blade
X1-X2 X3-XM	Terminal blocks

A) REFRIGERANT CIRCUIT

Cod. 713.0048.04.00 – Rev. 00
Model D12IN-A

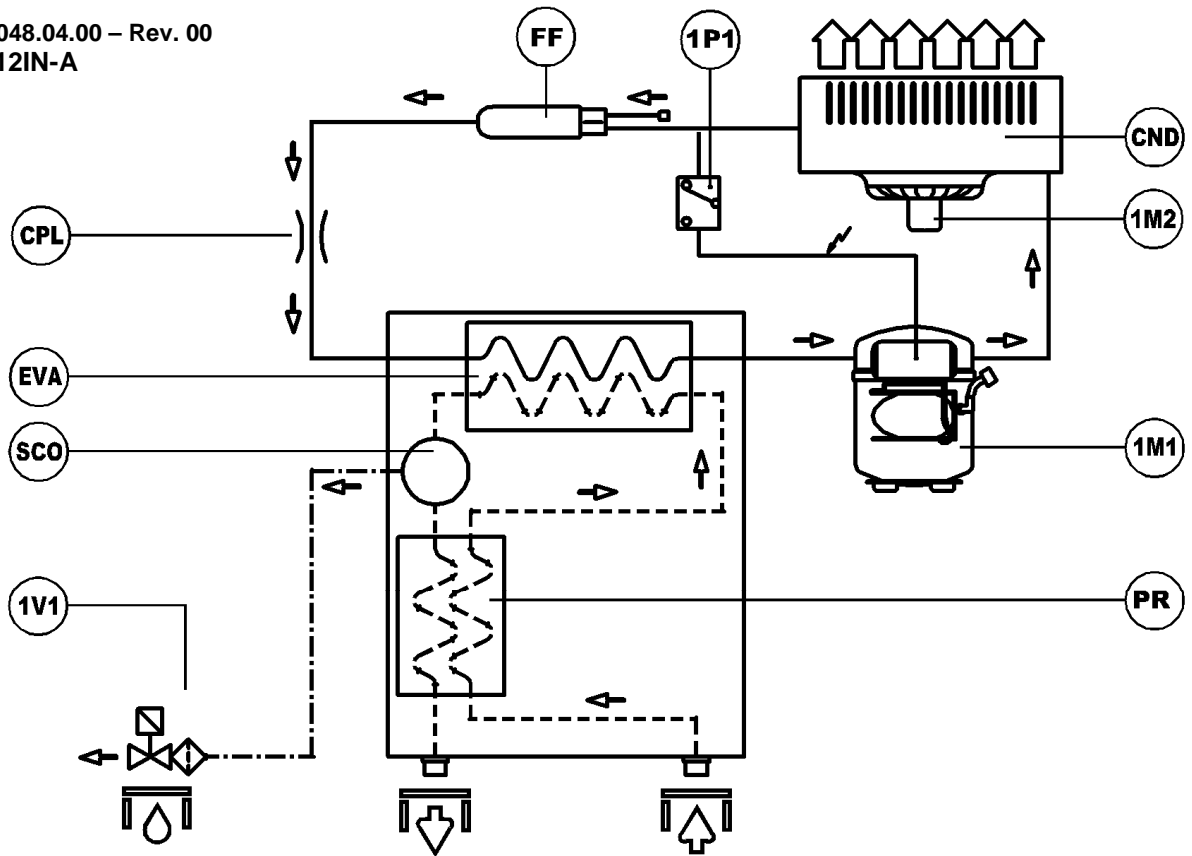

B) WIRING DIAGRAM

Cod. 714.0164.01.00 – Rev. 00
Model D12IN-A

(115V/1Ph/60Hz)

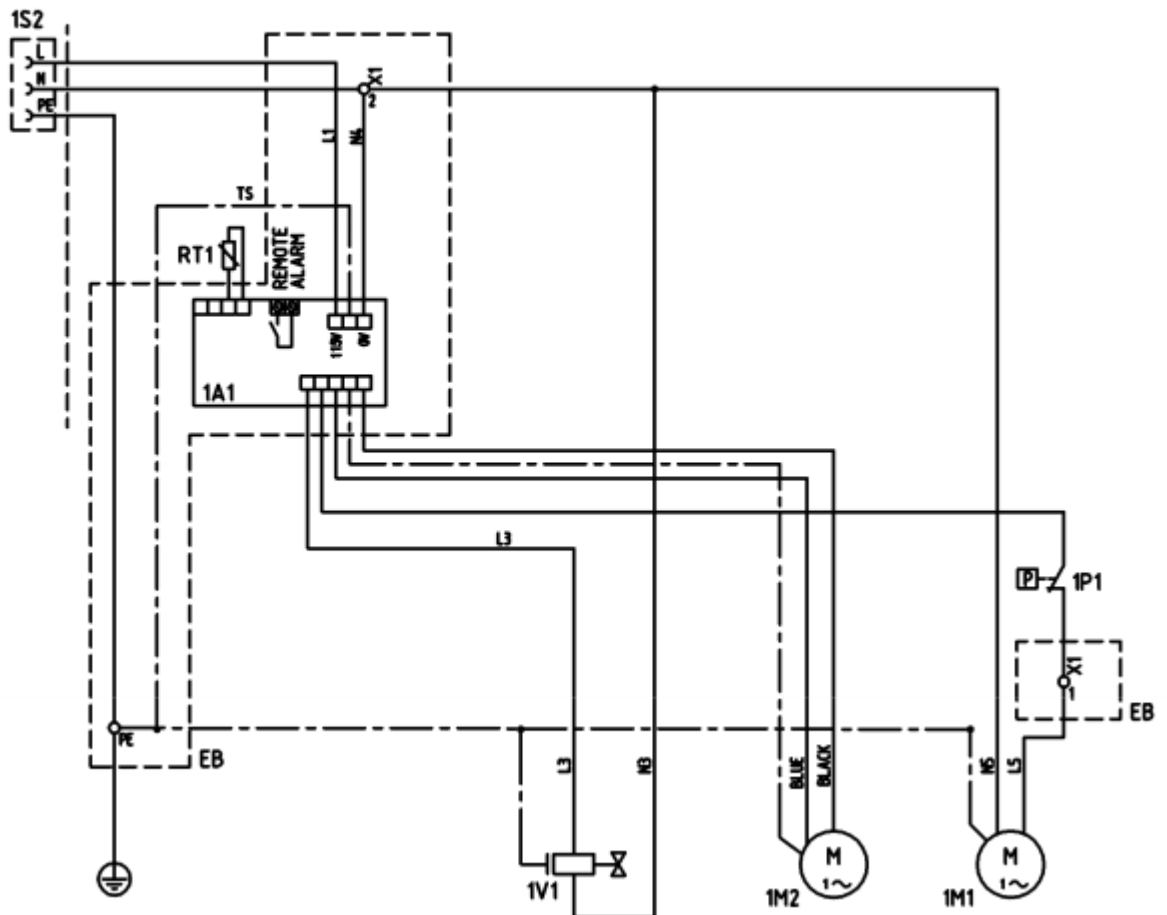

MODEL		D12IN-A
AR AIR FLOW RATE*	CFM	7
	M3/h	12
POW SUPPLY	VOLT/ PH/HZ	115/1/60
1M1 COMPRESSOR	HP	1/10
	kW	0.14
	Max kW	0.20
	RLA	1.83
	FLA	2.5
1M2 FAN MOTOR	LRA	14.5
	QTY	1
	HP	1/80
	RLA	0.58
TOTAL A	LRA	0.76
	A	2.8
CONNECTION	NPT	3/8"
AIR T	°F	100
	°C	38
AIR T MAX	°F	140
	°C	60
AMB T	°F	100
	°C	38
AMB T MIN-MAX	°F	36 - 122
	°C	2 - 50
AIR W PRESS	psi	100
	bar	7
AIR PRESS MAX	psi	203
	bar	14
DEW POINT*	°F	< 50 (ISO CLASS 6)
	°C	< 10 (ISO CLASS 6)
REFRIGERANT	TYPE	R134a
	LB	0.31
	OZ	4.94
	KG	0.14

W WEIGHT	LB	39.7
	KG	18
EVAP. TEMP.*	°F	37 - 41
	°C	3 - 5
SUCTION TEMP.*	°F	37 - 41
	°C	3 - 5
DISCH. PRESS.*	psig	170 - 230
	Bar	12 - 16
HP SWITCH SETTING	psig	435
	Bar	30

Legend

Pos.	DESCRIPTION
AR	Air flow rate
POW SUPPLY	Power supply
HP	Nominal power
kW	Nominal consumption
Max kW	Full load consumption
RLA	Nominal Current
FLA	Full load current
LRA	Locked rotor current
TOTAL A	Total current
CONNECTION	Air connections
AIR T	Air inlet temperature
AIR T MAX	Max. air inlet temperature
AMB T	Ambient temperature

Pos.	DESCRIPTION
AMB T MIN-MAX	Min-Max. ambient temperature
AIR W PRESS	Air working pressure
AIR PRESS MAX	Max. air pressure
DEWP	Pressure dew point
REF	Refrigerant
MAX FUSE	Max fuse size
MIN CIRCUIT AMPACITY	Minimum circuit ampacity
W	Weight
EVAP. TEMP	Evaporation Temperature
SUCTION TEMP	Suction Temperature
DISCH. PRESS.	Discharge Pressure
HP SWITCH SETTING	High pressure switch setting

*Rating conditions of: 38°C (100°F) and 100 psig Air Inlet, 38°C (100°F) Ambient
Performance and specifications - + / - 5%

D) CORRECTION FACTORS

Correction factor for working pressure										
bar	5	6	7	8	9	10	11	12	13	14
psi	73	87	102	116	131	145	160	174	188,5	203
FC1	0,85	0,93	1	1,06	1,11	1,15	1,18	1,2	1,22	1,24
Correction factor for inlet air temperature										
°C	26,5	32	37,8	43,5	49	54,5	60			
°F	80	90	100	110	120	130	140			
FC3	1,3	1,18	1	0,8	0,6	0,42	0,25			
Correction factor for ambient temperature										
°C	26,5	32	37,8	40,5	43,5	50				
°F	80	90	100	105	110	122				
FC2	1,1	1,05	1	0,93	0,83	0,65				

Calculation of the dryer REAL FLOW RATE = nominal dryer flow rate x FC1 x FC2 x FC3

Calculation of the GIVEN FLOW RATE to select a suitable dryer = given flow rate ÷ FC1 ÷ FC2 ÷ FC3

E) DRYER DIMENSIONS

Model D12IN-A

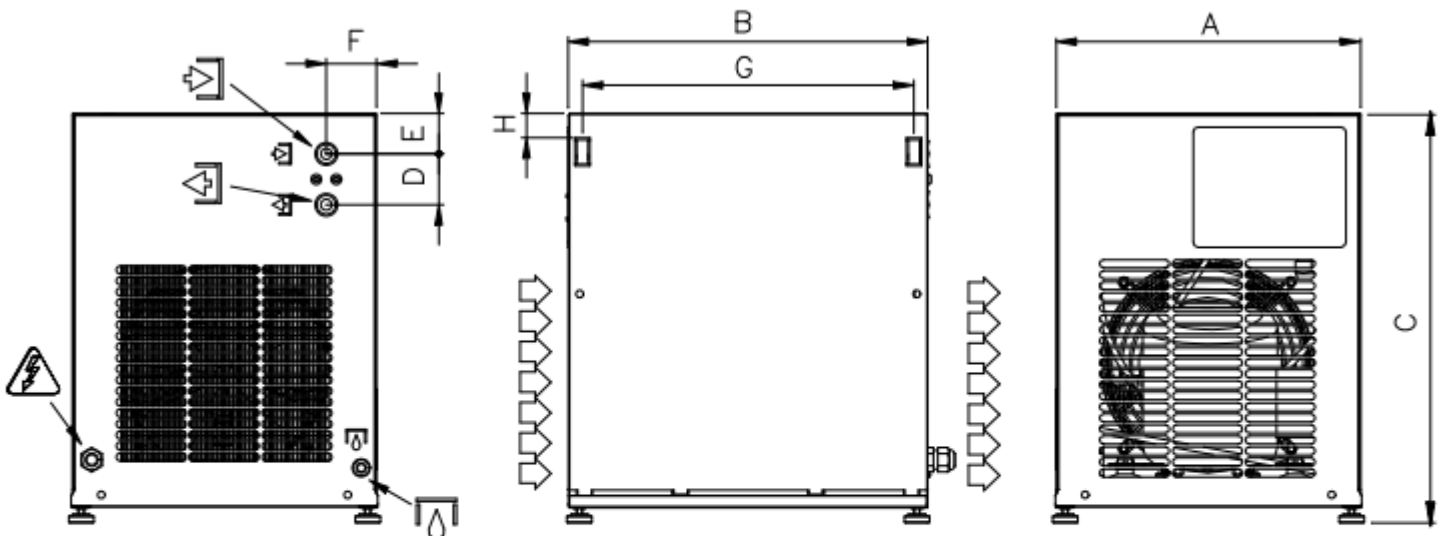

	A	B	C	D	E	F	G	H
mm	305	360	408	51	40	50	332	24
inches	12"	14" 3/16	16" 1/16	2"	1" 9/16	2"	13" 1/16	15/16"

3/8" NPT	3/8" NPT	∅ 6mm	115/1/60 V/ph/Hz

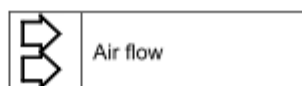
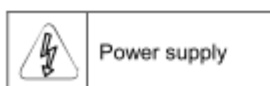

F) BASIC SPARE PARTS

Model		D12IN-A
Pos	Element	
1A1	Electronic Controller	38457404
RT1	Temperature probe	38457412
1M1	Refrigerant compressor	24062093
1M2	Fan Motor	38457768
VT	Fan blade	38457784
G	Grid	-
1P1	High pressure Switch	38457511
1S1	Main power switch	-
1V1	Complete solenoid drain valve	38457537
1B1	Drain solenoid valve coil	38457545
CND	Condenser	38457834
FF	Filter dryer	38457594
FR	Drain screen	38457891
K1	Contact switch	-
SC	Heat exchanger base	38457909
STC	Control panel cover	38457883

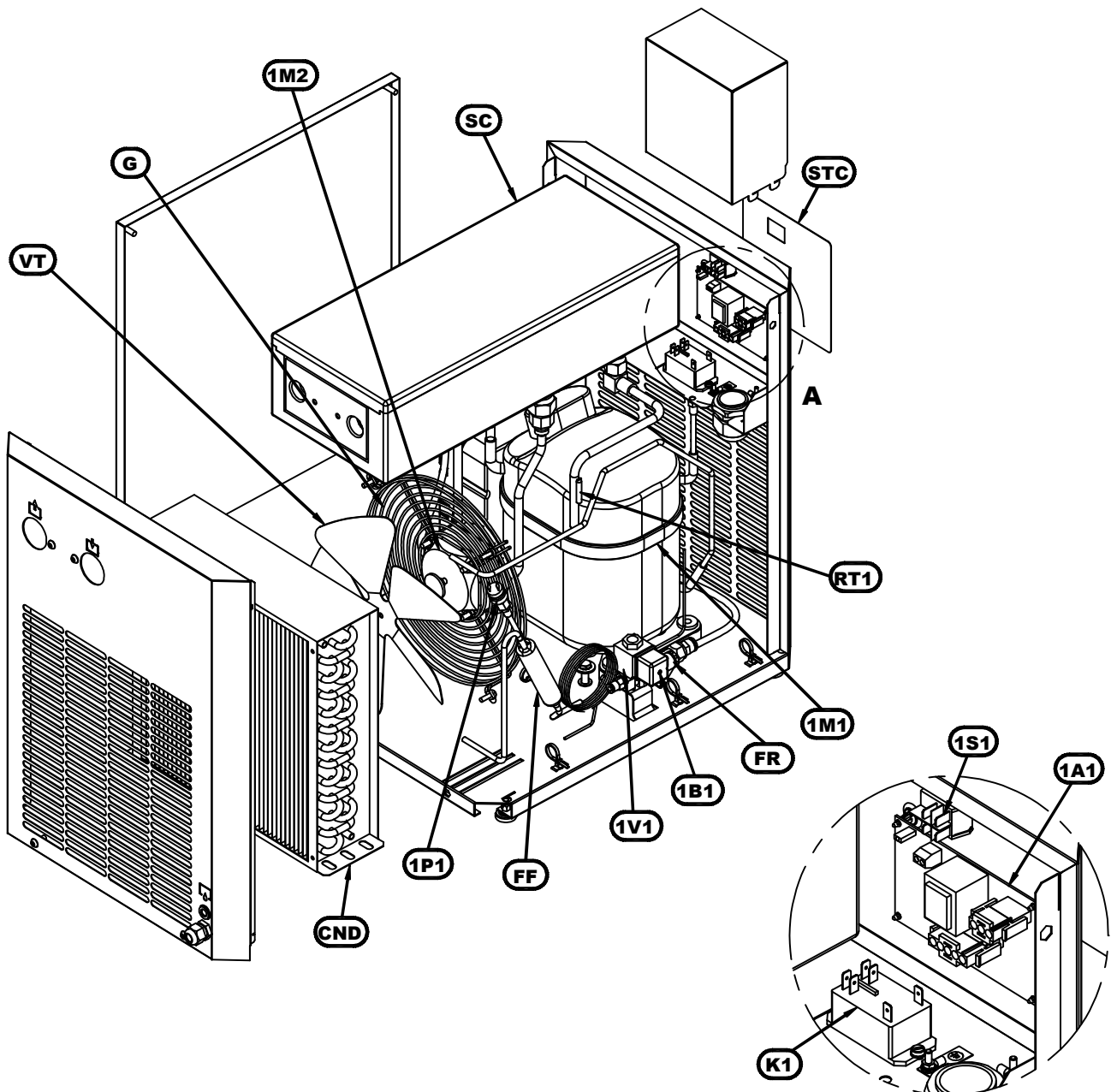

DETAIL A

VAN AIR SYSTEMS

INSTALLATION, OPERATION & MAINTENANCE INSTRUCTION

F200 SERIES

COMPRESSED AIR FILTERS



PRODUCT PURPOSE & FUNCTION:

Van Air's F200 series filters are designed to remove contaminants from compressed air systems. Available in 1/4" to 3" connection sizes and flow capacities from 15 to 1250 SCFM (at 100 psig) in 15 housings and 9 filtration grades, the F200 series can remove oil aerosols, oil vapors, water and particulates. Housings are made of cast aluminum and coated with an epoxy powder coating for corrosion resistance. All units include push-on elements with durable polyester drain layer (except RD grade). Accessories include differential pressure indicators, wall mounting kits, connector kits, and automatic drain valves.

FILTER DETAILS		FLOW DIRECTION THROUGH ELEMENT					
		(COALESCING) IN/OUT 			(PARTICULATE) OUT/IN 		
FILTRATION GRADES							
		APPLICATION	ELEMENT GRADE	PURPOSE	NOMINAL PARTICULE REMOVAL	ELEMENT FLOW DIRECTION	COLOR CODE
OPERATING CONDITIONS MAXIMUM WORKING PRESSURE All Models 250 PSIG OPERATING TEMPERATURE Minimum 35°F Maximum 225°F MAXIMUM RECOMMENDED INLET TEMPERATURE AA, A, RAA, RA, RB, and RC Series 225°F B Series 175°F C Series 125°F RD Series 80°F		OIL REMOVAL (LIQUIDS)	B	General Purpose Coalescing	1.00 μ	IN/OUT	RED
		PARTICULATE REMOVAL (SOLIDS)	RB	General Purpose Particulate	1.00 μ	OUT/IN	RED
WARNINGS							
<ul style="list-style-type: none"> DO NOT REPLACE ANY ITEM ON FILTER WHILE IT IS PRESSURIZED. DO NOT OPERATE A LEAKING FILTER. TAKE FILTER OUT OF SERVICE IMMEDIATELY. DO NOT OPERATE ABOVE MAXIMUM WORKING PRESSURE (MWP) AT MAXIMUM OPERATING TEMPERATURE (°F). 							

FILTER HOUSING DIMENSIONS & WEIGHTS

DIMENSIONS FOR:
F200-15-1/4
F200-25-3/8
F200-25-1/2

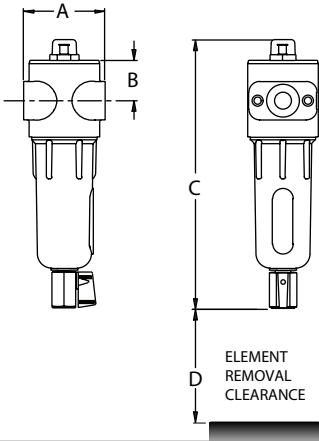

FILTER MODEL	FLOW** (SCFM)	IN/OUT CONN. (NPT)	A (INCHES)	B (INCHES)	C*** (INCHES)	D (INCHES)	HOUSING WEIGHT**** (LBS)	ELEMENT WEIGHT**** (LBS)
F200-25-1/2-(*)	25	1/2"	2-13/16	1-5/8	9-1/4	3	1.3	0.1

*Insert appropriate filtration grades here; for example F200-15-1/4-B.

**Flow is based on SCFM @ 100 PSIG @ 100°F.

***Dimensions include filter housing, PD-6 and manual drain.

****For total filter weight, add element weight to housing weight.

FLOW CAPACITIES AT VARIOUS OPERATING PRESSURES (SCFM)

FILTER MODEL	25 PSIG	50 PSIG	75 PSIG	100 PSIG	125 PSIG	150 PSIG	175 PSIG	200 PSIG	225 PSIG	250 PSIG
F200-25-1/2	13	18	22	25	28	31	33	35	38	40

INSTALLATION

- Before installing filter, check operating temperature and pressure conditions to verify that they are within the specified ranges. (See **Operating Conditions on page 1**). Also verify that system flow rate corresponds to the rated capacity of the filter. Operating at flows above rated capacity will result in increased pressure drop.
- Locate Filter at the point of lowest operating temperature to ensure that water and oil vapor do not condense downstream of the filter. Filter should be installed close to the point of use to minimize the risk of pipe scale, dirt, etc. recontaminating the compressed air. This is particularly important when installing a new filter on an existing system that has not had proper filtration.
- Install filter vertically. Provide required minimum clearance below filter to allow for replacement of element. (See **Element Removal Clearance on page 2**).
- Protect filter from reverse flow conditions. Do not install filter downstream of quick opening valves.
- Remove filter head from the bowl by turning bowl counter-clockwise. Pull element from locator. Set bowl and element aside for use later.
- Install inlet and outlet shutoff valves to facilitate replacement of element. Bypass piping is recommended (See **Figure 1A and 1B**). **MAKE SURE VALVES ARE CLOSED BEFORE PROCEEDING.**

- Connect filter head into piping. Avoid reducers or bushings to match inlet size. The resulting restriction will increase pressure drop. Make sure head is installed with flow arrows pointing in proper direction. Use pipe thread compound as required.

IMPORTANT

INSTALL FILTER HEAD INTO THE PIPING WITH ARROWS POINTING IN THE PROPER DIRECTION TO ENSURE PROPER OPERATION. (SEE FLOW DIRECTION DIAGRAM BELOW).

- Install element by pushing onto element locator on filter head.
- Check to make sure that the o-ring in the head is in the proper position. Thread filter bowl into filter head and tighten either by hand (models F200-15 through 55) or with strap wrench (models F200-85 through 1250). Do not over tighten. Overtightening could damage filter bowl or make it difficult to remove.
- Make sure drain valve on bottom of filter is closed. On filters equipped with ADM2-2 auto drain, provide a drain line to remove accumulated water and oil.
- Pressurize system and slowly open inlet and outlet shutoff valves.
- Check piping for leaks. Depressurize system and repair leaks as needed.
- Re-pressurize system and slowly open inlet and outlet shutoff valves. Close bypass valve if provided.

FIGURE 2A F200-15-1/4 THRU 25-1/2 REPLACEMENT PARTS

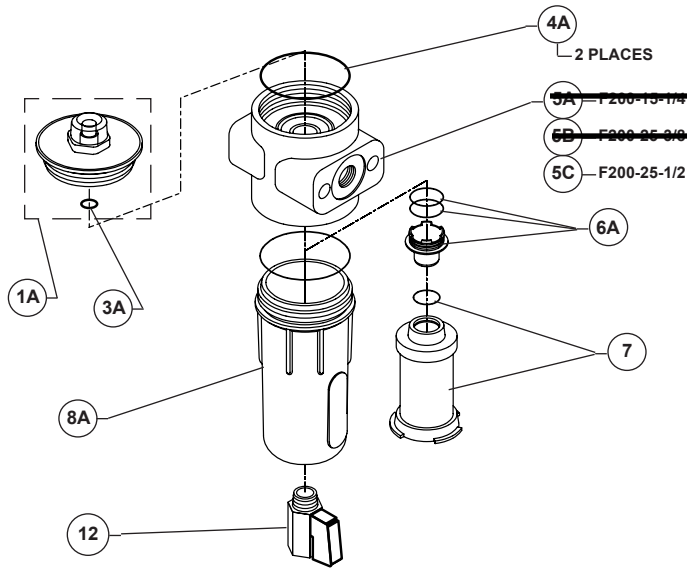

Finding a part number

1. Find the figure that references your filter.
2. Find the replacement part you need and the item number of that part.
3. Find the item number in the first column of the **Replacement Parts** table.
4. Find the part description that best describes the part.
5. See the last column for the part number.

REPLACEMENT PARTS

ITEM	PART DESCRIPTION	FIG 2-	QTY	PART NO.
1A	PD-6A-C DIFFERENTIAL PRESSURE INDICATOR KIT FOR COALESCING FILTERS	A	1	84-10126
	PD-6A-P DIFFERENTIAL PRESSURE INDICATOR KIT FOR PARTICULATE FILTERS	A	1	84-10127
3A	BLANKING PLATE O-RING FOR F200-15-1/4 THRU 25-1/2	A	1	475-00110
4A	BODY O-RING FOR F200-15-1/4 THRU 25-1/2	A	2	475-01000
5C	1/2" NPT FILTER HEAD FOR F200-25-1/2	A	1	201-00120
6A	EPL1 ELEMENT ADAPTOR FOR F200-15-1/4 THRU 25-1/2	A	1	328-00005
8A	FILTER BOWL FOR F200-15-1/4 THRU 25-1/2	A	1	201-01000
12	MANUAL DRAIN 1/4" KIT	A,B, C	1	84-10852

REPLACEMENT ELEMENTS

FILTER MODEL	ELEMENT MODEL	PART NO.
F200-25-1/2	E200-15/25-B	26-10404
	E200-15/25-RB	26-10405

**COALESCING
PARTICULATE**

MAINTENANCE

- Drain coalescing filters every shift.
- Check differential pressures weekly on coalescing and particulate filters (AA, A, B, C, RA, RB, and RC grades). When the indicator is red on differential pressure indicator, install clean elements. On adsorbing filters (grade RD), install clean elements when hydrocarbon vapors are first detected downstream or every six months, whichever comes first.
- For correct replacement element model numbers, see label on filter housing, the bottom endcap of the element, or page 5 of this instruction manual.
- When changing out element, inspect housing o-ring for nicks and/or cracks. If nicks and/or cracks are present, replace o-ring.

TROUBLE SHOOTING		
CONDITION	POTENTIAL CAUSE	RECOMMENDATION
Initial pressure drop too high	Filter undersized for flow rate.	Install larger filter.
	Filter grade too fine.	Install coarser grade element.
	Filter inlet smaller than pipe size.	Install larger filter.
Oil carryover	Oil present in system before installing filter.	Clean piping.
	Excessive inlet oil >50ppm.	Check compressor and/or gas/oil separator if compressor is rotary vane or screw type. Check lube rate if reciprocating compressor. Install coarse coalescer for prefiltration.
	Filter installed backwards.	Check flow direction (See page 1).
	Filter bowl not being drained.	Drain more frequently.
	High differential pressure.	Check differential pressure indicator, replace element if necessary.
	Defective seal.	Check o-ring in element.
	Incorrect element grade.	Use finer grade.
	By-pass valve leaking or open.	Close valve. Check seals on valve
Short element life	Excessive contamination.	Install coarse particulate filter immediately upstream of existing filter.
	High compression temperatures causing varnish/ carbon formation.	Use compression lubricant with good temperature stability. Lower lube rates where possible. Use coarser grade filter element.
	Oil/water emulsion overloading element.	Inspect moisture separator. Remove water with better separation.
	High viscosity oil or freeze-up due to low ambient temperature.	Raise ambient temperatures. Heat trace inlet piping and housing.

SAFETY PRECAUTIONS

Safety is everybody's business and is based on your use of good common sense. All situations or circumstances cannot always be predicted and covered by established rules. Therefore, use your past experience, watch out for safety hazards and be cautious.

⚠ DANGER	⚠ WARNING
	
<p style="font-size: small; margin: 0;">AIR AND OIL UNDER PRESSURE WILL CAUSE SEVERE PERSONAL INJURY OR DEATH. SHUT DOWN COMPRESSOR AND RELIEVE SYSTEM OF ALL PRESSURE BEFORE REMOVING VALVES, CAPS, PLUGS, FITTINGS, BOLTS AND FILTERS.</p>	<p style="font-size: small; margin: 0;">READ THE OPERATOR'S MANUAL BEFORE STARTING OR SERVICING THIS UNIT. FAILURE TO ADHERE TO INSTRUCTIONS CAN RESULT IN SEVERE PERSONAL INJURY OR DEATH. REPLACEMENT MANUALS CAN BE OBTAINED BY CONTACTING THE MANUFACTURER.</p>

VAN AIR SYSTEMS

2950 Mechanic Street
 Lake City, PA 16423-2095
 Phone: 800-840-9906
 Fax: 814-774-3482
www.vanairsystems.com

APPENDIX C - SC SERIES MANUAL

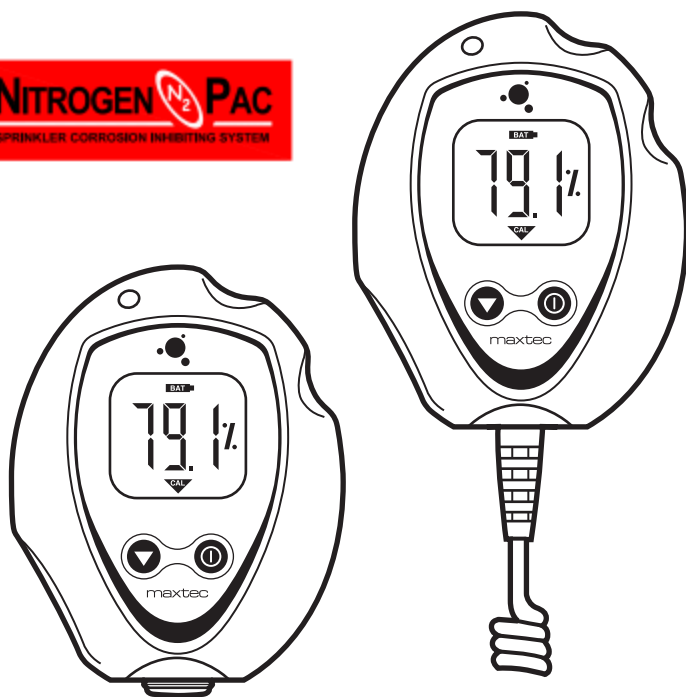

• Nitrogen Analyzer



OPERATING MANUAL &
INSTRUCTIONS FOR USE

R217P67

APPENDIX C - PAGE 1



☛ CONTACT INFORMATION

Manufacturer's Name:	Maxtec, Inc.
Product:	Nitrogen Analyzer
Model:	R217P67
Manufacturer's Address:	Maxtec, Inc. 6526 South Cottonwood Street Salt Lake City, Utah 84107
Manufacturer's Telephone:	800.748.5355
Manufacturer's Fax:	(801) 270.5590
Manufacturer's e-mail:	sales@maxtecinc.com
Manufacturer's Web-Site:	www.maxtecinc.com

☛ AUTHORIZED REPRESENTATIVE

EC REP

QNET BV
Hommerterweg 286
6436 AM Amstenrade
The Netherlands

☛ PREFACE

This manual describes the function, operation and maintenance of the N₂ analyzer hand-held and panel mount nitrogen analyzers. The Maxtec N₂ analyzer is engineered for long life, maximum reliability and stable performance.

NOTE: In order to obtain optimum performance from your analyzer, all operation and maintenance must be performed in accordance with this manual. Please read the manual thoroughly before using the analyzer and do not attempt any repair or procedure that is not described herein. Maxtec cannot warrant any damage resulting from misuse, unauthorized repair or improper maintenance of the instrument.

▲ WARNING:

Never allow an excess length of tubing, lanyard, or sensor cable near a person's head or neck, which may result in strangulation.

Before use, all individuals who will be using the N₂ analyzer must become thoroughly familiar with the information contained in this Operation Manual. Strict adherence to the operating instructions is necessary for safe, effective product performance. This product will perform only as designed if installed and operated in accordance with the manufacturer's operating instructions.

Use only genuine Maxtec accessories and replacement parts. Failure to do so may seriously impair the analyzer's performance. Repair or alteration of the N₂ analyzer beyond the scope of the maintenance instructions, or by anyone other than an authorized Maxtec service person, could cause the product to fail to perform as designed.

Calibrate the N₂ analyzer weekly when in operation, or if environmental conditions change significantly. (ie. Elevation, Temperature, Pressure, Humidity — refer to Section 4.0 of this manual).

Use of the N₂ analyzer near devices that generate electrical fields may cause erratic readings.

If the N₂ analyzer is ever exposed to liquids (from spills or immersion) or to any other physical abuse, turn the instrument OFF and then ON. This will allow the unit to go through its self test to assure everything is operating correctly. You may need to allow the sensor time to dry out.

Never immerse or expose the N₂ analyzer (including sensor) to high temperatures (>70°C). Never expose the device to pressure, irradiation vacuum, steam, or chemicals.

 Do not throw away. Dispose of properly in accordance with local regulations.

NOTE: Replace the batteries with recognized high quality AA Alkaline or Lithium batteries.

NOTE: If the unit is going to be stored (not in use for 1 month), we recommend that you remove the batteries to protect the unit from potential battery leakage.

FAILURE TO COMPLY WITH THESE WARNINGS AND CAUTIONS COULD RESULT IN INSTRUMENT DAMAGE AND POSSIBLY JEOPARDIZE THE WELL BEING OF THE USER.

⚡ CLASSIFICATION

Protection against electric shock:	Internally powered equipment.
Protection against water:	IPX1
Mode of Operation:	Continuous

⚡ SAFETY LABELING

The following symbols and safety labels are found on the N₂ analyzer:

 Attention, consult accompanying documents

 On/Off

 Calibration button

 Found to meet the requirements of the U.S. and Canadian nationally recognized codes and standards listed or classified by ETL.

 Do not throw away. Dispose of properly in accordance with local regulations.

❖ TABLE OF CONTENTS

1.0 SYSTEM OVERVIEW	1
1.1 Base Unit Description	1
1.2 Component Identification	2
1.3 Component Description	2
1.4 Oxygen Sensor	3
2.0 OPERATING INSTRUCTIONS	3
2.1 Getting Started	3
2.1.1 Protect Tape	3
2.1.2 Remove the Battery Ribbon	3
2.1.3 Automatic Calibration	4
2.2 Calibrating the N ₂ Analyzer	4
2.3 Operation with the Flow Restrictor	5
3.0 FACTORS INFLUENCING ACCURATE READINGS	5
3.1 Elevation Changes	5
3.2 Temperature Effects	5
3.3 Pressure Effects	6
3.4 Humidity Effects	6
4.0 CALIBRATION ERRORS AND ERROR CODES	6
5.0 CHANGING THE BATTERIES	7
6.0 CHANGING THE OXYGEN SENSOR	8
6.1 R217P65	8
6.2 R217P66	9
7.0 CLEANING AND MAINTENANCE	10
8.0 SPECIFICATIONS	11
8.1 Base Unit Specifications	11
8.2 Sensor Specifications	11
9.0 WARRANTY	12

❖ 1.0 SYSTEM OVERVIEW

1.1 Base Unit Description

The N₂ analyzer provides unparalleled performance and reliability due to an advanced design that includes the following features and operational benefits.

- » Extra-life oxygen sensor of approximately 900,000 O₂ percent hours (2-year warranty).
- » Durable, compact design that permits comfortable, hand-held operation and easy to clean.
- » Operation using only two AA Alkaline batteries (2 x 1.5 Volts) for approximately 5000 hours of performance with continuous use. For extra extended long life, two AA Lithium batteries may be used.
- » Oxygen-specific, galvanic sensor that achieves 90% of final value in approximately 15 seconds at room temperature.
- » Large, easy-to-read, 3 1/2-digit LCD display for readings in the 0-100% range.
- » Simple operation and easy one-key calibration.
- » Self-diagnostic check of analog and microprocessor circuitry.
- » Low battery indication.
- » Calibration reminder timer that alerts the operator, using a calibration icon on the LCD display, to perform a unit calibration.

1.2 Component Identification

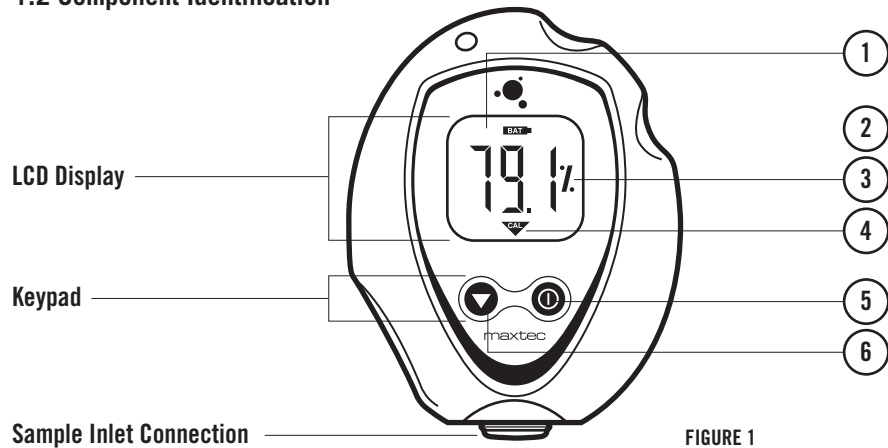

1.3 Component Description

- ① **3 1/2-Digit Display** - The 3 1/2 digit liquid crystal display (LCD) provides direct readout of nitrogen concentrations in the range of 0 - 105.0% (100.1% - 105.0% used for calibration determination purposes). The digits also display error codes and calibration codes as necessary.
- ② **Low Battery Indicator** - The low battery indicator is located at the top of the display and is only activated when the voltage on the batteries is below a normal operating level.
- ③ **“%” symbol** - The “%” sign is located to the right of the concentration number and is present during normal operation.
- ④ **Calibration symbol** - The calibration symbol is located at the bottom of the display and is timed to activate when a calibration is necessary.
- ⑤ **ON/OFF Key** - This key is used to turn the device on or off.
- ⑥ **Calibration Key** - This key is used to calibrate the device. Holding the key for more than three seconds will force the device to enter a calibration mode.

CAUTION: The device will assume a percent oxygen concentration when calibrating. Be sure to apply 100% oxygen, or ambient air concentration to the device during calibration or the device will not calibrate correctly.

Sample Inlet Connection - This is the port at which the device is connected to determine oxygen concentration.

1.4 Oxygen Sensor

The MAX-250 is a galvanic, partial pressure sensor that is specific to oxygen. It consists of two electrodes (a cathode and an anode), a oxygen permeable membrane and an electrolyte. Oxygen diffuses through the teflon membrane and immediately reacts at the cathode. Concurrently, oxidation occurs electrochemically at the lead anode, generating an electrical current and providing a voltage output. Since the sensor is specific to oxygen, the current generated is proportional to the amount of oxygen present in the sample gas. When no oxygen is present, there is no electrochemical reaction and therefore, negligible current is produced. In this sense, the sensor is self-zeroing.

CAUTION: The oxygen sensor is a sealed device containing a mild acid electrolyte, lead (Pb), and lead acetate. Lead and lead acetate are hazardous waste constituents and should be disposed of properly, or returned to Maxtec for proper disposal or recovery.

CAUTION: Do not immerse the sensor in any cleaning solution, autoclave or expose the sensor to high temperatures.

CAUTION: Dropping sensor may adversely affect its performance.



Do not throw away. Dispose of properly in accordance with local regulations.

2.0 OPERATING INSTRUCTIONS

2.1 Getting Started

2.1.1 Protect Tape

Prior to turning on the unit, a protective film covering the threaded sensor face must be removed. After removing the film, wait approximately 20 minutes for the sensor to reach equilibrium.

2.1.2 Remove the Battery Ribbon

A ribbon has been inserted between the two case halves to prevent a battery connection. Remove the ribbon by pulling it completely out of the case. To energize the unit, tighten all three screws with the included Phillips screwdriver.

NOTE: If you do not tighten all three screws, the unit may not turn on or it may erratically turn on and off.

2.1.3 Automatic Calibration

After the unit is turned on it will automatically calibrate to room air. The display should be stable and reading 79.1%.

To check the nitrogen concentration of a sample gas: *(after the unit has been calibrated)*

1. Connect the Tygon tubing to the bottom of the analyzer by threading the barbed adapter onto the oxygen sensor. **(Figure 2)**

2. Attach the other end of the sample hose to the sample gas source and initiate flow of the sample to the unit at a rate of 1-10 liters per minute (2 liters per minute is recommended).

3. Using the "ON/OFF" key, make sure the unit is in the power "ON" mode.

4. Allow the nitrogen reading to stabilize. This will normally take about 30 seconds or more.

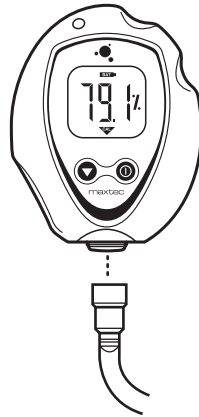

2.2 Calibrating the N₂ Analyzer

The N₂ analyzer should be calibrated upon initial power-up. Thereafter, Maxtec recommends calibration on a weekly basis. To serve as a reminder, a one week timer is started with each new calibration. At the end of one week a reminder icon "▼" will appear on the bottom of the LCD. Calibration is recommended if the user is unsure when the last calibration procedure was performed, or if the measurement value is in question.

Compressed air (79.1% N₂), new calibration is required when:

- » The measured N₂ percentage in 79.1% N₂ is above 80.1% N₂
- » The measured N₂ percentage in 79.1% N₂ is below 78.1% N₂
- » The CAL reminder icon is blinking at the bottom of the LCD
- » If you are unsure about the displayed N₂ percentage. *(See factors influencing accurate readings.)*

A simple calibration may be made with the sensor open to static Ambient air. For optimum accuracy Maxtec recommends that the sensor be placed in a closed loop circuit where gas flow is moving across the sensor in a controlled manner.

2.3 Operation with the Flow Restrictor

1. Attach the Barbed Adapter to the N₂ analyzer by threading it on to the bottom of the sensor.
2. Connect the Tygon tube to the barbed adapter.
3. Attach the BC adapter to the other end of the Tygon tube.
4. Connect the inflator hose on the other end of the Tygon tube.
5. If the N₂ analyzer is not already turned on, do so now by pressing the analyzer "ON" button.
6. Initiate flow of nitrox to the unit to allow the gas to saturate the sensor. The BC adapter will regulate the optimum flow and pressure. Although a stable value is usually observed within 30 seconds, allow at least two minutes to ensure that the sensor is completely saturated with the gas.
7. The analyzer will now look for a stable sensor signal and a good reading. When obtained, the analyzer will display the oxygen percentage on the LCD.

3.0 FACTORS INFLUENCING ACCURATE READINGS

3.1 Elevation Changes

- » Changes in elevation result in a reading error of approximately 1% of reading per 250 feet.
- » In general, calibration of the instrument should be performed. In general, calibration of the instrument should be performed

3.2 Temperature Effects

The N₂ analyzer will hold calibration and read correctly within ±3% when in thermal equilibrium within the operating temperature range. The device must be thermally stable when calibrated and allowed to thermally stabilize after experiencing temperature changes before readings are accurate. For these reasons, the following is recommended:

- » For best results, perform the calibration procedure at a temperature close to the temperature where analysis will occur.
- » Allow adequate time for the sensor to equilibrate to a new ambient temperature.

CAUTION: "CAL Err St" may result from a sensor that has not reached thermal equilibrium.

3.3 Pressure Effects

Readings from the N₂ analyzer are proportional to the partial pressure of oxygen. The partial pressure is equal to the concentration times the absolute pressure. Thus, the readings are proportional to the concentration if the pressure is held constant. Therefore, the following are recommended:

- » Calibrate the N₂ analyzer at the same pressure as the sample gas.
- » If sample gases flow through tubing, use the same apparatus and flow rates when calibrating as when measuring.
- » The N₂ analyzer oxygen sensor has been tested at pressures up to two atmospheres absolute. Calibration or operation above this pressure is beyond the intended use.

3.4 Humidity Effects

Humidity (non-condensing) has no effect on the performance of the N₂ analyzer other than diluting the gas, as long as there is no condensation. Depending on the humidity, the gas may be diluted by as much as 4%, which proportionally reduces the oxygen concentration. The device responds to the actual oxygen concentration rather than the dry concentration. Environments where condensation may occur are to be avoided since moisture may obstruct passage of gas to the sensing surface, resulting in erroneous readings and slower response time. For this reason, the following is recommended:

- » Avoid usage in environments greater than 95% relative humidity.

HELPFUL HINT: Dry sensor by lightly shaking moisture out, or flow a dry gas at two liters per minute across the sensor membrane.

❖ 4.0 CALIBRATION ERRORS AND ERROR CODES

The N₂ analyzer analyzers have a self test feature built into the software to detect faulty calibrations, oxygen sensor failures, and low operating voltage. These are listed below, and include possible actions to take, if an error code occurs.

E02: No sensor attached

Open the hand held N₂ analyzer and disconnect and reconnect sensor. Unit should perform an auto calibration and should read 79.1%. If not, contact Customer Service for possible sensor replacement.

E02: No valid calibration data available

Make sure unit has reached thermal equilibrium. Press and hold the Calibration Button for three seconds to manually force a new calibration.

E02: Battery below minimum operating voltage

Replace batteries.

CAL Err St: O₂ Sensor reading not stable

Wait for displayed nitrogen reading to stabilize, when calibrating the device at 100% oxygen.

Wait for unit to reach thermal equilibrium (Please note that this can take up to one half hour, if the device is stored in temperatures outside the specified operating temperature range).

CAL Err lo: Sensor voltage too low

Press and hold the Calibration Button for three seconds to manually force a new calibration. If unit repeats this error more than three times, contact Customer Service for possible sensor replacement.

CAL Err hi: Sensor voltage too high

Press and hold the Calibration Button for three seconds to manually force a new calibration. If unit repeats this error more than three times, contact Customer Service for possible sensor replacement.

CAL Err Bat: Battery voltage too low to recalibrate

Replace batteries.

❖ 5.0 CHANGING THE BATTERIES

Should the batteries require changing the device will indicate this in one of two ways:

- » The battery icon on the bottom of the display will begin to flash. This icon will continue to flash until the batteries are changed. The unit will continue to function normally for approx. 200 hours.
- » If the device detects a very low battery level, an error code of “E04” will be present on the display, and the unit will not function until the batteries are changed.

To change the batteries, begin by removing the three screws from the back of the device. A #1 phillips screwdriver is required to remove these screws.

Once the screws are removed, gently separate the two halves of the device.

The batteries can now be replaced from the back half of the case. Be sure to orient the new batteries as indicated in the embossed polarity on the back case.

NOTE: If the batteries are installed incorrectly the batteries will not make contact and the device will not operate.

Carefully, bring the two halves of the case together while positioning the wires so they are not pinched between the two case halves. The gasket separating the halves will be captured on the back case half.

Reinsert the three screws and tighten until the screws are snug. (Figure 4)

The device will automatically perform a calibration and begin displaying % of oxygen.

HELPFUL HINT: If unit does not function, verify that the screws are tight to allow proper electrical connection.

• 6.0 CHANGING THE OXYGEN SENSOR

6.1 R217P65

Should the oxygen sensor require changing, the device will indicate this by presenting “Cal Err lo” on the display after initiating a calibration.

To change the oxygen sensor, begin by removing the three screws from the back of the device. A #1 Phillips screwdriver is required to remove these screws.

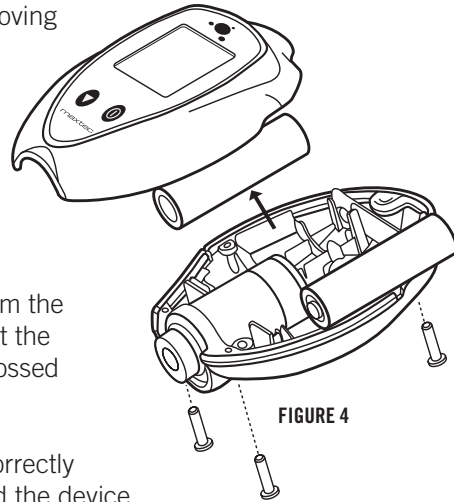

Once the screws are removed, gently separate the two halves of the device.

Disconnect the oxygen sensor from the printed circuit board by pressing the unlock lever first and then pulling the connector out of the receptacle. The oxygen sensor can now be replaced from the back half of the case.

HELPFUL HINT: Be sure to orient the new sensor by aligning the red arrow on the sensor with the arrow in the back case. A small tab is located on the back case that is designed to engage the sensor and prevent it from rotating within the case. (Figure 5)

NOTE: If the oxygen sensor is installed incorrectly, the case will not come back together and the unit may be damaged when the screws are reinstalled.

Reconnect the oxygen sensor to the connector on the printed circuit board.

Carefully bring the two halves of the case together while positioning the wires to ensure they are not pinched between the two case halves. Make sure the sensor is fully inserted and in the proper orientation.

Reinsert the three screws and tighten until the screws are snug. Verify the unit operates properly.

The device will automatically perform a calibration and begin displaying % of oxygen.

6.2 R217P66

Should the oxygen sensor require changing, the device will indicate this by presenting “Cal Err lo” on the display.

Unthread the sensor from the cable by rotating the thumbscrew connector counterclockwise and pull the sensor from the connection.

Replace the new sensor by inserting the electrical plug from the coiled cord into the receptacle on the oxygen sensor. Rotate the thumbscrew clockwise until snug.

The device will automatically perform a calibration and begin displaying % of nitrogen.

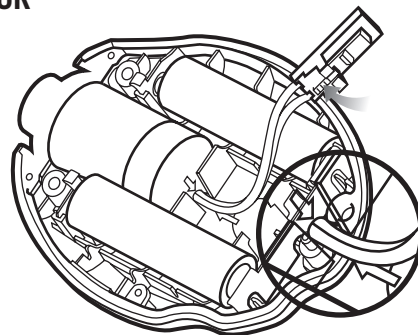

FIGURE 5

7.0 CLEANING AND MAINTENANCE

Store the N₂ analyzer in a temperature similar to its ambient environment of daily use.

The instruction given below describes the methods to clean and disinfect the instrument sensor and its accessories:

Instrument:

- » When cleaning or disinfecting the exterior of the N₂ analyzer, take appropriate care to prevent any solution from entering the instrument. Do not immerse unit in fluids.

Oxygen Sensor:

- » Clean the sensor with a cloth moistened with a 65% alcohol/water solution.
- » Maxtec does not recommend use of spray disinfectants because they can contain salt, which can accumulate in the sensor membrane and impair readings.

Accessories:

- » The threaded barbed adapter may be cleaned by washing them with a 65% alcohol/water solution (per manufacturer's instructions). The parts must be thoroughly dry before they are used.

Because of the variability of the cleaning processes, Maxtec cannot provide specific instructions. Therefore, we highly recommend referring to the manufacturer's instructions on the details of method.

8.0 SPECIFICATIONS

8.1 Base Unit Specifications

Measurement Range:	0-100%
Resolution:	0.1%
Accuracy and Linearity:	1% of full scale at constant temperature, R.H. and pressure when calibrated at full scale
Total Accuracy:	±3% actual oxygen level over full operating temp range
Response Time:	90% of final value in approximately 15 seconds at 23°C
Warm-up Time:	None required
Operating Temperature:	15°C - 40°C (59°F - 104°F)
Storage Temperature:	-15°C - 50°C (5°F - 122°F)
Humidity:	0-95% (non-condensing)
Power Requirements:	2, AA Alkaline batteries (2 x 1.5 Volts)
Battery Life:	approximately 5000 hours with continuous use
Low Battery Indication:	.BAT icon displayed on LCD
Sensor Type:	Galvanic fuel cell
Expected Sensor Life:	> 900,000 O ₂ percent hours minimum 2-years in typical applications
Model Dimensions:	3.0" (W) x 4.0" (H) x 1.5" (D) (76mm x 102mm x 38mm)
Weight:	0.4 lbs (170g)

8.2 Sensor Specifications

Type:	Galvanic fuel sensor (0-100%)
Life:	2-years in typical applications for Nitrogen A & AE 1-year in typical applications for Nitrogen A Fast

Air Maintenance Device

For Dry Pipe Sprinkler Systems,
Air Supervised Preaction Systems, &
Dry Pilot Actuated Deluge Systems

UL Listed and FM Approved



Manufactured by: General Air Products, Inc.
118 Summit Drive, Exton, PA 19341



Product Description

The enclosed Automatic Air Maintenance Device is a UL Listed and FM Approved assembly of valves, nipples, fittings, and actuators to automatically control the N₂ pressure in the piping of dry pipe sprinkler systems, preaction sprinkler systems, or dry pilot actuated deluge systems.

The Air Maintenance Device is designed to automatically feed N₂ into the system piping at the required volume and pressure from an N₂ source such as a NITROGEN-PAC sprinkler corrosion inhibiting system.

The pressure regulator in the Air Maintenance Device AMD-1 automatically regulates the air pressure to the designated level. The outlet pressure of the regulator is field adjustable.

The automatic N₂ supply is directed through a restricted orifice in the air maintenance device so that upon activation of a sprinkler, the N₂ supply will not interfere with the operation of the dry pipe valve, by continuing to supply high volumes of pressurized N₂ to the piping system.

It is a recommended safeguard that a low pressure switch and alarm be installed on dry pipe systems or other N₂ supervised piping systems. This will cause an alarm to sound if the pressure falls below a predetermined level.

Operation

The Air Maintenance Device provides a continuous but restricted N₂ supply to the piping system.

The activation of only one sprinkler in a dry pipe system, will cause the system pressure to diminish to the point where the dry pipe valve will "trip", thereby filling the system piping with water.

Small piping system N₂ leaks will be compensated for by the automatic N₂ feed provided the N₂ leaks do not exceed the restricted N₂ supply.

Technical Data

Model: AMD-1

Approvals: UL, FM

Factory Operation Test:
100% at 35 psi air

Design Data

An Air Maintenance Device should be permanently connected to all dry pipe sprinkler systems to avoid the possibility of false valve "trips" which may result from small piping leaks gradually lowering system N₂ pressure.

An Air Maintenance Device may also be utilized to automatically control the N₂ supply to the piping system of an N₂ supervised preaction system.

Installation

The Air Maintenance Device must be installed in the N₂ supply line leading to the dry pipe valve trim, preaction system piping or dry pilot system piping. The N₂ flow through the Device must be in the direction shown by the arrows on the units.

Note: The minimum pipe size is 1/2" diameter, although 3/4" diameter piping will provide a more rapid initial system fill.

The AMD-1 includes a non-listed pressure gage for use with the regulator. Gage ships uninstalled. To install, remove the 1/8" plug on the regulator and install the pressure gage into the open port.

Model AMD-1 (Pressure Regulator) (see Fig. 1)

Step 1. Close the 1/4" ball valves (#8) and open the bypass valve (#7) in the Air Maintenance Device and open the N₂ supply valve in the dry pipe valve trim.

Step 2. Open the N₂ supply control valve from the NITROGEN-PAC system to pressurize the system.

Step 3. When the system is pressurized, check the pressure gauge to verify the the pressure is at the design pressure requirement for the system.

Model AMD-1 (Pressure Regulator) (see Fig. 1)

Step 1. Close the 1/4" ball valves (#8) and open the bypass valve (#7) in the Air Maintenance Device and open the N2 supply valve in the dry pipe valve trim.

Step 2. Open the N2 supply control valve from the NITROGEN-PAC system to pressurize the system.

Step 3. When the system is pressurized, check the pressure gauge to verify the the pressure is at the design pressure requirement for the system.

Caution: Care must be taken NOT to overpressure the system above the regulator setting when using the quick fill line.

Note: If necessary to adjust the system pressure ensure the pressure gauge is installed in the regulator port. Move the locking nut away from the body of the regulator and turn the adjustment screw IN to increase the system pressure and OUT to reduce system pressure (see Fig. 1).

When reducing from a higher to a lower setting, first reduce to some pressure less than desired, then bring up to the desired point.

After achieving the desired pressure setting, lock the pressure setting by tightening the locking nut.

Step 4. Close the bypass valve (#7) and open the two 1/4" ball valves (#8). The Air Maintenance Device is now in service.

Care and Maintenance

The Air Maintenance Device does not require any regularly scheduled maintenance. However, it is recommended that proper operation and condition be periodically verified as follows:

1. Verify that the 3/4" bypass valve is closed, the two 1/4" ball valves are open and the N2 supply control valve in the dry pipe valve trim is open.

2. Verify that the regulated pressure is at the proper setting, if applicable.

3. The strainer should be cleaned.

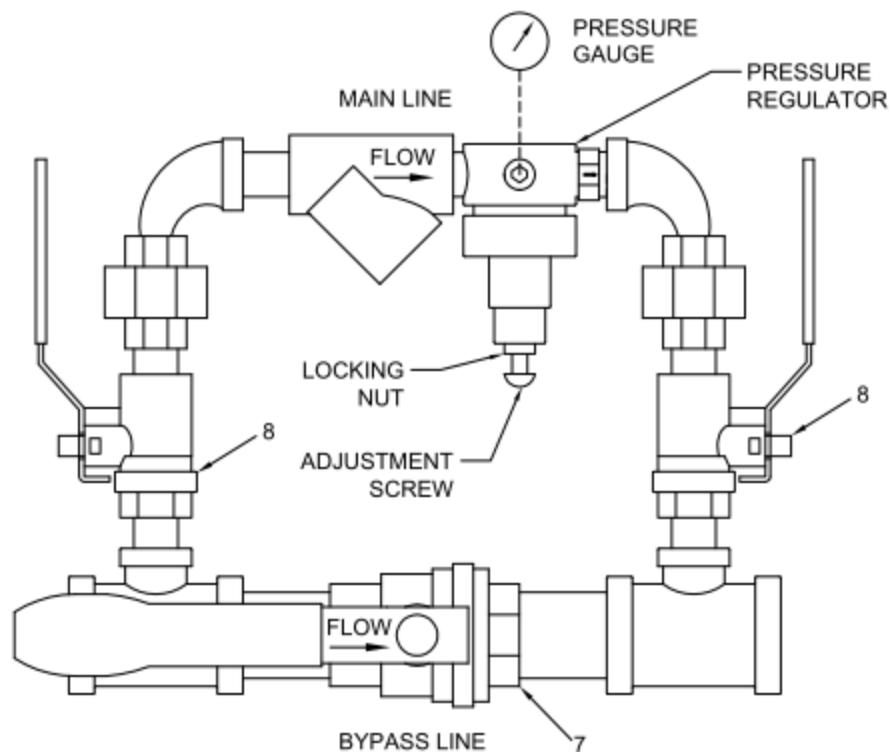

AMD-1
FIGURE 1

(THIS SURFACE DELIBERATELY LEFT BLANK)



UNITED Fire Systems

Division of UNITED Fire Protection Corporation

1 Mark Road

Kenilworth, NJ USA 07033

908-688-0300

www.unitedfiresystems.net