



PREP STATIONS

SPECIALTY CUSTOM SELF-CONTAINED RECESSED COLDWALL REFRIGERATOR MODELS NPO

Self-contained refrigerator storage unit with mechanically cooled pan opening. Cold-wall conductive cooled pan opening with recessed pan ledge provides easy reach and cold above pans for optimal temperatures. Separate base and pan opening controllers give the operator precise control of the temperature in each zone and the ability to shut the pan opening off at night-conserves up to 60% of the daytime energy usage. Standard clean-out port allows pan opening to be easily cleaned and sanitized.

SHORT FORM SPEC: Randell NPO series preparation table with natural R290 refrigeration system. Includes independently controlled mechanically cooled pan opening and refrigerated base, each controlled by their own electronic control. Single pan opening to come standard with recessed pan ledge, adapter bars and oversized clean-out port for ease of cleanability. Base interior ends and door openings shall be high impact ABS plastic with coved corner stainless steel interior to form bottom, back and top of cabinet and be cooled with a blower coil located behind the mullion. Base cabinet doors to have heavy duty 16 ga. top mounted handles and include press-fit magnetic gaskets. Unit to be shipped standard on adjustable legs mounted to full length leg rails. cUL, UL, NSF.

AVAILABLE MODELS:

1 Section:	3 Sections:	4 Sections:
NPO1x130	NPO2x357	NPO2x484
NPO1x133	NPO2x360	NPO2x487
2 Sections:	NPO2x363	NPO2x490
NPO1x236	NPO2x366	NPO2x493
NPO1x239	NPO2x369	NPO2x496
NPO1x242	NPO2x372	NPO2x499
NPO1x245	NPO2x375	NPO2x4102
NPO1x248	NPO2x378	NPO2x4105
NPO1x251	NPO2x381	NPO2x4108
NPO1x254		

STANDARD FEATURES:

- Cold-wall conductive cooled pan opening with recessed pan ledge for easy reach and cold above pans
- Base cooled by high capacity mullion coil refrigeration system with adaptive defrost
- Independent temp control for pan opening and base allows precise temperature maintenance in each zone
- 100% front breathing compressor housing allows sealing to wall and curb mounting without special requirements
- Easy maintenance press-fit gaskets (removable without tools)
- Exclusive completely sealed pan opening interior with clean-out port allows pan opening to be easily cleaned and sanitized
- Hinged compressor compartment panel for access to clean-out port and condenser coil cleaning
- 6" high legs, adjustable and movable along full length leg rail
- Available up to 16' under one common assembly
- Adapter bars to accommodate a compliment of 1/6 size pans

REFRIGERATION SYSTEM: All models will utilize state of the art, energy efficient R290 compressor systems with (0) ozone depletion (ODP) and (3) global warming potential (GWP). The pan opening is conductively cooled by coldwall wrapped tank utilizing Randell's exclusive aluminum cold transfer plates to maximize heat removal capacity. Independently controlled pan opening and base temperatures are managed by electronic controllers metered using capillary tube systems. Independent pan opening control (separate from the base cabinet temperature control) allows the operator precise control of the temperature in each zone and the ability to shut the pan opening off at night for energy savings up to 60% of the daytime usage. Independent base control featuring adaptive defrost allows precise control of the base cabinet.

CABINET EXTERIOR: Top to be one piece of die-formed 16 gauge stainless steel with 2 1/2" nosing. Ends at top fitted with recessed heavy duty steel bars for field bolting units together, producing a hairline seam. Hinged louver panel to be stainless steel. Exterior body to be corrosion resistant steel. Door opening frames are ABS and contain magnetic strip for positive seal of door gaskets. Work surface to be at 36" work height. Legs to be 6" high stainless steel with adjustable bullet foot. Legs mounted to full length channel frame assembly which is integrally welded to bottom of body assembly. Legs can be moved left to right to avoid floor obstacles during installation.

CABINET INTERIOR: Base interior to be ABS thermoplastic at ends only. Stainless steel interior liner to be coved cornered to form bottom, back and top. Unit insulation to be CFC free foamed in place urethane.

DOORS: Door fronts to be 22-gauge stainless steel exterior front with 16 gauge stainless steel door pulls/handles. The interior liner is vacuum formed ABS with integral gasket retainer for easy cleaning and accepts Randell's Exclusive Press Fit Gasket system. Doors are mounted on concealed hinges.



PROJECT NAME:	
LOCATION:	
ITEM NO:	
QTY:	
MODEL NO:	
AIA NO:	
SIS NO:	
CSI SECTION:	11400



NPO1L254-shown with stainless steel finished end and hinged slide-back covers

OPTIONS/ACCESSORIES:

Cabinet:

- Remove backsplash
- Intermediate shelves
- Adjustable shelves
- Stainless steel finished back
- Stainless steel finished ends
- Laminate fronts, ends and back
- Casters in lieu of legs
- Door lock(s)

Pan Opening Covers:

- Hood cover with slide-back front
- Lift-off (removable)
- See-through hinged cover
- Hinged slide-back cover

Work-Surface:

- White poly cutting board, 1/2" or 3/4"
- Richlite cutting board, 1/2" or 3/4"
- Wire prep racks (for placement on stainless steel surface)

Additional Storage:

- Partial length pan opening
- Overshelfing storage options

Voltage:

- 220-230V/50-60Hz supplied with cord (plug provided in field by others)

ADDITIONAL RESOURCES:

[Request A Quote](#)

[Sales Tools](#)

[Find A Rep](#)

NPO1L130

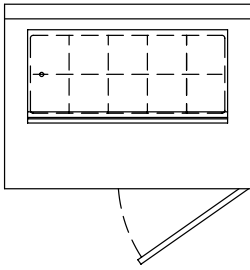

NPO1L133

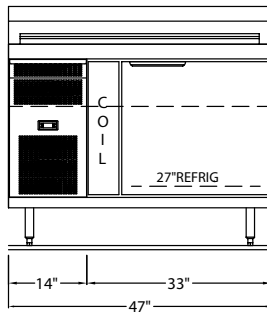
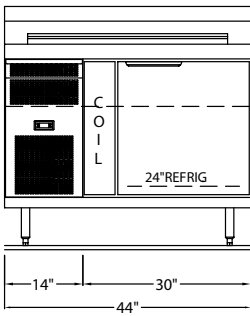
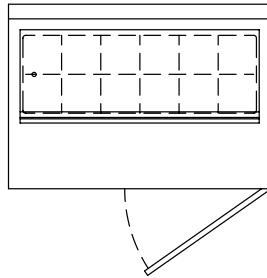

MODEL	COMPRESSOR		BASE SECTION(S)	STANDARD REF. BASE CONFIGURATION	MIN. UNIT LENGTH*	PAN OPENING CAPACITY 1/6 SIZE PAN	BASE STORAGE CUBIC FT/ DRAWER CAPACITY	H.P./ REFRIGERANT	VOLT/ CYCLE/ PHASE	AMPS	NEMA PLUG	SHIP WT.
	QTY/COMP. HSG SIZE	LOCATION "x"										
1 SECTION BASE STORAGE-SELF CONTAINED REFRIGERATORS WITH NARROW DEPTH FLAT OPENING												
NP01x130	(1)-14" MINIMUM	R= RIGHT, L=LEFT	1	(1) 24" DOOR, 6" COIL	44	10	4.13	1/3-R290	115/60/1	6	5-15P	489
NP01x133	(1)-14" MINIMUM	R= RIGHT, L=LEFT	1	(1) 27" DOOR, 6" COIL	47	12	4.78	1/3-R290	115/60/1	6	5-15P	510

*Additional length added to compressor housing.

All drawings shown with compressor left (NPOxL) version of unit; compressor right model (NPOxR) is mirrored. Section sizes and locations may be adjusted within the footprint of the model.

NPO1L236

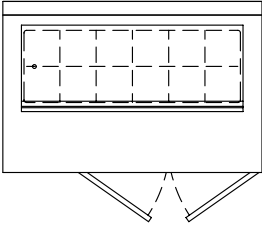

NPO1L239

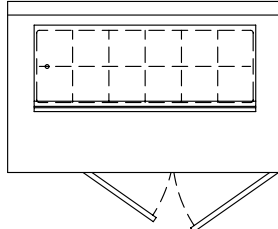

NPO1L242

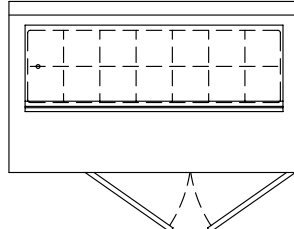

NPO1L245

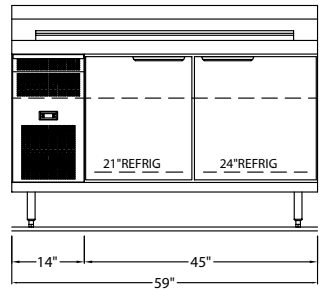
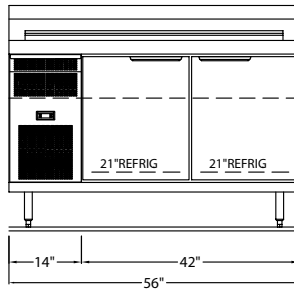
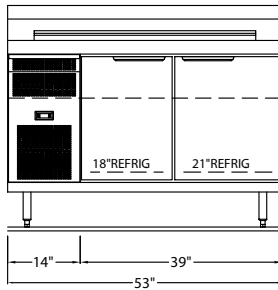
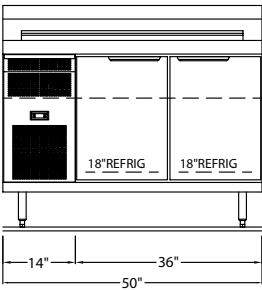
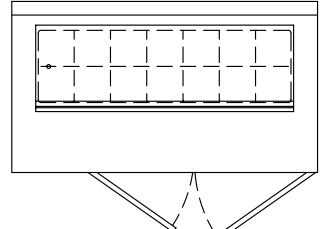

NPO1L248

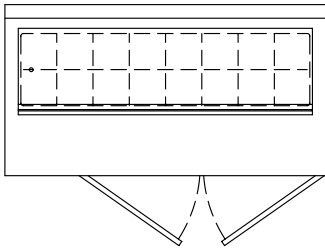

NPO1L251

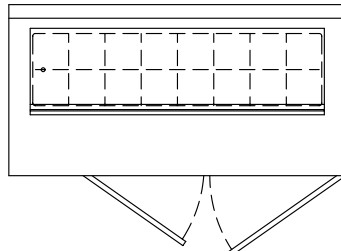

NPO1L254

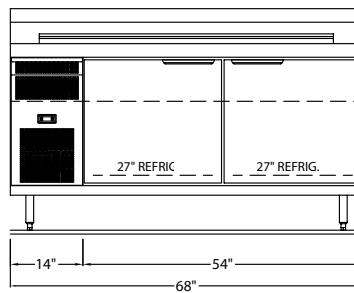
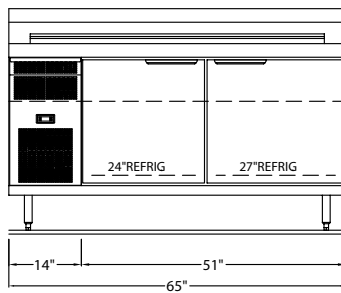
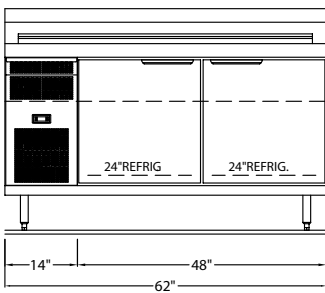
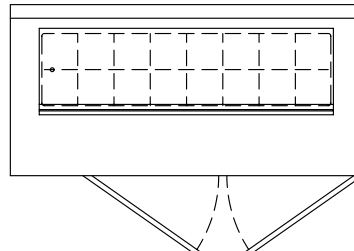

All drawings shown with compressor left (NPOxL) version of unit; compressor right model (NPOxR) is mirrored. Section sizes and locations may be adjusted within the footprint of the model.

MODEL	COMPRESSOR		BASE SECTION(S)	STANDARD REF. BASE CONFIGURATION	MIN. UNIT LENGTH*	PAN OPENING CAPACITY 1/6 SIZE PAN	BASE STORAGE CUBIC FT/ DRAWER CAPACITY	H.P./ REFRIGERANT	VOLT/ CYCLE/ PHASE	AMPS	NEMA PLUG	SHIP WT.
	QTY/COMP. HSG SIZE	LOCATION "x"										
2 SECTION BASE STORAGE-SELF CONTAINED REFRIGERATORS WITH NARROW DEPTH FLAT OPENING												
NP01x236	(1)-14" MINIMUM	R= RIGHT, L=LEFT	2	(2) 18" DOORS	50	12	5.69	1/3-R290	115/60/1	6	5-15P	542
NP01x239	(1)-14" MINIMUM	R= RIGHT, L=LEFT	2	(1) 21" DOOR, (1) 18" DOOR	53	12	6.33	1/3-R290	115/60/1	6	5-15P	563
NP01x242	(1)-14" MINIMUM	R= RIGHT, L=LEFT	2	(2) 21" DOORS	56	14	6.98	1/3-R290	115/60/1	6	5-15P	584
NP01x245	(1)-14" MINIMUM	R= RIGHT, L=LEFT	2	(1) 21" DOOR, (1) 24" DOOR	59	14	7.62	1/3-R290	115/60/1	6	5-15P	605
NP01x248	(1)-14" MINIMUM	R= RIGHT, L=LEFT	2	(1) 24" DOORS	62	16	8.27	1/3-R290	115/60/1	6	5-15P	626
NP01x251	(1)-14" MINIMUM	R= RIGHT, L=LEFT	2	(1) 24" DOOR, (1) 27" DOOR	65	16	8.91	1/3-R290	115/60/1	6	5-15P	647
NP01x254	(1)-14" MINIMUM	R= RIGHT, L=LEFT	2	(2) 27" DOORS	68	16	9.55	1/3-R290	115/60/1	6	5-15P	668

*Additional length added to compressor housing.

NPO2L357

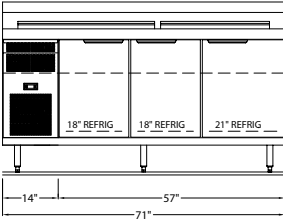
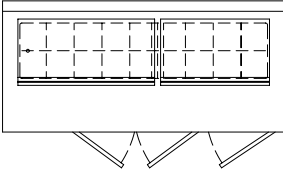

NPO2L360

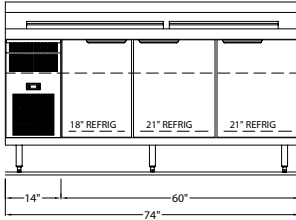
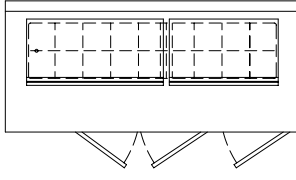

NPO2L363

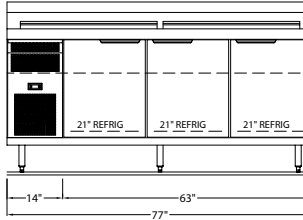
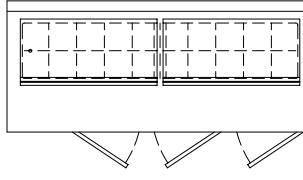

NPO2L366

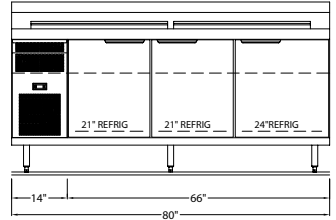
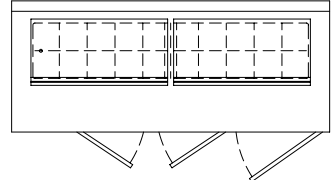

NPO2L369

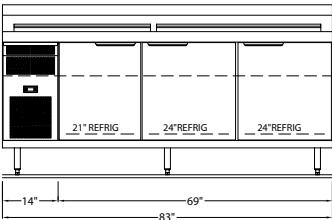
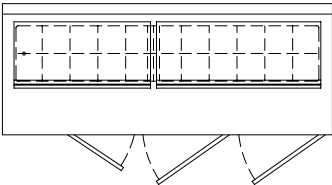

NPO2L372

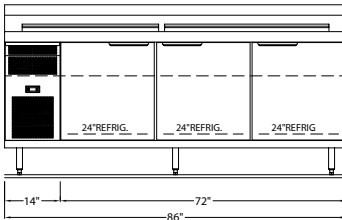
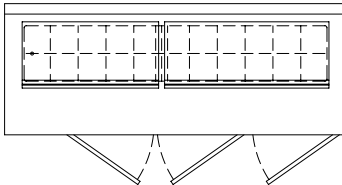

NPO2L375

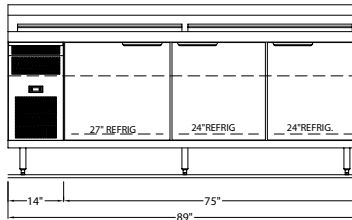
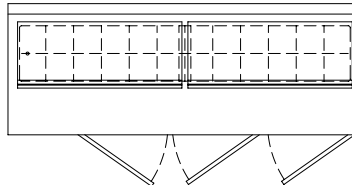

NPO2L378

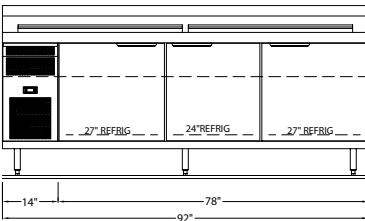
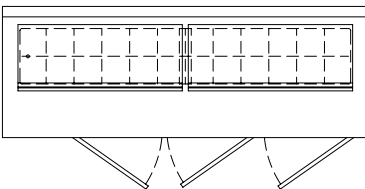

NPO2L381

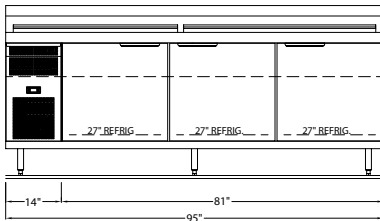
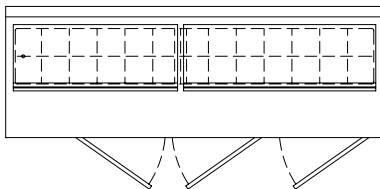

All drawings shown with compressor left (NPOxL) version of unit; compressor right model (NPOxR) is mirrored. Section sizes and locations may be adjusted within the footprint of the model.

MODEL	COMPRESSOR		BASE SECTION(S)	STANDARD REF. BASE CONFIGURATION	MIN. UNIT LENGTH*	PAN OPENING CAPACITY 1/6 SIZE PAN	BASE STORAGE CUBIC FT/ DRAWER CAPACITY	H.P./ REFRIGERANT	VOLT/ CYCLE/ PHASE	AMPS	NEMA PLUG	SHIP WT.
	QTY/COMP. HSG SIZE	LOCATION "x"										
3 SECTION BASE STORAGE-SELF CONTAINED REFRIGERATORS WITH NARROW DEPTH FLAT OPENING												
NP02x357	(2)-14" MINIMUM	R= RIGHT, L=LEFT	3	(2) 18" DOORS, (1) 21" DOOR	71	18	9.18	(2)1/4-R290	115/60/1	5.8	5-15P	715
NP02x360	(2)-14" MINIMUM	R= RIGHT, L=LEFT	3	(1) 18" DOOR, (2) 21" DOORS	74	18	9.82	(2)1/4-R290	115/60/1	5.8	5-15P	736
NP02x363	(2)-14" MINIMUM	R= RIGHT, L=LEFT	3	(3) 21" DOORS	77	20	10.47	(2)1/4-R290	115/60/1	5.8	5-15P	757
NP02x366	(2)-14" MINIMUM	R= RIGHT, L=LEFT	3	(2) 21" DOORS, (1) 24" DOOR	80	20	11.11	(2)1/4-R290	115/60/1	5.8	5-15P	778
NP02x369	(2)-14" MINIMUM	R= RIGHT, L=LEFT	3	(1) 21" DOOR, (2) 24" DOORS	83	22	11.75	(2)1/4-R290	115/60/1	5.8	5-15P	799
NP02x372	(2)-14" MINIMUM	R= RIGHT, L=LEFT	3	(3) 24" DOORS	86	22	12.40	(2)1/4-R290	115/60/1	5.8	5-15P	820
NP02x375	(2)-14" MINIMUM	R= RIGHT, L=LEFT	3	(1) 27" DOOR, (2) 24" DOORS	89	24	13.04	(2)1/4-R290	115/60/1	5.8	5-15P	841
NP02x378	(2)-14" MINIMUM	R= RIGHT, L=LEFT	3	(1) 24" DOOR, (2) 27" DOORS	92	24	13.69	(2)1/4-R290	115/60/1	5.8	5-15P	862
NP02x381	(2)-14" MINIMUM	R= RIGHT, L=LEFT	3	(3) 27" DOORS	95	26	14.33	(2)1/4-R290	115/60/1	5.8	5-15P	883

*Additional length added to compressor housing.

NPO2L484

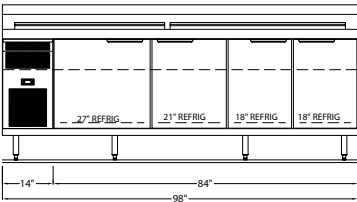
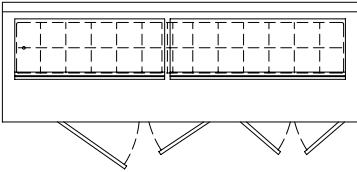

NPO2L487

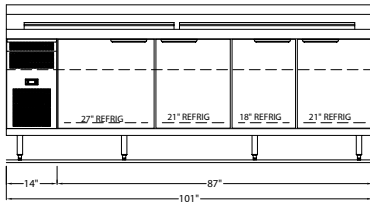
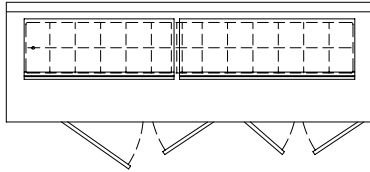

NPO2L490

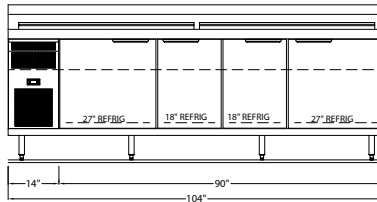
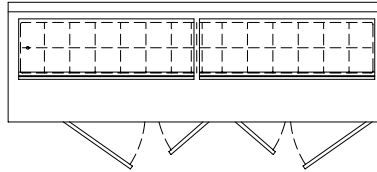

NPO2L493

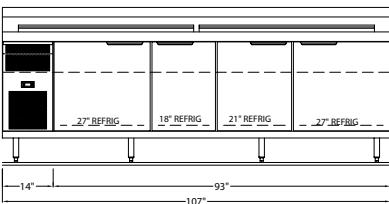
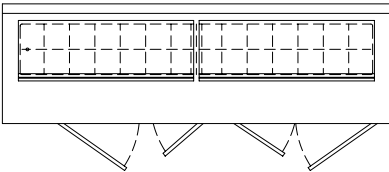

NPO2L496

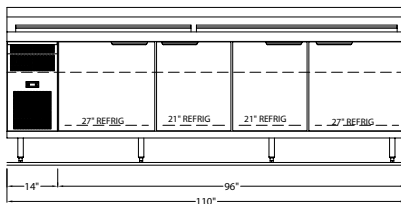
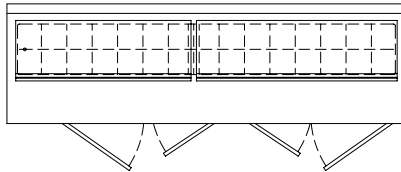

NPO2L499

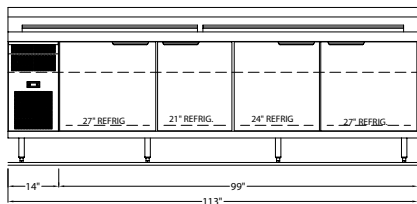
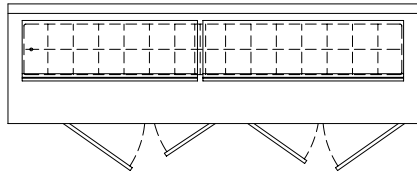

NPO2L4102

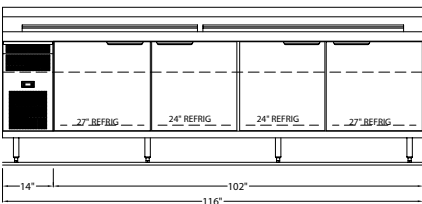
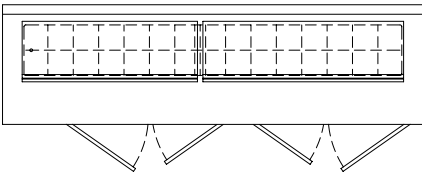

NPO2L4105

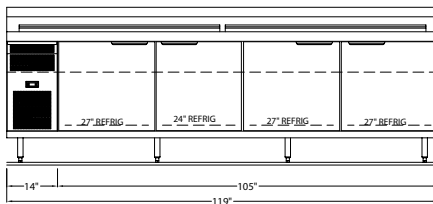
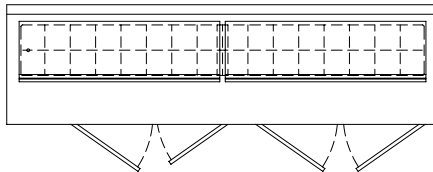

NPO2L4108

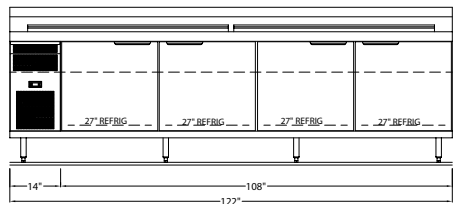
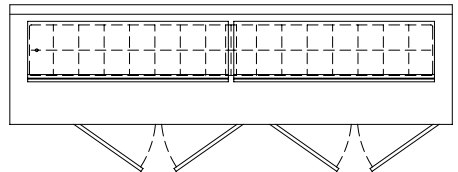

All drawings shown with compressor left (NPOxL) version of unit; compressor right model (NPOxR) is mirrored. Section sizes and locations may be adjusted within the footprint of the model.

MODEL	COMPRESSOR		BASE SECTION(S)	STANDARD REF. BASE CONFIGURATION	MIN. UNIT LENGTH*	PAN OPENING CAPACITY 1/6 SIZE PAN	BASE STORAGE CUBIC FT/ DRAWER CAPACITY	H.P./ REFRIGERANT	VOLT/ CYCLE/ PHASE	AMPS	NEMA PLUG	SHIP WT.
	QTY/COMP. HSG SIZE	LOCATION "x"										
4 SECTION BASE STORAGE-SELF CONTAINED REFRIGERATORS WITH NARROW DEPTH FLAT OPENING												
NP02x484	(2)-14" MINIMUM	R= RIGHT, L=LEFT	4	(1) 27" DOOR, (1) 21" DOOR, (2) 18" DOORS	98	26	13.96	(2)1/4-R290	115/60/1	5.8	5-15P	904
NP02x487	(2)-14" MINIMUM	R= RIGHT, L=LEFT	4	(1) 27" DOOR, (2) 21" DOORS, (1) 18" DOOR	101	26	14.60	(2)1/4-R290	115/60/1	5.8	5-15P	925
NP02x490	(2)-14" MINIMUM	R= RIGHT, L=LEFT	4	(2) 27" DOORS, (2) 18" DOORS	104	28	15.24	(2)1/4-R290	115/60/1	5.8	5-15P	946
NP02x493	(2)-14" MINIMUM	R= RIGHT, L=LEFT	4	(2) 27" DOORS, (1) 18" DOOR, (1) 21" DOOR	107	28	15.89	(2)1/4-R290	115/60/1	5.8	5-15P	967
NP02x496	(2)-14" MINIMUM	R= RIGHT, L=LEFT	4	(2) 27" DOORS, (2) 21" DOORS	110	30	16.53	(2)1/4-R290	115/60/1	5.8	5-15P	988
NP02x499	(2)-14" MINIMUM	R= RIGHT, L=LEFT	4	(2) 27" DOORS, (1) 21" DOOR, (1) 24" DOOR	113	30	17.18	(2)1/4-R290	115/60/1	5.8	5-15P	1009
NP02x4102	(2)-14" MINIMUM	R= RIGHT, L=LEFT	4	(2) 27" DOORS, (2) 24" DOORS	116	30	17.82	(2)1/4-R290	115/60/1	5.8	5-15P	1030
NP02x4105	(2)-14" MINIMUM	R= RIGHT, L=LEFT	4	(3) 27" DOORS, (1) 24" DOOR	119	32	18.46	(2)1/4-R290	115/60/1	5.8	5-15P	1051
NP02x4108	(2)-14" MINIMUM	R= RIGHT, L=LEFT	4	(4) 27" DOORS	122	32	19.11	(2)1/4-R290	115/60/1	5.8	5-15P	1072

*Additional length added to compressor housing.

DOORS:

DOOR OPENING SIZES	CLEARANCES THROUGH DOOR		INTERIOR DEPTH BEHIND DOOR	ACCEPTS SHEET PAN SLIDES
	DOOR WIDTH	LT. TO RT.	TOP TO BOTTOM	
18"	13 1/4"	14"	26.5"	No
21"	16 1/4"	14"	26.5"	No
24"	19 1/4"	14"	26.5"	Yes
27"	22 1/4"	14"	26.5"	Yes

DIMENSIONAL DETAIL:

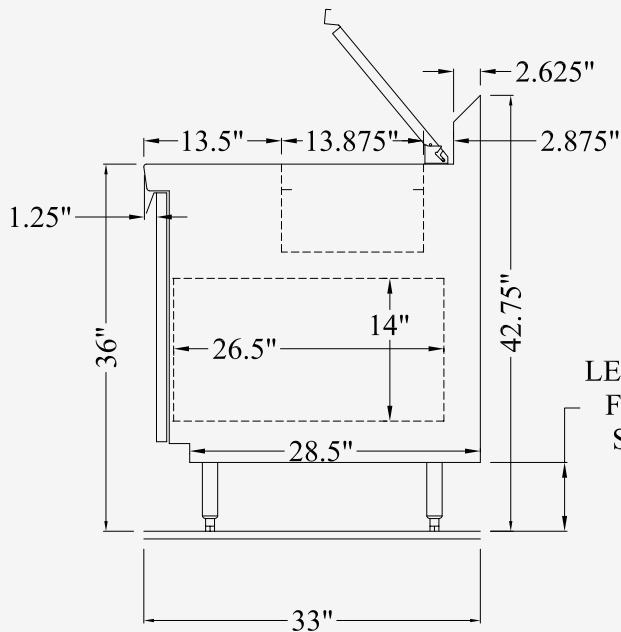

LEGS ADJUSTABLE FROM: 6" - 7.125" SHOWN @ 6.75"

Stainless Steel Finished End:

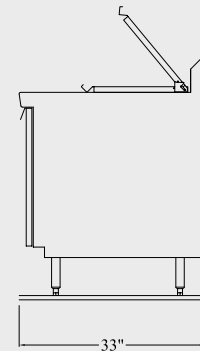

Unfinished End:

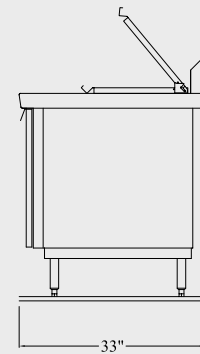

OPTIONAL COVERS:

Hinged Cover (standard):

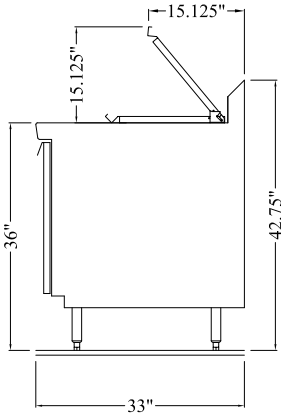

Hinged Slide-Back Cover:

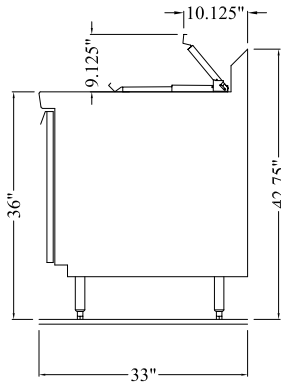

Lift-Off Cover:

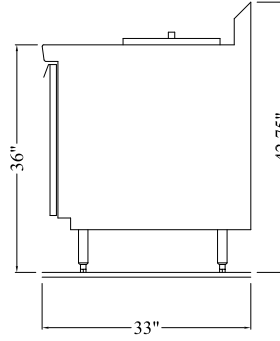

Hood Cover:

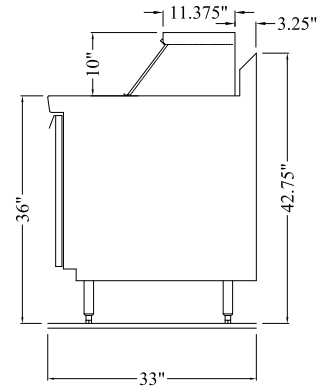

*Units shown with optional stainless steel end panels.