

**2018**

**Scales & Balances**



*The weigh you want... **today***

---

# the weigh you want... *today!*



Dear Customer:

This catalog has been prepared especially for the professional in the weighing industry. I am sure that you will find it informative and helpful.

We pride ourselves on answering the phone on the first ring and shipping your order the same day that you place it.

You will also benefit from our huge inventory. Our records indicate that we ship 49 out of 50 orders from stock.

Price is also important and you can depend on our price being the best in the industry. If you have large quantities we can give you better prices.

You will note that there are many new items in this catalog. Please take the time to see what has been added to see if it fits what you need.

Thank you for being our customer. We look forward to many successful years with you.

Best Personal Regards  
Rudolph J. Kolaci  
President

## **Mission**

Serve, Supply, & Inform You with Total**competence**.

## **Vision**

Embrace Change While Maintaining Values.

## **Values**

*Honest* in all of our dealings.

*Helpful* to our customers & each other.

*Happy* in both home and office.

*Healthy* in all aspects of our lives.



A&D WEIGHING DIVISION

**PV Pocket Scale**

Compact, battery operated (2) "AAA" batteries included. Weigh modes: g, oz, ozt, dwt. Auto power off function. Large easy to read LCD display. Low battery indicator. Simple fast calibration. Calibration weight is included. Protective vinyl cover included. Tare push button for easy quick rezeroing.

Part Number	Capacity	Platform	Weight	Stock	Price B5
PV-100	100g x 0.1g	3" x 3"	2 lb	3672	\$ 105.00
PV-200	200g x 0.1g	3" x 3"	2 lb	3673	160.00
PV-500	500g x 0.1g	3" x 3"	2 lb	3674	210.00



Pocket Scale



**HH Hand Held Pocket Scale**

Convenient, compact and portable for briefcase, backpack or pocket. Standard model HH120 for basic grams weighing. Professional HH320 has multiple weighing units for g, oz, dwt, ozt. Backlit display and protective cover. Large high contrast LCD display. Low battery indicator, overload and underload indicators, (2) "AAA" batteries, rugged plastic construction. The letter "D" in the part number indicates a User Calibration Feature. 1 year warranty.

Part Number	Capacity	Platform	Weight	Stock	Price D
HH120D	0-60g x 0.1g	3.25" x 3"	1 lb	4156	\$ 158.00
	60-120g x 0.2g				
HH120	120g x 0.1g	3.25" x 3"	1 lb	2312	189.00
HH320	320 x 0.1g	3.25" x 3"	1 lb	4157	235.00



HH320  
Pocket Scale



**PS Pocket Scale**

Unique pan design, durable ABS housing slides back to engage the load cell and expose the display and buttons for operation. Weighing units for g, oz, ozt, dwt. 0.3" LCD display. Text weight unit prompts with stability and overload indicators. Auto shut off to preserve battery. Cover protects display and keys and prevents load cell damage in transport. Smaller than most pocket scales, allows a comfortable fit in your pocket. Piano style mechanical buttons provide positive dependable operation. Includes calibration software using 100g weight for PS121 and 200g weight for PS251. Calibration weights are not included. Two CR2032 lithium batteries included. 1 year warranty.

Part Number	Capacity	Platform	Weight	Stock	Price C5
PS121	120g x 0.1g	2.8" x 2.5"	1 lb	2329	\$ 59.00
PS251	250g x 0.1g	2.8" x 2.5"	1 lb	2330	77.00



PS  
Pocket Scale

Prices are subject to change without notice. Please call for current prices.

Other items are available from the manufacturers, please call for prices.

99 Reagent Lane  
Fair Lawn NJ 07410  
201-797-2718 \* 800-631-0347



www.totalcomp.com  
Fax 201-797-2287  
Toll Free Fax 888-797-2288

# OHAUS®



**CL Series  
Pocket Scale**

## CL Series Pocket Scale

Compact, lightweight, portable. Perfectly suitable for use in industrial, jewelry and home use applications. Superior RF protection to deliver accurate and stable results when used in production areas or near cell phones. Easy to read LCD display. Keys are: UNIT/CAL, ON/ZERO/OFF. Weighing units in g, lb:oz, ozt, dwt. Applications can include quality control, formulation, soil sampling, jewelry, postal and dietary weighing. 3 AA batteries included. AC adapter optional.

Part Number	Capacity	Platform	Weight	Stock	Price C5
CL201	200g x 0.1g	4.75" dia	1 lb	2874	\$ 96.00
CL2000	2,000g x 1g	4.75" dia	1 lb	2875	96.00
CL-5000	5,000g x 1g	4.75" dia	1 lb	2876	132.00
CL-5000F	5,000g x 1g	4.75" dia	1 lb	2828	190.00

\*"F" model indicates carrying case

### Options

				A
46001724 AC adapter 120VAC to 12VDC, 500ma w/o prong set		1 lb	6164M	37.00
46001776 Prong set, US only		1 lb	6226M	14.00
46001780 Prong set, International		1 lb	714MB	15.00
80850075 Bowl 1050ml		1 lb	4226M	42.00
80250048 Black aluminum scoop		1 lb	1139M	29.00
80850364 Aluminum scoop		1 lb	1140M	23.00
30020842 Gold scoop		1 lb	1141M	23.00
80010624 Carrying case		1 lb	2877	51.00

Aug

# OHAUS®



**CS-2000  
Compact Bench Scale**

## CS Compact Bench Scale

Portable and compact with a durable, easy to clean housing. These slim and sleek balances feature two tactile feedback push button operation, full capacity tare and a bright high contrast 11mm LCD display. A button will select grams or pound & ounce mode. All operate on (3) AA batteries, included. Low battery indicator, overload and underload indicators, auto shut off after 5 minutes. Battery life is up to 40 hours. Optional Postal Chart, AC adapter and Bowl are available. 1 year warranty.

Part Number	Capacity	Platform	Weight	Stock	Price D
CS200	200g x 0.1 g 7.5 oz x 0.01 oz	5.75" x 5.25"	2 lb	4222	\$ 140.00
CS2000	2,000g x 1 g 4 lb-6.55 oz x 0.05 oz	5.75" x 5.25"	2 lb	4223	140.00
CS5000	5,000g x 1 g 11 lb-0.4 oz x 0.1 oz	5.75" x 5.25"	2 lb	4224	165.00

### Options

				A
46001724 AC adapter 120VAC to 12VAC, 500ma w/o prong set		1 lb	6164M	37.00
46001776 Prong set, US only		1 lb	6226M	14.00
46001780 Prong set, International		1 lb	714M	15.00
80850075 Bowl 1050ml		1 lb	4226M	42.00
80850076 Stainless Steel weigh pan cover		1 lb	4227	47.00

**NEW**



A&D WEIGHING DIVISION

**HL Compact Bench Scale**

Use in a wide range of applications including office, warehouse, laboratory and industry. Keys for ON/OFF, UNITS, RE-ZERO. Liquid crystal display(LCD) can be selected to various weighing modes which can include g, lb oz. Self contained, battery operated by (6) AA batteries or an optional AC adapter 120 VAC, 50/60 Hz, 1.5 watts. Auto shut off after 5 minutes. 7.8"W x 5.51"D x 1.75"H

Part Number	Capacity	Platform	Weight	Stock	Price C
HL-100	100 x 0.01g	70mm dia	3 lb	296	\$ 240.00
HL-400	400 x 0.1g	136 x 136mm	3 lb	915	160.00

**Options**

Options	Weight	Stock	Price C
TB:662 AC adapter 120 VAC	1 lb	1305M	43.00
FV-06 AC adapter 220 VAC	1 lb	1306M	53.00
HL-07 Stainless Steel pan	1 lb	3276	23.00

**Stainless Steel Full Washdown IP65 NEMA-4X**

Part Number	Capacity	Platform	Weight	Stock	Price C
HL-300WP	300 x 0.1g	5" x 5"	3 lb	6617	420.00
HL-1000WP	1,000 x 0.5g	5" x 5"	3 lb	6618	420.00
HL-3000WP	3,000 x 1g	5" x 5"	3 lb	6619	420.00
HL-3000WPN *	3,000 x 1g	5" x 5"	3 lb	6620	420.00
HL-3000LWP	3,000 x 1g	5.4" x 6.8"	4 lb	6621	420.00
HL-3000LWPN *	3,000 x 1g	5.4" x 6.8"	4 lb	6622	420.00

\* N suffix does not have lb/oz mode and is NTEP

**Service Parts**

Service Parts	Weight	Stock	Price C
04:3006434 SS pan 5" x 5"	1 lb	6676	14.00
07:4014219 adjustable foot	1 lb	6677	6.00



HL-100



HL-300WP  
Stainless Steel Washdown  
Compact Bench Scale



A&D WEIGHING DIVISION

**HLi Ninja Bench Scale**

Portable, battery operated. Simple, easy to operate. Clear 0.53" 7 segment LCD display. Keys are: ON/OFF, UNITS, O/T/RE-ZERO. Units: g, oz, tl. HL-200i has additional units of g. Indicators are: low batt, weight stability, scale overload. 1,000 hours of battery life. Auto power off. 2 year warranty. Includes (4) AA batteries, optional AC adapter. 5.1"W x 7.6"D x 2"H

Part Number	Capacity	Pan	Weight	Stock	Price C
HL-200i	200 x 0.1g	5.1" dia	2 lb	5360	\$ 105.00
HL-2000i	2,000 x 1g	5.1" dia	2 lb	5361	105.00

**Options**

Options	Weight	Stock	Price C
TB:662 AC adapter 120 VAC	1 lb	1305M	43.00
FV-06 AC adapter 240VAC	1 lb	1306M	53.00



HL-200i  
Bench Scale

Prices are subject to change without notice. Please call for current prices.

Other items are available from the manufacturers, please call for prices.



A&D WEIGHING DIVISION



HT-500  
Bench Scale

### HT Compact Bench Scale

Engineered with simplicity in mind. Low profile and lightweight. Designed with portability and protection. Unique to this scale are 3 included color bars that allow the user to categorize the scale by user or function. Choose one of the 3 color bars (red, green, orange) to personalize your scale. Clearly visible, 13.5mm high digital LCD display. Multiple units of measure for: g, oz, Troy oz, lb, lb-oz, N, tael, tola. Auto power off function to preserve battery life. 450 hour battery life (4AA batteries included). Standard plastic carrying case included that are stackable for easy storage. It is even possible to weigh on the scale as it rests in the case, no need to remove it. The case also comes with penholders for added convenience. Security slot in the rear of the scale can accommodate an anti-theft device. 7.68"W x 5.35"D x 1.73"H

Part Number	Capacity	Platform	Weight	Stock	Price C5
HT-300	310 x 0.1g	5.20" x 5.12"	3 lb	4278	\$ 130.00
HT-500	510 x 0.1g	5.20" x 5.12"	3 lb	4279	155.00
HT-3000	3100 x 1g	5.20" x 5.12"	3 lb	4280	130.00
HT-5000	5100 x 1g	5.20" x 5.12"	3 lb	4281	155.00

#### Options

HT-10 Stainless steel pan	5.20" x 5.12"	2 lb	4290	28.00	<b>A</b>
TB:662 AC adapter 120 VAC		1 lb	1305M	43.00	<b>A5</b>



A&D WEIGHING DIVISION



SJ-2000HS  
Bench Scale

### SJ Bench Scale

Full digital calibration, large, removable stainless steel pan. Easy to read 1" 7 segment LCD display. Less than one second response. Keys for ON/OFF, RE-ZERO, UNITS. Weighing units are: g, oz, lb-oz, lb. 800 hour battery life. Battery level indicator. Automatic power off. Optional AC adapter (not included). 10.4"W x 9.8"D x 4.1"H.

Part Number	Capacity	Pan	Weight	Stock	Price C
SJ-1000HS	1,000 x 0.5g	230 x 190mm	4 lb	4093	\$ 220.00
SJ-2000HS	2,000 x 1g	230 x 190mm	4 lb	4096	220.00
SJ-5000HS	5,000 x 2g	230 x 190mm	4 lb	4097	220.00
SJ-12KHS	12,000 x 5g	230 x 190mm	4 lb	4099	220.00
SJ-20KHS	20,000 x 0.01kg	230 x 190mm	4 lb	4094	250.00
SJ-30KHS	30,000 x 0.02 kg	230 x 190mm	4 lb	4095	270.00

#### Options

TB:662 AC adapter 120 VAC		1 lb	1305M	43.00	<b>A5</b>
---------------------------	--	------	-------	-------	-----------

#### Service Parts

707-4018232 Foot for SJ		1 lb	5798	15.00	<b>A5</b>
-------------------------	--	------	------	-------	-----------



A&D WEIGHING DIVISION

### EK (Old) Bench Scale

Old Series parts only.

Part Number	Weight	Stock	Price A5
<b>Old Version Service Parts</b>			
01:A33711-2A keysheet EK-1200A	1 lb	1503	\$ 28.00
01:A33744 keysheet for EK-12KA	1 lb	1956	31.00
PZ:690 Pushbutton assy for EK/EW Series	1 lb	18	39.00
AX:00A20559A protective dust cover for EK/EW 120/1200	1 lb	1674	12.00

Prices are subject to change without notice. Please call for current prices.

Other items are available from the manufacturers, please call for prices.



A&D WEIGHING DIVISION

**EK-i Bench Scale**

1/30,000 resolution and a complete range of features from a scale portable enough to carry in one hand. Gram, oz(avoird), oz(troy), lb, grain, carat, momme, tael, pennyweight, counting function, Percentage Function. Includes RS232C interface to communicate with computers and printers. Includes AC adapter. 115VAC, 50/60 Hz, 2.5VA, 7.5"W x 8.6"D x 2.6"H.

NTEP 04-019 Class III & II

Part Number	Capacity	Pan	Weight	Stock	Price C5
EK-120i*	120 x 0.01g	4.3"dia	4 lb	5647	\$ 520.00
EK-200i*	200 x 0.01g	4.3"dia	4 lb	5648	550.00
EK-300*i	300 x 0.01g	4.3"dia	4 lb	5649	575.00
EK-410i*	400 x 0.01g	4.3"dia	4 lb	5226	645.00
EK-610i*	600 x 0.01g	4.3"dia	4 lb	5227	750.00
EK-600i	600 x 0.1g	5.2" x 6.7"	5 lb	5650	520.00
EK-1200i	1,200 x 0.1g	5.2" x 6.7"	5 lb	5651	540.00
EK-2000i*	2,000 x 0.1g	5.2" x 6.7"	5 lb	5652	565.00
EK-3000i*	3,000 x 0.1g	5.2" x 6.7"	5 lb	5653	605.00
EK-4100i*	4,000 x 0.1g	5.2" x 6.7"	5 lb	5228	725.00
EK-6100i*	6,000 x 0.1g	5.2" x 6.7"	5 lb	5229	885.00
EK-6000i	6,000 x 1g	5.2" x 6.7"	5 lb	5654	565.00
EK-12Ki	12,000 x 1g	5.2" x 6.7"	5 lb	5655	730.00

\* Not NTEP

**Options**

			B5
EKW-04i	Comparator/Relay output/Buzzer	1 lb	5656M 160.00
EKW-07i	Underhook for EK-6000i & 12Ki	1 lb	5657M 52.00
EKW-09i	Rechargeable NiCd battery pack	4 lb	5658M 209.00

			A
AX:	3005824-5S Protective in use cover	1 lb	5231M 13.00
EJ-12	Carry case for EW/EK-i	2 lb	5659M 65.00
AD-100-2	Anti theft device	1 lb	1849M 73.00

**Service Parts**

			A
TB:662	AC adapter 120VAC	1 lb	1305MB 43.00
06:40110B4A	foot EK EW EJ	1 lb	6176M 13.40



**EK-12Ki  
Bench Scale**



A&D WEIGHING DIVISION

**FV+FW Portable Bench/Floor Scale**

Service parts only.

HV: NTEP 96-186 III 3,100 div Canadian SWA# AM-5093

Part Number	Weight	Stock	Price A5
<b>Service parts (Old Units FV &amp; FW)</b>			
01A	Wall mounting kit for display pod(FV/FW)	1 lb	1268 \$ 45.00
02	Display pod extension cable 5m	1 lb	1302 139.00
09:A34157-7	Keysheet unit for FV	1 lb	1495 93.00
06:A33710-1A	rubber cushion small for FV	1 lb	1462 23.50
06:A33710-2A	rubber cushion large for FV	1 lb	1463 16.50

Prices are subject to change without notice. Please call for current prices.

Other items are available from the manufacturers, please call for prices.

13-01 Pollitt Drive Ext  
Fair Lawn NJ 07410  
201-797-2718 \* 800-631-0347

**Totalcomp**  
Scales & Balances

www.totalcomp.com  
Fax 201-797-2287  
Toll Free Fax 888-797-2288

**NEW**



**T29 Washdown Bench Scale**

**T29 Washdown Bench Scale**

Stainless steel housing with steel case, locks out water, dust and dirt. Portable. Washdown with breathable knob design. Designed to withstand a variety of harsh conditions found in commercial and industrial facilities (tighten knob for complete seal). Large 25mm LCD display with white LED backlight make this scale easy to read. Keys for ON/OFF, TARE, ZERO. Indicators for Zero, Stable, Net, Battery, kg, lb, charging LED light. Adjustable feet and front bubble level makes it easy to level this scale. 6V/3.2Ah rechargeable battery included. Battery provides up to 70 hours of continuous use (without backlight). 12V/500mA AC adapter included. Operating temperature -10 C to +40 C. IP67.

9.5"W x 11.75"D x 5"H.  
NTEP 15-053 Class III 6,000 div

Part Number	Capacity	Platform	Weight	Stock	Price C
T29-6 lb	6 x 0.001 lb	7.5" x 9.0"	10 lb	7982	\$ 395.00
T29-12 lb	12 x 0.002 lb	7.5" x 9.0"	10 lb	7983	395.00
T29-24 lb	24 x 0.005 lb	7.5" x 9.0"	10 lb	7984	395.00
T29-30 lb	30 x 0.005 lb	7.5" x 9.0"	10 lb	7985	395.00
T29-60 lb	60 x 0.01 lb	7.5" x 9.0"	10 lb	7986	395.00

**Options**

AC Adapter 12VDC 1 lb 6362MB 23.80 **C**

**Service Parts**

Main board for T29 1 lb 7592 190.00 **C**



A&D WEIGHING DIVISION

**EW-i Bench Scale**

The EW-i Series scales offer attractive triple ranges at an even more economical price. Weighing modes include gram(g), decimal ounce(oz), decimal pound(lb), troy ounce(ozt), pennyweight(dwt), carat(ct), Momme(mm), Grain Unit(GU), tael(tl), percentage and counting functions. Includes RS-232C interface for connecting computers and printers. Includes AC adapter, 115 VAC 50/60 Hz, 2.5 VA, 7.5"W x 8.6"D x 2.2"H. NTEP 04-019 Class III



**EW-1500i Bench Scale**



Part Number	Capacity	Pan	Weight	Stock	Price C5
EW-150i *	30g x 0.01g 60g x 0.02g 150g x 0.05g	4.3" dia	4 lb	5644	\$ 425.00
EW-1500i	300g x 0.1g 600g x 0.2g 1500g x 0.5g	5.2" x 6.7"	5 lb	5645	425.00
EW-12Ki	3000g x 1g 6000g x 2g 12,000g x 5g	5.2" x 6.7"	5 lb	5646	425.00

\* Not NTEP

**Options**

EKW-04i Comparator/Relay output/Buzzer 1 lb 5656M 160.00 **B5**  
 EKW-07i Underhook for EK-6000i & 12Ki 1 lb 5657M 52.00  
 EKW-09i Rechargeable NiCd battery pack 4 lb 5658M 209.00

AX: 3005824-5S Protective in use cover 1 lb 5231M 13.00 **A**  
 EJ-12 106 Carry case for EW/EK-i 2 lb 5659M 43.00  
 AD-100-2 Anti theft device 1 lb 1849M 73.00

**Service Parts**

TB:662 AC adapter 120VAC 1 lb 1305MB 43.00 **A**

Prices are subject to change without notice. Please call for current prices.

Other items are available from the manufacturers, please call for prices.





A&D WEIGHING DIVISION

## SK-WP Water Proof Bench Scale

Stainless steel, rugged, high impact housing. Detachable stainless steel weighing pan. Large & clear LCD display 25mm high. Portable with (6) D size batteries (not included). Approx. 600 hours (manganese type), 1,200 hours (alkaline). Indicators for Stable. Net, Zero and Low battery. Keys for ON/OFF, ZERO, TARE. Auto power off function. SK-Z is LB w/decimal oz, fractional oz, decimal lb. Optional AC adapter (not included). 10.5"W x 11"D x 5.75"H.

NTEP 98-086 Class III,  
NSF pending

Part Number	Capacity	Pan	Weight	Stock	Price C
SK-1000WP	1,000 x 0.5g	232 x 192mm	8 lb	2936	\$ 445.00
SK-2000WP	2,000 x 1g	232 x 192mm	8 lb	2937	445.00
SK-5000WP	5,000 x 2g	232 x 192mm	8 lb	2938	445.00
SK-5001WP*	5,000 x 1g	232 x 192mm	8 lb	2939	445.00
SK-10KWP	10kg x 0.005kg	232 x 192mm	8 lb	2940	445.00
SK-20KWP	20kg x 0.01kg	232 x 192mm	10 lb	2941	445.00

### NSF Certified (pending) lb/oz Z version Not Legal for Trade

SK-2000WPZ	4 lb 6 oz x 0.05 oz	232 x 192mm	8 lb	2942	432.00
SK-5000WPZ	11 lb x 0.1 oz	232 x 192mm	8 lb	2943	432.00
SK-20KWPZ	44 lb x 1 oz	232 x 192mm	10 lb	2944	432.00

\*not NTEP

### Options

TB:662 AC adapter 120 VAC	1 lb	1305M	43.00	<b>A5</b>
FV-06 AC adapter 220 VAC	1 lb	1306M	53.00	<b>B</b>

### Service Parts

08:3005664A Keypad overlay for SK2000WP	1 lb	3028	9.00	<b>A5</b>
07:2000638 battery cover SKWP	1 lb	2935	20.00	
PZ:4334 main board SKWP	1 lb	2947	123.00	



**SK-WP**  
Bench Scale

Prices are subject to change without notice. Please call for current prices.

Other items are available from the manufacturers, please call for prices.

99 Reagent Lane  
Fair Lawn NJ 07410  
201-797-2718 \* 800-631-0347

**Totalcomp**  
Scales & Balances

www.totalcomp.com  
Fax 201-797-2287  
Toll Free Fax 888-797-2288



A&D WEIGHING DIVISION



EJ-200



EJ-2000

## EJ Series Bench Scale

Ten different capacities cover a broad range of applications for your user requirements. Easy to read, 16mm high LCD display with amber backlight allows for easy viewing in the worst conditions. Fast, 1 second response time. Keys for: ON/OFF, SAMPLE, PRINT, OT/RE-ZERO, PRINT. Weighing units are: grams, ounces, pounds, troy ounces, carats, momme, pennyweight, grains, newtons, tael. Counting mode with Automatic Counting Accuracy Improvement (ACAI). Percent weighing. Specific gravity function. Over-Under. Stackable ( up to 3 high) for easy storage and retrieval. 5 year warranty.

Part Number	Capacity	Pan	Weight	Stock	Price C5
EJ-123	120g x 0.001g	4.3"	4 lb	7626	\$ 530.00
EJ-303	300g x 0.001g	4.3"	4 lb	7624	560.00
EJ-120	120g x 0.01g	4.3"	4 lb	7540	280.00
EJ-200	200g x 0.01g	4.3"	4 lb	7541	340.00
EJ-300	300g x 0.01g	4.3"	4 lb	7542	400.00
EJ-410	410g x 0.01g	4.3"	4 lb	7543	435.00
EJ-610	610g x 0.01g	4.3"	4 lb	7544	575.00
EJ-1500	1500g x 0.1g	5" x 5.5"	6 lb	7545	275.00
EJ-2000	2100g x 0.1g	5" x 5.5"	6 lb	7546	330.00
EJ-3000	3100g x 0.1g	5" x 5.5"	6 lb	7547	400.00
EJ-4100	4100g x 0.1g	5" x 5.5"	6 lb	7548	460.00
EJ-6100	6100g x 0.1g	5" x 5.5"	6 lb	7549	515.00

### Options

EJ-02C USB interface w/ cable	1 lb	7550	75.00	<b>A</b>
EJ-03C RS232 interface w/ cable	1 lb	7551	65.00	
EJ-07 Underhook for EJ 3K, 4.1K, 6.1K	1 lb	7552	65.00	
EJ-08 Underhook for EJ 1500 and 2000	1 lb	7553	65.00	
EJ-11 Breeze break	1 lb	7554	75.00	
EJ-12 Carry case	1 lb	7555	43.00	
EJ-13 Density determination kit	1 lb	7556	53.00	

### Service Parts

06:4011084B-2 foot EK EW EJ	1 lb	6176M	13.40	<b>A</b>
-----------------------------	------	-------	-------	----------



A&D WEIGHING DIVISION

**SK Bench Scale**

1/2,000 resolution, solid & reliable design, splash proof (driptight), large & clear LCD display 25mm high, large stainless steel pan. Portable with (6) D size batteries (not included). Indicators for Stable. Net, Zero and Low battery. Keys for ON/OFF, ZERO, TARE. Auto power off function. SK-Z is LB w/decimal oz, fractional oz, decimal lb. Optional AC adapter (not included). 244mm x 232mm x 137mm.

USDA Approved

NTEP 98-086 Class III, CSA

Part Number	Capacity	Pan	Weight	Stock	Price C5
SK-5001*	5,000 x 1g	230 x 190mm	8 lb	4082	305.00

\*not NTEP

**NSF Certified lb/oz Z version Not Legal for Trade**

SK-5000Z	11 lb x 0.1 oz	230 x 190mm	8 lb	3609	305.00
----------	----------------	-------------	------	------	--------

**Dual Display**

SK-5000D	11 lb x 0.005 lb	230 x 190mm	9 lb	5541	330.00
----------	------------------	-------------	------	------	--------

**Options**

TB:662 AC adapter 120 VAC	1 lb	1305M			<b>A5</b> 43.00
---------------------------	------	-------	--	--	--------------------

FV-06 AC adapter 220 VAC	1 lb	1306M			<b>B</b> 53.00
--------------------------	------	-------	--	--	-------------------

**Service Parts**

PZ:3006 main board for SK (specify capacity)	1 lb	3251			<b>A5</b> 100.00
07:4003338 plastic foot	1 lb	3269			13.41
08:4003781 keysheet	1 lb	3270			13.41



**SK-5001\*  
Bench Scale**



A&D WEIGHING DIVISION

**EK-G Bench Scale**

Service Parts only for A&D EK-G.

Part Number	Weight	Stock	Price A
<b>Service parts</b>			
TB:102 AC adapter 120 VAC for EW/EK	1 lb	986	\$ 32.00
TB:119 AC adapter 220 VAC for EW/EK	1 lb	674	52.00
08:3000113 Keysheet for EK-G	1 lb	3138	28.00
SK:SKHAK Pushbutton switch individual	1 lb	3139	6.00
07:3001151 Protective covers for EW/EK	1 lb	3140	15.00



**EK-120G  
Service Parts only**

Prices are subject to change without notice. Please call for current prices.

Other items are available from the manufacturers, please call for prices.

99 Reagent Lane  
Fair Lawn NJ 07410  
201-797-2718 \* 800-631-0347

**Totalcomp**  
Scales & Balances

www.totalcomp.com  
Fax 201-797-2287  
Toll Free Fax 888-797-2288

# Bench



WBW  
Bench



## WBW Bench

WBW washdown scales feature IP66-rated waterproof housing and a large **stainless steel** weighing pan that can be easily cleaned down after use. For retail applications, the WBW-M is NTEP and Measurement Canada approved. Adjustable leveling feet help optimize setup, overload protection, audible overload alarm, vivid backlit LCD easily visible in any lighting conditions. Rechargeable battery included for operation almost everywhere and programmable auto power-off to save energy. 9.1"W x 10.4"D x 6"H.

Part Number	Capacity	Weight	Stock	Price C
<b>Non-NTEP</b>				
WBW 5a	5 x 0.0005 lb	10 lb	918	\$ 305.00
WBW 9a	9 x 0.001 lb	10 lb	919	305.00
WBW 18a	18 x 0.002 lb	10 lb	920	305.00
WBW 35a	35 x 0.005 lb	10 lb	921	305.00
<b>NTEP</b>				
WBW 6aM	6 x 0.002 lb	10 lb	922	325.00
WBW 15aM	15 x 0.005 lb	10 lb	923	325.00
WBW 30aM	30 x 0.01 lb	10 lb	924	325.00

**NEW**



SW-1RS  
POS Interface



## SW-RS POS Interface Bench Scale

Compact, use where space is limited. Stainless steel platter. Large easy to read 1", 5 digit LCD display. Customer rear display. Soft touch tactile keyboard. Keys for ZERO, TARE, UNIT, POWER. Indicators for Stable, Zero, Net, Batt. Lg, g, kg, switchable. RS-232 interface. DC 9V. AC adapter included. Auto power off. 1 year warranty. 10.23"W x 11.29"D x 5.39"H  
NTEP 99-002 III 2,500 div

Part Number	Capacity	Pan	Weight	Stock	Price C
SW-RS-10lb	10 x 0.005 lb	9.1" x 7.5"	10 lb	2696	\$ 449.00
SW-RS-20lb	20 x 0.01 lb	9.1" x 7.5"	10 lb	2697	449.00

Options	Weight	Stock	Price C
WS13 Serial cable	1 lb	2215	30.00

Prices are subject to change without notice. Please call for current prices.

Other items are available from the manufacturers, please call for prices.



## SW Bench Scale

Digital scale, battery operated. lb/kg/g/oz switchable with front panel key. Soft touch keys for ON/OFF, ZERO, TARE, UNIT. Large 1" LCD display. Indicators for ZERO, NET, STABLE, LOW BATTERY. 1,000 hour operating time with alkaline battery (not included). Includes A/C adapter 120 VAC, 50/60 Hz, 0.25 watts. **Stainless Steel** platform size 7.55" x 9.48". Overall size 10.23"W x 11.29"D x 5.39"H.

NTEP 99-002 III 2,500 div

Part Number	Capacity	Weight	Stock	Price D2
SW-5	5 lb x 0.002 lb	10 lb	1791	\$ 255.00
SW-10	10 lb x 0.005 lb	10 lb	1792	255.00
SW-20	20 lb x 0.01 lb	10 lb	1793	255.00
SW-50	50 lb x 0.02 lb	10 lb	1794	255.00

### Options

AC adapter 120 VAC for SW 1 lb 1731 28.60 **C**

CS11 In use cover for SW 1 lb 1740 19.80 **B5**

SW Large platter 3 lb 1753 85.00 **C**

### Service Parts

LS11 load cell SW-5 2kg 1 lb 124 88.00 **B5**

LS12 load cell SW-10 5kg 1 lb 125 88.00

LS13 load cell SW-20 10kg 1 lb 126 88.00

LS14 load cell SW-50 20kg 1 lb 127 88.00

Nov ZS25 battery 2 lb 7508M 47.00



**SW-20**  
Bench Scale



## SW-W Washdown Bench Scale

The SW-W is protected from water, dirt and other external agents (IP66). 5 digit, 1 inch high LCD display. Weighing units in: lb, oz, kg, g. Keys for ON/OFF, TARE, UNIT, ZERO. Indicators for Stable, Zero, Net, Battery. Dual range technology. (6) D size batteries not included. AC adapter included.

NTEP 99-002 III 2,500 div

Part Number	Capacity	Weight	Stock	Price C
SW-10W	10 x 0.005 lb	10 lb	6340	\$ 299.00
SW-20W	20 x 0.01 lb	10 lb	6341	299.00
SW-50W	50 x 0.02 lb	10 lb	6342	299.00

Nov Service Parts 2 lb 7508M 47.00 **B5**



**SW-W**  
Washdown Bench Scale



Prices are subject to change without notice. Please call for current prices.

Other items are available from the manufacturers, please call for prices.

# Bench



**SW-20Z**  
Bench scale

## SW-Z Bench Scale

The SW-Z features lb:oz displayed as fractions or decimals. 5 digit, 1 inch high LCD display. Keys for ON/OFF, TARE, UNIT, ZERO. Indicators for Stable, Zero, Net, Battery. Dual range technology. (6) D size batteries not included. AC adapter included. 10.2"W x 11.3"D x 5.4"H.

Part Number	Capacity	Pan	Weight	Stock	Price D
SW-5Z	5 x 0.002 lb	9" x 7.5"	10 lb	6349	\$ 255.00
SW-10Z	10 x 0.005 lb	9" x 7.5"	10 lb	6351	255.00
SW-20Z	20 x 0.01 lb	9" x 7.5"	10 lb	6352	255.00
SW-50Z	50 x 0.02 lb	9" x 7.5"	10 lb	6353	255.00

### Service Parts

ZS25 battery	2 lb	7508M	47.00	<b>B5</b>
--------------	------	-------	-------	-----------

Nov  
↓



## CBC Bench Scale

Easy to operate, the CBC bench counting scale is the best choice for businesses that require a robust portable counting scale. CBC scales offer the features and functions needed to perform a diverse variety of weighing and counting tasks. The scale is well-suited for packaging and inventory taking in factories or just about anywhere small parts are made. The large stainless steel pan removes for rapid cleaning. Checking individual pieces is speedy, as the LCD shows total weight, unit weight and count..



**CBC**

Part Number	Capacity	Pan	Weight	Stock	Price C
CBC-8a	8 x 0.0002 lb	8.9" x 10.8"	9 lb	2476	\$ 425.00
CBC-16a	16 x 0.0005 lb	8.9" x 10.8"	9 lb	2477	425.00
CBC-35a	35 x 0.001 lb	8.9" x 10.8"	9 lb	2478	425.00
CBC-70a	70 x 0.002 lb	8.9" x 10.8"	9 lb	2479	425.00
CBC-100a	100 x 0.005 lb	8.9" x 10.8"	9 lb	2480	425.00
CBC-8a w/usb	8 x 0.0002 lb	8.9" x 10.8"	9 lb	2481	500.00
CBC-16a w/usb	16 x 0.0005 lb	8.9" x 10.8"	9 lb	2482	500.00
CBC-35a w/usb	35 x 0.001 lb	8.9" x 10.8"	9 lb	2483	500.00
CBC-70a w/usb	70 x 0.002 lb	8.9" x 10.8"	9 lb	2484	500.00
CBC-100a w/usb	100 x 0.005 lb	8.9" x 10.8"	9 lb	2485	500.00

Prices are subject to change without notice. Please call for current prices.

Other items are available from the manufacturers, please call for prices.



**SPX STX Scout Portable Bench Scale**

Setting new standards in laboratory and industrial weighing. Bright Backlit LCD. Keys for: ZERO/PRINT/UNITS/FUNCTION/MODE/TARE/MENU. Weighing Units for: g, kg, ct, N, oz, ozt, dwt, lb, ln:oz, grn. Application modes: Weighing, Parts Counting, Percent Weighing, Check Weighing, Totalization, Display Hold. Draft shield. Weigh below hook. Lockswitch. Security slot. Connectivity. RS232, USB host, USB device, Ethernet. AC adapter (included) or (4) AA batteries (not included). 11.8" x 9.8" x 4.1" (SPX123/SPX223) 11.8" x 9.8" x 3.4" (SPX222, 422, 622, 1202, 2202, 421, 621, 2201, 6201, 8200). 2 year warranty.

Part Number	Capacity	Pan	Weight	Stock	Price C5
<b>Push Button</b>					
SPX123	120 x 0.001g	3.7"	4 lb	8173	\$ 608.00
SPX223	220 x 0.001g	3.7"	4 lb	8174	681.00
SPX222	220 x 0.01g	4.7"	4 lb	8175	446.00
SPX422	420 x 0.01g	4.7"	4 lb	8176	625.00
SPX622	620 x 0.01g	4.7"	4 lb	8177	731.00
SPX1202	1,200 x 0.01g	6.7" x 5.5"	4 lb	8178	835.00
SPX2202	2,200 x 0.01g	6.7" x 5.5"	4 lb	8179	939.00
SPX421	420 x 0.1g	4.7"	4 lb	8180	246.00
SPX621	620 x 0.1g	6.7" x 5.5"	4 lb	8181	364.00
SPX2201	2,200 x 0.1g	6.7" x 5.5"	4 lb	8182	459.00
SPX6201	6,200 x 0.1g	6.7" x 5.5"	4 lb	8183	758.00
SPX8200	8,200 x 1g	6.7" x 5.5"	4 lb	8184	381.00
<b>Touch Screen</b>					
STX123	120 x 0.001g	3.7"	4 lb	8185	681.00
STX223	220 x 0.001g	3.7"	4 lb	8186	762.00
STX222	220 x 0.01g	4.7"	4 lb	8187	499.00
STX422	420 x 0.01g	4.7"	4 lb	8188	699.00
STX622	620 x 0.01g	4.7"	4 lb	8189	819.00
STX1202	1,200 x 0.01g	6.7" x 5.5"	4 lb	8190	935.00
STX2202	2,200 x 0.01g	6.7" x 5.5"	4 lb	8191	1,051.00
STX421	420 x 0.1g	4.7"	4 lb	8192	282.00
STX621	620 x 0.1g	6.7" x 5.5"	4 lb	8193	418.00
STX2201	2,200 x 0.1g	6.7" x 5.5"	4 lb	8194	528.00
STX6201	6,200 x 0.1g	6.7" x 5.5"	4 lb	8195	848.00
STX8200	8,200 x 1g	6.7" x 5.5"	4 lb	8196	438.00
<b>Options</b>					<b>A</b>
30269021 carry case			1 lb	1988	103.00
<b>Service Parts</b>					<b>A</b>
30330714 AC adapter w/plug SPX/STX			1 lb	2740	20.00
30293385 AC USB connector SPX/STX			1 lb	4950	11.00
30268984 USB device interface			1 lb	5325	92.00
30268982 RS232			1 lb	1675	133.00
30301950 foot adjustable			1 lb	1034	21.10
71160302 top housing SP202			1 lb	6058	25.00
71160346 function label SP202			1 lb	6059	19.00

**NEW**



**SPX  
Push Button  
Portable Bench Scale**



**STX  
Touch Screen  
Portable Bench Scale**

Prices are subject to change without notice. Please call for current prices.

Other items are available from the manufacturers, please call for prices.

# NEW



**Ranger 3000  
Compact Bench Scale**



# OHAUS®

## Ranger 3000 Compact Bench Scale

Ranger 3000 has an ABS housing and a stainless steel platform. Compact basic bench scale with large bright backlit LCD display. Checkweighing LED with 3 colors for over/under/ok. Applications for: weighing, Percent Weighing, Parts Counting, Checkweighing, Checkcounting, Checkpercent, Accumulation, Dynamic Weighing/Display Hold, Weigh below (hook included). Weighing units: lb/kg/g/oz/lb:oz. Communication port included RS232, USB or Ethernet available as an option. Powered by AC adapter and battery (included) 210 hours of battery life with continuous use.

NTEP 13-022A1

Canada AM-5907C

Part Number	Capacity	Pan	Weight	Stock	Price C5
R31P1502	3 x 0.0001 lb	8.9" x 11.8"	12 lb	8016	\$ 561.00
R31P3	6 x 0.0002 lb	8.9" x 11.8"	12 lb	8017	561.00
R31P6	15 x 0.0005 lb	8.9" x 11.8"	12 lb	8018	561.00
R31P15	30 x 0.001 lb	8.9" x 11.8"	12 lb	8019	561.00
R31P30	60 x 0.002 lb	8.9" x 11.8"	12 lb	8020	561.00

### Options

Part Number	Description	Weight	Stock	Price C5
30037447	Ethernet kit	1 lb	7968M	122.00
30037448	RS232 kit	1 lb	7969M	122.00
30037449	USB kit	1 lb	3819M	122.00
30064203	SF40A Dot Matrix impact printer	2 lb	1754MB	798.00
80500525	Cable to IBM 9 pin serial	1 lb	3047M	155.00
80850084	Carrying case for Trooper	5 lb	4856M	304.00
80850080	WinWedge software	1 lb	2436M	437.00
71168359	battery pack	3 lb	6506	55.60
7220232	line cord	1 lb	6507	23.40





**Ranger 4000 Bench Scale**

Portable with die-cast metal housing with slip-resistant rubber feet and a rechargable lead acid battery that can provide power for up to 100 hours. A bright LED display makes the scale usable even in dim conditions. SmartText software makes scale setup and use very simple. Standard RS232 with optional Ethernet, second RS232 and USB offers additional data transfer capabilities and allows connection to multiple peripherals. Stabilization time of just one second. 12.4"Wx12.9"Lx4.8"H.

NTEP 13-022 III 3,000 div

Part Number	Capacity	Pan	Weight	Stock	Price C5
R41ME3	6 x 0.0002 lb	8.9 x 11.8"	17 lb	1742	\$ 814.00
R41ME6	15 x 0.0005 lb	8.9 x 11.8"	17 lb	1743	814.00
R41ME15	30 x 0.001 lb	8.9 x 11.8"	17 lb	1744	814.00
R41ME30	60 x 0.002 lb	8.9 x 11.8"	17 lb	1745	814.00

**Options**

				A
30037447 Ethernet kit		1 lb	7968M	122.00
30037448 RS232 kit		1 lb	7969M	122.00
30037449 USB kit		1 lb	3819M	122.00
30064203 SF40A printer		2 lb	1754M	798.00
80500525 Cable to IBM 9 pin serial		1 lb	3047M	155.00
80850080 TAL Software WinWedge v1.2		1 lb	2436M	437.00

**NEW**



**Ranger 4000 Bench Scale**



Prices are subject to change without notice. Please call for current prices.

Other items are available from the manufacturers, please call for prices.

99 Reagent Lane  
Fair Lawn NJ 07410  
201-797-2718 \* 800-631-0347



www.totalcomp.com  
Fax 201-797-2287  
Toll Free Fax 888-797-2288

**NEW**



**7000  
Compact Bench Scale**



**OHAUS®**

**Ranger 7000 Compact Bench Scale**

Ranger 7000 has a die-cast sealed metal indicator and housing, ensuring it's accurate and long term operation in even the most demanding industrial environments. Stainless steel platform. 4.3" TFT graphic LCD. 8 function, 5 quick, 12 alphanumeric membrane keys. SmarText 2.0 software. Advanced application modes for a variety of complex applications which minimize the need for manual calculations. Applications for: Weighing, Density Determination, Filling, Differential Weighing, Parts Counting, Dynamic Weighing, Formulation, Check Weighing/Counting, Percent Weighing. Weighing units are: kg, g, lb, oz, lb:oz. Weigh hook below. Easily export data through RS232 or USB device port. Additional connectivity options include a second RS232 or Ethernet, and USB host port for bar code scanner or flash drive. Remote base kit, 2 in/4 out digital I/O kit. 100-240 VAC 50/60 Hz Universal Power Supply. NTEP 14-033 II and III Canada AM 5940

Part Number	Capacity	Pan	Weight	Stock	Price C5
R71MD3	6 x 0.0001 lb	11" x 11" x 4.5"	28 lb	7960	\$ 1,561.00
R71MD6	15 x 0.0002 lb	11" x 11" x 4.5"	28 lb	7961	1,561.00
R7MD15	30 x 0.0005 lb	14.8" x 12.2" x 1.9"	29 lb	7962	1,561.00
R7MD35	70 x 0.001 lb	14.8" x 12.2" x 1.9"	29 lb	7963	1,561.00
R71MD60	150 x 0.002 lb	14.8" x 12.2" x 1.9"	29 lb	7343	1,561.00
R71MHD3	6 x 0.00002 lb	11" x 11" x 4.5"	28 lb	7964	2,440.00
R71MHD6	15 x 0.00005 lb	11" x 11" x 4.5"	28 lb	7965	2,706.00
R71MHD15	30 x 0.0002 lb	14.8" x 12.2" x 1.9"	29 lb	7966	3,602.00
R71MHD35	70 x 0.002 lb	14.8" x 12.2" x 1.9"	29 lb	7967	4,345.00

**Options**

Options	Weight	Stock	Price	A
30037447 Ethernet kit	1 lb	7968M	122.00	
30037448 RS232 kit	1 lb	7969M	122.00	
30095408 Column kit painted	5 lb	7970	122.00	
30097590 PCBA kit 2nd platform	1 lb	7971	123.00	
30097591 Discrete I/O Kit 2in/4 out	1 lb	7972	122.00	
30101495 Cable extension, 9 meter	2 lb	7973	86.00	

**Service Parts**

Service Parts	Weight	Stock	Price	A
30041267 AC linecord Ranger 7000	1 lb	4963	31.00	



## Valor 1000 Bench Scale

Economical, multipurpose weighing in a compact scale. ABS plastic housing with leveling adjustment. Easy to clean and transport. Designed for durability and accuracy. Removable stainless steel weighing platform. 6 digit, 7 segment large blue backlit LCD. Keys for: ZERO, TARE, SELECT/UNIT/M+. Weighing modes include, lb, kg, oz, g. Indicators for zero, stability, net, sum, over/under/accept, check, weighing unit, battery charge status. Easy to use checkweighing mode with user selectable settings. QuadraStance with four adjustable feet for stable weighing. User selectable auto shut off backlight. Includes internal rechargeable battery with AC power adapter. 2 year warranty. 10"W x 12"D x 4.3"H.



**Valor 1000  
Bench Scale**

Part Number	Capacity	Pan	Weight	Stock	Price D
<b>Single display</b>					
V11P3	6.6 x 0.001 lb	9.9" x 7.1"	9 lb	2083	\$ 235.00
V11P6	13 x 0.002 lb	9.9" x 7.1"	9 lb	2084	235.00
V11P15	33 x 0.01 lb	9.9" x 7.1"	9 lb	2085	235.00
V11P30	66 x 0.02 lb	9.9" x 7.1"	9 lb	2086	235.00
<b>Dual display</b>					
V11P3T	6.6 x 0.001 lb	9.9" x 7.1"	9 lb	2229	245.00
V11P6T	13 x 0.002 lb	9.9" x 7.1"	9 lb	2230	245.00
V11P15T	33 x 0.002 lb	9.9" x 7.1"	9 lb	2231	245.00
V11P30T	66 x 0.01 lb	9.9" x 7.1"	9 lb	2232	245.00
<b>Options</b>					
80850359 Polypropylene maxi scoop			2 lb	2027M	33.00
80250400 Stainless Steel scoop			2 lb	2025M	59.00
80250954 Stainless Steel scoop			2 lb	5274M	74.00
TSCP-431 Scoop white plastic			2 lb	2379M	49.00
<b>Service Parts</b>					
46001812 AC adapter Valor 1000			1 lb	4974	43.00
80252845 function label keypad			1 lb	4883	22.00
30035606 Feet Kit			1 lb	4838	22.50

Nov  
↓

Prices are subject to change without notice. Please call for current prices.

Other items are available from the manufacturers, please call for prices.

99 Reagent Lane  
Fair Lawn NJ 07410  
201-797-2718 \* 800-631-0347

 **Totalcomp**  
Scales & Balances

www.totalcomp.com  
Fax 201-797-2287  
Toll Free Fax 888-797-2288

# NEW



Valor 2000  
Bench Scale

# OHAUS®

## Valor 2000 Bench Scale

Valor 2000 has a ABS housing with a stainless steel platform. Also available with a stainless steel top housing. Compact water resistant bench scale with a red LED 0.8" high dual display and a polycarbonate knife proof keypad. Applications: Weighing and checkweighing. Weighing units g, kg, lb, lb:oz. Powered by AC adapter and internal battery with 50 hours of battery life for continuous use. 10.1"W x 11.3"D x 4.9"H.

Part Number	Capacity	Pan	Weight	Stock	Price D
<b>Stainless Steel w/checkweighing</b>					
V22XWE1501T	3 x 0.0005 lb	7.5" x 9.5"	11 lb	8311	\$ 470.00
V22XWE3T	6 x 0.001 lb	7.5" x 9.5"	11 lb	8312	470.00
V22XWE6T	15 x 0.002 lb	7.5" x 9.5"	11 lb	8313	470.00
<b>ABS housing w/stainless steel pan</b>					
V22PWE1501T	3 x 0.0005 lb	7.5" x 9.5"	9 lb	8316	393.00
V22PWE3T	6 x 0.001 lb	7.5" x 9.5"	9 lb	8317	393.00
V22PWE6T	15 x 0.002 lb	7.5" x 9.5"	9 lb	8318	393.00
V22PWE15T	30 x 0.005 lb	7.5" x 9.5"	9 lb	8319	393.00
V22PWE30T	60 x 0.01 lb	7.5" x 9.5"	9 lb	8320	393.00



Valor 3000  
Bench Scale



# OHAUS®

## Valor 3000 Xtreme Bench Scale

T304 stainless steel housing. Chemical resistant, durable and easy to clean, technically advanced overload protection rated at 10x capacity. Quadrastance design, adjustable rubber feet ensures firm contact with bench top. SmartText user interface, bright backlit LCD. Weighing modes are: lb, dec/oz, lb:oz, fractional oz, g, kg, fl/oz. User selectable and lockable. AC adapter included or (4) C batteries (not included), NSF listed warranty 120 VAC, USDA approved, supports HACCP systems. NEMA 4X/IP65 water resistant models. 2 year warranty. 8.5"W x 7.3"D x 3".H NTEP 08-008 III 3,000 div

Part Number	Capacity	Pan	NTEP	Weight	Stock	Price D
V31XH202 compact	200 x 0.01g	4.7" dia	----	5 lb	4761	\$ 647.00
V31XH402 compact	400 x 0.01g	5.8" x 6.2"	----	5 lb	5465	837.00
V31X501compact	500 x 0.1g	4.7" dia	----	5 lb	5464	474.00
V31XH2 compact	2,000 x 0.1g	5.8" x 6.2"	----	5 lb	4762	647.00
V31X3 compact	3,000 x 1g	5.8" x 6.2"	----	5 lb	4763	430.00
V31XH4 compact	4,000 x 0.1g	5.8" x 6.2"	----	5 lb	5466	889.00
V31X3N compact *	3,000 x 0.5g	5.8" x 6.2"	3,000x1g	5 lb	4897	502.00
V31X6 compact	6,000 x 1g	5.8" x 6.2"	----	5 lb	4764	430.00
V31X6N compact *	6,000 x 1g	5.8" x 6.2"	6,000x2g	5 lb	4898	492.00
<b>Washdown</b>						
V31XW301 washdown	300 x 0.1g	5.8" x 6.2"	----	5 lb	4765	509.00
V31XW3 * washdown	3,000 x 0.5g	5.8" x 6.2"	3,000x1g	5 lb	4766	509.00
V31XW6 * washdown	6,000 x 1g	5.8" x 6.2"	6,000x2g	5 lb	4767	509.00

\* NTEP

### Options

80850359 Polypropylene maxi scoop	2 lb	2027M	33.00	<b>A</b>
80250400 Stainless steel scoop	2 lb	2025M	59.00	
80250954 Stainless steel scoop	8 lb	5274M	74.00	

### Service Parts

46001803 AC adapter Valor 3000	1 lb	4992	41.00	<b>A</b>
72203363 load cell 10kg V31	1 lb	4891	140.00	

Prices are subject to change without notice. Please call for current prices.

Other items are available from the manufacturers, please call for prices.



**Valor 4000 Bench Scale**

Easy to clean, easy to transport. 6 digit, 7 segment 0.8" large dual red LED display. Keys for ON/OFF/ZERO, M+/UNITS, FUNCTION/MODE, TARE/MENU. Applications for Weighing, Percent Weighing, Checkweighing, Accumulation. Touchless sensor for Tare function. Fixed weighing pan. Overload and underload indicators. Less than 0.5s stabilization time. Low battery indicator. Level bubble. Power jack auto enclosed design. Rechargeable battery. AC adapter. IPX8. 2 year warranty. 16.1"W x 14.6"D x 8.7"H. NTEP 13-056 III 3,000 div Canada AM-5906C



**Valor 4000 Bench Scale**

Part Number	Capacity	Pan	Weight	Stock	Price D
<b>V41PW:</b> ABS housing with 304 Stainless Steel platform.					
V41PWE1501T	1.5 kg x 0.5 g	7.5" x 9.5"	4 lb	7974	\$ 438.00
V41PWE3T	3 kg x 1 g	7.5" x 9.5"	4 lb	7975	438.00
V41PWE6T	6 kg x 2 g	7.5" x 9.5"	4 lb	7976	438.00
V41PWE15T	15 kg x 0.5 g	7.5" x 9.5"	4 lb	7977	438.00
<b>V41XW:</b> Stainless Steel housing and platform.					
V41XWE1501T	1.5 kg x 0.5 g	7.5" x 9.5"	10 lb	7978	514.00
V41XWE3T	3 kg x 1 g	7.5" x 9.5"	10 lb	7979	514.00
V41XWE6T	6 kg x 2 g	7.5" x 9.5"	10 lb	7980	514.00
V41XWE15T	15 kg x 0.5 g	7.5" x 9.5"	10 lb	7981	514.00



**Service Parts**

					<b>A</b>
46001802 AC adapter 120 VAC w/o prong set		1 lb	716M		46.00
46001780 Prong set, International		1 lb	714M		15.00
46001776 Prong set, US only		1 lb	6226M		14.00
30272114 SP Mech 4 way module		1 lb	7590		23.30
30028582 function label		1 lb	7153		15.00

Sep



**Valor 7000 Bench Scale**

**Stainless steel**, removable weighing platform. ABS housing. Touchless sensors located in the front and rear allow you to do all of your weighing without ever touching the scale. Dual backlit displays; 1.5" front and 1" rear display are both equipped with an LCD backlight for added clarity. Keys for ON/ZERO/OFF, PRINT/UNITS, FUNCTION/MODE, M+/MENU, TARE. Weighing units for lb, oz, lb:oz, g. Application modes for Weighing, Check Weighing, Check Percent, Percent Weighing, Accumulation. Rapid stabilization. Non-slip grip. Carry handle. Rechargeable lead acid battery that can provide power for more than 210 hours between charges. IP43. 2 year warranty. 15.6"W x 17.6"D x 7.7"H. NTEP CC 13-022 III 3,000 div Canada AM-5907C



**Valor 7000 Bench Scale**

Part Number	Capacity	Pan	Weight	Stock	Price D
V71P1502T	3 x 0.0001 lb	11.8" x 8.9"	12 lb	3814	\$ 593.00
V71P3T	6 x 0.0002 lb	11.8" x 8.9"	12 lb	3815	593.00
V71P6T	15 x 0.0005 lb	11.8" x 8.9"	12 lb	3816	593.00
V71P15T	30 x 0.001 lb	11.8" x 8.9"	12 lb	3817	593.00
V71P30T	60 x 0.001 lb	11.8" x 8.9"	12 lb	3818	593.00



**Options**

					<b>A</b>
30037447 Ethernet kit		1 lb	7968M		122.00
30037448 RS232 kit		1 lb	7969M		122.00
30037449 USB kit		1 lb	3819M		122.00
30037445 In use cover		1 lb	3820		30.00
30064203 SF40A Dot Matrix impact printer		2 lb	1754MB		798.00

**Service Parts**

30037417 Platter		1 lb	7598		34.00
------------------	--	------	------	--	-------

Prices are subject to change without notice. Please call for current prices.

Other items are available from the manufacturers, please call for prices.



**Trooper  
Bench Scale**

**TR Trooper Bench Scale**

Economical compact industrial bench scale. A concave stainless steel weighing pan and ABS housing provide protection for light industrial conditions. Weighing modes are lb, oz, g and kg. Backlit LCD display. RS232 bidirectional interface. Gross/Tare/Net function. Auto off timer. Low battery warning. AC power or up to 100 hours battery operation. 120 VAC, 50/60 Hz, 1.5 watts. 2 Year warranty. Platform 9" x 13.5". 13.5"W x 14.5"D x 4.5"H NTEP 02-009 III 3,000 div, Recalibration is required for NTEP use.

Part Number	Factory	NTEP	Weight	Stock	Price C5
TR3RS	6 lb x 0.001 lb	6 lb x 0.002 lb	10 lb	4852	\$ 607.00
TR6RS	15 lb x 0.002 lb	15 lb x 0.005 lb	10 lb	4853	607.00

**Options**

Part Number	Description	Weight	Stock	Price C5
80850084	Carrying case for Trooper	5 lb	4856M	304.00
80500431	RS232 printer cable 25 pin for Trooper	2 lb	4857M	147.00
80500433	RS232 cable to IBM PC 9 pin for Trooper	1 lb	4859M	147.00
80850000	Anti theft security device	1 lb	1295M	72.00

**Service Parts**

Part Number	Description	Weight	Stock	Price C5
46001802	AC adapter 120 VAC w/o prong set	1 lb	716M	46.00
46001780	Prong set, International	1 lb	714M	15.00
46001776	Prong set, US only	1 lb	6226M	14.00



**VIC Portable Bench Scale**

High quality portable bench scales offer professional features, exceptional performance and value. Multiple weighing modes include g, oz, lb, lbs:oz, ozt, ct, dwt, tael HK, tael Taiwan, tael Singapore, tael China, Newton, grn, user defined. At start up the unit will default to the last mode used. Memory feature allows for consecutive weighing of multiple samples with totaled results displayed. Simple to use parts counting program. Large LCD with low battery, overload/underload and stability/mode indicators. Built-in lockdown bracket included, lock sold separately. Sealed keypad with audio function tone. Keys for ON/MEMORY, OFF, CAL/MODE, TARE. Auto shut-off after 4 minutes of no activity while operating on 9V battery. The following units are powered by A/C adapter only, VC-123, VIC-303, VIC-2mg, VIC-4mg. All other models are powered by a 9V alkaline battery or AC adapter (included). 6.8"W x 9.8"D x 3.15"H. 2 year warranty.

Part Number	Capacity	Weight	Stock	Price D
VIC-511	510 x 0.1g	4 lb	5195	\$ 154.00

**Options**

YADAP-USB USB Kit and cable		2 lb	5209	127.00	<b>C</b>
V-1kg calibration weight VI-1200		3 lb	2786	53.00	
V-2kg calibration weight VI-2400 VI-4800(2)		5 lb	2787	66.60	
VI-4kg VI-6kg(2) VI-10kg(3)					

**Service Parts**

6971989 adapter 120VAC to 12VDC,300ma		1 lb	2454M	121.00	<b>C</b>
6971955/6971990 adapter, England 220VAC to 12VDC,300ma		1 lb	2456M	193.00	

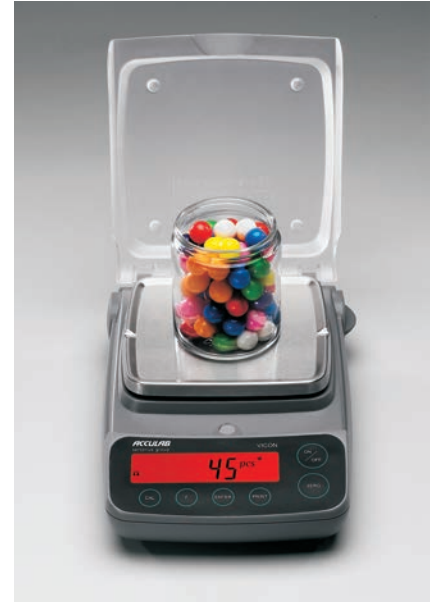

**VIC-511  
Portable Bench Scale**



**Stacking feature for  
minimum storage space**



**EC Portable Bench Scale**

High quality portable bench scales offer professional features, exceptional performance and value. Keys for ON/MODE, TARE/OFF. Liquid crystal display(LCD). Weighing modes g, oz, ozt, dwt and lb. Operates on 9VDC battery which is included. Optional adapters 120 VAC, 50/60 Hz, 1.5 watts. 6.26"W x 8.6"L x 2.07"H

Part Number	Capacity	Platform	Weight	Stock	Price D
EC-411	410 x 0.1g	5.5" x 5.3"	3 lb	5185	\$ 120.00

**Options**

6971989 adapter 120VAC to 12VDC,300ma		1 lb	2454M	68.00	<b>C</b>
6971955/16971990, England 220VAC to 12VDC,300ma		1 lb	2456M	104.00	



**EC  
Portable Bench Scale**

Prices are subject to change without notice. Please call for current prices.

Other items are available from the manufacturers, please call for prices.

99 Reagent Lane  
Fair Lawn NJ 07410  
201-797-2718 \* 800-631-0347



www.totalcomp.com  
Fax 201-797-2287  
Toll Free Fax 888-797-2288



**TLD  
Bench Scale**

### TLD Bench Scale

Weighing scale with electronic/electrostatic capacitance load cell. Push button TARE. Large liquid crystal display(LCD) can be selected to lb or kg. Auto dual range will automatically switch to a finer division below half capacity. Target mode will give an audible tone at and above a set point weight. Self contained, battery operated or AC adapter. Includes AC adapter 120 VAC, 50/60 Hz, 1.5 watts. (6) size "C" alkaline batteries are not included. Battery life is more than 1,000 hours and includes low battery warning. Industrial weighing (not legal for trade). **Stainless steel** platform size 8-3/4" x 8-3/4". Overall size 9-1/2"W x 12-3/8"D x 3-1/4"H. USDA Approved.

Part Number	Capacity	Auto Range	Weight	Stock	Price C
TLD-621-S	2,000 x 2g 64 x 0.1 oz	1,000 x 1g 32 x 0.05 oz	9 lb	2152	\$ 290.00

### Service Parts

Adapter 120VAC to 9VDC, 200ma	1 lb	2446	97.70
-------------------------------	------	------	-------



**T501-SSE-50/12 x 12  
Bench Scale**

### T501 & T900 Series Stainless Steel Platform Scale

Rugged washdown safe scale. Consists of the TPB scale base and Totalcomp indicator.

**T501SSE** indicator has bright green LED display, 120 VAC power.

**T501SSB** indicator has LCD display, battery operated (6) D cells.

**T900SS** indicator has bright green LED display, 120 VAC power, 0-9 keypad.

Annunciators for Gross, Net, Tare, Zero, Mot, lb & kg. Display units in lb, kg, oz, g, lb:oz. User can toggle between two units. Six weighing modes: Standard, Over/Under, Animal weighing, Percent weighing, Piece counting, Peak hold. Time & Date. RS232, 20ma & RS485 output. T900SS has accumulation and I.D. number entry via front keypad. Front panel keys for UNITS, ZERO, NET/GROSS, TARE, PRINT. Internal power supply, no AC adapter is required or battery operation.

Scale base has stainless steel cover with stainless steel substructure. Includes 4 built in overload stops and uses an NTEP approved potted single point load cell.

NTEP (pending), III, 5,000 div

Part Number	Capacity	Weight	Stock	Price C
<b>12" x 12" Platform x 4" High LED display AC</b>				
T501SSE-5/12x12	100 x 0.02 lb	35 lb	5470	\$ 895.00
<b>12" x 12" Platform x 4" High LED display AC 0-9 keypad</b>				
T900SS-50/12x12	50 x 0.01 lb	35 lb	5479	925.00
<b>9" x 9" Platform x 4" High LED display Battery operated</b>				
T900SSB-5/9x9	5 x 0.001 lb	19 lb	5481	845.00



**BCS40  
Portable Brief Case scale**



### BCS Brief Case Scale

9" x 9" cast platform with indicator in a briefcase. Weighing units: lb, kg, lb-oz, g. Large high contrast LCD display. Low battery indicator. Keys for ON/OFF, TARE, UNITS. (1) 9V battery (included). Case dimensions 11"L x 13"W x 2.5"H.

Part Number	Capacity	Weight	Stock	Price C
BCS-40 briefcase	40 kg x 10 g 88 lb x 0.02 lb	9 lb	6015	\$ 287.82
BCS-80 briefcase	80 kg x 20 g 176 lb x 0.05 lb	9 lb	6016	287.82

Prices are subject to change without notice. Please call for current prices.

Other items are available from the manufacturers, please call for prices.





A&D WEIGHING DIVISION

## HV Bench Scale

Waterproof and dustproof, IP-65 rating. Stainless steel construction.. Triple range on HV series. Comparator function for high and low set points with HI/OK/LO on display. GLP/GMP/ISO Compliant. CP models include built-in printer. The 10-digit alphanumeric keypad simplifies setting comparator limits.  
NTEP 90-064A2

Part Number	Capacity	Weight	Stock	Price C
<b>Multi Capacity Bench Scale</b>				
HV-15KC	6 x 0.002 lb 15 x 0.005 lb 30 x 0.001 lb	13 lb	2571	\$ 919.00
HV-60KC	30 x 0.01 lb 60 x 0.02 lb 150 x 0.05 lb	24 lb	2572	945.00
HV-200KG	150 x 0.05 lb 300 x 0.1 lb 500 x 0.2 lb	37 lb	2573	1,149.00
<b>Printer built into indicator</b>				
HV-15KCP	6 x 0.002 lb 15 x 0.005 lb 30 x 0.01 lb	13 lb	2578	1,619.00
HV-15KCP	30 x 0.01 lb 60 x 0.02 lb 150 x 0.05 lb	24 lb	2579	1,645.00
HV-200KCP	150 x 0.05 lb 300 x 0.1 lb 500 x 0.2 lb	37 lb	2580	1,849.00
<b>High Resolution Single Range</b>				
HW-10KC	20 x 0.002 lb	13 lb	2574	995.00
HW-60KC	150 x 0.01 lb	24 lb	2575	1,120.00
HW-100KC	200 x 0.02 lb	37 lb	2576	1,180.00
HW-200KC	500 x 0.05 lb	37 lb	2577	1,250.00
<b>Printer built into indicator</b>				
HW-10KCP	20 x 0.02 lb	13 lb	2581	1,695.00
HW-60KCP	150 x 0.01 lb	24 lb	2582	1,820.00
HW-100KCP	200 x 0.02 lb	37 lb	2583	1,880.00
HW-200KCP	500 x 0.05 lb	37 lb	2584	1,950.00
<b>Service parts</b>				<b>A5</b>
ED:HT4096A-TI LCD display HVG HWG AD-4406		1 lb	1303	37.70



HV-15KC



Prices are subject to change without notice. Please call for current prices.

Other items are available from the manufacturers, please call for prices.

99 Reagent Lane  
Fair Lawn NJ 07410  
201-797-2718 \* 800-631-0347

**Totalcomp**  
Scales & Balances

www.totalcomp.com  
Fax 201-797-2287  
Toll Free Fax 888-797-2288



A&D WEIGHING DIVISION



**HV-200KGV**  
Bench/Floor



## HV-G/HW-G Bench/Floor Scale

Reliable and rugged. Outstanding price performance. Indicator head tilts and rotates on the column to adjust for the best viewing angle. Standard RS232 interface. Counting and % function. M+ function for totaling weighing data. Front panel keys for ON/OFF, ZERO, TARE, F, SET, SAMPLE, MODE, PRINT. HV models have automatic triple range. LCD (Liquid Crystal Display) work on AC or (6) DD batteries. VFD (Vacuum Fluorescent Display) work on AC adapter only. Sealed to IP65.

NTEP 00-088 III 3,000 div (HV series)

Canadian W&M approval AM-5404 on HV-V and HV-L.

Part Number	Capacity	Platform	Weight	Stock	Price C
<b>VFD Vacuum Fluorescent Display</b>					
HV-15KGV	30 x 0.01 lb 15 x 0.005 lb 6 x 0.002 lb	9.8" x 9.8"	16 lb	4456	\$ 885.00
HV-60KGV	150 x 0.05 lb 60 x 0.02 lb 30 x 0.01 lb	13.0" x 16.7"	27 lb	4457	945.00
HV-60KA1NC	120 x 0.05 lb	15.4" x 20.8" x 4"H	47 lb	1970	855.00
HV-200KGV	500 x 0.2 lb 300 x 0.1 lb 150 x 0.05 lb	15.4" x 20.9"	50 lb	4458	1,055.00

### LCD Liquid Crystal Display

HV-15KGL	30 x 0.01 lb 15 x 0.005 lb 6 x 0.002 lb	9.8" x 9.8"	14 lb	4459	830.00
HV-60KGL	150 x 0.05 lb 60 x 0.02 lb 30 x 0.01 lb	13.0" x 16.7"	25 lb	4460	885.00
HV-200KGL	500 x 0.2 lb 300 x 0.1 lb 150 x 0.05 lb	15.4" x 20.9"	50 lb	4461	1,000.00

### VFD Vacuum Fluorescent Display

HW-10KGV	20 x 0.002 lb	9.8" x 9.8"	16 lb	4462	1,035.00
HW-60KGV	150 x 0.01 lb	13.0" x 16.7"	27 lb	4463	1,160.00
HW-100KGV	200 x 0.02 lb	15.4" x 20.9"	40 lb	4464	1,280.00
HW-200KGV	500 x 0.05 lb	15.4" x 20.9"	40 lb	4465	1,280.00

### LCD Liquid Crystal Display

HW-10KGL	20 x 0.002 lb	9.8" x 9.8"	14 lb	4466	980.00
HW-60KGL	150 x 0.01 lb	13.0" x 16.7"	25 lb	4467	1,090.00
HW-100KGL	200 x 0.02 lb	15.4" x 20.9"	38 lb	4468	1,225.00
HW-200KGL	500 x 0.05 lb	15.4" x 20.9"	38 lb	4469	1,230.00

### Options

HV/HWG-03 Comparator/setpoint relay outputs	1 lb	4470	160.00	<b>B5</b>
HV/HWG-04 RS422/485 interface	1 lb	4471	240.00	
HV/HWG-06 Built in printer for HV/HW-GV only	2 lb	4472	450.00	

### Options

TB:662 AC adapter 120 VAC	1 lb	1305M	43.00	<b>A5</b>
---------------------------	------	-------	-------	-----------

FV-06 AC adapter 220 VAC	1 lb	1306M	53.00	<b>B</b>
--------------------------	------	-------	-------	----------

### Service Parts

08:B31911 Keysheet for HV	1 lb	3123	16.00	<b>A5</b>
PZ:2755-LCD Main board w/display for HV-GL	1 lb	3125	219.00	
PZ:3414 main board HV-GV HW-GV	1 lb	5964M	283.00	

10:DH-26-1-AD Battery Holder for HV HW	1 lb	3128	10.00	
--	------	------	-------	--

AX:00A34062 Plastic cover for display pod HV HW	1 lb	1307	15.00	
---	------	------	-------	--

\*Continued on page 23



**HW-10KGL**  
Bench/Floor

Prices are subject to change without notice. Please call for current prices.

Other items are available from the manufacturers, please call for prices.



A&D WEIGHING DIVISION

**HV-G HW-G Bench/Floor Scale-Service Parts**

Service Parts for HV-G HW-G

Part Number	Capacity	Platform	Weight	Stock	Price A5
<b>Service Parts</b>					<b>A5</b>
10:A46050-2 swivel head bracket cap			1 lb	4754	14.12
07:1000097A upper case			1 lb	4755	15.00
LC:126-15K load cell SB15K10			2 lb	4938	149.00
07:1000098 lower case			1 lb	4757	19.78
07:2000417 battery cover			1 lb	4758	18.82
07:1000099 battery case			1 lb	4759	14.03
07:3003185 battery holder			1 lb	4760	14.03
08:4007481-4B HV-GL Display filter			1 lb	1297	15.95
08:4007463 HV-GL keysheet			1 lb	1298	21.18
08:3003337-9 HV-60KG capacity label (Non-NTEP)			1 lb	1299	14.12
08:4007465 HV-60KGL model label			1 lb	1300	14.12
PZ:3413 HV-GL/HW-GL main board w/display			1 lb	1301	287.60
Nov 07:3003186 HV-G/HW-G rear cover			1 lb	1399	13.09



A&D WEIGHING DIVISION

**HV-WP & HW-WP Washdown SS Bench/Floor Scale**

Waterproof and dustproof, NEMA 4 IP-65 rating. Stainless steel construction. Triple range on HV series. Up to 1/12,000 high resolution on HW series. Preset tare values can be digitally stored. Comparator function for high and low set points with HI/OK/LO on display. Optional comparator output sounds buzzer. High visibility VFD Vacuum fluorescent Display. Displays weight in lb, kg or piece count. Front panel keys for ZERO, TARE, SET, RANGE, MODE, PRINT, ON/OFF. Drip proof design for easy cleaning with water. 120 VAC.

Canadian approval AM-5404 (HV series)  
NTEP 00-088 III 3,000 div (HV series)

Part Number	Capacity	Platform	Weight	Stock	Price C
HV-15KWP	6 x 0.002 lb 15 x 0.005 lb 30 x 0.01 lb	9.8" x 9.8"	18 lb	4495	\$ 1,205.00
HV-60KWP	30 x 0.01 lb 60 x 0.02 lb 150 x 0.05 lb	13.0" x 16.7"	29 lb	4496	1,335.00
HV-200KWP	150 x 0.05 lb 300 x 0.1 lb 500 x 0.2 lb	15.4" x 20.9"	42 lb	4497	1,450.00
HW-10KWP	20 x 0.002 lb	9.8" x 9.8"	18 lb	4498	1,335.00
HW-60KWP	150 x 0.01 lb	13.0" x 16.7"	29 lb	4499	1,450.00
HW-100KWP	200 x 0.02 lb	15.4" x 20.9"	42 lb	4500	1,565.00
HW-200KWP	500 x 0.05 lb	15.4" x 20.9"	42 lb	4501	1,565.00

<b>Options</b>				<b>B5</b>	
HVWP-03 RS232, Comp/Setpoint output(relays & audio)	1 lb	4502	190.00		
HWWP-04 RS422/485, Comparator/Setpoint output(relays)	1 lb	4503	175.00		

<b>Service Parts</b>				<b>A5</b>	
PZ:3414 main board HV-WD HW-WP	1 lb	5964M	283.00		
707:A21456 swivel head bracket	1 lb	1992	93.00		
PZ:3415 power relay board	1 lb	1402	37.70		



**HV-15KWP  
Bench/Floor**



**HV-200KWP  
Bench/Floor**

Prices are subject to change without notice. Please call for current prices.

Other items are available from the manufacturers, please call for prices.



A&D WEIGHING DIVISION



**FG-K**  
Bench/Floor  
w/ column



**FG-K**  
Bench/Floor  
w/o column

## FG Bench/Floor scale

Self contained, battery operated (6)AA batteries (not included) and AC adapter (included). Approximately 100 hours with alkaline type cells. Full capacity push button tare. Switch selectable pound or kilogram display. All models can be wall or tower mounted. Rugged, durable and portable. 120 VAC, 50/60 Hz, 1.5 watts. Accuracy +/-1 div. 1 Year warranty. Canadian Weights & Measures AM-4995  
USDA Approved  
NTEP 93-063 III 3,000 div.

Part Number	Capacity	Pan	Weight	Stock	Price C
<b>No Column</b>					
FG-30KBMN	60 x 0.02 lb	11.8" x 15"	27 lb	3587	\$ 620.00
FG-60KBMN	150 x 0.05 lb	11.8" x 15"	27 lb	3588	620.00
FG-150KBMN	300 x 0.1 lb	11.8" x 15"	27 lb	3589	665.00
<b>With Column</b>					
FG-30KAMN	60 x 0.02 lb	11.8" x 15"	31 lb	5826	745.00
FG-60KAMN	150 x 0.05 lb	11.8" x 15"	31 lb	5827	745.00
FG-150KAMN	300 x 0.1 lb	11.8" x 15"	31 lb	5828	750.00
FG-60KALN	150 x 0.05 lb	15.4" x 20.9"	43 lb	5829	835.00
FG-150KALN	300 x 0.1 lb	15.4" x 20.9"	43 lb	5830	835.00
FG-200KALN	400 x 0.1 lb	15.4" x 20.9"	43 lb	932	945.00

### Options

Part Number	Weight	Stock	Price C	
FG-23 RS232 FG-N	1 lb	521	72.00	<b>B5</b>
FG-24 Comparator / Setpoints relay outputs	4 lb	3593	95.00	
FG-25 Display wall mount bracket for FG-N	1 lb	3590	77.00	
FG-26 Carrying handle for FG-N	1 lb	3595	93.00	
TCC-FGN Carrying case for FG-N	9 lb	2533	172.00	

### Service Parts (for new style FGN)

Part Number	Weight	Stock	Price C	
PZ: 4340 main board w/ display	1 lb	504	293.00	<b>A5</b>
07: 3007527A plastic display cover	1 lb	505	15.00	
08: 2000992A keysheet	1 lb	508	14.00	
07: 3007273 leveling foot	1 lb	509	16.00	
707: A21500 display column w/ tilt bracket	1 lb	514	57.00	
07:A21456 indicator support FG HV HW	5 lb	780	16.90	

### Service Parts (for old style w/o suffix N)

Part Number	Weight	Stock	Price C	
00:C40698 plastic display cover for FG	1 lb	796	15.00	<b>A5</b>
01:B30082A keysheet for FG S/N prefix H	1 lb	2775	19.00	
08:20009934 keysheet for FG-K S/N prefix M or EM	1 lb	4629	14.00	

07:B49929 leveling foot for FG

1 lb 6180 10.00

### Options

TB:662 AC adapter 120 VAC

1 lb 1305M 43.00

FV-06 AC adapter 240VAC

1 lb 1306M 53.00

### Options (for old style w/o suffix N)

FG-03 RS232 for FG	1 lb	3592	72.00	<b>B5</b>
TCC-FG carrying case for FG	9 lb	2779	95.00	



A&D WEIGHING DIVISION

**SE Washdown Scale**

Washdown construction for easy cleaning. Mild steel construction. Stainless steel weighing pan. IP68 dust and water proof. Waterproof and corrosion resistant load cell. Supersized LCD of 39 mm character height. Multiple weighing units for kg, lb, oz, pcs. 4500 hours of battery life. Stabilization of 1 second. Quick USB interface or RS232C+ comparator relay output available as options. 2 year warranty.

Part Number	Capacity	Pan	Weight	Stock	Price C
SE-30KAM	66 x 0.01 lb	11.8" x 15"	32 lb	5484	\$ 940.00
SE-60KAM	130 x 0.02 lb	11.8" x 15"	32 lb	5485	990.00
SE-150KAM	330 x 0.05 lb	11.8" x 15"	32 lb	5487	1,040.00
SE-60KAL	130 x 0.02 lb	15.4" x 20.9"	46 lb	5488	1,040.00
SE-150KAL	330 x 0.05 lb	15.4" x 20.9"	46 lb	5489	1,095.00

**Options**

				<b>B5</b>
SCE-02 Quick USB Interface	1 lb	3486M	160.00	
SCE-03 RS232C interface + comparator	1 lb	3488M	190.00	

Note: SCE-02 and SCE-03 cannot be used at the same time. With either options installed the scale is not IP68 compliant.



**SE**  
**Washdown Scale**  
**Mild steel**



A&D WEIGHING DIVISION

**SC Series Washdown Scale**

Washdown construction for easy cleaning. Stainless steel construction. Stainless steel weighing pan. IP68 dust and water proof. Waterproof and corrosion resistant load cell. Supersized LCD of 39 mm character height. Multiple weighing units for kg, lb, oz, pcs. 4500 hours of battery life. Stabilization of 1 second. Quick USB interface or RS232C+ comparator relay output available as options. 2 year warranty.

Part Number	Capacity	Pan	Weight	Stock	Price C
SC-30KAM	66 x 0.01 lb	11.8" x 15"	34 lb	3490	\$ 1,480.00
SC-60KAM	130 x 0.02 lb	11.8" x 15"	34 lb	3491	1,510.00
SC-150KAM	330 x 0.05 lb	11.8" x 15"	34 lb	3493	1,545.00
SC-60KAL	130 x 0.02 lb	15.4" x 20.9"	45 lb	3494	1,585.00
SC-150KAL	330 x 0.05 lb	15.4" x 20.9"	45 lb	3495	1,620.00

**Options**

				<b>B5</b>
SCE-02 Quick USB Interface	1 lb	3486M	160.00	
SCE-03 RS232C interface + comparator	1 lb	3488M	190.00	

Note: SCE-02 and SCE-03 cannot be used at the same time. With either options installed the scale is not IP68 compliant.



**SC**  
**Washdown Scale**  
**Stainless steel**

Prices are subject to change without notice. Please call for current prices.

Other items are available from the manufacturers, please call for prices.



A&D WEIGHING DIVISION



**SW**  
Washdown Scale

### SW High Pressure Washdown Scale

Stainless steel. IP69k, the highest level of dust and water proofing. Streamlined construction for easy cleaning of food processing residues. Capacitive keys for light touch operation. Bright, multicolored LED display with 5 level comparator lamps. Rugged and adjustable indicator bracket. Ultimate protection against condensation.

Part Number	Capacity	Pan	Weight	Stock	Price C
SW-6KS	13 x 0.001 lb	9.8" x 9.8"	25 lb	7579	\$ 1,775.00
SW-15KS	33 x 0.002 lb	9.8" x 9.8"	25 lb	7580	1,775.00
SW-15KM	33 x 0.002 lb	11.8" x 15"	39 lb	7581	2,085.00
SW-30KM	66 x 0.005 lb	11.8" x 15"	39 lb	7582	2,085.00
SW-60KM	130 x 0.01 lb	11.8" x 15"	39 lb	7583	2,190.00
SW-150KM	330 x 0.02 lb	11.8" x 15"	39 lb	7584	2,190.00
SW-60KL	130 x 0.01 lb	15.4" x 20.9"	49 lb	7585	2,400.00
SW-150KL	330 x 0.02 lb	15.4" x 20.9"	49 lb	7586	2,400.00

#### Options

SW-03 RS232C Plus comparator relay	1 lb	7587	175.00	<b>B</b>
SW-04 RS422/485 output for SW	1 lb	7588	130.00	
SW-11 Wall mount bracket	2 lb	7589	100.00	
HC-06i Rechargeable battery pack	4 lb	6786M	43.00	<b>B</b>



**DR400**  
Low profile  
Bench/Floor Scale

### Low Profile Bench/Floor Scale

Large 1" LCD display. Lb/kg conversion. Battery power. Auto shutoff. Push button tare. Indicator mounts on table or wall. Keys for LB/KG, TARE/HOLD, ON, OFF. Painted steel construction. Powered by (6) "AA" alkaline batteries or 120 VAC adapter (included) 50/60 Hz.

Part Number	Capacity	Pan	Weight	Stock	Price C
DR150 low profile	150 x 0.2 lb	12" x 12"	15 lb	6002	\$ 277.00
DR400 low profile	400 x 0.5 lb	12" x 12"	15 lb	6003	333.00



**TEI Bench/Floor Scale**

The TEI is a versatile bench top scale recommended for light industrial weighing, home, office, mail room, shipping and receiving applications. 6.5 digit, 1" high LCD with backlight display. With a generous 12" x 14" stainless steel platter and aluminum subframe it is rugged and durable with adjustable feet. TEI indicator has aluminum alloy housing. Keys for: Hold/Set-up, Print/Function, Acc/Total, Unit/Data, Tare/Pre-set, Zero/On/Off. Weighing units for: Standard Weighing, Check Weighing, Peak Hold, Percent. Selectable Weighing units for: lb/kg/lb.oz. TEI indicator is programmable for Over/Under, Check Weighing with Sound Alarm, Digital Filtering to meet different working environments. Includes a full duplex RS232 output. Data format 8N1, 701; 7E1, . Protocol: 8 selections. Baud rate 300-19200 bps selectable. TEI scale is powered by 4 (AA) batteries (not included). USB power plug or AC adapter included. Indicator mounts on table or wall with moveable bracket. TEI indicator has a 9' long coil cord with quick disconnect from indicator to base. Indicator can be used as a remote display, using the RS232 port. AC adapter, 6VDC/500mA included.



**TEI  
Bench/Floor Scale**

Part Number	Capacity	Pan	Weight	Stock	Price C
TEI-10	10kg x 0.001kg	12" x 14"	15 lb	5741	\$ 499.00
TEI-20	20kg x 0.002kg	12" x 14"	15 lb	5742	499.00
TEI 50	50kg x 0.005kg	12" x 14"	15 lb	5743	499.00
TEI-100	100kg x 0.01kg	12" x 14"	15 lb	5744	518.00

**Service Parts**

				C
DHC002 conn 7 pin, indicator		1 lb	7595	15.00
DHC001 conn 7 socket, load cell		1 lb	7596	15.00

Nov ↓	TEI-10 indicator w/ bracket		4 lb	6165	201.00
	TEI-20 indicator w/ bracket		4 lb	6166	201.00
	TEI-50 indicator w/ bracket		4 lb	5737	201.00
	TEI-100 indicator w/ bracket		4 lb	6167	201.00
	Keysheet TEI-10		1 lb	6168	16.00
	Keysheet TEI-20		1 lb	6169	16.00
	Keysheet TEI-50		1 lb	6170	16.00
	Keysheet TEI-100		1 lb	6171	16.00
	Adapter 120 VAC		1 lb	6172	29.00
	DHC002 connector 7 pin indicator		1 lb	7595	15.00
DHC001 connector 7 socket load cell		1 lb	7596	15.00	

Prices are subject to change without notice. Please call for current prices.

Other items are available from the manufacturers, please call for prices.

# Heading

Prices are subject to change without notice. Please call for current prices.

Other items are available from the manufacturers, please call for prices.

a30

[www.totalcomp.com](http://www.totalcomp.com)  
Fax 201-797-2287  
Toll Free Fax 888-797-2288

 **Totalcomp**<sup>®</sup>  
Scales & Balances

99 Reagent Lane  
Fair Lawn NJ 07410  
201-797-2718 \* 800-631-0347





## CPW plus 6 Bench/Floor Scale

Rugged construction. The CPWplus series offers an extensive range of models and configurations to accommodate a variety of applications. Desktop or wall mountable indicator. 1 " backlit LCD display. Color coded buttons with positive click feel, and simple, quick operation. Keys are: ON/OFF, PRINT/HOLD, UNIT, TARE/ZERO. Weighing units are: lb, kg, oz, lb/oz. Bi-directional RS232 interface allows connection to printers or computers. Using standard commands users can request gross, net and tare weights be sent automatically. Optional Adam data collection software collects scale data and can produce charts and statistics, or export raw data to Microsoft Excel or Word for further analysis. Alkaline battery or AC operation. (6) AA batteries not included.



**CPWplus 6  
Bench/Floor Scale**

Part Number	Capacity	Platform	Weight	Stock	Price B5
CPWplus 6	13 x 0.005 lb	11.8" x 11.8"	10 lb	7434	\$ 195.00
CPWplus 15	33 x 0.01 lb	11.8" x 11.8"	10 lb	7435	195.00
CPWplus 35	75 x 0.02 lb	11.8" x 11.8"	10 lb	7436	195.00
CPWplus 75	165 x 0.05 lb	11.8" x 11.8"	10 lb	7437	195.00
CPWplus 150	330 x 0.1lb	11.8" x 11.8"	10 lb	7438	205.00
CPWplus 200	440 x 0.1 lb	11.8" x 11.8"	10 lb	7439	215.00

### Options

			B5
700100099 Hard carrying case	8 lb	7440	85.00
Quick disconnect connector cable	1 lb	6517	38.00

### Service Parts

			B5
700400024 AC adapter	1 lb	7042	46.60

			C
02409160 adapter 120 vac	1 lb	252	55.50



**SD**  
Shipping Scale

## OHAUS®

### SD Shipping Scale

The SD is a well built portable bench scale designed specifically with affordability, utility and everyday usage in mind. Durable painted steel treaded platform, ABS plastic housing and mounting brackets on remote indicator. Ideal for home, office, mail room, shipping and receiving. 4 digit, 7 segment 0.8" high LCD. Weighing Units are lb, kg. Keys are: ON/OFF/ZERO, UNITS/CAL. AC Adapter 9V DC(included) or 360 hour battery operation. (3) "C" Alkaline batteries (not included). Auto shut off feature after 4 minutes of no activity (battery operation only). 1 year warranty.

Part Number	Capacity	Platform	Weight	Stock	Price C5
SD35	77 lb x 0.05 lb	12.4"L x 11"W x 1.77"H	8 lb	6499	\$ 203.00
SD75	165 lb x 0.1 lb	12.4"L x 11"W x 1.77"H	8 lb	6500	217.00
SD200	440 lb x 0.2 lb	12.4"L x 11"W x 1.77"H	8 lb	6501	257.00
SD75L	165 lb x 0.1 lb	20.5"L x 15.7"W x 3"H	36 lb	7242	356.00
SD200L	440 lb x 0.2 lb	20.5"L x 15.7"W x 3"H	36 lb	7243	388.00



**C11P9**  
Bench/Floor Scale

## OHAUS®

### Catapult 1000 Bench/Floor Scale

Reliable and precise performance in an affordable, compact design. ABS plastic housing and pan. Unparalleled Ohaus durability. Three capacities, from 20 lb to 165 lb. Reading in pounds and kilograms. Weighing and dynamic weighing modes. Overload protection for tough environments where capacity is exceeded regularly. Ultra portable design. Easy to transport and hold with it's light weight, battery operation and built in handles. Auto shut off mode. Rubber non-slip feet. Digital external calibration. AC powered (included) or (3) C batteries (not included). 1 year warranty.

Part Number	Capacity	Platform	Weight	Stock	Price C5
C11P9	20 x 0.01 lb	12.4" x 11"	7 lb	6906	\$ 227.00
C11P20	44 x 0.02 lb	12.4" x 11"	7 lb	6907	227.00
C11P75	165 x 0.1 lb	12.4" x 11"	7 lb	6908	253.00

#### Options

Part Number	Description	Platform	Weight	Stock	Price C5
80251248	Stainless steel cover	12.4" x 11"	1 lb	6909	42.00
80850359	Polypropylene maxi scoop		2 lb	2027M	33.00
80250400	Stainless steel scoop		2 lb	2025M	59.00
80250954	Scoop		8 lb	5274M	74.00



## ES Bench/Floor Scale

Self contained, battery operated. Low profile, rugged, durable and portable. Weighing units are kg, lb, oz, and lb:oz. Display is 1" high LCD. Unique 3-way mounting bracket allows the indicator to be mounted to the base, above the scale platform or on any vertical surface. Full capacity push button tare. **Stainless steel** platforms. Frame is painted steel. Power from 9VDC AC adapter (included) or (6) AA batteries (not included). Battery life is 120 hours or 30 hours continuous use. Battery saving auto off timer will turn unit off after 5 minutes of inactivity. Industrial weighing (not legal for trade). Accuracy +/-1 div. 1 Year warranty.

Part Number	Capacity	Pan	Weight	Stock	Price C5
ES6R	13.2 lb x 0.005 lb 6 kg x 0.002 kg	12.2"x10.8"x1.5"	10 lb	2904	\$ 730.00
ES30R	66 lb x 0.05 lb 30 kg x 0.01 kg	12.2"x10.8"x1.5"	10 lb	2905	730.00
ES50R	110 lb x 0.05 lb 50 kg x 0.02 kg	12.2"x10.8"x1.5"	10 lb	2906	730.00
ES50L	110 lb x 0.05 lb 50 kg x 0.02 kg	20.5"x15.7"x3"	36 lb	2907	775.00
ES100L	220 lb x 0.1 lb 100 kg x 0.05 kg	20.5"x15.7"x3"	36 lb	2908	775.00
ES200L	440 lb x 0.2 lb 200 kg x 0.1 kg	20.5"x15.7"x3"	37 lb	2909	775.00
<b>Service Parts</b>					<b>A</b>
46001724 AC adapter 120VAC to 12VDC, 500ma w/o prong set			1 lb	6164M	35.00
46001776 Prong set, US only			1 lb	6226M	14.00
46001780 Prong set, International			1 lb	714M	15.00
71148237 cable w/connector ES			1 lb	6712	26.40
71138841 display ES200L			1 lb	2587	395.00



**ES100L  
Bench/Floor**



**ES30R  
w/mounting bracket (included)**

# OHAUS®

## Defender 3000 Bench Scale

304 stainless steel pan with painted carbon steel frame. Simple, rugged, tubular frame base design. Adjustable non slip rubber leveling feet. Indicator features high impact durable ABS housing with reversible face for wall, column or table top mounting. 6 digit, 7 segment backlit LCD display. Keys are: ZERO/ON/OFF, PRINT/UNITS, FUNCTION/MODE, TARE/MENU. Weighing units are: lb, oz, lb/oz, kg, g. Auto off. Parts counting mode with selectable sample sizes, last sample size and average piece weight. Bi-directional RS 232C for manual, continuous and interval printing. 9 VDC 500mA, AC adapter. 2 year warranty.



**D31P60BR**  
Bench/Floor

**D31P150BL**  
Bench/Floor

Part Number	Capacity	Pan	Weight	Stock	Price C5
<b>13.8" column</b>					
D31P15BR	30 x 0.005 lb	12" x 14" x 4.8"	36 lb	5082	\$ 688.00
D31P30BR	60 x 0.01 lb	12" x 14" x 4.8"	36 lb	3410	688.00
D31P60BR	150 x 0.02 lb	12" x 14" x 4.8"	36 lb	3411	688.00
<b>26.8" column</b>					
D31P60BL	150 x 0.02 lb	16.5" x 21.6" x 5.4"	54 lb	3412	848.00
D31P150BL	300 x 0.05 lb	16.5" x 21.6" x 5.4"	54 lb	3413	848.00
D31P150BX	300 x 0.05 lb	19.7" x 25.6" x 5.8"	82 lb	330	903.00
D31P300BX	600 x 0.1 lb	19.7" x 25.6" x 5.8"	82 lb	331	903.00

### Options

			A
80850359 Polypropylene Maxi Scoop	2 lb	2027M	33.00
80250400 Stainless steel scoop	2 lb	2025M	59.00
80250954 Scoop	8 lb	5274M	74.00

### Service Parts

			A
46001802 AC adapter 120 VAC w/o prong set	1 lb	716M	46.00
46001780 Prong set, International	1 lb	714M	15.00
46001776 Prong set, US only	1 lb	6226M	14.00

# OHAUS®

## Defender 3000 Xtreme Bench Scale

The solution to your weighing applications that require dependability within an affordable budget. Ideal for general weighing and simple counting applications in wet or damp environments. 304 stainless steel pan and frame. Simple, rugged, tubular frame base design. 6 digit, 7 segment backlit LCD display. Keys are: ZERO/ON/OFF, PRINT/UNITS, FUNCTION/MODE, TARE/MENU. Weighing units are: lb, oz, lb/oz, kg, g. Parts counting mode with selectable sample sizes, last sample size and average piece weight data. Indicator features a **stainless steel** housing with NEMA 4X / IP65 protection. Flexible mounting capabilities. Hardware configuration lockout switch Built in bidirectional RS232C with manual/continuous/interval printing. Internal adapter with 100 hour internal rechargeable lead acid battery included. 2 year warranty.



**D31XW30VR**  
Bench/Floor

Part Number	Capacity	Pan	Weight	Stock	Price C5
<b>13.8" column</b>					
D32XW15VR	30 x 0.005 lb	12" x 14" x 4.8"	40 lb	5492	\$1,232.00
D32XW30VR	60 x 0.01 lb	12" x 14" x 4.8"	40 lb	5493	1,232.00
D32XW60VR	150 x 0.02 lb	12" x 14" x 4.8"	40 lb	5494	1,232.00
<b>26.8" column</b>					
D32XW60VL	150 x 0.02 lb	16.5" x 21.6" x 5.4"	67 lb	5495	1,541.00
D32XW150VL	300 x 0.05 lb	16.5" x 21.6" x 5.4"	67 lb	5496	1,541.00
D32XW150VX	300 x 0.05 lb	19.7" x 25.6" x 3.5"	96 lb	5497	2,054.00
D32XW300VX	600 x 0.1 lb	19.7" x 25.6" x 3.5"	96 lb	5502	2,054.00

### Options

			A
80850080 WinWedge software	1 lb	2436M	436.00
CBM-910 Impact printer 42 column	5 lb	7426MB	495.00
80850359 Polypropylene maxi scoop	2 lb	2027M	33.00
80250400 Stainless Steel scoop	2 lb	2025M	59.00
80250954 Stainless Steel scoop	2 lb	5274M	74.00
12101511 Roll paper (5) pack for SF 42 printer	1 lb	6197M	63.00

Prices are subject to change without notice. Please call for current prices.

Other items are available from the manufacturers, please call for prices.



**Defender 5000 Rectangular base**

Keys for ON/ZERO/OFF, PRINT/UNITS, FUNCTION/MODE, TARE/MENU. Three color LED's for over/under. Backlit LCD. Units for lb, oz, lb:oz, kg, g, T & Custom. Weighing modes: Static with single or dual resolution and up to 30,000 display divisions plus 10X temporary resolution increase, Dynamic Weighing, 300,000 div Counting resolution, Checkweighing, Percent, Display hold & Accumulation. Supports GMP/GLP data output with Date, Statistics, Time, User ID, Project ID, Scale ID. Optional interfaces include DC relay control kit, AC relay kit, 2nd RS232 and RS422/485. Integral 100-240 VAC, 50-60Hz power supply. 2 year warranty  
 NTEP 08-039, 10,000 III Indicator  
 NTEP 99-203A3, 3,000 III Base  
 Canada AM 5687

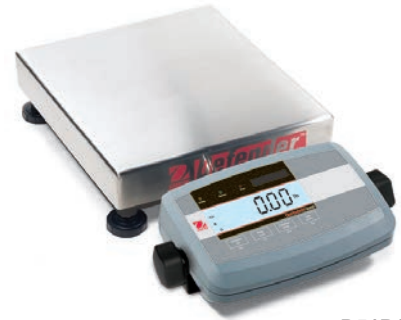

**D51P15HR5**  
Indicator  
ABS plastic Base,  
painted



**Plastic indicator with painted base (6C Cells)**

Part Number	Platform	Capacity	Weight	Stock	Price C5
D51P15HR5	12" x 14"	30 x 0.005 lb	36 lb	7383	\$ 1,142.00
D51P30HR5	12" x 14"	60 x 0.01 lb	36 lb	7384	1,142.00
D51P60HR5	16" x 20"	150 x 0.02 lb	36 lb	7385	1,142.00
D51P60HL5	16" x 20"	150 x 0.02 lb	54 lb	7386	1,322.00
D51P100HL5	16" x 20"	250 x 0.05 lb	54 lb	7387	1,322.00
D51P150HX5	16.5" x 21.7"	300 x 0.05 lb	65 lb	7388	1,392.00
D51P300HX5	16.5" x 21.7"	600 x 0.1 lb	65 lb	7389	1,549.00

**Plastic indicator with bracket & painted base (6 C Cells)**

Part Number	Platform	Column	Capacity	Weight	Stock	Price C5
D51P15HR1	12" x 14"	13.8"	30 x 0.005 lb	31 lb	7371	1,142.00
D51P30HR1	12" x 14"	13.8"	60 x 0.01 lb	31 lb	7372	1,142.00
D51P60HR1	12" x 14"	13.8"	150 x 0.02 lb	31 lb	7373	1,142.00
D51P60HL2	15.7" x 19.7"	26.8"	150 x 0.02 lb	57 lb	7374	1,322.00
D51P100HL2	15.7" x 19.7"	26.8"	250 x 0.05 lb	57 lb	7375	1,322.00
D51P150HX2	16.5" x 21.7"	26.8"	300 x 0.05 lb	68 lb	7376	1,392.00
D51P300HX2	16.5" x 21.7"	26.8"	600 x 0.1 lb	68 lb	7377	1,549.00



**D51P15HR1**  
Indicator ABS plastic Base,  
painted

**Stainless steel indicator with painted base (NEMA 4X, IP66)**

Part Number	Platform	Column	Capacity	Weight	Stock	Price C5
D51XW15HR1	12" x 14"	13.8"	30 x 0.005 lb	34 lb	7354	1,580.00
D51XW30HR1	12" x 14"	13.8"	60 x 0.01 lb	34 lb	7355	1,580.00
D51XW60HR1	12" x 14"	13.8"	150 x 0.02 lb	34 lb	7356	1,580.00
D51XW60HL2	15.7" x 19.7"	26.8"	150 x 0.02 lb	60 lb	7357	1,772.00
D51XW100HL2	15.7" x 19.7"	26.8"	250 x 0.05 lb	60 lb	7358	1,772.00
D51XW150HX2	16.5" x 21.7"	26.8"	300 x 0.05 lb	71 lb	7359	1,945.00
D51XW300HX2	16.5" x 21.7"	26.8"	600 x 0.1 lb	71 lb	7360	2,106.00

**Note:** Rectangular bases do not come in stainless steel



**D51XW15HR1**  
Indicator SS Base,  
painted

Prices are subject to change without notice. Please call for current prices.

Other items are available from the manufacturers, please call for prices.



**D51P10QR5**  
Indicator ABS plastic  
Base, painted



**D51P10QR1**  
Indicator ABS plastic  
Base, painted



**D51XW10WR3**  
Indicator SS  
Base, painted

## Defender 5000 Square base

Keys for ON/ZERO/OFF, PRINT/UNITS, FUNCTION/MODE, TARE/MENU. Three color LED's for over/under. Backlit LCD. Units for lb, oz, lb:oz, kg, g, T & Custom. Weighing modes: Static with single or dual resolution and up to 30,000 display divisions plus 10X temporary resolution increase, Dynamic Weighing, 300,000 div Counting resolution, Checkweighing, Percent, Display hold & Accumulation. Supports GMP/GLP data output with Date, Statistics, Time, User ID, Project ID, Scale ID. Optional interfaces include DC relay control kit, AC relay kit, 2nd RS232 and RS422/485. Integral 100-240 VAC, 50-60Hz power supply. 2 year warranty.  
NTEP 08-039 III Indicator, 10,000 div  
NTEP 01-048A1 III Base, 5,000 div  
Canada AM 5687

### Plastic indicator with Painted Base (6 C Cells)

Part Number	Platform	Column	Capacity	Weight	Stock	Price C5
D51P10QR5	12" x 12"	13.8"	25 x .002 lb	41 lb	7378	\$ 1,246.00
D51P25QR5	12" x 12"	13.8"	50 x .005 lb	41 lb	7379	1,246.00
D51P50QL5	18" x 18"	26.8"	100 x .01 lb	75 lb	7380	1,385.00
D51P100QL5	18" x 18"	26.8"	250 x .02 lb	75 lb	7381	1,385.00
D51P250QX5	24" x 24"	26.8"	500 x .05 lb	101 lb	7382	1,989.00

### Stainless Steel Indicator with Painted Base (NEMA4, IP66)

Part Number	Platform	Column	Capacity	Weight	Stock	Price C5
D51P10QR1	12" x 12"	13.8"	25 x .002 lb	38 lb	7366	1,246.00
D51P25QR1	12" x 12"	13.8"	50 x .005 lb	38 lb	7367	1,246.00
D51P50QL2	18" x 18"	26.8"	100 x .01 lb	72 lb	7368	1,385.00
D51P100QL2	18" x 18"	26.8"	250 x .02 lb	72 lb	7369	1,385.00
D51P250QX2	24" x 24"	26.8"	500 x .05 lb	98 lb	7370	1,989.00

### Stainless Steel Indicator with SS Base and Cell (NEMA 4, IP66)

Part Number	Platform	Column	Capacity	Weight	Stock	Price C5
D51XW10WR3	12" x 12"	13.8"	25 x .002 lb	45 lb	7349	1,530.00
D51XW25WR3	12" x 12"	13.8"	50 x .005 lb	45 lb	7350	1,556.00
D51XW50WL4	18" x 18"	13.8"	100 x .01 lb	75 lb	7351	2,412.00
D51XW100WL4	18" x 18"	13.8"	250 x 0.02 lb	75 lb	7352	2,412.00
D51XW250WL4	24" x 24"	13.8"	500 x .05 lb	101 lb	7353	2,776.00

**Note:** Please call for plastic indicator with SS base & SS Indicator with painted base.



**Defender 7000 Rectangular base**

Numeric keypad with alphanumeric text entry. Keys for ON/ZERO/OFF, PRINT/UNITS, FUNCTION/MODE, TARE/MENU, LIBRARY/EXIT. Three color LED's for over/under. Dual line backlit LCD with multi-language support. Units for lb, lb:oz, kg, g, T & Custom. Weighing modes: Static with single or dual resolution and up to 50,000 display divisions plus 10X temporary resolution increase, Dynamic Weighing, 500,000 div Counting Resolution with second scale connection, Checkweighing, Percent, Display Hold & Accumulation. Library storage for up to 255 records. Supports GMP/GLP data output with Date, Statistics, Time, User ID, Project ID, Scale ID. Optional interfaces include DC relay control kit, AC relay kit, 2nd RS232 and RS422/485. Integral 100-240 VAC, 50-60Hz power supply. 2 year warranty.  
 NTEP 09-102, 10,000 III Indicator  
 NTEP 99-203A3, 3,000 III Base



**D71P15HR5**  
Indicator ABS plastic  
Base, painted



**Plastic indicator with bracket & painted base (6C Cells)**

Part Number	Platform	Capacity	Weight	Stock	Price C5
D71P15HR5	12" x 14"	30 x 0.005 lb	36 lb	7879	\$ 1,142.00
D71P30HR5	12" x 14"	60 x 0.01 lb	36 lb	7880	1,142.00
D71P60HR5	12" x 14"	150 x 0.02 lb	36 lb	7881	1,142.00
D71P60HL5	15.7" x 19.7"	150 x 0.02 lb	51 lb	7882	1,322.00
D71P100HL5	15.7" x 19.7"	250 x 0.05 lb	51 lb	7883	1,322.00
D71P150HX5	16.5" x 21.7"	300 x 0.05 lb	65 lb	7884	1,392.00
D71P300HX5	16.5" x 21.7"	600 x 0.1 lb	65 lb	7885	1,549.00



**D71P15HR1**  
Indicator ABS plastic  
Base, painted

**Plastic indicator with column and painted base (6 C Cells)**

Part Number	Platform	Column	Capacity	Weight	Stock	Price C5
D71P15HR1	12" x 14"	13.8"	30 x 0.005 lb	37 lb	7886	1,142.00
D71P30HR1	12" x 14"	13.8"	60 x 0.01 lb	37 lb	7887	1,142.00
D71P60HR1	12" x 14"	13.8"	150 x 0.02 lb	37 lb	7888	1,142.00
D71P60HL2	15.7" x 19.7"	26.8"	150 x 0.02 lb	57 lb	7889	1,322.00
D71P100HL2	15.7" x 19.7"	26.8"	250 x 0.05 lb	57 lb	7890	1,322.00
D71P150HX2	16.5" x 21.7"	26.8"	300 x 0.05 lb	68 lb	7891	1,392.00
D71P300HX2	16.5" x 21.7"	26.8"	600 x 0.1 lb	68 lb	7892	1,549.00

**Stainless steel indicator with column and painted base (NEMA 4X, IP66)**

Part Number	Platform	Column	Capacity	Weight	Stock	Price C5
D71XW15HR1	12" x 14"	13.8"	30 x 0.005 lb	37 lb	7893	1,580.00
D71XW30HR1	12" x 14"	13.8"	60 x 0.01 lb	37 lb	7894	1,580.00
D71XW60HR1	12" x 14"	13.8"	150 x 0.02 lb	37 lb	7895	1,580.00
D71XW60HL2	15.7" x 19.7"	26.8"	150 x 0.02 lb	60 lb	7896	1,772.00
D71XW100HL2	15.7" x 19.7"	26.8"	250 x 0.05 lb	60 lb	7897	1,772.00
D71XW150HX2	21.7" x 16.5"	26.8"	300 x 0.02 lb	71 lb	7724	1,945.00
D71XW300HX2	21.7" x 16.5"	26.8"	600 x 0.05 lb	71 lb	7725	2,106.00



**D71XW15HR1**  
Indicator SS  
Base, painted

**Note:** Rectangular bases do not come in stainless steel.

Dec  
↓

**Service Parts**

30126959 indicator T72XW SS  
 30132164 USB I/O kit T72RW

Weight	Stock	Price B5
9 lb	7618	715.00
1 lb	7619	182.00

Prices are subject to change without notice. Please call for current prices.

Other items are available from the manufacturers, please call for prices.

99 Reagent Lane  
 Fair Lawn NJ 07410  
 201-797-2718 \* 800-631-0347



www.totalcomp.com  
 Fax 201-797-2287  
 Toll Free Fax 888-797-2288

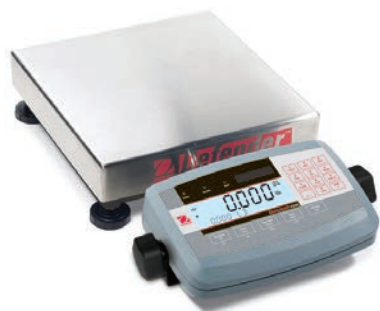

**D71P10QR5**  
Indicator ABS plastic  
Base, painted



## Defender 7000 Square base

Numeric keypad with alphanumeric text entry. Keys for ON/ZERO/OFF, PRINT/UNITS, FUNCTION/MODE, TARE/MENU, LIBRARY/EXIT. Three color LED's for over/under. Dual line backlit LCD with multi-language support. Units for lb, lb:oz, kg, g, T & Custom. Weighing modes: Static with single or dual resolution and up to 50,000 display divisions plus 10X temporary resolution increase, Dynamic Weighing, 500,000 div Counting Resolution with second scale connection, Checkweighing, Percent, Display Hold & Accumulation. Library storage for up to 255 records. Supports GMP/GLP data output with Date, Statistics, Time, User ID, Project ID, Scale ID. Optional interfaces include DC relay control kit, AC relay kit, 2nd RS232 and RS422/485. Integral 100-240 VAC, 50-60Hz power supply. 2 year warranty.  
NTEP 09-102, 10,000 III Indicator  
NTEP 01-048A, 5,000 III Base

### Plastic indicator with painted base (6C Cells)

Part Number	Platform	Capacity	Weight	Stock	Price C5
D71P10QR5	12" x 12"	25 x 0.002 lb	36 lb	7900	\$ 1,246.00
D71P25QR5	12" x 12"	50 x 0.005 lb	36 lb	7901	1,246.00
D71P50QL5	18" x 18"	100 x 0.01 lb	69 lb	7902	1,385.00
D71P100QL5	18" x 18"	250 x 0.02 lb	69 lb	7903	1,385.00
D71P250QX5	24" x 24"	500 x 0.05 lb	75 lb	7904	1,989.00

### Plastic indicator with column and painted base (6 C Cells)

Part Number	Platform	Column	Capacity	Weight	Stock	Price C5
D71P10QR1	12" x 12"	13.8"	25 x 0.002 lb	41 lb	7905	1,246.00
D71P25QR1	12" x 12"	13.8"	50 x 0.005 lb	41 lb	7906	1,246.00
D71P50QL2	18" x 18"	26.8"	100 x 0.01 lb	75 lb	7907	1,385.00
D71P100QL2	18" x 18"	26.8"	250 x 0.02 lb	75 lb	7908	1,385.00
D71P250QX2	24" x 24"	26.8"	500 x 0.05 lb	101 lb	7909	1,989.00



**D71P10QR1**  
Indicator ABS plastic  
Base, painted

### Stainless steel indicator with column and SS base and load cell (NEMA 4X, IP66)

Part Number	Platform	Column	Capacity	Weight	Stock	Price C5
D71XW10WR3	12" x 12"	13.8"	25 x 0.002 lb	45 lb	7910	1,530.00
D71XW25WR3	12" x 12"	13.8"	50 x 0.005 lb	45 lb	7911	1,556.00
D71XW50WL4	18" x 18"	26.8"	100 x 0.01 lb	75 lb	7912	2,412.00
D71XW100WL4	18" x 18"	26.8"	250 x 0.02 lb	75 lb	7913	2,412.00
D71XW250WX4	24" x 24"	26.8"	500 x 0.05 lb	101 lb	7914	2,776.00



**D71XW10WR3**  
Indicator & base SS

**Note:** Please call for plastic indicator with SS base and SS Indicator with painted base.

### Service Parts

30126959 indicator T72XW SS  
30132164 USB I/O kit T72RW

Weight	Stock	Price B5
9 lb	7618	715.00
1 lb	7619	182.00







**CQ31 Multi Functional Bench/Floor Scale**

Complete scale composed of the Ohaus CD-31 indicator, Ohaus base and 9 ft of load cell cable. Base has **stainless steel** platform with painted steel frame. Weighing units: lb, g, kg, user programmable custom unit. Application modes: % weighing, checkweighing, parts counting, dynamic weighing. Front panel switches are ENTER, PRINT, TARE, >0<, MODE, SETUP, GTN, UNITS. RS232 bidirectional interface. Digital calibration for zero and span. 2 Year warranty. 120 VAC adapter(included), 50/60 Hz. Canadian AM-5422 & AM-5339 NTEP 01-049 III/IIIL 5,000 div. Recalibration is required for NTEP use.

Part Number	Factory	NTEP	Weight	Stock	Price C5
<b>24" x 24" Platform, 6.4"H</b>					
CQ250XL31	500 x 0.05 lb	500 x 0.1 lb	83 lb	4255	\$ 1,390.00

**Service Parts**

				A	
46001802	AC adapter 120 VAC w/o prong set		1 lb	716M	46.00
46001780	Prong set, International		1 lb	714M	15.00
46001776	Prong set, US only		1 lb	6226M	14.00



**CQ50L31  
Bench/Floor**



**T5 Bench/Floor Scale**

Rugged general purpose scale. Consists of the T500E indicator and TPB scale base. T500E indicator has bright green LED display. Annunciators for Gross, Net, Tare, Zero, Mot, lb & kg. RS232 bi-directional interface. Front panel keys for UNITS, ZERO, Net/Gross, TARE, PRINT. Scale base has stainless steel cover with painted steel substructure. NTEP 96-028 Class III, 5,000 div Indicator NTEP 00-126 Class III, 5,000 div Base

Part Number	Capacity	Weight	Stock	Price C
<b>12" x 12" Platform x 4" High</b>				
T5005/1212	5 x 0.001 lb	35 lb	4740	\$ 655.00
T5010/1212	10 x 0.002 lb	35 lb	4741	655.00
T5025/1212	25 x 0.005 lb	35 lb	4742	655.00
T5050/1212	50 x 0.01 lb	35 lb	4743	655.00
T5100/1212	100 x 0.02 lb	35 lb	4744	655.00

**18" x 18" Platform x 4" High**

T5050/1818	50 x 0.01 lb	55 lb	4745	748.00
T5100/1818	100 x 0.02 lb	55 lb	4746	748.00
T5250/1818	250 x 0.05 lb	55 lb	4747	926.00
T5500/1818	500 x 0.1 lb	55 lb	4748	926.00

**24" x 24" Platform x 5.25" High**

T5050/2424	50 x 0.01 lb	80 lb	4749	1,060.00
T5100/2424	100 x 0.02 lb	80 lb	4750	1,060.00
T5250/2424	250 x 0.05 lb	85 lb	4751	1,194.00
T5500/2424	500 x 0.1 lb	85 lb	4752	1,194.00
T51000/2424	1,000 x 0.2 lb	85 lb	4753	1,239.00

**Options**

Column 24" painted steel for indicator		5 lb	2227MB	180.00	C
--	--	------	--------	--------	---



**T5100/1212  
Bench/Floor**



**T5100/1818  
w/optional column**



Prices are subject to change without notice. Please call for current prices.

Other items are available from the manufacturers, please call for prices.



TB Bench Scale  
w/ optional column

TB 1212/1214



TB Bench scale  
TRWS Indicator  
TBT Base  
Stainless Steel  
w/ optional column

TB 1616/2424



## TB All Stainless Steel

All stainless steel base and heavy gauge stainless steel pan. Stainless steel load cell. Integral overload protection is provided for both static and dynamic overloads.

Adjustable rubber feet. Bubble level.

2 mv/v, 0.02% total error, 385/350 ohms, 9 ft 6 conductor cable.

NTEP 13-091 Class III 6,000 div (Indicator)

14-050 Class III 5,000 div (Platform)

Part Number	Capacity	Weight	Stock	Price C
<b>12" x 12" Platform x 4.25" High</b>				
TB-1212-15-SS	15 x 0.002 lb	34 lb	7773	\$ 620.00
TB-1212-30-SS	30 x 0.005 lb	34 lb	7774	620.00
TB-1212-50-SS	50 x 0.005 lb	34 lb	7775	620.00
TB-1212-100-SS	100 x 0.01 lb	34 lb	7776	620.00
TB-1212-200-SS	200 x 0.02 lb	34 lb	7777	620.00
<b>12" x 14" Platform x 4.25" High</b>				
TB-1214-15-SS	15 x 0.002 lb	37 lb	7778	636.00
TB-1214-30-SS	30 x 0.005 lb	37 lb	7779	636.00
TB-1214-50-SS	50 x 0.005 lb	37 lb	7780	636.00
TB-1214-100-SS	100 x 0.01 lb	37 lb	7781	636.00
TB-1214-200-SS	200 x 0.02 lb	37 lb	7782	636.00
<b>16" x 16" Platform x 4.25" High</b>				
TB-1616-15-SS	15 x 0.002 lb	39 lb	7783	646.00
TB-1616-30-SS	30 x 0.005 lb	39 lb	7784	646.00
TB-1616-50-SS	50 x 0.005 lb	39 lb	7785	646.00
TB-1616-100-SS	100 x 0.01 lb	39 lb	7786	646.00
TB-1616-300-SS	300 x 0.02 lb	39 lb	7787	646.00
<b>24" x 24" Platform x 4.25" High</b>				
TB-2424-100-SS	100 x 0.01 lb	94 lb	7788	1,169.00
TB-2424-200-SS	200 x 0.02 lb	94 lb	7789	1,169.00
TB-2424-250-SS	250 x 0.05 lb	94 lb	7790	1,169.00
TB-2424-500-SS	500 x 0.05 lb	94 lb	7791	1,169.00
TB-2424-1000-SS	1,000 x 0.1 lb	94 lb	7792	1,169.00

### Options

Part Number	Weight	Stock	Price C
TBT-1212/1214 SS square column 8" high	4 lb	7661MB	34.30
TBT-1616/2424-SS pole and bracket 13" high	4 lb	6885MB	42.40
TBT-1616/2424 SS pole and bracket 23" high	4 lb	7662MB	48.60
TBT-1616/2424 SS pole and bracket 26" high	4 lb	7663MB	52.40

### Service Parts

Part Number	Weight	Stock	Price C
<b>Foot for 12" x 12" + 12" x 14"</b>			
TB-M10-SPB-SS foot M10, 2 1/8" dia	1 lb	7673MB	4.70
<b>Foot for 16" x 16" + 24" x 24"</b>			
TB-M12-SPB-SS foot M12, 2 3/4" dia	1 lb	7660MB	4.80
TB-M12-PB-MS foot M12, 2 3/4" dia	1 lb	7666MB	4.90

Prices are subject to change without notice. Please call for current prices.

Other items are available from the manufacturers, please call for prices.



**TBP Painted Mild Steel**

Painted mild steel base and heavy gauge stainless steel pan. Aluminum or nickel plated steel load cell. Integral overload protection is provided for both static and dynamic overloads. Adjustable rubber feet. Bubble level.

2 mv/v, 0.02% total error, 405/350 ohms, 9 ft 6 conductor cable.

NTEP 13-091 Class III 6,000 div (Indicator)

14-050 Class III 5,000 div (Platform)

Part Number	Capacity	Weight	Stock	Price C
<b>16" x 16" Platform</b> x 4.75" High w/ aluminum load cell				
TBP-1616-50-CS	50 x 0.005 lb	33 lb	7793	\$ 330.00
TBP-1616-100-CS	100 x 0.01 lb	33 lb	7794	330.00
TBP-1616-200-CS	200 x 0.02 lb	33 lb	7795	330.00
TBP-1616-400-CS	400 x 0.05 lb	33 lb	7796	330.00
<b>24" x 24" Platform</b> x 5.5" High w/ nickel plated steel load cell				
TBP-2424-100-CS	100 x 0.01 lb	85 lb	7797	532.00
TBP-2424-200-CS	200 x 0.02 lb	85 lb	7798	532.00
TBP-2424-250-CS	250 x 0.05 lb	85 lb	7799	532.00
TBP-2424-500-CS	500 x 0.05 lb	85 lb	7800	532.00
TBP-2424-1000-CS	1,000 x 0.1 lb	85 lb	7801	532.00

**Options**

				C
TBT-1616/2424-SS pole and bracket 13" high	4 lb	6885MB		42.40
TBT-1616/2424 SS pole and bracket 23" high	4 lb	7662MB		48.60
TBT-1616/2424 SS pole and bracket 26" high	4 lb	7663MB		52.40

**Service Parts**

				C
<b>Foot for 16" x 16" + 24" x 24"</b>				
TBT-M12-SPB-SS foot M12, 2 3/4" dia	1 lb	7660MB		4.80
TBT-M12-PB-MS foot M12, 2 3/4" dia	1 lb	7666MB		4.90



TB 1616/2424



TBP Bench scale  
TWP Indicator, plastic  
TBT Base, painted  
w/ optional column

Prices are subject to change without notice. Please call for current prices.

Other items are available from the manufacturers, please call for prices.



T8150-2424  
Bench/Floor



## T80 Stainless Steel Bench/Floor Scale

T80 Service parts only.  
S.WA-4406 Rev2 6,000 div, S.WA 4398 3,000 div.  
NTEP 91-110 3,000 div

Part Number	Capacity	Weight	Stock	Price C
<b>Options</b>				
Opt N Raised readout mount 5" higher includes Opt E brackets		2 lb	2092	109.00
<b>Service Parts</b>				
APS fixed 20" column mount		4 lb	2635	204.00



7050 Stainless Steel  
Bench/Floor

## 7000 Stainless Steel Bench/Floor Scale

Service parts only for Doran 7000.

Part Number	Weight	Stock	Price A
<b>Service Parts</b>			
SUB0568 Main board 7000/7000XL	2 lb	2461	\$ 415.00
SWI0007 Rubber boot for switch	1 lb	1311	8.00
SUB0004-3 foot 10-24 thread pk(6)	1 lb	1915	30.00
SUB000404 foot M6 thread pk(6)	1 lb	4994	35.00



## 7400 Stainless Steel Digital Bench Scale

Advanced features. One button, easy to operate. Quad spring base, 1000% overload protection. Checkweigh indicators. Zero band checkweighing is an included feature with OVER/ACCEPT/UNDER. LB, KG, OZ, LB & OZ weight display. IP69K/NEMA 4X washdown safe 304 stainless steel construction. 115 VAC, 60 Hz, 10 watts.

NTEP 99-129A2 Class III 5,000 div (7400M)  
 NTEP 97-097A1 Class III 5,000 div (15 x 15 )  
 NTEP 97-097A Class III 5,000 div  
 NTEP 02-086 Class III 3,000 div (18 x 18)  
 NTEP 05-062 Class III 3,000 div (18 x 24, 24 x 24)  
 Canadian approval AM-5241, AM-5347  
 Canadian approval AM-5188, AM-5241, AM-5475



**7400 Stainless Steel Digital Bench Scale**

Part Number	Capacity	Platform	Weight	Stock	Price C
<b>10" x 10" Platform</b>					
7402*	2 x 0.0005 lb	10" x 10"	21 lb	6827	\$ 1,225.00
7405*	5 x 0.001 lb	10" x 10"	21 lb	6828	1,225.00
7410*	10 x 0.002 lb	10" x 10"	21 lb	6829	1,225.00
7425	25 x 0.005 lb	10" x 10"	21 lb	6830	1,225.00
7450	50 x 0.01 lb	10" x 10"	21 lb	6831	1,225.00
<b>12" x 12" Platform</b>					
7450/12	50 x 0.01 lb	12" x 12"	26 lb	6832	1,365.00
74100/12	100 x 0.02 lb	12" x 12"	26 lb	6833	1,365.00
<b>15" x 15" Platform</b>					
7450/15	50 x 0.01 lb	15" x 15"	41 lb	6834	1,615.00
74100/15	100 x 0.02 lb	15" x 15"	41 lb	6835	1,615.00
74200/15	200 x 0.05 lb	15" x 15"	41 lb	6836	1,615.00
<b>15" x 15" Platform</b>					
APST7450P/15	50 x .01 lb		71 lb	6837	1,935.00
APST74100P/15	100 x .02 lb		71 lb	6838	1,935.00
APST74200P/15	200 x .05 lb		71 lb	6839	1,935.00
Shipped in 2 cartons 19" x 19" x 16" and 14" x 15" x 28", 41 lb and 30 lb.					
<b>18" x 18" Platform</b>					
APST74100P/18S	100 x .02 lb		87 lb	6841	2,080.00
APST74250P/18S	250 x .02 lb		87 lb	6842	2,080.00
APST74500P/18S	500 x .05 lb		87 lb	6843	2,080.00
Shipped in 2 cartons 21" x 21" x 17" and 14" x 15" x 28", 69 lb and 30 lb.					
Not NTEP					
<b>18" x 24" Platform</b>					
APST74250P/1824	250 x .05 lb		105 lb	6844	2,180.00
APST74500P/1824	500 x .1 lb		105 lb	6845	2,180.00
Shipped in 2 cartons 28" x 28" x 9" and 14" x 15" x 28", 75 lb and 30 lb.					
<b>24" x 24" Platform</b>					
APST74250P/2424	250 x .05 lb		116 lb	6847	2,480.00
APST74500P/2424	500 x .1 lb		116 lb	6848	2,480.00
APST741000P/2424	1000 x .2 lb		116 lb	6849	2,480.00
Shipped in 2 cartons 30" x 28" x 16" and 14" x 15" x 28", 86 lb and 30 lb.					
* Includes up overload stop.					
<b>Service Parts</b>					
7400M Digital Weight Indicator			10 lb	6563MB	735.00



Prices are subject to change without notice. Please call for current prices.

Other items are available from the manufacturers, please call for prices.

99 Reagent Lane  
 Fair Lawn NJ 07410  
 201-797-2718 \* 800-631-0347

**Totalcomp**  
 Scales & Balances

www.totalcomp.com  
 Fax 201-797-2287  
 Toll Free Fax 888-797-2288

# Bench/Floor

doran



7010XL  
Bench/Floor



## 7000XL Stainless Steel Bench/Floor Scale

Rugged 304 Washdown Safe **Stainless Steel** construction. Displays Weight In lb, kg, oz, g or lb & oz. Front panel keys: ZERO, PRINT, UNITS. Shockproof base with Quad Spring design that protects against shock and overload damage. 120 VAC, 60 Hz. Indicator 6" x 10" x 3"D 10 lb.

Canadian approval AM-5188, AM-5241  
NTEP 91-106 III 5,000 div (5 lb to 200 lb only)

Part Number	Capacity	Platform	Weight	Stock	Price C
<b>10" x 10" Platform</b>					
7002XL	2 lb x 0.0005 lb	10" x 10"	21 lb	6193	\$ 1,210.00
7005XL	5 lb x 0.001 lb	10" x 10"	21 lb	3626	1,210.00
7010XL	10 lb x 0.002 lb	10" x 10"	21 lb	3627	1,210.00
7025XL	25 lb x 0.005 lb	10" x 10"	21 lb	3628	1,210.00
7050XL	50 lb x 0.01 lb	10" x 10"	21 lb	3629	1,210.00
<b>12" x 12" Platform</b>					
7050XL/12	50 lb x 0.01 lb	12" x 12"	26 lb	3630	1,345.00
70100XL/12	100 lb x 0.02 lb	12" x 12"	26 lb	3631	1,345.00
<b>15" x 15" Platform</b>					
7050XL/15	50 lb x 0.01 lb	15" x 15"	42 lb	2128	1,560.00
	22.7kg x 5g				
7100XL/15	100 lb x 0.02 lb	15" x 15"	42 lb	2129	1,560.00
	45kg x 10g				
7200XL/15	200 lb x 0.05 lb	15" x 15"	42 lb	2130	1,560.00
	91kg x 20g				
<b>15" x 15" Platform</b>					
7050XL/15-C20	50 x 0.01 lb	15" x 15"	54 lb	3633	1,915.00
7100XL/15-C20	100 x 0.02 lb	15" x 15"	54 lb	3634	1,915.00
7200XL/15-C20 *	200 x 0.05 lb	15" x 15"	54 lb	3635	1,915.00
Shipped in 2 cartons 19" x 19" x 16" and 14" x 15" x 28", 41 lb and 30 lb.					
<b>18" x 18" Platform</b>					
7050XL/18S-C20	50 x 0.01 lb	18" x 18"	60 lb	6194	2,060.00
7100XL/18S-C20	100 x 0.02 lb	18" x 18"	60 lb	3636	2,060.00
7250XL/18S-C20 *	250 x 0.05 lb	18" x 18"	60 lb	3637	2,060.00
7500XL/18S-C20	500 x 0.1 lb	18" x 18"	60 lb	3638	2,060.00
Shipped in 2 cartons 21" x 21" x 17" and 14" x 15" x 28", 69 lb and 30 lb.					
<b>18" x 24" Platform</b>					
7250XL/1824-C20	250 x 0.05 lb	18" x 24"	75 lb	3641	2,160.00
7500XL/1824 -C20*	500 x 0.1 lb	18" x 24"	75 lb	3642	2,160.00
Shipped in 2 cartons 28" x 28" x 9" and 14" x 15" x 28", 75 lb and 30 lb.					
<b>24" x 24" Platform</b>					
7250XL/2424-C20	250 x 0.05 lb	24" x 24"	84 lb	3646	2,460.00
7500XL/2424-C20 *	500 x 0.1 lb	24" x 24"	84 lb	3647	2,460.00
71000XL/2424-C20*	1,000 x 0.2 lb	24" x 24"	84 lb	3648	2,460.00
Shipped in 2 cartons 30" x 28" x 16" and 14" x 15" x 28", 86 lb and 30 lb.					
* This model does not have lb & oz weight display capability.					
* Not NTEP					
<b>Service Parts</b>					<b>C</b>
7000XLM Digital Indicator			10 lb	3632MB	715.00
SWI0066 Touch Panel for 7000XLS (16) screws			1 lb	4053	186.00
SUB0427 Touch Panel for 7000XLS (4) screws			1 lb	4106	200.00
SUB0568 Main board 7000/7000XL			2 lb	2461M	415.00
ENC 0148 platter 10" x 10"			3 lb	3671MB	84.30

Prices are subject to change without notice. Please call for current prices.

Other items are available from the manufacturers, please call for prices.



## APS 2200 Bench/Floor Scale

Washdown safe 304 stainless steel construction. Displays weight in lb, oz, kg, g, lb & oz. 6 digit, red LED 0.56" high. Keys are: TARE, GROSS/NET, ZERO, PRINT, UNITS, ACCUM, ID, CLEAR, ENTER, SET POINT, DECIMAL POINT, KEYPAD 0-9. Indicators are: Net, zero, batt, mot. Bi-directional RS232 serial ports. Eight digital outputs. Internal rechargeable battery. 115VAC, 50/60 Hz. 2 year warranty

Indicator size 6"H x 10"W x 3"D

NTEP Indicator 06-101A1 Base 05-062

Part Number	Capacity	Weight	Stock	Price C
<b>10" x 10" platform</b>				
22002	2 x 0.0005 lb	21 lb	7208	\$ 1,240.00
22005	5 x 0.001 lb	21 lb	7209	1,240.00
22010	10 x 0.002 lb	21 lb	7210	1,240.00
22025	25 x 0.005 lb	21 lb	7211	1,240.00
22050	50 x 0.01 lb	21 lb	7212	1,240.00
<b>12" x 12" platform</b>				
22050/12	50 x 0.01 lb	26 lb	7213	1,400.00
22100/12	100 x 0.02 lb	26 lb	7214	1,400.00
<b>15" x 15" platform</b>				
22050/15	50 x 0.01 lb	41 lb	7215	1,700.00
22100/15	100 x 0.02 lb	41 lb	7216	1,700.00
22200/15	200 x 0.05 lb	41 lb	7217	1,700.00
<b>15" x 15"</b>				
APS22050/15	50 x 0.01 lb	71 lb	7218	1,950.00
APS22100/15	100 x 0.02 lb	71 lb	7219	1,950.00
APS22200/15	200 x 0.05 lb	71 lb	7220	1,950.00
<b>18" x 18"</b>				
APS22100/18S	100 x 0.02 lb	87 lb	7222	2,095.00
APS22250/18S	250 x 0.05 lb	87 lb	7223	2,095.00
APS22500/18S	500 x 0.1 lb	87 lb	7224	2,095.00
<b>18" x 24"</b>				
APS22250/1824	250 x 0.05 lb	105 lb	7225	2,195.00
APS22500/1824	500 x 0.1 lb	105 lb	7226	2,195.00
<b>24" x 24"</b>				
APS22250/2424	250 x 0.05 lb	116 lb	7227	2,495.00
APS22500/2424	500 x 0.1 lb	116 lb	7228	2,495.00
APS221000/2424	1,000 x 0.2 lb	116 lb	7229	2,495.00
<b>Service Parts</b>				
ENC 0148 platter	10" x 10"	3 lb	3671MB	84.00



APS 2200P  
w/ column

Prices are subject to change without notice. Please call for current prices.

Other items are available from the manufacturers, please call for prices.

99 Reagent Lane  
Fair Lawn NJ 07410  
201-797-2718 \* 800-631-0347

 **Totalcomp**  
Scales & Balances

www.totalcomp.com  
Fax 201-797-2287  
Toll Free Fax 888-797-2288



**8025XL/12**  
Bench Scale  
w/ optional 14" column



## 8000XL Bench/Floor Scale

Battery powered and portable. Stainless steel. Designed for use in portion control, food processing, general purpose weighing. 6 digit, 0.56" red LED display. Keys are: ZERO/OFF, UNITS, PRINT. Weighing Units are: g, lb, kg, oz, lb/oz. Indicators are: g, lb, kg, oz, neg, batt, mot, zero. Bi-directional RS232. Internal battery and charger, 60 hour battery life. 115/230VAC 50/60Hz. Two year warranty. Platform size: 10" x 10" x 2"H Indicator size: 10"W x 3"D x 6"H

NTEP (indicator) CC #99-129 Class III 10,000 div

NTEP (base) CC #97-097 Class III 5,000 div

Part Number	Capacity	Platform	Weight	Stock	Price B5
8025XL	25 x 0.005 lb	10" x 10"	24 lb	6650	1,310.00

### Options

Part Number	Description	Weight	Stock	Price C
SUB0417	14" Atlas column, fixed height	12 lb	417MB	213.00
SUB0425	20" Atlas column, fixed height	14 lb	422MB	333.00
SUB0426	30" Atlas column, fixed height	16 lb	425MB	533.00

### Service Parts

Part Number	Description	Weight	Stock	Price C
8000XLM		15 lb	2062MB	850.00
8000XLM Battery		2 lb	6657	113.00
8000XLM Touch Panel		1 lb	6658	126.00
8000XLM Main Board		1 lb	6659	646.00
PCA0348 Main Board 800XL		1 lb	6672	608.00



## 8000 Stainless Steel Bench/Floor Scale

Service parts only for Doran 8000

Part Number	Weight	Stock	Price C
SWI0042 touch panel for Doran 8000	1 lb	1279	\$ 186.00
SUB0209 Main PCB for 8000	1 lb	2014	665.00



**8000**  
Service Parts only





## MVP Bench/Floor Scale

Simple, intuitive, designed to withstand the use and abuse of extreme industrial applications. Seven overload stops provide outstanding load cell protection. Two part polyurethane paint provides excellent wear and abrasion protection. 6 digit, 0.56" red LED. Keys are: ZERO, GROSS/NET, TARE, UNITS, PRINT, ON/OFF. Weighing units are: g, lb, kg, oz, lb:oz. Bi-directional RS232. 115 VAC 60Hz, adapter, UL (230 VAC optional) Indicator 7.5"W x 1.75"D x 3.5"H  
 NTEP 05-061 Class III 5,000 div (Indicator)  
 NTEP 05-062 Class III 5,000 div (Base)  
 Canada pending

Part Number	Capacity	Platform	Weight	Stock	Price B5
MVP3100	100 x 0.02 lb	18" x 18"	67 lb	6084	\$ 915.00
MVP3250	250 x 0.05 lb	18" x 18"	67 lb	6085	915.00
MVP4250	250 x 0.05 lb	18" x 24"	73 lb	6086	995.00
MVP4500	500 x 0.1 lb	18" x 24"	73 lb	6087	995.00
MVP5250	250 x 0.05 lb	24" x 24"	85 lb	6089	1,115.00
MVP5500	500 x 0.1 lb	24" x 24"	85 lb	6091	1,115.00
MVP51000	1,000 x 0.2 lb	24" x 24"	85 lb	6092	1,115.00

### 20" Column

MVP3100-20	100 x 0.02 lb	18" x 18"	81 lb	6241	1,040.00
MVP3250-20	250 x 0.05 lb	18" x 18"	81 lb	6242	1,040.00
MVP4250-20	250 x 0.05 lb	18" x 24"	87 lb	6243	1,120.00
MVP4500-20	500 x 0.1 lb	18" x 24"	87 lb	6244	1,120.00
MVP5250-20	250 x 0.05 lb	24" x 24"	99 lb	6246	1,240.00
MVP5500-20	500 x 0.1 lb	24" x 24"	99 lb	6247	1,240.00
MVP51000-20 *	1,000 x 0.2 lb	24" x 24"	99 lb	6248	1,240.00

### 36" Column

MVP3100-36	100 x 0.02 lb	18" x 18"	97 lb	6249	1,065.00
MVP3250-36	250 x 0.05 lb	18" x 18"	97 lb	6250	1,065.00
MVP4250-36	250 x 0.05 lb	18" x 24"	103 lb	6251	1,145.00
MVP4500-36	500 x 0.1 lb	18" x 24"	103 lb	6252	1,145.00
MVP5250-36	250 x 0.05 lb	24" x 24"	115 lb	6254	1,265.00
MVP550-36	500 x 0.1 lb	24" x 24"	115 lb	6255	1,265.00
MVP51000-36 *	1,000 x 0.2 lb	24" x 24"	115 lb	6256	1,265.00

\* No lb:oz weight display

### Options

			A5
DSOPT-001 RS232 Serial Data Output w/ 4 wire shielded cable, 10 ft female 9 pin D connector	1 lb	6093	35.00
DSOPT-002 RS232 Serial Data Output w/ 4 wire shielded cable, 10 ft male 25 pin D connector	1 lb	6094	35.00
DSOPT-003 230 VAC operation	2 lb	6095	25.00
MVPOPT-001 Mobility kit w/ (4) 3" dia locking swivel casters	20 lb	6096	75.00
MVPOPT-002 24" x 24" Stainless steel platter	30 lb	6097	200.00
MVPOPT-003 18" x 18" Stainless steel platter	25 lb	6098	175.00
DMSOPT04 24" x 24" Roller conveyor w/ galvanized rollers 1-7/8" dia	45 lb	6099	300.00



MVP Bench Scale  
W/20" column

Prices are subject to change without notice. Please call for current prices.

Other items are available from the manufacturers, please call for prices.

99 Reagent Lane  
 Fair Lawn NJ 07410  
 201-797-2718 \* 800-631-0347

**Totalcomp**  
 Scales & Balances

www.totalcomp.com  
 Fax 201-797-2287  
 Toll Free Fax 888-797-2288

# Bench/Floor



**BW**  
Bench/Floor



## BW Battery Powered Bench/Floor Scale

Rechargeable or dry battery operation. Environmentally sealed (washdown IP65). Full 5 digit weight display (LCD) with backlight. Counting function. Standard RS232 output. Low battery indicator. Fast battery recharge. Battery life without use of backlight: Rechargeable batteries 100 hrs., Manganese 200 hrs., Alkaline 300 hrs Auto zero tracking. Comparator function (High, OK, Low). Automatic print function. Tactile keypad. Keys for ON, OFF, LIGHT, ZERO, TARE, NET/GROSS, kg/lb. Full tilt swivel indicator head. 120 VAC adapter included.  
 BW-60 & BW150 Platform 15-1/2" x 20-1/2" Height 31"  
 NTEP 98-085 Class III 3,000 div

Part Number	Capacity	Weight	Stock	Price D
BW-60 scale	150 lb x 0.05 lb	39 lb	3890	\$ 795.00
BW-150 scale	300 lb x 0.1 lb	39 lb	3891	795.00

### Options

Wall mount bracket for BW indicator	1 lb	3892	45.00	<b>C</b>
In use cover for BW indicator	1 lb	3893	35.00	

### Service Parts

7504-A00-0080 AC adapter 120 VAC	1 lb	3894	42.80	<b>C</b>
----------------------------------	------	------	-------	----------



**DL-150**  
Bench/Floor



## DL Bench/Floor Scale

Battery operated scale that is easy to operate. Keys for ON/OFF, ZERO, TARE, SET, MODE. Kg/Lb switchable. Large liquid crystal display(LCD). Auto power off after inactive period. Auto span calibration and auto zero tracking. Self contained, battery operated (6) 1.5 VDC batteries (Not included). Includes AC adapter 120 VAC, 50/60 Hz, 1 watt. Overall size 16.5" x 25" x 31"H. 2 year warranty.  
 NTEP 08-016 III 3,000 div,

Part Number	Capacity	Platform	Weight	Stock	Price D5
DL-150 scale	150 x 0.05 lb	15.8" x 20.6"	33 lb	2155	\$ 650.00
DL-300 scale	300 x 0.1 lb	15.8" x 20.6"	47 lb	2156	650.00

Prices are subject to change without

Other items are available from the manufacturers, please call for prices.



Sep

## PB Portable Bench/Floor Scale

Portable. Easy to carry. Rechargeable or dry cell battery. 6 digit, detachable LCD display with backlight. Keys for: ZERO, TARE, UNIT/PRINT, POWER. Auto power off, Weighing Hold, Backlight ON/OFF (bright) Control, Print Out functions. Auto zero tracking. Symbols for: Stable, Zero, Tare, kg, lb, Low Battery. RS232C interface. Wall mount bracket. Rechargeable battery included, 60 hours or (4) C cell batteries (not included). 14"W x 24.2"D x 3.3"H.  
NTEP 11-056 III 3,000 div

Part Number	Capacity	Platform	Weight	Stock	Price C
PB-150	150 lb x 0.02 lb	14" x 17.5"	19 lb	1262	\$ 416.00
PB-300	300 lb x 0.05 lb	14" x 17.5"	19 lb	1263	416.00
PB-500	300 lb x 0.1 lb	14" x 17.5"	19 lb	1264	450.00
	500 lb x 0.2 lb				



**PB**  
Portable Bench Scale  
w/ detachable LCD display

Sep



## ABK Bench Scale

ABK bench scales are ideal for most weighing and counting applications in a variety of settings. Checkweighing capabilities make the ABK an essential part of quality assurance tasks at manufacturing and process plants.

The oversized LCD provides high visibility in mailrooms, on production floors or in shipping/receiving operations. Dynamic weighing effectively captures readings of items that move during weighing, such as liquid ingredients during batching in a commercial bakery, at a chemical plant, or during concrete production.

Part Number	Capacity	Platform	Weight	Stock	Price C
ABK 16a	16 lb x 0.0005 lb	11.8" x 15.7"	17.4 lb	1732	\$ 715.00
ABK 35a	35 lb x 0.001 lb	11.8" x 15.7"	17.4 lb	1733	615.00
ABK 70a	70 lb x 0.002 lb	11.8" x 15.7"	17.4 lb	1734	665.00
ABK 130a	130 lb x 0.005 lb	11.8" x 15.7"	17.4 lb	1735	665.00
ABK 260a	260 lb x 0.01 lb	11.8" x 15.7"	17.4 lb	1736	695.00



**ABK**

Prices are subject to change without notice. Please call for current prices.

Other items are available from the manufacturers, please call for prices.

99 Reagent Lane  
Fair Lawn NJ 07410  
201-797-2718 \* 800-631-0347

**Totalcomp**  
Scales & Balances

www.totalcomp.com  
Fax 201-797-2287  
Toll Free Fax 888-797-2288



**GP-400-204**  
Low Profile Scale  
LCD



## GP Low Profile Scale

The 400-200 series models are stainless steel, equipped with carrying handles on the base. Auto shut off and sleep modes. Push button tare, bi-directional serial ports. Custom label and printing formats.

The 204 indicator can be used with many applications. 6 digit, 0.7" high LCD display. Keys are: ZERO, TARE, NET/GROSS, UNITS, PRINT, ON/OFF. Weighing units: lb, kg, g, oz. 120 VAC 50/60 Hz, Base 18"W x 14"D x 2"H. Indicator 8"W x 7"D x 2"H  
NTEP 02-016, Class III/IIIL 5,000 div indicator  
NTEP 94-098, Class III 2,000 div base

Part Number	Capacity	Base	Weight	Stock	Price A9
GP-400-204	400 x 0.02 lb	18"W x 14"D x 2"H	20 lb	5254	\$ 1,295.00



T4x4-5K  
Floor Scale



**Heavy Duty Floor Scale Base**

Rugged with sturdy deck and channel construction. Checkered safety tread deck. Painted steel construction.

NTEP 16-016 III, 5,000 div

Part Number	Size	Capacity	Weight	Stock	Price C
<b>Base only</b>					
T4x4-5K	4' x 4' x 3.75"	5,000 lb	214 lb	3433MB	\$ 685.00
T4x4-10K	4' x 4' x 3.75"	10,000 lb	214 lb	3434MB	685.00
<b>Package with indicator &amp; calibration</b>					
T4x4-5K package		5,000 lb	260 lb	4737	982.00
Includes	(1) T4x4-5K base (1) T500 Indicator, LED (1) Factory calibration				
T4x4-10K package		10,000 lb	260 lb	4738	982.00
Includes	(1) T4x4-10K base (1) T500 Indicator, LED (1) Factory calibration				
<b>Options</b>					
4'x3' Ramp steel safety tread			150 lb	5712MB	329.00
4'x4' Ramp steel safety tread			102 lb	5704MB	400.00



T500 Indicator  
Included with package

Prices for Floor scale bases and packages are FOB Factory



**VX**  
Standard Floor Scale  
w/ T32XW Indicator



## OHAUS®

### VX Standard Floor Scale

Portable, rugged. 1/8" and 5/16" thick top plate with raised cross hatch surface for added durability. Low profile floor platform scale package. Ideal solution for freight consolidators, forwarders, processing plants resellers, shipping and receiving departments as well as start up businesses. Quick connects and factory calibration allows the floor scale to operate out of the box with minimal setup. Four IP67 nickel plated alloy steel load cells. Side access NEMA4X, IP65 dust and water protected junction box with 25' long cable. Eye bolt mounting holes to allow easier lifting and positioning of the platform.

**T32XW:** Stainless steel. 6 digit, 7 segment backlit LCD. Raised tactical keys. Built in bidirectional RS232 with manual, continuous and interval printing. Hardware configuration lockout switch. Software included for parts counting mode with selectable sample sizes. Selectable span calibration points. Averaging level, auto zero tracking. Battery saving off, Geo Code geographical gravity calibration adjustment. Software menu lockouts. 120 VAC, 50-60 Hz. Internal AC power. IP66/NEMA4X.

Ships from Columbus Ohio within 3-5 days. Price is FOB Columbus Ohio.  
NTEP 08-069 III 5,000 div

Part Number	Size	Capacity	Weight	Stock	Price D
VX32XW2500L*	4' x 4' x 4.5"	2,500 x 0.5 lb	259 lb	5534	\$ 2,405.00
VX32XW5000L*	4' x 4' x 4.5"	5,000 x 1 lb	259 lb	5555	2,405.00
VX32XW10000L	4' x 4' x 4.5"	10,000 x 2 lb	349 lb	5557	3,045.00
VX32XW5000X	5' x 5' x 4.5"	5,000 x 1 lb	509 lb	5556	2,755.00
VX32XW10000X	5' x 5' x 4.5"	10,000 x 2 lb	729 lb	5558	3,475.00

\* NTEP

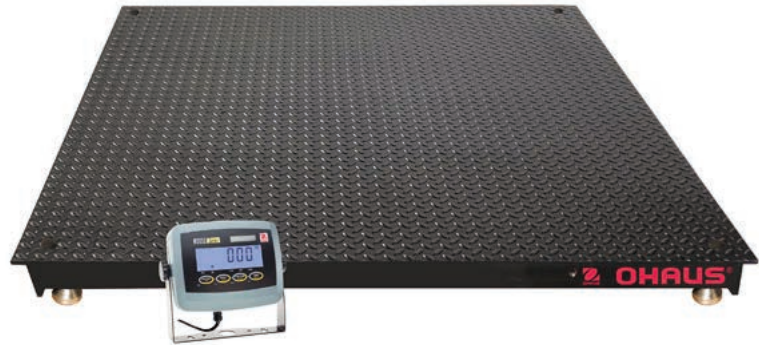

**OHAUS®**



VN  
Standard Floor Scale  
w/ T31P Indicator

**VN Standard Floor Scale**

High quality construction designed to minimize distortion under heavy loads and ensures years of dependable use. Welded steel rib design and thick 0.196"/5mm top plate design provides structural stiffness. Painted tread plate platform top of added slip resistance. Carbon steel eyebolts included for easy installation. Internal structural bracing ensures platform rigidity during everyday use. Four self swiveling ball in cup feet with top access leveling adjustment for easy installation. Available with ramps and mounting feet.

**T31P:** Large 1" high digit backlit LCD display with a choice of lb or kg. Durable mechanical switch keypad with dedicated Print, Tare and Function keys for quick and easy operation. Selectable power on unit. Counting mode with a minimum Average Piece Weight of 1d. Selectable sample sizes, automatic retention of last sample size used and Average Piece Weight. Counting software can be selected off where Counting Mode is not required. Built in bidirectional RS232C interface for printing or connection to PC. Printing intervals can be set to manual, continuous, on stable weight or an interval between 1 second and 60 minutes. Geographical gravity correction software allows quick adjustment of calibration to local conditions without need for recalibration of the VN Floor Scale. Four wall mounting holes for screw mounting to bench or wall. Wall or table mounting using the included wall mount or bracket for full tilt adjustment of the indicator. Software menu lockouts. 9VDC, 0.5A AC adapter or internal rechargeable sealed lead acid battery, 100 hour typical operation with full charge. Both included.

Ships from Columbus Ohio within 3-5 days. Price is FOB Columbus Ohio.  
NTEP 08-048A1 III 5,000 div

Part Number	Size	Capacity	Weight	Stock	Price D
VN31P5000L	4" x 4" x 3.5"	5000 x 1 lb	333 lb	4916	\$ 1,525.00
VN31P5000X	5" x 5" x 3.5"	5000 x 1 lb	533 lb	4917	1,785.00

Options				A
80252565 48" ramp for VN		95 lb	4918	630.00
80252566 60" ramp for VN		140 lb	4919	718.00

Prices are subject to change without notice. Please call for current prices.

Other items are available from the manufacturers, please call for prices.

99 Reagent Lane  
Fair Lawn NJ 07410  
201-797-2718 \* 800-631-0347

**Totalcomp**  
Scales & Balances

www.totalcomp.com  
Fax 201-797-2287  
Toll Free Fax 888-797-2288

doran



**PFS7500XLP**  
Portable Floor Scale  
w/ 7000XLM indicator



## PFS7000 Portable Floor Scale Stainless Steel

24" x 24" platform. 7000XLM indicator for fast, accurate digital weights. Pushbutton Zero for fast tare. Indicator height is 46" above the platform and 47" above the floor. 2 handles for easy moving. USDA approved. Washdown safe 304 stainless steel. LB, KG, OZ, LB & OZ weight display. 1 year warranty. 115 VAC, 60 Hz, 8 watts.  
NTEP 91-106, 89-113, III, 3,000 div  
Canadian approval AM-5188, S.WA-4398, 3,000 div

Part Number	Capacity	Platform	Weight	Stock	Price C
PFS7250XLP	250 x 0.1 lb	24" x 24"	200 lb	6496	\$ 4,515.00
PFS7500XLP *	500 x 0.2 lb	24" x 24"	200 lb	6497	4,515.00
PFS71000XL *	1,000 x 0.5 lb	24" x 24"	200 lb	6498	4,515.00

\* This model does not have lb & oz weight display capability.



**PFS8500XLP**  
Portable floor scale  
w/ 8000XLM indicator



doran

## PFS8000XL Portable Floor Scale Stainless Steel

24" x 24" platform. 8000XLM indicator with internal rechargeable battery for fast, accurate digital weights. Pushbutton Zero for fast tare. Indicator height is 46" above the platform and 47" above the floor. 2 handles for easy moving. USDA approved. Washdown safe 304 stainless steel. LB, KG, G, OZ, LB & OZ weight display. 2 year warranty. 115 VAC, 60 Hz, 8 watts.  
NTEP 99-129, 89-113, III, 3,000 div  
Canadian approval AM-5347, S.WA-4398, 3,000 div

Part Number	Capacity	Platform	Weight	Stock	Price C
PFS8250XLP	250 x 0.05 lb	24" x 24"	200 lb	6503	\$ 4,650.00
PFS8500XLP *	500 x 0.1 lb	24" x 24"	200 lb	6504	4,650.00
PFS81000XLP *	1,000 x 0.2 lb	24" x 24"	200 lb	6505	4,650.00

\* This model does not have lb & oz weight display capability.

Prices are subject to change without notice. Please call for current prices.

Other items are available from the manufacturers, please call for prices.



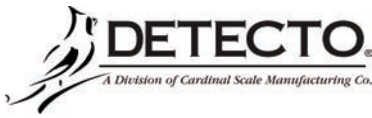

**RW Portable Floor Scale**

Portable low profile floor scale. Platform is made of heavy steel checkered plate with baked powder paint. Two built in ramps. Lifting handles and built in wheels for easy moving. Model 204 Indicator for desk or wall mounting. Stainless steel version has Model 205 indicator. Standard RS232 output. Overall dimensions 32.5"L x 42"W x 4.5"H. (6) "C" cells or NiCad batteries or 120 VAC adapter (included) 50/60 Hz.

Part Number	Capacity	Platform	Weight	Stock	Price A9
RW-500	500 x 0.2 lb	32.5" x 30"	105 lb	6004	\$ 1,611.00
RW-1000	1,000 x 0.5 lb	32.5" x 30"	105 lb	6006	1,817.00
RW-1000S stainless steel	1,000 x 0.5 lb	32.5" x 30"	109 lb	6007	3,186.00



**RW-1000  
204 Indicator**



Built-in wheels



Integral handles



**TDS Portable Drum Scale**

TDS platform is made out of industrial weight heavy duty 1/4" checkered thread steel plate baked powder painted. Two built in folding ramps are low enough to get a hand truck on with ease. Lifting handle and built in wheels for easy moving. Platform uses standard (4) 3 mv/v, 350 ohm load cells and stainless steel signal trim summing junction box. For easy leveling, top bubble level is included. Live rail makes the weighing surface even larger than 36". Select an indicator from our line of indicators and we will calibrate for you. Platform 36" x 36", ramps are 10", overall w/ ramps 44" x 56" x 3"H.

TRWS is Stainless steel, digital weight indicator with backlit LCD display. 6 mechanical switch keys. Applications for: Check Weighing, Accumulation, Over/Under, Animal Weighing. Units for: lb, kg, g, oz, tj, hj. Internal counts: 600,000. Rechargeable battery provide up to 35 hours of continuous use. IP65 housing. RS232 serial port. AC adapter included.

Max div 30,000.  
NTEP 13-091 III 6,000 div

Part Number	Min Height	Capacity	Cell(s)	Weight	Stock	Price C
TDS-1K	2.00"	1,000 x 0.5 lb	500 lb	150 lb	5247	\$ 1,240.00
TDS-2.5K	2.00"	2,500 x 1 lb	1,000 lb	150 lb	5248	1,240.00
TDS-5K	2.00"	5,000 x 1 lb	2,500 lb	158 lb	5249	1,371.00

TRWS Indicator 5 lb 7667MB 193.00

**Service Parts**

Load cell connector, 5 pin	1 lb	6359MB	29.00
Main board for TRWS	1 lb	6361MB	128.00
AC adapter for TRWS/TWP/TLI 100-240 VAC to 12 VDC	1 lb	6362MB	23.80
Battery for TRWS	1 lb	6363MB	42.80
TRWS front overlay	1 lb	7327MB	20.00

**Option**

Tripod for TRWS indicator 3 lb 6287MB 98.00

**NEW**

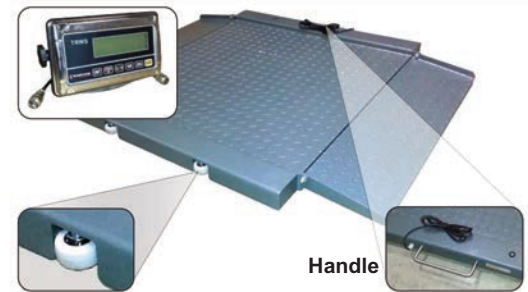

Built in wheels

TDS



Tripod

Prices are subject to change without notice. Please call for current prices.

Other items are available from the manufacturers, please call for prices.

# Floor



**CW250  
Floor Scale**



## CW250 Portable Floor Scale

Portable and compact scale designed for weighing 55 gallon drums, chlorine cylinders, propane tanks, Freon tanks and other heavy containers. This rugged all aluminum self contained scale has an accuracy of 0.1%. Includes (4)AA 1.2 volt nickel cadmium batteries, charger cable and adapter for charging from 12 VDC or 120 VAC. Batteries will give 200 hours use with full charge. Charging time is 8 hours max. Liquid Crystal weight display has Back Light for use at night. Optional data output is RS232 or 20ma current loop.

NTEP 95-024 III 2,000 div

Part Number	Capacity	Weight	Stock	Price B5
<b>15" x 15" x 4" Platform</b>				
CW250-150-1S	150 x 0.05 lb	38 lb	3036	\$ 1,335.00
CW250-300-1S	300 x 0.1 lb	38 lb	2237	1,335.00
CW250-500-2S	500 x 0.2 lb	38 lb	2238	1,335.00
CW250-1000-5S	1,000 x 0.5 lb	42 lb	2239	1,335.00
CW250-1500-5S	1,500 x 0.5 lb	42 lb	2457	1,335.00
CW250-2000-1S	2,000 x 1 lb	42 lb	2240	1,335.00
<b>24" x 24" x 4" Platform</b>				
CW250-150-1	150 x 0.05 lb	95 lb	3690	1,545.00
CW250-300-1	300 x 0.1 lb	95 lb	2241	1,545.00
CW250-500-2	500 x 0.2 lb	95 lb	2242	1,545.00
CW250-1000-5	1,000 x 0.5 lb	95 lb	2243	1,545.00
CW250-1500-5	1,500 x 0.5 lb	95 lb	2570	1,545.00
CW250-2000-1	2,000 x 1 lb	95 lb	2244	1,545.00



**RFX  
Handheld Wireless Indicator**



### Options

100480 Charger & cable (1) scale	2 lb	1508M	160.00	<b>B5</b>
100181 Cast aluminum ramp 24"x24"	30 lb	2247	445.00	
100449 Cast aluminum ramp 15"x15"	21 lb	2749	229.00	
100183 CW-TW Transport Wheels(2 per platform)	12 lb	2311	145.00	
330010 battery pack w/(6) AA NiCad batteries, old style	1 lb	1960M	62.85	<b>C</b>
330158 battery pack w/ (4)AA NiCad batteries	1 lb	2316M	55.00	
RFX Handheld wireless Indicator	4 lb	6177M	995.00	

### Service Parts

603091 Load Cell CW250-150/300	6 lb	2318	\$ 426.00	<b>C</b>
603162 Load Cell CW250-500	6 lb	2319	543.00	
603048 Load Cell CW250-1000/2000	6 lb	2320	543.00	

Sep  
↓

Prices are subject to change without notice. Please call for current prices.

Other items are available from the manufacturers, please call for prices.



# NEW

## Portable Platform Scale

Totalcomp's own stainless steel TLI Indicator assembled and calibrated. Rugged tubular frame with heavy gauge polished stainless steel platter. Equipped with environmentally protected NTEP aluminum load cell. (4) 4" USDA/FDA approved white plastic wheels (2) roller and (2) swivel with locking brakes, all wheels with bearings and grease fittings. OSHA orange safety handle grips on a 40" tall stainless steel column. (Base) Canadian AM-5881; NTEP 12-115A1

Part Number	Capacity	Platform	Weight	Stock	Price B5
SS640-PS-1824	100 lb	18" x 24" x 6"	170 lb	8157	\$ 2,700.00
SS640-PS-1824	250 lb	18" x 24" x 6"	170 lb	8158	2,700.00
SS640-PS-1824	500 lb	18" x 24" x 6"	170 lb	8159	2,800.00
SS640-PS-1824	1,000 lb	18" x 24" x 6"	170 lb	8160	2,800.00
SS640-PS-2424	100 lb	24" x 24" x 6"	190 lb	8161	2,900.00
SS640-PS-2424	250 lb	24" x 24" x 6"	190 lb	8162	2,900.00
SS640-PS-2424	500 lb	24" x 24" x 6"	190 lb	8163	3,000.00
SS640-PS-2424	1,000 lb	24" x 24" x 6"	190 lb	8164	3,000.00

### Options

TLI Indicator W/ RS232 & Adapter	10 lb	2658	288.00	<b>C</b>
----------------------------------	-------	------	--------	----------



**SS-640-PS**  
Portable Platform Scale





**FC6300**  
Formula Control Scale

## FC6300 Formula Control Scale

304 stainless steel. Simple to operate. Ideal production control and traceability of bulk and minor ingredients that meets the mandated requirements of the Bioterrorism Act, Section 396 (BTA) and HACCP. Survives the harsh environments of food processing. 5.7" STN, QVGA 320 x 240 LCD display protected with a thick Lexan® panel bolted and glued in place to prevent damage. Keys are: CLEAR, ENTER, START, STOP, LOT ID, RECIPE RECALL, ZERO, and 0-9 alphanumeric keypad. USB thumbdrive data output or optional wired Ethernet. 115 VAC, 50/60 Hz. 230 VAC optional. Overall dimensions 9.25"H x 10.5" x 5.5"D (indicator). 2 year warranty.

Part Number	Capacity	Weight	Stock	Price A5
<b>18" x 18" Platform</b>				
FC63100/1818	100 x 0.02 lb	116 lb	4979	\$ 8,995.00
FC63150/1818	150 x 0.02 lb	116 lb	4980	8,995.00
FC63250/1818	250 x 0.05 lb	116 lb	4981	8,995.00
FC63250/1818	500 x 0.1 lb	116 lb	4982	8,995.00
<b>18" x 24" Platform</b>				
FC63100/1824	100 x 0.02 lb	118 lb	4983	9,125.00
FC63150/1824	150 x 0.02 lb	118 lb	4984	9,125.00
FC63250/1824	250 x 0.05 lb	118 lb	4985	9,125.00
FC63500/1824	500 x 0.1 lb	118 lb	4986	9,125.00
<b>24" x 24" Platform</b>				
FC63100/2424	100 x 0.02 lb	131 lb	4988	9,395.00
FC63150/2424	150 x 0.02 lb	131 lb	4989	9,395.00
FC63250/2424	250 x 0.05 lb	131 lb	4990	9,395.00
FC63500/2424	500 x 0.1 lb	131 lb	4991	9,395.00

### Options

				A5
FC6300 Digital Weight Indicator and Formula Loader Windows software		5 lb	4993	7,595.00
63OPT10 Barcode scanners (IP65)		5 lb	4995	1,345.00
MSC0175 Barcode scanner stand		5 lb	4996	40.00



**TRANSCELL TECHNOLOGY, INC.**

**PC Bench Scale**

Shipping, Receiving, Manifest Systems, Portion Control, Filling, Packing, Parcel, Letter. Bright LED display. RS232 full duplex serial port. Front panel keys: lb/kg, Zero, Net/Gross, Tare, Print. Compatible with FedEx Ship Manager Software. 120 VAC, 50/60 Hz adapter 12VDC, 500 ma, 6 watt. Overall size 13" x 13" x 4.4"H. NTEP 96-000 III 3,500 div

Part Number	Capacity	Weight	Stock	Price D
PC-150 scale	0-5 x 0.01 lb	31 lb	1662	\$ 595.00
	5-70 x 0.02 lb			
	70-150 x 0.05 lb			

Options				C
TBT1313 Transfer ball top		15 lb	1663	275.00
Null modem cable		1 lb	1547	19.00



**PC-150  
Bench Scale**





## TRANSCELL TECHNOLOGY, INC.

### SRP Bench/Floor Scale

Shipping, Receiving, Manifest Systems, Portion Control. RS232 full duplex serial port.  
 Front panel keys: lb/kg, Zero, Net/Gross, Tare, Print. 120 VAC, 50/60 Hz adapter 6 watt.  
 Overall size (SRP)18" x 18" x 4.8"H.  
 NTEP 95-034 III 3,000 div (SRP)



**SRP-300**  
w/ Optional Transfer ball top



Part Number	Capacity	Weight	Stock	Price C
<b>Bright LED display (NTEP)</b>				
SRP-300	300 x 0.1 lb	49 lb	2712	\$ 895.00

#### Options

12" Swivel post for SPL/SRP	2 lb	2713	52.50	<b>C</b>
18" Swivel post for SPL/SRP	2 lb	2714	62.00	
TBT1818 Transfer ball top for SRP	14 lb	2715	325.00	



**PD-II POS Check Stand Scale**

Interface with register or computer. Stainless steel tray. Use as a bench scale. LED display, USB port. Easy to read tilt display. Auto zero tracking. Dual range. AC 120v, 60Hz. Platter size 14.9" x 11". Overall size 15"W x 11"D x 3.1"H  
NTEP 92-174A1 3,000 div

Part Number	Capacity	Weight	Stock	Price D2
PD-II 15 lb	6 x 0.002 lb 15 x 0.005 lb	15 lb	6979	\$ 649.00
PD-II 30lb	15 x 0.005 lb 30 x 0.01 lb	15 lb	6980	649.00
PD-II 60 lb	30 x 0.01 lb 60 x 0.02 lb	15 lb	6981	649.00
PD-II 150 lb	60 x 0.02 lb 150 x 0.05 lb	15 lb	6982	749.00

**Options**

				<b>C</b>
Remote display		5 lb	1502	150.00
PD-II Ball platter		8 lb	6335	169.00
7880-PDO-4128 cable 9 pin to RS232 25 pin		1 lb	949	33.00
JPD5 IBM/PC cable 9 pin to RS232 25 pin		1 lb	979	41.50



PD-II



**7300 Bench Scale**

Heavy duty cast construction. UPS Online 6.0 compatible. Stainless steel platform. Bright green LED display. Weight displayed in two units of measure. Front panel keys: ON/OFF, ZERO, UNITS, PRINT. RS232 bidirectional interface. Optional remote display. Optional battery operation. 120 VAC, 50/60 Hz, 8 watts. 14.25"W x 12.25"D x 4"H  
NTEP 91-149, III, 10,000 div 10 lb and higher  
Canadian AM-4869

Part Number	Capacity	Platform	Weight	Stock	Price C
7300-2 *	2 x 0.0002 lb	8" x 8"	19 lb	6564	\$ 775.00
7300-5 *	5 x 0.0005 lb	8" x 8"	19 lb	6565	775.00
7300-10	10 x 0.001 lb	12" x 14"	19 lb	6566	775.00
7300-20	20 x 0.002 lb	12" x 14"	19 lb	6567	775.00
7300-50	50 x 0.005 lb	12" x 14"	19 lb	6568	775.00
7300-100	100 x 0.01 lb	12" x 14"	19 lb	6569	775.00
7300-150	150 x 0.02 lb	12" x 14"	19 lb	6570	775.00
7300-200	200 x 0.02 lb	12" x 14"	19 lb	6571	775.00

\* Not NTEP

**Options**

				<b>B5</b>
57418-1 Remote display w/mini tower w/6' cable		5 lb	6572	195.00
57418-2 Remote display desk/wall mount w/6' cable		4 lb	6573	195.00
57418-4 Remote display flush or panel mount w/6' cable		3 lb	6574	195.00
57570 Battery operation AC/DC, factory installed		6 lb	6575	195.00
56750-5 Ball top 12"x14" for 50 lb and higher		12 lb	6576	235.00

**Service Parts**

				<b>B5</b>
57520 Spare 12VDC battery for 7300		4 lb	6577	95.00



7300 Bench scale UPS

Prices are subject to change without notice. Please call for current prices.

Other items are available from the manufacturers, please call for prices.

## OHAUS®



FD  
Portion Control



### FD Food Portion Control Scale

All stainless steel, dishwasher safe removable pan. Rugged, multi-use portioning scale. Bright backlit LCD display. Weighing units: lb, decimal and fractional oz, kg, g, lb:oz. Keys are: ON/OFF/ZERO, G/N/T/UNITS, TARGET/MENU, TARE. Indicators for: center of zero, net, tare. Checkweighing mode with 3 LED indicator and audible alarm. Text displays of weigh units. Audible buzzer alerts user when limits are reached. Manual or auto tare. 120VAC adapter included. Internal sealed lead-acid battery with 120 hours charge life. 1 year warranty. 8.8"W X 11.8"D X 2.8"H. Platform size 8.2" x 8.2". NSF listed/certified  
USDA accepted  
NTEP 05-072 Class III 3,000 div

Part Number	Capacity	NTEP	Weight	Stock	Price C5
FD3	6 x 0.001 lb	6 x 0.002 lb	11 lb	5295	\$ 735.00
FD6	15 x 0.002 lb	15 x 0.005 lb	11 lb	5296	735.00
FD15	30 x 0.005 lb	30 x 0.01 lb	11 lb	5297	735.00
FD3H	6 x 0.0002 lb		11 lb	6417	815.00
FD6H	15 x 0.001 lb		11 lb	6418	815.00
FD15H	30 x 0.001 lb		11 lb	6420	815.00

#### Options

71169633 Foot tare switch			1 lb	5371	140.00
---------------------------	--	--	------	------	--------

## RICE LAKE® WEIGHING SYSTEMS



RLP-S  
Portion Control Scale



### RLP-S Portion Control Scale

Stainless steel. Compact and easy to use. Removable weigh pan for quick and easy cleaning. 6 digit, LED display. Keys for: RE-ZERO, TARE, ON/OFF. Indicators for: Ounces, Grams, Pounds, NET, Center of Zero, Battery Usage. HAACP compliant. AC adapter included. IP68 water and dust resistant. Overall dimensions 9.9"W x 11.4"D x 5.3"H. One year warranty.

NTEP CC 10-068

Canada AM-5794

Part Number	Capacity	Platform	Weight	Stock	Price A3
RLP-6S	6 x 0.002 lb	9.3" x 7.8"	14 lb	3458	\$ 400.00
RLP-15S	15 x 0.005 lb	9.3" x 7.8"	14 lb	3460	400.00
RLP-30S	30 x 0.01 lb	9.3" x 7.8"	14 lb	3462	400.00
RLP-60S	60 x 0.02 lb	9.3" x 7.8"	14 lb	3467	400.00





**PS Portion control scale**

White baked enamel finish. Digital portion control scale. Lightweight and compact. 1/2" LCD display. Keys are: TARE, UNITS. Indicator for low battery. Selectable units: g, oz.. Low battery indicator. Uses (4) AA batteries or 120 VAC adapter. Stainless steel platter. 7"W x 7"D x 2 3/4"H

Part Number	Capacity	Platform	Weight	Stock	Price C
PS-5A	70 x 0.1 oz / 2,000 x 2g	5.25" x 6.75"	4 lb	5279	\$ 463.00
PS-6A	70 x 1/4 oz	5.25" x 6.75"	4 lb	5280	496.00



**PS-5A**  
Portion Control



**PW-II Portion Control Scale**

Stainless steel. Simple weighing scale. Soft touch tactile switch. Keys for: ON/OFF, ZERO, TARE, LB/OZ/G. Easy operating, auto calibration. 5 digit LCD display. Battery operated, (6) AA not included. Overall dimensions 9.4"W x 8.9"D x 2.6"H. Platter size 8.47"W x 5.9"D

Part Number	Capacity	Weight	Stock	Price D
PWII-5	5 x 0.002 lb	6 lb	7055	\$ 225.00
PWII-10	10 x 0.005 lb	6 lb	7056	225.00
PWII-20	20 x 0.01 lb	6 lb	7057	225.00



**PW-II**  
Portion Control Scale

Prices are subject to change without notice. Please call for current prices.

Other items are available from the manufacturers, please call for prices.

99 Reagent Lane  
Fair Lawn NJ 07410  
201-797-2718 \* 800-631-0347



www.totalcomp.com  
Fax 201-797-2287  
Toll Free Fax 888-797-2288



**PC400**  
Portion Control Scale  
Shockproof "Quad Spring" platform  
with rechargeable battery



## PC400 Portion Control Scale

304 **stainless steel** construction for wipedown cleaning not washdown. It can go anywhere with the internal rechargeable battery(included). It will also work on 120VAC power. "Quad Spring" shockproof platform. The electronics are environmentally sealed. Units are lb, kg, g, oz, lb/oz. Modular, replaceable components. Full digital calibration. Keys for ZERO, ON/OFF, UNITS. 4 digit, 0.66" high LCD. RS232 standard. 120 VAC, plug mount transformer with 6 ft. cord (UL/CSA listed) and rechargeable battery, included. Overall dimensions 6.5" W x 8.75" L x 2" H.

NSF Certification National Sanitary Foundation for sanitary food service equipment.  
NTEP 04-039A1 Class III 10,000 div

Part Number	Capacity	Platform	Weight	Stock	Price B5
PC400-02LFT	2.2 x 0.001 lb 35 x 0.02 oz 1,000 x 0.5g	6.5" x 6.5"	6 lb	6289	\$ 335.00
PC400-05	5 x 0.002 lb 80 x 0.05 oz 2,300 x 1g	6.5" x 6.5"	6 lb	6290	335.00
PC400-10	10 x 0.005 lb 160 x 0.1 oz 4,500 x 2g	6.5" x 6.5"	6 lb	6291	335.00
PC400-20	20 x .01 lb 320 x .2 oz 9100 x 5 g	6.5" x 6.5"	6 lb	2850	335.00

### Options

PC-OPT02 230 VAC operation		1 lb	6292	35.70
WCB-149 RS232 cable w/9 pin connector		1 lb	6293	21.40

### Service Parts

SWI0151 Touch panel 2 lb	S/N NPC405162 and higher	1 lb	8351	61.70
SWI0130 Touch panel 2 lb	S/N NPC405161 and lower	1 lb	8352	61.70
SWI0152 Touch panel 5 lb	S/N NPC404698 and higher	1 lb	8353	61.70
SWI0131 Touch panel 5 lb	S/N NPC404697 and lower	1 lb	8354	61.70
SWI0153 Touch panel 10 lb	S/N NPC404988 and higher	1 lb	8355	61.70
SWI0132 Touch panel 10 lb	S/N NPC404987 and lower	1 lb	8356	61.70
SWI0154 Touch panel 20 lb	S/N NPC405110 and higher	1 lb	8357	61.70
SWI0135 Touch panel 20 lb	S/N NPC405109 and lower	1 lb	8358	61.70
BAT0013 Replacement battery pack for PC400		2 lb	6294	50.00
XFR0035 AC adapter 115VAC negative center 6' cord for PC400		1 lb	6295	57.10
XFR0039 AC adapter 115VAC positive center 6' cord for PC400*		1 lb	6221	57.10
PC-OPT04 carry case PC400		3 lb	6298	100.00
ENC0804 Platter 6.5" x 6.5" for PC400		1 lb	6296	64.20
SUB0531 Foot assembly set of (4) for PC400		1 lb	6297	28.50

\*Note: PC400 with s/n NPC403000 and higher use the adapter with positive center, stock 6221.



**PC500 Portion Control Scale**

Stainless steel. IP66 washdown safe. The PC500 features a soft silicone seal that protects against washdown spray and allows a high level of accuracy. Tackles harsh environments of washdown, food service and industrial applications. 1000% overload "Quad Spring" design. 6 digit, 0.66" high LCD display. Keys for: ON/OFF, Zero, Units. Units are lb, kg, g, oz, or lb:oz. Five way weight display show the same weight in 5 different units. Indicators for motion, low battery, weighing units, and center of zero. 1,000 hour battery life. Battery operated, optional 115V AC adapter with 8' cable. Bi-directional RS-232. Overall dimensions 12.75"L x 9.75"W x 5.26"H. Platter size 8.5" x 8.5"

NSF Certification National Sanitary Foundation for sanitary food service equipment NTEP 09-032 Class III 2,000 div

Part number	Capacity	Weight	Stock	Price B5
<b>(1) Display</b>				
PC500-05	5 x 0.002 lb	13 lb	7451	\$ 425.00
PC500-10	10 x 0.005 lb	13 lb	7452	425.00
PC500-25	25 x 0.01 lb	13 lb	7453	425.00
PC500-50	50 x 0.02 lb	13 lb	7454	425.00
<b>(2) Displays</b>				
PC500-C05	5 x 0.002 lb	13 lb	7455	450.00
PC500-C10	10 x 0.005 lb	13 lb	7456	450.00
PC500-C25	25 x 0.01 lb	13 lb	7457	450.00
PC500-C50	50 x 0.02 lb	13 lb	7458	450.00
<b>Options</b>				
PC5OPT03 RS-232 Cable w/ 9 pin female		1 lb	7461	50.00
PC5OPT04 Washdown safe remote zero (IP68)		1 lb	7462	50.00
PC500 Zero switch remote non-washdown		1 lb	7463	106.25
<b>Service Parts</b>				
PC5OPT01 AC Adapter 115 V		1 lb	7459	42.00
PC5OPT02 AC Adapter 230V		1 lb	7460	42.00
SWI0159 keysheet 5 lb		1 lb	2499	48.00
SWI0160 keysheet 10 lb		1 lb	2500	48.00
SWI0161 keysheet 25 lb		1 lb	2501	48.00
SWI0162 keysheet 50 lb		1 lb	2502	48.00
LCP22010 load cell PC500-05		1 lb	2516	136.00
LCP22010 load cell PC500-10		1 lb	2517	136.00
LCP22010 load cell PC500-25		1 lb	2518	136.00
LCP22010 load cell PC500-50		1 lb	2519	136.00



**PC500-05**  
Portion control scale



**PC500--C05**  
Portion control scale  
w/ rear customer display



**PS Portion Control Scale**

**PS-10:** Multi-Purpose. Easy to clean stainless steel platform. 0.75" LCD, 6 digits with backlight display. Keys for: UNIT, ZERO, TARE/C, ON/OFF. Weighing units are: lb;oz, lb, oz, g. Battery operation for portable weighing. AC adapter (included) or (6) AA Alkaline batteries (not included). Overall dimensions 6.7" x 6.7" x 2.5". Platter size 6.3" x 6.3". 1 year warranty.

**PS-20:** Multi-purpose. Easy to clean stainless steel platform. 1.2" LCD, 6 digits with backlight. Keys for: ZERO/SET, ON/OFF, TARE/MODE, UNIT. Weighing units are: kg, lb, lb;oz. Battery operation for portable weighing. AC adapter (included) or (6) AA Alkaline batteries (not included). Overall dimensions 12.7" x 10.5" x 3.4". Platter size 10" x 9". 1 year warranty.

Part number	Capacity	Weight	Stock	Price B
PS10	10 x 0.001 lb	4 lb	7664	\$ 61.67
PS20	20 x 0.01 lb	7 lb	7665	100.83



**PS10**  
Portion Control Scale

Prices are subject to change without notice. Please call for current prices.

Other items are available from the manufacturers, please call for prices.



A&D WEIGHING DIVISION



SF-15KA  
Computing Scale



## SF Price Computing Scale

Tower type, dual display price computing scale. Splashproof keyboard & display. Fast, accurate, Legal for trade. Large wide angle display for Weight, Unit Price and Total price. Vacuum florescent display for A and C models. Liquid Crystal LCD display for B model. Three displays are on the operators side of the scale as well as three displays on the customers side. Keypad 0-9 for entering prices. Function keys for ZERO, TARE, M+, X, MEM, \*, MODE, CE, CHANGE. Memory for 30 items. Optional **stainless steel** pan. 11.8" x 11" pan. Overall size 11.8"W x 16.7"D x 18.1"H. A model 120 VAC adapter only. B and C models 120 VAC adapter or (6) D batteries, not included. 300 hours with manganese batteries. 500 hours with alkaline batteries. Optional rechargeable battery pack for C model only. 10 watt.  
NTEP 99-076 III 3,000 div.

Part Number	Capacity	Weight	Stock	Price C
SF-6KA	15 lb x 0.005 lb	13 lb	4599	\$ 495.00
SF-6KB	15 lb x 0.005 lb	13 lb	4602	455.00
SF-15KB	30 lb x 0.01 lb	13 lb	4603	455.00
SF-30KB	60 lb x 0.02 lb	13 lb	4604	455.00
SF-6KC	15 lb x 0.005 lb	13 lb	4605	495.00
SF-15KC	30 lb x 0.01 lb	13 lb	4606	495.00
SF-30KC	60 lb x 0.02 lb	13 lb	4607	495.00
<b>Options</b>				<b>B5</b>
SF-09 Rechargeable battery pack for SF-KC only		6 lb	4609	173.00
SF-10 Stainless steel weigh pan for SF		4 lb	4610	53.00
				<b>A</b>
TB:662 AC adapter 120VAC		1 lb	1305MB	43.00
TB:164 AC adapter 230VAC		1 lb	4612M	53.00



## AP1 Price Computing Scale

Preset prices are retained in memory for 28 items. Each item has its own separate key for easy entry by pressing a single button. Easy to read bright green tower mounted display has three readouts for Total Price, Weight and Unit Price. Keyboard for entry of values. Keys for ON/OFF, ZERO, TARE, MEM, SAVE, MODE, ADD, \*, 1/2, 1/4, TTP CALL, TTP CLP. Auto span calibration with auto zero tracking. Number of transactions display. Optional large tray 17.3" x 10" x 2"H for produce. **Stainless steel** platform size 8.8" x 13.5". Overall size 13.8" x 16.5" x 20"H. 120 VAC, 10 watt. NTEP 90-007A1 III 3,000 div.

Part Number	Capacity	Weight	Stock	Price E
AP1-15 Scale	15 lb x 0.005 lb	15 lb	2930	\$ 495.00
AP1-15 w/produce platter	15 lb x 0.005 lb	15 lb	2626	580.00
				<b>E</b>
AP1-60 Scale	30 lb x 0.01 lb	15 lb	2625	495.00
Dual range	60 lb x 0.02 lb			
AP1-60-P w/produce platter	30 lb x 0.01 lb	18 lb	2627	580.00
Dual range	60 lb x 0.02 lb			

KG version					<b>E</b>
AP1-15KG Scale	15kg x 5g	14 lb	1175	495.00	

Options					<b>C</b>
Produce platter for AP1		6 lb	5728	100.00	
Wet cover for AP1 for keyboard		3 lb	1142	10.00	



**AP1**  
Computing Scale



## EB Price Computing Scale

Tilt keyboard and display. Customer side display. Lb/kg switchable. 60 to 300 lb capacity dual range. 24 direct PLU's/176 indirect PLU's. Programmable tare. Auto power off function. Rechargeable battery included. RS232C interface, connect with PC or printer. Large platform for bulk weighing. Optional label and receipt printing. For use with Laundry, Farmers Markets, Retail and Recycling. NTEP 09-095

Part Number	Capacity	Pan	Weight	Stock	Price D
EB-60	60 x 0.02 lb	11" x 11"	33 lb	3477	\$ 725.00
EB-150	150 x 0.05 lb	15.75" x 20.3"	46 lb	3478	795.00
EB-300	300 x 0.1 lb	15.75" x 20.3"	46 lb	3479	795.00

Options					<b>D5</b>
Laundry basket		9 lb	4901M	170.00	



**Laundry basket**  
20" x 27" top 11" high 16" x 22" base



**EB-150**  
Computing scale

Prices are subject to change without notice. Please call for current prices.

Other items are available from the manufacturers, please call for prices.

99 Reagent Lane  
Fair Lawn NJ 07410  
201-797-2718 \* 800-631-0347

**Totalcomp**  
Scales & Balances

www.totalcomp.com  
Fax 201-797-2287  
Toll Free Fax 888-797-2288



LP-1000  
Computing Scale



LP-1000 w/Pole  
Computing Scale

## LP-1000 Label Printing Price Computing Scale

Programmable scale and . Auto printing and "Save" for pre-pack. 54 preset keys. 4,000 PLU(Price Look Up). Each PLU can have 5 lines with 80 characters each for 400 characters per PLU. Easy to read bright green display has three readouts for Total Price, Weight and Unit Price. Keyboard for entry of values. Keys for ZERO, TARE, PLU, SAVE, FOR, X, PRT, 1/2, 1/4. PLU data items: Commodity name, message, Item no., tare weight, unit price. Printing items: Commodity name, message, sell by data, unit price, weight, total price, store name & address. Smudge proof thermal label. Optional platter for fish. **Stainless steel** platform size 10" x 15". 16" x 17" x 7.7"H. 120 VAC, 140 watt. NTEP 92-169 III 3,000 div

Part Number	Capacity	Memory	Weight	Stock	Price D
LP-1000-N	30 lb x 0.01 lb	400 Char/4000 PLU	33 lb	7140	\$ 1,576.00

Pole mount display					D
LP-1000-NP	30 lb x 0.01 lb	400 Char/4000 PLU	34 lb	7142	1,675.50

Options					C
LP1000 Software w/cable			1 lb	2979	95.00
RS232 Interface cable			1 lb	2980	30.00

Service Parts					C
LST8000 Labels 58 x 30mm 1000/roll 12/case			9 lb	2981	130.00
LST8010 Labels 58 x 40mm 700/roll 12/case			9 lb	2982	130.00
LST8020 Labels 58 x 60mm 500/roll 12/case *			9 lb	2983	130.00
* For Models B & C only.					
LST8030 Labels 58 x 50mm 500/roll 12/case			9 lb	2984	130.00
LST8040 Labels 58 x 60mm 500/roll 12/case			9 lb	2985	130.00

LP-1000 Printhead			49 lb	2711	288.00
2100-LPO-1000 key pad numeric			1 lb	2282	61.00

Owners manual for LP-1000			1 lb	2772	48.50
1006-A00-0483 label pickup pin			1 lb	2248	10.00



Prices are subject to change without notice. Please call for current prices.

Other items are available from the manufacturers, please call for prices.



## LP-II Thermal Label Printing Scale

Service parts only for Cas LP-II.

Part Number	Capacity	Weight	Stock	Price B
<b>Service Parts</b>				
LST-8051 58mm wide x 100' continuous strip, 12 rolls/case		9 lb	2809	\$ 85.00



**LP-II**  
Label printing scale  
Ethernet TCP/IP network  
Computing Scale



## CL5000 Label Printing Scale

Designed for simplicity. Achieve print speeds up to 100mm/sec and print resolution of 202 dpi for crisp clear labels. VFD, Alphanumeric bright purple display. The CL5000 comes with over 50 preset common label formats stored in memory. Up to 40 more custom label formats can be added using the label editing function of the CL-Works software program. 3,000 PLU's and 1,500 ingredients. The Double Click Call feature allows the operator to recall PLU's by double clicking the speed key instead of having to use the shift key. The standard bench model comes with 96 total speed keys. The pole model comes equipped with a total of 144 speed keys. Includes the CL-Works software program which allows you to create and edit PLU's, program store information, design custom labels and unique keyboard layouts. Platform size 15"W x 9.6"D. Standard dimensions 16"W x 17"D x 6.8"H. Dual range with column 16"W x 17"D x 23.9"H. 240 VAC 50/60Hz  
NTEP 07-042 III 3,000 Div

Part Number	Capacity	Weight	Stock	Price B9
CL5000B Dual range	60 x 0.02 lb	31 lb	7445	\$ 1,995.00
CL5000R Dual range w/ column	30 x 0.01 lb	31 lb	7446	2,097.00

### Options

				<b>B5</b>
CL5000 Full body cover		1 lb	7003	25.00
PCL2 Network card		1 lb	7447	195.00
PCL3 Expanded memory		1 lb	7448	200.00



**CL5000R**  
Label Printing Scale



**CL5000B**  
Label Printing Scale

Prices are subject to change without notice. Please call for current prices.

Other items are available from the manufacturers, please call for prices.



**S2000JR**  
Price Computing Scale



## S2000JR Price Computing Scale

Soft touch silicon rubber key pad. Vacuum fluorescent display backlight LCD for Weight, Unit Price, Total Price. Auto power off. Keypad 0-9. Lb/kg/oz switchable. Function keys for: POWER, ZERO, TARE, LOW BATTERY, B/L. 3 Direct PLU & 199 indirect PLU's. Rechargeable battery (6V, 3.6Ah) LCD & VFD (standard) models. 120V, 60Hz 7 watt. 12hr charging time. 120hr operating time. Platform size 12"W x 8.7"D. Standard type: 12.9"W x 13.6"D x 4.2"H. Pole type: 12.9"W x 15.2"D x 16.2"H. NTEP 06-013 class III, 3,000 div

Part Number	Capacity	Weight	Stock	Price D5
S2000JR-15-LCD	15 x 0.005 lb	12 lb	7126	\$ 395.00
S2000JR-30-LCD	30 x 0.01 lb	12 lb	7127	395.00
S2000JR-60-LCD	60 x 0.02 lb	12 lb	7128	395.00
<b>D9</b>				
S2000JR-15-LCD-P w/ pole	15 x 0.005 lb	12 lb	7129	449.00
S2000JR-30-LCD-P w/ pole	30 x 0.01 lb	12 lb	7130	449.00
S2000JR-60-LCD-P w/ pole	60 x 0.02 lb	12 lb	7131	449.00
<b>D5</b>				
S2000JR-15-VFD	15 x 0.005 lb	12 lb	7132	395.00
S2000JR-30-VFD	30 x 0.01 lb	12 lb	7133	395.00
S2000JR-60-VFD	60 x 0.02 lb	12 lb	7134	395.00
<b>D9</b>				
S2000JR-15-VFD w/ pole	15 x 0.005 lb	12 lb	7135	449.00
S2000JR-30-VFD w/ pole	30 x 0.01 lb	12 lb	7136	449.00
S2000JR-60-VFD w/ pole	60 x 0.02 lb	12 lb	7137	449.00

### Options

Fish platter for S2000JR w/ scale	2 lb	7138	85.00	<b>D</b>
Fish platter for S2000JR w/o scale	2 lb	7139	100.00	
Full body protective cover for S2000JR	1 lb	7237	24.00	
<b>A5</b>				
DLP-50 Label printer for S2000JR	3 lb	7238M	299.00	
DEP-50 Receipt printer for S2000JR	3 lb	6860M	299.00	

### Service Parts

LST-8060 67 x 50mm Hi-Speed	9 lb	3421	55.00	<b>C</b>
Blue Beacon 570/roll, 12 rolls/case				
OT11 Foot	1 lb	3762	13.20	
ZS25 Battery S2000JR	1 lb	7508	44.00	
KS22 keypad S2000JR	1 lb	3780	26.80	
<b>A5</b>				
YS21 AC adapter 120 VAC	1 lb	7141	36.00	



**Laundry basket**  
20" x 26" top 11" high 18" x 24" base

### Laundry Scale

S2000JR-60-LCD	30 x 0.01 lb	22 lb	6038	565.00	<b>D5</b>
dual range & basket	60 x 0.02 lb				

### Options

Laundry basket 20 x 26 x 11	14 lb	4901M	170.00	<b>D5</b>
-----------------------------	-------	-------	--------	-----------



**DLP-50**  
Label printer



**DEP-50**  
Receipt printer

Prices are subject to change without notice. Please call for current prices.

Other items are available from the manufacturers, please call for prices.





## S2000 Price Computing Scale

Low profile price computing scale. Conductive silicone rubber switch with soft touch. Easy to read bright green vacuum fluorescent display for Weight, Unit Price and Total price. Three displays are on the operators side of the scale as well as three displays on the customers side. Keypad 0-9 for entering prices. Function keys for ZERO, TARE, 1/2, 1/4, PREPACK, MW, MR, TARE SAVE, ADD, RECALL. Auto span adjustment and auto zero tracking. Indirect memory backup of up to 800 items. RS232 interface for computerized cash registers only. Not for use with printer or cash register alone. Optional large tray 17" x 11.25" for fish. **Stainless steel** platform size 14.6" x 11". Overall size 15.3" x 14.4" x 5.9"H. 120 VAC, 10 watt. NTEP 91-141 III 3,000 div.

Part Number	Capacity	Weight	Stock	Price D
S2000 scale	30 lb x 0.01 lb	19 lb	2628	\$ 495.00
Dual range	60 lb x 0.02 lb			
S2000 w/fish platter	30 lb x 0.01 lb	19 lb	2629	580.00
Dual range	60 lb x 0.02 lb			

Options				C
Fish platter	3 lb	2630	100.00	
Wet cover for keyboard	1 lb	1569	15.00	



**S2000**  
Computing Scale



## PC Price Computing Scale

Fast, accurate and affordable. Easy to read bright red 1/2" vacuum fluorescent display for Weight, Unit Price and Total price. Three displays are on the operators side of the scale as well as three displays on the customers side. Keypad 0-9 for entering prices. Function keys for 200g/1/2, 100g/1/4, ENTER/ACCUM, CLEAR, PRESET PRICE, PREPACK. 1/2 lb and 1/4 lb price multiplier feature. Includes RS232 serial interface. **Stainless Steel** platform size 13.5"W x 8-3/4"D. Overall size 13.3"W x 12"D x 4"H. 120 VAC, 10 watt. NTEP 88-028 III 3,000 div.

Part Number	Capacity	Weight	Stock	Price C
PC-10	6 lb x 0.002 lb	21 lb	4030	\$ 807.00
PC-20	15 lb x 0.005 lb	21 lb	4031	807.00
PC-30	30 lb x 0.01 lb	21 lb	4032	807.00



**PC-30**  
Computing Scale

# TOR \* REY

## PC40L Price Computing Scale

More precise with 0.005 lb resolution. Highly sanitary stainless steel construction. Alphanumeric Liquid Crystal display for Weight, Price per pound and Total price. Three displays are on the operators side of the scale as well as three displays on the customers side. Keypad 0-9 for entering prices. Keys for ON/OFF. (15) direct access memory keys. (100) price memories. 1/2 lb and 1/4 lb price multiplier feature. Includes RS232 serial interface. Rechargeable battery, 200 hrs approx, included. **Stainless Steel** platform size 14"W x 11"D. Overall size 13-15/16"W x 14-3/16"D x 5-5/8"H. 120 VAC. NTEP 95-041 III 8,000 div.

Part Number	Capacity	Weight	Stock	Price B5
PC-40L	40 lb x 0.01 lb	19 lb	1269	\$ 350.00
PC-40LT w/ Tower	40 lb x 0.01 lb	26 lb	1270	370.00

Options				B5
Z-21900706 AC adapter for PC40L	1 lb	1540	12.00	

Service Parts				B5
Z-21900003 rechargeable battery	2 lb	1272	30.00	



**PC-40L**  
Computing Scale

Prices are subject to change without notice. Please call for current prices.

Other items are available from the manufacturers, please call for prices.

99 Reagent Lane  
Fair Lawn NJ 07410  
201-797-2718 \* 800-631-0347

**Totalcomp**  
Scales & Balances

www.totalcomp.com  
Fax 201-797-2287  
Toll Free Fax 888-797-2288



CBK  
Over/Under

## CBK Checkweighing Scale

Handles basic weighing, parts counting and checkweighing. Backlit display and graphic capacity tracker to show how much weighing range has been used or is available. Amber green and red indicators make checkweighing applications trouble free and show the operator if a sample is under, over or within the preset limits. CBK is powered by AC adapter or a built in rechargeable battery pack making it ideal for production, warehouse or field use. **Stainless steel** platform 8.9" x 10.8". 12.4"L x 14"W x 4.3"H.

Part Number	Capacity	Platform	Weight	Stock	Price B5
CBK 8a	8 x 0.0002 lb	4 kg x 0.1 g	11 lb	3718	\$ 395.00
CBK 16a	16 x 0.0005 lb	8 kg x 0.2 g	11 lb	3719	395.00
CBK 16aH	16 x 0.0002 lb	8 kg x 0.1 g	11 lb	3720	495.00
CBK 35a	35 x 0.001 lb	16 kg x 0.5 g	11 lb	3721	395.00
CBK 70a	70 x 0.002 lb	32 kg x 1 g	11 lb	3722	395.00
CBK 100a	100 x 0.005 lb	48 kg x 2 g	11 lb	3723	395.00
CBK 8a w/ USB	8 x 0.0002 lb	4 x 0.1 g	11 lb	3724	470.00
CBK 16a w/ USB	16 x 0.0005 lb	8 kg x 0.1 g	11 lb	3725	470.00
CBK 16aH w/ USB	16 x 0.0002 lb	8 kg x 0.1 g	11 lb	3726	570.00
CBK 35a w/ USB	35 x 0.001 lb	16 kg x 0.5 g	11 lb	3727	470.00
CBK 70a w/ USB	70 x 0.002 lb	32 kg x 1 g	11 lb	3728	470.00
CBK 100a w/ USB	100 x 0.005 lb	48 kg x 2 g	11 lb	3729	470.00

### Options

302000001 hand carrying case with lock		3 lb	3730	<b>A5</b> \$ 85.00
--	--	------	------	-----------------------



## 4300 Excel Checkweigher Scale

Stainless steel construction. Unique "Quad Spring" base design eliminates most common load cell damage. 6 digit, 0.56" red LED. Keys are: ZERO, PRINT, UNITS, OVER, UNDER. Weighing Units are: g, lb, kg, oz, lb:oz. Indicators are: g, lb, kg, oz, over, accept, under, neg, zero, mot. 3 or 5 zone checkweighing operations. Shock and overload are protected up to 10 times capacity. Rugged touch panel resists moisture and puncture damage. RS232 bi-directional interface. 115 VAC, 50/60 Hz. 2 year warranty. Canadian approved AM-5201 & AM-5241  
 NTEP (indicator) CC #97-038A1 Class III 10,000 div  
 NTEP (base) CC #97-097A1 Class III 5,000 div

Part Number	Capacity	Platform	Weight	Stock	Price B5
4302-C14	2 x 0.0005 lb	10" x 10"	26 lb	6190	\$ 1,387.00
4305-C14	5 x 0.001 lb	10" x 10"	26 lb	3680	1,387.00
4310-C14	10 x 0.002 lb	10" x 10"	26 lb	3681	1,387.00
4325-C14	25 x 0.005 lb	10" x 10"	26 lb	3682	1,387.00
4350-C14	50 x 0.01 lb	10" x 10"	26 lb	3683	1,387.00
4350/12S-C14	50 x 0.01 lb	12" x 12"	30 lb	3684	1,520.00
43100/12S-C14	100 x 0.02 lb	12" x 12"	30 lb	3685	1,520.00
4350/15-C14	50 x 0.01 lb	15" x 15"	45 lb	5412	1,758.00
43100/15-C14	100 x 0.02 lb	15" x 15"	45 lb	5413	1,758.00
43200/15-C14	200 x 0.05 lb	15" x 15"	45 lb	5414	1,758.00

### Options

EXOPT118 RS232 Serial Data Output w/ 4 wire shielded cable, 10 ft, pigtail ends	1 lb	6100M	86.60	<b>C</b>
EXOPT119 RS232 Serial Data Output w/ 4 wire shielded cable, 10 ft, 9 pin female D connector	1 lb	6175M	100.00	
EXOPT148 RS232 Serial Data Output w/ 4 wire shielded cable, 10 ft, 25 pin female connector	1 lb	6228M	100.00	
EXOPT115 Remote switch for ZERO, non washdown	1 lb	6260M	120.00	
EXOPT116 Remote switch for PRINT, non washdown	1 lb	6261M	120.00	
EXOPT117 Remote switch for UNITS, non washdown	1 lb	6262M	120.00	
EXOPT136 Stainless steel load cell for 10" x 10" base	2 lb	6270M	260.00	
EXOPT137 Stainless steel load cell for 12" x 12" base	2 lb	6283M	300.00	
EXOPT138 Stainless steel load cell for 15" x 15" base	2 lb	6284M	300.00	
EXOPT147 External DC power (12VDC)	3 lb	6306M	266.00	

### Service parts

4300M Digital Weight Indicator only	9 lb	6216MB	740.00	<b>C</b>
-------------------------------------	------	--------	--------	----------



4300 Checkweigher  
Over/Under





2200CW  
Over/Under



## 2200CW Over/Under Scale

Expansive 250 product ID database, versatile communications, powerful control options and outstanding PC support software in a simple to use, technologically advanced and extremely rugged package. Quad spring base. Heavy duty 304 stainless steel construction and NEMA 4X classification for washdown protection. 6 digit red LED. Keys for: TARE, GROSS/NET, ZERO, PRINT, UNITS, ACCUM, CLEAR, PROD ID, SET POINT, OVER, UNDER, ENTER, DECIMAL POINT, NUMERIC KEYPAD 0-9. Indicators for net, zero, batt, mot, over, under, accept. Units are lb, oz, kg, g/lb/oz. Two programmable inputs. Two configurable bidirectional RS232 serial ports. Eight digital outputs. 2 year warranty.

NTEP 06-101, III, 10,000 div (2200CW)

NTEP 97-097A1 (15" x 15")

NTEP 05-062 (18" x 18", 18" x 24", 24" x 24")

Part Number	Capacity	Platform	Weight	Stock	Price C
<b>14" column</b>					
22002CW	2 x 0.0005 lb	10" x 10"	21 lb	7301	\$ 1,435.00
22005CW	5 x 0.001 lb	10" x 10"	21 lb	7302	1,435.00
22010CW	10 x 0.002 lb	10" x 10"	21 lb	7303	1,435.00
22025CW	25 x 0.005 lb	10" x 10"	21 lb	7304	1,435.00
22050CW	50 x 0.01 lb	10" x 10"	21 lb	7305	1,435.00
22050CW/12	50 x 0.01 lb	12" x 12"	26 lb	7306	1,575.00
22100CW/12	100 x 0.02 lb	12" x 12"	26 lb	7307	1,575.00
22050CW/15	50 x 0.01 lb	15" x 15"	45 lb	7308	1,795.00
22100CW/15	100 x 0.02 lb	15" x 15"	45 lb	7309	1,795.00
22200CW/15	200 x 0.05 lb	15" x 15"	45 lb	7310	1,795.00
<b>20" column</b>					
APS22050CW/15*	50 x 0.01 lb	15" x 15"	30/41 lb	7311	1,995.00
APS22100CW/15*	100 x 0.02 lb	15" x 15"	30/41 lb	7312	1,995.00
APS22200CW/15*	200 x 0.05 lb	15" x 15"	30/41 lb	7313	1,995.00
APS22100CW/18S*	100 x 0.02 lb	18" x 18"	11/67 lb	7314	2,140.00
APS22250CW/18S*	250 x 0.05 lb	18" x 18"	11/67 lb	7315	2,140.00
APS22500CW/18S*	500 x 0.1 lb	18" x 18"	11/67 lb	7316	2,140.00
APS22250CW/1824*	250 x 0.05 lb	18" x 24"	30/75 lb	7317	2,240.00
APS22500CW/1824*	500 x 0.1 lb	18" x 24"	30/75 lb	7318	2,240.00
APS22250CW/2424*	250 x 0.05 lb	24" x 24"	30/86 lb	7319	2,540.00
APS22500CW/2424*	500 x 0.1 lb	24" x 24"	30/86 lb	7320	2,540.00
APS22100CW/2424*	1000 x 0.2 lb	24" x 24"	30/86 lb	7321	2,540.00

\* sent in (2) boxes.

### Service Parts

			C
2200CW Digital weight indicator	6 lb	7322	795.00
SUB0869 keypad (12)screws 2200CW	1 lb	7018	120.00
SUB0663 keypad (4)screws 2200CW	1 lb	7019	200.00

### Options

			C
EXOPT118 RS232 10' cable w/ pigtailed	1 lb	6100M	86.60
EXOPT148 RS232 10' cable 25 pin D female	1 lb	6228M	100.00
EXOPT119 RS232 10' cable 9 pin D female	1 lb	6175M	100.00
EXOPT147 External DC power 12VDC	3 lb	6306M	266.00
EXOPT136 Stainless steel load cell for 10" base	2 lb	6270M	260.00
EXOPT137 Stainless steel load cell for 12" base	2 lb	6283M	300.00
EXOPT138 Stainless steel load cell for 15" base	2 lb	6284M	300.00
EXOPT115 Remote ZERO switch	1 lb	6260M	120.00
EXOPT116 Remote PRINT switch	1 lb	6261M	120.00
EXOPT117 Remote UNITS switch	1 lb	6262M	120.00

Prices are subject to change without notice. Please call for current prices.

Other items are available from the manufacturers, please call for prices.



A&D WEIGHING DIVISION

**FS-i Over/Under Scale**

Stainless steel construction. Three resolution levels. Large bright comparator lights. 4 function analog sweep display. 99 item data memory. Programmable Tare. Easy to read backlight LCD display. Weighing units are: lb, kg, lb-oz, oz. RS 232/comparator output option. Optional rechargeable battery. 2 year warranty.

NSF certified

Part Number	Capacity	Pan Size	Weight	Stock	Price C
FS-6Ki	15 x 0.005 lb	9.8" x 9.8"	24 lb	3574	\$ 1,180.00
FS-15Ki	35 x 0.01 lb	9.8" x 9.8"	24 lb	3575	1,180.00
FS-30Ki	70 x 0.02 lb	15" x 11.8"	24 lb	3576	1,385.00

**Options**

HC-06i Rechargeable battery pack	1 lb	6786M	43.00	<b>B</b>
FS-C 17.5" Extension column (Only for FE-30Ki)	1 lb	3582	171.00	<b>B5</b>
FS-01i Wall mount bracket	1 lb	3583	63.00	
FS-03i RS 232C & Comparator output	1 lb	3584	128.00	

**Service Parts**

FS-D Indicator	1 lb	4005MB	902.00	<b>C</b>
PZ:2455B main board	1 lb	3586	446.00	

**Load Cells**

LC:FS6K	3 lb	1144	495.00	<b>A8</b>
LC:FS15K	3 lb	1145	495.00	
LC:FS30K	3 lb	1146	495.00	

Sep



**FS-15Ki  
Over/Under**



**FS-30Ki  
Over/Under**



**CIM In Motion Checkweigher**

Mild steel construction, epoxy paint. In-motion conveyor scale. Anti-static polyester fabric conveyor belt. Up to 200 ft. per minute belt speed. Package weight up to 200 lb. 1/2 horsepower AC fixed speed motor 230/460 VAC 3 PH, 50/60 Hz. Must add indicator. Suggest Cardinal 225 or Cardinal 825. Custom software is available. \$ 200/hr minimum (4) hours. 48"L x 24"W x 32"H

Part Number	Capacity	Weight	Stock	Price A9
CIM-100	100 lb x 0.01 lb	200 lb	5251	\$ 10,249.00
CIM-200	200 lb x 0.02 lb	200 lb	5252	10,249.00



**CIM-100  
Over/Under**

Prices are subject to change without notice. Please call for current prices.

Other items are available from the manufacturers, please call for prices.

99 Reagent Lane  
Fair Lawn NJ 07410  
201-797-2718 \* 800-631-0347

**Totalcomp**  
Scales & Balances

www.totalcomp.com  
Fax 201-797-2287  
Toll Free Fax 888-797-2288

# Over/Under



CK-10  
Over/Under

**FIRST-WEIGH**  
MANUFACTURING

## CK-10 Over/Under Scale

Service parts only for First-Weigh CK-10.

Part Number	Weight	Stock	Price C
<b>Service Parts</b>			
Display board for CK-10	1 lb	3990	\$ 105.75
Leveling foot for CK-10	1 lb	3994	12.90



TLC  
Over/Under



**TANITA**

## TLC Over/Under Scale

Weighing scale with electronic strain gauge load cell. Over/Under (Hi-Lo) function. Push button TARE. Large(5/8") liquid crystal display(LCD) can be selected to lb or kg. Over/Under mode will give an audible tone above the low set point and below the high set point weight. This means that the tone will only sound when the item on the scale platform is at the correct weight. Self contained, battery operated with (6) size "C" batteries(not included) or AC adapter 9VDC, 300ma output (included). Splash proof construction with **stainless steel** platform size 8-3/4" x 8-3/4". Overall size 9-1/2" x 12-3/8" x 3-1/4"H. USDA Approved. NTEP 93-078 III 3,000 div.

Part Number	Capacity	Weight	Stock	Price C
TLC-060A	6,000 x 2g 12 x 0.005 lb	9 lb	2444	\$ 385.00

<b>Service Parts</b>				<b>C</b>
Adapter 120VAC to 9VDC, 200ma	1 lb	2446	97.70	

Prices are subject to change without notice. Please call for current prices.

Other items are available from the manufacturers, please call for prices.



## TC-200 Counting Scale

Service parts only for Totalcomp TC-200.

Part Number	Weight	Stock	Price C5
<b>Service Parts</b>			
Level foot	1 lb	6113M	\$ 5.00
GH645 Battery, lead acid rechargeable 60 hours	4 lb	6114M	39.10
Stainless steel platform 10"x12"	5 lb	6115M	50.00
Keysheet, specify model and capacity	1 lb	6329	25.00
Display control board for TC-200	1 lb	5210	260.00
Power A/D board for TC-200	1 lb	5211	140.00
Display control board for TC-220	1 lb	5212	340.00
Power A/D board for TC-220	1 lb	5213	260.00
Battery box, plastic cover, cable assembly	1 lb	5220M	44.00
AC Power fuse socket	1lb	5221M	36.00



TC-220  
Counting Scale



ST-64 Sample pan



## TC-290 Coin Counting Scale

Service parts for TC-290 coin counting scale only.

Part Number	Weight	Stock	Price C5
<b>Options</b>			
Coin sorter	2 lb	6128	\$ 32.00
ST-64P Sample pan, plastic, triangular	2 lb	6109M	18.50
(1) RS232 output for printer, remote display, PC	1 lb	6110	100.00
(2) RS232 output for printers, remote displays, PCs	1 lb	6529	225.00
(1) RS232 (1) Relay output for light tower, 9 pin	1 lb	6530	225.00
Light tower Yellow Green Red w/9 pin conn	8 lb	6531	295.00
Relay output for light tower only, w/terminals	1 lb	6111	125.00
Carry case for TC series	9 lb	6139	95.00
<b>Service Parts</b>			
Level foot	1 lb	6113M	5.00
GH645 Battery, lead acid rechargeable 60 hours	4 lb	6114M	39.10
Stainless steel platform 10"x12"	5 lb	6115M	50.00
Display control board for TC-290	1 lb	5216	340.00
Power A/D board for TC-290	1 lb	5217	140.00
Display control board for TC-292	1 lb	5218	380.00
Power A/D board for TC-292	1 lb	5219	300.00
Battery box, plastic cover, cable assembly	1 lb	5220M	44.00
AC power fuse socket	1 lb	5221M	36.00



TC-290-60  
w/optional sample pan

Note: Load cells are listed with TC-210 Universal Bench scale.

Prices are subject to change without notice. Please call for current prices.

Other items are available from the manufacturers, please call for prices.

# NEW



**TCM2 Series  
Counting Scale**

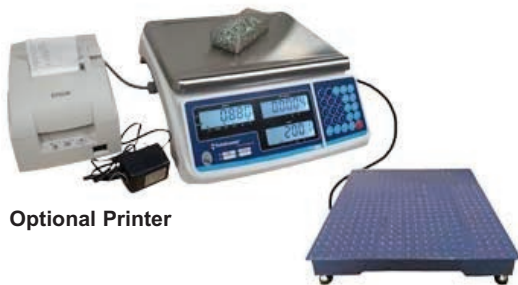

**Optional Printer**

**Optional second Base**

## TCM2 Counting Scale

Your perfect solution for your everyday high accuracy counting. The TCM2 is a single platform counting scale and includes a free connection for a second platform. The second platform can be added at any time and have either a larger or smaller capacity. This is important if you are counting large amounts such as on a pallet which cannot be placed on the main platter. Large 0.7" LCD blue back lighted display. TCM2 has 256 items memory locations for individual piece weight, tare weight and units (lb or kg). Three displays for WEIGHT, PIECE WEIGHT, COUNT. Front panel audible and tactile feedback keys for: ON/OFF, 0-9 KEYPAD, NET/GROSS, SCALE 1-2, UNIT, PCS, PcWt, ST.UTP, RC.UTP, PRINT, TARE, CLEAR, ENTER, EXIT. Annunciators for: Zero, Stable, Tare, Gross, Net, Print, Kg, Lb, Scale, 1-2, CHG, AC. Stainless steel platter 9" x 13" with spill guard. Front bubble level and adjustable rubber feet for easy leveling. Rechargeable battery included. Battery operating time is 60 hours. Time and date, RS232 output. 110 VAC power supply.

Part Number	Capacity	Pan	Weight	Stock	Price C5
TCM2-15	15 x 0.0005 lb	9" x 13"	14 lb	5902	\$ 307.00
TCM2-30	30 x 0.001 lb	9" x 13"	14 lb	5903	307.00
TCM2-60	60 x 0.002 lb	9" x 13"	14 lb	5904	307.00

### Service Parts

Part	Weight	Stock	Price C5
Keypad board for TCM2	1 lb	4375	74.50
Keypad overlay for TCM2	1 lb	4376	27.80
Display board for TCM2	1 lb	4422	105.00
Display overlay for TCM2	1 lb	4423	41.70
Main board for TCM2	1 lb	4432	177.00
AC adapter 12 VDC/600mA For TCM2	1 lb	4433	52.00
Battery lead acid	4 lb	6114MB	39.10
Stainless steel platter cover for TCM2	3 lb	4439	97.30
Plastic cover for TCM2	2 lb	4440	55.60
Leveling foot, each set of (4) for TCM2	1 lb	4518	18.00





A&D WEIGHING DIVISION

# Counting

## HCi Counting Scale

Simple and easy operation with high performance counting function. Keys are: ON OFF, ZERO, KEYBOARD TARE, TARE, ID, KEYBOARD, SAMPLE, STORE UNIT WEIGHT, ENTER, PRINT, TOTAL, M+, \*, RESET, 0-9, C. 7 segment LCD. Navigation system with LED for easy and simple operation. Up to 99 unit weights ID memory function. Auto power OFF function. Automatic Counting Accuracy Improvement (ACAI). Audible Weighing Assist (AWA) beeping function. Detachable display unit. Comparator function with "HI", "OK", "LO" display. Accumulation function. Universal Flex Coms function. Full digital calibration function. 120 VAC AC adapter. Platform size 11.8" x 8.3". Overall size 12.4"W x 13"D x 5"H.



HC-6Ki Counting Scale

Part Number	Capacity	Weight	Stock	Price C
HC-3KA	6 x 0.001 lb	11 lb	3212	\$ 560.00
HC-3Ki	6 x 0.001 lb	11 lb	6780	700.00
HC-6Ki	15 x 0.002 lb	11 lb	6781	700.00
HC-15Ki	30 x 0.005 lb	11 lb	6782	700.00
HC-12KA	30 x 0.005 lb	11 lb	3214	560.00
HC-30Ki	60 x 0.01 lb	11 lb	6783	700.00

### Options

				B5
HC-03i RS 232C		1 lb	6784	77.00
HC-04i RS 232C Relay output		1 lb	6785	97.00
HC-06i Rechargeable Battery Pack		1 lb	6786M	43.00
HC-08i Extension cable		1 lb	6787	53.00



A&D WEIGHING DIVISION

## HD Counting Scale

High performance, affordable, great features. A version is for simple operation w/one LCD display. B version has 10-key pad for entry of tare weight, piece weight and sample size w/three LCD displays for WEIGHT, UNIT-WEIGHT, COUNT. Key functions are /TOTAL, SAMPLE, ENTER/M+PRT, MODE/RESET, ZERO, TARE. Counting resolution 1/240,000 max count 120,000. Automatic Counting Accuracy Improvement. Optional rechargeable battery pack. Standard with 120 VAC AC adapter and (6) 'C' batteries. Platform size 8.5" x 11.57"(HC), 11.81" x 14.96"(HD). Overall size is 12.6" x 13" x 4.65"H(HC), 16.18" x 18.5" x 4.72"H(HD).



HD-12KA Counting Scale

Part Number	Capacity	Weight	Stock	Price C
<b>Detachable display head</b>				
HD-12KA	30 x 0.005 lb	26 lb	3221	\$ 1,040.00
HD-30KA	60 x 0.01 lb	26 lb	3222	1,040.00
HD-60KA	120 x 0.02 lb	26 lb	3223	1,040.00
HD-12KB w/keypad	30 x 0.005 lb	26 lb	3224	1,145.00
HD-30KB w/keypad	60 x 0.01 lb	26 lb	3225	1,145.00
HD-60KB w/keypad	120 x 0.02 lb	26 lb	3226	1,145.00

### Options

				B5
HD-03 RS232 output for HD Series		1 lb	3227	140.00
HD-04 Comparator output for HD Series		1 lb	3228	175.00
HD-05 20ma current loop output for HD Series		1 lb	3229	120.00
HD-06 Carrying handle for HD Series		2 lb	3230	87.00

### Service Parts

				A
TB:662 AC adapter 120VAC		1 lb	1305MB	43.00
TB:164 AC adapter 220VAC		1 lb	4612M	53.00

Prices are subject to change without notice. Please call for current prices.

Other items are available from the manufacturers, please call for prices.

99 Reagent Lane  
Fair Lawn NJ 07410  
201-797-2718 \* 800-631-0347

**Totalcomp**  
Scales & Balances

www.totalcomp.com  
Fax 201-797-2287  
Toll Free Fax 888-797-2288



A&D WEIGHING DIVISION



**FCi  
Counting Scale**

## FCi Counting Scale

High resolution: FC-Si has 1/5,000,000 internal and 1/20,000 display. FC-i has, 1/1,000,000 internal and 1/10,000 display. Four bright easy to read fluorescent displays for weight, average piece weight, piece count, item code, tare weight and accumulator. Durability for use in industrial environments. 500 Memories (with 6 digit ID) for unit weights, tare weights, alphanumeric names/codes (12 digits), accumulators & comparator limits. Standard RS232 interface with optional 2nd and 3rd RS232. Optional remote scale connector. Optional NiMH battery packs runs for up to 10 hours between charges. 120VAC. 12.5"W x 17"D x 3.66"H

Part Number	Capacity	Pan	Weight	Stock	Price C
FC-500Si	1 x 0.00005 lb	5" x 5"	19 lb	6129	\$ 1,750.00
FC-5000Si	10 x 0.0005 lb	6.5" x 6.5"	19 lb	6130	1,750.00
FC-500i	1 x 0.0001 lb	6" x 8"	19 lb	6523	1,285.00
FC-1000i	2 x 0.0002 lb	6" x 8"	19 lb	6524	1,285.00
FC-2000i	5 x 0.0005 lb	11" x 11.8"	19 lb	6525	1,285.00
FC-5000i	10 x 0.001 lb	11" x 11.8"	19 lb	6131	1,285.00
FC-10Ki	20 x 0.002 lb	11" x 11.8"	19 lb	6132	1,285.00
FC-20Ki	50 x 0.005 lb	11" x 11.8"	19 lb	6133	1,285.00
FC-50Ki	100 x 0.01 lb	11" x 11.8"	21 lb	6134	1,285.00
<b>Options</b>					<b>A</b>
FC-02i	Rechargeable NiMH battery pack for FCi		5 lb	6135	415.00
FC-03i	Second & third RS232 for FCi		1 lb	6136	230.00
FC-04i	RS232/Comparator/relays/Buzzer for FCi Can install either FC-03i or FC-04i		1 lb	6137	270.00
FC-05i	Remote scale connection for FCi		1 lb	6138	145.00
CC:110	Carrying & storage case for FCi		5 lb	6526	134.00
<b>Service parts</b>					<b>A</b>
TB:136	Adapter 120VAC		2 lb	3000	43.00
TB:137	Adapter 220VAC		1 lb	3001	55.00
08:200776A	keysheet		1 lb	6140	25.00
<b>Previous version</b>					<b>C</b>
FC-1000	2 X 0.0002 lb	6" x 8"	19 lb	2138	995.00



# Counting



**SC10P  
Counting Scale**

## SC Counting Scale

Counting scale with precise 5 digit unit weight calculation. 1,000 items of unit weight memory. Kilogram/pound conversion. Built in count comparator. Bright and easy to read green fluorescent displays for Weight, Unit Weight and Count. Three methods for entry of piece weight; with the keyboard, by weighing the actual sample or with internal memory and tare values. High internal counting resolution 1/100,000. Count comparator function. Count add up function. Keys for ENTRY, SAMPLE, CALL, STORE, M+, TOTAL, ZERO, TARE, g/lb, MODE, SET, PRINT, and 0-9 numeric. Platform size 14.6" x 11". Overall size is 15.3" x 14.4" x 5.9"H. 120 VAC, 10 watt.

Part Number	Capacity	Weight	Stock	Price E
SC-05P	10 lb x 0.002 lb	19 lb	2632	\$ 650.00
SC-10P	25 lb x 0.005 lb	19 lb	2633	650.00
SC-25P	50 lb x 0.01 lb	19 lb	2634	650.00



**EC Series  
Counting Scale**

## EC Series Counting Scale

Counting scale with accurate count and high resolution. Easy to read LCD display and blue backlight. Soft tact keyboard. Function keys for ON/OFF. Units of measure displays kg, g, or lb. 100 unit weight memory and accumulation functions. RS232C interface. Rechargeable battery with 80 hours continuous use, 12 hour recharge time. AC adapter included. Platter size 12"W x 8.74"D. Overall size 13"W x 13.6"D x 4.2"H

Part Number	Capacity	Weight	Stock	Price D
EC-6	6 x 0.0002 lb	12 lb	7441	\$ 495.00
EC-15	15 x 0.0005 lb	12 lb	7442	495.00
EC-30	30 x 0.001 lb	12 lb	7443	495.00
EC-60	60 x 0.002 lb	12 lb	7444	495.00

### Options

DLP-50 Label printer	5 lb	7238M	299.00	<b>A5</b>
YEC1 adapter 12VDC 800 ma must be programmed for EC	1 lb	7476	42.12	



**GFC Series  
Floor Counting Scale**

## GFC Floor Counting Scale

GFC counting scales simplify complex counting applications involving heavier loads. The GFC indicator can be mounted on the enclosed pillar or used on the bench depending on your viewing needs. Splash proof keypad, backlit 3 x 6 inch LCD. Keys for: SAMPLE, MEMORY PLUS, UNIT/WEIGHT/UNIT, PST/ZERO, ON, OFF. Auto calibration through keypad, overload indicator, preset count with alarm, low battery indicator, auto power off. Platform size 15.7" x 19.7". Overall size 16" x 24" x 34". 9 VDC rechargeable battery, 70 hours of operation. 120VAC Power supply adapter supplied as standard. Two year warranty.

Part Number	Capacity	Weight	Stock	Price C
GFC165a	165 lb x 0.01 lb	34 lb	6965	\$ 695.00
GFC330a	330 lb x 0.02 lb	34 lb	6966	695.00
GFC660a	660 lb x 0.05 lb	34 lb	6967	795.00

### Service Parts

302409160 adapter 120 VAC	1 lb	252M	55.50	<b>C</b>
---------------------------	------	------	-------	----------

Prices are subject to change without notice. Please call for current prices.

Other items are available from the manufacturers, please call for prices.



## 7600 Counting Scale

Heavy duty cast construction. Full numeric keyboard for entry of Tare weight, 6 digit ID, Sample quantity and Average piece weight. Easy one button counting. Auto sample update for improved accuracy. 1 part in 1 million internal resolution. Bright green LED display with time and date. Weight is displayed in two different units of measure and count. Keys for ZERO, SAMPLE SET, GROSS/NETT, TARE, PIECE WEIGHT, KEYPAD TARE, 0-9 KEYPAD, BASE, UNITS, PRINT, CLEAR, %, CHECK, ON/OFF, ENT. RS232 base for larger or smaller loads. Optional battery for portable operation.

120VAC, 15.5"W x 14"D x 5.25"H.

NTEP 91-149, III 10,000 div

Part Number	Capacity	Pan	Weight	Stock	Price C
7600-2	2 x 0.0002 lb	8" x 8"	17 lb	6554	\$ 995.00
7600-5	5 x 0.0005 lb	8" x 8"	17 lb	6555	995.00
7600-10	10 x 0.001 lb	12" x 14"	17 lb	6556	995.00
7600-20	20 x 0.002 lb	12" x 14"	17 lb	6557	995.00
7600-50	50 x 0.005 lb	12" x 14"	17 lb	6558	995.00
7600-100	100 x 0.01 lb	12" x 14"	17 lb	6559	995.00
7600-150	150 x 0.02 lb	12" x 14"	17 lb	6560	995.00
7600-200	200 x 0.02 lb	12" x 14"	17 lb	6561	995.00

### Options

57570 Battery pack, factory installed, AC/DC	6 lb	6551M	195.00	<b>B5</b>
56750-5 Ball top transfer plate for 50 lb cap and higher	12 lb	6552M	235.00	
57834 Remote base option Dual scale counting	1 lb	6562	275.00	
48445 Base connector kit*	1 lb	6678	40.00	

### Service Parts

57520 12VDC Battery pack	4 lb	6553M	95.00	<b>B5</b>
57512-3 display board	1 lb	6659M	168.00	

\*Needed w/ Remote base option when connecting to a base that is not a PA model.



**7600**  
Counting Scale



## 7500 Counting Scale

Easy one button counting. Auto sample update for improved accuracy. 1 prt in 1 million internal resolution. Bright green LED display Weight is displayed in two different units of measure and count. Keys for: ZERO, SAMPLE SET, UNITS, PRINT. Optional battery for portable operation. RS232 bidirectional interface for printers, data collection or manifest systems. 120VAC, 15.5"W x 14"D x 5.25"H.

NTEP 91-149, III 10,000 div

Part Number	Capacity	Pan	Weight	Stock	Price C
7500-2	2 x 0.0002 lb	8" x 8"	17 lb	6543	\$ 945.00
7500-5	5 x 0.0005 lb	8" x 8"	17 lb	6544	945.00
7500-10	10 x 0.001 lb	12" x 14"	17 lb	6545	945.00
7500-20	20 x 0.002 lb	12" x 14"	17 lb	6546	945.00
7500-50	50 x 0.005 lb	12" x 14"	17 lb	6547	945.00
7500-100	100 x 0.01 lb	12" x 14"	17 lb	6548	945.00
7500-150	150 x 0.02 lb	12" x 14"	17 lb	6549	945.00
7500-200	200 x 0.02 lb	12" x 14"	17 lb	6550	945.00

### Options

57570 Battery pack, factory installed, AC/DC	6 lb	6551M	195.00	<b>B5</b>
56750-5 Ball top transfer plate for 50 lb cap and higher	12 lb	6552M	235.00	

### Service Parts

57520 12VDC Battery pack	4 lb	6553M	95.00	<b>B5</b>
57512-3 display board	1 lb	6659M	168.00	

Prices are subject to change without notice. Please call for current prices.

Other items are available from the manufacturers, please call for prices.

99 Reagent Lane  
Fair Lawn NJ 07410  
201-797-2718 \* 800-631-0347

 **Totalcomp**  
Scales & Balances

www.totalcomp.com  
Fax 201-797-2287  
Toll Free Fax 888-797-2288



**7500**  
Counting Scale



Ranger 3000

## Ranger 3000 Counting Scale

ABS housing, stainless steel platform, numeric keypad, upfront level indicator, 30 item library. Weighing modes: weighing and parts counting with auto optimization. 3 color LED checkweighing lights, Accumulation, 120VAC power or rechargeable battery(included) 210 hour. RS232 output, auto print setting, auto shut-off.

Part Number	Capacity	Pan	Weight	Stock	Price C5
RC31P1502	3 x 0.0001 lb	8.9" x 11.8"	12 lb	8011	\$ 689.00
RC31P3	6 x 0.0002 lb	8.9" x 11.8"	12 lb	8012	689.00
RC31P6	15 x 0.0005 lb	8.9" x 11.8"	12 lb	8013	689.00
RC31P15	30 x 0.001 lb	8.9" x 11.8"	12 lb	8014	689.00
RC31P30	60 x 0.002 lb	8.9" x 11.8"	12 lb	8015	689.00

### Options

Part Number	Capacity	Pan	Weight	Stock	Price A
30037446	PCBA kit, Second Platform		1 lb	3010M	122.00
30037447	Ethernet kit		1 lb	7968M	122.00
30037448	RS232 kit		1 lb	7969M	122.00
30037449	USB kit		1 lb	3819M	122.00
30064203	SF40A printer		2 lb	1754M	798.00
80500525	Cable to IBM 9 pin serial		1 lb	3047M	155.00
80850084	Carrying case for Trooper		5 lb	4856M	304.00
80850080	TAL Software WinWedge v1.2		1 lb	2436M	437.00

Sep

# NEW



EC-2 Series



## EC2 Counting Scale Dual Channel

Designed with CAS reliability, the EC-2 Series Counting Scale stands alone its field. High accuracy and simple to use. Optional label or receipt printer. Great for use in manufacturing, parts shops, hardware stores, etc. Easily Connects Second Platform to Expand Capacity. Save Up to 200 Presets. Up to 4 External Devices can be used simultaneously. Lb/kg or Lb/g Switchable

Part Number	Capacity	Weight	Stock	Price D
EC2-6	6 x 0.0002 lb	10 lb	297	\$ 595.00
EC2-15	15 x 0.0005 lb	10 lb	298	595.00
EC2-30	30 x 0.001 lb	10 lb	299	595.00
EC2-60	60 x 0.002 lb	10 lb	300	595.00

Nov



**NEW**

**Ranger 4000 Counting Scale**

Sturdy cast aluminum housing for tough industrial weighing. 1,500,000 internal count, 30 item library. Weighing modes: weighing, part counting with optimization, check weighing and accumulation. LCD display, 3 color check weighing LEDs. 120 VAC power or rechargeable battery (included). RS232 output, **stainless steel** platform, up front level indicator, adjustable leveling feet, auto-print settings. Indicators for: stability, overload, underload and low battery. Auto tare, Auto shut-off.

Part Number	Capacity	Pan	Weight	Stock	Price C5
RC41M3	6 x 0.0002 lb	8.9" x 11.8"	16 lb	8007	\$ 815.00
RC41M6	15 x 0.0005 lb	8.9" x 11.8"	16 lb	8008	815.00
RC41M15	30 x 0.001 lb	8.9" x 11.8"	16 lb	8009	815.00
RC41M30	60 x 0.002 lb	8.9" x 11.8"	16 lb	8010	815.00

**Options**

Sep		Weight	Stock	Price C5	A
	30037446 PCBA kit Second Platform	1 lb	3010M	122.00	
	30037447 Ethernet kit	1 lb	7968M	122.00	
	30037448 RS232 kit	1 lb	7969M	122.00	
	30037449 USB kit	1 lb	3819M	122.00	
	30064203 SF40A printer	2 lb	1754M	798.00	
	80500525 Cable to IBM 9 pin serial	1 lb	3047M	155.00	
	80850080 TAL Software WinWedge v1.2	1 lb	2436M	437.00	



Range 4000

Prices are subject to change without notice. Please call for current prices.

Other items are available from the manufacturers, please call for prices.

99 Reagent Lane  
Fair Lawn NJ 07410  
201-797-2718 \* 800-631-0347



www.totalcomp.com  
Fax 201-797-2287  
Toll Free Fax 888-797-2288

# Counting



**2240-20**  
Counting scale w/ optional remote scale and optional printer



## 2240 Counting Scale

Very simple interface to a label printer. Dual channel for second and output for a label printer is standard. The remote scale can be used either as the sampling scale, the bulk scale or both. This counting scale retains the last average piece weight and recalculates the average piece weight when the sampling size is changed. It stores up to 30 ID numbers, each with it's own tare weight, average piece weight and accumulator. Time and date is standard. Display resolution is 1 part in 10,000. Internal resolution is 1,000,000. Count capacity is 999,999 pieces. Lb/Kg conversion. Two separate displays. One for weight and the other for piece count and data input. Both weight and count can be seen at the same time. Keys for COUNT, SAMPLE, ZERO and PRINT. Overall size 14.5"W x 12"D x 4"H. 90/230 VAC 50/50Hz.

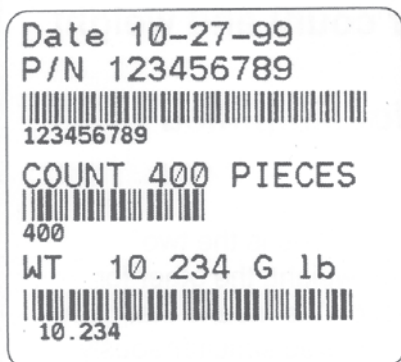

Part Number	Capacity	Pan	Weight	Stock	Price B
2240-5	5 x 0.0005 lb	6" dia	10 lb	4624	\$ 1,426.00
2240-10	10 x 0.001 lb	8.25" x 14.5" dia	10 lb	4625	1,426.00
2240-20	20 x 0.002 lb	8.25" x 14.5" dia	10 lb	4626	1,426.00
2240-50	50 x 0.005 lb	8.25" x 14.5" dia	10 lb	4627	1,426.00
2240-100	100 x 0.01 lb	8.25" x 14.5" dia	10 lb	4628	1,426.00

2240 Label



## C Counting Scale

1/300,000 resolution. Portable, with built-in battery pack. Includes second scale input port for remote base. Sleep mode for extended battery life. Preset count and weight limits, LCD display with backlight. 0.75" high. Units: lb, kg. 15,000 weight divisions. Color-coded key pad and vinyl dust cover. Memory accumulators, weight and piece weight up to 5 digits, count up to 6 digits. 115 VAC 50/60Hz, 11.75"W x 12.63"D x 4.25".



**C-30**  
Counting Scale

Part Number	Capacity	Platform	Weight	Stock	Price A9
C-30	30 x 0.002 lb	8.25" x 11.38"	13 lb	5245	\$ 467.00
C-65	65 x 0.005 lb	8.25" x 11.38"	13 lb	5246	467.00
C-100	100 x 0.01 lb	8.25" x 11.38"	13 lb	5243	467.00

Prices are subject to change without notice. Please call for current prices.

Other items are available from the manufacturers, please call for prices.





TBS-300 w/ 24" x 24" base  
Baggage Scale



## Baggage Scale Kit

This baggage scale indicator kit consists of

- (2) Remote digital weight displays, panel mountable.
- (1) Electronic control unit, high impact plastic, contains power supply and A/D.
- (2) Switches for LB/KG and ZERO/ON/OFF for remote mounting, includes cables for switches.

The remote displays have 0.56" high LEDs, bezels for panel mounting, and 10 ft of heavy duty data cable that connects to the control unit. The indicator kit is factory set up for use with a 300kg 2mv/v load cell. The scale bases offered below are set up for the indicator kit.

Part Number	Capacity	Weight	Stock	Price C
TBS-300 Indicator kit	300 x 0.5 lb	10 lb	537	\$ 819.00

**Bases** Select (1) base for use with the indicator kit above

Part Number	Capacity	Weight	Stock	Price C
<b>24" x 18" Platform x 5.25" High</b>				
TPB-2418-500-CS	500 lb	80 lb	3914MB	1,100.00
<b>24" x 24" Platform x 5.25" High</b>				
TPB-2424-500-CS	500 lb	120 lb	3920MB	1,150.00
<b>30" x 30" Platform x 5.25" High</b>				
TPB-3030-500-CS	500 lb	140 lb	4712MB	1,300.00



TBS Indicator

# Baggage



**64 Baggage scale**  
**24"x24" base**  
**Displays for both agent**  
**and passenger**



**PENNSYLVANIA**

## 64 Baggage Scale

This baggage scale consists of

(1) 24" x 24" x 5"H Stainless steel platform with black painted steel base.

(2) Digital weight displays, panel mounted, with 10' cable each.

Agent display is weight readout and pushbuttons for ZERO, LB/KG, and PRINT.

Passenger display is weight readout only.

Both displays have 0.56" high LEDs, stainless steel bezels for panel mounting, and 10 ft of heavy duty data cable that connects to the scale base. Bezels are 7.25"W x 5.25"H and have (4) mounting holes. Cutout necessary is 5.75"W x 3.5"H. RS232 interface using DB-9 connector. 110VAC 50/60 Hz. Two year warranty.

NTEP 98-013, III 5,000 div

Part Number	Capacity	Weight	Stock	Price C
64-2424 Baggage scale	500 x 0.1 lb	90 lb	3298	\$ 1,695.00

### Service Parts

57409-8 Overlay w/button for 64		1 lb	2688	64.30
49737-6 Level foot 2" dia x 1/2-20		1 lb	310	54.00

Prices are subject to change without notice. Please call for current prices.

Other items are available from the manufacturers, please call for prices.



**NEW**

**DBS Baggage Indicator**

Stainless steel face plate. Outstanding durability and reliability. 6 digit, 0.56" high red LED display. Damage to the electronics from electrostatic discharge generated by the dry airport environment is prevented through advanced electronics design, backed up with extensive testing and decades of field proven reliability. Baggage weight is easily read from up to 20 ft on the large and bright LED display. When baggage is placed on the scale, the displayed weight quickly stabilizes on the main and remote display to support fast passenger check in. The entire scale electronics is contained in the panel mount Main Display. No additional electronics control box to install inside the counter. Simply install the Main and Remote Displays into counter cutouts and connect the foolproof, keyed and locking cables through the counter, strain reliefs ensure that once the cables are connected, they stay connected. For use with scale base ordered separately. Load cell in base should be 2 or 3 mv/v output. Keys for: ZERO (ON/OFF), UNITS. Units are lb or kg. Indicators for: lb, kg, NEG, ZERO, MOT. Bi-directional RS-232. Panel mount display cut out size is 6.5" x 3.3" x 1.75" deep. 115 VAC 60Hz wall mount transformer. UL/ULc (230 VAC optional). 1 year parts and labor. NTEP 05-061 III 5,000 div



**DS100  
Baggage Indicator**



Part Number	Capacity	Weight	Stock	Price B7
DS100BMR Indicator Baggage Kit	300 x 0.5 lb	8 lb	302	\$ 600.00

Select one base for use with indicator kit above.



**DS100  
Remote Display**



**DMS Series Mild Steel Scale Bases**

Heavy gauge steel construction. All square tube construction. Seven overload stops provide 250% protection shielding the load cell from damaging shock. Royal blue Epoxy paint. Four adjustable feet and a bubble level to allow precise leveling in your work area. Two year warranty. NTEP 05-062 Class III 5,000 div



**DMS Series  
Mild Steel Scale Bases**



Part Number	Capacity	Load Cell	Weight	Stock	Price C
<b>18 x 24 Platform x 5.25" high</b>					
DMS4250	250 lb	1260-150kg	71 lb	6858MB	\$ 675.00
DMS4500	500 lb	1260-300kg	71 lb	6859MB	675.00
<b>24 x 24 Platform x 5.25" high</b>					
DMS5250	250 lb	1260-150kg	83 lb	6861MB	795.00
DMS5500	500 lb	1260-300kg	83 lb	6862MB	795.00
DMS51000	1000 lb	1260-500kg	83 lb	6863MB	795.00

Prices are subject to change without notice. Please call for current prices.

Other items are available from the manufacturers, please call for prices.



**NEW**

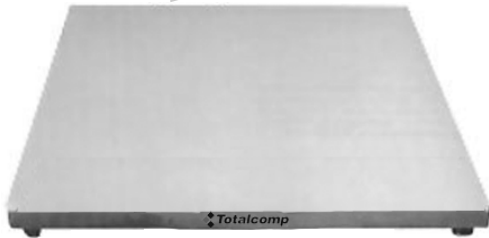

**Hazardous Floor Base**

**Hazardous Floor Base**

High performance powder coated heavy duty floor scale for hazardous environment. Already configured with FM Approved summing box, load cells and hazardous home run cable. Standard features include: Top access FM Approved signal trim junction box. 20ft blue jacket hostile environment load cell cable. 4 NTEP FM Approved alloy steel shear beam load cells. Heavy powder coated diamond safety deck. 4 adjustable mild steel foot. Threaded eye bolt holes for easy lifting. Top holes for easy leveling. NTEP 16-016 Class III 5,000 div

Part Number	Weight	Stock	Price C
T3x3-2.5K	240 lb	8142	\$ 1,229.00
T3x3-5K	240 lb	8143	1,229.00
T3x3-10K	245 lb	8144	1,536.00
T3x4-2.5K	280 lb	8145	1,331.00
T3x4-5K	280 lb	8146	1,331.00
T3x4-10K	285 lb	8147	1,690.00
T4x4-2.5K	370 lb	8148	1,311.00
T4x4-5K	370 lb	8149	1,311.00
T4x4-10K	375 lb	8150	1,311.00
T4x5-2.5K	430 lb	8151	1,433.00
T4x5-5K	430 lb	8152	1,677.00
T4x5-10K	435 lb	8153	1,579.00
T5x5-2.5K	540 lb	8154	1,579.00
T5x5-5K	540 lb	8155	1,872.00
T5x5-10K	545 lb	8156	1,872.00

**Service Parts**

			<b>C</b>
(1) FM J Box & (20)ft FM cable blue Both items shipped in same box	1 lb	7114	272.00



**PS500 Animal Scale**

All stainless steel construction. Rubber slip mat included with each unit. Animals enjoy the slip free surface and are weighed easily. Compact, light weight, accurate and reliable. Weighing modes: lbs, kg. 1" 7 segment LCD display. Hold feature, internal rechargeable batteries, auto power shut off. 8 hours continuous use with full charge. A display bracket is included for desk or wall mounting of indicator. 7VDC NI-MH battery, 15VDC 300mA AC adapter included. Indicator 3.0"H x 22.0"D x 22.0"L Base 10.6"W x 3.5"D x 1.8"H

Part Number	Capacity	Platform	Weight	Stock	Price C
PS500-22S	550 x 0.2 lb	22" x 22" x 2"	35 lb	3414	\$ 485.00
PS500-36S	550 x 0.2 lb	22" x 35.5" x 2"	55 lb	3415	555.00
PS500-42S	550 x 0.2 lb	22" x 42" x 2"	65 lb	3416	655.00

**Service Parts**

AWT05-501533 adapter 9V	1 lb	3409	42.85	<b>C</b>
-------------------------	------	------	-------	----------



**PS500-22S  
Animal Scale**



**TM901 Animal Scale**

Veterinary animal scale. Powder coated steel base available with steel base or stainless steel removable platform cover. 2' large LCD display with blue back light. Rubber mat included for both units for non-slip weighing surface. Compact with handle and transportation wheels. Easy to level with adjustable rubber feet. 300 lb/150 kg capacity. Weighing units: lb, kg, oz. Function keys: Hold, Tare, Zero, ON/Off. Hold function will take measurement even if the animal is moving on the platform. Indicator has ABS enclosure with quick disconnect for load cell and AC adapter. 6' cable from indicator to base. Built in rechargeable battery with 30 hours running time without backlight. Low battery symbol on display will remind you to recharge indicator. Desk or wall mountable. 1 year warranty.

Part Number	Capacity	Platform	Weight	Stock	Price C
TM901-150-SS	150kg x 50g	38" x 20" x 2"	61 lb	4924	\$ 481.00
TM901-150-P	150kg x 50g	38" x 20" x 2"	59 lb	4925	427.00

**Service Parts**

111700067 indicator bracket TM901	2 lb	4920	26.00	<b>C</b>
-----------------------------------	------	------	-------	----------



**TM901  
Animal Scale  
W/ Rubber Mat**



**TM902 Animal Scale**

Light weight, easy to use small animal Veterinary scale. 0.75" LCD display with blue back light. Keys for Tare, Zero, Hold, On/Off. Unit is changeable between kg/lb by pressing the "O" button and holding for 2 seconds. Hold feature for animal weighing while the animal is on the weighing pan the indicator will hold the weight even if the animal is moving on the platform. Stainless steel removable platter. Adjustable feet with front bubble level. Coil cord between indicator and base is 10' in length. In-use cover included. Powered by internal rechargeable battery. AC adapter for charging included.

Part Number	Capacity	Platform	Weight	Stock	Price C
TM902	30 x 0.01 kg	12" x 10"	11 lb	3960	\$ 250.00



**TM902  
Animal Scale**

Prices are subject to change without notice. Please call for current prices.

Other items are available from the manufacturers, please call for prices.

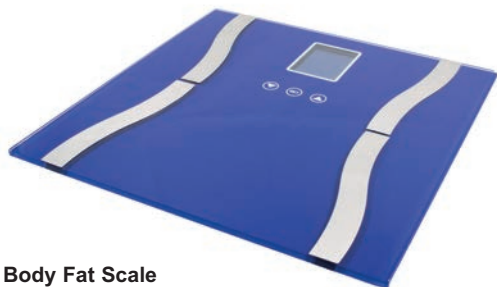

Body Fat Scale

### Body Fat Scale

Enjoy your life every day. Improve your family health. This scale adopts dielectrical impedance analyses technology which allow you to measure body fat, hydration and muscle and bone percentage. Smart memory of up to 12 people.

Part Number	Capacity	Weight	Stock	Price C
Love body fat scale	400 X 0.2 lb	3 lb	6056	\$ 30.00



Body Fat Talking Scale

### Body Fat Talking Scale

Scuff resistant chrome foot pads use true bioelectrical impedance analysis to safely measure body fat in increments of 0.1%. Automatically turns on when you step on scale. Easy to read extra large backlit LCD display. Convenient to use. Just program it once. Pounds or kilograms selectable with switch on back. Left and right keypad buttons for entering data. Set button stores data for up to 10 people. Operates on (1) 9 volt battery (included). Dimensions 13.25" x 11" x 2.25"H.

Part Number	Capacity	Platform	Weight	Stock	Price C
Body Fat Talking Scale	440 x 0.2 lb 200 x 0.1kg	13.25" x 11"	4 lb	6018	\$ 72.00



Talking scale

### Talking Scale

Precision talking bathroom scale. Just tap once. Step on the scale. The scale will tell your weight. This scale is for anyone with poor eyesight, or for those mornings when your eyes are a bit fuzzy. It uses strain gauge technology to be incredibly accurate and precise. Automatically turns on when you tap on the scale. Easy to read extra large backlit LCD display. Scuff resistant matte foot pads. Pounds or kilograms selectable with switch on back. Operates on (1) 9 volt battery (included). Dimensions 13.25" x 11" x 2.25"H.

Part Number	Capacity	Platform	Weight	Stock	Price C
Talking scale	330 x 0.2 lb 150 x 0.1kg	13.25" x 11"	4 lb	6014	\$ 58.00



**TM301 Personal Body Scale**

Digital scale with 550 lb maximum capacity. Resolution of 0.1 lbs is best in class. LCD weight display with blue LED backlight. LCD BMI bar graph for Slim; Normal; Fat. Height rod with dual measurements, inches and mm's. Indicator has 7 function keys Tare, Zero, Unit, Print, BMI, Lock (hold function), on/off. Platform size 14" x 14" with bubble level for easy adjustment. Painted white steel construction can be assembled in minutes with included Allen wrenches. ABS indicator with rechargeable battery pack 2000mAh Ni-MH and 12VDC, 500mA adapter is included.

Part Number	Capacity	Weight	Stock	Price C
TM301 Baby scale	550 x 0.1 lb	34 lb	6325	\$ 492.00



**TM301  
Personal Body Scale**



**TM302 Precision Health Scale**

Painted steel construction. Foot switch for ON/OFF, UNIT in LBS. ABS indicator has LCD display with blue backlight. Bubble level and adjustable feet makes it easy to level in seconds. Platform is 3.1" high. AC adapter 110VAC to 12VDC and 2000mAh Ni-MH battery included.

Part Number	Capacity	Platform	Weight	Stock	Price C5
TM302	500 x 0.2 lb	14.5" x 14.5"	22 lb	4820	\$ 391.00

Service Parts				C	
Foot for Health Scale					
TB-M10-SPB-SS foot M10, 2 1/8" dia		1 lb	7673MB	4.70	



**TM302  
Precision Health Scale**

Prices are subject to change without notice. Please call for current prices.

Other items are available from the manufacturers, please call for prices.

**NEW**



TM101  
Baby Scale



**TM101 Baby Scale**

Light weight, digital scale with unique feeding function for weighing before and after baby feeding. Dual capacity 13/33 lbs x 0.005/0.01 lbs. LCD weight display with blue LED backlight. Units of measure lbs/kg. Horizontal measuring rod with dual measurements, inches and mm's. Indicator has 7 function keys Tare, Zero, Unit, Lock (hold function), on/off and two dedicated keys for before and after feeding. Pan size 23.5"L x 9"W. Bubble level for easy adjustment. ABS indicator with rechargeable battery pack; 2000mAh Ni-MH and 12VDC, 500mA. Adapter included.

Part Number	Capacity	Weight	Stock	Price C
TM101 Baby scale	33 x 0.01 lb	15 lb	6299	\$ 302.00



**MBS Baby Scale**

Low profile design for maximum weighing security. Auto dampening feature ensures accurate readings even when baby is moving. Water resistant construction. Large easy to read wide angle 1" LCD display. Keys for ON/OFF, KG/LB, HOLD. Auto power saving function. Low battery indication. (1) 9V battery (not included) or 120V adapter (included). Base unit 10.8" x 9.8" x 3.4"H. Overall height 6.9"H.

Part Number	Capacity	Tray	Weight	Stock	Price C
MBSCU2 baby	44 lb x 0.5 oz 20 kg x 10 g	20.5" x 11.75"	9 lb	6017	\$ 84.00



MBS-2010  
Baby Scale



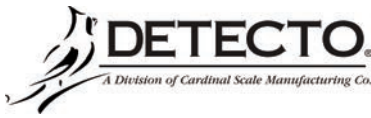

**Portable Personal Scale**

High capacity portable digital scale. 600 lb capacity. LCD weight display. Indicator has keys for ON/OFF, LB/KG, HOLD/RELEASE, ZERO. Auto power off to save batteries. Hold/release of display. Automatic zero. Motion detection. Non-slip rubber mat for comfort and safety. Painted white with stainless steel handrail. (6) "C" alkaline batteries (included). Platform size 14"W x 18"D

Part Number	Capacity	Weight	Stock	Price 6
6855 Digital scale	600 lb x 0.2 lb	70 lb	5977	\$ 2,002.00



**6855  
Portable  
Personal Scale**



**TM501 Portable Wheelchair scale**

Painted steel frame with bolted ABS high strength plastic chair. ABS indicator with LCD display. 7 function keys for ON/OFF, ZERO, TARE, BMI, F, UNITS, LB/KG selectable. Body Mass Index (BMI) function with bar graph, just press BMI and enter patient height and weight, display will show BMI value on LCD screen. Arm rests and handles are standard material made for all wheelchair scales. Foldable foot rest, transport wheels (4), back wheels with brakes. Removable cushion and storage bag included. AC adapter 110VAC to 12VDC and 1800mAh Ni-MH rechargeable battery included.

Part Number	Capacity	Weight	Stock	Price C
TM501	550 x 0.1 lb	92 lb	4826	\$ 794.00

**NEW**



**TM501  
Portable  
Wheelchair Scale**



**TM501  
Portable  
Wheelchair Scale  
w/ Indicator**

Prices are subject to change without notice. Please call for current prices.

Other items are available from the manufacturers, please call for prices.



**6550  
Portable  
Wheelchair Scale**

## 6500 Portable Wheelchair Scale

Lightweight digital foldup scale for heavyweight tasks. Used for wheelchairs, straight legged chairs and walk up traffic. Two sloped ramps allow loading from either side. Nonslip rubber mats cover deck and ramps. Will fold up for easy rolling to a new location or to storage. Vertical fold up feature takes up less storage space when not in use. Switchable to either pounds or kilograms. Indicator has easy to read LCD with auto power off, automatic zero, motion detect, weight lock-in. Keypad for ZERO, UNITS, HOLD/RELEASE. Power is from (6) "C" batteries (included). Platform size is 38"L x 36"W . Size 45"L x 10"W x 38"H when closed for storage.

Part Number	Capacity	Weight	Stock	Price 6
6550	800 lb x 0.2 lb	94 lb	5978	\$ 2,579.00



**CR-1000D  
Portable  
Wheelchair Scale**

## CR Portable Wheelchair Scale

Roll-A-Weigh is portable, easy to use and accurate. Built in handles and wheels. Includes 758C weight indicator that is mounted on the scale. Indicator can be removed and mounted on a wall or desktop with a 10' cable . Platform leveling is done thru the top of the platform. Feet are self aligning for uneven floors. Heavy duty construction with rubber mat on platform. Has a built in ramp on one side. Platform 32.5" x 30"W x 2.5"H. Overall size 32.5"L x 42"W x 4.5"H

Part Number	Capacity	Weight	Stock	Price 6
CR-500D	500 lb x 0.2 lb	113 lb	5979	\$ 2,444.00
CR-1000D	1,000 lb x 0.5 lb	113 lb	5980	2,444.00



**TM701 Portable Handrail Scale**

Accurate, fast and versatile. ABS indicator has front and rear LCD display, also settable to blue backlight. Hand rails on 3 sides. Indicator has 7 function keys for: ON/OFF, ZERO, TARE, HOLD, BMI, F, UNITS, LB/KG selectable. Body Mass Index (BMI) function with bar graph, just press BMI and enter patient weight and display will show BMI value on LCD screen live make it convenient for patient to hold rail while weighing. Painted steel construction can be assembled in minutes. Allen wrenches included. Indicator pole is 48" high. Platform size is 23.5" x 23.5". AC adapter 110VAC to 12VDC and 2000mAh Ni-MH battery included.

Part Number	Capacity	Weight	Stock	Price C
TM701	550 lb x 0.1 lb	94 lb	4860	\$ 941.00



**TM701  
Portable  
Handrail Scale**



**TM503 Portable Wheelchair Scale**

Accurate, fast and versatile. ABS indicator w/ 25mm LCD display and blue backlight. Hand rails on 3 sides. Indicator has 7 function keys for: ON/OFF, ZERO, TARE, HOLD, BMI, F, UNITS, LB/KG selectable. Non slip rubber mat, on and off ramps foldable up to 165 degrees. Handle and wheels for easy transportation around the facility. Live rails make it convenient for patient to hold rail while weighing. Hand rail and indicator pole are foldable for easy storage. Painted steel construction can be assembled in minutes. Allen wrenches included. Indicator pole is 46" high, adjustable indicator angle up to 25 degrees. AC adapter 110VAC to 12VDC and 2000mAh Ni-MH battery included.

Part Number	Capacity	Platform	Weight	Stock	Price C
TM503	550 x 0.1 lb	33" x 33"	104 lb	4831	\$ 1,080.00



**TM503  
Portable Wheelchair Scale**

Prices are subject to change without notice. Please call for current prices.

Other items are available from the manufacturers, please call for prices.



**339**  
**Physician Scale**

## Physician Scale

Pound and kilogram readings on both front and back of the graduated beam. 350 lb capacity and 160 kg capacity. Model 339 has a height rod 30" to 78" and 76cm to 198cm. Model 338 has both a height rod and wheels for easy transport. Platform size 10.5" x 14.5". Overall size 10.5"W x 14.5"D x 59"H.

Part Number	Capacity	Weight	Stock	Price A9
337 Physician	350 lb x 0.25 lb	34 lb	5974	\$ 314.00
338 Physician w/wheels	350 lb x 0.25 lb	39 lb	5975	398.00
339 Physician w/rod	350 lb x 0.25 lb	37 lb	5976	322.00



**400 Physician Scale**

Portable physician scale. Rotating poise bars for dual reading of pounds and kilograms. Rugged zinc die cast beam construction with copper, nickel, chrome plating. Beam graduations are engraved in die casting, paint filled with baked enamel finish. Maximum strength unitized steel base. Precision heavy duty unitized steel lever system with heat treated pivots and vee bearings. Vacuum formed ABS high impact plastic platform cover. Model 402KL has measuring rod 24" to 84" and includes 100 lb and 40kg counterweights to increase capacity to 450 lbs and 200kg. Platform size 10.4" x 14" x 3.4"H. Overall size 18-3/8" x 20-1/4" x 57-3/4"H.

Part Number	Capacity	Weight	Stock	Price C
400KL Physician scale	350 x 0.25 lb 160kg x 100g	37 lb	907	\$ 340.00
402KL Scale w/measuring rod	450 x 0.25 lb 200kg x 100g	40 lb	4324	363.00

Option for 400KL only				C
55070 counterweight to increase capacity to 450 lb		1 lb	1826	87.70



**400KL  
Physician Beam Scale**

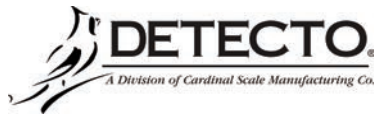

**MS-30**  
Postal Computing Scale



## MS Postal & UPS Rate Computing Scale

Mail room and shipping room scales. Fully supported USPA and UPS services. (15) keys for USPS. (8) keys for UPS. Function keys for COD, COUNT, MAN, ZIP, SET METER, ZERO, OK, ENTER, 0-9. 1/2" blue vacuum fluorescent display. Piece count for bulk mail. Zip to zone conversion. RS232 output for use with postage meter interface. Painted mild steel. 120 VAC, 60 Hz. 15"W x 12.25"D x 4.5"H  
NTEP 91-163

Part Number	Capacity	Platform	Weight	Stock	Price A9
MS-15	15 lb x 0.05 oz	15" x 8.25"	10 lb	4879	\$ 1,335.00
MS-30	30 lb x 0.1 oz	15" x 8.25"	10 lb	4880	1,408.00
MS-100	100 lb x 0.2 oz	15" x 8.25"	10 lb	4881	1,489.00
MS-1600 *	100 lb x 0.1 oz	15" x 8.25"	10 lb	4882	1,489.00

\* Not NTEP



**TRANSCELL TECHNOLOGY, INC.**

**SPS Postal Rate Computing Scale**

Postal rate computing scale. Rates include: 1st Class/Priority mail, Express Mail, Canada letter Airmail, Mexico letter airmail, Other International letter Air mail. Keys for ZERO, 1st, Express, Canada, Mexico, International. Liquid crystal display(LCD). Auto shut off after 5 minutes. AC adapter included 120 VAC, 50/60 Hz, 9 VDC, 100ma. 9.2" x 12.4" x 2.9" H  
 NTEP 97-088 III 960 div (SPS-30)  
 NTEP 10-015 III 2,240 div (SPS-70DL)

Part Number	Capacity	Platform	Weight	Stock	Price C
SPS-30	0-4 lb x 0.1 oz 4-30 lb x 0.5 oz	8.9" x 8.3"	12 lb	220	\$ 369.00
SPS-70DL	0-4 lb x 0.1 oz	10" x 9"	15 lb	3311	895.00



**SPS-30**  
Postal Computing Scale



**SPS-70DL**  
Postal Computing Scale



**NCI**

NCI scales service parts only

Part Number	Capacity	Weight	Stock	Price A5
1148-15536 NCI power supply		1 lb	7637	\$ 69.00

PS D/MT 15VDC 120V 60HZ VL/CSA



**NCI power supply**

Prices are subject to change without notice. Please call for current prices.

Other items are available from the manufacturers, please call for prices.



**TAJ203  
Carat Balance**



**SJX323N/E  
Carat Balance**



**SJX622N/E  
Gold Balance**



**SJX6201N/E  
Gold Balance**



**YA  
Gold Series**

## OHAUS®

### TAJ Carat Balance

Stainless steel platform. Adjustable feet and level bubble. Backlit LCD display. Jewelry weighing modes that include g, ct, oz, dwt, tical, tola, lb, grain, kg, ozt, 3 tael units - Hong Kong, Singapore, Taiwan. Application modes include weighing, parts counting, automatic sample recalibration. Calibration mass included. Battery and AC operation. RS232 output option. AC adapter included.

Part Number	Capacity	Pan	Weight	Stock	Price C5
TAJ203	200 x 0.005 ct	3.5" dia	4 lb	6173	\$ 446.00

## OHAUS®

### SJX Carat Balance

Stainless steel platform. Adjustable feet and level bubble. High contrast LCD display. Jewelry weighing modes that include g, ct, oz, dwt, tical, tola, grain, ozt, 3 tael units - Hong Kong, Singapore, Taiwan. Application modes include weighing, parts counting, display hold, automatic sample recalibration. Integral weigh below hook. Calibration mass included only for Carat and Gold 400g models. Battery and AC operation. USB and RS232 output option. AC adapter included.

Part Number	Capacity	Pan	Weight	Stock	Price C5
SJX323N/E	300 x 0.005 ct	3.5"	4 lb	6174	\$ 750.00
SJX622N/E	400 x 0.01 g	4.7"	4 lb	6710	510.00
SJX6201N/E	6,000 x 0.1 g	4.7"	4 lb	6711	555.00

#### Options

			A
CBM-910 Dot matrix printer	2 lb	7426MB	495.00
STP-103 Compact thermal printer	2 lb	7419MB	622.00
83032107 RS232 interface w/ cable scout	2 lb	6162M	133.00
83032108 USB interface w/ cable	1 lb	6163M	133.00
80251930 Adapter for Scout Pro	1 lb	7425M	27.00
80251934 Adapter	1 lb	7433MB	27.00
30268986 ethernet cable	1 lb	6357	144.00

## OHAUS®

### YA Gold Series

The ultimate in portability. Durable, high quality answer to precision weighing. Perfect for weighing gold and other fine jewelry. Bright blue backlit display. Hinged draftshield cover. SofTouch outer case. Stainless weighing pan.

Part Number	Capacity	Weight	Stock	Price C5
YA102	100 g x 0.01 g	2 lb	6412	\$ 95.00
YA302	300 g x 0.05 g	2 lb	6413	51.00
YA501	500 g x 0.1 g	2 lb	6414	58.00



## OHAUS®

### YJ Carat & Gold Series

The ultimate in portability. Durable, high quality answer to precision weighing. Perfect for weighing fine stones. Bright blue backlit display. Hinged draftshield cover. Carat models include calibration weight and gem scoop.

Part Number	Capacity	Weight	Stock	Price C5
YJ103	100 ct x 0.005 ct	3 lb	6407	\$ 272.00
YJ152	150 ct x 0.01 ct	3 lb	6408	243.00
YJ102	100g x 0.01g	3 lb	6409	198.00
YJ301	300g x 0.1g	3 lb	6410	140.00
YJ501	500g x 0.1g	3 lb	6411	160.00



YJ Carat & Gold Series

## OHAUS®

### JE Jewelry Emerald Scale

Convenient, compact, portable weighing in the palm of your hand. Throw it in a brief case, keep a few on your showcases, or slip it in your pocket. These little scales with sleek styling, convenient size and new higher capacities are ideal to keep anywhere. Jewelry weighing modes include g, oz, dwt, oz t. 1 Year warranty. 100-120 VAC adapter, 3.25"W x 5.35"D x 0.8"H.

Part Number	Capacity	Pan	Weight	Stock	Price C5
JE120	120g x 0.1g	3" dia	3 lb	6520	\$ 149.00
JE250	250g x 0.1g	5" x 5.75"	3 lb	6521	175.00
JE500	500g x 0.1g	5" x 5.75"	3 lb	6522	223.00



JE120 Emerald Jewelry Balance

Prices are subject to change without notice. Please call for current prices.

Other items are available from the manufacturers, please call for prices.

99 Reagent Lane  
Fair Lawn NJ 07410  
201-797-2718 \* 800-631-0347

**Totalcomp**  
Scales & Balances

www.totalcomp.com  
Fax 201-797-2287  
Toll Free Fax 888-797-2288



**JS10 Sapphire  
Jewelry Balance**

## OHAUS®

### Sapphire Jewelry Scale

Based on the successful Scout II. This model is made for jewelers. Easy to use two button operation and a large, high contrast LCD display. With jewelry weighing modes that include g, ct, oz t, dwt and grains, jewelers have the versatility that is needed for appraisals, bench, showcase and inventory applications. Stainless steel pan. 2 Year warranty. 100-120 VAC adapter, 6.75"W x 8.25"D x 2.4"H.

Part Number	Capacity	Pan	Weight	Stock	Price C5
JS10	50 ct x 0.01 ct 10g x 0.002 g	3" dia	5 lb	6515	\$ 375.00

## OHAUS®

### Ruby Jewelry Scale

Compact jewelry scale packs powerful features into a convenient portable package that makes weighing easy. This rugged, dependable scale is attractive and versatile with easy operation, higher weighing capacities, long battery life, and great performance making it a truly remarkable value. Jewelry weighing modes include g, lb:oz, dwt, oz t. This scale has the versatility that is needed for point of purchase, gold sales, inventory and bench jewelry weighing applications. 1 Year warranty. 100-120 VAC adapter, 5.5"W x 8"D x 1.5"H.



**JR300 Ruby  
Jewelry Balance**

Part Number	Capacity	Pan	Weight	Stock	Price C5
JR300	300g x 0.1g	5.25" x 5.75"	4 lb	6518	\$ 141.00
JR2500	2,500g x 1g	5.25" x 5.75"	4 lb	6519	141.00

**LTS SCALE**



**LTEF Lift Truck Scale**

Carriage size: Standard Class II 16" high x 36" wide. Capacity 5,000 lb with 1 lb divisions. Indicator is model DR2100A, dual line, 32 character LCD display with backlight, 0.5" character size. 12 VDC to 48 VDC power is required. Rugged metal enclosure, dust and water resistant. 8.25"L x 3.19"W x 6.69"H. Numeric keypad, APW entry, ID entry, Accumulation register. Universal mounting bracket. Standard coiled load cell cable fro 15 ft lift.

FOB Twinsburg, OH

Part Number	Capacity	Weight	Stock	Price B5
LTEF-16 Class II Lift truck scale	5,000 x 1 lb	400 lb	2744	\$6,503.00

Other models and capacities are available. Please call for a price quote.



**LTEF-16  
Class II  
Lift Truck Scale**



**DR2100A  
Indicator  
Lift Truck Scale**



**Fork lift**



**Coil lift**



**Chute lift**



**Tilt lift**

Prices are subject to change without notice. Please call for current prices.

Other items are available from the manufacturers, please call for prices.

# NEW



TPR  
Pallet Truck Scale



### TPR Pallet Truck Scale

Fast and easy to use. The TPR is great for instant weighing anywhere in your plant. Digital weight indicator programs include accumulation and unit conversion. As soon as your pallet is raised the display will show you the weight. 0.8" white backlit LCD display with 6 function keys: M+, G/N, TARE, ZERO, ON/OFF. Weighing units for: lb/kg. Rechargeable battery provides up to 30 hours of continuous use. AC adapter is also included for charging. Fork dimensions: 47" long, 27" wide, 3.3" high. FOB Fair Lawn NJ

Part Number	Capacity	Weight	Stock	Price B5
TPR-688mm Pallet scale	5,000 x 1 lb	350 lb	2384	\$ 1,675.00

#### Service Parts

				C
Pump assembly		20 lb	4552	457.00
GH645 Battery lead acid rechargeable		4 lb	6114M	39.10
Load cell for TPR-688mm		2 lb	2400	148.00



### PW800 Pallet Weigh Truck Scale

You can check weights anywhere in your plant with this pallet weigh truck. It has a built in load cell weighing system. As soon as you lift the load you know it's weight. There is no need to drive to a scale. It is fast and easy to use for parts counting and taking inventory. Digital weight indicator is 5,000 x 1 lb. (9) "D" cell alkaline batteries or rechargeable nickel-cadmium batteries (not included) will work up to 40 hours. Accuracy is +/-0.1%. Large easy to read .8" LED display. Function keys for TARE, PRINT, lb/kg, ZERO, MODE, SET, ON, OFF. Fork dimensions: 48" long, 27" wide, 3.25" high. FOB Plymouth MN.

Part Number	Weight	Stock	Price B5
PW800-2748 Pallet weigh truck (27" x 48" forks)	275 lb	2670	\$ 3,095.00

#### Options

			B5
100922 RS232 Serial output	1 lb	2672	195.00
100919 internal 120VAC Battery charger	2 lb	2674	355.00
100921 Battery operated printer	6 lb	2676	795.00

#### Service Parts

			B5
330111 Battery pack (3) D cell	2 lb	2671	108.00

Replacement Load Cells: Use any of the following models  
65023, TSB, 5123, 3411, DSB, GSB, NSB, BSA, PA6140



PW800  
Truck Scale



### CPS Pallet Truck Scale

The convenience of a scale in a pallet truck. It is fast and easy to use. Digital weight indicator is a CAS Model CI-2001B with a 6V rechargeable battery. Large easy to read large 1" LCD display. Function keys for ZERO, TARE, GROSS/NET, lb/kg, PRINT, ON, OFF. Fork dimensions: 47.2" long, 27.8" wide, 3.3" high. FOB East Rutherford NJ

Part Number	Capacity	Weight	Stock	Price B8
CPS 1 Pallet truck scale*	3,000 x 1 lb	410 lb	6039	\$ 2,995.00
CPS-2 Pallet truck scale	5,000 x 2 lb	410 lb	6040	2,995.00

\*NTEP 09-003 III 5,000 div

#### Service Parts

				B5
WCP1 cable, battery charger CPS-1	1 lb	6027		24.30
ZCP2 cable, battery charger CPS-2	1 lb	6037		260.00



CPS-2  
Truck Scale



Prices are subject to change without notice. Please call for current prices.

Other items are available from the manufacturers, please call for prices.



## SW Race Car Weigh System

Weighing is easily done by jacking up the car. Insert the scale under wheels. Lower car to weigh. Accuracy is 1/10 of 1%.

**SW system** includes: (4) light duty weigh pads w/ cables, (1) weight indicator, (1) battery recharger, (1) instruction manual. Indicator display is 2 line, 16 characters LCD display. Pushbuttons for ZERO, ON, OFF, PRINT/CONTRAST.

**SW Deluxe system** includes: (4) heavy duty weigh pads w/cables, (1) weight indicator and printer mounted in a waterproof carrying case, (1) battery recharger, (1) instruction manual. Indicator display is 4 line, 20 characters LCD display. Pushbuttons for ZERO, LB/KG, TEST, LIGHT, PRINT, HELP, SET TIME/DATE, ON, OFF.

**RFX PT20 CPU system** includes: CPU, waterproof case, printer, power supply. 15 digit, backlight LCD display. USB/RS232 output. Pushbuttons for SET LATITUDE/ALTITUDE CORRECTIONS, VEHICLE/USER INFORMATION, TIME/DATE STAMP, CONTINUOUS PRINTING, CALIBRATE, ON/OFF, ZERO, ON-DEMAND PRINTING, TARE, PEAK, LB/KG, SET ALARM/TARE/ARM.

**RFX Indicator:** Compatible with LP600, PT300, AX900, CS3000, SW and CW250 scale systems. 4 digit LCD backlight display. Capacity to interface up to 12 scales. 300 ft line of site. Up to 40 hours continuous use before recharge. Standard (AA) batteries. Read only mode. USB/RS232 output. Set latitude/altitude corrections. Pushbuttons for CONTINUOUS PRINTING, CALIBRATE, ON/OFF, ZERO, ON-DEMAND PRINTING, TARE, PEAK, LB/KG. Screens for: Individual Weight, Gross/NET/Tare, Axle Group, Accumulative Total, Center of Balance, Tare. Includes Indicator, rechargeable batteries, battery charger, case.

All indicators are powered by (6) internal "AA" NiCad batteries, except for PT20 CPU which uses "D" cell batteries, which are included.

All indicators will show a minimum of your choice of total weight, left or right side, front or back, or any wheel, also percent by wheel.

Deluxe weighing pads are 35 lb. SW Deluxe indicator case is 17"W x 11"D x 7"H, 10 lb.

Part Number	Capacity	Weight	Stock	Price B
SW-6K Race car system	6,000 x 1 lb	145 lb	4845	\$ 3,795.00
SW-8.8K Race car system	8,800 x 1 lb	145 lb	4846	4,495.00
SW-6K Deluxe race car system	6,000 x 1 lb	155 lb	4847	6,495.00
SW-8.8K Deluxe car system	8,800 x 1 lb	155 lb	4848	6,795.00
SW-20K Deluxe car system	20,000 x 1 lb	165 lb	1958	9,995.00

### Options

100056 System carrying case	39 lb	1962	895.00	<b>B</b>
100330 Ramp (4) 15" x 15" Snap in or SW Deluxe	66 lb	4849	795.00	
100417-4 Ramp (4) 15" x 36" x 4"	66 lb	4850	1,495.00	
PT20 CPU Wireless indicator, battery operated Includes tape printer. Prints axle, axle group, total weight T&D, etc.	20 lb	3698M	5,795.00	

RFX Handheld wireless indicator 4 lb 6177M 995.00

### Service Parts

603070 load cell	700 kg	4 lb	6392	285.00	<b>B</b>
------------------	--------	------	------	--------	----------



**SW-6K Race Car System**



**SW-6K Deluxe Race Car System**



**PT20 CPU Wireless Indicator**



**RFX Handheld Wireless Indicator**



Prices are subject to change without notice. Please call for current prices.

Other items are available from the manufacturers, please call for prices.

99 Reagent Lane  
Fair Lawn NJ 07410  
201-797-2718 \* 800-631-0347

**Totalcomp**  
Scales & Balances

www.totalcomp.com  
Fax 201-797-2287  
Toll Free Fax 888-797-2288



**Jack Point weighing systems**

## Road Runner Jack Point Weighing System

Hermetically sealed, compact stainless steel load cells. Aircraft and Helicopter scale designed around precision strain gage load cells which fit on top of existing aircraft jacks. High strength plastic case for storage, shipping and use. System capacity range covering 15,000 to 400,000 lbs. 4 channel digital indicator has liquid crystal display with built in back light for day or night use. Pound or kilogram readout selectable. Accuracy of 0.1% of applied load or 0.02% of channel capacity, whichever is greater. Weight can be displayed by individual load cell or total of any combination. Indicator is microprocessor controlled with full digital calibration. Color coded connecting cables. .7 amp circuit breaker. 12VDC internal rechargeable battery w/ 30 hour operation life. 120VAC wall mount plug. RS232 port for PC interface.

Part Number	Weight	Stock	Price B5
JP5000-3 Jack point scale (3) 5K cells	55 lb	7173	\$ 9,192.00
JP5000-4 Jack point scale (4) 5K cells	59 lb	7174	9,653.00
JP15000-3 Jack point scale (3) 15K cells	67 lb	7175	9,701.00
JP15000-4 Jack point scale (4) 15K cells	72 lb	7176	11,162.00
JP50000-3 Jack point scale (3) 50K cells	72 lb	7177	11,993.00
JP50000-4 Jack point scale (4) 50K cells	77 lb	7178	13,326.00
JP100000-3 Jack point scale (3) 100K cells	85 lb	7179	14,833.00
JP100000-4 Jack point scale (4) 100K cells	95 lb	7180	18,253.00



## Road Runner Platform Wheel Weigher

Rugged aluminum storage case. Fast, accurate weight readings for a variety of light to medium application. Transports easily to weigh sites. Easy set up and operation in minutes. 7,500 to 60,000 lbs capacity. Using the digital indicator, operator can display the weight of each pad individually or the total of any combination of pads. Digital indicator with LCD display and up to 4 channels. Pound or kilogram readout selectable by operator. Inteconnecting cables and power cords. .7 amp circuit breaker. Tire stops. Heavy duty cast aluminum platforms w/ interlocking ramps. RS232 port for PC interface. 12VDC internal rechargeable battery w/ 30 hour operation life. 120VAC wall mount plug.

Part Number	Weight	Stock	Price B5
AW2500-3 (3) 2.5K pads	250 lb	7167	\$ 8,746.00
AW6000/2500-3 (2) 6K/(1) 2.5K pads	405 lb	7168	9,520.00
AW6000-3 Wheel weigher (3) 6K pads	405 lb	7169	10,426.00
AW10000-3 Wheel weigher (2) 10K/(1) 6K	405 lb	7170	10,946.00
AW10000-3 Wheel weigher (3) 10K pads	405 lb	7171	11,173.00
AW15000-3 Wheel weigher (3) 15K pads	405 lb	7172	12,526.00



Platform wheel weigher



Wheel Weigher display



**Jet Weigh  
Aircraft Scale**

## Jet Weigh Aircraft Scale

Library of 200 aircraft types and characteristics. Simultaneous readings of all weights. Stainless steel hermetically sealed load cells. Portable storage and transportation case. Display prompts operator in weighing sequence. Automatic latitude weight correction. Total weight indication eliminates manual error. 15,000 to 600,000 lbs capacity. Microprocessor and customer software provide specific performance, functions and features. Three different weighing modes. Capability to reconfigure load cell arrangement without disconnecting load cell. Back up protection to prevent loss of data in the event of power failure. RS232 interface to PC for data storage. Operates on 10 to 32 VDC or 115/230 VAC.

Part Number	Weight	Stock	Price B5
JW-15 Jet weigh (3) 5K cells	72 lb	7181	\$ 17,500.00
JW-20 Jet weigh (4) 5K cells	78 lb	7182	18,200.00
JW-30 Jet weigh (3) 10K cells	72 lb	7183	18,200.00
JW-40 Jet weigh (4) 10K cells	78 lb	7184	18,900.00
JW-75 Jet weigh (3) 25K cells	72 lb	7185	18,900.00
JW-100 Jet weigh (4) 25K cells	78 lb	7186	19,600.00
JW-150 Jet weigh (3) 50K cells	72 lb	7187	19,253.00
JW-200 Jet Weigh (4) 50K cells	78 lb	7188	19,253.00
JW-300 Jet weigh (3) 100K cells	96 lb	7189	21,353.00
JW 400 Jet weigh (4) 100K cells	110 lb	7190	22,400.00
JW 425 Jet weigh (4) 100K cells	134 lb	7191	25,200.00
JW 450 Jet weigh (4) 100K cells	134 lb	7192	27,300.00
JW 500 Jet weigh (5) 100K cells	142 lb	7193	29,400.00
JW 600 Jet weigh (3) 200K cells	187 lb	7194	31,326.00
JW 250 Jet weigh (5) 250K cells	102 lb	7195	24,500.00





## RW-S/L Road Weigher Platform & Indicator

Wheel weigher scale made of rugged cast aluminum. Display is built in 1" LCD w/back light. Used for car, truck and custom applications. Can be used for any mobile weight inspection. Scales are linkable for multi-axle weighing. Up to 6 scales can be linked together. 1% accuracy. Single and double width platforms are available. Each scale will display the individual weight and total weight by pressing the LOCAL/TOTAL button. Battery operated using (12) AA rechargeable or dry cell batteries. Each scale has (2) battery sticks with (6) AA cells in each. 20 hours continuous use before recharging. Rechargeable batteries are included. Also includes a 120 VAC to 12 VDC charger. NTEP 03-047PA1, IIII, 500 div

Part Number	Capacity	Weight	Stock	Price B5
<b>12.2"W x 13.4" Platform</b> overall size 21.1"L x 18"W x 2.4"H				
RW-5S	10,000 x 5 lb	66 lb	4714	\$ 1,695.00
RW-05S NTEP	10,000 x 50 lb	66 lb	5383	1,695.00
RW-10S	20,000 x 10 lb	66 lb	4715	1,695.00
RW-10S NTEP	20,000 x 50 lb	66 lb	5384	1,695.00
<b>24.6"W x 13.4" Platform</b> overall size 22.3"L x 28.3"W x 2.4"H				
RW-5L	10,000 x 5 lb	102 lb	4716	2,195.00
RW-05L NTEP	10,000 x 50 lb	102 lb	5385	2,195.00
RW-10L	20,000 x 10 lb	102 lb	4717	2,195.00
RW-10L NTEP	20,000 x 50 lb	102 lb	5386	2,195.00
<b>Options</b>				
2 scale totalizer cable RW-S/L series		7 lb	4718	95.00
4 scale totalizer cable RW-S/L series		14 lb	4719	285.00
6 scale totalizer cable RW-S/L series		21 lb	4720	475.00
Cable to remote printer		1 lb	4780	130.00
<b>A5</b>				
DEP-50 printer		5 lb	6860M	299.00
<b>Service Parts</b>				
<b>C</b>				
Instruction Manual for RW-S/L series		1 lb	4781	17.20
<b>A5</b>				
Charger adapter 120VAC to 12VDC		3 lb	4782	55.00
YRW2 (2) batter sticks (6)AA each		3 lb	5331	89.00



RW-S  
Platform/Indicator



RW-L  
Platform/Indicator



Prices are subject to change without notice. Please call for current prices.

Other items are available from the manufacturers, please call for prices.

99 Reagent Lane  
Fair Lawn NJ 07410  
201-797-2718 \* 800-631-0347

**Totalcomp**  
Scales & Balances

www.totalcomp.com  
Fax 201-797-2287  
Toll Free Fax 888-797-2288

# Wheel Load

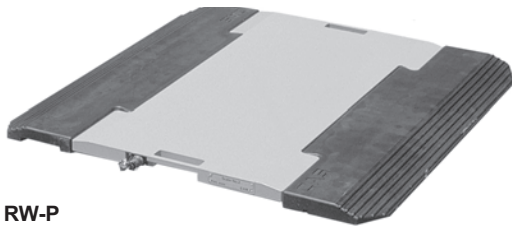

RW-P  
Platform

## RW-P Road Weigher Platform only

Rugged cast aluminum weighing plate is light enough to be portable yet large enough for any type of vehicle. The bright orange industrial paint is baked on to the aluminum alloy chassis. Solid rubber ramps provide maximum grip in the most severe unlevelled conditions. Solid rubber dummy plate spacers can be placed between platforms to accommodate different axle spacing. Connect up to 6 scales simultaneously using the RW-2601P Multi Platform indicator. 1% accuracy. Used for axle balancing & overloading applications. Only 1.5" high.

Part Number	Capacity	Weight	Stock	Price B5
<b>35.4" x 19.7" Platform</b> overall size 35.4"W x 19.7"D x 1.5"H				
RW-10P	20,000 x 10 lb	105 lb	4721	\$ 2,995.00
RW-15P	30,000 x 20 lb	105 lb	4722	2,995.00

Note: Other capacities are available. Call for special pricing.

### Options

Dummy plate for RW-P series 35.4"W x 19.7"D x 1.5"H	38 lb	4724	251.00	<b>C</b>
---	-------	------	--------	----------



RW-2601P  
Indicator

## RW-2601P Road Weigher Indicator only

This indicator will connect up to 6 scales simultaneously. Completely self contained portable unit. Will print weight and time & date with built in high speed dot matrix receipt printer. RS232 serial port to connect to a PC or remote display. 10 vehicle number memories. Large easy to read LCD display with back light. Display individual weight of each scale with printed total weight. Totalizer cable included with each scale. Rechargeable battery pack is built in. Charger/adaptor 120VAC is included.

Part Number	Capacity	Weight	Stock	Price B5
RW-2601P multi platform indicator		27 lb	4723	\$ 1,695.00

### Service Parts

Instruction Manual for RW-2601P	1 lb	4783	17.10	<b>C</b>
Charger adapter 120VAC to 12VDC	3 lb	4784	75.00	

Prices are subject to change without notice. Please call for current prices.

Other items are available from the manufacturers, please call for prices.



## LP600 Wheel Load Scale

Low profile, light weight all aluminum, digital, self contained, high capacity wheel load scale. 1% accuracy. Display units are either kg or lb depending on model. Battery charging cable, connectors and transformer 120 VAC to 12 VDC is included with orders for 2, 4 or 6 scales. Includes (4) Nicad batteries per scale. 300 hours continuous use before recharge. Low power 1" LCD display is easy to read in daylight. RS232, RS485 output to printers or remote displays. Separate switches for ON and OFF. ZERO switch will set zero. Platform 22.4" x 15". Overall 30" x 16" x 1.5"H. 44 lb. NTEP Class IV for LP600-20Kx50

**RFX Indicator:** Compatible with LP600, PT300, AX900, CS3000, SW and CW250 scale systems. 4 digit LCD backlight display. Capacity to interface up to 12 scales. 300 ft line of site. Up to 40 hours continuous use before recharge. Standard (AA) batteries. Read only mode. USB/RS232 output. Set latitude/altitude corrections. Pushbuttons for CONTINUOUS PRINTING, CALIBRATE, ON/OFF, ZERO, ON-DEMAND PRINTING, TARE, PEAK, LB/KG. Screens for: Individual Weight, Gross/NET/Tare, Axle Group, Accumulative Total, Center of Balance, Tare. Includes Indicator, rechargeable batteries, battery charger, case.

NTEP 00-091PA1 Class IIII

Part Number	Capacity	Weight	Stock	Price B5
<b>Pounds</b>				
LP600-30Kx50	30,000 x 50 lb	49 lb	6483	\$ 4,495.00
LP600-20Kx20	20,000 x 20 lb	45 lb	4822	3,495.00
LP600-20Kx10	20,000 x 10 lb	45 lb	4823	3,645.00
LP600-10Kx5	10,000 x 5 lb	45 lb	4824	3,645.00
LP600-5Kx5	5,000 x 5 lb	45 lb	4825	3,495.00
<b>Options</b>				<b>B5</b>
101025 2 Scale carrying case for LP600		40 lb	4827	1,095.00
101039 4 Scale carrying case for LP600		60 lb	4828	1,395.00
101044 6 Scale carrying case for LP600		90 lb	4829	1,795.00
170118 Dummy pad for LP600		45 lb	4830	599.00
PT20 CPU Wireless indicator, battery operated Includes tape printer. Prints axle, axle group, total weight T&D, etc.		20 lb	3698M	3,995.00
RFX Handheld wireless indicator		4 lb	6177M	995.00
<b>Service Parts</b>				<b>C</b>
330010 Battery pack (6) AA NiCad stick, old style		1 lb	1960M	62.85
				<b>B5</b>
100480 120V charging cable (1) scale w/ transformer		1 lb	1508M	160.00



LP600  
Wheel Load Scale



RFX Indicator



PT20 CPU  
Wireless Indicator

Prices are subject to change without notice. Please call for current prices.

Other items are available from the manufacturers, please call for prices.

99 Reagent Lane  
Fair Lawn NJ 07410  
201-797-2718 \* 800-631-0347

**Totalcomp**  
Scales & Balances

www.totalcomp.com  
Fax 201-797-2287  
Toll Free Fax 888-797-2288

# Wheel Load



**PT300DW  
Wheel Load Scale**



**100050  
2 Scale carrying case**



**100051  
4 Scale carrying case**

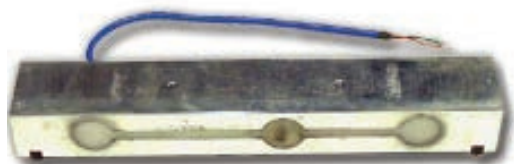

**000196-T  
for PT300**

## PT300DW Wheel Load Scale

Heavy duty, wireless, all aluminum electronic self contained wheel load scale. 1% accuracy. Includes (4) rechargeable Nicad batteries per scale. Has solar charging panels that virtually eliminate the need to manually recharge batteries between uses. LOCAL/TOTAL switch will show the individual scale weight or the total of all scales in the system. ZERO switch set the system to read zero. PRINT/ACCUMULATE button will print and also accumulate weight to total function. ON/OFF switch will control power. 22" x 26" x 3"H, 60 lb.

Part Number	Capacity	Weight	Stock	Price B5
<b>14" x 22" platform</b>				
PT300DW-20	20,000 x 20 lb	60 lb	1658	\$ 2,095.00
PT300DW-10	20,000 x 10 lb	60 lb	1659	2,245.00
PT300DW-10 (Wired)	20,000 x 10 lb	60 lb	2246	1,945.00
PT300DW-5	10,000 x 5 lb	60 lb	1660	2,245.00
PT300DW-55	5,000 x 5 lb	60 lb	2921	2,095.00
PT300DW-30K	30,000 x 50 lb	60 lb	2922	3,095.00
PT300DW-40K	40,000 x 100 lb	60 lb	2923	3,595.00

### Options

	Weight	Stock	Price B5
100050 2 Scale carrying case for PT300DW	40 lb	1677	945.00
100051 4 Scale carrying case for PT300DW	60 lb	1678	1,345.00
100052 6 Scale carrying case for PT300DW	90 lb	1679	1,795.00
100480 Charger & cable (1) scale	2 lb	1508M	160.00
100492 Charger & cable (2) scales	2 lb	1509M	254.00
100493 Charger & cable (4) scales	2 lb	1510M	424.00
100494 Charger & cable (6) scales	2 lb	1004M	594.00

### Service Parts

	Weight	Stock	Price A
000081 Main board for PT300 (8) button	2 lb	6183M	995.00
000091 Summing board for PT300	1 lb	6184M	104.50
250327 Keypad for PT300 (8) button	1 lb	6185M	133.49
250409 Keypad PT300 (4) button	1 lb	6199M	133.49
810027 Main board PT300 (4) button	1 lb	6200M	595.00
000210-T Load cell, gray cable (old style)	12 lb	6186MB	432.36
000196-T Load cell, blue cable	12 lb	5559MB	432.36
* Do not use blue and gray cable in same scale			
100490 Totalizer cable for 6 scales(15',25',15',25',15'), old style	1 lb	1519M	510.00
330010 battery pack w/(6) AA NiCad batteries	1 lb	1960M	44.00
330158 battery pack w/ (4)AA NiCad batteries	1 lb	2316M	39.00

1.3 mv/v, 1000/1000 ohms, 3 ft 4 cond cable, anodized aluminum, IP67.

Part Number	Capacity	Weight	Stock	Price A
000210-T Load cell, gray cable 10,000 lb		12 lb	6186M	\$ 432.36
Old style 0.8 mv/v +/- 0.1 mv/v				
000196-T Load cell, blue cable 10,000 lb		12 lb	5559M	432.36
New style 1.3 mv/v				

Prices are subject to change without notice. Please call for current prices.

Other items are available from the manufacturers, please call for prices.



## PT300 Wheel Load Scale

Heavy duty, wireless, all aluminum electronic self contained wheel load scale. 1% accuracy. Includes (4) rechargeable Nicad batteries per scale. Has solar charging panels that virtually eliminate the need to manually recharge batteries between uses. LOCAL/TOTAL switch will show the individual scale weight or the total of all scales in the system. ZERO switch set the system to read zero. PRINT/ACCUMULATE button will print and also accumulate weight to total function. ON/OFF switch will control power. 16" x 20" x 3"H, 42 lb.

NTEP 90-106, Class IV, 400 div, for PT300-50

Part Number	Capacity	Weight	Stock	Price B5
<b>12" x 12" platform</b>				
PT300-20	20,000 x 20 lb	42 lb	1413	\$ 1,595.00
PT300-10	20,000 x 10 lb	42 lb	1414	1,835.00
PT300-10 (Wired)	20,000 x 10 lb	42 lb	2151	1,495.00
PT300-50	20,000 x 50 lb	42 lb	1412	1,595.00
PT300-5	10,000 x 5 lb	42 lb	1415	1,745.00
PT300-55	5,000 x 5 lb	42 lb	4044	1,545.00

### Options

				B5
100047	2 Scale carrying case for PT300	30 lb	1417	785.00
100048	4 Scale carrying case for PT300	40 lb	1418	985.00
100049	6 Scale carrying case for PT300	60 lb	1419	1,185.00
100088	PT300-DP Dummy pad 12" x 20" x 3"H	30 lb	1296	445.00
RFX	Handheld wireless Indicator	4 lb	6177M	995.00

100480	Charger & cable (1) scale	2 lb	1508M	160.00
100492	Charger & cable (2) scales	2 lb	1509M	254.00
100493	Charger & cable (4) scales	2 lb	1510M	424.00
100494	Charger & cable (6) scales	2 lb	1004M	594.00

PT20 CPU wireless indicator, battery operated, 20 lb 3698M 2,995.00  
portable. Includes built in tape printer. Prints axle weight, axle group, total weight, time & date. Includes cables w/connectors.

### Service Parts

				A
000081	Main board for PT300 (8) button	2 lb	6183M	995.00
000091	Summing board for PT300 (8) button	1 lb	6184M	104.50
250327	Keypad for PT300	1 lb	6185M	133.49
250409	Keypad PT300 (4) button	1 lb	6199M	133.49
810027	Main board PT300 (4) button	1 lb	6200M	595.00
000210	Load cell for PT300, gray cable	12 lb	6186MB	432.36
000196-T	Load cell blue cable	12 lb	5559MB	432.36

\* Do not use blue and gray cable in same scale

100490 Totalizer cable for 6 scales(15',25',15',25',15'), old style 1 lb 1519M 510.00

				B5
330010	battery pack w/(6) AA NiCad batteries	1 lb	1960M	44.00
330158	battery pack w/ (4)AA NiCad batteries	1 lb	2316M	39.00

1.3 mv/v, 1000/1000 ohms, 3 ft 4 cond cable, anodized aluminum, IP67.

Part Number	Capacity	Weight	Stock	Price A
000210-T	Load cell, gray cable 10,000 lb	12 lb	6186M	\$ 432.36
Old style 0.8 mv/v +/- 0.1 mv/v				
000196-T	Load cell, blue cable 10,000 lb	12 lb	5559M	432.36
New style 1.3 mv/v				



PT300  
Wheel Load Scale

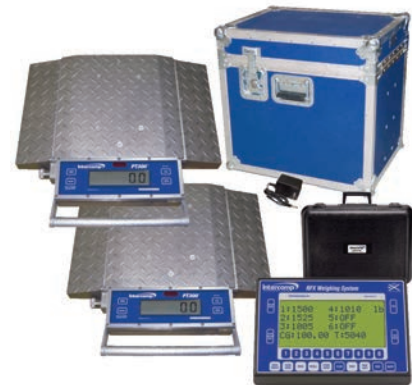

PT300  
Wireless Wheel Load  
Scale System



100088  
PT300-DP  
Dummy Pad



000196-T  
for PT300

Oct



Prices are subject to change without notice. Please call for current prices.

Other items are available from the manufacturers, please call for prices.

99 Reagent Lane  
Fair Lawn NJ 07410  
201-797-2718 \* 800-631-0347

**Totalcomp**  
Scales & Balances

www.totalcomp.com  
Fax 201-797-2287  
Toll Free Fax 888-797-2288



**235-6S**  
Hanging Scale

## 235-6S Hanging Scale

Shatterproof ABS case. Lightweight and corrosion resistant. Maintenance free. High strength stainless steel fittings.

Part Number	Capacity	Weight	Stock	Price A8
235-6S 11 lb	11 lb x 0.1 lb	10 lb	4396	\$ 112.00
235-6S 22 lb	22 lb x 0.2 lb	10 lb	4397	112.00
235-6S 56 lb	56 lb x 0.25 lb	10 lb	4398	115.00
235-6S 110 lb	110 lb x 0.5 lb	10 lb	4399	115.00
235-6S 220 lb	220 lb x 1 lb	10 lb	4400	115.00

Oct





## 820 Hanging Dial Scale

The 820 and 1030 dial scales are made to strict standards and designed to pass individual state's Weights and Measure inspections. They are sold as approximating scales only.

The 820 scale is modern both in construction and appearance. Designed to withstand hard usage and will continue to perform with accuracy. This scale has an 8" dial and has 3 different scoops. Bronze bearings and springs are made of alloys for precision weighing. Heat treated precision ground pinions assure repeatable and accurate weight readings. Single face or double face for customer to see weight reading. Open face or glass cover to protect pointer.

The 1030 scale has a 10" dial. All steel construction makes this scale rugged and accurate. Choice of deep pan and single or double face. Ball bearings make for smooth operation and guarantee long wear and trouble free service.

Part Number	Capacity	Weight	Stock	Price B
820V w/ vegetable scoop, w/o glass	20 lb x 1/2 oz	10 lb	5322	\$ 161.67
820VG-PX w/ vegetable scoop, glass	20 lb x 1/2 oz	10 lb	5323	184.87
820VGD-PX w/ vegetable scoop, glass, double face	20 lb x 1/2 oz	10 lb	5324	246.67

820PG w/ pan, glass	20 lb x 1/2 oz	10 lb	5326	264.38
1030P w/ deep pan	30 lb x 1 oz	15 lb	5330	538.00

Service Parts					B
820HG-PX Head only	20 lb x 1/2 oz	10 lb	5336	160.00	
820V Vegetable scoop only	20 lb	4 lb	5339	41.67	

Scoop	Construction	Dimensions
820V	Galvanized steel	16" x 11.5" x 5"
820P	Aluminum	12" x 3"
1030V	Galvanized steel	20" x 14" x 7"
1030P	Aluminum	12" x 3"



**820**  
Hanging dial scale



**820V**  
Vegetable scoop



**820P**  
Hanging pan



## IN-50 Hanging Scale

Heavy gauge solid brass construction. Precision steel springs for outstanding reliability, including salt water applications. Ideal for weighing fish, testing your line or setting your drag. Avoirdupois and metric graduations that are deeply embossed for easy reading. Zero/tare knob is standard. Fixed holding loop and large open hook included. 5 year exclusive warranty.

Part Number	Capacity	Weight	Stock	Price C
IN-50 w/ MRP	50 lb x 8oz	2 lb	2032	\$ 132.00



**IN-50**  
Hanging Scale

Prices are subject to change without notice. Please call for current prices.

Other items are available from the manufacturers, please call for prices.



**THS**  
Digital Hanging Scale

### THS Digital Hanging Scale

Safety overload up to 150%. 16.5mm digits high LCD display. Hanging loop and S-hook. Selectable weighing unit (kg/lb). Function keys for ZERO, TARE, CHANGE WEIGHING UNIT, HOLD. (3) AA batteries included.

Part Number	Capacity	Weight	Stock	Price C
THS-44	44 x 0.02 lb	1 lb	3481	\$ 169.00
THS-88	88 x 0.05 lb	1 lb	3482	169.00
THS-220	220 x 0.1 lb	1 lb	3483	169.00
THS-440	440 x 0.2 lb	1 lb	3484	169.00



**Electro Samson**  
Hand held  
hanging scale

### Electro Samson Hand Held Hanging Scale

Hand held scale. Angled LCD display for easy reading. Displayed units are kg, lb-oz and decimal lb. Function keys for ON/ZERO, OFF, HOLD, UNIT. Auto shut off after 2 minutes inactivity. Hold feature will hold the highest weight until reset. Dimensions 340mm x 95mm x 55mm. 9 volt alkaline battery not included.

Part Number	Capacity	Weight	Stock	Price A5
Electro Samson 22 lb	22 lb x 0.02 lb	3 lb	4378	\$ 115.00
Electro Samson 55 lb	55 lb x 0.05 lb	3 lb	4379	120.00
Electro Samson 100 lb	100 lb x 0.1 lb	3 lb	4363	130.00

Nov  
↓





## CS200 Hanging Scale

High accuracy, compact digital hanging scale uses a 12 bit A/D converter for accuracy +/- 0.1% of applied load. Weatherproof ABS plastic case assures maximum protection against moisture, dust and rough usage. High visibility 1/2" high LCD digital readout provides easy reading of weights. Membrane push button switches allow simple trouble free operation. Power is supplied by (1) 9 volt alkaline battery (not included). Peak hold, stainless steel hooks. Function keys for ZERO, lb/kg, ON/OFF. Overall case size 3.75"W x 2"D x 6"H.

Part Number	Capacity	Weight	Stock	Price B5
CS200-25	25 x 0.01 lb	2 lb	3867	\$ 595.00
CS200-50	50 x 0.02 lb	2 lb	3868	595.00
CS200-100	100 x 0.05 lb	2 lb	3869	595.00
CS200-250	250 x 0.1 lb	3 lb	3870	595.00
CS200-500	500 x 0.2 lb	3 lb	3032	595.00



**CS200**  
Hanging Scale



**CS750  
Crane Scale**



**Infrared  
Remote  
Control**

## CS750 Crane Scale

High accuracy, compact digital hanging scale uses a 20 bit A/D converter for accuracy +/- 0.1% of applied load. Keyboard setup and digital calibration. Includes wireless infrared remote control for ON, Off, Zero, Tare. High visibility 1" high LCD digital readout provides easy reading of weights. Programmable display updates from 1 to 127/sec. Programmable digital filter averaging sample size 1 to 31. Membrane push button switches allow simple trouble free operation. Power is supplied by (6) "D" cell batteries(not included). Efficient micro controller gives up to 1 year of battery life. Auto shut off after 5 minutes without use. Tare up to 100%. Zero up to 100%. Indicator lights for lb/kg. Function keys for ON/OFF, ZERO, BACK LIGHT. Overall case size 8.5"W x 5"D x 4.25"H.

Canadian Approval AM5228 (300 lb to 2,000 lb)

NTEP 97-135 III 3,000 div

Part Number	Capacity	Weight	Stock	Price B5
CS750-100	100 x 0.05 lb	8 lb	2644	\$ 945.00
CS750-300 *	300 x 0.1 lb	8 lb	2645	945.00
CS750-500 *	500 x 0.2 lb	8 lb	2646	945.00
CS750-1000 *	1,000 x 0.5 lb	8 lb	2647	945.00

\* NTEP & Canadian Approval

### Options

184256 RS232 Serial output	1 lb	2648	195.00	<b>B5</b>
----------------------------	------	------	--------	-----------

### Service Parts

360105 Remote Control	1 lb	3714M	34.95	<b>A</b>
250348 keypad 4 button (old)	1 lb	2673	133.50	
2505521 keypad 6 button (new)	1 lb	2675	133.50	



**CS1500  
Crane Scale**



**Infrared  
Remote  
Control**



## CS1500 Crane Scale

High accuracy, using a 20 bit A/D converter gives +/-0.1% of applied load. Keyboard setup and digital calibration. Includes wireless infrared remote control for ON, Off, Zero, Tare. All electronics are shock mounted in a weatherproof cast aluminum case which assures maximum protection against moisture, dust and rough usage. High visibility 0.8" high LED digital readout provides easy reading of weights. Programmable display updates from 1 to 127/sec. Programmable digital filter averaging sample size 1 to 31. Recessed push button switches allow simple trouble free operation. Power is supplied by (8) "D" cell batteries(not included). Efficient micro controller gives up to 100 hours of battery life. Auto shut off after 5 minutes without use. Indicator lights for lb/kg. Tare up to 100%. Zero up to 100%. Function keys for TARE, PRINT, lb/kg, ZERO, MODE, SET, ON, OFF. Overall size 9"Wx15"Dx17"H.

Canadian Approval AM5228 (300 lb to 2,000 lb)

NTEP 97-135 III 3,000 div

Part Number	Capacity	Weight	Stock	Price B5
CS1500-500 *	500 x 0.2 lb	25 lb	2652	\$ 1,595.00
CS1500-1000 *	1,000 x 0.5 lb	25 lb	2653	1,695.00
CS1500-2000 *	2,000 x 1 lb	25 lb	2654	1,695.00
CS1500-5000	5,000 x 2 lb	47 lb	2655	1,995.00
CS1500-10000	10,000 x 5 lb	47 lb	2656	1,995.00
CS1500-20000	20,000 x 10 lb	77 lb	2924	2,895.00

\* Canadian Approval

### Options

184507 RS232 Serial output	1 lb	7061	169.00	<b>B5</b>
----------------------------	------	------	--------	-----------

### Service Parts

360105 Remote Control	1 lb	3714M	34.95	<b>A</b>
-----------------------	------	-------	-------	----------



## CS3000 Crane Scale w/ RFX Wireless Handheld Indicator

High accuracy, using a 20 bit A/D converter gives +/-0.1% of applied load. Keyboard setup and digital calibration. All electronics are shock mounted in a NEMA 4 weatherproof cast aluminum case which assures maximum protection against moisture, dust and rough usage. High visibility 1" high LCD digital readout provides easy reading of weights. Programmable display updates from 1 to 127/sec. Programmable digital filter averaging sample size 1 to 31. Display automatically adjusts to lighting conditions. Recessed push button switches allow simple trouble free operation. Power is supplied by (8) "D" cell batteries(not included). Efficient micro controller gives up to 2,000 hours of battery life. Auto shut off after 5 minutes without use. Indicator lights for lb/kg, NET. Tare up to 100%. Zero up to 100%. Function keys for ON/OFF, ZERO, LB/KG, TARE, SET/DISPLAY, TARE CLEAR. Overall size 9"W x 15"D x 17"H.

NTEP 97-135 Class III 500 to 2,000 lb, Class IIIL 5,000 to 70,000 lb

**RFX Indicator:** Compatible with LP600, PT300, AX900, CS3000, SW and CW250 scale systems. 4 digit LCD backlight display. Capacity to interface up to 12 scales. 300 ft line of site. Up to 40 hours continuous use before recharge. Standard (AA) batteries. Read only mode. USB/RS232 output. Set latitude/altitude corrections. Pushbuttons for CONTINUOUS PRINTING, CALIBRATE, ON/OFF, ZERO, ON-DEMAND PRINTING, TARE, PEAK, LB/KG. Screens for: Individual Weight, Gross/NET/Tare, Axle Group, Accumulative Total, Center of Balance, Tare. Includes Indicator, rechargeable batteries, battery charger, case.



**CS3000  
Crane Scale**



Part Number	Capacity	Weight	Stock	Price B5
CS3000-2K-RFX	2,000 x 1 lb	50 lb	2660	\$ 3,795.00
CS3000-5K-RFX	5,000 x 1 lb	73 lb	2661	3,895.00
CS3000-10K	10,000 x 2 lb	73 lb	2662	3,995.00
CS3000-20K-RFX	20,000 x 5 lb	97 lb	2663	5,995.00
CS3000-30K-RFX	30,000 x 10 lb	122 lb	2664	6,445.00
CS3000-50K-RFX	50,000 x 10 lb	220 lb	2665	9,895.00
CS3000-70K-RFX	70,000 x 20 lb	248 lb	2666	13,495.00
CS3000-100K-RFX *	100,000 x 20 lb	392 lb	2667	17,495.00

\* Not NTEP

Options			B5
RFX Handheld wireless indicator	4 lb	6177M	995.00

Service Parts			A
360105 Remote Control, old style	1 lb	3714M	34.95



**RFX Handheld  
wireless Indicator  
Optional**



**Caston II  
Crane Scale**



**Remote Control**

## Caston II Crane Scale

Crane scale with wireless remote control. Large bright red LED display 1.2" high. Auto span calibration. (2) Ni-Cad rechargeable battery packs and recharger are included. One pack is in the scale and the other is a spare that should be kept fully charged. Typical 72 hours between recharge. Low battery indication. Tare up to 100%. Zero up to 2%. Function keys on both scale housing and remote control for ON, OFF, ZERO, TARE. Full tare subtraction. Dimensions 9.1" W x 14.2" D.

Part Number	Capacity	Height	Weight	Stock	Price C
Caston II-1000	1,000 lb x 0.5 lb	13.8"	49 lb	2639	\$ 1,425.00
Caston II-2000	2,000 lb x 1 lb	13.8"	50 lb	2640	1,425.00
Caston II-5000	5,000 lb x 2 lb	16.9"	62 lb	2641	1,425.00
Caston II-10000	10,000 lb x 2 lb	16.9"	72 lb	2470	1,595.00

### Service Parts

6794-A00-0050 battery, 6 volt,	4 lb	515	73.40
ZC27 Battery case assy	2 lb	259	73.00
ZC26 battery charger	3 lb	5267	280.50
WC26 battery box cable	1 lb	371	20.00
HC28 safety latch 2t-5t	1 lb	327M	37.85



**Caston III  
Crane Scale w/Remote Control**

## Caston III Crane Scale

Crane scale with wireless remote control. Large bright red LED display, 6 digit 1.5" high. Auto span calibration. (2) Ni-Cad rechargeable battery packs and recharger are included. One pack is in the scale and the other is a spare that should be kept fully charged. 14-24 hours between recharge. Low battery indication. Hold function automatic, manual. Function keys on both scale housing and remote control for ON, OFF, ZERO, TARE, HOLD, BATT. Sealed to NEMA 4 IP65. Dimensions 11" W x 13.1" D.

Part Number	Capacity	Height	Weight	Stock	Price B5
Caston III-10K	10,000 lb x 2 lb	22.0"	100 lb	2685	\$ 1,950.00
Caston III-20K	20,000 lb x 5 lb	33.3"	155 lb	2686	3,250.00
Caston III-30K	30,000 lb x 10 lb	35.0"	161 lb	1912	3,750.00
Caston III-40K	40,000 lb x 10 lb	39.0"	240 lb	1913	4,300.00
Caston III-60K	60,000 lb x 20 lb	53.2"	710 lb	1819	11,300.00
Caston III-100K	100,000 lb x 20 lb	73.2"	1,050 lb	1723	18,950.00

### Service Parts

6794-A00-0020 rechargeable battery, 6 volt, VT610	10 lb	516	87.50
ZC 3C rechargeable battery, 12 volt, VT 1207	10 lb	722	87.50
HC28 safety latch 2t-5t	1 lb	327M	37.85



## IE Crane Scale

Aluminum die-cast crane scale with hook and shackles. 5 digit, 1 1/4 LCD or LED display. Function keys for: ON/OFF, ZERO, TARE, HOLD. Units of measure displays kg or lb. Rechargeable battery with AC adapter. Operates 50 hours on LCD model and 20 hours on LED. Remote control included. Overall size 8.8"W x 14.8"H x 5.1"D

Part Number	Capacity	Weight	Stock	Price C
<b>LCD display</b>				
IE-100-C	100 x 0.05 lb	13 lb	7044	\$ 495.00
IE-200-C	200 x 0.1 lb	13 lb	7045	495.00
IE-500-C	500 x 0.2 lb	13 lb	7046	495.00
IE-1000-C	1,000 x 0.5 lb	13 lb	7047	545.00
IE-2000-C	2,000 x 1 lb	13 lb	7048	545.00
<b>LED display</b>				
IE-100-E	100 x 0.05 lb	13 lb	5732	495.00
IE-200-E	200 x 0.1 lb	13 lb	5733	495.00
IE-500-E	500 x 0.2 lb	13 lb	5734	495.00
IE-1000-E	1,000 x 0.5 lb	13 lb	5735	545.00
IE-2000-E	2,000 x 1 lb	13 lb	5736	545.00
<b>Service Parts</b>				<b>C</b>
ZIE1 battery for IE		3 lb	7043	75.00



**IE Series  
Crane Scale  
w/Remote Control**



## NC1 Crane Scale

Portable crane scale. Easy to install and operate. LCD display 1" high with electric luminescent back light. Ni-Cad battery (rechargeable) and AC adapter for recharging. Operating time is 48 hours. Charging time is 1.5 hours. Solid aluminum die casting case. Low battery indicator. Tare up to 100%. Zero up to 2%. Function keys for ON, OFF, ZERO, TARE, kg/lb. Full tare subtraction. Includes Wireless Remote Control. Sealed to IP67. Case dimensions 10.2"W x 5.3"D x 18.9" H. NTEP 96-164 III 2,500 div

Part Number	Capacity	Weight	Stock	Price C5
NC1-250	250 lb x 0.1 lb	19 lb	2636	\$ 795.00
NC1-500	500 lb x 0.2 lb	19 lb	2637	795.00
NC1-1000	1,000 lb x 0.5 lb	20 lb	2638	850.00
<b>Service Parts</b>				
ZNC4 battery, IA4A519B		3 lb	7022	66.00
7599-NC0-0000 AC adapter		1 lb	5962	65.70



**NC1  
Crane Scale  
w/Remote Control**

Prices are subject to change without notice. Please call for current prices.

Other items are available from the manufacturers, please call for prices.



**CS Series  
Electronic Crane Scale w/  
Remote**

## CS Series Electronic Crane Scale

Aluminum die-cast case, alloy steel load cell, hook and shackle. 5 digit, 1/2" Bright LED display has adjustable brightness for any environment. Function keys for ON/OFF, TARE, ZERO. Units of measure displays kg or lb. Calculates total weight. Rechargeable battery with AC power adapter. Operates 20 hours between charges. Includes wireless remote control, requires (2) "AA" batteries, puts all scale functions at your fingertips. Distance controls for zero, tare, peak, accumulator and power. Overall size 12"L x 11"W x 7.5"H.

Part Number	Capacity	KG	Weight	Stock	Price C8
CS1000	1,000 x 0.5 lb	500 x 0.2 kg	11 lb	6060	\$ 670.00
CS2000	2,000 x 1 lb	1,000 x 0.5 kg	11 lb	6061	700.00



## Caston III Bluetooth Crane Scale

Alodine (powder coated) cast aluminum crane scale with Bluetooth wireless remote control. Large bright red LED display 1.5" high. Auto span calibration. 14-24 hours between recharge. Low battery indication. Hold function automatic, manual. Tare up to 100%. Zero up to 2%. Function keys on both scale housing and remote control for ON, OFF, ZERO, TARE, HOLD. Sealed to IP67.

Part Number	Capacity	Height	Weight	Stock	Price C
Caston III Bluetooth-10K	10,000 lb x 2 lb	22.0"	98 lb	7049	\$ 2,900.00
Caston III Bluetooth-20K	20,000 lb x 5 lb	33.3"	153 lb	7050	4,200.00
Caston III Bluetooth-30K	30,000 lb x 10 lb	35.0"	158 lb	7051	4,700.00
Caston III Bluetooth-40K	40,000 lb x 10 lb	39.0"	240 lb	7052	5,250.00
					<b>B</b>
Caston III Bluetooth-60K	60,000 lb x 20 lb	53.2"	710 lb	7053	12,250.00
Caston III Bluetooth-100K	100,000 lb x 20 lb	73.2"	1,050 lb	7054	19,900.00
<b>Service Parts</b>					<b>C</b>
HC28 safety latch 2t-5t			1 lb	327M	37.85
WC32 battery cable 12V-4 pins			1 lb	707	46.00



**Caston III-10k  
Bluetooth Crane Scale**

## DILLON



AP Mechanical Dynamometer

### AP Mechanical Dynamometer

Portable 5" or highly visible 10" dials. Constructed of high strength composite (5") or rugged cast aluminum (10") to resist heavy blows. Used for diverse jobs such as stringing utility line, mounting cables for bridges, adjusting tension on guy wires, field testing chain, rope or wire and anything requiring precise force or tension measurement. Offers accurate readings from varying sight lines. Dial is mar and fog resistant. Can cancel preset loads up to 20% of capacity. Remains in position to indicate peak load point after load is removed from instrument. Includes users guide and signed calibration card, Dynamometer, shackles and pins, maximum pointer, zero adjust for tare, molded plastic carrying case on 5" models and calibration certificate traceable to NIST.

Part Number	Capacity	Weight	Stock	Price B5
<b>5" Diameter Dial</b>				
30006-0019	500 x 5 lb	15 lb	6864	\$ 1,140.00
30006-0027	1,000 x 10 lb	15 lb	6865	1,080.00
30006-0035	2,000 x 20 lb	15 lb	6866	1,080.00
30006-0043	4,000 x 25 lb	15 lb	6867	1,165.00
30006-0050	5,000 x 50 lb	15 lb	6868	1,140.00
30006-0076	8,000 x 50 lb	15 lb	6870	1,280.00
30006-0084	10,000 x 100 lb	15 lb	6871	1,270.00
30006-0092	15,000 x 100 lb	15 lb	6872	1,460.00
30006-0100	20,000 x 200 lb	15 lb	6873	1,430.00
<b>10" Diameter Dial</b>				
30007-0026	1,000 x 5 lb	26 lb	6875	1,330.00
30007-0034	2,000 x 10 lb	26 lb	6876	1,330.00
30007-0059	5,000 x 20 lb	26 lb	6878	1,385.00
30007-0083	10,000 x 50 lb	26 lb	6881	1,490.00
30007-0109	20,000 x 100 lb	26 lb	6883	1,630.00
30007-0017	30,000 x 200 lb	98 lb	6884	4,415.00
30007-0033	50,000 x 200 lb	98 lb	6886	4,415.00

#### Service parts

30079-0045 STD.10" dynamometer printer	6882	1 lb	38.00	<b>A</b>
--	------	------	-------	----------

## DILLON

### Quick-Check Tension Meter

Portable and rugged. Designed for outdoor use. Quick Check can be placed on cable, measure its tension and removed in under 5 seconds. Easy to read red LED display with full text prompts. Easy to read SOFTKEY interface. Tension units of measure: pound-force, kilogram force, Newtons. Built in averaging. Built in temperature sensor with patented automatic tension adjustment. Sheaves with bearings eliminate friction. Quick Check can be employed in many industries including tower and stack guy wires, pretensioned cable barriers, bridges, elevators, winch rope, prestressed concrete, fall arrest systems, aircraft cables and utilities. Stores calibration for up to 15 unique wire sizes and types. Uses AA batteries and has long life between changes. Includes carrying case.

10"W x 23"D x 3"H

Part Number	Capacity	Weight	Stock	Price B5
AWT05-508112	2,000 x 2 lb	11 lb	6930	\$ 2,660.00
AWT05-508111	10,000 x 10 lb	11 lb	6931	2,785.00

#### Sheave Select (select at least one)

36309-0085	Code L	Sheave 3/16" to 1/4" wire dia	6932	255.00
36309-0044	Code P	Sheave 3/16" to 1/2" wire dia	6933	255.00
36309-0010	Code S	Sheave 1/4" to 3/4" wire dia	6934	255.00
36309-0101	Code T	Sheave 1/2" to 1" wire dia	6894	255.00

#### Calibration Select (select at least one)

First wire calibration is included with each Quick Check	6935	no charge
Subsequent calibrations	6936	120.00

Indicate what wire sizes and types to calibrate

Each wire size is calibrated at 4-5 load points and confirmed by a validation run



Quick-Check Tension Meter

Prices are subject to change without notice. Please call for current prices.

Other items are available from the manufacturers, please call for prices.



## DILLON

### ED junior Dynamometer

Aircraft quality aluminum, easy to position, highly mobile instrument with exceptional strength. 7:1 factor of safety at all capacities and 5:1 on 25K. The EDjunior's design is a direct response to industries that have wanted an extremely well built instrument that could be relied upon for simple yet critical measurements of weight and force. The 6 digit dot matrix display features 1" high numerals for greater visibility. Provides peak detection as well as sustained load readings. SOFTKEY interface provides direct access to setup and display functions without the typical confusing menu structure. 200% safe overload. Distinctive angle body design further eliminates unnecessary weight and streamlines the unit to help prevent binding. Display update rate is 2 times per second. Peak hold sampling rate is 2 times per second. Designed to NEMA4X/IP55 for continuous exterior job site applications as well as in plant use. Calibration traceable to NIST. Includes carry case, manual, calibration card and (2) C cell batteries. Typical battery life is 200 hours. NEMA 4x/IP55.

Part Number	Capacity	Weight	Stock	Price B5
36190-0038 EDjr-2.5K	2,500 x 2 lb	6 lb	6912	\$ 1,500.00
36190-0046 EDjr-5K	5,000 x 5 lb	10 lb	6913	1,590.00
36190-0053 EDjr-10K	10,000 x 10 lb	18 lb	6914	1,735.00
36190-0103 EDjr-25K	25,000 x 20 lb	47 lb	6915	2,495 00



EDjunior  
Dynamometer

## DILLON

### EDxtreme Dynamometer

Constructed of electroless nickel plated aircraft quality alloy steel. Lower capacity models are anodized aircraft quality aluminum. Allows permanent attachment of centering spacers, which eliminates fumbling during high capacity rigging. 5:1 measure of strength and safety is maintained at all capacities. 200% safe overload capacity. Resolution mode is 1 part in 5,000. Wide angle LCD provides improved readability over a wider viewing angle. RS232 or RS485 communication. Display update rate a 2 times per second. Includes certificate of calibration, manual and (2) C cell batteries. Plastic carrying case included for EDx-2.5K to EDx-100K. Higher capacities include rugged plywood storage crate. Instruments with shackles include centering spacers (EDx-50K & up) and shackle storage crate (EDx-50K to EDx-160K). 9" x 4.6" x 1.8" NEMA 3/IP44

Part Number	Capacity	Weight	Stock	Price B5
36189-0031 EDx-2.5K	2,500 x 2 lb	13 lb	6920	\$ 1,990.00
36189-0049 EDx 5K	5,000 x 5 lb	13 lb	6921	2,245.00
36189-0056 EDx-10K	10,000 x 10 lb	22 lb	6922	2,650.00
36189-0064 EDx-25K	25,000 x 20 lb	46 lb	6923	3,385.00
36189-0072 EDx-50K	50,000 x 50 lb	125 lb	6924	4,225.00



EDxtreme  
Dynamometer

Prices are subject to change without notice. Please call for current prices.

Other items are available from the manufacturers, please call for prices.

99 Reagent Lane  
Fair Lawn NJ 07410  
201-797-2718 \* 800-631-0347

**Totalcomp**  
Scales & Balances

www.totalcomp.com  
Fax 201-797-2287  
Toll Free Fax 888-797-2288



**TL6000**  
Tension Link  
Scale w/ RF Antenna

## TL6000-RF Wireless Tension Link Scale

RF wireless. Aluminum or stainless steel. Cranes, riggers, shipyards, construction sites, surveyors, inspectors and utilities demand cost effective yet technologically advanced solutions for processing, monitoring and controlling overhead loads. +/-0.1% of applied load or +/-1 graduation: whichever is greater, +/- 0.2% or +/- 2 graduations for 25K & higher. Weights are easily viewed with the industry's largest digital 1.2" high LCD readout. The units easy to use membrane switches allow simple, trouble free operation. The TL6000 wireless remote control can communicate with 20 remote tension links simultaneously. The remote can display the weight from a specific tension link or the total weight from all tension links in the system. Can be interfaced with most PLC or notebook computers. Annunciators for low battery, peak hold, set points 1 & 2, lb, kg, tons, metric tons and dekaNewtons. Function keys for ON/OFF, ZERO, PEAK HOLD, MODE. RS232 or RS485 serial output. Efficient micro controller gives up to 800 hours of battery life, wireless remote control models have a reduced operating time. Power is supplied by (2) 9 volt alkaline batteries (not included). NEMA 4X and IP65.

Part Number	Capacity	Weight	Stock	Price B5
TL6000-50,000-RF	50,000 x 50 lb	55 lb	5477	\$ 2,735.00

### Options shackles

150103 Top & bottom	50,000 lb	63 lb	3886M	1,045.00	<b>B5</b>
---------------------	-----------	-------	-------	----------	-----------

### Remote Indicators

150114 Dual remote indicator, RF wireless		4 lb	705	995.00	<b>B5</b>
---	--	------	-----	--------	-----------

Two indicators, one at tension link and one remote



**150114**  
RF Wireless  
Dual remote indicator



## TL6000 Tension Link Scale

For crane overload and line tension measurement. High resolution using a 14 bit A/D converter gives +/-0.1% of applied load. All electronics are shock mounted in a weatherproof billet aluminum housing. Components are protected against moisture, dust and rough usage. Weights are easily checked with highly visible 1.2" high LCD digital readout. The units easy to use membrane switches allow simple, trouble free operation. Features include peak hold, set points for relay control and keypad setup. Function keys for ON/OFF, ZERO, PEAK, TARE, MODE. Readings can be displayed in lb, kg, tons, metric tons, and dekaNewtons. RS232 or RS485 serial output in continuous or on demand. Efficient micro controller gives up to 500 hours of battery life. Power is supplied by (2) 9 volt alkaline batteries (not included). NEMA 4X and IP65.

Part Number	Capacity	Weight	Stock	Price B5
TL6000-1,000	1,000 x 1 lb	5 lb	3876	\$ 1,250.00
TL6000-50,000	50,000 x 50 lb	55 lb	3881	2,235.00

### Options shackles

				B5
150100 Top & bottom	5,000 lb	3 lb	3883M	99.00
150103 Top & bottom	50,000 lb	63 lb	3886M	1,045.00

### Remote Indicators

				B5
189014 RFX Dual remote indicator,		6 lb	566M	995.00

Two indicators, one at tension link and one remote



**TL6000**  
Tension Link Scale



**150113**  
Dual Remote Indicators

Prices are subject to change without notice. Please call for current prices.

Other items are available from the manufacturers, please call for prices.

99 Reagent Lane  
Fair Lawn NJ 07410  
201-797-2718 \* 800-631-0347

 **Totalcomp**  
Scales & Balances

www.totalcomp.com  
Fax 201-797-2287  
Toll Free Fax 888-797-2288

# NEW



**TL8500**  
Tension Link Scale



## TL8500 Tension Link Scale

For crane overload and line tension measurement. High resolution using a 14 bit A/D converter gives +/-0.1% of applied load. All electronics are shock mounted in a weatherproof billet aluminum housing. Components are protected against moisture, dust and rough usage. Weights are easily checked with highly visible 1.2" high LCD digital readout. The units easy to use membrane switches allow simple, trouble free operation. Features include peak hold, set points for relay control and keypad setup. Function keys for ON/OFF, ZERO, PEAK, TARE, MODE. Readings can be displayed in lb, kg, tons, metric tons, and dekaNewtons. RS232 or RS485 serial output in continuous or on demand. Efficient micro controller gives up to 400 hours of battery life. Power is supplied by (2) 9 volt alkaline batteries (not included). NEMA 4X and IP65.

Part Number	Capacity	Weight	Stock	Price B5
TL8500-500	500 x 0.5 lb	5 lb	7928	\$ 1,295.00
TL8500-1,000	1,000 x 1 lb	5 lb	7929	1,295.00
TL8500-2,000	2,000 x 2 lb	5 lb	7930	1,295.00
TL8500-5,000	5,000 x 5 lb	5 lb	7931	1,345.00
TL8500-10,000	10,000 x 10 lb	8 lb	7932	1,395.00
TL8500-25,000	25,000 x 20 lb	35 lb	7933	1,895.00
TL8500-50,000	50,000 x 50 lb	55 lb	7934	2,395.00
TL8500-100,000	100,000 x 100 lb	75 lb	7935	3,395.00
TL8500-160,000*	160,000 x 200 lb	85 lb	7936	7,795.00
TL8500-220,000*	220,000 x 200 lb	100 lb	7937	8,295.00
TL8500-350,000*	350,000 x 500 lb	175 lb	7938	11,295.00
TL8500-400,000*	400,000 x 500 lb	235 lb	7939	13,295.00
TL8500-500,000*	500,000 x 500 lb	937 lb	7940	16,295.00

\* Requires a 25% non-refundable deposit

### Options shackles

Part Number	Capacity	Weight	Stock	Price B5
150100 Top & bottom	5,000 lb	3 lb	3883M	99.00
150101 Top & bottom	10,000 lb	6 lb	3884M	195.00
150102 Top & bottom	25,000 lb	39 lb	3885M	702.00
150103 Top & bottom	50,000 lb	63 lb	3886M	1,045.00
150104 Top & bottom	100,000 lb	104 lb	3887M	2,500.00

### Remote Indicators

Part Number	Description	Weight	Stock	Price B5
189014 RFX Dual remote indicator,	Two indicators, one at tension link and one remote	6 lb	566M	995.00

### Options

Part Number	Description	Weight	Stock	Price B5
150229 Set point relay output control kit		2 lb	770M	495.00
101055 AC Power input 120V-240V, factory installed		1 lb	1029M	345.00



A&D WEIGHING DIVISION

**GX Precision balance**

The world's most user friendly balances. Internal calibration mass. Super Hybrid Sensor. Vacuum fluorescent display. Weighing modes: gram, decimal ounce, decimal pound, pound/ounce, carat, pennyweight, troy ounce, grain, momme, percentage, counting, animal weighing. Standard RS232. Includes WinCT software on a CD for loading into your PC. This software will enable the output from the GX to be entered directly into a spread sheet program such as Excel. Splash proof keyboard and display. GLP/GMP/ISO compliance. Display auto power off function. Density calculation mode. Time & Date. Auto self calibration. Standard underhook. Auto power on function. Auto rezero function. Large square weighing pan. Front air bubble leveling. 120 VAC, 50/60 Hz, 7" x 12.5" x 3.4"H.



**GX Series  
Precision balance**

Part Number	Capacity	Pan	Weight	Stock	Price C5
GX-200	210g x 0.001g	128 x 128mm	12 lb	4685	\$ 1,950.00
GX-400	410g x 0.001g	128 x 128mm	12 lb	4686	2,430.00
GX-600	610g x 0.001g	128 x 128mm	12 lb	4687	2,880.00
GX-800	810g x 0.001g	128 x 128mm	12 lb	7033	3,050.00
GX-1000	1,110g x 0.001g	165 x 165mm	14 lb	7034	3,240.00
GX-2000	2,100g x 0.01g	165 x 165mm	14 lb	4688	1,950.00
GX-4000	4,100g x 0.01g	165 x 165mm	14 lb	4689	2,620.00
GX-6100	6,100g x 0.01g	165 x 165mm	14 lb	4690	2,925.00
GX-6000	6,100g x 0.1g	165 x 165mm	14 lb	4691	2,250.00
GX-8000	8,100g x 0.1g	165 x 165mm	14 lb	4692	2,460.00

**Options**

			<b>B5</b>
GX-04 Comparator output	1 lb	4693M	265.00
GX-06 Analog output	1 lb	4694M	840.00
GX-10 Glass breeze break for GX-200, 400, 600	2 lb	4695M	275.00
GX-11 Glass breeze break for GX-2000 & higher	2 lb	4696M	300.00
GX-12 Animal weighing pan for GX-400 & higher	1 lb	4697M	185.00
GX-13 Density determination kit	1 lb	4698M	640.00
AD-8121 Multifunction printer	5 lb	1974M	891.00
SW:128 Foot switch	1 lb	4699M	69.00
AX:073003691-S In use cover for GF/GX 200-1000	1 lb	4700M	20.00
AX:073003692-S In use cover GF/GX 1200-8000	1 lb	4701M	20.00

**Service Parts**

TB-648 AC adapter 120VAC	1 lb	5340	51.20
--------------------------	------	------	-------



**GX-400  
Precision balance w/  
Breezebreak**

Prices are subject to change without notice. Please call for current prices.

Other items are available from the manufacturers, please call for prices.

99 Reagent Lane  
Fair Lawn NJ 07410  
201-797-2718 \* 800-631-0347

**Totalcomp**  
Scales & Balances

www.totalcomp.com  
Fax 201-797-2287  
Toll Free Fax 888-797-2288



A&D WEIGHING DIVISION

## GX-A Balance - External Calibration

Super hybrid sensor. Reverse backlit LCD display. Software features include Impact Shock Detection, Flow Rate Display and Electronically Controlled Load where an automatic self diagnostic test is run before an internal readability test. Weighing applications: Counting with ACAI, Percent weighing, Density determination, Statistical calculation, Comparator HI/OK/LO, Underhook, Gross/Net/Tare. Weighing Units: g, lb, In-oz, ozt, ct. mom, dwt, gr, pcs, %, SG, user programmable unit. GLP/GMP/GCP compliance, Universal Flex Coms, Password protected. Function keys: ON/OFF, CAL, MODE, SAMPLE, PRINT, REZERO. Anti static breeze break, Front level buddle with LED illumination, key lock security, Fly Thumb Wheel feet. Stainless steel pan. 8.3" (W) x 12.5" (D) x 3.7" (H). 5 year warranty.



GX-A Balance

Part Number	Capacity	Pan	Weight	Stock	Price C5
GX-203A	220 x 0.001g	128 x 128mm	12 lb	1249	\$ 2,125.00
GX-303A	220 x 0.001g	128 x 128mm	12 lb	1250	2,550.00
GX-420A	420 x 0.001g	128 x 128mm	12 lb	1251	2,525.00
GX-630A	620 x 0.001g	128 x 128mm	12 lb	1252	3,195.00
GX-1003A	1,100 x 0.001g	128 x 128mm	12 lb	1253	4,195.00
GX-1603A	1,620 x 0.001g	128 x 128mm	12 lb	1254	4,495.00
GX-2002A	2,200 x 0.001g	128 x 128mm	12 lb	1255	2,345.00
GX-3002A	3,200 x 0.001g	128 x 128mm	12 lb	1256	2,525.00
GX-4002A	4,200 x 0.001g	128 x 128mm	12 lb	1257	2,995.00
GX-6002A	6,200 x 0.001g	128 x 128mm	12 lb	1258	3,295.00
GX-10002A	10,200 x 0.001g	128 x 128mm	12 lb	1259	3,600.00
GX.00-6001A	6,200 x 0.1g	128 x 128mm	12 lb	1260	2,250.00
GX-10001A	10,200 x 0.1g	128 x 128mm	12 lb	1261	2,985.00



A&D WEIGHING DIVISION

**FX-i Precision balance**

Small size to take up less counter space. 7.6" wide by 10.3" long is less than a sheet of paper 8.5" x 11". Fast stabilization time of 1 second is due to the super hybrid sensor. Comparator function. Vacuum fluorescent display. Weighing units: g, oz, lb, lb-oz, ozt, ct, mom, dwt, GN, tl, tol, mes, pcs, %, MLT. Digital calibration function. Statistical calculation function. Quick USB interface (FXi-02). Standard RS-232 interface. LAN Ethernet interface (FXi-08) with WINCT-Plus Software. 120 VAC adapter. 5 year warranty. 193 W x 262.5 D x 84.5 H mm.

NTEP 08-045A2  
Canada AM-5692

Part Number	Capacity	Pan	Weight	Stock	Price C5
FX-120i w/Breeze Break	122g x 0.001g	130mm	8 lb	6253	\$ 1,010.00
FX-120iN* w/Breeze Break	122g x 0.001g	130mm	8 lb	6737	1,060.00
FX-200i w/Breeze Break	220g x 0.001g	130mm	8 lb	6273	1,060.00
FX-200iN* w/Breeze Break	220g x 0.001g	130mm	8 lb	6738	1,110.00
FX-300i w/Breeze Break	320g x 0.001g	130mm	8 lb	6274	1,090.00
FX-300iN* w/Breeze Break	320g x 0.001g	130mm	8 lb	6310	1,140.00
FX-300iNC** w/Breeze Break	320g x 0.001g	130mm	8 lb	6791	1,140.00
FX-500i w/Breeze Break	520g x 0.001g	130mm	8 lb	6792	1,390.00
FX-1200i	1,220g x 0.01g	150mm	8 lb	6275	1,010.00
FX-1200iN*	1,200g x 0.01g	150mm	8 lb	6795	1,065.00
FX-2000i	2,200g x 0.01g	150mm	8 lb	6276	1,060.00
FX-2000iN*	2,200g x 0.01g	150mm	8 lb	6796	1,110.00
FX-3000i	3,200g x 0.01g	150mm	8 lb	6277	1,090.00
FX-3000iN*	3,200g x 0.01g	150mm	8 lb	6797	1,135.00
FX-5000i	5,200g x 0.01g	150mm	8 lb	6798	1,390.00

\* N suffix is NTEP.  
\*\* C suffix is Measurement Canada approved.

**Options**

			B5
FXi-02 USB interface w/ cable	2 lb	6278M	87.00
FXi-08 Ethernet w/ WinCT software	3 lb	6279M	480.00
FXi-09 Built in rechargeable battery	8 lb	6280M	320.00
FXi-10 Breeze break small 3.4" h	5 lb	6281M	77.00
FXi-11 Breeze break large 7.9" h	6 lb	6282M	130.00



**FX-300i**  
Precision balance





A&D WEIGHING DIVISION

## AD-4212A Production Weighing System

Made for a production line. Indicator and controls in base unit. Weigh platform in compact separate unit that is located in the production equipment. 2 meter cable connects display with weighing unit. Standard RS232 for computer control. 120 VAC, 50/60 Hz, 7.6" x 12.6" x 3.3"H.



**AD-4212A  
Production  
Weighing System**

Part Number	Capacity	Pan	Weight	Stock	Price C5
AD-4212A-100	110g x 0.1mg	50 x 50mm	6 lb	5531	\$ 5,660.00
AD-4212A-200	210g x 1mg	50 x 50mm	6 lb	5532	4,970.00
AD-4212A-600	610g x 1mg	50 x 50mm	6 lb	2408	5,485.00
AD-4212A-1000	1,100g x 1mg	50 x 50mm	6 lb	2409	5,690.00

### Options

AD-4212A-01 BCD output, factory installed			1 lb	5533	577.00	<b>C</b>
AD-4212A-07 Extension cable 3 meter			1 lb	5535	164.00	<b>A</b>
AD-4212A-08 Ethernet interference w/ winCT-Plus			5 lb	5536	788.00	<b>C</b>
AD-4212A-19 SS breeze break, 200g only			1 lb	5537	106.00	<b>C</b>
AD-4212A-20 Metal leveling feet			1 lb	5538	82.00	<b>B5</b>





A&D WEIGHING DIVISION

**FZ-i Precision balance**

Compact Super Hybrid Sensor (SHS). Internal calibration. Digital calibration. Comparator function. SCF- Statistical Calculation Function. Weighing Units: g, lb, oz, lb-oz, ozt, ct, mom, dwt, GN, tl, tol, mes, pcs, %, MLT. Standard RS232C interface. Breeze Break 3.4" high. 5 year warranty.

Part Number	Capacity	Pan	Weight	Stock	Price C5
FZ-120i w/ Breeze Break	122 x 0.001g	5.12" dia	12 lb	7557	\$ 1,265.00
FZ-200i w/ Breeze Break	220 x 0.001g	5.12" dia	12 lb	7558	1,300.00
FZ-300i w/ Breeze Break	320 x 0.001g	5.12" dia	12 lb	7559	1,360.00
FZ-500i w Breeze Break	520 x 0.001g	5.12" dia	12 lb	7573	1,590.00
FZ-1200i	1,220 x 0.01g	5.91" dia	12 lb	7560	1,300.00
FZ-2000i	2,200 x 0.01g	5.91" dia	12 lb	7561	1,350.00
FZ-3000i	3,000 x 0.01g	5.91" dia	12 lb	7562	1,390.00
FZ-5000i	5,200 x 0.01g	5.91" dia	12 lb	7574	1,590.00

**Options**

			A
AX: 073009456 FZ In use cover	1 lb	7005M	16.00
TB: 237 FZ AC adapter	1 lb	7006M	43.00



**FZ-300i**  
Precision balance



A&D WEIGHING DIVISION

**FX-iWP Precision balance**

Compact. Miniaturized Super Hybrid Sensor (SHS). B5 size footprint. Response indicator function. ACAI-Automatic Counting Accuracy Improvement. Comparator function. Vacuum fluorescent display. Weighing units: g, pcs, %, oz, ozt, ct, mom, dwt, GN, tl, mes, MLT. Percent mode function. Animal weighing function. Shock absorber function. Statistical Calculation Function. Auto power on/off function. GLP/GMP/GCP/ISO compliant. Built in rechargeable battery. AC Adapter. 5 year warranty. 193 W x 262.5 D x 84.5 Hmm

Part Number	Capacity	Pan	Weight	Stock	Price C5
FX-120iWP	122 x 0.001g	130 x 130mm	8 lb	4967	\$ 1,485.00
FX-200iWP	220 x 0.001g	130 x 130mm	8 lb	4968	1,565.00
FX-300iWP	320 x 0.001g	130 x 130mm	8 lb	4969	1,670.00
FX-1200iWP	1,220 x 0.01g	150 x 150mm	10 lb	4970	1,480.00
FX-2000iWP	2,200 x 0.01g	150 x 150mm	10 lb	4971	1,565.00
FX-3000iWP	3,200 x 0.01g	150 x 150mm	10 lb	4972	1,665.00

**Options**

			B5
FXi-02 USB interface w/ cable	2 lb	6278M	87.00
FXi-08 Ethernet w/ WinCT software	3 lb	6279M	480.00
FXi-09 Built in rechargeable battery	8 lb	6280M	320.00
FXi-10 Breeze break small 3.4" h	5 lb	6281M	77.00
FXi-11 Breeze break large 7.9" h	6 lb	6282M	130.00



**FX-120iWP**  
Precision balance

Prices are subject to change without notice. Please call for current prices.

Other items are available from the manufacturers, please call for prices.

99 Reagent Lane  
Fair Lawn NJ 07410  
201-797-2718 \* 800-631-0347



www.totalcomp.com  
Fax 201-797-2287  
Toll Free Fax 888-797-2288



A&D WEIGHING DIVISION



**FZ-120iWP**  
Precision balance  
Water proof/Dust proof

## FZ-iWP Water Proof/Dust proof

Compact Super Hybrid Sensor (SHS). Internal calibration. Digital calibration. IP65 water proof/dust proof. Comparator function. SCF- Statistical Calculation Function. Weighing Units: g, lb, oz, lb-oz, ozt, ct, mom, dwt, GN, tl, tol, mes, pcs, %, MLT. Standard RS232C interface. Breeze Break 3.4" high. 5 year warranty.

Part Number	Capacity	Pan	Weight	Stock	Price C5
FZ-120iWP w/ Breeze Break	122 x 0.001g	5.12" dia	24 lb	7563	\$ 1,825.00
FZ-200iWPw/ Breeze Break	220 x 0.001g	5.12" dia	24 lb	7564	1,910.00
FZ-300iWPw/ Breeze Break	320 x 0.001g	5.12" dia	24 lb	7565	1,955.00
FZ-1200iWP	1,220 x 0.01g	5.91" dia	24 lb	7566	1,825.00
FZ-2000iWP	2,000 x 0.01g	5.91" dia	24 lb	7567	1,910.00
FZ-3000iWP	3,000 x 0.01g	5.91" dia	24 lb	7568	1,955.00

### Options

AX: 073009456 FZ In use cover	1 lb	7005M	16.00	<b>A</b>
TB: 237 FZ AC adapter	1 lb	7006M	43.00	



A&D WEIGHING DIVISION

**GF Precision balance**

Super Hybrid Sensor. Vacuum fluorescent display. Weighing modes: gram, decimal ounce, decimal pound, pound/ounce, carat, pennyweight, troy ounce, grain, momme, percentage, counting, animal weighing. Standard RS232. Includes WinCT software on a CD for loading into your PC. This software will enable the output from the GF to be entered directly into a spread sheet program such as Excel. Splash proof keyboard and display. GLP/GMP/ISO compliance. Display auto power off function. Standard underhook. Auto power on function. Auto rezero function. Large square weighing pan. Front air bubble leveling. 120 VAC, 50/60 Hz, 8.25" x 12.5" x 3.4"H. NTEP 03-005

Part Number	Capacity	Pan	Weight	Stock	Price C5
GF-200*	210g x 0.001g	128 x 128mm	12 lb	4810	\$ 1,385.00
GF-300*	310g x 0.001g	128 x 128mm	12 lb	4811	1,555.00
GF-400	410g x 0.001g	128 x 128mm	12 lb	5560	1,840.00
GF-600	610g x 0.001g	128 x 128mm	12 lb	5561	2,480.00
GF-800	810g x 0.001g	128 x 128mm	12 lb	4102	2,720.00
GF-1000	1,100g x 0.001g	128 x 128mm	12 lb	4103	2,995.00
GF-1200*	1,210g x 0.01g	165 x 165mm	12 lb	4812	1,340.00
GF-2000*	2,100g x 0.01g	165 x 165mm	12 lb	4813	1,390.00
GF-3000*	3,100g x 0.01g	165 x 165mm	12 lb	4814	1,670.00
GF-4000	4,100g x 0.01g	165 x 165mm	12 lb	5562	1,985.00
GF-6100	6,100g x 0.01g	165 x 165mm	12 lb	5563	2,750.00
GF-6000*	6,100g x 0.1g	165 x 165mm	12 lb	4815	1,850.00
GF-8000	8,100g x 0.1g	165 x 165mm	12 lb	5564	2,170.00

\* NTEP

**Options**

			B5
GX-04 Comparator output	1 lb	4693M	265.00
GX-06 Analog output	1 lb	4694M	840.00
GX-10 Glass breeze break for GX-200, 400, 600	2 lb	4695M	275.00
GX-11 Glass breeze break for GX-2000 & higher	2 lb	4696M	300.00
GX-12 Animal weighing pan for GX-400 & higher	1 lb	4697M	185.00
GX-13 Density determination kit	1 lb	4698M	640.00
			<b>C</b>
AD-8121 Multifunction printer	5 lb	1974M	891.00
			<b>A</b>
SW:128 Foot switch	1 lb	4699M	69.00
AX:073003691-S In use cover for GF/GX 200-1000	1 lb	4700M	20.00
AX:073003692-S In use cover GF/GX 1200-8000	1 lb	4701M	20.00



**GF-600 Precision balance**



**GF-300 w/optional breeze break**



Prices are subject to change without notice. Please call for current prices.

Other items are available from the manufacturers, please call for prices.

99 Reagent Lane  
Fair Lawn NJ 07410  
201-797-2718 \* 800-631-0347

**Totalcomp**  
Scales & Balances

www.totalcomp.com  
Fax 201-797-2287  
Toll Free Fax 888-797-2288

# AND

A&D WEIGHING DIVISION



GF-A Precision Balance

## GF-A Precision Balance

Super hybrid sensor. Reverse backlit LCD display. Software features include Impact Shock Detection, Flow Rate Display and Electronically Controlled Load where an automatic self diagnostic test is run before an internal readability test. Weighing application: Counting with ACAI, Percent weighing, Density determination, Statistical calculation, Comparator HI/OK/LO, Underhook, Gross/Net/Tare. Weighing Units: g, lb, In-oz, ozt, ct, mom, dwt, gr, pcs, %, SG, user programmable unit. GLP/GMP/GCP compliance, Universal Flex Coms, Password protected. Function keys: ON/OFF, CAL, MODE, SAMPLE, PRINT, REZERO. Anti static breeze break, Front level bubble with LED illumination, key lock security, Fly Thumb Wheel Feet.

Part Number	Capacity	Pan	Weight	Stock	Price C5
GF-123A	122 x 0.001g	128 x 128mm	12 lb	2063	\$ 1,589.00
GF-203A	220 x 0.001g	128 x 128mm	12 lb	2064	1,789.00
GF-303A	320 x 0.001g	128 x 128mm	12 lb	2065	1,889.00
GF-403A	420 x 0.001g	128 x 128mm	12 lb	2066	2,246.00
GF-603A	620 x 0.001g	128 x 128mm	12 lb	2067	2,496.00
GF-1003A	1,100 x 0.001g	128 x 128mm	12 lb	2068	3,295.00
GF-603A	1,620 x 0.001g	128 x 128mm	12 lb	2069	3,046.00
GF-1202A	1,220 x 0.001g	128 x 128mm	12 lb	2070	2,225.00
GF-2002A	2,200 x 0.001g	128 x 128mm	12 lb	2071	1,968.00
GF-3002A	3,200 x 0.01g	128 x 128mm	12 lb	2072	2,150.00
GF-4002A	4,200 x 0.01g	128 x 128mm	12 lb	2073	2,300.00
GF-6002A	6,200 x 0.01g	128 x 128mm	12 lb	2074	2,750.00
GF-10002A	10,200 x 0.01g	128 x 128mm	12 lb	2075	2,850.00
GF-8001A	8,300 x 0.1g	128 x 128mm	12 lb	2076	2,025.00
GF-10000A	10,200 x 0.1g	128 x 128mm	12 lb	2077	3,083.00

# AND

A&D WEIGHING DIVISION



GF-P Precision balance

## GF-P Precision balance

Tough, die-cast aluminum housing. Ideal for pill counting and compounding. Fast, Super Hybrid Sensor (SHS). Removeable stainless steel pan. IP54 splash proof/dust proof stainless steel weighing pan. Large, bright vacuum fluorescent display. Multiple weighing modes. One second response time. Data memory function. Underhook. WinCT data collection software. Quick reference operation card. RS232C standard. GLP/LIMS/ISO compliance. 5 year warranty.

NTEP 04-077P

Part Number	Capacity	Pan	Weight	Stock	Price C5
GF-200P	200 x 0.001g	5" x 5"	16 lb	7575	\$ 1,385.00
GF-300P	310 x 0.001g	5" x 5"	16 lb	7576	1,540.00

### Options

GX-02 USB option for GF & GX	1 lb	7577M	150.00	<b>A5</b>
GX-10 Glass Breeze Break for GF	1 lb	7578	265.00	<b>A</b>
TB: 248 AC adapter	1 lb	7006M	43.00	

### Service Parts

08:3003976 Keysheet GF	1 lb	7510	17.95	<b>A</b>
------------------------	------	------	-------	----------





**Midrics Level 1 & 2 Precision balance**

Rugged construction. 2 display and indicator units. 4 adjustable feet. Level indicator. 10 weighing ranges from 3kg to 3t.

**Midrics 1** for simple weighing tasks.

**Midrics 2** with 10 key touch pad and applications programs. Applications include: counting, checkweighing, classification, totalizing, net-total formulation, animal weighing, percent weighing, neutral measurement.

32" x 24" is painted, all others are stainless steel. Indicator is stainless steel and IP65. Stainless steel versions are suited for industrial use in wet environments.

Part Number	Capacity	Pan	Weight	Stock	Price A5
<b>Midrics Level 1 Weigh Only</b>					
MW1P-3DC-L	3kg x 0.002kg	12.6" x 9.4"	21 lb	4943	\$ 1,260.00
MW1P-6DC-L	6kg x 0.005kg	12.6" x 9.4"	21 lb	4944	1,260.00
MW1P-15DC-L	15g x 0.001kg	12.6" x 9.4"	21 lb	4945	1,260.00
MW1P-30ED-L	30kg x 0.002kg	15.7" x 11.8"	30 lb	4946	1,335.00
MW1P-60ED-L	60kg x 0.005kg	15.7" x 11.8"	30 lb	4947	1,335.00
MW1P-60FE-L	60kg x 0.005kg	19.7" x 15.7"	37 lb	4948	1,470.00
MW1P-150FE-L	150kg x 0.01kg	19.7" x 15.7"	37 lb	4949	1,470.00
<b>Midrics Level 2 Weight &amp; Keypad</b>					
MW2P-3DC-L	3kg x 0.0002g	12.6" x 9.4"	21 lb	4951	1,315.00
MW2P-6DC-L	6kg x 0.0005kg	12.6" x 9.4"	21 lb	4952	1,315.00
MW2P-15DC-L	15kg x 0.001kg	12.6" x 9.4"	21 lb	4953	1,315.00
MW2P-30ED-L	30kg x 0.002kg	15.7" x 11.8"	30 lb	4954	1,355.00
MW2P-60ED-L	60kg x 0.005kg	15.7" x 11.8"	30 lb	4955	1,355.00
MW2P-60FE-L	60kg x 0.01kg	19.7" x 15.7"	37 lb	4956	1,515.00
MW2P-150FE-L	150kg x 0.01kg	19.7" x 15.7"	37 lb	4957	1,515.00
<b>Options</b>					
YDH01CWSUS 13" Column SS column			4 lb	4962	190.00
YDH02CWSUS 19.7" High SS column			5 lb	4964	205.00
YDH03CWSUS 29.5" SS Column			7 lb	4966	235.00



Midrics Level 1 Weigh only Precision balance

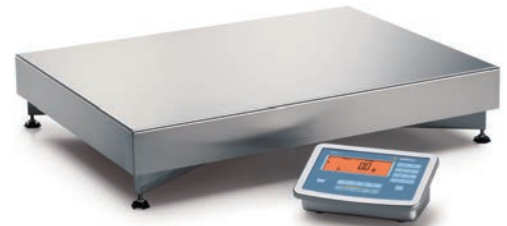

Midrics Level 2 Precision balance



**CP Precision balance**

Service parts only for Sartorius CP.

Part Number	Weight	Stock	Price C
<b>Service Parts</b>			
6971500 Power supply 110VAC	3 lb	3054	\$ 667.00
<b>A5</b>			
Roll paper (5 pack) for YDP03-OCE Data printer	1 lb	3786M	32.00
<b>A</b>			
YDP03-OCE Data printer with statistics & time/date*	5 lb	3751M	980.00

\* Order printer power supply separately

Prices are subject to change without notice. Please call for current prices.

Other items are available from the manufacturers, please call for prices.

# NEW



**Practum 2012-1S**  
Precision balance



**Practum 213-1S**  
Precision balance



**TE212**  
Precision Balance

# sartorius

## Practum

Unmatched reliability with the world class weighing instrument. Fast and easy data transfer. Touch screen with Sartorius graphical user interface. Overload protection for years of reliability. Glass level indicator with air bubble for centering. External calibration. Standard built in applications for: Weighing, Density, Percentage, Checkweighing, Peak Hold, Counting, Unstable Conditions. Selectable weighig units for: Gram, Kilogram, Carat, Pound, Ounce, Troy Ounce, Honk Kong Tael, Singapore Tael, Taiwan Tael, Grain, Pennyweights, Milligram, Parts Per Pound, China Tael, Mommies, Austrian Carat, Tola, Baht, Mesghal and Newton. USB port. 100-240 VAC, 50/60 Hz.

Part Number	Capacity	Pan	Weight	Stock	Price B5
Practum 124-1S	120g x 0.1mg	3.5"	11 lb	7605	\$ 2,385.00
Practum 224-1S	220g x 0.1mg	3.5"	11 lb	7606	2,620.00
Practum 213-1S	210g x 0.001g	4.75"	10 lb	7607	1,360.00
Practum 313-1S	310g x 0.001g	4.75"	10 lb	7608	1,465.00
Practum 612-1S	610g x 0.01g	7"	8 lb	7609	1,065.00
Practum 1102-1S	1100g x 0.01g	7"	8 lb	7610	1,180.00
Practum 2102-1S	2100g x 0.01g	7"	8 lb	7611	1,235.00
Practum 5101-1S	5100g x 0.1g	7"	8 lb	7612	1,255.00
Practum 5100-1S	5100g x 1.0g	7"	8 lb	7625	970.00

# sartorius

## TE Precision balance

Weighing craftsmanship that is easy to afford. Left and right tare keys. Typical modes of use are counting of small parts, weighing in percent, net-total calculation, toggling between two weight units, weigh averaging. Battery operable units without 'S' suffix use (8) AA batteries. RS232 data interface. LCD Liquid Crystal Display. Includes AC adapter.

Part Number	Capacity	Pan	Weight	Stock	Price C
TE212	210 x 0.01g	4.6"dia	8 lb	4677	\$ 595.00

### Options

YDP03-OCE Data printer with statistics & time/date	5 lb	3751M	980.00	<b>A</b>
YCC01-USBM2 cable RS232 to USB	1 lb	3763	146.00	



**Explorer Pro Precisiioin balance**

Explorer Pro balances are available with internal auto calibration or internal calibration. Weighing units: g, mg, kg, lb, oz, ozt, ct, dwt, taels(3), mommes, gn, ti, N, user definable custom unit. High resolution dot matrix alphanumeric display. User can select data fields to show on display including dual weighing units and ten messages. Configurable in English, French, Spanish, German and Italian. Applications include: Gross net tare weighing, GLP, GMP, parts counting, animal weighing, check weighing, filling, percent function, under hook for density and specific gravity. Cursor keys for ease in operation. RS232 interface. Adjustable filter for stabilization time. Stainless steel pan. 2 Year warranty. 100-120 VAC adapter, 8.3" x 14.5" x 14.5"H.



**EP612  
Precision balance**

Part Number	Capacity	Pan	Weight	Stock	Price C5
<b>Without internal calibration weight</b>					
EP413	410g x 0.001g	4.7" dia	19 lb	3338	\$ 2,376.00
<b>Options</b>					
80850043 Security Device up to 8kg			1 lb	1632M	185.00
80253384 Density determination kit			3 lb	2794	624.00
CBM-910 Impact printer, 42 column			5 lb	7426MB	495.00
80500570 RS232 cable to printer			1 lb	7429MB	155.00
<b>Service Parts Explorer Pro</b>					
30006112/ adapter 120 VAC			1 lb	602	69.00
83020938 line cord 120 VAC			1 lb	601	13.00
<b>Service Parts Explorer (Old)</b>					
80850042 In use cover for Voyager/Explorer			1 lb	1987	66.00

Prices are subject to change without notice. Please call for current prices.

Other items are available from the manufacturers, please call for prices.

# OHAUS®



**EX223**  
Precision balance



## Explorer Precision balance

Intelligent performance. Intuitive software. Ingenious draftshield. Practical touchless sensors. 5.7" full color VGA graphic display. Touch screen. Weighing applications for: Weighing, Percent Weighing, Check Weighing, Dynamic/Animal Weighing, Filling, Totalization, Formulation, Differential Weighing, Density Determination, Peak Hold, Ingredient Costing, Pipette Adjustment, SQC. Weighing units for: gram, milligram, kilogram, carat, ounce, ounce troy, pound, pennyweight, grain, newton, momme, mesghal, Hong Kong tael, Singapore tael, Taiwan tael, tical, tola, baht, 3 custom units. RS232, USB communication. 100-240 VAC adapter. 9.1"W x 15.5"D x 13.8"H. 2 year warranty.

Part Number	Capacity	Pan	Weight	Stock	Price C
<b>AutoCal</b>					
EX223	220g x 0.001g	5.1" dia	22 lb	7760	\$ 2,476.00
EX423	420g x 0.001g	5.1" dia	22 lb	7761	2,906.00
EX623	620g x 0.001g	5.1" dia	22 lb	7762	3,444.00
EX1103	1,100g x 0.001g	5.1" dia	22 lb	7763	4,090.00
EX2202	2,200g x 0.01g	7.5" x 7.9"	16 lb	7764	2,691.00
EX4202	4,200g x 0.01g	7.5" x 7.9"	16 lb	7765	3,067.00
EX6202	6,202g x 0.01g	7.5" x 7.9"	17 lb	7766	3,444.00
EX10202	10,200g x 0.01g	7.5" x 7.9"	17 lb	7767	4,090.00
EX6201	6,200g x 0.1g	7.5" x 7.9"	17 lb	7768	2,906.00
EX10201	10,200g x 0.1g	7.5" x 7.9"	17 lb	7769	3,122.00
<b>NTEP 12-012 I/II</b>					
EX423N	420g x 0.001g	5.1" dia	22 lb	7569	3,229.00
EX1103N	1,100g x 0.001g	5.1" dia	22 lb	7570	4,413.00
EX4202N	4,200g x 0.01g	7.5" x 7.9"	16 lb	7571	3,390.00
EX10202N	10,200g x 0.01g	7.5" x 7.9"	17 lb	7572	4,413.00
EX10201N	10,200g x 0.1g	7.5" x 7.9"	17 lb	7620	3,444.00
<b>Tradition Calibration (not AutoCal)</b>					
EX223/E	220g x 1mg	5.1" dia	22 lb	6957	2,045.00
EX423/E	420g x 1mg	5.1" dia	22 lb	6958	2,583.00
EX2202/E	2,200 x 0.01g	7.5" x 7.9"	16 lb	6959	2,261.00
EX4202/E	4,200g x 0.01g	7.5" x 7.9"	16 lb	6960	2,637.00
EX6202/E	6,200g x 0.01g	7.5" x 7.9"	16 lb	6961	3,014.00
EX6201/E	6,200g x 0.1g	7.5" x 7.9"	16 lb	6962	2,476.00
<b>Service Parts</b>					
83033684 Top cover			1 lb	424	16.00 <b>A</b>



# OHAUS®

## Adventurer Pro Precision balance

Service parts for Adventurer Pro Precision balance.

Part Number	Weight	Stock	Price A
<b>Service Parts</b>			
46001724 AC adapter 120VAC to 12VDC, 500ma w/o prong set	1 lb	6164M	37.00
12103876 Glass draft shield 115 mm	2 lb	6810	109.00
46001776 Prong set, US only	1 lb	6226M	14.00
46001780 Prong set, International	1 lb	714M	15.00



**AV412**  
Precision balance

# OHAUS®

## Adventurer Precision balance

Service parts only.

Part Number	Weight	Stock	Price A
<b>Service Parts</b>			
46001724/46001776 AC adapter 120 VAC	1 lb	212	48.00
12104951 In use cover	1 lb	4066	42.00
12105367 Keypad	1 lb	3702	102.00



**ARC120**  
Precision balance

# ACCULAB®

## ALC Precision balance

Stainless steel weighing platform. State of the art technology provides accuracy, repeatability and outstanding performance at remarkably affordable prices. Large LCD display. Keys are: CAL, ON/OFF, ZERO, PRINT, F. Piece counting. Percent weighing for solids, moisture loss, formulation, quality control. Averaging for unstable ambient conditions. Net totaling for formulation. User selectable two unit toggling. Advanced microprocessor for accurate weighing results, digital filtering and fast stabilization. RS 232 bi-directional interface for connection to computer or printer. Lock down capability. Four selectable application programs. 20 different weighing modes. Simple one button external calibration. 120 VAC

Part Number	Capacity	Pan	Weight	Stock	Price C5
ALC-150.3*	150g x 1mg	3.95" dia	6 lb	6818	\$ 920.00
ALC-1100.2	1,100g x 0.01g	5.9" dia	5 lb	6821	920.00
ALC-4100.1	4,100g x 0.1g	5.9" dia	5 lb	6825	750.00
ALC-6100.1	6,100g x 0.1g	5.9" dia	5 lb	6826	810.00



**ALC**  
Precision balance

Prices are subject to change without notice. Please call for current prices.

Other items are available from the manufacturers, please call for prices.

# Precision



**HI410S**  
Precision balance

**SI2000S**  
Precision balance

## HI & SI Precision balance

Award winning variable capacitance sensing technology. Large bright LED display. Rapid update rate for filling. Bidirectional RS232. Rugged die cast aluminum housing. Chemically resistant keypad. Stainless steel weighing pan. Standard RS232 interface. HI series has keys for CAL, MODE, PRINT, UNITS, TARE/POWER, %. Units are grams, ounces, carats, %, g per second, user defined unit. Fast or slow update rate. Print will transmit data instantaneously, continuously or at selected intervals. SI has keys for MODE, TARE/POWER. Dual range balances display the finest resolution whenever the balance is tared, regardless of how much weight is zeroed out. 120 VAC adapter, 11"L x 7"W x 3"H.

Part Number	Capacity	Pan	Weight	Stock	Price C
HI410S *	410g x 0.001g	4.75" dia	10 lb	6070	\$ 1,535.42
HI4100S	4,100g x 0.01g	6.25" dia	10 lb	6071	1,410.42
SI200S *	200g x 0.001g	4.75" dia	10 lb	6072	1,360.42
SI410D *	100g x 0.001g 410g x 0.01g	4.75" dia	10 lb	6073	1,185.42
SI410S *	410g x 0.001g	4.75" dia	10 lb	6074	1,410.42
SI2000S	2,000g x 0.01g	6.25" dia	10 lb	6075	1,185.42
SI4100D	1,000g x 0.01g 4,100g x 0.1g	6.25" dia	10 lb	6076	1,185.42

SI4100S 4,100g x 0.01g 6.25" dia 10 lb 6077 1,285.42  
\* Cylindrical draftshield included

Options	Weight	Stock	Price C
Draftshield, 3 way glass door for 4.75"dia pan	2 lb	6080	280.00
Dustcover	1 lb	6082	27.30

Service Parts	Weight	Stock	Price C
407712 120 VAC adapter	1 lb	6066	83.80
409748 Supercount AC adapter	1 lb	6083	92.90
404290-01R load cell 1kg	5 lb	6062	1,122.00
404290-02R load cell 2.5kg	5 lb	6041	1,122.00
404290-04R load cell 12.5kg	5 lb	6042	1,122.00
404290-05R load cell 25kg	5 lb	6043	1,122.00
404290-07R load cell 50kg	5 lb	6044	1,122.00

Nov

**NEW**



**TJA-103P**  
Precision balance

Prices are subject to change without notice. Please call for current prices.

Other items are available from the manufacturers, please call for prices.



## TJA Precision balance

Electronic precision balance. Easy to see in low light conditions 7 digit LCD display with blue back light. Stainless steel weighing pan 3.5" dia. Continuous output RS232 via 9 pin connector for remote display or computer input. Weighing functions for: Standard weighing and counting. Keys for ON/OFF, COUNT, ENTER, CAL, UNIT. Units are gram, ct, oz. Glass breeze break with top and side sliding doors for quick placement of item to be weighed. CAL button and 100g calibration weight and glove, included, for easy recalibration of balance. Front bubble level and four adjustable feet allow for quick leveling. Rechargeable battery makes the balance portable. 10.6"L x 7.8"W x 10.8"H. 100-240 VAC adapter output 6 VDC, 500ma.

Part Number	Capacity	Pan	Weight	Stock	Price C
TJA-103P	110g x 0.001g	3.5" dia	9 lb	5967	\$ 355.00

Service Parts	Weight	Stock	Price C
120 VAC adapter for TJA-103P	1 lb	5969	19.00



**NEW**

**Pioneer Precision Balance**

The Pioneer balances are available in both external and internal calibration models with suffix "C". Selectable environmental setting helps the balance adapt to real life working conditions weigh below feature for density and specific gravity determination, selectable upon calibration points, stability indication, mechanical and software overload/underload protection. Applications are weighing, parts counting, percent weighing, animal dynamic weighing and density determination. Keys are Unit/Menu, 0T, On/Off, Print/Cal. Weighing units are mg, g, ct, oz, dwt, tical, mommes, baht, gain, mesghal Newton, ozt, 1 Custom Unit. 100-240 VAC adapter 7.7" W x 12.6" D x 11.3" H.



Pioneer Precision

Part Number	Capacity	Pan	Weight	Stock	Price C
PA163	162 g x 0.001 g	120mm dia	17 lb	8364	\$ 1,037.00
PA163C	162 g x 0.001 g	120mm dia	17 lb	8365	1,253.00
PA323	320 g x 0.001 g	120mm dia	17 lb	8366	1,210.00
PA323C	320 g x 0.001 g	120mm dia	17 lb	8367	1,426.00
PA523	520 g x 0.001 g	120mm dia	17 lb	8368	1,442.00
PA523C	520 g x 0.001 g	120mm dia	17 lb	8369	1,657.00
PA1602	1620 g x 0.01 g	180mm dia	14 lb	8370	932.00
PA1602C	1620 g x 0.01 g	180mm dia	14 lb	8371	1,148.00
PA2202	2200 g x 0.01 g	180mm dia	14 lb	8372	1,095.00
PA2202C	2200 g x 0.01 g	180mm dia	14 lb	8378	1,310.00
PA3202	3200 g x 0.01 g	180mm dia	14 lb	8377	1,542.00
PA4202	4200 g x 0.01 g	180mm dia	14 lb	8378	1,499.00
PA4202C	4200 g x 0.01 g	180mm dia	14 lb	8379	1,714.00
PA2201	2200 g x 0.01 g	180mm dia	14 lb	8374	905.00
PA2201C	2200 g x 0.01 g	180mm dia	14 lb	8375	1,102.00
PA4201	4200 g x 0.01 g	180mm dia	14 lb	8380	1,062.00
PA4201C	4200 g x 0.01 g	180mm dia	14 lb	8381	1,261.00

Options			Price A
12120798 SF40A SF42A Ink ribbon	1 lb	5232B	\$ 44.00
12120799 SF40A Roll Paper 2/pk	1 lb	5230B	14.00
12122603 SF40A Cable kit Disc/MB/Pion/Troop	1 lb	5244B	155.00
80251931 Thermal paper	1 lb	7420B	16.00
80252571 RS232 Cable & adapter, Disc/Pion/MB	1 lb	7430B	155.00
80252581 RS232 Cable & adapter, Disc/Pion/MB	1 lb	7422B	155.00
80253384 Density determination kit	3 lb	2794M	624.00
80850000 Anti theft security device	1 lb	1295M	72.00
80850080 TAL Software WinWedge v1.2	1 lb	2436M	437.00
30064203 SF40A Dot Matrix impact printer	2 lb	1754MB	798.00
80500525 Cable to IBM 9 pin serial	1 lb	3047M	155.00
83021085 USB interface w/cable	1 lb	8234	155.00
80251396 Auzillary display for pioneer	2 lb	3996	56.00
83020224 Draft Shield	2 lb	7497	73.00

Prices are subject to change without notice. Please call for current prices.

Other items are available from the manufacturers, please call for prices.

**NEW**



WTC  
Bench

**WTC Precision**

Internal rechargeable battery for portable operation. Fast and precise mass determination in laboratory and industrial conditions. Stainless steel weighing pan. Backlit LCD display. Checkweighing, Parts Counting, Percent, Totalizing, Animal weighing, Peak hold. Includes internal rechargeable battery. Optional RS232 output. IP43.

Part Number	Capacity	Platform	Weight	Stock	Price C5
WTC200	200 g x 0.001 g	100mm dia	4 lb	67	\$ 325.00
WTC2000	2,000 g x 0.01 g	128mm x 128mm	5 lb	68	243.00



## WLC Precision

Stainless steel weighing platter. Fast and precise mass determination in laboratory and industrial conditions. Excellent in areas with no access to mains. Backlit LCD display. Counting pieces. Checkweighing and percentage. Animal weighing. Caps lock of max indication. Measurement in Newton. WLCA2 have the option of weighing loads outside the weighing platform (under hook weighing). Includes internal rechargeable battery and RS232 output.

Part Number	Capacity	Platform	Weight	Stock	Price C5
WLC2/A2	2kg x 0.01g	7.7" x 7.7"	5 lb	7617	\$ 566.00
WLC10/A2	10kg x 0.1g	7.7" x 7.7"	9 lb	7621	547.00
WLC20/A2	20kg x 0.1g	7.7" x 7.7"	9 lb	7622	585.00



**WLC  
Bench**



**HCB Highland Precision balance**

## HCB Highland Precision balance

HandiCal internal calibration for fast and accurate readings. Three point ShockProtect protection designed for the ultimate in performance reliability. ABS plastic with stainless steel platform. 6 digit, 0.6" backlit LCD display. Left and right tare keys. Applications include weighing, percent weighing, parts counting, totalization/accumulation. Audible overload indicator. Lock down mounting slot for Kensington type lock and cable. Internal rechargeable battery with auto power off and low battery indicator. Capacity tracker. Removable draft shield. USB and RS-232 bidirectional interface included for easy connection to computers and printers. 12VDC 800mA adapter.

Part Number	Capacity	Pan	Weight	Stock	Price B5
HCB123	120 x 0.001g	4.7" dia	5 lb	5299	\$ 435.00
HCB150	150 x 0.005g	4.7" dia	5 lb	5300	355.00
HCB302	300 x 0.01g	4.7" dia	5 lb	5301	355.00
HCB602H	600 x 0.01g	4.7" dia	5 lb	5302	445.00
HCB602	600 x 0.02g	4.7" dia	5 lb	5303	355.00
HCB1002	1,000 x 0.01g	4.7" dia	5 lb	5304	495.00
HCB1502	1,500 x 0.05g	4.7" dia	5 lb	5305	355.00
HCB3001	3,000 x 0.1g	4.7" dia	5 lb	5306	355.00
<b>Options</b>					<b>A5</b>
308232030 In use cover			1 lb	5307	20.00
<b>Service Parts</b>					<b>C</b>
302409160 adapter 120VAC			1 lb	252M	60.00



**PGL Series Precision Balance**

## PGL Series Precision Balance

Excellent for schools and universities. Metal die cast housing make the PGL well suited for applications that demand both high precision and ruggedness. PGL balances combine the solid construction and fundamental features of a high precision top loader with the simple operation of a portable balance. Left and right tare keys. Applications for weighing include parts counting, weighing, percent weighing, check weighing, density calculation. ShockGuard overload three point protection. Below balance weighing. RS-232 interface included. AC or rechargeable battery operation. Three year warranty.

Part Number	Capacity	Pan	Weight	Stock	Price B5
PGL4001	4,000 x 0.1g	7.6" x 7.6"	9 lb	7063	\$ 675.00
PGL20001	20,000 x 0.1g	15.7" x 11.8"	9 lb	7067	2,295.00
<b>Options</b>					<b>A5</b>
3074010266 RS-232 cable			1 lb	7068	35.00
<b>Service Parts</b>					<b>C</b>
302409160 adapter 120 VAC			1 lb	252M	55.50



A&D WEIGHING DIVISION

## MX MF ML MS Moisture Analyzers

Fast and uniform heating with halogen lamp. Four measurement programs: Standard, Automatic, timer, Manjal. Memory function for test parameters and results. Up to 20 measurements conditions can be stored and recalled in MX-50. 10 can be stored in MF-50. Large, clear, easy to see VFD display. Plexiglass window for checking heating process. Conformity to GLP, GMP, GCP and ISO with date/time. ID, calibration data and check record outputs. Includes (20) sample pans, (2) pan handles, tweezers, spoon, test sample (30g of sodium tartrate dihydrate), CD-ROM (WinCT-Moisture for MX-50, WinCT for MF-50), RS232C cable for MX-50, display cover, dust cover, instruction manual, quick reference card, power cable, (2) fuses. 120 VAC, 50/60 Hz, 400 Watts, 5.4"W x 8.1"D x 4.4"H.

Part Number	Capacity	Percent	Pan	Weight	Stock	Price C5
MX-50	51g x 0.001g	100 x 0.01%	2.16"dia	16 lb	4522	\$ 3,630.00
MF-50	51g x 0.002g	100 x 0.05%	2.16"dia	16 lb	4523	2,935.00
ML-50	51g x 0.005g	100 x 0.1%	2.16"dia	16 lb	4890	2,470.00
MS-70	71g x 0.001g	100 x 0.001%	2.16"dia	16 lb	4447	5,815.00

### Service Parts

			A
AX-31 Sample pans (washable, 100 ea)	1 lb	4524	95.00
AX-32 Glass fiber sheets (100 ea)	1 lb	4525	52.00
AX-33 Sodium tartrate dihydrate test samples (30g x 12 ea)	1 lb	4526	83.00
AX-34 Halogen lamp (replacement)	1 lb	4527	63.00
AX-35 Pan handles (2 ea)	1 lb	4528	27.00
AX-36 Tweezers (2 ea)	1 lb	4529	17.00
AX-37 Spoons (2 ea)	1 lb	4530	21.00
AX-38 Display covers (5 ea)	1 lb	4531	42.00
AX-39 Dust cover	1 lb	4532	17.00
AX-42 WinCT-Moisture (std for MX-50, option for MF-50)	1 lb	4533	237.00
AD-1700-20g Calibration Mass 20g	1 lb	4360	150.00
AX-43 Temperature Calibration (MX-50)	1 lb	4547	450.00
PZ:3844-3852 Transformer/power supply bd MX MF	1 lb	4548	172.00
PZ:3843-HITAR Heater relay bd MX MF	1 lb	4549	94.00



**MF-50**  
Moisture Balance



**MX-50**  
Moisture Balance

Prices are subject to change without notice. Please call for current prices.

Other items are available from the manufacturers, please call for prices.

99 Reagent Lane  
Fair Lawn NJ 07410  
201-797-2718 \* 800-631-0347

**Totalcomp**  
Scales & Balances

www.totalcomp.com  
Fax 201-797-2287  
Toll Free Fax 888-797-2288

# Moisture



**MB120**  
Moisture Balance

## OHAUS®

### MB Moisture Determination Balance

Automatic determination of moisture content. GLP compliant format when printed results are required. Fast halogen element provides uniform infrared heating up to 200 deg C. Heat from 50 deg C to 180 deg C in less than 1 minute. Display shows % moisture, % solids, weight, time, temperature and drying time. Program and recall up to 50 drying procedures. Once programmed, simply select and run test. Allows simple test editing to find best result. Auto shut off. Programming options are fast, standard, ramp or step. RS232 bidirectional interface is standard. 2 Year warranty. 120 VAC, 50/60 Hz, 7.5"W x 14"D x 6"H, 3.5" dia pan.

Part Number	Capacity	Percent	Pan	Weight	Stock	Price C5
MB120	120g x 0.01g	100 x 0.01%	3.5"dia	19 lb	4678	\$ 4,536.00

#### Options

					A
11113873	Sample pan holder for MB35		1 lb	1571	116.00
80850043	Security Device up to 8kg		1 lb	1632M	185.00
CBM-910	Impact printer, 42 column		5 lb	7426M	495.00
11113857	Temperature calibration kit		1 lb	3042	477.00
80500525	Cable to IBM 9 pin serial		1 lb	3047M	155.00
80500571	Cable to SF42 Impact printer		1 lb	3048M	155.00
80850080	TAL Software WinWedge v1.2		1 lb	2436M	437.00

#### Service Parts

					A
12101511	Roll paper (5) pack for SF42 printer		1 lb	6197M	63.00
80850087	Pads, glass fiber, 200/box		1 lb	3043	83.00
80850086	Sample pans, 50/box		1 lb	3044	51.00
80850088	Reusable sample pans, pack of 3		1 lb	3045	166.00
80850085	In use cover		1 lb	3046	63.00



**MB200**  
Moisture Balance

## OHAUS®

### MB200 Moisture Determination Balance

Options and service parts only for MB200.

Part Number	Weight	Stock	Price A
<b>Options</b>			
80850000	Anti theft security device	1 lb	1295M \$ 72.00

#### Service Parts

			C
80780012	Pan liners, pack of 100	1 lb	533 66.00
6081-B0	Pan liners, pack of 1,000	9 lb	577 256.00

## OHAUS®

### MB45 Service Parts Only

Service parts only for MB45

Part Number	Weight	Stock	Price A
80252851	Membrane switch	1 lb	3480 \$ 93.00

Prices are subject to change without notice. Please call for current prices.

Other items are available from the manufacturers, please call for prices.



# OHAUS®

## MB23 Moisture Analyzer Balance

Infrared heating. MB series combine high quality and durable construction into sleek, compact designs. One button setup. Large backlit LCD display. Manual, timed or auto shutoff. Standard RS232 port. Readabilities of 0.1%. 2 year warranty. 100 to 240 VAC, 50/60 Hz. 6.5"W x 11"D x 5"H.

Part Number	Capacity	Pan	Weight	Stock	Price C5
MB23	110g x 0.01g	3.5" dia	9 lb	4028	\$ 2,650.00



**MB23**  
Moisture Analyzer Balance

# OHAUS®

## MB27 Moisture Analyzer Balance

Halogen heating. MB series combine high quality and durable construction into sleek, compact designs. One button setup. Large backlit LCD display. Manual, timed or auto shutoff. Standard RS232 port. Readabilities of 0.01%. 2 year warranty. 100 to 240 VAC, 50/60 Hz. 6.5"W x 11"D x 5"H.

Part Number	Capacity	Pan	Weight	Stock	Price C5
MB27	90g x 0.001g	3.5" dia	9 lb	6491	\$ 2,750.00

**NEW**



**MB27**  
Moisture Analyzer Balance

# OHAUS®

## MB90 Moisture Analyzer Balance

Fast Halogen heating technology. Large touchscreen display. Icon driven menu navigation. Stainless steel drying pan. Four mechanical keys for fast one step operation, Tare, Start/Stop, Print, On/Off. Manual, timed or auto shutoff. Standard RS232 port. Readabilities of 0.01%. 2 year warranty. 100 to 240 VAC, 50/60 Hz. 6.5"W x 11"D x 5"H.

Part Number	Capacity	Pan	Weight	Stock	Price C5
MB90	90g x 0.001g	3.5" dia	9 lb	4065	\$ 3,570.00

**NEW**



**MB90**  
Moisture Analyzer Balance

Prices are subject to change without notice. Please call for current prices.

Other items are available from the manufacturers, please call for prices.



**MA35  
Moisture Balance**

## MA35 Moisture Balance

Quick and reliable analysis using thermogravimetric method. Fully Automatic infrared moisture analyzer, perfect for routine operation. Sartorius MA35 is a long-lasting, rugged built, impervious to vibration and dirt, reliable even in a harsh environment. Simple use, quick measurement results with heating elements generating 360 watts of power. Temp. settings 40-160 deg C. Measures display: % of moisture, % dry mass, % ATRO, g residue conformity to GLP, data interference RS232C-S, 7 data-bit ASCII multi language selection. POver consumption max. 400VA. Power 115VAC case dimensions 224"W x 366"D x 191"H mm.

Part Number	Capacity	Weight	Stock	Price C
MA35M-II5US	350g x 0.01g	17 lb	4725	\$2,912.00

## Weighing Dishes

These plastic anti-static weighing dishes are produced from a special grade of polystyrene and will resist diluted acids, aqueous solutions, alcohols and bases. They are safe, contaminant-free, biologically inert, economical containers which specially made for many applications such as weighing, dispersing or storing. They can be used as quick freeze trays for sample material, discard trays, for broken ampules, or mixing trays for small batches. They have a smooth surface providing accurate pour-outs with minimal sample loss. They are non-reactive with most substances and suitable for weighing static affected materials. Will withstand temperatures up to 80°C

### Hexagonal

Globe Scientific's hexagonal plastic weighing dishes are available in 4 different sizes. The molded hexagonal design provides greater balance protection and safety. They are ideal for handling solids or liquids during weighing. They can be easily bent into pouring spouts to provide pour-outs with minimal sample loss.

Part Number	Volume	Dimensions	Weight	Stock	Price A5
3615	20 mL	38 mm	1 lb	2547	\$ 27.90
3616	50 mL	64 mm	1 lb	2548	56.20
3617	200 mL	102 mm	1 lb	2549	64.10
3618	350 mL	127 mm	1 lb	2549	120.00

### Square

Globe Scientific's square weighing dishes are available in 3 different sizes. They have sloping sides, rounded corners and flat bottoms to ensure perfect stability on counters.

Part Number	Volume	Dimensions	Weight	Stock	A5
3620	20 mL	41mm x 8mm H	1 lb	2551	28.60
3621	100 mL	89mm x 25mm H	1 lb	2552	57.10
3622	330 mL	140mm x 25mm H	1 lb	2553	126.00

### Pour boat

Globe Scientific's pour boats are available in 3 sizes. They are specifically made to facilitate dispensing of powdered and liquid materials. Smooth, uniform and economical, the molded material used is thicker than conventional weighing dishes.

Part Number	Volume	Dimensions	Weight	Stock	A5
3623	2 mL	54 x 44 x 8mm	1 lb	2554	32.70
3624	140 mL	130 x 93 x 25mm	1 lb	2555	63.00
3625	270 mL	191 x 125 x 25mm	1 lb	2556	92.00

**Hexagonal**



**Square**



**Pour boat**





A&D WEIGHING DIVISION

### GF-K Industrial Balance

The resolution and functions of analytical balances with the capacity and ruggedness of industrial balances. Weighing modes: kg, gram, decimal ounce, troy ounce, pennyweight, carat, momme, grain, decimal pound, pound/ounce. 120 VAC, 50/60 Hz.

Overall size 12" x 14" x 4.4"H.

Part Number	Capacity	Pan	Weight	Stock	Price C5
GF-8K	8,000g x 0.01g	8.26" x 10.62"	22 lb	6641	\$ 3,375.00
GF-8K2	2,000g x 0.01g 8,000g x 0.1g	8.26" x 10.62"	22 lb	6642	2,860.00
GF-10K	10,100g x 0.01g	8.26" x 10.62"	22 lb	6877	3,600.00
GF-12K	12,000g x 0.1g	8.26" x 10.62"	22 lb	6643	3,035.00
GF-20K	20,000g x 0.1g	8.26" x 10.62"	22 lb	6644	3,240.00
GF-30K	30,000g x 0.1g	8.26" x 10.62"	22 lb	6645	3,800.00
GF-32K	6,000g x 0.1g 30,000g x 1g	8.26" x 10.62"	22 lb	6646	2,880.00

#### Options

				B5
GX-04K *	Comparator output & RS232/20ma interface	1 lb	6638M	365.00
GX-06K *	Analog output/20ma interface	1 lb	6639M	840.00
GX-07K	Waterproof cable for standard RS232	1 lb	6640M	310.00

\* 04 & 06 replace standard RS232 port. Only (1) option per balance.



**GF-12K**  
Industrial Balance



A&D WEIGHING DIVISION

### GX-K Industrial Balance

Internal motor driven calibration mass saves time and money. Automatic self calibration when the balance detects ambient temperature changes. One touch automatic calibration lets you calibrate the balance on demand with just the push of one button. The resolution and functions of analytical balances with the capacity and ruggedness of industrial balances. Weighing modes: kg, gram, decimal ounce, troy ounce, pennyweight, carat, momme, grain, decimal pound, pound/ounce. 120 VAC, 50/60 Hz, 12" x 14" x 4.4"H.

Part Number	Capacity	Pan	Weight	Stock	Price C5
GX-8K	8,000g x 0.01g	8.26" x 10.62"	22 lb	6632	\$ 3,570.00
GX-8K2	2,000g x 0.01g 8,000g x 0.1g	8.26" x 10.62"	22 lb	6633	3,085.00
GX-10K	10,100g x 0.01g	8.26" x 10.62"	22 lb	6874	3,800.00
GX-12K	12,000g x 0.1g	8.26" x 10.62"	22 lb	6634	3,240.00
GX-20K	20,000g x 0.1g	8.26" x 10.62"	22 lb	6635	3,495.00
GX-30K	30,000g x 0.1g	8.26" x 10.62"	22 lb	6636	4,045.00
GX-32K	6,000g x 0.1g 30,000g x 1g	8.26" x 10.62"	22 lb	6637	3,140.00

#### Options

				B5
GX-04K *	Comparator output & RS232/20ma interface	1 lb	6638M	365.00
GX-06K *	Analog output/20ma interface	1 lb	6639M	840.00
GX-07K	Waterproof cable for standard RS232	1 lb	6640M	310.00

\* 04 & 06 replace standard RS232 port. Only (1) option per balance.



**GX-12K**  
Industrial Balance  
Internal calibration weight

Prices are subject to change without notice. Please call for current prices.

Other items are available from the manufacturers, please call for prices.



A&D WEIGHING DIVISION



**GP-12K**  
w/ column

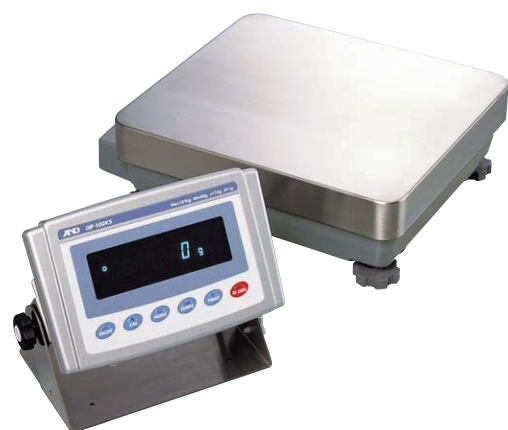

**GP-30KS**  
Industrial Balance  
w/ remote indicator

## GP Industrial Balance

The resolution and functions of analytical balances with the capacity and ruggedness of industrial balances. Adjustable swing arm display. Weighing modes: gram, decimal ounce, decimal pound, carat, pennyweight, troy ounce, grain, momme. Percentage and counting modes. Internal calibration weight. RS232 output is standard. Stainless steel weighing pan. 120 VAC, 50/60 Hz, 15"W x 24"D x 6"H.

Part Number	Capacity	Pan	Weight	Stock	Price C5
<b>Swing arm display column</b>					
GP-12K	12,000g x 0.1g	13.5" x 15"	39 lb	5505	\$ 3,500.00
GP-20K	21,000g x 0.1g	13.5" x 15"	39 lb	5506	3,840.00
GP-32K	6,000g x 0.1g	13.5" x 15"	39 lb	5507	3,115.00
	31,000g x 1g				
GP-30K	31,000g x 0.1g	13.5" x 15"	39 lb	5508	4,580.00
GP-40K	41,000g x 0.5g	13.5" x 15"	39 lb	5509	4,150.00
GP-60K	61,000g x 1g	13.5" x 15"	39 lb	5510	5,100.00
GP-61K	61,000g x 0.1g	13.5" x 15"	39 lb	3372	5,870.00
GP-100K	100,000g x 1g	13.5" x 15"	42 lb	5511	5,500.00
GP-102K	61,000g x 1g	13.5" x 15"	42 lb	5512	4,940.00
	101,000g x 10g				
<b>Remote Indicator</b>					
GP-30KS	31,000g x 0.1g	13.5" x 15"	39 lb	5513	4,825.00
GP-32KS	6,000g x 0.1g	13.5" x 15"	39 lb	3373	3,115.00
	31,000g x 1g				
GP-60KS	61,000g x 1g	13.5" x 15"	39 lb	3375	5,100.00
GP-61KS	61,000g x 1g	13.5" x 15"	39 lb	3376	5,690.00
GP-100KS	100,000g x 1g	13.5" x 15"	42 lb	5514	5,825.00
<b>Options</b>					
GP-04 Comparator output w/buzzer			1 lb	5515	255.00
GP-06 Analog output			1 lb	5516	835.00
GP-07 Extension cable			1 lb	5517	312.00
GP-20 Underhook GP-12K thru 40K			1 lb	5518	180.00
GP-21 Underhook GP-60K thru 102K			1 lb	5519	180.00
GP-22 Printer support for AD-8121A			1 lb	5520	160.00
<b>Service Parts</b>					
04:B31752D pan for CP/HP			1 lb	5772	155.00



**Navigator Industrial Balance**

Two touchless sensors which free up your hands for handling samples and minimizing wear and tear on the keypad. 6 digit, 7 segment with white LED backlight or red LED. 4 mechanical keys, raised with tactile feedback. Weighing units for: gram, kilogram, pound, ounce (decimal or fractional), pound (decimal or fractional), ounce troy, grain, newton, carat, pennyweight, Hong Kong tael, Taiwan teal, Singapore teal, tical, tola. Application modes for: Weighing, Percent Weighing, Parts Counting, Check Weighing, Display Hold, Accumulate/Totalize. Over-accept-under LCD or LED annunciators. Front mounted level bubble with illumination. Adjustable leveling feet with skid resistant rubber pads. Full capacity by subtraction tare range. User selectable external span or linearity calibration, digital with external weight. 12VDC AC adapter included or (4) AA batteries (not included). 8.03"W x 8.34"D x 5.27"H.



**Navigator Industrial Balance**

Part Number	Capacity	Pan	Weight	Stock	Price C5
NV212	210g x 0.01g	4.42" dia	4 lb	7802	\$ 360.00
NV211	210g x 0.01g	4.42" dia	4 lb	7347	216.00
NV511	510g x 0.1g	7.5" x 5.45"	4 lb	7803	246.00
NV1101	1,100g x 0.1g	7.5" x 5.45"	4 lb	7804	305.00
NV2101	2,100g x 0.1g	7.5" x 5.45"	4 lb	7805	395.00
NV4101	4,100g x 0.2g	7.5" x 5.45"	4 lb	7806	435.00
NV5101	5,100g x 0.5g	7.5" x 5.45"	4 lb	7807	502.00
NV4000	4,000g x 1g	7.5" x 5.45"	4 lb	7363	204.00

**Options**

				<b>A</b>
80251930	RS232 Adapter	1 lb	7425M	27.00
83032107	RS232 Interface w/ cable	2 lb	6162M	133.00
83032108	USB Interface w/ cable	2 lb	6163M	133.00



**Navigator XL Industrial Balance**

One second stabilization time providing fast, accurate weighing results improving efficiency, productivity and throughput. Two touchless sensors which free up your hands for handling samples and minimizing wear and tear on the keypad. 6 digit, 7 segment with white LED backlight or red LED. 4 mechanical keys, raised with tactile feedback. Weighing units for: gram, kilogram, pound, ounce (decimal or fractional), pound (decimal or fractional), ounce troy, grain, newton, carat, pennyweight, Hong Kong tael, Taiwan teal, Singapore teal, tical, tola. Application modes for: Weighing, Percent Weighing, Parts Counting, Check Weighing, Display Hold, Accumulate/Totalize. Over-accept-under LCD or LED annunciators. Front mounted level bubble with illumination. Adjustable leveling feet with skid resistant rubber pads. Full capacity by subtraction tare range. User selectable external span or linearity calibration, digital with external weight. 12VDC AC adapter included or (4) C batteries (not included) or internal rechargeable lead acid battery. 8.03"W x 11.10"D x 2.91"H.



**Navigator XL Industrial Balance**

Part Number	Capacity	Pan	Weight	Stock	Price C5
NVL511/1	510g x 0.1g	7.6" x 8"	6 lb	7808	\$ 552.00
NVL1101/1	1,100g x 0.1g	7.6" x 8"	6 lb	7809	602.00
NVL2101/1	2,100g x 0.1g	7.6" x 8"	6 lb	7810	653.00
NVL5101/1	5,100g x 0.5g	7.6" x 8"	6 lb	7811	629.00
NVL10000/1	10,000g x 1g	7.6" x 8"	6 lb	7812	703.00
NVL20000/1	20,000g x 1g	7.6" x 8"	6 lb	7813	703.00

**Options**

				<b>A</b>
80251930	RS232 Adapter	1 lb	7425M	27.00
83032107	RS232 Interface w/ cable	2 lb	6162M	133.00
83032108	USB Interface w/ cable	2 lb	6163M	133.00

Prices are subject to change without notice. Please call for current prices.

Other items are available from the manufacturers, please call for prices.

# OHAUS®



**NVT1601**  
Industrial Balance

## Navigator XT Industrial Balance

Front mounted level bubble with illumination, adjustable leveling feet with skid resistant rubber pads. User selectable external span or linearity calibration with external weight. 6 digit, 7 segment with white LED backlight or red LED. Over/accept/under LCD or LED annunciators. 4 mechanical keys, raised and with tactile feedback plus 2 touchless sensors. Weighing units: gram, kilogram, pound, ounce (decimal or fractional), pound:ounce (decimal or fractional), ounce troy, grain, newton, carat, pennyweight, Hong Kong tael, Taiwan tael, Singapore tael, tical, tola. Applications modes: weighing, percent weighing, parts counting, check weighing, display hold, accumulate/totalize. User enabled auto power off after 5 minutes of inactivity. (4) C batteries not included or internal rechargeable lead acid battery (optional). 12VDCAC adapter, 240V, 50-60Hz. 9.4"W x 9.8"D x 2.75H

Part Number	Capacity	Pan	Weight	Stock	Price C
NVT1601	1,600g x 0.1g	9" x 6.85"	7 lb	7668	\$ 486.00
NVT3201	3,200g x 0.2g	9" x 6.85"	7 lb	7669	486.00
NVT6401	6,400g x 0.5g	9" x 6.85"	7 lb	7670	468.00
NVT10001	10,000g x 0.5g	9" x 6.85"	7 lb	7671	486.00
NVT16000	16,000g x 1g	9" x 6.85"	7 lb	7672	486.00

# NEW



**Explorer**  
Industrial Balance

# OHAUS®

## Explorer EX Industrial Balance

Die cast metal base, stainless steel pan and thick metal housing. Explorer High Capacity is built to withstand daily wear and tear. 5.7" color VGA touch screen optimizes viewing and menu navigation. Two sensors on display offer hands free operation. The display can be separated from the base up to 1.5 meters in order to fit operational needs in almost any workspace. Weighing units: g, kg, ct, gn, lb, oz, ozt, N, dwt, hkt, sgt, twt, mom, tical, msg, tola, Custom Unit 1, Custom Unit 2, Custom Unit 3. Weighing applications: Weighing, Percent Weighing, Parts Counting, Check Weighing, Dynamic/Animal Weighing, Filling, Totalization, Formulation, Differential Determination, Peak Hold, Ingredient Costing, SQC. A 9 meter cable is also available when additional flexibility is needed. 2D Protection prevents shock and damage associated with movement and forces applied to the balance. Adjustable rolling feet provide assistance in easily moving the balance. IP54 protection guards balance and weighing cell from damage by dry particles, humidity and accidental spills/splashes (High Capacity models only). Rechargeable battery option provides 10 hours of operation away from a power source. Standard RS232, USB. 100-240 VAC. 17.4"W x 14.8"D x 4.72"H

Part Number	Capacity	Pan	Weight	Stock	Price C
EX12001	12,000g x 0.1g	15" x 12"	28 lb	7344	\$ 3,444.00
EX24001	24,000g x 0.1g	15" x 12"	28 lb	7345	4,198.00
EX35001	35,000g x 0.1g	15" x 12"	28 lb	7346	4,951.00



**EA Industrial Balance**

EA scales for weighing: Speed up technology produces high speed weighing results in 0.5 second. Bi directional RS232 is standard. Backlit LCD display. Rugged construction with overload protection up to 2X scale capacity. Generous sized stainless steel weighing platforms. Clearly marked function keys for easy operation. Capable of generating printout for tare/net/gross values.

Part Number	Capacity	Pan	Weight	Stock	Price B5
<b>High Resolution for weighing</b>					
EA6DCE-I	6,000g x 0.2g	12.6" x 9.4"	17 lb	3765	\$ 1,195.00

**Options**

YDP03-OCE Data printer with statistics & time/date*	5 lb	3751M	980.00	<b>A</b>
---	------	-------	--------	----------

\* Order printer power supply separately

6971991/6971954 Power supply for YDP03-OCE Data printer	2 lb	3752	181.00
---	------	------	--------



**EA6 DCE-LOUR  
Industrial Balance**



**Application Level 1  
Industrial Scale**



**Application Level 3  
Industrial Scale**



**Flexible display**

## Signum Series Industrial Balance

Compact. Extremely rugged. Easy to operate. Perfectly adapts to any ambient conditions in an industrial environment. Space saving design. Choice of various resolutions. Washdown resistant and splashproof to IP65. Smart customization. Speed up technology. Custom tailored application package. Overload protection. Side impact protection. Flexible display mounting options.

**Level 1:** Weighing, (6) keys.

**Level 3:** Weighing, (17), keys, 0-9 numeric keypad, port for reference, counting, totalization, checkweighing, classification, product data memory, identifiers (4 x 40 characters), filling and counting to a target weight.

Part Number	Capacity	Pan	Weight	Stock	Price A5
<b>Application Level 1</b>					
SIWADCP-V3	7kg x 0.1g	13.7" x 9.4"	30 lb	7498	\$ 2,244.00
SIWRDCP-V6	3kg x 0.1g	13.7" x 9.4"	30 lb	7502	1,786.00
SIWRDCP-V7	6kg x 0.2g	13.7" x 9.4"	30 lb	7503	1,786.00
<b>Application Level 3</b>					
SIWRDCP-V8	15kg x 0.5g	13.7" x 9.4"	30 lb	7504	1,816.00
SIWRDCP-V9	35kg x 1.0g	13.7" x 9.4"	30 lb	7505	1,816.00
SIWRDCP-V10	60kg x 2.0g	13.7" x 9.4"	30 lb	7506	1,816.00
<b>Application Level 3</b>					
SIWADCP-V4	7kg x 0.1g	13.7" x 9.4"	30 lb	7499	2,854.00
SIWADCP-V5	35kg x 0.5g	13.7" x 9.4"	30 lb	7500	2,885.00
SIWADCP-V6	65kg x 1.0g	13.7" x 9.4"	30 lb	7501	2,925.00





## WLC Industrial balance

Stainless steel weighing platform. Backlit LCD display. Designed for fast and precise mass determination in laboratory and industrial conditions. WLC can be used in areas with no access to mains (230V), as their standard equipment they include internal rechargeable batteries. Applications for: Counting pieces, Checkweighing, Animal weighing, Percentage, Caps lock of max indication, Measurement in Newton. Loads are hung under the instrument, an alternative for weighing loads with non-standard dimensions and shapes. RS232 output. IP43. 230 VAC.

Part Number	Capacity	Pan	Weight	Stock	Price C5
<b>Fixed Display</b>					
WLC6/F1/R	6kg x 0.1g	11" x 14"	18 lb	7623	\$ 720.00
WLC30/F1/R	30kg x 0.5g	11" x 14"	18 lb	7627	816.00
WLC60/C2/R	60kg x 1g	15.7" x 19.6"	40 lb	7629	864.00
<b>Detachable Display</b>					
WLC6/F1/K	6kg x 0.1g	11" x 14"	18 lb	7632	720.00
WLC30/F1/K	30kg x 0.5g	11" x 14"	18 lb	7636	816.00
WLC60/C2/K	60kg x 1g	15.7" x 19.6"	40 lb	7638	864.00



**WLC/R**  
Industrial balance



## WLY Industrial balance

Simple operation and maximum automation of the weighing process. 5.7" color touch screen panel. Counting pieces, filling, animal weighing, check weighing, density determination, percentage, statistics, formulation. GLP procedures. Infrared proximity sensors. Detachable indicator. Data exchange through USB storage devices. Communication interfaces: Ethernet, (2) USB ports, RS232.

Part Number	Capacity	Pan	Weight	Stock	Price C5
WLY2/D2	2 kg x 0.01g	7.7" dia	8 lb	7591	1,180.00
WLY10/D2	10 kg x 0.1g	7.7" dia	8 lb	7593	1,413.00
WLY20/D2	20 kg x 0.1g	7.7" dia	8 lb	7594	1,458.00



**WLY**  
Industrial balance

Prices are subject to change without notice. Please call for current prices.

Other items are available from the manufacturers, please call for prices.



**PGWe Series  
Topload Balance**

## PGWe Topload Balance

Delivering the ultimate in speed and accuracy, the PGWe sets a new industry benchmark for reliability, durability and ease of use. 17 weighing units, 7 weighing modes. Backlit LCD with multilingual display. Keys are: PRINT, CALIBRATE, MODE, UNIT. Weighing units are: gram, milligram, kilogram, carat, grain, newton, dram, pound, ounce, troy ounce, pennyweight, momme, tael (Taiwan, Hong Kong and Singapore), tola, tical and 1 custom unit. Applications for weighing, net/total, check weighing, percentage weighing, weight accumulation, averaging, parts counting, animal/dynamic weighing, density determination, below balance weighing. Capacity tracker, RS 232 bi-directional interface, second communication port. 120 VAC adapter for 15 VDC, 800 ma Three year ADAM warranty.

Part Number	Capacity	Pan	Weight	Stock	Price B5
PGW3502e	3,500g x 0.01g	7.6" x 7.6"	11 lb	6963	\$ 1,075.00

## Shimadzu

Service parts only for Shimadzu

Part Number	Weight	Stock	Price C
<b>Service Parts</b>			<b>C</b>
BLF-321-51552-01, Small pan support	1 lb	82	\$ 21.50



A&D WEIGHING DIVISION

## MC Analytical Balance

Precision balances with extended resolution. VFD display. Display weight results with an extra decimal place not normally found in balances of this capacity. Weighing units for: g, oz, lb, lb/oz, troy oz, ct, dwt, grain, momme. Applications include: Precious metal weighing, Fill ratio of gas cylinders, Electronic & semiconductor manufacturing, Moisture content of catalysts, Pharmaceutical manufacturing, Precision check-weighing with wider ranges, Discharge from feeders (loss in weight), Cutting dust (contaminants) left on mechanical parts, Particles trapped by particulate filters. Super hybrid sensor technology. Manage ASTM & OIML weights. Auto-centering pan options. Auto environmental adjustment. Counting, percentage, comparator modes. GLP/LIMS/ISO compliance. Underhook. Internal calibration standard. 5 year warranty.

Part Number	Capacity	Pan	Weight	Stock	Price C
MC-1000	1100 x 0.1mg	5.04" x 5.04"	5 lb	6318	\$ 6,470.00
MC-6100	6100 x 0.001g	6.49" x 6.49"	6 lb	6319	6,470.00
MC-10K	10.1kg x 0.001g	10.6" x 8.26"	10 lb	6320	7,750.00
MC-30K	3kg x 0.01g	10.6" x 8.26"	10 lb	6321	7,750.00

### Options

AX-MC1000 Auto centering pan	1 lb	6693	1,150.00	<b>B</b>
AX-MC6100 Auto centering pan	1 lb	6694	1,150.00	
AX-MC-10K/30K Auto centering pan	1 lb	6695	1,470.00	
				<b>A</b>
GX-15 Carrying case	1 lb	6696	525.00	
AD-1684 Electrostatic Fieldmaster	1 lb	6697	1,468.00	
				<b>B</b>
AD-1688 Weighing data logger	1 lb	6698	304.00	
				<b>A</b>
AD-1689 Tweezers for calibration weight	1 lb	6699	189.00	
KO:WW9/25 RS232C cable	1 lb	6700	47.00	
AX-USB-2920-25P USB to 25 pin	1 lb	6701	77.00	
				<b>A5</b>
GX-02* USB option w/ cable for MC-1000/6100	1 lb	7577M	150.00	
				<b>B5</b>
GX-04* Comparator Output, only for MC-1000/6100	1 lb	4693M	265.00	
GX-06* Analog output	1 lb	4694M	840.00	
GX-12 Animal weighing pan	1 lb	4697M	185.00	
GX-13* Density determination kit	1 lb	4698M	640.00	
AD-8922A Remote controller	1 lb	2234M	635.00	
GX-04K** Comparator output & RS232C	1 lb	6638M	365.00	
GX-06K** Analog voltage output/ 20ma interface	1 lb	6639M	840.00	
GX-07K Waterproof RS232C	1 lb	6640M	310.00	
AD-1682 External rechargeable battery pack	1 lb	1682M	678.00	
AD-1683 Static eliminator	4 lb	1248M	1,256.00	
AD-8121B Multifunction printer	5 lb	1974M	891.00	
				<b>A</b>
SW:128 Foot switch	1 lb	4699M	69.00	

\*GX-02, GX-04, GX-06, and the standard RS232C interface cannot be used at the same time.

\*\*GX-04K, GX-06K, and the standard RS232C interface cannot be used at the same time.



**MC-6100**  
Analytical Balance



**MC-10K**  
Analytical Balance

# AND

A&D WEIGHING DIVISION



**BM-252**  
Analytical Balance

## BM Series Analytical Balance

Built in Direct Current (DC) fanless ionizer. Clear, white backlit LCD. Interlockable slide doors. Large weighing chamber for improved usability. Built in environmental sensors. Weighing applications for: g, mg, oz, ozt, ct, mom, dwt, GN, tael, tola, PC (counting mode), percent mode. Density determination function. Data memory function can store up to 200 sets of weighing data. GLP/GMP/GCP/ISO compliant output. Motor driven internal calibration mass. Automatic response adjustment. RS-232C and Quick USB can be connected simultaneously to a balance. An external key plug for the optional foot switch is also provided. Overall dimensions 10"W x 18.3"D x 12.8"H.

Part Number	Capacity	Pan	Weight	Stock	Price A2
BM-20	22g x 0.001mg	0.98" dia	22 lb	6485	\$ 14,500.00
BM-22	22g x 0.001mg 5.1g x 0.001mg	0.98" dia	22 lb	6486	13,400.00
					<b>C</b>
BM-252	250g x 0.01mg	0.98" dia	22 lb	6487	8,235.00
BM-200	200 x 0.1mg	0.98" dia	22 lb	6488	6,485.00
BM-300	320g x 0.1mg	0.98" dia	22 lb	6489	6,795.00
BM-500	520g x 0.1mg	0.98" dia	22 lb	6490	7,200.00

# NEW



**HR-AZ**  
Analytical Balance

# AND

A&D WEIGHING DIVISION

## HR-AZ/HR-A Analytical Balance

Lean design for affordability. Clear, reverse backlit LCD. Large removable breeze break with antistatic coating. The 'Z' unit has internal clock and one touch internal calibration. Weighing units: g, mg, oz, oz-t, ct, momme, dwt, grain, tael, tola, pcs (counting mode), percent, DS (density mode). GLP/GMP/GCP/ISO compliant output. Adjustable response characteristics and hold function. Statistical calculation function. Density determination kit. Rechargeable battery unit. 120 VAC 7.8"W x 11.6"D x 12.4"H

Part Number	Capacity	Pan	Weight	Stock	Price C
HR-100A	102g x 0.1mg	3.54"	8 lb	7722	\$ 1,795.00
HR-150A	152g x 0.1mg	3.54"	8 lb	7723	1,920.00
HR-250A	252g x 0.1mg	3.54"	8 lb	7726	2,085.00
HR-100AZ	102g x 0.1mg	3.54"	8 lb	7727	2,240.00
HR-150AZ	152g x 0.1mg	3.54"	8 lb	7728	2,350.00
HR-250AZ	252g x 0.1mg	3.54"	8 lb	7729	2,555.00



**HR-A**  
Analytical Balance

Dec **Service Parts**  
 ↓ 00:C42767D front glass

**Weight** 1 lb  
**Stock** 7089  
**Price A5** \$ 44.00

Prices are subject to change without notice. Please call for current prices.

Other items are available from the manufacturers, please call for prices.



A&D WEIGHING DIVISION

## GH Phoenix Series

Automatic or manual full digital calibration. Weighing units: gram, milligram, decimal ounce, troy ounce, pennyweight, carat, momme, grain, tola, tael, percentage & counting. 10" tall weighing chamber. GLP/LIMS/ISO compliant. 5 year warranty. 120VAC 50/60 HZ, 8.54"W x 17.4"D x 12.24"H

Part Number	Capacity	Pan	Weight	Stock	Price C5
GH-120	120g x 0.1 mg	3.6" dia	18 lb	5233	\$ 3,540.00
GH-200	210g x 0.1 mg	3.6" dia	18 lb	5234	4,010.00
GH-300	310g x 0.1 mg	3.6" dia	18 lb	5235	4,765.00
GH-202	210g x 0.1g / 42g x 0.01mg	3.6" dia	18 lb	5236	5,350.00
GH-252	250g x 0.1g / 100g x 0.01mg	3.6" dia	18 lb	5237	5,895.00

### Options

AD-100-2 Anti-theft device	1 lb	1849M	73.00	<b>A</b>
				<b>B5</b>
AD-1653 Density determination kit	1 lb	2997M	535.00	
AD-1682 Rechargeable battery pack	5 lb	1682M	678.00	
AD-8920 Universal remote display	3 lb	1160MB	270.00	
AD-8922 Remote Controller	1 lb	2234M	635.00	<b>A</b>
AD-1683 Static eliminator	4 lb	1248M	1,256.00	
				<b>A</b>
SW: 128 Foot switch	1 lb	4699M	79.00	
TB: 636 AC adapter (120V)- standard with unit	1 lb	1304M	43.00	
TB: 123 AC adapter (220V)	1 lb	1542M	53.00	



**GH**  
Analytical Balance

Prices are subject to change without notice. Please call for current prices.

Other items are available from the manufacturers, please call for prices.

99 Reagent Lane  
Fair Lawn NJ 07410  
201-797-2718 \* 800-631-0347

 **Totalcomp**  
Scales & Balances

www.totalcomp.com  
Fax 201-797-2287  
Toll Free Fax 888-797-2288



A&D WEIGHING DIVISION



**GR-202**  
Analytical Balance

## GR Analytical Balance

High performance up to 0.01mg Semi-Micro weighing Automatic self calibration and ergonomic design. Weighing modes: gram, milligram, decimal ounce(av), troy ounce, pennyweight, carat, momme, grain, tola, tael, percentage & counting. Allows GLP or LIMS balance management by outputting the ID number and weight used to calibrate the balance, to A&D's AD-8121 printer or computer, indicating date time, balance ID number and calibration weight. 120 VAC 50/60 Hz, 9.8" x 12.99" x 12.87"H.

Part Number	Capacity	Pan	Weight	Stock	Price C5
GR-120	120g x 0.1mg	85mm dia	14 lb	4010	\$ 2,925.00
GR-200	210g x 0.1mg	85mm dia	14 lb	4011	3,395.00
GR-202	210g x 0.1mg 42g x 0.01mg	85mm dia	14 lb	4012	4,785.00
GR-300	310g x 0.1mg	85mm dia	14 lb	3955	4,195.00

### Options

AD-100-2 Anti-Theft Device		1 lb	1849M	70.00	<b>A</b>
					<b>B5</b>
AD-1653 Density Determination Kit		1 lb	2997M	535.00	
AD-1682 Rechargeable Battery Pack		5 lb	1682M	658.00	
AD-8920 Universal Remote Display		3 lb	1160MB	260.00	
AD-8922 Remote Controller		1 lb	2234M	615.00	
AD-1683 Static Eliminator		4 lb	1248M	1,219.00	
					<b>A</b>
SW: 128 Foot Switch		1 lb	4699M	72.00	

### Service Parts

TB:636 AC Adapter (120V)		1 lb	1304M	41.00	
TB:123 AC Adapter (220V)		1 lb	1542M	50.00	
PZ:3184 display board		1 lb	5472	72.00	
PZ:3184-SW Key Switch Board		1 lb	5427	52.00	

Oct



A&D WEIGHING DIVISION

## HR Analytical Balance

The HR Series Analytical Balances have price, performance and value. Weighing modes: gram, milligram, decimal ounce(av), troy ounce, pennyweight, carat, momme, grain, tola, tael, percentage & counting. Allows GLP or LIMS balance management by outputting the ID number and weight used to calibrate the balance, to A&D's AD-8121 printer or computer, which then can print date time, balance ID number and calibration weight. 120 VAC 50/60 Hz, 13 lb, 8.4" x 12.6" x 11.9"H  
NTEP 97-084 III HR-60 only

Part Number	Capacity	Pan	Weight	Stock	Price C5
HR-202i	42g x 0.01mg	85mm dia	24 lb	2411	\$ 4,645.00
	210g x 0.1mg				
HR-300i	310g x 0.1mg	85mm dia	24 lb	2412	4,185.00

### Options

HR-03 RS232 Interface for HM/HR/HF	1 lb	1043	180.00	<b>B5</b>
HR-05 20ma Current loop Interface for HM/HR/HF	1 lb	1044	125.00	
HR-09 Ni Cad battery pack for HR60/120/200	5 lb	2413	480.00	<b>A</b>
AD-100-2 Anti-Theft Device	1 lb	1849M	73.00	<b>B5</b>
AD-1653 Density determination kit	1 lb	2997M	552.00	
AD-1682 Rechargeable Battery Pack	5 lb	1682M	678.00	
AD-8920 Universal Remote Display	3 lb	1160MB	270.00	
AD-1683 Static Eliminator	4 lb	1248M	1,256.00	
AD-8922 Remote Controller	1 lb	2234M	635.00	

### Service Parts

TB: 636 AC Adapter (120V)- Standard with unit	1 lb	1304M	43.00	<b>A</b>
TB: AC Adapter (220V)	1 lb	1542M	50.00	
PZ:2741A-SW switch board HR HF	1 lb	2604	54.00	

\* NTEP only



**HR-120**  
Analytical Balance



A&D WEIGHING DIVISION

## AD-1683 Static Eliminator

Compact, lightweight and does not require high voltage wiring which makes it easy to handle. DC type, this static eliminator has a remarkable ability for generating ions and can be used for the elimination of static charges from highly electrified weigh samples. Achieves static elimination with a high degree of efficiency regardless of the polarity or the potential of the charged object. A current limiting circuit is incorporated in the ion generating electrode to reduce the possibility of electric shock. Suited for static elimination in narrow and remote places because of its lengthy ion irradiation distance. The AD-1683 is a great compliment to our GH Semi micro balances. 240 VAC, 50/60 Hz.

Part Number	Weight	Stock	Price C
AD-1683	4 lb	1248M	\$ 1,256.00



**AD-1683**  
Static Eliminator

Prices are subject to change without notice. Please call for current prices.

Other items are available from the manufacturers, please call for prices.

99 Reagent Lane  
Fair Lawn NJ 07410  
201-797-2718 \* 800-631-0347

**Totalcomp**  
Scales & Balances

www.totalcomp.com  
Fax 201-797-2287  
Toll Free Fax 888-797-2288

# NEW



Pioneer Analytical

# OHAUS®

## Pioneer Analytical Balance

Pioneer analytical balance is designed for economical reliable routine weighing. External and Internal calibration(suffix C) models are available. Easy to see in low light conditions LCD display with backlight. **Stainless steel** weighing pan 3.54" dia. Continuous output RS232 via 9 pin connector for remote display or computer input. Includes a built in weigh below hook for below balance weighing. Weighing functions for: Standard weighing, counting, percent weighing, Animal/Dynamic weighing and density determination. Keys for: UNIT, MENU, O/T, ON/OFF, PRINT, CAL. Units are g, mg, ct, oz, dwt, tola, mommes, baht, grain, mesghal, Newton, ozt, and custom unit. Glass breeze break with top and side doors allow for quick placement of item to be weighed. 13.4"L x 8.5"W x 13.8"H. 120 VAC.

Part Number	Capacity	Pan	Weight	Stock	Price C
PA84	85 g x 0.1 mg	90mm dia	17 lb	8305	\$ 1,729.00
PA84C	85 g x 0.1 mg	90mm dia	17 lb	8306	1,944.00
PA124	120 g x 0.1 mg	90mm dia	17 lb	8307	2,075.00
PA124C	120 g x 0.1 mg	90mm dia	17 lb	8308	2,290.00
PA224	220 g x 0.1 mg	90mm dia	17 lb	8309	2,305.00
PA224C	220 g x 0.1 mg	90mm dia	17 lb	8310	2,521.00

### Options

			Price A
12120798 SF40A SF42A Ink ribbon	1 lb	5232B	\$ 44.00
12120799 SF40A Roll Paper 2/pk	1 lb	5230B	14.00
12122603 SF40A Cable kit Disc/MB/Pion/Troop	1 lb	5244B	155.00
80251931 Thermal paper	1 lb	7420B	16.00
80252571 RS232 Cable & adapter, Disc/Pion/MB	1 lb	7430B	155.00
80252581 RS232 Cable & adapter, Disc/Pion/MB	1 lb	7422B	155.00
80253384 Density determination kit	3 lb	2794M	624.00
80850000 Anti theft security device	1 lb	1295M	72.00
80850080 TAL Software WinWedge v1.2	1 lb	2436M	437.00
30064203 SF40A Dot Matrix impact printer	2 lb	1754MB	798.00
80500525 Cable to IBM 9 pin serial	1 lb	3047M	155.00
83021085 USB interface w/cable	1 lb	8234	155.00
80251396 Auzillary display for pioneer	2 lb	3996	56.00
83020224 Draft Shield	2 lb	7497	73.00

# OHAUS®

## Explorer Semi Micro Balance

Sophisticated professional weighing. Autocal uses 2 internal weights for linear calibration. Color touchscreen display. Touchless Auto doors on AD models. Ionizer to eliminate static electricity. Includes a built in weigh below hook. Weighing functions for: Standard weighing, counting, percent weighing, checkweighing, Dynamic weighing, filling, totalization, formulation, differential weighing, peak hold, density determination, pipette adjustment. Keys for: Touchscreen. Units are g, mg, kg, ct, oz, ozt, lb, dwt, N, mom, tical, msg, tola, baht, tael(3), ozt and custom unit(3). 15.5"L x 9.1"W x 13.8"H. 120 VAC.

Part Number	Capacity	Pan	Weight	Stock	Price C
EX125D	52gx0.01mg/120gx0.1mg	90mm dia	25 lb	2563	\$ 5,100.00
EX125	120gx0.01mg	90mm dia	25 lb	2564	6,400.00
EX225D	120gx0.01mg/220gx0.1mg	90mm dia	25 lb	2565	6,510.00
EX225D/AD	120gx0.01mg/220gx0.1mg	90mm dia	27 lb	2566	8,100.00
EX225/AD	220gx0.01mg	90mm dia	27 lb	2567	8,820.00

### Options

			Price A
30252145 Pipette adjustment kit	4 lb	2568	1,168.00
30093334 Dust cover	1 lb	2569	39.00
30064203 SF40A Dot Matrix impact printer	2 lb	1754MB	798.00
80251932 Roll paper	1 lb	7427B	15.00
80251933 Ink ribbon	1 lb	7428B	44.00
80252571 RS232 Cable & adapter, Disc/Pion/MB	1 lb	7430B	155.00
80253384 Density determination kit	3 lb	2794M	624.00

Other items are available from the manufacturers, please call for prices.

Prices are subject to change without notice. Please call for current prices.

# NEW



Explorer Semi Micro Balance



# OHAUS®

## Adventurer Analytical and Precision Balance

Color Touchscreen with wide viewing angle. Ingenious draftshield opens wide on both sides. Automatic internal calibration system that calibrates the balance daily. Real time clock with GLP/GMP data. Application modes for Weighing, Dynamic Weighing, Display Hold, Parts Counting, Density Determination, Totalization/Statistic, Percent Weighing, Check Weighing and Formulation. Weighing units for: gram, milligram, mesgal, Newton, ounce, pennyweight, baht, carat, grain, pound, Hong Kong tael, Singapore tael, Taiwan tael, tical, tola, ounce troy, 1 custom unit. RS232, (2)USB ports. 100-240 VAC adapter. 9.05"W x 13.93"D x 13.39"H. 2 year warranty.

Part Number	Capacity	Pan	Weight	Stock	Price C
<b>Analytical, AutoCal.</b>					
AX124	120g x 0.0001g	90mm dia	18 lb	8223	\$ 3,090.00
AX224	220g x 0.0001g	90mm dia	18 lb	8224	3,399.00
AX324	320g x 0.0001g	90mm dia	18 lb	8225	3,820.00

### Analytical, External Calibration

AX124/E	120g x 0.01g	90mm dia	18 lb	3961	2,757.00
AX224/E	220g x 0.01g	90mm dia	18 lb	3962	3,053.00

### Precision, AutoCal.

AX223	220g x 0.001g	130mm dia	18 lb	8226	1,804.00
AX423	420g x 0.001g	130mm dia	18 lb	8227	2,122.00
AX523	520g x 0.001g	130mm dia	18 lb	8228	2,441.00
AX622	620 x 0.01g	195 x 175"	15 lb	3966	1,486.00

AX1502	1,520g x 0.01g	195 x 175"	15 lb	8229	1,804.00
AX2202	2,200g x 0.01g	195 x 175"	15 lb	8230	2,016.00
AX4202	4,200g x 0.01g	195 x 175"	15 lb	8231	2,334.00
AX5202	5,200g x 0.01g	195 x 175"	15 lb	8232	2,547.00

AX4201	4,200 x 0.01g	195 x 175"	28 lb	3973	1,406.00
AX8201	8,200g x 0.01g	195 x 175"	15 lb	8233	1,569.00

### Precision, External Calibration

AX223/E	220g x 1mg	130mm dia	18 lb	3963	1,574.00
AX423/E	420g x 1mg	130mm dia	18 lb	3964	1,827.00
AX523/E	520g x 1mg	130mm dia	18 lb	3965	2,132.00
AX422/E	420g x 0.01g	195 x 175mm	12 lb	3967	965.00

AX822/E	420g x 0.01g	195 x 175mm	12 lb	3968	1,218.00
AX1502/E	1,520g x 0.01g	195 x 175mm	49 lb	3969	1,523.00
AX2202/E	2,200g x 0.01g	195 x 175mm	47 lb	3970	1,726.00
AX4202/E	4,200g x 0.01g	195 x 175mm	47 lb	3971	2,030.00

AX2201/E	2,200g x 0.01g	195 x 175mm	28 lb	3972	994.00
AX4201/E	4,200g x 0.01g	195 x 175mm	28 lb	3974	1,150.00
AX8201/E	8,200 x 0.01g	195 x 175mm	28 lb	3975	1,308.00

### NTEP

AX423N	420g x 0.001g	130mm dia	18 lb	5329	2,228.00
--------	---------------	-----------	-------	------	----------

### NTEP, AutoCal

AX223N/E	220g x 1mg	130mm dia	18 lb	6532	1,650.00
AX423N/E	420g x 1mg	130mm dia	18 lb	6533	1,929.00
AX523N/E	520g x 1mg	130mm dia	18 lb	6534	1,279.00

AX622N/E	620g x 0.01g	195 x 1.75mm	18 lb	6535	1,279.00
AX220N/E	2,200g x 0.01g	195 x 1.75mm	18 lb	6536	1,599.00
AX2202N/E	2,200g x 0.01g	195 x 1.75mm	18 lb	6538	2,132.00
AX4202N/E	4,200g x 0.01g	195 x 1.75mm	18 lb	6538	2,132.00
AX8201N/E	8,200g x 0.1g	195 x 1.75mm	18 lb	6539	1,360.00

### Options

30064203 SF40A Dot Matrix impact printer	2 lb	1754MB	798.00
80500525 Cable to IBM 9 pin serial	1 lb	3047M	155.00
83021085 USB interface w/cable	1 lb	8234	155.00

Prices are subject to change without notice. Please call for current prices.

Other items are available from the manufacturers, please call for prices.

# NEW



**AX124**  
Precision Balance



**AX1502**  
Analytical Balance

# OHAUS®



**EX220**  
Analytical Balance



## Explorer Analytical Balance

Intelligent performance. Intuitive software. Ingenious draftshield. Practical touchless sensors. 5.7" full color VGA graphic display. Touch screen. Weighing applications for: Weighing, Percent Weighing, Check Weighing, Dynamic/Animal Weighing, Filling, Totalization, Formulation, Differential Weighing, Density Determination, Peak Hold, Ingredient Costing, Pipette Adjustment, SQC. Weighing units for: gram, milligram, kilogram, carat, ounce, ounce troy, pound, pennyweight, grain, newton, momme, mesghal, Hong Kong tael, Singapore tael, Taiwan tael, tical, tola, baht, 3 custom units. RS232, USB communication. 100-240 VAC adapter. 9.1"W x 15.5"D x 13.8"H. 2 year warranty.

Part Number	Capacity	Pan	Weight	Stock	Price C
EX124	120g x 0.1mg	3.5" dia	22 lb	7770	\$ 3,767.00
EX224	220g x 0.1mg	3.5" dia	22 lb	7771	4,198.00
EX324	320g x 0.1mg	3.5" dia	22 lb	7772	4,951.00

### Automatic Doors

EX124/AD	120g x 0.1 mg	3.5" dia	22 lb	7710	5,274.00
EX224/AD	220g x 0.1 mg	3.5" dia	22 lb	7711	5,705.00
EX324/AD	320g x 0.1 mg	3.5" dia	22 lb	7712	6,305.00

### NTEP 12-012 I/II Canada AM-5847

EX224N	220g x 0.1mg	3.5" dia	22 lb	7613	4,521.00
EX324N	320g x 0.1mg	3.5" dia	22 lb	7614	5,274.00

### Automatic Doors

EX124N/AD	120g x 0.1 mg	3.5" dia	22 lb	7713	5,597.00
EX224N/AD	220g x 0.1 mg	3.5" dia	22 lb	7714	6,027.00
EX324N/AD	120g x 0.1 mg	3.5" dia	22 lb	7715	6,673.00

# NEW

# Totalcomp



**TJA-203**  
Analytical Balance

## TJA Analytical Balance

Electronic analytical balance ideal for laboratory weighing. Easy to see in low light conditions 9 digit LCD display with backlight. Stainless steel weighing pan 3.15" dia. Sensitivity and speed are separately adjustable in 4 steps from low to high. Continuous output RS232 via 9 pin connector for remote display or computer input. Below balance weighing for specific gravity determination. Weighing functions for: Standard weighing and counting. Keys for: OFF, PRINT, O/T, CAL, ON. Units are g, mg, ct, oz. Glass breeze break with top and side doors allow for quick placement of item to be weighed. CAL button and 200g calibration weight allow for easy recalibration of balance. Rear bubble level and two adjustable feet allow for quick leveling. 13.4"L x 8.5"W x 13.8"H. 120 VAC.

Part Number	Capacity	Pan	Weight	Stock	Price C
TJA-203	200g x 0.001g	3.15" dia	17 lb	5966	\$ 679.00

Prices are subject to change without notice. Please call for current prices.

Other items are available from the manufacturers, please call for prices.



## Secura Analytical Balance

Easy, reliable weighing in regulated areas. The new operating concept of Secura® will noticeably ease your daily workload during weighing and, its APC function – Advanced Pharma Compliance – will relieve you from tedious and time-consuming documentation and monitoring tasks. Touch screen with Sartorius graphical user interface optimized for users in pharmaceutical laboratories always correctly leveled with Sartorius LevelControl. Special lab applications such as Mixing, Components, Statistics and Conversion; plus standard lab applications such as Weighing, Density, Percentage, Checkweighing, Peak Hold, Counting and Unstable Conditions. Regulatory Compliance with expert support. Intelligent, optoelectronic level sensor with alarm function and interactive user guidance for reliable and safe leveling.

Part Number	Capacity	Pan	Weight	Stock	Price B
SECURA1102-1S	1100 x 10mg	7"	12 lb	7161	\$ 2,230.00
SECURA224-1S	220g x 0.1mg	3.5"	12 lb	7150	4,420.00
SECURA124-1S	120g x 0.1mg	3.5"	12 lb	7154	3,820.00
SECURA513-1S	510g x 1mg	3.5"	12 lb	7155	3,185.00
SECURA313-1S	310g x 1mg	3.5"	12 lb	7156	2,545.00
SECURA213-1S	210g x 1mg	3.5"	12 lb	7157	2,335.00
SECURA5102-1S	5100g x 10mg	7"	12 lb	7158	3,290.00
SECURA3102-1S	3100g x 10mg	7"	12 lb	7159	2,865.00
SECURA2102-1S	2100g x 10mg	7"	12 lb	7160	2,650.00

### Options

			A5
YDP-20 OCE Printer	3 lb	7286M	1,120.00
YDP-40 Standard printer	3 lb	7287M	895.00
YRB11Z Battery kit	2 lb	7288	575.00
YCC04-D09 USB Data cable	1 lb	7289	53.00
YCC03-D09 USB /RS232 cable	1 lb	7290	53.00



SECURA1102-1S



SECURA1102-1S  
w/ Printer

Prices are subject to change without notice. Please call for current prices.

Other items are available from the manufacturers, please call for prices.

99 Reagent Lane  
Fair Lawn NJ 07410  
201-797-2718 \* 800-631-0347

**Totalcomp**  
Scales & Balances

www.totalcomp.com  
Fax 201-797-2287  
Toll Free Fax 888-797-2288

# NEW

# sartorius

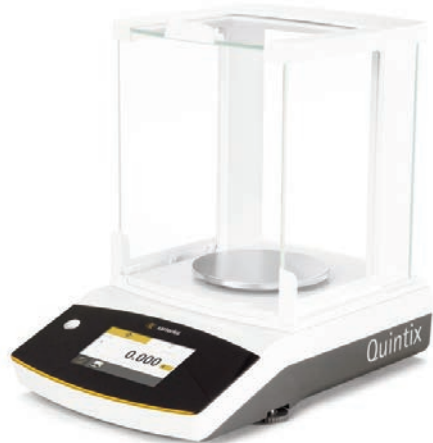

**Quintix-513-1S**  
Analytical



**Quintix-3102-1S**  
Analytical

## Quintix Analytical Balance

Sartorius teamed up with lab users to develop the user interface of the new Quintix. Lab users number one priority was to ensure easy, intuitive operation without having to read the manual first. Chemically resistant finish of the housing for the easiest cleaning ever. Quintix comes standard with convenient, built in applications for: Mixing, Components, Statistics, Checkweighing, Density, Weighing, Conversion, Peak Hold, Unstable Conditions, Percentages, Counting. Analytical draft shield chamber with doors that glide open smoothly for fatigue free weighing. All panels can be individually cleaned or exchanged. IsoCAL, fully automatic, temperature and time controlled internal calibration and adjustment. Mini USB port.

Part Number	Capacity	Pan	Weight	Stock	Price B
Quintix-124-1S	120g x 0.1mg	3.5"	12 lb	7477	\$ 3,380.00
Quintix-224-1S	220g x 0.1mg	3.5"	12 lb	7478	3,825.00
Quintix-213-1S	210g x 0.001g	4.75"	11 lb	7479	2,000.00
Quintix-313-1S	310g x 0.001g	4.75"	11 lb	7480	2,135.00
Quintix-513-1S	510g x 0.001g	4.75"	11 lb	7481	2,895.00
Quintix-612-1S	610g x 0.01g	7"	9 lb	7482	1,690.00
Quintix--1102-1S	1100g x 0.01g	7"	9 lb	7483	1,915.00
Quintix-2102-1S	2100g x 0.01g	7"	9 lb	7484	2,135.00
Quintix-3102-1S	3100g x 0.01g	7"	9 lb	7485	2,365.00
Quintix-5102-1S	5100g x 0.01g	7"	9 lb	7486	2,930.00
Quintix-5101-1S	5100g x 0.1g	7"	9 lb	7487	1,690.00
Quintix-5100-1S	5100g x 1.0g	7"	9 lb	7488	1,350.00

### Options

			A5
6971790 Universal power module 100-240V	1 lb	7489	142.00
YDP20-OCE Statistical data printer w time & date	3 lb	7286M	1,120.00
6906918 Ink ribbon for YDP20-OCE	1 lb	7507	71.47
YDP40 Standard thermal printer	3 lb	7287M	895.00
YRB112 Rechargeable battery	2 lb	7288	575.00
YDK03 Specific gravity kit	2 lb	7509	850.00
YDK04 Specific gravity kit for Top Loader	2 lb	7511	745.00
YCC03-D09 USB to RS232 cable	1 lb	7290	53.00
YCC04-D09 USB data cable	1 lb	7289	53.00
6960SE01 Analytical base cover	1 lb	7633	79.40
6960SE02 Top Load base cover	1 lb	7634	79.40
6960SE03 Dust cover for Analytical chamber	1 lb	7635	71.40

### Cubis Analytical Balance

The first balance in its class with automatic leveling. The first toploading balance with a motorized draft shield. The first balance with Q-Pan off-center load compensation. The first five digit toploading lab balance. Unique monolithic weigh cell.

**MSE** Black and white LCD display. Control unit detachable. Density calculation, averaging, net/total formulation, weighing in percent, counting. Mass unit conversion by toggling. SQmin function for minimum sample weigh according to the USP. iSOCAL automatic calibration/adjustment function, determination (buoyancy method only). Motorized draft shield activated by positive feedback tactile keys or touch free using IR switch (optional). Built in USB port. 25 pin RS232C port for connecting accessories.

**MSU** High resolution black and white 5.7" graphic display. Display tiltable, control unit detachable. Customized identification. Density determination, statistics, calculation, averaging, formulation, weighing in percent, time controlled functions, totalizing, second tare memory, counting, over/under checkweighing. Mass unit conversion by toggling. SQmin function for minimum sample weight according to the USP. iSOCAL automatic calibration/adjustment function. Motorized draft shield activated by positive feedback tactile keys or touch free using IR switch (optional). Built in USB port. Built in Ethernet. SD card reader. 25 pin RS232C port for connecting accessories.

**MSA** Touch screen. High resolution color TFT, 5.7" graphic display. Display tiltable, control unit detachable. Customized identification. Density determination, statistics, calculation, averaging, formulation, weighing in percent, time controlled functions, totalizing, second tare memory, counting, over/under checkweighing. Mass unit conversion by toggling. SQmin function for minimum sample weight according to the USP. iSOCAL automatic calibration/adjustment function. Motorized draft shield activated by positive feedback tactile keys or touch free using IR switch (optional). Built in USB port. Built in Ethernet. SD card reader. 25 pin RS232C port for connecting accessories.

Part Number	Capacity	Pan	Weight	Stock	Price A
MSE225S-100-DU	220g x 0.01mg	3.3"x3.3"	32 lb	7512	\$11,815.00
MSE225P-100-DU	60/120/220g x 0.01/0.02/0.05mg	3.3"x3.3"	32 lb	7513	10,150.00
MSE125P-100-DU	60/120g x 0.01/0.1mg	3.3"x3.3"	32 lb	7514	7,315.00
MSE324S-100-DU	320g x 0.1mg	3.3"x3.3"	29 lb	7515	7,435.00
MSE224S-100-DU	220g x 0.1mg	3.3"x3.3"	29 lb	7516	6,630.00
MSE324P-100-DU	80/160/320g x 0.1/0.2/0.5mg	3.3"x3.3"	29 lb	7517	6,580.00
MSE124S-100-DU	120g x 0.1mg	3.3"x3.3"	29 lb	7518	5,455.00
MSU225S-100-DU	220g x 0.01mg	3.3"x3.3"	32 lb	7519	12,945.00
MSU225P-100-DU	60/120/220g x 0.01/0.02/0.05mg	3.3"x3.3"	32 lb	7520	11,280.00
MSU125P-100-DU	60/120g x 0.01/0.1mg	3.3"x3.3"	32 lb	7521	8,445.00
MSU324S-100-DU	320g x 0.1mg	3.3"x3.3"	30 lb	7522	8,565.00
MSU224S-100-DU	220g x 0.1mg	3.3"x3.3"	30 lb	7523	7,760.00
MSU324P-100-DU	80/160/320g x 0.1/0.2/0.5mg	3.3"x3.3"	30 lb	7524	7,710.00
MSU124S-100-DU	120g x 0.1mg	3.3"x3.3"	30 lb	7525	6,585.00
MSA225S-100-DU	220g x 0.01mg	3.3"x3.3"	32 lb	7526	13,575.00
MSA225P-100-DU	60/120/220g x 0.01/0.02/0.05mg	3.3"x3.3"	32 lb	7527	11,910.00
MSA125P-100-DU	60/120g x 0.01/0.1mg	3.3"x3.3"	32 lb	7528	9,075.00
MSA324S-100-DU	320g x 0.1mg	3.3"x3.3"	30 lb	7529	9,195.00
MSA224S-100-DU	220g x 0.1mg	3.3"x3.3"	30 lb	7530	8,390.00
MSA324P-100-DU	80/160/320g x 0.1/0.2/0.5mg	3.3"x3.3"	30 lb	7531	8,340.00
MSA124S-100-DU	120g x 0.1mg	3.3"x3.3"	30 lb	7532	7,215.00

#### Options

		A5
TR Certificate of compliance	1 lb 7536	160.00
IR additional RS232 25 pin connector	1 lb 7537	316.00
IB Bluetooth wireless option	1 lb 7538	316.00
IP additional RS232C 9 pin w/ PS2 port	1 lb 7539	316.00



Cubis MSE Analytical Balance



Cubis MSU Analytical Balance



Cubis MSA Analytical Balance

Prices are subject to change without notice. Please call for current prices.

Other items are available from the manufacturers, please call for prices.

# Mechanical Portion



**Benchmark**



**Gourmet**



## 1304 Heirloom Scale

Durable. Rugged accuracy. Powder coated finishes in a variety of designer colors. Made of cast iron with case hardened steel pivots and bearings, and a polished brass 1lb beam in 1/4 ounce increments. The scales come in black, white, blue, pink, red, green, yellow, silver and copper vein.

**Benchmark:** This indispensable kitchen tool features (2) 6" cold rolled steel plates, a polished brass 1 lb beam in 1/4 ounce increments and (3) free-weights (2) 1lb and (1) 2 lb.

**Baker:** The baker features one (1 lb) 6" cold rolled steel plate and a claw that cradles a Stainless Steel London Style Scoop. Keeping with the entire line of kitchen scales, the Baker has a polished brass 1 lb beam in 1/4 ounce increments and (3) free-weights (2) 1 lb and (1) 2 lb.

**Gourmet:** The beauty of the Gourmet secures it a permanent home, on display, in the kitchen, while its utilitarian roots make it a solid choice for those precision measurements. In addition to the polished brass 1 lb beam with 1/4 oz increments and (3) free-weights (2) 1 lb and (1) 2 lb, this scale (1) 6" has cold rolled steel plate and a claw, with a Brass London Style Scoop.

Part Number	Capacity	Weight	Stock	Price B
1704B Benchmark	5 lb x 1 oz	16 lb	7597	\$ 341.67
1304 B Gourmet	5 lb x 1 oz	16 lb	7599	433.33



## TB Portion Control Baker's Dough Scale

Rugged, accurate, even-balance scale. Specially designed seamless white plastic commodity scoop. Includes counterweight and 9" dia plates. Finished in durable USDA approved white oven baked enamel.

Models 1051 & 1052 are stainless steel construction for the base, plates and poise weights. Beam is chrome plated. Mechanism is epoxy coated.

Part Number	Capacity	Weight	Stock	Price C
1001TB w/scoop	16 lb x 1/4 oz	38 lb	5981	\$ 728.00
1001TBNS w/o scoop	16 lb x 1/4 oz	38 lb	5982	707.00
1001TBKG w/scoop	8kg x 5g	38 lb	5983	774.00
1002TB w/scoop	8 lb x 1/4 oz	30 lb	5984	640.00
1002TBNS w/o scoop	8 lb x 1/4 oz	30 lb	5985	592.00
1002TBKG w/scoop	5kg x 5g	30 lb	5986	639.00

### Stainless Steel

1051TBS w/scoop	16 lb x 1/4 oz	38 lb	5987	917.00
1052TBS w/scoop	8 lb x 1/4 oz	30 lb	5988	836.00

### Options

				A9
1WP1-1 flat weight	1 lb	2 lb	5989	49.00
1WP2-1 flat weight	2 lb	3 lb	5990	60.00
1WP4-1 flat weight	4 lb	5 lb	5991	70.00
1WP8-1 flat weight	8 lb	9 lb	5992	91.00

285R31 Scoop white plastic w/spout 12"x6.5"x2.5"H	4 lb	5993	89.00
6100-0001 Scoop white plastic w/spout 10"x2.5"H	4 lb	5994	65.00
6100-0002 Scoop white plastic w/spout 21"x12"x5.75"H	4 lb	5995	94.00
6100-0003 Bowl SS w/o spout 6.25"x2.25"H	3 lb	5996	66.00



**1002TB  
Portion Control Scale**

Prices are subject to change without notice. Please call for current prices.

Other items are available from the manufacturers, please call for prices.



## 250 Series Portion Mechanical Scale

**250-6S** features a stainless steel platform, dashpot for fast readings and sturdy construction. Easy to read marked 6" dials with large pointers. Ideal for a variety of applications with fixed weight limits. Stainless steel bowl included. Overall dimensions 12"H x 10"W x 13"D.

**250-8** is an 8" mechanical scale with a fixed weight. Easy to read from a distance. Simultaneous readings of pounds and kilograms. Mild steel, sturdy construction suitable for many weighing applications. Overall dimensions 12"H x 10"W x 13"D.

Part Number	Capacity	Platform	Weight	Stock	Price B5
<b>6" dial</b>					
250-6S-11 lb	11 lb x 1 oz	7.87" x 7.87"	9 lb	6895	\$ 55.00
<b>8" dial</b>					
250-8-60 lb	66 lb x 4 oz	11.81" x 11.81"	17 lb	6898	100.00



**250-6 Series  
Portion Mechanical Scale**



**250-8 Series  
Portion Mechanical Scale**



## P Spring Dial Scale

The P-2 has an air damping dashpot that eliminates the bounce and provides a quick and accurate measurement everytime. Heavy gauge stainless steel housing. Heavy duty top loading mechanical spring scale. Large stainless steel platter. Dual easy to read dial in lb's and oz's, kg's and grams. Angled dial design for easy reading. Fine zero adjustment to ensure accuracy. Perfect for portioning and receiving.

Part Number	Capacity	Platform	Weight	Stock	Price B
P-2 Spring scale	2 lb x 1/4 oz	8" x 8"	8 lb	7600	\$ 60.60
P-5 Spring scale	5 lb x 1/2 oz	8" x 8"	8 lb	7601	60.60
P-10 Spring scale	10 lb x 1 oz	8" x 8"	8 lb	7602	60.60



**P-2  
Portion Mechanical Scale**

Prices are subject to change without notice. Please call for current prices.

Other items are available from the manufacturers, please call for prices.

99 Reagent Lane  
Fair Lawn NJ 07410  
201-797-2718 \* 800-631-0347

**Totalcomp**  
Scales & Balances

www.totalcomp.com  
Fax 201-797-2287  
Toll Free Fax 888-797-2288

# Mechanical Portion



**FS  
Spring Dial Scale**



**LCD  
Spring Dial Scale**



**HCD  
Spring Dial Scale**

## FS Spring Dial Scale

Heavy duty Industrial scales with high precision temperature compensated springs and reinforced dual spring level mechanism. Double beveled base plate and heavy duty sub assembly combine to give you durability you can count on. Lb/Kg dial face for dual reading is signified by DR at the end of the model number.

Part Number	Platform	Capacity	Weight	Stock	Price B5
<b>FS Series</b> 6" dial face w/SS platform 5-1/2"W x 7-3/8"D x 7-3/4"H					
FS3214-DR	5.75" x 5.75"	32 oz x 1/4 oz	4 lb	3837	\$ 71.50
FS0512-DR	5.75" x 5.75"	5 lb x 1/2 oz	4 lb	3838	79.00

### FS Options

Rotating dial (Tare feature)	1 lb	3839	4.41
Stainless steel construction	1 lb	3840	28.75

## LCD Series 8" dial face w/SS platform 6-3/4"W x 9-3/4"D x 10-3/4"H

LCD3218-DR	9" x 9"	32 oz x 1/8 oz	9 lb	3841	105.00
------------	---------	----------------	------	------	--------

### Option for LCD 3218 only

Rotating dial OVER/UNDER	1 lb	3858	25.00
--------------------------	------	------	-------

LCD0512-DR	9" x 9"	5 lb x 1/2 oz	9 lb	3842	105.00
LCD1001-DR	9" x 9"	10 lb x 1 oz	9 lb	3843	105.00
LCD2001-DR	9" x 9"	20 lb x 1 oz	10 lb	3844	105.00

LCD10K20 *	9" x 9"	10kg x 20g	10 lb	3845	110.00
LCD2501 *	9" x 9"	25 lb x 1 oz	10 lb	3846	110.00

\* Not available as dual reading

LCD2502-DR	9" x 9"	25 lb x 2 oz	10 lb	3847	110.00
LCD4002-DR	9" x 9"	40 lb x 2 oz	10 lb	3848	115.00
LCD5002-DR	9" x 9"	50 lb x 2 oz	12 lb	3849	120.00

LCD7004-DR	10" x 10"	70 lb x 4 oz w/Chrome platform	13 lb	3850	162.00
------------	-----------	-----------------------------------	-------	------	--------

### LCD Options

Air dash pot (quick stop)	1 lb	3851	50.25
Stainless steel construction	1 lb	3852	66.70
Produce pan 10" dia stainless steel	1 lb	3853	70.80

## HCD Series 10" dial face w/chrome platform 10-1/2"W x 14"D x 12-1/2"H

HCD7004-DR	13" x 13"	70 lb x 4 oz	24 lb	3855	227.00
HCD10004-DR	13" x 13"	100 lb x 4 oz	27 lb	3856	249.00
HCD20008 -DR	13" x 13"	200 lb x 8 oz	30 lb	3857	307.00

Prices are subject to change without notice. Please call for current prices.

Other items are available from the manufacturers, please call for prices.



## OHAUS®

### Triple Beam Balance

Triple Beam 700 and 800 Series Balances. Tiered notched beams. Choice of weighing platforms, scoop, animal container or pans. Magnetic damping. Optional tare beam. Equipped for specific gravity weighings. 5 Year warranty

Part Number	Capacity	Platform	Weight	Stock	Price C5
710-00	610g x 0.1g	SS Pan, 6" dia	7 lb	1523	\$ 249.00
710-T0	610g x 0.1g	SS Pan, tare	7 lb	1528	305.00
720-00	610g x 0.1g	Poly scoop	7 lb	1524	294.00
720-S0	610g x 0.1g	SS scoop	7 lb	1525	341.00
730-00	610g x 0.1g	Animal container	9 lb	1526	368.00
750-S0	610g x 0.1g	SS Plate, 6" dia	8lb	1521	139.00
760-00	610g x 0.1g	SS Plate, tare	8 lb	1527	258.00

#### Options

##### With counterweight

Part Number	Description	Weight	Stock	Price C5
80780014	Polypropylene Scoop 12" x 6" x 2-34" footed and counterweight	2 lb	2022	44.00
80780015	Stainless Steel Scoop 12" x 6" x 2-34" footed and counterweight	2 lb	2023	103.00
80780016	Polypropylene Maxi-Scoop 10" dia x 1-12"	3 lb	2024	47.00

##### Without counterweight

Part Number	Description	Weight	Stock	Price C5
80250400	Stainless Steel Scoop 12" x 6" x 2-3/4" footed, tare 190g	2 lb	2025M	59.00
80250954	Stainless Steel Scoop 17.2" x 11" x 3.4" footed, large	6 lb	5274M	74.00
80780006	Polypropylene Scoop 12" x 6" x 2-3/4" footed, tare 125g	2 lb	2026M	32.00
80850359	Polypropylene Maxi-Scoop 10" dia x 2-1/2" deep with pouring spout	2 lb	2027M	33.00



710-00 SS pan w/optional attachment weights



720-00 SS Scoop



730-00 Animal Container



750-S0 SS plate

Prices are subject to change without notice. Please call for current prices.

Other items are available from the manufacturers, please call for prices.

99 Reagent Lane  
Fair Lawn NJ 07410  
201-797-2718 \* 800-631-0347

**Totalcomp**  
Scales & Balances

www.totalcomp.com  
Fax 201-797-2287  
Toll Free Fax 888-797-2288

# Mechanical

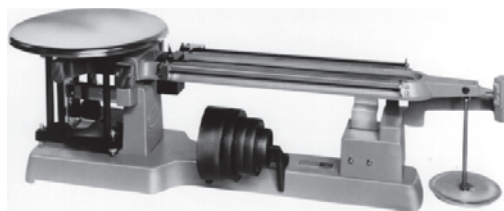

1119-DO  
Solution Balance

## OHAUS®

### Heavy Duty Solution Balance

Rugged and durable with magnetic dampening to provide quick, trouble free operation. Strongly built to resist corrosion and shrug off harsh environments it reads with a feather touch down to 1 g over the whole weighing range of 20 kg. It has a large, unobstructed **stainless steel** platform and a lockable tare for containers up to 2270 g. Covered self aligning bearings. Readings up to 1100 g are taken from two sliding weight beams and a set of slotted weights, which are stored in the base, extend the capacity to 20 kg. 5 year warranty.

Part Number	Capacity	Pan	Weight	Stock	Price C
1119-DO	20 kg x 1 g	11" dia	44 lb	1395	\$ 2,091.00



2400-11  
Field Test Scale

## OHAUS®

### Field Test Scale

The heavy duty Multi purpose field scale is for use in laboratory, production facilities or field testing locations. The beam reads 1 lb by 0.01 lb divisions or 500 g by 5 g divisions. The numbers and graduations are in black on a white background for maximum legibility. The scale has a sliding poise designed to eliminate reading errors. A set of slotted weights is supplied with the scale and they store in the cast metal base. For ease in moving the scale, a carrying handle is an integral part of the base. 5 year warranty. 22-1/4" x 9-3/4" x 10-1/8"H.

Part Number	Capacity	Pan	Weight	Stock	Price C
2400-11	16 kg x 5 g	9-3/4" dia	23 lb	1312	\$ 1,286.00
2400-12	36 lb x 0.01 lb	9-3/4" dia	23 lb	1396	1,333.00



1550-SD  
Harvard Trip Balance

## OHAUS®

### Harvard Trip Balance

Beam and dial models available. Easy, reliable operation. Two pan balances of this type are commonly used for comparative weighing - to determine the difference in mass between two objects rather than the absolute value. The built in sliding masses (up to 10 or 210g) are usually suitable for this purpose, but weighings up to 2kg can be achieved by using a suitable set of calibrated masses. Magnetic damping. 0.1g sensitivity. 5 Year warranty

Part Number	Capacity	Beam/platform	Weight	Stock	Price C5
1450-SD	2,000g x 0.1g	Single beam/Plate	7 lb	1825	\$ 335.00
1550-SD	2,000g x 0.1g	Double beam/Plate	8 lb	1828	360.00
1560-SD	2,000g x 0.1g	Dbl bm/Plate w/Tare	10 lb	1829	376.00

#### Options

Part Number	Description	Weight	Stock	Price A
80780001	Polypropylene Scoop 12" x 6" x 2-3/4" footed and counterweight	2 lb	2028	49.00
80850321	Analytical scoop 1.25" x 2" (3.8 x 5.1cm) w/counterweight	1 lb	822	31.00
80850322	Analytical scoop 2.25" x 3" (5.7 x 7.6cm) w/counterweight	1 lb	823	32.00
Scoop is used on one pan and counterweight on the other.				
80850262	Vinyl dust cover for Harvard Trip balance	1 lb	628	32.00

Prices are subject to change without notice. Please call for current prices.

Other items are available from the manufacturers, please call for prices.

# OHAUS®

## 311 Cent-O-Gram® Balance

## 310 Dial-O-Gram® Balance

These balances provide 0.01 g sensitivity and come with all the built-in extras that are expected from Ohaus. The Dial-O-Gram® has the fastest results which are read on the precision engraved dial. Poises are windowed for easy reading. Built in specific gravity platform. Four notched and tiered beams on 311 Model. 10 gram vernier dial on 310 Model. Rugged, durable construction. 5 Year warranty.

Part Number	Capacity	Weight	Stock	Price C5
<b>Cent-O-Gram</b>				
311-00	311g x 0.01g	6 lb	1531	\$ 296.00
	Front beam 1g x 0.01g			
	Second beam 10g x 1g			
	Third beam 100 x 10g			
	Rear beam 200 x 100g			
<b>Dial-O-Gram</b>				
310-00	310g x 0.01g	6 lb	1530	359.00
	Dial and vernier 10g x 0.01g			
	Front beam 100g x 10g			
	Rear beam 200g x 100g			



**311-00  
Cent-O-Gram  
Balance**

# OHAUS®

## Triple Pro Balance

Accurate, dependable and truly best in class. Triple Pro offers the convenience of a toploading balance while allowing hands-on experience through manipulation of the poises. Easy grip carrying handle is perfectly balanced for effortless movement. Convenient storage compartment for included attachment weight set. Two security features included to prevent theft, a security loop and Kensington lock (cables sold separately). Includes included weight set and rod & clamp assembly for specific gravity determinations. 10 Year limited warranty

Part Number	Capacity	Platform	Weight	Stock	Price C5
TP2611	2,610 x 0.1g	5.8" dia	9 lb	1536	\$ 198.00



**TP2611  
w/optional attachment weights**

# OHAUS®

## 1600 Dial-O-Gram® Balance

Direct reading vernier dial. Tare poise slides for coarse tare, rotates for fine adjustments. Maximum capacity of 2610 g with optional accessory weights. 5 Year warranty

Part Number	Capacity	Tare	Platf/9rm	Weight	Stock	Price C5
1610-00	610g x 0.1g	225 g	SS Pan, 6" dia	8 lb	1543	\$ 373.00
1650-00	610g x 0.1g	-----	SS Plate, 6" dia	8 lb	1541	323.00
1650-W0	2,610g x 0.1g	-----	SS Plate w/att wts	11 lb	1537	373.00

### Options

				<b>C</b>
80780017	Vinyl cover for Triple Beam	1 lb	96	32.00
80780108	Attachment weights, metric, 2.5 kg set	2 lb	877	61.00
701-00	Attachment weight, 500 g	1 lb	1532	16.00

The Attachment weights allow full utilization of the Triple Beam's capacity (2610g) by suspending weights from pivots on beam end. Requires (2)1,000g and (1)500g weights. Conveniently store in base of balance.



**1650-00 SS Plate**

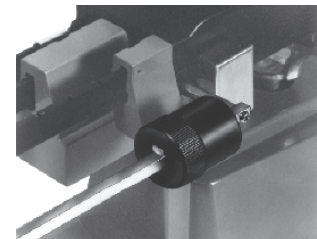

**Tare Feature**

Prices are subject to change without notice. Please call for current prices.

Other items are available from the manufacturers, please call for prices.

# OHAUS®

## D500M Mechanical Beam Scale

Verastile, adaptable to in-plant, receiving, commercial and general weighing applications. Constructed of fabricated carbon steel and designed for accuracy and long life. Die cast dual side flat beam with a shadow- proof poise, providing quick reading under most lighting conditions. A positive beam lock secures the indicator when the scale is not in use. Counterpoise weights allow for a scale capacities of up to 1000 pounds. Lightweight and easy to maneuver with low resistance, wear-resistant phenolic wheels. Platform size 19.25"W x 28.13"D. Overall size 50"W x 31.5"D x 7.3"H. NTEP 08-070 III 2,000 div

Part Number	Capacity	Weight	Stock	Price C5
D500M	1,000 lb x 0.5 lb	125 lb	4842	\$ 1,265.00



**D500M**  
Mechanical Beam Scale



## Mechanical Portable Beam Scale

Portable, durable accurate trouble free performance. Rust proof die cast beam is calibrated 100 lb x 1/2 lb on both front and back. Counterpoise weights are stored on a handy hanger. Easy to read lockable poise. Simplified lever system of fabricated steel for longer life and accuracy. Platform size 19"W x 28"D. Overall size 24"W x 35"D x 45"H. FOB Webb City, MO. NTEP 88-106/107 III 2,000 div.

Part Number	Capacity	Weight	Stock	Price C
854F100P portable	1,000 lb x 1/2 lb	132 lb	4037	\$ 912.00



**854F100P**  
Beam Scale  
mechanical portable



Prices are subject to change without notice. Please call for current prices.

Other items are available from the manufacturers, please call for prices.



**Mechanical Portable Beam Scale**

A Fairbanks classic. Rugged and economical. Large platform. Sturdy cast iron base, lever system, platform and wheels. Large easy-to-read graduations on a chrome plated beam with a brass insert. Open face poise with pointer clearly shows the exact weight. A set screw holds the poise firmly in place when set. Dimensions 21"W x 36"D x 42.75"H.  
 FOB Meridian, MS  
 Canadian AM-4657  
 NTEP 88-266, III, 2,000 div

Part Number	Capacity	Platform	Weight	Stock	Price C
1124	1,000 x 0.5 lb	24" x 17"	185 lb	6065	\$ 754.00
<b>Service Parts</b>					<b>A</b>
58935 cup hanger counterpoise			2 lb	6178	50.00



**1124  
Beam Scale  
Mechanical Portable**

Prices are subject to change without notice. Please call for current prices.

Other items are available from the manufacturers, please call for prices.

99 Reagent Lane  
 Fair Lawn NJ 07410  
 201-797-2718 \* 800-631-0347

**Totalcomp**  
 Scales & Balances

www.totalcomp.com  
 Fax 201-797-2287  
 Toll Free Fax 888-797-2288

# Scoops



**TSCP-431**  
White plastic scoop

## Scoops

For use with any balance or scale.

Part Number	Size	Weight	Stock	Price C
TSCP-431 scoop, anti static white plastic, FDA approved	21.5"x11.5"x5.5" w/6" dia foot	2 lb	2379M	\$ 49.00
Aluminum scoop, medium	15" x 10" x 5"	2 lb	4220	97.00
Aluminum scoop, large	21" x 14" x 6"	3 lb	4221	111.00
ST-64P Sample pan, anti static plastic, triangular	11"x10.5"x2.5"	2 lb	6109M	18.50

Aluminum scoop, large



**ST-64P**  
Sample pan, plastic, triangular



**TSCP-431-SS Scoop**  
Footed, large  
Stainless steel

## Scoops

Stainless steel for use in high washdown seafood and poultry applications.

Brass scoop is for decorative use where the look and feel of antique scales is needed.

Part Number	Size	Weight	Stock	Price B
TSCP-431-SSF footed scoop, large	12" x 23" x 5.5"	6 lb	6670	\$ 133.33
TSCP-441-SS scoop, large	12" x 22" x 5.5"	5 lb	6671	133.33
TSCP-474-B Brass scoop	6.5" x 10" x 6"	3 lb	6673	116.67

Prices are subject to change without notice. Please call for current prices.

Other items are available from the manufacturers, please call for prices.



## Scoops

For use with any balance.

Part Number		Size	Weight	Stock	Price A
80250048	Black aluminum scoop	4" x 3.5"	1 lb	1139M	\$ 29.00
80850364	Aluminum scoop	2" x 1.5"	1 lb	1140M	23.00
80250396	Gold scoop	3" x 2.25"	1 lb	1141M	23.00
80250400	Stainless Steel Scoop footed, tare 190g	12" x 6" x 2-3/4"	2 lb	2025M	59.00
80250954	Stainless Steel Scoop footed, large	17.2" x 11" x 3.4"	6 lb	5274M	74.00
1101-20	Polypropylene Scoop footed, tare 125g	12" x 6" x 2-3/4"	2 lb	2026M	32.00
3369-10	Polypropylene Maxi-Scoop pouring spout	10" dia x 2-1/2"	2 lb	2027M	33.00
80250954	Stainless steel scoop footed, large	17.2" x 11" x 3.4"	6 lb	5274M	74.00



1101-20 Polypropylene Maxi scoop



3369-10 Polypropylene Maxi scoop



80250954 Stainless Steel Scoop

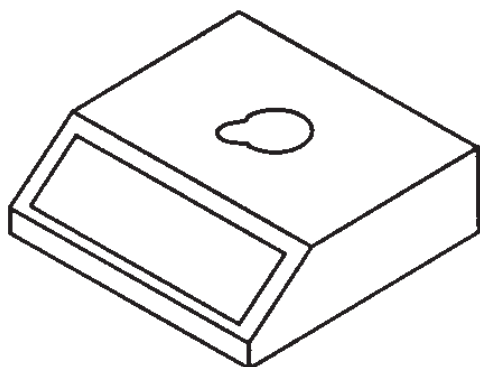

**TFC-EK12KA A&D**  
Flexible covers

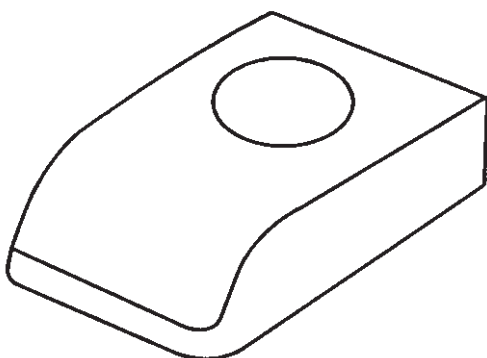

**TFC-V/G Acculab**  
Flexible covers

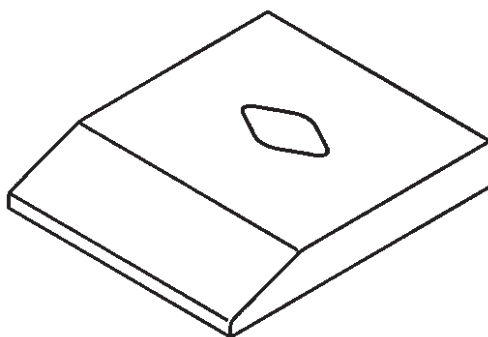

**TFC-XL/XE/XS Denver**  
Flexible covers

## Clear Flexible Covers

Inuse covers for use with a variety of popular scales and balances. These covers protect from dripping paint and dyes, dust and dirt or any dripping liquid. They are easily replaceable when they have accumulated an excess of the contaminated product. The covers are made of a semi rigid clear PVC or PETG, yet they are soft enough to allow the easy use of the front panel keys on the scale or balance.

Part Number	Weight	Stock	Price C
<b>A&amp;D</b>			
TFC-EK12KA	1 lb	5569	\$ 36.00
TFC-EK120/1200A	1 lb	5570	36.00
TFC-EK6000H	1 lb	5571	36.00
TFC-EK/EWG series	1 lb	5572	36.00
TFC-EP series	1 lb	5573	36.00
TFC-FX series	1 lb	5574	36.00
TFC-FY series	1 lb	5575	36.00
TFC-GX200/400/600	1 lb	5576	36.00
TFC-GX2000/4000/6100	1 lb	5577	36.00
TFC-HF200/400	1 lb	5578	36.00
TFC-HF1200/4000	1 lb	5579	36.00
TFC-HF6000/8000	1 lb	5580	36.00
TFC-HP series	1 lb	5581	36.00
TFC-HX6000	1 lb	5582	36.00
<b>Denver Instruments</b>			
TFC-TR series	1 lb	3367	36.00
TFC-XL/XE/XS series	1 lb	5587	36.00
TFC-XP series	1 lb	3368	36.00
<b>Mettler/Toledo</b>			
TFC-AB54/AB104/AB204	1 lb	5588	36.00
TFC-AT series	1 lb	5590	36.00
TFC-BB round pan	1 lb	5591	36.00
TFC-BB square pan	1 lb	5592	36.00
TFC-PB153-303	1 lb	5593	36.00
TFC-PB500-8001	1 lb	5595	36.00
TFC-PB602S-8001S	1 lb	5589	36.00
TFC-PC/AC	1 lb	5597	36.00
TFC-PE round pan	1 lb	5598	36.00
TFC-PE square pan	1 lb	5599	36.00
TFC-PE/PM large	1 lb	5600	64.00
TFC-PG-S 0.01&0.001	1 lb	5601	36.00
TFC-PG-S 0.1 - 1g	1 lb	5602	36.00
TFC-PG/SR display	1 lb	5603	36.00
TFC-PG/SR main body	1 lb	5604	36.00
TFC-PL-S	1 lb	5596	36.00
<b>Original Toledo</b>			
12102970 for AP/PL	1 lb	5500	81.50
12102980 for PL-S	1 lb	5501	112.00





## Clear Flexible Covers

Continued.

Part Number	Weight	Stock	Price C
<b>Mettler/Toledo</b>			
TFC-PM/PJ round pan	1 lb	5605	\$ 36.00
TFC-PM/PJ square pan	1 lb	5606	36.00
TFC-PR/PG main body	1 lb	5607	36.00
TFC-SB 8000-16000	1 lb	5608	64.00
TFC-SB 24000-32000	1 lb	5609	64.00
TFC-SR/SG display 1	1 lb	5610	36.00
TFC-SR/SG display 2	1 lb	5611	36.00
<b>Ohaus</b>			
TFC-Adventurer	1 lb	5612	36.00
TFC-B small	1 lb	5613	36.00
TFC-CT series	1 lb	5615	36.00
TFC-Explorer/Voyager top loader	1 lb	5616	36.00
TFC-Explorer/Voyager analytical	1 lb	5617	36.00
TFC-GT/E round pan	1 lb	5618	36.00
TFC-GT/E square pan	1 lb	5585	36.00
TFC-Navigator	1 lb	5619	36.00
TFC-SC Scout	1 lb	5620	36.00
TFC-TM Pro Scout	1 lb	5586	36.00
TFC-TS/TP series	1 lb	5621	36.00
<b>Precisa</b>			
TFC-Precisa low profile	1 lb	5622	36.00
TFC-Precisa old type (A)	1 lb	5623	36.00
<b>Sartorius</b>			
TFC-1200	1 lb	5624	36.00
TFC-1400	1 lb	5625	36.00
TFC-1500/E	1 lb	5626	36.00
TFC-BA round pan	1 lb	5627	36.00
TFC-BA square pan	1 lb	5628	36.00
TFC-BL round pan	1 lb	5276	36.00
TFC-BL square pan	1 lb	5277	36.00
TFC-BP round pan, small	1 lb	5629	36.00
TFC-BP square pan, small	1 lb	5630	36.00
TFC-BP square pan, large	1 lb	5631	36.00
TFC-CP series triangular pan	1 lb	5632	36.00
TFC-CP series square pan	1 lb	5633	36.00
TFC-CP series analytical	1 lb	5634	36.00
TFC-EA/EB series	1 lb	5635	36.00
TFC-Element Series	1 lb	5278	36.00
TFC-L2200 round pan	1 lb	5636	36.00
TFC-L2200 square pan	1 lb	5637	36.00
TFC-L610	1 lb	5638	36.00
TFC-PNA series	1 lb	5639	36.00
TFC-PT	1 lb	5640	36.00
TFC-Scaletec round pan	1 lb	5641	36.00
TFC-Scaletec square pan	1 lb	5642	36.00
TFC-U/B/LC	1 lb	5643	36.00

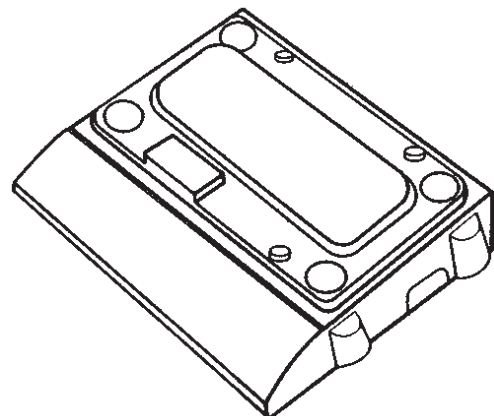

TFC-SB 8000-16000 Mettler Flexible covers

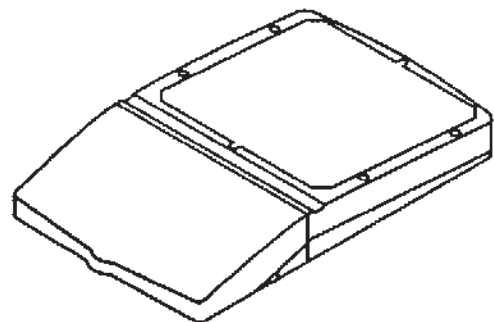

TFC-Explorer Ohaus Flexible covers

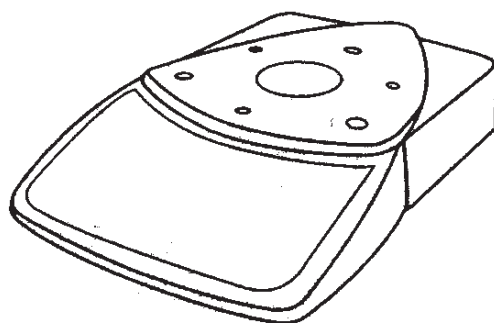

TFC-CP triangular Sartorius Flexible covers

Prices are subject to change without notice. Please call for current prices.

Other items are available from the manufacturers, please call for prices.

# AND

A&D WEIGHING DIVISION

## SV-10 Sine Wave Vibro Viscometer

Tuning fork vibration method. Vacuum fluorescent display. Data collection and graphic software. Viscosity calibration. Keys for: ON/OFF, PRINT, HOLD, MODE, START, STOP. Repeatability of 1% of reading. Low viscosity of 0.3 mPa s (cP) to high viscosity of 10,000 mPa s (cP). Frequency of 30Hz allows measurement of foam samples without breaking. Viscosity of flowing samples can be measured. RS-232C and connection cable (25 pin-9 pin) for PC or printer connectivity are standard accessories. Standard sample cup requires the sample fluid of just more than 35ml. 120 VAC adapter, 14 watt 13"W x 12.4"D x 21.1"H



SV-10  
Vibro Viscometer

Part Number	Measurement Range	Weight	Stock	Price A
SV-10	0.3cP - 10,000 cP	25 lb	5264	\$ 3,605.00

# MARK-10

## Economical M2 Force Gauge

Reversible housing for alternate load cell orientation. A backlit graphic LCD displays the current, peak tension, or peak compression reading. Keys for: Menu, Peak, Zero. Peak tension and compression readings are reliably captured via the gauges' ±0.5% accuracy and 500 Hz sampling rate. Powered by 9V battery or available AC adapter. Series 2 gauges are directly compatible with Mark-10 test stands and grips. 3 year warranty.

Part Number	Capacity	Weight	Stock	Price A5
M2-2	2 lbF	1 lb	8130	\$ 415.00
M2-5	5 lbF	1 lb	8131	415.00
M2-10	10 lbF	1 lb	8132	415.00
M2-20	20 lbF	1 lb	8133	415.00
M2-50	50 lbF	1 lb	8134	415.00
M2-100	100 lbF	1 lb	8135	415.00
M2-200	200 lbF	1 lb	8136	565.00
M2-500	500 lbF	1 lb	8137	565.00

### Options

	A5
12-1049 Carrying Case	1 lb 8138 35.00
CERT NIST traceable certificate of calibration w/ data	1 lb 8139 50.00
23-1031-2 Attachment kit for M2-2 - M2-100	1 lb 8140 85.00
23-1031-3 Attachment kit for M2-200 - M2-500	1 lb 8141 105.00

**NEW**



Series 2 Economical Force Gauge

# MARK-10

## Digital M3 Force Gauge

Ultra compact size. Ergonomic, reversible aluminum housing allows for hand held use or test stand mounting for more sophisticated testing requirements. Large backlit graphic display. 4 selectable units of measure: lbf, gF, kgF, N (depending on model). Display indicators for: Set Points, Pass/Fail indicators, Current Reading, Battery Indicator, Tension/Compression indicator, Peak Readings, Measurement Mode, Units of Measure, Analog Load Bar w/ Set Point Markers. High speed 2,000 Hz sampling rate. USB data output. Configurable audio alarms and key tones. MESUR Lite data collection software included. Included items are: Carrying case with chisel, cone, V-groove, hook, flat, extension rod, universal voltage AC adapter, battery, quick start guide, USB cable, resource CD (USB driver, MESUR Lite software, MESUR gauge DEMO software, and user's guide), and NIST-traceable certificate of calibration (certificate with data is available for an additional charge). AC or rechargeable battery. Multi-step low battery indicator is displayed, gauge shuts off automatically when power is too low. 3 year warranty.

Part Number	Capacity	Weight	Stock	Price A5
M3-012	0.12 x 0.0001 lbF	1 lb	6680	\$ 800.00
M3-025	0.25 x 0.0002 lbF	1 lb	6681	800.00
M3-05	0.05 x 0.0005 lbF	1 lb	6682	800.00
M3-2	2 x 0.002 lbF	1 lb	6683	650.00
M3-5	5 x 0.005 lbF	1 lb	6684	650.00
M3-10	10 x 0.01 lbF	1 lb	6685	650.00
M3-20	20 x 0.02 lbF	1 lb	6686	650.00
M3-50	50 x 0.05 lbF	1 lb	6687	650.00
M3-100	100 x 0.1 lbF	1 lb	6688	650.00
M3-200	200 x 0.2 lbF	1 lb	6689	800.00
M3-500	500 x 0.5 lbF	1 lb	6690	800.00



Series 3 Digital Force Gauge

Prices are subject to change without notice. Please call for current prices.

Other items are available from the manufacturers, please call for prices.

# NEW



**M4**  
Performance Force Gauge

## MARK-10

### Performance M4 Force Gauge

Live load bar graph with with set point markers. Large backlit graphic display. Keys for: ZERO, UNITS, MENU, DATA, MODE. 3,000 Hz sampling rate. 50 point data memory with statistics and outputs. MESUR Lite Data collection software. Configurable audio alarms and key tones. USB, RS232, Mitutoyo. Extension rods, chisel, cone, v-groove, flat, hook, AC adapter/charger. Carrying case NIST certificate. 3 year warranty.

Part Number	Capacity	Weight	Stock	Price A5
M4-012	0.12 lbF	1 lb	8119	\$ 995.00
M4-025	0.25 lbF	1 lb	8120	995.00
M4-05	0.5 lbF	1 lb	8121	995.00
M4-2	2 lbF	1 lb	8122	845.00
M4-5	5 lbF	1 lb	8123	845.00
M4-10	10 lbF	1 lb	8124	845.00
M4-20	20 lbF	1 lb	8125	845.00
M4-50	50 lbF	1 lb	8126	845.00
M4-100	100 lbF	1 lb	8127	845.00
M4-200	200 lbF	1 lb	8128	995.00
M4-500	500 lbF	1 lb	8129	995.00

## MARK-10

### Digital M5 Force Gauge

Series 5 advanced digital force gauges are designed for tension and compression force testing. Reversible housing allows the gauge to be handheld or mounted to a test stand. Large, backlit graphics LCD display. 5 selectable units of measure: lbF, ozF, gF, kgF, N, kN, mN (depending on model). Keys are: ENTER, ON, UNITS/DIRECTION, DATA/DELETE, ZERO, MENU/ESCAPE, MODE. Data can be transferred to a PC or other data collector via USB, RS232, Mitutoyo (Digimatic), or analog outputs. High speed 7,000 Hz peak sampling rate. 1,000 point data memory with statistics and outputs. Live load bar with set point markers. Programmable set points, with alarms and outputs. Peak readings and set points always displayed. Averaging mode calculates average readings over time. External trigger mode for switch contact testing or remotely stopping display update. Configurable audio alarms and key tones. Password protection, configurable for individual keys and calibration. Included items: Carrying case with chisel, cone, V-groove, hook, flat, extension rod, universal voltage AC adapter, battery, quick start guide, USB cable, resource CD and NIST traceable certificate of calibration with data. 3 years warranty.

Part Number	Capacity	Weight	Stock	Price A5
M5-012	0.12 x 0.00002 lbF	1 lb	7641	\$ 1,245.00
M5-025	0.25 x 0.00005 lbF	1 lb	7642	1,245.00
M5-05	0.5 x 0.0001 lbF	1 lb	7643	1,245.00
M5-2	2 x 0.0005 lbF	1 lb	7644	1,095.00
M5-5	5 x 0.001 lbF	1 lb	7645	1,095.00
M5-10	10 x 0.002 lbF	1 lb	7646	1,095.00
M5-20	20 x 0.005 lbF	1 lb	7647	1,095.00
M5-50	50 x 0.01 lbF	1 lb	7648	1,095.00
M5-100	100 x 0.02 lbF	1 lb	7649	1,095.00
M5-200	200 x 0.05 lbF	2 lb	7650	1,245.00
M5-500	500 x 0.1 lbF	2 lb	7651	1,245.00

#### Options

			A5
09-1163 Cable, Series 5 to RS232, 9 pin	1 lb	7652	75.00
09-1164 Cable, Series 5 to Mitutoyo	1 lb	7653	75.00
09-1166 Cable, Series 5 to Analog	1 lb	7654	75.00
09-1162 Cable, Series 5 to ESM301(-L)	1 lb	7655	125.00



Series 5  
Digital Force Gauge

# NEW



M7  
Professional Force Gauge

## MARK-10

### Professional M7 Force Gauge

High speed data capture. Foot switch. User defined unit. Keys for: ZERO, UNITS, MENU, DATA, MODE. 5,000 point memory and statistics. Break detection. USB, RS232. Mitutoyo and analog outputs. Averaging, set points with outputs, external trigger, extension rod chisel, cone, v-groove, flat, hook. AC adapter/charger. Carrying case. NIST certificate. 3 year warranty.

Part Number	Capacity	Weight	Stock	Price A5
M7-012	0.12 lbF	1 lb	8108	\$ 1,745.00
M7-025	0.25 lbF	1 lb	8109	1,745.00
M7-05	0.5 lbF	1 lb	8110	1,745.00
M7-2	2 lbF	1 lb	8111	1,595.00
M7-5	5 lbF	1 lb	8112	1,595.00
M7-10	10 lbF	1 lb	8113	1,595.00
M7-20	20 lbF	1 lb	8114	1,595.00
M7-50	50 lbF	1 lb	8115	1,595.00
M7-100	100 lbF	1 lb	8116	1,595.00
M7-200	200 lbF	1 lb	8117	1,745.00
M7-500	500 lbF	1 lb	8118	1,745.00

## MARK-10

### Digital BG Force Gauge

Reversible aluminum housing for hand held use or stand mounting. Programmable analog and digital filters. Compatible with all Mark 10 test stands and grips. Keys are: POWER, UNITS, ZERO, DATA, MODE, CLEAR. Units: lb, kg(g). 4-1/2 digit 0.3" LCD. 62 readings per second. GCL Gauge Control Language for full control of all functions. Measures tensile and compressive forces. Permanent configuration memory. Automatic peak memory, push button calibration. RS232 Mitutoyo and analog outputs, programmable auto shut off. Battery or AC operation. Includes cushioned carrying case with an AC adapter, user's manual and NIST certificate with a set of accessories: chisel, cone, V groove, hook, flat, extension.

Part Number	Capacity	Weight	Stock	Price A5
BG2	2 x 0.001 lb	9 lb	5763	\$ 995.00
BG10	10 x 0.005 lb	9 lb	5765	995.00
BG50	50 x 0.02 lb	9 lb	5767	995.00



**BG**  
Digital Force Gauge

## MARK-10

### TSC Test stand wheel, vertical

Hand wheel operated with Precision Acme screw and nut. Loading table with (25) 10-32 holes for fixture mounting. Mounting holes for bench mounting. 6"W x 8"D x 26"H

Part Number	Capacity	Weight	Stock	Price A5
TSC1000	1,000 lb	25 lb	5876	\$ 1,375.00

Verticle test stand

TSC1000H-	1,000 lb	20 lb	5877	1,375.00
-----------	----------	-------	------	----------

Horizontal test stand

#### Options

TSC001 Digital travel display for TSC/TSCH		1 lb	5878	A5 650.00
--	--	------	------	--------------



TSC  
Test stand  
vertical

## MARK-10

### ES-10 Test Stand

Lever operated test stand using rack and pinion. Large base plate with (5) # 10-32 holes for fixture mounting. Mounting holes for bench mounting. Maximum travel 9".  
6"W x 10"D x 13.3"H

Part Number	Capacity	Weight	Stock	Price A5
ES10 Test stand with lever	100 lb	10 lb	5879	\$ 495.00

#### Options

ES001 Dial indicator		1 lb	5882	A5 140.00
----------------------	--	------	------	--------------



ES-10  
Test Stand

Prices are subject to change without notice. Please call for current prices.

Other items are available from the manufacturers, please call for prices.



**MARK-10**

**TST Torque test stand, hand wheel operated, verticle**

Ultra smooth hand wheel operation ensures ease of use and a lever operated slider with travel stops makes engaging and disengaging samples quick and efficient. Versatile modular design allows it to be configured for a variety of torque sensors and gripping fixtures. Maximum angular travel; no limit. Throat; 4.10". Angular rate; 12 degree resolution. Maximum slider travel; 15.5". Slider travel rate; 1.047". Adjustable travel stops, torque plate with tapped holes for grip and fixture mounting. Smooth wheel operation, lever operated slider for engaging and disengaging samples. Includes a torque loading plate with tapped holes for grip and custom fixture mounting and a resetable angle indicator. Supplied with a wrench.

Part Number	Capacity	Weight	Stock	Price A5
TST	100 lb	17 lb	6740	\$ 2,600.00
TSTH	100 lb	17 lb	6741	2,600.00

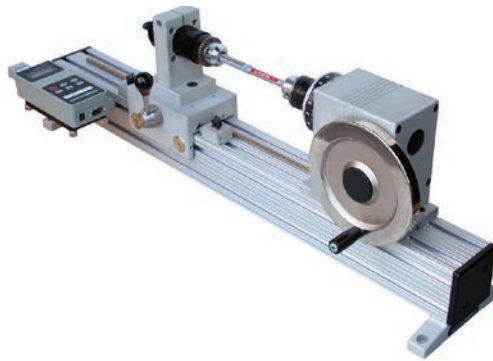

**TST Test Stand  
Horizontal**



**TST Test Stand  
Verticle**

## MARK-10

### TSA Test stand vertical

Mounting holes for bench mount. Loading lever can be positioned in 30 degree increments for ease of operation. Adjustable travel stops, precision ground rack and pinion mechanism. Optional digital travel display, frictional low force brake. 6"W x 8"D x 26"H



**TSA**  
Test stand vertical

Part Number	Capacity	Weight	Stock	Price A5
TSA750	750 lb load capacity	16 lb	5867	\$ 995.00
TSA750H	750 lb load capacity	13 lb	5868	995.00

#### Options

Options	Weight	Stock	A5
TSA-1 Digital travel display	1 lb	5869	650.00
TSA-2 Horizontal wall mount kit	1 lb	5870	150.00
TSA-3 Table assembly for TSA/TSAH	1 lb	5871	200.00

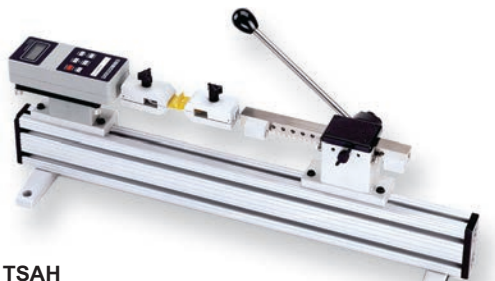

**TSAH**  
Test stand horizontal

## MARK-10

### TSB Test Stand Lever, Vertical

Loading lever can be positioned in 30 degree increments for ease of operation. Optional adjustable travel stops. Optional travel digital display. Mounting holes for bench mounting. Removable base plate with (25) 10-32 holes for fixture mounting. Frictional low force brake. 4"W x 8.5"D x 19"H

Part Number	Capacity	Weight	Stock	Price A5
TSB100 Test stand lever	100 lb	12 lb	5872	\$ 795.00

#### Options

				A5
TSB001 Digital travel display		1 lb	5873	600.00
TSB002 Horizontal wall mount kit		1 lb	5874	140.00
TSB003 Travel stops kit		1 lb	5875	95.00



TSB  
Test stand lever  
vertical

## MARK-10

### ES20 Test Stand

Hand wheel operated test stand. Small size, low cost. Mounting holes for bench mounting. Large base plate with (5) 10-32 holes for fixture mounting. 6"W x 10"D x 17"H

Part Number	Capacity	Weight	Stock	Price A5
ES20	100 lb	10 lb	5880	\$ 595.00



ES-20  
Test Stand

## MARK-10

### ES30 Test Stand

Hand wheel operated test stand that is upgradeable to a motorized stand. Modular design, base may be removed and the stand may be used as a component of a larger system. Field upgradeable to a motorized stand (ESM) by installing a motor drive kit. 6"W x 10"D x 23"H

Part Number	Capacity	Weight	Stock	Price A5
ES30	200 lb	17 lb	5881	\$ 895.00

#### Options

ESM001 Digital travel display		1 lb	5885	A5 750.00
-------------------------------	--	------	------	--------------



ES-30  
Test Stand

# MARK-10

## M5 Force/Torque Indicator

Indicator for use with fully interchangeable force and torque sensors with personality modules containing all calibration and user-set data. 4 1/2" digit LCD, 0.3" high characters. Keys are: POWER, UNITS, ZERO, DATA, MODE, CLEAR, ADVANCE, ESCAPE. Average mode for obtaining average force readings over time. Push button calibration. RS-232 fully configurable up to 9600 baud. GCL Gauge Control Language. Symbols for low battery, units and mode of operation. AC or rechargeable battery with IPM Intelligent Power Monitoring system. Includes cushioned carrying case with an AC adapter, user's manual and NIST certificate.

Part Number	Volts	Weight	Stock	Price A5
M5I	110V	1 lb	5799	\$ 895.00
M5E	220V	1 lb	5800	895.00



M5I  
Torque Indicator

# MARK-10

## MR53 Torque sensor, Closure tester

Spill-proof construction, rugged aluminum housing. Reversible jaws for round or rectangular containers. Remote operation, may be used for screw driver and torque wrench calibration. Accuracy: 0.7% of full scale. NIST traceable calibration included.

Part Number	Capacity	Weight	Stock	Price A5
MR53OZ	10 x 0.01 ozin	5 lb	5831	\$ 1,500.00
MR532OZ	20 x 0.02 ozin	5 lb	5832	1,500.00
MR535OZ	50 x 0.05 ozin	5 lb	5833	1,500.00
MR5312	12 x 0.01 lbin	5 lb	5834	1,500.00
MR5350	50 x 0.05 lbin	5 lb	5835	1,500.00
MR53100	100 x 0.1 lbin	5 lb	5836	1,500.00



MR53 Torque Sensor  
w/optional BGI  
indicator

Prices are subject to change without notice. Please call for current prices.

Other items are available from the manufacturers, please call for prices.

## MARK-10

### MTT01 Closure Torque Testers Series

The CT captures peak torque in both clockwise and counterclockwise directions for application and removal measurements. Tester features a solid aluminum housing and rugged construction for many years of service in laboratory or production environments. Adjustable posts effectively grip a broad range of container shapes and sizes, while a set of optional jaws is available as an alternative gripping method. Accepts samples up to 7.5" dia. Selectable units of measurement are lbin, kgFmm and Ncm. Movable container gripping posts. Battery or AC operation. Includes set of four posts, AC adapter and 9V non rechargeable battery, 30 hours of continuous operation. Users manual and NIST-traceable certificate of calibration. 3 year warranty.



**MTT01**  
Closure Torque Tester  
w/ standard adjustable posts

Part Number	Capacity	Weight	Stock	Price A5
MTT01-12	12 x 0.01 lbin	10 lb	4514	\$ 1,395.00
MTT01-50	50 x 0.05 lbin	10 lb	4515	1,395.00
MTT01-100	100 x 0.1 lbin	10 lb	4516	1,395.00

#### Options

CT001 Sample gripping jaws, pair	1 lb	3220	75.00	<b>A5</b>
----------------------------------	------	------	-------	-----------

For 220V operation add suffix E to model number.



Optional  
Gripping Jaws



Standard  
Adjustable Posts

## MARK-10

### TT02 Digital Torque Tester Series

Simple, yet accurate solution for testing torque screwdrivers, wrenches and other tools. Solid aluminum housing make it rugged enough for many years of service in production or laboratory use. Universal receptacle with square drive and grooves accepts common bits and attachments. Applications exist in virtually every industry. Captures peak torque in both clockwise and counterclockwise directions. Selectable units of measure are: lbin, kgFmm, Ncm. Push button calibration. RS-232 and Mitutoyo (Digimatic). WinWedge software allows the torque tester to send data to a PC for further analysis in Windows applications such as Excel. AC or non-rechargeable 9V battery with Intelligent Power Management System (IPM). IPM warns user via "LO BAT" indicator and then will power off the gauge. 30 hours of continuous use. 3 year warranty.



**TT02**  
Digital Torque Tester

Part Number	Capacity	Weight	Stock	Price A5
MTT02-12	12 x 0.01 lbin	5 lb	6900	\$ 1,295.00
MTT02-50	50 x 0.05 lbin	5 lb	6901	1,295.00
MTT02-100	100 x 0.1 lbin	5 lb	6902	1,295.00

#### Options

ST001 Bench mounting bracket	2 lb	6903	150.00	<b>A5</b>
------------------------------	------	------	--------	-----------

# MARK-10

## MR03 Force sensor, Tension compression

Rugged aluminum housing, small size. Remote operation. Measures tensile and compressive forces. Accuracy: 0.15% FS + BGI. NIST traceable calibration certification included.

Part Number	Capacity	Weight	Stock	Price A5
MR03-025	0.25 x 0.0001 lb	1 lb	5818	\$ 775.00
MR03-05	0.5 x 0.0002 lb	1 lb	5819	775.00
MR03-22	2 x 0.001 lb	1 lb	5820	650.00
MR03-5	5 x 0.002 lb	1 lb	5821	650.00
MR03-10	10 x 0.005 lb	1 lb	5822	650.00
MR03-20	20 x 0.01 lb	1 lb	5823	650.00
MR03-50	50 x 0.02 lb	1 lb	5824	650.00
MR03-100	100 x 0.05 lb	1 lb	5825	650.00

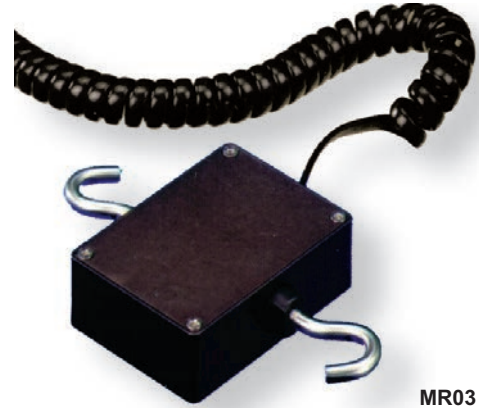

MR03  
Tension Compression

# MARK-10

## MR52 Torque sensor, Tool calibration

Small size, remote operation. Universal mounting, may be used for torque tool calibration or as a component of a torque testing system. Accuracy: 0.35% of full scale. NIST traceable calibration certificate included.

Part Number	Capacity	Weight	Stock	Price A5
MR52-1OZ	10 x 0.01 ozin	1 lb	5837	\$ 850.00
MR52-2OZ	20 x 0.02 ozin	1 lb	5838	850.00
MR52-5OZ	50 x 0.05 ozin	1 lb	5839	850.00
MR52-12	12 x 0.01 lbin	1 lb	5840	800.00
MR52-50	50 x 0.05 lbin	1 lb	5841	800.00
MR52-100	100 x 0.1 lbin	1 lb	5842	800.00
<b>Accessories</b>		1 lb		<b>A5</b>
AC 1006 Table top mount kit		1 lb	5843	50.00
AC 1014 Jacobs chuck 3/8"		1 lb	5844M	150.00



MR52  
Tool Calibration

Prices are subject to change without notice. Please call for current prices.

Other items are available from the manufacturers, please call for prices.

## MARK-10

### MR04 Miniature Force Sensor



**MR04**  
Miniature Force Sensor

Extremely compact force measurement sensor for tensile and compressive loads in a limited space. This sensor features outstanding mechanical overload protection of up to 1,000% of full scale for most applications and threaded holes on two sides for the mounting of attachments or implements. Member of the BGi family interchangeable sensors. Personality module holds all calibration and configuration data. Measures tensile and compressive forces. Mechanical overload protection of up to 200% for SJR50 and SJR100 when used in tension only. Accuracy  $\pm 0.2\%$  of full scale  $\pm 1$  digit + BGI. NIST traceable certificates of calibration included. 3 year warranty.

Part number	Capacity	Weight	Stock	Price A5
MR04-025	0.25 x 0.0001 lb	1 lb	6745	\$ 995.00
MR04-05	0.5 x 0.0002 lb	1 lb	6746	995.00
MR04-2	2 x 0.001 lb	1 lb	6747	995.00
MR05-5	5 x 0.002 lb	1 lb	6748	995.00
MR04-10	10 x 0.005 lb	1 lb	6749	995.00
MR04-20	20 x 0.01 lb	1 lb	6750	995.00
MR04-50	50 x 0.02 lb	1 lb	6751	995.00
MR04-100	100 x 0.05 lb	1 lb	6752	995.00

## MARK-10

### MR01 Force Sensor, S-Beam, Tension/Compression



**MR01**  
S-Beam

Small size, remote operation. Measures tensile and compressive forces. Accuracy: 0.15% FS. NIST traceable calibration certificate included.

Part Number	Capacity	Weight	Stock	Price A5
MR01-50	50 x 0.02 lb	2 lb	5810	\$ 595.00
MR01-100	100 x 0.05 lb	2 lb	5811	595.00
MR01-200	200 x 0.1 lb	2 lb	5812	595.00
MR01-500	500 x 0.2 lb	2 lb	5813	595.00
MR01-1000	1,000 x 0.5 lb	2 lb	5814	595.00
MR01-2000	2,000 x 0.1 lb	2 lb	5815	595.00
MR01-5000	5,000 x 0.2 lb	2 lb	5816	845.00
MR01-10000	10,000 x 0.5 lb	2 lb	5817	845.00



# MARK-10

## MR55 Torque sensor, Wrench extension

Rugged all metal construction. Converts any wrench to a torque tool. May be used as torque tool or as a component of a torque testing system. Accuracy: 0.6% of full scale NIST traceable calibration certificate included.

Part number	Capacity	Weight	Stock	Price A5
MR55-20	20 x 0.02 lbin	1 lb	6734	\$ 1,195.00
MR55-50	50 x 0.05 lbin	1 lb	6735	1,195.00
MR55-100	100 x 0.1 lbin	1 lb	6736	1,195.00
MR55-200	200 x 0.2 lbin	2 lb	5845	1,195.00
MR55-400	400 x 0.5 lbin	2 lb	5846	1,195.00
MR55-1000	1000 x 0.1 lbin	2 lb	5847	1,195.00
MR55-5000	5000 x 5 lbin	2 lb	5848	1,195.00

### Accessories

				A5
AC 1010 Mounting kit 200/400		2 lb	5849	90.00



MR54  
Wrench Extension

# MARK-10

## MR50 Torque sensor, Universal

Bi-directional, small size. Rugged aluminum housing, remote operation. Accuracy: 0.35% FS. NIST traceable calibration certificate included.

Part number	Capacity	Weight	Stock	Price A5
MR50-10OZ	10 x 0.01 ozin	1 lb	5850	\$ 845.00
MR50-20OZ	20 x 0.02 ozin	1 lb	5851	845.00
MR50-50OZ	50 x 0.05 ozin	1 lb	5852	845.00
MR50-12	12 x 0.01 lbin	1 lb	5853	795.00
MR50-50	50 x 0.05 lbin	1 lb	5854	795.00
MR50-100	100 x 0.1 lbin	1 lb	5855	795.00

### Accessories

				A5
AC 1007 Table top mount kit		2 lb	5856	90.00



MR50  
Universal torque sensor

## MARK-10

### MR02 Force Sensor, Compression

Stainless steel construction. Small size, measures compressive forces only. Accuracy: 0.5% FS. Remote operation. NIST traceable calibration certificate included.



**MR02**  
Force Sensor  
Compression

Part Number	Capacity	Weight	Stock	Price A5
MR02-100	100 x 0.05 lb	1 lb	5803	\$ 745.00
MR02-200	200 x 0.01 lb	1 lb	5804	745.00
MR02-500	500 x 0.2 lb	1 lb	5805	745.00
MR02-1000	1000 x 0.5 lb	1 lb	5806	745.00
MR02-2000	2000 x 1 lb	1 lb	5807	745.00
MR02-5000	5000 x 2 lb	1 lb	5808	745.00
MR02-10000	10000 x 0.5 lb	1 lb	5809	745.00

# MARK-10

## MR51 Torque Sensor, Universal

Member of the BGI interchangeable sensors. Outstanding overload protection, interchangeable chucks. Personality module holds all calibration and configuration data. Accuracy: 0.15% FS. NIST traceable calibration certificate included.

Part Number	Capacity	Weight	Stock	Price A5
MR51-1OZ	10 x 0.01 ozin	1.lb	5857	\$ 795.00
MR51-2OZ	20 x 0.02 ozin	1 lb	5858	795.00
MR51-5OZ	50 x 0.05 ozin	1 lb	5859	795.00
MR51-12	12 x 0.01 lbin	1.lb	5860	745.00
MR51-50	50 x 0.05 lbin	1.lb	5861	745.00
MR51-100	100 x 0.1 lbin	1.lb	5862	745.00
<b>Accessories</b>				<b>A5</b>
G1016-1 Jacobs chuck for STH	0.25"	1 lb	5863M	135.00
G1016-2 Jacobs chuck for STH	0.375"	1 lb	5864M	140.00
G1016-3 Jacobs chuck for STH	0.5"	1 lb	5865M	145.00
G1017 Bit holder for STH, 1/4" hex		1 lb	5866	145.00



**MR51**  
Universal torque sensor

## MARK-10

### EK Ergonomics Testing Kit

Compact design, easy to hold. Simple and accurate job task analysis and ergonomic testing. ADA compliance, workplace design, ergonomic studies. Measure in: kg, lb, N. Non-slip double and single handles. Flat, curved and square padded attachments mount directly to the force gauge for conducting musculoskeletal strength analysis. Rugged hook and flat adapter attach directly to the force gauge for push, pull and lift forces. Durable construction ensures longevity. Battery or Ac operation. Cushioned carrying case, AC adapter, battery, user's manual, NIST-traceable certificate of calibration included.

Part number	Weight	Stock	Price A5
EK3-200	8 lb	6756	\$ 995.00
EK3-500	8 lb	6757	995.00

For 220V operation add suffix E to model number.



**EK Series  
Ergonomics Testing Kit**



**Ergonomics Testing Kit**

## MARK-10

### Grips and attachments

For use with, digital force gauges, digital torque gauges, digital force/torque indicators, and test stands.

Part Number	Weight	Stock	Price A5
G1041 Adapter	1 lb	5933	\$ 20.00
09-1048A RS232 cable 9 (pin)	1 lb	5937	75.00
09-1049 Analog cable	1 lb	5938	75.00
09-1063 Chatillon cable	1 lb	5939	75.00
09-1066 Travel display cable	1 lb	5940	75.00
MRS-100A RS232 Adapter 25 (pin)	1 lb	5942	190.00
MRS-100A RS232 Adapter 9 (pin)	1 lb	5943	190.00
RSM-100 RS232 Adapter 25 (pin)	1 lb	5944	190.00
RMS-100A RS232 Adapter 9 (pin)	1 lb	5945	190.00
08-1026 Replacement battery	1 lb	5951	20.00
AC1030 110VAC Adapter	1 lb	5952	40.00
AC1031 220VAC Adapter	1 lb	5953	40.00
11-1022 HI/LO Limits indicator	1 lb	5954	90.00
AC1002 Double handle grip BG/EG	2 lb	5955	120.00
AC1002-1 Single handle grip BG/EG	1 lb	5956	110.00
AC1003 Double handle grip MG	2 lb	5957	100.00
AC1003-1 Single handle grip MG	1 lb	5958	85.00
AC1006 STC Mounting kit	1 lb	5843	50.00
AC1007 STJ Mounting kit	2 lb	5961	90.00
AC1010 STE Mounting kit	1 lb	5963	90.00
AC1014 Jacobs chuck STC 0.375 "	1 lb	5844M	150.00
AC1015 STH/TST Mounting kit	1 lb	5959	60.00
AC1016 STE200/400 to TST Mounting kit	1 lb	5960	60.00
SVC001 Calibration w/NIST certificate	1 lb	5965	268.00
SVC006 Load cell w/cal, NIST cert.	1 lb	5968	350.00
SVC008 Sensor w/cal, NIST cert	1 lb	5970	500.00
Certified NIST certificate w/data	1 lb	5971	75.00

Aug



**08-1006**  
Replacement battery

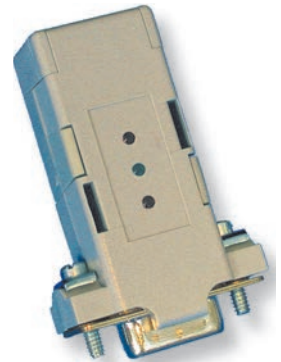

**11-1022**  
HI/LO Limits indicator



**AC1014**  
Jacobs chuck STC

Prices are subject to change without notice. Please call for current prices.

Other items are available from the manufacturers, please call for prices.

# Grips and Attachments

## MARK-10

### Grips and Attachments

For use with, digital force gauges, digital torque gauges, digital force/torque indicators, and test stands.



**G1001**  
Wire terminal group

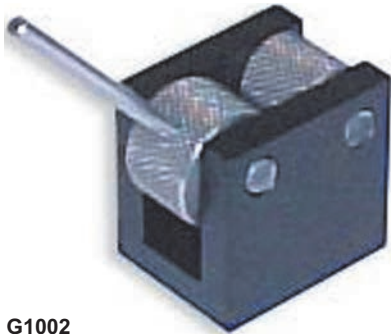

**G1002**  
Dual roller grip



**14-1064**  
Adapter



**14-1120**  
Coupling

Part Number	Capacity	Weight	Stock	Price A5
G1001 Wire terminal grip	up to 0.125" OD	1 lb	5889	\$ 230.00
G1002 Dual roller grip	up to 0.25" x 0.5"	1 lb	5890	190.00
G1003 Mini component grip	up to 0.07"	1 lb	5891	140.00
G1008 Film and paper grip	up to 1" wide	1 lb	5892	250.00
G1009 Compression plate	2" dia	1 lb	5893	40.00
G1009-1 Compression plate	3" dia	1 lb	5894	75.00
G1010 Pin vise	1.38" dia	1 lb	5895	100.00
G1011 Rubber tip	0.5" dia	1 lb	5896	30.00
G1012 Wedge grip #10-32F	200 lb	1 lb	5897	395.00
G1013 Parallel jaw grips	up to 0.25" dia	1 lb	5898	210.00
G1015-1 Film and paper grip	3" wide	1 lb	5899	310.00
G1015-2 Film and paper grip	5" wide	1 lb	5900	330.00
G1015-3 Film and paper grip	1.85" dia	1 lb	5901	350.00
G1016-1 Jacobs chuck for STH	0.25" dia	1 lb	5863M	135.00
G1016-2 Jacobs chuck for STH	0.375" dia	1 lb	5864M	140.00
G1016-3 Jacobs chuck for STH	0.5" dia	1 lb	5865M	145.00
G1017 Bit holder for STH	1.4" dia	1 lb	5905	145.00
G1018-1 Swivel adapter # 10-32 UNF	200 lb	1 lb	5906	65.00
G1018-2 Swivel adapter 5/16-18 UNC	500 lb	1 lb	5907	65.00
G1019 Square padded attachment		1 lb	5908	40.00
G1020 Rectangle padded attachment		1 lb	5909	60.00
G1021 Curved padded attachment		1 lb	5910	80.00
G1022-1 Jacobs chuck for TST	0.25" dia	1 lb	6730	180.00
G1022-2 Jacobs chuck for TST	0.375" dia	1 lb	6731	200.00
G1022-3 Jacobs chuck for TST	0.5" dia	1 lb	6732	220.00
G1023 Bottle grip for TST	6.000" dia	1 lb	6733	500.00
G1024 Extension rod	5"	1 lb	5911	20.00
G1024-1 Extension rod	2"	1 lb	5912	20.00
G1024-2 Extension rod	1"	1 lb	5913	20.00
G1025 Chisel point attachment		1 lb	5914	20.00
G1026 Cone attachment		1 lb	5915	20.00
G1027 V-groove attachment		1 lb	5916	20.00
G1028 Small hook attachment		1 lb	5917	20.00
G1029 Flat head attachment		1 lb	5919	20.00
G1030 Adapter		1 lb	5920	20.00
G1031 Extension rod 5"		1 lb	5921	25.00
G1031-1 Extension rod 2"		1 lb	5922	22.00
G1031-1 Extension rod 1"		1 lb	5923	25.00
G1032 Chisel point attachment		1 lb	5924	25.00
G1033 Cone attachment		1 lb	5925	25.00
G1034 V-groove attachment		1 lb	5926	25.00
G1035 Large hook attachment		1 lb	5927	25.00
G1036 Flat head attachment		1 lb	5928	25.00
G1037 Coupling		1 lb	5929	20.00
G1038 Medium hook attachment		1 lb	5930	15.00
G1039 Coupling		1 lb	5931	15.00
G1040 Adapter		1 lb	5932	20.00

Prices are subject to change without notice. Please call for current prices.

Other items are available from the manufacturers, please call for prices.

## International Wire Transfers

Beneficiary Bank	Wells Fargo
Beneficiary Bank Address	1266 Market St San Francisco CA 94102
Beneficiary Bank Swift #	WFBIUS6WFFX
Beneficiary Name	ConnectOne Bank
Beneficiary Address	301 Sylvan Ave Englewood Cliffs NJ 07632
Beneficiary Customer #	4124911215
To Further Credit	
Customer Name	Totalcomp Inc
Customer Address	99 Reagent Ln Fair Lawn NJ 07410
Cust Account #	xxxxxxxxxxx

\* Please contact us for Customer Account #.

## Domestic ACH (Automated Clearing House)

Bank Name	ConnectOne Bank
Bank Address	301 Sylvan Ave Englewood Cliffs NJ 07632
Bank ABA #	021213944
Beneficiary Name	Totalcomp Inc
Beneficiary Address	99 Reagent Ln Fair Lawn NJ 07410
Beneficiary Account #	xxxxxxxxxxx

\* Please contact us for Customer Account #.

## Tarjetas de Crédito

El despacho se hará el mismo día

Solo aceptamos VISA y MASTERCARD

Nota: Proveer siempre el número de cuenta y la Fecha de Vencimiento.

Estimado cliente tener en cuenta que: Mastercard y Visa cobran el 3.15% mas \$1.15 por transacción. Estos costos serán agregados a su factura.

## Con Cheque

Cheque de banco de USA o Money Order.

Despachamos cuando el cheque arribe a nuestras oficinas. Por ejemplo si lo envián por servicio courier como DHL o FedEx, el cheque llegaría en 2 ó 3 días a Totalcomp.

Cheque a nombre de: Totalcomp Inc

Enviarlo a: Totalcomp Inc  
99 Reagent Ln  
Fair Lawn NJ 07410  
USA

## Cheque por fax/email

Agilizan sus ordenes de compras

En Totalcomp ahora tenemos el nuevo sistema de cheques por fax que permitira el despacho de los productos el mismo día. Tambien agiliza los pagos de facturas vencidas, y ahorra gastos de transferencia y de courier cuando envian un cheque a nuestras oficinas.

¿Como trabaja?

Ustedes consiguen un cheque de un banco local con nexos bancarios Norteamericanos en Dólares Americanos y lo envían vía fax a Totalcomp, con una autorización firmada por el dueño de la cuenta que diga lo siguiente:

Este cheque autoriza cargar a nuestra cuenta la suma de \$ \_\_\_\_\_

Una vez que lo tengamos tomaremos el número de cuenta del cheque, el número de tránsito y el número MICR que identifica el banco original. Luego imprimimos un cheque con esos datos y lo depositamos normalmente. Esta transaccion es completamente legal y es permitida en los Estados Unidos.

Una vez que tengamos el cheque por fax podremos despachar el mismo día. Ustedes se ahorran los gastos de DHL, FEDEX, tranferencia, o cargos del 2.8% cuando pagan con Visa o MasterCard.

## Terms

Your choice of payment.

1. Check or money order with order.
2. Net 30 days for approved credit customers. If you desire a Totalcomp charge account, simply request a credit application with your next order (or at any time) and we will ship your order when your credit is approved.
3. C.O.D. will be delivered by UPS or Federal Express. They will collect total charges which will include merchandise, freight and handling.

Prices are FOB Fair Lawn, New Jersey or FOB Factory and are subject to change without notice. Orders will be filled with prices in effect at the date of shipment.  
Minimum order is \$20.00 excluding shipping charges.

## Stock

Your components will be shipped within 24 hours from when we receive your order.  
We normally carry an ample supply of every item on our stock shelf. It is very infrequent that our supply is depleted to zero due to unusual requests from our other customers.

## Shipping

- UPS . . . . .Your order will be shipped UPS whenever possible, unless you request a different method of shipment. Maximum 150 lbs per carton.
- UPS 2nd day air . . . . .Air freight via UPS. It is a guaranteed 2-day delivery not including Saturday or Sunday.
- UPS 3 day air . . . . .Ground service via UPS. It is guaranteed 3 day delivery not including Saturday and Sunday.
- UPS Next day air . . . . .Air freight via UPS. It is a guaranteed 1-day delivery not including Sunday.
- Express mail . . . . .Air freight via U S Postal Service. Guaranteed next day delivery not including Sunday.
- Air Freight . . . . .Air freight via Federal Express, DHL and other independent air cargo service. Normally next day service. Extra cost for Saturday delivery. No Sunday deliveries.
- Truck . . . . .When shipping load cells and other parts by truck specify shipping class as SCALES NOI CLASS 85.

## Warranty

Your Customer Warranty is the standard manufacturer's warranty, which is normally 1 year from date of shipment.

No prior return authorization is required.

Return to us the defective items. Enclose a note with the model number, serial number, invoice number and date of purchase and a brief description of defect.

Defective part will be forwarded to the manufacturer for evaluation. Customer will be advised of the status.

No credit will be issued unless offered by the manufacturer.

## Return Policy

All merchandise must be authorized prior to return. No return will be accepted without a **Return Authorization Number**, except for warranties.

If the wrong part was ordered:

1. A 20% restocking charge plus shipping charges will apply.
2. The merchandise being returned must be returned within 2 weeks of original shipping date.
3. The Merchandise being returned must be unused and received in new condition. If merchandise appears to have been used or received in poor or damaged condition, a refurbishing charge will be applied before credit is given.

If the wrong part was shipped:

1. The correct merchandise will be shipped at once.
2. Full credit will be issued upon return of incorrect merchandise.

## Damaged in Shipment

Merchandise that has been damaged in shipment must be reported to the freight carrier immediately.

Do not return the merchandise until after the freight carrier has inspected the damage. Keep all the original packaging material for the inspection. The freight carrier will not honor a claim for damage if the merchandise is not as you received it.

After the freight carrier has inspected the damage and has given us approval, we will give you a **Return Authorization Number**.

## Email

- sales@totalcomp.com
- purchasing@totalcomp.com
- accountspayable@totalcomp.com
- accountsreceivable@totalcomp.com



1119 174  
 1124 177  
 1450 174  
 150114 126  
 1610 175  
 2200 43  
 22000CW 72  
 2240 84  
 235 114  
 2400 174  
 250 171  
 30006 124  
 30007 124  
 310 175  
 311 175  
 337 96  
 400KL 97  
 4300 71  
 64 86  
 6550 94  
 6855 93  
 7000 40  
 7000XL 42  
 710 173  
 7300 59  
 7400 41  
 7500 81  
 7600 81  
 8000 44  
 8025XL 44  
 820 115  
 854F100P 176

## A

A&D, AD-1683 163  
 A&D, AD-4212A 132  
 A&D, BM 160  
 A&D, EJ 8  
 A&D, EK 4  
 A&D, EK-G 9  
 A&D, EK-i 5  
 A&D, EW 6  
 A&D, FCi 78  
 A&D, FG 26  
 A&D, FS-i 73  
 A&D, FV 5  
 A&D, FW 5  
 A&D, FX-i 131  
 A&D, FX-iWP 133  
 A&D, FZ-i 133  
 A&D, FZ-iWP 134  
 A&D, GF 135  
 A&D, GF-A 136  
 A&D, GF-K 151  
 A&D, GF-P 136  
 A&D, GH 161  
 A&D, GP 152  
 A&D, GR 162  
 A&D, GX 129  
 A&D, GX-A 130

A&D, GX-K 151  
 A&D, Hci 77  
 A&D, HD 77  
 A&D, HL 3  
 A&D, HLi 3  
 A&D, HR 163  
 A&D, HR-AZ/HR-A 160  
 A&D, HT 4  
 A&D, HV 23  
 A&D, HV-G 24, 25  
 A&D, HV-WP 25  
 A&D, HW-G 24, 25  
 A&D, HW-WP 25  
 A&D, MC 159  
 A&D, MF 147  
 A&D, ML 147  
 A&D, MS 147  
 A&D, MX 147  
 A&D, PV 1  
 A&D, SC 27  
 A&D, SE 27  
 A&D, SF 64  
 A&D, SJ 4  
 A&D, SK 9  
 A&D, SK-WP 7  
 A&D, SV-10 182  
 A&D, SW 28  
 Acculab, ALC 141  
 Acculab, EC 21  
 Acculab, VIC 21  
 AD-1683 163  
 AD-4212A 132  
 Adam, CBK 70  
 Adam, CPW 29  
 Adam, GFC 80  
 Adam, PGL 146  
 Adam, PGWe 158  
 Adam, WBW 10  
 Aircraft 106, 107, 108  
 ALC 141  
 Analytical 158, 159, 160, 161, 162, 163, 164,  
 165, 166, 167, 168, 169  
 Animal 89  
 AP1 65  
 AW 107  
 AWT05 124  
 AX 165

## B

Baggage 85, 86, 87  
 Baker 170  
 BCS 22  
 Bench 4, 5, 6, 7, 8, 9, 10, 11, 12, 13, 14, 15,  
 16, 17, 18, 19, 20, 21, 22  
 Bench/Floor 23, 24, 25, 26, 27, 28, 29, 30, 31,  
 32, 33, 34, 35, 36, 37, 38, 39, 40, 41, 42, 43,  
 44, 45, 46, 47, 48  
 Benchmark 170  
 BG 187  
 BM 160

body fat scale 90  
 Body fat talking scale 90  
 Brecknell, 235-6S 114  
 Brecknell, 250 171  
 Brecknell, CS 122  
 Brecknell, Electro Samson 116  
 Brecknell, PS500 89  
 BW 46

## C

C 84  
 C11P 30  
 Cambridge, Portable Platform Scale 55  
 Cardinal, 2240 84  
 Cardinal, C 84  
 Cardinal, CIM 73  
 Cardinal, GP 48  
 Cardinal, PS 61  
 Cas, AP1 65  
 Cas, BW 46  
 Cas, Caston II 120  
 Cas, Caston III 120  
 Cas, Caston III Bluetooth 123  
 Cas, CL5000 67  
 Cas, CPS 104  
 Cas, DL 46  
 Cas, EB 65  
 Cas, EC 80  
 Cas, IE 121  
 Cas, LP-1000 66  
 Cas, LP-II 67  
 Cas, NC1 121  
 Cas, PB 47  
 Cas, PD-II POS 59  
 Cas, PW-II 61  
 Cas, RW-2601P 110  
 Cas, RW-P 110  
 Cas, RW-S/L 109  
 Cas, S2000 69  
 Cas, S2000JR 68  
 Cas, SC 80  
 Cas, SW 11  
 Cas, SW-RS 10  
 Cas, SW-W 11  
 Cas, SW-Z 12  
 Caston II 120  
 Caston III 120  
 Caston III Bluetooth 123  
 CBK 70  
 CCI, FS 172  
 Chatillon, IN-50 115  
 CIM 73  
 CK-10 74  
 CL 2  
 CL5000 67  
 Computing 64, 65, 66, 67, 68, 69  
 Counting 75, 76, 77, 78, 79, 80, 81, 82, 83,  
 84  
 Covers 180, 181  
 CP 137

# Index

CPS 1 104  
CPW 29  
CPWplus 6 29  
CQ 37  
CR 94  
Crane 117, 118, 119, 120, 121, 122, 123  
CS 122  
CS1500 118  
CS200 117  
CS3000 119  
CS750 118  
CW250 54

## D

D31P 32  
D32XW 32  
D500M 176  
D51P 33, 34  
D51P250QX 34  
D71P 35, 36  
Detecto, 6500 94  
Detecto, CR 94  
Detecto, Low Profile 28  
Detecto, MS 98  
Detecto, PC 69  
Detecto, Physician Scale 96  
Detecto, Portable Beam Scale 176  
Detecto, Portable Personal Scale 93  
Detecto, RW500 53  
Detecto, TB 170  
Dillon, AP 124  
Dillon, ED junior 125  
Dillon, EDxtreme 125  
Dillon, Quick-Check 124  
DL 46  
DMS 87  
Doran, 2200CW 72  
Doran, 4300 71  
Doran, 7000 40  
Doran, 7000XL 42  
Doran, 7400 41  
Doran, 8000 44  
Doran, 8000XL 44  
Doran, APS 43  
Doran, DBS 87  
Doran, DMS 87  
Doran, FC6300 56  
Doran, MVP 45  
Doran, PC400 62  
Doran, PC500 63  
Doran, PFS7000 52  
Doran, PFS8000XL 52  
DR 28  
DS 87  
Dynamometers 124

## E

EA 155  
EB 65  
EC 79, 80

EC-411 21  
EDjr 125  
EDx 125  
EJ 8  
EK 4, 5  
EK-G 9  
EK3 200  
Electro Samson 116  
EP 139  
ES 31  
ES10 188  
ES20 192  
Evergreen Weigh, Road Runner 107  
Evergreen Weigh, Road Runner Jack Point 106  
EW 6  
EX 154, 164  
EX1 166

## F

Fairbanks, Portable Beam Scale 177  
FC63 56  
FCi 78  
FD 60  
FG 26  
First Weigh, CK-10 74  
Floor 49, 50, 51, 52, 53, 54  
FormasDePago 203  
Formula 56  
FS 73, 172  
FV 5  
FW 5  
FX 131  
FX-iWP 133  
FZ 133  
FZ-iWP 134

## G

Gauge 183, 184, 185, 187  
GF 135, 151  
GF-A 136  
GF-P 136  
GFC 80  
GH 161  
Gourmet 170  
GP 152  
GP-400-204 48  
GR 162  
Guage 186  
GX 129, 151  
GX-A 130

## H

Hanging 114, 115, 116  
Hazardous 88  
HC 77  
HCB 146  
HD 77  
Health 90, 91, 92, 93, 94, 95, 96, 97

Healthometer, 400 97  
HH 1  
HI 142  
HL 3  
HR 160, 163  
HT 4  
HV 23, 24  
HV-G 25  
HV-WP 25  
HW 23, 24  
HW-G 25  
HW-WP 25

## I

IE 121  
IN-50 115  
Industrial 151, 152, 153, 154, 155, PB 156, 157  
Intercomp, CS1500 118  
Intercomp, CS200 117  
Intercomp, CS3000 119  
Intercomp, CS750 118  
Intercomp, CW250 54  
Intercomp, LP600 111  
Intercomp, PT300 113  
Intercomp, PT300DW 112  
Intercomp, PW800 104  
Intercomp, SW 105  
Intercomp, TL6000 127  
Intercomp, TL6000-RF 126  
Intercomp, TL8500 128

## J

JE 101  
Jewelry 100, 101  
Jewelry 102  
JP 106  
JR 102  
JS 102  
JW 108

## L

Laundry basket 65  
Lift Truck 103  
LP-1000 66  
LP-II 67  
LP600 111  
LTEF-16 103  
LTS, LTEF 103

## M

M2 183  
M3 183  
M4 184  
M5 185, 193  
M7 186  
MA35 150  
Mark 10, BG Force Gauge 187

Mark 10, EK 200  
 Mark 10, ES-10 188  
 Mark 10, ES20 192  
 Mark 10, ES30 192  
 Mark 10, Grips and attachments 201  
 Mark 10, Grips and Attachments 201, 202  
 Mark 10, M2 Force Gauge 183  
 Mark 10, M3 Force Gauge 183  
 Mark 10, M4 Force Gauge 184  
 Mark 10, M5 Force Gauge 185  
 Mark 10, M5 Force/Torque Indicator 193  
 Mark 10, M7 Force Gauge 186  
 Mark 10, MR01 196  
 Mark 10, MR02 198  
 Mark 10, MR03 Force sensor 195  
 Mark 10, MR04 196  
 Mark 10, MR50 Torque sensor 197  
 Mark 10, MR51 Torque Sensor 199  
 Mark 10, MR52 Torque sensor 195  
 Mark 10, MR53 Torque sensor 193  
 Mark 10, MR55 Torque sensor 197  
 Mark 10, MTT01 194  
 Mark 10, TSA 190  
 Mark 10, TSB Test Stand Lever 191  
 Mark 10, TSC 188  
 Mark 10, TST Torque test stand 189  
 Mark 10, TT02 194  
 MB 148  
 MB200 148  
 MB23 149  
 MB27 149  
 MB90 149  
 MBS 92  
 MC 159  
 Mechanical 173, 174, 175, 176, 177  
 Mechanical Portion 170, 171, 172  
 MF 147  
 ML 147  
 Moisture 147, 148, 149, 150  
 MR01 196  
 MR02 198  
 MR03 195  
 MR04 196  
 MR50 197  
 MR51 199  
 MR52 195  
 MR53 193  
 MR55 197  
 MS 98, 147  
 MSA 169  
 MSE 169  
 MSU 169  
 MTT01 194  
 MTT02 194  
 MVP 45  
 MW1P 137  
 MX 147

## N

NC1 121

NCI scales service parts 99  
 NV 153  
 NVL 153  
 NVT 154

## O

Ohaus, 1600 Dial-O-Gram 175  
 Ohaus, 310 Dial-O-Gram 175  
 Ohaus, 311 Cent-O-Gram 175  
 Ohaus, Adventurer 141, 165  
 Ohaus, Adventurer Pro 141  
 Ohaus, Catapult 1000 30  
 Ohaus, CL 2  
 Ohaus, CQ31 37  
 Ohaus, CS 2  
 Ohaus, D500M 176  
 Ohaus, Defender 3000 32  
 Ohaus, Defender 5000 35, 36  
 Ohaus, Defender 5000 Rectangular 33  
 Ohaus, Defender 5000 Square 34  
 Ohaus, EC 79  
 Ohaus, ES 31  
 Ohaus, Explorer EX 154  
 Ohaus, Explorer Precision 140  
 Ohaus, Explorer Pro 139  
 Ohaus, Explorer Semi Micro 164  
 Ohaus, FD 60  
 Ohaus, Field Test 174  
 Ohaus, Harvard Trip 174  
 Ohaus, HH 1  
 Ohaus, JE 101  
 Ohaus, MB 148  
 Ohaus, MB200 148  
 Ohaus, MB23 149  
 Ohaus, MB27 149  
 Ohaus, MB90 149  
 Ohaus, Navigator 153  
 Ohaus, Navigator XL 153  
 Ohaus, Navigator XT 154  
 Ohaus, Pioneer 143, 164  
 Ohaus, PS 1  
 Ohaus, Ranger 3000 14  
 Ohaus, Ranger 3000 Counting 82  
 Ohaus, Ranger 4000 Counting 83  
 Ohaus, Ranger 7000 16  
 Ohaus, Ranger Counting 79  
 Ohaus, Ruby 102  
 Ohaus, Sapphire 102  
 Ohaus, Scoops 179  
 Ohaus, SD 30  
 Ohaus, SJX 100  
 Ohaus, Solution Balance 174  
 Ohaus, SPX 13  
 Ohaus, STX 13  
 Ohaus, TAJ 100  
 Ohaus, TR Trooper 20  
 Ohaus, Triple Beam 173  
 Ohaus, Triple Pro 175  
 Ohaus, Trooper Counting 79  
 Ohaus, Valor 2000 18

Ohaus, Valor 3000 18  
 Ohaus, Valor 4000 19  
 Ohaus, Valor 7000 19  
 Ohaus, VN 51  
 Ohaus, VX 50  
 Ohaus, YA 100  
 Ohaus, YJ 101  
 Ohaus, Explorer Analytical 166  
 Over/Under 70, 71, 72, 73, 74

## P

P 171  
 PA 143, 164  
 Pallet truck 104  
 PB 47  
 PC 69  
 PC-40L 69  
 PC400 62  
 PC500 63  
 PD-II 59  
 Penn Scale, 820 115  
 Penn Scale, Heirloom Scale 170  
 Penn Scale, P 171  
 Penn Scale, PS 63  
 Pennsylvania, 64 86  
 Pennsylvania, 7300 59  
 Pennsylvania, 7500 Counting 81  
 Pennsylvania, 7600 Counting 81  
 PFS 52  
 PGL 146  
 PGW 158  
 plastic weighing dishes 150  
 Pocket 1, 2, 3  
 Point of Sale 59  
 Portable Platform Scale 55  
 Portion/Food 60, 61, 62, 63  
 Postal 98, 99  
 Pour boat 150  
 Practum 138  
 Precision 129, 130, 131, 132, 134, 135, 136,  
 137, 138, 139, 140, 141, 142, 143, 144, 145,  
 146  
 PS 1, 61, 63  
 PS500 89  
 PT300 113  
 PT300DW 112  
 PV 1  
 PW800 104  
 PWII 61

## Q

Quintix 168

## R

R31P 14  
 R41ME 15  
 R71MD 16  
 Race Car 105  
 Radwag, WLC 145, 157

# Index

Radwag, WLY 157  
Radwag, WTC 144  
RC 79  
RC31P 82  
RC41 83  
Revere, Jet Weigh 108  
Rice Lake, RLP-S 60  
RLP 60  
RW 53, 109  
RW-2601P 110  
RW-P 110

**S**

S2000 69  
S2000JR 68  
Sartorius, Practum 138  
Sartorius, CP 137  
Sartorius, Cubis 169  
Sartorius, EA 155  
Sartorius, MA35 150  
Sartorius, Midrics 137  
Sartorius, Quintix 168  
Sartorius, Secura 167  
Sartorius, Signum 156  
Sartorius, TE 138  
SC 27, 80  
scoop 179  
Scoops 178, 179  
SD 30  
SE 27  
SECURA 167  
Sensor 195, 196, 197, 198, 199  
Setra, HI 142  
Setra, SI 142  
SF 64  
Shimadzu 158  
SI 142  
SIWADCP 156  
SJ 4  
SJX 100  
SK 9  
SK-WP 7  
SPS 99  
SPX 13  
square weighing dishes 150  
SRP 58  
SS640 55  
STX 13  
SV-10 182  
SW 11, 105  
SW-RS 10  
SW-Z 12

## T

T 88  
T29 6  
T32XW 50  
T4x4 49  
T5 37  
T501SSE 22

T80 40  
T900SS 22  
TAJ 100  
Talking scale 90  
Tanita, TLC 74  
Tanita, TLD 22  
TB 38, 170  
TBP 39  
TBS 85  
TC 79  
TC-200 75  
TC-290 75  
TCM2 76  
TDS 53  
TE 138  
TEI 29  
Tension Link 125, 126, 127, 128  
Terms 204  
Test Kit 200  
Test Stand 188, 189, 190, 191, 192  
THS 116  
TJA 142, 166  
TL6000 127  
TL6000-RF 126  
TL8500 128  
TLC 74  
TLD 22  
TM101 92  
TM301 91  
TM302 91  
TM501 93  
TM701 95  
TM901 89  
TM902 89  
Topload 133  
Torque 193, 194  
TorRey, PC40L 69  
Totalcomp, Baggage Scale Kit 85  
Totalcomp, BCS 22  
Totalcomp, Body Fat 90  
Totalcomp, Body Fat Scale 90  
Totalcomp, Clear Flexible Covers 180, 181  
Totalcomp, Floor Scale 49  
Totalcomp, Hazardous Floor Base 88  
Totalcomp, MBS 92  
Totalcomp, Scoops 178  
Totalcomp, T29 6  
Totalcomp, T5 37  
Totalcomp, T501 22  
Totalcomp, T80 40  
Totalcomp, T900 22  
Totalcomp, Talking Scale 90  
Totalcomp, TB 38  
Totalcomp, TBP 39  
Totalcomp, TC-200 75  
Totalcomp, TC-290 75  
Totalcomp, TCM2 76  
Totalcomp, TEI 29  
Totalcomp, THS 116  
Totalcomp, TJA 142  
Totalcomp, TJA Analytical 166

Totalcomp, TM101 92  
Totalcomp, TM301 91  
Totalcomp, TM302 91  
Totalcomp, TM501 93  
Totalcomp, TM701 95  
Totalcomp, TM901 89  
Totalcomp, TM902 89  
Totalcomp, TPR 104  
Totalcomp. TDS 53  
TP2611 175  
TPR 104  
TR 20  
Transcell, PC 57  
Transcell, SPS 99  
Transcell, SRP 58  
TSA 190  
TSB 191  
TSC 188  
TSCP 178  
TSCP-431 178  
TST 189

## U

UC-321  
Wheel Load 110, 111, 112  
UPS Shipping 57, 58

## V

V22PW 18  
V22XW 18  
V31X 18  
V41PW 19  
V41XW 19  
V71P 19  
VIC 21  
Viscometer 182  
VN 51  
VX 50

## W

WBW 10  
Weighing Dishes 150  
Wheel Load 109, 113  
WLC 145, 157  
WLY 157  
WTC 144

## Y

YA 100  
YJ 101

## **Mission**

Serve, Supply, & Inform You with Totalcompetence.

## **Vision**

Embrace Change While Maintaining Values.

## **Values**

*Honest* in all of our dealings.

*Helpful* to our customers & each other.

*Happy* in both home and office.

*Healthy* in all aspects of our lives.

---

Prices are subject to change without notice. Please call for current prices.

99 Reagent Lane  
Fair Lawn NJ 07410  
201-797-2718 \* 800-631-0347

 **Totalcomp**  
Scales & Balances

www.totalcomp.com  
Fax 201-797-2287  
Toll Free Fax 888-797-2288



13-01 Pollitt Drive Ext  
Fair Lawn NJ  
07410  
USA

Address Service Requested

BOUND PRINTED  
MATTER  
U.S. POSTAGE PAID  
PARAMUS, NJ  
PERMIT 545

**Mail Room Supervisor:** Our customer at your location has requested this catalog. If this catalog cannot be delivered as addressed, please forward to your company's Purchasing Manager and call us at **800-631-0347** to update the changes.



**write**

99 Reagent lane  
Fair Lawn NJ 07410

**phone**

Toll free: 800-631-0347  
Inside NJ: 201-797-2718

**fax**

Toll Free Fax: 888-797-2288  
Inside NJ fax: (201) 797-2287

**browse**

[www.totalcomp.com](http://www.totalcomp.com)

**e-mail**

[sales@totalcomp.com](mailto:sales@totalcomp.com)