

Lenovo ThinkSystem SR645 V3 Server Product Guide

The Lenovo ThinkSystem SR645 V3 is a dense, high performance, 2-socket 1U rack server. It is suitable for small businesses to large enterprises, and especially cloud service providers. The server features the AMD EPYC 9004 "Genoa" family of processors and support for the new PCIe 5.0 standard for I/O. It is designed to handle a wide range of workloads such as cloud computing, virtualization, VDI, enterprise applications, and database management.

The server offers a broad selection of drive and slot configurations and offers high performance features. Outstanding reliability, availability, and serviceability (RAS) and high-efficiency design can improve your business environment and can help save operational costs.



Figure 1. Lenovo ThinkSystem SR645 V3

Did you know?

The SR645 V3 server offers onboard NVMe PCIe ports that allow direct connections to 12x NVMe SSDs, which frees up PCIe slots and helps lower NVMe solution acquisition costs.

Key features

Combining performance and flexibility, the SR645 V3 server is a great choice for enterprises of all sizes. The server offers a broad selection of drive and slot configurations and offers high performance features that industries such as finance, healthcare and telco need. Outstanding reliability, availability, and serviceability (RAS) and high-efficiency design can improve your business environment and can help save operational costs.

Scalability and performance

The following features boost performance, improve scalability and reduce costs:

- Supports one or two fourth-generation AMD EPYC 9004 processors
 - Up to 128 cores and 256 threads
 - Core speed of up to 4.1 GHz
 - TDP rating of up to 360 W
- Support for DDR5 memory DIMMs to maximize the performance of the memory subsystem:
 - Up to 24 DDR5 memory DIMMs, 12 DIMMs per processor
 - 12 memory channels per processor (1 DIMM per channel)
 - DIMM speeds up to 4800 MHz
 - Using 256GB 3DS RDIMMs, the server supports up to 6TB of system memory
- Supports up to four single-width GPUs, each up to 75W for substantial processing power in a 1U system.
- The server is Compute Express Link (CXL) v1.1 Ready. With CXL 1.1 for next-generation workloads, you can reduce compute latency in the data center and lower TCO. CXL is a protocol that runs across the standard PCIe physical layer and can support both standard PCIe devices as well as CXL devices on the same link.
- Supports up to 12x 2.5-inch hot-swap drive bays, by using combinations of front-accessible (up to 10 bays) and rear-accessible (2 bays).
- Supports four 3.5-inch drive bays for lower-cost high-capacity HDD storage. 2.5-inch and 3.5-inch drive bays can be mixed if desired.
- Supports 12x NVMe drives without the need for additional NVMe adapters and without oversubscription of PCIe lanes (1:1 connectivity). Additional NVMe support with the use of NVMe Retimer adapters, also without oversubscription. The use of NVMe drives maximizes drive I/O performance, in terms of throughput, bandwidth, and latency.
- Supports 12x SATA drives using the onboard SATA controller (no additional adapter needed), enabling lower cost, high capacity storage solution for cold storage workloads.
- Supports 12x SAS drives using a variety of support RAID controllers or SAS HBAs.
- Supports high-speed RAID controllers from Lenovo and Broadcom providing 12 Gb SAS connectivity to the drive backplanes. A variety of PCIe 3.0 and PCIe 4.0 RAID adapters are available.
- Supports two externally accessible 7mm hot-swap drives for operating system boot functions or data storage. Optional RAID with the addition of a RAID adapter installed in a slot.
- Supports M.2 drives for convenient operating system boot functions or data storage. Available M.2 adapters support either one M.2 drive or two M.2 drives. Optional RAID with the addition of a RAID adapter installed in a slot.
- Supports up to 5x PCIe slots, 3x at the rear of the server and 2x at the front of the server. Also supports 1x OCP 3.0 slot, either in the front or in the rear.
- The server has a dedicated industry-standard OCP 3.0 small form factor (SFF) slot, with a PCIe 5.0 x16 interface, supporting a variety of Ethernet network adapters. Simple-swap mechanism with thumbscrews and pull-tab enables tool-less installation and removal of the adapter. Supports shared BMC network sideband connectivity to enable out-of-band systems management.

- The server offers PCI Express 5.0 (PCIe Gen 5) I/O expansion capabilities that doubles the theoretical maximum bandwidth of PCIe 4.0 (32GT/s in each direction for PCIe 5.0, compared to 16 GT/s with PCIe 4.0). A PCIe 5.0 x16 slot provides 128 GB/s bandwidth, enough to support a 400GbE network connection.
- The server uses the Lenovo Neptune closed-loop liquid-cooled heatsink design to more effectively remove heat from high-performance processors.

Availability and serviceability

The server provides many features to simplify serviceability and increase system uptime:

- Designed to run 24 hours a day, 7 days a week
- The server uses ECC memory and supports memory RAS features including Single Device Data Correction (SDDC, also known as Chipkill), Patrol/Demand Scrubbing, Bounded Fault, DRAM Address Command Parity with Replay, DRAM Uncorrected ECC Error Retry, On-die ECC, ECC Error Check and Scrub (ECS), and Post Package Repair.
- The server offers hot-swap drives, supporting RAID redundancy for data protection and greater system uptime.
- Available M.2 configuration with RAID support which can enable two SATA or two NVMe M.2 drives to be configured as a redundant pair.
- The server has up to two hot-swap redundant power supplies and up to eight hot-swap redundant fans to provide availability for business-critical applications.
- Optional front-accessible slots and drives so that most major components and cables (except power) are located at the front of the server
- The power-source-independent light path diagnostics uses LEDs to lead the technician to failed (or failing) components, which simplifies servicing, speeds up problem resolution, and helps improve system availability.
- Solid-state drives (SSDs) offer more reliability than traditional mechanical HDDs for greater uptime.
- Proactive Platform Alerts (including PFA and SMART alerts): Processors, voltage regulators, memory, internal storage (SAS/SATA HDDs and SSDs, NVMe SSDs, M.2 storage, flash storage adapters), fans, power supplies, RAID controllers, server ambient and subcomponent temperatures. Alerts can be surfaced through the XClarity Controller to managers such as Lenovo XClarity Administrator, VMware vCenter, and Microsoft System Center. These proactive alerts let you take appropriate actions in advance of possible failure, thereby increasing server uptime and application availability.
- The built-in XClarity Controller 2 continuously monitors system parameters, triggers alerts, and performs recovery actions in case of failures to minimize downtime.
- Built-in diagnostics in UEFI, using Lenovo XClarity Provisioning Manager, speed up troubleshooting tasks to reduce service time.
- Lenovo XClarity Provisioning Manager supports diagnostics and can save service data to a USB key drive or remote CIFS share folder for troubleshooting and reduce service time.
- Auto restart in the event of a momentary loss of AC power (based on power policy setting in the XClarity Controller service processor)
- Offers a diagnostics port on the front of the server to allow you to attach an external diagnostics handset for enhanced systems management capabilities.
- Support for the XClarity Administrator Mobile app running on a supported smartphone and connected to the server through the service-enabled USB port, enables additional local systems management functions.
- Three-year or one-year customer-replaceable unit and onsite limited warranty, 9 x 5 next business day. Optional service upgrades are available.

Manageability and security

Systems management features simplify local and remote management:

- The server includes an XClarity Controller 2 (XCC2) to monitor server availability. Optional upgrade to XCC Platinum to provide remote control (keyboard video mouse) functions, support for the mounting of remote media files, FIPS 140-3 security, enhanced NIST 800-193 support, boot capture, power capping, and other management and security features.

- Lenovo XClarity Administrator offers comprehensive hardware management tools that help to increase uptime, reduce costs and improve productivity through advanced server management capabilities.
- UEFI-based Lenovo XClarity Provisioning Manager, accessible from F1 during boot, provides system inventory information, graphical UEFI Setup, platform update function, RAID Setup wizard, operating system installation function, and diagnostic functions.
- Support for Lenovo XClarity Energy Manager which captures real-time power and temperature data from the server and provides automated controls to lower energy costs.
- An integrated industry-standard Unified Extensible Firmware Interface (UEFI) enables improved setup, configuration, and updates, and simplifies error handling.
- Support for industry standard management protocols, IPMI 2.0, SNMP 3.0, Redfish REST API, serial console via IPMI
- An integrated hardware Trusted Platform Module (TPM) supporting TPM 2.0 enables advanced cryptographic functionality, such as digital signatures and remote attestation.
- Administrator and power-on passwords help protect from unauthorized access to the server.
- Supports AMD Secure Root-of-Trust, Secure Run and Secure Move features to minimize potential attacks and protect data as the OS is booted, as applications are run and as applications are migrated from server to server.
- Supports Secure Boot to ensure only a digitally signed operating system can be used.
- Industry-standard Advanced Encryption Standard (AES) NI support for faster, stronger encryption.
- Additional physical security features are a chassis intrusion switch and a lockable front bezel.

Energy efficiency

The following energy-efficiency features help save energy, reduce operational costs, and increase energy availability:

- Energy-efficient planar components help lower operational costs.
- High-efficiency power supplies with 80 PLUS Titanium certifications
- Low-voltage 1.1 V DDR5 memory offers energy savings compared to 1.2 V DDR4 DIMMs, an approximately 20% decrease in power consumption
- Solid-state drives (SSDs) consume as much as 80% less power than traditional spinning 2.5-inch HDDs.
- The server uses hexagonal ventilation holes, which can be grouped more densely than round holes, providing more efficient airflow through the system and thus keeping your system cooler.
- Optional Lenovo XClarity Energy Manager provides advanced data center power notification and analysis to help achieve lower heat output and reduced cooling needs.

Comparing the SR645 V3 to the SR645

The ThinkSystem SR645 V3 improves on the previous generation SR645, as summarized in the following table.

Table 1. Comparing the ThinkSystem SR645 V3 to the previous generation SR645

Feature	SR645	ThinkSystem SR645 V3	Benefits
---------	-------	----------------------	----------

Feature	SR645	ThinkSystem SR645 V3	Benefits
Processor	<ul style="list-style-type: none"> • 2x 2nd or 3rd Gen AMD EPYC processors • Up to 64 cores • TDP ratings up to 280W • 64x PCIe 4.0 lanes per processor • 4x dedicated xGMI x16 interprocessor links 	<ul style="list-style-type: none"> • 2x 4th Gen AMD EPYC processors • Up to 128 cores • TDP ratings up to 360W • 64x PCIe 5.0 lanes per processor • 4x dedicated xGMI x16 interprocessor links 	<ul style="list-style-type: none"> • Significant increase in cores per processor • Increased performance • Consolidation of more apps on same number of servers, reducing costs • New PCIe 5.0 support means higher performance networking and NVMe storage
Memory	<ul style="list-style-type: none"> • DDR4 memory operating up to 2933 MHz • 8 channels per CPU • 32 DIMMs (16 per processor), 2 DIMMs per channel • Supports RDIMMs and 3DS RDIMMs • Up to 8TB of system memory 	<ul style="list-style-type: none"> • DDR5 memory operating up to 4800 MHz • 12 channels per CPU • 24 DIMMs (12 per processor), 1 DIMM per channel • Supports RDIMMs, 3DS RDIMMs and 9x4 RDIMMs • Up to 6TB of system memory 	<ul style="list-style-type: none"> • New DDR5 memory offers significant performance improvements over DDR4 • More memory channels means greater memory bandwidth • Support for lower-cost 9x4 DIMMs
Internal storage	<ul style="list-style-type: none"> • Front: 4x 3.5" SAS/SATA or AnyBay hot-swap drive bays • Front: Up to 8x SAS/SATA hot-swap drives bays • Front: 10x 2.5" SAS/SATA/NVMe (up to 4 AnyBay or 10x NVMe) • Rear: Up to 2x 2.5" SAS/SATA or NVMe hot-swap drive bays • Rear: 2x 7mm SATA or NVMe hot-swap drive bays, optional RAID • 2x Internal M.2 with optional RAID 	<ul style="list-style-type: none"> • Front: 4x 3.5" SAS/SATA hot-swap drive bays • Front: Up to 8x SAS/SATA hot-swap drives bays • Front: 10x 2.5" SAS/SATA/NVMe (up to 4 AnyBay or 10x NVMe) • Front: 16x E1.S EDSFF NVMe hot-swap drive bays • Front: 4x 2.5" SAS/SATA + 3x PCIe slots (LP, FH, OCP) • Rear: Up to 2x 2.5" SAS/SATA or NVMe hot-swap drive bays • Rear: 2x 7mm SATA or NVMe hot-swap drive bays (RAID support via a separate adapter) • 2x Internal M.2 with optional RAID 1 (RAID support via a separate adapter) 	<ul style="list-style-type: none"> • Flexible storage offerings • Support for up to 12x 2.5" NVMe drives • New 16x E1.S configuration • New front PCIe slots configuration

Feature	SR645	ThinkSystem SR645 V3	Benefits
RAID	<ul style="list-style-type: none"> 8-port and 16-port RAID adapters with up to 8GB flash Support for Lenovo and Broadcom adapters Support for PCIe or Internal cabled (CFF) form factor adapters Support for NVMe drives connected to 940 RAID adapters (Tri-Mode) Storage HBAs available PCIe 3.0 and PCIe 4.0 adapter choices 	<ul style="list-style-type: none"> 8-port and 16-port RAID adapters with up to 8GB flash Support for Lenovo and Broadcom adapters Support for PCIe or Internal cabled (CFF) form factor adapters Support for NVMe drives connected to 940 RAID adapters (Tri-Mode) Storage HBAs available PCIe 3.0 and PCIe 4.0 adapter choices with support for Gen 5 adapters when available 	<ul style="list-style-type: none"> Consistent RAID/HBA support Flexible config solution PCIe Gen 5 allows for greater storage performance
Networking	<ul style="list-style-type: none"> OCP 3.0 slot with PCIe Gen 4 x16 interface (rear of server) Additional PCIe adapters supported 1GbE dedicated Management port 	<ul style="list-style-type: none"> OCP 3.0 slot with PCIe x16 interface (rear or front of server) Additional PCIe adapters supported 1GbE dedicated Management port 	<ul style="list-style-type: none"> Improved performance with PCIe Gen 5 Optional front-accessible OCP slot
PCIe	<ul style="list-style-type: none"> Up to 3x PCIe slots (all rear) Additional OCP 3.0 slot (rear) Support up to 3x 75W GPUs All slots PCIe Gen4 At the rear, supports either 3x slots (all LP) or 2x slots (LP + FH) FH slot connects to CPU 1 (slot 2) Additional OCP 3.0 slot Supports a RAID/HBA in CFF form factor (does not occupy a PCIe slot) 	<ul style="list-style-type: none"> Up to 5x PCIe slots (3 rear, 2 front) Additional OCP 3.0 slot (front or rear) Support up to 4x 75W GPUs Mix of PCIe Gen4 or Gen5 slots At the rear, supports either 3x slots (all LP) or 2x slots (LP + FH) FH slot connects to either CPU 1 (slot 2) or CPU 2 (slot 3) Additional OCP 3.0 slot Supports a RAID/HBA in CFF form factor (does not occupy a PCIe slot) Support for 3x front-accessible slots (2x PCIe + 1x OCP) with 4 drive bays 	<ul style="list-style-type: none"> More PCIe slots, up to 5 (3 rear, 2 front) + 1 OCP slot PCIe Gen 5 allows for greater I/O performance Flexible PCIe offerings Front-accessible slots available

Feature	SR645	ThinkSystem SR645 V3	Benefits
Management and security	<ul style="list-style-type: none"> ● XClarity Controller ● Support for full XClarity toolset including XClarity Administrator ● Platform Firmware Resiliency (PFR) hardware Root of Trust (RoT) ● Tamper Switch security solution (intrusion switch) 	<ul style="list-style-type: none"> ● Integrated XClarity Controller 2 ● Support for full XClarity toolset including XClarity Administrator ● Platform Firmware Resiliency (PFR) hardware Root of Trust (RoT) ● Tamper Switch security solution (intrusion switch) 	<ul style="list-style-type: none"> ● New XCC2 offers improved management capabilities ● Same system management tool with previous generation ● Silicon-level security solution
Power	<ul style="list-style-type: none"> ● 500W, 750W, 1100W, 1800W AC Platinum/Titanium Hot Plug PSU ● 1100W -48VDC Platinum general support ● 240V HVDC support for PRC customers ● Active-Standby mode 	<ul style="list-style-type: none"> ● 500W, 750W, 1100W, 1800W AC Platinum/Titanium Hot Plug PSU ● 1100W -48VDC Platinum general support ● 240V HVDC support for PRC customers ● Active-Standby mode 	<ul style="list-style-type: none"> ● Multiple PSU offerings to suit the configuration selected ● New ErP Lot 9-compliant offerings ● Support for Telco customers with -48V requirements

Components and connectors

The following figure shows the front of the SR645 V3.

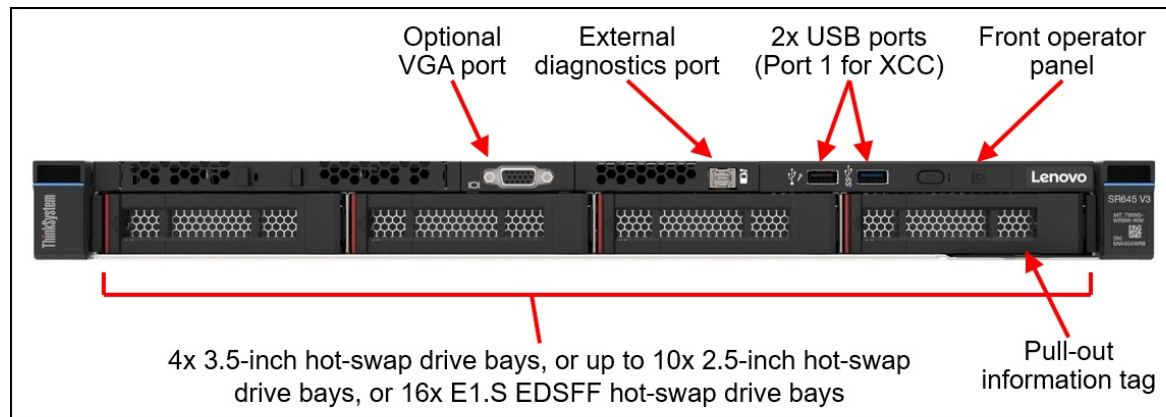

Figure 2. Front view of the ThinkSystem SR645 V3 with 3.5-inch drive bays

For details on the front ports, including the optional front VGA port and front external diagnostic port, see the [Local management](#) section.

The following figure shows the various front configurations supported by the SR645 V3. As shown, the server supports 2.5-inch, 3.5-inch or E1.S EDSFF drive bays. In some configurations, the front of the server includes a pull-out operator panel with LCD display. The SR645 V3 also supports a configuration with 4x 2.5-inch drive bays + 3x front-accessible PCIe slots - a low-profile slot, a full-height slot, and an OCP 3.0 slot.

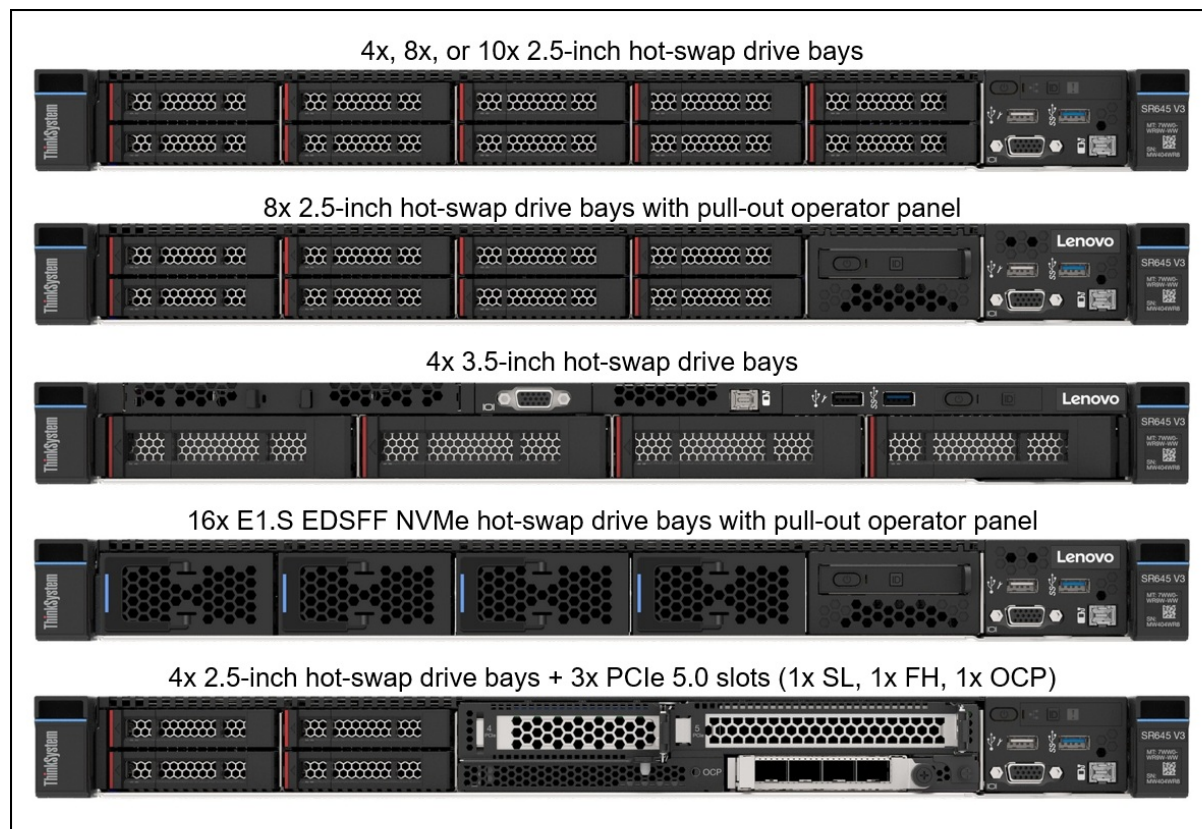

Figure 3. Front configurations of the ThinkSystem SR645 V3

The following figure shows the components visible from the rear of the server. As shown, there are five different configurations available, including two with rear-mounted drive bays: two 2.5-inch hot-swap drive bays (SAS, SATA or NVMe) or 7mm thickness hot-swap drives (SATA or NVMe). There are two configurations with a full-height slot, one where both slots are connected to CPU 1, and the other where the full-height slot is connected to CPU 2.

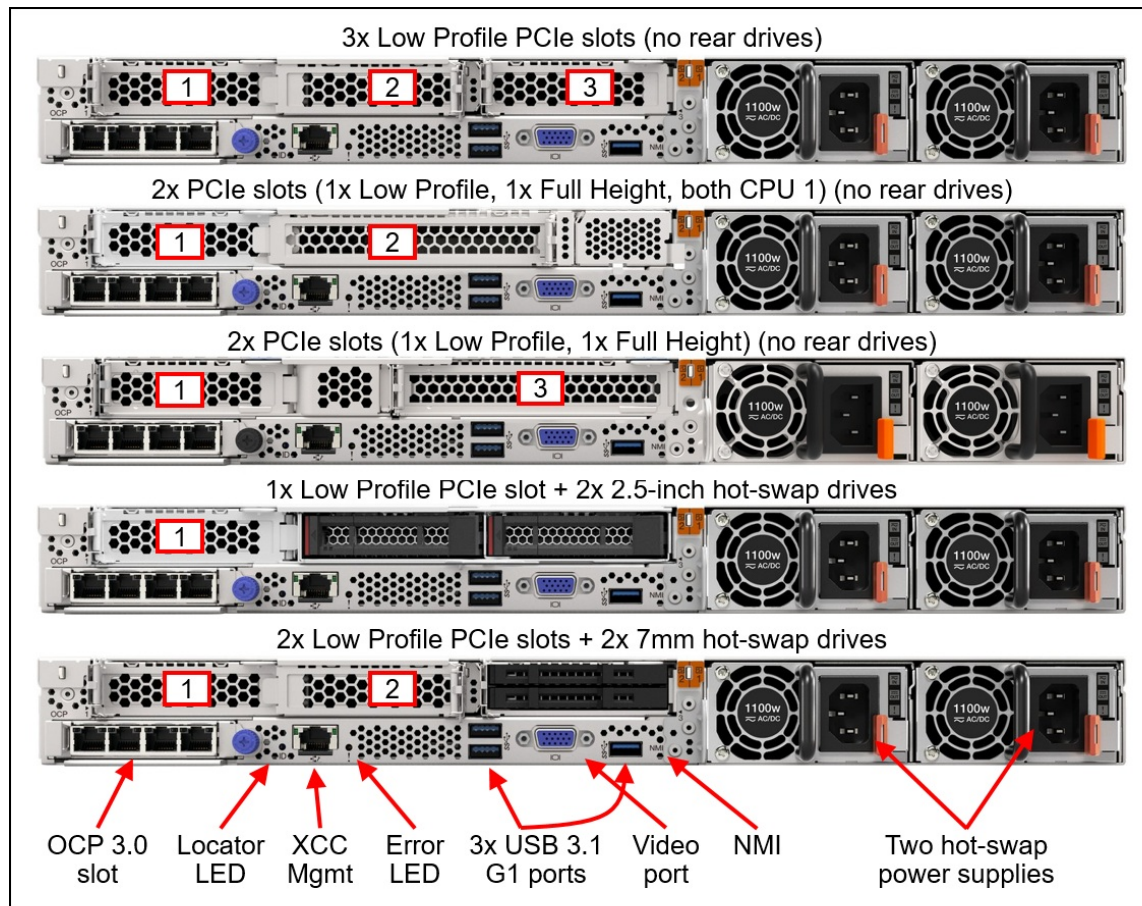

Figure 4. Rear view of the Lenovo ThinkSystem SR645 V3

The following figure shows the locations of key components inside the server.

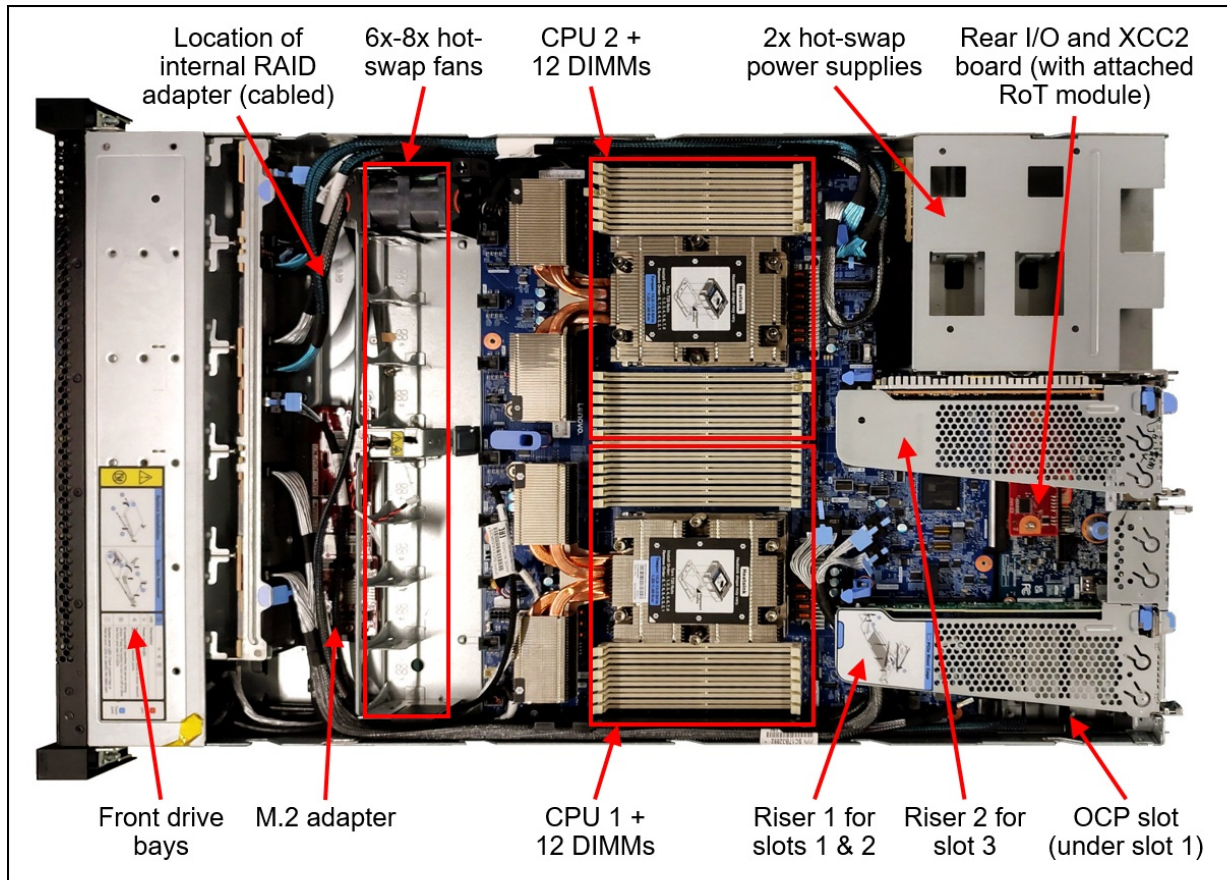

Figure 5. Internal view of the Lenovo ThinkSystem SR645 V3

System architecture

The following figure shows the architectural block diagram of the SR645 V3, showing the major components and their connections.

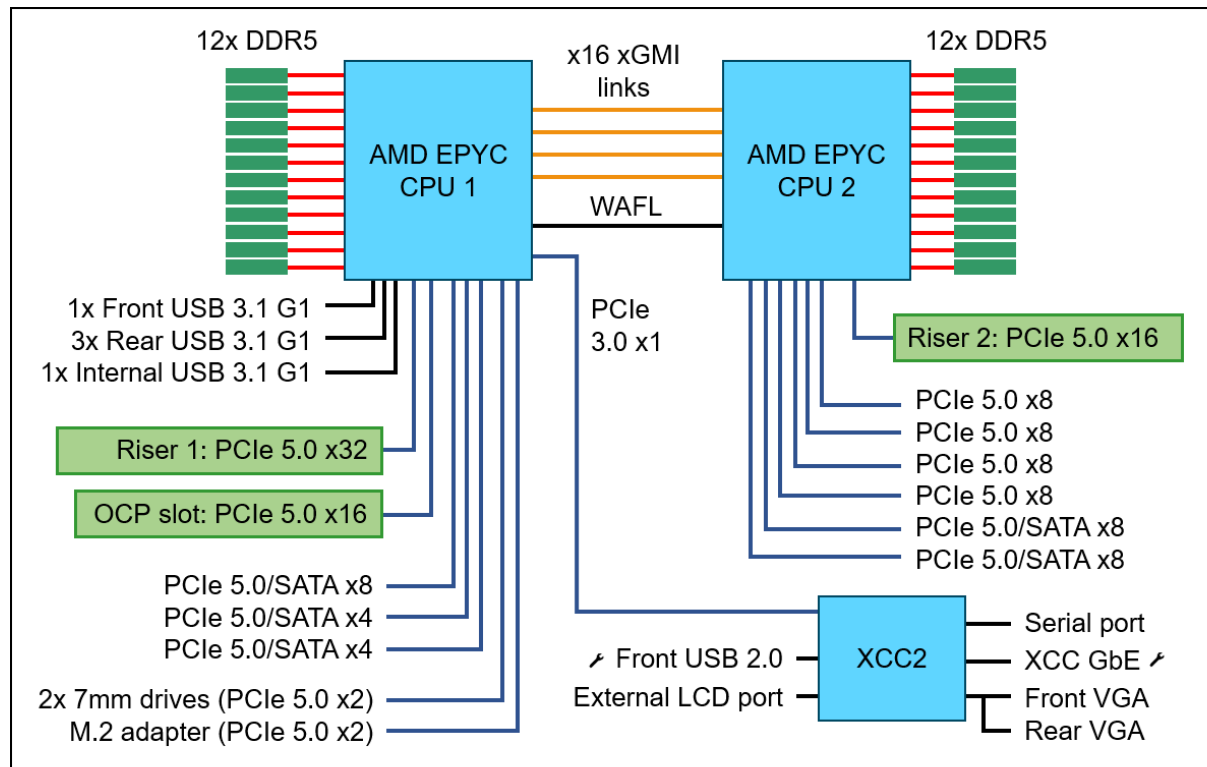

Figure 6. SR645 V3 system architectural block diagram

Standard specifications

The following table lists the standard specifications.

Table 2. Standard specifications

Components	Specification
Machine types	7D9D - 1 year warranty 7D9C - 3 year warranty
Form factor	1U rack.
Processor	One or two AMD EPYC 9004 Series processors (formerly codenamed "Genoa"). Supports processors up to 128 cores, core speeds of up to 4.1 GHz, and TDP ratings of up to 360W. Supports PCIe 5.0 for high performance I/O.
Chipset	Not applicable (platform controller hub functions are integrated into the processor)
Memory	24 DIMM slots with two processors (12 DIMM slots per processor). Each processor has 12 memory channels, with 1 DIMM per channel (DPC). Lenovo TruDDR5 RDIMMs, 3DS RDIMMs, and 9x4 RDIMMs are supported, up to 4800 MHz
Memory maximum	Up to 6TB with 24x 256GB 3DS RDIMMs
Persistent memory	Not supported

Components	Specification
Memory protection	ECC, SDDC, Patrol/Demand Scrubbing, Bounded Fault, DRAM Address Command Parity with Replay, DRAM Uncorrected ECC Error Retry, On-die ECC, ECC Error Check and Scrub (ECS), Post Package Repair
Disk drive bays	<p>Up to 4x 3.5-inch or 12x 2.5-inch hot-swap drive bays:</p> <ul style="list-style-type: none"> ● Front bays can be one of the following: <ul style="list-style-type: none"> ○ 4x 3.5-inch hot-swap SAS/SATA, AnyBay, or 2x SAS/SATA + 2x NVMe ○ 2x 2.5-inch hot-swap NVMe ○ 4x 2.5-inch hot-swap SAS/SATA, AnyBay or NVMe ○ 8x 2.5-inch hot-swap SAS/SATA ○ 10x 2.5-inch hot-swap SAS/SATA, AnyBay or NVMe, or combinations ○ 16x E1.S hot-swap EDSFF NVMe ● Rear can be one of the following: <ul style="list-style-type: none"> ○ 2x 2.5-inch hot-swap SAS/SATA bays ○ 2x 2.5-inch hot-swap NVMe bays ○ 2x 7mm 2.5-inch hot-swap SATA bays ○ 2x 7mm 2.5-inch hot-swap NVMe bays ● Internal M.2 module supporting up to two M.2 drives (optional RAID support), for OS boot and drive storage support <p>See Storage configurations for details. AnyBay bays support SAS, SATA or NVMe drives. NVMe bays only support NVMe drives. Rear drive bays can be used in conjunction with 2.5-inch front drive bays. The server supports up to 12x NVMe drives all with direct connections (no oversubscription).</p>
Maximum internal storage	<ul style="list-style-type: none"> ● 2.5-inch drives: <ul style="list-style-type: none"> ○ 368.64TB using 12x 30.72TB 2.5-inch SAS/SATA SSDs ○ 184.32TB using 12x 15.36TB 2.5-inch NVMe SSDs ○ 28.8TB using 12x 2.4TB 2.5-inch HDDs ● EDSFF drives <ul style="list-style-type: none"> ○ 122.88TB using 16x 7.68TB EDSFF NVMe SSDs ● 3.5-inch drives: <ul style="list-style-type: none"> ○ 88TB using 4x 22TB 3.5-inch HDDs ○ 61.44TB using 4x 15.36TB 3.5-inch SAS/SATA SSDs ○ 51.2TB using 4x 12.8TB 3.5-inch NVMe SSDs
Storage controller	<ul style="list-style-type: none"> ● Onboard NVMe (no RAID) - 12 drives, each x4 ● Onboard SATA (no RAID) - 12 drives ● NVMe Retimer Adapter ● 12 Gb SAS/SATA RAID adapters <ul style="list-style-type: none"> ○ 8, 16 or 32 ports ○ Up to 8GB flash-backed cache ○ PCIe 4.0 or PCIe 3.0 host interface ● 12 Gb SAS/SATA HBA (non-RAID) <ul style="list-style-type: none"> ○ 8-port and 16-port ○ PCIe 4.0 or PCIe 3.0 host interface
Optical drive bays	No internal optical drive
Tape drive bays	No internal backup drive

Components	Specification
Network interfaces	Dedicated OCP 3.0 SFF slot with PCIe 5.0 x16 host interface, either at the rear of the server (rear-accessible) for the front of the server (front-accessible, PCIe 4.0). Supports a variety of 2-port and 4-port adapters with 1GbE, 10GbE and 25GbE network connectivity. One port can optionally be shared with the XClarity Controller 2 (XCC2) management processor for Wake-on-LAN and NC-SI support. Additional PCIe network adapters supported in PCIe slots.
PCI Expansion slots	<p>Up to 5x slots, 3x at the rear and 2x at the front, plus 1 OCP 3.0 slot.</p> <p>Rear: Up to 3x PCIe slots (2x PCIe 5.0, 1x PCIe 4.0), all with rear access, plus a slot dedicated to the OCP adapter. Slot availability is based on riser selection and rear drive bay selection. Slot 3 requires two processors.</p> <p>Four choices for rear-access slots:</p> <ul style="list-style-type: none"> • 3x PCIe x16 low-profile slots • 1x PCIe x16 full-height half-length slot + 1x PCIe x16 low-profile slot • 1x PCIe x16 low-profile slot (also supports 2x rear 2.5-inch drive bays) • 2x PCIe x16 low-profile slot (also supports 2x rear 7mm 2.5-inch drive bays) <p>For 2.5-inch front drive configurations, the server supports the installation of a CFF RAID adapter or HBA in a dedicated area that does not consume any of the PCIe slots.</p> <p>Front: The server also supports slots at the front of the server:</p> <ul style="list-style-type: none"> • 1x PCIe x16 or x8 full-height half-length slot • 1x PCIe x8 low-profile slot • 1x OCP 3.0 slot (mutually exclusive with the OCP slot at the rear) <p>Note: Not all slots are available in a 1-processor configuration. See the I/O expansion for details.</p>
GPU support	Supports up to 4x single-wide GPUs
Ports	<p>Front: 1x USB 3.2 G1 (5 Gb/s) port, 1x USB 2.0 port (also for XCC local management), External diagnostics port, optional VGA port.</p> <p>Rear: 3x USB 3.2 G1 (5 Gb/s) ports, 1x VGA video port, 1x RJ-45 1GbE systems management port for XCC remote management. Optional 2nd XCC remote management port (installs in OCP slot). Optional DB-9 COM serial port (installs in slot 3).</p> <p>Internal: 1x USB 3.2 G1 (5 Gb/s) connector for operating system or license key purposes.</p>
Cooling	Up to 8x N+1 redundant hot swap 40 mm fans, configuration dependent. One fan integrated in each power supply. For high-performance CPUs, the SR645 V3 also uses a closed-loop liquid-cooled heatsink design to more effectively remove heat from the processors.
Power supply	Up to two hot-swap redundant AC power supplies, 80 PLUS Platinum or 80 PLUS Titanium certification. 500 W, 750 W, 1100 W and 1800 W AC options, supporting 220 V AC. 500 W, 750 W and 1100 W options also support 110V input supply. In China only, all power supply options support 240 V DC. Also available is a 1100W power supply with a -48V DC input.
Video	Embedded video graphics with 16 MB memory with 2D hardware accelerator, integrated into the XClarity Controller. Maximum resolution is 1920x1200 32bpp at 60Hz.
Hot-swap parts	Drives, power supplies, and fans.

Components	Specification
Systems management	Operator panel with status LEDs. Optional External Diagnostics Handset with LCD display. Models with 8x 2.5-inch front drive bays can optionally support an Integrated Diagnostics Panel. XClarity Controller 2 (XCC2) embedded management based on the ASPEED AST2600 baseboard management controller (BMC). Dedicated rear Ethernet port for XCC2 remote access for management. Optional 2nd redundant XCC2 remote port supported, installs in the OCP slot. XClarity Administrator for centralized infrastructure management, XClarity Integrator plugins, and XClarity Energy Manager centralized server power management. Optional XCC Platinum to enable remote control functions and other features.
Security features	Chassis intrusion switch, Power-on password, administrator's password, Root of Trust module supporting TPM 2.0 and Platform Firmware Resiliency (PFR). Optional lockable front security bezel.
Operating systems supported	Microsoft Windows Server, Microsoft Windows 10 & 11, Red Hat Enterprise Linux, SUSE Linux Enterprise Server, VMware ESXi, Ubuntu Server. See the Operating system support section for specifics.
Limited warranty	Three-year or one-year (model dependent) customer-replaceable unit and onsite limited warranty with 9x5 next business day (NBD).
Service and support	Optional service upgrades are available through Lenovo Services: 4-hour or 2-hour response time, 6-hour fix time, 1-year or 2-year warranty extension, software support for Lenovo hardware and some third-party applications.
Dimensions	Width: 440 mm (17.3 in.), height: 43 mm (1.7 in.), depth: 773 mm (30.4 in.). See Physical and electrical specifications for details.
Weight	Maximum: 20.2 kg (44.6 lb)

Models

ThinkSystem SR645 V3 models can be configured by using the [Lenovo Data Center Solution Configurator \(DCSC\)](#).

Topics in this section:

- [CTO models](#)
- [CTO models for Windows 10 and Windows 11](#)
- [Base feature codes](#)
- [Preconfigured models](#)

CTO models

ThinkSystem SR645 V3 models can be configured by using the [Lenovo Data Center Solution Configurator \(DCSC\)](#).

Configure-to-order (CTO) models are used to create models with factory-integrated server customizations. For CTO models, two base CTO models are available for the SR645 V3 as listed in the following table, CTO1WW and CTOLWW:

- The CTO1WW base CTO model is for general business and is selectable by choosing **General Purpose** mode in DCSC.
- The CTOLWW base model is intended for High Performance Computing (HPC) and Artificial Intelligence (AI) configurations and solutions, including configurations for Lenovo Scalable Infrastructure (LeSI), and is enabled using either the **HPC & AI LeSI Solutions** mode or **HPC & AI Hardware** mode in DCSC. CTOLWW configurations can also be built using [System x and Cluster Solutions Configurator \(x-config\)](#).

Preconfigured server models may also be available for the SR645 V3, however these are region-specific; that is, each region may define their own server models, and not all server models are available in every region.

The following table lists the base CTO models of the ThinkSystem SR645 V3 server.

Table 3. Base CTO models

Machine Type/Model General purpose	Machine Type/Model for HPC and AI	Description
7D9CCTO1WW	7D9CCTOLWW	ThinkSystem SR645 V3 – 3-year Warranty
7D9DCTO1WW	7D9DCTOLWW	ThinkSystem SR645 V3 – 1-year Warranty

CTO models for Windows 10 and Windows 11

The SR645 V3 can run Windows 10 and Windows 11, however only a subset of adapters and drives can be installed. For ease of configuration, the following Base CTO models have been announced to assist building a configuration that can be used with the client operating systems. For more information, see the [Windows 10 and Windows 11](#) section.

Table 4. Base CTO models for SR645 V3 with Windows 10 and Windows 11

Machine Type/Model	Description
7D9CCTO2WW	ThinkSystem SR645 V3 Workstation - 3 year Warranty
7D9DCTO2WW	ThinkSystem SR645 V3 Workstation - 1 year Warranty

Base feature codes

Models of the SR645 V3 are defined based on whether the server has 2.5-inch drive bays at the front (called the 10x 2.5" chassis or simply the 2.5-inch chassis) or whether it has 3.5-inch drive bays at the front (called the 3.5-inch chassis). For models with front PCIe slots, the SR645 V3 also offers a separate base feature code.

The feature codes for these chassis bases are as listed in the following table.

Table 5. Chassis base feature codes

Feature code	Description	Purpose
BLK3	ThinkSystem V3 1U 4x3.5" Chassis	3.5-inch drive configurations
BLK4	ThinkSystem V3 1U 10x2.5" Chassis	2.5-inch drive configurations without front PCIe slots EDSFF drive configurations
BQ7M	ThinkSystem V3 1U 4x2.5" Chassis with Front I/O Module	2.5-inch drive configurations with front PCIe slots

Preconfigured models

The following tables list the available preconfigured models, grouped by region.

- [Models for Australia and New Zealand](#)
- [Models for EMEA region](#)
- [Models for Latin American countries \(except Brazil\)](#)
- [Models for USA and Canada](#)

Refer to the Specifications section for information about standard features of the server.

Common to all models:

- Power supplies are Platinum unless otherwise stated
- All models include a Toolless Slide Rail Kit

Models for Australia and New Zealand

Common to all Australia and New Zealand models:

- All models include a Toolless Slide Rail Kit and Cable Management Arm

Table 6. Models for Australia and New Zealand

Model	AMD EPYC processor†	Memory	RAID	Drive bays	OCP	Slots	Power supply	Fans	Front VGA	Front diag	XCC2	Intru switch
TopSeller models with a 3-year warranty (machine type 7D9C)												
7D9CA01JAU	1x 9124 16C 200W 3.0G	1x 16GB	5350-8i	8x 2.5" SAS; Open bay	Open	LP+FH Gen4	1x750W	6x Perf	Yes	Yes	Std	Opt
7D9CA01KAU	1x 9124 16C 200W 3.0G	1x 16GB	9350-8i	8x 2.5" SAS; Open bay	Open	LP+FH Gen4	1x750W	6x Perf	Yes	Yes	Std	Opt
7D9CA01LAU	1x 9224 24C 200W 2.5G	1x 32GB 2Rx8	9350-8i	8x 2.5" SAS; Open bay	Open	LP+FH Gen4	1x750W	6x Perf	Yes	Yes	Std	Opt

† Processor description: Processor model, number of cores, thermal design power (TDP), core frequency

Models for EMEA region

Table 7. Models for EMEA region

Model	AMD EPYC processor†	Memory	RAID	Drive bays	OCP	Slots	Power supply	Fans	Front VGA	Front diag	XCC2	Intru switch
Standard models with a 3-year warranty (machine type 7D9C)												
7D9CA014EA	1x 9124 16C 200W 3.0G	1x 32GB 2Rx8	9350-8i	8x 2.5" SAS; Open bay	Open	2x LP Gen5	1x1100W Titanium	6x Perf	Opt	Yes	Plat	Opt
7D9CA017EA	1x 9334 32C 210W 2.7G	1x 32GB 2Rx8	9350-8i	8x 2.5" SAS; Open bay	Open	2x LP Gen5	1x1100W Titanium	6x Perf	Opt	Yes	Plat	Opt
7D9CA016EA	1x 9354 32C 280W 3.25G	1x 64GB	9350-8i	8x 2.5" SAS; Open bay	Open	2x LP Gen5	1x1100W Titanium	6x Perf	Opt	Yes	Plat	Opt
7D9CA015EA	1x 9534 64C 280W 2.45G	1x 64GB	9350-8i	8x 2.5" SAS; Open bay	Open	2x LP Gen5	1x1100W Titanium	6x Perf	Opt	Yes	Plat	Opt

† Processor description: Processor model, number of cores, thermal design power (TDP), core frequency

Models for Latin American countries (except Brazil)

Table 8. Models with a 3-year warranty for Latin American countries (except Brazil)

Model	AMD EPYC processor†	Memory	RAID	Drive bays	OCP	Slots	Power supply	Fans	Front VGA	Front diag	XCC2	Intru switch
TopSeller models with a 3-year warranty (machine type 7D9C)												
7D9CA01RLA	1x 9124 16C 200W 3.0G	1x 32GB 2Rx8	9350-8i	8x 2.5" SAS; Open bay; 2x 480GB 5400 PRO M.2; 1x M.2 SATA/NVMe	4x1Gb I350	2x LP Gen4	1x750W	6x Perf	Yes	Yes	Std	Yes
7D9CA01SLA	1x 9124 16C 200W 3.0G	1x 32GB 2Rx8	9350-8i	8x 2.5" SAS; Open bay; 2x 480GB 5400 PRO M.2; 1x M.2 SATA/NVMe	4x1Gb I350	2x LP Gen4	1x750W	6x Perf	Yes	Yes	Std	Yes

† Processor description: Processor model, number of cores, thermal design power (TDP), core frequency

Models for USA and Canada

Table 9. Models for USA and Canada

Model	AMD EPYC processor†	Memory	RAID	Drive bays	OCP	Slots	Power supply	Fans	Front VGA	Front diag	XCC2	Intru switch
Standard models with a 3-year warranty (machine type 7D9C)												
7D9CA01WNA	1x 9124 16C 200W 3.0G	4x 32GB 2Rx8	Option	8x 2.5" SAS; 2x 240GB S4520	2x25Gb E810	2x LP Gen4	2x750W	6x Perf	Opt	Yes	Std	Opt
7D9CA01XNA	1x 9124 16C 200W 3.0G	2x 32GB 2Rx8	Option	8x 2.5" SAS; 2x 240GB S4520	2x25Gb E810	2x LP Gen4	2x750W	6x Perf	Opt	Yes	Std	Opt

† Processor description: Processor model, number of cores, thermal design power (TDP), core frequency

Processors

The SR645 V3 supports processors in the fourth-generation AMD EPYC family of processors. The server supports one or two processors.

Topics in this section:

- [Processor options](#)
- [Processor features](#)
- [One-processor configurations](#)
- [Thermal requirements by processor](#)
- [UEFI operating modes](#)

Processor options

The table below lists the AMD processors that are currently supported by the SR645 V3.

All supported processors have the following characteristics:

- Fourth-generation AMD EPYC processors (formerly codenamed "Genoa")
- Also support
- 12 DDR5 memory channels
- 128 PCIe 5.0 I/O lanes, 64 lanes available for PCIe and NVMe devices

The SR645 V3 also supports the new 4th Gen AMD EPYC processors with "Zen 4c" architecture (formerly codenamed "Bergamo"). These processors have higher core counts, up to 128 cores, targeted at cloud native applications that are designed to exploit the scale, elasticity, resiliency, and flexibility of private & public clouds.

Table 10. SR645 V3 processor support

Part number*	Feature code	SKU	Description	Quantity supported*
4th Gen AMD EPYC processors ("Genoa")				
4XG7A85060	BREE	9124	ThinkSystem SR645 V3 AMD EPYC 9124 16C 200W 3.0GHz Processor w/o Fan	1 or 2
None†	BREJ	9174F	ThinkSystem AMD EPYC 9174F 16C 320W 4.1GHz Processor	2
4XG7A85057	BREH	9224	ThinkSystem SR645 V3 AMD EPYC 9224 24C 200W 2.5GHz Processor w/o Fan	1 or 2
4XG7A85059	BRED	9254	ThinkSystem SR645 V3 AMD EPYC 9254 24C 200W 2.9GHz Processor w/o Fan	1 or 2
None†	BREF	9274F	ThinkSystem AMD EPYC 9274F 24C 320W 4.05GHz Processor	2
4XG7A85058	BREC	9334	ThinkSystem SR645 V3 AMD EPYC 9334 32C 210W 2.7GHz Processor w/o Fan	1 or 2
4XG7A87040	BR30	9354	ThinkSystem SR645 V3 AMD EPYC 9354 32C 280W 3.25GHz Processor w/o Fan	1 or 2
None	BREG	9354P	ThinkSystem AMD EPYC 9354P 32C 280W 3.25GHz Processor	1
None†	BR32	9374F	ThinkSystem AMD EPYC 9374F 32C 320W 3.85GHz Processor	2
4XG7A85056	BREB	9454	ThinkSystem SR645 V3 AMD EPYC 9454 48C 290W 2.75GHz Processor w/o Fan	1 or 2
None	BREM	9454P	ThinkSystem AMD EPYC 9454P 48C 290W 2.75GHz Processor	1
None†	BR31	9474F	ThinkSystem AMD EPYC 9474F 48C 360W 3.6GHz Processor	2
4XG7A85055	BREA	9534	ThinkSystem SR645 V3 AMD EPYC 9534 64C 280W 2.45GHz Processor w/o Fan	1 or 2
None†	BPVJ	9554	ThinkSystem AMD EPYC 9554 64C 360W 3.1GHz Processor	2
4XG7A87041	BR2Z	9634	ThinkSystem SR645 V3 AMD EPYC 9634 84C 290W 2.25GHz Processor w/o Fan	1 or 2
None†	BPVK	9654	ThinkSystem AMD EPYC 9654 96C 360W 2.4GHz Processor	2
4th AMD EPYC processors with AMD 3D V-Cache ("Genoa-X")				
4XG7A90962	BW9U	9684X	ThinkSystem SR645 V3 AMD EPYC 9684X 96C 400W 2.55GHz Processor w/o Fan	2
4th Gen AMD EPYC processors with Zen 4c architecture ("Bergamo")				
None†	BW9S	9734	ThinkSystem AMD EPYC 9734 112C 340W 2.2GHz Processor	2
None†	BW9T	9754	ThinkSystem AMD EPYC 9754 128C 360W 2.25GHz Processor	2

* Processors with a P suffix are single-socket capable processors and are only available in configure-to-order builds or in preconfigured models. Not available as option part numbers.

† In the SR645 V3, processors with a TDP of 320W or more use a closed-loop liquid-cooled heatsink assembly which requires 2 CPUs. As a result, processors are CTO only and no field upgrades are available.

Configuration notes:

- Processor options include a heatsink but do not include a system fan

Processor features

The following table lists the features of the supported processors.

Table 11. Processor specifications

EPYC model**	Cores / Threads	Base Frequency	Max Boost Frequency†	L3 Cache	Memory channels	Memory bus	TDP
4th Gen AMD EPYC processors ("Genoa")							
9124	16 / 32	3.0 GHz	3.7 GHz	64 MB	12	4800 MHz	200W
9174F	16 / 32	4.1 GHz	4.4 GHz	256 MB	12	4800 MHz	320W
9224	24 / 48	2.5 GHz	3.7 GHz	64 MB	12	4800 MHz	200W
9254	24 / 48	2.9 GHz	4.15 GHz	128 MB	12	4800 MHz	200W
9274F	24 / 48	4.05 GHz	4.3 GHz	256 MB	12	4800 MHz	320W
9334	32 / 64	2.7 GHz	3.9 GHz	128 MB	12	4800 MHz	210W
9354	32 / 64	3.25 GHz	3.8 GHz	256 MB	12	4800 MHz	280W
9354P	32 / 64	3.25 GHz	3.8 GHz	256 MB	12	4800 MHz	280W
9374F	32 / 64	3.85 GHz	4.3 GHz	256 MB	12	4800 MHz	320W
9454	48 / 96	2.75 GHz	3.8 GHz	256 MB	12	4800 MHz	290W
9454P	48 / 96	2.75 GHz	3.8 GHz	256 MB	12	4800 MHz	290W
9474F	48 / 96	3.6 GHz	4.1 GHz	256 MB	12	4800 MHz	360W
9534	64 / 128	2.45 GHz	3.7 GHz	256 MB	12	4800 MHz	280W
9554	64 / 128	3.1 GHz	3.75 GHz	256 MB	12	4800 MHz	360W
9634	84 / 168	2.25 GHz	3.7 GHz	384 MB	12	4800 MHz	290W
9654	96 / 192	2.4 GHz	3.7 GHz	384 MB	12	4800 MHz	360W
4th AMD EPYC processors with AMD 3D V-Cache ("Genoa-X")							
9684X	96 / 192	2.55 GHz	3.7 GHz	1150 MB	12	4800 MHz	400W
4th Gen AMD EPYC processors with Zen 4c architecture ("Bergamo")							
9734	112 / 224	2.2 GHz	3.0 GHz	256 MB	12	4800 MHz	340W
9754	128 / 256	2.25 GHz	3.2 GHz	256 MB	12	4800 MHz	360W

† The maximum single-core frequency that the processor is capable of operating

** Processors with a P suffix are single-socket capable processors

One-processor configurations

The SR645 V3 can be used with only one processor installed. Most core functions of the server (including the XClarity Controller) are connected to processor 1 as shown in the [System architecture](#) section.

With only one processor, the server has the following capabilities:

- 12 memory DIMMs
- Slot 1 and Slot 2 are available; Slot 3 is not available

Drive support and controller support is as listed in the [Storage configurations](#) section - see the CPUs column in the tables for the configurations that support 1 processor.

Thermal requirements by processor

In the SR645 V3, most processors use a performance heatsink, which include two satellite heatsinks that connect to the main heatsink via liquid filled copper tubes. However, for processors with a TDP of 320W or higher, a new closed-loop liquid-cooled design is available to remove heat from the processors. Depending on the configuration, the closed-loop heatsink may be required, however some configurations can be configured either with a performance heatsink or the closed-loop design.

The use of processors with 320W or higher TDP has the following restrictions:

- The closed-loop heatsink may be required (feature BS34) - see the figure below
- Two processors are required
- 3.5-inch and EDSFF front drive bays are not supported
- The following 2.5-inch drive configurations are not supported:
 - 10x 2.5-inch AnyBay Gen4
 - 10x 2.5-inch AnyBay Gen5
 - 10x 2.5-inch NVMe Gen5
- The following components are not supported:
 - 2.5-inch or 3.5-inch rear drives (7mm drives are supported)
 - M.2 drives
 - Any internal RAID/HBAs (CFF form factor)

For details regarding supported combinations of processors, heat sinks, front drive bays, GPUs, and fans, see the Thermal Rules page of the User Guide:

https://pubs.lenovo.com/sr645-v3/thermal_rules

The following figure shows the placement of the components in the closed-loop system. Cold plates are mounted on top of each processor and these are connected via aluminum tubes to a radiator that is placed in front of the system fans. The tubes contain a mixture of water and ethylene glycol (EGW). The liquid is actively pumped through the pipes in a closed loop to remove the heat from the processors.

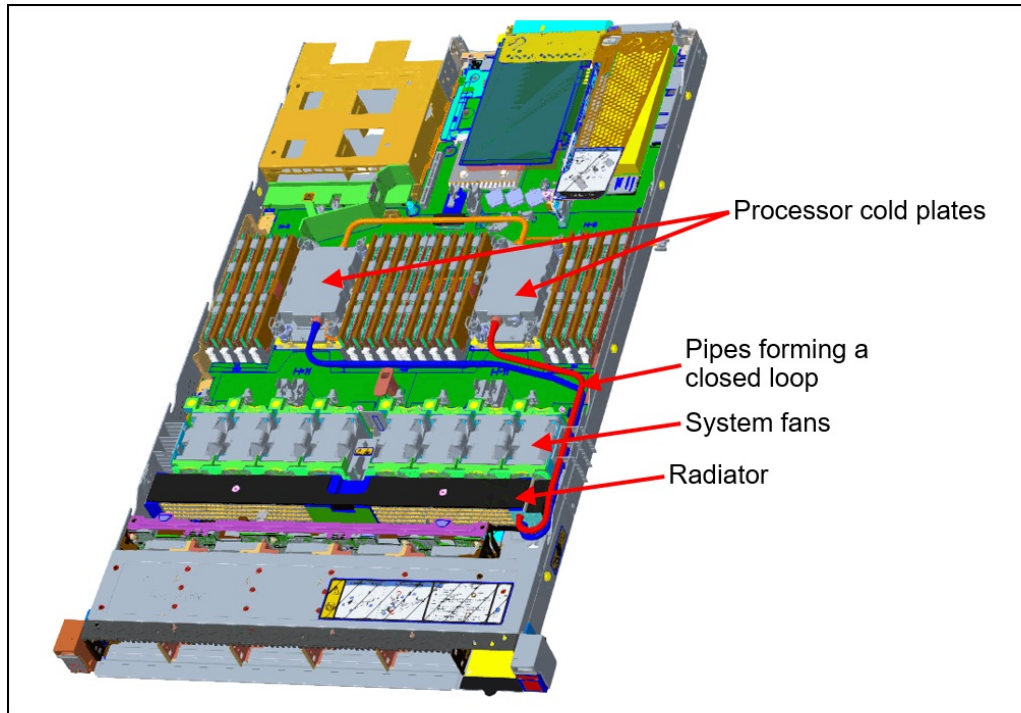

Figure 7. SR645 V3 with closed water loop (feature BS34)

Additional ambient temperature restrictions may apply. See the [Operating environment](#) section for details.

UEFI operating modes

The SR645 V3 offers preset operating modes that affect energy consumption and performance. These modes are a collection of predefined low-level UEFI settings that simplify the task of tuning the server to suit your business and workload requirements.

The following table lists the feature codes that allow you to specify the mode you wish to preset in the factory for CTO orders.

Table 12. UEFI operating mode presets in DCSC

Feature code	Description
BFYA	Operating mode selection for: "Maximum Efficiency Mode"
BFYB	Operating mode selection for: "Maximum Performance Mode"

The preset modes for the SR645 V3 are as follows:

- **Maximum Efficiency Mode** (feature BFYA): Maximizes performance/watt efficiency while maintaining reasonable performance
- **Maximum Performance Mode** (feature BFYB): Achieves maximum performance but with higher power consumption and lower energy efficiency.

For details about these preset modes, and all other performance and power efficiency UEFI settings offered in the SR645 V3, see the paper "Tuning UEFI Settings for Performance and Energy Efficiency on AMD Processor-Based ThinkSystem Servers", available from <https://lenovopress.lenovo.com/lp1267>.

Memory options

The SR645 V3 uses Lenovo TruDDR5 memory operating at up to 4800 MHz. The server supports up to 24 DIMMs with 2 processors. The processors have 12 memory channels and support 1 DIMM per channel. The server supports up to 6TB of memory using 24x 256GB 3DS RDIMMs and two processors.

The following table lists the memory options that are available for the server.

Lenovo TruDDR5 memory uses the highest quality components that are sourced from Tier 1 DRAM suppliers and only memory that meets the strict requirements of Lenovo is selected. It is compatibility tested and tuned to maximize performance and reliability. From a service and support standpoint, Lenovo TruDDR5 memory automatically assumes the system warranty, and Lenovo provides service and support worldwide.

Table 13. Memory options

Part number	Feature code	Description
9x4 RDIMMs		
4X77A81439	BQ3E	ThinkSystem 32GB TruDDR5 4800MHz (1Rx4) 9x4 RDIMM-A
4X77A81442	BQ36	ThinkSystem 64GB TruDDR5 4800MHz (2Rx4) 9x4 RDIMM-A
10x4 RDIMMs		
4X77A81438	BQ39	ThinkSystem 32GB TruDDR5 4800MHz (1Rx4) 10x4 RDIMM-A
4X77A81441	BQ3D	ThinkSystem 64GB TruDDR5 4800MHz (2Rx4) 10x4 RDIMM-A
4X77A81448	BUVV	ThinkSystem 96GB TruDDR5 4800MHz (2Rx4) 10x4 RDIMM-A
x8 RDIMMs		
4X77A81437	BQ3C	ThinkSystem 16GB TruDDR5 4800MHz (1Rx8) RDIMM-A
4X77A81440	BQ37	ThinkSystem 32GB TruDDR5 4800MHz (2Rx8) RDIMM-A
10x4 3DS RDIMMs		
4X77A81443	BQ3A	ThinkSystem 128GB TruDDR5 4800MHz (4Rx4) 3DS RDIMM-A v2
CTO only	BYEE	ThinkSystem 128GB TruDDR5 4800MHz (4Rx4) 3DS RDIMM-A v1
4X77A81444	BQ3B	ThinkSystem 256GB TruDDR5 4800MHz (8Rx4) 3DS RDIMM-A v2
CTO only	BZPN	ThinkSystem 256GB TruDDR5 4800MHz (8Rx4) 3DS RDIMM-A v1

9x4 RDIMMs (also known as Optimized or EC4 RDIMMs) are a new lower-cost DDR5 memory option supported in ThinkSystem V3 servers. 9x4 DIMMs offer the same performance as standard RDIMMs (known as 10x4 or EC8 modules), however they support lower fault-tolerance characteristics. Standard RDIMMs and 3DS RDIMMs support two 40-bit subchannels (that is, a total of 80 bits), whereas 9x4 RDIMMs support two 36-bit subchannels (a total of 72 bits). The extra bits in the subchannels allow standard RDIMMs and 3DS RDIMMs to support Single Device Data Correction (SDDC), however 9x4 RDIMMs do not support SDDC. Note, however, that all DDR5 DIMMs, including 9x4 RDIMMs, support Bounded Fault correction, which enables the server to correct most common types of DRAM failures.

For more information on DDR5 memory, see the Lenovo Press paper, *Introduction to DDR5 Memory*, available from <https://lenovopress.com/lp1618>.

The following rules apply when selecting the memory configuration:

- The SR645 V3 supports quantities 1, 2, 4, 6, 8, 10, 12 DIMMs per processor; other quantities not supported
- The server supports four types of DIMMs: 9x4 RDIMMs, 10x4 RDIMMs, x8 RDIMMs and 3DS RDIMMs; UDIMMs and LRDIMMs are not supported
- Mixing of DIMM types is not supported (for example, 9x4 DIMMs with 10x4 RDIMMs)
- Mixing of 128GB 3DS RDIMMs and 256GB 3DS RDIMMs is not supported

- Mixing of 128GB 3DS RDIMMs (features BYEE and BQ3A) is not supported
- Mixing of 256GB 3DS RDIMMs (features BZPN and BQ3B) is not supported
- Mixing x4 and x8 DIMMs is not supported
- Mixing of DIMM rank counts is supported. Follow the required installation order installing the DIMMs with the higher rank counts first.
- Mixing of DIMM capacities is supported, however only two different capacities are supported across all channels of the processor (eg 16GB and 32GB). Follow the required installation order installing the larger DIMMs first.
- The use of the 128GB 3D RDIMM feature BYEE has the following requirements for thermal reasons:
 - Performance fans are required
 - Rear 2.5-inch drives are not supported
 - GPUs are not supported
 - Additional ambient temperature requirements - see https://pubs.lenovo.com/sr645-v3/thermal_rules for information

Note: Memory mirroring and memory rank sparing are not supported.

For best performance, consider the following:

- Ensure the memory installed is at least the same speed as the memory bus of the selected processor.
- Populate all 12 memory channels with identical DIMMs (same Lenovo part number)

The following memory protection technologies are supported:

- ECC detection/correction
- Bounded Fault detection/correction
- SDDC (for x4-based memory DIMMs; look for "x4" in the DIMM description. Not supported with 9x4 RDIMMs)
- Patrol/Demand Scrubbing
- DRAM Address Command Parity with Replay
- DRAM Uncorrected ECC Error Retry
- On-die ECC
- ECC Error Check and Scrub (ECS)
- Post Package Repair

Internal storage

The SR645 V3 supports 4x 3.5-inch or 12x 2.5-inch or 16x EDSFF drive bays, depending on the selected chassis and backplane configuration. The server also supports configurations without any drive bays if desired.

The two drive bay zones are as follows:

- Front:
 - 4x 3.5-inch hot-swap bays, or
 - Up to 10x 2.5-inch hot-swap bays, or
 - 16x EDSFF hot-swap bays
- Rear:
 - 2x 2.5-inch hot-swap bays, or
 - 2x 7mm hot-swap drives bays

All drives are hot-swap and are accessible from the front or from the rear.

The server also supports one or two M.2 drives, installed in an M.2 adapter internal to the server.

In this section:

- [NVMe drive support](#)
- [Front drive bays](#)
- [Rear 2.5-inch and 7mm drive bays](#)
- [7mm and M.2 supported combinations](#)
- [Storage configurations](#)
- [Field upgrades for drive bays](#)
- [RAID flash power module \(supercap\) support](#)
- [M.2 drives](#)
- [SED encryption key management with ISKLM](#)

NVMe drive support

The SR645 V3 supports NVMe drives to maximize storage performance:

- In 2.5-inch front drive configurations, the server supports up to 12 NVMe drives without oversubscription (that is, each x4 drive has a dedicated x4 connection (4 lanes) to the processor):
 - 10x 2.5-inch NVMe drives at the front
 - 2x 2.5-inch NVMe drives at the rear
- In 3.5-inch front drive configurations, the server supports up to 6 NVMe drives without oversubscription:
 - 4x 3.5-inch NVMe drives at the front
 - 2x 2.5-inch NVMe drives at the rear
- In EDSFF front drive configurations, the server supports up to 16 NVMe drives without oversubscription:
 - 16x E1.S NVMe drives at the front

The specifics of these configurations are covered in the [Storage configurations](#) section.

In addition, the SR645 V3 supports two 7mm NVMe drives for use as boot drives. These two drives optionally support RAID via a separate RAID adapter installed in a PCIe slot.

The RAID 940-8i and RAID 940-16i adapters also support NVMe through a feature named Tri-Mode support (or Trimode support). This feature enables the use of NVMe U.3 drives at the same time as SAS and SATA drives. Tri-Mode requires an AnyBay backplane. Cabling of the controller to the backplanes is the same as with SAS/SATA drives, and the NVMe drives are connected via a PCIe x1 link to the controller.

NVMe drives connected using Tri-Mode support provide better performance than SAS or SATA drives: A SATA SSD has a data rate of 6Gbps, a SAS SSD has a data rate of 12Gbps, whereas an NVMe U.3 Gen 4 SSD with a PCIe x1 link will have a data rate of 16Gbps. NVMe drives typically also have lower latency and higher IOPS compared to SAS and SATA drives. Tri-Mode is supported with U.3 NVMe drives in either 2.5-inch and 3.5-inch form factor and requires an AnyBay backplane.

Tri-Mode requires U.3 drives: Only NVMe drives with a U.3 interface are supported. U.2 drives are not supported. See the [Internal drive options](#) section for the U.3 drives supported by the server.

Front drive bays

The front drive bay zone supports the following configurations. All drives are hot-swap.

- 3.5-inch hot-swap drive bays
 - 4x SAS/SATA 3.5-inch
 - 4x AnyBay 3.5-inch (PCIe Gen4)
 - 2x SATA + 2x SATA/NVMe 3.5-inch (PCIe Gen4)

- 2.5-inch hot-swap drive bays without support for front PCIe slots
 - 4x SAS/SATA
 - 4x NVMe (PCIe Gen4 or Gen5)
 - 8x SAS/SATA
 - 10x SAS/SATA
 - 6x SAS/SATA + 4x AnyBay (PCIe Gen4 or Gen5)
 - 6x SAS/SATA + 2x AnyBay + 2x NVMe (PCIe Gen4 or Gen5)
 - 10x AnyBay (PCIe Gen4 or Gen5)
 - 10x NVMe (PCIe Gen4 or Gen5)
- 2.5-inch hot-swap drive bays with support for front PCIe slots
 - 2x NVMe (PCIe Gen4)
 - 4x NVMe (PCIe Gen4 or Gen5)
 - 4x AnyBay (PCIe Gen5)
- EDSFF drive bays
 - 16x E1.S (9.5mm or 15mm) hot-swap NVMe drive bays (PCIe Gen4)
- Drive-less 2.5-inch configuration - No backplane and no drives (supports [field upgrades](#))
- Drive-less 3.5-inch configuration - No backplane and no drives (supports [field upgrades](#))

These configurations are shown in the following three figures. The feature codes listed correspond to the feature codes listed in the table below the figures.

The following figure shows the supported 3.5-inch and EDSFF drive bay configurations. EDSFF drive configurations can be configured with or without an Integrated Diagnostics Panel with pull-out LCD display. See the [Local management](#) section for details.

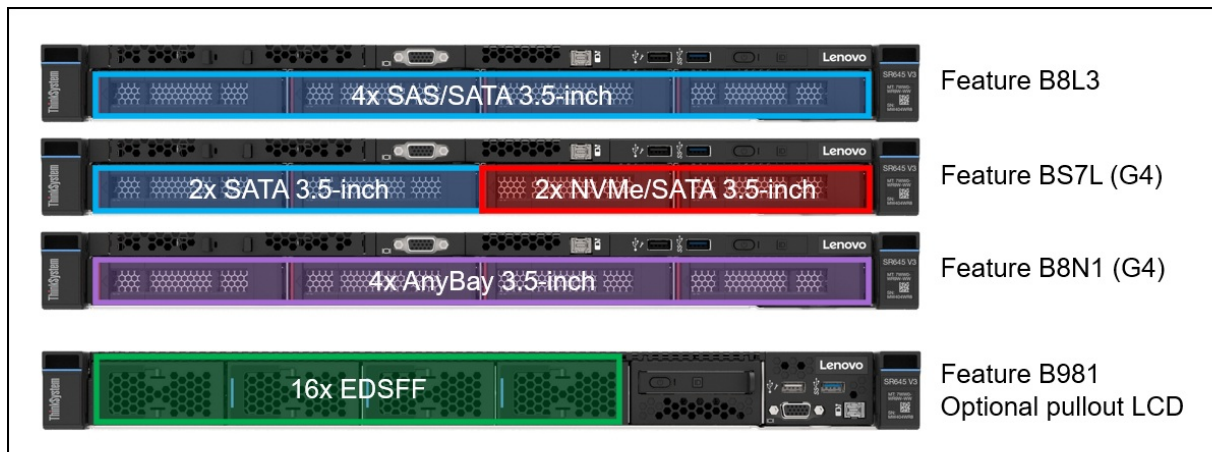

Figure 8. SR645 V3 front drive bay configurations - 3.5-inch and EDSFF drive bays

The following figure shows the supported 2.5-inch drive bays drive bay configurations without PCIe slot support.

8x 2.5-inch drive configurations can be configured with or without an Integrated Diagnostics Panel with pull-out LCD display. See the [Local management](#) section for details.

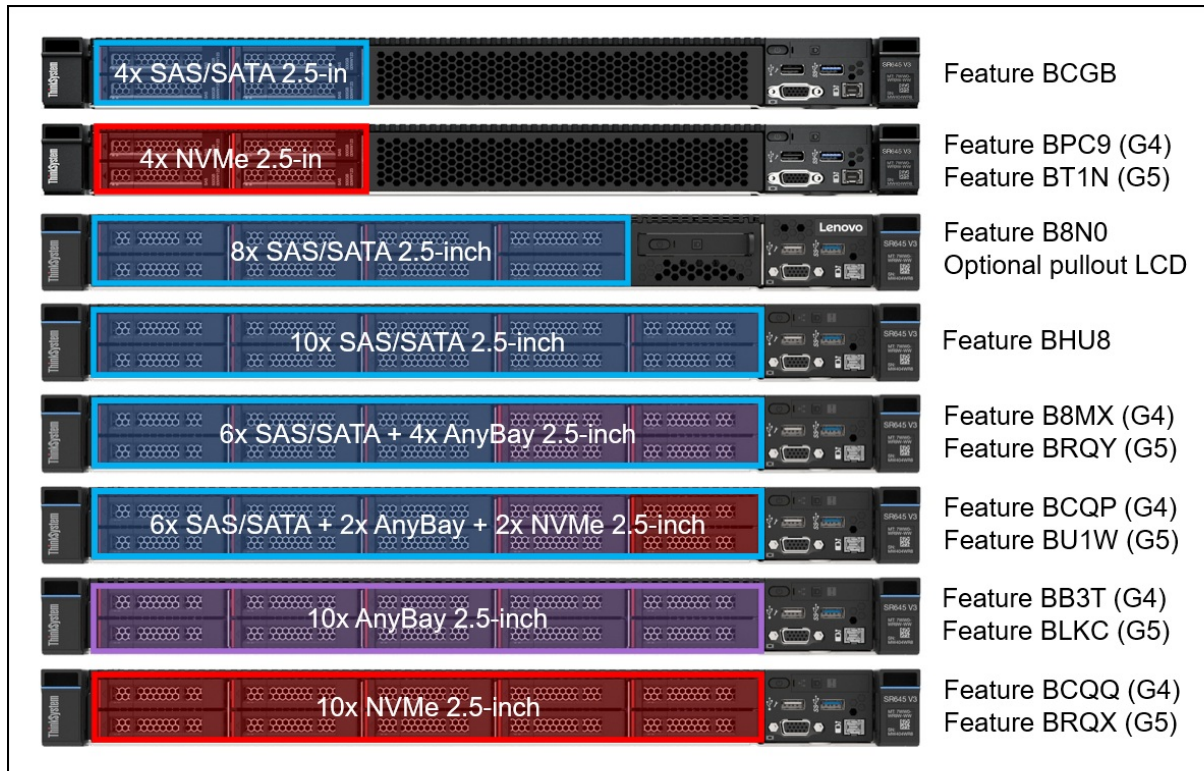

Figure 9. SR645 V3 front drive bay configurations - 2.5-inch drive bays without front PCIe slot support

The following figure shows the supported 2.5-inch drive bays drive bay configurations with front PCIe slot support. Front slots can be used with rear slots. See the [I/O expansion](#) for details.

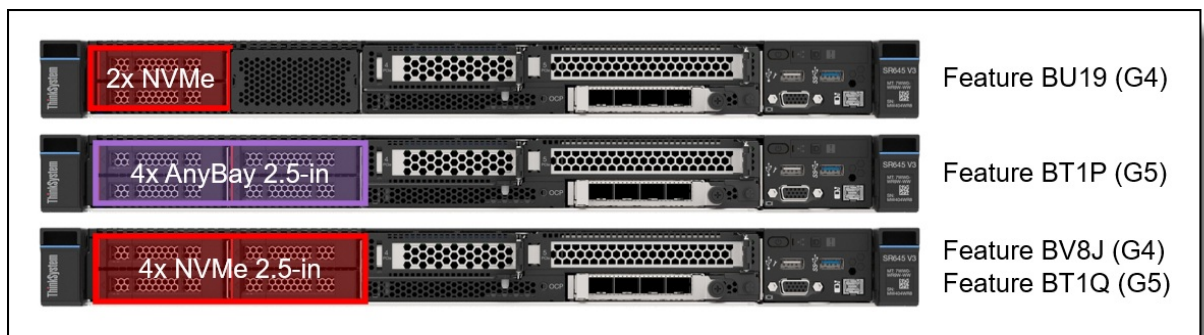

Figure 10. SR645 V3 front drive bay configurations - 2.5-inch drive bays with front PCIe slot support

The backplanes used to provide these drive bays are listed in the following table.

Field upgrades: Most front backplanes are available as part numbers for field upgrades using upgrade kits, as described in the [Field upgrades](#) section below.

Table 14. Backplanes for front drive bays

Feature code	Description	PCIe Gen	Maximum supported
Front 3.5-inch drive backplanes			
B8L3	ThinkSystem 1U/2U 4x3.5" SAS/SATA Backplane	-	1
BS7L	ThinkSystem V3 1U 3.5" 2x SATA+2x SATA/NVMe Backplane	Gen4	1
B8N1	ThinkSystem 1U 4x3.5" AnyBay Backplane	Gen4	1
Front EDSFF drive backplanes			
B981	ThinkSystem 1U 16xEDSFF Backplane	Gen4	1
Front 2.5-inch drive backplanes - 4 drive bays - no support for front PCIe slots			
BCGB	ThinkSystem 1U 4x2.5" SAS/SATA Backplane	-	1
BPC9	ThinkSystem 1U 4x 2.5" NVMe Gen 4 Backplane	Gen4	1
BT1N	ThinkSystem V3 1U 4x2.5" Gen5 NVMe Backplane	Gen5	1
Front 2.5-inch drive backplanes - 8 drive bays			
B8N0	ThinkSystem 1U 8x2.5" SAS/SATA Backplane	-	1
Front 2.5-inch drive backplanes - 10 drive bays			
BHU8	ThinkSystem 1U 10x2.5" SAS/SATA Backplane	-	1
B8MX	ThinkSystem 1U 10x2.5" (6x SAS/SATA 4x AnyBay) Backplane	Gen4	1
BRQY	ThinkSystem 1U 2.5" 6 SAS/SATA 4 AnyBay Gen5 Backplane	Gen5	1
BCQP	ThinkSystem 1U 10x2.5" (6x SAS/SATA 2x AnyBay 2x NVMe) Backplane	Gen4	1
BU1W	ThinkSystem 1U 10x2.5" (6x SAS/SATA 2x AnyBay 2x NVMe) Gen5 Backplane	Gen5	1
BB3T	ThinkSystem 1U 10x2.5" AnyBay Backplane	Gen4	1
BLKC	ThinkSystem V3 1U 10x2.5" AnyBay Gen5 Backplane	Gen5	1*
BCQQ	ThinkSystem 1U 10x2.5" NVMe Backplane	Gen4	1
BRQX	ThinkSystem 1U 2.5" 10 NVMe Gen5 Backplane	Gen5	1
Front 2.5-inch drive backplanes - 2 drive bays - with front PCIe slot support			
BU19	ThinkSystem V3 2x2.5" BP NVMe with 1U 4x2.5" Chassis	Gen4	1
Front 2.5-inch drive backplanes - 4 drive bays - with front PCIe slot support			
BT1P	ThinkSystem V3 1U Front I/O 4x2.5" Gen5 AnyBay Backplane	Gen5	1
BV8J	ThinkSystem V3 1U 4x2.5" Gen4 NVMe Backplane with 4x2.5" Chassis	Gen4	1
BT1Q	ThinkSystem V3 1U Front I/O 4x2.5" Gen5 NVMe Backplane	Gen5	1

Rear 2.5-inch and 7mm drive bays

The SR645 V3 supports hot-swap drives installed at the rear of the server chassis. Supported configurations are as follows:

- 2x 2.5-inch hot-swap SAS/SATA drive bays
- 2x 2.5-inch hot-swap NVMe drive bays (PCIe Gen 4)
- 2x 7mm SAS/SATA drive bays
- 2x 7mm NVMe drive bays (PCIe Gen 4)

The configurations are shown in the following figure.

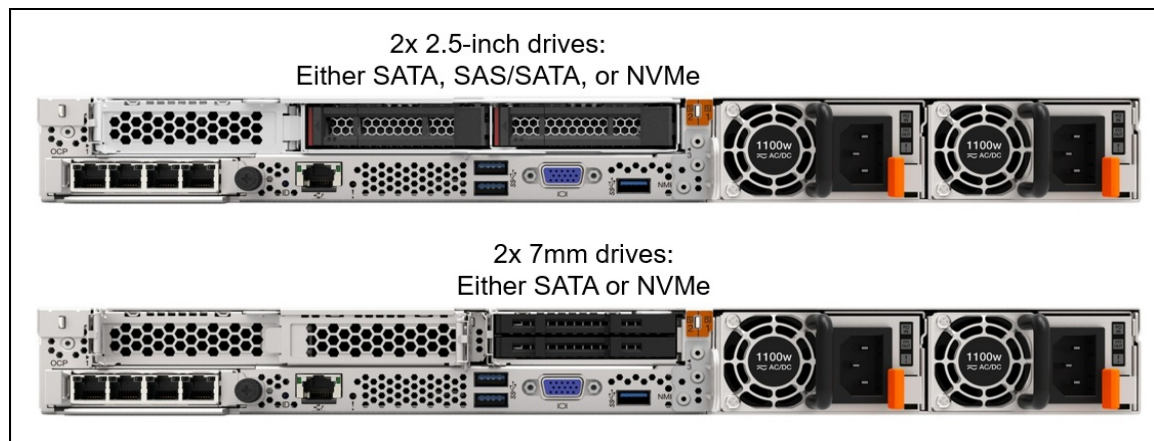

Figure 11. Rear drive bay configurations

The backplanes used to provide these drive bays in CTO orders are listed in the following table. Backplanes are also available as part numbers for field upgrades using upgrade kits, as described in the [Field upgrades](#) section below.

The SR645 V3 supports three different 7mm drive options installed in slot 3:

- 7mm drive backplane supporting SATA or NVMe drives, without integrated RAID. Optional RAID functionality is provided by a separate RAID adapter installed in a slot (feature BU0N)
- 7mm drive backplane supporting NVMe drives (no SATA support) with integrated RAID support via an onboard Marvell 88NR2241 NVMe RAID controller (feature B8Q2)
- 7mm drive backplane supporting SATA or NVMe drives with integrated RAID support via an onboard Broadcom RAID controller (feature BYFG)

Table 15. Backplanes for rear drive bays

Feature code	Description	Maximum supported
Rear - 2.5-inch drive backplanes		
BQZX	ThinkSystem 1U 2x2.5" SATA Rear Backplane	1
B8MY	ThinkSystem 1U 2x2.5" SAS/SATA Rear Backplane	1
BDY6	ThinkSystem 1U 2x2.5" NVMe Rear Backplane	1
Rear - 7mm drive backplane		
BU0N	ThinkSystem 7mm SATA/NVMe 2-Bay Rear Enablement Kit v2	1
B8Q2	ThinkSystem 1U 7mm Drive Kit w/ NVMe RAID (Marvell RAID)	1
BYFG	ThinkSystem 7mm SATA/NVMe 2-Bay Rear Hot-Swap RAID Enablement Kit (Broadcom RAID)	1
Hardware RAID support for ThinkSystem 7mm SATA/NVMe 2-Bay Rear Enablement Kit v2 (BU0N) (optional)		
BT7N	ThinkSystem RAID 5350-8i for M.2/7mm SATA Boot Enablement	1
BT7P	ThinkSystem RAID 540-8i for M.2/7mm NVMe Boot Enablement	1

The use of rear 2.5-inch drive bays has the following configuration rules:

- With 2.5-inch rear drive bays, only slot 1 is available. Slot 2 and 3 are not available
- GPUs are not supported

The use of the 7mm rear drive bays has the following configuration rules:

- 7mm rear drive bays occupy slot 3; slots 1 and 2 are available and slot 2 is a low profile slot. Slot 3 is not available.
- GPUs are not supported
- For ThinkSystem 7mm SATA/NVMe 2-Bay Rear Enablement Kit v2 (feature BU0N):
 - The 7mm drive bays support either SATA drives or NVMe drives but not both. You specify SATA or NVMe in the configurator using feature codes BTTV (SATA) or BTTW (NVMe).
 - If RAID support is not required, the 7mm drives connect to an onboard port; No additional adapter is required
 - If RAID support is required, select feature code BS7A in the configurator to enable RAID
 - The support of RAID-1 with the 7mm drives requires an additional RAID adapter that is installed in PCIe slot 2:
 - RAID support for 7mm SATA drives requires a RAID 5350-8i adapter (feature BT7N)
 - RAID support for 7mm NVMe drives requires a RAID 540-8i adapter operating in Tri-Mode (feature BT7P)
 - The RAID adapter used for 7mm drive support cannot be configured for use with other drive bays (not even with M.2)
- For ThinkSystem 1U 7mm Drive Kit w/ NVMe RAID (feature B8Q2)
 - The adapter only supports NVMe drives
 - RAID functionality is integrated into the 7mm backplane using a Marvell 88NR2241 NVMe RAID Controller
- For ThinkSystem 7mm SATA/NVMe 2-Bay Rear Hot-Swap RAID Enablement Kit (feature BYFG)
 - The 7mm drive bays support either SATA drives or NVMe drives but not both.
 - RAID functionality is integrated into the 7mm backplane using a Broadcom RAID Controller
 - Supports RAID-0, RAID-1
- M.2 and 7mm are supported together in certain combinations, as listed in the table in the following section.

7mm and M.2 supported combinations

The following table lists the supported combinations of 7mm drives and M.2 drives.

Table 16. Supported combinations of M.2 and 7mm drives

Combination	M.2					7mm								
	M.2 x1 SATA	M.2 x1 NVMe	M.2 x4 NVMe	M.2 x4 SATA	M.2 NVMe RAID	M.2 x4 SATA with RAID 5350-8i	M.2 x4 NVMe with RAID 540-8i	M.2 SATA/ NVMe RAID	7mm SATA	7mm NVMe	7mm NVMe RAID	7mm SATA with RAID 5350-8i	7mm NVMe with RAID 540-8i	7mm SATA/ NVMe RAID
Feature	B5XJ	B5XJ	BM8X	BM8X	B8P9	BM8X+ BT7N	BM8X+ BT7P	BYFF	BU0N	BU0N	B8Q2	BU0N+ BT7N	BU0N+ BT7P	BYFG
M.2 x1 SATA + 7mm SATA	Y								Y					
M.2 x1 SATA + 7mm NVMe	Y									Y				
M.2 x1 SATA + 7mm SATA with RAID 5350-8i	Y											Y		
M.2 x1 SATA + 7mm NVMe with RAID 540-8i	Y												Y	
M.2 x1 NVMe + 7mm SATA		Y							Y					
M.2 x1 NVMe + 7mm NVMe		Y								Y				
M.2 x1 NVMe + 7mm SATA with RAID 5350-8i		Y										Y		
M.2 x1 NVMe + 7mm NVMe with RAID 540-8i		Y											Y	
M.2 x4 NVMe + 7mm SATA			Y						Y					
M.2 x4 NVMe + 7mm NVMe			Y							Y				
M.2 x4 NVMe + 7mm SATA with RAID 5350-8i			Y									Y		
M.2 x4 NVMe + 7mm NVMe with RAID 540-8i			Y										Y	
M.2 x4 SATA + 7mm NVMe				Y						Y				
M.2 x4 SATA + 7mm SATA with RAID 5350-8i				Y								Y		

	M.2					7mm								
Combination	M.2 x1 SATA	M.2 x1 NVMe	M.2 x4 NVMe	M.2 x4 SATA	M.2 NVMe RAID	M.2 x4 SATA with RAID 5350-8i	M.2 x4 NVMe with RAID 540-8i	M.2 SATA/ NVMe RAID	7mm SATA	7mm NVMe	7mm NVMe RAID	7mm SATA with RAID 5350-8i	7mm NVMe with RAID 540-8i	7mm SATA/ NVMe RAID
Feature	B5XJ	B5XJ	BM8X	BM8X	B8P9	BM8X+ BT7N	BM8X+ BT7P	BYFF	BU0N	BU0N	B8Q2	BU0N+ BT7N	BU0N+ BT7P	BYFG
M.2 x4 SATA + 7mm NVMe with RAID 540-8i				Y									Y	
M.2 x4 SATA with RAID 5350-8i + 7mm SATA						Y			Y					
M.2 x4 SATA with RAID 5350-8i + 7mm NVMe						Y				Y				
M.2 x4 NVMe with RAID 540-8i + 7mm SATA							Y		Y					
M.2 x4 NVMe with RAID 540-8i + 7mm NVMe							Y			Y				
M.2 SATA/ NVMe RAID + 7mm SATA								Y	Y					
M.2 SATA/ NVMe RAID + 7mm NVMe								Y		Y				
M.2 SATA/ NVMe RAID + 7mm NVMe RAID								Y			Y			
M.2 x1 SATA + 7mm SATA/ NVMe RAID	Y													Y
M.2 x1 NVMe + 7mm SATA/ NVMe RAID		Y												Y
M.2 x4 NVMe + 7mm SATA/ NVMe RAID			Y											Y
M.2 x4 SATA + 7mm SATA/ NVMe RAID				Y										Y
M.2 NVMe RAID + 7mm SATA/ NVMe RAID					Y									Y
M.2 SATA/ NVMe RAID + 7mm SATA/ NVMe RAID								Y						Y

Storage configurations

This section describes the various combinations of front and rear drives that the server supports, as well as M.2 support.

Tip: These tables are based on the Config Matrix in TRD V2.9

In this section:

- [Overview - 3.5-inch front bays](#)
- [Overview - 2.5-inch front bays without front slots](#)
- [Overview - 2.5-inch front bays with front slots](#)
- [Details - 3.5-inch drive bay chassis configurations](#)
- [Details - 2.5-inch drive bay chassis configurations without front slots](#)
- [Details - 2.5-inch drive bay chassis configurations with front slots](#)

The following tables summarize the storage configurations for the SR645 V3. For details, including processor requirements, M.2 and 7mm support, and controller selections, see the Details tables.

Overview - 3.5-inch front bays

The following table summarizes the configurations that use 3.5-inch front drive bays.

Click to jump down to the [details of the 3.5-inch configurations](#).

Return to [Storage configurations](#).

Table 17. Overview - 3.5-inch front bays

Config	Total drives (NVMe)	Front		Rear 2.5"		Front backplane	Rear backplane
		SAS/SATA	Any Bay	SAS/SATA	NVMe		
1	4 (0)	4	0	0	0	4x SAS/SATA (B8L3)	None
2A	6 (2)	4	0	0	2	4x SAS/SATA (B8L3)	2x NVMe (BDY6)
3	6 (0)	4	0	2	0	4x SAS/SATA (B8L3)	2x SATA (BQZX) (for OB SATA) or 2x SAS/SATA (B8MY)
6S	4 (4)	0	4	0	0	4x AnyBay G4 (B8N1)	None
6	4 (4)	0	4	0	0	4x AnyBay G4 (B8N1)	None
11	4 (2)	2	2	0	0	2x SATA, 2x SATA/NVMe (BS7L)	None
11A	4 (2)	2	2	0	0	2x SATA, 2x SATA/NVMe (BS7L)	None
30	4 (4)	0	4	0	0	4x AnyBay G4 (B8N1)	None

Overview - 2.5-inch front bays without front slots

The following table summarizes the configurations that use 2.5-inch front drive bays but do not support front PCIe slots.

Click to jump down to the [details of the 2.5-inch configurations](#).

Return to [Storage configurations](#).

Table 18. Overview - 2.5-inch front bays without front slots

Config	Total drives (NVMe)	Front				Rear 2.5"		Front backplane	Rear backplane
		SAS/SATA	Any Bay	NVMe	EDSFF	SAS/SATA	NVMe		
9	10 (4)	6	4	0	0	0	0	6x SAS/SATA, 4x AnyBay G4 (B8MX)	None

Config	Total drives (NVMe)	Front				Rear 2.5"		Front backplane	Rear backplane
		SAS/SATA	Any Bay	NVMe	EDSFF	SAS/SATA	NVMe		
9H	10 (4)	6	4	0	0	0	0	6x SAS/SATA, 4x AnyBay G5 (BRQY)	None
9W	10 (4)	6	4	0	0	0	0	6x SAS/SATA, 4x AnyBay G4 (B8MX)	None
9WH	10 (4)	6	4	0	0	0	0	6x SAS/SATA, 4x AnyBay G5 (BRQY)	None
9S	10 (4)	6	4	0	0	0	0	6x SAS/SATA, 4x AnyBay G4 (B8MX)	None
9SH	10 (4)	6	4	0	0	0	0	6x SAS/SATA, 4x AnyBay G4 (B8MX)	None
10A	12 (4)	6	4	0	0	2	0	6x SAS/SATA, 4x AnyBay G4 (B8MX)	2x SAS/SATA (B8MY)
10AH	12 (4)	6	4	0	0	2	0	6x SAS/SATA, 4x AnyBay G5 (BRQY)	2x SAS/SATA (B8MY)
12S	10 (4)	6	2	2	0	0	0	6x SAS/SATA, 2x AnyBay, 2x NVMe G4 (BCQP)	None
12SH	10 (4)	6	2	2	0	0	0	6x SAS/SATA, 2x AnyBay, 2x NVMe G5 (BU1W)	None
12W	10 (4)	6	2	2	0	0	0	6x SAS/SATA, 2x AnyBay, 2x NVMe G4 (BCQP)	None
12WH	10 (4)	6	2	2	0	0	0	6x SAS/SATA, 2x AnyBay, 2x NVMe G5 (BU1W)	None
12B	10 (4)	6	2	2	0	0	0	6x SAS/SATA, 2x AnyBay, 2x NVMe G4 (BCQP)	None
12BH	10 (4)	6	2	2	0	0	0	6x SAS/SATA, 2x AnyBay, 2x NVMe G5 (BU1W)	None
13	10 (0)	10	0	0	0	0	0	10x SAS/SATA (BHU8)	None
13W	10 (0)	10	0	0	0	0	0	10x SAS/SATA (BHU8)	None
13A	10 (0)	10	0	0	0	0	0	10x SAS/SATA (BHU8)	None
14A	12 (0)	10	0	0	0	2	0	10x SAS/SATA (BHU8)	2x SATA (BQZX) (for OB SATA) or 2x SAS/SATA (B8MY)
15	12 (2)	10	0	0	0	0	2	10x SAS/SATA (BHU8)	2x NVMe (BDY6)
17	10 (0)	10	0	0	0	0	0	10x SAS/SATA (BHU8)	None
18	10 (10)	0	10	0	0	0	0	10x AnyBay G4 (BB3T)	None
18H	10 (10)	0	10	0	0	0	0	10x AnyBay G5 (BLKC)	None
21	8 (0)	8	0	0	0	0	0	8x SAS/SATA (B8N0)	None
21A	8 (0)	8	0	0	0	0	0	8x SAS/SATA (B8N0)	None
21W	8 (0)	8	0	0	0	0	0	8x SAS/SATA (B8N0)	None
25	16 (16)	0	0	0	16	0	0	16x EDSFF (B981)	None
26	4 (0)	4	0	0	0	0	0	4x SAS/SATA (BCGB)	None
26W	4 (0)	4	0	0	0	0	0	4x SAS/SATA (BCGB)	None
28	10 (10)	0	0	10	0	0	0	10x NVMe G4 (BCQQ)	None
28H	10 (10)	0	0	10	0	0	0	10x NVMe G5 (BRQX)	None
28A	12 (12)	0	0	10	0	0	2	10x NVMe G4 (BCQQ)	2x NVMe (BDY6)
28AH	12 (12)	0	0	10	0	0	2	10x NVMe G5 (BRQX)	2x NVMe (BDY6)
28W	10 (10)	0	0	10	0	0	0	10x NVMe G4 (BCQQ)	None
28WH	10 (10)	0	0	10	0	0	0	10x NVMe G5 (BRQX)	None
29	8 (8)	0	8	0	0	0	0	10x AnyBay G4 (BB3T)	None

Config	Total drives (NVMe)	Front				Rear 2.5"		Front backplane	Rear backplane
		SAS/SATA	Any Bay	NVMe	EDSFF	SAS/SATA	NVMe		
29W	8 (8)	0	8	0	0	0	0	10x AnyBay G4 (BB3T)	None
29A	10 (10)	0	10	0	0	0	0	10x AnyBay G4 (BB3T)	None
29AW	10 (10)	0	10	0	0	0	0	10x AnyBay G4 (BB3T)	None
45	4 (4)	0	0	4	0	0	0	4x NVMe G4 (BT1N)	None
45W	4 (4)	0	0	4	0	0	0	4x NVMe G4 (BT1N)	None
46	4 (4)	0	0	4	0	0	0	4x NVMe G4 (BPC9)	None
46W	4 (4)	0	0	4	0	0	0	4x NVMe G4 (BPC9)	None
45S	4 (4)	0	0	4	0	0	0	4x NVMe G4 (BT1N)	None
46S	4 (4)	0	0	4	0	0	0	4x NVMe G4 (BPC9)	None

Overview - 2.5-inch front bays with front slots

The following table summarizes the configurations that use 2.5-inch front drive bays and support front PCIe slots.

Click to jump down to the [details of the 2.5-inch configurations](#).

Return to [Storage configurations](#).

Table 19. Overview - 2.5-inch front bays with front slots

Config	Total drives (NVMe)	Front				Rear 2.5"		Front backplane	Rear backplane
		SAS/SATA	Any Bay	NVMe	EDSFF	SAS/SATA	NVMe		
31	4 (4)	0	4	0	0	0	0	4x AnyBay G4 (BT1P)	None
32	6 (6)	0	4	0	0	0	2	4x AnyBay G4 (BT1P)	2x NVMe (BDY6)
33	6 (4)	0	4	0	0	2	0	4x AnyBay G4 (BT1P)	2x SAS/SATA (B8MY)
35	4 (4)	0	4	0	0	0	0	4x AnyBay G4 (BT1P)	None
36	6 (6)	0	4	0	0	0	2	4x AnyBay G4 (BT1P)	2x NVMe (BDY6)
37	6 (4)	0	4	0	0	2	0	4x AnyBay G4 (BT1P)	2x SAS/SATA (B8MY)
39	4 (4)	0	0	4	0	0	0	4x NVMe G4 (BT1Q)	None
39	6 (6)	0	0	4	0	0	2	4x NVMe G4 (BT1Q)	2x NVMe (BDY6)
40	4 (4)	0	0	4	0	0	0	4x NVMe G4 (BT1Q)	None
40	6 (6)	0	0	4	0	0	2	4x NVMe G4 (BT1Q)	2x NVMe (BDY6)
41	2 (2)	0	0	2	0	0	0	2x NVMe G4 (BU19)	None
41	4 (4)	0	0	2	0	0	2	2x NVMe G4 (BU19)	2x NVMe (BDY6)
44	4 (4)	0	0	4	0	0	0	4x NVMe G4 (BV8J)	None
44	6 (6)	0	0	4	0	0	2	4x NVMe G4 (BV8J)	2x NVMe (BDY6)

Details - 3.5-inch front bays

The following table lists the detailed configurations that use 3.5-inch front drive bays.

Click to go back to the [overview of 3.5-inch configurations](#).

Return to [Storage configurations](#).

In the table:

- **M.2 x4 SATA/NVMe Non-RAID** means the M.2 SATA/x4 NVMe adapter (4Y37A79663) with either SATA or NVMe drives. RAID is not supported.

- **M.2 x4 SATA/NVMe with SFF RAID** means the M.2 SATA/x4 NVMe adapter (4Y37A79663) with either SATA or NVMe drives. RAID is supported with the addition of the RAID 5350-8i adapter (SATA drives only) or RAID 540-8i adapter (NVMe drives only) in a rear slot.
- **M.2 x1 SATA Non-RAID** means the M.2 SATA/x1 NVMe adapter (4Y37A09738) with SATA drives. NVMe drives not supported. RAID is not supported.
- **M.2 x1 NVMe Non-RAID** means the M.2 SATA/x1 NVMe adapter (4Y37A09738) with NVMe drives. SATA drives not supported. RAID is not supported.
- **M.2 NVMe RAID** means the M.2 RAID NVMe adapter (B8P9) with NVMe drives. SATA drives not supported. RAID-0 and RAID-1 are supported with the integrated Marvell RAID controller.
- **M.2 SATA/NVMe RAID** means the M.2 RAID SATA/NVMe adapter (BYFF) with SATA or NVMe drives. RAID-0 and RAID-1 are supported with the integrated Broadcom RAID controller.
- **7mm SATA Non-RAID** means the 7mm SATA/NVMe kit (BU0N) with SATA drives. RAID is not supported.
- **7mm NVMe Non-RAID** means the 7mm SATA/NVMe kit (BU0N) with NVMe drives. RAID is not supported.
- **7mm NVMe RAID** means the 7mm NVMe RAID kit (B8Q2) with NVMe drives. SATA drives not supported. RAID-0 and RAID-1 are supported with the integrated Marvell RAID controller.
- **7mm SATA/NVMe RAID** means the 7mm SATA/NVMe RAID kit (BYFG) with SATA or NVMe drives. RAID-0 and RAID-1 are supported with the integrated Broadcom RAID controller.
- **7mm SATA with SFF RAID 5350-8i** means the 7mm SATA/NVMe kit (BU0N) with SATA drives. NVMe drives not supported. RAID is supported with the addition of the RAID 5350-8i adapter in a rear slot.
- **7mm NVMe with SFF RAID 540-8i** means the 7mm SATA/NVMe kit (BU0N) with NVMe drives. SATA drives not supported. RAID is supported with the addition of the RAID 540-8i adapter in a rear slot.

Table 20. Details - 3.5-inch front bays

Config	CPUs	Front 3.5"		Rear 2.5"		Front backplane	Rear backplane	M.2						7mm		Supported controllers				
		SAS/SATA	Any Bay	SAS/SATA	NVMe			M.2 x4 SATA/NVMe Non-RAID	M.2 x4 SATA/NVMe with SFF RAID	M.2 x1 SATA Non-RAID	M.2 x1 NVMe Non-RAID	M.2 NVMe RAID	M.2 SATA/NVMe RAID	7mm SATA Non-RAID	7mm NVMe Non-RAID		7mm NVMe RAID	7mm SATA/NVMe RAID	7mm SATA with SFF RAID 5350-8i	7mm NVMe with SFF RAID 540-8i
1-1	1 or 2	4	0	0	0	4x SAS/SATA (B8L3)	None	N	N	Y	Y	Y	Y	Y	Y	Y	Y	Y	Y	OB SATA
1-2	1 or 2							N	N	Y	Y	Y	Y	Y	Y	Y	Y	Y	Y	RAID 5350-8i/9350-8i
1-3	1 or 2							N	N	Y	Y	Y	Y	Y	Y	Y	Y	Y	Y	HBA 4350-8i
1-4	1 or 2							N	N	Y	Y	Y	Y	Y	Y	Y	Y	Y	Y	RAID 940-8i/540-8i
1-5	1 or 2							N	N	Y	Y	Y	Y	Y	Y	Y	Y	Y	Y	HBA 440-8i

Config	CPUs	Front 3.5"		Rear 2.5"		Front backplane	Rear backplane	M.2						7mm				Supported controllers		
		SAS/SATA	AnyBay	SAS/SATA	NVMe			M.2 x4 SATA/NVMe Non-RAID	M.2 x4 SATA/NVMe with SFF RAID	M.2 x1 SATA Non-RAID	M.2 x1 NVMe Non-RAID	M.2 NVMe RAID	M.2 SATA/NVMe RAID	7mm SATA Non-RAID	7mm NVMe Non-RAID	7mm NVMe RAID	7mm SATA/NVMe RAID		7mm SATA with SFF RAID 5350-8i	7mm NVMe with SFF RAID 540-8i
2A-2	2	4	0	0	2	4x SAS/SATA (B8L3)	2x NVMe (BDY6)	N	N	Y	Y	Y	Y	N	N	N	N	N	N	RAID 5350-8i/9350-8i + OB NVMe
2A-3	2							N	N	Y	Y	Y	Y	N	N	N	N	N	N	HBA 4350-8i + OB NVMe
2A-4	2							N	N	Y	Y	Y	Y	N	N	N	N	N	N	RAID 940-8i/540-8i + OB NVMe
2A-5	2							N	N	Y	Y	Y	Y	N	N	N	N	N	N	HBA 440-8i + OB NVMe
3-1	1 or 2	4	0	2	0	4x SAS/SATA (B8L3)	2x SATA (BQZX) (for OB SATA) or 2x SAS/SATA (B8MY)	N	N	Y	Y	Y	Y	N	N	N	N	N	N	OB SATA
3-2	1 or 2							N	N	Y	Y	Y	Y	N	N	N	N	N	N	RAID 5350-8i/9350-8i
3-3	1 or 2							N	N	Y	Y	Y	Y	N	N	N	N	N	N	HBA 4350-8i
3-4	1 or 2							N	N	Y	Y	Y	Y	N	N	N	N	N	N	RAID 940-8i/540-8i
3-5	1 or 2							N	N	Y	Y	Y	Y	N	N	N	N	N	N	HBA 440-8i
6S-2	1	0	4	0	0	4x AnyBay G4 (B8N1)	None	N	N	N	Y	Y	Y	N	Y	Y	Y	Y	Y	RAID 5350-8i/9350-8i + OB NVMe
6S-3	1							N	N	N	Y	Y	Y	N	Y	Y	Y	Y	Y	HBA 4350-8i + OB NVMe
6S-4	1							N	N	N	Y	Y	Y	N	Y	Y	Y	Y	Y	RAID 940-8i/540-8i + OB NVMe
6S-5	1							N	N	N	Y	Y	Y	N	Y	Y	Y	Y	Y	HBA 440-8i + OB NVMe
6-2	2	0	4	0	0	4x AnyBay G4 (B8N1)	None	N	N	Y	Y	Y	Y	Y	Y	Y	Y	Y	Y	RAID 5350-8i/9350-8i + OB NVMe
6-3	2							N	N	Y	Y	Y	Y	Y	Y	Y	Y	Y	Y	HBA 4350-8i + OB NVMe
6-4	2							N	N	Y	Y	Y	Y	Y	Y	Y	Y	Y	Y	RAID 940-8i/540-8i + OB NVMe
6-5	2							N	N	Y	Y	Y	Y	Y	Y	Y	Y	Y	Y	HBA 440-8i + OB NVMe
6-6	2							N	N	Y	Y	Y	Y	Y	Y	Y	Y	Y	Y	RAID 9350-16i + OB NVMe

Config	CPUs	Front		Rear	Front backplane	Rear backplane	M.2						7mm				Supported controllers				
		3.5"	2.5"				SAS/SATA	AnyBay	SAS/SATA	NVMe	M.2 x4 SATA/NVMe Non-RAID	M.2 x4 SATA/NVMe with SFF RAID	M.2 x1 SATA Non-RAID	M.2 x1 NVMe Non-RAID	M.2 NVMe RAID	M.2 SATA/NVMe RAID		7mm SATA Non-RAID	7mm NVMe Non-RAID	7mm NVMe RAID	7mm SATA/NVMe RAID
6-7	2						N	N	Y	Y	Y	Y	Y	Y	Y	Y	Y	Y	Y	Y	RAID 940-16i/540-16i + OB NVMe
11-1	2	2	2	0	0	2x SATA, 2x SATA/NVMe (BS7L)	None	N	N	Y	Y	Y	Y	Y	Y	Y	Y	Y	Y	Y	OB SATA + OB NVMe
11A-1	2	2	2	0	0	2x SATA, 2x SATA/NVMe (BS7L)	None	N	N	Y	Y	Y	Y	Y	Y	Y	Y	Y	Y	Y	OB SATA + OB NVMe
30-1	1 or 2	0	4	0	0	4x AnyBay G4 (B8N1)	None	N	N	Y	Y	Y	Y	Y	Y	Y	Y	Y	Y	Y	940-8i Tri-mode

Details - 2.5-inch front bays without front slots

The following table lists the detailed configurations that use 2.5-inch front drive bays without front PCIe slots.

Click to go back to the [overview of 2.5-inch configurations](#).

Return to [Storage configurations](#).

Table 21. Details - 2.5-inch front bays without front slots

Config	CPUs	Front 2.5"				Rear 2.5"		Front backplane	Rear backplane	M.2						7mm				Supported controllers			
		SAS/SATA	AnyBay	NVMe	EDSFF	SAS/SATA	NVMe			M.2 x4 SATA/NVMe Non-RAID	M.2 x4 SATA/NVMe with SFF RAID	M.2 x1 SATA Non-RAID	M.2 x1 NVMe Non-RAID	M.2 NVMe RAID	M.2 SATA/NVMe RAID	7mm SATA Non-RAID	7mm NVMe Non-RAID	7mm NVMe RAID	7mm SATA/NVMe RAID		7mm SATA with SFF RAID 5350-8i	7mm NVMe with SFF RAID 540-8i	
9-1	2	6	4	0	0	0	0	6x SAS/SATA, 4x AnyBay G4 (B8MX)	None	Y	Y	Y	Y	Y	Y	Y	Y	Y	Y	Y	Y	Y	RAID 9350-16i + OB NVMe
9-2	2									Y	Y	Y	Y	Y	Y	Y	Y	Y	Y	Y	Y	Y	HBA 4350-16i + OB NVMe

Config	CPUs	Front 2.5"				Rear 2.5"		Front backplane	Rear backplane	M.2						7mm			Supported controllers					
		SAS/SATA	AnyBay	NVMe	EDSFF	SAS/SATA	NVMe			M.2 x4 SATA/NVMe Non-RAID	M.2 x4 SATA/NVMe with SFF RAID	M.2 x1 SATA Non-RAID	M.2 x1 NVMe Non-RAID	M.2 NVMe RAID	M.2 SATA/NVMe RAID	7mm SATA Non-RAID	7mm NVMe Non-RAID	7mm NVMe RAID		7mm SATA/NVMe RAID	7mm SATA with SFF RAID 5350-8i	7mm NVMe with SFF RAID 540-8i		
9-3	2									Y	Y	Y	Y	Y	Y	Y	Y	Y	Y	Y	Y	Y	Y	RAID 940-16i/540-16i + OB NVMe
9-4	2									Y	Y	Y	Y	Y	Y	Y	Y	Y	Y	Y	Y	Y	Y	HBA 440-16i + OB NVMe
9-5	2									Y	Y	Y	Y	Y	Y	Y	Y	Y	Y	Y	Y	Y	Y	RAID 9350-16i CFF + OB NVMe
9-6	2									Y	Y	Y	Y	Y	Y	Y	Y	Y	Y	Y	Y	Y	Y	RAID 940-16i CFF + OB NVMe
9-7	2									Y	Y	Y	Y	Y	Y	Y	Y	Y	Y	Y	Y	Y	Y	HBA 440-16i CFF + OB NVMe
9H-1	2	6	4	0	0	0	0	6x SAS/SATA, 4x AnyBay G5 (BRQY)	None	N	Y	N	Y	Y	Y	Y	Y	Y	Y	Y	Y	Y	Y	RAID 9350-16i + OB NVMe
9H-2	2									N	Y	N	Y	Y	Y	Y	Y	Y	Y	Y	Y	Y	Y	HBA 4350-16i + OB NVMe
9H-3	2									N	Y	N	Y	Y	Y	Y	Y	Y	Y	Y	Y	Y	Y	RAID 940-16i/540-16i + OB NVMe
9H-4	2									N	Y	N	Y	Y	Y	Y	Y	Y	Y	Y	Y	Y	Y	HBA 440-16i + OB NVMe
9H-5	2									N	Y	N	Y	Y	Y	Y	Y	Y	Y	Y	Y	Y	Y	RAID 9350-16i CFF + OB NVMe
9H-6	2									N	Y	N	Y	Y	Y	Y	Y	Y	Y	Y	Y	Y	Y	RAID 940-16i CFF + OB NVMe
9H-7	2									N	Y	N	Y	Y	Y	Y	Y	Y	Y	Y	Y	Y	Y	HBA 440-16i CFF + OB NVMe
9W-1	2	6	4	0	0	0	0	6x SAS/SATA, 4x AnyBay G4 (B8MX)	None	N	N	N	N	N	N	N	Y	Y	Y	Y	Y	Y	Y	RAID 9350-16i + OB NVMe

Config	CPUs	Front 2.5"				Rear 2.5"		Front backplane	Rear backplane	M.2						7mm					Supported controllers	
		SAS/SATA	AnyBay	NVMe	EDSFF	SAS/SATA	NVMe			M.2 x4 SATA/NVMe Non-RAID	M.2 x4 SATA/NVMe with SFF RAID	M.2 x1 SATA Non-RAID	M.2 x1 NVMe Non-RAID	M.2 NVMe RAID	M.2 SATA/NVMe RAID	7mm SATA Non-RAID	7mm NVMe Non-RAID	7mm NVMe RAID	7mm SATA/NVMe RAID	7mm SATA with SFF RAID 5350-8i		7mm NVMe with SFF RAID 540-8i
9W-2	2									N	N	N	N	N	N	N	Y	Y	Y	Y	Y	HBA 4350-16i + OB NVMe
9W-3	2									N	N	N	N	N	N	N	Y	Y	Y	Y	Y	RAID 940-16i/540-16i + OB NVMe
9W-4	2									N	N	N	N	N	N	N	Y	Y	Y	Y	Y	HBA 440-16i + OB NVMe
9WH-1	2	6	4	0	0	0	0	6x SAS/SATA, 4x AnyBay G5 (BRQY)	None	N	N	N	N	N	N	N	Y	Y	Y	Y	Y	RAID 9350-16i + OB NVMe
9WH-2	2									N	N	N	N	N	N	N	Y	Y	Y	Y	Y	HBA 4350-16i + OB NVMe
9WH-3	2									N	N	N	N	N	N	N	Y	Y	Y	Y	Y	RAID 940-16i/540-16i + OB NVMe
9WH-4	2									N	N	N	N	N	N	N	Y	Y	Y	Y	Y	HBA 440-16i + OB NVMe
9S-1	1	6	4	0	0	0	0	6x SAS/SATA, 4x AnyBay G4 (B8MX)	None	N	Y	N	Y	Y	Y	N	Y	Y	Y	Y	Y	RAID 9350-16i + OB NVMe
9S-2	1									N	Y	N	Y	Y	Y	N	Y	Y	Y	Y	Y	HBA 4350-16i + OB NVMe
9S-3	1									N	Y	N	Y	Y	Y	N	Y	Y	Y	Y	Y	RAID 940-16i/540-16i + OB NVMe
9S-4	1									N	Y	N	Y	Y	Y	N	Y	Y	Y	Y	Y	HBA 440-16i + OB NVMe
9SH-1	1	6	4	0	0	0	0	6x SAS/SATA, 4x AnyBay G4 (B8MX)	None	N	Y	N	Y	Y	Y	N	Y	Y	Y	Y	Y	RAID 9350-16i + OB NVMe
9SH-2	1									N	Y	N	Y	Y	Y	N	Y	Y	Y	Y	Y	HBA 4350-16i + OB NVMe

Config	CPUs	Front 2.5"				Rear 2.5"		Front backplane	Rear backplane	M.2						7mm					Supported controllers		
		SAS/SATA	AnyBay	NVMe	EDSFF	SAS/SATA	NVMe			M.2 x4 SATA/NVMe Non-RAID	M.2 x4 SATA/NVMe with SFF RAID	M.2 x1 SATA Non-RAID	M.2 x1 NVMe Non-RAID	M.2 NVMe RAID	M.2 SATA/NVMe RAID	7mm SATA Non-RAID	7mm NVMe Non-RAID	7mm NVMe RAID	7mm SATA/NVMe RAID	7mm SATA with SFF RAID 5350-8i		7mm NVMe with SFF RAID 540-8i	
9SH-3	1									N	Y	N	Y	Y	Y	N	Y	Y	Y	Y	Y	Y	RAID 940-16i/540-16i + OB NVMe
9SH-4	1									N	Y	N	Y	Y	Y	N	Y	Y	Y	Y	Y	Y	HBA 440-16i + OB NVMe
10A-5	2	6	4	0	0	2	0	6x SAS/SATA, 4x AnyBay G4 (B8MX)	2x SAS/SATA (B8MY)	Y	Y	Y	Y	Y	Y	N	N	N	N	N	N	N	RAID 9350-16i CFF + OB NVMe
10A-6	2									Y	Y	Y	Y	Y	Y	N	N	N	N	N	N	N	RAID 940-16i CFF + OB NVMe
10A-7	2									Y	Y	Y	Y	Y	Y	N	N	N	N	N	N	N	HBA 440-16i CFF + OB NVMe
10AH-5	2	6	4	0	0	2	0	6x SAS/SATA, 4x AnyBay G5 (BRQY)	2x SAS/SATA (B8MY)	N	Y	N	Y	Y	Y	N	N	N	N	N	N	N	RAID 9350-16i CFF + OB NVMe
10AH-6	2									N	Y	N	Y	Y	Y	N	N	N	N	N	N	N	RAID 940-16i CFF + OB NVMe
10AH-7	2									N	Y	N	Y	Y	Y	N	N	N	N	N	N	N	HBA 440-16i CFF + OB NVMe
12S-1	1	6	2	2	0	0	0	6x SAS/SATA, 2x AnyBay, 2x NVMe G4 (BCQP)	None	N	Y	N	Y	Y	Y	N	Y	Y	Y	Y	Y	Y	RAID 5350-8i/9350-8i + OB NVMe
12S-2	1									N	Y	N	Y	Y	Y	N	Y	Y	Y	Y	Y	Y	HBA 4350-8i + OB NVMe
12S-3	1									N	Y	N	Y	Y	Y	N	Y	Y	Y	Y	Y	Y	RAID 940-8i/540-8i + OB NVMe
12S-4	1									N	Y	N	Y	Y	Y	N	Y	Y	Y	Y	Y	Y	HBA 440-8i + OB NVMe
12SH-1	1	6	2	2	0	0	0	6x SAS/SATA, 2x AnyBay, 2x NVMe G5 (BU1W)	None	N	Y	N	Y	Y	Y	N	Y	Y	Y	Y	Y	Y	RAID 5350-8i/9350-8i + OB NVMe

Config	CPUs	Front 2.5"				Rear 2.5"		Front backplane	Rear backplane	M.2						7mm					Supported controllers	
		SAS/SATA	AnyBay	NVMe	EDSFF	SAS/SATA	NVMe			M.2 x4 SATA/NVMe Non-RAID	M.2 x4 SATA/NVMe with SFF RAID	M.2 x1 SATA Non-RAID	M.2 x1 NVMe Non-RAID	M.2 NVMe RAID	M.2 SATA/NVMe RAID	7mm SATA Non-RAID	7mm NVMe Non-RAID	7mm NVMe RAID	7mm SATA/NVMe RAID	7mm SATA with SFF RAID 5350-8i		7mm NVMe with SFF RAID 540-8i
12SH-2	1									N	Y	N	Y	Y	Y	N	Y	Y	Y	Y	Y	HBA 4350-8i + OB NVMe
12SH-3	1									N	Y	N	Y	Y	Y	N	Y	Y	Y	Y	Y	RAID 940-8i/540-8i + OB NVMe
12SH-4	1									N	Y	N	Y	Y	Y	N	Y	Y	Y	Y	Y	HBA 440-8i + OB NVMe
12W-1	2	6	2	2	0	0	0	6x SAS/SATA, 2x AnyBay, 2x NVMe G4 (BCQP)	None	N	N	N	N	N	N	N	Y	Y	Y	Y	Y	RAID 5350-8i/9350-8i + OB NVMe
12W-2	2									N	N	N	N	N	N	N	Y	Y	Y	Y	Y	HBA 4350-8i + OB NVMe
12W-3	2									N	N	N	N	N	N	N	Y	Y	Y	Y	Y	RAID 940-8i/540-8i + OB NVMe
12W-4	2									N	N	N	N	N	N	N	Y	Y	Y	Y	Y	HBA 440-8i + OB NVMe
12WH-1	2	6	2	2	0	0	0	6x SAS/SATA, 2x AnyBay, 2x NVMe G5 (BU1W)	None	N	N	N	N	N	N	N	Y	Y	Y	Y	Y	RAID 5350-8i/9350-8i + OB NVMe
12WH-2	2									N	N	N	N	N	N	N	Y	Y	Y	Y	Y	HBA 4350-8i + OB NVMe
12WH-3	2									N	N	N	N	N	N	N	Y	Y	Y	Y	Y	RAID 940-8i/540-8i + OB NVMe
12WH-4	2									N	N	N	N	N	N	N	Y	Y	Y	Y	Y	HBA 440-8i + OB NVMe
12B-2	2	6	2	2	0	0	0	6x SAS/SATA, 2x AnyBay, 2x NVMe G4 (BCQP)	None	Y	Y	Y	Y	Y	Y	Y	Y	Y	Y	Y	Y	RAID 5350-8i/9350-8i + OB NVMe
12B-3	2									Y	Y	Y	Y	Y	Y	Y	Y	Y	Y	Y	Y	HBA 4350-8i + OB NVMe

Config	CPUs	Front 2.5"				Rear 2.5"		Front backplane	Rear backplane	M.2						7mm			Supported controllers					
		SAS/SATA	AnyBay	NVMe	EDSFF	SAS/SATA	NVMe			M.2 x4 SATA/NVMe Non-RAID	M.2 x4 SATA/NVMe with SFF RAID	M.2 x1 SATA Non-RAID	M.2 x1 NVMe Non-RAID	M.2 NVMe RAID	M.2 SATA/NVMe RAID	7mm SATA Non-RAID	7mm NVMe Non-RAID	7mm NVMe RAID		7mm SATA/NVMe RAID	7mm SATA with SFF RAID 5350-8i	7mm NVMe with SFF RAID 540-8i		
12B-4	2									Y	Y	Y	Y	Y	Y	Y	Y	Y	Y	Y	Y	Y	Y	RAID 940-8i/540-8i + OB NVMe
12B-5	2									Y	Y	Y	Y	Y	Y	Y	Y	Y	Y	Y	Y	Y	Y	HBA 440-8i + OB NVMe
12B-6	2									Y	Y	Y	Y	Y	Y	Y	Y	Y	Y	Y	Y	Y	Y	RAID 5350-8i/9350-8i CFF + OB NVMe
12BH-2	2	6	2	2	0	0	0	6x SAS/SATA, 2x AnyBay, 2x NVMe G5 (BU1W)	None	N	Y	N	Y	Y	Y	N	Y	Y	Y	Y	Y	Y	Y	RAID 5350-8i/9350-8i + OB NVMe
12BH-3	2									N	Y	N	Y	Y	Y	N	Y	Y	Y	Y	Y	Y	Y	HBA 4350-8i + OB NVMe
12BH-4	2									N	Y	N	Y	Y	Y	N	Y	Y	Y	Y	Y	Y	Y	RAID 940-8i/540-8i + OB NVMe
12BH-5	2									N	Y	N	Y	Y	Y	N	Y	Y	Y	Y	Y	Y	Y	HBA 440-8i + OB NVMe
12BH-6	2									N	Y	N	Y	Y	Y	N	Y	Y	Y	Y	Y	Y	Y	RAID 5350-8i/9350-8i CFF + OB NVMe
13-11	1	10	0	0	0	0	0	10x SAS/SATA (BHU8)	None	N	N	N	N	N	N	N	N	N	N	N	N	N	N	HBA 440-16i CFF
13W-2	2	10	0	0	0	0	0	10x SAS/SATA (BHU8)	None	N	N	N	N	N	N	N	Y	Y	Y	Y	Y	Y	Y	RAID 9350-16i
13W-3	2									N	N	N	N	N	N	N	Y	Y	Y	Y	Y	Y	Y	HBA 4350-16i
13W-4	2									N	N	N	N	N	N	N	Y	Y	Y	Y	Y	Y	Y	RAID 940-16i/540-16i
13W-5	2									N	N	N	N	N	N	N	Y	Y	Y	Y	Y	Y	Y	HBA 440-16i
13A-1	1 or 2	10	0	0	0	0	0	10x SAS/SATA (BHU8)	None	N	Y	Y	Y	Y	Y	N	Y	Y	Y	Y	Y	Y	Y	OB SATA
13A-2	1 or 2									Y	Y	Y	Y	Y	Y	Y	Y	Y	Y	Y	Y	Y	Y	RAID 9350-16i

Config	CPUs	Front 2.5"				Rear 2.5"		Front backplane	Rear backplane	M.2						7mm			Supported controllers			
		SAS/SATA	AnyBay	NVMe	EDSFF	SAS/SATA	NVMe			M.2 x4 SATA/NVMe Non-RAID	M.2 x4 SATA/NVMe with SFF RAID	M.2 x1 SATA Non-RAID	M.2 x1 NVMe Non-RAID	M.2 NVMe RAID	M.2 SATA/NVMe RAID	7mm SATA Non-RAID	7mm NVMe Non-RAID	7mm NVMe RAID		7mm SATA/NVMe RAID	7mm SATA with SFF RAID 5350-8i	7mm NVMe with SFF RAID 540-8i
13A-3	1 or 2									Y	Y	Y	Y	Y	Y	Y	Y	Y	Y	Y	Y	HBA 4350-16i
13A-4	1 or 2									Y	Y	Y	Y	Y	Y	Y	Y	Y	Y	Y	Y	RAID 940-16i/540-16i
13A-5	1 or 2									Y	Y	Y	Y	Y	Y	Y	Y	Y	Y	Y	Y	HBA 440-16i
13A-6	2									Y	Y	Y	Y	Y	Y	Y	Y	Y	Y	Y	Y	RAID 9350-16i CFF
13A-7	2									Y	Y	Y	Y	Y	Y	Y	Y	Y	Y	Y	Y	RAID 940-16i CFF
13A-8	2									Y	Y	Y	Y	Y	Y	Y	Y	Y	Y	Y	Y	HBA 440-16i CFF
13A-9	1									Y	Y	Y	Y	Y	Y	Y	Y	Y	Y	Y	Y	RAID 9350-16i CFF
13A-10	1									Y	Y	Y	Y	Y	Y	Y	Y	Y	Y	Y	Y	RAID 940-16i CFF
13A-11	1									Y	Y	Y	Y	Y	Y	Y	Y	Y	Y	Y	Y	HBA 440-16i CFF
14A-1	2	10	0	0	0	2	0	10x SAS/SATA (BHU8)	2x SATA (BQZX) (for OB SATA) or 2x SAS/SATA (B8MY)	N	Y	Y	Y	Y	Y	N	N	N	N	N	N	OB SATA
14A-2	1 or 2									Y	Y	Y	Y	Y	Y	N	N	N	N	N	N	RAID 9350-16i
14A-3	1 or 2									Y	Y	Y	Y	Y	Y	N	N	N	N	N	N	HBA 4350-16i
14A-4	1 or 2									Y	Y	Y	Y	Y	Y	N	N	N	N	N	N	RAID 940-16i/540-16i
14A-5	1 or 2									Y	Y	Y	Y	Y	Y	N	N	N	N	N	N	HBA 440-16i
14A-6	2									Y	Y	Y	Y	Y	Y	N	N	N	N	N	N	RAID 9350-16i CFF
14A-7	2									Y	Y	Y	Y	Y	Y	N	N	N	N	N	N	RAID 940-16i CFF
14A-8	2									Y	Y	Y	Y	Y	Y	N	N	N	N	N	N	HBA 440-16i CFF
14A-9	1									Y	Y	Y	Y	Y	Y	N	N	N	N	N	N	RAID 9350-16i CFF
14A-10	1									Y	Y	Y	Y	Y	Y	N	N	N	N	N	N	RAID 940-16i CFF
14A-11	1									Y	Y	Y	Y	Y	Y	N	N	N	N	N	N	HBA 440-16i CFF

Config	CPUs	Front 2.5"				Rear 2.5"		Front backplane	Rear backplane	M.2						7mm						Supported controllers
		SAS/SATA	AnyBay	NVMe	EDSFF	SAS/SATA	NVMe			M.2 x4 SATA/NVMe Non-RAID	M.2 x4 SATA/NVMe with SFF RAID	M.2 x1 SATA Non-RAID	M.2 x1 NVMe Non-RAID	M.2 NVMe RAID	M.2 SATA/NVMe RAID	7mm SATA Non-RAID	7mm NVMe Non-RAID	7mm NVMe RAID	7mm SATA/NVMe RAID	7mm SATA with SFF RAID 5350-8i	7mm NVMe with SFF RAID 540-8i	
15-1	2	10	0	0	0	0	2	10x SAS/SATA (BHU8)	2x NVMe (BDY6)	N	Y	Y	Y	Y	Y	N	N	N	N	N	N	OB SATA + OB NVMe
15-2	2									Y	Y	Y	Y	Y	Y	N	N	N	N	N	N	RAID 9350-16i + OB NVMe
15-3	2									Y	Y	Y	Y	Y	Y	N	N	N	N	N	N	HBA 4350-16i + OB NVMe
15-4	2									Y	Y	Y	Y	Y	Y	N	N	N	N	N	N	RAID 940-16i/540-16i + OB NVMe
15-5	2									Y	Y	Y	Y	Y	Y	N	N	N	N	N	N	HBA 440-16i + OB NVMe
15-6	2									Y	Y	Y	Y	Y	Y	N	N	N	N	N	N	RAID 9350-16i CFF + OB NVMe
15-7	2									Y	Y	Y	Y	Y	Y	N	N	N	N	N	N	RAID 940-16i CFF + OB NVMe
15-8	2									Y	Y	Y	Y	Y	Y	N	N	N	N	N	N	HBA 440-16i CFF + OB NVMe
17-1	2	10	0	0	0	0	0	10x SAS/SATA (BHU8)	None	N	Y	Y	Y	Y	Y	Y	Y	Y	Y	Y	Y	OB SATA
18-1	2	0	10	0	0	0	0	10x AnyBay G4 (BB3T)	None	Y	Y	Y	Y	Y	Y	Y	Y	Y	Y	Y	Y	RAID 9350-16i + OB NVMe
18-2	2									Y	Y	Y	Y	Y	Y	Y	Y	Y	Y	Y	Y	HBA 4350-16i + OB NVMe
18-3	2									Y	Y	Y	Y	Y	Y	Y	Y	Y	Y	Y	Y	RAID 940-16i/540-16i + OB NVMe
18-4	2									Y	Y	Y	Y	Y	Y	Y	Y	Y	Y	Y	Y	HBA 440-16i + OB NVMe
18H-1	2	0	10	0	0	0	0	10x AnyBay G5 (BLKC)	None	N	Y	N	Y	Y	Y	N	Y	Y	Y	Y	Y	RAID 9350-16i + OB NVMe

Config	CPUs	Front 2.5"				Rear 2.5"		Front backplane	Rear backplane	M.2						7mm			Supported controllers			
		SAS/SATA	Any Bay	NVMe	EDSFF	SAS/SATA	NVMe			M.2 x4 SATA/NVMe Non-RAID	M.2 x4 SATA/NVMe with SFF RAID	M.2 x1 SATA Non-RAID	M.2 x1 NVMe Non-RAID	M.2 NVMe RAID	M.2 SATA/NVMe RAID	7mm SATA Non-RAID	7mm NVMe Non-RAID	7mm NVMe RAID		7mm SATA/NVMe RAID	7mm SATA with SFF RAID 5350-8i	7mm NVMe with SFF RAID 540-8i
18H-2	2									N	Y	N	Y	Y	Y	N	Y	Y	Y	Y	Y	HBA 4350-16i + OB NVMe
18H-3	2									N	Y	N	Y	Y	Y	N	Y	Y	Y	Y	Y	RAID 940-16i/540-16i + OB NVMe
18H-4	2									N	Y	N	Y	Y	Y	N	Y	Y	Y	Y	Y	HBA 440-16i + OB NVMe
21-1	1 or 2	8	0	0	0	0	0	8x SAS/SATA (B8N0)	None	Y	Y	Y	Y	Y	Y	Y	Y	Y	Y	Y	Y	OB SATA
21-2	1 or 2									Y	Y	Y	Y	Y	Y	Y	Y	Y	Y	Y	Y	RAID 5350-8i/9350-8i
21-3	1 or 2									Y	Y	Y	Y	Y	Y	Y	Y	Y	Y	Y	Y	HBA 4350-8i
21-4	1 or 2									Y	Y	Y	Y	Y	Y	Y	Y	Y	Y	Y	Y	RAID 940-8i/540-8i
21-5	1 or 2									Y	Y	Y	Y	Y	Y	Y	Y	Y	Y	Y	Y	HBA 440-8i
21-6	1 or 2									Y	Y	Y	Y	Y	Y	Y	Y	Y	Y	Y	Y	RAID 9350-16i
21-7	1 or 2									Y	Y	Y	Y	Y	Y	Y	Y	Y	Y	Y	Y	RAID 940-16i/540-16i
21-8	2									Y	Y	Y	Y	Y	Y	Y	Y	Y	Y	Y	Y	RAID 9350-16i CFF
21-9	2									Y	Y	Y	Y	Y	Y	Y	Y	Y	Y	Y	Y	RAID 940-16i CFF
21-10	2									Y	Y	Y	Y	Y	Y	Y	Y	Y	Y	Y	Y	HBA 440-16i CFF
21-11	2									Y	Y	Y	Y	Y	Y	Y	Y	Y	Y	Y	Y	RAID 5350-8i/9350-8i CFF
21A-1	1	8	0	0	0	0	0	8x SAS/SATA (B8N0)	None	Y	Y	Y	Y	Y	Y	Y	Y	Y	Y	Y	Y	RAID 9350-16i CFF
21A-2	1									Y	Y	Y	Y	Y	Y	Y	Y	Y	Y	Y	Y	RAID 940-16i CFF
21A-3	1									Y	Y	Y	Y	Y	Y	Y	Y	Y	Y	Y	Y	HBA 440-16i CFF
21A-4	1									Y	Y	Y	Y	Y	Y	Y	Y	Y	Y	Y	Y	RAID 5350-8i/9350-8i CFF

Config	CPUs	Front 2.5"				Rear 2.5"		Front backplane	Rear backplane	M.2						7mm					Supported controllers	
		SAS/SATA	AnyBay	NVMe	EDSFF	SAS/SATA	NVMe			M.2 x4 SATA/NVMe Non-RAID	M.2 x4 SATA/NVMe with SFF RAID	M.2 x1 SATA Non-RAID	M.2 x1 NVMe Non-RAID	M.2 NVMe RAID	M.2 SATA/NVMe RAID	7mm SATA Non-RAID	7mm NVMe Non-RAID	7mm NVMe RAID	7mm SATA/NVMe RAID	7mm SATA with SFF RAID 5350-8i		7mm NVMe with SFF RAID 540-8i
21W-1	2	8	0	0	0	0	0	8x SAS/SATA (B8N0)	None	N	N	N	N	N	N	N	Y	Y	Y	Y	Y	OB SATA
21W-2	2									N	N	N	N	N	N	N	Y	Y	Y	Y	Y	RAID 5350-8i/9350-8i
21W-3	2									N	N	N	N	N	N	N	Y	Y	Y	Y	Y	HBA 4350-8i
21W-4	2									N	N	N	N	N	N	N	Y	Y	Y	Y	Y	RAID 940-8i/540-8i
21W-5	2									N	N	N	N	N	N	N	Y	Y	Y	Y	Y	HBA 440-8i
21W-6	2									N	N	N	N	N	N	N	Y	Y	Y	Y	Y	RAID 9350-16i
21-7	2									N	N	N	N	N	N	N	Y	Y	Y	Y	Y	RAID 940-16i/540-16i
25-1	2	0	0	0	16	0	0	16x EDSFF (B981)	None	N	N	N	Y	Y	Y	N	Y	Y	Y	Y	Y	Retimer
26-1	1 or 2	4	0	0	0	0	0	4x SAS/SATA (BCGB)	None	N	Y	Y	Y	Y	Y	Y	Y	Y	Y	Y	Y	OB SATA
26-2	1 or 2									N	Y	Y	Y	Y	Y	Y	Y	Y	Y	Y	Y	RAID 5350-8i/9350-8i
26-3	1 or 2									N	Y	Y	Y	Y	Y	Y	Y	Y	Y	Y	Y	HBA 4350-8i
26-4	1 or 2									N	Y	Y	Y	Y	Y	Y	Y	Y	Y	Y	Y	RAID 940-8i/540-8i
26-5	1 or 2									N	Y	Y	Y	Y	Y	Y	Y	Y	Y	Y	Y	HBA 440-8i
26W-1	2	4	0	0	0	0	0	4x SAS/SATA (BCGB)	None	N	N	N	N	N	N	N	Y	Y	Y	Y	Y	OB SATA
26W-2	2									N	N	N	N	N	N	N	Y	Y	Y	Y	Y	RAID 5350-8i/9350-8i
26W-3	2									N	N	N	N	N	N	N	Y	Y	Y	Y	Y	HBA 4350-8i
26W-4	2									N	N	N	N	N	N	N	Y	Y	Y	Y	Y	RAID 940-8i/540-8i
26W-5	2									N	N	N	N	N	N	N	Y	Y	Y	Y	Y	HBA 440-8i
28-1	2	0	0	10	0	0	0	10x NVMe G4 (BCQQ)	None	Y	Y	Y	Y	Y	Y	Y	Y	Y	Y	Y	Y	OB NVMe
28H-1	2	0	0	10	0	0	0	10x NVMe G5 (BRQX)	None	N	Y	N	Y	Y	Y	Y	Y	Y	Y	Y	Y	OB NVMe
28A-1	2	0	0	10	0	0	2	10x NVMe G4 (BCQQ)	2x NVMe (BDY6)	Y	Y	Y	Y	Y	Y	N	N	N	N	N	N	OB NVMe
28AH-1	2	0	0	10	0	0	2	10x NVMe G5 (BRQX)	2x NVMe (BDY6)	N	Y	N	Y	Y	Y	N	N	N	N	N	N	OB NVMe

Config	CPUs	Front 2.5"				Rear 2.5"		Front backplane	Rear backplane	M.2						7mm					Supported controllers		
		SAS/SATA	AnyBay	NVMe	EDSFF	SAS/SATA	NVMe			M.2 x4 SATA/NVMe Non-RAID	M.2 x4 SATA/NVMe with SFF RAID	M.2 x1 SATA Non-RAID	M.2 x1 NVMe Non-RAID	M.2 NVMe RAID	M.2 SATA/NVMe RAID	7mm SATA Non-RAID	7mm NVMe Non-RAID	7mm NVMe RAID	7mm SATA/NVMe RAID	7mm SATA with SFF RAID 5350-8i		7mm NVMe with SFF RAID 540-8i	
28W-1	2	0	0	10	0	0	0	10x NVMe G4 (BCQQ)	None	N	N	N	N	N	N	N	Y	Y	Y	Y	Y	Y	OB NVMe
28WH-1	2	0	0	10	0	0	0	10x NVMe G5 (BRQX)	None	N	N	N	N	N	N	N	Y	Y	Y	Y	Y	Y	OB NVMe
29-1	1 or 2	0	8	0	0	0	0	10x AnyBay G4 (BB3T)	None	N	Y	Y	Y	Y	Y	Y	Y	Y	Y	Y	Y	Y	940-8i Tri-mode
29W-1	2	0	8	0	0	0	0	10x AnyBay G4 (BB3T)	None	N	N	N	N	N	N	N	Y	Y	Y	Y	Y	Y	940-8i Tri-mode
29A-1	1 or 2	0	10	0	0	0	0	10x AnyBay G4 (BB3T)	None	N	Y	Y	Y	Y	Y	Y	Y	Y	Y	Y	Y	Y	940-16i Tri-mode
29AW-1	2	0	10	0	0	0	0	10x AnyBay G4 (BB3T)	None	N	N	N	N	N	N	N	Y	Y	Y	Y	Y	Y	940-16i Tri-mode
45-1	2	0	0	4	0	0	0	4x NVMe G4 (BT1N)	None	N	Y	Y	Y	Y	Y	Y	Y	Y	Y	Y	Y	Y	OB NVMe
45W-1	2	0	0	4	0	0	0	4x NVMe G4 (BT1N)	None	N	N	N	N	N	N	N	Y	Y	Y	Y	Y	Y	OB NVMe
46-1	2	0	0	4	0	0	0	4x NVMe G4 (BPC9)	None	N	Y	Y	Y	Y	Y	Y	Y	Y	Y	Y	Y	Y	OB NVMe
46W-1	2	0	0	4	0	0	0	4x NVMe G4 (BPC9)	None	N	N	N	N	N	N	N	Y	Y	Y	Y	Y	Y	OB NVMe
45S-1	1	0	0	4	0	0	0	4x NVMe G4 (BT1N)	None	N	Y	N	Y	Y	Y	N	Y	Y	Y	Y	Y	Y	OB NVMe
46S-1	1	0	0	4	0	0	0	4x NVMe G4 (BPC9)	None	N	Y	N	Y	Y	Y	N	Y	Y	Y	Y	Y	Y	OB NVMe

Details - 2.5-inch front bays with front slots

The following table lists the detailed configurations that use 2.5-inch front drive bays without front PCIe slots.

Click to go back to the [overview of 2.5-inch configurations](#).

Return to [Storage configurations](#).

Table 22. Details - 2.5-inch front bays with front slots

Config	CPUs	Front 2.5"				Rear 2.5"		Front backplane	Rear backplane	M.2						7mm				Supported controllers		
		SAS/SATA	AnyBay	NVMe	EDSFF	SAS/SATA	NVMe			M.2 x4 SATA/NVMe Non-RAID	M.2 x4 SATA/NVMe with SFF RAID	M.2 x1 SATA Non-RAID	M.2 x1 NVMe Non-RAID	M.2 NVMe RAID	M.2 SATA/NVMe RAID	7mm SATA Non-RAID	7mm NVMe Non-RAID	7mm NVMe RAID	7mm SATA/NVMe RAID		7mm SATA with SFF RAID 5350-8i	7mm NVMe with SFF RAID 540-8i
31-1	2	0	4	0	0	0	0	4x AnyBay G4 (BT1P)	None	N	N	N	N	N	N	N	Y	Y	Y	Y	Y	RAID 5350-8i/9350-8i + OB NVMe
31-2	2									N	N	N	N	N	N	N	Y	Y	Y	Y	Y	HBA 4350-8i + OB NVMe
31-3	2									N	N	N	N	N	N	N	Y	Y	Y	Y	Y	RAID 940-8i/540-8i + OB NVMe
31-4	2									N	N	N	N	N	N	N	Y	Y	Y	Y	Y	HBA 440-8i + OB NVMe
32-1	2	0	4	0	0	0	2	4x AnyBay G4 (BT1P)	2x NVMe (BDY6)	N	N	N	N	N	N	N	N	N	N	N	N	RAID 5350-8i/9350-8i + OB NVMe
32-2	2									N	N	N	N	N	N	N	N	N	N	N	N	HBA 4350-8i + OB NVMe
32-3	2									N	N	N	N	N	N	N	N	N	N	N	N	RAID 940-8i/540-8i + OB NVMe
32-4	2									N	N	N	N	N	N	N	N	N	N	N	N	HBA 440-8i + OB NVMe
33-1	2	0	4	0	0	2	0	4x AnyBay G4 (BT1P)	2x SAS/SATA (B8MY)	N	N	N	N	N	N	N	N	N	N	N	N	RAID 5350-8i/9350-8i + OB NVMe
33-2	2									N	N	N	N	N	N	N	N	N	N	N	N	HBA 4350-8i + OB NVMe
33-3	2									N	N	N	N	N	N	N	N	N	N	N	N	RAID 940-8i/540-8i + OB NVMe
33-4	2									N	N	N	N	N	N	N	N	N	N	N	N	HBA 440-8i + OB NVMe
35-1	2	0	4	0	0	0	0	4x AnyBay G4 (BT1P)	None	N	N	N	N	N	N	N	Y	Y	Y	Y	Y	RAID 5350-8i/9350-8i + OB NVMe
35-2	2									N	N	N	N	N	N	N	Y	Y	Y	Y	Y	HBA 4350-8i + OB NVMe
35-3	2									N	N	N	N	N	N	N	Y	Y	Y	Y	Y	RAID 940-8i/540-8i + OB NVMe
35-4	2									N	N	N	N	N	N	N	Y	Y	Y	Y	Y	HBA 440-8i + OB NVMe
36-1	2	0	4	0	0	0	2	4x AnyBay G4 (BT1P)	2x NVMe (BDY6)	N	N	N	N	N	N	N	N	N	N	N	N	RAID 5350-8i/9350-8i + OB NVMe

Config	CPUs	Front 2.5"				Rear 2.5"		Front backplane	Rear backplane	M.2						7mm				Supported controllers					
		SAS/SATA	AnyBay	NVMe	EDSFF	SAS/SATA	NVMe			M.2 x4 SATA/NVMe Non-RAID	M.2 x4 SATA/NVMe with SFF RAID	M.2 x1 SATA Non-RAID	M.2 x1 NVMe Non-RAID	M.2 NVMe RAID	M.2 SATA/NVMe RAID	7mm SATA Non-RAID	7mm NVMe Non-RAID	7mm NVMe RAID	7mm SATA/NVMe RAID		7mm SATA with SFF RAID 5350-8i	7mm NVMe with SFF RAID 540-8i			
36-2	2									N	N	N	N	N	N	N	N	N	N	N	N	N	N	N	HBA 4350-8i + OB NVMe
36-3	2									N	N	N	N	N	N	N	N	N	N	N	N	N	N	N	RAID 940-8i/540-8i + OB NVMe
36-4	2									N	N	N	N	N	N	N	N	N	N	N	N	N	N	N	HBA 440-8i + OB NVMe
37-1	2	0	4	0	0	2	0	4x AnyBay G4 (BT1P)	2x SAS/SATA (B8MY)	N	N	N	N	N	N	N	N	N	N	N	N	N	N	N	RAID 5350-8i/9350-8i + OB NVMe
37-2	2									N	N	N	N	N	N	N	N	N	N	N	N	N	N	N	HBA 4350-8i + OB NVMe
37-3	2									N	N	N	N	N	N	N	N	N	N	N	N	N	N	N	RAID 940-8i/540-8i + OB NVMe
37-4	2									N	N	N	N	N	N	N	N	N	N	N	N	N	N	N	HBA 440-8i + OB NVMe
39-1	2	0	0	4	0	0	0	4x NVMe G4 (BT1Q)	None	N	N	N	N	N	N	N	N	Y	Y	Y	Y	Y	Y	Y	OB NVMe
39-2	2	0	0	4	0	0	2	4x NVMe G4 (BT1Q)	2x NVMe (BDY6)	N	N	N	N	N	N	N	N	N	N	N	N	N	N	N	OB NVMe
40-1	2	0	0	4	0	0	0	4x NVMe G4 (BT1Q)	None	N	N	N	N	N	N	N	N	N	Y	Y	Y	Y	Y	Y	OB NVMe
40-2	2	0	0	4	0	0	2	4x NVMe G4 (BT1Q)	2x NVMe (BDY6)	N	N	N	N	N	N	N	N	N	N	N	N	N	N	N	OB NVMe
41-1	2	0	0	2	0	0	0	2x NVMe G4 (BU19)	None	N	N	N	N	N	N	N	N	N	Y	Y	Y	Y	Y	Y	OB NVMe
41-2	2	0	0	2	0	0	2	2x NVMe G4 (BU19)	2x NVMe (BDY6)	N	N	N	N	N	N	N	N	N	N	N	N	N	N	N	OB NVMe
44-1	2	0	0	4	0	0	0	4x NVMe G4 (BV8J)	None	N	N	N	N	N	N	N	N	N	Y	Y	Y	Y	Y	Y	OB NVMe
44-2	2	0	0	4	0	0	2	4x NVMe G4 (BV8J)	2x NVMe (BDY6)	N	N	N	N	N	N	N	N	N	N	N	N	N	N	N	OB NVMe

Field upgrades for drive bays

The SR645 V3 is orderable without drive bays, allowing you to add a backplane, cabling and controllers as field upgrades. Rear backplane kits included cables, however for front drive bays, the backplane kits do not include cables and must be ordered separately. The following table summarizes the option part numbers you will need to order for each available drive configuration.

For more information about the backplane kits and cable kits, see the Lenovo Server Options site: https://serveroption.lenovo.com/cable_kit_options/

Tip: There is no upgrade path to add drive bays if the SR645 V3 already has a backplane, without removing the existing backplane. For example, you cannot upgrade a 4x 2.5-inch drive bay to 8 bays without first removing the existing backplane.

Table 23. Front drive bay field upgrades for servers without drive bays

Desired drive configuration (starting from zero bays)	Backplane and cable kits required
Front drive bays - 3.5-inch	
4x 3.5-inch SAS/SATA	<ol style="list-style-type: none"> 4XH7A83854, ThinkSystem V3 1U 4x3.5" SAS/SATA Backplane Option Kit 4X97A84609, ThinkSystem SR645 V3 4x3.5" SAS/SATA Backplane Cable Option kit
4x 3.5-inch AnyBay or 4x 3.5-inch (2x SATA, 2x NVMe/SATA)	<ol style="list-style-type: none"> 4XH7A83853, ThinkSystem V3 1U 4x3.5" AnyBay Backplane Option Kit 4X97A84610, ThinkSystem SR645 V3 4x3.5" AnyBay Backplane SAS/SATA Cable Option Kit 4X97A84611, ThinkSystem SR645 V3 4x3.5" AnyBay Backplane PCIe Cable Option Kit
Front drive bays - 2.5-inch	
4x 2.5-inch SAS/SATA	<ol style="list-style-type: none"> 4XH7A83855, ThinkSystem V3 1U 4x2.5" SAS/SATA Backplane Option Kit 4X97A84620, ThinkSystem SR645 V3 4x2.5" SAS/SATA Backplane Cable Option Kit
4x 2.5-inch NVMe G4	<ol style="list-style-type: none"> 4XH7A83852, ThinkSystem V3 1U 4x2.5" NVMe Backplane Option Kit 4X97A87042, ThinkSystem SR645 V3 4x2.5" NVMe Gen4 Cable Option Kit
4x 2.5-inch NVMe G5	<ol style="list-style-type: none"> 4XH7A86277, ThinkSystem V3 1U 4x2.5" NVMe Backplane Gen5 Option Kit 4X97A86276, ThinkSystem SR645 V3 4x2.5" NVMe Backplane PCIe Gen5 Cable Option Kit
8x 2.5-inch SAS/SATA	<ol style="list-style-type: none"> 4XH7A83850, ThinkSystem V3 1U 8x2.5" SAS/SATA Backplane Option Kit 4X97A84613, ThinkSystem SR645 V3 8x2.5" SAS/SATA Backplane Cable Option Kit
10x 2.5-inch SAS/SATA	<ol style="list-style-type: none"> 4XH7A83858, ThinkSystem V3 1U 10x2.5" SAS/SATA Backplane Option Kit 4X97A84619, ThinkSystem SR645 V3 10x2.5" SAS/SATA Backplane Cable Option Kit
10x 2.5-inch (6x SAS/SATA + 4x AnyBay) or (6x SAS/SATA + 2x AnyBay + 2x NVMe)	<ol style="list-style-type: none"> 4XH7A83856, ThinkSystem V3 1U 6x2.5" SAS/SATA+ 4xAnyBay Backplane Option Kit 4X97A84617, ThinkSystem SR645 V3 6x2.5" SAS/SATA+ 4xAnyBay Backplane Cable Option Kit
10x 2.5-inch AnyBay G4	<ol style="list-style-type: none"> 4XH7A83859, ThinkSystem V3 1U 10x2.5" AnyBay Backplane Option Kit 4X97A84615, ThinkSystem SR645 V3 Gen4 10x2.5" AnyBay Backplane SAS/SATA Cable Option Kit 4X97A84614, ThinkSystem SR645 V3 Gen4 10x2.5" AnyBay Backplane PCIe Cable Option Kit
10x 2.5-inch AnyBay G5	<ol style="list-style-type: none"> 4XH7A83851, ThinkSystem V3 1U 10x2.5" AnyBay Backplane Gen5 Option Kit 4X97A87600, ThinkSystem SR645 V3 10x2.5" AnyBay Backplane SAS/SATA Gen5 Cable Option Kit 4X97A87601, ThinkSystem SR645 V3 10x2.5" AnyBay Backplane NVMe Gen5 Cable Option Kit
Rear drive bays - 2.5-inch	

Desired drive configuration (starting from zero bays)	Backplane and cable kits required
2x 2.5-inch SAS/SATA	<ol style="list-style-type: none"> 1. 4XH7A83860, ThinkSystem V3 1U 2x2.5" SAS/SATA Backplane Option Kit 2. 4X97A84624, ThinkSystem SR645 V3 2x 2.5" SAS/SATA Rear Backplane Cable Option Kit
2x 2.5-inch NVMe	<ol style="list-style-type: none"> 1. 4XH7A83861, ThinkSystem V3 1U Rear 2x2.5" NVMe Backplane Option Kit 2. 4X97A84623, ThinkSystem SR645 V3 2x 2.5" Rear NVMe Backplane Cable Option Kit

When adding drive bays, you will also need to add the appropriate storage controller(s). Consult the tables in the [Storage configurations](#) section to determine what controller sections are supported and what additional controllers you will need. Controllers are described in the [Controllers for internal storage](#) section.

7mm drive bay upgrades

For field upgrades to add 7mm drive bays, order one of the part numbers listed in the following table.

Table 24. Field upgrades for 7mm drives

Part number	Description	Purpose
7mm Drive Enablement Kits		
4XH7A86467	ThinkSystem SR645 V3 Rear 2x7mm SATA/NVMe Enablement Kit <ul style="list-style-type: none"> • 7mm drive cage • 7mm drive backplane with cables for onboard connections • 2x drive bay fillers 	7mm drive bays for SATA or NVMe drive support with no RAID support (does not include cables needed for RAID support with a separate adapter)
4XH7A86765	ThinkSystem SR645 V3 Rear 2x7mm SATA/NVMe RAID Enablement Kit <ul style="list-style-type: none"> • 7mm drive cage • 7mm drive backplane • 2x drive bay fillers • Cables for connectivity to 540-8i or 9350-8i RAID adapter 	7mm drive bays for SATA or NVMe drives, plus cables for use with a RAID adapter. Requires a separate RAID adapter for RAID support.
4XH7A88746	ThinkSystem SR645 V3 Rear 2x7mm NVMe RAID Enablement Kit <ul style="list-style-type: none"> • 7mm drive cage • 7mm drive backplane with cables for onboard connections • 2x drive bay fillers 	7mm drive bays for NVMe drive support. RAID support is integrated into the adapter using an onboard Marvell 88NR2241 NVMe RAID controller.
4XH7A93166	ThinkSystem SR645 V3 7mm RAID B540p-2HS SATA/NVMe Enablement Kit <ul style="list-style-type: none"> • 7mm drive cage • 7mm drive backplane with cables for onboard connections • 2x drive bay fillers 	7mm drive bays for SATA or NVMe drive support. RAID support is integrated into the adapter using an onboard Broadcom RAID controller.
RAID adapters for optional 7mm HW RAID support (for use with 4XH7A86765)		
4Y37A72482	ThinkSystem RAID 5350-8i PCIe 12Gb Adapter	RAID adapter needed for SATA RAID-1 with 2x 7mm SATA drives
4Y37A78834	ThinkSystem RAID 540-8i PCIe Gen4 12Gb Adapter	RAID adapter needed for NVMe RAID-1 with 2x 7mm NVMe drives Tip: Once the 540-8i adapter is installed, it will need to be configured to operate in Trim-mode to enable NVMe RAID.

RAID flash power module (supercap) support

The SR645 V3 supports 1x RAID adapter flash power module (supercap). The adapters that this applies to are as follows:

- Any supported RAID 9350 adapter
- Any supported RAID 940 adapter, including RAID 940-8e

There are two possible locations for supercaps, depending on the front drive bays (2.5-inch or 3.5-inch) and the size of the processor heatsinks. Details are summarized in the following table. Location references are shown in the figure below.

Table 25. Supercap support

Front drive configuration	Processor heatsinks	Number of adapters & supercaps	Location of supercaps
2.5-inch	High Performance	1	Front of server behind operator panel ❶
	Closed-loop liquid*	1	Installed in slot 3 attached to Riser 2 ❷
3.5-inch	High Performance	1	Installed in slot 3 attached to Riser 2 ❷
2.5-inch with front slots	High Performance	1	Front of server behind operator panel ❶

* The Closed-loop liquid heatsink is only supported with 2.5-inch front drives without front PCIe slots

The locations where supercaps are installed is shown in the following figure.

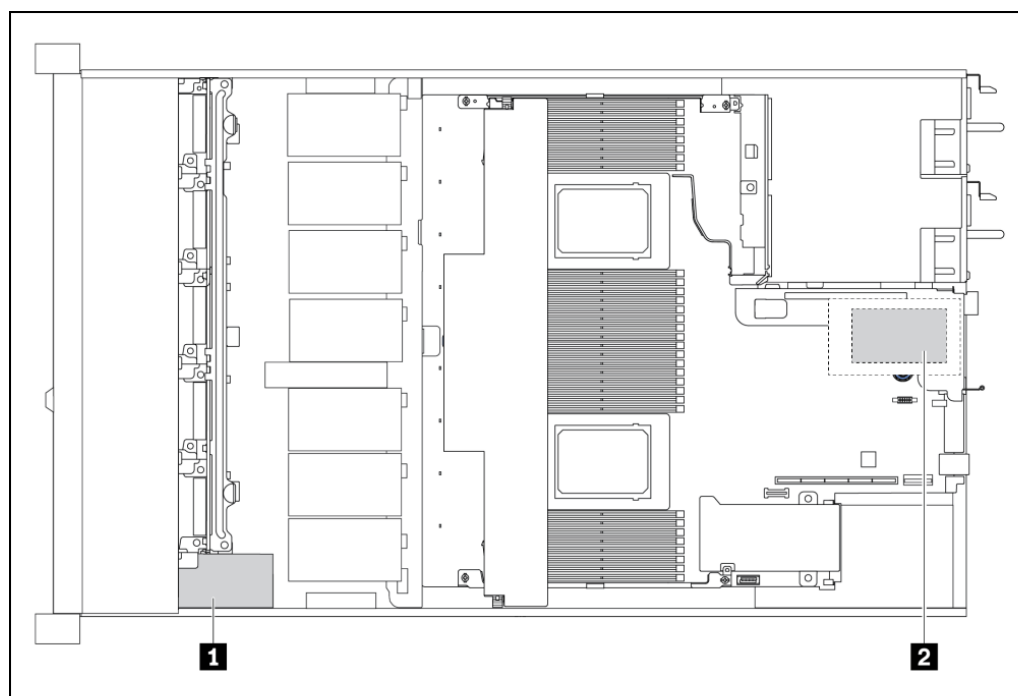

Figure 12. Location of the supercaps in the SR645 V3

If you plan to add one of the RAID adapters that includes a supercap as a field upgrade, then you will also need to order a supercap installation kit for the power module. For CTO orders, the components in the installation kit are automatically derived when you select the RAID adapter.

When adding a RAID adapter and supercap as a field upgrade, order the supercap installation kit list listed in the following table.

Table 26. RAID Flash Power Module installation kits

Part number	Feature code	Description	Maximum supported
4M17A61304	BK70	ThinkSystem V3 1U Supercap Holder Kit (For use in position ❶ at the front of the server)	1
4XF7A85032	BK5T	ThinkSystem V3 1U Supercap Holder Kit for PCIe Slot (Low profile adapter form factor for use in slot 3, position ❷)	1

M.2 drives

The SR645 V3 supports one or two M.2 form-factor SATA or NVMe drives for use as an operating system boot solution or as additional storage.

The M.2 drives install into an M.2 module which is mounted horizontally in the server in front of the fans as shown in the [Internal view](#) of the server. In configurations with 2.5-inch front drive bays, the M.2 module is position between the drive bays and the fans. In configurations with 3.5-inch front drive bays, the M.2 module is mounted on top of the front drive bays.

The supported M.2 modules are listed in the following table. For field upgrades see the [M.2 field upgrades](#) section below.

Table 27. M.2 modules

Part number	Feature code	Description	SATA drives	NVMe drives	RAID	Maximum supported	Windows 10/11 support
4Y37A09738	B5XJ	ThinkSystem M.2 SATA/NVMe 2-Bay Enablement Kit	Yes	Yes (x1 lane)	No	1	Supported
4Y37A79663	BM8X	ThinkSystem M.2 SATA/x4 NVMe 2-Bay Enablement Kit	Yes	Yes (x4 lanes)	Optional	1	Supported
4Y37A09750	B8P9	ThinkSystem M.2 NVMe 2-Bay RAID Enablement Kit	No	Yes (x1 lane)	Integrated (Marvell)	1	No
4Y37A90063	BYFF	ThinkSystem M.2 RAID B540i-2i SATA/NVMe Adapter	Yes	Yes (x1 lane)	Integrated (Broadcom)	1	No

The ThinkSystem M.2 SATA/x4 NVMe 2-Bay Enablement Kit (4Y37A79663) optionally supports RAID with the addition of a separate RAID adapter is required. For CTO orders, ordering information is listed in the following table to derive the required RAID adapter.

Table 28. CTO feature codes to select M.2 RAID (ThinkSystem M.2 SATA/x4 NVMe 2-Bay Enablement Kit only)

Feature code	Description	RAID support	Maximum supported	Windows 10/11 support
BT7N	ThinkSystem RAID 5350-8i for M.2/7mm SATA Boot Enablement	SATA	1	Supported
BT7P	ThinkSystem RAID 540-8i for M.2/7mm NVMe Boot Enablement	NVMe	1	Supported

Configuration notes:

- M.2 is not supported with all storage configurations - see [Storage configurations](#) for details.
- For ThinkSystem M.2 SATA/NVMe 2-Bay Enablement Kit (4Y37A09738):

- RAID is not supported
- The installation of at least one M.2 drive is required. In the configurator, at least one M.2 drive must be selected
- For ThinkSystem M.2 SATA/x4 NVMe 2-Bay Enablement Kit (4Y37A79663):
 - The support of RAID-1 with the M.2 drives requires an additional RAID adapter that is installed in PCIe slot 2:
 - RAID support for M.2 SATA drives requires a RAID 5350-8i adapter (feature BT7N)
 - RAID support for M.2 NVMe drives requires a RAID 540-8i adapter operating in Tri-Mode (feature BT7P)
 - The RAID adapter used for M.2 drive support cannot be configured for use with other drive bays (not even with 7mm)
 - M.2 without a RAID adapter + 7mm SATA are mutually exclusive: they are not supported together in the same configuration
 - If RAID support is not required, the M.2 adapter connects to an onboard port. No additional adapter is required
 - The M.2 adapter is not supported with the following storage configurations due to physical limitations:
 - Configurations with 3.5-inch front drive bays
 - Configurations with EDSFF drive bays
- For ThinkSystem M.2 NVMe 2-Bay RAID Enablement Kit (4Y37A09750):
 - RAID is implemented using an onboard Marvell 88NR2241 NVMe RAID controller
- For ThinkSystem M.2 RAID B540i-2i SATA/NVMe Adapter (4Y37A90063):
 - RAID is implemented using an onboard Broadcom controller
- M.2 and 7mm are supported together in certain combinations. See the [7mm and M.2 supported combinations](#) section

The ThinkSystem M.2 SATA/NVMe 2-Bay Enablement Kit has the following features:

- Supports one or two M.2 drives, either SATA or NVMe
- When two drives installed, they must be either both SATA or both NVMe
- Support 42mm, 60mm, 80mm and 110mm drive form factors (2242, 2260, 2280 and 22110)
- On the SR645 V3, no RAID support
- Either 6Gbps SATA or PCIe 3.0 x1 interface to the drives depending on the drives installed
- Supports monitoring and reporting of events and temperature through I2C
- Firmware update via Lenovo firmware update tools

The ThinkSystem M.2 SATA/x4 NVMe 2-Bay Enablement Kit has the following features:

- Supports one or two M.2 drives, either SATA or NVMe
- When two drives installed, they must be either both SATA or both NVMe
- Support 42mm, 60mm, 80mm and 110mm drive form factors (2242, 2260, 2280 and 22110)
- No onboard RAID; RAID functionality is provided by a separate adapter (SATA or NVMe)
- Either 6Gbps SATA or PCIe 4.0 x4 interface to the drives depending on the drives installed
- Supports monitoring and reporting of events and temperature through I2C
- Firmware update via Lenovo firmware update tools

The ThinkSystem M.2 NVMe 2-Bay RAID Enablement Kit (4Y37A09750) has the following features:

- Supports one or two NVMe M.2 drives
- Support 42mm, 60mm, 80mm and 110mm drive form factors (2242, 2260, 2280 and 22110)
- RAID support via an onboard Marvell 88NR2241 NVMe RAID Controller
- With 1 drive, supports single-drive RAID-0
- With 2 drives, supports 2-drive RAID-0, 2-drive RAID-1, or two single-drive RAID-0 arrays
- PCIe 3.0 x2 host interface; PCIe 3.0 x1 connection to each drive
- Management and configuration support via UEFI and OS-based tools
- Supports monitoring and reporting of events and temperature through I2C
- Firmware update via Lenovo firmware update tools

M.2 field upgrades

For field upgrades, the SR645 V3 also requires additional cables necessary to connect the M.2 to either the system board or RAID adapter.

Ordering information is listed in the following table. Note that the cable kit contains the necessary cables for all supported M.2 adapters, including the cables needed to connect to a supported RAID adapter (540-8i or 5350-8i).

Table 29. Cable kit for M.2 drive support

Part number	Description
M.2 Cable Kits	
4X97A87123	ThinkSystem SR645 V3 M.2 Enablement Cable Option Kit
RAID adapters for M.2 RAID support (for 4Y37A79663 only)	
4Y37A72482	ThinkSystem RAID 5350-8i PCIe 12Gb Adapter (SATA M.2 support)
4Y37A78834	ThinkSystem RAID 540-8i PCIe Gen4 12Gb Adapter (NVMe M.2 support using Tri-Mode) Tip: Once the 540-8i adapter is installed, it will need to be configured to operate in Tri-mode to enable NVMe RAID.

SED encryption key management with ISKLM

The server supports self-encrypting drives (SEDs) as listed in the [Internal drive options](#) section. To effectively manage a large deployment of these drives in Lenovo servers, IBM Security Key Lifecycle Manager (SKLM) offers a centralized key management solution. A Lenovo Feature on Demand (FoD) upgrade is used to enable this SKLM support in the management processor of the server.

The following table lists the part numbers and feature codes for the upgrades.

Table 30. FoD upgrades for SKLM support

Part number	Feature code	Description
Security Key Lifecycle Manager - FoD (United States, Canada, Asia Pacific, and Japan)		
00D9998	A5U1	SKLM for System x/ThinkSystem w/SEDs - FoD per Install with 1 year S&S
00D9999	AS6C	SKLM for System x/ThinkSystem w/SEDs - FoD per Install with 3 year S&S
Security Key Lifecycle Manager - FoD (Latin America, Europe, Middle East, and Africa)		
00FP648	A5U1	SKLM for System x/ThinkSystem w/SEDs - FoD per Install with 1 year S&S
00FP649	AS6C	SKLM for System x/ThinkSystem w/SEDs - FoD per Install with 3 year S&S

The IBM Security Key Lifecycle Manager software is available from Lenovo using the ordering information listed in the following table.

Table 31. IBM Security Key Lifecycle Manager licenses

Part number	Description
7S0A007FWW	IBM Security Key Lifecycle Manager Basic Edition Install License + SW Subscription & Support 12 Months
7S0A007HWW	IBM Security Key Lifecycle Manager For Raw Decimal Terabyte Storage Resource Value Unit License + SW Subscription & Support 12 Months
7S0A007KWW	IBM Security Key Lifecycle Manager For Raw Decimal Petabyte Storage Resource Value Unit License + SW Subscription & Support 12 Months
7S0A007MWW	IBM Security Key Lifecycle Manager For Usable Decimal Terabyte Storage Resource Value Unit License + SW Subscription & Support 12 Months
7S0A007PWW	IBM Security Key Lifecycle Manager For Usable Decimal Petabyte Storage Resource Value Unit License + SW Subscription & Support 12 Months

Controllers for internal storage

The SR645 V3 offers a variety of controller options for internal drives:

- For 2.5-inch and 3.5-inch drives:
 - Onboard SATA ports (feature AVUX)
 - Onboard NVMe ports (feature BC4V)
 - PCIe Retimer adapter for NVMe drives (PCIe slot-based)
 - RAID adapters and HBAs for SAS/SATA drives (PCIe slot-based)
 - RAID adapters and HBAs for SAS/SATA drives (cabled in a dedicated space)
- For 7mm drive bays in the rear of the server (see the [7mm drives](#) section)
 - SATA controller integrated into the 7mm drive bay enclosure
 - NVMe controller integrated into the 7mm drive bay enclosure
- For M.2 drives internal to the server (see [M.2 drives](#) section)
 - SATA controller integrated on the M.2 adapters
 - NVMe controller integrated on the M.2 adapters

As well as supporting RAID adapters and HBAs that install in a PCIe slot, the SR645 V3 with 2.5-inch front drive bays supports a custom form factor (CFF) adapter that is mounted in the server and cabled to one of the onboard NVMe ports. CFF adapters are not supported with 3.5-inch front drives due to a lack of physical space.

The following table lists the adapters used for the internal storage of the server.

Table 32. Internal Storage adapter support

Part number	Feature code	Description	Power module (supercap)	Max qty	Slots supported	Windows 10/11 support
Onboard controllers						
CTO only	AVUX	Onboard SATA AHCI Mode	No	1	N/A	Supported
CTO only	BC4V	Non RAID NVMe (Onboard NVMe)	No	1	N/A	Supported
SAS/SATA RAID - PCIe 3.0 adapters						
4Y37A72482	BJHK	ThinkSystem RAID 5350-8i PCIe 12Gb Adapter	No	1	1	Supported
4Y37A72483	BJHL	ThinkSystem RAID 9350-8i 2GB Flash PCIe 12Gb Adapter	Included	1	1	Supported

Part number	Feature code	Description	Power module (supercap)	Max qty	Slots supported	Windows 10/11 support
4Y37A72484	BJHM	ThinkSystem RAID 9350-8i 2GB Flash PCIe 12Gb Internal Adapter	Included	1*	None (cabled)	Supported
4Y37A72485	BJHN	ThinkSystem RAID 9350-16i 4GB Flash PCIe 12Gb Adapter	Included	1	1	Supported
4Y37A72486	BJHP	ThinkSystem RAID 9350-16i 4GB Flash PCIe 12Gb Internal Adapter	Included	1*	None (cabled)	Supported
SAS/SATA RAID - PCIe 4.0 adapters						
4Y37A78834	BMFT	ThinkSystem RAID 540-8i PCIe Gen4 12Gb Adapter	No	1	1	Supported
4Y37A78835	BNAX	ThinkSystem RAID 540-16i PCIe Gen4 12Gb Adapter	No	1	1	Supported
4Y37A09728†	B8NY	ThinkSystem RAID 940-8i 4GB Flash PCIe Gen4 12Gb Adapter	Included	1	1	Supported
4Y37A78600†	BM35	ThinkSystem RAID 940-16i 4GB Flash PCIe Gen4 12Gb Adapter	Included	1	1	Supported
4Y37A09730†	B8NZ	ThinkSystem RAID 940-16i 8GB Flash PCIe Gen4 12Gb Adapter	Included	1	1	Supported
4Y37A09735	B8P0	ThinkSystem RAID 940-16i 8GB Flash PCIe Gen4 12Gb Internal Adapter	Included	1*	None (cabled)	Supported
SAS/SATA HBA - PCIe 3.0 adapters						
4Y37A72480	BJHH	ThinkSystem 4350-8i SAS/SATA 12Gb HBA	No	1	1	No
4Y37A72481	BJHJ	ThinkSystem 4350-16i SAS/SATA 12Gb HBA	No	1	1	No
SAS/SATA HBA - PCIe 4.0 adapters						
4Y37A78601	BM51	ThinkSystem 440-8i SAS/SATA PCIe Gen4 12Gb HBA	No	1	1	No
4Y37A78602	BM50	ThinkSystem 440-16i SAS/SATA PCIe Gen4 12Gb HBA	No	1	1	No
4Y37A09725	B8P1	ThinkSystem 440-16i SAS/SATA PCIe Gen4 12Gb Internal HBA	No	1*	None (cabled)	No
NVMe						
4C57A65446	B98C	ThinkSystem 4-Port PCIe Gen4 NVMe Retimer Adapter	No	1	1	Supported
4Y37A78600†	BM36	ThinkSystem RAID 940-16i 4GB Flash PCIe Gen4 12Gb Adapter for U.3	Included	1	1	Supported
4Y37A09730†	BDY4	ThinkSystem RAID 940-16i 8GB Flash PCIe Gen4 12Gb Adapter for U.3	Included	1	1	Supported
4Y37A09728†	BGM1	ThinkSystem RAID 940-8i 4GB Flash PCIe Gen4 12Gb Adapter for U.3	Included	1	1	Supported

* Only supported with 2.5-inch front drive bays. Not supported in configurations with 3.5-inch front drive bays.

† Adapter also supports PCIe 4.0 x1 connectivity to NVMe drives (requires NVMe drives with U.3 interface)

Configuration notes:

- **Supercap support limits the number of RAID adapters installable** : The table lists whether the adapter includes a power module (supercap) to power the flash memory. The server supports only 1

supercap, the location of which depends on the server configuration as described in the [RAID flash power module \(supercap\) support](#) section. The number of supercaps supported determines the maximum number of RAID adapters with flash that can be installed in the server.

- **Field upgrades:** If you are adding a RAID adapter with supercap to the server as a field upgrade, you may need a supercap holder as described in the [RAID flash power module \(supercap\) support](#) section.
- **7mm drive support:** The storage adapters listed in the table below do *not* provide connectivity to the 7mm drive bays that are optionally available at the rear of the server. The 7mm drives have their own independent RAID controller. See the [Rear 2.5-inch and 7mm drive bays](#) section for details.
- **E810 Ethernet and X350 RAID/HBAs:** The use of both an Intel E810 network adapter and an X350 HBA/RAID adapter (9350, 5350 and 4350) is currently not supported in ThinkSystem servers. For details see [Support Tip HT513226](#). Planned support for this combination of adapters is 4Q/2023 (SI 23-2).

The RAID 940-8i and RAID 940-16i adapters also support NVMe through a feature named Tri-Mode support (or Trimode support). This feature enables the use of NVMe U.3 drives at the same time as SAS and SATA drives. Tri-Mode requires an AnyBay backplane. Cabling of the controller to the backplanes is the same as with SAS/SATA drives, and the NVMe drives are connected via a PCIe x1 link to the controller.

NVMe drives connected using Tri-Mode support provide better performance than SAS or SATA drives: A SATA SSD has a data rate of 6Gbps, a SAS SSD has a data rate of 12Gbps, whereas an NVMe U.3 Gen 4 SSD with a PCIe x1 link will have a data rate of 16Gbps. NVMe drives typically also have lower latency and higher IOPS compared to SAS and SATA drives. Tri-Mode is supported with U.3 NVMe drives in either 2.5-inch and 3.5-inch form factor and requires an AnyBay backplane.

Tri-Mode requires U.3 drives: Only NVMe drives with a U.3 interface are supported. U.2 drives are not supported. See the [Internal drive options](#) section for the U.3 drives supported by the server.

The onboard SATA controller has the following features:

- Controller integrated into the AMD processor
- JBOD only; no RAID support
- Supports up to 12 SATA drives in the SR645 V3
- Supports HDDs and SSDs; can be mixed

For specifications about the RAID adapters and HBAs supported by the SR645 V3, see the ThinkSystem RAID Adapter and HBA Reference, available from:

<https://lenovopress.lenovo.com/lp1288-thinksystem-raid-adapter-and-hba-reference#sr645-v3-support=SR645%2520V3>

For more information about each of the adapters, see the product guides in the RAID adapters or HBA sections of the Lenovo Press web site:

<https://lenovopress.com/servers/options/raid>
<https://lenovopress.com/servers/options/hba>

Internal drive options

The following tables list the drive options for internal storage of the server.

2.5-inch hot-swap drives:

- [2.5-inch hot-swap 12 Gb SAS HDDs](#)
- [2.5-inch hot-swap 24 Gb SAS SSDs](#)
- [2.5-inch hot-swap 12 Gb SAS SSDs](#)
- [2.5-inch hot-swap 6 Gb SATA SSDs](#)
- [2.5-inch hot-swap PCIe 5.0 NVMe SSDs](#)
- [2.5-inch hot-swap PCIe 4.0 NVMe SSDs](#)

2.5-inch 7mm hot-swap drives:

- [7mm 2.5-inch hot-swap 6 Gb SATA SSDs](#)
- [7mm 2.5-inch hot-swap PCIe 4.0 NVMe SSDs](#)

EDSFF hot-swap drives:

- [E1.S EDSFF hot-swap PCIe 4.0 NVMe SSDs](#)

3.5-inch hot-swap drives:

- [3.5-inch hot-swap 12 Gb SAS HDDs](#)
- [3.5-inch hot-swap 6 Gb SATA HDDs](#)
- [3.5-inch hot-swap 24 Gb SAS SSDs](#)
- [3.5-inch hot-swap 12 Gb SAS SSDs](#)
- [3.5-inch hot-swap 6 Gb SATA SSDs](#)
- [3.5-inch hot-swap PCIe 4.0 NVMe SSDs](#)

M.2 drives:

- [M.2 SATA drives](#)
- [M.2 PCIe 4.0 NVMe drives](#)

M.2 drive support: The use of M.2 drives requires an additional adapter as described in the [M.2 drives](#) subsection.

SED support: The tables include a column to indicate which drives support SED encryption. The encryption functionality can be disabled if needed. Note: Not all SED-enabled drives have "SED" in the description.

Table 33. 2.5-inch hot-swap 12 Gb SAS HDDs

Part number	Feature code	Description	SED support	Max Qty
2.5-inch hot-swap HDDs - 12 Gb SAS 15K				
7XB7A00021	AULV	ThinkSystem 2.5" 300GB 15K SAS 12Gb Hot Swap 512n HDD	No	12
7XB7A00022	AULW	ThinkSystem 2.5" 600GB 15K SAS 12Gb Hot Swap 512n HDD	No	12
7XB7A00023	AULX	ThinkSystem 2.5" 900GB 15K SAS 12Gb Hot Swap 512e HDD	No	12
2.5-inch hot-swap HDDs - 12 Gb SAS 10K				
7XB7A00025	AULZ	ThinkSystem 2.5" 600GB 10K SAS 12Gb Hot Swap 512n HDD	No	12
7XB7A00027	AUM1	ThinkSystem 2.5" 1.2TB 10K SAS 12Gb Hot Swap 512n HDD	No	12
7XB7A00028	AUM2	ThinkSystem 2.5" 1.8TB 10K SAS 12Gb Hot Swap 512e HDD	No	12
4XB7A83970	BRG7	ThinkSystem 2.5" 2.4TB 10K SAS 12Gb Hot Swap 512e HDD v2	No	12
2.5-inch hot-swap SED HDDs - 12 Gb SAS 10K				
7XB7A00031	AUM5	ThinkSystem 2.5" 600GB 10K SAS 12Gb Hot Swap 512n HDD SED	Support	12
7XB7A00033	B0YX	ThinkSystem 2.5" 1.2TB 10K SAS 12Gb Hot Swap 512n HDD SED	Support	12
4XB7A84038	BRG8	ThinkSystem 2.5" 2.4TB 10K SAS 12Gb Hot Swap 512e HDD FIPS v2	Support	12

Table 34. 2.5-inch hot-swap 24 Gb SAS SSDs

Part number	Feature code	Description	SED support	Max Qty
2.5-inch hot-swap SSDs - 24 Gb SAS - Mixed Use/Mainstream (3-5 DWPD)				
4XB7A80340	BNW8	ThinkSystem 2.5" PM1655 800GB Mixed Use SAS 24Gb HS SSD	Support	12
4XB7A80341	BNW9	ThinkSystem 2.5" PM1655 1.6TB Mixed Use SAS 24Gb HS SSD	Support	12
4XB7A80342	BNW6	ThinkSystem 2.5" PM1655 3.2TB Mixed Use SAS 24Gb HS SSD	Support	12
4XB7A80343	BP3K	ThinkSystem 2.5" PM1655 6.4TB Mixed Use SAS 24Gb HS SSD	Support	12
2.5-inch hot-swap SSDs - 24 Gb SAS - Read Intensive/Entry/Capacity (<3 DWPD)				
4XB7A80318	BNWC	ThinkSystem 2.5" PM1653 960GB Read Intensive SAS 24Gb HS SSD	Support	12
4XB7A80319	BNWE	ThinkSystem 2.5" PM1653 1.92TB Read Intensive SAS 24Gb HS SSD	Support	12
4XB7A80320	BNWF	ThinkSystem 2.5" PM1653 3.84TB Read Intensive SAS 24Gb HS SSD	Support	12
4XB7A80321	BP3E	ThinkSystem 2.5" PM1653 7.68TB Read Intensive SAS 24Gb HS SSD	Support	12
4XB7A80322	BP3J	ThinkSystem 2.5" PM1653 15.36TB Read Intensive SAS 24Gb HS SSD	Support	12
4XB7A80323	BP3D	ThinkSystem 2.5" PM1653 30.72TB Read Intensive SAS 24Gb HS SSD	Support	12

Table 35. 2.5-inch hot-swap 12 Gb SAS SSDs

Part number	Feature code	Description	SED support	Max Qty
2.5-inch hot-swap SSDs - 12 Gb SAS - Write Intensive/Performance (10+ DWPD)				
4XB7A83214	BR10	ThinkSystem 2.5" Nytro 3750 400GB Write Intensive SAS 12Gb HS SSD	Support	12
4XB7A83215	BR0Z	ThinkSystem 2.5" Nytro 3750 800GB Write Intensive SAS 12Gb HS SSD	Support	12
4XB7A83216	BR0Y	ThinkSystem 2.5" Nytro 3750 1.6TB Write Intensive SAS 12Gb HS SSD	Support	12
4XB7A83217	BR0X	ThinkSystem 2.5" Nytro 3750 3.2TB Write Intensive SAS 12Gb HS SSD	Support	12

Table 36. 2.5-inch hot-swap 6 Gb SATA SSDs

Part number	Feature code	Description	SED support	Max Qty
2.5-inch hot-swap SSDs - 6 Gb SATA - Mixed Use/Mainstream (3-5 DWPD)				
4XB7A90884	BYM2	ThinkSystem 2.5" Multi Vendor 480GB Mixed Use SATA 6Gb HS SSD v2	No	12
4XB7A90885	BYM4	ThinkSystem 2.5" Multi Vendor 960GB Mixed Use SATA 6Gb HS SSD v2	No	12
4XB7A90886	BYM5	ThinkSystem 2.5" Multi Vendor 1.92TB Mixed Use SATA 6Gb HS SSD v2	No	12
4XB7A90887	BYM6	ThinkSystem 2.5" Multi Vendor 3.84TB Mixed Use SATA 6Gb HS SSD v2	No	12
4XB7A82289	BQ21	ThinkSystem 2.5" 5400 MAX 480GB Mixed Use SATA 6Gb HS SSD	Support	12
4XB7A82290	BQ24	ThinkSystem 2.5" 5400 MAX 960GB Mixed Use SATA 6Gb HS SSD	Support	12
4XB7A82291	BQ22	ThinkSystem 2.5" 5400 MAX 1.92TB Mixed Use SATA 6Gb HS SSD	Support	12
4XB7A82292	BQ23	ThinkSystem 2.5" 5400 MAX 3.84TB Mixed Use SATA 6Gb HS SSD	Support	12
4XB7A17125	BA7Q	ThinkSystem 2.5" S4620 480GB Mixed Use SATA 6Gb HS SSD	No	12
4XB7A17126	BA4T	ThinkSystem 2.5" S4620 960GB Mixed Use SATA 6Gb HS SSD	No	12
4XB7A17127	BA4U	ThinkSystem 2.5" S4620 1.92TB Mixed Use SATA 6Gb HS SSD	No	12
4XB7A17128	BK7L	ThinkSystem 2.5" S4620 3.84TB Mixed Use SATA 6Gb HS SSD	No	12
2.5-inch hot-swap SSDs - 6 Gb SATA - Read Intensive/Entry (<3 DWPD)				
4XB7A90872	BYLQ	ThinkSystem 2.5" Multi Vendor 240GB Read Intensive SATA 6Gb HS SSD v2	No	12
4XB7A90873	BYLR	ThinkSystem 2.5" Multi Vendor 480GB Read Intensive SATA 6Gb HS SSD v2	No	12
4XB7A90874	BYLS	ThinkSystem 2.5" Multi Vendor 960GB Read Intensive SATA 6Gb HS SSD v2	No	12
4XB7A90875	BYLT	ThinkSystem 2.5" Multi Vendor 1.92TB Read Intensive SATA 6Gb HS SSD v2	No	12
4XB7A90876	BYLU	ThinkSystem 2.5" Multi Vendor 3.84TB Read Intensive SATA 6Gb HS SSD v2	No	12
4XB7A90877	BYLV	ThinkSystem 2.5" Multi Vendor 7.68TB Read Intensive SATA 6Gb HS SSD v2	No	12
4XB7A89423	BXDY	ThinkSystem 2.5" CM893a 1.92TB Read Intensive SATA 6Gb HS SSD	Support	12

Part number	Feature code	Description	SED support	Max Qty
4XB7A87524	BWKN	ThinkSystem 2.5" PM893a 480GB Read Intensive SATA 6Gb HS SSD	Support	12
4XB7A87525	BWKM	ThinkSystem 2.5" PM893a 960GB Read Intensive SATA 6Gb HS SSD	Support	12
4XB7A87526	BWKL	ThinkSystem 2.5" PM893a 1.92TB Read Intensive SATA 6Gb HS SSD	Support	12
4XB7A87527	BWKK	ThinkSystem 2.5" PM893a 3.84TB Read Intensive SATA 6Gb HS SSD	Support	12
4XB7A82258	BQ1Q	ThinkSystem 2.5" 5400 PRO 240GB Read Intensive SATA 6Gb HS SSD	Support	12
4XB7A82259	BQ1P	ThinkSystem 2.5" 5400 PRO 480GB Read Intensive SATA 6Gb HS SSD	Support	12
4XB7A82260	BQ1R	ThinkSystem 2.5" 5400 PRO 960GB Read Intensive SATA 6Gb HS SSD	Support	12
4XB7A82261	BQ1X	ThinkSystem 2.5" 5400 PRO 1.92TB Read Intensive SATA 6Gb HS SSD	Support	12
4XB7A82262	BQ1S	ThinkSystem 2.5" 5400 PRO 3.84TB Read Intensive SATA 6Gb HS SSD	Support	12
4XB7A82263	BQ1T	ThinkSystem 2.5" 5400 PRO 7.68TB Read Intensive SATA 6Gb HS SSD	Support	12
4XB7A72438	BM8B	ThinkSystem 2.5" PM893 480GB Read Intensive SATA 6Gb HS SSD	No	12
4XB7A72439	BM8A	ThinkSystem 2.5" PM893 960GB Read Intensive SATA 6Gb HS SSD	No	12
4XB7A72440	BM89	ThinkSystem 2.5" PM893 1.92TB Read Intensive SATA 6Gb HS SSD	No	12
4XB7A72441	BM88	ThinkSystem 2.5" PM893 3.84TB Read Intensive SATA 6Gb HS SSD	No	12
4XB7A72442	BM87	ThinkSystem 2.5" PM893 7.68TB Read Intensive SATA 6Gb HS SSD	No	12
4XB7A17072	B99D	ThinkSystem 2.5" S4520 240GB Read Intensive SATA 6Gb HS SSD	No	12
4XB7A17101	BA7G	ThinkSystem 2.5" S4520 480GB Read Intensive SATA 6Gb HS SSD	No	12
4XB7A17102	BA7H	ThinkSystem 2.5" S4520 960GB Read Intensive SATA 6Gb HS SSD	No	12
4XB7A17103	BA7J	ThinkSystem 2.5" S4520 1.92TB Read Intensive SATA 6Gb HS SSD	No	12
4XB7A17104	BK77	ThinkSystem 2.5" S4520 3.84TB Read Intensive SATA 6Gb HS SSD	No	12
4XB7A17105	BK78	ThinkSystem 2.5" S4520 7.68TB Read Intensive SATA 6Gb HS SSD	No	12

Table 37. 2.5-inch hot-swap PCIe 5.0 NVMe SSDs

Part number	Feature code	Description	SED support	Max Qty
2.5-inch SSDs - U.2 PCIe 5.0 NVMe - Read Intensive/Entry (<3 DWPD)				
4XB7A82366	BTPZ	ThinkSystem 2.5" U.3 PM1743 1.92TB Read Intensive NVMe PCIe 5.0 x4 HS SSD	Support	12
4XB7A82367	BTQ0	ThinkSystem 2.5" U.3 PM1743 3.84TB Read Intensive NVMe PCIe 5.0 x4 HS SSD	Support	12
4XB7A82368	BTQ1	ThinkSystem 2.5" U.3 PM1743 7.68TB Read Intensive NVMe PCIe 5.0 x4 HS SSD	Support	12
4XB7A82369	BTQ2	ThinkSystem 2.5" U.3 PM1743 15.36TB Read Intensive NVMe PCIe 5.0 x4 HS SSD	Support	12

Table 38. 2.5-inch hot-swap PCIe 4.0 NVMe SSDs

Part number	Feature code	Description	SED support	Max Qty
2.5-inch SSDs - U.2 PCIe 4.0 NVMe - Write Intensive/Performance (10+ DWPD)				
4XB7A17158	BKKY	ThinkSystem 2.5" U.2 P5800X 400GB Write Intensive NVMe PCIe 4.0 x4 HS SSD	No	12
4XB7A17159	BKKZ	ThinkSystem 2.5" U.2 P5800X 800GB Write Intensive NVMe PCIe 4.0 x4 HS SSD	No	12
4XB7A17160	BMM8	ThinkSystem 2.5" U.2 P5800X 1.6TB Write Intensive NVMe PCIe 4.0 x4 HS SSD	No	12
2.5-inch SSDs - U.2 PCIe 4.0 NVMe - Mixed Use/Mainstream (3-5 DWPD)				
4XB7A17129	BNEG	ThinkSystem 2.5" U.2 P5620 1.6TB Mixed Use NVMe PCIe 4.0 x4 HS SSD	Support	12
4XB7A17130	BNEH	ThinkSystem 2.5" U.2 P5620 3.2TB Mixed Use NVMe PCIe 4.0 x4 HS SSD	Support	12
4XB7A17133	BNEZ	ThinkSystem 2.5" U.2 P5620 6.4TB Mixed Use NVMe PCIe 4.0 x4 HS SSD	Support	12
4XB7A17136	BA4V	ThinkSystem 2.5" U.2 P5620 12.8TB Mixed Use NVMe PCIe 4.0 x4 HS SSD	Support	12
2.5-inch SSDs - U.3 PCIe 4.0 NVMe - Mixed Use/Mainstream (3-5 DWPD)				
4XB7A79639	BNF1	ThinkSystem 2.5" U.3 7450 MAX 800GB Mixed Use NVMe PCIe 4.0 x4 HS SSD	Support	12
4XB7A13967	BNEJ	ThinkSystem 2.5" U.3 7450 MAX 1.6TB Mixed Use NVMe PCIe 4.0 x4 HS SSD	Support	12
4XB7A13970	BNEY	ThinkSystem 2.5" U.3 7450 MAX 3.2TB Mixed Use NVMe PCIe 4.0 x4 HS SSD	Support	12
4XB7A13971	BNEL	ThinkSystem 2.5" U.3 7450 MAX 6.4TB Mixed Use NVMe PCIe 4.0 x4 HS SSD	Support	12
4XB7A84056	BRG0	ThinkSystem 2.5" U.3 7450 MAX 12.8TB Mixed Use NVMe PCIe 4.0 x4 HS SSD	Support	12
2.5-inch SSDs - U.2 PCIe 4.0 NVMe - Read Intensive/Entry (<3 DWPD)				
4XB7A90099	BXMB	ThinkSystem 2.5" U.2 PM9A3 960GB Read Intensive NVMe PCIe 4.0 x4 HS SSD	Support	12
4XB7A90100	BXMA	ThinkSystem 2.5" U.2 PM9A3 1.92TB Read Intensive NVMe PCIe 4.0 x4 HS SSD	Support	12
4XB7A90101	BXM9	ThinkSystem 2.5" U.2 PM9A3 3.84TB Read Intensive NVMe PCIe 4.0 x4 HS SSD	Support	12
4XB7A13941	BMGD	ThinkSystem 2.5" U.2 P5520 1.92TB Read Intensive NVMe PCIe 4.0 x4 HS SSD	Support	12
4XB7A13942	BMGE	ThinkSystem 2.5" U.2 P5520 3.84TB Read Intensive NVMe PCIe 4.0 x4 HS SSD	Support	12
4XB7A13943	BNEF	ThinkSystem 2.5" U.2 P5520 7.68TB Read Intensive NVMe PCIe 4.0 x4 HS SSD	Support	12
4XB7A13631	BNEQ	ThinkSystem 2.5" U.2 P5520 15.36TB Read Intensive NVMe PCIe 4.0 x4 HS SSD	Support	12
2.5-inch SSDs - U.3 PCIe 4.0 NVMe - Read Intensive/Entry (<3 DWPD)				

Part number	Feature code	Description	SED support	Max Qty
4XB7A79646	BNF3	ThinkSystem 2.5" U.3 7450 PRO 960GB Read Intensive NVMe PCIe 4.0 x4 HS SSD	Support	12
4XB7A79647	BNF2	ThinkSystem 2.5" U.3 7450 PRO 1.92TB Read Intensive NVMe PCIe 4.0 x4 HS SSD	Support	12
4XB7A79648	BNF5	ThinkSystem 2.5" U.3 7450 PRO 3.84TB Read Intensive NVMe PCIe 4.0 x4 HS SSD	Support	12
4XB7A79649	BNF4	ThinkSystem 2.5" U.3 7450 PRO 7.68TB Read Intensive NVMe PCIe 4.0 x4 HS SSD	Support	12
4XB7A83097	BQAV	ThinkSystem 2.5" U.3 7450 PRO 15.36TB Read Intensive NVMe PCIe 4.0 x4 HS SSD	Support	12

Table 39. 7mm 2.5-inch hot-swap 6 Gb SATA SSDs

Part number	Feature code	Description	SED support	Max Qty
7mm 2.5-inch hot-swap SSDs - 6 Gb SATA - Read Intensive/Entry (<3 DDP)				
4XB7A82264	BQ1U	ThinkSystem 7mm 5400 PRO 240GB Read Intensive SATA 6Gb HS SSD	Support	2
4XB7A82265	BQ1V	ThinkSystem 7mm 5400 PRO 480GB Read Intensive SATA 6Gb HS SSD	Support	2
4XB7A82266	BQ1W	ThinkSystem 7mm 5400 PRO 960GB Read Intensive SATA 6Gb HS SSD	Support	2
4XB7A17106	BK79	ThinkSystem 7mm S4520 240GB Read Intensive SATA 6Gb HS SSD	No	2
4XB7A17107	BK7A	ThinkSystem 7mm S4520 480GB Read Intensive SATA 6Gb HS SSD	No	2
4XB7A17108	BK7B	ThinkSystem 7mm S4520 960GB Read Intensive SATA 6Gb HS SSD	No	2

Table 40. 7mm 2.5-inch hot-swap PCIe 4.0 NVMe SSDs

Part number	Feature code	Description	SED support	Max Qty
7mm 2.5-inch hot-swap SSDs - PCIe 4.0 NVMe - Read Intensive/Entry (<3 DDP)				
4XB7A90096	BXMN	ThinkSystem 7mm U.2 PM9A3 960GB Read Intensive NVMe PCIe 4.0 x4 HS SSD	Support	2
4XB7A90097	BXMM	ThinkSystem 7mm U.2 PM9A3 1.92TB Read Intensive NVMe PCIe 4.0 x4 HS SSD	Support	2
4XB7A90098	BXML	ThinkSystem 7mm U.2 PM9A3 3.84TB Read Intensive NVMe PCIe 4.0 x4 HS SSD	Support	2
4XB7A82853	BPZ4	ThinkSystem 7mm U.3 7450 PRO 960GB Read Intensive NVMe PCIe 4.0 x4 HS SSD	Support	2
4XB7A82855	BPZ5	ThinkSystem 7mm U.3 7450 PRO 1.92TB Read Intensive NVMe PCIe 4.0 x4 HS SSD	Support	2
4XB7A82856	BPZ6	ThinkSystem 7mm U.3 7450 PRO 3.84TB Read Intensive NVMe PCIe 4.0 x4 HS SSD	Support	2

Table 41. E1.S EDSFF hot-swap PCIe 4.0 NVMe SSDs

Part number	Feature code	Description	SED support	Max Qty
E1.S hot-swap SSDs - PCIe 4.0 NVMe - Read Intensive/Entry (<3 DWPD)				
4XB7A13998	BP3L	ThinkSystem E1.S 5.9mm 7450 PRO 3.84TB Read Intensive NVMe PCIe 4.0 x4 HS SSD	Support	16
4XB7A80499	BPKW	ThinkSystem E1.S 5.9mm 7450 PRO 7.68TB Read Intensive NVMe PCIe 4.0 x4 HS SSD	Support	16

Table 42. 3.5-inch hot-swap 12 Gb SAS HDDs

Part number	Feature code	Description	SED support	Max Qty
3.5-inch hot-swap HDDs - 12 Gb NL SAS				
7XB7A00042	AUU5	ThinkSystem 3.5" 2TB 7.2K SAS 12Gb Hot Swap 512n HDD	No	4
7XB7A00043	AUU6	ThinkSystem 3.5" 4TB 7.2K SAS 12Gb Hot Swap 512n HDD	No	4
7XB7A00044	AUU7	ThinkSystem 3.5" 6TB 7.2K SAS 12Gb Hot Swap 512e HDD	No	4
7XB7A00045	B0YR	ThinkSystem 3.5" 8TB 7.2K SAS 12Gb Hot Swap 512e HDD	No	4
7XB7A00046	AUUG	ThinkSystem 3.5" 10TB 7.2K SAS 12Gb Hot Swap 512e HDD	No	4
7XB7A00067	B117	ThinkSystem 3.5" 12TB 7.2K SAS 12Gb Hot Swap 512e HDD	No	4
4XB7A13906	B496	ThinkSystem 3.5" 14TB 7.2K SAS 12Gb Hot Swap 512e HDD	No	4
4XB7A13911	B7EZ	ThinkSystem 3.5" 16TB 7.2K SAS 12Gb Hot Swap 512e HDD	No	4
4XB7A38266	BCFP	ThinkSystem 3.5" 18TB 7.2K SAS 12Gb Hot Swap 512e HDD	No	4
4XB7A80353	BPKU	ThinkSystem 3.5" 20TB 7.2K SAS 12Gb Hot Swap 512e HDD	No	4
4XB7A83766	BTR7	ThinkSystem 3.5" 22TB 7.2K SAS 12Gb Hot Swap 512e HDD	Support	4
3.5-inch hot-swap SED HDDs - 12 Gb NL SAS				
7XB7A00066	B0YQ	ThinkSystem 3.5" 8TB 7.2K SAS 12Gb Hot Swap 512e HDD FIPS	Support	4

Table 43. 3.5-inch hot-swap 6 Gb SATA HDDs

Part number	Feature code	Description	SED support	Max Qty
3.5-inch hot-swap HDDs - 6 Gb NL SATA				
7XB7A00049	AUUF	ThinkSystem 3.5" 1TB 7.2K SATA 6Gb Hot Swap 512n HDD	No	4
7XB7A00050	AUUD	ThinkSystem 3.5" 2TB 7.2K SATA 6Gb Hot Swap 512n HDD	No	4
7XB7A00051	AUU8	ThinkSystem 3.5" 4TB 7.2K SATA 6Gb Hot Swap 512n HDD	No	4
7XB7A00052	AUUA	ThinkSystem 3.5" 6TB 7.2K SATA 6Gb Hot Swap 512e HDD	No	4
7XB7A00053	AUU9	ThinkSystem 3.5" 8TB 7.2K SATA 6Gb Hot Swap 512e HDD	No	4
7XB7A00054	AUUB	ThinkSystem 3.5" 10TB 7.2K SATA 6Gb Hot Swap 512e HDD	No	4
7XB7A00068	B118	ThinkSystem 3.5" 12TB 7.2K SATA 6Gb Hot Swap 512e HDD	No	4
4XB7A13907	B497	ThinkSystem 3.5" 14TB 7.2K SATA 6Gb Hot Swap 512e HDD	No	4
4XB7A13914	B7F0	ThinkSystem 3.5" 16TB 7.2K SATA 6Gb Hot Swap 512e HDD	No	4
4XB7A38130	BCFH	ThinkSystem 3.5" 18TB 7.2K SATA 6Gb Hot Swap 512e HDD	No	4
4XB7A80354	BPKV	ThinkSystem 3.5" 20TB 7.2K SATA 6Gb Hot Swap 512e HDD	No	4
4XB7A83765	BTR8	ThinkSystem 3.5" 22TB 7.2K SATA 6Gb Hot Swap 512e HDD	Support	4

Table 44. 3.5-inch hot-swap 24 Gb SAS SSDs

Part number	Feature code	Description	SED support	Max Qty
3.5-inch hot-swap SSDs - 24 Gb SAS - Mixed Use/Mainstream (3-5 DWPD)				
4XB7A80344	BNW7	ThinkSystem 3.5" PM1655 800GB Mixed Use SAS 24Gb HS SSD	Support	4
4XB7A80345	BNWA	ThinkSystem 3.5" PM1655 1.6TB Mixed Use SAS 24Gb HS SSD	Support	4
4XB7A80346	BNWB	ThinkSystem 3.5" PM1655 3.2TB Mixed Use SAS 24Gb HS SSD	Support	4
4XB7A80347	BP3G	ThinkSystem 3.5" PM1655 6.4TB Mixed Use SAS 24Gb HS SSD	Support	4
3.5-inch hot-swap SSDs - 24 Gb SAS - Read Intensive/Entry/Capacity (<3 DWPD)				
4XB7A80324	BNWD	ThinkSystem 3.5" PM1653 960GB Read Intensive SAS 24Gb HS SSD	Support	4
4XB7A80325	BNWG	ThinkSystem 3.5" PM1653 1.92TB Read Intensive SAS 24Gb HS SSD	Support	4
4XB7A80326	BNWH	ThinkSystem 3.5" PM1653 3.84TB Read Intensive SAS 24Gb HS SSD	Support	4
4XB7A80327	BP3F	ThinkSystem 3.5" PM1653 7.68TB Read Intensive SAS 24Gb HS SSD	Support	4
4XB7A80328	BP3H	ThinkSystem 3.5" PM1653 15.36TB Read Intensive SAS 24Gb HS SSD	Support	4

Table 45. 3.5-inch hot-swap 12 Gb SAS SSDs

Part number	Feature code	Description	SED support	Max Qty
3.5-inch hot-swap SSDs - 12 Gb SAS - Write Intensive/Performance (10+ DWPD)				
4XB7A83218	BR0W	ThinkSystem 3.5" Nytro 3750 400GB Write Intensive SAS 12Gb HS SSD	Support	4
4XB7A83219	BR0V	ThinkSystem 3.5" Nytro 3750 800GB Write Intensive SAS 12Gb HS SSD	Support	4
4XB7A83220	BR0U	ThinkSystem 3.5" Nytro 3750 1.6TB Write Intensive SAS 12Gb HS SSD	Support	4
4XB7A83221	BR0T	ThinkSystem 3.5" Nytro 3750 3.2TB Write Intensive SAS 12Gb HS SSD	Support	4

Table 46. 3.5-inch hot-swap 6 Gb SATA SSDs

Part number	Feature code	Description	SED support	Max Qty
3.5-inch hot-swap SSDs - 6 Gb SATA - Mixed Use/Mainstream (3-5 DWPD)				
4XB7A90888	BYM3	ThinkSystem 3.5" Multi Vendor 480GB Mixed Use SATA 6Gb HS SSD v2	No	4
4XB7A90889	BYM7	ThinkSystem 3.5" Multi Vendor 960GB Mixed Use SATA 6Gb HS SSD v2	No	4
4XB7A90890	BYM8	ThinkSystem 3.5" Multi Vendor 1.92TB Mixed Use SATA 6Gb HS SSD v2	No	4
4XB7A90891	BYLX	ThinkSystem 3.5" Multi Vendor 3.84TB Mixed Use SATA 6Gb HS SSD v2	No	4
4XB7A17137	BA4W	ThinkSystem 3.5" S4620 480GB Mixed Use SATA 6Gb HS SSD	No	4
4XB7A17138	BA4X	ThinkSystem 3.5" S4620 960GB Mixed Use SATA 6Gb HS SSD	No	4
4XB7A17139	BA4Y	ThinkSystem 3.5" S4620 1.92TB Mixed Use SATA 6Gb HS SSD	No	4
4XB7A17140	BK7P	ThinkSystem 3.5" S4620 3.84TB Mixed Use SATA 6Gb HS SSD	No	4
3.5-inch hot-swap SSDs - 6 Gb SATA - Read Intensive/Entry (<3 DWPD)				
4XB7A90878	BYLW	ThinkSystem 3.5" Multi Vendor 240GB Read Intensive SATA 6Gb HS SSD v2	No	4
4XB7A90879	BYLJ	ThinkSystem 3.5" Multi Vendor 480GB Read Intensive SATA 6Gb HS SSD v2	No	4
4XB7A90880	BYLY	ThinkSystem 3.5" Multi Vendor 960GB Read Intensive SATA 6Gb HS SSD v2	No	4
4XB7A90881	BYLZ	ThinkSystem 3.5" Multi Vendor 1.92TB Read Intensive SATA 6Gb HS SSD v2	No	4
4XB7A90882	BYM0	ThinkSystem 3.5" Multi Vendor 3.84TB Read Intensive SATA 6Gb HS SSD v2	No	4
4XB7A90883	BYM1	ThinkSystem 3.5" Multi Vendor 7.68TB Read Intensive SATA 6Gb HS SSD v2	No	4
4XB7A17118	BA7K	ThinkSystem 3.5" S4520 240GB Read Intensive SATA 6Gb HS SSD	No	4
4XB7A17119	BA7L	ThinkSystem 3.5" S4520 480GB Read Intensive SATA 6Gb HS SSD	No	4
4XB7A17120	BA7M	ThinkSystem 3.5" S4520 960GB Read Intensive SATA 6Gb HS SSD	No	4
4XB7A17121	BA7N	ThinkSystem 3.5" S4520 1.92TB Read Intensive SATA 6Gb HS SSD	No	4
4XB7A17122	BK7F	ThinkSystem 3.5" S4520 3.84TB Read Intensive SATA 6Gb HS SSD	No	4
4XB7A17123	BK7G	ThinkSystem 3.5" S4520 7.68TB Read Intensive SATA 6Gb HS SSD	No	4

Table 47. 3.5-inch hot-swap PCIe 4.0 NVMe SSDs

Part number	Feature code	Description	SED support	Max Qty
3.5-inch SSDs - U.2 PCIe 4.0 NVMe - Write Intensive/Performance (10+ DWPD)				
4XB7A17161	BMM7	ThinkSystem 3.5" U.2 P5800X 400GB Write Intensive NVMe PCIe 4.0 x4 HS SSD	No	4
4XB7A17162	BMM5	ThinkSystem 3.5" U.2 P5800X 800GB Write Intensive NVMe PCIe 4.0 x4 HS SSD	No	4
4XB7A77070	BMM6	ThinkSystem 3.5" U.2 P5800X 1.6TB Write Intensive NVMe PCIe 4.0 x4 HS SSD	No	4
3.5-inch SSDs - U.2 PCIe 4.0 NVMe - Mixed Use/Mainstream (3-5 DWPD)				
4XB7A17141	BNEK	ThinkSystem 3.5" U.2 P5620 1.6TB Mixed Use NVMe PCIe 4.0 x4 HS SSD	Support	4
4XB7A17143	BNEM	ThinkSystem 3.5" U.2 P5620 3.2TB Mixed Use NVMe PCIe 4.0 x4 HS SSD	Support	4
4XB7A17144	BNEN	ThinkSystem 3.5" U.2 P5620 6.4TB Mixed Use NVMe PCIe 4.0 x4 HS SSD	Support	4
4XB7A17148	BNEP	ThinkSystem 3.5" U.2 P5620 12.8TB Mixed Use NVMe PCIe 4.0 x4 HS SSD	Support	4
3.5-inch SSDs - U.2 PCIe 4.0 NVMe - Read Intensive/Entry (<3 DWPD)				
4XB7A13632	BNES	ThinkSystem 3.5" U.2 P5520 1.92TB Read Intensive NVMe PCIe 4.0 x4 HS SSD	Support	4
4XB7A76777	BNET	ThinkSystem 3.5" U.2 P5520 3.84TB Read Intensive NVMe PCIe 4.0 x4 HS SSD	Support	4
4XB7A76778	BNEU	ThinkSystem 3.5" U.2 P5520 7.68TB Read Intensive NVMe PCIe 4.0 x4 HS SSD	Support	4
4XB7A76779	BNF0	ThinkSystem 3.5" U.2 P5520 15.36TB Read Intensive NVMe PCIe 4.0 x4 HS SSD	Support	4

Table 48. M.2 SATA drives

Part number	Feature code	Description	SED support	Max Qty
M.2 SSDs - 6 Gb SATA - Read Intensive/Entry (<3 DWPD)				
4XB7A89422	BYF7	ThinkSystem M.2 ER3 240GB Read Intensive SATA 6Gb NHS SSD	Support	2
4XB7A90049	BYF8	ThinkSystem M.2 ER3 480GB Read Intensive SATA 6Gb NHS SSD	Support	2
4XB7A90230	BYF9	ThinkSystem M.2 ER3 960GB Read Intensive SATA 6Gb NHS SSD	Support	2
4XB7A82286	BQ1Z	ThinkSystem M.2 5400 PRO 240GB Read Intensive SATA 6Gb NHS SSD	Support	2
4XB7A82287	BQ1Y	ThinkSystem M.2 5400 PRO 480GB Read Intensive SATA 6Gb NHS SSD	Support	2
4XB7A82288	BQ20	ThinkSystem M.2 5400 PRO 960GB Read Intensive SATA 6Gb NHS SSD	Support	2
7N47A00130	AUUV	ThinkSystem M.2 128GB SATA 6Gbps Non-Hot Swap SSD	No	2

Table 49. M.2 PCIe 4.0 NVMe drives

Part number	Feature code	Description	SED support	Max Qty
M.2 SSDs - PCIe 4.0 NVMe - Read Intensive/Entry (<3 DWPD)				
4XB7A90102	BXMH	ThinkSystem M.2 PM9A3 960GB Read Intensive NVMe PCIe 4.0 x4 NHS SSD	Support	2
4XB7A13999	BKSR	ThinkSystem M.2 7450 PRO 960GB Read Intensive NVMe PCIe 4.0 x4 NHS SSD	Support	2

USB memory key

For general portable storage needs, the server also supports the USB memory key option that is listed in the following table.

Table 50. USB memory key

Part number	Feature	Description
4X77A77065	BNWN	ThinkSystem USB 32GB USB 3.0 Flash Drive

Internal backup units

The SR645 V3 does not support any internal backup units, such as tape drives or RDX drives. External backup units are available as described in the [External backup units](#) section.

Optical drives

The server supports the external USB optical drive listed in the following table.

Table 51. External optical drive

Part number	Feature code	Description
7XA7A05926	AVV8	ThinkSystem External USB DVD RW Optical Disk Drive

The drive is based on the Lenovo Slim DVD Burner DB65 drive and supports the following formats: DVD-RAM, DVD-RW, DVD+RW, DVD+R, DVD-R, DVD-ROM, DVD-R DL, CD-RW, CD-R, CD-ROM.

I/O expansion

The SR645 V3 supports a total of up to 5x PCIe slots, 3x at the rear and 2x at the front, plus 1x OCP 3.0 SFF slot for networking. The OCP slot can be either at the front or at the rear (but not both). Slot availability is based on riser selection and drive bays configured. The use of slot 3 and the front slots require that both processors be installed.

Internal (CFF) RAID adapter/HBA: For configurations with 2.5-inch front drive bays, an internal RAID adapter or HBA (CFF, custom form factor) can be installed in a dedicated space and cabled to a PCIe 4.0 x8 connector, thereby freeing up a slot for other purposes.

Topics in this section:

- [Rear slots](#)
- [Front slots](#)
- [Serial port](#)

Rear slots

The following figure shows the locations of the rear-accessible slots for each configuration selection. The OCP slot is located below the PCIe slots.

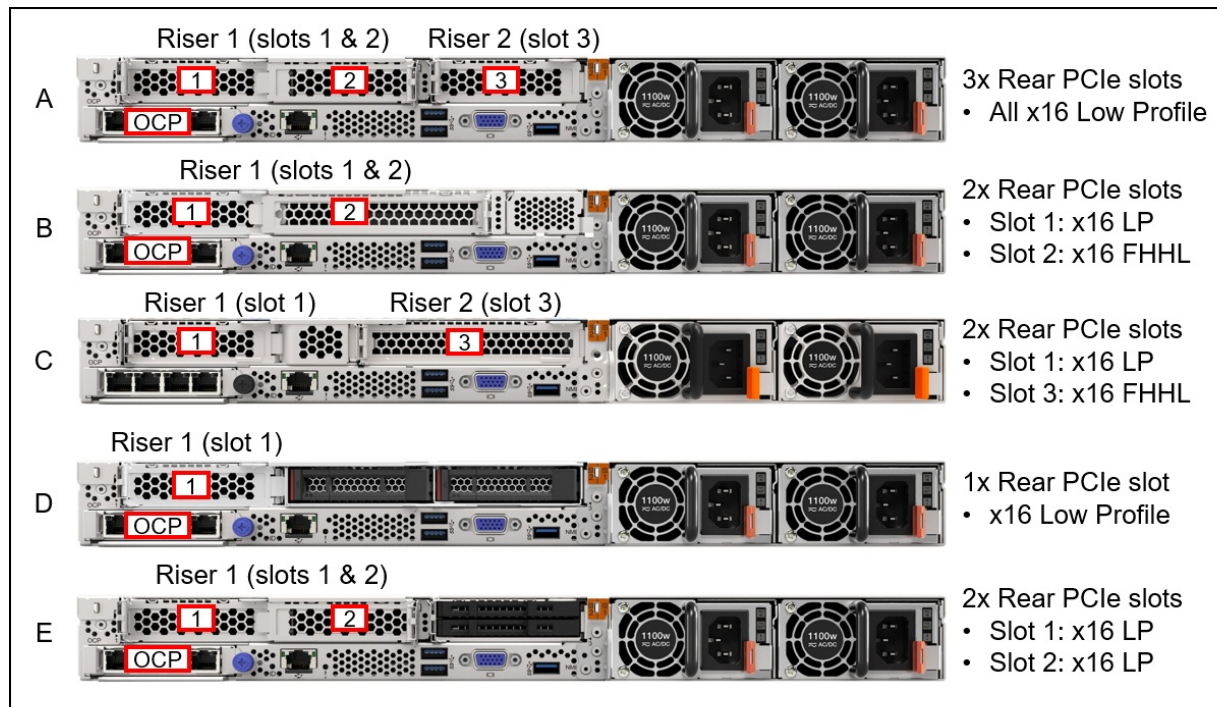

Figure 13. SR645 V3 rear slot configurations

The rear-accessible slots and riser cards are as follows:

- Riser 1: Slots 1 & 2 (connect to CPU 1)
 - Slot 1: Low Profile, PCIe x16
 - Slot 2: Low Profile or FHHL, PCIe x16 (only in configuration A, B, and E in the above figure)
- Riser 2: Slot 3 (connects to CPU 2)
 - Slot 3: Low Profile or FHHL, PCIe x16 (only in configuration A and C)

The PCIe slots can be configured as PCIe 5.0 (Gen 5) or PCIe 4.0 (Gen 4) depending on your workload requirements, however slot 2 will always be PCIe 4.0.

The following table lists the ordering information for the rear PCIe slots in the SR645 V3. The Cfg column matches the slot configurations shown in the preceding figure. The table is divided up into configurations with Gen5 slots with Gen4, and configurations with only Gen4 slots. Ordering information is as follows:

- For CTO orders, order the feature codes listed for the configuration, both riser and cage feature codes (2 or 4 feature codes, depending on the configuration)
- For field upgrades, order the part numbers listed for the configuration (1 or 2 part numbers, depending on the configuration). The part numbers include both the risers and cages needed for that configuration.

No slots: It is also possible to build a configuration without any slots, in which case slot fillers will be derived in the configurator. Slots can be added later as field upgrades using option part numbers as listed in the [Field upgrades table](#).

Table 52. Riser slot ordering information

Cfg	Part number	Features		Description	Slot configuration* (Green = Gen5, Blue = Gen4)			Purpose
		Riser	Cage		Slot 1	Slot 2	Slot 3	
Rear slots - Gen 5					Slot 1	Slot 2	Slot 3	
A	4XH7A83845	BLKB	BLK9	ThinkSystem V3 1U x16/x16 PCIe G5 Riser1 LP+LP	Gen5 x16 LP	Gen4 x16 LP		3x Low Profile slots (2x Gen5, 1x Gen4)
	4XH7A83843	BLKA	BLK6	ThinkSystem V3 1U x16 PCIe G5 Riser 2 Option Kit			Gen5 x16 LP	
B	4XH7A83844	BLKB	BLK8	ThinkSystem V3 1U x16/x16 PCIe G5 Riser1 LP+FH	Gen5 x16 LP	Gen4 x16 FH	No slot	2x slots, 1xLP+1xFH, both to CPU 1 (1x Gen5, 1x Gen4)
C	4XH7A85014	BP39	BP3A	ThinkSystem V3 1U x16 PCIe G5 Riser1 with Full Height Slot3	Gen5 x16 LP	No slot		2x slots: 1LP + 1FH, one to each CPU (2x Gen5)
	4XH7A83843	BLKA	BLK6	ThinkSystem V3 1U x16 PCIe G5 Riser 2 Option Kit			Gen5 x16 FH	
D	4XH7A85013	BP39	BLK6	ThinkSystem V3 1U x16 PCIe G5 Riser1 with Rear drive	Gen5 x16 LP	Drive	Drive	Supports 2x 2.5-inch drives (1x Gen5 slot)
E	4XH7A83845	BLKB	BLK9	ThinkSystem V3 1U x16/x16 PCIe G5 Riser1 LP+LP	Gen5 x16 LP	Gen4 x16 LP	Drives	Supports 2x 7mm drives (1x Gen5, 1x Gen4 slots)
Rear slots - Gen 4					Slot 1	Slot 3	Slot 3	
A	4XH7A83847	BLKF	BLK9	ThinkSystem V3 1U x16/x16 PCIe G4 Riser1 LP+LP Option Kit	Gen4 x16 LP	Gen4 x16 LP		3x Low Profile slots (2x Gen4)
	4XH7A83849	BLKG	BLK6	ThinkSystem V3 1U x16 PCIe G4 Riser 2 Option Kit			Gen4 x16 LP	
B	4XH7A83846	BLKF	BLK8	ThinkSystem V3 1U x16/x16 PCIe G4 Riser1 LP+FH Option Kit	Gen4 x16 LP	Gen4 x16 FH	No slot	2x slots, 1xLP+1xFH, both to CPU 1 (2x Gen4)
D	4XH7A83848	BLKE	BLK6	ThinkSystem V3 1U x16 PCIe G4 Riser 1 with Rear drive	Gen4 x16 LP	Drive	Drive	Supports 2x 2.5-inch drives (1x Gen4 slot)
E	4XH7A83847	BLKF	BLK9	ThinkSystem V3 1U x16/x16 PCIe G4 Riser1 LP+LP Option Kit	Gen4 x16 LP	Gen4 x16 LP	Drives	Supports 2x 7mm drives (2x Gen4 slots)

Configuration rules:

- For best performance, install PCIe 5.0 adapters in PCIe 5.0 (Gen5) slots

Front slots

As an addition or alternative to the rear slots, the SR645 V3 supports slots at the front of the server.

The following figure shows the locations of the front-accessible slots.

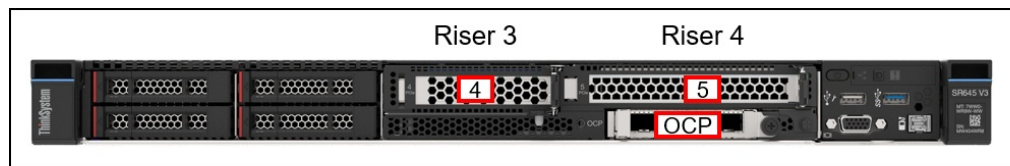

Figure 14. SR645 V3 front slots

The front-accessible slots and riser cards are as follows:

- Slot 4: Low Profile, PCIe 4.0 x8 (connects to CPU 2)
- Slot 5: FHHL, PCIe 4.0 x8 or x16 (connects to CPU 2)
- Slot 6: OCP 3.0 slot (PCIe 4.0 x16) (connects to CPU 1)

Ordering information is listed in the following table.

Table 53. Front slots

Part number	Feature code	Description
Slot 4 (Riser 3)		
CTO only	BUJY	ThinkSystem SR645 V3 Front x8 LP PCIe G4 Riser3
Slot 5 (Riser 4)		
CTO only	BUJZ	ThinkSystem SR645 V3 Front x8 FHFL PCIe G4 Riser4
CTO only	BQ2G	ThinkSystem V3 1U Front x16 FHFL PCIe G4 Riser4

Support for front slots is based on the riser selected as well as the front drive bays selected, as listed in the following table.

Table 54. Front slot & drive bays - supported combinations

Backplane	Backplane description	Slot 4 (LP)	Slot 5 (FHHL)	Front OCP
BU19	2x 2.5-inch NVMe G5 drive bays	PCIe 4.0 x8	PCIe 4.0 x16	PCIe 4.0 x16
BV8J	4x 2.5-inch NVMe G4 drive bays	PCIe 4.0 x8	PCIe 4.0 x16	PCIe 4.0 x16
BT1Q	4x 2.5-inch NVMe G5 drive bays	PCIe 4.0 x8	PCIe 4.0 x8	PCIe 4.0 x16
		Empty	PCIe 4.0 x16	PCIe 4.0 x16
BT1P	4x 2.5-inch AnyBay G5 drive bays	PCIe 4.0 x8	PCIe 4.0 x8	PCIe 4.0 x16
		Empty	PCIe 4.0 x16	PCIe 4.0 x16

Configuration notes:

- The use of front slots requires base feature code BQ7M as described in the [Base feature codes](#) section
- Front slots can be used in conjunction with rear drive bays. See the table of configurations in the [Overview - 2.5-inch front bays with front slots](#) section for specifics.
- The front OCP slot is automatically derived by the configurator with riser 4 (slot 5)
- The front and rear OCP slots are mutually exclusive; when the front OCP slot is configured, the rear OCP slot is disconnected
- M.2 is not supported
- The use of the closed-loop liquid-cooled processor heatsink is not supported
- The use of the security bezel is not supported

Serial port

The SR645 V3 optionally supports a RS-232 serial port by adding a COM port bracket to either slot 2 or slot 3. Ordering information is shown in the following table.

No front slot support: The serial port is not supported in the front PCIe slots

Table 55. Serial port

Part number	Feature code	Description
4X97A82921	BMNJ	ThinkSystem V2/V3 1U COM Port Upgrade Kit

The bracket is shown in the following figure. The option part number includes both Low Profile and Full Height brackets.

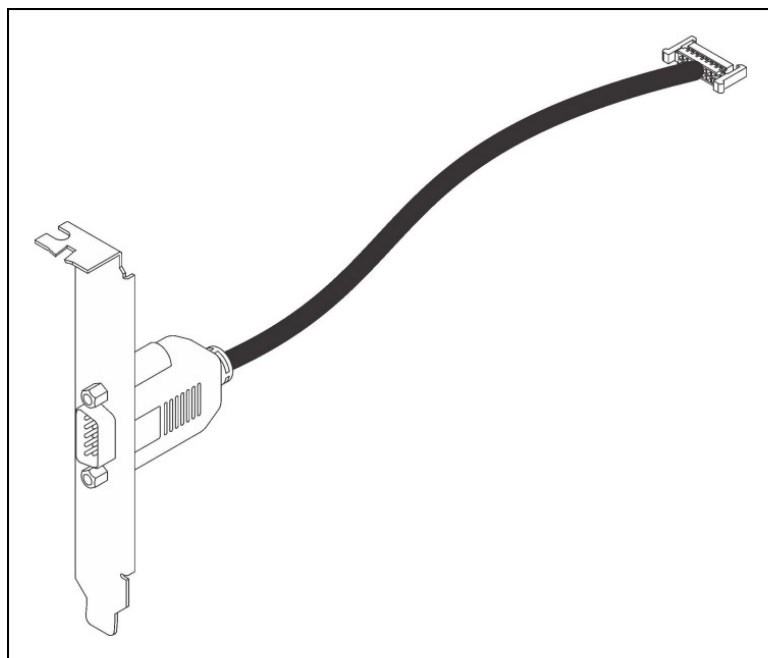

Figure 15. ThinkSystem V2/V3 1U COM Port Upgrade Kit

Network adapters

The server has a dedicated OCP 3.0 SFF slot with PCIe 5.0 x16 host interface. See [Figure 3](#) for the location of the OCP slot.

The following table lists the supported OCP adapters. One port can optionally be shared with the XCC management processor for Wake-on-LAN and NC-SI support. Only 1 OCP card can be installed in the server.

Table 56. Supported OCP adapters

Part number	Feature code	Description	Maximum supported	Windows 10/11 support
Gigabit Ethernet				
4XC7A08235	B5T1	ThinkSystem Broadcom 5719 1GbE RJ45 4-port OCP Ethernet Adapter	1	Supported
4XC7A08277	B93E	ThinkSystem Intel I350 1GbE RJ45 4-port OCP Ethernet Adapter	1	Supported
10 Gb Ethernet - 10GBASE-T				
4XC7A08236	B5ST	ThinkSystem Broadcom 57416 10GBASE-T 2-port OCP Ethernet Adapter	1	Supported
4XC7A08240	B5T4	ThinkSystem Broadcom 57454 10GBASE-T 4-port OCP Ethernet Adapter	1	Supported
4XC7A08278	BCD5	ThinkSystem Intel X710-T2L 10GBASE-T 2-port OCP Ethernet Adapter	1	Supported
4XC7A80268	BPPY	ThinkSystem Intel X710-T4L 10GBase-T 4-Port OCP Ethernet Adapter	1	Supported
25 Gb Ethernet				
4XC7A80567	BPPW	ThinkSystem Broadcom 57504 10/25GbE SFP28 4-Port OCP Ethernet Adapter	1	Supported
4XC7A08294	BCD4	ThinkSystem Intel E810-DA2 10/25GbE SFP28 2-Port OCP Ethernet Adapter	1	Supported
4XC7A80269	BP8L	ThinkSystem Intel E810-DA4 10/25GbE SFP28 4-Port OCP Ethernet Adapter	1	Supported
4XC7A62582	BE4T	ThinkSystem Mellanox ConnectX-6 Lx 10/25GbE SFP28 2-Port OCP Ethernet Adapter	1	No
100 Gb Ethernet				
4XC7A08243	BPPX	ThinkSystem Broadcom 57508 100GbE QSFP56 2-Port OCP Ethernet Adapter	1	Supported

Configuration rules:

- The ThinkSystem Broadcom 5719 1GbE RJ45 4-port OCP Ethernet Adapter (4XC7A08235, B5T1) is currently not supported with the following CPUs. The incompatibility is planned to be resolved in a future update to XCC firmware in December 2023.
 - ThinkSystem AMD EPYC 9124 16C 200W 3.0GHz Processor
 - ThinkSystem AMD EPYC 9224 24C 200W 2.5GHz Processor
 - ThinkSystem AMD EPYC 9254 24C 200W 2.9GHz Processor
 - ThinkSystem AMD EPYC 9334 32C 210W 2.7GHz Processor

The following table lists additional supported network adapters that can be installed in the regular PCIe slots.

Table 57. Supported PCIe Network Adapters

Part number	Feature code	Description	Form factor	Maximum quantity	Slots supported	Windows 10/11 support
Gigabit Ethernet						
7ZT7A00484	AUZV	ThinkSystem Broadcom 5719 1GbE RJ45 4-Port PCIe Ethernet Adapter	Low profile	3	1,2,3§	Supported

Part number	Feature code	Description	Form factor	Maximum quantity	Slots supported	Windows 10/11 support
7ZT7A00535	AUZW	ThinkSystem I350-T4 PCIe 1Gb 4-Port RJ45 Ethernet Adapter	Low profile	3	1,2,3§	Supported
10 Gb Ethernet - 10GBASE-T						
7ZT7A00496	AUKP	ThinkSystem Broadcom 57416 10GBASE-T 2-Port PCIe Ethernet Adapter	Low profile	5	1,2,3,4,5	Supported
4XC7A08245	B5SU	ThinkSystem Broadcom 57454 10GBASE-T 4-port PCIe Ethernet Adapter	Low profile	3	1,2,3§	Supported
4XC7A80266	BNWL	ThinkSystem Intel X710-T2L 10GBase-T 2-Port PCIe Ethernet Adapter	Low profile	5	1,2,3,4,5	Supported
4XC7A79699	BMXB	ThinkSystem Intel X710-T4L 10GBase-T 4-Port PCIe Ethernet Adapter	Low profile	3	1,2,3	Supported
25 Gb Ethernet						
4XC7A84827	BUQK	ThinkSystem AMD X3522 10/25GbE DSFP28 2-Port PCIe Ethernet Adapter (Low Latency)	Low profile	4	1,2,3,5	Supported
4XC7A80566	BNWM	ThinkSystem Broadcom 57504 10/25GbE SFP28 4-Port PCIe Ethernet Adapter	FHHL	1	2†	Supported
4XC7A08295	BCD6	ThinkSystem Intel E810-DA2 10/25GbE SFP28 2-Port PCIe Ethernet Adapter	Low profile	5	1,2,3,4,5	Supported
4XC7A80267	BP8M	ThinkSystem Intel E810-DA4 10/25GbE SFP28 4-Port PCIe Ethernet Adapter	FHHL	1	2,3†	Supported
4XC7A62580	BE4U	ThinkSystem Mellanox ConnectX-6 Lx 10/25GbE SFP28 2-Port PCIe Ethernet Adapter	Low profile	5	1,2,3,4,5	No
4XC7A62581	BHE2	ThinkSystem Solarflare X2522-Plus 10/25GbE SFP28 2-Port PCIe Ethernet Adapter	Low profile	5	1,2,3,4,5	Supported
100 Gb Ethernet / HDR100 InfiniBand						
4XC7A08297	BK1J	ThinkSystem Broadcom 57508 100GbE QSFP56 2-port PCIe 4 Ethernet Adapter	Low profile	4	1,2,3,5	Supported
4XC7A08248	B8PP	ThinkSystem Mellanox ConnectX-6 Dx 100GbE QSFP56 2-port PCIe Ethernet Adapter	Low profile	4	1,2,3,5	No
4C57A14177	B4R9	ThinkSystem Mellanox ConnectX-6 HDR100/100GbE QSFP56 1-port PCIe VPI Adapter	Low profile	4	1,2,3,5	No
4C57A14178	B4RA	ThinkSystem Mellanox ConnectX-6 HDR100/100GbE QSFP56 2-port PCIe VPI Adapter	Low profile	4	1,2,3,5	No
200 Gb Ethernet / HDR InfiniBand / NDR200 InfiniBand						
4C57A15326	B4RC	ThinkSystem Mellanox ConnectX-6 HDR/200GbE QSFP56 1-port PCIe 4 VPI Adapter	Low profile	3	1,3,2	No
4XC7A81883	BQBN	ThinkSystem NVIDIA ConnectX-7 NDR200/HDR QSFP112 2-Port PCIe Gen5 x16 InfiniBand Adapter	Low profile	2	1,3	No
400 Gb Ethernet						

Part number	Feature code	Description	Form factor	Maximum quantity	Slots supported	Windows 10/11 support
4XC7A80289	BQ1N	ThinkSystem NVIDIA ConnectX-7 NDR400 OSFP 1-Port PCIe Gen5 Adapter	Low profile	2	1,3	No

† In the SR645 V3, this adapter requires a full-height bracket and must be installed in a full-height slot. The use of a low-profile bracket and slot is not supported.

§ Not supported installed in slot 1 of the LP+FH riser cage (configuration B in the [I/O expansion](#) section)

For more information, including the transceivers and cables that each adapter supports, see the list of Lenovo Press Product Guides in the Networking adapters category:

<https://lenovopress.com/servers/options/ethernet>

Configuration rules:

- The following adapters are not supported installed into the LP+FH riser cage (configuration B in the [I/O expansion](#) section)
 - ThinkSystem Broadcom 5719 1GbE RJ45 4-Port PCIe Ethernet Adapter, 7ZT7A00484
 - ThinkSystem I350-T4 PCIe 1Gb 4-Port RJ45 Ethernet Adapter, 7ZT7A00535
 - ThinkSystem Broadcom 57454 10GBASE-T 4-port PCIe Ethernet Adapter, 4XC7A08245
- **E810 Ethernet and X350 RAID/HBAs:** The use of both an Intel E810 network adapter and an X350 HBA/RAID adapter (9350, 5350 and 4350) is currently not supported in ThinkSystem servers. For details see [Support Tip HT513226](#). Planned support for this combination of adapters is 4Q/2023 (SI 23-2).
- The ThinkSystem Broadcom 5719 1GbE RJ45 4-Port PCIe Ethernet Adapter (7ZT7A00484, AUZV) is currently not supported with the following CPUs. The incompatibility is planned to be resolved in a future update to XCC firmware in December 2023.
 - ThinkSystem AMD EPYC 9124 16C 200W 3.0GHz Processor
 - ThinkSystem AMD EPYC 9224 24C 200W 2.5GHz Processor
 - ThinkSystem AMD EPYC 9254 24C 200W 2.9GHz Processor
 - ThinkSystem AMD EPYC 9334 32C 210W 2.7GHz Processor

Fibre Channel host bus adapters

The following table lists the Fibre Channel HBAs supported by the SR645 V3.

No Windows 10/11 support: None of the adapters listed in the table are supported with Windows 10 or Windows 11.

Table 58. Fibre Channel HBAs

Part number	Feature code	Description	Maximum quantity	Slots supported
64 Gb Fibre Channel				
4XC7A77485	BLC1	ThinkSystem Emulex LPe36002 64Gb 2-port PCIe Fibre Channel Adapter	5	1,2,3,4,5
32 Gb Fibre Channel				
4XC7A76498	BJ3G	ThinkSystem Emulex LPe35000 32Gb 1-port PCIe Fibre Channel Adapter v2	5	1,2,3,4,5
4XC7A76525	BJ3H	ThinkSystem Emulex LPe35002 32Gb 2-port PCIe Fibre Channel Adapter v2	5	1,2,3,4,5
4XC7A08279	BA1G	ThinkSystem QLogic QLE2770 32Gb 1-Port PCIe Fibre Channel Adapter	5	1,2,3,4,5
4XC7A08276	BA1F	ThinkSystem QLogic QLE2772 32Gb 2-Port PCIe Fibre Channel Adapter	5	1,2,3,4,5
16 Gb Fibre Channel				
01CV830	ATZU	Emulex 16Gb Gen6 FC Single-port HBA	5	1,2,3,4,5
01CV840	ATZV	Emulex 16Gb Gen6 FC Dual-port HBA	5	1,2,3,4,5
01CV750	ATZB	QLogic 16Gb Enhanced Gen5 FC Single-port HBA	5	1,2,3,4,5
01CV760	ATZC	QLogic 16Gb Enhanced Gen5 FC Dual-port HBA	5	1,2,3,4,5

For more information, see the list of Lenovo Press Product Guides in the Host bus adapters category:
<https://lenovopress.com/servers/options/hba>

SAS adapters for external storage

The following table lists SAS HBAs and RAID adapters supported by SR645 V3 server for use with external storage.

No Windows 10/11 support: None of the adapters listed in the table are supported with Windows 10 or Windows 11.

Table 59. Adapters for external storage

Part number	Feature code	Description	Maximum supported	Slots supported
SAS HBAs				
4Y37A78837	BNWK	ThinkSystem 440-8e SAS/SATA PCIe Gen4 12Gb HBA	5	1,2,3,4,5
4Y37A09724	B8P7	ThinkSystem 440-16e SAS/SATA PCIe Gen4 12Gb HBA	5	1,2,3,4,5
External RAID adapters				
4Y37A78836	BNWJ	ThinkSystem RAID 940-8e 4GB Flash PCIe Gen4 12Gb Adapter	1	1,2,3*

* See configuration rules below regarding supercap requirements

For a comparison of the functions of the supported storage adapters, see the ThinkSystem RAID Adapter and HBA Reference:

<https://lenovopress.lenovo.com/lp1288#sr645-v3-support=SR645%2520V3&internal-or-external-ports=External>

Configuration rules

- The RAID 940-8e uses a flash power module (supercap), and the SR645 V3 supports only 1 supercap depending on the configuration. See the [RAID flash power module \(supercap\) support](#) section for details. If a RAID 9XXX adapter is configured for connectivity to internal drive bays, then no RAID 940-8e are supported.

For more information, see the list of Lenovo Press Product Guides in the Host bus adapters and RAID adapters categories:

<https://lenovopress.com/servers/options/hba>

<https://lenovopress.com/servers/options/raid>

Flash storage adapters

The SR645 V3 currently does not support any Flash storage adapters.

GPU adapters

The SR645 V3 supports the following graphics processing units (GPUs).

Table 60. Supported GPUs

Part number	Feature code	Description	TDP	Maximum supported	Slots supported	Windows 10/11 support
4X67A81547	BQZT	ThinkSystem NVIDIA A2 16GB PCIe Gen4 Passive GPU w/o CEC	60W	4	1,2,3,5	Yes

* See configuration rules below

For information about these GPUs, see the ThinkSystem GPU Summary, available at:

<https://lenovopress.com/lp0768-thinksystem-thinkagile-gpu-summary>

Configuration rules

The following configuration requirements must be met when installing GPUs:

- All GPUs installed must be identical
- Rear drive bays are not supported
- Flash storage adapters are not supported.
- Maximum ambient temperature is 30°C
- Performance fans are required and will be derived by the configurator for configure-to-order builds.
- When adding GPUs as field upgrades, you will be required to replace all Standard fans with Performance fans. See the [Cooling](#) section for ordering information.
- For details regarding supported combinations of front drive bays, processors, fans, and ambient temperature, see the Thermal Rules page of the User Guide:
https://pubs.lenovo.com/sr645-v3/thermal_rules#server-models-with-gpus

Cooling

The SR645 V3 server has up to eight 40 mm dual-rotor hot-swap variable-speed fans. Six fans are needed when one processor is installed and eight fans are required when two processors are installed. The server offers N+1 rotor redundancy. The server also has one additional fan integrated in each of the two power supplies.

Depending on the configuration, the server will need either Standard fans (21K RPM) or Performance fans (24K RPM)

Under the following conditions, Standard fans can be used:

- Processor with TDP ≤ 240W
- No GPUs
- Front drive bays ≤ 8x SAS/SATA drives
- Rear drive bays SAS/SATA, 7mm or 2.5-inch
- No NVMe drives, front or rear
- No 256GB 3DS RDIMMs
- None of the following network adapters:
 - Any 100Gb, 200Gb or 400Gb adapter
 - ThinkSystem Broadcom 57454 10GBASE-T 4-port OCP Ethernet Adapter

If any conditions are not met, Performance fans are required.

Ordering information for the fans is listed in the following table.

Table 61. Fan ordering information

Part number	Feature code	Description	Number required
4F17A14488	BH9N	ThinkSystem V3 1U Standard Fan Option Kit v2	1x CPU: 6 2x CPUs: 8
4F17A14487	BH9M	ThinkSystem V3 1U Performance Fan Option Kit v2	1x CPU: 6 2x CPUs: 8

Power supplies

The SR645 V3 supports up to two redundant hot-swap power supplies.

The power supply choices are listed in the following table. Both power supplies used in server must be identical.

Tip: When configuring a server in the DCSC configurator, power consumption is calculated precisely by interfacing with Lenovo Capacity Planner. You can therefore select the appropriate power supply for your configuration. However, do consider future upgrades that may require additional power needs.

Table 62. Power supply options

Part number	Feature code	Description	Maximum quantity	110V AC	220V AC	240V DC China only	-48V DC
AC input power -80 PLUS Titanium efficiency							
4P57A82019	BR1X	ThinkSystem 750W 230V Titanium Hot-Swap Gen2 Power Supply v3	2	No	Yes	Yes	No
4P57A72666	BLKH	ThinkSystem 1100W 230V Titanium Hot-Swap Gen2 Power Supply	2	No	Yes	Yes	No
4P57A78359	BPK9	ThinkSystem 1800W 230V Titanium Hot-Swap Gen2 Power Supply	2	No	Yes	Yes	No
AC input power -80 PLUS Platinum efficiency							
4P57A72670	BNFG	ThinkSystem 750W 230V/115V Platinum Hot-Swap Gen2 Power Supply v3	2	Yes	Yes	Yes	No
4P57A72671	BNFH	ThinkSystem 1100W 230V/115V Platinum Hot-Swap Gen2 Power Supply v3	2	Yes	Yes	Yes	No
4P57A26294	BMUF	ThinkSystem 1800W 230V Platinum Hot-Swap Gen2 Power Supply	2	No	Yes	Yes	No
-48V DC input power							
4P57A26296	B8QE	ThinkSystem 1100W -48V DC Hot-Swap Gen2 Power Supply	2	No	No	No	Yes

Supported power supplies are auto-sensing dual-voltage units, supporting both 110V AC (100-127V 50/60 Hz) and 220V AC (200-240V 50/60 Hz) power. For China customers, all power supplies support 240V DC. All supported AC power supplies have a C14 connector.

The supported -48V DC power supply has a Weidmuller TOP 4GS/3 7.6 terminal as shown in the following figure.

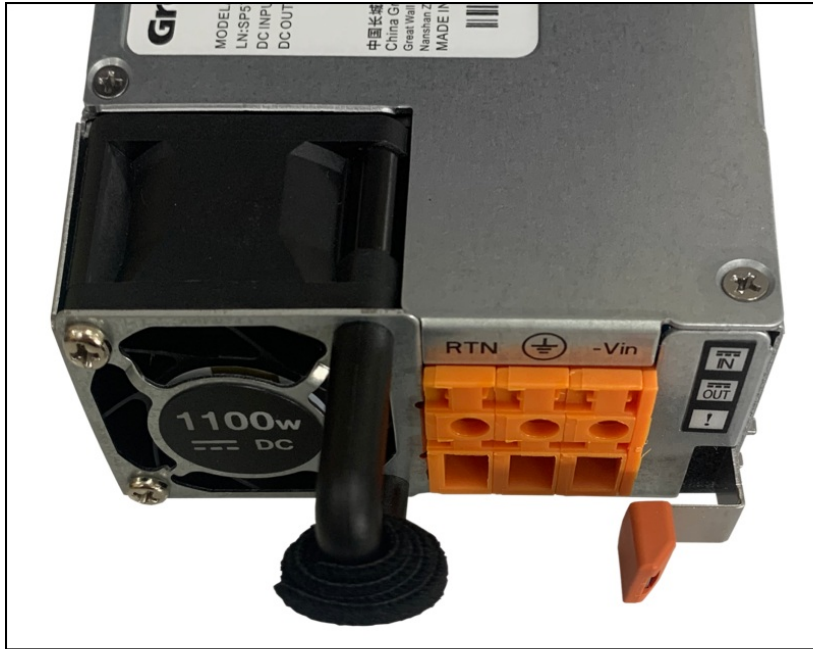

Figure 16. Connector on the ThinkSystem 1100W -48V DC Hot-Swap Gen2 Power Supply

Power supply options do not include a line cord. For server configurations, the inclusion of a power cord is model dependent. Configure-to-order models can be configured without power cords if desired.

Power supply LEDs

The supported hot-swap power supplies have the following LEDs:

- Power input LED:
 - Green: The power supply is connected to the AC power source
 - Off: The power supply is disconnected from the AC power source or a power problem has occurred
- Power output LED:
 - Green: The server is on and the power supply is working normally
 - Blinking green: The power supply is in Zero-output/Standby mode (see below)
 - Off: The server is powered off, or the power supply is not working properly
- Power supply error LED:
 - Off: The power supply is working normally
 - Yellow: The power supply has failed

Zero-output mode: When Zero-output mode (also known as Standby mode or Cold Redundancy mode) is configured in XCC and the server power load is sufficiently low, one of the installed power supplies enters into the Standby state while the other one delivers entire load. When the power load increases, the standby power supply will switch to Active state to provide sufficient power to the server. Zero-output mode can be enabled or disabled in the XClarity Controller web interface, Server Configuration > Power Policy. If you select Disable, then both power supplies will be in the Active state.

Power cords

Line cords and rack power cables with C13 connectors can be ordered as listed in the following table.

110V customers: If you plan to use the 1100W power supply with a 110V power source, select a power cable that is rated above 10A. Power cables that are rated at 10A or below are not supported with 110V power.

Table 63. Power cords

Part number	Feature code	Description
Rack cables - C13 to C14		
SL67B08593	BPHZ	0.5m, 10A/100-250V, C13 to C14 Jumper Cord
00Y3043	A4VP	1.0m, 10A/100-250V, C13 to IEC 320-C14 Rack Power Cable
4L67A08367	B0N5	1.0m, 13A/100-250V, C13 to C14 Jumper Cord
39Y7937	6201	1.5m, 10A/100-250V, C13 to IEC 320-C14 Rack Power Cable
4L67A08368	B0N6	1.5m, 13A/100-250V, C13 to C14 Jumper Cord
4L67A08365	B0N4	2.0m, 10A/100-250V, C13 to IEC 320-C14 Rack Power Cable
4L67A08369	6570	2.0m, 13A/100-250V, C13 to C14 Jumper Cord
4L67A08366	6311	2.8m, 10A/100-250V, C13 to IEC 320-C14 Rack Power Cable
4L67A08370	6400	2.8m, 13A/100-250V, C13 to C14 Jumper Cord
39Y7932	6263	4.3m, 10A/100-250V, C13 to IEC 320-C14 Rack Power Cable
4L67A08371	6583	4.3m, 13A/100-250V, C13 to C14 Rack Power Cable
Rack cables - C13 to C14 (Y-cable)		
00Y3046	A4VQ	1.345m, 2X C13 to C14 Jumper Cord, Rack Power Cable
00Y3047	A4VR	2.054m, 2X C13 to C14 Jumper Cord, Rack Power Cable
Rack cables - C13 to C20		
39Y7938	6204	2.8m, 10A/100-250V, C13 to IEC 320-C20 Rack Power Cable
Rack cables - C13 to C20 (Y-cable)		
47C2491	A3SW	1.2m, 16A/100-250V, 2 Short C13s to Short C20 Rack Power Cable
47C2492	A3SX	2.5m, 16A/100-250V, 2 Long C13s to Short C20 Rack Power Cable
47C2493	A3SY	2.8m, 16A/100-250V, 2 Short C13s to Long C20 Rack Power Cable
47C2494	A3SZ	4.1m, 16A/100-250V, 2 Long C13s to Long C20 Rack Power Cable
Line cords		
39Y7930	6222	2.8m, 10A/250V, C13 to IRAM 2073 (Argentina) Line Cord
81Y2384	6492	4.3m 10A/220V, C13 to IRAM 2073 (Argentina) Line Cord
39Y7924	6211	2.8m, 10A/250V, C13 to AS/NZ 3112 (Australia/NZ) Line Cord
81Y2383	6574	4.3m, 10A/230V, C13 to AS/NZS 3112 (Aus/NZ) Line Cord
69Y1988	6532	2.8m, 10A/250V, C13 to NBR 14136 (Brazil) Line Cord
81Y2387	6404	4.3m, 10A/250V, C13 - 2P+Gnd (Brazil) Line Cord
39Y7928	6210	2.8m, 220-240V, C13 to GB 2099.1 (China) Line Cord
81Y2378	6580	4.3m, 10A/220V, C13 to GB 2099.1 (China) Line Cord
39Y7918	6213	2.8m, 10A/250V, C13 to DK2-5a (Denmark) Line Cord
81Y2382	6575	4.3m, 10A/230V, C13 to DK2-5a (Denmark) Line Cord
39Y7917	6212	2.8m, 10A/230V, C13 to CEE7-VII (Europe) Line Cord

Part number	Feature code	Description
81Y2376	6572	4.3m, 10A/230V, C13 to CEE7-VII (Europe) Line Cord
39Y7927	6269	2.8m, 10A/250V, C13(2P+Gnd) (India) Line Cord
81Y2386	6567	4.3m, 10A/240V, C13 to IS 6538 (India) Line Cord
39Y7920	6218	2.8m, 10A/250V, C13 to SI 32 (Israel) Line Cord
81Y2381	6579	4.3m, 10A/230V, C13 to SI 32 (Israel) Line Cord
39Y7921	6217	2.8m, 220-240V, C13 to CEI 23-16 (Italy/Chile) Line Cord
81Y2380	6493	4.3m, 10A/230V, C13 to CEI 23-16 (Italy/Chile) Line Cord
46M2593	A1RE	2.8m, 12A/125V, C13 to JIS C-8303 (Japan) Line Cord
4L67A08362	6495	4.3m, 12A/200V, C13 to JIS C-8303 (Japan) Line Cord
39Y7926	6335	4.3m, 12A/100V, C13 to JIS C-8303 (Japan) Line Cord
39Y7922	6214	2.8m, 10A/250V, C13 to SABS 164 (S Africa) Line Cord
81Y2379	6576	4.3m, 10A/230V, C13 to SABS 164 (South Africa) Line Cord
39Y7925	6219	2.8m, 220-240V, C13 to KETI (S Korea) Line Cord
81Y2385	6494	4.3m, 12A/220V, C13 to KSC 8305 (S. Korea) Line Cord
39Y7919	6216	2.8m, 10A/250V, C13 to SEV 1011-S24507 (Swiss) Line Cord
81Y2390	6578	4.3m, 10A/230V, C13 to SEV 1011-S24507 (Sws) Line Cord
23R7158	6386	2.8m, 10A/125V, C13 to CNS 10917-3 (Taiwan) Line Cord
81Y2375	6317	2.8m, 10A/240V, C13 to CNS 10917-3 (Taiwan) Line Cord
81Y2374	6402	2.8m, 13A/125V, C13 to CNS 60799 (Taiwan) Line Cord
4L67A08363	AX8B	4.3m, 10A 125V, C13 to CNS 10917 (Taiwan) Line Cord
81Y2389	6531	4.3m, 10A/250V, C13 to 76 CNS 10917-3 (Taiwan) Line Cord
81Y2388	6530	4.3m, 13A/125V, C13 to CNS 10917 (Taiwan) Line Cord
39Y7923	6215	2.8m, 10A/250V, C13 to BS 1363/A (UK) Line Cord
81Y2377	6577	4.3m, 10A/230V, C13 to BS 1363/A (UK) Line Cord
90Y3016	6313	2.8m, 10A/120V, C13 to NEMA 5-15P (US) Line Cord
46M2592	A1RF	2.8m, 10A/250V, C13 to NEMA 6-15P Line Cord
00WH545	6401	2.8m, 13A/120V, C13 to NEMA 5-15P (US) Line Cord
4L67A08359	6370	4.3m, 10A/125V, C13 to NEMA 5-15P (US) Line Cord
4L67A08361	6373	4.3m, 10A/250V, C13 to NEMA 6-15P (US) Line Cord
4L67A08360	AX8A	4.3m, 13A/120V, C13 to NEMA 5-15P (US) Line Cord

-48V DC power cord

For the -48V DC Power Supply, the following power cable is supported.

Table 64. -48V DC power cable

Part number	Feature code	Description
4X97A59831	BE4V	2.5m, -48VDC Interconnecting Cable

Systems management

The SR645 V3 contains an integrated service processor, XClarity Controller 2 (XCC), which provides advanced control, monitoring, and alerting functions. The XCC2 is based on the AST2600 baseboard management controller (BMC) using a dual-core ARM Cortex A7 32-bit RISC service processor running at 1.2 GHz.

Topics in this section:

- [System I/O Board](#)
- [Local management](#)
- [System status with XClarity Mobile](#)
- [Remote management](#)
- [XCC2 Platinum](#)
- [Lenovo XClarity Provisioning Manager](#)
- [Lenovo XClarity Administrator](#)
- [Lenovo XClarity Integrators](#)
- [Lenovo XClarity Essentials](#)
- [Lenovo XClarity Energy Manager](#)
- [Lenovo Capacity Planner](#)

System I/O Board

The SR645 V3 implements a separate System I/O Board that connects to the Processor Board. The location of the System I/O Board is shown in the [Components and connectors](#) section. The System I/O Board contains all the connectors visible at the rear of the server as shown in the following figure.

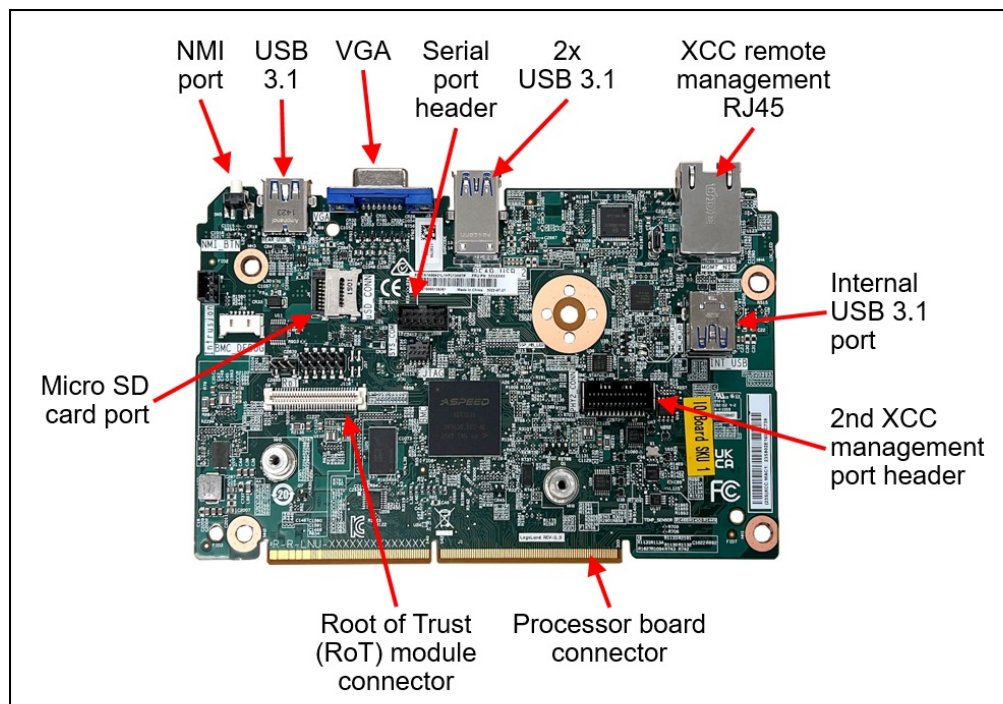

Figure 17. System I/O Board

The board also has the following components:

- XClarity Controller 2, implemented using the ASPEED AST2600 baseboard management controller (BMC).
- Root of Trust (RoT) module - a daughter card that implements Platform Firmware Resiliency (PFR)

hardware Root of Trust (RoT) which enables the server to be NIST SP800-193 compliant. For more details about PFR, see the [Security](#) section.

- Connector to enable an additional redundant Ethernet connection to the XCC2 controller. The connector is used in conjunction with the ThinkSystem Redundant System Management Port Adapter. For details, see the [Remote management](#) section.
- Internal USB port - to allow the booting of an operating system from a USB key. The VMware ESXi preloads use this port for example. Preloads are described in the [Operating system support](#) section.
- MicroSD card port to enable the use of a MicroSD card for additional storage for use with the XCC2 controller. XCC2 can use the storage as a Remote Disc on Card (RDOC) device (up to 4GB of storage). It can also be used to store firmware updates (including N-1 firmware history) for ease of deployment.

Tip: Without a MicroSD card installed, the XCC2 controller will have 100MB of available RDOC storage.

Ordering information for the supported USB drive and Micro SD card are listed in the following table.

Table 65. Media for use with the System I/O Board

Part number	Feature code	Description
4X77A77065	BNWN	ThinkSystem USB 32GB USB 3.0 Flash Drive
4X77A77064	BNWP	ThinkSystem MicroSD 32GB Class 10 Flash Memory Card

Local management

The SR645 V3 offers a front operator panel with key LED status indicators, as shown in the following figure.

Tip: The Network LED only shows network activity of the installed OCP network adapter.

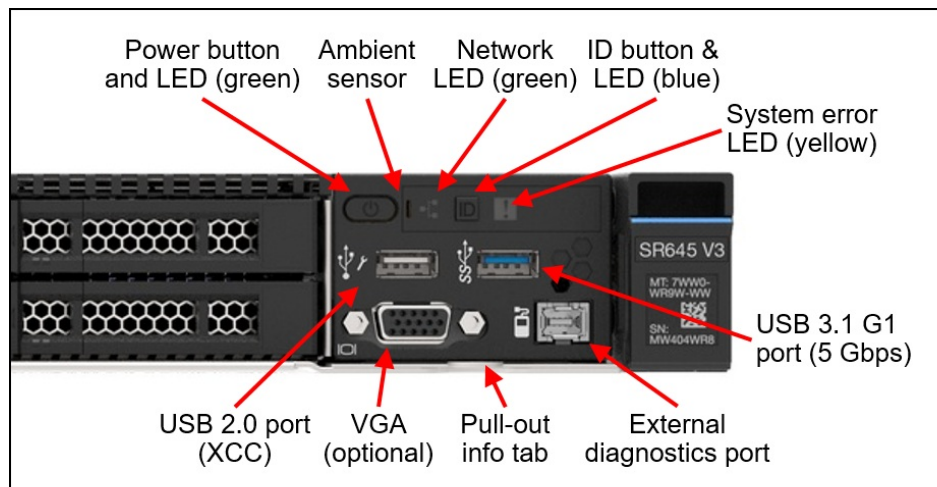

Figure 18. Front operator panel

Light path diagnostics

The server offers light path diagnostics. If an environmental condition exceeds a threshold or if a system component fails, the XCC lights LEDs inside the server to help you diagnose the problem and find the failing part. The server has fault LEDs next to the following components:

- Each memory DIMM
- Each drive bay

- Each power supply

Integrated Diagnostics Panel for 8x 2.5-inch and EDSFF configurations

For configurations with 8x 2.5-inch drive bays or 16x EDSFF drive bays at the front, the server can optionally be configured to have a pull-out Integrated Diagnostics Panel. The following figure shows the configurations with the standard (fixed) operator panel and the optional Integrated Diagnostics Panel.

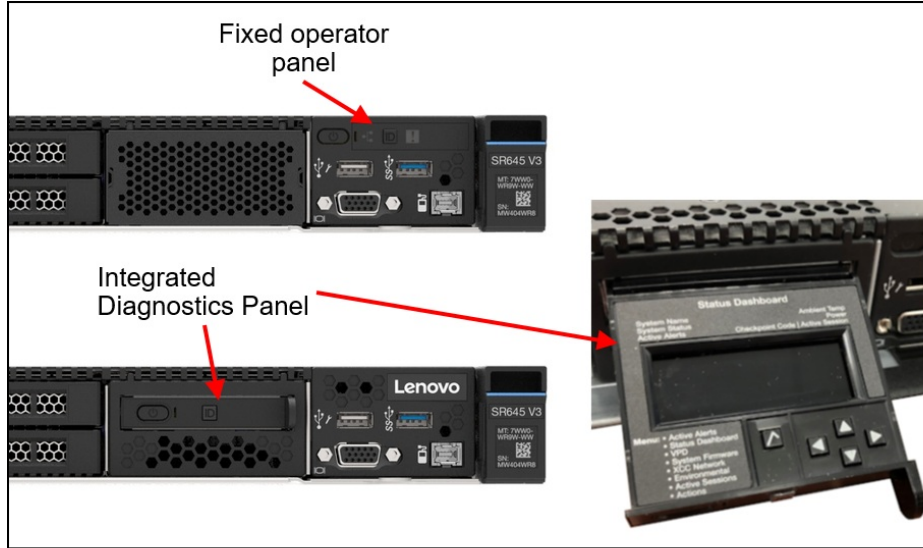

Figure 19. Operator panel choices for the EDSFF and 8x 2.5-inch drive bay configurations

The Integrated Diagnostics Panel allows quick access to system status, firmware, network, and health information. The LCD display on the panel and the function buttons give you access to the following information:

- Active alerts
- Status Dashboard
- System VPD: machine type & mode, serial number, UUID string
- System firmware levels: UEFI and XCC firmware
- XCC network information: hostname, MAC address, IP address, DNS addresses
- Environmental data: Ambient temperature, CPU temperature, AC input voltage, estimated power consumption
- Active XCC sessions
- System reset action

The Integrated Diagnostics Panel can be configured as listed in the following table. It is only available configure-to-order (CTO); not available as a field upgrade.

Table 66. Ordering information for the Integrated Diagnostics Panel

Part number	Feature code	Description
CTO only	B8NH	ThinkSystem 1U Integrated Diagnostics Panel

Configuration rules for the Pull-out operator panel:

- Only supported with configurations with 8x 2.5-inch drive bays or with EDSFF drive bays
- Not available as a field upgrade. The component is CTO or on pre-configured models only

Front VGA and External Diagnostics ports

The VGA port at the rear of the server is included in all models, however the VGA port at the front of the server is optional. The ThinkSystem V2/V3 1U Front VGA Cable Option Kit allows you to upgrade your server by adding a VGA video port to the front of the server (if the server does not already come with a front VGA port). When the front VGA is in use, the rear VGA port is automatically disabled.

The SR645 V3 optionally includes a port to connect an External Diagnostics Handset. To include in a server, ensure the appropriate feature code is included, based on the front drive configuration. Field upgrades to add the External Diagnostics port are not available.

Table 67. Front VGA and External Diagnostics ports

Part number	Feature code	Description
Optional VGA port (adds the VGA port to the front of the server)		
4X97A12644	BA2Y	ThinkSystem V2/V3 1U Front VGA Cable Option Kit
Optional port for the External Diagnostic Handset (adds the port to the front of the server)		
CTO only	BLKD	ThinkSystem 1U V3 10x2.5" Media Bay w/ Ext. Diagnostics Port
CTO only	B8NN	ThinkSystem 1U V3 8x2.5" Media Bay w/ External Diagnostics Port
CTO only	BR03	ThinkSystem 1U 4x3.5" Media Bay w/ External Diagnostics Port

External Diagnostics Handset

The SR645 V3 optionally includes a port to connect an External Diagnostics Handset as described in the previous section. The External Diagnostics Handset has the same functions as the Integrated Diagnostics Panel but has the advantages of not consuming space on the front of the server plus it can be shared among many servers in your data center. The handset has a magnet on the back of it to allow you to easily mount it on a convenient place on any rack cabinet.

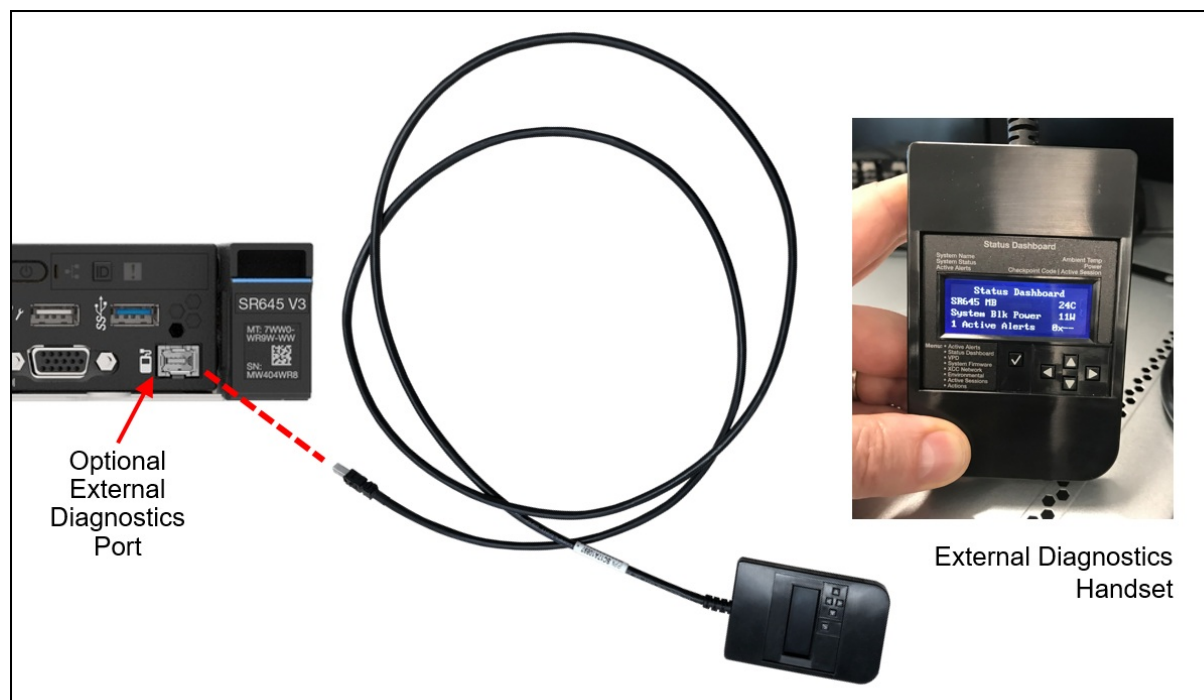

Figure 20. External Diagnostics Handset

The following table lists the ordering information for the handset.

Table 68. External Diagnostics Handset ordering information

Part number	Feature code	Description
4TA7A64874	BEUX	ThinkSystem External Diagnostics Handset

Information pull-out tab

The front of the server also houses an information pull-out tab (also known as the network access tag). See [Figure 2](#) for the location. A label on the tab shows the network information (MAC address and other data) to remotely access the service processor.

System status with XClarity Mobile

The XClarity Mobile app includes a tethering function where you can connect your Android or iOS device to the server via USB to see the status of the server.

The steps to connect the mobile device are as follows:

1. Enable USB Management on the server, by holding down the ID button for 3 seconds (or pressing the dedicated USB management button if one is present)
2. Connect the mobile device via a USB cable to the server's USB port with the management symbol 
3. In iOS or Android settings, enable Personal Hotspot or USB Tethering
4. Launch the Lenovo XClarity Mobile app

Once connected you can see the following information:

- Server status including error logs (read only, no login required)
- Server management functions (XClarity login credentials required)

Remote management

The server offers a dedicated RJ45 Ethernet port at the rear of the server for remote management via the XClarity Controller 2 management processor. The port supports 10/100/1000 Mbps speeds.

Remote server management is provided through industry-standard interfaces:

- Intelligent Platform Management Interface (IPMI) Version 2.0
- Simple Network Management Protocol (SNMP) Version 3 (no SET commands; no SNMP v1)
- Common Information Model (CIM-XML)
- Representational State Transfer (REST) support
- Redfish support (DMTF compliant)
- Web browser - HTML 5-based browser interface (Java and ActiveX not required) using a responsive design (content optimized for device being used - laptop, tablet, phone) with NLS support

The SR645 V3 also supports the use of an OCP adapter that provides an additional redundant Ethernet connection to the XCC2 controller. Ordering information is listed in the following table.

Table 69. Redundant System Management Port Adapter

Part number	Feature code	Description	Maximum quantity
4XC7A85319	BTMQ	ThinkSystem V3 Management NIC Adapter Kit	1

The use of this adapter allows concurrent remote access using both the connection on the adapter and the onboard RJ45 remote management port provided by the server. The adapter and onboard port have separate IP addresses.

Configuration rules:

- The Redundant System Management Port Adapter is installed in the OCP adapter slot at the rear of the server and is mutually exclusive with any OCP network adapter.
- It is not supported installed in the front OCP slot (if the front OCP slot is configured)
- If the Redundant System Management Port Adapter is installed in the rear slot, then the front OCP slot (if configured) cannot be used.

The following figure shows the server with the Redundant System Management Port Adapter installed in the OCP slot.

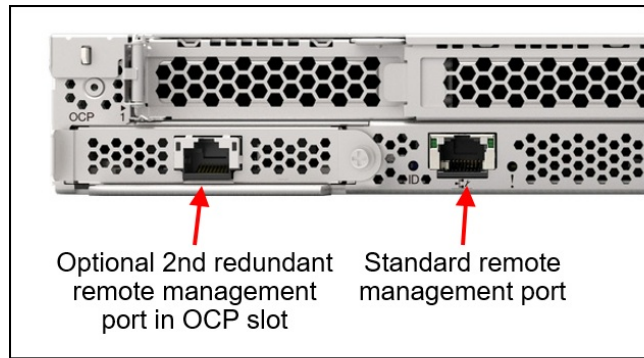

Figure 21. SR645 V3 with the Redundant System Management Port Adapter installed

IPMI via the Ethernet port (IPMI over LAN) is supported, however it is disabled by default. For CTO orders you can specify whether you want to the feature enabled or disabled in the factory, using the feature codes listed in the following table.

Table 70. IPMI-over-LAN settings

Feature code	Description
B7XZ	Disable IPMI-over-LAN (default)
B7Y0	Enable IPMI-over-LAN

XCC2 Platinum

The XCC2 service processor in the SR645 V3 supports an upgrade to the Platinum level of features. Compared to the XCC functions of ThinkSystem V2 and earlier systems, Platinum adds the same features as Enterprise and Advanced levels in ThinkSystem V2, plus additional features.

XCC2 Platinum adds the following Enterprise and Advanced functions:

- Remotely viewing video with graphics resolutions up to 1600x1200 at 75 Hz with up to 23 bits per pixel, regardless of the system state
- Remotely accessing the server using the keyboard and mouse from a remote client
- International keyboard mapping support
- Syslog alerting
- Redirecting serial console via SSH
- Component replacement log (Maintenance History log)
- Access restriction (IP address blocking)
- Lenovo SED security key management
- Displaying graphics for real-time and historical power usage data and temperature

- Boot video capture and crash video capture
- Virtual console collaboration - Ability for up to 6 remote users to be log into the remote session simultaneously
- Remote console Java client
- Mapping the ISO and image files located on the local client as virtual drives for use by the server
- Mounting the remote ISO and image files via HTTPS, SFTP, CIFS, and NFS
- Power capping
- System utilization data and graphic view
- Single sign on with Lenovo XClarity Administrator
- Update firmware from a repository
- License for XClarity Energy Manager

XCC2 Platinum also adds the following features that are new to XCC2:

- System Guard - Monitor hardware inventory for unexpected component changes, and simply log the event or prevent booting
- Enterprise Strict Security mode - Enforces CNSA 1.0 level security
- Neighbor Group - Enables administrators to manage and synchronize configurations and firmware level across multiple servers

Ordering information is listed in the following table. XCC2 Platinum is a software license upgrade - no additional hardware is required.

Table 71. XCC2 Platinum license upgrade

Part number	Feature code	Description
7S0X000KWW	SBCV	Lenovo XClarity Controller 2 (XCC2) Platinum Upgrade

With XCC2 Platinum, for CTO orders, you can request that System Guard be enabled in the factory and the first configuration snapshot be recorded. To add this to an order, select feature code listed in the following table. The selection is made in the Security tab of the DCSC configurator.

Table 72. Enable System Guard in the factory (CTO orders)

Feature code	Description
BUT2	Install System Guard

For more information about System Guard, see https://pubs.lenovo.com/xcc2/NN1ia_c_systemguard

Lenovo XClarity Provisioning Manager

Lenovo XClarity Provisioning Manager (LXPM) is a UEFI-based application embedded in ThinkSystem servers and accessible via the F1 key during system boot.

LXPM provides the following functions:

- Graphical UEFI Setup
- System inventory information and VPD update
- System firmware updates (UEFI and XCC)
- RAID setup wizard
- OS installation wizard (including unattended OS installation)
- Diagnostics functions

Lenovo XClarity Administrator

Lenovo XClarity Administrator is a centralized resource management solution designed to reduce complexity, speed response, and enhance the availability of Lenovo systems and solutions. It provides agent-free hardware management for ThinkSystem servers, in addition to ThinkServer, System x, and Flex System servers. The administration dashboard is based on HTML 5 and allows fast location of resources so tasks can be run quickly.

Because Lenovo XClarity Administrator does not require any agent software to be installed on the managed endpoints, there are no CPU cycles spent on agent execution, and no memory is used, which means that up to 1GB of RAM and 1 - 2% CPU usage is saved, compared to a typical managed system where an agent is required.

Lenovo XClarity Administrator is an optional software component for the SR645 V3. The software can be downloaded and used at no charge to discover and monitor the SR645 V3 and to manage firmware upgrades.

If software support is required for Lenovo XClarity Administrator, or premium features such as configuration management and operating system deployment are required, Lenovo XClarity Pro software subscription should be ordered. Lenovo XClarity Pro is licensed on a per managed system basis, that is, each managed Lenovo system requires a license.

The following table lists the Lenovo XClarity software license options.

Table 73. Lenovo XClarity Pro ordering information

Part number	Feature code	Description
00MT201	1339	Lenovo XClarity Pro, per Managed Endpoint w/1 Yr SW S&S
00MT202	1340	Lenovo XClarity Pro, per Managed Endpoint w/3 Yr SW S&S
00MT203	1341	Lenovo XClarity Pro, per Managed Endpoint w/5 Yr SW S&S
7S0X000HWW	SAYV	Lenovo XClarity Pro, per Managed Endpoint w/6 Yr SW S&S
7S0X000JWW	SAYW	Lenovo XClarity Pro, per Managed Endpoint w/7 Yr SW S&S

Lenovo XClarity Administrator offers the following standard features that are available at no charge:

- Auto-discovery and monitoring of Lenovo systems
- Firmware updates and compliance enforcement
- External alerts and notifications via SNMP traps, syslog remote logging, and e-mail
- Secure connections to managed endpoints
- NIST 800-131A or FIPS 140-2 compliant cryptographic standards between the management solution and managed endpoints
- Integration into existing higher-level management systems such as cloud automation and orchestration tools through REST APIs, providing extensive external visibility and control over hardware resources
- An intuitive, easy-to-use GUI
- Scripting with Windows PowerShell, providing command-line visibility and control over hardware resources

Lenovo XClarity Administrator offers the following premium features that require an optional Pro license:

- Pattern-based configuration management that allows to define configurations once and apply repeatedly without errors when deploying new servers or redeploying existing servers without disrupting the fabric
- Bare-metal deployment of operating systems and hypervisors to streamline infrastructure provisioning

For more information, refer to the Lenovo XClarity Administrator Product Guide:
<http://lenovopress.com/tips1200>

Lenovo XClarity Integrators

Lenovo also offers software plug-in modules, Lenovo XClarity Integrators, to manage physical infrastructure from leading external virtualization management software tools including those from Microsoft and VMware.

These integrators are offered at no charge, however if software support is required, a Lenovo XClarity Pro software subscription license should be ordered.

Lenovo XClarity Integrators offer the following additional features:

- Ability to discover, manage, and monitor Lenovo server hardware from VMware vCenter or Microsoft System Center
- Deployment of firmware updates and configuration patterns to Lenovo x86 rack servers and Flex System from the virtualization management tool
- Non-disruptive server maintenance in clustered environments that reduces workload downtime by dynamically migrating workloads from affected hosts during rolling server updates or reboots
- Greater service level uptime and assurance in clustered environments during unplanned hardware events by dynamically triggering workload migration from impacted hosts when impending hardware failures are predicted

For more information about all the available Lenovo XClarity Integrators, see the Lenovo XClarity Administrator Product Guide: <https://lenovopress.com/tips1200-lenovo-xclarity-administrator>

Lenovo XClarity Essentials

Lenovo offers the following XClarity Essentials software tools that can help you set up, use, and maintain the server at no additional cost:

- **Lenovo Essentials OneCLI**
OneCLI is a collection of server management tools that uses a command line interface program to manage firmware, hardware, and operating systems. It provides functions to collect full system health information (including health status), configure system settings, and update system firmware and drivers.
- **Lenovo Essentials UpdateXpress**
The UpdateXpress tool is a standalone GUI application for firmware and device driver updates that enables you to maintain your server firmware and device drivers up-to-date and help you avoid unnecessary server outages. The tool acquires and deploys individual updates and UpdateXpress System Packs (UXSPs) which are integration-tested bundles.
- **Lenovo Essentials Bootable Media Creator**
The Bootable Media Creator (BOMC) tool is used to create bootable media for offline firmware update.

For more information and downloads, visit the Lenovo XClarity Essentials web page:
<http://support.lenovo.com/us/en/documents/LNVO-center>

Lenovo XClarity Energy Manager

Lenovo XClarity Energy Manager (LXEM) is a power and temperature management solution for data centers. It is an agent-free, web-based console that enables you to monitor and manage power consumption and temperature in your data center through the management console. It enables server density and data center capacity to be increased through the use of power capping.

LXEM is a licensed product. A single-node LXEM license is included with the XClarity Controller Platinum upgrade as described in the [Remote Management](#) section. If your server does not have the XCC Platinum upgrade, Energy Manager licenses can be ordered as shown in the following table.

Table 74. Lenovo XClarity Energy Manager

Part number	Description
4L40E51621	Lenovo XClarity Energy Manager Node License (1 license needed per server)

Note: The SR645 V3 does not support the following Energy Manager functions:

- Power capping
- Policy-based management

For more information about XClarity Energy Manager, see the following resources:

- Lenovo Support page:
<https://datacentersupport.lenovo.com/us/en/solutions/Invo-lxem>
- Lenovo Information Center:
https://sysmgmt.lenovofiles.com/help/topic/LXEM/lxem_overview.html?cp=4

Lenovo Capacity Planner

Lenovo Capacity Planner is a power consumption evaluation tool that enhances data center planning by enabling IT administrators and pre-sales professionals to understand various power characteristics of racks, servers, and other devices. Capacity Planner can dynamically calculate the power consumption, current, British Thermal Unit (BTU), and volt-ampere (VA) rating at the rack level, improving the planning efficiency for large scale deployments.

For more information, refer to the Capacity Planner web page:

<http://datacentersupport.lenovo.com/us/en/solutions/Invo-lcp>

Security

Topics in this section:

- [Security features](#)
- [Platform Firmware Resiliency - Lenovo ThinkShield](#)
- [Security standards](#)

Security features

The SR645 V3 server offers the following electronic security features:

- Secure Boot function of the AMD EPYC processor
- Support for Platform Firmware Resiliency (PFR) hardware Root of Trust (RoT) - see the [Platform Firmware Resiliency](#) section
- Firmware signature processes compliant with FIPS and NIST requirements
- System Guard (part of [XCC Platinum](#)) - Proactive monitoring of hardware inventory for unexpected component changes
- Administrator and power-on password
- Integrated Trusted Platform Module (TPM) supporting TPM 2.0
- Self-encrypting drives (SEDs) with support for enterprise key managers - see the [SED encryption key management](#) section

The server is NIST SP 800-147B compliant.

The SR645 V3 server also offers the following optional physical security features:

- Optional chassis intrusion switch
- Optional lockable front security bezel

The optional lockable front security bezel is shown in the following figure and includes a key that enables you to secure the bezel over the drives and system controls thereby reducing the chance of unauthorized or accidental access to the server.

Front PCIe slots: The use of the security bezel is not supported when the server has front PCIe slots.



Figure 22. Lockable front security bezel

The dimensions of the security bezel are:

- Width: 437 mm (17.2 in.)
- Height: 43 mm (1.3 in.)
- Width: 23 mm (0.9 in.)

The following table lists the physical security options for the SR645 V3.

Table 75. Physical security features

Part number	Feature code	Description
4X97A59835	BA2X	ThinkSystem 1U Intrusion Cable
4XH7A09890	B8NL	ThinkSystem V2 1U Security Bezel
4XH7A90346	BXBP	ThinkSystem V3 1U Security Bezel Option Kit

Tip: The only difference between security bezels 4XH7A09890 and 4XH7A90346 is the Lenovo logo: On 4XH7A09890, the logo is made from plastic; on 4XH7A90346, the logo is made from aluminum alloy.

Platform Firmware Resiliency - Lenovo ThinkShield

Lenovo's ThinkShield Security is a transparent and comprehensive approach to security that extends to all dimensions of our data center products: from development, to supply chain, and through the entire product lifecycle.

The ThinkSystem SR645 V3 includes Platform Firmware Resiliency (PFR) hardware Root of Trust (RoT) which enables the system to be NIST SP800-193 compliant. This offering further enhances key platform subsystem protections against unauthorized firmware updates and corruption, to restore firmware to an integral state, and to closely monitor firmware for possible compromise from cyber attacks.

PFR operates upon the following server components:

- UEFI image – the low-level server firmware that connects the operating system to the server hardware
- XCC image – the management “engine” software that controls and reports on the server status separate from the server operating system
- FPGA image – the code that runs the server’s lowest level hardware controller on the motherboard

The Lenovo Platform Root of Trust Hardware performs the following three main functions:

- Detection – Measures the firmware and updates for authenticity
- Recovery – Recovers a corrupted image to a known-safe image
- Protection – Monitors the system to ensure the known-good firmware is not maliciously written

These enhanced protection capabilities are implemented using a dedicated, discrete security processor whose implementation has been rigorously validated by leading third-party security firms. Security evaluation results and design details are available for customer review – providing unprecedented transparency and assurance.

The SR645 V3 includes support for Secure Boot, a UEFI firmware security feature developed by the UEFI Consortium that ensures only immutable and signed software are loaded during the boot time. The use of Secure Boot helps prevent malicious code from being loaded and helps prevent attacks, such as the installation of rootkits. Lenovo offers the capability to enable secure boot in the factory, to ensure end-to-end protection. Alternatively, Secure Boot can be left disabled in the factory, allowing the customer to enable it themselves at a later point, if desired.

The following table lists the relevant feature code(s).

Table 76. Secure Boot options

Part number	Feature code	Description	Purpose
CTO only	BPKQ	TPM 2.0 with Secure Boot	Configure the system in the factory with Secure Boot enabled.
CTO only	BPKR	TPM 2.0	Configure the system without Secure Boot enabled. Customers can enable Secure Boot later if desired.

Tip: If Secure Boot is not enabled in the factory, it can be enabled later by the customer. However once Secure Boot is enabled, it cannot be disabled.

Security standards

The SR645 V3 supports the following security standards and capabilities:

- **Industry Standard Security Capabilities**
 - AMD CPU Enablement
 - AES-NI (Advanced Encryption Standard New Instructions)
 - GMET (Guest Mode Execute Trap)
 - Hardware-based side channel attack resilience enhancements
 - NX (No eXecute)
 - PSB (Platform Secure Boot)
 - Shadow Stack
 - SEV (Secure Encrypted Virtualization)
 - SEV-ES (Encrypted State register encryption)
 - SEV-SNP (Secure Nested Paging)
 - SVM (Secure Virtual Machine)
 - SME (Secure Memory Encryption)
 - UMIP (User Mode Instruction Prevention)
 - Microsoft Windows Security Enablement
 - Credential Guard
 - Device Guard
 - Host Guardian Service
 - TCG (Trusted Computing Group) TPM (Trusted Platform Module) 2.0
 - UEFI (Unified Extensible Firmware Interface) Forum Secure Boot
- **Hardware Root of Trust and Security**

- Independent security subsystem providing platform-wide NIST SP800-193 compliant Platform Firmware Resilience (PFR)
- Host domain RoT supplemented by AMD Platform Secure Boot (PSB)
- Management domain RoT supplemented by the Secure Boot features of XCC
- **Platform Security**

For more information on platform security, see the paper “How to Harden the Security of your ThinkSystem Server and Management Applications” available from <https://lenovopress.com/lp1260-how-to-harden-the-security-of-your-thinksystem-server>.

 - Boot and run-time firmware integrity monitoring with rollback to known-good firmware (e.g., “self-healing”)
 - Non-volatile storage bus security monitoring and filtering
 - Resilient firmware implementation, such as to detect and defeat unauthorized flash writes or SMM (System Management Mode) memory incursions
 - Patented IPMI KCS channel privileged access authorization (USPTO Patent# 11,256,810)
 - Host and management domain authorization, including integration with CyberArk for enterprise password management
 - KMIP (Key Management Interoperability Protocol) compliant, including support for IBM SKLM and Thales KeySecure
 - Reduced “out of box” attack surface
 - Configurable network services
 - FIPS 140-3 (in progress) validated cryptography for XCC
 - CNSA Suite 1.0 Quantum-resistant cryptography for XCC
 - Lenovo System Guard
- **Standards Compliance and/or Support**
 - NIST SP800-131A rev 2 “Transitioning the Use of Cryptographic Algorithms and Key Lengths”
 - NIST SP800-147B “BIOS Protection Guidelines for Servers”
 - NIST SP800-193 “Platform Firmware Resiliency Guidelines”
 - ISO/IEC 11889 “Trusted Platform Module Library”
 - Common Criteria TCG Protection Profile for “PC Client Specific TPM 2.0”
 - European Union Commission Regulation 2019/424 (“ErP Lot 9”) “Ecodesign Requirements for Servers and Data Storage Products” Secure Data Deletion
 - Optional FIPS 140-2 validated Self-Encrypting Disks (SEDs) with external KMIP-based key management
- **Product and Supply Chain Security**
 - Suppliers validated through Lenovo’s Trusted Supplier Program
 - Developed in accordance with Lenovo’s Secure Development Lifecycle (LSDL)
 - Continuous firmware security validation through automated testing, including static code analysis, dynamic network and web vulnerability testing, software composition analysis, and subsystem-specific testing, such as UEFI security configuration validation
 - Ongoing security reviews by US-based security experts, with attestation letters available from our third-party security partners
 - Digitally signed firmware, stored and built on US-based infrastructure and signed on US-based Hardware Security Modules (HSMs)
 - Manufacturing transparency via Intel Transparent Supply Chain (for details, see

<https://lenovopress.com/lp1434-introduction-to-intel-transparent-supply-chain-on-lenovo-thinksystem-servers>)

- TAA (Trade Agreements Act) compliant manufacturing, by default in Mexico for North American markets with additional US and EU manufacturing options
- US 2019 NDAA (National Defense Authorization Act) Section 889 compliant

Rack installation

The following table lists the rack installation options that are available for the SR645 V3.

Table 77. Rack installation options

Part number	Feature Code	Description
Rail slides		
4M17A13564	BK7W	ThinkSystem Toolless Friction Rail v2
4M17A11754	B8LA	ThinkSystem Toolless Slide Rail Kit v2
4M17A11758	B8LC	ThinkSystem Toolless Slide Rail Kit v2 with 1U CMA
Cable Management Arm		
7M27A05699	B136	ThinkSystem 1U CMA Upgrade Kit for Toolless Slide Rail

The following table summarizes the rail kit features and specifications.

Table 78. Rail kit features and specifications summary

Option name	ThinkSystem Toolless Friction Rail v2	ThinkSystem Toolless Slide Rail Kit v2	ThinkSystem Toolless Slide Rail Kit v2 with 1U CMA
Option part number	4M17A13564	4M17A11754	4M17A11758
Rail type	Half-out slide rail (friction)	Full-out slide rail (ball bearing)	Full-out slide rail (ball bearing)
Toolless installation	Yes	Yes	Yes
CMA support	No	Optional, 7M27A05699*	Included
Supported rack type	Four-post IBM and Lenovo standard rack, complying with the IEC standard	Four-post IBM and Lenovo standard rack, complying with the IEC standard	Four-post IBM and Lenovo standard rack, complying with the IEC standard
In-rack server maintenance	No	Yes	Yes
1U PDU support	Yes	Yes	Yes
0U PDU support	Yes	Limited support**	Limited support**
Supported mounting holes	Square or round	Square or round	Square or round
Thickness of mounting flanges	2.0-3.3 mm (0.08-0.13 inches)	2.0-3.3 mm (0.08-0.13 inches)	2.0-3.3 mm (0.08-0.13 inches)
Supported distance between front and rear mounting flanges ‡	610-864 mm (24-34 inches)	610-813 mm (24-32 inches)	610-813 mm (24-32 inches)
Rail length†	751 mm (29.6 inches)	740 mm (29.1 inches)	820 mm (32.3 inches)

* CMA mounting brackets are not preinstalled on the rail. The CMA mounting brackets are contained in the CMA option kit package and you will need to install the CMA mounting brackets first. For detailed instructions, refer to the documentation that comes with the CMA option kit.

** If you want to install the rails and a 0U PDU into the same rack, the rack must meet the height and depth requirements as described in [ThinkSystem Rail Support Matrix](#).

‡ For best performance, it is recommended that you install the rails to the racks with a 719-mm distance (28.31-inch, Lenovo rack default distance) between the front and rear mounting flanges.

† Measured when mounted on the rack, from the front surface of the front mounting flange to the rear most point of the rail. Rail is in closed position.

Operating system support

The SR645 V3 supports the following operating systems:

- Microsoft Windows 10 Professional (x64)
- Microsoft Windows 11 Professional (x64)
- Microsoft Windows Server 2019
- Microsoft Windows Server 2022
- Red Hat Enterprise Linux 8.6
- Red Hat Enterprise Linux 8.7
- Red Hat Enterprise Linux 8.8
- Red Hat Enterprise Linux 8.9
- Red Hat Enterprise Linux 9.0
- Red Hat Enterprise Linux 9.1
- Red Hat Enterprise Linux 9.2
- Red Hat Enterprise Linux 9.3
- SUSE Linux Enterprise Server 15 SP4
- SUSE Linux Enterprise Server 15 SP5
- SUSE Linux Enterprise Server 15 Xen SP4
- SUSE Linux Enterprise Server 15 Xen SP5
- Ubuntu 20.04 LTS 64-bit
- Ubuntu 22.04 LTS 64-bit
- VMware ESXi 7.0 U3
- VMware ESXi 8.0
- VMware ESXi 8.0 U1
- VMware ESXi 8.0 U2

For a complete list of supported, certified and tested operating systems, plus additional details and links to relevant web sites, see the Operating System Interoperability Guide:

<https://lenovopress.lenovo.com/osig#servers=sr645-v3-7d9d-7d9c&support=all>

For configure-to-order configurations, the server can be preloaded with VMware ESXi installed on M.2 cards. Ordering information is listed in the following table.

Table 79. VMware ESXi preload

Part number	Feature code	Description
CTO only	BMEY	VMware ESXi 7.0 U3 (Factory Installed)
CTO only	BMT5	VMware ESXi 8.0 (Factory Installed)
CTO only	BYC7	VMware ESXi 8.0 U2 (Factory Installed)

You can download supported VMware vSphere hypervisor images from the following web page and load it on the M.2 drives or 7mm drives using the instructions provided:

https://vmware.lenovo.com/content/custom_iso/

Windows 10 and Windows 11

The SR645 V3 can now run Windows 10 and Windows 11, however only a subset of adapters and drives can be installed. For ease of configuration, additional Base CTO models 7D9CCTO2WW and 7D9DCTO2WW have been created to assist building a configuration that can be used with the client operating systems. See the [Models](#) section for details.

The XClarity management toolset is supported with Windows 10 and Windows 11.

Windows client license: A Windows client license for the system cannot be ordered from Lenovo nor can the OS be preloaded on the system in the factory. For the Windows license and for preloads, please contact your Lenovo business partner. A Windows Pro license is required as a qualifying base OS license in order to use a client Volume License offering.

See the part number tables in the following sections to see which adapters are supported with Windows 10 and Windows 11:

- [Controllers for internal storage](#)
- [M.2 adapters](#)
- [Network adapters](#)
- [GPU adapters](#)

GPU recommended: Lenovo recommends that if you plan to install Windows 10 or 11 on this server to run graphics-intensive applications, then you should selected a dedicated graphics adapter (GPU).

The following components are not supported:

- Fibre Channel adapters
- InfiniBand and VPI adapters
- External storage adapters
- Flash storage adapters

Physical and electrical specifications

The SR645 V3 has the following overall physical dimensions, excluding components that extend outside the standard chassis, such as EIA flanges, front security bezel (if any), and power supply handles:

- Width: 440 mm (17.3 inches)
- Height: 43 mm (1.7 inches)
- Depth: 773 mm (30.4 inches)

The following table lists the detailed dimensions. See the figure below for the definition of each dimension.

Table 80. Detailed dimensions

Dimension	Description
482 mm	X_a = Width, to the outsides of the front EIA flanges
435 mm	X_b = Width, to the rack rail mating surfaces
440 mm	X_c = Width, to the outer most chassis body feature
43 mm	Y_a = Height, from the bottom of chassis to the top of the chassis
724 mm	Z_a = Depth, from the rack flange mating surface to the rearmost I/O port surface
738 mm	Z_b = Depth, from the rack flange mating surface to the rearmost feature of the chassis body
754 mm (≤1100W) 782 mm (1800W)	Z_c = Depth, from the rack flange mating surface to the rearmost feature such as power supply handle
36 mm	Z_d = Depth, from the forwardmost feature on front of EIA flange to the rack flange mating surface
47 mm	Z_e = Depth, from the front of security bezel (if applicable) or forwardmost feature to the rack flange mating surface

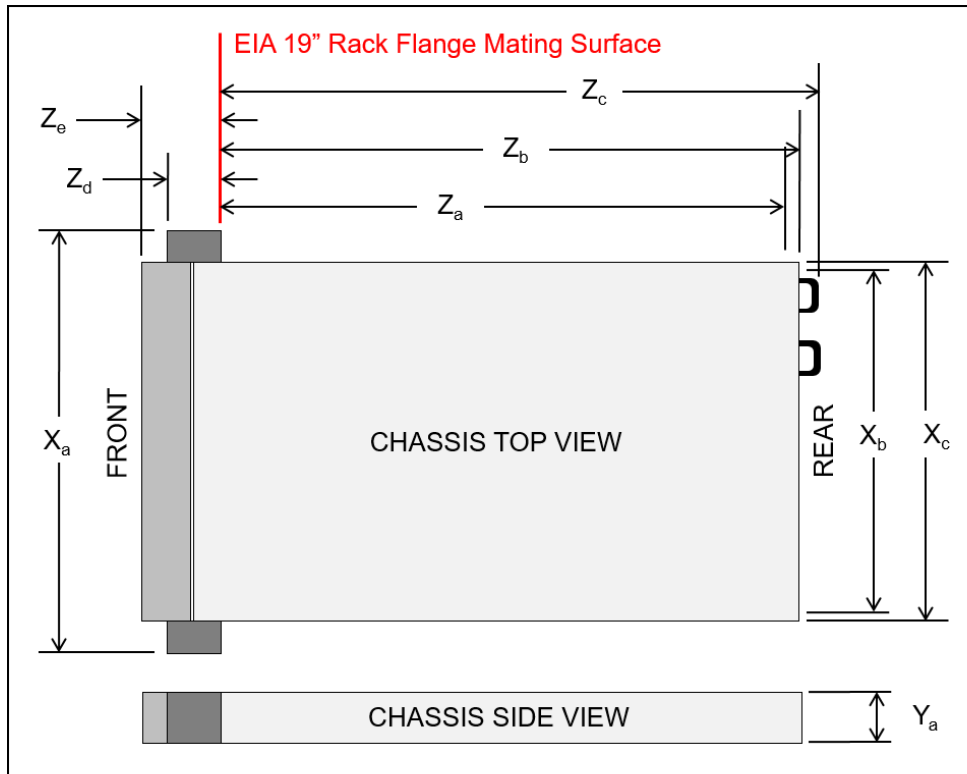

Figure 23. Server dimensions

The shipping dimensions (cardboard packaging) of the SR645 V3 are as follows:

- Width: 587 mm (23.1 inches)
- Height: 225 mm (8.9 inches)
- Depth: 998 mm (39.3 inches)

The server has the following weight:

- Maximum weight: 20.2 kg (44.6 lb)

The server has the following electrical specifications for AC input power supplies:

- Input voltage:
 - 100 to 127 (nominal) Vac, 50 Hz or 60 Hz
 - 200 to 240 (nominal) Vac, 50 Hz or 60 Hz
 - 180 to 300 Vdc (China only)
- Inlet current: see the following table.

Table 81. Maximum inlet current

Part number	Description	100V AC	200V AC	220V AC	240V DC
AC input power - 80 PLUS Titanium efficiency					
4P57A82019	ThinkSystem 750W 230V Titanium Hot-Swap Gen2 Power Supply v3	No support	4A	3.6A	3.3A
4P57A72666	ThinkSystem 1100W 230V Titanium Hot-Swap Gen2 Power Supply	No support	5.9A	5.3A	5A
4P57A78359	ThinkSystem 1800W 230V Titanium Hot-Swap Gen2 Power Supply	No support	9.7A	8.7A	8.3A
AC input power - 80 PLUS Platinum efficiency					
4P57A72670	ThinkSystem 750W 230V/115V Platinum Hot-Swap Gen2 Power Supply v3	8.4A	4.1A	3.69A	3.5A
4P57A72671	ThinkSystem 1100W 230V/115V Platinum Hot-Swap Gen2 Power Supply v3	12A	6A	5.4A	5.1A
4P57A26294	ThinkSystem 1800W 230V Platinum Hot-Swap Gen2 Power Supply v2	No support	10A	9.1A	9A

Electrical specifications for DC input power supply:

- Input voltage: -48 to -60 Vdc
- Inlet current (1100W power supply): 26 A

Operating environment

The SR645 V3 server complies with ASHRAE Class A2 specifications with most configurations, and depending on the hardware configuration, also complies with ASHRAE Class A3 and Class A4 specifications. System performance may be impacted when operating temperature is outside ASHRAE A2 specification.

Depending on the hardware configuration, the SR645 V3 server also complies with ASHRAE Class H1 specification. System performance may be impacted when operating temperature is outside ASHRAE H1 specification.

Topics in this section:

- [Ambient temperature requirements](#)
- [Temperature and humidity](#)
- [Acoustical noise emissions](#)
- [Shock and vibration](#)

Ambient temperature requirements

Additional restrictions to ASHRAE support, based on server configuration, are as follows:

- The ambient temperature must be no more than 25°C if your server meets any of the following condition:
 - $320\text{ W} \leq \text{TDP} \leq 400\text{ W}$
- The ambient temperature must be no more than 30°C if your server meets any of the following conditions:
 - $240\text{ W} < \text{TDP} \leq 300\text{ W}$
 - $\text{AOC} \geq 100\text{ GB}$
 - Installed with any rear 2.5-inch NVMe/SAS/SATA drive

- Installed with any TruDDR5 memory DIMM (256 GB or above)
 - Installed with any passive GPU
- The ambient temperature must be no more than 35°C if your server meets any of the following conditions:
 - $200\text{ W} \leq \text{TDP} \leq 240\text{ W}$
 - Installed with any 7mm boot drive
 - Installed with any M.2 NVMe drive
 - Installed with no less than four front 2.5" hot-swap drives
- The ambient temperature must be no more than 45°C if the CPU TDP < 200 W.

For additional information, see the Environmental specifications and Thermal rules sections in the product documentation:

https://pubs.lenovo.com/sr645-v3/server_specifications_environmental

https://pubs.lenovo.com/sr645-v3/thermal_rules

Temperature and humidity

The server is supported in the following environment:

- Air temperature:
 - Operating:
 - ASHRAE Class A2: 10°C to 35°C (50°F to 95°F); the maximum ambient temperature decreases by 1°C for every 300 m (984 ft) increase in altitude above 900 m (2,953 ft).
 - ASHRAE Class A3: 5°C to 40°C (41°F to 104°F); the maximum ambient temperature decreases by 1°C for every 175 m (574 ft) increase in altitude above 900 m (2,953 ft).
 - ASHRAE Class A4: 5°C to 45°C (41°F to 113°F); the maximum ambient temperature decreases by 1°C for every 125 m (410 ft) increase in altitude above 900 m (2,953 ft).
 - ASHRAE Class H1: 5 °C to 25 °C (41 °F to 77 °F); Decrease the maximum ambient temperature by 1°C for every 500 m (1640 ft) increase in altitude above 900 m (2,953 ft).
 - Server off: 5°C to 45°C (41°F to 113°F)
 - Shipment/storage: -40°C to 60°C (-40°F to 140°F)
- Maximum altitude: 3,050 m (10,000 ft)
- Relative Humidity (non-condensing):
 - Operating
 - ASHRAE Class A2: 8% to 80%; maximum dew point: 21°C (70°F)
 - ASHRAE Class A3: 8% to 85%; maximum dew point: 24°C (75°F)
 - ASHRAE Class A4: 8% to 90%; maximum dew point: 24°C (75°F)
 - ASHRAE Class H1: 8% to 80%; Maximum dew point: 17°C (63°F)
 - Shipment/storage: 8% to 90%

Acoustical noise emissions

The server has the following acoustic noise emissions declaration:

- Sound power level (L_{WAd}):
 - Idling: 5.6 Bel (Min), 6.7 Bel (Typical), 6.7 Bel (GPU rich), 7.5 Bel (Storage rich)
 - Operating: 7.6 Bel (Min), 8.7 Bel (Typical), 8.3 Bel (GPU rich), 7.7 Bel (Storage rich)
- Sound pressure level (L_{pAm}):
 - Idling: 41.3 dBA (Min), 52.5 dBA (Typical), 52.5 dBA (GPU rich), 60.1 dBA (Storage rich)
 - Operating: 61.5 dBA (Min), 72.5 dBA (Typical), 67.8 dBA (GPU rich), 62.8 dBA (Storage rich)

Notes:

- These sound levels were measured in controlled acoustical environments according to procedures specified by ISO7779 and are reported in accordance with ISO 9296.

- The declared acoustic sound levels are based on the following configurations, which may change depending on configuration/conditions :
 - Min: 2x 240W CPU, 24x 64GB RDIMMs, 8x SAS HDD, RAID 440-16i, Broadcom 5719 1GbE RJ45 4-port OCP Ethernet Adapter, 2x 1100W PSU
 - Typical: 2x 300W CPU, 24x 64GB RDIMMs, 10x SAS HDD, RAID 940-16i, Broadcom 5719 1GbE RJ45 4-port OCP Ethernet Adapter, 2x 1100W PSU
 - GPU rich: 2x 300W CPU, 24x 64GB RDIMMs, 10x SAS HDD, RAID 940-16i, Broadcom 5719 1GbE RJ45 4-port OCP Ethernet Adapter, 1x A2 GPU, 2x 1100W PSU
 - Storage rich: 2x 240W CPU, 12x 64GB RDIMMs, 12x SAS HDD, RAID 940-16i, Broadcom 5719 1GbE RJ45 4-port OCP Ethernet Adapter, 2x 750W PSU
- Government regulations (such as those prescribed by OSHA or European Community Directives) may govern noise level exposure in the workplace and may apply to you and your server installation. The actual sound pressure levels in your installation depend upon a variety of factors, including the number of racks in the installation; the size, materials, and configuration of the room; the noise levels from other equipment; the room ambient temperature, and employee's location in relation to the equipment. Further, compliance with such government regulations depends on a variety of additional factors, including the duration of employees' exposure and whether employees wear hearing protection. Lenovo recommends that you consult with qualified experts in this field to determine whether you are in compliance with the applicable regulations.

Shock and vibration

The server has the following vibration and shock limits:

- Vibration:
 - Operating: 0.21 G rms at 5 Hz to 500 Hz for 15 minutes across 3 axes
 - Non-operating: 1.04 G rms at 2 Hz to 200 Hz for 15 minutes across 6 surfaces
- Shock:
 - Operating: 15 G for 3 milliseconds in each direction (positive and negative X, Y, and Z axes)
 - Non-operating:
 - 12 kg - 22 kg: 50 G for 152 in./sec velocity change across 6 surfaces

Warranty and Support

The SR645 V3 has a 1-year or 3-year warranty based on the machine type of the system:

- 7D9D - 1 year warranty
- 7D9C - 3 year warranty

The standard warranty terms are customer-replaceable unit (CRU) and onsite (for field-replaceable units FRUs only) with standard call center support during normal business hours and 9x5 Next Business Day Parts Delivered.

Lenovo's additional support services provide a sophisticated, unified support structure for your data center, with an experience consistently ranked number one in customer satisfaction worldwide. Available offerings include:

- **Premier Support**

Premier Support provides a Lenovo-owned customer experience and delivers direct access to technicians skilled in hardware, software, and advanced troubleshooting, in addition to the following:

- Direct technician-to-technician access through a dedicated phone line
- 24x7x365 remote support
- Single point of contact service
- End to end case management
- Third-party collaborative software support
- Online case tools and live chat support
- On-demand remote system analysis

- **Warranty Upgrade (Preconfigured Support)**

Services are available to meet the on-site response time targets that match the criticality of your systems.

- 3, 4, or 5 years of service coverage
- 1-year or 2-year post-warranty extensions
- **Foundation Service:** 9x5 service coverage with next business day onsite response. YourDrive YourData is an optional extra (see below).
- **Essential Service:** 24x7 service coverage with 4-hour onsite response or 24-hour committed repair (available only in select markets). Bundled with YourDrive YourData.
- **Advanced Service:** 24x7 service coverage with 2-hour onsite response or 6-hour committed repair (available only in select markets). Bundled with YourDrive YourData.

- **Managed Services**

Lenovo Managed Services provides continuous 24x7 remote monitoring (plus 24x7 call center availability) and proactive management of your data center using state-of-the-art tools, systems, and practices by a team of highly skilled and experienced Lenovo services professionals.

Quarterly reviews check error logs, verify firmware & OS device driver levels, and software as needed. We'll also maintain records of latest patches, critical updates, and firmware levels, to ensure you systems are providing business value through optimized performance.

- **Technical Account Management (TAM)**

A Lenovo Technical Account Manager helps you optimize the operation of your data center based on a deep understanding of your business. You gain direct access to your Lenovo TAM, who serves as your single point of contact to expedite service requests, provide status updates, and furnish reports to track incidents over time. In addition, your TAM will help proactively make service recommendations and manage your service relationship with Lenovo to make certain your needs are met.

- **Enterprise Server Software Support**

Enterprise Software Support is an additional support service providing customers with software support on Microsoft, Red Hat, SUSE, and VMware applications and systems. Around the clock availability for critical problems plus unlimited calls and incidents helps customers address challenges fast, without incremental costs. Support staff can answer troubleshooting and diagnostic questions, address product comparability and interoperability issues, isolate causes of problems, report defects to software vendors, and more.

- **YourDrive YourData**

Lenovo's YourDrive YourData is a multi-drive retention offering that ensures your data is always under your control, regardless of the number of drives that are installed in your Lenovo server. In the unlikely event of a drive failure, you retain possession of your drive while Lenovo replaces the failed drive part. Your data stays safely on your premises, in your hands. The YourDrive YourData service can be purchased in convenient bundles and is optional with Foundation Service. It is bundled with Essential Service and Advanced Service.

- **Health Check**

Having a trusted partner who can perform regular and detailed health checks is central to maintaining efficiency and ensuring that your systems and business are always running at their best. Health Check supports Lenovo-branded server, storage, and networking devices, as well as select Lenovo-supported products from other vendors that are sold by Lenovo or a Lenovo-Authorized Reseller.

Examples of region-specific warranty terms are second or longer business day parts delivery or parts-only base warranty.

If warranty terms and conditions include onsite labor for repair or replacement of parts, Lenovo will dispatch a service technician to the customer site to perform the replacement. Onsite labor under base warranty is limited to labor for replacement of parts that have been determined to be field-replaceable units (FRUs). Parts that are determined to be customer-replaceable units (CRUs) do not include onsite labor under base warranty.

If warranty terms include parts-only base warranty, Lenovo is responsible for delivering only replacement parts that are under base warranty (including FRUs) that will be sent to a requested location for self-service. Parts-only service does not include a service technician being dispatched onsite. Parts must be changed at customer's own cost and labor and defective parts must be returned following the instructions supplied with the spare parts.

Lenovo Service offerings are region-specific. Not all preconfigured support and upgrade options are available in every region. For information about Lenovo service upgrade offerings that are available in your region, refer to the following resources:

- Service part numbers in Lenovo Data Center Solution Configurator (DCSC):
<http://dcsc.lenovo.com/#/services>
- Lenovo Services Availability Locator
<http://lenovolocator.com/>

For service definitions, region-specific details, and service limitations, please refer to the following documents:

- **Lenovo Statement of Limited Warranty for Infrastructure Solutions Group (ISG) Servers and System Storage**
<http://pcsupport.lenovo.com/us/en/solutions/ht503310>
- **Lenovo Data Center Services Agreement**
<http://support.lenovo.com/us/en/solutions/ht116628>

Services

Lenovo Services is a dedicated partner to your success. Our goal is to reduce your capital outlays, mitigate your IT risks, and accelerate your time to productivity.

Note: Some service options may not be available in all markets or regions. For more information, go to <https://www.lenovo.com/services>. For information about Lenovo service upgrade offerings that are available in your region, contact your local Lenovo sales representative or business partner.

Here's a more in-depth look at what we can do for you:

- **Asset Recovery Services**

Asset Recovery Services (ARS) helps customers recover the maximum value from their end-of-life equipment in a cost-effective and secure way. On top of simplifying the transition from old to new equipment, ARS mitigates environmental and data security risks associated with data center equipment disposal. Lenovo ARS is a cash-back solution for equipment based on its remaining market value, yielding maximum value from aging assets and lowering total cost of ownership for your customers. For more information, see the ARS page, <https://lenovopress.com/lp1266-reduce-e-waste-and-grow-your-bottom-line-with-lenovo-ars>.

- **Assessment Services**

An Assessment helps solve your IT challenges through an onsite, multi-day session with a Lenovo technology expert. We perform a tools-based assessment which provides a comprehensive and thorough review of a company's environment and technology systems. In addition to the technology based functional requirements, the consultant also discusses and records the non-functional business requirements, challenges, and constraints. Assessments help organizations like yours, no matter how large or small, get a better return on your IT investment and overcome challenges in the ever-changing technology landscape.

- **Design Services**

Professional Services consultants perform infrastructure design and implementation planning to support your strategy. The high-level architectures provided by the assessment service are turned into low level designs and wiring diagrams, which are reviewed and approved prior to implementation. The implementation plan will demonstrate an outcome-based proposal to provide business capabilities through infrastructure with a risk-mitigated project plan.

- **Basic Hardware Installation**

Lenovo experts can seamlessly manage the physical installation of your server, storage, or networking hardware. Working at a time convenient for you (business hours or off shift), the technician will unpack and inspect the systems on your site, install options, mount in a rack cabinet, connect to power and network, check and update firmware to the latest levels, verify operation, and dispose of the packaging, allowing your team to focus on other priorities.

- **Deployment Services**

When investing in new IT infrastructures, you need to ensure your business will see quick time to value with little to no disruption. Lenovo deployments are designed by development and engineering teams who know our Products & Solutions better than anyone else, and our technicians own the process from delivery to completion. Lenovo will conduct remote preparation and planning, configure & integrate systems, validate systems, verify and update appliance firmware, train on administrative tasks, and provide post-deployment documentation. Customer's IT teams leverage our skills to enable IT staff to transform with higher level roles and tasks.

- **Integration, Migration, and Expansion Services**

Move existing physical & virtual workloads easily, or determine technical requirements to support increased workloads while maximizing performance. Includes tuning, validation, and documenting ongoing run processes. Leverage migration assessment planning documents to perform necessary migrations.

Regulatory compliance

The SR645 V3 conforms to the following standards:

- ANSI/UL 62368-1
- IEC 62368-1 (CB Certificate and CB Test Report)
- FCC - Verified to comply with Part 15 of the FCC Rules, Class A
- Canada ICES-003, issue 7, Class A
- CSA C22.2 No. 62368-1
- CISPR 32, Class A, CISPR 35
- Japan VCCI, Class A
- Taiwan BSMI CNS15936, Class A; CNS15598-1; Section 5 of CNS15663
- CE, UKCA Mark (EN55032 Class A, EN62368-1, EN55024, EN55035, EN61000-3-2, EN61000-3-3, (EU) 2019/424, and EN IEC 63000 (RoHS))
- Korea KN32, Class A, KN35
- Russia, Belorussia and Kazakhstan, TP EAC 037/2016 (for RoHS)
- Russia, Belorussia and Kazakhstan, EAC: TP TC 004/2011 (for Safety); TP TC 020/2011 (for EMC)
- Australia/New Zealand AS/NZS CISPR 32, Class A; AS/NZS 62368.1
- UL Green Guard, UL2819
- Energy Star 3.0
- EPEAT (NSF/ ANSI 426) Bronze
- China CCC certificate, GB17625.1; GB4943.1; GB/T9254
- China CECP certificate, CQC3135
- China CELP certificate, HJ 2507-2011
- Japanese Energy-Saving Act
- Mexico NOM-019
- TUV-GS (EN62368-1, and EK1-ITB2000)
- India BIS 13252 (Part 1)
- Germany GS
- Brazil INMETRO
- Ukraine UkrCEPRO
- Morocco CMIM Certification (CM)

External drive enclosures

The server supports attachment to external drive enclosures using a RAID controller with external ports or a SAS host bus adapter. Adapters supported by the server are listed in the [SAS adapters for external storage](#) section.

Note: Information provided in this section is for ordering reference purposes only. For the operating system and adapter support details, refer to the interoperability matrix for a particular storage enclosure that can be found on the Lenovo Data Center Support web site:

<http://datacentersupport.lenovo.com>

Table 82. External drive enclosures

Model	Description
4587HC1	Lenovo Storage D1212 Disk Expansion Enclosure (2U enclosure wth 12x LFF drive bays)
4587HC2	Lenovo Storage D1224 Disk Expansion Enclosure (2U enclosure wth 24x SFF drive bays)
6413HC1	Lenovo Storage D3284 High Density Expansion Enclosure (5U enclosure wth 84x LFF drive bays)
7DAHCTO1WW	Lenovo ThinkSystem D4390 Direct Attached Storage (4U enclosure wth 90x LFF drive bays)

For details about supported drives, adapters, and cables, see the following Lenovo Press Product Guides:

- Lenovo Storage D1212 and D1224
<http://lenovopress.lenovo.com/lp0512>
- Lenovo Storage D3284
<http://lenovopress.lenovo.com/lp0513>
- Lenovo ThinkSystem D4390
<https://lenovopress.lenovo.com/lp1681>

External storage systems

Lenovo offers the ThinkSystem DE Series and ThinkSystem DM Series external storage systems for high-performance storage. See the DE Series and DM Series product guides for specific controller models, expansion enclosures and configuration options:

- ThinkSystem DE Series Storage
<https://lenovopress.com/storage/thinksystem/de-series#rt=product-guide>
- ThinkSystem DM Series Storage
<https://lenovopress.com/storage/thinksystem/dm-series#rt=product-guide>
- ThinkSystem DG Series Storage
<https://lenovopress.com/storage/thinksystem/dg-series#rt=product-guide>

External backup units

The following table lists the external backup options that are offered by Lenovo.

Table 83. External backup options

Part number	Description
External RDX USB drives	
4T27A10725	ThinkSystem RDX External USB 3.0 Dock
External SAS tape backup drives	
6160S7E	IBM TS2270 Tape Drive Model H7S
6160S8E	IBM TS2280 Tape Drive Model H8S
6160S9E	IBM TS2290 Tape Drive Model H9S
External SAS tape backup autoloaders	
6171S7R	IBM TS2900 Tape Autoloader w/LTO7 HH SAS
6171S8R	IBM TS2900 Tape Autoloader w/LTO8 HH SAS
6171S9R	IBM TS2900 Tape Autoloader w/LTO9 HH SAS
External tape backup libraries	
6741A1F	IBM TS4300 3U Tape Library-Base Unit
6741A3F	IBM TS4300 3U Tape Library-Expansion Unit
Full High 8 Gb Fibre Channel for TS4300	
01KP938	LTO 7 FH Fibre Channel Drive
01KP954	LTO 8 FH Fibre Channel Drive
02JH837	LTO 9 FH Fibre Channel Drive
Half High 8 Gb Fibre Channel for TS4300	
01KP936	LTO 7 HH Fibre Channel Drive
01KP952	LTO 8 HH Fibre Channel Drive
02JH835	LTO 9 HH Fibre Channel Drive
Half High 6 Gb SAS for TS4300	
01KP937	LTO 7 HH SAS Drive
01KP953	LTO 8 HH SAS Drive
02JH836	LTO 9 HH SAS Drive

For more information, see the list of Product Guides in the Backup units category:

<https://lenovopress.com/servers/options/backup>

Fibre Channel SAN switches

Lenovo offers the ThinkSystem DB Series of Fibre Channel SAN switches for high-performance storage expansion. See the DB Series product guides for models and configuration options:

- ThinkSystem DB Series SAN Switches:
<https://lenovopress.com/storage/switches/rack#rt=product-guide>

Uninterruptible power supply units

The following table lists the uninterruptible power supply (UPS) units that are offered by Lenovo.

Table 84. Uninterruptible power supply units

Part number	Description
55941AX	RT1.5kVA 2U Rack or Tower UPS (100-125VAC)
55941KX	RT1.5kVA 2U Rack or Tower UPS (200-240VAC)
55942AX	RT2.2kVA 2U Rack or Tower UPS (100-125VAC)
55942KX	RT2.2kVA 2U Rack or Tower UPS (200-240VAC)
55943AX	RT3kVA 2U Rack or Tower UPS (100-125VAC)
55943KX	RT3kVA 2U Rack or Tower UPS (200-240VAC)
55945KX	RT5kVA 3U Rack or Tower UPS (200-240VAC)
55946KX	RT6kVA 3U Rack or Tower UPS (200-240VAC)
55948KX	RT8kVA 6U Rack or Tower UPS (200-240VAC)
55949KX	RT11kVA 6U Rack or Tower UPS (200-240VAC)
55948PX	RT8kVA 6U 3:1 Phase Rack or Tower UPS (380-415VAC)
55949PX	RT11kVA 6U 3:1 Phase Rack or Tower UPS (380-415VAC)
55943KT†	ThinkSystem RT3kVA 2U Standard UPS (200-230VAC) (2x C13 10A, 2x GB 10A, 1x C19 16A outlets)
55943LT†	ThinkSystem RT3kVA 2U Long Backup UPS (200-230VAC) (2x C13 10A, 2x GB 10A, 1x C19 16A outlets)
55946KT†	ThinkSystem RT6kVA 5U UPS (200-230VAC) (2x C13 10A outlets, 1x Terminal Block output)
5594XKT†	ThinkSystem RT10kVA 5U UPS (200-230VAC) (2x C13 10A outlets, 1x Terminal Block output)

† Only available in China and the Asia Pacific market.

For more information, see the list of Product Guides in the UPS category:

<https://lenovopress.com/servers/options/ups>

Power distribution units

The following table lists the power distribution units (PDUs) that are offered by Lenovo.

Table 85. Power distribution units

Part number	Feature code	Description	ANZ	ASEAN	Brazil	EET	MEA	RUCIS	WE	HTK	INDIA	JAPAN	LA	NA	PRC
0U Basic PDUs															
00YJ776	ATZY	0U 36 C13/6 C19 24A 1 Phase PDU	N	Y	Y	N	N	N	N	N	N	Y	Y	Y	N
00YJ777	ATZZ	0U 36 C13/6 C19 32A 1 Phase PDU	Y	Y	N	Y	Y	Y	Y	Y	Y	N	N	Y	Y
0U Switched and Monitored PDUs															
00YJ783	AU04	0U 12 C13/12 C19 Switched and Monitored 48A 3 Phase PDU	N	N	Y	N	N	N	Y	N	N	Y	Y	Y	N
00YJ781	AU03	0U 20 C13/4 C19 Switched and Monitored 24A 1 Phase PDU	N	N	Y	N	Y	N	Y	N	N	Y	Y	Y	N
1U Switched and Monitored PDUs															
4PU7A81117	BNDV	1U 18 C19/C13 switched and monitored 48A 3P WYE PDU - ETL	N	N	N	N	N	N	N	N	N	N	N	Y	N
4PU7A77467	BLC4	1U 18 C19/C13 Switched and Monitored 80A 3P Delta PDU	N	N	N	N	N	N	N	N	N	Y	N	Y	N
4PU7A77469	BLC6	1U 12 C19/C13 switched and monitored 60A 3P Delta PDU	N	N	N	N	N	N	N	N	N	N	N	Y	N
4PU7A77468	BLC5	1U 12 C19/C13 switched and monitored 32A 3P WYE PDU	Y	Y	Y	Y	Y	Y	Y	Y	Y	N	Y	Y	Y
4PU7A81118	BNDW	1U 18 C19/C13 switched and monitored 48A 3P WYE PDU - CE	Y	Y	Y	Y	Y	Y	Y	Y	Y	N	Y	N	Y
1U Ultra Density Enterprise PDUs (9x IEC 320 C13 + 3x IEC 320 C19 outlets)															
71763NU	6051	Ultra Density Enterprise C19/C13 PDU 60A/208V/3PH	N	N	Y	N	N	N	N	N	N	Y	Y	Y	N
71762NX	6091	Ultra Density Enterprise C19/C13 PDU Module	Y	Y	Y	Y	Y	Y	Y	Y	Y	Y	Y	Y	Y
1U C13 Enterprise PDUs (12x IEC 320 C13 outlets)															
39Y8941	6010	DPI C13 Enterprise PDU Module (WW)	Y	Y	Y	Y	Y	Y	Y	Y	Y	Y	Y	Y	Y
1U Front-end PDUs (3x IEC 320 C19 outlets)															
39Y8938	6002	DPI Single-phase 30A/120V Front-end PDU (US)	Y	Y	Y	Y	Y	Y	Y	Y	Y	Y	Y	Y	Y
39Y8939	6003	DPI Single-phase 30A/208V Front-end PDU (US)	Y	Y	Y	Y	Y	Y	Y	Y	Y	Y	Y	Y	Y
39Y8934	6005	DPI Single-phase 32A/230V Front-end PDU (International)	Y	Y	Y	Y	Y	Y	Y	Y	Y	Y	Y	Y	Y
39Y8940	6004	DPI Single-phase 60A/208V Front-end PDU (US)	Y	N	Y	Y	Y	Y	Y	N	N	Y	Y	Y	N
39Y8935	6006	DPI Single-phase 63A/230V Front-end PDU (International)	Y	Y	Y	Y	Y	Y	Y	Y	Y	Y	Y	Y	Y
1U NEMA PDUs (6x NEMA 5-15R outlets)															
39Y8905	5900	DPI 100-127V NEMA PDU	Y	Y	Y	Y	Y	Y	Y	Y	Y	Y	Y	Y	Y

Part number	Feature code	Description	ANZ	ASEAN	Brazil	EET	MEA	RUCIS	WE	HTK	INDIA	JAPAN	LA	NA	PRC
Line cords for 1U PDUs that ship without a line cord															
40K9611	6504	4.3m, 32A/380-415V, EPDU/IEC 309 3P+N+G 3ph wye (non-US) Line Cord	Y	Y	Y	Y	Y	Y	Y	Y	Y	Y	Y	Y	Y
40K9612	6502	4.3m, 32A/230V, EPDU to IEC 309 P+N+G (non-US) Line Cord	Y	Y	Y	Y	Y	Y	Y	Y	Y	Y	Y	Y	Y
40K9613	6503	4.3m, 63A/230V, EPDU to IEC 309 P+N+G (non-US) Line Cord	Y	Y	Y	Y	Y	Y	Y	Y	Y	Y	Y	Y	Y
40K9614	6500	4.3m, 30A/208V, EPDU to NEMA L6-30P (US) Line Cord	Y	Y	Y	Y	Y	Y	Y	Y	Y	Y	Y	Y	Y
40K9615	6501	4.3m, 60A/208V, EPDU to IEC 309 2P+G (US) Line Cord	N	N	Y	N	N	N	Y	N	N	Y	Y	Y	N
40K9617	6505	4.3m, 32A/230V, Souriau UTG Female to AS/NZ 3112 (Aus/NZ) Line Cord	Y	Y	Y	Y	Y	Y	Y	Y	Y	Y	Y	Y	Y
40K9618	6506	4.3m, 32A/250V, Souriau UTG Female to KSC 8305 (S. Korea) Line Cord	Y	Y	Y	Y	Y	Y	Y	Y	Y	Y	Y	Y	Y

For more information, see the Lenovo Press documents in the PDU category:
<https://lenovopress.com/servers/options/pdu>

Rack cabinets

The following table lists the supported rack cabinets.

Table 86. Rack cabinets

Part number	Description
93072RX	25U Standard Rack (1000mm)
93072PX	25U Static S2 Standard Rack (1000mm)
7D6DA007WW	ThinkSystem 42U Onyx Primary Heavy Duty Rack Cabinet (1200mm)
7D6DA008WW	ThinkSystem 42U Pearl Primary Heavy Duty Rack Cabinet (1200mm)
93604PX	42U 1200mm Deep Dynamic Rack
93614PX	42U 1200mm Deep Static Rack
93634PX	42U 1100mm Dynamic Rack
93634EX	42U 1100mm Dynamic Expansion Rack
93074RX	42U Standard Rack (1000mm)
7D6EA009WW	ThinkSystem 48U Onyx Primary Heavy Duty Rack Cabinet (1200mm)
7D6EA00AWW	ThinkSystem 48U Pearl Primary Heavy Duty Rack Cabinet (1200mm)

For specifications about these racks, see the Lenovo Rack Cabinet Reference, available from:
<https://lenovopress.com/lp1287-lenovo-rack-cabinet-reference>

For more information, see the list of Product Guides in the Rack cabinets category:
<https://lenovopress.com/servers/options/racks>

KVM console options

The following table lists the supported KVM consoles.

Table 87. KVM console

Part number	Description
4XF7A84188	ThinkSystem 18.5" LCD Console (with US English keyboard)

The following table lists the available KVM switches and the options that are supported with them.

Table 89. KVM switches and options

Part number	Description
KVM Console switches	
1754D2X	Global 4x2x32 Console Manager (GCM32)
1754D1X	Global 2x2x16 Console Manager (GCM16)
1754A2X	Local 2x16 Console Manager (LCM16)
1754A1X	Local 1x8 Console Manager (LCM8)
Cables for GCM and LCM Console switches	
46M5383	Virtual Media Conversion Option Gen2 (VCO2)
46M5382	Serial Conversion Option (SCO)

For more information, see the list of Product Guides in the KVM Switches and Consoles category:

<http://lenovopress.com/servers/options/kvm>

Lenovo Financial Services

Lenovo Financial Services reinforces Lenovo's commitment to deliver pioneering products and services that are recognized for their quality, excellence, and trustworthiness. Lenovo Financial Services offers financing solutions and services that complement your technology solution anywhere in the world.

We are dedicated to delivering a positive finance experience for customers like you who want to maximize your purchase power by obtaining the technology you need today, protect against technology obsolescence, and preserve your capital for other uses.

We work with businesses, non-profit organizations, governments and educational institutions to finance their entire technology solution. We focus on making it easy to do business with us. Our highly experienced team of finance professionals operates in a work culture that emphasizes the importance of providing outstanding customer service. Our systems, processes and flexible policies support our goal of providing customers with a positive experience.

We finance your entire solution. Unlike others, we allow you to bundle everything you need from hardware and software to service contracts, installation costs, training fees, and sales tax. If you decide weeks or months later to add to your solution, we can consolidate everything into a single invoice.

Our Premier Client services provide large accounts with special handling services to ensure these complex transactions are serviced properly. As a premier client, you have a dedicated finance specialist who manages your account through its life, from first invoice through asset return or purchase. This specialist develops an in-depth understanding of your invoice and payment requirements. For you, this dedication provides a high-quality, easy, and positive financing experience.

For your region-specific offers, please ask your Lenovo sales representative or your technology provider about the use of Lenovo Financial Services. For more information, see the following Lenovo website:

<https://www.lenovo.com/us/en/landingpage/lenovo-financial-services/>

Seller training courses

The following sales training courses are offered for employees and partners (login required). Courses are listed in date order.

1. **Lenovo Data Center Product Portfolio**
2023-07-21 | 15 minutes | Employees and Partners

This course introduces the Lenovo data center portfolio, and covers servers, storage, storage networking, and software-defined infrastructure products. After completing this course about Lenovo data center products, you will be able to identify product types within each data center family, describe Lenovo innovations that this product family or category uses, and recognize when a specific product should be selected.

Published: 2023-07-21

Length: 15 minutes

Employee link: Grow@Lenovo

Partner link: [Lenovo Partner Learning](#)

Course code: SXXW1110r6

2. **Family Portfolio: ThinkSystem AMD Rackmount Servers**

2023-06-07 | 15 minutes | Employees and Partners

This course adds AI capability information, specifically Lenovo OVX 3.0, about AMD rackmount servers. After completing this course, you will be able to identify products and features within the ThinkSystem AMD rack server family, describe unique innovations that this product family uses, and recognize when a specific product should be selected. You will also be able to describe how AMD rackmount servers are used in AI environments.

Published: 2023-06-07

Length: 15 minutes

Employee link: [Grow@Lenovo](#)

Partner link: [Lenovo Partner Learning](#)

Course code: SXXW1216r6

3. **Introduction to the AMD EPYC Gen4 Processors**

2022-12-30 | 10 minutes | Employees and Partners

After completing this course, you should be able to describe the Gen4 AMD EPYC™ processors, discuss the new and improved features of the Gen4 processors, and describe the customer benefits of the AMD EPYC Gen4 processors. You should also be able to list the Lenovo servers that use AMD EPYC Gen4 processors.

Published: 2022-12-30

Length: 10 minutes

Employee link: [Grow@Lenovo](#)

Partner link: [Lenovo Partner Learning](#)

Course code: SXXW2501

4. **Partner Technical Webinar - ThinkSystem AMD V3 servers**

2022-11-22 | 60 minutes | Partners Only

In this 60-minute replay, Mark Bica and Joe Murphy presented the details of the new announced ThinkSystem Servers V3 based on the new 4th Generation AMD EPYC processor. They presented the ThinkSystem SR645 V3, SR665 V3, SR675 V3, SD665 V3 and SD665-N V3.

Published: 2022-11-22

Length: 60 minutes

Partner link: [Lenovo Partner Learning](#)

Course code: 111822

5. **ThinkSystem AMD Rack Servers Preview Oct 22**

2022-10-26 | 3 minutes | Employees and Partners

This Quick Hit introduces three new Lenovo ThinkSystem rackmount servers that use AMD EPYC Gen4 processors. The SR645 V3, SR665 V3, and SR675 V3 are two-socket servers that support TruDDR5 memory and PCIe Gen5.

After completing this Quick Hit, you will be able to identify the new servers within the family, describe why the new servers are important to a customer, and recognize keywords that lead to using the new servers.

Published: 2022-10-26

Length: 3 minutes

Employee link: [Grow@Lenovo](#)

Partner link: [Lenovo Partner Learning](#)

Course code: SXXW1216r4a

6. Lenovo Infrastructure Solutions Launch
2022-09-16 | 8 minutes | Employees and Partners

This Quick Hit introduces a wealth of new products, solutions, and services announced as part of the Lenovo ThinkSystem 30th Anniversary celebration.

Published: 2022-09-16
Length: 8 minutes
Employee link: [Grow@Lenovo](#)
Partner link: [Lenovo Partner Learning](#)
Course code: FY23Q2a

7. Lenovo Sustainable Computing
2022-09-16 | 4 minutes | Employees and Partners

This Quick Hit describes the Lenovo sustainable computing program, and the many ways in which Lenovo strives to respect and protect the environment.

Published: 2022-09-16
Length: 4 minutes
Employee link: [Grow@Lenovo](#)
Partner link: [Lenovo Partner Learning](#)
Course code: SXXW2504a

8. Introduction to DDR5 Memory
2022-08-23 | 10 minutes | Employees and Partners

This course introduces DDR5 memory, describes new features of this memory generation, and discusses the advantages to customers of this new memory generation.

Published: 2022-08-23
Length: 10 minutes
Employee link: [Grow@Lenovo](#)
Partner link: [Lenovo Partner Learning](#)
Course code: SXXW2502

9. Intel Transparent Supply Chain on Lenovo Servers
2021-12-03 | 12 minutes | Employees and Partners

This course introduces the Intel Transparent Supply Chain (TSC) program, explains how the program works, and discusses the benefits of the Intel TSC program to customers. Adding the Intel TSC feature to an order is explained.

Published: 2021-12-03
Length: 12 minutes
Employee link: [Grow@Lenovo](#)
Partner link: [Lenovo Partner Learning](#)
Course code: SXXW1230

10. Family Portfolio: Storage Controller Options

2021-10-19 | 25 minutes | Employees and Partners

This course covers the storage controller options available for use in Lenovo servers. The classes of storage controller are discussed, along with a discussion of where they are used, and which to choose.

Learning Objectives:

After completing this course, you will be able to:

- Describe the classes of storage controllers
- Discuss where each controller class is used
- Describe the available options in each controller class

Published: 2021-10-19

Length: 25 minutes

Employee link: Grow@Lenovo

Partner link: [Lenovo Partner Learning](#)

Course code: SXXW1111

Related publications and links

For more information, see these resources:

- Lenovo ThinkSystem SR645 V3 product page:
<https://www.lenovo.com/us/en/p/servers-storage/servers/racks/thinksystem-sr645-v3/len21ts0008>
- ThinkSystem SR645 V3 datasheet
<https://lenovopress.com/ds0147>
- Interactive 3D Tour of the ThinkSystem SR645 V3:
<https://lenovopress.lenovo.com/lp1627-sr645-v3-3d-tour>
- ThinkSystem SR645 V3 drivers and support
<http://datacentersupport.lenovo.com/products/servers/thinksystem/sr645v3/7d9c/downloads>
- Lenovo Hardware Installation & Removal Videos on the SR645 V3:
<https://www.youtube.com/playlist?list=PLYV5R7hVcs-AXJj66KkUL7leAbhsIZPkv>
- Lenovo ThinkSystem SR645 V3 product publications:
<https://pubs.lenovo.com/sr645-v3/>
 - User Guide, which includes:
 - System Configuration Guide
 - Hardware Maintenance Guide
 - Rack Installation Guides
 - Messages and Codes Reference
 - UEFI Manual for ThinkSystem Servers
- User Guides for options:
<https://serveroption.lenovo.com>
- ServerProven hardware compatibility:
<http://serverproven.lenovo.com>

Related product families

Product families related to this document are the following:

- [2-Socket Rack Servers](#)
- [ThinkSystem SR645 V3 Server](#)

Notices

Lenovo may not offer the products, services, or features discussed in this document in all countries. Consult your local Lenovo representative for information on the products and services currently available in your area. Any reference to a Lenovo product, program, or service is not intended to state or imply that only that Lenovo product, program, or service may be used. Any functionally equivalent product, program, or service that does not infringe any Lenovo intellectual property right may be used instead. However, it is the user's responsibility to evaluate and verify the operation of any other product, program, or service. Lenovo may have patents or pending patent applications covering subject matter described in this document. The furnishing of this document does not give you any license to these patents. You can send license inquiries, in writing, to:

Lenovo (United States), Inc.
8001 Development Drive
Morrisville, NC 27560
U.S.A.
Attention: Lenovo Director of Licensing

LENOVO PROVIDES THIS PUBLICATION "AS IS" WITHOUT WARRANTY OF ANY KIND, EITHER EXPRESS OR IMPLIED, INCLUDING, BUT NOT LIMITED TO, THE IMPLIED WARRANTIES OF NON-INFRINGEMENT, MERCHANTABILITY OR FITNESS FOR A PARTICULAR PURPOSE. Some jurisdictions do not allow disclaimer of express or implied warranties in certain transactions, therefore, this statement may not apply to you.

This information could include technical inaccuracies or typographical errors. Changes are periodically made to the information herein; these changes will be incorporated in new editions of the publication. Lenovo may make improvements and/or changes in the product(s) and/or the program(s) described in this publication at any time without notice.

The products described in this document are not intended for use in implantation or other life support applications where malfunction may result in injury or death to persons. The information contained in this document does not affect or change Lenovo product specifications or warranties. Nothing in this document shall operate as an express or implied license or indemnity under the intellectual property rights of Lenovo or third parties. All information contained in this document was obtained in specific environments and is presented as an illustration. The result obtained in other operating environments may vary. Lenovo may use or distribute any of the information you supply in any way it believes appropriate without incurring any obligation to you.

Any references in this publication to non-Lenovo Web sites are provided for convenience only and do not in any manner serve as an endorsement of those Web sites. The materials at those Web sites are not part of the materials for this Lenovo product, and use of those Web sites is at your own risk. Any performance data contained herein was determined in a controlled environment. Therefore, the result obtained in other operating environments may vary significantly. Some measurements may have been made on development-level systems and there is no guarantee that these measurements will be the same on generally available systems. Furthermore, some measurements may have been estimated through extrapolation. Actual results may vary. Users of this document should verify the applicable data for their specific environment.

© Copyright Lenovo 2023. All rights reserved.

This document, LP1607, was created or updated on December 5, 2023.

Send us your comments in one of the following ways:

- Use the online Contact us review form found at:
<https://lenovopress.lenovo.com/LP1607>
- Send your comments in an e-mail to:
comments@lenovopress.com

This document is available online at <https://lenovopress.lenovo.com/LP1607>.

Trademarks

Lenovo and the Lenovo logo are trademarks or registered trademarks of Lenovo in the United States, other countries, or both. A current list of Lenovo trademarks is available on the Web at <https://www.lenovo.com/us/en/legal/copytrade/>.

The following terms are trademarks of Lenovo in the United States, other countries, or both:

Lenovo®
AnyBay®
Bootable Media Creator
Flex System
Lenovo Neptune®
Lenovo Services
ServerProven®
System x®
ThinkShield®
ThinkServer®
ThinkSystem®
TopSeller
UpdateXpress System Packs
XClarity®

The following terms are trademarks of other companies:

Intel® and Xeon® are trademarks of Intel Corporation or its subsidiaries.

Linux® is the trademark of Linus Torvalds in the U.S. and other countries.

Microsoft®, ActiveX®, PowerShell, Windows PowerShell®, Windows Server®, and Windows® are trademarks of Microsoft Corporation in the United States, other countries, or both.

SPECpower® is a trademark of the Standard Performance Evaluation Corporation (SPEC).

Other company, product, or service names may be trademarks or service marks of others.