

DURAFLEX ARCH SIDE

Flexible Light Strip for Continuous Light Effects

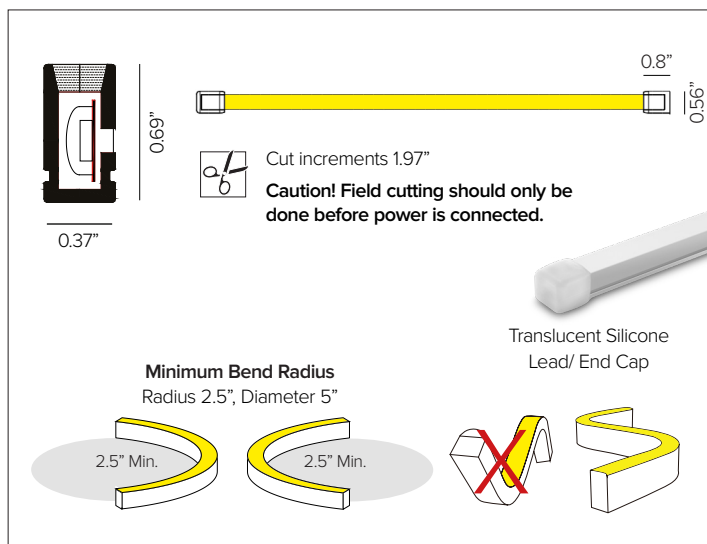
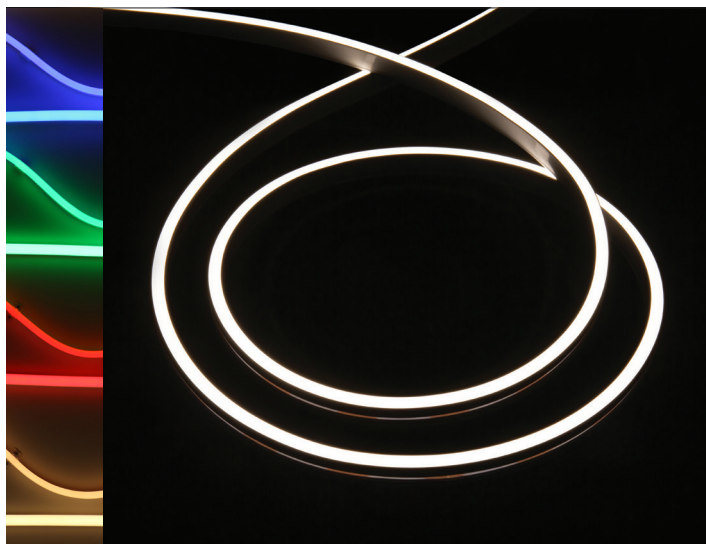

CONCEPT

Energy efficient LED flexible flat top neon light for linear continuous static white and monochromatic color applications.

MECHANICAL CHARACTERISTICS

Materials	Extruded silicone with LED strip and milky white diffusion lens.
Functionality	Extremely flexible and adjustable lengths for varied architectural applications.
Installation	Factory manufactured lengths with 12" IP65 connection lead with 12" power feed. To be completed with clip or channel mountings. Suitable for MRI installations. Driver to be mounted outside of MRI room and to be use with PVC or aluminum profiles only. To be installed with adhesive or MRI safe hardware only, no factory provided mounting hardware to be used.
Protection	IP65

CERTIFICATIONS

cULus Class 2 Listed
 Tested in accordance with LM-79-08
 Energy efficient for California installations.
 RoHS compliant

WARRANTY

5 year limited warranty

ELECTRICAL CHARACTERISTICS

Power Connection	Manufactured to specified lengths with factory attached translucent silicone end preps and various connector options for project requirements and efficient power configurations.
Wattage	2.8W/ft / 4.2W/ft
Voltage	Listed Class 2 output, 24V DC power supply required
Trigger Time	< 0.2s
Number of cycles	100,000
Operating Temp.	-25°C / +35°C
Max Continuous Length	Field trimmable every 1.97". 30ft / 2.8W/ft 20ft / 4.2W/ft

SOURCE

LEDs	36 LEDs/ft						
Spacing	0.33" O.C. LED Spacing						
TM30	CCT (Nominal)	CRI	Rf	Rg	R9	DUV	SDCM
	2700K	81	84	94	5	0.0004	2
	3000K	82	84	94	2	0.0008	2
	3500K	82	84	95	5	0.0009	2
	4000K	83	84	95	8	0.0005	2
	Red 630nm	-	-	-	-	-	2
	Green 530nm	-	-	-	-	-	2
	Blue 470nm	-	-	-	-	-	2
	Yellow 590nm	-	-	-	-	-	2
	Orange 605nm	-	-	-	-	-	2

Strip & LED Details	Model	W/LED	Delivered Lumens*		Viewing Angle
			3000K	4000K	
2.8W/FT	0.08W	81Lm/ft	84Lm/ft	114°	
4.2W/FT	0.13W	113Lm/ft	107Lm/ft	114°	

* Meets Title 24 High efficacy rating.

Efficacy	29Lm/W max. Refer to photometric graphs for specific values.
Lifetime	L70/B10 50,000hrs at max TA +25°C

DURAFLEX ARCH SIDE

SPECIFICATION INFORMATION

DFA									
1	2	3	4	5	6	7	8	9	10
						REQUIRED	OPTIONAL	REQUIRED	

Ex: DFASB42O2724 / KT10UVL1 / KT10UVC1 / DMLE301242UD

1 - PRODUCT CODE	2 - TYPE	3 - WATTAGE	4 - RATING	5 - KELVIN	6 - VOLTAGE
DFA — DURAFLEX ARCH	SB — SIDE Flex	28^A — 2.8W/ft 42^B — 4.2W/ft 28^A — 2.8W/ft	O — IP65	27 — 2700K 30 — 3000K 35 — 3500K 40 — 4000K 2200K and 2400K available upon request. RD — Red GR — Green BL — Blue YL — Yellow OR — Orange	24 — 24V DC
7 - END PREP CONNECTION	8 - MOUNTING	9 - POWER SUPPLY			
REQUIRED See section for details	REQUIRED See section for details	REQUIRED See section for details			

^A Wattage available in static white and static color versions.

^B Wattage available in static white versions only.



DFASB28O3024 + KT10UVL1 + KT10UVC1 + DMLE301242UD / DMLE601242UD / DMLE961242UD

* Lead time for quick ship fixtures is 1-2 weeks from processed PO date. Consult factory for quantities of over 500ft to confirm lead time.

DURAFLEX ARCH SIDE

7 - END PREP CONNECTION (REQUIRED)

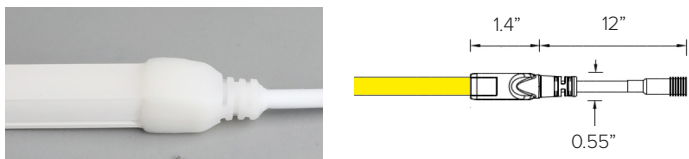

DURAFLEX ARCH SIDE straight end feed. Factory attached translucent silicone lead with two piece 12" wire, with IP65 quick disconnect at one end of product and dead end cap at other end. Lead wire/dead end allows for connection to power at lead end and field trim of DuraFlex product at the other end. Completed with translucent silicone factory attached end cap.

Part No. **KT10UVL1**

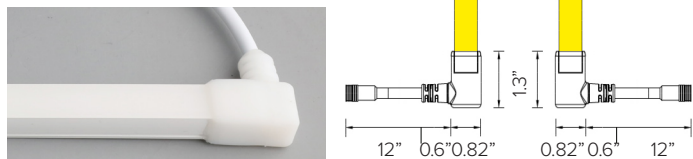

DURAFLEX ARCH SIDE left/right side feed. Factory attached translucent silicone lead with two piece 12" wire, with IP65 quick disconnect at one end of product and dead end cap at other end. Lead wire/dead end allows for connection to power at lead end and field trim of DuraFlex product at the other end. Completed with translucent silicone factory attached end cap.

Side	Left	Right
Part No.	KT10UVL2L	KT10UVL2R



DURAFLEX ARCH SIDE bottom feed. Factory attached translucent silicone lead with two piece 12" wire, with IP65 quick disconnect at one end of product and dead end cap at other end. Lead wire/dead end allows for connection to power at lead end and field trim of DuraFlex product at the other end. Completed with translucent silicone factory attached end cap.

Part No. **KT10UVL3**

8 - MOUNTING (REQUIRED)

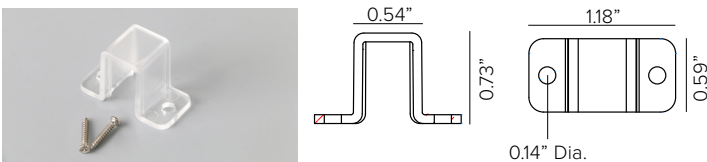

DURAFLEX ARCH SIDE transparent clips kit. Includes 5ea clips and 10ea screws.

Part No. **KT10UVS1**

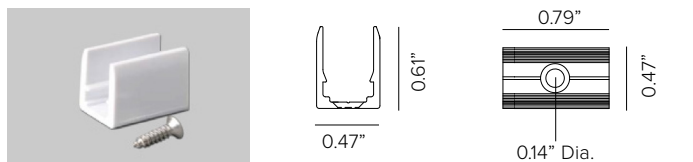

DURAFLEX ARCH SIDE bottom fixing clips. Includes 5ea clips and 5ea screws.

Part No. **KT10UVC1**

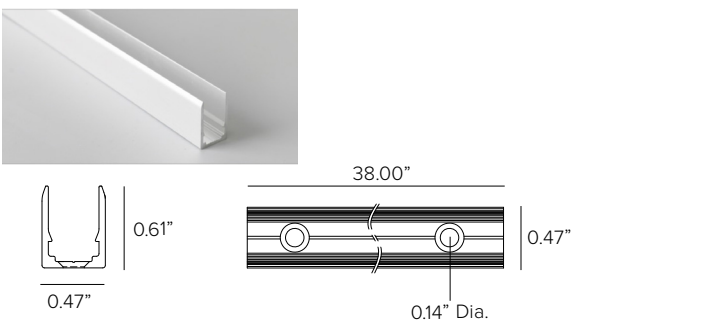

DURAFLEX ARCH SIDE aluminum rigid profile with 2ea screws. Note, termination end prep rest to outside of the profile.

Part No. **KT10UVP1**

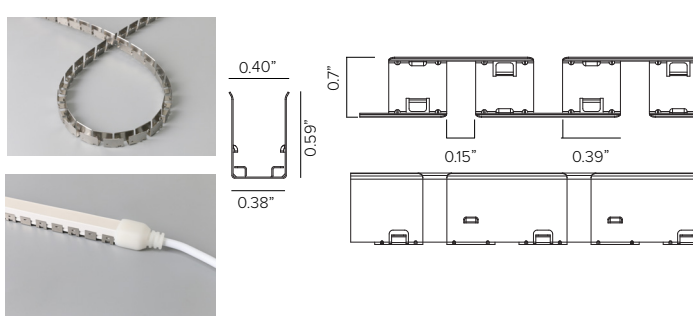

DURAFLEX ARCH SIDE flexible stamped stainless steel profile secured with screws, 1ea provided per foot. Available in 1ft lengths.

Part No. **KTUVFP2**

DURAFLEX ARCH SIDE

9 - POWER SUPPLY (REQUIRED)

ENCLOSURE								
Part No.	Wattage	Control	Dim Range	Rating	In / Out Voltage	Certification	Dimensions (Enclosure)	Description
DMLE301242UD	30W	MLV / ELV / 0-10V / TRIAC	MLV / ELV <10% 0-10V 1%	NEMA3R	120-277V / 24V	UL Class 2	4.47" X 6.79" X 1.38"	EMCOD electronic driver with wiring compartment.
DELV30124DJBX	30W	0-10V	0.1%	IP65	120-277V / 24V	UL Class 2	12.1" X 2.4" X 1.4"	Magnitude SOLIDrive electronic driver with built in junction box.
DMLE601242UD	60W	MLV / ELV / 0-10V / TRIAC	MLV / ELV <10% 0-10V 1%	NEMA3R	120-277V / 24V	UL Class 2	4.47" X 6.79" X 1.38"	EMCOD electronic driver with wiring compartment.
DELV60124DJBX	60W	0-10V	0.1%	IP65	120-277V / 24V	UL Class 2	12.1" X 2.4" X 1.4"	Magnitude SOLIDrive electronic driver with built in junction box.
DELI601241CPWM	60W	0-10V	1%	NEMA1	120-277V / 24V	UL Class 2	10" x 10" x 4"	MEANWELL electronic PWM driver.
DELI901241CPWM	90W	0-10V	1%	NEMA1	120-277V / 24V	UL Class 2	10" x 10" x 4"	MEANWELL electronic PWM driver.
DMLE961242UD	96W	MLV / ELV / 0-10V / TRIAC	MLV / ELV <10% 0-10V 1%	NEMA3R	120-277V / 24V	UL Class 2	5.16" X 7.73" X 1.54	EMCOD electronic driver with wiring compartment.
DELV96124DJBX	96W	0-10V	0.1%	IP65	120-277V / 24V	UL Class 2	12.1" X 2.4" X 1.4"	Magnitude SOLIDrive electronic driver with built in junction box.
DELI1802242CPWM	2X90W	0-10V	1%	NEMA1	120-277V / 24V	UL Class 2	12" x 12" x 4"	MEANWELL electronic PWM driver.
DMLE1922242UD	2X96W	MLV / ELV / 0-10V / TRIAC	MLV / ELV <10% 0-10V 1%	NEMA3R	120-277V / 24V	UL Class 2	5.04" X 10.94" X 1.81	EMCOD electronic driver with wiring compartment.
DELI2703243CPWM	3X90W	0-10V	1%	NEMA1	120-277V / 24V	UL Class 2	12" x 12" x 4"	MEANWELL electronic PWM driver.
DMLE2882242UD	3X96W	MLV / ELV / 0-10V / TRIAC	MLV / ELV <10% 0-10V 1%	NEMA3R	120-277V / 24V	UL Class 2	5.04" X 10.94" X 1.81	EMCOD electronic driver with wiring compartment.

STAND ALONE								
Part No.	Wattage	Control	Dim Range	Rating	In / Out Voltage	Certification	Dimensions (Standalone)	Description
DELV30124D	30W	0-10V	0.1%	IP65	120-277V / 24V	UR Class 2	7.5" X 2.4" X 1.4"	Magnitude SOLIDrive electronic standalone driver. UL listed enclosure provided by others.
DEL60PWM	60W	0-10V	1%	IP67	120-277V / 24V	UL Class 2	5.9" X 2.09" X 1.38"	MEANWELL electronic PWM driver. UL listed enclosure provided by others.
DELV60124D	60W	0-10V	0.1%	IP65	120-277V / 24V	UR Class 2	7.5" X 2.4" X 1.4"	Magnitude SOLIDrive electronic standalone driver. UL listed enclosure provided by others.
DEL90PWM	90W	0-10V	1%	IP67	120-277V / 24V	UL Class 2	6.73" X 2.48" X 1.48"	MEANWELL electronic PWM driver. UL listed enclosure provided by others.
DELV96124D	96W	0-10V	0.1%	IP65	120-277V / 24V	UR Class 2	7.5" X 2.4" X 1.4"	Magnitude SOLIDrive electronic standalone driver. UL listed enclosure provided by others.

MAX INTERCONNECTED FLEX LENGTHS PER DRIVER

Fixture Wattage	Driver Wattage							
	30W	60W	90W	96W	2X90W	2X96W	3X90W	3X96W
2.8W	8FT	17FT	25FT	27FT	(2) 25FT	(2) 51FT	(3) 48FT	(3) 52FT
4.2W	5FT	11FT	17FT	18FT	(2) 17FT	(2) 25FT	(3) 24FT	(3) 35FT

DURAFLEX ARCH SIDE

PHOTOMETRY

IES FILES SHOWN AT 1M (3.28FT) LENGTHS

2.8W/ft

	2700K	H(m)	D(m)	Emax(lx)		
	Ra80			114°		
	Fixture Power	9W	1	3.06	85	
	Source Flux	250lm	2	6.11	21	
	Fixture Flux	250lm	3	9.17	9	
	Efficacy	28lm/W	4	12.23	5	
933906	I _{max} =340cd/klm	I _{max}	85cd	5	15.28	3

	3000K	H(m)	D(m)	Emax(lx)		
	Ra80			114°		
	Fixture Power	9W	1	3.06	90	
	Source Flux	265lm	2	6.11	22	
	Fixture Flux	265lm	3	9.17	10	
	Efficacy	29lm/W	4	12.23	6	
933883	I _{max} =340cd/klm	I _{max}	90cd	5	15.28	4

	3500K	H(m)	D(m)	Emax(lx)		
	Ra80			114°		
	Fixture Power	9W	1	3.06	90	
	Source Flux	265lm	2	6.11	22	
	Fixture Flux	265lm	3	9.17	10	
	Efficacy	29lm/W	4	12.23	6	
933876	I _{max} =340cd/klm	I _{max}	90cd	5	15.28	4

	4000K	H(m)	D(m)	Emax(lx)		
	Ra80			114°		
	Fixture Power	9W	1	3.06	93	
	Source Flux	275lm	2	6.11	23	
	Fixture Flux	275lm	3	9.17	10	
	Efficacy	31lm/W	4	12.23	6	
933869	I _{max} =340cd/klm	I _{max}	93cd	5	15.28	4

4.2W/ft

	2700K	H(m)	D(m)	Emax(lx)		
	Ra80			114°		
	Fixture Power	14W	1	3.06	119	
	Source Flux	350lm	2	6.11	30	
	Fixture Flux	350lm	3	9.17	13	
	Efficacy	25lm/W	4	12.23	7	
920609	I _{max} =340cd/klm	I _{max}	119cd	5	15.28	5

	3000K	H(m)	D(m)	Emax(lx)		
	Ra80			114°		
	Fixture Power	14W	1	3.06	126	
	Source Flux	370lm	2	6.11	31	
	Fixture Flux	370lm	3	9.17	14	
	Efficacy	26lm/W	4	12.23	8	
920616	I _{max} =340cd/klm	I _{max}	126cd	5	15.28	5

	3500K	H(m)	D(m)	Emax(lx)		
	Ra80			114°		
	Fixture Power	14W	1	3.06	126	
	Source Flux	370lm	2	6.11	31	
	Fixture Flux	370lm	3	9.17	14	
	Efficacy	26lm/W	4	12.23	8	
920630	I _{max} =340cd/klm	I _{max}	126cd	5	15.28	5

	4000K	H(m)	D(m)	Emax(lx)		
	Ra80			114°		
	Fixture Power	14W	1	3.06	119	
	Source Flux	350lm	2	6.11	30	
	Fixture Flux	350lm	3	9.17	13	
	Efficacy	25lm/W	4	12.23	7	
920647	I _{max} =340cd/klm	I _{max}	119cd	5	15.28	5