



QUOTE BY: Jeff Gorin
SOLD TO: Tal-co Building Innovations LTD
Pat Newton
Phone: 613-821-3959

QUOTE #: JJDG01126
SHIP TO:

PROJECT NAME: 1 & 3 Meridian place with BM
REFERENCE: REVISED JUNE 12TH

PO#:
Ship Via: Ground/Next Truck

****SUPPLY ONLY****
****WINDOWS ONLY****
INCLUDED:

SHOP DRAWING REVIEW

REVIEWED
REVIEWED AS NOTED
REVISE AND RESUBMIT



SERIES- JELD-WEN SITELINE ALUMINUM CLAD WOOD
EXTERIOR COLOUR- BRILLANT WHITE
INTERIOR COLOUR- PRIMED WHITE - AURALAST PINE
INTERIOR JAMB MATERIAL- FJ PINE FOR 2X6 WALL CONSTRUCTIONS
WINDOW LOCKS- MULTI-POINT
WINDOW HANDLES- ENCORE FOLDING/NESTING
1-1/2" BRICKMOULD

"This review is for the sole purpose of ascertaining conformance with the general design concept for architectural features only, and does not in any way constitute review of the design of engineering elements which form part of the Contract Documents prepared by others. This review shall not mean that the Architect approves the detail design inherent in the shop drawings. This responsibility shall remain with the Contractor submitting same, and such review shall not relieve the Contractor of his responsibility for errors or omissions in the shop drawings or of his responsibility for meeting all requirements of the Contract Documents. The Contractor is responsible for dimensions to be confirmed and correlated at the job site, for information that pertains solely to fabrication processes, or to techniques of construction and installation and for co-ordination for the work of all trades."

NOT INCLUDED:

By: Bryan Bonell Date: June 28, 2019
HOBIN ARCHITECTURE INCORPORATED

POUR IN PLACE BASEMENT WINDWS
ANY OTHER OPTION OR FEATURE NOT MENTIONED OR REFERRED TO DIRECTLY IN THIS QUOTE

ADDITIONAL NOTES:

AuraLast is JELD-WEN's proprietary water-based wood protection process. Unlike traditional chemical dip-treatments that only coat a thin layer on the wood's surface, AuraLast delivers virtually 100 percent surface-to-core protection. JELD-WEN wood windows, patio doors and door frames with AuraLast Wood can protect you from the expense, damage and inconvenience of decaying wood.

- 1. PLEASE PROVIDE EXTERIOR COLOUR SAMPLE.
- 2. LIMITERS TO BE PROVIDED ON WINDOWS ON WEST ELEVATION AND ON W41 ON SOUTH ELEV.
- 3. ORIGINAL FIXED WINDOWS WERE NOT DONE AS FIXED CASEMENTS - SEE ATTACHED PHOTO. CAN THIS NOT BE DONE HERE?
- 4. SIZES TO BE CONFIRMED WITH GENERAL CONTRACTOR.

LINE NO.	LOCATION SIZE INFO	BOOK CODE DESCRIPTION	NET UNIT PRICE	QTY	EXTENDED PRICE
Line-1	W37 Rough Opening: 22 3/4 X 70 3/4	Main Line Item Frame Size : 22 X 70, BTM= 54 (Outside Casing Size: 25 X 71 13/16), Siteline Clad Casement, Auralast Pine, Single w/Transom Brilliant White Exterior, Primed Interior, Aluminum Brickmould, Standard Sill Nosing, Color Match Metal DripCap, Brilliant White Trim, 4 9/16 Jamb, 4/4 Thick, Stationary, Canada-NAFS 08 & 11/CSA A440, DP 35, Insulated Low-E 180 Annealed Glass, Neat, Protective Film, Silver Spacer, Argon Filled, Traditional Glz Bd, This mull configuration complies with AAMA 450 standards and is professional engineer-approved. <small>PEV 2019.1.2.2446/PDV 6.281 (02/20/19) DF</small>			
					12



Viewed from Exterior. Scale: 1/4" = 1'

Line-1-1 (A1)		Frame Size : 22 X 16 Siteline Clad Casement, Auralast Pine, DIRECT SET RECTANGLE? Brilliant White Exterior, Primed Interior, Nail Fin (Standard), 3 3/16 Jamb, Stationary, Canada-NAFS 08 & 11/CSA A440, PG 35, Water Penetration Resistance 500 Air Level Fixed Insulated Low-E 180 Annealed Glass, Neat, Protective Film, Silver Spacer, Argon Filled, Traditional Glz Bd, *Custom-Width*, *Custom-Height*, GlassThick=0.698, U-Factor: 1.59, SHGC: 0.55, VLT: 0.63, Energy Rating: 37.00, CPD: JEL-N-878-01569-00001, Canadian Energy Star: 123			
---------------	--	--	--	--	--

Line-1-2 (B1)		Frame Size : 22 X 54 Siteline Clad Casement, Auralast Pine, DIRECT SET RECTANGLE? Brilliant White Exterior, Primed Interior, Nail Fin (Standard), 3 3/16 Jamb, Stationary, Canada-NAFS 08 & 11/CSA A440, PG 35, Water Penetration Resistance 500 Air Level Fixed Insulated Low-E 180 Annealed Glass, Neat, Protective Film, Silver Spacer, Argon Filled, Traditional Glz Bd, *Custom-Width*, GlassThick=0.698, U-Factor: 1.59, SHGC: 0.55, VLT: 0.63, Energy Rating: 37.00, CPD: JEL-N-878-01569-00001, Canadian Energy Star: 123			
---------------	--	---	--	--	--

LINE NO.	LOCATION SIZE INFO	BOOK CODE DESCRIPTION	NET UNIT PRICE	QTY	EXTENDED PRICE
Line-2	W37B Rough Opening: 22 3/4 X 70 3/4	Main Line Item ✓ Frame Size : 22 X 70, BTM= 54 (Outside Casing Size: 25 X 71 13/16), ✓ Siteline Clad Casement, Auralast Pine, Single w/Transom Brilliant White Exterior, Primed Interior, Aluminum Brickmould, Standard Sill Nosing, Color Match Metal DripCap, Brilliant White Trim, 4 9/16 Jamb, 4/4 Thick, ✓ Stationary, Canada-NAFS 08 & 11/CSA A440, DP 35, Insulated Low-E 180 Annealed Glass, Neat, Protective Film, Silver Spacer, Argon Filled, Traditional Glz Bd, This mull configuration complies with AAMA 450 standards and is professional engineer-approved. <small>PEV 2019.1.2.2446/PDV 6.281 (02/20/19) DF</small>			
					2 ✓



Viewed from Exterior. Scale: 1/4" = 1'

Line-2-1 (A1)		Frame Size : 22 X 16 Siteline Clad Casement, Auralast Pine, DIRECT SET RECTANGLE? Brilliant White Exterior, Primed Interior, Nail Fin (Standard), 3 3/16 Jamb, Stationary, Canada-NAFS 08 & 11/CSA A440, PG 35, Water Penetration Resistance 500 Air Level Fixed Insulated Low-E 180 Annealed Glass, Neat, Protective Film, Silver Spacer, Argon Filled, Traditional Glz Bd, *Custom-Width*, *Custom-Height*, GlassThick=0.698, U-Factor: 1.59, SHGC: 0.55, VLT: 0.63, Energy Rating: 37.00, CPD: JEL-N-878-01569-00001, Canadian Energy Star: 123			
---------------	--	--	--	--	--

Line-2-2 (B1)		Frame Size : 22 X 54 Siteline Clad Casement, Auralast Pine, DIRECT SET RECTANGLE? Brilliant White Exterior, Primed Interior, Nail Fin (Standard), 3 3/16 Jamb, Stationary, Canada-NAFS 08 & 11/CSA A440, PG 35, Water Penetration Resistance 500 Air Level Fixed Insulated Low-E 180 Annealed Glass, Neat, Protective Film, Silver Spacer, Argon Filled, Traditional Glz Bd, *Custom-Width*, GlassThick=0.698, U-Factor: 1.59, SHGC: 0.55, VLT: 0.63, Energy Rating: 37.00, CPD: JEL-N-878-01569-00001, Canadian Energy Star: 123			
---------------	--	---	--	--	--

LINE NO.	LOCATION SIZE INFO	BOOK CODE DESCRIPTION	NET UNIT PRICE	QTY	EXTENDED PRICE
Line-3	W38 Rough Opening: 75 1/4 X 70 3/4	Main Line Item Frame Size : 74 1/2 X 70 ✓ (Outside Casing Size: 77 1/2 X 71 13/16), ✓ Siteline Clad Mull Auralast Pine, Casement/Awning Product, Brilliant White Exterior, Primed Interior, Aluminum Brickmould, Standard Sill Nosing, Color Match Metal DripCap, Brilliant White Trim, 2 Wide 2 High, Factory Structural Mull, 4 9/16 Jamb, 4/4 Thick, ✓ Insulated Low-E 180 Annealed Glass, Protective Film, Silver Spacer, Argon Filled, Traditional Glz Bd, Mulled Window Assembly Has Not Been Tested To AAMA 450. Vertical Structural Mull 1 Vertical Spread, 1/4" Wide, PEV 2019.1.2.2446/PDV 6.281 (02/20/19) DF		3 ✓	

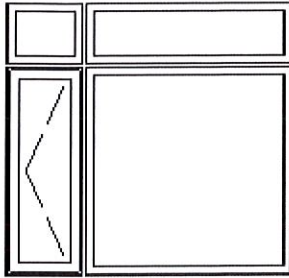

Viewed from Exterior. Scale: 1/4" = 1'

Line-3-1 (A1)

Frame Size : 20 X 16
Siteline Clad Geometric, Auralast Pine, Direct Set Rectangle,
Brilliant White Exterior,
Primed Interior,
Nail Fin (Standard),
3 3/16 Jamb,
PG 35,
Insulated Low-E 180 Annealed Glass, Neat, Protective Film,
Silver Spacer, Argon Filled,
GlassThick=0.7095,
U-Factor: 1.59, SHGC: 0.59, VLT: 0.68, Energy Rating: 39.00,
CPD: JEL-N-889-01384-00001, Canadian Energy Star: 123

Line-3-2 (A2)

Frame Size : 54 1/4 X 16
Siteline Clad Geometric, Auralast Pine, Direct Set Rectangle,
Brilliant White Exterior,
Primed Interior,
Nail Fin (Standard),
3 3/16 Jamb,
PG 35,
Insulated Low-E 180 Annealed Glass, Neat, Protective Film,
Silver Spacer, Argon Filled,
GlassThick=0.7095,
U-Factor: 1.59, SHGC: 0.59, VLT: 0.68, Energy Rating: 39.00,
CPD: JEL-N-889-01384-00001, Canadian Energy Star: 123

LINE NO.	LOCATION SIZE INFO	BOOK CODE DESCRIPTION	NET UNIT PRICE	QTY	EXTENDED PRICE
----------	-----------------------	--------------------------	-------------------	-----	-------------------

Line-3-3 (B1)

SCC2054
 Frame Size : 20 X 54
 Sitrine Clad Casement, Auralast Pine,
 Brilliant White Exterior,
 Primed Interior,
 Nail Fin (Standard),
 3 3/16 Jamb,
 Hinge Left,
 Nesting Crank Handle, White Hardware, HDWE-APPLIED,
 Stainless Steel Operator/Hinge,
 PG 35,
 Insulated Low-E 180 Annealed Glass, Neat, Protective Film,
 Silver Spacer, Argon Filled, Traditional Glz Bd,
 BetterVue Mesh Brilliant White Screen, Screen Applied
 GlassThick=0.698,
 Clear Opening:10.1w (258mm), 49.5h (1259.5mm), 3.4 sf
 (0.32sq.m)

 U-Factor: 1.65, SHGC: 0.47, VLT: 0.54, Energy Rating: 31.00,
 CPD: JEL-N-877-00014-00001, Canadian Energy Star: 12

Line-3-4 (B2)

Frame Size : 54 1/4 X 54
 Sitrine Clad Geometric, Auralast Pine, Direct Set Rectangle,
 Brilliant White Exterior,
 Primed Interior,
 Nail Fin (Standard),
 3 3/16 Jamb,
 PG 35,
 Insulated Low-E 180 Annealed Glass, Neat, Protective Film,
 Silver Spacer, Argon Filled,
 GlassThick=0.756,
 U-Factor: 1.59, SHGC: 0.58, VLT: 0.67, Energy Rating: 38.00,
 CPD: JEL-N-889-01514-00001, Canadian Energy Star: 123

Line-4 W38R
 Rough Opening: 75 1/4 X 70 3/4

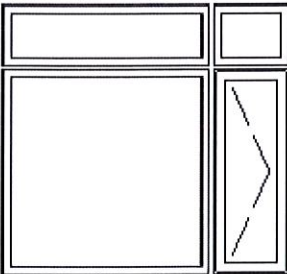

Viewed from Exterior. Scale: 1/4" = 1'

Main Line Item
 Frame Size : 74 1/2 X 70 ✓
 (Outside Casing Size: 77 1/2 X 71 13/16), ✓
 Sitrine Clad Mull Auralast Pine, Casement/Awning Product,
 Brilliant White Exterior,
 Primed Interior,
 Aluminum Brickmould, Standard Sill Nosing, Color Match Metal
 DripCap, Brilliant White Trim,
 2 Wide
 2 High,
 Factory Structural Mull,
 4 9/16 Jamb, 4/4 Thick, ✓
 Insulated Low-E 180 Annealed Glass, Protective Film, Silver Spacer,
 Argon Filled, Traditional Glz Bd,
 Mull Window Assembly Has Not Been Tested To AAMA 450.
 Vertical Structural Mull 1 Vertical Spread, 1/4" Wide,
 PEV 2019.1.2.2446/PDV 6.281 (02/20/19) DF

3 ✓

LINE NO.	LOCATION SIZE INFO	BOOK CODE DESCRIPTION	NET UNIT PRICE	QTY	EXTENDED PRICE
----------	-----------------------	--------------------------	-------------------	-----	-------------------

Line-4-1 (A1)

Frame Size : 54 1/4 X 16
 Sitrine Clad Geometric, Auralast Pine, Direct Set Rectangle,
 Brilliant White Exterior,
 Primed Interior,
 Nail Fin (Standard),
 3 3/16 Jamb,
 PG 35,
 Insulated Low-E 180 Annealed Glass, Neat, Protective Film,
 Silver Spacer, Argon Filled,
 GlassThick=0.7095,
 U-Factor: 1.59, SHGC: 0.59, VLT: 0.68, Energy Rating: 39.00,
 CPD: JEL-N-889-01384-00001, Canadian Energy Star: 123

Line-4-2 (A2)

Frame Size : 20 X 16
 Sitrine Clad Geometric, Auralast Pine, Direct Set Rectangle,
 Brilliant White Exterior,
 Primed Interior,
 Nail Fin (Standard),
 3 3/16 Jamb,
 PG 35,
 Insulated Low-E 180 Annealed Glass, Neat, Protective Film,
 Silver Spacer, Argon Filled,
 GlassThick=0.7095,
 U-Factor: 1.59, SHGC: 0.59, VLT: 0.68, Energy Rating: 39.00,
 CPD: JEL-N-889-01384-00001, Canadian Energy Star: 123

Line-4-4 (B1)

Frame Size : 54 1/4 X 54
 Sitrine Clad Geometric, Auralast Pine, Direct Set Rectangle,
 Brilliant White Exterior,
 Primed Interior,
 Nail Fin (Standard),
 3 3/16 Jamb,
 PG 35,
 Insulated Low-E 180 Annealed Glass, Neat, Protective Film,
 Silver Spacer, Argon Filled,
 GlassThick=0.756,
 U-Factor: 1.59, SHGC: 0.58, VLT: 0.67, Energy Rating: 38.00,
 CPD: JEL-N-889-01514-00001, Canadian Energy Star: 123

LINE NO.	LOCATION SIZE INFO	BOOK CODE DESCRIPTION	NET UNIT PRICE	QTY	EXTENDED PRICE
----------	-----------------------	--------------------------	-------------------	-----	-------------------

Line-4-3 (B2)

SCC2054
 Frame Size : 20 X 54
 Sitrine Clad Casement, Auralast Pine,
 Brilliant White Exterior,
 Primed Interior,
 Nail Fin (Standard),
 3 3/16 Jamb,
 Hinge Right,
 Nesting Crank Handle, White Hardware, HDWE-APPLIED,
 Stainless Steel Operator/Hinge,
 PG 35,
 Insulated Low-E 180 Annealed Glass, Neat, Protective Film,
 Silver Spacer, Argon Filled, Traditional Glz Bd,
 BetterVue Mesh Brilliant White Screen, Screen Applied
 GlassThick=0.698,
 Clear Opening:10.1w (258mm), 49.5h (1259.5mm), 3.4 sf
 (0.32sq.m)

U-Factor: 1.65, SHGC: 0.47, VLT: 0.54, Energy Rating: 31.00,
 CPD: JEL-N-877-00014-00001, Canadian Energy Star: 12

Line-5 W39
 Rough Opening: 55 3/4 X 70 3/4

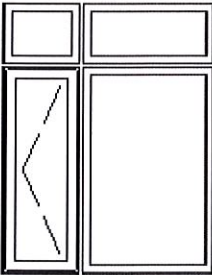

Viewed from Exterior. Scale: 1/4" = 1'

Main Line Item
 Frame Size : 55 X 70 ✓
 (Outside Casing Size: 58 X 71 13/16), ✓
 Sitrine Clad Mull Auralast Pine, Casement/Awning Product,
 Brilliant White Exterior,
 Primed Interior,
 Aluminum Brickmould, Standard Sill Nosing, Color Match Metal
 DripCap, Brilliant White Trim,
 2 Wide
 2 High,
 Factory Structural Mull, ✓
 4 9/16 Jamb, 4/4 Thick, ✓
 Canada-NAFS 08 & 11/CSA A440, DP 35,
 Insulated Low-E 180 Annealed Glass, Protective Film, Silver Spacer,
 Argon Filled, Traditional Glz Bd,
 This mull configuration complies with AAMA 450 standards and is
 professional engineer-approved.
 Vertical Structural Mull 1 Vertical Spread, 1/4" Wide,
 PEV 2019.1.2.2446/PDV 6.281 (02/20/19) DF

2 ✓

Line-5-1 (A1)

Frame Size : 20 X 16
 Sitrine Clad Geometric, Auralast Pine, Direct Set Rectangle,
 Brilliant White Exterior,
 Primed Interior,
 Nail Fin (Standard),
 3 3/16 Jamb,
 Canada-NAFS 08 & 11/CSA A440, PG 35, Water Penetration
 Resistance 400 Air Level A3
 Insulated Low-E 180 Annealed Glass, Neat, Protective Film,
 Silver Spacer, Argon Filled,
 GlassThick=0.7095,
 U-Factor: 1.59, SHGC: 0.59, VLT: 0.68, Energy Rating: 39.00,
 CPD: JEL-N-889-01384-00001, Canadian Energy Star: 123

LINE NO.	LOCATION SIZE INFO	BOOK CODE DESCRIPTION	NET UNIT PRICE	QTY	EXTENDED PRICE
----------	-----------------------	--------------------------	-------------------	-----	-------------------

Line-5-2 (A2)

Frame Size : 34 3/4 X 16
 Sitrine Clad Geometric, Auralast Pine, Direct Set Rectangle,
 Brilliant White Exterior,
 Primed Interior,
 Nail Fin (Standard),
 3 3/16 Jamb,
 Canada-NAFS 08 & 11/CSA A440, PG 35, Water Penetration
 Resistance 400 Air Level A3
 Insulated Low-E 180 Annealed Glass, Neat, Protective Film,
 Silver Spacer, Argon Filled,
 GlassThick=0.7095,
 U-Factor: 1.59, SHGC: 0.59, VLT: 0.68, Energy Rating: 39.00,
 CPD: JEL-N-889-01384-00001, Canadian Energy Star: 123

Line-5-3 (B1)

SCC2054
 Frame Size : 20 X 54
 Sitrine Clad Casement, Auralast Pine,
 Brilliant White Exterior,
 Primed Interior,
 Nail Fin (Standard),
 3 3/16 Jamb,
 Hinge Left,
 Nesting Crank Handle, White Hardware, HDWE-APPLIED,
 Stainless Steel Operator/Hinge,
 Canada-NAFS 08 & 11/CSA A440, PG 35, Water Penetration
 Resistance 700 Air Level A3
 Insulated Low-E 180 Annealed Glass, Neat, Protective Film,
 Silver Spacer, Argon Filled, Traditional Glz Bd,
 BetterVue Mesh Brilliant White Screen, Screen Applied
 GlassThick=0.698,
 Clear Opening:10.1w (258mm), 49.5h (1259.5mm), 3.4 sf
 (0.32sq.m)
 U-Factor: 1.65, SHGC: 0.47, VLT: 0.54, Energy Rating: 31.00,
 CPD: JEL-N-877-00014-00001, Canadian Energy Star: 12

Line-5-4 (B2)

Frame Size : 34 3/4 X 54
 Sitrine Clad Geometric, Auralast Pine, Direct Set Rectangle,
 Brilliant White Exterior,
 Primed Interior,
 Nail Fin (Standard),
 3 3/16 Jamb,
 Canada-NAFS 08 & 11/CSA A440, PG 35, Water Penetration
 Resistance 400 Air Level A3
 Insulated Low-E 180 Annealed Glass, Neat, Protective Film,
 Silver Spacer, Argon Filled,
 GlassThick=0.7095,
 U-Factor: 1.59, SHGC: 0.59, VLT: 0.68, Energy Rating: 39.00,
 CPD: JEL-N-889-01384-00001, Canadian Energy Star: 123

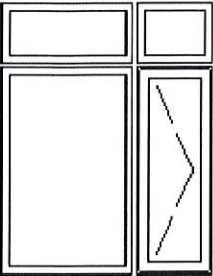
LINE NO.	LOCATION SIZE INFO	BOOK CODE DESCRIPTION	NET UNIT PRICE	QTY	EXTENDED PRICE
Line-6	W39R	Main Line Item			
	Rough Opening: 55 3/4 X 70 3/4	Frame Size : 55 X 70 ✓ (Outside Casing Size: 58 X 71 13/16), ✓ Siteline Clad Mull Auralast Pine, Casement/Awning Product, Brilliant White Exterior, Primed Interior, Aluminum Brickmould, Standard Sill Nosing, Color Match Metal DripCap, Brilliant White Trim, 2 Wide 2 High, Factory Structural Mull, 4 9/16 Jamb, 4/4 Thick, ✓ Canada-NAFS 08 & 11/CSA A440, DP 35, Insulated Low-E 180 Annealed Glass, Protective Film, Silver Spacer, Argon Filled, Traditional Glz Bd, This mull configuration complies with AAMA 450 standards and is professional engineer-approved. Vertical Structural Mull 1 Vertical Spread, 1/4" Wide, PEV 2019.1.2.2446/PDV 6.281 (02/20/19) DF			
					
	Viewed from Exterior. Scale: 1/4" = 1'				

2 ✓

Line-6-1 (A1)		Frame Size : 34 3/4 X 16 Siteline Clad Geometric, Auralast Pine, Direct Set Rectangle, Brilliant White Exterior, Primed Interior, Nail Fin (Standard), 3 3/16 Jamb, Canada-NAFS 08 & 11/CSA A440, PG 35, Water Penetration Resistance 400 Air Level A3 Insulated Low-E 180 Annealed Glass, Neat, Protective Film, Silver Spacer, Argon Filled, GlassThick=0.7095, U-Factor: 1.59, SHGC: 0.59, VLT: 0.68, Energy Rating: 39.00, CPD: JEL-N-889-01384-00001, Canadian Energy Star: 123			
---------------	--	--	--	--	--

Line-6-2 (A2)		Frame Size : 20 X 16 Siteline Clad Geometric, Auralast Pine, Direct Set Rectangle, Brilliant White Exterior, Primed Interior, Nail Fin (Standard), 3 3/16 Jamb, Canada-NAFS 08 & 11/CSA A440, PG 35, Water Penetration Resistance 400 Air Level A3 Insulated Low-E 180 Annealed Glass, Neat, Protective Film, Silver Spacer, Argon Filled, GlassThick=0.7095, U-Factor: 1.59, SHGC: 0.59, VLT: 0.68, Energy Rating: 39.00, CPD: JEL-N-889-01384-00001, Canadian Energy Star: 123			
---------------	--	--	--	--	--

LINE NO.	LOCATION SIZE INFO	BOOK CODE DESCRIPTION	NET UNIT PRICE	QTY	EXTENDED PRICE
----------	-----------------------	--------------------------	-------------------	-----	-------------------

Line-6-4 (B1)

Frame Size : 34 3/4 X 54
 Siteline Clad Geometric, Auralast Pine, Direct Set Rectangle,
 Brilliant White Exterior,
 Primed Interior,
 Nail Fin (Standard),
 3 3/16 Jamb,
 Canada-NAFS 08 & 11/CSA A440, PG 35, Water Penetration
 Resistance 400 Air Level A3
 Insulated Low-E 180 Annealed Glass, Neat, Protective Film,
 Silver Spacer, Argon Filled,
 GlassThick=0.7095,
 U-Factor: 1.59, SHGC: 0.59, VLT: 0.68, Energy Rating: 39.00,
 CPD: JEL-N-889-01384-00001, Canadian Energy Star: 123

Line-6-3 (B2)

SCC2054
 Frame Size : 20 X 54
 Siteline Clad Casement, Auralast Pine,
 Brilliant White Exterior,
 Primed Interior,
 Nail Fin (Standard),
 3 3/16 Jamb,
 Hinge Right,
 Nesting Crank Handle, White Hardware, HDWE-APPLIED,
 Stainless Steel Operator/Hinge,
 Canada-NAFS 08 & 11/CSA A440, PG 35, Water Penetration
 Resistance 700 Air Level A3
 Insulated Low-E 180 Annealed Glass, Neat, Protective Film,
 Silver Spacer, Argon Filled, Traditional Glz Bd,
 BetterVue Mesh Brilliant White Screen, Screen Applied
 GlassThick=0.698,
 Clear Opening:10.1w (258mm), 49.5h (1259.5mm), 3.4 sf
 (0.32sq.m)
 U-Factor: 1.65, SHGC: 0.47, VLT: 0.54, Energy Rating: 31.00,
 CPD: JEL-N-877-00014-00001, Canadian Energy Star: 12

LINE NO.	LOCATION SIZE INFO	BOOK CODE DESCRIPTION	NET UNIT PRICE	QTY	EXTENDED PRICE
Line-7	W40 Rough Opening: 46 3/4 X 63 3/4	Main Line Item Frame Size : 46 X 63, BTM= 40 (Outside Casing Size: 49 X 64 13/16), Siteline Clad Casement, Auralast Pine, Two Wide w/Two Transoms Brilliant White Exterior, Primed Interior, Aluminum Brickmould, Standard Sill Nosing, Color Match Metal DripCap, Brilliant White Trim, Factory Structural Mull, 6 9/16 Jamb, 4/4 Thick, , Left/Right, Stainless Steel Operator/Hinge, Nesting Crank Handle, White Hardware, Canada-NAFS 08 & 11/CSA A440, DP 35, Insulated Low-E 180 Annealed Glass, Neat, Protective Film, Silver Spacer, Argon Filled, Traditional Glz Bd, BetterVue Mesh Brilliant White Screen, This mull configuration complies with AAMA 450 standards and is professional engineer-approved. Vertical Structural Mull 1/4" Wide, PEV 2019.1.2.2446/PDV 6.281 (02/20/19) DF			

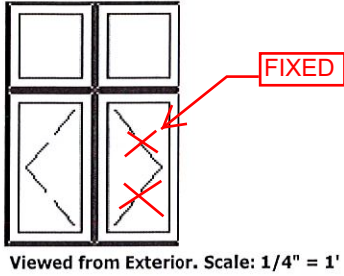

3 ✓

Line-7-1 (A1)	Frame Size : 22 7/8 X 23 Siteline Clad Casement, Auralast Pine, DIRECT SET RECTANGLE? Brilliant White Exterior, Primed Interior, Nail Fin (Standard), 3 3/16 Jamb, Stationary, Canada-NAFS 08 & 11/CSA A440, PG 35, Water Penetration Resistance 500 Air Level Fixed Insulated Low-E 180 Annealed Glass, Neat, Protective Film, Silver Spacer, Argon Filled, Traditional Glz Bd, *Custom-Width*, *Custom-Height*, GlassThick=0.698, U-Factor: 1.59, SHGC: 0.55, VLT: 0.63, Energy Rating: 37.00, CPD: JEL-N-878-01569-00001, Canadian Energy Star: 123
---------------	--

Line-7-2 (A2)	Frame Size : 22 7/8 X 23 Siteline Clad Casement, Auralast Pine, DIRECT SET RECTANGLE? Brilliant White Exterior, Primed Interior, Nail Fin (Standard), 3 3/16 Jamb, Stationary, Canada-NAFS 08 & 11/CSA A440, PG 35, Water Penetration Resistance 500 Air Level Fixed Insulated Low-E 180 Annealed Glass, Neat, Protective Film, Silver Spacer, Argon Filled, Traditional Glz Bd, *Custom-Width*, *Custom-Height*, GlassThick=0.698, U-Factor: 1.59, SHGC: 0.55, VLT: 0.63, Energy Rating: 37.00, CPD: JEL-N-878-01569-00001, Canadian Energy Star: 123
---------------	--

LINE NO.	LOCATION SIZE INFO	BOOK CODE DESCRIPTION	NET UNIT PRICE	QTY	EXTENDED PRICE
----------	-----------------------	--------------------------	-------------------	-----	-------------------

Line-7-3 (B1)

Frame Size : 22 7/8 X 40
 Siteline Clad Casement, Auralast Pine,
 Brilliant White Exterior,
 Primed Interior,
 Nail Fin (Standard),
 3 3/16 Jamb,
 Hinge Left,
 Nesting Crank Handle, White Hardware, HDWE-APPLIED,
 Stainless Steel Operator/Hinge,
 Canada-NAFS 08 & 11/CSA A440, PG 35, Water Penetration
 Resistance 700 Air Level A3
 Insulated Low-E 180 Annealed Glass, Neat, Protective Film,
 Silver Spacer, Argon Filled, Traditional Glz Bd,
 BetterVue Mesh Brilliant White Screen, Screen Applied
 Custom-Width, *Custom-Height*, GlassThick=0.698,
 Clear Opening:13w (331mm), 35.5h (903.9mm), 3.2 sf
 (0.29sq.m)

U-Factor: 1.65, SHGC: 0.47, VLT: 0.54, Energy Rating: 31.00,
 CPD: JEL-N-877-00014-00001, Canadian Energy Star: 12

Line-7-4 (B2)

Frame Size : 22 7/8 X 40
 Siteline Clad Casement, Auralast Pine, **DIRECT SET RECTANGLE?**
 Brilliant White Exterior,
 Primed Interior,
 Nail Fin (Standard),
 3 3/16 Jamb,
~~Hinge Right, **FIXED**~~
~~Nesting Crank Handle, White Hardware, HDWE-APPLIED,~~
~~Stainless Steel Operator/Hinge,~~
 Canada-NAFS 08 & 11/CSA A440, PG 35, Water Penetration
 Resistance 700 Air Level A3
 Insulated Low-E 180 Annealed Glass, Neat, Protective Film,
 Silver Spacer, Argon Filled, Traditional Glz Bd,
 BetterVue Mesh Brilliant White Screen, Screen Applied
 Custom-Width, *Custom-Height*, GlassThick=0.698,
 Clear Opening:13w (331mm), 35.5h (903.9mm), 3.2 sf
 (0.29sq.m)

U-Factor: 1.65, SHGC: 0.47, VLT: 0.54, Energy Rating: 31.00,
 CPD: JEL-N-877-00014-00001, Canadian Energy Star: 12

LINE NO.	LOCATION SIZE INFO	BOOK CODE DESCRIPTION	NET UNIT PRICE	QTY	EXTENDED PRICE
Line-8	W41 Rough Opening: 16 3/4 X 62 3/4	Main Line Item Frame Size : 16 X 62, BTM= 48 (Outside Casing Size: 19 X 63 13/16), Siteline Clad Casement, Auralast Pine, Single w/Transom Brilliant White Exterior, Primed Interior, Aluminum Brickmould, Standard Sill Nosing, Color Match Metal DripCap, Brilliant White Trim, 6 9/16 Jamb, 4/4 Thick, , Stationary, Canada-NAFS 08 & 11/CSA A440, DP 35, Insulated Low-E 180 Obscure Annealed Glass, Neat, Protective Film, Silver Spacer, Argon Filled, Traditional Glz Bd, This mull configuration complies with AAMA 450 standards and is professional engineer-approved. <small>PEV 2019.1.2.2446/PDV 6.281 (02/20/19) DF</small>			



Viewed from Exterior. Scale: 1/4" = 1'

2 ✓

Line-8-1 (A1)

Frame Size : 16 X 14
 Siteline Clad Casement, Auralast Pine, **DIRECT SET RECTANGLE?**
 Brilliant White Exterior,
 Primed Interior,
 Nail Fin (Standard),
 3 3/16 Jamb,
 Stationary,
 Canada-NAFS 08 & 11/CSA A440, PG 35, Water Penetration
 Resistance 500 Air Level Fixed
 Insulated Low-E 180 Obscure Annealed Glass, Neat, Protective
 Film, Silver Spacer, Argon Filled, Traditional Glz Bd,
 Custom-Width, *Custom-Height*, GlassThick=0.726,
 U-Factor: 1.59, SHGC: 0.54, VLT: 0.62, Energy Rating: 36.00,
 CPD: JEL-N-878-01699-00001, Canadian Energy Star: 123

Line-8-2 (B1)

Frame Size : 16 X 48
 Siteline Clad Casement, Auralast Pine, **DIRECT SET RECTANGLE?**
 Brilliant White Exterior,
 Primed Interior,
 Nail Fin (Standard),
 3 3/16 Jamb,
 Stationary,
 Canada-NAFS 08 & 11/CSA A440, PG 35, Water Penetration
 Resistance 500 Air Level Fixed
 Insulated Low-E 180 Obscure Annealed Glass, Neat, Protective
 Film, Silver Spacer, Argon Filled, Traditional Glz Bd,
 Custom-Width, GlassThick=0.726,
 U-Factor: 1.59, SHGC: 0.54, VLT: 0.62, Energy Rating: 36.00,
 CPD: JEL-N-878-01699-00001, Canadian Energy Star: 123

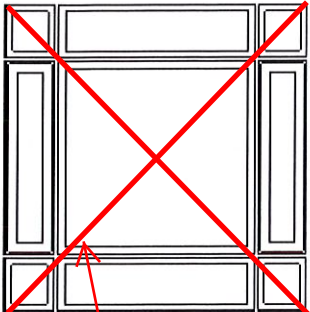
LINE NO.	LOCATION SIZE INFO	BOOK CODE DESCRIPTION	NET UNIT PRICE	QTY	EXTENDED PRICE
Line-9	W42 Rough Opening: 79 1/4 X 79 1/4	Main Line Item Frame Size : 78 1/2 X 78 1/2 (Outside Casing Size: 81 1/2 X 80 5/16), Siteline Clad Mull Auralast Pine, Casement/Awning Product, Brilliant White Exterior, Primed Interior, Aluminum Brickmould, Standard Sill Nosing, Color Match Metal DripCap, Brilliant White Trim, 3 Wide 3 High, Factory Structural Mull, 6 9/16 Jamb, 4/4 Thick, , Insulated Low-E 180 Annealed Glass, Protective Film, Silver Spacer, Argon Filled, Traditional Glz Bd, Mulled Window Assembly Has Not Been Tested To AAMA 450. Vertical Structural Mull 2 Vertical Spreads, 1/4" Wide, PEV 2019.1.2.2446/PDV 6.281 (02/20/19) DF			
 <p>Viewed from Exterior. Scale: 1/4" = 1'</p> <p>SEE ATTACHED PHOTO FOR TRIMS</p>		COMMENTS: DOES NOT INCLUDE METAL FEATURE TRIM - DRAWING REQUIRED		1 ✓	

Line-9-1 (A1)

Frame Size : 13 X 14
 Siteline Clad Geometric, Auralast Pine, Direct Set Rectangle,
 Brilliant White Exterior,
 Primed Interior,
 Nail Fin (Standard),
 3 3/16 Jamb,
 PG 35,
 Insulated Low-E 180 Annealed Glass, Neat, Protective Film,
 Silver Spacer, Argon Filled,
 GlassThick=0.7095,
 U-Factor: 1.59, SHGC: 0.59, VLT: 0.68, Energy Rating: 39.00,
 CPD: JEL-N-889-01384-00001, Canadian Energy Star: 123

Line-9-2 (A2)

Frame Size : 52 X 14
 Siteline Clad Geometric, Auralast Pine, Direct Set Rectangle,
 Brilliant White Exterior,
 Primed Interior,
 Nail Fin (Standard),
 3 3/16 Jamb,
 PG 35,
 Insulated Low-E 180 Annealed Glass, Neat, Protective Film,
 Silver Spacer, Argon Filled,
 GlassThick=0.7095,
 U-Factor: 1.59, SHGC: 0.59, VLT: 0.68, Energy Rating: 39.00,
 CPD: JEL-N-889-01384-00001, Canadian Energy Star: 123

LINE NO.	LOCATION SIZE INFO	BOOK CODE DESCRIPTION	NET UNIT PRICE	QTY	EXTENDED PRICE
----------	-----------------------	--------------------------	-------------------	-----	-------------------

Line-9-5 (A3)

Frame Size : 13 X 14
 Sitrine Clad Geometric, Auralast Pine, Direct Set Rectangle,
 Brilliant White Exterior,
 Primed Interior,
 Nail Fin (Standard),
 3 3/16 Jamb,
 PG 35,
 Insulated Low-E 180 Annealed Glass, Neat, Protective Film,
 Silver Spacer, Argon Filled,
 GlassThick=0.7095,
 U-Factor: 1.59, SHGC: 0.59, VLT: 0.68, Energy Rating: 39.00,
 CPD: JEL-N-889-01384-00001, Canadian Energy Star: 123

Line-9-3 (B1)

Frame Size : 13 X 50 1/2
GEOMETRIC Sitrine Clad ~~Casement~~, Auralast Pine, DIRECT SET RECTANGLE
 Brilliant White Exterior,
 Primed Interior,
 Nail Fin (Standard),
 3 3/16 Jamb,
 Stationary,
 PG 35,
 Insulated Low-E 180 Annealed Glass, Neat, Protective Film,
 Silver Spacer, Argon Filled, Traditional Glz Bd,
 Custom-Width, *Custom-Height*, GlassThick=0.698,
 U-Factor: 1.59, SHGC: 0.55, VLT: 0.63, Energy Rating: 37.00,
 CPD: JEL-N-878-01569-00001, Canadian Energy Star: 123

Line-9-4 (B2)

Frame Size : 52 X 50 1/2
 Sitrine Clad Geometric, Auralast Pine, Direct Set Rectangle,
 Brilliant White Exterior,
 Primed Interior,
 Nail Fin (Standard),
 3 3/16 Jamb,
 PG 35,
 Insulated Low-E 180 Annealed Glass, Neat, Protective Film,
 Silver Spacer, Argon Filled,
 GlassThick=0.756,
 U-Factor: 1.59, SHGC: 0.58, VLT: 0.67, Energy Rating: 38.00,
 CPD: JEL-N-889-01514-00001, Canadian Energy Star: 123

LINE NO.	LOCATION SIZE INFO	BOOK CODE DESCRIPTION	NET UNIT PRICE	QTY	EXTENDED PRICE
----------	-----------------------	--------------------------	-------------------	-----	-------------------

Line-9-6 (B3)

Frame Size : 13 X 50 1/2

GEOMETRIC Sitrine Clad ~~Casement~~, Auralast Pine, **DIRECT SET RECTANGLE**
 Brilliant White Exterior,
 Primed Interior,
 Nail Fin (Standard),
 3 3/16 Jamb,
 Stationary,
 PG 35,
 Insulated Low-E 180 Annealed Glass, Neat, Protective Film,
 Silver Spacer, Argon Filled, Traditional Glz Bd,
 Custom-Width, *Custom-Height*, GlassThick=0.698,
 U-Factor: 1.59, SHGC: 0.55, VLT: 0.63, Energy Rating: 37.00,
 CPD: JEL-N-878-01569-00001, Canadian Energy Star: 123

Line-9-7 (C1)

Frame Size : 13 X 14

Sitrine Clad Geometric, Auralast Pine, Direct Set Rectangle,
 Brilliant White Exterior,
 Primed Interior,
 Nail Fin (Standard),
 3 3/16 Jamb,
 PG 35,
 Insulated Low-E 180 Annealed Glass, Neat, Protective Film,
 Silver Spacer, Argon Filled,
 GlassThick=0.7095,
 U-Factor: 1.59, SHGC: 0.59, VLT: 0.68, Energy Rating: 39.00,
 CPD: JEL-N-889-01384-00001, Canadian Energy Star: 123

Line-9-8 (C2)

Frame Size : 52 X 14

Sitrine Clad Geometric, Auralast Pine, Direct Set Rectangle,
 Brilliant White Exterior,
 Primed Interior,
 Nail Fin (Standard),
 3 3/16 Jamb,
 PG 35,
 Insulated Low-E 180 Annealed Glass, Neat, Protective Film,
 Silver Spacer, Argon Filled,
 GlassThick=0.7095,
 U-Factor: 1.59, SHGC: 0.59, VLT: 0.68, Energy Rating: 39.00,
 CPD: JEL-N-889-01384-00001, Canadian Energy Star: 123

LINE NO.	LOCATION SIZE INFO	BOOK CODE DESCRIPTION	NET UNIT PRICE	QTY	EXTENDED PRICE
----------	-----------------------	--------------------------	-------------------	-----	-------------------

Line-9-9 (C3)

Frame Size : 13 X 14
 Sitrine Clad Geometric, Auralast Pine, Direct Set Rectangle,
 Brilliant White Exterior,
 Primed Interior,
 Nail Fin (Standard),
 3 3/16 Jamb,
 PG 35,
 Insulated Low-E 180 Annealed Glass, Neat, Protective Film,
 Silver Spacer, Argon Filled,
 GlassThick=0.7095,
 U-Factor: 1.59, SHGC: 0.59, VLT: 0.68, Energy Rating: 39.00,
 CPD: JEL-N-889-01384-00001, Canadian Energy Star: 123

Line-10 W43
 Rough Opening: 75 X 85 3/4

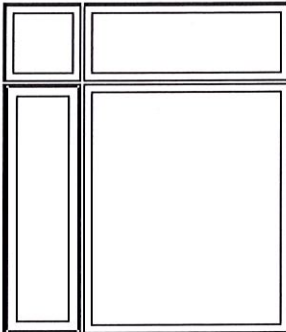

Viewed from Exterior. Scale: 1/4" = 1'

Main Line Item
 Frame Size : 74 1/4 X 85
 (Outside Casing Size: 77 1/4 X 86 13/16),
 Sitrine Clad Mull Auralast Pine, Casement/Awning Product,
 Brilliant White Exterior,
 Primed Interior,
 Aluminum Brickmould, Standard Sill Nosing, Color Match Metal
 DripCap, Brilliant White Trim,
 2 Wide
 2 High,
 Factory Structural Mull,
 6 9/16 Jamb, 4/4 Thick, ,
 Insulated Low-E 180 Annealed Glass, Protective Film, Silver Spacer,
 Argon Filled, Traditional Glz Bd,
 Mull Window Assembly Has Not Been Tested To AAMA 450.
 Vertical Structural Mull 1 Vertical Spread, 1/4" Wide,
 PEV 2019.1.2.2446/PDV 6.281 (02/20/19) DF

1 ✓

Line-10-1 (A1)

Frame Size : 20 X 20
 Sitrine Clad Geometric, Auralast Pine, Direct Set Rectangle,
 Brilliant White Exterior,
 Primed Interior,
 Nail Fin (Standard),
 3 3/16 Jamb,
 PG 35,
 Insulated Low-E 180 Annealed Glass, Neat, Protective Film,
 Silver Spacer, Argon Filled,
 GlassThick=0.7095,
 U-Factor: 1.59, SHGC: 0.59, VLT: 0.68, Energy Rating: 39.00,
 CPD: JEL-N-889-01384-00001, Canadian Energy Star: 123

LINE NO.	LOCATION SIZE INFO	BOOK CODE DESCRIPTION	NET UNIT PRICE	QTY	EXTENDED PRICE
----------	-----------------------	--------------------------	-------------------	-----	-------------------

Line-10-2 (A2)

Frame Size : 54 X 20
 Siteline Clad Geometric, Auralast Pine, Direct Set Rectangle,
 Brilliant White Exterior,
 Primed Interior,
 Nail Fin (Standard),
 3 3/16 Jamb,
 PG 35,
 Insulated Low-E 180 Annealed Glass, Neat, Protective Film,
 Silver Spacer, Argon Filled,
 GlassThick=0.7095,
 U-Factor: 1.59, SHGC: 0.59, VLT: 0.68, Energy Rating: 39.00,
 CPD: JEL-N-889-01384-00001, Canadian Energy Star: 123

Line-10-3 (B1)

Frame Size : 20 X 65
 Siteline Clad Casement, Auralast Pine, **DIRECT SET RECTANGLE?**
 Brilliant White Exterior,
 Primed Interior,
 Nail Fin (Standard),
 3 3/16 Jamb,
 Stationary,
 PG 35,
 Insulated Low-E 180 Annealed Glass, Neat, Protective Film,
 Silver Spacer, Argon Filled, Traditional Glz Bd,
 Custom-Height, GlassThick=0.698,
 U-Factor: 1.59, SHGC: 0.55, VLT: 0.63, Energy Rating: 37.00,
 CPD: JEL-N-878-01569-00001, Canadian Energy Star: 123

Line-10-4 (B2)

Frame Size : 54 X 65
 Siteline Clad Geometric, Auralast Pine, Direct Set Rectangle,
 Brilliant White Exterior,
 Primed Interior,
 Nail Fin (Standard),
 3 3/16 Jamb,
 PG 35,
 Insulated Low-E 180 Annealed Glass, Neat, Protective Film,
 Silver Spacer, Argon Filled,
 GlassThick=0.898,
 U-Factor: 1.59, SHGC: 0.56, VLT: 0.66, Energy Rating: 37.00,
 CPD: JEL-N-889-01959-00001, Canadian Energy Star: 123

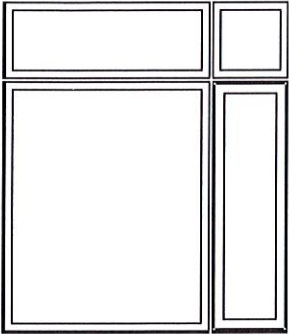
LINE NO.	LOCATION SIZE INFO	BOOK CODE DESCRIPTION	NET UNIT PRICE	QTY	EXTENDED PRICE
Line-11	W43R Rough Opening: 75 X 85 3/4	Main Line Item Frame Size : 74 1/4 X 85 (Outside Casing Size: 77 1/4 X 86 13/16), Siteline Clad Mull Auralast Pine, Casement/Awning Product, Brilliant White Exterior, Primed Interior, Aluminum Brickmould, Standard Sill Nosing, Color Match Metal DripCap, Brilliant White Trim, 2 Wide 2 High, Factory Structural Mull, 6 9/16 Jamb, 4/4 Thick, , Insulated Low-E 180 Annealed Glass, Protective Film, Silver Spacer, Argon Filled, Traditional Glz Bd, Mulled Window Assembly Has Not Been Tested To AAMA 450. Vertical Structural Mull 1 Vertical Spread, 1/4" Wide, PEV 2019.1.2.2446/PDV 6.281 (02/20/19) DF			
					
	Viewed from Exterior. Scale: 1/4" = 1'			1 ✓	

Line-11-1 (A1)

Frame Size : 54 X 20
 Siteline Clad Geometric, Auralast Pine, Direct Set Rectangle,
 Brilliant White Exterior,
 Primed Interior,
 Nail Fin (Standard),
 3 3/16 Jamb,
 PG 35,
 Insulated Low-E 180 Annealed Glass, Neat, Protective Film,
 Silver Spacer, Argon Filled,
 GlassThick=0.7095,
 U-Factor: 1.59, SHGC: 0.59, VLT: 0.68, Energy Rating: 39.00,
 CPD: JEL-N-889-01384-00001, Canadian Energy Star: 123

Line-11-2 (A2)

Frame Size : 20 X 20
 Siteline Clad Geometric, Auralast Pine, Direct Set Rectangle,
 Brilliant White Exterior,
 Primed Interior,
 Nail Fin (Standard),
 3 3/16 Jamb,
 PG 35,
 Insulated Low-E 180 Annealed Glass, Neat, Protective Film,
 Silver Spacer, Argon Filled,
 GlassThick=0.7095,
 U-Factor: 1.59, SHGC: 0.59, VLT: 0.68, Energy Rating: 39.00,
 CPD: JEL-N-889-01384-00001, Canadian Energy Star: 123

LINE NO.	LOCATION SIZE INFO	BOOK CODE DESCRIPTION	NET UNIT PRICE	QTY	EXTENDED PRICE
----------	-----------------------	--------------------------	-------------------	-----	-------------------

Line-11-3 (B1)

Frame Size : 54 X 65
 Siteline Clad Geometric, Auralast Pine, Direct Set Rectangle,
 Brilliant White Exterior,
 Primed Interior,
 Nail Fin (Standard),
 3 3/16 Jamb,
 PG 35,
 Insulated Low-E 180 Annealed Glass, Neat, Protective Film,
 Silver Spacer, Argon Filled,
 GlassThick=0.898,
 U-Factor: 1.59, SHGC: 0.56, VLT: 0.66, Energy Rating: 37.00,
 CPD: JEL-N-889-01959-00001, Canadian Energy Star: 123

Line-11-4 (B2)

Frame Size : 20 X 65
 Siteline Clad Casement, Auralast Pine, DIRECT SET RECTANGLE?
 Brilliant White Exterior,
 Primed Interior,
 Nail Fin (Standard),
 3 3/16 Jamb,
 Stationary,
 PG 35,
 Insulated Low-E 180 Annealed Glass, Neat, Protective Film,
 Silver Spacer, Argon Filled, Traditional Glz Bd,
 Custom-Height, GlassThick=0.698,
 U-Factor: 1.59, SHGC: 0.55, VLT: 0.63, Energy Rating: 37.00,
 CPD: JEL-N-878-01569-00001, Canadian Energy Star: 123

Line-12 W44
 Rough Opening: 93 1/4 X 85 3/4

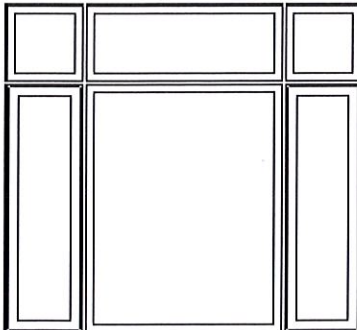

Viewed from Exterior. Scale: 1/4" = 1'

Main Line Item
 Frame Size : 92 1/2 X 85
 (Outside Casing Size: 95 1/2 X 86 13/16),
 Siteline Clad Mull Auralast Pine, Casement/Awning Product,
 Brilliant White Exterior,
 Primed Interior,
 Aluminum Brickmould, Standard Sill Nosing, Color Match Metal
 DripCap, Brilliant White Trim,
 3 Wide
 2 High,
 Factory Structural Mull,
 6 9/16 Jamb, 4/4 Thick, ,
 Insulated Low-E 180 Annealed Glass, Protective Film, Silver Spacer,
 Argon Filled, Traditional Glz Bd,
 Mullled Window Assembly Has Not Been Tested To AAMA 450.
 Vertical Structural Mull 2 Vertical Spreads, 1/4" Wide,
 PEV 2019.1.2.2446/PDV 6.281 (02/20/19) DF

2 ✓

LINE NO.	LOCATION SIZE INFO	BOOK CODE DESCRIPTION	NET UNIT PRICE	QTY	EXTENDED PRICE
----------	-----------------------	--------------------------	-------------------	-----	-------------------

Line-12-1 (A1)

Frame Size : 20 X 20
 Sitrine Clad Geometric, Auralast Pine, Direct Set Rectangle,
 Brilliant White Exterior,
 Primed Interior,
 Nail Fin (Standard),
 3 3/16 Jamb,
 PG 35,
 Insulated Low-E 180 Annealed Glass, Neat, Protective Film,
 Silver Spacer, Argon Filled,
 GlassThick=0.7095,
 U-Factor: 1.59, SHGC: 0.59, VLT: 0.68, Energy Rating: 39.00,
 CPD: JEL-N-889-01384-00001, Canadian Energy Star: 123

Line-12-2 (A2)

Frame Size : 52 X 20
 Sitrine Clad Geometric, Auralast Pine, Direct Set Rectangle,
 Brilliant White Exterior,
 Primed Interior,
 Nail Fin (Standard),
 3 3/16 Jamb,
 PG 35,
 Insulated Low-E 180 Annealed Glass, Neat, Protective Film,
 Silver Spacer, Argon Filled,
 GlassThick=0.7095,
 U-Factor: 1.59, SHGC: 0.59, VLT: 0.68, Energy Rating: 39.00,
 CPD: JEL-N-889-01384-00001, Canadian Energy Star: 123

Line-12-5 (A3)

Frame Size : 20 X 20
 Sitrine Clad Geometric, Auralast Pine, Direct Set Rectangle,
 Brilliant White Exterior,
 Primed Interior,
 Nail Fin (Standard),
 3 3/16 Jamb,
 PG 35,
 Insulated Low-E 180 Annealed Glass, Neat, Protective Film,
 Silver Spacer, Argon Filled,
 GlassThick=0.7095,
 U-Factor: 1.59, SHGC: 0.59, VLT: 0.68, Energy Rating: 39.00,
 CPD: JEL-N-889-01384-00001, Canadian Energy Star: 123

LINE NO.	LOCATION SIZE INFO	BOOK CODE DESCRIPTION	NET UNIT PRICE	QTY	EXTENDED PRICE
----------	-----------------------	--------------------------	-------------------	-----	-------------------

Line-12-3 (B1)

Frame Size : 20 X 65
 Sitrine Clad Casement, Auralast Pine, **DIRECT SET RECTANGLE?**
 Brilliant White Exterior,
 Primed Interior,
 Nail Fin (Standard),
 3 3/16 Jamb,
 Stationary,
 PG 35,
 Insulated Low-E 180 Annealed Glass, Neat, Protective Film,
 Silver Spacer, Argon Filled, Traditional Glz Bd,
 Custom-Height, GlassThick=0.698,
 U-Factor: 1.59, SHGC: 0.55, VLT: 0.63, Energy Rating: 37.00,
 CPD: JEL-N-878-01569-00001, Canadian Energy Star: 123

Line-12-4 (B2)

Frame Size : 52 X 65
 Sitrine Clad Geometric, Auralast Pine, Direct Set Rectangle,
 Brilliant White Exterior,
 Primed Interior,
 Nail Fin (Standard),
 3 3/16 Jamb,
 PG 35,
 Insulated Low-E 180 Annealed Glass, Neat, Protective Film,
 Silver Spacer, Argon Filled,
 GlassThick=0.898,
 U-Factor: 1.59, SHGC: 0.56, VLT: 0.66, Energy Rating: 37.00,
 CPD: JEL-N-889-01959-00001, Canadian Energy Star: 123

Line-12-6 (B3)

Frame Size : 20 X 65
 Sitrine Clad Casement, Auralast Pine, **DIRECT SET RECTANGLE?**
 Brilliant White Exterior,
 Primed Interior,
 Nail Fin (Standard),
 3 3/16 Jamb,
 Stationary,
 PG 35,
 Insulated Low-E 180 Annealed Glass, Neat, Protective Film,
 Silver Spacer, Argon Filled, Traditional Glz Bd,
 Custom-Height, GlassThick=0.698,
 U-Factor: 1.59, SHGC: 0.55, VLT: 0.63, Energy Rating: 37.00,
 CPD: JEL-N-878-01569-00001, Canadian Energy Star: 123

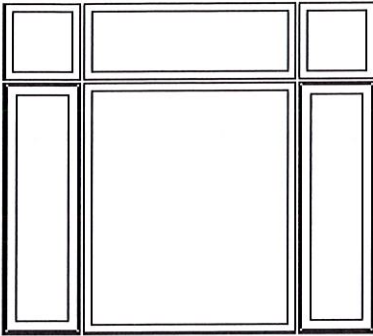
LINE NO.	LOCATION SIZE INFO	BOOK CODE DESCRIPTION	NET UNIT PRICE	QTY	EXTENDED PRICE
Line-13	W45	Main Line Item			
	Rough Opening: 97 1/4 X 85 3/4	Frame Size : 96 1/2 X 85			
		(Outside Casing Size: 99 1/2 X 86 13/16), Sitrine Clad Mull Auralast Pine, Casement/Awning Product, Brilliant White Exterior, Primed Interior, Aluminum Brickmould, Standard Sill Nosing, Color Match Metal DripCap, Brilliant White Trim, 3 Wide 2 High, Factory Structural Mull, 6 9/16 Jamb, 4/4 Thick, , Insulated Low-E 180 Annealed Glass, Protective Film, Silver Spacer, Argon Filled, Traditional Glz Bd, Mulled Window Assembly Has Not Been Tested To AAMA 450. Vertical Structural Mull 2 Vertical Spreads, 1/4" Wide, PEV 2019.1.2.2446/PDV 6.281 (02/20/19) DF		2	
	Viewed from Exterior. Scale: 1/4" = 1'				

2 ✓

Line-13-1 (A1)		Frame Size : 20 X 20 Sitrine Clad Geometric, Auralast Pine, Direct Set Rectangle, Brilliant White Exterior, Primed Interior, Nail Fin (Standard), 3 3/16 Jamb, PG 35, Insulated Low-E 180 Annealed Glass, Neat, Protective Film, Silver Spacer, Argon Filled, GlassThick=0.7095, U-Factor: 1.59, SHGC: 0.59, VLT: 0.68, Energy Rating: 39.00, CPD: JEL-N-889-01384-00001, Canadian Energy Star: 123			
----------------	--	--	--	--	--

Line-13-2 (A2)		Frame Size : 56 X 20 Sitrine Clad Geometric, Auralast Pine, Direct Set Rectangle, Brilliant White Exterior, Primed Interior, Nail Fin (Standard), 3 3/16 Jamb, PG 35, Insulated Low-E 180 Annealed Glass, Neat, Protective Film, Silver Spacer, Argon Filled, GlassThick=0.7095, U-Factor: 1.59, SHGC: 0.59, VLT: 0.68, Energy Rating: 39.00, CPD: JEL-N-889-01384-00001, Canadian Energy Star: 123			
----------------	--	--	--	--	--

LINE NO.	LOCATION SIZE INFO	BOOK CODE DESCRIPTION	NET UNIT PRICE	QTY	EXTENDED PRICE
----------	-----------------------	--------------------------	-------------------	-----	-------------------

Line-13-5 (A3)

Frame Size : 20 X 20
 Sitrine Clad Geometric, Auralast Pine, Direct Set Rectangle,
 Brilliant White Exterior,
 Primed Interior,
 Nail Fin (Standard),
 3 3/16 Jamb,
 PG 35,
 Insulated Low-E 180 Annealed Glass, Neat, Protective Film,
 Silver Spacer, Argon Filled,
 GlassThick=0.7095,
 U-Factor: 1.59, SHGC: 0.59, VLT: 0.68, Energy Rating: 39.00,
 CPD: JEL-N-889-01384-00001, Canadian Energy Star: 123

Line-13-3 (B1)

Frame Size : 20 X 65
 Sitrine Clad Casement, Auralast Pine, **DIRECT SET RECTANGLE?**
 Brilliant White Exterior,
 Primed Interior,
 Nail Fin (Standard),
 3 3/16 Jamb,
 Stationary,
 PG 35,
 Insulated Low-E 180 Annealed Glass, Neat, Protective Film,
 Silver Spacer, Argon Filled, Traditional Glz Bd,
 Custom-Height, GlassThick=0.698,
 U-Factor: 1.59, SHGC: 0.55, VLT: 0.63, Energy Rating: 37.00,
 CPD: JEL-N-878-01569-00001, Canadian Energy Star: 123

Line-13-4 (B2)

Frame Size : 56 X 65
 Sitrine Clad Geometric, Auralast Pine, Direct Set Rectangle,
 Brilliant White Exterior,
 Primed Interior,
 Nail Fin (Standard),
 3 3/16 Jamb,
 PG 35,
 Insulated Low-E 180 Annealed Glass, Neat, Protective Film,
 Silver Spacer, Argon Filled,
 GlassThick=0.898,
 U-Factor: 1.59, SHGC: 0.56, VLT: 0.66, Energy Rating: 37.00,
 CPD: JEL-N-889-01959-00001, Canadian Energy Star: 123

LINE NO.	LOCATION SIZE INFO	BOOK CODE DESCRIPTION	NET UNIT PRICE	QTY	EXTENDED PRICE
----------	-----------------------	--------------------------	-------------------	-----	-------------------

Line-13-6 (B3)

Frame Size : 20 X 65
 Sitrine Clad Casement, Auralast Pine, **DIRECT SET RECTANGLE?**
 Brilliant White Exterior,
 Primed Interior,
 Nail Fin (Standard),
 3 3/16 Jamb,
 Stationary,
 PG 35,
 Insulated Low-E 180 Annealed Glass, Neat, Protective Film,
 Silver Spacer, Argon Filled, Traditional Glz Bd,
 Custom-Height, GlassThick=0.698,
 U-Factor: 1.59, SHGC: 0.55, VLT: 0.63, Energy Rating: 37.00,
 CPD: JEL-N-878-01569-00001, Canadian Energy Star: 123

Line-14 W46
 Rough Opening: 79 1/4 X 85 3/4

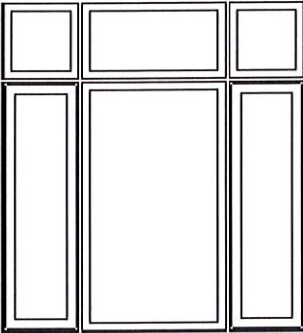

Viewed from Exterior. Scale: 1/4" = 1'

Main Line Item
 Frame Size : 78 1/2 X 85
 (Outside Casing Size: 81 1/2 X 86 13/16),
 Sitrine Clad Mull Auralast Pine, Casement/Awning Product,
 Brilliant White Exterior,
 Primed Interior,
 Aluminum Brickmould, Standard Sill Nosing, Color Match Metal
 DripCap, Brilliant White Trim,
 3 Wide
 2 High,
 Factory Structural Mull,
 6 9/16 Jamb, 4/4 Thick, ,
 Insulated Low-E 180 Annealed Glass, Protective Film, Silver Spacer,
 Argon Filled, Traditional Glz Bd,
 Mull Window Assembly Has Not Been Tested To AAMA 450.
 Vertical Structural Mull 2 Vertical Spreads, 1/4" Wide,
 PEV 2019.1.2.2446/PDV 6.281 (02/20/19) DF

2 ✓

Line-14-1 (A1)

Frame Size : 20 X 20
 Sitrine Clad Geometric, Auralast Pine, Direct Set Rectangle,
 Brilliant White Exterior,
 Primed Interior,
 Nail Fin (Standard),
 3 3/16 Jamb,
 PG 35,
 Insulated Low-E 180 Annealed Glass, Neat, Protective Film,
 Silver Spacer, Argon Filled,
 GlassThick=0.7095,
 U-Factor: 1.59, SHGC: 0.59, VLT: 0.68, Energy Rating: 39.00,
 CPD: JEL-N-889-01384-00001, Canadian Energy Star: 123

LINE NO.	LOCATION SIZE INFO	BOOK CODE DESCRIPTION	NET UNIT PRICE	QTY	EXTENDED PRICE
----------	-----------------------	--------------------------	-------------------	-----	-------------------

Line-14-2 (A2)

Frame Size : 38 X 20
 Sitrine Clad Geometric, Auralast Pine, Direct Set Rectangle,
 Brilliant White Exterior,
 Primed Interior,
 Nail Fin (Standard),
 3 3/16 Jamb,
 PG 35,
 Insulated Low-E 180 Annealed Glass, Neat, Protective Film,
 Silver Spacer, Argon Filled,
 GlassThick=0.7095,
 U-Factor: 1.59, SHGC: 0.59, VLT: 0.68, Energy Rating: 39.00,
 CPD: JEL-N-889-01384-00001, Canadian Energy Star: 123

Line-14-5 (A3)

Frame Size : 20 X 20
 Sitrine Clad Geometric, Auralast Pine, Direct Set Rectangle,
 Brilliant White Exterior,
 Primed Interior,
 Nail Fin (Standard),
 3 3/16 Jamb,
 PG 35,
 Insulated Low-E 180 Annealed Glass, Neat, Protective Film,
 Silver Spacer, Argon Filled,
 GlassThick=0.7095,
 U-Factor: 1.59, SHGC: 0.59, VLT: 0.68, Energy Rating: 39.00,
 CPD: JEL-N-889-01384-00001, Canadian Energy Star: 123

Line-14-3 (B1)

Frame Size : 20 X 65
 Sitrine Clad Casement, Auralast Pine, **DIRECT SET RECTANGLE?**
 Brilliant White Exterior,
 Primed Interior,
 Nail Fin (Standard),
 3 3/16 Jamb,
 Stationary,
 PG 35,
 Insulated Low-E 180 Annealed Glass, Neat, Protective Film,
 Silver Spacer, Argon Filled, Traditional Glz Bd,
 Custom-Height, GlassThick=0.698,
 U-Factor: 1.59, SHGC: 0.55, VLT: 0.63, Energy Rating: 37.00,
 CPD: JEL-N-878-01569-00001, Canadian Energy Star: 123

LINE NO.	LOCATION SIZE INFO	BOOK CODE DESCRIPTION	NET UNIT PRICE	QTY	EXTENDED PRICE
----------	-----------------------	--------------------------	-------------------	-----	-------------------

Line-14-4 (B2)

Frame Size : 38 X 65
 Sitrine Clad Geometric, Auralast Pine, Direct Set Rectangle,
 Brilliant White Exterior,
 Primed Interior,
 Nail Fin (Standard),
 3 3/16 Jamb,
 PG 35,
 Insulated Low-E 180 Annealed Glass, Neat, Protective Film,
 Silver Spacer, Argon Filled,
 GlassThick=0.756,
 U-Factor: 1.59, SHGC: 0.58, VLT: 0.67, Energy Rating: 38.00,
 CPD: JEL-N-889-01514-00001, Canadian Energy Star: 123

Line-14-6 (B3)

Frame Size : 20 X 65
 Sitrine Clad Casement, Auralast Pine, **DIRECT SET RECTANGLE?**
 Brilliant White Exterior,
 Primed Interior,
 Nail Fin (Standard),
 3 3/16 Jamb,
 Stationary,
 PG 35,
 Insulated Low-E 180 Annealed Glass, Neat, Protective Film,
 Silver Spacer, Argon Filled, Traditional Glz Bd,
 Custom-Height, GlassThick=0.698,
 U-Factor: 1.59, SHGC: 0.55, VLT: 0.63, Energy Rating: 37.00,
 CPD: JEL-N-878-01569-00001, Canadian Energy Star: 123

Line-15

DELIVER TO SITE

1

Total Units:

39

MERIDIAN COMMUNITY BUILDING REBUILD
Original Window W42 with Trim



Original Window W44

