

Magnetic Levitated Turbomolecular Pumps

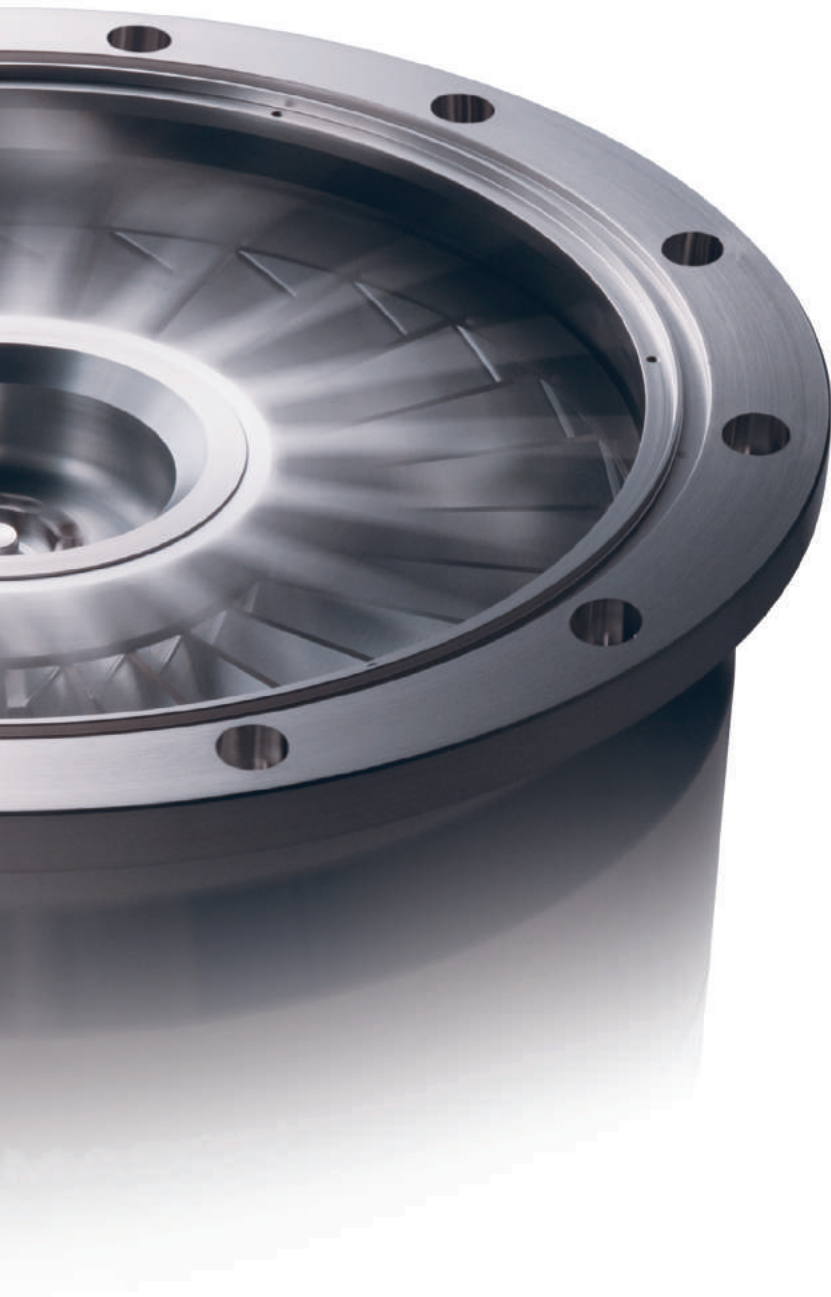

The Conditions Conducive to Quality



Made in Japan

Our integrated domestic production system, with its extremely high production efficiency, yields highly reliable products. It does this by providing in-house machining of components requiring a high degree of precision, one-by-one production that eliminates wastefulness from each process, and a production control system that responds in a timely manner to the needs of our customers. It also contributes to reductions in unnecessary power consumption at production sites, as well as reductions in CO₂ emissions. Shimadzu strives to be user-friendly and environmentally conscious on a daily basis by building on these sorts of straightforward measures.



Thoroughgoing Simulations to Heighten Quality

To ensure product quality, a number of simulations are done, such as for pumping performance analysis technology and rotor blade shape design, in pursuit of both performance and reliability. As a result of these measures, Shimadzu turbomolecular pumps are utilized world wide as highly reliable products with an extremely low failure rate.

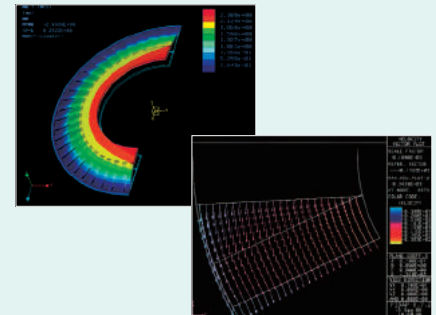

To Ensure Safety

Highly safe product is put into practice by implementing a wide range of tests involving rotor breakdown, air inrush, high-speed touchdown, and power supply reliability. It goes without saying that this verification knowledge and expertise obtained through many years of experience, is applied uncompromisingly to our new turbomolecular pumps.

At our manufacturing sites, quality control is scrupulously performed through the early detection of line defects based on statistical process control (SPC). In verifying reliability, there is no settling for "good enough."



Shimadzu and the Environment

To comply with the European WEEE and RoHS Directives, the Shimadzu Green Procurement Standards were established in May 2004. As measures adopted by the Shimadzu Group as a whole inside and outside Japan for the purpose of environmentally conscious manufacturing, all materials and components used in these products are investigated for 24 toxic chemical substances including six substances prohibited by RoHS Directive, as well as their alternatives, and the results are registered in a database with information on chemical substances contained in components.



Features of Shimadzu Turbomolecular Pumps

Shimadzu provides pumps compatible with a variety of applications, from high vacuum processes to gas throughput processes. We contribute to improving the flexibility of equipment designs through pumps with integrated power supplies, as well as environmentally friendly energy-saving and compact designs.

Model with Separate Power Supply Unit

V Series with Integrated Power Supply Unit

X Series with Integrated Power Supply Unit

Power supply unit and control rack

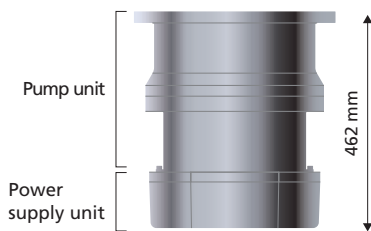
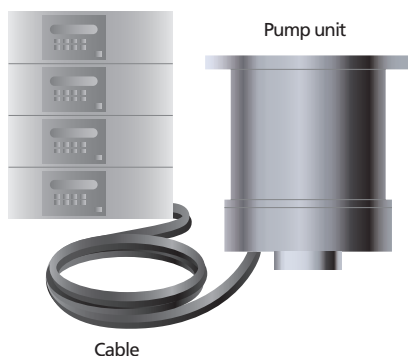

*in case of TMP-V3304

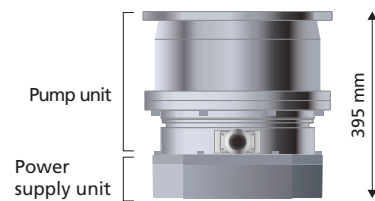

*in case of TMP-X3405

Network connection enabled

Various monitoring functions (power supply unit)

Coupling-free

A diverse lineup

Cable rack not required

Compact

Energy-saving

Even more compact

Temperature control function

IP54-compatible (power supply unit)

Energy-saving

Reactive Byproduct Resistant Wide-Range Turbomolecular Pumps

Shimadzu provides pumps with temperature control function. By keeping the pump temperature high, the deposition of leactive byproducts is prevented. As a result, the interval between pump overhauls is extended, contributing to long term stable operation.



Lineup

Flange Aperture (mm)		100	150 (160)	200	250	300 (320)	350	400
Application	Type							
CVD and etching	High-throughput chemical type				TMP-2404LMTB TMP-2804LMTF	TMP-3304LMTF TMP-3804LMTF	TMP-4304LMTF TMP-4805LMTF	TMP-5305LMTF
					TMP-2404LMTB TMP-2804LMTF TMP-X2905LMTF	TMP-3304LMTF TMP-3804LMTF TMP-X3405LMTF	TMP-4304LMTF TMP-4805LMTF	TMP-5305LMTF
Etching	Reactive byproduct resistant type		TMP-803LMTC	TMP-1003LMTC	TMP-2404LMTB TMP-2804LMTF TMP-X2905LMTF	TMP-3304LMTF TMP-3804LMTF TMP-X3405LMTF	TMP-4304LMTF TMP-4805LMTF	TMP-5305LMTF
Ion implantation, CVD and etching	Wide-range, water-cooled chemical type	TMP-203LMC TMP-303LMC	TMP-403LMC TMP-803LMC	TMP-1003LMC	TMP-2404LMC TMP-2804LMC	TMP-3304LMC TMP-3804LMC TMP-X3405LMC	TMP-4304LMC	
		TMP-203M TMP-303M	TMP-403M TMP-803M	TMP-1003M				
PVD and inspection instruments	Air-cooled type	TMP-203M TMP-303M	TMP-403M TMP-803M	TMP-1003M				
	Wide-range, water-cooled type	TMP-203LM TMP-303LM	TMP-403LM TMP-803LM TMP-X1205LM	TMP-1003LM TMP-V1704LM TMP-X1605LM	TMP-2404LM TMP-V2304LM TMP-V2804LM	TMP-3304LM TMP-V3304LM		

Standard Specifications

TMP-03/04 Series

Turbomolecular pump model	TMP-203LM	TMP-303LM	TMP-403LM	TMP-803LM (0)	TMP-1003LM	TMP-1303LM (0)	TMP-1503LM	
Corresponding power supply unit	EI-S04M			EI-R04M				
Inlet flange	VG100 ICF152 ISO100B ISO100C	VG100 ICF152 ISO100B ISO100C	VG150 ICF203 ISO160B ISO160C	VG150 ICF203 ISO160B	VG200 ICF253 ISO200B	VG200 ICF253 ISO200B	VG250 ICF305 ISO250B	
Outlet flange	KF25			KF40				
Pumping Speed *1)	N ₂	190 L/s	320 L/s	420 L/s	800 L/s	1080 L/s	1300 L/s	1500 L/s
	H ₂	120 L/s	320 L/s	340 L/s	700 L/s	790 L/s	750 L/s	800 L/s
Rated speed	50000 rpm	45000 rpm	45000 rpm	35000 rpm	35000 rpm	30300 rpm	30300 rpm	
Weight	9 kg	14 kg	14 kg	33 kg	32 kg	39 kg	42 kg	

*1: Without a protective net. If a protective net is used, the pumping speed for N₂ gas will be as follows: TMP-203: 180 L/s; TMP-303: 300 L/s; TMP-403: 400 L/s; TMP-803 (0): 730 L/s; TMP-1003: 970 L/s; TMP-1303 (0): 1130 L/s; TMP-1503: 1380 L/s; TMP-2404: 2000 L/s; TMP-2804 (VG250): 2550 L/s; (ISO250B): 2300 L/s; TMP-3304 (0): 2900 L/s; TMP-3804 (VG300): 3450 L/s; (ISO320B): 3600 L/s; TMP-4304: 4000 L/s.

Power supply unit model	EI-S04M			EI-R04M			
Corresponding pump	TMP-203LM	TMP-303LM	TMP-403LM	TMP-803LM (0)	TMP-1003LM	TMP-1303LM (0)	TMP-1503LM
Input power supply	Voltage	Single phase 100 to 120 V AC ±10 % (50/60 Hz ±2 Hz) Single phase 200 to 240 V AC ±10 % (50/60 Hz ±2 Hz)			Single phase 200 to 240 V AC ±10 % (50/60 Hz ±2 Hz)		
	Maximum power	450 VA	550 VA		1.0 kVA		
Weight	8 kg			8 kg			

TMP-V04 Series

Turbomolecular pump model	TMP-V1704LM	TMP-V2304LM	TMP-V2804LM	TMP-V3304LM (0)	
Inlet flange	VG200 ISO200B	VG250 ISO250B	VG250	VG300 VG350 ISO320B	
Outlet flange	KF40				
Pumping Speed *1)	N ₂	1400 L/s	2100 L/s	2800 L/s	3200 L/s
	Ar	1350 L/s	2000 L/s	2700 L/s	3100 L/s
Rated speed	33700 rpm	33700 rpm	27600 rpm	27600 rpm	
Input power supply	Voltage	Single phase 200 to 240 V AC ±10 % (50/60 Hz ±2 Hz)			
	Maximum power	1.2 kVA			
Weight	60 kg	56 kg	94 kg	94 kg	

*1: Without a protective net. If the protective net is used, the pumping speed for N₂ gas will be as follows: TMP-V1704: 1300 L/s; TMP-V2304: 1950 L/s; TMP-V2804: 2550 L/s; TMP-V3304 (0): 2900 L/s.

TMP-X05 Series

Turbomolecular pump model	TMP-X1205LM	TMP-X1605LM	TMP-X2905LMC	TMP-X3405LMC	
Inlet flange	VG150 ISO160B	VG200 VG250 ISO200B ISO250B	VG250 ISO250B	VG300 VG350 ISO320B	
Outlet flange	KF40				
Pumping Speed *1)	N ₂	1080 L/s	1400 L/s	2500 L/s	3400 L/s
	H ₂	710 L/s	750 L/s	1900 L/s	2300 L/s
Rated speed	37200 rpm	37200 rpm	27600 rpm	27600 rpm	
Input power supply	Voltage	Single phase 200 to 240 V AC ±10 % (50/60 Hz ±2 Hz)			
	Maximum power	0.75 kVA		1.7 kVA	
Weight	43 kg	41 kg	100 kg	89 kg	

*1: Without a protective net. If a protective net is used, the pumping speed for N₂ gas will be as follows: TMP-X2905: 2300 L/s; TMP-X3405: 3000 L/s.

	TMP-2404LMC	TMP-2804LMC		TMP-3304LMC (0)	TMP-3804LMC		TMP-4304LMC
	EI-R04M						
	VG250 ISO250B	VG250 ISO250B		VG300 VG350 ISO320B	VG300 ISO320B		VG350
	KF40						
	2100 L/s	2800 L/s	2500 L/s	3200 L/s	3800 L/s	4000 L/s	4400 L/s
	1770 L/s	2100 L/s	2000 L/s	2200 L/s	2500 L/s	2500 L/s	2600 L/s
	27000 rpm	27600 rpm		27600 rpm	24000 rpm		24000 rpm
	70 kg	84 kg		84 kg	115 kg		105 kg

	EI-R04M				
	TMP-2404LMC	TMP-2804LMC	TMP-3304LMC (0)	TMP-3804LMC	TMP-4304LMC
	Single phase 200 to 240 V AC $\pm 10\%$ (50/60 Hz ± 2 Hz)				
	1.5 kVA				
	8 kg				

Turbomolecular Pump Model

TMP-

① ② ③ ④ ⑤ ⑥

Example

TMP-

	Symbol	Meaning
①	None	With separate EI-R04 power supply
	V	With integrated EI-V04 power supply
	X	With integrated EI-X05 power supply
②	(Numeral)	The pumping speed is approximately 10 times the value.
③	(Numeral)	Product series
④	M	Air-cooled magnetic levitation type
	LM	Water-cooled magnetic levitation type
⑤	None	No temperature control function
	T	With temperature control function
⑥	None	No coating
	C	With corrosion-proof coating
	F	With special coating

Pump Structure

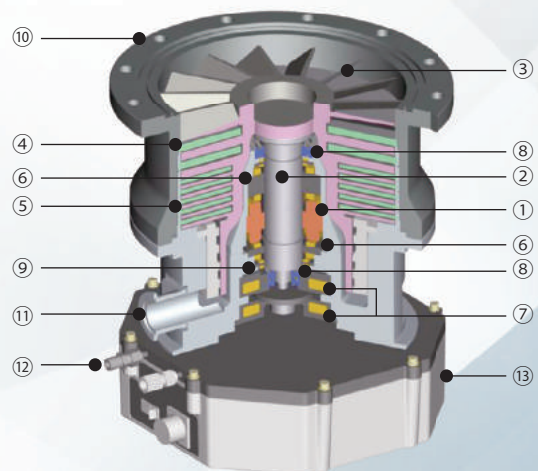

- | | |
|---------------------------|--------------------------|
| ① High-frequency motor | ⑧ Touchdown bearing |
| ② Shaft | ⑨ Gap sensor |
| ③ Rotor blade | ⑩ Inlet |
| ④ Stator blade | ⑪ Outlet |
| ⑤ Spacer | ⑫ Cooling water coupling |
| ⑥ Radial magnetic bearing | ⑬ Power supply unit |
| ⑦ Axial magnetic bearing | |

Service and Maintenance

Turbomolecular Pump Service Network

Inquiries received at our service center will be handled by our emergency response network. Also, to ensure our products can be used with confidence even outside Japan, turbomolecular pump service sites have been established at the subsidiaries indicated below. In addition to providing pump maintenance services, these sites are also stocked with backup units.



ISRAEL

ISI LTD.
32 Shaham St., Amargad House, Kiryat
Matalon, Petah-Tikva, Israel
PHONE:972-3-9232202 FAX:972-3-9229750

RUSSIA

CRYOSYSTEMS INCORPORATED
Nagorny Pr.7 117105, Moscow
PHONE:7-495-543-7360 FAX:7-495-543-7361

KOREA

SHIMADZU KOREA VACUUM
EQUIPMENT CO.,LTD.
2F, Jisamro 338-8, Giheung-gu, Yongin-si,
Gyeonggi-do, 446-909 Korea
PHONE:82-31-283-0242 FAX:82-31-283-0263

TAIWAN

SHIMADZU TAIWAN INDUSTRIAL
MACHINERY CO.,LTD.
8F-3, No.2, Wuling Rd., Hsinchu City, 30054
Taiwan
PHONE:886-3-531-0118 FAX:886-3-543-8180

CHINA

SHIMADZU (CHINA) CO., LTD.
SHANGHAI BRANCH
Building E Hongfang, No.570 Huaihai Road
(West), Shanghai, 200052 P. R. China
PHONE:86-21-2201-3888 FAX:86-21-2201-3800

SINGAPORE

SHIMADZU (ASIA PACIFIC) Pte. Ltd.
79 Science Park Drive, #02-01/08, Cintech IV
Singapore Science Park 1, Singapore 118264
PHONE:65-6778-6280 FAX:65-6779-2935

U.S.A

Shimadzu Industrial Equipment USA
SANTA CLARA OFFICE
2340-C Walsh Avenue, Santa Clara,
CA95051, U.S.A.
PHONE:1-408-566-0960 FAX:1-408-566-0961
AUSTIN SUPPORT CENTER
9210 Cameron Road, Suite 900, Austin, TX78754
PHONE:1-512-339-6007 FAX:1-512-339-6202

The TMP Group, Quality Assurance Department, accepts enquiries on a 24-hour basis to allow customers in industries operating day and night to use Shimadzu turbomolecular pumps with complete confidence.

Service Center

TMP Group, Quality Assurance Department,
Industrial Machinery Division, Shimadzu Corporation

E-mail : industry@group.shimadzu.co.jp

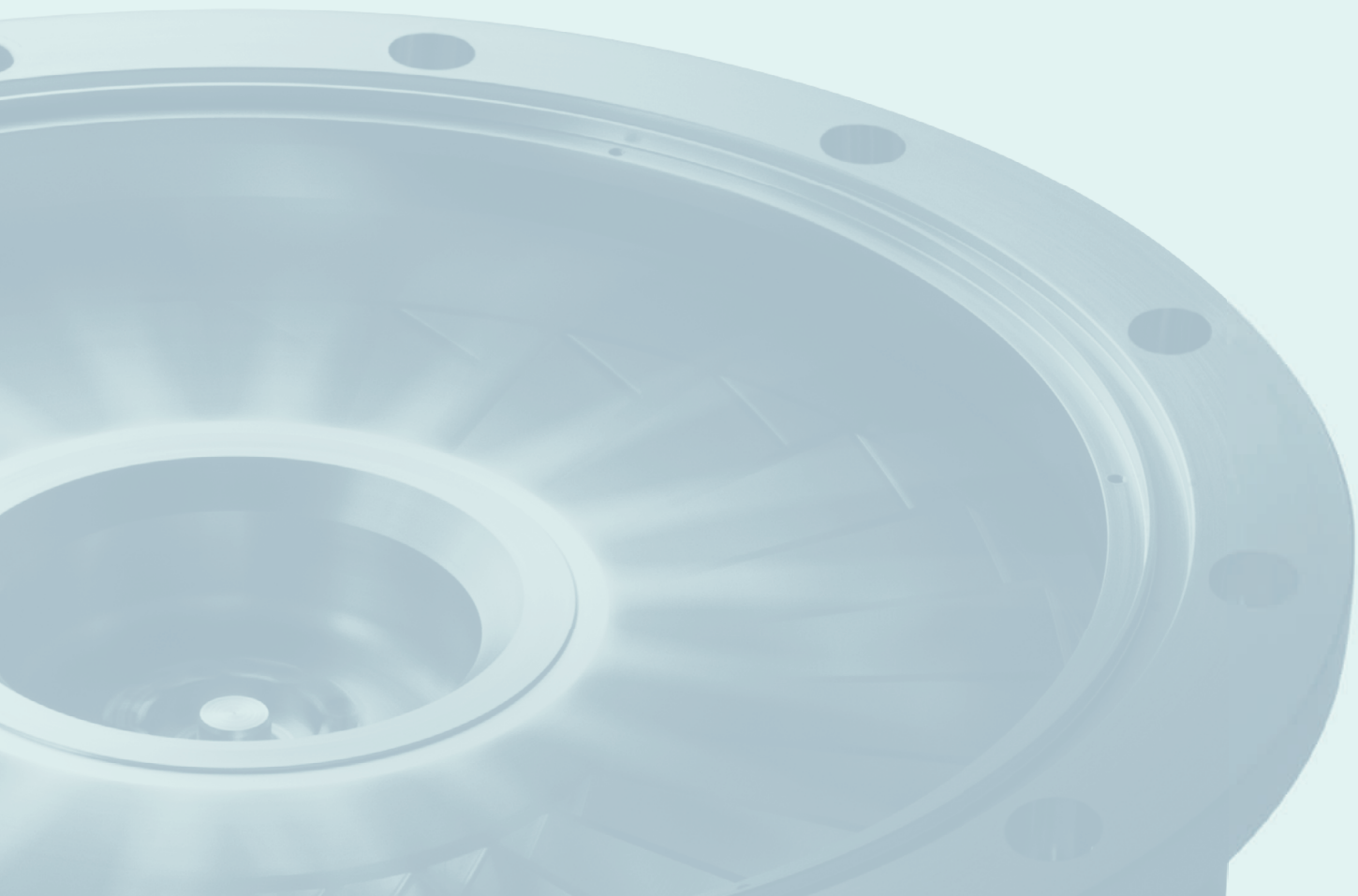

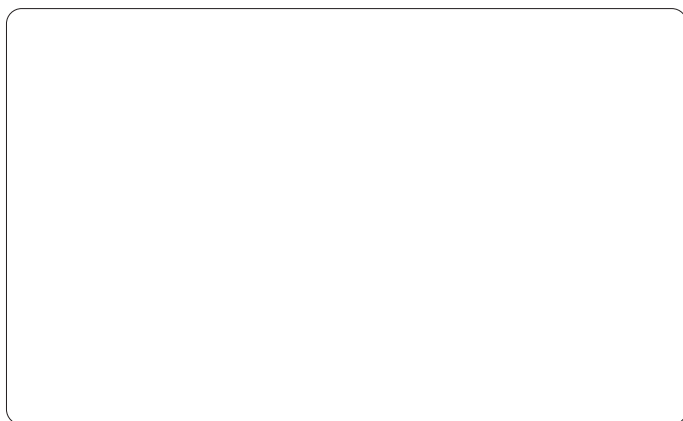

The Sanjo Works has been certified under ISO 14001:2004 Environmental Management System.



Shimadzu Corporation
www.shimadzu.com/industry/

Company names, product/service names and logos used in this publication are trademarks and trade names of Shimadzu Corporation or its affiliates, whether or not they are used with trademark symbol "TM" or "®". Third-party trademarks and trade names may be used in this publication to refer to either the entities or their products/services. Shimadzu disclaims any proprietary interest in trademarks and trade names other than its own.

For Research Use Only. Not for use in diagnostic procedures. The contents of this publication are provided to you "as is" without warranty of any kind, and are subject to change without notice. Shimadzu does not assume any responsibility or liability for any damage, whether direct or indirect, relating to the use of this publication.