

PUMP STRAINERS

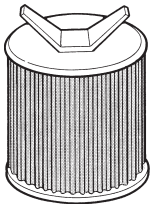

BOXED WITH S-71 GASKET

SSC-102
STRAINER TO FIT SUNTEC
J & H MODEL PUMPS
Replaces: 131622
(RS-950)

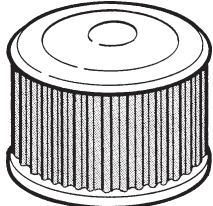

BOXED WITH S-70 GASKET

SSC-109
STRAINER TO FIT SUNTEC
A-70 SERIES PUMPS
1 1/8" High
Replaces: 3715101
(RS-939)

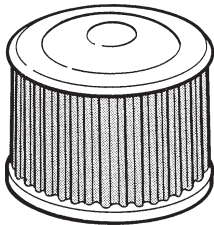

BOXED WITH S-70 GASKET

SSC-110
STRAINER TO FIT SUNTEC
B MODEL PUMPS
2 STAGE
1 3/8" High
Replaces: 3715171
(RS-917)

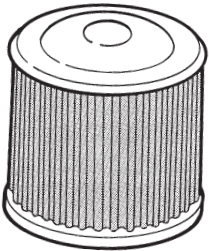

BOXED WITH S-70 GASKET

SSC-111
STRAINER TO FIT SUNTEC
A & B MODEL PUMPS
WITH HIGH COVER
1 5/8" High
Replaces: 3715744
(K-2646)

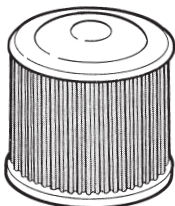

BOXED WITH S-70 GASKET

SSC-112
STRAINER TO FIT SUNTEC
B2TA-8851 MODEL PUMP
High Capacity Strainer
16 GPH, 1 5/8" High
Replaces: 3715742

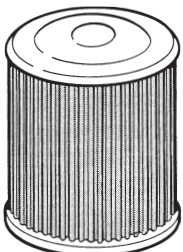

BOXED WITH S-70 GASKET

SSC-114
STRAINER TO FIT SUNTEC
B2GA-8852 MODEL PUMP
High Capacity Strainer
23 GPH, 2 1/16" High
Replaces: 3715746

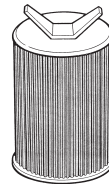

BAGGED WITH S-71 GASKET

SSC-115
"K" STRAINER TO FIT
SUNTEC H PUMP
Not for gear set with 6 screws.
Replaces: 131066
(RS-945)

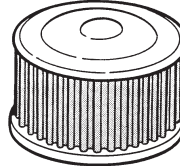

BOXED WITH S-74 GASKET

SSC-116
STRAINER TO FIT
SUNTEC EARLY A PUMP
1" High
(RS-955)

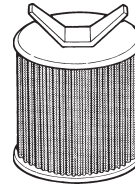

BOXED WITH S-71 GASKET

SSC-117
"P" STRAINER TO FIT
SUNTEC H PUMP
Same dimension as J
pump strainer except
high capacity.
Replaces: 135722

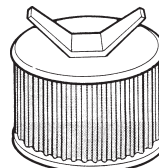

BOXED WITH S-71 GASKET

SSC-118
STRAINER TO FIT SUNTEC
LEVITT R-3 PUMP
1 3/8" High

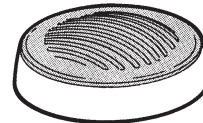

SSC-126
STRAINER TO FIT RIELLO
For Mectron Series -
3, 5, 10, 15 and 20
Replaces: 3005719
(O-ring and gasket
not included)

SSC-126G
STRAINER TO FIT RIELLO
BOXED WITH O-RING (R-64)
AND GASKET (R-64A)
For Mectron Series -
3, 5, 10, 15 and 20
Replaces: 3005719

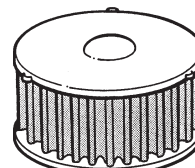

BOXED WITH COVER
O-RING (D-19)

SSC-127
STRAINER KIT TO
FIT DANFOSS
BFP FUEL PUMPS
New Style Pumps
(2-Bolt Cover)
Replaces: 071N1392

Note: The SSC-127 also fits the Beckett Clean Cut Pump.

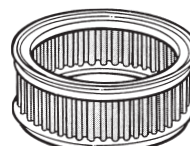

BOXED WITH COVER
O-RING (D-18)

SSC-128
STRAINER KIT
TO FIT DANFOSS
CFP FUEL PUMPS
Old Style Pumps
(4-Bolt Cover)
Replaces: 071H0015

PARTS TO FIT SUNTEC

**PARTS AND GASKETS TO FIT
SUNTEC A & B PUMPS**

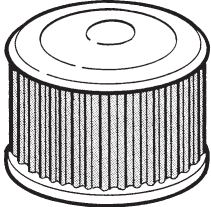

SSC-109
STRAINER TO FIT SUNTEC
A-70 SERIES PUMPS
1 1/8" High
Replaces: 3715101
(RS-939)

BOXED WITH S-70 GASKET

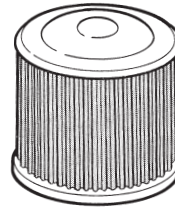

SSC-112
STRAINER TO FIT SUNTEC
B2TA-8851 MODEL PUMP
High Capacity Strainer
16 GPH, 1 5/8" High
Replaces: 3715742

BOXED WITH S-70 GASKET

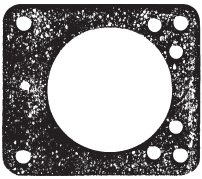

S-70
GASKET TO FIT SUNTEC
A-70 PUMP COVER
New Style
Replaces: 3779801
(GS-128)
Packed 50/Box

ACTUAL SIZE: 2 13/16" X 2 7/16"

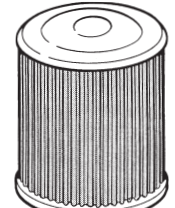

SSC-114
STRAINER TO FIT SUNTEC
B2GA-8852 MODEL PUMP
High Capacity Strainer
23 GPH, 2 1/16" High
Replaces: 3715746

BOXED WITH S-70 GASKET

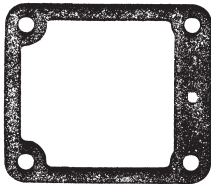

S-70A
SAME AS ABOVE EXCEPT
PACKED 12/HANGING BAG

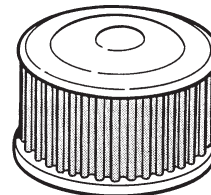

SSC-116
STRAINER TO FIT
SUNTEC EARLY A PUMP
1" High
(RS-955)

BOXED WITH S-74 GASKET

S-75
COVER GASKET TO FIT
SUNTEC A-70 PUMP
Replaces: 3779051
(GS-129)
Packed 50/Box

ACTUAL SIZE: 2 13/16" X 2 7/16"

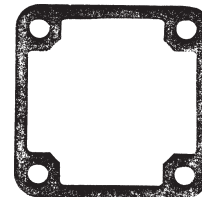

S-74
GASKET TO FIT SUNTEC
EARLY A PUMP COVER
Replaces: 160046
(GS-139)
Packed 50/Box

ACTUAL SIZE: 2 9/16" X 2 9/16"

S-75A
SAME AS ABOVE EXCEPT
PACKED 12/HANGING BAG

S-74A
SAME AS ABOVE EXCEPT
PACKED 12/HANGING BAG

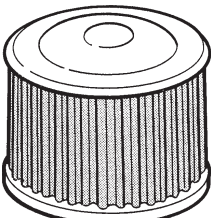

SSC-110
STRAINER TO FIT SUNTEC
B MODEL PUMPS
2 STAGE
1 3/8" High
Replaces: 3715171
(RS-917)

BOXED WITH S-70 GASKET



S-67A
O-RING TO FIT SUNTEC A
PUMP ADJUSTING SCREW
Replaces: 3773201
(GS-167)

SHOWN ACTUAL SIZE

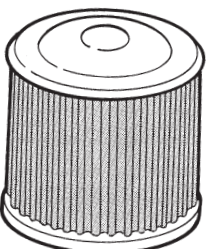

SSC-111
STRAINER TO FIT SUNTEC
A & B MODEL PUMPS
WITH HIGH COVER
1 5/8" High
Replaces: 3715744
(K-2646)

BOXED WITH S-70 GASKET



S-66
DIAPHRAGM TO FIT
SUNTEC A PUMP
Replaces: 3773151
(GS-165)

ACTUAL SIZE: 1 3/4" OD

MADE OF VITON FOR B5 & B20 BIOFUEL Use



SP-367
LIP SEAL TO FIT
SUNTEC A & B PUMPS
Replaces: 3754734
Made of Viton-Brown Color

VITON RUBBER-BROWN COLOR

PARTS TO FIT SUNTEC



SHOWN ACTUAL SIZE

S-79
 PORT GASKET TO FIT
 SUNTEC A PUMP
 Aluminum Ring
 Replaces: 3773071
 (GS-166)

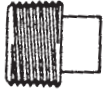

SP-339
 1/4" PIPE PLUG
 WITH SQUARE HEAD
 TO FIT SUNTEC
 Replaces: 3729241

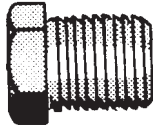

SP-344
 1/4" PIPE PLUG
 WITH HEX HEAD
 TO FIT SUNTEC
 Fits intake and return.
 Replaces: 3729241
 (RS-914)

SP-346
 1/8" PIPE PLUG
 HEX HEAD
 Replaces: 3759251
 (RS-923)

SP-347
 3/8" PIPE PLUG
 WITH HEX HEAD



SP-351
 1/16" BY-PASS PLUG TO
 FIT SUNTEC A, B PUMPS
 Replaces: 3779071
 (RS-944)

SP-353
 1/4" BY-PASS PLUG
 (RS-940)

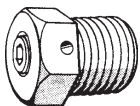

SP-335
 1/8" BRASS
 BLEEDER PLUG
 (PS-267)

SP-336
 1/4" BRASS
 BLEEDER PLUG
 (PS-268)

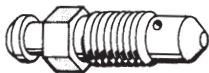

SP-337
 BRASS BLEEDER VALVE
 TO FIT SUNTEC
 A, B, & J PUMPS
 Use with vinyl
 tubing #OP-370.
 Replaces: 3759231
 (RS-986)

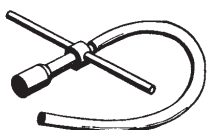

SP-334
 FUEL UNIT BLEEDER
 WRENCH
 Includes plastic
 drain hose.

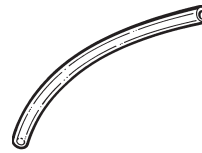

OP-370
 PLASTIC DRAIN HOSE
 FOR FUEL UNIT DRAINAGE
 10" Long

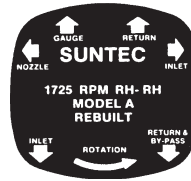

SP-338A
 LABEL TO FIT SUNTEC
 A (REBUILT) PUMPS
 Black Background
 Replaces: 3779756
 (RS-1015)

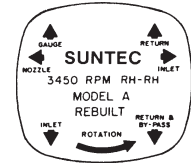

SP-338B
 LABEL TO FIT SUNTEC
 A (REBUILT) PUMPS
 White Background
 Replaces: 3779760
 (RS-1016)

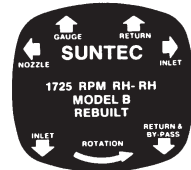

SP-338C
 LABEL TO FIT SUNTEC
 B (REBUILT) PUMPS
 Black Background
 Replaces: 3779764
 (RS-1017)

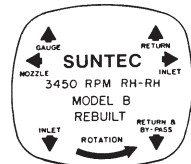

SP-338D
 LABEL TO FIT SUNTEC
 B (REBUILT) PUMPS
 White Background
 Replaces: 3779786
 (RS-1018)

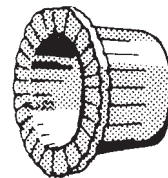

PM-369A
 1/8" PAPER MASKING PLUG
 (K-1378)

PM-369B
 1/4" PAPER MASKING PLUG
 (K-1379)

PM-369C
 3/8" PAPER MASKING PLUG
 (K-1380)

Ideal for pump rebuilders, use these plugs to prevent sprayed paint from entering and clogging internal pipe threads.



SSC stocks a complete line of **Brass Flare Fittings and Brass Compression Fittings**. Please see pages 85-88.

PARTS TO FIT SUNTEC

PARTS AND GASKETS TO FIT SUNTEC J & H PUMPS

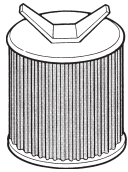

BOXED WITH S-71 GASKET

SSC-102
 STRAINER TO FIT SUNTEC
 J & H MODEL PUMPS
 Replaces: 131622
 (RS-950)

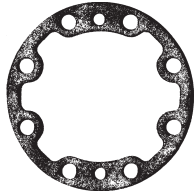

ACTUAL SIZE: 3 1/2" OD

S-71
 GASKET TO FIT SUNTEC
 H, J, K PUMP COVERS
 Replaces: 110441
 (GS-135)
 Packed 50/Box

S-71A
 SAME AS ABOVE EXCEPT
 PACKED 12/HANGING BAG

S-71 in DOUBLE THICKNESS

S-71B is double the thickness of S-71. It is a more substantial gasket which is ideal for J & H pumps with imperfect sealing surfaces.

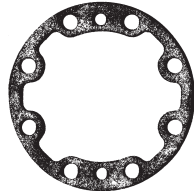

ACTUAL SIZE: 3 1/2" OD

S-71B
 GASKET TO FIT SUNTEC
 H, J, K PUMP COVERS
 1/32" Thick (Twice the
 Thickness of S-71)
 Packed 50/Package

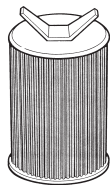

BAGGED WITH S-71 GASKET

SSC-115
 "K" STRAINER TO FIT
 SUNTEC H PUMP
 Not for gear set with 6 screws.
 Replaces: 131066
 (RS-945)

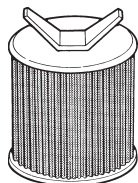

BOXED WITH S-71 GASKET

SSC-117
 "P" STRAINER TO FIT
 SUNTEC H PUMP
 Same dimension as J
 pump strainer except
 high capacity.
 Replaces: 135722



SP-366
 LIP SEAL TO FIT
 SUNTEC J PUMP
 Replaces: 135272
 (RS-1035)

FACE SEAL TO FIT J PUMP



SP-332
 SEAL ASSEMBLY (FACE SEAL)
 TO FIT SUNTEC J, H, K,
 S1 PUMPS
 Replaces: 100319-HK
 (RS-900)
 Packed with SP-332W washer.

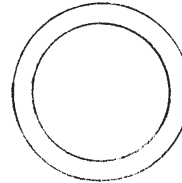

ACTUAL SIZE: 1 5/16" OD X 1" ID

SP-332W
 STEEL WASHER FOR
 J PUMP FACE SEAL
 Replaces: 101861
 (RS-911)

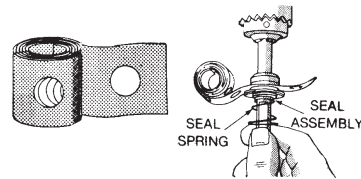

SP-355
 SEAL POLISH PAPER
 7/16" Hole
 Dimensions: 1" x 18"
 (RS-977)

SP-355A
 SEAL POLISH PAPER
 5/16" Hole
 Dimensions: 1" x 18"
 (RS-978)



SP-352
 1/8" BY-PASS PLUG
 TO FIT J, H, K, S1 PUMPS
 Also Fits Webster
 Replaces: 24800
 (RS-919)



SP-354
 VALVE DISC TO FIT
 SUNTEC J PUMP
 PISTON ASSEMBLY
 (RS-912)



SHOWN ACTUAL SIZE







S-67
 O-RING TO FIT
 SUNTEC J & H PUMPS
 For Piston Sleeve
 Replaces: 25815
 (RS-902)





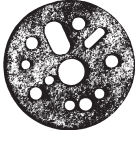

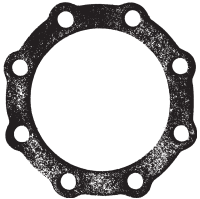
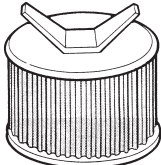
ACTUAL SIZE: 1 3/16" OD X 1" ID

S-78
 END PLUG GASKET
 TO FIT SUNTEC
 J, H, S1 PUMPS
 Replaces: 100901
 (GS-131)

PARTS TO FIT SUNTEC AND WEBSTER

	<p>S-80 END CAP NUT GASKET TO FIT SUNTEC Replaces: 100371 (GS-134)</p>
	<p>S-73 ANTI-HUM DIAPHRAGM TO FIT SUNTEC Replaces: 101511 (GS-133)</p>
	<p>S-76 PORT HOUSING GASKET TO FIT SUNTEC Replaces: 113331 (GS-137)</p>
	<p>S-76A PORT HOUSING GASKET TO FIT SID HARVEY RJP Reversal J Pump</p>
<p>MISCELLANEOUS PARTS AND GASKETS TO FIT SUNTEC</p>	
	<p>S-72 COVER GASKET TO FIT SUNTEC LSIL, SLIR, S-1, S-2, R-3, R-4 PUMPS Replaces: 100961 (GS-130) Packed 50/Box</p>
<p>ACTUAL SIZE: 3 1/4" OD X 2 3/8" ID</p>	<p>S-72A SAME AS ABOVE EXCEPT PACKED 12/HANGING BAG</p>
	<p>SSC-118 STRAINER TO FIT SUNTEC LEVITT R-3 PUMP 1 3/8" High</p>
<p>BOXED WITH S-71 GASKET</p>	
	<p>S-65 ANTI-HUM DIAPHRAGM (GS-138)</p>
<p>ACTUAL SIZE: 1 15/16" OD</p>	
	<p>S-77 PORT HOUSING GASKET TO FIT SUNTEC HEAVY OIL PUMP</p>
<p>ACTUAL SIZE: 2 3/8" OD</p>	

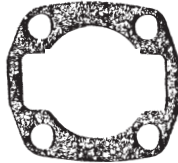
GASKETS AND PARTS TO FIT WEBSTER

	<p>W-83 FRONT COVER GASKET TO FIT WEBSTER M PUMP (GW-103)</p>
<p>ACTUAL SIZE: 3" X 3 5/16"</p>	<p>W-83A SAME AS ABOVE EXCEPT PACKED 12/HANGING BAG</p>
	<p>W-84 FRONT COVER GASKET TO FIT WEBSTER R PUMP 1R Series Replaces: 19871 (GW-100)</p>
<p>ACTUAL SIZE: 3 15/16" X 3 7/16"</p>	<p>W-84A SAME AS ABOVE EXCEPT PACKED 12/HANGING BAG</p>
	<p>W-87 STRAINER COVER GASKET TO FIT WEBSTER Replaces: P18T3 (GW-107)</p>
<p>ACTUAL SIZE: 2 5/16" X 2 1/8"</p>	<p>W-87A SAME AS ABOVE EXCEPT PACKED 12/HANGING BAG</p>
	<p>W-85 VALVE COVER GASKET TO FIT WEBSTER Replaces: P18Q12 (GW-109)</p>
<p>ACTUAL SIZE: 2 5/16" X 2 1/8"</p>	<p>W-85A SAME AS ABOVE EXCEPT PACKED 12/HANGING BAG</p>
	<p>W-86 STRAINER & VALVE COVER GASKET TO FIT WEBSTER Replaces: P18Q18 (GW-114)</p>
<p>ACTUAL SIZE: 2 1/4" X 2 1/16"</p>	
	<p>W-101 FRONT COVER GASKET TO FIT WEBSTER Replaces: P18T1 (GW-113)</p>
<p>ACTUAL SIZE: 4 7/16" X 4 1/8"</p>	

PARTS TO FIT WEBSTER



ACTUAL SIZE: 1 7/16"
OD X 1 1/4" ID

W-81
STRAINER & VALVE SEAT
GASKET TO FIT WEBSTER
Replaces: P18Q3
(GW-110)



ACTUAL SIZE: 1 1/4" OD
X 3/4" ID

W-82
SEAL BELLOWS GASKET
TO FIT WEBSTER
Replaces: P18Q1
(GW-111)



ACTUAL SIZE: 13/16" OD
X 9/16" ID

W-88
VALVE GASKET TO FIT
WEBSTER 1R SERIES
Replaces: 21204
(GW-104 / GW-120)



WP-247
SEAL BELLOWS ASSEMBLY
TO FIT WEBSTER Q PUMP
Replaces: A30Q4-3
(RW-602)

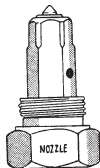

WP-249
1/4" NOZZLE PORT TO
FIT WEBSTER Q PUMP
Also called valve and
plug assembly.
(RW-626)

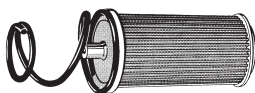

WP-250
STRAINER AND SPRING
TO FIT WEBSTER T PUMP
(RW-629)

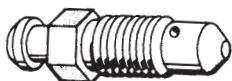

SP-337
BRASS BLEEDER VALVE TO
FIT WEBSTER PUMPS
Use with vinyl
tubing #OP-370.
(RS-986)

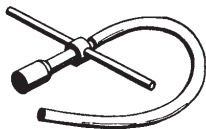

SP-334
FUEL UNIT BLEEDER
WRENCH
Includes plastic
drain hose.



OP-370
PLASTIC DRAIN HOSE
FOR FUEL UNIT DRAINAGE
10" Long

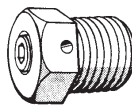

SP-335
1/8" BRASS
BLEEDER PLUG
(PS-267)

SP-336
1/4" BRASS
BLEEDER PLUG
(PS-268)



WP-207
SEAL DIAPHRAGM TO
FIT WEBSTER M PUMP
Replaces: 42561-1
(RW-631)



WP-208
SEAL DIAPHRAGM TO
FIT WEBSTER R PUMP
Replaces: 39435-1
(RW-640)

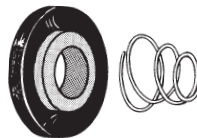

WP-219
SEAL KIT TO
FIT WEBSTER
Replaces: 41466
(RW-674)

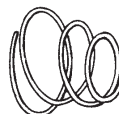

WP-221
SEAL SPRING TO FIT
WEBSTER R PUMP
Replaces: 32672-1



WP-212
OIL SEAL TO FIT
WEBSTER R PUMP
Replaces: 44161
(RW-668)



WP-228
OIL SEAL TO FIT
WEBSTER M PUMP
Replaces: 47986
(RW-654)

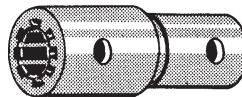

WP-220
PISTON GUIDE TO FIT
WEBSTER R PUMP
No Slot
Replaces: 25122-1
(RW-622)

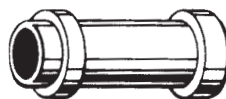

WP-224
PISTON TO FIT
WEBSTER M & R PUMPS
Replaces: 25121-5
(RW-649)

PARTS TO FIT WEBSTER



WP-214
DRIVE SHAFT
TO FIT WEBSTER
M34 PUMP
Replaces: 48061
(RW-669)

WP-215
DRIVE SHAFT
TO FIT WEBSTER
M17 PUMP
Replaces: 48062
(RW-670)

WP-241
DRIVE SHAFT
TO FIT WEBSTER
2M34 PUMP
Replaces: 48150-2



WP-206
RETAINING RING
TO FIT WEBSTER
Replaces: 29641-87
(RW-667)



WP-242
SHAFT RETAINING
RING TO FIT WEBSTER
R PUMP
Replaces: 29650-24



WP-229
RETAINING RING
TO FIT WEBSTER
Replaces: 29641-100
(RW-655)



WP-227
RETAINING RING
TO FIT WEBSTER
Replaces: 29642-1
(RW-656)

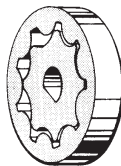

WP-225
1/8" GEAR SET
TO FIT WEBSTER
For all M34 and
2M34-15 pumps.
Replaces: 49490-1
(RW-645)

WP-226
1/4" GEAR SET
TO FIT WEBSTER
For all M17-6 & -15
and 2M17-15 pumps.
Replaces: 49490-3
(RW-646)

WP-234
3/32" GEAR SET TO FIT
WEBSTER M PUMP
Replaces: 49490

WP-216
CONVERSION KIT TO FIT
WEBSTER M-17 PUMP
Replaces: 47923-1
(RW-671)

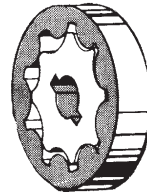

WP-209
3/8" GEAR SET
TO FIT WEBSTER
Replaces: 49488-3
(RW-664)

WP-210
1/4" GEAR SET
TO FIT WEBSTER
Replaces: 49488-2
(RW-665)

WP-211
3/16" GEAR SET
TO FIT WEBSTER
Replaces: 49488-1
(RW-666)

WP-239
1/2" GEAR SET
TO FIT WEBSTER
Replaces: 49488-4

WP-240
3/4" GEAR SET
TO FIT WEBSTER
Replaces: 49488-5

WP-244
3/8" GEAR SET
TO FIT WEBSTER
Replaces: 49488-3

WP-217
1/8" GEAR SET
TO FIT WEBSTER
Hardened
Replaces: 49489

WP-218
3/16" GEAR SET
TO FIT WEBSTER
Hardened
Replaces: 49489-1



WP-238
3/32" GEAR PLATE
TO FIT WEBSTER
Replaces: 42639

WP-237
1/8" GEAR PLATE
TO FIT WEBSTER
Replaces: 19859-5

WP-243
3/8" GEAR PLATE
TO FIT WEBSTER
Replaces: 25082-3



WP-233
CLEANER SPACER TO
FIT WEBSTER M PUMP
Replaces: 19867
(RW-662)



WP-222
CLEANER BLADE TO FIT
WEBSTER R PUMP
Replaces: 49230
(RW-650)

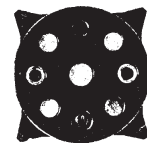

WP-230
CLEANER BLADE ADD ON
TO FIT WEBSTER R PUMP
Replaces: 25086

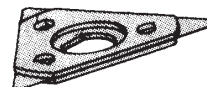

WP-223
CLEANER BLADE TO FIT
WEBSTER M PUMP
Replaces: 47776

PARTS TO FIT RIELLO AND DANFOSS

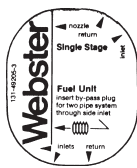

WP-231
PUMP LABEL
TO FIT WEBSTER
Single Stage
Replaces: 49205-3

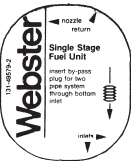

WP-235
PUMP LABEL
TO FIT WEBSTER
Single Stage
Replaces: 49579-2

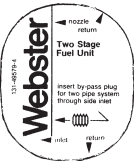

WP-245
PUMP LABEL
TO FIT WEBSTER
Two Stage
Replaces: 49579-4

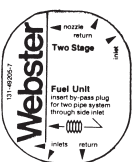

WP-232
PUMP LABEL
TO FIT WEBSTER
Two Stage
Replaces: 49205-7
(RW-661)

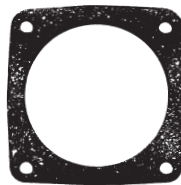

ACTUAL SIZE: 2 1/2" X 2 1/2"

R-64A
GASKET TO FIT RIELLO
FUEL PUMP COVER
Replaces O-ring
For Mectron Series
Packed 50/Bundle

R-64A-12
SAME AS ABOVE EXCEPT
PACKED 12/HANGING BAG



SHOWN ACTUAL SIZE

R-68
LARGE PUMP PLUNGER
O-RING TO FIT RIELLO
FUEL PUMP
Replaces: 3007029



SHOWN ACTUAL SIZE

R-69
SMALL PUMP PLUNGER
O-RING TO FIT RIELLO
FUEL PUMP
Replaces: 3007156

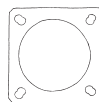

ACTUAL SIZE: 5 1/4" X 5 1/4"

R-264
BLAST TUBE GASKET
TO FIT RIELLO BURNER
Fits All Models

PARTS TO FIT RIELLO

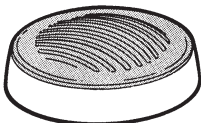

SSC-126
STRAINER TO FIT RIELLO
For Mectron Series -
3, 5, 10, 15 and 20
Replaces: 3005719
(O-ring and gasket
not included)

SSC-126G
STRAINER TO FIT RIELLO
BOXED WITH O-RING (R-64)
AND GASKET (R-64A)
For Mectron Series -
3, 5, 10, 15 and 20
Replaces: 3005719

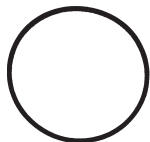

ACTUAL SIZE: 2 5/16" OD
X 2 1/8" ID

R-64
O-RING TO FIT RIELLO
FUEL PUMP COVER
For Mectron Series
Replaces: 3007162

R-64-12
SAME AS ABOVE EXCEPT
PACKED 12/HANGING BAG



SP-349
BY-PASS PLUG TO FIT
RIELLO PUMPS
Takes 2.5mm Hex Key

STRAINERS & O-RINGS TO FIT DANFOSS

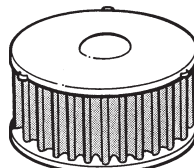

BOXED WITH COVER
O-RING (D-19)

SSC-127
STRAINER KIT TO
FIT DANFOSS
BFP FUEL PUMPS
New Style Pumps
(2-Bolt Cover)
Replaces: 071N1392

Note: The SSC-127 also fits the Beckett Clean Cut Pump.

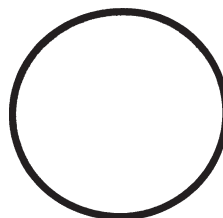

ACTUAL SIZE: 2 5/16" OD
X 2 1/8" ID

D-19
O-RING TO FIT
DANFOSS BFP PUMP
STRAINER COVER
For Pump #071N1151
New Style Pump
(2-Bolt Cover)
Replaces: 633B0090

D-19A
SAME AS ABOVE EXCEPT
PACKED 12/HANGING BAG

If you would like to see a life-sized illustration of many of the gaskets listed in this catalog, please contact us and we'll send you our **Gasket Picture Posters** for free. The two posters we offer measure 24" x 36".

PARTS TO FIT DANFOSS AND HONEYWELL

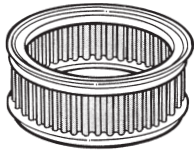

BOXED WITH COVER
O-RING (D-18)

SSC-128
STRAINER KIT
TO FIT DANFOSS
CFP FUEL PUMPS
Old Style Pumps
(4-Bolt Cover)
Replaces: 071H0015

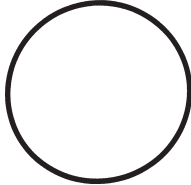

ACTUAL SIZE: 2 3/4" OD
X 2 5/8" ID

D-18
O-RING TO FIT DANFOSS
CFP PUMP STRAINER COVER
Old Style Pump
(4-Bolt Cover)
Replaces: 633B1463

D-18A
SAME AS ABOVE EXCEPT
PACKED 12/HANGING BAG

**GASKET TO FIT COMBU &
HAGO / DELTA PUMP**



ACTUAL SIZE: 2 1/2" X 2 1/2"

C-197
GASKET TO FIT COMBU
AND HAGO/DELTA
OIL PUMP
For Combu Pump #CV2RR

**GASKETS TO FIT WINKLER
AND STEWART WARNER**

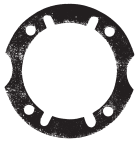

ACTUAL SIZE: 3 1/4" OD
X 2 9/16" ID

W-279A
GASKET TO FIT WINKLER,
STEWART WARNER
PUMP STRAINER COVER
Replaces: 170468
(GM-121)

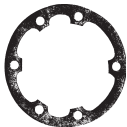

ACTUAL SIZE: 3 9/16" OD
X 2 1/2" ID

W-279B
GASKET TO FIT WINKLER,
STEWART WARNER
LIFT PUMP
(GM-122)

If we are missing the part you need, let us know
and we'll tool up for it.

PARTS TO FIT HONEYWELL



CC-601
CAD CELL EYE
(FLAME DETECTOR)
For use in Honeywell C554A.
Replaces: 130367
Bubble Packed

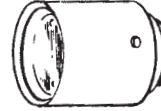

CC-602
CAD CELL EYE
(FLAME DETECTOR)
For use in Honeywell 630485.
Old Style
Bubble Packed

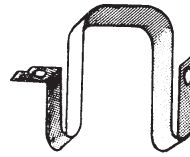

U-600
"U" ELEMENT FOR
STACK RELAY
With Screws
Replaces: 36486
(RM-809)



H-599
BAR RESET (LEVER) TO
FIT HONEYWELL RA-117
STACK RELAY
(RM-822)



H-598
RED CONTROL COVER
BUTTON TO FIT HONEYWELL
R8182 / R8184



H-598A
RED CONTROL COVER
BUTTON TO FIT HONEYWELL
R8184



ACTUAL SIZE: 2 3/8" ID
X 2" OD

H-597
UNION CONNECTION
GASKET TO FIT
HONEYWELL/SPARCO
MIXING VALVE

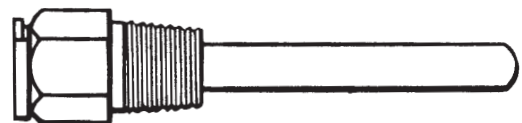

See page 56 for our complete line of
Immersion Wells to fit Honeywell.

OIL FILTER GASKETS

GASKETS TO FIT FULFLO FILTERS

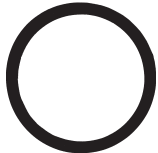

ACTUAL SIZE: 4 1/16" OD
X 3 3/8" ID

F-95
GASKET TO FIT FULFLO
FB4, 6, 8, 10 COVER
Black Rubber (Buna-N)
Replaces: 31300
(GF-200)
Packed 30/Box



SHOWN ACTUAL SIZE

F-97
GASKET TO FIT HEX
COVER NUT FOR FULFLO
FB4, 6, 8, 10 FILTERS
Replaces: 32014
(GF-216)



SHOWN ACTUAL SIZE

F-96
GASKET TO FIT VENT
SCREW FOR FULFLO
FB4, 6, 8, 10 FILTERS
Replaces: 32015

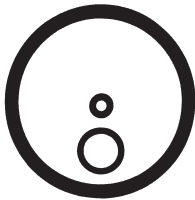

F-31
GASKET KIT TO FIT
FULFLO FB4, 6, 8, 10
FILTERS AND EQUALS
Contains:
1 F-95 Cover Gasket
1 F-96 Vent Screw Gasket
1 F-97 Cover Nut Gasket



ACTUAL SIZE: 2 5/8" OD
X 2 1/8" ID

F-99
GASKET TO FIT
FULFLO FB3 COVER
Black Rubber (Buna-N)
(K-1649)

GASKETS TO FIT GENERAL FILTERS



ACTUAL SIZE: 3 7/16" OD
X 2 7/8" ID

G-90
GASKET TO FIT
GENERAL 1A25A COVER
Black Rubber (Buna-N)
(GF-213)



ACTUAL SIZE: 4 1/8" OD
X 3 1/2" ID

G-100
GASKET TO FIT COVER FOR
GENERAL FILTER 2A-700A
AND EQUALS
Black Rubber (Buna-N)
Replaces: 2A-705



SHOWN ACTUAL SIZE

G-91
GASKET TO FIT GENERAL
FILTER AIR BLEEDER SCREW
(GF-221)



SHOWN ACTUAL SIZE

G-92
GASKET TO FIT GENERAL
FILTER HEX COVER NUT
(GF-214)

GK-1 Kit

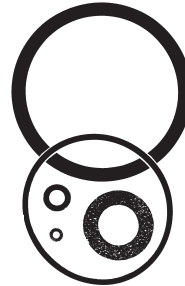

G-29A
GASKET KIT TO FIT
GENERAL 2A-710SL FILTER
Replaces: GK-1 Kit
Contains:
1 G-100 Cover Gasket
1 G-91 Vent Screw Gasket
1 G-92 Cover Nut Gasket
1 G-104 Top Gasket
1 G-103 Square Cut Bottom
Gasket

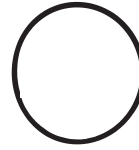

ACTUAL SIZE: 3 3/8" OD
X 3 1/16" ID

G-103
SQUARE CUT BOTTOM
GASKET TO FIT GENERAL
FILTER 2A-710SL
Black Rubber (Buna-N)
Goes in GK-1 kit.



ACTUAL SIZE: 1 5/8" OD
X 15/16" ID

G-104
TOP GASKET TO FIT
GENERAL FILTER 2A-710SL
Cork-Goes in GK-1 kit.

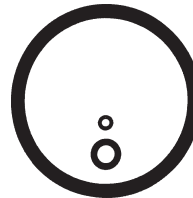

G-29
GASKET KIT TO FIT
GENERAL 2A-700A
FILTERS AND EQUALS
Contains:
1 G-100 Cover Gasket
1 G-91 Vent Screw Gasket
1 G-92 Cover Nut Gasket

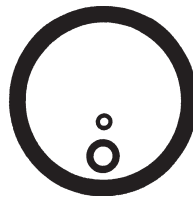

G-30
GASKET KIT TO FIT
GENERAL 1A-25A
FILTERS AND EQUALS
Contains:
1 G-90 Cover Gasket
1 G-91 Vent Screw Gasket
1 G-92 Cover Nut Gasket

MISCELLANEOUS OIL GASKETS

GASKETS TO FIT FIROMATIC FILTERS

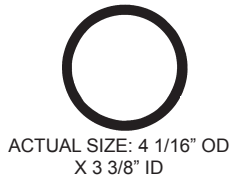

F-94
GASKET TO FIT FIROMATIC
RC-20, RC-30 COVERS
Black Rubber (Buna-N)

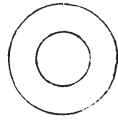

F-93
PLASTIC WASHER TO FIT
FIROMATIC RC-20, RC-30
For Top Screw



F-93A
GASKET TO FIT
FIROMATIC VENT SCREW

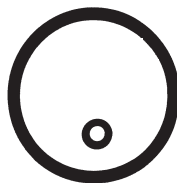

F-32
GASKET KIT TO FIT
FIROMATIC RC-20
AND RC-30 FILTERS
Contains:
1 F-94 Cover Gasket
1 F-93 Plastic Bolt Washer

**GASKET TO FIT
PUROLATOR / CUNO FILTERS**



F-98
GASKET TO FIT PUROLATOR /
CUNO COVERS
Black Rubber (Buna-N)
(GF-215)

**VACUUM GAUGE ADAPTER
FITTINGS FOR OIL FILTERS**

These adapter fittings make it easy to test for a vacuum reading on oil filter cans. Replace the top bolt on the cans with these fittings and then attach a vacuum gauge to get a reading. Available for all of the popular filters.

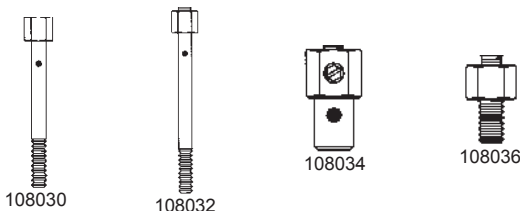

SSC#	FITS THIS OIL FILTER
108030	GENERAL 1A25A
108032	GENERAL 2A700
108034	FULFLO FB4, FB6, FB8, FB10
108036	FIROMATIC RC-40, RC-30
108040	GAR-BER SPIN ON

G.I. CAN GASKET SET



K-202
G.I. CAN GASKET
Set of 2
Black Rubber (Buna-N)

FILL BOX GASKET



G-263
FILL BOX GASKET
Leather

O-RING TO FIT PHILLY FILL CAP



G-263A
O-RING TO FIT PHILLY
CAP ON FILL BOX

GASKETS TO FIT KRAISSEL



K-132A
GASKET TO FIT KRAISSEL
BODY/STRAINER
Fits 1/2" Cover



K-132
GASKET TO FIT KRAISSEL
BODY/STRAINER
Fits 1" Cover



K-131
GASKET TO FIT KRAISSEL
BODY/STRAINER
Fits both 1 1/4" and
1 1/2" covers.



K-130
GASKET TO FIT KRAISSEL
BODY/STRAINER
Fits both 2" and
2 1/2" covers.

MISCELLANEOUS OIL GASKETS

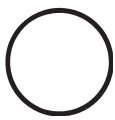

ACTUAL SIZE: 5 11/16" OD
X 5 1/8" ID

K-130A
GASKET TO FIT KRAISSEL
BODY/STRAINER
Fits 3" Cover



ACTUAL SIZE: 5 3/8" OD
X 5 1/8" ID

K-131R
O-RING TO FIT KRAISSEL
Buna-N Rubber

GASKETS TO FIT PETRO



ACTUAL SIZE: 3 1/8" OD
X 2 5/16" ID

P-135
GASKET TO FIT PETRO
1" STRAINER COVER
Replaces: 126260



ACTUAL SIZE: 4 1/4" OD
X 3 9/16" ID

P-134
GASKET TO FIT PETRO
1 1/2" STRAINER COVER
Replaces: 126261



ACTUAL SIZE: 5 1/8" OD
X 4 1/8" ID

P-133
GASKET TO FIT PETRO
2" STRAINER COVER
Replaces: 125502



ACTUAL SIZE: 6 1/16" OD
X 5 1/8" ID

P-133A
GASKET TO FIT PETRO
2 1/2" STRAINER COVER

O-RINGS TO FIT HAYWOOD

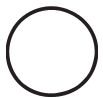

ACTUAL SIZE: 3 9/16" OD
X 3 1/4" ID

H-143
O-RING TO FIT HAYWOOD
LARGE STRAINER

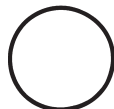

ACTUAL SIZE: 4 1/4" OD
X 4" ID

H-143A
O-RING TO FIT HAYWOOD
LARGER STRAINER



ACTUAL SIZE: 2 13/16" OD
X 2 9/16" ID

H-144
O-RING TO FIT HAYWOOD
SMALL STRAINER

GASKETS AND SIGHT GLASSES TO FIT CLEAVER BROOKS

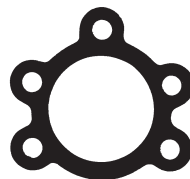

ACTUAL SIZE: 2 5/8" X 2 7/16"

C-139
INNER GASKET TO FIT
CLEAVER BROOKS
Thickness: 1/32"

C-139E
INNER GASKET TO FIT
CLEAVER BROOKS
Thickness: 1/64"

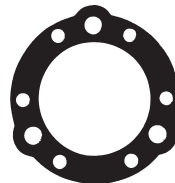

ACTUAL SIZE: 2 5/8" X 2 3/4"

C-140
OUTER GASKET TO FIT
CLEAVER BROOKS
Thickness: 1/32"

C-140E
OUTER GASKET TO FIT
CLEAVER BROOKS
Thickness: 1/64"



ACTUAL SIZE: 2 13/16" OD
X 1 7/16" ID

C-139A
OIL WICK TO FIT
CLEAVER BROOKS
AIR PISTON MODULATOR

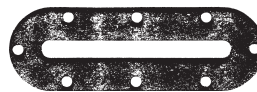

ACTUAL SIZE: 4 5/8" X 1 1/2"

C-141
GASKET TO FIT
CLEAVER BROOKS
LARGE SIGHT GLASS
Also for Industrial
Combustion.

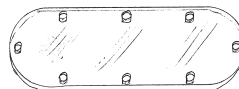

SG-509
8 HOLE SIGHT GLASS
TO FIT CLEAVER BROOKS
LUBE TANK
Uses C-141 Gasket

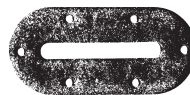

ACTUAL SIZE: 3 9/16" X 1 1/2"

C-138
GASKET TO FIT
CLEAVER BROOKS
SMALL SIGHT GLASS

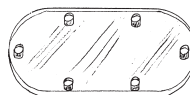

SG-508
6 HOLE SIGHT GLASS
TO FIT CLEAVER BROOKS
LUBE TANK
Uses C-138 Gasket

MISCELLANEOUS OIL GASKETS



ACTUAL SIZE: 4" OD X 2 7/8" ID

I-145
GASKET/SHIM TO FIT
CLEAVER BROOKS
METERING PUMP
Also for Industrial
Combustion.
Thickness: 1/32"

I-145C
GASKET/SHIM TO FIT
CLEAVER BROOKS
METERING PUMP
Also for Industrial
Combustion.
Thickness: 1/64"

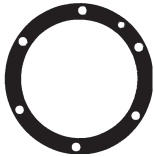

ACTUAL SIZE: 7 1/4" OD
X 5 1/2" ID

I-145D
GASKET/SHIM TO FIT
INDUSTRIAL COMBUSTION/
CLEAVER BROOKS
AIR COMPRESSOR
Fits 2", 2 3/4" & 5"
Thickness: .002"

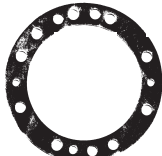

ACTUAL SIZE: 3 3/4" OD
X 2 3/4" ID

C-203A
SHIM GASKET TO FIT
CLEAVER BROOKS
METERING PUMP
FRONT AND BACK
Thickness: .002"

C-203B
SHIM GASKET TO FIT
CLEAVER BROOKS
METERING PUMP
FRONT AND BACK
Thickness: .004"

C-203C
SHIM GASKET TO FIT
CLEAVER BROOKS
METERING PUMP
FRONT AND BACK
Thickness: .006"

GASKETS TO FIT JOHNSON



ACTUAL SIZE: 4 3/8" OD
X 3 13/16" ID

J-136
GASKET TO FIT
JOHNSON



ACTUAL SIZE: 4 5/8" X 4 5/8"

J-137
GASKET TO FIT
JOHNSON PUMP

SSC offers over 250 different
**Pressure, Compound,
Vacuum, Liquid Filled and
Water Test Gauges.** We
have a wide selection at
competitive prices.
See pages 73-77.

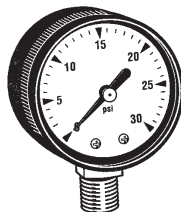

GASKETS TO FIT VIKING

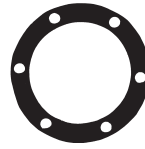

ACTUAL SIZE: 3 3/8" OD
X 2 1/2" ID

V-204C
GASKET TO FIT
VIKING 1" STRAIGHT
PUMP COVER
G-432
Thickness: .004"

V-204A
GASKET TO FIT
VIKING 1" STRAIGHT
PUMP COVER
G-432
Thickness: .002"

V-204D
GASKET TO FIT
VIKING 1" STRAIGHT
PUMP COVER
G-432
Thickness: .005"

V-204B
GASKET TO FIT
VIKING 1" STRAIGHT
PUMP COVER
G-432
Thickness: .003"

V-204E
GASKET TO FIT
VIKING 1" STRAIGHT
PUMP COVER
G-432
Thickness: .006"

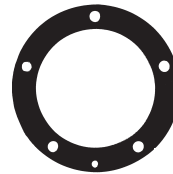

ACTUAL SIZE: 4 13/16" OD
X 3 7/16" ID

V-259A
GASKET TO FIT
VIKING 1" ANGLE
PUMP COVER
H-432
Thickness: .002"

V-259C
GASKET TO FIT
VIKING 1" ANGLE
PUMP COVER
H-432
Thickness: .004"

V-259D
GASKET TO FIT
VIKING 1" ANGLE
PUMP COVER
H-432
Thickness: .005"

V-259B
GASKET TO FIT
VIKING 1" ANGLE
PUMP COVER
H-432
Thickness: .003"

V-259E
GASKET TO FIT
VIKING 1" ANGLE
PUMP COVER
H-432
Thickness: .006"

**GASKETS AND SIGHT GLASSES TO FIT
INDUSTRIAL COMBUSTION**

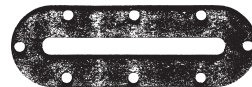

ACTUAL SIZE: 4 5/8" X 1 1/2"

C-141
GASKET TO FIT INDUSTRIAL
COMBUSTION 8 HOLES LUB.
Also fits Cleaver Brooks.

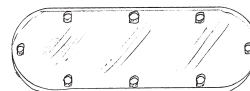

SG-509
8 HOLE SIGHT GLASS
TO FIT INDUSTRIAL
COMBUSTION
Also fits Cleaver Brooks.

MISCELLANEOUS OIL GASKETS

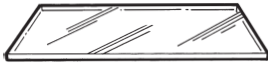

ACTUAL SIZE: 1 1/2" X 4"

SG-515
SIGHT GLASS TO FIT
INDUSTRIAL COMBUSTION
M.E. BLAST TUBE



ACTUAL SIZE: 4" OD X 2 7/8" ID

I-145
GASKET/SHIM TO FIT
INDUSTRIAL COMBUSTION
OIL METERING PUMP
Also for Cleaver Brooks.
Thickness: 1/32"

I-145C
GASKET/SHIM TO FIT
INDUSTRIAL COMBUSTION
OIL METERING PUMP
Also for Cleaver Brooks.
Thickness: 1/64"



ACTUAL SIZE: 1 5/8" OD
X 1 1/2" ID

I-145A
INNER SEAT O-RING
TO FIT INDUSTRIAL
COMBUSTION



SHOWN ACTUAL SIZE

I-145B
INNER SEAL O-RING
TO FIT INDUSTRIAL
COMBUSTION AIR AND
OIL METERING PUMP

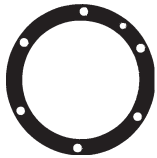

ACTUAL SIZE: 7 1/4" OD
X 5 1/2" ID

I-145D
GASKET/SHIM TO FIT
INDUSTRIAL COMBUSTION/
CLEAVER BROOKS
AIR COMPRESSOR
Fits 2", 2 3/4" & 5"
Thickness: .002"



ACTUAL SIZE: 5 1/4" OD
X 3 3/8" ID

I-145E
GASKET/SHIM TO FIT
INDUSTRIAL COMBUSTION
AIR COMPRESSOR
Fits Model 7-S
Thickness: .002"

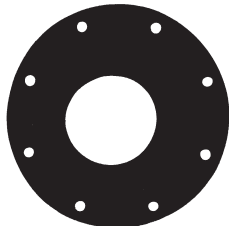

ACTUAL SIZE: 3 1/16" OD

I-179
GASKET TO FIT
INDUSTRIAL COMBUSTION
METERING PUMP
Thickness: 1/64"

I-179A
GASKET TO FIT
INDUSTRIAL COMBUSTION
METERING PUMP
Thickness: 1/32"

GASKET TO FIT WARREN



ACTUAL SIZE: 4 9/16" OD
X 3 1/4" ID

W-142
GASKET TO FIT
WARREN PRE-HEATER

GASKET TO FIT RAY VISCO



ACTUAL SIZE: 9 1/2" X 4 3/8"

M-195
GASKET TO FIT RAY
VISCO BOX HEAD

GASKET FOR SOLENOID VALVE



ACTUAL SIZE: 3 1/4" OD
X 2 1/2" ID

P-153
GASKET TO FIT
SOLENOID VALVE

GASKETS TO FIT MONITOR HEATERS



ACTUAL SIZE: 4 1/8" OD

M-292A
BURNER CLOTH GASKET
TO FIT MONITOR M422
Replaces: 6113



ACTUAL SIZE: 1 1/4" X 7/8"

M-292B
STRAINER GASKET
TO FIT MONITOR M422
Replaces: 6189



ACTUAL SIZE: 1 1/8" OD
X 11/16" ID

M-292C
GASKET TO FIT
MONITOR M422 & M441
Replaces: 6115

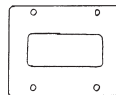

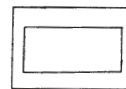

ACTUAL SIZE: 2 11/16" X 2 1/8"

M-292D
WINDOW FLAME GASKET
TO FIT MONITOR M422 & M441
Replaces: 6125



ACTUAL SIZE: 2 1/8" X 1 7/16"

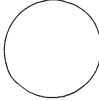
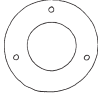
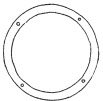
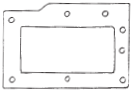
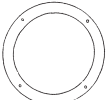
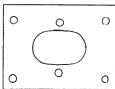

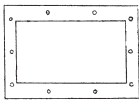
M-292E
WINDOW GASKET TO FIT
MONITOR M422 & M441
Replaces: 6124

	M-292F PLUG PACKING TO FIT MONITOR M422 & M441 Replaces: 6119
ACTUAL SIZE: 1 9/16" X 9/16"	
	M-292G GASKET TO FIT MONITOR M422 Replaces: 6112
ACTUAL SIZE: 4 1/8" OD	
	M-292H HEATER COVER PACKING TO FIT MONITOR M422 Replaces: 6117
ACTUAL SIZE: 3 1/16" OD X 1 5/8" ID	
	M-292I GASKET TO FIT MONITOR M422 Replaces: 6114
ACTUAL SIZE: 5 3/8" OD X 4 1/2" ID	
	M-292J WINDOW BASE GASKET TO FIT MONITOR M422 Replaces: 6126
ACTUAL SIZE: 5" X 3 3/8"	
	M-292K CHAMBER GASKET TO FIT MONITOR M422 Replaces: 6130
ACTUAL SIZE: 6 11/16" OD X 5 5/16" ID	
	M-292L GASKET TO FIT MONITOR M422 Replaces: 6120
ACTUAL SIZE: 6" X 4 5/16"	
	M-292M BURNER CLOTH GASKET TO FIT MONITOR M441 Replaces: 6363
ACTUAL SIZE: 4 1/16" X 3 1/8"	
	M-292N STRAINER GASKET TO FIT MONITOR M441 Replaces: 6344
ACTUAL SIZE: 1 9/16" X 1 1/16"	
	M-292P WINDOW BASE GASKET TO FIT MONITOR M441 Replaces: 6350
ACTUAL SIZE: 7 3/8" X 5 1/8"	

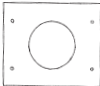
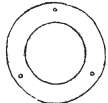
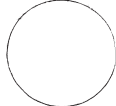
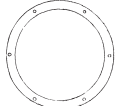
GASKETS TO FIT MONITOR / HALLMARK

	M-292Q GASKET TO FIT MONITOR M441 Replaces: 6313
ACTUAL SIZE: 6 11/16" X 5 1/2"	
	M-292R HEATER COVER PACKING GASKET TO FIT MONITOR M441 Replaces: 6354
ACTUAL SIZE: 3 1/4" OD X 2" ID	
	M-292T GASKET TO FIT MONITOR M441 Replaces: 6357
ACTUAL SIZE: 6 1/2" OD	
	M-292U CHAMBER GASKET TO FIT MONITOR M441 Replaces: 6317
ACTUAL SIZE: 8 3/8" OD X 7 1/16" ID	

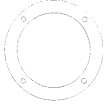
GASKETS AND KIT TO FIT HALLMARK FURNACES

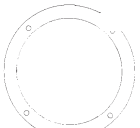
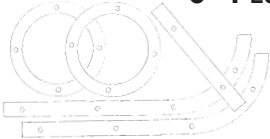
	108402 SMALL FLUE COLLAR/HOT PLATE GASKET TO FIT HALLMARK FURNACES Fits 6" Flue
ACTUAL SIZE: 8" OD X 6" ID	
	108404 CONNECTING GASKET TO FIT HALLMARK FURNACES Straight Piece
ACTUAL SIZE: 11" X 1 1/4"	
	108406 J GASKET TO FIT HALLMARK FURNACES
ACTUAL SIZE: 9" LONG	
	108408 LARGE FLUE COLLAR/ HOT PLATE GASKET TO FIT HALLMARK FURNACES 8" Flue
ACTUAL SIZE: 10" OD X 8" ID	
6" FLUE GASKET KIT	
	108420 6" GASKET SET TO FIT HALLMARK FURNACES Kit Contains: 2 - 108402, 1 - 108404, 2 - 108406
PACKED IN A PLASTIC BAG	

8" Flue Gasket Kit on next page.

BURNER FLANGE GASKETS

8" FLUE GASKET KIT

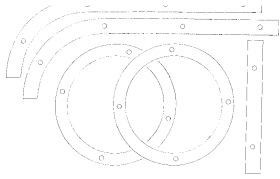

108430

8" GASKET SET TO FIT
HALLMARK FURNACES
Kit Contains: 2 - 108408,
1 - 108404, 2 - 108406

UNIVERSAL BURNER FLANGE GASKET

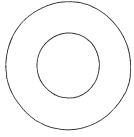

ACTUAL SIZE: 8" OD X 4" ID

U-268

UNIVERSAL BURNER
FLANGE GASKET
NO HOLES

GASKET TO FIT HEIL, BRAD, OLSEN

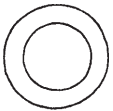

ACTUAL SIZE: 3" OD
X 2" ID

H-267

GASKET TO FIT HEIL,
BRAD, OLSEN COVERS
Fits All Burner Models

GASKET TO FIT G.E. DOOR

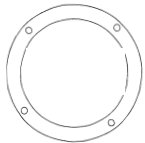

ACTUAL SIZE: 10" OD X 8" ID

G-266

GASKET TO FIT G.E. DOOR
Fits All Burner Models

CLEANOUT GASKET TO FIT YORK FURNACES



ACTUAL SIZE: 2 1/2" OD
X 2" ID

Y-819

CLEANOUT GASKET TO
FIT YORK FURNACES
Replaces: 028-10709-000

CLEANOUT GASKET TO FIT INTER-CITY (ICP)



ACTUAL SIZE: 2 3/4" OD
X 2 1/8" ID

I-820

CLEANOUT GASKET TO
INTER-CITY (ICP)
Replaces: 1149103

GASKET TO FIT RIELLO BURNER

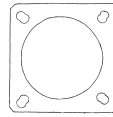

ACTUAL SIZE: 5 1/4" X 5 1/4"

R-264

GASKET TO FIT RIELLO
BURNER BLAST TUBE
Fits All Models

GASKETS TO FIT THERMO PRIDE

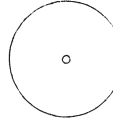

ACTUAL SIZE: 4" OD
X 3/8" ID

T-265

GASKET TO FIT THERMO
PRIDE COVER
Fits All Burner Models

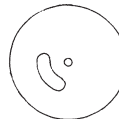

ACTUAL SIZE: 4" OD
X 3/8" ID

T-265A

GASKET WITH EXTRA
SLOT TO FIT THERMO
PRIDE COVER

GASKETS TO FIT WAYNE BURNERS

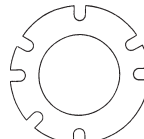

ACTUAL SIZE: 7 3/8" OD
X 5 5/16" ID

W-276

GASKET TO FIT
WAYNE EH, EASR
AND EHA FLANGE

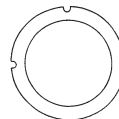

ACTUAL SIZE: 5 1/2" OD
X 4 5/16" ID

W-277

GASKET TO FIT WAYNE
MRS FLANGE

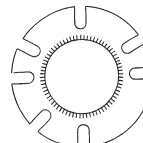

ACTUAL SIZE: 7 1/2" OD X 4" ID

W-278

GASKET TO FIT
WAYNE HS, HSR
AND HSG FLANGE

If you would like to see a life-sized illustration of many of the gaskets listed in this catalog, please contact us and we'll send you our **Gasket Picture Posters** for free. The two posters we offer measure 24" x 36".

GASKETS TO FIT CARLIN BURNERS

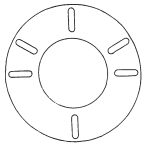

ACTUAL SIZE: 8 5/16" OD
X 4 3/16" ID

C-150
GASKET TO FIT CARLIN
CRD 99/100, EZ1
BURNER FLANGE
Will Fit Wayne E

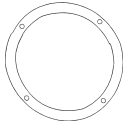

ACTUAL SIZE: 12" OD X 10" ID

C-269
GASKET TO FIT
CARLIN 1150 FLANGE

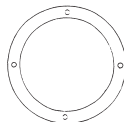

ACTUAL SIZE: 11" OD
X 8 3/4" ID

C-270
GASKET TO FIT
CARLIN 1050 FLANGE

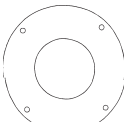

ACTUAL SIZE: 11" OD
X 5 1/4" ID

C-271
GASKET TO FIT CARLIN
801 PRESSURE FIRED
FLANGE

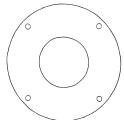

ACTUAL SIZE: 10" OD
X 4 1/8" ID

C-272
GASKET TO FIT CARLIN
301, 501, 601 AND 701
PRESSURE FIRED FLANGE

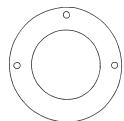

ACTUAL SIZE: 8 1/2" OD
X 5 1/4" ID

C-273
GASKET TO FIT CARLIN
801 STANDARD FLANGE



ACTUAL SIZE: 8 1/2" OD
X 4 1/8" ID

C-274
GASKET TO FIT CARLIN
201, 301, 501, 601 AND
701 STANDARD FLANGE

Try out our **High Temperature Rope and Knit Tape** for insulation and packing of boilers, furnaces, wood stoves and other applications. See page 24 for more details.

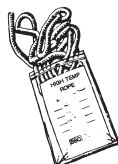

GASKETS AND PARTS TO FIT BECKETT

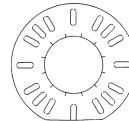

ACTUAL SIZE: 8 1/2" OD
X 3 5/16" ID

B-15
GASKET TO FIT BECKETT
BURNER FLANGE
Will also fit Aero, Ducane,
York and Trane.
Replaces: 3616

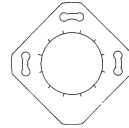

ACTUAL SIZE: 6 5/16" X 6 5/16"

B-187
GASKET TO FIT
BECKETT #68 OEM
BURNER FLANGE

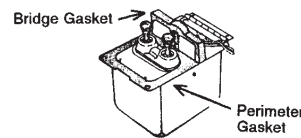

PACKED IN A PLASTIC BAG

T-262
GASKET KIT TO FIT
BECKETT AFG
TRANSFORMER
Kit Contains T-260 & T-261
Replaces: 51304



ACTUAL SIZE: 4 1/16" X 3 7/16"

T-260
GASKET TO FIT BECKETT
AFG TRANSFORMER
WIRING COMP
Replaces: 31519



ACTUAL SIZE: 3 3/4" X 1"

T-261
GASKET TO FIT BECKETT
AFG TRANSFORMER
Replaces: 31520



BF-521
FITTING TO FIT BECKETT
AF SERIES NOZZLE LINE
Includes Nut
(P127-12)



BC-661
COUPLING TO FIT
BECKETT AF
Replaces: 2454

STRAINER TO FIT BECKETT CLEAN CUT PUMP

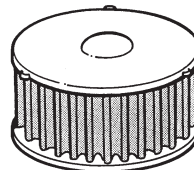

BOXED WITH COVER
O-RING (D-19)

SSC-127
STRAINER KIT TO
FIT BECKETT
CLEAN-CUT PUMP

This also fits the Danfoss BFP Pump

PARTS TO FIT MILLER FURNACES

GASKETS & FURNACE PADS TO FIT MILLER (MOBILE HOME BURNERS-OLD STYLE)

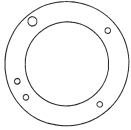

ACTUAL SIZE: 6 1/2" OD
X 4 3/8" ID

M-147
GASKET TO FIT MILLER
BURNER FLANGE
Replaces: 3000010000

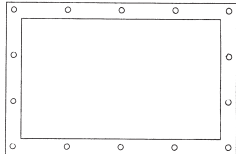

ACTUAL SIZE: 15 1/2" X 10 1/4"

M-148
GASKET TO FIT MILLER
BURNER PLATE
Replaces: 301205000

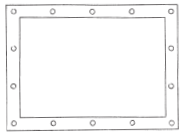

ACTUAL SIZE: 13 3/4" X 10"

M-149
GASKET TO FIT
MILLER POUCH
Replaces: 301181000

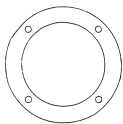

ACTUAL SIZE: 7 3/16" OD
X 5 1/8" ID

M-186
GASKET TO FIT
MILLER FLUE
Replaces: 3011950000

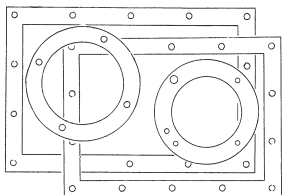

PACKED IN A PLASTIC
BAG WITH LABEL

M-185
GASKET KIT TO FIT
MILLER-GUN MOBILE
HOME FURNACE
Contains:
1 M-147 Burner Gasket
1 M-148 Burner Plate Gasket
1 M-149 Pouch Gasket
1 M-186 Flue Gasket

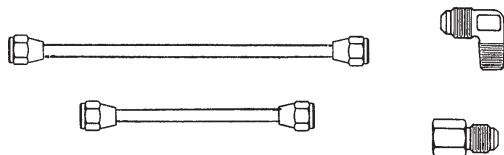

MP-405
OIL LINE PARTS KIT
TO FIT MILLER
Contains:
1 3/16" TH x 11" L Copper Oil Line
1 3/16" TH x 7" L Copper Oil Line
1 Adapter Flare Reducer
1 Fitting Elbow



ACTUAL SIZE: 12 13/16" X 4 9/16"

M-186A
GASKET TO FIT
MILLER MSH FLANGE
Replaces: 689505

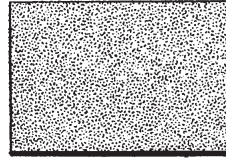

SSC's foam media pads will
fit the most popular Miller
Furnaces in the field.

MFP-401
FURNACE PAD TO
FIT MILLER
Size: 15 3/4" x 17 1/4"
x 1/4" TH

MFP-402
FURNACE PAD TO
FIT MILLER
Size: 15 3/4" x 26 1/4"
x 1/4" TH

SAVE MONEY BY CUTTING YOUR OWN SIZE!

MFP-403
FURNACE PAD MATERIAL
FOR USE ON MILLER
Size: 15 3/4" x 9 ft. x 1/4" TH

GASKETS & FURNACE PAD TO FIT MILLER MI SERIES FURNACE

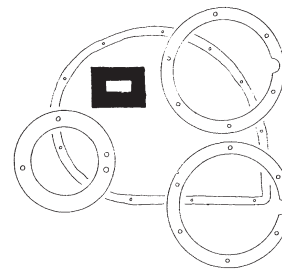

PACKED IN A PLASTIC
BAG WITH LABEL

M-187
GASKET KIT TO FIT MILLER
MI SERIES MOBILE
HOME FURNACE
Replaces: 730534
Contains:
1 M-187A 6 1/2" OD Gasket
2 M-187B 9 3/4" OD Gasket
1 M-187C 17" x 13" Gasket
1 M-187D 2 1/2" x 1 1/2" Gasket

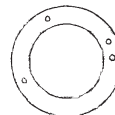

ACTUAL SIZE: 6 1/2" OD
X 4 3/8" ID

M-187A
GASKET TO FIT MILLER
MI SERIES FURNACE
6 1/2" OD

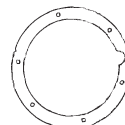

ACTUAL SIZE: 9 3/4" OD
X 7 3/4" ID

M-187B
GASKET TO FIT MILLER
MI SERIES FURNACE
9 3/4" OD

MILLER M1 PADS / OIL LINES / CO₂ TOOLS

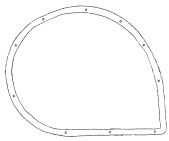

ACTUAL SIZE: 17" X 13"

M-187C
GASKET TO FIT MILLER
MI SERIES FURNACE
17" x 13"

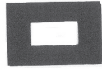

ACTUAL SIZE: 2 1/4" X 1 1/2"

M-187D
GASKET TO FIT MILLER
MI SERIES FURNACE
2 1/4" x 1 1/2"

MILLER M1 FURNACE PAD

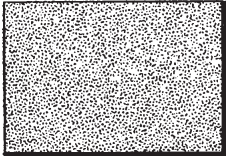

MFP-404
FURNACE PAD TO
FIT MILLER M1
Size: 20" x 28" x 1/4" TH
Replaces: 669064

FLEXIBLE OIL LINES WITH STEEL BRAID FOR BOILER SWING DOORS

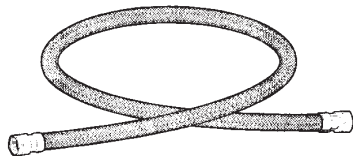

UL LISTED

- The Buna-N rubber lining (impervious to oil) is covered with a blue striped galvanized steel braid for protection
- Supplied with an instruction/warranty label and a 1/4" adapter fitting that fits most burner fuel pumps
- Successfully tested to UL 296-95
- 5 year warranty

SSC#	SIZE
108900	3/8" ID x 24" LONG
108902	3/8" ID x 36" LONG

3/8" ADAPTER FOR FLEXIBLE OIL LINES



1/4" x 3/8" REDUCING
FLARE UNION

130220
3/8" FLARE MALE ADAPTER
FOR FLEXIBLE OIL LINES
Turns 1/4" ends to 3/8".

FLEXIBLE OIL LINE WITH STEEL BRAID TO FIT RIELLO BURNERS

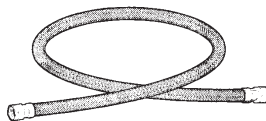

UL LISTED

108906
FLEXIBLE OIL LINE TO
FIT RIELLO BURNERS
36" Long
Stainless steel braided cover.
3/8" flare female swivel
on both ends.

COPPER OIL LINES (NOZZLE LINES)

Our oil lines are made of annealed, soft copper with attached, flared fittings. All lines are packed in a plastic bag.

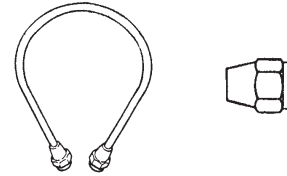

SSC#	DESCRIPTION
OL-301	1/4" BRASS FLARE NUT
OL-302	3/16" BRASS FLARE NUT
OL-306	1/4" x 12" OIL LINE WITH FLARE NUTS
OL-307	1/4" x 18" OIL LINE WITH FLARE NUTS
OL-308	3/16" x 18" OIL LINE WITH FLARE NUTS
OL-309	3/16" x 12" OIL LINE WITH FLARE NUTS
OL-310	3/16" x 8" OIL LINE WITH FLARE NUTS
OL-311	3/16" x 5" OIL LINE WITH FLARE NUTS

CO₂ BLOWOUT GUN CHARGES

SSC's high pressure CO₂ charges are used in blowout guns. They use high pressure to clear obstructions in fuel, hydraulic, or instrument transmission lines and pipes.

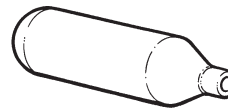

SSC-450
CO₂ CHARGES
Packed 10 cartridges
to a box.

CO₂ BLOWOUT GUNS

STANDARD

Use these guns for clearing plugged oil lines.
They use standard CO₂ charges.



SSC-451
CO₂ BLOWOUT GUN

WITH BUILT IN SAFETY VALVE

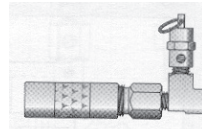

SSC-451A
CO₂ BLOWOUT GUN WITH
BUILT IN SAFETY VALVE



SHOWN ACTUAL SIZE

O-10011
REPLACEMENT O-RING
FOR BLOWOUT GUN

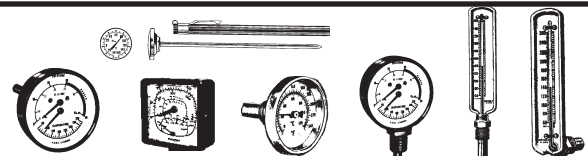

Tridicators and Thermometers are on page 77.

DUPLEX BUSHINGS / LABELS / HAND PUMP

HAND PUMP

Use this hand pump as an alternative to CO₂ charges when blowing out lines. The center access port allows the Service Technician to install a compound gauge to monitor the system pressure and vacuum during operation. Compound Gauges can be found on page 74.

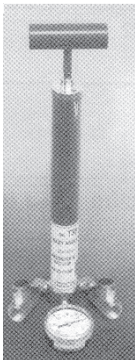

GAUGE NOT INCLUDED

SSC-452
HAND PUMP
With 1/8" NPT center access port.

SCHRADER VALVE

This bicycle type air valve allows the service technician to enter air into any system with a compressor or hand pump. It's handy for pressure testing tanks, plumbing systems, heating systems, pipe, etc.



107140
SCHRADER VALVE
1/8" NPT

FLOATING SUCTION LINE FOR OIL TANKS

The Oventrop Floating Suction Kit is a device used for the supply of #1 and #2 heating oil and diesel fuel from any oil supply tank having a height of no more than 68". It floats 1 1/2" below the surface of the top of the oil inside the tank, thus drawing clean oil into the heating system. It helps to prevent service problems due to dirty tank bottoms (sludge), cold (viscous) fuel and water in the fuel tank.

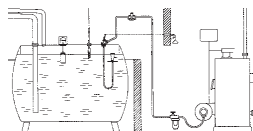

108005
FLOATING SUCTION
LINE FOR OIL TANKS



OIL TANK VALVES



SSC#	DESCRIPTION
108010	3/8" FLARE X 1/2" MPT
108012	3/8" FLARE X 3/4" MPT
108014	1/2" FLARE X 3/4" MPT

DUPLEX TANK BUSHINGS WITH FITTINGS

SSC's oil tank bushings are used to slip tubing into the oil tank and consist of 2" heavy cast iron hexagon shapes with brass connectors.

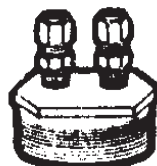

SSC#	SIZE
108001	2" x 3/8"
108002	2" x 1/2"

NOZZLE ADAPTERS



SHORT



STANDARD



LONG

SSC#	TYPE	SIZE
NA-700A	SHORT	1/8"
NA-700B	SHORT	1/4"
NA-701A	STANDARD	1/8"
NA-701B	STANDARD	1/4"
NA-702A	LONG	1/8"
NA-702B	LONG	1/4"

NOZZLE WRENCH

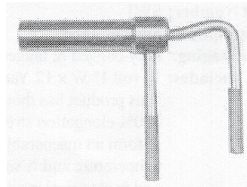

NW-705
NOZZLE WRENCH

OIL BURNER SAFETY LABELS

These safety labels are used by service technicians to alert homeowners of the proper procedures to follow in case of burner failure. They are printed on fluorescent orange label stock which has high visibility. The peel-and-stick label stock is easily affixed to equipment.

IF OIL BURNER FAILS TO OPERATE

1. Be sure the oil burner switch is on.
2. Thermostat should be set above the room temperature.
3. Be certain there is oil in the tank.
4. Check fuse or circuit breaker.
5. Press red reset button on relay - ONCE ONLY. If burner still fails to operate, call for service.

IS-623
INSTRUCTION STICKER
Fluorescent Orange
Peel-and-Stick Label Stock

ACTUAL SIZE: 3 1/2" X 1 3/4"

PRESS RESET BUTTON
ONCE ONLY. IF BURNER
DOES NOT START, CALL
FOR SERVICE.

IS-624
RESET STICKER
Fluorescent Orange
Peel-and-Stick Label Stock

ACTUAL SIZE: 1 7/8" X 1"

OIL BURNER COUPLINGS



SSC's flexible Oil Burner Couplings offer tough neoprene sleeves (1" wide) with high density plastic end pieces. This combination gives you a strong, lightweight connector which is unaffected by most humidity, oil, temperature and chemical extremes. In addition, the molded end pieces require no set screws and the sleeve is easily cut for a proper installation every time.

CARDERD AND BOXED KITS

BOXED

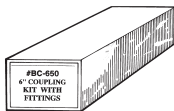

BC-650 6" COUPLING KIT

Contains:

- 1 6" Rubber Sleeve (BC-685)
- 1 1/2" End Fitting (BC-690)
- 1 7/16" End Fitting (BC-691)
- 1 5/16" End Fitting (BC-692)

Available Carded or Boxed

CARDERD

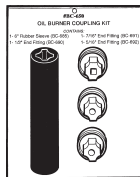

BC-652 6" COUPLING KIT WITH EXTRA FITTINGS

Contains:

- 1 6" Rubber Sleeve (BC-685)
- 2 1/2" End Fittings (BC-690)
- 1 7/16" End Fitting (BC-691)
- 2 5/16" End Fittings (BC-692)

Available Carded or Boxed

BC-649 5" COUPLING KIT

Contains:

- 1 5" Rubber Sleeve
- 1 1/2" End Fitting (BC-690)
- 1 7/16" End Fitting (BC-691)
- 1 5/16" End Fitting (BC-692)

Available Carded or Boxed

12 PIECE KIT



BC-653 12 PIECE COUPLING KIT

Contains:

- 12 6" Rubber Sleeves (BC-685)
- 12 1/2" End Fittings (BC-690)
- 12 5/16" End Fittings (BC-692)
- 5 7/16" End Fittings (BC-691)
- 5 Torrington Adapters (BC-693)

Available Boxed

6-PACK

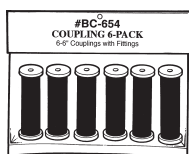

BC-654 COUPLING 6-PACK

Contains:

- 6 6" Couplings
With Fittings

OIL BURNER COUPLINGS

ASSEMBLED (READY-TO-USE) COUPLINGS



BC-661
COUPLING TO FIT
BECKETT AF
Replaces: 2454

SSC#	WILL FIT	LENGTH/FITTING SIZE
BC-660	BECKETT (2290)	2 7/8" L / 7/16" X 1/2"
BC-661	BECKETT AF (2454)	3 13/32" L / 5/16" X 1/2"
BC-662	CARLIN 99-100 (99RA10208)	2 3/16" L / 5/16" X 1/2"
BC-663	CARLIN CRD (99RA5220)	3 1/16" L / 7/16" X 1/2"
BC-664	CARLIN CRDA (1020J)	2 3/4" L / 7/16" X 1/2"
BC-665	DUCANE (B1011503)	3 13/16" L / 5/16" X 1/2"
BC-666	LENNOX (65A4101)	3 5/8" L / 5/16" X 1/2"
BC-667	WAYNE E (13279)	4 5/16" L / 5/16" X 1/2"
BC-668	WAYNE (13424)	3 13/16" L / 5/16" X 1/2"
BC-670	--	4 7/16" L / 7/16" X 1/2"
BC-671	--	4" L / 7/16" X 1/2"
BC-672	--	5 1/4" L / 5/16" X 1/2"
BC-673	--	6" L / 5/16" X 1/2"

COUPLING 10-PACK



BC-661K
COUPLING 10-PACK
TO FIT BECKETT AF
Replaces: 2454
10 couplings in a box
with label.

BC-662K
COUPLING 10-PACK
TO FIT CARLIN
99RA10208
10 couplings in a box
with label.

SLEEVE (TUBING) LENGTHS



SSC#	SLEEVE SIZE
BC-685	6" LENGTH X 1" WIDE
BC-686	12" LENGTH X 1" WIDE
BC-687	24" LENGTH X 1" WIDE
BC-688	36" LENGTH X 1" WIDE

COUPLING CUTTER



BC-695
COUPLING CUTTER

CAD CELL EYES / JUMPERS / TERMINALS

COUPLING END FITTINGS

1/2" - BLACK



BC-690
COUPLING END
FITTING
1/2" Shaft Size
Color: BLACK

7/16" - BLUE



BC-691
COUPLING END
FITTING
7/16" Shaft Size
Color: BLUE

5/16" - RED



BC-692
COUPLING END
FITTING
5/16" Shaft Size
Color: RED

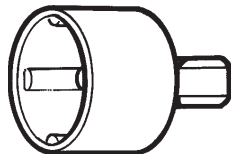

BC-693
TORRINGTON
ADAPTER

CAD CELL EYES

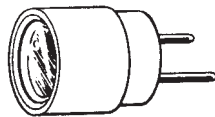

CC-601
CAD CELL EYE
(FLAME DETECTOR)
For use in Honeywell C554A.
Replaces: 130367
Bubble Packed

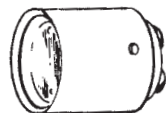

CC-602
CAD CELL EYE
(FLAME DETECTOR)
For use in Honeywell 630485.
Old Style
Bubble Packed

IGNITION WIRE (CABLE)

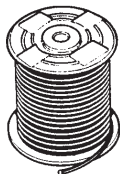

SSC's Ignition Wire is listed with Underwriters' Laboratories. It is flame retardant and is resistant to heat, oil and moisture. Temperature range is -40° to 140°.

SSC#	DESCRIPTION	LENGTH
IC-619	GTO-15, 14 GAUGE	25 FT. PACKAGE
IC-620	GTO-15, 14 GAUGE	100 FT. ROLL
IC-621	GTO-15, 14 GAUGE	500 FT. ROLL
IC-622	GTO-15, 14 GAUGE	1000 FT. ROLL

ELECTRICAL JUMPERS (TEST LEADS)

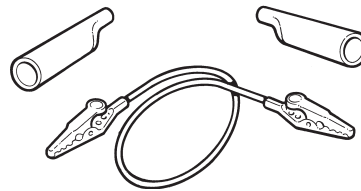

SSC#	DESCRIPTION	LENGTH
EJ-609	STANDARD JUMPERS-PAIR	12"
EJ-610	STANDARD JUMPERS-PAIR	18"
EJ-611	STANDARD JUMPERS-PAIR	36"
EJ-614	INSULATED JUMPERS-PAIR	12"
EJ-615	INSULATED JUMPERS-PAIR	18"
EJ-616	INSULATED JUMPERS-PAIR	36"
AC-617	ALLIGATOR CLIP ONLY	---
AC-617INB	AL. CLIP W/ BLACK INSULATOR	---
AC-617INR	AL. CLIP W/ RED INSULATOR	---

IGNITOR & TRANSFORMER TERMINAL CONNECTORS



PACKED 10/PACK

IT-640
STRAIGHT CAGE
TERMINAL

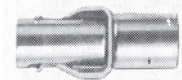

PACKED 10/PACK

IT-641
SPRING SNAP
CABLE TERMINAL



PACKED 10/PACK

IT-642
RING TERMINAL FOR
IGNITION CABLE

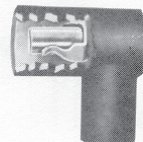

PACKED 10/PACK

IT-643
SPRING/ANGLE
EXTENDED NYLON CAP



PACKED 10/PACK

IT-644
SPRING/SOLDERLESS
BRASS FERULE

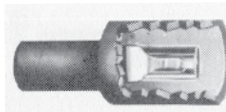

PACKED 10/PACK

IT-645
SPRING/EXTENDED
WITH NYLON CAP

ELECTRODES (IGNITORS)

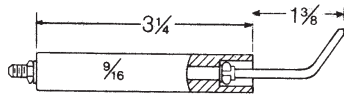

109001
ELECTRODE TO FIT
BECKETT AF & AFG
Set of 2

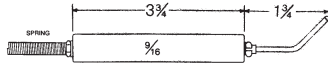

109002
ELECTRODE TO
FIT BECKETT
Set of 2

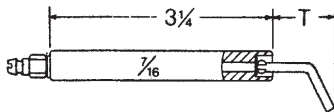

109051
ELECTRODE TO
FIT CARLIN 98
THRU 301 CRD
Set of 2

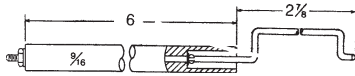

109052
ELECTRODE TO FIT
CARLIN 501, 600, 601,
701, 801, 1050 & 1150
Set of 2

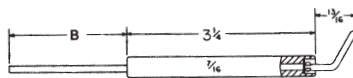

109053
ELECTRODE TO FIT
CARLIN ELITE (EZ1)
THRU 9" AIRTUBE
Set of 2

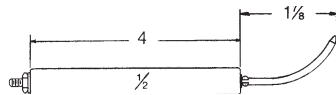

109130
ELECTRODE TO FIT
WAYNE EH, HSR, MSR
Set of 2

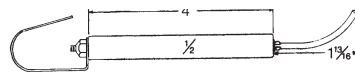

109131
ELECTRODE TO FIT
WAYNE BURNERS
Also Fits Miller, LSI

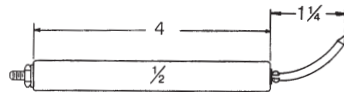

109132
ELECTRODE TO FIT
WAYNE EE, ER, ERA,
EHASR, OE, OEA,
M & MH
Set of 2

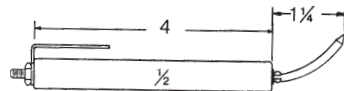

109133
ELECTRODE TO FIT
WAYNE MODEL M
3" TO 3 1/2" AIRTUBE
Set of 2

ELECTRODES / SMOKE CANDLES

PICTURE NOT
AVAILABLE

109134
ELECTRODE TO FIT
WAYNE BLUE ANGEL
HS NEW STYLE TO 18"
Set of 2

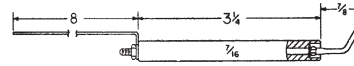

109135
ELECTRODE TO FIT
WAYNE BLUE ANGEL
HS OLD STYLE
Set of 2

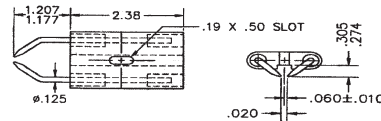

109145
ELECTRODE TO FIT
WEIL MCLAIN
QB180, QB300
Set of 2

SMOKE CANDLES



Smoke Candles are handy for
locating leaks in heating equipment.
Place the smoke candle in the area
you want to inspect, light it and look
for the leak.

SSC#	SMOKING TIME
SM-605	1/2 MINUTE
SM-606	1 MINUTE
SM-607	3 MINUTES

SMOKE PELLETS AND SMOKE MATCHES

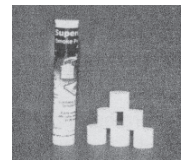

SMOKE PELLETS



SMOKE MATCHES

SSC's Smoke Pellets and Matches let you quickly test
flues, chimneys, exhaust hoods, ductwork, furnaces and
plumbing for leaks and backdrafts. The Pellets and Matches
have significantly less smoke volume than our popular Smoke
Candles for smaller test areas.

SSC#	DESCRIPTION	TIME	SMOKE VOLUME
SM-550	PELLET	30 SEC.	200 CU./FT.
SM-551	PELLET	60 SEC.	400 CU./FT.
SM-552	PELLET	60 SEC.	500 CU./FT.
SM-553	MATCHES	20 SEC.	50 CU./FT.

SMOKE TEST PAPER / HIGH TEMP. ROPE

SMOKE TEST PAPER



PACKED 50 STRIPS PER ZIP-LOCK BAG

STP-604

SMOKE TEST PAPER

Fits Bacharach, Dwyer and equivalent testers.
50 pre-cut strips per package.
Each strip is 7 1/2" long x 3/4" wide.

SMOKE TESTER

Our Smoke Tester is made of a virtually unbreakable polycarbonate barrel. It features brass and stainless steel hardware and silicone lubrication. The sampling tube hooks into the smokepipe and the device will fit into Brigon and Bacharach cases.

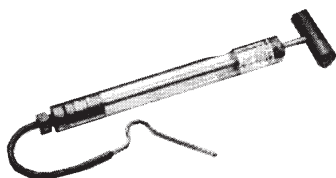

STP-605

SMOKE TESTER

Includes Smoke Tester,
Smoke Test Paper, Smoke
Scale and carrying case.

HIGH TEMPERATURE ROPE

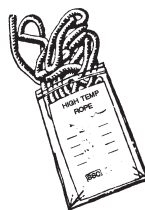

PACKED IN A ZIP-LOCK
BAG WITH LABEL

- Gasketing, insulation and packing material for boilers, wood stoves, ovens and other applications
- Good to 1000°F (538°C)
- Contains no asbestos
- Easily bondable
- Excellent chemical resistance
- Can be cut to any desired length

SSC#	DIAMETER	LENGTH
HTR-470	1/4"	25'
HTR-470A	1/4"	10'
HTR-470B	1/4"	50'
HTR-471	3/8"	25'
HTR-471A	3/8"	10'
HTR-471B	3/8"	50'
HTR-472	1/2"	25'
HTR-472A	1/2"	10'
HTR-472B	1/2"	50'
HTR-473	3/4"	25'
HTR-473A	3/4"	10'
HTR-473B	3/4"	50'
HTR-474	1"	25'
HTR-474A	1"	10'
HTR-474B	1"	50'

ALUMINUM FOIL TAPE

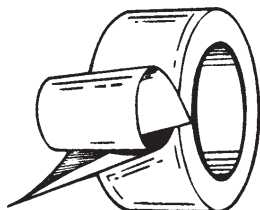

EACH ROLL IS
SHRINK-WRAPPED
FOR PROTECTION

SSC#	SIZE
DT-318	2" x 50 yds.
DT-318A	3" x 60 yds.

HIGH TEMPERATURE KNIT TAPE



PACKED IN A PLASTIC BAG

Made from the same fiberglass material as high temperature rope, our fiberglass knitted tape can be used for insulating pipe, lining furnaces and many other applications.

SSC#	SIZE	LENGTH
HTR-475	1/8" THICK x 1" WIDTH	25'
HTR-477	1/8" THICK x 1 1/2" WIDTH	25'
HTR-478	1/8" THICK x 2" WIDTH	25'

DUCT TAPE

GRAY

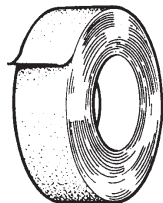

DT-317
GRAY COLORED
DUCT TAPE
2" x 60 yds.
Each roll is
shrink-wrapped
for protection.

BLACK

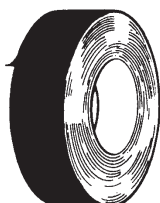

DT-320
BLACK COLORED
DUCT TAPE
2" x 50 yds.
Each roll is
shrink-wrapped
for protection.

HIGH TEMPERATURE RUBBER COATED TADPOLE TAPE

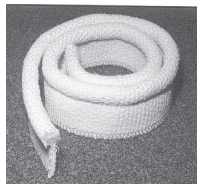

Our Tadpole Tape is coated with rubber to make installation easier.

PACKED IN A ZIP-LOCK BAG

SSC#	SIZE	LENGTH
HTR-479	3/8" BALL x 1 1/2" WIDTH	25'
HTR-479A	3/8" BALL x 1 1/2" WIDTH	10'
HTR-479B	3/8" BALL x 1 1/2" WIDTH	50'

V-BELTS / BLOWER BEARINGS / PULLEYS

V-BELTS



SSC's V-Belts come packed in a sleeve with the number clearly marked. Antistatic, oil and heat resistant, these belts give you superior performance at a competitive price.

SSC#	OUTSIDE LENGTH	SSC#	OUTSIDE LENGTH
4L-170	17"	4L-460	46"
4L-180	18"	4L-470	47"
4L-190	19"	4L-480	48"
4L-200	20"	4L-490	49"
4L-210	21"	4L-500	50"
4L-220	22"	4L-510	51"
4L-230	23"	4L-520	52"
4L-240	24"	4L-530	53"
4L-250	25"	4L-540	54"
4L-260	26"	4L-550	55"
4L-270	27"	4L-560	56"
4L-280	28"	4L-570	57"
4L-290	29"	4L-580	58"
4L-300	30"	4L-590	59"
4L-310	31"	4L-600	60"
4L-320	32"	4L-610	61"
4L-330	33"	4L-620	62"
4L-340	34"	4L-630	63"
4L-350	35"	4L-640	64"
4L-360	36"	4L-650	65"
4L-370	37"	4L-660	66"
4L-380	38"	4L-670	67"
4L-390	39"	4L-680	68"
4L-400	40"	4L-690	69"
4L-410	41"	4L-700	70"
4L-420	42"	4L-710	71"
4L-430	43"	4L-720	72"
4L-440	44"	4L-730	73"
4L-450	45"	4L-740	74"

BELT TO FIT LENNOX OIL BURNERS



L-1600
V-BELT TO FIT LENNOX
16" Outside Length
Replaces: 0160

V-BELT, FAN BELT DRESSING

Use SSC's V-Belt Dressing to temporarily shore up worn or slipping belts before replacing.



V-931
V-BELT, FAN BELT
DRESSING
12 oz. Spray Can

VARIABLE PITCH MOTOR PULLEYS

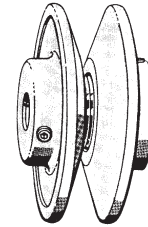

SSC#	BORE SIZE	OUTSIDE DIAMETER
VP-850A	1/2"	2.5"
VP-850B	1/2"	2.87"
VP-850C	1/2"	3.15"
VP-850D	1/2"	3.75"
VP-850E	1/2"	4.15"
VP-851A	5/8"	2.5"
VP-851B	5/8"	2.87"
VP-851C	5/8"	3.15"
VP-851D	5/8"	3.75"
VP-851E	5/8"	4.15"
VP-852A	3/4"	3.15"
VP-852B	3/4"	3.75"
VP-852C	3/4"	4.15"

FIXED HUB PULLEYS

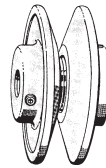

SSC#	BORE SIZE	OUTSIDE DIA.	LAU#
VP-853A	3/4"	4.80"	38221301
VP-853B	3/4"	6"	28331401
VP-853C	3/4"	7"	38221501
VP-853D	3/4"	8"	38221701

BLOWER SHAFTS

Our Blower Shafts are machined for a precise fit and packed in a sleeve for protection. Any excess shaft can be cut off.



SSC#	LAU#	DESCRIPTION
BL-841	38-2205-01	5/8" X 20" SHAFT
BL-842	38-2096-01	3/4" X 20" SHAFT
BL-843	38-2095-01	1" X 25" SHAFT
BL-844	---	1" X 35" SHAFT

BLOWER THRUST COLLAR KITS TO FIT LAU

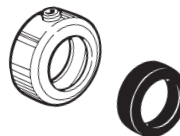

PACKED IN SETS OF 2 WITH THRUST WASHERS IN HANGING BAG WITH LABEL

SSC#	LAU#	DESCRIPTION
BL-832	38-2206-01	3/4" THRUST COLLAR KIT
BL-833	38-2207-01	1" THRUST COLLAR KIT

BLOWER BEARINGS / PILOT TUBING

BLOWER BEARINGS TO FIT LAU

SSC's Blower Bearings are made of sintered bronze, oil impregnated with an oil cup. They are self-aligning, self-oiling and come with rubber spacers. They are packed two per plastic bag with hanging label and include insulators.

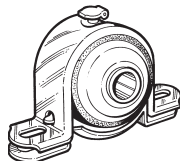

PILLOW BLOCK BEARINGS

SSC#	LAU#	DESCRIPTION
BL-801	38-2204-01	5/8" PILLOW BLOCK BEARING
BL-802	38-2086-01	3/4" PILLOW BLOCK BEARING
BL-803	38-2087-01	1" PILLOW BLOCK BEARING



OIL TYPE BEARINGS

SSC#	LAU#	DESCRIPTION
BL-815	38-2404-01	5/8" OIL TYPE BEARING
BL-816	38-2442-01	3/4" OIL TYPE BEARING
BL-817	38-2442-02	1" OIL TYPE BEARING



SEALED BEARINGS

SSC#	LAU#	DESCRIPTION
BL-821	38-2443-01	5/8" SEALED BEARING
BL-822	38-2694-01	3/4" SEALED BEARING
BL-823	38-2443-03	1" SEALED BEARING

SHEET METAL SCREWS



- #8 thread
- Self piercing
- Hard steel -- zinc plated
- Hex head type with screwdriver slot

PACKED 100/BOX

SSC#	SIZE	PACKAGE TYPE
SH-635A	1/2"	100/BOX
SH-635B	3/4"	100/BOX
SH-635C	1"	100/BOX

12" PILOT LIGHTER



ST-358
12" PILOT LIGHTER
Plated Handle
Non-telescoping

ALUMINUM PILOT TUBING



PACKED IN A PLASTIC BAG

AT-524A
1/4" OD ALUMINUM
PILOT TUBING FOR
GAS APPLIANCES
5 Foot Length

AT-524B
3/8" OD ALUMINUM
PILOT TUBING FOR
GAS APPLIANCES
5 Foot Length

GAS FLARE ADAPTERS FOR WATER HEATERS



BRASS

108140
1/4" GAS FLARE
ADAPTER FOR GAS
VALVE IN WATER
HEATER
Brass

108142
3/8" GAS FLARE
ADAPTER FOR GAS
VALVE IN WATER
HEATER
Brass

NYLON FLEXIBLE DUCT STRAPS

SSC's Duct Straps are used in attaching flex-duct to registers and grilles.



PACKED 25/BAG

SSC#	DESCRIPTION	FITS TUBE DIA.
WT-637A	WHITE-175LB TENSILE, 32" L	1" - 9"
WT-637B	BLACK-175LB TENSILE, 32" L	1" - 9"
WT-638A	WHITE-175LB TENSILE, 43" L	6" - 13"
WT-638B	BLACK-175LB TENSILE, 43" L	6" - 13"

AGA / CSA APPROVED BRASS BALL VALVE GAS COCK

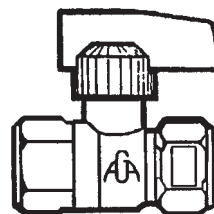

122032
AGA/CSA APPROVED
BRASS BALL VALVE
GAS COCK
Red Handle
1/2"

122034
AGA/CSA APPROVED
BRASS BALL VALVE
GAS COCK
Red Handle
3/4"

VAC BAGS / TUBE CLAMPS

ANTI-VIBRATION TUBE CLAMPS



Anti-Vibration Tube Clamps can be used to stop annoying vibrations in tubing. They are also used as a safety feature when hanging copper oil lines since the clamp's rubber cushion eliminates any copper-against-metal situations.

TC-630
ANTI-VIBRATION
TUBE CLAMP
3/8" ID

TC-631
ANTI-VIBRATION
TUBE CLAMP
1/2" ID

VACUUM BAGS TO FIT MASTERCRAFT



PACKED 5/BAG

SSC's Vacuum Bags will fit the most popular vacuums in the field including Mastercraft.

VB-632A
PACKAGE OF 5
VACUUM BAGS
TO FIT MASTERCRAFT
SMALL SIZED CLEANERS
3 1/2 Gallons
Style #: 4464

VB-632B
PACKAGE OF 5
VACUUM BAGS
TO FIT MASTERCRAFT
MEDIUM SIZED CLEANERS
5 Gallons
Style #: 4465

SOOT SNAKE FLEXIBLE VACUUM CLEANER HOSE

This handy attachment reaches places impossible to get with a standard hose during vacuum clean-ups. It works well with today's compact boilers and it slips easily onto any standard 1 1/2" rubber vacuum cleaner hose.



VB-632C
SOOT SNAKE FLEXIBLE
VACUUM CLEANER HOSE
7/8" Diameter x 48" Long

SOOT SHOVEL

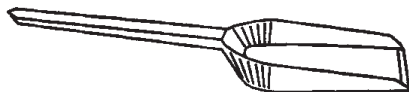

VB-632D
SOOT SHOVEL
4 1/2" W x 19 1/2" L
Steel with black
enamel finish.

SOOT SAW

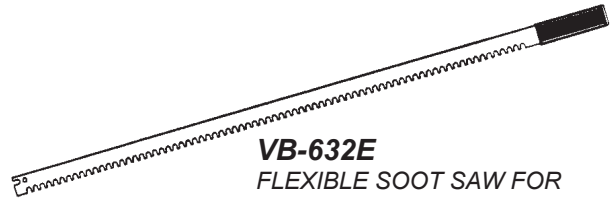

VB-632E
FLEXIBLE SOOT SAW FOR
CLEANING BOILERS & FURNACES
Zinc Coated Steel
Soft Vinyl Handle

DUST MASKS

Use these economical dust masks for protection against soot and undesirable particles while cleaning boilers, burners, furnaces, etc.

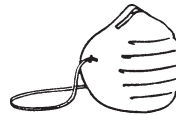

PACKED 50/BOX

108510
DUST/PARTICLE MASK

DISPOSABLE VINYL GLOVES



PACKED 100/BOX

Our vinyl disposable gloves are an economical way to protect the hands from dirt, grease and other harmful chemicals while working in the field. Unlike rubber surgical gloves, vinyl gloves do not become slippery when covered with #2 oil. Available in large and medium sizes, they can be thrown out after each job or used over and over.

GL-627
DISPOSABLE VINYL
GLOVES
Medium Size

GL-628
DISPOSABLE VINYL
GLOVES
Large Size

NITRILE GLOVES - BLUE COLOR



PACKED 100 GLOVES
PER BOX

SSC#	SIZE
GL-626	LARGE
GL-626A	MEDIUM

PLASTIC DISPOSABLE SHOE COVERS

Shoe covers minimize the chance of getting customers' homes dirty by tracking in dirt on shoes.



108512
PLASTIC DISPOSABLE
SHOE COVERS
Blue Color with Elastic
100/Bag

COUPLERS TO FIT BELL & GOSSETT

COUPLERS TO FIT BELL & GOSSETT

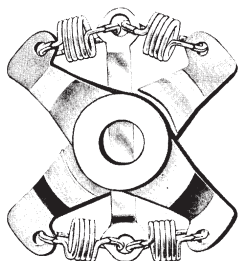

MADE OF DURABLE CAST IRON
WITH SHIELDED SPRINGS

SSC-779
COUPLER TO FIT B&G
MODELS 75 TO 150
(100 SERIES), 1 1/2, 2, HV,
PR; ARMSTRONG MODELS
S-25, S-34, S-35, H-32, H-41
1/2" x 1/2" Shafts
1/12 to 1/6 HP
Old #: PZ-4291
New #: 118705
Arm. #: 806026-001
(RM-876)

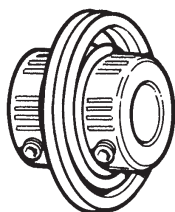

SPRING-FLEX COMPENSATES
FOR ANY SHAFT MISALIGN-
MENT AND OPERATES
SILENTLY IN START-UP AND
RUNNING MODES

SSC-790
SPRING-FLEX COUPLER
TO FIT B&G AND ARMSTRONG
CIRCULATORS
Can be used on majority of
1/2" x 1/2" shaft circulators.
1/12 to 1/3 HP
Old #: PZ-4291
New #: 118705
Arm. #: 806026-001
(RW-675)

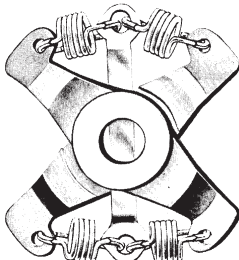

MADE OF DURABLE CAST IRON
WITH **HEAVY-DUTY** SPRINGS

SSC-780
COUPLER TO FIT B&G
MODELS 1 1/2, LD3, HD3;
ARMSTRONG MODELS
S-45, S-46
1/2" x 1/2" Shafts
1/4 to 1/3 HP
Heavy Springs
Old #: PSZ-12291
New #: 118723
Arm. #: 806168-001
(RM-858)

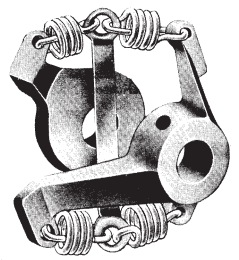

MADE OF DURABLE CAST IRON
WITH HEAVY-DUTY SPRINGS

SSC-781
COUPLER TO FIT B&G
MODELS 60-1, 60-2 (OLD),
60-11 (NEW); ARMSTRONG
MODELS H-51, H-52
1/2" x 1/2" Yoke
Old #: PDZ-12291
New #: 118473
Arm. #: 810120-003
(RM-798)

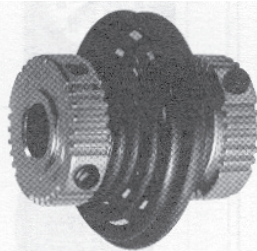

COMPENSATES FOR ANY
SHAFT MISALIGNMENT AND
OPERATES SILENTLY IN
START-UP AND RUNNING
MODES

SSC-790A
SPRING TYPE COUPLER
TO FIT B&G MODELS 60-1,
60-2 (OLD), 60-11 (NEW);
ARMSTRONG MODELS
H-51, H-52
1/2" x 1/2" Yoke
Old #: PDZ-12291
New #: 118473
Arm. #: 810120-003

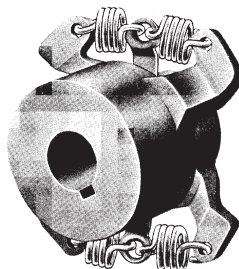

MADE OF DURABLE CAST IRON
WITH HEAVY-DUTY SPRINGS

SSC-782
COUPLER TO FIT B&G
MODELS PD35, PD37,
60-3, 60-4 (OLD), 60-13,
60-14 (NEW); ARMSTRONG
MODELS H-54, H-54
1/2" x 5/8" Keyway
Old #: P4Z-4291
New #: 118709
Arm. #: 810120-006
(RM-799)

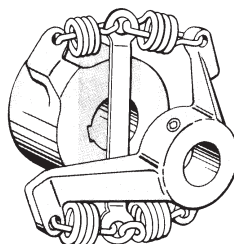

MADE OF DURABLE CAST IRON
WITH HEAVY-DUTY SPRINGS

SSC-783
COUPLER TO FIT B&G
MODELS PD39, 60-5 TO
60-10 (OLD), 60-15 TO
60-21 (NEW); ARMSTRONG
MODELS S-69, H-63 TO H-68
5/8" Keyway x 1/2" Yoke
Old #: PWHZ-6291
New #: 186410
Arm. #: 810120-008
(RM-791)

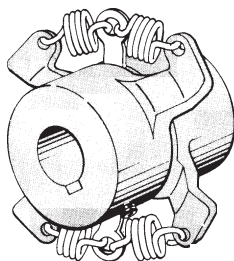

MADE OF DURABLE CAST IRON
WITH HEAVY-DUTY SPRINGS

SSC-784
COUPLER TO FIT B&G
5/8" Keyway x 5/8" Keyway
Old #: PD2Z-12291
New #: 118476
(RM-794)



BP-394
COUPLER SET SCREW
Old #: P-453
New #: PO1800
(RM-451)

WOODS SURE-FLEX COUPLERS

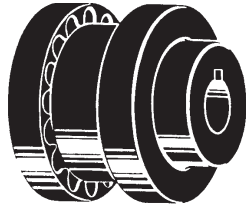

SSC#	DESCRIPTION
WC-792A	3JE RUBBER SLEEVE
WC-792B	3JE FLANGE-1/2"
WC-792C	3JE FLANGE-5/8
WC-792D	3JE COMPLETE COUPLER-1/2 X 1/2
WC-792E	3JE COMPLETE COUPLER-5/8 X 5/8
WC-792F	3JE COMPLETE COUPLER-1/2 X 5/8
WC-793A	4JE RUBBER SLEEVE
WC-793B	4JE FLANGE-1/2
WC-793C	4JE FLANGE-5/8
WC-793D	4JE COMPLETE COUPLER-1/2 X 1/2
WC-793E	4JE COMPLETE COUPLER-5/8 X 5/8
WC-793F	4JE COMPLETE COUPLER-1/2 X 5/8
WC-794A	5JE RUBBER SLEEVE
WC-794B	5JE FLANGE-1/2
WC-794C	5JE FLANGE-5/8
WC-794D	5JE FLANGE-3/4
WC-794E	5JE COMPLETE COUPLER-1/2 X 1/2
WC-794F	5JE COMPLETE COUPLER-5/8 X 5/8
WC-794G	5JE COMPLETE COUPLER-3/4 X 3/4
WC-794H	5JE COMPLETE COUPLER-1/2 X 5/8
WC-794I	5JE COMPLETE COUPLER-1/2 X 3/4
WC-794J	5JE COMPLETE COUPLER-5/8 X 3/4
WC-795A	6JE RUBBER SLEEVE
WC-795B	6JE FLANGE-5/8
WC-795C	6JE FLANGE-3/4
WC-795D	6JE FLANGE-1
WC-795E	6JE COMPLETE COUPLER-5/8 X 5/8
WC-795F	6JE COMPLETE COUPLER-3/4 X 3/4
WC-795G	6JE COMPLETE COUPLER-1 X 1
WC-795H	6JE COMPLETE COUPLER-5/8 X 3/4
WC-795I	6JE COMPLETE COUPLER-5/8 X 1
WC-795J	6JE COMPLETE COUPLER-3/4 X 1
WC-796A	7JE RUBBER SLEEVE
WC-797A	8JE RUBBER SLEEVE
WC-798A	9JE RUBBER SLEEVE
WC-799A	10JE RUBBER SLEEVE

Need Plumbing Parts? We stock **Bath & Shower specialties, Lav & Sink specialties and Toilet specialties.** See pages 94-103 for our complete line.

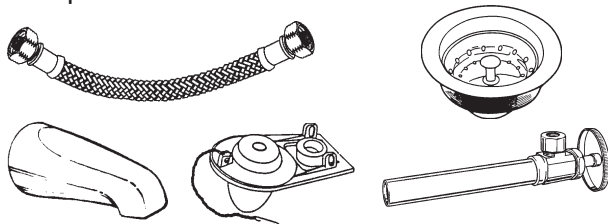

MOTOR PARTS TO FIT BELL & GOSSETT

A broken coupler is usually the result of sagging motor mounts. Both should be replaced at the same time. This kit offers a handy combination.



BP-395
COUPLER-MOTOR MOUNT KIT TO FIT 1/12 HP B&G 100 SERIES CIRCULATORS
 Contains 1 cast iron SSC-779 coupler and 1 set of BP-399 motor mounts with ground wire.

PACKED IN A PLASTIC BAG

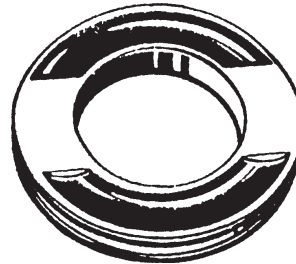

PACKED PAIR/BOX WITH COPPER GROUNDING WIRE

1/12 HP MOUNTS

BP-399
MOTOR MOUNTS TO FIT B&G 1/12 HP
 Sold By Set
 Replaces: 118223 (RM-539)

1/6 HP MOUNTS

BP-397
MOTOR MOUNTS TO FIT B&G 1/6 HP
 Sold By Set-Front & Rear
 MOT 102-6121
 Replaces: 118227 (K-1174)

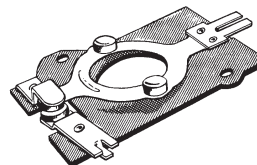

BP-382
SWITCH PLATE ASSEMBLY TO FIT B&G 1/12 HP
 MOT 100Z-516 (RM-549)

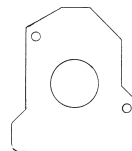

BP-382MY
MYLAR INSULATOR TO FIT NEW STYLE DIE CAST BELL & GOSSETT MOTORS
 (RM-549-N)



BP-383
KLIXON OVERLOAD PROTECTOR 1/12 HP
 MOT 100-547
 Replaces: 118181 (K-1181)

MOTOR PARTS TO FIT BELL & GOSSETT

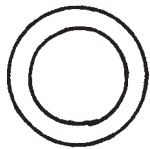

SHOWN ACTUAL SIZE

BP-398A
MOTOR SPACER
TO FIT 1/12 HP
B&G MOTORS
(RM-885A)

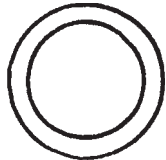

SHOWN ACTUAL SIZE

BP-398B
MOTOR SPACER
TO FIT 1/6 HP
B&G MOTORS
(RM-886A)



SC-737
SILVER CONTACT
Replaces: Hydrovalve
RD-737

SC-739
SILVER CONTACT
Replaces: Hydrovalve
RD-739

BALL BEARINGS



SSC's single row deep groove ball bearings have double, non-contact seals with a high temperature lubricant. They provide quiet, long-life performance with minimum vibration for most electric motors.

SSC#	I.D. (BORE)	OD	WIDTH
6202	.591" 15mm	1.378" 35mm	.433" 11mm
6202-16	.629" 16mm	1.378" 35mm	.433" 11mm
6203	.669" 17mm	1.574" 40mm	.472" 12mm
6203-625	.625" 15.875mm	1.574" 40mm	.472" 12mm
6204	.787" 20mm	1.854" 47mm	.551" 14mm
6205	.984" 25mm	2.047" 52mm	.590" 15mm
6206	1.181" 30mm	2.440" 62mm	.629" 16mm
6207	1.378" 35mm	2.834" 72mm	.669" 17mm
6303	.669" 17mm	1.854" 47mm	.551" 14mm
6304	.787" 20mm	2.047" 52mm	.590" 15mm

OPEN IMPELLER WRENCH



ST-361
OPEN IMPELLER WRENCH
Fits all open-faced impellers.

CLOSED IMPELLER WRENCH



ST-362
CLOSED IMPELLER WRENCH
Fits all closed impellers. Has large handle for leverage.

MOTOR BEARING PULLER

This is a special two armed puller designed to fit behind all pool motor bearings, eliminating the need for bearing puller adapters.

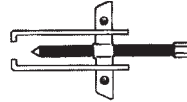

ST-377
MOTOR BEARING PULLER

ARMATURE HOLDING TOOL

This tool holds old style Century and Franklin armatures so the impeller can be removed. It fits into a 5/8" socket wrench.

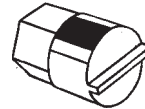

ST-375
ARMATURE HOLDING TOOL

SEAL SETTING TOOL

This makes setting seals a snap. Works on pumps up to 3 HP.



ST-379
SEAL SETTING TOOL

MOTOR START AND RUN CAPACITORS



SSC#	TYPE	MFD	VOLT
MC-510	START CAPACITOR	72-78	115
MC-511	START CAPACITOR	88-108	115
MC-512	START CAPACITOR	108-130	115
MC-513	START CAPACITOR	124-149	115
MC-514	START CAPACITOR	145-175	115
MC-515	START CAPACITOR	161-193	115
MC-516	START CAPACITOR	189-227	115
MC-517	START CAPACITOR	200-240	115
MC-518	START CAPACITOR	243-292	115
MC-519	START CAPACITOR	270-324	115
MC-520	START CAPACITOR	324-388	115
MC-521	START CAPACITOR	340-408	115
MC-522	START CAPACITOR	378-440	115
MC-523	START CAPACITOR	400-480	115
MC-524	START CAPACITOR	460-552	115
MC-525	START CAPACITOR	540-648	115
MC-535	START CAPACITOR	36-43	220
MC-536	START CAPACITOR	53-64	220
MC-537	START CAPACITOR	35UF	370
MC-540	RUN CAPACITOR	25	370
MC-541	RUN CAPACITOR	30	370

SEAL KITS TO FIT BELL & GOSSETT

1/2" SHAFT



**REPLACES #7
SEAL KIT**

BP-381
SEAL KIT #7 TO FIT B&G
MODELS 75 TO PD37,
HV TO 60-14; ARMSTRONG
MODELS S-25 TO S-57
1/2" Shaft
Old #: #7 Kit
New #: 118681
Arm. #: 816706-001
(RM-880W / K-1339)

1/2" SHAFT



BP-380
SEAL ASSEMBLY
TO FIT B&G MODELS
75 TO PD37, HV TO 60-14
Used primarily on cast
iron circulators where no
ceramic is needed.
New #: 118680
(RM-880)



BP-379
SEAL CERAMIC AND
RUBBER CUP TO FIT
B&G MODELS 75 TO
PD37, HV 50 60-14;
ARMSTRONG S-25, S-57
New #: 118619
Arm. #: 816558-000
(RM-880S / K-1249)

3/4" SHAFT



BP-384
SEAL KIT TO FIT
B&G 60 SERIES
3/4" Shaft
New #: 186499

1 1/4" SHAFT



BP-386
SEAL KIT TO FIT B&G
1 1/4" SHAFT
Replaces: 186862

1 1/4" SHAFT



BP-386A
SEAL KIT TO FIT B&G
1 1/2-2-5
1 1/4" For 3531 Pump
Replaces: 186877

5/8" SHAFT



MS-359
SEAL KIT TO FIT B&G
5/8" SHAFT
Replaces: 180014

SEAL KITS TO FIT B&G

1 1/8" SHAFT



MS-356
SEAL KIT TO FIT B&G
1 1/8" SHAFT
Replaces: DP0476, 180017

The BP-400K and the BP-371K seal kits eliminate expensive machine work such as grinding, refacing and lapping. It also converts cast iron assemblies into brass fitted pumps that can be used for fresh water service. We offer this as a kit or in individual pieces.

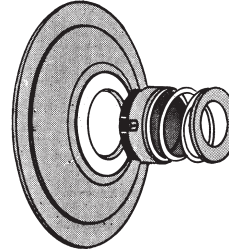

PACKED IN A PLASTIC BAG WITH LABEL

1/12 HP KIT

BP-400K
SEAL KIT WITH BRASS
PLATE TO FIT B&G
1/12 HP CAST IRON
CIRCULATORS
Contains:
1 BP-400 Seal
1 BP-400P Brass Plate
1 BP-400W Brass Washer
1 B-52 Body Gasket
(K-1150)

1/6 HP KIT

BP-371K
SEAL KIT WITH BRASS
PLATE TO FIT B&G
1/6 HP CAST IRON
CIRCULATORS
Contains:
1 BP-400 Seal
1 BP-371P Brass Plate
1 BP-400W Brass Washer
1 B-53 Body Gasket
(K-1151)

BP-400P
BRASS PLATE ONLY
Will Fit 1/12 HP Only

BP-371P
BRASS PLATE ONLY
Will Fit 1/6 HP only

BP-400
SEAL ONLY TO FIT
B&G 1/12 HP CAST IRON
Will Fit 1/12 & 1/6
Brass Plates
(K-1150Y)

BP-400C
CERAMIC FOR
SEAL ONLY
Will Fit 1/12 & 1/6
Brass Plates

BP-400W
BRASS WASHER ONLY

For a complete list of replacement pump seals for other manufacturers please turn to our **Pump Seal OEM Cross Reference** on pages 63-69.

CIRCULATOR PARTS TO FIT B&G

CIRCULATOR PARTS TO FIT BELL & GOSSETT

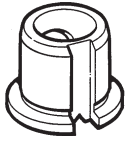

BP-387
FLANGED FRONT BEARING
To fit larger B&G and
Armstrong pumps.
(RM-892)



BP-388
FRONT BEARING
TO FIT B&G
(RM-828)

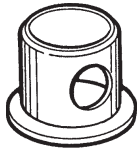

BP-389
FRONT BEARING
TO FIT B&G
Thin Wall
For Late Models
(K-1152)

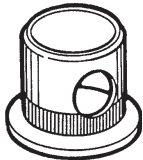

BP-389N
FRONT BEARING
TO FIT B&G
Knurled
(K-1152-N)

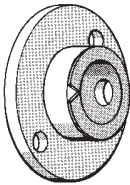

BP-387A
REAR BEARING TO FIT
B&G 1/12HP; ARMSTRONG
S-25
Old #: P4Z-4115
New #: 118697
Arm. #: 816001-000

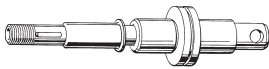

BP-372
PUMP SHAFT & SLEEVE
TO FIT B&G AND ARMSTRONG
Old #: PZ-440C
New #: 189035
Arm. #: 106028-000
(RM-881)



BP-372C
COPPER SLEEVE TO
FIT B&G, ARM. SHAFT
(RM-881-B)



BP-372K
SHAFT KEY TO FIT
B&G, ARM. SHAFT
Old #: P-4138, PO4940
Arm. #: 974507-100
(RM-519)

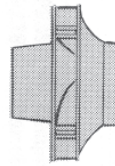

BLACK PLASTIC

BP-372A
PLASTIC IMPELLER FOR
B&G 100, ARM. S-25-1/12th HP
Old #: P4Z-335
New #: 189132
Arm. #: 812961-111
(RM-887-P-A & B)



BP-372N
SHAFT NUT FOR
B&G SHAFT
Old #: P44200
(RM-859)

BP-372W
LOCK WASHER
FOR ABOVE NUT



BP-385
OIL WICK TO FIT B&G
CIRCULATOR BEARING
ASSEMBLIES
Heavy Duty Wool
Replaces: PO4881, B62-2
(RM-506)



BP-385A
SPRING ONLY TO
FIT B&G OIL WELL
COVER ASSEMBLY
(RM-535C)

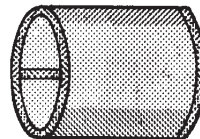

BP-390
PRESSURE REDUCING
VALVE STRAINER
TO FIT B&G
New #: 118036
(K-1276)



ACTUAL SIZE: 1 1/4" OD X 1" ID

B-63
STRAINER GASKET
TO FIT B&G PRESSURE
REDUCING VALVES
(K-1277)

ZOOM SPOUT OILER

Use the high quality turbine oil in SSC's Zoom-Spout Oiler to oil bearing assemblies, electric motors, heaters, blowers, bushings, shafts, air conditioners and home and shop appliances. The handy telescoping pole reaches into hard-to-get places.



ZM-322
ZOOM-SPOUT OILER
4oz. Tubes With
Zoom-Spout

**CAST IRON FLANGES PAINTED RED
TO FIT BELL & GOSSETT**

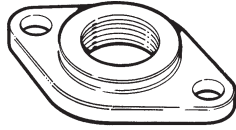

**CAST IRON - PAINTED RED
TO MATCH B&G**

SSC#	SIZE	FLANGE KIT CONTENTS
BP-373	3/4"	2 FLANGES, 4 BOLTS, 4 NUTS
BP-373A	3/4"	2 FLGS., 4 BOLTS, 4 NUTS, 2 T-36 GASK
BP-373B	3/4"	2 FLANGES ONLY
BP-374	1"	2 FLANGES, 4 BOLTS, 4 NUTS
BP-374A	1"	2 FLGS., 4 BOLTS, 4 NUTS, 2 T-36 GASK
BP-374B	1"	2 FLANGES ONLY
BP-375	1 1/4"	2 FLANGES, 4 BOLTS, 4 NUTS
BP-375A	1 1/4"	2 FLGS., 4 BOLTS, 4 NUTS, 2 T-45 GASK
BP-375B	1 1/4"	2 FLANGES ONLY
BP-376	1 1/2"	2 FLANGES, 4 BOLTS, 4 NUTS
BP-376A	1 1/2"	2 FLGS., 4 BOLTS, 4 NUTS, 2 T-45 GASK
BP-376B	1 1/2"	2 FLANGES ONLY

CIRCULATOR FLANGE TOOL

Use this tool to speed up the removal or tightening of circulator flanges.

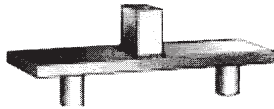

TP-442
CIRCULATOR
FLANGE TOOL
Made of Steel

**GASKET AND BOLT KITS TO FIT
BELL & GOSSETT**

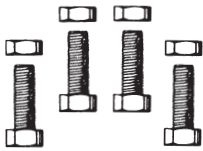

PACKED IN A HANGING PLASTIC
BAG WITH LABEL

BP-392
CIRCULATOR **BOLT KIT** TO
FIT B&G, TACO AND MOST
CIRCULATORS
Contains 4 bolts and 4 nuts.

INCLUDES RED RUBBER GASKETS

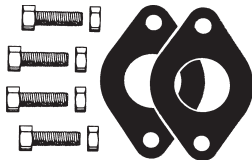

PACKED IN A HANGING PLASTIC
BAG WITH LABEL

BP-393
CIRCULATOR **BOLT &
GASKET KIT** TO FIT
MOST CIRCULATORS
Contains 4 bolts, 4 nuts
and 2 #T-36 gaskets.

CIRC. FLANGES / CIRC. BOLT & GASK. KITS

INCLUDES BLACK RUBBER GASKETS

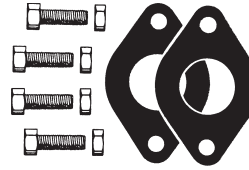

PACKED IN A HANGING PLASTIC
BAG WITH LABEL

BP-393BR
CIRCULATOR **BOLT
& GASKET KIT** WITH
NEOPRENE (BLACK
RUBBER) GASKETS TO
FIT MOST CIRCULATORS
Contains 4 bolts, 4 nuts
and 2 #T-36BR gaskets.



PACKED IN A HANGING PLASTIC
BAG WITH LABEL

BP-391
FLANGE GASKET AND
BOLT KIT TO FIT B&G
100 SERIES CIRCULATORS
Replaces: P64910
Contains 4 bolts, 4 nuts
and 2 B-54 gaskets.



PACKED IN A HANGING PLASTIC
BAG WITH LABEL

BP-396
SET OF 2 CIRCULATOR
FLANGE GASKETS
Contains 2 #T-36 gaskets.



BP-377
CIRCULATOR BEARING
ASSEMBLY TO PUMP
HOUSING BOLT KIT
Fits B&G 100 and Taco 110
4 Bolts Per Bag



BP-378
CIRCULATOR BEARING
ASSEMBLY TO MOTOR
BOLT KIT
Fits B&G 100 and Taco 100
4 Bolts Per Bag

**Use SSC's Website to Find Your Replacement
Parts and Order Online!**

- Place orders online using our shopping cart feature.
- Find your part using our multi-functional search engines.
- Registration is required. This ensures that only wholesalers & rebuilders, not the trade or general public, can see pricing and use the shopping cart.



www.strainerscreen.com

GASKETS TO FIT BELL & GOSSETT

GASKETS TO FIT BELL & GOSSETT

MATERIAL: SMOOTH FINISH RED RUBBER



ACTUAL SIZE: 4" X 2 5/8"

T-36

FLANGE GASKET TO FIT B&G, TACO, GRUNDFOS AND OTHER CIRCULATORS 1/8" Thick Smooth Finish Red Rubber
This will fit the majority of flanges in the field.
(Not for use on H.V. Flange) (GF-219)

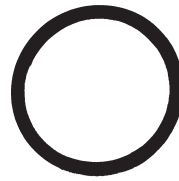

ACTUAL SIZE: 2 9/16" OD
X 2 1/8" ID

B-198

ROUND FLANGE GASKET TO FIT B&G MODELS 1 1/2, HV (HIGH VELOCITY PUMP); ARMSTRONG S-34, H-32
Old #: P-618
New #: 118373
Arm. #: 804034-000

MATERIAL: CLOTH FINISH RED RUBBER



ACTUAL SIZE: 4" X 2 5/8"

T-36CL

T-36 CIRCULATOR FLANGE GASKET IN 1/8" THICK CLOTH FINISH RED RUBBER



ACTUAL SIZE: 4 5/8" X 2 3/4"

B-16

FULL FACED FLANGE GASKET TO FIT B&G MODELS 1 1/2, HV (HIGH VELOCITY PUMP); ARMSTRONG S-34, H-32
Old #: P-618
New #: 118373
Arm. #: 804034-000

MATERIAL: BLACK NEOPRENE RUBBER



ACTUAL SIZE: 4" X 2 5/8"

T-36BR

T-36 CIRCULATOR FLANGE GASKET IN 1/8" THICK NEOPRENE RUBBER (Black Rubber)



ACTUAL SIZE: 2 3/16" OD
X 1 1/4" ID

B-188A

FLANGE GASKET TO FIT B&G LITTLE RED CIRCULATOR LR20 Pump

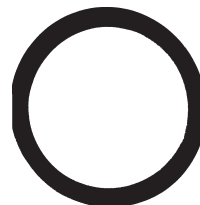

ACTUAL SIZE: 2 15/16" OD
X 2 3/8" ID

B-188

FLANGE GASKET TO FIT B&G 2" CIRCULATORS Fits B&G Pumps 60-14, 60-18 to 60-21; Armstrong H-54, H-66 to H-68
Old #: P-818
New #: 118378
Arm. #: 816117-000

MATERIAL: EPDM (HIGH-TEMP) BLACK RUBBER



ACTUAL SIZE: 4" X 2 5/8"

T-36EP

T-36 CIRCULATOR GASKET IN 1/8" THICK EPDM RUBBER (High-Temp Black Rubber)

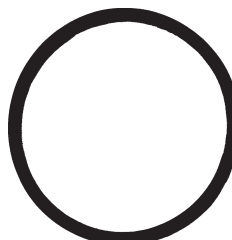

ACTUAL SIZE: 3 7/8" OD
X 3 3/8" ID

B-28

FLANGE GASKET TO FIT B&G MODELS LD3, HD3, PD35, PD37, PD39; ARMSTRONG S-45, S-55, S-57, S-69
Black Rubber-7/32" Thick
Old #: GKT2-1454
New #: 118129
Arm. #: 805201-000 (GB-271)

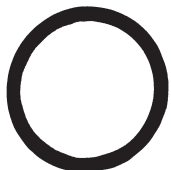

ACTUAL SIZE: 2 1/8" OD
X 1 3/4" ID

B-54

FLANGE GASKET TO FIT B&G MODELS 75 TO 150 (100 SERIES); ARM. S-25
Old #: P-518
New #: 118368
Arm. #: 816653-000 (GB-232)

If you would like to see a life-sized illustration of many of the gaskets listed in this catalog, please contact us and we'll send you our **Gasket Picture Posters** for free. The two posters we offer measure 24" x 36".

GASKETS TO FIT BELL & GOSSETT

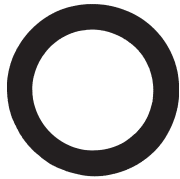

ACTUAL SIZE: 3 5/16" OD
X 2 5/16" ID

B-205
THIN FLANGE GASKET
TO FIT B&G MODEL 2;
ARMSTRONG S-35 WITH
FLAT FLANGE FACE
Old #: F-818
New #: 118065
Arm. #: 805209-000



ACTUAL SIZE: 2 3/4" OD
X 2" ID

B-205A
THICK GASKET TO FIT B&G
MODEL 2; ARMSTRONG
S-35 PUMP WITH
GROOVED FLANGE
Thickness: 1/4"

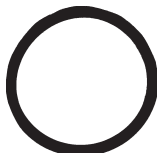

ACTUAL SIZE: 2 9/16" OD
X 2 3/16" ID

B-59
FLANGE GASKET
TO FIT B&G MODEL
80 SERIES
1/6 HP
(GB-253)



ACTUAL SIZE: 1 13/16" OD
X 1 3/8" ID

B-56
FLANGE GASKET
TO FIT B&G MODELS
75 AND 100 MADE
BEFORE 1956
Old #: P3-418
New #: 118351
(GB-237)

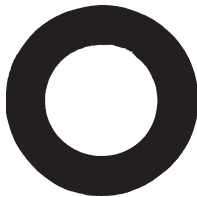

ACTUAL SIZE: 2 1/8" OD
X 1 1/4" ID

B-57
FLANGE GASKET
TO FIT B&G 4 BOLT
BOOSTER MADE
BEFORE 1950
Old #: F-418
New #: 118054
(GB-238)

ARMSTRONG ONLY FLANGE GASKET



ACTUAL SIZE: 2 1/4" OD
X 1 1/2" ID

A-288
FLANGE GASKET
TO FIT ARMSTRONG
H-41, H-51, H-52
Replaces: 805176-000

Please Note: Many B&G parts can be used on
Armstrong circulators and vice versa.

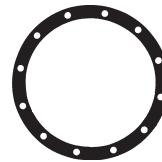

ACTUAL SIZE: 11 1/2" OD
X 9 1/2" ID

A-21
BASE GASKET TO FIT
B&G 1510 PUMP;
ARMSTRONG 4030 PUMP
Also Fits Marlow
(K-1442)

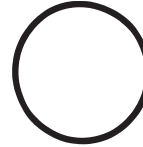

ACTUAL SIZE: 14" OD
X 12 3/4" ID

B-199
BODY GASKET TO FIT
B&G SERIES 1510 PUMPS
Old #: P-57770

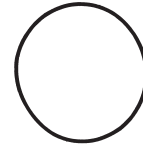

ACTUAL SIZE: 12 3/8" OD
X 11 7/8" ID

B-199A
BODY GASKET TO FIT
B&G SERIES 1510 PUMPS
Old #: P-80765

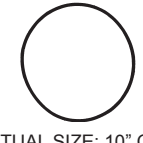

ACTUAL SIZE: 10" OD X
9 1/2" ID

B-200
BODY GASKET TO FIT
B&G SERIES 80 PUMPS
Old #: P-48690

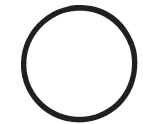

ACTUAL SIZE: 8 7/8" OD
X 8 1/16" ID

B-200A
BODY GASKET
TO FIT B&G 60
SERIES PUMP
Replaces: P-57701

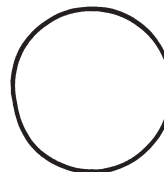

ACTUAL SIZE: 5 7/16" OD
X 5 1/8" ID

B-51
BODY GASKET TO FIT
B&G MODELS PD35,
PD37, 60-11 TO 60-14;
ARMSTRONG MODELS
S-55, S-57, H-51 TO H-54
Old #: PWH1-554
New #: P57410
Arm. #: 106158-000
(GB-229)

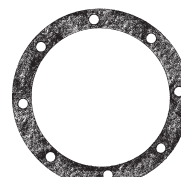

ACTUAL SIZE: 6 7/8" OD
X 5 3/8" ID

B-51A
BODY GASKET WITH
BOLT HOLES TO FIT
B&G 60 SERIES PUMPS
Alternate to #B-51

GASKETS TO FIT B&G / PARTS TO FIT TACO

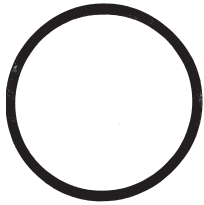

ACTUAL SIZE: 7 7/8" OD
X 7 1/16" ID

B-60
BODY GASKET TO FIT
B&G MODELS PD-39,
60-15 TO 60-21;
ARMSTRONG S-69,
H-63 TO H-68
Old #: PWH-1054
New #: P-57700
Arm. #: 106592-000
(GB-254)

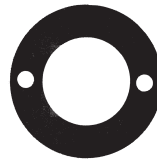

ACTUAL SIZE: 2 13/16" OD
X 1 5/8" ID

B-61
GASKET TO FIT B&G
REAR BEARING
Shim for larger
B&G pumps.
60 Series
(GB-257)

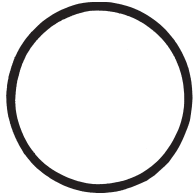

ACTUAL SIZE: 4 5/8" OD
X 4 1/4" ID

B-50
BODY GASKET TO FIT
B&G MODELS 2 1/2, 3LD,
3HD, 1 PR; ARMSTRONG
MODELS S-45, S-46, H-41
Old #: P1-12133
New #: PO5800
Arm. #: 106050-000
(GB-224)

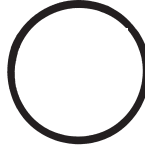

ACTUAL SIZE: 3 1/16" OD
X 2 3/4" ID

B-58
INTERIOR GASKET
TO FIT B&G SERIES
100 ALUMINUM
BOOSTERS
Only for aluminum 1/12 HP.
(GB-251)

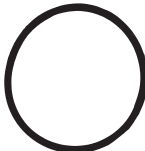

ACTUAL SIZE: 3 7/8" OD
X 3 1/2" ID

B-62
INTERIOR GASKET TO FIT
B&G ALUMINUM MODELS
Fits all aluminum models
except 1/12 HP.
(GB-261)

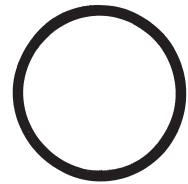

ACTUAL SIZE: 3 7/8" OD
X 3 3/8" ID

B-53
BODY GASKET TO FIT
B&G MODELS 1 1/2, 2,
HV; ARMSTRONG S-34,
S-35, H-32
Fiber-1/32" Thick
Old #: P-4133
New #: PO4890
Arm. #: 106049-000
(GB-231)

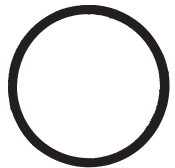

ACTUAL SIZE: 3 1/16" OD
X 2 11/16" ID

B-52
BODY GASKET TO FIT
B&G MODELS 75-150;
ARMSTRONG MODELS S-25
Popularly known as series
100 body gasket.
Old #: P-3133
New #: PO4080
Arm. #: 104442-000
(GB-230)

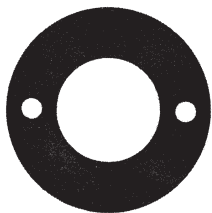

ACTUAL SIZE: 2 3/16" OD
X 1 1/8" ID

B-55
BEARING GASKET (SHIM)
TO FIT B&G MODELS 75 TO
PD-37, 60-11 TO 60-14;
ARMSTRONG MODELS S-25
TO S-57, H-51 TO H-54
Old #: P-455
New #: PO1830
Arm. #: 103408-000
(GB-233)

PARTS TO FIT TACO CIRCULATORS



TP-425
COUPLER TO FIT
TACO 110 CIRCULATOR
1/2" x 3/8" Shaft
Replaces: 110-009RP
(RM-883)

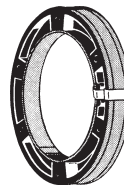

TP-427
MOTOR MOUNTS TO FIT
TACO 110, GE AND
MARATHON
Sold By Set
(RM-838)

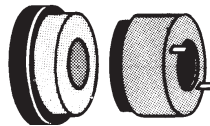

TP-420
WATER SEAL TO FIT
TACO 110 CIRCULATOR
Replaces: 110-275RP
(RM-860)



TP-420C
CERAMIC ONLY FOR
TACO 110 PUMP SEAL

Many Taco parts will fit Econo, Modern and Metal Master circulators.

110 SEAL KIT



TP-420K
WATER SEAL KIT TO FIT
TACO 110, 111, 112, 113,
117 AND 120
Kit includes gaskets and seal.

SKIN-PACKED FOR DISPLAY

1600 SEAL KIT



TP-415
WATER SEAL KIT TO FIT
TACO 121-138, ALL 1600
SERIES, ALL 1900 SERIES
Replaces: 1600-170RP
Kit includes 3 body gaskets,
1 seal, 1 bolt, 1 machined
washer and 1 packet of
lubricant.

SKIN-PACKED FOR DISPLAY



TP-414
SEAL ONLY TO FIT
TACO 1600, 1900
SERIES PUMPS



TP-415B
BOLT ONLY TO FIT
TACO 1600, 1900
SERIES PUMPS
Reverse Thread



TP-415W
WASHER ONLY TO FIT
TACO 1600, 1900
SERIES PUMPS
Machined Steel

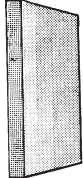

TP-424
FELT OIL WICK
TO FIT TACO 110
CIRCULATOR
(RM-871)

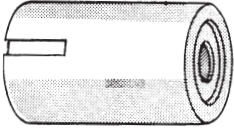

TP-422
STANDARD BEARING
TO FIT TACO 110
CIRCULATOR
1 1/2" Long
(RM-869)

SEAL KITS & PARTS TO FIT TACO



TP-428
OIL RETAINER
TO FIT TACO 110
CIRCULATOR
(RM-872)

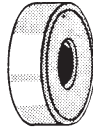

TP-412
OIL SEAL TO FIT TACO
110 CIRCULATOR
(RM-861)



TP-430
SHAFT TO FIT
TACO IMPELLER
4 7/8" Threaded
(K-1162)

TP-433
SHAFT TO FIT
TACO IMPELLER
4 1/2" Not Threaded
(RM-832-A)

TP-431
SHAFT TO FIT
TACO IMPELLER
5 1/2" Threaded
(RM-863)

TP-434
SHAFT TO FIT
TACO IMPELLER
4 3/4" Not Threaded
(K-1163)

TP-432
SHAFT TO FIT
TACO IMPELLER
Standard
4 3/8" Threaded
(RM-862)

TP-426
SHAFT TO FIT
ECONO CIRCULATOR
Knurled
See Econo section
for illustration.
(RM-864)



TP-410
INNER OIL SEAL TO FIT
TACO 110 CIRCULATOR
For Aluminum
Replaces: 110-263RP
(K-1447)



TP-411
OUTER OIL SEAL TO FIT
TACO 110 CIRCULATOR
For Aluminum
Replaces: 110-265RP
(K-1448)

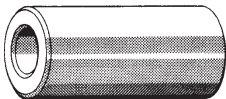

TP-421
BEARING TO FIT TACO
110 CIRCULATOR
For Aluminum
Replaces: 110-273RP
(K-1450)

FLANGES, CIRCULATOR KITS TO FIT TACO

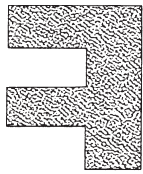

TP-423
CIRCULATOR FELT
PAD TO FIT TACO 110
For Aluminum
Replaces: 110-143RP
(K-1449)



TP-429
SHAFT RETAINER TO FIT
TACO 110 CIRCULATOR
Taco #: 110-111RP
(RM-836)

MOTOR BEARING PULLER

This is a special two armed puller designed to fit behind all pool motor bearings, eliminating the need for bearing puller adapters.

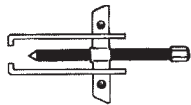

ST-377
MOTOR BEARING PULLER

ZOOM SPOUT OILER



ZM-322
ZOOM-SPOUT OILER
4 oz. Tubes With
Zoom-Spout

CAST IRON FLANGES PAINTED GREEN TO FIT TACO

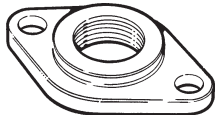

**CAST IRON - PAINTED GREEN
TO MATCH TACO**

SSC#	SIZE	FLANGE KIT CONTENTS
TP-438	3/4"	2 FLANGES, 4 BOLTS, 4 NUTS
TP-438A	3/4"	2 FLGS., 4 BOLTS, 4 NUTS, 2 T-36 GASK
TP-438B	3/4"	2 FLANGES ONLY
TP-439	1"	2 FLANGES, 4 BOLTS, 4 NUTS
TP-439A	1"	2 FLGS., 4 BOLTS, 4 NUTS, 2 T-36 GASK
TP-439B	1"	2 FLANGES ONLY
TP-440	1 1/4"	2 FLANGES, 4 BOLTS, 4 NUTS
TP-440A	1 1/4"	2 FLGS., 4 BOLTS, 4 NUTS, 2 T-45 GASK
TP-440B	1 1/4"	2 FLANGES ONLY
TP-441	1 1/2"	2 FLANGES, 4 BOLTS, 4 NUTS
TP-441A	1 1/2"	2 FLGS., 4 BOLTS, 4 NUTS, 2 T-45 GASK
TP-441B	1 1/2"	2 FLANGES ONLY

CIRCULATOR FLANGE TOOL

Use this tool to speed up the removal or tightening of circulator flanges.

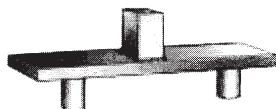

TP-442
CIRCULATOR
FLANGE TOOL
Made of Steel

OPEN IMPELLER WRENCH



ST-361
OPEN IMPELLER WRENCH
Fits all open-faced impellers.

CLOSED IMPELLER WRENCH



ST-362
CLOSED IMPELLER WRENCH
Fits all closed impellers. Has
large handle for leverage.

GASKET AND BOLT KITS TO FIT TACO

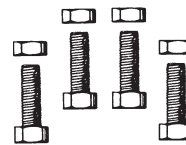

PACKED IN A HANGING PLASTIC
BAG WITH LABEL

BP-392
CIRCULATOR BOLT KIT
TO FIT B&G, TACO AND
MOST CIRCULATORS
Contains 4 bolts & 4 nuts.

INCLUDES RED RUBBER GASKETS

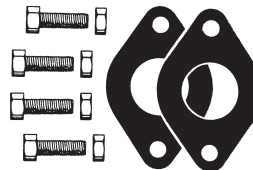

PACKED IN A HANGING PLASTIC
BAG WITH LABEL

BP-393
CIRCULATOR BOLT &
GASKET KIT TO FIT
MOST CIRCULATORS
Contains 4 bolts, 4 nuts
and 2 T-36 gaskets.

INCLUDES BLACK RUBBER GASKETS

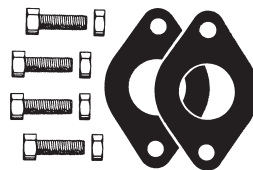

PACKED IN A HANGING PLASTIC
BAG WITH LABEL

BP-393BR
CIRCULATOR BOLT &
GASKET KIT WITH
NEOPRENE (BLACK
RUBBER) GASKETS TO
FIT MOST CIRCULATORS
Contains 4 bolts, 4 nuts
and 2 #T-36BR gaskets.

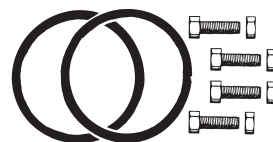





PACKED IN A HANGING PLASTIC
BAG WITH LABEL





TP-435
FLANGE GASKET AND
BOLT KIT TO FIT TACO
110, 007, ETC.
CIRCULATORS
Contains 4 bolts, 4 nuts
and 2 #T-42 gaskets.



PACKED IN A HANGING PLASTIC
BAG WITH LABEL

BP-396
SET OF 2 CIRCULATOR
FLANGE GASKETS
Contains 2 #T-36 gaskets.

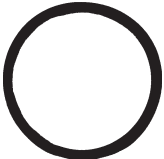
GASKETS TO FIT TACO	
<p>MATERIAL: SMOOTH FINISH RED RUBBER</p>  <p>T-36 FLANGE GASKET TO FIT TACO, B&G, GRUNDFOS AND OTHER CIRCULATORS 1/8" Thick Smooth Finish Red Rubber This will fit a majority of flanges in the field. (GF-219)</p> <p>ACTUAL SIZE: 4" X 2 5/8"</p>	
<p>MATERIAL: CLOTH FINISH RED RUBBER</p>  <p>T-36CL T-36 CIRCULATOR FLANGE GASKET IN 1/8" THICK CLOTH FINISH RED RUBBER</p> <p>ACTUAL SIZE: 4" X 2 5/8"</p>	
<p>MATERIAL: BLACK NEOPRENE RUBBER</p>  <p>T-36BR T-36 CIRCULATOR FLANGE GASKET IN 1/8" THICK NEOPRENE RUBBER (Black Rubber)</p> <p>ACTUAL SIZE: 4" X 2 5/8"</p>	
<p>MATERIAL: EPDM (HIGH-TEMP) BLACK RUBBER</p>  <p>T-36EP T-36 CIRCULATOR FLANGE GASKET IN 1/8" THICK EPDM RUBBER (High-Temp Black Rubber)</p> <p>ACTUAL SIZE: 4" X 2 5/8"</p>	
<p>MATERIAL: SMOOTH FINISH RED RUBBER</p>  <p>T-45 FLANGE GASKET TO FIT TACO, GRUNDFOS 1/8" Thick Smooth Finish Red Rubber Replaces: 110-023RP (GT-218)</p> <p>ACTUAL SIZE: 4" X 2 5/8"</p>	

GASKETS TO FIT TACO	
<p>MATERIAL: CLOTH FINISH RED RUBBER</p>  <p>T-45CL T-45 CIRCULATOR FLANGE GASKET IN 1/8" THICK CLOTH FINISH RED RUBBER</p> <p>ACTUAL SIZE: 4" X 2 5/8"</p>	
<p>MATERIAL: BLACK NEOPRENE RUBBER</p>  <p>T-45BR T-45 CIRCULATOR FLANGE GASKET IN 1/8" THICK NEOPRENE RUBBER (Black Rubber)</p> <p>ACTUAL SIZE: 4" X 2 5/8"</p>	
<p>MATERIAL: EPDM (HIGH-TEMP) BLACK RUBBER</p>  <p>T-45EP T-45 CIRCULATOR FLANGE GASKET IN 1/8" THICK EPDM RUBBER (High-Temp Black Rubber)</p> <p>ACTUAL SIZE: 4" X 2 5/8"</p>	
 <p>T-42 FLANGE GASKET TO FIT TACO 007, 110 PUMPS Black Rubber Replaces: 110-339RP (GT-148)</p> <p>ACTUAL SIZE: 2 1/4" OD X 2" ID</p>	
 <p>T-43 FLANGE GASKET TO FIT TACO OLD STYLE 007 CIRCULATOR Replaces: 110-227RP (GT-149)</p> <p>ACTUAL SIZE: 2 7/16" OD X 1 15/16" ID</p>	
 <p>T-287 FLANGE GASKET TO FIT TACO 0010, 0012, 0013 Replaces: 110-339RP</p> <p>ACTUAL SIZE: 2 7/16" OD X 2 1/16" ID</p>	

GASKETS TO FIT TACO



ACTUAL SIZE: 5 5/8" X 3 5/8"

T-287A
FLANGE GASKET TO FIT
TACO 1400-52
Also fits flange #194-2124 for 2"
and #194-1543 for 1 1/2".



ACTUAL SIZE: 3 3/16" OD
X 2 3/8" ID

T-152
FLANGE GASKET TO
FIT TACO 120 & 1600
CIRCULATORS
Replaces: 1600-169RP



ACTUAL SIZE: 6" X 3 3/8"

T-152A
FULL FACED FLANGE
GASKET TO FIT TACO
120, 1600 CIRCULATORS
Replaces: 1600-169RP



ACTUAL SIZE: 5 1/4" OD
X 2 1/2" ID

T-152B
GASKET TO FIT
TACO 120

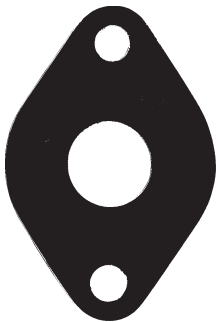

ACTUAL SIZE: 4 1/8" X 2 3/4"

T-286
FLANGE GASKET TO FIT
TACO SHUT-OFF VALVE
Material: Smooth Red Rubber
Replaces: 254 for 3/4", 255
for 1", 256 for 1 1/4"

T-286N
FLANGE GASKET TO FIT
TACO SHUT-OFF VALVE
Material: Neoprene
(Black Rubber)
Replaces: 254 for 3/4",
255 for 1", 256 for 1 1/4"

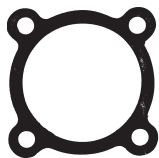

ACTUAL SIZE: 3 9/16" OD
X 2 15/16" ID

T-44
BODY GASKET TO FIT
TACO 110, 112, 117
Commonly For Aluminum
Replaces: 110-364RP
(GT-172)

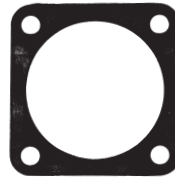

ACTUAL SIZE: 3 5/8" X 3 5/8"

T-41
BODY GASKET TO
FIT TACO 110 PUMP
Also fits Econo, Modern
and Metalmaster.
Commonly for cast iron.
Replaces: 110-364RP
(GF-210)

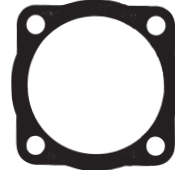

ACTUAL SIZE: 4 7/16" OD
X 3 9/16" ID

T-47
BODY GASKET
TO FIT TACO HC
(GT-235)

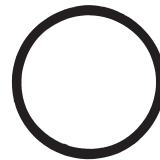

ACTUAL SIZE: 4 1/4" OD
X 3 11/16" ID

T-46
BODY GASKET TO FIT
TACO HDH, 111, 113, 120
Replaces: 120-009RP



ACTUAL SIZE: 2 3/8" OD
X 1 15/16" ID

T-48
BODY GASKET (O-RING) TO
FIT TACO 006, 007 PUMPS
Replaces: 007-003RP
(GT-262)

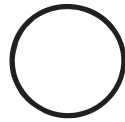

ACTUAL SIZE: 2 3/8" OD
X 1 15/16" ID

T-49
BODY GASKET (O-RING) TO
FIT TACO 005, 008 PUMPS
Replaces: 008-005RP
(GT-263)

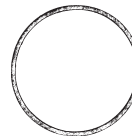

ACTUAL SIZE: 5 1/8" OD
X 4 3/4" ID

T-183
BODY GASKET TO FIT
TACO 1600 SERIES PUMPS
Part of #1600-170 (TP-415)
Seal Kit.



ACTUAL SIZE: 7 1/8" OD
X 6 1/2" ID

T-184
BODY GASKET TO FIT
TACO 1600 SERIES PUMPS
Part of #1600-170 (TP-415)
Seal Kit.



ACTUAL SIZE: 8 1/2" OD X 8" ID

T-196
BODY GASKET TO FIT
TACO 1600 SERIES PUMPS
Part of #1600-170 (TP-415)
Seal Kit.

If you would like to see a life-sized illustration of many of the gaskets listed in this catalog, please contact us and we'll send you our **Gasket Picture Posters** for free. The two posters we offer measure 24" x 36".

**GASKET AND SHAFT TO FIT
ECONO CIRCULATORS**

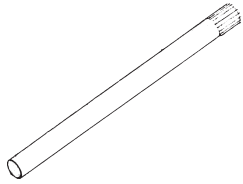

TP-426
SHAFT TO FIT ECONO
CIRCULATOR
Knurled, Stainless Steel
(RM-864)



ACTUAL SIZE: 3 5/8" X 3 5/8"

E-26
FLANGE GASKET TO FIT
ECONO CIRCULATORS
(GE-217)

GASKETS TO FIT THRUSH CIRCULATOR



ACTUAL SIZE: 3 1/2" X 3 1/2"

T-201A
GASKET TO FIT THRUSH
CIRCULATOR
Replaces: TJ-046-00A
(K-1329)



ACTUAL SIZE: 4" OD X 3" ID

T-201B
GASKET TO FIT THRUSH
CIRCULATOR
Replaces: TJ-010-000
(K-1360)

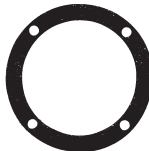

ACTUAL SIZE: 4 3/4" OD
X 3 11/16" ID

T-201C
GASKET TO FIT THRUSH
CIRCULATOR
Replaces: TJ-001-00
(K-1361)



ACTUAL SIZE: 5 7/16" OD
X 4" ID

T-201D
GASKET TO FIT THRUSH
CIRCULATOR
Replaces: TJ-012-00A
(K-1362)

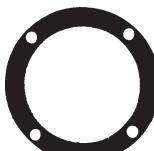

ACTUAL SIZE: 4 1/2" OD
X 3 3/8" ID

T-201E
GASKET TO FIT THRUSH
CIRCULATOR
Replaces: TJ-001-00A
(K-1363)

PARTS TO FIT ECONO & THRUSH



ACTUAL SIZE: 4 3/4" OD
X 4" ID

T-201F
GASKET TO FIT THRUSH
CIRCULATOR
Replaces: TJ-043-000

**WATER SEALS TO FIT
THRUSH CIRCULATOR**

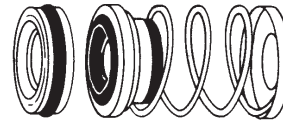

TP-417
SEAL TO FIT THRUSH
CIRCULATOR
HVC
Fits 7/16" Shaft

TP-418
SEAL TO FIT THRUSH
CIRCULATOR
GT
Fits 1/2" Shaft

**COUPLERS TO FIT THRUSH AND
GLOBE CIRCULATORS**

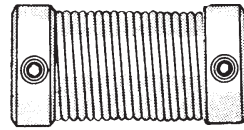

TP-437
COUPLER TO FIT
THRUSH CIRCULATOR
Model #26
1/2" x 7/16" Bore
1 3/4" Long
(RM-510)

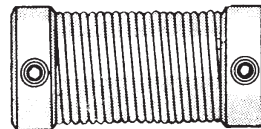

TP-436
COUPLER TO FIT
GLOBE CIRCULATOR
1/2" x 1/2" Bore
2" Long
(RM-531)

**GASKETS TO FIT
SUNDSTRAND CIRCULATOR**



ACTUAL SIZE: 4 3/16" X 2 1/2"

S-283
FLANGE GASKET TO
FIT SUNDSTRAND
CIRCULATOR
Replaces: 5478051
(GS-157)

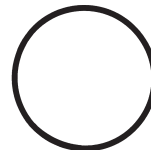

ACTUAL SIZE: 2 7/8" OD
X 2 5/8" ID

S-283A
BODY O-RING TO FIT
SUNDSTRAND CIRCULATOR
Replaces: 5479021
(GS-158)

GASKETS TO FIT GRUNDFOS, WATTS

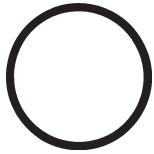

ACTUAL SIZE: 2" OD
X 1 3/4" ID

S-283B
O-RING TO FIT
SUNDSTRAND
CIRCULATOR ROTOR
(GS-159)



ACTUAL SIZE: 1 1/16" OD
X 7/8" ID

S-283C
GASKET TO FIT SUNDSTRAND
CIRCULATOR INDICATOR
Replaces: 5477081
(GS-161)



ACTUAL SIZE: 1 3/8" OD X 1" ID

W-23
GASKET TO FIT WATTS
BACKFLOW PREVENTER
Old Style
9D



ACTUAL SIZE: 1 3/16" OD
X 13/16" ID

W-22
GASKET TO FIT WATTS
PRESSURE REDUCING
VALVE
Old Style Valve
S1156F

GASKETS TO FIT GRUNDFOS



ACTUAL SIZE: 4" X 2 5/8"

T-36
FLANGE GASKET TO FIT
GRUNDFOS, TACO, B&G,
ETC. CIRCULATORS
Smooth Red Rubber
(GF-219)



ACTUAL SIZE: 1 1/8" OD
X 11/16" ID

W-22A
GASKET TO FIT NEW
STYLES OF WATTS
PRESSURE REDUCING
VALVES AND BACKFLOW
PREVENTERS
1/2" S1156F
1/2" 9DSM3

Please Note: The W-22A is used on the majority of backflow preventers and pressure reducing valves out in the field. A good strategy is to stock all three SSC nut gaskets to fit Watts, with a majority of W-22A.



ACTUAL SIZE: 3 7/8" X 2 3/8"

G-20
ISOLATIONAL FLANGE
GASKET TO FIT GRUNDFOS
SHUT-OFF VALVE
Black Neoprene Rubber
SST-SF
Fits K-2197, K-2180 &
K-2181 Flanges



ACTUAL SIZE: 2 1/2" OD
X 2 1/8" ID

G-20HV
FLANGE GASKET TO FIT
GRUNDFOS HIGH VELOCITY
(HV) PUMP FLANGES
Fits Flange #539615

GASKET TO FIT VALLIANT BOILER



ACTUAL SIZE: 5" X 3 5/8"

V-291
BOTTOM RETURN YOKE
FLANGE GASKET TO FIT
VALLIANT BOILER

GASKETS TO FIT WATTS

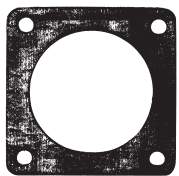

ACTUAL SIZE: 3 1/16" X 3 1/16"

W-24
BODY GASKET TO FIT
WATTS LOW WATER
CUT-OFF
Used In: 93A, 89A,
101A, 193A
(GM-123)



ACTUAL SIZE: 4 7/8" OD
X 3 15/16" ID

W-25
BODY GASKET TO FIT
WATTS CIRCULATORS
(W-1000-G)

See pages 73-77 for our line of Pressure, Vacuum and Compound Gauges. We also have Liquid Filled Gauges, Water Test Gauges, Fire Sprinkler Gauges, Gas Test Gauges, Low Pressure Diaphragm Gauges, Thermometers and Tridicators.

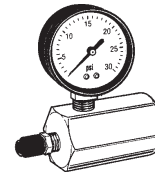
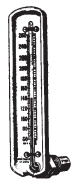

TANKLESS HEATER GASKETS

Most SSC tankless heater gaskets are available in the following materials: Red Rubber, Neoprene (black rubber) and EPDM which is black rubber of high quality - excellent for higher heat and steam applications. Please see our price list or website for details.

Outside measurements are used.



ACTUAL SIZE: 5" X 12 1/4"

T-155

Will Fit:

Burnham V-1, V-7, V-9
New Yorker CLW Water, CLS
Steam



ACTUAL SIZE: 8 1/2" X 12 1/2"

T-156

Will Fit:

Burnham Fiesta FT, Fiesta II,
Liberty, Yellow Jacket

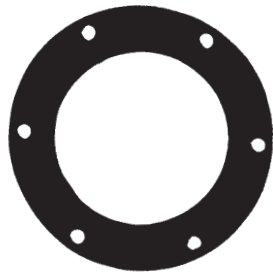

ACTUAL SIZE: 8" OD

T-157

Will Fit:

American Arcoleader
Amstel 32
Burnham Jubilee 200, Patriot
Freedom 6 VP-V3-PF
Crown Montego
Dunkirk Lexington, Lex Pak DF
H.B. Smith OHB 13 Water
Memco
Peerless WBV Water
Portmar-Norse-Delta
Texaco Water
Thermo Dynamics VTF, CWL, S
Weil McLain Gold 65-66-68
Steam
York-Shipley Levitown Boiler

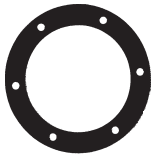

ACTUAL SIZE: 8 1/4" OD
X 6" ID

T-157A

Will Fit:

Peerless JO-JOT (PF), LC, WB



ACTUAL SIZE: 5 1/16" X 9 15/16"

T-157B

Will Fit:

Peerless ECT Side Coil,
WBV Steam



ACTUAL SIZE: 6 1/4" X 11 3/4"

T-158

Will Fit:

Crown Bon-Air ULT, Bahama
Dunkirk ULT
Ultimate ULT



ACTUAL SIZE: 4" X 9 1/2"

T-159

Will Fit:

New Yorker AP580, 660, I-224,
V295, 112, 125

TANKLESS HEATER GASKETS



ACTUAL SIZE: 7" X 8"

T-160

Will Fit:

New Yorker NY



ACTUAL SIZE: 8 1/4" X 7 1/2"

T-160A

Will Fit:

Burnham RSA
New Yorker 6 & 10 Bolt Hole



ACTUAL SIZE: 5 1/4" X 13 1/2"

T-161

Will Fit:

Utica Starfire OU, UST



ACTUAL SIZE: 6 1/2" X 17"

T-162

Will Fit:

Dunkirk 13 Steam
H.B. Smith 50B Steam
Texaco Steam
Utica GU



ACTUAL SIZE: 5 3/4" X 11 1/4"

T-163

Will Fit:

Weil McLain 94 Supply Outlet



ACTUAL SIZE: 6 1/2" X 10 1/2"

T-164

Will Fit:

Utica POBT, B-C, STS, Starfire
II-III Steam



ACTUAL SIZE: 7 1/2" X 7 1/2"

T-165

Will Fit:

Trianco TR



ACTUAL SIZE: 6 1/4" X 14 1/4"

T-166

Will Fit:

Peerless JO-JOT (PE)



ACTUAL SIZE: 5 1/4" X 13"

T-167

Will Fit:

Gilbralter Rectangular



ACTUAL SIZE: 6" X 10"

T-168

Will Fit:

Weil McLain 65-66-68-EG
Steam, 76, 86, 88 Steam

Check out our Tankless Heater Gasket **cross reference chart** on page 49.

TANKLESS HEATER GASKETS

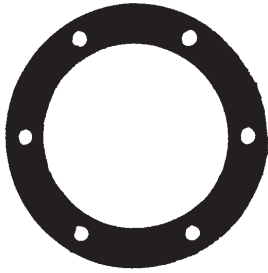

ACTUAL SIZE: 7 - 7 1/2" OD

T-169
Will Fit:
 American V-3, A-3, FRA-3, PFA-3,
 G-2, G-40
 Burnham Jubilee 100, Holiday
 6-72 Gas, Pacemaker
 Holiday 60-61
 Columbia GSFH
 Crane 2-8-111-12, 202, 300, 302
 Crown Tobago
 Gilbralter
 Hydrotherm Aquarius
 National-U.S. 17-18, 70-101-109-
 209-300
 Slant Fin Vantage II, Futura,
 Liberty Water
 Thatcher G-OP
 Utica Starfire II Water STW
 Valliant VA
 Weil McLain 65-66-68 EG Eater,
 42-62 Water

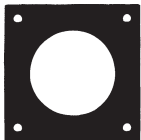

ACTUAL SIZE: 7 3/4" X 7 3/4"

T-170
Will Fit:
 H.B. Smith FD-12



ACTUAL SIZE: 8 1/8" X 15 5/16"

T-171
Will Fit:
 Slant Fin Liberty Steam (LS)



ACTUAL SIZE: 6 1/2" X 12"

T-172
Will Fit:
 H.B. Smith SS



ACTUAL SIZE: 6 1/2" X 17 1/2"

T-173
Will Fit:
 National-U.S. Sunray 4-19
 Thatcher O.C. T-194-198

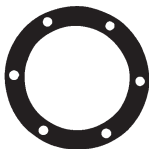

ACTUAL SIZE: 6" OD

T-174
Will Fit:
 Crane 15-26
 Crown Energy Pak (CEP)
 Hydrotherm VO-WT Water
 Koven-V&E-Pietro-O.B.N.



ACTUAL SIZE: 6" X 11"

T-175
Will Fit:
 Burnham RSM, RS

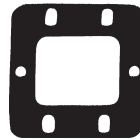

ACTUAL SIZE: 7 3/8" X 7 5/8"

T-176
Will Fit:
 Federal GFS & SDF



ACTUAL SIZE: 6" X 17"

T-176A
Will Fit:
 Federal FVW



ACTUAL SIZE: 6" X 13 3/8"

T-177
Will Fit:
 Thermo Dynamics CWL

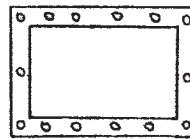

ACTUAL SIZE: 6 1/2" X 7 3/4"

T-902
Will Fit:
 American Arcoliner Wide Back

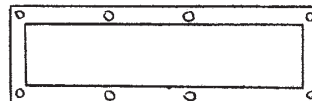

ACTUAL SIZE: 4 1/2" X 14 1/2"

T-903
Will Fit:
 American A-5, FRA-5 Water
 Only

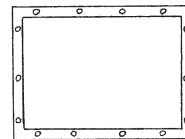

ACTUAL SIZE: 10" X 13 1/2"

T-904
Will Fit:
 American Exbrook

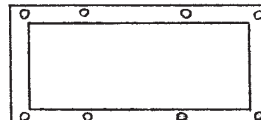

ACTUAL SIZE: 5 1/2" X 12"

T-905
Will Fit:
 American G-10 - Water Only

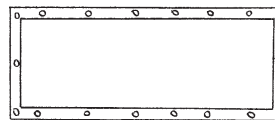

ACTUAL SIZE: 8" X 19 1/2"

T-906
Will Fit:
 American Oakmont 8-11 - Cast
 Iron Shell

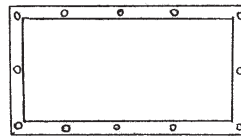

ACTUAL SIZE: 7 1/2" X 13 1/2"

T-908
Will Fit:
 American Severn - Extended
 Shell

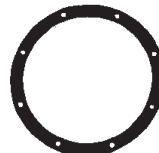

ACTUAL SIZE: 10 1/2" DIAMETER

T-909
Will Fit:
 Burnham Holiday 70-80-81,
 Packing FR

If we are missing the gasket you need, let us know and we'll tool up for it.

TANKLESS HEATER GASKETS

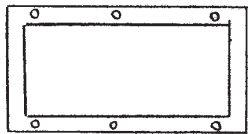

ACTUAL SIZE: 5 3/4" X 11"

T-910
Will Fit:
 Burnham PF-5,
 American PFA-5

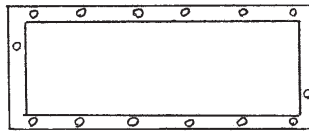

ACTUAL SIZE: 6 1/2" X 16"

T-920
Will Fit:
 H.B. Smith 1100-1500 Flange
 Type

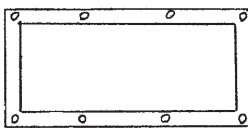

ACTUAL SIZE: 6 3/16" X 12 3/8"

T-911
Will Fit:
 Burnham V11

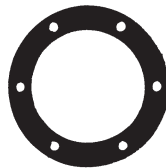

ACTUAL SIZE: 12" OD

T-921
Will Fit:
 H.B. Smith OB-14, BB-14

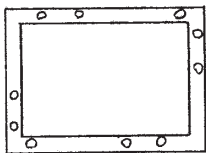

ACTUAL SIZE: 7" X 9 3/4"

T-912
Will Fit:
 Burnham Yellow Jacket

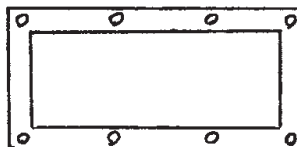

ACTUAL SIZE: 4 3/4" X 10"

T-922
Will Fit:
 Hydrotherm OS-SO2

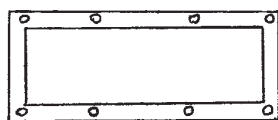

ACTUAL SIZE: 5" X 12 1/4"

T-914
Will Fit:
 Crown Kingston

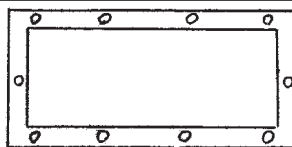

ACTUAL SIZE: 5 1/4" X 11 1/4"

T-923
Will Fit:
 Hydrotherm VOA - Steam,
 VGA

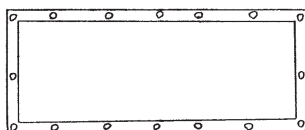

ACTUAL SIZE: 8 3/4" X 20"

T-915
Will Fit:
 Delco DB 3-4-5 Shell Type

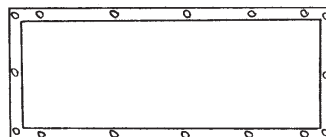

ACTUAL SIZE: 8 1/4" X 20"

T-924
Will Fit:
 National - U.S.-2-9-16-16C-
 20-25-28-32-Cast Iron Shell

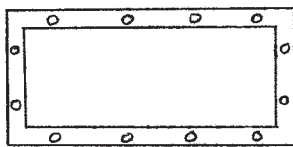

ACTUAL SIZE: 5 3/4" X 12"

T-916
Will Fit:
 Delco DB 3-4-5 Shell Type



T-925
Will Fit:
 National - U.S.-10-15-27-37-
 47, 100-200-300-400
 Crane 21-31-41

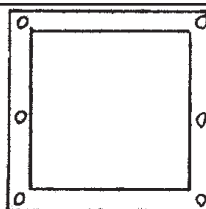

ACTUAL SIZE: 7 1/4" X 7 1/4"

T-917
Will Fit:
 H.B. Smith Series 8 Steam -
 4 or 5 GPM only

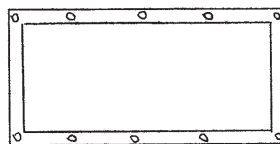

ACTUAL SIZE: 7 3/4" X 15 3/4"

T-926
Will Fit:
 National - U.S.-109SS-SW,
 200SS-SW
 Crane 20255-SW

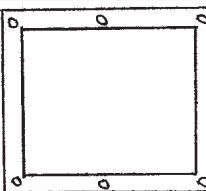

ACTUAL SIZE: 7 1/2" X 8 1/2"

T-918
Will Fit:
 H.B. Smith 28 Steam Boilers

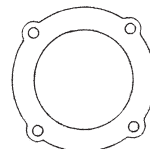

ACTUAL SIZE: 6" OD

T-927
Will Fit:
 Crane 15-26

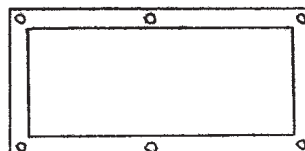

ACTUAL SIZE: 5 3/4" X 12"

T-919
Will Fit:
 H.B. Smith 18-19 Series

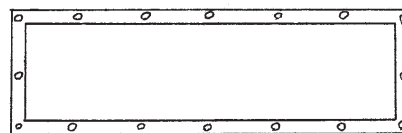

ACTUAL SIZE: 7" X 22 1/2"

T-928
Will Fit:
 National - U.S.-12-12W Flange
 Type

TANKLESS HEATER GASKETS

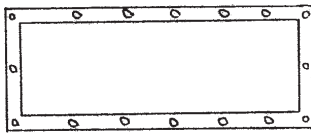

T-929
Will Fit:
 National - U.S. - Sunray
 1-3-46

ACTUAL SIZE: 6 1/2" X 16 1/4"

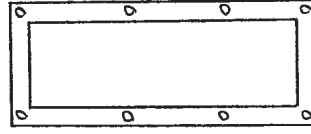

T-941
Will Fit:
 Slant Fin 78

ACTUAL SIZE: 5" X 12 1/2"

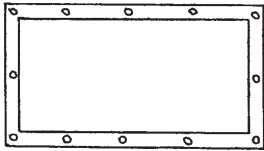

T-930
Will Fit:
 Crane 14-20

ACTUAL SIZE: 7 1/2" X 13 1/2"

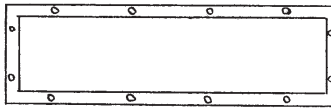

T-942
Will Fit:
 Thatcher 015 Thru 020

ACTUAL SIZE: 6" X 20 1/4"

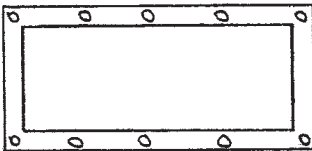

T-931
Will Fit:
 Crane 16

ACTUAL SIZE: 5 1/2" X 12"

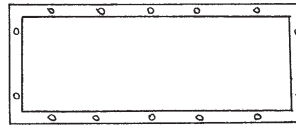

T-943
Will Fit:
 Thatcher 56 Series

ACTUAL SIZE: 7 3/4" X 19"

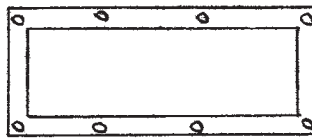

T-932
Will Fit:
 National - U.S. - Crane 73,
 70SS-SW

ACTUAL SIZE: 5 1/2" X 12 1/2"

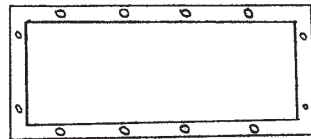

T-944
Will Fit:
 Thatcher 525 Series

ACTUAL SIZE: 6 1/4" X 14 1/4"

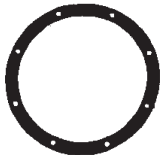

T-933
Will Fit:
 National - U.S. - Crane 80

ACTUAL SIZE: 11 3/4" OD

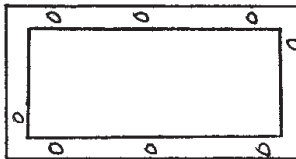

T-946
Will Fit:
 Weil McLain 80, 78 Series

ACTUAL SIZE: 5 1/4" X 10 1/8"

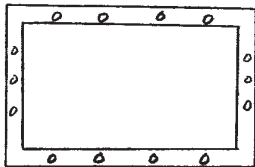

T-935
Will Fit:
 Peerless HEO Steam or
 Water

ACTUAL SIZE: 7 1/4" X 11"

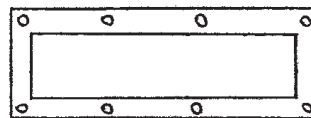

T-947
Will Fit:
 Weil McLain LG Steam

ACTUAL SIZE: 4" X 11 1/2"

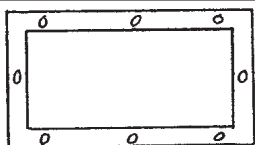

T-937
Will Fit:
 Peerless WBV Steam

ACTUAL SIZE: 5 9/16" X 9 7/8"

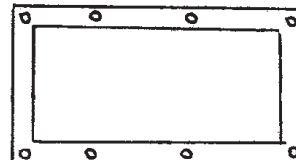

T-948
Will Fit:
 Weil McLain E Steam
 Boilers

ACTUAL SIZE: 5 3/4" X 10 3/4"

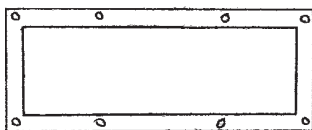

T-938
Will Fit:
 Rheem G-O-PO
 Richmond RWA, H-WFD-R-
 RW-PR

ACTUAL SIZE: 5 1/4" X 13 1/2"



T-949
Will Fit:
 Weil McLain 62 Steam

ACTUAL SIZE: 5 1/4" X 8 3/4"

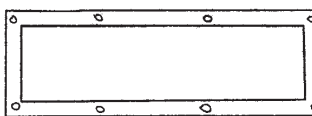

T-939
Will Fit:
 Rheem G-O-PO
 Richmond RWA, H-WFD-R-
 RW-PR

ACTUAL SIZE: 5 1/4" X 15 1/2"

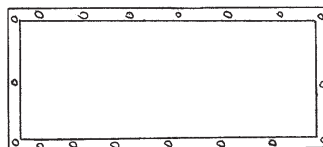

T-950
Will Fit:
 Weil McLain 57-77, 78-B5
 Cast Iron Shell

ACTUAL SIZE: 8 3/4" X 20"

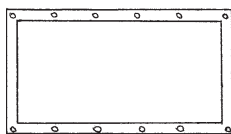

T-940
Will Fit:
 Slant Fin Galaxy Malibu

ACTUAL SIZE: 8 3/4" X 15 3/4"

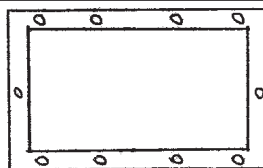

T-951
Will Fit:
 Weil McLain 72-73

ACTUAL SIZE: 6 1/4" X 10 1/4"

TANKLESS HEATER GASKETS

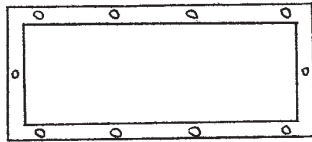

ACTUAL SIZE: 6" X 14"

T-952
Will Fit:
Weil McLain 82-84

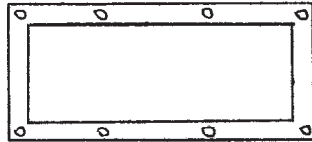

ACTUAL SIZE: 5 1/4" X 11 3/4"

T-953
Will Fit:
Weil McLain OB-15

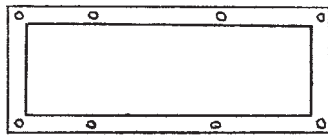

ACTUAL SIZE: 5 1/4" X 13 1/2"

T-954
Will Fit:
Weil McLain OB-18

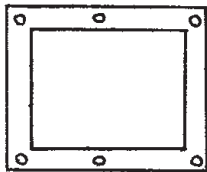

ACTUAL SIZE: 5 3/4" X 7"

T-955
Will Fit:
Weil McLain 92-94K

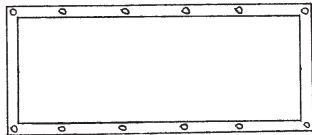

ACTUAL SIZE: 8 1/2" X 20"

T-956
Will Fit:
Weil McLain H Gas

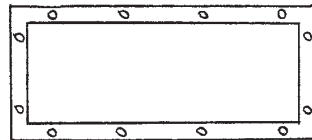

ACTUAL SIZE: 6 1/4" X 14 1/4"

T-957
Will Fit:
Williams-Winkler-Stewart
Warner Oilomatic

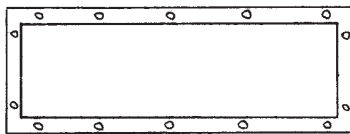

ACTUAL SIZE: 6 1/4" X 17 1/2"

T-958
Will Fit:
Williams-Winkler-Stewart
Warner Oilomatic

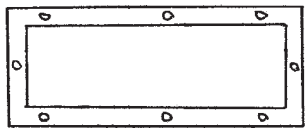

ACTUAL SIZE: 5" X 12 1/2"

T-959
Will Fit:
Crotty

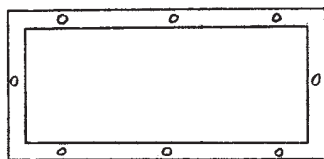

ACTUAL SIZE: 6 1/4" X 13 1/2"

T-960
Will Fit:
Zambelli

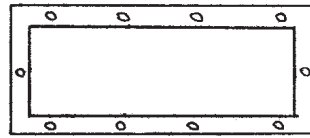

ACTUAL SIZE: 5" X 12"

T-961
Will Fit:
Gent-Janitor

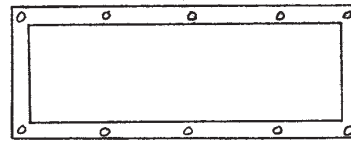

ACTUAL SIZE: 6" X 16"

T-962
Will Fit:
Diesel-Plymouth

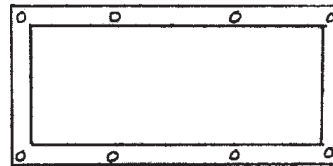

ACTUAL SIZE: 6" X 12 1/2"

T-963
Will Fit:
Edwards

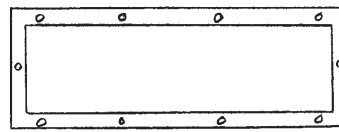

ACTUAL SIZE: 6" X 17"

T-964
Will Fit:
Federal FC-FD-FLR-FM-
FCA-FM2
Portmar-Windsor

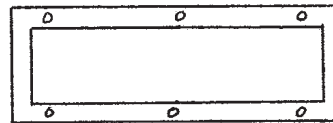

ACTUAL SIZE: 4 3/8" X 13"

T-965
Will Fit:
Fitzgibbons 400
Chrysler Airtemp
Percoflash

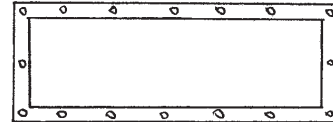

ACTUAL SIZE: 6" X 16 1/2"

T-967
Will Fit:
Iron Fireman
Fairbanks Morse
Utica-Torrid Heat

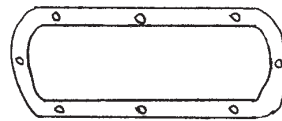

ACTUAL SIZE: 5" X 12 1/2"

T-968
Will Fit:
Kewanee R

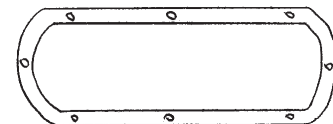

ACTUAL SIZE: 6 1/4" X 15 1/2"

T-969
Will Fit:
Kewanee 3R

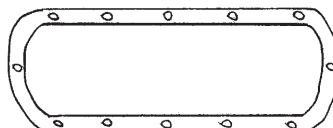

ACTUAL SIZE: 6 1/4" X 15 1/2"

T-970
Will Fit:
Kewanee 83R

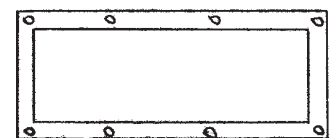

ACTUAL SIZE: 6 1/2" X 13 1/2"

T-971
Will Fit:
Koven
Delco
Paragon V&E

All of our Tankless Gaskets are available in **Red Rubber, Neoprene Rubber & EPDM Rubber.** Please see our price list or website for details.

TANKLESS HEATER GASKETS

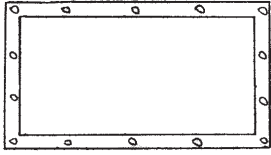

ACTUAL SIZE: 8" X 14 1/4"

T-972
Will Fit:
Koven Deluxe

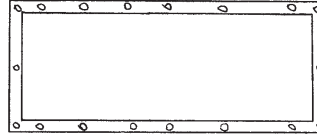

ACTUAL SIZE: 8" X 14 1/4"

T-984
Will Fit:
Cast Iron Boilers - 16 Bolts

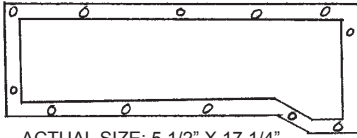

ACTUAL SIZE: 5 1/2" X 17 1/4"

T-973
Will Fit:
National-Pacific Series 200
Thru 700

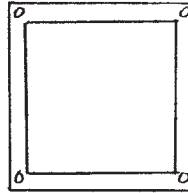

ACTUAL SIZE: 7 3/4" X 7 3/4"

T-985
Will Fit:
Hydrotherm PB150-180
Water

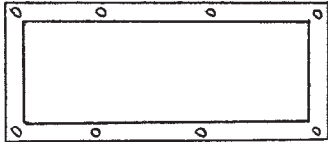

ACTUAL SIZE: 5 3/4" X 13 1/2"

T-974
Will Fit:
Percoflash

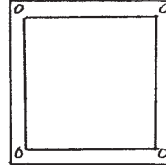

ACTUAL SIZE: 7 1/4" X 7 1/4"

T-986
Will Fit:
Hydrotherm PB150-180
Steam

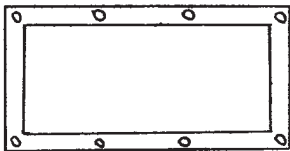

ACTUAL SIZE: 6" X 12"

T-975
Will Fit:
Fitzgibbons RZU JUR-80-
200-400

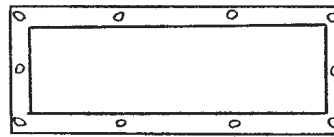

ACTUAL SIZE: 5" X 13"

T-988
Will Fit:
Trianco TOC

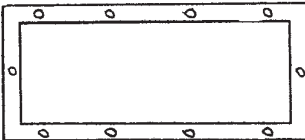

ACTUAL SIZE: 6" X 13 1/2"

T-977
Will Fit:
Columbia GEM

TANKLESS HEATER BOLT AND NUT

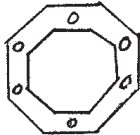

ACTUAL SIZE: 6" X 7"

T-978
Will Fit:
Axeman Anderson AA



T-178B
TANKLESS HEATER BOLT

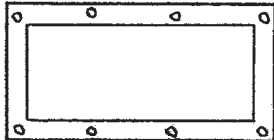

ACTUAL SIZE: 4" X 8 1/8"

T-979
Will Fit:
Axeman Anderson PVT



T-178N
TANKLESS HEATER NUT
Brass

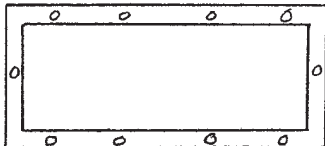

ACTUAL SIZE: 6" X 13 1/2"

T-980
Will Fit:
Burnham CB, PENN

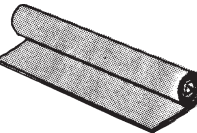

Specifically sized for replacing gaskets on tankless heaters, these packages of gasketing material are rolled and bagged or shrink-wrapped for protection. Red Rubber, Neoprene and EPDM are the materials to choose from.

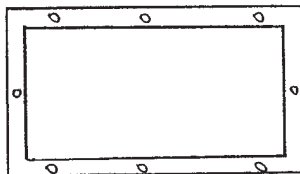

ACTUAL SIZE: 7" X 12 1/4"

T-982
Will Fit:
Columbia Emerald

SSC#	MATERIAL	SIZE
GS-3E	RED RUBBER	12" x 24" x 1/8" TH
GS-3F	RED RUBBER	18" x 36" x 1/8" TH
GS-10TA	NEOPRENE	12" x 24" x 1/8" TH
GS-10TB	NEOPRENE	12" x 24" x 1/4" TH
GS-10TC	NEOPRENE	18" x 36" x 1/8" TH
GS-10TD	NEOPRENE	18" x 36" x 1/4" TH
GS-11J	EPDM	12" x 24" x 1/8" TH
GS-11K	EPDM	12" x 24" x 1/4" TH
GS-11L	EPDM	18" x 36" x 1/8" TH
GS-11M	EPDM	18" x 36" x 1/4" TH

Check out our Tankless Heater Gasket **cross reference chart** on page 49.

TANKLESS GASKETS CROSS REF. CHART

FITS OEM	TANKLESS HEATER MODEL	SSC#	FITS OEM	TANKLESS HEATER MODEL	SSC#
AMERICAN	AMERICAN A-5, FRA-5-WATER ONLY	T-903	KOVEN	KOVEN-DELCO-PARAGON V&E	T-971
AMERICAN	AMERICAN ARCOLLEADER	T-157	KOVEN	KOVEN-DELUXE	T-972
AMERICAN	AMERICAN ARCOLINER WIDE BACK	T-902	KOVEN	KOVEN-V&E-PIETRO-O.B.N.	T-174
AMERICAN	AMERICAN EXBROOK	T-904	MEMCO	MEMCO	T-157
AMERICAN	AMERICAN G-10-WATER ONLY	T-905	NATIONAL	NATIONAL-U.S. SUNRAY 4-19	T-173
AMERICAN	AMERICAN OAKMONT 8-11-CAST IRON SHELL	T-906	NATIONAL-PACIFIC	NATIONAL-PACIFIC SERIES 200 THRU 700	T-973
AMERICAN	AMERICAN PFA-5	T-910	NATIONAL-U.S.	CRANE 15-26	T-927
AMERICAN	AMERICAN SEVERN-EXTENDED SHELL	T-908	NATIONAL-U.S.	NATIONAL-U.S. 17-18, 70-101-109-209-300	T-169
AMERICAN	AMERICAN V-3, A-3, FRA-3, PFA-3, G-2, G-40	T-169	NATIONAL-U.S.	NATIONAL-U.S.-10-15-27-37-47, 100-200-300-400;	T-925
AMSTEL	AMSTEL 732	T-157		CRANE 21-31-41	
AXEMAN ANDERSON	AXEMAN ANDERSON AA	T-978	NATIONAL-U.S.	NATIONAL-U.S.-109SS-SW, 200SS-SW,	T-926
AXEMAN ANDERSON	AXEMAN ANDERSON PVT	T-979		CRANE 20255-SW	
BURNHAM	BURNHAM CB, PENN	T-980	NATIONAL-U.S.	NATIONAL-U.S.-12-12W FLANGE TYPE	T-928
BURNHAM	BURNHAM FIESTA FT, FIESTA II, LIBERTY, YELLOW JACKET	T-156	NATIONAL-U.S.	NATIONAL-U.S.-2-9-16-16C-20-25-28-32-CAST IRON SHELL	T-924
BURNHAM	BURNHAM HOLIDAY 70-80-81, PACKING FR	T-909	NATIONAL-U.S.	NATIONAL-U.S.-SUNRAY 1-3-46	T-929
BURNHAM	BURNHAM JUBILEE 100, HOLIDAY 6-72 GAS, PACEMAKER HOLIDAY 60-61	T-169	NATIONAL-U.S.-CRANE	NATIONAL-U.S.-CRANE-73, 70SS-SW	T-932
BURNHAM	BURNHAM JUBILEE 200, PATRIOT FREEDOM 6 VP-V3-PF	T-157	NATIONAL-U.S.-CRANE	NATIONAL-U.S.-CRANE-80	T-933
BURNHAM	BURNHAM PF-5	T-910	NEW YORKER	NEW YORKER AP580, 660, I-224, V295,112, 125	T-159
BURNHAM	BURNHAM RSA, NEW YORKER 6&10 BOLT HOLE	T-160A	NEW YORKER	NEW YORKER CLW-WATER, CLS STEAM	T-155
BURNHAM	BURNHAM RSM, RS	T-175	NEW YORKER	NEW YORKER NY	T-160
BURNHAM	BURNHAM V11	T-911	PEERLESS	PEERLESS JO-JOT (PE)	T-166
BURNHAM	BURNHAM VI, V-7, V-9	T-155	PEERLESS	PEERLESS ECT SIDE COIL, WBV STEAM	T-157B
BURNHAM	BURNHAM YELLOW JACKET	T-912	PEERLESS	PEERLESS HEO STEAM OR WATER	T-935
CAST IRON BOILERS	CAST IRON BOILERS-16 BOLTS	T-984	PEERLESS	PEERLESS JO-JOT (PF), LC, WB	T-157A
COLUMBIA	COLUMBIA EMERALD	T-982	PEERLESS	PEERLESS WBV STEAM	T-937
COLUMBIA	COLUMBIA GEM	T-977	PEERLESS	PEERLESS WBV WATER	T-157
COLUMBIA	COLUMBIA GSFH	T-169	PERCOFLASH	PERCOFLASH-5 3/4" X 13 1/2"	T-974
CRANE	CRANE 14-20	T-930	PORTMAR-NORSE-DELTA	PORTMAR-NORSE-DELTA	T-157
CRANE	CRANE 15-26	T-174	RHEEM / RICHMOND	RHEEM-G-O-PO, RICHMOND-RWA,	T-938
CRANE	CRANE 16	T-931		H-WFD-R-RW-PR-5 1/4"x13 1/2"	
CRANE	CRANE 2-8-11-12, 202, 300, 302	T-169	RHEEM / RICHMOND	RHEEM-G-O-PO, RICHMOND-RWA,	T-939
CROTTY	CROTTY	T-959		H-WFD-R-RW-PR-5 1/4"x15 1/2"	
CROWN	CROWN BON-AIR ULT, BAHAMA	T-158	SLANT FIN	SLANT FIN 78	T-941
CROWN	CROWN ENERGY PAK (CEP)	T-174	SLANT FIN	SLANT FIN GALAXY MALIBU	T-940
CROWN	CROWN KINGSTON	T-914	SLANT FIN	SLANT FIN LIBERTY STEAM-LS	T-171
CROWN	CROWN MONTEGO	T-157	SLANT FIN	SLANT FIN VANTAGE II, FUTURA, LIBERTY WATER	T-169
CROWN	CROWN TOBAGO	T-169	TEXACO	TEXACO STEAM	T-162
DELCO	DELCO DB 3-4-5-SHELL TYPE	T-915	TEXACO	TEXACO WATER	T-157
DIESEL-PLYMOUTH	DIESEL-PLYMOUTH	T-962	THATCHER	THATCHER O.C. T-194-198	T-173
DUNKIRK	DUNKIRK 13 STEAM	T-162	THATCHER	THATCHER 015 THRU 020	T-942
DUNKIRK	DUNKIRK LEXINGTON & LEX PAK DF	T-157	THATCHER	THATCHER 525 SERIES	T-944
DUNKIRK	DUNKIRK ULT	T-158	THATCHER	THATCHER 56 SERIES	T-943
EDWARDS	EDWARDS	T-963	THATCHER	THATCHER G-OP	T-169
FEDERAL	FEDERAL FC-FD-FLR-FM-FCA-FM2, PORTMAR-WINDSOR	T-964	THERMO DYNAMICS	THERMO DYNAMICS CWL	T-177
FEDERAL	FEDERAL FWV	T-176A	THERMO DYNAMICS	THERMO DYNAMICS VTF, CWL, S	T-157
FEDERAL	FEDERAL GFS & SDF	T-176	TRIANCO	TRIANCO TOC	T-988
FITZGIBBONS	FITZGIBBONS 400, CHRYSLER AIRTEMP, PERCOFLASH	T-965	TRIANCO	TRIANCO TR	T-165
FITZGIBBONS	FITZGIBBONS RZU JUR-80-200-400	T-975	ULTIMATE	ULTIMATE ULT	T-158
GENT-JANITOR	GENT-JANITOR	T-961	UTICA	UTICA GU	T-162
GILBRALTER	GILBRALTER	T-169	UTICA	UTICA POBT, B-C, STS, STARFIRE II-III STEAM	T-164
GILBRALTER	GILBRALTER RECTANGULAR	T-167	UTICA	UTICA STARFIRE II WATER STW	T-169
H.B. SMITH	H.B. SMITH 1100-1500 FLANGE TYPE	T-920	UTICA	UTICA STARFIRE OU, UST	T-161
H.B. SMITH	H.B. SMITH 18-19 SERIES	T-919	VALLIANT	VALLIANT VA	T-169
H.B. SMITH	H.B. SMITH 28 STEAM BOILERS	T-918	WEIL MCLAIN	WEIL-MCLAIN 65-66-68 EG EATER; 42-62-WATER	T-169
H.B. SMITH	H.B. SMITH 50B STEAM	T-162	WEIL MCLAIN	WEIL-MCLAIN 65-66-68-EG STEAM, 75, 86, 88 STEAM	T-168
H.B. SMITH	H.B. SMITH FD-12	T-170	WEIL MCLAIN	WEIL-MCLAIN 94 SUPPLY OUTLET	T-163
H.B. SMITH	H.B. SMITH OB-14, BB-14	T-921	WEIL MCLAIN	WEIL-MCLAIN GOLD 65-66-68 STEAM	T-157
H.B. SMITH	H.B. SMITH OHB 13 WATER	T-157	WEIL MCLAIN	WEIL-MCLAIN 57-77, 78-B5-CAST IRON SHELL	T-950
H.B. SMITH	H.B. SMITH SERIES 8 STEAM-4 OR 5 GPM ONLY	T-917	WEIL MCLAIN	WEIL-MCLAIN 62 STEAM	T-949
H.B. SMITH	H.B. SMITH SS	T-172	WEIL MCLAIN	WEIL-MCLAIN 72-73	T-951
HART & CROUSE	HART & CROUSE-BRYANT COMPACT 230-231-234	T-916	WEIL MCLAIN	WEIL-MCLAIN 80, 78 SERIES	T-946
HYDROTHERM	HYDROTHERM AQUARIUS	T-169	WEIL MCLAIN	WEIL-MCLAIN 82-84	T-952
HYDROTHERM	HYDROTHERM OS-S02	T-922	WEIL MCLAIN	WEIL-MCLAIN E STEAM BOILERS	T-948
HYDROTHERM	HYDROTHERM PB150-180 STEAM	T-986	WEIL MCLAIN	WEIL-MCLAIN H-GAS	T-956
HYDROTHERM	HYDROTHERM PB150-180 WATER	T-985	WEIL MCLAIN	WEIL-MCLAIN LG STEAM	T-947
HYDROTHERM	HYDROTHERM VOA-STEAM, VGA	T-923	WEIL MCLAIN	WEIL-MCLAIN OB 18	T-954
HYDROTHERM	HYDROTHERM VO-WT WATER	T-174	WEIL MCLAIN	WEIL-MCLAIN OB 15	T-953
IRON FIREMAN	IRON FIREMAN, FAIRBANKS MORSE, UTICA-TORRID HEAT	T-967	WEIL MCLAIN	WEIL-MCLAIN 92-94K	T-955
KEWANEE	KEWANEE 3R	T-969	WILLIAMS WINKLER	WILLIAMS-WINKLER STEWART WARNER OILOMATIC-6 1/4"x14 1/4"	T-957
KEWANEE	KEWANEE 83R	T-970	WILLIAMS WINKLER	WILLIAMS-WINKLER STEWART WARNER OILOMATIC-6 1/4"x17 1/2"	T-958
KEWANEE	KEWANEE R	T-968	YORK-SHIPLEY	YORK-SHIPLEY LEVITOWN BOILER	T-157
			ZAMBELLI	ZAMBELLI	T-960

PARTS TO FIT MCDONNELL & MILLER

DIRT POCKET CAP AND KIT



BOXED WITH GASKET AND
4 HEXHEAD SCREWS

SSC-300
DIRT POCKET CAP WITH
GASKET AND BOLTS
TO FIT MCDONNELL &
MILLER

Cast Iron; 3/4" NPT
Part #: 309510
Used In: 47, 67
(RM-889)

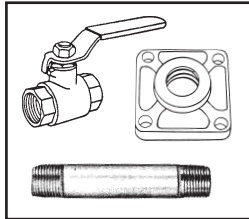

PACKED IN A ZIP-LOCK
BAG WITH LABEL

SSC's Blowdown Kit to fit McDonnell & Miller low water cut-offs contains one Dirt Pocket Cap boxed with gasket and 4 hexhead screws, one 3/4" ball valve (full port) and one 3/4" Nipple (4" long).

SSC-300A
BLOWDOWN KIT
Replaces: 14B

MP-294
BOLT TO FIT MCDONNELL
& MILLER DIRT POCKET
CAP AND STRAINER
BASKET ASSEMBLY
Catalog #: 37-134
Part #: 313650
Used In: 21, 25A, 27,
47, 51, 53, 3155, 67,
70, 101A



TUBE, NUT AND KIT TO FIT MCDONNELL & MILLER®

*Please Note: McDonnell & Miller is a registered
trademark of ITT Corporation*



MP-297
BRASS TUBE TO FIT
MCDONNELL & MILLER
Catalog #: 66-35
Part #: 318300
Used In: 67



MP-296
BRASS COMPRESSION NUT
TO FIT MCDONNELL & MILLER
Catalog #: 66-133
Part #: 318700
Used In: 67

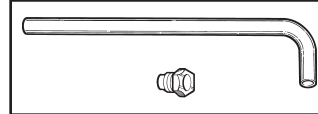

MP-299
TUBE AND NUT KIT
TO FIT MCDONNELL
& MILLER
Kit includes #MP-296
and #MP-297.



MP-295
BRASS TUBE TO FIT
MCDONNELL & MILLER
Fits Utica Oil Steam boilers.
45° Angle

STRAINER BASKET ASSEMBLIES TO FIT MCDONNELL & MILLER

This item features a cast iron base and pleated stainless steel mesh for more filtering area.

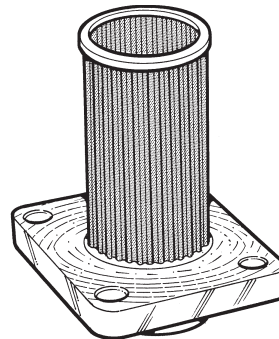

BOXED WITH 1 M-38 GASKET
AND 4 HEXHEAD SCREWS

MP-290
STRAINER BASKET
ASSEMBLY TO FIT
MCDONNELL & MILLER
Catalog #: SA101-38
Part #: 347100
Used In: 47, 51, 101

MP-291
STRAINER BASKET
ASSEMBLY TO FIT
MCDONNELL & MILLER
Strainer Height: 3 3/16"
Catalog #: SA37-38
Part #: 340700
Used In: 51S, 53

GASKETS TO FIT MCDONNELL & MILLER

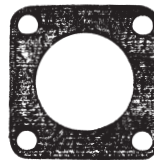

ACTUAL SIZE: 2 3/8" X 2 3/8"

M-38
GASKET TO FIT MCD. & MLR.
BLOW OFF VALVE, STRAINER
BODY, DIRT POCKET CAP
Catalog #: 37-39
Part #: 313200
Used In: 47, 53, 67, 70



ACTUAL SIZE: 2" OD
X 1 13/16" ID

M-154
SQUARE CUT O-RING
TO FIT MCD. & MLR.
Part #: 324435
Used In: 21, 25A, 47,
51, 53, 101A

GASKETS TO FIT MCDONNELL & MILLER

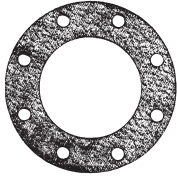

ACTUAL SIZE: 5 1/2" OD
X 3 1/4" ID

M-39
GASKET TO FIT
MCD. & MLR. HEAD
Specifically designed
for raised flange heads.
Catalog #: 150-14
Part #: 325500
Used In: 93, 193, 150
(K-3508)

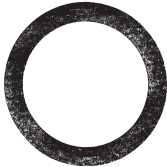

ACTUAL SIZE: 4 1/4" OD
X 3 3/16" ID

M-39A
GASKET TO FIT
MCD. & MLR. HEAD
Specifically designed
for flat flange heads.
Catalog #: 150-14
Part #: 325400
Used In: 93, 193, 150

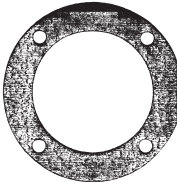

ACTUAL SIZE: 5" OD
X 3 3/8" ID

M-40
GASKET TO FIT
MCD. & MLR. BODY
Catalog #: CO-12
Part #: 302600
Used In: 42, 61, 63,
64, 65
(K-3509)

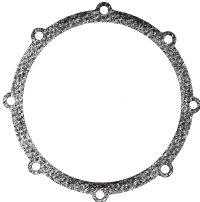

ACTUAL SIZE: 7 1/4" OD
X 6 5/16" ID

M-37
GASKET TO FIT MCD.
& MLR. FLOAT BODY
Catalog #: 37-26
Part #: 312700
Used In: 47
(GF-236)



ACTUAL SIZE: 7 7/8" OD
X 6 7/8" ID

M-35
GASKET TO FIT
MCD. & MLR.
Catalog #: F-26
Part #: 304100
Used In: 221, 25A
51, 53, 3155

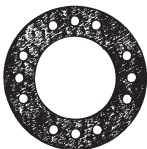

ACTUAL SIZE: 2 3/4" OD
X 1 9/16" ID

M-33
GASKET TO FIT
MCD. & MLR. FLOAT
Catalog #: 67-12
Part #: 318800
Used In: 61, 64, 67,
70, 80



ACTUAL SIZE: 3 1/8" OD
X 2 9/16" ID

M-34
GASKET TO FIT
MCD. & MLR. HEAD
Catalog #: 69-112
Part #: 320500
Used In: 69

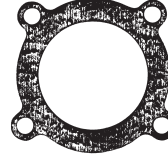

ACTUAL SIZE: 3 1/8" OD
X 2 1/4" ID

M-12
GASKET TO FIT MCD. &
MLR. VALVE BRACKET
Catalog #: 21-27
Part #: 311100
Used In: 21, 25A, 27



ACTUAL SIZE: 2 7/8" OD
X 2 1/4" ID

M-11
GASKET TO FIT MCD. &
MLR. VALVE BRACKET
Catalog #: 37-27
Part #: 312800
Used In: 47, 51, 53, 3155



ACTUAL SIZE: 2 11/16" OD
X 1 5/8" ID

M-9
GASKET TO FIT
MCD. & MLR.
Catalog #: CO-11
Part #: 302500
Used In: 63

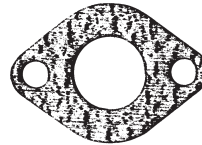

ACTUAL SIZE: 2 15/16" OD
X 2 1/16" ID

M-14
GASKET TO FIT
MCD. & MLR.
Catalog #: 37-28
Part #: 312900
Used In: 53, 3155,
21, 25A, 51

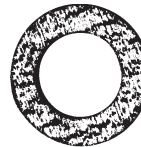

ACTUAL SIZE: 1 7/8" OD
X 1 1/8" ID

M-8
GASKET TO FIT MCD. &
MLR. BELLOWS BASE
Catalog #: 150-9
Part #: 325300
Used In: 42, 150



ACTUAL SIZE: 1 3/8" OD
X 7/8" ID

M-4
GASKET TO FIT
MCD. & MLR. CAP
Catalog #: 159-37
Part #: 328900
Used In: 42A, 47, 64A

Our replacement gaskets to fit McDonnell & Miller are made of a superior gasket material designed to keep a positive seal under the most strenuous temperatures and conditions. They are treated with an anti-stick coating for easy removal.

GASKETS TO FIT MCD. & MLR. / PIGTAILS

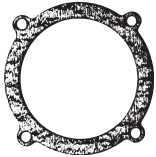

ACTUAL SIZE: 3 1/4" OD
X 2 1/2" ID

M-2
GASKET TO FIT MCD.
& MLR. SINGLE PROBE
SENSOR COVER
Part #: 354370
Used In: RS-1

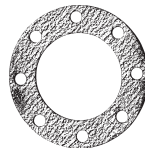

ACTUAL SIZE: 8 15/16" OD
X 5 1/2" ID

M-27
GASKET TO FIT
MCD. & MLR. HEAD
Part #: 355081
Used In: DFC, DFS



ACTUAL SIZE: 3 5/16" OD
X 2 7/16" ID

M-10
GASKET TO FIT
MCD. & MLR.
Catalog #: 21-12
Part #: 310800
Used In: 21

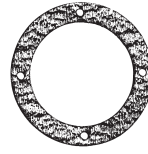

ACTUAL SIZE: 3 5/8" OD
X 2 5/8" ID

M-5
GASKET TO FIT
MCD. & MLR.
Catalog #: 27-T-13
Part #: 312100
Used In: 25A

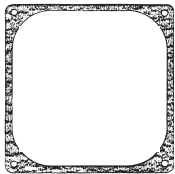

ACTUAL SIZE: 5 1/2" X 5 1/2"

M-1
GASKET TO FIT
MCD. & MLR. VAPOR
PROOF COVER
Part #: 354380
Used In: VFC, VFS,
DFC, DFS

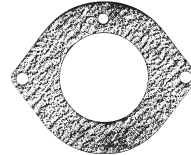

ACTUAL SIZE: 5 3/8" OD
X 3 11/16" ID

M-7
GASKET TO FIT
MCD. & MLR. HEAD
Catalog #: 92-68
Part #: 323300
Used In: 94-194



ACTUAL SIZE: 4 1/2" X 3 5/16"

M-146
GASKET TO FIT
MCD. & MLR.
Catalog #: 355-73
Part #: 333800



ACTUAL SIZE: 5 1/2" OD
X 3 1/4" ID

M-3
GASKET TO FIT MCD. &
MLR. PFC, VFC HEAD
Part #: 354310
Used In: VFC, VFS, PFC

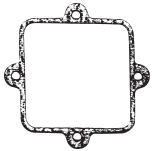

ACTUAL SIZE: 3 1/16" X 3 1/16"

M-13
GASKET TO FIT MCD.
& MLR. 2, 3 & 4 PROBE
SENSOR COVER
Part #: 354410
Used In: PCL



ACTUAL SIZE: 6 5/8" OD
X 4 3/4" ID

M-6
GASKET TO FIT
MCD. & MLR. HEAD
Catalog #: 847-26
Part #: 335400
Used In: 21, 847, 851

PIGTAIL STEAM SYPHONS

STRAIGHT



PT-711
STRAIGHT PIGTAIL
STEAM SYPHON
Black Iron
1/4" I.P.S.

PT-712
STRAIGHT PIGTAIL
STEAM SYPHON
Brass
1/4" I.P.S.

ANGLE



PT-714
ANGLE (90°) PIGTAIL
STEAM SYPHON
Black Iron
1/4" I.P.S.

PT-715
ANGLE (90°) PIGTAIL
STEAM SYPHON
Brass
1/4" I.P.S.

If you would like to see a life-sized illustration of many of the gaskets listed in this catalog, please contact us and we'll send you our **Gasket Picture Posters** for free. The two posters we offer measure 24" x 36".

STEAM GAUGE GLASS PARTS

5/8" GAUGE GLASS VALVE KITS

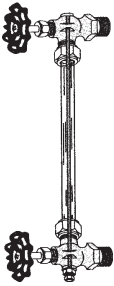

WHOLE KIT IS BOXED

GG-280

5/8" GAUGE GLASS VALVE KIT

Fits 1/2" Pipe Size

Includes:

- 2 Valves With Needle Drain on Lower Valve
- 2 Brass Nuts
- 2 Brass Friction Rings
- 2 Gauge Glass Gaskets
- 2 Support Rods
- 1 5/8" x 12" Gauge Glass

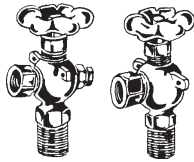

PACKED PAIR/BOX

GG-281

VALVES ONLY FOR 5/8" GAUGE GLASS

Same as above except without gauge glass and support rods.

5/8" STANDARD, RED LINE & HIGH PRESSURE GAUGE GLASS



SSC#	DESCRIPTION	LENGTH	PKG.
GG-525A	5/8" STANDARD	8"	12
GG-525B	5/8" STANDARD	10"	12
GG-525C	5/8" STANDARD	12"	12
GG-525D	5/8" STANDARD	11"	12
GG-525E	5/8" STANDARD	14"	12
GG-525F	5/8" STANDARD	18"	12
GG-525G	5/8" STANDARD	24"	12
GG-525H	5/8" STANDARD	36"	12
GG-526A	5/8" RED LINE	10"	1
GG-526B	5/8" RED LINE	12"	1
GG-526C	5/8" RED LINE	14"	1
GG-526D	5/8" RED LINE	18"	1
GG-526E	5/8" RED LINE	24"	1
GG-526F	5/8" RED LINE	36"	1
GG-527A	5/8" HIGH PRESSURE	10"	1
GG-527B	5/8" HIGH PRESSURE	12"	1
GG-527C	5/8" HIGH PRESSURE	14"	1

STEAM GAUGE GLASS PARTS

GAUGE GLASS GASKET REPLACEMENT KIT

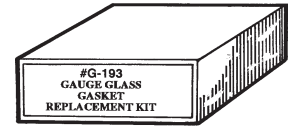
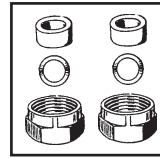

AVAILABLE PACKED IN A HANGING BAG OR BOXED

G-193

GAUGE GLASS GASKET REPLACEMENT KIT

Contains:

- 2 G-17 Gauge Glass Gaskets
- 2 G-191 Brass Nuts
- 2 G-192 Brass Friction Rings

5/8" GAUGE GLASS WASHER



G-17

5/8" GAUGE GLASS WASHER / GASKET

5/8" BRASS FRICTION RING



G-192

BRASS FRICTION RING FOR 5/8" GAUGE GLASS

5/8" BRASS NUT

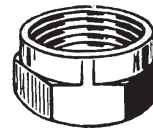

G-191

BRASS NUT FOR 5/8" GAUGE GLASS

SUPPORT RODS



GG-282

14" LONG STAINLESS STEEL SUPPORT ROD FOR 5/8" GAUGE GLASS (Order 2 For Set)

GG-282A

24" LONG STAINLESS STEEL SUPPORT ROD FOR 5/8" GAUGE GLASS (Order 2 For Set)

MISCELLANEOUS STEAM PARTS

MARVEL HIGH PRESSURE GAUGE GLASS WASHERS



SSC#	TYPE	SIZE	OD	DEPTH
G-285	#3	5/8"	7/8"	9/32"
G-285A	#7	3/4"	1 1/4"	13/32"
G-285B	#11	3/4"	1 3/16"	13/32"
G-285C	#53	3/4"	1 1/4"	1/2"

RADIATOR VALVES AND PARTS

RADIATOR STEAM AND HOT WATER VALVES

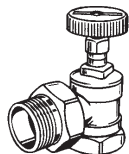

STEAM VALVE

BRASS

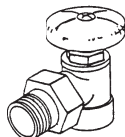

HOT WATER VALVE

SSC#	TYPE	SIZE
108105	RADIATOR HOT WATER VALVE-ANGLE	1/2"
108106	RADIATOR HOT WATER VALVE-ANGLE	3/4"
108107	RADIATOR HOT WATER VALVE-ANGLE	1"
108110	RADIATOR STEAM VALVE-ANGLE	1/2"
108112	RADIATOR STEAM VALVE-ANGLE	3/4"
108114	RADIATOR STEAM VALVE-ANGLE	1"
108116	RADIATOR STEAM VALVE-ANGLE	1 1/4"
108118	RADIATOR STEAM VALVE-ANGLE	1 1/2"

RADIATOR HANDLE

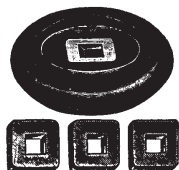

108100
THREE LUG
RADIATOR HANDLE
Three lugs will fit most
valves in the field.
Black Plastic

RADIATOR AIR VALVE - 1/8" ANGLE

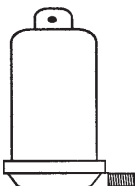

1" DIA. X 3" LONG

108130
ECONOMY AIR VALVE
1/8" IPS male thread
connection.
Single fixed vent toward
radiator with a maximum
operating pressure of 5 PSI.

COIN / KEY AIR VALVE

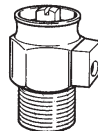

CK-518
COIN / KEY
AIR VALVE
Nickle Plated

KEY FOR COIN / KEY AIR VALVE



RV-517
RADIATOR VENT KEY
Nickle Plated

3 IN 1 RADIATOR REPAIR TOOL

This handy tool extracts broken air valves, retaps the radiator and rethreads air valves.

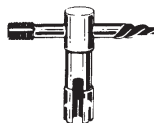

108103
3 IN 1 RADIATOR
REPAIR TOOL

RADIATOR (NIPPLE) SPUD WRENCH



111040
RADIATOR SPUD WRENCH

BRASS "Y" STRAINERS

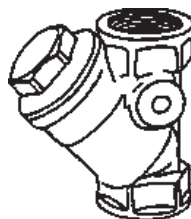

SSC#	SIZE
121340	3/8" IPS
121342	1/2" IPS
121344	3/4" IPS
121346	1" IPS
121348	1 1/4" IPS
121350	1 1/2" IPS
121352	2" IPS

Use SSC's Website to Find Your Replacement Parts and Order Online!

- Place orders online using our shopping cart feature.
- Find your part using our multi-functional search engines.
- Registration is required. This ensures that only wholesalers & rebuilders, not the trade or general public, can see pricing and use the shopping cart.

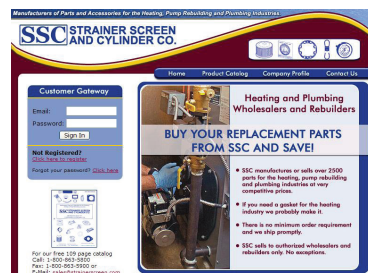

www.strainerscreen.com

BOILER SIGHT GLASSES

BOILER SIGHT GLASS CIRCLES

Our Boiler Sight Glass Circles are made of a 1/8" thick clear Pyrex glass which is capable of withstanding high temperatures.



APPROXIMATE SIZE: 1 7/16" OD

SG-510
SIGHT GLASS CIRCLE
FOR 1 1/4" SLIPNUT



APPROXIMATE SIZE: 1 11/16" OD

SG-511
SIGHT GLASS CIRCLE
FOR 1 1/2" SLIPNUT

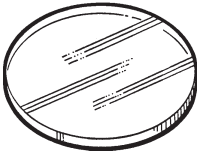

APPROXIMATE SIZE: 2 3/16" OD

SG-512
SIGHT GLASS CIRCLE
FOR 2" SLIPNUT

BOILER SIGHT GLASS CIRCLE GASKETS



ACTUAL SIZE: 1 1/2" OD
X 1 5/16" ID

G-180
SIGHT GLASS/SLIPNUT
GASKET FOR 1 1/4"



ACTUAL SIZE: 1 1/4" OD
X 1 5/16" ID

G-181
SIGHT GLASS/SLIPNUT
GASKET FOR 1 1/2"



ACTUAL SIZE: 2 1/8" OD
X 1 1/2" ID

G-182
SIGHT GLASS/SLIPNUT
GASKET FOR 2"

Available in various thicknesses, SSC's **Gasket Sheets** are perfect for emergency repairs and for replacing hard to find gaskets and washers. See pages 70-72.



BOILER SIGHT GLASSES

SLIPNUTS FOR BOILER SIGHT GLASS CIRCLES

SN-500
1 1/4" X 1 1/4" SLIPNUT
FOR 1 1/4" SIGHT GLASS

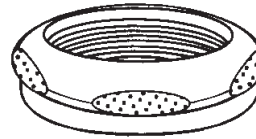

SN-501
1 1/2" X 1 1/4" SLIPNUT
FOR 1 1/2" SIGHT GLASS

SN-502
2" X 1 1/2" SLIPNUT
FOR 2" SIGHT GLASS

SIGHT GLASS TO FIT H.B. SMITH BOILER

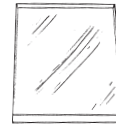

ACTUAL SIZE: 2 1/4" X 2 1/4"

SG-507
SIGHT GLASS TO
FIT H.B. SMITH
Thickness: 1/4"

SIGHT GLASS TO FIT INDUSTRIAL COMBUSTION



ACTUAL SIZE: 1 1/2" X 4"

SG-515
SIGHT GLASS TO FIT
INDUSTRIAL COMBUSTION
BLAST TUBE SIGHT GLASS

SIGHT GLASSES TO FIT CLEAVER BROOKS

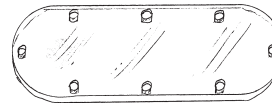

SG-509
8 HOLE SIGHT GLASS
TO FIT CLEAVER BROOKS
LUBE TANK
Uses C-141 Gasket

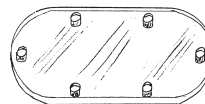

SG-508
6 HOLE SIGHT GLASS
TO FIT CLEAVER BROOKS
LUBE TANK
Uses C-138 Gasket

AQUASTAT WELL ADAPTER

SSC's Aquastat Well Adapter is made of heat conducting brass. This enables the service technician to replace obsolete Aquastats without replacing the existing well in the boiler. The W-603 fits existing wells of L444, L170, B6510 and L165. It also adapts to White-Rogers, Perfex and Detroit wells.

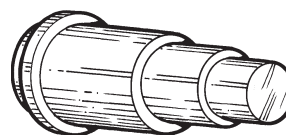

W-603
AQUASTAT WELL
ADAPTER
Brass

WELLS/MISCELLANEOUS STEAM GASKETS

IMMERSION WELLS

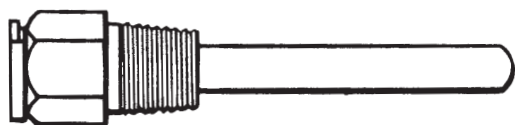

SSC#	HONEYWELL#	TAP	LGTH.	DEPTH
------	------------	-----	-------	-------

STANDARD STYLE

W-590	123869A / 121371A	1/2"	3 1/8"	1 5/8"
W-591	121371L / 123872A	1/2"	3 1/8"	3"
W-592	121371B / 123870A	3/4"	3 1/8"	1 5/8"
W-593	121371M, N / 12387	3/4"	3 1/8"	3"
W-594	122555	3/4"	3 1/8"	4 1/4"

REMOTE ELEMENT WITH SET SCREW

W-595	123732AA	1/2"	3 1/8"	1 3/4"
W-596	124299AA	3/4"	3 1/8"	1 3/4"

DUAL ELEMENT

W-597	138134C / 138134E	3/4"	3 1/8"	2 1/4"
W-597A	123871E	3/4"	3 1/8"	3"
W-597B	122555E	3/4"	3 1/8"	4 1/4"

W-590 and **W-592** are used on L4006, L6006, L8124, L8148, R8182.

W-593 and **W-594** are used on long insersion water heaters.

Well Adapter is on previous page.

GASKETS TO FIT DYNATHERM



ACTUAL SIZE: 3 5/8" OD X 3" ID

D-190
GASKET TO FIT
SMALL DYNATHERM
NOZZLE ASSEMBLY



ACTUAL SIZE: 4 3/8" OD X 3 5/8" ID

D-190A
GASKET TO FIT
LARGE DYNATHERM
NOZZLE ASSEMBLY



ACTUAL SIZE: 7" X 4 1/4"

D-190B
GASKET TO FIT
LARGE DYNATHERM
NOZZLE ASSEMBLY

GASKET TO FIT ARMSTRONG / WATSON MCDANIEL BUCKET STEAM TRAP



ACTUAL SIZE: 2 15/16" OD
X 2 3/8" ID

M-195A
GASKET TO FIT ARMSTRONG/
WATSON MCDANIEL BUCKET
STEAM TRAP
Fits: Armstrong 800, 801, 860,
880; Part #: A1433
Also Fits: Watson McDaniel 1031,
1041

GASKETS TO FIT ARMSTRONG FLOAT AND THERMOSTATIC STEAM TRAPS



ACTUAL SIZE: 5 1/8" X 4 1/4"

A-288A
GASKET TO FIT ARMSTRONG
FLOAT AND THERMOSTATIC
STEAM TRAPS
Fits Traps: 15B2, 15B3, 15B1-2,
15B1-3, 30B2, 30B-3, 30B1-2,
30B1-3
Replaces #: A21348-1



ACTUAL SIZE: 4 3/8" X 3 1/4"

A-288B
GASKET TO FIT ARMSTRONG
FLOAT AND THERMOSTATIC
STEAM TRAPS
Fits Traps: 15A3, 30A3, 75-A3,
125A3, 175A3
Replaces #: A21958-1

GASKET TO FIT VENT-RITE CONDENSATE PUMP



ACTUAL SIZE: 8" OD X 6 3/8" ID

V-293
BODY GASKET TO FIT
VENT-RITE CONDENSATE
PUMP

GASKETS TO FIT HOFFMAN TRAPS AND PUMPS



ACTUAL SIZE: 5 3/8" X 3 1/2"

H-289A
COVER GASKET TO
FIT HOFFMAN TRAPS
FTH, FT1, B1, B2,
B1030A, B11808,
B1250A, B1075A
Replaces: 604030

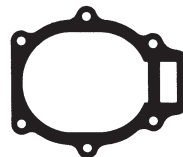

ACTUAL SIZE: 7 11/16" X 6 7/16"

H-289B
1 1/2" COVER GASKET
TO FIT HOFFMAN TRAP
Replaces: 601270

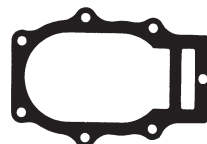

ACTUAL SIZE: 10 1/8" X 6 5/8"

H-289C
COVER GASKET TO FIT
HOFFMAN TRAP FT
Replaces: 600345

DUNHAM BUSH GASKETS / O-RING CORD



ACTUAL SIZE: 3 3/16" OD
X 2 1/2" ID

H-289D
GASKET TO FIT
HOFFMAN
601-A TRAP
Replaces: 601273



ACTUAL SIZE: 6 1/4" X 4"

H-289E
GASKET TO FIT HOFFMAN
CONDENSATE TANK PUMP
Replaces: DG0060

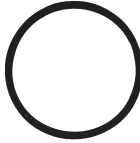

ACTUAL SIZE: 4 1/2" OD X 4" ID

H-289F
VOLUTE BODY GASKET
TO FIT HOFFMAN PUMP
Replaces: DG0092

GASKETS TO FIT DUNHAM BUSH TRAPS AND PUMPS



ACTUAL SIZE: 4 1/2" X 3 3/4"

D-151A
GASKET TO FIT
DUNHAM BUSH TRAP
For 30-1A & 302A
Replaces: C5698

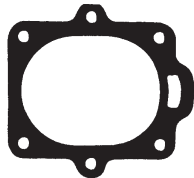

ACTUAL SIZE: 5 13/16" X 5 1/2"

D-151B
GASKET TO FIT
DUNHAM BUSH TRAP
Fits: 1 1/4" or 1 1/2" Trap
For 40-515 & 40-715
Replaces: D5449

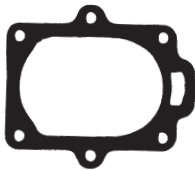

ACTUAL SIZE: 5 11/16" X 4 15/16"

D-151C
GASKET TO FIT
DUNHAM BUSH TRAP
Fits: 3/4" or 1" Trap
For 40-215 & 40-415
Replaces: D5442



ACTUAL SIZE: 11 1/8" X 8"

D-151D
GASKET TO FIT
DUNHAM BUSH TRAP
For 30-7 & 30-A
Replaces: D263

If we are missing the gasket you need, let us know and we'll tool up for it.

D-151E
GASKET/SHIM TO FIT
DUNHAM BUSH OIL PUMP
For Models H-100/200/300
Thickness: .003"

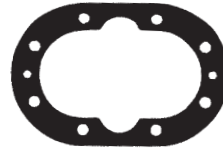

ACTUAL SIZE: 5 7/8" X 4"

D-151H
GASKET/SHIM TO FIT
DUNHAM BUSH OIL PUMP
For Models H-100/200/300
Thickness: .004"

D-151G
GASKET/SHIM TO FIT
DUNHAM BUSH OIL PUMP
For Models H-100/200/300
Thickness: 1/64"

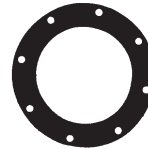

ACTUAL SIZE: 7 11/16" OD
X 5 1/4" ID

D-151
GASKET TO FIT DUNHAM
BUSH A5 PUMP
Replaces: D5352



ACTUAL SIZE: 2 7/8" OD
X 1 13/16" ID

D-151F
FRONT GASKET TO FIT
DUNHAM BUSH
A5 PUMP

O-RING CORD

Priced by the foot, O-ring cord is handy to have in case you have to make emergency O-rings in the field.

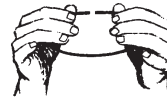

SSC#	DIAMETER	SSC#	DIAMETER
OC-7000	1/16"	OC-7006	5/16"
OC-7000A	3/32"	OC-7008	3/8"
OC-7001	1/8"	OC-7010	7/16"
OC-7001A	5/32"	OC-7012	1/2"
OC-7002	3/16"	OC-7014	.535"
OC-7004	1/4"	OC-7016	9/16"
OC-7005	9/32"		

O-RING CORD INSTANT ADHESIVE

Use this adhesive to bond together O-rings. It's good to have on hand in case you don't have the right O-ring in stock. Sold in 3 gram tubes.



OCAD-7025
O-RING CORD
INSTANT ADHESIVE
3 Gram Tube

BOILER HANDHOLE / MANHOLE GASKETS

BOILER HANDHOLE & MANHOLE GASKETS - DIE CUT

All SSC Boiler Gaskets are made of 1/4" thick EPDM Rubber. Whether using SSC's Boiler Gaskets or someone else's, always make sure the material is 1/4" EPDM rubber. EPDM has excellent resistance to steam and high temperature, while other types of rubber may not.

Inside measurements are used.



ELLIPTICAL - "E"

SSC#	SIZE	TYPE
HH-2E	2" x 3" x 3/8" E	HANDHOLE
HH-4E	2 1/4" x 3 1/4" x 1/2" E	HANDHOLE
HH-7E	2 1/2" x 3 1/2" x 1/2" E	HANDHOLE
HH-8E	[2 1/2" x 3 3/4" x 1/2" E 2 3/4" x 3 1/2" x 1/2" E	HANDHOLE
HH-9E	2 3/4" x 3 3/4" x 1/2" E	HANDHOLE
HH-10E	[2 7/8" x 3 7/8" x 1/2" E 3" x 3 3/4" x 1/2" E	HANDHOLE
HH-12E	2 3/4" x 4 1/2" x 1/2" E	HANDHOLE
HH-14E	3" x 4" x 1/2" E	HANDHOLE
HH-17E	3" x 4 1/2" x 1/2" E	HANDHOLE
HH-18E	3" x 5" x 1/2" E	HANDHOLE
HH-20E	3 1/4" x 4 1/4" x 1/2" E	HANDHOLE
HH-22E	3 1/4" x 4 1/2" x 1/2" E	HANDHOLE
HH-23E	3 1/4" x 5" x 9/16" E	HANDHOLE
HH-26E	3 1/2" x 4 1/2" x 1/2" E	HANDHOLE
HH-27E	3 1/2" x 4 1/2" x 5/8" E	HANDHOLE
HH-28E	3 1/2" x 5" x 1/2" E	HANDHOLE
HH-31E	3 1/2" x 5 1/2" x 5/8" E	HANDHOLE
HH-32E	3 3/4" x 4 3/4" x 1/2" E	HANDHOLE
HH-33E	3 3/4" x 5 1/2" x 1/2" E	HANDHOLE
HH-35E	4" x 5" x 5/8" E	HANDHOLE
HH-39E	4" x 6" x 3/4" E	HANDHOLE
HH-40E	4 1/2" x 5 1/2" x 1/2" E	HANDHOLE
HH-41E	4 1/2" x 6 1/2" x 9/16" E	HANDHOLE
HH-44E	5" x 6" x 5/8" E	HANDHOLE
HH-45E	5" x 7" x 9/16" E	HANDHOLE
HH-46E	5 3/4" x 7 1/4" x 9/16" E	HANDHOLE
HH-47E	6" x 8" x 3/4" E	HANDHOLE
HH-50E	6" x 10" x 5/8" E	HANDHOLE
MH-56E	9" x 14" x 1 1/4" E	MANHOLE
MH-63E	10" x 14" x 1 1/2" E	MANHOLE
MH-67E	[10 1/2" x 14 1/2" x 1 3/8" E 10" x 15" x 1 3/8" E	MANHOLE
MH-69E	11" x 14 1/2" x 1" E	MANHOLE
MH-75E	[11" x 15" x 1 1/4" E 10" x 16" x 1 1/4" E	MANHOLE
MH-80E	[11" x 16" x 1 1/4" E 12" x 15" x 1 1/4" E	MANHOLE
MH-82E	12" x 16" x 1 1/4" E	MANHOLE
MH-83E	12" x 16" x 1 3/8" E	MANHOLE
MH-84E	14" x 18" x 1 1/2" E	MANHOLE



OBROUND - "OB"

SSC#	SIZE	TYPE
HH-101B	2" x 3" x 3/8" OB	HANDHOLE
HH-103B	2 1/4" x 3 1/4" x 1/2" OB	HANDHOLE
HH-104B	2 1/2" x 3 1/2" x 1/2" OB	HANDHOLE
HH-105B	2 1/4" x 3 3/4" x 1/2" OB	HANDHOLE
HH-107B	2 1/2" x 3 3/4" x 1/2" OB	HANDHOLE
HH-108B	2 3/4" x 3 1/2" x 1/2" OB	HANDHOLE
HH-110B	2 3/4" x 3 3/4" x 1/2" OB	HANDHOLE
HH-111B	[2 3/4" x 4 1/2" x 1/2" OB 3" x 4 1/4" x 1/2" OB	HANDHOLE
HH-112B	3" x 4" x 1/2" OB	HANDHOLE
HH-114B	[3" x 4 1/2" x 9/16" OB 3 1/4" x 4 1/4" x 9/16" OB	HANDHOLE
HH-115B	3" x 5" x 9/16" OB	HANDHOLE
HH-116B	3 1/4" x 4 1/2" x 1/2" OB	HANDHOLE
HH-117B	3 1/4" x 4 3/4" x 1/2" OB	HANDHOLE
HH-118B	3 1/2" x 4 1/2" x 1/2" OB	HANDHOLE
HH-119B	3 1/2" x 5" x 9/16" OB	HANDHOLE
HH-120B	3 1/2" x 5 1/2" x 5/8" OB	HANDHOLE
HH-121B	4" x 5" x 1/2" OB	HANDHOLE
HH-122B	4" x 6" x 3/4" OB	HANDHOLE
HH-123B	4 1/2" x 5 1/2" x 5/8" OB	HANDHOLE
HH-125B	4 1/2" x 6 1/2" x 5/8" OB	HANDHOLE
HH-128B	5" x 7" x 1/2" OB	HANDHOLE
MH-130B	11" x 15" x 1 1/4" OB	MANHOLE
MH-132B	12" x 16" x 1 1/2" OB	MANHOLE



ROUND - "R"

PEAR - "P"



SSC#	SIZE	TYPE
HH-202R	2 1/2" x 1/2" TH ROUND	HANDHOLE
HH-203R	2 3/4" x 1/2" TH ROUND	HANDHOLE
HH-204R	3" x 1/2" TH ROUND	HANDHOLE
HH-207R	3 1/4" x 1/2" TH ROUND	HANDHOLE
HH-210R	3 1/2" x 1/2" TH ROUND	HANDHOLE
HH-211R	4" x 1/2" TH ROUND	HANDHOLE
HH-215R	4 1/2" x 1/2" TH ROUND	HANDHOLE
HH-216R	5" x 1/2" TH ROUND	HANDHOLE
HH-234P	3 5/8" x 4 3/4" x 1/2" PEAR	HANDHOLE
HH-235P	4" x 5 1/2" PEAR	HANDHOLE

[- Gaskets marked with this symbol will fit both sizes listed.

Please Note: Inside measurements are used.

Try out our **High Temperature Rope and Knit Tape** for insulation and packing of boilers, furnaces, wood stoves and other applications. See page 24 for more details.

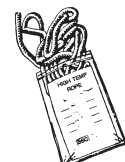

PIPE FLANGE GASKETS

PIPE FLANGE GASKETS

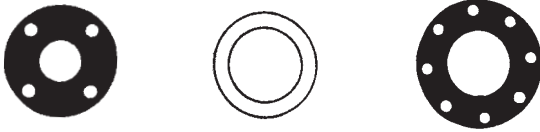

*For 150 lb. flanges and fittings. Old standard or new ANSI.
Inside measurements are used.*

MATERIAL: 1/8" THICK RED RUBBER

SIZE	RING GASKET	FULL FACE GASKET
1/2	PF-50RR8	PF-50RF8
3/4	PF-75RR8	PF-75RF8
1	PF-100RR8	PF-100RF8
1 1/4	PF-125RR8	PF-125RF8
1 1/2	PF-150RR8	PF-150RF8
2	PF-200RR8	PF-200RF8
2 1/2	PF-250RR8	PF-250RF8
3	PF-300RR8	PF-300RF8
3 1/2	PF-350RR8	PF-350RF8
4	PF-400RR8	PF-400RF8
4 1/2	PF-450RR8	PF-450RF8
5	PF-500RR8	PF-500RF8
6	PF-600RR8	PF-600RF8
7	PF-700RR8	PF-700RF8
8	PF-800RR8	PF-800RF8
10	PF-1000RR8	PF-1000RF8
12	PF-1200RR8	PF-1200RF8

MATERIAL: 1/16" THICK RED RUBBER

SIZE	RING GASKET	FULL FACE GASKET
1/2	PF-50RR16	PF-50RF16
3/4	PF-75RR16	PF-75RF16
1	PF-100RR16	PF-100RF16
1 1/4	PF-125RR16	PF-125RF16
1 1/2	PF-150RR16	PF-150RF16
2	PF-200RR16	PF-200RF16
2 1/2	PF-250RR16	PF-250RF16
3	PF-300RR16	PF-300RF16
3 1/2	PF-350RR15	PF-350RF16
4	PF-400RR16	PF-400RF16
4 1/2	PF-450RR16	PF-450RF16
5	PF-500RR16	PF-500RF16
6	PF-600RR16	PF-600RF16
7	PF-700RR16	PF-700RF16
8	PF-800RR16	PF-800RF16
10	PF-1000RR16	PF-1000RF16
12	PF-1200RR16	PF-1200RF16

ACTUAL SIZES OF PIPE FLANGE GASKETS

SIZE	RING GASKET	FULL FACE GASKET	BOLT HOLES
1/2	13/16" ID x 1 7/8" OD	13/16" ID X 3 1/2" OD	4
3/4	15/16" ID X 2 5/16" OD	1" ID X 3 7/8" OD	4
1	1 1/4" ID X 2 5/8" OD	1 1/4" ID X 4 1/4" OD	4
1 1/4	1 5/8" ID X 3" OD	1 9/16" ID X 4 5/8" OD	4
1 1/2	1 7/8" ID X 3 3/8" OD	1 15/16" ID X 5" OD	4
2	2 1/4" ID X 4 1/8" OD	2 5/16" ID X 6" OD	4
2 1/2	2 13/16" ID X 5" OD	2 7/8" ID X 7" OD	4
3	3 1/2" ID X 5 1/2" OD	3 1/2" ID X 7 1/2" OD	4
3 1/2	4" ID X 6 3/8" OD	4" ID X 8 1/2" OD	8
4	4 1/2" ID X 6 7/8" OD	4 1/2" ID X 9" OD	8
4 1/2	5" ID X 7" OD	4 15/16" ID X 9 1/2" OD	8
5	5 1/2" ID X 7 3/4" OD	5 1/2" ID X 10" OD	8
6	6 1/2" ID X 8 5/8" OD	6 5/8" ID X 11" OD	8
7	7 1/2" ID X 10" OD	7 9/16" ID X 12 1/2" OD	8
8	8 1/2" ID X 11" OD	8 5/8" ID X 13 1/2" OD	8
10	10 5/8" ID X 13 1/4" OD	10 1/2" ID X 15 5/8" OD	8
12	12 1/16" ID X 15 5/8" OD	11 7/8" ID X 18 3/4" OD	12

MATERIAL: 1/8" THICK NEOPRENE (BLACK) RUBBER

SIZE	RING GASKET	FULL FACE GASKET
1/2	PF-50NR8	PF-50NF8
3/4	PF-75NR8	PF-75NF8
1	PF-100NR8	PF-100NF8
1 1/4	PF-125NR8	PF-125NF8
1 1/2	PF-150NR8	PF-150NF8
2	PF-200NR8	PF-200NF8
2 1/2	PF-250NR8	PF-250NF8
3	PF-300NR8	PF-300NF8
3 1/2	PF-350NR8	PF-350NF8
4	PF-400NR8	PF-400NF8
4 1/2	PF-450NR8	PF-450NF8
5	PF-500NR8	PF-500NF8
6	PF-600NR8	PF-600NF8
7	PF-700NR8	PF-700NF8
8	PF-800NR8	PF-800NF8
10	PF-1000NR8	PF-1000NF8
12	PF-1200NR8	PF-1200NF8

MATERIAL: 1/16" THICK NEOPRENE (BLACK) RUBBER

SIZE	RING GASKET	FULL FACE GASKET
1/2	PF-50NR16	PF-50NF16
3/4	PF-75NR16	PF-75NF16
1	PF-100NR16	PF-100NF16
1 1/4	PF-125NR16	PF-125NF16
1 1/2	PF-150NR16	PF-150NF16
2	PF-200NR16	PF-200NF16
2 1/2	PF-250NR16	PF-250NF16
3	PF-300NR16	PF-300NF16
3 1/2	PF-350NR16	PF-350NF16
4	PF-400NR16	PF-400NF16
4 1/2	PF-450NR16	PF-450NF16
5	PF-500NR16	PF-500NF16
6	PF-600NR16	PF-600NF16
7	PF-700NR16	PF-700NF16
8	PF-800NR16	PF-800NF16
10	PF-1000NR16	PF-1000NF16
12	PF-1200NR16	PF-1200NF16

MATERIAL: 1/16" THICK NON-ASBESTOS

SIZE	RING GASKET	FULL FACE GASKET
1/2	PF-50AR16	PF-50AF16
3/4	PF-75AR16	PF-75AF16
1	PF-100AR16	PF-100AF16
1 1/4	PF-125AR16	PF-125AF16
1 1/2	PF-150AR16	PF-150AF16
2	PF-200AR16	PF-200AF16
2 1/2	PF-250AR16	PF-250AF16
3	PF-300AR16	PF-300AF16
3 1/2	PF-350AR16	PF-350AF16
4	PF-400AR16	PF-400AF16
4 1/2	PF-450AR16	PF-450AF16
5	PF-500AR16	PF-500AF16
6	PF-600AR16	PF-600AF16
7	PF-700AR16	PF-700AF16
8	PF-800AR16	PF-800AF16
10	PF-1000AR16	PF-1000AF16
12	PF-1200AR16	PF-1200AF16

BOLT PACKS / WATER PUMP GASKETS

MATERIAL: 1/8" THICK NON-ASBESTOS

SIZE	RING GASKET
1/2	PF-50AR8
3/4	PF-75AR8
1	PF-100AR8
1 1/4	PF-125AR8
1 1/2	PF-150AR8
2	PF-200AR8
2 1/2	PF-250AR8
3	PF-300AR8



ACTUAL SIZE: 4 1/8" X 3 1/4"

108222
GASKET TO FIT
AEROMOTOR PUMP
Replaces: 27687



ACTUAL SIZE: 9 1/2" OD
X 7 13/16" ID

108223
GASKET TO FIT
AEROMOTOR PUMP
Replaces: 27749

BOLT PACKS



SSC's Bolt Packs include any of the above listed Pipe Flange Gaskets individually packed with the appropriate ASTM-A307 Grade 2 hex head bolts with finished hex nuts. These kits offer the convenience of having all flange parts in one package. To order a kit just add the letters "BP" to the end of the gasket number listed above. For example to order a 4" full faced flange gasket (1/8" Red Rubber) bolt pack, use part #PF-400RF9BP. See our price list or website for details.

PIPE FLANGE BOLTS AND NUTS

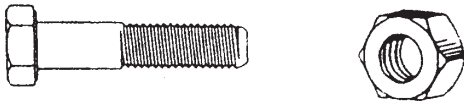

SSC#	DESCRIPTION
PF-100B	BOLT FOR 1/2", 3/4", 1", 1 1/4", 1 1/2" PIPE FLGS.
PF-100N	NUT FOR 1/2", 3/4", 1", 1 1/4", 1 1/2" PIPE FLGS.
PF-200B	BOLT FOR 2", 2 1/2", 3", 3 1/2", 4", 4 1/2" PIPE FLG
PF-200N	NUT FOR 2", 2 1/2", 3", 3 1/2", 4", 4 1/2" PIPE FLGS.
PF-500B	BOLT FOR 5", 6", 7", 8" PIPE FLANGES
PF-500N	NUT FOR 5", 6", 7", 8" PIPE FLANGES
PF-1000B	BOLT FOR 10", 12" PIPE FLANGES
PF-1000N	NUT FOR 10", 12" PIPE FLANGES

GASKETS TO FIT ALLIED PUMP



ACTUAL SIZE: 7" X 4 3/4"

108227
GASKET TO FIT
ALLIED WATER
PUMP RESEVOIR



ACTUAL SIZE: 6 1/2" OD
X 5 5/8" ID

108228
GASKET TO FIT
ALLIED WATER
PUMP VOLUTE
Thickness: 1/64"



ACTUAL SIZE: 6 1/2" OD
X 5 5/8" ID

108229
GASKET TO FIT
ALLIED WATER
PUMP VOLUTE
Thickness: 1/32"

GASKET TO FIT ALLIS CHALMERS



ACTUAL SIZE: 6 7/16" OD
X 5 3/4" ID

108231
GASKET TO FIT
ALLIS CHALMERS
PUMP

GASKET TO FIT ACE



ACTUAL SIZE: 6 15/16" X 6 15/16"

108202
GASKET TO FIT
ACE PUMPS
Universal Type



ACTUAL SIZE: 6 1/2" OD
X 5 1/8" ID

108241
GASKET TO FIT
BERKELY PUMP

GASKETS TO FIT AEROMOTOR



ACTUAL SIZE: 7 5/8" OD X 6" ID

108221
GASKET TO FIT
AEROMOTOR PUMP
Replaces: 26360



ACTUAL SIZE: 6 15/16" X 6 15/16"

108242
GASKET TO FIT
BERKELY PUMP



ACTUAL SIZE: 6 7/8" OD X 5 15/16" ID

108243
GASKET TO FIT
BERKELY PUMP

WELL & MISC. WATER PUMP GASKETS



ACTUAL SIZE: 7 5/8" OD
X 6 5/8" ID

108244
GASKET TO FIT
BERKELY PUMP
Replaces: S0-4757

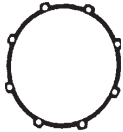

ACTUAL SIZE: 10" OD
X 9 1/8" ID

108245
GASKET TO FIT
BERKELY PUMP
Replaces: S0-5126

GASKETS TO FIT FLINT & WALLING (F&W)



ACTUAL SIZE: 6 13/16" OD X 4" ID

108250
GASKET TO FIT
FLINT & WALLING
PUMP



ACTUAL SIZE: 4 1/16" X 3 1/2"

108251
GASKET TO FIT
FLINT & WALLING
PUMP
Replaces: 103969



ACTUAL SIZE: 7" OD X 4 1/2" ID

108252
GASKET TO FIT
FLINT & WALLING
PUMP
Replaces: 130968



ACTUAL SIZE: 8 7/16" OD
X 5 1/16" ID

108253
GASKET TO FIT
FLINT & WALLING
PUMP
Replaces: 125994



ACTUAL SIZE: 6 1/8" OD X 5" ID

108254
GASKET TO FIT
FLINT & WALLING
PUMP
Replaces: 127782



ACTUAL SIZE: 4 3/16" OD

108255
GASKET TO FIT
FLINT & WALLING
PUMP
Replaces: 131743

GASKETS TO FIT FAIRBANKS



ACTUAL SIZE: 6 7/8" OD
X 6 1/4" ID

108260
GASKET TO FIT
FAIRBANKS PUMP



ACTUAL SIZE: 7 1/4" OD
X 6 5/8" ID

108261
GASKET TO FIT
FAIRBANKS PUMP
Replaces: 40039765



ACTUAL SIZE: 7 5/16" X 8 1/8"

108262
GASKET TO FIT
FAIRBANKS PUMP
Replaces: 40039766



ACTUAL SIZE: 8 3/8" X 7 3/8"

108263
GASKET TO FIT
FAIRBANKS PUMP
Replaces: 40071117



ACTUAL SIZE: 9 3/4" OD
X 8 1/8" ID

108264
GASKET TO FIT
FAIRBANKS PUMP
Perfected Series



ACTUAL SIZE: 7 3/16" OD
X 6 1/2" ID

108265
GASKET TO FIT
FAIRBANKS PUMP
SWP Series

GASKET TO FIT GEORGIA PACIFIC



ACTUAL SIZE: 7" OD X 6 1/2" ID

108271
GASKET TO FIT
GEORGIA PACIFIC
PUMP

GASKETS TO FIT GOULDS



ACTUAL SIZE: 9 1/8" OD

108275
GASKET TO FIT
GOULDS PUMP
Replaces: 5K5

Pump Seals for the above pumps start on page 64.

WELL & MISC. WATER PUMP GASKETS



ACTUAL SIZE: 10" OD

108276
GASKET TO FIT
GOULDS PUMP
Replaces: 5K12



ACTUAL SIZE: 7 3/4" OD

108277
GASKET TO FIT
GOULDS PUMP
Replaces: 5K107



ACTUAL SIZE: 5" X 4"

108278
GASKET TO FIT
GOULDS PUMP
Replaces: 5K108



ACTUAL SIZE: 7 3/4" OD

108279
GASKET TO FIT
GOULDS PUMP
Replaces: 5K109



ACTUAL SIZE: 9" OD

108280
GASKET TO FIT
GOULDS PUMP
Replaces: 5K110



ACTUAL SIZE: 10" OD

108281
GASKET TO FIT
GOULDS PUMP
Replaces: 5K122



ACTUAL SIZE: 7 5/8" OD
X 5 1/2" ID

108282
GASKET TO FIT
GOULDS PUMP
Replaces: 5K144



ACTUAL SIZE: 7 7/8" OD
X 6 7/8" ID

108283
GASKET TO FIT
GOULDS PUMP
Replaces: 5K145



ACTUAL SIZE: 7 3/4" OD
X 6 3/4" ID

108284
GASKET TO FIT
GOULDS PUMP
Replaces: 5K146



ACTUAL SIZE: 4 1/2" X 4 5/16"

108285
GASKET TO FIT
GOULDS PUMP
Replaces: 5K151



ACTUAL SIZE: 7 3/4" OD

108286
GASKET TO FIT
GOULDS PUMP
Replaces: 5K162



ACTUAL SIZE: 7 3/4" OD

108287
GASKET TO FIT
GOULDS PUMP
Replaces: 5K256



ACTUAL SIZE: 7 3/4" OD
X 3 7/8" ID

108288
GASKET TO FIT
GOULDS PUMP
5K2 pattern for
Balance Flow.
Replaces: 5K2

GASKET TO FIT F.E. MEYERS



ACTUAL SIZE: 6 7/8" OD
X 6 1/8" ID

108301
GASKET TO FIT
F.E. MEYERS PUMP
Replaces: 5059A-332

GASKETS TO FIT JET AERATOR



ACTUAL SIZE: 4" OD
X 3 1/4" ID

108330
RELAY COVER GASKET
TO FIT JET AERATOR
Replaces: 4600102
Buna-N Rubber



ACTUAL SIZE: 1" OD X 3/4" ID

108332
CENTER GASKET TO
FIT JET AERATOR
Replaces: 660290
Buna-N Rubber

GASKETS TO FIT PEABODY BARNES



ACTUAL SIZE: 6 1/2" OD
X 5 15/16" ID

108305
GASKET TO FIT
PEABODY BARNES
PUMP



ACTUAL SIZE: 5 1/4" X 3"

108306
GASKET TO FIT
PEABODY BARNES
PUMP



ACTUAL SIZE: 9 1/4" OD
X 7 1/2" ID

108307
GASKET TO FIT
PEABODY BARNES
PUMP
Replaces: 27344

WELL & MISC. WATER PUMP GASKETS

GASKETS TO FIT RAPID DAYTON



ACTUAL SIZE: 7 3/16" OD
X 4 1/2" ID

108310
GASKET TO FIT
RAPID DAYTON
PUMP



ACTUAL SIZE: 7 3/16" OD
X 4 1/2" ID

108312
GASKET TO FIT
RAPID DAYTON
PUMP



ACTUAL SIZE: 7 1/8" OD
X 6 5/16" ID

108314
GASKET TO FIT
RAPID DAYTON
PUMP



ACTUAL SIZE: 7" OD
X 4 1/4" ID

108315
GASKET TO FIT
RAPID DAYTON
PUMP



ACTUAL SIZE: 7 1/8" OD
X 5 7/8" ID

108316
GASKET TO FIT
RAPID DAYTON
PUMP
Replaces: W-16675

GASKET TO FIT STERLING



ACTUAL SIZE: 6 3/8" OD
X 5" ID

108319
CONDENSATE RETURN
GASKET TO FIT
STERLING PUMP
Hot Water Use

GASKET TO FIT VAK PAK

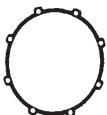

ACTUAL SIZE: 10" OD
X 9 1/8" ID

108320
GASKET TO FIT
VAK PAK PUMP
Replaces: 9118

Pump Seals for the above pumps start on page 64.

STICKY SPRAY

This spray holds O-rings and gaskets in place during installation. Spray the surface where you are installing the part, wait 1-2 minutes until it becomes tacky and apply the part. The part can easily be separated from the surface at a later date.



LUB-990
STICKY SPRAY
4oz. Spray Bottle

GASKET REMOVING SOLUTION

Make the removal of stubborn, baked-on gaskets easy. With this product's foaming action you can remove gaskets without the work and without damage to the part. Sold in 18 oz. spray cans.



GR-957
GASKET REMOVING
SOLUTION
18 oz. Spray Can

PLUMBERS TEFLON GREASE

The U.S.D.A. has rated this lubricant as Food Grade Acceptable. Safely lubricate everything from O-rings and seals to valves and faucet components. This is a waterproof, non-melting, pure synthetic grease which will seal out water and lubricate under the most adverse conditions.



3 OZ. TUBE

LUB-985
TEFLON LUBRICANT/
SEALANT
U.S.D.A. H-1 Rated

PLUMBERS SILICONE GREASE

SSC's Silicone Lube has similar uses as the teflon lube except that it is silicone based, making it a higher grade product than the teflon. It is also rated as Food Grade Acceptable by the U.S.D.A.

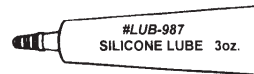

3 OZ. TUBE

LUB-987
SILICONE LUBRICANT/
SEALANT
U.S.D.A. H-1 Rated

SILICONE BASED SPRAY LUBRICANT

A coating of this food-grade rated spray lubricant will protect everything from O-rings to nuts and bolts. The superior and safe lubrication properties of silicone are packaged here in a spray for a cleaner and easier application.



4 OZ. SPRAY
BOTTLE

LUB-989
SILICONE BASED
SPRAY LUBRICANT

PUMP SEALS

REPLACEMENT PUMP SEALS



We stock replacement pump seals for the more popular pumps on the market. Below is a cross reference listed by pump manufacturer and the corresponding seals that go in that equipment. On page 67 is a reverse cross reference which shows the seals in SSC part number order and the listings they fit.

PUMP SEAL OEM CROSS REFERENCE

FITS OEM	SSC#	DIA.	FITS OEM#
Ace Pump	MS-100	5/8"	ACH-25,33,50,75,100
	MS-201	3/4"	ACX-H150
	MS-185V	1 1/4"	30265F
Advance	MS-200	5/8"	
Aeromotor	MS-100	5/8"	
	MS-200	5/8"	
	MS-201	3/4"	SJ-47
AG Chemical EQP	MS-185V	1 1/4"	513745
Air Injector	MS-200	5/8"	SEA-1A, 2A
Allis Chalmers	MS-359	5/8"	52-104-945-804
	MS-200	5/8"	52-104-969-803,813.823
	MS-358	3/4"	607986
	MS-356	1 1/8"	52-104-945-806
	MS-185	1 1/4"	52-113-592-801
American Machine	MS-758	1 1/2"	52-112-870-801
	MS-200	5/8"	MS-626V
	MS-356	1 1/8"	287-15A/B
American Products	MS-1000	5/8"	397,012,397,020
	MS-1000	5/8"	397012, 397020
	MS-201	3/4"	395005
	MS-201	3/4"	395005
Ampro	MS-1000	5/8"	AP-304D
Ampro-Diaclear	MS-1000	5/8"	AP-304D
Anthony	MS-1000	5/8"	4380
	MS-1000	5/8"	4380
	MS-100	5/8"	4547
	MS-100	5/8"	4547
	MS-100	5/8"	4547
Aqua Chem	MS-358	3/4"	925-7526
Aqua Flo	MS-309	7/8"	92500000
	MS-200	5/8"	90500150
	MS-2131	5/8"	91049000
	MS-1000	5/8"	92509040, 92500050
Armstrong Pump	MS-185	1 1/4"	975000-991
Arneson	MS-200	5/8"	A-8
Atlantic Fluidics	MS-1000	5/8"	
	MS-356	1 1/8"	
	MS-185	1 1/4"	
Aurora Pump	MS-100	5/8"	712-7042-750
	MS-358	3/4"	712-1004-753
	MS-356	1 1/8"	712-0907-735
	MS-185	1 1/4"	
	MS-758	1 1/2"	712-1010-753
Baker	MS-100	5/8"	MI-29-3
Baker-Hydro	MS-200	5/8"	35B1178
Barnes, John S.	MS-358	3/4"	67562
Beach Russ	MS-185	1 1/4"	
Bell & Gossett	MS-359	5/8"	180014
	MS-356	1 1/8"	DP0476, 180017
	MS-185V	1 1/4"	186877, P70513
	MS-200	5/8"	S8019, S-20790
Berkeley	MS-201	3/4"	S-20791, S-20792
	MS-201	3/4"	S-5646, S-21961
	MS-356	1 1/8"	S-32690
	MS-201	3/4"	
Braden Winch	MS-201	3/4"	
Browne & Sharp	MS-185	1 1/4"	(W/P66)213-744-274
	MS-185	1 1/4"	713-9245-270

FITS OEM	SSC#	DIA.	FITS OEM#
BSM Pump	MS-185V	1 1/4"	466-292-1
	MS-200	5/8"	17038
Burks Pumps	MS-358	3/4"	
	MS-201	3/4"	17039
	MS-185	1 1/4"	9917
	MS-185V	1 1/4"	9926
	MS-200	5/8"	2661
	MS-201	3/4"	1661
C.B. Tool Co.	MS-200	5/8"	W-105-7
C.H. & E. Mfg.	MS-201	3/4"	W-105-1
	MS-185	1 1/4"	W-105-15A
Carter, Ralph B.	MS-200	5/8"	1S-5005A, 1S-505
	MS-100	5/8"	1S-5010
	MS-201	3/4"	1S-5039
Carver	MS-200	5/8"	B20-1, B1-2-1-1/4 (NAMEPL)
	MS-359	5/8"	BB20-1 (NAMEPLATE)
	MS-201	3/4"	K1/2, L20-11 (NAMEPL)
	MS-358	3/4"	MODEL T14C6
	MS-356	1 1/8"	A300-810 (NAMEPLATE)
	MS-185V	1 1/4"	090-125-01-0103 (NAMEPL)
Chainbelt	MS-185	1 1/4"	K2L-20-9 (NAMEPLATE)
	MS-201	3/4"	X7718
Chicago Pump	MS-185	1 1/4"	X8023
	MS-200	5/8"	2658090
Clay Equipment	MS-100	5/8"	2665171
	MS-185	1 1/4"	0-902718-0
Clayton Mark	MS-758	1 1/2"	0-902719-0
	MS-501	5/8"	29304B
Cleaver Brooks	MS-358	3/4"	925-65
Clow Corp.	MS-185	1 1/4"	C3-2-57
Consol. Dies./Elect.	MS-758	1 1/2"	0338-0275
Construction Mach	MS-758	1 1/2"	
Continental Pump	MS-359	5/8"	V8-15A, U8-15Q
Cooper	MS-185	1 1/4"	2-01S-073-003
Crane-Deming	MS-200	5/8"	15
	MS-359	5/8"	34427
Decatur Pump	MS-501	5/8"	5/8 PACKAGE SEAL
	MS-201	3/4"	59
	MS-185V	1 1/4"	0088458, 0088459
	MS-185	1 1/4"	30880
	MS-758	1 1/2"	30884
Dempster Ind.	MS-359	5/8"	
	MS-501	5/8"	20888
	MS-358	3/4"	8991
	MS-185	1 1/4"	9917
Denison	MS-185V	1 1/4"	9926
	MS-200	5/8"	907-06030
	MS-358	3/4"	907-060403
Detroit Harvester	MS-201	3/4"	622-03102
Devilbiss	MS-100	5/8"	
Dixie Pump	MS-358	3/4"	QM4509
	MS-200	5/8"	
Doerr	MS-201	3/4"	
	MS-359	5/8"	
Domestic Pump	MS-200	5/8"	180013
	MS-359	5/8"	180014
	MS-201	3/4"	
Doughboy	MS-358	3/4"	180010
	MS-1000	5/8"	306-1002
	MS-200	5/8"	306-1006
Douglas Motor	MS-201	3/4"	47406
Dresser	MS-200	5/8"	125-101/113-1
Dunham-Bush	MS-359	5/8"	S-472
East Side Mfg.	MS-200	5/8"	
	MS-359	5/8"	
	MS-1000	5/8"	MODEL BTH
	MS-100	5/8"	P28322
Economy Pump	MS-358	3/4"	
	MS-201	3/4"	
	MS-100	5/8"	
Enpo-Cornell	MS-201	3/4"	
Essick	MS-358	3/4"	9014009
	MS-185	1 1/4"	9014025

PUMP SEALS

FITS OEM	SSC#	DIA.	FITS OEM#	FITS OEM	SSC#	DIA.	FITS OEM#
Everite	MS-501	5/8"			MS-358	3/4"	10-479
	MS-200	5/8"	2544		MS-235	1"	10-504,10-1299-063
	MS-359	5/8"	2584		MS-205-21	1 3/4"	10-330
Fairbanks Morse	MS-359	5/8"			MS-185	1 1/4"	10-0369-29, 10-1400-02
	MS-200	5/8"	82480-75, 82723		MS-758	1 1/2"	10-1348-07
	MS-501	5/8"	S625, 82635-60,82702-75	Jaeger	MS-201	3/4"	
	MS-201	3/4"	MODEL AC,AEC,AS,AES	Kenco	MS-200	5/8"	MODEL 139A
	MS-356	1 1/8"	HYD1AC	Kinney Vac Pump	MS-358	3/4"	KC2.5-15, KS-13, KC-5, KC-8(491)
	MS-185	1 1/4"	HYD1AC2		MS-358	3/4"	KC-5, KC-8(491)
Finn Corp.	MS-185	1 1/4"	80485	Lancaster	MS-200	5/8"	2661
Flint & Walling	MS-800	5/8"	AC-16,131100,132377		MS-1000	5/8"	523-6
	MS-201	3/4"	126544, 126545		MS-358	3/4"	1361
Frederick Pump/Eng	MS-185	1 1/4"			MS-201	3/4"	1661
Geco Sales	MS-1000	5/8"		Leland Faraday	MS-800	5/8"	LFP-333 TO 615, 14107 TO14120
General Pump	MS-200	5/8"			MS-1000	5/8"	MDL LFP-2075, 2100, 2150, 2200
Georgia Pacific	MS-200	5/8"		Lomart	MS-1000	5/8"	
GG Industries	MS-200	5/8"	P-M03885	Luitweiler Pump	MS-201	3/4"	
	MS-1000	5/8"	P-SEAL, 4/P-SEAL		MS-361-21	1 1/4"	
Gilbert Barker	MS-1000	5/8"	K81159X	Marine Swim Pool	MS-201	3/4"	
Gorman Rupp	MS-633	5/8"	25271-824	Marlow	MS-201	3/4"	38592-00
	MS-200	5/8"	S-1531, S-756		MS-978	1 1/4"	45672-20
	MS-359	5/8"	S-765	McDonald, A.Y.	MS-501	5/8"	5MCD4
	MS-112	3/4"	S-1679		MS-201	3/4"	5MCD5
	MS-358	3/4"	S-936, S-1575	Memphis	MS-100	5/8"	0625-6BC
	MS-235	1"	S-1906,S-1832		MS-201	3/4"	
	MS-446	1 3/4"	S-1822	Metal Master	MS-200	5/8"	
	MS-185V	1 1/4"	25271-888		MS-702	5/8"	15110
	MS-756	1 1/4"	S-1621	Midland Products	MS-201	3/4"	6070-0
	MS-361-21	1 1/4"	S-335	Monarch Ind.	MS-200	5/8"	240160
	MS-758	1 1/2"	S-1150		MS-201	3/4"	24034/MS17, 240170
Goulds Pumps	MS-702	5/8"	10K1, 70470-5062		MS-185	1 1/4"	240070
	MS-702	5/8"	72598-1062, 20-83-1100	Montgomery Ward	MS-185V	1 1/4"	240359
	MS-446	1 3/4"	9152091001	MP Pump	MS-358	3/4"	24181
	MS-356	1 1/8"	10K21		MS-112	3/4"	15112
	MS-185	1 1/4"	10K13, 9152071001	Murphy Diesel	MS-358	3/4"	15151
	MS-185V	1 1/4"	10K19	Myers, F.E.	MS-358	3/4"	MD-4090
	MS-185V	1 1/4"	10K25 (W/CMS)		MS-309	7/8"	21576A
Gusher Pumps	MS-235	1"	84001-2		MS-200	5/8"	14525A, 16275A
H & F Mfg. Co.	MS-1000	5/8"			MS-359	5/8"	22447A
Hale Products	MS-201	3/4"	292-5040-00-3		MS-101	3/4"	11416A, A2, A3
	MS-235	1"	25D-G444,1001-02-20-00		MS-185	1 1/4"	22577A
	MS-356	1 1/8"	296-5220-00	Nash Elmo	MS-758	1 1/2"	22922A
	MS-758	1 1/2"	296-5021-03		MS-100	5/8"	HTG PUMP
Hall Scott	MS-200	5/8"			MS-758	1 1/2"	PK -791
Hayward	MS-200	5/8"	62729	National Ice Corp.	MS-359	5/8"	
	MS-200	5/8"	SPX-1250-Z-2	Oberdorfer	MS-359	5/8"	A5935
	MS-2131	5/8"	SPX-1500-KA		MS-235	1"	32315
	MS-201	3/4"	A75911	Osmonics Inc.	MS-359	5/8"	1113515
	MS-201	3/4"	SPX-1600-Z-2	Pac Fab	MS-200	5/8"	354545
	MS-235	1"	47046		MS-100	5/8"	P28280
	MS-446	1 3/4"	46150		MS-501	5/8"	P28322, 071733
Heinecke	MS-101	3/4"	MODEL 2T		MS-1000	5/8"	P28323, 071734
Hobart Mfg.	MS-235	1"	R-79205	Paco	MS-201	3/4"	P28300, 071728, 354001
	MS-758	1 1/2"			MS-200	5/8"	SL-7101, 7741, K102-1
Homart-Sears	MS-100	5/8"	42G2377W		MS-201	3/4"	K101-1
Hydromatic Pump	MS-200	5/8"	83		MS-235	1"	SL-7735
	MS-358	3/4"	00100-000-1		MS-446	1 3/4"	K104-1
	MS-201	3/4"	17048-0-1		MS-205-21	1 3/4"	SL-7090, 14007090
	MS-235	1"	00300-000-1		MS-361-21	1 1/4"	14007099
	MS-446	1 3/4"	11049-001-1		MS-756	1 1/4"	SL-7094
	MS-185	1 1/4"	04916-000-1		MS-758	1 1/2"	SL-7107
	MS-185V	1 1/4"	04916-002-1	Peabody-Barnes	MS-200	5/8"	11397-12839, 12703
	MS-758	1 1/2"	00920-001-1		MS-359	5/8"	18873A
Hypro Corp.	MS-235	1"	21399		MS-201	3/4"	13110, 14017122
Ingersoll Rand	MS-633	5/8"	CPM-625171		MS-358	3/4"	15344, 67562
	MS-359	5/8"	CPM-6251C1		MS-235	1"	18004-30090
	MS-200	5/8"	CPM-6252C1, 6258C1		MS-185	1 1/4"	70713, 19146
	MS-185V	1 1/4"	CPM-10613A		MS-758	1 1/2"	24998
Jacuzzi	MS-290	5/8"	10-1202, 10-1203	Peerless	MS-200	5/8"	2658090
	MS-200	5/8"	10-467,10-1436-00, 10-0002-06		MS-100	5/8"	2665171
	MS-201	3/4"	10-477,10-486,10-120,10-1390-04				
	MS-359	5/8"	10-478, 10-506				

PUMP SEALS

FITS OEM	SSC#	DIA.	FITS OEM#
Perfecting	MS-205-21	1 3/4"	2663044
	MS-361-21	1 1/4"	2657093, 2663048
	MS-359	5/8"	732015 (Division of Duff-Norton)
	MS-356	1 1/8"	732049 (Division of Duff-Norton)
Polaris	MS-1000	5/8"	P55
Premier	MS-1000	5/8"	31-813
	MS-201	3/4"	31-812
Price Pump Co.	MS-359	5/8"	841
	MS-201	3/4"	MODEL SP-15
	MS-758	1 1/2"	MODEL E150, E200
Prosser Pump	MS-359	5/8"	2-31001
	MS-756	1 1/4"	25 & 40HP MOD. 9-26032-3
Purex	MS-100	5/8"	P28280
	MS-501	5/8"	P28322/071733
	MS-1000	5/8"	P28323/071734
	MS-201	3/4"	P28300/071728
Rainbow Irrigation	MS-185	1 1/4"	14821
Red Jacket	MS-100	5/8"	C76-98A-C, C76-78A, 176-037 (Veeder Root)
	MS-201	3/4"	76-129, 76-189 (Veeder Root)
Reliance Electric	MS-446	1 3/4"	64262-12C
	MS-185	1 1/4"	64262-12A
Rice	MS-200	5/8"	21-024
	MS-201	3/4"	12-023
Robbins & Myers	MS-359	5/8"	32-02424
	MS-200	5/8"	POD-3054
	MS-201	3/4"	32-01625, 48-65C
	MS-358	3/4"	32-03945-000
Romar Filter	MS-200	5/8"	618-001
Ruth Berry	MS-201	3/4"	601, 601A
Scot Pump	MS-309	7/8"	101-000-156
	MS-200	5/8"	101-000-340
	MS-501	5/8"	118-000-340D
	MS-446	1 3/4"	101-000-196
	MS-185	1 1/4"	101-000-104, 101-000-104, 101-000-294
	MS-185V	1 1/4"	101-000-194A
Service Filtration	MS-309	7/8"	55-488
	MS-358	3/4"	55-407
Sethco Mfg.	MS-359	5/8"	
Shelter Pump	MS-200	5/8"	
	MS-201	3/4"	
Sherwood Brass	MS-200	5/8"	10159
Sigmund	MS-356	1 1/8"	
	MS-758	1 1/2"	
Simmons	MS-200	5/8"	MODEL 6
Skidmore	MS-309	7/8"	50625-2, 142-54055
	MS-290	5/8"	142-54009
	MS-100	5/8"	142-54049
	MS-359	5/8"	50625-1
	MS-356	1 1/8"	50625-3, 142-54058
Somat Corp.	MS-309	7/8"	54302
	MS-359	5/8"	54300
SPP Pump	MS-633	5/8"	
	MS-359	5/8"	
	MS-356	1 1/8"	
	MS-758	1 1/2"	
Sta Rite	MS-501	5/8"	118-000-340
	MS-200	5/8"	17304-0100S
	MS-1000	5/8"	U109-136SS
	MS-100	5/8"	U109-6,U109-6A,U109-93SS, U9-48,17351-0102S
	MS-201	3/4"	U109-358SS,U9-122,U109-372SS, 17351-0101S, 37400-0027S
	MS-358	3/4"	U109-99
	MS-235	1"	16504
	MS-446	1 3/4"	S-32015
	MS-185	1 1/4"	U109-433SS,U109- 220, S-32014
Sterling Machinery	MS-201	3/4"	

FITS OEM	SSC#	DIA.	FITS OEM#
Sterling Machinery	MS-358	3/4"	1616
	MS-185	1 1/4"	1636
Stevens Pump Co.	MS-200	5/8"	16-062-03
Stone Construction	MS-201	3/4"	32223, 322231H
	MS-446	1 3/4"	377281H
	MS-185	1 1/4"	37692
	MS-758	1 1/2"	37691, 376911H
Swaby Mfg. Co.	MS-359	5/8"	
	MS-758	1 1/2"	
	MS-446	1 3/4"	
Swim-Quip	MS-201	3/4"	AS-201
Taco	MS-359	5/8"	121-009, 122-009
	MS-633	5/8"	170-102RP,1600-170RP
	MS-200	5/8"	172-009, 172-017
	MS-356	1 1/8"	950-670RP, 951-3161DRP
	MS-758	1 1/2"	950-671RP
Tait	MS-201	3/4"	25062
Teel Pump	MS-359	5/8"	1R304, 1P567, 5P386
	MS-800	5/8"	1R307, 5P387, 5P-421
	MS-100	5/8"	1R311, 5P404, 5P403
	MS-200	5/8"	1R312, 5P406, 5P405
	MS-501	5/8"	1R315, 5P410, 5P409
	MS-1000	5/8"	1R317, 1R318, 5P368, 5P369
	MS-201	3/4"	1R313, 5P412, 5P411, 1R299, 5P414
	MS-101	3/4"	1R319, 5P416
	MS-235	1"	5P390
	MS-205-21	1 3/4"	5P-378
	MS-356	1 1/8"	1R301, 5P391, 3P608
	MS-185	1 1/4"	1R439, 5P394
	MS-361-21	1 1/4"	5P-374
	MS-756	1 1/4"	5P-396
Toledo	MS-501	5/8"	A14067
Trupar	MS-201	3/4"	P-11201
Uniflow	MS-200	5/8"	
US Electric Motor	MS-358	3/4"	PUL2112
	MS-356	1 1/8"	
Vertiflow	MS-358	3/4"	SJ-2112-C1-00
	MS-185V	1 1/4"	SJ2120-C1-X0
Vico	MS-2136	3/4"	PPSFSEAL
Waterway	MS-1000	5/8"	319-3100B
Watts	MS-1000	5/8"	
Waukesha Motors	MS-201	3/4"	152243-B
	MS-185	1 1/4"	178033
Wayne Home Equip.	MS-200	5/8"	15559/56104
	MS-1000	5/8"	15996/56109
	MS-201	3/4"	15693/56105
Weber Ind.	MS-185V	1 1/4"	70X123-M
Weil Pump Co.	MS-1000	5/8"	
	MS-100	5/8"	17-30009-005
	MS-201	3/4"	17-62372-008
	MS-358	3/4"	205-016-101
	MS-356	1 1/8"	137-000-129
Weinman	MS-309	7/8"	Q26-394-Y02
	MS-501	5/8"	Q26-77
	MS-205-21	1 3/4"	Q26-222-Y03,Q26-217-Y03
	MS-361-21	1 1/4"	Q26-243-Y03
	MS-185	1 1/4"	Q26-395-402, Q26-166-402
	MS-756	1 1/4"	Q26-395-Y34
Wells Bloomfield	MS-359	5/8"	35902
Wet Institute	MS-1000	5/8"	1000
White	MS-200	5/8"	
Worthington	MS-200	5/8"	43008
	MS-359	5/8"	50675
	MS-201	3/4"	
Zoeller Co.	MS-356	1 1/8"	6510

Please see our Bell & Gossett and Taco sections on pages 28-41 for seals and replacement parts for those manufacturers. Also, please see our separate 117 page Pool & Spa Parts Catalog for our complete listings of seals, gaskets, O-rings and motor parts for the Pool & Spa Industry.

PUMP SEALS



TYPE: A

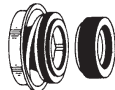

TYPE: B



TYPE: C

PUMP SEAL REVERSE CROSS REFERENCE

SSC#	FITS OEM	DIA.	FITS OEM#	
MS-100 (Type: A)	Ace Pump	5/8"	ACH-25,33,50,75,100	
	Aeromotor	5/8"		
	Anthony	5/8"	4547	
	Anthony	5/8"	4547	
	Aurora Pump	5/8"	712-7042-750	
	Baker	5/8"	MI-29-3	
	Carter, Ralph B.	5/8"	1S-5010	
	Chicago Pump	5/8"	2665171	
	Detroit Harvester	5/8"		
	East Side Mfg.	5/8"	P28322	
	Economy Pump	5/8"		
	Homart-Sears	5/8"	42G2377W	
	Memphis	5/8"	0625-6BC	
	Nash Elmo	5/8"	HTG PUMP	
	Pac Fab	5/8"	P28280	
	Peerless	5/8"	2665171	
	Purex	5/8"	P28280	
	Red Jacket	5/8"	C76-98A-C, C76-78A, 176-037 (Veeder Root)	
	Skidmore	5/8"	142-54049	
	Sta Rite	5/8"	U109-6,U109-6A, U109-93SS,U9-48, 17351-0102S	
	Teel Pump	5/8"	1R311, 5P404, 5P403	
	Weil Pump Co.	5/8"	17-30009-005	
	MS-101 (Type: A)	Heinecke	3/4"	MODEL 2T
		Myers, F.E.	3/4"	11416A, A2, A3
	MS-112 (Type: C)	Teel Pump	3/4"	1R319, 5P416
		Gorman Rupp	3/4"	S-1679
	MS-185 (Type: C)	MP Pump	3/4"	15112
		Allis Chalmers	1 1/4"	52-113-592-801
		Armstrong Pump	1 1/4"	975000-991
		Atlantic Fluidics	1 1/4"	
		Aurora Pump	1 1/4"	
		Beach Russ	1 1/4"	
		Browne & Sharp	1 1/4"	(W/P66)213-744-274
Browne & Sharp		1 1/4"	713-9245-270	
Burks Pumps		1 1/4"	9917	
C.H. & E. Mfg.		1 1/4"	W-105-15A	
Carver		1 1/4"	K2L-20-9 (NAMEPLATE)	
Chainbelt		1 1/4"	X8023	
Clay Equipment		1 1/4"	0-902718-0	
Clow Corp.		1 1/4"	C3-2-57	
Cooper		1 1/4"	2-01S-073-003	
Crane-Deming		1 1/4"	30880	
Decatur Pump		1 1/4"	9917	
Essick		1 1/4"	9014025	
Fairbanks Morse		1 1/4"	HYD1AC2	
Finn Corp.		1 1/4"	80485	
Frederick Pump/Eng		1 1/4"		
Goulds Pumps		1 1/4"	10K13, 9152071001	
Hydromatic Pump		1 1/4"	04916-000-1	
Jacuzzi		1 1/4"	10-0369-29, 10-1400-02	
Monarch Ind.		1 1/4"	240070	
Myers, F.E.		1 1/4"	22577A	
Peabody-Barnes		1 1/4"	70713, 19146	
Rainbow Irrigation		1 1/4"	14821	
Reliance Electric		1 1/4"	64262-12A	
Scot Pump		1 1/4"	101-000-104,101-000-104, 101-000-294	
Sta Rite		1 1/4"	U109-433SS,U109- 220, S-32014	
Sterling Machinery		1 1/4"	1636	
Stone Construction		1 1/4"	37692	
Teel Pump		1 1/4"	1R439, 5P394	
Waukesha Motors		1 1/4"	178033	

SSC#	FITS OEM	DIA.	FITS OEM#
MS-185V (Type: C)	Weinman	1 1/4"	Q26-395-402, Q26-166-402
	Zoeller Co.	1 1/4"	8165
	Ace Pump	1 1/4"	30265F
	AG Chemical EQP	1 1/4"	513745
	Bell & Gossett	1 1/4"	186877, P70513
	BSM Pump	1 1/4"	466-292-1
	Burks Pumps	1 1/4"	9926
	Carver	1 1/4"	090-125-01-0103 (NAMEPL)
	Crane-Deming	1 1/4"	0088458, 0088459
	Decatur Pump	1 1/4"	9926
	Gorman Rupp	1 1/4"	25271-888
	Goulds Pumps	1 1/4"	10K19
	Goulds Pumps	1 1/4"	10K25 (W/CMS)
	Hydromatic Pump	1 1/4"	04916-002-1
	Ingersoll Rand	1 1/4"	CPM-10613A
	Monarch Ind.	1 1/4"	240359
	MS-200 (Type: A)	Scot Pump	1 1/4"
Vertiflow		1 1/4"	SJ2120-C1-X0
Weber Ind.		1 1/4"	70X123-M
Advance		5/8"	
Aeromotor		5/8"	
Air Injector		5/8"	SEA-1A, 2A
Allis Chalmers		5/8"	52-104-969-803,813.823
American Machine		5/8"	MS-626V
Aqua Flo		5/8"	90500150
Arneson		5/8"	A-8
Baker-Hydro		5/8"	35B1178
Berkeley		5/8"	S8019, S-20790
Burks Pumps		5/8"	17038
C.B. Tool Co.		5/8"	2661
C.H. & E. Mfg.		5/8"	W-105-7
Carter, Ralph B.		5/8"	1S-5005A, 1S-505
Carver		5/8"	B20-1, B1-2-1-1/4 (NAMEPL)
Chicago Pump	5/8"	2658090	
Crane-Deming	5/8"	15	
Dempster Ind.	5/8"	907-06030	
Dixie Pump	5/8"		
Domestic Pump	5/8"	180013	
Doughboy	5/8"	306-1006	
Dresser	5/8"	125-101/113-1	
East Side Mfg.	5/8"		
Everite	5/8"	2544	
Fairbanks Morse	5/8"	82480-75, 82723	
General Pump	5/8"		
Georgia Pacific	5/8"		
GG Industries	5/8"	P-M03885	
Gorman Rupp	5/8"	S-1531, S-756	
Hall Scott	5/8"		
Hayward	5/8"	62729	
Hayward	5/8"	SPX-1250-Z-2	
Hydromatic Pump	5/8"	83	
Ingersoll Rand	5/8"	CPM-6252C1, 6258C1	
Jacuzzi	5/8"	10-467,10-1436-00, 10-0002-06	
Kenco	5/8"	MODEL 139A	
Lancaster	5/8"	2661	
Metal Master	5/8"		
Monarch Ind.	5/8"	240160	
Myers, F.E.	5/8"	14525A, 16275A	
Pac Fab	5/8"	354545	
Paco	5/8"	SL-7101, 7741, K102-1	
Peabody-Barnes	5/8"	11397-12839, 12703	
Peerless	5/8"	2658090	
Rice	5/8"	21-024	
Robbins & Myers	5/8"	POD-3054	
Romar Filter	5/8"	618-001	
Scot Pump	5/8"	101-000-340	
Shelter Pump	5/8"		
Sherwood Brass	5/8"	10159	
Simmons	5/8"	MODEL 6	
Sta Rite	5/8"	17304-0100S	

PUMP SEALS

SSC#	FITS OEM	DIA.	FITS OEM#
MS-201 (Type: A)	Stevens Pump Co.	5/8"	16-062-03
	Taco	5/8"	172-009, 172-017
	Teel Pump	5/8"	1R312, 5P406, 5P405
	Uniflow	5/8"	
	Wayne Home Equip.	5/8"	15559/56104
	White	5/8"	
	Worthington	5/8"	43008
	Ace Pump	3/4"	ACX-H150
	Aeromotor	3/4"	SJ-47
	American Products	3/4"	395005
	American Products	3/4"	395005
	Berkeley	3/4"	S-20791, S-20792
	Berkeley	3/4"	S-5646, S-21961
	Braden Winch	3/4"	
	Burks Pumps	3/4"	17039
	C.B. Tool Co.	3/4"	1661
	C.H. & E. Mfg.	3/4"	W-105-1
	Carter, Ralph B.	3/4"	1S-5039
	Carver	3/4"	K1/2, L20-11 (NAMEPL)
	Chainbelt	3/4"	X7718
	Crane-Deming	3/4"	59
	Denison	3/4"	622-03102
	Dixie Pump	3/4"	
	Domestic Pump	3/4"	
	Douglas Motor	3/4"	47406
	East Side Mfg.	3/4"	
	Enpo-Cornell	3/4"	
	Fairbanks Morse	3/4"	MODEL AC,AEC,AS,AES
	Flint & Walling	3/4"	126544, 126545
	Hale Products	3/4"	292-5040-00-3
	Hayward	3/4"	A75911
	Hayward	3/4"	SPX-1600-Z-2
	Hydromatic Pump	3/4"	17048-0-1
	Jacuzzi	3/4"	10-477,10-486,10-120, 10-1390-04
	Jaeger	3/4"	
	Lancaster	3/4"	1661
	Luitweiler Pump	3/4"	
	Marine Swim Pool	3/4"	
	Marlow	3/4"	38592-00
	McDonald, A.Y.	3/4"	5MCD5
	Memphis	3/4"	
	Midland Products	3/4"	6070-0
	Monarch Ind.	3/4"	24034/MS17, 240170
	Pac Fab	3/4"	P28300, 071728, 354001
	Paco	3/4"	K101-1
	Peabody-Barnes	3/4"	13110, 14017122
	Premier	3/4"	31-812
	Price Pump Co.	3/4"	MODEL SP-15
	Purex	3/4"	P28300/071728
	Red Jacket	3/4"	76-129, 76-189 (Veeder Root)
Rice	3/4"	12-023	
Robbins & Myers	3/4"	32-01625, 48-65C	
Ruth Berry	3/4"	601, 601A	
Shelter Pump	3/4"		
Sta Rite	3/4"	U109-358SS,U9-122, U109-372SS17351- 0101S, 37400-0027S	
Sterling Machinery	3/4"		
Stone Construction	3/4"	32223, 322231H	
Swim-Quip	3/4"	AS-201	
Tait	3/4"	25062	
Teel Pump	3/4"	1R313, 5P412, 5P411, 1R299, 5P414	
Trupar	3/4"	P-11201	
Waukesha Motors	3/4"	152243-B	
Wayne Home Equip.	3/4"	15693/56105	
Weil Pump Co.	3/4"	17-62372-008	
Worthington	3/4"		
MS-205-21 (Type: C)	Jacuzzi	1 3/4"	10-330
	Paco	1 3/4"	SL-7090, 14007090
	Peerless	1 3/4"	2663044
	Teel Pump	1 3/4"	5P-378

SSC#	FITS OEM	DIA.	FITS OEM#	
MS-235 (Type: C)	Weinman	1 3/4"	Q26-222-Y03,Q26-217-Y03	
	Gorman Rupp	1"	S-1906,S-1832	
	Gusher Pumps	1"	84001-2	
	Hale Products	1"	25D-G444,1001-02-20-00	
	Hayward	1"	47046	
	Hobart Mfg.	1"	R-79205	
	Hydromatic Pump	1"	00300-000-1	
	Hypro Corp.	1"	21399	
	Jacuzzi	1"	10-504,10-1299-063	
	Oberdorfer	1"	32315	
	Paco	1"	SL-7735	
	Peabody-Barnes	1"	18004-30090	
	Sta Rite	1"	16504	
	Teel Pump	1"	5P390	
	MS-290 (Type: C)	Jacuzzi	5/8"	10-1202, 10-1203
		Skidmore	5/8"	142-54009
	MS-309 (Type: C)	Aqua Flo	7/8"	92500000
		Myers, F.E.	7/8"	21576A
	MS-356 (Type: C)	Scot Pump	7/8"	101-000-156
		Service Filtration	7/8"	55-488
		Skidmore	7/8"	50625-2, 142-54055
		Somat Corp.	7/8"	54302
		Weinman	7/8"	Q26-394-Y02
Allis Chalmers		1 1/8"	52-104-945-806	
American Machine		1 1/8"	287-15A/B	
Atlantic Fluidics		1 1/8"		
Aurora Pump		1 1/8"	712-0907-735	
Bell & Gossett		1 1/8"	DP0476, 180017	
Berkeley		1 1/8"	S-32690	
Carver		1 1/8"	A300-810 (NAMEPLATE)	
Fairbanks Morse		1 1/8"	HYD1AC	
Goulds Pumps		1 1/8"	10K21	
Hale Products		1 1/8"	296-5220-00	
Perfecting		1 1/8"	732049 (Division of Duff-Norton)	
Sigmund		1 1/8"		
Skidmore		1 1/8"	50625-3, 142-54058	
SPP Pump		1 1/8"		
Taco		1 1/8"	950-670RP, 951-3161DRP	
Teel Pump		1 1/8"	1R301, 5P391, 3P608	
US Electric Motor		1 1/8"		
Weil Pump Co.		1 1/8"	137-000-129	
Zoeller Co.	1 1/8"	6510		
MS-358 (Type: C)	Allis Chalmers	3/4"	607986	
	Aqua Chem	3/4"	925-7526	
	Aurora Pump	3/4"	712-1004-753	
	Barnes, John S.	3/4"	67562	
	Burks Pumps	3/4"		
	Carver	3/4"	MODEL T14C6	
	Cleaver Brooks	3/4"	925-65	
	Decatur Pump	3/4"	8991	
	Dempster Ind.	3/4"	907-060403	
	Devilbiss	3/4"	QM4509	
	Domestic Pump	3/4"	180010	
	East Side Mfg.	3/4"		
	Essick	3/4"	9014009	
	Gorman Rupp	3/4"	S-936, S-1575	
	Hydromatic Pump	3/4"	00100-000-1	
	Jacuzzi	3/4"	10-479	
	Kinney Vac Pump	3/4"	KC2.5-15, KS-13, KC-5, KC-8(491)	
	Kinney Vac Pump	3/4"	KC-5, KC-8(491)	
	Lancaster	3/4"	1361	
	Montgomery Ward	3/4"	24181	
	MP Pump	3/4"	15151	
	Murphy Diesel	3/4"	MD-4090	
	Peabody-Barnes	3/4"	15344, 67562	
Robbins & Myers	3/4"	32-03945-000		
Service Filtration	3/4"	55-407		
Sta Rite	3/4"	U109-99		
Sterling Machinery	3/4"	1616		
US Electric Motor	3/4"	PUL2112		
Vertiflow	3/4"	SJ-2112-C1-00		
Weil Pump Co.	3/4"	205-016-101		

PUMP SEALS

SSC#	FITS OEM	DIA.	FITS OEM#
MS-359 (Type: C)	Allis Chalmers	5/8"	52-104-945-804
	Bell & Gossett	5/8"	180014
	Carver	5/8"	BB20-1 (NAMEPLATE)
	Continental Pump	5/8"	V8-15A, U8-15Q
	Crane-Deming	5/8"	34427
	Decatur Pump	5/8"	
	Doerr	5/8"	
	Domestic Pump	5/8"	180014
	Dunham-Bush	5/8"	S-472
	East Side Mfg.	5/8"	
	Everite	5/8"	2584
	Fairbanks Morse	5/8"	
	Gorman Rupp	5/8"	S-765
	Ingersoll Rand	5/8"	CPM-6251C1
	Jacuzzi	5/8"	10-478, 10-506
	Myers, F.E.	5/8"	22447A
	National Ice Corp.	5/8"	
	Oberdorfer	5/8"	A5935
	Osmonics Inc.	5/8"	1113515
	Peabody-Barnes	5/8"	18873A
	Perfecting	5/8"	732015 (Division of Duff-Norton)
	Price Pump Co.	5/8"	841
	Prosser Pump	5/8"	2-31001
	Robbins & Myers	5/8"	32-02424
	Sethco Mfg.	5/8"	
	Skidmore	5/8"	50625-1
	Somat Corp.	5/8"	54300
	SPP Pump	5/8"	
	Swaby Mfg. Co.	5/8"	
	Taco	5/8"	121-009, 122-009
	Teel Pump	5/8"	1R304, 1P567, 5P386
	Wells Bloomfield	5/8"	35902
	Worthington	5/8"	50675
MS-361-21 (Type: C)	Gorman Rupp	1 1/4"	S-335
	Luitweiler Pump	1 1/4"	
	Paco	1 1/4"	14007099
	Peerless	1 1/4"	2657093, 2663048
	Teel Pump	1 1/4"	5P-374
	Weinman	1 1/4"	Q26-243-Y03
MS-446 (Type: C)	Gorman Rupp	1 3/4"	S-1822
	Goulds Pumps	1 3/4"	9152091001
	Hayward	1 3/4"	46150
	Hydromatic Pump	1 3/4"	11049-001-1
	Paco	1 3/4"	K104-1
	Reliance Electric	1 3/4"	64262-12C
	Scot Pump	1 3/4"	101-000-196
	Sta Rite	1 3/4"	S-32015
	Stone Construction	1 3/4"	377281H
	Swaby Mfg. Co.	1 3/4"	
MS-501 (Type: A)	Clayton Mark	5/8"	29304B
	Crane-Deming	5/8"	5/8 PACKAGE SEAL
	Decatur Pump	5/8"	20888
	Everite	5/8"	
	Fairbanks Morse	5/8"	S625, 82635-60,82702-75
	McDonald, A.Y.	5/8"	5MCD4
	Pac Fab	5/8"	P28322, 071733
	Purex	5/8"	P28322/071733
	Scot Pump	5/8"	118-000-340D
	Sta Rite	5/8"	118-000-340
	Teel Pump	5/8"	1R315, 5P410, 5P409
	Toledo	5/8"	A14067
	Weinman	5/8"	Q26-77
MS-633 (Type: C)	Gorman Rupp	5/8"	25271-824
	Ingersoll Rand	5/8"	CPM-625171
	SPP Pump	5/8"	
	Taco	5/8"	170-102RP,1600-170RP
MS-702 (Type: A)	Goulds Pumps	5/8"	10K1, 70470-5062
	Goulds Pumps	5/8"	72598-1062, 20-83-1100
	Metal Master	5/8"	15110
MS-756 (Type: C)	Gorman Rupp	1 1/4"	S-1621
	Paco	1 1/4"	SL-7094
	Prosser Pump	1 1/4"	25 & 40HP MOD. 9-26032-3
	Teel Pump	1 1/4"	5P-396

SSC#	FITS OEM	DIA.	FITS OEM#
	Weinman	1 1/4"	Q26-395-Y34
MS-758 (Type: C)	Allis Chalmers	1 1/2"	52-112-870-801
	Aurora Pump	1 1/2"	712-1010-753
	Clay Equipment	1 1/2"	0-902719-0
	Consol. Dies./Elect.	1 1/2"	0338-0275
	Construction Mach	1 1/2"	
	Crane-Deming	1 1/2"	30884
	Gorman Rupp	1 1/2"	S-1150
	Hale Products	1 1/2"	296-5021-03
	Hobart Mfg.	1 1/2"	
	Hydromatic Pump	1 1/2"	00920-001-1
	Jacuzzi	1 1/2"	10-1348-07
	Myers, F.E.	1 1/2"	22922A
	Nash Elmo	1 1/2"	PK -791
	Paco	1 1/2"	SL-7107
	Peabody-Barnes	1 1/2"	24998
	Price Pump Co.	1 1/2"	MODEL E150, E200
	Sigmund	1 1/2"	
	SPP Pump	1 1/2"	
	Stone Construction	1 1/2"	37691, 376911H
	Swaby Mfg. Co.	1 1/2"	
	Taco	1 1/2"	950-671RP
MS-800 (Type: C)	Flint & Walling	5/8"	AC-16,131100,132377
	Leland Faraday	5/8"	LFP-333 TO 615,14107 TO 14120
	Teel Pump	5/8"	1R307, 5P387, 5P-421
MS-978	Marlow	1 1/4"	45672-20 (Type: C)
MS-1000 (Type: B)	American Products	5/8"	397,012,397,020
	American Products	5/8"	397012, 397020
	Ampro	5/8"	AP-304D
	Ampro-Diaclear	5/8"	AP-304D
	Anthony	5/8"	4380
	Anthony	5/8"	4380
	Aqua Flo	5/8"	92509040, 92500050
	Atlantic Fluidics	5/8"	
	Doughboy	5/8"	306-1002
	East Side Mfg.	5/8"	MODEL BTH
	Geco Sales	5/8"	
	GG Industries	5/8"	P-SEAL, 4/P-SEAL
	Gilbert Barker	5/8"	K81159X
	H & F Mfg. Co.	5/8"	
	Lancaster	5/8"	523-6
	Leland Faraday	5/8"	MDL LFP-2075, 2100, 2150, 2200
	Lomart	5/8"	
	Pac Fab	5/8"	P28323, 071734
	Polaris	5/8"	P55
	Premier	5/8"	31-813
	Purex	5/8"	P28323/071734
	Sta Rite	5/8"	U109-136SS
	Teel Pump	5/8"	1R317, 1R318, 5P368, 5P369
	Waterway	5/8"	319-3100BM
	Watts	5/8"	
	Wayne Home Equip.	5/8"	15996/56109
	Weil Pump Co.	5/8"	
	Wet Institute	5/8"	1000
MS-2131 (Type: A)	Aqua Flo	5/8"	91049000
	Hayward	5/8"	SPX-1500-KA
MS-2136	Vico	3/4"	PPSFSEAL (Type: A)

SEAL SETTING TOOL

This makes setting seals a snap. Works on pumps up to 3 HP.



ST-379
SEAL SETTING TOOL

Please see our Bell & Gossett and Taco sections on pages 28-41 for seals and replacement parts for those manufacturers. Also, please see our separate 117 page Pool & Spa Parts Catalog for our complete listings of seals, gaskets, O-rings and motor parts for the Pool & Spa Industry.

GASKET SHEETS

GASKET SHEETS



Available in various thicknesses, SSC's gasket sheets are perfect for emergency repairs and for replacing hard to find gaskets and washers. All materials can be cut into any shape or size. Available in the following materials and sizes:

CORK-RUBBER

The highest quality material of its kind, it can be used to seal applications involving oil or water. It will not shrink, stretch or lose bolt tension. **Temperature Rating: -20° F to 250° F**

SSC#	SIZE
GS-1A	6" x 6" x 1/32" TH
GS-1B	6" x 6" x 1/16" TH
GS-1C	12" x 12" x 1/32" TH
GS-1D	12" x 12" x 1/16" TH
GS-1E	24" x 24" x 1/32" TH
GS-1F	24" x 24" x 1/16" TH
GS-1G	20" x 40" x 1/32" TH
GS-1H	20" x 40" x 1/16" TH

BUNA-N RUBBER

This black rubber is ideal for sealing oil applications. It has a high nitrile content which means it is oil resistant. **Temperature Rating: -40° F to 180° F**

SSC#	SIZE
GS-2A	6" x 6" x 1/32" TH
GS-2B	6" x 6" x 1/16" TH
GS-2C	6" x 6" x 3/32" TH
GS-2D	6" x 6" x 1/8" TH
GS-2E	12" x 12" x 1/32" TH
GS-2F	12" x 12" x 1/16" TH
GS-2G	12" x 12" x 3/32" TH
GS-2H	12" x 12" x 1/8" TH
GS-2I	24" x 24" x 1/32" TH
GS-2J	24" x 24" x 1/16" TH
GS-2K	24" x 24" x 3/32" TH
GS-2L	24" x 24" x 1/8" TH
GS-2M	20" x 36" x 1/32" TH
GS-2N	20" x 36" x 1/16" TH
GS-2P	20" x 36" x 3/32" TH
GS-2Q	20" x 36" x 1/8" TH

RED RUBBER (RAINBOW PACKING)

The most popular rubber for sealing water applications, it can be used on everything from pipe flanges to pump housings. Not to be put in contact with any petroleum product. **Temperature Rating: -20° F to 170° F**

SSC#	SIZE
GS-3A	6" x 6" x 1/16" TH
GS-3B	6" x 6" x 1/8" TH
GS-3C	12" x 12" x 1/16" TH
GS-3D	12" x 12" x 1/8" TH
GS-3E	12" x 24" x 1/8" TH
GS-3F	18" x 36" x 1/8" TH
GS-3G	24" x 24" x 1/16" TH
GS-3H	24" x 24" x 1/8" TH
GS-3I	20" x 36" x 1/16" TH

TAN FIBER (FOR OIL)

This has been used successfully in the oil industry for over 20 years. It will seal oil or water.

Temperature Rating: -20° F to 250° F

SSC#	SIZE
GS-4M	6" x 6" x 1/64" TH
GS-4A	6" x 6" x 1/32" TH
GS-4B	6" x 6" x 1/16" TH
GS-4N	12" x 12" x 1/64" TH
GS-4C	12" x 12" x 1/32" TH
GS-4D	12" x 12" x 1/16" TH
GS-4P	24" x 24" x 1/64" TH
GS-4E	24" x 24" x 1/32" TH
GS-4F	24" x 24" x 1/16" TH
GS-4Q	20" x 40" x 1/64" TH
GS-4G	20" x 40" x 1/32" TH
GS-4H	20" x 40" x 1/16" TH

HIGH DENSITY CORK-RUBBER

This high grade material can be used in oil or water applications. It forms to imperfections on the flange and is very durable. **Temperature Rating: -20° F to 250° F**

SSC#	SIZE
GS-5A	6" x 6" x 1/32" TH
GS-5B	12" x 12" x 1/32" TH
GS-5C	24" x 24" x 1/32" TH
GS-5D	20" x 36" x 1/32" TH

GASKET CUTTING SHEARS

These high leverage shears give you extra powerful cutting power to make gasket cutting easy, especially when working with thick material.



GS-100SH
HEAVY-DUTY SHEARS
FOR CUTTING GASKET
MATERIAL
Made of hot drop forged
nickel-plated steel.

TAN FIBER (FOR WATER)

This fiber material is designed to be used in applications involving the sealing of water. Especially good for pump housings and flanges. Not to be used in oil applications.
Temperature Rating: -20° F to 250° F

<u>SSC#</u>	<u>SIZE</u>
GS-6A	6" x 6" x 1/32" TH
GS-6B	6" x 6" x 1/16" TH
GS-6C	12" x 12" x 1/32" TH
GS-6D	12" x 12" x 1/16" TH
GS-6E	24" x 24" x 1/32" TH
GS-6F	24" x 24" x 1/16" TH
GS-6G	20" x 40" x 1/32" TH
GS-6H	20" x 40" x 1/16" TH

BLACK FIBER

This material for higher temperatures can be used in oil or water. It is frequently used for applications like steam and hot water. **Temperature Rating: -20° F to 350° F**

<u>SSC#</u>	<u>SIZE</u>
GS-7A	6" x 6" x 1/32" TH
GS-7B	6" x 6" x 1/16" TH
GS-7C	12" x 12" x 1/32" TH
GS-7D	12" x 12" x 1/16" TH
GS-7E	24" x 24" x 1/32" TH
GS-7F	24" x 24" x 1/16" TH
GS-7G	20" x 40" x 1/32" TH
GS-7H	20" x 40" x 1/16" TH

BLACK FIBER WITH ANTI-STICK COATING

Same as black fiber except with the added feature of anti-stick coating. This allows easy removal from flanges.
Temperature Rating: -20° F to 350° F

<u>SSC#</u>	<u>SIZE</u>
GS-8A	6" x 6" x 1/32" TH
GS-8B	6" x 6" x 1/16" TH
GS-8C	12" x 12" x 1/32" TH
GS-8D	12" x 12" x 1/16" TH
GS-8E	24" x 24" x 1/32" TH
GS-8F	24" x 24" x 1/16" TH
GS-8G	20" x 40" x 1/32" TH
GS-8H	20" x 40" x 1/16" TH

NON-ASBESTOS

This is the most popular material used for pipe flange gaskets and gaskets used in higher pressure applications. Excellent with water but not with oil/petroleum product.
Temperature Rating: -200° F to 572° F

<u>SSC#</u>	<u>SIZE</u>
GS-9A	6" x 6" x 1/16" TH
GS-9B	6" x 6" x 1/8" TH
GS-9C	12" x 12" x 1/16" TH
GS-9D	12" x 12" x 1/8" TH
GS-9E	24" x 24" x 1/16" TH
GS-9F	24" x 24" x 1/8" TH
GS-9G	20" x 36" x 1/16" TH
GS-9H	20" x 36" x 1/8" TH

NEOPRENE

This black rubber is the most popular rubber in the world. Automobile tires are made of neoprene. Very effective in sealing water, it will not dry out or harden as fast as Red Rubber. Do not use this rubber in oil/petroleum product as it will swell up and then break down.

Temperature Rating: -20° F to 170° F

<u>SSC#</u>	<u>SIZE</u>
GS-10A	6" x 6" x 1/32" TH
GS-10B	6" x 6" x 1/16" TH
GS-10C	6" x 6" x 3/32" TH
GS-10D	6" x 6" x 1/8" TH
GS-10E	6" x 6" x 3/16" TH
GS-10F	6" x 6" x 1/4" TH
GS-10G	12" x 12" x 1/32" TH
GS-10H	12" x 12" x 1/16" TH
GS-10I	12" x 12" x 3/32" TH
GS-10J	12" x 12" x 1/8" TH
GS-10K	12" x 12" x 3/16" TH
GS-10L	12" x 12" x 1/4" TH
GS-10M	24" x 24" x 1/32" TH
GS-10N	24" x 24" x 1/16" TH
GS-10P	24" x 24" x 3/32" TH
GS-10Q	24" x 24" x 1/8" TH
GS-10R	24" x 24" x 3/16" TH
GS-10S	24" x 24" x 1/4" TH
GS-10T	20" x 36" x 1/32" TH
GS-10U	20" x 36" x 1/16" TH
GS-10V	20" x 36" x 3/32" TH
GS-10W	20" x 36" x 1/8" TH
GS-10X	20" x 36" x 3/16" TH
GS-10Y	20" x 36" x 1/4" TH
GS-10TA	12" x 24" x 1/8" TH
GS-10TB	12" x 24" x 1/4" TH
GS-10TC	18" x 36" x 1/8" TH
GS-10TD	18" x 36" x 1/4" TH

EPDM

The "Cadillac" of rubber, this black rubber will withstand higher heat and tends not to dry out or harden in extreme environments. This is the material of choice for higher heat steam applications such as boiler handhole and manhole gaskets. **Temperature Rating: -40° F to 225° F**

<u>SSC#</u>	<u>SIZE</u>
GS-11A	6" x 6" x 1/8" TH
GS-11B	6" x 6" x 1/4" TH
GS-11C	12" x 12" x 1/8" TH
GS-11D	12" x 12" x 1/4" TH
GS-11E	24" x 24" x 1/8" TH
GS-11F	24" x 24" x 1/4" TH
GS-11G	20" x 36" x 1/8" TH
GS-11H	20" x 36" x 1/4" TH
GS-11J	12" x 24" x 1/8" TH
GS-11K	12" x 24" x 1/4" TH
GS-11L	18" x 36" x 1/8" TH
GS-11M	18" x 36" x 1/4" TH

Don't Forget - Tankless Heater Gaskets are available in EPDM rubber. While more expensive, EPDM will give your gaskets longer life.

GASKET SHEETS

WHITE BUNA-N RUBBER

This material has the same properties as the black Buna-N. It is a high grade material and will not stain equipment.

Temperature Rating: -25° F to 220° F

SSC#	SIZE
GS-14A	6" x 6" x 3/32" TH
GS-14B	12" x 12" x 3/32" TH
GS-14C	24" x 24" x 3/32" TH
GS-14D	20" x 36" x 3/32" TH

FIBERGLASS SHEETS

This high temperature material (good to 1000°F) is perfect for most gasketing or insulating applications involving boilers and furnaces. Temperature Rating: -20° F to 1000° F

SSC#	SIZE
GS-15A	6" x 6" x 1/8" TH
GS-15B	12" x 12" x 1/8" TH
GS-15C	17" x 24" x 1/8" TH
GS-15D	17" x 36" x 1/8" TH

Try out our **High Temperature Rope and Knit Tape** for insulation and packing of boilers, furnaces, wood stoves and other applications. See page 24 for more details.

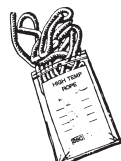

SHIM STOCK MATERIAL

Use this material to shim up an area in small increments.

SSC#	COLOR	SIZE
GS-16A	ORANGE	6" x 6" x .002" TH
GS-16B	ORANGE	12" x 12" x .002" TH
GS-16C	ORANGE	20" x 50" x .002" TH
GS-16D	CREAM	6" x 6" x .003" TH
GS-16E	CREAM	12" x 12" x .003" TH
GS-16F	CREAM	20" x 50" x .003" TH
GS-16G	CLEAR	6" x 6" x .004" TH
GS-16H	CLEAR	12" x 12" x .004" TH
GS-16J	CLEAR	20" x 50" x .004" TH
GS-16K	PURPLE	6" x 6" x .005" TH
GS-16L	PURPLE	12" x 12" x .005" TH
GS-16M	PURPLE	20" x 50" x .005" TH

ALUMINIZED HIGH TEMPERATURE CLOTH

Rated at 2300°, this material is excellent as a thermal barrier. It is used primarily as a **flame shield** when welding or soldering. Temperature Rating: -20° F to 2300° F

SSC#	SIZE
GS-18A	6" x 6" x 1/32" TH
GS-18B	12" x 12" x 1/32" TH
GS-18C	24" x 24" x 1/32" TH
GS-18D	20" x 36" x 1/32" TH

FULL ROLLS OF RED RUBBER (RAINBOW PACKING)



GS-3Y
1/16" THICK RED RUBBER
RAINBOW PACKING
100 lb Roll

GS-3Z
1/8" THICK RED RUBBER
RAINBOW PACKING
100 lb Roll

FULL ROLLS OF NEOPRENE RUBBER



GS-10TX
1/16" THICK
NEOPRENE RUBBER
100 lb Roll

GS-10TY
1/8" THICK
NEOPRENE RUBBER
100 lb Roll

FULL ROLLS OF BUNA-N RUBBER



GS-2Y
1/16" THICK
BUNA-N RUBBER
100 lb Roll

GS-2Z
1/8" THICK
BUNA-N RUBBER
100 lb Roll

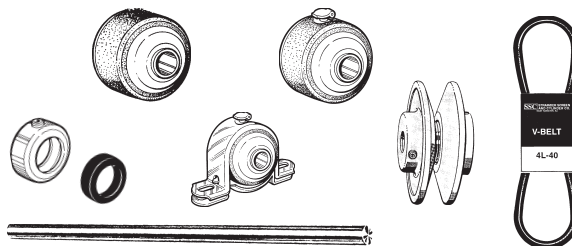

We stock **Blower Parts** such as V-Belts, Pulleys, Blower Shafts as well as Pillow, Oil and Sealed Blower Bearings. Please see pages 25-26.

PRESSURE, VACUUM & COMPOUND GAUGES

SSC's gauges are constructed with a steel case painted black, all brass internals and a glass lens. Competitively priced, the styles to choose from are pressure, vacuum or compound.

LM = LOWER MOUNT
CBM = CENTER BACK MOUNT

PRESSURE GAUGES

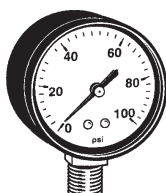

INDIVIDUALLY BOXED

SSC#	DIAL SIZE	MOUNT	PRESSURE
102902	1"	1/8" CBM	30
102903	1"	1/8" CBM	60
102904	1"	1/8" CBM	100
102905	1"	1/8" CBM	160
102907	1"	1/8" CBM	300
102921	1 1/2"	1/8" LM	15
102922	1 1/2"	1/8" LM	30
102923	1 1/2"	1/8" LM	60
102924	1 1/2"	1/8" LM	100
102925	1 1/2"	1/8" LM	160
102926	1 1/2"	1/8" LM	200
102927	1 1/2"	1/8" LM	300
103001	1 1/2"	1/8" CBM	15
103002	1 1/2"	1/8" CBM	30
102991	1 1/2"	1/8" CBM	60
103003	1 1/2"	1/8" CBM	100
102992	1 1/2"	1/8" CBM	160
102993	1 1/2"	1/8" CBM	200
103004	1 1/2"	1/8" CBM	300
102994	1 1/2"	1/8" CBM	400
102995	1 1/2"	1/8" CBM	600
103022	2"	1/8" LM	15
103023	2"	1/8" LM	30
103024	2"	1/8" LM	60
103025	2"	1/8" LM	100
103026	2"	1/8" LM	160
103027	2"	1/8" LM	200
103028	2"	1/8" LM	300
103029	2"	1/8" LM	400
103013	2"	1/4" LM	15
103014	2"	1/4" LM	30
103015	2"	1/4" LM	60
103016	2"	1/4" LM	100
103017	2"	1/4" LM	160
103018	2"	1/4" LM	200
103019	2"	1/4" LM	300
103020	2"	1/4" LM	400
103021	2"	1/4" LM	600
103031	2"	1/8" CBM	15
103032	2"	1/8" CBM	30
103033	2"	1/8" CBM	60
103034	2"	1/8" CBM	100
103035	2"	1/8" CBM	160

SSC#	DIAL SIZE	MOUNT	PRESSURE
103036	2"	1/8" CBM	200
103037	2"	1/8" CBM	300
103039	2"	1/8" CBM	600
103041	2"	1/4" CBM	15
103008	2"	1/4" CBM	30
103009	2"	1/4" CBM	60
103010	2"	1/4" CBM	100
103042	2"	1/4" CBM	160
103011	2"	1/4" CBM	200
103012	2"	1/4" CBM	300
103043	2"	1/4" CBM	400
103044	2"	1/4" CBM	600
103104	2 1/2"	1/4" LM	15
103105	2 1/2"	1/4" LM	30
103106	2 1/2"	1/4" LM	60
103107	2 1/2"	1/4" LM	100
103108	2 1/2"	1/4" LM	160
103109	2 1/2"	1/4" LM	200
103110	2 1/2"	1/4" LM	300
103111	2 1/2"	1/4" LM	400
103112	2 1/2"	1/4" LM	600
103099	2 1/2"	1/4" CBM	15
103100	2 1/2"	1/4" CBM	30
103101	2 1/2"	1/4" CBM	60
103102	2 1/2"	1/4" CBM	100
103120	2 1/2"	1/4" CBM	160
103121	2 1/2"	1/4" CBM	200
103122	2 1/2"	1/4" CBM	300
103123	2 1/2"	1/4" CBM	400
103124	2 1/2"	1/4" CBM	600
103200	3 1/2"	1/4" LM	15
103202	3 1/2"	1/4" LM	30
103203	3 1/2"	1/4" LM	60
103204	3 1/2"	1/4" LM	100
103205	3 1/2"	1/4" LM	160
103206	3 1/2"	1/4" LM	200
103207	3 1/2"	1/4" LM	300
103208	3 1/2"	1/4" LM	400
103209	3 1/2"	1/4" LM	600
103201	3 1/2"	1/4" CBM	30
103221	3 1/2"	1/4" CBM	60
103222	3 1/2"	1/4" CBM	100
103223	3 1/2"	1/4" CBM	160
103224	3 1/2"	1/4" CBM	200
103225	3 1/2"	1/4" CBM	300
103226	3 1/2"	1/4" CBM	400
103227	3 1/2"	1/4" CBM	600
103301	4 1/2"	1/4" LM	15
103302	4 1/2"	1/4" LM	30
103303	4 1/2"	1/4" LM	60
103304	4 1/2"	1/4" LM	100
103305	4 1/2"	1/4" LM	160
103306	4 1/2"	1/4" LM	200
103307	4 1/2"	1/4" LM	300
103308	4 1/2"	1/4" LM	400
103309	4 1/2"	1/4" LM	600
103322	4 1/2"	1/4" CBM	30
103323	4 1/2"	1/4" CBM	60
103324	4 1/2"	1/4" CBM	100
103325	4 1/2"	1/4" CBM	160
103326	4 1/2"	1/4" CBM	200
103327	4 1/2"	1/4" CBM	300

GAUGES

VACUUM GAUGES



INDIVIDUALLY BOXED

SSC#	DIAL SIZE	MOUNT	VACUUM
104990	1 1/2"	1/8" LM	30
104991	1 1/2"	1/8" CBM	30
105002	2"	1/8" LM	30
105001	2"	1/4" LM	30
105003	2"	1/8" CBM	30
105004	2"	1/4" CBM	30
105011	2 1/2"	1/4" LM	30
105012	2 1/2"	1/4" CBM	30

COMPOUND GAUGES

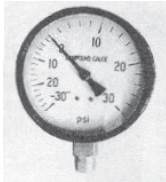

INDIVIDUALLY BOXED

SSC#	DIAL SIZE	MOUNT	VAC / PRESS
102000	2"	1/8" LM	30 / 30
102001	2"	1/8" LM	30 / 60
102002	2"	1/8" LM	30 / 150
102003	2"	1/8" LM	30 / 300
101971	2"	1/4" LM	30 / 30
101972	2"	1/4" LM	30 / 60
101973	2"	1/4" LM	30 / 150
101974	2"	1/4" LM	30 / 300
101991	2"	1/8" CBM	30 / 30
101992	2"	1/8" CBM	30 / 60
101993	2"	1/8" CBM	30 / 150
101994	2"	1/8" CBM	30 / 300
101981	2"	1/4" CBM	30 / 30
101982	2"	1/4" CBM	30 / 60
101983	2"	1/4" CBM	30 / 150
101984	2"	1/4" CBM	30 / 300
102011	2 1/2"	1/4" LM	30 / 30
102012	2 1/2"	1/4" LM	30 / 60
102013	2 1/2"	1/4" LM	30 / 150
102014	2 1/2"	1/4" LM	30 / 300
102021	2 1/2"	1/4" CBM	30 / 30
102022	2 1/2"	1/4" CBM	30 / 60
102023	2 1/2"	1/4" CBM	30 / 150
102024	2 1/2"	1/4" CBM	30 / 300
102031	3 1/2"	1/4" LM	30 / 30
102032	3 1/2"	1/4" LM	30 / 60
102033	3 1/2"	1/4" LM	30 / 150

PLASTIC CASE GAUGES

Our plastic case gauges are corrosion and weather resistant. They can be used in extreme environmental situations such as outdoor use or very wet areas where a standard gauge might rust. These economical gauges are constructed with a plastic case, a plastic lens and all brass internals.

PLASTIC CASE PRESSURE GAUGES

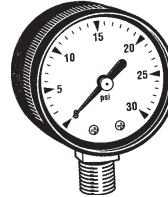

INDIVIDUALLY BOXED

SSC#	DIAL SIZE	MOUNT	PRESSURE
103013PL	2"	1/4" LM	15
103014PL	2"	1/4" LM	30
103015PL	2"	1/4" LM	60
103016PL	2"	1/4" LM	100
103017PL	2"	1/4" LM	160
103018PL	2"	1/4" LM	200
103019PL	2"	1/4" LM	300
103041PL	2"	1/4" CBM	15
103008PL	2"	1/4" CBM	30
103009PL	2"	1/4" CBM	60
103010PL	2"	1/4" CBM	100
103042PL	2"	1/4" CBM	160
103011PL	2"	1/4" CBM	200
103012PL	2"	1/4" CBM	300

PLASTIC CASE VACUUM GAUGES

105001PL	2"	1/4" LM	30VAC
105004PL	2"	1/4" CBM	30VAC

Liquid Filled Gauges start on next page.

Hose Parts are listed on pages 83-84.

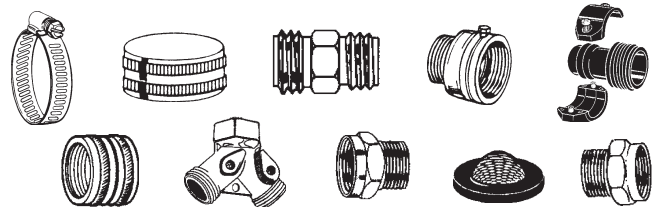

GAUGES

LIQUID (GLYCERIN) FILLED GAUGES

SSC's glycerin filled gauges are good for applications where there is a lot of movement. The liquid inside the gauge acts as a vibration and pulsation damper giving the technician a more accurate read. They are constructed with a stainless steel case, a plastic lens and all brass internals.

LM = LOWER MOUNT
CBM = CENTER BACK MOUNT

LIQUID FILLED PRESSURE GAUGES

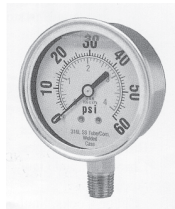

INDIVIDUALLY BOXED

SSC#	DIAL SIZE	MOUNT	PRESSURE
100301	1 1/2"	1/8" LM	15
100302	1 1/2"	1/8" LM	30
100303	1 1/2"	1/8" LM	60
100304	1 1/2"	1/8" LM	100
100305	1 1/2"	1/8" LM	160
100306	1 1/2"	1/8" LM	200
100307	1 1/2"	1/8" LM	300
100310	1 1/2"	1/8" CBM	15
100311	1 1/2"	1/8" CBM	30
100312	1 1/2"	1/8" CBM	60
100313	1 1/2"	1/8" CBM	100
100314	1 1/2"	1/8" CBM	160
100315	1 1/2"	1/8" CBM	200
100316	1 1/2"	1/8" CBM	300
100318	1 1/2"	1/8" CBM	600
100332	2"	1/8" LM	30
100333	2"	1/8" LM	60
100334	2"	1/8" LM	100
100335	2"	1/8" LM	160
100336	2"	1/8" LM	200
100337	2"	1/8" LM	300
100339	2"	1/8" LM	600
100340	2"	1/4" LM	15
100341	2"	1/4" LM	30
100342	2"	1/4" LM	60
100343	2"	1/4" LM	100
100344	2"	1/4" LM	160
100345	2"	1/4" LM	200
100346	2"	1/4" LM	300
100348	2"	1/4" LM	600
100350	2"	1/8" CBM	30
100351	2"	1/8" CBM	60
100352	2"	1/8" CBM	100
100353	2"	1/8" CBM	160
100354	2"	1/8" CBM	200
100355	2"	1/8" CBM	300
100357	2"	1/8" CBM	600
100358	2"	1/4" CBM	15
100359	2"	1/4" CBM	30
100360	2"	1/4" CBM	60
100361	2"	1/4" CBM	100
100362	2"	1/4" CBM	160
100363	2"	1/4" CBM	200

SSC#	DIAL SIZE	MOUNT	PRESSURE
100364	2"	1/4" CBM	300
100366	2"	1/4" CBM	600
100381	2 1/2"	1/4" LM	15
100382	2 1/2"	1/4" LM	30
100383	2 1/2"	1/4" LM	60
100384	2 1/2"	1/4" LM	100
100385	2 1/2"	1/4" LM	160
100386	2 1/2"	1/4" LM	200
100387	2 1/2"	1/4" LM	300
100388	2 1/2"	1/4" LM	400
100389	2 1/2"	1/4" LM	600
100390	2 1/2"	1/4" CBM	15
100391	2 1/2"	1/4" CBM	30
100392	2 1/2"	1/4" CBM	60
100393	2 1/2"	1/4" CBM	100
100394	2 1/2"	1/4" CBM	160
100395	2 1/2"	1/4" CBM	200
100396	2 1/2"	1/4" CBM	300
100397	2 1/2"	1/4" CBM	400
100398	2 1/2"	1/4" CBM	600
100410	4"	1/4" LM	15
100411	4"	1/4" LM	30
100412	4"	1/4" LM	60
100413	4"	1/4" LM	100
100414	4"	1/4" LM	160
100415	4"	1/4" LM	200
100416	4"	1/4" LM	300
100417	4"	1/4" LM	400
100418	4"	1/4" LM	600
100419	4"	1/4" CBM	15
100420	4"	1/4" CBM	30
100421	4"	1/4" CBM	60
100422	4"	1/4" CBM	100
100423	4"	1/4" CBM	160
100424	4"	1/4" CBM	200
100425	4"	1/4" CBM	300
100426	4"	1/4" CBM	400
100427	4"	1/4" CBM	600

LIQUID FILLED VACUUM GAUGES

100461	1 1/2"	1/8" CBM	30VAC
100462	2"	1/8" LM	30VAC
100463	2"	1/4" LM	30VAC
100464	2"	1/8" CBM	30VAC
100465	2"	1/4" CBM	30VAC
100466	2 1/2"	1/4" LM	30VAC
100467	2 1/2"	1/4" CBM	30VAC
100468	4"	1/4" LM	30VAC
100469	4"	1/4" CBM	30VAC

If we are missing the gauge you need let us know and we'll try to get it.

Liquid Filled Compound Gauges start on next page...

GAUGES

LIQUID FILLED COMPOUND GAUGES

SSC#	DIAL SIZE	MOUNT	VAC / PRESS.
100105	1 1/2"	1/8" CBM	30 / 30
100125	2"	1/4" LM	30 / 30
100150	2 1/2"	1/4" LM	30 / 30
100151	2 1/2"	1/4" LM	30 / 60
100152	2 1/2"	1/4" LM	30 / 150
100153	2 1/2"	1/4" LM	30 / 300
100154	2 1/2"	1/4" CBM	30 / 30
100155	2 1/2"	1/4" CBM	30 / 60
100156	2 1/2"	1/4" CBM	30 / 150
100157	2 1/2"	1/4" CBM	30 / 300
100170	4"	1/4" LM	30 / 30
100171	4"	1/4" LM	30 / 60
100172	4"	1/4" LM	30 / 150
100173	4"	1/4" LM	30 / 300
100174	4"	1/4" CBM	30 / 30
100175	4"	1/4" CBM	30 / 60
100176	4"	1/4" CBM	30 / 150
100177	4"	1/4" CBM	30 / 300

WATER TEST GAUGES



INDIVIDUALLY BOXED

106001
WATER TEST GAUGE
 2 1/2" Dial Size
 3/4" Female Garden Hose
 Connection; 0-300 PSI
 Made of all brass internals,
 brass fitting, plastic body and
 plastic lens.

WITH LAZY HAND

The regular pressure hand pushes the lazy hand to the peak operating or surge pressure point where it remains until you manually reset it. The lazy hand comes in handy when you have to determine if equipment is malfunctioning due to intermittent surging pressure.



INDIVIDUALLY BOXED

106002
WATER TEST GAUGE
WITH LAZY HAND
 2 1/2" Dial Size
 3/4" Female Garden Hose
 Connection; 0-300 PSI
 Made of all brass internals,
 brass fitting, plastic body
 and plastic lens.

BRASS ADAPTER FOR WATER TEST GAUGE

Use this adapter to turn any gauge you have on hand temporarily into a water test gauge.



106005
BRASS ADAPTER FOR
WATER TEST GAUGE
 3/4" female garden hose
 connection x 1/4" female
 fitting.

FIRE SPRINKLER GAUGES



INDIVIDUALLY BOXED

SSC#	DESCRIPTION
106720	300LB, 3 1/2" DIAL, 1/4" LM, BRASS CASE
106722	300LB, 3 1/2" DIAL, 1/4" LM, PLASTIC CASE

GAS TEST GAUGES

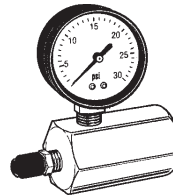

HORIZONTAL TYPE SHOWN
 INDIVIDUALLY BOXED

SSC's Gas Test Gauges feature a horizontal and vertical 3/4" FIP chrome plated steel block with a 1/8" chrome air valve with plastic cap.

SSC#	DIAL SIZE	PRESSURE	GAS TEST MOUNT
106611	2"	30	HORIZONTAL
106622	2"	60	HORIZONTAL
106623	2"	100	HORIZONTAL
106631	2"	30	VERTICAL
106632	2"	60	VERTICAL
106633	2"	100	VERTICAL

CHROME PLATED STEEL BLOCK FOR GAS TEST GAUGES

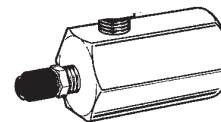

106650
HORIZONTAL BODY
ONLY FOR GAS TEST
GAUGES
 Chrome plated steel block
 with an air valve and
 plastic cap; 3/4" FIP.

106652
VERTICAL BODY
ONLY FOR GAS TEST
GAUGES
 Chrome plated steel block
 with an air valve and
 plastic cap; 3/4" FIP.

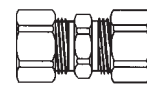
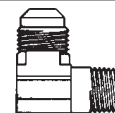

SSC stocks a complete line of **Brass Flare Fittings and Brass Compression Fittings.** Please see pages 85-88.

DIA. GAGE/TRIDICATORS/THERMOMETERS

**LOW PRESSURE DIAPHRAGM GAUGES
(MANOMETERS)**

These gauges feature a highly sensitive capsule type diaphragm to measure extremely low positive or negative pressure applications such as gas feed systems. These are a required test gauge for building code inspection in many municipalities.



INDIVIDUALLY BOXED

SSC#	DIAL SIZE	MOUNT	PRESSURE
106801	2 1/2"	1/4" LM	3 PSI
106802	2 1/2"	1/4" LM	5 PSI
106803	2 1/2"	1/4" LM	10 PSI
106811	2 1/2"	1/4" LM	20 OZ./35" WC
106812	2 1/2"	1/4" LM	35 OZ./60" WC
106821	2 1/2"	1/4" LM	0-10" WC
106822	2 1/2"	1/4" LM	0-15" WC
106823	2 1/2"	1/4" LM	0-30" WC
106824	2 1/2"	1/4" LM	0-60" WC
106825	2 1/2"	1/4" LM	0-100" WC
106826	2 1/2"	1/4" LM	0-160" WC
106827	2 1/2"	1/4" LM	0-200" WC
106850	2 1/2"	1/4" LM	30-0" WC(VAC)

THERMOMETERS

ALL INDIVIDUALLY BOXED



GLASS TUBE TYPE
STRAIGHT

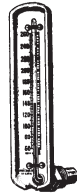

GLASS TUBE TYPE
ANGLE

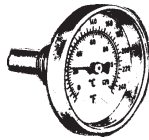

DIAL TYPE
ANGLE



POCKET TYPE

SSC#	TYPE	WELL	TEMP.	CONNECTION
107101	GLASS TUBE	STEEL	60° - 260°	STR-1/2" LM
107102	GLASS TUBE	BRASS	60° - 260°	STR-1/2" LM
107111	GLASS TUBE	STEEL	60° - 260°	ANG-1/2" LBM
107112	GLASS TUBE	BRASS	60° - 260°	ANG-1/2" LBM
107122	DIAL TYPE	BRASS	60° - 260°	ANG-1/2" LBM
107131	POCKET	--	-40° - 160°	1" DIAL
107132	POCKET	--	0° - 220°	1" DIAL

STR = STRAIGHT
ANG = ANGLE
LM = LOWER MOUNT
LBM = LOWER BACK MOUNT

**TRIDICATORS
(PRESSURE / TEMPERATURE GAUGES)**

SSC's Tridicators are designed to withstand the extreme conditions found in all hot water heating boilers. These combination temperature and pressure gauges give you an accurate temperature and pressure read simultaneously.

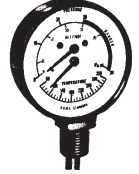
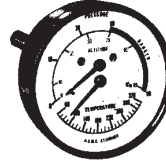

ALL INDIVIDUALLY BOXED

SSC#	DIAL TYPE	MOUNT	PRES.	TEMP.
106501	3 1/4" ROUND	1/2" CBM	75	60-260
106505	3 1/4" ROUND	1/2" LM	75	60-260
106520	2 1/2" ROUND	1/4" CBM	75	70-320
106525	2 1/2" ROUND	1/4" CBM-L.S.	75	70-320
106550	3 1/4" SQUARE	1/2" LM	75	75-260
106555	3 1/4" SQUARE	1/2" CBM	75	75-260
106556	3 1/2" SQUARE	1/2" CBM	200	70-320

LM = LOWER MOUNT
CBM = CENTER BACK MOUNT
L.S. = LONG SHANK - 3" LENGTH

SNUBBERS

Snubbers even out spikes in pressure for a more accurate reading.

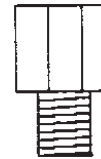

106868
STAINLESS
STEEL SNUBBER
FOR GAUGES
1/4" Female NPT x
1/4" Male NPT

106870
BRASS SNUBBER
FOR GAUGES
1/4" Female NPT x
1/4" Male NPT

106872
BRASS SNUBBER
FOR GAUGES
1/2" Female NPT x
1/2" Male NPT

TEST PLUGS

Screw these plugs into the line and use the needle adapter shown on next page to read the pressure.

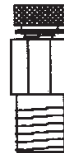

106860
GAUGE TEST PLUG
Brass Body,
Rubber Core
1/4" Male NPT

106862
GAUGE TEST PLUG
Brass Body,
Rubber Core
1/2" Male NPT

GAUGE ACCESSORIES

NEEDLE ADAPTER

Use SSC's Needle Adapters to read the pressure in a pipe or line with a gauge test plug on it. It is similar to blowing up a ball with a needle on an air pump.

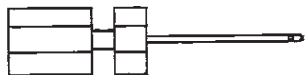

106863
NEEDLE ADAPTER FOR
READING PRESSURE
THROUGH TEST PLUGS
1/4" Female NPT x 1/8"
Diameter Needle

SCHRADER VALVE

This bicycle type air valve allows the service technician to enter air into any system with a compressor or hand pump. It's handy for pressure testing tanks, plumbing systems, pipe, etc.



107140
SCHRADER VALVE
1/8" NPT

BRASS ADAPTER FITTINGS FOR GAUGES

Our Brass Adapter Fittings are handy to have in case the service technician needs to convert the pipe thread size for the gauge opening on the equipment he is working on to another size to fit the particular gauge he has in his tool box.



BRASS

SSC# CONVERTS THESE PIPE THREADS

106875	1/8" MALE TO 1/4" FEMALE
106876	1/4" MALE TO 1/8" FEMALE
106878	3/8" MALE TO 1/8" FEMALE
106880	3/8" MALE TO 1/4" FEMALE
106882	1/2" MALE TO 1/8" FEMALE
106884	1/2" MALE TO 1/4" FEMALE
106886	3/4" MALE TO 1/8" FEMALE
106888	3/4" MALE TO 1/4" FEMALE
106890	1" MALE TO 1/4" FEMALE

INTERNAL SEAT

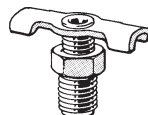

BRASS

SSC#	SIZE
122070	1/8"
122072	1/4"
122074	3/8"

BRASS PLUGS

Use SSC's solid brass plugs for plugging air-relief valves, drain openings, etc. Similar to our drain cocks except solid.



BRASS

SSC#	SIZE
122080	1/8"
122082	1/4"
122084	3/8"

NEEDLE VALVES

SSC's needle valves are handy to use when leaving gauges on equipment. Open the valve to test pressure and turn off when not in use.



FIP x FIP

BRASS

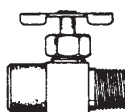

FIP x MIP

SSC#	SIZE
122040	1/8" FIP x 1/8" FIP
122042	1/4" FIP x 1/4" FIP
122046	1/8" FIP x 1/8" MIP
122048	1/4" FIP x 1/4" MIP

STRAIGHT



PT-711
STRAIGHT PIGTAIL
STEAM SYPHON
Black Iron
1/4" I.P.S.

PT-712
STRAIGHT PIGTAIL
STEAM SYPHON
Brass
1/4" I.P.S.

ANGLE



PT-714
ANGLE (90°) PIGTAIL
STEAM SYPHON
Black Iron
1/4" I.P.S.

PT-715
ANGLE (90°) PIGTAIL
STEAM SYPHON
Brass
1/4" I.P.S.

1/4" IPS FULL PORT BRASS BALL VALVE

The 1/4" ball valve is handy to have when a service technician wishes to permanently leave a gauge on a piece of equipment. Just install the valve, attach the gauge to the valve and turn the valve on or off when you wish to get a reading.

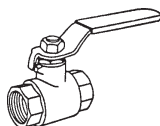

122130
1/4" IPS FULL PORT
BALL VALVE
600 WOG

SELF-TAPPING SADDLE VALVE



INDIVIDUALLY BAGGED

122600
SELF-PIERCING
SADDLE VALVE
Connects 1/4" bleed
lines to copper tubing
from 3/8" to 1 3/8".

BALL VALVES / GAS COCKS / PACKING

FULL PORT FORGED BRASS BALL VALVES - 600 WOG

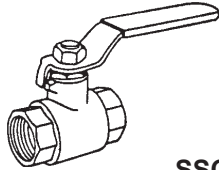

IPS

- Full Port
- 600 WOG / 150 WSP
- Forged Brass
- Yellow Vinyl Covered Handle

SSC#	SIZE
122130	1/4"
122132	3/8"
122134	1/2"
122136	3/4"
122138	1"
122140	1 1/4"
122142	1 1/2"
122144	2"

C x C

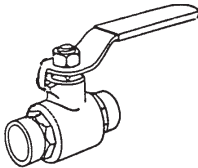

- Full Port
- 600 WOG / 150 WSP
- Forged Brass
- Yellow Vinyl Covered Handle

SSC#	SIZE
122104	1/2"
122106	3/4"
122108	1"
122110	1 1/4"
122112	1 1/2"
122114	2"

BRASS COMPRESSION BALL VALVES

SSC's Brass Compression Ball Valves will fit copper tubing.

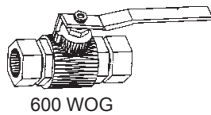

600 WOG

SSC#	COPPER PIPE
122184	1/2" (5/8" OD)
122186	3/4" (7/8" OD)
122188	1" (1 1/8" OD)

PVC BALL VALVES

IPS

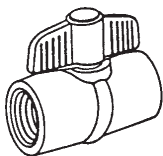

1 PIECE CONSTRUCTION
1/4 TURN OPERATION

SSC#	SIZE
122324	1/2"
122326	3/4"
122328	1"
122330	1 1/4"
122332	1 1/2"
122334	2"

SOLVENT WELD

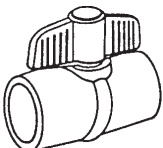

1 PIECE CONSTRUCTION
1/4 TURN OPERATION

SSC#	SIZE
122354	1/2"
122356	3/4"
122358	1"
122360	1 1/4"
122362	1 1/2"
122364	2"

SINGLE UNION PVC BALL VALVES

SSC's Single Union Ball Valves are lightweight and compact and designed for Pool & Spa installations. The full port ball valve gives minimum pressure drop and the valves are rated at 225 psi test pressure and 150 psi working pressure.

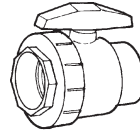

SOCKET / IPS (FIP) END

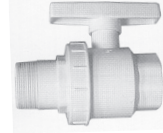

NIPPLE END

SSC#	SIZE
120270	1 1/2" SOLVENT END
120272	2" SOLVENT END
120280	1 1/2" IPS (FIP)
120282	2" IPS (FIP)
120290	1 1/2" NIPPLE END-SOLVENT
120292	1 1/2" NIPPLE END-THREADED

AGA / CSA APPROVED BRASS BALL VALVE GAS COCK

122032

AGA/CSA APPROVED
BRASS BALL VALVE
GAS COCK
Red Handle
1/2"

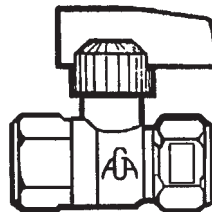

122034

AGA/CSA APPROVED
BRASS BALL VALVE
GAS COCK
Red Handle
3/4"

MECHANICAL PACKING - GRAPHITE AND TEFLON

SSC's packing can be used to seal shafts, valve plugs and other general service applications.



PACKED IN 1 LB. SPOOLS
& INDIVIDUALLY BOXED

SSC#	TYPE	SIZE	FT/LB	TEMP.
PAC-30A	GRAPHITE	1/8"	101	550°
PAC-30B	GRAPHITE	3/16"	60	550°
PAC-30C	GRAPHITE	1/4"	25	550°
PAC-30D	GRAPHITE	5/16"	14.1	550°
PAC-30E	GRAPHITE	3/8"	10	550°
PAC-30F	GRAPHITE	1/2"	5.7	550°
PAC-31A	TEFLON	1/8"	75.5	500°
PAC-31B	TEFLON	3/16"	34.3	500°
PAC-31C	TEFLON	1/4"	20.9	500°
PAC-31D	TEFLON	5/16"	13.4	500°
PAC-31E	TEFLON	3/8"	8.7	500°
PAC-31F	TEFLON	1/2"	6	500°

BOILER DRAINS / SILLCOCKS

BOILER DRAINS

MALE IRON PIPE

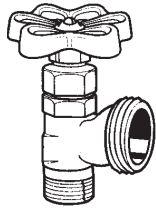

122408
BOILER DRAIN WITH
STUFFING BOX
3/4" Hose End
Brass
1/2" MIP

122410
BOILER DRAIN WITH
STUFFING BOX
3/4" Hose End
Brass
3/4" MIP

FEMALE IRON PIPE

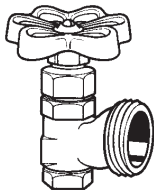

122404
BOILER DRAIN WITH
STUFFING BOX
3/4" Hose End
Brass
1/2" FIP

STOP AND WASTE VALVES

C x C

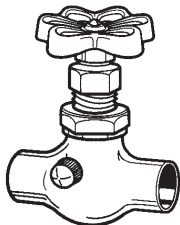

122606
STOP AND WASTE VALVE
With Bleeder Cap
Brass
1/2"

122608
STOP AND WASTE VALVE
With Bleeder Cap
Brass
3/4"

STOP AND WASTE CAP



122620
STOP AND WASTE CAP
5/16" x 24T
Includes Washer
Brass

4-WAY SILLCOCK KEY

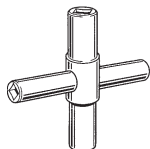

111020
4-WAY SILLCOCK KEY
Fits 1/4", 9/32", 5/16", 11/32"

HOSE BIBBS

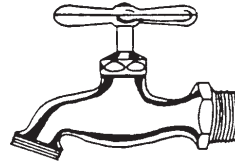

CHROME PLATED BRASS

SSC#	TYPE	SIZE
160010	3/4" HOSE END	1/2" MIP
160020	3/4" HOSE END	3/4" MIP
160030	PLAIN END	1/2" MIP
160035	PLAIN END	3/4" MIP

ANGLE SILLCOCKS

FEMALE IRON PIPE

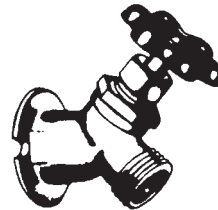

122544
ANGLE SILLCOCK
3/4" Hose Outlet
Brass
1/2" FIP

122546
ANGLE SILLCOCK
3/4" Hose Outlet
Brass
3/4" FIP

C x C



122540
ANGLE SILLCOCK
3/4" Hose Outlet
Brass
1/2" C x C

122542
ANGLE SILLCOCK
3/4" Hose Outlet
Brass
3/4" C x C

FROST FREE SILLCOCKS

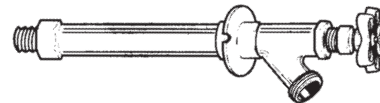

CHROME PLATED BRASS

SSC#	DESCRIPTION	LENGTH
122505	1/2" MIP x 1/2" CxC	6"
122507	1/2" MIP x 1/2" CxC	8"
122509	1/2" MIP x 1/2" CxC	10"
122511	1/2" MIP x 1/2" CxC	12"

CHECK VALVES/COMPRESSION COUPLINGS

ANTI-SYPHON FROST FREE SILLCOCKS

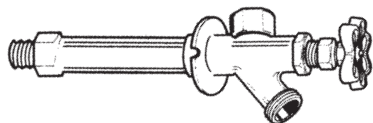

CHROME PLATED BRASS

SSC#	DESCRIPTION	LENGTH
122525	1/2" MIP x 1/2" CxC	6"
122527	1/2" MIP x 1/2" CxC	8"
122529	1/2" MIP x 1/2" CxC	10"
122531	1/2" MIP x 1/2" CxC	12"

HOSE BACKFLOW PREVENTER



122570
HOSE BACKFLOW PREVENTER
(Vacuum Breaker)
 Rough Brass
 3/4" female hose x 3/4" male
 with break-off set screw.

BRASS SWING CHECK VALVES

Our brass swing check valves have a hinged flap and can be used in water or oil applications.

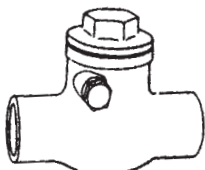

IPS



C x C

SSC#	SIZE
121004	1/2" CxC
121006	3/4" CxC
121008	1" CxC
121010	1 1/4" CxC
121012	1 1/2" CxC
121014	2" CxC
121032	1/2" IPS
121034	3/4" IPS
121036	1" IPS
121038	1 1/4" IPS
121040	1 1/2" IPS
121042	2" IPS

SEWAGE EJECTOR CHECK VALVE

COMBINATION SIZE - FITS 1 1/4" & 1 1/2" IPS



121170
SEWAGE EJECTOR CHECK VALVE
Plastic valve body with rubber ends and hose clamps.
 Combination Size: 1 1/4" & 1 1/2" IPS

PVC CHECK VALVES - SPRING LOADED



IPS



SOLVENT WELD

SSC#	SIZE
121132	1 1/2" IPS
121150	1 1/2" SOLVENT
121152	2" SOLVENT

PVC SCHEDULE 40 UNIONS

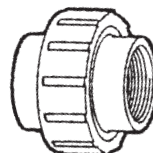

IPS

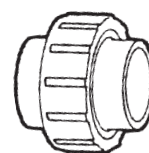

SOLVENT

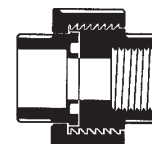

SOLVENT X IPS

SSC#	SIZE
120230	1 1/2" IPS-FEMALE THREAD
120232	2" IPS-FEMALE THREAD
120250	1 1/2" SOLVENT
120252	2" SOLVENT
120260	1 1/2" SOLVENT X IPS-FEM. THD
120262	2" SOLVENT X IPS-FEM. THD

PVC COMPRESSION COUPLINGS - LONG PATTERN

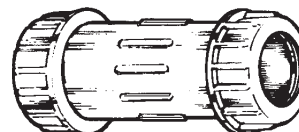

SSC#	DESCRIPTION	PIPE SIZE
121222	LONG PATTERN	1/2"
121224	LONG PATTERN	3/4"
121226	LONG PATTERN	1"
121228	LONG PATTERN	1 1/4"
121230	LONG PATTERN	1 1/2"
121232	LONG PATTERN	2"

GALVANIZED COMPRESSION COUPLINGS - LONG PATTERN



SSC#	DESCRIPTION	PIPE SIZE
121253	LONG PATTERN	1/2"
121255	LONG PATTERN	3/4"
121257	LONG PATTERN	1"
121259	LONG PATTERN	1 1/4"
121261	LONG PATTERN	1 1/2"
121263	LONG PATTERN	2"

PIPE COUPLINGS / ESCUTCHEONS

NO-HUB COUPLINGS

SSC's no-hub pipe couplings are used to join no-hub cast iron soil pipe and fittings. A stainless steel corrugated shield and hose clamps are assembled over a molded neoprene sleeve to give you a strong, positive seal every time.

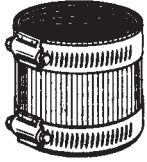

SSC#	PIPE SIZE
110300	1 1/2" x 1 1/2"
110302	2" x 1 1/2"
110304	2" x 2"
110306	3" x 3"
110310	4" x 4"

FLEXIBLE PIPE (TRANSITION) COUPLINGS

Our pipe couplings will fit over plastic and cast iron pipe. They feature all stainless steel clamps and thick-walled neoprene sleeves for strength, durability and an easy installation.

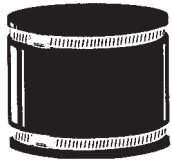

SSC#	PIPE SIZE
110254	1 1/2" x 1 1/2"
110258	2" x 2"
110264	3" x 3"
110270	4" x 3"
110272	4" x 4"

FLEXIBLE PIPE TEST (CLEAN-OUT) CAPS



NEOPRENE RUBBER
STAINLESS CLAMP

SSC#	PIPE SIZE
110380	1 1/2"
110382	2"
110384	3"
110386	4"

TEST PLUGS (DOLLAR PLUGS)

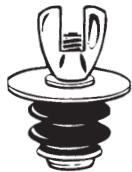

GALVANIZED STEEL FLANGE
MOLDED RUBBER GASKET

SSC#	PIPE SIZE
110202	1 1/2"
110204	2"
110206	3"
110208	4"

RAISED HEAD BRASS CLEANOUT PLUG

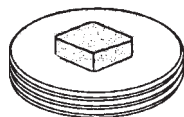

CAST BRASS

SSC#	SIZE
110102	1 1/2"
110104	2"
110106	2 1/2"
110108	3"
110110	3 1/2"
110112	4"

PLASTIC SPLIT-RING FLOOR & CEILING PLATES (ESCUTCHEONS)

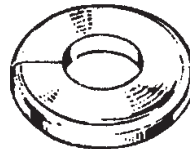

Sure-grip, non-breakable, 100% rustproof, easy to use, beautifully plated and non-corrosive are some of the reasons to use SSC's plastic split-ring floor and ceiling plates. They can be used on most sized pipe - hot or cold.

CHROME PLATED - FOR IRON PIPE

SSC#	DESCRIPTION	SIZE	PKG.
110602	CHROME FINISH	3/8" IPS	12
110604	CHROME FINISH	1/2" IPS	12
110606	CHROME FINISH	3/4" IPS	12
110608	CHROME FINISH	1" IPS	12
110610	CHROME FINISH	1 1/4" IPS	12
110612	CHROME FINISH	1 1/2" IPS	12
110614	CHROME FINISH	2" IPS	12
110616	CHROME FINISH	2 1/2" IPS	12
110618	CHROME FINISH	3" IPS	12
110620	CHROME FINISH	4" IPS	12
110622	CHROME FINISH	6" IPS	6

CHROME PLATED - FOR COPPER TUBING

SSC#	DESCRIPTION	SIZE	PKG.
110640	CHROME FINISH	1/2" COP	12
110642	CHROME FINISH	3/4" COP	12
110644	CHROME FINISH	1" COP	12
110646	CHROME FINISH	1 1/4" COP	12
110648	CHROME FINISH	1 1/2" COP	12

WHITE - FOR IRON PIPE

SSC#	DESCRIPTION	SIZE	PKG.
110660	WHITE FINISH	3/8" IPS	12
110661	WHITE FINISH	1/2" IPS	12
110662	WHITE FINISH	3/4" IPS	12
110663	WHITE FINISH	1" IPS	12
110664	WHITE FINISH	1 1/4" IPS	12
110665	WHITE FINISH	1 1/2" IPS	12
110666	WHITE FINISH	2" IPS	12
110667	WHITE FINISH	2 1/2" IPS	12
110668	WHITE FINISH	3" IPS	12
110669	WHITE FINISH	4" IPS	12

WHITE - FOR COPPER TUBING

SSC#	DESCRIPTION	SIZE	PKG.
110675	WHITE FINISH	1/2" COP	12
110676	WHITE FINISH	3/4" COP	12
110677	WHITE FINISH	1" COP	12
110678	WHITE FINISH	1 1/4" COP	12
110679	WHITE FINISH	1 1/2" COP	12

POLISHED BRASS FINISH

SSC#	DESCRIPTION	SIZE	PKG.
110690	POLISHED BRASS FINISH	3/8" IPS	12
110691	POLISHED BRASS FINISH	1/2" IPS	12
110695	POLISHED BRASS FINISH	1/2" COP	12
110696	POLISHED BRASS FINISH	3/4" COP	12

HOSE CLAMPS

HINGED PIPE REPAIR CLAMPS

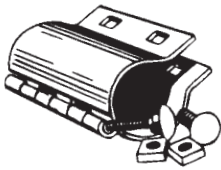

SSC#	PIPE SIZE
110350	1/2"
110352	3/4"
110354	1"
110356	1 1/4"
110358	1 1/2"
110360	2"

TORQUE WRENCH FOR HOSE CLAMPS

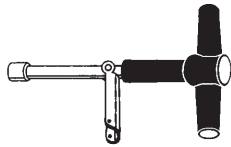

111062
TORQUE WRENCH
Tightens to 60 ft. lbs.

MINI HOSE CLAMPS

WITH PLATED STEEL SCREW



PACKED 10/BOX

- 304 series stainless steel band
- 430 series stainless steel housing
- Plated steel screw
- 5/16" wide band
- Packed 10 clamps in a box

SSC#	CLAMP#	SIZE
110501	4 Mini	7/32" to 5/8"
110502	6 Mini	7/16" to 25/32"

WITH STAINLESS STEEL SCREW



PACKED 10/BOX

- 304 stainless steel band & housing
- 302 stainless steel screw
- 5/16" wide band
- Packed 10 clamps in a box

SSC#	CLAMP#	SIZE
110401	4 Mini	7/32" to 5/8"
110402	6 Mini	7/16" to 25/32"

STAINLESS STEEL HOSE CLAMPS WITH PLATED STEEL SCREW

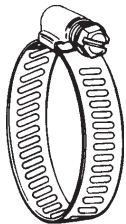

PACKED 10/BOX

- 304 series stainless steel band
- 430 series stainless steel housing
- Plated steel screw
- 1/2" wide band
- Packed 10 clamps in a box

SSC#	CLAMP#	SIZE
110506	6	3/8" to 7/8"
110508	8	7/16" to 1"
110510	10	9/16" to 1 1/16"
110512	12	11/16" to 1 1/4"
110516	16	13/16" to 1 1/2"
110520	20	13/16" to 1 3/4"
110524	24	11/16" to 2"
110528	28	1 5/16" to 2 1/4"
110532	32	1 9/16" to 2 1/2"
110536	36	1 13/16" to 2 3/4"
110540	40	2 1/16" to 3"
110544	44	2 5/16" to 3 1/4"
110548	48	2 9/16" to 3 1/2"
110552	52	2 13/16" to 3 3/4"
110556	56	3 1/16" to 4"
110560	60	3 5/16" to 4 1/4"
110564	64	3 9/16" to 4 1/2"
110572	72	4 1/8" to 5"

STAINLESS STEEL HOSE CLAMPS WITH STAINLESS STEEL SCREW

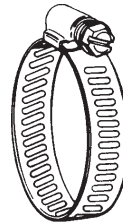

PACKED 10/BOX

- 304 series stainless steel band
- 304 series stainless steel housing
- 302 series stainless steel screw
- Commonly known as "Marine Grade"
- 1/2" wide band
- Packed 10 clamps in a box

SSC#	CLAMP#	SIZE
110406	6	3/8" to 7/8"
110408	8	7/16" to 1"
110410	10	9/16" to 1 1/16"
110412	12	11/16" to 1 1/4"
110416	16	13/16" to 1 1/2"
110420	20	13/16" to 1 3/4"
110424	24	11/16" to 2"
110428	28	1 5/16" to 2 1/4"
110432	32	1 9/16" to 2 1/2"
110436	36	1 13/16" to 2 3/4"
110440	40	2 1/16" to 3"
110444	44	2 5/16" to 3 1/4"
110448	48	2 9/16" to 3 1/2"
110452	52	2 13/16" to 3 3/4"
110456	56	3 1/16" to 4"
110460	60	3 5/16" to 4 1/4"
110464	64	3 9/16" to 4 1/2"
110472	72	4 1/8" to 5"

HOSE CAPS / HOSE PARTS / HOSE FITTINGS

HOSE CAPS AND GASKETS

BRASS HOSE CAP WITH GASKET INCLUDED

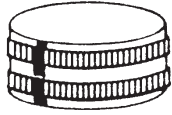

INCLUDES GASKET

HC-305
BRASS HOSE CAP
FOR 3/4" THREAD
For capping boiler drains,
valves, hoses etc.
Made of knurled brass.
Includes G-194 gasket.

PLASTIC HOSE CAP WITH GASKET INCLUDED



INCLUDES GASKET

HC-306
PLASTIC HOSE CAP
FOR 3/4" THREAD
Same as above except
made of plastic.
Includes G-194 gasket.

BRASS HOSE CAP WITH CHAIN



HC-307A
BRASS HOSE CAP
WITH CHAIN
FOR 3/4" THREAD
Does not include gasket.

HOSE CAP WASHERS



ACTUAL SIZE: 1 1/16" OD
X 9/16" ID

G-194
HOSE CAP WASHER
Neoprene (Black Rubber)

G-194RR
HOSE CAP WASHER
Red Rubber

MISCELLANEOUS HOSE PARTS

HOSE INLET FILTER SCREEN



122569
Prevents Sediment
3/4"

SIAMESE HOSE CONNECTION



122568
With Dual Shut-Off
Chrome Plated Zinc
3/4"

REPAIR COUPLING - MALE END



122565
Plastic
3/4"

REPAIR COUPLING - FEMALE END



122566
Plastic
3/4"

HOSE MENDER



122567
Connects 2 Hose Pieces
Plastic
3/4"

BACKFLOW PREVENTER (VACUUM BREAKER)



122570
Rough Brass
3/4"

BRASS HOSE FITTINGS

FEMALE HOSE TO FEMALE PIPE



122573
3/4" FH X 3/4" FIP

MALE HOSE TO FEMALE PIPE



122576
3/4" MH X 3/4" FIP

MALE HOSE TO MALE HOSE



122579
3/4" MH X 3/4" MH

FEMALE HOSE TO MALE PIPE



122581
3/4" FH X 3/4" MIP
(1/2" FIP TAPPED)

MALE HOSE TO MALE PIPE



122584
3/4" MH X 3/4" MIP
(1/2" FIP TAPPED)

FEMALE HOSE TO FEMALE HOSE - WITH SWIVEL



122587
3/4" FH X 3/4" FH

FEMALE HOSE TO FEMALE PIPE - WITH SWIVEL



122590
3/4" FH X 3/4" FIP

HOSE BARBS / FLARE FITTINGS

BRASS HOSE BARBS



#29
HOSE BARB TO MALE PIPE
(Barb refers to hose I.D.)

SSC#	BARB x MPT	SSC#	BARB x MPT
130001	1/8" x 1/8"	130017	3/8" x 1/2"
130003	3/16" x 1/8"	130021	1/2" x 1/4"
130004	3/16" x 1/4"	130022	1/2" x 3/8"
130005	1/4" x 1/8"	130023	1/2" x 1/2"
130006	1/4" x 1/4"	130024	1/2" x 3/4"
130007	1/4" x 3/8"	130025	5/8" x 3/8"
130009	5/16" x 1/8"	130026	5/8" x 3/4"
130010	5/16" x 1/4"	130028	3/4" x 1/2"
130011	5/16" x 3/8"	130029	3/4" x 3/4"
130014	3/8" x 1/8"	130030	1" x 3/4"
130015	3/8" x 1/4"	130031	1" x 1"
130016	3/8" x 3/8"		

45° FLARE TUBE FITTINGS - BRASS

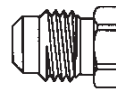

#39
PLUG

SSC#	TUBE SIZE	SSC#	TUBE SIZE
130100	3/16"	130106	1/2"
130102	1/4"	130108	5/8"
130104	3/8"		



#40
CAP

SSC#	TUBE SIZE	SSC#	TUBE SIZE
130118	3/16"	130124	3/8"
130120	1/4"	130126	1/2"
130122	5/16"	130128	5/8"



#29S **BARB TO BARB**
HOSE SPLICERS

SSC#	BARB	SSC#	BARB
130054	3/16"	130060	3/8"
130056	1/4"	130062	1/2"
130058	5/16"		



#41S
SHORT FLARE NUT

SSC#	TUBE SIZE	SSC#	TUBE SIZE
130140	3/16"	130148	1/2"
130142	1/4"	130150	5/8"
130144	5/16"	130152	3/4"
130146	3/8"	130154	7/8"

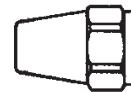

#41L
LONG FLARE NUT

SSC#	TUBE SIZE
130156	1/8"
130157	3/16"
130158	1/4"
130159	5/16"
130160	3/8"



#641FS
SHORT FORGED FLARE NUT

SSC#	TUBE SIZE	SSC#	TUBE SIZE
130168	3/16"	130174	1/2"
130170	1/4"	130176	5/8"
130172	3/8"	130177	3/4"



#641FSR **SHORT FORGED FLARE**
REDUCING NUT

SSC#	TUBE SIZE
130175	1/4" x 3/16"
130178	3/8" x 1/4"
130180	1/2" x 3/8"
130182	5/8" x 1/2"

Use SSC's Website to Find Your Replacement Parts and Order Online!

- Place orders online using our shopping cart feature.
- Find your part using our multi-functional search engines.
- Registration is required. This ensures that only wholesalers & rebuilders, not the trade or general public, can see pricing and use the shopping cart.



www.strainerscreen.com

FLARE FITTINGS

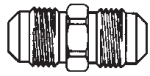

#42
FLARE UNION

<u>SSC#</u>	<u>TUBE SIZE</u>	<u>SSC#</u>	<u>TUBE SIZE</u>
130200	3/16"	130208	1/2"
130202	1/2"	130210	5/8"
130204	5/16"	130212	3/4"
130206	3/8"	130214	7/8"

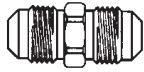

#42R
REDUCING FLARE UNION

<u>SSC#</u>	<u>TUBE SIZE</u>	<u>SSC#</u>	<u>TUBE SIZE</u>
130218	1/4" x 3/16"	130224	1/2" x 3/8"
130220	3/8" x 1/4"	130226	5/8" x 3/8"
130222	1/2" x 1/4"	130228	5/8" x 1/2"



#44
FLARE TEE

<u>SSC#</u>	<u>TUBE SIZE</u>	<u>SSC#</u>	<u>TUBE SIZE</u>
130236	1/8"	130244	3/8"
130238	3/16"	130246	1/2"
130240	1/4"	130248	5/8"
130242	5/16"	130250	3/4"



#44R
REDUCING FLARE TEE

<u>SSC#</u>	<u>TUBE SIZE</u>
130258	1/4" x 1/4" x 3/8"
130260	3/8" x 3/8" x 1/4"
130262	1/2" x 1/2" x 3/8"
130264	5/8" x 5/8" x 1/2"



#45
FLARE X MIP BRANCH TEE

<u>SSC#</u>	<u>TUBE X MIP</u>
130268	3/16" x 1/8"
130272	3/8" x 1/4"
130274	3/8" x 3/8"

BLOCK FLARING TOOL

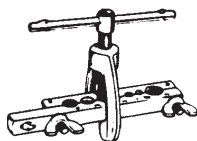

111012
BLOCK FLARING TOOL
Produces 45° Flares
Sizes: 3/16", 1/4", 5/16",
3/8", 7/16", 1/2" & 5/8"

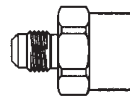

#46
FLARE X FIP COUPLING

<u>SSC#</u>	<u>TUBE X FIP</u>	<u>SSC#</u>	<u>TUBE X FIP</u>
130278	3/16" x 1/8"	130300	3/8" x 3/4"
130280	1/4" x 1/8"	130302	1/2" x 1/4"
130282	1/4" x 1/4"	130304	1/2" x 3/8"
130284	1/4" x 3/8"	130306	1/2" x 1/2"
130286	1/4" x 1/2"	130308	1/2" x 3/4"
130288	5/16" x 1/8"	130310	5/8" x 1/2"
130290	5/16" x 1/4"	130312	5/8" x 3/4"
130292	3/8" x 1/8"	130314	3/4" x 1/2"
130294	3/8" x 1/4"	130316	3/4" x 3/4"
130296	3/8" x 3/8"	130318	7/8" x 3/4"
130298	3/8" x 1/2"		

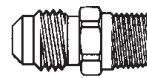

#48
FLARE X MIP HALF UNION

<u>SSC#</u>	<u>TUBE X MIP</u>	<u>SSC#</u>	<u>TUBE X MIP</u>
130320	3/16" x 1/8"	130342	3/8" x 3/4"
130321	3/16" x 1/4"	130344	1/2" x 1/4"
130322	1/4" x 1/8"	130346	1/2" x 3/8"
130324	1/4" x 1/4"	130348	1/2" x 1/2"
130326	1/4" x 3/8"	130350	1/2" x 3/4"
130328	1/4" x 1/2"	130352	5/8" x 3/8"
130330	5/16" x 1/8"	130354	5/8" x 1/2"
130332	5/16" x 1/4"	130356	5/8" x 3/4"
130334	3/8" x 1/8"	130358	3/4" x 1/2"
130336	3/8" x 1/4"	130360	3/4" x 3/4"
130338	3/8" x 3/8"	130362	7/8" x 3/4"
130340	3/8" x 1/2"		

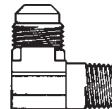

#49
FLARE X MIP ELBOW

<u>SSC#</u>	<u>TUBE X MIP</u>	<u>SSC#</u>	<u>TUBE X MIP</u>
130368	3/16" x 1/8"	130388	3/8" x 3/4"
130370	1/4" x 1/8"	130390	1/2" x 1/4"
130372	1/4" x 1/4"	130392	1/2" x 3/8"
130374	1/4" x 3/8"	130394	1/2" x 1/2"
130376	5/16" x 1/8"	130396	1/2" x 3/4"
130378	5/16" x 1/4"	130398	5/8" x 3/8"
130380	3/8" x 1/8"	130400	5/8" x 1/2"
130382	3/8" x 1/4"	130402	5/8" x 3/4"
130384	3/8" x 3/8"	130404	3/4" x 1/2"
130386	3/8" x 1/2"	130406	3/4" x 3/4"

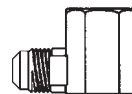

#50
FLARE X FIP ELBOW

<u>SSC#</u>	<u>TUBE X FIP</u>	<u>SSC#</u>	<u>TUBE X FIP</u>
130408	3/16" x 1/8"	130418	3/8" x 1/2"
130410	1/4" x 1/4"	130420	1/2" x 3/8"
130412	1/4" x 3/8"	130422	1/2" x 1/2"
130414	3/8" x 1/4"	130424	5/8" x 1/2"
130416	3/8" x 3/8"	130426	5/8" x 3/4"

FLARE FITTINGS / COMPRESSION FITTINGS



#55
FLARE ELBOW

<u>SSC#</u>	<u>TUBE SIZE</u>	<u>SSC#</u>	<u>TUBE SIZE</u>
130428	3/16"	130434	1/2"
130430	1/4"	130436	5/8"
130432	3/8"		



#70
FEMALE FLARE SWIVEL

<u>SSC#</u>	<u>TUBE SIZE</u>	<u>SSC#</u>	<u>TUBE SIZE</u>
130438	3/16"	130444	1/2"
130440	1/4"	130446	5/8"
130442	3/8"		

BRASS COMPRESSION FITTINGS

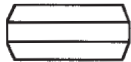

#60
COMPRESSION SLEEVE

<u>SSC#</u>	<u>TUBE SIZE</u>	<u>SSC#</u>	<u>TUBE SIZE</u>
132200	1/8"	132210	7/16"
132202	3/16"	132212	1/2"
132204	1/4"	132214	5/8"
132206	5/16"	132216	3/4"
132208	3/8"	132218	7/8"



#60P
DELRIN COMPRESSION FERULE SLEEVE

<u>SSC#</u>	<u>TUBE SIZE</u>	<u>SSC#</u>	<u>TUBE SIZE</u>
132220	1/4"	132224	1/2"
132222	3/8"	132226	5/8"



#61
COMPRESSION NUT

<u>SSC#</u>	<u>TUBE SIZE</u>	<u>SSC#</u>	<u>TUBE SIZE</u>
132230	1/8"	132240	7/16"
132232	3/16"	132242	1/2"
132234	1/4"	132244	5/8"
132236	5/16"	132246	3/4"
132238	3/8"	132248	7/8"



#61C
COMPRESSION CAP

<u>SSC#</u>	<u>TUBE SIZE</u>
132260	1/4"
132262	3/8"
132264	1/2"

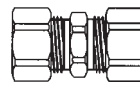

#62
COMPRESSION UNION

<u>SSC#</u>	<u>TUBE SIZE</u>	<u>SSC#</u>	<u>TUBE SIZE</u>
132270	1/8"	132280	7/16"
132272	3/16"	132282	1/2"
132274	1/4"	132284	5/8"
132276	5/16"	132286	3/4"
132278	3/8"	132288	7/8"

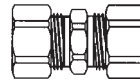

#62R
REDUCING COMPRESSION UNION

<u>SSC#</u>	<u>TUBE SIZE</u>	<u>SSC#</u>	<u>TUBE SIZE</u>
132288	1/4" x 3/16"	132294	5/8" x 3/8"
132290	3/8" x 1/4"	132296	5/8" x 1/2"
132292	1/2" x 3/8"		

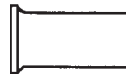

#63P
BRASS COMPRESSION INSERT

<u>SSC#</u>	<u>TUBE SIZE</u>	<u>SSC#</u>	<u>TUBE SIZE</u>
132298	3/16"	132304	1/2"
132300	1/4"	132306	5/8"
132302	3/8"		

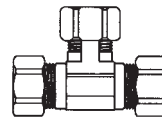

#64
COMPRESSION TEE

<u>SSC#</u>	<u>TUBE SIZE</u>	<u>SSC#</u>	<u>TUBE SIZE</u>
132308	3/16"	132320	1/2" x 1/2" x 3/8"
132309	1/4" x 1/4" x 3/16"	132322	5/8"
132310	1/4"	132324	5/8" x 5/8" x 3/8"
132312	5/16"	132326	5/8" x 5/8" x 1/2"
132314	3/8"	132328	3/4"
132316	3/8" x 3/8" x 1/4"	132330	7/8"
132318	1/2"		

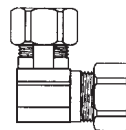

#65
COMPRESSION ELBOW

<u>SSC#</u>	<u>TUBE SIZE</u>	<u>SSC#</u>	<u>TUBE SIZE</u>
132338	3/16"	132348	5/8"
132340	1/4"	132350	5/8" x 3/8"
132342	3/8"	132352	5/8" x 1/2"
132344	1/2"	132354	3/4"
132346	1/2" x 3/8"	132356	7/8"

COMPRESSION FITTINGS

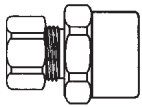

#66
COMPRESSION X FIP CONNECTOR

SSC#	TUBE X FIP	SSC#	TUBE X FIP
132366	3/16" x 1/8"	132388	3/8" x 3/8"
132368	3/16" x 1/4"	132390	3/8" x 1/2"
132370	1/4" x 1/8"	132392	1/2" x 1/4"
132372	1/4" x 1/4"	132394	1/2" x 3/8"
132374	1/4" x 3/8"	132396	1/2" x 1/2"
132378	1/4" x 1/2"	132400	5/8" x 1/2"
132380	5/16" x 1/8"	132402	5/8" x 3/4"
132382	5/16" x 1/4"	132404	3/4" x 1/2"
132384	3/8" x 1/8"	132406	3/4" x 3/4"
132386	3/8" x 1/4"	132410	7/8" x 3/4"

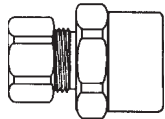

#666
COMPRESSION X SWEAT ADAPTER

SSC#	TUBE X OD
132416	3/8" x 5/8" (1/2" sweat)

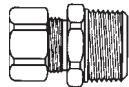

#68
COMPRESSION X MIP CONNECTOR

SSC#	TUBE X MIP	SSC#	TUBE X MIP
132430	1/8" x 1/8"	132454	3/8" x 3/4"
132432	3/16" x 1/8"	132456	1/2" x 1/4"
132433	3/16" x 1/4"	132458	1/2" x 3/8"
132434	1/4" x 1/8"	132460	1/2" x 1/2"
132436	1/4" x 1/4"	132462	1/2" x 3/4"
132438	1/4" x 3/8"	132464	5/8" x 3/8"
132440	1/4" x 1/2"	132466	5/8" x 1/2"
132442	5/16" x 1/8"	132468	5/8" x 3/4"
132444	5/16" x 1/4"	132470	3/4" x 1/2"
132446	3/8" x 1/8"	132472	3/4" x 3/4"
132448	3/8" x 1/4"	132474	7/8" x 1/2"
132450	3/8" x 3/8"	132476	7/8" x 3/4"
132452	3/8" x 1/2"		

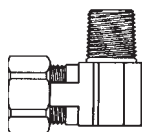

#69
COMPRESSION X MIP ELBOW

SSC#	TUBE X MIP	SSC#	TUBE X MIP
132490	1/8" x 1/8"	132514	3/8" x 3/4"
132492	3/16" x 1/8"	132516	1/2" x 1/4"
132493	3/16" x 1/4"	132518	1/2" x 3/8"
132494	1/4" x 1/8"	132520	1/2" x 1/2"
132496	1/4" x 1/4"	132522	1/2" x 3/4"
132498	1/4" x 3/8"	132524	5/8" x 3/8"
132500	1/4" x 1/2"	132526	5/8" x 1/2"
132502	5/16" x 1/8"	132528	5/8" x 3/4"
132504	5/16" x 1/4"	132530	3/4" x 1/2"
132506	3/8" x 1/8"	132532	3/4" x 3/4"
132508	3/8" x 3/8"	132534	7/8" x 3/4"
132510	3/8" x 1/2"		

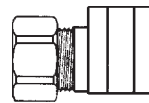

#70
COMPRESSION X FIP ELBOW

SSC#	TUBE X FIP	SSC#	TUBE X FIP
132548	3/16" x 1/8"	132564	3/8" x 1/2"
132550	1/4" x 1/8"	132566	1/2" x 1/4"
132552	1/4" x 1/4"	132568	1/2" x 3/8"
132554	1/4" x 3/8"	132570	1/2" x 1/2"
132558	3/8" x 1/8"	132572	5/8" x 1/2"
132560	3/8" x 1/4"	132574	5/8" x 3/4"
132562	3/8" x 3/8"		

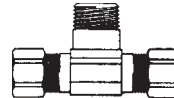

#72
COMPRESSION X MIP BRANCH TEE

SSC#	TUBE X MIP
132584	3/16" x 3/16" x 1/8"
132586	1/4" x 1/4" x 1/8"
132588	1/4" x 1/4" x 1/4"
132590	3/8" x 1/4"
132592	3/8" x 3/8"

BRASS COMPRESSION BALL VALVES

SSC's Brass Compression Ball Valves will fit copper tubing.

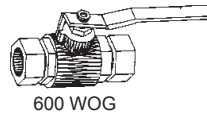

SSC#	COPPER PIPE
122184	1/2" (5/8" OD)
122186	3/4" (7/8" OD)
122188	1" (1 1/8" OD)



SSC manufactures many Tankless Heater (Coil) Gaskets in various materials such as red rubber, neoprene rubber and long lasting EPDM rubber. See pages 43-49 for our complete list.

GLOVES / BULBS / TIE DOWNS / WIRE TIES

DISPOSABLE VINYL GLOVES



PACKED 100 GLOVES PER BOX

Our vinyl disposable gloves are an economical way to protect the hands from dirt, grease and other harmful chemicals while working in the field. Unlike rubber surgical gloves, vinyl gloves do not become slippery when covered with #2 oil. They can be thrown out after each job or used over and over.

GL-627
DISPOSABLE VINYL GLOVES
Medium Size

GL-628
DISPOSABLE VINYL GLOVES
Large Size

NITRILE GLOVES - BLUE COLOR



PACKED 100 GLOVES PER BOX

SSC#	SIZE
GL-626	LARGE
GL-626A	MEDIUM

PLASTIC DISPOSABLE SHOE COVERS

Shoe covers minimize the chance of getting customers' homes dirty by tracking in dirt on shoes.



108512
PLASTIC DISPOSABLE SHOE COVERS
Blue Color with Elastic
100/Bag

DUST MASKS

Use these economical dust masks for protection against soot and undesirable particles while cleaning boilers, burners, furnaces or while doing general service work.



PACKED 50/BOX

108510
DUST/PARTICLE MASK

ROUGH SERVICE BULBS



PACKED 6/PACKAGE

LB-608A
ROUGH SERVICE BULB
75 Watt

LB-608B
ROUGH SERVICE BULB
100 Watt

RUBBER TIE DOWN STRAPS



MADE OF EPDM RUBBER FOR MAXIMUM DURABILITY

SSC#	LENGTH
RS-629A	10"
RS-629B	15"
RS-629C	20"
RS-629D	31"
RS-629E	41"

WIRE TIES AND MOUNTS

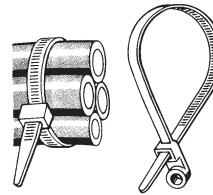

PACKED 100/BAG

SSC#	DESCRIPTION	LENGTH	STRENGTH
WT-625A	WHITE WIRE TIE	4"	18 LBS.
WT-625B	BLACK WIRE TIE	4"	18 LBS.
WT-625C	WHITE WIRE TIE	8"	18 LBS.
WT-625D	BLACK WIRE TIE	8"	18 LBS.
WT-625E	WHITE WIRE TIE	8"	50 LBS.
WT-625F	BLACK WIRE TIE	8"	50 LBS.
WT-625G	WHITE WIRE TIE	12"	50 LBS.
WT-625H	BLACK WIRE TIE	12"	50 LBS.
WT-625I	MNTG WIRE TIE-WH.	8 1/2"	50 LBS.
WT-625J	MNTG WIRE TIE-BL.	8 1/2"	50 LBS.
WT-625K	WIRE TIE MOUNT	3/4"	--
WT-625L	WIRE TIE MOUNT	1"	--
WT-625M	WHITE WIRE TIE	14"	40 LBS.
WT-625N	BLACK WIRE TIE	14"	40 LBS.
WT-625P	WHITE WIRE TIE	28 1/4"	120 LBS.
WT-625R	BLACK WIRE TIE	28 1/4"	120 LBS.

SHEET METAL SCREWS



PACKED 100/BOX

- #8 thread
- Self piercing
- Hard steel--zinc plated
- Hex head type with screwdriver slot

SSC#	SIZE	PACKAGE TYPE
SH-635A	1/2"	100/BOX
SH-635B	3/4"	100/BOX
SH-635C	1"	100/BOX

GROMMETS / EXPANSION PLUGS

RUBBER GROMMETS

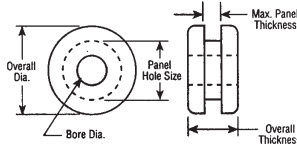

SSC#	BORE DIA.	PANEL HOLE/THICK.	DIA./THICK
RG-634A	1/8"	1/4" / 1/16"	11/32" / 3/16"
RG-634B	3/16"	5/16" / 1/16"	1/2" / 1/4"
RG-634C	3/16"	5/16" / 3/16"	7/16" / 5/16"
RG-634D	5/16"	7/16" / 1/16"	5/8" / 9/32"
RG-634E	1/2"	1/2" / 1/16"	5/8" / 1/4"
RG-634F	3/8"	3/4" / 3/32"	7/8" / 11/32"
RG-634G	5/8"	7/8" / 1/16"	1 1/8" / 5/16"
RG-634H	3/4"	1 1/16" / 1/16"	1 3/8" / 3/8"
RG-634I	7/8"	1 1/4" / 1/16"	1 5/8" / 7/16"

WINTERIZING EXPANSION PLUGS

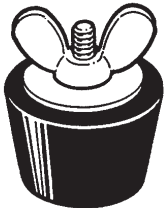

Our Winterizing Plugs are made of a high quality rubber for maximum expandability which ensures a tight seal. These plugs are perfect for pressure testing the system for leaks as well as normal winterizing applications. They are made of a stainless steel slotted screw, washers, a rubber plug and a nylon wing nut for easy tightening.

SSC#	DIAMETER	FITS
WP-000	.46"	3/8" PIPE
WP-00	.54"	1/2" PIPE
WP-0	.63"	1/2" PIPE
WP-1	.70"	1/2" PIPE
WP-2	.75"	3/4" PIPE
WP-3	.89"	3/4" PIPE
WP-4	.96"	3/4" FITTING & 1" PIPE
WP-5	1.02"	1" TUBE
WP-6	1.20"	1" FITTING
WP-7	1.39"	1 1/4" PIPE
WP-8	1.54"	1 1/2" PIPE
WP-9	1.69"	1 1/4" FITTING & 1 1/2" PIPE
WP-9 1/2	1.73"	1 1/2" WALL FITTING
WP-9 3/4	1.78"	1 1/2" WALL FITTING
WP-10	1.89"	1 1/2" FITTING
WP-11	2.13"	2" PIPE
WP-12	2.42"	2" FITTING
WP-13	2.58"	2 1/2" PIPE
WP-14	3.40"	3" PIPE
WP-15	3.86"	4" PIPE
WP-16	4.64"	4" PIPE

BLOW THRU EXPANSION PLUGS

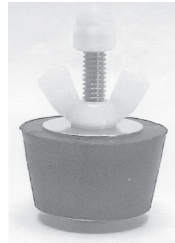

These plugs allows the service technician to release pressure from the pipe or fitting without removing the entire plug. Blow Thru Winterizing Plugs are made of a rubber plug, nylon wing nut and cap, stainless steel washers and a hollow brass blow thru slotted screw.

SSC#	DIAMETER	FITS
WP-2BT	.75"	3/4" PIPE
WP-3BT	.89"	3/4" PIPE
WP-4BT	.96"	3/4" FITTING & 1" PIPE
WP-5BT	1.02"	1" TUBE
WP-6BT	1.20"	1" FITTING
WP-7BT	1.39"	1 1/4" PIPE
WP-8BT	1.54"	1 1/2" PIPE
WP-9BT	1.69"	1 1/4" FITTING & 1 1/2" PIPE
WP-10BT	1.89"	1 1/2" FITTING
WP-11BT	2.13"	2" PIPE
WP-12BT	2.42"	2" FITTING
WP-13BT	2.58"	2 1/2" PIPE

EXTENDED EXPANSION PLUGS

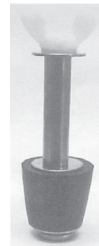

Extended Winterizing Plugs allow you to locate the plug deeper into the pipe or fitting thus ensuring a positive seal. They are made of a rubber plug, nylon wing nut, stainless steel washers, slotted screw and a 1.625" extension.

SSC#	DIAMETER	FITS
WP-2X	.75"	3/4" PIPE
WP-3X	.89"	3/4" PIPE
WP-4X	.96"	3/4" FITTING & 1" PIPE
WP-5X	1.02"	1" TUBE
WP-6X	1.20"	1" FITTING
WP-7X	1.39"	1 1/4" PIPE
WP-8X	1.54"	1 1/2" PIPE
WP-9X	1.69"	1 1/4" FITTING & 1 1/2" PIPE
WP-10X	1.89"	1 1/2" FITTING
WP-11X	2.13"	2" PIPE
WP-12X	2.42"	2" FITTING
WP-13X	2.58"	2 1/2" PIPE

UNIVERSAL EXPANSION PLUGS AND UNIVERSAL BLOW THRU PLUGS

These plugs are made of the same material described above and fit the range of sizes listed below.

UNIVERSAL PLUGS

SSC#	FITS
WP-1-5UP	1 to 5
WP-5-7UP	5 to 7
WP-7-10UP	7 to 10



UNIVERSAL BLOW THRU

SSC#	FITS
WP-1-5UPBT	1 to 5
WP-5-7UPBT	5 to 7
WP-7-10UPBT	7 to 10



DUCT / ALUMINUM / ELECTRICAL TAPE

VIBRO-INSULATORS

Vibro-Insulators are rubber mountings which reduce or prevent the travel of vibrations to or from machinery. They control vibration and reduce noise on electric motors, pumps, compressors, blowers, generators, etc.



VI-633D

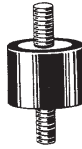

VI-633E



VI-633G

SSC#	DESCRIPTION
VI-633A	DOUBLE STUD-1 5/8" DIA.x1 1/2" Hx5/16-18 THR
VI-633B	DOUBLE STUD-1 5/8" DIA.x1"Hx5/16-18 THREAD
VI-633C	DOUBLE FEMALE-1" DIA.x1"Hx5/16-18-24 THR.
VI-633D	DOUBLE STUD-1"DIA.x1"Hx5/16-18 THREAD
VI-633E	DOUBLE STUD-1"DIA.x3/4"Hx1/4-20 THREAD
VI-633F	SINGLE STUD-1 5/8" DIA.x1 1/2"H x5/16-18 THR.
VI-633G	SINGLE STUD-1 5/8" DIA.x1"Hx5/16-18 THREAD

DUCT TAPE

GRAY

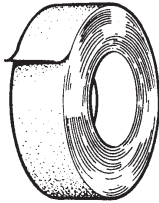

DT-317
GRAY COLORED
DUCT TAPE
2" x 60 yds.
Each roll is
shrink-wrapped
for protection.

BLACK



DT-320
BLACK COLORED
DUCT TAPE
2" x 50 yds.
Each roll is
shrink-wrapped
for protection.

DUCT TAPE - VARIOUS COLORS

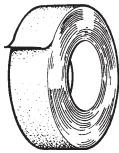

2" X 50 YDS

SSC#	COLOR
DT-320W	WHITE
DT-320B	BLUE
DT-320R	RED
DT-320G	GREEN
DT-320Y	YELLOW
DT-320D	DARK GREEN

ALUMINUM FOIL TAPE

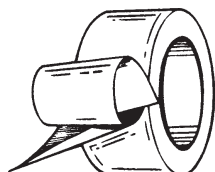

EACH ROLL IS
SHRINK-WRAPPED
FOR PROTECTION

SSC#	SIZE
DT-318	2" W x 50 yds.
DT-318A	3" W x 60 yds.

ELECTRICAL TAPE

Our Electrical Tape comes in rolls of 3/4" Wide x 60' Long. It has a temperature range of -10° to 176°F. It is UL approved, suitable for uses under 600V and is 7.0 mil thick. Available in the variety of colors listed below.

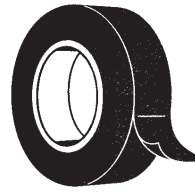

SSC#	COLOR
ET-323	BLACK
ET-323B	BLUE
ET-323G	GREEN
ET-323Y	YELLOW
ET-323W	WHITE
ET-323R	RED

GASKET REMOVING SOLUTION

Make the removal of stubborn, baked-on gaskets easy. With this product's foaming action you can remove gaskets without the work and without damage to the part. Sold in 18 oz. spray cans.



GR-957
GASKET REMOVING
SOLUTION
18 oz. Spray Can

V-BELT, FAN BELT DRESSING



V-931
V-BELT, FAN BELT
DRESSING
12 oz. Spray Can

STICKY SPRAY

Sticky Spray is a convenient way to hold O-rings and gaskets in place during installation. Spray the surface where you are installing the part, wait 1-2 minutes until it becomes tacky and apply the part. The part can easily be separated from the surface at a later date.



LUB-990
STICKY SPRAY
4 oz. Spray Bottle

ZOOM-SPOUT OILER

Use the high quality turbine oil in SSC's Zoom-Spout Oiler to oil bearing assemblies, electric motors, heaters, blowers, bushings, shafts, air-conditioners and home and shop appliances. The handy telescoping pole reaches into hard-to-get places.



ZM-322
ZOOM-SPOUT OILER
4 oz. Tubes With
Zoom-Spout

PACKING / TEFLON TAPE / LUBRICANTS

MECHANICAL PACKING - GRAPHITE, TEFLON AND NON-STAINING GRAPHITE

SSC's packing can be used to seal shafts, valve plugs and other general service applications.



PACKED IN 1 LB. SPOOLS & INDIVIDUALLY BOXED

SSC#	TYPE	SIZE	FT/LB	TEMP.
PAC-29A	N/S GRAPHITE	1/8"	101	550°
PAC-29B	N/S GRAPHITE	3/16"	60	550°
PAC-29C	N/S GRAPHITE	1/4"	25	550°
PAC-29D	N/S GRAPHITE	5/16"	14.1	550°
PAC-29E	N/S GRAPHITE	3/8"	10	550°
PAC-29F	N/S GRAPHITE	1/2"	5.7	550°
PAC-30A	GRAPHITE	1/8"	101	550°
PAC-30B	GRAPHITE	3/16"	60	550°
PAC-30C	GRAPHITE	1/4"	25	550°
PAC-30D	GRAPHITE	5/16"	14.1	550°
PAC-30E	GRAPHITE	3/8"	10	550°
PAC-30F	GRAPHITE	1/2"	5.7	550°
PAC-31A	TEFLON	1/8"	75.5	500°
PAC-31B	TEFLON	3/16"	34.3	500°
PAC-31C	TEFLON	1/4"	20.9	500°
PAC-31D	TEFLON	5/16"	13.4	500°
PAC-31E	TEFLON	3/8"	8.7	500°
PAC-31F	TEFLON	1/2"	6	500°

TEFLON TAPE

REGULAR TEFLON TAPE

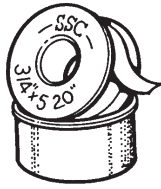

.003" THICK

SSC#	SIZE
TT-312	3/4" X 520"
TT-314	1" X 520"
TT-315	1/2" X 260"
TT-316	1/2" X 520"

YELLOW GAS SEAL TEFLON TAPE

Our Yellow Gas Seal Teflon Tape is UL approved, has 1.6" density and is .004" thick. This extra heavy duty tape is made especially for natural gas, propane, butane, water, oil and chemical lines.



.004" THICK

SSC#	SIZE
TT-324	1/2" X 260"
TT-325	1/2" X 520"
TT-326	3/4" X 520"

TEFLON PASTE (PIPE DOPE)



TT-319
TEFLON PASTE
(PIPE DOPE)
1/2 Pint With Brush Top

PLUMBERS TEFLON GREASE

The U.S.D.A. has rated this lubricant as Food Grade Acceptable. Safely lubricate everything from O-rings and seals to valves and faucet components. This is a waterproof, non-melting, pure synthetic grease which will seal out water and lubricate under the most adverse conditions.



3 OZ. TUBE

LUB-985
TEFLON LUBRICANT/
SEALANT
U.S.D.A. H-1 Rated

COMBINATION TEFLON / SILICONE GREASE

The LUB-986 lubricates and seals with a patented barrier of silicone and teflon. The U.S.D.A. has rated this lubricant as Food Grade Acceptable. It will not melt, dry out, form gummy deposits, separate, crack, evaporate, run or drip. It will safely lubricate O-rings, seals, bearings, valves, gears, faucet components and more.



4 OZ. TUBE

LUB-986
COMBINATION
TEFLON/SILICONE
LUBRICANT/SEALANT
U.S.D.A. H-1 Rated

PLUMBERS SILICONE GREASE

SSC's Silicone Lube has similar uses as the teflon lube except that it is silicone based, making it a higher grade product than the teflon. It is also rated as Food Grade Acceptable by the U.S.D.A.

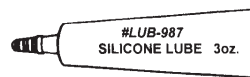

3 OZ. TUBE

LUB-987
SILICONE LUBRICANT/
SEALANT
U.S.D.A. H-1 Rated

SILICONE BASED SPRAY LUBRICANT

A coating of this food-grade rated spray lubricant will protect everything from O-rings to nuts and bolts. The superior and safe lubrication properties of silicone are packaged here in a spray for a cleaner and easier application.



4 OZ. SPRAY
BOTTLE

LUB-989
SILICONE BASED
SPRAY LUBRICANT

COPPER FITTING BRUSHES

WIRE HANDLE

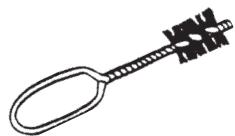

SSC#	SIZE
111202	1/2"
111204	3/4"
111206	1"

WOOD HANDLE

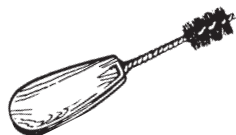

SSC#	SIZE
111212	1/2"
111214	3/4"
111216	1"

OPEN MESH GRIT CLOTH



EACH ROLL IS INDIVIDUALLY BOXED

110031
OPEN MESH GRIT CLOTH
 Fully Waterproof
 180 Grit
 For brass, copper or
 aluminum fittings.
 1 1/2" W x 10 yds.

SANDCLOTH



EACH ROLL IS INDIVIDUALLY BOXED

110037
SANDCLOTH
 120 Grit
 1 1/2" W x 10 yds.

COPPER TUBING CUTTERS

STANDARD

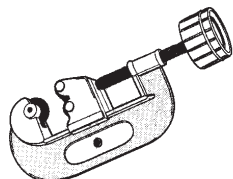

111030
COPPER TUBE CUTTER
 Double roller with groove
 for cutting flared end and
 pull out reamer.
 1/8" to 1" cutting capacity.

MINI

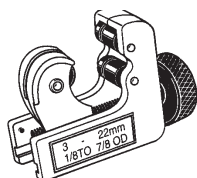

111032
**MINI (MIDGET) COPPER
 TUBE CUTTER**
 Requires only 1 1/16"
 swing clearance.
 1/8" to 7/8" cutting capacity.

2300° FLAME SHIELD

SSC's Flame Shield protects wood and metal during soldering or brazing. The material is a fire retardant high temperature cloth with an aluminum backing to hold shape. It is rated at 2300°. It can be easily cut to the size you need.

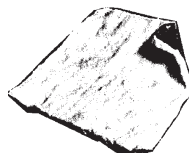

1/32" THICK

SSC#	SIZE
GS-18A	6" x 6"
GS-18B	12" x 12"
GS-18C	24" x 24"
GS-18D	20" x 36"

COPPER SWEDGE TOOL

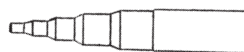

111016
COPPER SWEDGE TOOL
 For use on 3/8" to 7/8"
 copper tubing.

WIRE PVC PIPE SAW

This PVC saw is perfect for tight spots as it only needs 1/4" clearance. It easily cuts through water-filled pipes.

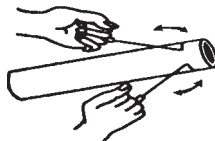

ST-365
PVC WIRE SAW

PIPE STRAP WRENCH



111014
**PIPE STRAP
 WRENCH**
 7"

**FIBERGLASS TAPE KIT -
 USED TO REPAIR PIPES & HOSES**

Use our tape kit to repair broken pipe and hose. Just add water to the tape and wrap the broken area of pipe. Let it cure and the hole is patched. Rated at 300+ psi, -60° F to 800° F. It can be used on all types of pipe--plastics, poly, metal and copper.



SW-350
**FIBERGLASS TAPE
 PIPE & HOSE
 REPAIR KIT**
 2" Wide x 60" Long

SEAL SETTING TOOL

This makes setting seals a snap. Works on pumps up to 3 HP.



ST-379
SEAL SETTING TOOL

TOOLS

BLOCK FLARING TOOL

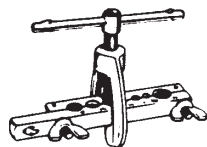

111012
BLOCK FLARING TOOL
Produces 45° Flares
Sizes: 3/16", 1/4", 5/16",
3/8", 7/16", 1/2" and 5/8"

MOTOR BEARING PULLER

This is a special two armed puller designed to fit behind all pool motor bearings, eliminating the need for bearing puller adapters.

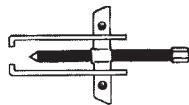

ST-377
MOTOR BEARING PULLER

3 IN 1 RADIATOR REPAIR TOOL

This handy tool extracts broken air valves, retaps the radiator and rethreads air valves.

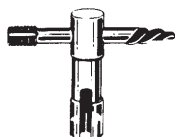

108103
3 IN 1 RADIATOR
REPAIR TOOL

ARMATURE HOLDING TOOL

This tool holds old style Century and Franklin armatures so the impeller can be removed. It fits into a 5/8" socket wrench.

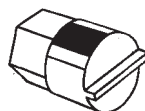

ST-375
ARMATURE HOLDING TOOL

RADIATOR (NIPPLE) SPUD WRENCH



111040
RADIATOR SPUD
WRENCH

BRASS CLEANING BRUSH



SSC-78BR
BRASS CLEANING BRUSH
Hickory Handle
Toothbrush Size

WATER HEATER ELEMENT WRENCH

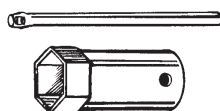

111064
WATER HEATER
ELEMENT WRENCH
3" Length

GASKET SHEET SHEARS

These shears make gasket cutting easy, especially when working with thick material.



GS-100SH
HEAVY-DUTY SHEARS FOR
CUTTING GASKET MATERIAL

TORQUE WRENCH

This ratchet tool is used to tighten no-hub fittings and hose clamps. The wrench tightens clamps to 60 foot pounds of torque. The bar extends to help back off bolts.

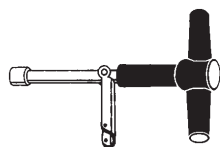

111062
TORQUE WRENCH

4 WAY SILLCOCK KEY

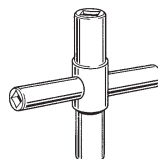

111020
4 WAY SILLCOCK KEY
Fits: 1/4", 9/32", 5/16"
and 11/32"

OPEN IMPELLER WRENCH

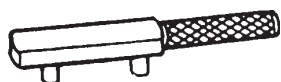

ST-361
OPEN IMPELLER WRENCH
Fits all open-faced impellers.

GARBAGE DISPOSAL WRENCH

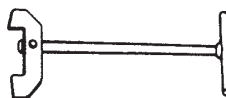

111022
GARBAGE DISPOSAL
WRENCH
Loosens frozen and jammed
disposals with a twist of
the handle.

CLOSED IMPELLER WRENCH



ST-362
CLOSED IMPELLER
WRENCH
Fits all closed impellers.
Has large handle for
excellent leverage.

4 WAY P.O. PLUG WRENCH

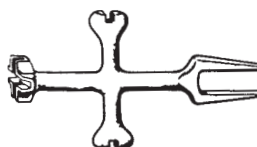

111004
4 WAY P.O. PLUG
WRENCH
Prevents rotation of
pop up plugs and basket
strainers during installation.

TOOLS / WATER SUPPLY TUBES & STOPS

INSIDE DUO BASKET STRAINER WRENCH



111024
INSIDE DUO BASKET
STRAINER WRENCH
Also used on tub drains.
4" Length

STANDARD HANDLE PULLER

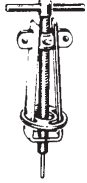

111060
STANDARD HANDLE
PULLER
With Screw Action

SEAT WRENCHES

ANGLE

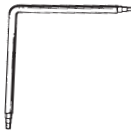

111042
ANGLE SEAT WRENCH
1 end tapered, 1 end hex
to fit most faucet seats.

STRAIGHT



111044
STRAIGHT SEAT WRENCH
1 end tapered, 1 end hex
to fit most faucet seats.

O-RING PULLER TOOL

Save those fingers! This inexpensive tool makes O-ring removal fast and easy.



O-10950
O-RING PICK

4 IN 1 LOCKNUT WRENCH



111002
4 IN 1 LOCKNUT WRENCH
Fits all sizes of closet spuds
and duo locknuts.

BASIN WRENCHES - 11" AND 15"



SSC#	SIZE
111008	11" LENGTH
111010	15" LENGTH

SHOWER VALVE SOCKET WRENCH SET

These sockets can be used on shower valves, faucets, bibbs and basin cocks. The kit consists of 5 two-sized sockets.

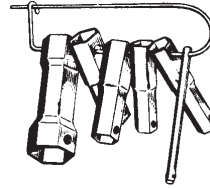

111046
SOCKET WRENCH SET
Socket Sizes: 21/32",
27/32", 29/32", 31/32",
1 1/32", 1 3/32", 1 5/32",
1 9/32", 1 11/32" and 1 7/16"

STAINLESS STEEL BRAIDED FLEXIBLE LAVATORY SUPPLY TUBES



RUBBER CONE WASHER CONNECTION

SSC#	CONNECTION	LENGTH
150002	3/8" COMP. x 1/2" FIP	12"
150006	3/8" COMP. x 1/2" FIP	20"
150010	3/8" COMP. x 1/2" FIP	30"

STAINLESS STEEL BRAIDED FLEXIBLE TOILET SUPPLY TUBES



PLASTIC BALLCOCK NUT - RUBBER CONE WASHERS

SSC#	CONNECTION	LENGTH
150020	3/8" COMP. x 7/8" BALLCOCK	9"
150024	3/8" COMP. x 7/8" BALLCOCK	12"
150028	3/8" COMP. x 7/8" BALLCOCK	20"

PLASTIC (POLYBUTYLENE) LAVATORY SUPPLY TUBES



DELTRIN SLEEVE INCLUDED

SSC#	SIZE
150052	3/8" OD x 12" L
150054	3/8" OD x 20" L

PLASTIC (POLYBUTYLENE) TOILET SUPPLY TUBES

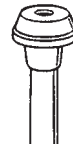

DELTRIN SLEEVE INCLUDED

SSC#	SIZE
150062	3/8" OD x 12" L
150064	3/8" OD x 20" L

STOPS / TOILET SPECIALTIES

SUPPLY STOPS

All stops are made of chrome plated brass and celcon stems.

ANGLE COMPRESSION x IPS

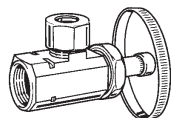

SSC#	CONNECTION
150150	3/8" COMP. x 1/2" IPS
150154	3/8" COMP. x 3/8" IPS

ANGLE COMPRESSION x SWEAT

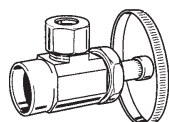

150152
ANGLE STOP
3/8" Comp. x 1/2" Sweat

ANGLE COMPRESSION x SWEAT WITH 5" EXTENSION

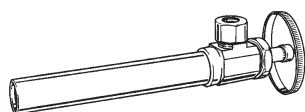

150170
ANGLE STOP
WITH 5" EXTENSION
3/8" Comp. x 1/2" Sweat

STRAIGHT COMPRESSION x IPS

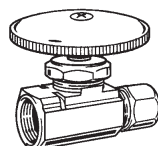

SSC#	CONNECTION
150180	3/8" COMP. x 1/2" IPS
150184	3/8" COMP. x 3/8" IPS

STRAIGHT COMPRESSION x SWEAT

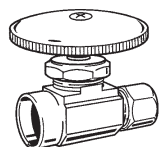

150182
STRAIGHT STOP
3/8" Comp. x 1/2" Sweat

STRAIGHT COMPRESSION x SWEAT WITH 5" EXTENSION



150199
STRAIGHT STOP
WITH 5" EXTENSION
3/8" Comp. x 1/2" Sweat

STRAIGHT SWEAT ADAPTER - CHROME PLATED

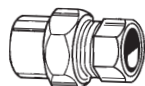

150103
CHROME PLATED
3/8" OD x 1/2" Sweat

STRAIGHT SWEAT ADAPTER - ROUGH BRASS

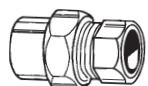

150105
ROUGH BRASS
3/8" OD x 1/2" Sweat

COMPRESSION NUT - CHROME PLATED



150129
CHROME PLATED
Fits 3/8" Tubing

PLASTIC ADJUSTABLE ANTI-SYPHON BALLCOCK



200503
ADJUSTABLE FIT-ALL MODEL
Fits 8" -12"
Anti-Syphon
Long Lasting Plastic

BALLCOCK COUPLING NUT



150125
PLASTIC
7/8"

PLASTIC DOUGLAS TYPE FLUSH VALVE

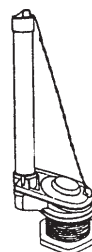

200233
PLASTIC DOUGLAS TYPE
FLUSH VALVE ASSEMBLY
Includes Rubber Flapper

RUBBER FLAPPERS - KORKY TYPE

BLACK RUBBER

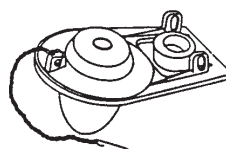

200230
BLACK RUBBER FLAPPER
Korky Style
Includes Chain

BLUE RUBBER - LONGER LASTING

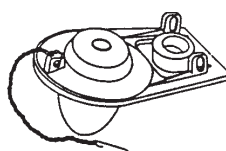

200231
BLUE RUBBER FLAPPER
Korky Style
Includes Chain
Greater chemical resistance
than black rubber.

SEAT DISKS TO FIT AMERICAN STANDARD

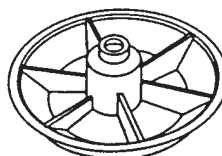

BLACK RUBBER

200153
SEAT DISK TO FIT
AMERICAN STANDARD
TILT FLUSH VALVES
Scew-On Type

200155
SEAT DISK TO FIT
AMERICAN STANDARD
TILT FLUSH VALVES
Snap-On Type

TOILET SPECIALTIES

ACTUATORS TO FIT AMERICAN STANDARD



#4
200160
 ACTUATOR TO FIT
 A/S #4 FLUSHVALVE
 Replaces: 147086
 Includes rubber disk,
 chain and grommet.

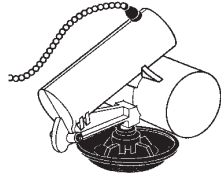

#5
200161
 ACTUATOR TO FIT
 A/S #5 FLUSHVALVE
 Replaces: 173380
 Includes rubber disk,
 chain and grommet.

TANK LEVER

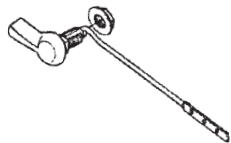

200322
 STANDARD TANK LEVER
 Includes chrome plated zinc
 handle, zinc plated steel
 arm and plastic nut.

CLOSET FLANGE BOLTS

SSC's toilet flange bolts are packed a pair per bag and have a steel nut and round steel washer.

BRASS

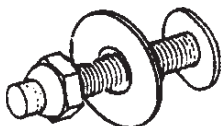

PACKED PAIR/BAG

SSC#	SIZE
200665	1/4" x 2 1/4"
200669	5/16" x 2 1/4"

BRASS PLATED

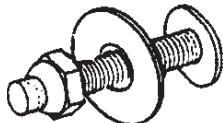

PACKED PAIR/BAG

SSC#	SIZE
200655	1/4" x 2 1/4"
200660	5/16" x 2 1/4"

BOLT CAPS

ROUND



200269
 ROUND CAP
 White Plastic

OVAL



200267
 OVAL CAP
 White Plastic

CLOSE COUPLED BOLTS



PACKED PAIR/BAG

200601
 CLOSE COUPLED BOLTS
 Brass Plated

ADJUSTABLE (OFFSET)

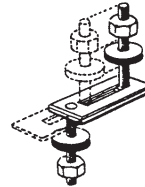

PACKED PAIR/BAG

200670
 ADJUSTABLE (OFFSET)
 TANK TO BOWL BOLTS
 These connect different
 makes of tanks and bowls
 where holes are not centered.
 Brass

MISCELLANEOUS TOILET GASKETS

BALLCOCK SHANK WASHER



140010
 Black Rubber

TANK TO BOWL GASKET



140032
 3 1/4" x 2 1/4"
 Rubber

SPUD WASHERS



SSC#	SIZE
140040	1 1/4"
140041	1 1/2"

REPLACEMENT VACUUM BREAKER TO FIT SLOAN



140045
 FOR V-500

Available in various thicknesses, SSC's **Gasket Sheets** are perfect for emergency repairs and for replacing hard to find gaskets and washers. See pages 70-72.



BATH / SHOWER SPECIALTIES

SHOWER HEADS

SPEAKMAN TYPE

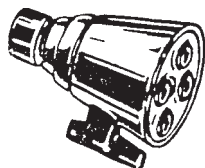

INDIVIDUALLY BOXED

190050
 SPEAKMAN TYPE
 SHOWER HEAD
 Chrome plated
 zinc die cast body.
 Has volume control.
 2"

CHROME PLATED PLASTIC

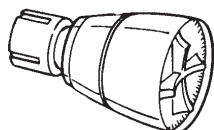

INDIVIDUALLY BOXED

190052
 CHROME PLATED
 PLASTIC SHOWER HEAD
 2"

MINI (WATER SAVER)

The mini shower head compacts the spray thus saving water and giving you more water pressure (thrust) than most shower heads.



INDIVIDUALLY BOXED

190054
 MINI SHOWER HEAD
 (WATER SAVER)
 Chrome Plated
 1"

SHOWER ARMS

CHROME PLATED BRASS



INDIVIDUALLY WRAPPED

190030
 SHOWER ARM
 Chrome Plated Brass
 1/2" IPS x 6" Long
 45°

CHROME PLATED PLASTIC



INDIVIDUALLY WRAPPED

190032
 SHOWER ARM
 Chrome Plated Plastic
 1/2" IPS x 6" Long
 45°

SHOWER ARM ESCUTCHEONS



190020
 SHOWER ARM ESCUTCHEON
 Chrome Plated Plastic



190022
 SHOWER ARM ESCUTCHEON
 Chrome Plated Plastic
 With Set Screw

SHOWER ROD HOLDERS - JIFFY TYPE

These are for installing shower bars without screws. Friction caps secure the holders to wall. They are adjustable.

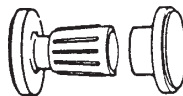

SSC#	MATERIAL
190061	CHROME PLATED PLASTIC
190062	CHROME PLATED METAL

TUB SPOUTS

OVERRIM



190105
 OVERRIM SPOUT
 Chrome Plated Zinc
 Die Cast
 1/2" FIP

WITH ADJUSTABLE SLIDE CONNECTOR

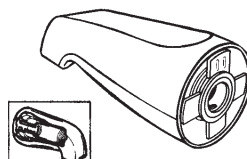

INDIVIDUALLY BOXED

- Chrome plated zamak (hard plastic)
- 1 3/4" adjustable telescoping fit
- Slide connector for fast installation
- Fits 1/2" copper stub

SSC#	TYPE
190101	REGULAR (SHOWN)
190103	WITH DIVERTER

TRIP LEVER FACE PLATE



190112
 TRIP LEVER FACE
 PLATE ASSEMBLY
 Square handle
 with coil spring.
 Chrome plated die cast.
 Does not include screws.

FACE PLATE SCREW



190115
 FACE PLATE SCREW
 1/4"-20 x 1 3/4" L
 Phillips Head
 Chrome Plated

BLANK FACE PLATE WITH 2 HOLES



190110
 BLANK FACE PLATE
 FOR TRIP LEVER ASSEMBLY
 2 Holes
 Chrome Plated

DOMED STRAINER GRID FOR BATH DRAINS



180500
DOMED STRAINER GRID
FOR BATH DRAINS
Stainless Steel

PACKED IN A PLASTIC
BAG WITH SCREW

MISCELLANEOUS BATH GASKETS

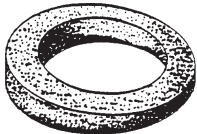

140015
BEVELED WASTE AND
OVERFLOW GASKET
Sponge Rubber



140021
FLAT BATH SHOE
WASHER
Rubber

**TIP-TOE DRAIN ASSEMBLIES
AND CARTRIDGES**

Screw in the tip-toe drain to replace the trip lever assembly. This ends the difficult process of tearing down walls and reaching into tight places to fix or replace the old trip lever assembly. Use the blank face plate with two holes, shown on previous page, to fill the hole left by the old trip lever face plate.

CHROME PLATED BRASS

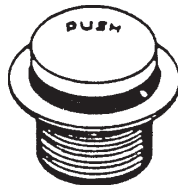

INDIVIDUALLY BOXED

180510
TIP-TOE DRAIN
ASSEMBLY
Chrome plated brass
with C.P. plastic cap.
1 1/2" x 3/8"

CHROME PLATED ZINC

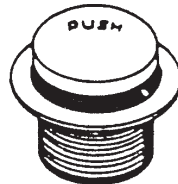

INDIVIDUALLY BOXED

180514
TIP-TOE DRAIN
ASSEMBLY
Chrome plated zinc
with C.P. plastic cap.
1 1/2" x 3/8"

REPLACEMENT CARTRIDGES / STOPPERS

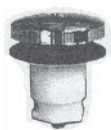

SSC#	SIZE
180518	5/16"
180519	3/8"

SINK STRAINERS

ALL STAINLESS DUO STRAINER

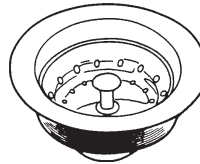

INDIVIDUALLY BOXED

180200
STANDARD DUO STRAINER
Stainless Steel
4 1/2"
Includes S.S. Basket Strainer

PLASTIC BODY DUO STRAINER

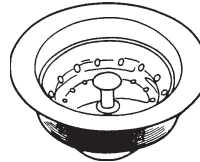

INDIVIDUALLY BOXED

180204
PLASTIC BODY DUO
STRAINER
ABS Plastic Body with
Stainless Steel Flange
4 1/2"
Includes S. S. Basket Strainer

QUICK CONNECT STRAINER

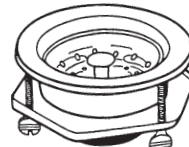

INDIVIDUALLY BOXED

180208
QUICK CONNECT
STRAINER
Stainless Steel
4 1/2"
Includes S.S. Basket Strainer

DEEP CUP STRAINER

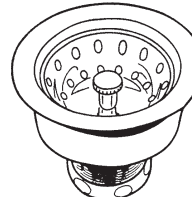

INDIVIDUALLY BOXED

180212
DEEP CUP DUO
STRAINER
Stainless Steel
4 1/2"
Includes S.S. Basket Strainer

JUNIOR DUO STRAINER

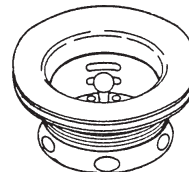

INDIVIDUALLY BOXED

180216
JUNIOR DUO STRAINER
Stainless Steel
2 1/2"
Includes Basket

STAINLESS STEEL BASKET STRAINER

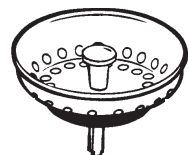

180201
BASKET STRAINER
Stainless steel with
chrome plated post.
Has rubber seal
and fits most drains.

LAV & SINK SPECIALTIES

DUO STRAINER WASHER



140019
DUO STRAINER WASHER
Rubber

SLIPNUTS

CHROME PLATED DIE CAST

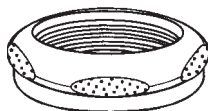

SSC#	SIZE
130602	1 1/4" x 1 1/4"
130604	1 1/2" x 1 1/4"
130608	1 1/2" x 1 1/2"

PLASTIC

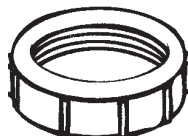

SSC#	SIZE
130622	1 1/4" x 1 1/4"
130628	1 1/2" x 1 1/2"

SLIP JOINT WASHERS

RUBBER



PACKED 100/BAG

SSC#	SIZE
140220	1 1/4" x 1 1/4"
140222	1 1/2" x 1 1/4"
140224	1 1/2" x 1 1/2"

TAPERED PLASTIC



PACKED 100/BAG

SSC#	SIZE
140320	1 1/4" x 1 1/4"
140322	1 1/2" x 1 1/4"
140324	1 1/2" x 1 1/2"

TAILPIECE WASHERS

NYLON



140329
NYLON TAILPIECE WASHER
1 1/2"

RUBBER



W-189
SINK TAILPIECE WASHER
Neoprene (Black Rubber)
1 1/2"

TUBULAR PIPE CONNECTOR



180010
TUBULAR DRAIN PIPE
CONNECTOR
Rubber
1 1/2" x 1 1/2"
For Under Sink

DISHWASHER / DISPOSAL CONNECTION WITH 4 CLAMPS

This rubber connector makes a quick seal between the drain and disposal or dishwasher.



180102
DISHWASHER / DISPOSAL
CONNECTION WITH
4 HOSE CLAMPS
Black Rubber

AIR GAP FOR DISHWASHERS

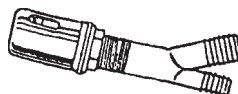

180100
AIR GAP FOR AUTOMATIC
DISHWASHERS
Plastic with Chrome Top

LAVATORY POP-UP WASTE ASSEMBLIES

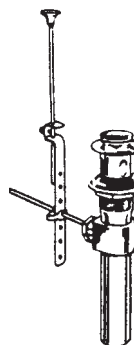

180402
CHROME PLATED BRASS

180400
ABS PLASTIC WITH
STAINLESS STEEL RIM

Hose Parts are listed on pages 83-84.

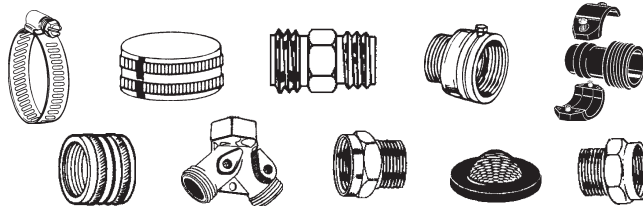

LAV & SINK SPECIALTIES

RINSE GUN, HOSE AND HOLDER

COMPLETE UNIT



PACKED TOGETHER
IN A PLASTIC BAG

170150
RINSE GUN, HOSE
AND HOLDER
Black

SPRAY GUN ONLY



170155
SPRAY GUN ONLY
Black

BASIN FAUCETS

REGULAR

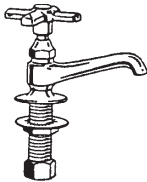

170103
BASIN FAUCET
Chrome Plated Brass

SELF CLOSING



170101
SELF-CLOSING
BASIN COCK
Chrome Plated Brass

BASIN COCK COUPLING NUT

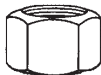

130529
BASIN COCK
COUPLING NUT
Brass

HOSE BIBBS

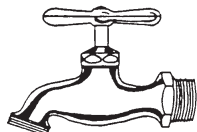

CHROME PLATED BRASS

SSC#	TYPE	SIZE
160010	3/4" HOSE END	1/2" MIP
160020	3/4" HOSE END	3/4" MIP
160030	PLAIN END	1/2" MIP
160035	PLAIN END	3/4" MIP

AERATOR WASHERS - BLACK RUBBER



100/PACKAGE

SSC#	SIZE
140002	THICK
140004	THIN

MACK BASIN WASHERS



SSC#	SIZE
140024	1 1/2" BATH
140026	1 1/4" BASIN

BEVELED FAUCET WASHERS



100/PACKAGE

SSC#	SIZE
140101	0
140103	00
140105	1/4M
140107	1/4L
140109	3/8
140111	3/8L
140112	3/8M
140115	1/2
140117	1/2L

PLUMBER'S O-RING ASSORTMENT KIT

SSC's Plumber's O-ring Assortment Kit contains the O-rings the Plumber is most often called upon to replace. This handy assortment kit contains 150 total O-rings which fit the majority of residential requirements. Every service truck and shop should have one.

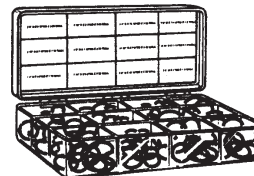

O-10960
O-RING ASSORTMENT KIT
12 Different Sizes
150 Total O-rings

SSC#	SIZE	QTY.
O-10010	1/4" ID x 3/8" OD x 1/16" TH	10
O-10011	5/16" ID x 7/16" OD x 1/16" TH	20
O-10110	3/8" ID x 9/16" OD x 3/32" TH	30
O-10111	7/16" ID x 5/8" OD x 3/32" TH	10
O-10112	1/2" ID x 11/16" OD x 3/32" TH	10
O-10113	9/16" ID x 3/4" OD x 3/32" TH	10
O-10114	5/8" ID x 13/16" OD x 3/32" TH	10
O-10115	11/16" ID x 7/8" OD x 3/32" TH	10
O-10116	3/4" ID x 15/16" OD x 3/32" TH	10
O-10210	3/4" ID x 1" OD x 1/8" TH	10
O-10211	13/16" ID x 1 1/16" OD x 1/8" TH	10
O-10212	7/8" ID x 1 1/8" OD x 1/8" TH	10

O-RING PULLER

Save those fingers! This inexpensive tool makes O-ring removal fast and easy.



O-10950
O-RING PICK

O-RING LIST



SSC's O-rings are made of durable Buna-N Rubber which will give you a superior performance in either oil or water.

SSC#	SIZE
O-10006	1/8" ID x 1/4" OD x 1/16" TH
O-10007	5/32" ID x 9/32" OD x 1/16" TH
O-10008	3/16" ID x 5/16" OD x 1/16" TH
O-10009	7/32" ID x 11/32" OD x 1/16" TH
O-10010	1/4" ID x 3/8" OD x 1/16" TH
O-10011	5/16" ID x 7/16" OD x 1/16" TH
O-10012	3/8" ID x 1/2" OD x 1/16" TH
O-10013	7/16" ID x 9/16" OD x 1/16" TH
O-10014	1/2" ID x 5/8" OD x 1/16" TH
O-10015	9/16" ID x 11/16" OD x 1/16" TH
O-10016	5/8" ID x 3/4" OD x 1/16" TH
O-10017	13/16" ID x 11/16" OD x 1/16" TH
O-10018	3/4" ID x 7/8" OD x 1/16" TH
O-10019	13/16" ID x 15/16" OD x 1/16" TH
O-10020	7/8" ID x 1" OD x 1/16" TH
O-10021	15/16" ID x 1 1/16" OD x 1/16" TH
O-10022	1" ID x 1 1/8" OD x 1/16" TH
O-10023	1 1/16" ID x 1 3/16" OD x 1/16" TH
O-10024	1 1/8" ID x 1 1/4" OD x 1/16" TH
O-10025	1 3/16" ID x 1 5/16" OD x 1/16" TH
O-10026	1 1/4" ID x 1 3/8" OD x 1/16" TH
O-10027	1 5/16" ID x 1 7/16" OD x 1/16" TH
O-10028	1 3/8" ID x 1 1/2" OD x 1/16" TH
O-10029	1 1/2" ID x 1 5/8" OD x 1/16" TH
O-10030	1 5/8" ID x 1 3/4" OD x 1/16" TH
O-10031	1 3/4" ID x 1 7/8" OD x 1/16" TH
O-10032	1 7/8" ID x 2" OD x 1/16" TH
O-10033	2" ID x 2 1/8" OD x 1/16" TH
O-10034	2 1/8" ID x 2 1/4" OD x 1/16" TH
O-10035	2 1/4" ID x 2 3/8" OD x 1/16" TH
O-10036	2 3/8" ID x 2 1/2" OD x 1/16" TH
O-10108	1/4" ID x 7/16" OD x 3/32" TH
O-10109	5/16" ID x 1/2" OD x 3/32" TH
O-10110	3/8" ID x 9/16" OD x 3/32" TH
O-10111	7/16" ID x 5/8" OD x 3/32" TH
O-10112	1/2" ID x 11/16" OD x 3/32" TH
O-10113	9/16" ID x 3/4" OD x 3/32" TH
O-10114	5/8" ID x 13/16" OD x 3/32" TH
O-10115	11/16" ID x 7/8" OD x 3/32" TH
O-10116	3/4" ID x 15/16" OD x 3/32" TH
O-10117	13/16" ID x 1" OD x 3/32" TH
O-10118	7/8" ID x 1 1/16" OD x 3/32" TH
O-10119	15/16" ID x 1 1/8" OD x 3/32" TH
O-10120	1" ID x 1 3/16" OD x 3/32" TH
O-10121	1 1/16" ID x 1 1/4" OD x 3/32" TH
O-10122	1 1/8" ID x 1 5/16" OD x 3/32" TH
O-10123	1 3/16" ID x 1 3/8" OD x 3/32" TH
O-10124	1 1/4" ID x 1 7/16" OD x 3/32" TH
O-10125	1 5/16" ID x 1 1/2" OD x 3/32" TH
O-10126	1 3/8" ID x 1 9/16" OD x 3/32" TH
O-10127	1 7/16" ID x 1 5/8" OD x 3/32" TH
O-10128	1 1/2" ID x 1 11/16" OD x 3/32" TH
O-10129	1 9/16" ID x 1 3/4" OD x 3/32" TH
O-10130	1 5/8" ID x 1 13/16" OD x 3/32" TH

SSC#	SIZE
O-10131	1 11/16" ID x 1 7/8" OD x 3/32" TH
O-10132	1 3/4" ID x 1 15/16" OD x 3/32" TH
O-10133	1 13/16" ID x 2" OD x 3/32" TH
O-10134	1 7/8" ID x 2 1/16" OD x 3/32" TH
O-10135	1 15/16" ID x 2 1/8" OD x 3/32" TH
O-10136	2" ID x 2 3/16" OD x 3/32" TH
O-10202	1/4" ID x 1/2" OD x 1/8" TH
O-10203	5/16" ID x 9/16" OD x 1/8" TH
O-10204	3/8" ID x 5/8" OD x 1/8" TH
O-10205	7/16" ID x 11/16" OD x 1/8" TH
O-10206	1/2" ID x 3/4" OD x 1/8" TH
O-10207	9/16" ID x 13/16" OD x 1/8" TH
O-10208	5/8" ID x 7/8" OD x 1/8" TH
O-10209	11/16" ID x 15/16" OD x 1/8" TH
O-10210	3/4" ID x 1" OD x 1/8" TH
O-10211	13/16" ID x 1 1/16" OD x 1/8" TH
O-10212	7/8" ID x 1 1/8" OD x 1/8" TH
O-10213	15/16" ID x 1 3/16" OD x 1/8" TH
O-10214	1" ID x 1 1/4" OD x 1/8" TH
O-10215	1 1/16" ID x 1 5/16" OD x 1/8" TH
O-10216	1 1/8" ID x 1 3/8" OD x 1/8" TH
O-10217	1 3/16" ID x 1 7/16" OD x 1/8" TH
O-10218	1 1/4" ID x 1 1/2" OD x 1/8" TH
O-10219	1 5/16" ID x 1 9/16" OD x 1/8" TH
O-10220	1 3/8" ID x 1 5/8" OD x 1/8" TH
O-10221	1 7/16" ID x 1 11/16" OD x 1/8" TH
O-10222	1 1/2" ID x 1 3/4" OD x 1/8" TH
O-10223	1 5/8" ID x 1 7/8" OD x 1/8" TH
O-10327	1 3/4" ID x 2 1/8" OD x 3/16" TH
O-10328	1 7/8" ID x 2 1/4" OD x 3/16" TH
O-10329	2" ID x 2 3/8" OD x 3/16" TH

OEM CROSS REFERENCE CHART

MFG.#	SSC#	PG.#	MFG.#	SSC#	PG.#	MFG.#	SSC#	PG.#
AEROMOTOR			180017	MS-356	31	FULFLO		
26360	108221	60	186410	SSC-783	28	31300	F-95	10
27687	108222	60	186499	BP-384	31	32014	F-97	10
27749	108223	60	186862	BP-386	31	32015	F-96	10
AMERICAN STANDARD			186877	BP-386A	31	GENERAL		
147086	200160	97	189035	BP-372	32	2A-705	G-100	10
173380	200161	97	189132	BP-372A	32	GK-1	G-29A	10
ARMSTRONG PUMP			P44200	BP-372N	32	GOULDS		
103408-000	B-55	36	P48690	B-200	35	5K107	108227	62
104442-000	B-52	36	P57410	B-51	35	5K108	108278	62
106028-000	BP-372	32	P57700	B-60	36	5K109	108279	62
106049-000	B-53	36	P57701	B-200A	35	5K110	108280	62
106050-000	B-50	36	P57770	B-199	35	5K12	108276	62
106158-000	B-51	35	P64910	B-199A	35	5K122	108281	62
106592-000	B-60	36	P80765	BP-391	33	5K144	108282	62
804034-000	B-198	34	PO1800	BP-394	32	5K145	108283	62
804034-000	B-16	34	PO1830	B-55	36	5K146	108284	62
805176-000	A-288	35	PO4080	B-52	36	5K151	108285	62
805201-000	B-28	34	PO4881	BP-385	32	5K162	108286	62
805209-000	B-205	35	PO4890	B-53	36	5K256	108287	62
806026-001	SSC-779	28	PO4940	BP-372K	32	5K2	108288	62
806168-001	SSC-780	28	PO5800	B-50	36	5K5	108275	61
810120-003	SSC-781	28	BECKETT			HOFFMAN		
810120-006	SSC-782	28	2454	BC-661	17	600345	H-289C	56
810120-008	SSC-783	28	3616	B-15	17	601270	H-289B	56
812961-111	BP-372A	32	31519	T-260	17	601273	H-289D	57
816001-000	BP-387A	32	31520	T-261	17	604030	H-289A	56
816117-000	B-188	34	51304	T-262	17	DG0060	H-289E	57
816558-000	BP-379	31	BERKELY			DG0092	H-289F	57
816653-000	B-54	34	SO-4757	108244	61	HONEYWELL		
816706-001	BP-381	31	SO-5126	108245	61	121371A	W-590	56
974507-100	BP-372K	32	DANFOSS			121371B	W-592	56
ARMSTRONG TRAP			071N1392	SSC-127	8	121371L	W-591	56
A21348-1	A-288A	56	633B0090	D-19	8	121371M	W-593	56
A21958-1	A-288B	56	633B1463	D-18	9	121371N	W-593	56
BELL & GOSSETT			DUNHAM BUSH			122555E	W-597B	56
118036	BP-390	32	C5698	D-151A	57	123732AA	W-595	56
118054	B-57	35	D263	D-151D	57	123869A	W-590	56
118065	B-205	35	D5352	D-151	57	123870A	W-592	56
118129	B-28	34	D5442	D-151C	57	123871E	W-597A	56
118181	BP-383	29	D5449	D-151B	57	123872A	W-591	56
118223	BP-399	29	F.E. MEYERS			124299AA	W-596	56
118227	BP-397	29	5059A-332	108301	62	130367	CC-601	9
118351	B-56	35	FAIRBANKS			138134C	W-597	56
118368	B-54	34	40039765	108261	61	138134E	W-597	56
118373	B-198	34	40049766	108262	61	36486	U-600	9
118373	B-16	34	40071117	108263	61	R8182	H-598	9
118378	B-188	34	FLINT & WALLING			R8184	H-598A	9
118473	SSC-781	28	103969	108251	61	<div style="border: 1px solid black; border-radius: 15px; padding: 10px;"> Please visit our Website to see cross reference charts (to SSC#) for Crown Engineering, Westwood Products, Mitco Manufacturing and Wal-Rich Corp. www.strainerscreen.com </div>		
118476	SSC-784	28	125994	108253	61			
118619	BP-379	31	127782	108254	61			
118680	BP-380	31	130968	108252	61			
118681	BP-381	31	131743	108255	61			
118697	BP-387A	32						
118705	SSC-779	28						

OEM CROSS REFERENCE CHART

MFG.#	SSC#	PG.#	MFG.#	SSC#	PG.#	MFG.#	SSC#	PG.#
HYDROVALVE			K-1150	BP-400K	31	RM-872	TP-428	37
GB-224	B-50	36	K-1150Y	BP-400	31	RM-876	SSC-779	28
GB-229	B-51	35	K-1151	BP-371K	31	RM-880	BP-380	31
GB-230	B-52	36	K-1152	BP-389	32	RM-880S	BP-379	31
GB-231	B-53	36	K-1152N	BP-389N	32	RM-880W	BP-381	31
GB-232	B-54	34	K-1162	TP-430	37	RM-881-B	BP-372C	32
GB-233	B-55	36	K-1163	TP-434	37	RM-883	TP-425	36
GB-237	B-56	35	K-1174	BP-397	29	RM-885A	BP-398A	30
GB-238	B-57	35	K-1181	BP-383	29	RM-886A	BP-398B	30
GB-251	B-58	36	K-1249	BP-379	31	RM-887PA	BP-372A	32
GB-253	B-59	35	K-1276	BP-390	32	RM-887PB	BP-372A	32
GB-254	B-60	36	K-1277	B-63	32	RM-889	SSC-300	50
GB-257	B-61	36	K-1329	T-201A	41	RM-892	BP-387	32
GB-261	B-62	36	K-1339	BP-381	31	RS-1015	SP-338A	3
GB-271	B-28	34	K-1360	T-201B	41	RS-1016	SP-338B	3
GE-217	E-26	41	K-1361	T-201C	41	RS-1017	SP-338C	3
GF-200	F-95	10	K-1362	T-201D	41	RS-1018	SP-338D	3
GF-210	T-41	40	K-1363	T-201E	41	RS-1035	SP-366	4
GF-213	G-90	10	K-1378	PM-369A	3	RS-900	SP-332	4
GF-214	G-92	10	K-1379	PM-369B	3	RS-902	S-67	4
GF-215	F-98	10	K-1380	PM-369C	3	RS-911	SP-332W	4
GF-216	F-97	10	K-1442	A-21	35	RS-912	SP-354	4
GF-219	T-36	42	K-1447	TP-410	37	RS-914	SP-344	3
GF-221	G-91	10	K-1448	TP-411	37	RS-917	SSC-110	2
GF-236	M-37	51	K-1449	TP-423	38	RS-919	SP-352	4
GM-121	W-279A	9	K-1450	TP-421	37	RS-923	SP-346	3
GM-122	W-279B	9	K-1649	F-99	10	RS-939	SSC-109	2
GM-123	W-24	42	K-2646	SSC-111	2	RS-940	SP-353	3
GS-128	S-70	2	K-3508	M-39	51	RS-944	SP-351	3
GS-129	S-75	2	K-3509	M-40	51	RS-945	SSC-115	4
GS-130	S-72	5	PS-267	SP-335	3	RS-950	SSC-102	4
GS-131	S-78	4	PS-268	SP-336	3	RS-955	SSC-116	2
GS-133	S-73	5	RD-737	SC-737	30	RS-977	SP-355	4
GS-134	S-80	5	RD-739	SC-739	30	RS-978	SP-355A	4
GS-135	S-71	4	RM-451	BP-394	28	RS-986	SP-337	3, 6
GS-137	S-76	4	RM-506	BP-385	32	RW-602	WP-247	6
GS-138	S-65	5	RM-510	TP-437	41	RW-622	WP-220	6
GS-139	S-74	2	RM-519	BP-372K	32	RW-625	WP-248	6
GS-157	S-283	41	RM-531	TP-436	41	RW-626	WP-249	6
GS-158	S-283A	41	RM-535C	BP-385A	32	RW-629	WP-250	6
GS-159	S-283B	42	RM-539	BP-399	29	RW-631	WP-207	6
GS-161	S-283C	42	RM-549	BP-382	29	RW-640	WP-208	6
GS-165	S-66	2	RM-549-N	BP-382MY	29	RW-645	WP-225	7
GS-166	S-79	3	RM-791	SSC-783	28	RW-646	WP-226	7
GS-167	S-67A	2	RM-794	SSC-784	28	RW-649	WP-224	6
GT-148	T-42	39	RM-798	SSC-781	28	RW-650	WP-222	7
GT-149	T-43	39	RM-799	SSC-782	28	RW-654	WP-228	6
GT-172	T-44	40	RM-809	U-600	9	RW-655	WP-229	7
GT-218	T-45	39	RM-822	H-599	9	RW-656	WP-227	7
GT-235	T-47	40	RM-828	BP-388	32	RW-661	WP-232	8
GT-262	T-48	40	RM-832-A	TP-433	37	RW-662	WP-233	7
GT-263	T-49	40	RM-836	TP-429	38	RW-664	WP-209	7
GW-100	W-84	5	RM-838	TP-427	36	RW-665	WP-210	7
GW-103	W-83	5	RM-858	SSC-780	28	RW-666	WP-211	7
GW-104	W-88	6	RM-859	BP-372N	32	RW-667	WP-206	7
GW-107	W-87	5	RM-860	TP-420	36	RW-668	WP-212	6
GW-109	W-85	5	RM-861	TP-412	37	RW-669	WP-214	7
GW-110	W-81	6	RM-862	TP-432	37	RW-670	WP-215	7
GW-111	W-82	6	RM-863	TP-431	37	RW-671	WP-216	7
GW-113	W-101	5	RM-864	TP-426	41, 37	RW-674	WP-219	6
GW-114	W-86	5	RM-869	TP-422	37	RW-675	SSC-790	28
GW-120	W-88	6	RM-871	TP-424	37	W-1000-G	W-25	42

OEM CROSS REFERENCE CHART

MFG.#	SSC#	PG.#	MFG.#	SSC#	PG.#	MFG.#	SSC#	PG.#
ICP			355081	M-27	52	101861	SP-332W	4
1149103	I-820	16	MILLER			110441	S-71	4
JET AERATOR			301181000	M-149	18	113331	S-76	5
4600102	108330	62	301205000	M-148	18	131066	SSC-115	4
660290	108332	62	3000010000	M-147	18	131622	SSC-102	4
LAU			3011950000	M-186	18	135272	SP-366	4
38-2086-01	BL-802	26	669064	MFP-404	19	135722	SSC-117	4
38-2087-01	BL-803	26	689505	M-186A	18	160046	S-74	2
38-2095-01	BL-843	25	730534	M-187	18	3715101	SSC-109	2
38-2096-01	BL-842	25	MONITOR			3715171	SSC-110	2
38-2204-01	BL-801	26	6112	M-292G	15	3715742	SSC-112	2
38-2205-01	BL-841	25	6113	M-292A	14	3715744	SSC-111	2
38-2206-01	BL-832	25	6114	M-292I	15	3715746	SSC-114	2
38-2207-01	BL-833	25	6115	M-292C	14	3729241	SP-339	3
38-2404-01	BL-815	26	6117	M-292H	15	3754734	SP-344	3
38-2442-01	BL-816	26	6119	M-292F	15	3759231	SP-337	3
38-2442-02	BL-817	26	6120	M-292L	15	3759251	SP-346	3
28-2443-01	BL-821	26	6124	M-292E	14	3773151	S-79	3
38-2443-03	BL-822	26	6125	M-292D	14	3773201	S-66	2
38-2694-01	BL-823	26	6126	M-292J	15	3779051	S-75	2
LENNOX			6130	M-292K	15	3779071	SP-351	3
160	L-1600	25	6189	M-292B	14	3779756	SP-338A	3
MASTERCRAFT			6313	M-292Q	15	3779760	SP-338B	3
4464	VB-632A	27	6317	M-292U	15	3779764	SP-338C	3
4465	VB-632B	27	6344	M-292N	15	3779786	SP-338D	3
MCDONNELL & MILLER			6350	M-292P	15	3779801	S-70	2
302500	M-9	51	6354	M-292R	15	TACO		
302600	M-40	51	6357	M-292T	15	007-003RP	T-48	40
304100	M-35	51	6363	M-292M	15	008-005RP	T-49	40
309510	SSC-300	50	PEABODY BARNES			110-009	TP-425	36
310800	M-10	52	27344	108307	62	110-023RP	T-45	39
311100	M-12	51	PETRO			110-023RP	T-45	39
312100	M-5	51	125502	P-133	12	110-111RP	TP-429	38
312700	M-37	51	126260	P-135	12	110-143RP	TP-423	38
312800	M-11	51	126261	P-134	12	110-227RP	T-43	39
312900	M-14	51	RAPID DAYTON			110-263RP	TP-410	37
313200	M-38	50	W-16675	108316	63	110-265RP	TP-411	37
313650	MP-294	50	RIELLO			110-273RP	TP-421	37
318300	MP-297	50	3005719	SSC-126G	8	110-275RP	TP-420	36
318700	MP-296	50	3007029	R-68	8	110-339RP	T-42	39
318800	M-33	51	3007156	R-69	8	110-339RP	T-287	39
320500	M-34	51	3007162	R-64	8	110-364RP	T-44	40
323300	M-7	52	SUNDSTRAND			110-364RP	T-41	40
324435	M-154	50	5477081	S-283C	42	120-009RP	T-46	40
325300	M-8	51	5478051	S-283	41	1600-169RP	T-152	40
325400	M-39A	51	5479021	S-283A	41	1600-169RP	T-152A	40
325500	M-39	51	SUNTEC			1600-170RP	TP-415	37
328900	M-4	51	24800	SP-352	4	THRUSH		
333800	M-146	52	25815	S-67	4	TJ-001-00	T-201C	41
335400	M-6	52	100901	S-78	4	TJ-001-00A	T-201E	41
340700	MP-291	50	100961	S-72	5	TJ-010-000	T-201B	41
347100	MP-290	50	101511	S-73	5	TJ-012-000A	T-201D	41
354310	M-3	52	VAK PAK			TJ-043-000	T-201F	41
354370	M-2	52	9118	108320	63	TJ-046-00A	T-201A	41
354380	M-1	52						
354410	M-13	52						

OEM CROSS REFERENCE CHART

MFG.#	SSC#	PG.#	MFG.#	SSC#	PG.#	MFG.#	SSC#	PG.#
VIKING								
G-432	V-204A	13						
H-432	V-259A	13						
WATSON MCDANIEL								
A1433	M-195A	56						
WEBSTER								
19867	WP-233	7						
19871	W-84	5						
21204	W-88	6						
25086	WP-230	7						
41466	WP-219	6						
42639	WP-238	7						
44161	WP-212	6						
47776	WP-233	7						
47986	WP-228	6						
48061	WP-214	7						
48062	WP-215	7						
49230	WP-222	7						
49489	WP-217	7						
49490	WP-234	7						
19859-5	WP-237	7						
25082-3	WP-243	7						
24121-5	WP-224	6						
25122-1	WP-220	6						
29641-100	WP-229	7						
29641-87	WP-206	7						
29642-1	WP-227	7						
29650-24	WP-242	7						
32672-1	WP-221	6						
39435-1	WP-208	6						
42561-1	WP-207	6						
47923-1	WP-216	7						
48150-2	WP-241	7						
49205-3	WP-231	8						
49205-7	WP-232	8						
49488-1	WP-211	7						
49488-2	WP-210	7						
49488-3	WP-209	7						
49488-3	WP-244	7						
49488-4	WP-239	7						
49488-5	WP-240	7						
49489-1	WP-218	7						
49490-1	WP-225	7						
49490-3	WP-226	7						
49579-2	WP-235	8						
49579-4	WP-245	8						
A30Q4-3	WP-247	6						
P18Q1	W-82	6						
P18Q12	W-85	5						
P18Q18	W-86	5						
P18Q3	W-81	6						
P18T1	W-101	5						
P18T3	W-87	5						
WINKLER								
170468	W-279A	9						
YORK								
028107209-000	Y-819	16						

Please Note: Many of the parts that SSC offers are not listed in this cross reference. This is because there is no OEM number for these parts. Please view the main sections of this catalog for a description of these parts.

Please visit our Website to see cross reference charts (to SSC#) for Crown Engineering, Westwood Products, Mitco Manufacturing and Wal-Rich Corp. www.strainerscreen.com

PRODUCT INDEX

Ace Type Gasket	60	CO ₂ Guns	19	G.I. Can Gaskets	11
Actuators	97	Coil Gaskets-Tankless	43-49	Galvanized Compression Couplings	81
Adhesive-O-ring Cord	57	Coin / Key Air Valve	54	Garbage Disposal Wrench	94
Aerator Washers	101	Combu Type Gasket	9	Gas Ball Valves	26
Aeromotor Type Gaskets	60	Companion Flange Gaskets	59-60	Gas Flare Adapters	26
Air Bleeder Valves	78	Compound Gauges	74	Gas Test Gauges	76
Air Gap	100	Compression Couplings-Galvanized	81	Gasket Removing Solution	63, 91
Allied Pump Type Gaskets	60	Compression Couplings-PVC	81	Gasket Sheet Shears	70, 94
Allis Chalmers Type Gaskets	60	Compression Fittings	87-88	Gasket Sheets	70-72
Aluminum Foil Tape	24, 91	Copper Fitting Brushes	93	Gauge Adapter Fittings	78
Aluminum Pilot Tubing	26	Copper Oil Lines	19	Gauge Glass	53
American Standard Type Actuators	97	Copper Tubing Cutters	93	Gauge Glass Parts	53-54
American Standard Type Seat Disks	96	Cord-O-ring	57	Gauge Glass Valve Kits	53
Anti-Vibration Tube Clamps	27	Couplings-Circulator	28, 36, 41	Gauges	73-77
Armature Holding Tool	30, 94	Couplings-No-Hub	82	General Type Gaskets	10
Armstrong Trap Type Gaskets	56	Couplings-Oil Burner	21	Georgia Pacific Type Gasket	61
Armstrong Type Parts	28-36	Couplings-Pipe	82	Globe Type Coupler	41
Backflow Preventer	81, 84	Couplings-Woods	29	Gloves-Nitrile	27, 89
Bags-Vacuum	27	Cross Reference Chart	103-106	Gloves-Vinyl	27, 89
Ball Bearings	30	Cuno Type Gasket	11	Goulds Type Gaskets	61-62
Ball Valves-Brass	79	Danfoss Type Parts	8-9	Graphite Packing	79
Ball Valves-PVC	79	Diaphragm Gauges	77	Grease	63, 92
Ballcock-Adjustable	96	Dirt Pocket Cap	50	Grit Cloth	93
Basin Faucets	101	Dishwasher / Disposal Connection	100	Grommets	90
Basin Washers	101	Dollar Plugs	82	Grundfos Type Gaskets	42
Basin Wrench	95	Douglas Type Flush Valve	96	Hago / Delta Type Gasket	9
Bath Gaskets	99	Drain Cocks	78	Hallmark Furnace Type Gaskets	15-16
Bath Specialties	98-99	Duct Straps-Flexible	26	Handhole and Manhole Gaskets	58
Bearing Puller	30, 38, 94	Duct Tape	91	Handle Puller	95
Bearings-Ball	30	Dunham Bush Type Gaskets	57	Haywood Type O-rings	12
Bearings-Blower	26	Duo Basket Strainer Wrench	95	Heil Type Gasket	16
Beckett Type Parts	17	Duplex Tank Bushings	20	High Temperature Knit Tape	24
Bell & Gossett Type Couplers	28	Dust Masks	27, 89	High Temperature Rope	24
Bell & Gossett Type Flanges	33	Dynatherm Type Gaskets	55	Hinged Pipe Repair Clamps	83
Bell & Gossett Type Gaskets	34-36	Econo Type Parts	41	Hoffman Type Gaskets	56
Bell & Gossett Type Parts	29-36	Electrical Jumpers	22	Honeywell Type Parts	9
Bell & Gossett Type Seal Kits	31	Electrical Tape	91	Hose Barbs	85
Belt Dressing	25, 91	Electrodes	23	Hose Bibbs	80, 101
Belts-V-Belts	25	Escutcheons-Split Ring	82	Hose Caps and Gaskets	84
Berkely Type Gaskets	60-61	Expansion Plugs	90	Hose Clamps	83
Bleeder Wrench-Fuel Unit	3, 6	F.E. Meyers Type Gasket	62	Hose Fittings-Brass	84
Block Flaring Tool	86, 94	Face Plate Screw	98	Hose Parts	84
Blower Bearings	26	Face Plates-Bath	98	Hot Water Valves	54
Blower Shafts	25	Fairbanks Type Gaskets	61	ICP Type Gasket	16
Boiler Drains	80	Faucet Washers	101	Ignition Wire	22
Boiler Handhole and Manhole Gaskets	58	Faucets-Basin	101	Ignitors	23
Bolt Caps-Toilet	97	Fiberglass Pipe Repair Kit	93	Immersion Wells	56
Bolt Kits-Circulator	33, 38	Fill Box Gasket	11	Impeller Wrenches	30, 38, 94
Bolt Packs	60	Fire Sprinkler Gauges	76	Industrial Combustion Type Parts	13-14
Brad Type Gasket	16	Firomatic Type Gaskets	11	Jet Aerator Type Gaskets	62
Braided Stainless Steel Supply Tubes	95	Fitting Brushes	93	Jiffy Rod Holders	98
Brass Brush	94	Fittings-Brass Compression	87-88	Johnson Type Gaskets	13
Brass Cleanout Plugs	78	Fittings-Brass Flare	85-87	Jumpers-Electrical	22
Brass Compression Fittings	87-88	Fittings-Brass Hose	84	Keys-Radiator	54
Brass Flare Fittings	85-87	Fixed Hub Pulleys	25	Korky Type Flappers	96
Brass Swing Check Valves	81	Flame Shield	93	Knit Tape	24
Brush-Brass	94	Flange Bolts-Toilet	97	Kraissel Type Gaskets	11-12
Bulbs-Rough Service	89	Flange Gaskets-Pipe	59-60	Lavatory Pop-Up Assemblies	100
By-Pass Plugs	3	Flanges-Circulator	33, 38	Lavatory Supply Tubes	96
Cad Cell Eyes	9, 13	Flappers	96	Lennox Type V-Belt	25
Candles-Smoke	23	Flange Tool-Circulator	33, 38	Light Bulbs-Rough Service	89
Capacitors-Motor	30	Flanges-Circulator	33, 38	Lighter-Pilot	26
Carlin Type Gaskets	17	Flare Adapters	26	Liquid Filled Gauges	75-76
Check Valve-Sewage Ejector	81	Flare Fittings	85-87	Locknut Wrench	95
Check Valves-Brass Swing	81	Flaring Tool	94	Lubricants	63
Check Valves-PVC	81	Flexible Oil Lines	19	Mack Washers	101
Circulator Bolt Kits	33, 38	Flexible Pipe Couplings	82	Manhole Gaskets	58
Circulator Couplings	28, 36, 41	Flint & Walling Type Gaskets	61	Manometers	77
Circulator Flange Tool	33	Floating Suction Oil Line	20	McDonnell & Miller Type Gaskets	50-52
Circulator Flanges	33, 38	Flush Valve	96	McDonnell & Miller Type Parts	50-52
Clamps-Hose	83	Frost Free Sillcocks	80-81	Mechanical Packing	79
Clamps-Pipe	83	Fuel Unit Bleeder Wrench	3, 6	Miller Type Parts	18-19
Cleaver Brooks Type Parts	12-13	Fulflo Type Gaskets	10	Monitor Heater Type Gaskets	14-15
Close Coupled Bolts	97	Furnace Pads-Miller Type	19	Motor Bearing Puller	30, 38, 94
CO ₂ Charges	19	G.E. Door Gasket	16	Motor Capacitors	30

PRODUCT INDEX

Motor Mounts	29, 36	Rubber Rolls	72	Tape-Aluminum Foil	24, 91
Motor Pulleys	25	Saddle Valve	78	Tape-Duct	24, 91
Needle Valves	78	Safety Labels-Oil Burner	20	Tape-Electrical	91
Nitrile Gloves	27	Sandcloth	93	Tape-Teflon	92
No-Hub Couplings	82	Saw-Boiler Cleaning (Soot)	27	Teflon Grease	63, 92
Nozzle Adapters	20	Schrader Valve	20, 78	Teflon Packing	79
Nozzle Lines	19	Seal Setting Tool	30, 69, 93	Teflon Paste	92
Nozzle Wrench	20	Seals-Pump	31, 37, 63-69	Teflon Tape	92
OEM Cross Reference Chart	103-106	Seat Disks	96	Terminal Connectors	22
Oil Burner Couplings	21	Seat Wrenches	95	Test Caps-Flexible	82
Oil Burner Pump Strainers	1, 2, 4, 5, 8, 9	Sewage Ejector Check Valve	81	Test Leads	22
Oil Burner Safety Labels	21	Shafts-Blower	25	Test Plugs	82
Oil Filter Gaskets	10-11	Sheet Metal Screws	26, 89	Thermo Pride Type Gaskets	16
Oil Filter Vacuum Gauge Adapter	11	Shoe Covers-Disposable	27, 89	Thermometers	77
Oil Lines-Copper	19	Shovel-Soot	27	Thrush Type Parts	41
Oil Lines-Flexible	19	Shower Arm Escutcheons	98	Thrust Collar Kits	25
Oil Tank Bushings (Duplex)	20	Shower Arms	98	Tie Down Straps	89
Oil Tank Floating Suction Line	20	Shower Heads	98	Tip-Toe Drains	99
Oil Tank Valves	20	Shower Rod Holders	98	Toilet Bolt Caps	97
Olsen Type Gasket	16	Shower Socket Wrench	95	Toilet Flange Bolts	97
Open Mesh Grit Cloth	93	Shower Specialties	98-99	Toilet Gaskets	97
O-ring Assortment Kit	101	Sight Glass and Gaskets	55	Toilet Specialties	96-97
O-ring Cord	57	Silicone Grease	63, 91	Toilet Supply Tubes	96
O-ring Cord Adhesive	57	Silicone Spray	63, 92	Toilet Tank Lever	97
O-ring Puller	95	Sillcock Key	80, 94	Tools-Plumbing	93-95
O-rings	102	Sillcocks-Angle	80	Torque Wrench	83, 94
P.O. Plug Wrench	94	Sillcocks-Frost Free	80-81	Tridicators	77
Packing	79	Single Union Ball Valves	79	Trip Lever Face Plate	98
Peabody Barnes Type Gaskets	62	Sink Pop-Up Assemblies	100	Tub Spouts	98
Petro Type Gaskets	12	Sink Rinse Gun	101	Tube Clamps	27
Philly Type O-ring	11	Sink Specialties	99-102	Tubing Cutters	93
Pilot Lighter	26	Sink Strainers	99	Tubular Pipe Connector	100
Pilot Tubing	26	Slip Joint Washers	100	Unions	81
Pigtail Steam Syphons	52, 78	Slipnuts	55, 100	Universal Burner Gasket	16
Pipe Clamps-Hinged	83	Smoke Candles	23	Vacuum Bags	27
Pipe Couplings-No Hub	82	Smoke Matches	23	Vacuum Cleaner Hose-Soot Snake	27
Pipe Couplings-Rubber	82	Smoke Pellets	23	Vacuum Gauge Adapter Fitting	11
Pipe Flange Bolts and Nuts	60	Smoke Test Paper	24	Vacuum Gauges	74
Pipe Flange Gaskets	59-60	Smoke Tester	24	Vak Pak Type Gasket	63
Pipe Plugs	3	Snubbers	77	Valliant Boiler Type Gasket	42
Pipe Repair Clamps-Hinged	83	Solenoid Valve Gasket	14	Valve-Schrader	20
Pipe Repair Kit-Fiberglass	93	Soot Saw	27	Valves-Brass Ball	79
Pipe Strap Wrench	93	Soot Shovel	27	Valves-Gas	26
Plastic Case Gauges	74	Soot Snake	27	Valves-Oil Tank	20
Plastic Supply Tubes	95	Spouts	98	Valves-PVC	79
Plugs-Brass	78	Spring Flex Couplers	28	Valves-Radiator	54
Plugs-By-Pass	3	Spud Wrench	54, 94	Valves-Single Union	79
Plugs-Pipe	3	Stainless Steel Supply Tubes	95	V-Belts	25
Plumbing Specialties	94-102	Steam Parts	52-54	Vent-Rite Type Gasket	56
Polybutylene Supply Tubes	95	Sterling Type Gaskets	63	Vibro-Insulators	91
Pop-Up Waste Assemblies	100	Stewart Warner Type Gaskets	9	Viking Type Gaskets	13
Pressure Gauges	73	Sticky Spray	63, 91	Vinyl Gloves	27
Pulleys	25	Stop and Waste Valves	80	Warren Type Gasket	14
Pump-Hand	20	Stops	96	Washers-Slip Joint Nut	100
Pump Seals	63-69	Strainer Basket Assemblies	50	Washers-Tailpiece	100
Pump Strainers-Oil Burner	1, 2, 4, 5, 8, 9	Strainers-Oil Burner Pump	1, 2, 4, 5, 8, 9	Water Heater Element Wrench	94
Purolator Type Gasket	11	Strainers-Sink	99	Water Heater Gas Flare Adapters	26
PVC Ball Valves	79	Strainers-"Y"	54	Water Pump Gaskets	60-63
PVC Check Valves	81	Sundstrand Circulator Type Gaskets	41-42	Water Test Gauges	76
PVC Compression Couplings	81	Suntec Type Parts	2-5	Watson McDaniel Type Gasket	56
PVC Saw	93	Supplies-Sink	95	Watts Type Gaskets	42
PVC Unions	81	Supplies-Toilet	95	Wayne Type Gaskets	16
Radiator Parts	54	Supply Stops	96	Webster Type Parts	5-8
Radiator Tools	54, 94	Swedge Tool	93	Well Adapter	55
Radiator Valves	54	Taco Type Flanges	38	Well Pump Gaskets	60-63
Rapid Dayton Type Gaskets	63	Taco Type Gaskets	39-40	Wells	56
Ray Visco Type Gasket	14	Taco Type Parts	36-40	Winkler Type Gaskets	9
Riello Type Flexible Oil Line	19	Taco Type Seal Kits	36-40	Winterizing Plugs	90
Riello Type Gaskets	8	Tadpole Tape	24	Wire Ties	89
Riello Type Oil Line Adapter	19	Tailpiece Washers	100	Woods Couplers	29
Riello Type Parts	8	Tank Lever	97	Wrench-Fuel Unit Bleeder	3, 6
Rinse Gun	101	Tankless Gasket Cross Reference Chart	49	Wrench-Nozzle	20
Rope-High Temperature	24	Tankless Heater Bolt and Nut	48	Y Strainers	54
Rough Service Bulbs	89	Tankless Heater Gasket Sheets	48	York Type Gasket	16
Rubber Flappers	96	Tankless Heater Gaskets	43-49	Zoom Spout Oiler	91

Use SSC's Website to Find Your Replacement Parts and Order Online!

Manufacturers of Parts and Accessories for the Heating, Pump Rebuilding and Plumbing Industries.

SSC STRAINER SCREEN
AND CYLINDER CO.



Home

Product Catalog

Company Profile

Contact Us

Customer Gateway

Email:

Password:

Sign In

Not Registered?

[Click here to register](#)

Forgot your password? [Click here](#)



For our free 109 page catalog
Call: 1-800-863-5800
Fax: 1-800-863-5900 or
E-Mail: sales@strainerscreen.com



Heating and Plumbing Wholesalers and Rebuilders

**BUY YOUR REPLACEMENT PARTS
FROM SSC AND SAVE!**



- SSC manufactures or sells over 2500 parts for the heating, pump rebuilding and plumbing industries at very competitive prices.
- If you need a gasket for the heating industry we probably make it.
- There is no minimum order requirement and we ship promptly.
- SSC sells to authorized wholesalers and rebuilders only. No exceptions.

www.strainerscreen.com

- Place orders online using our shopping cart feature.
- Find more than 2500 different listings of heating, pump rebuilding and plumbing parts using our multi-functional search engines. Part listings are also accompanied by a picture for your reference.
- Take advantage of our unique "View Past Orders" section to look at previous orders you've placed. You can then order from this list.
- This website also enables you to save the current order you are working on by using our "Save Cart" feature. You can come back to it at another time if you are interrupted or save all of your orders for future reference. These can be activated to be your current order/cart at any time.
- Registration is required. This ensures that only authorized Wholesalers and Rebuilders, not the trade or general public, can see pricing and use the shopping cart.
- Download the SSC catalog, price list and all of our literature from the website.