

SECO
HOLEMAKING
PERFOMAX®
DRILLING

**GET DRILL BODIES THAT
STAND THE TEST OF TIME**

 **Seco**



DRILL SMARTER

DRILL WITH STRENGTH, STABILITY AND PRECISION

Increase your drilling parameters and boost tool life with Seco's Perfomax® indexable insert drill with optimized chip flutes for superior chip control and evacuation. An improved design makes the already outstanding drill even better. Innovative features, including a new flute design, wave-patterned anti-friction technology and laser hardening, add strength, stability and accuracy, and have been implemented on all Perfomax drills.

Take charge for stronger more stable and more accurate performance in addition to design changes that makes switching to this tool quick and easy. For example, the same setting length has been used on the new drill as the previous Perfomax, and most of the drills will keep the same inserts as the previous drill. There are some cases, however, in which some of the drill diameters require a new insert combination. This has been done to add more security by building in more strength.

All of the new Perfomax drills have new product numbers and descriptions.

Introduction	2
The new drill body	4
DRILL BODIES	
Body Code Keys	6
SD522	7
SD523	10
SD524	17
SD525	22
SD542	23
SD572	24
Spare Parts	25

Inserts/Code Key	28
CUTTING DATA	
Inch	30
Metric	42
Custom Design Online	54
TECHNICAL INFO	
Shanks	55
Troubleshooting	58
Feed force	59



PERFOMAX® RE-ENGINEERED

Many new design features add strength, stability and accuracy to the Perfomax drills. These features have been implemented in all Perfomax drills and work together to take the performance of the newly designed drill to an even higher level.

NEW FLUTE DESIGN

A new design of the front flute optimizes chip forming and increases application security. The design features a larger helix, smoother chip flute exit and larger center chip flute area. This leads to the creation of shorter chips that are easier to evacuate, reduces the risk of chip jamming and results in longer tool body life and better surface finish of the hole. This is especially true when machining long chipping materials like soft carbon steels, austenitic stainless steels and super duplex stainless steels.

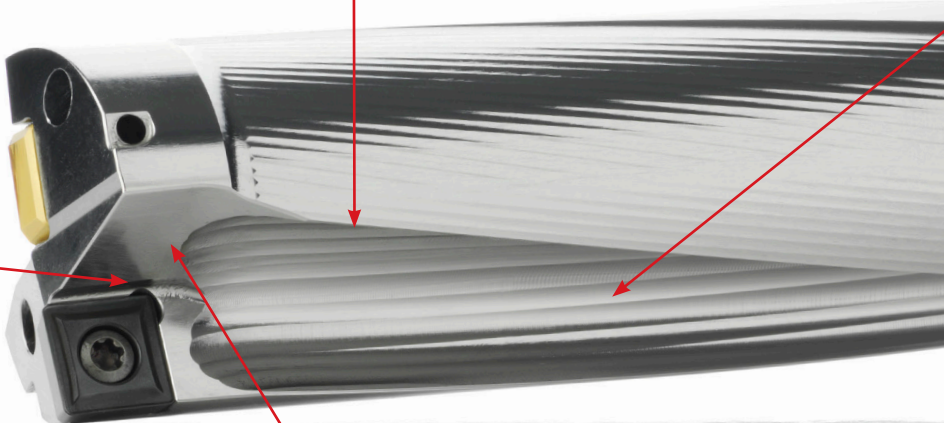
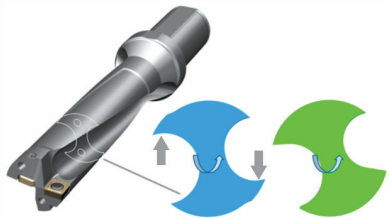

LASER HARDENING

To enhance the drill tool life, the front of the flute is now laser hardened. The high hardness of HRC 60 increases the tool life of the drill body up to 140% due a lower risk of chip erosion compared with the previous design.

NEW POCKET DESIGN

An improved design creates a bigger radius at the bottom of the insert pocket and makes it more rigid. The inserts in the periphery and center pocket have also more support thanks to longer contact zone with the insert wall for improved reliability and better application security.

New Pocket Design



Periphery



Center

Previous Pocket Design



Periphery



Center

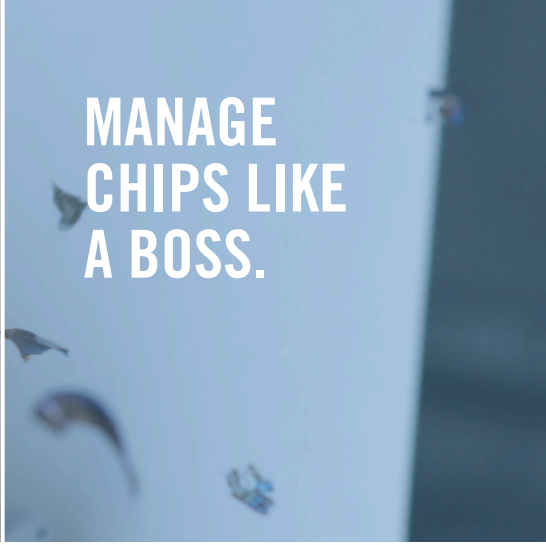
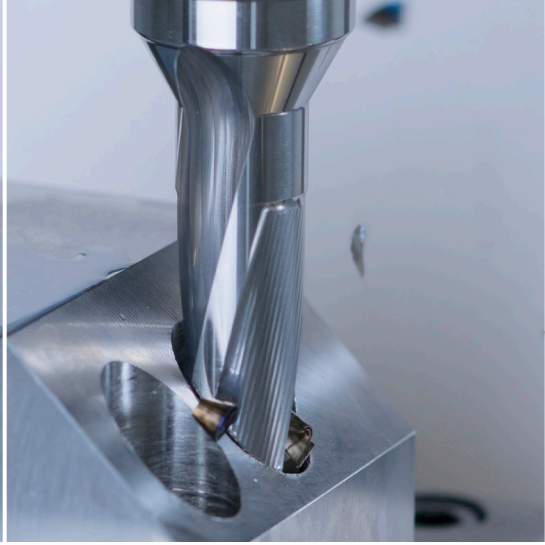
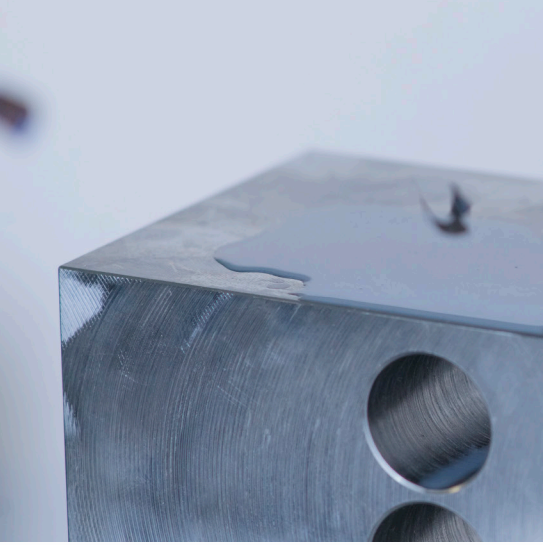

MANAGE CHIPS LIKE A BOSS.

WAVE PATTERN IN THE FLUTE

To further improve chip evacuation, the flutes now feature a wave pattern that generates an “anti-friction” surface. This minimizes the contact between the chip and the flute and leads to higher application security.

CHAMFER ON THE FLATS

To avoid marks in the toolholder, chamfers have been added on the flats of the shank.

COOLANT HOLES

Relocated for better cooling and improved chip evacuation.

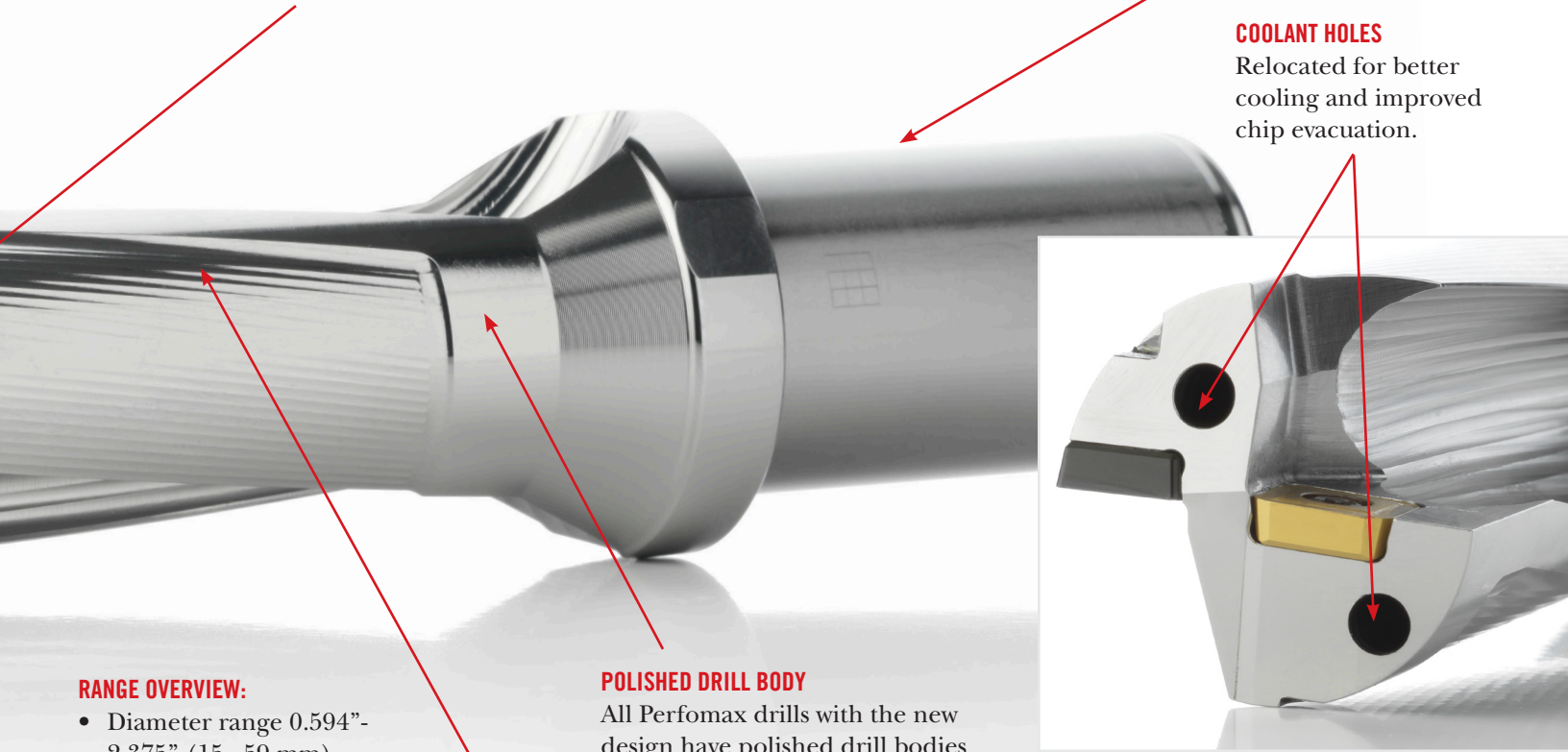

RANGE OVERVIEW:

- Diameter range 0.594”- 2.375” (15 - 59 mm)
- Length to diameter ratios of 2xD, 3xD, 4xD and 5xD
- Intermediate diameters and lengths available at launch
- All standard spindle interfaces
- R7 shank for rotating and R7-C shank for stationary applications

POLISHED DRILL BODY

All Perfomax drills with the new design have polished drill bodies instead of the coated design of the previous version. This speeds production of the drills and leaves a more eco-friendly footprint. The polished drill body also results in improved chip evacuation and longer tool life for the body.

RADIAL CLEARANCE

Thanks to the radial clearance of the outside of the drill body, there is more room for the chips between the drill body and the hole surface. This leads to increased application security and lower tool cost by reducing the risk of chip jamming, which can cause breakage and shorten body tool life.

INDEXABLE INSERT DRILLS

INCH

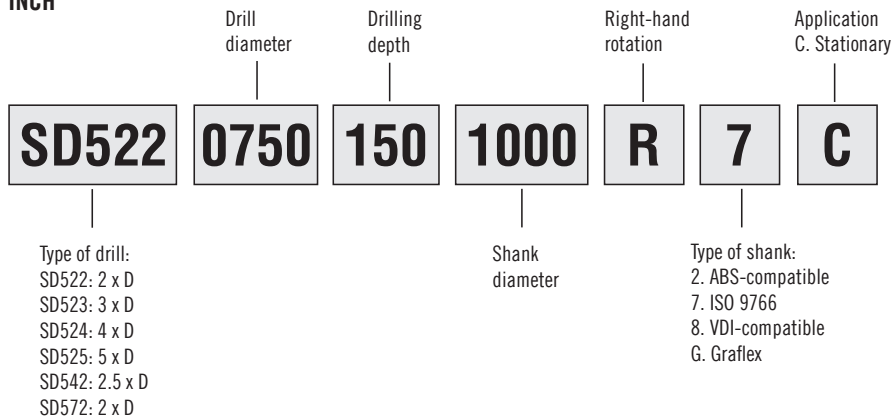

METRIC

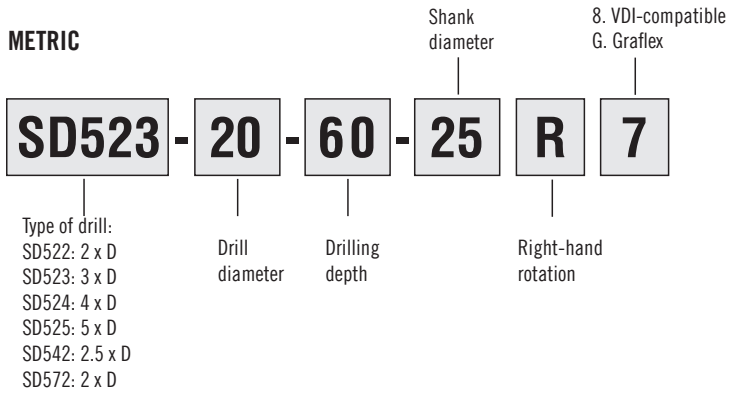

SECO-CAPTO™

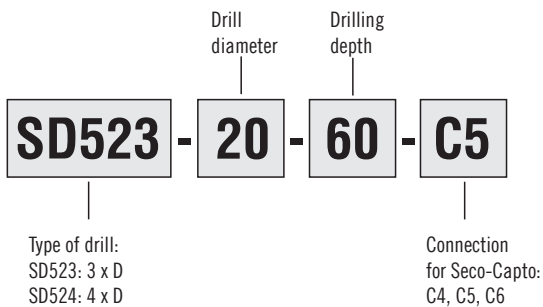

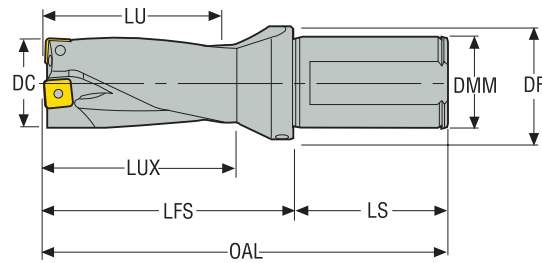

PERFOMAX® SD522 - 2 x D, R7 & R7-C SHANKS - INCH

DIMENSIONS IN INCH		PRODUCT NO.	DESCRIPTION	DIMENSIONS IN INCH						INSERT		RADIAL ADJUSTMENT	
DC	LU			OAL	LFS	LS	LUX	DMM	DF	CENTER INSERT	PERIPH INSERT	-	+
0.594	1.190	03080704	SD522-0594-119-1000R7	4.621	2.371	2.250	1.387	1.000	1.378	SPGX0502	SCGX050204	0.008	0.013
0.625	1.250	03080705	SD522-0625-125-1000R7	4.681	2.431	2.250	1.447	1.000	1.378	SPGX0502	SCGX050204	0.005	0.015
0.656	1.310	03080707	SD522-0656-131-1000R7	4.741	2.491	2.250	1.507	1.000	1.378	SPGX0502	SCGX050204	0.002	0.019
0.687	2.030	03080709	SD522-0687-137-1000R7	5.461	3.211	2.250	2.227	1.000	1.378	SPGX0502	SCGX050204	0.000	0.020
0.709	1.420	03080710	SD522-0709-142-1000R7	4.851	2.601	2.250	1.617	1.000	1.378	SPGX0602	SCGX050204	0.013	0.008
0.750	1.500	03080712	SD522-0750-150-1000R7	4.931	2.681	2.250	1.697	1.000	1.378	SPGX0602	SCGX050204	0.004	0.017
0.766	1.530	03080713	SD522-0766-153-1000R7	4.961	2.711	2.250	1.727	1.000	1.378	SPGX0602	SCGX050204	0.001	0.020
0.787	1.570	03080714	SD522-0787-157-1000R7	5.001	2.751	2.250	1.767	1.000	1.378	SPGX0602	SCGX060204	0.003	0.018
0.812	1.620	03080715	SD522-0812-162-1000R7	5.051	2.801	2.250	1.817	1.000	1.378	SPGX0602	SCGX060204	0.001	0.020
0.827	1.650	03080717	SD522-0827-165-1000R7	5.081	2.831	2.250	1.847	1.000	1.378	SPGX0602	SCGX060204	0.000	0.020
0.875	1.750	03080718	SD522-0875-175-1000R7	5.181	2.931	2.250	1.947	1.000	1.378	SPGX0703	SCGX060204	0.015	0.020
0.906	1.810	03080720	SD522-0906-181-1000R7	5.241	2.991	2.250	2.007	1.000	1.378	SPGX0703	SCGX070308	0.013	0.020
0.922	1.840	03080721	SD522-0922-184-1000R7	5.271	3.021	2.250	2.037	1.000	1.378	SPGX0703	SCGX070308	0.010	0.020
0.937	1.870	03080722	SD522-0937-187-1000R7	5.301	3.051	2.250	2.067	1.000	1.378	SPGX0703	SCGX070308	0.004	0.020
0.984	1.970	03080724	SD522-0984-197-1250R7	5.526	3.151	2.375	2.167	1.250	1.654	SPGX0703	SCGX070308	0.004	0.020
1.000	2.000	03080725	SD522-1000-200-1250R7	5.556	3.181	2.375	2.197	1.250	1.654	SPGX0703	SCGX070308	0.004	0.020
1.032	2.060	03080727	SD522-1032-206-1250R7	5.616	3.241	2.375	2.257	1.250	1.654	SPGX0903	SCGX070308	0.020	0.004
1.062	2.120	03080728	SD522-1062-212-1250R7	5.676	3.301	2.375	2.317	1.250	1.654	SPGX0903	SCGX070308	0.020	0.010
1.125	2.250	03080730	SD522-1125-225-1250R7	5.806	3.431	2.375	2.447	1.250	1.654	SPGX0903	SCGX09T308	0.008	0.020
1.187	2.370	03080732	SD522-1187-237-1250R7	5.926	3.551	2.375	2.567	1.250	1.654	SPGX0903	SCGX09T308	0.005	0.020
1.250	2.500	03080735	SD522-1250-250-1500R7	6.306	3.681	2.625	2.697	1.500	1.969	SPGX11T3	SCGX09T308	0.020	0.011
1.312	2.620	03080736	SD522-1312-262-1500R7	6.426	3.801	2.625	2.817	1.500	1.969	SPGX11T3	SCGX09T308	0.020	0.020
1.375	2.750	03080737	SD522-1375-275-1500R7	6.556	3.931	2.625	2.947	1.500	1.969	SPGX11T3	SCGX11T308	0.009	0.020
1.437	2.870	03080739	SD522-1437-287-1500R7	6.676	4.051	2.625	3.067	1.500	1.969	SPGX11T3	SCGX11T308	0.004	0.020
1.500	3.000	03080743	SD522-1500-300-1500R7	6.806	4.181	2.625	3.197	1.500	1.969	SPGX12T3	SCGX11T308	0.020	0.020
1.625	3.250	03080748	SD522-1625-325-1500R7	7.056	4.431	2.626	3.447	1.500	1.969	SPGX12T3	SCGX120408	0.007	0.020
1.750	3.500	03080756	SD522-1750-350-1500R7	7.306	4.681	2.625	3.697	1.500	1.969	SPGX1504	SCGX120408	0.020	0.016
1.875	3.750	03080763	SD522-1875-375-1500R7	7.556	4.931	2.625	3.947	1.500	1.969	SPGX1504	SCGX150512	0.020	0.020
2.000	4.000	03080769	SD522-2000-400-1500R7	7.806	5.181	2.625	4.197	1.500	2.337	SPGX1504	SCGX150512	0.008	0.020
2.125	4.250	03080773	SD522-2125-425-1500R7	8.056	5.431	2.625	4.447	1.500	2.337	SPGX1904	SCGX150512	0.020	0.020
2.250	4.500	03080779	SD522-2250-450-1500R7	8.306	5.681	2.625	4.697	1.500	2.337	SPGX1904	SCGX150512	0.013	0.020
2.375	4.750	03080783	SD522-2375-475-1500R7	8.556	5.931	2.625	4.947	1.500	2.480	SPGX1904	SCGX150512	0.004	0.020
R7-C SHANKS													
0.625	1.25	03080706	SD522-0625-125-1000R7-C	5.378	2.628	2.75	1.447	1	1.378	SPGX0502	SCGX050204	0.005	0.015
0.687	1.37	03080708	SD522-0687-137-1000R7-C	5.498	2.748	2.75	1.567	1	1.378	SPGX0502	SCGX050204	0	0.02
0.750	1.50	03080711	SD522-0750-150-1000R7-C	5.628	2.878	2.75	1.697	1	1.378	SPGX0602	SCGX050204	0.003	0.018
0.812	1.62	03080716	SD522-0812-162-1000R7-C	5.748	2.998	2.75	1.817	1	1.378	SPGX0602	SCGX060204	0.001	0.02
0.875	1.75	03080719	SD522-0875-175-1000R7-C	5.878	3.128	2.75	1.947	1	1.378	SPGX0703	SCGX060204	0.015	0.02
0.937	1.87	03080723	SD522-0937-187-1000R7-C	5.998	3.248	2.75	2.067	1	1.378	SPGX0703	SCGX070308	0.004	0.02
1.000	2.00	03080726	SD522-1000-200-1250R7-C	6.128	3.378	2.75	2.197	1.25	1.654	SPGX0703	SCGX070308	0.004	0.02
1.062	2.12	03080729	SD522-1062-212-1250R7-C	6.059	3.309	2.75	2.128	1.25	1.654	SPGX0903	SCGX070308	0.020	0.01
1.125	2.25	03080731	SD522-1125-225-1250R7-C	6.378	3.628	2.75	2.447	1.25	1.654	SPGX0903	SCGX09T308	0.008	0.02
1.187	2.37	03080733	SD522-1187-237-1250R7-C	6.498	3.748	2.75	2.567	1.25	1.654	SPGX0903	SCGX09T308	0.005	0.02
1.250	2.50	03080734	SD522-1250-250-1500R7-C	6.628	3.878	2.75	2.697	1.5	1.969	SPGX11T3	SCGX09T308	0.020	0.011
1.375	2.75	03080738	SD522-1375-275-1500R7-C	6.878	4.128	2.625	2.947	1.5	1.969	SPGX11T3	SCGX11T308	0.009	0.02
1.500	3.00	03080742	SD522-1500-300-1500R7-C	7.128	4.378	2.75	3.197	1.5	1.969	SPGX12T3	SCGX11T308	0.020	0.02
1.750	3.50	03080757	SD522-1750-350-1500R7-C	7.628	4.878	2.625	3.697	1.5	1.969	SPGX1504	SCGX120408	0.020	0.016
2.000	4.00	03080770	SD522-2000-400-1500R7-C	8.128	5.378	2.75	4.197	1.5	2.337	SPGX1504	SCGX150512	0.008	0.02
2.125	4.25	03080774	SD522-2125-425-1500R7-C	8.378	5.628	2.75	4.447	1.5	2.337	SPGX1904	SCGX150512	0.020	0.02
2.250	4.50	03080780	SD522-2250-450-1500R7-C	8.628	5.878	2.75	4.697	1.5	2.337	SPGX1904	SCGX150512	0.013	0.02
2.375	4.75	03080784	SD522-2375-475-1500R7-C	8.878	6.128	2.75	4.947	1.5	2.48	SPGX1904	SCGX150512	0.004	0.02

PERFOMAX® SD522 - 2 x D, R7 SHANKS - METRIC

DIMENSIONS IN MM		PRODUCT NO.	DESCRIPTION	DIMENSIONS IN METRIC						INSERT		RADIAL ADJUSTMENT	
DC	LU			OAL	LFS	LS	LUX	DMM	DF	CENTER INSERT	PERIPH INSERT	-	+
15	30	03080744	SD522-15-30-20R7	110	60	50	35	20	30	SPGX0502	SCGX050204	0.22	0.31
15	30	03080745	SD522-15-30-25R7	116	60	56	35	25	35	SPGX0502	SCGX050204	0.22	0.31
15.5	31	03080740	SD522-15.5-31-20R7	111	61	50	36	20	30	SPGX0502	SCGX050204	0.3	0.35
15.5	31	03080741	SD522-15.5-31-25R7	117	61	56	36	25	35	SPGX0502	SCGX050204	0.17	0.36
16	32	03080749	SD522-16-32-20R7	112	62	50	37	20	30	SPGX0502	SCGX050204	0.12	0.41
16	32	03080750	SD522-16-32-25R7	118	62	56	37	25	35	SPGX0502	SCGX050204	0.12	0.41
16.5	33	03080746	SD522-16.5-33-20R7	113	63	50	38	20	30	SPGX0502	SCGX050204	0.07	0.46
16.5	33	03080747	SD522-16.5-33-25R7	119	63	56	38	25	35	SPGX0502	SCGX050204	0.07	0.46
17	34	03080754	SD522-17-34-20R7	114	64	50	39	20	30	SPGX0502	SCGX050204	0.02	0.5
17	34	03080755	SD522-17-34-25R7	120	64	56	39	25	35	SPGX0502	SCGX050204	0.1	0.5
17.5	35	03080752	SD522-17.5-35-20R7	115	65	50	40	20	30	SPGX0602	SCGX050204	0.43	0.1
17.5	35	03080753	SD522-17.5-35-25R7	121	65	56	40	25	35	SPGX0602	SCGX050204	0.43	0.1
18	36	03080760	SD522-18-36-20R7	116	66	50	41	20	30	SPGX0602	SCGX050204	0.32	0.21
18	36	03080761	SD522-18-36-25R7	122	66	56	41	25	35	SPGX0602	SCGX050204	0.32	0.21
18.5	37	03080758	SD522-18.5-37-20R7	117	67	50	42	20	30	SPGX0602	SCGX050204	0.1	0.31
18.5	37	03080759	SD522-18.5-37-25R7	123	67	56	42	25	35	SPGX0602	SCGX050204	0.22	0.31
19	38	03080765	SD522-19-38-20R7	118	68	50	43	20	30	SPGX0602	SCGX050204	0.11	0.42
19	38	03080766	SD522-19-38-25R7	124	68	56	43	25	35	SPGX0602	SCGX050204	0.11	0.42
19.5	39	03080764	SD522-19.5-39-20R7	119	69	50	44	20	30	SPGX0602	SCGX060204	0.11	0.42
20	40	03080771	SD522-20-40-25R7	126	70	56	45	25	35	SPGX0602	SCGX060204	0.07	0.46
21	42	03080775	SD522-21-42-25R7	128	72	56	47	25	35	SPGX0602	SCGX060204	0.01	0.5
22	44	03080777	SD522-22-44-25R7	130	74	56	49	25	35	SPGX0703	SCGX060204	0.44	0.46
23	46	03080781	SD522-23-46-25R7	132	76	56	51	25	35	SPGX0703	SCGX070308	0.33	0.5
24	48	03080785	SD522-24-48-25R7	134	78	56	53	25	35	SPGX0703	SCGX070308	0.11	0.5
25	50	03080788	SD522-25-50-32R7	140	80	60	55	32	42	SPGX0703	SCGX070308	0.11	0.5
26	52	03080790	SD522-26-52-32R7	142	82	60	57	32	42	SPGX0903	SCGX070308	0.5	0.11
27	54	03080792	SD522-27-54-32R7	144	84	60	59	32	42	SPGX0903	SCGX070308	0.5	0.26
28	56	03080795	SD522-28-56-32R7	146	86	60	61	32	42	SPGX0903	SCGX070308	0.28	0.5
29	58	03080796	SD522-29-58-32R7	148	88	60	63	32	42	SPGX0903	SCGX09T308	0.18	0.5
30	60	03080798	SD522-30-60-32R7	150	90	60	65	32	42	SPGX0903	SCGX09T308	0.12	0.5
31	62	03080801	SD522-31-62-32R7	152	92	60	67	32	42	SPGX0903	SCGX09T308	0.12	0.5
32	64	03080802	SD522-32-64-32R7	154	94	60	69	32	42	SPGX11T3	SCGX09T308	0.5	0.31
32	64	03080803	SD522-32-64-40R7	162	94	68	69	40	50	SPGX11T3	SCGX09T308	0.5	0.35
33	66	03080805	SD522-33-66-32R7	156	96	60	71	32	42	SPGX11T3	SCGX09T308	0.5	0.46
33	66	03080806	SD522-33-66-40R7	164	96	68	71	40	50	SPGX11T3	SCGX09T308	0.5	0.46
34	68	03080808	SD522-34-68-32R7	158	98	60	73	32	42	SPGX11T3	SCGX09T308	0.22	0.5
34	68	03080809	SD522-34-68-40R7	166	98	68	73	40	50	SPGX11T3	SCGX09T308	0.22	0.5
35	70	03080810	SD522-35-70-32R7	160	100	60	75	32	42	SPGX11T3	SCGX11T308	0.22	0.5
35	70	03080811	SD522-35-70-40R7	168	100	68	75	40	50	SPGX11T3	SCGX11T308	0.22	0.5
36	72	03080813	SD522-36-72-32R7	162	102	60	77	32	42	SPGX11T3	SCGX11T308	0.09	0.5
36	72	03080814	SD522-36-72-40R7	170	102	68	77	40	50	SPGX11T3	SCGX11T308	0.09	0.5
37	74	03080816	SD522-37-74-32R7	164	104	60	79	32	42	SPGX11T3	SCGX11T308	0.09	0.5
37	74	03080817	SD522-37-74-40R7	172	104	68	79	40	50	SPGX11T3	SCGX11T308	0.09	0.5
38	76	03080818	SD522-38-76-32R7	166	106	60	81	32	42	SPGX12T3	SCGX11T308	0.07	0.46
38	76	03080819	SD522-38-76-40R7	174	106	68	81	40	50	SPGX12T3	SCGX11T308	0.07	0.46
39	78	03080821	SD522-39-78-32R7	168	108	60	83	32	42	SPGX12T3	SCGX11T308	0.07	0.46
39	78	03080822	SD522-39-78-40R7	176	108	68	83	40	50	SPGX12T3	SCGX11T308	0.39	0.5
40	80	03080823	SD522-40-80-32R7	170	110	60	85	32	50	SPGX12T3	SCGX11T308	0.19	0.5
40	80	03080824	SD522-40-80-40R7	178	110	68	85	40	50	SPGX12T3	SCGX11T308	0.19	0.5
41	82	03080826	SD522-41-82-40R7	180	112	68	87	40	50	SPGX12T3	SCGX120408	0.07	0.46
42	84	03080828	SD522-42-84-40R7	182	114	68	89	40	50	SPGX12T3	SCGX120408	0.19	0.5
43	86	03080830	SD522-43-86-40R7	184	116	68	91	40	50	SPGX12T3	SCGX120408	0.05	0.5
44	88	03080832	SD522-44-88-40R7	186	118	68	93	40	50	SPGX1504	SCGX120408	0.5	0.41
45	90	03080834	SD522-45-90-40R7	188	120	68	95	40	50	SPGX1504	SCGX150512	0.5	0.41
46	92	03080835	SD522-46-92-40R7	190	122	68	97	40	50	SPGX1504	SCGX150512	0.5	0.5
47	94	03080836	SD522-47-94-40R7	192	124	68	99	40	50	SPGX1504	SCGX150512	0.5	0.5
48	96	03080837	SD522-48-96-40R7	194	126	68	101	40	59	SPGX1504	SCGX150512	0.45	0.5
49	98	03080838	SD522-49-98-40R7	196	128	68	103	40	59	SPGX1504	SCGX150512	0.2	0.5
50	100	03080839	SD522-50-100-40R7	198	130	68	105	40	59	SPGX1504	SCGX150512	0.2	0.5
51	102	03080840	SD522-51-102-40R7	200	132	68	107	40	59	SPGX1504	SCGX150512	0.2	0.5
52	104	03080841	SD522-52-104-40R7	202	134	68	109	40	59	SPGX1904	SCGX150512	0.5	0.42
53	106	03080842	SD522-53-106-40R7	204	136	68	111	40	59	SPGX1904	SCGX150512	0.5	0.42
54	108	03080843	SD522-54-108-40R7	206	138	68	113	40	59	SPGX1904	SCGX150512	0.5	0.5

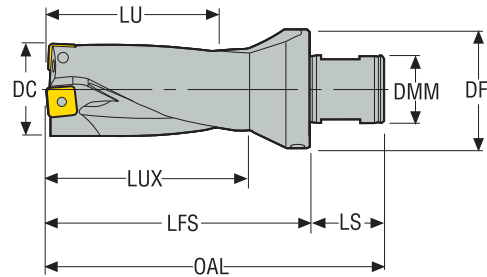

PERFOMAX® SD522 - 2 x D, R7 SHANKS & ABS 50 COMPATIBLE R2 SHANKS - METRIC

DIMENSIONS IN MM		PRODUCT NO.	DESCRIPTION	DIMENSIONS IN METRIC						INSERT		RADIAL ADJUSTMENT	
DC	LU			OAL	LFS	LS	LUX	DMM	DF	CENTER INSERT	PERIPH INSERT	-	+
55	110	03080844	SD522-55-110-40R7	208	140	68	115	40	59	SPGX1904	SCGX150512	0.50	0.5
56	112	03080845	SD522-56-112-40R7	210	142	68	117	40	59	SPGX1904	SCGX150512	0.50	0.5
57	114	03080846	SD522-57-114-40R7	212	144	68	119	40	59	SPGX1904	SCGX150512	0.39	0.5
58	116	03080847	SD522-58-116-40R7	214	146	68	121	40	63	SPGX1904	SCGX150512	0.09	0.5
59	118	03080848	SD522-59-118-40R7	216	148	68	123	40	59	SPGX1904	SCGX150512	0.15	0.5
ABS 50 COMPATIBLE SHANKS R2													
15	30	03081056	SD522-15-30-50R2	91	60	31	35	28	50	SPGX0502	SCGX050204	0.22	0.31
15.5	31	03081057	SD522-15.5-31-50R2	92	61	31	36	28	50	SPGX0502	SCGX050204	0.30	0.35
16	32	03080751	SD522-16-32-50R2	93	62	31	37	28	50	SPGX0502	SCGX050204	0.12	0.41
16.5	33	03081058	SD522-16.5-33-50R2	94	63	31	38	28	50	SPGX0502	SCGX050204	0.07	0.46
17	34	03081059	SD522-17-34-50R2	95	64	31	39	28	50	SPGX0502	SCGX050204	0.10	0.5
17.5	35	03081060	SD522-17.5-35-50R2	96	65	31	40	28	50	SPGX0602	SCGX050204	0.43	0.1
18	36	03080762	SD522-18-36-50R2	97	66	31	41	28	50	SPGX0602	SCGX050204	0.32	0.21
18.5	37	03081061	SD522-18.5-37-50R2	98	67	31	42	28	50	SPGX0602	SCGX050204	0.1	0.31
19	38	03080767	SD522-19-38-50R2	99	68	31	43	28	50	SPGX0602	SCGX050204	0.11	0.42
20	40	03080772	SD522-20-40-50R2	101	70	31	45	28	50	SPGX0602	SCGX060204	0.1	0.46
20.62	42	03080768	SD522-20.62-42-50R2	103	92	31	47	28	50	SPGX0602	SCGX060204	0.1	0.5
21	42	03081062	SD522-21-42-50R2	103	72	31	47	28	50	SPGX0602	SCGX060204	0.1	0.5
22	44	03080778	SD522-22-44-50R2	105	74	31	49	28	50	SPGX0703	SCGX060204	0.45	0.5
22.23	45	03080776	SD522-22.23-45-50R2	106	75	31	50	28	50	SPGX0703	SCGX060204	0.2	0.5
23	46	03080782	SD522-23-46-50R2	107	76	31	51	28	50	SPGX0703	SCGX070308	0.35	0.5
24	48	03080786	SD522-24-48-50R2	109	78	31	53	28	50	SPGX0703	SCGX070308	0.11	0.5
25	50	03080789	SD522-25-50-50R2	111	80	31	55	28	50	SPGX0703	SCGX070308	0.11	0.5
25.4	51	03080787	SD522-25.40-51-50R2	112	81	31	56	50	50	SPGX0703	SCGX070308	0.11	0.5
26	52	03080791	SD522-26-52-50R2	113	82	31	57	28	50	SPGX0903	SCGX070308	0.5	0.15
27	54	03080793	SD522-27-54-50R2	115	84	31	59	28	50	SPGX0903	SCGX070308	0.5	0.26
28	56	03081087	SD522-28-56-50R2	117	86	31	61	28	50	SPGX0903	SCGX070308	0.3	0.5
28.59	58	03080794	SD522-28.59-58-50R2	119	88	31	63	28	50	SPGX0903	SCGX09T308	0.2	0.5
29	58	03080797	SD522-29-58-50R2	119	88	31	63	28	50	SPGX0903	SCGX09T308	0.2	0.5
30	60	03080799	SD522-30-60-50R2	121	90	31	65	28	50	SPGX0903	SCGX09T308	0.12	0.5
31	62	03081063	SD522-31-62-50R2	123	92	31	67	28	50	SPGX0903	SCGX09T308	0.07	0.46
31.75	64	03080800	SD522-31.75-64-50R2	125	94	31	69	28	50	SPGX11T3	SCGX09T308	0.5	0.28
32	64	03080804	SD522-32-64-50R2	125	94	31	69	28	50	SPGX11T3	SCGX09T308	0.5	0.35
33	66	03080807	SD522-33-66-50R2	127	96	31	71	28	50	SPGX11T3	SCGX09T308	0.5	0.5
34	68	03081064	SD522-34-68-50R2	129	98	31	73	28	50	SPGX11T3	SCGX09T308	0.22	0.5
35	70	03080812	SD522-35-70-50R2	131	100	31	75	28	50	SPGX11T3	SCGX11T308	0.07	0.46
36	72	03080815	SD522-36-72-50R2	133	102	31	77	28	50	SPGX11T3	SCGX11T308	0.07	0.46
37	74	03081065	SD522-37-74-50R2	135	104	31	79	28	50	SPGX11T3	SCGX11T308	0.07	0.46
38	76	03080820	SD522-38-76-50R2	137	106	31	81	28	50	SPGX12T3	SCGX11T308	0.07	0.46
39	78	03081066	SD522-39-78-50R2	139	108	31	83	28	50	SPGX12T3	SCGX11T308	0.07	0.46
40	80	03080825	SD522-40-80-50R2	141	110	31	85	28	50	SPGX12T3	SCGX11T308	0.19	0.5
41	82	03080827	SD522-41-82-50R2	143	112	31	87	28	50	SPGX12T3	SCGX120408	0.07	0.46
42	84	03080829	SD522-42-84-50R2	145	114	31	89	28	50	SPGX12T3	SCGX120408	0.19	0.5
43	86	03081067	SD522-43-86-50R2	147	116	31	91	28	50	SPGX12T3	SCGX120408	0.05	0.5
44.45	89	03080831	SD522-44.45-89-50R2	150	119	31	94	28	50	SPGX1504	SCGX120408	0.5	0.5

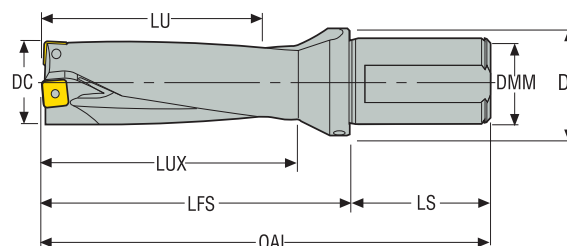

PERFORMAX® SD523 - 3 x D, R7 & R7-C SHANKS - INCH

DIMENSIONS IN INCH				DIMENSIONS IN INCH						INSERT		RADIAL ADJUSTMENT	
DC	LU	PRODUCT NO.	DESCRIPTION	OAL	LFS	LS	LUX	DMM	DF	CENTER INSERT	PERIPH INSERT	-	+
0.5940	1.780	03080486	SD523-0594-178-1000R7	5.211	2.961	2.250	1.977	1.000	1.378	SPGX0502	SCGX050204	0.008	0.013
0.6250	1.880	03080488	SD523-0625-188-1000R7	5.311	3.061	2.250	2.077	1.000	1.378	SPGX0502	SCGX050204	0.005	0.015
0.6560	1.970	03080490	SD523-0656-197-1000R7	5.401	3.151	2.250	2.167	1.000	1.378	SPGX0502	SCGX050204	0.002	0.019
0.6870	2.030	03080493	SD523-0687-206-1000R7	5.461	3.211	2.250	2.227	1.000	1.378	SPGX0502	SCGX050204	0.000	0.020
0.7090	2.130	03080494	SD523-0709-213-1000R7	5.561	3.311	2.250	2.327	1.000	1.378	SPGX0602	SCGX050204	0.013	0.008
0.7500	2.250	03080497	SD523-0750-225-1000R7	5.681	3.431	2.250	2.447	1.000	1.378	SPGX0602	SCGX050204	0.004	0.017
0.7660	2.300	03080499	SD523-0766-230-1000R7	5.731	3.481	2.250	2.497	1.000	1.378	SPGX0602	SCGX050204	0.001	0.020
0.7870	2.360	03080501	SD523-0787-236-1000R7	5.791	3.541	2.250	2.557	1.000	1.378	SPGX0602	SCGX060204	0.003	0.018
0.8120	2.440	03080503	SD523-0812-244-1000R7	5.871	3.621	2.250	2.637	1.000	1.378	SPGX0602	SCGX060204	0.001	0.020
0.8270	2.480	03080505	SD523-0827-248-1000R7	5.911	3.661	2.250	2.677	1.000	1.378	SPGX0602	SCGX060204	0.000	0.020
0.8750	2.630	03080507	SD523-0875-263-1000R7	6.061	3.811	2.250	2.827	1.000	1.378	SPGX0703	SCGX060204	0.015	0.020
0.9060	2.720	03080509	SD523-0906-272-1000R7	6.151	3.901	2.250	2.917	1.000	1.378	SPGX0703	SCGX070308	0.013	0.020
0.9220	2.760	03080512	SD523-0922-276-1000R7	6.191	3.941	2.250	2.957	1.000	1.378	SPGX0703	SCGX070308	0.010	0.020
0.9370	2.810	03080514	SD523-0937-281-1000R7	6.241	3.991	2.250	3.007	1.000	1.378	SPGX0703	SCGX070308	0.004	0.020
0.9840	2.950	03080516	SD523-0984-295-1250R7	6.506	4.131	2.375	3.147	1.250	1.654	SPGX0703	SCGX070308	0.004	0.020
1.0000	3.000	03080518	SD523-1000-300-1250R7	6.556	4.181	2.375	3.197	1.250	1.654	SPGX0703	SCGX070308	0.004	0.020
1.0320	3.100	03080521	SD523-1032-310-1250R7	6.656	4.281	2.375	3.297	1.250	1.654	SPGX0903	SCGX070308	0.020	0.004
1.0620	3.190	03080522	SD523-1062-319-1250R7	6.746	4.371	2.375	3.387	1.250	1.654	SPGX0903	SCGX070308	0.020	0.010
1.1090	3.320	03080525	SD523-1109-332-1250R7	6.876	4.501	2.375	3.517	1.250	1.654	SPGX0903	SCGX070308	0.009	0.020
1.1250	3.380	03080526	SD523-1125-338-1250R7	6.936	4.561	2.375	3.577	1.250	1.654	SPGX0903	SCGX09T308	0.008	0.020
1.1720	3.510	03080528	SD523-1172-351-1250R7	7.066	4.691	2.375	3.707	1.250	1.654	SPGX0903	SCGX09T308	0.005	0.020
1.1870	3.560	03080530	SD523-1187-356-1250R7	7.116	4.741	2.375	3.757	1.250	1.654	SPGX0903	SCGX09T308	0.005	0.020
1.2500	3.750	03080533	SD523-1250-375-1500R7	7.556	4.931	2.625	3.947	1.500	1.969	SPGX11T3	SCGX09T308	0.020	0.011
1.3120	3.940	03080535	SD523-1312-394-1500R7	7.746	5.121	2.625	4.137	1.500	1.969	SPGX11T3	SCGX09T308	0.020	0.020
1.3440	4.030	03080537	SD523-1344-403-1500R7	7.836	5.211	2.625	4.227	1.500	1.969	SPGX11T3	SCGX09T308	0.006	0.020
1.3750	4.130	03080539	SD523-1375-413-1500R7	7.936	5.311	2.625	4.327	1.500	1.969	SPGX11T3	SCGX11T308	0.009	0.020
1.4220	4.260	03080541	SD523-1422-426-1500R7	8.066	5.441	2.625	4.457	1.500	1.969	SPGX11T3	SCGX11T308	0.004	0.020
1.4370	4.310	03080542	SD523-1437-431-1500R7	8.116	5.491	2.625	4.507	1.500	1.969	SPGX11T3	SCGX11T308	0.004	0.020
1.5000	4.500	03080547	SD523-1500-450-1500R7	8.306	5.681	2.625	4.697	1.500	1.969	SPGX12T3	SCGX11T308	0.020	0.020
1.5620	4.690	03080550	SD523-1562-469-1500R7	8.496	5.871	2.625	4.887	1.500	1.969	SPGX12T3	SCGX11T308	0.010	0.020
1.6250	4.880	03080555	SD523-1625-488-1500R7	8.686	6.061	2.625	5.077	1.500	1.969	SPGX12T3	SCGX120408	0.007	0.020
1.6870	5.060	03080560	SD523-1687-506-1500R7	8.866	6.241	2.625	5.257	1.500	1.969	SPGX12T3	SCGX120408	0.004	0.020
1.7500	5.250	03080565	SD523-1750-525-1500R7	9.056	6.431	2.625	5.447	1.500	1.969	SPGX1504	SCGX120408	0.020	0.016
1.8120	5.440	03080572	SD523-1812-544-1500R7	9.246	6.621	2.625	5.637	1.500	1.969	SPGX1504	SCGX150512	0.020	0.020
1.8750	5.630	03080577	SD523-1875-563-1500R7	9.436	6.811	2.625	5.827	1.500	1.969	SPGX1504	SCGX150512	0.020	0.020
1.9370	5.810	03080581	SD523-1937-581-1500R7	9.616	6.991	2.625	6.007	1.500	2.337	SPGX1504	SCGX150512	0.008	0.020
2.0000	6.000	03080588	SD523-2000-600-1500R7	9.806	7.181	2.625	6.197	1.500	2.337	SPGX1504	SCGX150512	0.008	0.020
2.0620	6.190	03080593	SD523-2062-619-1500R7	9.996	7.371	2.625	6.387	1.500	2.337	SPGX1904	SCGX150512	0.020	0.017
2.1250	6.380	03080596	SD523-2125-638-1500R7	10.186	7.561	2.625	6.577	1.500	2.337	SPGX1904	SCGX150512	0.020	0.020
2.2500	6.750	03080603	SD523-2250-675-1500R7	10.556	7.931	2.625	6.947	1.500	2.337	SPGX1904	SCGX150512	0.013	0.020
2.3750	7.130	03080609	SD523-2375-713-1500R7	10.936	8.311	2.625	7.327	1.500	2.480	SPGX1904	SCGX150512	0.004	0.020
R7-C SHANKS													
0.5940	1.780	03080487	SD523-0594-178-1000R7-C	5.908	3.158	2.750	1.977	1.000	1.378	SPGX0502	SCGX050204	0.008	0.013
0.6250	1.880	03080489	SD523-0625-188-1000R7-C	6.008	3.258	2.750	2.077	1.000	1.378	SPGX0502	SCGX050204	0.005	0.015
0.6560	1.970	03080491	SD523-0656-197-1000R7-C	6.098	3.348	2.750	2.167	1.000	1.378	SPGX0502	SCGX050204	0.002	0.019
0.6870	2.060	03080492	SD523-0687-206-1000R7-C	6.188	3.438	2.750	2.257	1.000	1.378	SPGX0502	SCGX050204	0.000	0.020
0.7090	2.130	03080495	SD523-0709-213-1000R7-C	6.258	3.508	2.750	2.327	1.000	1.378	SPGX0602	SCGX050204	0.013	0.008
0.7500	2.250	03080496	SD523-0750-225-1000R7-C	6.378	3.628	2.750	2.447	1.000	1.378	SPGX0602	SCGX050204	0.004	0.017
0.7660	2.300	03080500	SD523-0766-230-1000R7-C	6.428	3.678	2.750	2.497	1.000	1.378	SPGX0602	SCGX050204	0.001	0.020
0.7870	2.360	03080502	SD523-0787-236-1000R7-C	6.488	3.738	2.750	2.557	1.000	1.378	SPGX0602	SCGX060204	0.003	0.018

PERFOMAX® SD523 - 3 x D, R7-C SHANKS - INCH

DIMENSIONS IN INCH		PRODUCT NO.	DESCRIPTION	DIMENSIONS IN INCH						INSERT		RADIAL ADJUSTMENT	
DC	LU			OAL	LFS	LS	LUX	DMM	DF	CENTER INSERT	PERIPH INSERT	-	+
0.8120	2.440	03080504	SD523-0812-244-1000R7-C	6.568	3.818	2.750	2.637	1.000	1.378	SPGX0602	SCGX060204	0.001	0.020
0.8270	2.480	03080506	SD523-0827-248-1000R7-C	6.608	3.858	2.750	2.677	1.000	1.378	SPGX0602	SCGX060204	0.000	0.020
0.8750	2.630	03080508	SD523-0875-263-1000R7-C	6.758	4.008	2.750	2.827	1.000	1.378	SPGX0703	SCGX060204	0.015	0.020
0.9060	2.720	03080511	SD523-0906-272-1000R7-C	6.848	4.098	2.750	2.917	1.000	1.378	SPGX0703	SCGX070308	0.013	0.020
0.9220	2.760	03080513	SD523-0922-276-1000R7-C	6.888	4.138	2.750	2.957	1.000	1.378	SPGX0703	SCGX070308	0.010	0.020
0.9370	2.810	03080515	SD523-0937-281-1000R7-C	6.938	4.188	2.750	3.007	1.000	1.378	SPGX0703	SCGX070308	0.004	0.020
0.9840	2.950	03080517	SD523-0984-295-1250R7-C	7.078	4.328	2.750	3.147	1.250	1.654	SPGX0703	SCGX070308	0.004	0.020
1.0000	3.000	03080519	SD523-1000-300-1250R7-C	7.128	4.378	2.750	3.197	1.250	1.654	SPGX0703	SCGX070308	0.004	0.020
1.0320	3.100	03080520	SD523-1032-310-1250R7-C	7.228	4.478	2.750	3.297	1.250	1.654	SPGX0903	SCGX070308	0.020	0.004
1.0620	3.190	03080523	SD523-1062-319-1250R7-C	7.318	4.568	2.750	3.387	1.250	1.654	SPGX0903	SCGX070308	0.020	0.010
1.1090	3.320	03080524	SD523-1109-332-1250R7-C	7.448	4.698	2.750	3.517	1.250	1.654	SPGX0903	SCGX070308	0.009	0.020
1.1250	3.380	03080527	SD523-1125-338-1250R7-C	7.508	4.758	2.750	3.577	1.250	1.654	SPGX0903	SCGX09T308	0.008	0.020
1.1720	3.510	03080529	SD523-1172-351-1250R7-C	7.638	4.888	2.750	3.707	1.250	1.654	SPGX0903	SCGX09T308	0.005	0.020
1.1870	3.560	03080531	SD523-1187-356-1250R7-C	7.688	4.938	2.750	3.757	1.250	1.654	SPGX0903	SCGX09T308	0.005	0.020
1.2500	3.750	03080532	SD523-1250-375-1500R7-C	7.878	5.128	2.625	3.947	1.500	1.969	SPGX11T3	SCGX09T308	0.020	0.011
1.3120	3.940	03080536	SD523-1312-394-1500R7-C	8.068	5.318	2.750	4.137	1.500	1.969	SPGX11T3	SCGX09T308	0.020	0.020
1.3440	4.030	03080538	SD523-1344-403-1500R7-C	8.158	5.408	2.625	4.227	1.500	1.969	SPGX11T3	SCGX09T308	0.006	0.020
1.3750	4.130	03080540	SD523-1375-413-1500R7-C	8.258	5.508	2.625	4.327	1.500	1.969	SPGX11T3	SCGX11T308	0.009	0.020
1.4220	4.260	03080900	SD523-1422-426-1500R7-C	8.388	5.638	2.625	4.457	1.500	1.969	SPGX11T3	SCGX11T308	0.004	0.020
1.4370	4.310	03080543	SD523-1437-431-1500R7-C	8.438	5.688	2.625	4.507	1.500	1.969	SPGX11T3	SCGX11T308	0.004	0.020
1.5000	4.500	03080546	SD523-1500-450-1500R7-C	8.628	5.878	2.750	4.697	1.500	1.969	SPGX12T3	SCGX11T308	0.020	0.020
1.5620	4.690	03080551	SD523-1562-469-1500R7-C	8.818	6.068	2.625	4.887	1.500	1.969	SPGX12T3	SCGX11T308	0.010	0.020
1.6250	4.880	03080556	SD523-1625-488-1500R7-C	9.008	6.258	2.625	5.077	1.500	1.969	SPGX12T3	SCGX120408	0.007	0.020
1.6870	5.060	03080561	SD523-1687-506-1500R7-C	9.188	6.438	2.625	5.257	1.500	1.969	SPGX12T3	SCGX120408	0.004	0.020
1.7500	5.250	03080566	SD523-1750-525-1500R7-C	9.378	6.628	2.750	5.447	1.500	1.969	SPGX1504	SCGX120408	0.020	0.016
1.8120	5.440	03080573	SD523-1812-544-1500R7-C	9.568	6.818	2.750	5.637	1.500	1.969	SPGX1504	SCGX150512	0.020	0.020
1.8750	5.630	03080578	SD523-1875-563-1500R7-C	9.758	7.008	2.625	5.827	1.500	1.969	SPGX1504	SCGX150512	0.020	0.020
1.9370	5.810	03080582	SD523-1937-581-1500R7-C	9.938	7.188	2.750	6.007	1.500	2.337	SPGX1504	SCGX150512	0.008	0.020
2.0000	6.000	03080589	SD523-2000-600-1500R7-C	10.128	7.378	2.750	6.197	1.500	2.337	SPGX1504	SCGX150512	0.008	0.020
2.1250	6.380	03080598	SD523-2125-638-1500R7-C	10.508	7.758	2.750	6.577	1.500	2.337	SPGX1904	SCGX150512	0.020	0.020
2.2500	6.750	03080604	SD523-2250-675-1500R7-C	10.878	8.128	2.750	6.947	1.500	2.337	SPGX1904	SCGX150512	0.013	0.020
2.3750	7.130	03080610	SD523-2375-713-1500R7-C	11.258	8.508	2.750	7.327	1.500	2.480	SPGX1904	SCGX150512	0.004	0.020

PERFOMAX® SD523 - 3 x D, R7 SHANKS - METRIC

DIMENSIONS IN MM		PRODUCT NO.	DESCRIPTION	DIMENSIONS IN METRIC						INSERT		RADIAL ADJUSTMENT	
DC	LU			OAL	LFS	LS	LUX	DMM	DF	CENTER INSERT	PERIPH INSERT	-	+
15	45	03080548	SD523-15-45-20R7	125	75	50	50	20	30	SPGX0502	SCGX050204	0.22	0.31
15	45	03080549	SD523-15-45-25R7	131	75	56	50	25	35	SPGX0502	SCGX050204	0.22	0.31
15.5	47	03080544	SD523-15.5-47-20R7	127	77	50	52	20	30	SPGX0502	SCGX050204	0.3	0.35
15.5	47	03080545	SD523-15.5-47-25R7	133	77	56	52	25	35	SPGX0502	SCGX050204	0.3	0.35
16	48	03080557	SD523-16-48-20R7	128	78	50	53	20	30	SPGX0502	SCGX050204	0.12	0.41
16	48	03080558	SD523-16-48-25R7	134	78	56	53	25	35	SPGX0502	SCGX050204	0.12	0.41
16.5	50	03080552	SD523-16.5-50-20R7	130	80	50	55	20	30	SPGX0502	SCGX050204	0.07	0.46
16.5	50	03080554	SD523-16.5-50-25R7	136	80	56	55	25	35	SPGX0502	SCGX050204	0.07	0.46
17	51	03080568	SD523-17-51-20R7	131	81	50	56	20	30	SPGX0502	SCGX050204	0.02	0.5
17	51	03080569	SD523-17-51-25R7	137	81	56	56	25	35	SPGX0502	SCGX050204	0.02	0.5
17.5	53	03080562	SD523-17.5-53-20R7	133	83	50	58	20	30	SPGX0602	SCGX050204	0.43	0.1
17.5	53	03080563	SD523-17.5-53-25R7	139	83	56	58	25	35	SPGX0602	SCGX050204	0.43	0.1
18	54	03080574	SD523-18-54-20R7	134	84	50	59	20	30	SPGX0602	SCGX050204	0.32	0.21
18	54	03080575	SD523-18-54-25R7	140	84	56	59	25	35	SPGX0602	SCGX050204	0.32	0.21
18.5	56	03080570	SD523-18.5-56-20R7	136	86	50	61	20	30	SPGX0602	SCGX050204	0.1	0.31
18.5	56	03080571	SD523-18.5-56-25R7	142	86	56	61	25	35	SPGX0602	SCGX050204	0.1	0.31
19	57	03080583	SD523-19-57-20R7	137	87	50	62	20	30	SPGX0602	SCGX050204	0.11	0.42
19	57	03080584	SD523-19-57-25R7	143	87	56	62	25	35	SPGX0602	SCGX050204	0.11	0.42
19.5	59	03080579	SD523-19.5-59-20R7	139	89	50	64	20	30	SPGX0602	SCGX060204	0.11	0.42
19.5	59	03080580	SD523-19.5-59-25R7	145	89	56	64	25	35	SPGX0602	SCGX060204	0.11	0.42
20	60	03080590	SD523-20-60-25R7	146	90	56	65	25	35	SPGX0602	SCGX060204	0.07	0.46
20.5	62	03080586	SD523-20.5-62-25R7	148	92	56	67	25	35	SPGX0602	SCGX060204	0.1	0.5
21	63	03080599	SD523-21-63-25R7	149	93	56	68	25	35	SPGX0602	SCGX060204	0.01	0.5
21.5	65	03080595	SD523-21.5-65-25R7	151	95	56	70	25	35	SPGX0703	SCGX060204	0.1	0.5
22	66	03080605	SD523-22-66-25R7	152	96	56	71	25	35	SPGX0703	SCGX060204	0.45	0.5

PERFOMAX® SD523 - 3 x D, R7 SHANKS - METRIC

DIMENSIONS IN MM		PRODUCT NO.	DESCRIPTION	DIMENSIONS IN METRIC						INSERT		RADIAL ADJUSTMENT	
DC	LU			OAL	LFS	LS	LUX	DMM	DF	CENTER INSERT	PERIPH INSERT	-	+
22.5	68	03080602	SD523-22.5-68-25R7	154	98	56	73	25	35	SPGX0703	SCGX070308	0.42	0.47
23	69	03080608	SD523-23-69-25R7	155	99	56	74	25	35	SPGX0703	SCGX070308	0.33	0.5
23.5	71	03080607	SD523-23.5-71-25R7	157	101	56	76	25	35	SPGX0703	SCGX070308	0.1	0.5
24	72	03080612	SD523-24-72-25R7	158	102	56	77	25	35	SPGX0703	SCGX070308	0.11	0.5
24.5	74	03080611	SD523-24.5-74-25R7	160	104	56	79	25	35	SPGX0703	SCGX070308	0.11	0.5
25	75	03080616	SD523-25-75-32R7	165	105	60	80	32	42	SPGX0703	SCGX070308	0.11	0.5
25.5	77	03080615	SD523-25.5-77-32R7	167	107	60	82	32	42	SPGX0703	SCGX070308	0.5	0.11
26	78	03080619	SD523-26-78-32R7	168	108	60	83	32	42	SPGX0903	SCGX070308	0.5	0.15
26.5	80	03080618	SD523-26.5-80-32R7	170	110	60	85	32	42	SPGX0903	SCGX070308	0.5	0.19
27	81	03080622	SD523-27-81-32R7	171	111	60	86	32	42	SPGX0903	SCGX070308	0.5	0.26
27.5	83	03080621	SD523-27.5-83-32R7	173	113	60	88	32	42	SPGX0903	SCGX070308	0.46	0.44
28	84	03080626	SD523-28-84-32R7	174	114	60	89	32	42	SPGX0903	SCGX070308	0.3	0.5
28.5	86	03080624	SD523-28.5-86-32R7	176	116	60	91	32	42	SPGX0903	SCGX070308	0.21	0.5
29	87	03080629	SD523-29-87-32R7	177	117	60	92	32	42	SPGX0903	SCGX09T308	0.2	0.5
29.5	89	03080628	SD523-29.5-89-32R7	179	119	60	94	32	42	SPGX0903	SCGX09T308	0.15	0.5
30	90	03080632	SD523-30-90-32R7	180	120	60	95	32	42	SPGX0903	SCGX09T308	0.12	0.5
30.5	92	03080631	SD523-30.5-92-32R7	182	122	60	97	32	42	SPGX0903	SCGX09T308	0.12	0.5
31	93	03080636	SD523-31-93-32R7	183	123	60	98	32	42	SPGX0903	SCGX09T308	0.12	0.5
31.5	95	03080634	SD523-31.5-95-32R7	185	125	60	100	32	42	SPGX11T3	SCGX09T308	0.5	0.2
32	96	03080638	SD523-32-96-32R7	186	126	60	101	32	42	SPGX11T3	SCGX09T308	0.5	0.31
32	96	03080639	SD523-32-96-40R7	194	126	68	101	40	50	SPGX11T3	SCGX09T308	0.5	0.31
33	99	03080641	SD523-33-99-32R7	189	129	60	104	32	42	SPGX11T3	SCGX09T308	0.5	0.46
33	99	03080642	SD523-33-99-40R7	197	129	68	104	40	50	SPGX11T3	SCGX09T308	0.5	0.5
34	102	03080644	SD523-34-102-32R7	192	132	60	107	32	42	SPGX11T3	SCGX09T308	0.22	0.5
34	102	03080645	SD523-34-102-40R7	200	132	68	107	40	50	SPGX11T3	SCGX09T308	0.22	0.5
35	105	03080648	SD523-35-105-32R7	195	135	60	110	32	42	SPGX11T3	SCGX11T308	0.22	0.5
35	105	03080649	SD523-35-105-40R7	203	135	68	110	40	50	SPGX11T3	SCGX11T308	0.22	0.5
35.5	107	03080647	SD523-35.5-107-40R7	205	137	68	112	40	50	SPGX11T3	SCGX11T308	0.09	0.5
36	108	03080651	SD523-36-108-32R7	198	138	60	113	32	42	SPGX11T3	SCGX11T308	0.09	0.5
36	108	03080652	SD523-36-108-40R7	206	138	68	113	40	50	SPGX11T3	SCGX11T308	0.09	0.5
37	111	03080653	SD523-37-111-32R7	201	141	60	116	32	42	SPGX11T3	SCGX11T308	0.07	0.46
37	111	03080654	SD523-37-111-40R7	209	141	68	116	40	50	SPGX11T3	SCGX11T308	0.09	0.5
38	114	03080655	SD523-38-114-32R7	204	144	60	119	32	42	SPGX12T3	SCGX11T308	0.07	0.46
38	114	03080656	SD523-38-114-40R7	212	144	68	119	40	50	SPGX12T3	SCGX11T308	0.5	0.5
39	117	03080658	SD523-39-117-32R7	207	147	60	122	32	42	SPGX12T3	SCGX11T308	0.39	0.5
39	117	03080659	SD523-39-117-40R7	215	147	68	122	40	50	SPGX12T3	SCGX11T308	0.39	0.5
40	120	03080661	SD523-40-120-32R7	210	150	60	125	32	50	SPGX12T3	SCGX11T308	0.19	0.5
40	120	03080662	SD523-40-120-40R7	218	150	68	125	40	50	SPGX12T3	SCGX11T308	0.19	0.5
41	123	03080665	SD523-41-123-40R7	221	153	68	128	40	50	SPGX12T3	SCGX120408	0.19	0.5
41.5	125	03080663	SD523-41.5-125-40R7	223	155	68	130	40	50	SPGX12T3	SCGX120408	0.19	0.5
42	126	03080666	SD523-42-126-40R7	224	156	68	131	40	50	SPGX12T3	SCGX120408	0.19	0.5
43	129	03080667	SD523-43-129-40R7	227	159	68	134	40	50	SPGX12T3	SCGX120408	0.05	0.5
44	132	03080670	SD523-44-132-40R7	230	162	68	137	40	50	SPGX1504	SCGX120408	0.5	0.41
44.5	134	03080669	SD523-44.5-134-40R7	232	164	68	139	40	50	SPGX1504	SCGX150512	0.5	0.41
45	135	03080672	SD523-45-135-40R7	233	165	68	140	40	50	SPGX1504	SCGX150512	0.5	0.41
46	138	03080673	SD523-46-138-40R7	236	168	68	143	40	50	SPGX1504	SCGX150512	0.5	0.5
47	141	03080675	SD523-47-141-40R7	239	171	68	146	40	50	SPGX1504	SCGX150512	0.5	0.5
47.5	143	03080674	SD523-47.5-143-40R7	241	173	68	148	40	50	SPGX1504	SCGX150512	0.5	0.5
48	144	03080676	SD523-48-144-40R7	242	174	68	149	40	59	SPGX1504	SCGX150512	0.45	0.5
49	147	03080677	SD523-49-147-40R7	245	177	68	152	40	59	SPGX1504	SCGX150512	0.2	0.5
50	150	03080678	SD523-50-150-40R7	248	180	68	155	40	59	SPGX1504	SCGX150512	0.2	0.5
51	153	03080679	SD523-51-153-40R7	251	183	68	158	40	59	SPGX1504	SCGX150512	0.2	0.5
52	156	03080680	SD523-52-156-40R7	254	186	68	161	40	59	SPGX1904	SCGX150512	0.5	0.42
53	159	03080681	SD523-53-159-40R7	257	189	68	164	40	59	SPGX1904	SCGX150512	0.5	0.42
54	162	03080682	SD523-54-162-40R7	260	192	68	167	40	59	SPGX1904	SCGX150512	0.5	0.5
55	165	03080683	SD523-55-165-40R7	263	195	68	170	40	59	SPGX1904	SCGX150512	0.5	0.5
56	168	03080684	SD523-56-168-40R7	266	198	68	173	40	59	SPGX1904	SCGX150512	0.5	0.5
57	171	03080685	SD523-57-171-40R7	269	201	68	176	40	59	SPGX1904	SCGX150512	0.39	0.5
58	174	03080686	SD523-58-174-40R7	272	204	68	179	40	63	SPGX1904	SCGX150512	0.09	0.5
59	177	03080687	SD523-59-177-40R7	275	207	68	182	40	63	SPGX1904	SCGX150512	0.09	0.5

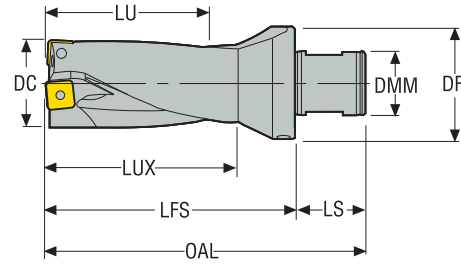

PERFOMAX® SD523 - 3 x D, ABS 50 COMPATIBLE R2 SHANKS - METRIC

DIMENSIONS IN MM		PRODUCT NO.	DESCRIPTION	DIMENSIONS IN METRIC						INSERT		RADIAL ADJUSTMENT	
DC	LU			OAL	LFS	LS	LUX	DMM	DF	CENTER INSERT	PERIPH INSERT	-	+
15	45	03080864	SD523-15-45-50R2	106	75	31	50	28	50	SPGX0502	SCGX050204	0.22	0.31
15.5	47	03080865	SD523-15.5-47-50R2	108	77	31	52	28	50	SPGX0502	SCGX050204	0.3	0.35
16	48	03080559	SD523-16-48-50R2	109	78	31	53	28	50	SPGX0502	SCGX050204	0.12	0.41
16.5	50	03080866	SD523-16.5-50-50R2	111	80	31	55	28	50	SPGX0502	SCGX050204	0.07	0.46
17	51	03080867	SD523-17-51-50R2	112	81	31	56	28	50	SPGX0502	SCGX050204	0.1	0.5
17.5	53	03080564	SD523-17.5-53-50R2	114	83	31	58	28	50	SPGX0602	SCGX050204	0.43	0.1
18	54	03080576	SD523-18-54-50R2	115	84	31	59	28	50	SPGX0602	SCGX050204	0.32	0.21
18.5	56	03080868	SD523-18.5-56-50R2	116	86	31	61	28	50	SPGX0602	SCGX050204	0.1	0.31
19	57	03080585	SD523-19-57-50R2	118	87	31	62	28	50	SPGX0602	SCGX050204	0.11	0.42
20	60	03080591	SD523-20-60-50R2	121	90	31	65	28	50	SPGX0602	SCGX060204	0.1	0.46
20.62	62	03080587	SD523-20.62-62-50R2	123	92	31	67	28	50	SPGX0602	SCGX060204	0.1	0.5
21	63	03080600	SD523-21-63-50R2	124	93	31	68	28	50	SPGX0602	SCGX060204	0.1	0.5
22	66	03080606	SD523-22-66-50R2	127	96	31	71	50	50	SPGX0703	SCGX060204	0.44	0.46
22.23	67	03080601	SD523-22.23-67-50R2	128	97	31	72	28	50	SPGX0703	SCGX060204	0.2	0.5
23	69	03080869	SD523-23-69-50R2	130	99	31	74	28	50	SPGX0703	SCGX070308	0.35	0.5
24	72	03080613	SD523-24-72-50R2	133	102	31	77	28	50	SPGX0703	SCGX070308	0.11	0.5
25	75	03080617	SD523-25-75-50R2	136	105	31	80	28	50	SPGX0703	SCGX070308	0.11	0.5
25.4	77	03080614	SD523-25.40-77-50R2	138	107	31	82	28	50	SPGX0703	SCGX070308	0.11	0.5
26	78	03080620	SD523-26-78-50R2	139	108	31	83	28	50	SPGX0903	SCGX070308	0.5	0.15
27	81	03080623	SD523-27-81-50R2	142	111	31	86	28	50	SPGX0903	SCGX070308	0.5	0.26
28	84	03080627	SD523-28-84-50R2	145	114	31	89	28	50	SPGX0903	SCGX070308	0.3	0.5
28.59	86	03080625	SD523-28.59-86-50R2	147	116	31	91	28	50	SPGX0903	SCGX09T308	0.5	0.5
29	87	03080630	SD523-29-87-50R2	148	117	31	92	28	50	SPGX0903	SCGX09T308	0.2	0.5
30	90	03080633	SD523-30-90-50R2	151	120	31	95	28	50	SPGX0903	SCGX09T308	0.12	0.5
31	93	03080637	SD523-31-93-50R2	154	123	31	98	28	50	SPGX0903	SCGX09T308	0.07	0.46
31.75	96	03080635	SD523-31.75-96-50R2	157	126	31	101	28	50	SPGX11T3	SCGX09T308	0.5	0.28
32	96	03080640	SD523-32-96-50R2	157	126	31	101	28	50	SPGX11T3	SCGX09T308	0.5	0.35
33	99	03080643	SD523-33-99-50R2	160	129	31	104	28	50	SPGX11T3	SCGX09T308	0.5	0.5
34	102	03080646	SD523-34-102-50R2	163	132	31	107	28	50	SPGX11T3	SCGX09T308	0.22	0.5
35	105	03080650	SD523-35-105-50R2	166	135	31	110	28	50	SPGX11T3	SCGX11T308	0.07	0.46
36	108	03080870	SD523-36-108-50R2	169	138	31	113	28	50	SPGX11T3	SCGX11T308	0.07	0.46
37	111	03080871	SD523-37-111-50R2	172	141	31	116	28	50	SPGX11T3	SCGX11T308	0.07	0.46
38	114	03080657	SD523-38-114-50R2	175	144	31	119	28	50	SPGX12T3	SCGX11T308	0.07	0.46
39	117	03080660	SD523-39-117-50R2	178	147	31	122	28	50	SPGX12T3	SCGX11T308	0.07	0.46
40	120	03080872	SD523-40-120-50R2	181	150	31	125	28	50	SPGX12T3	SCGX11T308	0.19	0.5
41	123	03080873	SD523-41-123-50R2	184	153	31	128	28	50	SPGX12T3	SCGX120408	0.07	0.46
42	126	03080874	SD523-42-126-50R2	187	156	31	131	28	50	SPGX12T3	SCGX120408	0.19	0.5
43	129	03080875	SD523-43-129-50R2	190	159	31	134	28	50	SPGX12T3	SCGX120408	0.05	0.5
44	132	03080671	SD523-44-132-50R2	193	162	31	137	28	50	SPGX1504	SCGX120408	0.5	0.41
44.45	134	03080668	SD523-44.45-134-50R2	195	164	31	139	28	50	SPGX1504	SCGX120408	0.5	0.5

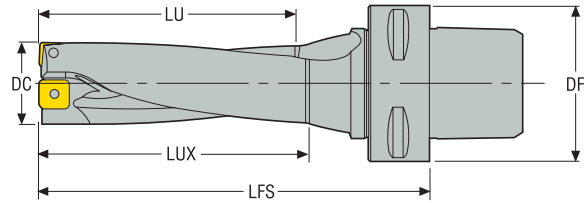

PERFOMAX® SD523 - 3 x D, SECO-CAPTO™ C4 SHANK - METRIC

SHANK	DIMENSIONS IN MM		PRODUCT NO.	DESCRIPTION	DIMENSIONS IN METRIC			INSERT		RADIAL ADJUSTMENT	
	DC	LU			LUX	LFS	DF	CENTER INSERT	PERIPH INSERT	-	+
C4	15	45	03080920	SD523-15-45-C4	50	82	40	SPGX0502	SCGX050204	0.22	0.31
	15.5	47	03080921	SD523-15.5-47-C4	52	84	40	SPGX0502	SCGX050204	0.22	0.31
	16	48	03080922	SD523-16-48-C4	53	86	40	SPGX0502	SCGX050204	0.1	0.41
	16.5	50	03080923	SD523-16.5-50-C4	55	88	40	SPGX0502	SCGX050204	0.15	0.4
	17	51	03080925	SD523-17-51-C4	56	89	40	SPGX0502	SCGX050204	0.1	0.5
	17.5	53	03080926	SD523-17.5-53-C4	58	92	40	SPGX0602	SCGX050204	0.43	0.1
	18	54	03080927	SD523-18-54-C4	59	93	40	SPGX0602	SCGX050204	0.32	0.21
	18.5	56	03080928	SD523-18.5-56-C4	61	95	40	SPGX0602	SCGX050204	0.1	0.31
	19	57	03080929	SD523-19-57-C4	62	96	40	SPGX0602	SCGX050204	0.11	0.42
	20	60	03080930	SD523-20-60-C4	65	101	40	SPGX0602	SCGX060204	0.1	0.46
	20.62	62	03081006	SD523-20.62-62-C4	67	103	40	SPGX0602	SCGX060204	0.1	0.5
	21	63	03080931	SD523-21-63-C4	68	104	40	SPGX0602	SCGX060204	0.1	0.5
	22	66	03080932	SD523-22-66-C4	71	107	40	SPGX0703	SCGX060204	0.45	0.5
	22.23	67	03081008	SD523-22.23-67-C4	72	108	40	SPGX0703	SCGX060204	0.45	0.5
	23	69	03080933	SD523-23-69-C4	74	111	40	SPGX0703	SCGX070308	0.35	0.5
	24	72	03080934	SD523-24-72-C4	77	115	40	SPGX0703	SCGX070308	0.11	0.5
	25	75	03080935	SD523-25-75-C4	80	119	40	SPGX0703	SCGX070308	0.11	0.5
	25.4	77	03081009	SD523-25.4-77-C4	82	121	40	SPGX0703	SCGX070308	0.07	0.46
	26	78	03080936	SD523-26-78-C4	83	122	40	SPGX0903	SCGX070308	0.5	0.15
	27	81	03080937	SD523-27-81-C4	86	125	40	SPGX0903	SCGX070308	0.07	0.46
28	84	03080938	SD523-28-84-C4	89	129	40	SPGX0903	SCGX070308	0.3	0.5	
28.59	86	03081010	SD523-28.59-86-C4	91	131	40	SPGX0903	SCGX09T308	0.2	0.5	
29	87	03080939	SD523-29-87-C4	92	132	40	SPGX0903	SCGX09T308	0.2	0.5	
30	90	03080940	SD523-30-90-C4	95	135	40	SPGX0903	SCGX09T308	0.15	0.5	

PERFOMAX® SD523 - 3 x D, SECO-CAPTO™ C4, C5 & C6 SHANKS - METRIC

SHANK	DIMENSIONS IN MM		PRODUCT NO.	DESCRIPTION	DIMENSIONS IN METRIC			INSERT		RADIAL ADJUSTMENT	
	DC	LU			LUX	LFS	DF	CENTER INSERT	PERIPH INSERT	-	+
C5	15	45	03080941	SD523-15-45-C5	50	82	50	SPGX0502	SCGX050204	0.22	0.31
	15.5	47	03080942	SD523-15.5-47-C5	52	84	50	SPGX0502	SCGX050204	0.22	0.31
	16	48	03080943	SD523-16-48-C5	53	86	50	SPGX0502	SCGX050204	0.1	0.41
	16.5	50	03080944	SD523-16.5-50-C5	55	88	50	SPGX0502	SCGX050204	0.15	0.4
	17	51	03080945	SD523-17-51-C5	56	89	50	SPGX0502	SCGX050204	0.1	0.5
	17.5	53	03080946	SD523-17.5-53-C5	58	92	50	SPGX0602	SCGX050204	0.43	0.1
	18	54	03080947	SD523-18-54-C5	59	93	50	SPGX0602	SCGX050204	0.32	0.21
	18.5	56	03080948	SD523-18.5-56-C5	61	95	50	SPGX0602	SCGX050204	0.1	0.31
	19	57	03080949	SD523-19-57-C5	62	96	50	SPGX0602	SCGX050204	0.11	0.42
	20	60	03080950	SD523-20-60-C5	65	101	50	SPGX0602	SCGX060204	0.1	0.46
	20.62	62	03081001	SD523-20.62-62-C5	67	103	50	SPGX0602	SCGX060204	0.1	0.5
	21	63	03080951	SD523-21-63-C5	68	104	50	SPGX0602	SCGX060204	0.1	0.5
	22	66	03080952	SD523-22-66-C5	71	107	50	SPGX0703	SCGX060204	0.45	0.5
	22.23	67	03081002	SD523-22.23-67-C5	72	108	50	SPGX0703	SCGX060204	0.45	0.5
	23	69	03080953	SD523-23-69-C5	74	111	50	SPGX0703	SCGX070308	0.35	0.5
	24	72	03080954	SD523-24-72-C5	77	115	50	SPGX0703	SCGX070308	0.11	0.5
	25	75	03080955	SD523-25-75-C5	80	119	50	SPGX0703	SCGX070308	0.11	0.5
	25.4	77	03081003	SD523-25.4-77-C5	82	121	50	SPGX0703	SCGX070308	0.07	0.46
	26	78	03080956	SD523-26-78-C5	83	122	50	SPGX0903	SCGX070308	0.5	0.15
	27	81	03080957	SD523-27-81-C5	86	125	50	SPGX0903	SCGX070308	0.07	0.46
	28	84	03080958	SD523-28-84-C5	89	129	50	SPGX0903	SCGX070308	0.3	0.5
	28.59	86	03081004	SD523-28.59-86-C5	91	131	50	SPGX0903	SCGX09T308	0.2	0.5
	29	87	03080959	SD523-29-87-C5	92	132	50	SPGX0903	SCGX09T308	0.2	0.5
	30	90	03080960	SD523-30-90-C5	95	135	50	SPGX0903	SCGX09T308	0.15	0.5
	31	93	03080961	SD523-31-93-C5	98	138	50	SPGX0903	SCGX09T308	0.07	0.46
	31.75	96	03081005	SD523-31.75-96-C5	101	142	50	SPGX11T3	SCGX09T308	0.5	0.28
	32	96	03080962	SD523-32-96-C5	101	142	50	SPGX11T3	SCGX09T308	0.5	0.35
	33	99	03080963	SD523-33-99-C5	104	145	50	SPGX11T3	SCGX09T308	0.5	0.5
	34	102	03080964	SD523-34-102-C5	107	148	50	SPGX11T3	SCGX09T308	0.07	0.46
	35	105	03080965	SD523-35-105-C5	110	151	50	SPGX11T3	SCGX11T308	0.07	0.46
	36	108	03080966	SD523-36-108-C5	113	154	50	SPGX11T3	SCGX11T308	0.07	0.46
	37	111	03080967	SD523-37-111-C5	116	157	50	SPGX11T3	SCGX11T308	0.07	0.46
38	114	03080968	SD523-38-114-C5	119	160	50	SPGX12T3	SCGX11T308	0.07	0.46	
39	117	03080969	SD523-39-117-C5	122	163	50	SPGX12T3	SCGX11T308	0.07	0.46	
40	120	03080970	SD523-40-120-C5	125	166	50	SPGX12T3	SCGX11T308	0.07	0.46	
C6	15	45	03080971	SD523-15-45-C6	50	84	63	SPGX0502	SCGX050204	0.22	0.31
	15.5	47	03080972	SD523-15.5-47-C6	52	86	63	SPGX0502	SCGX050204	0.22	0.31
	16	48	03080973	SD523-16-48-C6	53	88	63	SPGX0502	SCGX050204	0.1	0.41
	16.5	50	03080974	SD523-16.5-50-C6	55	90	63	SPGX0502	SCGX050204	0.15	0.4
	17	51	03080975	SD523-17-51-C6	56	91	63	SPGX0502	SCGX050204	0.1	0.5
	17.5	53	03080976	SD523-17.5-53-C6	58	94	63	SPGX0602	SCGX050204	0.43	0.1
	18	54	03080977	SD523-18-54-C6	59	95	63	SPGX0602	SCGX050204	0.32	0.21
	18.5	56	03080978	SD523-18.5-56-C6	61	97	63	SPGX0602	SCGX050204	0.1	0.31
	19	57	03080979	SD523-19-57-C6	62	98	63	SPGX0602	SCGX050204	0.11	0.42
	20	60	03080980	SD523-20-60-C6	65	103	63	SPGX0602	SCGX060204	0.1	0.46
	20.62	62	03081011	SD523-20.62-62-C6	67	105	63	SPGX0602	SCGX060204	0.1	0.5
	21	63	03080981	SD523-21-63-C6	68	106	63	SPGX0602	SCGX060204	0.1	0.5
	22	66	03080982	SD523-22-66-C6	71	109	63	SPGX0703	SCGX060204	0.45	0.5
	22.23	67	03081012	SD523-22.23-67-C6	72	110	63	SPGX0703	SCGX060204	0.45	0.5
	23	69	03080983	SD523-23-69-C6	74	113	63	SPGX0703	SCGX070308	0.35	0.5
	24	72	03080984	SD523-24-72-C6	77	117	63	SPGX0703	SCGX070308	0.11	0.5
25	75	03080985	SD523-25-75-C6	80	121	63	SPGX0703	SCGX070308	0.11	0.5	
25.4	77	03081013	SD523-25.4-77-C6	82	123	63	SPGX0703	SCGX070308	0.07	0.46	
26	78	03080986	SD523-26-78-C6	83	124	63	SPGX0903	SCGX070308	0.5	0.15	
27	81	03080987	SD523-27-81-C6	86	127	63	SPGX0903	SCGX070308	0.07	0.46	
28	84	03080988	SD523-28-84-C6	89	131	63	SPGX0903	SCGX070308	0.3	0.5	

PERFORMAX® SD523 - 3 x D, SECO-CAPTO™ C6 SHANKS - METRIC

SHANK	DIMENSIONS IN MM		PRODUCT NO.	DESCRIPTION	DIMENSIONS IN METRIC			INSERT		RADIAL ADJUSTMENT	
	DC	LU			LUX	LFS	DF	CENTER INSERT	PERIPH INSERT	-	+
C6	28.59	86	03081014	SD523-28.59-86-C6	91	133	63	SPGX0903	SCGX09T308	0.2	0.5
	29	87	03080989	SD523-29-87-C6	92	134	63	SPGX0903	SCGX09T308	0.2	0.5
	30	90	03080990	SD523-30-90-C6	95	137	63	SPGX0903	SCGX09T308	0.15	0.5
	31	93	03080991	SD523-31-93-C6	98	140	63	SPGX0903	SCGX09T308	0.07	0.46
	31.75	96	03081015	SD523-31.75-96-C6	101	144	63	SPGX11T3	SCGX09T308	0.5	0.28
	32	96	03080992	SD523-32-96-C6	101	144	63	SPGX11T3	SCGX09T308	0.5	0.35
	33	99	03080993	SD523-33-99-C6	104	147	63	SPGX11T3	SCGX09T308	0.5	0.5
	34	102	03080994	SD523-34-102-C6	107	150	63	SPGX11T3	SCGX09T308	0.07	0.46
	35	105	03080995	SD523-35-105-C6	110	153	63	SPGX11T3	SCGX11T308	0.07	0.46
	36	108	03080996	SD523-36-108-C6	113	156	63	SPGX11T3	SCGX11T308	0.07	0.46
	37	111	03080997	SD523-37-111-C6	116	159	63	SPGX11T3	SCGX11T308	0.07	0.46
	38	114	03080998	SD523-38-114-C6	119	162	63	SPGX12T3	SCGX11T308	0.07	0.46
	39	117	03080999	SD523-39-117-C6	122	165	63	SPGX12T3	SCGX11T308	0.07	0.46
	40	120	03081000	SD523-40-120-C6	125	168	63	SPGX12T3	SCGX11T308	0.07	0.46



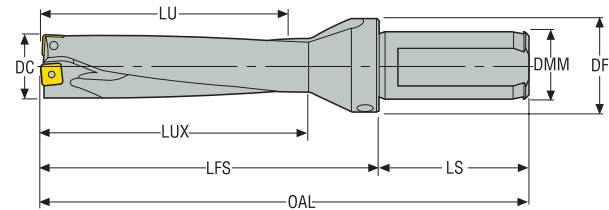

PERFORMAX® SD524 - 4 x D, R7 SHANKS - INCH

DIMENSIONS IN INCH		PRODUCT NO.	DESCRIPTION	DIMENSIONS IN INCH						INSERT	
DC	LU			OAL	LFS	LS	LUX	DMM	DF	CENTER INSERT	PERIPH INSERT
0.5940	2.380	03080280	SD524-0594-238-1000R7	5.811	3.561	2.250	2.577	1.000	1.378	SPGX0502	SCGX050204
0.6250	2.500	03080281	SD524-0625-250-1000R7	5.931	3.681	2.250	2.697	1.000	1.378	SPGX0502	SCGX050204
0.6560	2.620	03080283	SD524-0656-262-1000R7	6.051	3.801	2.250	2.817	1.000	1.378	SPGX0502	SCGX050204
0.6870	2.750	03080285	SD524-0687-275-1000R7	6.181	3.931	2.250	2.947	1.000	1.378	SPGX0502	SCGX050204
0.7090	2.840	03080286	SD524-0709-284-1000R7	6.271	4.021	2.250	3.037	1.000	1.378	SPGX0602	SCGX050204
0.7500	3.000	03080288	SD524-0750-300-1000R7	6.431	4.181	2.250	3.197	1.000	1.378	SPGX0602	SCGX050204
0.7660	3.060	03080289	SD524-0766-306-1000R7	6.491	4.241	2.250	3.257	1.000	1.378	SPGX0602	SCGX050204
0.7870	3.150	03080290	SD524-0787-315-1000R7	6.581	4.331	2.250	3.347	1.000	1.378	SPGX0602	SCGX060204
0.8120	3.250	03080292	SD524-0812-325-1000R7	6.681	4.431	2.250	3.447	1.000	1.378	SPGX0602	SCGX060204
0.8270	3.310	03080294	SD524-0827-331-1000R7	6.741	4.491	2.250	3.507	1.000	1.378	SPGX0602	SCGX060204
0.8750	3.500	03080295	SD524-0875-350-1000R7	6.931	4.681	2.250	3.697	1.000	1.378	SPGX0703	SCGX060204
0.9060	3.620	03080297	SD524-0906-362-1000R7	7.051	4.801	2.250	3.817	1.000	1.378	SPGX0703	SCGX070308
0.9220	3.690	03080298	SD524-0922-369-1000R7	7.121	4.871	2.250	3.887	1.000	1.378	SPGX0703	SCGX070308
0.9370	3.750	03080299	SD524-0937-375-1000R7	7.181	4.931	2.250	3.947	1.000	1.378	SPGX0703	SCGX070308
0.9840	3.940	03080301	SD524-0984-394-1250R7	7.496	5.121	2.375	4.137	1.250	1.654	SPGX0703	SCGX070308
1.0000	4.000	03080302	SD524-1000-400-1250R7	7.556	5.181	2.375	4.197	1.250	1.654	SPGX0703	SCGX070308
1.0320	4.130	03080304	SD524-1032-413-1250R7	7.686	5.311	2.375	4.327	1.250	1.654	SPGX0903	SCGX070308
1.0620	4.250	03080305	SD524-1062-425-1250R7	7.806	5.431	2.375	4.447	1.250	1.654	SPGX0903	SCGX070308
1.1090	4.430	03080307	SD524-1109-443-1250R7	7.986	5.611	2.375	4.627	1.250	1.654	SPGX0903	SCGX070308
1.1250	4.500	03080308	SD524-1125-450-1250R7	8.056	5.681	2.375	4.697	1.250	1.654	SPGX0903	SCGX09T308
1.1720	4.690	03080310	SD524-1172-469-1250R7	8.246	5.871	2.375	4.887	1.250	1.654	SPGX0903	SCGX09T308
1.1870	4.750	03080311	SD524-1187-475-1250R7	8.306	5.931	2.375	4.947	1.250	1.654	SPGX0903	SCGX09T308
1.2500	5.000	03080314	SD524-1250-500-1500R7	8.806	6.181	2.625	5.197	1.500	1.969	SPGX11T3	SCGX09T308
1.3120	5.250	03080315	SD524-1312-525-1500R7	9.056	6.431	2.626	5.447	1.500	1.969	SPGX11T3	SCGX09T308
1.3440	5.380	03080317	SD524-1344-538-1500R7	9.186	6.561	2.626	5.573	1.500	1.969	SPGX11T3	SCGX09T308
1.3750	5.500	03080318	SD524-1375-550-1500R7	9.306	6.681	2.626	5.697	1.500	1.969	SPGX11T3	SCGX11T308
1.4370	5.750	03080320	SD524-1437-575-1500R7	9.556	6.931	2.625	5.947	1.500	1.969	SPGX11T3	SCGX11T308
1.5000	6.000	03080322	SD524-1500-600-1500R7	9.806	7.181	2.625	6.197	1.500	1.969	SPGX12T3	SCGX11T308
1.5620	6.250	03080323	SD524-1562-625-1500R7	10.056	7.431	2.626	6.447	1.500	1.969	SPGX12T3	SCGX11T308
1.6250	6.500	03080324	SD524-1625-650-1500R7	10.306	7.681	2.625	6.697	1.500	1.969	SPGX12T3	SCGX120408
1.6870	6.750	03080325	SD524-1687-675-1500R7	10.556	7.931	2.626	6.947	1.500	1.969	SPGX12T3	SCGX120408
1.7500	7.000	03080328	SD524-1750-700-1500R7	10.806	8.181	2.625	7.197	1.500	1.969	SPGX1504	SCGX120408
1.8120	7.250	03080332	SD524-1812-725-1500R7	11.056	8.431	2.626	7.447	1.500	1.969	SPGX1504	SCGX150512
1.8750	7.500	03080334	SD524-1875-750-1500R7	11.306	8.681	2.626	7.697	1.500	1.969	SPGX1504	SCGX150512
1.9370	7.750	03080335	SD524-1937-775-1500R7	11.556	8.931	2.625	7.947	1.500	2.337	SPGX1504	SCGX150512
2.0000	8.000	03080337	SD524-2000-800-1500R7	11.806	9.181	2.625	8.197	1.500	2.337	SPGX1504	SCGX150512
2.0620	8.250	03080339	SD524-2062-825-1500R7	12.056	9.431	2.625	8.447	1.500	2.337	SPGX1904	SCGX150512
2.1250	8.500	03080342	SD524-2125-850-1500R7	12.306	9.681	2.625	8.697	1.500	2.337	SPGX1904	SCGX150512
2.2500	9.000	03080346	SD524-2250-900-1500R7	12.806	10.181	2.625	9.197	1.500	2.337	SPGX1904	SCGX150512
2.3750	9.500	03080349	SD524-2375-950-1500R7	13.306	10.681	2.625	9.697	1.500	2.480	SPGX1904	SCGX150512
2.0000	8.000	03080337	SD524-2000-800-1500R7	11.806	9.181	2.625	8.197	1.500	2.337	SPGX1504	SCGX150512
2.0620	8.250	03080339	SD524-2062-825-1500R7	12.056	9.431	2.625	8.447	1.500	2.337	SPGX1904	SCGX150512
2.1250	8.500	03080342	SD524-2125-850-1500R7	12.306	9.681	2.625	8.697	1.500	2.337	SPGX1904	SCGX150512
2.2500	9.000	03080346	SD524-2250-900-1500R7	12.806	10.181	2.625	9.197	1.500	2.337	SPGX1904	SCGX150512
2.3750	9.500	03080349	SD524-2375-950-1500R7	13.306	10.681	2.625	9.697	1.500	2.480	SPGX1904	SCGX150512

PERFOMAX® SD524 - 4 x D, R7-C SHANKS - INCH

DIMENSIONS IN INCH		PRODUCT NO.	DESCRIPTION	DIMENSIONS IN INCH						INSERT	
DC	LU			OAL	LFS	LS	LUX	DMM	DF	CENTER INSERT	PERIPH INSERT
0.6250	2.500	03080282	SD524-0625-250-1000R7-C	6.628	3.878	2.750	2.697	1.000	1.378	SPGX0502	SCGX050204
0.6870	2.750	03080284	SD524-0687-275-1000R7-C	6.878	4.128	2.750	2.947	1.000	1.378	SCGX0502	SCGX050204
0.7500	3.000	03080287	SD524-0750-300-1000R7-C	7.128	4.378	2.750	3.197	1.000	1.378	SPGX0602	SCGX050204
0.8120	3.250	03080293	SD524-0812-325-1000R7-C	7.378	4.628	2.750	3.447	1.000	1.378	SPGX0602	SCGX060204
0.8750	3.500	03080296	SD524-0875-350-1000R7-C	7.628	4.878	2.750	3.697	1.000	1.378	SPGX0703	SCGX060204
0.9370	3.750	03080300	SD524-0937-375-1000R7-C	7.878	5.128	2.750	3.947	1.000	1.378	SPGX0703	SCGX070308
1.0000	4.000	03080303	SD524-1000-400-1250R7-C	8.128	5.378	2.750	4.197	1.250	1.654	SPGX0703	SCGX070308
1.0620	4.250	03080306	SD524-1062-425-1250R7-C	8.378	5.628	2.750	4.447	1.250	1.654	SPGX0903	SCGX070308
1.1250	4.500	03080309	SD524-1125-450-1250R7-C	8.628	5.878	2.750	4.697	1.250	1.654	SPGX0903	SCGX09T308
1.1870	4.750	03080312	SD524-1187-475-1250R7-C	8.878	6.128	2.750	4.947	1.250	1.654	SPGX0903	SCGX09T308
1.2500	5.000	03080313	SD524-1250-500-1500R7-C	9.128	6.378	2.750	5.197	1.500	1.969	SPGX11T3	SCGX09T308
1.3120	5.250	03080316	SD524-1312-525-1500R7-C	9.378	6.628	2.625	5.447	1.500	1.969	SPGX11T3	SCGX09T308
1.3750	5.500	03080319	SD524-1375-550-1500R7-C	9.628	6.878	2.625	5.697	1.500	1.969	SPGX11T3	SCGX11T308
1.5000	6.000	03080321	SD524-1500-600-1500R7-C	10.128	7.378	2.750	6.197	1.500	1.969	SPGX12T3	SCGX11T308
1.7500	7.000	03080329	SD524-1750-700-1500R7-C	10.341	8.378	2.625	7.197	1.500	1.969	SPGX1504	SCGX120408
2.0000	8.000	03080338	SD524-2000-800-1500R7-C	12.128	9.378	2.750	8.197	1.500	2.337	SPGX1504	SCGX150512
2.1250	8.500	03080343	SD524-2125-850-1500R7-C	12.628	9.878	2.750	8.697	1.500	2.337	SPGX1904	SCGX150512
2.2500	9.000	03080347	SD524-2250-900-1500R7-C	13.128	10.378	2.750	9.197	1.500	2.337	SPGX1904	SCGX150512
2.3750	9.500	03080350	SD524-2375-950-1500R7-C	13.628	10.878	2.750	9.697	1.500	2.480	SPGX1904	SCGX150512

PERFOMAX® SD524 - 4 x D, R7 SHANKS - METRIC

DIMENSIONS IN MM		PRODUCT NO.	DESCRIPTION	DIMENSIONS IN METRIC						INSERT	
DC	LU			OAL	LFS	LS	LUX	DMM	DF	CENTER INSERT	PERIPH INSERT
17	68	03080330	SD524-17-68-25R7	154	98	56	73	25	35	SPGX0502	SCGX050204
17.5	70	03080326	SD524-17.5-70-25R7	156	100	56	75	25	35	SPGX0602	SCGX050204
18	72	03080333	SD524-18-72-25R7	158	102	56	77	25	35	SPGX0602	SCGX050204
18.5	74	03080331	SD524-18.5-74-25R7	160	104	56	79	25	35	SPGX0602	SCGX050204
19	76	03080336	SD524-19-76-25R7	162	106	56	81	25	35	SPGX0602	SCGX050204
20	80	03080340	SD524-20-80-25R7	166	110	56	85	25	35	SPGX0602	SCGX060204
21	84	03080344	SD524-21-84-25R7	170	114	56	89	25	35	SPGX0602	SCGX060204
22	88	03080348	SD524-22-88-25R7	174	118	56	93	25	35	SPGX0703	SCGX060204
23	92	03080351	SD524-23-92-25R7	178	122	56	97	25	35	SPGX0703	SCGX070308
24	96	03080352	SD524-24-96-25R7	182	126	56	101	25	35	SPGX0703	SCGX070308
25	100	03080353	SD524-25-100-32R7	190	130	60	105	32	42	SPGX0703	SCGX070308
26	104	03080354	SD524-26-104-32R7	194	134	60	109	32	42	SPGX0903	SCGX070308
27	108	03080355	SD524-27-108-32R7	198	138	60	113	32	42	SPGX0903	SCGX070308
28	112	03080356	SD524-28-112-32R7	202	142	60	117	32	42	SPGX0903	SCGX070308
29	116	03080357	SD524-29-116-32R7	206	146	60	121	32	42	SPGX0903	SCGX09T308
30	120	03080358	SD524-30-120-32R7	210	150	60	125	32	42	SPGX0903	SCGX09T308
31	124	03080360	SD524-31-124-32R7	214	154	60	129	32	42	SPGX0903	SCGX09T308
32	128	03080361	SD524-32-128-40R7	226	158	68	133	40	50	SPGX11T3	SCGX09T308
33	132	03080362	SD524-33-132-40R7	230	162	68	137	40	50	SPGX11T3	SCGX09T308
34	136	03080363	SD524-34-136-40R7	234	166	68	141	40	50	SPGX11T3	SCGX09T308
35	140	03080364	SD524-35-140-40R7	238	170	68	145	40	50	SPGX11T3	SCGX11T308
36	144	03080365	SD524-36-144-40R7	242	174	68	149	40	50	SPGX11T3	SCGX11T308
37	148	03080366	SD524-37-148-40R7	246	178	68	153	40	50	SPGX11T3	SCGX11T308
38	152	03080367	SD524-38-152-40R7	250	182	68	157	40	50	SPGX12T3	SCGX11T308
39	156	03080368	SD524-39-156-40R7	254	186	68	161	40	50	SPGX12T3	SCGX11T308
40	160	03080369	SD524-40-160-40R7	258	190	68	165	40	50	SPGX12T3	SCGX11T308
41	164	03080370	SD524-41-164-40R7	262	194	68	169	40	50	SPGX12T3	SCGX120408
42	168	03080371	SD524-42-168-40R7	266	198	68	173	40	50	SPGX12T3	SCGX120408
43	172	03080372	SD524-43-172-40R7	270	202	68	177	40	50	SPGX12T3	SCGX120408
44	176	03080373	SD524-44-176-40R7	274	206	68	181	40	50	SPGX1504	SCGX120408
45	180	03080374	SD524-45-180-40R7	278	210	68	185	40	50	SPGX1504	SCGX150512

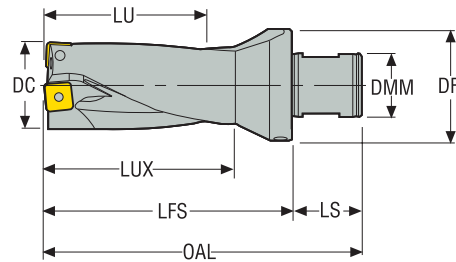

PERFOMAX® SD524 - 4 x D, R7 SHANKS & ABS 50 COMPATIBLE R2 SHANKS - METRIC

DIMENSIONS IN MM		PRODUCT NO.	DESCRIPTION	DIMENSIONS IN METRIC						INSERT	
DC	LU			OAL	LFS	LS	LUX	DMM	DF	CENTER INSERT	PERIPH INSERT
46	184	03080375	SD524-46-184-40R7	282	214	68	159	40	50	SPGX1504	SCGX150512
47	188	03080376	SD524-47-188-40R7	286	218	68	193	40	50	SPGX1504	SCGX150512
48	192	03080377	SD524-48-192-40R7	290	222	68	197	40	59	SPGX1504	SCGX150512
49	196	03080378	SD524-49-196-40R7	294	226	68	201	40	59	SPGX1504	SCGX150512
50	200	03080379	SD524-50-200-40R7	298	230	68	205	40	59	SPGX1504	SCGX150512
51	204	03080380	SD524-51-204-40R7	302	234	68	209	40	59	SPGX1504	SCGX150512
52	208	03080381	SD524-52-208-40R7	306	238	68	213	40	59	SPGX1904	SCGX150512
53	212	03080382	SD524-53-212-40R7	310	242	68	217	40	59	SPGX1904	SCGX150512
54	216	03080383	SD524-54-216-40R7	314	246	68	221	40	59	SPGX1904	SCGX150512
55	220	03080384	SD524-55-220-40R7	318	250	68	225	40	59	SPGX1904	SCGX150512
56	224	03080385	SD524-56-224-40R7	322	254	68	229	40	59	SPGX1904	SCGX150512
57	228	03080386	SD524-57-228-40R7	326	258	68	233	40	59	SPGX1904	SCGX150512
58	232	03080387	SD524-58-232-40R7	330	262	68	237	40	63	SPGX1904	SCGX150512
59	236	03080388	SD524-59-236-40R7	334	266	68	241	40	63	SPGX1904	SCGX150512
ABS 50 COMPATIBLE SHANKS - R2											
17	68	03080208	SD524-17-68-50R2	129	98	31	73	28	50	SPGX0502	SCGX050204
17.5	70	03080327	SD524-17.5-70-50R2	131	100	31	75	28	50	SPGX0602	SCGX050204
18	72	03080209	SD524-18-72-50R2	133	102	31	77	28	50	SPGX0602	SCGX050204
18.5	74	03080210	SD524-18.5-74-50R2	135	104	31	79	28	50	SPGX0602	SCGX050204
19	76	03080422	SD524-19-76-50R2	137	106	31	81	28	50	SPGX0602	SCGX050204
20	80	03080341	SD524-20-80-50R2	141	110	31	85	28	50	SPGX0602	SCGX060204
20.62	83	03080215	SD524-20.62-83-50R2	144	113	31	88	28	50	SPGX0602	SCGX060204
21	84	03080345	SD524-21-84-50R2	145	114	31	89	28	50	SPGX0602	SCGX060204
22	88	03080193	SD524-22-88-50R2	149	118	31	93	28	50	SPGX0703	SCGX060204
22.23	89	03080216	SD524-22.23-89-50R2	150	119	31	94	28	50	SPGX0703	SCGX060204
23	92	03080194	SD524-23-92-50R2	153	122	31	97	28	50	SPGX0703	SCGX070308
24	96	03080195	SD524-24-96-50R2	157	126	31	101	28	50	SPGX0703	SCGX070308
25	100	03080196	SD524-25-100-50R2	161	130	31	105	28	50	SPGX0703	SCGX070308
25.4	102	03080217	SD524-25.4-102-50R2	163	132	31	107	28	50	SPGX0703	SCGX070308
26	104	03080423	SD524-26-104-50R2	165	134	31	109	28	50	SPGX0903	SCGX070308
27	108	03080197	SD524-27-108-50R2	169	138	31	113	28	50	SPGX0903	SCGX070308
28	112	03080424	SD524-28-112-50R2	173	142	31	117	28	50	SPGX0903	SCGX070308
28.59	115	03080218	SD524-28.59-115-50R2	176	145	31	120	28	50	SPGX0903	SCGX070308
29	116	03080198	SD524-29-116-50R2	177	146	31	121	28	50	SPGX0903	SCGX09T308
30	120	03080199	SD524-30-120-50R2	181	150	31	125	28	50	SPGX0903	SCGX09T308
31	124	03080200	SD524-31-124-50R2	185	154	31	129	28	50	SPGX0903	SCGX09T308
31.75	127	03080359	SD524-31.75-127-50R2	188	157	31	132	28	50	SPGX11T3	SCGX09T308
32	128	03080425	SD524-32-128-50R2	189	158	31	133	28	50	SPGX11T3	SCGX09T308
33	132	03080201	SD524-33-132-50R2	193	162	31	137	28	50	SPGX11T3	SCGX09T308
34	136	03080207	SD524-34-136-50R2	197	166	31	141	28	50	SPGX11T3	SCGX09T308
35	140	03080202	SD524-35-140-50R2	201	170	31	145	28	50	SPGX11T3	SCGX11T308
36	144	03080203	SD524-36-144-50R2	205	174	31	149	28	50	SPGX11T3	SCGX11T308
37	148	03080204	SD524-37-148-50R2	209	178	31	153	28	50	SPGX11T3	SCGX11T308
38	152	03080426	SD524-38-152-50R2	213	182	31	157	28	50	SPGX12T3	SCGX11T308
39	156	03080205	SD524-39-156-50R2	217	186	31	161	28	50	SPGX12T3	SCGX11T308
40	160	03080206	SD524-40-160-50R2	221	190	31	165	28	50	SPGX12T3	SCGX11T308

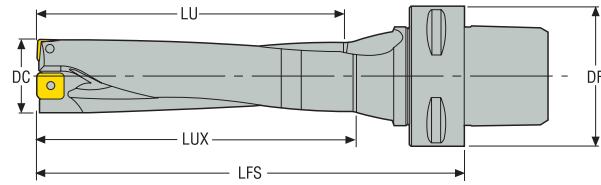

PERFOMAX® SD524 - 4 x D, SECO-CAPTO™ C4 & C5 SHANK - METRIC

SHANK	DIMENSIONS IN MM		PRODUCT NO.	DESCRIPTION	DIMENSIONS IN METRIC			INSERT	
	DC	LU			LUX	LFS	DF	CENTER INSERT	PERIPH INSERT
C4	17	68	03080219	SD524-17-68-C4	73	106	40	SPGX0502	SCGX050204
	17.5	70	03080220	SD524-17.5-70-C4	75	109	40	SPGX0602	SCGX050204
	18	72	03080221	SD524-18-72-C4	77	111	40	SPGX0602	SCGX050204
	18.5	74	03080222	SD524-18.5-74-C4	79	113	40	SPGX0602	SCGX050204
	19	76	03080223	SD524-19-76-C4	81	115	40	SPGX0602	SCGX050204
	20	80	03080224	SD524-20-80-C4	85	121	40	SPGX0602	SCGX060204
	20.62	83	03080413	SD524-20.62-83-C4	88	124	40	SPGX0602	SCGX060204
	21	84	03080225	SD524-21-84-C4	89	125	40	SPGX0602	SCGX060204
	22	88	03080226	SD524-22-88-C4	93	129	40	SPGX0703	SCGX060204
	22.23	89	03080414	SD524-22.23-89-C4	94	130	40	SPGX0703	SCGX060204
	23	92	03080227	SD524-23-92-C4	97	134	40	SPGX0703	SCGX070308
	24	96	03080228	SD524-24-96-C4	101	139	40	SPGX0703	SCGX070308
	25	100	03080229	SD524-25-100-C4	105	144	40	SPGX0703	SCGX070308
	25.4	102	03080415	SD524-25.4-102-C4	107	146	40	SPGX0703	SCGX070308
	26	104	03080230	SD524-26-104-C4	109	148	40	SPGX0903	SCGX070308
	27	108	03080231	SD524-27-108-C4	113	152	40	SPGX0903	SCGX070308
	28	112	03080232	SD524-28-112-C4	117	157	40	SPGX0903	SCGX070308
	28.59	115	03080416	SD524-28.59-115-C4	120	160	40	SPGX0903	SCGX070308
	29	116	03080233	SD524-29-116-C4	121	161	40	SPGX0903	SCGX09T308
	30	120	03080234	SD524-30-120-C4	125	165	40	SPGX0903	SCGX09T308
C5	17	68	03080235	SD524-17-68-C5	73	106	50	SPGX0502	SCGX050204
	17.5	70	03080237	SD524-17.5-70-C5	75	109	50	SPGX0602	SCGX050204
	18	72	03080238	SD524-18-72-C5	77	111	50	SPGX0602	SCGX050204
	18.5	74	03080239	SD524-18.5-74-C5	79	113	50	SPGX0602	SCGX050204
	19	76	03080240	SD524-19-76-C5	81	115	50	SPGX0602	SCGX050204
	20	80	03080241	SD524-20-80-C5	85	121	50	SPGX0602	SCGX060204
	20.62	83	03080408	SD524-20.62-83-C5	88	124	50	SPGX0602	SCGX060204
	21	84	03080242	SD524-21-84-C5	89	125	50	SPGX0602	SCGX060204
	22	88	03080243	SD524-22-88-C5	93	129	50	SPGX0703	SCGX060204
	22.23	89	03080409	SD524-22.23-89-C5	94	130	50	SPGX0703	SCGX060204
	23	92	03080244	SD524-23-92-C5	97	134	50	SPGX0703	SCGX070308
	24	96	03080245	SD524-24-96-C5	101	139	50	SPGX0703	SCGX070308
	25	100	03080246	SD524-25-100-C5	105	144	50	SPGX0703	SCGX070308
	25.4	102	03080410	SD524-25.4-102-C5	107	146	50	SPGX0703	SCGX070308
	26	104	03080247	SD524-26-104-C5	109	148	50	SPGX0903	SCGX070308
	27	108	03080248	SD524-27-108-C5	113	152	50	SPGX0903	SCGX070308
	28	112	03080249	SD524-28-112-C5	117	157	50	SPGX0903	SCGX070308
	28.59	115	03080411	SD524-28.59-115-C5	120	160	50	SPGX0903	SCGX070308
	29	116	03080250	SD524-29-116-C5	121	161	50	SPGX0903	SCGX09T308
	30	120	03080251	SD524-30-120-C5	125	165	50	SPGX0903	SCGX09T308
31	124	03080252	SD524-31-124-C5	129	169	50	SPGX0903	SCGX09T308	
31.75	127	03080412	SD524-31.75-127-C5	132	173	50	SPGX11T3	SCGX09T308	
32	128	03080253	SD524-32-128-C5	133	174	50	SPGX11T3	SCGX09T308	
33	132	03080254	SD524-33-132-C5	137	178	50	SPGX11T3	SCGX09T308	
34	136	03080255	SD524-34-136-C5	141	182	50	SPGX11T3	SCGX09T308	
35	140	03080256	SD524-35-140-C5	145	186	50	SPGX11T3	SCGX11T308	
36	144	03080257	SD524-36-144-C5	149	190	50	SPGX11T3	SCGX11T308	
37	148	03080258	SD524-37-148-C5	153	194	50	SPGX11T3	SCGX11T308	
38	152	03080259	SD524-38-152-C5	157	198	50	SPGX12T3	SCGX11T308	
39	156	03080260	SD524-39-156-C5	161	202	50	SPGX12T3	SCGX11T308	
40	160	03080261	SD524-40-160-C5	165	206	50	SPGX12T3	SCGX11T308	

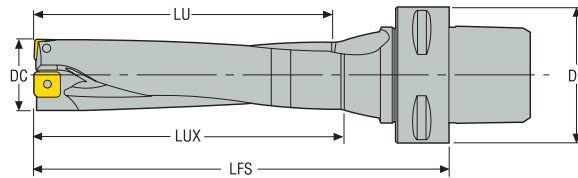

PERFOMAX® SD524 - 4 x D, SECO-CAPTO™ C6 SHANK - METRIC

SHANK	DIMENSIONS IN MM		PRODUCT NO.	DESCRIPTION	DIMENSIONS IN METRIC			INSERT	
	DC	LU			LUX	LFS	DF	CENTER INSERT	PERIPH INSERT
C6	17	68	03080262	SD524-17-68-C6	73	108	63	SPGX0502	SCGX050204
	17.5	70	03080263	SD524-17.5-70-C6	75	111	63	SPGX0602	SCGX050204
	18	72	03080265	SD524-18-72-C6	77	113	63	SPGX0602	SCGX050204
	18.5	74	03080266	SD524-18.5-74-C6	79	115	63	SPGX0602	SCGX050204
	19	76	03080267	SD524-19-76-C6	81	117	63	SPGX0602	SCGX050204
	20	80	03080268	SD524-20-80-C6	85	123	63	SPGX0602	SCGX060204
	20.62	83	03080417	SD524-20.62-83-C6	88	126	63	SPGX0602	SCGX060204
	21	84	03080269	SD524-21-84-C6	89	127	63	SPGX0602	SCGX060204
	22	88	03080270	SD524-22-88-C6	93	131	63	SPGX0703	SCGX060204
	22.23	89	03080418	SD524-22.23-89-C6	94	132	63	SPGX0703	SCGX060204
	23	92	03080271	SD524-23-92-C6	97	136	63	SPGX0703	SCGX070308
	24	96	03080272	SD524-24-96-C6	101	141	63	SPGX0703	SCGX070308
	25	100	03080392	SD524-25-100-C6	105	146	63	SPGX0703	SCGX070308
	25.4	102	03080419	SD524-25.4-102-C6	107	148	63	SPGX0703	SCGX070308
	26	104	03080393	SD524-26-104-C6	109	150	63	SPGX0903	SCGX070308
	27	108	03080394	SD524-27-108-C6	113	154	63	SPGX0903	SCGX070308
	28	112	03080395	SD524-28-112-C6	117	159	63	SPGX0903	SCGX070308
	28.59	115	03080420	SD524-28.59-115-C6	120	162	63	SPGX0903	SCGX070308
	29	116	03080396	SD524-29-116-C6	121	163	63	SPGX0903	SCGX09T308
	30	120	03080397	SD524-30-120-C6	125	167	63	SPGX0903	SCGX09T308
	31	124	03080398	SD524-31-124-C6	129	171	63	SPGX0903	SCGX09T308
	31.75	127	03080421	SD524-31.75-127-C6	132	175	63	SPGX0903	SCGX09T308
	32	128	03080399	SD524-32-128-C6	133	176	63	SPGX11T3	SCGX09T308
	33	132	03080400	SD524-33-132-C6	137	180	63	SPGX11T3	SCGX09T308
	34	136	03080401	SD524-34-136-C6	141	184	63	SPGX11T3	SCGX09T308
	35	140	03080402	SD524-35-140-C6	145	188	63	SPGX11T3	SCGX11T308
	36	144	03080403	SD524-36-144-C6	149	192	63	SPGX11T3	SCGX11T308
	37	148	03080404	SD524-37-148-C6	153	196	63	SPGX11T3	SCGX11T308
	38	152	03080405	SD524-38-152-C6	157	200	63	SPGX12T3	SCGX11T308
	39	156	03080406	SD524-39-156-C6	161	204	63	SPGX12T3	SCGX11T308
	40	160	03080407	SD524-40-160-C6	165	208	63	SPGX12T3	SCGX11T308

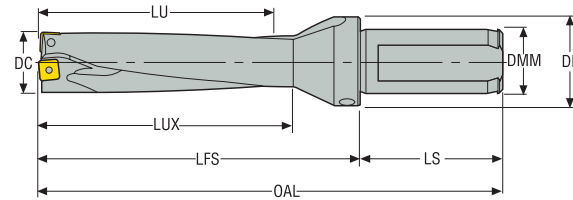

PERFOMAX® SD525 - 5 x D, R7 SHANKS - INCH

DIMENSIONS IN INCH		PRODUCT NO.	DESCRIPTION	DIMENSIONS IN INCH						INSERT	
DC	LU			OAL	LFS	LS	LUX	DMM	DF	CENTER INSERT	PERIPH INSERT
0.7500	3.750	03079565	SD525-0750-375-1000R7	7.181	4.931	2.250	3.947	1.000	1.378	SPGX0602	SCGX050204
0.8120	4.060	03079566	SD525-0812-406-1000R7	7.491	5.241	2.250	4.257	1.000	1.378	SPGX0602	SCGX060204
0.8750	4.380	03079567	SD525-0875-438-1000R7	7.811	5.561	2.250	4.577	1.000	1.378	SPGX0703	SCGX060204
0.9370	4.690	03079568	SD525-0937-469-1000R7	8.121	5.871	2.250	4.887	1.000	1.378	SPGX0703	SCGX070308
1.0000	5.000	03079569	SD525-1000-500-1250R7	8.556	6.181	2.375	5.197	1.250	1.654	SPGX0703	SCGX070308
1.0620	5.310	03079570	SD525-1062-531-1250R7	8.866	6.491	2.375	5.507	1.250	1.654	SPGX0903	SCGX070308
1.1250	5.630	03079571	SD525-1125-563-1250R7	9.186	6.811	2.375	5.827	1.250	1.654	SPGX0903	SCGX09T308
1.1870	5.940	03079572	SD525-1187-594-1250R7	9.496	7.121	2.375	6.137	1.250	1.654	SPGX0903	SCGX09T308
1.2500	6.250	03079573	SD525-1250-625-1500R7	10.056	7.431	2.625	6.447	1.500	1.969	SPGX11T3	SCGX09T308
1.3750	6.870	03079574	SD525-1375-687-1500R7	10.676	8.051	2.626	7.067	1.500	1.969	SPGX11T3	SCGX11T308
1.5000	7.500	03079575	SD525-1500-750-1500R7	11.306	8.681	2.625	7.697	1.500	1.969	SPGX12T3	SCGX11T308
1.6250	8.120	03079576	SD525-1625-812-1500R7	11.926	9.301	2.626	8.317	1.500	1.969	SPGX12T3	SCGX120408
1.7500	8.750	03079577	SD525-1750-875-1500R7	12.556	9.931	2.626	8.947	1.500	1.969	SPGX1504	SCGX120408
1.8750	9.370	03079578	SD525-1875-937-1500R7	13.176	10.551	2.626	9.567	1.500	1.969	SPGX1504	SCGX150512
1.9370	9.680	03079579	SD525-1937-968-1500R7	13.486	10.861	2.625	9.877	1.500	2.337	SPGX1504	SCGX150512
2.0000	10.000	03079581	SD525-2000-1000-1500R7	13.806	11.181	2.625	10.197	1.500	2.337	SPGX1504	SCGX150512

PERFOMAX® SD525 - 5 x D, R7 SHANKS - METRIC

DIMENSIONS IN MM		PRODUCT NO.	DESCRIPTION	DIMENSIONS IN METRIC						INSERT	
DC	LU			OAL	LFS	LS	LUX	DMM	DF	CENTER INSERT	PERIPH INSERT
19	95	03079580	SD525-19-95-25R7	181	125	56	100	25	35	SPGX0602	SCGX050204
20	100	03079582	SD525-20-100-25R7	186	130	56	105	25	35	SPGX0602	SCGX060204
21	105	03079583	SD525-21-105-25R7	191	135	56	110	25	35	SPGX0602	SCGX060204
22	110	03079584	SD525-22-110-25R7	196	140	56	115	25	35	SPGX0703	SCGX060204
23	115	03079585	SD525-23-115-25R7	201	145	56	120	25	35	SPGX0703	SCGX070308
24	120	03079586	SD525-24-120-25R7	206	150	56	125	25	35	SPGX0703	SCGX070308
25	125	03079587	SD525-25-125-32R7	215	155	60	130	32	42	SPGX0703	SCGX070308
26	130	03079588	SD525-26-130-32R7	220	160	60	135	32	42	SPGX0903	SCGX070308
27	135	03079589	SD525-27-135-32R7	225	165	60	140	32	42	SPGX0903	SCGX070308
28	140	03079590	SD525-28-140-32R7	230	170	60	145	32	42	SPGX0903	SCGX070308
29	145	03079591	SD525-29-145-32R7	235	175	60	150	32	42	SPGX0903	SCGX09T308
30	150	03079592	SD525-30-150-32R7	240	180	60	155	32	42	SPGX0903	SCGX09T308
31	155	03079593	SD525-31-155-32R7	245	185	60	160	32	42	SPGX0903	SCGX09T308
32	160	03079595	SD525-32-160-40R7	258	190	68	165	40	50	SPGX11T3	SCGX09T308
33	165	03079596	SD525-33-165-40R7	263	195	68	170	40	50	SPGX11T3	SCGX09T308
34	170	03079597	SD525-34-170-40R7	268	200	68	175	40	50	SPGX11T3	SCGX09T308
35	175	03079598	SD525-35-175-40R7	273	205	68	180	40	50	SPGX11T3	SCGX11T308
36	180	03079599	SD525-36-180-40R7	278	210	68	185	40	50	SPGX11T3	SCGX11T308
37	185	03079600	SD525-37-185-40R7	283	215	68	190	40	50	SPGX11T3	SCGX11T308
38	190	03079601	SD525-38-190-40R7	288	220	68	195	40	50	SPGX12T3	SCGX11T308
39	195	03079602	SD525-39-195-40R7	293	225	68	200	40	50	SPGX12T3	SCGX11T308
40	200	03079603	SD525-40-200-40R7	298	230	68	205	40	50	SPGX12T3	SCGX11T308
41	205	03079604	SD525-41-205-40R7	303	235	68	210	40	50	SPGX12T3	SCGX120408
42	210	03079605	SD525-42-210-40R7	308	240	68	215	40	50	SPGX12T3	SCGX120408
43	215	03079606	SD525-43-215-40R7	313	245	68	220	40	50	SPGX12T3	SCGX120408
44	220	03079607	SD525-44-220-40R7	318	250	68	225	40	50	SPGX1504	SCGX120408
45	225	03079608	SD525-45-225-40R7	323	255	68	230	40	50	SPGX1504	SCGX150512

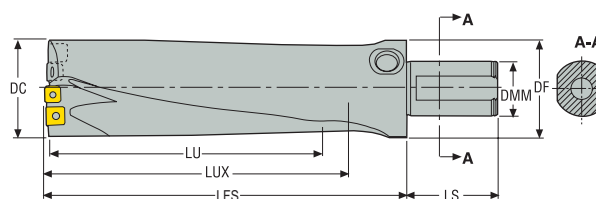

PERFOMAX® SD542 - 2.5 x D, R7 SHANKS - INCH

DIMENSIONS IN INCH		PRODUCT NO.	EDP	DESCRIPTION	DIMENSIONS IN INCH					INSERT TYPES	
DC	LU				LFS	LS	LUX	DMM	DF	CENTER INSERT	PERIPH INSERT
2.250	5.630	02602085	36767	SD542-2250-563-1500R7	7.000	4.500	5.800	1.500	3.110	SPGX 0903-C1	SCGX 09T308..
2.500	6.250	02602087	36769	SD542-2500-625-1500R7	8.280	4.500	6.520	1.500	3.110	SPGX 0903-C1	SCGX 09T308..
2.750	6.880	02602088	36770	SD542-2750-688-1500R7	8.900	4.500	7.190	1.500	3.110	SPGX 11T3-C1	SCGX 120408..
3.000	7.500	02602089	36771	SD542-3000-750-2000R7	9.530	4.500	7.860	2.000	3.110	SPGX 11T3-C1	SCGX 120408..
3.250	8.130	02602090	36772	SD542-3250-813-2500R7	10.150	4.500	8.460	2.500	3.500	SPGX 12T3-C1	SCGX 120408..
3.500	8.750	02602091	36773	SD542-3500-875-2500R7	10.780	4.500	9.140	2.500	3.500	SPGX 1504-C1	SCGX 120408..

PERFOMAX® SD542 - 2.5 x D, R7 SHANKS - METRIC

DIMENSIONS IN MM		PRODUCT NO.	EDP	DESCRIPTION	DIMENSIONS IN METRIC					INSERT TYPES	
DC	LU				LFS	LS	LUX	DMM	DF	CENTER INSERT	PERIPH INSERT
60	150	02590456	34747	SD542-60-150-40R7	201.5	68	156	40	79	SPGX 0903-C1	SCGX 09T308..
65	162.5	02590457	34748	SD542-65-162.5-40R7	214	68	169.5	40	79	SPGX 11T3-C1	SCGX 09T308..
70	175	02590458	34749	SD542-70-175-40R7	226.5	68	182.5	40	79	SPGX 11T3-C1	SCGX 120408..
75	187.5	02590459	34750	SD542-75-187.5-50R7	239	78	196	50	79	SPGX 11T3-C1	SCGX 120408..
80	200	02590460	34751	SD542-80-200-50R7	251.5	78	210	50	79	SPGX 12T3-C1	SCGX 120408..
85	212.5	02590461	34752	SD542-85-212.5-50R7	264	78	221	50	89	SPGX 12T3-C1	SCGX 120408..

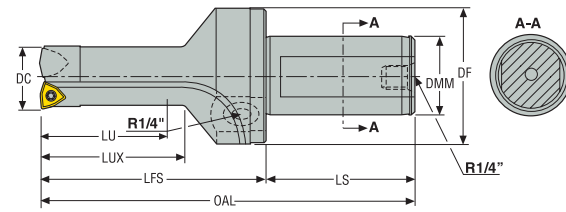

PERFOMAX® SD572 - 2 x D, R7 SHANKS - INCH

DIMENSIONS IN INCH			*Hole dia. min-max (IN)	PRODUCT NO.	EDP	DESCRIPTION	DIMENSIONS IN INCH					INSERT TYPES	
DC	LU	OAL					LFS	LS	LUX	DMM	DF	CENTER INSERT	PERIPH INSERT
0.591	1.182	.591-.709	02602128	36807	SD572-0591-118-1000R7	5.599	2.560	3.000	1.379	1.000	1.772	WCMX 030208-86	WCMX 030208..
0.669	1.338	.669-.748	02602129	36810	SD572-0669-134-1000R7	5.755	2.716	3.000	1.535	1.000	1.772	WCMX 030208-86	WCMX 030208..
0.748	1.496	.748-.866	02602131	36811	SD572-0748-150-1000R7	5.913	2.874	3.000	1.690	1.000	1.772	WCMX 040208-86	WCMX 030208..
0.866	1.732	.866-1.062	02602132	36812	SD572-0866-173-1000R7	6.149	3.110	3.000	1.929	1.000	1.772	WCMX 050308-86	WCMX 040208..
1.062	2.124	1.06-1.299	02602133	36813	SD572-1062-212-1250R7	6.600	3.502	3.000	2.321	1.250	2.165	WCMX 06T308-86	WCMX 050308..
1.299	2.598	1.299-1.61	02602134	36814	SD572-1299-260-1500R7	6.917	3.976	3.000	2.795	1.500	2.303	WCMX 080412-86	WCMX 06T308..
1.614	3.228	1.61-1.85	02602135	36815	SD572-1614-322-1500R7	7.547	4.606	3.000	3.425	1.500	2.303	WCMX 080412-86	WCMX 080412..
1.850	3.700	1.85-2.047	02602136	36816	SD572-1850-370-1500R7	8.019	5.078	3.000	3.700	1.500	2.303	WCMX 080412-86	WCMX 080412..

PERFOMAX® SD572 - 2 x D, R7 SHANKS - METRIC

DIMENSIONS IN MM			*Hole dia. min-max (MM)	PRODUCT NO.	EDP	DESCRIPTION	DIMENSIONS IN METRIC					INSERT TYPES	
DC	LU	OAL					LFS	LS	LUX	DMM	DF	CENTER INSERT	PERIPH INSERT
15	30	14.8-18	02595777	35701	SD572-15-30-25R7	121	65	56	35	25	45	WCMX 030208-86	WCMX 030208..
16	32	15.8-18	02595778	35703	SD572-16-32-25R7	123	67	56	37	25	45	WCMX 030208-86	WCMX 030208..
17	34	16.8-19	02595779	35704	SD572-17-34-25R7	125	69	56	39	25	45	WCMX 030208-86	WCMX 030208..
19	38	18.8-22	02595780	35705	SD572-19-38-25R7	129	73	56	43	25	45	WCMX 040208-86	WCMX 030208..
22	44	21.8-27	02595781	35706	SD572-22-44-25R7	135	79	56	49	25	45	WCMX 050308-86	WCMX 040208..
27	54	26.8-33	02595783	35707	SD572-27-54-32R7	149	89	60	59	32	50	WCMX 06T308-86	WCMX 050308..
33	66	32.8-41	02595784	35708	SD572-33-66-40R7	169	101	68	71	40	59	WCMX 080412-86	WCMX 06T308..
41	82	40.8-47	02595785	35709	SD572-41-82-40R7	185	117	68	87	40	59	WCMX 080412-86	WCMX 080412..
47	94	46.8-52	02595786	35710	SD572-47-94-40R7	197	129	68	99	40	59	WCMX 080412-86	WCMX 080412..

*For stationary applications only

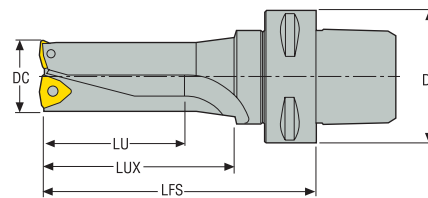

PERFOMAX® SD572 - 2 x D, SECO-CAPTO™ G6 SHANK - METRIC

SHANK	DIMENSIONS IN MM			*Hole dia. min-max (MM)	PRODUCT NO.	EDP	DESCRIPTION	DIMENSIONS IN METRIC			INSERT TYPES	
	DC	LU	LFS					LUX	DF	CENTER INSERT	PERIPH INSERT	
G6	15	30	14.8-18	02595831	35752	SD572-15-30-25R7	85	35	50	WCMX 030208-86	WCMX 030208..	
	16	32	15.8-18	02595832	35753	SD572-16-32-25R7	87	37	50	WCMX 030208-86	WCMX 030208..	
	17	34	16.8-19	02595833	35754	SD572-17-34-25R7	89	39	50	WCMX 030208-86	WCMX 030208..	
	19	38	18.8-22	02595834	35755	SD572-19-38-25R7	93	43	50	WCMX 040208-86	WCMX 030208..	
	22	44	21.8-27	02595835	35756	SD572-22-44-25R7	99	49	50	WCMX 050308-86	WCMX 040208..	
	27	54	26.8-33	02595836	35757	SD572-27-54-32R7	109	59	50	WCMX 06T308-86	WCMX 050308..	
	33	66	32.8-41	02595837	35758	SD572-33-66-40R7	121	71	50	WCMX 080412-86	WCMX 06T308..	
	41	82	40.8-47	02595838	35759	SD572-41-82-40R7	157	87	50	WCMX 080412-86	WCMX 080412..	
47	94	46.8-52	02595839	35760	SD572-47-94-40R7	169	99	50	WCMX 080412-86	WCMX 080412..		

*For stationary applications only

SPARE PARTS - SD522, SD523, SD524 -C SHANKS & SD525 - INCH & METRIC

FOR DRILL DIA. (IN)	FOR DRILL DIA. (MM)	INSERT SCREW						INSERT KEY			PLUG		HOSE ADAPTER			
		CENTER INSERT	PRODUCT NO.	EDP	PERIPH INSERT	PRODUCT NO.	EDP	PRODUCT NO.	EDP	PRODUCT NO.	EDP	PRODUCT NO.	EDP			
0.594-0.687	15.00-17.45	C02245-T07P	02441041	16783	C02245-T07P	02441041	16783	T07P	02440054	16665	R1/4	75010885	10885	1310	75010888	43070
0.688-0.767	17.46-19.49	C02205-T07P	02440117	16700	C02245-T07P	02441041	16783	T07P	02440054	16665	R1/4	75010885	10885	1310	75010888	43070
0.768-0.836	19.50-21.24	C02205-T07P	02440117	16700	C02205-T07P	02440117	16700	T07P	02440054	16665	R1/4	75010885	10885	1310	75010888	43070
0.837-0.885	21.25-22.49	C02506-T08P	00040419	07369	C02506-T08P	00040419	07369	T08P	02440057	16667	R1/4	75010885	10885	1310	75010888	43070
0.886-1.003	22.50-25.49	C02507-T08P	02440217	16712	C03007-T08P	02457030	13215	T08P	02440057	16667	R1/4	75010885	10885	1310	75010888	43070
1.004-1.121	25.50-28.49	C03007-T09P	02409609	00060	C03007-T09P	02409609	00060	T09P	02440058	16672	R1/4	75010885	10885	1310	75010888	43070
1.122-1.239	28.50-31.49	C03007-T09P	02409609	00060	C03009-T09P	02440221	16714	T09P	02440058	16672	R1/4	75010885	10885	1310	75010888	43070
1.240-1.593	31.50-40.49	C03508-T15P	02415354	00902	C03508-T15P	02415354	00902	T15P	02440061	16674	R1/4	75010885	10885	1310	75010888	43070
1.594-1.702	40.50-43.24	C03508-T15P	02415354	00902	C05012-T15P	02440238	16723	T15P	02440061	16674	R1/4	75010885	10885	1310	75010888	43070
1.703-2.375	43.25-59.00	C04011-T15P	00040421	04199	C05012-T15P	02440238	16723	T15P	02440061	16674	R1/4	75010885	10885	1310	75010888	43070

Accessories, to be ordered separately. For more technical information see mypages.secotools.com
 Plug & hose adapter for -C shanks only.



ACCESSORIES

TORQUE WRENCH*			REPLACEMENT BLADE			TORQUE VALUE
PRODUCT NO.	EDP	PRODUCT NO.	EDP	PRODUCT NO.	EDP	
T00-07P09	02453152	09618	T00-07P	02440080	16689	0.9 Nm
T00-07P09	02453152	09618	T00-07P	02440080	16689	0.9 Nm
T00-07P09	02453152	09618	T00-07P	02440080	16689	0.9 Nm
T00-08P12	02453153	12856	T00-08P	02440082	16692	1.2 Nm
T00-08P12	02453153	12856	T00-08P	02440082	16692	1.2 Nm
T00-09P20	02453166	12858	T00-09P	02440084	16697	2.0 Nm
T00-09P20	02453166	12858	T00-09P	02440084	16697	2.0 Nm
T00-15P30	02453168	12860	T00-15P	02440087	16698	3.0 Nm
T00-15P30	02453168	12860	T00-15P	02440087	16698	3.0 Nm
T00-15P30	02453168	12860	T00-15P	02440087	16698	3.0 Nm

Accessories, to be ordered separately. *Including blade. For more technical information see mypages.secotools.com





SD542 SPARE PARTS

FOR DRILL DIA. (IN)	FOR DRILL DIA. (MM)	LOCKING SCREW 			PERIPHERAL INSERT	PRODUCT NO.	EDP	KEY* 			BLANKING SCREW (R7-C ONLY) 		
		CENTER INSERT	PRODUCT NO.	EDP				PRODUCT NO.	EDP	PRODUCT NO.	EDP	PRODUCT NO.	EDP
2.250-2.500	60	C03007-T09P	02409609	00060	C03009-T09P	02440221	16714	T09P-2	02440058	16672	R3/8" plug	00059748	60718
	65	C03508-T15P	02415354	00902	C03508-T15P	02415354	00902	T15P-2D	02440063	16675	R3/8" plug	00059748	60718
2.750-3.250	70	C03508-T15P	02415354	00902	C05012-T15P	02440238	16723	T15P-2D	02440063	16675	R3/8" plug	00059748	60718
	75	C03508-T15P	02415354	00902	C05012-T15P	02440238	16723	T15P-2D	02440063	16675	R3/8" plug	00059748	60718
	80	C03508-T15P	02415354	00902	C05012-T15P	02440238	16723	T15P-2D	02440063	16675	R3/8" plug	00059748	60718
	85	C03508-T15P	02415354	00902	C05012-T15P	02440238	16723	T15P-2D	02440063	16675	R3/8" plug	00059748	60718
3.5	90	C04011-T15P	02415354	04199	C05012-T15P	02440238	16723	T15P-2D	02440063	16675	R3/8" plug	00059748	60718

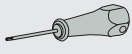

SD542 SPARE PARTS

SD542 ACCESSORIES (NOT INCLUDED IN DELIVERY)

FOR DRILL DIA. (IN)	FOR DRILL DIA. (MM)	HOSE ADAPTER (R7 ONLY) 			DYNAMOMETRIC KEY** 			REPLACEMENT BLADE 			TORQUE VALUE (NM)	TORQUE VALUE (IN/LBS)
		PRODUCT NO.	EDP	PRODUCT NO.	EDP	PRODUCT NO.	EDP	PRODUCT NO.	EDP			
2.250-2.500	60	R3/8"-HA	00059747	10373	T00-09P20	02453166	12858	T00-09P	02440084	16697	3	26.6
	65	R3/8"-HA	00059747	10373	T00-15P30	02453168	12860	T00-15P	02440087	16698	3	26.6
2.750-3.250	70	R3/8"-HA	00059747	10373	T00-15P30	02453168	12860	T00-15P	02440087	16698	3	26.6
	75	R3/8"-HA	00059747	10373	T00-15P30	02453168	12860	T00-15P	02440087	16698	3	26.6
	80	R3/8"-HA	00059747	10373	T00-15P30	02453168	12860	T00-15P	02440087	16698	3	26.6
	85	R3/8"-HA	00059747	10373	T00-15P30	02453168	12860	T00-15P	02440087	16698	3	26.6
3.5	90	R3/8"-HA	00059747	10373	T00-15P30	02453168	12860	T00-15P	02440087	16698	3	26.6



**Including blade.

SD572 SPARE PARTS

FOR DRILL DIA. (IN)	FOR DRILL DIA. (MM)	LOCKING SCREW 			PERIPHERAL INSERT	PRODUCT NO.	EDP	KEY* 			BLANKING SCREW (R7-C ONLY) 				
		CENTER INSERT	PRODUCT NO.	EDP				PRODUCT NO.	EDP	PRODUCT NO.	EDP	PRODUCT NO.	EDP		
0.591-0.748	15-19	C02205-T07P	02440117	16700	C02205-T07P	02440117	16700	T07P-2	02440054	16665	R1/4	75010885	10885		
	0.866	22	C03007-T08P	02457030	13215	C02506-T08P	00040419	07369	T08P-2	02440057	16667	R1/4	75010885	10885	
	1.062	C03508-T15P	02415354	00902	C03007-T08P	02457030	13215	T15P-2D, T08P-2	02440063	02440057	16675	16667	R1/4	75010885	10885
	1.299	C03508-T15P	02415354	00902	C03508-T15P	02415354	00902	T15P-2D	02440063	16675	R1/4	75010885	10885		
1.614-1.850	41-47	C04011-T15P	00040421	04199	C04011-T15P	00040421	04199	T15P-2D	02440063	16675	R1/4	75010885	10885		

SD572 SPARE PARTS

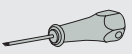
SD572 ACCESSORIES (NOT INCLUDED IN DELIVERY)

FOR DRILL DIA. (IN)	FOR DRILL DIA. (MM)	HOSE ADAPTER (R7 ONLY) 			DYNAMOMETRIC KEY** 			REPLACEMENT BLADE 			TORQUE VALUE (NM)	TORQUE VALUE (IN/LBS)	
		PRODUCT NO.	EDP	PRODUCT NO.	EDP	PRODUCT NO.	EDP	PRODUCT NO.	EDP				
0.591-0.748	15-19	1310	75010888	43070	T00-07P09	02453152	09618	T00-07P	02440080	16689	0.9	8	
	0.866	22	1310	75010888	43070	T00-08P12	02453153	12856	T00-08P	02440082	16692	1.2	10.6
	1.062	27	1310	75010888	43070	T00-08P12	02453153	12856	T00-08P	02440082	16692	1.2	10.6
	1.299	33	1310	75010888	43070	T00-15P30	02453168	12860	T00-15P	02440087	16698	3	26.6
1.614-1.850	41-47	1310	75010888	43070	T00-15P30	02453168	12860	T00-15P	02440087	16698	3	26.6	

**Including blade.

INDEXABLE INSERTS



CENTER INSERT GRADES

T400D

- First choice general grade for machining steel, cast iron and stainless steel
- Tough PVD-coated grade for maximum application security

DP3000

Duratomic® coating technology

- Grade of productivity-oriented applications and material
- Superior wear resistance
- Gradient substrate

DS4050

- First choice for titanium, superalloys, difficult stainless steel and aluminum
- New chip breaker, -MC, with improved chip control

PERIPHERY INSERT GRADES

DP3000

Duratomic® coating technology

- First choice general grade for machining steel and stainless steel
- The grade for deep hole drilling (5xD)
- The grade for interrupted cuts and other difficult applications when high toughness is required

DP2000

Duratomic® coating technology

- Recommended in steel and cast iron applications where high cutting speed can be used
- Cutting speed should not be too low, heat is needed to benefit from the toughness in the grade
- Be careful below V_c 490 sfm (150 m/min) in steel applications

T250D

- Use a PVD-coated, micro grain carbide grade to get the edge sharpness needed to minimize the heat generated

DS2050

- First choice for titanium, superalloys and difficult stainless steel
- New, sharp chipbreaker, -MP, with improved chip control
- Low cutting forces to minimize heat generation

INSERT CODE KEY

S	C	G	X	06	02	04	-	P1
1	2	3	4	5	6	7		10



GEOMETRIES

SCGX-MP	SCGX-P1	SCGX-P2	SPGX-MC	SPGX-C1	WCMX-85	WCMX-86

1. Insert shape		2. Insert side clearance angle		4. Type
S	W	C	P	X=Special

3. Tolerances										5. Cutting edge length				
Tol. class	Tolerance +/- mm			For d dimension in inch							S	W		
				0.2187	0.2500	0.3125	0.3126	0.3750	0.4631	0.5000			0.6250	0.7500
	m	s	d											
G	0.001	0.005	0.001	•	•	•		•	•	•	•	•		
M	0.005	0.005	0.002	•	•		•	•						
	0.005	0.005	0.003						•					

6. Thickness	
02 = 0.094" (2.38 mm) 03 = 0.125" (3.18 mm) T3 = 0.156" (3.97 mm)	04 = 0.187" (4.76 mm) 05 = 0.219" (5.56 mm)

7. Insert with corner chamfers/nose radius	
	04 = 0.016" (0.4 mm) 08 = 0.031" (0.8 mm) 12 = 0.047" (1.2 mm) etc.
nose radius	

10. Internal DESCRIPTION
e.g. chipbreaker DESCRIPTION
P1 = xx P2 = xx 85 = xx 86 = xx MP = xx MC = xx

PERIPHERAL INSERTS

DESCRIPTION	GRADE								
	T250D		DP2000		DP3000		DS2050	T400D	
	PRODUCT NO.	EDP	PRODUCT NO.	EDP	PRODUCT NO.	EDP	PRODUCT NO	PRODUCT NO.	EDP
SCGX060204-P1	00059712	59712	02590849	34791	02807362	09916	-	-	-
SCGX070308-P1	00059713	59713	02590850	34792	02807363	09914	-	-	-
SCGX09T308-P1	00059714	59714	02590851	34793	02807364	09919	-	-	-
SCGX11T308-P1	03136962	-	03136963	-	03136964	-	-	-	-
SCGX120408-P1	00059715	59715	02590852	34794	02807365	09912	-	-	-
SCGX150512-P1	00059716	59716	02590853	34795	02807366	09910	-	-	-
SCGX050204-P2	00059711	59711	02590854	34796	02807356	09917	-	-	-
SCGX060204-P2	02526803	71439	02590855	34797	02807357	09915	-	-	-
SCGX070308-P2	02526787	71460	02590856	34798	02807358	09913	-	02568947	76495
SCGX09T308-P2	02794476	02358	02590857	34799	02807359	09918	-	02568949	76517
SCGX120408-P2	03097760	02357	03097761	34800	03097762	09911	-	02568948	76500
SCGX150512-P2	02794477	00136	02590858	34801	02807360	09909	-	-	-
SCGX050204-MP	-	-	-	-	-	-	03134312	-	-
SCGX060204-MP	-	-	-	-	-	-	03134313	-	-
SCGX070308-MP	-	-	-	-	-	-	03134314	-	-
SCGX09T308-MP	-	-	-	-	-	-	03134315	-	-
SCGX11T308-MP	-	-	-	-	-	-	03134316	-	-
SCGX120408-MP	-	-	-	-	-	-	03134317	-	-
SCGX150512-MP	-	-	-	-	-	-	03134318	-	-

CENTER INSERTS

DESCRIPTION	GRADE					
	DP3000		DS2050	DS4050	T400D	
	PRODUCT NO.	EDP	PRODUCT NO.	PRODUCT NO.	PRODUCT NO.	EDP
SPGX0502-C1	02807367	09934	-	-	74077370	77370
SPGX0602-C1	02807368	09933	-	-	74077371	77371
SPGX0703-C1	02807369	09932	-	-	74077372	77372
SPGX0903-C1	02807370	09931	-	-	74077373	77373
SPGX11T3-C1	02807371	09936	-	-	74077374	77374
SPGX12T3-C1	02807372	09935	-	-	74077375	77375
SPGX1504-C1	02807373	09930	-	-	74077376	77376
SPGX1904-C1	02807374	09929	-	-	74077377	77377
SPGX0502-MC	-	-	-	03134319	-	-
SPGX0602-MC	-	-	-	03134320	-	-
SPGX0703-MC	-	-	-	03134321	-	-
SPGX0903-MC	-	-	-	03134322	-	-
SPGX11T3-MC	-	-	-	03134323	-	-
SPGX12T3-MC	-	-	-	03134324	-	-
SPGX1504-MC	-	-	-	03134325	-	-
SPGX1904-MC	-	-	-	03134326	-	-

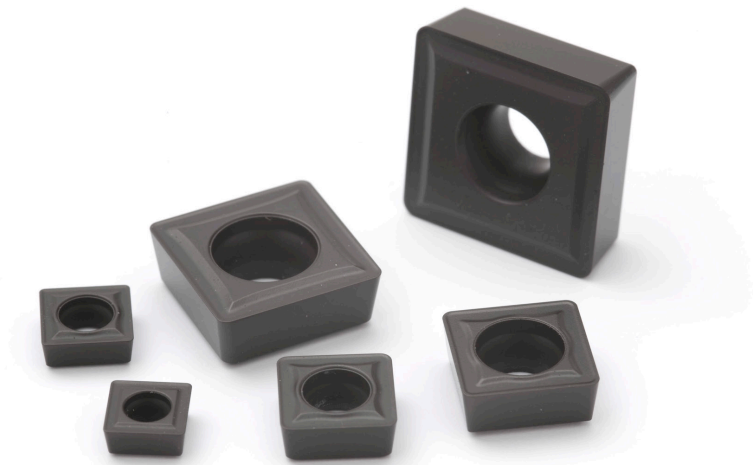

SD522 - Ø 0.590-2.375 - Inch

SMG		f							v _c
		Ø 0.590-0.767	Ø 0.768-0.885	Ø 0.886-1.121	Ø 1.122-1.357	Ø 1.358-1.593	Ø 1.594-1.751	Ø 1.752-2.375	
P1	P1 DP2000	0.0024	0.0028	0.0033	0.0037	0.0043	0.0047	0.0051	1525
P2	P1 DP2000	0.0024	0.0028	0.0033	0.0039	0.0043	0.0047	0.0051	1475
P3	P2 DP3000	0.0047	0.0055	0.0067	0.0075	0.0087	0.0087	0.010	1150
P4	P2 DP3000	0.0047	0.0051	0.0063	0.0075	0.0087	0.0087	0.010	720
P5	P2 DP3000	0.0043	0.0051	0.0063	0.0071	0.0079	0.0087	0.0094	690
P6	P2 DP3000	0.0043	0.0051	0.0063	0.0071	0.0079	0.0087	0.0094	780
P7	P2 DP3000	0.0043	0.0051	0.0063	0.0071	0.0079	0.0087	0.0094	730
P8	P2 DP3000	0.0047	0.0055	0.0067	0.0075	0.0087	0.0087	0.010	690
P11	P2 DP3000	0.0043	0.0051	0.0063	0.0071	0.0079	0.0087	0.0094	710
P12	P2 DP3000	0.0030	0.0035	0.0043	0.0047	0.0055	0.0059	0.0067	420
M1	P2 DP3000	0.0033	0.0039	0.0047	0.0055	0.0063	0.0067	0.0075	850
M2	P2 DP3000	0.0031	0.0035	0.0043	0.0051	0.0055	0.0059	0.0067	690
M3	MP DS2050	0.0026	0.0030	0.0035	0.0039	0.0047	0.0051	0.0055	530
M4	MP DS2050	0.0022	0.0026	0.0031	0.0035	0.0039	0.0043	0.0047	460
M5	MP DS2050	0.0022	0.0026	0.0031	0.0035	0.0039	0.0043	0.0047	385
K1	P2 DP2000	0.0047	0.0055	0.0067	0.0079	0.0087	0.0094	0.010	820
K2	P2 DP2000	0.0043	0.0051	0.0063	0.0071	0.0079	0.0087	0.0094	710
K3	P2 DP2000	0.0043	0.0051	0.0063	0.0071	0.0079	0.0087	0.0094	600
K4	P2 DP2000	0.0043	0.0051	0.0063	0.0071	0.0079	0.0087	0.0094	570
K5	P2 DP2000	0.0039	0.0043	0.0055	0.0063	0.0071	0.0075	0.0087	340
N1	P1 T250D	0.0047	0.0055	0.0067	0.0079	0.0087	0.0094	0.010	1200
N2	P1 T250D	0.0047	0.0055	0.0067	0.0079	0.0087	0.0094	0.010	770
N3	P1 T250D	0.0047	0.0055	0.0067	0.0079	0.0087	0.0094	0.010	510
N11	P1 T250D	0.0047	0.0055	0.0067	0.0079	0.0087	0.0094	0.010	1025
S1	MP DS2050	0.0035	0.0043	0.0051	0.0059	0.0067	0.0071	0.0079	195
S2	MP DS2050	0.0035	0.0043	0.0051	0.0059	0.0067	0.0071	0.0079	160
S3	MP DS2050	0.0033	0.0039	0.0047	0.0055	0.0063	0.0067	0.0075	135
S11	MP DS2050	0.0043	0.0047	0.0059	0.0067	0.0075	0.0079	0.0094	285
S12	MP DS2050	0.0043	0.0047	0.0059	0.0067	0.0075	0.0079	0.0094	215
S13	MP DS2050	0.0035	0.0043	0.0051	0.0059	0.0067	0.0071	0.0079	170
H3	P1 T250D	0.0020	0.0024	0.0028	0.0031	0.0037	0.0039	0.0043	230
H5	P1 T250D	0.0030	0.0035	0.0043	0.0047	0.0055	0.0059	0.0067	430
H7	P1 T250D	0.0020	0.0024	0.0028	0.0031	0.0037	0.0039	0.0043	230
H8	P1 T250D	0.0024	0.0028	0.0033	0.0037	0.0043	0.0043	0.0051	430
H11	P1 T250D	0.0030	0.0035	0.0043	0.0047	0.0055	0.0059	0.0067	550
H12	P1 T250D	0.0024	0.0028	0.0033	0.0037	0.0043	0.0043	0.0051	500
H21	P1 T250D	0.0024	0.0028	0.0033	0.0037	0.0043	0.0043	0.0051	430

SMG = Seco material group

f = in/rev

v_c = sf/min

All cutting data are start values

SD522 Cutting Speed - Inch

SMG	v _c			
	DP2000	DP3000	T250D	DS2050
P1	1525	1350	1025	1350
P2	1475	1325	1000	1325
P3	1275	1150	870	1150
P4	930	720	460	-
P5	890	690	440	-
P6	1000	780	495	-
P7	940	730	465	-
P8	890	690	440	-
P11	920	710	455	-
P12	540	420	270	-
M1	-	850	530	-
M2	-	690	430	-
M3	-	530	330	530
M4	-	395	245	460
M5	-	330	205	385
K1	820	780	-	-
K2	710	680	-	-
K3	600	570	-	-
K4	570	550	-	-
K5	340	325	-	-
N1	-	1375	1200	1200
N2	-	890	770	770
N3	-	590	510	510
N11	-	1150	1025	1025
S1	-	-	130	195
S2	-	-	100	160
S3	-	-	100	135
S11	-	-	255	285
S12	-	-	195	215
S13	-	-	150	170
H3	-	230	230	-
H5	-	430	430	-
H7	-	230	230	-
H8	-	430	430	-
H11	-	550	550	-
H12	-	250	500	-
H21	-	430	430	-

SMG = Seco material group
 v_c = sf/min
 All cutting data are start values

SD523 - Ø 0.590-2.375 - Inch

SMG		f							v _c
		Ø 0.590-0.767	Ø 0.768-0.885	Ø 0.886-1.121	Ø 1.122-1.357	Ø 1.358-1.593	Ø 1.594-1.751	Ø 1.752-2.375	
P1	P1 DP2000	0.0024	0.0028	0.0033	0.0037	0.0043	0.0047	0.0051	1350
P2	P1 DP2000	0.0024	0.0028	0.0033	0.0039	0.0043	0.0047	0.0051	1325
P3	P2 DP3000	0.0047	0.0055	0.0067	0.0075	0.0087	0.0087	0.010	1025
P4	P2 DP3000	0.0047	0.0051	0.0063	0.0075	0.0087	0.0087	0.010	620
P5	P2 DP3000	0.0043	0.0051	0.0063	0.0071	0.0079	0.0087	0.0094	590
P6	P2 DP3000	0.0043	0.0051	0.0063	0.0071	0.0079	0.0087	0.0094	660
P7	P2 DP3000	0.0043	0.0051	0.0063	0.0071	0.0079	0.0087	0.0094	630
P8	P2 DP3000	0.0047	0.0055	0.0067	0.0075	0.0087	0.0087	0.010	590
P11	P2 DP3000	0.0043	0.0051	0.0063	0.0071	0.0079	0.0087	0.0094	610
P12	P2 DP3000	0.0030	0.0035	0.0043	0.0047	0.0055	0.0059	0.0067	360
M1	P2 DP3000	0.0033	0.0039	0.0047	0.0055	0.0063	0.0067	0.0075	800
M2	P2 DP3000	0.0031	0.0035	0.0043	0.0051	0.0055	0.0059	0.0067	650
M3	MP DS2050	0.0026	0.0030	0.0035	0.0039	0.0047	0.0051	0.0055	495
M4	MP DS2050	0.0022	0.0026	0.0031	0.0035	0.0039	0.0043	0.0047	395
M5	MP DS2050	0.0022	0.0026	0.0031	0.0035	0.0039	0.0043	0.0047	330
K1	P2 DP2000	0.0047	0.0055	0.0067	0.0079	0.0087	0.0094	0.010	740
K2	P2 DP2000	0.0043	0.0051	0.0063	0.0071	0.0079	0.0087	0.0094	640
K3	P2 DP2000	0.0043	0.0051	0.0063	0.0071	0.0079	0.0087	0.0094	550
K4	P2 DP2000	0.0043	0.0051	0.0063	0.0071	0.0079	0.0087	0.0094	520
K5	P2 DP2000	0.0039	0.0043	0.0055	0.0063	0.0071	0.0075	0.0087	310
N1	P1 T250D	0.0047	0.0055	0.0067	0.0079	0.0087	0.0094	0.010	1025
N2	P1 T250D	0.0047	0.0055	0.0067	0.0079	0.0087	0.0094	0.010	650
N3	P1 T250D	0.0047	0.0055	0.0067	0.0079	0.0087	0.0094	0.010	435
N11	P1 T250D	0.0047	0.0055	0.0067	0.0079	0.0087	0.0094	0.010	860
S1	MP DS2050	0.0035	0.0043	0.0051	0.0059	0.0067	0.0071	0.0079	175
S2	MP DS2050	0.0035	0.0043	0.0051	0.0059	0.0067	0.0071	0.0079	140
S3	MP DS2050	0.0033	0.0039	0.0047	0.0055	0.0063	0.0067	0.0075	120
S11	MP DS2050	0.0043	0.0047	0.0059	0.0067	0.0075	0.0079	0.0094	250
S12	MP DS2050	0.0043	0.0047	0.0059	0.0067	0.0075	0.0079	0.0094	190
S13	MP DS2050	0.0035	0.0043	0.0051	0.0059	0.0067	0.0071	0.0079	150
H3	P1 T250D	0.0020	0.0024	0.0028	0.0031	0.0037	0.0039	0.0043	195
H5	P1 T250D	0.0030	0.0035	0.0043	0.0047	0.0055	0.0059	0.0067	365
H7	P1 T250D	0.0020	0.0024	0.0028	0.0031	0.0037	0.0039	0.0043	195
H8	P1 T250D	0.0024	0.0028	0.0033	0.0037	0.0043	0.0043	0.0051	365
H11	P1 T250D	0.0030	0.0035	0.0043	0.0047	0.0055	0.0059	0.0067	465
H12	P1 T250D	0.0024	0.0028	0.0033	0.0037	0.0043	0.0043	0.0051	425
H21	P1 T250D	0.0024	0.0028	0.0033	0.0037	0.0043	0.0043	0.0051	365

SMG = Seco material group

f = in/rev

v_c = sf/min

All cutting data are start values

SD523 Cutting Speed - Inch

SMG	v _c			
	DP2000	DP3000	T2500	DS2050
P1	1350	1225	880	1225
P2	1325	1175	850	1175
P3	1125	1025	730	1025
P4	760	620	390	-
P5	720	590	375	-
P6	810	660	420	-
P7	770	630	395	-
P8	720	590	375	-
P11	750	610	385	-
P12	440	360	225	-
M1	-	800	450	-
M2	-	650	365	-
M3	-	495	280	495
M4	-	370	210	395
M5	-	310	175	330
K1	740	710	-	-
K2	640	610	-	-
K3	550	520	-	-
K4	520	495	-	-
K5	310	295	-	-
N1	-	1175	1025	1025
N2	-	760	650	650
N3	-	510	435	435
N11	-	990	860	860
S1	-	-	110	175
S2	-	-	85	140
S3	-	-	85	120
S11	-	-	215	250
S12	-	-	165	190
S13	-	-	130	150
H3	-	200	195	-
H5	-	370	365	-
H7	-	200	195	-
H8	-	370	365	-
H11	-	470	465	-
H12	-	215	425	-
H21	-	370	365	-

SMG = Seco material group
 v_c = sf/min
 All cutting data are start values

SD524 - Ø 0.590-2.375 - Inch

SMG		f							v _c
		Ø 0.590-0.767	Ø 0.768-0.885	Ø 0.886-1.121	Ø 1.122-1.357	Ø 1.358-1.593	Ø 1.594-1.751	Ø 1.752-2.375	
P1	P1 DP2000	0.0024	0.0028	0.0033	0.0037	0.0043	0.0047	0.0051	1250
P2	P1 DP2000	0.0024	0.0028	0.0033	0.0039	0.0043	0.0047	0.0051	1225
P3	P2 DP3000	0.0047	0.0055	0.0067	0.0075	0.0087	0.0087	0.010	940
P4	P2 DP3000	0.0047	0.0051	0.0063	0.0075	0.0087	0.0087	0.010	550
P5	P2 DP3000	0.0043	0.0051	0.0063	0.0071	0.0079	0.0087	0.0094	520
P6	P2 DP3000	0.0043	0.0051	0.0063	0.0071	0.0079	0.0087	0.0094	580
P7	P2 DP3000	0.0043	0.0051	0.0063	0.0071	0.0079	0.0087	0.0094	550
P8	P2 DP3000	0.0047	0.0055	0.0067	0.0075	0.0087	0.0087	0.010	520
P11	P2 DP3000	0.0043	0.0051	0.0063	0.0071	0.0079	0.0087	0.0094	540
P12	P2 DP3000	0.0030	0.0035	0.0043	0.0047	0.0055	0.0059	0.0067	315
M1	P2 DP3000	0.0033	0.0039	0.0047	0.0055	0.0063	0.0067	0.0075	770
M2	P2 DP3000	0.0031	0.0035	0.0043	0.0051	0.0055	0.0059	0.0067	620
M3	MP DS2050	0.0026	0.0030	0.0035	0.0039	0.0047	0.0051	0.0055	470
M4	MP DS2050	0.0022	0.0026	0.0031	0.0035	0.0039	0.0043	0.0047	345
M5	MP DS2050	0.0022	0.0026	0.0031	0.0035	0.0039	0.0043	0.0047	290
K1	P2 DP2000	0.0047	0.0055	0.0067	0.0079	0.0087	0.0094	0.010	690
K2	P2 DP2000	0.0043	0.0051	0.0063	0.0071	0.0079	0.0087	0.0094	600
K3	P2 DP2000	0.0043	0.0051	0.0063	0.0071	0.0079	0.0087	0.0094	500
K4	P2 DP2000	0.0043	0.0051	0.0063	0.0071	0.0079	0.0087	0.0094	480
K5	P2 DP2000	0.0039	0.0043	0.0055	0.0063	0.0071	0.0075	0.0087	285
N1	P1 T250D	0.0047	0.0055	0.0067	0.0079	0.0087	0.0094	0.010	880
N2	P1 T250D	0.0047	0.0055	0.0067	0.0079	0.0087	0.0094	0.010	570
N3	P1 T250D	0.0047	0.0055	0.0067	0.0079	0.0087	0.0094	0.010	380
N11	P1 T250D	0.0047	0.0055	0.0067	0.0079	0.0087	0.0094	0.010	750
S1	MP DS2050	0.0035	0.0043	0.0051	0.0059	0.0067	0.0071	0.0079	155
S2	MP DS2050	0.0035	0.0043	0.0051	0.0059	0.0067	0.0071	0.0079	125
S3	MP DS2050	0.0033	0.0039	0.0047	0.0055	0.0063	0.0067	0.0075	110
S11	MP DS2050	0.0043	0.0047	0.0059	0.0067	0.0075	0.0079	0.0094	225
S12	MP DS2050	0.0043	0.0047	0.0059	0.0067	0.0075	0.0079	0.0094	175
S13	MP DS2050	0.0035	0.0043	0.0051	0.0059	0.0067	0.0071	0.0079	135
H3	P1 T250D	0.0020	0.0024	0.0028	0.0031	0.0037	0.0039	0.0043	170
H5	P1 T250D	0.0030	0.0035	0.0043	0.0047	0.0055	0.0059	0.0067	315
H7	P1 T250D	0.0020	0.0024	0.0028	0.0031	0.0037	0.0039	0.0043	170
H8	P1 T250D	0.0024	0.0028	0.0033	0.0037	0.0043	0.0043	0.0051	315
H11	P1 T250D	0.0030	0.0035	0.0043	0.0047	0.0055	0.0059	0.0067	405
H12	P1 T250D	0.0024	0.0028	0.0033	0.0037	0.0043	0.0043	0.0051	370
H21	P1 T250D	0.0024	0.0028	0.0033	0.0037	0.0043	0.0043	0.0051	315

SMG = Seco material group

f = in/rev

v_c = sf/min

All cutting data are start values

SD524 Cutting Speed - Inch

SMG	v _c			
	DP2000	DP3000	T250D	DS2050
P1	1250	1125	760	1125
P2	1225	1100	740	1100
P3	1050	940	640	940
P4	640	550	340	-
P5	610	520	325	-
P6	680	580	365	-
P7	640	550	345	-
P8	610	520	325	-
P11	620	540	335	-
P12	370	315	195	-
M1	-	770	395	-
M2	-	620	315	-
M3	-	470	240	470
M4	-	355	180	345
M5	-	295	150	290
K1	690	650	-	-
K2	600	570	-	-
K3	500	480	-	-
K4	480	455	-	-
K5	285	270	-	-
N1	-	1050	880	880
N2	-	670	570	570
N3	-	445	380	380
N11	-	870	750	750
S1	-	-	95	155
S2	-	-	75	125
S3	-	-	75	110
S11	-	-	190	225
S12	-	-	145	175
S13	-	-	110	135
H3	-	175	170	-
H5	-	325	315	-
H7	-	175	170	-
H8	-	325	315	-
H11	-	415	405	-
H12	-	190	370	-
H21	-	325	315	-

SMG = Seco material group
 v_c = sf/min
 All cutting data are start values

SD525 - Ø 0.750-2.000 - Inch

SMG		f					v _c
		Ø 0.750-0.885	Ø 0.886-1.121	Ø 1.122-1.357	Ø 1.358-1.593	Ø 1.594-2.000	
P1	P2 DP3000	0.0028	0.0033	0.0037	0.0043	0.0047	1050
P2	P2 DP3000	0.0028	0.0033	0.0039	0.0043	0.0047	1025
P3	P2 DP3000	0.0055	0.0067	0.0075	0.0087	0.0087	870
P4	P2 DP3000	0.0051	0.0063	0.0075	0.0087	0.0087	490
P5	P2 DP3000	0.0051	0.0063	0.0071	0.0079	0.0087	465
P6	P2 DP3000	0.0051	0.0063	0.0071	0.0079	0.0087	520
P7	P2 DP3000	0.0051	0.0063	0.0071	0.0079	0.0087	495
P8	P2 DP3000	0.0055	0.0067	0.0075	0.0087	0.0087	465
P11	P2 DP3000	0.0051	0.0063	0.0071	0.0079	0.0087	480
M1	P2 DP3000	0.0039	0.0047	0.0055	0.0063	0.0067	740
M2	P2 DP3000	0.0035	0.0043	0.0051	0.0055	0.0059	600
M3	MP DS2050	0.0030	0.0035	0.0039	0.0047	0.0051	455
M4	MP DS2050	0.0026	0.0031	0.0035	0.0039	0.0043	310
M5	MP DS2050	0.0026	0.0031	0.0035	0.0039	0.0043	260
K1	P2 DP3000	0.0055	0.0067	0.0079	0.0087	0.0094	610
K2	P2 DP3000	0.0051	0.0063	0.0071	0.0079	0.0087	530
K3	P2 DP3000	0.0051	0.0063	0.0071	0.0079	0.0087	450
K4	P2 DP3000	0.0051	0.0063	0.0071	0.0079	0.0087	430
K5	P2 DP3000	0.0043	0.0055	0.0063	0.0071	0.0075	255
N1	P1 T250D	0.0055	0.0067	0.0079	0.0087	0.0094	780
N2	P1 T250D	0.0055	0.0067	0.0079	0.0087	0.0094	500
N3	P1 T250D	0.0055	0.0067	0.0079	0.0087	0.0094	335
N11	P1 T250D	0.0055	0.0067	0.0079	0.0087	0.0094	660
S1	MP DS2050	0.0043	0.0051	0.0059	0.0067	0.0071	145
S2	MP DS2050	0.0043	0.0051	0.0059	0.0067	0.0071	115
S3	MP DS2050	0.0039	0.0047	0.0055	0.0063	0.0067	100
S11	MP DS2050	0.0047	0.0059	0.0067	0.0075	0.0079	210
S12	MP DS2050	0.0047	0.0059	0.0067	0.0075	0.0079	160
S13	MP DS2050	0.0043	0.0051	0.0059	0.0067	0.0071	125
H3	P1 T250D	0.0024	0.0028	0.0033	0.0037	0.0039	150
H5	P1 T250D	0.0035	0.0043	0.0047	0.0055	0.0059	280
H7	P1 T250D	0.0024	0.0028	0.0033	0.0037	0.0039	150
H8	P1 T250D	0.0028	0.0033	0.0037	0.0043	0.0043	280
H11	P1 T250D	0.0035	0.0043	0.0047	0.0055	0.0059	355
H12	P1 T250D	0.0028	0.0033	0.0037	0.0043	0.0043	325
H21	P1 T250D	0.0028	0.0033	0.0037	0.0043	0.0043	280

SMG = Seco material group

f = in/rev

v_c = sf/min

All cutting data are start values

SD525 Cutting Speed - Inch

SMG	v _c			
	DP2000	DP3000	T250D	DS2050
P1	1150	1050	680	1050
P2	1125	1025	660	1025
P3	970	870	570	870
P4	540	490	300	-
P5	520	465	290	-
P6	580	520	325	-
P7	550	495	305	-
P8	520	465	290	-
P11	530	480	295	-
P12	315	285	175	-
M1	-	740	350	-
M2	-	600	280	-
M3	-	455	215	455
M4	-	340	160	310
M5	-	285	135	260
K1	650	610	-	-
K2	560	530	-	-
K3	475	450	-	-
K4	450	430	-	-
K5	270	255	-	-
N1	-	930	780	780
N2	-	600	500	500
N3	-	400	335	335
N11	-	780	660	660
S1	-	-	85	145
S2	-	-	65	115
S3	-	-	65	100
S11	-	-	165	210
S12	-	-	130	160
S13	-	-	100	125
H3	-	155	150	-
H5	-	290	280	-
H7	-	155	150	-
H8	-	290	280	-
H11	-	370	355	-
H12	-	170	325	-
H21	-	290	280	-

SMG = Seco material group
 f = in/rev
 v_c = sf/min
 All cutting data are start values

SD542 - Ø 2.250-3.500 - Inch

SMG		f		v _c
		Ø 2.250-2.559	Ø 2.750-3.500	
P1	P2 DP3000	0.0070	0.0085	760
P2	P2 DP3000	0.0040	0.0048	740
P3	P2 DP3000	0.0070	0.0080	640
P4	P2 DP3000	0.0065	0.0080	670
P5	P2 DP3000	0.0065	0.0080	640
P6	P2 DP3000	0.0065	0.0075	710
P7	P2 DP3000	0.0065	0.0075	670
P8	P2 DP3000	0.0070	0.0080	640
P11	P2 DP3000	0.0065	0.0075	660
M1	P2 DP3000	0.0075	0.0085	750
M2	P2 DP3000	0.0065	0.0080	610
M3	P1 T250D	0.0055	0.0065	300
M4	P1 T250D	0.0048	0.0055	225
M5	P1 T250D	0.0048	0.0055	190
K1	P2 DP3000	0.0075	0.0085	550
K2	P2 DP3000	0.0065	0.0080	475
K3	P2 DP3000	0.0065	0.0080	400
K4	P2 DP3000	0.0065	0.0080	380
K5	P2 DP3000	0.0060	0.0070	225
N1	P1 T250D	0.0095	0.011	1100
N2	P1 T250D	0.0095	0.011	710
N3	P1 T250D	0.0095	0.011	470
N11	P1 T250D	0.0095	0.011	930
S1	P1 T250D	0.0048	0.0055	120
S2	P1 T250D	0.0048	0.0055	90
S3	P1 T250D	0.0044	0.0050	90
S11	P1 T250D	0.0055	0.0065	235
S12	P1 T250D	0.0055	0.0065	180
S13	P1 T250D	0.0048	0.0055	140
H3	P1 T250D	0.0030	0.0036	210
H5	P1 T250D	0.0048	0.0050	395
H7	P1 T250D	0.0030	0.0036	210
H8	P1 T250D	0.0036	0.0040	395
H11	P1 T250D	0.0048	0.0050	500
H12	P1 T250D	0.0048	0.0050	760
H21	P1 T250D	0.0036	0.0040	395

SMG = Seco Material Group

f = in/rev

v_c = sf/min

All cutting data are start values

SD542 - Cutting Speed - Inch

SMG	v _c		
	DP2000	DP3000	T2500
P1	920	760	570
P2	890	740	560
P3	770	640	480
P4	840	670	420
P5	800	640	405
P6	900	710	455
P7	850	670	425
P8	800	640	405
P11	820	660	415
M1	-	750	490
M2	-	610	395
M3	-	460	300
M4	-	345	225
M5	-	290	190
K1	710	550	-
K2	620	475	-
K3	520	400	-
K4	495	380	-
K5	295	225	-
N1	-	1275	1100
N2	-	820	710
N3	-	550	470
N11	-	1050	930
S1	-	-	120
S2	-	-	90
S3	-	-	90
S11	-	-	235
S12	-	-	180
S13	-	-	140
H3	-	215	210
H5	-	395	395
H7	-	215	210
H8	-	395	395
H11	-	510	500
H12	-	760	760
H21	-	395	395

SMG = Seco Material Group
 f = in/rev
 v_c = sf/min
 All cutting data are start values

SD572 - Ø 0.590-1.850 - Inch

SMG		f						v _c
		Ø 0.590-0.669	Ø 0.670-0.787	Ø 0.788-0.944	Ø 0.945-1.259	Ø 1.260-1.417	Ø 1.418-1.850	
P1	85 DP3000	0.0012	0.0014	0.0017	0.0020	0.0024	0.0028	1025
P2	85 DP3000	0.0012	0.0014	0.0017	0.0022	0.0024	0.0028	1000
P3	86 DP3000	0.0040	0.0048	0.0050	0.0065	0.0065	0.0080	860
P4	86 DP3000	0.0040	0.0048	0.0050	0.0060	0.0065	0.0075	760
P5	86 DP3000	0.0040	0.0044	0.0050	0.0060	0.0065	0.0075	720
P6	86 DP3000	0.0040	0.0044	0.0050	0.0060	0.0065	0.0075	810
P7	86 DP3000	0.0040	0.0044	0.0050	0.0060	0.0065	0.0075	760
P8	86 DP3000	0.0040	0.0048	0.0050	0.0065	0.0065	0.0080	720
P11	86 DP3000	0.0040	0.0044	0.0050	0.0060	0.0065	0.0075	740
M1	86 DP3000	0.0044	0.0050	0.0055	0.0065	0.0070	0.0080	770
M2	86 DP3000	0.0040	0.0044	0.0050	0.0060	0.0065	0.0075	620
M3	85 DP3000	0.0032	0.0036	0.0040	0.0048	0.0050	0.0060	475
M4	85 DP3000	0.0028	0.0032	0.0036	0.0040	0.0048	0.0050	355
M5	85 DP3000	0.0028	0.0032	0.0036	0.0040	0.0048	0.0050	295
K1	86 DP3000	0.0044	0.0050	0.0055	0.0065	0.0070	0.0080	590
K2	86 DP3000	0.0040	0.0044	0.0050	0.0060	0.0065	0.0075	510
K3	86 DP3000	0.0040	0.0044	0.0050	0.0060	0.0065	0.0075	435
K4	86 DP3000	0.0040	0.0044	0.0050	0.0060	0.0065	0.0075	415
K5	86 DP3000	0.0036	0.0040	0.0048	0.0050	0.0060	0.0065	245
S1	85 DP3000	0.0028	0.0032	0.0036	0.0040	0.0048	0.0050	130
S2	85 DP3000	0.0028	0.0032	0.0036	0.0040	0.0048	0.0050	100
S3	85 DP3000	0.0026	0.0030	0.0034	0.0038	0.0044	0.0048	100
S11	85 DP3000	0.0032	0.0036	0.0040	0.0048	0.0050	0.0060	255
S12	85 DP3000	0.0032	0.0036	0.0040	0.0048	0.0050	0.0060	195
S13	85 DP3000	0.0028	0.0032	0.0036	0.0040	0.0048	0.0050	155
H3	86 DP3000	0.0017	0.0020	0.0024	0.0026	0.0030	0.0034	265
H5	86 DP3000	0.0028	0.0032	0.0036	0.0040	0.0044	0.0050	495
H7	86 DP3000	0.0017	0.0020	0.0024	0.0026	0.0030	0.0034	265
H8	86 DP3000	0.0020	0.0024	0.0026	0.0032	0.0034	0.0040	495
H11	86 DP3000	0.0028	0.0032	0.0036	0.0040	0.0044	0.0050	630
H12	86 DP3000	0.0028	0.0032	0.0036	0.0040	0.0044	0.0050	950
H21	86 DP3000	0.0020	0.0024	0.0026	0.0032	0.0034	0.0040	495

SMG = Seco Material Group

f = in/rev

v_c = sf/min

All cutting data are start values

SD572 - Cutting Speed - Inch

SMG	v_c
	DP2000
P1	1225
P2	1200
P3	1025
P4	910
P5	870
P6	980
P7	920
P8	870
P11	890
M1	930
M2	750
M3	570
M4	430
M5	360
K1	710
K2	610
K3	520
K4	495
K5	295
S1	-
S2	-
S3	-
S11	-
S12	-
S13	-
H3	265
H5	495
H7	265
H8	495
H11	630
H12	950
H21	495

SMG = Seco Material Group
 f = in/rev
 v_c = sf/min
 All cutting data are start values

SD522 - Ø15-60 - Metric

SMG		f							v _c
		Ø 15,00-19,49	Ø 19,50-22,49	Ø 22,50-28,49	Ø 28,50-34,49	Ø 34,50-40,49	Ø 40,49-44,49	Ø 44,50-59,99	
P1	P1 DP2000	0,060	0,070	0,085	0,095	0,11	0,12	0,13	460
P2	P1 DP2000	0,060	0,070	0,085	0,10	0,11	0,12	0,13	450
P3	P2 DP3000	0,12	0,14	0,17	0,19	0,22	0,22	0,26	345
P4	P2 DP3000	0,12	0,13	0,16	0,19	0,22	0,22	0,26	220
P5	P2 DP3000	0,11	0,13	0,16	0,18	0,20	0,22	0,24	210
P6	P2 DP3000	0,11	0,13	0,16	0,18	0,20	0,22	0,24	235
P7	P2 DP3000	0,11	0,13	0,16	0,18	0,20	0,22	0,24	225
P8	P2 DP3000	0,12	0,14	0,17	0,19	0,22	0,22	0,26	210
P11	P2 DP3000	0,11	0,13	0,16	0,18	0,20	0,22	0,24	215
P12	P2 DP3000	0,075	0,090	0,11	0,12	0,14	0,15	0,17	130
M1	P2 DP3000	0,085	0,10	0,12	0,14	0,16	0,17	0,19	260
M2	P2 DP3000	0,080	0,090	0,11	0,13	0,14	0,15	0,17	210
M3	MP DS2050	0,065	0,075	0,090	0,10	0,12	0,13	0,14	160
M4	MP DS2050	0,055	0,065	0,080	0,090	0,10	0,11	0,12	140
M5	MP DS2050	0,055	0,065	0,080	0,090	0,10	0,11	0,12	115
K1	P2 DP2000	0,12	0,14	0,17	0,20	0,22	0,24	0,26	250
K2	P2 DP2000	0,11	0,13	0,16	0,18	0,20	0,22	0,24	215
K3	P2 DP2000	0,11	0,13	0,16	0,18	0,20	0,22	0,24	185
K4	P2 DP2000	0,11	0,13	0,16	0,18	0,20	0,22	0,24	175
K5	P2 DP2000	0,10	0,11	0,14	0,16	0,18	0,19	0,22	105
N1	P1 T250D	0,12	0,14	0,17	0,20	0,22	0,24	0,26	365
N2	P1 T250D	0,12	0,14	0,17	0,20	0,22	0,24	0,26	235
N3	P1 T250D	0,12	0,14	0,17	0,20	0,22	0,24	0,26	155
N11	P1 T250D	0,12	0,14	0,17	0,20	0,22	0,24	0,26	310
S1	MP DS2050	0,090	0,11	0,13	0,15	0,17	0,18	0,20	60
S2	MP DS2050	0,090	0,11	0,13	0,15	0,17	0,18	0,20	48
S3	MP DS2050	0,085	0,10	0,12	0,14	0,16	0,17	0,19	41
S11	MP DS2050	0,11	0,12	0,15	0,17	0,19	0,20	0,24	85
S12	MP DS2050	0,11	0,12	0,15	0,17	0,19	0,20	0,24	65
S13	MP DS2050	0,090	0,11	0,13	0,15	0,17	0,18	0,20	50
H3	P1 T250D	0,050	0,060	0,070	0,080	0,095	0,10	0,11	70
H5	P1 T250D	0,075	0,090	0,11	0,12	0,14	0,15	0,17	130
H7	P1 T250D	0,050	0,060	0,070	0,080	0,095	0,10	0,11	70
H8	P1 T250D	0,060	0,070	0,085	0,095	0,11	0,11	0,13	130
H11	P1 T250D	0,075	0,090	0,11	0,12	0,14	0,15	0,17	165
H12	P1 T250D	0,060	0,070	0,085	0,095	0,11	0,11	0,13	150
H21	P1 T250D	0,060	0,070	0,085	0,095	0,11	0,11	0,13	130

SMG = Seco material group

f = mm/rev

v_c = m/min

All cutting data are start values

SD522 Cutting Speed - Metric

SMG	v _c			
	DP2000	DP3000	T250D	DS2050
P1	460	415	315	415
P2	450	405	305	405
P3	385	345	265	345
P4	285	220	140	-
P5	270	210	135	-
P6	305	235	150	-
P7	285	225	140	-
P8	270	210	135	-
P11	280	215	140	-
P12	165	130	80	-
M1	-	260	160	-
M2	-	210	130	-
M3	-	160	100	160
M4	-	120	75	140
M5	-	100	60	115
K1	250	235	-	-
K2	215	205	-	-
K3	185	175	-	-
K4	175	165	-	-
K5	105	100	-	-
N1	-	420	365	365
N2	-	270	235	235
N3	-	180	155	155
N11	-	350	310	310
S1	-	-	40	60
S2	-	-	30	48
S3	-	-	30	41
S11	-	-	80	85
S12	-	-	60	65
S13	-	-	46	50
H3	-	70	70	-
H5	-	130	130	-
H7	-	70	70	-
H8	-	130	130	-
H11	-	165	165	-
H12	-	75	150	-
H21	-	130	130	-

SMG = Seco material group
 f = mm/rev
 v_c = m/min
 All cutting data are start values

SD523 - Ø 15-60 - Metric

SMG		f							v _c
		Ø 15,00-19,49	Ø 19,50-22,49	Ø 22,50-28,49	Ø 28,50-34,49	Ø 34,50-40,49	Ø 40,49-44,49	Ø 44,50-59,99	
P1	P1 DP2000	0,060	0,070	0,085	0,095	0,11	0,12	0,13	415
P2	P1 DP2000	0,060	0,070	0,085	0,10	0,11	0,12	0,13	405
P3	P2 DP3000	0,12	0,14	0,17	0,19	0,22	0,22	0,26	310
P4	P2 DP3000	0,12	0,13	0,16	0,19	0,22	0,22	0,26	190
P5	P2 DP3000	0,11	0,13	0,16	0,18	0,20	0,22	0,24	180
P6	P2 DP3000	0,11	0,13	0,16	0,18	0,20	0,22	0,24	200
P7	P2 DP3000	0,11	0,13	0,16	0,18	0,20	0,22	0,24	190
P8	P2 DP3000	0,12	0,14	0,17	0,19	0,22	0,22	0,26	180
P11	P2 DP3000	0,11	0,13	0,16	0,18	0,20	0,22	0,24	185
P12	P2 DP3000	0,075	0,090	0,11	0,12	0,14	0,15	0,17	110
M1	P2 DP3000	0,085	0,10	0,12	0,14	0,16	0,17	0,19	245
M2	P2 DP3000	0,080	0,090	0,11	0,13	0,14	0,15	0,17	195
M3	MP DS2050	0,065	0,075	0,090	0,10	0,12	0,13	0,14	150
M4	MP DS2050	0,055	0,065	0,080	0,090	0,10	0,11	0,12	120
M5	MP DS2050	0,055	0,065	0,080	0,090	0,10	0,11	0,12	100
K1	P2 DP2000	0,12	0,14	0,17	0,20	0,22	0,24	0,26	225
K2	P2 DP2000	0,11	0,13	0,16	0,18	0,20	0,22	0,24	195
K3	P2 DP2000	0,11	0,13	0,16	0,18	0,20	0,22	0,24	165
K4	P2 DP2000	0,11	0,13	0,16	0,18	0,20	0,22	0,24	160
K5	P2 DP2000	0,10	0,11	0,14	0,16	0,18	0,19	0,22	95
N1	P1 T250D	0,12	0,14	0,17	0,20	0,22	0,24	0,26	310
N2	P1 T250D	0,12	0,14	0,17	0,20	0,22	0,24	0,26	200
N3	P1 T250D	0,12	0,14	0,17	0,20	0,22	0,24	0,26	135
N11	P1 T250D	0,12	0,14	0,17	0,20	0,22	0,24	0,26	260
S1	MP DS2050	0,090	0,11	0,13	0,15	0,17	0,18	0,20	55
S2	MP DS2050	0,090	0,11	0,13	0,15	0,17	0,18	0,20	43
S3	MP DS2050	0,085	0,10	0,12	0,14	0,16	0,17	0,19	37
S11	MP DS2050	0,11	0,12	0,15	0,17	0,19	0,20	0,24	75
S12	MP DS2050	0,11	0,12	0,15	0,17	0,19	0,20	0,24	60
S13	MP DS2050	0,090	0,11	0,13	0,15	0,17	0,18	0,20	45
H3	P1 T250D	0,050	0,060	0,070	0,080	0,095	0,10	0,11	60
H5	P1 T250D	0,075	0,090	0,11	0,12	0,14	0,15	0,17	110
H7	P1 T250D	0,050	0,060	0,070	0,080	0,095	0,10	0,11	60
H8	P1 T250D	0,060	0,070	0,085	0,095	0,11	0,11	0,13	110
H11	P1 T250D	0,075	0,090	0,11	0,12	0,14	0,15	0,17	140
H12	P1 T250D	0,060	0,070	0,085	0,095	0,11	0,11	0,13	130
H21	P1 T250D	0,060	0,070	0,085	0,095	0,11	0,11	0,13	110

SMG = Seco material group

f = mm/rev

v_c = m/min

All cutting data are start values

SD523 Cutting Speed - Metric

SMG	v_c			
	DP2000	DP3000	T2500	DS2050
P1	415	370	265	370
P2	405	360	260	360
P3	345	310	225	310
P4	230	190	120	-
P5	220	180	115	-
P6	250	200	130	-
P7	235	190	120	-
P8	220	180	115	-
P11	225	185	115	-
P12	135	110	70	-
M1	-	245	135	-
M2	-	195	110	-
M3	-	150	85	150
M4	-	115	65	120
M5	-	95	55	100
K1	225	215	-	-
K2	195	185	-	-
K3	165	160	-	-
K4	160	150	-	-
K5	95	90	-	-
N1	-	360	310	310
N2	-	230	200	200
N3	-	155	135	135
N11	-	300	260	260
S1	-	-	34	55
S2	-	-	25	43
S3	-	-	25	37
S11	-	-	65	75
S12	-	-	50	60
S13	-	-	39	45
H3	-	60	60	-
H5	-	115	110	-
H7	-	60	60	-
H8	-	115	110	-
H11	-	145	140	-
H12	-	65	130	-
H21	-	115	110	-

SMG = Seco material group
 f = mm/rev
 v_c = m/min
 All cutting data are start values

SD524 - Ø 17-60 - Metric

SMG		f							v _c
		Ø 17,00-19,49	Ø 19,50-22,49	Ø 22,50-28,49	Ø 28,50-34,49	Ø 34,50-40,49	Ø 40,49-44,49	Ø 44,50-59,99	
P1	P1 DP2000	0,060	0,070	0,085	0,095	0,11	0,12	0,13	380
P2	P1 DP2000	0,060	0,070	0,085	0,10	0,11	0,12	0,13	370
P3	P2 DP3000	0,12	0,14	0,17	0,19	0,22	0,22	0,26	285
P4	P2 DP3000	0,12	0,13	0,16	0,19	0,22	0,22	0,26	165
P5	P2 DP3000	0,11	0,13	0,16	0,18	0,20	0,22	0,24	160
P6	P2 DP3000	0,11	0,13	0,16	0,18	0,20	0,22	0,24	180
P7	P2 DP3000	0,11	0,13	0,16	0,18	0,20	0,22	0,24	170
P8	P2 DP3000	0,12	0,14	0,17	0,19	0,22	0,22	0,26	160
P11	P2 DP3000	0,11	0,13	0,16	0,18	0,20	0,22	0,24	165
P12	P2 DP3000	0,075	0,090	0,11	0,12	0,14	0,15	0,17	95
M1	P2 DP3000	0,085	0,10	0,12	0,14	0,16	0,17	0,19	235
M2	P2 DP3000	0,080	0,090	0,11	0,13	0,14	0,15	0,17	190
M3	MP DS2050	0,065	0,075	0,090	0,10	0,12	0,13	0,14	145
M4	MP DS2050	0,055	0,065	0,080	0,090	0,10	0,11	0,12	105
M5	MP DS2050	0,055	0,065	0,080	0,090	0,10	0,11	0,12	90
K1	P2 DP2000	0,12	0,14	0,17	0,20	0,22	0,24	0,26	210
K2	P2 DP2000	0,11	0,13	0,16	0,18	0,20	0,22	0,24	180
K3	P2 DP2000	0,11	0,13	0,16	0,18	0,20	0,22	0,24	155
K4	P2 DP2000	0,11	0,13	0,16	0,18	0,20	0,22	0,24	145
K5	P2 DP2000	0,10	0,11	0,14	0,16	0,18	0,19	0,22	85
N1	P1 T250D	0,12	0,14	0,17	0,20	0,22	0,24	0,26	270
N2	P1 T250D	0,12	0,14	0,17	0,20	0,22	0,24	0,26	175
N3	P1 T250D	0,12	0,14	0,17	0,20	0,22	0,24	0,26	115
N11	P1 T250D	0,12	0,14	0,17	0,20	0,22	0,24	0,26	230
S1	MP DS2050	0,090	0,11	0,13	0,15	0,17	0,18	0,20	48
S2	MP DS2050	0,090	0,11	0,13	0,15	0,17	0,18	0,20	39
S3	MP DS2050	0,085	0,10	0,12	0,14	0,16	0,17	0,19	33
S11	MP DS2050	0,11	0,12	0,15	0,17	0,19	0,20	0,24	70
S12	MP DS2050	0,11	0,12	0,15	0,17	0,19	0,20	0,24	55
S13	MP DS2050	0,090	0,11	0,13	0,15	0,17	0,18	0,20	41
H3	P1 T250D	0,050	0,060	0,070	0,080	0,095	0,10	0,11	50
H5	P1 T250D	0,075	0,090	0,11	0,12	0,14	0,15	0,17	95
H7	P1 T250D	0,050	0,060	0,070	0,080	0,095	0,10	0,11	50
H8	P1 T250D	0,060	0,070	0,085	0,095	0,11	0,11	0,13	95
H11	P1 T250D	0,075	0,090	0,11	0,12	0,14	0,15	0,17	125
H12	P1 T250D	0,060	0,070	0,085	0,095	0,11	0,11	0,13	110
H21	P1 T250D	0,060	0,070	0,085	0,095	0,11	0,11	0,13	95

SMG = Seco material group

f = mm/rev

v_c = m/min

All cutting data are start values

SD524 Cutting Speed - Metric

SMG	v _c			
	DP2000	DP3000	T250D	DS2050
P1	380	340	230	340
P2	370	330	225	330
P3	320	285	195	285
P4	195	165	105	-
P5	185	160	100	-
P6	210	180	110	-
P7	195	170	105	-
P8	185	160	100	-
P11	190	165	100	-
P12	110	95	60	-
M1	-	235	120	-
M2	-	190	95	-
M3	-	145	75	145
M4	-	110	55	105
M5	-	90	46	90
K1	210	200	-	-
K2	180	170	-	-
K3	155	145	-	-
K4	145	140	-	-
K5	85	85	-	-
N1	-	315	270	270
N2	-	205	175	175
N3	-	135	115	115
N11	-	265	230	230
S1	-	-	29	48
S2	-	-	22	39
S3	-	-	22	33
S11	-	-	55	70
S12	-	-	44	55
S13	-	-	34	41
H3	-	55	50	-
H5	-	100	95	-
H7	-	55	50	-
H8	-	100	95	-
H11	-	125	125	-
H12	-	55	110	-
H21	-	100	95	-

SMG = Seco material group

f = mm/rev

v_c = m/min

All cutting data are start values

SD525 - Ø 19-45 - Metric

SMG		f					v _c
		Ø 19,00-22,49	Ø 22,50-28,49	Ø 28,50-34,49	Ø 34,50-40,49	Ø 40,49-45,00	
P1	P2 DP3000	0,070	0,085	0,095	0,11	0,12	320
P2	P2 DP3000	0,070	0,085	0,10	0,11	0,12	310
P3	P2 DP3000	0,14	0,17	0,19	0,22	0,22	265
P4	P2 DP3000	0,13	0,16	0,19	0,22	0,22	150
P5	P2 DP3000	0,13	0,16	0,18	0,20	0,22	140
P6	P2 DP3000	0,13	0,16	0,18	0,20	0,22	160
P7	P2 DP3000	0,13	0,16	0,18	0,20	0,22	150
P8	P2 DP3000	0,14	0,17	0,19	0,22	0,22	140
P11	P2 DP3000	0,13	0,16	0,18	0,20	0,22	145
M1	P2 DP3000	0,10	0,12	0,14	0,16	0,17	225
M2	P2 DP3000	0,090	0,11	0,13	0,14	0,15	180
M3	MP DS2050	0,075	0,090	0,10	0,12	0,13	140
M4	MP DS2050	0,065	0,080	0,090	0,10	0,11	95
M5	MP DS2050	0,065	0,080	0,090	0,10	0,11	80
K1	P2 DP3000	0,14	0,17	0,20	0,22	0,24	185
K2	P2 DP3000	0,13	0,16	0,18	0,20	0,22	160
K3	P2 DP3000	0,13	0,16	0,18	0,20	0,22	135
K4	P2 DP3000	0,13	0,16	0,18	0,20	0,22	130
K5	P2 DP3000	0,11	0,14	0,16	0,18	0,19	80
N1	P1 T250D	0,14	0,17	0,20	0,22	0,24	240
N2	P1 T250D	0,14	0,17	0,20	0,22	0,24	155
N3	P1 T250D	0,14	0,17	0,20	0,22	0,24	100
N11	P1 T250D	0,14	0,17	0,20	0,22	0,24	200
S1	MP DS2050	0,11	0,13	0,15	0,17	0,18	44
S2	MP DS2050	0,11	0,13	0,15	0,17	0,18	36
S3	MP DS2050	0,10	0,12	0,14	0,16	0,17	31
S11	MP DS2050	0,12	0,15	0,17	0,19	0,20	65
S12	MP DS2050	0,12	0,15	0,17	0,19	0,20	49
S13	MP DS2050	0,11	0,13	0,15	0,17	0,18	38
H3	P1 T250D	0,060	0,070	0,085	0,095	0,10	46
H5	P1 T250D	0,090	0,11	0,12	0,14	0,15	85
H7	P1 T250D	0,060	0,070	0,085	0,095	0,10	46
H8	P1 T250D	0,070	0,085	0,095	0,11	0,11	85
H11	P1 T250D	0,090	0,11	0,12	0,14	0,15	110
H12	P1 T250D	0,070	0,085	0,095	0,11	0,11	100
H21	P1 T250D	0,070	0,085	0,095	0,11	0,11	85

SMG = Seco material group

f = mm/rev

v_c = m/min

All cutting data are start values

SD525 Cutting Speed - Metric

SMG	v _c			
	DP2000	DP3000	T250D	DS2050
P1	355	320	205	320
P2	345	310	200	310
P3	295	265	170	265
P4	165	150	90	-
P5	155	140	90	-
P6	175	160	100	-
P7	165	150	95	-
P8	155	140	90	-
P11	160	145	90	-
P12	95	85	55	-
M1	-	225	105	-
M2	-	180	85	-
M3	-	140	65	140
M4	-	105	49	95
M5	-	85	41	80
K1	195	185	-	-
K2	170	160	-	-
K3	145	135	-	-
K4	140	130	-	-
K5	80	80	-	-
N1	-	285	240	240
N2	-	185	155	155
N3	-	120	100	100
N11	-	235	200	200
S1	-	-	26	44
S2	-	-	20	36
S3	-	-	20	31
S11	-	-	50	65
S12	-	-	39	49
S13	-	-	30	38
H3	-	48	46	-
H5	-	90	85	-
H7	-	48	46	-
H8	-	90	85	-
H11	-	115	110	-
H12	-	50	100	-
H21	-	90	85	-

SMG = Seco material group
 f = mm/rev
 v_c = m/min
 All cutting data are start values

SD542 - Ø 60-85 - Metric

SMG		f		v _c
		Ø60,00-65,00	Ø70,00-85,00	
P1	P2 DP3000	0,095	0,12	230
P2	P2 DP3000	0,10	0,12	225
P3	P2 DP3000	0,19	0,22	195
P4	P2 DP3000	0,19	0,22	205
P5	P2 DP3000	0,18	0,22	195
P6	P2 DP3000	0,18	0,22	220
P7	P2 DP3000	0,18	0,22	205
P8	P2 DP3000	0,19	0,22	195
P11	P2 DP3000	0,18	0,22	200
M1	P2 DP3000	0,14	0,17	230
M2	P2 DP3000	0,13	0,15	185
M3	P1 T250D	0,10	0,12	90
M4	P1 T250D	0,090	0,11	70
M5	P1 T250D	0,090	0,11	55
K1	P2 DP3000	0,20	0,24	165
K2	P2 DP3000	0,18	0,22	145
K3	P2 DP3000	0,18	0,22	120
K4	P2 DP3000	0,18	0,22	115
K5	P2 DP3000	0,16	0,19	70
N1	P1 T250D	0,20	0,24	335
N2	P1 T250D	0,20	0,24	215
N3	P1 T250D	0,20	0,24	145
N11	P1 T250D	0,20	0,24	285
S1	P1 T250D	0,13	0,15	37
S2	P1 T250D	0,13	0,15	27
S3	P1 T250D	0,12	0,14	27
S11	P1 T250D	0,15	0,18	70
S12	P1 T250D	0,15	0,18	55
S13	P1 T250D	0,13	0,15	43
H3	P1 T250D	0,080	0,10	65
H5	P1 T250D	0,12	0,15	120
H7	P1 T250D	0,080	0,10	65
H8	P1 T250D	0,095	0,11	120
H11	P1 T250D	0,12	0,15	155
H12	P1 T250D	0,12	0,15	230
H21	P1 T250D	0,095	0,11	120

SMG = Seco Material Group
 f = mm/rev
 v_c = m/min
 All cutting data are start values

SD542 - Cutting Speed - Metric

SMG	v _c		
	DP2000	DP3000	T250D
P1	280	230	175
P2	270	225	170
P3	235	195	145
P4	255	205	130
P5	245	195	125
P6	275	220	140
P7	260	205	130
P8	245	195	125
P11	250	200	125
M1	-	230	150
M2	-	185	120
M3	-	140	90
M4	-	105	70
M5	-	90	55
K1	215	165	-
K2	190	145	-
K3	160	120	-
K4	150	115	-
K5	90	70	-
N1	-	390	335
N2	-	250	215
N3	-	165	145
N11	-	325	285
S1	-	-	37
S2	-	-	27
S3	-	-	27
S11	-	-	70
S12	-	-	55
S13	-	-	43
H3	-	65	65
H5	-	120	120
H7	-	65	65
H8	-	120	120
H11	-	155	155
H12	-	235	230
H21	-	120	120

SMG = Seco Material Group
 f = mm/rev
 v_c = m/min
 All cutting data are start values

SD572 - Ø 15-52 - Metric

SMG		f						v _c
		Ø15,00-17,00	Ø18,00-20,00	Ø21,00-24,00	Ø25,00-32,00	Ø33,00-36,00	Ø37,00-52,00	
P1	85 DP3000	0,034	0,034	0,038	0,048	0,055	0,065	310
P2	85 DP3000	0,034	0,034	0,040	0,048	0,055	0,070	305
P3	86 DP3000	0,070	0,070	0,080	0,10	0,12	0,16	260
P4	86 DP3000	0,070	0,070	0,080	0,10	0,12	0,16	230
P5	86 DP3000	0,065	0,065	0,080	0,10	0,12	0,15	220
P6	86 DP3000	0,065	0,065	0,075	0,10	0,12	0,15	245
P7	86 DP3000	0,065	0,065	0,075	0,10	0,12	0,15	235
P8	86 DP3000	0,070	0,070	0,080	0,10	0,12	0,16	220
P11	86 DP3000	0,065	0,065	0,075	0,10	0,12	0,15	225
M1	86 DP3000	0,038	0,038	0,042	0,055	0,065	0,085	235
M2	86 DP3000	0,034	0,034	0,038	0,050	0,060	0,075	190
M3	85 DP3000	0,042	0,042	0,048	0,060	0,070	0,080	145
M4	85 DP3000	0,036	0,036	0,042	0,050	0,060	0,070	110
M5	85 DP3000	0,036	0,036	0,042	0,050	0,060	0,070	90
K1	86 DP3000	0,065	0,065	0,080	0,10	0,12	0,15	180
K2	86 DP3000	0,060	0,060	0,070	0,090	0,11	0,14	155
K3	86 DP3000	0,060	0,060	0,070	0,090	0,11	0,14	130
K4	86 DP3000	0,060	0,060	0,070	0,090	0,11	0,14	125
K5	86 DP3000	0,055	0,055	0,065	0,080	0,10	0,13	75
S1	85 DP3000	0,070	0,070	0,085	0,10	0,12	0,14	40
S2	85 DP3000	0,070	0,070	0,085	0,10	0,12	0,14	30
S3	85 DP3000	0,065	0,065	0,075	0,095	0,11	0,13	30
S11	85 DP3000	0,080	0,080	0,095	0,12	0,14	0,16	80
S12	85 DP3000	0,080	0,080	0,095	0,12	0,14	0,16	60
S13	85 DP3000	0,070	0,070	0,085	0,10	0,12	0,14	47
H3	86 DP3000	0,030	0,030	0,036	0,044	0,055	0,070	80
H5	86 DP3000	0,046	0,046	0,055	0,065	0,080	0,10	150
H7	86 DP3000	0,030	0,030	0,036	0,044	0,055	0,070	80
H8	86 DP3000	0,036	0,036	0,040	0,050	0,060	0,080	150
H11	86 DP3000	0,046	0,046	0,055	0,065	0,080	0,10	195
H12	86 DP3000	0,046	0,046	0,055	0,065	0,080	0,10	290
H21	86 DP3000	0,036	0,036	0,040	0,050	0,060	0,080	150

SMG = Seco Material Group

f = mm/rev

v_c = m/min

All cutting data are start values

SD572 - Cutting Speed - Metric

SMG	v_c
	DP2000
P1	375
P2	365
P3	315
P4	280
P5	265
P6	300
P7	280
P8	265
P11	275
M1	285
M2	230
M3	175
M4	130
M5	110
K1	215
K2	185
K3	160
K4	150
K5	90
S1	-
S2	-
S3	-
S11	-
S12	-
S13	-
H3	80
H5	150
H7	80
H8	150
H11	195
H12	290
H21	150

SMG = Seco Material Group
 f = mm/rev
 v_c = m/min
 All cutting data are start values

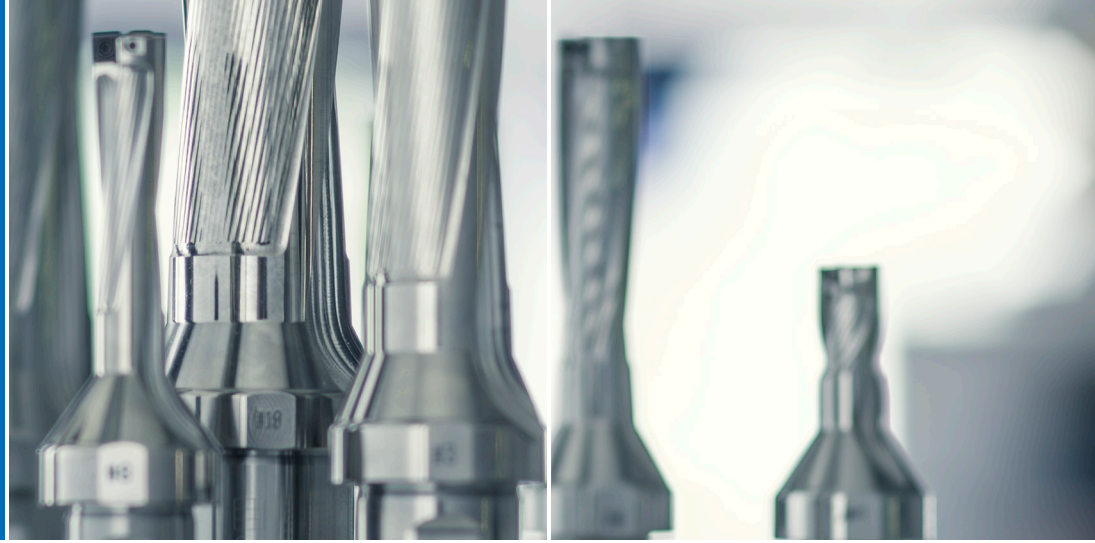

PRICE & DELIVERY TIME AVAILABLE INSTANTLY

A well defined strategy has been created for the total process for custom-made drills from quotation to finished drill. You can now design your own customized Performax drill using our Custom Design software.

- No waiting for quotations! Price and delivery time available on demand
- Directly visualises your needs. No risk of misinterpretation
- Short delivery time

SECO **CUSTOM DESIGN** Version 1.0.4.1

Drilling >> Performax® - SD570 - SD540 - SD600 >> Single Diameter - A... >> Single Diameter - A... >> Drill Diameter 15-60. [Feedback](#)

[Back](#) [Start Page](#) [Login](#) [English](#)

[Print this page](#)

Step 1: Tool Specification
Step 2: Request for Quotation

Inch:

DC ±0.1	Min	Max	<input type="text"/>
	15	60.33	

[Previous](#) [Request quotation](#)

[Spare Parts / Inserts](#)

Note! Inserts have to be ordered separately.
Note! New periphery insert size 11 for diameters 34.5 to 40.49

Designation
SD520-xxx-xxxxxxx

Delivery Time
Quantity: [Send request](#)

Visit: secotools.com
> Business Services
> Custom Products
> Find the tool generator here

DIFFERENT TYPES OF CUSTOM DRILLS - DETAILED INFORMATION CAN BE FOUND IN THE CUSTOM DESIGN SOFTWARE - SD570 THROUGH SD600

A1. Single diameter



A1. Drill dia 0.591-2.362" (15-60 mm)



A1. Drill dia 2.362-4.331" (60-110 mm)

A2. Reinforced

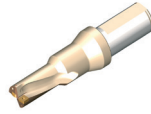

A3. Chamfer

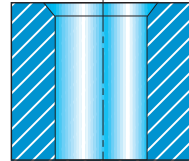

A4. Face

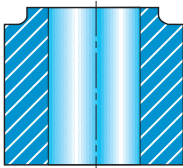
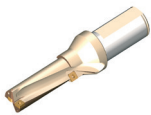

A5. Face with chamfer

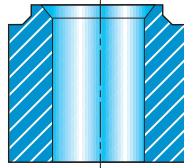
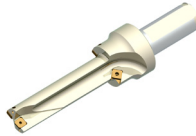

A6. Straight flutes

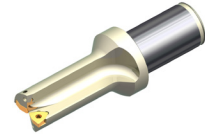

B1. Counterbore

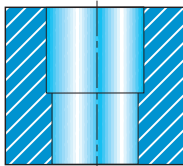

B2. Counterbore and chamfer

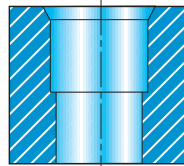

B2. Step

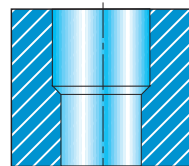

DIFFERENT TYPES OF CUSTOM DRILLS - DETAILED INFORMATION CAN BE FOUND IN THE CUSTOM DESIGN SOFTWARE

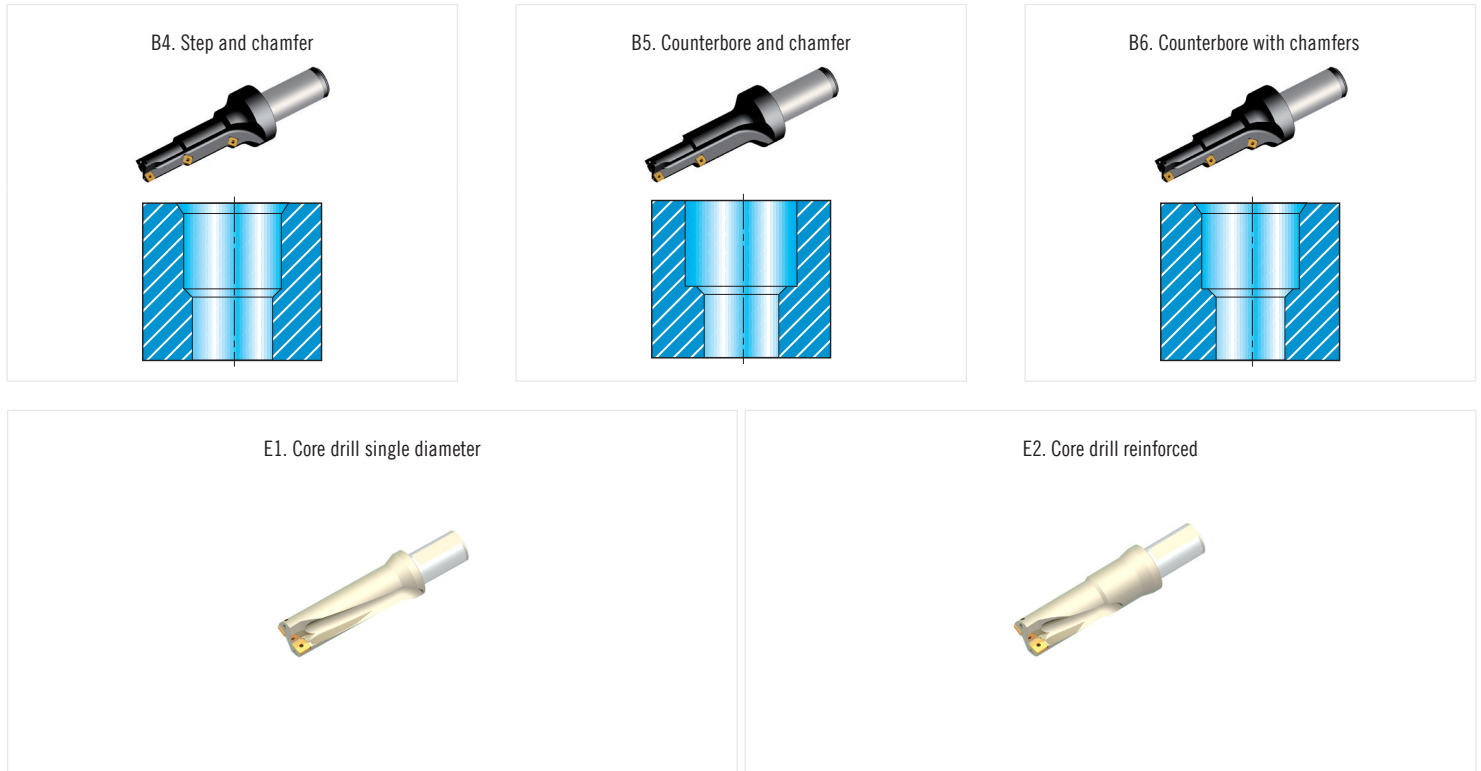

SHANKS - ISO 9766

Universal choice fits into most holders on the market such as:

- Weldon 1835B
- ISO 5414
- DIN 69880

Coolant inlet at the back end of the drill.

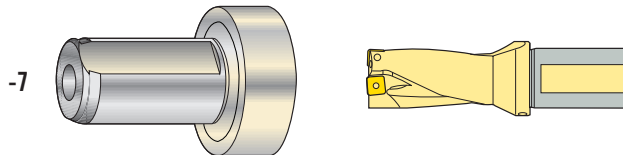

Shank with two flats - Center insert cutting edge above workpiece center line

Center insert cutting edge below workpiece center line

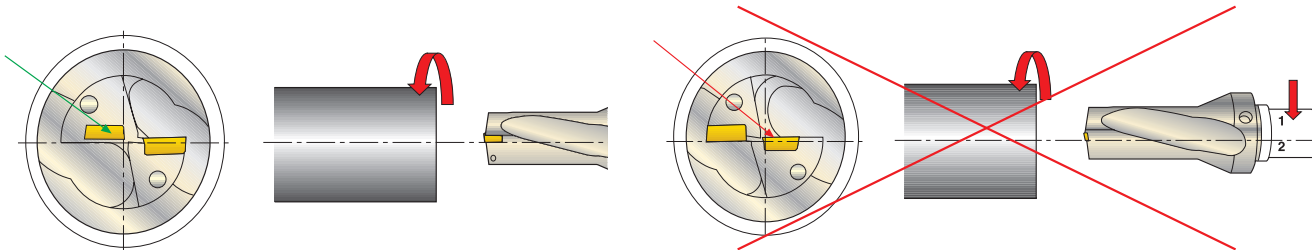

By turning the drill 180 degrees the second flat gives the possibility to compensate for this misalignment in a fast and simple way.

For non rotating applications:

An additional flat is added to the shank for increased flexibility in lathe applications. In such applications the workpiece center line and the drill center line must align. If they don't the center insert could be located above the workpiece center line resulting in poor performance of the drill.

NOTE! If a drill with -7 shank is used in a rotating application together with our adjustable holder, the flat located on the same side as the center insert must be used. Otherwise the drill diameter will be positioned in the wrong way.

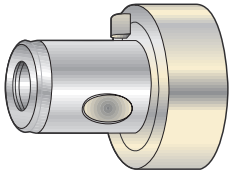
<p>Seco-Capto™</p> <ul style="list-style-type: none"> • Flexible - Same tool holder can easily be used in different machines • Modular - Possibility to build tools with extension adapters • High torque transmission - Torque load is spread symmetrically • High rigidity - Tight press fit guarantees that there is no play in the coupling • Accurate - Tapered polygon coupling produces a strong, self centering joint within 2 microns 		<p>SHANK TYPE</p> <p>-C (4, 5, 6)</p>
<p>Graflex®</p> <ul style="list-style-type: none"> • Fits directly into Graflex holders and locked with two ball headed locking screws placed 120° apart • Short overhang - rigidity and productivity • Cylinder/face connection - great accuracy • Coolant inlet at the back end of the drill 		<p>-G</p>
<p>ABS 50</p> <ul style="list-style-type: none"> • An ABS 50 Compatible shank • Fits directly into ABS 50 holder with one locking screw • Coolant inlet at the back end of the drill 		<p>-2</p>
<p>VDI30 and VDI 40</p> <ul style="list-style-type: none"> • VDI compatible shank • Fits directly into holders for <ul style="list-style-type: none"> - VDI 3425 bl.2 - DIN 69880 <p>NOTE! The coolant ring must ordered separately</p>		<p>-8</p>

1. Fit the ring around the drill but do not tighten the locking screw

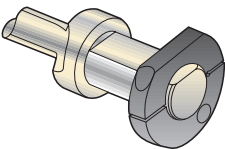

2. Lock the drill in the collet

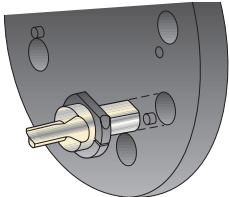

3. Tighten the locking screw in the coolant ring

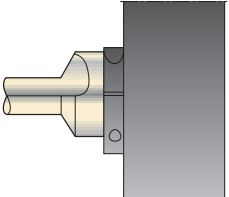

Coolant ring

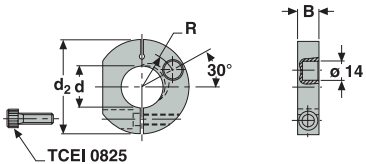

Available in:

VDI 30	VDI 40
	
<p>Accessories Coolant ring</p>	<p>Accessories Coolant ring</p>
<p>SDA5-30R8</p>	<p>SDA5-40R8</p>

Vibrations

- Check mounting of drill.
- Check mounting of workpiece.
- Increase feed. If a very soft material, reduce feed and increase speed.
- Reduce cutting speed.

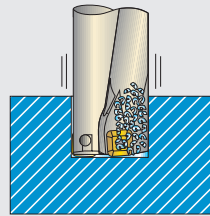

Insufficient torque

- Reduce feed.
- Choose a geometry with harder chipbreaking for lower feeds.

Insufficient power

- Reduce cutting speed.
- Reduce feed.
- Choose a geometry with harder chipbreaking for lower feeds. (SCGX-P1)

Chip jamming problems

Chip jamming due to long chips

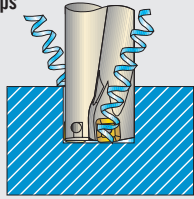

- Increase feed. If a very soft material, reduce feed and increase speed.
- Choose a geometry with harder chipbreaking for lower feeds. (SCGX-P1)

Chip jamming despite short chips

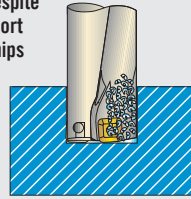

- Increase coolant pressure/ volume.
- Reduce cutting speed.

METHODS

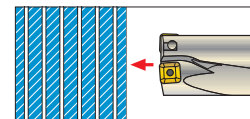

Drilling of stacked materials with no air gaps between the layers, max. .008" (0.2 mm) can be done with the SD502 2xD, SD503 3xD, and the SD542 2.5xD drills. The component must be securely fixed so that no flexing occurs when breaking through each layer.

Tool life problems

Chipping of periphery insert

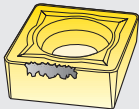

- Reduce entrance feed.
- Choose a tougher grade.
- Choose a geometry with softer chipbreaking for higher feeds. (SCGX-P2)
- Reduce feed.
- Reduce cutting speed.

Too fast flank wear on periphery insert

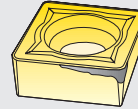

- Reduce cutting speed.
- Increase coolant pressure volume.
- Choose a more wear resistant grade.

Chipping of center insert

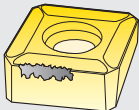

- Check mounting of drill.
- Check mounting of workpiece.
- Reduce entrance feed.
- Increase feed.
- Reduce cutting speed.

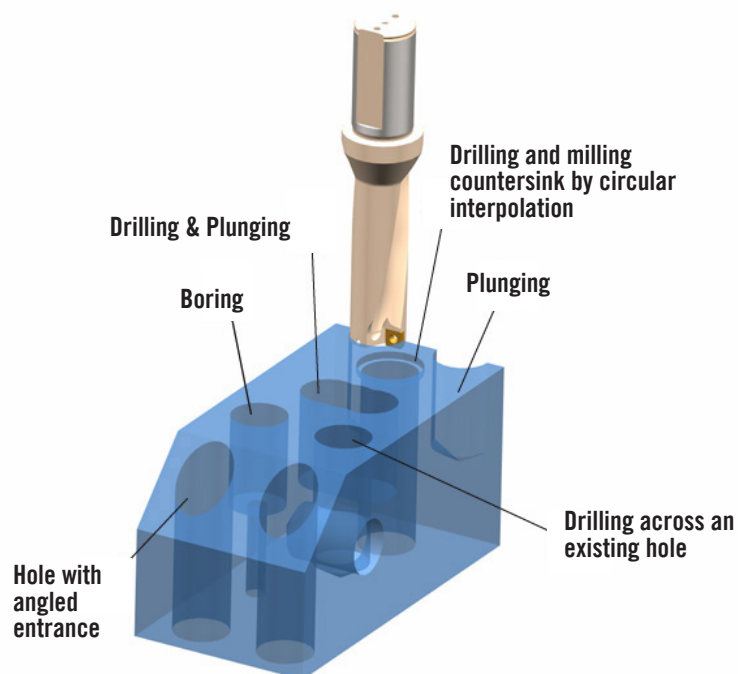

FEED FORCE, NET POWER CONSUMPTION, FORCE GRAPH AND COOLANT VOLUME REQUIREMENT GRAPHS - SD522, 523, 524, 525, 542, 572

INCH

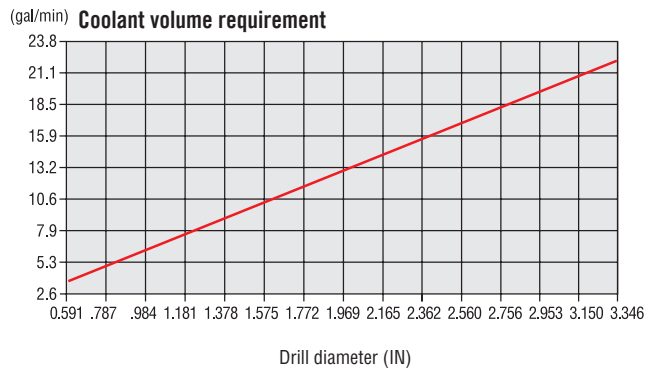
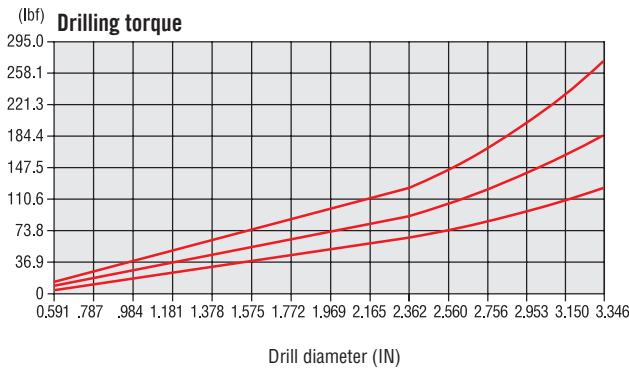
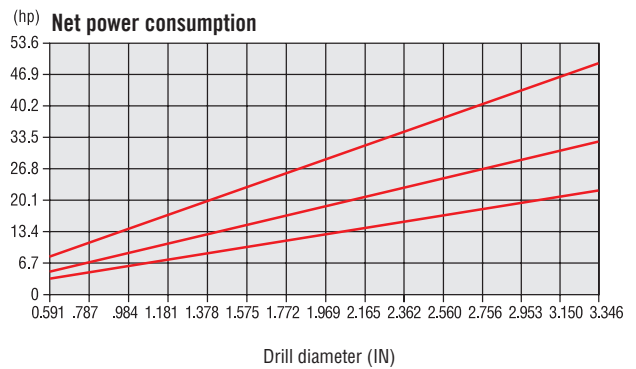
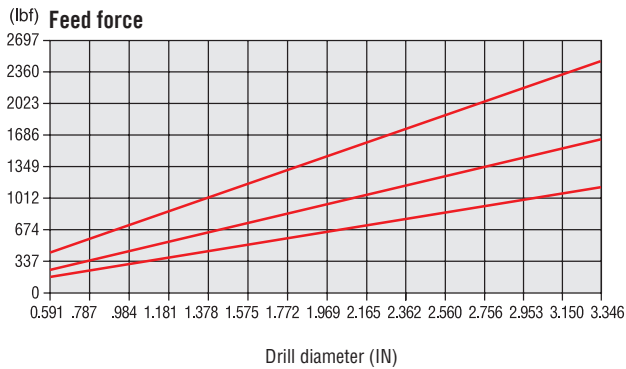

f = 0.007 ipr f = 0.005 ipr f = 0.003 ipr

METRIC

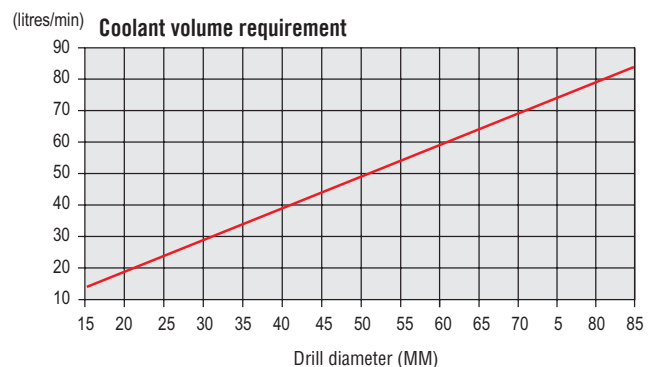
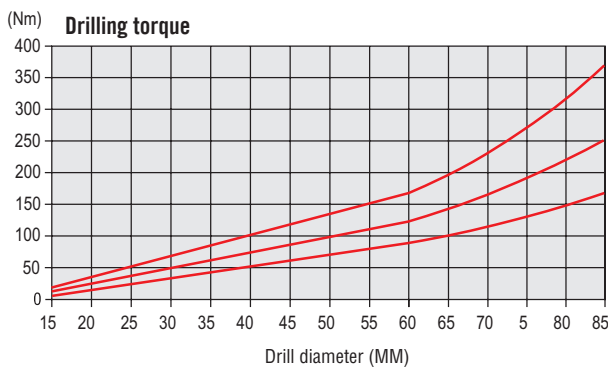
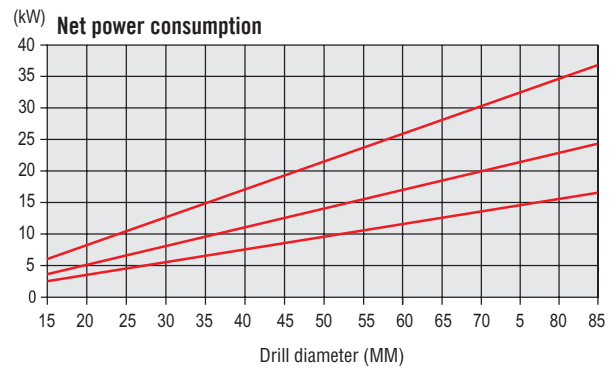
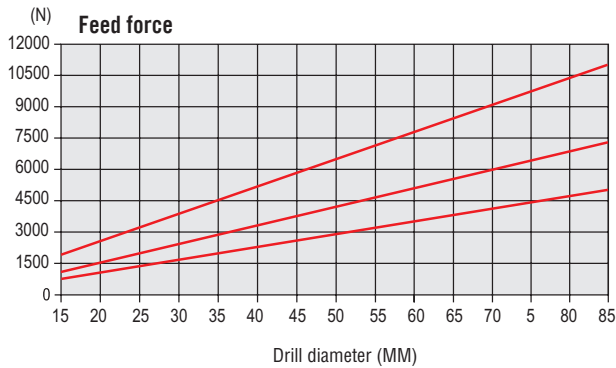

f = 0,18 mm/rev f = 0,12 mm/rev f = 0,08 mm/rev



Follow Seco Tools on Twitter, Facebook, Blogger and YouTube. Stay up to date on new products and technology, special events, promotions and more.

[YOUTUBE.COM/SECOTOOLSUS](https://www.youtube.com/secotoolsus)

SECO TOOLS, LLC
NORTH AMERICAN HEADQUARTERS
2805 Bellingham Drive
Troy, MI 48083
248-528-5200

[SECOTOOLS.COM](https://www.secotools.com)

P-1803-3000 GT18-504D
Copyright © 2018 Seco Tools, LLC
Printed in USA. All rights reserved.

To find an Authorized SECO
Distributor near you, please refer
to our Distributor Locator:

[SECOLOCATOR.COM](https://www.secolocator.com)

For technical assistance, call:
1-800-832-8326

For customer service, call:
1-248-528-5220

