



PIPE TOOLS & VISES
SINCE 1896



REED

Cutters & Cutter Wheels

*Groovers, Power Drives,
Threaders & Dies*

Vises

*Water Services Tools
& Machines*

Plastic Pipe Tools

*Large Diameter
Pipe Tools*

Wrenches

*General Pipe
Working Tools*



Reed Manufacturing has been producing fine tools for worldwide professional trades since its founding, in 1896, by Carl Reed. Purchased in 1902 by Reuben Wright with money he made selling water and hardware during the 1849 California Gold Rush, the company continues to be operated by his descendants: fifth generation members of the Wright family. Standing in front of the portraits of the 1st, 2nd, and 3rd generations of Wrights at Reed are (L-R) Scott Wright (5th generation), Ralph Wright (4th), and Mark Wright (5th). Scott and Mark are co-presidents of Reed and uphold the family traditions of product innovation, highest quality pipe tools, great customer service, a cutting-edge factory (P. 20), and extra value to customers. Ralph continues as chairman of the board. Five generations of Wrights have also provided a great place to work and exceptional contributions to the community. For example, all Reed associates averaged \$2850 each to the United Way 2008-2009 campaign, by far the highest in the region.



PIPE TOOLS & VISES
SINCE 1896



We are dedicated to earning and keeping your business.

Reach us at:

Phone: **800-666-3691** (US/Canada) or **814-452-3691**

7:30 am - 5:30 pm U.S. Eastern Time

Fax: **800-456-1697** (US/Canada) or **814-455-1697**

e-mail: **reedsales@reedmfgco.com**

www.reedmfgco.com

For the latest information on **NEW REED** Tools!

Reed Mission Statement P. 45

Reed Lifetime Warranty P. 76

CUTTERS & CUTTER WHEELS 5

1

- Cutter Wheels..... 6 - 9
- Cutter Wheel Headquarters™..... 10
- NEW** Quick Release™ Tubing Cutters 11
- Tubing Cutters..... 11 - 12
- NEW** Telescoping Tubing Cutters..... 11
- Mini Tubing Cutters..... 12
- Repair Kits..... 12
- Deburring Tools..... 12
- NEW** CSST Tubing Cutters 13
- Steel Pipe Cutters..... 14
- Pipe Reamer..... 14
- Soil Pipe Cutters 15
- Pipe Descalers 16
- Saw It®..... 16
- NEW** Universal Pipe Cutters..... 17
- Hinged Cutters™..... 18
- Rotary™ Cutters & Low Clearance Rotary™ Cutters..... 19

GROOVERS, POWER DRIVES, THREADERS & DIES 21

2

- NEW** Combo Roll Groovers 22
- Roll Groovers..... 23
- NEW** 5301PD Power Drives 24
- 700PD Power Drives..... 24
- 701PD Power Drives..... 25
- 601PD Power Drives..... 25
- Ground Fault Interrupter..... 25
- NEW** R12+ Segmental Dies, Dropheads & Threader Sets 26 - 27
- Dropheads Complete for PVC-Coated Pipe & Conduit..... 27
- Universal Dies..... 28
- Universal Die Head..... 28
- Enclosed Ratchet Threader Sets..... 29
- Enclosed Dropheads..... 29
- Oilers 30
- Threadguard Cutting Oil..... 30
- Adjustable Guide Threader Sets..... 31
- Block Dies..... 31

VISES 32

3

- NEW** Tripod Vises..... 33
- Pipe Jacks 34
- Chain Vises..... 34
- Field Pipe Vise..... 34
- Yoke Pipe Vises..... 35
- Clamping Vises & Jaws for PVC-Coated Pipe & Conduit..... 35
- Utility Workshop Vises..... 36
- Mid-Line Vises..... 36
- Combination Bench & Pipe Vises..... 36
- Machinists' Vises..... 37
- Vise Accessories..... 37
- Pipe Welding Vise..... 37

LARGE DIAMETER PIPE TOOLS 38 - 39

WATER SERVICES TOOLS & MACHINES 40

Direct Tapping Machine.....	41
Drilling Machines.....	42
NEW Combination Drilling / Tapping Machines.....	44
PVC/PE Drilling Machines.....	44
NEW Power Tapping & Drilling Machines.....	45
NEW Feed Tap™ Drilling Machines.....	46
PE Water Service Shut-Off Tool.....	47
Standing Shut-Off Tool.....	47
Copper Shut-Off Tools.....	47
Hammer & Flare Tools.....	48
Rerounding Tools.....	48
NEW Round It® Straightener/Rerounders.....	48
NEW Electric Hydrostatic Test Pumps.....	49
Hydrostatic Test Pumps.....	49
Meter Pit Pump.....	49
NEW Valve & Curb Keys.....	50
NEW Ratcheting Valve Keys.....	50 - 51
NEW Valve Operators.....	51
NEW Valve Key Socket Kit.....	52
Meter Box & Curb Box Lid Keys.....	52
NEW Valve Box Cleaners.....	52
Manhole Hooks.....	52

PLASTIC PIPE TOOLS 53

Quick Release™ Cutters.....	54
Internal Pipe Cutters.....	54
NEW Ratchet Shears.....	55
Scissor Shears.....	55
NEW Plastic Pipe Saws.....	56
NEW PLAS In-Line Rotary™ Cutter.....	56
Bevelers.....	57
Plastic Pipe Joiners.....	57
NEW PE Squeeze-Off Tools.....	58
Guillotine Pipe Cutters.....	59
Grounding Accessory.....	59
Static Discharge Alarm.....	59
NEW PEX Crimpers.....	60
NEW PEX Shut-Off Tools.....	60
Flare Tools for PE Water Service Lines.....	60
Deburring Tools for Plastic.....	61
Chain Vises for Plastic Pipe.....	61

WRENCHES 62

Pipe Wrenches.....	63
Aluminum Pipe Wrenches.....	63
Chain Tongs.....	64
Adjustable Wrenches.....	64
Comfort Grip Wrenches.....	64
Strap Wrenches.....	65
Hydrant Wrenches.....	65
Chain Wrenches.....	65
Ratchet Wrenches & Sockets.....	66
Square Drive Ratchet Wrenches.....	66
NEW Larger Ratchet Wrench & Sockets.....	67
Extended Sockets.....	67
NEW Dual Socket Ratchet Wrenches.....	67
Basin Wrenches.....	68
Torque Wrenches.....	68
One Hand Wrenches.....	68
Comfort Grip One Hand Wrenches.....	68
Operator's Wrench.....	69
Valve Packing Wrenches.....	69
NEW Valve Wheel Wrenches.....	69
Internal Wrench.....	70
NEW Smooth Jaw Wrenches.....	70
NEW Meter Nut Wrenches.....	70

GENERAL PIPE WORKING TOOLS 71

Mechanical Hot Tapping Machine.....	72
NEW Hole Master® Hole Cutting Base.....	72
Hole Saws for DM3MECH & Hole Master®.....	72
NEW Self-Feed Bits.....	73
Bit Extensions.....	73
NEW Ship Augers.....	74
Hack Saw & Blades.....	74
NEW Portable Power Hack Saw Blades.....	74
Stud Punches.....	75
Dam It® Soldering Aids.....	75
Bi-Metal Hole Saws.....	75
Flaring Tools.....	76
Tubing Benders.....	77
Torpedo Level.....	77
Multi-Purpose Pipe Joiner.....	77
Pipe Wrench Pliers®.....	78
Water Pump Pliers.....	78
NEW Smooth Jaw Pliers.....	78
Positive Grip Pliers.....	78

Reed Special Features

Throughout the catalog, various symbols are used to help the reader identify key points:



Reed Exclusive Tool – The tool is unique, available only from Reed, offers operational cost savings or safety features, and at least one advantage to buying Reed.



Reed Exclusive Features – The tool has special features available only from Reed. These meaningful features are advantages to buying Reed.



Reed Exclusive Sizes – The tool is available in certain capacities only from Reed. These unique capacities are advantages to buying Reed.



Reed Best Ever – The tool has been improved over all previous versions. These continuous improvements are advantages to buying Reed.



Reed Training Available – Demonstrations of all Reed products are available on request. Many of the more complex tools are featured on the Reed Piping Solutions video on DVD, CD, or on-line at www.reedmfgco.com.



Next to many of the tools in this catalog, there is a brief statement headed by the term: "**WHY REED?**" This statement explains why that particular Reed tool is superior to any other on the market, and can be used with confidence to compare Reed products with the competition.



New Tool Families are indicated by  symbol, while models added to the Reed line are highlighted in **Red Ink**. To Reed, "**NEW**" means the tool was introduced within the last 12 months.



Reed Extra Value – The tool offers extra cost savings over the previous Reed version – or the competitors'.



Truck Freight Required – These tools require truck freight due to size or weight.



Reed - Registered and Trademarked

Clean Cut®
Cutter Wheel Headquarters™
Dam It®
Feed Tap™

Hinged Cutter™
Hole Master®
Quality First®
Quick Release™ Cutter

Rotary™ Cutter
Round It®
Saw It®
Thru-Bolt™

REED Education and Training

Why Reed Training Services are better...

**Best Service + Best Quality +
 Best People = The Lowest Total Cost**

Reed Manufacturing believes in the importance of continuing education and training. To provide our customers with the best service, all Reed Regional Managers, Manufacturer's Representatives, and Reed Associates are extensively trained in-house. The Product Development department engineers, senior Regional Managers, and Reed management give hands-on tool training sessions annually in addition to the formal, one-on-one, two-week session for new Regional Managers. Reed people know the products inside and out. They assemble them and disassemble them in addition to working with the tools in simulated and field situations. The Reed sales team understands tool applications and recommends to customers how to achieve the best results with Reed pipe tools and vises. These trained salespersons, the Reed Piping Solutions DVD (#01070), and on-line training videos extend the training beyond Reed's Erie, Pennsylvania classrooms.

To request a tool demonstration or consultation, contact Reed: 800-666-3691 (US/Canada), 814-452-3691 (International) or reedsales@reedmfgco.com.

www.reedmfgco.com
 For the latest information on **NEW REED Tools!**



CUTTERS & CUTTER WHEELS

SECTION

1

Cutter Wheels

Quick Release™
Tubing Cutters 

Tubing Cutters

Telescoping Tubing Cutters 

Tubing Cutters for Stainless Steel

Mini Tubing Cutters

Repair Kits

Deburring Tools

CSST Tubing Cutters 

Steel Pipe Cutters

Pipe Reamer

Soil Pipe Cutters

Pipe Descalers

Saw It®

Universal Pipe Cutters 

Hinged Cutters™

Rotary™ Cutters & Low
Clearance Rotary™ Cutters

CUTTERS & CUTTER WHEELS

BEST EVER!

✓ WHY REED? CUTTER WHEELS ARE BETTER...

All Reed cutter wheels are made from high shock-resistant tool steel, while competitive wheels are made from carbon steel or still lower quality tool steel. By using this higher quality raw material, Reed cutter wheels can be made thinner and can therefore cut pipe more easily and leave less burr. Also, because of their higher quality, certified material, only Reed wheels can be heat-treated for the perfect balance between hardness and toughness to make the wheels resist breakage and last longer.

Reed pioneered the development of wheels for plastic pipe and today has the widest variety and highest quality wheels for various types and wall thicknesses of plastic pipe and tubing.

Reed offers the largest cutter wheel line for all types of pipe, tubing and conduit. Reed wheels are the best value for use in Reed cutters, or in the cutters of any other manufacturer.

[CUTTER WHEEL INTERCHANGEABILITY P. 6 - 9](#)

DESIGNED FOR PERFORMANCE

Thickness of
Reed Wheels

Thickness of
All Other Wheels

NEW Reed 2-Pack Replacement Cutter Wheels

Item Code	Reed Catalog No.	Standard Pack*	Reed Cutter	Blade Exposure** inches	mm	Application
2-PACK REPLACEMENT WHEELS						
63655	2PK-OSS	2	TC1Q; TC1.6Q; TC2Q; T10; T15; T20	0.160	4.1	Stainless Steel
63660	2PK-O	2	TC1Q; TC1.6Q; TC2Q; T10; T15; T20; MC3; RT15T1; RT15T2; RT15T3; RTC1.1; RTC1.4	0.180	4.6	Copper; Aluminum; Brass; Steel Tubing
63665	2PK-30-40	2	TC3Q; TC4Q; TC5Q; TC6Q; TC8Q	0.250	6.4	Copper; Aluminum; Brass; Steel Tubing
63670	2PK-R2558	2	TC3Q; TC4Q; TC5Q; TC6Q; TC8Q	0.188	4.8	Muffler Systems Tubing
63671	2PK-30-40SS	2	TC3Q; TC4Q; TC5Q; TC6Q; TC8Q	0.160	4.1	Stainless Steel
64180	2PK-OP2	2	TC1Q; TC1.6Q; TC2Q; T10; T15; T20	0.275	7.0	ABS; PE; PEX; PP; PEX/AL/PEX
64184	2PK-1-2PVC	2	TC1Q; TC1.6Q; TC2Q; T10; T15; T20	0.160	4.1	Stainless Steel
64190	2PK-30-40P	2	TC3Q; TC4Q; TC5Q; TC6Q	0.343	8.7	ABS; PE; PP
64194	2PK-3-6PVC	2	TC3Q; TC4Q; TC5Q; TC6Q	0.377	9.6	3"-6" PVC; 4" Heavy Wall; CPVC
63662	2PK-75015	2	TC11; TC17	0.125	3.2	Copper; Aluminum; Brass; Steel Tubing
63663	2PK-75046	2	TC11; TC17	0.125	3.2	Copper; Aluminum; Brass; Steel; Stainless Steel
63690	2PK-73505	2	TC14	0.170	4.3	Copper; Aluminum; Brass; Steel Tubing
63691	2PK-73515	2	TC14	0.170	4.3	Stainless Steel Only
63661	2PK-32633	2	MC1	0.127	3.2	Copper; Aluminum; Brass; Steel Tubing
63666	2PK-345T	2	MC2	0.146	3.7	Copper; Aluminum; Brass
63659	2PK-OCSST-2	2	TC1.6ORGT; TC2Q; TC2ORGT	0.281	7.1	CSST Tubing
63612	2PK-2RBS	2	2-1; 2-1Q; 2-4WG; 2-3; 2-3Q; 2-4	0.300	7.6	Steel; Stainless Steel
63613	2PK-2RBHD	2	2-1; 2-1Q; 2-4WG; 2-3; 2-3Q; 2-4	0.296	7.5	HD for Steel; Stainless Steel
63634	2PK-ACWR	2	GENERAL - ATC12; ATC34; ATC100	0.125	3.2	Copper

Reed Replacement Cutter Wheels

Item Code	Reed Catalog No.	Standard Pack*	Reed Cutter	Blade Exposure**		Application
				inches	mm	
FOR TUBING CUTTERS – METAL						
03655	OSS	12	TC1Q; TC1.6Q; TC2Q; T10; T15; T20	0.160	4.1	Stainless Steel
03657	3T23	4	T23	0.125	3.2	Copper; Aluminum; Brass; Steel Tubing
03659	OCSST-2	12	TC1Q; TC2Q; TC2QRGT	0.281	7.1	CSST Tubing
03660	O	12	TC1Q; TC1.6Q; TC2Q; T10; T15; T20; MC3; RT15T1; RT15T2; RT15T3; RTC1.1; RTC1.4	0.180	4.6	Copper; Aluminum; Brass; Steel Tubing
03661	32633	12	MC1	0.127	3.2	Copper; Aluminum; Brass; Steel Tubing
03662	75015	12	TC11; TC17	0.125	3.2	Copper; Aluminum; Brass; Steel Tubing
03663	75046	12	TC11; TC17	0.125	3.2	Copper; Aluminum; Brass; Steel; Stainless Steel
03665	30-40	12	TC3Q; TC4Q; TC5Q; TC6Q; TC8Q	0.250	6.4	Copper; Aluminum; Brass; Steel Tubing
03666	345T	12	MC2	0.146	3.7	Copper; Aluminum; Brass
03668	R4546	6	MC2	0.161	4.1	Steel; Stainless Steel
03670	R2558	12	TC3Q; TC4Q; TC5Q; TC6Q; TC8Q	0.188	4.8	Muffler Systems Tubing
03671	30-40SS	12	TC3Q; TC4Q; TC5Q; TC6Q; TC8Q	0.250	6.4	Stainless Steel Tubing
03690	73505	12	TC14; TC166	0.170	4.3	Copper; Aluminum; Brass; Steel Tubing
03691	73515	12	TC14; TC166	0.170	4.3	Stainless Steel Only
FOR TUBING CUTTERS – PLASTIC						
04180	OP2	12	TC1Q; TC1.6Q; TC2Q; T10; T15; T20	0.275	7.0	ABS; PE; PEX; PP; PEX/AL/PEX
04181	2CON	4	TC2Q	0.180	4.6	2" PE Conduit
04184	1-2PVC	12	TC1Q; TC1.6Q; TC2Q; T10; T15; T20	0.280	7.1	PVC; CPVC; PVDS
04187	R10279	4	TC3Q; TC4Q; TC5Q; TC6Q	0.221	5.6	Thin Wall PVC
04188	R1740	4	MC2	0.148	3.7	Soft Flexible Plastic
04190	30-40P	12	TC3Q; TC4Q; TC5Q; TC6Q	0.343	8.7	ABS; PE; PP
04192	680PVC	4	TC6Q; TC8Q	0.575	14.6	PVC – Standard & Heavy Wall; CPVC
04194	3-6PVC	12	TC3Q; TC4Q; TC5Q; TC6Q	0.377	9.6	3"–6" PVC; 4" Heavy Wall; CPVC
04198	6QP	4	TC4Q; TC5Q; TC6Q; TC8Q	0.550	14.0	Thick Wall PE
04199	80P	4	TC6Q; TC8Q	0.750	19.1	ABS; PE; PP
FOR PIPE CUTTERS						
03504	HS4	4	3-1; 3-3; 3-4	0.383	9.7	Steel; Stainless Steel
03522	HI4	4	3-1; 3-3; 3-4	0.258	6.6	Cast Iron; Ductile Iron
03612	2RBS	12	2-1; 2-1Q; 2-4WG; 2-3; 2-3Q; 2-4; 5301PD	0.300	7.6	Steel; Stainless Steel
03613	2RBHD	12	2-1; 2-1Q; 2-4WG; 2-3; 2-3Q; 2-4; 5301PD	0.296	7.5	HD for Steel; Stainless Steel
03620	REU2	4	2-1; 2-3; 2-4; 2-4WG	0.295	7.5	Steel; Stainless Steel
03624	2RBCI	4	2-1; 2-1Q; 2-4WG; 2-3; 2-3Q; 2-4	0.172	4.4	Cast Iron
03532	R1032/S	6	5301PD	0.450	11.4	Steel; Stainless Steel; Schedule 80
FOR HINGED CUTTERS						
03502	HS21/2	4	H21/2	0.312	7.9	Steel; Stainless Steel
03504	HS4	4	H4	0.320	8.1	Steel; Stainless Steel
03505	HSI4	4	H4	0.275	7.0	Steel; Stainless Steel; Cast Iron; Ductile Iron
03506	HS6	4	H6	0.390	9.9	Steel; Stainless Steel
03507	HSI6-8	4	H6; H8	0.350	8.9	Steel; Stainless Steel; Cast Iron; Ductile Iron
03508	HS8-12	4	H8; H12	0.450	11.4	Steel; Stainless Steel
03510	HX21/2	4	H21/2	0.383	9.7	Steel; Stainless Steel; Schd 80
03512	HX4	4	H4	0.383	9.7	Steel; Stainless Steel; Schd 80
03514	HX6	4	H6	0.476	12.1	Steel; Stainless Steel; Schd 80
03516	HX8	4	H8; H12	0.567	14.4	Steel; Stainless Steel; Schd 80
03518	HXX8	4	H8; H12	0.682	17.3	Steel; Stainless Steel; Schd 100
03522	HI4	4	H4	0.258	6.6	Cast Iron; Ductile Iron
03524	HI6	4	H6; H8; H12	0.410	10.4	Cast Iron; Ductile Iron
03525	H6PSE5	4	H6; H8; H12	0.400	10.2	Steel; Cast Iron; Ductile Iron
03624	2RBCI	4	H21/2	0.172	4.4	Cast Iron; Ductile Iron
FOR ROTARY™ CUTTERS						
03530	RCS8-36	4	LCRC8; LCRC12; LCRC16; RC20; RC24; RC30; RC36	0.635	16.1	Steel; Stainless Steel
03531	RC58-36 7MM	4	LCRC8; LCRC12; LCRC16; RC20; RC24; RC30; RC36	0.512	13.0	Spiral Weld Pipe
03533	RCS8-36 6MM	4	LCRC8; LCRC12; LCRC16; RC20; RC24; RC30; RC36	0.394	10.0	Spiral Weld Pipe
03535	RCI8-30	4	LCRC8; LCRC12; LCRC16; RC20; RC24; RC30; RC36	0.500	12.7	Cast Iron; Ductile Iron (manual)
03545	RCDX	4	LCRC8; LCRC12; LCRC16; RC20; RC24; RC30; RC36	0.531	13.5	Heavy Cast Iron; Ductile Iron (PRC)
03550	RCX	4	LCRC8; LCRC12; LCRC16; RC20; RC24; RC30; RC36	0.800	20.3	Heavy Wall Steel; Stainless Steel

REQUIRES: ONE SET (8) OF THE RC8-30XR ROLLERS WHEN USING RCX WHEELS

* Cutter wheels sold to distributors in standard package quantities only.

** Blade Exposure determines wall thickness capacity of cutter wheel.

Cutter Wheel Conversions

Manufacturer Cutter No.	Manufacturer Wheel	Reed Catalog No.	Reed Item Code	Standard Pack*	Blade Exposure**		Application
					inches	mm	
RIDGID®							
50	M-50	R2558	03670	12	0.188	4.8	Muffler Systems Tubing
315	E-2990	R2990	03667	6	0.117	3.0	Copper; Aluminum; Brass; Steel Tubing
10; 15; 20	E-1240	OSS	03655	12	0.160	4.1	Stainless Steel
10; 15; 20	E-1240	O	03660	12	0.180	4.6	Steel
10; 15; 20	F-158	O	03660	12	0.180	4.6	Copper; Aluminum
101; 103; 104; 105; 150; 131P; 132P; 151P; 152P; 153P; 205P; 150L	E-1740	R1740	04188	4	0.148	3.7	Soft Flexible Plastic
101; 103; 104; 105; 118; 150; 150L; 131; 132; 151; 152; 153; 205	E-3469	345T	03666	12	0.146	3.7	Copper; Aluminum; Brass
105; 150; 150L; 131; 132; 151; 152; 153; 205	E-4546	R4546	03668	6	0.161	4.1	Steel; Stainless Steel
131P; 132P; 151P; 152P; 153P; 205P	E-2155	R2155	04185	6	0.295	7.5	PE; PP – Standard & Heavy Wall
131P; 132P; 151P; 152P; 153P; 205P	E-5272	R5272	04186	6	0.295	7.5	PVC; ABS – Standard Wall
134P; 136P; 154P; 156P	E-702	680PVC	04192	4	0.575	14.6	PVC – Standard & Heavy Wall; CPVC
134P; 136P; 154P; 156P	E-2157	6QP	04198	4	0.550	14.0	Thick Wall PE
134P; 154P; 136P; 156P	E-10279	R10279	04187	4	0.221	5.6	Thin Wall PVC
136P; 156P	E-2880	80P	04199	4	0.750	19.1	ABS; PE; PP
1A; 2A; 42A; 202; 360; 820; 364; 732; 300 power drive	E-1032S	R1032/S	03532	6	0.450	11.4	Steel; Stainless Steel; Schedule 80
1A; 2A; 42A; 202; 360; 820; 364; 732	F-514	2RBS	03612	12	0.300	7.6	Steel; Stainless Steel
1A; 2A; 42A; 202; 360; 820; 364; 732	F-3	2RBHD	03613	12	0.296	7.5	HD for Steel; Stainless Steel
1A; 2A; 42A; 202; 360; 820; 364; 733	F-3S	2RBHD	03613	12	0.296	7.5	HD for Steel; Stainless Steel
1A; 2A; 42A; 206; 360; 820; 364; 732	F-119	2RBCI	03624	4	0.172	4.4	Cast Iron
30; 40; 106; 108; 109; 133; 134; 136; 154; 156	E-2191	30-40	03665	12	0.250	6.4	Copper; Aluminum; Brass; Steel Tubing
30; 40; 106; 108; 109; 133; 134; 136; 154; 156	E-2558	30-40	03665	12	0.250	6.4	Copper; Aluminum; Brass; Steel Tubing
30; 40; 106; 108; 109; 133; 134; 154; 136; 156	E-2558	R2558	03670	12	0.188	4.8	Muffler Systems Tubing
30P; 40P; 106; 108; 109P; 133P; 134P; 136P; 154P; 156P	E-5299	3-6PVC	04194	12	0.377	9.6	3”-6” PVC; 4” Heavy Wall
30P; 40P; 106; 108; 109P; 133P; 134P; 154P; 136P; 156P	E-5299	30-40P	04190	12	0.343	8.7	ABS; PE; PP
30P; 40P; 133P; 134P; 136P; 154P; 156P	E-2156	30-40P	04190	12	0.343	8.7	ABS; PE; PP
3S; 4S; 44S; 466S; 466C; 466HWS; 468C; 468S; 468HWS; 472C; 472S; 472HWS; 764	F-229	3RG	03616	4	0.399	10.1	Steel; Stainless Steel
3S; 4S; 44S; 466S; 466C; 466HWS; 468C; 468S; 468HWS; 472C; 472S; 472HWS; 764	F-229S	3RG	03616	4	0.399	10.1	Steel; Stainless Steel
3S; 4S; 44S; 466S; 466C; 466HWS; 468C; 468S; 468HWS; 472C; 472S; 472HWS; 764	F-515	3RG	03616	4	0.399	10.1	Steel; Stainless Steel
42A; 202; 360; 820; 364; 732; 300 power drive	E-1032	R1032/S	03532	6	0.450	11.4	Steel; Stainless Steel; Schedule 80
466; 468; 472; 1224	E-1962	3RGCI	03617	4	0.285	7.2	Cast Iron; Ductile Iron
466C; 466S; 466HWS; 468C; 468S; 468HWS; 472C; 472S; 472HWS	E-3186	R3186	03526	4	0.680	17.3	Steel; Ductile Iron Heavy Wall
6S; 208; 209	F-367	R367	03639	6	0.480	12.2	Steel; Ductile Iron Heavy Wall
ARMSTRONG®							
1T; 2T; 2TA		2RBS	03612	12	0.300	7.6	Steel; Stainless Steel
1T; 2T; 2TA		2RBHD	03613	12	0.296	7.5	HD for Steel; Stainless Steel
4A		3RG	03616	4	0.399	10.1	Steel; Stainless Steel
4A		3RGCI	03617	4	0.285	7.2	Cast Iron; Ductile Iron
GASTITE®							
RT15T1; RT15T3; RT15T2; T15T1; T15T2		O	03660	12	0.180	4.6	Copper; Aluminum; Brass; Steel Tubing; CSST
GENERAL WIRE SPRING®							
ATC12; ATC34; ATC100	ATCW	ACWR	03634	12	0.125	3.2	Copper
IMPERIAL EASTMAN®							
127-F/FA/FB; TC1050; 227-FA	S32633	32633	03661	12	0.127	3.2	Copper; Aluminum; Brass
TC1000; TC1020; 374; 312-FC/FB; 274-FC/FB; 174-F	S75015	75015	03662	12	0.125	3.2	Copper; Aluminum; Brass; Steel Tubing
TC1000; TC1020; 374; 312-FC/FB; 274-FC/FB; 174-F	S75046	75046	03663	12	0.125	3.2	Copper; Aluminum; Brass; Steel; Stainless Steel

Cutter Wheel Conversions

Manufacturer Cutter No.	Manufacturer Wheel	Reed Catalog No.	Reed Item Code	Standard Pack*	Blade Exposure** inches	Blade Exposure** mm	Application
LENOX®							
21010-TC11/8; 21011-TC13/8; 21012-TC13/4	21017-TCW158C	O	03660	12	0.180	4.6	Copper; Aluminum; Brass; Steel Tubing
21010-TC11/8; 21012-TC13/4; 21011-TC13/8; 21013-TC25/8	21015-TCW158SS	OSS	03655	12	0.160	4.1	Brass; Stainless Steel
21013-TC25/8	21016-TCW158P	1-2PVC	04184	12	0.280	7.1	PVC; Plastic
STAHLWILLE®							
2" PIPE CUTTER		REU2	03620	4	0.295	7.5	Steel; Stainless Steel
SWAGELOK®							
MS-TC-308	MS-TCW-308	OSS	03655	12	0.160	4.1	Stainless Steel
VIRAX®							
2101 10; 2101 20; 2101 30		REU2	03620	4	0.295	7.5	Steel; Stainless Steel
WHEELER REX®							
95041	8050	HS4	03504	4	0.320	8.1	Steel; Stainless Steel
95041	8078	HS4	03504	4	0.320	8.1	Steel; Stainless Steel
95061	8052	HS6	03506	4	0.390	9.9	Steel; Stainless Steel
95081; 95121	8054	HS8-12	03508	4	0.450	11.4	Steel; Stainless Steel
	8002	HX21/2	03510	4	0.383	9.7	Steel; Stainless Steel; Schd 80
95041	8051	HI4	03522	4	0.258	6.6	Cast Iron; Ductile Iron
95061; 95081; 95121	8053	HI6	03524	4	0.410	10.4	Cast Iron; Ductile Iron
95061; 95081; 95121	8076	H6PSE5	03525	4	0.400	10.2	Steel; Cast Iron; Ductile Iron
	8839	RCS8-36	03530	4	0.635	16.1	Steel; Stainless Steel
6090; 7090; 6190; 6290; 6390; 6490; 6590; 6790; 6793; 6794; 6890	60324	RXM	03534	1	0.432	11	Steel Pipe
	8838	RCI8-30	03535	4	0.500	12.7	Cast Iron; Ductile Iron
9590	8001	2RBHD	03613	12	0.296	7.5	HD for Steel; Stainless Steel
	8004	3RG	03616	4	0.399	10.1	Steel; Stainless Steel
	8016	3RG	03616	4	0.399	10.1	Steel; Stainless Steel
	8006	R367	03639	6	0.480	12.2	Steel; Ductile Iron Heavy Wall
9290; 9291	8012	OSS	03655	12	0.160	4.1	Stainless Steel
9290; 9291	8015	O	03660	12	0.180	4.6	Copper; Aluminum; Brass; Steel Tubing
	8021	30-40	03665	12	0.250	6.4	Copper; Aluminum; Brass; Steel Tubing
9490	8025	30-40	03665	12	0.250	6.4	Copper; Aluminum; Brass; Steel Tubing
	8034	345T	03666	12	0.146	3.7	Copper; Aluminum; Brass
	8045	R4546	03668	6	0.161	4.1	Steel; Stainless Steel
90735; 90728; 90750	8071	73505	03690	12	0.170	4.3	Copper; Aluminum; Brass; Steel Tubing
	8065	OP2	04180	12	0.275	7	ABS; PE; PEX; PP; PEX/AL/PEX
	8036	30-40P	04190	12	0.343	8.7	ABS; PE; PP
	8037	3-6PVC	04194	12	0.377	9.6	3"-6" PVC; 4" Heavy Wall; CPVC

* Cutter wheels sold to distributors in standard package quantities only.

** Blade Exposure determines wall thickness capacity of cutter wheel.



PIPE TOOLS & VISES
SINCE 1896

**Reed has the widest variety of high-quality wheels
for more cutters and more brands than any other manufacturer!**



Replacement wheels for every pipe and every pipe cutter

Be on the **CUTTING** edge with Reed!

DESIGNED FOR PERFORMANCE

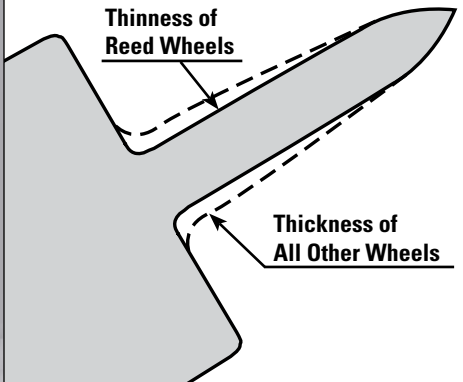

Optimally thin tool profile cuts pipe easily, leaves less burr and lasts longer!

Reed offers the largest cutter wheel line for all types of pipe, tubing and conduit.

The most popular types of genuine Reed cutter wheels (P. 6) are also sold in convenient, two-pack display bags for quick and easy showroom purchases.



Front

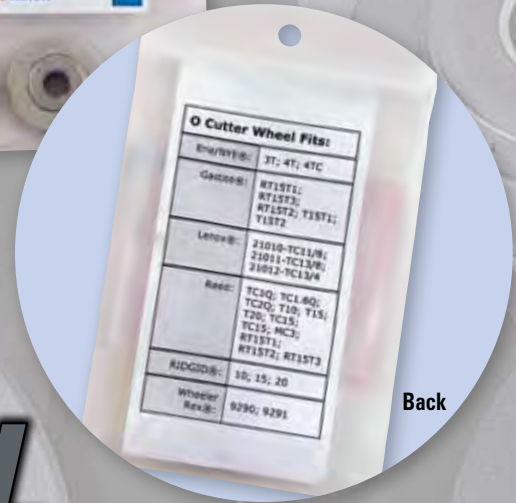

Back

Your distributorship can become a

CUTTER WHEEL HEADQUARTERS™



Distributors participating in Cutter Wheel Annual Contracts are eligible for this durable, metal display case that makes choosing the right wheel easy. Additional showroom support includes our large counter mat with handy wheel conversion charts. Wheel conversions are also available at www.reedmfgco.com. Contact your Reed Rep or Regional Manager for program details.

www.reedmfgco.com



PIPE TOOLS & VISES
SINCE 1898

Quick Release™ Tubing Cutters

Best tracking, easiest cutting tubing cutters available. Cut copper, aluminum, light wall steel, and stainless steel tubing. With alternate wheels it will cut a wide variety of plastic pipe and tubing. Three new cutters feature the **R2558** wheel for muffler systems tubing. **TC10**, **TC1.6Q** and **TC20** sliding bars are die-cast zinc aluminum for greater strength. Each of these three also features a built-in reamer and **spare cutter wheel in the knob**. Xtra Value – just change the wheel to cut a wide variety of tubing.

Catalog No.	Item Code	O.D. Capacity		Length		Weight		Wheel
		Actual Inches	Actual Ø mm	in	mm	lbs	kg	
TC1Q*	03410	1/8 - 1 5/16	3 - 33	6	152	0.6	0.3	0
TC1.6Q*	03416	1/4 - 1 5/8	6 - 42	6.5	165	0.8	0.4	0
TC2Q*	03420	1/4 - 2 5/8	6 - 63	8	203	1.2	0.5	0
TC3Q	03430	3/8 - 3 1/2	10 - 90	11	279	2.5	1.1	30 - 40
★ TC3Q2558	03439	3/8 - 3 1/2	10 - 90	11	279	2.5	1.1	R2558
TC4Q	03440	1 7/8 - 4 1/2	48 - 114	12	305	2.8	1.3	30 - 40
★ TC5Q2558	03459	2 1/2 - 5	63 - 125	13	330	3.0	1.4	R2558
TC6Q	03460	4 - 6 5/8	102 - 168	15	381	3.9	1.8	30 - 40
★ TC6Q2558	03469	4 - 6 5/8	102 - 168	15	381	3.9	1.8	R2558

★ **NEW**

*Spare "0" Cutter Wheel in Knob.

CUTTER WHEELS ON P. 6 - 7

QUICK RELEASE™ CUTTERS FOR PLASTIC ON P. 54



✓ WHY REED?

Quick Release™ cutter is a Reed invention and still the industry standard! First used by Reed, the ball detent wheel pin makes cutter wheel change easy. No other cutter on the market tracks or cuts as well!

Tubing Cutters

Popular copper tubing cutters are long-lasting due to quality construction and have a large grip knob for comfort during use. A reamer is built inside grip knob for convenience and safety. Wide rollers yield a square cut while thin cutter wheel profile ensures a quick, clean cut. When structures, equipment, or ditch walls get in the way, the three wheel **T23** requires only 3" clearance and a 150° cutting radius. Large capacity (2" nominal) means the T23 gets the job done when mini cutters are too small. Includes large knob with built-in reamer for comfort and convenience, plus large reamer in body for larger tubing clean-up.

Catalog No.	Item Code	O.D. Capacity		Weight		Cutter Wheel**		
		Actual Inches	Actual Ø mm	lbs	kg	Copper	Plastic	
T10	03483	1/8 - 1	3 - 25	0.9	0.4	0	OP2	1 - 2PVC
T15	03485	3/16 - 1 1/4	4 - 32	1.3	0.6	0	OP2	1 - 2PVC
T20*	03487	5/8 - 2 1/8	15 - 54	1.5	0.7	0	OP2	1 - 2PVC
T23*	03496	3/4 - 2 1/8	19 - 54	1.4	0.6	3T23	-	-

*EXCLUSIVE

**Ships with wheel for copper. To cut plastic pipe, order recommended cutter wheel separately.

*AWWA Approved for Tapping Contest.

CUTTER WHEELS ON P. 6 - 7

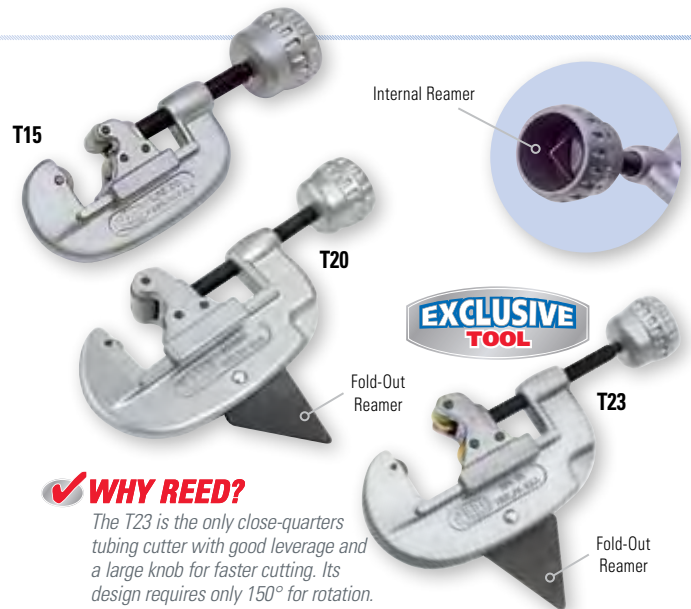

✓ WHY REED?

The T23 is the only close-quarters tubing cutter with good leverage and a large knob for faster cutting. Its design requires only 150° for rotation.

Telescoping Tubing Cutters

Telescoping Tubing Cutters are a good choice for tight spaces as their feed screw keeps them a consistent size throughout the cut. **TC11** tubing cutter with strong, aluminum alloy body and nickel-chrome finish, makes a clean, square cut. Cutters have easy action, enclosed feed screw, fold-out reamer, grooved rollers, and spare cutting wheel. **TC14** and **TC166** move smoothly and offer a pencil reamer. TC14 features a spare cutter wheel.

Catalog No.	Item Code	O.D. Capacity		Weight		Cutter Wheel**	Heavy-Duty Wheel
		Actual Inches	Actual Ø mm	lbs	kg		
TC11	03480	1/8 - 1 1/8	3 - 28	0.7	0.3	75015	75046
TC14*	03475	1/4 - 1 3/8	6 - 35	1.1	0.5	73505	73515
★ TC166	03485	1/4 - 1 5/8	6 - 42	1.2	0.5	73505	73515

★ **NEW**

*Replacement deburring blade available (Item Code #03473 or #94437 for 10 pack).

**Ships with regular wheel. Order heavy-duty wheels separately.

CUTTER WHEELS ON P. 6 - 7



1

T15SS



✓ WHY REED?
 Only Reed offers such a wide variety of professional-quality cutters with wheels for stainless installed. No more early replacement of the first wheel!

TC11SS

Fold-Out Reamer

Spare Cutter Wheel Storage



MC3



MC2



MC2GRIP



MC1

✓ WHY REED?

MC1 features smallest cutting radius in the industry and finer screw thread for easier tightening. MC2 is heavy-duty – the strongest mini cutter available. MC2GRIP also includes a larger, high-torque feed. Larger, deeply knurled knob allows easier tightening.

Tubing Cutters for Stainless Steel

Reed tubing cutters are equipped with special wheels for stainless steel. Reed wheels for stainless tubing use specialized steel for toughness and heat dissipation, resulting in long wheel life. **T10SS, T15SS, and T20SS** offer a large knob for firm grip and easy turning, along with an internal reamer in the knob. **TC11SS** telescoping cutter includes a fold-out reamer and spare wheel for stainless tubing.

Catalog No.	Item Code	Capacity		Cutter Wheel	Weight	
		Actual in	Actual mm		lbs	kg
T10SS	03476	1/8 - 1	3 - 25	OSS	0.9	0.4
T15SS	03477	3/16 - 1 1/4	4 - 32	OSS	1.4	0.6
T20SS	03479	5/8 - 2 1/8	15 - 54	OSS	1.5	0.7
TC11SS*	03481	1/8 - 1 1/8	3 - 28	75046*	0.7	0.3

*Includes spare cutter wheel.

CUTTER WHEELS ON P. 6 - 7

Mini Tubing Cutters

For use in extremely tight places, these tubing cutters require minimal swing around the tubing. Mini cutters can be used on copper, steel, stainless steel, and aluminum tubing. **MC2GRIP** has rounded corners and edges of the body for a more comfortable grip when rotating the cutter around tubing. **MC3SL** contains a self-feeding cutter wheel. After tightening the feed screw, the tool cuts faster by providing a more consistent cutting force on the wheel.

Catalog No.	Item Code	O.D. Capacity		Weight		Cutter Wheel	Cutter Swing Inches
		Actual Inches	Actual Ø mm	lbs	kg		
MC1	03470	1/8 - 5/8	3 - 15	0.2	0.1	32633	1 1/4
MC2	03490	1/8 - 15/16	3 - 24	0.3	0.1	345T	1 11/16
MC2GRIP	03493	1/8 - 15/16	3 - 24	0.4	0.2	345T	1 11/16
MC3	03495	1/8 - 1 1/8	3 - 28	0.4	0.2	0	1 7/8
MC3SL	03341	1/8 - 1 1/8	3 - 28	0.4	0.2	0	1 7/8

CUTTER WHEELS ON P. 6 - 7

Repair Kits for Tubing Cutters

RPR Kit contains the parts, except body, for all Reed TCQ and TCQP sizes 1 through 6. It also contains blades for ratchet and scissor shears. It is a great choice for distributor counter repairs or maintenance departments. Simple field repairs can be handled with **1-2 Parts** and **3-4-6 Parts** kits which are plastic bags containing the most popular parts for Quick Release™ Cutters. Common spare parts for T10, T15, and T20 cutters are contained in **T10-T15-T20 Parts** kit.

Catalog No.	Item Code	Weight	
		lbs	kg
1-2 Parts	03009	2.2 oz	0.1
3-4-6 Parts	03010	3.3 oz	0.1
RPR Kit	03011	5.5 lbs	2.5
T10-T15-T20 Parts	03014	3.0 oz	0.1

Deburring Tools

These feature a long-lasting, hardened tool steel deburring blade. **DEBO** eliminates internal burrs in copper tubing. It has an aluminum handle and handy pocket clip. **DEB3** deburrs aluminum, copper, and steel tubing. It has a plastic body and three spare blades stored in its handle, giving this tool extra value.

Catalog No.	Item Code	Nominal Pipe Capacity	Weight	
			lbs	kg
DEBO	04434	unlimited	0.1	0.05
DEB3*	04437	unlimited	0.1	0.05

*Reamer replacement blade #94437 fits DEB3, TC1.6Q, and TC14.

DEBURRING TOOLS FOR PLASTIC ON P. 61

Repair cutters on-site for less lost time!

RPR Kit

1-2 PARTS

3-4-6 PARTS



XTRA VALUE!

DEB3



DEBO



CSST Tubing Cutters †

Reed offers CSST (corrugated stainless steel tubing) Tubing Cutters in different models for cuts with the outer plastic wrapper jacket on or off. They fit 1/4" up to 2 1/2" CSST flexible gas piping. For cuts with the jacket off, Reed recommends the **RT15T1** and the **RT15T2** which feature a special nylon roller design allowing square and central cuts for optimal flaring in various CSST systems. The **TC1.6QCSST** is a great option for cutting CSST tubing up to 1 5/8" with the jacket on. For cuts of 1 1/4" up to 2 1/2" with the jacket either off or on, Reed recommends the **TC2QRGT**.

Catalog No.	Item Code	Capacity	Weight		Roller	Jacket
			lbs	kg		
RT15T1	03497	3/8" & 1/2"	1.3	0.6	RT15T1R	Off
RT15T2	03498	3/4" & 1"	1.3	0.6	RT15T2R	Off
★ TC1.6QCSST	03418	1/4" - 1 5/8"	0.8	0.4	CORRUGATED	On
★ NEW TC2QRGT	03426	1/4" - 2 1/2"	1.2	0.5	RGT2QLR	Off or On

† Reed's tested cutters are suitable for Gastite®, Parker Parflex®, WARDFLEX®, TracPipe®, and Pro-Flex® systems.

ACCESSORIES

ROLLERS

Item Code	Roller	Description
93628	TC16QR	Regular Roller for TC1.6Q/TC1.6QCSST
93438	RT15T1R	Corrugated Rollers for 1/2" and 3/8" CSST tubing
93439	RT15T2R	Corrugated Rollers for 3/4" and 1" CSST tubing
93444	RGT2QSR	Small Roller for TC2QRGT
93446	RGT2QLR	Large Roller for TC2QRGT

CSST CUTTER WHEELS

Catalog No.	Item Code	Blade Exposure		Fits
		in	mm	
0	03660	0.180	4.6	RT15T1, RT15T2
OCSST-2	03659	0.281	7.1	TC1.6QCSST, TC2QRGT

CUTTER WHEELS ON P. 6-7

XTRA VALUE!

EXCLUSIVE FEATURES

Change the rollers and cutter wheel to use as a regular tubing cutter.



✓ WHY REED?

Reed works with pipe and tube manufacturers to constantly improve piping solutions.



Left Photo - Top Row, L to R - Mike Pruzinsky, Pat Reinke, Bill Stevens, Debbie Sulecki, Steve Angermeier
Seated L to R - Joyce Carr, Todd Gilpatrick, LaVerna Ritchie



Above Photo - Top Row, L to R - Gene Lachman, Minnie Confer, Tom Fess, Marnie Caldwell
Seated L to R - Julie Machinski, Patty Soderberg, Rich Stummer



Left Photo - Top Row, L to R - Carrie Applequist, Sophia Liuxuelian, Matt Harvey, Michael Balliett
Seated L to R - Brian Gunderson, Wan-Xin Werstler, Tim Donohue

From our family to yours...

Reed Associates have produced fine tools for professional trades around the world since 1896. Reed engineers developed many of the most innovative and effective tools in the industry – such as the Quick Release™ Tubing Cutter, the Hinged Cutter™, the Rotary™ Cutter, and the Universal Pipe Cutter. Many of these tools have been copied by others, but through continuous improvements and everyday dedication to quality workmanship, Reed products remain the finest in the world.

The goals of each Reed Associate are to ship 98% of orders within three working days, to provide immediate, informed responses to customer inquiries and to produce 100% error-free work. Reed works diligently to cultivate relationships with dependable distributors to reach the end-user market. Selling through traditional, local distributors is the best avenue to strengthen ties with Reed tool users. The strong links in the customer service chain – from product development and manufacturing, through order processing and inquiry fulfillment, to distribution – make Reed a leader in customer satisfaction. Reed identifies the best people to provide the best quality tools which results in the best service available.

**Best Service + Best Quality +
Best People = The Lowest Total Cost**

**QUALITY
& Service**
that Last a Lifetime

Steel Pipe Cutters

4-Wheel With Guides – Spring-tensioned guide bars of **2-4WGA** provide square alignment for 4-wheel cutters. The short handle allows for close-quarter work. Thinnest wheels of highest quality tool steel make cutting easier and faster. Sharper wheels allow shorter handles for work in smaller spaces.

Standard – Strong malleable iron frames and wide rollers ensure square cuts. Thinnest wheels of highest quality tool steel make cutting easier and faster. Sharper wheels allow shorter handles for work in smaller spaces. The **2-1** cutter leaves no burr, which is great for threading jobs; the **2-3** with three wheels means more cutting surface and less handle swing.

Catalog No.	Item Code	Pipe Capacity		Length		Weight		Wheel*
		Inches-Nom.	Actual OD Ø mm	in	mm	lbs	kg	
4-WHEEL WITH GUIDES								
2-4WGA*	03338	1/2 - 2	21 - 63	14.3	362	7.2	3.3	2RBS
STANDARD 1-WHEEL								
2-1	03320	1/8 - 2	10 - 63	15.8	400	6.9	3.1	2RBS
STANDARD 3-WHEEL								
2-3	03305	1/8 - 2	10 - 63	15.8	400	6.8	3.1	2RBS
STANDARD 4-WHEEL								
2-4	03335	1/2 - 2	21 - 63	14.3	362	6.8	3.1	2RBS

***EXCLUSIVE**

*2RBS wheels available for cast iron. 2RBHD heavy-duty wheels available for steel and stainless steel. CUTTER WHEELS ON P. 6 - 7

Replacement Wheel Pins available for Ridgid® cutters: 1-A, 2-A, 42-A, 202, 2000A. Order Reed pin R34780 #93320 5/pk. to replace Ridgid® pin No. 34780 (Old #F-9).

Pipe Reamer

Pipe Reamers are used to deburr steel pipe before threading. Cone is made from tool steel and hardened for maximum life. Unique cutting edge makes this spiral reamer self-feeding and easy to start and operate.

Catalog No.	Item Code	Pipe Capacity		Weight	
		Inches-Nom.	Actual ID Ø mm	lbs	kg
2-71	06060	1/8 - 2	3 - 50	6.7	3.0

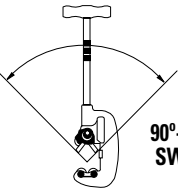

✓ WHY REED?

Guide bars are exclusive to Reed and the best way to get a square cut on stainless steel and corroded pipe. Guide bars also reduce wheel breakage.

90°- 140° SWING



2-4WGA

✓ WHY REED?

With rollers on the side away from the operator and the cutter wheel closer, Reed Steel Pipe Cutters are the easiest to line up with the cut-off mark. Wheel change is quick as the ring on the top of the wheel pin makes it convenient to find and center the pin through the second hole.

2-1



2-3

Convert 2-1 and 2-3 back and forth simply by changing wheels and rollers.

2-4

✓ WHY REED?

This Reed invention has two pawls for faster action and for work in tight places – requires half the handle swing space of competitive reamers.

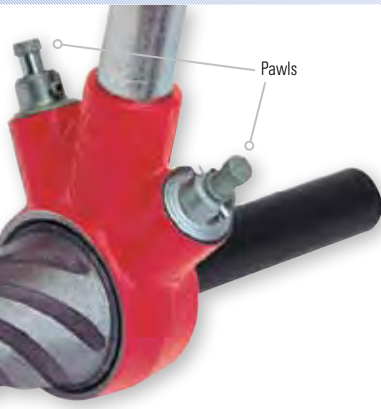

Ridgid® is a registered trademark of Ridgid, Inc. and is not associated with Reed Manufacturing Company.

Soil Pipe Cutters

The fastest way to cut cast iron soil pipe, clay pipe, and small diameter concrete pipe is with a chain pipe cutter. Great for gray water applications! Reed has improved the original manufacturer's design by providing stronger jaws and more durable adjusting screws which are interchangeable with the original tools. Reed soil pipe cutters are available in a single stroke **SC59** model and a ratcheting **SC49** model for close quarter work. Multiple use 1/2" ratchet wrench ships with SC49 models. No-Hub® Roller Kit is standard on all models.

FOR CUTTING DUCTILE IRON PIPE, REED RECOMMENDS HINGED CUTTERS™ ON P. 18 AND LOW CLEARANCE ROTARY™ CUTTERS ON P. 19

RATCHET

Catalog No.	Item Code	Pipe Capacity**		Length		Weight	
		Inches-Nom.	Actual Ø mm	in	mm	lbs	kg
SC49-6*	08049	1 1/2 - 6	160	26	660	17.6	8.0
SC49-8*	08050	1 1/2 - 8	212	26	660	19.4	8.8
SC49-10*	08051	1 1/2 - 10	268	26	660	21.2	9.6
SC49-12*	08052	1 1/2 - 12	317	26	660	23.0	10.5
SC49-15*	08053	1 1/2 - 15	403	26	660	24.8	11.3

SINGLE STROKE

SC59-6	08059	1 1/2 - 6	160	43	1,092	23.8	10.8
SC59-8	08060	1 1/2 - 8	212	43	1,092	25.6	11.6
SC59-10	08061	1 1/2 - 10	268	43	1,092	27.4	12.5
SC59-12	08062	1 1/2 - 12	317	43	1,092	29.2	13.3
SC59-15	08063	1 1/2 - 15	403	43	1,092	31.0	14.1

*Ratchet Wrench (#40208) included with all SC49 cutters.

**Maximum Pipe Capacities (determined by maximum pressure applied):

- Extra heavy cast iron soil pipe 2-4" (62-125 mm)
- Service weight cast iron soil pipe 2-8" (62-212 mm)
- Concrete pipe 4-6" (125-160 mm)
- No-Hub® cast iron soil pipe 1 1/2"-8" (38-212 mm)
- Clay pipe 2-15" (62-403 mm)

Extension chains available to increase capacity of smaller cutters.

NOTE: Jaw sets and cutter chains are interchangeable with Wheeler-Rex® models. Pressure Screw Assembly available offering heavy-duty parts for current and prior Reed models, along with Wheeler-Rex® 490. Order #98046 for Reed SC49 models and Wheeler-Rex® 490 series; use #98047 for Reed SC59 models.

ACCESSORIES

Catalog No.	Item Code	Description
SCEXT	40336	10" Extension Chain with 8 pitches at 1.25" per pitch
TW516	02298	5/16" Torque Wrench
TW38	02300	3/8" Torque Wrench



TORQUE WRENCHES FOR CAST IRON SOIL PIPE ON P. 38



TRAINING AVAILABLE

Captured Screw

✓ WHY REED?

First introduced by Reed, the captured screw makes the SC49 close-quarter soil pipe cutters both easy to use and less costly. The screw does not have to be manipulated into place which reduces screw and cutter breakage.



www.reedmfgco.com

For the latest information on NEW REED Tools!

Pipe Descalers

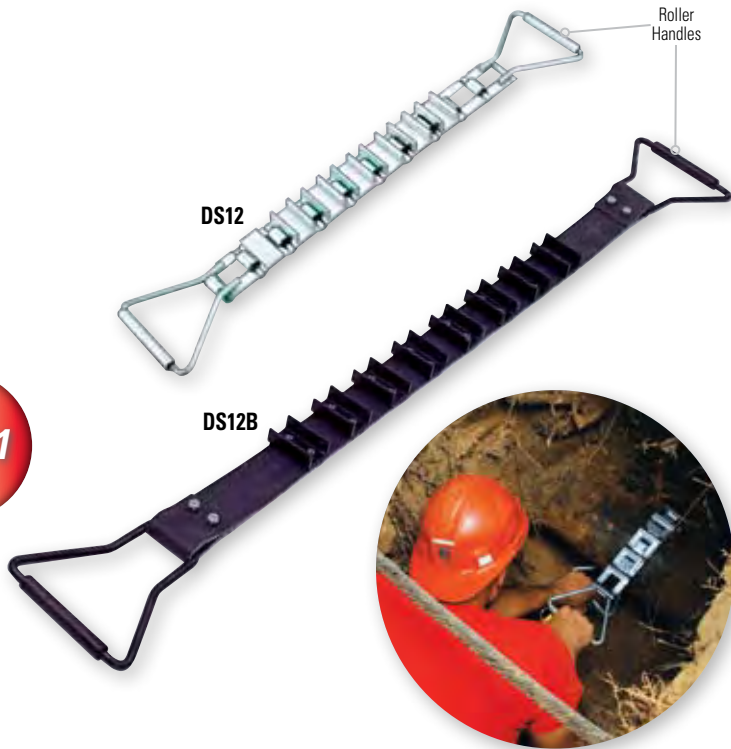

Reed pipe descalers feature wide, tough scrapers that remove scale, dirt, and corrosion cleanly and quickly from the pipe surface to allow more effective cutting, joining, gasket/valve seating, or other operations. Descalers are faster and more effective than chisels, chains or files and need only 2" of clearance around the pipe. Use descalers to clean pipe before cutting or water tapping or drilling. Roller handles allow smoother movement in use. **DS12** and **DS36** chain descalers are made entirely of steel that is zinc-plated for corrosion resistance and toughness. The scrapers are welded on for long life and can be sharpened. Also, Reed produces a heavy-duty power transmission belting pipe descender, **DS12B**. Its handles and scrapers are blackened for good rust protection. Belt descender benefits include lighter weight than all-metal descalers or chains, longer length to ease back strain during use, and high-profile scrapers that don't clog with dirt as readily. Reed also offers replacement belts with scrapers attached; simply bolt the new belt onto the handles.

Catalog No.	Item Code	Type	Pipe Capacity		Length		Weight	
			Inches-Nom.	mm	in	mm	lbs	kg
DS12	08000	Steel Chain	3 - 12	70 - 300	32	810	5.7	2.6
DS36	08006	Steel Chain	3 - 36	70 - 910	44	1110	8.2	3.7
DS12B	08008	Belt	3 - 12	70 - 300	50	1257	4.2	1.9

REPLACEMENT BELT

Catalog No.	Item Code	Description	Length		Weight	
			in	mm	lbs	kg
DS12BRB	98008	Replacement belt fits REED DS12B or Wheeler-Rex® 1300	45	1143	3.0	1.4

Saw It® Pneumatic Saw



Saw It® provides pneumatic power and reciprocating motion to blades. Saw improvements allow the tool to turn and work more freely, along with starting easier and running smoother. Reed offers blades to cut plastic, steel, stainless steel, and C900 PVC pipe.* **Saw It®** needs a 6" clearance beyond the pipe to accommodate blade movement. Cuts up to 20" (500 mm) diameter pipe with a single setup. The **Saw It®** must have a means to hold it in place. The recommended **Saw It® Vise** (sold separately) fits 4" - 12" diameter pipe (up to 24" with chain extensions), and provides stability and safety for the cut. Pneumatic saws are less likely to ignite materials than gas-powered saws and even some electrical-powered saws. However, the **Saw It®** is not recommended for gas lines.

Catalog No.	Item Code	Diameter Capacity*		Maximum Power	Air Consumption	Speed	Weight	
		In - Nom.	mm Nom.				Strokes/Min.	lbs
SAWIT	07600	up to 24" max.	up to 610 max.	1.5 HP; 1100 watts	50 cfm @ 90 psi 1.4 cu. m/min. @ 6.2 BAR	300	17.0	7.7
SAWITVISE	04600	4" - 12"	102 - 305	—	—	—	14.0	6.4

*Capacity is dependent on blade and chain extensions.
NOTE: **Saw It®**, **Saw It® Vise**, and **Blades** are all sold separately.
PORTABLE POWER HACK SAW BLADES ON P. 74

ACCESSORIES

CHAIN EXTENSIONS

Item Code	Description
40628	6" diameter increment plus pin
40629	12" diameter increment plus pin



In Use on Plastic

Great for work on process piping!

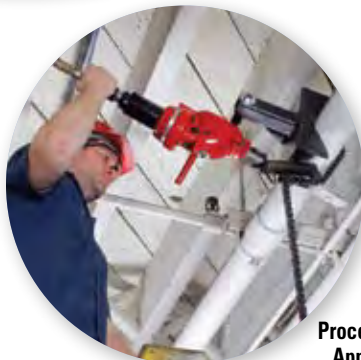

Process Piping Application

✓ WHY REED?

This saw is safer and cuts straighter than a gas-powered chop saw. The **Saw It® Vise** allows the saw to pivot straight into the pipe, giving the operator better control over the cut. Used together, this saw is **EASY** to handle.

Universal Pipe Cutters (6"-48" or 150-1300 mm)

These lightweight, easy-to-use Universal Pipe Cutters (UPC) are available to cut 6" - 48" (150-1300 mm) outside diameter ductile iron, cast iron, clay, concrete, **steel**, PVC, or PE pipe. The cutters are pneumatic powered. The lower cost **UPC616A** uses the same motor as the others, but does not need connecting frames. The UPC616 is shipped in a steel toolbox with a three-gallon, formed-steel water tank. The **UPC636A** and **UPC648A** come in a steel toolbox with a seven-gallon, stainless steel water tank and cart.

PNEUMATIC

Catalog No.	Item Code	Pipe Diameter		Net Weight*	
		Inches-Nom.	O.D. mm	lbs	kg
UPC616A	07512	6 - 16	150 - 450	89	40.5
UPC636A	07510	6 - 36	150 - 1000	131	59.5
UPC648A	07511	6 - 48	150 - 1300	138	62.7

*NET WEIGHT includes all components that may be part of any given tool item code, but does not include packing materials.

MUST ORDER REQUIRED BLADES SEPARATELY.

BLADE SELECTION CHART

Catalog No.	Item Code	Description	Pipe Diameter	Pipe Material
UPCARB4	97510	4" BLADES cut up to $^{23}/_{32}$ " (18.3 mm) wall thickness	6" (150 mm)	PVC
UPBEVEL	97512	Available by special order. Minimum order applies.		PVC
UPCARB6	97514	6" BLADES cut up to $1^{23}/_{32}$ " (43.7 mm) wall thickness	8" - 48" (200-1300 mm)	PVC
★UPCSTEELA	97519	4" BLADES cut up to $^{23}/_{32}$ " (18.3 mm) wall thickness	6" - 8" (150-200 mm)	Steel, PE
★UPCSTEEL6	97520	6" BLADES cut up to $1^{23}/_{32}$ " (43.7 mm) wall thickness	8" - 48" (200-1300 mm)	Steel, PE
UPDIA6C	97524	6" BLADES cut up to $1^{23}/_{32}$ " (43.7 mm) wall thickness	8" - 48" (200-1300 mm)	Cast Iron, Pit Cast, Ductile Iron Clay, Concrete
UPDIA4C	97528	4" BLADES cut up to $^{23}/_{32}$ " (18.3 mm) wall thickness	6" (150 mm)	Cast Iron, Pit Cast, Ductile Iron Clay, Concrete

★ **NEW**
PIPE DESCALERS ON P. 16

UPC POWER REQUIREMENTS

Pneumatic

Horsepower = 1.7 H.P.
Maximum R.P.M. = 3675
Air Consumption = 50 cu. ft./min. (1.4 cu. m/min.)
Pressure = 90 P.S.I. Maximum (6 BAR)
Shut-Off = $^{3}/_{4}$ " Ball Valve
Air Supply Fittings = $^{3}/_{4}$ " Dixon "Air King" Coupling

ACCESSORIES

Accessory	Item Code
Air-Line Oil	97583
Arbor Locknut	97543
Arbor Wrench	97590
Chain Hooks	97546
Diamond Blade Sharpening Stone	97595
Filter for the FRL	40139
Hex Key Set	40156
Motor Grease, 2 oz.	97588
Release Pins	97545
Water Tank Hose System	97581
Wedges	97589

SERVICE

UPC motor reconditioning/refurbishing is available. Complete UPC cutters can also be reconditioned/refurbished.

BEFORE shipping items, contact Reed by phone, fax, or email for a return authorization number.

All items should arrive freight prepaid at the Reed factory. Quotes, including any labor charges, will be issued upon inspection of the unit.



**Blades for Steel Pipe
NOW AVAILABLE!**

NEW



✓ WHY REED?

The Reed UPC is lightweight; cuts fast; requires only 12" (300 mm) clearance around the pipe; provides a square cut virtually every time; and can be operated underwater. It is by far the safest, easiest and fastest power cutter to setup, operate and maintain, which nets a low operating cost.

**TRAINING
AVAILABLE**



UPC636A

Hinged Cutters™ (1"-12" or 32-356 mm)

Four wheels cut steel, stainless steel, cast and ductile iron with only 90° to 110° handle swing. Only 4" (125 mm) clearance required around pipe. Strong guide fingers ensure perfect wheel alignment for square cuts. A closed 360° frame forces all energy into cutting the pipe for maximum efficiency. There is no shower of sparks in this cold cut. This is the only hinged cutter that tracks every time and the only one recommended for ductile iron, steel, and stainless steel to Schedule 100. This tool is a Reed invention.

✓ WHY REED?

Hinged Cutters™ are a Reed invention! They are lighter, track better for square cuts, and require less clearance, yet provide better torque so the cut is made faster and with less effort. Can be used anywhere – in the ditch, underwater, in explosive atmospheres (cold cut), in noise-free zones, over head, in racks of pipes, etc.

Catalog No.	Item Code	Pipe Capacity		Length		Weight	
		Inches-Nom.	Actual Ø mm	in	mm	lbs	kg
H21/2S*	03110	1 - 2 1/2	32 - 76	17	419	7.2	3.3
H21/2I*	03112	1 - 2 1/2	32 - 76	17	419	7.2	3.3
H21/2X*	03114	1 - 2 1/2	32 - 76	17	419	7.2	3.3
H4S	03120	2 - 4	60 - 125	22	559	12.8	5.8
H4I	03122	2 - 4	60 - 125	22	559	12.8	5.8
H4X	03124	2 - 4	60 - 125	22	559	12.8	5.8
H6S	03130	4 - 6	114 - 182	28	711	19.4	8.8
H6I	03132	4 - 6	114 - 182	28	711	19.4	8.8
H6X	03134	4 - 6	114 - 182	28	711	19.4	8.8
H8S	03140	6 - 8	168 - 240	32	813	24.4	11.1
H8I	03142	6 - 8	168 - 240	32	813	24.4	11.1
H8X	03144	6 - 8	168 - 240	32	813	24.4	11.1
H8XX	03146	6 - 8	168 - 240	32	813	24.4	11.1
H12S	03150	8 - 12	219 - 356	34	864	34.9	15.9
H12I	03152	8 - 12	219 - 356	34	864	34.9	15.9
H12X	03154	8 - 12	219 - 356	34	864	34.9	15.9
H12XX	03156	8 - 12	219 - 356	34	864	34.9	15.9

*EXCLUSIVE

NOTE: S= includes cutter wheels for steel; I= includes cutter wheels for cast and ductile iron; X= includes cutter wheels for schedule 80 steel; XX= for schedule 100 steel.

Wheels for same size cutters are interchangeable. Recommend only Reed cutter wheels be used with these Hinged Cutters™. Reed wheels are made from high shock-resistant tool steel on computerized (CNC) machines and then precisely heat-treated. This allows for a thinner profile yet stronger blade, so they:

- Cut easier and faster, especially stainless steel and ductile pipe
- Last much longer
- Allow for shorter cutter handle for work in tight spaces
- Provide the best value

CUTTER WHEELS ON P. 7
PIPE DESCALERS ON P. 16

Replacement Wheel Pins for Ridgid® cutters: 3S, 4S, 6S, 44S, 466, 468, 472. Order Reed pin R34790 #93322 5/pkg. to replace Ridgid® pin No. 34790 (Old #F-14).

Ridgid® is a registered trademark of Ridgid, Inc. and is not associated with Reed Manufacturing Company.



TRAINING AVAILABLE

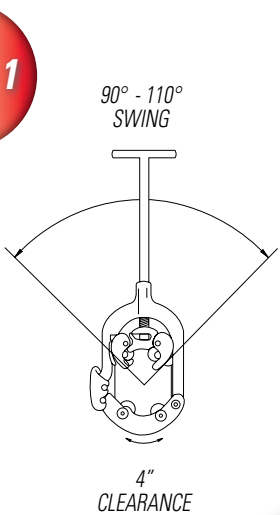

EXCLUSIVE SIZE

LIFETIME WARRANTY

www.reedmfgco.com
For the latest information on NEW REED Tools!

Rotary™ Cutters & Low Clearance Rotary™ Cutters (6"-36" or 159-915 mm)

Cold cut large diameter steel, most stainless steel, ductile, and cast iron pipe in close quarters. The low profile design of the LCRC models needs only 4" clearance for up to 16" pipe diameter; only 8" clearance for the **RC20** and **RC24**; and just 11.8" clearance for the **RC30** and **RC36** large diameter pipe cutters. Each cutter is supplied with a slip-on handle that is used to turn the cutter around the pipe in one direction. The handle is also used to tighten the cutter every 1/2 revolution.

Best manual cutters for ductile iron. With good leverage from long handle, pipe snaps off squarely before wheel penetrates halfway through pipe. Cutters have heavy-duty frames.

All sizes use the same cutter wheels: either RCS8-36 for steel and RC18-30 for ductile and cast iron. RCX wheels cut up to 25/32" wall thickness for steel pipe.

WHY REED?

Rotary™ cutters are a Reed invention! Reed Rotary™ cutters cut pipe safely, easily, quickly, and at a low cost. Provides a square cut and can be used anywhere – in the ditch, underwater, in explosive atmospheres (cold cut), in noise-free zones, over head, in racks of pipes, etc. Reed Rotary™ cutters last for decades.



EXCLUSIVE TOOL

TRAINING AVAILABLE

CLEARANCES

Cat. No.	in	mm
RC20	8.0	204
RC24	8.0	204
RC30	11.8	300
RC36	11.8	300

Catalog No.	Item Code	Pipe Capacity			Length		Weight	
		Steel**	Cast Iron & Ductile	Actual Ø mm	in	mm	lbs	kg
		Inches-Nom.	Inches-Nom.					
LCRC8S*	03309	6 - 8		159 - 246	58	1473	41	18.6
LCRC8I*	03308		6 - 8	159 - 246	58	1473	41	18.6
LCRC12S*	03313	10 - 14		266 - 358	61	1549	50	22.7
LCRC12I*	03312		10 - 12	266 - 358	61	1549	50	22.7
LCRC16S*	03317	16 - 18		368 - 462	66	1664	60	27.3
LCRC16I*	03316		14 - 16	368 - 462	66	1664	60	27.3
RC20S*	03240	20 - 22		476 - 572	106	2680	89	40.5
RC20I*	03242		18 - 20	476 - 572	106	2680	89	40.5
RC24S*	03250	24 - 26		584 - 660	111	2807	107	48.6
RC24I*	03252		22 - 24	584 - 660	111	2807	107	48.6
RC30S*†	03260	28 - 34		698 - 864	96	2438	283	128.6
RC30I*†	03262		30	698 - 864	96	2438	283	128.6
RC36S*†	03264	32 - 36		813 - 915	96	2438	295	134.1

*EXCLUSIVE

† Conversion Kits Available Below

**For heavy wall steel and stainless steel, order RCX cutter wheels (03550) and eight RC8-30XR rollers (93222).

NOTE: S= includes cutter wheels for steel; I= for cast and ductile iron. Wheels for same size cutters are interchangeable. Recommend only Reed cutter wheels be used with these cutters. Reed wheels are made from high shock-resistant tool steel on computerized (CNC) machines and then precisely heat-treated. This allows for a thinner profile yet stronger blade, so they:

- Cut easier and faster, especially stainless steel and ductile pipe
- Last much longer
- Provide the best value

CUTTER WHEELS ON P. 7

PIPE DESCALERS ON P. 16

CONVERSION KITS

Catalog No.	Item Code	Converts
RC30CONV	03267	RC36 to RC30
RC36CONV	03268	RC30 to RC36

NEW

LCRC ACCESSORY

To improve use in awkward locations, Reed now offers an angled handle option that allows the user to turn the LCRC cutter from the side of a ditch, using one's body weight, rather than having to turn the cutter from on top.

Catalog No.	Item Code	Converts
BAHANDLE	93177	Angled Handle option for use with LCRC (Low Clearance Rotary Cutters)

★ **NEW**

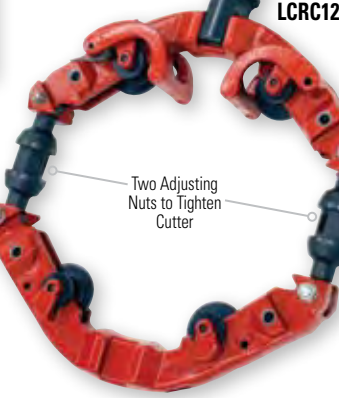
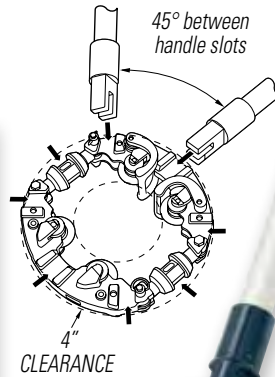

Handle Extension
Affixes to main handle for additional leverage. Included with RC20/RC24 models.

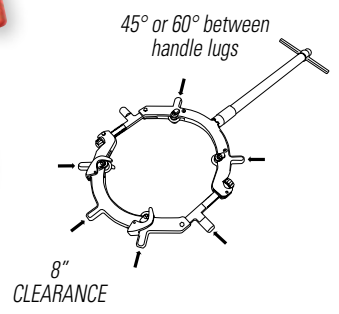

1



CNC Horizontal Mill



CNC technology is widely used for milling and machining components in Reed's product line.

CNC Vertical Mill



CNC Lathe



CNC Surface Grinder

REED *Manufacturing Technology*

Leading-edge processes and state-of-the-art equipment infused with old world craftsmanship have been and remain the standard at Reed Manufacturing for over 110 years. The results of this century of commitment are unparalleled professional trade products offering quite possibly the world's best quality, service and value. Products made to exacting specifications, products made to last for a lifetime, and products with a full lifetime warranty.



GROOVERS, POWER DRIVES, THREADERS & DIES

SECTION

2

Combo Roll Groovers 

Roll Groovers

5301PD Power Drives 

700PD Power Drives

701PD Power Drives

601PD Power Drives

Ground Fault Interrupter

R12+ Segmental Dies 

R12+ Dropheads 

R12+ Threader Sets 

Dropheads for PVC-Coated Pipe
& Conduit

Universal Dies

Universal Die Head

Enclosed Ratchet Threader Sets

Enclosed Dropheads

Oilers

Threadguard Cutting Oil

Adjustable Guide Threader Sets

Block Dies

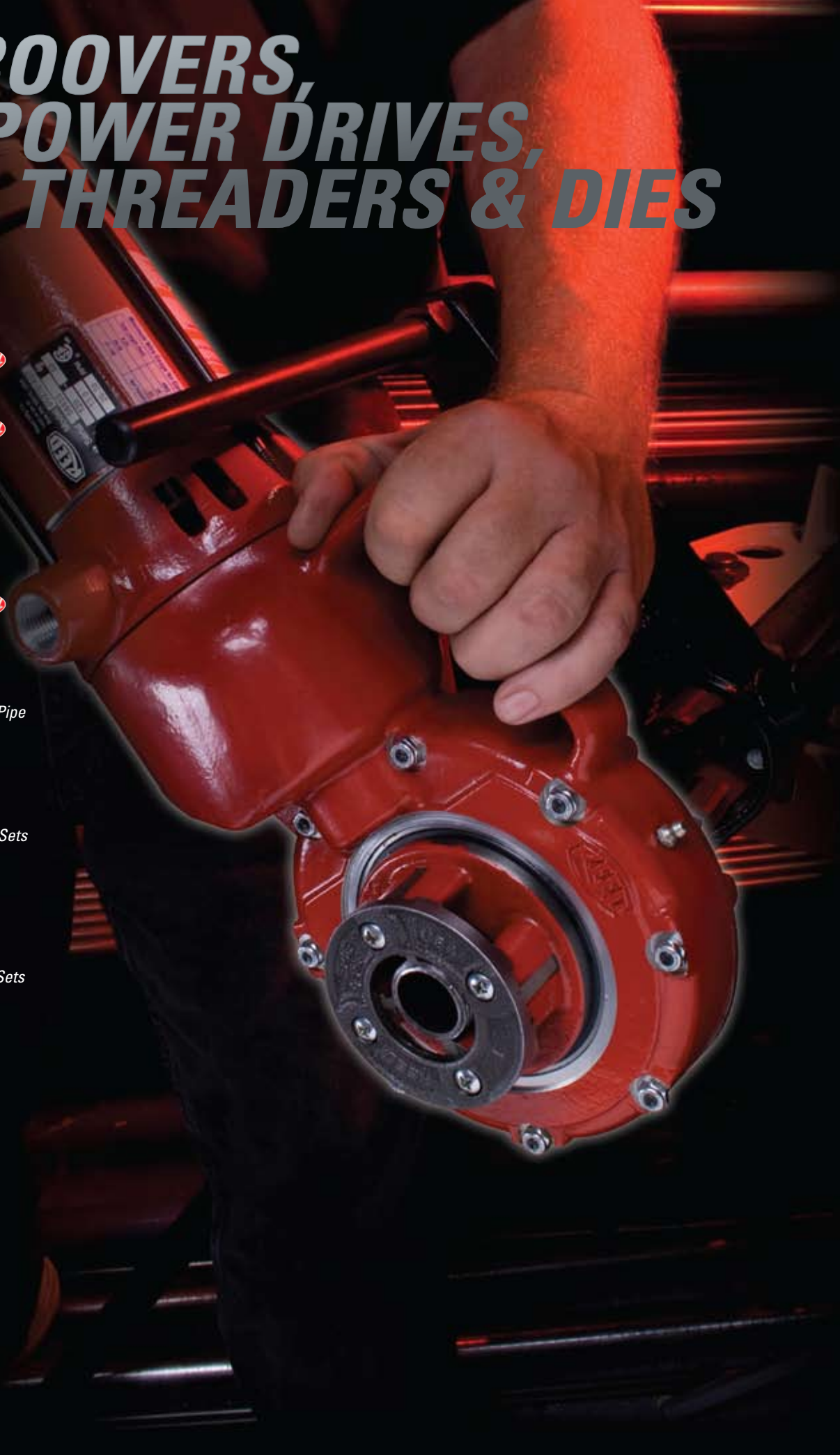

NEW Combo Roll Groovers

These 2-in-1 service tools yield cost savings of time and money by allowing a complete change in minutes from power machine operation to manual work or back. They are operated either manually or under power.

RGCOMB02 forms standard rolled grooves in steel, stainless steel, and aluminum pipe from 1 1/4" to 6". The formed grooves comply with the specifications required for mechanical coupling systems. The only adjustment required is for the depth of the groove.

RGCOMB0812 forms standard rolled grooves in 8" - 12" steel, stainless steel, and aluminum pipe up to 0.188" wall thickness. The formed grooves comply with the specifications required for mechanical coupling systems. The only adjustment required is for the depth of the groove. The RGCOMB0812 is the only combo roll groover that will groove 8" - 12" pipe. Competitive tools in this size range are either hydraulic or manual power, not 2-in-1.



RGCOMB02

NEW

✓ WHY REED?

Combo Roll Groovers feature a compact, light-weight design with built-in handle for improved mounting and transporting. All gears enclosed in the casting minimize debris entering tool. Consistent tracking makes this tool great to use time after time.

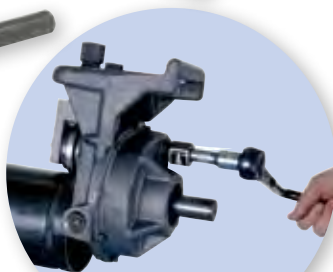

RGCOMB02

Catalog No.	Item Code	Pipe Material	Power Source	Pipe Capacity		Net Weight*	
				In. - Nom.	mm	lbs	kg
★ RGCOMB02	09200	Sch. 10 - 40 for Steel, SS, Al	Power or Manual	1 1/4" - 6"	32 - 152	31.4	14.3
★ RGCOMB0812	09210	Steel, SS, Aluminum up to 0.188" wall	Power or Manual	8" - 12"	203 - 305	32.4	14.7

★ **NEW**

***NET WEIGHT** includes all components that may be part of any given tool item code, but does not include packing materials.
NOTE: RGCOMB0812 is sized to comply with ANSI/AWWA C-606 and mechanical coupling manufacturers for 8"-12" pipe.

Selection Chart

To select the roll groover for the proper type of pipe, use the below chart.

Catalog No.	Item Code	Power Source*	Tool Weight		Pipe Capacity		Type of Pipe				
			lbs	kg	In. - Nom.	mm	SS	Steel	Al	PVC	Copper Tubing
RG6S	08500	Power	22.7	10.3	1 1/4" - 6" Sch. 5S to 40	32 - 152	X	X	X	X	
RG26S	08510	Manual	19.1	8.7	2" - 6" Sch. 5S to 10S 2" - 3" Sch. 40	51 - 152 51 - 76	X	X	X	X	
RG26CU	08512	Manual	19.1	8.7	2" - 6"	51 - 152					X
RG1.5	08532	Manual	7.2	3.3	1 1/2"	51		X			
RGCOMB02	09200	Power or Manual	27.5	12.5	1 1/4" - 6"	32 - 152	X	X	X		
RGCOMB0812	09210	Power or Manual	28.5	12.9	8" - 12"	203 - 305	X	X	X		

*5301PD Power Drive (P. 24) is the recommended power source.



RGCOMB02 with 5301PD and Tripod

XTRA VALUE!

Two wrenches ship with RGCOMB02 and RGCOMB0812. There's a straight handle for power grooving and an angled handle for easier, more efficient manual grooving.

EXCLUSIVE FEATURES



RGCOMB0812

Groove Roll
Drive Shaft

2-in-1 groovers feature reliable, effortless tracking!

TRAINING AVAILABLE

www.reedmfgco.com
For the latest information on **NEW REED Tools!**

RG6S Roll Groover

Reed portable roll groovers are compact, durable tools for use at installation sites. The **RG6S** is designed to be powered by Reed 5301PD power drive. RG6S has heavy-duty bearings and a steel body to withstand the punishment of severe grooving applications, including use on Schedule 40 pipe. Finger-adjust depth screw and gauge provide quick adjustment and accurate, repeatable groove depths. No bulky adjusting wrenches required. Sealed bearings for long life.

Catalog No.	Item Code	Pipe Material	Power Source	Pipe Capacity		Net Weight*	
				In. - Nom.	mm	lbs	kg
RG6S	08500	Steel, SS, PVC, Aluminum	Power	1 1/4" - 6" Sch. 5S to 40	32 - 152	26.6	12.1

*NET WEIGHT includes all components that may be part of any given tool item code, but does not include packing materials.

NOTE: Grooves will comply with dimensional specifications published by ANSI/AWWA C-606 and mechanical coupling manufacturers.

ELECTRIC HYDROSTATIC TEST PUMPS ON P. 49
5301PD POWER DRIVES ON P. 24



✓ WHY REED?

Combines the compact RG6S design for long life with sealed, heavy-duty bearings and up to 6" capacity.



RG6S with 5301PD and Tripod

RG26 Roll Groovers

The **RG26** is for grooving in-place pipe, and pipe too short for powered groovers. It is easily carried and positioned with a convenient handle. Screw knob on top of unit makes for easy depth adjustments. Included ratcheting crank is used for feeding and turning. For copper tubing the **RG26CU** has special rollers and shafts to meet copper grooving specifications.

Catalog No.	Item Code	Pipe Material	Power Source	Pipe Capacity		Net Weight*	
				In. - Nom.	mm	lbs	kg
RG26S	08510	Steel, SS, PVC, Aluminum	Manual	2" - 6" Sch. 5S to 10S	51 - 152	20.0	9.1
RG26CU	08512	Copper Tubing	Manual	2" - 6"	51 - 152	20.0	9.1

*NET WEIGHT includes all components that may be part of any given tool item code, but does not include packing materials.



✓ WHY REED?

Angled rollers keep the groover on the pipe and in-line: **will not "walk off" pipe**. It uses heavy-duty bearings, hardened and ground shafts, and rollers mounted in a ductile iron housing for durability. Ratchet wrench is easier to use in tight spaces – no cranking needed!



RG26S

RG1.5 Roll Groover

The **RG1.5** is used to roll groove 1 1/2" and smaller schedule 10 and 40 steel pipe by hand with 360 degrees of rotation. The **RG1.5KIT** groover kit converts a 2" Reed pipe cutter to a roll groover. Simply remove the rollers and cutter wheels from a Reed Steel Pipe Cutter, then install the groove wheels, alignment plate, and depth collar. To roll groove 2" and larger pipe, use Reed's larger roll groovers.

Catalog No.	Item Code	Pipe Material	Power Source	Pipe Capacity		Weight	
				In. - Nom.	mm	lbs	kg
RG1.5	08532	Sch. 10 & 40 for Steel	Manual	1 1/2	51	7.2	3.3

NOTE: Grooves will comply with dimensional specifications published by ANSI/AWWA C-606 and mechanical coupling manufacturers.

ACCESSORIES

Catalog No.	Item Code	Description	Weight	
			lbs	kg
RG1.5KIT	08530	Groover Kit: groover wheels, alignment plate & depth collar	0.8	0.4
RG1.5GRWH	08531	Groover Wheels: 3/pack & depth collar	0.8	0.4



RG1.5



**240V Models
NOW AVAILABLE!**

5301PD is CSA Approved for Canada!

**EXCLUSIVE
FEATURE**



Catalog No.	Item Code	Capacity		Net Weight*		Description
		Inches - Nom.	mm	lbs	kg	
5301PD	05301	1/8 - 2 Pipe 1/4 - 2 Bolt	3 - 50 Pipe 6 - 50 Bolt**	93.0	43.0	5301PD @ 38 RPM with Footswitch only, 120V
5301PD57RPM	05302	1/8 - 2 Pipe 1/4 - 2 Bolt	3 - 50 Pipe 6 - 50 Bolt	93.0	43.0	5301PD @ 57 RPM with Footswitch only, 120V
5301PDCOMP	05303	1/8 - 2 Pipe 1/4 - 2 Bolt	3 - 50 Pipe 6 - 50 Bolt	208.0	95.0	5301PD COMPLETE***, 38 RPM, HSS NPT dies, 120V
5301PD57RPMCOMP	05304	1/8 - 2 Pipe 1/4 - 2 Bolt	3 - 50 Pipe 6 - 50 Bolt	208.0	95.0	5301PD COMPLETE***, 57 RPM, HSS NPT dies, 120V
★5301PD240	05321	1/8 - 2 Pipe 1/4 - 2 Bolt	3 - 50 Pipe 6 - 50 Bolt	93.0	43.0	5301PD Power Drive, 38 RPM, 240V Export
★5301PDCOMP240B	05322	1/8 - 2 Pipe 1/4 - 2 Bolt	3 - 50 Pipe 6 - 50 Bolt	208.8	95.0	5301PD COMPLETE***, 38 RPM, HSS BSPT dies, 240V Export
★5301PDCOMP240	05323	1/8 - 2 Pipe 1/4 - 2 Bolt	3 - 50 Pipe 6 - 50 Bolt	208.0	95.0	5301PD COMPLETE***, 38 RPM, HSS NPT dies, 240V Export
★5301PD240US	05325	1/8 - 2 Pipe 1/4 - 2 Bolt	3 - 50 Pipe 6 - 50 Bolt	93.0	43.0	5301PD Power Drive, 38 RPM, 240V US
★5301PDCOMP240US	05327	1/8 - 2 Pipe 1/4 - 2 Bolt	3 - 50 Pipe 6 - 50 Bolt	208.0	95.0	5301PD COMPLETE***, 38 RPM, HSS NPT dies, 240V US

✓ WHY REED?

Flat top of housing is ideal for placing tools. 5301PD includes long-lasting high speed steel (HSS) dies, not alloy dies. All steel oiler (not plastic) with 60" (not 54") hose included with COMP units.

★ NEW

*NET WEIGHT includes all components that may be part of any given tool item code, but does not include packing materials.

** Bolt dies not currently available from Reed.

***COMPLETE units contain Footswitch, Tripod, Carriage with Lever, Pipe Cutter, Reamer, R811 Universal Die Head, Set 1/2" - 3/4" Universal Dies, Set 1" - 2" Universal Dies, Transporter, Oiler, and 1 gallon of Thread Cutting Oil.



5301PD



Transporter with 5301PD

ACCESSORIES

Catalog No.	Item Code	Description	Weight	
			lbs	kg
5301PDTP	05305	5301PD Tripod	26.0	11.8
5301PDTRANSPRTR	05306	5301PD Transporter	28.0	12.7
5301PDCARRIAGE	05307	5301PD Carriage	16.0	7.3
5301PDCREAMER	05308	5301PD Reamer	6.8	3.1
5301PDCUTTER	05309	5301PD Cutter	8.5	3.9

OILERS ON P. 30
UNIVERSAL DIE HEAD ON P. 28

700PD Power Drives



700PD is CSA Approved for Canada!

700PD POWER DRIVE Ships with Free Safety Arm!

Catalog No.	Item Code	Capacity		Net Weight*		Description
		Inches - Nom.	mm	lbs	kg	
700PD	05270	1/8 - 2	3 - 50	40.5	18.4	Power Drive & Safety Arm, 120V, 60 Hz
700PDSET	05272	1/2 - 2 NPT	12 - 50	67.0	30.5	700PD, Safety Arm, 1/2 - 2" NPT Dropheads
700V	05275	1/8 - 2	3 - 50	10.5	4.8	700PD Safety Arm Only

*NET WEIGHT includes all components that may be part of any given tool item code, but does not include packing materials.

R12+ DROPHEADS AND DIES ON P. 26 - 27
POWER TAPPING/DRILLING MACHINES ON P. 45
OILERS ON P. 30

✓ WHY REED?

Reed 700PD comes with a FREE safety arm – 10% extra value over the competition! The vinyl-coated handle provides better electrical safety. Flexible pigtail cord retainer extends cord life and prevents pull-out. The neoprene sealed switch keeps dirt out and prolongs switch life.

700PD15/16 (P. 45) can be used with Ridgid® 141/161 geared threaders to thread 2 1/2" - 6" pipe.

701PD Power Drives

Reed **701PD** Power Drive automates the threading process for pipe 1/8" through 2" (3-50 mm). 701PD is the lightest threading machine at 15.9 pounds (7.2 kg) available for the popular R12+ or 12R style dropheads. 701PD comes with a free safety arm and is equipped with a gearshift that backs the machine off the work twice as fast at 60 RPM. **Safety Arm** absorbs the forces generated when threading and frees up the operator to oil the dies during threading. Gearing gives this compact tool plenty of torque to thread 2" pipe.

701PD POWER DRIVE Ships with Free Safety Arm!

Catalog No.	Item Code	Capacity		Net Weight*		Description
		In - Nom.	mm	lbs	kg	
701PD	05250	1/8 - 2	3 - 50	23.5	10.7	Power Drive & Safety Arm, 115V
701PD W/BOX	05251	1/8 - 2	3 - 50	43.1	19.6	Power Drive & Safety Arm with Box
701PDE	05252	1/8 - 2	3 - 50	23.5	10.7	Power Drive & Safety Arm, 230V Export
701PDSET2 W/Box	05253	1/2 - 2	12 - 50	69.7	31.7	701PD, Safety Arm, Box and 1/2" - 2" Dropheads
701PDSET2	05254	1/2 - 2	12 - 50	50.1	22.8	701PD, Safety Arm, 1/2" - 2" Dropheads
701V	05255	1/8 - 2	3 - 50	7.5	3.4	701PD Safety Arm Only
701BOX	95252	-	-	19.6	8.9	Box for 701PD Models and Dropheads

*NET WEIGHT includes all components that may be part of any given tool item code, but does not include packing materials.
R12+ DROPHEADS AND DIES ON P. 26 - 27



701V Safety Arm



701PD



601PD Power Drives

Reed **601PD** Power Drive weighs only 15.4 pounds, yet delivers plenty of torque for threading through 1 1/4" pipe. A safety arm is always included, as is a carrying case. No load forward speed is 25 RPM, with a fast reverse switch that allows 60 RPM backoff to expedite jobs. An entire kit (#05244, #05245) weighs from 30 to 32 pounds, making the 601PD the easiest machine to get to gas pipe and other on-site jobs. 601PD uses R11 Enclosed Dropheads or Ridgid® 11-R dropheads. **Safety Arm** absorbs the forces generated when threading and frees up the operator to oil the dies during threading.

601PD POWER DRIVE Ships with Free Safety Arm!

Catalog No.	Item Code	Capacity		Net Weight*		Description
		In - Nom.	mm	lbs	kg	
601PD	05240	1/4 - 1 1/4	6 - 32	25.0	11.4	Power Drive & Safety Arm, 115V, with Case
601V	05242	1/4 - 1 1/4	6 - 32	5.7	2.6	601PD Safety Arm Only
601PDKIT1	05244	1/2 - 1	12 - 25	30.0	13.6	601PD, Safety Arm, 1/2" - 1" NPT Dropheads, with Case
601PDKIT1-1/4	05245	1/2 - 1 1/4	12 - 32	32.0	14.5	601PD, Safety Arm, 1/2" - 1 1/4" NPT Dropheads, with Case

*NET WEIGHT includes all components that may be part of any given tool item code, but does not include packing materials.

R11 ENCLOSED DROPHEADS ON P. 29
POWER TAPPING/DRILLING MACHINES ON P. 45



601PD

601V Safety Arm

Eliminate hand-threading with this portable, lightweight machine!

Ground Fault Interrupter

The **PDGFI** Ground Fault Interrupter can be used with any Reed Power Drive. When drilling/tapping live pipe or actuating a valve with the potential for water to be present, the PDGFI is recommended.

Catalog No.	Item Code	Description	Weight	
			lbs	kg
PDGFI	05277	Ground Fault Interrupter	0.8	0.4



PDGFI



701PD W/BOX

701PD, OLBUCT1 and R450+

OILERS ON P. 30

✓ WHY REED?

Reed 701PD is lighter, faster, safer, and a 25% less expensive alternative to the Ridgid® 700 (with arm) and uses R12+ or 12R style dropheads. The FREE 701V safety arm stabilizes the power drive firmly in both forward and reverse. 701PD has speeds of 25 RPM forward and 60 RPM reverse. Great for overhead work due to its light weight and safety arm.



R12DN1

Reed provides over 110 years of quality die-making expertise.

✓ WHY REED?

Reed offers high speed steel (HSS) dies for the price of competitor's alloy dies: a 10%+ cost savings. Reed R12+ series is made in USA. HSS dies last longer than alloy dies, especially if used with power drives.



DHR122NPT

XTRA VALUE!

✓ WHY REED?

Reed's dropheads are designed for improved chip flow and easier cutting. Reed's dropheads are more than 10% less expensive than Ridgid® 12-R dropheads with HSS dies.

R12+ Segmental Dies, Dropheads & Threader Sets

Reed knows how to cut a good thread and high speed steel (HSS) **R12+ Segmental Dies** show this with cutting edges manufactured in-house by precision CNC machinery. The 1/2" through 2" die segments are available in NPT, NPSM, NPT for PVC, and BSPT. The design of the dies enables smooth chip flow and easy cutting. R12+ die sets are replaceable parts for Reed R12+ Dropheads, as well as the following Ridgid® dropheads: 12-R, 00-R, 111-R, 0-R, 11-R, 30A and 31A threaders. Dies are sold in full sets of four.

R12+ SEGMENTAL DIES

Catalog No.	Item Code	Size	Material Threaded	Weight	
				lbs	kg
★ R12DNPVC1/2	05560	1/2" PVC (NPT)	PVC	0.2	0.1
★ R12DNPVC3/4	05561	3/4" PVC (NPT)	PVC	0.2	0.1
★ R12DNPVC1	05562	1" PVC (NPT)	PVC	0.3	0.1
★ R12DNPVC1 1/4	05563	1 1/4" PVC (NPT)	PVC	0.3	0.1
★ RD12DNPVC1 1/2	05564	1 1/2" PVC (NPT)	PVC	0.5	0.2
★ R12DNPVC2	05565	2" PVC (NPT)	PVC	0.5	0.2
R12DN1/2	05606	1/2" NPT	Steel	0.2	0.1
R12DN3/4	05608	3/4" NPT	Steel	0.2	0.1
R12DN1	05610	1" NPT	Steel	0.3	0.1
R12DN1 1/4	05612	1 1/4" NPT	Steel	0.3	0.1
R12DN1 1/2	05614	1 1/2" NPT	Steel	0.5	0.2
R12DN2	05616	2" NPT	Steel	0.5	0.2
★ R12DNBSPT1/2	05643	1/2" BSPT	Steel	0.2	0.1
★ R12DNBSPT3/4	05644	3/4" BSPT	Steel	0.2	0.1
★ R12DNBSPT1	05645	1" BSPT	Steel	0.3	0.1
★ R12DNBSPT1 1/4	05646	1 1/4" BSPT	Steel	0.3	0.1
★ R12DNBSPT1 1/2	05647	1 1/2" BSPT	Steel	0.5	0.2
★ R12DNBSPT2	05648	2" BSPT	Steel	0.5	0.2
R12DNPSM1/2	05680	1/2" NPSM	Steel	0.2	0.1
R12DNPSM3/4	05681	3/4" NPSM	Steel	0.2	0.1
R12DNPSM1	05682	1" NPSM	Steel	0.3	0.1
R12DNPSM1 1/4	05683	1 1/4" NPSM	Steel	0.3	0.1
R12DNPSM1 1/2	05684	1 1/2" NPSM	Steel	0.5	0.2
R12DNPSM2	05685	2" NPSM	Steel	0.5	0.2

★ **NEW**
THREADGUARD CUTTING OIL ON P. 30

R12+ DROPHEADS

Reed **R12+ Dropheads** ship completely assembled and ready to use with HSS segmental dies already in place. R12+ Dropheads can be used manually with the ratchet ring and handle (#05638) or with Reed's 700PD and 701PD Power Drives. Reed's R12+ dropheads are interchangeable with Ridgid® 12-R dropheads and can also be utilized in the Ridgid® 700 power drive.

Catalog No.	Item Code	Size	Material Threaded	Weight	
				lbs	kg
DHR121/2NPT	05626	1/2" NPT	Steel	3.6	1.6
DHR123/4NPT	05628	3/4" NPT	Steel	3.6	1.6
DHR121NPT	05630	1" NPT	Steel	4.2	1.9
DHR121 1/4NPT	05632	1 1/4" NPT	Steel	4.7	2.1
DHR121 1/2NPT	05634	1 1/2" NPT	Steel	5.1	2.3
DHR122NPT	05636	2" NPT	Steel	5.4	2.5
★ DHR121/2PVC	05568	1/2" PVC (NPT)	PVC	3.6	1.6
★ DHR123/4PVC	05569	3/4" PVC (NPT)	PVC	3.6	1.6
★ DHR121PVC	05570	1" PVC (NPT)	PVC	4.2	1.9
★ DHR121 1/4PVC	05571	1 1/4" PVC (NPT)	PVC	4.7	2.1
★ DHR121 1/2PVC	05572	1 1/2" PVC (NPT)	PVC	5.1	2.3
★ DHR122PVC	05573	2" PVC (NPT)	PVC	5.4	2.5
★ DHR121/2BSPT	05593	1/2" BSPT	Steel	3.6	1.6
★ DHR123/4BSPT	05594	3/4" BSPT	Steel	3.6	1.6
★ DHR121BSPT	05595	1" BSPT	Steel	4.2	1.9
★ DHR121 1/4BSPT	05596	1 1/4" BSPT	Steel	4.7	2.1
★ DHR121 1/2BSPT	05597	1 1/2" BSPT	Steel	5.1	2.3
★ DHR122BSPT	05598	2" BSPT	Steel	5.4	2.5
DHR121/2NPSM	05690	1/2" NPSM	Steel	3.6	1.6
DHR123/4NPSM	05691	3/4" NPSM	Steel	3.6	1.6
DHR121NPSM	05692	1" NPSM	Steel	4.2	1.9
DHR121 1/4NPSM	05693	1 1/4" NPSM	Steel	4.7	2.1
DHR121 1/2NPSM	05694	1 1/2" NPSM	Steel	5.1	2.3
DHR122NPSM	05695	2" NPSM	Steel	5.4	2.5

★ **NEW**

R12+ THREADER SETS

Reed **R12+ Drophead Threader Sets** include complete dropheads in sizes from 1/2" to 2" NPT, NPSM, BSPT or for PVC (NPT thread). Each set has a ratchet ring and handle. In addition, the Reed R12+ ratcheting ring (#05638) accepts all Ridgid® 12-R dropheads. All sets thread steel pipe, except R12PVC-6 and R12PVC-6-BOX which thread PVC pipe.

Catalog No.	Item Code	Size	Weight	
			lbs	kg
R12NPT-3	05712	1/2" to 1" NPT	16.4	7.5
R12NPT-4	05714	1/2" to 1 1/4" NPT	21.1	9.6
R12NPT-5	05716	1" to 2" NPT	24.4	11.1
R12NPT-6	05720	1/2" to 2" NPT	31.6	14.4
★ R12NPT-6-BOX	05721	1/2" to 2" NPT with R12BOX	52.6	23.9
R12NPSM-6	05725	1/2" to 2" NPSM	31.6	14.4
★ R12NPSM-6-BOX	05726	1/2" to 2" NPSM with R12BOX	52.6	23.9
★ R12BSPT-6	05727	1/2" to 2" BSPT	31.6	14.4
★ R12BSPT-6-BOX	05728	1/2" to 2" BSPT with R12BOX	52.6	23.9
★ R12PVC-6	05730	1/2" to 2" PVC (NPT)	31.6	14.4
★ R12PVC-6-BOX	05731	1/2" to 2" PVC with R12BOX	52.6	23.9
★ NEW				



R12RRHC

ACCESSORIES

R12BOX	05715	Box Only	21.0	9.5
R12RRHC	05638	Ring & Handle	5.0	2.3



R12NPT-6-BOX

NOTE: Most REED threader sets **DO NOT** include the R12 box. It can be ordered separately as #05715.

Dropheads Complete for PVC-Coated Pipe & Conduit

Reed drophead threaders for PVC-coated steel pipe and conduit are opened up to fit snugly over and without damaging the PVC coating on pipe and conduit made by companies such as Robroy®. The tapered NPT threads make for leak-free connections and allow pipe use for liquid or electric lines in corrosive atmospheres. The NPSM drophead produces a straight thread with less tight connection. Different color from standard red R12+ Dropheads helps avoid mix-up. Replacement dies are R12+ Segmental Dies (P. 26), which fit these specially designed dropheads.

Catalog No.	Item Code	Size	Weight	
			lbs	kg
DHR12COAT1/2	05650	1/2" NPT	3.6	1.6
DHR12COAT3/4	05652	3/4" NPT	3.6	1.6
DHR12COAT1	05654	1" NPT	4.0	1.8
DHR12COAT1 1/4	05656	1 1/4" NPT	4.7	2.1
DHR12COAT1 1/2	05658	1 1/2" NPT	5.0	2.3
DHR12COAT2	05660	2" NPT	5.3	2.4
DHR12COAT1/2NPSM	05663	1/2" NPSM	3.6	1.6
DHR12COAT3/4NPSM	05664	3/4" NPSM	3.6	1.6
DHR12COAT1NPSM	05665	1" NPSM	4.0	1.8
DHR12COAT1 1/4NPSM	05666	1 1/4" NPSM	4.7	2.1
DHR12COAT1 1/2NPSM	05667	1 1/2" NPSM	5.0	2.3
DHR12COAT2NPSM	05668	2" NPSM	5.3	2.4

THREADER SETS

Catalog No.	Item Code	Size	Weight	
			lbs	kg
R12COAT-6	05735	1/2" - 2" NPT	31.2	14.2
R12COAT-6NPSM	05738	1/2" - 2" NPSM	31.2	14.2

YOKE VISES ON P. 35

RJAWS ON P. 35

STRAP WRENCHES ON P. 65

Reed provides over 110 years of quality die-making expertise.



DHR12COAT1 1/2

✓ WHY REED?

Reed offers the broadest line of tools for plastic coated pipe and conduit, including dropheads and adjustable guide sets for threading and PVCcoat vises and jaws for gripping.





UHN1-2

Reed provides over 110 years of quality die-making expertise.

✓ WHY REED?

Reed Universal Dies are made in the USA, lab tested and proven, then field tested and approved by threading specialist contractors and industrial users. Years of on-going lab and field tests have shown Reed Universal Dies give clean threads and long die life.



Universal Dies

Reed used its 110+ years of die-making experience to select the best materials, methods, and CNC production for its Universal Dies. These dies fit Reed's 5301PD power drive, Ridgid® 300, 300 Compact, 535, 535 Automatic, 1215, 1822-I, 1224 plus the Reed R811 Universal Die Head. Choose from Reed's full line of High Speed Steel (HSS) dies in geometries for NPT, NPSM and BSPT. HSS dies last longer than alloy dies because HSS dies withstand high temperature without losing hardness. This feature allows them to cut faster than the alloy at room temperature.

Catalog No.	Item Code	Size	Die Material	Standard Package	Weight	
					lbs	kg
UAN1/2-3/4	05805	1/2 - 3/4" NPT	Alloy	4	1.5	0.7
UAN1-2	05810	1 - 2" NPT	Alloy	4	1.3	0.6
UHN1/2-3/4	05815	1/2 - 3/4" NPT	HSS	4	1.5	0.7
UHN1-2	05820	1 - 2" NPT	HSS	4	1.3	0.6
UHS1/2-3/4	05825	1/2 - 3/4" NPT	HSS for Stainless	4	1.5	0.7
UHS1-2	05830	1 - 2" NPT	HSS for Stainless	4	1.3	0.6
UHC1/2-3/4	05845	1/2 - 3/4" NPSM	HSS	4	1.4	0.6
UHC1-2	05850	1 - 2" NPSM	HSS	4	1.3	0.6
UHB1/2-3/4	05865	1/2 - 3/4" BSPT	HSS	4	1.4	0.6
UHB1-2	05870	1 - 2" BSPT	HSS	4	1.3	0.6

5301PD POWER DRIVE ON P. 24



R811

Universal Die Head

This Reed R811 Universal Die Head uses Reed or other universal dies from Ridgid®, Wheeler-Rex®, Berkley and some private brands. It fits Reed's 5301PD Power Drive and Ridgid® machine models 300, 535 and 1822. The R811 head offers easy-to-adjust size selection with manual open/close operation, along with die lubrication slots. R811 does not include universal dies; order them separately.

Catalog No.	Item Code	Capacity		Weight	
		Inches - Nom.	Actual mm	lbs	kg
R811	05380	1/8 - 2	3 - 50	12.5	5.7

5301PD POWER DRIVE ON P. 24

AROUND THE JOB SITE AND AROUND THE WORLD

Serving the world of hard-working tradesmen and women from our Erie, Pennsylvania location since 1896. Reed Manufacturing is still family-owned and operated, producing quality pipe tools and vises. Sold worldwide exclusively through local distributors, Reed tools are the first choice of professionals around the world!



Enclosed Ratchet Threader Sets

Precise dies and dieheads are manufactured on CNC machines. Sets contain dropheads and handle in a compact, reinforced plastic carrying case. Dropheads available from 1/4" to 2" NPT. Dropheads in these sets fit Reed's 601PD. Heads up through 1 1/4" are interchangeable with Ridgid® 11-R and R200, Super-Ego® 600, Virax® 1362, Rothenberger™ Super Cut hand ratchet threaders and Supertronic portable power threaders.

Catalog No.	Item Code NPT	Range Inches	Heads Included	Weight	
				lbs	kg
DH82-5	05198	3/4 - 1 1/4	3	10.9	5.0
DH82-4	05200	1/2 - 1 1/4	4	12.2	5.5
DH82-3	05201	3/8 - 1 1/4	5	13.4	6.1
DH81-2	05202	1/4 - 1	5	12.7	5.8
DH81-3	05203	3/8 - 1	4	10.2	5.1
DH81-4	05204	1/2 - 1	3	10.1	4.6
DH84-4	05222	1/2 - 2	6	22.8	10.4
DH84-5	05223	3/4 - 2	5	21.5	9.8
DH84-6	05224	1 - 2	4	20.0	9.1
DH84-7	05225	1 1/4 - 2	3	18.2	8.3



✓ WHY REED?

No alignment problems as dies are enclosed within each drophead. These complete dropheads are less expensive than models requiring individual segment replacement.

DH81-2

XTRA VALUE!

Enclosed Dropheads

Enclosed Dropheads for NPT fit Reed 601PD and are interchangeable with Ridgid® 11-R and R200 (through 1 1/4"), Super Ego® 600, Virax® 1362, Rothenberger™ Super Cut hand ratchet threaders and Supertronic portable power threaders. Separate replacement die segments are not available for these disposable dropheads. Use **R11SC** ratchet ring and handle with 1/4" - 1 1/4" dropheads. **R20SC** ratchet ring and handle works with all R11 dropheads, including 1 1/2" and 2", provided that the **R20 ADAPTER** is used with the smaller 1/4" - 1 1/4" dropheads.

Catalog No.	Item Code	Description	Weight	
			lbs	kg
R111/4NPT	05210	1/4" NPT Drophead	1.2	0.5
R113/8NPT	05211	3/8" NPT Drophead	1.2	0.5
R111/2NPT	05212	1/2" NPT Drophead	1.3	0.6
R113/4NPT	05213	3/4" NPT Drophead	1.4	0.6
R111NPT	05214	1" NPT Drophead	1.9	0.9
R111 1/4NPT	05215	1 1/4" NPT Drophead	2.0	0.9
R151 1/2NPT	05226	1 1/2" NPT Drophead	3.7	1.7
R202NPT	05227	2" NPT Drophead	3.4	1.5

ACCESSORIES

Catalog No.	Item Code	Description	Weight	
			lbs	kg
R11SC	05230	Ratchet Ring and Handle for R11 1/4" - 1 1/4" Dropheads	3.7	1.7
R20SC	05231	Ratchet Ring and Handle for R11 1 1/2" - 2" Dropheads	5.4	2.5
R20 ADAPTER	05234	Adapts R11 1/4" - 1 1/4" Dropheads to R20SC	0.6	0.3

XTRA VALUE!

Affordable, ready-to-use dropheads have the dies in-line every time making them quick to grab and use.



R151 1/2NPT

R20 ADAPTER

R20SC

R11SC with R113/8NPT



Oilers

Reed Oilers effectively deliver threading oil as the gun-and-trigger approach makes it easy to pump oil directly on the work. The rugged and completely portable Reed **OLBUCKET1** (#06150) comes with a 20-gauge steel bucket and steel drip pan/chip tray along with oil gun and a 60" industrial-grade hose. #97375 drip pan/chip tray is available separately and interchanges with Ridgid's® plastic chip tray. The system double-filters and recirculates oil as the chip tray catches the big waste pieces and the filter strains out any small particles. Oil gun features a sturdy nozzle made from turned aluminum. This system ships with one gallon of Reed Threadguard dark cutting oil (#06120).

OLKIT1 is the oil gun, hose, cap, clamp, and seal.

NOTE: Approximately one gallon of oil in the bucket is required to meet the minimum fill line. USE REED DARK OR CLEAR THREADGUARD CUTTING OIL (BELOW) FOR BEST RESULTS.

Catalog No.	Item Code	Weight	
		lbs	kg
OLBUCKET1*	06150	21.0	9.5
OLKIT1	06158	2.5	0.9

*Includes 1 Gallon of Oil.

NOTE: Please recycle or dispose of used threading oil according to the regulations of your own state or country.

ACCESSORIES

Item Code	Description
06120	Dark Cutting Oil – Gallon
97370*	60" Hose (1524 mm)
97375*	Metal Drip Pan/Chip Tray - 20 gauge sheet steel
97376*	Metal Bucket - 20 gauge sheet steel
97380	Oil Pan Strainer
97395*	Oil Gun

*Interchangeable with similar parts on Ridgid® oilers.

Threadguard Cutting Oil

Reed Threadguard Cutting Oil was developed by thousands of actual work-condition tests by Reed and oil company laboratories. It is specifically formulated for cooling the work, prolonging die life, and increasing cutting speed for both machine threading and hand threading.

DARK OIL

Catalog No.	Item Code	Size	Cans to Case	Weight per Case	
				lbs	kg
OQD	06118	Quart	12	2.0	0.9
OGD	06120	Gallon*	6	8.2	3.7
O5GD	06122	5 Gallon	1	39.0	17.7
O55GD	06124	55 Gallon	1	465.0	211.4

CLEAR OIL

OQC	06110	Quart	12	2.0	0.9
OGC	06112	Gallon*	6	7.9	3.6
O5GC	06114	5 Gallon	1	37.0	16.8
O55GC	06116	55 Gallon	1	465.0	211.4

*36 or more gallon bottles must ship by truck freight.

Ridgid® is a registered trademark of Ridgid, Inc. and is not associated with Reed Manufacturing Company.

OLBUCKET1



✓ WHY REED?

Much stronger and longer-lasting than oilers with plastic drip pans/chip trays. 60" (not 54") hose maximizes user convenience. Both features eliminate downtime and save money.



OLKIT1



Metal Drip Pan

Metal Bucket

**EXCLUSIVE
FEATURE**

Reed provides over 110 years of quality die-making expertise.



✓ WHY REED?

Higher lubricity for longer die life and faster cutting speed.



Adjustable Guide Threader Sets

The Reed adjustable guide system and solid block dies make these the most economical, most convenient, and most versatile threader sets on the market. Because the guide system adjusts to different sizes of pipe, it is only necessary to have a die for each pipe size, not a die plus a head. Other threader sets which require a die and a head for each size take up considerably more room in the toolbox or truck. Further, with two pawls, handle swing is faster – half that of one pawl competitive sets, and best for close quarter work. Adjustable Guide Threader Sets work well on coated pipe because the diehead can fit over the coating and then be tightened down into place. There is no need to peel back the coating before threading. This speeds up the job and permits maximum retention of the protective coating to extend pipe life. These sets use Reed Block Dies (below) for easy cutting and precise threading. **Block dies may be used as pipe thread chasers.**

SERIES SD81 FULL RANGE 1/8" - 1" USES OS (2" X 2") DIES

Catalog No.	Item Code	Range Inches	No. Dies Included	Weight	
				lbs	kg
SD81-1*	05111	1/8 - 1	6	8.4	3.8
SD81-2*	05109	1/4 - 1	5	7.8	3.6
SD81-3*	05107	3/8 - 1	4	7.4	3.4
SD81-4*	05105	1/2 - 1	3	6.8	3.1

SERIES SD82 FULL RANGE 1/4" - 1 1/4" - USES 1S (2 1/2" X 2 1/2") DIES

SD82-2*	05131	1/4 - 1 1/4	6	12.2	5.6
SD82-3*	05129	3/8 - 1 1/4	5	11.3	5.1
SD82-4*	05127	1/2 - 1 1/4	4	10.4	4.7
SD82-5*	05125	3/4 - 1 1/4	3	9.5	4.3

SERIES SD84 FULL RANGE 1/2" - 2" - USES 2S (4" X 4") DIES

SD84-4*	05151	1/2 - 2	6	29.1	13.2
SD84-5*	05149	3/4 - 2	5	26.1	11.9
SD84-6*	05147	1 - 2	4	23.2	10.6
SD84-7*	05145	1 1/4 - 2	3	19.8	9.0

SERIES SD84 FULL RANGE 1/2" - 2" - USES 2SPP DIES FOR PVC PIPE

SD84-4P*	04405	1/2 - 2	6	29.1	13.2
SD84-5P*	04406	3/4 - 2	5	26.1	11.9
SD84-6P*	04407	1 - 2	4	23.2	10.6
SD84-7P*	04408	1 1/4 - 2	3	19.8	9.0

*EXCLUSIVE

Block Dies

Only Reed solid block dies have wide throats and extra-fine threads that actually pull the die onto the pipe, even if the burr is large. CNC-milled from solid tool steel, dies are available in NPT threads. Chasers do not have to be individually set. Reed chasers are machined as a unit (not bolted in place) for perfect alignment. Lower cost and less weight are two more good reasons to use Reed dies. Reed Threadguard cutting oil yields better and faster threads and longer die life.

NPT - SOLID DIES FOR STEEL / STAINLESS STEEL

Catalog No.	Item Code	Size	Block Size (In.)	Stocks That Dies Fit	Weight	
OSP1/8*	05400	1/8	2 X 2	S81, SD81, 81	71D	0.6
OSP1/4*	05402	1/4	2 X 2	S81, SD81, 81	71D	0.6
OSP3/8*	05404	3/8	2 X 2	S81, SD81, 81	71D	0.6
OSP1/2*	05406	1/2	2 X 2	S81, SD81, 81	71D	0.5
OSP3/4*	05408	3/4	2 X 2	S81, SD81, 81	71D	0.5
OSP1*	05410	1	2 X 2	S81, SD81, 81	71D	0.5
1SP1/4*	05462	1/4	2 1/2 X 2 1/2	S82, SD82, 82	72, 72D	0.9
1SP3/8*	05464	3/8	2 1/2 X 2 1/2	S82, SD82, 82	72, 72D	0.9
1SP1/2*	05466	1/2	2 1/2 X 2 1/2	S82, SD82, 82	72, 72D	0.9
1SP3/4*	05468	3/4	2 1/2 X 2 1/2	S82, SD82, 82	72, 72D	0.9
1SP1*	05470	1	2 1/2 X 2 1/2	S82, SD82, 82	72, 72D	0.9
1SP1 1/4*	05472	1 1/4	2 1/2 X 2 1/2	S82, SD82, 82	72, 72D	0.7
2SP1/2*	05524	1/2	4 X 4	S84, SD84, 84	-	3.0
2SP3/4*	05526	3/4	4 X 4	S84, SD84, 84	-	2.9
2SP1*	05528	1	4 X 4	S84, SD84, 84	-	3.4
2SP1 1/4*	05530	1 1/4	4 X 4	S84, SD84, 84	-	3.2
2SP1 1/2*	05532	1 1/2	4 X 4	S84, SD84, 84	-	3.0
2SP2*	05534	2	4 X 4	S84, SD84, 84	-	2.6

THREADGUARD CUTTING OIL ON P. 30



✓ WHY REED?

Reed threader sets:

- Best choice for close quarters work!
- Threads pipe out of wall with as little as 1" pipe showing.
- 15%-20% less expensive for a full set versus Ridgid® 12-R sets.
- Reed block dies thread both stainless steel and carbon steel, using the same die.
- Reed makes block dies and sets for PVC and CPVC pipe, too.

Full Range Includes: 1/8, 3/8, 1/4, 1/2, 3/4, 1, 1 1/4, 1 1/2, 2

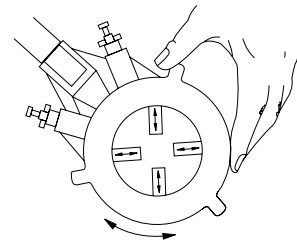

EXCLUSIVE TOOL

NPT - SOLID DIES FOR PVC/CPVC PIPE



✓ WHY REED?

The Reed block die is machined as a unit to ensure perfect threads and to eliminate the danger of inserting a chaser into the wrong slot.

Catalog No.	Item Code	Size	Block Size (In.)	Stocks That Dies Fit	Weight	
2SPP1/2*	04411	1/2	4 X 4	SD84	-	3.0
2SPP3/4*	04412	3/4	4 X 4	SD84	-	2.9
2SPP1*	04413	1	4 X 4	SD84	-	3.4
2SPP1 1/4*	04414	1 1/4	4 X 4	SD84	-	3.2
2SPP1 1/2*	04415	1 1/2	4 X 4	SD84	-	3.0
2SPP2*	04416	2	4 X 4	SD84	-	2.6

*EXCLUSIVE

VICES

SECTION 3

Tripods Vises **NEW**

Pipe Jacks

Chain Vises

Field Pipe Vise

Yoke Pipe Vises

*Clamping Vises & Jaws for
PVC-Coated Pipe & Conduit*

Utility Workshop Vises

Mid-Line Vises

Combination Bench & Pipe Vises

Machinists' Vises

Vise Accessories

Pipe Welding Vise



Tripod Vises

Reed Tripod Vises remain the sturdiest on the market. Tripods are manufactured with the heaviest gauge steel, overlapping hinges, and the best adjustable tray clamp, not a set screw, to keep the lower tray assembly and entire portable workbench tight – even after many hours of use! The heavy-duty design permits use with pipe up to 6" diameter. The **exclusive double-faced jaws** provide a second set of jaws with options available for both metal and plastic pipe (**R450P**). **R40+** features a 2 1/2" yoke vise on the same sturdy Tripod workbench. **R470+** offers the same great features as Reed's **R450+**, but features a 60 percent larger top tray and a 45° cranking handle. Tripods fold into a compact shape, have a padded handle grip, and boast the lightest weight for the easiest portability of all well-known Tripods.

Catalog No.	Item Code	Vise Style	Pipe Capacity		Folded Length		Weight	
			Inches-Nom.	Actual Ø mm	in	mm	lbs	kg
R450+	02306	Chain	1/8 - 6	10 - 178	44	1118	36.3	16.5
★ R470+	09402	Chain	1/8 - 6	10 - 178	44	1118	42.0	19.1
R450P	04457	Chain	1/8 - 6	10 - 178	44	1118	36.3	16.5
R450C*	04458	Chain	1/8 - 6	10 - 178	44	1118	37.4	17.0
R450GB*†	02307	Chain	1/8 - 4	10 - 114	44	1118	27.6	12.5
R450EXPORT	02312	Chain	1/8 - 6	10 - 178	44	1118	36.3	16.5
R40+	02311	Yoke	1/8 - 2 1/2	10 - 75	51	1295	39.1	17.8
R40EXPORT	02313	Yoke	1/8 - 2 1/2	10 - 75	51	1295	39.1	17.8

★ **NEW**
 ***EXCLUSIVE**
 † **NSN# 5120-00-293-1108**

MORE ABOUT TRIPODS...

- R450+: double-sided jaws for up to 6" metal pipe; best for holding both standard and irregular shapes
- R470+: 60% larger top tray than R450+ and 45 degree crank handle
- R450P: for plastic pipe up to 6"; one side of jaw for plastic/soft metal; one side of double-sided jaw for metal pipe
- R450C: stainless steel jaws, with rubber on one side; anodized (not painted) aluminum base; clear slip tube over chain; food grade lubricant; good for clean room use
- R450GB: aluminum legs for weight-critical field uses; up to 4" pipe capacity; no ceiling jack screw lowers weight for easier portability
- R450EXPORT: unassembled R450+ designed for low cost international shipment
- R40+: two-sided lower jaws for up to 2 1/2" metal pipe; best Tripod for high torque applications like hand or power drive threading
- R40EXPORT: unassembled R40+ designed for low cost international shipment

Ask for Reed/Ridgid® interchangeable parts list for Ridgid® 450 and 40.

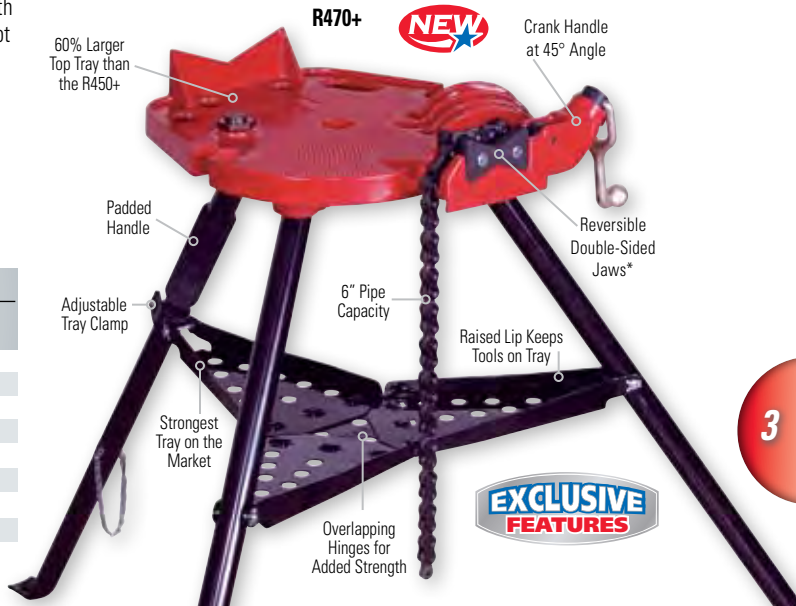

*Patented

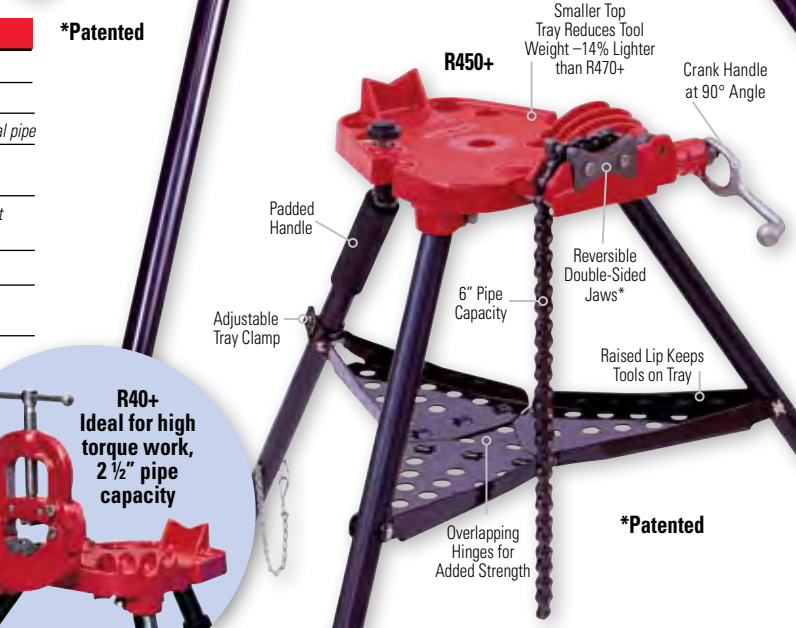

*Patented



Clean Room Tripod

The **R450C** Clean Room Tripod comes with reversible 410 stainless steel jaws (with bonded rubber on one side), anodized aluminum base, and a clear polymer slip tube (easily removed) to cover the chain. Chain lubricant is food grade, non-petroleum based.

Ridgid® is a registered trademark of Ridgid, Inc. and is not associated with Reed Manufacturing Company.



✓ WHY REED?

Reed Tripods are the sturdiest on the market. Double-sided jaws give user an extra set of jaws FREE. Tripods are lightweight and feature a padded handle for carrying ease, making it the most portable and best value Tripod available. Further, Reed has the only Clean Room Tripod: R450C.

3

Pipe Jacks

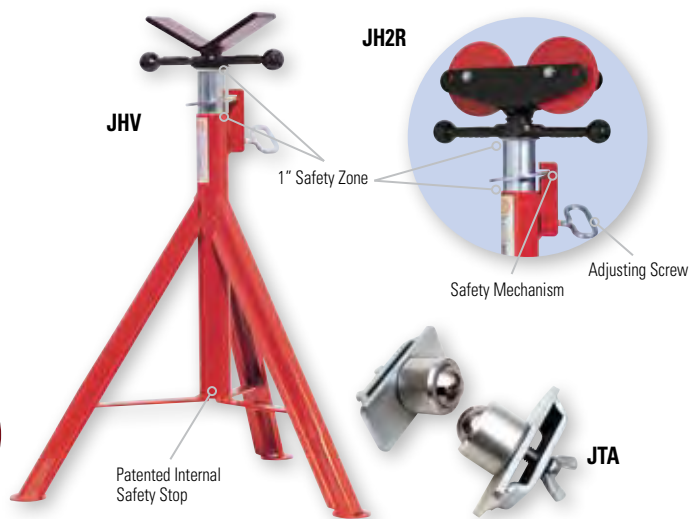

Convenient adjusting screw and a hardened steel locking ring are two features that make these 2,000 lb (909 kg) capacity **JHV** high jacks last for many years of use. Patented internal safety stop creates a 1" safety zone and prevents injuries to hands and fingers. Roller head jack (**JH2R**) has extra wide bearing for greater strength (2,000 lb capacity) and tool life. Adjusting screw gives proper working height. Outer surfaces are powder painted or zinc phosphate plated to resist corrosion. The 1,000 lb (454 kg) capacity ball transfer attachment (**JTA**) with replaceable ball casters bolts to either side of V-head. Ball transfer head attaches to Ridgid® brand and Sumner® models while all Reed heads (JTA, JH2R) and bases interchange with Sumner® and Greenlee®. All heads fit both high jacks and low jacks.

Catalog No.	Item Code	Description	Height Adj.		Pipe Capacity		Weight	
			in	mm	in	mm	lbs	kg
JHV*	06350	V-Head High Jack	24-47	610-1190	24	610	22.8	10.4
JTA	06351	Ball Transfer Head Attachment (pair)	-	-	³ / ₈ - 12	10-300	4.6	2.1
JH2R*	06352	Roller Head High Jack	24-47	610-1190	24	610	25.0	11.4

*6 or more pieces in any combination must ship by truck freight.



Chain Vises

Chain Vises permit the holding of irregular shapes and provide an excellent cost-for-capacity value. Reed chain vises are the fastest to use: two turns to open or close. These vises are the strongest available and hardened tool steel jaws are triple-faced for rotations instead of replacements, providing two free sets of jaws.

Catalog No.	Item Code	Pipe Capacity		Weight	
		Inches-Nom.	Actual Ø mm	lbs	kg
CV2	02510	¹ / ₈ - 2 1/2	10 - 75	9.3	4.5
CV4	02520	¹ / ₈ - 4	10 - 114	14.6	6.8
CV5	02530	¹ / ₈ - 5	10 - 141	15.5	6.8
CV6	02540	¹ / ₄ - 6	14 - 168	28.4	13.0
CV8	02550	¹ / ₂ - 8	21 - 219	46.3	22.0
CV12*	02560	³ / ₄ - 12	25 - 335	111.0	55.0

*EXCLUSIVE

✓ WHY REED?

Reed chain vises save money because they come standard with three-sided jaws. Only Reed has a 12" capacity chain vise – excellent cost for capacity value.

Field Pipe Vise

Field Pipe Vise holds pipe up to 20" (500 mm) diameter. More pipe capacity than other Reed vises and 2,000 lb (909 kg) vise capacity yet weighs only 22 lbs (10 kg) without legs and backbone. Super choice for pre-trench work and above ground cuts. Excellent flexibility achieved in height and length of vise appropriate to application as customer may cut own pipe for legs and backbone.

Catalog No.	Item Code	Pipe Capacity		Weight	
		Inches-Nom.	Actual Ø mm	lbs	kg
FPV20*	06027	2 - 20	50 - 500	20.6	9.4

ACCESSORY

Catalog No.	Item Code	Description	Weight	
			lbs	kg
FPVBLS	96014	Legs and Backbone	50.0	22.7

*To create legs and backbone, use 1 1/2" diameter Sch. 40 steel pipe.



Yoke Pipe Vises

Yoke vises permit the strongest jaw-to-jaw gripping of pipe for high-torque applications like threading. Reed yoke vises are made of ductile or malleable iron and have hardened, high carbon steel jaws for toughness and long life. These vises easily convert from right- to left-hand operation and back, making it simple to work around obstructions or to accommodate right- or left-hand user preference.

Catalog No.	Item Code	Pipe Capacity		Weight	
		Inches-Nom.	Actual Ø mm	lbs	kg
R0	02420	1/8 - 2	10 - 60	6.7	3.0
R1	02430	1/8 - 2 1/2	10 - 75	9.8	4.5
R2	02440	1/8 - 3 1/2	10 - 102	16.3	7.4
R3	02450	1/8 - 4 1/2	10 - 127	25.0	11.4
64	02460	1/4 - 6	14 - 168	49.0	22.3
65*	02470	1 - 8	32 - 219	80.0	36.4
66*	02480	1 1/2 - 12	48 - 335	168.0	76.4

*EXCLUSIVE

Clamping Vises & Jaws for PVC-Coated Pipe & Conduit

Reed offers solutions to grip without damaging PVC-coated steel pipe and conduit used in high corrosive environments like chemical plants, piping at water and sewer companies, and electrical work. Tripod Vise (TVCOAT) Kits come complete with tripod, yoke vise, and jaws for the clamshell, wraparound grip preferred by contractors. Pipe Vise (PVCOAT) Kits include the yoke vise and clamshell jaws for bench mounting. **RJAWS** and **RJAWS REED** convert Reed R40+, R1, Ridgid® 40-A, and 22 yoke vises for work with PVC-coated pipe and conduit. The RJAWS are smooth with three-point grip suggested by manufacturers such as Robroy®. In all cases, Reed uses high strength alloys in 6" long jaws to allow the firmest grip with the least damage.

KITS

Catalog No.	Item Code	Pipe Capacity		Length		Weight	
		In-Nom.	O.D. mm	in	mm	lbs	kg
TVCOATKIT-6	02562	1/2 - 2	25 - 64	45	1143	65.0	29.5
TVCOATKIT-4*	02563	3/4 - 2	29 - 64	45	1143	58.5	26.6
PVCOATKIT-6	02569	vise, 1/2 - 2	vise, 25 - 64	12	305	33.5	15.2
PVCOATKIT-4*	02570	vise, 3/4 - 2	vise, 29 - 64	12	305	27.3	12.4

*Includes the four most popular jaws: 3/4", 1", 1 1/2", 2".

JAWS

Catalog No.	Item Code	Pipe Capacity		Length		Weight	
		In-Nom.	O.D. mm	in	mm	lbs	kg
PVCOATJ1/2	02572	1/2	25	6	152	2.6	1.2
PVCOATJ3/4	02574	3/4	29	6	152	3.0	1.3
PVCOATJ1	02576	1	37	6	152	3.2	1.5
PVCOATJ11/4	02578	1 1/4	47	6	152	3.6	1.6
PVCOATJ11/2	02580	1 1/2	51	6	152	3.6	1.6
PVCOATJ2	02582	2	64	6	152	3.7	1.7
RJAWSREED	02584	Fits Reed R40+, R1		6	152	4.9	2.2

ACCESSORIES

Catalog No.	Item Code	Description	Length		Weight	
			in	mm	lbs	kg
TRIPOD	02564	stand only	42	1067	30.6	13.9
PVCOATV	02568	vise only	12	305	13.8	6.3

JAWS FOR RIDGID® VISES

Catalog No.	Item Code	Description	Length		Weight	
			in	mm	lbs	kg
RJAWS	02585	Fits Ridgid® brand 40-A, 22	6	152	5.0	2.3

Ridgid® is a registered trademark of Ridgid, Inc. and is not associated with Reed Manufacturing Company.



✓ WHY REED?

Double-faced lower jaws on R Series allow reversal before replacement. Only Reed makes yoke vises in 8" and 12" capacities.

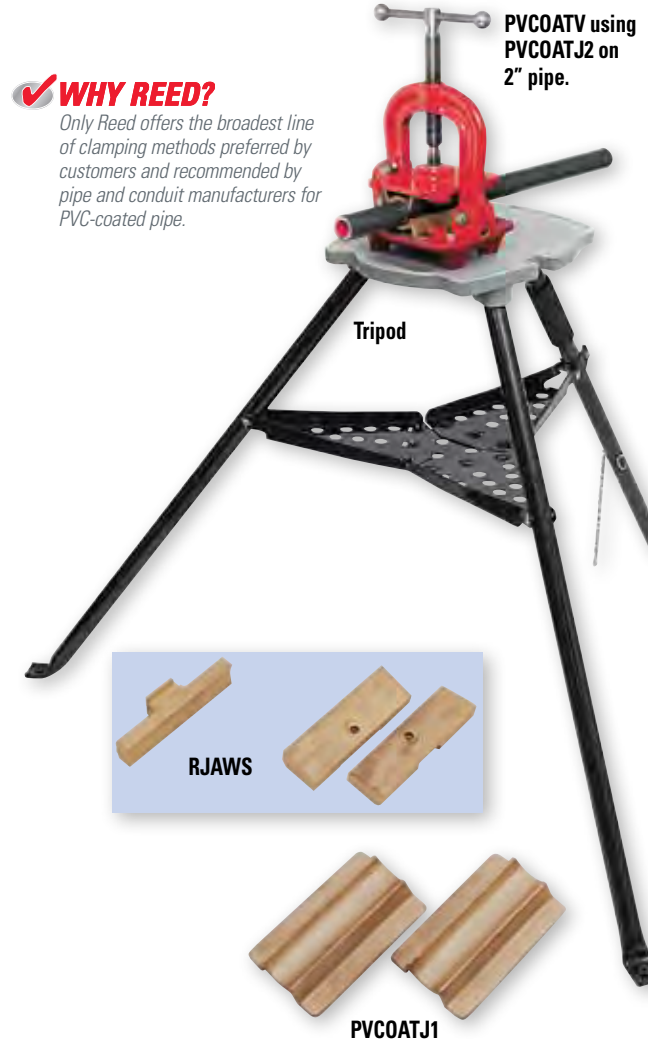

✓ WHY REED?

Only Reed offers the broadest line of clamping methods preferred by customers and recommended by pipe and conduit manufacturers for PVC-coated pipe.

3

Utility Workshop Vises (Swivel Base)

Heavy-duty design strengthens this ideal utility workshop vise. Cast vises with pipe jaws, anvil and horn feature a swivel base with positive locking in addition to replaceable, hardened steel, serrated jaw facings for user convenience.

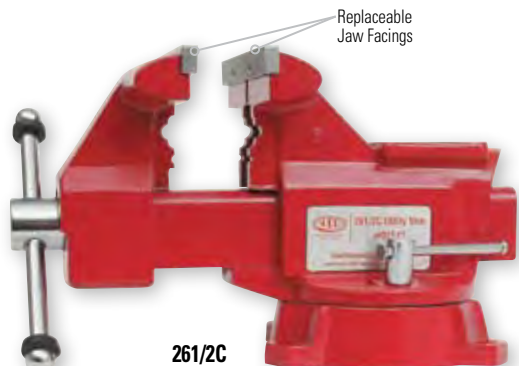

261/2C

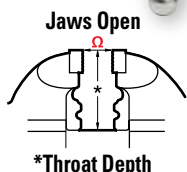

Catalog No.	Item Code	Throat Depth*		Jaw Width		Jaws Open ^Ω		Weight	
		in	mm	in	mm	in	mm	lbs	kg
241/2C	01522	2 1/2	64	4 1/2	115	4	102	18.0	8.2
251/2C	01532	3	76	5 1/2	140	5	127	27.0	12.3
261/2C	01542	3 3/8	86	6 1/2	165	6	152	41.0	18.6
26B	01545	4 3/16	120	6	150	6	152	60.0	27.3

*See illustration

Ω See illustration

Mid-Line Vises

A vise of strength and price between the Machinist vise and Utility vise. Design features a machined work surface. The main screw and nut are totally enclosed to keep out dirt and eliminate wear. Vise has replaceable, hardened steel jaw facings and pipe jaws, along with two swivel-base side clamps for a positive lock.

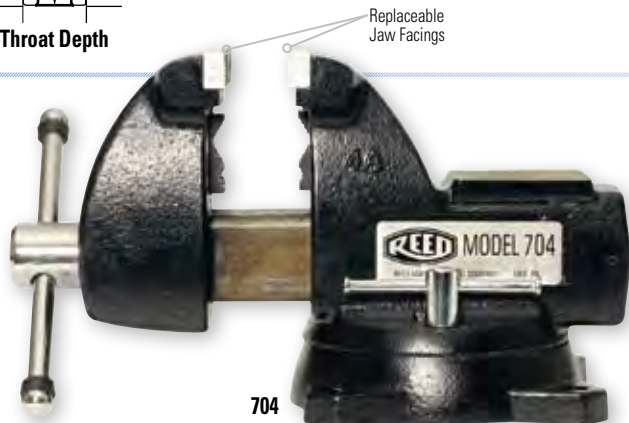

704

Catalog No.	Item Code	Throat Depth*		Jaw Width		Jaws Open ^Ω		Pipe Capacity In-Nom.	Weight	
		in	mm	in	mm	in	mm		lbs	kg
704	01385	3.45	88	4	102	4.5	114	1/2 - 2	36.0	16.4
705	01387	3.75	95	5	127	5.5	140	1/4 - 2 1/2	47.0	21.4
706	01389	4.10	104	6	152	5.7	146	1/4 - 3 1/2	61.0	27.7

*See illustration

Ω See illustration

✓ WHY REED?

Vises have enclosed screw assembly for all-weather protection.

Swivel-base models feature positive-locking base.

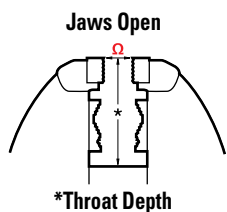

Combination Bench & Pipe Vises (Swivel Base)

Designed to provide decades of service, these cast vises carry Reed's lifetime warranty. Steel pipe jaws made of heat-treated, hardened steel are reversible and replaceable, and jaw facings are replaceable, too. This yields long jaw life. Vises are designed with maximum throat depth for greater clamping action to hold large parts. Forged steel, geared clamp bolt on swivel base maintains positive lock to avoid slippage under heavy pressure.

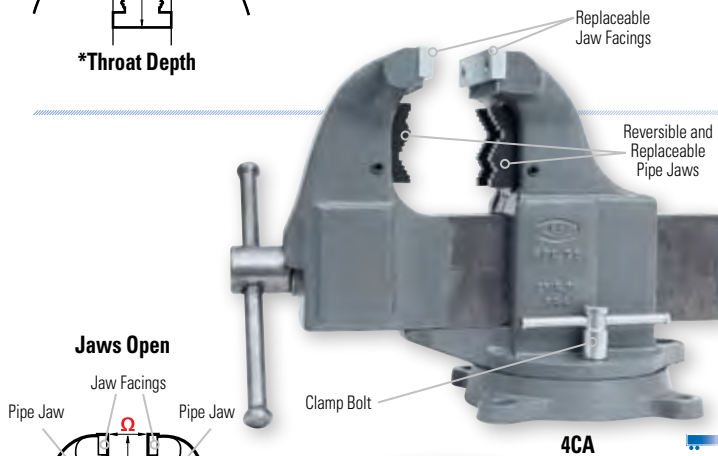

4CA

Catalog No.	Item Code	Throat Depth*		Jaw Width		Jaws Open ^Ω		Pipe Capacity In-Nom.	Weight	
		in	mm	in	mm	in	mm		lbs	kg
1CA	01350	4	102	3 1/2	89	4	102	1/8 - 2 1/2	35.0	15.9
2CA	01360	5 3/8	137	4 1/2	114	5	127	1/8 - 3 1/2	60.0	27.3
3CA	01370	6 1/4	159	5	127	6	152	1/8 - 4 1/2	95.0	43.2
4CA	01380	7 1/8	181	6	152	10	254	1/8 - 6	157.0	71.4

*See illustration

Ω See illustration

Swivel-base models feature positive-locking base.

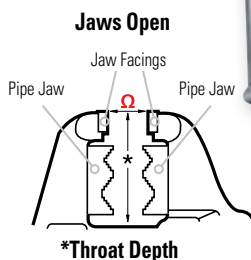

✓ WHY REED?

Only Reed has backed up its bench vises with a Lifetime Warranty for over 110 years.



Machinists' Vises

Designed to provide decades of service, these cast vises carry Reed's lifetime warranty. Malleable or ductile iron bar, body, and base with a machined work surface. Replaceable hardened tool steel jaw facings for long jaw life. Lubricated thrust bearing to reduce wear. Swivel base features positive locking. Both stationary and swivel base models are available. A swivel base can be retrofitted to stationary base models.

STATIONARY BASE

Catalog No.	Item Code	Throat Depth*		Jaw Width		Jaws Open Ω		Weight	
		in	mm	in	mm	in	mm	lbs	kg
304N	01430	3 5/8	92	4	102	6	152	37.0	16.8
305N	01450	4 1/4	108	5	127	8	203	63.0	28.6
306N	01460	4 3/8	111	6	152	10	254	92.0	41.8

SWIVEL BASE

304S	01432	3 5/8	92	4	102	6	152	46.0	20.9
305S	01452	4 1/4	108	5	127	8	203	74.5	33.9
306S	01462	4 3/8	111	6	152	10	254	107.0	48.6

*See illustration
 Ω See illustration

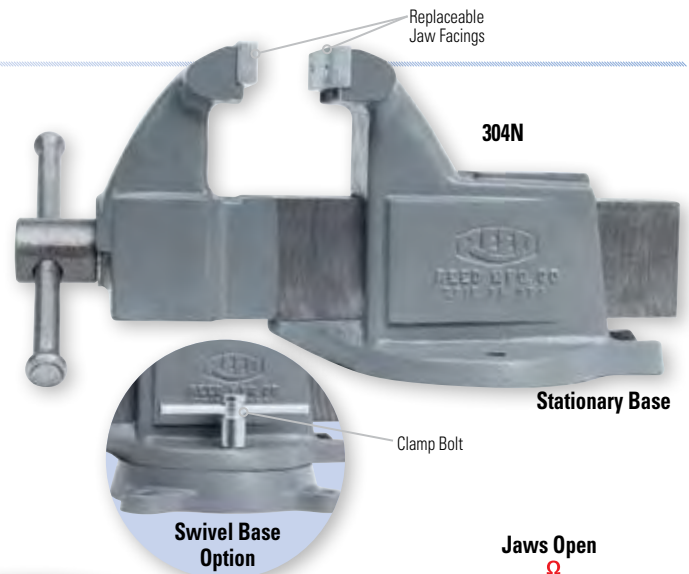

Swivel-base models feature positive-locking base.

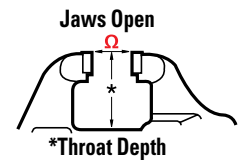

Vise Accessories

SWIVEL BASE KITS

Any Reed Machinists' Vise stationary base may be converted to a swivel base vise by adding the proper base kit. Kits include base plate, clamp bolt, nut, and center bolt.

Catalog No.	Item Code	Converts	Weight	
			lbs	kg
304K	01492	304N to 304S	12.0	5.5
305K	01494	305N to 305S	18.0	8.2
306K	01495	306N to 306S	20.0	9.1



BRASS VISE JAW CAPS

Protect fine work in vises with universal serrated jaw facings. Convert any Reed vise jaw facing to smooth surface with proper size brass caps. Caps available for 4"-6" jaw width.

Catalog No.	Item Code	Jaw Width		Weight	
		in	mm	lbs	kg
VC4	01570	4"	102	1.0	0.5
VC5	01580	5"	127	1.8	0.8
VC6	01590	6"	152	2.7	1.2

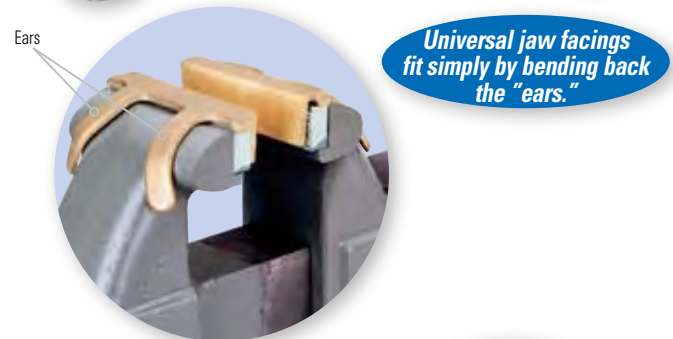

Pipe Welding Vise

Reed Pipe Welding Vise offers positive alignment for the most common pipe welding needs. Machined surfaces ensure correct meeting of straight pipe with the **PWV461R**. Screws and chains allow easy, firm clamping.

Catalog No.	Item Code	Capacity		Length		Weight	
		In-Nom.	O.D. mm	in	mm	lbs	kg
PWV461R	02491	1/2 - 8	21 - 225	15	381	16.4	7.5

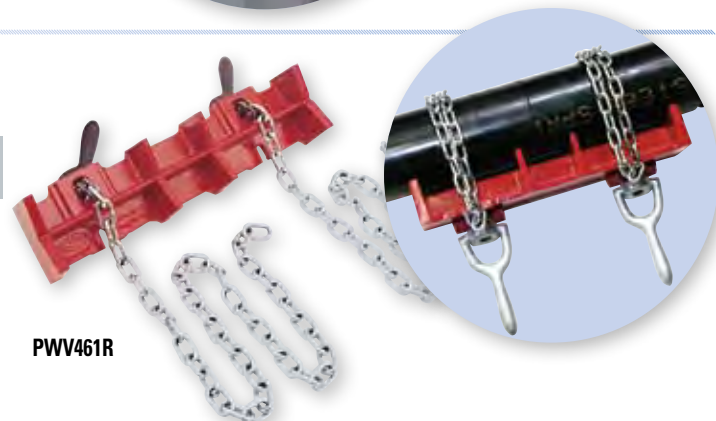

3

LARGE DIAMETER pipe tools

Reed's large diameter pipe tools meet and exceed the demands of the toughest projects – and are made to last for years. These tools provide unique solutions and save the contractor money on the job. Maximum capacities are shown here. For more detailed information on any of these heavy-duty, specialized tools, turn to the catalog page numbers listed.

Pipe Descalers

36" (910 mm) P. 16



BEST EVER!

PES8H

PES8M



PE Squeeze-Off Tools

8" (711 mm) P. 58



Universal Pipe Cutters

48" (1300 mm) P. 17

NEW

Blades for steel pipe!



Quick Release™ Cutters

10" (254 mm) P. 54

PLAS In-Line Rotary™ Cutters

28" (800 mm) P. 56

NEW



Chain Tongs

18" (457 mm) P. 64



Chain Wrenches

18" (457 mm) P. 65



Strap Wrenches

12" (324 mm) P. 65





Guillotine Cutters

12" (350 mm) P. 59



Rotary™ Cutters

36" (915 mm) P. 19



Hinged Cutters™

12" (356 mm) P. 18



Field Pipe Vise

20" (500 mm) P. 34



Saw It®

24" (610 mm) P. 16



Yoke Vises

12" (325 mm) P. 35



Chain Vises

12" (335 mm) P. 34



Soil Pipe Cutters

15" (403 mm) P. 15



Ratchet Wrenches & Sockets

17" (432 mm) Handle and Sockets for Bolts on 30" - 36" Pipe P. 67

WATER SERVICES TOOLS & MACHINES

SECTION 4

Direct Tapping Machine

Drilling Machines

Combination Drilling/
Tapping Machines **NEW**

PVC/PE Drilling Machines

Power Tapping &
Drilling Machines **NEW**

Feed Tap™ Drilling Machines **NEW**

PE Water Service Shut-Off Tool

Standing Shut-Off Tool

Copper Shut-Off Tools

Hammer & Flare Tools

Rerounding Tools

Round It® Straightener/Rerounders **NEW**

Electric Hydrostatic Test Pumps **NEW**

Hydrostatic Test Pumps

Meter Pit Pump

Valve & Curb Keys **NEW**

Ratcheting Valve Keys **NEW**

Valve Operators **NEW**

Valve Key Socket Kit **NEW**

Meter Box & Curb Box Lid Keys

Valve Box Cleaners **NEW**

Manhole Hooks



Direct Tapping Machine†

Reed's Direct Tapping Machine is used to drill and tap water mains while under pressure, then to install 3/4" or 1" corporation stops in a 2-step operation. It covers a range of 4" - 48" cast or ductile iron and C900 PVC with the use of saddles and chain extensions (saddles sold separate). The **TM1100** features a **flip clamp** feed system. Anodized and epoxy-painted aluminum frames provide a lightweight yet sturdy machine for tough in-ditch applications. The swing valve allows easy change-out from drill tap to corporation insertion tool without main shutdown. Uses Reed DT and DTP series drill taps.



TM1100

BEST EVER!

Catalog No.	Item Code	Size Inches	Pipe Diameter		Weight*	
			In-Nom.	Actual Ømm	lbs	kg
TM1100	09300	3/4 - 1	4 - 48	100 - 1300	101.8	46.3

*Including Box & Accessories – TM1100 unit alone weighs 40.4 lbs / 21 kg
SMOOTH JAW WRENCHES ON P. 70

Contact Reed for information on #09319 retro fit kit for old style TM1000 series to TM1100 series.

†Spec Booklet available #01071



DT75

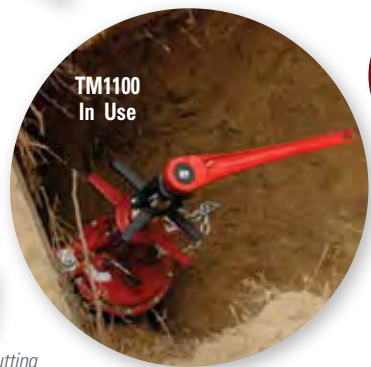

TM1100 In Use

4

ACCESSORIES

DRILL TAPS

Reed Drill Taps fit all Reed, Mueller® B-100, B-101, A-2 and A-3, Ridgid®/Footage®, plus the Romac® / Transmate® B1 tapping machines.

Catalog No.	Item Code	Drill Size Inches	Thread	Pipe Material	Weight	
					lbs	kg
DT75*	04390	3/4	CC	Cast/Ductile	1.1	0.5
DT100	04391	1	CC	Cast/Ductile	1.3	0.6
DT75P	04396	3/4	CC	C900 PVC	1.0	0.5
DT100P	04397	1	CC	C900 PVC	1.4	0.6

*AWWA Approved for Tapping Contest.

✓ WHY REED?
DT75/DT100 performs fast with six cutting edges for clean threads and fewer leaks. Has a sharper point for easiest starting.



DT75P

✓ WHY REED?
The unique three-flute design of DT75P/DT100P bores into the pipe with less effort than other drill tap designs and ensures that the coupon and cuttings are retained.

TAPPING SADDLES*

Catalog No.	Item Code	Description
TS4	98442	4" Saddle
TS6	98439	6" Saddle
TS8	98440	8" Saddle
TS10	98441	10" Saddle
TS12	98438	12" Saddle
TS16	98443	16" Saddle
TS18	98444	18" Saddle
TS20	98445	20" Saddle
TS24	98446	24" Saddle
TS36	98447	36" Saddle
TS42	98448	42" Saddle
TS48	98449	48" Saddle



TS6

TMTC



✓ WHY REED?
Food-grade compound that **does not** contaminate water, making this compound environmentally friendly.

TAPPING COMPOUND

Catalog No.	Item Code	Description
TMTC	98425	16 oz. (.45 kg) Resealable Can
★ TMTC8	99139	8 oz. Bottle
★ NEW		

BEST EVER!



Flip Clamp

✓ WHY REED?
"Flip Clamp" feed system is fast and easy to use; just flip the yoke to engage the boring bar. Reed's Tapping Machine is a better value than the competition and is made in the USA. TM1100 ships with all necessary parts, including the corp insertion tools. Plus, by ordering the saddles and drill taps separately, one only needs to purchase the right sizes for the job. Additionally, the Tapping Machine can be converted to a drilling machine for up to 2" saddle taps, thus saving money over the purchase of a separate machine.†

Ridgid® is a registered trademark of Ridgid, Inc. and is not associated with Reed Manufacturing Company.



BEST EVER!



DM2100

†Spec Booklet available #01071

TRAINING AVAILABLE

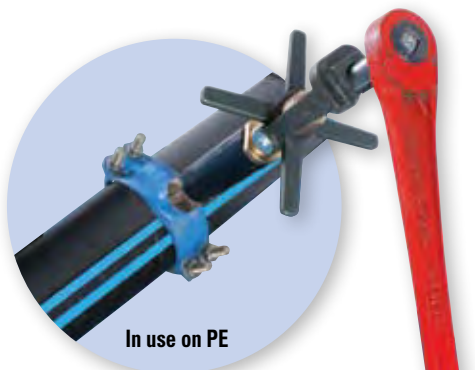

In use on PE



D688

PL1438

NOTE: For shell cutters and hole cutters, attachment thread is 5/8 - 18.



HS1750

Slot for Easy Coupon Removal

HDHS1438

Drilling Machines†

Drilling Machines cut or drill through the pipe wall of cast iron, ductile iron, C900 PVC and PE water mains via the corporation stop inserted into the service saddle while under pressure. They use Reed D series drill bits or hole cutters. The **DM2100B** machine consists of the base unit, which allows the customer to purchase separately individual corporation adapters, drill or hole cutter adapters, along with necessary drills or hole cutters. With shell cutters and necessary adapters, these units can also be used on C900 PVC pipe. **DM2100110** is for use with Mueller® 110 compression corporation stops. **DM2100CCNPT** is a combination of 3/4" and 1" AWWA CC thread and 1 1/2" and 2" NPT thread adapters. **DM2100UNIVERSAL** has the base and accessories to work for AWWA and NPT threads up to 2".

Catalog No.	Item Code	Size Inches	Weight**	
			lbs	kg
DM2100B	09301	DM2100 Base Machine	49.5	22.5
DM1100	09302	3/4 - 1	53.0	24.1
DM1100NPT	09305	3/4 - 1 NPT	53.0	24.1
DM1100BSPT	09307	1/2 - 1 BSPT	53.0	24.1
DM2100BSPT	09308	3/4 - 2 BSPT	55.5	25.2
DM2100	09312	3/4 - 2	55.5	25.2
DM2100NPT*	09315	3/4 - 2 NPT	55.5	25.2
DM2100110*	09317	3/4 - 2 110 Compression	55.5	25.2
DM2100CCNPT	09318	3/4 - 1 AWWA 1 1/2 - 2 NPT	55.5	25.2
DM2100UNIVERSAL	09321	3/4 - 2 AWWA & NPT	60.0	27.3

*#99390 boring bar needed for 2" iron body gate valves.

**Drilling Machine unit alone weighs 13.3 lbs / 6.0 kg

SMOOTH JAW WRENCHES ON P. 70

ACCESSORIES SELECTION CHART ON P. 43

D SERIES DRILL BITS

Drill bits are designed for use with Reed drilling machines and Mueller® E5/D5 only; both of which use saddles. These spiral drills are made from strong, high-speed steel, and are heat-treated for longer life. They are black oxide coated for corrosion resistance, and are much easier cutting than other drills as the spiral motion clears chips away from the cut. Recommended for cast iron and ductile iron, including cement-lined ductile iron.

Catalog No.	Item Code	Drill Size in	Nom. Corp. Size in*	Weight	
				lbs	kg
D438	04379	7/16	1/2"	0.2	0.1
D688	04380	11/16	3/4"	0.3	0.1
D875	04381	7/8	1"	0.5	0.2
D938	04382	15/16	1"	0.6	0.3

*Check manufacturer's fitting specifications for proper hole diameter.

PVC/PE SHELL CUTTERS

Shells cut through service saddles on PVC and PE. For use with Reed's Drilling Machines and DMPVC. They also fit Ford® and Mueller D® and PL-2 machines.

Catalog No.	Item Code	Shell Size in.	Nom. Corp. Size in.*	Weight	
				lbs	kg
PL688	04385	11/16	3/4"	0.2	0.1
PL875	04386	7/8	1"	0.2	0.1
PL1438	04387	17/16	1 1/2"	0.5	0.2
PL1750	04392	13/4	2"	0.7	0.3

STANDARD CARBIDE-TIPPED HOLE CUTTERS

Economical, carbide-tipped hole cutters are used with an adapter for Reed DM2100 series and Ford #77® machines. Black oxide coated for corrosion resistance. Recommended for cast iron and ductile iron, including cement-lined ductile iron.

Catalog No.	Item Code	Hole Cutter Size inches*	Nom. Corp. Size in*	Weight	
				lbs	kg
HS1438	04370	1 7/16	1 1/2"	0.2	0.1
HS1750	04371	1 3/4	2"	0.2	0.1
HS1875	04372	1 7/8	2"	0.3	0.1

*Check manufacturer's fitting specifications for proper hole diameter.

HEAVY-DUTY CARBIDE-TIPPED HOLE CUTTERS

For use with Reed DM2100 Series Drilling Machines, these cutters provide more cuts into mains than standard hole cutters. Thicker walls, bigger carbides, and high-temperature brazing are the heavy-duty features that help withstand many cuts. These are the best choice for cutting cast iron and ductile iron pipe, including cement-lined ductile iron.

Catalog No.	Item Code	Hole Cutter Size in.	Nom. Corp. Size in.	Weight	
				lbs	kg
HDHS1438	04354	1 7/16	1 1/2"	0.4	0.18
HDHS1750	04355	1 3/4	2"	0.5	0.23
HDHS1875	04356	1 7/8	2"	0.6	0.27

PILOT DRILLS

Catalog No.	Item Code	Size	Weight	
			lbs	kg
PD25	04373	3" x 1/4" for HS Series	0.1	0.05
HSPD	04561	4 3/8" x 1/4" for HDHS Series	0.1	0.05

ADAPTERS FOR DRILLS, HOLE CUTTERS, AND SHELL CUTTERS

Catalog No.	Item Code	Fits Size	Weight	
			lbs	kg
DMHSA*	08413	1 1/2" & 2" Shell & Hole Cutters	0.4	0.2
HSAS	98457	3/4" & 1" Hole Cutter Adapter	0.5	0.2
DMDA75	98461	3/4" for D688	0.4	0.2
DMDA100	98462	1" for D875 & D938	0.5	0.2
DMCA75EXT	98481	3/4" Extended	0.4	0.2
DMCA100EXT	98482	1" Extended	0.7	0.3
DMAVPCEXT	98489	3/4" & 1" PVC Extended	0.6	0.3
DMAVPVC	94150	3/4" & 1" PVC Shell	0.5	0.2

*DMHSA (#08413) is included with purchase of any new 2100 Series Drilling or Combination Machine.

CORPORATION ADAPTERS

Catalog No.	Item Code	Fits Size	Weight	
			lbs	kg
DMCA75	08423	3/4" AWWA	2.2	1.0
DMCA100	08424	1" AWWA	2.2	1.0
DMCA150	08425	1 1/2" AWWA	1.0	0.5
DMCA200	08426	2" AWWA	1.1	0.5
DMCA110150	08431	1 1/2" Mueller® 110 Comp	1.3	0.6
DMCA110200	08432	2" Mueller® 110 Comp	1.3	0.6
DMCA150NPT	08428	1 1/2" NPT	0.8	0.4
DMCA200NPT	08429	2" NPT	0.8	0.4
DMCA2.5	08433	2.5" NPT	1.1	0.5
DMCA125BSPT	08434	1 1/4" BSPT	2.2	1.0
DMCA150BSPT	08435	1 1/2" BSPT	0.8	0.4
DMCA200BSPT	08436	2" BSPT	0.8	0.4
DMCA100IPS	98499	1" IPS	0.8	0.4

BORING BARS

Catalog No.	Item Code	Description
DM1100BB	99304	Boring Bar
DM11BBEXT	99390	Extended Boring Bar for 2" Gate Valves

Selection Chart

To select the proper cutter for the proper type of pipe, use the below chart.

Catalog No.	Item Code	Size Inches	Type of Water Main		
			PE/PVC	Cast Iron	Cement-Lined Ductile
D SERIES DRILL BITS					
D438	04379	7/16		X	X
D688	04380	11/16		X	X
D875	04381	7/8		X	X
D938	04382	15/16		X	X
PVC/PE SHELL CUTTERS					
PL688	04385	11/16	X		
PL875	04386	7/8	X		
PL1438	04387	17/16	X		
PL1750	04392	13/4	X		
CARBIDE-TIPPED HOLE CUTTERS					
HS1438	04370	1 7/16			X
HS1750	04371	1 3/4			X
HS1875	04372	1 7/8			X
HEAVY-DUTY CARBIDE-TIPPED HOLE CUTTERS					
HDHS1438	04354	1 7/16		X	X
HDHS1750	04355	1 3/4		X	X
HDHS1875	04356	1 7/8		X	X

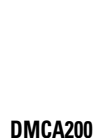

Contact Reed for information on retro fit kits #09320 for old style DM1000 and DM2000 series.



✓ WHY REED?

Heavy-duty Drilling Machine is compact and lightweight to make up to 2" saddle taps. Reed offers many different versions to meet individual customer needs.



www.reedmfgco.com

For the latest information on **NEW REED Tools!**



Combination Drilling/Tapping Machines†

Combination Drilling/Tapping Machines are easier to use, save operating time, and are a better value than any other machine. The CDTM models are tapping machines with the necessary components for conversion to drilling machines. The **CDTM1100** is a TM1100 with components for converting to a DM1100. The **CDTM2100** is a TM1100 with components for converting to a DM2100. All these models feature Reed's **flip clamp**. It utilizes Reed DT series drill taps and Reed D series drill bits, hole cutters, heavy-duty hole cutters, and PVC shell cutters. These items must be purchased separately. NPT adapters also available.

Catalog No.	Item Code	Description	Pipe Diameter		Weight*	
			In-Nom.	Actual Ømm	lbs	kg
CDTM1100	09304	3/4" - 1" Tap & Drill	4 - 48	100 - 1200	114.4	52.0
CDTM2100	09314	3/4" - 1" Tap 3/4" - 2" Drill	4 - 48	100 - 1200	116.5	53.0
CDTM2100110	09323	CDTM2100 with 110 Adapters 3/4" - 1" Tap, 3/4" - 2" Drill	4 - 48	100 - 1200	116.5	53.0

*Including Box
TAPS, BITS, CUTTERS AND ADAPTERS ON P. 41-43
SMOOTH JAW WRENCHES ON P. 70

CONVERSION KITS †

Catalog No.	Item Code	Converts
CDTM1CONV	09306	TM1100 to CDTM1100
CDTM2CONV	09316	TM1100 to CDTM2100
★ CDTM2110CONV	09322	TM1100 to CDTM2100110

★ **NEW**
† Spec Booklet available #01071

PVC/PE Drilling Machines†

The PVC/PE Drilling Machine is used to cut through the pipe wall via the corporation stop inserted into the service saddle while under pressure. The **DMPVC** consists of the base unit and corporation (corp) adapters in a carrying case. PVC/PE Shell Cutters are sold separately. The **DMPVCBASE** machine consists of the base unit in a storage tube, allowing the customer to purchase necessary corp adapters and shell cutters. **DMPVC3/4** and **DMPVC1** kits include one shell cutter, one corp adapter, DMPVCBASE, and a storage tube. **DMPVC COMPLETE** ships in a plastic toolbox and includes the DMPVCBASE along with corp adapters and PVC shell cutters for both 3/4" and 1" drilling projects. NPT to CC corp adapter converters, and a 7/16" socket wrench complete the set.

Catalog No.	Item Code	Size Inches	Weight	
			lbs	kg
DMPVC	04402	3/4 - 1	8.4	3.8
DMPVCBASE	04401	3/4 - 1	3.7	1.7
DMPVC COMPLETE	04404	3/4 - 1	11.0	5.0
DMPVC3/4	04418	3/4	4.0	1.8
DMPVC1	04420	1	4.0	1.8

† Spec Booklet available #01071

ACCESSORIES

PVC/PE SHELL CUTTERS

Shells cut through service saddles on PVC and PE, retaining the coupon and gathering all chips. For use with Reed's DMPVC and Drilling Machines. They also fit Mueller D® and PL-2 machines.

Catalog No.	Item Code	Shell Size in.	Nom. Corp. Size in.	Weight	
				lbs	kg
PL688	04385	1 1/16	3/4"	0.2	0.1
PL875	04386	7/8	1"	0.2	0.1

CORPORATION ADAPTERS

Catalog No.	Item Code	Fits Size	Weight	
			lbs	kg
DMCA75PVC	04426	3/4" AWWA	1.5	0.7
DMCA100PVC	04427	1" AWWA	1.1	0.5
DM75CONV	98472	3/4" NPT - AWWA Converter	0.4	0.2
DM100CONV	98473	1" NPT - AWWA Converter	0.6	0.3

✓ WHY REED?

One combination machine assembles as a drilling machine or a direct tapping machine. Offers 10%+ cost savings versus the purchase of two separate machines.



✓ WHY REED?

These shell cutters easily bore through even the heaviest wall PVC/PE pipe and retain the coupon and most cuttings.

PL688

NEW Power Tapping & Drilling Machines

Add power to your drilling and tapping, and save hours of hand-cranking. Economical **601PDTAP** is a portable, electric-motor-driven, lightweight, good value power drive. 601PDTAP specifically powers the Reed DM1100, DM2100, TM1100, CDTM1100, and CDTM2100 models including all variations. Plated metal bar reinforces the plastic handle to protect the housing from excess torque. The **700PDTMPDA** is a heavy-duty workhorse designed for constant, everyday use and consists of the 700PD Power Drive and the **TMPDA** adapter. The TMPDA fits the $\frac{13}{16}$ " boring bar that is common on popular drilling and tapping machines. The operator manually turns the star feed on the tapping or drilling machine while the 700PD power drive adapter turns the boring bar. The **700PD15/16** can be used with Ridgid® 141/161 geared threaders to thread 2 1/2" through 6" pipe or can be tightened down to fit Reed's tap/drill machines.

Catalog No.	Item Code	Weight		Description
		lbs	kg	
★ 601PDTAP	05246	17.0	7.7	601PD Tap/Drill with adapter*
★ 700PDTMPDA	05276	34.0	15.5	700PD and TMPDA adapter
★ 700PDA15/16	05279	33.7	15.3	700PD Power Drive and $\frac{15}{16}$ " square drive adapter

★ **NEW**

* 601PDTAP adapter *NOT* sold separately.

ACCESSORIES

Catalog No.	Item Code	Weight		Description
		lbs	kg	
PDGFI	05277	0.7	0.3	Ground Fault Interrupter
TMPDA	08430	4.0	1.8	$\frac{13}{16}$ " Power Drive Adapter Only for 700PD
TMPDA1516	05278	4.0	1.8	$\frac{15}{16}$ " Square Drive Adapter for 700PD

GROUND FAULT INTERRUPTER ON P. 25
POWER DRIVES ON P. 24-25



4

**REED DELIVERS
VALUE
WORLDWIDE...
GUARANTEED!**

**QUALITY
& Service**
that Last a Lifetime

Mission Statement

Reed will develop a growing market position in the pipe tool industry by providing the most innovative and the highest quality tools, the best customer service, the lowest total cost, and the greatest value to distributors and users.

Reed seeks to utilize very effective personnel, the most modern, cost-effective equipment, and total quality management concepts in order to achieve challenging objectives. Reed also seeks to provide a great place to work, to be environmentally responsible, and to be a good corporate citizen.

NEW Feed Tap™ Drilling Machine

Reed's Feed Tap™ is a great waterworks tool that drills through PVC, PE, cast iron, ductile iron and steel pipe while under pressure using a corporation stop inserted into a service saddle. The compact design, featuring a separate, independent feed control for advancing the heavy-duty shell cutter into the pipe, allows the user to easily complete the tap using an electric or cordless drill, right angle drill, or even a 7/16" wrench with manual power. Forcing a cutter without a controlled feed can break the pipe. The **FTB** consists of the base unit which allows the user to purchase individual shell cutters and corporation adapters separately, as needed. A complete kit is sold as **FT2000UNIV**.

Catalog No.	Item Code	Description	Weight	
			lbs	kg
★ FTB	09160	Feed Tap™ Base Machine	22.5	10.2
★ FT2000UNIV	09165	Complete Feed Tap™ Kit 3/4" - 2"	34.0	15.5
★ FT2000CC110	09161	AWWA/110 Comp Feed Tap™ Kit 3/4" - 2"	31.5	14.3
★ FT2000	09162	AWWA Feed Tap™ Kit 3/4" - 2"	27.8	12.6
★ FT2000110	09163	110 Comp Feed Tap™ Kit 3/4" - 2"	28.0	12.7
★ FT2000NPT	09164	NPT Feed Tap™ Kit 3/4" - 2"	26.5	12.0
★ FT2000CCNPT	09166	AWWA/110 Comp 3/4" - 1" NPT 1 1/2" - 2" Feed Tap™ Kit	28.7	13.0
★ FT1000CC110	09167	AWWA/110 Comp Feed Tap™ Kit 3/4" - 1"	24.4	11.1

NOTE: Feed Tap™ is designed to be used with corporation stops and bronze gate valves up to 2". The tool is not designed to be used with 2" iron body gate valves.

ACCESSORIES

CORPORATION ADAPTERS

Catalog No.	Item Code	Description	Weight	
			lbs	kg
★ FT75CC110	09170	3/4" AWWA and 110 Comp	.60	.27
★ FT100CC110	09171	1" AWWA and 110 Comp	.55	.25
★ FT150	09172	1 1/2" AWWA	1.20	.55
★ FT200	09174	2" AWWA	1.40	.64
★ FT150110	09173	1 1/2" 110 Comp	1.35	.61
★ FT200110	09175	2" 110 Comp	1.40	.64
★ DMCA100IPS*	98499	1" IPS	.80	.40
★ FT75NPT	99117	3/4" NPT	.45	.20
★ FT100NPT	99118	1" NPT	.45	.20
★ FT150NPT	99109	1 1/2" NPT	.80	.36
★ FT200NPT	99112	2" NPT	.80	.36

*Requires #09171 adapter.

HEAVY-DUTY SHELL CUTTERS

Shell cutters cut up to 2" deep and fit most standard arbors and competitive machines. The attachment thread is 1/2 - 20. Each tooth has carbide inserts which long outlast bi-metal teeth.

Catalog No.	Item Code	Shell Cutter Size Inches*	Weight	
			lbs	kg
★ FTSC688	99132	11/16	.09	.04
★ FTSC875	99134	7/8	.15	.07
★ FTSC1438	99137	1 7/16	.41	.19
★ FTSC1750	99138	1 3/4	.57	.26

*Check manufacturer's fitting specifications for proper hole diameter.

MISCELLANEOUS

Catalog No.	Item Code	Description
★ FTAA	09113	Arbor Assembly used with 1 7/16 and 1 3/4 Shell Cutter
★ CRPD25	99129	1/4" diameter Carbide Tipped Coupon Retaining Drill Bit

TAPPING COMPOUND

Food-grade compound that **does not** contaminate water, making this compound environmentally friendly.

Catalog No.	Item Code	Description
TMTC	98425	16 oz. (.45 kg) Resealable Can
★ TMTC8	99139	8 oz. Bottle

FT2000UNIV



Works great with cordless or corded drills.



FTSC875

Manual Feed Control



Independent, controlled feed makes this the preferred tool for PVC taps.

CRPD25



TMTC



NEW

TMTC8



PE Water Service Shut-Off Tool

Designed for emergency shut-off of PE water services. Front end features a snap hinge device that can be taken apart quickly to allow work in confined areas. Knurled grip catches and holds the pipe. Open end has latch to hold tool closed until the repair is made. Zinc plated for corrosion resistance.

Catalog No.	Item Code	Pipe Capacity		Length		Weight	
		Inches-Nom.	Actual Ø mm	in	mm	lbs	kg
PES01	04300	3/4 - 1	19 - 25	18	457	2.7	1.2



Standing Shut-Off Tool

Reed's Standing Shut-Off Tool compresses 3/4" to 1" PE plastic tubes to stop the flow of water. The tool uses 30" handles to develop a clamping force in a manner similar to a pair of bolt cutters. The long handles make for easy shut off from above the ditch with a chain (not included*) to hold the tool closed. Not intended for gas service lines.

Catalog No.	Item Code	Pipe Capacity		Length		Weight	
		Inches-Nom.	Actual Ø mm	in	mm	lbs	kg
SS01C	04281	3/4 - 1	19 - 25	47	1194	17.0	7.7

*9 3/4" Chain #99055 may be ordered separately.
PE SQUEEZE-OFF TOOLS (FOR GAS SERVICES) ON P. 58



Copper Shut-Off Tools

These tools are designed to shut off and reshape 3/4" through 2" Type K copper tubing. The tool swings open to go around the pipe. Fine threads on the screw provide smooth, easy tightening. Sliding bar handle is used to increase leverage for turning and to permit work in tight places. The handle can be positioned in two different spots, depending on where there is clearance. The bottom open area is used to reround the tubing to allow 80-90% return of flow. All parts are corrosion-protected for long service life. Grease fittings for lubrication yield long tool life and easy operation.

Catalog No.	Item Code	Tube Capacity		Weight	
		in	mm	lbs	kg
CS01	08200	3/4 - 1	19 - 25	7.9	3.6
CS02	08202	1 1/4 - 2	32 - 51	13.0	5.9



Hammer & Flare Tools

High quality hardened steel flaring tools for making 45° flares on Type K soft copper water service tubing. Flare tools have larger pilots and finger grip areas for safety. Soft-faced brass hammer has an overall length of 14 1/2" and is designed for safe use of flaring tools as the brass head absorbs some of the striking shock.

FLARE TOOLS

Catalog No.	Item Code	Copper Tube Size	Weight	
			lbs	kg
HF3/4*	06071	3/4"	1.0	0.5
HF1	06072	1"	1.5	0.7
HF1 1/2	06077	1 1/2"	3.2	1.5
HF2	06078	2"	4.9	2.2

BRASS HAMMER

Catalog No.	Item Code	Weight	
		lbs	kg
HAM3*	06088	2.8	1.3

*AWWA Approved for Tapping Contest.

PRESSURE-RELIEVING HAMMER FLARES

With precision channels drilled from the tool's end to its side, they allow flaring even when water is in the service line. Use only on Type K soft copper water service tubing, with brass hammers for safety.

Catalog No.	Item Code	Copper Tube Size	Length		Weight	
			in	mm	lbs	kg
PRHF3/4	06073	3/4"	7.5	191	2.0	0.9
PRHF1	06074	1"	7.5	191	2.3	1.0

Rerounding Tools

Tools easily and quickly reround Type K copper tubing for better seal when compression fittings are used. Use only with brass hammers for added safety.

Catalog No.	Item Code	Copper Tube Size	Length		Weight	
			in	mm	lbs	kg
RR 3/4	06081	3/4"	6	152	0.7	0.3
RR1	06082	1"	6.5	165	1.3	0.6
RR1 1/2	06084	1 1/2"	8	203	2.8	1.3
RR2	06085	2"	9	229	5.4	2.5

Round It® Straightener/Rerounder

Time-and-material saving **CSR2** handles 1 1/2" and 2" K annealed copper. Grips the end of a coil so uncoiling is easy; rerounds oval tubing or mild kinks anywhere along its length so cutter will track and fitting will seal properly. Provides safe grip when flaring, and guides copper into alignment for easier fit-ups. 3/4" **RCR3/4** and 1" **RCR1** tools are especially useful when tubing is wet for a solid grip when straightening and fitting up. **RCR341** offers all the same features as both RCR1 and RCR3/4 as it includes jaws for either size tubing. The long-handled RCR rerounders are beneficial when extra leverage is needed. The **CSR3/4** and **CSR1** have shorter handles to fit into close quarters.

Catalog No.	Item Code	Nominal Capacity	Length		Weight	
			in	mm	lbs	kg
CSR2	08220	1 1/2" & 2"	38	965	22.0	10.0
★ CSR3/4	08222	3/4"	9	230	2.0	0.9
★ CSR1	08223	1"	9 1/2	241.3	1.8	0.8
RCR3/4	08226	3/4"	18	457	4.5	2.0
RCR1	08227	1"	18	457	4.5	2.0
RCR341	08228	3/4" & 1"	18	457	5.5	2.5

★ NEW



✓ WHY REED?

Safety first! Reed always recommends brass hammers with Flare Tools, Pressure Relieving Hammer Flares, and Rerounding Tools.



TRAINING AVAILABLE



XTRA VALUE!

NEW Electric Hydrostatic Test Pumps

Reed's **EHTP500** and **EHTP500C** are designed for pressure testing water systems such as water meters, plumbing lines, pressure vessels, solar systems and sprinkler systems, in both residential and commercial buildings. A standard 110V outlet is required and the electric motor is UL certified. The output pressure is easily adjusted simply by turning a knob and watching the attached gauge. A built-in bypass allows for automatic water recirculation once the set pressure is reached. When the pump is turned off, it can be easily disconnected from the test system and taken elsewhere or stored away. The hose-to-pump connection features a quick disconnect with built-in check valve, which allows for convenient setup and portability. Each pump includes a high pressure **EHTPOUTHOSE** for filling the system.

Electric models reach pressure faster and save labor costs.

EHTP500C



EHTP500

Catalog No.	Item Code	Capacity	Weight	
			lbs	kg
★ EHTP500	08170	500 psi	37.5	17.0
★ EHTP500C	08175	500 psi	48.0	21.8

★ **NEW**

REPLACEMENT HOSE

Catalog No.	Item Code	Description
★ EHTPOUTHOSE	08172	15' (4.6 m) High Pressure Output Hose

★ **NEW**

Hydrostatic Test Pumps

Reed's **HTP300** and **HTP1000** are designed to test water meters, plumbing lines, pressure vessels, solar systems and sprinkler systems, in both residential and commercial buildings. The units are portable and can be used to test modest irrigation lines. Pump operation requires the user to first fill the system that needs to be tested. Next, the user raises the system pressure by actuating the pump handle. Finally, the user closes the pump's ball valve at the desired pressure. The user determines leakage based on dropping pressure as indicated by the pump's pressure gauge. The pump has a relief valve that reduces the likelihood of over-pressuring the system. Hoses are sold separately.

Catalog No.	Item Code	Capacity	Weight	
			lbs	kg
HTP300	08150	300 psi	8.6	3.9
HTP1000	08160	1000 psi	8.6	3.9

ACCESSORIES

Catalog No.	Item Code	Description
HTPINHOSE	08152	Input Hose
HTPOUTHOSE	08154	Output Hose

Meter Pit Pump

Reed offers solutions for those encountering flooded meter pits. **MP175** pulls water out of pits, making them more visible, convenient, and safe. Pump could be used on a fire hydrant to drain the water for repair work. Includes a 36" (914 mm) hose of 1 3/4" diameter. The hose simply screws into a threaded section of the pump. Use the MP175 for easier, deeper pumping.

Catalog No.	Item Code	Description	Capacity oz. per Stroke	Weight	
				lbs	kg
MP175	02325	1 3/4" x 36" (914 mm) hose and pump	35	1.6	0.7

REPLACEMENT HOSES

Catalog No.	Item Code	Description	Weight	
			lbs	kg
HOSE175-6	42326	1 3/4" x 6' (1829 mm) Replacement Hose	0.8	0.4
HOSE175-3	42325	1 3/4" x 3' (914 mm) Replacement Hose	0.4	0.2



HTP300



MP175

Valve & Curb Keys

Reed Valve Keys are built for strength and durability. Upper shafts are made from heavy-gauge, mechanical steel tubing. Curb key ends are machined from solid steel. The keys have a telescoping design. When telescoped in, they are under 4 feet long and fit easily in small utility trucks, behind pickup seats, and in car trunks. When telescoped out, lengths of 5 feet to 7 feet are possible. **VK10** reaches nearly 10 feet when fully extended. **VKEXT** shaft is available to extend the keys to over 12 feet. For greater control and versatility, a variety of tools can be used on the end of T handles to turn curb stops. Optional clip-on tools can be used to turn small valve wheels, curb box rods, pentagon bolts, and Buffalo box lids. Reed customers can choose keys according to the needs of their systems.

The **VKA45** is an adjustable valve key for mains with the curb key at a 45 degree angle. This angle provides a visual indication of a ball valve's open or closed status. The handle lines up with the pipe when the valve is in the open position. The handle crosses the pipe (seeming perpendicular) with the valve in the closed position. **VK916PENT** fits gas company curb stops and lids with its 9/16" pentagon key. **VKEXT** is an extension bar with 3 positions that can be used on most Reed keys for up to 6 feet (1829 mm) of extra reach. **VKKIT** uses the VK3 upper shaft to create all VK2 and VK3 variations of valve keys.



WHY REED?

When it comes to turning gate valves in the street and curb stop valves to buildings, Reed's selection of Valve Keys is the most complete and compact around.

KEY CHOICES

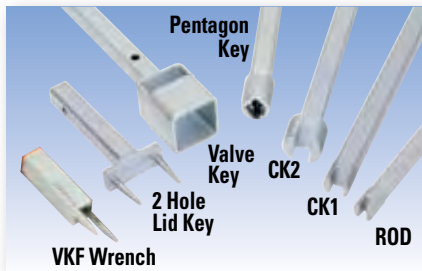

NOTE: Key ends fit regular Valve & Curb Keys only.

Catalog No.	Item Code	Description	Closed Length		Weight	
			in	mm	lbs	kg
VKA	02340	Adjustable Valve Key for Mains	45.5	1156	14.4	6.5
VKA45	02341	Adjustable Valve Key with 45° angle Curb Key	45.5	1156	14.9	6.8
VK2CK1	02346	Main Valve Key + 1" Curb Key	45.5	1156	14.4	6.5
VK2CK2	02347	Main Valve Key + 2" Curb Key	45.5	1156	14.5	6.6
VK2COMBO	02348	Main Valve Key + Combination curb box pentagon & rod tool	45.5	1156	14.4	6.5
VK916PENT	02352	9/16" Pentagon Key	45.5	1156	21.0	9.5
VK3CK1WHL	02353	Main Valve Key + 1" Curb Key + valve wheel 2 prong tool	45.5	1156	15.3	7.0
VK3CK1-2HL	02354	Main Valve Key + 1" Curb Key + 2 prong tool for 2 hole curb boxes	45.5	1156	15.4	7.0
VK3CK1COMBO	02355	Main Valve Key + 1" Curb Key + Combo curb box pent. & rod tool	45.5	1156	18.4	8.4
VK3CK1ROD	02356	Main Valve Key + 1" Curb Key + 9/8" slotted tool for curb box rods	45.5	1156	18.7	8.5
VK3CK1CK2	02357	Main Valve Key + 1" Curb Key + 2" Curb Key	45.5	1156	18.4	8.4
VK3CK1EXT	02358	Main Valve Key + 1" Curb Key + Extension shaft for additional 6' reach	45.5	1156	25.7	11.7
VKKIT	02360	Kit contains parts to make all VK2 and VK3 variations using the VK3 upper shaft	45.5	1156	42.5	19.3
★ HWVK	02361	Hydrant Wrench with hole to attach to valve key	20	500	3.9	1.8
★ VK3CK1HW	02362	Valve Key with CK1 curb key and Hydrant Wrench	45.5	1156	19.5	8.9
★ VK10	02720	Basic 10' Valve Key	65.0	1524	18.8	8.5
★ VK10-3CK1CK2	02737	10' Valve Key with CK1 and CK2 Keys	65.0	1524	20.2	9.2
★ VK10-3CK1EXT	02738	10' Valve Key with CK1 Key and Extension	65.0	1524	27.5	12.5
★ VKEXT	92358	Valve Key Extension	72.0	1829	11.3	5.1
★ NEW						



NEW Ratcheting Valve Keys

Ratcheting Valve Keys are great for water utilities. Back-saving ratchet handle allows work in one's comfort zone. Under 4 feet long when telescoped in, Reed keys fit well in today's smaller utility trucks, behind pickup seats, or in car trunks.

Catalog No.	Item Code	Description	Closed Length		Weight	
			in	mm	lbs	kg
★ VKRCK1	02349	Main Valve Key + 1" Curb Key & Ratchet Handle	45.5	1156	20.1	9.1
★ VKREXT	02350	Main Valve Key + Ext & Ratchet Handle	45.5	1156	26.2	11.9
★ NEW						

NOTE: Regular Valve & Curb Keys (P. 50) do not fit the ratcheting handle.

NEW Valve Operators

Provide power to make valve turns easy! This portable and economical tool is handy for preventive maintenance. Individuals working alone can isolate a leak by shutting multiple valves with this time-saving tool. In the **VOK700PD** the power drive uses electricity to drive the **VOKCLUTCH**. Clutch applies up to 150 ft-lbs of torque and disengages when torque exceeds preset value. The VOKCLUTCH accepts 1" square shafts. The Valve Key extends from 4' to 9" and recommended operation is at chest height for best leverage.



Catalog No.	Item Code	Description	Weight	
			lbs	kg
★ VOKCLUTCH	05281	Spring-Loaded Valve Key Clutch	6.8	3.1
★ VOK700PD	05288	Kit includes 700PD power drive, VOKCLUTCH, 2" valve key, and valve key extension	61.7	28.0

★ **NEW**
KEY CHOICES (P. 50) fit the Valve Operator. The selected key plus #92341 handle and #32340 wire pins are generally required.

Valve & Curb Keys Matrix

Catalog No.	Item Code	32340 PIN	92337 VKR LOWER	92339 LOWER	92340 43.25" UPPER	92342 43.25" UPPER	92343 VKR UPPER	92346 HDL9/16K	92347 HDL3/4K	92348 HDL PENT	92341 HDL	92345 HDL RODKY	92354 LID KEY	92356 VK RATCHET	92349 WHL WRE	92358 EXT	92359 LOWER 45°	92519 LOWER	92520 61.25" UPPER	92522 61.25" UPPER	02361 HWVK	Closed Length		Open Length*		Weight		
																						in	mm	ft	meters	lbs	kg	
																						VKA	02340	X	X	X		
VKA45	02341	X		X						X							X						45.5	1156	6' 8"	2.03	14.9	6.8
VK2CK1	02346	X	X	X			X																45.5	1156	6' 8"	2.03	14.4	6.5
VK2CK2	02347	X	X	X				X															45.5	1156	6' 8"	2.03	14.5	6.6
VK2COMBO	02348	X	X	X					X														45.5	1156	6' 8"	2.03	14.4	6.5
VKRCK1	02349	X	X			X	X						X			X							45.5	1156	6' 7"	2.01	20.1	9.1
VKREXT	02350	X	X			X							X		X								45.5	1156	12' 6"	3.81	26.2	11.9
VK916PENT	02352	X			X		X	X		X													45.5	1156	5' 4"	1.63	21.0	9.5
VK3CK1WHL	02353	X	X	X	X	X	X							X									45.5	1156	6' 8"	2.03	15.3	7.0
VK3CK1-2HL	02354	X	X	X	X	X						X											45.5	1156	6' 8"	2.03	15.4	7.0
VK3CK1COMBO	02355	X	X	X	X	X	X	X		X													45.5	1156	6' 8"	2.03	18.4	8.4
VK3CK1ROD	02356	X	X	X	X	X					X												45.5	1156	6' 8"	2.03	18.7	8.5
VK3CK1CK2	02357	X	X	X	X	X	X	X								X							45.5	1156	6' 8"	2.03	18.4	8.4
VK3CK1EXT	02358	X	X	X	X	X									X								45.5	1156	12' 7"	3.84	25.7	11.7
VKKIT	02360	X	X	X	X	X	X	X	X	X	X	X	X	X	X	X							45.5	1156	12' 7"	3.84	42.5	19.3
VK3CK1HW	02362	X	X	X	X	X	X	X												X			45.5	1156	6' 8"	2.03	19.5	8.9
VK10	02720	X									X							X	X				65.0	1524	9' 11"	3.02	18.8	8.5
VK10-3CK1CK2	02737	X					X	X										X	X				65.0	1524	9' 11"	3.02	22.8	10.3
VK10-3CK1EXT	02738	X					X									X		X	X				65.0	1524	15' 10"	4.83	30.1	13.7

*As sold, without any extra extensions.



92343 VKR Upper Shaft

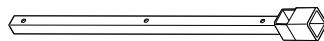

92337 VKR Lower Shaft

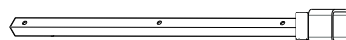

92359 Lower 45°



92519 Lower

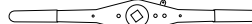

92356 VKR Ratchet



92354 Handle + 2 Hole Lid Key

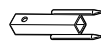

92349 VKF Wrench



92358 Extension Shafts

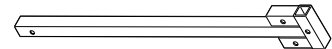

92342 Upper Shaft/92522 Upper Shaft

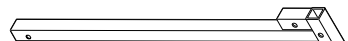

92340 Upper Shaft/92520 Upper Shaft

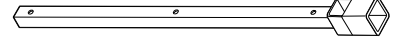

92339 Lower Shaft + 2" Key

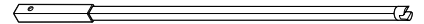

92345 Handle + Rod Key (one piece, expand with #92358)

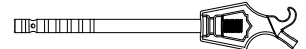

20361 HWVK Hydrant Wrench

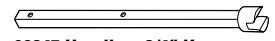

92347 Handle + 3/4" Key

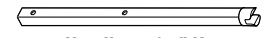

92346 Handle + 9/16" Key

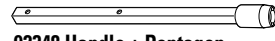

92348 Handle + Pentagon

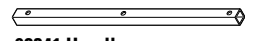

92341 Handle



www.reedmfgco.com
For the latest information on **NEW REED Tools!**

NEW Valve Key Socket Kit



Reed Valve Key Sockets are specifically designed to engage a rounded or corroded operating nut on valves in difficult situations. Kits include small, medium, and large sockets. Socket will attach to a standard gate key with the VKSK's screw and plate. Rugged and durable, yellow zinc-plated, hardened-steel sockets. Lower cost and lower maintenance than alternative tools.

Catalog No.	Item Code	Description	Weight	
			lbs	kg
★ VKSK	02730	3 sockets, 3" screw and attachment plate in a durable carrying case	6.7	3.0
★ NEW				

Meter Box & Curb Box Lid Keys

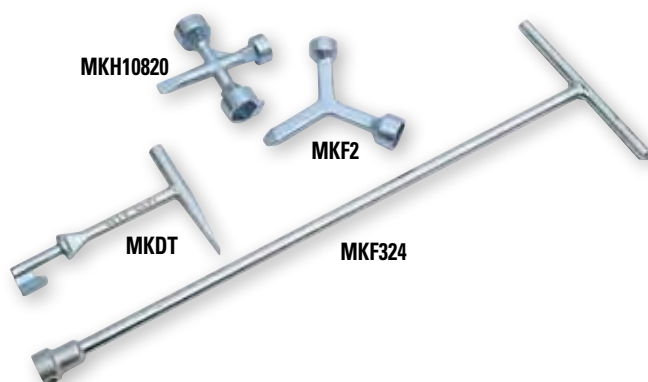

Reed Meter Keys open many styles of meter pit lids and curb box lids. Reed has the widest choice of pentagon keys and "skeleton" keys available, ending lengthy searches for the right key. Reed pentagon Meter Key capacities include standard waterworks pentagon bolts and plugs, as well as the large pentagon bolts made by both Mueller® and Ford®. Careful design and production ensure the Reed pentagon and skeleton keys fit many brands of lids and bolts. Reed Meter Keys all have a turn and lift feature, allowing tool users to open a lid, lock onto it, and lift the lid off with a single motion. All Reed Meter Keys are made of strong, plated ductile iron to inhibit rust.

Catalog No.	Item Code	Description	Length		Weight	
			in	mm	lbs	kg
MKF2	02364	Ford® Lg. & Std. Pentagons	5.5	140	0.9	0.4
MKF324	02367	24" T w/ Std., Slotted Pentagon	24.5	622	2.4	1.1
MKDT	02375	Ductile T Skeleton	7.0	178	0.8	0.4
MKH10820	02380	Mueller® 2 Lg. & 1 Std. Pentagon	5.0	127	1.2	0.5

NEW Valve Box Cleaners

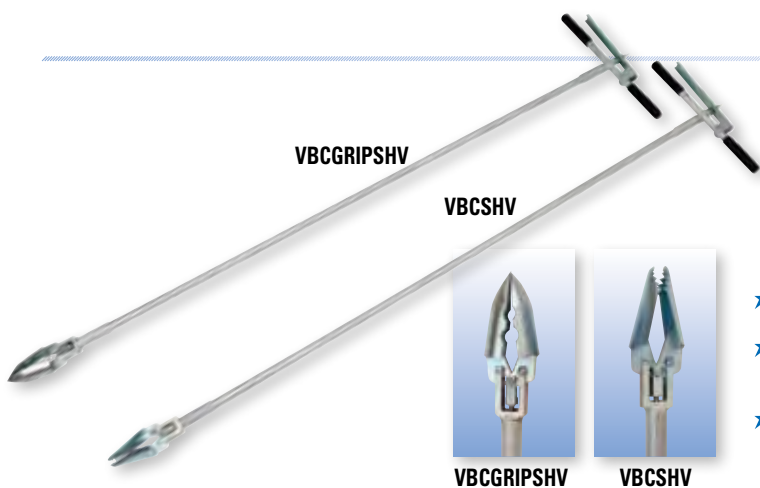

Make valve and curb box cleanouts easier with these all steel, zinc-plated (no brass) tools. Heads are welded to the handle for strength and no loose parts. Tools are spring loaded – when the handle is released, the jaws continue to hold while the operator lifts the cleaner from the pit. Use the shovel or grip cleaners to grab debris, dirt and twigs.

Catalog No.	Item Code	Description	Length		Weight	
			in	mm	lbs	kg
★ VBCGRIPSHV	09434	Combination mud shovel and gripper; fits thru 2 7/8" opening and opens to 5 1/2"	72	1829	9.9	4.5
★ VBCSHV	09410	Mud shovel with cut-out to grab brush and small branches; fits thru 2 7/8" opening and opens to 4 1/2"	72	1829	9.8	4.4

★ NEW

Manhole Hooks



MH26

EXCLUSIVE FEATURES

WHY REED?
Red powder paint insulates handle from hot sun for greater safety and comfort.

Hooks are forged of 5/8" hex high carbon steel. Handle fits large hand. MH30 has rotated handle and rocker head to more easily enter notch in stubborn covers. Points are 1/2" wide for cover openings. Powder painted for corrosion protection.

Catalog No.	Item Code	Handle to Hook Relationship	Length		Weight	
			in	mm	lbs	kg
MH26	02301	Same plane	26	650	3.3	1.5
MH30	02302	Hook 90° to handle	30	760	4.0	1.8
MH36	02303	Same plane	36	900	4.3	2.0



PLASTIC PIPE TOOLS

SECTION 5

Quick Release™ Cutters

Internal Pipe Cutters

Ratchet Shears 

Scissor Shears

Plastic Pipe Saws 

PLAS In-Line Rotary™ Cutter 

Bevelers

Plastic Pipe Joiners

PE Squeeze-Off Tools 

Guillotine Pipe Cutters

Grounding Accessory

Static Discharge Alarm

PEX Crimpers 

PEX Shut-Off Tools 

Flare Tools for PE Water
Service Lines

Deburring Tools For Plastic

Chain Vises for Plastic Pipe



Quick Release™ Cutters

Reed Quick Release™ tubing cutters are the industry standard; most recommended by plastic pipe companies and most imitated by other manufacturers. They are the most practical cutters for small, medium, and large diameter work and feature sliding bars now with magnesium for added strength. They cut clean with very little burr. Field tests show that Quick Release™ cutters with Reed OP2 or 30-40P cutter wheels are excellent for use on ABS pipe.

Catalog No.	Item Code	O.D. Capacity		Length		Weight		Wheel	Material Cut
		Actual Inches	Actual Ø mm	in	mm	lbs	kg		
TC1QP*	04110	1/8 - 1 5/16	3 - 33	6	152	0.6	0.3	OP2	PE - PP - ABS
TC1QPVC*	04114	1/8 - 1 5/16	3 - 33	6	152	0.6	0.3	1 - 2 PVC	PVC, CPVC
TC1.6QP*	04116	1/4 - 1 5/8	6 - 42	6.5	165	0.8	0.4	OP2	PE - PP - ABS
TC1.6QPVC*	04118	1/4 - 1 5/8	6 - 42	6.5	165	0.8	0.4	1 - 2 PVC	PVC, CPVC
TC2QP*	04120	1/4 - 2 5/8	6 - 63	8	203	1.2	0.5	OP2	PE - PP - ABS
TC2QPVC*	04124	1/4 - 2 5/8	6 - 63	8	203	1.2	0.5	1 - 2 PVC	PVC, CPVC
TC3QP	04130	3/8 - 3 1/2	10 - 90	11	279	2.5	1.1	30 - 40P	PE - PP - ABS
TC3QPVC	04134	3/8 - 3 1/2	10 - 90	11	279	2.5	1.1	3 - 6 PVC	PVC, CPVC
TC3Q6QP	04138	3/8 - 3 1/2	10 - 90	11	279	2.5	1.1	6QP	THICK PE
TC4QP	04140	1 7/8 - 4 1/2	48 - 114	12	305	2.8	1.3	30 - 40P	PE - PP - ABS
TC4QPVC	04144	1 7/8 - 4 1/2	48 - 114	12	305	2.8	1.3	3 - 6 PVC	PVC, CPVC
TC4Q6QP	04148	1 7/8 - 4 1/2	48 - 114	12	305	2.8	1.3	6QP	.55 THICK PE
TC5QP*	04150	2 1/2 - 5	63 - 125	13	330	3.0	1.4	30 - 40P	PE - PP - ABS
TC5QPVC*	04154	2 1/2 - 5	63 - 125	13	330	3.0	1.4	3-6 PVC	4" C900
TC6QP	04160	4 - 6 5/8	102 - 168	15	381	3.9	1.8	30 - 40P	PE - PP - ABS
TC6QPVC	04164	4 - 6 5/8	102 - 168	15	381	3.9	1.8	3 - 6 PVC	PVC
TC6Q680PVC	04125	4 - 6 5/8	102 - 168	15	381	3.9	1.8	680PVC	PVC-HVY WALL
TC6Q6QP	04168	4 - 6 5/8	102 - 168	15	381	3.9	1.8	6QP	.55 THICK PE
TC6Q80P	04123	4 - 6 5/8	102 - 168	15	381	3.9	1.8	80P	.75 THICK PE
TC8QP*	04170	6 1/4 - 10	159 - 254	26	660	8.0	3.6	80P	PE - PVC**
TC8QPL*	04171	6 1/4 - 10	159 - 254	26	660	8.0	3.6	80P	.75 THICK PE
TC8Q680PVC*	04172	6 1/4 - 10	159 - 254	26	660	8.0	3.6	680PVC	PVC-NYLON

*EXCLUSIVE

*Features spare cutter wheel in knob. TC1QP, TC1QPVC, TC1.6QP, and TC1.6QPVC have spare "O" wheel. TC2QP has "OP2" wheel, TC2QPVC gets "1-2PVC" wheel.

**The TC8QP comes with a cradle and blade for cutting thick PVC.

QUICK RELEASE™ TUBING CUTTERS FOR METAL ON P. 11
CUTTER WHEELS ON P. 6 - 7

Internal Pipe Cutters

Reed Internal Pipe Cutters cut pipe from the inside (i.e. drain pipes or sprinkler drops, etc). Heat-treated steel, saw-toothed blades on the IC1S, IC1SL, IC3/4S, and IC3/4SL make for fast cutting. The IC1A comes with an abrasive blade for areas where the blade may come in contact with concrete or other hard surfaces which would destroy a saw-tooth blade. Available in a variety of sizes and styles, all cutters fit in a standard 3/8" drill. During use, flats on the larger cutters keep the cutter from slipping in the jaws of the drill while a lock washer on the smaller cutters keeps the blades from slipping. All saw-toothed models cut plastic pipe aggressively and can cut wood for sink lugs. IC1SL and IC3/4SL feature an exclusive, adjustable guide as a depth gauge. The IC3/4S and IC3/4SL are exclusive in their 3/4" pipe diameter.

Catalog No.	Item Code	Description	Shaft Size	Weight	
				lbs	kg
IC1A	04500	1 1/2" minimum I.D. - abrasive blade	4" shaft	0.2	0.1
IC1S	04501	1 1/4" minimum I.D. - saw blade	4" shaft	0.2	0.1
IC1SL*	04505	1 1/4" minimum I.D. - saw blade	7" shaft	0.7	0.3
IC3/4S*	04506	3/4" minimum I.D. - saw blade	4" shaft	0.2	0.1
IC3/4SL*	04507	3/4" minimum I.D. - saw blade	6" shaft	0.4	0.2

*EXCLUSIVE

REPLACEMENT BLADES

Catalog No.	Item Code	Description
IC1RA	04502	Abrasive Blades for IC1
IC1RS	04503	Saw Tooth Blades for IC1
IC3/4RS	04508	Saw Tooth Blades for IC3/4



EXCLUSIVE SIZES

BEST EVER!

✓ WHY REED?

Quick Release™ tubing cutters were invented by Reed and cover capacities up to 10" (254 mm). First used by Reed, the ball detent wheel pin makes cutter wheel change easy. Reed has the best cutter wheels specifically designed for all plastic applications, especially for ABS pipe.

✓ WHY REED?

SL models offer exclusive, adjustable guide and depth gauge making it easier to cut from inside pipe where other tools won't go.



EXCLUSIVE SIZE

EXCLUSIVE FEATURES

Ratchet Shears

Ratchet shears with hardened steel blades are ideal for cutting PVC, PE, PP, PEX, and ABS pipe. For CPVC, use the RS1PLT, RS7290, or RSP1 because of blade thinness and finish. One-hand models **RS1** and **RS1PLT** offer a 7-step ratchet mechanism for best mechanical advantage and smoothest operation. RS1PLT is unique with a corrosion-resistant, nickel-plated, steel blade. Pointed blade in one-hand model **RSP1** helps start the cut in tough plastics such as CPVC, and helps avoid bounce in thin wall material. The two-hand **RS2** features 2" capacity, extra wide, v-style jaws for easy alignment, and long handles for leverage on tough-to-cut pipe. **RS7290** one-hand style, 2" capacity shears cut PE, PVC, and CPVC pipe used in gas, water, plumbing, and industrial applications, as do the other ratchet shears. All ratchet shears' blades can be easily sharpened or replaced, enhancing performance and saving money. These tools are not disposable and perform better, longer, and for less money over the tool's lifetime.

Catalog No.	Item Code	Capacity		Length		Weight	
		Actual Inches	Actual Ø mm	in	mm	lbs	kg
RS1*	04176	1.66	42	8.3	210	0.8	0.4
RS1PLT*	04175	1.66	42	8.3	210	0.8	0.4
RS2	04177	2.4	63	17.0	440	2.8	1.3
RS7290	04182	2.4	63	13.25	337	2.4	1.1
★ RSP1*	04276	1.66	42	8.75	222	0.9	0.4

★ **RSP1***
★ **NEW**

*Actual O.D. 1 5/8"

REPLACEMENT BLADES

Catalog No.	Item Code	Description
RS1B	94175	RS1 Hardened Steel Blade
RS1BPLT	94180	RS1PLT Nickel-plated Steel Blade
RS2B	94176	RS2 Hardened Steel Blade
RS7290B	94555	Blade fits Reed RS7290 and Wheeler® 7290
★ RSP1B	94276	RSP1 Stainless Steel Blade

★ **RSP1B**
★ **NEW**

BEST EVER!



Scissor Shears

Scissor Shears squeeze together for fast cutting of thin wall and small diameter PE, PEX, rubber, or nylon tubing. Use the **SC1SS** for PVC cuts. Rotate shears around tubing while squeezing handles together for the best cut. All models feature a new grip design for more secure hold. **SC1SL** and **SC125SL** are spring-loaded for quick open and faster cutting. Regular replacement blades are Teflon®-coated and there is a tough, stainless steel blade option (SC1BSS) which is better for cutting PVC.

Catalog No.	Item Code	Capacity		Length		Weight	
		Actual Inches	Actual Ø mm	in	mm	lbs	kg
SC1SS	04169	1.3	32	8.0	203	0.3	0.1
SC1SL	04272	1.3	32	8.3	210	0.3	0.1
SC125SL	04273	1.7	42	8.3	210	0.3	0.1
SC1	04174	1.3	32	8.3	210	0.3	0.1
SC125	04178	1.7	42	8.3	210	0.3	0.1

REPLACEMENT BLADES

Catalog No.	Item Code	Description
SC1B	94170	High Carbon Steel Teflon®-coated Blade fits SC1, SC1SL, SC1SS
SC1BSS	94187	Stainless Steel Blade fits SC1, SC1SL, SC1SS
SC125B	94169	High Carbon Steel Teflon®-coated Blade fits SC125, SC125SL

BEST EVER!

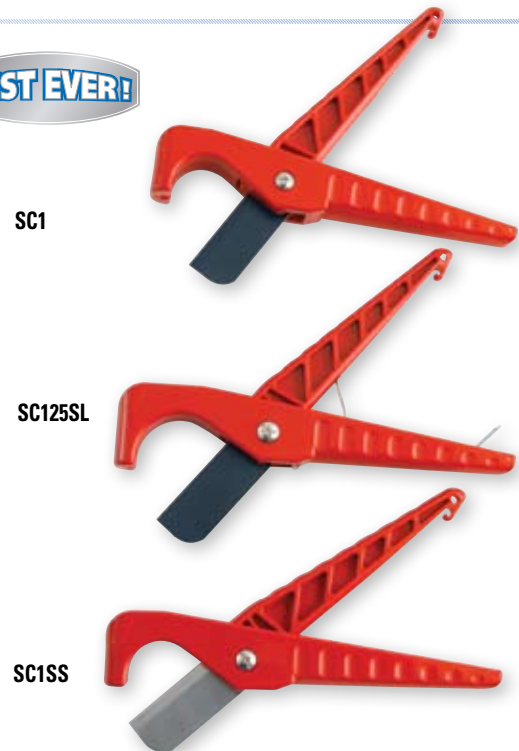

LIFETIME WARRANTY

Plastic Pipe Saws

Reed's plastic pipe saws are specifically designed to cut plastic pipe. The composition of plastic pipe, especially PVC, tends to be very abrasive, hence, saws designed to cut only wood become dull very quickly. It is therefore necessary to make saws with the proper profile, set and hardness to most effectively cut plastic pipe. The traditional PPS saws offered by Reed in 12" and 18" lengths respond to this need while offering a competitive price and replaceable blades. **PPS20** and **PPS24** are longer blade saws also with replaceable blades. The saws cut Schedules 40 and 80 PVC, CPVC, C900, ABS, along with wood. All four models are designed to cut on both the forward and backward stroke for faster work.



PPS20

PPS24

PPS18

PPS12

Catalog No.	Item Code	Pipe Capacity		Length		Weight	
		Inches-Nom.	Actual Ø mm	in	mm	lbs	kg
PPS12	04512	3	75	16	426	0.6	0.3
PPS18	04510	4	100	22	560	0.7	0.3
★ PPS20	04720	6	150	20	508	1.0	0.5
★ PPS24	04724	8	200	24	610	1.1	0.5

REPLACEMENT BLADES

Catalog No.	Item Code	Description
PPS18B	94510	PPS18 Blade
PPS12B	94512	PPS12 Blade
★ PPS20B	94720	PPS20 Blade
★ PPS24B	94724	PPS24 Blade

★ NEW

PLAS In-Line Rotary™ Cutters (for PE/PVC)

Reed's PLAS In-Line Rotary™ Cutters are excellent for cutting 4" to 28" (110 - 800 mm) diameter PVC or PE pipe in-trench or above ground. Each cutter needs just 6" to 8" clearance around the pipe. Outboard rollers keep the cutter aligned on pipe, ensuring a square cut every time. The tool's carbide-tipped blades for PVC are long-lasting and penetrate up to a 2" wall thickness. Each PVC cutter also can produce, in-line with the cut, a 15° bevel on both sides of the cut. In addition, Reed has developed a hardened, tool steel blade to cut PE pipe. The curved blade drives chips out of the way, making PE cuts much easier. Regular PLAS cutters can be retrofitted for PE by purchasing the new blade (#94485) separately.

PLAS2



Bevel Blade

✓ WHY REED?

Proprietary tool cuts square on even the largest plastic pipe: 28" (800 mm). Cut and bevel in-line.

PLAS1

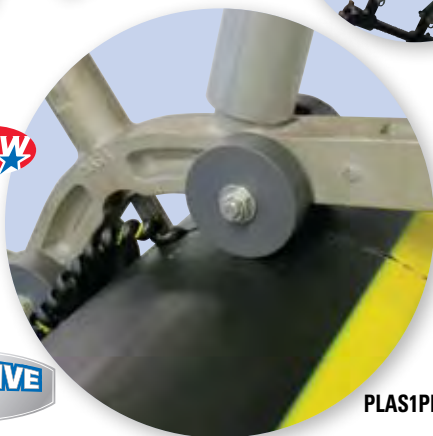

PLAS1PE

Catalog No.	Item Code	Pipe Capacity		Weight		Sections Used
		Inches-Nom.	Actual Ø mm	lbs	kg	
PLAS0*	04465	4 - 8	110 - 240	39	17.7	A0, C0
★ PLAS0PE*	04466	4 - 8	110 - 240	39	17.7	A0, C0
★ PLAS1*	04470	6 - 12	160 - 335	52	23.6	A, B, C
★ PLAS1PE*	04474	6 - 12	160 - 335	52	23.6	A, B, C
★ PLAS2*	04475	14 - 18	355 - 500	57	25.9	B, C (2), D
★ PLAS2PE*	04477	14 - 18	335 - 500	57	25.9	B, C (2), D
★ PLAS3*	04480	14 - 24	355 - 630	62	28.2	B, C (3), D
★ PLAS3PE*	04483	14 - 24	355 - 630	62	28.2	B, C (3), D
★ PLAS4*	04485	14 - 28	355 - 800	68	14.1	B, C (4), D
★ PLAS4PE*	04487	14 - 28	355 - 800	68	14.1	B, C (4), D

★ NEW

* EXCLUSIVE

NOTE: Models beginning with PLAS ship with the cutting blade for PVC and models beginning with PLASPE ship with the cutting blade for PE.

PLAS CUTTERS WILL CUT PVC AND PE PIPE. SPECIFIC LIMITATIONS FOR PE ARE AS FOLLOWS:
 2" wall thickness PE - up to 14" pipe, 1 1/2" wall thickness PE - up to 18" pipe,
 1" wall thickness PE - up to 28" pipe.

PLAS0 and PLAS1 work great for C900 water pipe.

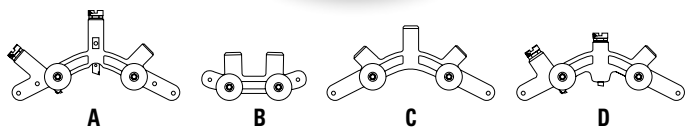

A

B

C

D

Bevelers

With a strong aluminum alloy frame, effective roller locking, and good tool life, a smooth 15° bevel is produced on all types of plastic pipe, including gasketed PVC and C900 PVC in about one minute. Depending on wall thickness, the bevel can be up to 1 1/2" long. Easily adjustable for different pipe sizes and thicknesses, with no part changes. Bevel blade can be sharpened or replaced.

Catalog No.	Item Code	Pipe Capacity		Weight	
		Inches-Nominal	Actual Ø mm	lbs	kg
BT1	04395	1 1/2 - 8	40 - 200	3.0	1.4
BT2	04398	1 1/2 - 12	40 - 300	6.1	2.8

IF PIPE IS NOT STATIONARY, A REED PIPE VISE (P. 33-37) IS RECOMMENDED.

REPLACEMENT BLADES

Catalog No.	Item Code	Description
BT1B	94388	Bevel Blade for BT1 and BT2
BT1SB	94386	Support Blade for BT1 and BT2

✓ WHY REED?

Much faster, safer, and far more effective than a file or power saw as it reduces the possibility of injury and leaks after joining pipe.



Plastic Pipe Joiners

With 28-to-1 leverage, it is easy for one person to join PVC pipe up to 16" gasketed or up to 12" solvent cement joints.

FOR GASKETED PIPE:

The Plastic Pipe Joiner can connect and separate 4" - 16" IPS and cast iron size gasketed pipe. Components required for joining gasketed pipe include the Plastic Pipe Joiner (PPJ) and V-shaped saddles (PPJVS).

FOR SOLVENT CEMENT CONNECTIONS:

The Plastic Pipe Joiner connects solvent cement joints on all pipe schedules, IPS, and water pipe from 4" - 12". For solvent cement connections, individually sized saddles must be ordered together with the Plastic Pipe Joiner (PPJ) and the plastic pipe joiner fitting attachment (PPJFA). PPJFA is only used for branch attachments.

GASKETED PIPE

Catalog No.	Item Code	Pipe Capacity		Weight	
		Inches-Nominal	Actual Ø mm	lbs	kg
PPJ*	04446	—	—	44.0	20.0
PPJVS*	04441	4 - 16	114 - 434	8.0	3.6

*EXCLUSIVE

SOLVENT CEMENT CONNECTION

Catalog No.	Item Code	O.D. Capacity		Weight	
		Inches-Nominal	Actual Ø mm	lbs	kg
PPJ*	04446	—	—	44.0	20.0
PPJFA	04439	4 - 12	114 - 324	39.0	17.7

*EXCLUSIVE

SADDLES FOR SOLVENT CEMENT CONNECTION (sold in pairs)

Catalog No.	Item Code	O.D. Capacity		Weight	
		Actual Ø in	Actual Ø mm	lbs	kg
PPJ4S	04442	4.5	114	4.0	1.8
PPJ6S	04444	6.625	168	4.5	2.0
PPJ8S	04447	8.825	224	6.0	2.7
PPJ10S	04448	10.75	273	7.0	3.2
PPJ12S	04449	12.75	324	7.0	3.2

EXCLUSIVE TOOL

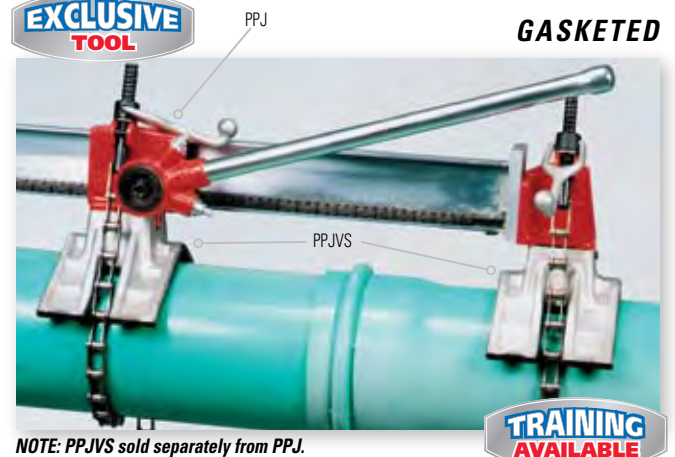

NOTE: PPJVS sold separately from PPJ.

✓ WHY REED?

Easy-to-use design for one person operation with no leaks.

EXCLUSIVE TOOL



NOTE: Fitting attachment (PPJFA) and saddles sold separately from PPJ.



www.reedmfgco.com

For the latest information on NEW REED Tools!

PE Squeeze-Off Tools

Reed offers the best designed tools for stopping flow in PE pipe with capacities of 1/2" to 8". Different models come with a variety of features to handle a wide range of applications. Sliding bar handles make work in tight places easier and increase leverage for tightening. Other features include fine-pitched thread to allow for a controlled, low-effort squeeze; greased fittings to make operation easier and extend life; and aluminum parts to make tools lighter for easier handling. Aluminum castings also withstand varied climate and soil conditions. All tools use positive stops to prevent damage caused by over-clamping.

PES1 models feature a stationary bottom bar. The **PES2** and **PES4** series have an affixed bottom bar, which swings open to fit over any location on the pipe. **PES2PC160** features CTS-specialized stops for Pressure Class 160 tube. **PES2-2** models have a new double-bar design with two squeeze points in a row which provide better shut-off and extra protection against leaks, right in one tool. Reed's PES8s are available in manual or hydraulic models and also feature the new double-bar design. **PES8M** requires manual operation, uses two stops, and allows a dozen different pipe/SDR combinations. **PES8H** utilizes a hydraulic pump and offers a pressure gauge and saddle clamps. An optional Flow Control Valve Kit is available to control release of the upper jaw to reduce risk of static build-up.

Attention Utility Contractors: PES2 models can be used on both CTS and IPS PE pipe by simply changing the safety stops.

Catalog No.	Item Code	Capacity Inches	Pipe/SDR Stops	Length		Weight	
				in	mm	lbs	kg
PES1IPS	04290	1/2 - 1	3	11	280	6.5	3.0
PES1CTS	04292	1/2 - 1	3	11	280	6.5	3.0
PES2IPS	04302	1/2 - 2	6	12	305	11.6	5.3
PES2CTS	04304	1/2 - 2	6	12	305	11.6	5.3
PES2PC160*	04305	1/2 - 2	6	12	305	11.6	5.3
PES4	04306	2 - 4	7	20	508	38.6	17.5
PES8M	04308	3 - 8	12	28	711	130.0	59.1
PES8H	04309	3 - 8	12	28	711	130.0	59.1
★ PES2-2IPS	04322	1/2 - 2	6	12	305	11.5	5.2
★ PES2-2CTS	04324	1/2 - 2	6	12	305	11.5	5.2

*Rated for working pressure to 160 psi

ACCESSORY

Item Code	Description
94317	Flow Control Valve Kit for PES8H

CONVERSION KITS

Use easy-to-adjust stops to convert PE Squeeze-Off Tool PES2 models from CTS to IPS or vice versa.

Stops	Item Code	Converts
CTS	98078	PES2IPS to PES2CTS
IPS	98079	PES2CTS to PES2IPS

CUSTOM & METRIC STOPS

Custom stops available for PES2 models with a minimum of 20 tools per custom stop. Metric stops are available for the PES2, PES4, and PES8 models, with no minimum quantity. Visit www.reedmfgco.com for specifications or contact Reed for more details.



WHY REED?

Reed automatically provides multiple pipe/SDR stops in one tool. Also, all parts store on the tool, making it self-contained.

NOTE: PE Squeeze-Off Tools conform to ASTM F1041.

Guillotine Pipe Cutters

FOR PE PIPE THICKER THAN SDR17

These robust tools are designed to cut PE pipe thicker than SDR17 within 1/8" (3 mm) of square on up to 12" (350 mm) medium and high-density pipe so that no facing is needed for electrofusion and only minimal facing for butt fusion joints. Its durable, Teflon®-coated blade makes many square cuts with no chips to clog valves and small openings. Blades are easy to sharpen or replace.

FOR PE PIPE SDR17 AND THINNER

Exclusive to Reed, this innovative tool, **HPC8TN**, is designed specifically to cut without deforming or crushing thin wall pipe, yet retains all the advantages of Reed's standard Guillotine Cutter. The thin wall cutter works by simply rocking the tool on its built-in wheels around the firmly anchored PE pipe, thus effectively slicing the wall of the pipe without crushing it. HPC8TN requires 30°-60° swing and up to 6" clearance around pipe to get the cut started. Once the wall has been breached, the remainder of the cut is made in the normal way. Blades can be sharpened or replaced.

Catalog No.	Item Code	Capacity		Length		Weight	
		Inches-Nom.	Actual Ø mm	in	mm	lbs	kg
HPC4	04604	2 - 4	63 - 125	19	482	15.6	7.1
HPC8	04608	3 - 8	90 - 225	30	750	35.0	15.9
HPC12	04612	4 - 12	125 - 350	51	1295	100.0	45.5
HPC8TN*	04618	3 - 8	90 - 225	30	750	34.5	15.7

*EXCLUSIVE

REPLACEMENT BLADES

Catalog No.	Item Code	Description
HPC4B	40329	HPC4 Blade
HPC8B	40027	HPC8 Blade
HPC8TNB	94137	HPC8TN Blade
HPC12B	94903	HPC12 Blade

CONVERSION KITS

Only Reed offers a universal PE pipe solution for regular and thin wall pipe by adding a conversion kit to a Reed HPC8 model. Convert tool in approximately five minutes from regular to thin wall models and back.

Catalog No.	Item Code	Converts
HPCKIT1	94141	HPC8TN to HPC8
HPCKIT2	94142	HPC8 to HPC8TN

Grounding Accessory

The Static Electricity Grounding Accessory (**PEGR**) provides a path to ground for any static charge. Because static can build up on plastic pipe, even for water services, there is a possibility of a spark discharge of sufficient energy to cause ignition if the proper air/gas mixture is present. Use of a grounding accessory is a precaution that can dissipate the charge and minimize the possibility of ignition. Reed strongly recommends use of the Grounding Accessory with PE Squeeze-Off Tools and Guillotine Pipe Cutters in all gas applications.

Catalog No.	Item Code	Weight	
		lbs	kg
PEGR	04619	1.5	0.7

Static Discharge Alarm

Alarm warns of static build-up leading to possible pinholing of PE pipe resulting from electrical forces discharging through the pipe wall during squeezing or cutting. Features test circuit and low battery warning. Plastic case included. Use with Grounding Accessory.

Catalog No.	Item Code	Dimensions	Weight	
			lbs	kg
STDA1	04620	1 3/8" X 3 1/4" X 5 1/2"	0.6	0.3



✓ WHY REED?

Because of the crosshead and blade design, all HPCs produce a much straighter cut with minimal blade wear. Safer than abrasive saws because no PE chip residue remains in the pipe that may later clog valves.



EXCLUSIVE TOOL

✓ WHY REED?

Straight blade and rollers on HPC8TN allow for easier slicing through thin wall pipe and provide a square cut. The blade slices through the top pipe wall without distorting the pipe.

Save over 25% by using a conversion kit and cutter instead of buying two separate cutters.





PEXSD in use with PEX



WHY REED?
Reed offers the widest selection of high-quality solutions for PEX.

PEX Crimpers

PXCR and PEXOH Reed crimpers squeeze the copper rings used on PEX brass fittings. PEX systems are used for potable water lines, radiant heat, snow melt and ice rink systems, among other applications. The design of these PEX crimpers eliminates tool marks and distortion on the rings. The tools crimp rings easily, making PEX installation a breeze. For one-hand use on 1/2" and 3/4" PEX, consider the **PEXOH12** or **PEXOH34**. The close quarters **PEXSD** model utilizes a screw drive for crimping. It features 4 sizes in its compact shape. Each Reed crimpers for copper rings comes with its own go/no-go gauge.

The **PEXSSPINCH** gives reliable, watertight crimps on stainless steel clamps. It is lightweight and valuable for reaching into tight quarters. It features a comfort grip, ratcheting handle for its full-cycle mechanism crimps. An included calibration gauge makes it easy to verify adjustments before crimping.

FOR COPPER RINGS

Catalog No.	Item Code	Description	Handle Length*	Weight	
				lbs	kg
PXCR12S	04900	1/2" capacity	8 3/4"	3.0	1.4
PXCR34S	04903	3/4" capacity	9"	3.0	1.4
PXCR1M	04904	1" capacity	11 1/2"	4.0	1.8
PXCR1234M	04910	1/2" and 3/4" capacity	11"	4.3	1.9
★ PEXOH12	04920	1/2" capacity, one-hand style	8 1/2"	2.5	1.1
★ PEXOH34	04925	3/4" capacity, one-hand style	9"	2.6	1.2
★ PEXSD	04935	3/8", 1/2", 3/4", 1" capacity, screw drive	-	1.2	0.5

FOR STAINLESS CLAMPS

Catalog No.	Item Code	Description	Handle Length*	Weight	
				lbs	kg
★ PEXSSPINCH	04930	3/8", 1/2", 3/4" and 1" lines	8 1/2"	1.2	0.5

★ **NEW**
#04930 Crimps conform to ASTM F2098.
*Handle length does not include head.

NEW PEX Shut-Off Tools

These shut-off tools, designed just for PEX, work on both 1/2" and 3/4" diameter PEX. The **SSPEX1** allows the user to quickly seal off PEX tubing in an emergency, or to replace a faulty valve. Front end features a snap hinge that can be taken apart quickly to allow work in confined areas. Open end has one wingnut to secure tool closed until repair is done. Knurled grip catches and holds the pipe. The compact design of **SSPEX2** allows the user to reach into difficult locations to seal off PEX tubing.

Catalog No.	Item Code	Weight		Description
		lbs	kg	
★ SSPEX1	04950	1.8	0.8	Two-hand squeeze
★ SSPEX2	04955	0.9	0.4	Wing nut squeeze

★ **NEW**

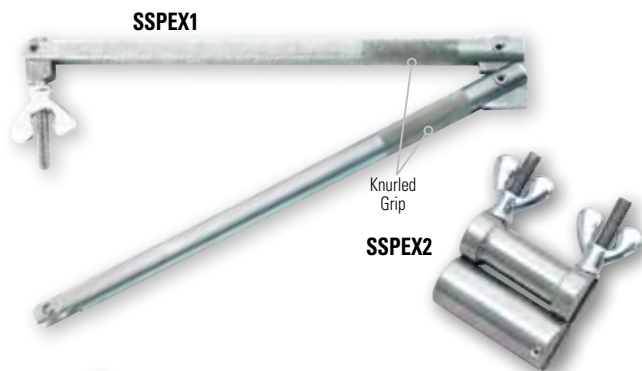

Flare Tools for PE Water Service Lines

Forms a permanent cold flare with ten easy revolutions to connect PE 160 psi water service tubing (SDR 9), using inexpensive, standard AWWA flare fittings for CTS tubing. These tools flare medium and high density PE.

Catalog No.	Item Code	CTS Tubing	Weight	
		Inches - Nom.	lbs	kg
SFPE3/4*	04200	3/4	1.9	0.9
SFPE1*	04202	1	2.2	1.0

*EXCLUSIVE

EXCLUSIVE TOOL



Deburring Tools for Plastic

DEB2 deburrs inner and outer edges of PVC, CPVC, ABS, PP, and PE pipe through 2" diameter. Made from steel, the cone design allows it to be used on even the smallest pipe, including 1/8" diameter. **DEB4** deburrs fast – one easy revolution produces a 3/32" 15° chamfer in seconds. This aluminum die-cast tool features a hardened steel blade that is reversible for two cutting edges and sharpenable. DEB4 fits comfortably in one's hand and creates a smooth chamfered pipe end so solvent spreads evenly as pipe is joined. Deburrs six pipe sizes: 1/4" through 4". Used on PVC, CPVC, ABS.

Catalog No.	Item Code	Nominal Pipe Capacity						Weight		
								lbs	kg	
DEB2	04436	up to 2" (60 mm)						0.2	0.09	
DEB4*	04430	in	1 1/4	1 1/2	2	2 1/2	3	4	0.7	0.32
		mm	42	50	63	75	90	114		

*EXCLUSIVE
DEBURRING TOOLS FOR METAL ON P. 22



Chain Vises for Plastic Pipe

Standard Reed Chain and Tripod vises have dual-purpose jaws for holding plastic and metal pipe. Rubber-coated jaws provide protection against damaging plastic pipe and soft metal pipe. Jaws are easily rotated from plastic pipe position to metal pipe position to protect against damage to pipe and to maximize productivity. Rotate jaws for two sets of free jaws for the chain vise and one extra pair of jaws on a tripod vise.

Catalog No.	Item Code	Pipe Capacity		Weight	
		Inches-Nom.	Actual Ø mm	lbs	kg
CV4P	04452	1/8 - 4	10 - 114	14.6	6.6
R450P	04457	1/8 - 6	10 - 178	36.3	16.5

TRIPODS ON P. 33
CHAIN VISES ON P. 34

JAWS FIT REED VISES

Catalog No.	Jaw Item Code	Converts
CV4PJ	94452	CV4, CV5 to CV4P jaws (Order 4 for complete conversion)
450PJ	99077	R450+ or R470+ to R450P jaw (ships as a pair)

WHY REED?

- 3-sided jaws for chain vises are easily rotated from plastic pipe position to metal pipe position and back.
- 2-sided Tripod jaws are easily reversed for plastic pipe position or metal pipe position.



For Plastic Pipe Up to 6";
One Side of Jaw for
Plastic/Soft Metal

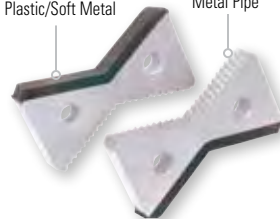

R450P Tripod Jaws



XTRA VALUE!

2 Sides for
Metal Pipe

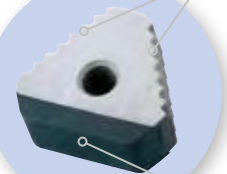

CV4P Jaws

Rubber-Coated
Side for
Soft Metals or
Plastic Pipe



R450P Tripod



WRENCHES

SECTION 6

Pipe Wrenches

Aluminum Pipe Wrenches

Chain Tongs

Adjustable Wrenches

Comfort Grip Wrenches

Strap Wrenches

Hydrant Wrenches

Chain Wrenches

Ratchet Wrenches & Sockets

Square Drive Ratchet Wrenches

Larger Ratchet Wrench & Sockets 

Extended Sockets

Dual Socket Ratchet Wrenches 

Basin Wrenches

Torque Wrenches

One Hand Wrenches

Operator's Wrench

Valve Packing Wrenches

Valve Wheel Wrenches 

Internal Wrench

Smooth Jaw Wrenches 

Meter Nut Wrenches 

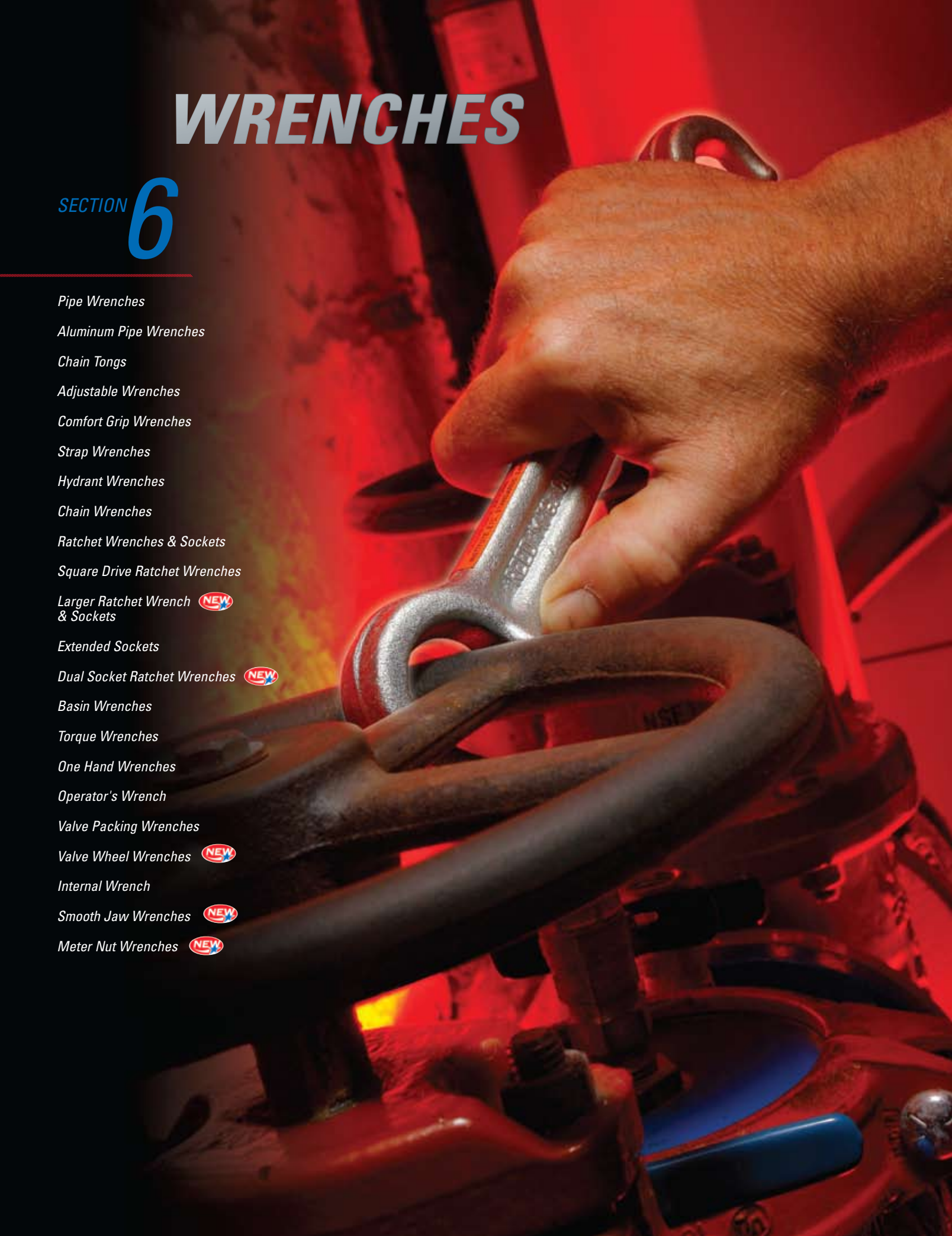

Pipe Wrenches (Heavy-Duty)

The most popular pipe wrench style. High-tensile ductile iron handle and hardened, alloy steel parts are designed to withstand the heaviest demands. Offset wrenches have similar construction and provide longer swing and better access to hard-to-reach places. New production tooling for the hook jaws produces sharper teeth on the 18", 24", and 36" models. This change yields a still better grip for hard oil field pipe.

STRAIGHT

Catalog No.	Item Code	Pipe Capacity		Length		Weight	
		Inches-Nom.	Actual Ø mm	in	mm	lbs	kg
RW6	02110	1/8 - 3/4	10 - 27	6	152	0.5	0.2
RW8	02120	1/8 - 1	10 - 33	8	203	0.9	0.4
RW10	02130	1/8 - 1 1/2	10 - 48	10	254	1.8	0.8
RW12	02140	1/8 - 2	10 - 60	12	305	2.8	1.3
RW14*	02150	1/4 - 2	14 - 63	14	356	3.7	1.7
RW18	02160	1/4 - 2 1/2	14 - 75	18	457	6.2	2.8
RW24	02170	1/4 - 3	14 - 90	24	610	11.0	5.0
RW36	02180	1/4 - 5	14 - 141	36	914	20.3	9.2
RW48	02190	1 1/2 - 6	48 - 168	48	1219	35.5	16.1

45° OFFSET

RW08	02210	1/8 - 1	10 - 33	8	203	0.8	0.4
RW010	02220	1/8 - 1 1/2	10 - 48	10	254	1.7	0.8
RW012	02232	1/8 - 2	10 - 60	12	305	2.6	1.2
RW014	02230	1/4 - 2	14 - 63	14	356	3.5	1.6
RW018	02240	1/4 - 2 1/2	14 - 75	18	457	5.4	2.5
RW024	02242	1/4 - 3	14 - 90	24	610	9.3	4.2

*AWWA Approved for Tapping Contest.

Pipe Wrench Parts

Forged alloy steel replacement parts meet the most demanding applications. These high quality components are direct replacement parts for the Ridgid® 60" iron pipe wrench. Heel jaw fits both hook and handle.

Catalog No.	Item Code	Description	Replaces Ridgid® Part No.	Weight	
				lbs	kg
RW60B	92169	Hook Jaw Assembly	31770	12.5	5.7
RW60C	92179	Heel Jaw & Pin	31775	1.2	0.5

BEST EVER!



STRAIGHT

OFFSET

✓ WHY REED?

No minimum order quantities on wrenches or parts!

Reed pipe wrench parts are interchangeable with most major, heavy-duty U.S. brands (including Ridgid®) of straight wrenches, 45° offset wrenches, and end wrenches from 6" - 60". Parts available include hook jaw, heel jaw and pin, coil and flat spring, and nut. Contact Reed for details.

Aluminum Pipe Wrenches (Heavy-Duty)

Light and strong, the titanium-aluminum alloy handle is heat-treated for maximum strength. Now with tighter tolerances for a snugger wrench, "beefier" housing for a stronger wrench, and textured paint for a better grip. Offset wrenches have similar construction with longer swing for hard-to-reach places.

STRAIGHT

Catalog No.	Item Code	Pipe Capacity		Length		Weight	
		Inches-Nom.	Actual Ø mm	in	mm	lbs	kg
ARW10	02093	1/8 - 1 1/2	10 - 48	10	254	1.1	0.5
ARW14	02095	1/4 - 2	14 - 63	14	356	2.1	1.0
ARW18	02097	1/4 - 2 1/2	14 - 75	18	457	3.5	1.6
ARW24	02099	1/4 - 3	14 - 90	24	610	5.7	2.6
ARW36	02101	1/4 - 5	14 - 141	36	914	10.9	5.0
ARW48	02102	1 1/2 - 6	48 - 168	48	1200	18.5	8.4

90° OFFSET

ARW014	02202	2	50	14	350	1.9	0.9
ARW018	02204	2 1/2	65	18	450	3.2	1.5



STRAIGHT

OFFSET

Ridgid® is a registered trademark of Ridgid, Inc. and is not associated with Reed Manufacturing Company.

Chain Tongs (Heavy-Duty)

Durable long-lasting tongs for all types of pipe fitting jobs, from oil field to general work. Tools consist of solid, full-length handles of forged steel and strong, flat link chains. Hardened steel jaws are replaceable and interchangeable with major brands, including Ridgid®. As with Reed and other brands, single- and double-end tongs require different chains, jaws, and bolts.

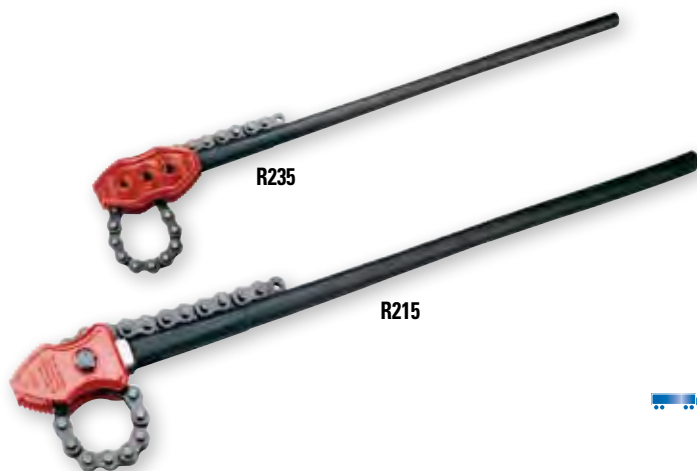

DOUBLE-END

Catalog No.	Item Code	Pipe Capacity		Length		Chain Length		Breaking Strain lbs	Weight	
		Inches-Nom.	Actual Ø mm	in	mm	in	mm		lbs	kg
R229	06329	1/4 - 2 1/2	14 - 75	27	686	18	445	13,800	10	4.5
R231	06331	3/4 - 4	27 - 114	37	940	23	572	17,600	19	8.6
R233	06333	1 - 6	33 - 168	44	1118	32	813	20,000	29	13.2
R235	06335	1 1/2 - 8	48 - 219	51	1283	41	1029	22,000	34	15.5
R237	06337	2 - 12	60 - 324	65	1638	56	1410	31,000	59	26.8

SINGLE-END

R215	06315	4 - 18	114 - 457	88	2235	75	1892	56,000	149	67.7
------	-------	--------	-----------	----	------	----	------	--------	-----	------

Adjustable Wrenches

With hardened and tempered forged alloy steel handles, phosphorous bronze springs, and a triple-coated nickel-chrome exterior finish, these Reed wrenches are constructed of the finest materials available. Parallel jaw surfaces ensure good grip of nut. 22° 30' angle allows for closest quarter work on hex nuts. Precision-ground jaw slides make smoothest action. Less slippery handle, lower cost, blackened wrenches of same construction are also available.



XTRA VALUE!

CW12

CWB12

✓ WHY REED?

Reed's jaws are machined precisely after assembly to be the smoothest operating adjustable wrenches made.

CHROME

Catalog No.	Item Code	Capacity		Length		Weight	
		Inches-Nom.	Actual Ø mm	in	mm	lbs	kg
CW4	02199	7/16	13	4	114	0.1	0.05
CW6	02201	3/4	20	6	152	0.3	0.1
CW8	02203	7/8	25	8	203	0.5	0.2
CW10	02205	1 1/8	30	10	254	0.8	0.4
CW12*	02207	1 5/16	35	12	305	1.4	0.6
CW15	02209	1 11/16	40	15	381	2.7	1.2
CW18	02211	2 1/16	50	18	457	4.7	2.1
CW24	02218	2 1/2	63	24	610	7.9	3.6

BLACKENED

CWB6	02212	3/4	20	6	152	0.3	0.1
CWB8	02213	7/8	25	8	203	0.5	0.2
CWB10	02214	1 1/8	30	10	254	0.8	0.4
CWB12	02215	1 5/16	35	12	305	1.4	0.6
CWB15	02216	1 11/16	40	15	381	2.7	1.2
CWB18	02217	2 1/16	50	18	457	4.7	2.1

*AWWA Approved for Tapping Contest.

Comfort Grip – Adjustable Wrenches

Use the best adjustable wrenches in new ways: a plastic dip coating gives ergonomic advantages of greater comfort, higher torque, and less fatigue. Reed comfort grips are thicker and harder than most, resulting in greater ergonomic benefits and longer grip life. The plastic grip is also stickier than the steel handle, which combines with the larger diameter to make these wrenches easier to grip while working.



CW12GRIP

XTRA VALUE!

CW8GRIP

✓ WHY REED?

Reed puts a thicker, harder, more comfortable, longer lasting coating on the smoothest, most exact wrenches available.

Catalog No.	Item Code	Capacity		Length		Weight	
		Nominal in	Actual mm	in	mm	lbs	kg
CW6GRIP	02906	3/4	20	6	152	0.3	0.1
CW8GRIP	02908	7/8	25	8	203	0.5	0.2
CW10GRIP	02910	1 1/8	30	10	254	1.0	0.5
CW12GRIP	02912	1 5/16	35	12	305	1.5	0.7

NOTE: These are comfort grips only, they are not made for electrical insulation.

Ridgid® is a registered trademark of Ridgid, Inc. and is not associated with Reed Manufacturing Company.

Strap Wrenches

Provides gripping power without scratching or deforming plastic or polished metal pipe. Use on plastic pipe, filters, or any slick or smooth surface. Strap wrenches work well on irregular shapes, too. Reed's extra strong, coated polyester strap provides slip resistance, and durability. **SW12A30** and **SW18A48** have extra-long straps for increased leverage on large diameters. SW12A30 is popular for filters.

Catalog No.	Item Code	Pipe Capacity		Tube Capacity		Handle Length		Weight	
		Inches-Nom.	Actual Ø mm	Actual inches	Actual Ø mm	in	mm	lbs	kg
SW12A	02248	1/8 - 2	10 - 63	3 1/2	90	12	305	1.6	0.7
SW12A30	02247	1/8 - 5	10 - 127	7 1/2	190	12	305	1.7	0.8
SW18A	02249	1 - 5	33 - 127	6	150	18	458	2.6	1.2
SW18A48	02255	1 - 12	33 - 305	12	300	18	458	2.9	1.3
SW24A	02250	2 - 12	60 - 324	14	350	24	610	5.1	2.0

REPLACEMENT STRAPS

Catalog No.	Item Code	Fits	Size
SW12AS	92248	SW12A	1 1/4" x 17"
SW12A30S	92247	SW12A30	1 1/4" x 30"
SW18AS	92249	SW18A	1 3/4" x 30"
SW18A48S	92246	SW18A48	1 3/4" x 48"
SW24AS	92250	SW24A	2 1/4" x 54"

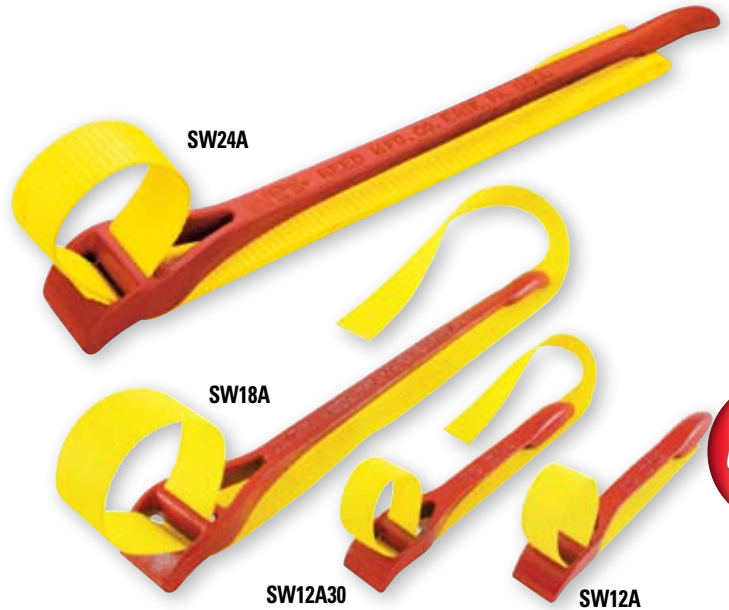

Hydrant Wrenches

The **HW** forged steel and economical **HWB** cast ductile iron wrenches fit pentagon nuts up to 1 3/4" or square nuts up to 1 1/4". Both wrenches also have spanners for either pin or lug style hose couplings. Hydrant Wrenches are zinc-chromate plated for corrosion-resistance. The **HWS45** is a Storz® style wrench for hydrants and 4" and 5" Storz® fittings. HWS45 has a ductile iron head and a steel handle. The head and threaded handle adjust to fit standard sizes of pentagon and square hydrant nuts. A spanner hook is part of the head casting, which loops out to grab lugs on the Storz® style fittings, allowing the whole wrench to turn these fittings for maximum leverage.

Catalog No.	Item Code	Pentagon		Square		Length		Weight	
		Inches-Nom.	Actual Ø mm	Inches-Nom.	Actual Ø mm	in	mm	lbs	kg
HWB	02283	1 3/4	45	1 1/4	31	20.0	500	4.5	2.0
HW	02295	1 3/4	45	1 1/4	31	20.0	500	4.0	1.8
HWS45	02390	1 3/4	45	1 1/4	31	20.5	517	4.9	2.2



Chain Wrenches (Heavy-Duty)

Turn any shape in close quarters. Dual reversible (and therefore more economical) jaws permit ratchet action in either direction without removing the wrench from the pipe.

Catalog No.	Item Code	Pipe Capacity		Handle Length		Max. O.D.		Chain Tensile Strength lbs	Weight	
		Inches-Nom.	Actual Ø mm	in	mm	in	mm		lbs	kg
WA14	02040	1/8 - 2	10 - 60	14	362	4.6	117	6,500	3.2	1.5
WA18A	02050	1/4 - 2 1/2	14 - 75	18	445	5	127	12,100	6.0	2.7
WA24A	02060	1/4 - 3	14 - 90	24	610	5.8	147	12,100	8.4	3.8
WA36	02070	1/2 - 4 1/2	21 - 127	33	832	7.1	180	17,750	16.4	7.5
WA48*	02080	1 - 6	33 - 168	44	1118	8.5	216	24,500	29.4	13.4
WA60*	02090	1 1/2 - 8	48 - 225	46	1175	11	279	27,000	47.0	21.4
WA72*	02092	2 1/2 - 12	73 - 324	46	1175	13	330	35,000	80.0	36.4
WA84*	02094	2 1/2 - 18	73 - 457	46	1175	18	457	35,000	90.0	40.9

*EXCLUSIVE



6

Ratchet Wrenches & Sockets

Reed Thru-Bolt™ ratchet wrenches work faster than pipe wrenches or adjustable wrenches for tightening or loosening nuts on long, threaded bolts of service saddles, repair clamps, flanges, mechanical couplings, etc. Individual handles are available, made with traditional malleable iron or lower cost steel stampings. Individual sockets made of strong, cast ductile iron are available, as well as whole sets, and fit all wrench handles listed.

DUAL SOCKET RATCHET WRENCHES ON P. 67

THRU-BOLT™ UTILITY SETS*

Catalog No.	Item Code	Handle	Sockets	Weight	
				lbs	kg
L511	02284	L500	7/8", 15/16", 1 1/8", 1 1/4" and corp.	6.8	3.1
L514	02286	L564	3/4", 7/8", 5/16", 1 1/16", 1 1/8", 1 1/4" with adjustable angle handle	9.5	4.3
L515	02285	L500	3/4", 7/8", 5/16", 1 1/16", 1 1/8", 1 1/4" and corp.	8.9	4.0

THRU-BOLT™ METRIC UTILITY SETS*

L511M	02243	L500	22mm, 24mm, 27mm, 30mm, 32mm	6.8	3.1
L514M	02245	L564	19mm, 22mm, 24mm, 27mm, 30mm, 32mm with adjustable angle handle	9.5	4.3
L515M	02246	L500	17mm, 19mm, 22mm, 24mm, 27mm, 30mm, 32mm	8.9	4.0

*Sets include steel storage case

RATCHET WRENCH HANDLES

Catalog No.	Item Code	Type		Handle Length		Weight	
		Handle	Socket Retention	in	mm	lbs	kg
L50	02258	Cast	Retaining Ring	11	280	1.5	0.7
L51	02259	Cast	Retaining Ring	13	330	1.7	0.8
L500	02260	Cast	Quick Release	13	330	1.7	0.8
L150	02261	Stamped	Retaining Ring	11	280	1.4	0.6
L151	02262	Stamped	Retaining Ring	13	330	1.7	0.8
L564	02263	Adjustable	Quick Release	16	420	3.5	1.6

INDIVIDUAL HEX SOCKETS-INCHES

Catalog No.	L10	L12	L14	L15	L16	L17	L18	L20	L25
Item Code	02264	02265	02266	02267	02268	02269	02270	02271	02272
Hex Size	5/8" *	3/4"	7/8"	15/16"	1"	1 1/16"	1 1/8"	1 1/4"	Corp.

*MegaLug® coupling bolts

INDIVIDUAL HEX SOCKETS-METRIC

Catalog No.	M17	M19	M22	M24	M27	M30	M32
Item Code	02274	02275	02276	02277	02278	02279	02280
Hex Size	17 mm	19 mm	22 mm	24 mm	27 mm	30 mm	32 mm

ACCESSORIES

Catalog No.	Item Code	Description	Length: Shoulder to End	Weight	
				lbs	kg
L6EXT	02257	Thru-Bolt™ Extension	6 in/152 mm	2.2	1.0
LRRP	92288	Retaining Ring Pliers	—	0.2	0.1

Square Drive Ratchet Wrenches

Female drive ratchets are great for ratcheting line-up clamps for welding steel pipe and for other process piping needs. Certain valves require square drive wrenches, and the ratchet and reverse option speeds up jobs.

Catalog No.	Item Code	Type		Handle Length		Weight	
		Handle	Description	in	mm	lbs	kg
L16-7/8	02292	Cast	7/8" Female Drive	16.4	420	4.3	2.0
L16-1	02291	Cast	1" Female Drive	16.4	420	4.4	2.0
RWR13/16	40383	Cast	13/16" Female Drive	19.5	495	5.2	2.4



L564 and L20

✓ WHY REED?

L564 features a "quick release" button along with an adjustable handle for hard-to-reach spots.



✓ WHY REED?

The Reed Thru-Bolt™ ratchet handles and sockets substantially reduce the time required to tighten or remove nuts so assembly time and cost are cut considerably.



L500 and L17 on Service Saddle



NEW Larger Ratchet Wrench & Sockets

For larger hardware found on 30" - 36" diameter pipe, the **L152** is the Thru-Bolt™ ratchet wrench suited to the job. **L26** fits mechanical joints with 1 5/8" hex bolts. **L23** and **L24** sockets fit bolts used on repair clamps, tapping sleeves and other bolt-on pipe apparatus for 30" - 36" diameter pipe. Sockets sold separately.

HANDLE

Catalog No.	Item Code	Type		Handle Length		Weight	
		Handle	Socket Retention	in	mm	lbs	kg
★ L152	02670	Stamped	Retaining Ring	17	432	2.5	1.1

INDIVIDUAL HEX SOCKETS-INCHES

Catalog No.	Item Code	Hex Bolt Size	Weight	
			lbs	kg
★ L23	02680	1 7/16"	1.0	0.4
★ L24	02682	1 1/2"	1.1	0.5
★ L26	02684	1 5/8"	1.1	0.5
★ NEW				

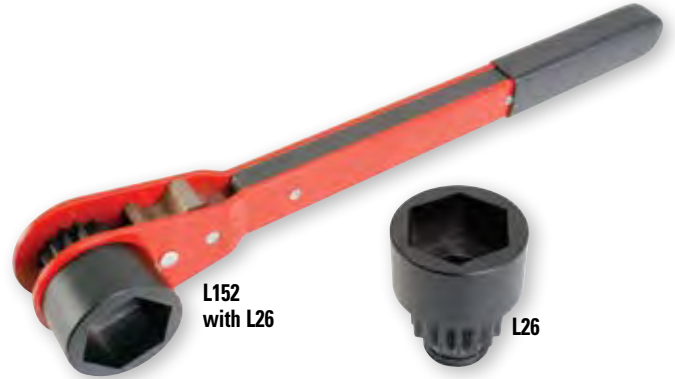

L152 with L26

L26

Extended Sockets

For hard-to-reach deep well bolts, Reed offers Extended Sockets that are made of tool steel and are impact grade. Use Extended Sockets to tighten hex nuts on repair clamps, mechanical joint fittings, and saddles. Drive them with a 1/2" square drive impact wrench or hand tighten. Finish on sockets provides corrosion-resistance.

Catalog No.	Item Code	Hex Size	Finish	Length	Weight	
					lbs	kg
EDS12	02622	3/4"	Blackened	6 1/2"	1.5	0.7
EDS14	02624	7/8"	Blackened	6 1/2"	1.6	0.7
EDS17	02626	1 1/16"	Zinc Phosphate	6"	1.5	0.7
EDS18	02628	1 1/8"	Zinc Phosphate	6"	1.5	0.7
EDS20	02630	1 1/4"	Zinc Phosphate	6"	1.5	0.7

EDS20

EDS17

EDS14



ACCESSORY

Catalog No.	Item Code	Description
SCFR	40208	1/2" male Square Drive Ratchet Wrench

Dual Socket Ratchet Wrenches

Dual socket wrenches fit the most popular water works fasteners for mechanical joints, flange bolts, repair clamps, service saddles and sleeves. Each wrench also offers a handy switch on the head for safe action reversal. Ratchet wrenches are faster to use than pipe wrenches or adjustable wrenches. Thru-bolt sockets work by letting the bolt pass completely through the socket and arm head so nuts can be worked on any threaded length. Thru-bolt sockets replace the need for separate regular and deep sockets. **LDSSET** features three popular sizes in a convenient storage case. **LHM2275** has red sockets to identify this tool as suitable for Hymax™ reducer couplings.

Catalog No.	Item Code	Sockets	Application	Handle Length		Weight	
				in	mm	lbs	kg
★ LDSSET	02222	LHM2275, L2017 & L1815	see individual wrenches	13	330	8.3	3.8
	LHM2275	3/4" & 7/8" 19mm + 22mm	Hymax™ Reducer Couplings	13	330	2.2	1.0
	L2017	1 1/4" & 1 1/16"	Mechanical Joints & Restraints, Repair Clamps Service Saddles	13	330	2.4	1.1
	L1817	1 1/8" & 1 1/16"	Gas & Water Industry Couplings, Repair Clamps, Service Saddles, Flange Bolts	13	330	2.4	1.1
	L1815	1 1/8" & 1 5/16"	Flange Bolts, Friction Clamps, Hydrant Break Flange & Some Bonnet Bolts	13	330	2.3	1.0

★ **NEW**



L2017

LHM2275

XTRA VALUE!

NEW LDSSET

✓ WHY REED?

One wrench with two sockets means no lost sockets. And, made in the USA!



Basin Wrenches

Basin Wrenches are designed for use under sinks and in other tight quarters. They feature long-lasting, hardened, forged jaws which are spring-loaded for one-hand ratcheting. Heads move to hold up to 90° angle. For easier reach, popular **BW125** telescopes from 10" - 17" as does **BW190** which grips larger fittings. Lightweight, economical **BW11** features a solid hex bar. These quality tools are imported.

Catalog No.	Item Code	Capacity		Length		Weight	
		Inches-Nom.	Actual Ø mm	in	mm	lbs	kg
BW125	11601	3/8 - 1 1/4	10 - 30	10 - 17	250 - 425	1.8	0.8
BW11	11611	1 1/4	31.8	11" Bar	279.4	1.3	0.6
BW190	11620	1.9	48.3	10 - 17	250 - 425	1.8	0.8



Torque Wrenches for Cast Iron Soil Pipe

Engineered to provide recommended torque on No-Hub® soil pipe connections/ fitting clamps. Wrenches can also loosen clamp screws and are designed for hand comfort. Ratcheting action is fast and maximum torque is preset. It releases with a click when reached for secure, leak free joints. Guaranteed accurate to ±10%.

Catalog No.	Item Code	Hex Size	Torque		Length		Weight	
			inch pounds	Newton meter	in	mm	lbs	kg
TW516	02298	5/16"	60	6.8	6	152	0.9	0.4
TW38	02300	3/8"	80	9.0	5.8	148	0.9	0.4

SOIL PIPE CUTTERS ON P. 15



One Hand Wrenches

The original and still the best for working in tight places, including meter pits! This Reed invention features strong, forged steel, one-piece handle. Spring-loaded jaws grip any shape: meter nuts, round pipe, or parts of fittings without adjustment. One Hand Wrench works like a pipe wrench and provides better grip than pliers due to the jaws and tooth direction. Securely and immediately tighten and loosen the wrench from pipe.

Catalog No.	Item Code	Capacity-Fittings		Pipe Capacity		Length		Weight	
		in	mm	in-nom.	Actual Ø mm	in	mm	lbs	kg
MW 3/4*	02289	1/8 - 3/4	17 - 33	3/8 - 1	17 - 33	11	267	1.2	0.5
MW1 1/4*	02281	3/8 - 1 1/4	27 - 48	3/4 - 1 1/2	27 - 48	16	394	3.2	1.5

*EXCLUSIVE

✓ WHY REED?
Ratchets for easiest one-hand operation.



Comfort Grip – One Hand Wrenches

Same great attributes as the One Hand Wrenches, but with a comfort hand grip for the ergonomic advantages of higher torque and less fatigue.

Catalog No.	Item Code	Capacity-Fittings		Pipe Capacity		Length		Weight	
		in	mm	in-nom.	Actual Ø mm	in	mm	lbs	kg
MW3/4GRIP*	02385	1/8 - 3/4	17 - 33	3/8 - 1	17 - 33	11	267	1.3	0.6
MW1 1/4GRIP*	02386	3/8 - 1 1/4	27 - 48	3/4 - 1 1/2	27 - 48	16	394	3.2	1.5

*EXCLUSIVE

NOTE: These are comfort grips only. These grips are not made for electrical insulation.

Operator's Wrench

Double-ended **RF10** has forged alloy steel pipe wrench jaws on one end and a VO size valve wheel wrench hook on the opposite end. Cast alloy steel RF10 is designed for gripping pipe, test plugs, packing glands, and flange nuts. Hook end assists in opening and closing valves while length of wrench provides for needed leverage. The hook end fits hand valve wheels (up to $\frac{5}{8}$ " rims) without gouging the wheel. OSHA inspectors can assess penalties for using a pipe wrench on a valve wheel rim as wrench teeth can leave sharp burrs on the wheel rim, which result in hand injuries. Use of the RF10 prevents these problems. Handle is painted with chemical-resistant powder coating.

Catalog No.	Item Code	Pipe Capacity		Length		Weight	
		Inches-Nom.	Actual Ø mm	in	mm	lbs	kg
RF10	02121	$\frac{1}{8}$ - 1	10 - 33	10	254	1.2	0.5



RF10

Keep this lightweight 2-in-1 wrench handy all day!

Valve Packing Wrenches

Combination tools help maintain valves without stripping the nuts or gouging the wheel rims. One end is an adjustable wrench while the other end provides leverage to turn valve wheels with up to $\frac{5}{8}$ " thick rims. Lightweight for easy portability. Fits O style valve wheels.

Catalog No.	Item Code	Wrench Capacity	Length		Weight	
			in	mm	lbs	kg
A8VO*	02808	0 - $\frac{15}{16}$ "	8.4	213	0.6	0.3
A10VO*	02810	0 - 1 $\frac{1}{8}$ "	11	267	0.9	0.4

*EXCLUSIVE

EXCLUSIVE TOOL



A8VO

Valve Wheel Wrenches

Reed valve wheel wrenches grip the rims of hand valve wheels securely and provide leverage for opening and closing. These are the solution for handling hard-to-open valves. Choose a wrench based on the hook opening. The hooks work without gouging the wheel rim. OSHA inspectors can assess penalties for using a pipe wrench on a valve wheel rim as wrench teeth can leave sharp burrs on the wheel rim, which result in hand injuries. **VKVV** fits standard valve nuts and is made of heavy-duty mechanical steel tubing. **VWALP1** and **VWALP2** offer a low-sparking benefit due to aluminum-magnesium alloy construction. They also bend before they break, thus warning users of excess loads.

Catalog No.	Item Code	Style	Material	Hook Opening		Length		Weight	
				in	mm	in	mm	lbs	kg
★ VKVV	02363	2" Square Nut	mechanical steel tubing	2" Square	—	21	533	3.4	1.5
VW0	02830	Double-end	forged steel	$\frac{1}{2}$ & $\frac{21}{32}$	13 & 17	8	203	1.0	0.5
VW1	02831	Single-end	forged steel	1	25	15	381	2.4	1.1
VW2	02832	Single-end	forged steel	1 $\frac{5}{16}$	33	22	559	4.8	2.2
VW3	02833	Single-end	forged steel	2	51	27	686	11.4	5.2
VW10	02834	Double-end	forged steel	$\frac{11}{16}$ & 1	18 & 25	10	254	1.6	0.7
VWALP1	02851	Single-end	aluminum	1 $\frac{3}{8}$	35	14	356	2.2	1.0
VWALP2	02852	Single-end	aluminum	1 $\frac{3}{4}$	44	18	457	4.0	1.8

★ **NEW**



VWALP1

VW2

VW10

VW0

VKVV

NEW



www.reedmfgco.com

For the latest information on **NEW REED** Tools!

Internal Wrench

Made of hardened steel, this heavy-duty wrench is used to remove short pieces from fittings and mains. Wrench expands to twist out nipples, broken pipe, and broken corporation stops from pipe fittings and utility mains.



IW342

Catalog No.	Item Code	Capacity		Length		Weight	
		in - nom.	I.D. mm	in	mm	lbs	kg
IW342	02115	1 - 2	26 - 50	4.5	114	1.6	0.7

Smooth Jaw Wrenches

Reed offers large capacity wrenches for geometric and delicate work. The **R110HEX** hex wrench works for hex-shaped fittings on meters, drains, spuds, and chrome valves without damage from teeth. The **RSPUD** wrench is for square, hex, or octagonal shapes where toothed pipe wrenches are not a good option. Both are heavy-duty, made from ductile iron with forged steel hook jaws, and offer larger capacity than adjustable wrenches. Reed's **RCORP** smooth jaw wrench fits up to 2" corp stops and opens to 4 5/8". A coarse adjustment thread and a large thumbscrew provide quick, easy adjustments for the numerous size changes encountered during jobs. Ford Meter Box® and A.Y. McDonald®, along with other brass fittings manufacturers, recommend a smooth jaw wrench when tightening corp stops, either into the pipe or tapping saddle, or for tightening the service line connection on any waterworks brass valve or fitting.



R110HEX

RSPUD

RCORP

Catalog No.	Item Code	Capacity		Length		Weight	
		in - nom.	Actual mm	in	mm	lbs	kg
R110HEX	02111	2 5/8	67	10	254	1.6	0.7
RSPUD	02112	2 5/8	67	11	279	2.6	1.2
★ RCORP	02114	2	50.8	18	457	4.4	2.0

★ **RCORP**
★ **NEW**
SMOOTH JAW PLIERS ON P. 78



NEW Meter Nut Wrenches

These spring-loaded wrenches are designed for installing and removing gas meter nuts. Spring-loaded head allows operator to use one hand to reach into meter pits. Head design grips maximum number of edges on the meter nut. This allows even rusted, frozen meter nuts to be removed without slipping or squeezing the nut. The wrench is made with strong alloy steel to deliver 300 ft.-lbs. maximum torque. Tool can also serve as a pipe wrench.



MN020

MNH18

Catalog No.	Item Code	Wrench Size	Use for Meter Nut	Length		Weight	
				in	mm	lbs	kg
★ MNH18	02880	1 7/8" hex.	#1A	15	280	2.8	1.3
★ MN020	02885	2" oct.	#20 Lt.	15	280	3.0	1.4
★ NEW							



GENERAL PIPE WORKING TOOLS

SECTION 7

*Mechanical Hot
Tapping Machines*

Hole Master® 

*Hole Saws for DM3MECH &
Hole Master®*

Self-Feed Bits 

Bit Extensions

Ship Augers 

Hack Saw & Blades

*Portable Power Hack
Saw Blades* 

Stud Punches

Dam It® Soldering Aids

Bi-Metal Hole Saws

Flaring Tools

Tubing Benders

Torpedo Level

Multi-Purpose Pipe Joiner

Pipe Wrench Pliers®

Water Pump Pliers

Smooth Jaw Pliers 

Positive Grip Pliers

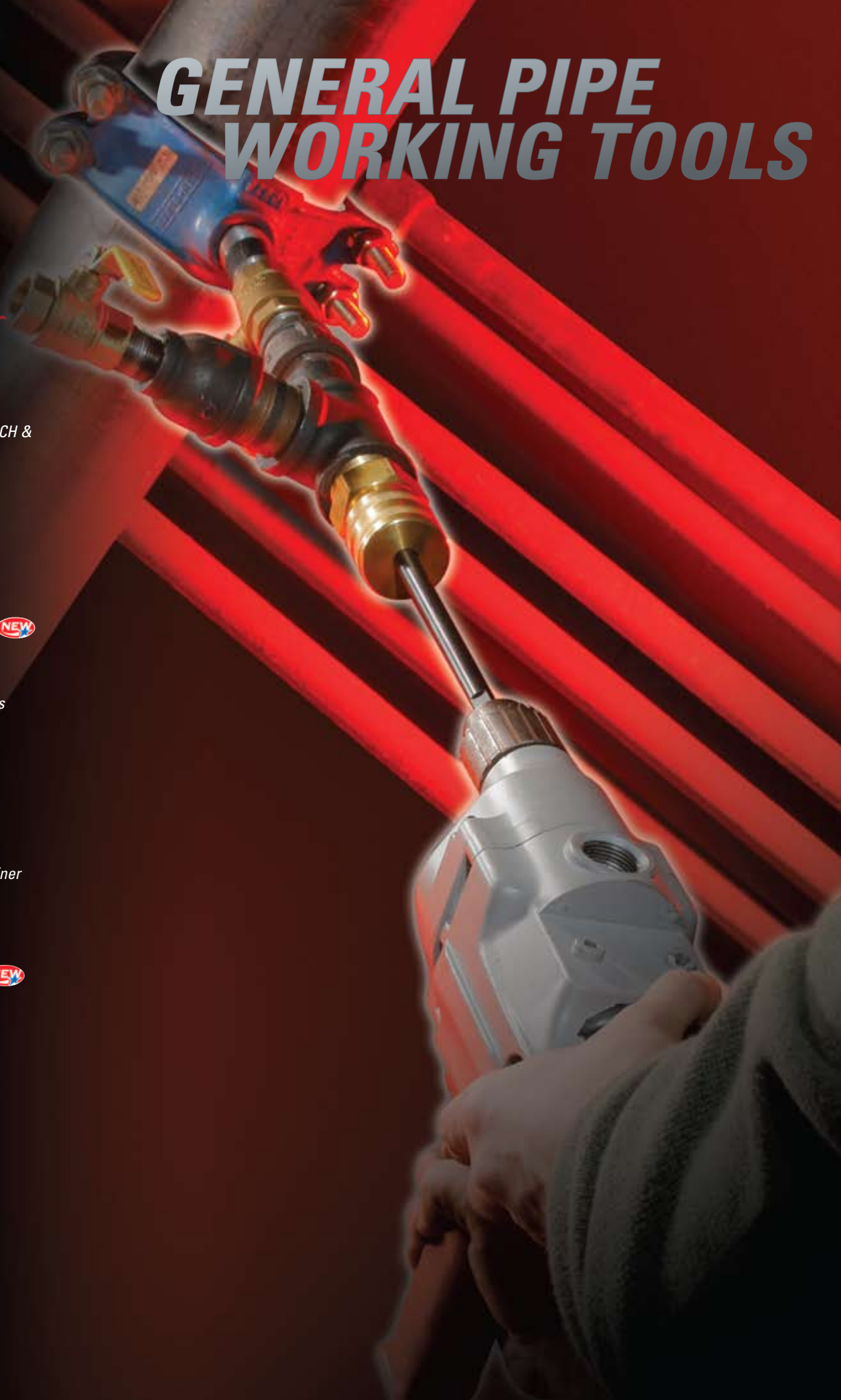



DM3MECH

Mechanical Hot Tapping Machine

Hot tap using the DM3MECH. With the right hole saw, cut or drill into copper, steel, or plastic pipe for up to 4" valves. **DM3MECH** contains the base machine, along with 7/16" Hex Arbor, 1/4" Drill Bit, Hole Saws 5/8", 7/8", 1 1/8", 1 3/8", 1 3/4", 2 1/4", 3 1/4", Allen wrenches and toolbox. **DM3MECHB** is the base machine in a toolbox only, without hole saws or arbor. These tools require a 1/2" drill motor, valves and fittings that are all sold separately.

Catalog No.	Item Code	Valve Size	Weight	
			lbs	kg
DM3MECH	08350	3/4" - 4"	12.0	5.5
DM3MECHB	08351	3/4" - 4"	10.0	4.5

*NOTE: User adds fittings and valves according to the application.
Pressure Rating for ambient (room) temperature liquid systems: 300 psi.
Pressure Rating for steam systems: 125 psi.
NOT recommended for ammonia or other caustic systems. The seals do not support it.*

ACCESSORIES

DB25	43507	1/4" Drill Bit
HSA716	43508	7/16" Hex Arbor
★ CRPD25	99129	1/4" Diameter Carbide-tipped Coupon Retaining Drill Bit

★ **NEW**
HOLE SAWS AT BOTTOM OF PAGE.

✓ WHY REED?

A great deal on a versatile tapping machine that is priced well for the market.

Pipe fittings and valves sold separately.

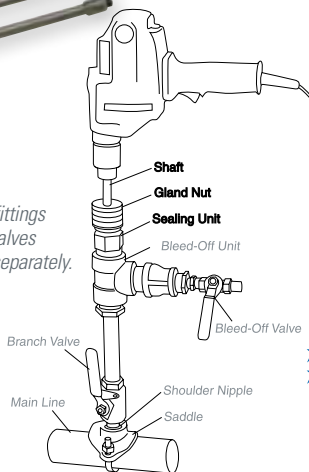

HCB-475



HCB-200



Hole Master® Hole Cutting Base

The Hole Master® provides a means of clamping onto pipe and using a drill to cut a hole in the pipe. Hole Master comes with a base, chain and screw for clamping, along with a plate and drill holder for mounting a drill and hole saw to the unit. Use the Hole Master in depressurized piping systems only. The handle and gear provide leverage for cutting holes. Hole Master has a pipe diameter mounting range of 1 1/4" - 10" nom. (42 - 273 mm) and uses hole saws/cutters up through 4 3/4" (120 mm). For convenience, Reed offers options with one cordless DeWalt® or regular Milwaukee® drill and a plastic toolbox. Hole Master requires a hole saw for steel/copper pipe or shell cutter for plastic/ductile iron pipe (sold separately). **HCB-200** Hole Master® is a drill guide with 6 bushings to work with 1", 1 3/16", 1 1/4", 1 1/2", 1 3/4", and 2" hole saws. It works with any drill that fits the selected hole saw.

Catalog No.	Item Code	Size	Hole Saw Diameter	Weight		Description
				lbs	kg	
For Milwaukee® Drill Models 1660-1 and 1660-6, and 1663-20						
HCB-475M	08441	13" x 12" x 5"	fits up to 4 3/4"	28.0	12.7	without Drill
HCB-475M-D	08443	13" x 12" x 5"	fits up to 4 3/4"	40.0	18.0	with Milwaukee® 1660-6 Drill
HCB-475M-DB	08447	13" x 12" x 5"	fits up to 4 3/4"	46.0	21.0	with Milwaukee® 1660-6 Drill and Toolbox
For DeWALT® Drill Model DW131, Spade Handle						
HCB-475D	08442	13" x 12" x 5"	fits up to 4 3/4"	28.0	12.7	without Drill
For DeWALT® 18V Drill Model DC987KA						
HCB-475BAT	08449	13" x 12" x 5"	fits up to 4 3/4"	28.0	12.7	without Drill
HCB-475BAT-D	08445	13" x 12" x 5"	fits up to 4 3/4"	40.0	18.0	with DeWalt® 18V Cordless Drill
HCB-475BAT-DB	08448	13" x 12" x 5"	fits up to 4 3/4"	46.0	21.0	with DeWalt® 18V Cordless Drill and Toolbox
★ HCB-200	08460	6" x 5" x 4"	fits up to 2"	7.2	3.3	Drill Guide for 1", 1 3/16", 1 1/4", 1 1/2", 1 3/4", and 2" hole saws

★ **NEW**
HOLE SAWS BELOW
HEAVY-DUTY SHELL CUTTERS ON P. 46
BIHSD68 HOLE SAW AND HSA45P ON P. 75

✓ WHY REED?

Hole Master's plate, with the drill attached, separates quickly from the base. This allows securing the base to the pipe without wrestling with the added weight of the drill.

Hole Saws for DM3MECH & Hole Master®

Bi-metal hole saws work well for steel and copper pipe. They fit both the DM3MECH and the Hole Master®.

Catalog No.	Item Code	Description
BMHS10	43500	Hole Saw, 5/8" Diameter 1 1/2" cutdepth
BMHS14	43501	Hole Saw, 7/8" Diameter 1 1/2" cutdepth
BMHS18	43502	Hole Saw, 1 1/8", Diameter 1 1/2" cutdepth
BMHS22	43503	Hole Saw, 1 3/8", Diameter 1 1/2" cutdepth
BMHS28	43504	Hole Saw, 1 3/4", Diameter 1 1/2" cutdepth
BMHS36	43505	Hole Saw, 2 1/4", Diameter 1 1/2" cutdepth
BMHS52	43506	Hole Saw, 3 1/4", Diameter 1 1/2" cutdepth



Self-Feed Bits

Self-Feed Bits provide faster boring of clean, accurate holes in wood for pipe, conduit and tubing. The bits are designed with precise, hardened cutting edges that hold up cut after cut. An aggressive self-feed lead screw helps draw the bit into the wood without applying pressure. The lead screws are machine ground and therefore burr-free. In addition, the inside cutting plane ensures clean, smooth holes for consistent and even work. Easy removal from the hole is accomplished because the sides of the bit are tapered. The bits have a 5 1/4" overall length. Teeth can be sharpened with a file, with best results from a diamond grit file. All shanks are 1/2" diameter with 6 fully machined flats that can be tightly gripped by the chuck, which eliminates wobble while drilling. Use only with 1/2" heavy-duty angle drills, specifically designed for self-feed bits.

Catalog No.	Item Code	Nominal Pipe Capacity*	Hole Size		Weight	
			Ø in	Ø mm	lbs	kg
B16	06400	1/2 IPS - 3/4 CTS	1	25	0.3	0.1
B18	06401	3/4 IPS	1 1/8	28	0.3	0.1
B20	06402	1 CTS	1 1/4	32	0.3	0.1
B22	06403	1 IPS	1 3/8	35	0.4	0.2
B24	06404	1 1/4 CTS	1 1/2	38	0.4	0.2
B28	06405	1 1/2 CTS	1 3/4	44	0.5	0.2
B32	06406	1 1/4 IPS	2	51	0.5	0.2
B34	06407	1 1/2 IPS	2 1/8	54	0.6	0.3
B36	06408	2 CTS	2 1/4	57	0.7	0.3
B41	06409	2 IPS	2 9/16	65	0.8	0.4
B48	06410	2 1/2 IPS - 2 1/2 CTS	3	76	0.9	0.4
B58	06411	3 IPS - 3 CTS	3 5/8	92	1.9	0.9
B74	06412	4 IPS - 4 CTS	4 5/8	117	2.5	1.1

*NOTE: IPS-Iron Pipe Size - All steel, PVC, and rigid conduit sizes.
CTS-Copper Tubing Size - All types (K, L, M, & DWV) copper tubing nominal sizes, and thin wall conduit.

NEW SELF-FEED BITS KITS

Catalog No.	Item Code	Description	Weight	
			lbs	kg
★SFBK4PC	06440	Contains 1 3/8", 1 1/2", 2 1/8", 2 9/16" bits in a handy plastic toolbox.	4.0	1.8
★SFBK8PC	06480	Contains 1 1/8", 1 1/4", 1 3/8", 1 1/2", 1 3/4", 2 1/8", 2 9/16" bits, 5 1/2" extension, and Allen wrench in a handy plastic toolbox.	5.5	2.5

★NEW ACCESSORIES

SELF-FEED BITS PARTS

Replacement parts for self-feed bits include lead screws and complete repair kits. Lead screws feed the bit through both hard and soft wood, practically without effort from the operator. Repair kits contain lead screws plus a set screw and hex key.

Catalog No.	Item Code	Description
★BPRP4 5/8	40120	Kit for 3 - 4 5/8" (3 lead screws, 1 set screw, 1 hex key)
★BPRP2 9/16	40121	Kit for 1" - 2 9/16" (3 lead screws, 1 set screw, 1 hex key)
★BPLS4 5/8	96418	Lead screws (3) for 3" - 4 5/8"
★BPLS2 9/16	96424	Lead screws (3) for 1" - 2 9/16"

★NEW

Bit Extensions

One-piece extensions are designed for quick change with hex shank bits. They are made of tool steel, which has been heat-treated and hardened for durability, especially to resist bending. Two set screws secure the extension to the shank of a self-feed bit, ship auger, or other 7/16" shank accessory and keep the bit from vibrating loose.

Catalog No.	Item Code	Length		Weight	
		in	mm	lbs	kg
BEX512	06424	5 1/2	140	0.5	0.2
BEX12	06425	12	305	0.9	0.4
BEX18	06426	18	457	1.2	0.5

SELF-FEED BITS ABOVE
SHIP AUGERS ON P. 74

BEST EVER!

NEW

SFBK8PC



✓ WHY REED?

Reed bit extensions are interchangeable and may be used with Lenox®, Milwaukee®, and Greenlee® bits.



BEST EVER!

7

NEW Ship Augers

Superior steel and single-piece induction hardening make for long life on Reed's Ship Augers. They make a hole that's true to size with cutting edges that stay sharp for easy drilling. Each auger is 7 1/2" long with double spurs and fits into standard drills. (A spur refers to the cutting edge on either side of the threaded screw start tip.) Ship augers are used by all trades to bore deep holes in wood for running pipe, wire, cable, etc.



Catalog No.	Item Code	Hole Size	Weight	
			lbs	kg
★ AUG3/4	06710	3/4"	.45	.20
★ AUG7/8	06715	7/8"	.50	.23
★ AUG1	06720	1"	.60	.27
★ AUG11/8	06725	1 1/8"	.75	.34
★ AUG11/4	06730	1 1/4"	.85	.39
★ AUG13/8	06735	1 3/8"	.90	.41

★ **NEW**
BIT EXTENSIONS ON P. 73

Hack Saw & Blades

The HK1228 is a high-tension style saw. Bi-metal blades have a high speed steel cutting edge and are electron-beam welded to alloy steel back, with wavy set. When used with high-tension frames, bi-metal blades provide best performance and safety. Blades and frames are interchangeable with Stanley®, Lenox®, Starrett®, M.K. Morse® and Ridgid®, among others.

HACK SAW

Catalog No.	Item Code	Description	Blade	Throat Depth Inches	Weight	
					lbs	kg
HK1228	04489	High Tension Hack Saw	Bi-Metal Blade	4 3/4	1.8	0.8

BI-METAL BLADES

Catalog No.	Item Code	Teeth per Inch	Length/Width/Thickness		Std. Pkg.	Weight	
			Inches-Nom.	mm		lbs	kg
BH18	04491	18	12 x 1/2 x .025	300 x 13 x 0.6	10	0.5	0.2
BH24	04492	24	12 x 1/2 x .025	300 x 13 x 0.6	10	0.5	0.2
BH32	04493	32	12 x 1/2 x .025	300 x 13 x 0.6	10	0.5	0.2

NOTE: Coarse teeth (less teeth per inch) are to be used for softer materials like aluminum, brass, or low carbon steels. The larger spaces between teeth keep them from clogging with metal fragments. Finer teeth are to be used on tougher or slightly harder materials like alloy and tool steels and some stainless steels.

Portable Power Hack Saw Blades

For speed, straightness of cut, long life and safety, these bi-metal blades are the best choice for the Reed Saw It® and heavy-duty power hack saws made by Widder®, Fein®, and Spitznas®. The extra blade depth (1 3/8") and the Matrix® high-speed steel (HSS) cutting edge allow a straighter cut. Bi-metal blade construction reduces the tendency of solid HSS blades to shatter. Wavy set and high tooth hardness for longer life. Blades cut copper, steel, stainless steel, aluminum, and harder plastics like PVC and ABS.

Catalog No.	Item Code	Teeth Per Inch	Length/Width/Thickness		Std. Pkg.
			Inches-Nom.	mm	
★ Z814	04478	14	8 x 1 3/8 x .062	200 x 35 x 1.6	10
★ Z1014	04479	14	10 x 1 3/8 x .062	250 x 35 x 1.6	10
Z1214	04494	14	12 x 1 3/8 x .062	300 x 35 x 1.6	10
Z1614	04495	14	16 x 1 3/8 x .062	400 x 35 x 1.6	10
Z2114	04496	14	21 x 1 3/8 x .062	530 x 35 x 1.6	10
Z2414	04497	14	24 x 1 3/8 x .062	600 x 35 x 1.6	10
Z3014	04498	14	30 x 1 3/8 x .062	760 x 35 x 1.6	10
Z1608	04499	8	16 x 1 3/8 x .062	400 x 35 x 1.6	10
Z2108	04597	8	21 x 1 3/8 x .062	533 x 35 x 1.6	10

★ **NEW**
NOTE: Blade length should be at least 6" more than the O.D. of the pipe.
SAW IT® PNEUMATIC SAW ON P. 16

Ridgid® is a registered trademark of Ridgid, Inc. and is not associated with Reed Manufacturing Company.



14 TPI (teeth per inch) work best on materials at least 1/8" thick. 8 TPI work best on materials at least 3/16" thick. Use fewer teeth per inch on softer materials like plastic.

Stud Punches

Reed offers the most common sizes of stud punches for metal studs, plumbing, and electrical work. Give fast punches for running wires or lines through metal studs without pre-drilling. Punches up to 20 gauge mild steel. **STP710** features two cutting edges while **STP709** has four cutting edges. For punches made with the STP710 and other 1 11/32" holes, use **GR1.3** plastic grommets to protect pipe and wire from the metal edges.

Catalog No.	Item Code	Punch Size		Length		Weight	
		Actual in	mm	in	mm	lbs	kg
STP709	06460	7/8	22.2	21.0	533.4	6.4	2.9
STP710	06465	1 11/32	34.1	21.0	533.4	6.6	3.0

ACCESSORY

PLASTIC GROMMETS

Catalog No.	Item Code	Punch Size		Length		Weight*	
		Actual in	mm	in	mm	lbs	kg
GR1.3	06475	1 11/32	34.1	1.8	44	0.9	0.4

*100 Count



Dam It® Soldering Aids

Dam It® stops the dripping that cools and prevents fast soldering. Slip the tool into the copper pipe and tighten the nut to make the seal expand to dam the water. Dam It® remains in an L-shape and does not hinge. Dam It® can also be used to sweat off and remove faulty valves that are cooled by dripping water. In addition to individual sizes, two kits (#03380, #03382) are available.

Catalog No.	Item Code	Description	Capacity		Length		Weight	
			in-nom.	Actual mm	in	mm	lbs	kg
SA200K	03380	1/2" to 2" kit	1/2" - 2"	13-51	13	330	4.3	2.0
SA100K	03382	1/2" to 1" kit	1/2" - 1"	13-25	10	253	1.0	0.5
SA050	03384	1/2"	1/2"	13	10	253	0.3	0.1
SA075	03386	3/4"	3/4"	16	10	253	0.4	0.2
SA100	03388	1"	1"	25	10	253	0.4	0.2
SA125	03390	1 1/4"	1 1/4"	32	13	330	1.0	0.5
SA150	03392	1 1/2"	1 1/2"	38	13	330	1.0	0.5
SA200	03394	2"	2"	51	13	330	1.3	0.6

NOTE: Not for use with live systems. Use only on piping when the water pressure is turned off.



Bi-Metal Hole Saws

Bi-metal variable pitch hole saws for all machinable aluminum, cast iron, PVC, mild, tool and stainless steels as well as nail embedded wood. Depth of cut is 1 7/8" deep for sewer taps. High-speed tool steel cutting teeth for shock resistance and longer life. The 4/6 variable pitch tooth design reduces vibration and promotes faster and smoother cutting. For steel, use Reed Threadguard cutting oil. Cut cast iron dry and PVC with water.

Catalog No.	Item Code	Hole Saw Size	Weight	
			lbs	kg
BIHSD68*	04550	4 1/4"	0.8	0.4
BIHSD106	04551	6 5/8"	2.0	0.9

*Fits HCB-475 Hole Master® HOLE MASTER® ON P. 72
 HEAVY-DUTY HOLE CUTTERS FOR DRILLING MACHINES ON P. 42
 CARBIDE-TIPPED HOLE CUTTERS FOR DRILLING MACHINES ON P. 42
 THREADGUARD CUTTING OIL ON P. 30

ACCESSORY

ARBOR

Hole Saws require an arbor, which is interchangeable with all major brands. Arbors have high-speed pilot drills for heavy-duty use. Saws disassemble from arbors without the use of tools.

Catalog No.	Item Code	Chuck Size in	Weight	
			lbs	kg
HSA45P	04559	1/2	0.5	0.2

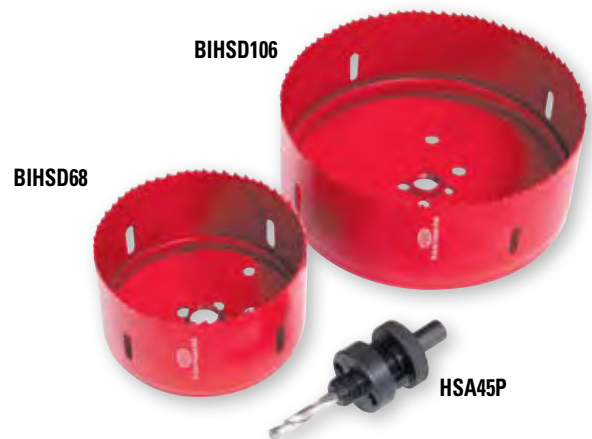

Flaring Tools



FT6

Sliding Bar Handle



FT195

✓ WHY REED?

Only Reed has all three of the most popular approaches to flaring.



R458

Popular **FT6** one-piece tool conveniently clamps on and flares six sizes of $\frac{3}{16}$ " - $\frac{5}{8}$ " copper tubing (K&L soft copper, annealed M copper) with various wall thicknesses. With both a dial-a-size adjustment and a pressure adjustment for tighter squeeze, the tool also works effectively on aluminum, brass, and steel tubing to produce a perfect 45° flare.

The **FT195** is a very affordable tool for 45° flaring of soft tubing (K&L soft copper, annealed M copper) up to $\frac{5}{8}$ " OD. It offers a smooth, spinning cone for ease of flaring and plating of important components to inhibit corrosion. Sliding bar handle is used to increase leverage for turning and to permit work in tight places.

The Reed **R458** makes 45° flaring of soft (K&L soft copper, annealed M copper) and hard tubing easy. The tool includes an eccentric cone design that rolls out only a portion of the tubing at a time as it swivels around. This, plus bearings throughout, makes flaring less strenuous and allows work even with stainless steel tubing up to .035" wall thickness. The built-in clutch mechanism stops flaring at the proper time, preventing damage to the tubing and allowing burnishing for a smooth, even flare. Capacity is $\frac{1}{8}$ " to $\frac{3}{4}$."

Catalog No.	Item Code	Description	Weight	
			lbs	kg
FT6	02748	Flares $\frac{3}{16}$ ", $\frac{1}{4}$ ", $\frac{5}{16}$ ", $\frac{3}{8}$ ", $\frac{1}{2}$ ", $\frac{5}{8}$ "	2.1	1.0
FT195	02755	Plated, yoke flaring tool, SAE 45° Inch OD: $\frac{3}{16}$, $\frac{1}{4}$, $\frac{5}{16}$, $\frac{3}{8}$, $\frac{7}{16}$, $\frac{1}{2}$, $\frac{5}{8}$	2.3	1.0
R458	02758	Eccentric head flaring tool, SAE 45° Inch OD: $\frac{1}{8}$, $\frac{3}{16}$, $\frac{1}{4}$, $\frac{5}{16}$, $\frac{3}{8}$, $\frac{1}{2}$, $\frac{5}{8}$, $\frac{3}{4}$	3.2	1.5

NOTE: SAE refers to Society of Automotive Engineers www.sae.org
HAMMER & FLARE TOOLS ON P. 48

REED Lifetime Warranty

Reed Hand Tools are for the professional trade and are warranted against all failure due to defects in workmanship and materials for the **normal life of the tool**.

FAILURES DUE TO MISUSE, ABUSE, OR NORMAL WEAR AND TEAR ARE NOT COVERED BY THIS WARRANTY.

Power units for Universal Pipe Cutters, Saw It®, electric test pumps, and threading power drives are warranted for a period of one year from date of purchase.

NO PARTY IS AUTHORIZED TO EXTEND ANY OTHER WARRANTY. NO WARRANTY FOR MERCHANTABILITY OR FITNESS FOR A PARTICULAR PURPOSE SHALL APPLY.

No warranty claims will be allowed unless the product in question is received freight prepaid at the Reed factory. All warranty claims are limited to repair or replacement, at the option of the company, at no charge to the customer. REED IS NOT LIABLE FOR ANY DAMAGE OF ANY SORT, INCLUDING INCIDENTAL AND CONSEQUENTIAL DAMAGES. Some states do not allow the exclusion or limitation of incidental or consequential damages, so the above exclusion may not apply.

This warranty gives you specific legal rights, and you may also have other rights which vary from state to state.



Tube Benders

These bending tools, in the most popular sizes, are ideal for bending soft metal tubes of copper, steel, stainless steel, and aluminum. The benders should not, however, be used on extremely thin or hard-tempered material. All metal parts are chrome plated for corrosion resistance. Starting at a 90° angle, ergonomic round offset handles allow bends up to 180°. Calibrated angle markings appear every 15°, with separate gauge marks for right (R), left (L), and normal (O). **TB3456** Quad Bender is ideal for plumbing and HVAC applications because there are four sizes in one tool.

Catalog No.	Item Code	Tube Capacity		Bend Radius	Weight	
		in O.D.*	mm		lbs	kg
TB04	02745	1/4	-	9/16	1.0	0.5
TB05	02743	5/16	-	11/16	1.8	0.8
TB06	02746	3/8	-	15/16	2.0	0.9
TB07	02744	7/16	-	1 1/2	3.5	1.6
TB08	02747	1/2	-	1 1/2	3.5	1.6
TB12	02749	3/4	-	3	7.0	3.2
TB3456**	02742	1/8, 1/4, 5/16, 3/8	3.2, 6.5, 7.9, 9.5	15/16	1.9	0.9

*1/4" = 1/8" nominal 3/8" = 1/4" nominal 1/2" = 3/8" nominal

** For annealed tubing



Torpedo Level (Pitch & Magnetic)

Sturdy plastic frame with magnetic base and working edges precision ground flat to sit flat. V-groove edge allows level to sit on pipe. Easy-to-read as white frames surround the yellow vials for contrast. Top view window for convenience. Vials read level, plumb, and 45°. Vial indicates pitch at 1/8", 1/4" or 3/8" per foot without adjustments.

Catalog No.	Item Code	Material	Size-Inches	Weight	
				lbs	kg
LV9PM	06212	Plastic	5/8 X 1 1/4 X 9	0.3	0.1

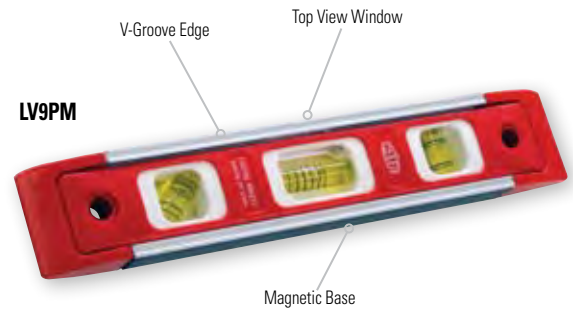

Multi-Purpose Pipe Joiner

The **PJ414** allows a basic lever-and-chain approach to joining medium and large gasketed pipe and fittings up to 14" size. It works for PVC, ductile iron, clay tile, cast iron soil pipe and concrete pipe. Use two PJ414's for heavier pipe. Quarter-inch proof coil chain is rated at 1600 lbs (727 kg). PJ414 comes complete with two 12' (3.7 m) lengths of chain, two grab hooks, plus a 2-piece extendable handle of over 4 feet that allows for a variety of applications.

Catalog No.	Item Code	Capacity		Weight	
		in - nom.	Actual mm	lbs	kg
PJ414	08080	4 - 14	102 - 355	34.0	15.5

NOTE: Not for use with solvent cement joining of plastic pipe.

NOTE: Double wrap chain around PVC for best grip.

PLASTIC PIPE JOINERS ON P. 57

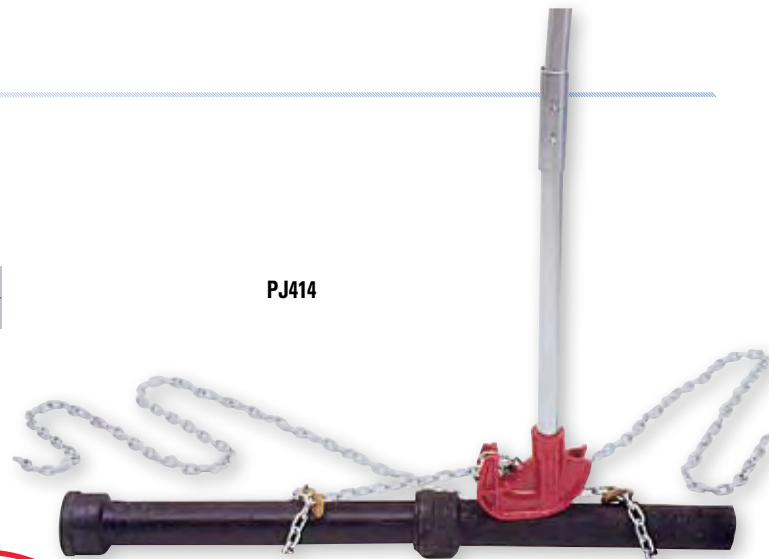

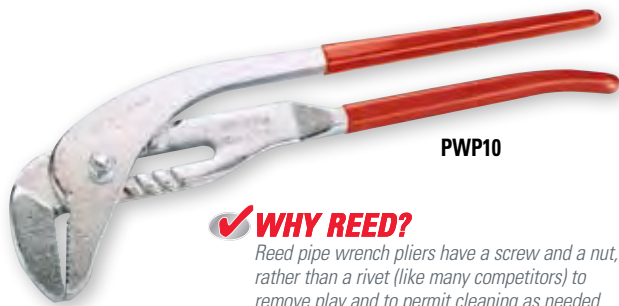

PWP10

✓ WHY REED?

Reed pipe wrench pliers have a screw and a nut, rather than a rivet (like many competitors) to remove play and to permit cleaning as needed. For one-hand operation, the handles are parallel, even when the jaws are fully extended.

Pipe Wrench Pliers®

The 90° jaws permit reaching into tight areas and also provide up to 20% more leverage than traditional jaws. Tongue-and-groove construction forged from alloy steel, fully heat-treated, and zinc-plated for strength and corrosion resistance. Self-gripping, pipe-wrench-style teeth give ratchet-like action for turning fittings. Built-in handle stop eliminates pinched fingers.

Catalog No.	Item Code	Pipe Capacity		Length		Weight	
		Inches-Nom.	Actual Ø mm	in	mm	lbs	kg
PWP10	02610	1 1/2	54	10	254	1.2	0.5
PWP13	02620	2	63	12.75	324	2.2	1.0



WPP10

Water Pump Pliers

Forged, slip joint design, for one-hand operation. Pipe-wrench-style milled teeth, traditional 32° angle nose and zinc plating which inhibits corrosion. Pliers are large enough to handle 1 1/2" slip nuts on traps and have maximum capacity of 2" nominal. Handles are always parallel, even with jaws fully extended.

Catalog No.	Item Code	Pipe Capacity		Length		Weight	
		Inches-Nom.	Actual Ø mm	in	mm	lbs	kg
WPP10	02650	2" pipe 1 1/2" slip nuts	63	10	254	0.9	0.4



WPPS10

NEW Smooth Jaw Pliers

Same great features as the WPP10 – use **WPPS10** when working on vulnerable fixtures and soft fittings, such as brass and chrome plating, which will be visible when the job is done – no teeth marks! Good for gripping PVC piping without damaging the fittings with teeth marks like typical adjustable pliers. Grip wires without inadvertently crimping them. Allow positive grip and less chance of damaging the hex head of a nut or bolt.

Catalog No.	Item Code	Pipe Capacity		Length		Weight	
		Inches-Nom.	Actual Ø mm	in	mm	lbs	kg
★ WPPS10	02652	2	60	10	254	0.9	0.4

★ NEW
SMOOTH JAW WRENCHES ON P. 70



PGP12

PGP10

Positive Grip Pliers

This combination of jaw design, offset head, handle, and tongue-and-groove design only requires downward pressure on handle, no squeezing, once pliers are engaged. Smooth tongue-and-groove action makes these the most effective pliers on the market for one-hand operation. Patented rib prevents finger pinching. Forged from high quality, high carbon steel and fully heat-treated for long life.

Catalog No.	Item Code	Pipe Capacity		Length		Weight	
		Inches-Nom.	Actual Ø mm	in	mm	lbs	kg
PGP10	02655	1	35	9.5	245	0.7	0.3
PGP12	02656	2	63	12	305	1.5	0.7



Reed Local Distributors

Reed sells only through traditional distributors, and for very good reasons. Good distributors add value for users of Reed tools in these important ways:

Local Stock

Local distributors, both in the U.S. and worldwide, provide readily available stock for Reed tool users. Local distributors help to avoid costly delays when tools are needed immediately to get the job done right!

✓ WHY REED? Reed ships over 98% of its orders complete within three working days, with same-day expediting if necessary; very low prepaid freight requirements, with no minimum orders, standard packs or drop ship penalties that slow service and add costs. All Reed products are marketed through traditional distributors: **NO BIG BOXES/ MASS MERCHANTS.**

Product Information

Local distributors provide information on both existing and new, quality tools.

✓ WHY REED? Reed has developed new, problem-solving products each and every year for over 110 years.

Problem Solving

Local distributors provide problem-solving efforts such as product recommendations, order expediting, and replacement part identification on Reed tools. Distributors also can arrange visits by factory representatives.

✓ WHY REED? Reed factory and field service personnel are by far the most responsive in the industry to distributor and tool user requests. Reed people do not feel that a sale is successfully concluded unless the transaction is smooth and error-free, and the final customer is completely satisfied.



Florida Industrial Products - Tampa, FL



Ranger Supply
Bronx, NY



Raritan Supply - Edison, NJ



Reed Lifetime Warranty p. 76

Reed also participates in many regional organizations.

*Traditional Values and Cutting Edge
Products ★ Service ★ Technology ★ People*



www.reedmfgco.com

1425 West 8th Street • P.O. Box 1321 • Phone: **(800) 666 3691** or **(814) 452 3691** • Erie, Pennsylvania 16512 USA
reedsales@reedmfgco.com • Fax: (800) 456 1697 or (814) 455 1697

© 2009 01002