



C e m b r e



Certified Occupational Health & Safety Management System



Certified Environmental Management System



Certified Quality Management System



GENERAL CATALOGUE

QUALITY POLICY AND OBJECTIVES



This catalogue illustrates the range of our standard products. For each product family we indicate the principal features, and sometimes the most frequent applications and the necessary guidelines for a correct application. Our sales personnel are at your disposal to supply more detailed information and our design and development engineers are available to study new solutions to particular applications.



All Cembre products comply with Directive 2011/65/EU of the European Parliament and Council dated 8 June 2011 (and subsequent amendment).

On 14th December 1990 **Cembre SpA Quality Management System** was certified by Lloyd's Register of Quality Assurance (LRQA) according to **ISO 9002-1987 EN 29002 - 1987 BS 5750: Part 2: 1987** for the manufacture of insulated and uninsulated copper crimping connectors. Then on 22nd December 1992 **Cembre SpA** was certified **ISO 9001** for the design and manufacture of cable accessories, electrical connectors and associated tools. The activities of the main premises in Brescia, the Italian regional offices and the subsidiary companies in Great Britain, France, Spain, Germany and USA are governed by a single Quality System, assessed by Lloyd's Register of Quality as conforming to the **ISO 9001:2008** norm, for the design, manufacture and sales of electrical connectors and associated tools, cable accessories, marking systems, tooling and products for railway applications. In house repair, refurbishment and calibration of tooling. This guarantees a homogeneous and high quality level of the products and services that Cembre offers to its customers.

Cembre S.p.A. has recently recognised the need to align its Environmental Management System with the spirit and content of **UNI EN ISO 14001: 2004** as fundamental to future development. To this end the company undertook a wide-ranging review of all functions including development and design stages, material selection, usage and manufacturing processes. The resulting definition of operational procedures in line with these aims and provisions has enabled **Cembre S.p.A.** to achieve Environmental Certification, further highlighting the companies sensitive and careful approach to environmental protection.

Cembre S.p.A. has recently enhanced its business processes with the certification by Lloyd's Register of Quality Assurance, of its Management System for the Health and Safety of Workers,

in accordance with the standard **OHSAS18001:2007 (Occupational Health and Safety Management System)**. The project, launched in early 2011, was strategically designed to facilitate the active participation of all employees at every level in the application of systems management, in order to optimise compliance of risk management capability with regard to laws and regulations concerning the health and safety of workers. All employees have received exhaustive training and are involved, by exercising their individual responsibility and competence, as key players in the identification of residual risk situations and the proposal of corrective solutions. For Cembre then, this certification is not only the proper recognition of the quality of work performed, but also an incentive to maintain a determined competitive advantage in increasingly difficult and aggressive international markets.

Cembre S.p.A. factory in Brescia (ITALY) covers an area of approximately 121.000 sqm

Cembre Ltd.
factory in Curdworth (Birmingham)



**Production
Units**



CONNECTORS FOR CONTROL, POWER AND DISTRIBUTION

Halogen free insulated terminals type VP, RP, BP, GP	4-5
Insulated chain terminals type CRP, CBP, CGP	6-7
PVC insulated crimp terminals type RF, BF, GF	8-9
Reinforced PA 6.6 insulated terminals type RKY, BKY, GKY	10-11
Female disconnect terminals type RF-F, BF-F, GF-F	12
Male disconnect terminals type RF-M, BF-M, GF-M	12
Partially insulated male/female connectors type RF-FM, BF-FM	12
Insulated bullet and socket connectors type RF-B, BF-B	12
Butt and parallel connectors type PL-M, PL-P	13
Butt connectors type NL-M	13
PE HD insulated, heat shrinkable type WL-M	13
Close end connectors type NL-P	13
Reinforced disconnect terminals type RKF, BKF, GKF	14
Female connectors, open barrel type RN-FA, BN-FA	14
Male connectors, open barrel type RN-MA, BN-MA	15
Male tabs, for board mounting type MP, MPD	15
Connector sleeves type CFA, CMA	15
Insulated end sleeves type PKE, PKC, CPKD	16
"Twin" insulated end sleeves type PKET, PKCT	17
Uninsulated end sleeves type KE	17
Uninsulated terminals type S	18-19
Uninsulated terminals type RN, BN, GN	20-21
Copper tube crimping lugs type A-M	22-23
Ring tongue terminals with contained palm for L.V. circuit breakers type A-M	24
Copper tube crimping lugs type A-L angled 90°	25
Copper tube terminals type A-2M	26
Through connectors type L-M	27
Parallel connectors type L-P	27
PA6.6 insulated Copper tube lugs type ANE-M	28
PA6.6 insulated fork terminals type ANE-U	29
Flexible braids type FL	29
PA6.6 insulated pin terminals type ANE-P	30
Uninsulated pin connectors type A-P	30
PA6.6 insulated Copper tube lugs type ANE-M, for extra flexible Copper conductor	31
Copper tube crimping lugs type A-M, for extra flexible Copper conductor	32
Copper tube lugs 4ESI fixing	33
Insulated covers type ES	33
Copper tube crimping lugs according to DIN 46235 type DR	34-35
Crimping through connectors according to DIN 46267 T.1 type DSV	35
Colour coded Copper crimping lugs type C	36-37
Colour coded Copper crimping lugs type CL	38
Colour coded Copper crimping lugs type C-D	39
Colour coded splices type BSCL	40

CONNECTORS FOR DERIVATIONS AND EARTHING

Sleeve connectors type C-C	41
Mechanical fixing lugs	42
Cable clamps	43

HIGH VOLTAGE COPPER TERMINALS

High voltage terminals type 2A-M	44
High voltage terminals type 2A-2M	45
High voltage heavy duty Copper terminals type CA-M	46
High voltage heavy duty Copper terminals type CA-2M	47
High voltage terminals type 2A-2M/55°	47
High voltage stalk connectors type MT-C	48
High voltage Copper through connectors type MT-TD, MT-GC	49

CONNECTORS FOR ALUMINIUM CONDUCTORS

Aluminium terminals type AA-M	50
Through connectors type MTMA-GC, MTMA/1	51
Reducer through connectors type MTMA-GC	51
Aluminium terminals type AAD-M	52
Aluminium through connectors type DSA	53
Bimetallic connectors, Copper palm fixing type CAA-M	54
Bimetallic connectors, Copper pin type MTA-C	54

TERMINAL BLOCKS

ZETA più single pole terminal blocks	56-59
ZETA block power distribution blocks	60-61
ZETA mini one way terminal blocks	62

CABLE GLANDS AND ACCESSORIES

MAXI block cable glands, Polyamide, IP68	64-66
<i>spiral</i> block cable glands, Polyamide, IP68	67
MAXI block ATEX cable glands, Polyamide, IP65	68
Compression cable glands, Polyamide PA6, IP54	69-70
Compression cable glands & hole plugs, Polystyrene, IP54	71
MAXI brass cable glands, Nickel plated Brass, IP68	72-75
MAXI brass ATEX cable glands, Nickel plated Brass, IP65	76
EMC cable glands & locknuts, Nickel plated Brass, IP68	76
Compression cable glands, Nickel plated & plain Brass, IP54	77
MAXI inox cable glands, Stainless Steel, IP68	78-79
Locknuts with & without collar, Polyamide	80-81
Locknuts, Nickel plated & plain Brass	82
EMC locknuts, Nickel plated Brass	83
MAXI inox locknuts, Stainless Steel	83
Internal plugs & multi-entry seals for cable glands	84-85
Thread enlargers, reducers and converters, Nickel plated Brass	86-87
Accessories	88
O-rings, sealing rings and compression washers	89-91
Entry plugs, Polyamide PA6, Polystyrene, IP54	92-93
Entry bushes, Polyamide PA6	94
Entry plugs & bushes, Nickel plated & plain Brass, IP54	95
RUTASEAL grommets, EPDM, IP67	96

CABLE & CONDUIT ACCESSORIES

SICUR clips retaining clips for cable & conduit, ABS	96
---	----

MECHANICAL TOOLS

Mechanical tools	98-115
Pneumatic press and bench tools	117-122

HYDRAULIC TOOLS

Hydraulic crimping tools	124-135
Hydraulic cable cutters	136-144
Special tools	145-147
Accessories	148
Crimping force gauges & pressure test devices	148

CORDLESS HYDRAULIC TOOLS

	150-168
--	---------

HYDRAULIC PUMPS

	170-174
--	---------

HYDRAULIC UNITS

	175-176
--	---------

DIE SELECTOR CHART

	178-190
--	---------

APPENDIX

Reference/Code cross-chart	192-201
Comparison of AWG, MCM and Metric conductor cross sections	202
IEC 60228 : 2004 - 11 Conductor Tables	203-205
System of denomination of harmonised cables according to CENELEC HD 361	206
UL & VDE approvals	207
IP ratings, flammability tests, torque settings	208-210

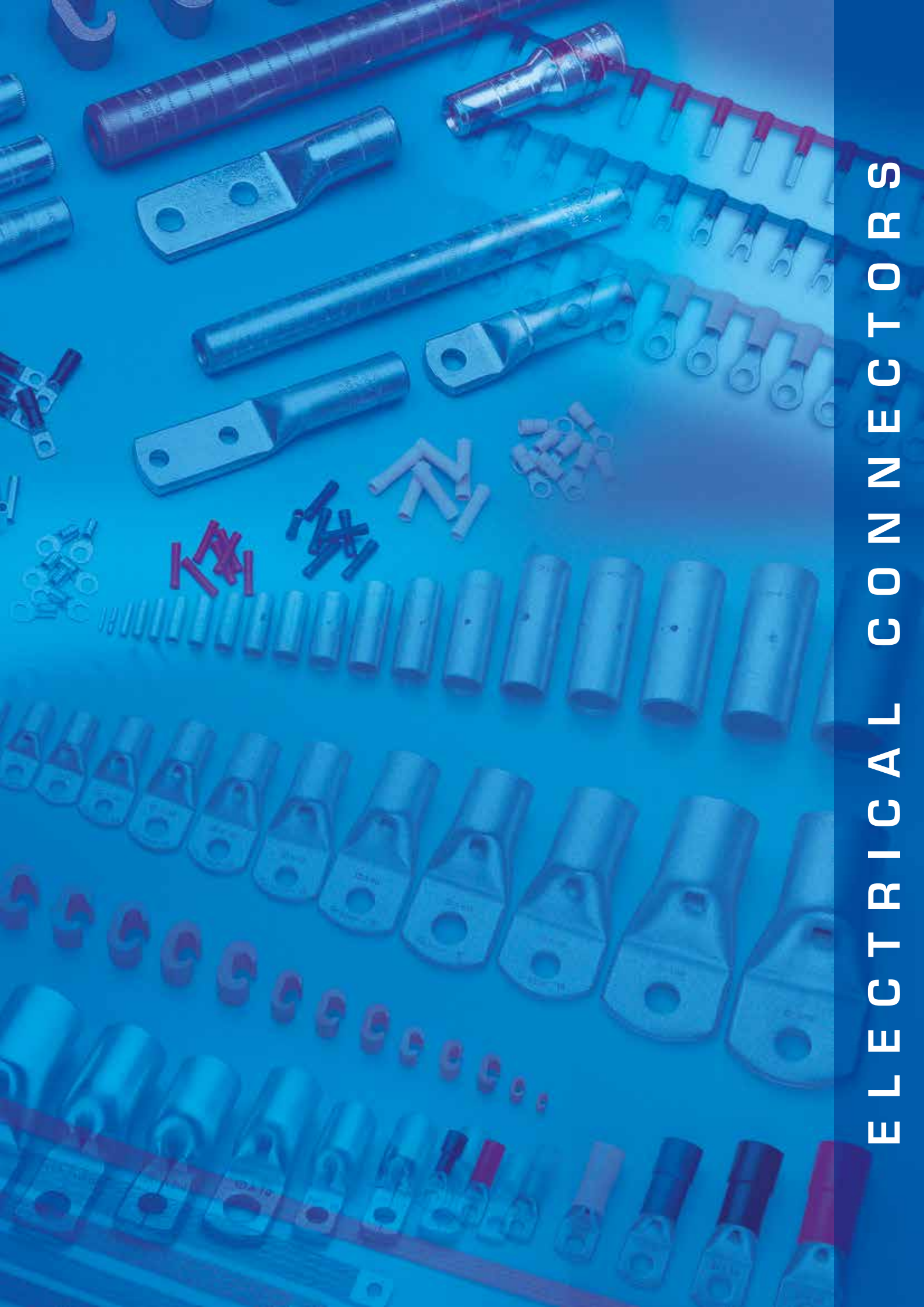

ELECTRICAL CONNECTORS

HALOGEN FREE INSULATED TERMINALS

VP RP
BP GP

P range funnel entry

Certified according to
EN 45545-2:2013



OPERATING
TEMPERATURE
UP TO 115° C

HALOGEN FREE



The "P" range of terminals has been designed, to meet the increasing demands for improved safety and reliability of electrical connectors. The Polycarbonate insula-

tion, is a Halogen free, self extinguishing thermoplastic material class VO (UL 94). The unique funnel shaped entry of the insulation sleeve, guarantees total

insertion of the conductor strands into the terminal barrel, creating a secure and reliable, electrical and mechanical connection.

The operating temperature range is - 20 to + 115°C (Surge + 130°C). Recommended crimping tools are shown on pages 98 to 117, 152.

pin terminals

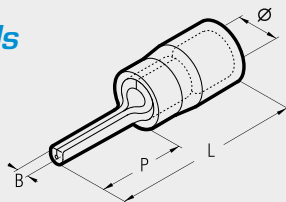

Cond. Size sqmm (AWG)	Ref.	Dimensions mm				Quantity Box/Bag
		Ø	B	P	L	
0,2÷0,5 (24÷20)	VP-P 10	3,0	1,0	9,8	20,2	4.000/100
	RP-P 8	4,0	1,6	7,8	17,9	3.000/100
	RP-P 10	4,0	1,6	9,8	19,9	3.000/100
0,25÷1,5 (22÷16)	RP-P 12	4,0	1,6	12,0	22,1	3.000/100
	BP-P 8	4,9	1,7	7,8	17,9	3.000/100
	BP-P 10	4,9	1,8	9,8	19,9	3.000/100
1,5÷2,5 (16÷14)	BP-P 12	4,9	1,8	11,8	21,9	2.500/100
	GP-P 10	6,6	2,2	10,4	24,5	1.000/100
	GP-P 12	6,6	2,2	12,6	26,7	1.000/100
4÷6 (12÷10)	GP-P 14	6,6	2,2	14,6	28,7	1.000/100

blade terminals

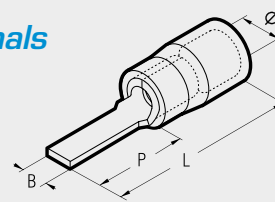

Cond. Size sqmm (AWG)	Ref.	Dimensions mm				Quantity Box/Bag
		Ø	B	P	L	
0,2÷0,5 (24÷20)	VP-PP 12/19	3,0	1,9	12,4	22,4	4.000/100
	RP-PP 12	4,0	3,0	12,8	22,9	3.000/100
	RP-PP 12/1	4,0	3,0	11,3	21,4	3.000/100
	RP-PP 12/19	4,0	1,9	13,2	23,3	3.000/100
	RP-PP 12/23	4,0	2,3	13,2	23,3	2.500/100
0,25÷1,5 (22÷16)	RP-PP 14	4,0	3,0	14,8	24,9	2.500/100
	RP-PP 16/23	4,0	2,3	17,2	27,3	2.500/100
	BP-PP 12	4,9	3,5	12,8	22,9	2.500/100
	BP-PP 12/25	4,9	2,5	13,3	23,4	2.000/100
1,5÷2,5 (16÷14)	BP-PP 12/29	4,9	2,9	13,3	23,4	2.500/100
	BP-PP 16/25	4,9	2,5	17,2	27,3	2.500/100
	GP-PP 12	6,6	4,0	13,3	27,4	1.000/100
4÷6 (12÷10)	GP-PP 17	6,6	2,9	19,1	33,2	1.000/100

hooked blade terminals

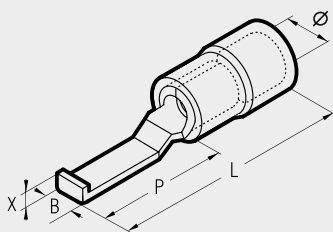

Cond. Size sqmm (AWG)	Ref.	Dimensions mm					Quantity Box/Bag
		Ø	B	P	L	X	
	RP-PPL 30*	4,0	3,0	17,5	28,3	1,7	3.000/100
0,25÷1,5 (22÷16)	RP-PPL 46*	4,0	4,6	17,5	28,3	1,7	3.000/100
	BP-PPL 30*	4,9	3,0	17,5	28,3	1,7	2.500/100
1,5÷2,5 (16÷14)	BP-PPL 46*	4,9	4,6	17,5	28,8	1,7	2.500/100
4÷6 (12÷10)	GP-PPL 46*	6,6	4,6	17,5	32,6	1,9	1.000/100

*Not UL approved

HALOGEN FREE INSULATED TERMINALS

P range funnel entry

**VP RP
BP GP**



ring terminals

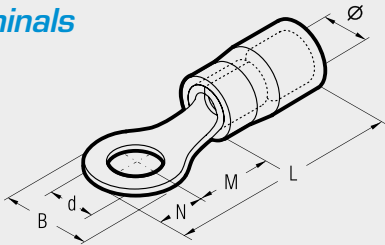

Cond. Size sqmm (AWG)	Ø Stud mm	Ref.	Dimensions mm						Quantity Box/Bag
			Ø	B	M	N	L	d	
0,2÷0,5 (24÷20)	2	*VP-M 2	3,0	5,6	4,5	2,8	17,5	2,2	4.000/100
	3	VP-M 3	3,0	5,6	4,5	2,8	17,5	3,2	4.000/100
	3,5	VP-M 3.5	3,0	5,6	4,5	2,8	17,5	3,7	4.000/100
	4	VP-M 4	3,0	7,0	6,5	3,5	20,2	4,3	4.000/100
	5	VP-M 5	3,0	7,8	7,1	3,9	21,2	5,3	4.000/100
	6	*VP-M 6	3,0	9,4	8,1	4,7	23,0	6,4	4.000/100
0,25÷1,5 (22÷16)	2	*RP-M 2	4,0	5,6	4,5	2,8	17,4	2,2	3.000/100
	3	RP-M 3	4,0	5,6	4,5	2,8	17,4	3,2	3.000/100
	3,5	RP-M 3.5	4,0	5,6	4,5	2,8	17,4	3,7	3.000/100
	3,5	RP-M 3.5/1	4,0	6,2	7,1	3,1	20,2	3,7	3.000/100
	4	RP-M 4	4,0	7,0	6,5	3,5	20,1	4,3	3.000/100
	4	RP-M 4/3	4,0	7,8	7,1	3,9	21,1	4,3	3.000/100
	5	RP-M 5	4,0	7,8	7,1	3,9	21,1	5,3	3.000/100
	6	RP-M 6	4,0	9,4	8,1	4,7	22,9	6,4	2.500/100
1,5÷2,5 (16÷14)	6	RP-M 6/1	4,0	12,0	10,3	6,0	26,4	6,4	2.000/100
	7	RP-M 7	4,0	9,4	8,1	4,7	22,9	7,2	2.500/100
	8	RP-M 8	4,0	12,0	10,3	6,0	26,4	8,4	2.500/100
	10	RP-M 10	4,0	15,5	13,0	7,7	30,9	10,5	2.000/100
	12	RP-M 12	4,0	18,0	15,5	9,0	34,6	13,0	2.000/100
	2	*BP-M 2	4,9	5,6	5,0	2,8	17,9	2,2	2.500/100
	3	BP-M 3	4,9	5,6	5,0	2,8	17,9	3,2	2.500/100
	3,5	BP-M 3.5	4,9	5,6	5,0	2,8	17,9	3,7	3.000/100
	3,5	BP-M 3.5/1	4,9	6,2	6,5	3,1	19,7	3,7	2.500/100
	4	BP-M 4	4,9	8,0	6,5	4,0	20,6	4,3	2.500/100
4÷6 (12÷10)	5	BP-M 5	4,9	8,0	7,5	4,0	21,6	5,3	2.500/100
	6	BP-M 6	4,9	9,4	8,6	4,7	23,4	6,4	2.000/100
	6	BP-M 6/1	4,9	12,0	10,3	6,0	26,4	6,4	2.500/100
	6	*BP-M 6/2	4,9	8,4	5,4	4,2	19,7	6,4	2.500/100
	7	BP-M 7	4,9	10,0	7,8	5,0	22,9	7,2	2.500/100
	8	BP-M 8	4,9	12,0	10,3	6,0	26,4	8,4	1.500/100
	10	BP-M 10	4,9	15,5	13,0	7,7	30,9	10,5	1.500/100
	12	BP-M 12	4,9	18,0	15,5	9,0	34,6	13,0	1.500/100
	3	GP-M 3	6,6	8,0	8,1	4,0	26,2	3,2	1.000/100
	3,5	GP-M 3.5	6,6	8,0	8,1	4,0	26,2	3,7	1.500/100
4	GP-M 4	6,6	9,0	8,1	4,5	26,7	4,3	1.000/100	
5	GP-M 5	6,6	9,0	8,1	4,5	26,7	5,3	1.000/100	
6	GP-M 6	6,6	11,0	11,1	5,5	30,7	6,4	1.000/100	
6	GP-M 6/1	6,6	11,0	8,1	5,5	27,7	6,4	1.000/100	
7	GP-M 7	6,6	11,0	11,1	5,5	30,7	7,2	1.000/100	
8	GP-M 8	6,6	13,6	12,1	6,8	33,0	8,4	1.000/100	
8	*GP-M 8/1	6,6	11,0	8,1	5,5	27,7	8,4	1.000/100	
10	GP-M 10	6,6	13,6	12,1	6,8	33,0	10,5	1.000/100	
10	GP-M 10/1	6,6	15,5	13,8	7,7	35,7	10,5	1.000/100	
12	GP-M 12	6,6	19,0	15,1	9,5	38,7	13,0	500/100	
14	GP-M 14	6,6	21,0	16,1	10,5	40,7	15,0	500/100	
16	GP-M 16	6,6	24,0	17,1	12,0	43,2	17,0	500/100	

fork/spade terminals

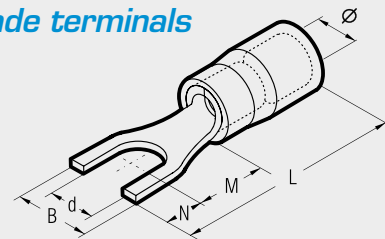

Cond. Size sqmm (AWG)	Ø Stud mm	Ref.	Dimensions mm						Quantity Box/Bag
			Ø	B	M	N	L	d	
0,2÷0,5 (24÷20)	3	VP-U 3	3,0	5,5	5,5	4,0	18,7	3,2	4.000/100
	3,5	VP-U 3.5	3,0	6,0	6,5	3,8	19,5	3,7	4.000/100
	4	VP-U 4	3,0	6,5	7,5	3,7	20,4	4,3	4.000/100
	3	RP-U 3	4,0	5,5	5,5	4,0	19,6	3,2	3.000/100
	3,5	RP-U 3.5	4,0	6,0	6,5	3,8	20,4	3,7	3.000/100
	3,5	RP-U 3.5/2	4,0	6,4	6,5	3,8	20,4	3,7	3.000/100
0,25÷1,5 (22÷16)	4	RP-U 4	4,0	6,5	7,5	3,7	21,3	4,3	3.000/100
	4	RP-U 4/1	4,0	8,5	7,5	3,7	21,3	4,3	3.500/100
	4	RP-U 4/2	4,0	7,5	7,5	3,7	21,3	4,3	3.500/100
	5	RP-U 5	4,0	8,5	7,5	3,7	21,3	5,3	3.000/100
	5	*RP-U 5/1	4,0	9,4	7,5	3,7	21,3	5,3	3.000/100
	6	RP-U 6	4,0	9,4	8,1	4,7	22,9	6,4	2.000/100
	6	RP-U 6/1	4,0	12,0	9,2	7,1	26,4	6,4	2.000/100
	8	RP-U 8	4,0	14,0	10,0	6,3	26,4	8,4	2.000/100
	10	RP-U 10	4,0	17,5	13,0	7,7	30,9	10,5	1.500/100
	12	RP-U 12	4,0	20,0	15,5	9,0	34,6	13,0	1.500/100
1,5÷2,5 (16÷14)	3	BP-U 3	4,9	5,5	5,5	4,0	19,6	3,2	2.500/100
	3,5	BP-U 3.5	4,9	6,4	6,5	3,8	20,4	3,7	2.500/100
	3,5	*BP-U 3.5/1	4,9	7,2	6,5	3,8	20,4	3,7	2.500/100
	4	BP-U 4	4,9	6,5	7,5	3,7	21,3	4,3	2.500/100
	4	BP-U 4/1	4,9	8,5	7,5	3,7	21,3	4,3	3.000/100
	4	BP-U 4/2	4,9	7,5	7,5	3,7	21,3	4,3	2.000/100
	5	BP-U 5	4,9	8,5	7,5	3,7	21,3	5,3	2.000/100
	6	BP-U 6	4,9	9,4	8,1	4,7	22,9	6,4	2.000/100
	6	BP-U 6/1	4,9	12,0	9,2	7,1	26,4	6,4	2.000/100
	8	BP-U 8	4,9	14,0	10,0	6,3	26,4	8,4	1.500/100
4÷6 (12÷10)	10	BP-U 10	4,9	17,5	13,0	7,7	30,9	10,5	2.000/100
	12	BP-U 12	4,9	20	15,5	9,0	34,6	13,0	1.500/100
	3,5	GP-U 3.5	6,6	7,5	8,5	3,9	26,5	3,7	1.500/100
	4	GP-U 4	6,6	7,5	8,0	4,4	26,5	4,3	1.000/100
	5	GP-U 5	6,6	9,5	8,0	4,4	26,5	5,3	1.000/100
	6	GP-U 6	6,6	10,0	11,0	5,5	30,6	6,4	1.000/100
	8	GP-U 8	6,6	13,5	12,0	8,0	34,1	8,4	1.000/100
	10	GP-U 10	6,6	15,5	13,0	8,0	35,1	10,5	1.000/100
	10	GP-U 10/1	6,6	17,5	13,8	7,7	35,7	10,5	1.000/100
	12	GP-U 12	6,6	21,0	15,1	9,5	38,7	13,0	500/100
14	GP-U 14	6,6	23,0	16,1	10,5	40,7	15,0	500/100	
16	GP-U 16	6,6	26,0	17,1	11,5	42,7	17,0	500/100	

*Made to order

INSULATED CHAIN TERMINALS

CP range with easy entry

CRP
CBP
CGP

HALOGEN FREE
OPERATING TEMPERATURE UP TO 115°C



Certified according to EN 45545-2:2013

The "CP" range of terminals has been designed to meet the increasing demands for improved safety and reliability of electrical connectors.

Developed for use with production equipment, to give a quick and reliable crimped joint, the Polycarbonate insulation is a Halogen free, self extinguishing thermoplastic material class

VO (UL 94). The unique funnel shaped entry of the insulation sleeve guarantees total insertion of the conductor strands into the terminal barrel, creating a se-

cure and reliable, electrical and mechanical connection. The operating temperature range is - 20 to + 115°C (Surge + 130°C).

pin terminals

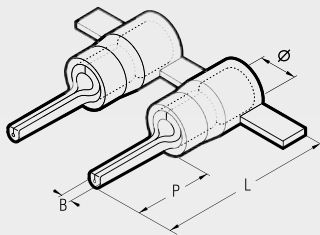

blade terminals

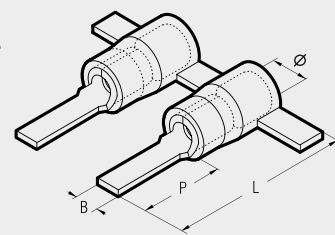

Conductor Size sqmm (AWG)	Ref.	Dimensions mm				Quantity
		Ø	B	P	L	
0,25÷1,5 (22÷16)	CRP-P 8	4,0	1,6	8,0	17,9	2.000
	CRP-P 10	4,0	1,6	10,0	19,9	2.000
	CRP-P 12	4,0	1,6	12,0	22,1	2.000
1,5÷2,5 (16÷14)	CBP-P 8	4,9	1,8	8,0	17,9	1.750
	CBP-P 10	4,9	1,8	10,0	19,9	1.750
	CBP-P 12	4,9	1,8	12,0	21,9	1.750
4÷6 (12÷10)	CGP-P 10	6,6	2,2	10,0	24,5	1.250
	CGP-P 12	6,6	2,2	12,0	26,7	1.250
	CGP-P 14	6,6	2,2	14,0	28,7	1.250

Conductor Size sqmm (AWG)	Ref.	Dimensions mm				Quantity
		Ø	B	P	L	
0,25÷1,5 (22÷16)	CRP-PP 12	4,0	3,0	12,8	22,9	2.000
	*CRP-PP 12/1	4,0	3,0	11,3	21,4	2.000
	*CRP-PP 12/23	4,0	2,3	13,2	23,3	2.000
	CRP-PP 14	4,0	3,0	14,8	24,9	2.000
1,5÷2,5 (16÷14)	CBP-PP 12	4,9	3,5	12,8	22,9	1.750
	*CBP-PP 12/25	4,9	2,5	13,3	23,4	1.750
4÷6 (12÷10)	CGP-PP 12	6,6	4,0	13,3	27,4	1.250
	*CGP-PP 17	6,6	2,9	19,1	33,2	1.250

male disconnect terminals

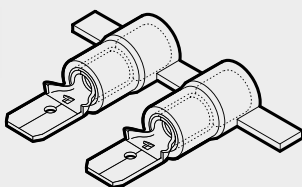

female disconnect terminals

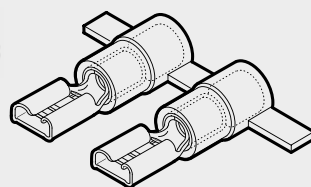

female disconnect terminals fully insulated

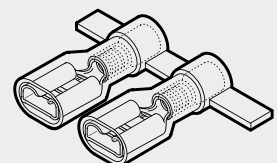
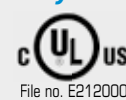

Conductor Size sqmm (AWG)	Ref.	Tab mm	Quantity
0,25÷1,5 (22÷16)	CRP-M 608	6,35 x 0,8	2.000
1,5÷2,5 (16÷14)	CBP-M 608	6,35 x 0,8	1.750
4÷6 (12÷10)	CGP-M 608	6,35 x 0,8	1.250

Conductor Size sqmm (AWG)	Ref.	Tab mm	Quantity
0,25÷1,5 (22÷16)	CRP-F 305	2,8 x 0,5	2.000
	CRP-F 308	2,8 x 0,8	2.000
	CRP-F 405	4,8 x 0,5	2.000
	CRP-F 408	4,8 x 0,8	2.000
	CRP-F 608	6,35 x 0,8	2.000
	1,5÷2,5 (16÷14)	CBP-F 405	4,8 x 0,5
CBP-F 408		4,8 x 0,8	1.750
CBP-F 608		6,35 x 0,8	1.750
4÷6 (12÷10)	CGP-F 608	6,35 x 0,8	1.250

Conductor Size sqmm (AWG)	Ref.	Tab mm	Quantity
0,25÷1,5 (22÷16)	CRP-F 405P*	4,8 x 0,5	2.000
	CRP-F 408P*	4,8 x 0,8	2.000
	CRP-F 608P	6,35 x 0,8	1.500
1,5÷2,5 (16÷14)	CBP-F 408P*	4,8 x 0,8	1.500
	CBP-F 608P	6,35 x 0,8	1.500
4÷6 (12÷10)	CGP-F 608P	6,35 x 0,8	1.250

*Not UL approved

*Made to order

INSULATED CHAIN TERMINALS

CP range with easy entry

fork/spade terminals

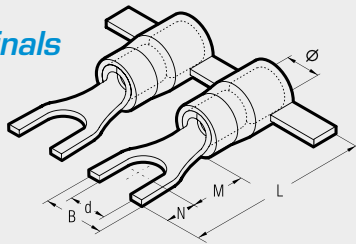

CRP
CBP
CGP

Cond. Size sqmm (AWG)	Ø Stud mm	Ref.	Dimensions mm						Quantity
			Ø	B	M	N	L	d	
0,25÷1,5 (22÷16)	3	CRP-U 3	4,0	5,5	5,5	4,0	19,6	3,2	2.000
	3,5	CRP-U 3.5	4,0	6,0	6,5	3,8	20,4	3,7	2.000
	3,5	*CRP-U 3.5/2	4,0	6,4	6,5	3,8	20,4	3,7	2.000
	4	CRP-U 4	4,0	6,5	7,5	3,7	21,3	4,3	2.000
	4	*CRP-U 4/1	4,0	8,5	7,5	3,7	21,3	4,3	2.000
	4	*CRP-U 4/2	4,0	7,5	7,5	3,7	21,3	4,3	2.000
	5	CRP-U 5	4,0	8,5	7,5	3,7	21,3	5,3	2.000
	6	CRP-U 6	4,0	9,4	8,1	4,7	22,9	6,4	2.000
1,5÷2,5 (16÷14)	6	*CRP-U 6/1	4,0	12,0	9,2	7,1	26,4	6,4	2.000
	8	*CRP-U 8	4,0	14,0	10,0	6,3	26,4	8,4	2.000
	3	CBP-U 3	4,9	5,5	5,5	4,0	19,6	3,2	1.750
	3,5	CBP-U 3.5	4,9	6,4	6,5	3,8	20,4	3,7	1.750
	4	CBP-U 4	4,9	6,5	7,5	3,7	21,3	4,3	1.750
	4	*CBP-U 4/1	4,9	8,5	7,5	3,7	21,3	4,3	1.750
	4	*CBP-U 4/2	4,9	7,5	7,5	3,7	21,3	4,3	1.750
	5	CBP-U 5	4,9	8,5	7,5	3,7	21,3	5,3	1.750
4÷6 (12÷10)	6	CBP-U 6	4,9	9,4	8,1	4,7	22,9	6,4	1.750
	3,5	*CGP-U 3.5	6,6	7,5	8,5	3,9	26,5	3,7	1.250
	4	*CGP-U 4	6,6	7,5	8,0	4,4	26,5	4,3	1.250
	5	CGP-U 5	6,6	9,5	8,0	4,4	26,5	5,3	1.250
6	CGP-U 6	6,6	10,0	11,0	5,5	30,6	6,4	1.250	

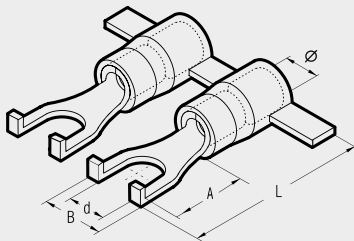

Cond. Size sqmm (AWG)	Ø Stud mm	Ref.	Dimensions mm					Quantity
			Ø	B	A	L	d	
1,5÷2,5 (16÷14)	4	CBP-U 4/3L*	4,9	6,5	9,5	14,5	4,3	1.750

hooked blade terminals

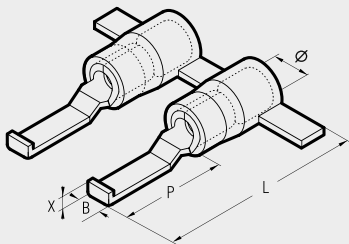

Cond. Size sqmm (AWG)	Ref.	Dimensions mm					Quantity
		Ø	B	P	L	X	
0,25÷1,5 (22÷16)	CRP-PPL30*	4,0	3,0	17,5	28,8	1,7	2.000
1,5÷2,5 (16÷14)	CBP-PPL30*	4,9	3,0	17,5	28,8	1,7	1.750

*Not UL approved

*Made to order

ring terminals

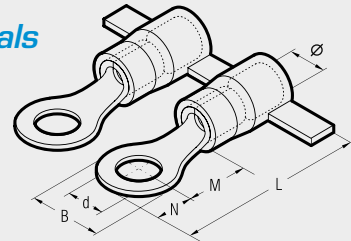

Cond. Size sqmm (AWG)	Ø Stud mm	Ref.	Dimensions mm						Quantity
			Ø	B	M	N	L	d	
0,25÷1,5 (22÷16)	3	CRP-M 3	4,0	5,6	4,5	2,8	17,4	3,2	2.000
	3,5	CRP-M 3.5	4,0	5,6	4,5	2,8	17,4	3,7	2.000
	3,5	*CRP-M 3.5/1	4,0	6,2	7,1	3,1	20,2	3,7	2.000
	4	CRP-M 4	4,0	7,0	6,5	3,5	20,1	4,3	2.000
	4	*CRP-M 4/3	4,0	7,8	7,1	3,9	21,1	4,3	2.000
	5	CRP-M 5	4,0	7,8	7,1	3,9	21,1	5,3	2.000
	6	CRP-M 6	4,0	9,4	8,1	4,7	22,9	6,4	2.000
	6	*CRP-M 6/1	4,0	12,0	10,3	6,0	26,4	6,4	2.000
1,5÷2,5 (16÷14)	7	CRP-M 7	4,0	9,4	8,1	4,7	22,9	7,2	2.000
	8	CRP-M 8	4,0	12,0	10,3	6,0	26,4	8,4	2.000
	3	CBP-M 3	4,9	5,6	5,0	2,8	17,9	3,2	1.750
	3,5	CBP-M 3.5	4,9	5,6	5,0	2,8	17,9	3,7	1.750
	3,5	*CBP-M 3.5/1	4,9	6,2	6,5	3,1	19,6	3,7	1.750
	4	CBP-M 4	4,9	8,0	6,5	4,0	20,6	4,3	1.750
	5	CBP-M 5	4,9	8,0	7,5	4,0	21,6	5,3	1.750
	6	CBP-M 6	4,9	9,4	8,6	4,7	23,4	6,4	1.750
4÷6 (12÷10)	6	*CBP-M 6/1	4,9	12,0	10,3	6,0	26,4	6,4	1.750
	7	CBP-M 7	4,9	10,0	7,8	5,0	22,9	7,2	1.750
	8	CBP-M 8	4,9	12,0	10,3	6,0	26,4	8,4	1.750
	3	CGP-M 3	6,6	8,0	8,1	4,0	26,2	3,2	1.250
	3,5	CGP-M 3.5	6,6	8,0	8,1	4,0	26,2	3,7	1.250
	4	CGP-M 4	6,6	9,0	8,1	4,5	26,7	4,3	1.250
	5	CGP-M 5	6,6	9,0	8,1	4,5	26,7	5,3	1.250
	6	CGP-M 6	6,6	11,0	11,1	5,5	30,7	6,4	1.250
6	*CGP-M 6/1	6,6	11,0	8,1	5,5	27,7	6,4	1.250	
7	CGP-M 7	6,6	11,0	11,1	5,5	30,7	7,2	1.000	
8	CGP-M 8	6,6	13,6	12,1	6,8	33,0	8,4	1.250	
8	*CGP-M 8/1	6,6	11,0	8,1	5,5	27,7	8,4	1.250	



Interchangeable application heads are available for crimping these terminals with the bench press ELB-3 (see page 122).

PVC INSULATED CRIMP TERMINALS

F range funnel entry



RF BF GF



The unique funnel shaped PVC sleeve guarantees total insertion of the conductor strands into the terminal barrel, creating a secure and reliable, electrical and mechanical connection. The internal surface of the

barrel is rifled to improve contact with conductor strands when crimped and to increase tensile strength. The "F" range of terminals offers a wide selection of rings, forks, pins and blades, designed to meet the ever

changing end user requirements.

The operating temperature range is - 20 to + 80°C (Surge + 90°C).

Recommended crimping tools are shown on pages 98 to 117, 152.

pin terminals

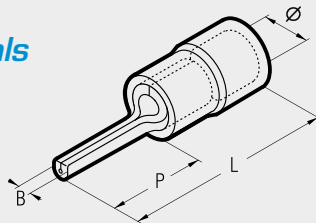

blade terminals

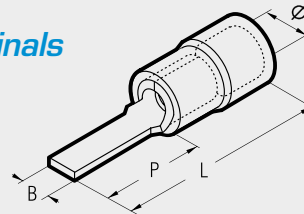

Conductor Size sqmm (AWG)	Ref.	Dimensions mm				Quantity Box/Bag
		Ø	B	P	L	
0,25÷1,5 (22÷16)	RF-P 8	3,9	1,6	8,0	17,9	3.000/100
	RF-P 10	3,9	1,6	10,0	19,9	3.000/100
	RF-P 12	3,9	1,6	12,0	22,1	3.000/100
1,5÷2,5 (16÷14)	BF-P 8	4,9	1,7	8,0	17,9	2.500/100
	BF-P 10	4,9	1,8	10,0	19,9	2.500/100
	BF-P 12	4,9	1,8	12,0	21,9	2.500/100
4÷6 (12÷10)	GF-P 10	6,7	2,2	10,0	24,6	1.000/100
	GF-P 12	6,7	2,2	12,0	26,8	1.000/100
	GF-P 14	6,7	2,2	14,0	28,8	1.000/100

Conductor Size sqmm (AWG)	Ref.	Dimensions mm				Quantity Box/Bag
		Ø	B	P	L	
0,25÷1,5 (22÷16)	RF-PP 12	3,9	3,0	12,8	22,9	3.000/100
	RF-PP 12/1	3,9	3,0	11,3	21,4	3.000/100
	RF-PP 12/19	3,9	1,9	13,2	23,3	3.000/100
	RF-PP 12/23	3,9	2,3	13,2	23,3	2.500/100
	RF-PP 14	3,9	3,0	14,8	24,9	2.500/100
	RF-PP 16/23	3,9	2,3	17,2	27,3	2.500/100
1,5÷2,5 (16÷14)	BF-PP 12	4,9	3,5	12,8	22,9	2.500/100
	BF-PP 12/25	4,9	2,5	13,3	23,4	2.000/100
	BF-PP 12/29*	4,9	2,9	13,3	23,4	2.500/100
	BF-PP 16/25	4,9	2,5	17,2	27,3	2.500/100
4÷6 (12÷10)	GF-PP 12	6,7	4,0	13,3	27,5	1.000/100
	GF-PP 17	6,7	2,9	19,2	33,4	1.000/100

hooked blade terminals

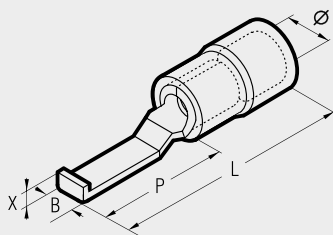

Conductor Size sqmm (AWG)	Ref.	Dimensions mm					Quantity Box/Bag
		Ø	B	P	L	X	
0,25÷1,5 (22÷16)	RF-PPL 30*	3,9	3,0	17,5	28,4	1,7	2.500/100
	RF-PPL 46*	3,9	4,6	17,5	28,4	1,7	2.500/100
1,5÷2,5 (16÷14)	BF-PPL 30*	4,9	3,0	17,5	28,4	1,7	2.000/100
	BF-PPL 46*	4,9	4,6	17,5	28,4	1,7	2.000/100
4÷6 (12÷10)	GF-PPL 46*	6,7	4,6	17,5	32,7	1,9	1.000/100

*Not UL approved

PVC INSULATED CRIMP TERMINALS

F range funnel entry



File no. E125401

RF BF GF

VALSTAR V3-F

Robust plastic case with compartments, containing:

- An assortment of PVC insulated crimp terminals for conductor sizes 0,25 to 6 mm² (22÷10 AWG).
- Tool Crimpstar® HP 3.



Connectors included:

- Qty 50 terminals RF-U4
- Qty 50 terminals RF-U5
- Qty 50 terminals RF-P10
- Qty 50 terminals BF-U4
- Qty 50 terminals BF-U5
- Qty 50 terminals BF-P10
- Qty 25 terminals GF-U5
- Qty 25 terminals GF-U6
- Qty 25 terminals GF-P12
- Qty 25 connectors PLO6-M
- Qty 25 connectors PL1-M

ring terminals

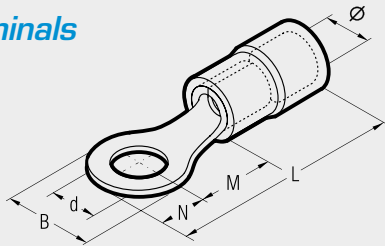

fork/spade terminals

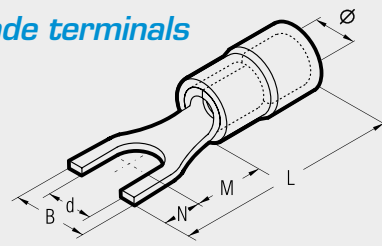

Cond. Size sqmm (AWG)	Ø Stud mm	Ref.	Dimensions mm						Quantity Box/Bag
			Ø	B	M	N	L	d	
2	*RF-M 2*	3,9	5,6	4,5	2,8	17,4	2,2	3.000/100	
3	RF-M 3	3,9	5,6	4,5	2,8	17,4	3,2	3.000/100	
3,5	RF-M 3.5	3,9	5,6	4,5	2,8	17,4	3,7	3.000/100	
3,5	RF-M 3.5/1	3,9	6,2	7,1	3,1	20,3	3,7	3.000/100	
4	RF-M 4	3,9	7,0	6,5	3,5	20,1	4,3	3.000/100	
4	RF-M 4/3*	3,9	7,8	7,1	3,9	21,1	4,3	3.000/100	
5	RF-M 5	3,9	7,8	7,1	3,9	21,1	5,3	2.500/100	
6	RF-M 6	3,9	9,4	8,1	4,7	22,9	6,4	2.500/100	
6	RF-M 6/1	3,9	12,0	10,3	6,0	26,4	6,4	2.000/100	
7	RF-M 7	3,9	9,4	8,1	4,7	22,9	7,2	2.500/100	
8	RF-M 8	3,9	12,0	10,3	6,0	26,4	8,4	2.000/100	
0,25÷1,5 (22÷16)	10	RF-M 10	3,9	15,5	13,0	7,7	30,9	10,5	1.500/100
0,25÷1,5 (22÷16)	12	RF-M 12	3,9	18,0	15,5	9,0	34,6	13,0	1.500/100
2	*BF-M 2*	4,9	5,6	5,0	2,8	17,9	2,2	3.000/100	
3	BF-M 3	4,9	5,6	5,0	2,8	17,9	3,2	2.500/100	
3,5	BF-M 3.5	4,9	5,6	5,0	2,8	17,9	3,7	2.500/100	
3,5	BF-M 3.5/1	4,9	6,2	6,5	3,1	19,7	3,7	2.500/100	
4	BF-M 4	4,9	8,0	6,5	4,0	20,6	4,3	2.500/100	
5	BF-M 5	4,9	8,0	7,5	4,0	21,6	5,3	2.000/100	
6	BF-M 6	4,9	9,4	8,6	4,7	23,4	6,4	2.000/100	
6	BF-M 6/1	4,9	12,0	10,3	6,0	26,4	6,4	2.000/100	
6	*BF-M 6/2*	4,9	8,4	5,4	4,2	19,7	6,4	2.500/100	
7	BF-M 7	4,9	10,0	7,8	5,0	22,9	7,2	2.000/100	
8	BF-M 8	4,9	12,0	10,3	6,0	26,4	8,4	1.500/100	
1,5÷2,5 (16÷14)	10	BF-M 10	4,9	15,5	13,0	7,7	30,9	10,5	1.500/100
1,5÷2,5 (16÷14)	12	BF-M 12	4,9	18	15,5	9,0	34,6	13,0	1.000/100
3	GF-M 3	6,7	8,0	8,1	4,0	26,3	3,2	1.000/100	
3,5	GF-M 3.5	6,7	8,0	8,1	4,0	26,3	3,7	1.000/100	
4	GF-M 4	6,7	9,0	8,1	4,5	26,8	4,3	1.000/100	
5	GF-M 5	6,7	9,0	8,1	4,5	26,8	5,3	1.000/100	
6	GF-M 6	6,7	11,0	11,1	5,5	30,8	6,4	1.000/100	
6	GF-M 6/1	6,7	11,0	8,1	5,5	27,8	6,4	1.000/100	
7	GF-M 7	6,7	11,0	11,1	5,5	30,8	7,2	1.000/100	
8	GF-M 8	6,7	13,6	12,1	6,8	33,1	8,4	800/100	
8	*GF-M 8/1*	6,7	11,0	8,1	5,5	27,8	8,4	1.000/100	
10	GF-M 10	6,7	13,6	12,1	6,8	33,1	10,5	1.000/100	
10	GF-M 10/1	6,7	15,5	13,8	7,7	35,8	10,5	1.000/100	
12	GF-M 12	6,7	19,0	15,1	9,5	38,8	13,0	500/100	
14	GF-M 14	6,7	21,0	16,1	10,5	40,8	15,0	500/100	
16	GF-M 16	6,7	24,0	17,1	12,0	43,3	17,0	500/100	

Cond. Size sqmm (AWG)	Ø Stud mm	Ref.	Dimensions mm						Quantity Box/Bag
			Ø	B	M	N	L	d	
3	RF-U 3	3,9	5,5	5,5	4,0	19,6	3,2	3.000/100	
3,5	RF-U 3.5	3,9	6,0	6,5	3,8	20,4	3,7	3.000/100	
3,5	RF-U 3.5/1	3,9	7,2	6,5	3,8	20,4	3,7	3.000/100	
3,5	RF-U 3.5/2*	3,9	6,4	6,5	3,8	20,4	3,7	3.000/100	
4	RF-U 4	3,9	6,5	7,5	3,7	21,3	4,3	3.000/100	
4	RF-U 4/1	3,9	8,5	7,5	3,7	21,3	4,3	3.000/100	
4	RF-U 4/2	3,9	7,5	7,5	3,7	21,3	4,3	3.000/100	
5	RF-U 5	3,9	8,5	7,5	3,7	21,3	5,3	2.500/100	
5	*RF-U 5/1*	3,9	9,4	7,5	3,7	21,3	5,3	3.000/100	
6	RF-U 6	3,9	9,4	8,1	4,7	22,9	6,4	2.000/100	
6	RF-U 6/1	3,9	12,0	9,2	7,1	26,4	6,4	2.500/100	
8	RF-U 8	3,9	14,0	10,0	6,3	26,4	8,4	2.000/100	
0,25÷1,5 (22÷16)	10	RF-U 10	3,9	17,5	13,0	7,7	30,9	10,5	1.500/100
0,25÷1,5 (22÷16)	12	RF-U 12	3,9	20,0	15,5	9,0	34,6	13,0	1.500/100
3	BF-U 3	4,9	5,5	5,5	4,0	19,6	3,2	2.500/100	
3,5	BF-U 3.5	4,9	6,4	6,5	3,8	20,4	3,7	2.500/100	
3,5	*BF-U 3.5/1	4,9	7,2	6,5	3,8	20,4	3,7	3.000/100	
4	BF-U 4	4,9	6,5	7,5	3,7	21,3	4,3	2.500/100	
4	BF-U 4/1	4,9	8,5	7,5	3,7	21,3	4,3	2.000/100	
4	BF-U 4/2	4,9	7,5	7,5	3,7	21,3	4,3	2.000/100	
5	BF-U 5	4,9	8,5	7,5	3,7	21,3	5,3	2.000/100	
5	BF-U 5/2*	4,9	12,0	11,3	5,0	26,3	5,3	1.500/100	
6	BF-U 6	4,9	9,4	8,1	4,7	22,9	6,4	2.000/100	
6	BF-U 6/1	4,9	12,0	9,2	7,1	26,4	6,4	2.000/100	
8	BF-U 8	4,9	14,0	10,0	6,3	26,4	8,4	1.500/100	
1,5÷2,5 (16÷14)	10	BF-U 10	4,9	17,5	13,0	7,7	30,9	10,5	1.000/100
1,5÷2,5 (16÷14)	12	BF-U 12	4,9	20,0	15,5	9,0	34,6	13,0	1.500/100
3,5	GF-U 3.5	6,7	7,5	8,5	3,9	26,6	3,7	1.000/100	
4	GF-U 4	6,7	7,5	8,0	4,4	26,6	4,3	1.000/100	
5	GF-U 5	6,7	9,5	8,0	4,4	26,6	5,3	1.000/100	
6	GF-U 6	6,7	10,0	11,0	5,5	30,7	6,4	1.000/100	
8	GF-U 8	6,7	13,5	12,0	8,0	34,2	8,4	1.000/100	
10	GF-U 10	6,7	15,5	13,0	8,0	35,2	10,5	1.000/100	
10	GF-U 10/1	6,7	17,5	13,8	7,7	35,8	10,5	1.000/100	
12	GF-U 12	6,7	21,0	15,1	9,5	38,8	13,0	500/100	
14	GF-U 14	6,7	23,0	16,1	10,5	40,8	15,0	500/100	
16	GF-U 16	6,7	26,0	17,1	11,5	42,8	17,0	500/100	

*Not UL approved

*Made to order

REINFORCED PA 6.6 INSULATED TERMINALS

RKY
BKY
GKY

KY range

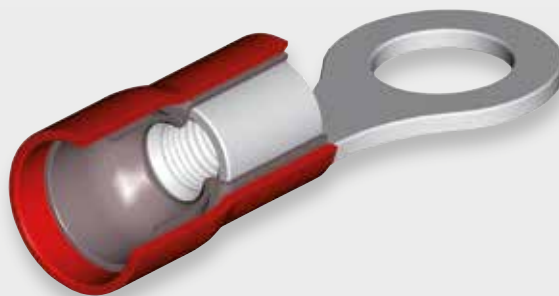

HALOGEN FREE

'KY' type terminals are designed to offer improved mechanical and electrical integrity under heavy-duty application. This is achieved via a Copper sleeve located between

the Copper barrel and Polyamide insulation of the terminal. Then, during crimping, the insulation of the conductor is integrated into the crimp due to the Copper sleeve being deformed

around it to maintain the level of 'grip' required in applications subject to continuous mechanical vibrations (e.g: mobile plant, vehicles, moving components).

The operating temperature range is - 20 to + 105°C (Surge + 110°C). Recommended crimping tools are shown on pages 98 to 117, 152.

pin terminals

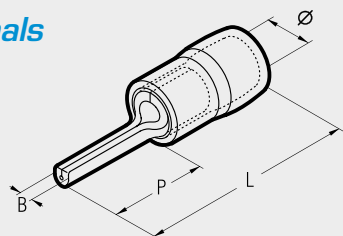

blade terminals

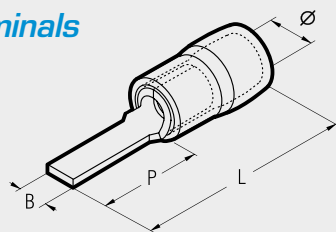

Conductor Size sqmm (AWG)	Ref.	Dimensions mm				Quantity Box/Bag
		Ø	B	P	L	
0,25÷1,5 (22÷16)	RKY-P 8	4,5	1,9	9,0	19,8	3.000/100
	RKY-P 10	4,5	1,9	10,0	20,8	3.500/100
	RKY-P 12	4,5	1,9	12,0	22,8	3.000/100
1,5÷2,5 (16÷14)	BKY-P 8	5,2	1,9	9,0	19,8	3.000/100
	BKY-P 10	5,2	1,9	10,0	20,8	3.000/100
	BKY-P 12	5,2	1,9	12,0	22,8	3.000/100
4÷6 (12÷10)	GKY-P 14	7,0	2,8	14,0	27,0	1.000/100

Conductor Size sqmm (AWG)	Ref.	Dimensions mm				Quantity Box/Bag
		Ø	B	P	L	
0,25÷1,5 (22÷16)	RKY-PP 12	4,5	3,0	13,0	23,8	3.000/100
	RKY-PP 12/19	4,5	2,0	18,0	28,8	3.000/100
	RKY-PP 16/23	4,5	2,2	18,0	28,8	2.500/100
1,5÷2,5 (16÷14)	BKY-PP 12	5,2	3,0	13,0	23,8	2.500/100
	BKY-PP 12/25	5,2	2,4	13,0	23,8	2.000/100
	BKY-PP 16/23	5,2	2,2	18,0	28,8	2.500/100
4÷6 (12÷10)	GKY-PP 12	7,0	4,0	14,0	27,0	1.000/100
	GKY-PP 17	7,0	2,0	18,0	31,0	1.000/100

Consult Cembre for a wider range of pin and blade dimensions.

hooked blade terminals

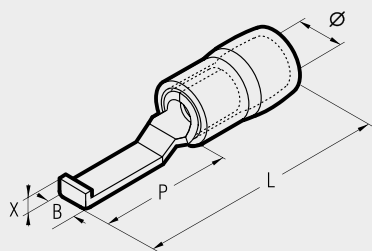

Conductor Size sqmm (AWG)	Ref.	Dimensions mm					Quantity Box/Bag
		Ø	B	P	L	X	
0,25÷1,5 (22÷16)	RKY-PPL 30	4,5	3,0	16,8	28,2	2,1	3.000/100
	RKY-PPL 46	4,5	4,6	16,8	28,2	2,1	3.000/100
1,5÷2,5 (16÷14)	BKY-PPL 30	5,2	3,0	16,8	28,2	2,1	2.500/100
	BKY-PPL 46	5,2	4,6	16,8	28,2	2,1	2.500/100
4÷6 (12÷10)	GKY-PPL 46	7,0	4,6	17,2	30,2	2,4	1.000/100

REINFORCED PA 6.6 INSULATED TERMINALS

KY range

RKY
BKY
GKY

ring terminals

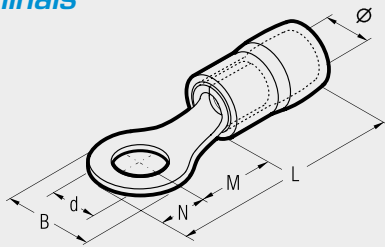

fork/spade terminals

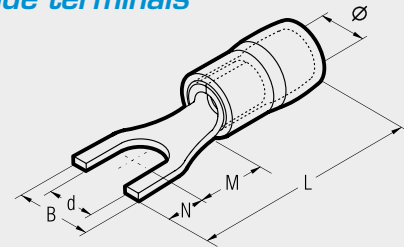

Cond. Size sqmm (AWG)	Ø Stud mm	Ref.	Dimensions mm						Quantity Box/Bag
			Ø	B	M	N	L	d	
0,25÷1,5 (22÷16)	3	RKY-M 3	4,5	5,5	5,0	2,5	18,5	3,2	3.000/100
	3,5	RKY-M 3.5	4,5	5,5	5,0	2,5	18,5	3,7	3.000/100
	3,5	RKY-M 3.5/1	4,5	6,6	6,3	3,1	20,4	3,7	3.000/100
	4	RKY-M 4	4,5	6,6	6,3	3,1	20,4	4,3	3.000/100
	5	RKY-M 5	4,5	8,0	7,0	3,8	21,8	5,3	2.500/100
	6	RKY-M 6/1	4,5	11,6	11,0	5,8	27,8	6,4	2.000/100
	8	RKY-M 8	4,5	11,6	11,0	5,8	27,8	8,4	2.500/100
	10	RKY-M 10	4,5	13,6	13,9	6,6	31,5	10,5	1.500/100
1,5÷2,5 (16÷14)	12	RKY-M 12	4,5	19,6	16,0	9,4	36,4	13,0	1.500/100
	3	BKY-M 3	5,2	6,6	4,8	3,0	18,8	3,2	2.500/100
	3,5	BKY-M 3.5	5,2	6,6	4,8	3,0	18,8	3,7	2.500/100
	3,5	BKY-M 3.5/1	5,2	6,6	6,3	3,1	20,4	3,7	2.500/100
	4	BKY-M 4	5,2	8,5	7,8	4,0	22,8	4,3	2.500/100
	5	BKY-M 5	5,2	8,5	7,8	4,0	22,8	5,3	2.500/100
	6	BKY-M 6/1	5,2	12,0	11,0	5,8	27,8	6,4	2.500/100
	8	BKY-M 8	5,2	12,0	11,0	5,8	27,8	8,4	1.500/100
4÷6 (12÷10)	10	BKY-M 10	5,2	13,6	13,9	6,6	31,5	10,5	1.500/100
	12	BKY-M 12	5,2	19,2	16,0	9,4	36,4	13,0	1.000/100
	3,5	GKY-M 3.5	7,0	7,2	6,1	3,6	22,7	3,7	1.000/100
	4	GKY-M 4	7,0	9,5	9,1	4,5	26,6	4,3	1.000/100
	5	GKY-M 5	7,0	9,5	9,1	4,5	26,6	5,3	1.000/100
	6	GKY-M 6	7,0	12,0	10,5	6,0	29,5	6,4	1.000/100
	8	GKY-M 8	7,0	15,0	13,5	7,5	34,0	8,4	1.000/100
	10	GKY-M 10	7,0	15,0	13,5	7,5	34,0	10,5	1.000/100
4÷6 (12÷10)	12	GKY-M 12	7,0	19,2	16,0	9,6	38,6	13,0	1.000/100
	14	GKY-M 14	7,0	32,0	25,2	16,0	54,2	15,0	500/100
	16	GKY-M 16	7,0	32,0	25,2	16,0	54,2	17,0	500/100

Cond. Size sqmm (AWG)	Ø Stud mm	Ref.	Dimensions mm						Quantity Box/Bag
			Ø	B	M	N	L	d	
0,25÷1,5 (22÷16)	3	RKY-U 3	4,5	5,7	6,5	4,5	22,0	3,2	2.500/100
	3,5	RKY-U 3.5	4,5	5,7	6,5	4,5	22,0	3,7	2.500/100
	4	RKY-U 4	4,5	6,4	6,5	4,5	22,0	4,3	3.000/100
	5	RKY-U 5	4,5	8,1	6,5	4,5	22,0	5,3	3.000/100
	6	RKY-U 6	4,5	9,5	6,5	4,5	22,0	6,4	2.000/100
	6	RKY-U 6/1	4,5	12,0	11,0	6,0	28,0	6,4	2.000/100
1,5÷2,5 (16÷14)	3	BKY-U 3	5,2	5,7	6,5	4,5	22,0	3,2	2.500/100
	3,5	BKY-U 3.5	5,2	6,0	6,5	4,5	22,0	3,7	2.500/100
	4	BKY-U 4	5,2	6,4	6,5	4,5	22,0	4,3	2.500/100
	5	BKY-U 5	5,2	7,9	6,5	4,5	22,0	5,3	2.500/100
	6	BKY-U 6	5,2	9,3	6,5	4,5	22,0	6,4	2.000/100
	6	BKY-U 6/1	5,2	12,0	11,0	6,0	28,0	6,4	2.000/100
4÷6 (12÷10)	3,5	GKY-U 3.5	7,0	7,2	7,5	3,9	24,4	3,7	1.500/100
	4	GKY-U 4	7,0	7,2	7,5	3,9	24,4	4,3	1.000/100
	5	GKY-U 5	7,0	9,0	7,0	5,5	25,5	5,3	1.000/100
	6	GKY-U 6	7,0	12,0	12,0	6,5	31,5	6,4	1.000/100
	8	GKY-U 8	7,0	14,0	10,5	7,0	30,5	8,4	1.000/100

Consult Cembre for a wider range of pin and blade dimensions.

RF-F BF-F GF-F











Manufactured from Brass strip
- Electrolytically Tin plated
- The operating temperature range is -20 to +115°C (Surge +130°C).
- Recommended crimping tools are shown on pages 98 to 117, 152

FEMALE DISCONNECT TERMINALS









Certified according to
EN 45545-2:2013



Polycarbonate insulated terminals - partially reinforced with Copper sleeve

Cond. Size sqmm (AWG)	Ref.	Tab Size	Quantity Box/Bag
0,25÷1,5 (22÷16)	 RF-F 305	2,8 x 0,5	3.000/100
	 RF-F 308*	2,8 x 0,8	3.000/100
	 RF-F 405	4,8 x 0,5	2.500/100
	 RF-F 408	4,8 x 0,8	2.500/100
1,5÷2,5 (16÷14)	 BF-F 608	6,35 x 0,8	2.000/100
	 BF-F 405	4,8 x 0,5	2.500/100
	 BF-F 408	4,8 x 0,8	2.500/100
4÷6 (12÷10)	 GF-F 608	6,35 x 0,8	1.000/100

Polycarbonate fully insulated terminals - partially reinforced with Copper sleeve

Cond. Size sqmm (AWG)	Ref.	Tab Size	Quantity Box/Bag
0,25÷1,5 (22÷16)	 RF-F 305P	2,8 x 0,5	2.000/100
	 RF-F 308P*	2,8 x 0,8	2.000/100
	 RF-F 405P	4,8 x 0,5	1.500/100
	 RF-F 408P	4,8 x 0,8	1.500/100
1,5÷2,5 (16÷14)	 BF-F 608P	6,35 x 0,8	1.000/100
	 BF-F 405P	4,8 x 0,5	1.500/100
	 BF-F 408P	4,8 x 0,8	1.500/100
4÷6 (12÷10)	 GF-F 608P	6,35 x 0,8	800/100

*Not UL approved

RF-M BF-M GF-M





Manufactured from Brass strip
- Electrolytically Tin plated
- The operating temperature range is -20 to +115°C (Surge +130°C).
- Recommended crimping tools are shown on pages 98 to 117, 152

MALE DISCONNECT TERMINALS



Certified according to
EN 45545-2:2013



Polycarbonate insulated terminals - partially reinforced with Copper sleeve

Cond. Size sqmm (AWG)	Ref.	Tab Size	Quantity Box/Bag
0,25÷1,5 (22÷16)	 RF-M 608	6,35 x 0,8	3.000/100
1,5÷2,5 (16÷14)	 BF-M 608	6,35 x 0,8	2.000/100
4÷6 (12÷10)	 GF-M 608	6,35 x 0,8	1.000/100

Polycarbonate fully insulated terminals - partially reinforced with Copper sleeve

Cond. Size sqmm (AWG)	Ref.	Tab Size	Quantity Box/Bag
0,25÷1,5 (22÷16)	 RF-M 608P	6,35 x 0,8	1.000/100
1,5÷2,5 (16÷14)	 BF-M 608P	6,35 x 0,8	1.000/100

RF-FM BF-FM RF-B BF-B





Manufactured from Brass strip
- Electrolytically Tin plated
- The operating temperature range is -20 to +115°C (Surge +130°C).
- Recommended crimping tools are shown on pages 98 to 117, 152

MALE/FEMALE CONNECTORS

Certified according to
EN 45545-2:2013







Polycarbonate insulated terminals - partially reinforced with Copper sleeve

Cond. Size sqmm (AWG)	Ref.	Tab Size	Quantity Box/Bag
0,25÷1,5 (22÷16)	 RF-FM 608	6,35 x 0,8	1.000/100
1,5÷2,5 (16÷14)	 BF-FM 608	6,35 x 0,8	1.000/100

BULLET AND SOCKET CONNECTORS

Polycarbonate insulated terminals - partially reinforced with Copper sleeve

Cond. Size sqmm (AWG)	Ref.	Ø mm	Quantity Box/Bag
0,25÷1,5 (22÷16)	 RF-BM 4*	4	2.500/100
	 RF-BF 4*	4	800/100
1,5÷2,5 (16÷14)	 BF-BM 5*	5	2.000/100
	 BF-BF 5*	5	800/100

*Not UL approved

BUTT AND PARALLEL CONNECTORS



butt connectors

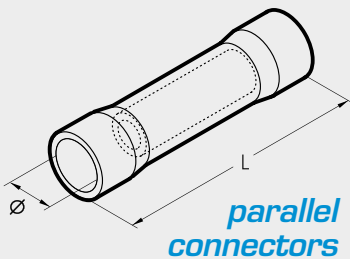

parallel connectors

PVC insulated

Cond. Size sqmm (AWG)	Ref.	Ø mm	L mm	Quantity Box/Bag
0,25÷0,5 (24÷20)	PL 01-M*	3,0	25	3.000/100
0,25÷1,5 (22÷16)	PL 03-M	4,0	25	1.000/100
1,5÷2,5 (16÷14)	PL 06-M	5,0	25	1.500/100
4÷6 (12÷10)	PL 1-M	6,5	32	500/100
0,25÷1,5 (22÷16)	PL 03-P*	4,0	20	3.000/100
1,5÷2,5 (16÷14)	PL 06-P*	5,0	16	2.000/100

*Not UL approved

PL



- Manufactured from Copper tube
- Electrolytically Tin plated
 - The operating temperature range is - 20 to + 80°C (Surge + 90°C).
 - Recommended crimping tools are shown on pages 98 to 117, 152

BUTT CONNECTORS

Polyamide PA6.6 insulated

Cond. Size sqmm (AWG)	Ref.	Øi mm	L mm	Quantity Box/Bag
0,25÷1,5 (22÷16)	NL 03-M	4,0	25,0	1.000/100
1,5÷2,5 (16÷14)	NL 06-M	5,4	25,5	1.500/100
4÷6 (12÷10)	NL 1-M	5,4	32,0	1.000/100
10 (8÷7)	NL 2-M	6,8	43,0	500/100
16 (6÷5)	NL 3-M	7,9	44,0	500/100

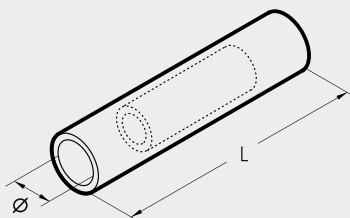

NL-M



- Manufactured from Copper tube
- Electrolytically Tin plated
 - The operating temperature range is - 20 to + 115°C (Surge + 130°C).
 - Recommended crimping tools are shown on pages 98 to 117, 152

PE HD insulated, heat shrinkable

Cond. Size sqmm (AWG)	Ref.	Ø i mm	L1 mm	L2 mm	Quantity Box/Bag
0,5÷1 (20÷17)	WL 03-M	1,7	15,0	36,0	1.500/100
1,5÷2,5 (16÷14)	WL 06-M	2,3	15,0	36,0	1.000/100
4÷6 (12÷10)	WL 1-M	3,4	15,0	41,0	500/100

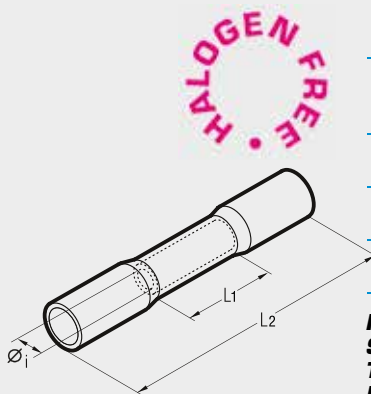

HALOGEN FREE

Max operating voltage: 600 V
Shrink temperature: 150 °C
Temperature range: -40 °C to + 105 °C
Protection: IP68

WL-M



- Manufactured from Copper tube
- Electrolytically Tin plated
 - Heat shrink sleeve with sealant
 - Recommended crimping tools are shown on pages 100.

CLOSE END CONNECTORS

Polyamide PA6.6 insulated

Cond. Size sqmm (AWG)	Ref.	Ø mm	L mm	Quantity Box/Bag
0,25÷1,5 (22÷16)	NL 03-P	9,8	21,0	1.000/100
1,5÷2,5 (16÷14)	NL 06-P	7,9	19,9	1.000/100
	NL 06-PB	6,5	13,6	1.500/100
4÷6 (12÷10)	NL 1-P	10,5	21,5	500/100
	NL 1-PG	9,0	17,8	1.000/100

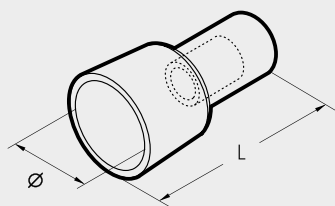

NL-P



- Manufactured from Copper tube
- Electrolytically Tin plated
 - The operating temperature range is - 20 to + 115°C (Surge + 130°C).
 - Recommended crimping tools are shown on pages 98 to 117, 152

REINFORCED DISCONNECT TERMINALS

for Copper cables

female connectors, fully reinforced with Copper sleeve

HALOGEN FREE

RKF-F
BKF-F
GKF-F



- Manufactured from Brass strip
- Electrolytically Tin plated
- fully reinforced with Copper sleeve, funnel entry
- The operating temperature range is -20°C to $+105^{\circ}\text{C}$ (Surge $+110^{\circ}\text{C}$)
- Recommended crimping tools are shown on pages 98 to 117, 152

PA6.6 insulated terminals

Cond. Size sqmm (AWG)	Ref.	Tab Size	Quantity Box/Bag
0,25÷1,5 (22÷16)	RKF-F 305	2,8 x 0,5	3.000/100
	RKF-F 308	2,8 x 0,8	3.500/100
	RKF-F 405	4,8 x 0,5	3.000/100
1,5÷2,5 (16÷14)	RKF-F 408	4,8 x 0,8	2.500/100
	RKF-F 608	6,35 x 0,8	2.500/100
	BKF-F 405	4,8 x 0,5	3.000/100
4-6 (12÷10)	BKF-F 408	4,8 x 0,8	3.000/100
	BKF-F 608	6,35 x 0,8	2.000/100
	GKF-F 608	6,35 x 0,8	1.500/100

PA6.6 fully insulated terminals

Cond. Size sqmm (AWG)	Ref.	Tab Size	Quantity Box/Bag
0,25÷1,5 (22÷16)	RKF-F 405P	4,8 x 0,5	1.500/100
	RKF-F 408P	4,8 x 0,8	2.000/100
	RKF-F 608P	6,35 x 0,8	1.000/100
1,5÷2,5 (16÷14)	BKF-F 405P	4,8 x 0,5	2.000/100
	BKF-F 408P	4,8 x 0,8	2.000/100
	BKF-F 608P	6,35 x 0,8	1.000/100
4-6 (12÷10)	GKF-F 608P	6,35 x 0,8	1.000/100

RKF
BKF
GKF



- Manufactured from Brass strip
- Electrolytically Tin plated
- fully reinforced with Copper sleeve, funnel entry
- The operating temperature range is -20°C to $+105^{\circ}\text{C}$ (Surge $+110^{\circ}\text{C}$)
- Recommended crimping tools are shown on pages 98 to 117, 152

male connectors, fully reinforced with Copper sleeve - PA6.6 insulated terminals

Cond. Size sqmm (AWG)	Ref.	Tab Size	Quantity Box/Bag
0,25÷1,5 (22÷16)	RKF-M 608	6,35 x 0,8	3.000/100
1,5÷2,5 (16÷14)	BKF-M 608	6,35 x 0,8	2.500/100
4-6 (12÷10)	GKF-M 608	6,35 x 0,8	1.000/100

male/female connectors, fully reinforced with Copper sleeve - PA6.6 insulated terminals

Cond. Size sqmm (AWG)	Ref.	Tab Size	Quantity Box/Bag
0,25÷1,5 (22÷16)	RKF-FM 608	6,35 x 0,8	1.500/100
1,5÷2,5 (16÷14)	BKF-FM 608	6,35 x 0,8	1.500/100

bullet and socket connectors fully reinforced with Copper sleeve PA6.6 insulated terminals

Cond. Size sqmm (AWG)	Ref.	Ø mm	Quantity Box/Bag
0,25÷1,5 (22÷16)	RKF-BM 4	4	2.500/100
	RKF-BF 4	4	1.000/100
1,5÷2,5 (16÷14)	BKF-BM 4	4	2.000/100
	BKF-BF 4	4	800/100

RN-FA
BN-FA



- Manufactured from Brass strip
- The operating temperature range is -40 to $+125^{\circ}\text{C}$.
- Recommended crimping tools are shown on pages 104.

FEMALE CONNECTORS

open barrel

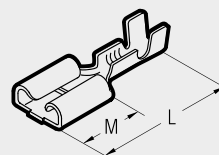

Conductor Size sqmm (AWG)	Ref.	Tab mm	M mm	L mm	Quantity Box/Bag
0,5÷1 (20÷17)	RN-FA 305	2,8 x 0,5	6,3	15,0	6.000/100
	RN-FA 405	4,8 x 0,5	6,3	15,0	5.000/100
	RN-FA 608	6,3 x 0,8	7,7	19,0	3.000/100
1÷2,5 (17÷14)	BN-FA 608	6,3 x 0,8	7,7	19,0	2.000/100
	* BN-FAB 608	6,3 x 0,8	7,7	15,5	1.000/100
	** BN-FAR 608	6,3 x 0,8	7,7	19,0	3.000/100

*flag type **with retainer

MALE CONNECTORS

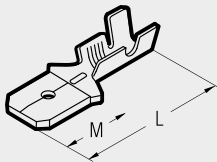

open barrel

RN-MA BN-MA



Conductor Size sqmm (AWG)	Ref.	Tab mm	M mm	L mm	Quantity Box/Bag
0,5÷1 (20÷17)	RN-MA 305	2,8 x 0,5	5,8	13,0	6.000/100
	RN-MA 405	4,8 x 0,5	6,3	17,3	5.000/100
	RN-MA 608	6,3 x 0,8	7,9	19,7	4.000/100
1÷2,5 (17÷14)	BN-MA 608	6,3 x 0,8	7,9	20,0	4.000/100

- Manufactured from Brass strip
- The operating temperature range is - 40 to + 125°C.
- Recommended crimping tool is shown on page 104.

MALE TABS

for board mounting

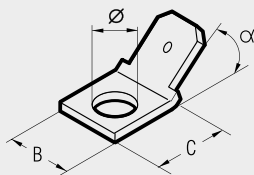

MP MPD



Ref.	Tab mm	Ø Stud mm	B mm	C mm	α	Quantity Box/Bag
MP 608	6,3 x 0,8	4	8	8,5	0°	5.000/100
MP 608/45	6,3 x 0,8	4	8	8,5	45°	6.000/100
MP 608/90	6,3 x 0,8	4	8	8,5	90°	5.000/100
* MP 608D	6,3 x 0,8	5	8	14	0°	5.000/100

- Manufactured from Brass strip
- The operating temperature range is - 40 to + 125°C.

*double tab

CONNECTOR SLEEVES

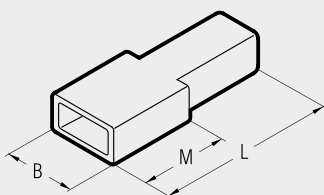

CFA CMA



Ref.	Connector	B mm	M mm	L mm	Material	Quantity Box/Bag
CFA 300	Female 2,8	5,5	7	18	Polyethylene	3.000/100
*CFA 400	Female 4,8	7,5	9	20	Polyethylene	2.000/100
*CFA 600	Female 6,3	9,0	11	24	Polyethylene	1.500/100
**CFA2 600	Female 6,3	9,0	9	22	Polyethylene	1.500/100
CFAR 600	Female 6,3 frontal insertion with retainer	9,0	12	25	Polyamide 6.6	500/100
CFAB 600	Female 6,3 flag	10,0	-	18	Polyamide 6.6	1.000/100
*CMA 600	Male 6,3	12,0	11	22	Polyethylene	1.000/100

- * For a single cable.
Colours available:
Transparent: no suffix
Red: add suffix R
Black: add suffix N

- ** For twin cables.
Colours available:
Transparent: no suffix
Red: add suffix R
Black: add suffix N
Green: add suffix V
Blue: add suffix B
Yellow: add suffix G

POLYPROPYLENE INSULATED END SLEEVES

for flexible Copper cables

**PKE
PKC
CPKD**



HALOGEN FREE

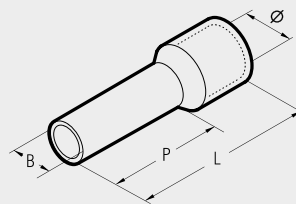

The PKE, PKC, CPKD range of end sleeves is manufactured from Tin plated electrolytic Copper. Designed and developed to reinforce fine wire strands when terminating a cable into a connector block.

The operating temperature range is - 20 to + 105°C (Surge + 110°C).

Recommended crimping tools are shown on pages 98 to 122, 125, 152, 154, 156.

VALSTAR ND#2/PKE

Comprising:

- a selection of PKE end sleeves conductor size 1÷6 sqmm
- tool ND#2

VALSTAR ND#2/PKC

Comprising:

- a selection of PKC end sleeves conductor size 1÷6 sqmm
- tool ND#2



HALOGEN FREE

Insulated chain end sleeves

Developed for use with production equipment to give a quick and reliable crimped joint. Conforms to DIN standard 46 228/4.

Conductor Size sqmm	Ref.	Dimensions mm				Insulation Colour	Quantity Reel
		Ø	B	P	L		
0,3÷0,5	CPKD 508	2,6	1,3	8,0	14,0	○ white	5.000
0,75	CPKD 7508	2,8	1,5	8,0	14,0	○ grey	5.000
1	CPKD 108	3,0	1,7	8,0	14,0	● red	5.000
1,5	CPKD 1508	3,5	2,0	8,0	14,0	● black	5.000
2,5	CPKD 2508	4,2	2,5	8,0	14,0	● blue	3.000

Conductor Size sqmm	Ref.	Dimensions mm				Insulation Colour	Quantity Box/Bag
		Ø	B	P	L		
0,1÷0,3	PKE 308	1,9	1,1	8,0	12,4	● yellow	25.000/500
0,3÷0,5	PKE 508	2,6	1,3	8,0	14,0	○ white	10.000/500
0,75	PKE 7508	3,4	1,6	8,2	14,6	● blue	10.000/500
1,0	PKE 108	3,4	1,8	8,2	14,6	● red	10.000/500
1,5	PKE 1508	3,8	2,1	8,2	14,6	● black	10.000/500
	PKE 1518	3,8	2,1	18,0	24,4		5.000/500
2,5	PKE 2508	4,4	2,6	8,2	15,2	○ grey	7.500/500
	PKE 2518	4,4	2,6	18,0	25,0		5.000/500
4,0	PKE 409	4,8	3,2	9,0	16,0	● orange	5.000/200
	PKE 418	4,8	3,2	18,0	25,0		3.000/200
6,0	PKE 612	5,8	3,9	12,0	20,0	● green	2.500/100
	PKE 618	5,8	3,9	18,0	26,0		2.000/100
10,0	PKE 1012	7,4	4,8	12,0	21,5	● brown	1.500/100
	PKE 1018	7,4	4,8	18,0	27,5		1.500/100
16,0	PKE 1612	9,3	5,9	12,0	22,7	○ white	1.000/100
	PKE 1618	9,3	5,9	18,0	28,6		1.000/100
25,0	PKE 25016	10,0	7,9	16,0	29,0	● black	500/50
	PKE 25022	10,0	7,9	22,0	35,0		500/50

Conductor Size sqmm	Ref.	Dimensions mm				Insulation Colour	Quantity Box/Bag
		Ø	B	P	L		
0,1÷0,3	PKC 306	1,9	1,1	6,0	10,4	● light blue	25.000/500
	PKC 308	1,9	1,1	8,0	12,4		25.000/500
0,3÷0,5	PKC 508	2,6	1,3	8,0	14,0	● orange	10.000/500
	PKC 510	2,6	1,3	10,0	16,0		10.000/500
0,75	PKC 7508	3,4	1,6	8,2	14,6	○ white	10.000/500
	PKC 7512	3,4	1,6	12,0	18,4		10.000/500
1,0	PKC 108	3,4	1,8	8,2	14,6	● yellow	10.000/500
	PKC 112	3,4	1,8	12,0	18,4		10.000/500
1,5	PKC 1508	3,8	2,1	8,2	14,6	● red	10.000/500
	PKC 1518	3,8	2,1	18,0	24,4		5.000/500
2,5	PKC 2508	3,9	2,6	8,2	15,2	● blue	7.500/500
	PKC 2518	3,9	2,6	18,0	25,0		5.000/500
4,0	PKC 409	4,8	3,2	9,0	16,0	○ grey	5.000/200
	PKC 418	4,8	3,2	18,0	25,0		3.000/200
6,0	PKC 612	5,8	3,9	12,0	20,0	● black	2.500/100
	PKC 618	5,8	3,9	18,0	26,0		2.000/100
10,0	PKC 1012	7,4	4,8	12,0	21,5	○ ivory	1.500/100
	PKC 1018	7,4	4,8	18,0	27,5		1.500/100
16,0	PKC 1612	9,3	5,9	12,0	22,7	● green	1.000/100
	PKC 1618	9,3	5,9	18,0	28,6		1.000/100
25,0	PKC 25016	10,0	7,9	16,0	29,0	● brown	500/50
	PKC 25022	10,0	7,9	22,0	35,0		500/50
35,0	PKC 35016	12,0	8,9	16,0	30,0	● beige	500/50
	PKC 35025	12,0	8,9	25,0	39,0		400/50
50,0	PKC 50020	13,8	11,0	20,0	36,0	● olive	300/50
	PKC 50030	13,8	11,0	30,0	46,0		250/50
70	PKC 70022	16,0	14,3	22,0	38,0	● yellow	100/25
95	PKC 95025	18,0	15,7	25,0	44,0	● red	100/25
120	PKC 120027	21,0	17,5	27,0	48,0	● blue	100/25

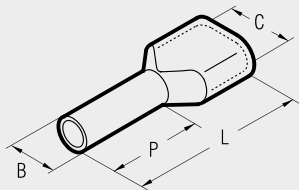

“TWIN” POLYPROPYLENE INSULATED END SLEEVES

for fine stranded cables

Conductor Size sqmm	Ref.	Dimensions mm				Insulation Colour	nd#4, HNKE16 and HNKE 50	Quantity Bag
		C	B	P	L			
2 x 0,5	PKET 508	4,6x2,6	1,5	8,0	15,0	○ white	1	500
2 x 0,75	PKET 7508	5,2x2,6	2,1	8,0	15,0	● blue	1,5	500
	PKET 7512	5,2x2,6	2,1	12,0	19,0			500
2 x 1	PKET 108	5,8x3,2	2,6	8,0	16,0	● red	2,5	500
	PKET 112	5,8x3,2	2,6	12,0	20,0			500
2 x 1,5	PKET 1508	6,5x3,6	2,6	8,0	16,0	● black	2,5	500
	PKET 1512	6,5x3,6	2,6	12,0	20,0		2,4	500
2 x 2,5	PKET 2510	7,5x4,3	3,2	10,0	18,0	○ grey	4	250
	PKET 2512	7,5x4,3	3,2	12,0	21,0			250
2 x 4	PKET 412	9,0x5,2	4,2	12,0	23,0	● orange	6	100
2 x 6	PKET 614	10,0x7,2	5,3	14,0	26,0	● green	10	100
2 x 10	PKET 1014	13,0x7,2	7,0	14,0	26,0	● brown	16	100
2 x 16	PKET 1616	18,0x9,5	8,8	16,0	30,0	○ white	35	100

Conductor Size sqmm	Ref.	Dimensions mm				Insulation Colour	nd#4, HNKE16 and HNKE 50	Quantity Bag
		C	B	P	L			
2 x 0,5	PKCT 508	4,6x2,6	1,5	8,0	15,0	● orange	1	500
2 x 0,75	PKCT 7508	5,2x2,6	2,1	8,0	15,0	○ white	1,5	500
	PKCT 7512	5,2x2,6	2,1	12,0	19,0			500
2 x 1	PKCT 108	5,8x3,2	2,6	8,0	16,0	● yellow	2,5	500
	PKCT 112	5,8x3,2	2,6	12,0	20,0			500
2 x 1,5	PKCT 1508	6,5x3,6	2,6	8,0	16,0	● red	2,5	500
	PKCT 1512	6,5x3,6	2,6	12,0	20,0		2,4	500
2 x 2,5	PKCT 2510	7,5x4,3	3,2	10,0	18,0	● blue	4	250
	PKCT 2512	7,5x4,3	3,2	12,0	21,0			250
2 x 4	PKCT 412	9,0x5,2	4,2	12,0	23,0	○ grey	6	100
2 x 6	PKCT 614	10,0x7,2	5,3	14,0	26,0	● black	10	100
2 x 10	PKCT 1014	13,0x7,2	7,0	14,0	26,0	○ ivory	16	100
2 x 16	PKCT 1616	18,0x9,5	8,8	16,0	30,0	● green	35	100

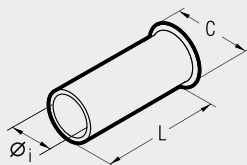

UNINSULATED END SLEEVES

for flexible Copper cables

Conductor Size sqmm	Ref.	Dimensions mm			Quantity Box/Bag
		Ø	L	C	
0,5	*KE 506 ST	1,0	6,0	1,9	50.000/500
	KE 508 ST	1,0	8,0	1,9	50.000/500
0,75	*KE 7506 ST	1,2	6,0	2,2	40.000/500
	KE 7508 ST	1,2	8,0	2,2	50.000/500
1	*KE 106 ST	1,4	6,0	2,4	25.000/500
	*KE 110 ST	1,4	10,0	2,4	25.000/500
1,5	KE 1508 ST	1,7	8,0	2,8	25.000/500
	*KE 1510 ST	1,7	10,0	2,8	25.000/500
2,5	KE 2508 ST	2,2	8,0	3,4	25.000/500
	*KE 2510 ST	2,2	10,0	3,4	15.000/500
4	KE 410 ST	2,8	10,0	4,0	12.500/500
	*KE 412 ST	2,8	12,0	4,0	10.000/500
6	*KE 610 ST	3,5	10,0	4,7	10.000/500
	*KE 612 ST	3,5	12,0	4,7	7.500/500
10	*KE 616 ST	3,5	15,0	4,7	5.000/500
	*KE 1016 ST	4,5	15,0	5,8	4.000/250
16	*KE 1616 ST	5,8	15,0	7,5	3.000/250
	KE 25015 ST	7,3	15,0	9,5	1.500/100
25	*KE 25018 ST	7,3	18,0	9,5	1.500/100
	KE 35012 ST	8,3	12,0	10,5	1.500/100
35	KE 35015 ST	8,3	16,0	10,5	1.500/100
	*KE 35018 ST	8,3	18,0	10,5	1.000/100

*To DIN standard 46 228/1

PKET PKCT



Type PKET, PKCT ranges of twin end sleeves are manufactured from Tin plated electrolytic Copper. Designed to accommodate two cables terminating in the same sleeve they are ideal for looping conductors. The operating temperature range is - 20 to + 105°C (Surge + 110°C).

Recommended crimping tools are shown on pages 98 to 121, 125, 152, 154, 156.

KE



KE series end sleeves are manufactured from Tin plated electrolytic Copper. Designed and developed for use with flexible cables.

Recommended crimping tools are shown on pages 98 to 121, 125, 152, 154, 156.

S

UNINSULATED TERMINALS

S range - brazed seam



S range terminals are manufactured from electrolytic Copper strip and Tin plated. The seam is brazed to

provide uniform mechanical strength. The terminal barrel is rifled to enhance electrical con-

tact and to improve mechanical strength.

Recommended crimping tools are shown on pages 98 to 117, 152.

pin terminals

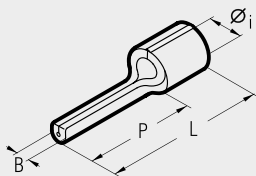

blade terminals

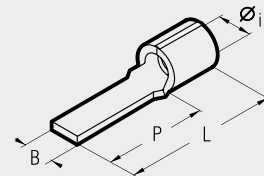

Conductor Size sqmm (AWG)	Ref.	Dimensions mm				Quantity Box/Bag
		Øi	B	P	L	
0,25÷1,25 (22÷16)	S 1.5-P 8	1,8	1,6	8,0	12,0	8.000/100
	S 1.5-P 10	1,8	1,6	10,0	14,0	8.000/100
	S 1.5-P 12	1,8	1,6	12,0	16,2	8.000/100
1,5÷2,5 (16÷14)	S 2.5-P 8	2,4	1,7	8,0	12,0	7.000/100
	S 2.5-P 10	2,4	1,8	10,0	14,0	7.000/100
	S 2.5-P 12	2,4	1,8	12,0	16,0	7.000/100
4÷6 (12÷10)	S 6-P 10	3,6	2,2	10,0	16,8	4.000/100
	S 6-P 12	3,6	2,2	12,0	19,4	4.000/100
	S 6-P 14	3,6	2,2	14,0	21,0	3.500/100

Conductor Size sqmm (AWG)	Ref.	Dimensions mm				Quantity Box/Bag
		Øi	B	P	L	
0,25÷1,25 (22÷16)	S 1.5-PP 12	1,8	3,0	12,8	17,0	8.000/100
	*S 1.5-PP 12/1	1,8	3,0	11,3	15,5	8.000/100
	S 1.5-PP 12/19	1,8	1,9	13,2	17,4	8.000/100
	S 1.5-PP 14	1,8	3,0	14,8	19,0	8.000/100
1,5÷2,5 (16÷14)	S 2.5-PP 12	2,4	3,5	12,8	17,0	7.000/100
	S 2.5-PP 12/25	2,4	2,5	13,3	17,5	7.000/100
	S 2.5-PP 16/25	2,4	2,5	17,2	21,4	7.000/100
4÷6 (12÷10)	S 6-PP 12	3,6	4,0	13,3	19,7	4.000/100
	S 6-PP 17	3,6	2,9	19,1	25,5	4.000/100

*Made to order

UNINSULATED TERMINALS

S range - brazed seam

S

ring terminals

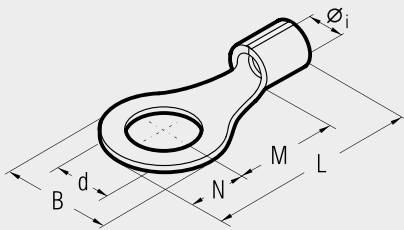

fork/spade terminals

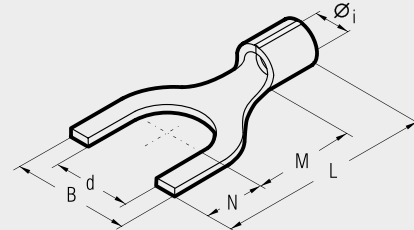

Cond. Size sqmm (AWG)	Ø Stud mm	Ref.	Dimensions mm						Quantity Box/Bag
			Øi	B	M	N	L	d	
0,25÷1,25 (22÷16)	2	*S 1.5-M 2	1,8	5,6	4,5	2,8	11,5	2,2	7.000/100
	3	S 1.5-M 3	1,8	5,6	4,5	2,8	11,5	3,2	7.000/100
	3,5	S 1.5-M 3,5	1,8	5,6	4,5	2,8	11,5	3,7	7.000/100
	3,5	*S 1.5-M 3,5/1	1,8	6,2	7,1	3,1	14,4	3,7	7.000/100
	4	S 1.5-M 4	1,8	7,0	6,5	3,5	14,2	4,3	7.000/100
	4	*S 1.5-M 4/3	1,8	7,8	7,1	3,9	15,2	4,3	7.000/100
	5	S 1.5-M 5	1,8	7,8	7,1	3,9	15,2	5,3	7.000/100
	6	S 1.5-M 6	1,8	9,4	8,1	4,7	17,0	6,4	6.000/100
	6	S 1.5-M 6/1	1,8	12,0	10,3	6,0	20,5	6,4	5.000/100
	7	S 1.5-M 7	1,8	9,4	8,1	4,7	17,0	7,2	6.000/100
	8	S 1.5-M 8	1,8	12,0	10,3	6,0	20,5	8,4	4.000/100
	10	S 1.5-M 10	1,8	15,5	13,0	7,7	25,0	10,5	3.000/100
12	S 1.5-M 12	1,8	18,0	15,5	9,0	28,7	13,0	2.000/100	
1,5÷2,5 (16÷14)	3	S 2.5-M 3	2,4	5,6	5,0	2,8	12,0	3,2	6.000/100
	3,5	S 2.5-M 3,5	2,4	5,6	5,0	2,8	12,0	3,7	6.000/100
	3,5	*S 2.5-M 3,5/1	2,4	6,2	6,5	3,1	13,8	3,7	5.000/100
	4	S 2.5-M 4	2,4	8,0	6,5	4,0	14,7	4,3	5.000/100
	5	S 2.5-M 5	2,4	8,0	7,5	4,0	15,7	5,3	5.000/100
	6	S 2.5-M 6	2,4	9,4	8,6	4,7	17,5	6,4	5.000/100
	6	S 2.5-M 6/1	2,4	12,0	10,3	6,0	20,5	6,4	5.000/100
	7	S 2.5-M 7	2,4	10,0	7,8	5,0	17,0	7,2	5.000/100
	8	S 2.5-M 8	2,4	12,0	10,3	6,0	20,5	8,4	4.000/100
	10	S 2.5-M 10	2,4	15,5	13,0	7,7	25,0	10,5	2.500/100
	12	S 2.5-M 12	2,4	18,0	15,5	9,0	28,7	13,0	2.000/100
	4÷6 (12÷10)	3	S 6-M 3	3,6	8,0	8,1	4,0	18,5	3,2
3,5		S 6-M 3,5	3,6	8,0	8,1	4,0	18,5	3,7	3.000/100
4		S 6-M 4	3,6	9,0	8,1	4,5	19,0	4,3	3.000/100
5		S 6-M 5	3,6	9,0	8,1	4,5	19,0	5,3	2.500/100
6		S 6-M 6	3,6	11,0	11,1	5,5	23,0	6,4	2.500/100
6		*S 6-M 6/1	3,6	11,0	8,1	5,5	20,0	6,4	2.500/100
7		S 6-M 7	3,6	11,0	11,1	5,5	23,0	7,2	2.500/100
8		S 6-M 8	3,6	13,6	12,1	6,8	25,3	8,4	2.000/100
8		*S 6-M 8/1	3,6	11,0	8,1	5,5	20,0	8,4	2.500/100
10		S 6-M 10	3,6	13,6	12,1	6,8	25,3	10,5	2.000/100
10		S 6-M 10/1	3,6	15,5	13,8	7,7	28,0	10,5	2.000/100
12		S 6-M 12	3,6	19,0	15,1	9,5	31,0	13,0	1.000/100
14	S 6-M 14	3,6	21,0	16,1	10,5	33,0	15,0	1.000/100	
16	S 6-M 16	3,6	24,0	17,1	12,0	35,5	17,0	1.000/100	
10 (8)	4	S 10-M 4	4,8	11,5	9,0	5,8	23,8	4,3	2.000/100
	5	S 10-M 5	4,8	11,5	9,0	5,8	23,8	5,3	2.000/100
	6	S 10-M 6	4,8	11,5	9,0	5,8	23,8	6,4	2.000/100
	7	S 10-M 7	4,8	11,5	9,0	5,8	23,8	7,2	1.500/100

*Made to order

Cond. Size sqmm (AWG)	Ø Stud mm	Ref.	Dimensions mm						Quantity Box/Bag
			Øi	B	M	N	L	d	
0,25÷1,25 (22÷16)	3	S 1.5-U 3	1,8	5,5	5,5	4,0	13,7	3,2	7.000/100
	3,5	S 1.5-U 3,5	1,8	6,0	6,5	3,8	14,5	3,7	7.000/100
	3,5	*S 1.5-U 3,5/2	1,8	6,4	6,5	3,8	14,5	3,7	7.000/100
	4	S 1.5-U 4	1,8	6,5	7,5	3,7	15,4	4,3	7.000/100
	4	*S 1.5-U 4/1	1,8	8,5	7,5	3,7	15,4	4,3	7.000/100
	4	S 1.5-U 4/2	1,8	7,5	7,5	3,7	15,4	4,3	7.000/100
	5	S 1.5-U 5	1,8	8,5	7,5	3,7	15,4	5,3	7.000/100
	5	*S 1.5-U 5/1	1,8	9,4	7,5	3,7	15,4	5,3	7.000/100
	6	S 1.5-U 6	1,8	9,4	8,1	4,7	17,0	6,4	6.000/100
	6	*S 1.5-U 6/1	1,8	12,0	9,2	7,1	20,5	6,4	6.000/100
	8	S 1.5-U 8	1,8	14,0	10,0	6,3	20,5	8,4	3.000/100
	10	S 1.5-U 10	1,8	17,5	13,0	7,7	25,0	10,5	2.500/100
12	S 1.5-U 12	1,8	20,0	15,5	9,0	28,7	13,0	2.000/100	
1,5÷2,5 (16÷14)	3	S 2.5-U 3	2,4	5,5	5,5	4,0	13,7	3,2	6.000/100
	3,5	S 2.5-U 3,5	2,4	6,4	6,5	3,8	14,5	3,7	6.000/100
	3,5	*S 2.5-U 3,5/12,4	2,4	7,2	6,5	3,8	14,5	3,7	6.000/100
	4	S 2.5-U 4	2,4	6,5	7,5	3,7	15,4	4,3	5.000/100
	4	*S 2.5-U 4/1	2,4	8,5	7,5	3,7	15,4	4,3	6.000/100
	4	*S 2.5-U 4/2	2,4	7,5	7,5	3,7	15,4	4,3	6.000/100
	5	S 2.5-U 5	2,4	8,5	7,5	3,7	15,4	5,3	6.000/100
	6	S 2.5-U 6	2,4	9,4	8,1	4,7	17,0	6,4	5.000/100
	6	*S 2.5-U 6/1	2,4	12,0	9,2	7,1	20,5	6,4	4.000/100
	8	S 2.5-U 8	2,4	14,0	10,0	6,3	20,5	8,4	2.500/100
	10	S 2.5-U 10	2,4	17,5	13,0	7,7	25,0	10,5	2.000/100
	12	S 2.5-U 12	2,4	20,0	15,5	9,0	28,7	13,0	2.000/100
4÷6 (12÷10)	3,5	S 6-U 3,5	3,6	7,5	8,5	3,9	18,8	3,7	3.000/100
	4	S 6-U 4	3,6	7,5	8,0	4,4	18,8	4,3	3.000/100
	5	S 6-U 5	3,6	9,5	8,0	4,4	18,8	5,3	2.500/100
	6	S 6-U 6	3,6	10,0	11,0	5,5	22,9	6,4	2.500/100
	8	S 6-U 8	3,6	13,5	12,0	8,0	26,4	8,4	2.000/100
	10	S 6-U 10	3,6	15,5	13,0	8,0	27,4	10,5	2.000/100
	10	*S 6-U 10/1	3,6	17,5	13,8	7,7	28,0	10,5	2.000/100
	12	S 6-U 12	3,6	21,0	15,1	9,5	31,0	13,0	1.000/100
	14	*S 6-U 14	3,6	23,0	16,1	10,5	33,0	15,0	1.000/100
	16	*S 6-U 16	3,6	26,0	17,1	11,5	35,0	17,0	1.000/100

UNINSULATED TERMINALS

RN, BN, GN range - unbrazed

RN
BN
GN



RN, BN, GN range terminals are manufactured from electrolytic Copper strip and

Tin plated.
The seam is unbrazed.
The terminal barrel is rifled

to enhance electrical contact and to improve mechanical strength.

Recommended crimping tools are shown on pages 98 to 117, 152.

pin terminals

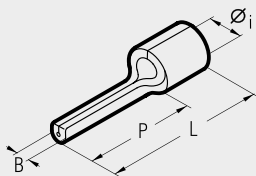

blade terminals

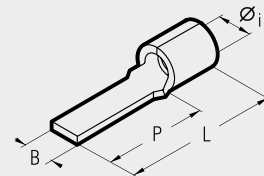

Conductor Size sqmm (AWG)	Ref.	Dimensions mm				Quantity Box/Bag
		Øi	B	P	L	
0,25÷1,5 (22÷16)	RN-P 8	1,8	1,6	8,0	12,0	8.000/100
	RN-P 10	1,8	1,6	10,0	14,0	8.000/100
	RN-P 12	1,8	1,6	12,0	16,2	8.000/100
1,5÷2,5 (16÷14)	BN-P 8	2,4	1,7	8,0	12,0	7.000/100
	BN-P 10	2,4	1,8	10,0	14,0	7.000/100
	BN-P 12	2,4	1,8	12,0	16,0	7.000/100
4÷6 (12÷10)	GN-P 10	3,6	2,2	10,0	16,8	4.000/100
	GN-P 12	3,6	2,2	12,0	19,0	4.000/100
	GN-P 14	3,6	2,2	14,0	21,0	3.500/100

Conductor Size sqmm (AWG)	Ref.	Dimensions mm				Quantity Box/Bag
		Øi	B	P	L	
0,25÷1,5 (22÷16)	RN-PP 12	1,8	3,0	12,8	17,0	8.000/100
	RN-PP 12/1	1,8	3,0	11,3	15,5	8.000/100
	RN-PP 12/19	1,8	1,9	13,2	17,4	8.000/100
	RN-PP 14	1,8	3,0	14,8	19,0	8.000/100
	RN-PP 16/23	1,8	2,3	17,2	21,4	8.000/100
1,5÷2,5 (16÷14)	BN-PP 12	2,4	3,5	12,8	17,0	7.000/100
	BN-PP 12/25	2,4	2,5	13,3	17,5	7.000/100
	BN-PP 16/25	2,4	2,5	17,2	21,4	7.000/100
4÷6 (12÷10)	GN-PP 12	3,6	4,0	13,3	19,7	4.000/100
	GN-PP 17	3,6	2,9	19,1	25,5	4.000/100

UNINSULATED TERMINALS

RN, BN, GN range - unbraided

RN
BN
GN

ring terminals

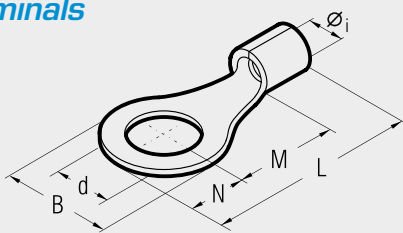

fork/spade terminals

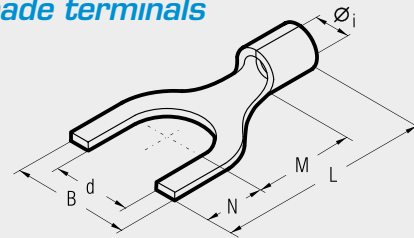

Cond. Size sqmm (AWG)	Ø Stud mm	Ref.	Dimensions mm						Quantity Box/Bag
			Øi	B	M	N	L	d	
0,25÷1,5 (22÷16)	2	*RN-M 2	1,8	5,6	4,5	2,8	11,5	2,2	7.000/100
	3	RN-M 3	1,8	5,6	4,5	2,8	11,5	3,2	7.000/100
	3,5	RN-M 3.5	1,8	5,6	4,5	2,8	11,5	3,7	7.000/100
	3,5	RN-M 3.5/1	1,8	6,2	7,1	3,1	14,4	3,7	7.000/100
	4	RN-M 4	1,8	7,0	6,5	3,5	14,2	4,3	7.000/100
	4	RN-M 4/3	1,8	7,8	7,1	3,9	15,2	4,3	7.000/100
	5	RN-M 5	1,8	7,8	7,1	3,9	15,2	5,3	7.000/100
	6	RN-M 6	1,8	9,4	8,1	4,7	17,0	6,4	6.000/100
	6	RN-M 6/1	1,8	12,0	10,3	6,0	20,5	6,4	4.000/100
	7	RN-M 7	1,8	9,4	8,1	4,7	17,0	7,2	6.000/100
	8	RN-M 8	1,8	12,0	10,3	6,0	20,5	8,4	4.000/100
	10	RN-M 10	1,8	15,5	13,0	7,7	25,0	10,5	3.000/100
12	RN-M 12	1,8	18,0	15,5	9,0	28,7	13,0	2.000/100	
1,5÷2,5 (16÷14)	2	*BN-M 2	2,4	5,6	5,0	2,8	12,0	2,2	6.000/100
	3	BN-M 3	2,4	5,6	5,0	2,8	12,0	3,2	6.000/100
	3,5	BN-M 3.5	2,4	5,6	5,0	2,8	12,0	3,7	6.000/100
	3,5	BN-M 3.5/1	2,4	6,2	6,5	3,1	13,8	3,7	6.000/100
	4	BN-M 4	2,4	8,0	6,5	4,0	14,7	4,3	5.000/100
	5	BN-M 5	2,4	8,0	7,5	4,0	15,7	5,3	5.000/100
	6	BN-M 6	2,4	9,4	8,6	4,7	17,5	6,4	5.000/100
	6	BN-M 6/1	2,4	12,0	10,3	6,0	20,5	6,4	5.000/100
	7	BN-M 7	2,4	10,0	7,8	5,0	17,0	7,2	5.000/100
	8	BN-M 8	2,4	12,0	10,3	6,0	20,5	8,4	4.000/100
	10	BN-M 10	2,4	15,5	13,0	7,7	25,0	10,5	2.500/100
	12	BN-M 12	2,4	18,0	15,5	9,0	28,7	13,0	2.000/100
4÷6 (12÷10)	3	GN-M 3	3,6	8,0	8,1	4,0	18,5	3,2	3.000/100
	3,5	GN-M 3.5	3,6	8,0	8,1	4,0	18,5	3,7	3.000/100
	4	GN-M 4	3,6	9,0	8,1	4,5	19,0	4,3	3.000/100
	5	GN-M 5	3,6	9,0	8,1	4,5	19,0	5,3	2.500/100
	6	GN-M 6	3,6	11,0	11,1	5,5	23,0	6,4	2.500/100
	6	GN-M 6/1	3,6	11,0	8,1	5,5	20,0	6,4	2.500/100
	7	GN-M 7	3,6	11,0	11,1	5,5	23,0	7,2	2.500/100
	8	GN-M 8	3,6	13,6	12,1	6,8	25,3	8,4	2.000/100
	8	*GN-M 8/1	3,6	11,0	8,1	5,5	20,0	8,4	2.500/100
	10	GN-M 10	3,6	13,6	12,1	6,8	25,3	10,5	2.000/100
	10	GN-M 10/1	3,6	15,5	13,8	7,7	28,0	10,5	2.000/100
	12	GN-M 12	3,6	19,0	15,1	9,5	31,0	13,0	1.000/100
	14	GN-M 14	3,6	21,0	16,1	10,5	33,0	15,0	1.000/100
	16	GN-M 16	3,6	24,0	17,1	12,0	35,5	17,0	1.000/100

Cond. Size sqmm (AWG)	Ø Stud mm	Ref.	Dimensions mm						Quantity Box/Bag
			Øi	B	M	N	L	d	
0,25÷1,5 (22÷16)	3	RN-U 3	1,8	5,5	5,5	4,0	13,7	3,2	7.000/100
	3,5	RN-U 3.5	1,8	6,0	6,5	3,8	14,5	3,7	7.000/100
	3,5	RN-U 3.5/2	1,8	6,4	6,5	3,8	14,5	3,7	7.000/100
	4	RN-U 4	1,8	6,5	7,5	3,7	15,4	4,3	7.000/100
	4	RN-U 4/1	1,8	8,5	7,5	3,7	15,4	4,3	7.000/100
	4	RN-U 4/2	1,8	7,5	7,5	3,7	15,4	4,3	7.000/100
	5	RN-U 5	1,8	8,5	7,5	3,7	15,4	5,3	5.000/100
	5	*RN-U 5/1	1,8	9,4	7,5	3,7	15,4	5,3	5.000/100
	6	RN-U 6	1,8	9,4	8,1	4,7	17,0	6,4	6.000/100
	6	RN-U 6/1	1,8	12,0	9,2	7,1	20,5	6,4	3.000/100
	8	RN-U 8	1,8	14,0	10,0	6,3	20,5	8,4	2.500/100
	10	RN-U 10	1,8	17,5	13,0	7,7	25,0	10,5	3.000/100
12	RN-U 12	1,8	20,0	15,5	9,0	28,7	13,0	2.000/100	
1,5÷2,5 (16÷14)	3	BN-U 3	2,4	5,5	5,5	4,0	13,7	3,2	6.000/100
	3,5	BN-U 3.5	2,4	6,4	6,5	3,8	14,5	3,7	6.000/100
	3,5	*BN-U 3.5/1	2,4	7,2	6,5	3,8	14,5	3,7	6.000/100
	4	BN-U 4	2,4	6,5	7,5	3,7	15,4	4,3	6.000/100
	4	BN-U 4/1	2,4	8,5	7,5	3,7	15,4	4,3	6.000/100
	4	BN-U 4/2	2,4	7,5	7,5	3,7	15,4	4,3	6.000/100
	5	BN-U 5	2,4	8,5	7,5	3,7	15,4	5,3	5.000/100
	6	BN-U 6	2,4	9,4	8,1	4,7	17,0	6,4	5.000/100
	6	BN-U 6/1	2,4	12,0	9,2	7,1	20,5	6,4	4.000/100
	8	BN-U 8	2,4	14,0	10,0	6,3	20,5	8,4	4.000/100
	10	BN-U 10	2,4	17,5	13,0	7,7	25,0	10,5	2.000/100
	12	BN-U 12	2,4	20,0	15,5	9,0	28,7	13,0	2.000/100
4÷6 (12÷10)	3,5	GN-U 3.5	3,6	7,5	8,5	3,9	18,8	3,7	3.000/100
	4	GN-U 4	3,6	7,5	8,0	4,4	18,8	4,3	3.000/100
	5	GN-U 5	3,6	9,5	8,0	4,4	18,8	5,3	2.500/100
	6	GN-U 6	3,6	10,0	11,0	5,5	22,9	6,4	2.500/100
	8	GN-U 8	3,6	13,5	12,0	8,0	26,4	8,4	2.000/100
	10	GN-U 10	3,6	15,5	13,0	8,0	27,4	10,5	2.000/100
	10	GN-U 10/1	3,6	17,5	13,8	7,7	28,0	10,5	2.000/100
	12	GN-U 12	3,6	21,0	15,1	9,5	31,0	13,0	1.000/100
	14	GN-U 14	3,6	23,0	16,1	10,5	33,0	15,0	1.000/100
	16	GN-U 16	3,6	26,0	17,1	11,5	35,0	17,0	1.000/100

*Made to order

A-M



COPPER TUBE CRIMPING LUGS

for Copper conductors



File no. E125401

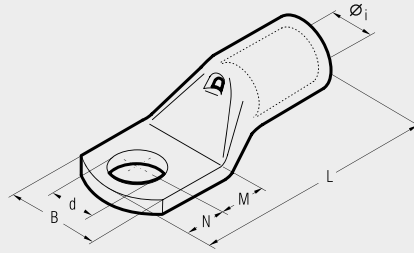

A-M series lugs are manufactured from electrolytic Copper tube.

The dimensions of the tube are designed to obtain the most efficient electrical conductivity and mechanical strength to resist vibration and pull out.

Cembre lugs are annealed to guarantee optimum ductility which is an absolute necessity for connectors which will have to withstand the severe deformation arising when compressed and any bending of the palm during installation.

In applications subject to vibration, lugs still have to provide a reliable connection and annealing plays a vital role in avoiding cracking or breaks between the barrel and palm.

The presence of an inspection hole facilitates full insertion of the conductor, whilst the barrel length has been designed to allow easy and accurate positioning of the dies during the crimping operation.

Lugs are electrolytically plated to avoid oxidation. A-M series lugs form an important part of Cembre crimping systems for power carrying conductors, details of the appropriate crimping tools and dies are shown opposite and in detail on pages 178 to 179.

Our technicians are always available to provide any technical advice which may be required.

The enclosed table is only indicative of the range and many variations in stud fixing and palm lengths are also available.

Cond. Size sqmm	Ø Stud mm	Ref.	Dimensions mm						Quantity Box/Bag	Mechanical Tools	Hydraulic Tools
			Øi	B	M	N	L	d			
0,25÷1,5	3	A 03-M 3*	1,8	6,0	4,5	3,5	16,0	3,2	5.000/100	HNT	B 15WDE
	3,5	A 03-M 3.5*	1,8	6,5	4,5	3,5	16,0	3,7	5.000/100		
	4	A 03-M 4*	1,8	6,5	5,0	4,0	17,0	4,3	5.000/100		
	5	A 03-M 5*	1,8	7,5	5,5	4,5	18,0	5,3	5.000/100		
	6	A 03-M 6*	1,8	9,0	6,0	5,0	19,0	6,4	5.000/100		
1,5÷2,5	3	A 06-M 3*	2,4	6,0	4,5	3,5	17,0	3,2	4.000/100		
	3,5	A 06-M 3.5*	2,4	6,5	4,5	3,5	17,0	3,7	4.000/100		
	4	A 06-M 4*	2,4	7,5	5,0	4,0	18,0	4,3	4.000/100		
	5	A 06-M 5*	2,4	8,5	5,5	4,5	19,0	5,3	4.000/100		
	6	A 06-M 6*	2,4	9,0	6,0	5,0	20,0	6,4	4.000/100		
4÷6	8	A 06-M 8*	2,4	12,0	9,0	8,0	26,0	8,4	2.500/100		
	3	A 1-M 3	3,6	7,5	4,5	3,5	20,5	3,2	2.000/100		
	3,5	A 1-M 3.5	3,6	7,5	4,5	3,5	20,5	3,7	2.000/100		
	4	A 1-M 4	3,6	8,0	5,0	4,0	21,5	4,3	2.000/100		
	5	A 1-M 5	3,6	9,0	6,5	6,0	25,0	5,3	2.000/100		
10	6	A 1-M 6	3,6	11,0	7,0	6,0	25,5	6,4	2.000/100		
	8	A 1-M 8	3,6	14,0	9,0	8,0	29,5	8,4	1.500/100		
	10	A 1-M 10	3,6	16,5	11,0	10,0	33,5	10,5	1.000/100		
	4	A 2-M 4	4,6	10,0	5,0	4,0	22,5	4,3	1.500/100		
	5	A 2-M 5	4,6	10,0	6,5	6,0	26,0	5,3	1.500/100		
16	6	A 2-M 6	4,6	11,0	7,0	6,0	26,5	6,4	1.500/100		
	8	A 2-M 8	4,6	15,0	9,0	8,0	30,5	8,4	1.000/100		
	10	A 2-M 10	4,6	18,0	11,0	10,0	34,5	10,5	1.000/100		
	12	A 2-M 12	4,6	19,0	14,0	12,0	39,5	13,2	500/100		
	4	A 3-M 4	5,8	11,5	5,0	4,0	25,5	4,3	1.000/100		
25	5	A 3-M 5	5,8	11,5	6,5	6,0	29,0	5,3	1.000/100		
	6	A 3-M 6	5,8	11,5	7,0	6,0	29,5	6,4	1.000/100		
	8	A 3-M 8	5,8	15,0	9,0	8,0	33,5	8,4	500/100		
	10	A 3-M 10	5,8	18,0	11,0	10,0	37,5	10,5	500/100		
	12	A 3-M 12	5,8	20,0	14,0	12,0	42,5	13,2	500/100		
35	4	A 5-M 4	7,0	14,0	5,0	4,0	28,0	4,3	1.000/100		
	5	A 5-M 5	7,0	14,0	6,5	6,0	31,5	5,3	500/100		
	6	A 5-M 6	7,0	14,0	7,0	6,0	32,0	6,4	500/100		
	8	A 5-M 8	7,0	15,0	9,0	8,0	36,0	8,4	500/100		
	10	A 5-M 10	7,0	18,0	11,0	10,0	40,0	10,5	500/100		
50	12	A 5-M 12	7,0	21,0	14,0	12,0	45,0	13,2	500/100		
	5	A 7-M 5	8,9	17,0	6,5	6,0	34,0	5,3	500/100		
	6	A 7-M 6	8,9	17,0	7,0	6,0	34,5	6,4	500/100		
	8	A 7-M 8	8,9	17,0	9,0	8,0	38,5	8,4	400/100		
	10	A 7-M 10	8,9	19,0	11,0	10,0	42,5	10,5	400/100		
70	12	A 7-M 12	8,9	21,0	14,0	12,0	47,5	13,2	300/50		
	6	A 10-M 6	10,0	19,0	8,0	7,0	38,5	6,4	200/50		
	8	A 10-M 8	10,0	19,0	9,0	8,0	40,5	8,4	200/50		
	10	A 10-M 10	10,0	20,0	11,5	9,5	44,5	10,5	200/50		
	12	A 10-M 12	10,0	21,0	12,0	12,0	47,5	13,2	200/50		
	14	A 10-M 14	10,0	25,0	16,0	14,0	55,5	15,0	200/50		
	16	A 10-M 16	10,0	26,0	18,0	16,0	59,5	17,0	200/50		
	6	A 14-M 6	11,3	21,0	8,0	7,0	44,0	6,4	200/50		
	8	A 14-M 8	11,3	21,0	9,0	8,0	46,0	8,4	200/50		
	10	A 14-M 10	11,3	21,0	11,0	10,0	50,0	10,5	200/50		
	12	A 14-M 12	11,3	22,0	14,0	12,0	55,0	13,2	150/50		
	14	A 14-M 14	11,3	25,0	16,0	14,0	59,0	15,0	100/50		
	16	A 14-M 16	11,3	26,0	18,0	16,0	63,0	17,0	100/50		

*Not UL approved

COPPER TUBE CRIMPING LUGS

for Copper conductors

A-M

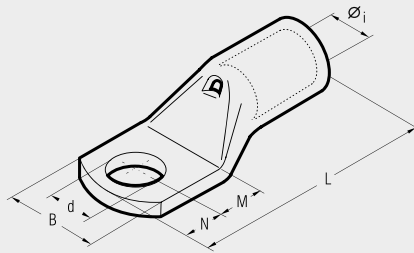

Cond. Size sqmm	Ø Stud mm	Ref.	Dimensions mm						Quantity Box/Bag	Mechanical Tools	Hydraulic Tools		
			Øi	B	M	N	L	d					
95	95	6 A 19-M 6	13,5	25,0	8,0	7,0	50,5	6,4	100/25	TN-120 SE** B 35-45MDE B 35-50MDE HT 45-E			
		8 A 19-M 8	13,5	25,0	9,0	8,0	52,5	8,4	100/25				
		10 A 19-M 10	13,5	25,0	11,0	10,0	56,5	10,5	100/25				
		12 A 19-M 12	13,5	25,0	14,0	12,0	61,5	13,2	100/25				
		14 A 19-M 14	13,5	25,0	16,0	14,0	65,5	15,0	100/25				
		16 A 19-M 16	13,5	27,0	18,0	16,0	69,5	17,0	100/25				
		20 A 19-M 20	13,5	29,5	22,0	20,0	77,5	21,0	50/25				
120	95	8 A 24-M 8	15,2	28,5	9,0	8,0	54,0	8,4	100/25				
		10 A 24-M 10	15,2	28,5	11,0	10,0	58,0	10,5	100/25				
		12 A 24-M 12	15,2	28,5	14,0	12,0	63,0	13,2	100/25				
		14 A 24-M 14	15,2	28,5	16,0	14,0	67,0	15,0	50/25				
		16 A 24-M 16	15,2	28,5	18,0	16,0	71,0	17,0	50/25				
		20 A 24-M 20	15,2	30,0	22,0	20,0	79,0	21,0	50/25				
150	120	8 A 30-M 8	16,7	31,5	13,0	11,0	69,0	8,4	50/25			HT 51 B 550E RH 50 B 500E HT 81-U RHU 81 HT 120 and tools and heads with 130 kN crimping force ECW-H3D RHU 920	
		10 A 30-M 10	16,7	31,5	13,0	11,0	69,0	10,5	50/25				
		12 A 30-M 12	16,7	31,5	16,0	14,0	75,0	13,2	50/25				
		14 A 30-M 14	16,7	31,5	18,0	16,0	79,0	15,0	50/25				
		16 A 30-M 16	16,7	31,5	19,0	17,0	81,0	17,0	50/25				
		20 A 30-M 20	16,7	31,5	22,0	20,0	87,0	21,0	50/25				
185	150	8 A 37-M 8	19,2	35,5	13,0	11,0	76,0	8,4	50/25				
		10 A 37-M 10	19,2	35,5	13,0	11,0	76,0	10,5	40/20				
		12 A 37-M 12	19,2	35,5	16,0	14,0	82,0	13,2	40/20				
		14 A 37-M 14	19,2	35,5	18,0	16,0	86,0	15,0	30/15				
		16 A 37-M 16	19,2	35,5	19,0	17,0	88,0	17,0	30/15				
		20 A 37-M 20	19,2	35,5	22,0	20,0	94,0	21,0	30/15				
240	185	8 A 48-M 8	21,1	39,0	13,0	11,0	77,5	8,4	30/15				
		10 A 48-M 10	21,1	39,0	13,0	11,0	77,5	10,5	30/15				
		12 A 48-M 12	21,1	39,0	14,0	12,0	79,5	13,2	30/15				
		14 A 48-M 14	21,1	39,0	18,0	16,0	92,0	15,0	30/15				
		16 A 48-M 16	21,1	39,0	19,0	17,0	94,0	17,0	30/15				
		20 A 48-M 20	21,1	39,0	22,0	20,0	100,0	21,0	30/15				
300	240	10 A 60-M 10	23,7	44,0	20,0	11,0	96,0	10,5	20/10				
		12 A 60-M 12	23,7	44,0	20,0	14,0	99,0	13,2	20/10				
		14 A 60-M 14	23,7	44,0	22,0	16,0	103,0	15,0	20/10				
		16 A 60-M 16	23,7	44,0	22,0	19,0	106,0	17,0	20/10				
		20 A 60-M 20	23,7	44,0	24,0	23,0	112,0	21,0	20/10				
400	300	12 A 80-M 12	27,0	51,0	22,0	19,0	113,0	13,2	20/5				
		14 A 80-M 14	27,0	51,0	22,0	19,0	113,0	15,0	15/5				
		16 A 80-M 16	27,0	51,0	22,0	19,0	113,0	17,0	15/5				
		20 A 80-M 20	27,0	51,0	24,0	23,0	119,0	21,0	15/5				
500	500	16 A 100-M 16	30,3	56,5	22,0	19,0	117,0	17,0	15/1				
		20 A 100-M 20	30,3	56,5	24,0	23,0	123,0	21,0	15/1				
630	500	16 A 120-M 16♦	33,4	61,6	22,0	19,0	128,0	17,0	12/1				
		20 A 120-M 20♦	33,4	61,6	24,0	23,0	134,0	21,0	10/1				
800	630	16 A 160-M 16♦	38,0	72,0	24,0	19,0	141,0	17,0	6/1				
		20 A 160-M 20♦	38,0	72,0	24,0	23,0	145,0	21,0	6/3				
1000	800	16 A 200-M 16♦	44,0	80,0	24,0	19,0	158,0	17,0	6/1				
		20 A 200-M 20♦	44,0	80,0	24,0	23,0	162,0	21,0	6/1				

*Actual conductor section may require a larger lug eg for 120mm² size use A30-... lug.

**See page 111



Isolated covers made of PVC for subsequent isolation of the uninsulated connectors, see page 33.



♦Not UL approved

A-M



RING TONGUE TERMINALS WITH CONTAINED PALM

for L.V. circuit breakers
for Copper conductors

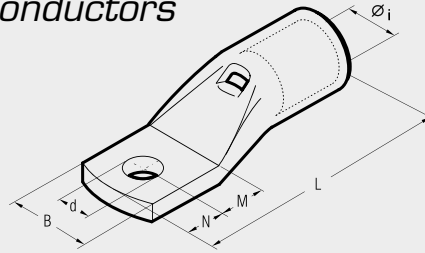

This range of terminals features contained palm width and has been specifically developed for application on L.V. circuit breakers with reduced space terminal blocks. The contained palm width allows an immediate and easier installation. Cembre terminals are manufactured from electrolytic Copper tube.

The specifically designed section of the barrel and the choice of principal dimensions are optimising the best combination of mechanical strength and electrical conductivity. These terminals are annealed to guarantee optimum ductility and are electrolytically Tin plated to avoid oxidation. The barrel is provided with an internal taper to ease the introduction of the conductor; furthermore, its length grants a comfortable and correct positioning between dies, during crimping operations. Each palm is marked with the Cembre logo and part number.

Cond. Size Flexible sqmm	Ø Stud mm	Ref.	Dimensions mm						Quantity Box/Bag	Mechanical Tools	Hydraulic Tools
			Øi	B	M	N	L	d			
10	5	A 2-M 5/9	4,6	9,0	6,5	6,0	26,0	5,3	1000/100	HNG HN-A25	B 15MDE
16	5	A 3-M 5/9	5,8	9,0	6,5	6,0	29,0	5,3	1000/100		
25	5	A 5-M 5/9	7,0	9,0	6,5	6,0	31,5	5,3	500/100	TN 70 SE	B 35-45MDE B 35-50MDE
35	6	A 7 B-M 6/11.5	8,9	11,5	8,0	7,0	36,5	6,4	400/100		
50	6	A 10 B-M 6/11.5	10,0	11,5	8,0	7,0	40,5	6,4	200/50	TN 120 SE	HT 45-E
70	6	A 14 B-M 6/11.5	11,3	11,5	8,0	7,0	44,0	6,4	200/50		
95	8	A 19 B-M 8/15.5	13,5	15,5	9,0	8,0	52,5	8,4	100/25	HT 51 B 550E	RH 50 B 500E
120	8	A 24 B-M 8/19	15,2	19,0	14,0	9,0	60,0	8,4	100/25		
150	10	A 24 B-M 10/19	15,2	19,0	14,0	9,0	60,0	10,5	100/25	HT 81-U RHU 81	ECW-H3D
	8	A 30 B-M 8/19	16,7	19,0	18,0	9,0	70,0	8,4	50/25		
185	10	A 30 B-M 10/19	16,7	19,0	18,0	9,0	70,0	10,5	50/25	HT 120 and tools and heads with 130 kN crimping force	
	10	A 37 B-M 10/24.5	19,2	24,5	18,0	9,0	77,0	10,5	50/25		
240	12	A 48-M 12/31	21,1	31,0	16,0	12,0	86,0	13,2	30/15		
	16	A 48-M 16/31	21,1	31,0	19,0	17,0	94,0	17,0	30/15		
300	10	A 60 B-M 10/31	23,7	31,0	16,0	12,0	95,0	10,5	20/10		
	12	A 60 B-M 12/31	23,7	31,0	16,0	12,0	95,0	13,2	20/10		

Details of the appropriate crimping tools and dies are shown on pages 178 to 179.



COPPER TUBE CRIMPING LUGS ANGLED 90°

for Copper conductors

A-L

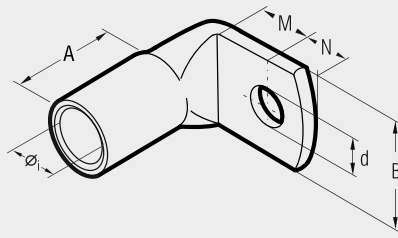

Cond. Size sqmm	Ø Stud mm	Ref.	Dimensions mm						Quantity Box/Bag	Mechanical Tools	Hydraulic Tools
			Øi	B	M	N	A	d			
6	6	A 1-L 6*	3,6	11,0	7,0	6,0	9,5	6,4	2.000/100	HMT	B 15MDE
	5	A 2-L 5	4,6	10,0	6,5	6,0	10,5	5,3	1.500/100		
10	6	A 2-L 6	4,6	11,0	7,0	6,0	10,5	6,4	1.500/100	HNS HN4E5	B 15MDE
	8	A 2-L 8	4,6	15,0	9,0	8,0	10,5	8,4	500/100		
16	5	A 3-L 5	5,8	11,5	6,5	6,0	12,0	5,3	1.000/100	TN 70 SE	B 35-45MDE B 35-50MDE HT 45E HT 51 B 550E RH 50 B 500E HT 81-U RHU 81
	6	A 3-L 6	5,8	11,5	7,0	6,0	12,0	6,4	1.000/100		
	8	A 3-L 8	5,8	15,0	9,0	8,0	12,0	8,4	1.000/100		
25	6	A 5-L 6	7,0	14,0	7,0	6,0	13,0	6,4	500/100	TN 120 SE**	HT 120 and tools and heads with 130 kN crimping force ECW-H3D RHU 520
	8	A 5-L 8	7,0	15,0	9,0	8,0	13,0	8,4	500/100		
	10	A 5-L 10	7,0	18,0	11,0	10,0	13,0	10,5	500/100		
35	6	A 7-L 6	8,9	17,0	7,0	6,0	15,5	6,4	500/100	TN 120 SE**	HT 120 and tools and heads with 130 kN crimping force ECW-H3D RHU 520
	8	A 7-L 8	8,9	17,0	9,0	8,0	15,5	8,4	300/100		
	10	A 7-L 10	8,9	19,0	11,0	10,0	15,5	10,5	400/100		
50	12	A 7-L 12	8,9	21,0	14,0	12,0	15,5	13,2	300/100	TN 120 SE**	HT 120 and tools and heads with 130 kN crimping force ECW-H3D RHU 520
	6	A 10-L 6	10,0	19,0	8,0	7,0	16,5	6,4	300/100		
	8	A 10-L 8	10,0	19,0	9,0	8,0	16,5	8,4	300/100		
70	10	A 10-L 10	10,0	20,0	11,5	9,5	16,5	10,5	200/50	TN 120 SE**	HT 120 and tools and heads with 130 kN crimping force ECW-H3D RHU 520
	12	A 10-L 12	10,0	21,0	12,0	12,0	16,5	13,2	200/50		
	16	A 10-L 16	11,3	26,0	18,0	16,0	20,0	17,0	150/50		
95	8	A 14-L 8	11,3	21,0	9,0	8,0	20,0	8,4	200/50	TN 120 SE**	HT 120 and tools and heads with 130 kN crimping force ECW-H3D RHU 520
	10	A 14-L 10	11,3	21,0	11,0	10,0	20,0	10,5	200/50		
	12	A 14-L 12	11,3	22,0	14,0	12,0	20,0	13,2	150/50		
120	16	A 14-L 16	11,3	26,0	18,0	16,0	20,0	17,0	150/50	TN 120 SE**	HT 120 and tools and heads with 130 kN crimping force ECW-H3D RHU 520
	8	A 19-L 8	13,5	25,0	9,0	8,0	24,5	8,4	100/25		
	10	A 19-L 10	13,5	25,0	11,0	10,0	24,5	10,5	100/25		
150	12	A 19-L 12	13,5	25,0	14,0	12,0	24,5	13,2	100/25	TN 120 SE**	HT 120 and tools and heads with 130 kN crimping force ECW-H3D RHU 520
	10	A 24-L 10	15,2	28,5	11,0	10,0	25,5	10,5	50/25		
185	12	A 24-L 12	15,2	28,5	14,0	12,0	25,5	13,2	50/25	TN 120 SE**	HT 120 and tools and heads with 130 kN crimping force ECW-H3D RHU 520
	10	A 30-L 10	16,7	31,5	13,0	11,0	28,5	10,5	50/25		
240	12	A 30-L 12	16,7	31,5	16,0	14,0	28,5	13,2	50/25	TN 120 SE**	HT 120 and tools and heads with 130 kN crimping force ECW-H3D RHU 520
	10	A 37-L 10	19,2	35,5	13,0	11,0	31,5	10,5	50/25		
300	12	A 37-L 12	19,2	35,5	16,0	14,0	31,5	13,2	50/25	TN 120 SE**	HT 120 and tools and heads with 130 kN crimping force ECW-H3D RHU 520
	12	A 48-L 12	21,1	39,0	16,0	14,0	33,0	13,2	30/15		
300	12	A 60-L 12	23,7	44,0	20,0	14,0	42,0	13,2	20/10	TN 120 SE**	HT 120 and tools and heads with 130 kN crimping force ECW-H3D RHU 520
	12	A 60-L 12	23,7	44,0	20,0	14,0	42,0	13,2	20/10		

*Actual conductor section may require a larger lug eg for 120mm² size use A30-... lug.

**See page 111

♦Not UL approved

A-L series lugs angled 90° are manufactured from electrolytic Copper tube. The dimensions of the tube are designed to obtain the most efficient electrical conductivity and mechanical strength to resist vibration and pull out.

Cembre lugs are annealed to guarantee optimum ductility which is an absolute necessity for connectors which will have to withstand the severe deformation arising when compressed and any bending of the palm during installation.

In applications subject to vibration, terminals still have to perform a reliable connection, annealing plays a vital role in avoiding cracking or breaks between the barrel and palm.

The presence of an inspection hole facilitates full insertion of the conductor, whilst the barrel length has been designed to allow easy and accurate positioning of the dies during the crimping operation.

Lugs are electrolytically tinned to avoid oxidation. Details of the appropriate crimping tools and dies are shown on pages 178 to 179.

A-2M

COPPER TUBE CRIMPING LUGS

double hole fixing
for Copper conductors



File no. E125401

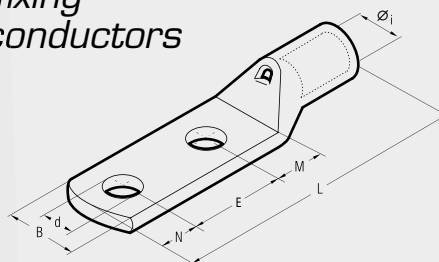

A-2M.. series lugs are manufactured from electrolytic Copper tube conforming to EN13600.

The tube dimensions are designed to optimise electrical conductivity and mechanical strength.

Palms feature double stud holes at standard 44.5mm centres.

Other configurations are available upon request.

Lugs are annealed to ensure ductility and satisfactory performance when subjected to deformation and vibration.

Inspection holes facilitate verification of full conductor insertion, while the barrel length has been determined to allow easy and accurate positioning of the crimping dies.

Lugs are electrolytically Tin plated to avoid oxidation.

Details of the appropriate crimping tools and dies are shown on pages 178 to 179.

Cond. Size AWG	Ø Stud in.	Ref.	Dimensions in.							Quantity Bag	Mechanical Tools	Hydraulic Tools
			Øi	B	M	N	E	L	d			
35	8	A7-2M8*	8,9	21,0	13,0	11,0	44,5	90,0	8,4	100	TN 70 SE	
	10	A7-2M10*	8,9	19,0	11,0	10,0	44,5	87,0	10,5	100		
	12	A7-2M12*	8,9	21,0	16,0	14,0	44,5	96,0	13,2	100		
50	8	A10-2M8*	10,0	19,0	11,0	11,0	44,5	92,0	8,4	50	TN 120 SE*	
	10	A10-2M10*	10,0	20,0	13,0	11,0	44,5	94,0	10,5	50		
	12	A10-2M12	10,0	21,0	16,0	14,0	44,5	100,0	13,2	50		
70	8	A14-2M8*	11,3	21,0	11,0	11,0	44,5	95,5	8,4	50	B 35-45WDE B 35-50WDE HT 45-E	
	10	A14-2M10*	11,3	21,0	13,0	11,0	44,5	97,5	10,5	50		
	12	A14-2M12*	11,3	22,0	16,0	14,0	44,5	103,5	13,2	50		
95	14	A14-2M14*	11,3	25,0	18,0	16,0	44,5	107,5	15,0	50	HT 51 B 550E RH 50 B 500E HT 81-U RHU 81	
	10	A19-2M10*	13,5	25,0	13,0	11,0	44,5	104,0	10,5	25		
	12	A19-2M12*	13,5	25,0	16,0	14,0	44,5	110,0	13,2	25		
120	14	A19-2M14*	13,5	25,0	18,0	16,0	44,5	114,0	15,0	25	HT 120 and tools and heads with 130 kN crimping force ECWH3D RHU 500	
	16	A19-2M16*	13,5	25,0	19,0	17,0	44,5	116,0	17,0	25		
	10	A24-2M10	15,2	28,5	13,0	11,0	44,5	105,5	10,5	25		
150	12	A24-2M12*	15,2	28,5	16,0	14,0	44,5	113,0	13,2	25		
	14	A24-2M14	15,2	28,5	18,0	16,0	44,5	116,5	15,0	25		
	16	A24-2M16	15,2	28,5	19,0	17,0	44,5	119,0	17,0	25		
185	10	A30-2M10*	16,7	31,5	13,0	11,0	44,5	113,5	10,5	25		
	12	A30-2M12*	16,7	31,5	16,0	14,0	44,5	119,5	13,2	25		
	14	A30-2M14	16,7	31,5	18,0	16,0	44,5	123,5	15,0	25		
240	16	A30-2M16*	16,7	31,5	19,0	17,0	44,5	125,5	17,0	25		
	10	A37-2M10*	19,2	35,5	13,0	11,0	44,5	120,5	10,5	15		
	12	A37-2M12	19,2	35,5	16,0	14,0	44,5	126,5	13,2	15		
300	14	A37-2M14	19,2	35,5	18,0	16,0	44,5	130,5	15,0	15		
	16	A37-2M16*	19,2	35,5	19,0	17,0	44,5	132,5	17,0	15		
	10	A48-2M10*	21,1	39,0	13,0	11,0	44,5	126,5	10,5	15		
400	12	A48-2M12	21,1	39,0	16,0	14,0	44,5	132,5	13,2	15		
	14	A48-2M14	21,1	39,0	18,0	16,0	44,5	136,5	15,0	15		
	16	A48-2M16*	21,1	39,0	19,0	17,0	44,5	138,5	17,0	15		
500	10	A60-2M10*	23,7	44,0	13,0	11,0	44,5	133,5	10,5	5		
	12	A60-2M12	23,7	44,0	20,0	14,0	44,5	143,5	13,2	5		
	14	A60-2M14	23,7	44,0	22,0	16,0	44,5	147,5	15,0	5		
630	16	A60-2M16	23,7	44,0	22,0	17,0	44,5	148,5	17,0	5		
	12	A80-2M12*	27,0	51,0	22,0	14,0	44,5	152,5	13,2	5		
	14	A80-2M14*	27,0	51,0	22,0	16,0	44,5	154,5	15,0	5		
800	16	A80-2M16*	27,0	51,0	22,0	19,0	44,5	157,5	17,0	5		
	12	A100-2M12*	30,3	56,5	17,0	14,0	44,5	151,5	13,2	5		
	16	A100-2M16*	30,3	56,5	19,0	19,0	44,5	158,5	17,0	5		
800	12	A120-2M12*	33,4	61,6	22,0	14,0	44,5	167,5	13,2	1		
	16	A120-2M16*	33,4	61,6	22,0	19,0	44,5	172,5	17,0	1		
	12	A160-2M12*	38,0	72,0	20,0	14,0	44,5	176,5	13,2	1		
800	16	A160-2M16*	38,0	72,0	22,0	19,0	44,5	183,5	17,0	1		

*See page 111

♦Not UL approved

THROUGH CONNECTORS



File no. E125401

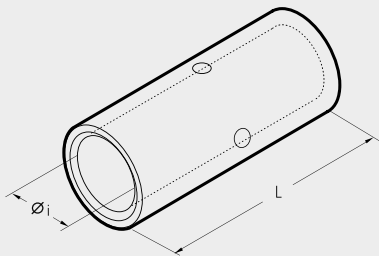

Conductor Size sqmm		Ref.	Dimensions mm		Quantity Box/Bag	Mechanical Tools	Hydraulic Tools
low stranded	Flexible		Øi	L			
0,25÷1,5	0,25÷1,5	L 03-M*	1,8	15	6.000/100		
1,5÷2,5	1,5÷2,5	L 06-M*	2,4	15	4.000/100	HN 1	
4÷6	4÷6	L 1-M*	3,6	22	2.000/100	HN 5	
10	10	L 2-M	4,6	25	1.000/100	HN A25	
16	16	L 3-M	5,8	27	1.000/100	TN 70 SE	
25	25	L 5-M	7,0	29	500/100	TN 120 SE*	B 15MDE
35	25÷35	L 7-M	8,9	33	400/100		B 35-45MDE
50	35÷50	L 10-M	10,0	37	200/50		B 35-50MDE
70	50÷70	L 14-M	11,3	39	200/50		HT 45-E
95	70÷95	L 19-M	13,5	43	100/25		HT 51 B 550E
120	95÷120	L 24-M	15,2	47	100/25		RH 50 B 500E
150	120÷150	L 30-M	16,7	58	50/25		HT 81-U RHU 81
185	150÷185	L 37-M	19,2	64	50/25		HT 120 and tools and heads with 130 kN crimping force
240	185÷240	L 48-M	21,1	75	30/15		ECW-H3D
300	240÷300	L 60-M	23,7	90	20/10		RHU 520
400	300÷400	L 80-M	27,0	94	20/5		
500	400÷500	L 100-M	30,3	98	12/1		
630	500÷630	L 120-M*	33,4	105	12/1		
800	600	L 160-M*	38,0	112	9/1		
1000	800	L 200-M*	44,0	120	6/1		

*See page 111

♦Not UL approved

L-M



L-M range of connectors are designed for jointing low voltage conductors. Made of electrolytic Copper tube having the same dimension as A-M series lugs: L-M connectors are annealed and electrolytically Tin plated.

They feature an internal taper at both ends to ease the introduction of the conductor and a central stop to ensure correct positioning.

Details of the appropriate crimping tools and dies are shown on pages 178 to 179.

PARALLEL CONNECTORS

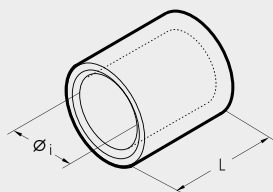

Total Conductor Size sqmm		Ref.	Dimensions mm		Quantity Box/Bag	Mechanical Tools	Hydraulic Tools
low stranded	Flexible		Øi	L			
0,25÷1,5	0,25÷1,5	L 03-P	1,8	6,0	10.000/100		
1,5÷2,5	1,5÷2,5	L 06-P	2,4	6,0	5.000/100	HN 1	
4÷6	4÷6	L 1-P	3,6	9,0	3.000/100	HN 5	
10	10	L 2-P	4,6	10,5	3.000/100	HN A25	
16	16	L 3-P	5,8	11,5	2.000/100	TN 70 SE	
25	25	L 5-P	7,0	13,0	1.500/100	TN 120 SE*	B 15MDE
35	25÷35	L 7-P	8,9	14,0	500/100		B 35-45MDE
50	35÷50	L 10-P	10,0	16,0	500/100		B 35-50MDE
70	50÷70	L 14-P	11,3	18,0	500/100		HT 45-E
95	70÷95	L 19-P	13,5	19,0	300/50		HT 51 B 550E
120	95÷120	L 24-P	15,2	22,0	200/50		RH 50 B 500E
150	120÷150	L 30-P	16,7	26,5	100/50		HT 81-U RHU 81
185	150÷185	L 37-P	19,2	26,5	100/50		HT 120 and tools and heads with 130 kN crimping force
240	185÷240	L 48-P	21,1	34,0	60/15		ECW-H3D
300	240÷300	L 60-P	23,7	43,0	50/25		RHU 520

*See page 111

L-P



Made of electrolytic Copper tube, having the same dimensions as A-M series lugs, L-P connectors are annealed and electrolytically Tin plated.

They feature an internal taper to ease the introduction of the conductor.

Details of the appropriate crimping tools and dies are shown on pages 178 to 179.

POLYAMIDE PA6.6 INSULATED COPPER TUBE LUGS

ANE-M

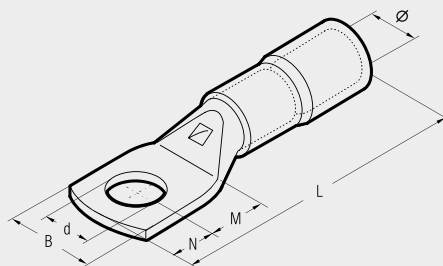

ANE-M series lugs are manufactured from electrolytic Copper tube annealed and Tin plated.

The interior of the PA6.6 insulated sleeve is funnel shaped so as to ensure complete and easy introduction of the conductor strands.

It also eliminates the need to insulate the terminal using either tape or heat shrinkable tubing.

Furthermore the PA6.6 sleeve avoids the possibility of conductor breakage at the barrel entrance.

The operating temperature range is - 20 to + 115°C (Surge + 130°C).

In order to achieve the best electrical and mechanical performance it is suggested that they are crimped using dies and tools specifically developed for this purpose by Cembre.

Details of the appropriate crimping tools and dies are shown on pages 182 to 183.

Cond. Size Flexible sqmm	Ø Stud mm	Ref.	Dimensions mm						Quantity Box/Bag	Mechanical Tools	Hydraulic Tools
			Ø	B	M	N	L	d			
10	4	ANE 2-M 4	8,0	10,0	5,0	4,0	34,1	4,3	500/100	HN33	B 15MDE
	5	ANE 2-M 5	8,0	10,0	6,5	6,0	37,6	5,3	500/100		
	6	ANE 2-M 6	8,0	11,0	7,0	6,0	38,1	6,4	500/100		
	8	ANE 2-M 8	8,0	15,0	9,0	8,0	42,1	8,4	500/100		
	10	ANE 2-M 10	8,0	18,0	11,0	10,0	46,1	10,5	500/100		
	12	ANE 2-M 12	8,0	19,0	14,0	12,0	51,1	13,2	500/100		
16	4	ANE 3-M 4	9,2	11,5	5,0	4,0	38,6	4,3	500/100	HN34	B 15MDE
	5	ANE 3-M 5	9,2	11,5	6,5	6,0	42,1	5,3	500/100		
	6	ANE 3-M 6	9,2	11,5	7,0	6,0	42,6	6,4	500/100		
	8	ANE 3-M 8	9,2	15,0	9,0	8,0	46,6	8,4	500/100		
	10	ANE 3-M 10	9,2	18,0	11,0	10,0	50,6	10,5	400/100		
	12	ANE 3-M 12	9,2	20,0	14,0	12,0	55,6	13,2	300/100		
25	4	ANE 5-M 4	11,1	14,0	5,0	4,0	41,0	4,3	300/100	TNM 70	B 35-50MDE
	5	ANE 5-M 5	11,1	14,0	6,5	6,0	44,5	5,3	300/100		
	6	ANE 5-M 6	11,1	14,0	7,0	6,0	45,0	6,4	300/100		
	8	ANE 5-M 8	11,1	15,0	9,0	8,0	49,0	8,4	300/100		
	10	ANE 5-M 10	11,1	18,0	11,0	10,0	53,0	10,5	300/100		
	12	ANE 5-M 12	11,1	21,0	14,0	12,0	58,0	13,2	250/50		
35	6	ANE 7-M 6	13,6	17,0	7,0	6,0	50,0	6,4	200/50	TNM 120	B 500 E B 550E
	8	ANE 7-M 8	13,6	17,0	9,0	8,0	54,0	8,4	200/50		
	10	ANE 7-M 10	13,6	19,0	11,0	10,0	58,0	10,5	200/50		
	12	ANE 7-M 12	13,6	21,0	14,0	12,0	63,0	13,2	200/50		
	6	ANE 10-M 6	13,8	19,0	8,0	7,0	53,0	6,4	200/50		
	8	ANE 10-M 8	13,8	19,0	9,0	8,0	55,0	8,4	150/50		
50	10	ANE 10-M 10	13,8	20,0	11,5	9,5	59,0	10,5	150/50	TNM 120	HT 51 RH 50 B 500 E B 550E
	12	ANE 10-M 12	13,8	21,0	12,0	12,0	62,0	13,2	150/50		
	6	ANE 14-M 6	15,8	21,0	8,0	7,0	61,0	6,4	100/25		
	8	ANE 14-M 8	15,8	21,0	9,0	8,0	63,0	8,0	100/25		
	10	ANE 14-M 10	15,8	21,0	11,0	10,0	67,0	10,5	100/25		
	12	ANE 14-M 12	15,8	22,0	14,0	12,0	72,0	13,2	100/25		
70	14	ANE 14-M 14	15,8	25,0	16,0	14,0	76,0	15,0	100/25	TNM 120	HT 120 and tools and heads with 130 kN crimping force
	8	ANE 19-M 8	18,0	25,0	9,0	8,0	73,0	8,4	50/25		
	10	ANE 19-M 10	18,0	25,0	11,0	10,0	77,0	10,5	50/25		
	12	ANE 19-M 12	18,0	25,0	14,0	12,0	82,0	13,2	50/25		
	14	ANE 19-M 14	18,0	25,0	16,0	14,0	86,0	15,0	50/25		
	16	ANE 19-M 16	18,0	27,0	18,0	16,0	80,0	17,0	50/25		
120	10	ANE 24-M 10	20,0	28,5	11,0	10,0	77,7	10,5	50/25	TNM 120	ECW-H3D
	12	ANE 24-M 12	20,0	28,5	14,0	12,0	86,5	13,2	50/25		
	14	ANE 24-M 14	20,0	28,5	16,0	14,0	88,5	15,0	50/25		
	16	ANE 24-M 16	20,0	28,5	18,0	16,0	90,5	17,0	50/25		
	12	ANE 30-M 12	23,0	31,5	16,0	14,0	101,0	13,2	30/15		
	14	ANE 30-M 14	23,0	31,5	18,0	16,0	105,0	15,0	30/15		
150	16	ANE 30-M 16	23,0	31,5	19,0	17,0	107,0	17,0	30/15	TNM 120	ECW-H3D
	20	ANE 30-M 20	23,0	31,5	22,0	20,0	113,0	21,0	30/15		



POLYAMIDE PA6.6 INSULATED FORK TERMINALS



File no. E125401

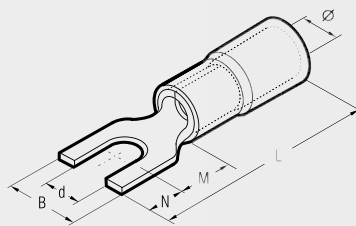

ANE-U



Conductor Size Flexible sqmm	Ø Stud mm	Ref.	Dimensions mm						Quantity Box/Bag	Mechanical Tools				Hydraulic Tools			
			Ø	B	M	N	L	d		HNN 3	HNN 4	TNN70	TNN 120	B 15MDE	B 35-50MDE	HT 51 RH 50	B 50DE - B 55OE
10	4	ANE 2-U 4	8,0	9,8	7,5	7,0	35,1	4,3	500/100								
	5	ANE 2-U 5	8,0	11,5	7,5	7,0	35,1	5,3	500/100								
16	4	ANE 3-U 4	9,2	10,0	10,0	8,0	41,1	4,3	500/100								
	5	ANE 3-U 5	9,2	11,5	10,0	8,0	41,1	5,3	500/100								

The operating temperature range is - 20 to + 115°C (Surge + 130°C).

In order to achieve the best electrical and mechanical performance it is suggested that they are crimped using dies and tools specifically developed for this purpose by Cembre.

Details of the appropriate crimping tools and dies are shown on pages 182 to 183.

ANE-U series terminals are made from electrolytic Copper, rolled, Tin plated and brazed.

The interior of the PA6.6 insulated sleeve is funnel shaped so as to ensure complete and easy introduction of the conductor strands.

FLEXIBLE BRAIDS

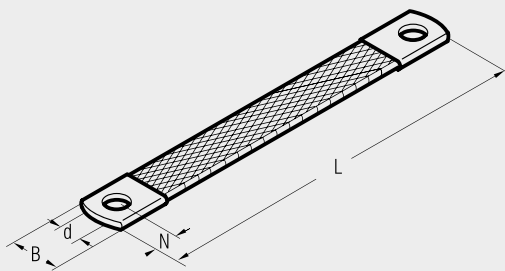

FL



Size sqmm	Ø Stud mm	Ref.	Dimensions mm				Quantity
			B	N	L	d	
10	8	FL 10-150	17	10	150	8,5	50
	8	FL 10-200	17	10	200	8,5	50
	8	FL 10-250	17	10	250	8,5	50
	8	FL 16-150	17	10	150	8,5	50
	8	FL 16-200	17	10	200	8,5	50
16	8	FL 16-250	17	10	250	8,5	50
	8	FL 16-320	17	10	320	8,5	50
	8	FL 16-350	17	10	350	8,5	50
	8	FL 16-420	17	10	420	8,5	25
	8	FL 16-570	17	10	570	8,5	25
	8	FL 16-660	17	10	660	8,5	25
25	8	FL 25-150	21	10	150	8,5	50
	8	FL 25-200	21	10	200	8,5	50
	8	FL 25-250	21	10	250	8,5	50
	8	FL 25-300	21	10	300	8,5	50

Flexible braids are manufactured from electrolytic Copper wire.

Braids of different conductor sizes or lengths are available on request.

Standard finish - bright Copper.

Flexible braids can be supplied Tin plated, in this case add the suffix "ST" to reference.

E.g.:

- FL 10-150 (Bright Copper)

- FL 10-150-ST (Tin plated)

ANE-P



POLYAMIDE PA6.6 INSULATED PIN TERMINALS



File no. E125401

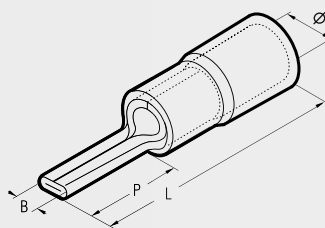

ANE-P series terminals are made from electrolytic Copper, rolled, Tin plated and brazed. The interior of the PA6.6 insulated sleeve is funnel shaped so as to ensure complete and easy introduction of the conductor strands.

The operating temperature range is - 20 to + 115°C (Surge + 130°C).

In order to achieve the best electrical and mechanical performance it is suggested that they are crimped using dies and tools specifically developed for this purpose by Cembre.

Conductor Size Flexible sqmm	Ref.	Dimensions mm				Quantity Box/Bag	Mechanical Tools				Hydraulic Tools		
		Ø	B	P	L		HNN 3	HNN 4	TNN 70	TNN 120	B 15MDE	B 35-50MDE HT 51 RH 50 B 50OE B 55OE	HT 120 and tools and heads with 130 kN crimping force
10	ANE 2-P 12	8,0	4,3	14,5	35,1	500/100							
16	ANE 3-P 14	9,2	5,5	18,0	41,1	500/100							
25	ANE 5-P 16	11,1	7,0	20,3	45,0	300/100							
35	ANE 7-P 20	13,6	8,0	24,5	55,0	200/50							

Details of the appropriate crimping tools and dies are shown on pages 182 to 183.

A-P



UNINSULATED PIN CONNECTORS

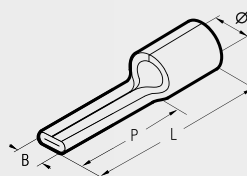

A-P series pin connectors are designed to terminate conductors into contact blocks.

They are manufactured from Copper strip, rolled, brazed and Tin plated.

Details of the appropriate crimping tools and dies are shown on pages 178 to 179.

Cond. Size sqmm	Ref.	Dimensions mm				Quantity Box/Bag	Mechanical Tools				Hydraulic Tools		
		Ø1	B	P	L		HN 1	HN 5	HN-A25	TN 70 SE	TN 120 SE	B 15MDE	B 35-45MDE B 35-50MDE HT 45-E
10	A 2-P 12	4,8	4,3	14,5	23,5	1.000/100							
16	A 3-P 14	5,9	5,5	18,0	28,0	1.500/100							
25	A 5-P 16	7,0	7,0	20,3	32,0	1.000/100							
35	A 7-P 20	8,9	8,0	24,5	39,0	500/100							
50	A 10-P 25	10,0	9,5	26,0	45,0	250/50							
70	A 14-P 30	11,5	11,0	31,0	55,0	200/50							

POLYAMIDE PA6.6 INSULATED COPPER TUBE LUGS

for extra flexible Copper conductors

ANE-M

for fine stranded
SPECIAL
flexible conductors

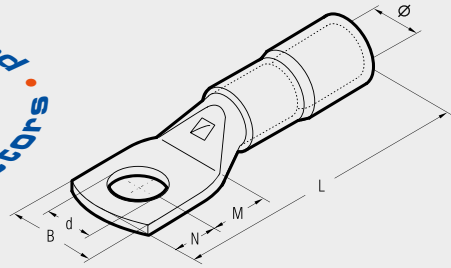

Conductor Size Extra Flexible sqmm	Ø Stud mm	Ref.	Dimensions mm						Quantity Box/Bag	Mechanical Tools	Hydraulic Tools				
			Ø	B	M	N	L	d							
35	6	ANE 9-M 6/15	13,6	15,0	8,0	7,0	54,0	6,4	200/50	TMM 70	B 35-50MDE B 550E				
	8	ANE 9-M 8	13,6	17,0	9,0	8,0	56,0	8,4	200/50						
	10	ANE 9-M 10	13,6	18,5	11,0	10,0	60,0	10,5	150/50						
	12	ANE 9-M 12	13,6	21,0	14,0	12,0	65,0	13,2	150/50						
50	6	ANE 12-M 6/15	15,7	15,0	8,0	7,0	59,5	6,4	100/25			TMM 120	B 500E B 550E		
	8	ANE 12-M 8	15,7	19,8	9,0	8,0	61,5	8,4	100/25						
	10	ANE 12-M 10	15,7	19,8	11,0	10,0	65,5	10,5	100/25						
	10	ANE 12-M 10/19	15,7	19,0	11,0	10,0	65,5	10,5	100/25						
70	12	ANE 12-M 12	15,7	22,0	14,0	12,0	70,5	13,2	100/25					HT 51 RH 50 ECW-H3D	HT 120 and tools and heads with 130 kN crimping force
	6	ANE 17-M 6	17,9	23,0	8,0	7,0	63,8	6,4	100/25						
	8	ANE 17-M 8	17,9	23,0	9,0	8,0	65,8	8,4	100/25						
	10	ANE 17-M 10	17,9	23,0	11,0	10,0	69,8	10,5	50/25						
	10	ANE 17-M 10/19	17,9	19,0	11,0	10,0	69,8	10,5	100/25						
	12	ANE 17-M 12	17,9	23,0	14,0	12,0	74,8	13,2	50/25						
95	14	ANE 17-M 14	17,9	25,0	15,5	12,0	76,3	15,0	50/25	HT 120 and tools and heads with 130 kN crimping force	ECW-H3D				
	16	ANE 17-M 16	17,9	27,0	16,5	13,5	78,8	17,0	50/25						
	8	ANE 20-M 8	20,0	27,0	9,0	8,0	70,6	8,4	50/25						
	10	ANE 20-M 10	20,0	27,0	11,0	10,0	74,6	10,5	50/25						
120	12	ANE 20-M 12	20,0	27,0	14,0	12,0	79,6	13,2	50/25			HT 120 and tools and heads with 130 kN crimping force	ECW-H3D		
	14	ANE 20-M 14	20,0	27,0	15,5	12,0	81,1	15,0	50/25						
	16	ANE 20-M 16	20,0	27,0	16,5	13,5	83,6	17,0	50/25						
	10	ANE 29-M 10	22,4	30,0	11,0	10,0	81,5	10,5	50/25						
150	12	ANE 29-M 12	22,4	30,0	14,0	12,0	86,5	13,2	50/25					HT 120 and tools and heads with 130 kN crimping force	ECW-H3D
	14	ANE 29-M 14	22,4	30,0	15,5	12,0	88,5	15,0	50/25						
	16	ANE 29-M 16	22,4	30,0	16,5	13,5	90,5	17,0	50/25						
	20	ANE 29-M 20	22,4	30,0	22,0	20,0	102,5	21,0	40/20						
150	12	ANE 35-M 12	25,0	34,2	16,0	14,0	95,0	13,2	30/15	HT 120 and tools and heads with 130 kN crimping force	ECW-H3D				
	14	ANE 35-M 14	25,0	34,2	18,0	16,0	99,0	15,0	30/15						
	16	ANE 35-M 16	25,0	34,2	19,0	17,0	101,0	17,0	30/15						
	20	ANE 35-M 20	25,0	34,2	22,0	20,0	107,0	21,0	30/15						

These lugs are particularly recommended for use with extra flexible conductors on for instance, welding machines.

ANE-M series lugs are manufactured from electrolytic Copper tube annealed and Tin plated.

The interior of the PA6.6 insulated sleeve is funnel shaped so as to ensure complete and easy introduction of the conductor strands.

It also eliminates the need to insulate the terminal using either tape or heat shrinkable tubing.

Furthermore the PA6.6 sleeve avoids the possibility of conductor breakage at the barrel entrance.

The operating temperature range is - 20 to + 115°C (Surge + 130°C).

In order to achieve the best electrical and mechanical performance it is suggested that they are crimped using dies and tools specifically developed for this purpose by Cembre.

Details of the appropriate crimping tools and dies are shown on pages 182 to 183.

A-M



COPPER TUBE CRIMPING LUGS

for extra flexible Copper conductors

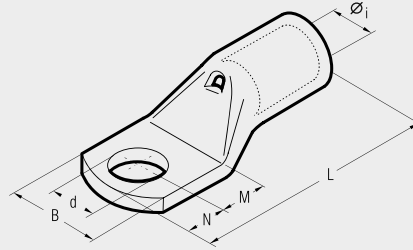

for fine stranded
SPECIAL
flexible conductors

These lugs are particularly recommended for use with extra flexible conductors on for instance, welding machines.

A-M series lugs are designed to suit panel applications.

The dimensions of the tube are designed to obtain the most efficient electrical conductivity and mechanical strength to resist vibration and pull out.

Cembre lugs are annealed to guarantee optimum ductility and electrolytically Tin plated to avoid oxidation.

The presence of an inspection hole facilitates full insertion of the conductor.

Details of the appropriate crimping tools and dies are shown on pages 178 to 179.

Conductor Size Extra Flexible sqmm	Ø Stud mm	Ref.	Dimensions mm						Quantity Box/Bag	Mechanical Tools	Hydraulic Tools		
			Øi	B	M	N	L	d					
35	6	A 9-M 6/15	9,3	15,0	8,0	7,0	38,5	6,4	400/100	TN 70 SE			
	8	A 9-M 8	9,3	17,0	9,0	8,0	40,5	8,4	400/100				
	10	A 9-M 10	9,3	18,5	11,0	10,0	44,5	10,5	400/100				
	12	A 9-M 12	9,3	21,0	14,0	12,0	49,5	13,2	300/50				
50	6	A 12-M 6/15	11,0	15,0	8,0	7,0	40,5	6,4	200/50				
	8	A 12-M 8	11,0	19,3	9,0	8,0	42,5	8,4	200/50				
	10	A 12-M 10	11,0	19,3	11,0	10,0	46,5	10,5	200/50				
	10	A 12-M 10/19	11,0	19,0	11,0	10,0	46,5	10,5	200/50				
70	12	A 12-M 12	11,0	22,0	14,0	12,0	51,5	13,2	200/50			TN 120 SE	B 35-45WIDE B 35-50WIDE HT 45E HT 50E HT 51 RH 50 B 500E B 550E HT 81-U RHU 81 HT 120 and tools and heads with 130 kN crimping force ECW-H30 RHU 520
	6	A 17-M 6	13,0	23,0	8,0	7,0	45,0	6,4	200/50				
	8	A 17-M 8	13,0	23,0	9,0	8,0	47,0	8,4	150/50				
	10	A 17-M 10	13,0	23,0	11,0	10,0	51,0	10,5	150/50				
	10	A 17-M 10/19	13,0	19,0	11,0	10,0	51,0	10,5	200/50				
	12	A 17-M 12	13,0	23,0	14,0	12,0	56,0	13,2	150/50				
95	14	A 17-M 14	13,0	25,0	15,5	12,0	57,5	15,0	150/25				
	16	A 17-M 16	13,0	27,0	16,5	13,5	60,0	17,0	150/25				
	8	A 20-M 8	15,0	27,0	9,0	8,0	50,0	8,4	100/25				
	10	A 20-M 10	15,0	27,0	11,0	10,0	54,0	10,5	100/25				
120	12	A 20-M 12	15,0	27,0	14,0	12,0	59,0	13,2	100/25				
	14	A 20-M 14	15,0	27,0	15,5	12,0	60,5	15,0	100/25				
	16	A 20-M 16	15,0	27,0	16,5	13,5	63,0	17,0	100/25				
	8	A 29-M 8	16,5	30,0	9,0	8,0	53,5	8,4	100/25				
150	10	A 29-M 10	16,5	30,0	11,0	10,0	57,5	10,5	100/25				
	12	A 29-M 12	16,5	30,0	14,0	12,0	62,5	13,2	100/25				
	14	A 29-M 14	16,5	30,0	15,5	12,0	64,0	15,0	100/25				
	16	A 29-M 16	16,5	30,0	16,5	13,5	66,5	17,0	100/25				
185	20	A 29-M 20	16,5	30,0	22,0	20,0	78,5	21,0	75/25				
	10	A 35-M 10	19,2	34,2	13,0	11,0	65,5	10,5	50/25				
	12	A 35-M 12	19,2	34,2	16,0	14,0	71,5	13,2	50/25				
	14	A 35-M 14	19,2	34,2	18,0	16,0	75,5	15,0	50/25				
185	16	A 35-M 16	19,2	34,2	19,0	17,0	77,5	17,0	50/25				
	20	A 35-M 20	19,2	34,2	22,0	20,0	83,5	21,0	50/25				
	10	A 40-M 10	21,0	37,5	13,0	11,0	73,0	10,5	30/15				
	12	A 40-M 12	21,0	37,5	16,0	14,0	79,0	13,2	30/15				
185	14	A 40-M 14	21,0	37,5	18,0	16,0	83,0	15,0	30/15				
	16	A 40-M 16	21,0	37,5	19,0	17,0	85,0	17,0	30/15				
185	20	A 40-M 20	21,0	37,5	22,0	20,0	91,0	21,0	30/15				

COPPER TUBE LUGS 4-ESI FIXING

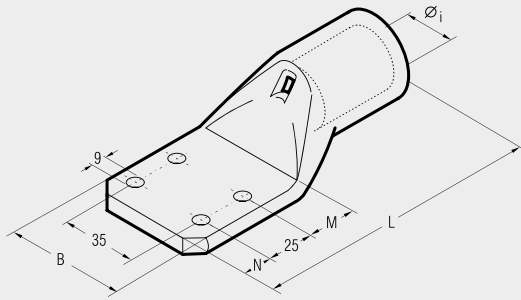

A-4ESI



Conductor Size sqmm	Ref.	Dimensions mm					Quantity Box/Bag	Hydraulic Tools						
		Øi	B	M	N	L		HT 51	B 550E	RH 50	B500E	HT 81-U RHU 81	HT 120 and tools and heads with 130 kN crimping force	ECW-H3D
185	A 37-4ESI	19,2	61	20	15	124	20/10							
240	A 48-4ESI	21,1	61	20	15	128	20/10							
300	A 60-4ESI	23,7	61	20	15	133	15/5							
400	A 80-4ESI	27,0	61	20	15	134	15/5							
500	A 100-4ESI	30,3	61	20	15	139	10/5							
630	A 120-4ESI	33,4	61	20	15	144	10/5							
800	A 160-4ESI	38,0	61	20	15	158	8/1							

A-4ESI series lugs are made from high purity electrolytic Copper tube, annealed and Tin plated. The four hole stud fixing in accordance with E.A. specifications ensures compatibility with most transformer fixing arrangements. Details of the appropriate crimping tools and dies are shown on pages 178 to 179.

INSULATED COVERS

For uninsulated connectors

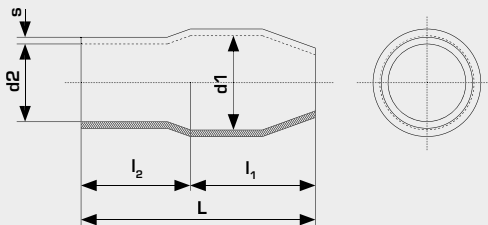

ES

Ref.	Connectors A-M*	d1 Ø	d2 Ø	l ₁ ±1	l ₂ ±1	L ± 2	s ± 0.2	Quantity	Minimum Order Qty
ES03..	A03	3.3	3.1	7.0	8.0	15.0	0.6	100	3.000
ES06..	A06	4.5	3.7	8.0	8.0	16.0	0.7	100	
ES1..	A1	5.7	4.1	9.0	9.0	18.0	0.8	100	
ES2..	A2	7.2	6.2	11.0	10.0	21.0	1.0	100	1.000
ES3..	A3	10.0	8.0	15.0	13.0	28.0	1.1	100	
ES5..	A5	12.0	9.5	15.0	14.0	29.0	1.2	100	
ES10..	A7, A9, A10	14.0	11.8	17.0	17.0	34.0	1.4	100	500
ES14..	A12, A14	17.0	13.9	22.0	20.0	42.0	1.5	100	
ES19..	A17, A19	19.0	16.0	25.0	21.0	46.0	1.5	50	
ES24..	A20, A24	22.0	18.0	31.0	24.0	55.0	1.7	50	200
ES30..	A29, A30	24.0	20.0	32.0	28.0	60.0	1.8	50	
ES37..	A35, A37	26.0	22.0	34.0	31.0	65.0	1.8	50	
ES40..	A40, A48**	32.2	24.0	38.0	31.0	69.0	2.0	50	100
ES48..	A48**	36.5	27.2	42.0	33.0	75.0	2.0	50	
ES80..	A60, A80	36.7	30.0	42.0	33.0	75.0	2.0	25	

Dimensions are in mm

Add the suffix corresponding to the selected colour to the reference:

-BU blue, **-GY** grey, **-BR** brown, **-BK** black, **-RE** red, **-YE** yellow,

* See A-M type copper tube lugs on pages 22-23, 32

** Depending on the diameter of the insulated cable

Insulated covers in PVC for general use with Cembre A-M copper tube lugs characterised by environmental tolerance, flexibility, not inflammability & stable performance. Widely used for the insulation and protection of connections and electrical terminations.

General features:

- **Material:** PVC
- **Self extinguishing (UL94):** VO
- **Working temperature:** 85 °C
- **Colours:** red, yellow, blue, black, grey, brown.

COPPER TUBE CRIMPING LUGS ACCORDING TO DIN 46235

for Copper conductors

DR

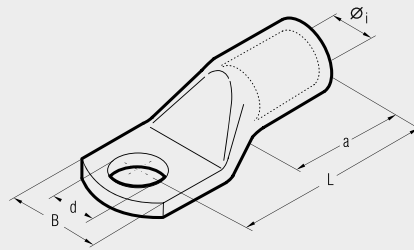

DR series lugs are manufactured from electrolytic Copper tube and designed to obtain high electrical conductivity combined with the mechanical strength required to resist vibration and pull out.

Cembre lugs are annealed and Tin plated for improved surface protection.

The annealing process optimises the structural features of the material allowing easier crimping and greater resistance to mechanical stresses.

Dimensions are according to DIN 46235.

The barrel entrance of the lug is chamfered to allow easy conductor insertion, while its length facilitates precise positioning in the crimping die.

Each lug is marked with:

- Cembre logo and part code.
- conductor type and csa (mm²).
- Stud Ø (mm).
- crimping die code

Details of the appropriate crimping tools and dies are shown on page 189.

Consult us for special requirements

Conductor Size sqmm	Ø Stud mm	Ref.	Code	Dimensions mm					Quantity Box/Bag	Mechanical Tools	Hydraulic Tools				
				Øi	d	L	B	a							
6	5	DR6-5	5	3,8	5,3	24,0	8,5	10,0	800/100	HIN025	B 15WDE				
	6	DR6-6	5	3,8	6,4	24,0	9,0	10,0	800/100						
	8	DR6-8*	5	3,8	8,4	26,0	13,0	10,0	800/100						
10	5	DR10-5	6	4,5	5,3	27,5	10,0	10,0	800/100	HIN025	B 15WDE				
	6	DR10-6	6	4,5	6,4	27,0	10,0	10,0	800/100						
	8	DR10-8*	6	4,5	8,4	28,0	13,0	10,0	800/100						
16	10	DR10-10*	6	4,5	10,5	28,5	15,0	10,0	800/100	HIN025	B 15WDE				
	5	DR16-5*	8	5,5	5,3	36,0	13,0	20,0	400/100						
	6	DR16-6	8	5,5	6,4	36,0	13,0	20,0	400/100						
25	8	DR16-8	8	5,5	8,4	37,0	13,0	20,0	400/100	HIN025	B 15WDE				
	10	DR16-10	8	5,5	10,5	40,0	17,0	20,0	400/100						
	12	DR16-12*	8	5,5	13,0	41,0	19,0	20,0	400/100						
35	6	DR25-6	10	7,0	6,4	39,0	14,6	20,0	400/100	TND 6-70					
	8	DR25-8	10	7,0	8,4	39,5	16,0	20,0	400/100						
	10	DR25-10	10	7,0	10,5	40,0	17,0	20,0	200/100						
50	12	DR25-12	10	7,0	13,0	40,5	19,0	20,0	200/100	TND 6-70					
	6	DR35-6*	12	8,2	6,4	42,5	17,5	20,0	200/100						
	8	DR35-8	12	8,2	8,4	42,0	17,0	20,0	200/100						
70	10	DR35-10	12	8,2	10,5	43,0	19,0	20,0	200/100	TND 10-120	B 35-45WDE	B 35-50WDE	HT 45-E	HT 51 RH 50 B 500E	HT 81-U RHU 81
	12	DR35-12	12	8,2	13,0	43,0	21,0	20,0	200/100						
	16	DR35-16*	12	8,2	17,0	44,0	28,0	20,0	200/100						
120	6	DR50-6*	14	10,0	6,4	52,0	20,0	28,0	100/25	TND 10-120	B 35-45WDE	B 35-50WDE	HT 45-E	HT 51 RH 50 B 500E	HT 81-U RHU 81
	8	DR50-8	14	10,0	8,4	52,0	20,0	28,0	100/25						
	10	DR50-10	14	10,0	10,5	53,0	22,0	28,0	100/25						
185	12	DR50-12	14	10,0	13,0	53,0	24,0	28,0	100/25	TND 10-120	B 35-45WDE	B 35-50WDE	HT 45-E	HT 51 RH 50 B 500E	HT 81-U RHU 81
	16	DR50-16	14	10,0	17,0	57,0	28,0	28,0	100/25						
	8	DR70-8	16	11,5	8,4	56,0	24,0	28,0	50/25						
240	10	DR70-10	16	11,5	10,5	56,0	24,0	28,0	50/25	TND 10-120	B 35-45WDE	B 35-50WDE	HT 45-E	HT 51 RH 50 B 500E	HT 81-U RHU 81
	12	DR70-12	16	11,5	13,0	56,0	24,0	28,0	50/25						
	16	DR70-16	16	11,5	17,0	60,0	30,0	28,0	50/25						
95	20	DR70-20*	16	11,5	21,0	84,5	30,0	28,0	50/25	TND 10-120	B 35-45WDE	B 35-50WDE	HT 45-E	HT 51 RH 50 B 500E	HT 81-U RHU 81
	8	DR95-8*	18	13,5	8,4	65,0	28,0	35,0	50/25						
	10	DR95-10	18	13,5	10,5	66,0	28,0	35,0	50/25						
120	12	DR95-12	18	13,5	13,0	66,0	28,0	35,0	50/25	TND 10-120	B 35-45WDE	B 35-50WDE	HT 45-E	HT 51 RH 50 B 500E	HT 81-U RHU 81
	16	DR95-16	18	13,5	17,0	65,5	32,0	35,0	50/25						
	20	DR95-20*	18	13,5	21,0	71,0	33,0	35,0	50/25						
150	8	DR120-8*	20	15,5	8,4	70,0	31,0	35,0	50/25	TND 10-120	B 35-45WDE	B 35-50WDE	HT 45-E	HT 51 RH 50 B 500E	HT 81-U RHU 81
	10	DR120-10	20	15,5	10,5	70,0	32,0	35,0	50/25						
	12	DR120-12	20	15,5	13,0	70,5	32,0	35,0	50/25						
185	16	DR120-16	20	15,5	17,0	70,0	32,0	35,0	50/25	TND 10-120	B 35-45WDE	B 35-50WDE	HT 45-E	HT 51 RH 50 B 500E	HT 81-U RHU 81
	20	DR120-20	20	15,5	21,0	72,0	36,0	35,0	50/25						
	10	DR150-10	22	17,0	10,5	79,0	34,0	35,0	50/25						
240	12	DR150-12	22	17,0	13,0	78,5	34,0	35,0	50/25	TND 10-120	B 35-45WDE	B 35-50WDE	HT 45-E	HT 51 RH 50 B 500E	HT 81-U RHU 81
	16	DR150-16	22	17,0	17,0	78,0	34,0	35,0	50/25						
	20	DR150-20	22	17,0	21,0	78,0	40,0	35,0	50/25						
185	10	DR185-10	25	19,0	10,5	83,0	37,0	40,0	25/25	TND 10-120	B 35-45WDE	B 35-50WDE	HT 45-E	HT 51 RH 50 B 500E	HT 81-U RHU 81
	12	DR185-12	25	19,0	13,0	82,5	37,0	40,0	25/25						
	16	DR185-16	25	19,0	17,0	82,0	37,0	40,0	25/25						
240	20	DR185-20	25	19,0	21,0	83,0	40,0	40,0	25/25	TND 10-120	B 35-45WDE	B 35-50WDE	HT 45-E	HT 51 RH 50 B 500E	HT 81-U RHU 81
	10	DR240-10*	28	21,5	10,5	92,0	42,0	40,0	20/10						
	12	DR240-12	28	21,5	13,0	92,0	42,5	40,0	20/10						
240	16	DR240-16	28	21,5	17,0	92,0	42,5	40,0	20/10	TND 10-120	B 35-45WDE	B 35-50WDE	HT 45-E	HT 51 RH 50 B 500E	HT 81-U RHU 81
	20	DR240-20	28	21,5	21,0	92,0	45,0	40,0	20/10						

* Dimensions of the tube according to DIN 46235; Stud hole not included within the standard.

HT 120 and tools and heads with 130 kN crimping force
ECW43D
RHU 920

COPPER TUBE CRIMPING LUGS ACCORDING TO DIN 46235

for Copper conductors

DR

Conductor Size sqmm	Ø Stud mm	Ref.	Code	Dimensions mm					Quantity Box/Bag	Hydraulic Tools	
				Øi	d	L	B	a			
300	12	DR300-12*	32	24,5	13,0	104,0	47,0	50,0	10/5	RH 50 B 500E	HT 120 and tools and heads with 130 kN crimping force
	16	DR300-16	32	24,5	17,0	100,0	48,0	50,0	10/5		
	20	DR300-20	32	24,5	21,0	100,0	47,0	50,0	10/5		
400	12	DR400-12*	38	27,5	13,0	117,0	55,0	70,0	5/5	ECW-H3D RHU 520	
	16	DR400-16	38	27,5	17,0	117,0	55,0	70,0	5/5		
	20	DR400-20	38	27,5	21,0	117,0	55,0	70,0	5/5		
500	12	DR500-12*	42	31,0	13,0	130,0	60,0	70,0	5/5		
	16	DR500-16*	42	31,0	17,0	130,0	60,0	70,0	5/5		
	20	DR500-20	42	31,0	21,0	130,0	60,0	70,0	5/5		
625	20	DR625-20	44	34,5	21,0	135,0	63,0	80,0	5/5		
800	20	DR800-20	52	40,0	21,0	166,0	75,0	100,0	5/5		
1.000	20	DR1000-20	58	44,0	21,0	166,0	85,0	100,0	5/5		

* Dimensions of the tube according to DIN 46235; Stud hole not included within the standard.

Consult us for special requirements

CRIMPING THROUGH CONNECTORS ACCORDING TO DIN 46267 T.1

for Copper cables

DSV

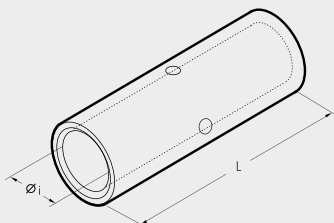

Conductor Size sqmm	Ref.	Code	Dimensions mm		Quantity Box/Bag	Mechanical Tools	Hydraulic Tools	
			Øi	L				
6	DSV 6	5	3,7	30	1.200/100	HN-D25	B 15MDE	
10	DSV 10	6	4,4	30	1.200/100			
16	DSV 16	8	5,5	50	400/100	TND 6-70	B 35-45MDE	
25	DSV 25	10	7,0	50	200/100			
35	DSV 35	12	8,2	50	200/100	TND 10-120	B 35-50MDE	
50	DSV 50	14	10,0	56	200/50			
70	DSV 70	16	11,5	56	100/50	HT 45-E	HT 51	
95	DSV 95	18	13,5	70	100/50			
120	DSV 120	20	15,5	70	50/25	RH 50 B 500E	HT 81-U RHU 81	
150	DSV 150	22	17,0	80	50/25			
185	DSV 185	25	19,0	85	25/25	HT 120 and tools and heads with 130 kN crimping force	ECW-H3D	RHU 520
240	DSV 240	28	21,5	90	15/15			
300	DSV 300	32	24,5	100	10/5			
400	DSV 400	38	27,5	150	10/5			
500	DSV 500	42	31,0	160	5/5			
625	DSV 625	44	34,5	160	5/5			
800	DSV 800	52	40,0	200	5/5			
1.000	DSV 1000	58	44,0	200	5/5			

DSV series through connectors are manufactured from electrolytic Copper tube, annealed and surface protected by tin plating. Internal and external dimensions match those of DR series lugs.

Chamfered ends and a central stop provide easy and correct insertion of the conductor.

Details of the appropriate crimping tools and dies are shown on page 189.

Consult us for special requirements

C



COLOUR CODED COPPER CRIMPING LUGS

for Copper conductors

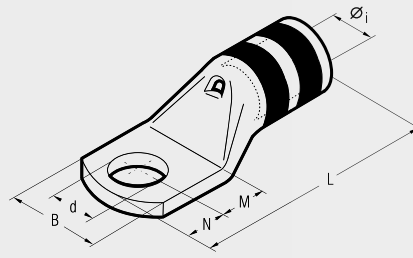

C series lugs are manufactured from electrolytic Copper tube.

The dimensions of the tube are designed to obtain the most efficient electrical conductivity and mechanical strength to resist vibration and pull out.

Cembre lugs are annealed to guarantee optimum ductility, an absolute necessity for connectors which will have to withstand the severe deformation arising when compressed and any bending of the palm during installation.

In applications subject to vibration, terminals have to perform a reliable connection, the annealing process plays a vital role in avoiding cracking or breaks between the barrel and palm.

The presence of an inspection hole facilitates full insertion of the conductor. The barrel length has been designed to allow easy and accurate positioning of the dies during the crimping operation.

Lugs are electrolytically tinned to avoid oxidation.

The tongue is clearly marked with wire size and die index for Cembre tools.

UL listed for US and Canada per UL486A up to 35 KV.

C series lugs are an important part of Cembre crimping systems for power carrying conductors.

Details of the appropriate crimping tools and dies are shown on page 188.

Cembre technicians are available to provide technical advice as required.

Please consult Cembre for products not listed.

Cond. Size sqmm	Conductor AWG		Ø Stud mm	Ref.	Dimensions mm						Colour Code	Quantity Box/Bag	Mechanical Tools	Hydraulic Tools
	Size	Navy			Øi	B	M	N	L	d				
10	8	23	4	C8-8	4,6	10,0	5,0	4,0	22,5	4,3	RED	600/50	B15MDE	
			5	C8-10	4,6	10,0	6,5	6,0	26,0	5,3		600/50		
			6	C8-14	4,6	11,0	7,0	6,0	26,5	6,4		600/50		
			8	C8-516	4,6	15,0	9,0	8,0	30,5	8,4		600/50		
			10	C8-38	4,6	18,0	11,0	10,0	34,5	10,5		600/50		
			12	C8-12	4,6	19,0	14,0	12,0	39,5	13,2		600/50		
16	6	40	4	C6-8	5,8	11,5	5,0	4,0	25,5	4,3	BLUE	600/50		
			5	C6-10	5,8	11,5	6,5	6,0	29,0	5,3		600/50		
			6	C6-14	5,8	11,5	7,0	6,0	29,5	6,4		600/50		
			8	C6-516	5,8	15,0	9,0	8,0	33,5	8,4		600/50		
			10	C6-38	5,8	18,0	11,0	10,0	37,5	10,5		600/50		
			12	C6-12	5,8	20,0	14,0	12,0	42,5	13,2		600/50		
25	4	40	4	C4-8	6,2	12,5	5,0	4,0	25,5	4,3	GREY	600/50		
			5	C4-10	6,2	12,5	6,5	6,0	29,0	5,3		600/50		
			6	C4-14	6,2	12,5	7,0	6,0	29,5	6,4		600/50		
			8	C4-516	6,2	15,0	9,0	8,0	33,5	8,4		600/50		
			10	C4-38	6,2	18,0	11,0	10,0	37,5	10,5		400/50		
			12	C4-12	6,2	20,0	14,0	12,0	42,5	13,2		400/50		
	3	50	4	C3-8	7,0	14,0	5,0	4,0	28,0	4,3	WHITE	600/50		
			5	C3-10	7,0	14,0	6,5	6,0	31,5	5,3		600/50		
			6	C3-14	7,0	14,0	7,0	6,0	32,0	6,4		600/50		
			8	C3-516	7,0	15,0	9,0	8,0	36,0	8,4		600/50		
			10	C3-38	7,0	18,0	11,0	10,0	40,0	10,5		400/50		
			12	C3-12	7,0	21,0	14,0	12,0	45,0	13,2		400/50		
35	2	60	5	C2-10	7,6	17,0	6,5	6,0	33,0	5,3	BROWN	400/50		
			6	C2-14	7,6	17,0	7,0	6,0	33,5	6,4		400/50		
			8	C2-516	7,6	17,0	9,0	8,0	37,5	8,4		400/50		
			10	C2-38	7,6	19,0	11,0	10,0	41,5	10,5		400/50		
			12	C2-12	7,6	21,0	14,0	12,0	46,5	13,2		200/50		
			6	C1-14	8,9	17,0	7,0	6,0	34,5	6,4		400/50		
	1	75	8	C1-516	8,9	17,0	9,0	8,0	38,5	8,4	GREEN	400/50		
			10	C1-38	8,9	19,0	11,0	10,0	42,5	10,5		400/50		
			12	C1-12	8,9	21,0	14,0	12,0	47,5	13,2		200/50		
			6	C1/0-14	10,0	19,0	8,0	7,0	40,5	6,4		200/25		
			8	C1/0-516	10,0	19,0	9,0	8,0	42,5	8,4		200/25		
			10	C1/0-38	10,0	20,0	11,0	10,0	46,5	10,5		200/25		
50	1/0	100	12	C1/0-12	10,0	21,0	14,0	12,0	51,5	13,2	PINK	200/25		
			14	C1/0-916	10,0	25,0	16,0	14,0	55,5	15,0		200/25		
			16	C1/0-58	10,0	26,0	18,0	16,0	59,5	17,0		200/25		
			6	C2/0-14	11,3	21,0	8,0	7,0	44,0	6,4		200/25		
			8	C2/0-516	11,3	21,0	9,0	8,0	46,0	8,4		200/25		
			10	C2/0-38	11,3	21,0	11,0	10,0	50,0	10,5		200/25		
70	2/0	125	12	C2/0-12	11,3	22,0	14,0	12,0	55,0	13,2	BLACK	200/25		
			14	C2/0-916	11,3	25,0	16,0	14,0	59,0	15,0		100/25		
			16	C2/0-58	11,3	26,0	18,0	16,0	63,0	17,0		100/25		
			20	C2/0-34	11,3	29,5	22,0	20,0	75,0	21,0		100/25		
			6	C3/0-14	12,4	23,0	8,0	7,0	45,0	6,4		200/25		
			8	C3/0-516	12,4	23,0	9,0	8,0	47,0	8,4		200/25		
95	3/0	150	10	C3/0-38	12,4	23,0	11,0	10,0	51,0	10,5	ORANGE	100/25		
			12	C3/0-12	12,4	24,0	14,0	12,0	56,0	13,2		100/25		
			14	C3/0-916	12,4	27,0	16,0	14,0	60,0	15,0		100/25		
			16	C3/0-58	12,4	28,0	18,0	16,0	64,0	17,0		100/25		
			20	C3/0-34	12,4	31,5	22,0	20,0	72,0	21,0		100/25		

TN 70 SE

TN 120 SE

B35-50MDE

HT 51 RH 50 B 500E

HT 120 and tools and heads with 130 kN crimping force

ECWH3D

RHU 520

COLOUR CODED COPPER CRIMPING LUGS

for Copper conductors



File no. E125401

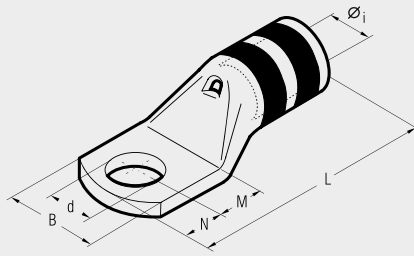

C

Cond. Size sqmm	Conductor AWG		Ref.	Dimensions mm						Colour Code	Quantity Box/Bag	Mechanical Tools	Hydraulic Tools	
	Size	Navy		Ø Stud mm	Øi	B	M	N	L					d
4/0	200	6	C4/0-14	13,5	25,0	8,0	7,0	50,5	6,4	PURPLE	100/25	TN 120 SE B35-50MDE	HT 120 and tools and heads with 130 kN crimping force ECW-H3D RHU 520	
		8	C4/0-516	13,5	25,0	9,0	8,0	52,5	8,4		100/25			
		10	C4/0-38	13,5	25,0	11,0	10,0	56,5	10,5		100/25			
		12	C4/0-12	13,5	25,0	14,0	12,0	61,5	13,2		100/25			
		14	C4/0-916	13,5	25,0	16,0	14,0	65,5	15,0		100/25			
		16	C4/0-58	13,5	27,0	18,0	16,0	69,5	17,0		50/25			
		20	C4/0-34	13,5	29,5	22,0	20,0	77,5	21,0		50/25			
120	250 MCM	6	C250-14	15,2	28,5	8,0	7,0	52,0	6,4	YELLOW	100/25			
		8	C250-516	15,2	28,5	9,0	8,0	54,0	8,4		100/25			
		10	C250-38	15,2	28,5	11,0	10,0	58,0	10,5		100/25			
		12	C250-12	15,2	28,5	14,0	12,0	63,0	13,2		50/25			
		14	C250-916	15,2	28,5	16,0	14,0	67,0	15,0		50/25			
		16	C250-58	15,2	28,5	18,0	16,0	71,0	17,0		50/25			
		20	C250-34	15,2	30,0	22,0	20,0	79,0	21,0		50/25			
150	300 MCM	8	C300-516	16,7	31,5	13,0	11,0	69,0	8,4	WHITE	40/10			
		10	C300-38	16,7	31,5	13,0	11,0	69,0	10,5		40/10			
		12	C300-12	16,7	31,5	16,0	14,0	75,0	13,2		40/10			
		14	C300-916	16,7	31,5	18,0	16,0	79,0	15,0		40/10			
		16	C300-58	16,7	31,5	19,0	17,0	81,0	17,0		40/10			
		20	C300-34	16,7	31,5	22,0	20,0	87,0	21,0		40/10			
		22	C300-78	16,7	31,5	24,0	23,0	92,0	23,0		40/10			
185	350 MCM	10	C350-38	17,6	33,0	13,0	11,0	70,5	10,5	RED	40/20			
		12	C350-12	17,6	33,0	16,0	14,0	76,5	13,2		40/20			
		14	C350-916	17,6	33,0	18,0	16,0	80,5	15,0		40/20			
		16	C350-58	17,6	33,0	19,0	17,0	82,5	17,0		40/20			
		20	C350-34	17,6	33,0	22,0	20,0	88,5	21,0		40/20			
		22	C350-78	17,6	37,0	24,0	23,0	93,5	23,0		30/15			
		400	400 MCM	10	C400-38	19,2	35,5	13,0	11,0		76,0			10,5
12	C400-12			19,2	35,5	16,0	14,0	82,0	13,2	40/20				
14	C400-916			19,2	35,5	18,0	16,0	86,0	15,0	40/20				
16	C400-58			19,2	35,5	19,0	17,0	88,0	17,0	40/20				
20	C400-34			19,2	35,5	22,0	20,0	94,0	21,0	40/20				
22	C400-78			19,2	35,5	24,0	23,0	99,0	23,0	40/20				
240	500 MCM			10	C500-38	21,1	39,0	13,0	11,0	82,0	10,5	BROWN	30/15	
		12	C500-12	21,1	39,0	16,0	14,0	88,0	13,2	30/15				
		14	C500-916	21,1	39,0	18,0	16,0	92,0	15,0	30/15				
		16	C500-58	21,1	39,0	19,0	17,0	94,0	17,0	30/15				
		20	C500-34	21,1	39,0	22,0	20,0	100,0	21,0	20/10				
		22	C500-78	21,1	39,0	24,0	23,0	105,0	23,0	20/10				
		300	600 MCM	12	C600-12	23,7	44,0	20,0	14,0	99,0	13,2		GREEN	20/10
14	C600-916			23,7	44,0	22,0	16,0	103,0	15,0	20/10				
16	C600-58			23,7	44,0	22,0	19,0	106,0	17,0	20/10				
20	C600-34			23,7	44,0	24,0	23,0	112	21,0	10/5				
22	C600-78			23,7	44,0	24,0	23,0	112,0	23,0	10/5				
750	MCM			12	C750-12	26,0	48,0	22,0	19,0	113,0	13,2	BLACK		10/5
				16	C750-58	26,0	48,0	22,0	19,0	113,0	17,0			10/5
		20	C750-34	26,0	48,0	24,0	23,0	119,0	21,0	10/5				
		22	C750-78	26,0	48,0	24,0	23,0	119,0	23,0	10/5				

CL

COLOUR CODED COPPER CRIMPING LUGS

one hole long barrel for Copper conductors

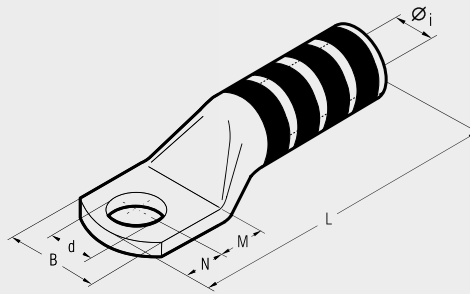

CL series lugs are manufactured from electrolytic Copper tube for use in heavy duty applications.

The dimensions of the tube are designed to obtain the most efficient electrical conductivity and mechanical strength to resist vibration and pull out.

Cembre lugs are annealed to guarantee optimum ductility which is an absolute necessity for connectors which will have to withstand the severe deformation arising when compressed and any bending of the palm during installation.

In applications subject to vibration, terminals have to perform a reliable connection, the annealing process plays a vital role in avoiding cracking or breaks between the barrel and palm.

The long barrel provides better mechanical pull-out strength.

Lugs are electrolytically plated to avoid oxidation.

The tongue is clearly marked with wire size and die index for Cembre tools.

UL listed for US and Canada per UL486A up to 35 KV.

CL series lugs are an important part of Cembre crimping systems for power carrying conductors. Details of the appropriate crimping tools and dies are shown on page 188.

Cembre technicians are available to provide technical advice as required.

Please consult Cembre for products not listed.

Cond. Size sqmm	Conductor AWG		Ø Stud mm	Ref.	Dimensions mm						Colour Code	Quantity Box/Bag	Mechanical Tools	Hydraulic Tools
	Size	Navy			Øi	B	M	N	L	d				
10	8	23	5	CL8-10	4,6	10,0	6,5	6,0	37,5	5,3	RED	400/50	TN 70 SE	B15MDE
			6	CL8-14	4,6	11,0	7,0	6,0	38,0	6,4		400/50		
			10	CL8-38	4,6	18,0	11,0	10,0	46,0	10,5		400/50		
16	6	20	5	CL6-10	5,8	11,5	6,5	6,0	40,0	5,3	BLUE	400/50		
			6	CL6-14	5,8	11,5	7,0	6,0	40,5	6,4		400/50		
			12	CL6-12	5,8	20,0	14,0	12,0	53,5	13,2		400/50		
25	4	40	5	CL4-10	6,2	12,5	6,5	6,0	47,0	5,3	GREY	400/50		
			6	CL4-14	6,2	12,5	7,0	6,0	47,5	6,4		400/50		
			10	CL4-38	6,2	18,0	11,0	10,0	55,5	10,5		400/50		
			12	CL4-12	6,2	20,0	14,0	12,0	60,5	13,2		400/50		
35	2	60	6	CL3-14	7,0	14,0	7,0	6,0	47,5	6,4	WHITE	200/100		
			8	CL3-516	7,0	15,0	9,0	8,0	51,5	8,4		200/100		
			10	CL3-38	7,0	18,0	11,0	10,0	55,5	10,5		200/100		
			12	CL3-12	7,0	21,0	14,0	12,0	60,5	13,2		200/100		
50	1	75	5	CL2-10	7,6	17,0	6,5	6,0	46,0	5,3	BROWN	200/50		
			8	CL2-14	7,6	17,0	7,0	6,0	46,5	6,4		200/50		
			8	CL2-516	7,6	17,0	9,0	8,0	50,5	8,4		200/50		
			12	CL2-12	7,6	21,0	14,0	12,0	59,5	13,2		200/50		
70	2/0	125	5	CL1-10	8,9	17,0	6,5	6,0	48,0	5,3	GREEN	200/50		
			8	CL1-516	8,9	17,0	9,0	8,0	52,5	8,4		200/50		
			12	CL1-12	8,9	21,0	14,0	12,0	61,5	13,2		200/50		
			5	CL1/0-10	10,0	19,0	8,0	7,0	53,5	5,3		100/50		
95	3/0	150	8	CL1/0-516	10,0	19,0	9,0	8,0	55,5	8,4	PINK	100/50		
			10	CL1/0-38	10,0	20,0	11,0	10,0	59,5	10,5		100/50		
			10	CL1/0-12	10,0	21,0	14,0	12,0	64,5	13,2		100/50		
			10	CL2/0-38	11,3	21,0	11,0	10,0	67,5	10,5		100/50		
120	250 MCM	250	12	CL2/0-12	11,3	22,0	14,0	12,0	72,5	13,2	BLACK	100/50		
			12	CL3/0-12	12,4	24,0	14,0	12,0	71,5	13,2		100/50		
			10	CL4/0-38	13,5	25,0	11,0	10,0	73,5	10,5		60/30		
150	300 MCM	300	12	CL4/0-12	13,5	25,0	14,0	12,0	78,5	13,2	PURPLE	60/30		
			12	CL250-12	15,2	28,5	14,0	12,0	84,0	13,2		50/25		
185	350 MCM	350	12	CL300-12	16,7	31,5	16,0	14,0	98,0	13,2	WHITE	30/15		
			12	CL350-12	17,6	33,0	16,0	14,0	98,0	13,2		30/15		
240	500 MCM	400	12	CL400-12	19,2	35,5	16,0	14,0	107,0	13,2	BLUE	20/10		
			16	CL400-58	19,2	35,5	19,0	17,0	113,0	17,0		20/10		
			12	CL500-12	21,1	39,0	16,0	14,0	108,0	13,2		20/10		
			16	CL500-58	21,1	39,0	19,0	17,0	114,0	17,0		20/10		
300	600 MCM	600	12	CL600-12	23,7	44,0	20,0	14,0	128,5	13,2	BROWN	10/5		
			16	CL600-58	23,7	44,0	22,0	19,0	135,5	17,0		10/5		
			12	CL750-12	26,0	48,0	22,0	19,0	140,5	13,2		10/5		
			16	CL750-58	26,0	48,0	22,0	19,0	140,5	17,0		10/5		

Also available with inspection hole.

In case of order, add suffix IH to the part number.

E.g.: CL250IH-12

HT 51 RH 50 B 500E
ECW-H3D
RHU 520

COLOUR CODED COPPER CRIMPING LUGS

double hole long barrel for Copper conductors

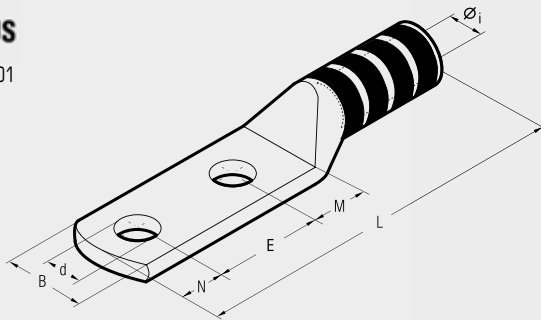

CL-D

Cond. Size sqmm	Conductor		Ref.	Dimensions mm							Colour Code	Quantity Box/Bag	Mechanical Tools	Hydraulic Tools							
	AWG	Size		Navy	Ø Stud mm	Øi	B	M	E	N					L	d					
10	8	23	6	CL8-D14	4,6	11,0	7,0	16,0	6,0	53,0	6,4	RED	400/50	B75MDE							
			6	CL8-D141	4,6	11,0	7,0	19,0	6,0	56,0	6,4	400/50									
			10	CL8-D38	4,6	18,0	11,0	25,5	10,0	70,5	10,5	400/50									
16	6	6	6	CL6-D14	5,8	11,5	7,0	16,0	6,0	54,5	6,4	BLUE	400/50								
			6	CL6-D141	5,8	11,5	7,0	19,0	6,0	57,5	6,4	400/50									
			10	CL6-D38	5,8	18,0	11,0	25,5	10,0	72,0	10,5	400/50									
25	4	40	6	CL4-D14	6,2	12,5	7,0	16,0	6,0	62,0	6,4	GREY	200/50			TN 70 SE					
			6	CL4-D141	6,2	12,5	7,0	19,0	6,0	65,0	6,4	200/50									
			10	CL4-D38	6,2	18,0	11,0	25,5	10,0	79,5	10,5	200/50									
35	2	60	6	CL2-D14	7,6	17,0	7,0	16,0	6,0	61,0	6,4	BROWN	200/50					TN 120 SE	B35-50MDE		
			6	CL2-D141	7,6	17,0	7,0	19,0	6,0	64,0	6,4	200/50									
			10	CL2-D38	7,6	19,0	11,0	25,5	10,0	78,5	10,5	100/50									
50	1	75	6	CL1-D14	8,9	17,0	7,0	16,0	6,0	63,0	6,4	GREEN	200/50	HT 51 RH 50 B 500E ECWH30 RHU 520							
			6	CL1-D141	8,9	17,0	7,0	19,0	6,0	66,0	6,4	200/50									
			10	CL1-D38	8,9	19,0	11,0	25,5	10,0	80,5	10,5	100/25									
70	1/0	100	6	CL1/O-D14	10,0	19,0	7,9	16,0	7,0	68,0	6,4	PINK	100/25							HT 120 and tools and heads with 130 kN crimping force	
			6	CL1/O-D141	10,0	19,0	7,9	19,0	7,0	71,0	6,4	100/25									
			10	CL1/O-D38	10,0	20,0	10,9	25,5	10,0	83,5	10,5	100/25									
95	3/0	150	6	CL1/O-DN	10,0	21,0	14,0	44,5	12,0	107,5	13,2	100/25	HT 120 and tools and heads with 130 kN crimping force								
			6	CL2/O-D14	11,3	21,0	7,8	16,0	7,0	76,0	6,4	60/30									
			6	CL2/O-D141	11,3	21,0	7,8	19,0	7,0	79,0	6,4	60/30									
120	250	200	10	CL2/O-D38	11,3	21,0	11,0	25,5	10,0	91,5	10,5	60/30					HT 120 and tools and heads with 130 kN crimping force				
			10	CL3/O-D141	12,4	23,3	8,0	19,0	7,0	82,0	6,4	60/30									
			10	CL3/O-D38	12,4	23,3	11,0	25,5	10,0	94,5	10,5	60/30									
150	300	200	12	CL3/O-DN	12,4	24,0	14,0	44,5	12,0	118,5	13,2	60/30		HT 120 and tools and heads with 130 kN crimping force							
			6	CL4/O-D141	13,5	25,0	13,0	19,0	11,0	94,0	6,4	50/25									
			10	CL4/O-D38	13,5	25,0	11,0	25,5	10,0	97,5	10,5	50/25									
185	350	200	10	CL4/O-DN38	13,5	25,0	11,0	44,5	10,0	116,5	10,5	50/25							HT 120 and tools and heads with 130 kN crimping force		
			12	CL4/O-DN	13,5	25,0	14,0	44,5	12,0	121,5	13,2	50/25									
			10	CL250-D38	15,2	28,5	11,0	25,5	10,0	103,0	10,5	40/20									
240	500	400	12	CL250-DN	15,2	28,5	14,0	44,5	12,0	127,0	13,2	40/20	HT 120 and tools and heads with 130 kN crimping force								
			10	CL300-D38	16,7	31,5	13,0	25,5	11,0	116,0	10,5	30/15									
			12	CL300-DN	16,7	31,5	16,0	44,5	14,0	141,0	13,2	30/15									
300	600	400	6	CL350-D141	17,6	33,0	13,0	19,0	11,0	109,5	6,4	RED					30/15	HT 120 and tools and heads with 130 kN crimping force			
			10	CL350-D38	17,6	33,0	13,0	25,5	11,0	116,0	10,5	30/15									
			12	CL350-DN	17,6	33,0	16,0	44,5	14,0	141,0	13,2	30/15									
300	750	400	6	CL400-D141	19,2	35,5	13,0	19,0	11,0	118,5	6,4	BLUE		20/10	HT 120 and tools and heads with 130 kN crimping force						
			10	CL400-D38	19,2	35,5	13,0	25,5	11,0	125,0	10,5	20/10									
			12	CL400-DN	19,2	35,5	16,0	44,5	14,0	150,0	13,2	20/10									
300	750	400	6	CL500-D141	21,1	39,0	13,0	19,0	11,0	119,5	6,4	BROWN		10/5					HT 120 and tools and heads with 130 kN crimping force		
			10	CL500-D38	21,1	39,0	13,0	25,5	11,0	126,0	10,5	10/5									
			12	CL500-DN	21,1	39,0	16,0	44,5	14,0	151,0	13,2	10/5									
300	750	400	10	CL600-D38	23,7	44,0	20,0	25,5	11,0	149,5	10,5	GREEN	20/5	HT 120 and tools and heads with 130 kN crimping force							
			12	CL600-DN	23,7	44,0	20,0	44,5	14,0	171,5	13,2	20/5									
			10	CL750-DN38	26,0	48,0	20,0	44,5	11,0	173,5	10,5	15/5									
300	750	400	10	CL750-D38	26,0	48,0	20,0	25,5	11,0	154,5	10,5	BLACK	15/5					HT 120 and tools and heads with 130 kN crimping force			
			12	CL750-DN	26,0	48,0	20,0	44,5	14,0	176,5	13,2	15/5									

CL series lugs are manufactured from electrolytic Copper tube.

The dimensions of the tube are designed to obtain the most efficient electrical conductivity and mechanical strength to resist vibration and pull out.

Cembre lugs are annealed to guarantee optimum ductility, an absolute necessity for connectors which will have to withstand the severe deformation arising when compressed and any bending of the palm during installation.

In applications subject to vibration, terminals have to perform a reliable connection, the annealing process plays a vital role in avoiding cracking or breaks between the barrel and palm.

The barrel length has been designed to allow easy and accurate positioning of the dies during the crimping operation.

Lugs are electrolytically tinned to avoid oxidation.

The tongue is clearly marked with wire size and die index for Cembre tools.

UL listed for US and Canada per UL486A up to 35 KV.

CL series lugs are an important part of Cembre crimping systems for power carrying conductors. Details of the appropriate crimping tools and dies are shown on page 188.

Cembre technicians are available to provide technical advice as required.

Please consult Cembre for products not listed.

BSCL

COLOUR CODED SPLICES

long barrel

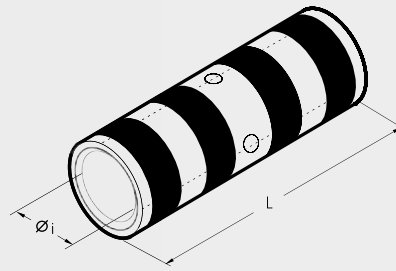

BSCL range of connectors are designed for jointing low voltage conductors in heavy duty applications. Made of electrolytic Copper tube having the same dimension as C and CL series lugs, BSCL connectors are annealed and electrolytically Tin plated. They feature an internal taper at both ends to ease the introduction of the conductor and a central stop to ensure correct positioning. **UL listed for US and Canada per UL486A up to 35 KV.**

Appropriate crimping tools and dies are shown in details on page 188.

Conductor Size sqmm	Conductor Size AWG	Ref.	Dimensions mm		Colour Code	Quantity Box/Bag	Mechanical Tools		Hydraulic Tools					
			Øi	L										
10	8	BSCL8	4,6	50,5	RED	600/150	HN1	HN5	B15MDE	HT 51 RH 50 B500E ECW-H3D RHU 520				
16	6	BSCL6	5,8	50,5	BLUE	400/100								
25	4	BSCL4	6,2	60,5	GREY	200/100	TN 70 SE	B35-50MDE						
	3	BSCL3	7,0	60,5	WHITE	200/50								
35	2	BSCL2	7,6	60,5	BROWN	200/50	TN 120 SE							
	1	BSCL1	8,9	65,5	GREEN	200/50								
50	1/0	BSCL1/0	10,0	73,0	PINK	200/50								
70	2/0	BSCL2/0	11,3	79,0	BLACK	100/50								
95	3/0	BSCL3/0	12,4	79,0	ORANGE	80/40								
	4/0	BSCL4/0	13,5	85,5	PURPLE	50/25								
120	250 MCM	BSCL250	15,2	85,5	YELLOW	50/25								
150	300 MCM	BSCL300	16,7	104,5	WHITE	40/20								
185	350 MCM	BSCL350	17,6	104,5	RED	40/20								
	400 MCM	BSCL400	19,2	111,0	BLUE	20/10								
240	500 MCM	BSCL500	21,1	117,0	BROWN	20/10								
300	600 MCM	BSCL600	23,7	139,5	GREEN	20/10								
	750 MCM	BSCL750	26,0	149,0	BLACK	10/10								

SLEEVE CONNECTORS

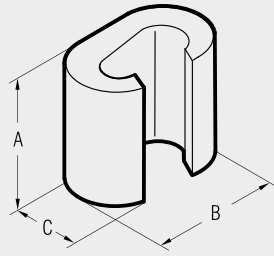

C-C



tin plated version

Conductor Size sqmm		Ref.	Dimensions mm			Quantity Box/Bag	Mechanical Tools	Hydraulic Tools					
Run	Tap		A	B	C								
6÷2,5	6÷1,5	C 6-C 6 ST	9,0	9,8	6,4	1.000/100	HP4-C10	B 35-45MDE	B 35-50MDE	HT 45-E	B 500E	RHU 81	HT 120 and tools and heads with 130 kN crimping force
10	10÷1,5	C 10-C 10 ST	12,0	12,6	8,4	500/100							
16	16÷1,5	C 16-C 16 ST	17,0	19,4	12,0	500/100							
25÷16	10÷1,5	C 25-C 10 ST	17,0	19,8	13,0	400/50							
25	25÷16	C 25-C 25 ST	17,0	21,4	13,0	300/50							
40÷35	16÷1,5	C 35-C 16 ST	21,0	24,6	15,4	200/25							
40÷35	40÷25	C 35-C35 ST	21,0	26,6	15,6	200/25							
70÷63	25÷1,5	C 70-C 25 N ST	21,0	26,4	17,5	200/25							
50	25÷4	C 50-C 25 ST	25,0	32,9	21,0	100/25							
50	50÷35	C 50-C 50 ST	26,0	33,0	21,0	100/25							
70÷50	40÷4	C 70-C 35 ST	28,0	33,0	21,0	100/25							
70÷50	70÷35	C 70-C 70 ST	28,0	34,0	21,0	100/25							
100÷95	40÷4	C 95-C 35 ST	29,0	40,6	26,0	50/25							
100÷95	70÷40	C 95-C 70 ST	29,0	41,0	26,0	50/25							
100÷95	100÷63	C 95-C 95 ST	29,0	41,0	26,0	50/25							
125÷110	125÷25	C 120-C 120 ST	30,0	45,0	28,0	50/25							
160÷150	125÷25	C 150-C 120 ST	31,0	45,0	28,0	50/25							
150	150÷63	C 150-C 150 ST	30,0	45,0	28,0	50/25							
185	100÷16	C 185-C 95 ST	31,0	45,0	28,0	50/25							
185÷120	185÷120	C 185-C 185 ST	22,6	68,0	34,0	30/15							
240÷150	120÷95	C 240-C 120 ST	22,6	68,0	34,0	30/15							

"C" connectors are manufactured from high purity copper profiles and are suitable for a variety of uses either to create an earthing network or tapping off from overhead distribution lines. Each connector is marked as follows:

- Cembre trade mark
- Reference number
- Conductor size-Run
- Conductor size-Tap
- Number of crimps
- Die reference.

Details of the appropriate crimping tools and dies are shown on page 184.

bright surface version

Conductor Size sqmm		Ref.	Dimensions mm			Quantity Box/Bag	Mechanical Tools	Hydraulic Tools					
Run	Tap		A	B	C								
6÷2,5	6÷1,5	C 6-C 6	9,0	9,8	6,4	1.000/100	HP4-C10	B 35-45MDE	B 35-50MDE	HT 45-E	B 500E	RHU 81	HT 120 and tools and heads with 130 kN crimping force
10	10÷1,5	C 10-C 10	12,0	12,6	8,4	500/100							
16	16÷1,5	C 16-C 16	17,0	19,4	12,0	500/100							
25÷16	10÷1,5	C 25-C 10	17,0	19,8	13,0	400/50							
25	25÷16	C 25-C 25	17,0	21,4	13,0	300/50							
40÷35	16÷1,5	C 35-C 16	21,0	24,6	15,4	200/25							
40÷35	40÷25	C 35-C35	21,0	26,6	15,6	200/25							
70÷63	25÷1,5	C 70-C 25 N	21,0	26,4	17,5	200/25							
50	25÷4	C 50-C 25	25,0	32,9	21,0	100/25							
50	50÷35	C 50-C 50	26,0	33,0	21,0	100/25							
70÷50	40÷4	C 70-C 35	28,0	33,0	21,0	100/25							
70÷50	70÷35	C 70-C 70	28,0	34,0	21,0	100/25							
100÷95	40÷4	C 95-C 35	29,0	40,6	26,0	50/25							
100÷95	70÷40	C 95-C 70	29,0	41,0	26,0	50/25							
100÷95	100÷63	C 95-C 95	29,0	41,0	26,0	50/25							
125÷110	125÷25	C 120-C 120	30,0	45,0	28,0	50/25							
160÷150	125÷25	C 150-C 120	31,0	45,0	28,0	50/25							
150	150÷63	C 150-C 150	30,0	45,0	28,0	50/25							
185	100÷16	C 185-C 95	31,0	45,0	28,0	50/25							
185÷120	185÷120	C 185-C 185	22,6	68,0	34,0	30/15							
240÷150	120÷95	C 240-C 120	22,6	68,0	34,0	30/15							

Example of tap connection

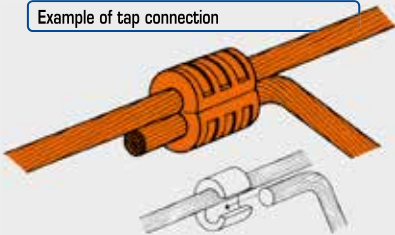

Example of joint connection

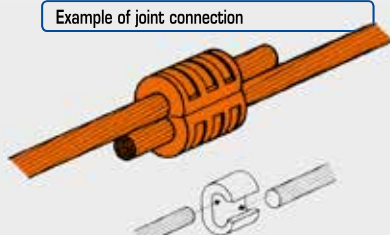

Example of joining two running conductors

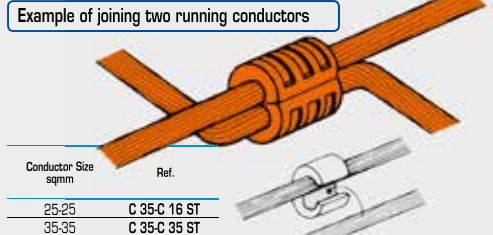

Conductor Size sqmm	Ref.
25-25	C 35-C 16 ST
35-35	C 35-C 35 ST
50-50	C 70-C 70 ST
63-63	C 95-C 70 ST
70-70	
95-95	C 150-C 120 ST
120-120	C 150-C 150
125-125	C 150-C 150
120-120	C 185-C 95 ST
125-125	

MECHANICAL FIXING LUGS

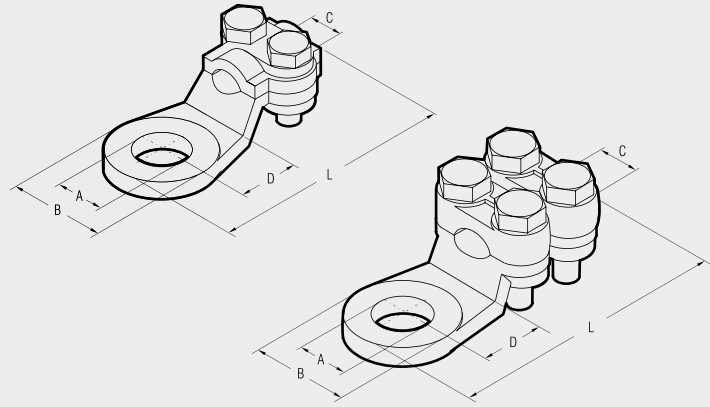

Material:
Brass CB754S EN 1982
Nickel plated.
Zinc plated Steel bolts.

2 bolt fixing lugs

Conductor Size sqmm	Ref.	A bolt	Dimensions mm				Quantity
			B	C	D	L	
16	2155	M8	18,0	4,5	12,5	39	100
16	2171	M10	18,0	4,5	12,5	39	100
25	2156	M8	19,5	6,0	13,0	43	100
25	2172	M10	19,5	6,0	13,0	43	100
35	2157	M12	23,0	7,0	15,0	49	50
35	2173	M14	23,0	7,0	15,0	49	50
50	2174	M14	25,0	8,0	17,0	56	50

4 bolt fixing lugs

Conductor Size sqmm	Ref.	A bolt	Dimensions mm				Quantity
			B	C	D	L	
50	2158	M12	23,5	8	16,0	57	50
75	2160	M12	28,0	10	20,0	65	25
75	2176	M16	28,0	10	20,0	65	25
100	2161	M12	31,0	13	17,0	66	25
125	2162	M15	33,0	14	18,0	71	25
150	2163	M14	34,0	16	19,5	75	25
175	2164	M15	36,0	16	21,0	78	25

CABLE CLAMPS

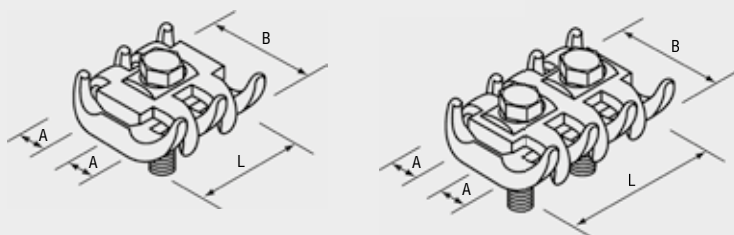

Single bolt fixing

Conductor Size sqmm	Ref.	Ø A for cable mm	Dimensions mm		Quantity
			B	L	
6÷16	2323	3÷ 5	24	20	50
16÷50	2326	5÷ 8	30	25	50
35÷70	2329	7÷12	40	30	25

Material:
Brass CB754S EN 1982
Zinc plated Steel bolts.
Zinc plated Steel nut.

2 bolt fixing

Conductor Size sqmm	Ref.	Ø A for cable mm	Dimensions mm		Quantity
			B	L	
6÷16	2333	3÷ 5	24,5	30	50
16÷50	2336	5÷ 8	32	40	50
35÷70	2339	7÷12	40	44	25
50÷95	2342	8÷14	48	48	10
70÷150	2344	12÷16	51	53	10
150÷300	2346*	16÷22	66	66	5

* Stainless Steel bolts

HIGH VOLTAGE TERMINALS

2A-M

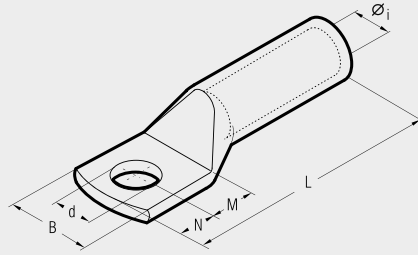

2A-M series terminals are made from high purity Copper tube, and are annealed.

They feature a double length barrel for enhanced electrical and mechanical performance in heavy duty applications.

The absence of an inspection hole prevents the entry of water or moisture into the crimped joint making these terminals suitable for outdoor applications.

The terminals are electrolytically Tin plated to prevent atmospheric corrosion.

Details of the appropriate crimping tools and dies are shown on pages 180 to 181.

Conductor Size sqmm	Ø Stud mm	Ref.	Dimensions mm						Quantity Box/Bag	Mechanical Tools	Hydraulic Tools
			Øi	B	M	N	L	d			
16	8	2 A 3-M 8	5,8	15,0	9,0	8,0	43,5	8,4	600/100	HN6	B 15NDE
	10	2 A 3-M 10	5,8	18,0	11,0	10,0	47,5	10,5	500/100		
25	8	2 A 5-M 8	7,0	15,0	9,0	8,0	51,0	8,4	400/100	HN-A25	B 15NDE
	10	2 A 5-M 10	7,0	18,0	11,0	10,0	55,0	10,5	300/50		
35	12	2 A 5-M 12	7,0	21,0	14,0	12,0	60,0	13,2	300/50	TN 70 SE	B 15NDE
	8	2 A 7-M 8	8,9	17,0	9,0	8,0	53,0	8,4	250/50		
50	10	2 A 7-M 10	8,9	19,0	11,0	10,0	57,0	10,5	250/50	TN 70 SE	B 15NDE
	12	2 A 7-M 12	8,9	21,0	14,0	12,0	62,0	13,2	200/50		
63	10	2 A 10-M 10	10,0	20,0	11,0	10,0	63,0	10,5	200/50	TN 120 SE*	B 35-45NDE B 35-50NDE
	12	2 A 10-M 12	10,0	21,0	14,0	12,0	68,0	13,2	150/50		
70	14	2 A 10-M 14	10,0	25,0	16,0	14,0	72,0	15,0	150/50	TN 120 SE*	HT 45-E
	16	2 A 10-M 16	10,0	26,0	18,0	16,0	76,0	17,0	150/50		
95	10	2 A 14-M 10	11,3	21,0	11,0	10,0	70,0	10,5	100/50	TN 120 SE*	HT 51 B 550E RH 50 B 500E
	12	2 A 14-M 12	11,3	22,0	14,0	12,0	75,0	13,2	100/50		
120	14	2 A 14-M 14	11,3	25,0	16,0	14,0	79,0	15,0	100/50	TN 120 SE*	RHU 81
	16	2 A 14-M 16	11,3	26,0	18,0	16,0	83,0	17,0	100/50		
125	10	2 A 19-M 10	13,5	25,0	11,0	10,0	76,5	10,5	75/25	TN 120 SE*	RHU 520
	12	2 A 19-M 12	13,5	25,0	14,0	12,0	81,5	13,2	75/25		
150	14	2 A 19-M 14	13,5	25,0	16,0	14,0	85,5	15,0	75/25	TN 120 SE*	RHU 520
	16	2 A 19-M 16	13,5	27,0	18,0	16,0	90,5	17,0	75/25		
185	20	2 A 19-M 20	13,5	29,5	22,0	20,0	97,5	21,0	75/25	TN 120 SE*	RHU 520
	10	2 A 24-M 10	15,2	28,5	11,0	10,0	82,0	10,5	50/25		
240	12	2 A 24-M 12	15,2	28,5	14,0	12,0	87,0	13,2	50/25	TN 120 SE*	RHU 520
	14	2 A 24-M 14	15,2	28,5	16,0	14,0	91,0	15,0	50/25		
300	16	2 A 24-M 16	15,2	28,5	18,0	16,0	95,0	17,0	50/25	TN 120 SE*	RHU 520
	20	2 A 24-M 20	15,2	30,0	22,0	20,0	103,0	21,0	50/25		
400	10	2 A 30-M 10	16,7	31,5	13,0	11,0	92,0	10,5	50/25	TN 120 SE*	RHU 520
	12	2 A 30-M 12	16,7	31,5	16,0	14,0	98,0	13,2	30/15		
500	14	2 A 30-M 14	16,7	31,5	18,0	16,0	102,0	15,0	30/15	TN 120 SE*	RHU 520
	16	2 A 30-M 16	16,7	31,5	19,0	17,0	104,0	17,0	30/15		
630	20	2 A 30-M 20	16,7	31,5	22,0	20,0	110,0	21,0	30/15	TN 120 SE*	RHU 520
	12	2 A 37-M 12	19,2	35,5	16,0	14,0	108,0	13,2	30/15		
800	14	2 A 37-M 14	19,2	35,5	18,0	16,0	112,0	15,0	30/15	TN 120 SE*	RHU 520
	16	2 A 37-M 16	19,2	35,5	19,0	17,0	114,0	17,0	30/15		
1000	20	2 A 37-M 20	19,2	35,5	22,0	20,0	120,0	21,0	30/15	TN 120 SE*	RHU 520
	12	2 A 48-M 12	21,1	39,0	16,0	14,0	109,0	13,2	20/5		
1200	14	2 A 48-M 14	21,1	39,0	18,0	16,0	113,0	15,0	20/5	TN 120 SE*	RHU 520
	16	2 A 48-M 16	21,1	39,0	19,0	17,0	115,0	17,0	20/5		
1500	20	2 A 48-M 20	21,1	39,0	22,0	20,0	121,0	21,0	25/5	TN 120 SE*	RHU 520
	12	2 A 60-M 12	23,7	44,0	20,0	14,0	129,5	13,2	20/5		
2000	14	2 A 60-M 14	23,7	44,0	22,0	16,0	133,5	15,0	20/5	TN 120 SE*	RHU 520
	16	2 A 60-M 16	23,7	44,0	22,0	19,0	136,5	17,0	20/5		
2500	20	2 A 60-M 20	23,7	44,0	24,0	23,0	142,5	21,0	20/5	TN 120 SE*	RHU 520
	12	2 A 80-M 12	27,0	51,0	22,0	19,0	140,0	13,2	15/5		
3000	14	2 A 80-M 14	27,0	51,0	22,0	19,0	140,0	15,0	10/5	TN 120 SE*	RHU 520
	16	2 A 80-M 16	27,0	51,0	22,0	19,0	140,0	17,0	10/5		
4000	20	2 A 80-M 20	27,0	51,0	24,0	23,0	146,0	21,0	15/5	TN 120 SE*	RHU 520
	16	2 A 100-M 16*	30,3	56,5	22,0	19,0	147,0	17,0	10/1		
5000	20	2 A 100-M 20*	30,3	56,5	24,0	23,0	153,0	21,0	10/1	TN 120 SE*	RHU 520
	16	2 A 120-M 16*	33,4	61,5	22,0	19,0	159,0	17,0	20/1		
6000	20	2 A 120-M 20*	33,4	61,5	24,0	23,0	165,0	21,0	20/1	TN 120 SE*	RHU 520
	20	2 A 160-M 20*	38,0	72,0	24,0	23,0	187,0	21,0	12/1		
8000	20	2 A 200-M 20*	44,0	82,0	24,0	23,0	202,0	21,0	6/1	TN 120 SE*	RHU 520

*See page 109

†Not UL approved

HIGH VOLTAGE TERMINALS

two hole fixing

2A-2M

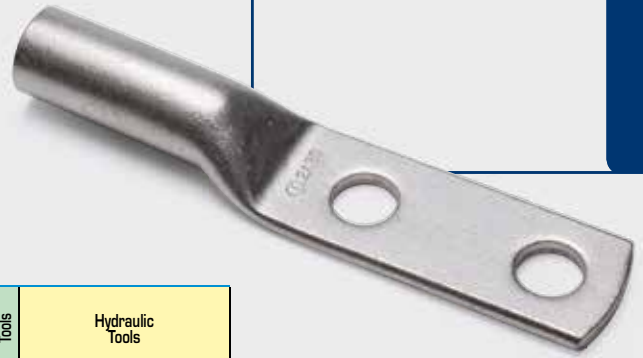
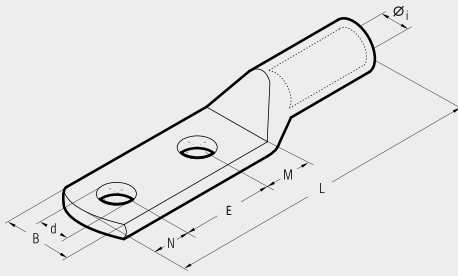

Cond. Size AWG	Ø Stud in.	Ref.	Dimensions in.							Quantity Bag	Mechanical Tools	Hydraulic Tools
			Øi	B	M	N	E	L	d			
50	8	2A10-2M12	10,0	21,0	14,0	12,0	44,5	112,5	13,2	25	TN 70 SE	
	10	2A14-2M12	11,3	22,0	16,0	14,0	44,5	123,5	13,2	25		
70	12	2A14-2M14	11,3	25,0	18,0	16,0	44,5	127,5	15,0	25	TN 120 SE	
	8	2A19-2M12	13,5	25,0	16,0	14,0	44,5	128,0	13,2	25		
95	10	2A19-2M14	13,5	25,0	18,0	16,0	44,5	132,0	15,0	25	B 35-45MDE B 35-50MDE	
	12	2A24-2M12	15,2	28,5	16,0	14,0	44,5	135,5	13,2	25		
120	8	2A24-2M14	15,2	28,5	18,0	16,0	44,5	139,5	15,0	25	HT 45-E	
	10	2A24-2M16	15,2	28,5	18,0	17,0	44,5	140,5	17,0	25		
	12	2A30-2M12	16,7	31,5	16,0	14,0	44,5	142,5	13,2	15		
150	14	2A30-2M14	16,7	31,5	18,0	16,0	44,5	146,5	15,0	15	HT 51	
	10	2A30-2M16*	16,7	31,5	19,0	17,0	44,5	148,5	17,0	15		
	12	2A37-2M12	19,2	35,5	16,0	14,0	44,5	152,5	13,2	15		
185	14	2A37-2M14	19,2	35,5	18,0	16,0	44,5	156,5	15,0	15	RH 50	
	16	2A37-2M16	19,2	35,5	19,0	17,0	44,5	158,5	17,0	15		
	10	2A48-2M12	21,1	39,0	16,0	14,0	44,5	153,5	13,2	5		
240	12	2A48-2M14	21,1	39,0	18,0	16,0	44,5	157,5	15,0	5	HT 50	
	14	2A48-2M16	21,1	39,0	19,0	17,0	44,5	159,5	17,0	5		
	16	2A60-2M12	23,7	44,0	20,0	14,0	44,5	174,0	13,2	5		
300	10	2A60-2M14	23,7	44,0	22,0	16,0	44,5	178,0	15,0	5	HT 81-U	
	12	2A60-2M16	23,7	44,0	19,0	17,0	44,5	176,0	17,0	5		
	14	2A80-2M12	27,0	51,0	20,0	14,0	44,5	177,5	13,2	5		
400	16	2A80-2M14	27,0	51,0	22,0	16,0	44,5	181,5	15,0	5	RH 50	
	10	2A80-2M16	27,0	51,0	22,0	19,0	44,5	184,5	17,0	5		
	12	2A100-2M12*	30,3	56,5	20,0	14,0	44,5	178,5	13,2	5		
500	14	2A100-2M14*	30,3	56,5	22,0	16,0	44,5	182,5	15,0	5	HT 81-U	
	16	2A100-2M16*	30,3	56,5	22,0	19,0	44,5	185,5	17,0	5		
	10	2A120-2M12*	33,4	61,5	20,0	14,0	44,5	196,5	13,2	5		
630	12	2A120-2M14*	33,4	61,5	22,0	19,0	44,5	200,5	15,0	5	RH 50	
	14	2A120-2M16*	33,4	61,5	22,0	19,0	44,5	203,5	17,0	5		
	16	2A160-2M12*	38,0	72,0	20,0	14,0	44,5	218,5	13,2	1		
800	10	2A160-2M14*	38,0	72,0	22,0	19,0	44,5	225,5	15,0	1	HT 120 and tools and heads with 130 kN crimping force ECW-H3D	
	12	2A160-2M16*	38,0	72,0	24,0	19,0	44,5	227,5	17,0	1		
	14	2A200-2M12*	44,0	80,0	20,0	14,0	44,5	233,5	13,2	1		
1000	16	2A200-2M14*	44,0	80,0	22,0	16,0	44,5	237,5	15,0	1	RHU 520	
	16	2A200-2M16*	44,0	80,0	22,0	19,0	44,5	240,5	17,0	1		
	12	2A200-2M20*	44,0	80,0	24,0	23,0	44,5	246,5	21,0	1		

*Not UL approved

2A-2M.. series lugs are manufactured from electrolytic Copper tube conforming to EN13600.

The tube dimensions are designed to optimise electrical conductivity and mechanical strength.

Double length barrels enhance electrical and mechanical performance in heavy duty applications.

Palms feature double stud holes at standard 44.5mm centres.

Other configurations are available upon request.

Lugs are annealed to ensure ductility and satisfactory performance when subjected to deformation and vibration.

The absence of an inspection hole prevents the ingress of water or moisture into the crimped joint making these terminals suitable for outdoor applications.

Lugs are electrolytically Tin plated to avoid oxidation.

Details of the appropriate crimping tools and dies are shown on pages 180 to 181.

HIGH VOLTAGE HEAVY DUTY COPPER TERMINALS

CA-M

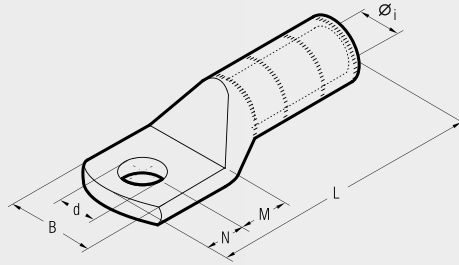

Series CA-M and 2A-M terminals are designed for high voltage applications up to 33 kV.

They are manufactured from high purity Copper tube, annealed and Tin plated.

The extended barrel enhances both electrical and mechanical performance. The absence of an inspection hole prevents moisture entry into the crimped joint and makes these terminals suitable for outdoor applications.

Details of the appropriate crimping tools and dies are shown on page 184.

Conductor Size (sqmm) & Format	Ø Stud mm	Ref.	Dimensions mm					Quantity Box/Bag	Hydraulic Tools	
			Øi	B	M	N	L			d
25 R/BR/BS*	8	CA 25-M 8	6,8	14,0	9	8	65,0	8,4	300/50	B35-50/MD
	10	CA 25-M 10	6,8	18,0	13	11	72,0	10,5	200/50	
	12	CA 25-M 12	6,8	21,0	16	14	78,0	13,2	200/50	
30 RC/S ÷ 40 S	12	CA 40 S-M 12	8,2	21,0	16	14	79,0	13,2	150/50	
	16	CA 40 S-M 16	8,2	26,0	19	17	85,0	17,0	100/50	
35 BR/BS*	10	CA 35-M 10	8,25	21,0	13	11	73,0	10,5	150/50	
	12	CA 35-M 12	8,25	21,0	16	14	79,0	13,2	150/50	
50 RC	12	CA 50 R-M 12	8,7	20,5	16	14	79,0	13,2	150/50	
	16	CA 50 R-M 16	8,7	25,5	19	17	85,0	17,0	100/50	
50 S	12	CA 50 S-M 12	9,5	21,0	16	14	79,0	13,2	150/50	
	16	CA 50 S-M 16	9,5	26,0	19	17	85,0	17,0	100/50	
50 BR/BS*	10	CA 50-M 10	9,5	21,0	13	11	73,0	10,5	150/50	
	12	CA 50-M 12	9,5	21,0	16	14	79,0	13,2	150/50	
	14	CA 50-M 14	9,5	25,0	18	16	83,0	15,0	100/50	
63 S ÷ 70 S	16	CA 50-M 16	9,5	26,0	19	17	85,0	17,0	100/50	
	12	CA 70 S-M 12	11,0	28,0	16	14	81,2	13,2	50/25	
	16	CA 70 S-M 16	11,0	30,0	19	17	87,2	17,0	50/25	
70 BR/BS*	10	CA 70 S-M 10	11,0	26,0	13	11	75,2	10,5	50/25	
	12	CA 70 S-M 12	11,0	28,0	16	14	81,2	13,2	50/25	
	14	CA 70 S-M 14	11,0	28,0	18	16	85,2	15,0	50/25	
80 S ÷ 95 RC	16	CA 70 S-M 16	11,0	30,0	19	17	87,2	17,0	50/25	
	12	CA 95 R-M 12	12,0	28,0	16	14	91,0	13,2	50/25	
	14	CA 95 R-M 14	12,0	29,0	18	16	95,0	15,0	50/25	
95 S ÷ 100 S	12	CA 95 S-M 12	13,5	28,0	16	14	91,0	13,2	50/25	
	14	CA 95 S-M 14	13,5	29,0	18	16	94,5	15,0	50/25	
	16	CA 95 S-M 16	13,5	30,0	20	17	97,0	17,0	50/25	
95 BR/BS*	10	CA 95-M 10	13,5	28,0	13	11	85,0	10,5	50/25	
	12	CA 95-M 12	13,5	28,0	16	14	91,0	13,2	50/25	
	16	CA 95-M 16	13,5	30,0	20	17	97,0	17,0	50/25	
120 RC/S ÷ 150 RC	12	CA 150 R-M 12	15,0	31,0	16	14	97,0	13,2	30/15	
	14	CA 150 R-M 14	15,0	31,0	18	16	101,0	15,0	30/15	
120 BR/BS*	12	CA 120-M 12	15,0	31,0	16	14	97,0	13,2	30/15	
	16	CA 120-M 16	15,0	31,0	19	17	103,0	17,0	30/15	
150 S ÷ 160 RC	12	CA 150 S-M 12	16,5	32,0	16	14	97,0	13,2	30/15	
	14	CA 150 S-M 14	16,5	32,0	18	16	101,0	15,0	30/15	
150 BR/BS*	12	CA 150-M 12	16,5	32,0	16	14	97,0	13,2	30/15	
	16	CA 150-M 16	16,5	32,0	19	17	103,0	17,0	30/15	
160 S ÷ 200 RC	14	CA 200 R-M 14	17,0	32,5	18	16	101,0	15,0	30/15	
	12	CA 185-M 12	18,0	33,5	16	14	97,0	13,2	30/15	
185 BR/BS*	16	CA 185-M 16	18,0	33,5	19	17	103,0	17,0	30/15	
	14	CA 240 R-M 14	19,2	43,0	18	16	107,0	15,0	15/5	
200 S ÷ 240 RC	12	CA 315 R-M 12	20,5	42,0	16	14	103,0	13,2	15/5	
	16	CA 240-M 16	20,5	42,0	19	17	109,0	17,0	15/5	
240 BR/BS*	20	CA 240-M 20	20,5	42,0	22	20	115,0	21,0	15/5	
	12	CA 300-M 12	23,0	43,5	16	14	109,5	13,2	15/5	
300 BR/BS*	16	CA 300-M 16	23,0	43,5	19	17	115,5	17,0	15/5	
	20	CA 300-M 20	23,0	43,5	22	20	121,5	21,0	15/5	
315 S	14	CA 315 S-M 14	23,7	44,0	18	16	105,0	15,0	15/5	

Conductor Format: R = Round, RC = Round Compact, S = Sector, BR = IEC228 (BS6360) Round, BS* = IEC228 (BS6360) Sector
 * = Pre-rounding required, consult Cembre for appropriate die set

HIGH VOLTAGE HEAVY DUTY COPPER TERMINALS

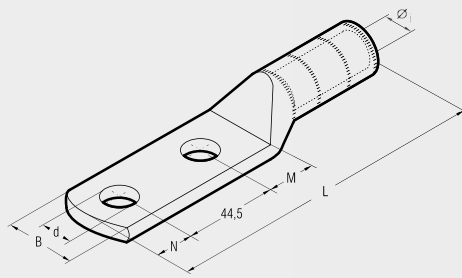

two hole fixing

CA-2M

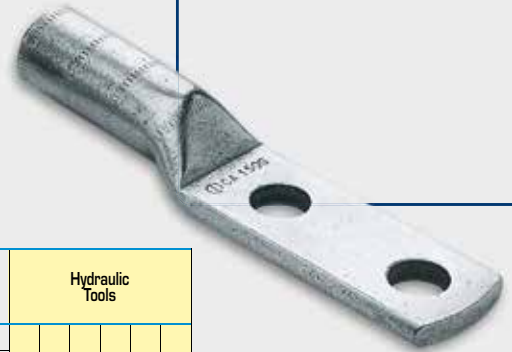

Conductor Size (sqmm) & Format	Ø Stud mm	Ref.	Dimensions mm					Quantity Box/Bag	Hydraulic Tools
			Øi	B	M	N	L		
25 R	8	CA 25-2 M 8	6,8	14,0	10	11	113,5	8,4	B35-50MDE HT 51 RH 50 B 500E B 550E HT 81-U RHU 81 HT 120 and tools and heads with 130 kN crimping force ECW-H3D RHU 520
	12	CA 25-2 M 12	6,8	21,0	16	14	122,5	13,2	
25 BR/BS*	8	CA 25-2 M 8	6,8	14,0	10	11	113,5	8,4	
	10	CA 25-2 M 10	6,8	18,0	13	11	116,5	10,5	
30 RC/S ÷ 40 S	12	CA 40 S-2 M 12	8,2	21,5	16	14	123,5	13,2	
	12	CA 35-2 M 12	8,25	21,5	16	14	123,5	13,2	
35 BR/BS*	12	CA 35-2 M 12	8,25	21,5	16	14	123,5	13,2	
50 RC	12	CA 50 R-2 M 12	8,7	20,5	16	14	123,5	13,2	
50 S	12	CA 50 S-2 M 12	9,5	21,0	16	14	123,5	13,2	
50 BR/BS*	12	CA 50-2 M 12	9,5	21,0	16	14	123,5	13,2	
63 S ÷ 70 S	12	CA 70 S-2 M 12	11,0	27,0	16	14	127,7	13,2	
70 BR/BS*	12	CA 70 S-2 M 12	11,0	27,0	16	14	127,7	13,2	
80 S ÷ 95 RC	14	CA 95 R-2 M 14	12,0	28,0	18	16	139,5	15,0	
95 S ÷ 100 S	14	CA 95 S-2 M 14	13,5	29,0	18	16	139,5	15,0	
95 BR/BS*	12	CA 95-2 M 12	13,5	28,0	16	14	135,5	13,2	
120 RC/S ÷ 150 RC	14	CA 150 R-2 M 14	15,0	31,0	18	16	145,5	15,0	
120 BR/BS*	12	CA 120-2 M 12	15,0	31,0	16	14	141,5	13,2	
150 S ÷ 160 RC	14	CA 150 S-2 M 14	16,5	32,0	18	16	145,5	15,0	
150 BR/BS*	12	CA 150-2 M 12	16,5	32,0	16	14	141,5	13,2	
160 S ÷ 200 RC	14	CA 200 R-2 M 14	17,0	32,5	18	16	145,0	15,0	
185 BR/BS*	12	CA 185-2 M 12	18,0	32,5	16	14	141,5	13,2	
200 S ÷ 240 RC	14	CA 240 R-2 M 14	19,2	43,0	18	16	151,5	15,0	
240 S ÷ 315 RC	14	CA 315 R-2 M 14	21,5	43,0	18	16	149,5	15,0	
240 BR/BS*	12	CA 240-2 M 12	20,5	43,0	16	14	147,5	13,2	
300 BR/BS*	12	CA 300-2 M 12	23,0	43,0	16	14	145,5	13,2	
315 S	14	CA 315 S-2 M 14	23,7	44,0	18	16	149,5	15,0	

Conductor Format: R = Round, RC = Round Compact, S = Sector; BR = IEC228 (BS6360) Round, BS* = IEC228 (BS6360) Sector
* = Pre-rounding required, consult Cembre for appropriate die set

CA-2M and 2A-2M Copper Tube Terminal Lugs are designed for high voltage applications up to 33kV. Manufactured from high purity Copper tube, annealed and Tin plated. The extended barrel enhances electrical and mechanical performance. The absence of an inspection hole prevents moisture entry into the crimped joint. Featuring an extended palm with two fixing holes at 44.5mm centres. Details of the appropriate crimping tools and dies are shown on page 184.

HIGH VOLTAGE TERMINALS

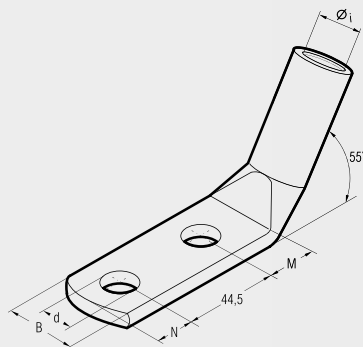

two hole fixing - 55°

2A-2M/55°



Conductor Size (sqmm) & Format	Ø Stud mm	Ref.	Dimensions mm					Quantity Box/Bag	Hydraulic Tools
			Øi	B	M	N	d		
400 R	14	2 A 80 - 2 M 14/55°	27,0	51,0	22	16	15	10/5	HT 120 and tools and heads with 130 kN crimping force ECW-H3D RHU 520
600 R ÷ 630 R	14	2 A 120 - 2 M 14/55°	33,4	61,5	22	16	15	15/3	

Conductor Format: R = Round

The 2A-2M/55° Copper Tube Terminal Lugs have the same characteristics as the CA-2M and 2A-2M ranges, with the additional feature of the palm bent at 55°.

HIGH VOLTAGE STALK CONNECTORS

MT-C

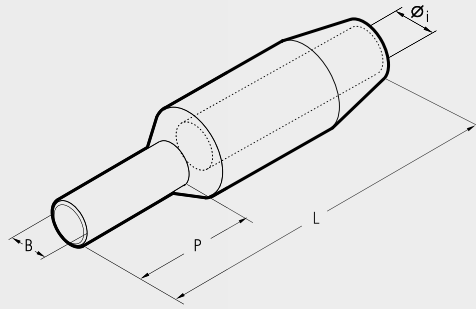

MT-C series connectors are designed for high voltage applications up to 33 kV. They are manufactured from high purity Copper, annealed and Tin plated. The extended barrel enhances both electrical and mechanical performance. The stalk or pin makes these connectors ideal for terminating conductors into contact blocks. Details of the appropriate crimping tools and dies are shown on page 184.

Conductor Size (sqmm) & Format	Ref.	Dimensions mm				Quantity Box/Bag	Hydraulic Tools			
		Ø1	B	P	L					
25 R	MT 25-C 8	6,8	8	35	80	90/3	B35-50MDE			
30 RC/S ÷ 40 S	MT 40 S-C 8	8,2	8	35	80	90/3				
	MT 40 S-C 10	8,2	10	35	80	90/3				
35 BR/BS*	MT 40 S-C 14-80	8,2	14	80	123	30/3				
	MT 35-C 8	8,2	8	35	80	90/3				
	MT 35-C 10	8,2	10	35	80	90/3				
50 RC	MT 35-C 14-80	8,2	14	80	123	30/3				
	MT 50 R-C 8	8,8	8	35	80	90/3				
	MT 50 R-C 10	8,8	10	35	80	90/3				
50 S	MT 50 S-C 8	9,5	8	35	80	90/3				
	MT 50 S-C 10	9,5	10	35	80	90/3				
	MT 50 S-C 14-80	9,5	14	80	123	30/3				
50 BR/BS*	MT 50-C 8	9,5	8	35	80	90/3				
	MT 50-C 10	9,2	10	35	80	90/3				
	MT 50-C 14-80	9,5	14	80	123	90/3				
63 S ÷ 70 S	MT 70 S-C 10	11,2	10	35	90	30/3	HT 51 RH 50 B 50DE B 55DE			
70 BR/BS*	MT 70-C 10	11,2	10	35	90	30/3				
80 S ÷ 95 RC	MT 95 R-C 10	12,0	10	45	110	60/3				
	MT 95 R-C 12	12,0	12	45	110	60/3				
95 S ÷ 100 S	MT 95 S-C 10	13,5	10	45	110	60/3				
	MT 95 S-C 12	13,5	12	45	110	60/3				
	MT 95 S-C 14-80	13,5	14	80	145	60/3				
95 BR/BS*	MT 95-C 10	13,5	10	45	110	60/3				
	MT 95-C 12	13,5	12	45	110	60/3				
	MT 95-C 14-80	13,5	14	80	145	60/3				
120 RC/S ÷ 150 RC	MT 150 R-C 12	15,0	12	45	110	60/3	HT 81-U RHU 81			
	MT 150 R-C 16	15,0	16	45	110	30/3				
120 BR/BS*	MT 120-C 12	15,0	12	45	110	60/3				
	MT 120-C 16	15,0	16	45	110	60/3				
150 S ÷ 160 RC	MT 150 S-C 12	16,5	12	45	110	60/3				
	MT 150 S-C 14-80	16,5	14	80	145	45/3				
	MT 150 S-C 16	16,5	16	45	110	60/3				
150 BR/BS*	MT 150-C 10	16,5	10	45	110	60/3				
	MT 150-C 12	16,5	12	45	110	60/3				
	MT 150-C 14-80	16,5	14	80	145	45/3				
	MT 150-C 16	16,5	16	45	110	60/3				
160 S ÷ 200 RC	MT 200 R-C 10	17,0	10	45	110	30/3	HT 120 and tools and heads with 130 kN crimping force			
	MT 200 R-C 16	17,0	16	45	110	30/3				
185 BR/BS*	MT 185-C 10	18,0	10	45	110	30/3				
	MT 185-C 16	18,0	16	45	110	30/3				
200 S ÷ 240 RC	MT 240 R-C 12	19,5	12	50	115	30/3				
	MT 240 R-C 16	19,5	16	50	115	30/3				
240 S ÷ 315 RC	MT 315 R-C 16	21,5	16	50	115	30/3				
	MT 240-C 12	20,5	12	45	110	30/3				
240 BR/BS*	MT 240-C 16	20,5	16	50	115	30/3				
	MT 300-C 16	23,0	16	50	115	30/3				
300 BR/BS*	MT 300-C 16	23,0	16	50	115	30/3				
315 S	MT 315 S-C 16	24,0	16	60	130	30/3				

Conductor Format: R = Round, RC = Round Compact, S = Sector, BR = IEC228 (BS6360) Round, BS* = IEC228 (BS6360) Sector
 * = Pre-rounding required, consult Cembre for appropriate die set

HIGH VOLTAGE COPPER THROUGH CONNECTORS

MT-TD MT-GC

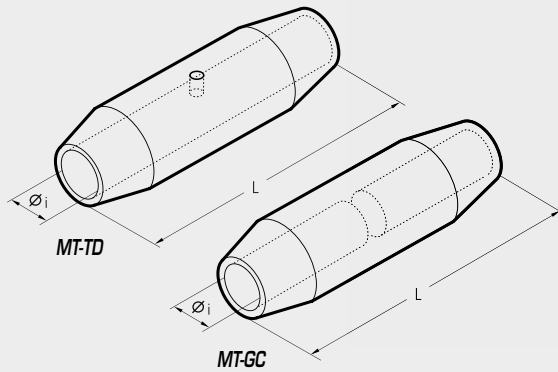

Conductor Size (sqmm) & Format	Ref.	Ref.	Dimensions mm		Quantity Box/Bag	Hydraulic Tools					
			Øi	L							
25 R/BR/BS*	MT 25-TD	MT 25-GC	6,8	60	90/3	B35-SOMDE	HT 51	RH 50	B 550E	RHU 81	RHU 81
30 RC/S ÷ 40 S	MT 40 S-TD	MT 40 S-GC	8,2	60	90/3						
30 BR/BS*	MT 35-TD	MT 35-GC	8,2	60	90/3						
50 RC	MT 50 R-TD	MT 50 R-GC	8,7	60	90/3						
50 S	MT 50 S-TD	MT 50 S-GC	9,5	60	90/3						
50 BR/BS*	MT 50-TD	MT 50-GC	9,5	60	90/3						
63 S ÷ 70 S	MT 70 S-TD	MT 70 S-GC	11,0	70	30/3						
70 BR/BS*	MT 70-TD	MT 70-GC	11,0	70	30/3						
80 S ÷ 95 RC	MT 95 R-TD	MT 95 R-GC	12,0	80	30/3						
95 S ÷ 100 S	MT 95 S-TD	MT 95 S-GC	13,5	80	30/3						
95 BR/BS*	MT 95-TD	MT 95-GC	13,5	80	30/3						
120 RC/S ÷ 150 RC	MT 150 R-TD	MT 150 R-GC	15,0	80	30/3						
120 BR/BS*	MT 120-TD	MT 120-GC	15,0	80	30/3						
150 S ÷ 160 RC	MT 150 S-TD	MT 150 S-GC	16,5	80	30/3						
150 BR/BS*	MT 150-TD	MT 150-GC	16,5	80	30/3						
160 S ÷ 200 RC	MT 200 R-TD	MT 200 R-GC	17,0	100	30/3						
185 BR/BS*	MT 185-TD	MT 185-GC	18,0	100	30/3						
200 S ÷ 240 RC	MT 240 R-TD	MT 240 R-GC	19,2	100	30/3						
240 S ÷ 315 RC	MT 315 R-TD	MT 315 R-GC	21,5	100	30/3						
240 BR/BS*	MT 240-TD	MT 240-GC	20,5	100	30/3						
300 BR/BS*	MT 300-TD	MT 300-GC	23,0	100	30/3						
315 S	MT 315 S-TD	MT 315 S-GC	23,7	100	30/3						
400 BR/BS*	MT 400-TD	MT 400-GC	27,0	120	15/3						
500 R	MT 500-TD		30,3	118	15/3						
600 R ÷ 630 R	MT 630-TD		33,4	130	9/3						

Conductor Format: R = Round, RC = Round Compact, S = Sector; BR = IEC228 (BS6360) Round, BS* = IEC228 (BS6360) Sector
* = Pre-rounding required, consult Cembre for appropriate die set

MT-TD and MT-GC series connectors are designed to join conductors in high voltage applications up to 33 kV.

They are manufactured from high purity Copper, annealed and Tin plated.

MT-GC series feature a solid stop which forms a barrier between the two conductors being joined, this prevents the migration of oils or greases, which may be present, in one cable contaminating the other cable.

MT-TD connectors are unblocked and are suitable for joining cables of the same type.

Details of the appropriate crimping tools and dies are shown on page 184.

ALUMINIUM TERMINALS

AA-M

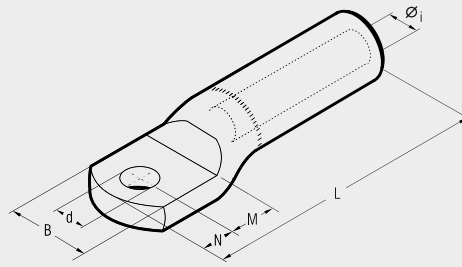

AA-M series terminals are made from Aluminium of a purity equal to or greater than 99,5%.

They are designed to accept a variety of conductor forms especially low stranded compacted conductors.

Non circular conductors may require pre-rounding prior to introduction to the terminal.

Barrels are capped and filled with grease so as to avoid oxidation of the Aluminium.

Details of the appropriate crimping tools and dies are shown on page 185.

Conductor Size sqmm	Ø Stud mm	Ref.	Dimensions mm						Quantity Box/Bag	Hydraulic Tools	
			Øi	B	M	N	L	d			
16	8	AA 16-M 8	5,5	21	13	11	77,0	8,4	60/3	HT 131-UC RHU 131-C B 1300-UC	
25	8	AA 25-M 8	6,5	21	13	11	77,0	8,4	60/3		
35	8	AA 35-M 8	8,0	23	13	11	77,5	8,4	60/3		
	10	AA 35-M 10	8,0	23	13	11	77,5	10,5	60/3		
50	12	AA 50-M 12	9,0	26	16	14	91,0	13,2	60/3		
	14	AA 50-M 14	9,0	26	18	16	95,0	15,0	60/3		
70	12	AA 70-M 12	11,0	27	16	14	91,0	13,2	45/3		
	14	AA 70-M 14	11,0	27	18	16	95,0	15,0	45/3		
95	12	AA 95-M 12	12,5	27	16	14	91,0	13,2	45/3		
	14	AA 95-M 14	12,5	27	18	16	95,0	15,0	45/3		
120	12	AA 120-M 12	13,7	35	16	14	115,0	13,2	30/3		
	14	AA 120-M 14	13,7	35	18	16	119,0	15,0	30/3		
150	12	AA 150-M 12	15,5	34	16	14	115,0	13,2	30/3		
	14	AA 150-M 14	15,5	34	18	16	119,0	15,0	30/3		
185	12	AA 185-M 12	17,0	42	20	14	122,0	13,2	18/3		
	14	AA 185-M 14	17,0	42	22	16	126,0	15,0	18/3		
240	12	AA 240-M 12	19,5	44	20	14	122,0	13,2	15/3		
	14	AA 240-M 14	19,5	44	22	16	126,0	15,0	15/3		
300	12	AA 300-34 M 12	22,5	47	22	14	130,0	13,2	15/3	HT120 HT131-C RHC 131	ECW-H3D
	14	AA 300-34 M 14	22,5	47	22	16	132,0	15,0	15/3		
	16	AA 300-34 M 16	22,5	47	22	17	133,0	17,0	15/3		
400	16	AA 400-M 16	23,3	54	19	17	172,0	17,0	12/3	RHU 230-630	
500	16	AA 500-40 M 16	29,1	57	22	19	177,0	17,0	12/3		
630	16	AA 630-M 16	32,5	70	22	19	177,0	17,0	9/3		



THROUGH CONNECTORS

for Aluminium conductors

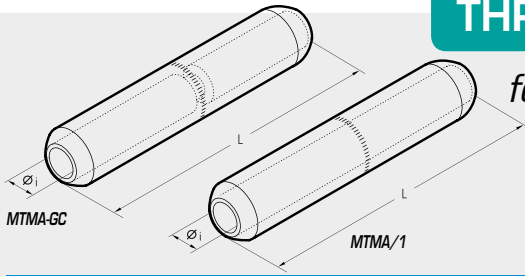

MTMA-GC MTMA/1



Conductor Size sqmm	Ref.	Ref.	Dimensions mm		Quantity Box/Bag	Hydraulic Tools	
			Øi	L			
10	MTMA 10-GC		4,3	90,5	60/3	HT 131-UC RHU 131-C B 1300-UCE	
16	MTMA 16-GC	MTMA 16/1	5,5	90,5	60/3		
25	MTMA 25-GC	MTMA 25/1	6,5	90,5	60/3		
35	MTMA 35-GC	MTMA 35/1	8,0	90,5	60/3		
	MTMA 35-20-GC		8,0	106,5	30/3		
50	MTMA 50-GC	MTMA 50/1	9,0	106,5	30/3		
70	MTMA 70-GC	MTMA 70/1	11,0	106,5	30/3		
95	MTMA 95-GC		12,5	110,0	30/3		
		MTMA 95/1	12,5	106,5	30/3		
120	MTMA 120-GC	MTMA 120/1	13,7	133,0	30/3		
150	MTMA 150-GC		15,5	135,0	30/3		
		MTMA 150/1	15,5	133,5	30/3		
185	MTMA 185-GC	MTMA 185/1	17,0	143,5	15/3		
240	MTMA 240-GC	MTMA 240/1	19,5	143,5	15/3		
300	MTMAD 300-GC		22,5	144,5	15/3		
		MTMAD 300/1	22,5	135,0	15/3	HT120 HT131-C RHC 131	
	MTMA 300-GC		23,3	218,0	15/3	ECW-H3D	
400		MTMA 400/1	26,0	218,0	15/3		
500	MTMA 500-GC		29,1	218,5	15/3	RHU 230-630	
500		MTMA 500-40/1	29,1	218,0	12/3		
630		MTMA 630/1	32,5	218,5	12/3		

MTMA-GC series through connectors are made from Aluminium of a purity equal to or greater than 99,5%. They feature a solid stop which creates a barrier between the two sides of conductors to be joined. Barrels are capped and filled with grease so as to avoid oxidation of the connector. MTMA/1 series through connectors are unblocked and are suitable for joining cables of the same type. Details of the appropriate crimping tools and dies are shown on pages 186-187.

REDUCER THROUGH CONNECTORS

for Aluminium or copper conductors

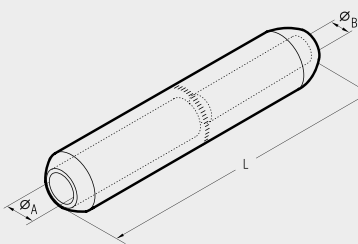

MTMA-GC



Conductor Size sqmm	Side A Al	Side B Al/Cu	Ref.	Dimensions mm			Quantity Box/Bag	Hydraulic Tools	
				ØA	ØB	L			
16	10	10	MTMA 16-10-GC	5,5	4,3	90,5	60/3	HT 131-UC RHU 131-C B 1300-UCE	
		16	MTMA 16-16-GC	5,5	4,3	90,5	60/3		
25	16	16	MTMA 25-16-GC	6,5	5,5	90,5	60/3		
		25	MTMA 25-25-GC	6,5	5,5	90,5	60/3		
50	25	25	MTMA 50-25-GC	9,0	6,5	106,5	30/3		
		35	MTMA 50-35-GC	9,0	8,0	106,5	30/3		
70	35	35	MTMA 70-35-GC	11,0	8,0	106,5	30/3		
		50	MTMA 70-50-GC	11,0	9,0	106,5	30/3		
95	50	50	MTMA 95-50-GC	12,5	9,0	109,4	30/3		
		70	MTMA 95-70-GC	12,5	11,0	106,5	30/3		
120	70	70	MTMA 120-70-GC	13,7	11,0	133,0	30/3		
		95	MTMA 120-95-GC	13,7	12,5	133,0	30/3		
150	70	70	MTMA 150-70-GC	15,5	11,0	133,0	30/3		
		95	MTMA 150-95-GC	15,5	12,5	134,4	30/3		
185	120	120	MTMA 150-120-GC	15,5	13,7	133,0	30/3		
		150	MTMA 185-120-GC	17,0	13,7	143,5	15/3		
240	150	150	MTMA 185-150-GC	17,0	15,5	143,5	15/3		
		185	MTMA 240-150-GC	19,5	15,5	143,5	15/3		
300	150	185	MTMA 240-185-GC	19,5	17,0	143,5	15/3		
		240	MTMAD 300-95-GC	22,5	12,5	144,5	15/3		
400	240	150	MTMAD 300-150-GC	22,5	15,5	144,5	15/3	HT120 HT131-C RHC 131	
		185	MTMAD 300-185-GC	22,5	17,0	144,5	15/3	ECW-H3D	
500	300	240	MTMAD 300-240-GC	22,5	19,5	144,5	15/3		RHU 230-630
		400	MTMA 400-240-GC	26,0	19,5	218,0	15/3		
	300	MTMA 400-300-GC	26,0	23,3	218,0	15/3			
500	300	300	MTMA 500-300-GC	29,1	23,3	218,5	12/3		
		400	MTMA 500-400-GC	29,1	26,0	218,5	12/3		

MTMA-GC series reducer through connectors are manufactured to the same specification as MTMA-GC series through connectors. Details of the appropriate crimping tools and dies are shown on pages 186-187.

AAD-M

ALUMINIUM TERMINALS

for non-tension connections on Aluminium conductors according to DIN EN 50182



Tube dimensions according to DIN 46329

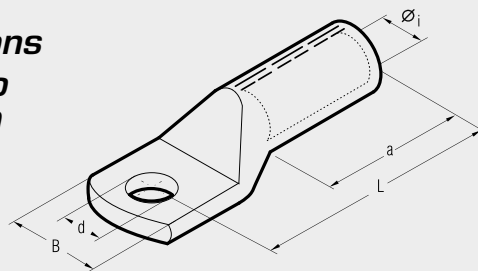

Terminals type AAD.-M.. are made from Aluminium tube of a purity equal or greater than 99,5%. They are suitable for Aluminium conductors according to DIN EN 50182, up to 10 kV.

All terminals are filled with a special grease that avoids Aluminium oxidation after crimping thereby assuring an optimal compression.

Barrel is closed with a cap for storage and transport.

Bright surface finish

The following data is stamped on the terminal:

- Cembre logo
- Terminal description
- Section
- Fixing bolt size
- Number and position of crimps
- Cembre Die reference according to DIN 48083

Details of the appropriate crimping tools and dies are shown on page 190.

Conductor Size sqmm		Ø Stud mm	Ref.	Code	Dimensions mm					Quantity Bag	Hydraulic Tools																																																
rm sm	re se				Øi	B	L	d	a																																																		
16	25	8	AAD16-M8	12	5,8	18	52	8,5	32	50	B35-45MDE B35-50MDE	HT45-E	HT 51	RH 50	RH 50	RHU 50	RHU 50																																										
		10	AAD16-M10	12	5,8	18	52	10,5	32	50																																																	
25	35	8	AAD25-M8	12	6,8	19	60	8,5	37	50								B35-45MDE B35-50MDE	HT45-E	HT 51	RH 50	RH 50	RHU 50	RHU 50																																			
		10	AAD25-M10	12	6,8	19	60	10,5	37	50																																																	
35	50	8	AAD35-M8	14	8,0	21	67	8,5	42	35															B35-45MDE B35-50MDE	HT45-E	HT 51	RH 50	RH 50	RHU 50	RHU 50																												
		10	AAD35-M10	14	8,0	21	67	10,5	42	35																																																	
		12	AAD35-M12	14	8,0	21	67	13,0	42	35																																																	
50	70	8	AAD50-M8	16	9,8	25	72	8,5	42	30																						B35-45MDE B35-50MDE	HT45-E	HT 51	RH 50	RH 50	RHU 50	RHU 50																					
		10	AAD50-M10	16	9,8	25	72	10,5	42	30																																																	
		12	AAD50-M12	16	9,8	25	72	13,0	42	30																																																	
70	95	10	AAD70-M10	18	11,2	28	83	10,5	52	15																													B35-45MDE B35-50MDE	HT45-E	HT 51	RH 50	RH 50	RHU 50	RHU 50														
		12	AAD70-M12	18	11,2	28	83	13,0	52	15																																																	
		16	AAD70-M16	18	11,2	28	83	17,0	52	15																																																	
95	120	10	AAD95-M10	22	13,2	32	90	10,5	55	10																																				B35-45MDE B35-50MDE	HT45-E	HT 51	RH 50	RH 50	RHU 50	RHU 50							
		12	AAD95-M12	22	13,2	32	90	13,0	55	10																																																	
		16	AAD95-M16	22	13,2	34	90	17,0	55	10																																																	
120	150	10	AAD120-M10	22	14,7	32	91	10,5	55	10																																											B35-45MDE B35-50MDE	HT45-E	HT 51	RH 50	RH 50	RHU 50	RHU 50
		12	AAD120-M12	22	14,7	32	91	13,0	55	10																																																	
		16	AAD120-M16	22	14,7	34	91	17,0	55	10																																																	
150	185	10	AAD150-M10	25	16,5	35	104	10,5	60	8																																																	
		12	AAD150-M12	25	16,5	35	104	13,0	60	8																																																	
		16	AAD150-M16	25	16,5	35	104	17,0	60	8																																																	
		20	AAD150-M20	25	16,5	41	104	21,0	60	8																																																	
185	240	12	AAD185-M12	28	18,3	40	105	13,0	60	15	B35-45MDE B35-50MDE	HT45-E	HT 51	RH 50	RH 50	RHU 50	RHU 50																																										
		16	AAD185-M16	28	18,3	40	105	17,0	60	15																																																	
		20	AAD185-M20	28	18,3	40	105	21,0	60	15																																																	
240	300	12	AAD240-M12	32	21,0	45	119	13,0	70	12								B35-45MDE B35-50MDE	HT45-E	HT 51	RH 50	RH 50	RHU 50	RHU 50																																			
		16	AAD240-M16	32	21,0	45	119	17,0	70	12																																																	
		20	AAD240-M20	32	21,0	45	119	21,0	70	12																																																	
300		12	AAD300-M12	34	23,3	49	125	13,0	70	9															B35-45MDE B35-50MDE	HT45-E	HT 51	RH 50	RH 50	RHU 50	RHU 50																												
		16	AAD300-M16	34	23,3	49	125	17,0	70	9																																																	
		20	AAD300-M20	34	23,3	49	125	21,0	70	9																																																	
400		12	AAD400-M12	38	26,0	58	140	13,0	100	3																						B35-45MDE B35-50MDE	HT45-E	HT 51	RH 50	RH 50	RHU 50	RHU 50																					
		16	AAD400-M16	38	26,0	58	140	17,0	100	3																																																	
		20	AAD400-M20	38	26,0	58	140	21,0	100	3																																																	
500		12	AAD500-M12	44	29,0	63	160	13,0	100	3																													B35-45MDE B35-50MDE	HT45-E	HT 51	RH 50	RH 50	RHU 50	RHU 50														
		16	AAD500-M16	44	29,0	63	160	17,0	100	3																																																	
		20	AAD500-M20	44	29,0	63	160	21,0	100	3																																																	

rm = round stranded
sm = sector stranded
re = round solid
se = sector solid

ALUMINIUM THROUGH CONNECTORS

for non-tension connections on Aluminium conductors according to DIN EN 50182

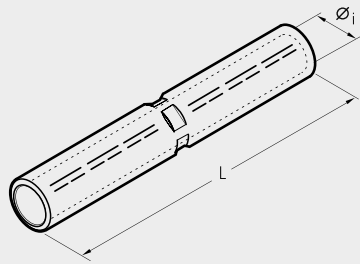

Manufactured according to DIN 46267 Part 2

DSVA



Conductor Size sqmm		Code	Ref.	Dimensions mm		Quantity Bag	Hydraulic Tools												
rm sm	re se			Øi	L		B 35-45MDE	B 35-50MDE	HT 45-E	HT 51	RH 50	B 500E	HT 81-U	RHU 81					
16	25	12	DSVA16	5.8	55	30													
25	35	12	DSVA25	6.8	70	25													
35	50	14	DSVA35	8.0	85	25													
50	70	16	DSVA50	9.8	85	20													
70	95	18	DSVA70	11.2	105	20													
95	120	22	DSVA95	13.2	105	15													
120	150	22	DSVA120	14.7	105	15													
150	185	25	DSVA150	16.5	125	10													
185	240	28	DSVA185	18.3	125	10													
240	300	32	DSVA240	21.0	145	5													
300		34	DSVA300	23.3	145	10													
400		38	DSVA400	26.0	210	3													
		42	DSVA401	28.0	210	3													
500		44	DSVA500	29.0	210	3													
		46	DSVA501	31.0	210	3													
600		52	DSVA625	35.0	330	4													
800		58	DSVA800	40.0	350	3													
1000		60	DSVA1000	44.0	350	3													

rm = round stranded
sm = sector stranded
re = round solid
se = sector solid

Crimping through connectors type DSVA .. are manufactured according to DIN 46267 part 2.

The aluminum tube has a purity equal to or greater than 99.5%. The crimping through connectors are suitable for aluminum conductors according to DIN EN 50182, up to 10 kV.

All connectors are filled with a special grease that avoids aluminum oxidation after crimp and thus guarantees an optimal compression. Barrels are capped for storage and transport.

On the connector following information is shown:

- Cembre logo
- Connector description
- Section
- Number and position of crimps
- Compression code according to DIN 48083

Details of the appropriate crimping tools and dies are shown on page 190.

CAA-M



BIMETALLIC CONNECTORS

*copper palm fixing
Aluminium barrels*

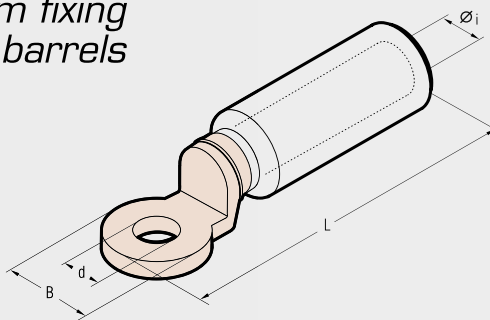

The barrels of series CAA-M connectors are made from Aluminium of a purity equal to or greater than 99,5%. The barrel is friction welded to the palm thus achieving the best possible transition between the copper palm and Aluminium barrel. Barrels are capped and filled with grease so as to avoid oxidation of the Aluminium.

Details of the appropriate crimping tools and dies are shown on pages 185, 187.

Conductor Size sqmm	Ø Stud mm	Ref.	Dimensions mm				Quantity Box/Bag	Hydraulic Tools		
			Øi	B	L	d				
10	12	CAA 10-M 12	4,3	24	87,0	13,0	90/3	HT 131-UC RHU 131-C B 1300-UCE		
16	12	CAA 16-M 12	5,5	24	87,0	13,0	90/3			
25	12	CAA 25-M 12	6,5	24	87,0	13,0	90/3			
35	12	CAA 35-M 12	8,0	24	87,0	13,0	90/3			
	12	CAA 35-20-M 12	8,0	24	87,0	13,0	60/3			
50	12	CAA 50-M 12	9,0	24	87,0	13,0	60/3			
70	12	CAA 70-M 12	11,0	24	87,0	13,0	60/3			
95	12	CAA 95-M 12	12,5	24	87,0	13,0	60/3			
120	12	CAA 120-M 12	13,7	31	111,0	13,0	30/3			
150	12	CAA 150-M 12	15,5	31	111,0	13,0	30/3			
185	12	CAA 185-M 12	17,0	35	116,0	13,0	18/3			
240	12	CAA 240-M 12	19,5	35	116,0	13,0	18/3			
300	12	CAA 300-34 M 12	22,5	35	120,0	13,0	15/3		HT120 HT131C PHC131	
	16	CAA 300-34 M 16	22,5	35	120,0	17,0	15/3			
	16	CAA 300-M 16	23,3	35	152,5	16,5	12/3	ECW-HSD RHU 230-630		
400	16	CAA 400-M 16	26,0	35	152,5	16,5	12/3			
500	16	CAA 500-M 16 TNBD	29,1	35	152,5	16,5	12/3			
630	8	CAA 630-4 M 8	32,5	60	192,0	4 x 9,0*	9/3			

* 4 holes with 30 mm between axes

MTA-C



BIMETALLIC CONNECTORS

*copper pin
Aluminium barrels*

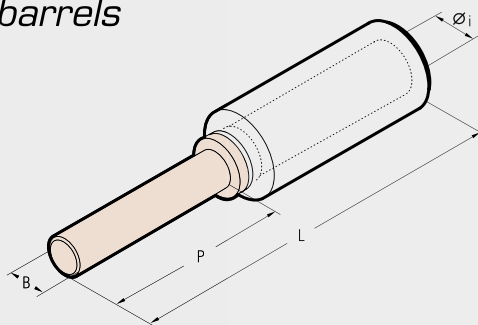

The barrels of series MTA-C connectors are made from Aluminium of a purity equal to or greater than 99,5%. The barrel is friction welded to the pin thus achieving the best possible transition between the copper pin and Aluminium barrel. Barrels are capped and filled with grease so as to avoid oxidation of the Aluminium.

Details of the appropriate crimping tools and dies are shown on pages 185, 187.

Conductor Size sqmm	Ref.	Dimensions mm				Quantity Box/Bag	Hydraulic Tools
		Øi	B	P	L		
16	MTA 16-C	5,5	8	30	82	90/3	HT 131-UC RHU 131-C B 1300-UCE
25	MTA 25-C	6,5	8	30	82	90/3	
35	MTA 35-C	8,0	8	30	82	90/3	
50	MTA 50-C	9,0	12	45	97	60/3	
70	MTA 70-C	11,0	12	45	97	60/3	
95	MTA 95-C	12,5	12	45	97	60/3	
120	MTA 120-C	13,7	14	55	125	30/3	
150	MTA 150-C	15,5	14	55	125	30/3	
185	MTA 185-C	17,0	14	55	125	24/3	
240	MTA 240-C	19,5	14	55	125	24/3	

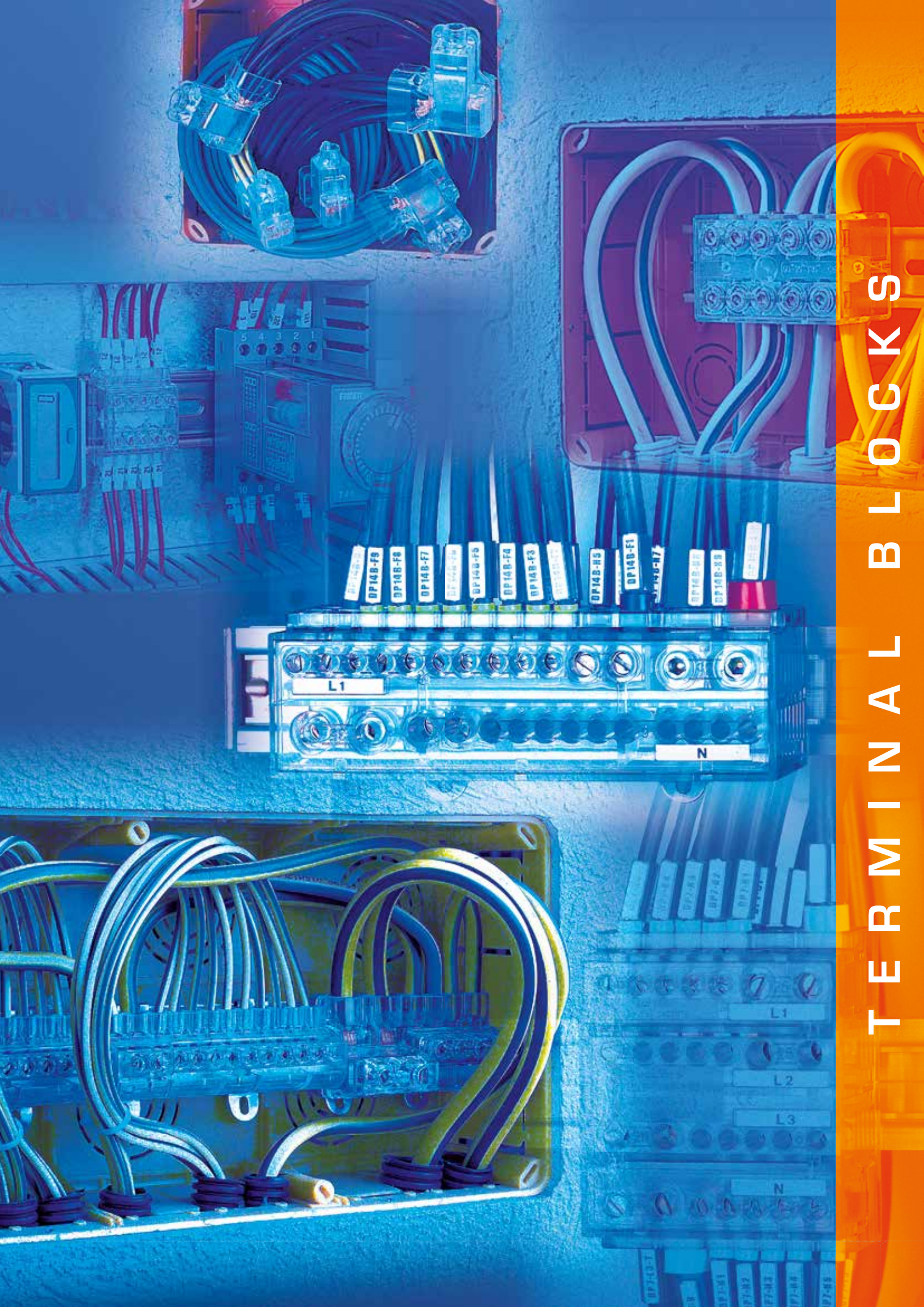

TERMINAL BLOCKS

Z6

SINGLE POLE TERMINAL BLOCKS

indirect clamping
nominal section 6 sqmm



The "Z...D" version has been designed for mounting on DIN rails



3, 5, 6 and 10 way, single pole terminal blocks for conductor section 1 to 6 sqmm. Self contained and robust, they are quick and easy to install for both industrial and domestic use. The indirect clamping of the "ZETA più" terminal blocks guarantees a low and stable contact resistance. Indirect clamping eliminates damage to the conductor strands. The easy-entry receptacles also grant a fast and reliable insertion of the cable.

Ref.	No. of Ways	Connecting Capacity sqmm	Nominal Voltage V	Maximum Operating Temperature °C	Insulation Specification	Self Extinguishing Specification	Dimensions mm	Weight g	Quantity
Z6-3	3	(3 way) 1÷6	450	85	IP 20	V-0 (UL 94)	23x23xh27,5	15	30
Z6-3D							23x40xh36,5	18,5	10
Z6-5	5	(5 way) 1÷6	450	85	IP 20	V-0 (UL 94)	35x23xh27,5	23	20
Z6-5D							35x40xh36,5	26,5	10
Z6-6	6	(6 way) 1÷6	450	85	IP 20	V-0 (UL 94)	23x43xh28,5	26	15
Z6-6D							23x53xh33	31	10
Z6-10	10	(10 way) 1÷6	450	85	IP 20	V-0 (UL 94)	35x43xh28,5	41	10
Z6-10D							35x53xh33	46	15

D= Version with clamp for DIN rail

- Technical features:**
- Self-extinguishing Polycarbonate body
 - Tempered Steel clamps
 - Electrolytically tin plated copper interconnections

Z16

SINGLE POLE TERMINAL BLOCKS

indirect clamping
nominal section 16 sqmm



3, 4, 5, 8 and 12 way, single pole terminal blocks. Ideal for use as an equipotential bonding connector for both industrial and domestic use.

Ref.	No. of Ways	Connecting Capacity sqmm	Nominal Voltage V	Maximum Operating Temperature °C	Insulation Specification	Self Extinguishing Specification	Dimensions mm	Weight g	Quantity
Z16-3	3	16	450	85	IP 20	V-0 (UL 94)	38x31,3xh38	52	20
Z16-3D							38x50xh44	55,5	15
Z16-4	4	16	450	85	IP 20	V-0 (UL 94)	27x54xh37	50	15
Z16-4D							27x58xh43	54	10
Z16-5N	5	16	450	85	IP 20	V-0 (UL 94)	61x31,5xh38	64,5	10
Z16-5ND							61x50xh44	68	4
Z16-8	8	(2 way) 16 + (6 way) 6	450	85	IP 20	V-0 (UL 94)	35,5x50xh36,5	50	15
Z16-8D							35,5x57xh42	56	10
Z16-12	12	(2 way) 16 + (10 way) 6	450	85	IP 20	V-0 (UL 94)	104,5x32,5xh36,5	115	8
Z16-12D							104,5x50xh42	125	5

D= Version with clamp for DIN rail



SINGLE POLE TERMINAL BLOCKS

indirect clamping
nominal section 35 sqmm

Z35



Z35-3

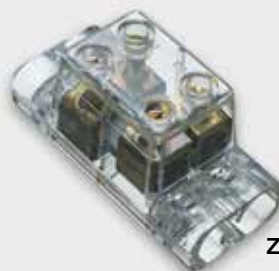

Z35-4



Z35-6

Ref.	No. of Ways	Connecting Capacity sqmm	Nominal Voltage V	Maximum Operating Temperature °C	Insulation Specification	Self Extinguishing Specification	Dimensions mm	Weight g	Quantity
Z35-3	3	35	450	85	IP 20	V-0 (UL 94)	53x48,5xh42	110	10
Z35-3D							53x50xh48	114	5
Z35-4	4	35	450	85	IP 20	V-0 (UL 94)	37x85xh42	129	5
Z35-4D							37x85xh48	133	5
Z35-6	6	(2 way) 35 +	450	85	IP 20	V-0 (UL 94)	83x41xh43	130	8
Z35-6D	(2+4)	(4 way) 16					83x49xh52	140	5

D= Version with clamp for DIN rail

3, 4 and 6 way, single pole terminal blocks. Ideal for use as an equipotential bonding connector for both industrial and domestic use.



SINGLE POLE TERMINAL BLOCKS

indirect clamping
for earthing applications 

Z35 Z50



Z50-10D



Z35T-11
Z35T-11D



Z35-26D

















Ref.	No. of Ways	Connecting Capacity sqmm	Maximum Operating Temperature °C	Self Extinguishing Specification	Dimensions mm	Weight g	Quantity
Z35T-11	11	(1 way) 35 +	85	V-0 (UL 94)	58x43xh42	70	10
Z35T-11D	(1+10)	(10 way) 6			58x53xh47	75	
Z35-26D	26	(2 way) 35 +	85	V-0 (UL 94)	151x52xh48	379	4
	(2+24)	(24 way) 10					
Z50-10D	10	(2 way) 50 +	85	V-0 (UL 94)	77,5x55xh49	320	6
	(2+8)	(8 way) 25					

D= Version with clamp for DIN rail

10, 11 and 26 way, single pole terminal blocks. Ideal for use as an equipotential bonding connector for both industrial and domestic use.

CONNECTING CAPACITY OF TERMINAL BLOCKS

TERMINAL BLOCKS TYPE "ZETA più"







TYPE		NOMINAL SECTION	No. OF WAYS X NOMINAL SECTION	CONNECTING CAPACITY OF EACH WAY* No. of Conductors x Section	MARKINGS
Z6-3	Z6-3D	6 ²	3 x 6 ²	1 x 6 ² R/F	   
Z6-5	Z6-5D	6 ²	5 x 6 ²	1 x 4 ² R/F	
Z6-6	Z6-6D	6 ²	6 x 6 ²	1÷2 x 2,5 ² R/F	
Z6-10	Z6-10D	6 ²	10 x 6 ²	1÷2 x 1,5 ² R/F 1÷4 x 1 ² R/F	
Z16-3	Z16-3D	16 ²	3 x 16 ²	1 x 16 ² R/F 1 x 10 ² R/F 1÷2 x 6 ² R/F 1÷3 x 4 ² R/F 1÷4 x 2,5 ² R/F 1÷8 x 1,5 ² R/F	   
Z16-4	Z16-4D	16 ²	4 x 16 ²	1 x 16 ² F 1 x 10 ² F 1÷2 x 6 ² F 1÷3 x 4 ² F 1÷4 x 2,5 ² F 1÷8 x 1,5 ² F	 
Z16-5N	Z16-5ND	16 ²	5 x 16 ²	1 x 16 ² R/F 1 x 10 ² R/F 1÷2 x 6 ² R/F 1÷3 x 4 ² R/F 1÷4 x 2,5 ² R/F 1÷8 x 1,5 ² R/F	 
Z16-8	Z16-8D	16 ² /6 ²	2 x 16 ²	1 x 16 ² R/F 1 x 10 ² R/F 1÷2 x 6 ² R/F 1÷3 x 4 ² R/F 1÷4 x 2,5 ² R/F 1÷8 x 1,5 ² R/F	 
			6 x 6 ²	1 x 6 ² R/F 1 x 4 ² R/F 1÷2 x 2,5 ² R/F 1÷2 x 1,5 ² R/F 1÷4 x 1 ² R/F	
Z16-12	Z16-12D	16 ² /6 ²	2 x 16 ²	1 x 16 ² F 1 x 10 ² F 1÷2 x 6 ² F 1÷3 x 4 ² F 1÷4 x 2,5 ² F	 
			10 x 6 ²	1 x 6 ² F 1 x 4 ² F 1÷2 x 2,5 ² F 1÷2 x 1,5 ² F 1÷4 x 1 ² F	

*A mixture of conductor sizes may be connected to the terminal block provided that the sum of their sections is less than the nominal section.

R = Rigid conductor F = Flexible conductor

CONNECTING CAPACITY OF TERMINAL BLOCKS

TERMINAL BLOCKS TYPE "ZETA più"

TYPE	NOMINAL SECTION	No. OF WAYS X NOMINAL SECTION	CONNECTING CAPACITY OF EACH WAY* No. of Conductors x Section	MARKINGS
Z35-3 Z35-3D	35 ²	3 x 35 ²	1 x 35 ² R/F 1 x 25 ² R/F 1÷2 x 16 ² R/F 1÷3 x 10 ² R/F 1÷5 x 6 ² R/F	CE 
Z35-4 Z35-4D	35 ²	4 x 35 ²	1 x 35 ² F 1 x 25 ² F 1÷2 x 16 ² F 1÷3 x 10 ² F 1÷6 x 6 ² F	CE 
Z35-6 Z35-6D	35 ² /16 ²	2 x 35 ²	1 x 35 ² R/F 1 x 25 ² R/F 1÷2 x 16 ² R/F 1÷3 x 10 ² R/F 1÷6 x 6 ² F	CE   
		4 x 16 ²	1 x 16 ² R/F 1 x 10 ² R/F 1÷2 x 6 ² R/F 1÷3 x 4 ² R/F 1÷5 x 2,5 ² F	
Z35T-11 Z35T-11D	35 ² /6 ²	1 x 35 ²	1 x 35 ² R/F 1 x 25 ² R/F 1 x 16 ² R/F 1 x 10 ² R/F	CE 
		10 x 6 ²	1 x 6 ² R/F 1 x 4 ² R/F 1÷2 x 2,5 ² R/F 1÷2 x 1,5 ² R/F 1÷4 x 1 ² R/F	
Z35-26D	35 ² /10 ²	2 x 35 ²	1 x 35 ² R/F 1 x 25 ² R/F 1÷2 x 16 ² R/F 1÷3 x 10 ² R/F 1÷6 x 6 ² R/F	CE   
		24 x 10 ²	1 x 10 ² R/F 1 x 6 ² R/F 1÷2 x 4 ² R/F 1÷4 x 2,5 ² R/F	
Z50-10D	50 ² /25 ²	2 x 50 ²	1 x 50 ² R/F 1 x 35 ² R/F 1÷2 x 25 ² R/F 1÷4 x 16 ² R/F	CE ** 
		8 x 25 ²	1 x 25 ² R/F 1÷2 x 16 ² R/F 1÷3 x 10 ² R/F 1÷6 x 6 ² R/F 1÷9 x 4 ² R/F	

*A mixture of conductor sizes may be connected to the terminal block provided that the sum of their sections is less than the nominal section.

R = Rigid conductor F = Flexible conductor

MARKINGS:



Istituto italiano del Marchio di Qualità type approval



Lloyd's Register of Shipping type approval



Registro Italiano Navale type approval



** EN 60947-7-1: 2002

CONFORM TO:

Directives 2006/95/CE

EN 60998-1: 2004 and
EN 60998-2-1: 2004 Norms

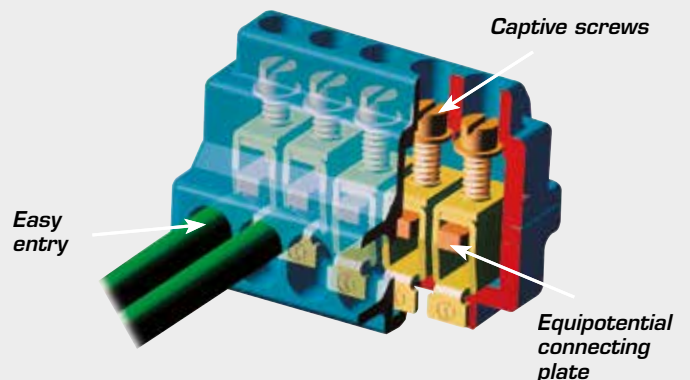

Z-DP

POWER DISTRIBUTION BLOCK

indirect clamping

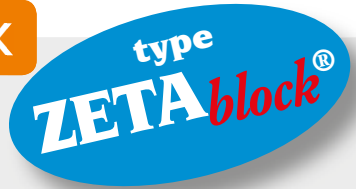

FOUR POLE
100 A



Z 25-DP7-100

TWO POLE
125 A



Z 35-DP14B-125

FOUR POLE
125 A



Z 35-DP14-125

FOUR POLE
160 A



Z 50-DP12-160

100, 125 and 160A, 2-4 pole distribution blocks with 7, 14 and 12 ways per pole respectively.

Accepting a wide cable CSA range (1 - 50 sqmm) and of compact size, ZETA blocks are ideal for control cabinets and distribution panels.

The lateral arrangement of terminals on upper and lower faces (Z35-DP14B one face only), simplifies connection and promotes tidy, homogeneous cable routing to assist subsequent wiring operations.

Easy entry apertures provide quick, effective cable insertion while the indirect clamping feature eliminates damage to cable strands and assures a low, stable contact resistance.

Ref.	No. of poles	No. of Ways per pole	Nominal CSA for each pole sqmm	Maximum operating voltage Ui	Impulse voltage Uimp	Maximum operating current In	Allowable short duration fault current Icw	Maximum allowed peak fault current Ipk	Self Extinguishing Specification	Dimensions mm	Weight g	Qty
Z 25-DP7-100	4	7 (2+5)	(2 way) 25 + (5 way) 6	800 V	8 kV	100 A	3 kA	18 kA	V-0 (UL 94)	70x84xh45	290	2
Z 35-DP14-125	4	14 (2+2+10)	(2 way) 35 + (2 way) 16 + (10 way) 6	800 V	8 kV	125 A	4,2 kA	18 kA	V-0 (UL 94)	137x83xh46	700	1
Z 35-DP14B-125	2	14 (2+2+10)	(2 way) 35 + (2 way) 16 + (10 way) 6	800 V	8 kV	125 A	4,2 kA	18 kA	V-0 (UL 94)	137x44xh46	360	2
Z 50-DP12-160	4	12 (2+4+6)	(2 way) 50 + (4 way) 25 + (6 way) 16	800 V	8 kV	160 A	6 kA	18 kA	V-0 (UL 94)	150x84xh48	780	1

Technical features:

- Self extinguishing antishock Polycarbonate body
- Tempered Steel captive clamping screws and plates
- Electrolytically tin plated copper interconnectors

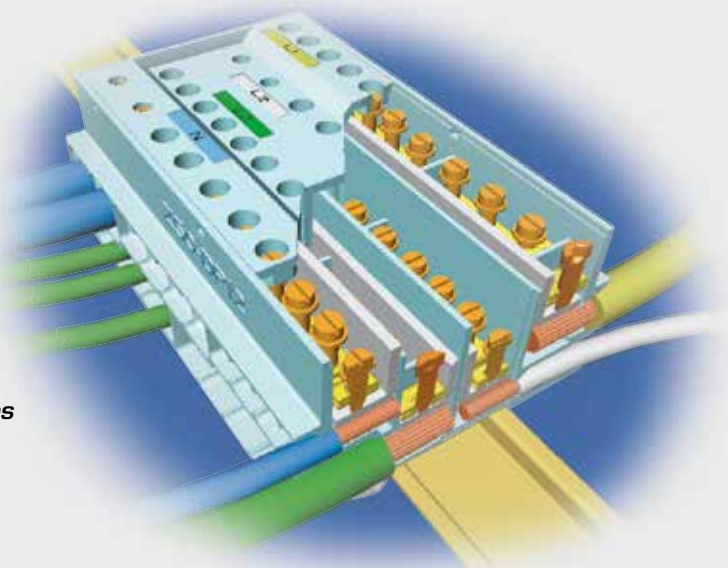

type
ZETAblock®

POWER DISTRIBUTION BLOCK







indirect clamping

Z-DP



CONNECTING CAPACITY OF POWER DISTRIBUTION BLOCK

POWER DISTRIBUTION BLOCK TYPE "ZETAblock"

TYPE	NOMINAL SECTION	No. OF WAYS x NOMINAL SECTION	CONNECTING CAPACITY OF EACH WAY No. of Conductors x Section	MARKINGS
Z25-DP7-100	25 ² /6 ²	2 x 25 ²	1 x 25 ² F 1 x 16 ² F 1÷2 x 10 ² F	  25-6 agmm
		5 x 6 ²	1 x 6 ² F 1 x 4 ² F 1÷2 x 2,5 ² F 1÷2 x 1,5 ² F 1÷4 x 1 ² F	
Z35-DP14-125 Z35-DP14B-125	35 ² /16 ² /6 ²	2 x 35 ²	1 x 35 ² F 1 x 25 ² F 1÷2 x 16 ² F 1÷3 x 10 ² F	  35-16-6 agmm
		2 x 16 ²	1 x 16 ² F 1 x 10 ² F 1÷2 x 6 ² F 1÷3 x 4 ² F 1÷4 x 2,5 ² F	
		10 x 6 ²	1 x 6 ² F 1 x 4 ² F 1÷2 x 2,5 ² F 1÷2 x 1,5 ² F 1÷4 x 1 ² F	
Z50-DP12-160	50 ² /25 ² /16 ²	2 x 50 ²	1 x 50 ² F 1 x 35 ² F 1÷2 x 25 ² F	  50-25-16 agmm
		4 x 25 ²	1 x 25 ² F 1 x 16 ² F 1÷2 x 10 ² F	
		6 x 16 ²	1 x 16 ² F 1 x 10 ² F 1÷2 x 6 ² F	

F = Flexible conductor

MARKINGS:



Istituto italiano del Marchio
di Qualità type approval

CONFORM TO:

Directives 2006/95/CE

EN 60947-7-1: 2009 Norms

ONE WAY TERMINAL BLOCKS



Z-1

indirect clamping



Ref.	Connecting Capacity sqmm	Nominal Voltage V	Maximum Operating Temperature °C	Insulation Specification	Self Extinguishing Specification	Dimensions mm	Weight g	Quantity Box/Bag
Z2.5-1	2,5	450	85	IP 20	V-0 (UL 94)	7,6x20xh23,5	3	500/25
Z6-1	6					11,5x28xh29	6	250/25
Z10-1	10					15,6x32xh32,5	11	100/10
Z16-1	16					18x34xh38	15	100/10
Z25-1	25					20,8x42,5xh43,5	29	50/10
Z35-1	35					25x45xh51,5	37	40/10

One way, single pole terminal blocks for conductors sections from 0.5 to 35 sqmm. Self contained and robust, they are ideal for the fast and safe installation for industrial and domestic applications.

The indirect clamping of the "ZETAmini" terminal blocks guarantees a low and stable contact resistance.

The easy-entry receptacle also grants a fast and reliable insertion of the cable.

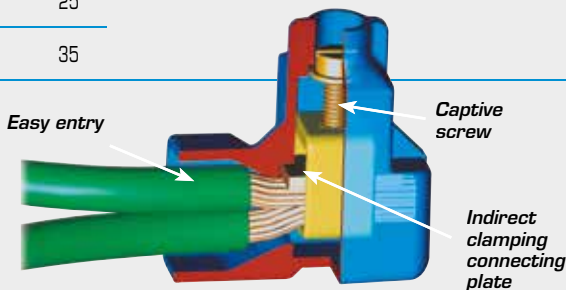

Technical features:

- Self-extinguishing Polycarbonate body
- Electrolytically Zinc plated, tempered Steel clamp and screw

- Electrolytically tin plated Steel connection plate

CONNECTING CAPACITY OF TERMINAL BLOCKS

TYPE	NOMINAL SECTION	CONNECTING CAPACITY *		MARKINGS
		No. of Conductors x Section		
Z2.5-1	2,5 ²	2 x 2,5 ² R/F 2÷3 x 1,5 ² R/F 2÷5 x 1,0 ² R/F	2÷6 x 0,75 ² R/F 2÷10 x 0,5 ² R/F 2÷18 x Ø0,4÷0,6 mm communication type wire	CE, 2.5 sqmm 450 V T 85°C P 20
Z6-1	6 ²	2 x 6 ² R/F 2÷3 x 4 ² R/F 2÷4 x 2,5 ² R/F 2÷6 x 1,5 ² R/F 2÷6 x 1 ² R/F	2÷10 x 0,75 ² R/F 2÷12 x 0,5 ² R/F (1 x 6 ²) + (4 x 1,5 ²) (1 x 6 ²) + (2 x 2,5 ²)	CE, 6 sqmm 450 V T 85°C P 20
Z10-1	10 ²	2 x 10 ² R/F 2÷3 x 6 ² R/F 2÷5 x 4 ² R/F 2÷8 x 2,5 ² R/F (1 x 6 ²) + (1 x 4 ²) + (2 x 2,5 ²) + (3 x 1,5 ²)	2÷12 x 1,5 ² R/F 2÷20 x 1 ² R/F 2÷25 x 0,75 ² R/F	CE, 10 sqmm 450 V T 85°C P 20
Z16-1	16 ²	2 x 16 ² R/F 2÷3 x 10 ² R/F 2÷5 x 6 ² R/F	2÷8 x 4 ² R/F 2÷12 x 2,5 ² R/F 2÷18 x 1,5 ² R/F	CE, 16 sqmm 450 V T 85°C P 20
Z25-1	25 ²	2 x 25 ² R/F 2÷3 x 16 ² R/F 2÷4 x 10 ² R/F	2÷8 x 6 ² R/F 2÷11 x 4 ² R/F 4÷16 x 2,5 ² R/F	CE, 25 sqmm 450 V T 85°C P 20
Z35-1	35 ²	2 x 35 ² R/F 2÷3 x 25 ² R/F 2÷4 x 16 ² R/F 2÷7 x 10 ² R/F	2÷11 x 6 ² R/F 4÷17 x 4 ² R/F 5÷28 x 2,5 ² R/F	CE, 35 sqmm 450 V T 85°C P 20

*A mixture of conductor sizes may be connected to the terminal block provided that the sum of their sections is less than twice the nominal section.

R = Rigid conductor

F = Flexible conductor

MARKINGS:

Lloyd's Register of Shipping type approval

Registro Italiano Navale type approval



Istituto italiano del Marchio di Qualità type approval

CONFORM TO:

Directives 2006/95/CE

EN 60998-1: 2004 and EN 60998-2-1: 2004 Norms



CABLE GLANDS AND ACCESSORIES

MAXIblock® CABLE GLANDS

Polyamide PA6.6

1900



Material: POLYAMIDE PA6.6
self-extinguishing class V2 (UL 94)
Temperature range:
-20°C to +90°C (continuous)
Sealing ring: NEOPRENE® 50 sh A
Protection: IP 68
Colour: RAL 7035 light grey,
RAL 9005 black, RAL 7001 dark
grey

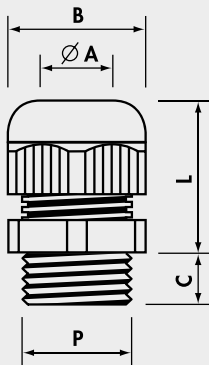

MAXIblock® standard

Metric thread M 1.5 pitch CEI EN 60423 CEI EN 50262

Ref. Light Grey	P	Fixing Hole Ø (mm)	Ø A mini-max (mm)	B Spanner (mm)	C (mm)	L min-max (mm)	Quantity
1900.M12	M12x1,5	12,2	3,5- 7	15	8	18-22	100
1900.M16	M16x1,5	16,2	5 -10	19	8	22-27	100
1900.M20	M20x1,5	20,5	7 -13	25	9	24-30	100
1900.M25	M25x1,5	25,4	10 -17	30	10	28-39	50
1900.M32	M32x1,5	32,5	13 -21	36	10	33-44	25
1900.M40	M40x1,5	40,5	19 -28	46	10	36-45	15
1900.M50	M50x1,5	50,5	27 -35	55	12	43-52	10
1900.M63	M63x1,5	64,0	34 -45	66	12	45-55	5

Add to Ref: N for Black, G for Dark Grey

MAXIblock® reduced cable entry

Metric thread M 1.5 pitch CEI EN 60423 CEI EN 50262

Ref. Light Grey	P	Fixing Hole Ø (mm)	Ø A mini-max (mm)	B Spanner (mm)	C (mm)	L min-max (mm)	Quantity
1910.M12	M12x1,5	12,2	2- 5	15	8	18-22	100
1910.M16	M16x1,5	16,2	3- 7	19	8	22-27	100
1910.M20	M20x1,5	20,5	5-10	25	9	24-30	100
1910.M25	M25x1,5	25,4	7-13	30	10	28-39	50
1910.M32	M32x1,5	32,5	8-14	36	10	33-44	25
1910.M40	M40x1,5	40,5	15-23	46	10	36-45	15
1910.M50	M50x1,5	50,5	21-29	55	12	43-52	10
1910.M63	M63x1,5	64,0	27-39	66	12	45-55	5

Add to Ref: N for Black, G for Dark Grey

MAXIblock® extended thread

Metric thread M 1.5 pitch CEI EN 60423 CEI EN 50262

Ref. Light Grey	P	Fixing Hole Ø (mm)	Ø A mini-max (mm)	B Spanner (mm)	C (mm)	L min-max (mm)	Quantity
1901.M12	M12x1,5	12,2	3,5- 7	15	15	18-22	100
1901.M16	M16x1,5	16,2	5 -10	19	15	22-27	100
1901.M20	M20x1,5	20,5	7 -13	25	15	24-30	50
1901.M25	M25x1,5	25,4	10 -17	30	15	30-41	50
1901.M32	M32x1,5	32,5	13 -21	36	15	33-44	25
1901.M40	M40x1,5	40,5	19 -28	46	18	36-45	15
1901.M50	M50x1,5	50,5	27 -35	55	18	43-52	10
1901.M63	M63x1,5	64,0	34 -45	66	18	45-55	5

Add to Ref: N for Black, G for Dark Grey

MAXIblock® CABLE GLANDS

Polyamide PA6.6

1900

MAXIblock® standard

Pg thread DIN 40 430

Ref. Light Grey	P	Fixing Hole Ø (mm)	Ø A mini-max (mm)	B Spanner (mm)	C (mm)	L min-max (mm)	Quantity
1900.07	Pg 7	12,7	3,5- 7	15	8	18-22	100
1900.09	Pg 9	15,5	5 - 8	19	8	22-26	100
1900.11	Pg11	18,8	5 -10	22	8	23-28	100
1900.13	Pg13,5	20,5	7 -12	24	9	24-29	100
1900.16	Pg16	22,6	10 -14	27	10	26-31	50
1900.21	Pg21	28,5	13 -18	33	12	30-35	50
1900.29	Pg29	37,2	18 -25	42	12	33-39	25
1900.36	Pg36	47,2	20 -32	53	14	42-49	10
1900.42	Pg42	54,2	28 -38	60	14	42-50	5
1900.48	Pg48	60,0	37 -45	66	15	45-55	5

Add to Ref: N for Black, G for Dark Grey



Material: POLYAMIDE PA6.6 self-extinguishing class V2 (UL 94)
 Temperature range:
 -20°C to +90°C (continuous)
 Sealing ring: NEOPRENE® 50 sh A
 Protection: IP 68
 Colour: RAL 7035 light grey,
 RAL 9005 black, RAL 7001 dark grey

MAXIblock® reduced cable entry

Pg thread DIN 40 430

Ref. Light Grey	P	Fixing Hole Ø (mm)	Ø A mini-max (mm)	B Spanner (mm)	C (mm)	L min-max (mm)	Quantity
1910.07	Pg 7	12,7	2- 5	15	8	18-22	100
1910.09♦	Pg 9	15,5	2- 6	19	8	22-26	100
1910.11	Pg11	18,8	4- 7	22	8	23-28	100
1910.13	Pg13,5	20,5	5-10	24	9	24-29	100
1910.16♦	Pg16	22,6	6-12	27	10	26-31	50
1910.21	Pg21	28,5	9-15	33	12	30-35	50
1910.29♦	Pg29	37,2	12-20	42	12	33-39	25
1910.36	Pg36	47,2	18-26	53	14	42-49	10
1910.42	Pg42	54,2	25-31	60	14	42-50	5
1910.48♦	Pg48	60,0	27-39	66	15	45-55	5

Add to Ref: N for Black

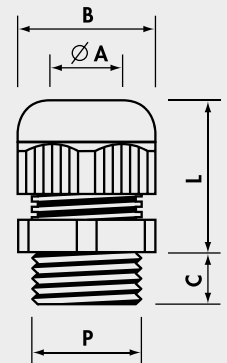

MAXIblock® extended thread

Pg thread DIN 40 430

Ref. Light Grey	P	Fixing Hole Ø (mm)	Ø A mini-max (mm)	B Spanner (mm)	C (mm)	L min-max (mm)	Quantity
1901.07	Pg 7	12,7	3,5- 7	15	15	18-22	100
1901.09	Pg 9	15,5	5 - 8	19	15	22-26	100
1901.11	Pg11	18,8	5 -10	22	15	23-28	100
1901.13	Pg13,5	20,5	7 -12	24	15	24-29	100
1901.16	Pg16	22,6	10 -14	27	15	26-31	50
1901.21	Pg21	28,5	13 -18	33	15	30-35	50
1901.29	Pg29	37,2	18 -25	42	15	33-39	25
1901.36	Pg36	47,2	20 -32	53	18	42-49	10
1901.42	Pg42	54,2	28 -38	60	18	42-50	5
1901.48	Pg48	60,0	37 -45	66	18	45-55	5

Add to Ref: N for Black

♦Not UL approved

MAXIblock® CABLE GLANDS

Polyamide PA6.6

1900/X



Material: POLYAMIDE PA6.6
self-extinguishing class V2 (UL 94)
Temperature range:
-20°C to +90°C (continuous)
Sealing ring: NEOPRENE® 50 sh A
Protection: IP 68
Colour: RAL 7035 light grey

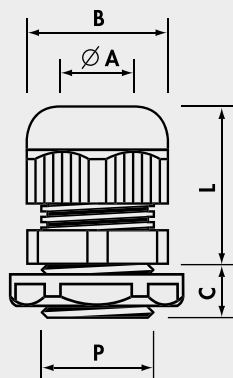

MAXIblock® standard, factory fitted with locknuts with collar

Metric thread M 1.5 pitch CEI EN 60423 CEI EN 50262

Ref.	P	Fixing Hole Ø (mm)	Ø A mini-max (mm)	B Spanner (mm)	C (mm)	L min-max (mm)	Quantity Box/Bag
1900.M12/X	M12x1,5	12,2	3,5- 7	15	8	18-22	100/10
1900.M16/X	M16x1,5	16,2	5 -10	19	8	22-27	100/10
1900.M20/X	M20x1,5	20,5	7 -13	25	9	24-30	50/10
1900.M25/X	M25x1,5	25,4	10 -17	30	10	28-39	30/10
1900.M32/X	M32x1,5	32,5	13 -21	36	10	33-44	20/10
1900.M40/X	M40x1,5	40,5	19 -28	46	10	36-45	10/5
1900.M50/X	M50x1,5	50,5	27 -35	55	12	43-52	10/5
1900.M63/X	M63x1,5	64,0	34 -45	66	12	45-55	5/5



Pg thread DIN 40 430

Ref.	P	Fixing Hole Ø (mm)	Ø A mini-max (mm)	B Spanner (mm)	C (mm)	L min-max (mm)	Quantity Box/Bag
1900.07/X	Pg 7	12,7	3,5- 7	15	8	18-22	100/10
1900.09/X	Pg 9	15,5	5 - 8	19	8	22-26	100/10
1900.11/X	Pg11	18,8	5 -10	22	8	23-28	100/10
1900.13/X	Pg13,5	20,5	7 -12	24	9	24-29	50/10
1900.16/X	Pg16	22,6	10 -14	27	10	26-31	30/10
1900.21/X	Pg21	28,5	13 -18	33	12	30-35	20/10
1900.29/X	Pg29	37,2	18 -25	42	12	33-39	20/10
1900.36/X	Pg36	47,2	20 -32	53	14	42-49	10/5
1900.42/X	Pg42	54,2	28 -38	60	14	42-50	5/5
1900.48/X	Pg48	60,0	37 -45	66	15	45-55	5/5

MAXIblock® CABLE GLANDS

Polyamide PA6.6

1900DP



MAXIblock® standard, factory fitted with Polyethylene foam discs

Metric thread M 1.5 pitch CEI EN 60423 CEI EN 50262

Ref.	P	Fixing Hole Ø (mm)	Ø A mini-max (mm)	B Spanner (mm)	C (mm)	L min-max (mm)	Quantity Box/Bag
1900DP.M12	M12x1,5	12,2	3,5- 7	15	8	18-22	100/10
1900DP.M16	M16x1,5	16,2	5 -10	19	8	22-27	100/10
1900DP.M20	M20x1,5	20,5	7 -13	25	9	24-30	50/10
1900DP.M25	M25x1,5	25,4	10 -17	30	10	28-39	30/10
1900DP.M32	M32x1,5	32,5	13 -21	36	10	33-44	20/10
1900DP.M40	M40x1,5	40,5	19 -28	46	10	36-45	10/5
1900DP.M50	M50x1,5	50,5	27 -35	55	12	43-52	10/5
1900DP.M63	M63x1,5	64,0	34 -45	66	12	45-55	5/5

Material: POLYAMIDE PA6.6 self-extinguishing class V2 (UL 94)
 Temperature range: -20°C to +90°C (continuous)
 Sealing ring: NEOPRENE® 50 sh A
 Protection: IP 68
 Colour: RAL 7035 light grey
 Discs: 2 mm thick Polyethylene foam

Pg thread DIN 40 430

Ref.	P	Fixing Hole Ø (mm)	Ø A mini-max (mm)	B Spanner (mm)	C (mm)	L min-max (mm)	Quantity Box/Bag
1900DP.07	Pg 7	12,7	3,5- 7	15	8	18-22	100/10
1900DP.09	Pg 9	15,5	5 - 8	19	8	22-26	100/10
1900DP.11	Pg11	18,8	5 -10	22	8	23-28	100/10
1900DP.13	Pg13,5	20,5	7 -12	24	9	24-29	50/10
1900DP.16	Pg16	22,6	10 -14	27	10	26-31	30/10
1900DP.21	Pg21	28,5	13 -18	33	12	30-35	20/10
1900DP.29	Pg29	37,2	18 -25	42	12	33-39	20/10
1900DP.36	Pg36	47,2	20 -32	53	14	42-49	10/5
1900DP.42	Pg42	54,2	28 -38	60	14	42-50	5/5
1900DP.48	Pg48	60,0	37 -45	66	15	45-55	5/5

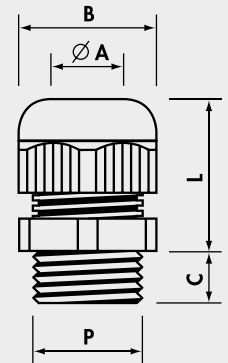

1900



MAXIblock® standard

BSP thread ISO 228/1

Ref. Grey	P Light	Fixing Hole Ø (mm)	Ø A mini-max (mm)	B Spanner (mm)	C (mm)	L min-max (mm)	Quantity
1900.14	G1/4"	13,5	3- 6,5	15	8	18-22	100
1900.38	G3/8"	17,0	4- 8	19	8	22-26	100
1900.12	G1/2"	21,5	7-12	24	10	24-29	100
1900.34	G3/4"	27,0	13-18	33	12	30-35	50

Add to Ref: N for Black



File no. E220310



File no. E220310



Material: POLYAMIDE PA6.6 self-extinguishing class V2 (UL 94)
 Temperature range: -20°C to +90°C (continuous)
 Sealing ring: NEOPRENE® 50 sh A
 Protection: IP 68
 Colour: RAL 7035 light grey, RAL 9005 black

spiralblock® CABLE GLANDS

Polyamide PA6.6



1500



Material: POLYAMIDE PA6.6
self-extinguishing class V2 (UL 94)
Temperature range:
-20°C to +90°C (continuous)
Sealing ring: NEOPRENE® 50 sh A
Protection: IP 68
Colour: RAL 7035 light grey,
RAL 9005 black

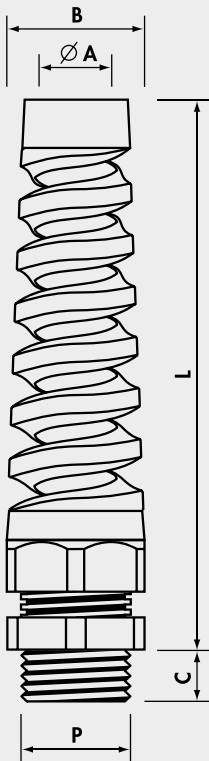

spiralblock® standard

Metric thread M 1.5 pitch CEI EN 60423 CEI EN 50262

Ref. Light Grey	P	Fixing Hole Ø (mm)	Ø A mini-max (mm)	B Spanner (mm)	C (mm)	L min-max (mm)	Quantity
1500.M12	M12x1,5	12,2	3,5- 7	15	8	57	100
1500.M16	M16x1,5	16,2	5 -10	19	8	79	50
1500.M20	M20x1,5	20,5	7 -13	25	9	90	25
1500.M25	M25x1,5	25,4	10 -17	30	10	120	20
1500.M32	M32x1,5	32,5	13 -21	36	10	140	10

Add to Ref: N for Black

spiralblock® standard

Pg thread DIN 40 430

Ref. Light Grey	P	Fixing Hole Ø (mm)	Ø A mini-max (mm)	B Spanner (mm)	C (mm)	L min-max (mm)	Quantity
1500.07	Pg 7	12,7	3,5- 7	15	8	57	100
1500.09	Pg 9	15,5	5 - 8	19	8	68	100
1500.11	Pg11	18,8	5 -10	22	8	80	50
1500.13	Pg13,5	20,5	7 -12	24	10	90	50
1500.16	Pg16	22,6	10 -14	27	10	100	25
1500.21	Pg21	28,5	13 -18	33	12	112	20

Add to Ref: N for Black

spiralblock® standard

BSP thread ISO 228/1

Ref. Light Grey	P	Fixing Hole Ø (mm)	Ø A mini-max (mm)	B Spanner (mm)	C (mm)	L min-max (mm)	Quantity
1500.14	G1/4"	13,5	3- 6,5	15	8	57	100
1500.38	G3/8"	17,0	4- 8	19	9	68	100
1500.12	G1/2"	21,5	7-12	24	10	90	50
1500.34	G3/4"	27,0	13-18	33	12	112	20

Add to Ref: N for Black

MAXIblock® CABLE GLANDS



Certificate No IMQ ATEX 028X

Polyamide PA6.6

4900

Metric thread M 1.5 pitch CEI EN 60423 CEI EN 50262

Ref. Light Grey	P	Fixing Hole Ø (mm)	Ø A mini-max (mm)	B Spanner (mm)	C (mm)	L min-max (mm)	Quantity
4900.M12	M12x1,5	12,2	3,5- 6,5	15	8	18-22	100
4900.M16	M16x1,5	16,2	6,5-10	19	8	22-27	100
4900.M20	M20x1,5	20,5	9 -13	25	9	24-30	100
4900.M25	M25x1,5	25,4	11 -17	30	10	28-39	50
4900.M32	M32x1,5	32,5	16 -21	36	10	33-44	25
4900.M40	M40x1,5	40,5	21 -28	46	10	36-45	15
4900.M50	M50x1,5	50,5	27 -35	55	12	43-52	10
4900.M63	M63x1,5	64,0	35 -42	66	12	45-55	5

extended thread

Ref. Light Grey	P	Fixing Hole Ø (mm)	Ø A mini-max (mm)	B Spanner (mm)	C (mm)	L min-max (mm)	Quantity
4901.M12	M12x1,5	12,2	3,5- 6,5	15	15	18-22	100
4901.M16	M16x1,5	16,2	6,5-10	19	15	22-27	100
4901.M20	M20x1,5	20,5	9 -13	25	15	24-30	50
4901.M25	M25x1,5	25,4	11 -17	30	15	30-41	50
4901.M32	M32x1,5	32,5	16 -21	36	15	33-44	25
4901.M40	M40x1,5	40,5	21 -28	46	18	36-45	15
4901.M50	M50x1,5	50,5	27 -35	55	18	43-52	10
4901.M63	M63x1,5	64,0	35 -42	66	18	45-55	5

Pg thread DIN 40 430

Ref. Light Grey	P	Fixing Hole Ø (mm)	Ø A mini-max (mm)	B Spanner (mm)	C (mm)	L min-max (mm)	Quantity
4900.07	Pg 7	12,7	3,5- 6,5	15	8	18-22	100
4900.09	Pg 9	15,5	6,5- 8	19	8	22-26	100
4900.11	Pg11	18,8	8 -10	22	8	23-28	100
4900.13	Pg13,5	20,5	9 -12	24	9	24-29	100
4900.16	Pg16	22,6	10 -14	27	10	26-31	50
4900.21	Pg21	28,5	14 -18	33	12	30-35	50
4900.29	Pg29	37,2	18 -22	42	12	33-39	25
4900.36	Pg36	47,2	22 -32	53	14	42-49	10
4900.42	Pg42	54,2	28 -38	60	14	42-50	5
4900.48	Pg48	60,0	38 -45	66	15	45-55	5

extended thread

Ref. Light Grey	P	Fixing Hole Ø (mm)	Ø A mini-max (mm)	B Spanner (mm)	C (mm)	L min-max (mm)	Quantity
4901.07	Pg 7	12,7	3,5- 6,5	15	15	18-22	100
4901.09	Pg 9	15,5	6,5- 8	19	15	22-26	100
4901.11	Pg11	18,8	8 -10	22	15	23-28	100
4901.13	Pg13,5	20,5	9 -12	24	15	24-29	100
4901.16	Pg16	22,6	10 -14	27	15	26-31	50
4901.21	Pg21	28,5	14 -18	33	15	30-35	50
4901.29	Pg29	37,2	18 -22	42	15	33-39	25
4901.36	Pg36	47,2	22 -32	53	18	42-49	10
4901.42	Pg42	54,2	28 -38	60	18	42-50	5
4901.48	Pg48	60,0	38 -45	66	18	45-55	5



Material: POLYAMIDE PA6.6
self-extinguishing class V2 (UL 94)
Safety level: Ex e IIC/Ex tb IIIC
according to
EN 60079-0 : 2009
EN 60079-7 : 2007
EN 60079-31 : 2009
Areas of utilisation: 1 & 2, 21 & 22
Temperature range:
-20°C to +75°C (continuous)
Sealing ring: NEOPRENE®
Protection: IP 65
Colour: RAL 7035 light grey

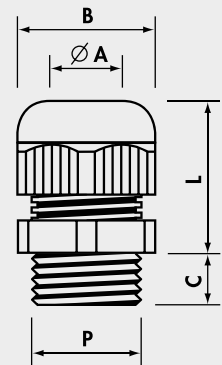

COMPRESSION CABLE GLANDS

Polyamide PA6

1700
1400



Material: POLYAMIDE PA6
self-extinguishing class VO (UL 94)
Temperature range:
-20°C to +90°C (continuous)
Sealing ring: PVC 50 sh A
Protection: IP 54
Colour: RAL 7035 light grey,
RAL 9005 black

Pg thread DIN 40 430 - Dimensions DIN 46 320

Ref. Light Grey	P	Fixing Hole Ø (mm)	Ø A min-max (mm)	B1 Spanner (mm)	B2 Spanner (mm)	C (mm)	L min-max (mm)	Quantity Box/Bag
1709	Pg 7	12,7	5,5- 7	15	16	8	16-20	300/100
*1700	Pg 9	15,5	6,5- 8,5	17	20	8	19-22	200/100
*1701	Pg11	18,8	8 -10	19	22	8	21-25	100/100
*1702	Pg13,5	20,5	8 -11	21	24	9	22-26	100/100
1703	Pg16	22,6	11 -14	23	27	10	24-33	50/50
1704	Pg21	28,5	14,5-18	30	33	11	25-32	50/25
1705	Pg29	37,2	19 -26	40	42	11	27-32	20/10
1706	Pg36	47,2	30 -34	50	53	14	33-42	10/10
1707	Pg42	54,2	30 -38	55	60	13	37-48	5/5
1708	Pg48	60,0	38 -44	60	65	14,5	37-48	5/5

*Add to Ref: N for Black

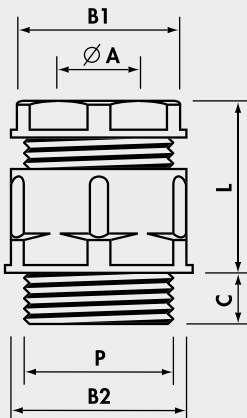

BSP thread ISO 228/1

Ref. Light Grey	P	Fixing Hole Ø (mm)	Ø A min-max (mm)	B1 Spanner (mm)	B2 Spanner (mm)	C (mm)	L min-max (mm)	Quantity Box/Bag
1400	G1/4"	13,5	5,5- 7	15	16	8	16-20	300/100
*1401	G3/8"	17,0	6,5- 8,5	17	20	8	19-22	200/100
*1401B	G3/8"	17,0	8 -10	19	22	8	18-24	100/100
*1401C	G3/8"	17,0	10 -12	22	24	9	22-26	100/100
*1402	G1/2"	21,5	8 -11	21	24	9	22-26	100/100
1403	G5/8"	23,5	11 -14	23	27	10	24-33	50/50
1404	G3/4"	27,0	14,5-18	30	33	11	25-32	50/25
1405	G1"	34,0	17 -22	34	38	11,5	27-35	20/10
1407	G1"1/2	48,0	30 -34	50	53	14	33-42	10/10
1408	G2"	60,0	38 -44	60	65	14,5	37-48	5/5

*Add to Ref: N for Black

Metric thread M 1.5 pitch CEI EN 60423

Ref. Light Grey	P	Fixing Hole Ø (mm)	Ø A min-max (mm)	B1 Spanner (mm)	B2 Spanner (mm)	C (mm)	L min-max (mm)	Quantity Box/Bag
1730M20	M20x1,5	20,5	8-11	21	24	9	22-26	100

*Add to Ref: N for Black

COMPRESSION CABLE GLANDS

Polyamide PA6

1700T



Compression cable glands

special Internal blanking disc: PVC 50 sh

Pg thread DIN 40 430 - Dimensions DIN 46 320

Ref. Light Grey	P	Fixing Hole Ø (mm)	Ø A min-max (mm)	B1 Spanner (mm)	B2 Spanner (mm)	C (mm)	L min-max (mm)	Quantity Box/Bag
* 1700T	Pg 9	15,5	6,5- 8,5	17	20	8	19-22	200/100
* 1701T	Pg11	18,8	8 -10	19	22	8	21-25	100/100
* 1702T	Pg13,5	20,5	8 -11	21	24	9	22-26	100/100

*Add to Ref: N for Black

Material: POLYAMIDE PA6
self-extinguishing class VO (UL 94)
Temperature range:
-20°C to +90°C (continuous)
Protection: IP 54
Colour: RAL 7035 light grey,
RAL 9005 black

Compression cable gland - reduced cable entry

Sealing ring: CHLOROPRENE, concentric, multi-sector

Pg thread DIN 40 430 - Dimensions DIN 46 320

Ref Light Grey	P	Fixing Hole Ø (mm)	Ø A min-max (mm)	B1 Spanner (mm)	B2 Spanner (mm)	C (mm)	L min-max (mm)	Quantity
1702CONC	Pg13,5	20,5	5,5-13	21	24	9	22-26	100

Add to Ref: N for Black

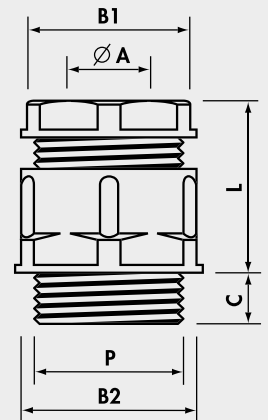

POLYSTYRENE CABLE GLANDS

Polystyrene PS

1700P



Cable Glands

Sealing ring: PVC 50 sh A - Protection: IP 54

Pg thread DIN 40 430 - Dimensions DIN 46 320

Ref. Light Grey	P	Fixing Hole Ø (mm)	Ø A min-max (mm)	B1 Spanner (mm)	B2 Spanner (mm)	C (mm)	L min-max (mm)	Quantity Box/Bag
1700P	Pg9	15,5	7 - 8,5	17	20	8	19-22	200/100
* 1701P	Pg11	18,8	8 -10	19	22	8	21-25	100/100
* 1702P	Pg13,5	20,5	8 -11	21	24	9	22-26	100/100
1703P	Pg16	22,6	11 -14	24	27	10	24-33	50/50
1704P	Pg21	28,5	14,5-18	30	33	11	25-32	50/25

*Add to Ref: N for Black

Material: POLYSTYRENE PS
Temperature range:
-20°C to +60°C (continuous)
Colour: RAL 7035 light grey,
RAL 9005 black

MAXIbrass® CABLE GLANDS

Nickel Plated Brass



2900



Material:
NICKEL PLATED BRASS
(CuZn 40 Pb 3)
Sealing-ring: NEOPRENE®
Cable grip insert:
POLYAMIDE PA6.6
O-Ring: NITRILE 70 sh A
(factory fitted)
Protection: IP 68
Temperature range:
-25°C to +100°C (continuous)

MAXIbrass® standard

Metric thread M 1.5 pitch CEI EN 60423 CEI EN 50262

Ref. Nickel Plated Brass	P	Fixing Hole Ø (mm)	Ø A min-max (mm)	B Spanner (mm)	E (mm)	C (mm)	L min-max (mm)	Quantity
2900.M12N	M12x1,5	12,2	3 - 7	16	18	6,5	16-20	100
2900.M16N	M16x1,5	16,2	4,5-10	20	23	7,0	20-25	100
2900.M20N	M20x1,5	20,5	7 -13	24	27	8,0	20-27	50
2900.M25N	M25x1,5	25,4	10 -17	29	32	8,0	24-30	50
2900.M32N	M32x1,5	32,5	11 -21	36	40	9,0	27-34	25
2900.M40N	M40x1,5	40,5	19 -28	45	50	9,0	34-42	10
2900.M50N	M50x1,5	50,5	26 -35	54	60	10,0	35-43	8
2900.M63N	M63x1,5	64,0	34 -45	67	74	15,0	40-52	5

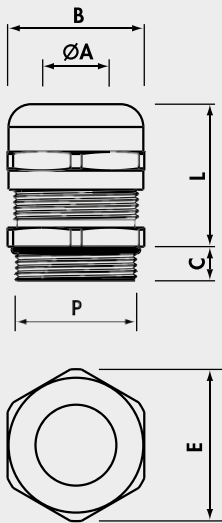

MAXIbrass® reduced cable entry

Metric thread M 1.5 pitch CEI EN 60423 CEI EN 50262

Ref. Nickel Plated Brass	P	Fixing Hole Ø (mm)	Ø A min-max (mm)	B Spanner (mm)	E (mm)	C (mm)	L min-max (mm)	Quantity
2910.M12N	M12x1,5	12,2	1 - 5	16	18	6,5	16-20	100
2910.M16N	M16x1,5	16,2	2,5- 7	20	23	7,0	20-25	100
2910.M20N	M20x1,5	20,5	5 -10	24	27	8,0	20-27	50
2910.M25N	M25x1,5	25,4	6 -13	29	32	8,0	24-30	50
2910.M32N	M32x1,5	32,5	7 -14	36	40	9,0	27-34	25
2910.M40N	M40x1,5	40,5	13 -23	45	50	9,0	34-42	10
2910.M50N	M50x1,5	50,5	20 -29	54	60	10,0	35-43	8
2910.M63N	M63x1,5	64,0	27 -39	67	74	15,0	40-52	5

MAXIbrass® CABLE GLANDS

Nickel Plated Brass

2900



MAXIbrass® extended thread

Metric thread M 1.5 pitch CEI EN 60423 CEI EN 50262

Ref. Nickel Plated Brass	P	Fixing Hole Ø (mm)	Ø A min-max (mm)	B Spanner (mm)	E (mm)	C (mm)	L min-max (mm)	Quantity
2901.M12N	M12x1,5	12,2	3 - 7	16	18	12	16-20	100
2901.M16N	M16x1,5	16,2	4,5-10	20	23	12	20-25	100
2901.M20N	M20x1,5	20,5	7 -13	24	27	12	20-27	50
2901.M25N	M25x1,5	25,4	10 -17	29	32	12	24-30	50
2901.M32N	M32x1,5	32,5	11 -21	36	40	15	27-34	25
2901.M40N	M40x1,5	40,5	19 -28	45	50	15	34-42	10
2901.M50N	M50x1,5	50,5	26 -35	54	60	15	35-43	8

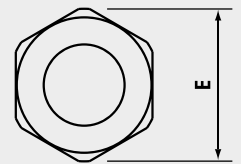
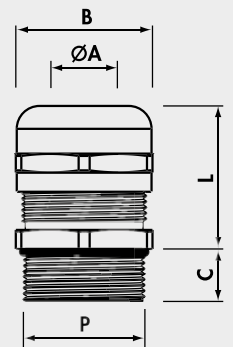

MAXIbrass® extended thread and reduced cable entry

Metric thread M 1.5 pitch CEI EN 60423 CEI EN 50262

Ref. Nickel Plated Brass	P	Fixing Hole Ø (mm)	Ø A min-max (mm)	B Spanner (mm)	E (mm)	C (mm)	L min-max (mm)	Quantity
2911.M12N	M12x1,5	12,2	1 - 5	16	18	12	16-20	100
2911.M16N	M16x1,5	16,2	2,5- 7	20	23	12	20-25	100
2911.M20N	M20x1,5	20,5	5 -10	24	27	12	20-27	50
2911.M25N	M25x1,5	25,4	6 -13	29	32	12	24-30	50
2911.M32N	M32x1,5	32,5	7 -14	36	40	15	27-34	25
2911.M40N	M40x1,5	40,5	13 -23	45	50	15	34-42	10
2911.M50N	M50x1,5	50,5	20 -29	54	60	15	35-43	8

MAXIbrass® CABLE GLANDS

Nickel Plated Brass



2900



Material:
NICKEL PLATED BRASS
(CuZn 40 Pb 3)
Sealing-ring: NEOPRENE®
Cable grip insert:
POLYAMIDE PA6.6
O-Ring: NITRILE 70 sh A
(factory fitted)
Protection: IP 68
Temperature range:
-25°C to +100°C (continuous)

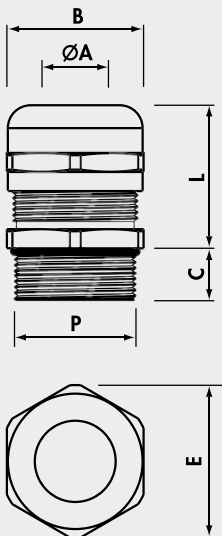

MAXIbrass® standard

Pg thread DIN 40 430

Ref. Nickel Plated Brass	P	Fixing Hole Ø (mm)	Ø A min-max (mm)	B Spanner (mm)	E (mm)	C (mm)	L min-max (mm)	Quantity
2900.07N	Pg 7	12,7	3 - 7	16	18	5,0	16-20	100
2900.09N	Pg 9	15,5	4 - 8	17	19	6,0	17-23	100
2900.11N	Pg11	18,8	4,5-10	20	23	6,0	20-25	100
2900.13N	Pg13,5	20,5	5 -12	22	25	6,5	20-26	50
2900.16N	Pg16	22,6	7 -13	24	27	6,5	20-27	50
2900.21N	Pg21	28,5	10 -17	30	33	7,0	24-30	50
2900.29N	Pg29	37,2	17 -25	40	45	8,0	30-37	25
2900.36N	Pg36	47,2	20 -32	50	55	8,0	38-48	10
2900.42N	Pg42	54,2	28 -38	57	63	10,0	39-48	5
2900.48N	Pg48	60,0	34 -45	67	74	15,0	40-52	5

MAXIbrass® reduced cable entry

Pg thread DIN 40 430

Ref. Nickel Plated Brass	P	Fixing Hole Ø (mm)	Ø A min-max (mm)	B Spanner (mm)	E (mm)	C (mm)	L min-max (mm)	Quantity
2910.07N	Pg 7	12,7	1 - 5	16	18	5,0	16-20	100
2910.09N	Pg 9	15,5	2 - 6	17	19	6,0	17-23	100
2910.11N	Pg11	18,8	2,5- 7	20	23	6,0	20-25	100
2910.13N	Pg13,5	20,5	4 -10	22	25	6,5	20-26	50
2910.16N	Pg16	22,6	5 -10	24	27	6,5	20-27	50
2910.21N	Pg21	28,5	6 -13	30	33	7,0	24-30	50
2910.29N	Pg29	37,2	11 -20	40	45	8,0	30-37	25
2910.36N	Pg36	47,2	18 -26	50	55	8,0	38-48	10
2910.42N	Pg42	54,2	24 -31	57	63	10,0	39-48	5
2910.48N	Pg48	60,0	27 -39	67	74	15,0	40-52	5

MAXIbrass® extended thread

Pg thread DIN 40 430

Ref. Nickel Plated Brass	P	Fixing Hole Ø (mm)	Ø A min-max (mm)	B Spanner (mm)	E (mm)	C (mm)	L min-max (mm)	Quantity
2901.07N	Pg 7	12,7	3 - 7	16	18	12	16-20	100
2901.09N	Pg 9	15,5	4 - 8	17	19	12	17-23	100
2901.11N	Pg11	18,8	4,5-10	20	23	12	20-25	100
2901.13N	Pg13,5	20,5	5 -12	22	25	12	20-26	50
2901.16N	Pg16	22,6	7 -13	24	27	12	20-27	50
2901.21N	Pg21	28,5	10 -17	30	33	12	24-30	50
2901.29N	Pg29	37,2	17 -25	40	45	15	30-37	25
2901.36N	Pg36	47,2	20 -32	50	55	15	38-48	10
2901.42N	Pg42	54,2	28 -38	57	63	15	39-48	5

MAXIbrass® CABLE GLANDS

Nickel Plated Brass



2900

MAXIbrass® extended thread and reduced cable entry

Pg thread DIN 40 430

Ref. Nickel Plated Brass	P	Fixing Hole Ø (mm)	Ø A min-max (mm)	B Spanner (mm)	E (mm)	C (mm)	L min-max (mm)	Quantity
2911.07N	Pg 7	12,7	1 - 5	16	18	12	16-20	100
2911.09N	Pg 9	15,5	2 - 6	17	19	12	17-23	100
2911.11N	Pg11	18,8	2,5- 7	20	23	12	20-25	100
2911.13N	Pg13,5	20,5	4 -10	22	25	12	20-26	50
2911.16N	Pg16	22,6	5 -10	24	27	12	20-27	100
2911.21N	Pg21	28,5	6 -13	30	33	12	24-30	50
2911.29N	Pg29	37,2	11 -20	40	45	15	30-37	25
2911.36N	Pg36	47,2	18 -26	50	55	15	38-48	10
2911.42N	Pg42	54,2	24 -31	57	63	15	39-48	5

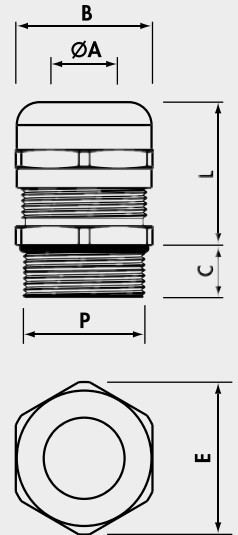

MAXIbrass® standard, factory fitted with Polyethylene foam discs

Metric thread M 1.5 pitch CEI EN 60423 CEI EN 50262

Ref. Nickel Plated Brass	P	Fixing Hole Ø (mm)	Ø A min-max (mm)	B Spanner (mm)	E (mm)	C (mm)	L min-max (mm)	Quantity
2900DP.M12N	M12x1,5	12,2	3 - 7	16	18	6,5	16-20	100
2900DP.M16N	M16x1,5	16,2	4,5-10	20	23	7,0	20-25	100
2900DP.M20N	M20x1,5	20,5	7 -13	24	27	8,0	20-27	50
2900DP.M25N	M25x1,5	25,4	10 -17	29	32	8,0	24-30	50
2900DP.M32N	M32x1,5	32,5	11 -21	36	40	9,0	27-34	25
2900DP.M40N	M40x1,5	40,5	19 -28	45	50	9,0	34-42	10
2900DP.M50N	M50x1,5	50,5	26 -35	54	60	10,0	35-43	8
2900DP.M63N	M63x1,5	64,0	34 -45	67	74	15,0	40-52	5



2900DP



MAXIbrass®

Pg thread DIN 40 430

Ref. Nickel Plated Brass	P	Fixing Hole Ø (mm)	Ø A min-max (mm)	B Spanner (mm)	E (mm)	C (mm)	L min-max (mm)	Quantity
2900DP.07N	Pg 7	12,7	3 - 7	16	18	5,0	16-20	100
2900DP.09N	Pg 9	15,5	4 - 8	17	19	6,0	17-23	100
2900DP.11N	Pg11	18,8	4,5-10	20	23	6,0	20-25	100
2900DP.13N	Pg13,5	20,5	5 -12	22	25	6,5	20-26	50
2900DP.16N	Pg16	22,6	7 -13	24	27	6,5	20-27	50
2900DP.21N	Pg21	28,5	10 -17	30	33	7,0	24-30	50
2900DP.29N	Pg29	37,2	17 -25	40	45	8,0	30-37	25
2900DP.36N	Pg36	47,2	20 -32	50	55	8,0	38-48	10
2900DP.42N	Pg42	54,2	28 -38	57	63	10,0	39-48	5
2900DP.48N	Pg48	60,0	34 -45	67	74	15,0	40-52	5



Material:
NICKEL PLATED BRASS
(CuZn 40 Pb 3)
Sealing-ring: NEOPRENE®
Cable grip insert:
POLYAMIDE PA6.6
O-Ring: NITRILE 70 sh A
(factory fitted)
Protection: IP 68
Discs: 2 mm thick Polyethylene
foam
Temperature range:
-25°C to +100°C (continuous)

MAXIbrass® ATEX CABLE GLANDS

5900



Material: NICKEL PLATED BRASS
 Sealing-ring: NEOPRENE®
 Cable grip insert: POLYAMIDE PA6.6
 O-Ring: NITRILE 70 sh A (factory fitted)
 Safety level: Ex e IIC/Ex tb IIIC
 according to
 EN 60079-0 : 2009
 EN 60079-7 : 2007
 EN 60079-31 : 2009
 Areas of utilisation: 1 & 2, 21 & 22

Nickel Plated Brass



Temperature range: -25°C to +75°C (continuous)
 Protection: IP 65

Certificate No IMQ ATEX 028X

Metric thread M 1.5 pitch CEI EN 60423 CEI EN 50262

Ref. Nickel Plated Brass	P	Fixing Hole Ø (mm)	Ø A min-max (mm)	B Spanner (mm)	E (mm)	C (mm)	L min-max (mm)	Quantity
5900.M12N	M12x1,5	12,2	3 - 6,5	16	18	6,5	16-20	100
5900.M16N	M16x1,5	16,2	6,5-10	20	23	7,0	20-25	100
5900.M20N	M20x1,5	20,5	10 -13	24	27	8,0	20-27	50
5900.M25N	M25x1,5	25,4	11 -17	29	32	8,0	24-30	50
5900.M32N	M32x1,5	32,5	14 -21	36	40	9,0	27-34	25
5900.M40N	M40x1,5	40,5	21 -27	45	50	9,0	34-42	10
5900.M50N	M50x1,5	50,5	26 -35	54	60	10,0	35-43	8
5900.M63N	M63x1,5	64,0	35 -42	67	74	15,0	40-52	5

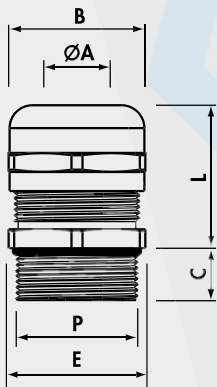

extended thread

Ref. Nickel Plated Brass	P	Fixing Hole Ø (mm)	Ø A min-max (mm)	B Spanner (mm)	E (mm)	C (mm)	L min-max (mm)	Quantity
5901.M12N	M12x1,5	12,2	3 - 6,5	16	18	12	16-20	100
5901.M16N	M16x1,5	16,2	6,5-10	20	23	12	20-25	100
5901.M20N	M20x1,5	20,5	10 -13	24	27	12	20-27	50
5901.M25N	M25x1,5	25,4	11 -17	29	32	12	24-30	50
5901.M32N	M32x1,5	32,5	14 -21	36	40	12	27-34	25
5901.M40N	M40x1,5	40,5	21 -27	45	50	12	34-42	10
5901.M50N	M50x1,5	50,5	26 -35	54	60	12	35-43	8

EMC CABLE GLANDS

20M3



Material: NICKEL PLATED BRASS (CuZn 40 Pb 3)
 Sealing-ring: CLOROPRENE (CR)
 Cable grip insert: PA6.6
 O-Ring: (NBR) (factory fitted)

Nickel Plated Brass

Protection: IP 68, 5 bar
 Temperature range: -30°C to +120°C (continuous)



Metric thread M 1.5 pitch CEI EN 60423 CEI EN 50262

Ref. Nickel Plated Brass	P	Fixing Hole Ø (mm)	Ø A min-max (mm)	B Spanner (mm)	C (mm)	L max (mm)	Quantity Box/Bag
20M3M1261N	M12x1,5	12,2	3 - 6,5	14	5	22	300/100
20M3M1661N	M16x1,5	16,2	5,5-10	17	5,5	24,5	200/100
20M3M2061N	M20x1,5	20,5	8 -13	22	6	27	100/50
20M3M2561N	M25x1,5	25,4	11 -18	30	7	31	50/25
20M3M3261N	M32x1,5	32,5	15 -21	34	8	33	30/10
20M3M4061N	M40x1,5	40,5	19 -27	44	8	40	20/10
20M3M5061N	M50x1,5	50,5	26 -35	55	9	48	10/5
20M3M6361N	M63x1,5	64,0	39 -48	66	10	50	5/5

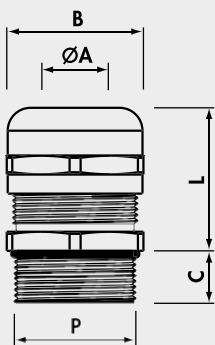

EMC Cable glands and locknuts are designed to work together in electrical or electronic applications where a metallic cable shielding must be equipotential with a metallic enclosure, in accordance with the EMC directive.

Offering IP68 ingress protection at 5 bar pressure, EMC Cable glands will maintain shielding from electromagnetic disturbance in underground applications.

EMC locknuts have serrated teeth to maintain electrical contact through paint or surface coatings, a feature which also enhances vibration resistance.

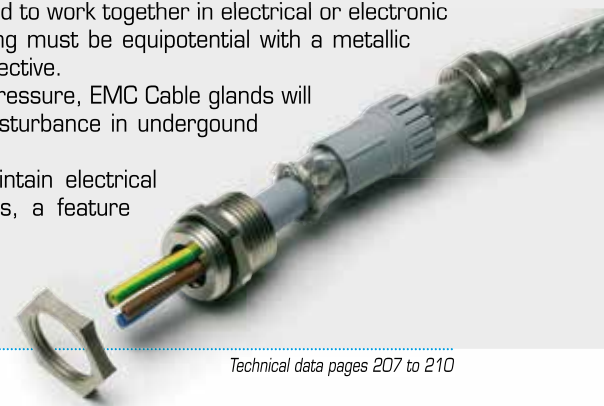



COMPRESSION CABLE GLANDS

Brass

2003
2002
2001

Metric thread M 1.5 pitch CEI EN 60423 CEI EN 50262

Ref. Nickel Plated Brass	P	Fixing Hole Ø (mm)	Ø A min-max (mm)	B1 Spanner Head (mm)	B2 Spanner Body (mm)	C (mm)	L min-max (mm)	Quantity Box/Bag
2003M1221N	M12x1,5	12,2	4 - 6	13	14	5	13-16	500/100
2003M1621N	M16x1,5	16,2	8 -10	15	17	5	14-17	200/100
2003M2021N	M20x1,5	20,5	10 -12	20	22	6	16-19	150/50
2003M2521N	M25x1,5	25,4	17 -19	28	30	7	19-23	50/50
2003M3221N	M32x1,5	32,5	26 -28	37	39	8	21-25	100/50
2003M4021N	M40x1,5	40,5	33 -35	47	50	8	24-30	20/20
2003M5021N	M50x1,5	50,5	39 -41	54	57	9	28-34	10/5
2003M6321N	M63x1,5	64,0	43 -45	60	66/68	10	30-36	10/5



Material: Metric & Pg threads
NICKEL PLATED BRASS
(CuZn 40 Pb 3)

BSP thread - PLAIN BRASS

Protection: IP 54

Sealing ring:

Metric thread - RUBBER 55sh A

Pg thread - RUBBER 55 sh A

BSP thread - PVC 50 sh A

Pg thread DIN 40 430 - Dimensions DIN 46 320

Ref. Nickel Plated Brass	P	Fixing Hole Ø (mm)	Ø A min-max (mm)	B1 Spanner Head (mm)	B2 Spanner Body (mm)	C (mm)	L min-max (mm)	Quantity Box/Bag
200200721N	Pg 7	12,7	5 - 7	13	14	5	13-16	400/100
200200921N	Pg 9	15,5	8 -10	15	17	6	14-17	300/100
200201121N	Pg11	18,8	8 -10	18	20	6	14-18	200/50
200201321N	Pg13,5	20,5	10 -12	20	22	6,5	16-19	100/50
200201621N	Pg16	22,6	12 -14	22	24	6,5	17-20	50/50
200202121N	Pg21	28,5	17 -19	28	30	7	19-23	50/50
200202921N	Pg29	37,2	26 -28	37	40	8	21-25	15/15
200203621N*	Pg36	47,2	33 -35	47	50	9	24-30	10/10
200204221N	Pg42	54,2	39 -41	54	57	10	28-34	10/10
200204821N*	Pg48	60,0	43 -45	60	64	10	36-45	10/10

* Double sealing ring

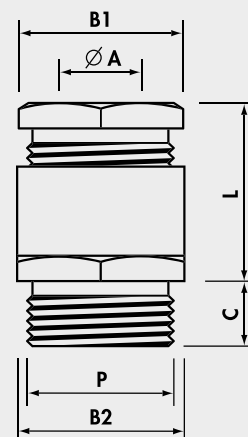

BSP thread ISO 228/1

Ref. Nickel Plated Brass	P	Fixing Hole Ø (mm)	Ø A min-max (mm)	B1 Spanner Head (mm)	B2 Spanner Body (mm)	C (mm)	L min-max (mm)	Quantity Box/Bag
200101441	G1/4"	13,5	5,5 - 7	13	15	6,5	14-17	400/100
207101441	G1/4"	13,5	5,5 - 7	13	∅15	6,5	14-17	400/100
200103841	G3/8"	17,0	6,5 - 8,5	17	19	7,5	15-19	200/100
200101241	G1/2"	21,5	8 -11	21	23	8	17-23	100/100
200105841	G5/8"	23,5	11 -14	23	25	8,5	20-24	100/50
200103441	G3/4"	27,0	14,5-17,5	27	29	9	20-26	50/50
200110041	G1"	34,0	18 -22	34	36	10	23-28	25/25
200111841	G1"1/8	38,0	21 -26	38	40	10,5	23-28	25/25
200111441	G1"1/4	42,0	28 -32	42	45	11,5	25-31	20/20
200111241	G1"1/2	48,0	32 -36	48	50	11,5	28-35	20/20
200120041	G2"	60,0	38 -42	60	64	13,5	31-37	10/10
• 200121221*	G2"1/2	76,0	44 -57	80	80	20	32-37	5/5
• 200130021	G3"	89,0	67 -69	95	95	20	42-52	5/5

Add to Ref: N for NICKEL PLATED BRASS

• Sealing ring: CLOROPRENE

* Concentric sealing ring

MAXIinox CABLE GLANDS



7900
7900A



Stainless Steel 303 (X8 CrNiS 18-9)

Stainless Steel 316L (X2 CrNiMo 17-12-2)

Material:
STAINLESS STEEL 303/316L
Sealing-ring: NEOPRENE®
Cable grip insert:
POLYAMIDE PA6.6
O-Ring: NITRILE 70 sh A
(factory fitted)
Protection: IP 68
Temperature range:
-25°C to +100°C (continuous)

MAXIinox Stainless Steel AISI 303

Metric thread M 1.5 pitch CEI EN 60423 CEI EN 50262

Stainless Steel AISI 303	P	Fixing Hole Ø (mm)	Ø A min-max (mm)	B Spanner (mm)	E (mm)	C (mm)	L min-max (mm)	Quantity Box/Bag
7900.M12	M12x1,5	12,2	3 - 7	16	18	6,5	16-20	90/30
7900.M16	M16x1,5	16,2	4,5-10	20	23	7,0	20-25	120/30
7900.M20	M20x1,5	20,5	7 -13	24	27	8,0	20-27	75/25
7900.M25	M25x1,5	25,4	10 -17	29	32	8,0	24-30	40/20
7900.M32	M32x1,5	32,5	11 -21	36	40	9,0	27-34	15
7900.M40	M40x1,5	40,5	19 -28	45	50	9,0	34-42	15
7900.M50	M50x1,5	50,5	26 -35	54	60	10,0	35-43	10
7900.M63	M63x1,5	64,0	34 -45	67	74	15,0	40-52	5

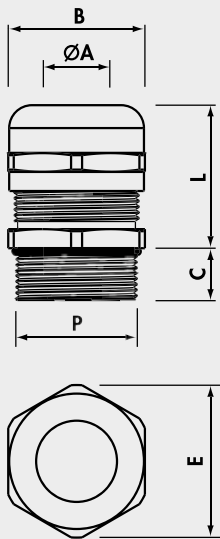

MAXIinox Stainless Steel AISI 316L

Metric thread M 1.5 pitch CEI EN 60423 CEI EN 50262

Stainless Steel AISI 316L	P	Fixing Hole Ø (mm)	Ø A min-max (mm)	B Spanner (mm)	E (mm)	C (mm)	L min-max (mm)	Quantity Box/Bag
7900A.M12	M12x1,5	12,2	3 - 7	16	18	6,5	16-20	60/20
7900A.M16	M16x1,5	16,2	4,5-10	20	23	7,0	20-25	80/20
7900A.M20	M20x1,5	20,5	7 -13	24	27	8,0	20-27	60/20
7900A.M25	M25x1,5	25,4	10 -17	29	32	8,0	24-30	30/15
7900A.M32	M32x1,5	32,5	11 -21	36	40	9,0	27-34	12
7900A.M40	M40x1,5	40,5	19 -28	45	50	9,0	34-42	10
7900A.M50	M50x1,5	50,5	26 -35	54	60	10,0	35-43	7
7900A.M63	M63x1,5	64,0	34 -45	67	74	15,0	40-52	5



MAXIinox CABLE GLANDS

Stainless Steel 303 (X8 CrNiS 18-9)

Stainless Steel 316L (X2 CrNiMo 17-12-2)

7900 7900A



MAXIinox Stainless Steel AISI 303

Pg thread DIN 40 430

Stainless Steel AISI 303	P	Fixing Hole Ø (mm)	Ø A min-max (mm)	B Spanner (mm)	E (mm)	C (mm)	L min-max (mm)	Quantity Box/Bag
7900.07	Pg 7	12,7	3 - 7	16	18	5,0	16-20	90/30
7900.09	Pg 9	15,5	4 - 8	17	19	6,0	17-23	90/30
7900.11	Pg11	18,8	4,5-10	20	23	6,0	20-25	60/30
7900.13	Pg13,5	20,5	5 -12	22	25	6,5	20-26	90/30
7900.16	Pg16	22,6	7 -13	24	27	6,5	20-27	60/30
7900.21	Pg21	28,5	10 -17	30	33	7,0	24-30	40/20
7900.29	Pg29	37,2	17 -25	40	45	8,0	30-37	30/15
7900.36	Pg36	47,2	20 -32	50	55	8,0	38-48	10
7900.42	Pg42	54,2	28 -38	57	63	10,0	36-46	5
7900.48	Pg48	60,0	34 -45	67	74	15,0	40-52	5

Material: STAINLESS STEEL 303/316L
 Sealing-ring: NEOPRENE®
 Cable grip insert: POLYAMIDE PA6.6
 O-Ring: NITRILE 70 sh A (factory fitted)
 Protection: IP 68
 Temperature range: -25°C to +100°C (continuous)

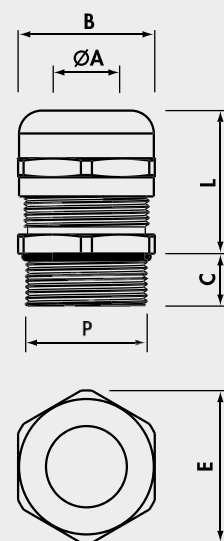

MAXIinox Stainless Steel AISI 316L

Pg thread DIN 40 430

Stainless Steel AISI 316L	P	Fixing Hole Ø (mm)	Ø A min-max (mm)	B Spanner (mm)	E (mm)	C (mm)	L min-max (mm)	Quantity Box/Bag
7900A.07	Pg 7	12,7	3 - 7	16	18	5,0	16-20	60/20
7900A.09	Pg 9	15,5	4 - 8	17	19	6,0	17-23	60/20
7900A.11	Pg11	18,8	4,5-10	20	23	6,0	20-25	100/20
7900A.13	Pg13,5	20,5	5 -12	22	25	6,5	20-26	100/20
7900A.16	Pg16	22,6	7 -13	24	27	6,5	20-27	40/20
7900A.21	Pg21	28,5	10 -17	30	33	7,0	24-30	60/15
7900A.29	Pg29	37,2	17 -25	40	45	8,0	30-37	20/10
7900A.36	Pg36	47,2	20 -32	50	55	8,0	38-48	7
7900A.42	Pg42	54,2	28 -38	57	63	10,0	36-46	5
7900A.48	Pg48	60,0	34 -45	67	74	15,0	40-52	5

LOCKNUTS WITH COLLAR

Polyamide PA6 or PA6.6

1143
1142
1141



Metric thread M 1.5 pitch CEI EN 60423

Material: POLYAMIDE PA6 or 6.6 self-extinguishing class V2 (UL 94)
Temperature range:
-20°C to +90°C (continuous)
Colour: RAL 7035 light grey,
RAL 9005 black,
RAL 7001 dark grey

Ref. Light Grey	P	Ø A (mm)	B Spanner (mm)	H (mm)	Quantity Box/Bag
1143M12	M12X1,5	18,5	17	5	1.000/100
1143M16	M16X1,5	24	22	5	600/100
1143M20	M20X1,5	29	27	6	400/100
1143M25	M25X1,5	35,5	32	6	100
1143M32	M32X1,5	45	41	7	50
1143M40	M40X1,5	55	50	7	30
1143M50	M50X1,5	65	60	8	30
1143M63	M63X1,5	82	75	8	15

Add to Ref: N for Black, G for Dark Grey

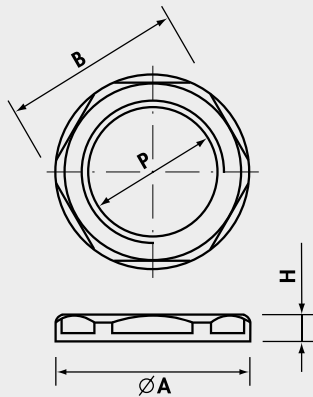

Pg thread DIN 40 430 - Dimensions DIN 46 320

Ref. Light Grey	P	Ø A (mm)	B Spanner (mm)	H (mm)	Quantity Box/Bag
1142007	Pg 7	21	19	5	100
1142009	Pg 9	24	22	5	700/100
1142011	Pg11	26	24	5	500/100
1142013	Pg13,5	29	27	6	400/100
1142016	Pg16	33	30	6	100
1142021	Pg21	39	36	7	200/50
1142029	Pg29	50	46	7	50
1142036	Pg36	66	60	8	30
1142042	Pg42	73	65	8	25
1142048	Pg48	78	70	8	20

Add to Ref: N for Black, G for Dark Grey

BSP thread ISO 228/1

Ref. Light Grey	P	Ø A (mm)	B Spanner (mm)	H (mm)	Quantity Box/Bag
1141012	G1/2"	29	27	6	400/100
1141112	G1"1/2	66	60	8	30
1141200	G2"	78	70	8	20

Add to Ref: N for Black

LOCKNUTS WITHOUT COLLAR

Polyamide PA6 or PA6.6

1112
1710
1410



Metric thread M 1.5 pitch CEI EN 60423

Ref. Light Grey	P	B Spanner (mm)	H (mm)	Quantity Box/Bag
1112	M12X1,5	17	5	1.000/100
1116	M16X1,5	22	5	700/100
1120	M20X1,5	27	6	400/100
1125	M25X1,5	32	6	100
1132	M32X1,5	41	7	50
1140	M40X1,5	50	7	30
1150	M50X1,5	60	8	30
1163	M63X1,5	75	8	15

Add to Ref: N for Black

Pg thread DIN 40 430 - Dimensions DIN 46 320

Ref. Light Grey	P	B Spanner (mm)	H (mm)	Quantity Box/Bag
* 1719E17	Pg 7	17	5	1.000/100
1719	Pg 7	19	5	100
1710	Pg 9	22	5	700/100
1711	Pg11	24	5	500/100
1712	Pg13,5	27	6	400/100
1713	Pg16	30	6	100
△*1714E34	Pg21	34	7	200/100
1714	Pg21	36	7	200/100
1715	Pg29	46	7,5	100/50

Add to Ref: N for Black

△ Light Grey only

* Not DIN 46 320

BSP thread ISO 228/1

Ref. Light Grey	P	B Spanner (mm)	H (mm)	Quantity Box/Bag
1410	G1/4"	19	5	800/100
1411	G3/8"	23	6	600/100
1412	G1/2"	27	6	400/100
1413	G5/8"	30	6	100
1414	G3/4"	34	7	200/100
1415	G1"	40	7	50

Add to Ref: N for Black

Material:
POLYAMIDE PA6 or 6.6
self-extinguishing class V2 (UL 94)
Temperature range:
-20°C to +90°C (continuous)
Colour: RAL 7035 light grey,
RAL 9005 black

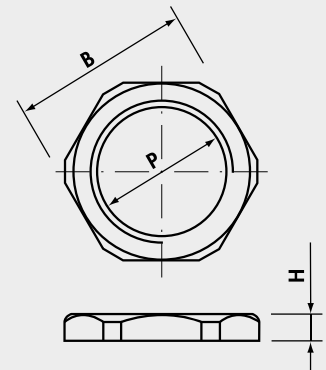

LOCKNUTS

Brass

2033
2032
2031



Metric thread M 1.5 pitch CEI EN 60423

Ref. Nickel Plated Brass	P	B Spanner (mm)	H (mm)	Quantity Box/Bag
2033M12N	M12X1,5	16	2,8	2.000/100
2033M16N	M16X1,5	19	2,8	1.000/100
2033M20N	M20X1,5	24	3	600/100
2033M25N	M25X1,5	30	4,0	400/50
2033M32N	M32X1,5	36	4	250/25
2033M40N	M40X1,5	45	5,0	150/10
2033M50N	M50X1,5	60	5	100/10
2033M63N	M63X1,5	70	5,5	50/5

Pg thread DIN 40 430 - Dimensions DIN 46 320

Ref. Nickel Plated Brass	P	B Spanner (mm)	H (mm)	Quantity Box/Bag
2032007N	Pg 7	16*	2,8	1.500/100
2032009N	Pg 9	18	2,8	1.500/100
2032011N	Pg11	21	3	1.000/100
2032013N	Pg13,5	23	3	1.000/100
2032016N	Pg16	26	3	600/100
2032021N	Pg21	32	3,5	500/100
2032029N	Pg29	41	4	300/50
2032036N	Pg36	51	5	100/10
2032042N	Pg42	60	5	50/10
2032048N	Pg48	64	5,5	50/10

*Different dimension to DIN 46320

BSP thread ISO 228/1

Ref. Plain Brass	P	B Spanner (mm)	H (mm)	Quantity Box/Bag
2031014	G1/4"	16	3	2.400/100
2031038	G3/8"	19	3	2.000/100
2031012	G1/2"	24	3,5	1.000/100
2031058	G5/8"	26	4	500/50
2031034	G3/4"	30	4	500/50
2031100	G1"	37	4	250/25
2031118	G1"1/8	41	4,5	100/25
2031114	G1"1/4	45	4,5	200/20
2031112	G1"1/2	52	5,5	100/20
2031200	G2"	64	7	50/10
2031212	G2"1/2	80	7	20/5
2031300	G3"	95	8	20/5

Add to Ref: N for NICKEL PLATED BRASS

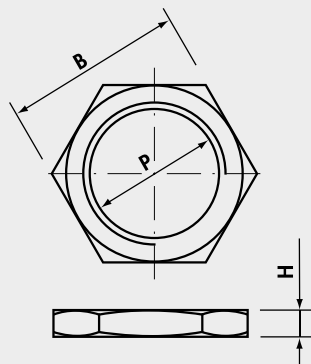
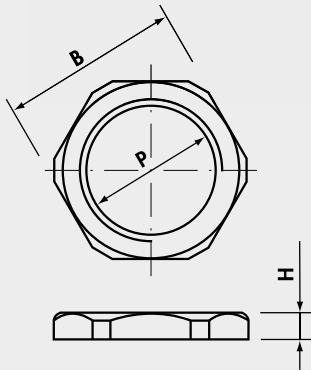

EMC LOCKNUTS

Nickel Plated Brass

EMC Locknuts

Material: NICKEL PLATED BRASS (CuZn 40 Pb 3)

Metric thread M 1.5 pitch CEI EN 60423

Ref. Nickel Plated Brass	P	B Spanner (mm)	H (mm)	Quantity Box/Bag
20N3M12N	M12X1,5	15	3,5	1,000/100
20N3M16N	M16X1,5	19	3,5	1,000/100
20N3M20N	M20X1,5	24	3,5	500/100
20N3M25N	M25X1,5	30	4,0	400/100
20N3M32N	M32X1,5	36	4,0	200/100
20N3M40N	M40X1,5	46	4,7	100/50
20N3M50N	M50X1,5	60	5,7	50/50
20N3M63N	M63X1,5	70	6,7	50/25

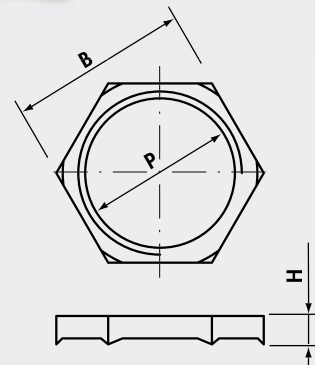

MAXInox LOCKNUTS

Stainless Steel 303 (X8 CrNiS 18-9)

Stainless Steel 316L (X2 CrNiMo 17-12-2)

Metric thread M 1.5 pitch CEI EN 60423

Stainless Steel AISI 303	Stainless Steel AISI 316L	P	B Spanner (mm)	H (mm)	AISI 303 Quantity Box/Bag	AISI 316L Quantity Box/Bag
7033M12	7033AM12	M12X1,5	16	2,8	450/30	300/20
7033M16	7033AM16	M16X1,5	20	2,8	450/30	300/20
7033M20	7033AM20	M20X1,5	24	3,5	250/25	200/20
7033M25	7033AM25	M25X1,5	29	4	160/20	120/15
7033M32	7033AM32	M32X1,5	36	4	105/15	84/12
7033M40	7033AM40	M40X1,5	45	5	60/15	40/10
7033M50	7033AM50	M50X1,5	57	5	40/10	28/7
7033M63	7033AM63	M63X1,5	70	5,5	32/8	20/5

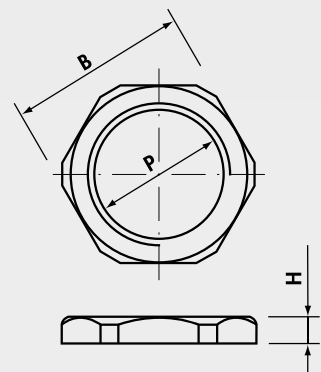

Pg thread DIN 40 430

Stainless Steel AISI 303	Stainless Steel AISI 316L	P	B Spanner (mm)	H (mm)	AISI 303 Quantity Box/Bag	AISI 316L Quantity Box/Bag
7032007	7032A007	Pg 7	16	2,8	450/30	300/20
7032009	7032A009	Pg 9	20	2,8	450/30	300/20
7032011	7032A011	Pg11	22	3	300/30	200/20
7032013	7032A013	Pg13,5	22	3	300/30	200/20
7032016	7032A016	Pg16	27	3	240/30	160/20
7032021	7032A021	Pg21	32	3,5	160/20	150/15
7032029	7032A029	Pg29	41	4	60/15	40/10
7032036	7032A036	Pg36	50	5	40/10	28/7
7032042	7032A042	Pg42	60	5	40/10	20/5
7032048	7032A048	Pg48	64	5,5	32/8	20/5

INTERNAL PLUGS FOR CABLE GLANDS

TCP

Polyamide PA6.6



Material: POLYAMIDE PA6.6
 self-extinguishing class V2 (UL 94)
 Temperature range:
 -20°C to +90°C (continuous)
 Colour: RAL 9005 black
 Application:
 Blanking the cable entry of
MAXIblock[®], **MAXIbrass**[®] and
MAXIinox cable glands and
 maintaining IP 68.

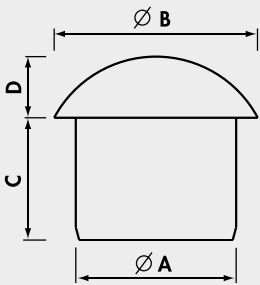

Plugs

Ref.	Suitable for		Ø A (mm)	Ø B (mm)	C (mm)	D (mm)	Quantity Box/Bag
	MAXIblock [®]	MAXIbrass [®] MAXIinox					
TCP5	M12R + Pg7R	M12R	4,5	8,5	10,8	4,5	3.000/100
TCP10	Pg9R	Pg9R	6	12	12	4,5	2.000/100
TCP12	M12 + Pg7	M12 + Pg7	6,8	12	12	4,5	1.000/100
	M16R + Pg11R	M16R + Pg11R					
TCP15	Pg9	Pg9	8	11	11,5	5	1.500/100
TCP18	M16 + Pg11	M16 + Pg11	9,5	12,5	13	5	800/100
TCP20	M20R	M20R	10	15	14	6	800/100
	Pg13,5 + Pg13,5R Pg16R	Pg13 + Pg13,5R Pg16R					
TCP25	M20 + Pg16	M20 + Pg16	12,5	17	15	8	400/100
TCP30	M25R + M32R	M25R + M32R	12,5	22,5	18	9	300/100
	Pg21R	Pg21R					
TCP35	M25 + Pg21	M25 + Pg21	16	19,5	18	8	300/100
TCP40	M32	M32	19	22,5	19	9	150/50
TCP45	M40R + Pg29 + Pg36R	M40R + Pg29	22	30	20	10	100/50
TCP50	M40 + M50R + Pg42R	M40 + M50R	27,5	38	25	12	50/25
TCP55	Pg36	Pg36	31,5	36,5	23,5	12	50/25
TCP60	M50	M50	34,5	40	23,5	12	50/25
TCP65	M63R + Pg42 + Pg48R	M63R + Pg42	37,5	48	26,5	12	30/15
TCP70	M63 + Pg48	M63 + Pg48	43	48	26,5	12	30/15

R: reduced cable entry

MULTI-ENTRY SEALS & PLUGS FOR CABLE GLANDS

36 TGM

Material: NEOPRENE® 70 sh A
 Temperature range:
 -40°C to +130°C
 Protection: IP 68
 Colour: RAL 9005 black
 Application:
 IP68 sealing of multiple cables entering
MAXIblock®, **MAXIbrass**® or
MAXIinox cable glands.



Multi-entry seals

Ref.	Suitable for		n° entries	Ø Dia entry (mm)	Quantity Box/Bag
	MAXIblock ®	MAXIbrass ® MAXIinox			
36A3M1623	M16 + Pg11	M16 + Pg11	2	3	1.500/100
36A3M1624	M16 + Pg11	M16 + Pg11	2	4	1.000/100
36A3M16322	M16 + Pg11	M16 + Pg11	3	2,2	1.500/100
36A3M2025	M20 + Pg13,5	M20 + Pg13,5 + Pg16	2	5	500/100
36A3M2034	M20 + Pg13,5	M20 + Pg13,5 + Pg16	3	4	500/100
36A3M20356	M20 + Pg13,5	M20 + Pg13,5 + Pg16	3	5,6	500/100
36A3M2526	M25	M25 + Pg21	2	6	300/50
36A3M2536	M25	M25 + Pg21	3	6	300/50
36A3M2537	M25	M25 + Pg21	3	7	300/50
36A3M2545	M25	M25 + Pg21	4	5	300/50
36A3M2546	M25	M25 + Pg21	4	6	300/50
36A3M2554	M25	M25 + Pg21	5	4	300/50
36A3M3228	M32	M32	2	8	150/50
36A3M3239	M32	M32	3	9	150/50
36A3M32465	M32	M32	4	6,5	150/50
36A3M3248	M32	M32	4	8	150/50
36A3M4078	M40	M40	7	8	100/100
36A3M40106	M40	M40	10	6	100/100
36A3M5088	M50	M50	8	8	50/50
36C201629	Pg16	-	2	3+9	400/50

2 ENTRIES

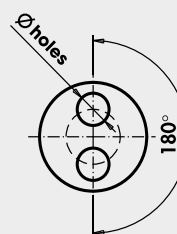

3 ENTRIES

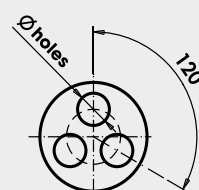

4 ENTRIES

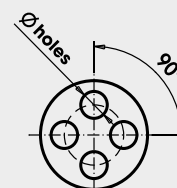

5 ENTRIES

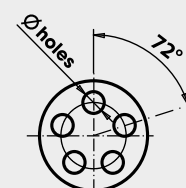

Material: POLYAMIDE PA6.6
 Temperature range:
 -20°C to +90°C (continuous)
 Colour: RAL 7035 light grey

Application:
 Plugging unused entries
 in multi-entry seals and
 maintaining IP68.

Multi-entry seal plugs

Ref.	Suitable for Seal	Ø A	L	Quantity Box/Bag
		(mm)	(mm)	
TGM38	36A3M1623	3	10	5.000/100
TGM48	36A3M1624 + 36A3M2034 + 36A3M2554	4	8	5.000/100
TGM58	36A3M2025	5	8	5.000/100
TGM513	36A3M2545	5	13	2.500/50
TGM613	36A3M2526 + 36A3M2536 + 36A3M40106	6	13	2.000/50
TGM713	36A3M2537	7	13	2.000/50
TGM817	36A3M3248 + 36A3M5088 + 36A3M4078	8	17	100

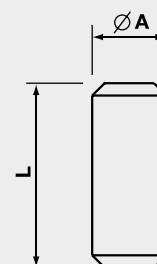

ENTRY THREAD ADAPTERS

Nickel Plated Brass

Entry thread enlargers

Metric thread M 1.5 pitch CEI EN 60423

Ref.	P EXT	P INT	Ø A (mm)	C (mm)	H (mm)	Quantity Box/Bag
20931216N	M12X1,5	M16X1,5	18	5	15,5	500/100
20931620N	M16X1,5	M20X1,5	22	5	17,5	300/100
20932025N	M20X1,5	M25X1,5	27	6	20	150/50
20932532N	M25X1,5	M32X1,5	34	7	22,5	100/50
20932540N	M25X1,5	M40X1,5	42	7	23,5	50/50
20933240N	M32X1,5	M40X1,5	42	8	24,5	50/50
20933250N	M32X1,5	M50X1,5	52	8	27,5	25/25
20934050N	M40X1,5	M50X1,5	52	8	27,5	25/25
20935063N	M50X1,5	M63X1,5	66	9	31	20/10

Entry thread reducers

Metric thread M 1.5 pitch CEI EN 60423

Ref.	P EXT	P INT	Ø A (mm)	C (mm)	H (mm)	Quantity Box/Bag
20431612N	M16X1,5	M12X1,5	18	5	7,5	1.000/100
20432012N	M20X1,5	M12X1,5	22	6	9	600/100
20432016N	M20X1,5	M16X1,5	22	6	9	500/100
20432512N	M25X1,5	M12X1,5	27	7	10	300/50
20432516N	M25X1,5	M16X1,5	27	7	10	300/50
20432520N	M25X1,5	M20X1,5	27	7	10	300/100
20433220N	M32X1,5	M20X1,5	34	8	11	100/25
20433225N	M32X1,5	M25X1,5	34	8	11	200/50
20434025N	M40X1,5	M25X1,5	43	8	11,5	100/25
20434032N	M40X1,5	M32X1,5	43	8	11,5	100/25
20435032N	M50X1,5	M32X1,5	53	9	12,5	50/10
20435040N	M50X1,5	M40X1,5	53	9	12,5	50/25
20436340N	M63X1,5	M40X1,5	66	10	14	30/10
20436350N	M63X1,5	M50X1,5	66	10	14	30/10

Entry thread converters - Metric to Pg

Ref.	P EXT	P INT	Fig.	Ø A (mm)	C (mm)	H (mm)	Quantity Box/Bag
20A42011N	M20X1,5	Pg11	1	22	6,5	17,5	300/100
20A42016N	M20X1,5	Pg16	1	24	6,5	20	200/50
20A42513N	M25X1,5	Pg13,5	2	27	7	10	300/50
20A42516N	M25X1,5	Pg16	2	27	7	10	300/50
20A43216N	M32X1,5	Pg16	2	36	8	11,5	100/25
20A43221N	M32X1,5	Pg21	2	36	8	11,5	100/25

Entry thread converters - Pg to Metric

20A40916N	Pg 9	M16X1,5	1	20	6	15	400/100
20A41120N	Pg11	M20X1,5	1	22	6	16	300/100
20A41320N	Pg13,5	M20X1,5	1	24	6,5	16,5	200/50
20A41620N	Pg16	M20X1,5	2	24	6,5	9,5	50/50
20A42120N	Pg21	M20X1,5	2	30	7	10	100/100
20A42125N	Pg21	M25X1,5	2	30	7	10	100/100
20A42925N	Pg29	M25X1,5	2	39	8	11,5	50/50

2093
2043
20A4



Material: NICKEL PLATED BRASS
(CuZn 40 Pb 3)

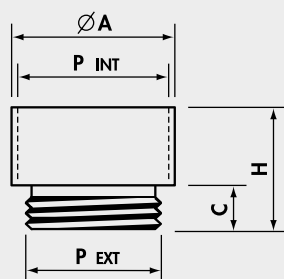

Fig. 1

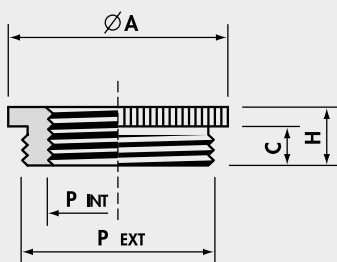

Fig. 2

ENTRY THREAD ADAPTERS

Nickel Plated Brass

1800
2042



Entry thread enlargers

Pg thread DIN 40 430 - Dimensions DIN 46 320-K

Ref.	P EXT	P INT	Ø A (mm)	C (mm)	H (mm)	Quantity Box/Bag
180709	Pg 7	Pg 9	17	5	15	600/100
180911	Pg 9	Pg11	20	6	16,5	500/100
180913	Pg 9	Pg13,5	22	6	17,5	300/100
181113	Pg11	Pg13,5	22	6	17,5	300/100
181116	Pg11	Pg16	24	6	18,5	100/50
181316	Pg13,5	Pg16	24	6,5	19	200/50
181321	Pg13,5	Pg21	30	6,5	21	150/50
181621	Pg16	Pg21	30	6,5	21	100/25
182129	Pg21	Pg29	39	7	23	75/25
182936	Pg29	Pg36	50	8	27,5	30/10
183642	Pg36	Pg42	57	9	31	20/10
184248	Pg42	Pg48	64	10	33	20/10

Material: NICKEL PLATED BRASS
(CuZn 40 Pb 3)

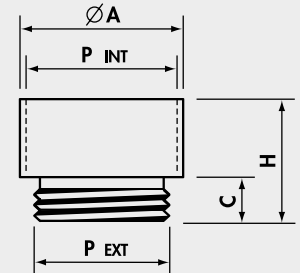

Entry thread reducers

Pg thread DIN 40 430 - Dimensions DIN 46 320-H

Ref.	P EXT	P INT	Ø A (mm)	C (mm)	H (mm)	Quantity Box/Bag
20420907N	Pg 9	Pg 7	17	6	8,5	800/100
20421107N	Pg11	Pg 7	20	6	8,5	600/100
20421109N	Pg11	Pg 9	20	6	8,5	600/100
20421307N	Pg13,5	Pg 7	22	6,5	9	600/100
20421309N	Pg13,5	Pg 9	22	6,5	9	600/100
20421311N	Pg13,5	Pg11	22	6,5	9	600/100
20421607N	Pg16	Pg 7	24	6,5	9,5	300/50
20421609N	Pg16	Pg 9	24	6,5	9,5	400/100
20421611N	Pg16	Pg11	24	6,5	9,5	400/100
20421613N	Pg16	Pg13,5	24	6,5	9,5	400/100
20422111N	Pg21	Pg11	30	7	10	200/50
20422113N	Pg21	Pg13,5	30	7	10	200/50
20422116N	Pg21	Pg16	30	7	10	200/50
20422916N	Pg29	Pg16	39	8	11,5	100/25
20422921N	Pg29	Pg21	39	8	11,5	100/25
20423621N	Pg36	Pg21	50	9	12,5	50/25
20423629N	Pg36	Pg29	50	9	12,5	50/25
20424236N	Pg42	Pg36	57	10	14	50/25
20424836N	Pg48	Pg36	64	10	14	50/25
20424842N	Pg48	Pg42	64	10	14	50/25

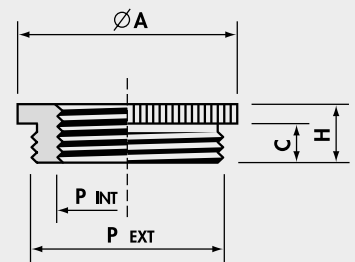

ACCESSORIES

6010

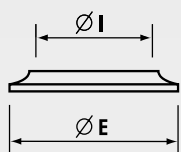

Type A

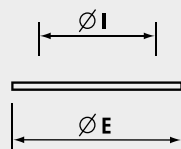

Type B

Compression washers

Material: Zinc plated STEEL UNI 5961/84

Ref.	Fits thread	Ø E (mm)	Ø I (mm)	Quantity Box/Bag
6010.14	Pg7 + G1/4"	11	8	15.000/1.000
6010.38	Pg9 + G3/8"	14,5	10	5.000/1.000
6010.11	Pg11 + G3/8"	17	12	5.000/1.000
6010.12	Pg13,5 + G1/2"	18	14	4.000/1.000
6010.58	Pg16 + G5/8"	20	15,5	3.000/1.000
6010.34	G3/4"	24	18,5	2.500/500
6010.114	G1"1/4	38	33	1.000/500
6010.21	Pg21 + G3/4"	26,5	20	2.000/500
6010.01	G1"	30	24,5	1.500/500
6010.29	Pg29 + G1"1/8	35	26,5	1.000/500
6010.36	Pg36 + G1"1/2	45	38	750/250
6010.42	Pg42	51	42,5	500/250
6010.48	Pg48 + G2"	57	48	400/100

Subject to availability, the compression washers could be of type A or B

SEALING RINGS

1880 1890



Concentric sealing rings Material: BUTADIENE-NITRILE NBR with concentric perforations

Ref.	Suitable only for Cable Glands IP54 (1700... 2002...)	Ø E (mm)	Ø 3 (mm)	Ø 2 (mm)	Ø 1 (mm)	Ø I (mm)	H (mm)	Quantity Box/Bag		
1880	Pg9 + M16	13,3	-	-	-	10	7,5	5,5	1.500/100	
1881	Pg11	16,5	-	-	-	12,5	10	7,5	6	1.000/100
1882	Pg13,5 + M20 + G1/2"	18,3	-	-	-	12,5	10	7,5	6	800/100
1883	Pg16 + G5/8"	20,4	-	-	15	12,5	10	7,5	7	600/100
1884	Pg21 + M25	26,0	-	-	19	16	13	10	8	300/100
1884A	Pg21 + M25	26,0	-	-	20,5	18	15	10,5	8	300/100
*1885	Pg29 + M32 + G1 1/8"	34,7	-	-	27	24	21	18	9,5	150/50
1886	Pg36 + G1 1/2" + M40	44,7	-	-	33	30	27	24	12	100/50
*1887	Pg42 + M50	51,7	-	-	39	36	33	30	14	50/25
1888/5	Pg48 + G2" + M63	57,0	45	41	37	33	29	24	14	75/25
*1888	Pg48 + G2" + M63	57,0	-	-	45	42	39	36	14	75/25

*material: RUBBER NR

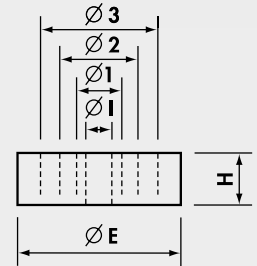

O-rings

Material: BUTADIENE-NITRILE 70 sh

Ref.	Fits thread	Ø E (mm)	Ø I (mm)	H (mm)	Quantity Box/Bag
1889	M12	12,81	9,25	1,78	1.000
1890	Pg7 + G1/4"	14,38	10,82	1,78	5.000/1.000
1890A	M16 + Pg9 + G3/8"	15,98	12,42	1,78	5.000/1.000
1891	Pg11	19,16	15,60	1,78	5.000/1.000
1891A	M20	20,73	17,17	1,78	5.000/1.000
1892	Pg13,5 + G1/2"	22,33	18,77	1,78	5.000/1.000
1892A	Pg16 + G5/8"	23,91	20,35	1,78	5.000/1.000
1892B	M25	25,51	21,95	1,78	5.000/1.000
1893	Pg21	28,68	25,12	1,78	3.000/500
1893A	M32	30,00	26,00	2,00	500
1925,3	G3/4"	30,31	25,07	2,62	1.000/500
1894	G1"	35,06	29,82	2,62	1.000/500
1895	M40 + Pg29 + G1 1/8"	39,84	34,60	2,62	1.000/500
1896	G1 1/4"	43,01	37,77	2,62	500
1897	Pg36 + G1 1/2"	49,36	44,12	2,62	800/100
1898	Pg42 + G1 3/4"	55,71	50,47	2,62	800/100
1899	Pg48 + G2"	62,06	56,82	2,62	100
1899A	G2 1/2"	76,50	69,44	3,53	100/1
1899B	G3"	92,60	81,92	5,34	100/1

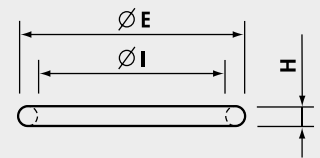

SEALING RINGS

PVC 50 sh A

341
342
343
344



Material: PVC 50 sh A

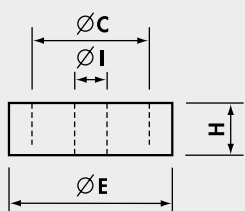
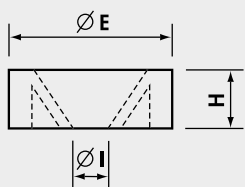
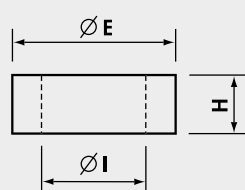

Cylindrical sealing rings

Ref.	Fits thread	C (mm)	Ø E (mm)	Ø I (mm)	H (mm)	Quantity Box/Bag
3411014	G1/4"	-	10,9	6,7	6	1.500/100
3411038	G3/8" + M16	-	14,5	8,5	6	1.000/100
3411012	Pg13,5 + G1/2" + M20	-	18	11	7,5	500/100
3412016	Pg16 + G5/8"	-	20	14	7,5	300/100
3422016	Pg16 + G5/8"	-	20	10	7,5	300/100
3411034	G3/4"	-	23,5	17,5	8	300/100
3411100	G1"	-	29	22	10	200/100
3412011	Pg11	-	16,5	10	7	1.000/100
3412021	Pg21 + M25	-	26	18	8,5	300/100
3422021	Pg21 + M25	-	26	13	8,5	250/50
3412029	Pg29 + G1"1/8 + M32	-	35	26	10	200/100

Membrane sealing rings

Ref.	Fits thread	C (mm)	Ø E (mm)	Ø I (mm)	H (mm)	Quantity Box/Bag
3431100	G1"	-	29	15	9,5	200/100

Double sealing rings

Ref.	Fits thread	C (mm)	Ø E (mm)	Ø I (mm)	H (mm)	Quantity Box/Bag
3441012	G1/2" + Pg13,5 + M20	13	18,5	8	6,5	500/100
3441034	G3/4"	17	23	12,5	8,5	300/100

SEALING RINGS

357 FD



Material: BUTADIENE-NITRILE NBR 70 sh A

Temperature range: -20°C to +70°C

Colour: RAL 7035 light grey

Ref.	Fits thread	Ø E (mm)	Ø I (mm)	H (mm)	Quantity Box/Bag
3572007	Pg7	16,5	11,5	1	4.000/100
3572011	Pg11	23	17,5	1	2.500/100
35720131	Pg13,5 + M20X1,5 + G1/2"	27,5	20,5	1,4	1.000/100
3572013	Pg13,5	30	20,5	2,2	1.000/100
3572016	Pg16	29	23	2	1.000/100
3572021	Pg21	33,5	27	3	500/100
3573M16	M16X1,5	20,5	16,3	1	3.000/100
3573M20	M20X1,5 + Pg13,5 + G1/2"	25,5	20,5	1	4.000/100
3573M25	M25X1,5	30,5	25,5	1	2.000/100
3573M32	M32X1,5	40,5	32,5	1	1.500/100

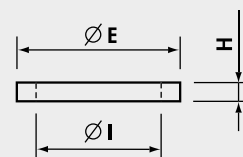

Material: NEOPRENE® 80 sh A

Temperature range: -25°C to +100°C

Colour: RAL 9005 black

Ref.	Fits thread	Ø E (mm)	Ø I (mm)	H (mm)	Quantity Box/Bag
FD M12	M12	16	10	1,2	2.500/50
FD 7	Pg7 + G1/4"	17	11,3	1,2	3.000/50
FD 9	Pg9 + M16	20	13,9	1,2	2.000/50
FD M16	M16* + G3/8"	20	15,5	1,2	2.000/50
FD 11	Pg11	23	17,1	1,2	2.000/50
FD M20	M20	24	18	1,2	2.000/50
FD 13,5	Pg13,5 + G1/2"	25	19	1,2	2.500/50
FD 16	Pg16 + G5/8"	27	21	1,2	1.500/50
FD M25	M25	31	23	1,2	1.000/20
FD 21	Pg21 + G3/4"	34,5	27	1,5	1.000/25
FD M32	M32 + G1"	40	30	1,5	600/20
FD 29	Pg29 + G1"1/8"	45	35,2	1,5	500/25
FD M40	M40 + G1"1/4"	48	38	1,5	500/20
FD 36	Pg36 + G1"1/2"	56	45,2	1,5	250/25
FD M50	M50	55	47,5	1,0	10
FD 42	Pg42 + G1"3/4"	62	52	1,0	10
FD 48	Pg48 + G2"	68	58	1,0	10
FD M63	M63	68	60,5	1,0	500/5

*recommended with set screws

ENTRY PLUGS

Polyamide PA6

1053
1052



Material: POLYAMIDE PA6
reinforced with fibreglass
self-extinguishing class HB (UL 94)
Temperature range:
-20°C to +90°C (continuous)
Protection: IP 54
Colour: RAL 7035 light grey,
RAL 9005 black

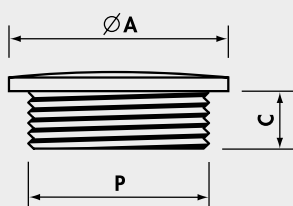

Metric thread M 1.5 pitch CEI EN 60423

Ref. Light Grey	P	Ø A (mm)	C (mm)	Quantity
1053M12	M12X1,5	15	6	100
1053M16	M16X1,5	20	6	100
1053M20	M20X1,5	25	7	100
1053M25	M25X1,5	30	7	100
1053M32	M32X1,5	37	9	50
1053M40	M40X1,5	47	9	30
1053M50	M50X1,5	58	10	20
1053M63	M63X1,5	72	12	10

Add to Ref: N for Black

Pg thread DIN 40 430 - Dimensions DIN 46 320

Ref. Light Grey	P	Ø A (mm)	C (mm)	Quantity Box/Bag
1052007	Pg 7	15	6	100
1052009	Pg 9	19	6	100
1052011	Pg11	22	7	100
1052013	Pg13,5	25	7	100
1052016	Pg16	27	7	100
1052021	Pg21	33	9	50
1052029	Pg29	44	9	100/50
1052036	Pg36	55	10	20
1052042	Pg42	62	10	10
1052048	Pg48	69	12	10

Add to Ref: N for Black

ENTRY PLUGS

Polystyrene PS

1253
1840



Protection: IP 54

Metric thread M 1.5 pitch CEI EN 60423

Ref. Light Grey	P	Ø A (mm)	C (mm)	Quantity
1253M12	M12X1,5	15	6	100
1253M16	M16X1,5	20	6	100
1253M20	M20X1,5	25	7	100
1253M25	M25X1,5	30	7	100
1253M32	M32X1,5	37	9	50
1253M40	M40X1,5	47	9	30
1253M50	M50X1,5	58	10	20
1253M63	M63X1,5	72	12	10

Add to Ref: N for Black

Material: POLYSTYRENE PS
Temperature range:
-20°C to +60°C (continuous)
Colour: RAL 7035 light grey,
RAL 9005 black

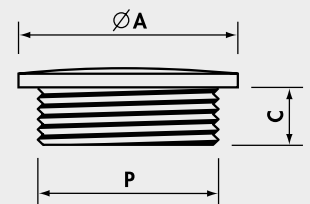

Pg thread DIN 40 430 - Dimensions DIN 46 320

Ref. Light Grey	P	Ø A (mm)	C (mm)	Quantity Box/Bag
1840	Pg 7	15	6	100
1841	Pg 9	19	6	100
1842	Pg11	22	7	100
1843	Pg13,5	25	7	100
1844	Pg16	27	7	100
1845	Pg21	33	9	50
1846	Pg29	44	9	100/50
1847	Pg36	55	10	20
1848	Pg42	62	10	10
1849	Pg48	69	12	10

Add to Ref: N for Black

1700

ENTRY BUSHES

Polyamide PA6



Material: POLYAMIDE PA6
 self-extinguishing class VO (UL 94)
 Temperature range:
 -20°C to +90°C (continuous)
 Colour: RAL 7035 light grey,
 RAL 9005 black

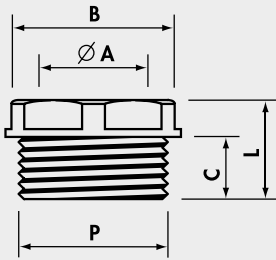

Entry bushes

Pg thread DIN 40 430 - Dimensions DIN 46 320

Ref. Light Grey	P	ØA (mm)	B Spanner (mm)	C (mm)	L (mm)	Quantity Box/Bag
* 1700.2	Pg 9	10	16	9	14	600/100
* 1701.2	Pg11	11,5	19	10	15	300/100
* 1702.2	Pg13,5	13,5	21	11	16,5	300/100
1703.2	Pg16	16	23	12,5	18,5	200/100
1704.2	Pg21	22	30	12	17,5	100/50
1705.2	Pg29	27	40	15	22	50/50

BSP thread ISO 228/1

* 1830	G1/4"	8,5	15	8,5	13,5	800/100
* 1831	G3/8"	11,5	17	9	14	300/100
* 1832	G1/2"	13	21	11	16,5	300/100

Metric thread M 1.5 pitch CEI EN 60423

△1835G	M16X1,5	11,5	17	9	14	100/100
* 1836	M20X1,5	13,5	21	11	16,5	300/100

* Add to Ref: N for Black

△ Dark Grey only

Blind entry bushes

Pg thread DIN 40 430 - Dimensions DIN 46 320

Ref. Light Grey	P	ØA (mm)	B Spanner (mm)	C (mm)	L (mm)	Quantity Box/Bag
* 1702.5	Pg13,5	-	21	11	17	300/100
1703.5	Pg16	-	23	12,5	18,5	200/100

BSP thread ISO 228/1

* 1861	G3/8"	-	17	9	14	600/100
* 1862	G1/2"	-	21	11	16,5	200/100

Metric thread M 1.5 pitch CEI EN 60423

* 1866	M20X1,5	-	21	11	17	100
--------	---------	---	----	----	----	-----

*Add to Ref: N for Black

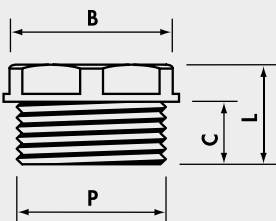

ENTRY PLUGS AND BUSHES

Brass

2053
2052
2021

Entry plugs

Metric thread M 1.5 pitch CEI EN 60423

Ref. Nickel Plated Brass	P	Ø A (mm)	C (mm)	Quantity Box/Bag
2053M12N	M12X1,5	14	5	1,500/100
2053M16N	M16X1,5	18	5	1,000/100
2053M20N	M20X1,5	22	6,5	500/100
2053M25N	M25X1,5	28	7	200/100
2053M32N	M32X1,5	35	8	150/25
2053M40N	M40X1,5	44	8,5	100/25
2053M50N	M50X1,5	54	9	50/25
2053M63N	M63X1,5	67	10	25/25

Pg thread DIN 40 430 - Dimensions DIN 46 320

Ref. Nickel Plated Brass	P	Ø A (mm)	C (mm)	Quantity Box/Bag
2052007N	Pg 7	14	5	1,500/100
2052009N	Pg 9	17	6	1,000/100
2052011N	Pg11	20	6	500/100
2052013N	Pg13,5	22	6,5	500/100
2052016N	Pg16	24	6,5	500/100
2052021N	Pg21	30	7	200/50
2052029N	Pg29	39	8	100/25
2052036N	Pg36	50	9	50/25
2052042N	Pg42	57	10	25/25
2052048N	Pg48	64	10	25/25



Material: Entry plugs - NICKEL PLATED BRASS (CuZn 40 Pb 3)
Entry bushes - PLAIN BRASS
Protection: Entry plugs - IP 54

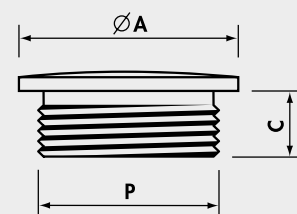

Entry bushes

BSP thread ISO 228/1

Ref. Brass	P	Ø A (mm)	B Spanner (mm)	C (mm)	L (mm)	Quantity Box/Bag
2021014	G1/4"	10	13	6	8,5	1,000/100
2021038	G3/8"	12	17	7,5	10,5	800/100
2021012	G1/2"	16	21	9,5	13	400/100
2021058	G5/8"	18	23	10	13,5	250/50
2021034	G3/4"	21	27	10	14	200/50
2021100	G1"	26,5	34	11	15,5	100/50
2021118	G1"1/8	31	38	12	16,5	100/25
2021114	G1"1/4	35	42	13	18	50/25
2021112	G1"1/2	41,5	48	13	18,5	50/25
2021200	G2"	51,5	60	13,5	19,5	25/25

Add to Ref: N for NICKEL PLATED BRASS

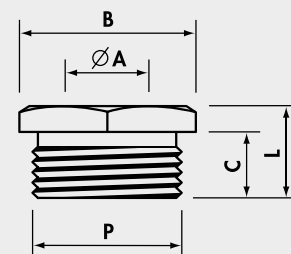

RUTASEAL GROMMETS



RS



Material: EPDM
 halogen-free and chemical resistant
 Temperature range: -40°C to +110°C
 Protection: IP 67
 Colour: RAL 7001 light grey
 Application:
 IP67 sealing of cables and conduits
 in Metric and Pg threaded entries
 through material thickness 0,5-4 mm

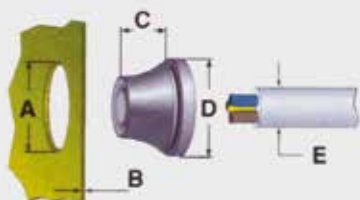

Fits Metric thread

Ref.	Fits Threaded Entry	Dimensions					Quantity Box/Bag
		A (mm)	B (mm)	C (mm)	D (mm)	E (mm)	
RS0407.M12	M12	12,5	0,5 - 2	5,6	20,0	4 - 7	2,000/50
RS0509.M16	M16	16,5	1 - 4	11,0	21,0	5 - 9	2,000/50
RS0813.M20	M20/Pg13,5	20,5	1 - 4	13,4	25,5	8 - 13	3,000/50
RS1117.M25	M25	25,5	1 - 4	15,3	30,5	11 - 17	2,000/50
RS1520.M32	M32	32,5	1 - 4	18,6	38,5	15 - 20	1,000/25
RS1928.M40	M40	40,5	1 - 4	21,7	48,5	19 - 28	600/25
RS2735.M50	M50	50,5	1 - 4	25,0	60,5	27 - 35	250/10

Fits Pg thread

Ref.	Fits Threaded Entry	Dimensions					Quantity Box/Bag
		A (mm)	B (mm)	C (mm)	D (mm)	E (mm)	
RS0305.07	Pg 7	12,5	0,5 - 2	5,4	20,0	3 - 5	2,000/50
RS0507.09	Pg 9	16,0	1 - 4	10,3	21,0	5 - 7	2,000/50
RS0710.11	Pg11	19,0	1 - 4	12,7	24,0	7 - 10	3,000/50
RS1014.16	Pg16	23,0	1 - 4	14,7	28,0	10 - 14	2,000/50
RS1420.21	Pg21	29,0	1 - 4	17,6	35,0	14 - 20	1,000/25
RS2026.29	Pg29	38,0	1 - 4	20,0	46,0	20 - 26	600/25
RS2635.36	Pg36	48,0	1 - 4	23,9	58,0	26 - 35	250/10

3600



Material: ABS self-extinguishing class V0 (UL94) UV stabilised
 Glow wire resistance: 750° C (CEI EN 60695-2-1)
 Temperature range:
 -20°C to +80°C (continuous)
 Colour: RAL 7035 light grey

SICURclips

modular retaining clips - ABS

Application: Fix SICURclip base to surface using dia. 5 - 6 mm screw (Ref. Fig. A).
 Insert cable, tubing or flexible conduit.
 Fit adjustable cover and press to secure.
 Modular SICURclips of the same or different size may easily be joined together.

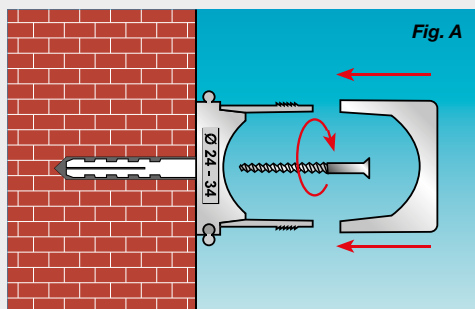

SICURclips for cable, tubing & flexible conduit

Ref.	Ø A min-max (mm)	H (mm)	S (mm)	Quantity
3601	13-21	8,5	16	100
3602	24-34	8,5	16	50
3603	38-50	8,5	16	25

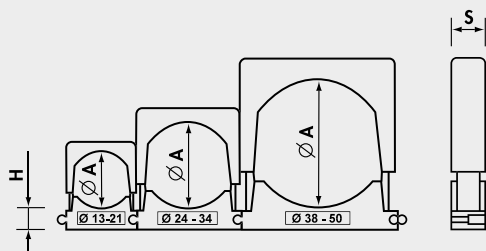



MECHANICAL AND PNEUMATIC TOOLS

HP 1



Manual tool, compact and easy to use, equipped with:

- treated steel crimp jaws with high mechanical properties.
- factory-set ratchet for crimping control (automatic handle opening upon completion of crimping operation).
- Emergency release lever which, if necessary, opens the crimp jaws before their complete closure.
- Ergonomically designed non-slip moulded plastic grips.

Technical features:



Crimpstar[®] HP 1

Crimp style:



PVC, PC and PA6.6 insulated terminals and connectors for conductor sizes 0,2 to 2,5 sqmm

Crimping range:

Dimensions:

Length (closed handles)

234,5 mm

Width (closed handles)

73,0 mm

Height

18,3 mm

Weight:

512 g

Package dimensions:

240 x 81 x 25 mm



HP 3



Manual tool, compact and easy to use, equipped with:

- treated steel crimp jaws with high mechanical properties.
- factory-set ratchet for crimping control (automatic handle opening upon completion of crimping operation).
- Emergency release lever which, if necessary, opens the crimp jaws before their complete closure.
- Ergonomically designed non-slip moulded plastic grips.

Technical features:



Crimpstar[®] HP 3

Crimp style:



PVC, PC and PA6.6 insulated terminals and connectors for conductor sizes 0,25 to 6 sqmm

Crimping range:

Dimensions:

Length (closed handles)

234,5 mm

Width (closed handles)

73,0 mm

Height

18,3 mm

Weight:

498 g

Package dimensions:

240 x 81 x 25 mm



HNN 3



Technical features:



Crimpstar[®] HNN 3

Crimping range:	PA6.6 insulated terminals and connectors for conductor sizes 1,5 to 10 sqmm
Dimensions:	
Length (closed handles)	234,5 mm
Width (closed handles)	73,0 mm
Height	18,3 mm
Weight:	491 g
Package dimensions:	240 x 81 x 25 mm

Crimp style:



Manual tool, compact and easy to use, equipped with:

- treated steel crimp jaws with high mechanical properties.
- factory-set ratchet for crimping control (automatic handle opening upon completion of crimping operation).
- Emergency release lever which, if necessary, opens the crimp jaws before their complete closure.
- Ergonomically designed non-slip moulded plastic grips.



HNN 4



Technical features:



Crimpstar[®] HNN 4

Crimping range:	PA6.6 insulated terminals and connectors for conductor sizes 10 and 16 sqmm
Dimensions:	
Length (closed handles)	234,5 mm
Width (closed handles)	73,0 mm
Height	18,3 mm
Weight:	492 g
Package dimensions:	240 x 81 x 25 mm

Crimp style:



Manual tool, compact and easy to use, equipped with:

- treated steel crimp jaws with high mechanical properties.
- factory-set ratchet for crimping control (automatic handle opening upon completion of crimping operation).
- Emergency release lever which, if necessary, opens the crimp jaws before their complete closure.
- Ergonomically designed non-slip moulded plastic grips.



MECHANICAL TOOLS *Crimpstar*[®] RANGE

HPH 1



Manual tool, compact and easy to use, equipped with:

- treated steel crimp jaws with high mechanical properties.
- factory-set ratchet for crimping control (automatic handle opening upon completion of crimping operation).
- Emergency release lever which, if necessary, opens the crimp jaws before their complete closure.
- Ergonomically designed non-slip moulded plastic grips.

Technical features:



Crimpstar[®] HPH 1

Crimp style:



Through connectors
PE HD insulated, heat shrinkable.
for conductor sizes 0,5 to 6 sqmm
and PA6.6 connectors NL-M, NL-P
for conductor sizes 0,25 to 6 mm²

Crimping range:

Dimensions:

Length (closed handles)

234,5 mm

Width (closed handles)

73,0 mm

Height

18,3 mm

Weight:

512 g

Package dimensions:

240 x 81 x 25 mm



HNKE 4



Manual tool, compact and easy to use, equipped with:

- treated steel crimp jaws with high mechanical properties.
- factory-set ratchet for crimping control (automatic handle opening upon completion of crimping operation).
- Emergency release lever which, if necessary, opens the crimp jaws before their complete closure.
- Ergonomically designed non-slip moulded plastic grips.

Technical features:



Crimpstar[®] HNKE 4

Crimp style:



End sleeves
for conductor sizes 0,5 to 4 sqmm

Crimping range:

Dimensions:

Length (closed handles)

236 mm

Width (closed handles)

73,0 mm

Height

18,3 mm

Weight:

516 g

Package dimensions:

240 x 81 x 25 mm



MECHANICAL TOOLS *Crimpstar*[®] RANGE

HNKE 16



Manual tool, compact and easy to use, equipped with:

- treated steel crimp jaws with high mechanical properties.
- factory-set ratchet for crimping control (automatic handle opening upon completion of crimping operation).
- Emergency release lever which, if necessary, opens the crimp jaws before their complete closure.
- Ergonomically designed non-slip moulded plastic grips.

Technical features:

Crimpstar[®] HNKE 16

Crimp style:



Crimping range:

End sleeves for conductor sizes 4 to 16 mm²

Dimensions:

Length (closed handles)

236 mm

Width (closed handles)

73,0 mm

Height

18,3 mm

Weight:

491 g

Package dimensions:

240 x 81 x 25 mm



HNKE 50



Manual tool, compact and easy to use, equipped with:

- treated steel crimp jaws with high mechanical properties.
- factory-set ratchet for crimping control (automatic handle opening upon completion of crimping operation).
- Emergency release lever which, if necessary, opens the crimp jaws before their complete closure.
- Ergonomically designed non-slip moulded plastic grips.

Technical features:

Crimpstar[®] HNKE 50

Crimp style:



Crimping range:

End sleeves for conductor sizes 25 - 35 - 50 mm²

Dimensions:

Length (closed handles)

234,5 mm

Width (closed handles)

73,0 mm

Height

18,3 mm

Weight:

590 g

Package dimensions:

240 x 81 x 25 mm



MECHANICAL TOOLS *Crimpstar*[®] RANGE

HN 1



Manual tool, compact and easy to use, equipped with:

- treated steel crimp jaws with high mechanical properties.
- factory-set ratchet for crimping control (automatic handle opening upon completion of crimping operation).
- Emergency release lever which, if necessary, opens the crimp jaws before their complete closure.
- Ergonomically designed non-slip moulded plastic grips.

Technical features:



Crimpstar[®] HN 1

Crimp style:



Uninsulated terminals and connectors for conductor sizes 0,25 to 10 sqmm

Crimping range:

Dimensions:

Length (closed handles) 234,5 mm

Width (closed handles) 73,0 mm

Height 18,3 mm

Weight: 480 g

Package dimensions:

240 x 81 x 25 mm



HN 5



Manual tool, compact and easy to use, equipped with:

- treated steel crimp jaws with high mechanical properties.
- factory-set ratchet for crimping control (automatic handle opening upon completion of crimping operation).
- Emergency release lever which, if necessary, opens the crimp jaws before their complete closure.
- Ergonomically designed non-slip moulded plastic grips.

Technical features:



Crimpstar[®] HN 5

Crimp style:



Uninsulated terminals and connectors for conductor sizes 10 and 16 sqmm

Crimping range:

Dimensions:

Length (closed handles) 234,5 mm

Width (closed handles) 73,0 mm

Height 18,3 mm

Weight: 489 g

Package dimensions:

240 x 81 x 25 mm



MECHANICAL TOOLS *Crimpstar*[®] RANGE

HN-A25



Manual tool, compact and easy to use, equipped with:

- treated steel crimp jaws with high mechanical properties.
- factory-set ratchet for crimping control (automatic handle opening upon completion of crimping operation).
- Emergency release lever which, if necessary, opens the crimp jaws before their complete closure.
- Ergonomically designed non-slip moulded plastic grips.

Technical features:



Crimpstar[®] HN-A25

Crimping range:	Uninsulated terminals and connectors A-M, L-M and L-P series for conductor sizes 10 to 25 mm ²
Dimensions:	
Length (closed handles)	229 mm
Width (closed handles)	78,6 mm
Height	18,3 mm
Weight:	500 g
Package dimensions:	240 x 81 x 25 mm

Crimp style:



HN-D25



Manual tool, compact and easy to use, equipped with:

- treated steel crimp jaws with high mechanical properties.
- factory-set ratchet for crimping control (automatic handle opening upon completion of crimping operation).
- Emergency release lever which, if necessary, opens the crimp jaws before their complete closure.
- Ergonomically designed non-slip moulded plastic grips.

Technical features:



Crimpstar[®] HN-D25

Crimping range:	Cu tube lugs DR (DIN 46235) and through connectors DSV (DIN 46267) for conductor sizes 10 to 25 sqmm
Dimensions:	
Length (closed handles)	229 mm
Width (closed handles)	78,6 mm
Height	18,3 mm
Weight:	500 g
Package dimensions:	240 x 81 x 25 mm

Crimp style:



MECHANICAL TOOLS *Crimpstar*[®] RANGE

HF 1



Manual tool, compact and easy to use, equipped with:

- treated steel crimp jaws with high mechanical properties.
- factory-set ratchet for crimping control (automatic handle opening upon completion of crimping operation).
- Emergency release lever which, if necessary, opens the crimp jaws before their complete closure.
- Ergonomically designed non-slip moulded plastic grips.

Technical features:



Crimpstar[®] HF 1

Crimping range:

Dimensions:

Length (closed handles)

Width (closed handles)

Height

Weight:

Package dimensions:

Crimp style:



Open barrel brass terminals for conductors sizes 0,5 to 4 sqmm (not BN-FAB/FAR type)

234,5 mm

73,0 mm

18,3 mm

509 g

240 x 81 x 25 mm



HF 2



Manual tool, compact and easy to use, equipped with:

- treated steel crimp jaws with high mechanical properties.
- factory-set ratchet for crimping control (automatic handle opening upon completion of crimping operation).
- Emergency release lever which, if necessary, opens the crimp jaws before their complete closure.
- Ergonomically designed non-slip moulded plastic grips.

Technical features:



Crimpstar[®] HF 2

Crimping range:

Dimensions:

Length (closed handles)

Width (closed handles)

Height

Weight:

Package dimensions:

Crimp style:



Open barrel brass terminals for conductors sizes 0,08 to 1,3 sqmm (28 to 16 AWG)

234,5 mm

73,0 mm

18,3 mm

497 g

240 x 81 x 25 mm





Manual tool, compact and easy to use, equipped with:

- treated steel crimp jaws with high mechanical properties.
- factory-set ratchet for crimping control (automatic handle opening upon completion of crimping operation).
- Emergency release lever which, if necessary, opens the crimp jaws before their complete closure.
- Ergonomically designed non-slip moulded plastic grips.

Technical features:

Crimpstar® HX 1

Crimp style:



Crimping range:

Coaxial connectors type
RG58, RG59, RG62 and RG 71

Dimensions:

Length (closed handles)

234,5 mm

Width (closed handles)

73,0 mm

Height

18,3 mm

Weight:

481 g

Package dimensions:

240 x 81 x 25 mm



MECHANICAL TOOLS *nd*[®] RANGE

ND#1



A generation of tools, with a unique mechanism to reduce operator effort. Small and compact, with ergonomically designed handles for ease of operation.

High quality materials combined with advanced design and manufacturing technology, produce a reliable tool with a guaranteed consistent, crimping operation.

Technical features:

ND#1	Crimp style:	
Crimping range:	Insulated and uninsulated end sleeves for conductors sizes 0,3 to 1,5 sqmm	
Dimensions:		
Length (closed handles)	190 mm	
Width (closed handles)	72 mm	
Height	21 mm	
Weight:	470 g	

ND#2



Technical features:

ND#2	Crimp style:	
Crimping range:	Insulated and uninsulated end sleeves for conductors sizes 1 to 6 sqmm	
Dimensions:		
Length (closed handles)	190 mm	
Width (closed handles)	72 mm	
Height	21 mm	
Weight:	470 g	

ND#3



Technical features:

ND#3	Crimp style:	
Crimping range:	Insulated and uninsulated end sleeves for conductors sizes 6 to 16 sqmm	
Dimensions:		
Length (closed handles)	190 mm	
Width (closed handles)	72 mm	
Height	21 mm	
Weight:	470 g	

ND#4



Technical features:

ND#4	Crimp style:	
Crimping range:	Insulated and uninsulated end sleeves for conductors sizes 0,5 to 4 sqmm	
Dimensions:		
Length (closed handles)	190 mm	
Width (closed handles)	72 mm	
Height	21 mm	
Weight:	470 g	

Package dimensions: 195 x 76 x 20 mm

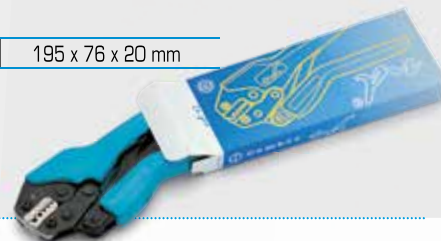

MECHANICAL TOOLS ZKE RANGE

Crimp style:



ZKE 6-F

Tool for crimping end sleeves
0,5 to 6 sqmm
front insertion

Crimp style:



ZKE 610

Single aperture, ratchet controlled tool
for crimping end sleeves,
0,08 to 10 sqmm
side insertion

Crimp style:



ZKE 2

For end sleeves
0,5 to 16 sqmm

MECHANICAL TOOL HWE1

with interchangeable dies

HWE1



Rapid insertion/extraction of
dies without using other tools



A robust and reliable tool designed to
optimise the installers time and
effort. A single tool body with
a range of interchangeable
dies allows a quick and simple
transfer from one cable/connector
combination to another, across a range
of applications.

Technical features

- Length: 240 mm
- Weight: 590 g
- Automatic opening of handles following completion of the crimping operation
- Dull Nickel finish
- Anti-slip handle grips

INTERCHANGEABLE DIES TO ORDER SEPARATELY

INSULATED AND UNINSULATED END SLEEVES

WF16

Size 0,5 ÷ 16 mm²

INSULATED CONNECTORS RED, BLUE AND YELLOW

IT6

Size 0,5 ÷ 6 mm²

PHOTOVOLTAIC CONNECTORS (MULTI-CONTACT)

MC3

Size 4 ÷ 6 mm²

MC4

Size 4 ÷ 6 mm²

INSULATED AND UNINSULATED END SLEEVES

WF6

Size 0,5 ÷ 6 mm²

WF35

Size 16 ÷ 35 mm²



UNINSULATED CABLE LUGS

NIT10

Size 0,5 ÷ 10 mm²

OPEN BARREL BRASS CONNECTORS

OB2.5P

Size 0,5 and 2,5 mm²

SUB-D 075

Size 0,05 and 0,75 mm²

SUB-D 050

Size 0,08 and 0,5 mm²

COAXIAL CONNECTORS

C59

RG58, RG59, RG62

See page 113 for **HB 11** cable stripper



Also available:

HWE1 KIT

comprising:

- HWE1 Manual mechanical tool
- WF16 die
- IT6 die
- all contained in a sturdy plastic case with extra compartments for interchangeable dies

MECHANICAL TOOLS HP4 RANGE

HP4-R

Professional manual mechanical tool with ratchet mechanism that prevents the handles from opening again before reaching the ratchet.

Equipped with a positioning device to reduce the operator's effort and facilitate proper crimping of the conductor. According to the different thicknesses of the conductor insulation, the crimping on the insulation can be carried out by adjusting the jaws through three different settings:

1) strong, 2) medium, 3) light.

The tool is particularly easy to use thanks to its shape and handle coating.

At the end of the crimping the outer surface of the conductor is automatically stamped with the following crimping code:

one point for red conductor sizes from 0.25 to 1.5 mm²



Construction features:

- Special treated and externally protected steel body, ratchet and handles.
- Handle coating in soft red PVC plastic.

Technical features:



HP4-R

Crimping range:

Dimensions:

Length (closed handles)

Width (closed handles)

Weight:

Package dimensions:

Crimp style:



PVC, PC and PA6.6 insulated terminals and connectors for conductor sizes 0,25 to 1,5 sqmm

265 mm

80 mm

500 g

330 x 110 x 50 mm



HP4-B

Professional manual mechanical tool with ratchet mechanism that prevents the handles from opening again before reaching the ratchet.

Equipped with a positioning device to reduce the operator's effort and facilitate proper crimping of the conductor. According to the different thicknesses of the conductor insulation, the crimping on the insulation can be carried out by adjusting the jaws through three different settings:

1) strong, 2) medium, 3) light.

The tool is particularly easy to use thanks to its shape and handle coating.

At the end of the crimping the outer surface of the conductor is automatically stamped with the following crimping code:

two points for blue conductor sizes from 1.5 to 2.5 mm²



Construction features:

- Special treated and externally protected steel body, ratchet and handles.
- Handle coating in soft blue PVC plastic.

Technical features:



HP4-B

Crimping range:

Dimensions:

Length (closed handles)

Width (closed handles)

Weight:

Package dimensions:

Crimp style:



PVC, PC and PA6.6 insulated terminals and connectors for conductor sizes 1,5 to 2,5 sqmm

265 mm

80 mm

500 g

330 x 110 x 50 mm



MECHANICAL TOOLS HP4 RANGE



Construction features:

- Special treated and externally protected steel body, ratchet and handles.
- Handle coating in soft yellow PVC plastic.



HP4-G

Professional manual mechanical tool with ratchet mechanism that prevents the handles from opening again before reaching the ratchet.

Equipped with a positioning device to reduce the operator's effort and facilitate proper crimping of the conductor. According to the different thicknesses of the conductor insulation, the crimping on the insulation can be carried out by adjusting the jaws through three different settings:

1) strong, 2) medium, 3) light.

The tool is particularly easy to use thanks to its shape and handle coating.

At the end of the crimping the outer surface of the conductor is automatically stamped with the following crimping code: three points for yellow conductor from 4 to 6 sqmm

Technical features:

HP4-G

Crimp style:



Crimping range:

PVC, PC and PA6.6 insulated terminals and connectors for conductor sizes 4 to 6 sqmm

Dimensions:

Length (closed handles)

320 mm

Width (closed handles)

105 mm

Weight:

810 g

Package dimensions:

330 x 110 x 50 mm



HP4-C10

Professional manual mechanical tool with ratchet mechanism that prevents the handles from opening again before reaching the ratchet.

The tool is particularly easy to use thanks to its shape and handle coating.

Construction features:

- Specially treated and externally protected steel body, ratchet and handles.
- Handle coating in soft yellow PVC.

Technical features:

HP4-C10

Crimp style:



Crimping range:

For sleeve connectors type C6-C6 and C10-C10

Dimensions:

Length (closed handles)

325 mm

Width (closed handles)

105 mm

Weight:

730 g

Package dimensions:

330 x 110 x 50 mm



MECHANICAL TOOLS TN RANGE

TN 70SE

Professional manual mechanical tool suitable for crimping A-M Cu lugs and non-insulated L-M and L-P connectors.
Heat treated steel crimp jaws.
Easily adjustable die positioning by knurled screw and reference vernier scale.
Handles made from anti-slip plastic with hilt.



Technical features:



TN 70SE

Crimping range:

Dimensions:

Length (closed handles)

Width (closed handles)

Weight:

Crimp style:



*Uninsulated terminals and connectors for conductor sizes 6 R/F to 70 R/F mm²

450 mm

127 mm

2 kg

*R= Rigid conductor F= Flexible conductor

TNN 70

Professional manual mechanical tool suitable for the crimping of wire terminals and PA 6.6 insulated connectors.
Heat treated steel crimp jaws.
Easily adjustable die positioning by knurled screw and reference vernier scale.
Handles made from anti-slip plastic with hilt.



Technical features:



TNN 70

Crimping range:

Dimensions:

Length (closed handles)

Width (closed handles)

Weight:

Crimp style:



*Polyamide PA6.6 insulated terminals and connectors for conductor sizes 10 F to 70 F mm²

450 mm

127 mm

2 kg

*F= Flexible conductor

MECHANICAL TOOLS TN RANGE

TN 120SE



Professional manual mechanical tool suitable for crimping A-M Cu lugs and non-insulated L-M and L-P connectors. Heat treated steel crimp jaws. Easily adjustable die positioning by knurled screw and reference vernier scale. Handles made from anti-slip plastic with hilt.

Technical features:

TN 120SE

Crimp style:



Crimping range:

*Uninsulated terminals and connectors for conductor sizes 10 R/F to 120 R/150 F mm²

Dimensions:

Length (closed handles) 700 mm

Width (closed handles) 170 mm

Weight: 3 kg

*R= Rigid conductor F= Flexible conductor

TNN 120



Professional manual mechanical tool suitable for the crimping of wire terminals and PA 6.6 insulated connectors. Heat treated steel crimp jaws. Easily adjustable die positioning by knurled screw and reference vernier scale. Handles made from anti-slip plastic with hilt.

Technical features:

TNN 120

Crimp style:



Crimping range:

*Polyamide PA6.6 insulated terminals and connectors for conductor sizes 10 F to 120 F mm²

Dimensions:

Length (closed handles) 700 mm

Width (closed handles) 170 mm

Weight: 3 kg

*F= Flexible conductor

MECHANICAL TOOLS TND RANGE

TND 6-70

Mechanical tools equipped with rotating dies with hexagonal imprint compliant with **DIN 480863** suitable to crimp copper lugs according to **DIN 46235** and through connectors according to **DIN 46267 T.1** (refer to page 34-35), Particularly sturdy and easy to handle.



Technical features:



TND 6-70

Crimp style:



Crimping range:

Uninsulated terminals and connectors according to **DIN 46235** and **DIN 46267 T.1** for conductor sizes 6 to 70 mm²

Dimensions:

Length (closed handles)

515 mm

Width (closed handles)

132 mm

Weight:

2 kg

TND 10-120

Mechanical tools equipped with rotating dies with hexagonal imprint compliant with **DIN 480863** suitable to crimp copper lugs according to **DIN 46235** and through connectors according to **DIN 46267 T.1** (refer to page 34-35), Particularly sturdy and easy to handle.



Technical features:



TND 10-120

Crimp style:



Crimping range:

Uninsulated terminals and connectors according to **DIN 46235** and **DIN 46267 T.1** for conductor sizes 10 to 120 mm²

Dimensions:

Length (closed handles)

665 mm

Width (closed handles)

162 mm

Weight:

3,7 kg

CABLE CUTTERS

KT



KT 1

Cutting Capacity - Section Cond. sqmm

Rigid	Multi-Cond.	Flexible
Cu 16 Al 35	Cu 50 Al 50	Cu 70



KT 2

Cutting Capacity - Section Cond. sqmm

Rigid	Multi-Cond.	Flexible
Cu 16 Al 50	Cu 70 Al 70	Cu 95



KT 5

Hand operated tool for cutting cables up to max section 25 sqmm



KT 3

For cutting cables Ø max 32 mm
Weight: 0,59 kg
Length: 255 mm



KT 4

For cutting cables Ø max 52 mm
Weight: 0,89 kg
Length: 310 mm

511

5116660250

For cutting cables Ø max 18 mm
Weight: 1,5 kg
Length: 600 mm

5116660500

For cutting cables Ø max 25.4 mm
Weight: 3 kg
Length: 800 mm



WIRE STRIPPERS

HB 1-U



Wire stripper for PVC insulated cables 0,1 to 6 sqmm



HB 11



For photovoltaics insulated cables 2,5 to 6 sqmm stripping length 8,5 mm

SCISSORS

New

SC 1



Electricians scissors with high tensile steel blades allowing for excellent strength and performance. Specially micro-serrated blades for anti-slip purpose. Handles are made from dual component materials.

SC 3X



Multi-purpose scissors with high hardness blades (56 HRC) and anti slide serrations. The moulded plastic handles combine a rigid structure with a softer material for finger comfort. Cutting of flexible conductors up to 35 mm²

SC 5X



Robust-A

New

Professional scissors with Special Steel frame, high hardness blades (58 HRC) and anti slide serrations. The moulded plastic handles combine a rigid structure with a softer material for finger comfort. Cutting of flexible conductors up to 50 mm²

CABLE STRIPPING TOOLS

HB 13UE

Universal cable stripping tool for external sleeves of Low/Medium Voltage cables Ø 12,7 to 63,5 mm and primary insulator in XLPE max Ø 38,1 mm



HB 12N

HB12N cable stripping tool removes the semiconductor layer by being manually rotated around the cable while lateral advancement is achieved automatically. Safe and convenient, it can be used on cables with a semi-con diameter between 18 - 60 mm.

- Sturdy frame in anodised Aluminium alloy and Steel.
- Special Steel blade with precise cutting depth regulation.
- Stripping operation can start at any point along the conductor.
- Bearing mounted rollers provide smooth cutting action.



For vulcanised extruded semiconductor

- With "REVERSE" function, which allows the removal of semiconductor up to 7 mm thick from the sheath of the cable.
- Double speed for each direction.



The **HB 12N** kit includes:

- HB 12N cable stripping tool
- sturdy plastic case

HB 29-U HB 40-U

Wire stripper, for circular cables.



- Three types of cut:
 - Circumferential
 - Linear
 - Spiral
- Blade height adjustable to suit insulation thickness
- Blade profile suits difficult insulation
- PTFE blade housing reduces friction
- Spare blade HBSJ29/40

- **HB 29-U:** Ø 4,5 - 29 mm
- **HB 40-U:** Ø 19 - 40 mm

Dimensions:	HB 29-U	HB 40-U
Length mm:	138	153
Width mm:	38	54
Depth mm:	38	28
Weight g:	100	110

HAND TOOL FOR CUTTING AND SEALING FLEXIBLE CONDUIT

KTS 1632



Cuts and seals flexible plastic conduit in a single operation. Lightweight and easy to operate. Suitable for flexible conduits from Ø16 to Ø32 mm.

Length: 230 mm
Width: 58 mm
Thickness: 32 mm.
Weight: 0,32 kg.



PC 1

Plastic pipe cutting tool
 Cutting capacity: Ø 6 to Ø 42 mm.

Body:
 die-cast aluminium alloy
Blade material:
 hardened Carbon Steel

FRAME-TYPE HOLE PUNCHING TOOL FOR CABLE TRUNKING

MT-FC48N

Table denotes the punch/die set reference, for each hole size.
 Suitable for punching holes in mild steel, fibreglass or plastic material, up to 2 mm thick.

Hole dimensions					Maximum thickness of mild steel (mm)	Code
Nominal	Ø (inch)	Pg	ISO	Inch		
15,5	.610	Pg9	-	-	2	RD 15.5 SS-FC
16,2	.638	-	ISO-16	-		RD 16.2 SS-FC
17,5	.689	-	-	-		RD 17.5 SS-FC
18,8	.740	Pg11	-	-		RD 18.8 SS-FC
19,1	.752	-	-	-		RD 19.1 SS
20,5	.807	Pg 13,5	ISO-20	-		RD 20.5 SS
22,6	.890	Pg16	-	-		RD 22.6 SS
23,8	.937	-	-	5/8"		RD 23.8 SS
25,4	1.000	-	ISO-25	-		RD 25.4 SS
27,0	1.063	-	-	3/4"		RD 27.0 SS
28,5	1.122	Pg21	-	-		RD 28.5 SS
30,5	1.201	-	-	7/8"		RD 30.5 SS
31,8	1.252	-	-	-		RD 31.8 SS
32,5	1.279	-	ISO-32	-		RD 32.5 SS
34,6	1.362	-	-	-		RD 34.6 SS
37,2	1.464	Pg29	-	-		RD 37.2 SS
38,1	1.500	-	-	-		RD 38.1 SS
40,5	1.594	-	ISO-40	-		RD 40.5 SS-FC
41,3	1.626	-	-	-		RD 41.3 SS-FC
42,5	1.673	-	-	1 1/4"		RD 42.5 SS-FC
43,2	1.701	-	-	-	RD 43.2 SS-FC	
44,5	1.752	-	-	-	RD 44.5 SS-FC	
47,2	1.858	Pg36	-	-	RD 47.2 SS-FC	



VAL P30
 Supplied in a robust plastic case.

Lightweight and easy to operate, designed for punching holes up to 47,2 mm diameter in the side wall of trunking without the need for pre drilling.

Max centre of hole to edge of trunking: 53,5 mm

Length : 251,5 mm
Width: 224 mm
Thickness : 66 mm
Weight: 3,28 kg



BENCH PRESSTOOLS



BENCH PRESS TOOLS



INTERCHANGEABLE DIES (to be ordered separately)

Die Set	Guard*	Connector Type	Nominal Conductor Size sqmm		
PV-1			green 0,2÷0,5		
PR-1	PU-1	Insulated connectors	red 0,25÷1,5		
PB-1			blue 1,5÷2,5		
PG-1			yellow 4÷6		
PH1-1	PH-1**	Through connectors PE HD insulated NL-M, NL-P connectors PA6.6 insulated	0,5÷6 0,25÷6		
KE 0.75-1			0,3 - 0,5 - 0,75		
KE 2.5-1	PK-1	End Sleeves	1 - 1,5 - 2,5		
KE 10-1			KE, PK... 4 - 6 - 10		
MTT 16-50			16		
MTT 25-50	ME-1		25		
N1-1	PU-1	A 03-M.. S 1.5.. RN..	0,25 - 1,5		
		A 06-M.. S 2.5.. BN..	1,5 - 2,5		
		A 1-M.. S 6.. GN..	4 - 6		
ME 1-50	PU-1	Uninsulated Copper lugs	A1-M.. 4 - 6		
ME 2-50			A2-M.. S10-M.. 10		
ME 3-50			A3-M.. 16		
ME 5-50			A5-M.. 25		
ME 7-50			A7-M.. 35		
ME 9-50			A9-M.. 50		
ME 10-50			A10-M.. 50		
ME 12-50			A12-M.. 50		
MN 2RF-50			MN RF-1	Polyamide insulated lugs	ANE2-M.. 10
MN 3RF-50					ANE3-M.. 16
MN 5RF-50					ANE5-M.. 25
MN 7RF-50					ANE7-M.. 35
		ANE9-M.. 35			

* Supplied as standard with the machine

** Supplied as standard with the die

PNB-1

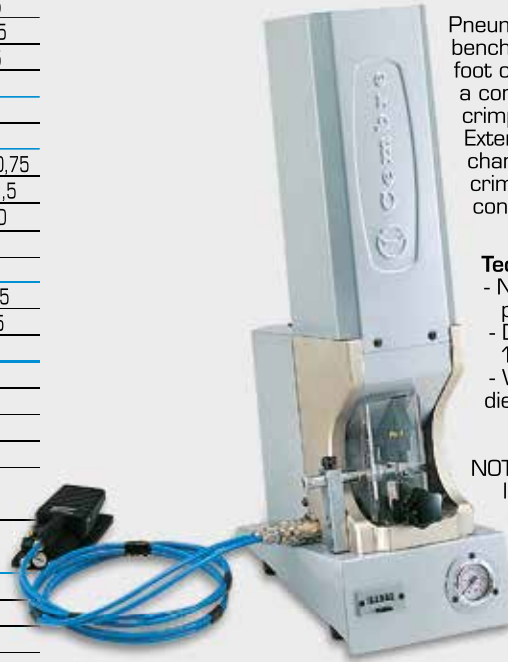

Pneumo-hydraulic, production bench press, controlled by a foot operated pedal, provides a consistent and reliable crimped connection. Extensive range of interchangeable dies available for crimping a wide variety of connectors.

Technical details:

- Nominal operating pressure: 6 bar
- Dimensions LxDxH: 180x320x700 mm
- Weight: 23 kg (without dies)

NOTE: for applications not listed, please contact Cembre.



Tool	Connector Type	Conductor Size sqmm
PNB-3P*	Insulated connectors red, blue and yellow	0,25÷6
PNB-3PD	Insulated terminals and butt connectors - frontal insertion	0,25÷6
PNB-3N1	Uninsulated terminals	0,25÷10
PNB-3N5	Uninsulated terminals	10÷16
PNB-3NN3	Polyamide insulated terminals	1,5÷10
PNB-3NN4	Polyamide insulated terminals	10÷16
PNB-3F/M	Bullet connectors	0,5÷2,5

* Will also crimp Polycarbonate fully-insulated terminals if fitted with PNB3F/M positioner; available as an optional accessory.

PNB-3

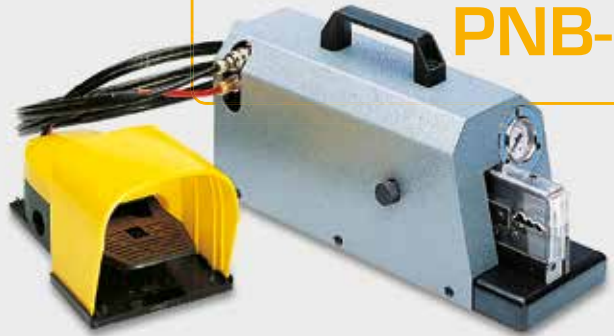

Technical details:

- Normal operating pressure: 6÷7 bar
- Dimensions LxDxH: 130x370x195 mm
- Weight: 10,3 kg

Pneumatic bench press operated by foot pedal for crimping terminals and connectors 0,25 to 16 sqmm.



Tool	Connector Type	Conductor Size sqmm
PNB-4KE	End Sleeves type PK. and type KE	0,3÷10

Technical details:

- Nominal operating pressure: 6 bar
- Dimensions LxDxH: 120x160x300mm
- Weight: 6 kg



PNB-4KE

Pneumatic bench press, controlled by a foot operated pedal. Supplied with a multi-aperture die suitable for crimping insulated and uninsulated end sleeves from 0,3 to 10 sqmm. Compact and efficient. Easy to operate, producing a secure and reliable crimped connection.

ELECTRO-PNEUMATIC BENCH PRESS

EPB-1N

*automatic stripping / crimping machine
for insulated end sleeves*

New



Bench press type **EPB-1N**, electro-pneumatically operated, is designed for stripping and crimping insulated end sleeves Cembre type PKC, PKD and PKE.

The basic configuration processes connectors of c.s.a 0,5/0,75/1,0 and 1,5 mm² with a sleeve lengths of 6, 8, 10 and 12 mm.

Adapter kits are available:

KIT 2.5-EPB1N

for insulated end sleeves c.s.a **2,5 mm²** with a sleeve length of 8, 10 and 12 mm

KIT 4-EPB1N

for insulated end sleeves c.s.a **4,0 mm²** with a sleeve length of 10 mm

Stripping and crimping operations are carried out in quick succession. Adjustable loading speed of vibrating charger.

Quick and easy change of configuration for different connector sizes. Automatic adjustment of operating parameters to suit each configuration.

Modular structure and wear-free components guarantee excellent reliability.



Adapter Kit for insulated end sleeves c.s.a **2,5 mm²** (KIT 2.5-EPB1N)



Technical data

Bench Press EPB-1N	
Power Supply:	230 V/50 Hz (110 V/60 Hz)
Current:	0,5 A
Connector c.s.a:	0,5-1,5 mm ² (basic configuration)
Length of crimp:	6, 8, 10 and 12 mm
Geometry of crimp:	Trapezoidal
Cycle time:	2 s
Compressed Air supply:	Min. 4 - Max 6 bar
Air consumption:	1,2 l/cycle
Cycle controller:	Electro-pneumatic, with microprocessor
Counter:	Digital
Dimensions (w x l x d):	240 x 390 x 490 mm
Weight:	29 kg

ELECTRICAL CRIMPING TOOL

Portable

ECT-KE2.5N



Tool	Connector Type	Conductor Size sqmm
ECT-KE2.5N	End Sleeves type PK.. and type KE	0.14÷2.5

Portable electrical crimping tool for end sleeves 0,14 to 2,5 sqmm with 13 mm crimp length.

Crimping occurs automatically when the end sleeve activates an internal pressure switch.



Technical details:

- Supply voltage: 220/230V 50Hz
- Maximum operating temperature: 40 °C
- Crimp length: 13 mm

Crimp style:



PNEUMATIC CRIMPING TOOLS

Hand held - PNB series

PNB-6KE
PNB-7KE



Technical details:

PNB-6KE

Crimping range	0,25 ÷ 2,5 sqmm / 24 ÷ 14 AWG
Weight	400 g
Dimensions	Ø 44 x 200 mm
Spiral hose length	2 m

PNB-7KE

Crimping Range	4 ÷ 10 sqmm / 12 ÷ 8 AWG
Weight	400 g
Dimensions	Ø 44 x 200 mm
Spiral hose length	2 m

PNB-6KE and **PNB-7KE** hand tools facilitate the rapid crimping of insulated end sleeves while avoiding the operator discomfort associated with ordinary manual tools.

Lightweight and easy to use, these tools are ideal for panel building applications and component assembly.

Both tools are designed to be maintenance-free and need no routine calibration. A 4-6 bar air supply is required for connection via the quick coupler fitted to the hose supplied with the tool.



PNEUMATIC CRIMPING TOOLS

Bench mounted tools with foot pedal - PNB series

PNB-6KE-T
PNB-7KE-T



PNB-6KE-T

Crimping range	0,25 ÷ 2,5 sqmm / 24 ÷ 14 AWG
Weight	1000 g
Dimensions	Ø 140 x 200 x 70 mm
Inclusive of spiral hose, foot pedal and bench mount with storage	

Technical details:

PNB-7KE-T

Crimping Range	4 ÷ 10 sqmm / 12 ÷ 8 AWG
Weight	1000 g
Dimensions	Ø 140 x 200 x 70 mm
Inclusive of spiral hose, foot pedal and bench mount with storage	

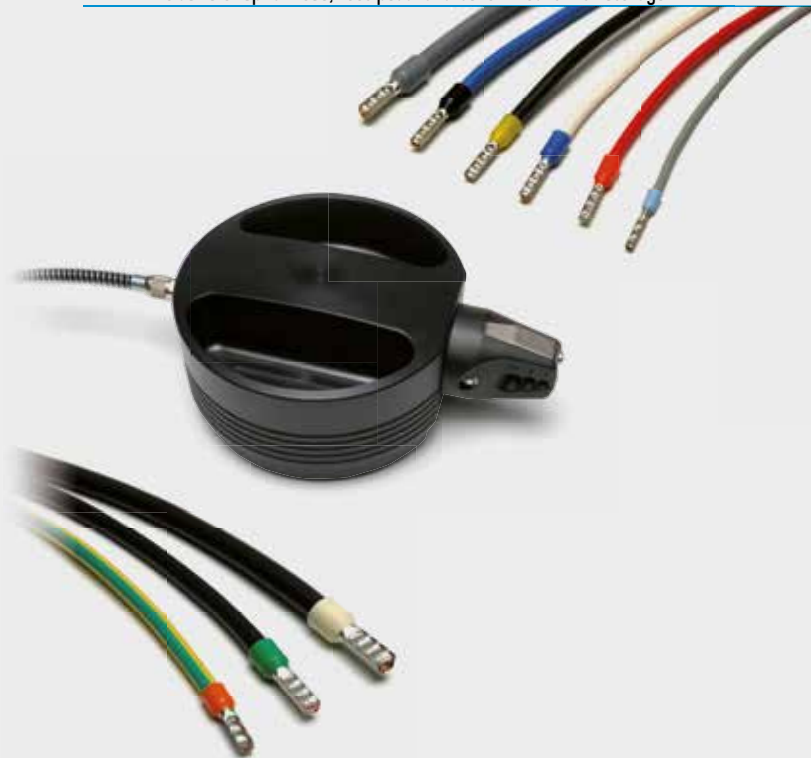

PNB-6KE-T and **PNB-7KE-T** have bench mounts with storage and are foot pedal operated to allow operators to have both hands free when assembling cable harnesses.

Both tools are designed to be maintenance-free and need no routine calibration. A 4-6 bar air supply is required for connection via the quick coupler fitted to the hose supplied with the tool.

BENCH PRESS

ELB-3

for Polycarbonate insulated chain connectors



Electro-pneumatic, production bench press, controlled by a foot operated pedal. Producing a consistent and reliable crimped connection. Interchangeable application heads available to suit the complete range of polycarbonate insulated connectors.

Technical details:

- Air supply: 6 bar (90 psi)
- Dimensions LxDxH: 180x250x620mm
- Weight: 41 kg (without application heads)
- Motor:
 - Power 0,55 kW / 0,75 HP
 - Supply Voltage 220 V / 50 Hz
 - Speed 2.800 r.p.m

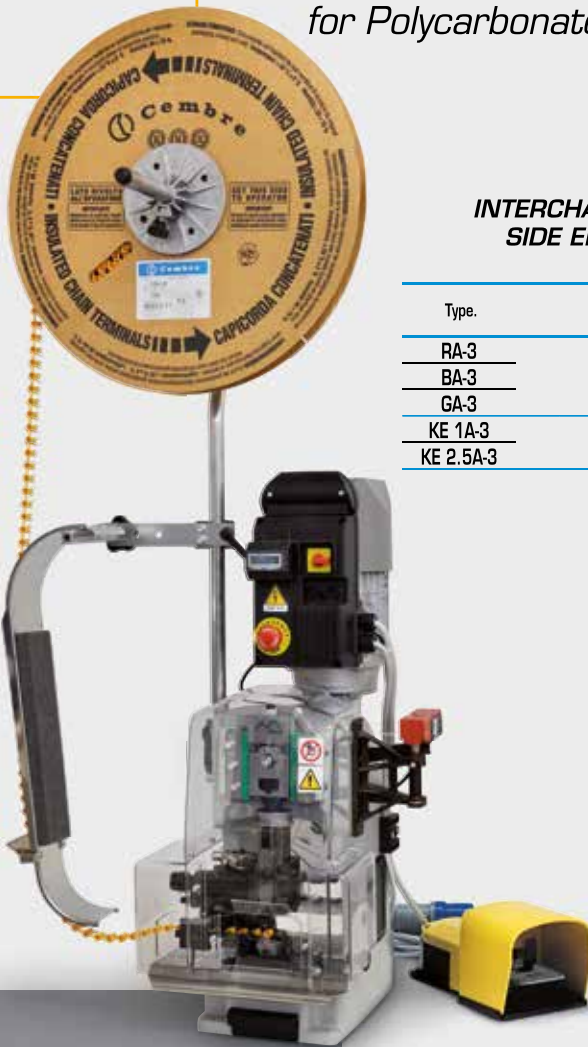

INTERCHANGEABLE APPLICATION HEADS, SIDE ENTRY WITH PNEUMATIC FEED (ORDER AS REQUIRED)

Type.	Connectors	Conductor Size sqmm
RA-3	Polycarbonate insulated chain terminals	red
BA-3		blue
GA-3		yellow
KE 1A-3	Insulated chain end sleeves	0,5÷1
KE 2.5A-3		1÷2,5



OPERATING TEMPERATURE UP TO 115°C



See pages 6-7 and 16 for types and features of the insulated chain connectors and end sleeves.

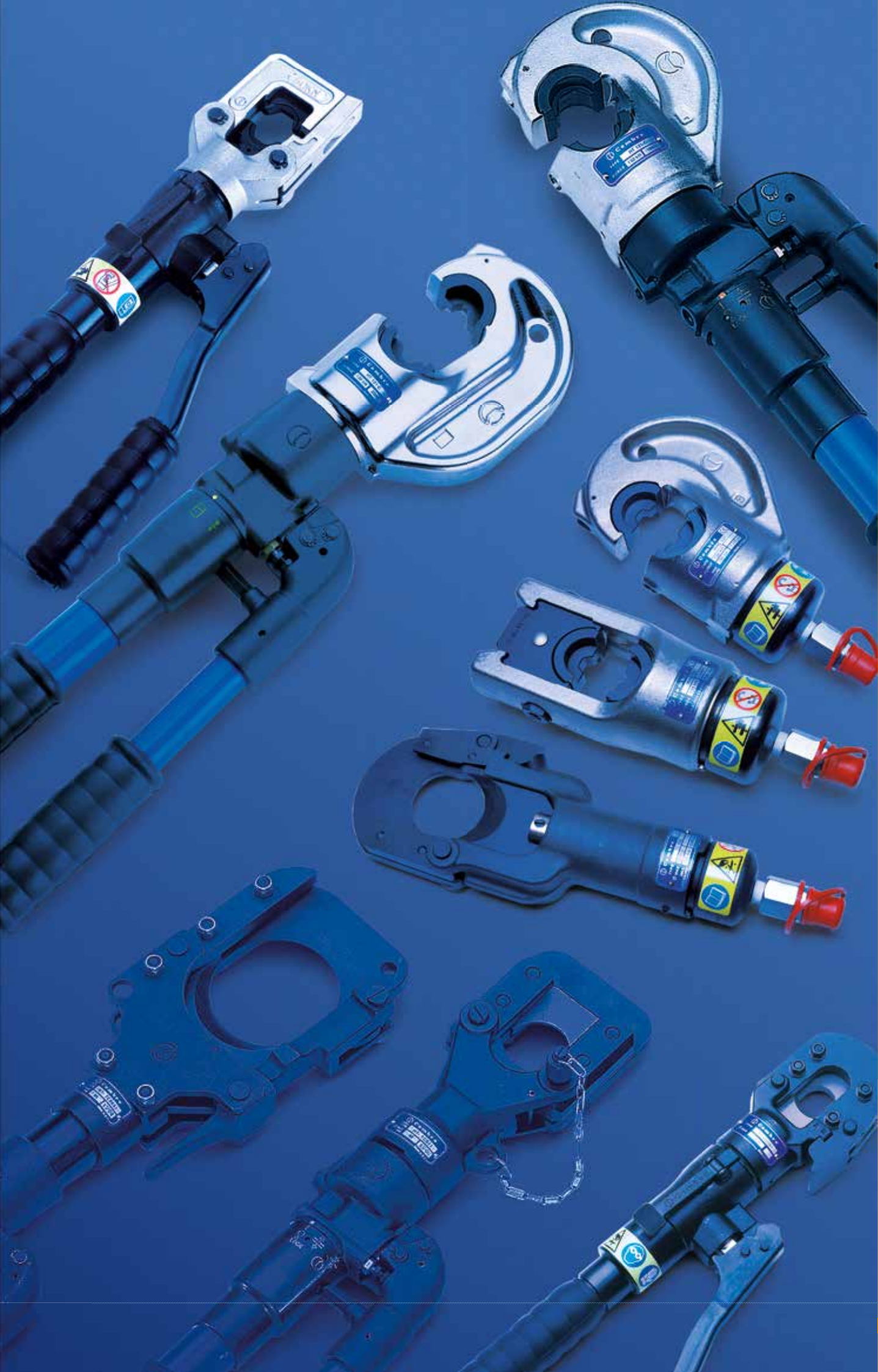

HYDRAULIC CRIMPING TOOLS AND CUTTERS

HYDRAULIC CRIMPING TOOL

HT 45-E

general features

Crimping force kN	Dimensions mm		Weight kg
	length	width	
50	346	130	2,0

MAIN APPLICATIONS - max section mm²

L.V. lugs and splices	"C" sleeve connectors	H.V. lugs and splices
150	35	70

STORAGE

Type	Dimensions mm	Weight kg	Supplied with the tool	Purchase separately
VAL P1*	445x290xh95	1,2	✳	—

*Suitable for storage of the tool and 20 sets of dies.

Lightweight and compact, this tool is ideal for the compression of connectors on over head lines and other general applications.

Having the benefit of spring loaded handles, the dies can be advanced using only one hand; therefore leaving the other hand free to position the connector.

For ease of operation and comfort of the operator, the tool head can be fully rotated through 180 degrees.

The built-in safety valve will by-pass the oil supply when the maximum pressure is reached, and a pressure releasing system can easily be operated at any stage of the compression.



The operator can advance the dies using only one hand, leaving the other hand free to position the connector.

Openable head, ideal for derivations from running conductors

180° rotatable head, to work in the most comfortable position

Safety valve bypassing the oil supply when the maximum pressure is reached

Pressure releasing system, that can be operated at any stage.



HYDRAULIC CRIMPING TOOL

general features

Crimping force kN	Dimensions mm		Weight kg
	length	width	
50	380	130	2,7

MAIN APPLICATIONS - max section mm²

L.V. lugs and splices	Insulated terminals	End sleeves	"C" sleeve Connectors
240	120	120	70

STORAGE

Type	Dimensions mm	Weight kg	Supplied with the tool	Purchase separately
VAL P1*	445x290x95	1,2	✳	—

* Suitable for storage of the tool and 20 sets of dies.

HT 51-KV version also available for Power Supply Companies

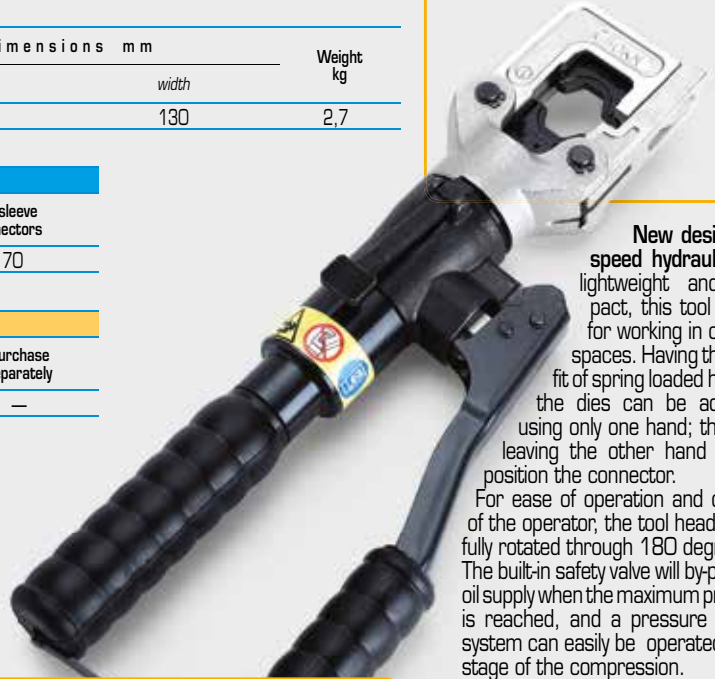

HT 51

New design two speed hydraulic tool, lightweight and compact, this tool is ideal for working in confined spaces. Having the benefit of spring loaded handles, the dies can be advanced using only one hand; therefore leaving the other hand free to position the connector.

For ease of operation and comfort of the operator, the tool head can be fully rotated through 180 degrees. The built-in safety valve will by-pass the oil supply when the maximum pressure is reached, and a pressure release system can easily be operated at any stage of the compression.

HYDRAULIC PRESSHEAD

general features



Crimping force kN	Max operating pressure bar	Dimensions mm		Weight kg
		length	width	
50	700	196	75	1,6

MAIN APPLICATIONS - max section mm²

L.V. lugs and splices	Insulated terminals	End sleeves	"C" sleeve Connectors
300	120	120	70

STORAGE

Type	Dimensions mm	Weight kg	Supplied with the tool	Purchase separately
VAL P1*	445x290x95	1,2	✳	—
Canvas bag 007	350x105	0,13	—	✳

* Suitable for storage of the tool and 20 sets of dies.



Hydraulic presshead complete with quick automatic coupler for connection to a hydraulic pump with a working pressure of 700 bar max. (see page 170-174) RH 50 is suitable for installing the same range of connectors as HT 51.

RH 50

HYDRAULIC PRESSHEAD

general features



Crimping force kN	Max operating pressure bar	Dimensions mm		Weight kg
		length	width	
50	700	210	70	1,6

MAIN APPLICATIONS - max section mm²

L.V. lugs and splices	Insulated terminals	End sleeves
300	120	120

STORAGE

Type	Dimensions mm	Weight kg	Supplied with the tool	Purchase separately
VAL P1*	445x290x95	1,2	✳	—
Canvas bag 007	350x105	0,13	—	✳

* Suitable for storage of the tool and 20 sets of dies.



Hydraulic press-head complete with quick automatic coupler for connection to hydraulic pump with working pressure of 700 bar max. (see page 170-174). RHM50 is suitable for installing the same range of connectors as RH50.

Particularly suitable for high volume bench crimping.

RHM 50

These tools are supplied without dies. For die selection, please refer to chart on pages 178 to 190

HYDRAULIC CRIMPING TOOL

HT 81-U

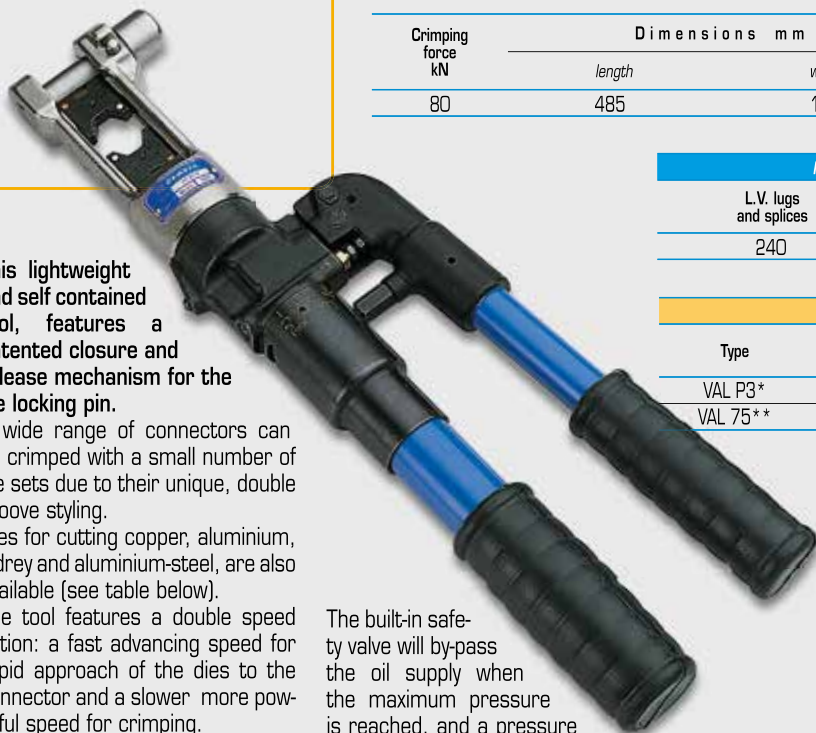

This lightweight and self contained tool, features a patented closure and release mechanism for the die locking pin.

A wide range of connectors can be crimped with a small number of die sets due to their unique, double groove styling.

Dies for cutting copper, aluminium, aldreyl and aluminium-steel, are also available (see table below).

The tool features a double speed action: a fast advancing speed for rapid approach of the dies to the connector and a slower more powerful speed for crimping.

For ease of operation and comfort of the operator the tool head can be fully rotated through 180 degrees.

The built-in safety valve will by-pass the oil supply when the maximum pressure is reached, and a pressure releasing system can easily be operated at any stage of the compression.

general features

Crimping force kN	Dimensions mm		Weight Kg
	length	width	
80	485	141	3,4

MAIN APPLICATIONS - max section mm²

L.V. lugs and splices	"C" sleeve connectors	H.V. lugs and splices
240	100	200

STORAGE

Type	Dimensions mm	Weight kg	Supplied with the tool	Purchase separately
VAL P3*	620x380xh135	2,5	✳	—
VAL 75**	270x80xh30	0,15	—	✳

* Suitable for storage of the tool and three VAL 75.

** Suitable for storing five sets of dies.



HYDRAULIC PRESSHEAD

RHU 81

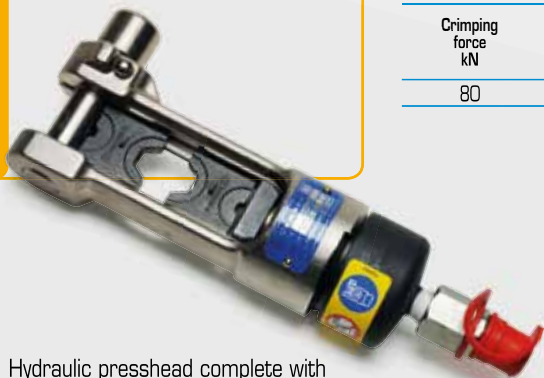

Hydraulic presshead complete with quick automatic coupler for connection to a hydraulic pump with a working pressure of 700 bar max, (see page 170-174).

This lightweight and self contained head, features a patented closure and release mechanism for the die locking pin.

The head is easy to use and is ideally suited for crimping in confined spaces.

RHU81 is suitable for installing the same range of connectors as HT 81-U.

general features

Crimping force kN	Max operating pressure bar	Dimensions mm		Weight kg
		length	width	
80	700	235	91	1,9

MAIN APPLICATIONS - max section mm²

L.V. lugs and splices	"C" sleeve connectors	H.V. lugs and splices
240	100	200

STORAGE

Type	Dimensions mm	Weight kg	Supplied with the tool	Purchase separately
Canvas bag 007	350x105	0,13	—	✳

HT 81-U and RHU 81 ACCESSORIES FOR CUTTING CONDUCTORS

Die Type	Cutting Capacity	Conductor Type
	Ø 16 mm	Cu, Alu, Aldreyl and Alu-Steel
MB2-80U	This die is suitable to cut steel conductors (R ≤ 160 daN/mm ²) having the most common strandings, i.e.: 19 x 1,2 = Ø est. 6,0 mm 7 x 3,0 = Ø est. 9,0 mm 19 x 2,1 = Ø est. 10,5 mm 19 x 2,3 = Ø est. 11,5 mm	
MB3-80U	Suitable to cut aluminium strands of 150 mm ² aluminium-steel conductors, without damage to the steel core	



HYDRAULIC CRIMPING TOOL

general features

HT 120

Crimping force kN	Dimensions mm		Weight kg
	length	width	
120	488	138	5,7

MAIN APPLICATIONS - max section mm²

L.V. lugs and splices	Insulated terminals	"C" sleeve Connectors	H.V. lugs	H.V. Splices
400	240	185	400	400*

* limited to the cable insulation diameter

STORAGE

Type	Dimensions mm	Weight kg	Supplied with the tool	Purchase separately
VAL P3*	620x380x135	2,5	✳	—

* Suitable for storage of the tool and 14 sets of dies.



The built-in safety valve will by-pass the oil supply when the maximum pressure is reached, and a pressure release system can easily be operated at any stage of the compression.



This lightweight and self contained tool will accept the semi-circular slotted dies, common to most 130 kN tools.

It is particularly suitable for installing crimp type electrical connectors for overhead line applications.

The tool features a double speed action: a fast advancing speed for rapid approach of the dies to the connector and a slower more powerful speed for crimping.

For ease of operation and comfort of the operator the tool head can be fully rotated through 180 degrees.

HT 120-KV
version also available for
Power Supply Companies



Die release system, protected from accidental operation

HT 120 features a double speed action: a fast advancing speed for rapid approach of the dies to the connector and a slower more powerful speed for crimping.



Pressure release trigger, which can be operated at any stage of the compression.

HYDRAULIC CRIMPING TOOL

HT 131-C

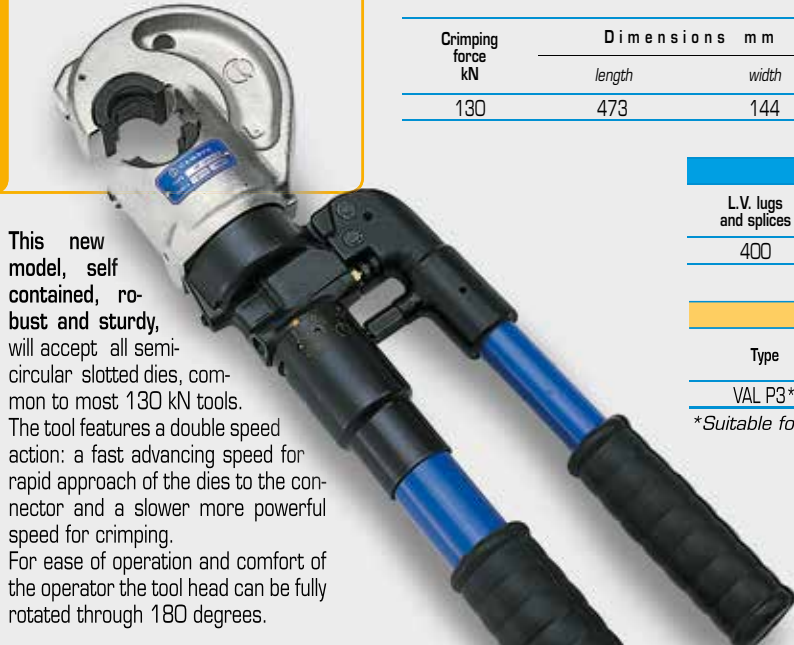

This new model, self contained, robust and sturdy, will accept all semi-circular slotted dies, common to most 130 kN tools. The tool features a double speed action: a fast advancing speed for rapid approach of the dies to the connector and a slower more powerful speed for crimping. For ease of operation and comfort of the operator the tool head can be fully rotated through 180 degrees.

general features

Crimping force kN	Dimensions mm		Jaw Opening mm	Weight kg
	length	width		
130	473	144	25	5,5

MAIN APPLICATIONS - max section mm²

L.V. lugs and splices	Insulated terminals	"C" sleeve Connectors	H.V. lugs	H.V. Splices
400	240	185	400	400*

* limited to the cable insulation diameter

STORAGE

Type	Dimensions mm	Weight kg	Supplied with the tool	Purchase separately
VAL P3*	620x380xh135	2,5	✳	—

*Suitable for storage of the tool and 14 sets of dies

The built-in safety valve will by-pass the oil supply when the maximum pressure is reached, and the pressure release system can easily be operated at any stage of compression.



HYDRAULIC PRESSHEADS

RHC 131



Hydraulic presshead complete with quick automatic coupler for connection to a hydraulic pump with a working pressure of 700 bar max, (see page 170-174) This new design with improved mechanical features, is suitable for installing the same range of connectors as HT 131-C.

general features

Crimping force kN	Max operating pressure bar	Dimensions mm		Jaw Opening mm	Weight kg
		length	width		
130	700	232	124	25	3,8

MAIN APPLICATIONS - max section mm²

L.V. lugs and splices	Insulated terminals	"C" sleeve Connectors	H.V. lugs	H.V. Splices
400	240	185	400	400*

* limited to the cable insulation diameter

STORAGE

Type	Dimensions mm	Weight kg	Supplied with the tool	Purchase separately
VAL P26*	445x290xh115	1,2	—	✳

*Suitable for storage of the head and 14 sets of dies



RHM 132



Hydraulic presshead complete with quick automatic coupler for connection to a hydraulic pump with a working pressure of 700 bar max, (see page 170-174).

general features

Crimping force kN	Max operating pressure bar	Dimensions mm		Weight kg
		length	width	
130	700	216	80	3,1

MAIN APPLICATIONS - max section mm²

L.V. lugs	Insulated terminals	H.V. lugs
400	240	400

STORAGE

Type	Dimensions mm	Weight kg	Supplied with the tool	Purchase separately
VAL P26*	445x290xh115	1,2	—	✳

*Suitable for storage of the head and 14 sets of dies



Particularly suitable for high volume bench crimping.



These tools are supplied without dies. For die selection, please refer to chart on pages 178 to 190

HYDRAULIC CRIMPING TOOL

general features

Crimping force kN	Dimensions mm		Jaw Opening mm	Weight kg
	length	width		
130	538	144	42	7,0

MAIN APPLICATIONS - max section mm²

L.V. lugs and splices	Insulated terminals	"C" sleeve connectors	H.V. lugs and splices
400	240	185	400

STORAGE

Type	Dimensions mm	Weight kg	Supplied with the tool	Purchase separately
VAL P3*	620x380x135	2,5	⌘	—

*Suitable for storage of the tool and 12 sets of dies

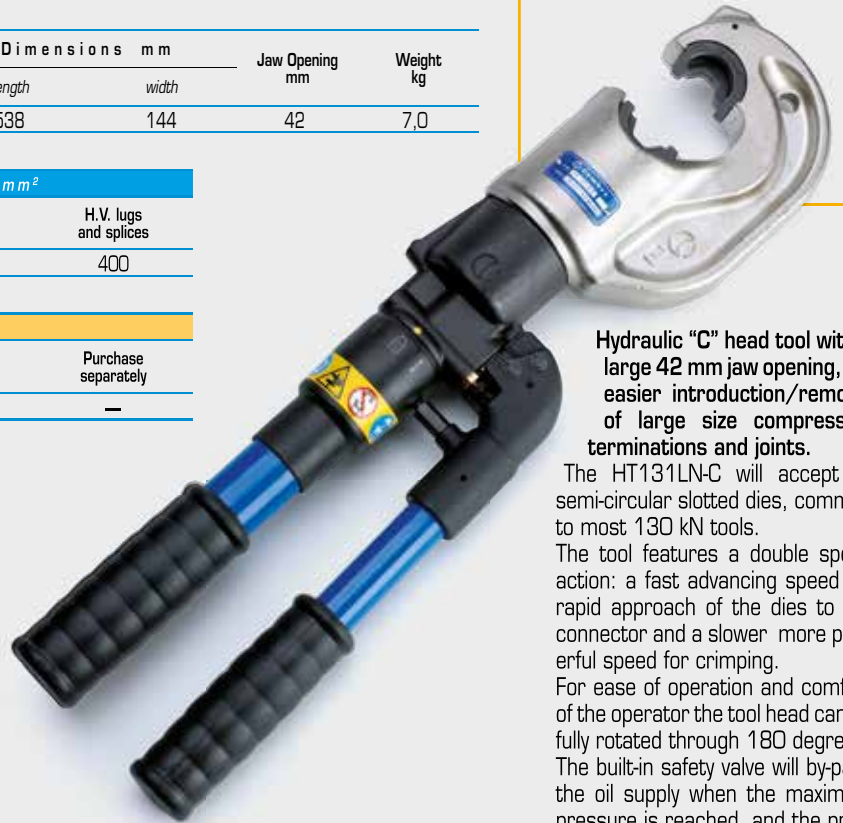

Hydraulic "C" head tool with a large 42 mm jaw opening, for easier introduction/removal of large size compression terminations and joints.

The HT131LN-C will accept all semi-circular slotted dies, common to most 130 kN tools.

The tool features a double speed action: a fast advancing speed for rapid approach of the dies to the connector and a slower more powerful speed for crimping.

For ease of operation and comfort of the operator the tool head can be fully rotated through 180 degrees. The built-in safety valve will by-pass the oil supply when the maximum pressure is reached, and the pressure release system can easily be operated at any stage of compression.

HYDRAULIC PRESSHEAD

general features



Crimping force kN	Max operating pressure bar	Dimensions mm		Jaw Opening mm	Weight kg
		length	width		
130	700	298	122	42	5,4

MAIN APPLICATIONS - max section mm²

L.V. lugs and splices	Insulated terminals	"C" sleeve connectors	H.V. lugs and splices
400	240	185	400

STORAGE

Type	Dimensions mm	Weight kg	Supplied with the tool	Purchase separately
VAL P26*	445x290x115	1,2	—	⌘

*Suitable for storage of the head and 14 sets of dies

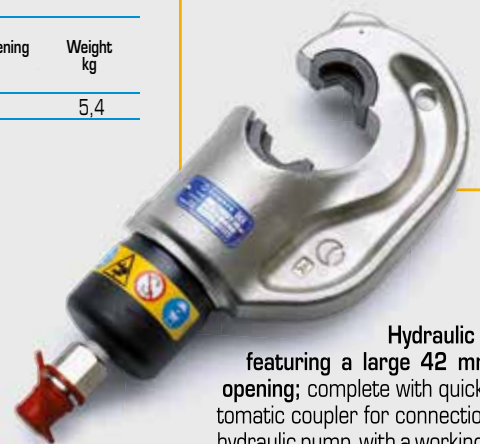

RHC 131LN

Hydraulic head featuring a large 42 mm jaw opening; complete with quick automatic coupler for connection to a hydraulic pump with a working pressure of 700 bar max, (see page 170-174). Is suitable for installing the same range of connectors as HT 131LN-C.

These tools are supplied without dies. For die selection, please refer to chart on pages 178 to 190

HT 131-UC

HYDRAULIC CRIMPING TOOL

general features

Crimping force kN	Dimensions mm		Weight kg
	length	width	
130	488	149	5,4

MAIN APPLICATIONS - max section mm ²				
L.V. lugs and splices	Insulated terminals	"C" sleeve connectors	H.V. lugs and splices	Alu lugs and splices
400	240	185	400	300

STORAGE				
Type	Dimensions mm	Weight kg	Supplied with the tool	Purchase separately
VAL P3*	620x380xh135	2,5	✳	—
VAL 130**	360x280xh48	3,0	—	✳

* Suitable for storage of the tool and 14 sets of dies
 ** Suitable for the storage of accessories for crimping Aluminium connectors



This robust and self contained tool will accept the accessories for performing the "Deep Stepped Indent" system of crimping on Aluminium cables.

This tool will also accept the semi-circular slotted dies, common to most 130 kN tools. HT 131-UC performance features are the same as those of HT 131-C.



HYDRAULIC PRESSHEAD

general features



Crimping force kN	Max operating pressure bar	Dimensions mm		Weight kg
		length	width	
130	700	245	89	3,7

MAIN APPLICATIONS - max section mm ²				
L.V. lugs and splices	Insulated terminals	"C" sleeve connectors	H.V. lugs and splices	Alu lugs and splices
400	240	185	400	300

STORAGE				
Type	Dimensions mm	Weight kg	Supplied with the tool	Purchase separately
VAL P26*	445x290xh115	1,2	—	✳
VAL 130**	360x280xh48	3,0	—	✳
VAL 130-U***	450x305xh80	5,0	—	✳

* Suitable for storage of the head and 14 sets of dies
 ** Suitable for the storage of accessories for crimping Aluminium connectors
 *** Suitable for storage of the head, semi-circular slotted dies and dies for crimping Aluminium connectors

RHU 131-C



Hydraulic presshead complete with quick automatic coupler for connection to a hydraulic pump with a working pressure of 700 bar max, (see page 170-174).

RHU 131-C is suitable for installing the same range of connectors as HT 131-UC.



VAL 130



VAL 130-U



VAL P26

These tools are supplied without dies. For die selection, please refer to chart on pages 178 to 190

HYDRAULIC PRESSHEAD



general features

Crimping force kN	Max operating pressure bar	Dimensions mm		Weight kg
		length	width	
230	700	290	120	5,5

MAIN APPLICATIONS - max section mm²

L.V. lugs and splices	Insulated terminals	"C" sleeve connectors	H.V. lugs and splices
630	300	240	630

STORAGE

Type	Dimensions mm	Weight kg	Supplied with the tool	Purchase separately
VAL ECW-H3D*	345x305xh90	4,2	—	*

* Suitable for storage of the head and 10 sets of dies

ECW-H3D ACCESSORIES FOR CUTTING CONDUCTORS

Die Type	Cutting Capacity	Conductor Type
WT2-3D	Ø 20 mm	Cu, Alu, Aldrey and Alu-Steel
	Ø 20 mm	Extra flexible Steel with ≥ 200 strands
This die is suitable to cut Steel conductors (R ≤ 160 daN/mm ²) having the most common strandings, i.e.: 19 x 1,2 = Ø est. 6,0 mm 7 x 3,0 = Ø est. 9,0 mm 19 x 2,1 = Ø est. 10,5 mm 19 x 2,3 = Ø est. 11,5 mm		

ECW-H3D



Hydraulic presshead complete with quick automatic coupler for connection to a hydraulic pump with a working pressure of 700 bar max, (see page 170-174).

Adaptor type **AU230-130D** is available as an optional extra enabling the head to utilise the semi-circular slotted dies which are common to most 130 kN tools. Also available is a series of dies for the compression of DIN electrical connectors, and a die for cutting Copper, Aluminium, aldrej, Aluminium-Steel and Steel conductors.



HYDRAULIC PRESSHEAD



general features

Crimping force kN	Max operating pressure bar	Dimensions mm		Weight kg
		length	width	
230	700	320	110	6,4

MAIN APPLICATIONS - max section mm²

Alu lugs and splices	Cu lugs and splices
500	630

STORAGE

Type	Dimensions mm	Weight kg	Supplied with the tool	Purchase separately
VAL 231*	470x273xh96	7,2	*	—

* Suitable for storage of the head and dies for Aluminium compression

RHU 231

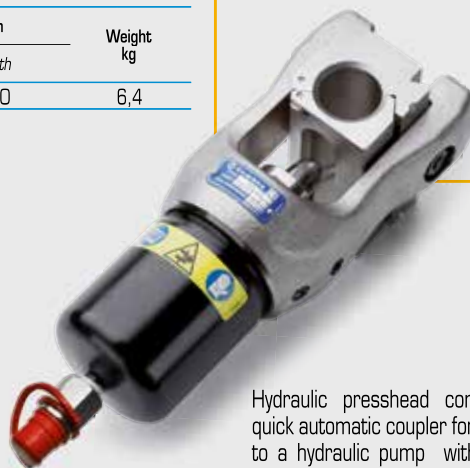

Hydraulic presshead complete with quick automatic coupler for connection to a hydraulic pump with a working pressure of 700 bar max, (see page 170-174).

For crimping up to 500 sqmm Aluminium.

Dies are available also for crimping Copper connectors.



These tools are supplied without dies. For die selection, please refer to chart on pages 178 to 190

RHU 230-630



Hydraulic presshead complete with quick automatic coupler for connection to a hydraulic pump with a working pressure of 700 bar max, (see page 170-174).

It allows for crimping up to 630 sqmm Aluminium (according to HN 68 S90).

Adapters **AU 230-130-C/N**, and **AU 230-PS/E**, are available as an optional extra enabling the head to utilise the semicircular slotted dies which are common to most 130 kN tools.

HYDRAULIC PRESSHEAD

general features



Crimping force kN	Max operating pressure bar	Dimensions mm		Weight kg
		length	width	
230	700	365	193	9,0

MAIN APPLICATIONS - max section mm²

CU lugs and splices	Alu lugs and splices	"C" sleeve connectors	H.V. lugs and splices
400	630	185	400

STORAGE

Type	Dimensions mm	Weight kg	Supplied with the tool	Purchase separately
VAL 230-630*	405x230xh145	3,5	✳	—
VAL MAT 230-630*	290x260xh70	3,1	—	✳

* Suitable for storage of the head

** Suitable for storage of the accessories



VAL MAT 230-630



VAL 230-630

RHU 450



Hydraulic presshead complete with quick automatic coupler for connection to a hydraulic pump with a working pressure of 700 bar max, (see page 170-174).

HYDRAULIC PRESSHEAD

general features



Crimping force kN	Max operating pressure bar	Dimensions mm		Weight kg
		length	width	
450	700	260	120	10,3

MAIN APPLICATIONS - Hexagonal crimp according to DIN 48083 max section mm²

Cu	Al	Al/St
1000	1000	680/85

STORAGE

Type	Dimensions mm	Weight kg	Supplied with the tool	Purchase separately
VAL 450*	285x212xh124	2,8	✳	—

* Suitable for storage of the head



Adaptor type **AU 450-130 D** is available as an optional extra enabling the head to utilise the semi-circular slotted dies which are common to most 130 kN tools.

These tools are supplied without dies. For die selection, please refer to chart on pages 178 to 190

HYDRAULIC PRESSHEAD

general features



Crimping force kN	Max operating pressure bar	Dimensions mm		Weight kg
		length	width	
520	700	306	200	18,0

MAIN APPLICATIONS - max section mm²

Lugs and splices	H.V. overhead lines
1200	630

STORAGE

Type	Dimensions mm	Weight kg	Supplied with the tool	Purchase separately
VAL 520*	384x231xh145	3,2	—	✳
VAL MAT 520**	500x310xh68	5,1	—	✳

* Suitable for storage of the head

** Suitable for storage of 10 sets of dies



VAL MAT 520



VAL 520

RHU 520



Hydraulic presshead complete with quick automatic coupler for connection to a hydraulic pump with a working pressure of 700 bar max, (see page 170-174).

Adaptor type **AU520-130C** is available as an optional extra enabling the head to utilise the semi-circular slotted dies which are common to most 130 kN tools.

RHU 600

HYDRAULIC PRESSHEAD

general features



Crimping force kN	Max operating pressure bar	Dimensions with support mm		Weight with support kg
		length	width	
600	700	447	241	22.4

MAIN APPLICATIONS

- "U" Alcoa series die and "L" Burndy series die, etc.
- Aluminium and Copper max size 2156 MCM

STORAGE

Type	Dimensions mm	Weight kg	Supplied with the tool	Purchase separately
VAL 600*	480x235xh260	8,6	✳	—

* Suitable for storage of the head



VAL 600

Hydraulic presshead complete with quick automatic coupler for connection to a hydraulic pump with a working pressure of 700 bar max, (see page 170-174).

HYDRAULIC PRESSHEAD



general features

RHU 1000

Crimping force kN	Max operating pressure bar	Dimensions mm		Weight kg
		length	width	
1.100	700	414	278	50,6

STORAGE

Type	Dimensions mm	Weight kg	Supplied with the tool	Purchase separately
VAL 1000*	334x244xh435	12	✳	—

*Suitable for storage of the head



VAL 1000

New

Operable from single or double acting hydraulic power source



Lifting eye; screwed into the base of the cylinder; allows easy transportation of the head in aerial operation.

RHU 1000 is a 1.100 kN hydraulic presshead for full tension, transmission and substation connections, complete with quick automatic coupler for connection to hydraulic pumps with a working pressure of 700 bar max, (see pages 170-174).

The standard version must be operated by a single acting pump; possibility to convert from single to double acting by substitution of the breather valve with a female quick coupling. RHU1000 will accept all semi-circular slotted dies common to most

100 ton heads as the Alcoa ones. The die cap is removable for an easy connector positioning; the upper part of the cap automatically rotates during the die changing process to present the correct positioning of the die. Lifting eye included.

Insertion of the upper die:



After substitution of the dies, insert the die cap into the head.



Pull the pin.



The upper part of the cap automatically rotates...



...to the correct position.

INDUSTRIAL APPLICATION
HT-TC051



Hand operated hydraulic tool specifically designed to cut Copper, Aluminium and Telecommunications cable having a max overall diameter of 50 mm. The tool features a double speed action: a fast advancing speed for rapid approach of the blades to the cable and a slower more powerful speed for cutting. The blades are manufactured from high strength special Steel, heat treated to ensure a long service life. The head can be easily opened to allow the cutting of running cables.

The head can rotate through 90 degrees, to enable the operator to work in the most comfortable position. HT-TC051 features an automatic

HYDRAULIC CUTTING TOOL

general features

Max cutting Ø mm	Dimensions mm		Weight kg
	length	width	
50	497	129	4,38

STORAGE

Type	Dimensions mm	Weight kg	Supplied with the tool	Purchase separately
Canvas Bag 010	545x160	0,15	✳	—

safety valve to bypass oil when reaching maximum pressure; a pressure release device can also be operated at any stage of operation.



INDUSTRIAL APPLICATION
TC 050



Hydraulic cutting head complete with quick automatic coupler for connection to a hydraulic pump with a working pressure of 700 bar max, (see page 170-174) TC050 features the same cutting capability as HT-TC051.

HYDRAULIC CUTTING HEAD

general features



Max cutting Ø mm	Max operating pressure bar	Dimensions mm		Weight kg
		length	width	
50	700	325	112	3,2

STORAGE

Type	Dimensions mm	Weight kg	Supplied with the tool	Purchase separately
Canvas bag 011	360x137	0,13	✳	—



INDUSTRIAL APPLICATION
HT-TC065



Hand operated hydraulic tool specifically designed to cut Copper, Aluminium and Telecommunications cable having a max overall diameter of 65 mm. The tool features a double speed action. The blades are manufactured from high strength special Steel, heat treated to ensure a long service life. The head can be easily opened to allow the cutting of running cables.

The head can rotate through 320 degrees, to enable the operator to work in the most comfortable position. HT-TC065 features an automatic safety valve to bypass oil when reach-

HYDRAULIC CUTTING TOOL

general features

Max cutting Ø mm	Dimensions mm		Weight kg
	length	width	
65	523	129	5

STORAGE

Type	Dimensions mm	Weight kg	Supplied with the tool	Purchase separately
Canvas bag 010	545x160	0,15	✳	—

ing maximum pressure; a pressure release device can also be operated at any stage of operation.



HYDRAULIC CUTTING TOOL

general features

Max cutting Ø mm	Dimensions mm		Weight kg
	length	width	
85	652,5	175	6,6

STORAGE

Type	Dimensions mm	Weight kg	Supplied with the tool	Purchase separately
VAL P7	727x202xh115	1,3	✳	—

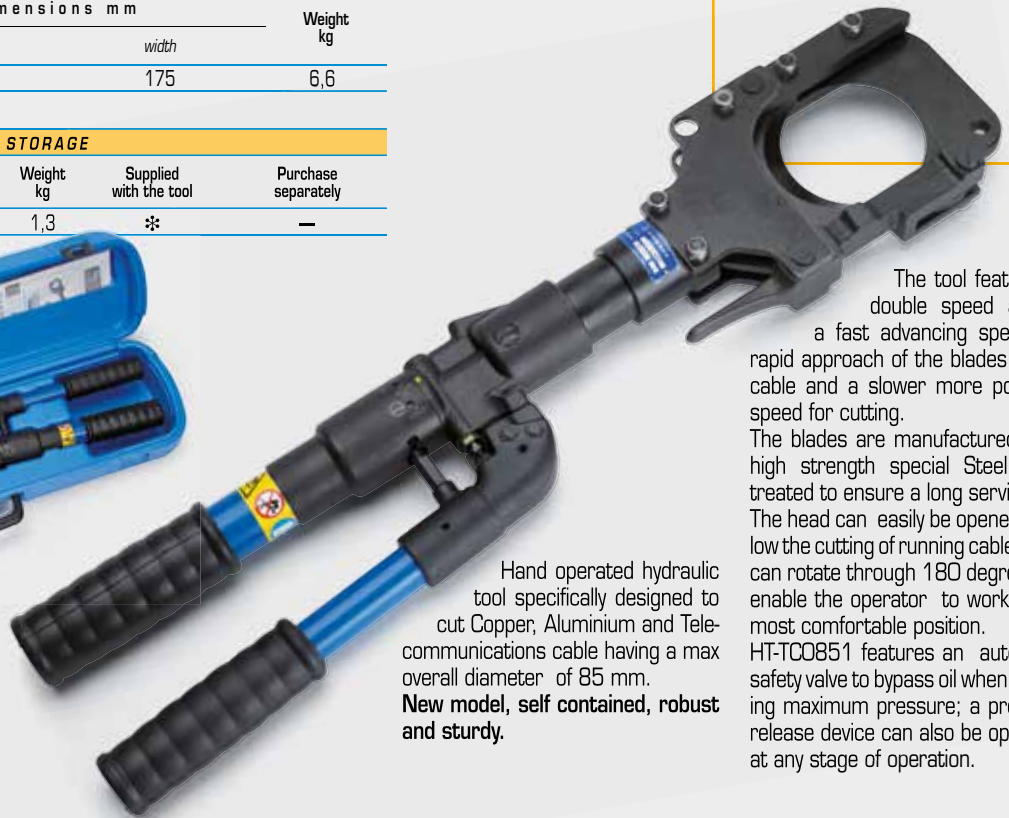

Hand operated hydraulic tool specifically designed to cut Copper, Aluminium and Telecommunications cable having a max overall diameter of 85 mm.
New model, self contained, robust and sturdy.

INDUSTRIAL APPLICATION HT-TC0851

The tool features a double speed action: a fast advancing speed for rapid approach of the blades to the cable and a slower more powerful speed for cutting. The blades are manufactured from high strength special Steel, heat treated to ensure a long service life. The head can easily be opened to allow the cutting of running cables, and can rotate through 180 degrees, to enable the operator to work in the most comfortable position. HT-TC0851 features an automatic safety valve to bypass oil when reaching maximum pressure; a pressure release device can also be operated at any stage of operation.

HYDRAULIC CUTTING HEAD

general features

Max cutting Ø mm	Max operating pressure bar	Dimensions mm		Weight Kg
		length	width	
85	700	409	135	4,9

STORAGE

Type	Dimensions mm	Weight kg	Supplied with the tool	Purchase separately
VAL TC 085	465x155xh65	2,4	✳	—



Hydraulic cutting head complete with quick automatic coupler for connection to a hydraulic pump with a working pressure of 700 bar max, (see page 170-174)

TC085 features the same cutting capability as HT-TC0851.

INDUSTRIAL APPLICATION TC 085



INDUSTRIAL APPLICATION
TC 096

HYDRAULIC CUTTING HEAD



general features

Max cutting Ø mm	Max operating pressure bar	Dimensions mm		Weight kg
		length	width	
95	700	397	249	7,9

STORAGE

Type	Dimensions mm	Weight kg	Supplied with the tool	Purchase separately
VAL 096	450x265xh145	6,8	✳	—



Hydraulic cutting head specifically designed to cut Copper and Aluminium cable having a max overall diameter of 95 mm.

The head is complete with a quick automatic coupler for connection to a hydraulic pump with a working pressure of 700 bar max, (see page 170-174).



Handle designed for ease of operation



HYDRAULIC CUTTING HEAD

general features

INDUSTRIAL APPLICATION
TC 120

Max cutting Ø mm	Max operating pressure bar	Dimensions mm		Weight kg
		length	width	
120	700	536	175	9,5

STORAGE

Type	Dimensions mm	Weight kg	Supplied with the tool	Purchase separately
VAL TC 120	590x209xh84	4,9	✳	—



Hydraulic cutting head specifically designed to cut Copper, Aluminium and Telecommunications cable having a max overall diameter of 120 mm.

The head can easily be opened to cut running cables, and the handle allows the most comfortable positioning of the head onto the cable to be cut.

The head is complete with a quick automatic coupler for connection to a hydraulic pump with a working pressure of 700 bar max, (see page 170-174).

TC 120 cutting capacity - a few examples:

Cable type	Capacity
3x150 mm ² Steel armoured	Ø80 mm
1000 mm ² Cu - EPR rubber insulated	Ø85 mm
1000 mm ² Cu - EPR rubber insulated + lead sheath	Ø92 mm
1000 mm ² Cu - EPR rubber insulated + lead sheath + PE sheath	Ø100 mm
240 mm ² EPR rubber insulated	



Handle designed for ease of operation



Opening head, to allow cutting of running cables

OVERHEAD LINE APPLICATION
HT-TC026



Hand operated hydraulic tool specifically designed to cut Copper, Al, Aluminium, Aluminium-Steel cables and Steel ropes, Aluminium and Steel rods having a max overall diameter of 25 mm. The tool features a double speed action: a fast advancing speed for rapid approach of the blades to the cable and a slower more powerful speed for cutting. The blades are manufactured from high strength special Steel, heat treated to ensure a long service life. The head can rotate through 180 degrees, to enable the operator to work in the most comfortable position, and can easily be opened to allow the cutting of running cables. HT-TC026 features an automatic safety valve to bypass oil when reaching maximum pressure; a pressure release device can also be operated at any stage of operation.

HYDRAULIC CUTTING TOOL

general features

Max cutting Ø mm	Dimensions mm		Weight kg
	length	width	
25	382	129	3,2

STORAGE				
Type	Dimensions mm	Weight kg	Supplied with the tool	Purchase separately
Canvas bag 001	430x155	0,15	✳	—



CUTTING CAPACITY

	MATERIAL	TENSILE STRENGTH (daN/mm²)	MAX CUTTING DIAMETER (mm)	
			HT-TC026 TC 025	HT-TC026Y B-TC250E
ROPE & CONDUCTORS	COPPER	≤ 41	25	
	ALUMINIUM	≤ 20	25	
	ALMELEC	≤ 34	25	
	STEEL	≤ 180	INDICATIVE EXAMPLES: 7 x 3,0 : Ø est. = 9,0 mm 19 x 2,1 : Ø est. = 10,5 mm 19 x 2,2 : Ø est. = 11,0 mm 19 x 2,3 : Ø est. = 11,5 mm	
	MULTI STRANDS STEEL (STRANDS Qty ≥ 200)	≤ 180	18	
RODS	ACSR	≤ 180	25 INDICATIVE EXAMPLES: 26 x 2,50 + 7 x 1,95 : Ø est. = 15,85 26 x 3,06 + 7 x 2,38 : Ø est. = 19,38 26 x 3,60 + 7 x 2,80 : Ø est. = 22,80	
	STEEL	≤ 60	13	
		≤ 42	16	
	COPPER	≤ 30	20	
	≤ 25	23		
	ALUMINIUM	≤ 16	25	

OVERHEAD LINE APPLICATION
TC 025



Hydraulic cutting head complete with quick automatic coupler for connection to a hydraulic pump with a working pressure of 700 bar max, (see page 170-174)

TC025 has the same cutting capability as HT-TC026.

HYDRAULIC CUTTING HEAD

general features

Max cutting Ø mm	Max operating pressure bar	Dimensions mm		Weight kg
		length	width	
25	700	213	82	2,0

STORAGE				
Type	Dimensions mm	Weight kg	Supplied with the tool	Purchase separately
Canvas bag 007	350x105	0,13	✳	—



HYDRAULIC CUTTING TOOL

general features

OVERHEAD LINE APPLICATION HT-TC026Y

Max cutting Ø mm	Dimensions mm		Weight kg
	length	width	
25	394,5	129	3,35

STORAGE

Type	Dimensions mm	Weight kg	Supplied with the tool	Purchase separately
Canvas Bag 001	430x155	0,15	✳	—



Hand operated hydraulic tool specifically designed to cut Copper, Alu, Aluminum, Aluminum-Steel cables, **stay wire and Steel ropes having a max overall diameter of 25 mm and Steel earthing rod up to 16 mm.** The tool features a double speed action.

The blades are manufactured from high strength special Steel, heat treated to ensure a long service life.

The head can rotate through 180 degrees, to enable the operator to work in the most comfortable position, and can easily be opened to allow the cutting of running cables. HT-TC026Y features an automatic safety valve to bypass oil when reaching maximum pressure; a pressure release device can also be operated at any stage of operation.

Ideal for earthing rod and stay wire

HT-TC026Y cutting capacity - a few examples:

Ø		EARTHING RODS AND STAY WIRES
mm	in.	
12,7	1/2"	STEEL EARTHING ROD, COPPER PLATED; Tensile strength = 79 daN/mm ²
14,2	/	STEEL EARTHING ROD, COPPER PLATED; Tensile strength = 69 daN/mm ²
15,6	/	STEEL EARTHING ROD; Tensile strength = 69 daN/mm ²
15,9	5/8"	STEEL EARTHING ROD, COPPER PLATED (CON ED - ILLINOIS); Tensile strength = 57 daN/mm ²
15,9	5/8"	STEEL EARTHING ROD, COPPER PLATED (CON ED - STATEN ISLAND); Tensile strength = 78 daN/mm ²
19	3/4"	STEEL EARTHING ROD, COPPER PLATED; Tensile strength = 74 daN/mm ²
9,15 (3,05x7)	/	STAY WIRE
10,8 (3,6x7)	/	STAY WIRE (PORTLAND GENERAL ELECTRIC)
11,1 (3,7x7)	/	STAY WIRE (PORTLAND GENERAL ELECTRIC)
12,3 (4,1x7)	/	STAY WIRE (PORTLAND GENERAL ELECTRIC)
12,6 (4,2x7)	/	STAY WIRE (PORTLAND GENERAL ELECTRIC)

OVERHEAD LINE APPLICATION
HT-TC041N



Hand operated hydraulic tool specifically designed to cut Copper, Alredy, Aluminium, Aluminium-Steel cables and Steel ropes, Aluminium and Steel rods having a max overall diameter of 45 mm.

New model, even more self contained, robust and sturdy.

The blades are manufactured from high strength special Steel, heat treated to ensure a long service life. The head can rotate through 180 degrees, to enable the operator to work in the most comfortable position, and can easily be opened to allow cutting of running cables.

HT-TC041N features an automatic safety valve to bypass oil when reaching maximum pressure; a pressure release device can also be operated at any stage of operation.



HYDRAULIC CUTTING TOOL

general features

Max cutting Ø mm	Dimensions mm		Weight kg
	length	width	
45	550	144	5,8

STORAGE				
Type	Dimensions mm	Weight kg	Supplied with the tool	Purchase separately
VAL P7	727x202xh115	1,3	✳	—

CUTTING CAPACITY			
MATERIAL	TENSILE STRENGTH (daN/mm ²)	MAX CUTTING DIAMETER (mm)	
		HT-TC 041N	TC 04N B-TC450E
COPPER	≤ 41	45	
ALUMINIUM	≤ 20	45	
ALMELEC	≤ 34	45	
ROPE & CONDUCTORS	STEEL	INDICATIVE EXAMPLES: 7 x 3,0 : Ø est. = 9,0 mm 19 x 2,1 : Ø est. = 10,5 mm 19 x 2,3 : Ø est. = 11,5 mm	
	MULTI STRANDS STEEL (STRANDS Q.TY ≥ 200)	18	
	ACSR	45 INDICATIVE EXAMPLES: 26 x 2,50 + 7 x 1,95 : Ø est. = 15,85 26 x 3,06 + 7 x 2,38 : Ø est. = 19,38 26 x 3,60 + 7 x 2,80 : Ø est. = 22,80 54 x 3,50 + 19 x 2,10 : Ø est. = 31,50 54 x 4,36 + 19 x 2,62 : Ø est. = 39,20	
RODS	STEEL	≤ 60	18
		≤ 42	20
	COPPER	≤ 30	30
	ALUMINIUM	≤ 16	45

OVERHEAD LINE APPLICATION
TC 04N



Hydraulic cutting head complete with quick automatic coupler for connection to a hydraulic pump with a working pressure of 700 bar max, (see page 170-174)
TC04N has the same cutting capability as HT-TC041N.

HYDRAULIC CUTTING HEAD

general features



Max cutting Ø mm	Max operating pressure bar	Dimensions mm		Weight kg
		length	width	
45	700	311	100	4,0

STORAGE				
Type	Dimensions mm	Weight kg	Supplied with the tool	Purchase separately
VAL 04	350x125xh68	2,0	✳	—



HYDRAULIC CUTTING TOOL

general features

Max cutting Ø mm	Dimensions mm		Weight kg
	length	width	
50	503	129	4,7

STORAGE

Type	Dimensions mm	Weight kg	Supplied with the tool	Purchase separately
Canvas Bag 010	545x160	0,15	✳	—



OVERHEAD LINE APPLICATION HT-TC051Y

Hand operated hydraulic tool specifically designed to cut Copper, Aluminum, Aluminum-Steel cables (ACSR) having a max overall diameter of 50 mm.

The HT-TC051Y is provided with a two stage hydraulic system, which advances the blades quickly to the cable. This proven system saves operator time and effort.

The HT-TC051Y is provided with an automatic safety valve to bypass oil when reaching max pressure. This means safety to the operator and protection to the blades.

The blades are manufactured from high strength special Steel, heat treated to ensure a long service life. The shape of the blades provides a "clean" cut.

The head can be opened to allow cutting of running cables and ropes. The head rotates 90 degrees allowing the operator to perform the cut in the most comfortable position.

The tool is supplied complete with canvas bag 010 for protection and storage when not in use.

Not suitable for cutting stay wire, Steel rope or earthing rod.

HYDRAULIC CUTTING HEAD

general features



Max cutting Ø mm	Max operating pressure bar	Dimensions mm		Weight kg
		length	width	
50	700	331	112	3,3

STORAGE

Type	Dimensions mm	Weight kg	Supplied with the tool	Purchase separately
Canvas bag 011	360x137	0,13	✳	—



OVERHEAD LINE APPLICATION TC 050Y

Hydraulic cutting head complete with quick automatic coupler for connection to a hydraulic pump with a working pressure of 700 bar max, (see page 170-174).

TC 050Y features the same cutting capability as HT-TC051Y.

Not suitable for cutting stay wire, Steel rope or earthing rod.

OVERHEAD LINE APPLICATION
HT-TC055



Hand operated hydraulic tool specifically designed to cut Copper, Al, Aluminium, Aluminium-Steel cables and Steel ropes, Aluminium and Steel rods having a max overall diameter of 55 mm.

The HT-TC055 is provided with a two stage hydraulic system, which advances the blades quickly to the cable. This proven system saves operator time and effort. The HT-TC055 is provided with an automatic safety valve to bypass oil when reaching max pressure. This means safety to the operator and protection to the blades. The blades are manufactured from high strength special Steel, heat treated to ensure a long service life. The shape of the blades provides a "clean" cut.

The head can be opened to allow cutting of running cables and ropes. The head rotates 330 degrees allowing the operator to perform the cut in the most comfortable position. The tool is supplied complete with plastic case VAL P7 for protection and storage when not in use.



HYDRAULIC CUTTING TOOL

general features

Max cutting Ø mm	Dimensions mm		Weight kg
	length	width	
55	595	144	8,3

STORAGE				
Type	Dimensions mm	Weight kg	Supplied with the tool	Purchase separately
VAL P7	727x202x115	1,3	*	—

CUTTING CAPACITY				
MATERIAL	TENSILE STRENGTH (daN/mm ²)	MAX CUTTING DIAMETER (mm)		
		HT-TC055 TC 055 B-TC550E		
COPPER	≤ 41	55		
ALUMINIUM	≤ 20	55		
ALMELEC	≤ 34	55		
STEEL	≤ 180	INDICATIVE EXAMPLES: 7 x 3,0 : Ø est. = 9,0 mm 19 x 2,1 : Ø est. = 10,5 mm 19 x 2,3 : Ø est. = 11,5 mm		
		MULTI STRANDS STEEL (STRANDS Q.TY ≥ 200)	≤ 180	22
		ACSR	≤ 180	50 INDICATIVE EXAMPLES: 26 x 2,50 + 7 x 1,95 : Ø est. = 15,85 26 x 3,06 + 7 x 2,38 : Ø est. = 19,38 26 x 3,60 + 7 x 2,80 : Ø est. = 22,80 26 x 4,44 + 7 x 3,45 : Ø est. = 28,14 54 x 3,50 + 19 x 2,10 : Ø est. = 31,50 54 x 4,36 + 19 x 2,62 : Ø est. = 39,20 83 x 4,60 + 16 x 2,80 : Ø est. = 50,00
GUY WIRE (GW15-9/16-188)	Extra high strength grade	7 x 4,77 : Ø est. = 14,30 mm		
RODS	STEEL	≤ 60	20	
		≤ 42	22	
	COPPER	≤ 30	34	
		≤ 25	38,5	
ALUMINIUM	≤ 16	50		

OVERHEAD LINE APPLICATION
TC 055



Hydraulic cutting head complete with quick automatic coupler for connection to a hydraulic pump with a working pressure of 700 bar max, (see page 170-174) TC055 has the same cutting capability as HT-TC055.

HYDRAULIC CUTTING HEAD

general features



Max cutting Ø mm	Max operating pressure bar	Dimensions mm		Weight kg
		length	width	
55	700	357	134	6,6

STORAGE				
Type	Dimensions mm	Weight kg	Supplied with the tool	Purchase separately
VAL TC055	384x231x145	3,7	*	—



SPECIAL TOOLS



Type	Max piercing Ø mm	Max centre of hole to edge of trunking (mm)	Max operating pressure bar	Dimensions mm		Weight kg
				length	width	
RH-FC 48N	47,2	53,5	700	259,5	147,5	3,7

Storage type	Dimensions mm	Weight kg
VAL P30*	315x300x95	0,93

*Supplied with the head

Hole Dimensions					Maximum thickness of mild Steel (mm)	Code
Nominal Ø (mm)	Ø (inch)	Pg	ISO	Inch		
15,5	.610	Pg9	-	-	2	RD 15.5 SS-FC
16,2	.638	-	ISO-16	-		RD 16.2 SS-FC
17,5	.689	-	-	-		RD 17.5 SS-FC
18,8	.740	Pg11	-	-		RD 18.8 SS-FC
19,1	.752	-	-	-		RD 19.1 SS
20,5	.807	Pg13,5	ISO-20	-		RD 20.5 SS
22,6	.890	Pg16	-	-		RD 22.6 SS
23,8	.937	-	-	5/8"		RD 23.8 SS
25,4	1.000	-	ISO-25	-		RD 25.4 SS
27,0	1.063	-	-	3/4"		RD 27.0 SS
28,5	1.122	Pg21	-	-		RD 28.5 SS
30,5	1.201	-	-	7/8"		RD 30.5 SS
31,8	1.252	-	-	-		RD 31.8 SS
32,5	1.279	-	ISO-32	-		RD 32.5 SS
34,6	1.362	-	-	-		RD 34.6 SS
37,2	1.464	Pg29	-	-		RD 37.2 SS
38,1	1.500	-	-	-		RD 38.1 SS
40,5	1.594	-	ISO-40	-		RD 40.5 SS-FC
41,3	1.626	-	-	-		RD 41.3 SS-FC
42,5	1.673	-	-	1 1/4"		RD 42.5 SS-FC
43,2	1.701	-	-	-		RD 43.2 SS-FC
44,5	1.752	-	-	-		RD 44.5 SS-FC
47,2	1.858	Pg36	-	-		RD 47.2 SS-FC

general features

Frame-type hole punching head RH-FC48N

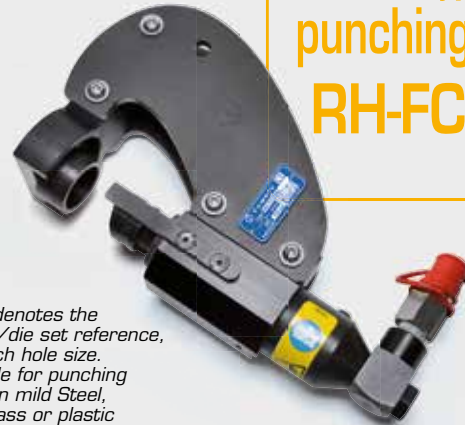

Table denotes the punch/die set reference, for each hole size. Suitable for punching holes in mild Steel, fibreglass or plastic material, up to 2 mm thick.

VAL P30

Supplied in a robust plastic case.



Hydraulic head complete with automatic quick coupler, designed for punching holes from 15,5 up to 47,2 mm diameter in the side wall of trunking without the need for pre drilling. For operation, the head must be joined to a hydraulic pump developing a pressure of 700 bar (see page 170-174).

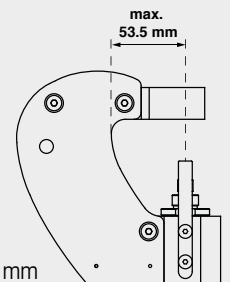

Max centre of hole to edge of trunking: 53,5 mm



Type	Max piercing Ø mm	Max hole distance from bar edge (mm)	Max operating pressure bar	Dimensions mm		Weight kg
				length	width	
RHT 160	21	30	700	240	153	6,5
RHT 160-60N	21	60	700	240	181	9,2

Storage type	Dimensions mm	Weight kg
VAL 160*	283x180x100	2,3

*Supplied with the head



Piercing heads RHT



Hydraulic head complete with automatic quick coupler, for piercing holes of various diameters in Copper, Aluminium and Steel bars with max. thickness of 10 mm.

This compact and handy tool is widely used for transformer room connections, control switch boards and power plants.

For operation the head must be joined to a hydraulic pump developing a pressure of 700 bar (see page 170-174).

Available accessories (to be ordered separately):

Piercing Ø mm	6,5	8,5	9	10,5	11	13	13,5	14	15	17	19	21
Set die - indenter	RT 6,5	RT 8,5	RT 9	RT 10,5	RT 11	RT 13	RT 13,5	RT 14	RT 15	RT 17	RT 19	RT 21

MAX. THICKNESS

Hole diameter (mm)	6,5	8,5	9	10,5	11	13	13,5	14	15	17	19	21
Max thickness strep in Copper	10	10	10	10	10	10	10	10	10	10	8	8
Max thickness strep in Steel	10	10	10	10	10	9	9	9	8	7	6	4
Punch die/set	RT 6,5	RT 8,5	RT 9	RT 10,5	RT 11	RT 13	RT 13,5	RT 14	RT 15	RT 17	RT 19	RT 21

SPECIAL TOOLS



Puller-type hole punching tool HT-FL75

general features

New



Hand operated hydraulic tool specifically designed for hole punching stainless Steel, mild Steel, fibreglass and plastic sheet materials up to 3,5 mm thickness. Compact, lightweight and easy to handle.

The balanced punching head pivots 180deg through a full 360deg rotation for ease of use in confined spaces.

The tool is supplied complete with plastic case VAL P28 for protection and storage when not in use.

Supplied with Pullers TD-11, TD-19 and spiral bit Ø 11,5 mm.

For the punch-die selection chart see page 168.



Universal joint allows punching head to pivot 180deg over a full 360deg rotation.

Max punching Ø mm	Dimensions mm		Weight kg
	length	width	
140	452	129	3,67

STORAGE				
Type	Dimensions mm	Weight kg	Supplied with the tool	Purchase separately
VAL P28	620x360xh138	2,4	✳	—



Puller-type hole punching head RH-FL75



Hydraulic head, for hole punching stainless Steel, mild Steel, fibreglass and plastic sheet materials up to 3,5 mm thickness.

Compact and lightweight, easy to handle in confined spaces due to a rotating 90deg quick automatic coupler for connection to a hydraulic pump with a working pressure of 700 bar max (see page 170-174).

Supplied with Pullers TD-11, TD-19 and spiral bit Ø 11,5 mm.

For the punch-die selection chart see page 168.

Max punching Ø mm	Max operating pressure bar	Dimensions mm		Weight kg
		length	width	
140	700	163	106	1,9

STORAGE				
Type	Dimensions mm	Weight kg	Supplied with the head	Purchase separately
VAL P29	448x288xh105	1,4	✳	—





SPECIAL TOOLS

general features

Nut splitting heads RHTD

RHTD 1724

Suitable for splitting nuts mm	Max operating pressure bar	Weight kg
16 (M10) ÷ 27 (M18)	700	1,76

RHTD 3241

Suitable for splitting nuts mm	Max operating pressure bar	Weight kg
27 (M18) ÷ 41 (M27)	700	4,6

RHTD 410T

Suitable for splitting square and hexagonal nuts or fastening bushes mm	Max operating pressure bar	Weight kg
27 (M18) ÷ 41 (M27)	700	4,9

STORAGE

Type	Dimensions mm	Weight kg
VAL P4*	315x300x95	0,93

*Supplied with the head



VAL P4

Supplied in a robust plastic case.

DIMENSIONS mm:

	RHTD 3241	RHTD 1724	RHTD 410T
A	66	40,5	83
B	36	25	41
C	208	150,5	231
D	75,5	54	76
E	16	7,5	46

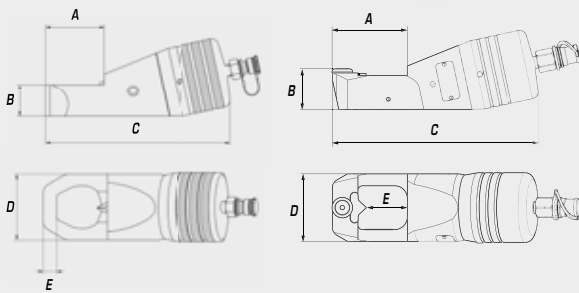

Hydraulic nut splitting head complete with automatic quick coupler. For operating the head must be joined to a hydraulic pump developing a pressure of 700 bar (see page 170-174).

APPLICATION RANGE TOOLS TYPE RHTD AND B-TD

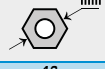
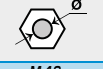
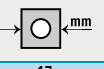
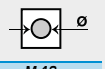
TOOL TYPE	HEXAGONAL NUTS		SQUARE NUTS	
				
RHTD 1724 B-TD270E	16	M 10	17	M 10
	17	M 10	19	M 12
	18	M 12	22	M 14
	19	M 12	24	M 16
	21	M 14	27	M 18
	22	M 14		
	24	M 16		
RHTD 3241 RHTD 410T B-TD410TE	27	M 18	27	M 18
	27	M 18	27	M 18
	30	M 20	30	M 20
	32	M 22	32	M 22
	34	M 22	34	M 24
	36	M 24	36	M 27
	41	M 27		

B-TD410TE

Suitable for splitting square and hexagonal nuts or fastening bushes mm	Dimensions mm	Weight kg
27 (M18) ÷ 41 (M27)	1.360 x 83 x 350	8,8

B-TD410TE

18.0 V battery operated hydraulic tool suitable for splitting fastening bushes, hexagonal and square nuts as per RHTD 410T.



18.0V
4.0Ah
Li-Ion



B-TD270E

18.0 V battery operated hydraulic tool suitable for splitting fastening bushes, hexagonal and square nuts as per RHTD 1724.



18.0V
4.0Ah
Li-Ion



B-TD270E

Suitable for splitting nuts mm	Dimensions mm	Weight kg
16 (M10) ÷ 27 (M18)	1.292,5 x 83 x 350	5,5

PRESSURE TEST DEVICE FOR HYDRAULIC PUMPS AND TOOLS

MPC 1

The MPC1 device, complete with test adapter set, is used to measure the maximum oil pressure on all Cembre tools.



MPC 2

The MPC2 device, complete with test die set, to measure the maximum force developed by Cembre tools:
HT 131-C, HT 131LN-C, HT 120, HT 120-KV, RHC 131, RHC 131-KV, RHC 131LN, B 131-C, B 131-C-KV, B 131LN-C, B 131LN-C-KV, B 135-C, B 135-C-KV, B 135LN-C, B 135LN-C-KV.



MPC 4

The MPC4 device, complete with test die set, to measure the maximum force developed by Cembre tools:
ECW-H3D, RHU240-3D-850, RHU 300-3D



MPC 7

The MPC7 device, complete with test die set, to measure the maximum force developed by Cembre tools:
HT45, HT 51, HT 51-KV, HT 51L, HT 51L-KV, RH 50, HT 61, RH 61, B15D (use adaptor available separately), B 35-45D, B 35-50D, B 46, B 51, B 51-KV, B 51L, B 51L-KV, B 54D, B 55, B 55-KV, B 62.



ACCESSORIES

Flexible hoses

High pressure flexible hoses for joining hydraulic heads to pumps. In addition to the standard versions listed below alternative hose lengths are available, upon request:



TF 300-Q 38 FM
3 m length flexible hose fitted with an automatic female quick coupler and a male quick coupler.

TF 600-Q 38 FM
6 m length flexible hose fitted with an automatic female quick coupler and a 3/8" NPT male threaded bush.

TF 300-Q 38 F
3 m length flexible hose equipped with automatic female quick coupler at one end and male threading at the other end.

Quick couplers

STANDARD VERSIONS



Q 14-MS
Male automatic coupler for hydraulic heads (1/4" NPT).

Q 14-MS



Q 38-F
Female automatic coupler for hydraulic pumps and flexible hoses (3/8" NPT).

Q 38-F



Q 38-MS
Male automatic coupler for flexible hoses (3/8" NPT).

Q 38-MS

INSULATED VERSIONS



I 38-F
Female automatic coupler for insulated hydraulic pumps and flexible hoses (3/8" NPT).

I 38-F



I 38-MS
Male automatic coupler for insulated flexible hoses (3/8" NPT).

I 38-MS



CORDLESS HYDRAULIC TOOLS

18.0 V - 4.0 Ah CORDLESS TOOL FEATURES

- 1 Head rotates through 180°.
- 2 Switch protected against accidental operation.
- 3 Pressure release button.
- 4 Slot-in battery with release button.
- 5 LED lighting of the working area.
- 6 Motor ventilation.
- 7 Bi-component body for increased impact resistance.

- 8 Multifunction OLED display with touch button.
- 9 Improved balance for better handling.
- 10 Anatomically shaped grip for greater comfort.
- 11 18.0 V - 4.0 Ah Li-Ion high power batteries.
- 12 SMARTOOL technology for visualizing and download the recorded data

**18.0V
4.0Ah
Li-Ion**

**NEW
18V Li-Ion
BATTERY**

**DOUBLE
ACTION
SPEED**

New



SUPPLIED WITH

- 1 CB 1840L, 18.0 V - 4.0 Ah Li-Ion high power battery (2 pcs.)
 - 2 ASC 30-36 UK 27045000 Battery charger.
(INPUT 220-240 V / 50-60 Hz; OUTPUT 12-42 V DC / 3.0 A max.)
 - 3 USB cable.
 - 4 Shoulder strap.
- Plastic or Metal carrying case.



Multifunction OLED display:

LED ON *General operating information*

15
9985 *Tool service required to maintain optimum condition*

BATTERY *Battery power availability*

P_m 692 bar
OK *Pressure level check*

F_m 125.2 kN
OK *Crimping force check*



18.0 V - 2.0 Ah CORDLESS TOOL FEATURES

- 1 Head rotates for ease of operation in confined spaces
- 2 Switch protected against accidental operation
- 3 Pressure release button
- 4 Slot-in battery with release button
- 5 Battery condition displayed to show the residual battery power
- 6 Motor ventilation.
- 7 The tools are fitted with a maximum pressure valve to indicate a correct crimping operation or the full extent of the ram travel.
- 8 Can be operated with one hand
- 9 Durable moulded body offering high resistance to wear and damage in all operating conditions.
- 10 Extremely quiet in operation with very little vibration.
- 11 Improved balance for better handling.
- 12 Anatomically shaped grip for greater comfort.
- 13 18.0 V - 2.0 Ah Li-Ion high power batteries.

New

**18.0V
2.0Ah
Li-Ion**

**NEW
18V Li-Ion
BATTERY**



SUPPLIED WITH

- 1 CB 1820L, 18.0 V - 2.0 Ah Li-Ion high power battery (2 pcs.)
 - 2 ASC 30-36 UK 27045000 Battery charger.
(INPUT 220-240 V / 50-60 Hz; OUTPUT 12-42 V DC / 3.0 A max.)
- Plastic carrying case or vinyl bag.

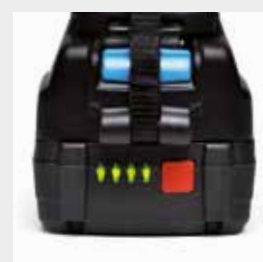

18.0 V CORDLESS HYDRAULIC CRIMPING TOOL

B 15MDE

general features



Crimping force kN	Dimensions mm			Battery Li-Ion	Weight kg (with battery)
	length	height	width		
15	337	133	81	18.0V 2.0Ah	1,74

**18.0V
2.0Ah
Li-Ion**

New

**NEW
18V Li-Ion
BATTERY**



Can be operated with one hand. Balanced for greater control. Head rotates by 340° for ease of operation in confined spaces. The tool is fitted with a maximum pressure valve.

MAIN APPLICATIONS - max section mm²

Copper lugs and splices	Insulated terminals	End sleeves
0,25 - 16	0,25 - 16	0,3 - 35

STORAGE

Type	Dimensions mm	Weight kg	Supplied with the tool	Purchase separately
VAL P22	465x315x116	1,5	✳	—

The tool is supplied as:

- Basic tool with battery and wrist strap
- Spare battery
- Battery charger

- Plastic carrying case suitable for storing the tool and accessories



Extremely quiet, minimal vibration. Durable moulded body offering high resistance to wear and damage in all operating conditions. New Li-Ion 18.0V 2.0Ah High Power battery.

Many different interchangeable crimping dies available

CRIMPING DIES AVAILABLE				
Conductor size mm ²	Conductor size (AWG)	Connector type	DIE SET	
0,25 ÷ 16	22 ÷ 6	A...; L...-M; L...-P; S...; RN...; BN...; GN...	MA03/3-15	☺
1,5 ÷ 10	16 ÷ 8	A...; L...-M; L...-P	ME03/2-15	☺
10 ÷ 16	8 ÷ 6	A...; 2A...; L...-M; L...-P	ME2/3-15	
4 ÷ 10	12 ÷ 8	T... (NF C 20130 style); L...-T	MS4/10-15	
10 ÷ 16	8 ÷ 6	T... (NF C 20130 style); L...-T	MS10/16-15	
10 ÷ 16	8 ÷ 6	HR...; HSV...	MH10/16-15	
6 ÷ 16	10 ÷ 6	DR... (DIN 46235 style); DSV... (DIN 46267 T1 style)	MK5/8-15	☺
10 ÷ 16	8 ÷ 6	ANE...; AN...; IN...; EN...	NN4-15	
0,25 ÷ 6	22 ÷ 10	R...; B...; G... (not suffix P); PL...; NL...	RBG-15	☺
0,25 ÷ 6	22 ÷ 10	R...; B...; G... (not suffix P, RF/BF-BF)	RBV-15 with positioner	
0,3 ÷ 4	22 ÷ 12	PKE; PKC; PKD; PKT; KE	KE4-15	☺
4 ÷ 16	12 ÷ 6	PKE; PKC; PKD; PKT; KE	KE16-15	
16 ÷ 35	6 ÷ 2	PKE; PKC; PKD; PKT; KE	KE35-15	
2,5 - 4 - 6	14 - 12 - 10	CS4 (per impianti fotovoltaici) ☼	MCS4-15	☺

The battery is equipped with LED indicators to show the remaining battery life at any time by pressing the adjacent button.

Supplied in a robust plastic case to accommodate the tool and all the accessories.

Two batteries and charger included. Many different interchangeable crimping dies available.

Operating temperature: -15 to +50 °C



Battery condition display



Interchangeable die sets



Ergonomically designed operating switch



Automatic slot-in battery

18.0 V CORDLESS HYDRAULIC CRIMPING TOOL



general features

B 35-45MDE

**18.0V
2.0Ah
Li-Ion**

Crimping force kN	Dimensions mm			Battery Li-Ion	Weight kg (with battery)
	length	height	width		
35	354	133	81	18.0V 2.0Ah	2,19

MAIN APPLICATIONS - max section mm²

L.V. lugs and splices	"C" sleeve Connectors	H.V. lugs and splices
150	35	70

STORAGE

Type	Dimensions mm	Weight kg	Supplied with the tool	Purchase separately
VAL P22	465x315x116	1,5	✳	—

The tool is supplied as:

- Basic tool with battery and wrist strap
- Spare battery
- Battery charger
- Plastic carrying case suitable for storing the tool and accessories



Can be operated with one hand. Balanced for greater control. Head rotates 180° for ease of operation in confined spaces. Fitted with a maximum pressure valve. Extremely quiet, minimal vibration. Durable moulded body offering high resistance to wear and damage in all operating conditions.

New Li-Ion 18.0V 2.0Ah High Power battery. The battery is equipped with LED indicators to show the remaining battery life at any time by pressing the adjacent button. Supplied in a robust plastic case to accommodate the tool and all the accessories. Two batteries and charger included.

New

**NEW
18V Li-Ion
BATTERY**



B35-45MDE accepts many of the dies common to 45 kN Cembre crimping tools. B35-45MDE specific dies available for crimping 120 mm² and 150 mm². Application field as shown in the table above. For further details please refer to tables of page 178-190. Operating temperature: -15 to +50 °C

Wide-opening head, ideal for derivations from running conductors



Motor ventilation



Head rotates 180° for ease of operation



Pressure release button



Sculptured body for optimum comfort

These tools are supplied without dies. For die selection, please refer to chart on pages 178 to 190

18.0 V CORDLESS HYDRAULIC CRIMPING TOOL

B 35-50MDE

general features



Crimping force kN	Dimensions mm			Battery Li-Ion	Weight kg (with battery)
	length	height	width		
35	387	133	81	18.0V 2.0Ah	2,6

**18.0V
2.0Ah
Li-Ion**

New

MAIN APPLICATIONS - max section mm ²			
L.V. lugs and splices	Insulated terminals	End sleeves	"C" sleeve Connectors
150	50	95	35

STORAGE				
Type	Dimensions mm	Weight kg	Supplied with the tool	Purchase separately
VAL P22	465x315x116	1,5	✳	—

The tool is supplied as:

- Basic tool with battery and wrist strap
- Spare battery
- Battery charger
- Plastic carrying case suitable for storing the tool and accessories



**NEW
18V Li-Ion
BATTERY**

Can be operated with one hand. Balanced for greater control. Head rotates 180° for ease of operation in confined spaces. Fitted with a maximum pressure valve. Extremely quiet, minimal vibration. Durable moulded body offering high resistance to wear and damage in all operating conditions. New Li-Ion 18.0V 2.0Ah High Power battery. The battery is equipped with LED indicators to show the remaining battery life at any time by pressing the adjacent button.

Supplied in a robust plastic case to accommodate the tool and all the accessories. Two batteries and charger included. B35-50MDE accepts many of the dies common to 50 kN Cembre crimping tools.

B35-50MDE specific dies available for crimping 120 mm² and 150 mm². Application field as shown in the table above. For further details please refer to tables of page 178-190. Operating temperature: -15 à +50 °C



Wide-opening head, ideal for derivations from running conductors



Battery condition display



Pressure release button



Switch ergonomically designed



Automatic slot-in battery

These tools are supplied without dies. For die selection, please refer to chart on pages 178 to 190

18.0 V CORDLESS HYDRAULIC CRIMPING TOOL



general features

B 54MD-D6E

18.0V
2.0Ah
Li-Ion

Crimping force kN	Dimensions mm			Battery Li-Ion	Weight kg (with battery)
	length	height	width		
54	458	133	81	18.0V 2.0Ah	2,95

MAIN APPLICATIONS - max section AWG

Copper lugs and splices	Aluminum lugs and splices	Aluminum H taps
300 MCM	4/0	4/0 - 4/0

STORAGE

Type	Dimensions mm	Weight kg	Supplied with the tool	Purchase separately
VAL P45	497x370x137	2,3	✳	—
VAL MAT-W	175x96x45	0,93	—	✳

The tool is supplied as:

- Basic tool with battery and wrist strap
- Spare battery
- Battery charger
- Plastic carrying case suitable for storing the tool and accessories



VAL MAT-W



Available as optional accessories:
VAL MAT-W metal case for storing 12 Index die sets, fits into VAL-P45.

The professional tool ideal for OH lines and residential service applications.

Stick tool shape for better handling. Can be operated with one hand. Balanced for greater control. Jaws rotate by 180° for ease of operation in confined spaces. The tool is fitted with a maximum pressure valve. Extremely quiet, minimal vibration. Durable moulded body offering high resistance to wear and damage in all operating conditions. New Li-Ion 18V 2Ah High Power battery. The battery is equipped with LED indicators to show the remaining battery life at any time by pressing the adjacent button. Supplied in a robust plastic case for storing the tool and all accessories. Two batteries and charger included. Standard interchangeable crimping jaw: **CDD6** with "D3" groove to accept all "W" style crimping dies + "BG" fixed groove. Operating temperature: -15 à +50 °C

New

NEW
18V Li-Ion
BATTERY



INTERCHANGEABLE CRIMPING JAWS

CAT. No	GROOVES	CRIMPING DIE COMPATIBILITY
CDD6	"D3" TO ACCEPT ALL "W" STYLE CRIMPING DIES + "BG" FIXED GROOVE	FCI Burndy Green lee IlSCO
CDD6-8	"D3" TO ACCEPT ALL "W" STYLE CRIMPING DIES + "O" FIXED GROOVE	Huskie Panduit
CMB1	Cutting jaws for: one-time disposable lock hasps; 4AWG Alumoweld; ACSR 4/0	
CMB2	Cutting jaws for: # 8 Copperweld; 4/0 Cu.; 336 MCM Aluminium; 477 MCM ACSR (Str. 26/7)	
CMB3	Cutting jaws for: 1/4" Guy Wire ; 5/16" Guy Wire	

CDD6 jaws

With "D3" groove to accept all "W" style crimping dies + "BG" fixed groove.



CDD6-8 jaws

With "D3" groove to accept all "W" style crimping dies + "O" fixed groove.



CMB1 jaws

Cutting jaws for: one-time disposable lock hasps, 4AWG Alumoweld; ACSR 4/0



CMB2 jaws

Cutting jaws for:
- # 8 Copperweld
- 4/0 Cu.
- 336 MCM Aluminium
- 477 MCM ACSR (Str. 26/7)



CMB3 jaws

Cutting jaws for:
- 1/4" Guy Wire
- 5/16" Guy Wire



Canvas Bag 013

Sturdy canvas bag, suitable for storing the cutting jaws



Jaws rotate 180°



Detail of the quick jaw change device.

18.0 V CORDLESS HYDRAULIC CRIMPING TOOL

B 500E

New



**NEW
18V Li-Ion
BATTERY**

general features



Nominal Compression Force kN	Dimensions mm			Battery Li-Ion	Weight kg (with battery)
	length	height	width		
63	300	343	83	18.0 V 4.0 Ah	4,2



**18.0V
4.0Ah
LI-ION**

MAIN APPLICATIONS - max section mm²

L.V. lugs and splices	Insulated terminals	End sleeves	"C" sleeve Connectors
300	120	120	70

STORAGE

Type	Dimensions mm	Weight kg	Supplied with the tool	Purchase separately
VALP38	520x432x126	2,6	*	—

The tool is supplied as:

- Basic tool with battery and shoulder strap
- Spare battery
- Battery charger
- USB cable
- Plastic carrying case suitable for storing the tool and 14 die sets



The next generation of Cembre cordless hydraulic tools represents a significantly advantageous evolution from current models.

Born of the renowned B51 type crimping tool, the 63 kN B500E is suitable for a wide range of connectors up to 240 sqmm using die sets common to the Cembre 50 kN tooling range.

New Li-Ion 18 V 4 Ah batteries offer a higher capacity than 14.4 V 3 Ah, while greater crimping speed and crimping force result from a revitalised hydraulic system with double speed action: a rapid approach of the dies to the connector then a slower, more powerful speed for crimping.

A maximum pressure sensor and pressure relief valve assure greater precision and repeatability of the pressure cycle and double the provision for operator safety.

The OLED display provides essential real time tool operating information data including:

- Crimping pressure and force being generated, for confirmation of adherence to norms and best practice
- Battery power availability
- Tool identification, LED work light state, reset, no. of operational and service crimping cycles
- Tool service required to maintain optimum condition.

Designed with improved balance, B500E is easily manageable during the crimping process and, by the use of bi-component plastics, has a shell with high resistance to wear and damage.

Rubber grip inserts, low noise and minimal vibration aid operator comfort while additional convenience and safety are provided by LED lighting of the working area. Crimping cycle data (up to 200,000 events) is automatically stored on a memory card for transfer to PC by USB interface.

Operating temperature:
-15 to +50 ° C

New



B 500E-KV
version also available for
Power Supply Companies

LED lighting of the working area



Anatomically shaped grip for improved comfort



Multifunction OLED display with touch button



Slot-in battery with release button



These tools are supplied without dies. For die selection, please refer to chart on pages 178 to 190

18.0 V CORDLESS HYDRAULIC CRIMPING TOOL



general features



**18.0V
4.0Ah
Li-Ion**

Crimping force kN	Dimensions mm			Battery Li-Ion	Weight kg (with battery)
	length	height	width		
57.7	358	358	83	18.0 V 4.0 Ah	5,3

MAIN APPLICATIONS - max section mm²

Copper lugs and splices	Insulated terminals	End sleeves	"C" sleeve Connectors
240	120	120	70

STORAGE

Type	Dimensions mm	Weight kg	Supplied with the tool	Purchase separately
VALP40	520x432x126	2,6	✳	—

The tool is supplied as:

- Basic tool with battery, wrist strap and shoulder strap
- Spare battery
- Battery charger
- USB cable
- Plastic carrying case suitable for storing the tool and accessories



With adapter AU55-50 for accepting Cembre dies.

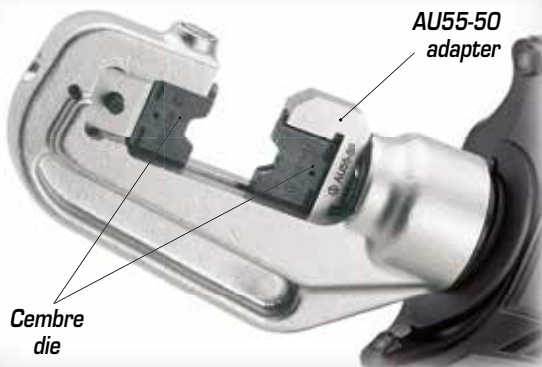

With adapter AU55-W for accepting "W" dies.

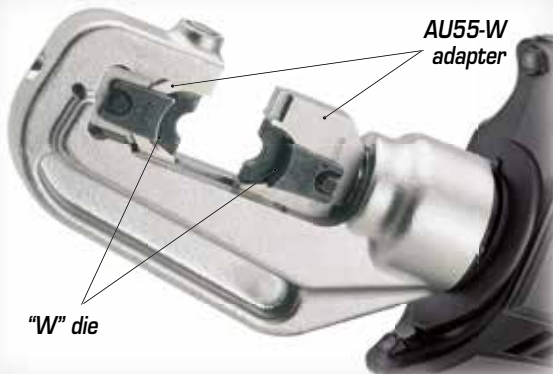

The next generation of Cembre cordless hydraulic tools represents a significantly advantageous evolution from current models.

The B 550E, with adapter AU55-50, will accept all Cembre 50 kN dies; with adapter AU55-W it will accept "W" dies.

New Li-Ion 18 V 4 Ah batteries offer a higher capacity than 14.4 V 3 Ah, while greater crimping speed and crimping force result from a revitalised hydraulic system with double speed action: a rapid approach of the dies to the connector then a slower, more powerful speed for crimping. A maximum pressure sensor and pressure relief valve assure greater precision and repeatability of the pressure cycle and double the provision for operator safety.

The OLED display provides essential real time tool operating information data including:

- Crimping pressure and force being generated, for confirmation of adherence to norms and best practice
- Battery power availability
- Tool identification, LED work light state, reset, no. of operational and service crimping cycles
- Tool service required to maintain optimum condition.

B 550E

New



**NEW
18V Li-Ion
BATTERY**

Designed with improved balance, B550E is easily manageable during the crimping process and, by the use of bi-component plastics, has a shell with high resistance to wear and damage.

Rubber grip inserts, low noise and minimal vibration aid operator comfort while additional convenience and safety are provided by LED lighting of the working area. Crimping cycle data (up to 200,000 events) is automatically stored on a memory card for transfer to PC by USB interface.

Operating temperature:
-15 to +50 ° C

New



B 550E-KV

Suitable for installing the same range of connectors of B 550E, B 550E-KV tool is provided with additional coatings to protect the operator and tool against accidental brush contact with energised conductors.

Particularly suitable for Power Supply Companies.

These tools are supplied without dies. For die selection, please refer to chart on pages 178 to 190

18.0 V CORDLESS HYDRAULIC CRIMPING TOOL

B 1350-CE

New

general features



Nominal Compression Force kN	Dimensions mm			Jaw Opening mm	Battery Li-Ion	Weight kg (with battery)
	length	height	width			
132	338	344	83	25	18.0 V 4.0 Ah	6,4



**18.0V
4.0Ah
Li-Ion**

The next generation of Cembre cordless hydraulic tools represents a significantly advantageous evolution from current models. Born of the renowned B135-C type crimping tool, B1350-CE is suitable for a wide range of connectors up to 400 sqmm using die sets common to the Cembre 130 kN tooling range. New Li-Ion 18 V 4 Ah batteries offer a higher capacity than 14.4 V 3 Ah, while greater crimping speed and crimping force result from a revitalised hydraulic system with double speed action: a rapid approach of the dies to the connector then a slower, more powerful speed for crimping. A maximum pressure sensor and pressure relief valve assure greater precision and repeatability of the pressure cycle and double the provision for operator safety.



**NEW
18V Li-Ion
BATTERY**

The OLED display provides essential real time tool operating information data including:

- Crimping pressure and force being generated, for confirmation of adherence to norms and best practice
- Battery power availability
- Tool identification, LED work light state, reset, no. of operational and service crimping cycles
- Tool service required to maintain optimum condition.

MAIN APPLICATIONS - max section mm²

L.V. lugs and splices	Insulated terminals	"C" sleeve Connectors	H.V. lugs	H.V. Splices
400	240	185	400	400*

* limited to the cable insulation diameter

STORAGE

Type	Dimensions mm	Weight kg	Supplied with the tool	Purchase separately
VALP39	520x432x126	2,6	✳	—

The tool is supplied as:

- Basic tool with battery and shoulder strap
- Spare battery
- Battery charger
- USB cable
- Plastic carrying case suitable for storing the tool and 8 die sets

Designed with improved balance, B1350-CE is easily manageable during the crimping process and, by the use of bi-component plastics, has a shell with high resistance to wear and damage. Rubber grip inserts, low noise and minimal vibration aid operator comfort while additional convenience and safety are provided by LED lighting of the working area. Crimping cycle data (up to 200,000 events) is automatically stored on a memory card for transfer to PC by USB interface. Operating temperature: -15 to +50 °C



B 1350-CE-KV version also available for Power Supply Companies

18.0 V CORDLESS HYDRAULIC CRIMPING TOOL

B 1350L-CE

New

general features



Crimping force kN	Dimensions mm			Jaw Opening mm	Battery Li-Ion	Weight kg (with battery)
	length	height	width			
132	395	372	83	42	18.0 V 4.0 Ah	8,2



**18.0V
4.0Ah
Li-Ion**

B1350L-CE version, featuring a large 42 mm jaw opening, for an easier introduction/removal of large size compression terminations and joints.

The tool is supplied as:

- Basic tool with battery and shoulder strap
- Spare battery
- Battery charger
- USB cable
- Plastic carrying case suitable for storing the tool and 8 die sets

MAIN APPLICATIONS - max section mm²

L.V. lugs and splices	Insulated terminals	"C" sleeve Connectors	H.V. lugs and splices
400	240	185	400

STORAGE

Type	Dimensions mm	Weight kg	Supplied with the tool	Purchase separately
VALP39	520x432x126	2,6	✳	—



B 1350L-CE-KV version also available for Power Supply Companies

These tools are supplied without dies. For die selection, please refer to chart on pages 178 to 190

18.0 V CORDLESS HYDRAULIC CRIMPING TOOL



general features

B 1350-UCE

New



18.0V
4.0Ah
Li-Ion

Crimping force kN	Dimensions mm			Battery Li-Ion	Weight kg (with battery)
	length	height	width		
132	351	369	83	18.0 V 4.0 Ah	5,9

MAIN APPLICATIONS - max section mm²

L.V. lugs and splices	Insulated terminals	"C" sleeve Connectors	H.V. lugs and splices	Alu lugs and splices
400	240	185	400	300

STORAGE

Type	Dimensions mm	Weight kg	Supplied with the tool	Purchase separately
VALP39	520x432x126	2,6	✳	—
VAL 130*	360x280x48	3,0	—	✳

*Suitable for the storage of accessories for crimping Aluminium connectors

The tool is supplied as:

- Basic tool with battery and shoulder strap
- Spare battery
- Battery charger
- USB cable
- Plastic carrying case suitable for storing the tool and 8 die sets

The next generation of Cembre cordless hydraulic tools represents a significantly advantageous evolution from current models.

Born of the renowned B135-UC type crimping tool, B1350-UCE will accept the accessories for performing the "Deep Stepped Indent" system of crimping on Aluminium cables.

The B1350-UCE will accept all semi-circular slotted dies, common to most 12 tons tools (U dies).

New Li-Ion 18 V 4 Ah batteries offer a higher capacity than 14.4 V 3 Ah, while greater crimping

speed and crimping force result from a revitalised hydraulic system with double speed action: a rapid approach of the dies to the connector then a slower, more powerful speed for crimping.

A maximum pressure sensor and pressure relief valve assure greater precision and repeatability of the pressure cycle and double the provision for operator safety.

The OLED display provides essential real time tool operating information

data including:

- Crimping pressure and force being generated, for confirmation of adherence to norms and best practice
- Battery power availability
- Tool identification, LED work light state, reset, no. of operational and service crimping cycles
- Tool service required to maintain optimum condition.

Designed with improved balance, B1350-UCE is easily manageable

Multifunction
OLED display
with touch button

during the crimping process and, by the use of bi-component plastics, has a shell with high resistance to wear and damage.

Rubber grip inserts, low noise and minimal vibration aid operator comfort while additional convenience and safety are provided by LED lighting of the working area.

Crimping cycle data (up to 200,000 events) is automatically stored on a memory card for transfer to PC by USB interface.

Operating temperature:
-15 to +50 ° C



VAL P39



VAL 130



NEW
18V Li-Ion
BATTERY



LED lighting of the working area



Multifunction
OLED display
with touch button



Anatomically shaped grip for improved comfort



Slot-in battery with release button

These tools are supplied without dies. For die selection, please refer to chart on pages 178 to 190

18.0 V CORDLESS HYDRAULIC CRIMPING TOOL

B 1300-CE

New

general features



Crimping force kN	Dimensions mm			Jaw Opening mm	Battery Li-Ion	Weight kg (with battery)
	length	height	width			
132	406	239	102,5	25	18.0 V - 4.0 Ah	6,5



**18.0V
4.0Ah
Li-Ion**



**NEW
18V Li-Ion
BATTERY**

MAIN APPLICATIONS - max section mm²

L.V. lugs and splices	Insulated terminals	"C" sleeve Connectors	H.V. lugs	H.V. Splices
400	240	185	400	400*

* limited to the cable insulation diameter

STORAGE

Type	Dimensions mm	Weight kg	Supplied with the tool	Purchase separately
VAL P44	680x473x151	3,7	✳	—

The tool is supplied as:

- Basic tool with battery and shoulder strap
- Spare battery
- Battery charger
- USB cable
- Plastic carrying case suitable for storing the tool and 12 die sets



The next generation of Cembre cordless hydraulic tools represents a significantly advantageous evolution from current models.

Born of the renowned B131-C type crimping tool, B1300-CE is suitable for a wide range of connectors up to 400 sqmm using die sets common to the Cembre 130 kN tooling range.

New Li-Ion 18 V 4 Ah batteries offer a higher capacity than 14.4 V 3 Ah, while greater crimping speed and crimping force result from a revitalised hydraulic system with double speed action: a rapid approach of the dies to the connector then a slower, more powerful speed for crimping.

A maximum pressure sensor and pressure relief valve assure greater precision and repeatability of the pressure cycle and double the provision for operator safety.

The OLED display provides essential real time tool operating information data including:

- Crimping pressure and force being generated, for confirmation of adherence to norms and best practice
- Battery power availability
- Tool identification, LED work light state, reset, no. of operational and service crimping cycles
- Tool service required to maintain optimum condition.

Designed with improved balance, B1300-CE is easily manageable during the crimping process and, by the use of bi-component plastics, has a shell with high resistance to wear and damage.

Rubber grip inserts, low noise and minimal vibration aid operator comfort while additional convenience and safety are provided by LED lighting of the working area.

Crimping cycle data (up to 200,000 events) is automatically stored on a memory card for transfer to PC by USB interface.

Operating temperature: -15 to +50 °C



New

B 1300-CE-KV
version also available for
Power Supply Companies

Anatomically shaped grip for improved comfort



LED lighting of the working area



New

B 1300L-CE-KV
version also available for
Power Supply Companies



Slot-in battery with release button



Multifunction OLED display with touch button

These tools are supplied without dies. For die selection, please refer to chart on pages 178 to 190

18.0 V CORDLESS HYDRAULIC CRIMPING TOOL



general features



18.0V
4.0Ah
Li-Ion

Crimping force kN	Dimensions mm			Jaw Opening mm	Battery Li-Ion	Weight kg (with battery)
	length	height	width			
132	471	239	102,5	42	18.0 V - 4.0 Ah	8,0

MAIN APPLICATIONS - max section mm²

L.V. lugs and splices	Insulated terminals	"C" sleeve Connectors	H.V. lugs and splices
400	240	185	400

STORAGE

Type	Dimensions mm	Weight kg	Supplied with the tool	Purchase separately
VAL P44	680x473x151	3,7	✳	—

The tool is supplied as:

- Basic tool with battery and shoulder strap
- Spare battery
- Battery charger
- USB cable
- Plastic carrying case suitable for storing the tool and 12 die sets

Also available in the B1300L-CE version, featuring a large 42 mm jaw opening, for an easier introduction/removal of large size compression terminations and joints.



New

NEW
18V Li-Ion
BATTERY

18.0 V CORDLESS HYDRAULIC CRIMPING TOOL



general features



18.0V
4.0Ah
Li-Ion

Crimping force kN	Dimensions mm			Battery Li-Ion	Weight kg (with battery)
	length	height	width		
132	423	239	102,5	18.0 V - 4.0 Ah	6,5

MAIN APPLICATIONS - max section mm²

L.V. lugs and splices	Insulated terminals	"C" sleeve Connectors	H.V. lugs and splices	Alu lugs and splices
400	240	185	400	300

STORAGE

Type	Dimensions mm	Weight kg	Supplied with the tool	Purchase separately
VAL P44	680x473x151	3,7	✳	—
VAL 130*	360x280x48	3,0	—	✳

*Suitable for the storage of accessories for crimping Aluminium connectors

The tool is supplied as:

- Basic tool with battery and shoulder strap
- Spare battery
- Battery charger
- USB cable
- Plastic carrying case suitable for storing the tool and 12 die sets



VAL P44



VAL 130

The next generation of Cembre cordless hydraulic tools represents a significantly advantageous evolution from current models. Born of the renowned B131-UC type crimping tool, B1300-UCE will accept the accessories for performing the "Deep Stepped Indent" system of crimping on Aluminium cables. The B1300-UCE will accept all semi-circular slotted dies, common to most 12 tons tools (U dies).

New Li-Ion 18 V 4 Ah batteries offer a higher capacity than 14.4 V 3 Ah, while greater crimping speed and crimping force result from a revitalised hydraulic system with double speed action: a rapid approach of the dies to the connector then a slower, more powerful speed for crimping. A maximum pressure sensor and pressure relief valve assure greater precision and repeatability of the pressure cycle and double the provision for operator safety.

The OLED display provides essential real time tool operating information data including:

- Crimping pressure and force being generated, for confirmation of adherence to norms and best practice
- Battery power availability
- Tool identification, LED work light state, reset, no. of operational and service crimping cycles
- Tool service required to maintain optimum condition.

Designed with improved balance, B1300-UCE is easily manageable during the crimping process and, by the use of bi-component plastics, has a shell with high resistance to wear and damage. Rubber grip inserts, low noise and minimal vibration aid operator comfort while additional convenience and safety are provided by LED lighting of the working area. Crimping cycle data (up to 200,000 events) is automatically stored on a memory card for transfer to PC by USB interface. Operating temperature: -15 to +50 °C

B 1300-UCE

New

NEW
18V Li-Ion
BATTERY

These tools are supplied without dies. For die selection, please refer to chart on pages 178 to 190

OVERHEAD LINE APPLICATION
B35M-TC025E

18.0 V CORDLESS HYDRAULIC CUTTING TOOL

general features



**18.0V
2.0Ah
Li-Ion**

Max cutting Ø mm	Dimensions mm			Battery Li-Ion	Weight kg (with battery)
	length	height	width		
25	391	133	81	18.0V 2.0 Ah	3,1



STORAGE

Type	Dimensions mm	Weight kg	Supplied with the tool	Purchase separately
VAL P22	465x315x116	1,5	✳	—

- The tool is supplied as:**
- Battery charger
 - Basic tool with battery and wrist strap
 - Spare battery
 - Plastic carrying case suitable for storing the tool and accessories

CUTTING CAPACITY

MATERIAL	TENSILE STRENGTH (daN/mm ²)	MAX CUTTING DIAMETER (mm)	
		B35M-TC025	
ROPE & CONDUCTORS	COPPER	≤ 41	25
	ALUMINIUM	≤ 20	25
	ALMELEC	≤ 34	25
	STEEL	≤ 180	INDICATIVE EXAMPLES: 19 x 2,1 : Ø est. = 10,5 mm 19 x 2,2 : Ø est. = 11,0 mm
	MULTI STRANDS STEEL (STRANDS Qty ≥ 200)	≤ 180	-
RODS	ACSR	≤ 180	25 INDICATIVE EXAMPLES: 26 x 2,50 + 7 x 1,95 : Ø est. = 15,85 26 x 3,06 + 7 x 2,38 : Ø est. = 19,38 26 x 3,60 + 7 x 2,80 : Ø est. = 22,80
	STEEL	≤ 60	10
		≤ 42	-
	COPPER	≤ 30	-
ALUMINIUM	≤ 25	16	
	≤ 16	25	

ration in confined spaces. Fitted with a maximum pressure valve. Extremely quiet, minimal vibration. Durable moulded body offering high resistance to wear and damage in all operating conditions. New Li-Ion 18V 2Ah High Power battery. The battery is equipped with LED indicators to show the remaining battery life at any time by pressing the adjacent button. Supplied in a robust plastic case to accommodate the tool and all the accessories. Two batteries and charger included. Operating temperature: -15 to +50 °C

Can be operated with one hand. Balanced for greater control. Head rotates 180° for ease of ope-

18.0 V CORDLESS HYDRAULIC CUTTING TOOL

general features



**18.0V
2.0Ah
Li-Ion**

Max cutting Ø mm	Dimensions mm			Battery Li-Ion	Weight kg (with battery)
	length	height	width		
26	436	140	81	18.0V 2.0 Ah	3,4



STORAGE

Type	Dimensions mm	Weight kg	Supplied with the tool	Purchase separately
VAL P48	620x360x138	2,4	✳	—

- The tool is supplied as:**
- Battery charger
 - Basic tool with battery and wrist strap
 - Spare battery
 - Plastic carrying case suitable for storing the tool and accessories

CUTTING CAPACITY - a few examples

Section mm ²	Ø		CABLE TYPE
	mm	mm	
120	13,34	12,0	RIM120
95	-	-	Steel cable with Bitum (DIEPA)
95	-	-	Steel cable Lidra
-	~ 10	-	10mm grounding wire with insulation
50	~ 8,85	-	Bronze
70	~ 10,3	-	Bronze
95	~ 12,5	-	Bronze
70	~ 10,5	-	Aluminium
95	~ 12,5	-	Aluminium
150	~ 15,8	-	Aluminium
35/6	~ 8,0	-	Aluminium-steel
50/8	~ 9,5	-	Aluminium-steel
50/3	~ 11,5	-	Aluminium-steel
70/12	~ 11,8	-	Aluminium-steel
95/15	~ 13,8	-	Aluminium-steel
150/25	~ 17,0	-	Aluminium-steel
230/30	~ 21,0	-	Aluminium-steel
265/35	~ 23,0	-	Aluminium-steel

Can be operated with one hand. Balanced for greater control. Head rotates 180° for ease of operation in confined spaces. Fitted with a maximum pressure valve. Extremely quiet, minimal vibration. Durable moulded body offering high resistance to wear and damage in all operating conditions. New Li-Ion 18V 2Ah High Power battery. The battery is equipped with LED indicators to show the remaining battery life at any time by pressing the adjacent button. Supplied in a robust plastic case to accommodate the tool and all the accessories.

Two batteries and charger included. Operating temperature: -15 to +50 °C

OVERHEAD LINE APPLICATION
B-TC250BSE

New

**NEW
18V Li-Ion
BATTERY**

New

**NEW
18V Li-Ion
BATTERY**



18.0 V CORDLESS HYDRAULIC CUTTING TOOL



general features



18.0V
4.0Ah
Li-Ion

Max cutting Ø mm	Dimensions mm			Battery Li-Ion	Weight kg (with battery)
	length	height	width		
25	300	337	83	18.0 V 4.0 Ah	4,65

STORAGE

Type	Dimensions mm	Weight kg	Supplied with the tool	Purchase separately
VALP40	520x432x126	2,6	✳	—

The tool is supplied as:

- Basic tool with battery and shoulder strap
- Spare battery
- Battery charger
- Cable USB
- Plastic carrying case suitable for storing the tool and accessories



Next generation of 18.0V cordless hydraulic cutting tool specifically designed to cut Copper, aldrej, Aluminium, Aluminium-Steel cables and Steel ropes, Aluminium and Steel rods having a max overall diameter of 25 mm.

The blades are manufactured from high strength special Steel, heat treated to ensure a long service life. New Li-Ion 18 V 4 Ah batteries offer a higher capacity than 14.4 V 3 Ah, while greater cutting speed and cutting force result from a revitalised hydraulic system with double speed action. The battery is equipped with LED indicators to show the remaining battery life at any time by pressing the adjacent button.

The head can rotate through 180 degrees, to enable the operator to work in the most comfortable position, and can easily be opened to allow cutting of running cables.

Fitted with a maximum hydraulic pressure valve.

Designed with improved balance, B-TC250E is easily manageable during the cutting process and, by the use of bi-component plastics, has a shell with high resistance to wear and damage.

Rubber grip inserts, low noise and minimal vibration aid operator comfort while additional convenience and safety are provided by LED lighting of the working area. For cutting capacity data see page 140.

Operating temperature: -15 to +50 ° C

New



NEW
18V Li-Ion
BATTERY

OVERHEAD LINE APPLICATION
B-TC250E

18.0 V CORDLESS HYDRAULIC CUTTING TOOL



general features



18.0V
4.0Ah
Li-Ion

Max cutting Ø mm	Dimensions mm			Battery Li-Ion	Weight kg (with battery)
	length	height	width		
45	407	401	88	18.0 V 4.0 Ah	6,7

STORAGE

Type	Dimensions mm	Weight kg	Supplied with the tool	Purchase separately
VALP40	520x432x126	2,6	✳	—

The tool is supplied as:

- Basic tool with battery and shoulder strap
- Spare battery
- Battery charger
- Cable USB
- Plastic carrying case suitable for storing the tool and accessories



Next generation of 18.0V cordless hydraulic cutting tool specifically designed to cut Copper, aldrej, Aluminium, Aluminium-Steel cables and Steel ropes, Aluminium and Steel rods having a max overall diameter of 45 mm.

The blades are manufactured from high strength special Steel, heat treated to ensure a long service life. New Li-Ion 18 V 4 Ah batteries offer a higher capacity than 14.4 V 3 Ah, while greater cutting speed and cutting force result from a revitalised hydraulic system with double speed action. The battery is equipped with LED indicators to show the remaining battery life at any time by pressing the adjacent button.

The head can rotate through 180 degrees, to enable the operator to work in the most comfortable position, and can easily be opened to allow cutting of running cables.

Fitted with a maximum hydraulic pressure valve.

Designed with improved balance, B-TC450E is easily manageable during the cutting process and, by the use of bi-component plastics, has a shell with high resistance to wear and damage.

Rubber grip inserts, low noise and minimal vibration aid operator comfort while additional convenience and safety are provided by LED lighting of the working area. For cutting capacity data see page 142.

Operating temperature: -15 to +50 ° C

New



NEW
18V Li-Ion
BATTERY

OVERHEAD LINE APPLICATION
B-TC450E

OVERHEAD LINE APPLICATION
B-TC500YE

New



Next generation of 18.0 V cordless hydraulic cutting tool specifically designed to cut Copper, Aluminium, Aluminium-Steel cables (ACSR) having a max overall diameter of 50 mm. The blades are manufactured from high strength special Steel, heat treated to ensure a long service life. New Li-Ion 18 V 4 Ah batteries offer a higher capacity than 14.4 V 3 Ah, while greater cutting speed and cutting force result from a revitalised hydraulic system with double speed action.

NEW 18V Li-Ion BATTERY

The battery is equipped with LED indicators to show the remaining battery life at any time by pressing the adjacent button. The head can rotate through 90 degrees, to enable the operator to work in the most comfortable position, and can easily be opened to allow cutting of running cables.

18.0 V CORDLESS HYDRAULIC CUTTING TOOL

general features



Max cutting Ø mm	Dimensions mm			Battery	Weight kg (with battery)
	length	height	width		
50	405	398	83	18.0 V 4.0 Ah	5,8



18.0V 4.0Ah Li-Ion

STORAGE

Type	Dimensions mm	Weight kg	Supplied with the tool	Purchase separately
VALP40	520x432x126	2,6	*	—

The tool is supplied as:

- Basic tool with battery and shoulder strap
- Spare battery
- Battery charger
- USB cable
- Plastic carrying case suitable for storing the tool and accessories



Fitted with a maximum hydraulic pressure valve. Designed with improved balance, B-TC500YE is easily manageable during the cutting process and, by the use of bi-component plastics, has a shell with high resistance to wear and damage.

Rubber grip inserts, low noise and minimal vibration aid operator comfort while additional convenience and safety are provided by LED lighting of the working area. Operating temperature: -15 to +50 °C

Not suitable for cutting stay wire, Steel rope or earthing rod.

OVERHEAD LINE APPLICATION
B-TC550E

New



Next generation of 18.0 V cordless hydraulic cutting tool specifically designed to cut Copper, Aluminium, Aluminium-Steel cables and Steel ropes, Aluminium and Steel rods having a max overall diameter of 55 mm. The blades are manufactured from high strength special Steel, heat treated to ensure a long service life. New Li-Ion 18 V 4 Ah batteries offer a higher capacity than 14.4 V 3 Ah, while greater cutting speed and

NEW 18V Li-Ion BATTERY

cutting force result from a revitalised hydraulic system with double speed action. The battery is equipped with LED indicators to show the remaining battery life at any time by pressing the adjacent button.

18.0 V CORDLESS HYDRAULIC CUTTING TOOL

general features



Max cutting Ø mm	Dimensions mm			Battery	Weight kg (with battery)
	length	height	width		
55	441	424	87	18.0 V 4.0 Ah	8,9



18.0V 4.0Ah Li-Ion

STORAGE

Type	Dimensions mm	Weight kg	Supplied with the tool	Purchase separately
VALP40	520x432x126	2,6	*	—

The tool is supplied as:

- Basic tool with battery and shoulder strap
- Spare battery
- Battery charger
- USB cable
- Plastic carrying case suitable for storing the tool and accessories



The head can rotate through 320 degrees, to enable the operator to work in the most comfortable position, and can easily be opened to allow cutting of running cables. Fitted with a maximum hydraulic pressure valve. Designed with improved balance, B-TC550E is easily manageable during the cutting process and, by the use of bi-component plastics, has a shell with high resistance to wear and damage.

Rubber grip inserts, low noise and minimal vibration aid operator comfort while additional convenience and safety are provided by LED lighting of the working area. For cutting capacity data see page 144. Operating temperature: -15 to +50 °C

18.0 V CORDLESS HYDRAULIC CUTTING TOOL



general features



**18.0V
4.0Ah
Li-Ion**

Max cutting Ø mm	Dimensions mm			Battery	Weight kg (with battery)
	length	height	width		
50	405	398	83	18.0 V 4.0 Ah	5,8

STORAGE

Type	Dimensions mm	Weight kg	Supplied with the tool	Purchase separately
VALP40	520x432x126	2,6	✳	—

The tool is supplied as:

- Basic tool with battery and shoulder strap
- Spare battery
- Battery charger
- USB cable
- Plastic carrying case suitable for storing the tool and accessories



Next generation of 18.0 V cordless hydraulic cutting tool specifically designed to cut Copper, Aluminium and telecommunication cable having a max overall diameter of 50 mm. The blades are manufactured from high strength special Steel, heat treated to ensure a long service life. New Li-Ion 18 V 4 Ah batteries offer a higher capacity than 14.4 V 3 Ah, while greater cutting speed and cutting force result from a revitalised hydraulic system with double speed

action. The battery is equipped with LED indicators to show the remaining battery life at any time by pressing the adjacent button. The head can rotate through 90 degrees, to enable the operator to work in the most comfortable position, and can easily be opened to allow cutting of running cables.

Fitted with a maximum hydraulic pressure valve. Designed with improved balance, B-TC500E is easily manageable during the cutting process and, by the use of bi-component plastics, has a shell with high resistance to wear and damage. Rubber grip inserts, low noise and minimal vibration aid operator comfort while additional convenience and safety are provided by LED lighting of the working area. Operating temperature: -15 to +50 ° C



INDUSTRIAL APPLICATION
B-TC500E

New

**NEW
18V Li-Ion
BATTERY**

18.0 V CORDLESS HYDRAULIC CUTTING TOOL



general features



**18.0V
4.0Ah
Li-Ion**

Max cutting Ø mm	Dimensions mm			Battery	Weight kg (with battery)
	length	height	width		
65	429	415	83	18.0 V 4.0 Ah	6,4

STORAGE

Type	Dimensions mm	Weight kg	Supplied with the tool	Purchase separately
VALP40	520x432x126	2,6	✳	—

The tool is supplied as:

- Basic tool with battery and shoulder strap
- Spare battery
- Battery charger
- USB cable
- Plastic carrying case suitable for storing the tool and accessories



Next generation of 18.0 V cordless hydraulic cutting tool specifically designed to cut Copper, Aluminium and telecommunication cable having a max overall diameter of 65 mm. The blades are manufactured from high strength special Steel, heat treated to ensure a long service life. New Li-Ion 18 V 4 Ah batteries offer a higher capacity than 14.4 V 3 Ah, while greater cutting speed and cutting force result from a revitalised hydraulic system with double speed

action. The battery is equipped with LED indicators to show the remaining battery life at any time by pressing the adjacent button. The head can rotate through 335 degrees, to enable the operator to work in the most comfortable position, and can easily be opened to allow cutting of running cables. Fitted with a maximum hydraulic pressure valve.

Designed with improved balance, B-TC650E is easily manageable during the cutting process and, by the use of bi-component plastics, has a shell with high resistance to wear and damage. Rubber grip inserts, low noise and minimal vibration aid operator comfort while additional convenience and safety are provided by LED lighting of the working area. Operating temperature: -15 to +50 ° C



INDUSTRIAL APPLICATION
B-TC650E

New

**NEW
18V Li-Ion
BATTERY**

18.0 V CORDLESS HYDRAULIC CUTTING TOOL

INDUSTRIAL APPLICATION B-TC650-SCE



New

**NEW
18V Li-Ion
BATTERY**

Next generation of 18.0 V cordless hydraulic cutting tool specifically designed to cut Copper, Aluminium and telecommunication cable having a max overall diameter of 65 mm. The blades are manufactured from high strength special Steel, heat treated to ensure a long service life. The open head and the "scissor" movement of the blades facilitate the cutting of running cables. New Li-Ion 18 V 4 Ah batteries offer a higher capacity than 14.4 V 3 Ah, while greater cutting speed and cutting force result from a revitalised hydraulic system with double speed action. The battery is equipped with LED indicators to show the remain-

ing battery life at any time by pressing the adjacent button. The head can rotate through 180 degrees, to enable the operator to work in

general features

Max cutting Ø mm	Dimensions mm			Battery	Weight kg (with battery)
	length	height	width		
65	503	464	105	18.0V 4.0Ah	7,7



**18.0V
4.0Ah
Li-Ion**

STORAGE

Type	Dimensions in.	Weight kg	Supplied with the tool	Purchase separately
VAL B-TC950	565x410x132	6,7	✳	—

The tool is supplied as:

- Basic tool with battery and shoulder strap
- Spare battery
- Battery charger • USB cable
- Metal carrying case suitable for storing the tool and accessories



the most comfortable position, and can easily be opened to allow cutting of running cables. Fitted with a maximum hydraulic pressure valve. Designed with improved balance, B-TC650-SCE is easily manageable during the cutting process and, by the use of bi-component plastics, has a shell with high resistance to wear and damage. Rubber grip inserts, low noise and minimal vibration aid operator comfort while

additional convenience and safety are provided by LED lighting of the working area. Operating temperature: -15 to +50 °C

18.0 V CORDLESS HYDRAULIC CUTTING TOOL

INDUSTRIAL APPLICATION B-TC950E



New

**NEW
18V Li-Ion
BATTERY**

Next generation of 18.0 V cordless hydraulic cutting tool specifically designed to cut Copper, Aluminium and telecommunication cable having a max overall diameter of 95 mm. The blades are manufactured from high strength special Steel, heat treated to ensure a long service life. New Li-Ion 18 V 4 Ah batteries offer a higher capacity than 14.4 V 3 Ah, while greater cutting speed and cutting force result from a revital-

ised hydraulic system with double speed action. The battery is equipped with LED indicators to show the remaining battery life

general features

Max cutting Ø mm	Dimensions mm			Battery	Weight kg (with battery)
	length	height	width		
95	518	468	83	18.0V 4.0Ah	7,8



**18.0V
4.0Ah
Li-Ion**

STORAGE

Type	Dimensions mm	Weight kg	Supplied with the tool	Purchase separately
VAL B-TC950	565x410x132	6,7	✳	—

The tool is supplied as:

- Basic tool with battery and shoulder strap
- Spare battery
- Battery charger
- USB cable
- Metal carrying case suitable for storing the tool and accessories



at any time by pressing the adjacent button. The head can rotate through 335 degrees, to enable the operator to work in the most comfortable position, and can easily be opened to allow cutting of running cables. Fitted with a maximum hydraulic pressure valve. Designed with improved balance, B-TC950E is easily manageable during the cutting process and, by the

use of bi-component plastics, has a shell with high resistance to wear and damage. Rubber grip inserts, low noise and minimal vibration aid operator comfort while additional convenience and safety are provided by LED lighting of the working area. Operating temperature: -15 to +50 °C

18.0 V CORDLESS HYDRAULIC FRAME-TYPE HOLE PUNCHING TOOL



general features

B-FC470E

New



**18.0V
4.0Ah
Li-Ion**

Max hole punch Ø in.	Dimensions in.			Battery Ni-MH	Weight lbs. (with battery)
	length	height	width		
47,2	379	346	83	18.0V - 4.0 Ah	6,2

STORAGE

Type	Dimensions in.	Weight lbs	Supplied with the tool	Purchase separately
VAL FC470	559x459x131	6,7	✳	—

The tool is supplied as:

- Basic tool with battery and shoulder strap
- Spare battery
- Battery charger
- USB cable
- Metal carrying case suitable for storing the tool and accessories



Next generation of 18.0 V cordless hydraulic cutting tool specifically designed to punching holes from 15,5 up to 47,2 mm diameter in the side wall of trunking without the need for pre drilling.

New Li-Ion 18 V 4 Ah batteries offer a higher capacity than 14.4 V 3 Ah, while greater punch speed and punching force result from a revitalised hydraulic system with double speed action.

The battery is equipped with led indicators that indicate the remaining battery life at any time by pressing the adjacent button.

The head can rotate through 180 degrees, to enable the operator to work in the most comfortable position, and can easily be opened to allow cutting of running cables.

Fitted with a maximum hydraulic pressure valve.

Designed with improved balance, B-FC470E is easily manageable during the punching process and, by the use of bi-component plastics, has a shell with high resistance to wear and damage. Rubber grip inserts, low noise and minimal vibration aid operator comfort while additional convenience and safety are provided by LED lighting of the working area.

Operating temperature:

-15 to +50 ° C

Also available in the hand operated mechanical version MT-FC48N (see page 115).



**NEW
18V Li-Ion
BATTERY**

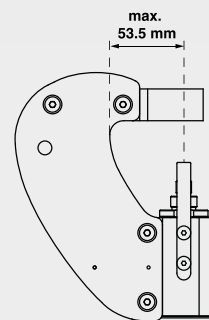

Max centre of hole to edge of trunking: 53,5 mm

Table denoting the punch/die set reference, for each hole size. Suitable for punching holes in mild steel, fiberglass or plastic material, up to 2 mm thick.

Hole Dimensions					Maximum thickness of mild Steel (mm)	Code
Nominal	Ø (mm)	Ø (inch)	Pg	ISO		
15,5	.610	Pg9	-	-	2	RD 15.5 SS-FC
16,2	.638	-	ISO-16	-		RD 16.2 SS-FC
17,5	.689	-	-	-		RD 17.5 SS-FC
18,8	.740	Pg11	-	-		RD 18.8 SS-FC
19,1	.752	-	-	-		RD 19.1 SS
20,5	.807	Pg 13,5	ISO-20	-		RD 20.5 SS
21,5	.846	-	-	1/2"		RD 21.5 SS
22,6	.890	Pg16	-	-		RD 22.6 SS
23,8	.937	-	-	5/8"		RD 23.8 SS
25,4	1.000	-	ISO-25	-		RD 25.4 SS
27,0	1.063	-	-	3/4"		RD 27.0 SS
28,5	1.122	Pg21	-	-		RD 28.5 SS
30,5	1.201	-	-	7/8"		RD 30.5 SS
31,8	1.252	-	-	-		RD 31.8 SS
32,5	1.279	-	ISO-32	-		RD 32.5 SS
34,0	1.338	-	-	1"		RD 34.0 SS
34,6	1.362	-	-	-		RD 34.6 SS
37,2	1.464	Pg29	-	-		RD 37.2 SS
38,1	1.500	-	-	-		RD 38.1 SS
38,5	1.516	-	-	1-1/8"		RD 38.5 SS
40,5	1.594	-	ISO-40	-		RD 40.5 SS-FC
41,3	1.626	-	-	-		RD 41.3 SS-FC
42,5	1.673	-	-	1-1/4"		RD 42.5 SS-FC
43,2	1.701	-	-	-		RD 43.2 SS-FC
44,5	1.752	-	-	-		RD 44.5 SS-FC
47,2	1.858	Pg36	-	-		RD 47.2 SS-FC

18.0 V CORDLESS HYDRAULIC PULLER-TYPE HOLE PUNCHING TOOL

general features



B-FL750E



New
NEW 18V Li-Ion BATTERY

New Li-Ion 18 V 4 Ah batteries offer a higher capacity than 14.4 V 3 Ah, while greater punch speed and punching force result from a revitalised hydraulic system with double speed action. The battery is equipped with LED indicators to show the remaining battery life at any time by pressing the adjacent button. The balanced punching head pivots 180deg through a full 360deg rotation for ease of use in confined spaces. Fitted with a maximum hydraulic pressure valve.

Next generation of 18.0 V cordless hydraulic tool specifically designed for hole punching stainless Steel, mild Steel, fibreglass and plastic sheet materials up to 3,5 mm thickness.

Max punching Ø mm	Dimensions mm			Battery	Weight kg (with battery)
	length	height	width		
Ø 140	363	366	83	18.0 V 4.0 Ah	5,1



18.0V
4.0Ah
Li-Ion

STORAGE

Type	Dimensions mm	Weight kg	Supplied with the tool	Purchase separately
VALP40	520x432x126	2,6	✳	—

The tool is supplied as:

- Basic tool with battery
- and shoulder strap
- Spare battery
- Battery charger
- USB cable
- Puller TD-11
- Puller TD-19
- Spiral bit Ø 11,5 mm

- Plastic carrying case suitable for storing the tool and accessories



Designed with improved balance, B-FL750E is easily manageable during the punching process and, by the use of bi-component plastics, has a shell with high resistance to wear and damage. Rubber grip inserts, low noise and minimal vibration aid operator comfort while additional convenience and safety are provided by LED lighting of the working area.

Operating temperature:
-15 to +50 ° C

PUNCHING ACCESSORIES AVAILABLE

ROUND PUNCH

Hole diameter				Material max thickness	Pilot hole Ø	Code				
Nominal	Pg	ISO	GAS			KIT (Punch+die)	Punch	Die	Puller	
Ø (mm)	Ø (inch)			Stainless Steel	Mild Steel	(mm)				
15,5	.610	Pg9	-	2,5 mm (0,1 in.) Rm= 700 N/mm²	3,5 mm (0,14 in.) Rm= 510 N/mm²	11,5	RD 15.5SS	P-RD15.5SS	M-RD15.5SS	TD-11
16,2	.638	-	ISO-16				RD 16.2SS	P-RD16.2SS	M-RD16.2SS	
17,0	.669	-	G3/8"				RD 17SS	P-RD17SS	M-RD17SS	
17,5	.689	-	-				RD 17.5SS	P-RD17.5SS	M-RD17.5SS	
18,8	.740	Pg11	-				RD 18.8SS	P-RD18.8SS	M-RD18.8SS	
19,1	.752	-	-				RD 19.1SS	P-RD19.1SS	M-RD19.1SS	
20,5	.807	Pg 13,5	ISO-20				RD 20.5SS	P-RD20.5SS	M-RD20.5SS	
21,5	.846	-	G1/2"				RD 21.5SS	P-RD21.5SS	M-RD21.5SS	
22,6	.890	Pg16	-				RD 22.6SS	P-RD22.6SS	M-RD22.6SS	
23,8	.937	-	G5/8"				RD 23.8SS	P-RD23.8SS	M-RD23.8SS	
25,4	1.000	-	ISO-25				RD 25.4SS	P-RD25.4SS	M-RD25.4SS	
27,0	1.063	-	G3/4"				RD 27SS	P-RD27SS	M-RD27SS	
28,5	1.122	Pg21	-				RD 28.5SS	P-RD28.5SS	M-RD28.5SS	
30,5	1.201	-	G7/8"				RD 30.5SS	P-RD30.5SS	M-RD30.5SS	
28,5	1.122	Pg 21	-				RD 28.5SS-19	P-RD28.5SS-19	M-RD28.5SS-19	
30,5	1.201	-	G7/8"			RD 30.5SS-19	P-RD30.5SS-19	M-RD30.5SS-19		
31,8	1.252	-	-			RD 31.8SS	P-RD31.8SS	M-RD31.8SS		
32,5	1.279	-	ISO-32			RD 32.5SS	P-RD32.5SS	M-RD32.5SS		
34,0	1.338	-	G1"			RD 34SS	P-RD34SS	M-RD34SS		
34,6	1.362	-	-			RD 34.6SS	P-RD34.6SS	M-RD34.6SS		
37,2	1.464	Pg29	-			RD 37.2SS	P-RD37.2SS	M-RD37.2SS		
38,1	1.500	-	-			RD 38.1SS	P-RD38.1SS	M-RD38.1SS		
38,5	1.515	-	G1 1/8"			RD 38.5SS	P-RD38.5SS	M-RD38.5SS		
40,5	1.594	-	ISO-40			RD 40.5SS	P-RD40.5SS	M-RD40.5SS		
41,3	1.626	-	-			RD 41.3SS	P-RD41.3SS	M-RD41.3SS		
42,5	1.673	-	G1 1/4"			RD 42.5SS	P-RD42.5SS	M-RD42.5SS		
43,2	1.701	-	-			RD 43.2SS	P-RD43.2SS	M-RD43.2SS		
44,5	1.752	-	-			RD 44.5SS	P-RD44.5SS	M-RD44.5SS		
47,2	1.858	Pg36	-			RD 47.2SS	P-RD47.2SS	M-RD47.2SS		
48,5	1.909	-	G1 1/2"			RD 48.5SS	P-RD48.5SS	M-RD48.5SS		
50,5	1.988	-	ISO-50	RD 50.5SS	P-RD50.5SS	M-RD50.5SS				
51,4	2.023	-	-	RD 51.4SS	P-RD51.4SS	M-RD51.4SS				
52,4	2.063	-	-	RD 52.4SS	P-RD52.4SS	M-RD52.4SS				
54,2	2.134	Pg42	G1 3/4"	RD 54.2SS	P-RD54.2SS	M-RD54.2SS				
60,0	2.362	Pg48	G2"	RD 60SS	P-RD60SS	M-RD60SS				
60,5	2.381	-	-	RD 60.5SS	P-RD60.5SS	M-RD60.5SS				
64,0	2.520	-	ISO-63	RD 64SS	P-RD64SS	M-RD64SS				
65,0	2.559	-	-	RD 65SS	P-RD65SS	M-RD65SS				
76,0	2.992	-	G2 1/2"	RD 76SS	P-RD76SS	M-RD76SS				
76,5	3.011	-	-	RD 76.5SS	P-RD76.5SS	M-RD76.5SS				
80,5	3.169	-	-	RD 80.5SS	P-RD80.5SS	M-RD80.5SS				
89,0	3.503	-	G3"	RD 89SS	P-RD89SS	M-RD89SS				
90,0	3.543	-	-	RD 90SS	P-RD90SS	M-RD90SS				
100,0	3.937	-	-	RD 100SS	P-RD100SS	M-RD100SS				
102,0	4.015	-	-	RD 102SS	P-RD102SS	M-RD102SS				
114,0	4.488	-	-	RD 114SS	P-RD114SS	M-RD114SS				
120,0	4.724	-	-	RD 120SS	P-RD120SS	M-RD120SS				
140,0	5.512	-	-	RD 140SS	P-RD140SS	M-RD140SS				

* Puller included in the kit

SQUARE PUNCH

Hole size		Material max thickness (mm)	Pilot hole Ø	Code
Nominal				
(mm)	(inch)	Stainless Steel	Mild Steel	KIT (Punch+die + Puller)
21,0 x 21,0	.827 x .827	2,5	3,5	RD 21X21
46,0 x 46,0	1.811 x 1.811	2,0	3,0	RD 46X46
68,0 x 68,0	2.677 x 2.677	1,5	2,0	RD 68X68
92,0 x 92,0	3.622 x 3.622			
126,0 x 126,0	4.960 x 4.960	1,0	1,5	RD 126X126
138,0 x 138,0	5.433 x 5.433			
220,0 x 220,0	8.661 x 8.661			RD 220X220

RECTANGULAR PUNCH

Hole size		Material max thickness (mm)	Pilot hole Ø	Code
Nominal				
(mm)	(inch)	Stainless Steel	Mild Steel	KIT (Punch+die + Puller)
18,0 x 46,0	.709 x 1.811	2,0	16,5	RD 18X46
22,0 x 30,0	.866 x 1.181			
22,0 x 46,0	.866 x 1.811			
35,0 x 86,0	1.377 x 3.385			
35,0 x 112,0	1.377 x 4.409			
36,0 x 46,0	1.417 x 1.811		23,8	
37,0 x 54,0	1.456 x 2.125			
37,0 x 67,0	1.456 x 2.637			
37,0 x 88,0	1.456 x 3.464			
37,0 x 104,0	1.456 x 4.094			
37,0 x 115,0	1.456 x 4.527	26,5		
46,0 x 54,0	1.811 x 2.126			
46,0 x 72,0	1.811 x 2.835			
46,0 x 107,0	1.811 x 4.212			
50,0 x 98,0	1.968 x 3.858			
67,0 x 126,0	2.637 x 4.960			
			28,5	

Stainless Steel = Rm= 700 N/mm² - Mild Steel = Rm= 500 N/mm²

USE OF NON-CEMBRE PUNCHING ACCESSORIES

Code	Punch & Die	Pilot hole Ø mm
KIT TRD-9,4C (*)	KLAUKE, GREENLEE 3/8" - 24 UNF	Ø 9.7
KIT TRD-M11C (*)	IMB, BM, COSMEC (M11x1.5)	Ø 11.5
TD-M16C	IMB, BM, COSMEC (M16x1.5)	Ø 16.5 or KIT RD17.5SS
TD27	COSMEC (Ø105xØ140)	Ø 27.5
TD14X14-M14	COSMEC 46x46	Ø 18.8
TD120X20-M20	COSMEC 92x92	Ø 27.5
TD20X20-M20	BM, COSMEC 42x95	Ø 27.5
KIT TGD-13.5X13.5-M13	COSMEC 40x40; 45x45; 46x46	Ø 18.8
KIT TGD-10X10-M9	COSMEC 006505	Ø 13.8

(*) The washer supplied with the KIT must be threaded onto the draw stud and positioned between the head and the die to allow the die to rest correctly.



HYDRAULIC PUMPS AND UNITS

HYDRAULIC PUMPS

PO 7000

Foot operated double speed pump, developing a maximum pressure of 700 bar.

The pump is supplied with 3 m long high pressure flexible hose complete with female self-lock quick coupler.

Pressure can be withdrawn at any time during operation by depressing the release lever.

A solid shaped stand gives the pump stability during operation.



Operating pressure bar	Dimensions mm			Weight kg
	length	width	height	
700	680	200	163	9,8

Storage type	Dimensions mm	Weight kg
VAL P21*	820x430xh290	6,74

*Supplied with the pump



CPP-0

The CPP-0 air hydraulic power unit intensifies an air supply of 6-8 bar (87-115 psi) to a power crimping or cutting force of up to 700 bar (10.000 psi) depending upon the input pressure.

The control pedal allows for advancing and pressure release at any stage of the operation.

The unit is provided with a 2 m high pressure flexible hose, including a 3/8" NPT female self-lock quick coupler.



Operating pressure bar	Dimensions mm			Weight kg
	length	width	height	
700	320	150	200	6,8

HYDRAULIC PUMPS

CPE-1

CPE-1-110



Operating pressure bar	Dimensions mm			Weight kg
	length	width	height	
700	372	223	482	21

The pump is supplied with:

- high pressure flexible hose with male and female automatic quick coupler
- remote hand controller
- external supply connection cable

Available as optional accessories:

- Remote foot controller **RCP-B70**.
- Transportation trolley **CS-CPE-1**
- Control handle integrated with 3 m length flex hoses **ERCH-WH**



Electrically driven hydraulic pump, powered by a 230V / 50-60Hz single-phase electric motor.

The remote hand controller allows advancement and pressure release on completion of the crimping operation.

The mechanically actuated emergency button located on the pump body allows the pressure release at any time in case of power shortage.

Also available **CPE-1-110** version for 110-115V / 50-60Hz. Both models are IP 55 rated.



PORTABLE ELECTRO-HYDRAULIC PUMPS B70M-P24 RANGE

BATTERY OPERATED

Easily accessible oil top-up inlet



Remote electrical hand or foot controller connection (not KV version)



Remote pneumatic hand controller connection (KV version only)



24V dc external power supply socket with protective cap

**24V
3.1Ah
Ni-MH**



Powerful 24V Ni-MH rechargeable battery



Battery residual power level display



Manual pressure release button



High pressure hose connects to automatic self-lock quick coupling with protective cap

Variously supplied with different versions:



HYDRAULIC PUMPS

B70M-P24



Operating pressure bar	Dimensions mm			Weight kg
	length	width	height	
700	390	163	323	9,2*

*without accessories



B70M-P24

- 1 Portable electro-hydraulic pump, 24V dc battery for independent use, developing 700 bar pressure; equipped with an integral socket for connection to an external 24 V dc supply
- 2 **BH2433** Battery 24V dc 3.1Ah
- 3 **DC24** External battery charger
- 4 Shoulder strap
- 5 Canvas holdall for carrying accessories
- 6 3 m flexible hose complete with male + female 3/8" NPT self-lock quick couplers
- 7 **ERCH** Remote control



Operating pressure bar	Dimensions mm			Weight kg
	length	width	height	
700	390	163	323	9,2*

*without accessories



B70M-P24-CH

B70M-P24-CH

- 1 Portable electro-hydraulic pump, 24V dc battery for independent use, developing 700 bar pressure; equipped with an integral socket for connection to an external 24 V dc supply
- 2 **BH2433** Battery 24V dc 3.1Ah
- 3 **DC24** External battery charger
- 4 Shoulder strap
- 5 Canvas holdall for carrying accessories
- 6 **ERCH-WH** Remote hand controller integrated with 3 m length flexible hose complete with male + female 3/8" NPT self-lock quick couplers



Operating pressure bar	Dimensions mm			Weight kg
	length	width	height	
700	390	163	323	9,2*

*without accessories



B70M-P24-KV

B70M-P24-KV

- 1 Portable electro-hydraulic pump, 24V dc battery for independent use. Equipped with high dielectric insulated oil and automatic "insulated" lock quick coupler to allow connection only with insulated hoses.
- 2 **BH2433** Battery 24V dc 3.1Ah.
- 3 **DC24** External battery charger.
- 4 Shoulder strap
- 5 Canvas holdall for carrying accessories.
- 6 **PRCH** Remote pneumatic hand controller

Insulated heads suitable for use with this pump are generally supplied complete with high pressure insulated hoses; if necessary the hose can be purchased separately.

ACCESSORIES FOR B70M-P24

ESC 300CEE
CONNECTING CABLE WITH 24V dc CEE TYPE PLUG
(for power from an external source, length 3 meters)



ESC 600
CONNECTING CABLE WITH CROCODILE CLIPS
(for power from an external source, length 6 meters)



BPS 230.24
network power supply (not for intensive use)
INPUT 230V ac 50-60Hz; OUTPUT 24V dc
thermal and short circuit protection.
Current supply: up to 4A extended use;
18A for 50 s; 25A for 8 s.



EPS 115-230.24
network power supply
SUPPLY IN: 110/240V
ac autorange
50-60Hz; 700W
SUPPLY OUT: 24V dc; 30A max



ERCH-WH
Remote hand controller
integrated with 3 m
length flexible hose



Operating
push-button

Pressure release button

TRS-B70
CANVAS RUCKSACK
(for carrying the pump)



SH-B70
HOOK
(for hanging the pump
from a ladder)



VAL-P18
Durable transport
case for pump and
accessories.



RCP-B70
PORTABLE REMOTE
FOOT CONTROL



HYDRAULIC UNITS

(pump PO 7000 + head RHC 131)

Crimping force kN	Dimensions pump mm	Dimensions head mm	Weight kg
130	680x200xh163	232x124	13,6

MAIN APPLICATIONS - max section mm²

L.V. lugs and splices	Insulated terminals	"C" sleeve connectors	H.V. lugs and splices
400	240	185	400

Storage type	Dimensions mm	Weight kg
VAL P21*	820x430xh290	6,74

*Supplied with the unit, suitable for storage of 24 semi-circular slotted dies



CP 1131

Hydraulic units are obtained by combining the double stage hydraulic foot pump with the various hydraulic press heads featured on previous

pages. The use of the double speed pump considerably reduces operating time.

(pump PO 7000 + head RHU 131-C)

Crimping force kN	Dimensions pump mm	Dimensions head mm	Weight kg
130	680x200xh163	245x89	13,5

MAIN APPLICATIONS - max section mm²

L.V. lugs and splices	Insulated terminals	"C" sleeve connectors	H.V. lugs and splices	Alu lugs and splices
400	240	185	400	300

Storage type	Dimensions mm	Weight kg
VAL P21*	820x430xh290	6,74

*Supplied with the unit, suitable for storage of 24 semi-circular slotted dies and accessories for crimping Aluminium connectors



CPU 1131-C

(pump PO 7000 + head ECW-H3D)

Crimping force kN	Dimensions pump mm	Dimensions head mm	Weight kg
230	680x200xh163	290x120	15,3

MAIN APPLICATIONS - max section mm²

L.V. lugs and splices	Insulated terminals	"C" sleeve connectors	H.V. lugs and splices
630	300	240	630

Storage type	Dimensions mm	Weight kg
VAL P21*	820x430xh290	6,74

*Supplied with the unit, suitable for storage of 24 semi-circular slotted dies and adaptors and dies specific for head ECW-H3D



CPU 1230-3D

HYDRAULIC CUTTING UNITS

CP 1096



(pump PO 7000 + head TC 096)

Max cutting Ø mm	Dimensions pump mm	Dimensions head mm	Weight kg
95	680x200x163	397x249	17,7

Storage type	Dimensions mm	Weight kg
VAL CP 096*	785x430x175	14,0

*Supplied with the unit



CP 1120



(pump PO 7000 + head TC 120)

Max cutting Ø mm	Dimensions pump mm	Dimensions head mm	Weight kg
120	680x200x163	536x175	19,3

Storage type	Dimensions mm	Weight kg
VAL22-TC120*	766x305x191	8,3

*Supplied with the unit



Units CP-W-KV



GS approval
n. ET 13045



Hydraulic units provide protection against short circuit when cutting accidentally live L.V. / M.V. cables with nominal voltage up to 60 kV.

Unit Type	Max cutting Ø mm	Dimensions pump	Dimensions head	Weight kg
CP 1086-W-1000-KV	85	680x200x163	405x143	16,6
CP 1096-W-1000-KV	95	680x200x163	407x245	19,0
CP 1120-W-1000-KV	120	680x200x163	556x185	20,2

Storage case type	Dimensions mm	Weight kg
VAL CPO96-W*	785x430x175	12,6

*Supplied with the unit



Available as optional accessories:







- EK100 earth cable for the pump (1 m length)
- EK500P earth cable for the head (5 m length) with earth rod and canvas bag





DIE SELECTOR CHART

DIE SELECTOR CHART

APPLICATION	CONDUCTOR		CONNECTOR		HYDRAULIC TOOLS										
					B 15MDE		B 35-45MDE		B 35-50MDE			HT 45-E			
					DIE SET	NEST	INDENTOR	DIE SET	NEST	INDENTOR	DIE SET	NEST	INDENTOR	DIE SET	
	Conductor Size sqmm <i>Low str.</i> <i>Flex</i>		TERMINAL	SPLICE	DIE SET	NEST	INDENTOR	DIE SET	NEST	INDENTOR	DIE SET	NEST	INDENTOR	DIE SET	
	0,25 ÷ 2,5		A 03-M.. A 06-M..	L 03-M / L 03-P L 06-M / L 06-P	ME03/2-15 MA03/3-15										
	4 ÷ 6		A 1-M.. A 1-L..	L 1-M L 1-P	ME03/2-15 MA03/3-15	MA 1	PA 1	ME 1	MA 1-50	PA 1-50	ME 1-50	MA 1	PA 1	ME 1	
	10		A 2-M.. A 2-L..	A 2-P12	L 2-M L 2-P	ME03/2-15 ME2/3-15 MA03/3-15			ME 2			ME 2-50			ME 2
	16		A 3-M.. A 3-L..	A 3-P14	L 3-M L 3-P	ME2/3-15 MA03/3-15	MA 2.3	PA 5	ME 3	MA 2.3-50	PA 5-50	ME 3-50	MA 2.3	PA 5	ME 3
	25		A 5-M.. A 5-L..	A 5-P16	L 5-M L 5-P		MA 5		ME 5	MA 5-50		ME 5-50	MA 5		ME 5
	35		25* 35	A 7-M.. A 7-L..	A 7-P20	L 7-M L 7-P		PA 10	ME 7	MA 7-50		ME 7-50	MA 7	PA 10	ME 7
	50		35* 50	A 10-M.. A 10-L..	A 10-P25	L 10-M L 10-P		PA 10	ME 10	MA 10-50	PA 10-50	ME 10-50	MA 10	PA 10	ME 10
	70		50* 70	A 14-M.. A 14-L..		L 14-M L 14-P			ME 14	MA 14-50		ME 14-50			ME 14
	95		70* 95	A 19-M.. A 19-L..		L 19-M L 19-P			ME 19	MA 19-50		ME 19-50			ME 19
	120		95* 120	A 24-M.. A 24-L..		L 24-M L 24-P			ME 24	MA 24-50	PA 24-50	ME 24-50			ME 24
	70		A 14-M.. A 14-L..	A 14-P30				ME 17		PA 19-50	ME 17-50			ME 17	
	95		A 19-M.. A 19-L..		L 19-M L 19-P			ME 19	MA 19-50		ME 19-50			ME 19	
	120		A 24-M.. A 24-L..		L 24-M L 24-P			ME 24	MA 24-50	PA 24-50	ME 24-50			ME 24	
	150		A 30-M.. A 30-L..		L 30-M L 30-P			ME 30L			ME 30L-50			ME 30	
	185		A 37-M.. A 37-L..	A 37-4ESI	L 37-M L 37-P										
	240		A 48-M.. A 48-L..	A 48-4ESI	L 48-M L 48-P										
	300		A 60-M.. A 60-L..	A 60-4ESI	L 60-M L 60-P										
	400		A 80-M..	A 80-4ESI	L 80-M										
	500		A 100-M..	A 100-4ESI	L 100-M										
	630		A 120-M..	A 120-4ESI	L 120-M										
	800		A 160-M..	A 160-4ESI	L 160-M										
	1000		A 200-M..		L 200-M										
	35		A 9-M..			MA 9	PA 10	ME 9	MA 9-50	PA 10-50	ME 9-50	MA 9	PA 10	ME 9	
	50		A 12-M..					ME 12	MA 12-50		ME 12-50			ME 12	
	70		A 17-M..					ME 17	MA 17-50	PA 19-50	ME 17-50			ME 17	
	95		A 20-M..					ME 20	MA 20-50		ME 20-50			ME 20	
	120		A 29-M..					ME 29			ME 29-50			ME 29	
	150		A 35-M..												
	185		A 40-M..												

⬡ Hexagonal crimp (use one size up with fine stranded conductors, E.G.: 95² fine stranded use A19... + ME 19 or A 20... + ME 20)

⬢ Indent crimp

* Contact Cembre for appropriate die set

N.B.: Number inside symbol indicates the number of crimps on A-M barrel, L-P and each side of L-M products







































DIE SELECTOR CHART

H Y D R A U L I C T O O L S

HT 51 B 500E		RH 50 B 550E		HT 81-U RHU 81		HT 120 and tools and heads with 130 kN crimping force			ECW-H3D			RHU 520		
NEST	INDENTOR	DIE SET		DIE SET		NEST	INDENTOR	DIE SET	NEST	INDENTOR	DIE SET	NEST	INDENTOR	DIE SET
MA 1-50	PA 1-50	ME 1-50												
MA 2.3-50	PA 5-50	ME 2-50	MA 3.5-U	ME 2.19-U	MA 2-C	PA 10-C		ME 2-C						
		ME 3-50		ME 3.14-U	MA 3-C			ME 3-C						
MA 5-50	PA 10-50	ME 5-50	MA 7.14-U	ME 5.7-U	MA 5-C	PA 24-C		ME 5-C						
MA 7-50		ME 7-50			MA 7-C			ME 7-C						
MA 10-50		ME 10-50			MA 10.19-U			ME 10.24-U						
MA 14-50	PA 19-50	ME 14-50	MA 7.14-U	ME 3.14-U	MA 14-C	PA 48-C		ME 14-C						
		ME 17-50			MA 19-C			ME 17-C						
MA 19-50	PA 24-50	ME 19-50	MA 10.19-U MA 19-U	ME 2.19-U	MA 19-C	PA 60-C		ME 19-C						
MA 24-50		ME 24-50	MA 24-U	ME 10.24-U	MA 24-C			ME 24-C						
		ME 30-50	MA 30.80-U	ME 30-U	MA 30-C			ME 30-C						
		ME 37-50	MA 37-U	ME 37-U	MA 37-C	PA 80-C		ME 37-C						
		ME 48-50	MA 48-U	ME 48-U	MA 48-C			ME 48-C						
		ME 60-50**			MA 60-C			ME 60-C						
								ME 80-C	MA 80-3D	PA 100-3D	ME 80-3D	MA 80-520	PA 120-520	ME 80-520
									MA 100-3D		ME 100-3D	MA 100-520		ME 100-520
									MA 120-3D	PA 120-3D	ME 120-3D	MA 120-520		ME 120-520
												MA 160-520	PA 200-520	ME 160-520
												MA 200-520		ME 200-520
MA 9-50	PA 10-50	ME 9-50	MA 9.17-U	ME 9.20-U	MA 9-C	PA 10-C		ME 9-C	Adaptor AU 230-130 D with die set MA.-C and indentor PA.-C	Adaptor AU 230-130 D with die set ME.-C	Adaptor AU 520-130 C with die set MA.-C and indentor PA.-C	Adaptor AU 520-130 C with die set ME.-C		
MA 12-50	PA 19-50	ME 12-50	MA 12.20-U	ME 12.17-U	MA 12-C	PA 24-C		ME 12-C						
MA 17-50		ME 17-50	MA 9.17-U	ME 12.17-U	MA 17-C		ME 17-C							
MA 20-50		ME 20-50	MA 12.20-U	ME 9.20-U	MA 20-C	PA 48-C		ME 20-C						
		ME 29-50	MA 29.80-U	ME 29-U	MA 29-C		ME 29-C							
		ME 35-50	MA 35-U	ME 35-U	MA 35-C		ME 35-C							
		ME 40-50	MA 40-U	ME 40-U	MA 40-C			ME 40-C						

** Only for B 500 and RH 50.

DIE SELECTOR CHART

APPLICATION	CONDUCTOR		CONNECTOR	HYDRAULIC TOOLS											
				B 15MDE		B 35-45MDE			B 35-50MDE			HT 45-E			
	Low str.	Flex	TERMINAL	DIE SET	NEST	INDENTOR	DIE SET	NEST	INDENTOR	DIE SET	NEST	INDENTOR	DIE SET		
 2A..M.  2A..2M.	16		2A 3-M..	ME2/3-15  MA03/3-15 	MA 2.3 	PA 5	ME 3 	MA 2.3-50 	PA 5-50	ME 3-50 	MA 2.3 		ME 3 		
	25		2A 5-M..		MA 5 			ME 5 		MA 5-50 			ME 5-50 	MA 5 	
	35	25* 35		2A 7-M..		MA 7 	PA 10	ME 7 	MA 7-50 	PA 10-50	ME 7-50 	MA 7 	PA 10	ME 7 	
	50	35* 50		2A 10-M.. 2A 10-2M..		MA 10 			ME 10 		MA 10-50 			ME 10-50 	MA 10 
	70	50* 70		2A 14-M.. 2A 14-2M..			PA 19-50	ME 14 	MA 14-50 		ME 14-50 			ME 14 	
	95	70* 95		2A 19-M.. 2A 19-2M..				ME 19 	MA 19-50 			ME 19-50 			
	120	95* 120		2A 24-M.. 2A 24-2M..				ME 24L 	MA 24-50 	PA 24-50	ME 24L-50 			ME 24 	
	150	120* 150		2A 30-M.. 2A 30-2M..					ME 30L 					ME 30L-50 	
	185	150* 185		2A 37-M.. 2A 37-2M..											
	240	185* 240		2A 48-M.. 2A 48-2M..											
	300	240 300		2A 60-M.. 2A 60-2M..											
	400	300 400		2A 80-M.. 2A 80-2M..											
	500	400 500		2A 100-M.. 2A 100-2M..											
	630	500 630		2A 120-M.. 2A 120-2M..											
	800	630		2A 160-M.. 2A 160-2M..											
	1000	800		2A 200-M.. 2A 200-2M..											

 Hexagonal crimp (use one size up with fine stranded conductors, E.G.: 95² fine stranded use A19... + ME 19 or A 20... + ME 20)

 Indent crimp

* Contact Cembre for appropriate die set







DIE SELECTOR CHART



H Y D R A U L I C T O O L S

HT 51 B 500E		RH 50 B 550E		HT 81-U RHU 81			HT 120 and tools and heads with 130 kN crimping force			ECW-H3D			RHU 520		
NEST	INDENTOR	DIE SET		DIE SET	DIE SET	NEST	INDENTOR	DIE SET	NEST	INDENTOR	DIE SET	NEST	INDENTOR	DIE SET	
MA 2.3-50 (2)	PA 5-50	ME 3-50 (2)	MA 3.5-U (2)	ME 3.14-U (2)	MA 3-C (2)	PA 10-C		ME 3-C (2)							
MA 5-50 (2)		ME 5-50 (2)		MA 5-C (2)	ME 5-C (2)										
MA 7-50 (2)	PA 10-50	ME 7-50 (2)	MA 7.14-U (2)	ME 10.24-U (3)	MA 7-C (2)			ME 7-C (2)							
MA 10-50 (2)		ME 10-50 (3)	MA 10.19-U (2)		MA 10-C (2)			ME 10-C (2)							
MA 14-50 (2)	PA 19-50	ME 14-50 (3)	MA 7.14-U (2)	ME 3.14-U (3)	MA 14-C (2)	PA 24-C		ME 14-C (2)							
MA 19-50 (2)		ME 19-50 (3)	MA 10.19-U MA 19-U (2)	ME 2.19-U (3)	MA 19-C (2)			ME 19-C (2)							
MA 24-50 (2)	PA 24-50	ME 24-50 (4)	MA 24-U (2)	ME 10.24-U (4)	MA 24-C (2)			ME 24-C (3)							
		ME 30-50 (5)	MA 30.80-U (2)	ME 30-U (4)	MA 30-C (2)			ME 30-C (3)							
		ME 37-50 (5)	MA 37-U (5)	ME 37-U (5)	MA 37-C (2)	PA 48-C		ME 37-C (3)							
		ME 48-50 (6)	MA 48-U (5)	ME 48-U (5)	MA 48-C (2)	ME 48-C (3)									
		ME 60-50** (8)			MA 60-C (2)	PA 60-C		ME 60-C (5)							
						ME 80-C (6)		MA 80-3D (2)							ME 80-3D (3)
								PA 100-3D							
								MA 100-3D (2)	ME 100-3D (3)	MA 100-520 (2)	PA 120-520	ME 100-520 (3)			
								MA 120-3D (2)	PA 120-3D	ME 120-3D (4)	MA 120-520 (2)		ME 120-520 (4)		
											MA 160-520 (2)		ME 160-520 (3)		
											PA 200-520	MA 200-520 (2)	ME 200-520 (3)		

** Only for B 500 and RH 50.













































































DIE SELECTOR CHART

APPLICATION	CONDUCTOR	CONNECTOR					
 ANE.-M..	Conductor Size Flex sqmm	TERMINAL					
	10	ANE 2-M..	ANE 2-P12	ANE 2-U..			
	16	ANE 3-M..	ANE 3-P14	ANE 3-U..			
	25	ANE 5-M..	ANE 5-P16				
	35	ANE 7-M..	ANE 7-P20				
	50	ANE 10-M..					
	 ANE.-P..	70	ANE 14-M..				
		95	ANE 19-M..				
		120	ANE 24-M..				
	 ANE.-U..	150	ANE 30-M..				
 ANE.-M..	Conductor Size Flex sqmm	TERMINAL					
	35	ANE 9-M..					
	50	ANE 12-M..					
	70	ANE 17-M..					
	95	ANE 20-M..					
	120	ANE 29-M..					
150	ANE 35-M..						
 PK ...	Conductor Size Flex sqmm	TERMINAL					
	0,3 ÷ 4	PKD 506 ÷ PKD 418	PKE 508 ÷ PKE 418	PKC 508 ÷ PKC 418	KE 506 ÷ KE 412		
	4 ÷ 16	PKD 410 ÷ PKD 1618	PKE 410 ÷ PKE 1618	PKC 410 ÷ PKC 1618	KE 410 ÷ KE 1616		
	16	PKD 16..	PKE 16..	PKC 16..	KE 16..		
	25	PKD 25..	PKE 25..	PKC 25..	KE 25..		
	 KE ...	35	PKD 35..		PKC 35..	KE 35..	
		50	PKD 50..		PKC 50..		
		70			PKC 70..		
		95			PKC 95..		
	120			PKC 120..			
 PKT ...	Conductor Size Flex sqmm	TERMINAL					
	2 x 0,5	PKT 508 PKT 510					
	2 x 0,75	PKT 7508 PKT 7512					
	2 x 1	PKT 108 PKT 112					
	2 x 1,5	PKT 1508 PKT 1512					
	2 x 2,5	PKT 2510 PKT 2512					
	2 x 4	PKT 412					
	2 x 6	PKT 614					
	2 x 10	PKT 1014					
	2 x 16	PKT 1614					



 Indent crimp
  Radial crimp
  Trapezium crimp

DIE SELECTOR CHART



H Y D R A U L I C T O O L S

B 15MDE		B 35-45MDE	B 35-50MDE	HT 45-E	HT 51 RH 50 B 500E B 550E	HT 81-U RHU 81	HT 120 and tools and heads with 130 kN crimping force			ECW-H3D	
DIE SET			DIE SET		DIE SET		NEST	INDENTOR	DIE SET	NEST	INDENTOR
NN4-15 			MN 2 RF-50 		MN 2 RF-50 		MN 2-C 	PN 7-C	MN 2 RF-C 	Adaptor AU 230-130 D with die set MN..C and indentor PN..C or with die set MN..RFC and die set MN..FC	
			MN 3 RF-50 		MN 3 RF-50 		MN 3-C 		MN 3 RF-C 		
			MN 5 RF-50 		MN 5 RF-50 		MN 5-C 		MN 5 RF-C 		
			MN 7 RF-50 		MN 7 RF-50 		MN 7-C 		MN 7 RF-C 		
			MN 10 RF-50 		MN 10 RF-50 		MN 10-C 		MN 10 RF-C 		
					MN 14 RF-50 		MN 14-C 	PN 14-C	MN 14 RF-C 		
					MN 19 RF-50 		MN 19-C 	PN 24-C	MN 19 RF-C 		
					MN 24 RF-50 		MN 24-C 		MN 24 RF-C 		
								MN 30-C 	PN 37-C		MN 30 RF-C 
			MN 7 RF-50 		MN 7 RF-50 		MN 9-C 	PN 14-C	MN 7 RF-C 	Adaptor AU 230-130 D with die set MN..C and indentor PN..C or with die set MN..RFC and die set MN..FC	
			MN 12 F-50 		MN 12 F-50 		MN 12-C 		MN 12 FC 		
					MN 17 F-50 		MN 17-C 	PN 24-C	MN 17 FC 		
					MN 20 F-50 		MN 20-C 		MN 20 FC 		
							MN 29-C 	PN 37-C	MN 29 FC 		
							MN 35-C 		MN 35 FC 		
DIE SET			DIE SET		DIE SET						
KE 4-15 											
KE 16-15 											
KE 35-15 			MTT 16-50 		MTT 16-50 						
			MTT 25-50 		MTT 25-50 						
			MTT 35-50 		MTT 35-50 						
			MTT 50-50 		MTT 50-50 						
			MTT 70-50 		MTT 70-50 						
			MTT 95-50 		MTT 95-50 						
					MTT 120-50 						
DIE SET	COMP. APERTURE		DIE SET		DIE SET						
KE 4-15 	1										
	1,5										
	2,5										
	2,5										
KE 4-15  KE 16-15 	4										
KE 16-15 	6										
	10										
KE 16-15  KE 35-15 	16		MTT 16-50 		MTT 16-50 						
KE 35-15 	35		MTT 35-50 		MTT 35-50 						

TAP-OFF ON COPPER CONDUCTOR

APPLICATION	CONDUCTOR		CONNECTORS		
	Run	Tap	CONNECTOR	CONNECTOR	
c..c..ST 	Conductor Size sqmm		CONNECTOR	CONNECTOR	
	6 ÷ 2,5	6 ÷ 1,5			
	10	10 ÷ 1,5	C 10 - C 10 ST	C 10 - C 10	
	16	16 ÷ 1,5	C 16 - C 16 ST	C 16 - C 16	
	25 ÷ 16	10 ÷ 1,5	C 25 - C 10 ST	C 25 - C 10	
	25	25 ÷ 16	C 25 - C 25 ST	C 25 - C 25	
	40 ÷ 35	16 ÷ 1,5	C 35 - C 16 ST	C 35 - C 16	
	40 ÷ 35	40 ÷ 25	C 35 - C 35 ST	C 35 - C 35	
	50	25 ÷ 10			
	70 ÷ 63	25 ÷ 1,5	C 70 - C 25N ST	C 70 - C 25N	
	50	25 ÷ 4	C 50 - C 25 ST	C 50 - C 25	
	*50	50 ÷ 35	C 50 - C 50 ST	C 50 - C 50	
	*70 ÷ 50	40 ÷ 4	C 70 - C 35 ST	C 70 - C 35	
	*70 ÷ 50	70 ÷ 35	C 70 - C 70 ST	C 70 - C 70	
c..c.. 	100 ÷ 95	40 ÷ 4	C 95 - C 35 ST	C 95 - C 35	
	100 ÷ 95	70 ÷ 40	C 95 - C 70 ST	C 95 - C 70	
	100 ÷ 95	100 ÷ 63	C 95 - C 95 ST	C 95 - C 95	
	125 ÷ 110	125 ÷ 25	C 120 - C 120 ST	C 120 - C 120	
	160 ÷ 150	125 ÷ 25	C 150 - C 120 ST	C 150 - C 120	
	150	150 ÷ 63	C 150 - C 150 ST	C 150 - C 150	
	185	100 ÷ 16	C 185 - C 95 ST	C 185 - C 95	
	185 ÷ 120	185 ÷ 120	C 185 - C 185 ST	C 185 - C 185	
	240 ÷ 150	120 ÷ 95	C 240 - C 120 ST	C 240 - C 120	

H.V. COPPER CONDUCTORS

APPLICATION	Conductor Size sqmm	TERMINALS		TERMINALS		
		TERMINALS	TERMINALS	TERMINALS	TERMINALS	TERMINALS
MT..TD MT..GC  CA..M.. CA..2M..  MT..C.. 	25 R	MT 25 - TD	MT 25 - GC	CA 25 - M..	CA 25 - 2M..	MT 25 - C..
	35 RC/S ÷ 40 S	MT 40 S - TD	MT 40 S - GC	CA 40 S - M..	CA 40 S - 2M..	MT 40 S - C..
	50 RC	MT 50 R - TD	MT 50 R - GC	CA 50 R - M..	CA 50 R - 2M..	MT 50 R - C..
	50 S	MT 50 S - TD	MT 50 S - GC	CA 50 S - M..	CA 50 S - 2M..	MT 50 S - C..
	63 S ÷ 70 S	MT 70 S - TD	MT 70 S - GC	CA 70 S - M..	CA 70 S - 2M..	MT 70 S - C..
	80 S ÷ 95 RC	MT 95 R - TD	MT 95 R - GC	CA 95 R - M..	CA 95 R - 2M..	MT 95 R - C..
	95 S ÷ 100 S	MT 95 S - TD	MT 95 S - GC	CA 95 S - M..	CA 95 S - 2M..	MT 95 S - C..
	120 RC/S ÷ 150 RC	MT 150 R - TD	MT 150 R - GC	CA 150 R - M..	CA 150 R - 2M..	MT 150 R - C..
	150 S ÷ 160 RC	MT 150 S - TD	MT 150 S - GC	CA 150 S - M..	CA 150 S - 2M..	MT 150 S - C..
	160 S ÷ 200 RC	MT 200 R - TD	MT 200 R - GC	CA 200 R - M..	CA 200 R - 2M..	MT 200 R - C..
	185 BR/BS	MT 185 - TD	MT 185 - GC	CA 185 - M..	CA 185 - 2M..	MT 185 - C..
	200 S ÷ 240 RC	MT 240 R - TD	MT 240 R - GC	CA 240 R - M..	CA 240 R - 2M..	MT 240 R - C..
	240 S ÷ 315 RC	MT 315 R - TD	MT 315 R - GC	CA 315 R - M..	CA 315 R - 2M..	MT 315 R - C..
	315 S	MT 315 S - TD	MT 315 S - GC	CA 315 S - M..	CA 315 S - 2M..	MT 315 S - C..

 = Hexagonal crimp

 = Oval crimp

 = circular crimp

* When using die se



H Y D R A U L I C T O O L S

	B 35-45MDE	B 35-50MDE	HT 45-E	HT 51 B 500E	RH 50 B 550E	HT 81-U RHU 81	HT 120 and tools and heads with 130 kN crimping force	ECW-H3D	RHU 520
	DIE SET	DIE SET	DIE SET	DIE SET	DIE SET	DIE SET	DIE SET	DIE SET	DIE SET
	MC 6 (1)	MC 6-50 (1)	MC 6 (1)	MC 6-50 (1)	MC 6.25-U (1)				
	MC 10 (1)	MC 10-50 (1)	MC 10 (1)	MC 10-50 (1)	MC 10-U (1)	MC 10-C (1)	Adaptor AU 230-130 D with die set MC..C	Adaptor AU 520-130 C with die set MC..C	
	MC 25 (2)	MC 25-50 (2)	MC 25 (2)	MC 25-50 (2)	MC 6.25-U MC 25-U (1)	MC 25-C (1)			
	MC 35 (2)	MC 35-50 (2)	MC 35 (2)	MC 35-50 (2)	MC 35-U (1)	MC 35-C (1)			
				*MC 70-50 (3)	MC 70-80-U (3)	MC 70-C (3)			MC 70-3D (1)
					MC 95-80-U (3)	MC 95-C (3)	MC 95-3D (1)		
						MC 185-C (3)	MC 185-3D (1)		
							MC 240-3D (1)		
		DIE SET		DIE SET	DIE SET	DIE SET	DIE SET	DIE SET	
C..		MMT 25-50 (0)		MMT 25-50 (0)	MMT 25-U (0)	MMT 25-C (0)	Adaptor AU 230-130 D with die set MMT..C	Adaptor AU 520-130 C with die set MMT..C	
C..		MMT 50-50 (0)		MMT 50-50 (0)	MMT 50-U (0)	MMT 50-C (0)			
C..				MMT 95-50 (0)	MMT 95-U (0)	MMT 95-C (0)			
C..				MMT 200-50 (0)	MMT 200-U (0)	MMT 200-C (0)			
C..						MMT 315-C (0)			
C..									

et type MC70-50, the conductors marked with a star must be annealed.



DIE SELECTOR CHART FOR DEEP STEP

ALUMINIUM CONDUCTORS

APPLICATIONS	CONDUCTOR	CONNECTORS		
<div style="display: flex; flex-direction: column; align-items: center;"> <div style="margin-bottom: 20px;">  <p>CAA..M.</p> </div> <div>  <p>MTA..C</p> </div> </div>	Conductor Size sqmm	LUGS		
	10	CAA 10 - M..		
	16	CAA 16 - M..	MTA 16 - C	
	25	CAA 25 - M..	MTA 25 - C	
	35	CAA 35 - M..	MTA 35 - C	
	50	CAA 50 - M..	MTA 50 - C	
	70	CAA 70 - M..	MTA 70 - C..	
	95	CAA 95 - M..	MTA 95 - C..	
	120	CAA 120 - M..	MTA 120 - C..	
	150	CAA 150 - M..	MTA 150 - C..	
	185	CAA 185 - M..	MTA 185 - C..	
	240	CAA 240 - M..	MTA 240 - C..	
	300	CAA 300 - 34 - M..		
<div style="display: flex; flex-direction: column; align-items: center;">  <p>AA..M.</p> </div>	Conductor Size sqmm	LUGS		
	16	AA 16 - M..		
	25	AA 25 - M..		
	35	AA 35 - M..		
	50	AA 50 - M..		
	70	AA 70 - M..		
	95	AA 95 - M..		
	120	AA 120 - M..		
	150	AA 150 - M..		
	185	AA 185 - M..		
	240	AA 240 - M..		
300	AA 300 - 34 - M..			

Indent crimp

PPED INDENTING WITH CONTAINING DIES

HYDRAULIC TOOLS			
HYDRAULIC TOOLS	HT 131-UC	RHU 131-C	B 1350-UCE B 1300-UCE
DIE HOLDER	DIE		INDENTOR
AU 130-150	MV 35 	MUA 35 	PS 130-35/E
	MV 95 	MUA 95 	PS 130-95/E
	MV 150 	MUA 150 	PS 130-150/E
AU 130-240	MV 240 	MUA 240 	PS 130-240/E
	MUA 300-34 		
DIE HOLDER	DIE		INDENTOR
AU 130-150	MUA 35 		PS 130-35/E
	MUA 95 		PS 130-95/E
	MUA 150 		PS 130-150/E
AU 130-240	MUA 240 		PS 130-240/E
	MUA 300-34 		

ALUMINIUM CONDUCTORS



MTMA...GC

DIE SELECTOR CHART FOR DEEP STEEL

Conductor Size sqmm	SPLICES		Conductor Size sqmm		SP
			Al	Al/Cu	
10	MTMA 10-GC				
16	MTMA 16-GC	MTMA 16/1	16	10	MTMA 16
25	MTMA 25-GC	MTMA 25/1	25	10	MTMA 25
			25	16	MTMA 25
35	MTMA 35-GC	MTMA 35/1			
50	MTMA 50-GC	MTMA 50/1	50	25	MTMA 50
			50	35	MTMA 50
70	MTMA 70-GC	MTMA 70/1	70	35	MTMA 70
			70	50	MTMA 70
95	MTMA 95-GC	MTMA 95/1	95	50	MTMA 95
			95	70	MTMA 95
120	MTMA 120-GC	MTMA 120/1	120	70	MTMA 120
			120	95	MTMA 120
150	MTMA 150-GC	MTMA 150/1	150	70	MTMA 150
			150	95	MTMA 150
185	MTMA 185-GC	MTMA 185/1	185	120	MTMA 185
			185	150	MTMA 185
240	MTMA 240-GC	MTMA 240/1	240	150	MTMA 240
			240	185	MTMA 240
300	MTMAD 300-GC	MTMAD 300/1	300	185	MTMAD 300
			300	240	MTMAD 300

PRE-ROUNDERS SELECTION

ALUMINIUM CONDUCTOR SIZE sqmm

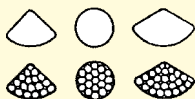

PRE-ROUNDER



DIE-SUPPORT



25

UP 130-25

35

UP 130-35

50

UP 130-50

70

UP 130-70

95

UP 130-95

120

UP 130-120

150

UP 130-150

185

UP 130-185

240

UP 130-240

AC 130-P

DIES D

1) AU 130-.. DIE-HOLDER

Used to house dies and pre-rounders.

2) UP 130-.. PRE-ROUNDERS

Used to round aluminium sectoral conductors in order to intro

Each pre-rounder is made of two parts: the upper part is hous

AC 130-P.. die support.

3) AC 130-P.. DIE SUPPORT

Houses lower part of pre-rounder UP 130-..

4) MUA... DIES

Containing dies.























5) PS 130-../E INDENTORS







Such indentors are specifically engineered for deep indentation



Indent crimp

PPED INDENTING WITH CONTAINING DIES

SIZES	HYDRAULIC TOOLS HT 131-UC RHU 131-C B 1350-UCE B 1300-UCE																													
	DIE HOLDER	DIE		INDENTOR																										
16-10 GC	AU 130-150	MVM 35 	MUA 35 	PS 130-35/E																										
25-10 GC		AU 130-150	MVM 95 		MUA 95 	PS 130-95/E																								
25-16 GC							AU 130-150	MVM 150 	MUA 150 	PS 130-150/E																				
50-25 GC											AU 130-240	MVM 240 	MUA 240 	PS 130-240/E																
50-35 GC															AU 130-240	MUA 300-34 	PS 130-240/E													
70-35 GC																		AU 130-240	MUA 300-34 	PS 130-240/E										
70-50 GC																					AU 130-240	MUA 300-34 	PS 130-240/E							
95-50 GC																								AU 130-240	MUA 300-34 	PS 130-240/E				
95-70 GC																											AU 130-240	MUA 300-34 	PS 130-240/E	
120-70 GC																														AU 130-240
120-95 GC	AU 130-240			MUA 300-34 																										
150-70 GC		AU 130-240	MUA 300-34 		PS 130-240/E																									
150-95 GC						AU 130-240	MUA 300-34 	PS 130-240/E																						
150-120 GC									AU 130-240	MUA 300-34 	PS 130-240/E																			
185-120 GC												AU 130-240	MUA 300-34 	PS 130-240/E																
185-150 GC															AU 130-240	MUA 300-34 	PS 130-240/E													
240-150 GC																		AU 130-240	MUA 300-34 	PS 130-240/E										
240-185 GC																					AU 130-240	MUA 300-34 	PS 130-240/E							
300-185 GC																								AU 130-240	MUA 300-34 	PS 130-240/E				
300-240 GC																											AU 130-240	MUA 300-34 	PS 130-240/E	

DESCRIPTION	DIES SEQUENCE	
<p>duce them into circular connectors. ed in die-holder AU 130.. and the lower part is locked onto</p> <p>of aluminium conductors of any stranding configuration.</p>	CONDUCTOR ROUNDING	CRIMPING
	1 	 1
	2 	 4
3 	 5	

APPLICATIONS	CONDUCTOR	CONNECTORS				HT 120 and 150 kV and heads with 10 kN crimping force
		LUGS	SPLICES		DIE SET	
 CAA..M..	Conductor Size sqmm	LUGS			HEXAGONAL CRIMP	
	300	CAA 300-34 - M..			DIE SET	
	300	CAA 300 - M16			MK34L-C	
	400	CAA 400 - M16				
	500	CAA 500 - M16 TNBD				
	630	CAA 630 - 4M8				
 AA..M..	Conductor Size sqmm	LUGS			DIE SET	
	300	AA 300 - 34 - M..			MK34L-C	
	300	AA 300 - M16				
	400	AA 400 - M16				
	500	AA 500 - 40 - M16				
	630	AA 630 - M16				
 MTMA..	Conductor Size sqmm	SPLICES	Conductor Size sqmm Al	Al/Cu	SPLICES	DIE SET
	300	MTMAD 300/1	300	95	MTMAD 300-95-GC	MK34L-C
				150	MTMAD 300-150-GC	
		MTMAD 300-GC		185	MTMAD 300-185-GC	
				240	MTMAD 300-240-GC	
	300	MTMA 300-GC				
	400	MTMA 400/1	400	240	MTMA 400-240-GC	
				300	MTMA 400-300-GC	
	500	MTMA 500-40/1				
	500	MTMA 500-GC	500	300	MTMA 500-300-GC	
400				MTMA 500-400-GC		
630	MTMA 630/1					



Indent crimp



Hexagonal crimp

CTOR CHART

H Y D R A U L I C T O O L S

Tools in 130 force	HT 131-UC RHU 131-C B 1350-UCE B 1300-UCE			ECW-H3D	RHU 230-630		
CRIMP	INDENT CRIMP			HEXAGONAL CRIMP	INDENT CRIMP		
	DIE HOLDER	DIE	INDENTOR	DIE SET	ADAPTOR	DIE	INDENTOR
	AU 130-240	MUA 300-34	PS 130-240/E	MK34-3D			
				MK38-3D	AU 230-630	MV 230-400 MC5E	PS 230-400 5E
				MK46-3D		MV 230-630 MC6E	PS 230-630 6E
	DIE HOLDER	DIE	INDENTOR	DIE SET	ADAPTOR	DIE	INDENTOR
	AU 130-240	MUA 300-34	PS 130-240/E	MK34-3D			
				MK38-3D	AU 230-630	MUA 230-630-400	PS 230-400 5E
				MK46-3D		MUA 230-630-630	PS 230-630 6E
	DIE HOLDER	DIE	INDENTOR	DIE SET	ADAPTOR	DIE	INDENTOR
	AU 130-240	MUA 300-34	PS 130-240/E	MK34-3D			
				MK38-3D	AU 230-630	MVM 230-400 MJ5E	PS 230-400 5E
				MK46-3D		MVM 230-630 MJ6E	PS 230-630 6E

COPPER CONDUCTORS

APPLICATIONS	CONDUCTOR			CONNECTOR			B 15MDE	B35-50MDE	
	Conductor Size sqmm	Conductor Size AWG	Conductor Size Navy	LUGS	SPLICES	DIE SET		DIE SET	
C...	10	8	23	C8..	CL8..	BSCL8	ME03/2-15 (1) ME2/3-15 (1) MA03/3-15 (2)	MY 2-50 (1)	
	16	6		C6..	CL6..	BSCL6	ME2/3-15 (1) MA03/3-15 (2)	MY 3-50 (1)	
	25	4	40	C4..	CL4..	BSCL4		MY 4-50 (1)	
			3	50	C3..	CL3..	BSCL3		MY 5-50 (1)
CL...	35	2	60	C2..	CL2..	BSCL2		MY 6-50 (1)	
			1	75	C1..	CL1..	BSCL1		MY 7-50 (1)
	50	1/0	100	C1/0..	CL1/0..	BSCL1/0		MY 10-50 (2)	
	70	2/0	125	C2/0..	CL2/0..	BSCL2/0		MY 14-50 (2)	
CL...	95	3/0	150	C3/0..	CL3/0..	BSCL3/0		MY 16-50 (2)	
			4/0	200	C4/0..	CL4/0..	BSCL4/0		MY 19-50 (2)
	120	250 MCM	250	C250..	CL250..	BSCL250		MY 24-50 (2)	
	150	300 MCM	300	C300..	CL300..	BSCL300		MY 30L-50 (2)	
BSCL..	185	350 MCM	350	C350..	CL350..	BSCL350			
		400 MCM	400	C400..	CL400..	BSCL400			
	240	500- MCM		C500..	CL500..	BSCL500			
	300	600 MCM		C600..	CL600..	BSCL600			
		750 MCM		C750..	CL750..	BSCL750			

 Circular crimp

 Hexagonal crimp























 Indent crimp

H Y D R A U L I C T O O L S

HT 51 RH 50 B 500E		HT 120 and tools and heads with 130 kN crimping force		ECW-H3D	RHU 520
	DIE SET		DIE SET	DIE SET	DIE SET
	MY 2-50 (1)		MY 2-C (1)	Adaptor AU 230-130 D with die set MY..-C	Adaptor AU 520-130 C with die set MY..-C
	MY 3-50 (1)		MY 3-C (1)		
	MY 4-50 (1)		MY 4-C (1)		
	MY 5-50 (1)		MY 5-C (1)		
	MY 6-50 (1)		MY 6-C (1)		
	MY 7-50 (1)		MY 7-C (1)		
	MY 10-50 (2)		MY 10-C (1)		
	MY 14-50 (2)		MY 14-C (1)		
	MY 16-50 (2)		MY 16-C (1)		
	MY 19-50 (2)		MY 19-C (1)		
	MY 24-50 (2)		MY 24-C (1)		
	MY 30-50 (2)		MY 30-C (1)		
	MY 36-50 (2)		MY 36-C (1)		
	MY 37-50 (2)		MY 37-C (1)		
	MY 48-50 (3)		MY 48-C (2)		
			MY 60-C (2)		
			MY 76-C (2)		

N.B.: Number inside symbol indicates the number of crimps for C short barrel lugs only

DIN 46235 - 46267 T.1

APPLICATIONS	CONDUCTOR	CONNECTORS		B 15MDE	B 35-45MDE	B 35-50MDE
				DIE SET	DIE SET	DIE SET
 DR.  DSV.		LUGS	SPLICES			
	6	DR6..	DSV6	MK5/8-15 	MK5 	MK5-50 
	10	DR10..	DSV10		MK6 	MK6-50 
	16	DR16..	DSV16		MK8 	MK8-50 
	25	DR25..	DSV25		MK10 	MK10-50 
	35	DR35..	DSV35		MK12 	MK12-50 
	50	DR50..	DSV50		MK14 	MK14-50 
	70	DR70..	DSV70		MK16 	MK16-50 
	95	DR95..	DSV95		MK18 	MK18-50 
	120	DR120..	DSV120		MK20 	MK20-50 
	150	DR150..	DSV150		MK22L 	MK22L-50 
	185	DR185..	DSV185			
	240	DR240..	DSV240			
	300	DR300..	DSV300			
	400	DR400..	DSV400			
500	DR500..	DSV500				
625	DR625..	DSV625				

 Hexagonal crimp

 Indent crimp

NB: for through connectors this is the number of crimps per

CONDUCTOR CHART

H Y D R A U L I C T O O L S









HT 45-E	HT 51 RHM 50	RH 50 B 500E	HT 81-U	RHU 81 [◊]	HT 120 and tools and heads with 130 kN crimping force	ECW-H3D	
DIE SET	DIE SET	DIE SET	DIE SET	DIE SET	DIE SET	DIE SET	
MK5	1	MK5-50	1	MK5-50	1	Adaptor AU 230-130 D with die set MK...C	
MK6	1	MK6-50	1	MK6-50	1		
MK8	2	MK8-50	2	MK8-50	1		
MK10	2	MK10-50	2	MK10-50	1		
MK12	2	MK12-50	2	MK12-50	1		
MK14	3	MK14-50	3	MK14-50	2		MK14-3D
MK16	3	MK16-50	3	MK16-50	2		MK16-3D
MK18	4	MK18-50	4	MK18-50	2		MK18-3D
MK20	4	MK20-50	4	MK20-50	2		MK20-3D
MK22L	4	MK22-50	4	MK22-50	2		MK22-3D
		MK25-50	5	MK25-50	2	MK25-3D	
		MK28-50	5	MK28-50	4	MK28-3D	
		MK32-50**	6		4	MK32-3D	
						MK38-3D	
						MK42-3D	
						MK44-3D	

er conductor

[◊] Tools type HT 81-U and RHU 81 with adaptor type 6780232 can use the same dies of HT 51 but are equipped with spring type 6522051.

** Only for B 500 and RH 50.

DIN EN 50182

	Conductor Size sqmm		MATERIAL (Al)		B 35-45MDE	B 35-50
	<i>rm / sm</i>	<i>re / se</i>	LUGS	SPLICES	DIE SET	DIE SET
 AAD...	16	25	AAD16-M..	DSVA16	MK12B  4	MK12B-50
	25	35	AAD25-M..	DSVA25	MK12B  4	MK12B-50
	35	50	AAD35-M..	DSVA35	MK14B  5	MK14B-50
	50	70	AAD50-M..	DSVA50	MK16B  5	MK16B-50
	70	95	AAD70-M..	DSVA70	MK18B  6	MK18B-50
	95	120	AAD95-M..	DSVA95	MK22B  6	MK22B-50
	120	150	AAD120-M..	DSVA120	MK22B  6	MK22B-50
	150	185	AAD150-M..	DSVA150		MK25B-50
	185	240	AAD185-M..	DSVA185		
	240	300	AAD240-M..	DSVA240		
 DSVA...	300		AAD300-M..	DSVA300		
	400		AAD400-M..	DSVA400 / DSVA401		
	500		AAD500-M..	DSVA500 / DSVA501		
	600			DSVA625		
	800			DSVA800		
	1000			DSVA1000		

rm = round stranded
sm = sector stranded
re = round solid
se = sector solid

 Hexagonal crimp

NB: for through connectors this is the number of crimps

H Y D R A U L I C T O O L S

CODE	HT 45-E	HT 51 RHM 50	RH 50 B 500E	HT 81-U	RHU 81 [◇]	HT 120 and tools and heads with 130 kN crimping force	ECW-H3D	RHU 450	RHU 520
TYPE	DIE SET	DIE SET		DIE SET		DIE SET	DIE SET	DIE SET	DIE SET
4	MK12B 4	MK12B-50 4		MK12B-50 4		MK12-C 2	Adaptor AU 230-130 D with die set MK...C	Adaptor AU 450-130 D with die set MK...C	Adaptor AU 520-130 C with die set MK...C
4	MK12B 4	MK12B-50 4		MK12B-50 4		MK12-C 2			
5	MK14B 5	MK14B-50 5		MK14B-50 5		MK14-C 2			
5	MK16B 5	MK16B-50 5		MK16B-50 5		MK16-C 2			
6	MK18B 6	MK18B-50 6		MK18B-50 6		MK18-C 3			
6	MK22B 6	MK22B-50 6		MK22B-50 6		MK22-C 3			
6	MK22B 6	MK22B-50 6		MK22B-50 6		MK22-C 3			
		MK25B-50 6		MK25B-50 6		MK25-C 3			
		MK28B-50 6		MK28B-50 6		MK28-L-C 3			
		MK32B-50 8				MK32-L-C 3			
						MK34-L-C 3			
						MK38-3D 4	MK38-450 4	MK38-520 4	
						MK44-3D 4	MK44-450 4	MK44-520 4	
							MK52-450 5	MK52-520 5	
							MK58-450 5	MK58-520 5	
							MK60-450 5	MK60-520 5	

per conductor

[◇] Tools type HT 81-U and RHU 81 with adaptor type 6780232 can use the same dies of HT 51 but are equipped with spring type 6522051.



A P P E N D I X

REFERENCE/CODE CROSS-REFERENCE CHART

Ref.	Code	Ref.	Code	Ref.	Code	Ref.	Code	Ref.	Code
1052007	3005900	1142048G	3005057	1500.14	3002110	181113	3017630	1900.11G	3001022
1052007N	3005901	1142048N	3005056	1500.14N	3002111	181116	3017640	1900.11N	3001021
1052009	3005903	1143M12	3005215	1500.16	3002030	181316	3017650	1900.11/X	3001083
1052009N	3005904	1143M12G	3005217	1500.16N	3002031	181321	3017655	1900.12	3001120
1052011	3005906	1143M12N	3005216	1500.21	3002035	181621	3017660	1900.12N	3001121
1052011N	3005907	1143M16	3005220	1500.21N	3002036	182129	3017670	1900.13	3001025
1052013	3005909	1143M16G	3005222	1500.34	3002130	182936	3017680	1900.13G	3001027
1052013N	3005910	1143M16N	3005221	1500.34N	3002131	1830	3004110	1900.13N	3001026
1052016	3005912	1143M20	3005225	1500.38	3002115	1830N	3004111	1900.13/X	3001086
1052016N	3005913	1143M20G	3005227	1500.38N	3002116	1831	3004115	1900.14	3001110
1052021	3005915	1143M20N	3005226	1500.M12	3002205	1831N	3004116	1900.14N	3001111
1052021N	3005916	1143M25	3005230	1500.M12N	3002206	1832	3004120	1900.16	3001030
1052029	3005918	1143M25G	3005232	1500.M16	3002210	1832N	3004121	1900.16G	3001032
1052029N	3005919	1143M25N	3005231	1500.M16N	3002211	1835G	3004222	1900.16N	3001031
1052036	3005921	1143M32	3005235	1500.M20	3002215	1836	3004225	1900.16/X	3001089
1052036N	3005922	1143M32G	3005237	1500.M20N	3002216	183642	3017690	1900.21	3001035
1052042	3005924	1143M32N	3005236	1500.M25	3002220	1836N	3004226	1900.21G	3001037
1052042N	3005925	1143M40	3005240	1500.M25N	3002221	1840	3006610	1900.21N	3001036
1052048	3005927	1143M40G	3005242	1500.M32	3002225	1840N	3006611	1900.21/X	3001092
1052048N	3005928	1143M40N	3005241	1500.M32N	3002226	1841	3006615	1900.29	3001040
1053M12	3005958	1143M50	3005245	1700	3003015	1841N	3006616	1900.29G	3001042
1053M12N	3005959	1143M50G	3005247	1700.2	3004015	1842	3006620	1900.29N	3001041
1053M16	3005961	1143M50N	3005246	1700.2N	3004016	184248	3017700	1900.29/X	3001095
1053M16N	3005962	1143M63	3005250	1700N	3003016	1842N	3006621	1900.34	3001130
1053M20	3005964	1143M63G	3005252	1700P	3006015	1843	3006625	1900.34N	3001131
1053M20N	3005965	1143M63N	3005251	1700T	3003515	1843N	3006626	1900.36	3001045
1053M25	3005967	1150	3005745	1700TN	3003516	1844	3006630	1900.36G	3001047
1053M25N	3005968	1150N	3005746	1701	3003020	1844N	3006631	1900.36N	3001046
1053M32	3005970	1163	3005750	1701.2	3004020	1845	3006635	1900.36/X	3001098
1053M32N	3005971	1163N	3005751	1701.2N	3004021	1845N	3006636	1900.38	3001115
1053M40	3005973	1253M12	3006750	1701N	3003021	1846	3006640	1900.38N	3001116
1053M40N	3005974	1253M12N	3006751	1701P	3006020	1846N	3006641	1900.42	3001050
1053M50	3005976	1253M16	3006755	1701PN	3006021	1847	3006645	1900.42G	3001052
1053M50N	3005977	1253M16N	3006756	1701T	3003517	1847N	3006646	1900.42N	3001051
1053M63	3005979	1253M20	3006760	1701TN	3003518	1848	3006650	1900.42/X	3001101
1053M63N	3005980	1253M20N	3006761	1702	3003025	1848N	3006651	1900.48	3001055
1112	3005715	1253M25	3006765	1702.2	3004025	1849	3006655	1900.48G	3001057
1112N	3005716	1253M25N	3006766	1702.2N	3004026	1849N	3006656	1900.48N	3001056
1116	3005720	1253M32	3006770	1702.5	3004425	1861	3004515	1900.48/X	3001104
1116N	3005721	1253M32N	3006771	1702.5N	3004426	1861N	3004516	1900.M12	3001215
1120	3005725	1253M40	3006775	1702CONC	3003523	1862	3004520	1900.M12G	3001217
1120N	3005726	1253M40N	3006776	1702CONCN	3003524	1862N	3004521	1900.M12N	3001216
1125	3005730	1253M50	3006780	1702N	3003026	1866	3004615	1900.M12/X	3001310
1125N	3005731	1253M50N	3006781	1702P	3006025	1866N	3004616	1900.M16	3001220
1132	3005735	1253M63	3006785	1702PN	3006026	1880	3016215	1900.M16G	3001222
1132N	3005736	1253M63N	3006786	1702T	3003519	1881	3016220	1900.M16N	3001221
1140	3005740	1400	3003110	1702TN	3003520	1882	3016225	1900.M16/X	3001313
1140N	3005741	1401	3003114	1703	3003030	1883	3016230	1900.M20	3001225
1141012	3005120	1401B	3003116	1703.2	3004030	1884	3016235	1900.M20G	3001227
1141012N	3005121	1401BN	3003117	1703.5	3004430	1884A	3016236	1900.M20N	3001226
1141112	3005155	1401C	3003118	1703P	3006030	1885	3016240	1900.M20/X	3001316
1141112N	3005156	1401CN	3003119	1704	3003035	1886	3016245	1900.M25	3001230
1141200	3005170	1401N	3003115	1704.2	3004035	1887	3016250	1900.M25G	3001232
1141200N	3005171	1402	3003120	1704P	3006035	1888	3016255	1900.M25N	3001231
1142007	3005010	1402N	3003121	1705	3003040	1888/5	3016256	1900.M25/X	3001319
1142007G	3005012	1403	3003125	1705.2	3004040	1889	3016405	1900.M32	3001235
1142007N	3005011	1404	3003130	1706	3003045	1890	3016410	1900.M32G	3001237
1142009	3005015	1405	3003135	1707	3003050	1890A	3016420	1900.M32N	3001236
1142009G	3005017	1407	3003155	1708	3003055	1891	3016430	1900.M32/X	3001322
1142009N	3005016	1408	3003170	1709	3003010	1891A	3016431	1900.M40	3001240
1142011	3005020	1410	3005610	1710	3005515	1892	3016440	1900.M40G	3001242
1142011G	3005022	1410N	3005611	1710N	3005516	1892A	3016450	1900.M40N	3001241
1142011N	3005021	1411	3005615	1711	3005520	1892B	3016451	1900.M40/X	3001325
1142013	3005025	1411N	3005616	1711N	3005521	1893	3016460	1900.M50	3001245
1142013G	3005027	1412	3005620	1712	3005525	1893A	3016461	1900.M50G	3001247
1142013N	3005026	1412N	3005621	1712N	3005526	1894	3016480	1900.M50N	3001246
1142016	3005030	1413	3005625	1713	3005530	1895	3016490	1900.M50/X	3001328
1142016G	3005032	1413N	3005626	1713N	3005531	1896	3016500	1900.M63	3001250
1142016N	3005031	1414	3005630	1714	3005535	1897	3016510	1900.M63G	3001252
1142021	3005035	1414N	3005631	1714E34	3005572	1898	3016520	1900.M63N	3001251
1142021G	3005037	1415	3005635	1714N	3005536	1899	3016530	1900.M63/X	3001331
1142021N	3005036	1415N	3005636	1715	3005540	1899A	3016535	1900DP.07	3001150
1142029	3005040	1500.07	3002010	1715N	3005541	1899B	3016540	1900DP.09	3001153
1142029G	3005042	1500.07N	3002011	1719	3005510	1900.07	3001010	1900DP.11	3001156
1142029N	3005041	1500.09	3002015	1719E17	3005581	1900.07G	3001012	1900DP.13	3001159
1142036	3005045	1500.09N	3002016	1719E17N	3005580	1900.07N	3001011	1900DP.16	3001162
1142036G	3005047	1500.11	3002020	1719N	3005511	1900.07/X	3001077	1900DP.21	3001165
1142036N	3005046	1500.11N	3002021	1730M20	3003225	1900.09	3001015	1900DP.29	3001168
1142042	3005050	1500.12	3002120	1730M20N	3003226	1900.09G	3001017	1900DP.36	3001171
1142042G	3005052	1500.12N	3002121	180709	3017610	1900.09N	3001016	1900DP.42	3001174
1142042N	3005051	1500.13	3002025	180911	3017620	1900.09/X	3001080	1900DP.48	3001177
1142048	3005055	1500.13N	3002026	180913	3017625	1900.11	3001020	1900DPM12	3013380

REFERENCE/CODE CROSS-REFERENCE CHART

Ref.	Code	Ref.	Code	Ref.	Code	Ref.	Code	Ref.	Code
1900DP.M16	3013383	1910.M25N	3001721	2031038	3015615	2053M16N	3011915	2176	3051430
1900DP.M20	3013386	1910.M32	3001725	2031038N	3015616	2053M20N	3011920	2323	3052010
1900DP.M25	3013389	1910.M32G	3001727	2031058	3015625	2053M25N	3011925	2326	3052020
1900DP.M32	3013392	1910.M32N	3001726	2031058N	3015626	2053M32N	3011930	2329	3052030
1900DP.M40	3013395	1910.M40	3001730	2031100	3015635	2053M40N	3011935	2333	3052110
1900DP.M50	3013398	1910.M40G	3001732	2031100N	3015636	2053M50N	3011940	2336	3052120
1900DP.M63	3013401	1910.M40N	3001731	2031112	3015655	2053M63N	3011945	2339	3052130
1901.07	3001503	1910.M50	3001735	2031112N	3015656	207101441	3013607	2342	3052140
1901.07N	3001504	1910.M50G	3001737	2031114	3015645	207101441N	3013608	2344	3052150
1901.09	3001515	1910.M50N	3001736	2031114N	3015646	208200711N	3011010	2346	3052160
1901.09N	3001516	1910.M63	3001740	2031118	3015640	208200911N	3011015	2900.07N	3012010
1901.11	3001520	1910.M63G	3001742	2031118N	3015641	208201111N	3011020	2900.09N	3012015
1901.11N	3001521	1910.M63N	3001741	2031200	3015670	208201311N	3011025	2900.11N	3012020
1901.13	3001535	1925.3	3016470	2031200N	3015671	208201611N	3011030	2900.13N	3012025
1901.13N	3001536	200101241	3013120	2031212	3015685	208202111N	3011035	2900.16N	3012030
1901.16	3001550	200101241N	3013121	2031212N	3015686	208202911N	3011040	2900.21N	3012035
1901.16N	3001551	200101441	3013110	2031300	3015695	208203611N	3011045	2900.29N	3012040
1901.21	3001568	200101441N	3013111	2031300N	3015696	208204211N	3011050	2900.36N	3012045
1901.21N	3001569	200103441	3013130	2032007N	3015511	208204811N	3011055	2900.42N	3012050
1901.29	3001575	200103441N	3013131	2032009N	3015516	20931216N	3017705	2900.48N	3012055
1901.29N	3001576	200103841	3013115	2032011N	3015521	20931620N	3017707	2900.M12N	3012215
1901.36	3001582	200103841N	3013116	2032013N	3015526	20932025N	3017709	2900.M16N	3012220
1901.36N	3001583	200105841	3013125	2032016N	3015531	20932532N	3017711	2900.M20N	3012225
1901.42	3001590	200105841N	3013126	2032021N	3015536	20932540N	3017713	2900.M25N	3012230
1901.42N	3001591	200110041	3013135	2032029N	3015541	20933240N	3017715	2900.M32N	3012235
1901.48	3001596	200110041N	3013136	2032036N	3015546	20933250N	3017717	2900.M40N	3012240
1901.48N	3001597	200111241	3013155	2032042N	3015551	20934050N	3017719	2900.M50N	3012245
1901.M12	3001650	200111241N	3013156	2032048N	3015556	20935063N	3017721	2900.M63N	3012250
1901.M12G	3001652	200111441	3013145	2033M12N	3015751	20A40916N	3018650	2900DP.07N	3012160
1901.M12N	3001651	200111441N	3013146	2033M16N	3015756	20A41120N	3018655	2900DP.09N	3012162
1901.M16	3001655	200111841	3013140	2033M20N	3015761	20A41320N	3018657	2900DP.11N	3012164
1901.M16G	3001657	200111841N	3013141	2033M25N	3015766	20A41620N	3018659	2900DP.13N	3012166
1901.M16N	3001656	200120041	3013170	2033M32N	3015771	20A42011N	3018610	2900DP.16N	3012168
1901.M20	3001660	200120041N	3013171	2033M40N	3015776	20A42016N	3018612	2900DP.21N	3012170
1901.M20G	3001662	200121221	3013185	2033M50N	3015781	20A42120N	3018661	2900DP.29N	3012172
1901.M20N	3001661	200121221N	3013186	2033M63N	3015786	20A42125N	3018665	2900DP.36N	3012174
1901.M25	3001665	200130021	3013195	20420907N	3017810	20A42513N	3018615	2900DP.42N	3012176
1901.M25G	3001667	200130021N	3013196	20421107N	3017820	20A42516N	3018617	2900DP.48N	3012178
1901.M25N	3001666	200200721N	3013011	20421109N	3017822	20A42925N	3018667	2900DP.M12N	3012315
1901.M32	3001670	200200921N	3013016	20421307N	3017830	20A43216N	3018620	2900DP.M16N	3012317
1901.M32G	3001672	200201121N	3013021	20421309N	3017832	20A43221N	3018621	2900DP.M20N	3012319
1901.M32N	3001671	200201321N	3013026	20421311N	3017835	20E200711N	3011102	2900DP.M25N	3012321
1901.M40	3001675	200201621N	3013031	20421607N	3017840	20E200911N	3011104	2900DP.M32N	3012323
1901.M40G	3001677	200202121N	3013036	20421609N	3017842	20E201111N	3011106	2900DP.M40N	3012325
1901.M40N	3001676	200202921N	3013041	20421611N	3017845	20E201311N	3011108	2900DP.M50N	3012327
1901.M50	3001680	200203621N	3013046	20421613N	3017847	20E201611N	3011110	2900DP.M63N	3012329
1901.M50G	3001682	200204221N	3013051	20422111N	3017850	20E202111N	3011112	2901.07N	3012590
1901.M50N	3001681	200204821N	3013056	20422113N	3017855	20E202911N	3011114	2901.09N	3012593
1901.M63	3001685	2003M1221N	3013215	20422116N	3017858	20E203611N	3011116	2901.11N	3012596
1901.M63G	3001687	2003M1621N	3013220	20422916N	3017860	20E204211N	3011118	2901.13N	3012599
1901.M63N	3001686	2003M2021N	3013225	20422921N	3017865	20E204811N	3011120	2901.16N	3012602
1910.07	3001501	2003M2521N	3013230	20423621N	3017870	20M3M1261N	3011410	2901.21N	3012605
1910.07N	3001502	2003M3221N	3013235	20423629N	3017875	20M3M1661N	3011412	2901.29N	3012608
1910.09	3001509	2003M4021N	3013240	20424229N	3017880	20M3M2061N	3011414	2901.36N	3012611
1910.09N	3001510	2003M5021N	3013245	20424236N	3017885	20M3M2561N	3011416	2901.42N	3012614
1910.11	3001526	2003M6321N	3013250	20424836N	3017890	20M3M3261N	3011418	2901.M12N	3012650
1910.11N	3001527	2021012	3014120	20424842N	3017895	20M3M4061N	3011420	2901.M16N	3012652
1910.13	3001539	2021012N	3014121	20431612N	3017949	20M3M5061N	3011422	2901.M20N	3012654
1910.13N	3001540	2021014	3014110	20432012N	3017951	20M3M6361N	3011424	2901.M25N	3012656
1910.16	3001552	2021014N	3014111	20432016N	3017953	20N3M12N	3015810	2901.M32N	3012658
1910.16N	3001553	2021034	3014130	20432512N	3017955	20N3M16N	3015812	2901.M40N	3012660
1910.21	3001565	2021034N	3014131	20432516N	3017957	20N3M20N	3015814	2901.M50N	3012662
1910.21N	3001566	2021038	3014115	20432520N	3017959	20N3M25N	3015816	2910.07N	3012501
1910.29	3001578	2021038N	3014116	20433220N	3017961	20N3M32N	3015818	2910.09N	3012511
1910.29N	3001579	2021058	3014125	20433225N	3017963	20N3M40N	3015820	2910.11N	3012521
1910.36	3001588	2021058N	3014126	20434025N	3017965	20N3M50N	3015822	2910.13N	3012531
1910.36N	3001589	2021100	3014135	20434032N	3017967	20N3M63N	3015824	2910.16N	3012541
1910.42	3001592	2021100N	3014136	20435032N	3017969	2155	3051010	2910.21N	3012551
1910.42N	3001593	2021112	3014155	20435040N	3017971	2156	3051015	2910.29N	3012555
1910.48	3001598	2021112N	3014156	20436340N	3017973	2157	3051020	2910.36N	3012560
1910.48N	3001599	2021114	3014145	20436350N	3017975	2158	3051125	2910.42N	3012565
1910.M12	3001705	2021114N	3014146	2052007N	3011810	2160	3051130	2910.48N	3012570
1910.M12G	3001707	2021118	3014140	2052009N	3011815	2161	3051135	2910.M12N	3012710
1910.M12N	3001706	2021118N	3014141	2052011N	3011820	2162	3051140	2910.M16N	3012712
1910.M16	3001710	2021200	3014170	2052013N	3011825	2163	3051145	2910.M20N	3012714
1910.M16G	3001712	2021200N	3014171	2052016N	3011830	2164	3051150	2910.M25N	3012716
1910.M16N	3001711	2031012	3015620	2052021N	3011835	2165	3051155	2910.M32N	3012718
1910.M20	3001715	2031012N	3015621	2052029N	3011840	2167	3051165	2910.M40N	3012720
1910.M20G	3001717	2031014	3015610	2052036N	3011845	2171	3051310	2910.M50N	3012722
1910.M20N	3001716	2031014N	3015611	2052042N	3011850	2172	3051315	2910.M63N	3012724
1910.M25	3001720	2031034	3015630	2052048N	3011855	2173	3051320	2911.07N	3012110
1910.M25G	3001722	2031034N	3015631	2053M12N	3011910	2174	3051325	2911.09N	3012113

REFERENCE/CODE CROSS-REFERENCE CHART

Ref.	Code	Ref.	Code	Ref.	Code	Ref.	Code	Ref.	Code
2911.11N	3012116	2A37-2M16	2507490	4900.M40	3002765	7033AM25	3010676	A06-M5	2101150
2911.13N	3012119	2A48-2M12	2508380	4900.M50	3002768	7033AM32	3010678	A06-M6	2101190
2911.16N	3012122	2A48-2M14	2508410	4900.M63	3002771	7033AM40	3010680	A06-M8	2101230
2911.21N	3012125	2A48-2M16	2508430	4901.07	3002910	7033AM50	3010682	A10-M10	2220150
2911.29N	3012128	2A60-2M12	2508700	4901.09	3002913	7033AM63	3010684	A10-M12	2220190
2911.36N	3012131	2A60-2M14	2508760	4901.11	3002916	7900.07	3010000	A10-M14	2220230
2911.42N	3012134	2A60-2M16	2508770	4901.13	3002919	7900.09	3010005	A10-M16	2220270
2911.M12N	3012750	2A80-2M12	2509310	4901.16	3002922	7900.11	3010010	A10-M6	2220070
2911.M16N	3012752	2A80-2M14	2509350	4901.21	3002925	7900.13	3010015	A10-M8	2220110
2911.M20N	3012754	2A80-2M16	2509390	4901.29	3002928	7900.16	3010020	A10-P25	2221990
2911.M25N	3012756	2A100-2M12	2509742	4901.36	3002931	7900.21	3010025	A100-M16	2370030
2911.M32N	3012758	2A100-2M14	2509760	4901.42	3002934	7900.29	3010030	A100-M20	2370110
2911.M40N	3012760	2A100-2M16	2509780	4901.48	3002937	7900.36	3010035	A10B-M6/11,5	2220078
2911.M50N	3012762	2A120-2M12	2509910	4901.M12	3002950	7900.42	3010040	A12-M10	2230270
2A10-M10	2502070	2A120-2M14	2509930	4901.M16	3002953	7900.48	3010045	A12-M10/19	2230280
2A10-M12	2502150	2A120-2M16	2509970	4901.M20	3002956	7900A.07	3010060	A12-M12	2230310
2A10-M14	2502190	2A160-2M12	8008602	4901.M25	3002959	7900A.09	3010062	A12-M6/15	2230210
2A10-M16	2502230	2A160-2M14	8008603	4901.M32	3002962	7900A.11	3010064	A12-M8	2230230
2A100-M16	2509630	2A160-2M16	2509982	4901.M40	3002965	7900A.13	3010066	A120-M16	2372070
2A100-M20	2509670	2A200-2M12	2509993	4901.M50	3002968	7900A.16	3010068	A120-M20	2372150
2A120-2M14/55°	2509952	2A200-2M14	8008604	4901.M63	3002971	7900A.21	3010070	A14-M10	2240230
2A120-M16	2509870	2A200-2M16	2509985	5900.M12N	3012810	7900A.29	3010072	A14-M12	2240270
2A120-M20	2509890	2A200-2M20	2509994	5900.M16N	3012812	7900A.36	3010074	A14-M14	2240310
2A14-M10	2503030	3411012	3016645	5900.M20N	3012814	7900A.42	3010076	A14-M16	2240350
2A14-M12	2503110	3411014	3016615	5900.M25N	3012816	7900A.48	3010078	A14-M6	2240110
2A14-M14	2503150	3411034	3016665	5900.M32N	3012818	7900.M12	3010110	A14-M8	2240150
2A14-M16	2503190	3411038	3016625	5900.M40N	3012820	7900.M16	3010113	A14-P30	2241730
2A160-M20	2509980	3411100	3016695	5900.M50N	3012822	7900.M20	3010116	A14B-M6/11,5	2240118
2A19-M10	2504030	3412011	3016635	5900.M63N	3012824	7900.M25	3010119	A160-M16	2374150
2A19-M12	2504110	3412016	3016657	5901.M12N	3012850	7900.M32	3010122	A160-M20	2374170
2A19-M14	2504190	3412021	3016685	5901.M16N	3012852	7900.M40	3010125	A17-M10	2250270
2A19-M16	2504270	3412029	3016705	5901.M20N	3012854	7900.M50	3010128	A17-M10/19	2250280
2A19-M20	2504350	3422016	3016658	5901.M25N	3012856	7900.M63	3010131	A17-M12	2250310
2A200-M20	2509989	3422021	3016686	5901.M32N	3012858	7900A.M12	3010150	A17-M14	2250350
2A24-M10	2505030	3431100	3016895	5901.M40N	3012860	7900A.M16	3010152	A17-M16	2250860
2A24-M12	2505150	3441012	3017045	5901.M50N	3012862	7900A.M20	3010154	A17-M6	2250210
2A24-M14	2505230	3441034	3017065	5116660250	3061210	7900A.M25	3010156	A17-M8	2250230
2A24-M16	2505310	3572007	3017410	5116660500	3061215	7900A.M32	3010158	A17-M10	2260190
2A24-M20	2505390	3572011	3017430	6010.01	3016090	7900A.M40	3010160	A19-M12	2260230
2A3-M10	2500070	3572013	3017445	6010.11	3016030	7900A.M50	3010162	A19-M14	2260270
2A3-M8	2500030	35720131	3017446	6010.12	3016040	7900A.M63	3010164	A19-M16	2260310
2A30-M10	2506020	3572016	3017455	6010.14	3016010	A1-L6	2103200	A19-M20	2260390
2A30-M12	2506030	3572021	3017480	6010.21	3016080	A2-L5	2170820	A19-M6	2260110
2A30-M14	2506110	3573M16	3017520	6010.29	3016100	A2-L6	2170830	A19-M8	2260150
2A30-M16	2506190	3573M20	3017530	6010.34	3016060	A2-L8	2170850	A19B-M8/15,5	2260163
2A30-M20	2506270	3573M25	3017540	6010.36	3016110	A3-L5	2180620	A1-M10	2103270
2A37-M12	2507070	3573M32	3017550	6010.38	3016020	A3-L6	2180630	A1-M3	2103030
2A37-M14	2507110	36A3M1623	3016910	6010.42	3016120	A3-L8	2180640	A1-M3,5	2103070
2A37-M16	2507190	36A3M1624	3016912	6010.48	3016130	A3-L10	2180659	A1-M4	2103110
2A37-M20	2507270	36A3M16322	3016913	6010.58	3016050	A5-L6	2190670	A1-M5	2103150
2A48-M12	2508030	36A3M2025	3016920	6010.114	3016070	A5-L8	2190710	A1-M6	2103190
2A48-M14	2508070	36A3M2034	3016922	7032007	3010604	A5-L10	2190750	A1-M8	2103230
2A48-M16	2508110	36A3M20356	3016923	7032009	3010606	A7-L6	2200710	A20-M10	2270270
2A48-M20	2508190	36A3M2526	3016930	7032011	3010608	A7-L8	2200750	A20-M12	2270310
2A5-M10	2500570	36A3M2536	3016932	7032013	3010610	A7-L10	2200790	A20-M14	2270350
2A5-M12	2500650	36A3M2537	3016934	7032016	3010614	A7-L12	2200830	A20-M16	2270390
2A5-M8	2500530	36A3M2545	3016936	7032021	3010616	A10-L6	2220605	A20-M8	2270230
2A60-M12	2508480	36A3M2546	3016937	7032029	3010618	A10-L8	2220610	A200-M16	2376090
2A60-M14	2508500	36A3M2554	3016938	7032036	3010620	A10-L10	2220650	A200-M20	2376100
2A60-M16	2508530	36A3M3228	3016944	7032042	3010622	A10-L12	2220690	A24-M10	2280150
2A60-M20	2508610	36A3M3239	3016946	7032048	3010624	A14-L8	2241245	A24-M12	2280190
2A7-M10	2501110	36A3M32465	3016945	7032A007	3010628	A14-L10	2241250	A24-M14	2280230
2A7-M12	2501150	36A3M3248	3016943	7032A009	3010630	A14-L12	2241290	A24-M16	2280270
2A7-M8	2501030	36A3M4078	3016952	7032A011	3010632	A19-L8	2260560	A24-M20	2280310
2A80-2M14/55°	2509346	36A3M40106	3016954	7032A013	3010634	A19-L10	2260570	A24-M8	2280110
2A80-M12	2509030	36A3M5088	3016968	7032A016	3010636	A19-L12	2260610	A24B-M10/19	2280155
2A80-M14	2509070	36C201629	3016982	7032A021	3010638	A24-L10	2281010	A24B-M8/19	2280115
2A80-M16	2509150	4900.07	3002710	7032A029	3010640	A24-L12	2281050	A29-M10	2290270
2A80-M20	2509230	4900.09	3002713	7032A036	3010642	A30-L10	2300870	A29-M12	2290310
2A10-2M12	2502410	4900.11	3002716	7032A042	3010644	A30-L12	2300910	A29-M14	2290350
2A14-2M12	2503310	4900.13	3002719	7032A048	3010646	A37-L10	2320510	A29-M16	2290390
2A14-2M14	2503315	4900.16	3002722	7033M12	3010652	A37-L12	2320550	A29-M20	2290430
2A19-2M12	2504480	4900.21	3002725	7033M16	3010654	A48-L12	2341295	A29-M8	2290230
2A19-2M14	2504510	4900.29	3002728	7033M20	3010656	A60-L12	2351010	A2-M10	2170270
2A24-2M12	2505490	4900.36	3002731	7033M25	3010658	A03-M3	2100030	A2-M12	2170310
2A24-2M14	2505560	4900.42	3002734	7033M32	3010660	A03-M3,5	2100070	A2-M4	2170070
2A24-2M16	2505590	4900.48	3002737	7033M40	3010662	A03-M4	2100110	A2-M5	2170150
2A30-2M12	2506400	4900.M12	3002750	7033M50	3010664	A03-M5	2100150	A2-M5/9	2170155
2A30-2M14	2506410	4900.M16	3002753	7033M63	3010666	A03-M6	2100190	A2-M6	2170190
2A30-2M16	8008601	4900.M20	3002756	7033AM12	3010670	A06-M3	2101030	A2-M8	2170230
2A37-2M12	2507420	4900.M25	3002759	7033AM16	3010672	A06-M3,5	2101070	A2-P12	2170650
2A37-2M14	2507440	4900.M32	3002762	7033AM20	3010674	A06-M4	2101110	A30-M10	2300110

REFERENCE/CODE CROSS-REFERENCE CHART

Ref.	Code	Ref.	Code	Ref.	Code	Ref.	Code	Ref.	Code
A30-M12	2300150	A19-2M12	2261385	AAD95-M16	8016830	ANE30-M12	2458320	BF-M6/2	2052280
A30-M14	2300230	A19-2M14	8008463	AAD120-M10	8016832	ANE30-M14	2458350	BF-M608	2053650
A30-M16	2300270	A19-2M16	2261420	AAD120-M12	8016834	ANE30-M16	2458370	BF-M608P	2053655
A30-M20	2300350	A24-2M10	2281810	AAD120-M16	8016836	ANE30-M20	2458390	BF-M7	2052310
A30-M8	2300070	A24-2M12	2281930	AAD150-M10	8016838	ANE35-M12	2460010	BF-M8	2052350
A30B-M10/19	2300120	A24-2M14	2282210	AAD150-M12	8016840	ANE35-M14	2460030	BF-P10	2053250
A30B-M8/19	2300080	A24-2M16	2282213	AAD150-M16	8016842	ANE35-M16	2460050	BF-P12	2053290
A35-M10	2310265	A30-2M10	2301280	AAD150-M20	8016844	ANE35-M20	2460070	BF-P8	2053210
A35-M12	2310270	A30-2M12	2301370	AAD185-M12	8016846	ANE5-M10	2418540	BF-PP12	2053330
A35-M14	2310310	A30-2M14	2301650	AAD185-M16	8016848	ANE5-M12	2418550	BF-PP12/25	2053370
A35-M16	2310350	A30-2M16	8008479	AAD185-M20	8016850	ANE5-M4	2418500	BF-PP12/29	2053380
A35-M20	2310390	A37-2M10	2320902	AAD240-M12	8016852	ANE5-M5	2418510	BF-PP16/25	2053410
A37-M10	2320110	A37-2M12	2320910	AAD240-M16	8016854	ANE5-M6	2418520	BF-PPL30	2053460
A37-M12	2320150	A37-2M14	2320970	AAD240-M20	8016856	ANE5-M8	2418530	BF-PPL46	2053465
A37-M14	2320190	A37-2M16	8008485	AAD300-M12	8016858	ANE5-P16	2418560	BF-U10	2052910
A37-M16	2320230	A48-2M10	2340750	AAD300-M16	8016860	ANE7-M6	2422300	BF-U12	2052950
A37-M20	2320270	A48-2M12	2340820	AAD300-M20	8016862	ANE7-M8	2422310	BF-U3	2052630
A37-M8	2320070	A48-2M14	2340860	AAD400-M12	8016864	ANE7-M10	2422320	BF-U3,5	2052670
A37B-M10/24,5	2320120	A48-2M16	2340870	AAD400-M16	8016866	ANE7-M12	2422330	BF-U3,5/1	2052671
A3-M10	2180270	A60-2M10	2350580	AAD400-M20	8016868	ANE7-P20	2422360	BF-U4	2052710
A3-M12	2180310	A60-2M12	2350600	AAD500-M12	8016870	ANE9-M10	2430170	BF-U4/1	2052720
A3-M4	2180030	A60-2M14	2350660	AAD500-M16	8016872	ANE9-M12	2430180	BF-U4/2	2052730
A3-M5	2180110	A60-2M16	2350740	AAD500-M20	8016874	ANE9-M6/15	2430150	BF-U5	2052750
A3-M5/9	2180120	A60-2M16/36	8008380	AC130-P	2615531	ANE9-M8	2430160	BF-U5/2	2052765
A3-M6	2180150	A80-2M12	2360450	ANE10-M6	2439350	ASC30-36 UK	2598486	BF-U6	2052790
A3-M8	2180190	A80-2M14	2360510	ANE10-M8	2439360	AU130-150	2615560	BF-U6/1	2052830
A3-P14	2180830	A80-2M16	8008498	ANE10-M10	2439370	AU130-240	2615590	BF-U8	2052870
A40-M10	2330230	A80-2M16/41	8008382	ANE10-M12	2439380	AU230-130D	2636960	BH2433	2596105
A40-M12	2330270	A100-2M12	8008499	ANE12-M10	2442220	AU230-630	2680300	BKF-BF4	2053632
A40-M14	2330310	A100-2M16	2370350	ANE12-M10/19	2442225	AU520-130C	2648230	BKF-BM4	2053662
A40-M16	2330350	A120-2M12	2372490	ANE12-M12	2442230	B-FC470E	2598882	BKF-F405	2053562
A40-M20	2330390	A120-2M16	2372510	ANE12-M6/15	2442200	B-FL750E	2598867	BKF-F405P	2053567
A48-M10	2340110	A160-2M12	8008431	ANE12-M8	2442210	B-TC250E	2596268	BKF-F408	2053572
A48-M10/31	2340120	A160-2M16	8008432	ANE14-M6	2446410	B-TC250BSE	2596264	BKF-F408P	2053577
A48-M12	2340150	A100-4ESI	2370990	ANE14-M8	2446420	B-TC450E	2599407	BKF-F608	2053612
A48-M12/31	2340158	A120-4ESI	2372850	ANE14-M10	2446430	B-TC500E	2598829	BKF-F608P	2053622
A48-M14	2340190	A160-4ESI	2374350	ANE14-M12	2446440	B-TC500YE	2598817	BKF-FM608	2053692
A48-M16	2340230	A200-4ESI	2376165	ANE14-M14	2446450	B-TC550E	2599422	BKF-M608	2053652
A48-M16/31	2340238	A37-4ESI	2321510	ANE17-M10	2447260	B-TC650E	2599442	BKY-M3	2145842
A48-M20	2340310	A48-4ESI	2340950	ANE17-M10/19	2447265	B-TC650-SCE	2599432	BKY-M3.5	2145845
A48-M8	2340070	A60-4ESI	2350850	ANE17-M12	2447270	B-TC950E	2599462	BKY-M3.5/1	2145847
A5-M10	2190190	A80-4ESI	2360850	ANE17-M14	2447280	B-TD270E	2598953	BKY-M4	2145853
A5-M12	2190230	AA16-M8	2740020	ANE17-M16	2447290	B-TD410TE	2598947	BKY-M5	2145856
A5-M4	2190030	AA25-M8	2740050	ANE17-M6	2447240	B15MDE	2598939	BKY-M6/1	2145862
A5-M5	2190070	AA35-M8	2740070	ANE17-M8	2447250	B1300-CE	2599352	BKY-M8	2145871
A5-M5/9	2190075	AA35-M10	2740075	ANE19-M8	2449510	B1300-CE-KV	2599390	BKY-M10	2145874
A5-M6	2190110	AA120-M12	2741510	ANE19-M10	2449520	B1300-UCE	2599367	BKY-M12	2145878
A5-M8	2190150	AA120-M14	2741550	ANE19-M12	2449530	B1300L-CE	2599360	BKY-P8	2145930
A5-P16	2191510	AA150-M12	2742030	ANE19-M14	2449540	B1350-CE	2599323	BKY-P10	2145932
A60-M10	2350030	AA150-M14	2742070	ANE19-M16	2449550	B1350L-CE	2599329	BKY-P12	2145934
A60-M12	2350070	AA185-M12	2742510	ANE2-M10	2408840	B1350-UCE	2599337	BKY-PP12	2145940
A60-M14	2350150	AA185-M14	2742550	ANE2-M12	2408845	B35-45MDE	2598892	BKY-PP12/25	2145942
A60-M16	2350190	AA240-M12	2743030	ANE2-M4	2408820	B35-50MDE	2599780	BKY-PP16/23	2145944
A60-M20	2350230	AA240-M14	2743070	ANE2-M5	2408825	B35M-TC025E	2599517	BKY-PP130	2145950
A60B-M10/31	2350033	AA300-M16	2743150	ANE2-M6	2408830	B500E	2596212	BKY-PP146	2145952
A60B-M12/31	2350072	AA300-34-M12	2743205	ANE2-M8	2408835	B500E-KV	2596208	BKY-U3	2145900
A7-M10	2200190	AA300-34-M14	2743210	ANE2-P12	2408850	B54MD-D6E	2599976	BKY-U3.5	2145903
A7-M12	2200230	AA300-34-M16	2743215	ANE2-U4	2408860	B550E	2598970	BKY-U4	2145906
A7-M5	2200070	AA400-M16	2743310	ANE2-U5	2408865	B550E-KV	2598973	BKY-U5	2145909
A7-M6	2200110	AA50-M12	2740110	ANE20-M10	2451320	B70M-P24	2596120	BKY-U6	2145912
A7-M8	2200150	AA50-M14	2740150	ANE20-M12	2451330	B70M-P24-CH	2596136	BKY-U6/1	2145914
A7-P20	2201750	AA500-40-M16	2743330	ANE20-M14	2451340	B70M-P24-KV	2596127	BN-FAB08	3031640
A7B-M6/11,5	2200120	AA630-M16	2743370	ANE20-M16	2451350	BA-3	2598424	BN-FAB608	3031660
A80-M12	2360030	AA70-M12	2740510	ANE20-M8	2451310	BF-BF5	2053630	BN-FAR608	3031680
A80-M14	2360070	AA70-M14	2740550	ANE24-M10	2453530	BF-BM5	2053660	BN-M10	2152390
A80-M16	2360110	AA95-M12	2741030	ANE24-M12	2453550	BF-F405	2053560	BN-M12	2152430
A80-M20	2360150	AA95-M14	2741070	ANE24-M14	2453570	BF-F405P	2053565	BN-M2	2152010
A9-M10	2210270	AAD16-M8	8016800	ANE24-M16	2453590	BF-F408	2053570	BN-M3	2152030
A9-M12	2210310	AAD16-M10	8016802	ANE29-M10	2456010	BF-F408P	2053575	BN-M3,5	2152070
A9-M6/15	2210210	AAD25-M8	8016804	ANE29-M12	2456030	BF-F608	2053610	BN-M3,5/1	2152110
A9-M8	2210230	AAD25-M10	8016806	ANE29-M14	2456050	BF-F608P	2053620	BN-M4	2152150
A7-2M8	8008433	AAD35-M8	8016808	ANE29-M16	2456070	BF-FM608	2053690	BN-M5	2152190
A7-2M10	8008441	AAD35-M10	8016810	ANE29-M20	2456090	BF-M10	2052390	BN-M6	2152230
A7-2M12	2200998	AAD35-M12	8016812	ANE3-M10	2415840	BF-M12	2052430	BN-M6/1	2152270
A10-2M8	8008434	AAD50-M8	8016814	ANE3-M12	2415850	BF-M2	2052010	BN-M7	2152310
A10-2M10	8008442	AAD50-M10	8016816	ANE3-M4	2415800	BF-M3	2052030	BN-M8	2152350
A10-2M12	2221480	AAD50-M12	8016818	ANE3-M5	2415810	BF-M3,5	2052070	BN-MA608	3031740
A14-2M8	2241555	AAD70-M10	8016820	ANE3-M6	2415820	BF-M3,5/1	2052110	BN-P10	2153190
A14-2M10	8008438	AAD70-M12	8016822	ANE3-M8	2415830	BF-M4	2052150	BN-P12	2153230
A14-2M12	2241605	AAD70-M16	8016824	ANE3-P14	2415860	BF-M5	2052190	BN-P8	2153150
A14-2M14	2241620	AAD95-M10	8016826	ANE3-U4	2415870	BF-M6	2052230	BN-PP12	2153270
A19-2M10	2261363	AAD95-M12	8016828	ANE3-U5	2415875	BF-M6/1	2052270	BN-PP12/25	2153310

REFERENCE/CODE CROSS-REFERENCE CHART

Ref.	Code	Ref.	Code	Ref.	Code	Ref.	Code	Ref.	Code
BN-PP16/25	2153350	C2-10	2395820	C8-38	2395100	CA35M12	8005526	CBP-U4	2076395
BN-U10	2152910	C2-12	2395900	C8-516	2395080	CA35M16	8005530	CBP-U4/1	2076400
BN-U12	2152950	C2-14	2395840	C8-8	2395020	CA315R-2M14	2534430	CBP-U4/2	2076405
BN-U3	2152630	C2-38	2395880	C10-C10	2490070	CA315R-M14	2534330	CBP-U4/3L	2076408
BN-U3,5	2152670	C250-12	2397080	C120-C120	2490680	CA315S-2M14	2534610	CBP-U5	2076410
BN-U3,5/1	2152680	C250-14	2397020	C150-C120	2490670	CA315S-M14	2534530	CBP-U6	2076415
BN-U4	2152710	C250-34	2397140	C150-C150	2490690	CA40S-2M12	2530510	CDD6	2599940
BN-U4/1	2152730	C250-38	2397060	C16-C16	2490110	CA40S-M12	2530450	CDD6-8	2599941
BN-U4/2	2152732	C250-516	2397040	C185-C185	2490745	CA40S-M16	2530490	CFA2600	3031942
BN-U5	2152750	C250-58	2397120	C185-C95	2490710	CA50RM12	2530790	CFA300	3031900
BN-U6	2152790	C250-78	2397160	C240-C120	2490760	CA50SM12	2531110	CFA400	3031914
BN-U6/1	2152830	C250-916	2397100	C25-C10	2490150	CA50SM16	2531150	CFA600	3031928
BN-U8	2152870	C2-516	2395860	C25-C25	2490190	CA50R-2M12	2530870	CFAB600	3031970
BP-M10	2046345	C3/0-12	2396680	C35-C16	2490230	CA50R-M12	2530790	CFAR600	3031956
BP-M12	2046350	C3/0-14	2396620	C35-C35	2490270	CA50S-2M12	2531190	CGP-F608	2076845
BP-M2	2046305	C3/0-34	2396740	C50-C25	2490350	CA50S-M12	2531110	CGP-F608P	2076850
BP-M3	2046310	C3/0-38	2396660	C50-C50	2490390	CA50S-M16	2531150	CGP-M3	2076610
BP-M3,5	2046315	C3/0-516	2396640	C59	8420035	CA70-M12	2531870	CGP-M3,5	2076615
BP-M3,5/1	2046316	C3/0-58	2396720	C6-C6	2490030	CA70SM10	2531420	CGP-M4	2076625
BP-M4	2046320	C3/0-916	2396700	C6-C6	2490030	CA70SM12	2531430	CGP-M5	2076635
BP-M5	2046325	C300-12	2397360	C70-C25N	2490310	CA70SM14	2531450	CGP-M6	2076640
BP-M6	2046330	C300-34	2397420	C70-C70	2490470	CA70S-2M12	2531510	CGP-M6/1	2076645
BP-M6/1	2046331	C300-38	2397340	C95-C35	2490510	CA70S-M12	2531430	CGP-M608	2076660
BP-M6/2	2046332	C300-516	2397320	C95-C70	2490550	CA70S-M16	2531470	CGP-M7	2076650
BP-M7	2046335	C300-58	2397400	C95-C95	2490590	CA95R-2M14	2532230	CGP-M8	2076660
BP-M8	2046340	C300-78	2397440	C10-C10ST	2492070	CA95R-M12	2532150	CGP-M8/1	2076665
BP-P10	2046415	C300-916	2397380	C120-C120ST	2492630	CA95R-M14	2532190	CGP-P10	2076755
BP-P12	2046420	C3-10	2395640	C150-C120ST	2492670	CA95M10	8005554	CGP-P12	2076760
BP-P8	2046410	C3-12	2395720	C150-C150ST	2492690	CA95M12	8005556	CGP-P14	2076765
BP-PP12	2046440	C3-14	2395660	C16-C16ST	2492110	CA95M16	8005560	CGP-PP12	2076780
BP-PP12/25	2046445	C3-38	2395700	C185-C185ST	2492745	CA95S-2M14	2532610	CGP-PP17	2076790
BP-PP12/29	2046450	C350-12	2397540	C185-C95ST	2492710	CA95S-M12	2532450	CGP-U3,5	2076685
BP-PP16/25	2046455	C350-34	2397600	C240-C120ST	2492760	CA95S-M14	2532490	CGP-U4	2076695
BP-PPL30	2046470	C350-38	2397520	C25-C10ST	2492150	CA95S-M16	2532500	CGP-U5	2076710
BP-PPL46	2046475	C350-58	2397580	C25-C25ST	2492190	Canvas Bag 001	2593300	CGP-U6	2076715
BP-U10	2046565	C350-78	2397620	C35-C16ST	2492230	Canvas Bag 007	2593295	CL1/0-10	2396385
BP-U12	2046570	C350-916	2397560	C35-C35ST	2492270	Canvas Bag 010	2593298	CL1/0-12	2396397
BP-U3	2046510	C3-516	2395680	C50-C25ST	2492350	Canvas Bag 011	2593299	CL1/0-38	2396394
BP-U3,5	2046515	C3-8	2395620	C50-C50ST	2492390	Canvas Bag 013	2593294	CL1/0-516	2396391
BP-U3,5/1	2046516	C4/0-12	2396880	C6-C6ST	2492030	CAA10-M12	2760005	CL1/0-D14	2396360
BP-U4	2046530	C4/0-14	2396820	C70-C25NST	2492310	CAA120-M12	2760310	CL1/0-D141	2396361
BP-U4/1	2046531	C4/0-34	2396940	C70-C35ST	2492430	CAA150-M12	2760350	CL1/0-D38	2396370
BP-U4/2	2046540	C4/0-38	2396860	C70-C70ST	2492470	CAA16-M12	2760012	CL1/0-DN	2396375
BP-U5	2046545	C4/0-516	2396840	C95-C35ST	2492510	CAA185-M12	2760430	CL1/OIH-10	2396405
BP-U6	2046555	C4/0-58	2396920	C95-C70ST	2492550	CAA240-M12	2760590	CL1/OIH-12	2396413
BP-U6/1	2046556	C4/0-916	2396900	C95-C95ST	2492590	CAA25-M12	2760030	CL1/OIH-14	2396407
BP-U8	2046560	C400-12	2397740	CA1202M12	8005766	CAA300-M16	2760710	CL1/OIH-38	2396411
BPS230.24	2596093	C400-34	2397800	CA1502M12	8005776	CAA300-34-M12	2760680	CL1/OIH-516	2396409
BSCL1	2489535	C400-38	2397720	CA1852M12	8005786	CAA300-34-M16	2760715	CL1/OIH-58	2396417
BSCL1/0	2489540	C400-58	2397780	CA252M10	2530170	CAA35-M12	2760070	CL1/OIH-916	2396415
BSCL2	2489530	C400-78	2397820	CA3002M12	8005806	CAA35ADN	2762260	CL1-10	2396183
BSCL2/0	2489545	C400-916	2397760	CA352M12	8005726	CAA400-M16	2760750	CL1-12	2396191
BSCL250	2489560	C4-10	2395440	CA502M12	8005736	CAA50-M12	2760110	CL1-516	2396187
BSCL3	2489525	C4-12	2395520	CA952M12	8005756	CAA500-M16-TNBD	2760852	CL1-D14	2396160
BSCL3/0	2489550	C4-14	2395460	CA120M12	8005566	CAA630-4M8	2760950	CL1-D141	2396161
BSCL300	2489565	C4-38	2395500	CA120M16	8005570	CAA70-M12	2760150	CL1-D38	2396170
BSCL350	2489570	C4-516	2395480	CA150M12	8005576	CAA95-M12	2760190	CL1-DN	2396175
BSCL4	2489520	C4-8	2395420	CA150M16	8005580	CB182OL	2598495	CL1IH-10	2396205
BSCL4/0	2489555	C500-12	2397940	CA150R-2M14	2533010	CB184OL	2598493	CL1IH-12	2396217
BSCL400	2489575	C500-34	2398000	CA150R-M12	2532810	CBP-F405	2076535	CL1IH-14	2396208
BSCL500	2489580	C500-38	2397920	CA150R-M14	2532850	CBP-F408	2076540	CL1IH-38	2396214
BSCL6	2489515	C500-58	2397980	CA150S-2M14	2533330	CBP-F408P	2076543	CL1IH-516	2396211
BSCL600	2489585	C500-78	2398020	CA150S-M12	2533210	CBP-F608	2076545	CL2/0-12	2396594
BSCL750	2489590	C500-916	2397960	CA150S-M14	2533250	CBP-F608P	2076550	CL2/0-38	2396591
BSCL8	2489510	C600-12	2398120	CA185M12	8005586	CBP-M3	2076310	CL2/0-D14	2396560
C1/0-12	2396280	C600-34	2398180	CA185M16	8005590	CBP-M3,5	2076315	CL2/0-D141	2396561
C1/0-14	2396220	C600-58	2398160	CA240M12	8005594	CBP-M3,5/1	2076320	CL2/0-D38	2396570
C1/0-38	2396260	C600-78	2398200	CA240M16	8005596	CBP-M4	2076325	CL2/0-DN	2396575
C1/0-516	2396240	C600-916	2398140	CA240M20	8005600	CBP-M5	2076335	CL2/OIH-12	2396611
C1/0-58	2396320	C6-10	2395240	CA200R-2M14	2533570	CBP-M6	2076340	CL2/OIH-14	2396605
C1/0-916	2396300	C6-12	2395320	CA200R-M14	2533530	CBP-M6/1	2076345	CL2/OIH-34	2396617
C1-12	2396080	C6-14	2395260	CA240R-2M14	2533850	CBP-M608	2076560	CL2/OIH-38	2396609
C1-14	2396020	C6-38	2395300	CA240R-M14	2533770	CBP-M7	2076350	CL2/OIH-516	2396607
C1-38	2396060	C6-516	2395280	CA300M12	8005604	CBP-M8	2076355	CL2/OIH-58	2396615
C1-516	2396040	C6-8	2395220	CA300M16	8005608	CBP-P10	2076455	CL2/OIH-916	2396613
C2/0-12	2396480	C750-12	2398320	CA300M20	8005610	CBP-P12	2076460	CL2-10	2395985
C2/0-14	2396420	C750-34	2398380	CA25-2M12	2530210	CBP-P8	2076450	CL2-12	2395997
C2/0-34	2396540	C750-58	2398360	CA25-2M8	2530130	CBP-PP12	2076480	CL2-14	2395988
C2/0-38	2396460	C750-78	2398400	CA25-M10	2530050	CBP-PP12/25	2076490	CL250-12	2397204
C2/0-516	2396440	C8-10	2395040	CA25-M12	2530090	CBP-PPL30	2076498	CL250-D38	2397180
C2/0-58	2396520	C8-12	2395120	CA25-M8	2530010	CBP-U3	2076380	CL250-DN	2397185
C2/0-916	2396500	C8-14	2395060	CA35M10	8005524	CBP-U3,5	2076385	CL250IH-12	2397229

REFERENCE/CODE CROSS-REFERENCE CHART

Ref.	Code	Ref.	Code	Ref.	Code	Ref.	Code	Ref.	Code
CL250IH-14	2397220	CL4-14	2395588	CRP-F405P	2076237	DR150-12	2388540	ES48-BU	2470423
CL250IH-34	2397238	CL4-38	2395594	CRP-F408	2076240	DR150-16	2388560	ES80-BU	2470424
CL250IH-38	2397226	CL4-D14	2395560	CRP-F408P	2076242	DR150-20	2388570	ES03-GY	2470430
CL250IH-516	2397223	CL4-D141	2395561	CRP-F608	2076245	DR185-10	2388600	ES06-GY	2470431
CL250IH-58	2397235	CL4-D38	2395570	CRP-F608P	2076250	DR185-12	2388610	ES1-GY	2470432
CL250IH-916	2397232	CL4-DN	2395575	CRP-M3	2076010	DR185-16	2388620	ES2-GY	2470433
CL2-516	2395991	CL4IH-10	2395605	CRP-M3,5	2076015	DR185-20	2388630	ES3-GY	2470434
CL2-D14	2395960	CL4IH-12	2395617	CRP-M3,5/1	2076020	DR240-10	2388710	ES5-GY	2470435
CL2-D141	2395961	CL4IH-14	2395608	CRP-M4	2076025	DR240-12	2388720	ES10-GY	2470436
CL2-D38	2395970	CL4IH-38	2395614	CRP-M4/3	2076030	DR240-16	2388730	ES14-GY	2470437
CL2-DN	2395975	CL4IH-516	2395611	CRP-M5	2076035	DR240-20	2388740	ES19-GY	2470438
CL2-DN38	2395971	CL500-12	2398088	CRP-M6	2076040	DR300-10	2388780	ES24-GY	2470439
CL2IH-10	2396005	CL500-58	2398094	CRP-M6/1	2076045	DR300-12	2388790	ES30-GY	2470440
CL2IH-12	2396017	CL500-D141	2398061	CRP-M608	2076260	DR300-16	2388810	ES37-GY	2470441
CL2IH-14	2396008	CL500-D38	2398070	CRP-M7	2076050	DR300-20	2388820	ES40-GY	2470442
CL2IH-38	2396014	CL500-DN	2398075	CRP-M8	2076055	DR400-12	2388870	ES48-GY	2470443
CL2IH-516	2396011	CL500IH-12	2398108	CRP-P10	2076155	DR400-16	2388890	ES80-GY	2470444
CL3/O-12	2396794	CL500IH-34	2398117	CRP-P12	2076160	DR400-20	2388900	ES03-BR	2470450
CL3/O-D141	2396761	CL500IH-38	2398105	CRP-P8	2076150	DR500-12	2388950	ES06-BR	2470451
CL3/O-D38	2396770	CL500IH-58	2398114	CRP-PP12	2076180	DR500-16	2388970	ES1-BR	2470452
CL3/O-DN	2396775	CL500IH-916	2398111	CRP-PP12/1	2076185	DR500-20	2388980	ES2-BR	2470453
CL3/OIH-12	2396811	CL600-12	2398285	CRP-PP12/23	2076190	DR625-12	2389030	ES3-BR	2470454
CL3/OIH-14	2396805	CL600-58	2398291	CRP-PP14	2076195	DR625-16	2389050	ES5-BR	2470455
CL3/OIH-34	2396817	CL600-D38	2398270	CRP-PPL30	2076205	DR625-20	2389060	ES10-BR	2470456
CL3/OIH-38	2396809	CL600-DN	2398275	CRP-U3	2076080	DR800-20	2389110	ES14-BR	2470457
CL3/OIH-516	2396807	CL600IH-12	2398305	CRP-U3,5	2076085	DR1000-20	2389130	ES19-BR	2470458
CL3/OIH-58	2396815	CL600IH-34	2398314	CRP-U3,5/2	2076090	DSV6	2489010	ES24-BR	2470459
CL3/OIH-916	2396813	CL600IH-58	2398311	CRP-U4	2076095	DSV10	2489015	ES30-BR	2470460
CL300-12	2397491	CL600IH-916	2398308	CRP-U4/1	2076100	DSV16	2489020	ES37-BR	2470461
CL300-D38	2397470	CL6-10	2395385	CRP-U4/2	2076105	DSV25	2489025	ES40-BR	2470462
CL300-DN	2397475	CL6-12	2395397	CRP-U6	2076115	DSV35	2489030	ES48-BR	2470463
CL300IH-12	2397509	CL6-14	2395388	CRP-U6/1	2076120	DSV50	2489035	ES80-BR	2470464
CL300IH-34	2397515	CL6-D14	2395360	CRP-U6/1	2076120	DSV70	2489040	ES03-BK	2470470
CL300IH-38	2397507	CL6-D141	2395361	CRP-U8	2076125	DSV95	2489045	ES06-BK	2470471
CL300IH-516	2397505	CL6-D38	2395370	CS-CPE-1	2592748	DSV120	2489050	ES1-BK	2470472
CL300IH-58	2397513	CL6-DN	2395375	DC24	2596100	DSV150	2489055	ES2-BK	2470473
CL300IH-916	2397511	CL6IH-10	2395405	DR6-5	2387910	DSV185	2489060	ES3-BK	2470474
CL3-12	2395797	CL6IH-12	2395417	DR6-6	2387920	DSV240	2489065	ES5-BK	2470475
CL3-14	2395788	CL6IH-14	2395408	DR6-8	2387930	DSV300	2489070	ES10-BK	2470476
CL3-38	2395794	CL6IH-38	2395414	DR10-5	2388000	DSV400	2489075	ES14-BK	2470477
CL350-12	2397688	CL6IH-516	2395411	DR10-6	2388005	DSV500	2489080	ES19-BK	2470478
CL350-D141	2397661	CL750-12	2398485	DR10-8	2388010	DSV625	2489085	ES24-BK	2470479
CL350-D38	2397670	CL750-58	2398488	DR10-10	2388015	DSV800	2489090	ES30-BK	2470480
CL350-DN	2397675	CL750-D38	2398470	DR16-5	2388025	DSV1000	2489095	ES37-BK	2470481
CL350IH-12	2397708	CL750-DN	2398475	DR16-6	2388030	DSVA16	8016400	ES40-BK	2470482
CL350IH-34	2397717	CL750-DN38	2398471	DR16-8	2388040	DSVA25	8016401	ES48-BK	2470483
CL350IH-38	2397705	CL750IH-12	2398505	DR16-10	2388050	DSVA35	8016402	ES80-BK	2470484
CL350IH-58	2397714	CL750IH-34	2398511	DR16-12	2388060	DSVA50	8016403	ES03-RE	2470510
CL350IH-916	2397711	CL750IH-58	2398508	DR25-6	2388110	DSVA70	8016404	ES06-RE	2470511
CL3-516	2395791	CL8-10	2395183	DR25-8	2388120	DSVA95	8016405	ES1-RE	2470512
CL3-D38	2395770	CL8-14	2395186	DR25-10	2388130	DSVA120	8016406	ES2-RE	2470513
CL3-DN	2395775	CL8-38	2395192	DR25-12	2388140	DSVA150	8016407	ES3-RE	2470514
CL3IH-10	2395805	CL8-D14	2395160	DR25-16	2388160	DSVA185	8016408	ES5-RE	2470515
CL3IH-12	2395817	CL8-D141	2395161	DR35-6	2388210	DSVA240	8016409	ES10-RE	2470516
CL3IH-14	2395808	CL8-D38	2395170	DR35-8	2388220	DSVA300	8016410	ES14-RE	2470517
CL3IH-38	2395814	CL8IH-10	2395203	DR35-10	2388230	DSVA400	8016411	ES19-RE	2470518
CL3IH-516	2395811	CL8IH-12	2395215	DR35-12	2388240	DSVA500	8016412	ES24-RE	2470519
CL4/O-12	2396994	CL8IH-14	2395206	DR35-16	2388246	DSVA401	8016413	ES30-RE	2470520
CL4/O-38	2396991	CL8IH-38	2395212	DR50-6	2388250	DSVA501	8016414	ES37-RE	2470521
CL4/O-D141	2396961	CL8IH-516	2395209	DR50-8	2388255	DSVA625	8016415	ES40-RE	2470522
CL4/O-D38	2396970	CMA600	3031984	DR50-10	2388260	DSVA800	8016416	ES48-RE	2470523
CL4/O-DN	2396975	CMB1	2599943	DR50-12	2388270	DSVA1000	8016417	ES80-RE	2470524
CL4/O-DN38	2396971	CMB2	2599945	DR50-14	2388280	ECT-KE2.5	8030200	ES03-GN	2470530
CL4/OIH-12	2397011	CP1086-W-1000-KV	2597905	DR50-16	2388290	ECW-H3D	2630073	ES06-GN	2470531
CL4/OIH-14	2397005	CP1096	2597700	DR70-8	2388320	ELB-3	2598422	ES1-GN	2470532
CL4/OIH-34	2397017	CP1096-W-1000-KV	2597695	DR70-10	2388330	EPB-1N	2598453	ES2-GN	2470533
CL4/OIH-38	2397009	CP1120	2597962	DR70-12	2388340	EPS115-230.24	2596091	ES3-GN	2470534
CL4/OIH-516	2397007	CP1120-W-1000-KV	2597958	DR70-14	2388350	ERCH	2596112	ES5-GN	2470535
CL4/OIH-58	2397015	CP1131	2610120	DR70-16	2388360	ERCH-WH	2596114	ES10-GN	2470536
CL4/OIH-916	2397013	CPE-1	2592751	DR70-20	2388380	ES03-BU	2470410	ES14-GN	2470537
CL400-12	2397888	CPE-1-110	2592752	DR95-8	2388390	ES06-BU	2470411	ES19-GN	2470538
CL400-58	2397894	CPKD108	2808582	DR95-10	2388395	ES1-BU	2470412	ES24-GN	2470539
CL400-D141	2397861	CPKD1508	2808587	DR95-12	2388400	ES2-BU	2470413	ES30-GN	2470540
CL400-D38	2397870	CPKD2508	2808592	DR95-14	2388410	ES3-BU	2470414	ES37-GN	2470541
CL400-DN	2397875	CPKD508	2808573	DR95-16	2388420	ES5-BU	2470415	ES40-GN	2470542
CL400IH-12	2397908	CPKD7508	2808578	DR95-20	2388430	ES10-BU	2470416	ES48-GN	2470543
CL400IH-34	2397917	CPP-0	2592671	DR120-8	2388450	ES14-BU	2470417	ES80-GN	2470544
CL400IH-38	2397905	CPU1131-C	2610150	DR120-10	2388460	ES19-BU	2470418	ES03-YE	2470550
CL400IH-58	2397914	CPU1230-3D	2630200	DR120-12	2388470	ES24-BU	2470419	ES06-YE	2470551
CL400IH-916	2397911	CRP-F305	2076225	DR120-16	2388490	ES30-BU	2470420	ES1-YE	2470552
CL4-10	2395585	CRP-F308	2076230	DR120-20	2388500	ES37-BU	2470421	ES2-YE	2470553
CL4-12	2395597	CRP-F405	2076235	DR150-10	2388530	ES40-BU	2470422	ES3-YE	2470554

REFERENCE/CODE CROSS-REFERENCE CHART

Ref.	Code	Ref.	Code	Ref.	Code	Ref.	Code	Ref.	Code
ES5-YE	2470555	GF-PP12	2055390	GP-PPL46	2046755	KE508ST	2802030	M208-U	2603780
ES10-YE	2470556	GF-PP17	2055430	GP-U10	2046865	KE508ST	2802070	M215-50	2675910
ES14-YE	2470557	GF-PPL46	2055465	GP-U10/1	2046866	KE610ST	2802990	M215-520	2648773
ES19-YE	2470558	GF-U10	2054810	GP-U12	2046870	KE612ST	2803030	M215-C	2612490
ES24-YE	2470559	GF-U10/1	2054850	GP-U14	2046875	KE616ST	2803070	M220-520	2648774
ES30-YE	2470560	GF-U12	2054890	GP-U16	2046880	KE7506ST	2802110	M232-C	2612590
ES37-YE	2470561	GF-U14	2054930	GP-U3,5	2046825	KE7508ST	2802150	M255-520	2648776
ES40-YE	2470562	GF-U16	2054970	GP-U4	2046830	KIT2.5EPB1N	2598463	M295-520	2648780
ES48-YE	2470563	GF-U3,5	2054610	GP-U5	2046845	KIT4EPB1N	2598464	M340-520	2648784
ES80-YE	2470564	GF-U4	2054650	GP-U6	2046855	KITHWE1	8420012	M440-520	2648840
ES03-PK	2470570	GF-U5	2054690	GP-U8	2046860	KITTRD-9.4C	2685015	M540-520	2648910
ES06-PK	2470571	GF-U6	2054730	HB1-U	2598062	KITTRD-M11C	2685016	M70	2651090
ES1-PK	2470572	GF-U8	2054770	HB29-U	8060030	KT1	2591319	M70-50	2675800
ES2-PK	2470573	GK-F608	2145500	HB40-U	8060035	KT2	2591320	M70-C	2611590
ES3-PK	2470574	GK-F608P	2145502	HB11	2591343	KT3	2591330	M70.140-U	2603710
ES5-PK	2470575	GK-F608	2055672	HB12N	2591345	KT4	2598060	M75	2651100
ES10-PK	2470576	GK-Y-M3.5	2145982	HB13UE	2591347	KT5	2591279	M75-50	2675605
ES14-PK	2470577	GKY-M4	2145985	HF1	2590900	KTS1632	2590700	M75-C	2611650
ES19-PK	2470578	GKY-M5	2145988	HF2	2590905	L03-M	2480020	M75.96-U	2603715
ES24-PK	2470579	GKY-M6	2145991	HN1	2590300	L03-P	2485010	M96	2651110
ES30-PK	2470580	GKY-M8	2145994	HN5	2590291	L06-M	2480050	M96-50	2675850
ES37-PK	2470581	GKY-M10	2145997	HNA25	2590401	L06-P	2485040	M96-C	2611800
ES40-PK	2470582	GKY-M12	2146000	HND25	2590403	L10-M	2480030	MA03/3-15	2599870
ES48-PK	2470583	GKY-M14	2146003	HNKE4	2590299	L10-P	2485270	MA1	2650110
ES80-PK	2470584	GKY-M16	2146006	HNKE16	2590329	L100-M	2480930	MA10	2650190
ESC300CEE	2596110	GKY-P14	2146040	HNKE50	2590342	L120-M	2481010	MA10-50	2675666
ESC600	2599001	GKY-PP12	2146045	HNN3	2590296	L14-M	2480410	MA10-C	2610860
F1-15	2599865	GKY-PP17	2146047	HNN4	2590292	L14-P	2485350	MA10.19-U	2600290
FD11	3017354	GKY-PPL46	2146055	HP1	2590500	L160-M	2481050	MA100-3D	2631790
FD13,5	3017356	GKY-U3.5	2146020	HP1-1	2590502	L19-M	2480490	MA100-520	2645690
FD16	3017358	GKY-U4	2146023	HP3	2590531	L19-P	2485430	MA12-C	2610870
FD21	3017360	GKY-U5	2146026	HP3-1	2590532	L1-M	2480090	MA12.20-U	2600310
FD29	3017362	GKY-U6	2146029	HP4-B	2590032	L1-P	2485070	MA120-3D	2631810
FD36	3017364	GKY-U8	2146032	HP4-C10	2590040	L200-M	2481090	MA120-520	2645711
FD42	3017366	GN-M10	2154250	HP4-G	2590033	L24-M	2480570	MA14-50	2675670
FD48	3017368	GN-M10/1	2154290	HP4-R	2590031	L24-P	2485510	MA14-C	2610880
FD7	3017350	GN-M12	2154330	HPH-1	2590029	L2-M	2480130	MA160-520	2645731
FD9	3017352	GN-M14	2154370	HT-FL75	2665030	L2-P	2485100	MA17-50	2675672
FDM12	3017375	GN-M16	2154410	HT-TC026	2591406	L30-M	2480650	MA17-C	2610890
FDM16	3017374	GN-M3	2154010	HT-TC026Y	2591408	L30-P	2485590	MA19-50	2675674
FDM20	3017377	GN-M3,5	2154030	HT-TC041N	2591427	L37-M	2480730	MA19-C	2610900
FDM25	3017379	GN-M4	2154070	HT-TC051	2591472	L37-P	2485670	MA19-U	2600320
FDM32	3017381	GN-M5	2154110	HT-TC051Y	2591475	L3-M	2480170	MA2-C	2610810
FDM40	3017383	GN-M6	2154150	HT-TC055	2591445	L3-P	2485130	MA2.3	2650130
FDM50	3017385	GN-M6/1	2154160	HT-TC065	2591477	L48-M	2480810	MA2.3-50	2675660
FDM63	3017387	GN-M7	2154170	HT-TC0851	2591496	L48-P	2485680	MA20-50	2675675
FL10-150	2510070	GN-M8	2154210	HT120	2610420	L5-M	2480210	MA20-C	2610910
FL10-200	2510150	GN-M8/1	2154220	HT120-KV	2610430	L5-P	2485160	MA200-520	2645750
FL10-250	2510190	GN-M10	2155250	HT131-C	2610416	L60-M	2480850	MA24-50	2675676
FL16-150	2510470	GN-P12	2155290	HT131-UC	2610436	L60-P	2485690	MA24-C	2610920
FL16-200	2510550	GN-P14	2155310	HT131LN-C	2610419	L7-M	2480250	MA24-U	2600330
FL16-250	2510590	GN-PP12	2155330	HT45-E	2650040	L7-P	2485190	MA29-C	2610930
FL16-320	2510670	GN-PP17	2155370	HT51	2670610	L80-M	2480890	MA29.80-U	2600360
FL16-350	2510690	GN-U10	2154850	HT51-KV	2670611	M108-520	2648752	MA3-C	2610820
FL16-420	2510710	GN-U10/1	2154890	HT81-U	2600036	M108-C	2611860	MA3.5-U	2600210
FL16-570	2510750	GN-U12	2154930	HWE-1	8420010	M108.215-U	2603723	MA30-80-U	2600380
FL16-660	2510790	GN-U14	2154970	I38-F	6060130	M110-520	2648754	MA30-C	2610940
FL25-150	2510950	GN-U16	2155010	I38-MS	6060128	M113	2651130	MA35-C	2610950
FL25-200	2511070	GN-U3,5	2154650	IT6	8420016	M113-50	2675855	MA35-U	2600390
FL25-250	2511110	GN-U4	2154690	KE0,75-1	2591050	M113-C	2611870	MA37-C	2610960
FL25-300	2511190	GN-U5	2154730	KE10-1	2591049	M113.173-U	2603730	MA37-U	2600410
GA-3	2598429	GN-U6	2154770	KE1016ST	2803150	M118	2651150	MA40-C	2610970
GF-F608	2055630	GN-U8	2154810	KE106ST	2802310	M118-50	2675860	MA40-U	2600430
GF-F608P	2055650	GP-M10	2046645	KE110ST	2802390	M118-C	2611910	MA48-C	2610980
GF-M10	2054250	GP-M10/1	2046646	KE1508ST	2802510	M118.158-U	2603725	MA48-U	2600450
GF-M10/1	2054290	GP-M12	2046650	KE1510ST	2802550	M140	2651170	MA5	2650150
GF-M12	2054330	GP-M14	2046655	KE16-15	2599861	M140-50	2675870	MA5-50	2675662
GF-M14	2054370	GP-M16	2046660	KE1616ST	2803190	M140-C	2612010	MA5-C	2610830
GF-M16	2054410	GP-M3	2046610	KE1A-3	2598439	M140.190-U	2603800	MA60-C	2610990
GF-M3	2054010	GP-M3,5	2046615	KE2,5-1	2598450	M145-520	2648770	MA7	2650170
GF-M3,5	2054030	GP-M4	2046620	KE2,5A-3	2598432	M158	2651200	MA7-50	2675664
GF-M4	2054070	GP-M5	2046625	KE25015ST	2803455	M158-50	2675880	MA7-C	2610840
GF-M5	2054110	GP-M6	2046630	KE25018ST	2803460	M158-C	2612130	MA7.14-U	2600250
GF-M6	2054150	GP-M6/1	2046631	KE2508ST	2802670	M160-520	2648771	MA80-3D	2631770
GF-M6/1	2054160	GP-M7	2046635	KE2510ST	2802710	M173	2651210	MA80-520	2645671
GF-M608	2055670	GP-M8	2046640	KE35-15	2599862	M173-50	2675890	MA9	2650180
GF-M7	2054170	GP-M8/1	2046641	KE35012ST	2803470	M173-C	2612230	MA9-50	2675665
GF-M8	2054210	GP-P10	2046715	KE35015ST	2803475	M173L-C	2612240	MA9-C	2610850
GF-M8/1	2054220	GP-P12	2046720	KE35018ST	2803480	M190-50	2675900	MA9.17-U	2600270
GF-P10	2055310	GP-P14	2046725	KE4-15	2599860	M190-520	2648772	MB2-80U	2604350
GF-P12	2055350	GP-PP12	2046740	KE410ST	2802870	M190-C	2612330	MB3-80U	2604400
GF-P14	2055370	GP-PP17	2046750	KE412ST	2802910	M208-C	2612420	MCO	2650490

REFERENCE/CODE CROSS-REFERENCE CHART

Ref.	Code	Ref.	Code	Ref.	Code	Ref.	Code	Ref.	Code
MC0-U	2603510	ME35-50	2676150	MK25-50	2675550	MN48-C	2610650	MT50TD	8006020
MC02-U	2603550	ME35-C	2614229	MK25B-50	2675551	MN48RF-C	2610790	MT70TD	8006030
MC10	2650530	ME35-U	2604910	MK28-50	2675560	MN5-C	2610530	MT95TD	8006040
MC10-50	2675610	ME37-50	2676160	MK28B-50	2675561	MN5RF-50	2676230	MT150R-C12	2545010
MC10-C	2611100	ME37-C	2614231	MK32-50	2675564	MN5RF-C	2610764	MT150R-C16	2545090
MC10-U	2600610	ME37-U	2604930	MK32B-50	2675565	MN60-C	2610660	MT150S-C16	2541870
MC185-3D	2632030	ME40-50	2676165	MK22L	2651791	MN7-C	2610540	MT150R-TD	2540550
MC185-C	2611150	ME40-C	2614233	MK22L-50	2675534	MN7RF-50	2676240	MT150S-C12	2545310
MC2	2650500	ME40-U	2604950	MK25-50	2675550	MN7RF-C	2610766	MT150S-C14-80	2546270
MC240-3D	2632035	ME48-50	2676170	MK28-50	2675560	MN80-3D	2631450	MT150S-C16	2545350
MC25	2650550	ME48-C	2614235	MK28-60	2671460	MN9-C	2610551	MT150S-GC	2541910
MC25-50	2675620	ME48-U	2604970	MK6-C	2614250	MP608	3031810	MT150S-TD	2540630
MC25-C	2611110	ME5	2652070	MK8-C	2614260	MP608/45	3031815	MT200R-C10	2545540
MC25-U	2600650	ME5-50	2676030	MK10-C	2614270	MP608/90	3031820	MT200R-C16	2545550
MC3	8420018	ME5-C	2614205	MK12-C	2614280	MP608D	3031830	MT200R-GC	2542030
MC35	2650570	ME5.7-U	2604790	MK14-C	2614290	MPC1	2595201	MT200R-TD	2540670
MC35-50	2675630	ME60-C	2614237	MK16-C	2614300	MPC2	2595203	MT240R-C12	2545710
MC35-C	2611120	ME7	2652090	MK18-C	2614310	MPC4	2595208	MT240R-C16	2545750
MC35-U	2600690	ME7-50	2676040	MK20-C	2614320	MPC5	8460004	MT240R-GC	2542110
MC4	8420019	ME7-C	2614207	MK22-C	2614330	MPC7	2595221	MT240R-TD	2540710
MC6	2650510	ME80-3D	2634930	MK25-C	2614340	MQ10-50	2675010	MT25-C8	2543030
MC6-50	2675605	ME80-520	2648550	MK28-C	2614350	MQ16-50	2675013	MT25-GC	2541570
MC6.25-U	2600630	ME80-C	2614239	MK32-C	2614360	MQ25-50	2675016	MT25-TD	2540150
MC70-3D	2632010	ME9	2652110	MK34L-C	2614371	MQ35-50	2675019	MT315R-C16	2545950
MC70-50	2675640	ME9-50	2676050	MK38-450	2640285	MQ50-50	2675021	MT315R-GC	2542150
MC70-80U	2600720	ME9-C	2614209	MK38-520	2648640	MQ70-50	2675024	MT315R-TD	2540750
MC70-C	2611130	ME9.20-U	2604810	MK44-450	2640287	MQM10-C	2610661	MT315S-C16	2545990
MC95-3D	2632020	MFB13-40	2598040	MK44-520	2648700	MQM16-C	2610662	MT315S-GC	2542290
MC95-80U	2600730	MFB50-63	2598045	MK52-450	2640295	MQM25-C	2610663	MT315S-TD	2540790
MC95-C	2611140	MH10/16-15	2599886	MK52-520	2648670	MQM35-C	2610664	MT400-TD	2540830
MCCC16-C	2617050	MK17S-C	2614307	MK58-450	2640297	MQM50-C	2610665	MT40S-C10	2543410
MCCC25-C	2617070	MK17S-C	2614307	MK58-520	2648710	MQM70-C	2610666	MT40S-C14-80	2546070
MCCC35-C	2617090	MK14-3D	2634781	MK60-450	2640298	MQM95-C	2610667	MT40S-C8	2543400
MCCC50-C	2617110	MK16-3D	2634783	MK60-520	2648730	MQM120-C	2610668	MT40S-GC	2541610
MCS4-15	2599868	MK18-3D	2634785	MMT200-50	2676388	MQM150-C	2610669	MT40S-TD	2540190
ME03/2-15	2599875	MK20-3D	2634786	MMT200-C	2611190	MQM185-C	2610670	MT500-TD	2540870
ME1	2652010	MK22-3D	2634787	MMT200-U	2601170	MQM240-C	2610671	MT50R-C10	2543650
ME1-50	2676005	MK25-3D	2634788	MMT25-50	2676380	MGS16-C	2610752	MT50R-C8	2543610
ME10	2652130	MK28-3D	2634790	MMT25-C	2611160	MGS35-C	2610753	MT50R-GC	2541690
ME10-50	2676060	MK32-3D	2634800	MMT25-U	2601050	MGS70-C	2610754	MT50R-TD	2540270
ME10-C	2614211	MK34-3D	2634810	MMT315-C	2611200	MGS150-C	2610755	MT50S-C10	2543850
ME10.24-U	2604830	MK38-3D	2634830	MMT50-50	2676382	MGS240-C	2610756	MT50S-C14-80	2546110
ME100-3D	2634940	MK42-3D	2634850	MMT50-C	2611170	MS4/10-15	2599880	MT50S-C8	2543810
ME100-520	2648552	MK44-3D	2634870	MMT50-U	2601090	MS10/16-15	2599881	MT50S-GC	2541650
ME12	2652150	MK46-3D	2634880	MMT95-50	2676384	MT-FC48N	2685903	MT50S-TD	2540230
ME12-50	2676070	MK5	2651575	MMT95-C	2611180	MT120C12	8006254	MT630-TD	2540890
ME12-C	2614213	MK6	2651580	MMT95-U	2601130	MT120C16	8006258	MT70S-C10	2544050
ME12.17-U	2604850	MK8	2651610	MN10-C	2610560	MT150C10	8006252	MT70S-GC	2541730
ME120-3D	2634950	MK10	2651640	MN10RF-C	2676250	MT150C12	8006264	MT70S-TD	2540350
ME120-520	2648554	MK12	2651670	MN10RF-C	2610768	MT150C1480	8006266	MT95R-C10	2544290
ME14	2652170	MK12B	2651672	MN12-C	2610570	MT150C16	8006268	MT95R-C12	2544330
ME14-50	2676080	MK14	2651700	MN12F-50	2676260	MT185C10	8006262	MT95R-GC	2541770
ME14-C	2614215	MK14B	2651710	MN12F-C	2610770	MT185C16	8006278	MT95R-TD	2540390
ME160-520	2648556	MK16	2651730	MN14-C	2610580	MT240C12	8006284	MT95S-C10	2544530
ME17	2652190	MK16B	2651740	MN14RF-50	2676270	MT240C16	8006288	MT95S-C12	2544570
ME17-50	2676090	MK18	2651750	MN14RF-C	2610772	MT300C16	8006298	MT95S-C14-80	2546230
ME17-C	2614217	MK18B	2651760	MN17-C	2610591	MT35C8	8006210	MT95S-GC	2541850
ME19	2652210	MK20	2651770	MN17F-50	2676280	MT35C10	8006212	MT95S-TD	2540470
ME19-50	2676100	MK22B	2651800	MN17F-C	2610774	MT35C1480	8006216	MTA16-C	2770001
ME19-C	2614219	MK5/8-15	2599890	MN19-C	2610600	MT50C8	8006220	MTA25-C	2770020
ME2	2652030	MK5-50	2675360	MN19RF-50	2676285	MT50C10	8006222	MTA35-C	2770030
ME2/3-15	2599876	MK6-50	2675370	MN19RF-C	2610776	MT50C1480	8006226	MTA50-C	2770310
ME2-50	2676010	MK7-50	2675380	MN2-C	2610511	MT70C10	8006232	MTA70-C	2770550
ME2-C	2614201	MK8-50	2675390	MN20-C	2610610	MT95C10	8006242	MTA95-C	2770830
ME2.19-U	2604750	MK9-50	2675400	MN20F-50	2676290	MT95C12	8006244	MTA120-C	2771510
ME20	2652230	MK10-50	2675410	MN20F-C	2610778	MT95C1480	8006246	MTA150-C	2771710
ME20-50	2676110	MK12-50	2675430	MN24-C	2610620	MT120GC	8006150	MTA185-C	2772150
ME200-520	2648558	MK12B-50	2675431	MN24RF-50	2676295	MT150GC	8006160	MTA240-C	2773010
ME20-C	2614221	MK13-50	2675440	MN24RF-C	2610780	MT185GC	8006170	MTMA10-GC	2720025
ME24	2652250	MK14-50	2675450	MN29-C	2610625	MT240GC	8006180	MTMA120-70-GC	2721410
ME24-50	2676120	MK14B-50	2675451	MN29F-C	2610782	MT300GC	8006190	MTMA120-95-GC	2721450
ME24-C	2614223	MK16-50	2675470	MN29F-50	2676210	MT35GC	8006110	MTMA120-GC	2720272
ME29-50	2676130	MK16B-50	2675471	MN2RF-C	2610760	MT400GC	8006195	MTMA150-120-GC	2721630
ME29-C	2614225	MK18-50	2675490	MN3-C	2610520	MT50GC	8006120	MTMA150-70-GC	2721550
ME29-U	2604870	MK18B-50	2675491	MN30-C	2610630	MT70GC	8006130	MTMA150-95-GC	2721590
ME3	2652050	MK19-50	2675500	MN30RF-C	2610784	MT95GC	8006140	MTMA150-GC	2720330
ME3-50	2676020	MK20-50	2675510	MN35-C	2610635	MT120TD	8006050	MTMA16-10-GC	2720560
ME3-C	2614203	MK20B-50	2675511	MN35F-C	2610786	MT150TD	8006060	MTMA16-GC	2720035
ME3.14-U	2604770	MK22-50	2675530	MN37-C	2610640	MT185TD	8006070	MTMA185-120-GC	2721900
ME30-50	2676140	MK22L	2651791	MN37RF-C	2610788	MT240TD	8006080	MTMA185-150-GC	2721910
ME30-C	2614227	MK22L-50	2675534	MN3RF-50	2676220	MT300TD	8006090	MTMA185-GC	2720360
ME30-U	2604890	MK22B-50	2675531	MN3RF-C	2610762	MT35TD	8006010	MTMA240-GC	2720410

REFERENCE / CODE CROSS-REFERENCE CHART

Ref.	Code	Ref.	Code	Ref.	Code	Ref.	Code	Ref.	Code
MTMA240-150-GC	2722050	MY3-50	2677315	PKC120027	2809605	Q38-F	6060126	RD89SS	2685621
MTMA240-185-GC	2722090	MY36-50	2677370	PKE108	8020020	Q38-MS	6060124	RD90SS	2685625
MTMA25-10-GC	2720575	MY36-C	2613410	PKE1012	8020110	RA-3	2598428	RD92X92	2685668
MTMA25-16-GC	2720580	MY37-50	2677375	PKE1018	8020120	RBG-15	2599850	RF-BF4	2051630
MTMA25-GC	2720090	MY37-C	2613415	PKE1508	8020030	RBV-15	2599852	RF-BM4	2051660
MTMA300-GC	2720430	MY3-C	2613355	PKE1518	8020040	RCP-B70	2596116	RF-F305	2051560
MTMA35-20-GC	2720135	MY4-50	2677320	PKE1612	8020126	RD100SS	2685623	RF-F305P	2051565
MTMA35-GC	2720130	MY48-50	2677380	PKE1618	8020128	RD102SS	2685636	RF-F308	2051580
MTMA400-240-GC	2722245	MY48-C	2613420	PKE2508	8020050	RD114SS	2685626	RF-F308P	2051585
MTMA400-300-GC	2722250	MY4-C	2613360	PKE25016	8020130	RD120SS	2685624	RF-F405	2051600
MTMA50-25-GC	2720650	MY5-50	2677325	PKE25022	8020140	RD126X126	2685669	RF-F405P	2051605
MTMA50-35-GC	2720660	MY5-C	2613365	PKE2518	8020060	RD138X138	2685670	RF-F408	2051590
MTMA50-GC	2720152	MY60-C	2613425	PKE308	8010197	RD140SS	2685637	RF-F408P	2051595
MTMA500-GC	2720515	MY6-50	2677330	PKE409	8020070	RD15.5SS	2685560	RF-F608	2051610
MTMA500-300-GC	2722260	MY6-C	2613370	PKE418	8020080	RD15.5SS-FC	2685550	RF-F608P	2051620
MTMA500-400-GC	2722270	MY7-50	2677335	PKE508	8020000	RD16.2SS	2685562	RF-FM608	2051690
MTMA70-35-GC	2720940	MY76-C	2613430	PKE612	8020090	RD16.2SS-FC	2685552	RF-M10	2050390
MTMA70-50-GC	2720980	MY7-C	2613375	PKE618	8020100	RD17SS	2685563	RF-M12	2050430
MTMA70-GC	2720195	ND1	2590080	PKE7508	8020010	RD17.5SS	2685564	RF-M2	2050010
MTMA95-50-GC	2721030	ND2	2590082	PKCT108	8020220	RD17.5SS-FC	2685554	RF-M3	2050030
MTMA95-70-GC	2721070	ND3	2590084	PKCT112	8020225	RD18.8SS	2685566	RF-M3,5	2050070
MTMA95-GC	2720232	ND4	2590086	PKCT1014	8020260	RD18.8SS-FC	2685556	RF-M3,5/1	2050110
MTMA16/1	2720031	NIT10	8420017	PKCT1508	8020230	RD18X46	2685654	RF-M4	2050150
MTMA25/1	2720071	NLO3-M	2469328	PKCT1512	8020235	RD19.1SS	2685568	RF-M4/3	2050170
MTMA35/1	2720111	NLO3-P	2110870	PKCT2510	8020240	RD20.5SS	2685570	RF-M5	2050190
MTMA50/1	2720160	NLO6-M	2469330	PKCT2512	8020245	RD21.5SS	2685571	RF-M6	2050230
MTMA70/1	2720191	NLO6-P	2111950	PKCT412	8020250	RD21X21	2685650	RF-M6/1	2050270
MTMA95/1	2720250	NLO6-PB	2111960	PKCT508	8020200	RD22.6SS	2685572	RF-M608	2051650
MTMA120/1	2720280	NL1-M	2469350	PKCT614	8020255	RD22X30	2685651	RF-M608P	2051655
MTMA150/1	2720320	NL1-P	2113970	PKCT1616	8020265	RD22X46	2685656	RF-M7	2050310
MTMA185/1	2720370	NL1-PG	2113990	PKCT7508	8020210	RD220X220	2685676	RF-M8	2050350
MTMA240/1	2720400	NL2-M	2469390	PKCT7512	8020215	RD23.8SS	2685574	RF-P10	2051250
MTMAD300/1	2720460	NL3-M	2469430	PKET108	8020320	RD25.4SS	2685576	RF-P12	2051290
MTMA400/1	2720475	NN4-15	2599867	PKET112	8020327	RD27SS	2685578	RF-P8	2051210
MTMA500-40/1	2720509	OB2.5P	8420034	PKET1014	8020360	RD28.5SS	2685580	RF-PP12	2051330
MTMA630/1	2720530	PA1	2650230	PKET1508	8020330	RD30.5SS	2685582	RF-PP12/1	2051340
MTMAD300-GC	2720440	PA10	2650290	PKET1512	8020335	RD28.5SS-19	2685584	RF-PP12/19	2051370
MTMAD300-95-GC	2722121	PA10-50	2675686	PKET1616	8020365	RD30.5SS-19	2685586	RF-PP12/23	2051380
MTMAD300-150-GC	2722140	PA10-C	2611010	PKET2510	8020340	RD31.8SS	2685588	RF-PP14	2051410
MTMAD300-185-GC	2722160	PA100-3D	2631930	PKET2512	8020345	RD32.5SS	2685590	RF-PP16/23	2051450
MTMAD300-240-GC	2722220	PA120-3D	2631950	PKET412	8020350	RD34SS	2685591	RF-PPL30	2051460
MTT16-50	2677220	PA120-520	2645600	PKET508	8020300	RD34.6SS	2685592	RF-PPL46	2051465
MTT25-50	2677230	PA19-50	2675694	PKET614	8020355	RD36X46	2685658	RF-U10	2050950
MTT35-50	2677240	PA200-520	2645610	PKET7508	8020310	RD37.2SS	2685594	RF-U12	2050990
MTT50-50	2677250	PA24-50	2675696	PKET7512	8020315	RD37X104	2685674	RF-U3	2050630
MTT70-50	2677260	PA24-C	2611020	PL01-M	2049510	RD37X115	2685661	RF-U3,5	2050670
MTT95-50	2677270	PA48-C	2611030	PL03-M	2051850	RD37X54	2685671	RF-U3,5/1	2050680
MTT120-50	2677275	PA5	2650250	PL03-P	2051860	RD37X67	2685672	RF-U3,5/2	2050681
MUA150	2616050	PA5-50	2675682	PL06-M	2053850	RD37X88	2685673	RF-U4	2050710
MUA230-630-400	2680129	PA60-C	2611040	PL06-P	2053860	RD38.1SS	2685596	RF-U4/1	2050730
MUA230-630-630	2680130	PB-1	2591046	PL1-M	2055870	RD38.5SS	2685597	RF-U4/2	2050750
MUA240	2616070	PC-1	2590705	PN14-C	2610710	RD40.5SS	2685598	RF-U5	2050790
MUA300-34	2616090	PG-1	2591047	PN24-C	2610720	RD40.5SS-FC	2685627	RF-U5/1	2050791
MUA95	2616030	PH1-1	2591061	PN37-C	2610730	RD41.3SS	2685600	RF-U6	2050830
MV150	2616170	PKC108	8010070	PN48-C	2610740	RD41.3SS-FC	2685628	RF-U6/1	2050870
MV230-400 MC5E	2680860	PKC112	8010075	PN60-C	2610750	RD42.5SS	2685602	RF-U8	2050910
MV230-630 MC6E	2680870	PKC1012	8010120	PN7-C	2610700	RD42.5SS-FC	2685629	RH50	2670050
MV240	2616180	PKC1018	8010125	PN80-3D	2631460	RD43.2SS	2685604	RHC131	2619010
MV35	2616150	PKC1508	8010080	PNB-1	2591040	RD43.2SS-FC	2685630	RHC131LN	2619021
MV95	2616160	PKC1518	8010085	PNB-3F/M	2591088	RD44.5SS	2685606	RH-FC48N	2592596
MVM150	2616310	PKC1612	8010130	PNB-3N1	2591092	RD44.5SS-FC	2685632	RH-FL75	2592597
MVM230-400 MJ5E	2680910	PKC1618	8010135	PNB-3N5	2591096	RD46X107	2685652	RHM132	2619410
MVM230-630 MJ6E	2680920	PKC2508	8010090	PNB-3NN3	2591094	RD46X46	2685660	RHM50	2670035
MVM240	2616320	PKC2518	8010095	PNB-3NN4	2591095	RD46X54	2685662	RHT160	2592422
MVM35	2616290	PKC25016	8010140	PNB-3P	2591090	RD46X72	2685664	RHT160-60N	2592584
MVM95	2616300	PKC25022	8010145	PNB-3P1	2591084	RD47.2SS	2685608	RHTD1724	2682482
MY10-50	2677340	PKC306	8010040	PNB-3PD	2591091	RD47.2SS-FC	2685634	RHTD3241	2682502
MY10-C	2613380	PKC308	8010045	PNB-4KE	2591251	RD48.5SS	2685609	RHTD410T	2682520
MY14-50	2677345	PKC35016	8010150	PNB-6KE	2591260	RD50.5SS	2685610	RHU131-C	2619210
MY14-C	2613385	PKC35025	8010155	PNB-6KE-T	2591262	RD50X98	2685663	RHU230-630	2680075
MY16-50	2677350	PKC409	8010100	PNB-7KE	2591268	RD51.4SS	2685611	RHU450	2640011
MY16-C	2613390	PKC418	8010105	PNB-7KE-T	2591270	RD52.4SS	2685613	RHU520	2640151
MY19-50	2677355	PKC508	8010050	PO7000	2595904	RD54.2SS	2685612	RHU600	2640250
MY19-C	2613395	PKC510	8010055	PR-1	2591045	RD60SS	2685614	RHU1000	2640810
MY24-50	2677360	PKC50020	8010160	PRCH	2596113	RD60.5SS	2685615	RHU81	2600045
MY24L-50	2677362	PKC50030	8010165	PS130-150/E	2616371	RD64SS	2685616	RKF-BF4	2051632
MY24-C	2613400	PKC612	8010110	PS130-240/E	2616381	RD65SS	2685618	RKF-BM4	2051662
MY2-50	2677310	PKC618	8010115	PS130-35/E	2616351	RD67X126	2685665	RKF-F305	2051562
MY2-C	2613350	PKC70022	2809595	PS130-95/E	2616361	RD68X68	2685666	RKF-F308	2051582
MY30-50	2677365	PKC7508	8010060	PS230-400 5E	2680186	RD76SS	2685620	RKF-F405	2051602
MY30L-50	2677366	PKC7512	8010065	PS230-630 6E	2680189	RD76.5SS	2685619	RKF-F405P	2051607
MY30-C	2613405	PKC95025	2809600	Q14-MS	6060120	RD80.5SS	2685622	RKF-F408	2051592

REFERENCE/CODE CROSS-REFERENCE CHART

Ref.	Code	Ref.	Code	Ref.	Code	Ref.	Code	Ref.	Code
RKF-F408P	2051597	RP-P12	2046120	S1,5-U6	2160830	TCP30	3019260	VP-P10	2049210
RKF-F608	2051612	RP-P8	2046110	S1,5-U6/1	2160870	TCP35	3019270	VP-PP12/19	2049370
RKF-F608P	2051622	RP-PP12	2046140	S1,5-U8	2160910	TCP40	3019280	VP-U3	2048630
RKF-FM608	2051692	RP-PP12/1	2046145	S2,5-M10	2162170	TCP45	3019290	VP-U3,5	2048670
RKF-M608	2051652	RP-PP12/19	2046150	S2,5-M12	2162210	TCP5	3019210	VP-U4	2048710
RKY-M3	2145684	RP-PP12/23	2046155	S2,5-M2	2161800	TCP50	3019300	WF6	8420030
RKY-M3.5	2145685	RP-PP14	2046160	S2,5-M3	2161810	TCP55	3019305	WF16	8420015
RKY-M3.5/1	2145687	RP-PP16/23	2046165	S2,5-M3,5	2161850	TCP60	3019310	WF35	8420031
RKY-M4	2145690	RP-PPL30	2046180	S2,5-M3,5/1	2161890	TCP65	3019315	WL03-M	8440100
RKY-M5	2145699	RP-PPL46	2046185	S2,5-M4	2161930	TCP70	3019320	WL06-M	8440101
RKY-M6/1	2145705	RP-U10	2046265	S2,5-M5	2161970	TD-M16C	2685010	WL1-M	8440102
RKY-M8	2145711	RP-U12	2046270	S2,5-M6	2162010	TF300-Q38F	2592862	WT2-3D	2636970
RKY-M10	2145715	RP-U3	2046210	S2,5-M6/1	2162050	TF300-Q38FM	2592863	Z10-1	2845030
RKY-M12	2145718	RP-U3,5	2046215	S2,5-M7	2162090	TF600-Q38FM	2592981	Z16-1	2845040
RKY-P8	2145782	RP-U3,5/2	2046217	S2,5-M8	2162130	TGM38	3016155	Z16-12	2844156
RKY-P10	2145783	RP-U4	2046230	S2,5-M8	2162130	TGM48	3016157	Z16-12D	2844157
RKY-P12	2145784	RP-U4/1	2046231	S2,5-P10	2163050	TGM513	3016165	Z16-3	2844115
RKY-PP12	2145790	RP-U4/2	2046240	S2,5-P12	2163090	TGM58	3016159	Z16-3D	2844116
RKY-PP12/19	2145792	RP-U5	2046245	S2,5-P8	2163010	TGM613	3016167	Z16-4	2844130
RKY-PP16/23	2145793	RP-U5/1	2046246	S2,5-PP12	2163170	TGM713	3016169	Z16-4D	2844131
RKY-PPL30	2145795	RP-U6	2046255	S2,5-PP12/25	2163210	TGM817	3016171	Z16-5N	2844122
RKY-PPL46	2145798	RP-U6	2046255	S2,5-PP16/25	2163250	TN120S	2590270	Z16-5ND	2844123
RKY-U3	2145730	RP-U6/1	2046256	S2,5-U10	2162730	TN70	2590230	Z16-8	2844140
RKY-U3.5	2145733	RP-U8	2046260	S2,5-U12	2162770	TNN120	2590290	Z16-8D	2844141
RKY-U4	2145736	RS0305.07	3008006	S2,5-U3	2162410	TNN70	2590240	Z25-1	2845050
RKY-U5	2145739	RS0407.M12	3008050	S2,5-U3,5	2162450	TNN71	2590241	Z25-DP7-100	2845180
RKY-U6	2145742	RS0507.09	3008008	S2,5-U3,5/1	2162460	TRS-B70	2593280	Z2,5-1	2845010
RKY-U6/1	2145743	RS0509.M16	3008052	S2,5-U4	2162490	UP130-120	2616520	Z35-1	2845060
RN-FA305	3031610	RS0710.11	3008010	S2,5-U4/1	2162510	UP130-150	2616530	Z35-26D	2844216
RN-FA405	3031615	RS0813.M20	3008054	S2,5-U4/2	2162530	UP130-185	2616550	Z35-3	2844205
RN-FA608	3031620	RS1014.16	3008012	S2,5-U5	2162570	UP130-240	2616560	Z35-3D	2844206
RN-M10	2150430	RS1117.M25	3008056	S2,5-U6	2162610	UP130-50	2616470	Z35-4	2844201
RN-M12	2150470	RS1420.21	3008014	S2,5-U6/1	2162650	UP130-70	2616490	Z35-4D	2844202
RN-M12	2150470	RS1520.M32	3008058	S2,5-U8	2162690	UP130-95	2616500	Z35-6	2844210
RN-M2	2150010	RS1928.M40	3008060	S6-M10	2163830	VAL04	2593310	Z35-6D	2844211
RN-M3	2150030	RS2026.29	3008016	S6-M10/1	2163850	VAL096	2593669	Z35-DP14-125	2845210
RN-M3,5	2150070	RS2635.36	3008018	S6-M12	2163890	VAL1000	2593426	Z35-DP14B-125	2845212
RN-M3,5/1	2150110	RS2735.M50	3008062	S6-M14	2163930	VAL130	2610450	Z35T-11	2844220
RN-M4	2150150	RT11	2592480	S6-M16	2163970	VAL130-U	2610451	Z35T-11D	2844221
RN-M4/3	2150170	RT10.5	2592470	S6-M3	2163510	VAL160	2593405	Z50-10D	2844230
RN-M5	2150190	RT21	2592550	S6-M3,5	2163550	VAL22	2593370	Z50-DP12-160	2845220
RN-M6	2150230	RT13	2592490	S6-M4	2163590	VAL22-3	2593406	Z6-1	2845020
RN-M6/1	2150270	RT13,5	2592495	S6-M6	2163670	VAL22-C	2593402	Z6-10	2844106
RN-M7	2150350	RT14	2592500	S6-M6/1	2163710	VAL22-TC120	2593391	Z6-10D	2844107
RN-M8	2150390	RT15	2592510	S6-M7	2163750	VAL230-630	2680085	Z6-3	2844080
RN-MA305	3031710	RT17	2592530	S6-M8	2163790	VAL450	2593424	Z6-3D	2844081
RN-MA405	3031715	RT6.5	2592430	S6-M8/1	2163800	VAL520	2593410	Z6-5	2844100
RN-MA608	3031720	RT8.5	2592450	S6-P10	2164710	VAL600	2593425	Z6-5D	2844101
RN-P10	2151270	RT9	2592460	S6-P12	2164750	VAL75	2600110	Z6-6	2844108
RN-P12	2151310	S10-M4	2165130	S6-P14	2164790	VALCPO96	2593671	Z6-6D	2844109
RN-P8	2151230	S10-M5	2165150	S6-PP12	2164830	VALCPO96-W	2593674	ZKE2	2590710
RN-PP12	2151350	S10-M6	2165190	S6-PP17	2164870	VALB-TC950	2593704	ZKE610	2590718
RN-PP12/1	2151370	S10-M7	2165230	S6-U10	2164370	VALECW-H3D	2593421	ZKE6-F	2590716
RN-PP12/19	2151390	S1,5-M10	2160390	S6-U10/1	2164390	VALFC470	2593710	ZS-B16	2842185
RN-PP14	2151400	S1,5-M12	2160430	S6-U12	2164430	VALMAT230-630	2680086	ZS-B4	2842115
RN-PP16/23	2151410	S1,5-M2	2160010	S6-U14	2164470	VALMAT520	2593411	ZS-B6	2842155
RN-U10	2150990	S1,5-M3	2160030	S6-U16	2164510	VALMATW	2670076	ZS-T16	2842190
RN-U12	2151030	S1,5-M3,5	2160070	S6-U3,5	2164170	VALP1	2590595	ZS-T4	2842120
RN-U3	2150670	S1,5-M3,5/1	2160110	S6-U4	2164210	VALP3	2590610	ZS-T6	2842160
RN-U3,5	2150710	S1,5-M4	2160150	S6-U5	2164250	VALP4	2590612	ZS-U16	2842180
RN-U3,5/2	2150720	S1,5-M4/3	2160160	S6-U6	2164290	VALP7	2590616	ZS-U4	2842110
RN-U4	2150750	S1,5-M5	2160190	S6-U8	2164330	VALP19	2590629	ZS-U6	2842150
RN-U4/1	2150760	S1,5-M6	2160230	S1,5-M6/1	2160270	VALP21	2874156		
RN-U4/2	2150790	S1,5-M7	2160310	SC3X	2591264	VALP22	2874157		
RN-U5	2150830	S1,5-M8	2160350	SC4X	2591265	VALP26	2590635		
RN-U5/1	2150840	S1,5-P10	2161190	SH-B70	2596080	VALP27	2590638		
RN-U6	2150870	S1,5-P12	2161230	SUB-DO50	8420033	VALP28	2590639		
RN-U6/1	2150910	S1,5-P8	2161150	SUB-DO75	8420032	VALP30	2590642		
RN-U8	2150950	S1,5-PP12	2161310	TC025	2591895	VALP38	2590650		
RP-M10	2046045	S1,5-PP12/1	2161330	TC04N	2591392	VALP39	2590651		
RP-M12	2046050	S1,5-PP12/19	2161350	TC050	2597050	VALP40	2590652		
RP-M2	2046005	S1,5-PP14	2161360	TC050Y	2597056	VALP44	2590654		
RP-M3	2046010	S1,5-U10	2160950	TC055	2591860	VALP48	2590655		
RP-M3,5	2046015	S1,5-U12	2160990	TC085	2597150	VALSTAR V3-F	2590577		
RP-M3,5/1	2046016	S1,5-U3	2160630	TC096	2597360	VALTC085	2593323		
RP-M4	2046020	S1,5-U3,5	2160670	TC120	2597250	VALTC120	2593322		
RP-M4/3	2046023	S1,5-U3,5/2	2160682	TC10	3019220	VP-M2	2048010		
RP-M5	2046025	S1,5-U4	2160710	TCP12	3019225	VP-M3	2048030		
RP-M6	2046030	S1,5-U4/1	2160730	TCP15	3019230	VP-M3,5	2048070		
RP-M6/1	2046031	S1,5-U4/2	2160750	TCP18	3019235	VP-M4	2048150		
RP-M7	2046035	S1,5-U5	2160790	TCP20	3019240	VP-M5	2048190		
RP-M8	2046040	S1,5-U5/1	2160800	TCP25	3019250	VP-M6	2048210		
RP-P10	2046115								

COMPARISON OF AWG, MCM AND METRIC CONDUCTOR CROSS SECTIONS

AWG comparison to Metric

AWG	Actual conductor csa mm ²	Comparable metric csa mm ²
27	0,10	
26	0,13	0,14
25	0,16	-
24	0,21	0,2
23	0,26	0,25
22	0,33	0,34
21	0,41	-
20	0,52	0,5
19	0,65	-
18	0,82	0,75
17	1,04	1
16	1,31	-
15	1,65	1,5
14	2,08	-
13	2,63	2,5
12	3,31	-
11	4,15	4
10	5,27	6
9	6,62	-
8	8,35	-
7	10,6	10
6	13,3	-
5	16,8	16
4	21,2	-
3	26,7	25
2	33,6	35
1	42,4	-
1/0	53,4	50
2/0	67,5	70
3/0	85,0	95
4/0	107,2	120

MCM comparison to Metric

MCM	Actual conductor csa mm ²	Comparable metric csa mm ²
250	127	120
300	152	150
350	177	185
400	203	-
500	253	240
600	304	300
700	355	-
800	405	400
900	456	-
1000	507	500
1250	633	625
1500	760	800
1750	887	-
2000	1010	1000

MAXIMUM DIAMETERS OF CIRCULAR COPPER CONDUCTORS: SOLID, NON COMPACTED STRANDED AND FLEXIBLE

Cross sectional area [mm ²]	Conductors in cables for fixed installations		Flexible conductors (Classes 5 and 6) Maximum diameter [mm]
	Solid (Class 1) Maximum diameter [mm]	Stranded (Class 2) Maximum diameter [mm]	
0,5	0,9	1,1	1,1
0,75	1,0	1,2	1,3
1	1,2	1,4	1,5
1,5	1,5	1,7	1,8
2,5	1,9	2,2	2,4
4	2,4	2,7	3,0
6	2,9	3,3	3,9
10	3,7	4,2	5,1
16	4,6	5,3	6,3
25 ^a	5,7	6,6	7,8
35 ^a	6,7	7,9	9,2
50 ^a	7,8	9,1	11,0
70 ^a	9,4	11,0	13,1
95 ^a	11,0	12,9	15,1
120 ^a	12,4	14,5	17,0
150 ^a	13,8	16,2	19,0
185	15,4	18,0	21,0
240	17,6	20,6	24,0
300	19,8	23,1	27,0
400	22,2	26,1	31,0
500	-	29,2	35,0
630	-	33,2	39,0
800	-	37,6	-
1000	-	42,2	-

NOTE: The values given for flexible conductors represent both class 5 and class 6 conductors.

^a Solid Copper conductor shaving cross-sectional areas of 25 mm² and above are for particular types of cable, e.g. mineral insulated, and not for general purposes.

MINIMUM AND MAXIMUM DIAMETERS OF STRANDED COMPACTED CIRCULAR COPPER, ALUMINIUM AND ALUMINIUM ALLOY CONDUCTORS

Cross-sectional area [mm ²]	Stranded compacted circular conductors (Class 2)	
	Minimum diameter [mm]	Maximum diameter [mm]
10	3,6	4,0
16	4,6	5,2
25	5,6	6,5
35	6,6	7,5
50	7,7	8,6
70	9,3	10,2
95	11,0	12,0
120	12,3	13,5
150	13,7	15,0
185	15,3	16,8
240	17,6	19,2
300	19,7	21,6
400	22,3	24,6
500	25,3	27,6
630	28,7	32,5

NOTES: - The dimensional limits of Aluminium conductors with cross-sectional areas above 630 mm² are not given as the compaction technology is not generally established.

- The values are given for compacted Copper conductors in the size range 1,5 mm² to 6 mm².

MINIMUM AND MAXIMUM DIAMETERS OF CIRCULAR ALUMINIUM CONDUCTORS

Cross-sectional area [mm ²]	Solid conductors (Class 1)	
	Minimum diameter [mm]	Maximum diameter [mm]
10	3,4	3,7
16	4,1	4,6
25	5,2	5,7
35	6,1	6,7
50	7,2	7,8
70	8,7	9,4
95	10,3	11,0
120	11,6	12,4
150	12,9	13,8
185	14,5	15,4
240	16,7	17,6
300	18,8	19,8
400	21,2	22,2
500	24,0	25,1
630	27,3	28,4
800	30,9	32,1
1000	34,8	36,0
1200	37,8	39,0

CLASS 1:

SOLID CONDUCTORS FOR SINGLE-CORE AND MULTI-CORE CABLES

Nominal cross-sectional area [mm ²]	Maximum resistance of conductor at 20 °C		
	Circular, annealed Copper conductors		Aluminium and Aluminium alloy conductors, circular or shaped ^c [ohm/km]
	Plain [ohm/km]	Metal [ohm/km]	
0,5	36	36,7	-
0,75	24,5	24,8	-
1	18,1	18,2	-
1,5	12,1	12,2	-
2,5	7,41	7,56	-
4	4,61	4,70	-
6	3,08	3,11	-
10	1,83	1,84	3,08 ^a
16	1,15	1,16	1,91 ^a
25	0,727 ^b	-	1,20 ^a
35	0,524 ^b	-	0,868 ^a
50	0,387 ^b	-	0,641
70	0,268 ^b	-	0,443
95	0,193 ^b	-	0,320 ^d
120	0,153 ^b	-	0,253 ^d
150	0,124 ^b	-	0,206 ^d
185	0,101 ^b	-	0,164 ^d
240	0,0775 ^b	-	0,125 ^d
300	0,0620 ^b	-	0,100 ^d
400	0,0465 ^b	-	0,0778
500	-	-	0,0605
630	-	-	0,0469
800	-	-	0,0367
1000	-	-	0,0291
1200	-	-	0,0247

^a Aluminium conductors 10 mm² to 35 mm² circular only

^b Solid Copper conductors having nominal cross-sectional area of 25 mm² and above are for particular types of cable, e.g. mineral insulated, and not for general purposes.

^c For solid Aluminium alloy conductors, having the same nominal cross-sectional area as an Aluminium conductor, the resistance value given in the table should be multiplied by a factor of 1,162 unless otherwise agreed between the manufacturer and the purchaser.

^d For single core cables, four sectoral shaped conductors may be assembled into a single circular conductor. The maximum resistance of the assembled conductor shall be 25% of that of the individual component conductors.

CLASS 2:

STRANDED CONDUCTORS FOR SINGLE-CORE AND MULTI-CORE CABLES

Nominal cross-sectional area [mm ²]	Minimum number of wires in the conductor						Maximum resistance of conductor at 20 °C		
	Circular		Circular compacted		Shaped		Annealed Copper conductor		Aluminium or Aluminium alloy conductor ^c [ohm/km]
	Cu	Al	Cu	Al	Cu	Al	Plain wires [ohm/km]	Metal-coated wires [ohm/km]	
0,5	7	-	-	-	-	-	36,0	36,7	-
0,75	7	-	-	-	-	-	24,5	24,8	-
1,0	7	-	-	-	-	-	18,1	18,2	-
1,5	7	-	6	-	-	-	12,1	12,2	-
2,5	7	-	6	-	-	-	7,41	7,56	-
4	7	-	6	-	-	-	4,61	4,70	-
6	7	-	6	-	-	-	3,08	3,11	-
10	7	7	6	6	-	-	1,83	1,84	3,08
16	7	7	6	6	-	-	1,15	1,16	1,91
25	7	7	6	6	6	6	0,727	0,734	1,20
35	7	7	6	6	6	6	0,524	0,529	0,868
50	19	19	6	6	6	6	0,387	0,391	0,641
70	19	19	12	12	12	12	0,268	0,270	0,443
95	19	19	15	15	15	15	0,193	0,195	0,320
120	37	37	18	15	18	15	0,153	0,154	0,253
150	37	37	18	15	18	15	0,124	0,126	0,206
185	37	37	30	30	30	30	0,0991	0,100	0,164
240	61	61	34	30	34	30	0,0754	0,0762	0,125
300	61	61	34	30	34	30	0,0601	0,0607	0,100
400	61	61	53	53	53	53	0,0470	0,0475	0,0778
500	61	61	53	53	53	53	0,0366	0,0369	0,0605
630	91	91	53	53	53	53	0,0283	0,0286	0,0469
800	91	91	53	53	-	-	0,0221	0,0224	0,0367
1000	91	91	53	53	-	-	0,0176	0,0177	0,0291
1200			<i>b</i>				0,0151	0,0151	0,0247
1400 ^a			<i>b</i>				0,0129	0,0129	0,0212
1600			<i>b</i>				0,0113	0,0113	0,0186
1800 ^a			<i>b</i>				0,0101	0,0101	0,0165
2000			<i>b</i>				0,0090	0,0090	0,0149
2500			<i>b</i>				0,0072	0,0072	0,0127

^a Non-preferred sizes. Other non-preferred sizes are recognized for some specialized applications but are not within the scope of this standard.

^b The minimum number of wires for these sizes is not specified. These sizes may be constructed from 4, 5 or 6 equal segments (Milliken).

^c For stranded Aluminium alloy conductors having the same nominal cross-sectional area as an Aluminium conductor the resistance value should be agreed between the manufacturer and the purchaser.

CLASS 5:

FLEXIBLE COPPER CONDUCTORS FOR SINGLE-CORE AND MULTI-CORE CABLES

Nominal cross-sectional [mm ²]	Maximum diameter of wires in conductor [mm]	Maximum resistance of conductor at 20 °C	
		Plain wires [ohm/km]	Metal-coated wires [ohm/km]
0,5	0,21	39,0	40,1
0,75	0,21	26,0	26,7
1,0	0,21	19,5	20,0
1,5	0,26	13,3	13,7
2,5	0,26	7,98	8,21
4	0,31	4,95	5,09
6	0,31	3,30	3,39
10	0,41	1,91	1,95
16	0,41	1,21	1,24
25	0,41	0,780	0,795
35	0,41	0,554	0,565
50	0,41	0,386	0,393
70	0,51	0,272	0,277
95	0,51	0,206	0,210
120	0,51	0,161	0,164
150	0,51	0,129	0,132
185	0,51	0,106	0,108
240	0,51	0,0801	0,0817
300	0,51	0,0641	0,0654
400	0,51	0,0486	0,0495
500	0,61	0,0384	0,0391
630	0,61	0,0287	0,0292

CLASS 6:

FLEXIBLE COPPER CONDUCTORS FOR SINGLE-CORE AND MULTI-CORE CABLES

Nominal cross-sectional [mm ²]	Maximum diameter of wires in conductor [mm]	Maximum resistance of conductor at 20 °C	
		Plain wires [ohm/km]	Metal-coated wires [ohm/km]
0,5	0,16	39,0	40,1
0,75	0,16	26,0	26,7
1,0	0,16	19,5	20,0
1,5	0,16	13,3	13,7
2,5	0,16	7,98	8,21
4	0,16	4,95	5,09
6	0,21	3,30	3,39
10	0,21	1,91	1,95
16	0,21	1,21	1,24
25	0,21	0,780	0,795
35	0,21	0,554	0,565
50	0,31	0,386	0,393
70	0,31	0,272	0,277
95	0,31	0,206	0,210
120	0,31	0,161	0,164
150	0,31	0,129	0,132
185	0,41	0,106	0,108
240	0,41	0,0801	0,0817
300	0,41	0,0641	0,0654

- H** Cable conforming to harmonised standards
- A** Recognised national type of cable
- N** Other type of national cable

- 00** Less than 100 / 100 V
- 01** Above 100 / 100 V and less than 300 / 300 V
- 03** 300 / 300 V
- 05** 300 / 500 V
- 07** 450 / 750 V
- 1** 0,6 / 1 kV

- B** Ethylenpropylene rubber for working temperature of 60° C
- N** Polychloroprene
- N2** Polychloroprene for welding cables
- Q** Polyurethane
- R** Rubber
- V** Common-quality PVC
- V2** PVC for working temperatures of 90° C
- V3** PVC for low temperature cables
- V4** Reticulate PVC
- V5** Oil-resistant PVC
- Z** Polyolefin mixture

- C** Concentric Copper core
- C4** Copper braid screen on multiple cores
- C5** Copper braid screen on single cores
- C7** Screen made of Copper straps or ribbons

- Z2** Round Steel strand armour
- Z3** Steel strap armour
- Z4** Steel ribbon armour
- Z5** Steel strand braid

- H** Flat divisible cable with or without sheath
- H2** Flat indivisible cable
- H3** Flat cable with cores separated by a slot
- H6** Flat cable with three or more cores
- H7** Cable with double-layered insulation
- H8** Extendable cord

- D** Flexible core for weldings cables
- E** Very flexible core for welding cables
- F** Flexible core for moving connections
- H** Very flexible core for moving connections
- K** Flexible core for fixed laying
- R** Rigid round cord
- U** Round rigid single strand

REFERENCE TO THE STANDARDS

RATED VOLTAGE

INSULATION AND SHEATH MATERIAL

SCREENS

ARMOURS

CONSTRUCTIVE FORM OF THE CABLE

CONDUCTOR FLEXIBILITY DEGREE

UL AND VDE MARKING OF CABLE GLANDS

MAXIblock® - spiralblock®

Ref. Light Grey	Thread	COMPRESSION RANGE Ø min-max				IMPACT CATEGORY (*)	MARKING
		Nominal [mm]	UL 514B		EN 62444 [mm]		
			[mm]	[inches]			
1900.M12	M12x1.5	3.5-7	3.5	0.14	3.5-7	1	USR-CNR / VDE
1900.M16	M16x1.5	5-10	7	0.28	7-10	1	USR-CNR / VDE
1900.M20	M20x1.5	7-13	13	0.51	8-13	3	USL-CNL / VDE
1900.M25	M25x1.5	10-17	17	0.67	10-17	3	USL-CNL / VDE
1900.M32	M32x1.5	13-21	15-21	0.60-0.83	15-21	3	USL-CNL / VDE
1900.M40	M40x1.5	19-28	21-28	0.83-1.10	19-28	3	USL-CNL / VDE
1900.M50	M50x1.5	27-35	27-34	1.06-1.34	27-35	3	USL-CNL / VDE
1900.M63	M63x1.5	34-45	35-45	1.38-1.77	34-45	3	USL-CNL / VDE
1910.M12	M12x1.5	2-5	2-5	0.08-0.20	2-5	1	USR-CNR / VDE
1910.M16	M16x1.5	3-7	4-7	0.16-0.28	5-7	1	USR-CNR / VDE
1910.M20	M20x1.5	5-10	5-10	0.20-0.40	6-10	3	USR-CNR / VDE
1910.M25	M25x1.5	7-13	7-13	0.28-0.51	7-13	3	USR-CNR / VDE
1910.M32	M32x1.5	8-14	8-14	0.31-0.55	8-14	3	USR-CNR / VDE
1910.M40	M40x1.5	15-23	15-23	0.59-0.91	15-23	3	USL-CNL / VDE
1910.M50	M50x1.5	21-29	21-29	0.83-1.14	21-29	3	USL-CNL / VDE
1910.M63	M63x1.5	27-39	28-39	1.1-1.54	28-39	3	USL-CNL / VDE
1901.M12	M12x1.5	3.5-7	3.5	0.14	3.5-7	1	USR-CNR / VDE
1901.M16	M16x1.5	5-10	7	0.28	5-10	1	USR-CNR / VDE
1901.M20	M20x1.5	7-13	13	0.51	8-13	3	USL-CNL / VDE
1901.M25	M25x1.5	10-17	17	0.67	10-17	3	USL-CNL / VDE
1901.M32	M32x1.5	13-21	15-21	0.60-0.83	15-21	3	USL-CNL / VDE
1901.M40	M40x1.5	19-28	21-28	0.83-1.10	19-28	3	USL-CNL / VDE
1901.M50	M50x1.5	27-35	27-34	1.06-1.34	27-35	3	USL-CNL / VDE
1901.M63	M63x1.5	34-45	35-45	1.38-1.77	34-45	3	USL-CNL / VDE
1500.M12	M12x1.5	3.5-7	3.5	0.14	3.5-7	1	USR-CNR / VDE
1500.M16	M16x1.5	5-10	7	0.28	7-10	1	USR-CNR / VDE
1500.M20	M20x1.5	7-13	13	0.51	8-13	3	USL-CNL / VDE
1500.M25	M25x1.5	10-17	17	0.67	10-17	3	USL-CNL / VDE
1500.M32	M32x1.5	13-21	15-21	0.60-0.83	15-21	3	USL-CNL / VDE

Add to Ref. **N** for Black, **G** for Dark Grey

MAXIblock® - spiralblock®

Ref. Light Grey	Thread	COMPRESSION RANGE Ø min-max				MARKING
		Nominal [mm]	UL 514B		EN 62444 [mm]	
			[mm]	[inches]		
1900.07	Pg 7	3.5-7	4.5-6.5	0.18-0.25	USR-CNR	
1900.09	Pg 9	5-8	5.5-8	0.22-0.31	USR-CNR	
1900.11	Pg 11	5-10	6.5-9.5	0.26-0.37	USR-CNR	
1900.13	Pg 13.5	7-12	8-11.5	0.31-0.45	USL-CNL	
1900.16	Pg 16	10-14	10.5-14	0.41-0.55	USL-CNL	
1900.21	Pg 21	13-18	13-18	0.51-0.71	USL-CNL	
1900.29	Pg 29	18-25	18.5-25	0.73-0.98	USL-CNL	
1900.36	Pg 36	20-32	21.5-32	0.85-1.26	USL-CNL	
1900.42	Pg 42	28-38	28-38	1.10-1.49	USL-CNL	
1900.48	Pg 48	37-45	40-44	1.57-1.73	USL-CNL	
1910.07	Pg 7	2-5	2-5	0.08-0.20	USR-CNR	
1910.11	Pg 11	4-7	4-7	0.16-0.28	USR-CNR	
1910.13	Pg 13	5-10	10	0.39	USR-CNR	
1910.21	Pg 21	9-15	10-14	0.39-0.55	USR-CNR	
1910.36	Pg 36	18-26	18-26	0.71-1.02	USR-CNR	
1910.42	Pg 42	25-31	25-31	0.98-1.22	USL-CNL	
1901.07	Pg 7	3.5-7	6.5	0.26	USR-CNR	
1901.09	Pg 9	5-8	5.5-8	0.22-0.31	USR-CNR	
1901.11	Pg 11	5-10	6.5-9.5	0.26-0.37	USR-CNR	
1901.13	Pg 13.5	7-12	8-11.5	0.31-0.45	USL-CNL	
1901.16	Pg 16	10-14	10.5-14	0.41-0.55	USL-CNL	
1901.21	Pg 21	13-18	13-18	0.51-0.71	USL-CNL	
1901.29	Pg 29	18-25	18.5-25	0.73-0.98	USL-CNL	
1901.36	Pg 36	20-32	21.5-32	0.85-1.26	USL-CNL	
1901.42	Pg 42	28-38	28	1.10	USL-CNL	
1901.48	Pg 48	37-45	40-44	1.57-1.73	USL-CNL	
1500.07	Pg 7	3.5-7	4.5-6.5	0.18-0.25	USR-CNR	
1500.09	Pg 9	5-8	5.5-8	0.22-0.31	USR-CNR	
1500.11	Pg 11	5-10	6.5-9.5	0.26-0.37	USR-CNR	
1500.13	Pg 13.5	7-12	8-11.5	0.31-0.45	USL-CNL	
1500.16	Pg 16	10-14	10.5-14	0.41-0.55	USL-CNL	
1500.21	Pg 21	13-18	13-18	0.51-0.71	USL-CNL	

1900.14	G1/4"	3-6.5	4.5-6.5	0.18-0.25	USR-CNR
1900.38	G3/8"	4-8	5.5-8	0.22-0.31	USR-CNR
1900.12	G1/2"	7-12	8-11.5	0.31-0.45	USL-CNL
1900.34	G3/4"	13-18	13-18	0.51-0.71	USL-CNL
1901.12	G1/2"	7-12	8-11.5	0.31-0.45	USL-CNL
1500.14	G1/4"	3-6.5	4.5-6.5	0.18-0.25	USR-CNR
1500.38	G3/8"	4-8	5.5-8	0.22-0.31	USR-CNR
1500.12	G1/2"	7-12	8-11.5	0.31-0.45	USL-CNL
1500.34	G3/4"	13-18	13-18	0.51-0.71	USL-CNL

Add to Ref. **N** for Black, **G** for Dark Grey

MAXIbrass®

Ref.	Thread	COMPRESSION RANGE Ø min-max			MARKING
		Nominal [mm]	UL 514B		
			[mm]	[inches]	
2900.07N	Pg 7	3-7	3-7	0.12-0.28	USR-CNR
2900.09N	Pg 9	4-8	4-8	0.16-0.31	USR-CNR
2900.11N	Pg 11	4.5-10	4.5-10	0.18-0.39	USR-CNR
2900.13N	Pg 13.5	5-12	9-12	0.35-0.47	USL-CNL
2900.16N	Pg 16	7-13	10-13	0.39-0.51	USL-CNL
2900.21N	Pg 21	10-17	12-17	0.47-0.67	USL-CNL
2900.29N	Pg 29	17-25	18-25	0.71-0.98	USL-CNL
2900.36N	Pg 36	20-32	22-32	0.86-1.26	USL-CNL
2900.42N	Pg 42	28-38	28-35	1.10-1.38	USL-CNL
2900.48N	Pg 48	34-45	34-45	1.33-1.77	USL-CNL
2910.07N	Pg 7	1-5	1-5	0.04-0.20	USR-CNR
2910.09N	Pg 9	2-6	3-6	0.12-0.24	USR-CNR
2910.11N	Pg 11	2.5-7	3.5-7	0.14-0.28	USR-CNR
2910.13N	Pg13.5	4-10	5.5-10	0.22-0.39	USR-CNR
2910.16N	Pg 16	5-10	6-10	0.24-0.39	USR-CNR
2910.21N	Pg 21	6-13	7-13	0.28-0.51	USR-CNR
2910.29N	Pg 29	11-20	12-20	0.47-0.79	USR-CNR
2910.36N	Pg 36	18-26	19-26	0.75-1.02	USL-CNL
2910.42N	Pg 42	24-31	24-31	0.94-1.22	USL-CNL
2910.48N	Pg 48	27-39	31-39	1.22-1.54	USL-CNL
2901.07N	Pg 7	3-7	3-7	0.12-0.28	USR-CNR
2901.09N	Pg 9	4-8	4-8	0.16-0.31	USR-CNR
2901.11N	Pg 11	4.5-10	4.5-10	0.18-0.39	USR-CNR
2901.13N	Pg13.5	5-12	9-12	0.35-0.47	USL-CNL
2901.16N	Pg 16	7-13	10-13	0.39-0.51	USL-CNL
2901.21N	Pg 21	10-17	12-17	0.47-0.67	USL-CNL
2901.29N	Pg 29	17-25	18-25	0.71-0.98	USL-CNL
2901.36N	Pg 36	20-32	22-32	0.86-1.26	USL-CNL
2901.42N	Pg 42	28-38	28-35	1.10-1.38	USL-CNL
2911.07N	Pg 7	1-5	1-5	0.04-0.20	USR-CNR
2911.09N	Pg 9	2-6	3-8	0.12-0.31	USR-CNR
2911.11N	Pg 11	2.5-7	3.5-7	0.14-0.28	USR-CNR
2911.13N	Pg13.5	4-10	5.5-10	0.22-0.39	USR-CNR
2911.16N	Pg 16	5-10	6-10	0.24-0.39	USR-CNR
2911.21N	Pg 21	6-13	7-13	0.28-0.51	USR-CNR
2911.29N	Pg29	11-20	12-20	0.47-0.79	USR-CNR
2911.36N	Pg36	18-26	19-26	0.75-1.02	USL-CNL
2911.42N	Pg42	24-31	24-31	0.94-1.22	USL-CNL

VDE: Licence nos 40008472, 40008474, 40008475 and 40008476

USL-CNL: UL LISTING file no E220310; control no 48SB valid in USA & Canada

USR-CNR: UL RECOGNITION file no E220310 valid in USA & Canada (with reduced tightening force)

(*) EN 50262 § 9.4

MAXIbrass®

Ref.	Thread	COMPRESSION RANGE Ø min-max				IMPACT CATEGORY (*)	MARKING
		Nominal [mm]	UL 514B		EN 62444 [mm]		
			[mm]	[inches]			
2900.M12N	M12x1.5	3-7	3-7	0.12-0.28	3-7	5	USR-CNR / VDE
2900.M16N	M16x1.5	4.5-10	4.5-10	0.18-0.39	4.5-10	6	USL-CNL / VDE
2900.M20N	M20x1.5	7-13	8-13	0.31-0.51	7-13	6	USL-CNL / VDE
2900.M25N	M25x1.5	10-17	10-17	0.39-0.67	11-17	6	USL-CNL / VDE
2900.M32N	M32x1.5	11-21	11-21	0.43-0.83	13-21	6	USL-CNL / VDE
2900.M40N	M40x1.5	19-28	19-28	0.75-1.10	19-28	6	USL-CNL / VDE
2900.M50N	M50x1.5	26-35	27-35	1.06-1.38	26-35	6	USL-CNL / VDE
2900.M63N	M63x1.5	34-45	34-45	1.33-1.77	34-45	6	USL-CNL / VDE
2910.M12N	M12x1.5	1-5	2-5	0.08-0.20	2-5	5	USR-CNR / VDE
2910.M16N	M16x1.5	2.5-7	3.5-7	0.14-0.28	4-7	6	USR-CNR / VDE
2910.M20N	M20x1.5	5-10	5-10	0.20-0.39	5.5-10	6	USR-CNR / VDE
2910.M25N	M25x1.5	6-13	6-13	0.24-0.51	6-13	6	USR-CNR / VDE
2910.M32N	M32x1.5	7-14	7-14	0.28-0.55	9-14	6	USR-CNR / VDE
2910.M40N	M40x1.5	13-23	15-23	0.59-0.90	17-23	6	USR-CNR / VDE
2910.M50N	M50x1.5	20-29	20-29	0.79-1.14	25-29	6	USL-CNL / VDE
2910.M63N	M63x1.5	27-39	28-39	1.10-1.54	31-39	6	USL-CNL / VDE
2901.M12N	M12x1.5	3-7	3-7	0.12-0.28	3-7	5	USR-CNR/VDE
2901.M16N	M16x1.5	4.5-10	4.5-10	0.18-0.39	4.5-10	6	USL-CNL / VDE
2901.M20N	M20x1.5	7-13	8-13	0.31-0.51	7-13	6	USL-CNL / VDE
2901.M25N	M25x1.5	10-17	10-17	0.39-0.67	11-17	6	USL-CNL / VDE
2901.M32N	M32x1.5	11-21	11-21	0.43-0.83	13-21	6	USL-CNL / VDE
2901.M40N	M40x1.5	19-28	19-28	0.75-1.10	19-28	6	USL-CNL / VDE
2901.M50N	M50x1.5	26-35	27-35	1.06-1.38	26-35	6	USL-CNL / VDE
2911.M12N	M12x1.5	1-5	2-5	0.08-0.20	2-5	5	USR-CNR/VDE
2911.M16N	M16x1.5	2.5-7	3.5-7	0.14-0.28	4-7	6	USR-CNR / VDE
2911.M20N	M20x1.5	5-10	5-10	0.20-0.39	5.5-10	6	USR-CNR / VDE
2911.M25N	M25x1.5	6-13	6-13	0.24-0.51	6-13	6	USR-CNR / VDE
2911.M32N	M32x1.5	7-14	7-14	0.28-0.55	9-14	6	USR-CNR/VDE
2911.M40N	M40x1.5	13-23	15-23	0.59-0.90	17-23	6	USL-CNL / VDE
2911.M50N	M50x1.5	20-29	20-29	0.79-1.14	25-29	6	USL-CNL / VDE

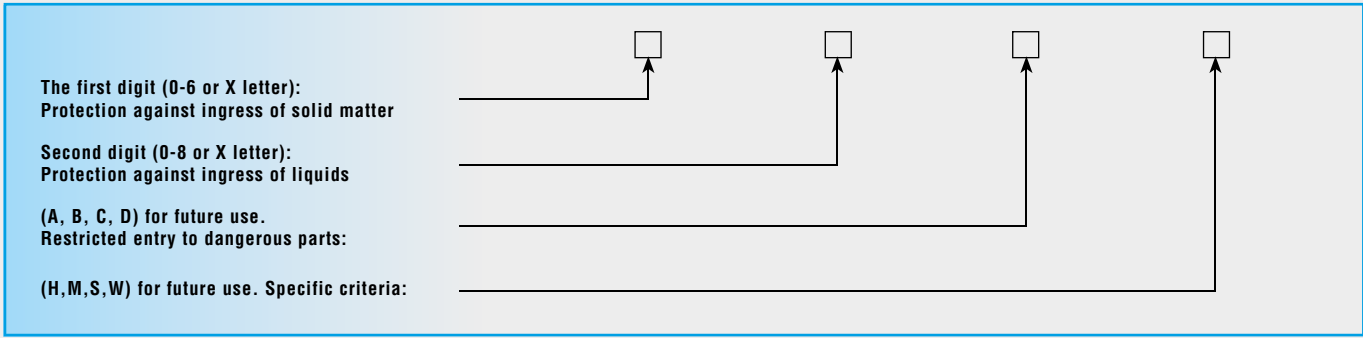

**1st CHARACTERISTIC NUMBER:
PROTECTION AGAINST INGRESS OF SOLID MATTER**

PROTECTION	0	1	2	3	4	5	6
Protection against ingress of solid matter caused by		solid bodies measuring over 50 mm	solid bodies measuring over 12,5 mm	solid bodies measuring over 2,5 mm	solid bodies measuring over 1 mm	powder in harmful quantities	Powder (completely protected)
Test method		Accessability gauge ø 50 mm	Accessability gauge ø 12,5 mm	Accessability gauge ø 2,5 mm	Accessability gauge ø 1 mm	talcum powder	talcum powder

**2nd CHARACTERISTIC NUMBER:
PROTECTION AGAINST INGRESS OF LIQUIDS**



PROTECTION	0	1	2	3	4	5	6	7	8
Protection against ingress of liquids caused by		Drops of water falling vertically	Vertical drops of water with inclination of casing up to 15°	Rain	Sprays of water	Jets of water	Powerful jets of water	Temporary Immersion	Permanent Immersion
Test method		Drops of water falling vertically	Vertical drops of water with inclination of casing up to 15°	Rain	Sprays of water	Jets of water	Powerful jets of water	Temporary Immersion	Permanent Immersion

**1st ADDITIONAL LETTER
RESTRICTED ENTRY TO DANGEROUS PARTS**

RESTRICTED ENTRY	A	B	C	D
Restricted entry to dangerous parts caused by	back of hand	finger	tool	wire
Test method	accessibility gauge ø 50 mm	articulated test finger	accessibility gauge ø 2,5 mm	accessibility gauge ø 1 mm

**2nd ADDITIONAL LETTER
MEANING OF THE SECOND ADDITIONAL LETTER**

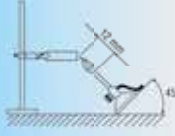
SPECIFIC CRITERIA	H	M	S	W
Specific criteria	High voltage equipment	Tested against negative effects of water penetration, when the moveable parts of the equipment (e.g. wheels of a revolving machine) are moving	Tested against the negative effects of water penetration, when the moveable parts of the equipment (e.g. wheels of a revolving machine) are stationary	Suitable for use in environmental conditions as specified and equipped with additional measures of protection

TYPE OF TEST	TEST EQUIPMENT	COMPLIANCE WITH STANDARDS	OBJECTIVE OF TEST	TEST RESULTS	TEST CONDITIONS		
					heat source	length of test	characteristic features
CHARACTERISTIC FEATURES		IEC 695-2-1 CEI 50-11 DIN VDE 0471-2-1	Check that abnormal heating produced by overcurrent and bad contacts does not compromise the safety of the insulating material. Lighting test. The wire is pressed against the sample using force and penetrates up to 7 mm.	Any sign of flame starting must stop within 30 sec. of removing the glowing wire TEST TEMPERATURE <ul style="list-style-type: none"> • 650° for materials which do not support parts under tension • 750° for materials which support parts under tension of moving sockets and plugs • 850° for materials which support parts under tension of fixed sockets and switches 	Glow-wire 4 mm in diameter	Wire applied for 30 seconds	Flame extinction time
NEEDLE FLAME		IEC 695-2-1 CEI 50-11	Simulates the effect small flames have which may occur due to internal faults of products in order to judge the fire risk.	<ul style="list-style-type: none"> • the sample does not catch fire • the flame and incandescent particles do not spread the fire • combustion lasts less than 30 seconds 	Bunsen burner flame	Flame applied for (Ta) 5, 10, 20, 30, 60, 120 sec. According to particular standards	The degree of severity: flame application time (Ta)
UL (UNDERWRITER LABORATORIES)		UL 94	Measuring of time the sample continues to burn after the direct flame has been removed	<ul style="list-style-type: none"> • V0 if the sample burns for less than 5 sec. before going out. • V1 if it burns for less than 25 sec. • V2 if it burns for less than 25 sec. With incandescent drops • HB if it burns for more than 25 sec. (horizontal sample and burning speed less than 38 mm per minute) Comparable to ASTM D-635 	Bunsen burner flame	Flame applied for 10 seconds twice following	Length of combustion

MAXIblock[®], *spiralblock*[®], **MAXIbrass**[®], **MAXIinox**

to obtain IP68 ingress protection in accordance with EN 50262

Torque ratio values apply to mounting in a threaded entry and to use with a locknut

THREAD CABLE GLAND	CABLE GLAND torque ratio Nm	
	metallic	non-metallic
M12 x 1,5	6	2,7
M16 x 1,5	6	5,0
M20 x 1,5	8	7,0
M25 x 1,5	8	7,5
M32 x 1,5	12	8,0
M40 x 1,5	18	8,0
M50 x 1,5	18	10,0
M63 x 1,5	18	10,0

MAXIblock[®], *spiralblock*[®], **MAXIbrass**[®], **MAXIinox**

to obtain IP68 ingress protection in accordance with DIN VDE for Pg threads

Torque ratio values apply to mounting in a threaded entry and to use with a locknut

THREAD CABLE GLAND	CABLE GLAND torque ratio Nm		
	metallic	non-metallic series	
		1900	1910
Pg 7	6.25	2.5	2.5
Pg 9	6.25	3.75	3.75
Pg 11	6.25	3.75	3.75
Pg 13,5	6.25	3.75	3.75
Pg 16	7.5	5.0	5.0
Pg 21	10.0	7.5	7.5
Pg 29	10.0	7.5	7.5
Pg 36	18.0	7.5	7.5
Pg 42	18.0	7.5	10.0
Pg 48	18.0	7.5	10.0

MAXIblock[®], *spiralblock*[®]

to obtain IP68 with reduced tightening force for GAS threads

Torque ratio values apply to mounting in a threaded entry and to use with a locknut

THREAD CABLE GLAND	CABLE GLAND non-metallic torque ratio Nm
	G1/4"
G3/8"	5
G1/2"	6
G3/4"	10

Also available in the Cembre product range

"Industrial Marking Systems"

ROLLY
THERMAL TRANSFER SYSTEM
FOR REEL MEDIA PRINTING



MARKINGENIUS 3

PC-DRIVEN THERMAL
TRANSFER MARKER
PRINTING SYSTEM

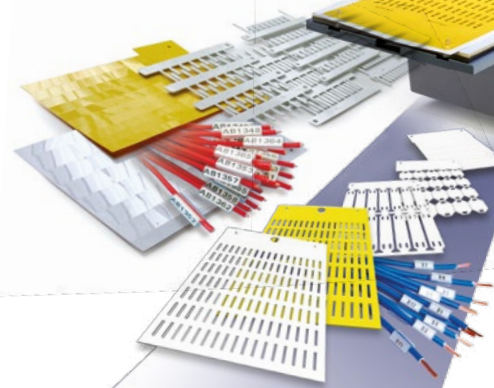

serie
FLAT

NEW MARKERS FOR THE IDENTIFICATION OF
TERMINAL BLOCKS AND CABLES

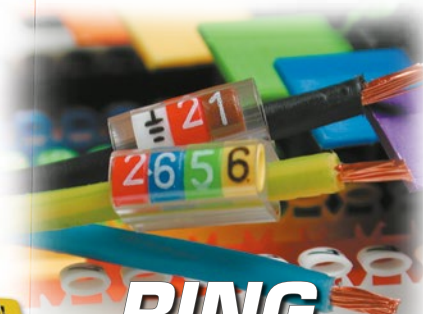

RING
cablesys

MANUAL CABLE
MARKING SYSTEMS



SIGN
stick-onsys
WARNING, PROHIBITION
AND MANDATORY SIGNS

ASK FOR THE CATALOGUES



Cembre

Crimpstar

ZETAmini

MAXIblock



nd

ZETApiù

spiralblock

oelma

MARKIN
Genius

ZETAblock

MAXIbrass



SICURclips

are registered trademarks of Cembre S.p.A.

The information contained in this catalogue is to aid the commercial selection of products. It is not intended for use as an instruction manual. Information concerning application and the correct operational use is provided by the specific manual delivered with the products.

This catalogue is the property of Cembre. Any reproduction (in full or in part) is forbidden without the prior written permission of Cembre.

Cembre reserve the right to modify the specifications in this catalogue without prior notice.



Dunton Park
Kingsbury Road, Curdworth
Sutton Coldfield - West Midlands B76 9EB UK
Tel.: 01675 470440
Fax: 01675 470220
E-mail: sales@cembre.co.uk
Web: www.cembre.co.uk



Design, manufacture and sales of electrical connectors and associated tools, cable accessories, marking systems, tooling and products for railway applications. In house repair, refurbishment and calibration of tooling.

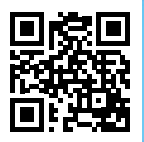

www.cembre.co.uk



Cod. 6280567