

# **WORKABOUT PRO4 HAND-HELD COMPUTER**

**(Windows Embedded CE 6.0)**

## **USER GUIDE**



# **WORKABOUT PRO4 HAND-HELD COMPUTER USER GUIDE**

**8000290-001**

**April 2015**

This user manual supports the model number 7528X which contains the approved radio module 21-148603-0B. The applicable FCC ID and Industry Canada numbers are as follows:

- FCC ID: UZ7211486030B
- IC: 109AN-211486030B'

---

## Copyright

No part of this publication may be reproduced or used in any form, or by any electrical or mechanical means, without permission in writing from us. This includes electronic or mechanical means, such as photocopying, recording, or information storage and retrieval systems. The material in this manual is subject to change without notice.

The software is provided strictly on an “as is” basis. All software, including firmware, furnished to the user is on a licensed basis. We grant to the user a non-transferable and non-exclusive license to use each software or firmware program delivered hereunder (licensed program). Except as noted below, such license may not be assigned, sublicensed, or otherwise transferred by the user without our prior written consent. No right to copy a licensed program in whole or in part is granted, except as permitted under copyright law. The user shall not modify, merge, or incorporate any form or portion of a licensed program with other program material, create a derivative work from a licensed program, or use a licensed program in a network without written permission from us. The user agrees to maintain our copyright notice on the licensed programs delivered hereunder, and to include the same on any authorized copies it makes, in whole or in part. The user agrees not to decompile, disassemble, decode, or reverse engineer any licensed program delivered to the user or any portion thereof.

We reserve the right to make changes to any software or product to improve reliability, function, or design.

We do not assume any product liability arising out of, or in connection with, the application or use of any product, circuit, or application described herein.

No license is granted, either expressly or by implication, estoppel, or otherwise under any of our intellectual property rights. An implied license only exists for equipment, circuits, and subsystems contained in our products.

---

## Disclaimer

Every effort has been made to make this material complete, accurate, and up-to-date. In addition, changes are periodically incorporated into new editions of the publication.

We reserve the right to make improvements and/or changes in the product(s) and/or the program(s) described in this document without notice, and shall not be responsible for any damages including, but not limited to, consequential damages, caused by reliance on the material presented.

Zebra and the Zebra head graphic, Workabout Pro4 and the names of other products and services provided by us are trademarks of Zebra.

Windows® and the Windows Logo are trademarks or registered trademarks of Microsoft Corporation in the United States and/or other countries.



The Bluetooth® word mark and logos are owned by Bluetooth SIG, Inc. and any use of such marks by us is under license.

All trademarks used herein are the property of their respective owners.

---

## Revision History

Changes to the original guide are listed below:

Change	Date	Description
-001 Rev A	04/2015	Zebra rebrand.



# TABLE OF CONTENTS

## About This Guide

About This Manual .....	xiii
Text Conventions .....	xiv
Overview of the Workabout Pro4 Hand-Held Computer .....	xiv
Regulatory Labels .....	xvi
SE655 LED Device – Class 1 .....	xvi
SE965, SE4500 and SE1524 Lasers – Class 2.....	xvii

## Chapter 1: Basic Operation

Workabout Pro4 Features .....	1-1
Workabout Pro4 Modules Available .....	1-2
Documents Available .....	1-2
Preparing the Workabout Pro4 for Operation .....	1-2
The Battery .....	1-2
Switching the Workabout Pro4 On and Off .....	1-3
Resetting the Workabout Pro4 .....	1-4
Performing a Warm Reset.....	1-4
Performing a Cold Reset.....	1-4
Performing a Clean Start .....	1-5
Boot to BooSt.....	1-5
Attaching Carrying Accessories .....	1-5
Calibrating the Touchscreen .....	1-5
Imager and Scanner Options .....	1-5
Connectivity .....	1-5
Data Transfer .....	1-6
Voice Communication .....	1-6

## Chapter 2: Getting to Know the Workabout Pro4

Operating System .....	2-1
Battery Details.....	2-1
Battery Swap Time .....	2-1
Charging the Battery .....	2-2

The Keyboard .....	2-2
Regular Keys .....	2-2
The [Power] Button .....	2-2
Standard Keys .....	2-3
Modifier Keys .....	2-4
Activating Modifier Keys .....	2-4
Locking Modifier Keys .....	2-4
Function Keys and Macro Keys .....	2-4
Function Keys .....	2-4
Macro Keys (Workabout Pro4 Long only) .....	2-5
Numeric Keyboards — Accessing Alpha Keys .....	2-5
The Keypad Backlight .....	2-6
The Display .....	2-6
Adjusting the Display Backlight .....	2-6
Calibrating the Touchscreen .....	2-7
Indicators .....	2-7
LED .....	2-7
Onscreen Indicators .....	2-7
Audio Indicators .....	2-9
Inserting the microSD Card and SIM Card .....	2-9
Inserting and Removing the Cards .....	2-9
Scanners and Imagers .....	2-10
Basic Scanner Operations .....	2-10
Scanning Techniques .....	2-10
Troubleshooting .....	2-10
Operating 1D Internal Laser Scanners .....	2-11
Operating Internal 2D Imagers .....	2-11
Windows Embedded CE 6.0 .....	2-12
Navigating in Windows Embedded CE and Applications .....	2-12
Navigating Using a Touchscreen .....	2-12
Navigating Using the Keyboard .....	2-12
The Windows Classic Shell Startup Desktop .....	2-13
The Taskbar .....	2-14
The Start Menu .....	2-15
The Kiosk Desktop Shell .....	2-20
Restoring the Windows Classic Shell .....	2-22
General Maintenance .....	2-22
Caring for the Touchscreen .....	2-22
Cleaning the Workabout Pro4 .....	2-23
<b>Chapter 3: Configuration</b>	
Overview of Software .....	3-1
Software Advantage .....	3-1
Microsoft Software .....	3-1
The Control Panel .....	3-2
Control Panel Applications .....	3-2



App Launch Keys .....	3-5
<b>Bluetooth</b> <sup>®</sup> Setup .....	3-7
Paired .....	3-8
Device .....	3-9
Discovering and Removing Devices .....	3-9
Filtering By Class of Device (COD).....	3-9
Device Pop-up Menu.....	3-10
Pairing a Device .....	3-10
Servers .....	3-12
Mode .....	3-12
About .....	3-13
The <b>Bluetooth</b> GPRS WAN Connection .....	3-13
Certificates .....	3-16
Data Transfer between Workabout Pro4 and a PC .....	3-17
Using Microsoft ActiveSync.....	3-17
Using Windows Mobile Device Center.....	3-18
Using Windows Mobile Device Center.....	3-18
DataWedge .....	3-18
Scanner Services.....	3-19
Display Properties.....	3-19
Background .....	3-19
Appearance .....	3-20
Backlight.....	3-20
Dr. Debug .....	3-21
Status.....	3-21
Utilities .....	3-22
Settings.....	3-22
Error Reporting .....	3-22
GPS (Global Positioning System) Settings .....	3-23
Input Panel.....	3-25
Keyboard Properties .....	3-26
Key Repeat.....	3-26
Keyboard Backlight .....	3-27
Keyboard One Shot Modes.....	3-27
Macro Keys.....	3-29
Unicode Mapping .....	3-30
Scancode Remapping.....	3-31
Lock Sequence.....	3-33
Manage Triggers .....	3-34
Trigger Mappings.....	3-34
Add and Edit Trigger Mapping.....	3-35
Microphone .....	3-36
TekTerm Client .....	3-37
PartnerUp.....	3-37
Power Properties .....	3-37
Battery Capacity .....	3-37
Power Saving Suspend.....	3-38

Suspend Threshold and Estimated Battery Backup .....	3-38
Advanced .....	3-39
Wakeup Sources .....	3-40
Battery Health .....	3-40
Kiosk Access .....	3-41
Administrator Password .....	3-42
Shell Settings .....	3-43
Restrictions .....	3-45
Control Panel Settings .....	3-45
Import/Export to File .....	3-46
Remote Desktop Connection .....	3-47
Storage Manager .....	3-47
Formatting a Memory Card .....	3-47
Creating Partitions .....	3-48
Partition Management .....	3-49
Stylus Properties .....	3-51
Double-Tap .....	3-51
Calibration .....	3-51
Touch .....	3-52
System Properties .....	3-52
Total Recall .....	3-53
Creating a Backup .....	3-53
Creating a Clone .....	3-54
Managing Profiles .....	3-55
Viewing a Profile .....	3-55
Profile Options .....	3-55
Deleting a Profile .....	3-57
TweakIt .....	3-57
Advanced .....	3-58
Advanced CE Services Settings .....	3-58
Advanced Interface and Network Settings .....	3-58
Advanced Services Settings .....	3-59
Registry Editor .....	3-59
Voice – Using the WWAN Phone Dialer .....	3-59
Dialing a Number .....	3-60
Receiving an Incoming Call .....	3-61
Voice Menu .....	3-61
Call Management .....	3-61
Call Lists .....	3-62
Services .....	3-63
File Menu – Phonebook Management .....	3-63
Volume & Sounds Properties .....	3-64
Volume Adjustments .....	3-65
Sound Adjustments .....	3-65
Fusion Wireless Companion - Setting Up the 802.11a/b/g/n .....	3-65
Creating a New Profile .....	3-67
Launching an Existing Profile .....	3-69

Resetting the Radio to Default Factory Settings .....	3-69
Monitoring the Network Connection .....	3-69

#### **Chapter 4: Peripheral Devices & Accessories**

Carrying Accessories .....	4-1
Attaching the Hand Strap .....	4-2
Attaching the Pistol Grip .....	4-2
The Trigger Back Plate Kit with Flush Mount Pistol Grip .....	4-3
Protective Carrying Case .....	4-7
Soft Shell Holster .....	4-7
The Battery .....	4-8
Adaptor Cable Options.....	4-9
Chargers and Cradles.....	4-9
Installation – Chargers and Cradles .....	4-9
Power Consumption Considerations.....	4-9
Operator Controls .....	4-10
Important Charger Safety Instructions .....	4-10
Single Bay USB Cradle.....	4-10
Charging a Battery Installed in the Workabout Pro4 .....	4-12
Charging a Spare Battery .....	4-12
Battery Charge Duration.....	4-12
Charger LED Indicators.....	4-12
Troubleshooting the Charging Operation of the Cradle .....	4-12
Linking a Workabout Pro4 to a PC.....	4-13
Linking a Workabout Pro4 to an Ethernet Network.....	4-13
Network Access.....	4-13
Troubleshooting the Single Bay USB Cradle Operations .....	4-13
AC Wall Adaptor – Model #PS1050-G1 .....	4-14
Four Bay Ethernet Cradle – WA4204-G2 & WA4304-G2 .....	4-14
Four Bay Ethernet Cradle Setup .....	4-15
Four Bay Ethernet Cradle Indicators.....	4-15
Inserting a Workabout Pro4 in the Four Bay Ethernet Cradle .....	4-15
Network Access.....	4-15
Network Addressing .....	4-15
Battery Charging – LED Behaviour.....	4-15
Troubleshooting.....	4-16
Network Link Unsuccessful.....	4-16
Hand-Held LED does not Light when Docked.....	4-16
Four Slot Battery Charger .....	4-16
Charging the Battery .....	4-16
Battery Charge Duration.....	4-16
Charge Indicators – The LEDs.....	4-17
Troubleshooting.....	4-17
The Vehicle Cradle.....	4-17
Vehicle Cradle Mounting Recommendations.....	4-18
Mounting Template.....	4-18
Wiring Guidelines.....	4-18

Using the Vehicle Cradle .....	4-19
Maintaining the Vehicle Cradle .....	4-19
Powered Cradle Installation in High Voltage Vehicles .....	4-19
Powered Vehicle Cradle Installation .....	4-19
Wiring Vehicle Power to the Cradle.....	4-20
The Port Replicator .....	4-20
Scanners and Imagers.....	4-20
Scanning Techniques .....	4-21
Troubleshooting.....	4-21
Operating One Dimensional (1D) Laser Scanners .....	4-21
Operating Two Dimensional (2D) Imagers.....	4-21
<i>Bluetooth</i> Peripherals .....	4-22

### Appendix A: Port Pinouts

LIF (Low Insertion Force) Pinout .....	A-1
Tether Port Pinout.....	A-1
Battery Contact Pinout.....	A-2
Positive Female Battery Connector .....	A-3

### Appendix B: DataWedge

DataWedge .....	B-1
Where to Find More Information .....	B-1

### Appendix C: Scanner Settings

Scanner Services.....	C-1
Barcodes.....	C-2
Restoring Default Settings .....	C-2
Decoded (Zebra EMDK) .....	C-3
Barcodes Tab .....	C-3
Options.....	C-3
Advanced Options.....	C-3
Barcode Symbologies .....	C-4
Options .....	C-5
Double Click Parameters .....	C-5
Display Parameters.....	C-6
Data Handling .....	C-7
Translations .....	C-7
Case Rules .....	C-8
Ports .....	C-9
Port Replicator Port A (COM5) and Port B (COM6).....	C-9

### Appendix D: Internal Imager & Scanner Specifications

SE965 Scanner.....	D-1
SE965 Decode Zones.....	D-2
SE655 Scanner.....	D-3
SE655 Decode Ranges .....	D-4

SE1524ER – Extended Range Scanner .....	D-4
SE1524ER Decode Zones .....	D-5
SE4500SR – Standard Range Imager .....	D-6
SE4500SR Decode Zone .....	D-8

## Appendix E: Workabout Pro4 Specifications

The Workabout Pro4 Hand-Held Computer (7528 Long and 7528 Short) .....	E-1
Hardware .....	E-1
Regulatory Approvals .....	E-2
Battery Specifications .....	E-2
Rechargeable Lithium-ion Battery .....	E-2
Wireless Radios .....	E-3
802.11a/b/g/n Radio .....	E-3
Cinterion PHS8-P GSM/GPRS/EDGE/UMTS/HSPA+ Radio .....	E-5
<i>Bluetooth</i> Radio .....	E-7

## Appendix F: Wireless Wide Area Network (WWAN) Settings

Wireless WAN .....	F-1
Taskbar Icons .....	F-1
Establishing a Packet Data Connection .....	F-2
Disconnecting From a Network .....	F-3
Shutting Down the Wireless WAN User Interface .....	F-3
Advanced Information .....	F-4
Entering a PIN Number .....	F-4
Error States .....	F-4
Tools Menu .....	F-5
WWAN Data Configuration .....	F-5
Security Configuration .....	F-8
Network Configuration .....	F-9
Driver Mode Configuration .....	F-10
Modem Information .....	F-11
User Interface .....	F-12
AT Terminal .....	F-13
SMS Menu .....	F-14
New .....	F-14
Inbox .....	F-14
Outbox .....	F-14
SMS Configuration .....	F-15
Voice .....	F-15
Power Mode .....	F-15

## Appendix G: Wireless Zero Config Settings

Wireless Information .....	G-1
Wireless Information Tab .....	G-2
Wireless Properties .....	G-3
Assigning an IP Address .....	G-4
Name Servers Tab .....	G-5
Advanced Features .....	G-6

Rearranging Preferred Networks .....	G-6
Deleting a Preferred Network.....	G-6
Changing Network Properties .....	G-6
<b>Index.....</b>	<b>I</b>

# ABOUT THIS GUIDE

---

## About This Manual

This user manual describes the configuration, operation, and maintenance of the Workabout Pro4 Hand-Held Computer.

**Chapter : About This Guide.** provides a basic overview of the Workabout Pro4.

**Chapter 1: Basic Operation.** describes the steps required to get the Workabout Pro4 ready for operation.

**Chapter 2: Getting to Know the Workabout Pro4.** describes Workabout Pro4 features, including how to charge and maintain the battery, the keyboard features, the display, using the internal scanner, etc. This chapter also describes the Microsoft® Windows® Embedded CE 6.0 desktop, and how to change the appearance and actions of the desktop from Windows Classic Shell to the Kiosk Shell.

**Chapter 3: Configuration.** describes the programs and applications accessed through two main areas from the Desktop Start Menu: *Programs* and *Settings>Control Panel*. The software includes both Zebra Software Advantage and Microsoft programs, and details how to use them to configure the Workabout Pro4, along with scanners/imagers, *Bluetooth*, etc. This chapter also details the Kiosk program, which enables you to customize your computer settings.

**Chapter 4: Peripheral Devices & Accessories.** describes the peripherals and accessories available for your Workabout Pro4 computer.

**Appendix A: Port Pinouts.** describes the Workabout Pro4 and accessories pinouts.

**Appendix B: Imager & Camera Settings.** describes in detail your imager settings.

**Appendix C: Scanner Settings.** details your barcode options.

**Appendix D: Internal Imager & Scanner Specifications.** lists the specifications for the Workabout Pro4 scanners and imagers.



**Appendix E: Workabout Pro4 Specifications.** lists the specifications for your Workabout Pro4 computer, radios, and battery.

**Appendix F: Wireless Wide Area Network (WWAN) Settings.** describes WWAN configuration information.

**Appendix G: Wireless Zero Config Settings.** describes how to configure the Workabout Pro4 using *Wireless Zero Config*.

---

## Text Conventions

- ✓ **NOTE** Notes highlight additional helpful information.
-  **IMPORTANT** These statements provide particularly important instructions or additional information that is critical to the operation of the equipment.
-  **WARNING!** These statements provide critical information that may prevent physical injury, equipment damage or data loss.

---

## Overview of the Workabout Pro4 Hand-Held Computer

The Workabout Pro4 is a modular, industrial hand-held computer available in two form factors: Long and Short. Several options are available to suit applications in courier/delivery, field service, meter reading, asset management, warehousing and logistics, manufacturing and other specialized data capture applications.

- ✓ **NOTE** The Workabout Pro4 Hand-Held Computer is a body-worn device. To maintain compliance with the FCC RF exposure guidelines, use a Zebra approved carrying case. Use of non-approved accessories may violate FCC RF exposure guidelines.
- ✓ **NOTE** For product specifications, refer to [Chapter E: Workabout Pro4 Specifications](#)

### Model

- 7528X, 7528XP, 7528XLF, 7528XHF, 7528XPLF, 7528XPHF, 7528XUHFE, 7528XPUHFE, 7528XUHFN & 7528XPUHFN

### Platform (standard)

- CPU: Sitara™ AM37x ARM Cortex™-A8 processor
- Memory: 512 MB RAM/4GB Flash

### Operating System

- Microsoft Windows® Embedded CE 6.0

### Bundled Applications

- Internet Explorer® 6
- Wordpad®
- ActiveSync®

### Terminal Emulation

- TekTerm Client Terminal Emulation
- Wavelink Terminal Emulation



**Additional Software**

- Kiosk
- MobiControl
- A.R.C.
- Total Recall/TweakIt/Dr. Debug
- Windows® Mobile Device Center

**Wireless Data and Voice Communications****Standard**

- *Bluetooth*® - Integrated *Bluetooth*® V2 + EDR
- WLAN - 802.11a/b/g/n WiFi. Optional diversity antenna module available.

✓ **NOTE** Optional diversity antenna module available (model number RA3052).

**Optional**

- WWAN - UMTS/HSPA+ WAN radio with GPS receiver (supports AGPS, GLONASS and SBAS)

✓ **NOTE** Data only. In the Americas the Workabout Pro4 is not approved to be used with any VoIP application using Wide Area Network (WAN) or Wireless Local Area Network (WLAN).

- GPS within the Options below -- option 1 or 2  
Option 1: GPS receiver with SBAS support  
Option 2: GPS receiver with GLONASS support (only available with WWAN option)

✓ **NOTE** 802.11a/b/g/n and **Bluetooth** are available simultaneously.

**Barcode Scanners (optional)**

- SE9651D Laser
- SE655 1D Imager
- SE1524 1D Laser
- SE4500 1D/2D Imager

✓ **NOTE** All scan engines are available factory configured or user installable as either an end-cap or slim pod.

**RFID Modules**

- LF Module
  - Frequency: 125 kHz
  - Protocols supported: EM 4x02; EM 4x05; EM 4x50; EM 4200; Q5; Hitag 1 & 2; Hitag S
- UHF Module
  - Frequency: 868 MHz or 915 MHz
  - Protocols supported: EPC Class 1 Gen 2; ISO 18000-6C
- HF Module
  - Frequency: 13.56 MHz

- Protocols supported: ISO14443 type A, B and C, ISO 15693; NFC “Reader to Tag” Mode; full Mifare support
- Data encryption: 2 SAM slots; ID1 SAM format; Class A, B and C

### **User Interface**

- Display
  - Transflective colour/touch display 9.4 cm (3.7 in) VGA/QVGA (640 x 480)
  - Sunlight visibility with 240 cd/m<sup>2</sup> brightness
- Keyboards
  - Alphanumeric (7528 Long)
  - QWERTY or Numeric (7528 Short)
  - High reliability keypad with ultra-white backlight
- Voice & Audio
  - Push-to-Talk – *VoIP* (In the Americas the Workabout Pro4 is not approved to be used with any VoIP application using Wide Area Network (WAN) or Wireless Local Area Network (WLAN).)
  - Standard integrated microphone and receiver.
  - Standard high volume 86 dBA beeper (95 dBA beeper with extended ranger laser).
  - Optional speech module, certified with Vocollect and Wavelink Speakeasy clients.

### **Power Management**

- 4400 mAh Lithium-ion battery – Model No. WA3010
- 2850 mAh Lithium-ion battery – Model No. WA3025
- 4680 mAh Lithium-ion battery – Model No. WA3026
- Super capacitor power backup

---

## **Regulatory Labels**

Each scanner has a laser warning label accompanied by a protective housing and certificate label.



**WARNING!** Using controls or adjustments or performing procedures other than those specified herein may result in hazardous radiation exposure.

### **SE655 LED Device – Class 1**

#### **LED Compliance Statement**

Classified as “EXEMPT RISK GROUP” according to IEC 62471:2006 and EN 62471:2008

**Figure 1** SE655 End-Cap LED Warning Label - Class 1



**Figure 2** SE655 Slim Pod Laser Window Warning Label



## SE965, SE4500 and SE1524 Lasers – Class 2

**Figure 3** SE965 End-Cap Laser Warning Label



Figure 4 SE965 Slim Pod Laser Window Warning Label



Figure 5 SE965 Protective Housing and Certificate Label



Figure 6 SE4500 End-Cap Laser/LED Warning Label



**Figure 7** SE4500 Slim Pod Laser Window Warning Label



**Figure 8** SE4500 Protective Housing and Certificate Label

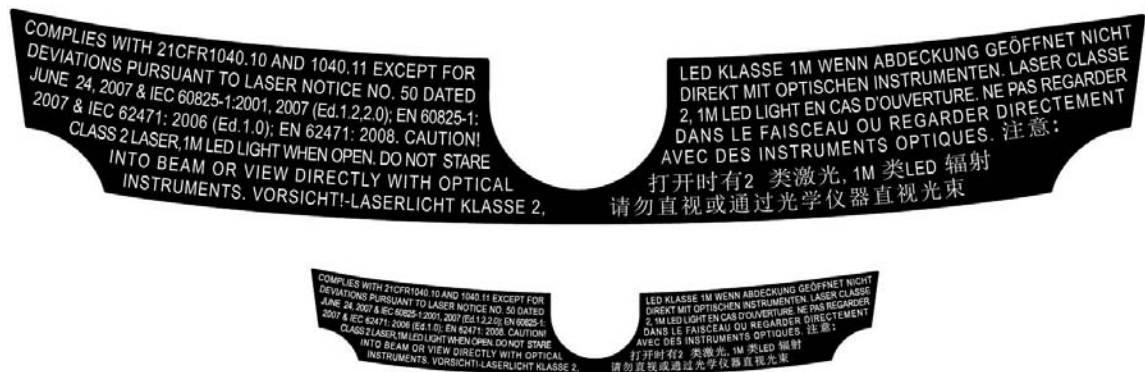

**Figure 9** SE1524 Laser Warning Label





# CHAPTER 1 BASIC OPERATION

---

## Workabout Pro4 Features

**Figure 1-1** *Front View of the Workabout Pro4 7528 Long Alphanumeric Keyboard*



**Figure 1-2** Front View of Workabout Pro4 7528 Short Numeric Keyboard (QWERTY keyboard also available)



---

## Workabout Pro4 Modules Available

To see a current list of Workabout Pro4 accessories and modules, go to the website a [http://www.zebra.com/US-EN/Product+Lines/Psion/?WT.mc\\_id=psion\\_us\\_p\\_handheld](http://www.zebra.com/US-EN/Product+Lines/Psion/?WT.mc_id=psion_us_p_handheld)

---

## Documents Available

To see a current list of documents and download what you need, go to the Knowledge Base on the IngenuityWorking community website:

<http://www.ingenuityworking.com/knowledge/w/knowledgebase/product-manuals.aspx>

---

## Preparing the Workabout Pro4 for Operation

### The Battery

The Workabout Pro4 can be powered by the following Lithium-ion battery packs:

- 4400 mAh – WA3010
- 2850 mAh – WA3025
- 4680 mAh – WA3026



**IMPORTANT** Before charging the battery, it is critical that you review the battery safety guidelines in the Workabout Pro4 Hand-Held Computer Regulatory & Warranty Guide (PN 8000296).

Battery packs shipped from the factory are charged to approximately 40% and must be fully charged prior to use. Batteries can be charged using a variety of chargers and cradles. For detailed information, see [Battery Details on page 2-1](#).



## Replacing the Battery Pack



**IMPORTANT** Always switch the unit off before changing the battery. However, assuming the default power saving parameters and battery reserve level have not been altered, battery swap time is a minimum of minutes — you will not lose data if the battery is replaced within this time frame.



**NOTE** If you are using a cradle or an external power supply, you can insert an uncharged battery and use the device while the battery charges.

Assuming the default power saving parameters and battery reserve level have not been altered, a battery can be removed for up to 4 minutes without losing data. Beyond 4 minutes, the hand-held may reboot.

### Removing the Battery Pack

1. If your unit is equipped with a hand strap, unhook it from the base of the battery.
2. Turn the latches at the bottom of the battery to unlock the battery cover. Remove the battery.

### Installing the Battery Pack

1. Insert the charged battery into the unit making certain that the contacts on the battery match those on the hand-held. Replace the battery cover and lock both latches to secure the battery in place.
2. If your computer is equipped with a hand strap, re-attach the clip to the slot at the base of the battery.
3. Switch the unit on (see [Switching the Workabout Pro4 On and Off on page 1-3](#)).

---

## Switching the Workabout Pro4 On and Off

Follow the instructions below for your Workabout Pro4.

### Switching the Workabout Pro4 On

- Press and hold the **[Power]** button down for at least one second.

When the unit is turned off, it automatically enters a power-saving “suspend” state. When the Workabout Pro4 is switched on from the suspend state, operation resumes within a few seconds in the screen in which you were working prior to turning the computer off.



**IMPORTANT** If your Workabout Pro4 fails to power up, consider the following troubleshooting options:

The battery may be overheated (>60C°), a non-Zebra battery may be installed, or the battery may have fallen below the configured Suspend Threshold. See [Suspend Threshold and Estimated Battery Backup](#) for details.

To switch on the hand-held, you will need to replace the overheated battery.

However, if you supply AC power to the Workabout Pro4 with a battery that falls below the configured Suspend Threshold, the unit will switch on.

### Switching the Workabout Pro4 Off

- To switch off the Workabout Pro4, press the **[Power]** button. The Workabout Pro4 will automatically enter the *Suspend* state.



**IMPORTANT** Turning off the hand-held does not result in a complete shutdown; rather, the unit enters a power-saving, “suspend” state. When the Workabout Pro4 is turned on from suspend state, operation resumes within a few seconds.

To shut down the unit, press and hold down the [Power] button until the *Power Option* screen is displayed where you can choose the **Power off** option.

---

## Resetting the Workabout Pro4

To perform a warm or cold reset, you can access the menu by going to *Start>Shutdown*. Alternatively you can use the keyboard shortcuts described below.



**NOTE** If your Desktop is switched to the Kiosk Shell (refer to [The Kiosk Desktop Shell on page 2-20](#)), resetting the unit is done solely by use of the keyboard shortcuts.



### Performing a Warm Reset

During a *warm reset*, running programs are halted. The contents of the file system, RAM Disk, Flash Disk, and the registry are preserved.

- Press and hold down the **[FN/BLUE]** key and the **[Power]** key simultaneously for a minimum of four seconds.

### Performing a Cold Reset

A *cold reset* reinitializes all hardware. All RAM including the RAM Disk is erased. Non-volatile storage such as the Flash Disk is preserved, as is the file system.

To execute a cold reset:

- Press and hold down the **[FN/ORANGE]** key, the **[FN/BLUE]** key, and the **[Power]** key, simultaneously for a minimum of four seconds.



**NOTE** As part of the normal Windows Embedded CE cold boot process, the screen may go blank for a few seconds after the splash screen loading bar reaches the end. The desktop is displayed after a few moments.

## Performing a Clean Start

A *clean start* returns the Workabout Pro4 to factory settings, flushes the registry keys, and deletes volatile storage and the file system. The Flash Disk is preserved.

- Press and hold down the **[FN/BLUE]** key, the **[Power]** button and the **[Front SCAN]** key simultaneously for a minimum of six seconds.

The Workabout Pro4 displays the Boot to BooSt menu.

- On an *alpha keyboard*, type **.clean**.
- On a *numeric keyboard*, type **.25326**.

## Boot to BooSt

If you choose Boot to BooSt, the BooSt menu is loaded.

1. Press and hold down the **[FN/BLUE]** key, the **[Power]** button and the **[Front SCAN]** key for a minimum of four seconds.
2. Press **[1]** to launch the OS.

---

## Attaching Carrying Accessories

Zebra recommends that a carrying accessory — a hand strap — be installed on the Workabout Pro4 before use. For detailed information, please see [Attaching the Hand Strap on page 4-2](#).

---

## Calibrating the Touchscreen



**NOTE** The touchscreen function can be turned off (see [Touch on page 3-52](#)).

The Workabout Pro4 touchscreen feature is factory-calibrated and ready-to-go; however, over time the touchscreen operating parameters may change, and it may need to be recalibrated for correct operation. Refer to [Calibrating the Touchscreen on page 2-7](#) for details.

---

## Imager and Scanner Options

[Appendix D: Internal Imager & Scanner Specifications](#) lists the current model numbers, descriptions, and specifications.

---

## Connectivity

For information on connecting the Workabout Pro4 to a PC, please refer to “Data Transfer between Workabout Pro4 and a PC” on page 17

The Workabout Pro4 contains an 802.11a/b/g/n radio module. The *Fusion Wireless Companion* software contains applications to create wireless profiles. To configure the radio, follow the steps outlined under the heading [Fusion Wireless Companion - Setting Up the 802.11a/b/g/n Radio on page 4-31](#).

To configure your *Bluetooth* settings, go to **Bluetooth**<sup>®</sup> [Setup on page 3-7](#).

If you have a GPS (Global Positioning System) module, see [GPS \(Global Positioning System\) Settings on page 3-23](#).

To see the radio specifications, please go to [Appendix E: Workabout Pro4 Specifications](#).

---

## Data Transfer

Data transfer options vary slightly depending on the type of operating system installed in your PC. Various options exist depending on whether you are using Windows XP or earlier, Windows Vista<sup>®</sup>, Windows 7 or later. For connection details, please refer to [Data Transfer between Workabout Pro4 and a PC on page 3-17](#).

---

## Voice Communication

If the Cinterion PHS8-P HSPA+ radio modem is installed and enabled, the *Phone icon* and the *GSM signal strength icon* will appear when you tap on the navigation bar at the top of the screen. The keyboards are equipped with [Talk] and [End] phone keys. For details on using your Voice options, please refer to [Voice – Using the WWAN Phone Dialer on page 3-59](#).

# CHAPTER 2 GETTING TO KNOW THE WORKABOUT PRO4

---

## Operating System

- Microsoft® Windows® Embedded CE 6.0

---

## Battery Details

Workabout Pro4 Hand-Held Computer is available with the following Lithium-ion battery pack options:

- 4400 mAh battery – Model Number WA3010
- 2850 mAh battery pack – Model Number WA3025
- 4680 mAh battery pack – Model Number WA3026
- Super capacitor power backup

For details battery specifications, refer to [Appendix E: Workabout Pro4 Specifications](#)

## Battery Swap Time

Assuming the default power saving parameters and battery reserve level have not been altered, battery swap time is a minimum of 4 minutes — you will not lose data if the battery is replaced within this time frame.

To protect data, the safest place to store data is on a microSD memory card or externally on a USB memory stick or on a PC. You can also save data in the “Application” (Flash Disk) partition of the file system.

Refer to [Suspend Threshold and Estimated Battery Backup on page 3-38](#) for details about reserving battery power for data backup purposes.

The *Suspend Threshold* adjustment in the *Power Properties* tab allows you to determine the battery capacity at which the Workabout Pro4 will be shut down. If left at the default value, *Maximum Operating Time*, the unit will run until the battery is completely empty; the RAM is only backed up for a short period of time. If you choose *Maximum Backup Time*, the Workabout Pro4 shuts off with more energy left in the battery so RAM can be backed up for a longer period of time.



**IMPORTANT** If your Workabout Pro4 fails to power up, consider the following troubleshooting options:

The battery may be overheated (>60C°), a non-Zebra battery may be installed, or the battery may have fallen below the configured Suspend Threshold. See [Suspend Threshold and Estimated Battery Backup on page 3-38](#) for details.

To switch on the hand-held, you will need to replace the overheated battery.

**However, if you supply AC power to the Workabout Pro4 with a battery that falls below the configured Suspend Threshold, the unit will switch on.**

### Charging the Battery



**IMPORTANT RISK OF EXPLOSION IF BATTERY IS REPLACED BY AN INCORRECT TYPE.  
DISPOSE OF USED BATTERIES ACCORDING TO INSTRUCTIONS.**

Batteries shipped from the factory are charged to approximately 40% of capacity. Lithium-ion battery packs must be fully charged before use. These batteries can be charged with a variety of chargers and cradles. For detailed information about these accessories, please see [Chapter 4: Peripheral Devices & Accessories](#).

Normally it takes 3 to 4 hours to charge a battery.



**IMPORTANT** To avoid damaging the battery, chargers will not begin the charge process until the battery temperature is between 0°C to 45°C (32°F to 113°F).

---

## The Keyboard

Keyboard options varied depending on the Workabout Pro4 model

Workabout Pro4 Variants	Keyboard Type Available
Workabout Pro4 Long	Alphanumeric only
Workabout Pro4 Short	Numeric <i>or</i> QWERTY

This hand-held is equipped with a [Power] button in the lower left corner of the keyboard.

The [FN/BLUE] modifier key provides access to additional keys and system functions. These functions are colour coded in blue print above the keyboard keys.



**NOTE** Almost all keys can be reprogrammed to suit your requirements.

### Regular Keys

#### The [Power] Button

The [Power] button in the lower left corner of the keyboard switches the unit on and off.

## Standard Keys

### The [ENTER] Key

The [ENTER] key is used to execute the usual Enter keyboard functions.

### The [SHIFT] Key

The [SHIFT] key is used to display uppercase alpha characters and to provide access to other symbols and functions on the numeric keyboards. Press the [SHIFT] key to turn the shift state 'on' (it will be represented in the shift-state indicator in the navigation bar at the top of the screen), then press another key to access the shifted function of that key.

Press the [SHIFT] key twice to lock the shift state on (the shift-state will be outlined in a black frame to indicate it is locked 'on'). It is now in CAPS LOCK mode. Press [SHIFT] again to turn the shift state off.

### The Arrow Keys

The [Arrow] keys are located near the top of the keyboard, and are represented on the keyboard as triangles pointing in different directions. The [Arrow] keys move the cursor around the screen in the direction of the arrow: up, down, left and right. The left arrow key should not be confused with the [BACKSPACE] key which is depicted as a left arrow. The cursor is the flashing box or underline character that indicates where the next character you type will appear.

### The [BACKSPACE/DEL] Key

The [BACKSPACE] key (represented on the keyboard as an arrow pointing left) moves the cursor one character to the left, erasing the previous key stroke.

The [DEL] key ([FN/BLUE] +[BACKSPACE]) erases the character at the current cursor position.

### The [CTRL] and [ALT] Key

The [CTRL] and [ALT] keys modify the function of the next key pressed and are application dependent. Pressing either key twice locks it 'on'. Pressing the key once again unlocks it.

### The [TAB] Key

Typically, the [TAB] key moves the cursor to the next field to the right or downward.

### The [ESC] Key

Generally, this key is used as a keyboard shortcut to close the current menu, dialog box, or activity.

### The [SPACE] Key

The [SPACE] key is represented on the keyboard by a long, horizontal line bracketed by a small vertical line on each side. Pressing this key inserts a blank space between characters. In a Windows dialog box, pressing the [SPACE] key enables or disables a check box.

### The [SCAN] Key

The Workabout Pro4 is equipped with a single [SCAN] key at the top of the keyboard and two [SCAN] buttons located on the left and right sides of the unit. [SCAN] keys activate the scanner beam. For units that do not have internal scanners, these keys can be remapped to serve other functions.

### Volume Control – [UP ARROW] [DOWN ARROW]

The volume keys are located above the [UP ARROW] and [DOWN ARROW] and are labelled with blue icons - the [UP ARROW] is labelled with a plus (+) symbol indicating volume increase while the [DOWN ARROW] is labelled with a minus (-) symbol indicating volume decrease.

- To increase the volume, press the [FN/BLUE] key followed by the [UP ARROW] key.

- To decrease the volume, press **[FN/BLUE]** followed by the **[DOWN ARROW]** key.

### Modifier Keys

The [SHIFT], [CTRL], [ALT], [FN/BLUE] and [FN/ORANGE] keys are modifier keys. Pressing a modifier key changes the function of the next key pressed. For example, on a Workabout Pro4 Short Qwerty keyboard, a bracket is printed in orange print above the [U] key. Pressing the [FN/ORANGE] key followed by the [U] key displays a bracket rather than the letter U.

The [SHIFT], [CTRL] and [ALT] keys operate much like a desktop keyboard except that they are not chorded (two keys held down simultaneously). The modifier key must be pressed first followed by the key whose function you want modified.

### Activating Modifier Keys

When a modifier key is pressed, it is shown in the softkey bar at the bottom of the screen, making it easier to determine whether a modifier key is active. For example, if the [CTRL] key is pressed, **Ctrl** is displayed at the bottom of the unit screen. Once the next key is pressed, the modifier key becomes inactive and disappears from the taskbar.

### Locking Modifier Keys

When a modifier key is pressed twice, it is 'locked' on. A 'locked' modifier key is displayed in underlined letters in the taskbar. For example, pressing the [FN/BLUE] key twice locks it on — it is displayed as an underlined blue 'FN' in the taskbar at the bottom of the computer screen. The same is true of the [FN/ORANGE] key, which is shown as an underlined orange 'ORG' in the taskbar.

The locked modifier key will remain active until it is pressed a third time to unlock or turn it off. Once a modifier key is unlocked, the underline representation at the bottom of the screen is no longer displayed.



**NOTE** The locking function of the modifier keys can be changed so that pressing a key **once** will lock the key 'on'.

If you disable the 'One Shot' function of the key, pressing it once will lock the key 'on'. Pressing the same key a second time will unlock or turn it 'off'. Refer to [Keyboard One Shot Modes on page 3-27](#) for details.

### Function Keys and Macro Keys

In addition to the standard keyboard functions, the Workabout Pro4 supports Function keys and Macro keys (Macro keys are only available on Workabout Pro4 Long units).

All function keys and macro keys can be custom defined for each application.

### Function Keys

Function keys perform special, custom-defined functions within an application. These keys are accessed by pressing one of the dedicated function keys on the keyboard, or through the appropriate [SHIFT] or [FN/BLUE] key sequence, depending on the keyboard variant being used.

All Workabout Pro4 keyboards are equipped with a total of 14 function keys. Function keys [F1] to [F4] located near the top of the keyboard are directly accessible – a key combination is not required. Ten additional function keys from [F1] to [F10] are colour coded in blue print on the unit body; these keys are accessed by executing a key combination, [FN/BLUE] followed by the appropriate key.

For example, to access [F6] on a QWERTY keyboard:

- Press the [FN/BLUE] key followed by the [F] alpha key – the alpha key to which function key [F6] is mapped.



## Macro Keys (Workabout Pro4 Long only)



**IMPORTANT** Refer to [Macro Keys on page 3-29](#) for details about creating macros.

Workabout Pro4 Long units are equipped with 10 Macro keys. Workabout Pro4 Short hand-helds are not equipped with these keys. Macro keys can be programmed to replace frequently used keystrokes, along with the function of executable keys like the [ENTER] key, the [BACKSPACE] key, any function key and arrow key, etc.

Alphanumeric keyboards have ten macro keys: [M1] to [M10]. These keys are colour coded in orange print above the numeric keys.

To access a macro key:

- Press the **[FN/ORANGE]** key followed by the appropriate numeric key from [1] to [0]. For example, to access macro key [M1], press **[FN/ORANGE] [1]**. To access macro key [M2], press **[FN/ORANGE] [2]**, and so on.

Whether your keyboard does or does not have macro keys physically stamped on the keyboard, up to 15 macro functions can be added using the *Scancode Remapping* function. Refer to [Scancode Remapping on page 3-31](#) for details about mapping keys.

## Numeric Keyboards — Accessing Alpha Keys

On Numeric Workabout Pro4 keyboards, all alphabetic characters are printed on the unit plastic in blue type-face above the keys. Alpha characters are accessed by pressing the [FN] modifier key, then pressing another key on the keyboard.

Alpha Modified Numeric 789 keyboards have each blue alphabetic character assigned as a single [FN]-shifted character on individual keys.

Numeric 123 keyboards have telephone-style alphabetic keys, with the blue alphabetic characters located in groups of 3 or 4 above each of the numeric keys. To access characters on these keyboards, a few extra steps are needed, as described below.

### Choosing a Single Alpha Character



**NOTE** The following examples assume that the [FN/ORANGE] key is enabled as 'Lock' mode in the 'One Shot' screen (accessed by choosing Start>Settings>Personal>Buttons icon). In 'Lock' mode, pressing the [FN/ORANGE] key once locks it 'on'. Refer to [OneShot/Lock on page 3-28](#) for details.

The examples below illustrate how to access A, B and C, all of which are printed in blue characters above the numeric key [2] on a numeric keyboard.



**IMPORTANT** The letters you choose appear in the shift-indicator icon at the top of the screen, providing a visual indicator of which letter will be displayed on the screen.

To choose the letter 'a':

1. Press the **[FN/ORANGE]** key, and press the numeric key **[2]**.
2. Press the **[FN/ORANGE]** key again to unlock or turn it off.

- ✓ **NOTE** To choose the second, third or fourth alpha character assigned to a numeric key, you may want to lock the [FN/ORANGE] key 'on'. Remember that depending on how your Workabout Pro4 is set up in the 'One Shots' tab, you may find that you need to press the [FN/ORANGE] key twice to lock it 'on'. Refer to [Keyboard One Shot Modes on page 3-27](#) for details.

To choose the letter 'b':

1. Lock the [FN/ORANGE] key 'on', and press [2] twice.
2. Press the [FN/ORANGE] key again to unlock or turn it off.

To choose the letter 'c':

1. Lock the [FN/ORANGE] key 'on', and press [2] three times.
2. Press the [FN/ORANGE] key again to unlock or turn it off.

- ✓ **NOTE** Keep in mind that there is a timeout of one second between key presses when sequencing through the alphabetic characters on a key. If you pause longer than one second between key presses, the alphabetic character that is displayed at that time will be entered.

### Creating Uppercase Letters

To display capital letters, you need to first lock the [SHIFT] key 'on'.

- Press the [SHIFT] key twice.

All alpha keys are displayed in uppercase until you press the [SHIFT] key again to 'unlock' (switch off) the function of this key.

### Choosing Multiple Alpha Characters

- Lock the [FN/ORANGE] key 'on'

## The Keypad Backlight

The intensity of the keypad backlight and the conditions under which this backlight is activated can be configured using the *Keyboard* icon in the Windows Embedded CE *Control Panel*. The behaviour of the keypad backlight is tailored in the *Keyboard Properties* dialog box. Refer to [Keyboard Backlight on page 3-27](#) for details about this option.

---

## The Display

The Workabout Pro4 is equipped with display backlighting to improve character visibility in low light conditions. The backlight switches on when a key is pressed.

### Adjusting the Display Backlight

The behaviour of the display backlight and the intensity of the backlight can be specified in the *Display Properties* dialog box in the *Control Panel*.

- ✓ **NOTE** Refer to [Backlight on page 3-20](#) for details about the Display Properties dialog box.

## Calibrating the Touchscreen

If your Workabout Pro4 touchscreen has never been calibrated, or if you find that the stylus pointer is not accurate when you tap on an item, use the *Stylus Properties* dialog box in the *Control Panel* to recalibrate the screen.

1. In the *Control Panel*, choose the **Stylus** icon to display the *Stylus Properties* window.



Stylus

2. Select the **Calibration** tab, and then choose the **Recalibrate** button.



3. Follow the directions on the calibration screen to calibrate the screen.

---

## Indicators

The Workabout Pro4 uses a LED (Light Emitting Diode), onscreen messages, and audio tones as indicators.

### LED

The Workabout Pro4 is equipped with a single, orange coloured LED. This section outlines what the LED indicates.

Charge LED Behaviour	Indication
3 flashes, pause, repeat	'Power on' was attempted. Unit will retry.
Rapid blinking for 1 second	Reset or resume is being ignored because the battery door is open. If the door is closed during this process, reset or resume will proceed normally.
Fast blip (500 ms period, 13% duty cycle)	Windows is in "unattended mode".
Slow blink (2 second period, 50% duty cycle)	Charge temperature fault.
Solid Orange	Booting/resuming.

### Onscreen Indicators

The taskbar at the bottom of the screen displays a variety of system status indicators.

**Figure 2-1** Taskbar



The taskbar changes dynamically, and only those icons that are applicable are displayed. For example, if a radio is not installed in your Workabout Pro4, the radio signal icon is not displayed in the taskbar.



### Windows® Start Button

If you are using the touchscreen, you can either tap the Windows icon at the bottom left of the screen, or press the [Windows] key to display the Start Menu, and then tap on the desired application.



### Modifier Key Indicators

[SHIFT], [CTRL], [ALT], [FN/BLUE] and [FN/ORANGE] are modifier keys that have onscreen indicators to show when a key is active or locked. If a modifier key is pressed once to activate it, the key is displayed in the taskbar, for example, pressing the [FN/BLUE] key once displays 'FN' in the taskbar. If a modifier key is pressed twice, it is 'locked on' and the onscreen indicator is displayed with underlined letters in the taskbar, for example, pressing [FN] twice displays 'FN' in the taskbar.



### Power

The battery shaped icon displayed in the taskbar provides quick access to the charge state of the battery. Tapping on the icon once will show the percentage charge left in the battery. Tapping on the icon twice opens the *Power Properties* menus (see [Power Properties on page 3-37](#)), where you can set the low battery warnings levels, and time to enter Suspend.



If the Workabout Pro4 is using external AC power, an AC icon is displayed in the taskbar.



### Fusion Radio

The Fusion Wireless Companion software is used to configure the radio for one or more wireless network profiles. Each profile specifies the security parameters used to connect to a particular WLAN as identified by its Extended Service Set Identification (ESSID).



### 802.11 Radio Signal Quality

Increasing radio signal quality is represented by longer, filled bars within this icon.



Good  
Reception



Weak  
Reception



No Radio  
Link



### WWAN Radio Signal Quality

Wireless WAN icons in the taskbar indicate the status of your wide area network connection. For details, see “Taskbar Icons” on page F-1.



### Docking Device

When a hand-held is inserted in a charger or cradle, an associated icon appears in the taskbar.



Combo Charger &  
Combo cradle



Quad Cradle



Powered Vehicle Cradle & Single Bay  
USB Cradle



### Bluetooth Radio

This icon displayed in the taskbar represents the installed *Bluetooth* radio.

## Audio Indicators

The Workabout Pro4 supports several audio options, including *Bluetooth*. Sounds are emitted through the front receiver. The beeper provides a variety of sounds and can be configured to emit a sound to signal a number of events such as screen taps, notifications, and so on. Information on configuring sounds is detailed in [Volume & Sounds on page 3-5](#).

## Inserting the microSD Card and SIM Card

There are two slots available when the battery is removed from the battery compartment — the smaller slot to the left is used to load the *microSD* (Secure Digital) card, which provides additional non-volatile memory to your Workabout Pro4, and the slot to the right is used to load a *SIM* (Subscriber Identity Module) card, which allows access to the Voice option, access to the Internet, and so on.

### Inserting and Removing the Cards

1. Switch off the power to the Workabout Pro4.
2. Remove the battery.

To insert a microSD card:

1. Flip up the rubber cover of the microSD card door on the left.
2. Slide the microSD card into the slot until it clicks into place. (The microSD slot is spring-loaded.)
3. Push the rubber cover back in place.
4. To remove the microSD card, lift the rubber cover and push the microSD card inward until it pops out of the slot.

The SIM slot is equipped with a release tab. To insert a SIM card:

1. Slide the SIM card into the slot on the right until it clicks into place.
2. To remove the SIM card, depress the metal release tab and slide the card out of the slot.

---

## Scanners and Imagers



**IMPORTANT** It is critical that you review the “Laser Warnings” in the Workabout Pro4 Hand-Held Computer Regulatory & Warranty Guide (PN 8000296) before using any of the scanners described in this chapter.



**NOTE** To enable a newly-installed imager or scanner, press and hold down the [FN/BLUE] key and the [Power] button for a minimum of three seconds.

The Workabout Pro4 supports a wide range of scanner options to address a variety of user application requirements. Refer to the following sections for detailed information:

- Scanner list and specifications: [Appendix D: Internal Imager & Scanner Specifications](#).
- Configuration: [Appendix B: DataWedge](#), [Appendix C: Scanner Settings](#) and [Manage Triggers on page 3-3](#).

### Basic Scanner Operations

- Turn the hand-held on. Wait until the unit has booted up completely.
- Aim at the barcode and press the scan key or the trigger. A scan beam and a warning indicator appear until a successful decode is achieved or six seconds have elapsed.

### Scanning Techniques

- Hold the scanner at an angle. Do not hold it perpendicular to the barcode.
- Do not hold the scanner directly over the barcode. In this position, light can reflect back into the scanner’s exit window and prevent a successful decode.
- Scan the entire barcode. If you are using a 1D or PDF laser scanner, make certain that the scan beam crosses every bar and space on the barcode, including the margins on either end of the symbol.
- If you are using a 2D imaging scanner, make certain the red, oval shaped framing mark is centered within the barcode you want to scan.
- When using imaging scanners, do not move the scanner while decoding the barcode. Movement blurs the image.
- Hold the scanner farther away for larger barcodes.
- Hold the scanner closer for barcodes with bars that are close together.

### Troubleshooting

If the scanner is not working, investigate the following:

- Is the unit on?
- Check that the barcode symbology being scanned is enabled for the hand-held you are using. Check any other parameters that affect the scanning procedure or the barcode.

- Check the barcode to make sure it is not damaged. Try scanning a different barcode to verify that the problem is not with the barcode.
- Check that the barcode is within the proper range.
- Does the hand-held display the warning without scanning? This suggests a hardware problem in the hand-held.
- Is the laser beam scanning across the barcode?
- Once the scan beam has stopped, check the scanner window for dirt or fogging.

## Operating 1D Internal Laser Scanners

- Turn the hand-held on. Wait until the unit has booted up completely.
- Aim at the barcode and press the scan key or the trigger. A scan beam and a warning indicator appear until a successful decode is achieved or six seconds have elapsed.

## Operating Internal 2D Imagers

An imager scanner takes a snap shot of a single barcode or multiple barcodes (at one time). It can find a barcode regardless of its orientation — that is, even a barcode printed at a 45 degree angle to the hand-held will be decoded successfully.



**NOTE** When scanning **multiple** barcodes, ensure that all of the desired barcodes are within the field of view of the scanner. It is possible that even when all barcodes are within the field of view, not all of them will be decoded. Only successfully decoded barcodes are passed to the application program. The application program then issues a warning, asking that you scan the missing barcodes.

When scanning a **single** barcode, ensure that only the desired barcode is within the field of view of the scanner.

Because imager scanners generally have a shorter depth of field than laser scanners, some practise may be required to find the optimal distance from the types of barcodes being scanned. Although the imager includes illumination LEDs, ambient light will help the imager decode the barcodes, especially if the barcode is far from the hand-held.



**IMPORTANT** Keep in mind that the imager scanner is a camera, and the LED illumination is a flash. Glare can be an issue on reflective media such as plastic coated barcodes, just as glare is an issue for photographers. When pointing at a shiny surface, either shift the barcode to the side or top, or angle the barcode so that the glare reflects away from the imager scanner.

Most imagers take several 'snap shots' of the barcode in order to decode it. It is normal for the LEDs to flash two or three times. Hold the unit steady between flashes to improve decode performance.

- Turn the hand-held computer on. Wait until the unit has booted up completely.
- Aim at the barcode and press the scan key or the trigger. Hold the trigger until a successful or failed scan result is obtained.
- When the scan button or trigger is pressed, a red, oval shaped light (the framing marker) is displayed. Centre the framing marker in the field — either in the centre of the barcode you want to scan or in the centre of the area in which multiple barcodes are to be scanned.

The illumination LEDs will flash (typically several times) and a picture of the barcode is taken.

## Windows Embedded CE 6.0

### Navigating in Windows Embedded CE and Applications

Graphic user interfaces such as Windows Embedded CE for portable devices and desktop Windows (Windows Vista™, Windows 7, Windows 8, etc.) utilize 'point and click' navigation. An equivalent keyboard shortcut is also available for every 'point and click' action.

Windows Embedded CE supports the same 'point and click' user interface and keyboard shortcuts as desktop Windows with one difference — the 'point and click' action is accomplished using a touchscreen rather than a mouse. Actions can be performed using any combination of keyboard shortcuts or touchscreen tapping. In those applications that support it, you can also flick and pan your finger to scroll through screens.

#### Navigating Using a Touchscreen

- ✓ **NOTE** If the touchscreen is not registering your screen taps accurately, the touchscreen may need recalibration. Refer to [Calibrating the Touchscreen on page 2-7](#).

The Workabout Pro4 comes equipped with a stylus — a pointing tool that looks like a pen. The stylus is used to select objects on the touchscreen. You can also use gestures with your fingers. You can use two gestures: pan and flick. Use left or right flicks to quickly move between tabs of a multi-tab control panel, or to scroll long lists of options. Use panning by touching and dragging a page that has scrollbars.

- ✓ **NOTE** To prevent damage to the touchscreen, use only a finger touch or the stylus (pen) supplied with your Workabout Pro4.

To choose an icon, open a file, launch an applet or open a folder:

- Double-tap on the appropriate icon.

#### Navigating Using the Keyboard

If you would like to use keyed input to choose icons and to navigate dialog boxes, refer to the table following for a description of the navigation keys.

Operation	Key or Key Combination
Switch between active applications	[ALT] [TAB]
Open task manager	[ALT] [ESC]
Move the cursor	Arrow keys
Open file, folder or icon	[Enter]
Exit & Save	[Enter]
Close/Exit & Do Not Save	[ESC]
Navigate Dialog Boxes	[TAB] To move cursor up [SHIFT] [TAB] To display the contents of the next 'tab' in a dialog box [CTRL] [TAB]



Operation	Key or Key Combination
Select Radio Button/Press Button	[SPACE]
Go to Start Menu	[Windows]

Keep in mind that unlike a desktop computer, the Workabout Pro4 does not support key chording (pressing two keys at the same time). You must press one key followed by the next in sequence.

## The Windows Classic Shell Startup Desktop

When the Workabout Pro4 boots up, the default startup desktop (Windows Classic Shell) is displayed. Any applications stored in the Startup folder start up immediately.



**NOTE** The startup folder is located in \Windows\StartUp and \Flash Disk\StartUp (also the Application folder).

**Figure 2-2** Workabout Pro4 Windows Classic Shell Startup Desktop



To access desktop icons:

- Double-tap on the icon to open a window or, in the case of an application icon, launch an application.

On the keyboard:

- Use the arrow keys to highlight the icon, and press **[Enter]** to launch the highlighted icon.



**NOTE** If the arrow keys do not highlight the desktop icons, the desktop may not be selected. Press **[Windows]** to display the Start Menu, and select Desktop. Now the desktop will be “in focus” and the arrow keys will highlight the icons.

### The Taskbar



The Workabout Pro4 is equipped with a taskbar at the bottom of the screen. It displays icons through which you can view the battery capacity and radio signal quality of your unit. If the hand-held is attached to a charger or cradle, an associated icon is displayed. In addition, the taskbar displays the application(s) currently running on your unit.

The taskbar also displays active modifier keys: [SHIFT], [ALT], [CTRL], [FN/BLUE] and [FN/ORANGE]. Keys that have been locked "on" are displayed with underlined letters. For example, if you have set the [CTRL] key lock to "on" in the Keyboard menu and you press the key, it is displayed as an underlined 'Ctrl' in the taskbar. (For detailed information on modifier keys and keyboard options, see [The Keyboard on page 2-2](#)).

### Using the Taskbar

A tooltip is displayed as each taskbar icon is highlighted. The tooltip provides the status of each icon.

If you're using the touchscreen:

- Tap and hold on an icon to display the icon's tooltip. Double-tap the icon to open the Control Panel dialog box associated with the icon. For example, double-tap the battery icon to display a dialog box listing the current battery capacity information.

On the keyboard:

1. Tap on the **[Start]** button to display the *Start Menu*.
2. Choose **Shortcuts** from the *Start Menu*, and then press the **[RIGHT]** arrow key to display the sub-menu.
3. Choose **System Tray** in the sub-menu.
4. Use the arrow keys to highlight the icon in the taskbar about which you'd like more information.
5. Press **[Enter]** to display the appropriate dialog box.

### Customizing the Taskbar

To customize the taskbar so that it displays only those icons you require:

- In the *Start Menu*, choose **Settings**, and then **Taskbar**.

If you're using the keyboard:

- Tap on the **[Start]** button in the taskbar to display the *Start Menu*.

- Highlight the **Settings** option, highlight **Taskbar** in the sub-menu, and press **[Enter]**.

The *Taskbar and Start Menu* dialog box is displayed.



- Tap on the items you want to activate or deactivate. The check mark indicates active items.

If you're using the keyboard:

- Highlight the options you want to activate, and press the **[SPACE]** key to select them. A check mark indicates active items.

## The Start Menu

The *Start Menu* lists the operations you can access and work with. It is available from the startup desktop or from within any application.

- To display the menu, tap on the **Start Menu**.



**NOTE** Tap on the item in the menu with which you want to work.

If you're using the keyboard:

- Use the arrow keys to highlight a menu item, and press **[Enter]**, or

If the menu item has an underlined character:

- Type the underlined alpha character. For example, to display the *Run* dialog box, type the letter 'r'.

### Programs

- Choose **Programs** to display a sub-menu of options. The programs displayed will be those resident in the *Windows\Programs* folder of the computer.

**Figure 2-3** Program Sub-Menu



This sub-menu allows you to choose *Demo*, *Fusion Radio*, *Internet Command Prompt*, installed applications (e.g., Microsoft WordPad), *Kiosk*, *Remote Desktop Connection*, or *Windows Explorer*.

### Demo

This folder contains the *Scanner Demo*, *DemoScannerDemoSignature* and *Demo Sound* applications can be used to test how the hand-held reads barcodes. *Demo Signature* allows you to capture a signature written on the screen with your stylus and save it to a file. *Demo Sound* allows you to record and playback sound files. The 'Sample Rate' and the 'Bits Per Sample' are the rates at which the sound will be recorded. Sounds recorded at the higher sample rate or bits per sample will be higher quality sound but will require more file storage space. Lower sample rates and/or bits per sample produces a smaller file, but the sound quality suffers. The record and play buttons operate the same as any recording device. The X icon deletes the sound and the *diskette* icon allows you to save your sound.

### Fusion

The *Fusion* application is used to configure the Workabout Pro4 802.11a/b/g/n radio for one or more wireless network profiles.

### Command Prompt

*Command Prompt* is used to access the DOS command prompt. At the prompt, you can type DOS commands such as *dir* to display all the directories in the drive.

### Internet Explorer

The Workabout Pro4 is equipped with Microsoft Internet Explorer for Windows Embedded CE. You can access the *Internet Options* icon through the *Start Menu* under *Settings>Control Panel* or by double-tapping on the desktop icon **My Device** and then, double-tapping on the **Control Panel** icon.

### Microsoft WordPad

*WordPad* is a basic word processor used to create, edit, and print *.rtf*, *.doc*, and *.txt* files.

## Kiosk

*Kiosk* allows you to change the appearance and actions of the desktop from the default Windows Classic Shell to the Kiosk shell.

## Remote Desktop Connection

Remote Desktop Connection is an Workabout Pro4 application used to connect to a Windows Terminal Server so that you can run a “session” on the Server machine using the hand-held (Windows Embedded CE device). “Remote Desktop Connection” on page 47 provides a website with details about this option.

## Windows Explorer

The Windows Explorer installed on your Workabout Pro4 is consistent with all Windows Embedded CE devices.

## Shortcuts

Figure 2-4 Shortcuts Sub-Menu



## System Tray

If your touchscreen is not enabled, you can use the *System Tray* option to access the icons in the taskbar at the bottom of the screen. The taskbar displays indicators such as a radio signal icon. These indicators are attached to dialog boxes that provide additional information.

- Choose **Shortcuts>System Tray**.

When *System Tray* is chosen, the taskbar icons become accessible. To display the dialog box attached to an icon:

- Use the arrow keys to highlight an icon.
- Press **[Enter]** to display the icon menus.

## Cycle Tasks

When *Cycle Tasks* is selected (and the Task Manager is not open), you can cycle through active applications.

To cycle through your active applications:

- Choose **Shortcuts>Cycle Tasks**, or
- Press **[ALT] [TAB]**.

### Task Manager

The *Task Manager* allows you to switch to another task or to end an active task. To display the task manager window:

- Tap on **Shortcuts>Task Manager**, or
- Press **[ALT] [ESC]**.

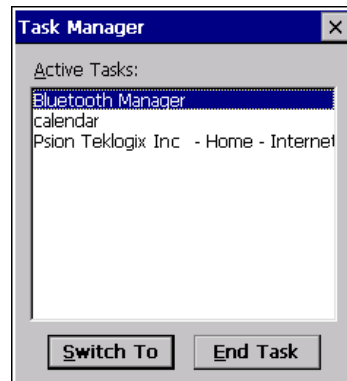

### Settings

The **Settings** sub-menu includes the following settings: *Control Panel*, *Network and Dial-up Connections* and *Taskbar and Start Menu*.

**Figure 2-5** *Settings Sub-Menu*



### Control Panel

The *Control Panel* contains applets used to configure hardware, the operating system and the shell. If your Workabout Pro4 is running with the TekTerm application or another application, additional configuration applets may appear in the *Control Panel*.

### Network and Dial-Up Connections

The *Network and Dial-up Connections* window allows you to configure the Workabout Pro4 network interfaces or execute an existing configuration. Refer to [Connectivity on page 1-5](#) for radio setup details.

### Taskbar and Start Menu

The *Taskbar and Start Menu* option displays a dialog box in which you can customize the taskbar, choosing which options will be displayed. Refer to [Customizing the Taskbar on page 2-14](#) for additional details about this option.

## Run

Choosing the *Run* option from the *Start Menu* displays a dialog box in which you can enter the name of the program, folder or document you want to open or launch.



## Shutdown

The *Shutdown* menu includes these options: *Suspend*, *Warm Reset* and *Cold Reset*.



## Suspend

The *Suspend* option suspends the Workabout Pro4 immediately. This is equivalent to turning the hand-held off.

## Warm Reset

The *Warm Reset* option resets the hand-held, leaving all saved files and registry settings intact. Any unsaved data is lost.

## Cold Reset

The *Cold Reset* option resets the hand-held. Any files not stored in permanent memory are lost; however, the registry settings are saved.

## The Kiosk Desktop Shell

The appearance and actions of the desktop can be changed by tapping on the **Kiosk Shell** icon on your desktop, which activates the Kiosk shell.



**NOTE** The Workabout Pro4 will be reset if you choose to switch shells.



**Figure 2-6** Switch to Kiosk Shell



After resetting the Workabout Pro4, the desktop appearance will be very different. The programs are accessed with finger (or stylus) taps and swipes. If there are more applications than shown on one screen, a white animated dot will be present on the side of the screen in the direction of the next set of icons. Swiping the screen to that direction will move the display to the next screen.



**NOTE** Although the Desktop appearance defaults to the “Ingenuity” theme, the theme is not changed using the **Kiosk Shell** icon. To change themes, open the Shell Settings>Advanced menu in **Kiosk Access** (see [Shell Settings on page 3-43](#)).



Hold the stylus or your finger on the Active Tasks, Favourites, or Notifications Bar, and swipe to the left or right to switch to the next screen.

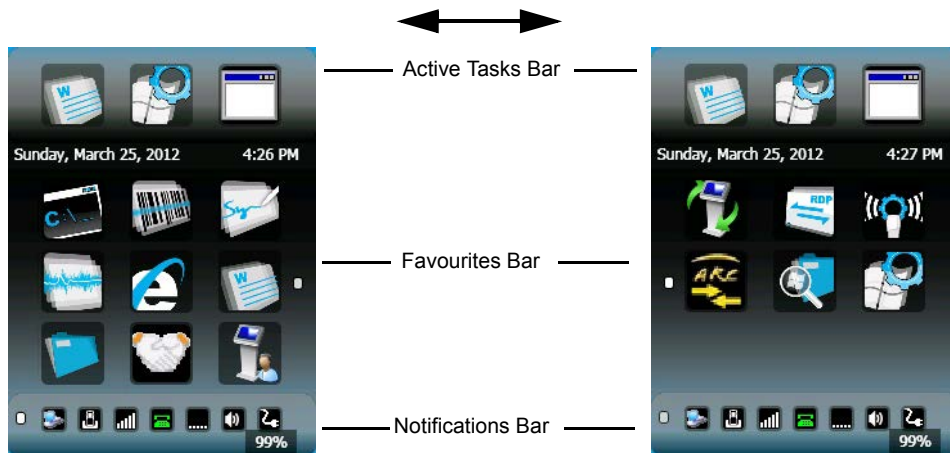

A different program, *Kiosk Access*, enables you to customize your computer settings, remove or add shortcuts to the Favourites Bar and Control Panel, and limit access to various different components on the computer and the system tray icons for security. For details see [Kiosk Access on page 3-41](#). To change your Desktop background, refer to [Shell Settings on page 3-43](#).

### Active Tasks Bar

Open applications are shown in the top bar — the most recently opened is the first icon on the left. Tapping once on a program icon will maximize the application. This feature replaces the Task Manager of the Windows Classic Shell.

### Date/Time Bar

Tapping once on the date or time will open the *Date/Time Properties* settings to enable you to change your settings and time zone.

### Favourites Bar

The *Favourites Bar* replaces the Windows Classic Shell's Desktop and Start Menu. These icons are the program shortcuts from your *Windows>Start Menu*. Tapping once will open the program. If you tap and hold on an icon, the application name is displayed.

### Notifications Bar

This bar shows the run-time program notifications for *Battery*, *Volume*, *Fusion*, *Phone* or *GPRS*, and other notifications for the programs you are running. This feature replaces the Taskbar of the Windows Classic Shell.

### Desktop Minimized View

When an application is opened and maximized, the desktop view is minimized and the *Notifications Bar* is shown at the bottom of the screen. Tapping anywhere on the **Notifications Bar** (except on the SIP) will restore the Kiosk desktop.



**NOTE** In order to use the SIP, turn on the automatic settings in **Control Panel>Input Panel**.

### Kiosk Access

The *Kiosk Access program* allows you to open a different program, *Kiosk*, which enables you to customize your computer settings, remove or add shortcuts to the Favourites Bar and Control Panel, and limit access to

various different components on the computer and the system tray icons for security. For details see [Kiosk Access on page 3-41](#). To change your Desktop background, refer to [Shell Settings on page 3-43](#).

To open Kiosk:

- Tap on the **Kiosk Access** icon in the *Favourites Bar*.



### Restoring the Windows Classic Shell

The default Desktop appearance and actions can be restored by tapping on the **Kiosk Shell** icon in the *Favourites Bar*.



**Figure 2-7** Shell Switch to Windows Classic Shell Desktop

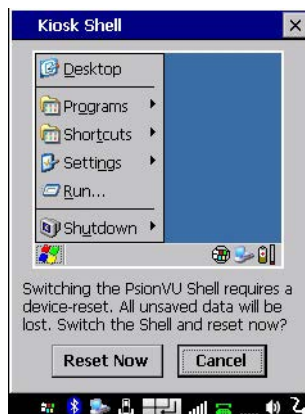

**NOTE** The Workabout Pro4 will be reset if you choose to switch shells.

---

## General Maintenance

### Caring for the Touchscreen

The touchscreen is covered with a thin, flexible polyester plastic sheet with a conductive coating on the inside. The polyester can be permanently damaged by harsh chemicals and is susceptible to abrasions and scratches. Using sharp objects on the touchscreen can scratch or cut the plastic, or crack the internal conductive coating. The chemicals listed below must not come into contact with the touchscreen:

- mustard
- ketchup
- sodium hydroxide
- concentrated caustic solutions

- benzyl alcohol
- concentrated acids

If the touchscreen is used in harsh environments, consider applying a disposable screen protector (WA6113). These covers reduce the clarity of the display slightly but will dramatically extend the useful life of the touchscreen. When they become scratched and abraded, they are easily removed and replaced.

Do not to expose the touchscreen to direct sunlight for prolonged periods of time. If this is unavoidable, use a UV screen protector to extend the life of the screen.

## Cleaning the Workabout Pro4



**IMPORTANT** Do not immerse the unit in water. Dampen a soft cloth with mild detergent to wipe the unit clean.

To prevent damage to the touchscreen, use only your finger or the stylus (pen) supplied with your Workabout Pro4.

- Use only mild detergent or soapy water to clean the hand-held unit.
- Avoid abrasive cleaners, solvents or strong chemicals for cleaning. The Workabout Pro4 has a plastic case that is susceptible to harsh chemicals. The plastic is partially soluble in oils, mineral spirits and gasoline. The plastic slowly decomposes in strong alkaline solutions.
- Exposure to aircraft de-icing fluids can degrade the plastics on Workabout Pro4. If the Workabout Pro4 is used near aircraft de-icing environments, regular rinsing with water is recommended.
- To clean ink marks from the keypad and touchscreen, use isopropyl alcohol.



# CHAPTER 3 CONFIGURATION

---

## Overview of Software

The Workabout Pro4 programs and applications are accessed through two main areas from the Desktop Start Menu: *Programs and Settings*>*Control Panel*. This chapter details the configuration for the major software from both areas, listed alphabetically.

### Software Advantage

Software Advantage is a collection of applications and features designed to support system administrators and end users. These tools enable enterprises to customize the product to meet their needs and to maximize productivity.

- App Launch Keys      Kiosk
- Battery Health      TweakIt
- Bluetooth Manager      Scanner
- DataWedge      Manage Triggers
- Dr. Debug      Total Recall
- PartnerUp      Fusion Wireless Companion

### Microsoft Software

Windows CE 6.0 R3 is a 32-bit, real-time, multitasking Operating System. The OS features a small footprint, with compatibility to port existing Win32 applications and Touch & Gesture support.

Some of the major Windows CE 6.0 R3 components are:

- Control Panel, where both Zebra Advantage and Microsoft applications are listed
- Internet Explorer Embedded
- Microsoft WordPad
- Remote Desktop Connection
- Windows Explorer

---

# The Control Panel

The Windows Embedded CE *Control Panel* provides a group of applications through which you can set a variety of system-wide properties, such as power, keyboard sensitivity, network configuration, system backup, desktop appearance, and so on.

When the Workabout Pro4 boots up, the startup desktop (Windows Classic Shell) is displayed, and any applications stored in the Startup folder start up immediately.

To access the *Control Panel*:

- Press the **Windows** icon in the taskbar to display the *Start Menu*.
- Tap on **Settings>Control Panel**.

If you're using the keyboard:

- Press the **[Windows icon]** key to display the *Start Menu*.
- Highlight **Settings** in *Start Menu*, and press the **[RIGHT]** arrow key to highlight the *Control Panel*.
- Press the **[Enter]** key.

The *Control Panel* folder contains icons used in the setup of your Workabout Pro4.

## Control Panel Applications

The *Control Panel* provides a group of applications that allow you to customize and adjust settings on your Workabout Pro4. This section shows the related icons in the Control Panel and gives a brief description of each.

### App Launch Keys

By mapping keys to applications using this program, you can then launch those applications from a single key-press.

### Bluetooth

Opens the *Bluetooth Manager* which provides options for configuring various Bluetooth peripherals. It also provides the capability to use a *Bluetooth*-enabled cellular phone as a data modem to exchange information with other *Bluetooth* devices and provide network access. While the *Microsoft Bluetooth Manager* stack is the default, TweakIt can be used to switch to *Stonestreet One BTEplorer*.

### Certificates

This program provides access to the Certificates Manager and Stores. The Certificates Manager displays the certificates in the Windows Certificates Store, and allows you to import, delete, and view these certificates. [Certificates on page 3-2](#) directs you to the appropriate setup information.

### DataWedge

DataWedge is a Zebra mobile device application that reads data from input devices and sends it as keystrokes to consumer applications executing in the foreground on the mobile devices.

### Date/Time

Allows you to set the current Month, Date, Time, and Time Zone on your unit.

### Dialing

Specifies dialing settings, including area code, country code, dial type and the code to disable call waiting. You can store multiple patterns — for example, *Work*, *Home*, and so on using this dialog box.

**Display**

Changes the display backlight and the appearance (colour scheme) on the unit desktop.

**Dr. Debug**

Provides both error diagnostic and troubleshooting tools.

**Error Reporting**

Allows you to enable or disable Microsoft error reporting prompts.

**Kiosk**

Kiosk enables you to customize your computer settings, remove or add shortcuts to the desktop and Control Panel, and lock down access to various different components on the computer and the system tray icons for security. With *Kiosk* and *Kiosk Shell* (see [The Kiosk Desktop Shell on page 2-20](#)) you can customize the entire look and feel of your User Experience.

**Input Panel**

Provides the framework for a Microsoft Soft Input Panel (SIP) should you need to design your own SIP, or change some soft keyboard options.

**Internet Options**

Provides options to configure your Internet browser. You can determine items such as the default and search page that the browser applies when connecting to the Internet, the cache size, the Internet connection options, and the security level that is applied when browsing.

**Keyboard**

Toggles character repeat on and off and specifies delay and rate for repeated characters. It also allows you to adjust the keyboard backlight threshold and intensity, and many other functions.

**Manage Triggers**

This utility allows you to define buttons as triggers for different devices. For example you would use this utility to configure a button for the scanner, RFID reader, and camera.

**Microphone**

Enables you to adjust the gain for the specific microphones associated with your hand-held.

**Network and Dial-up Connections**

Displays network interfaces and allows new dial-up and VPN interfaces to be created. It also allows Windows configuration of the interface. Refer to [Connectivity on page 1-5](#) for details.

**Owner**

Provides fields in which you can specify owner information. A *Notes* tab allows additional information to be entered and displayed when the unit is powered up. *Network ID* tab information is used to access network resources. (This information should be provided by your System Administrator.)

**PartnerUp**

This app displays a number of pre-loaded applications. By tapping on an application in the list, you are taken to the associated web site and allowed to install the application.

## **Password**

Allows you to assign a password to restrict access to elements of the unit. Once assigned, password access cannot be circumvented so it is important that you write down your password and keep it in a safe place.

## **PC Connection**

Enables direct connection to a desktop computer (or through ActiveSync — see [Data Transfer on page 1-6](#)). Selecting the *Change Connection* button allows you to change the type of direct connection to your PC.

## **Power**

Displays battery pack power status. (Alternately, battery status can be accessed through the taskbar.) Additional tabs allow you to determine suspend states and specify a suspend threshold.

## **Region and Language**

Allows you to specify the local language that is to be displayed on the hand-held screen along with the format of numbers, currency, time and date for your region.

## **Remove Programs**

Lists the programs that can be removed from your unit. To remove a program, select it and then click on the **Remove** button.

## **Scanners**

Provides scanner parameters and the barcode symbologies that the Workabout Pro4 barcode scanner will successfully read.

## **Storage Manager**

Allows you to view information about the storage devices that are present, such as SD-MMC flash cards. For details, see [Storage Manager on page 3-4](#).

## **Stylus**

Adjusts how Windows Embedded CE recognizes your double-tap (as slow or rapid successive taps). In the *Calibration* tab, you can recalibrate your touchscreen by tapping on the **Recalibrate** button and following the directions on the screen.

## **System**

You can display the system and memory properties, as well as create your device name. In the *Memory* tab, you can allocate memory between storage memory and program memory.

## **System Properties**

Identifies the computer software and hardware components, indicating which components are installed, their version or part numbers, and whether they are enabled or disabled.

## **Total Recall**

Provides access to a backup/restore and deployment utility to maintain applications and settings over cold reboots and for multiple devices.

## **TweakIt**

Allows you to change Advanced System Settings (interface, network, and servers), User System Settings (display font size), and provides the Registry Editor.



## Volume & Sounds

Allows you to adjust the volume of the sound emitted to indicate events like warnings, key clicks, and screen taps. You can also configure system (Windows) sounds and .wav files.

## Wireless WAN

Provides access to technology like GSM/GPRS, which allows wide area networking capability such as internet browsing via GSM/GPRS. It also provides access to the Phone API. For detailed information, see [Appendix F: Wireless Wide Area Network \(WWAN\) Settings](#).

## App Launch Keys

The *App Launch Keys* icon allows you to map a key to an application so that you can then launch the application from a single key-press.

- Under *Start>Setting>Control Panel*, choose the **App Launch Keys** icon.



To assign an application key:

- Tap the **Add** button.

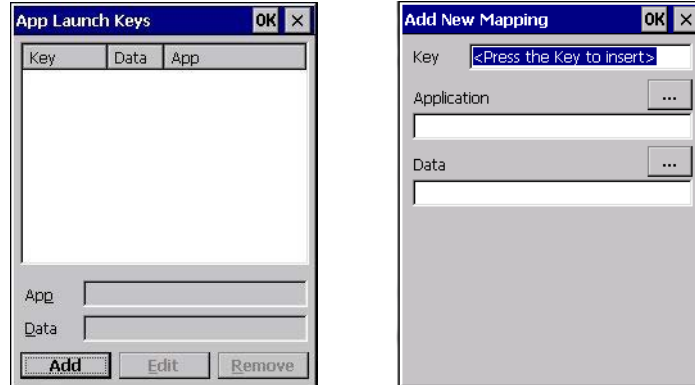

- Press the key you want to use to launch an application. (If an unsupported key is pressed, a message appears on this screen letting you know.)

The cursor moves to the *App* field and a new screen is displayed where you can choose the application to which you want to assign the application key. If you need to, you can *Browse* through the information in your *Workabout Pro4* until you locate the application you want to launch.

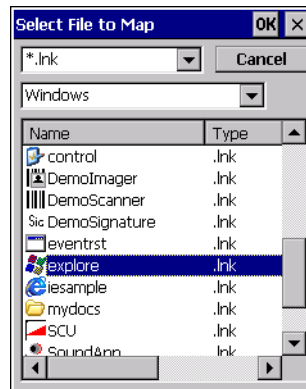

- Once you've selected the file you want to map, tap on **OK**.

The cursor moves to the *Data* field. You can use this field if you need to define command line parameters for your application. If you don't want to assign any parameters, you can leave the *Data* field blank. If, for example, you want to assign an application launch key to launch the *WordPad* application, you can leave this field blank. If you want to assign an application launch key that will open a specific document in the *WordPad* application, you need to browse to and choose that document while the cursor is in the *Data* field.

- Tap on **OK**.

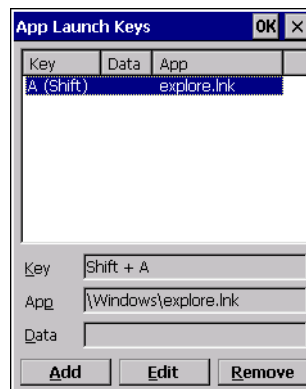

- If you need to Edit, Remove or Add another *App Launch Key*, you can do it from this final screen. Otherwise, tap on **OK** to save your *Application Launch Key*.
- To launch the application you chose, press the application key you assigned.

## Bluetooth® Setup



**IMPORTANT** By default, units with the Windows Embedded CE 6.0 operating system use the *Microsoft Bluetooth Manager* stack described in this section. However, the *Stonestreet One BTE Explorer* is also available.

To switch **from Microsoft Bluetooth to BTE Explorer**, use *TweakIt* to set the following registry values:

1. [HKEY\_LOCAL\_MACHINE\SOFTWARE\SymbolBluetooth]  
"SSStack"=dword:1
2. Warm reset

To switch **from BTE Explorer back to Microsoft Bluetooth**, use *TweakIt* to set the following registry values:

1. HKEY\_LOCAL\_MACHINE\SOFTWARE\SymbolBluetooth]  
"SSStack"=dword:0
2. Warm reset

*Bluetooth* is a global standard for wireless connectivity for digital devices and is intended for Personal Area Networks (PAN). The technology is based on a short-range radio link that operates in the ISM band at 2.4 GHz. When two *Bluetooth*-equipped devices come within a 10 metre (32 ft.) range of each other, they can establish a connection. Because *Bluetooth* utilizes a radio-based link, it does not require a line-of-sight connection in order to communicate.

Keep in mind that *Bluetooth* and IEEE 802.11g radios both operate in the 2.4GHz band. Although the Workabout Pro4 includes features to minimize interference, performance of the system will not be optimal if you use both radios simultaneously. Typically, when both radios operate in the hand-held at the same time, they cannot transmit simultaneously — this has a negative impact on overall system throughput. To minimize the impact on the backbone 802.11 network, Zebra recommends using *Bluetooth* peripherals that have low transaction rates (such as printers and scanners).

*Bluetooth* peripherals are configured by choosing the **Bluetooth** icon in the *Control Panel*. In addition, review the manual shipped with your *Bluetooth* device to determine the method used to associate with the Workabout Pro4 host.



**NOTE** The **Bluetooth** radio uses an internal antenna.

- In the *Start>Settings>Control Panel*, choose the **Bluetooth** icon to display the *Bluetooth Manager* screen.



The *Bluetooth Manager* allows users to search, pair and connect to other *Bluetooth* devices within their personal area network.

The *Bluetooth* radio is disabled by default. Before you begin the setup process:

- Tap on the **Mode** tab, and tap in the check box next to *Turn on Bluetooth*. Tap on **OK**.

When the radio is enabled, a *Bluetooth* icon appears on the taskbar at the bottom of the screen. It is ready for setup.

## Paired

This tab lists all paired devices and their corresponding services. The format of the name is <Device Name>:<Service Name>. Additional information may appear in this screen such as the Port Numbers for Serial Profiles service.

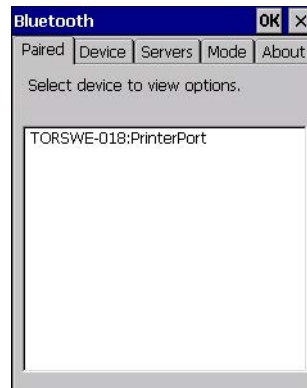

To learn how to scan for devices to pair, review [Device on page 3-9](#).



**NOTE** If a service is actively paired and connected, the device and its services are displayed in bold typeface in this list.

- Tap on an item in the *Paired* tab to display an associated pop-up menu.

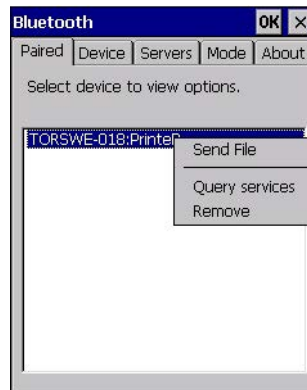

The displayed menu depends on the type of the service chosen.

### Query Services and Remove Commands

- *Query Services* displays a *Services* dialog box where a pairing service is chosen.
- *Remove* unpairs the highlighted service and deletes the entry from the tab.

### OBEX OPP (Object Exchange-Object Push Profile) Commands

The *OPP* defines two roles — a *Push Server* and a *Push Client*. *Push Server* is the device that provides an object exchange server. *Push Client* is the device that pushes and pulls objects to and from the *Push Server*.

*OBEX OPP* contains the following unique menu option:

- *Send File* displays an *Open File* dialog box where the file to be sent can be selected. When the transmission begins, another dialog box tracks the progress of the file transmission.

## HSP/HFP (Headset Profile/Hands-Free Profile) Service Commands

The *HSP (Headset Profile)* allows users to connect their device to *Bluetooth* enabled headsets and other audio devices.

*HSP/HFP services* provide the following unique menu options:

- *Connect Audio* establishes an audio connection to the *Bluetooth* headset.
- *Disconnect Audio* disconnects the audio connection from the *Bluetooth* headset.
- *Volume Control* displays a dialog box where the headset and microphone volume can be adjusted.

## Device

In this tab, users can discover and display *Bluetooth* devices.



## Discovering and Removing Devices

*Scan* discovers *Bluetooth* devices in range of the Workabout Pro4 and lists them in this tab. Any existing devices previously discovered and listed will also be displayed.

*Clear* removes all *Bluetooth* devices listed except those with currently paired and connected services.

- ✓ **NOTE** To limit the number of devices listed to a particular type of device, refer to [Filtering By Class of Device \(COD\) on page 3-9](#), next section.

## Filtering By Class of Device (COD)

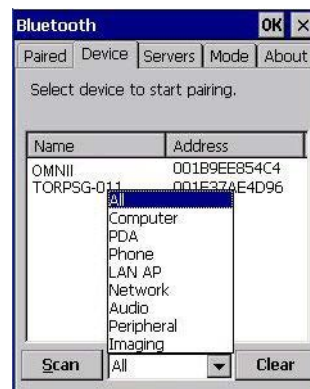

This menu allows you to filter the displayed devices by their COD. If, for example, you choose **Computer** from this menu, only the devices that have the matching *Computer* COD value will be displayed. Choosing *All* lists all detected devices.

## Device Pop-up Menu



The *Device* pop-up menu allows you to pair a device, update a device name or delete a device from the list.

*Pair* begins the pairing process by querying the services and profiles of the discovered device. An *authentication* dialog box is displayed the first time a *Bluetooth* device is paired.

*Refresh Name* repeats the device name inquiry, updating the name. This command is useful if a device is listed without a name (unknown), or if a device name has been changed remotely.

*Delete* removes this device from the list.

## Pairing a Device

To pair devices:

- Follow the manufacturer instructions to place the remote device in pairing mode.
- Choose the **Devices** tab and **Scan** for devices in your area.
- When the scan is complete, tap on the **device** to which you want to pair.
- In the pop-up *Device* menu, tap on **Pair**.

An *Authentication* dialog box is displayed.



- If the remote device has authentication enabled, type the PIN in this dialog box.
- To proceed *without* authentication, tap on **Next**.

After entering the device *PIN*, the *Services* dialog appears with a list of services available for that device.

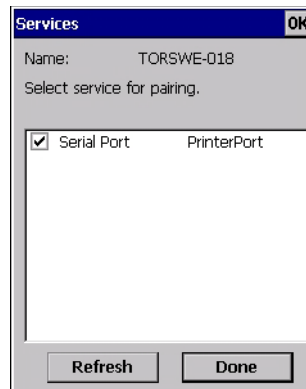

- Click in the check box to the left of the service to activate it.
- Click on **Done**.

Services that require more information present a configuration dialog box. *Serial Profile* is an example.

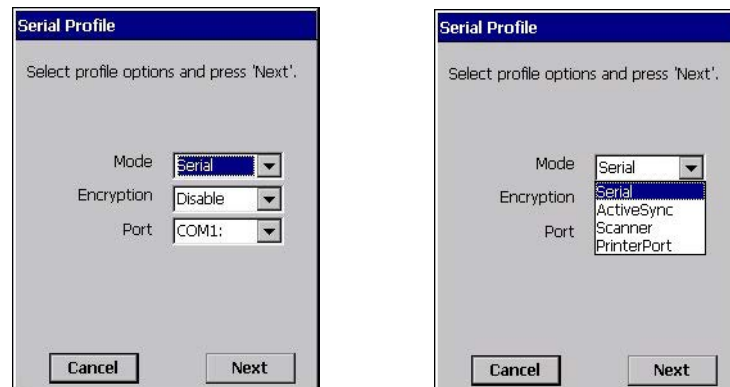

This dialog box offers a number of additional options such as enabling *Encryption* and selecting four different *Modes*: *Serial*, *ActiveSync*, *Scanner*, and *Printer Port*.

**Serial** is used for simple serial port communication.

**ActiveSync** is for *ActiveSync-over-Bluetooth*.

**Scanner** is used to create a connection to a barcode scanner. A serial connection is created, then the *Scanner Services* is notified of the connection so that the incoming barcode scan will be forwarded to *Scanner Services* directly.

**Printer Port** must be chosen here if you want to communicate with a paired *Bluetooth* printer. For further details, see [Mode on page 3-12](#).

- Once you've completed the information, tap on **Next** and then in the *Services* screen, click on **Done**.

## Servers



When a remote *Bluetooth* device initiates a *Bluetooth* connection to the Workabout Pro4, the remote device is considered the *Bluetooth master* and the hand-held, the *Bluetooth slave*. In order for the remote device to connect to the hand-held, the Workabout Pro4 must offer a service in the form of a server. The *Servers* tab allows these services to be enabled and configured. There are three server services available: *Serial*, *Scanner* and *OBEX OPP*.

**Serial** server enables the Serial Port Profile server; a Serial Port can be selected from the drop-down menu.

You can assign either a BSP or a COM prefix from the drop-down menu. BSP (*Bluetooth Serial Port*) was created by Microsoft to allow *Bluetooth* to have its own serial prefix in order to free up virtual COM prefixes as these are limited and are widely used.

✓ **NOTE** Even after a Serial Port Profile server is created, an application must open the created port before a remote device can connect.

**Scanner** server enables a Serial Port Profile server and then relays it to the Scanner Service (SCS). This is used for *Bluetooth* barcode scanners that operate in client mode. SCS opens the server port and handles the scanner input.

**OBEX OPP** server enables the Object Push Profile server. A warm reset must be performed on the Workabout Pro4 after a change is made to this option. The OPP Server allows other *Bluetooth* devices to send files to this device.

- Tap on the check box to activate the server.

## Mode

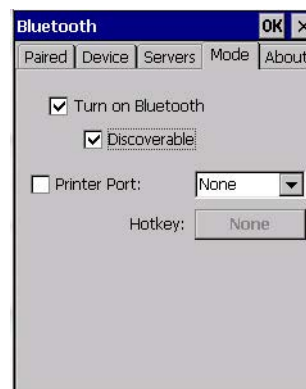



**Turn on Bluetooth** activates the *Bluetooth* radio.

**Discoverable** determines whether the Workabout Pro4 is visible or invisible to other devices.

**Printer Port** allows you to assign and enable a virtual outgoing COM port selected from the drop-down menu to communicate with a paired *Bluetooth* printer. Keep in mind that when a port is chosen, the printer must be on and connected to the chosen port for a remote device to be able to connect.

- Select a port within the *Printer Port* drop-down list, e.g. **BSP1**:
- Check the *Printer Port* check box.
- Open the *Device* tab and tap on **Scan**.
- Tap-and-hold each *Bluetooth* Printer device entry and then select **Pair**, key-in the Pass code (if needed) and then tap **Done**. DO NOT select any services!
- Close the *Bluetooth* Manager.
- Select the *Bluetooth* device to print to — you will need to key-in (or programmatically raise) the following key sequence [CTRL] [ALT] [F1].
- You can now select the *Bluetooth* device to which you wish to print.

## About

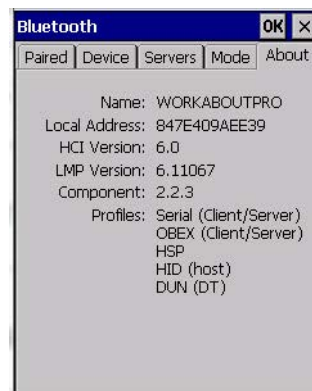

**Device Name** displays the broadcasted name of the hand-held. The name can be changed in the *System Properties* applet: *Start>Settings>Control Panel>System icon>Device Name* tab.

**Local Address** displays the MAC address (BD\_Addr) of the *Bluetooth* chip.

**HCI Version & LMP Version** display the version of the chip firmware.

**Component** indicates the version of the *Bluetooth* Subsystem (the manager, drivers, etc).

**Profiles** lists the supported profiles on this specific Workabout Pro4.

## The *Bluetooth* GPRS WAN Connection

The following steps describe how to set up an Internet data connection using a GSM cellular telephone with *Bluetooth*. The Workabout Pro4 communicates via *Bluetooth* to the cell phone, which then accesses a WAN (Wide Area Network) and transfers data using GPRS.

1. Enable the *Dial-Up Networking* service in the cell phone.
2. Make the phone *discoverable*.
3. Pair the phone service with the Workabout Pro4 Dial-Up Networking service using the *Bluetooth Manager*. (For instructions on pairing devices, refer to [Pairing a Device on page 3-10.](#))

- To set up the Internet parameters, choose the **Network And Dial-up Connections** icon from the *Control Panel*.



- Tap on **Make New Connection**.

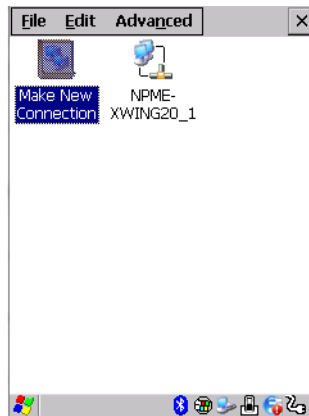

- In the *Make New Connection* dialog box, choose **Dial-Up Connection**. Enter a name for your GPRS network connection.

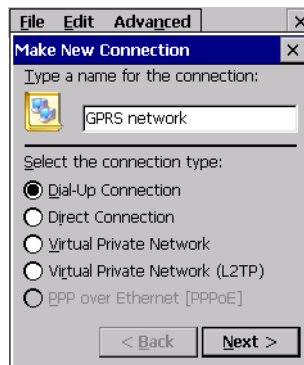

- Choose the **Next** button to display the *Modem* dialog box.

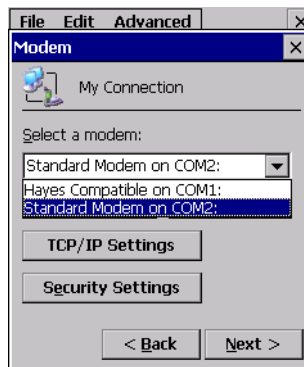

- In the drop-down menu labelled *Select a modem*, choose the name of the modem with which you want to connect, and then choose the **Configure** button to display the *Device Properties* dialog box.

The Workabout Pro4 communicates via *Bluetooth* to your *Bluetooth* equipped cellular telephone and retrieves the parameters for the *Device Properties* dialog box. Workabout Pro4 then disconnects.

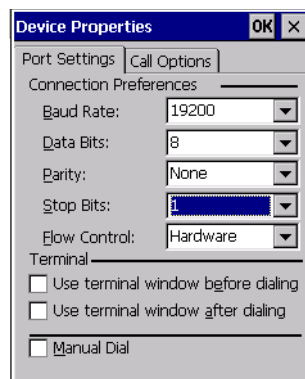

9. Under the *Call Options* tab, turn off **Cancel the call if not connected within**, and press [Enter] to save your changes.

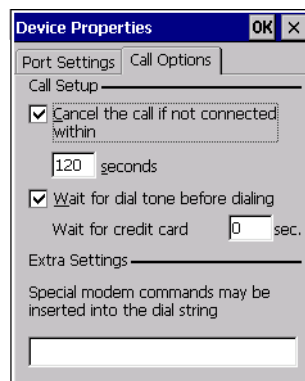

10. In the *Modem* dialog box, choose the **Next** button to display the *Phone Number* dialog box.



The phone number you enter is network carrier dependent. Once you've specified all the necessary information, choose the **Finish** button.

11. In the *Control Panel*, choose the **Dialing** icon.



12. The values in the *Dialing Properties* dialog box need to be edited according to your network carrier specifications.



Once you've edited this dialog box to reflect your network carrier requirements, press **[Enter]** to save your changes.

13. At this point, return to the *Control Panel*, and choose the **Network and Dial-up Connections** icon.
14. In the network connection window, the new network configuration — in this case, *New Connection* is displayed. Tap on the **new** icon.

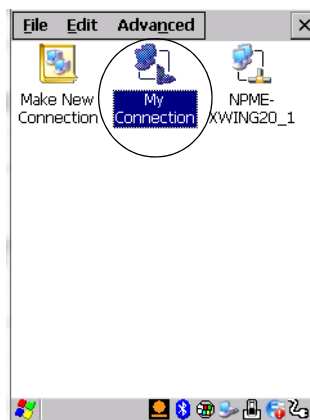

When you tap on your new connection, an onscreen message indicates the status of your connection: *connected*, *disconnected*, *error messages*, and so on.

---

## Certificates

This program provides access to the Certificate Manager and Stores. The Certificate Manager displays the certificates in the Windows Certificate Store, and allows you to import, delete, and view these certificates. Workabout Pro4 checks that the certificate has been digitally signed by a certification authority that the Workabout Pro4 explicitly trusts. This option is used in conjunction with 802.1x authentication to enhance Workabout Pro4 security.

- In the *Control Panel*, choose the **Certificates** icon.



Your Workabout Pro4 has certificates preinstalled in the computer. *My Certificates* is the repository for the personal certificate store on the device, *Other Authorities* is the repository for the intermediate certificate store, and *Trusted Authorities* is the repository for the Trusted Root certificate store.



You can import or remove certificates, and view certificate information for any listing, including names, dates, serial numbers, etc.

For a detailed description about Certificate setup for both the server and client-side devices (Workabout Pro4 Hand-Held Computers), refer to the following web site:

<http://technet.microsoft.com/en-us/windowsserver/dd448615.aspx>

## Data Transfer between Workabout Pro4 and a PC

Data transfer options vary slightly depending on the type of operating system installed in your PC.

For Windows XP SP2 operating systems or earlier, Microsoft® ActiveSync® connectivity software can be used to connect your Workabout Pro4 to PCs.

If the Windows Vista®, Windows 7 or later, operating system is installed in your PC, ActiveSync is not required to transfer data between your Workabout Pro4 and your PC.

By using a single bay USB cradle with your Workabout Pro4, you can connect to a PC with a cable to:

- View Workabout Pro4 files from Windows Explorer.
- Drag and drop files between the Workabout Pro4 and the PC in the same way that you would between PC drives.
- Back up Workabout Pro4 files to the PC, restore them from the PC to the hand-held again, etc.

### Using Microsoft ActiveSync



**NOTE** If you use a serial port to connect devices like the Workabout Pro4 to your desktop computer, the connection may not succeed because ActiveSync has trouble connecting at non-default baud rates.

To work around this problem, set the ActiveSync baud rate on the desktop to use the same baud rate as the device. You can set the baud rate by editing the registry on the desktop host computer, as detailed in the steps outlined at the following website:

<http://support.microsoft.com/kb/324466>

To install ActiveSync, follow the step-by-step instructions provided with the program's setup wizard. For details, go to the following web site and type the name into the search box:

<http://www.microsoft.com/downloads/en/default.aspx>

### Using Windows Mobile Device Center

If you are running *Windows Vista*, *Windows 7*, or later, your data transfers do not require ActiveSync. Instead, you will need to download *Windows Mobile Device Center*. For instructions, go to the following web site and type the name into the search box:

<http://www.microsoft.com/downloads/en/default.aspx>

To transfer data between your PC and your hand-held:

- Tap on **Start>Computer** to display the drives. The Workabout Pro4 will be visible here.
- Open drives, files and folders as you would on your PC.

### Using Windows Mobile Device Center

If you are running *Windows Vista*, *Windows 7*, or later, your data transfers do not require ActiveSync. Instead, you will need to download *Windows Mobile Device Center*. For instructions, go to the following web site and type the name into the search box:

<http://www.microsoft.com/downloads/en/default.aspx>

To transfer data between your PC and your hand-held:

- Tap on **Start>Computer** to display the drives. Workabout Pro4 will be visible here.
- Open drives, files and folders as you would on your PC.

---

## DataWedge



**IMPORTANT** Go to [www.zebra.com/support](http://www.zebra.com/support) for help with this application.

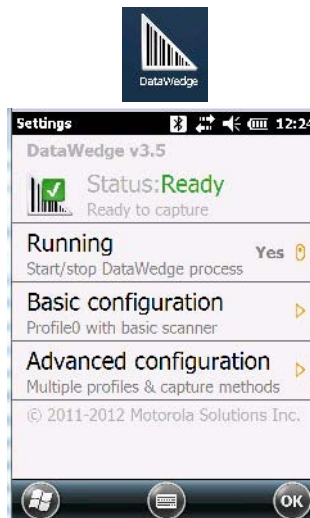

*DataWedge* is a mobile device application that allows any application to receive data from barcode, RFID, magnetic stripe and serial devices.

- Tap on **Start>Settings**, and then tap on **System** followed by the **DataWedge** icon.

---

## Scanner Services

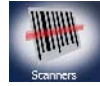

**NOTE** For detailed information about this application, refer to [Appendix C: Scanner Settings](#).



**IMPORTANT** The default barcode application is *DataWedge*. If you prefer to use the *Scanner Services* application, you'll need to take a few extra steps to display the icon. Follows the steps in the bulleted points below.

- Tap on **Start>Settings>System>TweakIt** icon.



- Under the *Advanced* tab, tap on **Advanced Services Settings**, and double-tap on **Scanner Services**.
- In the *Scanner Services* dialog box, **uncheck** *Use DataWedge (Uncheck for Psion Legacy)*.
- Press and hold down the **[FN/BLUE]** and **[Power]** buttons to reset the unit.



**IMPORTANT** To enable a newly-installed scanner, press and hold down the **[FN/BLUE]** key and the **[Power]** button simultaneously for a minimum of three seconds.

---

## Display Properties

- In the *Control Panel*, choose the **Display** icon.



## Background

- In the *Display Properties* dialog box, open the **Background** tab. This dialog box allows you to customize your background image.

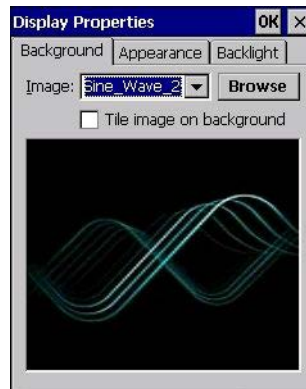

## Appearance

- In the *Display Properties* dialog box, open the **Appearance** tab. This dialog box allows you to customize the display colour scheme.

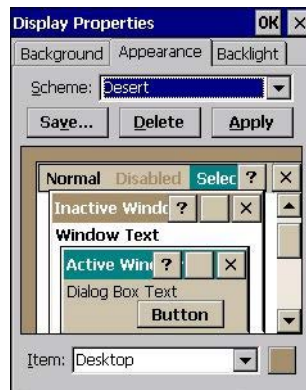

## Backlight

The backlight is activated for a configurable amount of time. The *Display Properties* dialog box in the *Control Panel* allows you to specify the intensity of the backlight along with how long the backlight remains on when the unit is not in use (no key press, scanner trigger, etc.).



**NOTE** Keep in mind that this option may be restricted to supervisory use only.

- In the *Display Properties* dialog box, open the **Backlight** tab.

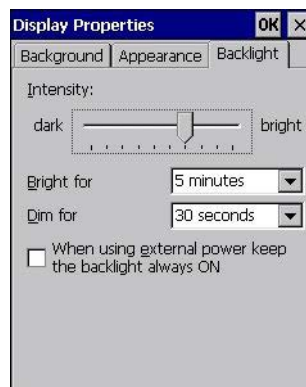





**NOTE** Backlight changes take effect immediately. You do not need to reset the unit.

To maximize battery run time, keep the display backlight brightness and active durations as low as possible.

### Intensity

This parameter is used to adjust the light intensity of the Workabout Pro4 backlight. Sliding the bar to the left lowers the light intensity, and sliding it to the right raises the intensity.

### Bright For

The value chosen from this drop-down menu determines the duration of time that the backlight stays on at the configured intensity after the last user action (keypress, scan trigger).

### Dim For

The value chosen from this drop-down menu determines the duration of time that the backlight stays on at half the configured intensity (dimmed backlight) after expiration of the Bright For delay and as long as no user action takes place (such as a keypress or scan trigger). At the expiration of the Dim For duration, the display backlight shuts off.

### External Power Check Box

When you select the check box next to *When using external power keep the backlight always ON*, the backlight remains ON at the configured intensity when the Workabout Pro4 is operating with external power (not battery power). If the Workabout Pro4 is drawing power from its battery, this option is ignored and the other parameters defined in *Display Properties* dialog box take effect.

---

## Dr. Debug

*Dr. Debug* is an error diagnostic and troubleshooting tool.

- Tap on **Start>Settings>Control Panel**. Tap on the **Dr. Debug** icon.



Dr. Debug

## Status

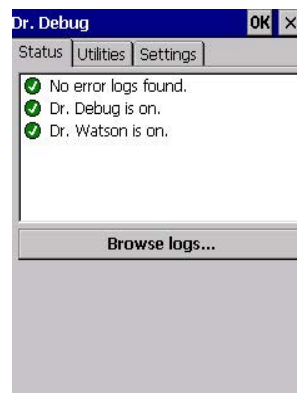

This tab indicates the status (on/off) of the debug engines. Tapping on **Browse logs** displays error logs for your review. The logs should be used as reference when working with Zebra Technical Support personnel.

## Utilities

The *Utilities* tab can be used to log network traffic. When you tap on the **Start** button, debug data is collected so that, if necessary, it can be forwarded to a Zebra technician for evaluation.



## Settings

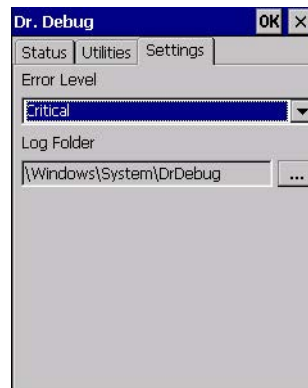

- Choose an **Error Level** from the drop-down menu.
- To change the location where debug information will be stored, tap on the button to the right of the *Log Folder* option.

---

## Error Reporting

*Error Reporting* allows you to enable or disable Microsoft error reporting prompts.

- Tap on **Start>Settings>Control Panel>Error Reporting** icon to access your options.

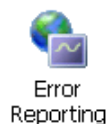

## GPS (Global Positioning System) Settings

This applet allows you to define how the GPS module operates.

- Tap on **Start>Settings>Control Panel>GPS Settings** icon.

### GPS Tab

The *GPS* tab provides two options for the *GPS Source* depending on the radio installed in the unit: *On-board GPS* if a WiFi radio is installed or *WAN GPS* if a PH8 radio is installed.

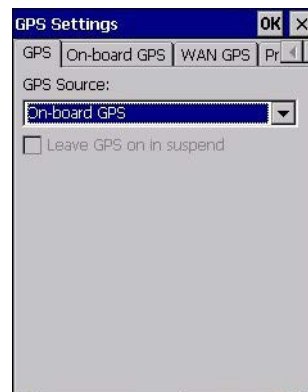

**NOTE** *Leave GPS on in suspend* is only available with the *WAN GPS* source. If this option is enabled, the GPS remains *on* even when the hand-held is in suspend mode to provide better satellite fix response time.

### On-Board GPS

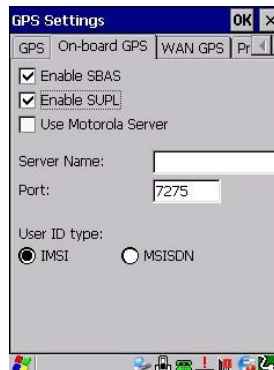

#### **Enable SBAS**

SBAS (Satellite Based Augmentation System) downloads satellite ephemeris (orbital) data to the hand-held, increasing the likelihood of finding and keeping a fix in poor coverage areas.

#### **Enable SUPL**

Enabling SUPL (Secure User Plane Location) is an IP based protocol for Assisted GPS to receive information of GPS satellites quickly via IP rather than the slower process over GPS satellite signalling.

#### **Use Zebra Server**

This option is available when *Enable SUPL* is chosen so that the hand-held can be connected to the Zebra Server.

### **Server Name and Port**

These fields are used to enter your server IP address and Port number.

### **User ID Type**

*IMSI* (International Mobile Subscriber Identity) is used to identify the device on a cellular network. It is also used to identify the radio on the network. To protect the identity of the radio subscriber, this signal is rarely sent out.

*MSISDN* (Mobile Station International Subscriber Directory Number) reads the phone number of the SIM card to identify the subscriber. *IMSI* is often used as a key in the subscriber database while MSISDN is the number normally dialled to connect a call to the device. A SIM has a unique IMSI that does not change, while the MSISDN can change in time – different MSISDNs can be associated with one SIM.

### **WAN GPS**

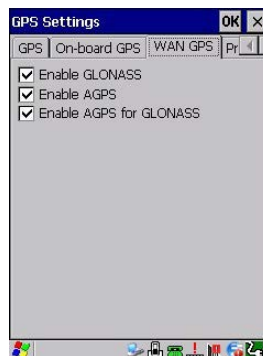

#### **Enable GLONASS (Global Navigation Sputnik System)**

Enabling this option provides support for Russian satellites. Selecting GLONASS prompts a search for GLONASS satellites first, then GPS satellites.

#### **Enable AGPS**

AGPS (Assisted Global Positioning System) reduces the fix time and increases the likelihood of finding and keeping a fix in poor coverage areas. AGPS downloads satellite ephemeris (orbital) data to the hand-held periodically through the radio. The downloaded data is used by the GPS module to speed the process of getting a fix.

#### **Enable AGPS for GLONASS**

This option, as the title suggests, enables AGPS for GLONASS satellite connections.

### **Programs**

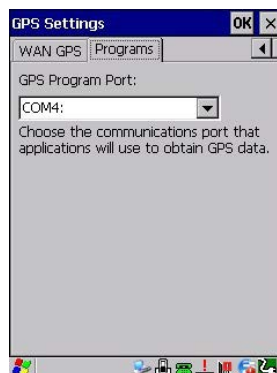

This tab allows the communication port for GPS data to be defined.

## Input Panel

The Workabout Pro4 is equipped with a Soft Input Panel (SIP). Shown below is the standard Microsoft SIP, accessed from the Control Panel.

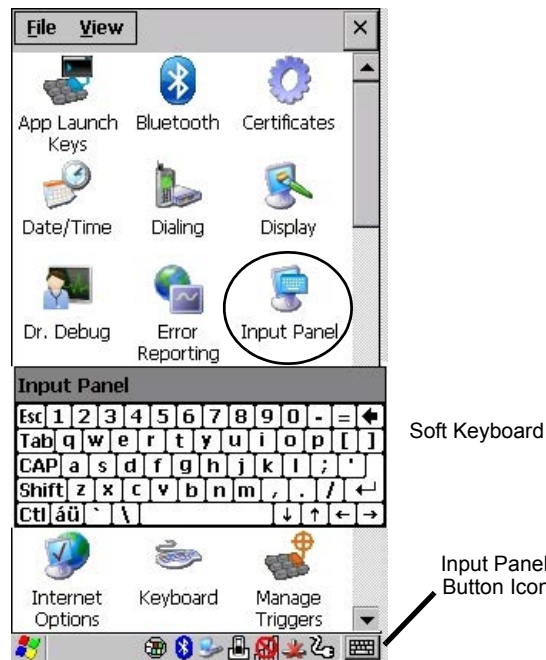

Tapping on the Input Panel button displays a soft input panel (soft keyboard) that can be customized using the Input Panel dialog box.



**IMPORTANT** If the Input Panel button icon is not visible in the taskbar, from the **Start menu**, tap on **Settings>Taskbar** and **Start Menu**. Tap the check box next to **Show Input Panel Button**. To remove this icon from the taskbar, tap in the check box to erase the check mark.

The soft keyboard operates just like a standard keyboard except that rather than pressing a key, you tap on letters, numbers, modifier keys, etc. on the Workabout Pro4 screen.

To customize the appearance and behaviour of the soft keyboard:

Tap on the **Input Panel** icon in the *Control Panel*.

**Figure 3-1** *Input Panel Properties*

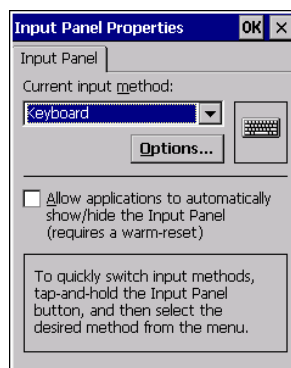

- Tap on the **Options** button to change the appearance of your soft keyboard.

✓ **NOTE** You can also display this dialog box by double-tapping on the Input icon in the far-right corner of the taskbar.

Figure 3-2 Soft Keyboard Options

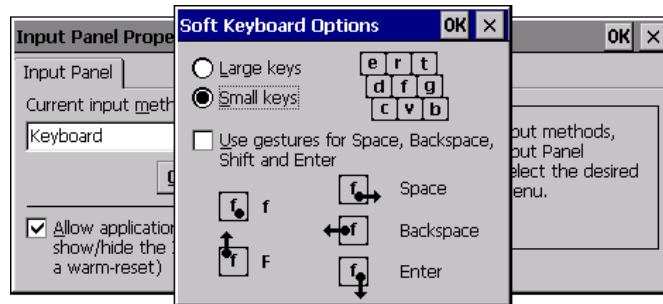

## Keyboard Properties

This icon displays the *Keyboard Properties* dialog box in which you can adjust the repeat rate of the keys, the intensity of the keyboard backlight and the behaviour of the [FN] and [SYM] modifier keys. This dialog box also allows you to define macro keys and Unicode characters.

- In the *Control Panel*, choose the **Keyboard** icon.



### Key Repeat

✓ **NOTE** These settings apply when a key is held down continuously.

- In the *Keyboard Properties* dialog box, open the **Repeat** tab.

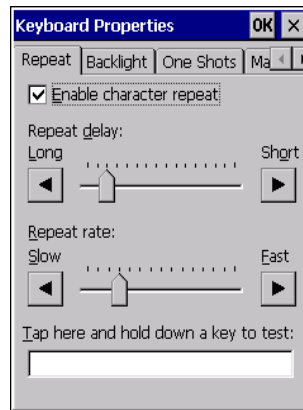

### Repeat Delay

The value assigned for this parameter determines the delay in milliseconds between repeat characters. Sliding the *Repeat Delay* bar to the left increases the delay between key repeats, and sliding the bar to the right shortens the repeat delay time.

### Repeat Rate

The value assigned for the *Repeat Rate* parameter determines how quickly the key you press repeats and is measured in characters per second (cps). Sliding the bar to the left slows the repeat rate, and sliding the bar to the right increases the repeat rate.

- ✓ **NOTE** Use the field at the bottom of this dialog box to test the repeat delay and rate settings you've chosen.

### Keyboard Backlight

- In the *Keyboard Properties* dialog box, open the **Backlight** tab.



#### Intensity

This parameter is used to adjust the light intensity of the Workabout Pro4 keyboard backlight. Sliding the bar to the left darkens the keyboard backlight intensity, and sliding it to the right lightens the intensity.

- ✓ **NOTE** The keypad backlight maximum brightness will decrease over time as it ages. Use mid-range intensity settings when possible to extend the backlight lifespan. When the backlight starts to dim, use this parameter to make it brighter.

#### ON For

The value chosen from this drop-down menu determines the duration of time that the keyboard backlight stays on after the last user action (keypress or scan trigger).

- ✓ **NOTE** Tapping in the check box next to **When using external power, keep the backlight always ON** forces the keypad backlight to remain on when the unit is operating with external power.

### Keyboard One Shot Modes

- In the *Keyboard Properties* dialog box, open the **One Shots** tab.



The options in this tab allow you to determine how modifier keys on your Workabout Pro4 behave. For each modifier key — [ALT], [SHIFT], [CTRL], [FN/BLUE], and [FN/ORANGE] — you have the following options in the drop-down menu: *Lock*, *OneShot*, and *OneShot/Lock*.



**NOTE** Keep in mind that checking the taskbar lets you know whether or not these keys are locked on. For example, if the [FN/BLUE] key is locked *on*, the taskbar at the bottom of the screen displays it underlined. If this key is displayed without the underline in the taskbar, you'll know that the key is not locked. It will become inactive following a key press.



**IMPORTANT** Once you've assigned a One Shot mode to a modifier key, you need to tap on the OK button at the top of the tab to activate your selection.

### Lock

If you choose *Lock* from the drop-down menu, pressing a modifier key once locks it *on* until you press the modifier key a second time to unlock or turn it off.

### OneShot

If you choose *OneShot*, the modifier key remains active only until the next key is pressed.

### OneShot/Lock

*OneShot/Lock* allows you to combine these functions. When you choose this option and you press the modifier key once, it remains active only until the next key is pressed.

If you press the modifier key twice, it is locked *on*, remaining active until the modifier key is pressed a third time to turn it *off*.



## Macro Keys

- In the *Keyboard Properties* dialog box, open the **Macros** tab.

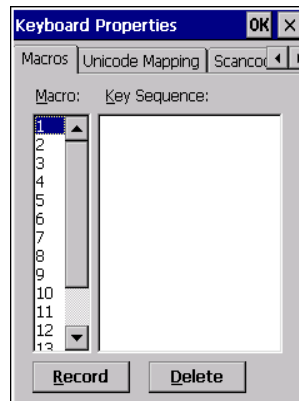

A macro key is a single keypress that can be configured to output up to 200 characters (including [ENTER], [BACKSPACE], [DEL], function keys, arrow keys, etc.). This feature can save time and effort when entering frequently used key sequences. For example, a macro key can be programmed to output a standard signature, such as “Sincerely yours, Bob” with a single keypress.

For all keyboard types, you can program up to 15 macro keys. Some Workabout Pro4 keyboards have macro keys ([M1], [M2] and so on) that are physically present on the keyboard. When you record a macro sequence and assign it to one of these predetermined macro keys, pressing that key (e.g., [M1]) executes the macro and sends the programmed key sequence to the hand-held as if it were entered from the keyboard.

### Recording and Saving a Macro

You can increase the number of virtual macro keys up to 15 using *Scancode Remapping* (for details, see [Scancode Remapping on page 3-31](#)).

- In the *Macro* menu highlight a macro key number, for example macro 1, to assign a macro to macro key [M1]. Choose the **Record** button.

A message screen is displayed instructing you to *Enter Key Strokes to Record*.



- Type the macro sequence you want to assign to the Macro key. You can type text and numbers, and you can program the function of special keys into a macro.
- When you've finished recording your macro sequence, press the key sequence: [CTRL] [ALT] [Enter], or choose the **Stop Recording** button.

A new screen *Verify Macro* displays the macro sequence you created. The **Save** button is highlighted.

- Press **[Enter]** to save your macro, or highlight CANCEL and press **[Enter]** to discard it.

### Executing a Macro

To execute a macro:

- Press the macro key to which you've assigned the macro.

### Deleting a Macro

To delete a macro:

- In the *Macros* tab, highlight the *macro number* you want to delete.
- Choose the **Delete** button.

## Unicode Mapping

- In the *Keyboard Properties* dialog box, open the **Unicode Mapping** tab.

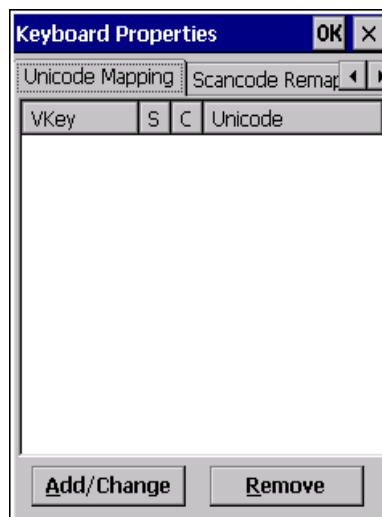

The *Unicode Mapping* tab is used to map combinations of virtual key values and [CTRL] and [SHIFT] states to Unicode™ values. This tab shows the configured Unicode character along with the Unicode value. For example, the sample screen above shows “a (U+0061)” indicating that the character “a” is represented by the Unicode value “0061”, and so on. Keep in mind that Unicode configurations are represented as hexadecimal rather than decimal values.

All user-defined Unicode mappings are listed in the *Unicode Mapping* tab in order of virtual key value, and then by order of the shift state. If a Unicode mapping is not listed, the Unicode mapping is mapped to the default Unicode value.

### Adding and Changing Unicode Values



**IMPORTANT** Changes to Unicode mappings are not saved until you exit the Keyboard Properties dialog box.

1. Choose the **Add/Change** button.

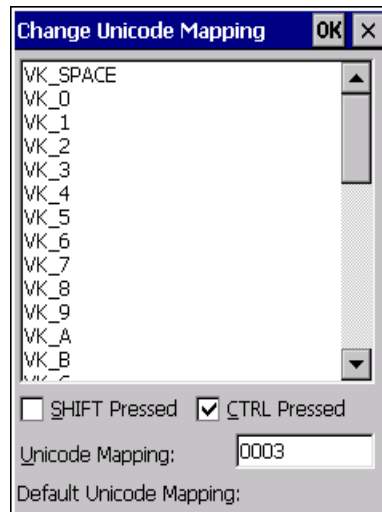

2. Highlight a value in the Unicode mapping list. In the sample screen above, a value will be assigned to virtual key 0 (VK 0).
3. Position the cursor in the *Unicode Mapping* field, and type a **Unicode value** for the highlighted key.



**NOTE** To add a shifted state, [SHIFT] and/or [CTRL], press [TAB] to position the cursor in the check box next to *SHIFT Pressed* and/or *CTRL Pressed*. Press [SPACE] to select the shift state you want to assign.

### Removing Unicode Values

- In the *Unicode Mapping* tab, highlight the item you want to delete, and choose the **Remove** button.

## Scancode Remapping

A scancode is a number that is associated with a physical key on a keyboard. Every key has a unique scancode that is mapped to a virtual key, a function or a macro. *Scancode Remapping* allows you to change the functionality of any key on the keyboard. A key can be remapped to send a virtual key (e.g. VK\_F represents the *F* key; VK\_RETURN represents the *[Enter]* key, etc.), perform a function (e.g. turn the scanner on, change volume, etc.) or run a macro.

There are four different tables of scancode mappings: *Normal*, *Orange*, *Blue*, and *Shift*.

The *Normal* table defines unmodified key presses; the *Blue* table defines key presses that occur when the [FN/BLUE] modifier is on; the *Orange* table defines key presses that occur when the [FN/ORANGE] modifier is on. The default mappings of these scancodes can be overwritten for each of these three tables using the *Scancode Remapping* tab accessed from the *Keyboard Properties* dialog box.

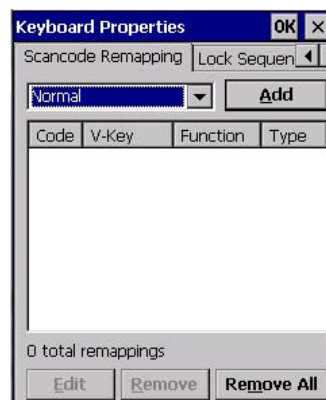

The first column in the *Scancode Remapping* tab displays the scancodes in hexadecimal. If the scancode is remapped to a virtual key, that virtual key is displayed in the next column labelled *V-Key*. A virtual key that is *Shifted* or *Unshifted* is displayed in the third column labelled *Function*.

If the scancode is remapped to a function or a macro, the first and second columns remain blank while the third column contains the function name or macro key number (e.g., Macro 2).

### Adding a Remap

To add a new remapping:

- Choose the **Add** button at the bottom of the dialog box.

The *Remap Scancode* dialog box is displayed.



- Type the scan code in hexadecimal in the field labelled *Scancode*.



**NOTE** The Label field displays the default function of the scancode you are remapping.

### Virtual Key, Function and Macro



The drop-down menu under *Key Modifier*: allows you to define to what the scan code will be remapped: Virtual Key, Function or Macro.

When one of the *Virtual Key* options is selected, you can choose to force [SHIFT] to be *on* or *off* when the virtual key is sent. If *No Force* is selected, the shift state is dependent on whether the shift state is on or off at the time the virtual key is sent.

When *Function Key* is selected, a list of valid functions appears in the dialog box.

When *Macro* is selected, the macro keys available on your unit are listed in the dialog box.

- Choose one of the **Virtual Key** options, the **Function Key** option or the **Macro Key** option.
- Choose a function from the *Function* list in the dialog box, and tap on **OK**.

### Editing a Scancode Remap

To edit a scancode:

- In the *Scancode Remapping* tab, tap on the remap you want to edit.
- Tap on the **Edit** button, and make the appropriate changes.
- Tap on **OK** to save your changes.

### Removing a Remap

To delete a remap:

- In the *Scancode Remapping* tab, highlight the scancode you want to delete, and tap on the **Remove** button.
- Tap on **OK**.

## Lock Sequence

The *Lock Sequence* menu allows you to lock the Workabout Pro4 keyboard to prevent keys from being pressed accidentally when, for example, the unit is inserted in a holster.

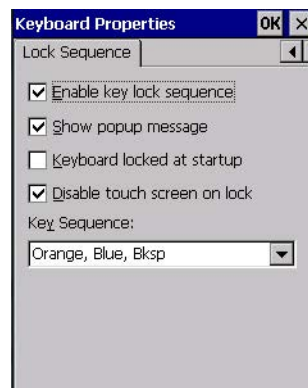

- To lock the keyboard, tap in the check box next to *Enable key lock sequence*.
- Tap in the check box next to *Keyboard locked at startup*.
- In the *Key sequence* drop-down menu, choose the key sequence you will need to type to unlock the keyboard.



**NOTE** It is useful to leave the *Show popup message* enabled (default) so that anyone attempting to use the keyboard will see the key sequence they will need to enter to unlock the keyboard displayed on the screen.

A *locked keyboard* icon is displayed in the taskbar when the keyboard is locked.



- Type the key sequence to unlock the keyboard.

## Manage Triggers

Allows users to configure how barcode scanners and other devices such as RFID readers are triggered. You can configure the trigger ID for each trigger button for both single- and double-click, and the double-click time.

- In the *Control Panel*, choose the **Manage Triggers** icon.



- In the *Manage Triggers* screen you'll see a list of trigger mappings.

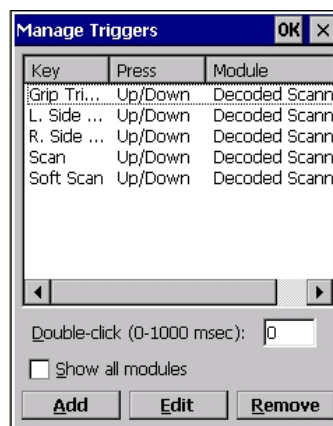

## Trigger Mappings

A trigger mapping is an association between a particular key on the keyboard and a driver or application, the module(s) — sometimes referred to as “trigger consumer(s)” — of the trigger source. Along with keyboard keys, the external trigger (scan button) is software-based. When the specified key is pressed, the owner (for example, a decoded scanner) is sent a message.



**IMPORTANT** It is not possible to have two or more identical mappings — for example [F1] cannot be mapped to the Non-Decoded Scanner twice — even if the trigger type is different.

A keyboard key that is used as a trigger source will no longer generate key data, or perform its normal function. For example, if the space button is used as a trigger source, it will not be able to send space characters to applications.

### Double-Click

When a key is pressed and released, then pressed again within the configured time (between 0 to 1000 msec), a double-click occurs. See also [Trigger-Press Type on page 3-36](#).

### Show All Modules

By default, the trigger mapping list only shows active mappings. Mappings for drivers or applications that are not currently active are not normally displayed. By checking this check box, all mappings, both active and inactive, are displayed.

**Add**

Tapping this button brings up the *Add Mapping* dialog (see next section), so that you can add new trigger mappings.

**Edit**

Tapping this button brings up the *Edit Mapping* dialog (see [Add and Edit Trigger Mapping on page 3-35](#)), so that you can edit existing trigger mappings.

**Remove**

Tapping this button removes an existing mapping.

**OK**

The *OK* button in the top right of the *Manage Triggers* screen saves all changes made. If the cancel button *X* is tapped instead, or the [ESC] key is pressed, all changes made will be discarded.

**Add and Edit Trigger Mapping**

These dialogs allow you to add and edit trigger mappings.

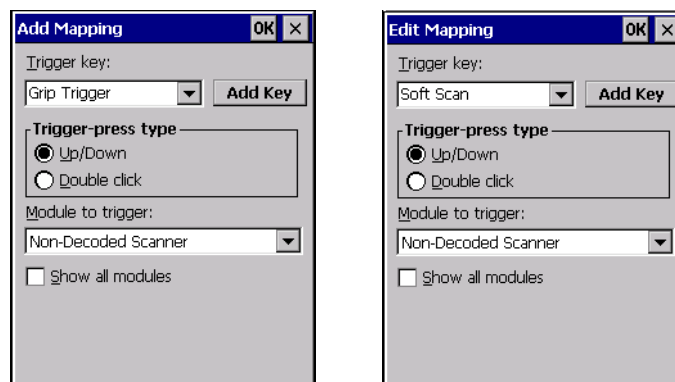
**Trigger Key**

This drop-down list allows you to specify the source of the trigger events, such as the *Soft Scan*, *Left Scan*, etc., for the trigger module selected.



**NOTE** It is possible to map the same source to different modules (trigger consumers) – for example, to both the Imager and Non-Decoded Scanner. If so, both devices/operations will occur simultaneously. This is not recommended in most cases, especially with devices such as Imagers or RFID Readers.

It is also possible to map different sources to the same module (trigger consumer) – for example, two different trigger keys can be mapped to the RFID File System.

**Add Key**

Only existing trigger sources are shown in the Source combo-box. To add a new source to this list, tap on the **Add Key** button. A dialog will pop up and allow you to select the keyboard key to use as a trigger source.

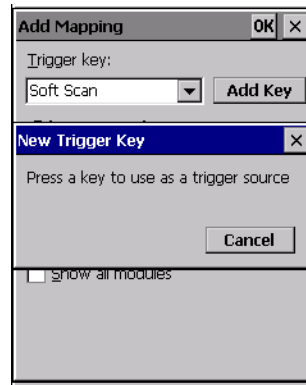

### Trigger-Press Type

You can enable either an *Up/Down* or *Double Click* response to a trigger press. Normally, when a trigger (keyboard key, etc.) is pressed and released, a *trigger down* event is sent to the *owner* — that is, the application receiving the trigger press information — followed by a *trigger up*. If *Double Click* is chosen in this menu, when the trigger is pressed, released, and then pressed again, a *double-click* event will have occurred. If a mapping with the type *Up/Down* has also been configured for the same source, it will only receive the first set of trigger events.

### Module Trigger

This identifies the driver or application receiving the trigger presses.

### Show All Modules

By default, inactive owners are not shown. By checking this check box, all owners, both active and inactive, are displayed.

---

## Microphone

- In the *Control Panel*, choose the **Microphone** icon. Use this dialog box to adjust the gain for the specific microphones associated with your hand-held.



- Tap on the drop-down menu, and choose the microphone for which you want to adjust the gain.
- Slide the microphone tab to the left to decrease the gain and to the right to increase the gain.

Tapping on the *Default* button sets the current microphone you've chosen to the default gain. Tapping on *Default All* sets *all* microphones listed to their default gain.



---

## TekTerm Client

TekTerm Client is a powerful emulation application ideally suited for real time data transaction applications associated with mainframes and servers. The Workabout Pro4 includes unique features that support TekTerm, a Zebra application that has the ability to maintain multiple simultaneous sessions with a variety of host computers. For detailed information, please refer to the *Open TekTerm Software User Manual*, PN 8000073.

---

## PartnerUp

This app displays a number of pre-loaded applications. Tapping on an app in the list takes you to an associated web site.

The operator can then install the application. If a license is required, it can be obtained by sending an e-mail to the software license mailbox or by contacting a Sales Representative from the contact web page.

[http://www.zebra.com/US-EN/Pages/Contact\\_Us](http://www.zebra.com/US-EN/Pages/Contact_Us)

Additional pieces of software such as a server must be obtained through Zebra.



PartnerUp

Tapping on a preloaded client in this screen displays a drop-down menu from which the operator can choose from an array of related options.

---

## Power Properties

This icon displays a Power Properties dialog box that indicates the battery capacity and allows you to manage battery use.

- In the *Control Panel*, choose the **Power** icon.



Power

## Battery Capacity

- In the *Power Properties* dialog box, open the **Battery** tab to view battery details.

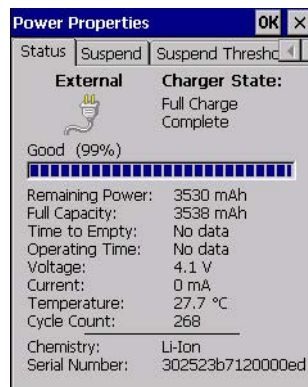

## Power Saving Suspend

- In the *Power Properties* dialog box, open the **Suspend** tab.

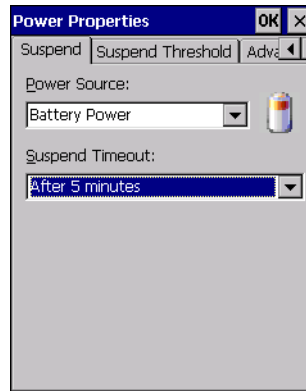

### Power Source

This drop-down menu allows you to specify whether the unit is using *AC Power* or *Battery Power*.

### Suspend Timeout



**IMPORTANT** Zebra recommends setting the Suspend value to 3 minutes. To further reduce power consumption, carefully consider the duration of time that the display backlight is *on* (see [Backlight on page 3-20](#)).

When the Workabout Pro4 is idle — not receiving any user input (a key touch, a scan, and so on) or system activity (serial data, an activity initiated by an application, and so on) — the hand-held uses the value assigned in the *Suspend Timeout* field to determine when the unit will go to sleep (appear to be off).

When the time in the *Suspend Timeout* field elapses without any activity, the unit enters *suspend* state. In suspend state, the Workabout Pro4 CPU enters a sleep state, and wireless communication is shut off. The state of the device (RAM contents) is preserved. Pressing **[Enter]** wakes the system from suspend state.

## Suspend Threshold and Estimated Battery Backup

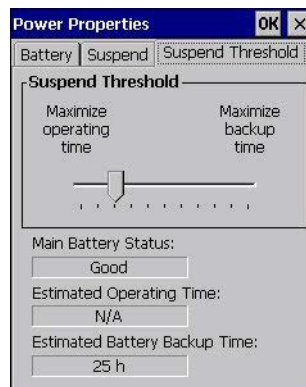

The *Suspend Threshold* adjustment tells the system when to shut down when the battery drains. If you choose *Maximum Operating Time*, the unit will run until the battery is completely empty; the RAM is only backed up for a short period of time. If you choose *Maximum Backup Time*, the hand-held shuts off with more energy left in the battery so RAM can be backed up for a longer period of time.



**IMPORTANT** Selecting Maximum backup time will reserve approximately 20% of the battery capacity for memory backup. Once the battery is drained, the system RAM memory is lost and the unit must cold boot.

In most real-time transaction environments this is not a problem (it only takes a few seconds to cold boot). Batch transaction environments, where data is not saved to a non-volatile memory (such as an SD FLASH card), may need to pay particular attention to this parameter. Zebra does not recommend the storage of any valuable data in system RAM.

The Workabout Pro4 Windows Embedded CE 6.0 environment does not store any critical data in RAM (such as the registry or file system).

If your application does not save data to RAM, Zebra recommends keeping the Suspend Threshold setting as low as possible to maximize battery run time.

The *Estimated Battery Backup* is the amount of battery power that has been reserved or set aside to protect data until a charged battery can be installed in the hand-held. When the battery capacity is depleted up to the *Estimated Battery Backup* reserve specified in the *Suspend Threshold* menu, the Workabout Pro4 shuts off automatically and uses the reserve power to preserve the data stored on the computer. Once the Workabout Pro4 shuts down, it cannot be switched on until a fresh battery is installed, or the unit is inserted in a cradle.

- Slide the **Suspend Threshold** button to the right to increase the battery capacity reserved for backup purposes. Data will be preserved to a maximum of 124 hours.
- Slide the **Suspend Threshold** button to the left to decrease the power reserved for backup purposes; this increases the Workabout Pro4 operating time — the amount of time the unit will operate before shutting down — but reduces the power reserved for backup purposes to a minimum of 24 hours.

The internal super-capacitor will protect the data stored in the computer while the battery is swapped for a fully charged one.



**IMPORTANT** Once the battery is removed, the super-capacitors will preserve the data stored on the Workabout Pro4 for approximately 4 minutes. It is critical that you install a charged battery before this time elapses.

## Advanced

- In the *Power Properties* dialog box, open the **Advanced** tab.

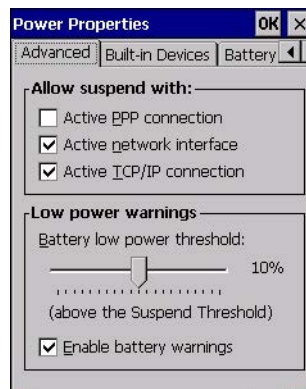

### Allow Suspend With

This menu allows you to specify whether or not your unit will enter Suspend Mode while it is operating with an active PPP connection, network interface or active TCP/IP connection.

### Low Power Warnings

The sliding scale at the bottom of this menu allows you to specify the remaining battery capacity at which a warning message is displayed on the Workabout Pro4 screen, from 0% to 20%.

### Wakeup Sources

- In the *Power Properties* dialog box, open the **WakeUp Sources** tab.

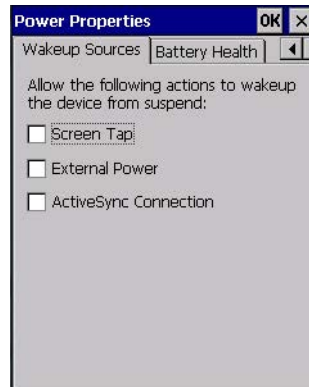

This dialog box allows you to choose the actions that will wake your unit from a suspend state.

### Battery Health

The Battery Health service provides an estimate of battery health based on a number of different measurements, beyond just capacity.



**IMPORTANT** Battery Health is an estimate and should not be depended on to provide a 100% account of battery condition.

- In the *Power Properties* dialog box, open the **Battery Health** tab.

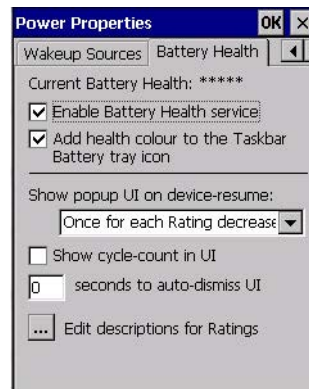

### Current Battery Health Meter

The Current Battery Health Meter default values are shown here as \*\*\*\*\* (Excellent), \*\*\* (Used), and \* (Battery should be replaced). If you tap on the battery icon in the taskbar, a pop-up screen will show the state of the battery. The image below shows the default *Excellent* status screen.



### Enable Battery Health Service

This option allows you to enable the service. To access the menus after enabling the service, you will need to either wait until a resume from Suspend or restart the Workabout Pro4.

### Wakeup Device on Battery Insert

When this option is enabled, whenever the battery is replaced the Workabout Pro4 is powered up from Suspend and the current health of the battery is displayed.

### Add Health Colour to the Taskbar Battery Tray Icon

Enabling this option changes the background colour for the battery icon in the Taskbar, based on battery condition: *Green* (excellent), *Yellow* (used), and *Red* (battery should be replaced).

### Show Popup UI on Device-Resume

You can decide when the battery status pop-up user interface (UI) will appear, for how many seconds, and whether the battery cycle count is displayed (**off** by default).

### Edit – Changing Ratings Text

You can customize the ratings text with the *Edit* option. By enclosing your text within the html tag used for **Bold** `<b>` (or removing the tag to unbold the text), you can change the text that will appear in the pop-up battery status screen. For example, the default text “**Excellent**” can be changed to: “**Battery is excellent, and will last one day shift.**”...

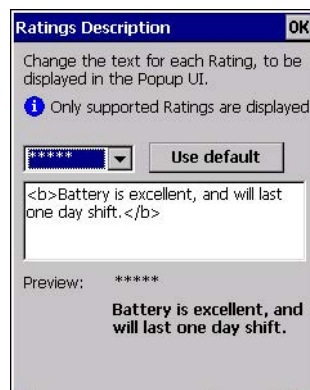

---

## Kiosk Access

*Kiosk Access* enables you to customize your computer settings, remove or add shortcuts to the desktop and Control Panel, and limit access to various different components on the computer and the system tray icons for security.

✓ **NOTE** The Desktop theme can be changed from the default Windows Classic Shell to the Kiosk Shell either in the **Kiosk Access** settings (see [Other Shell Themes on page 3-44](#)) or by tapping on the Desktop icon **Kiosk Shell** (see [The Kiosk Desktop Shell on page 2-20](#)).

- In the *Control Panel*, choose the **Kiosk** icon.



When opening the *Kiosk* application, the *Kiosk Access* dialog will come up that enables you to either proceed to the *Kiosk Settings* menus, or change from you current Access mode to the other (Administrator or User). The computer must be reset following a change, and a confirmation will appear to enable you to continue or dismiss the change.

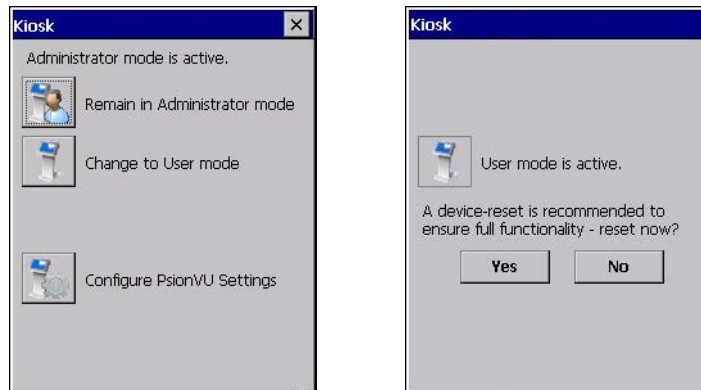

When opening the *Kiosk Settings* option, the following menu will be available:

**Figure 3-3** *Kiosk Settings*



### Administrator Password

By setting an Administrator Password, you can limit access to various different components on the computer and the system tray icons for security. The default security setting allows User access to all options, therefore restrictions and settings can be configured without setting a password.

✓ **NOTE** If a setting or restriction is configured without setting an Administrator password, the following message is displayed: “!Administrator password is currently not set.” Once a password has been set, the message will disappear.

When an administrator password is set, the restricted options are accessed using a key combination. If a password has been set, the user would be prompted for the password.

The option *Show Password* changes the displayed password from hidden (\*\*\*) to readable.

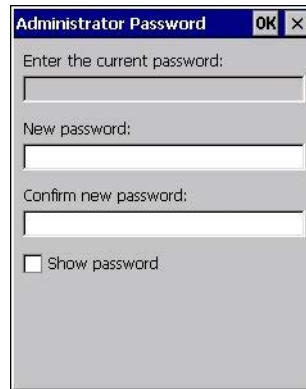

## Shell Settings

The Shell Settings application has two menus: *Applications* and *Advanced*.

### Applications

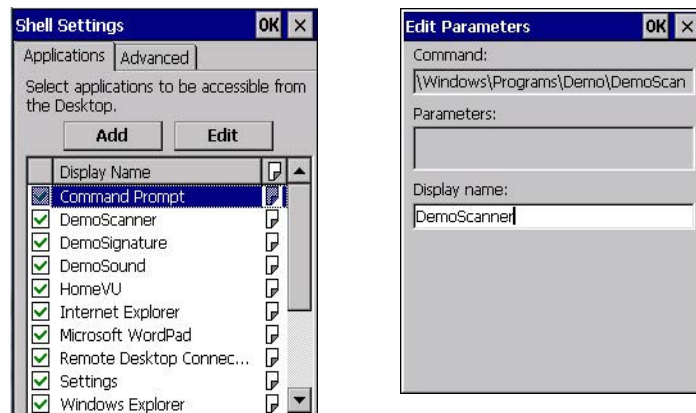

The Applications menu lists all the applications installed on the computer, alphabetically. The items checked in this view are shown on the Desktop.

The *Add* and *Edit* buttons allow you to search for and add an application to the list of items in the selection window. You can add a maximum of 18 applications, after which the Add option will be greyed out and the following message is displayed: "Maximum 18 entries reached."

When you select an application and tap on Edit, you will see fields for *Command*, *Parameters*, and *Display Name*.

- **Command:** The *Command* field is prefilled with the path and name of the executable (.exe) or corresponding link (.lnk). If the selected file can't be found (e.g. external memory card has been removed, files have been deleted), a message will be displayed at the bottom of the screen: *These files cannot be found*.
- **Parameters:** The *Parameters* option provides the option of adding extra parameters to the application (for .exe files only, not .lnk). For example, if the Command field is running *pword.exe* (Microsoft WordPad), the Parameters field could specify a document to open.
- **Display name:** This is an editable field which is prefilled with the name of the application.

**Advanced**

The Applications menu allows you to enable or disable some device functions.

**Windows Classic Shell**

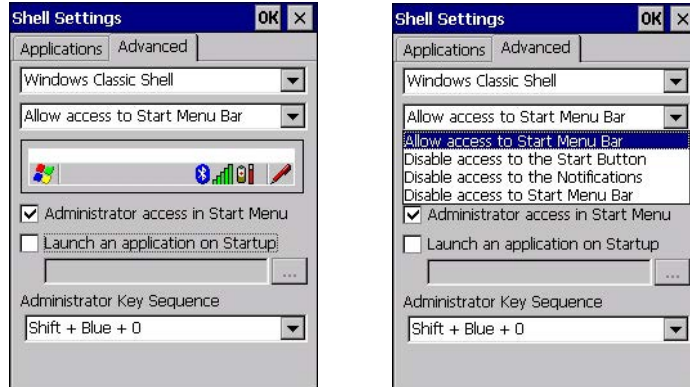

The following options can be enabled or disabled in the Windows Classic Shell Desktop theme:

- **Start Menu Bar:** If disabled, access to both Start Menu and Notifications are disabled. The Notification tooltips will still display. Any changes made will occur after a device reset.
- **Start Button:** If disabled, access to the Start Button and Notifications are disabled. The Notification tooltips will still display.



**NOTE** If “Disable access to the Start Button” is selected, but the “Kiosk Access by Key Sequence” remains unchecked, you will see the following status-message “!A Key Sequence is required when the Start Button is disabled.”, the check box will be auto-checked, and the focus will be set to the key-sequence selection.

**Notifications:** If disabled, the Notifications tooltips will still display.

**Administrator Access in Start Menu:** When this box is checked, the *Kiosk Access* program will be shown in the *Start Menu>Programs* list.

The following item is not optional:

- **Administrator Key Sequence:** Sets the key sequence to open *Kiosk Access*.

**Other Shell Themes**

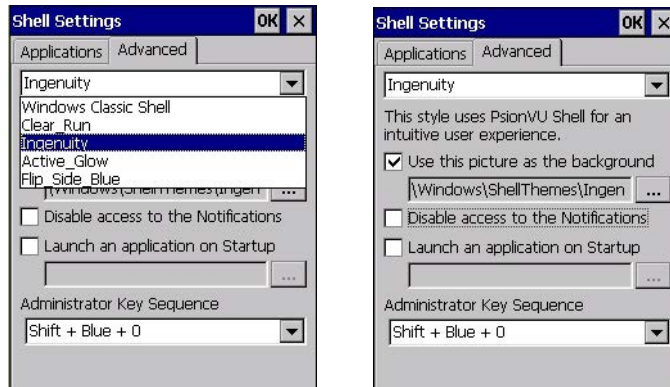

The following options can be enabled or disabled in the Kiosk Shell Desktop themes (shown in the drop-down list as *Windows Classic Shell*, *Clear\_Run*, *Ingenuity*, *Active\_Glow*, and *Flip\_Side\_Blue*):





**NOTE** The Desktop theme can be changed from the default Windows Classic Shell to one of the Kiosk themes shown here — but by tapping on the Desktop icon **Kiosk Shell** (see [The Kiosk Desktop Shell on page 2-20](#)), the “Ingenuity” theme is automatically loaded. The computer must be reset in order for the shell to change.

- **Use this picture as the background:** You can select a picture as the Desktop background.
- **Notifications:** If disabled, the Notifications tooltips will still display.
- **Launch an application Startup:** A window is displayed listing all of the installed and added applications. Any applications selected will startup after a reboot.

The following item is not optional:

- **Administrator Key Sequence:** Sets the key sequence to open *Kiosk Access*.

## Restrictions

This section deals with items that are by default available to users but can be restricted by an administrator.

### Advanced

The Advanced menu lists the system features you can restrict or block.



### Notifications

The Notifications menu allows you to block or disable notifications.



## Control Panel Settings

In these menus you can set which applets and tabs you want to *Hide* in Control Panel, and which applets and tabs will be *Accessible* as a shortcut icon from the Desktop.

- You have the option of setting the entire applet or specific tabs within the applet as hidden or accessible. Any applet that can't be set is greyed out.

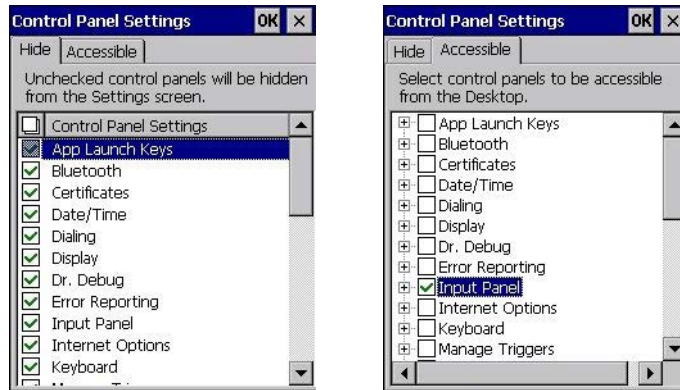

- You can add a maximum of 18 applications, after which the following message is displayed: “!Maximum 18 entries reached.”

### Import/Export to File

This option enables you to *Export* your settings file (.xml), and save it in the location of your choice. In addition, an Administrator has the option to *Import* these settings from one device to multiple devices of the same operating system.



**IMPORTANT** A copy of this file should also be saved in a central repository for all Zebra .xml files with a predefined name so that other Zebra utilities can locate it.



Tapping on the **Export** button will display a “Save As” Export Settings dialog, with the default name *Kiosk\_Settings.xml*, which the Administrator can change even after it has been saved.

The .xml file contains all of the Kiosk configured settings, including the *Administrator Password*. When the file is imported to a device, the new password is applied immediately.

- Whether choosing to import or export files, the same file location options under *My Device* will be listed. Following the action, a message stating the success of the operation and the location of the file will be displayed.
- With the exception of the password, changes made to settings will take effect only after a warm reset. If further changes to the configuration are made, they will overwrite the changes caused by the import operation. After importing a file, a dialog will appear to enable you to reset now or later.



---

## Remote Desktop Connection

*Remote Desktop Connection*, located in **Start>Programs**, is an Workabout Pro4 application used to connect to a Windows Terminal Server so that you can run a “session” on the Server machine, using the Workabout Pro4 (Windows Embedded CE device).

Refer to the following web site for step-by-step information about setting up this connection:

<http://windows.microsoft.com/en-CA/windows7/products/features/remote-desktop-connection> or Zebra Customer Support at: <http://www.zebra.com/support>.

---

## Storage Manager

The Storage Manager allows you to view information about the storage devices that are present in the Workabout Pro4, such as SD-MMC flash cards and Compact Flash cards.



### Formatting a Memory Card

Formatting a memory card bulk-erases it. Once a card is erased, partitions may be created in it, similarly to those on a hard drive. Memory-card devices are normally *mounted* (made available to the system) automatically when they are inserted. They must be *dismounted* before they can be formatted.

To format an entire memory card:

1. Select **Start> Settings>Control Panel**.
2. In Control Panel, double-click on the **Storage Manager** icon. The Storage Manager menu opens:

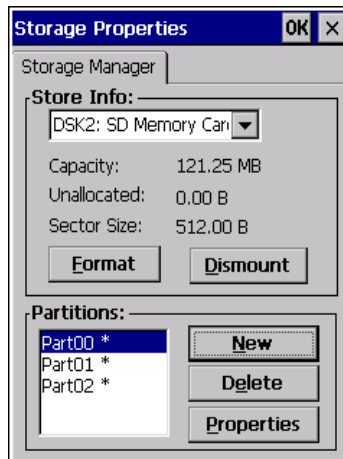

1. Select the memory card from the drop-down list.
2. Press the **Dismount** button to dismount the memory card. All partitions on the card will be dismounted.
3. Press the **Format** button to format the memory card.

All partitions and information on the card will be erased during the formatting process.

## Creating Partitions

Once the card is formatted, new partitions can be created in it. The default is to create one partition that occupies the whole card, but a card can be divided into more than one partition if desired. Each partition appears as a separate folder in Windows Explorer.

To create new partitions:

1. Press the **New** button next to the *Partitions* list box. The *Create New Partition* dialog box appears:

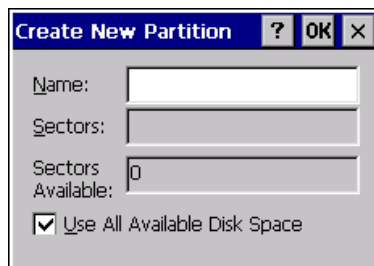

2. Type a name for the partition.
3. If more than one partition is desired, uncheck the *Use All Available Diskspace* check box, then specify the desired number of sectors to be used by the partition.
4. Press **OK**. The new partition appears in the *Partitions* list.

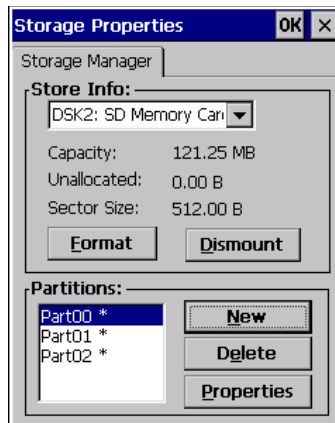

The new partition is automatically mounted. This is indicated by an asterisk (\*) next to its name in the partition list. Any unallocated space on the card is indicated at the left, and additional partitions can be created in it.

## Partition Management

Partitions can be individually dismantled, mounted, deleted, or formatted as well. These and additional tasks are available from the *Partition Properties* dialog:

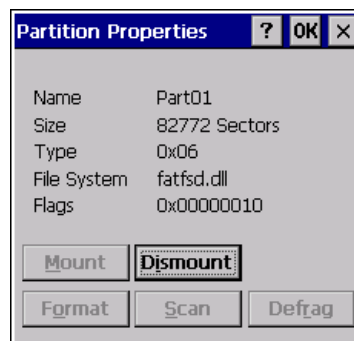

To dismantle a partition:

1. Choose the desired partition.
2. Tap the **Properties** button. The *Partition Properties* dialog appears.
3. Tap the **Dismount** button. The partition is dismantled. The asterisk disappears next to its name in the partitions list.

To delete a partition:

1. Select the desired partition.
2. Tap the **Delete** button. A warning dialog appears.
3. Tap the **OK** button. The partition is deleted.

To format a partition:

1. Choose the desired partition.
2. Tap the **Properties** button. The *Partition Properties* dialog appears.
3. Tap the **Dismount** button. The partition is dismantled. The asterisk disappears next to its name in the partitions list.
4. Tap the **Format** button. The *Format* dialog appears:

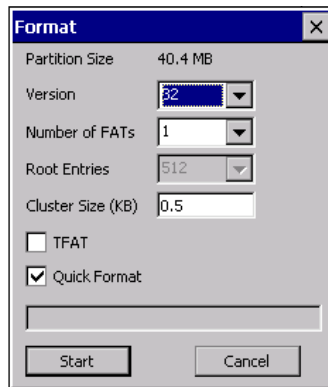

5. Choose your format options. These options include:
  - Version of file system (FAT-16, for devices holding up to 4 GB; or FAT-32, for devices containing up to 32 GB).
  - Number of FATs (File-Allocation Tables).
  - Number of entries allowed in the root directory.
  - Cluster size (.5 KB to 64 KB).

There are also two check boxes, which govern:

- Whether to use the transaction-safe FAT file system (TFAT). This file system keeps multiple copies of the file-allocation table, changing one while maintaining another as a backup.
- Whether to perform a quick format. Quick formatting removes all reference to data in the partition without erasing the actual partition. The partition will be treated as empty, and new data will overwrite it.

6. Tap **Start**. The partition is formatted.

To mount a partition:

1. Choose the desired partition.
2. Tap the **Properties** button. The *Partition Properties* dialog appears.
3. Tap the **Mount** button. The partition is mounted. The asterisk appears next to its name in the partitions list.

The *Partition Properties* dialog has buttons for additional functions. Partitions can be defragmented, and their file structure can be scanned.

## Stylus Properties

✓ **NOTE** Touchscreen calibration may not be enabled on your unit. If your screen appears to require recalibration, contact your supervisor.

- In the *Control Panel*, choose the **Stylus** icon.



### Double-Tap

- In the *Double-Tap* menu, follow the directions to tailor the sensitivity of the stylus when you tap on the touchscreen.

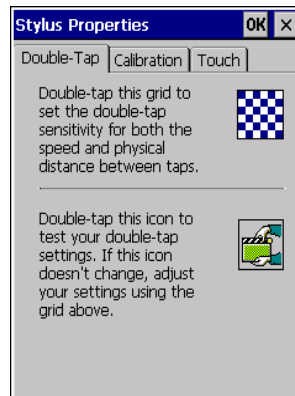

### Calibration

Touchscreens rarely require recalibration. However, if your touchscreen has never been calibrated or if you find that the stylus pointer is not accurate when you tap on an item, follow the directions below.

- Choose the **Calibration** tab, and then tap on the **Recalibrate** button.

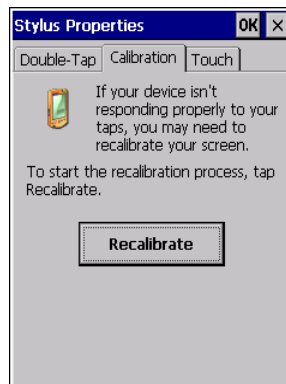

- Follow the directions in the *Calibration* tab to recalibrate the screen. You will be prompted to save the calibration data.



**NOTE** If you do not receive a prompt to save your data, there could be a problem with your touchscreen hardware. Contact your Zebra representative.

### Touch

This tab allows you to disable the touchscreen.

- Choose the **Touch** tab. Select the check box next to *Disable the touch panel*.

---

### System Properties

This program identifies the computer software and hardware components, indicating which components are installed, their identification, version or part numbers, and whether they are enabled or disabled.

- In *Control Panel*, choose the **System Properties** icon.



- By choosing the *Export* button, you can create a log (*SystemProperties.xml*) of your current components, which will be placed in the *My Device* folder in Windows Explorer.
- Instead of expanding each section of items individually, you can also choose to open all the lists at once by choosing the *Expand* button, which will then change to a *Collapse* button to enable you to collapse all the sections as well.



## Total Recall

*Total Recall* is a Zebra utility developed to maintain applications and settings during a cold boot, as well as clone settings to other devices. This utility creates a restore point of a device at a known state. This can be used as a backup of the device (the administrator can clean the terminal and restore the profile at any time), or a clone (the administrator can store different configurations for different uses to clone to other hand-held computers).



**NOTE** Total Recall works differently (e.g. restore on cold boot or on clean boot) on different OS platforms and versions (e.g. Windows CE 5.0, 6.0, Windows Mobile, Windows Embedded Hand-held). For detailed information and other updates on Total Recall information, please go to the IngenuityWorking web site at:

<http://community.psim.com/knowledge/w/knowledgebase/total-recall.aspx>

- In the *Control Panel*, choose the **Total Recall** icon.

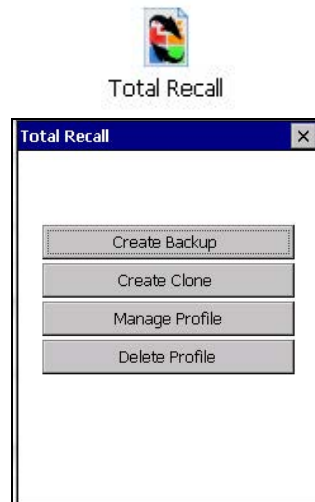

In the start up screen, you can choose from four options: *Create Backup*, *Create Clone*, *Manage Profile*, and *Delete Profile*.

### Creating a Backup

- Tap on the **Create Backup** button to begin the process.

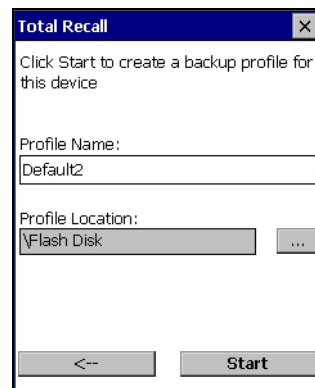

This dialog box displays the Profile Name and the storage destination for the profile file.

- In the *Profile Name* field, type a name for a profile.

- If you want to choose another location for your backup file (optional), tap on the [...] button to the right of the *Profile Location* field and choose one of a number of folders.



**IMPORTANT** Any profile not stored in persistent memory (Application, Flash Disk, external USB drive) will be erased during a clean boot, therefore you should store profiles on a persistent drive.

When performing an autorestore, the program only searches for the profile located in the \Application\ or \Flash Disk\TotalRecall folder. If you store your profile anywhere else it will not be restored. Only one profile can reside in that folder.

- Tap on **Start**. A backup of the current settings will be created and saved to the specified location. The unit will then reboot.

To view profiles and choose restore options, refer to [Managing Profiles on page 3-55](#).

### Creating a Clone

Cloning allows you to copy settings or configurations from one computer to another. There are two types of clones to choose from: a *Full Clone* and a *Settings Only Clone*.

A *Full Clone* contains all files, most of the registry, and the settings files.



**IMPORTANT** The target device for a Full Clone MUST have the same model type and OS build as the source, otherwise problems can occur. For example, if the target device has a newer build of the OS, the new build may have a different set of registry keys that may conflict with the source.

A *Settings Only Clone* can be copied to a wider array of devices, but it should not be used as an autorestore profile.

- Tap on the **Create Clone** button to begin the process. Your Workabout Pro4 model type and OS will be identified in the cloning statement to ensure that you target devices of the same type. Give the clone profile a name and location, then tap on **Next**.

Total Recall

Click Next to create a clone profile of this device for another Motorola 7528L running Windows CE 6.0

Profile Name:  
Clone1

Profile Location:  
\\Flash Disk

<-- Next

- In this menu, select **All** for a *Full Clone*, or **Selected Options** for a *Settings Only Clone*. If you choose *Selected Options*, a menu will open to enable you to decide which options you want cloned.

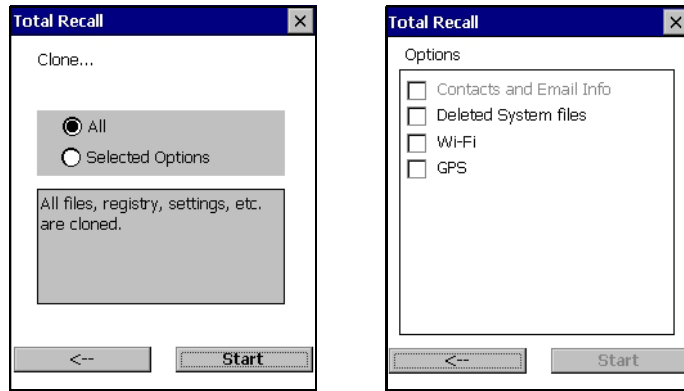

## Managing Profiles

You can view profiles and choose profile options from the menus in this section.

### Viewing a Profile

- Tap on the **Manage Profile** button to see your list of profiles. Highlight a profile, and then you can choose to **View** the Profile Summary and go on to the next menu, Profile Details.

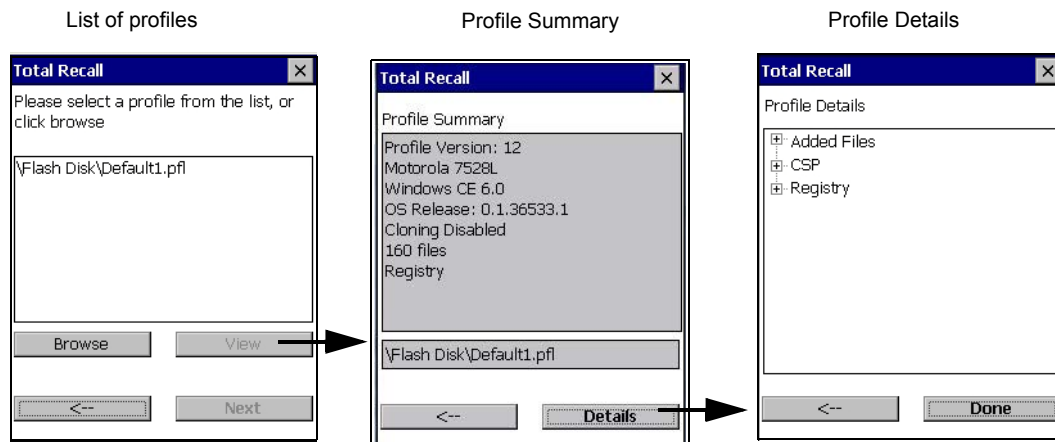

### Profile Options

- Tap on the **Manage Profile** button to see your list of profiles, as shown above. Highlight a profile, and tap on the **Next** button to choose from options to restore or clone the profile. You can choose from four profile options: *Restore Now*, *Set for Autorestore*, *Upload to A.R.C.*, and *Clone to USB*.

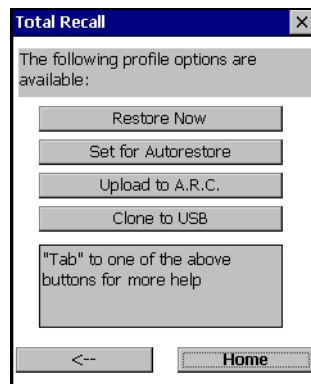

- Next, tap on the option button you want to use:
- **Restore Now** – restores the profile immediately. If you are restoring a profile that is a backup or Full Clone, the computer will clean reset first; if the profile is a Settings Only Clone, it will not.
- **Set for AutoRestore** – creates a profile that is automatically restored following a cold reset or a clean start. The profile is stored in the *\Flash Disk\TotalRecall* folder.



**IMPORTANT** After setting an autorestore profile, that profile will overwrite any other profile already placed in the Application\ or \Flash Disk\TotalRecall folder.

In an autorestore, Total Recall only restores the profile located in the Application\ or \Flash Disk\TotalRecall folder. If you store your profile anywhere else it will not be restored.

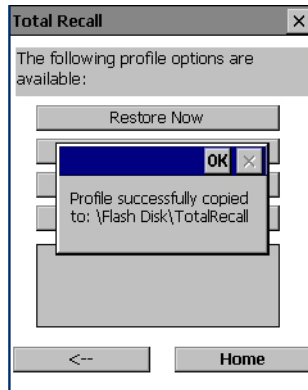

- **Upload to A.R.C** – uploads the profile to the Active Remote Configuration server. After you tap on **Send**, a message will come up either confirming that the upload was complete or that the connection to the server failed.

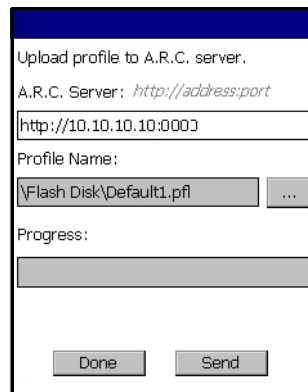

- **Clone to USB** – writes a clone of the profile to the USB drive. After you tap on the button, a message will come up either confirming that the USB drive is ready for deployment, or that it is not available.
- When you are ready to install the profile on another unit, turn on the next computer to be cloned and insert the USB key. The profile will be automatically installed to the *\Flash Disk\TotalRecall* folder. There is a short delay in deployment so that you can cancel the process if needed.

USB drive prepared for cloning

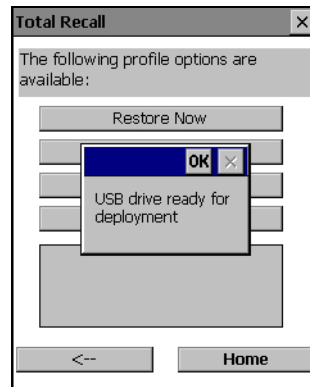

Autorun installation on next Workabout Prc

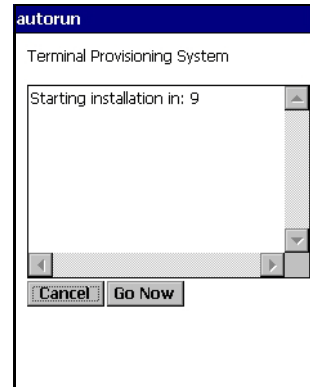

## Deleting a Profile

- In the *Total Recall* home screen, tap on **Delete Profile**.
- In the next screen, locate your backup file, and tap on **OK**.

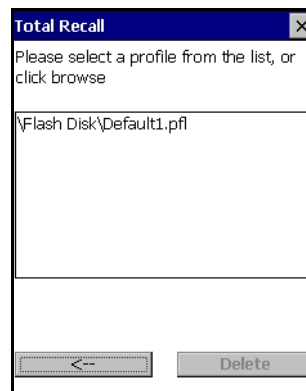

A warning pop-up screen appears asking if you're certain that you want to delete this file.

- Tap on **Yes** to delete the file.

---

## TweakIt



This utility allows you to tweak or adjust *Advanced* system settings (interface, network, servers, driver, and radio) and provides a *Registry Editor*.

## Advanced

### Advanced CE Services Settings



#### FTP Server

This option is enabled by default to allow file transfers. Keep in mind that data transfer in either direction is restricted to the Temp folder — that is, data are always loaded from the *FTP Server* to the *Temp* folder and from the *Temp* folder to the *FTP Server*.

If this option is disabled, a warm reset must be performed to accept the change.

### Advanced Interface and Network Settings

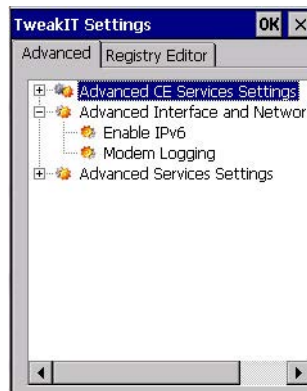

#### Enable IPv6

This option allows you to enable Internet Protocol specification, version 6, that has been published to enable 128-bit IP addresses (replacing version 4).

#### Modem Logging

When this option is enabled, the Workabout Pro4 logs AT commands (e.g., dial-out information, password string, etc.) that the administrator can monitor for debugging purposes. Modem commands are stored in: \\MdmLog.txt.

## Advanced Services Settings

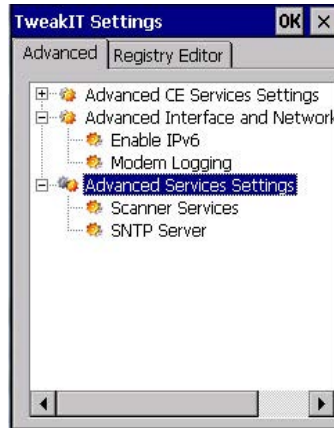

### Scanner Services

The *Scanner Services* option is used to disable DataWedge application and enable *Scanner Services* application.

### SNTP (Simple Network Time Protocol) Server

The *SNTP Server Name* typed in this dialog box is used to synchronize Workabout Pro4 time with the server time. A warm reset must be performed once the server name as been entered.

## Registry Editor

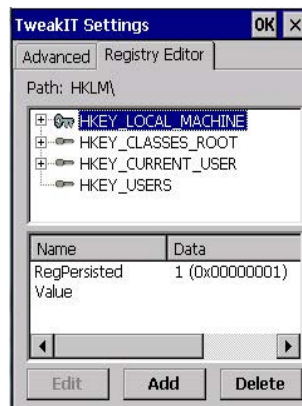

This option is reserved for senior administrators who have a strong understanding of registry keys and values.



**WARNING!** Careless registry editing can cause irreversible damage to the Workabout Pro4.

## Voice – Using the WWAN Phone Dialer

If the WWAN modem is installed and enabled, the *Phone icon* and the *GSM signal strength icon* will appear automatically on the taskbar.

- Double click on the **Phone icon** to access the phone dialer.

- ✓ **NOTE** On 55- and 66-key Workabout Pro4 keyboards, you can also press the [Talk] key to display the phone keypad providing it has been activated. The [Talk] key is labelled with a green telephone receiver icon. Refer to [Sending and Ending Calls Using the Workabout Pro4 Keyboard on page 3-60](#) for details.

You can also follow the steps below to access the phone dialer:

1. To access the dialer, tap on **Start>Settings>Control Panel**.
2. Tap on the **Wireless WAN icon**, and then tap on the **Voice** tab.

The *Voice* tab displays a phone dialer used to dial phone numbers. The *Voice* menu provides commands which allow you to manage your phone contacts, view your phone history, and so on.

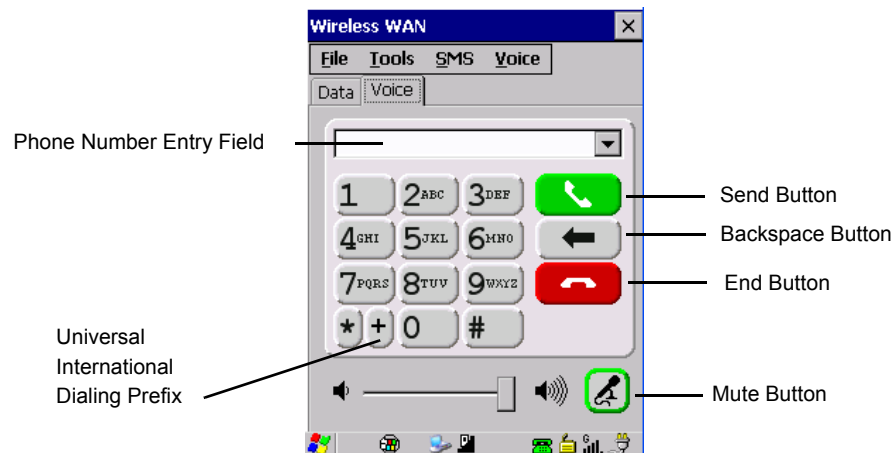

## Dialing a Number

To make a phone call:

- Type the recipient's phone number in the phone number entry field.
  - Send button** – tap to dial the number you typed.
  - Backspace button** – tap to erase characters in the phone number entry field.
  - End button** – tap to disconnect the phone call.
  - Mute button** – During a phone call, tap to mute sound transmission. Tap again to restore sound.
  - + button** – When making an international call, the + sign can be used as a universal substitute for any international dialing prefix and is guaranteed to work worldwide. The entry sequence must be as follows: **+ country code** followed by **phone number**.

*Example:* A standard phone number: 011 36 30 275 28466 using the + substitution is typed as follows: +36 30 275 28466

The + symbol replaces the universal dialing prefix 011.

## Sending and Ending Calls Using the Workabout Pro4 Keyboard

The 55-key and the 66-key Workabout Pro4 keyboards come equipped with phone keys — each has a [Talk] and an [End] key on the physical keyboard.



- Press the **[Talk]** key to answer a call or to display the onscreen phone keypad so you can initiate a call.
- Press the **[End]** key to terminate a phone call.

## Receiving an Incoming Call

To answer an incoming call:

- Tap on the **[Talk]** button; it's labelled with a *green* phone receiver.

## Voice Menu

This menu allows you to manage calls, view your call history, and if required, assign a call forwarding service to your hand-held.

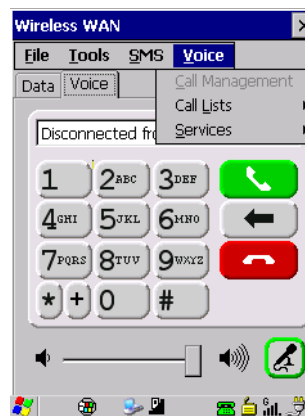

## Call Management

The *Call Management* option only becomes available in the *Voice* menu when at least one phone call is either *On hold* or *Active*. When you choose this command, the currently active phone call is listed in a dialog box.



Using the drop-down menu, you can choose to:

**Hang Up All Calls** - This option only appears when more than one call is listed.

**Hang Up** - This option disconnects only the call you've highlighted in the list.

**Hold** - This option places the call you've highlighted on hold.

**Retrieve** - This option is only available when a call is on hold, and choosing it retrieves the call you have highlighted from hold.

1. In the *Call Management* list, highlight the phone number to which you'd like to apply a command.

- Choose a command from the drop-down menu, and tap on **Execute** to carry out the command on the highlighted phone number.

If you have two active calls on your hand-held, one *On Hold* and one *Active*, you can set up a conference call between yourself and the other callers. To set up a conference call:

- Highlight the phone number that is currently *On Hold*, and choose **Retrieve**. Tap on **Execute**.

Both calls will be listed as *Active* in the *Call Management* list. All calls are now conferenced so that you as well as your callers can speak to one another.

## Call Lists

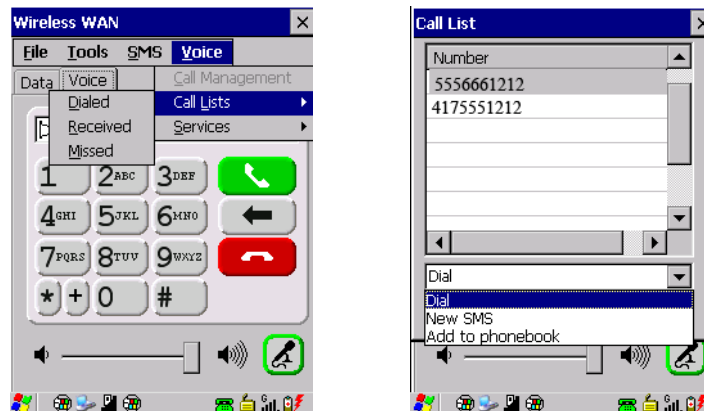

The *Call List* command manages your call history, listing calls you've *Dialed*, *Received* and *Missed*. When you choose one of these commands, a dialog box lists the phone numbers.

A drop-down menu provides a list of commands you can execute on a phone number in the *Call List*. You can choose to:

- Dial the number,
- Send a New SMS, or
- Add to phonebook to add the highlighted phone number to your phonebook. (Refer to [Phonebook on page 3-63](#) for details additional details about the Phonebook.)

In the *Call List*:

- Highlight the **phone number** with which you want to work.
- Choose a command in the drop-down menu.
- Tap on the **Execute** button to carry out the command.

## Services



The *Service* menu offers several options for your hand-held to customize the behaviour of your phone. You can, for example, bar incoming calls, tailor to whom your caller ID will be transmitted, set up call forwarding, and so on. If you choose an option, it may take a number of seconds for your unit to read the network settings.



**NOTE** Keep in mind that some services may not be supported by your network, or they may not have been subscribed to.

- Tap on the **service** you want to enable.

The *service* dialog boxes allow you to tailor your available services to meet your requirements.

### Voicemail Access

If your service includes *Voicemail*, choosing this option for the first time displays a screen in which you can enter your voice mail provider phone number.

## File Menu – Phonebook Management

Tapping on the *File* menu provides access to your *Phonebook*.

### Phonebook

The *Phonebook* allows you to store frequently used phone numbers. When no numbers have been added to your phonebook, the only command available to you is *New Entry*.



To add a new phone number to your phonebook:

- Choose *New Entry* in the drop-down menu, and tap on **Execute**.



- Type the name corresponding to the phone number you want to add.
- Press **Tab** and type the phone number you want to store.
- Tap in the check box next to *Store in SIM* to save the phone number there, or leave this check box blank if you prefer not to store the number on the SIM card.
- Tap on the **Execute** button to save the phone number in your *Phonebook*.

*Phonebook* entries are saved even after you exit Wireless WAN.

Once you've added a phone number to the *Phonebook*, a list of new commands is available in the drop-down menu.

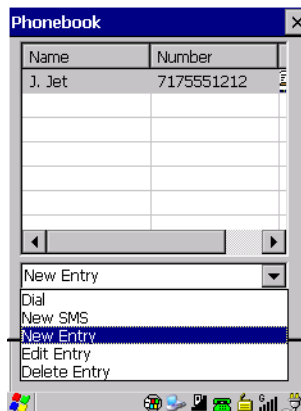

You can choose one of the following:

- **New Entry** to add another phone number,
- **New SMS (Short Message Service)** to send a new SMS,
- **Edit Entry** to change an existing name and/or phone number, *or*
- **Delete Entry** to erase an existing phone entry.

In the *Phonebook*:

- Highlight the entry with which you want to work.
- Choose a command from the drop-down menu, and tap on **Execute** to carry out the command.

---

## Volume & Sounds Properties

The Workabout Pro4 supports several audio options, including *Bluetooth*. The beeper is used for the standard sounds: key clicks, screen taps, and scanning. The optional rear speaker can be used for system (Windows) sounds and .wav files. When a rear speaker is absent, those sounds are routed to the front receiver.

- In the *Control Panel*, choose the **Volume & Sounds** icon.



## Volume Adjustments

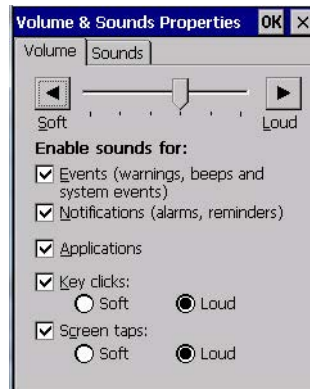

- Slide the volume button to the left to lower the volume or to the right to increase the volume.
- Under the heading *Enable sounds for*, enable the conditions under which you want the hand-held to emit a sound.

## Sound Adjustments



This dialog box allows you to assign sounds to identify particular actions. For example, you can choose the sound your hand-held will emit when you close a program and choose another sound for a failed scan, etc.

## Fusion Wireless Companion - Setting Up the 802.11a/b/g/n

- ✓ **NOTE** For information about setting up your radio using *Windows Wireless Zero Config*, refer to [Appendix F: Wireless Zero Config Settings](#).

Workabout Pro4 contains an integrated 802.11a/b/g/n radio module. The *Fusion Wireless Companion* software is used to configure the radio for one or more wireless network profiles. Each profile specifies the security parameters used to connect to a particular WLAN as identified by its Extended Service Set Identification (ESSID). The *Fusion Wireless Companion* software also allows the operator to control which profile out of a set of profiles is used to connect. Follow the steps in this section to help configure the radio in your unit.



**WARNING!** Due to regulatory requirements, this unit is set to **Enable 802.11d** by default. If your Access Point does not support this setting, your unit may not be able to properly connect to the network.

A network profile contains settings for SSID (Service Set Identifier) and security options.

- ✓ **NOTE** In most situations, the configuration of your 802.11 radio will require parameter setting and access keys from a network administrator.
- Tap on the **Fusion** icon at the bottom of the screen to display the *Fusion menu*. Alternately, you can tap on **Start>Programs>Fusion>Wireless Launch**.
- ✓ **NOTE** The Fusion setup example following uses *Open* encryption. Depending on what you choose, the setup may vary slightly.



The *Fusion Launcher* menu items and their corresponding applications are summarized in the table following.

Application	Description
Find WLANS	Displays a list of the WLANs active in the area.
Manage Profiles	Used to create new profiles and manage and edit existing profiles.
Manage Certs	Used to manage authentication certificates.
Manage PACs	Used to manage a list of Protected Access Credentials (PAC) used with Extensible Authentication Protocol-Flexible Authentication via Secure Tunneling (EAP-FAST) authentication.
Options	Provides options which allow the user to configure the Fusion option settings.
Wireless Status	Displays the status of the current wireless connection (view only).
Wireless Diagnostics	Provides tools with which to diagnose problems encountered with the wireless connection.
Log on/off	Displays the Network Login dialog box used to log on to a particular profile or to log off the currently active profile.
Disable/Enable Radio	Allows user to enable or disable the Fusion radio.

## Creating a New Profile



**IMPORTANT** The steps below describe how to manually create a network. Keep in mind that this is intended only as an *example* and may vary from your own network requirements. If, for example, you are using a different type of security for your network, the fields you complete may not match those described here.

- Tap on **Manage Profiles**.
- Tap and hold the stylus on the **Manage Profiles** window, and choose **Add** from the pop-up menu to display the *Wireless LAN Profile Entry* window.
- In the *Profile Name* dialog box, type a **name for the profile**
- In the *ESSID Profile ID* dialog box, type the **ESSID**.

The screenshot shows the 'Manage Profiles' window with the 'Profile Name' field selected. Below it, the 'Wireless LAN Profile Entry' window is open, showing 'Profile Name' and 'ESSID' fields, both containing the value '101'. The progress indicator at the bottom shows '1 of 7'.

- Tap **Next** to display the *Operating Mode* dialog box.

The screenshot shows the 'Manage Profiles' window with the 'Operating Mode' drop-down menu selected and set to 'Infrastructure'. The progress indicator at the bottom shows '2 of 7'.

- In the *Operating Mode* drop-down menu, choose **Infrastructure**. (Keep in mind that because the *Regulatory* option for this unit is set to *Enable 802.11d* by default, the operating mode is limited to *Infrastructure*.)
- Tap **Next** to display the *Security Mode* dialog box.

The screenshot shows the 'Wireless LAN Profile Entry' window with the 'Security Mode' drop-down menu set to 'Legacy (Pre-WPA)' and the 'Authentication Type' drop-down menu set to 'None'. The progress indicator at the bottom shows '3 of 7'.

- In the *Security Mode* drop-down menu, choose **Legacy (Pre-WPA)**.

✓ **NOTE** Each Authentication Type has a unique *configuration* screen attached to it with fields appropriate to the authorization type you've chosen.

- In the *Authentication Type* drop-down menu, choose **None**.
- Tap **Next** to display the *Encryption* dialog box.



✓ **NOTE** Each Encryption Type has a unique *configuration* screen attached to it with fields appropriate to the encryption type you've chosen.

- Choose an **Encryption Type** from the drop-down menu.
- Tap **Next** to display the *IPv4 Address Entry* dialog box.



- Ensure that all three items are checked. Tap on **Next**.

✓ **NOTE** These *IPv4 Address Type* options are enabled (checked) by default. If you deselect one or more of them, additional dialog boxes are displayed where you can specify the IP Address, Subnet Mask, Preferred Gateway and Alternate Gateway.

- Tap **Next** to display the *Battery Usage* dialog box, and choose a power consumption option.

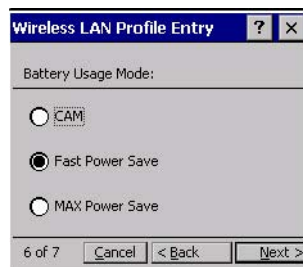



- Tap **Next** to display the *Performance Settings* dialog box, and choose one of the performance options.

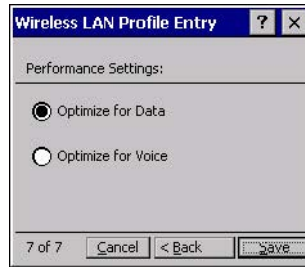

- Tap **Save**.

## Launching an Existing Profile

Your configured network profiles are listed in the *Manage Profiles* screen.

- To activate a profile in the *Manage Profiles* screen, tap and hold the stylus on the profile you want to launch.
- In the drop-down menu, choose **Connect**.

## Resetting the Radio to Default Factory Settings

Resetting your unit, including a clean start, will not return the radio settings to the default values. To reset the radio to factory settings:

- Tap on the **Fusion** icon in the taskbar to display the *Fusion menu*.
- Choose **Options**.
- In the drop-down menu, choose **Data Management**. Tap on the **Reset Options** button and **Reset Data-store** button, and tap on **Save**. Close the window.
- Press and hold down the **[FN/BLUE]** and **[Power]** button to perform a *warm reset*.

## Monitoring the Network Connection

To view the radio signal:

- Tap on the **Fusion** icon in the taskbar, and choose **Wireless Status** from the menu.

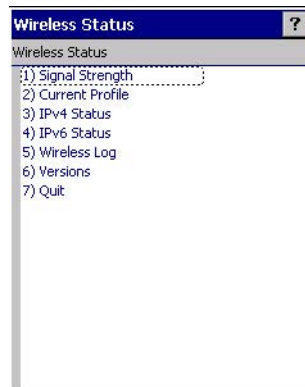

**NOTE** Moving in and out of the radio coverage area can have varying effects on a network session. At times, you may need to renew your connection connecting again.



# CHAPTER 4 PERIPHERAL DEVICES & ACCESSORIES

## Carrying Accessories

There is a variety of carrying accessories to help the operator work safely and comfortably with the Workabout Pro4.

Carrying Accessory	Model Number
Hand Strap - 7528 Long	WA6025
Hand Strap - 7528 Short	WA6125
Shoulder Strap for carrying case	CV6021
Carry Case -7528 Long Standard	WA6080
Carry Case - 7528 Long with universal end-cap - open ended	WA6081
Carry Case - 7528 Short Standard	WA6180
Carry Case - 7528 Short with universal end cap - open ended	WA6181
Rubber Boot - 7528 Long with GSM	WA6400
Rubber Boot - 7528 with SE1524ER laser end-cap	WA6402
Soft Holster and Belt - for use with pistol grip	WA6083
Pouch Nylon with metal swivel and belt loop	WA6084
Pistol Grip for slim pod	WA6003
Pistol Grip - Flush Mount for SE1524ER laser and other end cap scanners	WA6103



**IMPORTANT** Do not use adhesives such as Loctite to secure screws on carrying accessories. These chemicals may damage the plastic casing.

---

## Attaching the Hand Strap

The hand strap can be attached to the back of the Workabout Pro4 to provide a secure means for operators to carry the hand-held.

The hand strap is attached to the back of unit using two Phillips head screws provided with this accessory.

- Use a Phillips screwdriver to attach the strap to the two threaded inserts on the back of the Workabout Pro4, near the top of the unit.

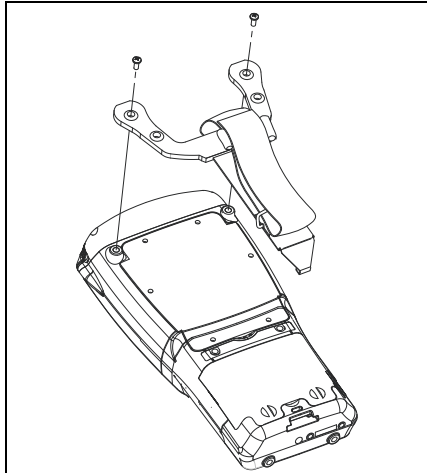

- Stretch the hand strap toward the base of the Workabout Pro4, and hook the bottom of the strap into the slot near the base of the battery pack. A tethered stylus and optional external stylus tube can be attached to the hand strap as illustrated below

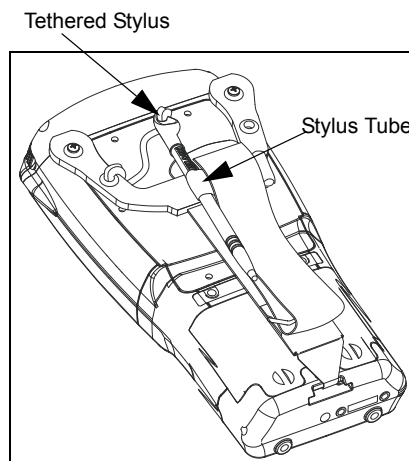
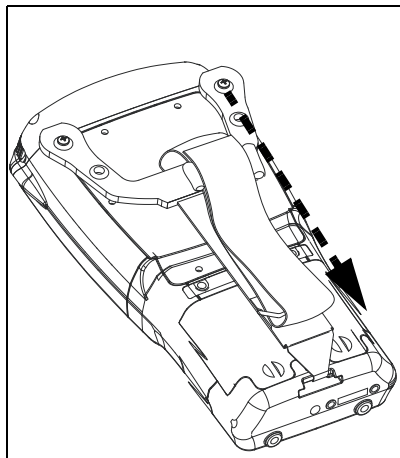

---

## Attaching the Pistol Grip

There are a number of pistol grips available to you depending on the type of scanner/imager installed in your hand-held. Refer to the table in [Carrying Accessories on page 4-1](#) for a list of pistol grip model numbers and the scanners/imagers with which they are compatible.



**NOTE** The few steps required to attach the pistol grip to the Workabout Pro4 are common to all types of pistol grips. However, if you plan to use the Flush Mount Pistol Grip (WA6103), you'll need to install a special trigger back plate before following these steps to attach the pistol grip. Refer to [The Trigger Back Plate Kit with Flush Mount Pistol Grip](#) on page 4-3.

The pistol grip is attached to the four threaded inserts on the back of the Workabout Pro4. Four Phillips head screws are provided with this accessory.

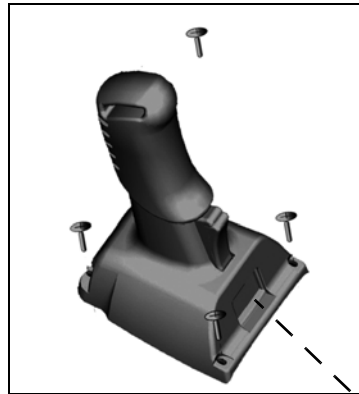

**NOTE** Prior to installation, make sure the trigger mechanism is securely snapped into the pistol grip body and that the trigger operates properly.

- Position the pistol grip so that it fits snugly over the back of the unit and the holes in the pistol grip are aligned with the threaded inserts on the back of the Workabout Pro4.
- Tighten the screws to a torque of 3 lbs-in (3 kgf-cm) to secure the pistol grip in place.
- Insert the stylus in the base of the pistol grip.

## The Trigger Back Plate Kit with Flush Mount Pistol Grip

The trigger back cover kit, model number WA9301, provides a special back cover that incorporates a scanner interface board and a switch; and triggers the SE1524ER long range laser, model number WA9022. WA9301 is required for WA9022 to function (with or without a pistol grip). This kit is also compatible with the Flush Mount Pistol Grip, model number WA6103.

The trigger back cover kit, model number WA9302, provides a special back cover that incorporates a scanner interface board and a switch. This kit enables a pistol grip to trigger the following end cap scanners for the Workabout Pro 4:

Model Number	End-Cap
WA9016	SE965 end-cap
WA9018	SE655 end-cap
WA9020	SE4500 end-cap

The pistol grip is available separately from this kit as model number WA6103.



**WARNING!** The installation of this scanner/imager end-cap must be performed using the appropriate anti-static devices. If unavailable, discharge static from your body by touching a grounded metallic object before opening any covers on the unit.



**WARNING!** The use of optical instruments with this product will increase eye hazard. This product may contain a laser scanner that emits less than 1.4 mW maximum radiant power at a wavelength of 650 nm. This product complies with CRH 21 CFR 1040 Class II and IEC 60825-1:1993+A1:1997+A2:2001 Class 2 laser product.

### Before You Begin



**WARNING!** Back up any data in RAM before you begin.

### Installing the Back Plate

If your unit is using AC power, disconnect it.

- Remove the stylus from the end-cap.
- Remove the battery pack.
- Loosen the four screws securing the end-cap, and remove the end-cap.
- Unlatch the two connectors on the interface board on the new back plate.

Figure 4-1

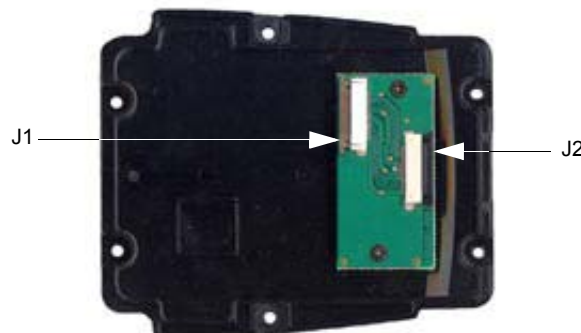

- Position the lower end of the new back plate next to the back opening of the unit.

- Insert the flex cable from the end-cap into J2 on the interface board. The contacts on the flex cable face towards the interface board.

**Figure 4-2**

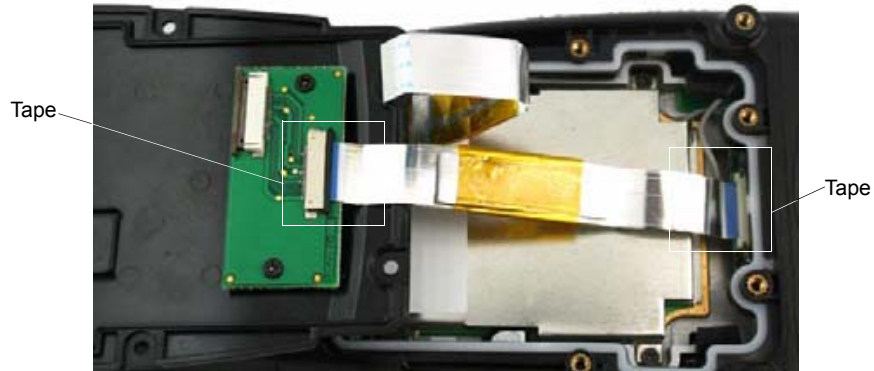

1. Latch the connector.
2. Flip the back plate upwards.
3. Insert the flex cable from the Workabout Pro4 main logic board into J1 on the interface board. The contacts on the flex cable face towards the interface board.
4. Latch the connectors.
5. Cut the Kapton tape square provided in two equal pieces.
6. Remove the Kapton tape from the release liner. Apply one piece over the end of the flex cable and the imager's flex connector. Apply the other piece over the other end of the flex cable and the back plate flex connector, as shown in [Figure 4-1](#) . This secures the flex cable at both ends.
7. Turn the back plate over.



8. Fasten the new back plate onto the Workabout Pro4 using the supplied screws (PN 9009770).



9. Insert the battery, and install the battery compartment cover.

### Installing the Flush Mount Pistol Grip

The Flush Mount Pistol Grip, model WA6103, is intended for use with Workabout Pro4 units (7528 Long and 7528 Short) which have the Trigger Back Plate installed. Review the first few paragraphs at the beginning of [The Trigger Back Plate Kit with Flush Mount Pistol Grip on page 4-3](#) for a list of compatible scanners/imagers.



**IMPORTANT** Back up any data in RAM before you begin.

1. If your unit is using AC power, disconnect it.
2. Remove the battery cover and battery pack.
3. Remove the screw-on cap, if present, from the switch in the middle of the back plate.

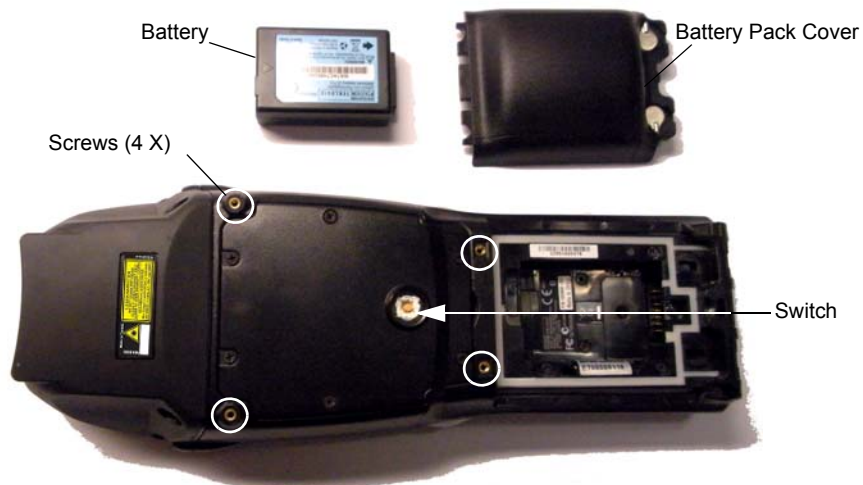



4. Lower the Flush Mount Pistol Grip into place over the back plate, aligning the screw inserts on the hand-held with the screw holes in the pistol grip.



5. Insert and tighten the four screws provided with the pistol grip.
6. Replace the battery and battery cover.
7. Insert the stylus in the bottom of the pistol grip handle.

---

## Protective Carrying Case

A carrying case is available for the Workabout Pro4 to shield the unit from damage. It is equipped with a soft plastic window to protect the unit display and keyboard. A variety of cases are available, depending on the type of end-cap attached to your unit.

---

## Soft Shell Holster

A soft shell holster with removable belt and swivel holster pad can be used to hang a Workabout Pro4 with a pistol grip from your waist.

Figure 4-3 Soft Shell Holster



- Insert the belt in the swivel holster pad.
- Attach the pad on either the left or right side of the holster case, depending on whether you are left- or right-handed.
- Fasten the belt comfortably around your waist. Slide the adjustable ring on the belt to tighten the holster in place.
- Connect the safety tether cord to one of the clips on the bottom of the soft shell holster. Connect the other end to the hole in the end of the Workabout Pro4 pistol grip. This tether will catch the unit in case of a drop. The tether can be adjusted to the operator's height. The clips will break away in case of a severe force.

---

## The Battery

✓ **NOTE** Review [Appendix E: Workabout Pro4 Specifications](#) for details.

The Workabout Pro4 will operate with the following Lithium-Ion battery packs:

- 4400 mAh battery pack (Model Number WA3010)
- 2850 mAh battery pack (Model Number WA3025)
- 4680 mAh battery pack (Model Number WA3026)

## Adaptor Cable Options

The following adaptors can be ordered for your Workabout Pro4:

Adaptor Cable Description	Model Number
Tether to USB A cable. This cable is used to connect USB devices such as USB Flash memory devices.	WA1002
Tether to Dsub9 converter Cable	WA4020-G2
USB to Ethernet adaptor.	WA4071
RS232 adaptor for single bay USB cradle WA4003-G2.	WA4015-G1

## Chargers and Cradles



**IMPORTANT** Keep in mind when ordering a charger or cradle, you must also order the appropriate power cord separately.

Zebra offers a variety of chargers and cradles for the Workabout Pro4. These include:

- AC Adaptor – Model No. PS1050-G1
- Automotive Adaptor – Model No. WA3113-G2
- Single Bay USB Cradle – Model No. WA4003-G2
- Single Bay Cradle for 7528 Long – Model No. WA4204-G2
- Four Bay Ethernet Cradle for 7528 Short – Model No. WA4304-G2
- Four Slot Battery Charger with AC Adapter 110-240V - no lead – WA3004-G1
- Port Replicator – Model No. WA4005-G1
- Powered Vehicle Cradles – Model Nos. WA1210-G2 and WA1310-G2
- CLA (5V DC Jack) – Model No. PS3050

### Installation – Chargers and Cradles

When installing a charger or cradle, consider the following guidelines.

- Keep chargers and cradles away from excessive dirt, dust and contaminants.
- Chargers will not charge batteries outside an ambient temperature range of 0° C to 45 °C (32° F to 113° F). It is recommended that the charger or cradles be operated at room temperature – between 18° C and 25° C (64° F to 77° F) for maximum performance.

After unpacking your unit:

- Visually inspect the charger for possible damage.
- Install the IEC power cord and apply power.

### Power Consumption Considerations

Check to ensure the mains circuit supplying chargers and/or cradles is adequate for the load, especially if several chargers and cradles are being powered from the same circuit.

- Four Slot Battery Charger – can consume up to 2A @ 120VAC or 1A @ 240VAC.
- Four Bay Ethernet Cradle – can consume up to 3A @ 120VAC or 1.5A @ 240VAC.

### Operator Controls

Workabout Pro4 cradles and chargers have no operator controls or power switches.

### Important Charger Safety Instructions

- **SAVE THESE INSTRUCTIONS** – This manual contains important safety and operating instructions for battery chargers.
- Before using the battery charger, read all instructions and cautionary markings on (1) battery charger, (2) battery, and (3) product using battery.
- The mains power cord shall comply with national safety regulations of the country where the equipment is to be sold.
- Use of an attachment not recommended or sold by the battery charger manufacturer may result in fire, electric shock, or personal injury.
- To reduce risk of damage to the electric plug and cord when unplugging the charger, pull the plug rather than the cord.
- Make sure the cord is positioned so that it is not stepped on, tripped over, or otherwise subjected to damage or stress.
- Do not operate the charger with a damaged cord or plug. Replace immediately.
- Do not operate the charger if it has received a sharp blow, been dropped, or otherwise damaged in any way; it should be inspected by qualified service personnel.
- Do not disassemble the charger; it should be repaired by qualified service personnel. Incorrect reassembly may result in electric shock or fire.
- To reduce risk of electric shock, unplug the charger from the outlet before attempting any maintenance or cleaning.
- An extension cord should not be used unless absolutely necessary. Use of an improper extension cord could result in fire or electric shock. If an extension cord must be used, make sure:
  - The plug pins on the extension cord are the same number, size and shape as those on the charger.
  - The extension cord is properly wired and in good electrical condition and that the wire size is larger than 16 AWG.
- Do not expose the charger to rain or snow.
- Do not place batteries in the charger if they are cold from extended exposure to a freezer or outside temperatures below 10°C (50°F). Allow them to warm up to room temperature for at least two hours.
- Do not use the charger if, after an overnight charge, any of the batteries feel warmer than the charger housing. The charger should be inspected by qualified service personnel.
- Do not use the charger if any of the batteries or the charger get more than lukewarm. The equipment should be inspected by qualified personnel.

---

### Single Bay USB Cradle

The Workabout Pro4 can be inserted in a single bay USB cradle, model number WA4003-G2.

Figure 4-4 Single Bay USB Cradle

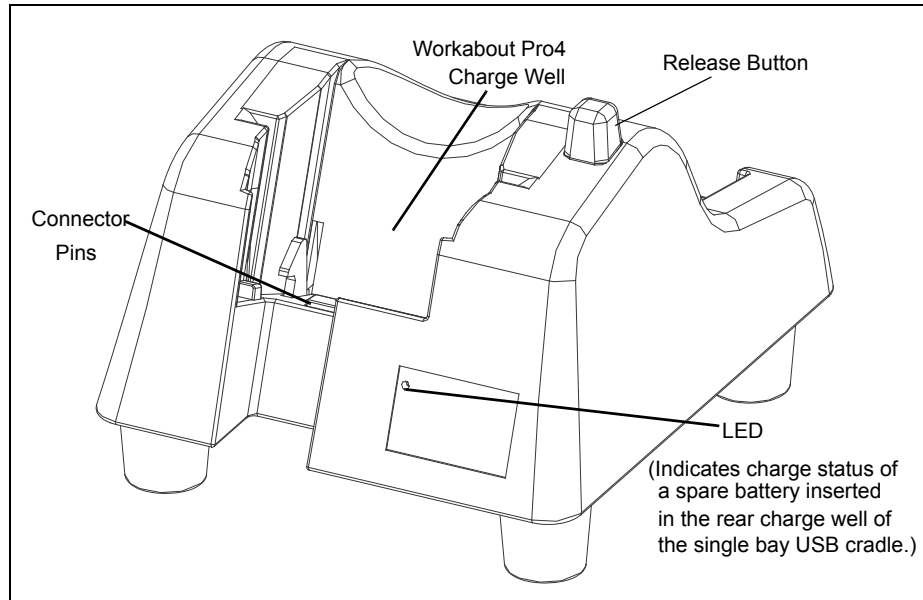

**NOTE** The single bay USB cradle is shipped with its own user manual. It is critical that it be reviewed for additional information and updates.

Figure 4-5 Back Of Single Bay USB Cradle

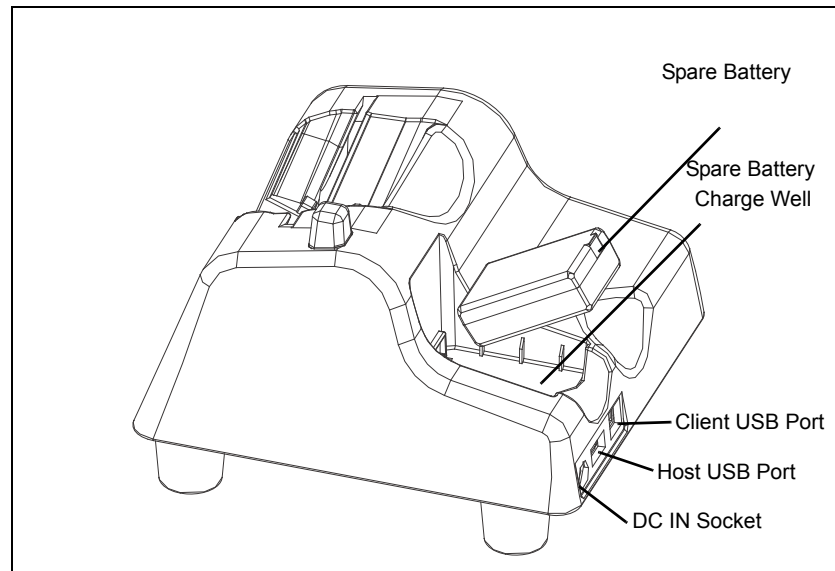

**IMPORTANT** This single bay USB cradle can only be used to charge Zebra approved Lithium-Ion batteries.

## Charging a Battery Installed in the Workabout Pro4

**CAUTION**  
**RISK OF EXPLOSION IF BATTERY IS REPLACED**  
**BY AN INCORRECT TYPE.**  
**DISPOSE OF USED BATTERIES ACCORDING**  
**TO THE INSTRUCTIONS.**

- Insert the DC power cable to the DC IN socket on the single bay USB cradle. Plug the pronged end of the cable into an AC outlet.
- Slide the hand-held into the cradle, making certain that the LIF (Low Insertion Force) port on base of the Workabout Pro4 is securely seated on the cradle connector pins. An icon is displayed briefly in the navigation bar at the top of the hand-held screen indicating that the unit is properly installed in the station – .

The LED on the Workabout Pro4 lights up indicating that the unit has external power and battery charging will begin. It is safe to leave the unit in the single bay USB cradle while it is not in use – the battery will not be overcharged.

## Charging a Spare Battery

- Insert the battery in the spare battery charge well at the back of the single bay USB cradle, aligning the contacts on the battery with the contacts in the spare battery charge well.

## Battery Charge Duration

A fully discharged battery can take up to 5 hours to charge. The single bay USB cradle stops applying power to the battery when it is fully charged – there is no risk of overcharge if the battery remains in the charge well.

## Charger LED Indicators

The single bay USB cradle is equipped with a single dual-coloured LED indicator in the lower-right corner of the front panel.

LED Behaviour	Charge Status
Off	No battery detected in the slot.
Solid Green	Charge complete.
Fast Flashing Green	Battery charged to less than 80% of capacity.
Slow Flashing Green	Battery charged to greater than 80% of capacity.
Solid Red	Battery temperature outside of charge range – 0° C to 50 °C.
Flashing Red	Battery is not charging. Battery fault.



**NOTE** Battery charging continues whether the hand-held is switched on or off.

## Troubleshooting the Charging Operation of the Cradle

The [Four Bay Ethernet Cradle – WA4204-G2 & WA4304-G2 on page 4-14](#) LED operation also applies to the charging behaviour of the single bay USB cradle.

---

## Linking a Workabout Pro4 to a PC

The desktop single bay USB cradle can be connected to a PC so that you can exchange files in the same way that you would between PC drives. A USB cable is included with your single bay USB cradle.



**NOTE** For details about data transfer through Windows XP and ActiveSync and through Vista, refer to [Data Transfer between Workabout Pro4 and a PC on page 3-17](#).

To link the Workabout Pro4 to a PC:

- Insert the hand-held in the single bay USB cradle.
- Insert the USB cable into the cradle Client USB connector. Attach the other end of the cable to a USB port on the PC.

---

## Linking a Workabout Pro4 to an Ethernet Network

An USB-Ethernet adaptor cable – model number WA4010-G1 – is used to connect the Workabout Pro4 to an Ethernet network through a single bay USB cradle.

**Figure 4-6** *USB-Ethernet Adaptor Cable*



- Insert the adaptor's USB connector into the Host USB port on the single bay USB cradle.
- Connect your network Ethernet cable to the Ethernet port on the adaptor cable.

### Network Access

The hand-held unit automatically detects insertion into the cradle and loads the appropriate drivers to communicate with the USB-Ethernet converters.

#### Network Addressing

The host application uses standard TCP/IP protocol to name, locate and communicate with a specific Workabout Pro4 on the network. If a link is established between a Workabout Pro4 and a host, the application on the host and on the hand-held must have a recovery mechanism in the event that the Workabout Pro4 is removed from the cradle, interrupting the link.

---

## Troubleshooting the Single Bay USB Cradle Operations

The indicators, applications and drivers required to use and monitor the single bay USB cradle as a dock (as opposed to a charger) are installed on the Workabout Pro4 – no applications are present on the cradle itself.

---

## AC Wall Adaptor – Model #PS1050-G1

The AC wall adaptor available for your Workabout Pro4 allows you to operate your hand-held using AC power while charging the battery inserted in the unit.

Adaptor plugs suitable for use in the following countries are shipped with the AC wall adaptor: United Kingdom, Australia, Europe and North America.



- Choose the adaptor plug that is suitable for use in your country. Slide the adaptor plug into the Universal AC power supply, snapping it into place. These two pieces, coupled together, are referred to as an AC wall adaptor.
- Insert the DC power plug into the DC IN socket at the base of Workabout Pro4, located between the tether and LIF ports.
- Plug the pronged end into an AC outlet.

---

## Four Bay Ethernet Cradle – WA4204-G2 & WA4304-G2

Figure 4-7 Four Bay Ethernet Cradle



**NOTE** WA4204-G2 is designed for Workabout Pro4 Long models; WA4304-G2 is designed for Workabout Pro4 Short models.

The four bay Ethernet cradle is shipped with a manual. It is critical that this manual be reviewed for additional information and updates.



The four bay Ethernet Cradle permits each of four docked Workabout Pro4s to communicate with a 10/100 BaseT Ethernet network at greater than 2Mbps. It also provides sufficient power to operate and fast charge the batteries in the units.

## Four Bay Ethernet Cradle Setup

After unpacking the unit:

- Visually inspect the unit for any damage.
- Install the IEC power cord and apply power.

A green indicator in the lower-right corner of the front panel lights up to indicate that power is present.

- Attach a CAT5 RJ45 network patch cable (supplied) between your network and the RJ45 jack on the rear of the cradle.

A green LED is illuminated next to the RJ45 connector when a valid network link is established.

A user application must be loaded onto each Workabout Pro4 that utilizes the cradle for communication. When the network is connected and this application is loaded, the cradle is ready for use.

## Four Bay Ethernet Cradle Indicators

The four bay Ethernet cradle is equipped with a power indicator LED and RJ45 link and traffic indicator LEDs. When a valid network link is established, a green LED is illuminated next to the RJ45 connector.

## Inserting a Workabout Pro4 in the Four Bay Ethernet Cradle

- Slide the unit into the cradle portion of the four bay Ethernet cradle until lightly latched.

The hand-held detects that it is in a four bay Ethernet cradle and momentarily displays the appropriate icon in the navigation bar at the top of the screen – . The LED on the hand-held unit lights up to show it has external power and may start charging the battery.

Interaction with the Workabout Pro4 while in the four bay Ethernet cradle is a function of the user application software used to communicate with the host network.

## Network Access

The four bay ethernet Cradle has one 10/100 Ethernet port. You can insert up to four hand-held units. The hand-helds are connected to an internal USB hub. The hand-held unit automatically detects insertion into a four bay Ethernet cradle and loads the appropriate drivers to communicate with the USB/Ethernet converters.

### Network Addressing

Although the USB converters have fixed Ethernet MAC addresses, there is generally no correlation between these addresses and a specific hand-held. The host application uses standard TCP/IP protocol to name, locate and communicate with a specific Workabout Pro4 on the network.

If a link is established between a Workabout Pro4 and a host, the application on the host and on the hand-held must have a recovery mechanism in the event that the Workabout Pro4 is removed from the cradle and the link is interrupted.

## Battery Charging – LED Behaviour

The four bay Ethernet cradle supplies DC power to enable the Workabout Pro4 internal fast charger. Charge status is displayed on the hand-held LED – the LED turns red while the battery is being charged and turns green once the charge is complete. If the battery is fully charged when the unit is inserted in the cradle, the

LED flashes red for less than a second and then turns green. Battery charging continues whether the Workabout Pro4 is switched on or off.

It can take up to 4 hours to fully charge the internal battery.

### Troubleshooting

The indicators, applications and drivers required to use and monitor the cradle are installed on the Workabout Pro4 – no indicators or applications are present on the cradle itself.

#### Network Link Unsuccessful

If a network link fails, the Workabout Pro4 application alerts the operator that the link was unsuccessful.

#### Hand-Held LED does not Light when Docked

- Check that the four bay Ethernet cradle has power – is the Power LED on the cradle illuminated?
- Try inserting the Workabout Pro4 in another well in the cradle.
- Check for dirt or contamination on the docking contacts at the bottom of the Workabout Pro4. Wipe the contacts with a damp cloth if necessary.
- Check the pogo pins inside the cradle for dirt. Gently wipe with a damp cloth if they appear to be dirty or discoloured.
- Check that the pogo pins are not bent or damaged.
- Remove and reinsert the Workabout Pro4 in the cradle, and check that the latch is holding the unit in place (the pogo pins must be compressed for proper contact).
- Make certain that the battery installed in the Workabout Pro4 is not defective.

---

## Four Slot Battery Charger

The four slot battery charger is designed to charge up to four Lithium Ion batteries at one time.



### Charging the Battery

- Slide the battery into a charge well, aligning the contacts on the battery with the contacts in the charge well.

### Battery Charge Duration

A fully discharged battery can take up to 4 hours to charge. The four slot battery charger stops applying power to the battery when it is fully charged – there is no risk of overcharge if the battery remains in the charge well. The 75% charge indicator is handy if you need a quick recharge – a quick charge often takes less than one hour.

## Charge Indicators – The LEDs

Each battery charge well is equipped with an LED to indicate the charge status of the battery. When a battery is inserted in the charger, the colour and behaviour of the LED associated with the charge well in use indicates the status of the charge. Refer to the table below the heading [Charger LED Indicators on page 4-12](#) for details.

## Troubleshooting

### Excessive Charge Duration

The charger is equipped with a recalibration function – a function that fully discharges and then fully recharges the battery. This process is necessary to recalibrate the battery capacity gauge internal to the battery. The charger attempts recalibration when:

- the battery capacity is at less than 30%, *and*
- the battery has undergone more than 40 partial charge cycles since the last full discharge.

### Indicator Flashing Red

If the indicator flashes red:

- Remove all batteries and disconnect the mains power cable.
- Wait at least 20 seconds, and then plug the cable in again.

If any of the charge well LEDs continue to flash red, the charger is defective and requires service. If all indicators are flashing red, there is a power supply problem and the charger requires service.

### Power LED Does Not Light Up

- Remove all batteries, and unplug the charger.
- Connect another device to the mains outlet to ensure there is power.
- Remove the IEC mains power cable from the charger, and check it for damage.
- Reconnect the mains cable in the charger and mains outlet.

If the power LED still does not light up:

- Unplug the mains cable, and check the fuse at the rear of the charger.

If the fuse appears to be intact, the charger requires service.

### Indicator Does Not Light When Battery Installed

- Remove the battery, and clean the contacts on the battery and the charge well.
- Reinstall the battery, and check that it is fully seated in the charger well.
- Inspect the charge well contacts for damage (are they bent, flattened, twisted or broken).
- Try inserting a battery that you know to be working in the charger well.
- Reconnect the mains power cable, and check that the charger well indicator flashes at power up.

---

## The Vehicle Cradle

The vehicle cradle is a highly ruggedized, single station dock. Although it provides quick insertion and removal, the cradle holds the Workabout Pro4 securely even when operated in high vibration environments.

The model number for vehicle cradles varies depending on the type of hand-held:

- Workabout Pro4 Long
- Workabout Pro4 Short

A port replicator option is available for powered vehicle cradles. Refer to [The Port Replicator on page 4-20](#) for details.

### Vehicle Cradle Mounting Recommendations



**IMPORTANT** Shock and vibration specifications for the Workabout Pro4 are verified using Zebra-approved RAM mounts and mounting hardware. Use of non-certified Zebra mounting hardware is not recommended, and may void warranty coverage.

Before mounting a vehicle cradle in a vehicle, there are a number of operator safety issues that require careful attention. An improperly mounted cradle may result in one or more of the following: operator injury, operator visibility obstruction, operator distraction and/or poor ease of egress for the operator. Zebra strongly recommends that you seek professional mounting advice from the vehicle manufacturer.

Cable routing within a vehicle cab also requires careful consideration, especially for separately tethered scanners and other devices with loose cables.

Note also that for better protection, the equipment should be mounted inside the vehicle roll cage.

Pedestal mounts are recommended for all fixed mount locations because they offer optimal operator access. In addition, for safety reasons, only pedestal mounts with fully locking joints should be used in vehicles. Always adjust the pedestal for the optimum viewing angle, and securely tighten the hex and wing screws.

The most effective way to mount the vehicle cradle is to use the four #8-32 threaded inserts on the rear of the unit. Bolts must not extend more than 10mm (3/8") into the cradle.

To accommodate the service loop of the connector cable, leave a 4" clearance at the bottom of the cradle. Leave a 7" (minimum) clearance at the top of the cradle to allow easy removal of the hand-held. Also remember to leave at least a 3" clearance at the sides of the cradle to allow activation of the release knobs. Refer to the detailed assembly instructions that are packaged with the cradle when selecting a mounting location.

---

## Mounting Template

The vehicle cradle is shipped with detailed mounting instructions including a drill template.

---

## Wiring Guidelines

Before installing cables between the cradle and other devices, review the following:

- Ensure that drilling holes will not damage the vehicle or its wiring.
- Protect cable runs from pinching, overheating and physical damage.
- Use grommets to protect cables that pass through metal.
- Use plastic straps and tie-downs to secure cables and connectors in their desired location, away from areas where they may get snagged or pulled.
- Keep cables away from heat sources, grease, battery acid and other potential hazards.
- Keep cables away from control pedals and other moving parts that may damage the cables or interfere with the operation of the vehicle.

---

## Using the Vehicle Cradle

If your Workabout Pro4 is equipped with a shoulder strap or cover, these accessories need to be removed before installing the unit in a vehicle cradle. There is no need to remove hand straps, pistol grips or tethered devices from the unit.

- Slide the Workabout Pro4 into the cradle, and press firmly downward until it locks into place. On a vehicle, it's a good idea to pull up on the Workabout Pro4 to be certain that it is secure.
- To remove the unit, press firmly on the RELEASE button on the front face of the unit until it releases from its latch. The hand-held will be slightly raised so that it can be removed.

---

## Maintaining the Vehicle Cradle

Two latches in the cradle hold the Workabout Pro4 firmly in place. Although these latches are designed for robustness and endurance, they will wear over time and will no longer lock the hand-held securely in the cradle. For replacement parts and instructions contact Zebra. Partial disassembly is required.

---

## Powered Cradle Installation in High Voltage Vehicles

Voltages exceeding 60VDC are considered hazardous. For powered cradle installations on vehicles with batteries above this voltage, ensure the powered cradle power connector is mounted in a dry location on the vehicle, or that the connector is insulated with an appropriate waterproof material after installation. The connector must also be installed out of the vehicle operator's reach. Exposing an accessible power connector to water or other liquids could create a hazardous situation resulting in serious injury or death.

Installation of powered cradles in vehicles that operate above 60VDC require special consideration.

Due to the hazardous voltages present on these vehicles, it is necessary to ensure that the powered cradle power supply cable connector is not accessible to the vehicle operator, and does not get exposed to water or other liquids. This can be accomplished in one of the following ways:

- Ensure the power connector is installed in a dry location on the vehicle, away from the vehicle operator's reach (perhaps under a vehicle dash or in a sealed housing).
- Cover the power connector with a waterproof heat shrink material.
- Wrap the connector securely with a waterproof electrical tape in an area out of the vehicle operators reach.

All other installation requirements outlined in this document should also be followed for High Voltage vehicles to insure safe installation and operation of the powered cradle.

---

## Powered Vehicle Cradle Installation

The powered cradle is designed to allow the Workabout Pro4 to be powered by a vehicle battery. The battery installed in the hand-held is also recharged by the vehicle battery. This option accepts DC power sources ranging from 9 to 20V, with optional pre-regulator.

The vehicle cradle can be ordered with the powered cradle option installed.

Applying a voltage greater than that specified or reversing or reversing polarity may result in permanent damage to the cradle power option and will void the product warranty.

## Wiring Vehicle Power to the Cradle

An optional 1.8 meter (6 foot) extension power cable (CA1210) compatible with your powered vehicle cradle can be purchased from Zebra. This optional cable should be wired to a filtered, fused (maximum 10A) accessory supply on the vehicle. The power cradle draws no more than 8A (less if the accessory supply is greater than 12V). Any additional wiring, connectors or disconnects used should be rated for at least 10A.

The red lead of the power cable attaches to the positive vehicle supply. The black lead connects to the negative supply – this should be connected to a proper terminal block and not to the vehicle body. The power cradle is fully isolated and can be used with both negative and positive chassis vehicles.

You may have the option of connecting power before or after the ‘key’ switch. It is preferable to wire the power cradle after the key switch – that is, it cannot be turned on without the key on. However, if the operator switches the key off repeatedly for long periods during a shift, it may make more sense to wire the cradle before the switch.

A car lighter adaptor (CA3002) is another option to power the vehicle cradle.

Keep in mind that the Workabout Pro4 will continue to operate with or without vehicle power as long as its battery has sufficient charge.

If an unfused power source must be used, a fuse assembly (PN 19440) must be added to the extension power cable (the fuse and instructions are supplied with the cable). Use only a 10A slow blow UL approved fuse in the fuse assembly.

---

## The Port Replicator

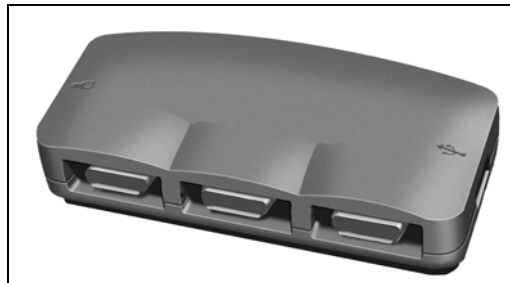

The port replicator (Model# WA4005-G1) is an optional accessory that allows tethered devices as well as mounted peripherals (e.g., bar code printers or weigh scales) to be attached to the vehicle cradle. The replicator can be used with or without the cradle power option.

The functionality of the Workabout Pro4 tether port is replicated into RS-232 serial interfaces by the port replicator. It provides the user with 3 DB9 serial interfaces as well as one Type B USB port (for connecting a Host device).

---

## Scanners and Imagers

The Workabout Pro4 supports a wide range of scanner/imager options to address a variety of user application requirements. Refer to [Appendix B: Imager & Camera Settings](#) and [Appendix C: Scanner Settings](#) for details about configuring the unit installed in your hand-held.

Scanners/imagers available for your hand-held include:

Scanner/Imager	Description
SE4500	1D/2D imager
SE965	1D laser scanner
SE655	1D imager
SE1524	1D laser scanner

It is critical that you review the safety information in the *Workabout Pro4 Hand-Held Computer Regulatory & Warranty Guide*, PN 8000296, before proceeding.

## Scanning Techniques

For helpful hints, refer to [Scanning Techniques on page 2-10](#).

- Hold the scanner at an angle. Do not hold it perpendicular to the bar code.
- Do not hold the scanner directly over the bar code. In this position, light can reflect back into the scanner's exit window and prevent a successful decode.
- Scan the entire bar code. If you are using a 1D or PDF laser scanner, make certain that the scan beam crosses every bar and space on the bar code, including the margins on either end of the symbol.
- If you are using a 2D imaging scanner, make certain the red, oval shaped framing mark is centred within the bar code you want to scan.
- When using imaging scanners, do not move the scanner while decoding the bar code. Movement blurs the image.
- Hold the scanner farther away for larger bar codes.
- Hold the scanner closer for bar codes with bars that are close together.

A bar code icon appears on the screen during a scan. While the scanner beam is active, the onscreen message states: SCANNING. If you want to turn off the onscreen message, disable "Scan Indication" in the Options tab of the Scanner Settings menu in the Control Panel

When the scan is successful, the bar code data is displayed on the screen until the scan button (or pistol trigger) is released, but only if "Scan Result" is turned on in the Options tab of the Scanner Settings menu in the Control Panel.

## Troubleshooting

If the scanner is not operating as expected, refer to [Troubleshooting on page 2-10](#).

## Operating One Dimensional (1D) Laser Scanners

For helpful scanning tips, refer to [Operating 1D Internal Laser Scanners on page 2-11](#).

## Operating Two Dimensional (2D) Imagers

For helpful tips when using an imager, refer to [Operating Internal 2D Imagers on page 2-11](#).

---

## Bluetooth Peripherals

The Workabout Pro4 is equipped with a *Bluetooth* radio, making it possible to communicate with a variety of Bluetooth peripherals, including GSM/GPRS handsets, scanners, printers, and so on.

The range of the *Bluetooth* radio is limited to approximately 5 meters.

Zebra provides built-in support for the Bluetooth peripherals listed below.

- GSM/GPRS universal handset
- *Bluetooth* printer
- *Bluetooth* headset

Keep in mind that *Bluetooth* and IEEE 802.11b/g radios both operate in the 2.4GHz band. Although the Workabout Pro4 includes features to minimize interference, performance of the system will not be optimal if you use both radios simultaneously. Typically, when both radios operate in the hand-held at the same time, they cannot transmit simultaneously – this has a negative impact on overall system throughput. To minimize the impact on the backbone 802.11g network, Zebra recommends using Bluetooth peripherals that have low transaction rates (such as printers and scanners).

Refer to **Bluetooth**® [Setup on page 3-7](#) for information about setting up your *Bluetooth* devices for communication. In addition, review the manual shipped with your *Bluetooth* device to determine the method used to pair with the Workabout Pro4 host.



# APPENDIX A PORT PINOUTS

---

## LIF (Low Insertion Force) Pinout

PIN #	Signal Name
1	Ground
2	Ground
3	USB Host Data Plus, For connecting USB devices
4	USB Host Data Minus, For connecting USB devices
5	USB Host Power, for powering USB devices (5V, 100mA Max)
6	DC Power in, for supplying power to WORKABOUT PRO <sup>3</sup> / charging battery (5V, 3A)
7	DC Power in, for supplying power to WORKABOUT PRO <sup>3</sup> / charging battery (5V, 3A)
8	LIF Detect, determines if a device is attached to the LIF
9	USB Device Data Minus, for operating the WORKABOUT PRO <sup>3</sup> as a USB device
10	USB Device Data Plus, for operating the WORKABOUT PRO <sup>3</sup> as a USB device
11	Ground
12	Ground

---

## Tether Port Pinout

PIN #	Signal Name
1	Ground
2	USB Data Plus (can be configured as Host or Device)
3	USB Data Minus (can be configured as Host or Device)
4	USB VBUS (can provide 5V, 100mA Max for powering USB Devices)
5	RS232 Tx data

<b>PIN #</b>	<b>Signal Name</b>
6	RS232 Rx Data
7	Tether detect resistor ID. Determines what kind of device is attached to the Tether port
8	DC Power In
9	DC Power In
10	DC Power In
11	RS232 CTS
12	RS232 RTS
13	RS232 DSR
14	RS232 DTR
15	RS232 DCD
16	RS232 RI
17	Ground
18	Ground
19	Ground
20	Ground

---

## **Battery Contact Pinout**

<b>PIN #</b>	<b>Signal Name</b>	<b>Function</b>
1	P-	Power Pin for Battery Pack Negative
2	DQ	Maxim DS2762 Data
3	TH (GND)	Ground
4	P+	Power Pin for Battery Pack Positive
5	PS	Power Switch Sensor
-	Plastic Rip	-
6	P-	Power Pin for Battery Pack Negative

---

## Positive Female Battery Connector

---

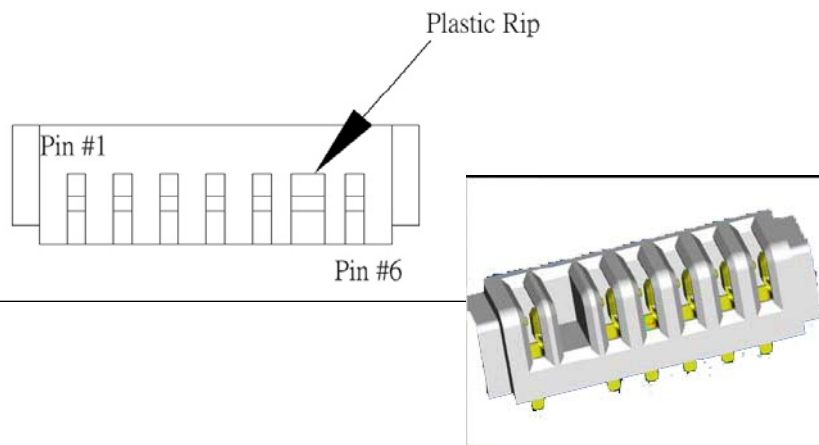



# APPENDIX B DATAWEDGE

---

## DataWedge

DataWedge is a Zebra mobile device application that reads data from input devices and sends it as keystrokes to consumer applications executing in the foreground on the mobile devices.



- Tap on **Start>Settings> System>DataWedge** icon.

## Where to Find More Information

For DataWedge support, go to:

[www.zebra.com/support](http://www.zebra.com/support)



# APPENDIX C SCANNER SETTINGS

---

## Scanner Services

The *Scanners* icon in the *Control Panel* provides dialog boxes in which you can tailor barcode scanner configuration and choose the barcodes your scanner will recognize. The parameters are preset with the default settings of the decoded scanner installed in the unit.



**IMPORTANT** The default barcode application is *DataWedge*. If you prefer to use the *Scanner Services* application, you'll need to take a few extra steps to display this option. Follow the steps below.

- Tap on **Start>Settings>Control Panel..**
- Tap on the **TweakIt** icon. Under the *Advanced* tab, tap on **Advanced Services Settings**, and double-tap on **Scanner Services**.
- In the *Scanner Services* dialog box, **uncheck** *Use DataWedge (Uncheck for Psion Legacy)*.
- Press and hold down the **[FN/BLUE]** and **[Power]** buttons to reset the unit.



**IMPORTANT** To enable a newly-installed scanner, press and hold down the [FNBLUE] key and the [Power] button simultaneously for a minimum of three seconds.

The *Scanners* icon becomes available.



- Tap on **Start>Settings>Control Panel.**
- Tap on the **Scanners** icon.

For a listing of available scanners/imagers and their specifications, please refer to [Appendix D: Internal Imager & Scanner Specifications](#).

## Barcodes

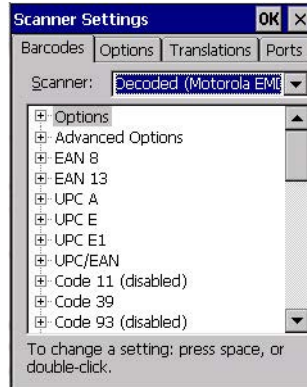

- ✓ **NOTE** Your Workabout Pro4 comes preconfigured from the factory for internal scanner types. The type of scanner installed can be determined from the **System** icon in the *Control Panel*, under the *System Properties* tab.



- IMPORTANT** To improve the decode speed and performance, enable (set to 'on') only those codes that are required by the application.

All internal scanners can be configured using these dialog boxes.

### Restoring Default Settings

If you want to restore the factory defaults after making changes, the defaults can be applied to a selected parameter, sub-tree of parameters or all scanner parameters.

- Press and hold on a symbology (e.g., Code 128) to display a pop-up menu.

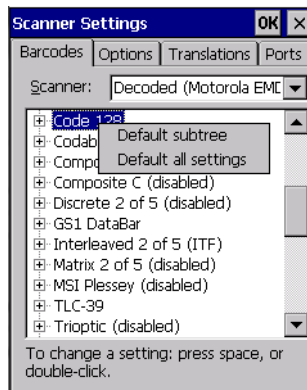

- Choose **Default subtree** to reset only the parameters in the symbology you selected, or choose **Default all settings** to reset all scanner parameters to default settings.

To reset a single parameter to its default setting:

- Press and hold on the parameter you want to reset.



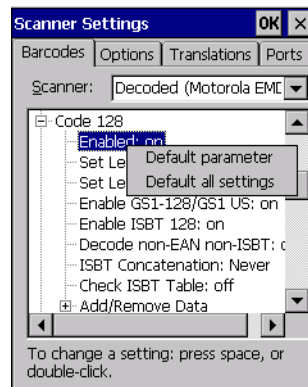

- Choose **Default parameter** to reset the parameter to the default setting.

## Decoded (Zebra EMDK)

This section describes the tabs used to configure this scanner type.

### Barcodes Tab

### Options

#### Laser On Time

The value assigned to this parameter determines how long the laser will remain on when the scan button or trigger is pressed.

Double-tapping on this parameter displays a dialog box in which you can enter a value between 5 and 99. The value is measured in tenths of seconds.

#### Picklist Mode

Picklist mode lets you target a single barcode within a group. The bar code closest to the aiming cross hair is decoded.

### Advanced Options

#### Scan Mode

This parameter sets the method of scanning to *Scan beam only*.

#### Aim Duration

This parameter determines the total time the aiming pattern appears before the scanner laser begins sweeping. When you double-tap on this parameter, a dialog box is displayed in which you can enter a value from 0 to 30 (0 to 3 sec.). A value of 0 (zero) disables the aiming-dot.

#### Linear Security Level

This parameter allows you to select the security level appropriate for your barcode quality. There are four levels of decode security for linear code types (e.g., Code 39, Interleaved 2 of 5). Higher security levels should be selected for decreasing levels of barcode quality. As security levels increase, the scanner's decode speed decreases.

Double-tapping on this parameter displays a dialog box in which you can enter a value from 1 to 4.

*Linear security level 1* specifies that the following code types must be successfully read twice before being decoded:

Codabar	All
MSI Plessey	4 or less
D 5 of 5	8 or less
I 2 of 5	8 or less

*Linear security level 2* specifies that all types of codes must be successfully read twice before being decoded.

*Linear security level 3* specifies that code types other than the following must be successfully read twice before being decoded. The following codes must be read three times:

MSI Plessey	4 or less
D 2 of 5	8 or less
I 2 of 5	8 or less

*Linear security level 4* requires that all code types be successfully read three times before being decoded.

### Use LED lighting

This option enables and disables the illumination LEDs. In bright light, for example outdoors, the LEDs can remain off saving power.

### Barcode Symbolologies

The table below list the available symbolologies.



**IMPORTANT** To improve the decode speed and performance, enable only those codes that are required by the application.

Zebra EMDK Barcode Symbolologies	
EAN 8	TLC-39
EAN 13	Trioptic (disabled)
UPC-A	PDF-417
UPC-E	Macro PDF-417
UPC-E1	Micro PDF-417
UPC/EAN	Macro-Micro PDF-417
Code 11 (disabled)	2D Aztec (disabled)
Code 39	2D Data Matrix
Code 93 (disabled)	2D Maxicode
Code 128	2D QR Code
Codabar	Postal: Australian (disabled)
Composite AB (disabled)	Postal: Canadian (disabled)

Zebra EMDK Barcode Symbologies	
Composite C (disabled)	Postal: Japanese (disabled)
Code 11 (disabled)	Postal: Kix (disabled)
Discrete 2 of 5 (disabled)	Postal: Korean (disabled)
GS1 DataBar (disabled)	Postal: PlaNET (disabled)
Interleaved 2 of 5 (disabled)	Postal: PostNET (disabled)
Matrix 2 of 5 (disabled)	Postal: Royal Mail (disabled)
MSI Plessey (disabled)	

## Options

This tab allows you to tailor the double-click parameters, display, and data handling options associated with your scanner.

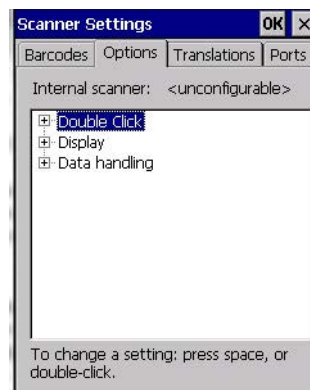

### Double Click Parameters

#### Click Time (msec)

This parameter controls the maximum gap time (in milliseconds) for a double-click. If the time between the first and second clicks of the scanner trigger is within this time, it is considered a double-click. The allowable range is 0 to 1000. A value of zero disables this feature.

A double-click produces different results depending on whether or not a value is assigned in the “Click Data” parameter. When a value is not assigned for the “Click Data”, double-clicking the scanner trigger overrides the target dot delay set in the “Dot Time” parameter and initiates a normal scan sweep. If a value is assigned for the “Click Data” parameter, double-clicking the scanner trigger inserts the “Click Data” value rather than initiating a scan.

#### Click Data

This parameter determines which character is sent to the application installed in your Workabout Pro4 following a double-click. A dialog box appears, asking that you press the key you want to insert. The ASCII/Unicode key value of the keypress is displayed.

Pressing the [ESC] key in this dialog box resets the data to zero.

## Display Parameters

### Scan Result

When this parameter is enabled, the type of barcode and the result of the scan appear on the screen. Note that this information is only displayed after a successful decode and is visible only while the scanner trigger is pressed. When the trigger is released, this information is cleared from the screen.

### Scan Indicator

When this parameter is enabled, the laser warning logo appears on the display whenever the scanner is activated.

### Scan Result Time (sec)

The value assigned to the *Scan Result Time* parameter determines how long the scan results of a successful scan are displayed on the screen. Time is measured in seconds, and a value of 0 (zero) disables the parameter. When you choose this option, a dialog box appears where you can enter a value.

✓ **NOTE** To remove the scan result from the screen before the “Result Time” has expired, point the scanner away from the barcode and press the trigger.

### Good Scan Beep and Bad Scan Beep

These parameters determine whether or not the Workabout Pro4 emits an audible scanner beep when a good (successful) scan or a bad (unsuccessful) scan is performed. Set these parameters to either **on** to enable the beeper or **off** to disable it.

### Multiple Beep Tones

You can set the audible scanner ‘beep’ to emit a series of three beeps instead of one. Set this parameter to **on** to enable the multiple beep tones.

### Good Scan Vibrates and Bad Scan Vibrates

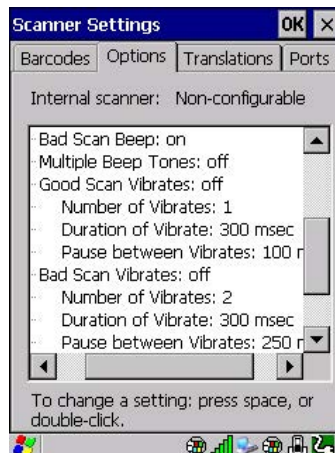

These parameters determine whether or not the Workabout Pro4 creates a vibration when a good (successful) scan or a bad (unsuccessful) scan is performed. Set these parameters to **on** to enable the vibration. You can set the *Number* and *Duration* of vibrations, as well as the *Pause* between vibrations. The screen above shows the default settings.

### Soft Scan Timeout

This parameter is used by the Mobile Devices SDK Scan function (soft-scan: starting a scan session via the SDK function, instead of a physical user trigger press). The value assigned to this parameter determines the soft-scan timeout from 1 to 10 sec (default is 3 sec).

## Scan Log File

If this parameter is enabled, the input barcode and the modified/translated output barcode are logged in the file *Flash Disk\ScanLog.txt*. Keep in mind that if *Scan Log File* is enabled, there is a slight performance reduction when performing multiple scans since the log file is written to persistent storage.

## Data Handling

### Codepage

Tapping on this option displays a window in which you can define the code page your Workabout Pro4 will use – either *Default Local ASCII* or *ISO-8859-1 Latin 1*

If you choose *Default Local ASCII*, the code page of the local OS is used. For example, if the local OS uses double-byte Chinese characters, choosing this option will filter data through the local ASCII of that OS and display it accurately, in this example, using double-byte characters.

If you choose *ISO-8859-1 Latin 1*, data will be displayed according to the character mapping of this Latin 1 code page, ignoring the local OS code page.



**IMPORTANT** Do not change this parameter from the default setting unless you are certain that it will correct your scan problem.

### Data Transmission:

Tapping on this option displays a window in which you can how data will be handled – either *Paste data* or *Wedge data*.

If *Paste data* is enabled (highlighted), the barcode output is copied to the system clipboard and then automatically pasted to an application.

If *Wedge data* is enabled, each character that composes the barcode data is turned into a keyboard sequence that is transmitted to the cursor location of the current application – that is, to the application, it looks like the barcode data was typed on the keyboard.



**NOTE** The default *Paste data* option is a faster method of data transmission.

## Translations

The *Translations* menu allows you to define up to 10 cases, each consisting of up to 10 rules in sequential order. Only one case will be applied to a barcode and a case will only be applied if all rules specified in the case are successful — if a rule within a case fails, the entire case fails.

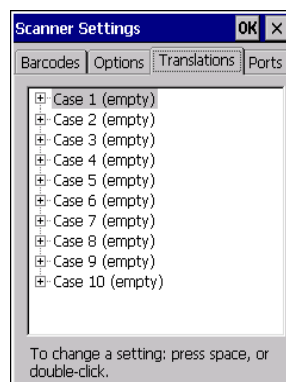

- In the *Translation* menu, tap on the **Case #** to create rules.

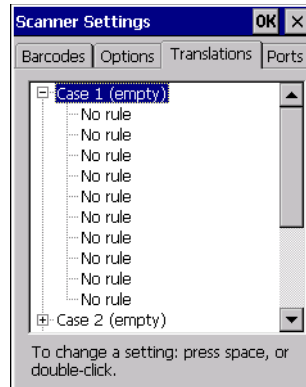

- Tap on the **No rule** drop-down menu to display the rules.

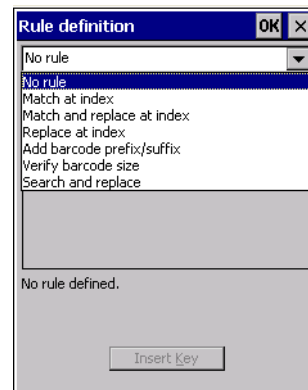
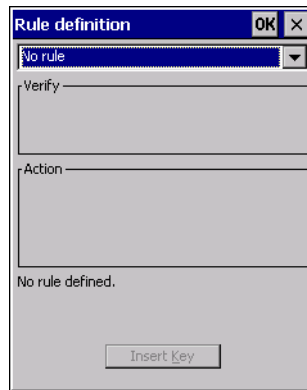

When you choose a rule, an associated screen is displayed in which you can define the rule.



## Case Rules

The case rules are defined as follows:

- **No rule** – ignored.
- **Match at index** – matches the match string at a specified index.
- **Match and replace at index** – matches the match string at a specified index and replaces/changes it.
- **Replace at index** – replaces/changes unspecified data in a given range.
- **Add barcode prefix/suffix** – adds a global prefix or suffix.
- **Verify barcode size** – verifies the barcode size. This rule should generally be assigned first, before creating subsequent rules.
- **Search and replace** – replaces all instances of the match string. (Note that this rule cannot fail.)



**NOTE** Keep in mind that the effects of previously applied rules must be taken into account when creating subsequent rules. For example, if the barcode size is important, it should be checked before any rules that might change the size are applied.

Translation information about the status of each case/rule is displayed in the scan log file (see [Scan Log File on page C-7](#)) when enabled. This is useful if a case fails, and you are trying to determine why a rule is failing.

## Ports

**Figure C-1** Console and Port Replicator Port Settings

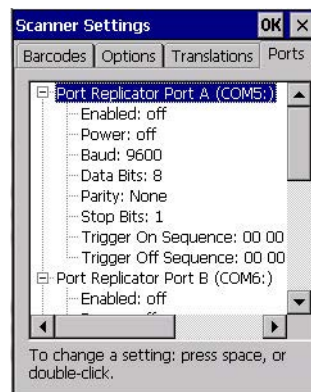

While you cannot configure the scanner, you can configure communications with a serial decoded scanner using the options in this tab.

Use these settings to ensure that the communication ports on the Workabout Pro4 match the settings of the serial devices to which they are connected. If the settings do not match exactly, the devices may not function. Note that some devices can auto-detect serial port settings (such as baud rate), and in this case the Workabout Pro4 will dictate the settings. Baud rates often have a direct impact on performance — they should be set as high as possible while still ensuring reliable communication.

### Port Replicator Port A (COM5) and Port B (COM6)

Port Replicator Port A (COM5) and Port B (COM6) are standard RS-232 DE-9 DTE ports on the Workabout Pro4 port replicator module, available on some cradle types.

#### Enabled

This parameter must be set to ON in order for the Workabout Pro4 to recognize the device connected to the Port Replicator 9-pin (COM5).

#### Power (COM6 only)

Pin 9 on the Workabout Pro4 COM6 is reserved for 5V power out and is defaulted to OFF. This parameter must be set to ON to enable power to Vehicle cradle.

#### Baud

Double-tapping on this parameter displays a pop-up window in which you can choose an appropriate rate of data transfer.

Figure C-2 Port Baud Rates

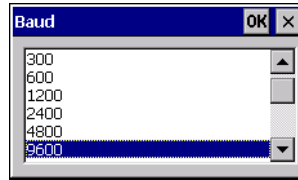

### Data Bits

This parameter determines the number of data bits included in each asynchronous data byte. Most devices use 8-bit data bytes. Double-tapping on this option displays a pop-up window in which you can choose either 7 or 8 data bits.

### Parity

This parameter determines the type of parity checking used on the data going through the port replicator port. Double-tapping on this option displays a pop-up window in which you can choose the appropriate parity.

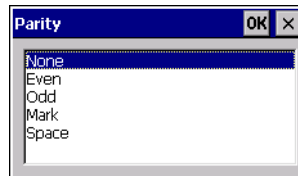

### Stop Bits

This parameter specifies the number of stop bits — 1, 1.5 or 2 — used for asynchronous communication.

### Trigger On Sequence And Trigger Off Sequence

If a SICK scanner connected to an Workabout Pro4 port requires a serial stream of data bytes to trigger the scanner *on* and another to trigger the scanner *off*, the *Trigger On Sequence* and *Trigger Off Sequence* parameters allow you to define these serial streams.

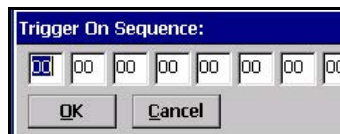

Double-tapping on *Trigger On Sequence* or *Trigger Off Sequence* displays a screen with a hex array of 10 elements.

These parameters work in conjunction with *Manage Triggers* sending on and off data streams to the trigger module you assigned. For example, suppose you launch *Manage Triggers* and choose *Decoded Scanner* as the 'module to trigger'. Next, you assign a 'trigger key' — for this example, . (period). To define the serial stream of data bytes to control the *on* and *off* function of the 'trigger key', enter a hex value in the *Trigger On Sequence* and the *Trigger Off Sequence* fields. When you press the trigger key, the *Trigger On Sequence* is sent and when you release the trigger key, the *Trigger Off Sequence* is sent, turning the trigger key *on* and *off*.



# APPENDIX D INTERNAL IMAGER & SCANNER SPECIFICATIONS

This appendix lists specifications for the following internal scanners. For a current list of model numbers and descriptions for Workabout Pro4 scanner pod and back cover kits, please contact your Zebra representative or go to:

[http://www.zebra.com/US-EN/Product+Lines/Psion/?WT.mc\\_id=psion\\_us\\_p\\_handheld](http://www.zebra.com/US-EN/Product+Lines/Psion/?WT.mc_id=psion_us_p_handheld)

## SE965 Scanner

SE965	
Dimensions	0.46 in. H x 0.85 in. W x 0.61 in. D 11.75 mm H x 21.6 mm W x 15.5 mm D
Weight	0.27 oz./7.6 g
Configuration	Decoded
Interface	SSI Control over TTL Serial on a 12-pin ZIF connector
Scan Angle	Wide (default): 47° (typical) Medium: 35° (typical) Narrow: 10° (typical)  Note: The SE965 scan engine does not require margin on either side of the barcode to decode. The 47° scan line provides identical scanning performance to older scan engines with a scan line of 53°.
Skew Tolerance	± 40° from normal
Pitch Tolerance	± 65° from normal
Roll Tolerance	± 35° from vertical
Specular Dead Zone	± 8°
Optical Resolution	0.005 in. minimum element width
Scan Repetition Rate	104 (± 12) scans/sec (bidirectional)
Print Contrast	Minimum 25% absolute dark/light reflectance measured at 650 nm

SE965	
Ambient Lighting Tolerance	Tolerant to typical artificial indoor and natural outdoor (direct sunlight) lighting conditions. Fluorescent, Incandescent, Mercury Vapor, Sodium Vapor, LED <sup>5</sup> . 450 Ft Candles (4,844 Lux) Sunlight 8000 Ft Candles (86,111 Lux)
Operating Temperature	-22° F to 140° F / -30° C to 60° C
Storage Temperature	-40° F to 158° F / -40° C to 70° C

### SE965 Decode Zones

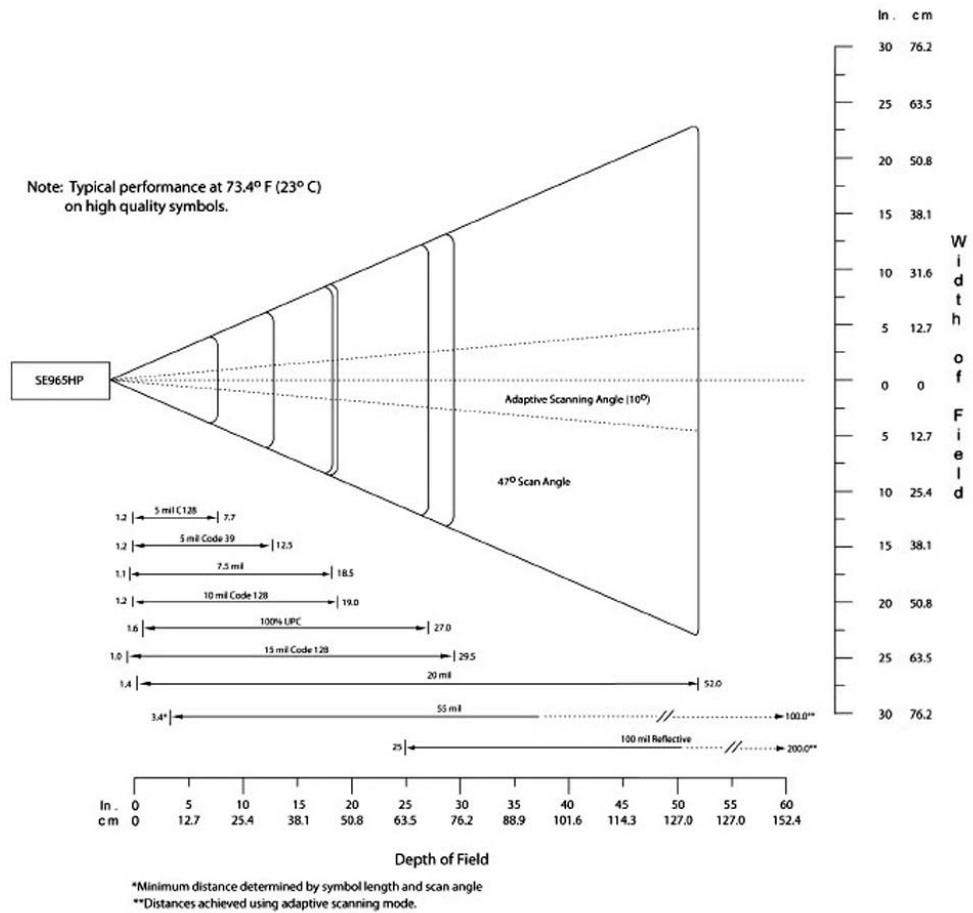

## SE655 Scanner

Parameter	Specifications
Physical Characteristics	
Dimensions	0.3 in. H x 0.94 in. W x 0.47 in. DUMTS/HSPA+: Five band, 800/850/900/1900/2100MHz 7.7 mm H x 23.8 mm W x 12.0 mm D
Weight	<7 grams
Interface	Serial
Performance Characteristics	
Scan angle	53.3° ± 3°
Field of view	Horizontal: 53° ± 3° Vertical: 0.4°
Illumination	LED 630 ± 30 nm
Skew tolerance	± 30° from normal
Pitch tolerance	± 65° from normal
Roll tolerance	± 25° from vertical
Optical resolution	5 mil
Scan repetition rate	Nominally 50 scans/second
Minimum print contrast	20% MRD measured at 630 nm
Power on to first scan	300 milliseconds
User Environment	
Ambient light	0 ft. candles (0 Lux) to 10,000 ft.(110,000 Lux)
Operating temperature	-4° to 122° F/-20° to 50° C
Storage temperature	-40° to 158° F/-40° to 70° C
Humidity	Operating: 5% – 95% non-condensing
Power	Camera/Aim Input Voltage: 3.3V ± 0.3V Camera/Aim Operating Current: 165mA Low Power Current: 115iA typical Power Supply Noise: 100mV p-p max.
Shock	2000 G
Regulatory	
Classification	Intended for use in CDRH Class I/IEC Class 1 devices
Electrical Safety	UL, VDE, and CUL recognized
EMI/RFI	EMI- FCC Part 15 Class B, ICES-003 Class B, CISPR Class B, Japan VCCI Class B
Environmental	RoHS Compliant

### SE655 Decode Ranges

		Typical	Guaranteed
Code 128 5 mil	Near	2.75 in./70 mm	3.90 in./99 mm
	Far	8.25 in./210 mm	6.25 in./159 mm
Code 39 5 mil	Near	2.25 in./57 mm	3.15 in./80 mm
	Far	9.75 in./248 mm	8.00 in./203 mm
Code 39 7.5 mil	Near	1.50 in./38 mm	2.50 in./64 mm
	Far	12.75 in./324 mm	10.25 in./260 mm
100% UPC-A	Near	2.00* in./51 mm	2.25 in./57 mm
	Far	15.75 in./400 mm	11.00 in./279 mm
Code 39 20 mil	Near	1.50* in./38 mm	2.00* in./51 mm
	Far	24.0 in./610 mm	18.25 in./464 mm

Note: The distances marked with an asterisk (\*) are a result of the field of view (FOW) limitation.

### SE1524ER – Extended Range Scanner

Parameter	Specification
Type	Laser Class 2
Light Source	Visible Laser Diode 650 nm
Scan Rate	35 (± 5) scans/sec (bi-directional).
Scan Angle/Field of View	13.5° ± 0.7°
Scan Patterns	Linear
Minimum Print Contrast	Minimum 25% absolute dark/light reflectance measured at 650 nm.
Symbologies	UPC/EAN, Code 128, UCC.EAN128, RSS, Code 39, Code 93, I 2 of 5, Discrete 2 of 5, Codabar, MSI.
Programmable Parameters	Laser On Time, Aim Duration, Power Mode, Trigger Mode, Bi-directional Redundancy, Symbology types/lengths, Data formatting.
Ambient Light	Artificial: 450 ft. candles (4,844 Lux) Sunlight: 4,000 ft. candles (86,112 Lux).
Laser Output Power (peak)	1.26 mW

### SE1524ER Decode Zones

#### SE1524ER Decode Zone A (Short Range, Small Codes)

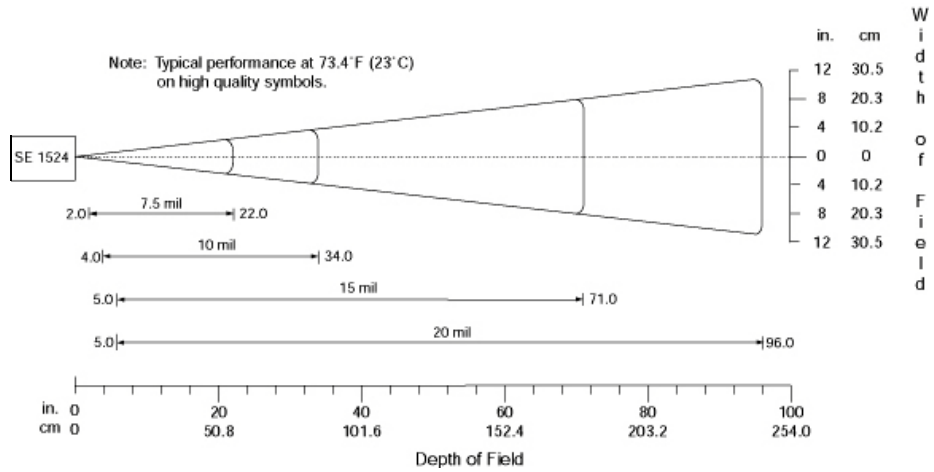

#### SE1524ER Decode Zone B (Long Range, Large Codes)

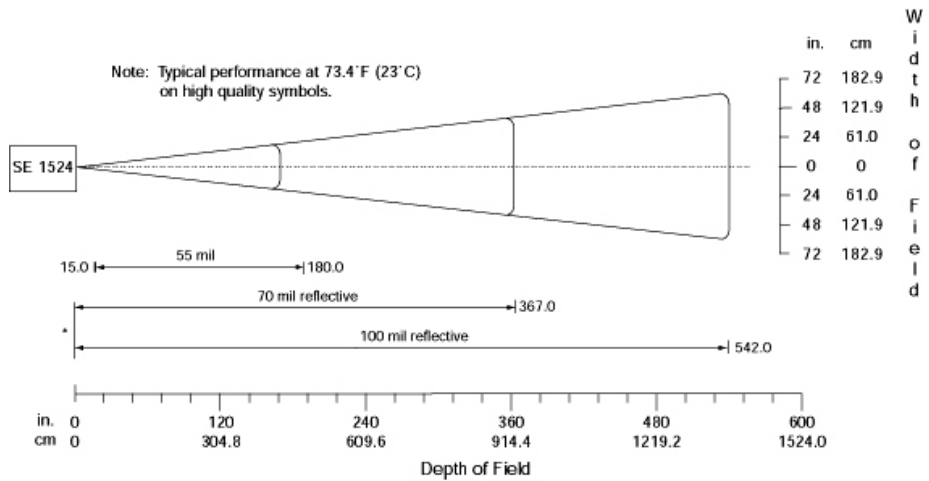

\* Near range determined by degree of reflectivity and width of bar code.

## SE4500SR – Standard Range Imager

Parameter	Specification
Power Requirements - Input Voltage	3.3 V $\pm$ 0.3 V at 23° C
Operating Mode Supply Currents (conditions VCC=VCC_SENSOR=VCC_ILLUM = 3.3VDC) (at 23° C):	
Low Power	500 $\mu$ A
Idle	18 mA
Image Acquisition	80 mA
Illumination Enabled	200 mA
Maximum Operating Current	250 mA (aiming on during exposure, illumination enabled)
Maximum Sensor Power Supply Noise* (at 23° C)	100 mVp-p (3.3 V, 10 Hz - 100 kHz) for decoding 30 mVp-p (3.3 V, 10 Hz - 100 kHz) for image capture
Optical Resolution	SR focus: 5.0 mil (Code 39), 6.7 mil (PDF417)
*For better image quality in image capture applications, use an additional filter on VCC_SENSOR. For additional performance improvement, provide a separately regulated 3.3 V supply for the sensor.	
Specular Dead Zone:	
Illumination On	Up to 20° depending on target distance and substrate glossiness
Illumination Off	None
Skew Tolerance	$\pm$ 60°
Pitch Angle	$\pm$ 60°
Roll	360°
Ambient Light Immunity (Sunlight)	9000 ft. candles (96,900 lux)
Imaging Sensor:	
Image Resolution	752 H x 480 V pixels (Wide VGA)
Grey Scale	256 levels (8 bits per pixel)
Field of View (FOV)	SE4500-SR: 39.6° horizontal, 25.7° vertical
Focusing Distance from Front of Engine (SR)	8 in. / 20.3 cm
Aiming Element:	
Visible Laser Diode (VLD)	655 $\pm$ 10 nm
Central Dot Optical Power	0.6 mW (typical)
Pattern Angle	40° horizontal, 30° vertical
Illumination System:	
LEDs	625 $\pm$ 5 nm (dominant wavelength)
Pattern Angle	60° x 40° at 80% center intensity

Parameter	Specification
Shock	2000 G $\pm$ 5% applied via any mounting surface at -30° and 55° C for a period of 0.85 $\pm$ 0.05 msec  2500 G $\pm$ 5% applied via any mounting surface at 23° C for a period of  0.85 $\pm$ 0.05 msec
Vibration	Unpowered SE4500 withstands a random vibration along each of the X,  Y, and Z axes for a period of one hour per axis (6 G rms), defined as follows:  20 to 80 Hz Ramp up at 0.04 G <sup>2</sup> /Hz at 3 dB/octave  80 to 350 Hz 0.04 G <sup>2</sup> /Hz  350 Hz to 2 kHz Ramp down at 0.04 G <sup>2</sup> /Hz at 3 dB/octave
ESD	$\pm$ 2 kV @ connector
Laser Safety Class	CDRH / IEC Class 2
LED Class	IEC Class 1M
Maximum Engine Dimensions	11.8 mm H x 21.50 mm W x 16.3 mm D  0.46 in. H x 0.85 in.W x 0.64 in. D
Weight	8.0 grams (0.28 oz)
Electrical Interface	21 pin 0.3 mm pitch ZIF connector

### SE4500SR Decode Zone

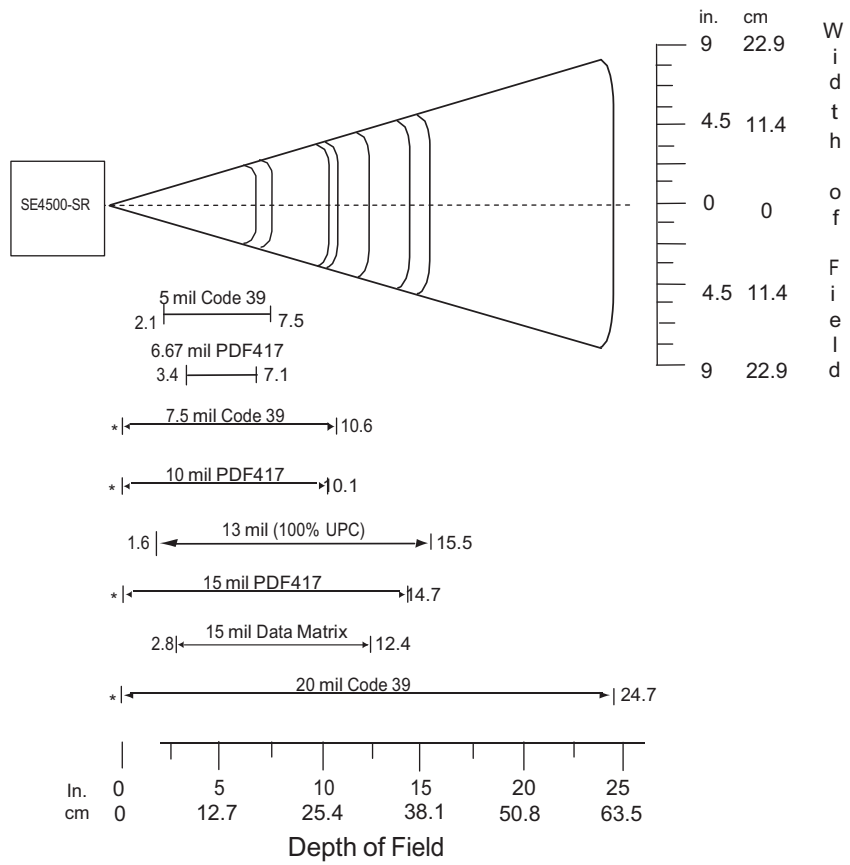



# APPENDIX E WORKABOUT PRO4 SPECIFICATIONS

---

## The Workabout Pro4 Hand-Held Computer (7528 Long and 7528 Short)

✓ **NOTE** Performance specifications are nominal and subject to change without notice.

### Hardware

#### Dimensions and Weight

##### **7528 Long**

- 223 mm x 75/100 mm x 31/42 mm (8.78 x 2.95/3.94 x 1.22 x 1.65 inches)
- 526g (18.6 oz)

##### **7528 Short**

- 200 mm x 75/100 mm x 31/42 mm (7.87 x 2.95/3.94 x 1.22/1.65 inches)
- 461g (16.2 oz)

#### Processor and Memory

- CPU: Sitara™ AM37x ARM Cortex™-A8 processor
- Memory: 512 MB RAM/4 GB Flash

#### Operating System

- Microsoft Windows® Embedded Hand-Held 6.5

#### Power Management

- Battery Packs (Lithium-ion): 4400 mAh, 2850 mAh, 4680 mAh
- Super capacitor power backup

#### Expansion Ports

- Micro SD slot
- 100 Pin Expansion Interface

- Dedicated USB port
- Audio port

### Camera (optional)

- Optional colour, 8Mpixel, autofocus, 4X digital zoom, Bright LED flash, video capable

### Environmental

- Standard Operating temperature: -20° C to +50° C (-4° F to +122° F)
- Storage temperature: -40° C to +60° C (-40° F to +140° F)
- Humidity: 5% to 95% non-condensing
- IP Sealing: IP65, IEC 60529
- Drop rating: 1.5m (5 ft), 26 drops to polished concrete (powered with options and accessories), multiple 1.8m (6 ft) drops to polished concrete

### Regulatory Approvals

- Worldwide Safety, EMC, RF, Laser approvals
- CE Mark
- E Mark (vehicle cradles)
- RoHS compliant
- WEEE compliant
- REACH compliant

---

## Battery Specifications

### Rechargeable Lithium-ion Battery

#### Electrical Specifications



**NOTE** The electrical specifications apply for ambient temperature TAMB of 0° to +40°C unless otherwise stated.

Item	Description	Specifications	Remark
1	Interface Chipset	Maxim DS2762	-
2	Rated Voltage	3.7 V	Typical
10	Charging Temperature	0° C to 40° C	Typical

**Safety License**

Item	Licenses	Standard
1	UL 1642	The lithium-ion cell has been listed and pass the UL1642 standard by UL Lab. File No. MH12383.
2	UL 2054	The WA3010 battery pack passes the UL 2054 battery standard with File No. MH29921.
3	IEC/UL60950-1	The WA3025 and WA3026 battery packs pass the IEC/UL60950-1 standard and are UL listed with File No. MH29577.
4	2004/108/EC EMC Directive	The battery packs comply with 2004/108/EC EMC Directive.
5	2011/65/EU	The materials of the battery packs are used in accordance with the European RoHS directive.
6	2006/66/EC	The battery packs meet the EU Battery Directive.

**Wireless Radios**

**802.11a/b/g/n Radio**

✓ **NOTE** A GPS/WiFi Diversity Kit, Model Number RA3052 is an available option for this radio.

Parameter	Sub-parameter	Specifications
Form Factor		Embedded surface mount module, 15.0 x 15.0 mm * This is a combo module containing both Wi-Fi 802.11a/b/g/n and Blue-tooth V 4.0 LE radio
Antenna Port	802.11a/b/g/n	2x U.FL jacks. Switched diversity.
Antenna Type	802.11a/b/g/n	PCB substrate patch antenna. Covers 2400-2484 MHz @ <2:1 VSWR and 5150-5850MHz @ <2.5:1 VSWR. * Number of antenna: one or two, depending on configuration.
Antenna Gain	802.11b/g/n	5 dBi
	802.11a/n	4 dBi
Transmit Power	802.11b	+20 dBm max (depending on region)
	802.11g	+19 dBm max (depending on region)
	802.11a	+17.5 dBm max (depending on region)
	802.11n (2.4 GHz)	+17 dBm max (depending on region)
	802.11n (5 GHz)	+17.5 dBm max (depending on region)
Frequency Range	802.11b/g/n	2400-2483.5 MHz
	802.11a/n	5150-5350 MHz, 5480-5720 MHz and 5725-5845 MHz

Parameter	Sub-parameter	Specifications
Channels	802.11b/g/n	1 to 14. Up to 14 channels (depending on country). Only 3 channels are non-overlapping.
	802.11a/n	36, 40, 44, 48, 52, 56, 60, 64 100, 104, 108, 112, 116, 120, 124, 128, 132, 136, 140 149, 153, 157, 161, 165 Up to 24 channels (depending on country). All channels are non-overlapping.
RX Sensitivity (hardware)	802.11b	-86 dBm @ 11 Mbps, -94 dBm @ 1 Mbps
	802.11g	-73 dBm @ 54 Mbps, -89 dBm @ 6Mbps
	802.11a	-71 dBm @ 54Mbps, -87 dBm @ 6Mbps
	802.11n (2.4 GHz)	-71 dBm @ MCS7 (65 Mbps), -88 dBm @ MCS0 (6.5Mbps)
	802.11n (5 GHz)	-68 dBm @ MCS7 (65 Mbps), -87 dBm @ MCS0 (6.5Mbps)
Data Rates	802.11b	1,2,5.5,11 Mbps
	802.11a/g	6,9,12,18,24,36,48,54 Mbps
	802.11n	6.5,13,19.5,26,39,52,58.5,65 Mbps
EVM	802.11b	35% max
	802.11g	-25 dB max @ 54 Mbps, -5 dB max @ 6 Mbps
	802.11a	-25 dB max @ 54 Mbps, -5 dB max @ 6 Mbps
	802.11n (2.4 GHz)	-28 dB max @ MCS7 (65 Mbps), -5 dB max @ MCS0 (6.5 Mbps)
	802.11n (5 GHz)	-28 dB max @ 54 Mbps, -5 dB max @ 6 Mbps
WiFi-BT Co-existent	PTA	This software feature is not enabled in Workabout Pro4.

**Cinterion PHS8-P GSM/GPRS/EDGE/UMTS/HSPA+ Radio**

Parameter	Specifications
General	
Frequency bands	GSM/GPRS/EDGE: Quad band, 850/900/1800/1900MHz UMTS/HSPA+: Five band, 800/850/900/1900/2100MHz
GSM class	Small MS
Output power (according to Release 99)	Class 4 (+33 dBm $\pm$ 2 dB) for EGSM850 Class 4 (+33 dBm $\pm$ 2 dB) for EGSM900 Class 1 (+30 dBm $\pm$ 2 dB) for GSM1800 Class 1 (+30 dBm $\pm$ 2 dB) for GSM1900 Class E2 (+27 dBm $\pm$ 3 dB) for GSM 850 8-PSK Class E2 (+27 dBm $\pm$ 3 dB) for GSM 900 8-PSK Class E2 (+26 dBm +3 /-4 dB) for GSM 1800 8-PSK Class E2 (+26 dBm +3 /-4 dB) for GSM 1900 8-PSK Class 3 (+24 dBm +1/-3 dB) for UMTS 2100, WCDMA FDD Bd I Class 3 (+24 dBm +1/-3 dB) for UMTS 1900, WCDMA FDD Bd II Class 3 (+24 dBm +1/-3 dB) for UMTS 900, WCDMA FDD Bd VIII Class 3 (+24 dBm +1/-3 dB) for UMTS 850, WCDMA FDD Bd V Class 3 (+24 dBm +1/-3 dB) for UMTS 800, WCDMA FDD Bd VI
HSPA	
3GPP Release 6, 7	DL 14.4 Mbps, UL 5.7 Mbps UE CAT. [1-6], 11, 12 supported Compressed mode (CM) supported according to 3GPP TS25.212
UMTS features	
3GPP Release 6, 7	DL 14.4 Mbps, UL 5.7 Mbps UE CAT. 1-12 supported Compressed mode (CM) supported according to 3GPP TS25.212
GSM GPRS/EGPRS	

Parameter	Specifications
Data transfer	GPRS: <ul style="list-style-type: none"> <li>- Multislot Class 10</li> <li>- Full PBCCH support</li> <li>- Mobile Station Class B</li> <li>- Coding Scheme 1 - 4</li> </ul> EGPRS: <ul style="list-style-type: none"> <li>- Multislot Class 10</li> <li>- EDGE E2 power class for 8 PSK</li> <li>- Downlink coding schemes - CS 1-4, MCS 1-9</li> <li>- Uplink coding schemes - CS 1-4, MCS 1-9</li> <li>- SRB loopback and test mode B</li> <li>- 8-bit, 11-bit RACH</li> <li>- PBCCH support</li> <li>- 1 phase/2 phase access procedures</li> <li>- Link adaptation and IR</li> <li>- NACC, extended UL TBF</li> <li>- Mobile Station Class B</li> </ul> CSD: <ul style="list-style-type: none"> <li>- V.110, RLP, non-transparent</li> <li>- 14.4 kbps</li> <li>- USSD</li> </ul>
SMS	Point-to-point MT and MO Cell Broadcast Text and PDU mode
GNSS Features	
Protocol	NMEA
Modes	Standalone GNSS Assisted GNSS <ul style="list-style-type: none"> <li>- Control plane-E911</li> <li>- User plane- gpsOneXTRA™</li> </ul>
General	GPS and GLONASS Power saving modes
Software	
AT commands	Hayes, 3GPP TS 27.007 and 27.005, and proprietary Cinterion Wireless Modules commands
SIM Application Toolkit	SAT Release 99

Parameter	Specifications
Audio	Audio speech codecs GSM: AMR, EFR, FR, HR 3GPP: AMR echo cancellation, noise suppression
Interface	
Antenna	50Ohms. Main GSM/UMTS antenna, UMTS diversity antenna, GNSS antenna (passive)
USB	USB 2.0 High Speed (480Mbit/s) device interface, Full Speed(12Mbit/s) compliant
UICC interface	Supported chip cards: UICC/SIM/USIM 3V, 1.8V
Special features	
Phonebook	SIM and phone
Antenna	SAIC (Single Antenna Interference Cancellation) / DARP (Downlink Advanced Receiver Performance) RX diversity (receiver type 3i-16-QAM)

### **Bluetooth Radio**

Parameter	Specifications
Manufacturer	Zebra, PN 21-148603-02
Form Factor	Embedded surface mount module, 15 x 15 mm * This is a combo module containing both Wi-Fi 802.11a/b/g/n and Bluetooth V4.0 LE radio
Antenna Port	U.FL jack
Antenna Type	Surface mount PIFA antenna. Covers 2400-2484 MHz @ <2.5:1 VSWR
Antenna Gain	0 dBi
Transmit Power	1 mW (0 dBm)
Frequency Range	2.400-2.4835 GHz
Channels	79
RX Sensitivity	-91 dBm @ 1 Mbps -83 dBm @ 3 Mbps
Data Rates	V1.2=732.2 kbps and 57.6 kbps asymmetric, 433.9 kbps symmetric V 2.0=2 & 3 Mbps
IEEE802.11 Coexistence	Co-existent is realized through antenna isolation. SW co-existent disabled in Workabout Pro4.





# APPENDIX F WIRELESS WIDE AREA NETWORK (WWAN) SETTINGS

---

## Wireless WAN

The Workabout Pro4 is available with one of the following Wireless WAN (WWAN) radio options: the Cinterion MC75i EDGE and the Cinterion PH8-P HSPA+. An Workabout Pro4 Hand-Held Computer equipped with a GSM/GPRS radio has wide area networking capabilities. With either of these radios and a SIM card, you can wirelessly transfer data, and you use the Workabout Pro4 voice option to place phone calls.

### Taskbar Icons

Wireless WAN icons in the taskbar indicate the status of your wide area network connection. Note that these icons are only visible when the relative radio is installed in the computer, and the interface is enabled.

The following taskbar icons are used:

- G - GSM/GPRS
- E - GSM/EDGE
- 3G - UMTS 3G
- U - UMTS/HSPA+



User interaction is required (e.g. the user is required to enter a PIN).



A non-recoverable (fatal) error has occurred.



The modem status is unknown or the modem is not connected to any network (the signal strength is 0%).



The modem has found a network, and the signal strength is between 1% and 20%.



The modem has found a network, and the signal strength is between 21% and 40%.



The modem has found a network, and the signal strength is between 41% and 60%.



The modem has found a network, and the signal strength is between 61% and 80%.



The modem has found a network, and the signal strength is between 81% and 100%.

Once the modem detects that a packet data service is available, a letter is added to the signal strength icon indicating the kind of packet data service. Keep in mind that the signal strength icon is displayed without a letter if packet data service is not available, or if it is available but not yet initialized.

For example:



The modem has found a network, the signal strength is between 41% and 60%, and GSM/GPRS packet service is available.

The signal strength icon is replaced by a connection indicator icon when a packet data connection is started:



A GPRS packet data connection is active.

In addition to the signal strength or connection indicator a second icon may be shown.



A new SMS (Short Message Service) message has arrived.



The dialer icon is displayed when the Voice option is available (SIM card and GPRS radio are installed). When you have an active call, this icon flashes yellow, and then green.

### Establishing a Packet Data Connection

To display the main *Wireless WAN dialog box*:

- Double-tap on the **Wireless WAN** icon in the taskbar.

If the icon is not visible in the taskbar, the radio interface has been shut down or the modem has been removed:

- In the *Control Panel*, choose the **Wireless WAN** icon.



The main *Wireless WAN dialog box* is displayed.

Figure F-3 Establishing a Connection

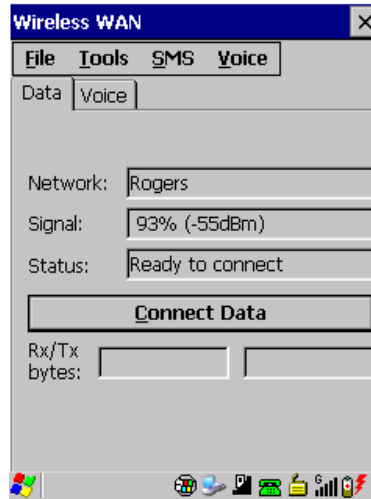

✓ **NOTE** If you are prompted to enter a PIN, refer to [Entering a PIN Number on page F-4](#) for details.

When “*Ready to connect*” is displayed in the *Status* field, the *Connect Data* button is enabled.

- Tap on the **Connect Data** button.

The progress of the connection is tracked in the *Status* field.

- Connecting.
- PPP link to modem active.
- Authenticating user.
- User authenticated.
- Connected.

✓ **NOTE** Keep in mind that these states may be displayed fairly quickly if the progress of the connection is rapid.

When the connection state reaches *PPP link to modem active*, the taskbar icon changes to indicate an active connection. The *Connect Data* button changes to *Disconnect*.

### Disconnecting From a Network

To disconnect from the network:

- Tap the stylus on the **Disconnect** button, and then on **OK**.

When the computer’s network connection is severed, the *Status* field displays “*Ready to connect*”.

The signal strength is displayed in the main Wireless WAN screen, even while a connection is active. The *Rx bytes* and *Tx bytes* fields estimate the amount of data transmitted and received, respectively.

### Shutting Down the Wireless WAN User Interface

While it is not usual to shut down the GSM/GPRS user interface, you can accomplish this by tapping on the **File** menu and choosing the **Exit** command at the bottom of the main *Wireless WAN* dialog box.

- ✓ **NOTE** Once you've shut down the user interface, you can only enable the radio by opening the Control Panel and tapping on the Wireless WAN icon to display the Wireless WAN dialog box.

## Advanced Information

In most cases, when a GSM/GPRS radio and SIM are installed in your computer, setup is automatic. Follow the steps outlined under the heading "Establishing a Packet Data Connection" on page F-2 to make a connection. The information in this section is for advanced setup purposes.

### Entering a PIN Number

If a PIN is required, a PIN entry dialog box is displayed.

- Type your PIN, and press **[Enter]**.

- ✓ **NOTE** If you exceed the number of allowable attempts, a PUK entry window is brought to the foreground. You'll need to enter a new PIN number.

Once the correct PIN or PUK is entered or if none was required, the modem is instructed to perform a GSM network registration followed by a GPRS attach. The main *Wireless WAN* dialog box reflects the progress of the initialization.

- Searching for modem.
- Initializing modem.
- SIM is ready.
- Searching for network.
- Registered on network.
- Searching for GPRS.
- Ready to connect.

If the modem loses the connection to the GSM network, the following states are repeated: *Searching for network*, *Registered on network*, *Searching for packet data*, and *Ready to connect*.

### Error States

The following temporary error states (i.e., these states may disappear without interaction) may be displayed:

- Emergency calls only.  
The modem has found a network but is not allowed to register (e.g. no roaming agreement between networks). The modem keeps searching for another network.
- No network found.  
A network is not currently available. The modem continues searching for a network.
- Packet data not available.  
The current network does not support a packet data service.
- Packet data not allowed.  
The modem is not allowed to use the packet data service on the current network (e.g. no GPRS roaming agreement between network; a roaming agreement for voice may still be in place). It is also possible that you do not have a subscription for GPRS at all.

The remaining error states are permanent:

- SIM is missing.

The SIM card is missing. After the SIM has been inserted a warm boot may be required.

- SIM failure.

The SIM card is permanently disabled (e.g. because the wrong PUK has been entered too many times). A new SIM is needed.

- Modem failure.

The modem did not respond to commands as expected. If a warm boot does not clear this condition, the modem may need to be replaced.

- NDIS error.

An internal software error has occurred. If a warm boot does not clear this condition, Zebra technical support may need to investigate further.

## Tools Menu

The Tools menu in the main *Wireless WAN* dialog box offers some additional, advanced setup features.

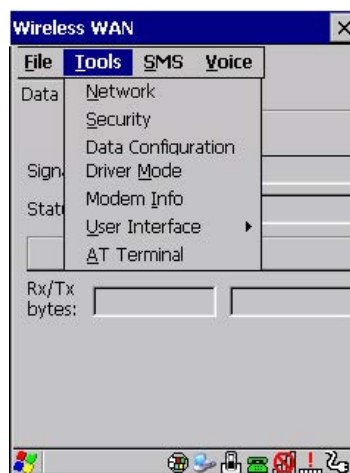

## WWAN Data Configuration

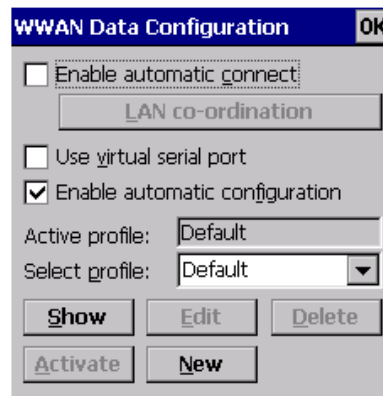

### Enable Automatic Connect

If the *Enable automatic connect* check box is checked (unchecked by default), the Wireless WAN user interface will attempt to establish a GPRS connection whenever GPRS is available (e.g. after resume from suspend without further user interaction).

To activate the automatic connection mode:

- Tap on the **OK** button.

While automatic connection mode is enabled, the *Connect Data* button in the main *Wireless LAN* dialog box changes to *Disable Auto*. To close the currently active connection (if any) and disable the automatic connection mode:

- Tap on **Disable Auto**.



**IMPORTANT** Automatic connection mode should not be used if applications other than the Wireless WAN user interface (e.g. Connection Manager) are expected to open and close connections.

If the automatic connection mode is enabled and another application closes the GPRS connection, the WWAN user interface will immediately try to re-establish the connection.

### Use Virtual Serial Port

If *Use virtual serial port* is enabled, packet data connections are established through the virtual serial port of the WWAN driver rather than through the WWAN driver directly. This check box should *only* be checked if certain third-party VPN (Virtual Private Network) clients are used that do not work correctly otherwise. The default setting is **disabled** (unchecked).



**NOTE** The connection setup takes longer through the virtual serial port.

### Enable Automatic Configuration

In most cases, *the data connection is configured automatically and no user interaction is required*. This is true even if multiple SIM cards from different operators are used with the same device. The connection parameters are adjusted automatically when a new SIM card is detected (this may require a warm boot). The connection parameters are retrieved from a database.

Manual configuration should be necessary only if:

- One or more parameters in the database are incorrect or a new operator is not yet in the database. (The database should be corrected for subsequent software releases.)
- An operator has assigned individual GPRS user names and passwords.
- A very large site has its own APN. Such connections always have to be configured manually.
- A customer has subscribed for a static IP address. By definition this must be configured manually.
- An operator may use a different APN for certain groups of customers. Since the automatic configuration can configure only one APN per operator such connections have to be configured manually.

### Profiles

In the following section, all the parameters that need to be configured for a connection (such as APN, user name, password, DNS server addresses etc.) are referred to as a 'profile'. Every profile is identified by an arbitrary, unique name. The profile named *Default* is special in that it is always present and can neither be edited nor deleted. The *Default* profile uses parameters from a built-in database. The home network (the network that issued the SIM) is used for the database look-up. While there can be many configured profiles, only one profile can be active at any time.

If connection profiles are configured manually, the *Enable automatic configuration* check box should normally be unchecked.

In one particular use case, manually configured profiles may be combined with automatic configuration. If multiple SIM cards are used with the same device, each SIM card being from a different operator and some or all of them requiring a manually set up profile, automatic configuration may be used to automatically pick

the correct manually configured profile for each SIM card. For this to work, each profile must be configured while the corresponding SIM card is inserted in the device and initialized (i.e. the status is at least *Searching for network*).

The *Select profile*: drop-down list in the data configuration profile selects to which profile a subsequent action applies. A profile named *Default* is always present and contains the current parameters from the database. The following actions are available:

#### **Show**

The parameters for the selected profile are displayed when you tap the stylus on this button. For the *Default* profile, the publicly known password is shown — otherwise, the password is hidden.

#### **Edit**

The parameters of the selected profile can be edited when you choose the *Edit* button. Keep in mind that you cannot edit the *Default* profile.

#### **Delete**

The selected profile is deleted. You cannot delete the *Default* profile.

#### **Activate**

When this button is chosen, the selected profile becomes the active profile. Activation is possible only if the *Enable automatic configuration*: check box is unchecked.

#### **New**

Tapping on the *New* button allows you to create a new profile.

**Figure F-4** *Creating a New Profile*

The name of the newly created profile must be different from all existing profiles. Also, the name cannot be *Default*. When the *New Data Profile* dialog box is opened, a proposal for a unique name is filled in the corresponding entry field. If a manually configured profile has a secret password and unauthorized access to the device is a concern even after the SIM PIN has been entered, the password should not be entered in the *New Data Profile* dialog box and the *Prompt user for password* check box should be checked instead. In this case, you will be prompted for the password each time a connection is initiated (the *Connect Data* button in the main *Wireless WAN* dialog box is selected).

By default the connection uses PAP (Password Authentication Protocol), a simple authentication protocol used to authenticate a user to a remote access server or Internet Service Provider. However, if your ISP does not support PAP, tapping in the box to the left of *Force PAP authentication* disables PAP and directs the connection to use CHAP (Challenge Handshake Authentication Protocol) instead.

**Reset**

The *Reset* button in the *New Profile* and *Edit Profile* dialog boxes resets all entry fields to the values they had when the dialog box was opened.

**Advanced IP**

Figure F-5 Assigning IP Information

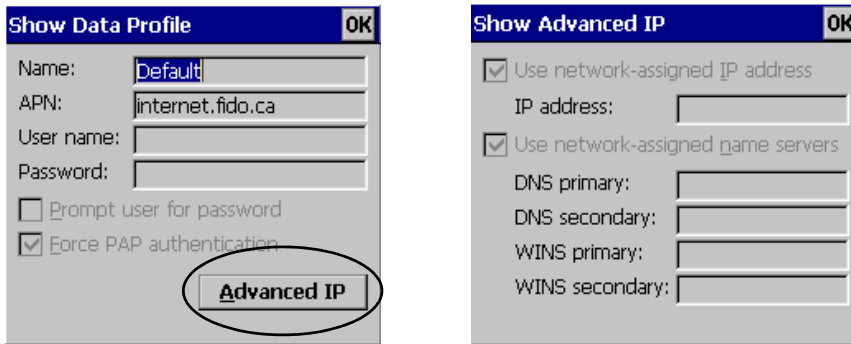

The *Advanced IP* button in the *Show Profile* and *Edit Profile* dialog boxes opens another dialog box that allows you to configure a static IP address as well providing DNS and WINS fields so that you can specify DNS and WINS resolvers.

**Security Configuration**

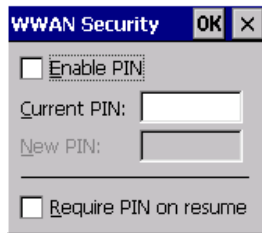

The *Security Configuration* dialog box is accessed through the *Tools* menu. The *Security Configuration* dialog box allows you to enable, disable and change the PIN. You will need the current PIN to make any of these changes. The PIN must be enabled in order to be changed. (If the PIN is disabled, the *New PIN* entry field is greyed out.)



**NOTE** Keep in mind that some network operators do not allow the SIM PIN to be disabled. A new PIN must consist of 4 to 8 numeric digits.

The *Require PIN on resume* check box is independent of the aforementioned settings. By default, this check box is unchecked. While this option remains unchecked, any PIN entered on startup or through the *Security Configuration* dialog box and submitted successfully to the modem is stored in memory for as long as the device is not rebooted. This stored PIN is then used without further user interaction whenever the modem requires a PIN (such as resume after suspend or modem removal). The stored PIN is also automatically entered in the *Current PIN* text box whenever the *Security Configuration* dialog box is called up.

If unauthorized access to the device is a concern, the *Require PIN on resume* check box should be checked. In this case, the PIN is not stored; whenever a PIN is required, you will be prompted to enter an appropriate value.



## Network Configuration

In the main Wireless WAN window:

- Tap on the **Tools** menu, and choose **Network**.

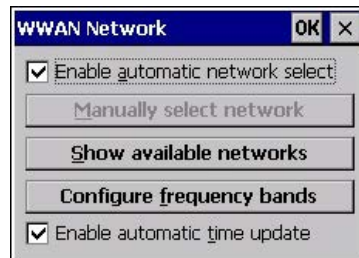

### Enable Automatic Network Select

By default the GSM radio modem automatically chooses from the available and allowed networks (allowed networks are the home network and all other networks with which the home network has a roaming agreement). You may find there are some situations in which you want to override this default behaviour. For example, you may want to disable roaming if you find yourself in a border area where the home network is not available but a foreign roaming partner is available. Abroad, you may find that an available network does not have GPRS roaming agreements. In this case, you'll need to manually select the network which you know to support GPRS roaming.

Automatic network selection is enabled or disabled by checking or unchecking *Enable automatic network select* in the *Network* dialog box. When automatic network selection is disabled, you must select a network manually.

### Show Available Networks

Available networks can also be viewed without changing any settings. Scanning for available networks is a lengthy operation — a progress bar is shown while the scan is active. For every network that is found, the network name, country, status and numeric network identifier (MCC/MNC, Mobile Country Code followed by the Mobile Network Code) is displayed.



**NOTE** Your home network operator will need to let you know which other networks have roaming agreements. Even when a network is listed with an 'Available' status, it does not necessarily follow that it can be used or that the roaming agreement covers GPRS.

A status of 'Forbidden' indicates that the network cannot be used. If you choose a network that is not covered by a roaming agreement, the status in the main WWAN dialog box changes to 'Emergency calls only', 'No network found', 'GPRS not available' or 'GPRS not allowed'.

### Configure Frequency Bands

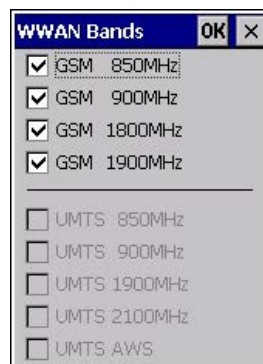

The network selection can be modified by enabling or disabling GSM and UMTS frequency bands.



**IMPORTANT** Care must be taken when disabling bands — the wrong band will prevent the modem from registering with the network (that is, not even emergency calls are possible if a mistake is made).

By default all bands supported by the installed WWAN modem are enabled. All bands that are not supported by the installed modem are greyed-out. While some modems (e.g. Cinterion PH8-P) allow all possible combinations of supported bands to be selected, others do not (e.g. Cinterion MC75i). A warning is displayed if an unsupported band combination is chosen.

By enabling only bands in use on a given network, the network search time (e.g. after losing the network due to a coverage gap) is improved. Through the band configuration it is possible to force the modem into GSM-only or UMTS-only mode. As an example, this is useful if a legacy application needs to use a dial-up connection and the network supports dial-up connections only on GSM but not on UMTS (as is the case with many European networks).

### Enable Automatic Time Update

If this feature is enabled, it allows the system time and time zone to be updated with information received from the WWAN network. This feature is network-dependent. If the WWAN network supports NITZ (“Network Information and Time Zone”), then it can send the current time, time zone, or both to the terminal.

### Driver Mode Configuration

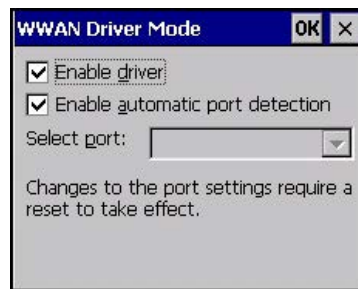

By default, the Wireless WAN driver is enabled (the *Enable driver* check box is checked). If the *Enable driver* check box is not checked, the driver is shut down as soon as the *OK* button in the *Driver Mode* dialog box is chosen.

If, on the other hand, the Wireless WAN driver is not running and the *Enable driver* check box is checked, the Wireless WAN driver is started as soon the *Driver Mode* dialog box is closed using the *OK* button.



**NOTE** When the driver is not running, no network status or signal strength can be displayed.

Since all currently supported GSM modems are automatically detected, the *Enable automatic port detection* check box should always be checked. If this check box is not checked, a serial port can be selected manually. This experimental feature allows the driver to be used with an internal GSM modem that was not recognized by the automatic detection or an external GSM modem connected to a serial port of the computer through USB or through *Bluetooth*. An external modem connected to a serial port must support 115.2 kbit/s, 8bit, no parity and hardware flow control.

## Modem Information

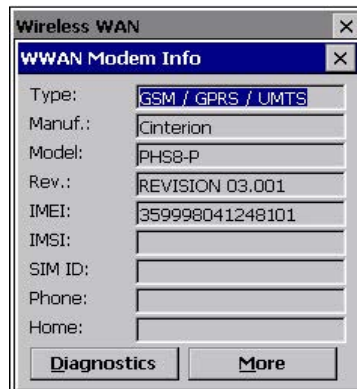

The fields in this dialog box cannot be edited, they only display information about the computer's modem. If the network operator has not programmed a user's phone number into his SIM, the *Phone*: field remains empty. If the main menu shows an error status, at least partial modem information may be available.

## Diagnostics and More

The *Diagnostics* screen may be useful when diagnosing network problems. The information presented here is not needed for normal operation. The *More* button shows you some additional detail about your modem.

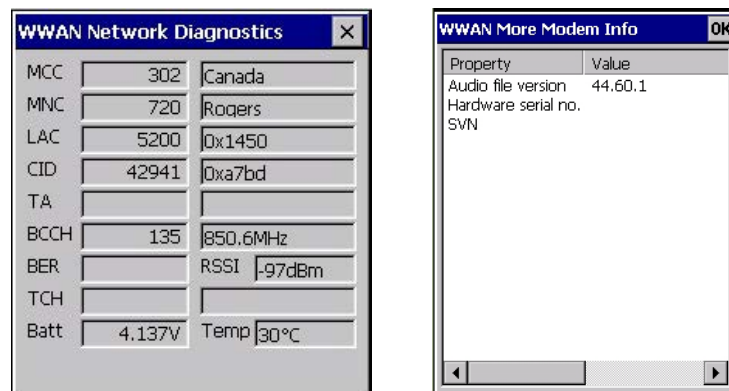

The following Diagnostics values are displayed:

Diagnostic Value	Description
MCC	Mobile Country Code (decimal value and, if available, decoded country name)
MNC	Mobile Network Code (decimal value and, if available, decoded network name)
LAC	Location Area Code (decimal and hexadecimal value)
CID	Cell Identifier (decimal and hexadecimal value)
TA	Timing Advance (decimal value and converted distance to base station in meters)
BCCH	Broadcast Control Channel (ARFCN or UARFCN value and converted frequency in MHz)
BER	Bit Error Rate
RSSI	Received Signal Strength Indication
TCH	Traffic Channel (ARFCN value and converted frequency in MHz)

Diagnostic Value	Description
Batt	Battery voltage as measured by the WWAN modem
Temp	WWAN modem Temperature

Note that *TA*, *BER*, and *TCH* are available only in GSM mode and only while there is an active connection (e.g. a voice call). If the status in the main window shows “No network found” or “Searching for network”, then typically only *Batt* and *Temp* are available. For the status “Emergency calls only”, *MCC*, *MNC*, *LAC*, *CID*, and *BCCH* may be available. For the GSM 1800MHz and GSM 1900MHz bands it may not be possible to convert the ARFCN for BCCH and TCH to a frequency because the channel numbers overlap. This can be overcome by enabling only the GSM bands used by a particular network (i.e. either GSM 1800MHz or GSM 1900MHz is disabled). If the network uses frequency hopping during GSM voice calls, then “hopping” is displayed in the TCH field.

### User Interface

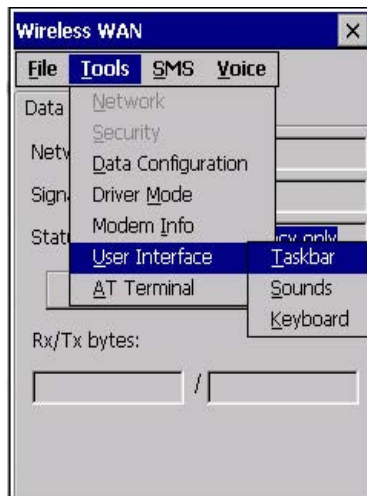

### Taskbar

Choosing *Taskbar* displays a dialog box in which you can determine which Wireless WAN icons will be displayed in the taskbar.

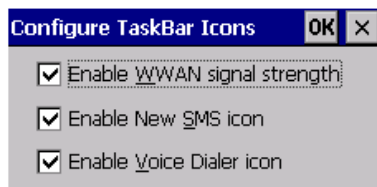

## Sounds

Tapping on the *Sounds* option displays a dialog box in which you can customize which sounds your Workabout Pro4 will emit and when these sounds will be played.



## Keyboard

Tapping on the *Keyboard* option displays a dialog box in which you can determine the phone SEND and END hotkeys.

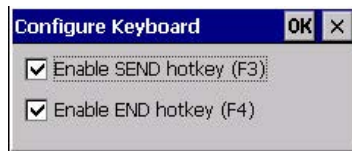

## AT Terminal

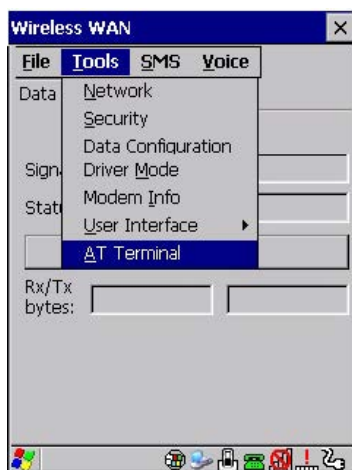

The AT Terminal window allows AT commands to be entered and sent to the modem. In some situations (e.g. during approval testing) it may be required to enter AT commands. This feature should only be used if one has a good understanding of the AT command set of the installed WWAN modem.

## SMS Menu

SMS (Short Message Service) functions are accessed through the SMS menu. For modems that support a SIM card, the SIM initialization typically takes longer than the network initialization, resulting in a noticeable delay before the SMS functions become available.

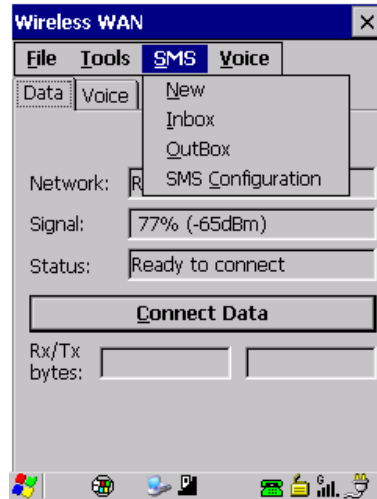

### New

Tapping on the *New* button opens a dialog for sending a new SMS message. The recipient's phone number (to be entered in the *To:* field) can consist of the digits 0 through 9, as well as the \* and # characters, optionally preceded by one + character, indicating an international number (i.e. the country code follows immediately after the + character).

By checking the *Store message in Outbox* field a new message can be stored in the Outbox before being sent. If no storage space is available, or the modem does not support the storage of outgoing messages, then this check box is disabled.

### Inbox

Tapping on the *Inbox* button opens the list of received messages. Reading 50 messages, for example, from the SIM can take about 30 seconds. By default the list of messages is sorted with the most recently received message first. The list can be sorted by any other column by clicking on the corresponding column heading. Clicking the same column heading twice reverses the sort order. Tapping on any letter or digit moves the highlight to the next message whose address begins with that letter or number.



**NOTE** The date and time formats can be changed through the Region and Language menu in Control Panel. For a new date or time format to take effect the Inbox has to be closed and re-opened.

The *Open* button opens the selected message in a new window such that the entire message can be read including the original formatting (line breaks are replaced by spaces in the Inbox message list). Pressing the **Reply** button opens the new message dialog as described above, except the destination phone number is filled in already.

### Outbox

Tapping on the *Outbox* button opens the list of sent messages. Otherwise the *Outbox* behaves exactly as the Inbox described above. The date and time when a message was sent is not available for GSM modems.

## SMS Configuration

Tapping on the *SMS Configuration* button opens the SMS configuration dialog. The SMS Centre address follows the same rules as the recipient's phone number in the New message dialog. The message validity period parameter is sent to the SMS Centre with each message sent subsequently and instructs the SMS Centre on how long it should attempt to deliver the message to the recipient (the SMS Centre may impose an upper limit on the validity period regardless of the setting).



**NOTE** Only certain discrete validity period values can be sent and thus the validity period is rounded to the nearest allowed value. The next time the SMS configuration dialog is opened the rounded value is shown.

The user interface tries to keep the SMS storage location available for a new incoming message if the Delete oldest message when full check box is checked. In this case, when a new message arrives and the SMS storage becomes full, the oldest received message is deleted. If any string is entered as the 'Message Suppression Prefix', then messages beginning with that string will not be shown in either the Inbox or Outbox. In this way messages intended for another application running on the same device can be hidden from the user, as long as those messages begin with the string configured here.

## Voice

The *Voice* tab is described in detail under "Voice – Using the WWAN Phone Dialer" on page 59.

---

## Power Mode

The power mode of the modem is controlled through the *Power* menu in the *Control Panel* (not through the Wireless WAN user interface).





# APPENDIX G WIRELESS ZERO CONFIG SETTINGS

## Wireless Information

This appendix describes how to set up your radio using *Windows Wireless Zero Configuration* – an alternative to the *Fusion Wireless Companion*.

- ✓ **NOTE** For details about using *Fusion Wireless Companion*, refer to [Fusion Wireless Companion - Setting Up the 802.11a/b/g/n on page 3-65](#).
- Tap on the **Fusion** icon in the taskbar at the bottom of the screen to display the menu. In the *Fusion Launch* menu, tap on **Options**.



- Choose **WLAN Management** from the *Options* drop-down menu, and tap on **Save**.



- Tap on the radio button next to **Windows Manages WLAN**, and tap on **Save** and **OK**.



- Press and hold down the **[Power]** button and the **[FN/BLUE]** key to reset the unit.

## Wireless Information Tab

This tab displays existing networks to which you can connect, and it allows you to add a new network or modify the settings for an existing network.

- **Configure** button: To change the settings in an existing network, highlight the network you want to modify, and tap on the Configure button to display the Wireless Properties dialog box.
- **Connect** button: To force connection to a specific, existing network, highlight the network to which you want the Workabout Pro4 to connect, and tap on the **Connect** button.

Figure G-6 *Wireless Information*

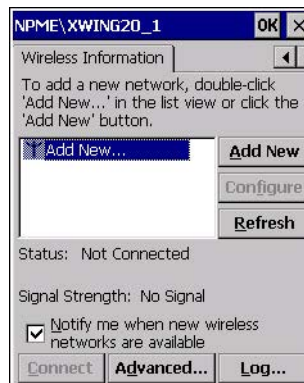

This tab lists available networks — any access points that are broadcasting an SSID, and it lists preferred networks — networks that you have configured. Since access points are generally secure, they will most likely not be listed here. By default, the Workabout Pro4 attempts to connect to preferred networks. This behaviour can be changed by enabling *Automatically connect to non-preferred networks* in the *Advanced* dialog box (see [Figure G-9 Advanced Wireless Settings](#)).

- To add a new configuration, tap on the **Add New** button. A blank *Wireless Properties* dialog box is displayed.

## Wireless Properties

Figure G-7 Wireless Properties



- Type the appropriate SSID (Service Set Identifier) in the **Network name (SSID):** dialog box. The *Network name* field can contain a maximum of 32 characters. The name assigned here is listed as a preferred network.



**IMPORTANT** Keep in mind that the Workabout Pro4 will only communicate with access points that are configured with the same SSID.

- **Ad Hoc And Infrastructure:** If you are using an *Infrastructure* network — one in which the hand-helds must pass data through an access point — leave the check box next to *This is an ad hoc network* blank. If you are using an *Ad Hoc* network — a network in which the hand-helds pass data directly to other Ad Hoc devices without an access point — add a check mark in the check box next to *This is an ad hoc network* to enable Ad Hoc.
- **Encryption:** *WEP* (Wired-Equivalent Privacy) encryption prevents others from accidentally accessing your network. If you are not using encryption, you can choose *Disabled* from the drop-down encryption menu. Otherwise, leave this field as is.

*AES* (Advanced Encryption Standard) is a standard for protecting data through encryption. *AES* supports key sizes of 128 bits, 192 bits and 256 bits and will serve as a replacement for the Data Encryption Standard (*DES*), which has a key size of 56 bits. In addition to the increased security that comes with larger key sizes, the *AES* algorithm is a symmetrical block cipher that can encrypt (encipher) and decrypt (decipher) information.

*TKIP* (Temporal Key Integrity Protocol) uses the original *WEP* programming but wraps additional code at the beginning and end to encapsulate and modify it. Like *WEP*, *TKIP* uses the *RC4* stream encryption algorithm as its basis. The new protocol, however, encrypts each data packet with a unique encryption key, and the keys are much stronger than those of its predecessor.

- **Authentication:** 802.11 supports several subtypes of network authentication services: *Open*, *Shared*, *WPA*, and *WPA-PSK*. Under *Open* authentication, any wireless station can request authentication. The station that needs to authenticate with another wireless station sends an authentication management frame that contains the identity of the sending station. The receiving station then sends back a frame that indicates whether it recognizes the identity of the sending station.

Under *Shared* authentication, each wireless station is assumed to have received a secret shared key over a secure channel that is independent from the 802.11 wireless network communications channel.

Under *WPA* and *WPA-PSK* authentication, the use of 802.1x authentication is required. For wireless networks *without* a Remote Authentication Dial-In User Service (*RADIUS*) infrastructure, *WPA* supports the use of a preshared key. For wireless networks *with* a *RADIUS* infrastructure, Extensible Authentication Protocol (*EAP*) and *RADIUS* is supported.

- **Network Key:** This text box is used to specify a 5 or 13 ASCII character sequence or an equivalent 10 or 26 Hexadecimal digit sequence that matches the active WEP key on the access point.

To assign a *Network key*, highlight **The key is provided automatically**, and *uncheck* the check box to disable this option.

Figure G-8 Network Key and Key Index



- **Key Index:** This field is used to identify the WEP key.  
Enter a value from **1** to **4**.
- **Enable 802.1x authentication:** *802.1X* is the IEEE standard that offers additional security for local area networks. It provides authentication for user devices attached to an Ethernet network, whether wired or wireless. A security protocol packet such as TLS or MD5 encapsulated in an *EAP* is used in conjunction with the 802.1X standard to authenticate users at the MAC layer. Available EAPs are listed in the drop-down menu next to the *EAP* option.  
To activate 802.1X, highlight **802.1x authentication**, and check the check box.
- **EAP Type (Extensible Authentication Protocol):** This drop-down menu lists the EAP types available on your system. The items in this drop-down menu will vary depending on your network setup. Keep in mind also that some authentication protocols require that you select a Certificate. By selecting the *Properties* button, you will be able to select a *Certificate*.
- **Saving and exiting the radio setup:** Once you've completed the configuration, press **[Enter]**, or tap on **OK**.

The connection you created will be listed in the *Wireless Information* tab as a preferred network. The radio will search for the SSID and compare the WEP and authentication information you specified. If there is a match between the hand-held settings and the access point settings, the hand-held will communicate on the network through the access point.

---

## Assigning an IP Address

If your network is not using a DHCP server, you will need to assign an IP address.

- Use the *arrow buttons* at the top of the *Wireless Information* tab to scroll to the **IP Information** tab.

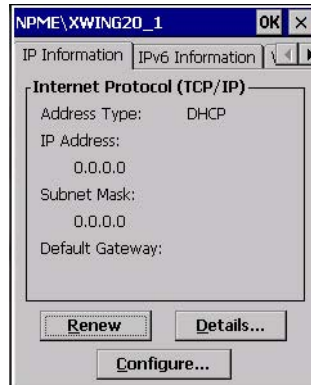

- Tap on the **Configure** button., and then tap on the **radio button** next to *Specify an IP address*, and enter values in the fields next to **IP address**, **Subnet Mask**, and **Default Gateway**.

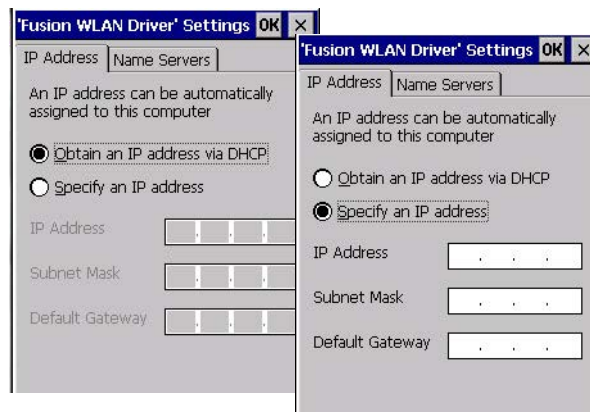

## Name Servers Tab

The DNS and WINS fields in the *Name Servers* tab allow you to specify additional WINS and DNS resolvers. The format for these fields is **###.###.###.###**.

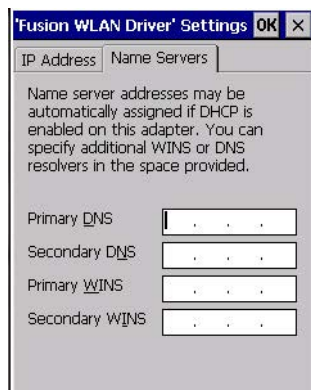

## Advanced Features

To display the *Advanced Wireless Settings* dialog box:

- Tap on the **Advanced** button in the *Wireless Information* tab. (Refer to [Figure G-6 Wireless Information](#).)

This window lists the available preferred networks.

**Figure G-9** *Advanced Wireless Settings*

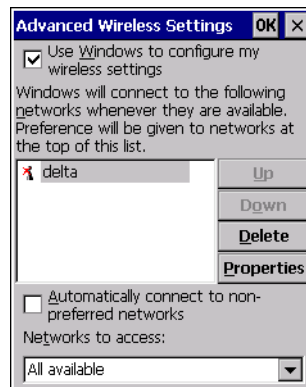

### Rearranging Preferred Networks

The Workabout Pro4 attempts to connect with the networks listed in this dialog box in sequence, beginning at the top of the list. If you need to rearrange this list of networks — move networks up and down in the list:

- Tap in the *Networks List*, and highlight the **network** that you want to move up or down in the list.
- To move the highlighted item in the list upward or downward, tap on the **Up** or **Down** button.

### Deleting a Preferred Network

To delete a network from this list:

- In the *preferred networks* list, highlight the **network** you want to remove.
- Tap on the **Delete** button.

### Changing Network Properties

To change the properties of an existing preferred network:

- Highlight the **network** that you want to modify.
- Tap on the **Properties** button.
- Make any necessary changes in the *Wireless Properties* dialog box, and press **[Enter]** to save the changes.

# INDEX

## Numerics

- 1D internal scanner ..... 2-10, 2-11
- 2D imager ..... 2-11
- 2D imager scanner ..... 4-21
- 36-key keyboard
  - alpha keys, accessing ..... 2-5
  - uppercase letters, creating ..... 2-6
- 802.11a/b/g/n radio ..... E-3
- 802.11a/b/g/n radio, configuring ..... 3-65

## A

- accessories
  - carrying case ..... 4-7
  - Ethernet adaptor cable ..... 4-13
  - four bay Ethernet cradle ..... 4-14
  - hand strap ..... 4-1
  - holster, soft shell ..... 4-7
  - pistol grip ..... 4-2
  - port replicator ..... 4-20
  - single bay USB cradle ..... 4-10
  - vehicle cradle ..... 4-17
- adaptor cable
  - USB-Ethernet ..... 4-13
- Administrator Password (Kiosk settings) ..... 3-42
- Aim Duration ..... C-3
- ALT Key ..... 2-3
- appearance (display colour scheme) ..... 3-20
- appending to barcodes
  - characters ..... C-5
- App Launch Keys ..... 3-5
- approvals, Workabout Pro (including scanner) ..... E-2
- arrow keys
  - moving the cursor ..... 2-3
- AT Terminal, WWAN ..... F-13
- audio indicators

- adjusting volume ..... 2-9
- description of beep conditions ..... 2-9
- AutoRestore ..... 3-56

## B

- background, choosing for Desktop ..... 3-45
- background image (display scheme) ..... 3-19
- backlight
  - display ..... 3-20
  - intensity ..... 2-6
- backplate, trigger ..... 4-3
- Backspace (DEL Key) ..... 2-3
- backup Profile (Total Recall)
  - AutoRestore ..... 3-56
  - Clone to USB ..... 3-56
  - creating ..... 3-53
  - Restore ..... 3-56
  - restoring ..... 3-55
  - Upload to A.R.C. .... 3-56
  - viewing ..... 3-55
- backups, managing profiles ..... 3-55
- Bad Scan Vibrates ..... C-6
- barcode
  - appending to ..... C-5
  - displaying type of barcode ..... C-6
  - parameters ..... C-2
  - Translation tab ..... C-7
- bar code reader
  - integrated scanner, operation of ..... 4-20
- barcode reader
  - integrated scanner, operation of ..... 2-10
- batteries
  - a description of ..... 4-8
- battery ..... 2-1-2-2
  - Advanced dialog box ..... 3-39
  - Battery Health dialog box ..... 3-40

capacity dialog box	3-37
charging	2-2
estimated battery backup time	3-38
installing	1-3
power saving suspend dialog box	3-38
removing	1-3
replacing	1-3
specifications	E-2
Suspend Threshold dialog box	3-38
swap time	2-1
taskbar icon	2-8
Wakeup Sources dialog box	3-40
battery charger	
safety instructions	4-10
Baud, port replicator	C-9
beeper	
adjusting volume	2-9
description of beep conditions	2-9
Bluetooth radio	
devices, pairing	3-10
GPRS setup	3-13
ISM band	3-7
radio configuration	3-7–3-16
setup	3-7
specifications	E-7
Bluetooth Setup	
Microsoft Bluetooth, switching to	3-7
Stonestreet One BTE Explorer, switching to and from	3-7
Bluetooth setup	
peripherals	4-22
Bluetooth stack, switching	3-7
Boot to BooSt	1-5
Bright For (backlight)	3-21

## C

cable diagrams	A-1
calibrating touchscreen	2-7, 3-51
Call Lists	3-61
Call Management	3-61
camera	
specifications	E-2
case, carrying	4-7
Certificates	3-16
charger	
safety instructions	4-10
chargers	4-9
installing at a site	4-9
operator controls	4-10
single bay USB cradle	4-10
chargers and cradles available	4-9
Cinterion	

PH8-P GSM/GPRS/EDGE/UMTS/HSPA+ radio specifications	E-5
clean start	1-5
Click Data (scanner double-click)	C-5
Click Time (scanner double-click)	C-5
clone (Total Recall)	3-54
Clone to USB	3-56
Codepage	C-7
Command Prompt	2-16
communication	
Ethernet connection	4-13
Ethernet connection (four bay Ethernet cradle)	4-15
WORKABOUT to PC	4-13
computer hardware properties	3-52
conference calls, creating	3-62
Control Panel	
accessing	3-2
App Launch Keys icon	3-5
applications list	3-2
Display Properties	3-19
keyboard properties	3-26
power management properties	3-37
stylus properties	3-51
Control Panel Settings (Kiosk settings)	3-45
cradles	
installation at site	4-9
cradles and chargers available	4-9
cradle <i>See also</i> Picker cradle	4-17
CTRL Key	2-3
cycle tasks	2-17

## D

Data Bits, port replicator	C-10
Data Transmission	
Paste data	C-7
Wedge data	C-7
DataWedge	B-1
decoded (internal) scanner parameters	C-3
DEL (Backspace) Key	2-3
Demo	
Scanner	2-16
Signature	2-16
Sound	2-16
Desktop background, choosing	3-45
desktop connection, remote	3-47
desktop shell appearance	2-20
desktop themes	3-44
diagnostics, WWAN network	F-11
dialer (phone), using	1-6, 3-59
dialing, phone number	1-6, 3-59, 3-60
Dim For (backlight)	3-21
dismounting partitions	3-49
display	



- appearance (colour scheme) . . . . . 3-20
  - background (image) . . . . . 3-19
  - backlight . . . . . 3-20
  - backlight, adjusting . . . . . 2-6
  - Display Properties . . . . . 3-19
  - Display Properties . . . . . 3-19
  - docking device icons . . . . . 2-9
  - docking stations
    - operator controls . . . . . 4-10
  - double-click
    - appending characters to a decoded barcode . . . . . C-5
    - scanner trigger . . . . . C-5
  - Double-Click, Manage Triggers menu . . . . . 3-34
  - Double-Tap (stylus settings) . . . . . 3-51
  - Dr. Debug . . . . . 3-21
  - Driver Mode configuration, WWAN . . . . . F-10
- E**
- Error Reporting . . . . . 3-22
  - ESC Key . . . . . 2-3
- F**
- Flush Mount Pistol Grip, installing . . . . . 4-6
  - formatting
    - entire memory card . . . . . 3-47
    - partitions . . . . . 3-49
  - four bay Ethernet cradle (WA4204-G2 and WA4304-G2) . . . . . 4-14
  - FTP Server, Registry Editor . . . . . 3-58
  - Fusion Wireless Companion (802.11a/b/g/n), configuring . . . . . 3-65
- G**
- Good Scan Beep . . . . . C-6
  - Good Scan Vibrates . . . . . C-6
  - GPRS (*Bluetooth*) . . . . . 3-13
  - GPS Settings (built-in profiles) . . . . . 3-23
  - GSM/EDGE . . . . . G-1
  - GSM/GPRS/EDGE radio specifications . . . . . E-5
- H**
- hand-held specifications . . . . . E-1
  - hand strap . . . . . 4-1
  - hard reset . . . . . 1-4
  - headsets, pairing (*Bluetooth*) . . . . . 3-10
  - holster, soft shell . . . . . 4-7
- I**
- imager
    - two dimensional (2D) imager . . . . . 2-11
  - imager (2D) scanner
    - scanning
      - 2D . . . . . 4-21
  - imager options . . . . . 4-20
  - Import/Export to File (Kiosk settings) . . . . . 3-46
  - indicators
    - 802.11 radio signal quality . . . . . 2-8
    - battery . . . . . 2-8
    - docking devices . . . . . 2-9
    - LED functions . . . . . 2-7
    - modifier keys . . . . . 2-8
    - onscreen . . . . . 2-7
    - scanner message . . . . . 2-10, 2-11
    - task bar . . . . . 2-14
    - WWAN radio signal quality . . . . . 2-9
  - Ingenuity (Kiosk Shell), settings . . . . . 3-44
  - input panel (Control Panel) . . . . . 3-3
  - integrated scanner option . . . . . 2-10, 4-20
  - Intensity (7035 backlighting) . . . . . 3-27
  - Intensity (backlighting) . . . . . 3-21
  - Internet Explorer . . . . . 2-16
  - IPv6 . . . . . 3-58
  - ISM band, *Bluetooth* radio . . . . . 3-7
- K**
- keyboard
    - 36-key keyboard . . . . . 2-5
    - alpha keys, 36-key keyboard . . . . . 2-5
    - backlight . . . . . 3-27
    - key repeat . . . . . 3-26, 3-27
    - One Shot Mode . . . . . 3-27
    - onscreen, Microsoft SIP . . . . . 3-25
    - Properties . . . . . 3-26
  - keyboard keys . . . . . 2-2
    - ALT . . . . . 2-3
    - arrow keys . . . . . 2-3
    - Backspace . . . . . 2-3
    - CTRL . . . . . 2-3
    - DEL . . . . . 2-3
    - ESC . . . . . 2-3
    - macro keys . . . . . 2-5, 3-29
    - modifiers . . . . . 2-4
    - navigating using the keyboard . . . . . 2-12
    - SCAN . . . . . 2-3
    - SHIFT . . . . . 2-3
    - SPACE . . . . . 2-3
    - Tab . . . . . 2-3
    - Volume . . . . . 2-3
  - Key Repeat tab . . . . . 3-26
  - Kiosk menus . . . . . 3-41
  - Kiosk settings
    - Administrator Password . . . . . 3-42

Control Panel Settings .....	3-45
Import/Export to File .....	3-46
Restrictions .....	3-45
Shell Settings .....	3-43
Kiosk Shell .....	2-20

## L

Laser On Time .....	C-3
LED	
functions .....	2-7
Linear Security Level .....	C-3
Lithium-ion batteries	
installing .....	1-3
removing .....	1-3
replacing .....	1-3
Lock Sequence .....	3-33

## M

Macro keys	
accessing .....	2-5
executing a macro .....	3-30
Macros menu, accessing .....	3-29
recording and saving .....	3-29
maintenance .....	2-22
Manage Triggers .....	3-34
memory card	
creating partitions .....	3-48
formatting entire .....	3-47
formatting partition .....	3-49
messages	
Scan Indicator .....	C-6
scanner warning message .....	C-6
Scan Result .....	C-6
microphone adjustments .....	3-64
microphone gain adjustment .....	3-36
microSD Card, inserting .....	2-9
Microsoft® ActiveSync® .....	3-17
Microsoft Soft Input Panel (SIP) .....	3-25
Mobile Device Center (Windows), setting up .....	3-18
model number .....	xiv
modem information, WWAN .....	F-11
modem using VPN clients .....	F-6
modifier keys .....	2-4
locking .....	2-4
One Shot Mode .....	3-27
unlocking .....	2-4
mounting partitions .....	3-50
Multiple Beep Tones .....	C-6

## N

network connection, monitoring .....	3-69
--------------------------------------	------

## O

On & Off button .....	1-3
One BTEplorer .....	3-7
one dimensional internal scanner .....	2-10, 2-11
One Shot Mode .....	3-27
ON For .....	3-27
onscreen keyboard, Soft Input Panel (SIP) .....	3-3, 3-25
Open TekTerm application .....	3-37
operating system properties .....	3-52

## P

pairing <i>Bluetooth</i> devices .....	3-10
Parity, port replicator .....	C-10
partitions	
creating .....	3-48
deleting .....	3-49
dismounting .....	3-49
formatting .....	3-49
management .....	3-49
mounting .....	3-50
<b>Paste data</b> (Data Transmission) .....	C-7
PC, connecting WORKABOUT to .....	4-13
PH8-P GSM/GPRS/EDGE/UMTS/HSPA+ radio specifications .....	E-5
phone	
Services, setting up .....	3-63
Voicemail, setting up .....	3-63
phone, dialing .....	1-6, 3-59
Phonebook .....	3-62
phone number, dialing .....	1-6, 3-59, 3-60
picker cradle	
installing cable .....	4-18
Picklist Mode .....	C-3
pinouts .....	A-1
pistol grip	
Flush Mount, installing .....	4-6
installing .....	4-2
trigger backplate, installing .....	4-3
port pinouts .....	A-1
port replicator .....	4-20
Port Replicator settings (COM5 and COM6)	
Baud .....	C-9
Data Bits .....	C-10
Parity .....	C-10
Port B (COM6), Power .....	C-9
Stop Bits .....	C-10
Trigger On Sequence .....	C-10
ports	
parameters .....	C-9
Power	
Properties .....	3-37
Source .....	3-38

- to Port B (COM6) . . . . . C-9
  - Power button . . . . . 1-3
  - Power Management Properties
    - Advanced . . . . . 3-39
    - battery capacity . . . . . 3-37
    - Battery Health . . . . . 3-40
    - suspend, power saving . . . . . 3-38
    - Suspend Threshold . . . . . 3-38
    - Wakeup Sources . . . . . 3-40
  - Profile
    - restoring backup . . . . . 3-55
    - viewing backup . . . . . 3-55
  - Programs
    - Command Prompt . . . . . 2-16
    - Internet Explorer . . . . . 2-16
    - Remote Desktop Connection . . . . . 2-16
    - Windows Explorer . . . . . 2-16
  - protective case . . . . . 4-7
  - punctuation marks, accessing (SHIFT Key) . . . . . 2-3
- R**
- radio
    - 802.11 signal quality . . . . . 2-8
    - Bluetooth . . . . . 3-7–3-16
    - Cinterion PH8-P GSM/GPRS/EDGE/UMTS/HSPA+
      - radio specifications . . . . . E-5
    - specifications
      - 802.11a/b/g/n . . . . . E-3
      - Bluetooth . . . . . E-7
    - WWAN signal quality . . . . . 2-9
  - recalibrating touchscreen . . . . . 2-7, 3-51
  - Registry Editor . . . . . 3-57
    - Advanced Interface and Network . . . . . 3-58
  - Remote Desktop Connection . . . . . 2-16, 3-47
  - Repeat
    - Delay (between key repeats) . . . . . 3-26
    - menu (key repeat settings) . . . . . 3-26
    - Rate (of key repeats) . . . . . 3-27
  - resetting
    - Boot to BooSt . . . . . 1-5
    - clean start . . . . . 1-5
    - hard reset . . . . . 1-4
    - warm reset . . . . . 1-4
  - Restore Now . . . . . 3-56
  - Restrictions, Kiosk settings . . . . . 3-45
  - Run (Start Menu) . . . . . 2-19
- S**
- safety instructions
    - battery charger . . . . . 4-10
    - scanner . . . . . 2-10, 4-20
  - safety warning, scanner . . . . . 2-10, 4-20
  - Scan Indicator . . . . . C-6
  - SCAN Key . . . . . 2-3
  - Scan Log File . . . . . C-7
  - Scan Mode . . . . . C-3
  - scanner
    - Aim Duration . . . . . C-3
    - aiming dot duration . . . . . C-3
    - appending data . . . . . C-5
    - Bad Scan Vibrates . . . . . C-6
    - barcode, appending data to . . . . . C-5
    - Click Data (appending data) . . . . . C-5
    - Click Time (double-click) . . . . . C-5
    - Codepage . . . . . C-7
    - decoded (internal) . . . . . C-3
    - double-click . . . . . C-5
    - Good Scan Beep . . . . . C-6
    - Good Scan Vibrates . . . . . C-6
    - Laser On Time . . . . . C-3
    - Linear Security Level . . . . . C-3
    - Multiple Beep Tones . . . . . C-6
    - one dimensional (1D) internal scanner . . . . . 2-10, 2-11
    - Picklist Mode . . . . . C-3
    - ports parameters . . . . . C-9
    - safety warnings . . . . . 2-10, 4-20
    - scan failure, codepage . . . . . C-7
    - Scan Indicator . . . . . C-6
    - Scan Log File . . . . . C-7
    - Scan Mode . . . . . C-3
    - Scan Result Time . . . . . C-6
    - SE 1524 ER specifications . . . . . D-4
    - Soft Scan Timeout . . . . . C-6
    - techniques (scanning) . . . . . 2-10, 4-21
    - troubleshooting tips . . . . . 2-10, 4-21
    - two dimensional (2D) imager scanner . . . . . 4-21
    - Use LED lighting . . . . . C-4
    - warning message . . . . . C-6
  - scanner options . . . . . 4-20
  - Scanner services . . . . . 3-59
  - scanning
    - 1D internal . . . . . 2-10, 2-11
    - appending characters . . . . . C-5
    - bar code settings . . . . . 3-18
    - safety instructions . . . . . 2-10, 4-20
    - symbologies . . . . . C-2
    - Translations tab . . . . . C-7
  - Scan Result . . . . . C-6
  - Scan Result Time . . . . . C-6
  - screen
    - stylus, using to navigate . . . . . 2-12
    - touch pen, using . . . . . 2-12
    - Windows Embedded CE, navigating . . . . . 2-12
  - SE 1524 ER specifications . . . . . D-4
  - Services . . . . . 3-63
  - Set for AutoRestore . . . . . 3-56

Settings	
Control Panel	2-18
Network and Dial-up connections	2-18
Run	2-18
Taskbar and Start Menu	2-18
Shell Settings (Kiosk settings)	3-43
SHIFT Key	2-3
Shutdown	
Suspend	2-19
Shutdown (Start Menu)	2-19
signal quality, 802.11	2-8
signal quality, WWAN	2-9
SIM card, inserting	2-9
single bay USB cradle (WA4003-G2)	4-10
SIP (Soft Input Panel)	3-25
Sled <i>See</i> vehicle cradle	4-17
SMS menu, WWAN	F-14
SNTP, Registry Editor	3-59
Soft Input Panel	
Control Panel	3-3
Microsoft SIP	3-25
Soft Scan Timeout	C-6
sound settings	3-64
SPACE Key	2-3
specifications	
camera	E-2
Symbol SE4500 imager	D-6
Workabout Pro Hand-Held Computer	E-1
Start Menu	2-15
cycle tasks	2-17
programs	2-16
Run	2-19
Settings	2-18
Shutdown	2-19
system tray	2-17
task manager	2-18
Stonestreet One BTEplorer	3-7
Stop Bits, port replicator	C-10
stylus (touch pen), using	2-12
Stylus Properties	3-51
Double-tap (stylus sensitivity)	3-51
Suspend (Shutdown menu)	2-19
Suspend Timeout	3-38
swap time (for battery)	2-1
symbolologies, barcode	C-2
displaying type of barcode	C-6
Symbol SE5400 imager specifications	D-6
System Properties	3-52
system tray	2-17
<b>T</b>	
Tab Key	2-3
taskbar	
onscreen indicators	
802.11 radio signal quality	2-8
AC power	2-8
battery	2-8
docking devices	2-9
modifier keys	2-8
WWAN radio signal quality	2-9
using	2-14
task manager	2-18
themes, desktop	3-44
Total Recall	
AutoRestore Profile	3-56
backup, creating	3-53
backup Profile, restoring	3-55
clone, creating	3-54
Clone to USB	3-56
managing profiles	3-55
Restore Profile	3-56
Upload to A.R.C.	3-56
view Profile	3-55
touch pen, using	2-12
touchscreen	
recalibration	2-7, 3-51
stylus, using	2-12
touch pen, using	2-12
Translations parameters (barcodes)	C-7
trigger, double-click	C-5
trigger backplate kit, installing	4-3
trigger mappings	3-34
Trigger On Sequence, port replicator	C-10
Trigger-Press Type, Manage Triggers menu	3-36
triggers, configuring	3-34
troubleshooting tips (scanning)	2-10, 4-21
TweakIt	
Scanner services	3-59
<b>U</b>	
UMTS/HSPA+ radio specifications	E-5
Upload to A.R.C.	3-56
USB-Ethernet adaptor cable (WA4010)	4-13
Use LED lighting	C-4
Use Virtual Serial Port	F-6
<b>V</b>	
vehicle cradle	4-17
powered 10-55 VDC	4-17
powered 12 VDC	4-17
unpowered	4-17
Voice	
Call Lists	3-61
Call Management	3-61
conference calls	3-62

dialing a number . . . . .	3-60
Phonebook . . . . .	3-62
phone dialer . . . . .	1-6, 3-59
phone options . . . . .	1-6, 3-59
Services . . . . .	3-63
voicemail, setting up . . . . .	3-63
Volume & Sounds Properties . . . . .	3-64

## W

warm reset . . . . .	1-4
warnings . . . . .	C-6
<b>Wedge data</b> (Data Transmission) . . . . .	C-7
Windows® Start Menu <i>See</i> Start Menu . . . . .	2-15
Windows 7 . . . . .	3-17
Windows Embedded CE, navigating in . . . . .	2-12
Windows Explorer . . . . .	2-16
Windows Mobile Device Center, setting up . . . . .	3-18
Windows Vista® . . . . .	3-17
Wireless WAN	
AT Terminal . . . . .	F-13
Drive Mode configuration . . . . .	F-10
modem information . . . . .	F-11, G-11
network diagnostics . . . . .	F-11
SMS Menu . . . . .	F-14
Use Virtual Serial Port . . . . .	F-6
Voice . . . . .	F-15
Wireless Zero Config . . . . .	G-1–G-6
Workabout Pro	
approvals . . . . .	E-2
specifications . . . . .	E-1
Workabout Pro specifications . . . . .	E-1







Zebra Technologies Corporation  
Lincolnshire, IL U.S.A.

<http://www.zebra.com>

Zebra and the Zebra head graphic are registered trademarks of ZIH Corp. The Symbol logo is a registered trademark of Symbol Technologies, Inc., a Zebra Technologies company.

© 2015 Symbol Technologies, Inc.

