

TP-LINK®

User Guide

M5360

3G Mobile Wi-Fi, 5200mAh Power Bank



COPYRIGHT & TRADEMARKS

Specifications are subject to change without notice. **TP-LINK**[®] is a registered trademark of TP-LINK TECHNOLOGIES CO., LTD. Other brands and product names are trademarks or registered trademarks of their respective holders.

No part of the specifications may be reproduced in any form or by any means or used to make any derivative such as translation, transformation, or adaptation without permission from TP-LINK TECHNOLOGIES CO., LTD. Copyright © 2015 TP-LINK TECHNOLOGIES CO., LTD. All rights reserved.

<http://www.tp-link.com>

FCC STATEMENT



This equipment has been tested and found to comply with the limits for a Class B digital device, pursuant to part 15 of the FCC Rules. These limits are designed to provide reasonable protection against harmful interference in a residential installation. This equipment generates, uses and can radiate radio frequency energy and, if not installed and used in accordance with the instructions, may cause harmful interference to radio communications. However, there is no guarantee that interference will not occur in a particular installation. If this equipment does cause harmful interference to radio or television reception, which can be determined by turning the equipment off and on, the user is encouraged to try to correct the interference by one or more of the following measures:

- Reorient or relocate the receiving antenna.
- Increase the separation between the equipment and receiver.
- Connect the equipment into an outlet on a circuit different from that to which the receiver is connected.
- Consult the dealer or an experienced radio/ TV technician for help.

This device complies with part 15 of the FCC Rules. Operation is subject to the following two conditions:

This device may not cause harmful interference.

This device must accept any interference received, including interference that may cause undesired operation.

Any changes or modifications not expressly approved by the party responsible for compliance could void the user's authority to operate the equipment.

Note: The manufacturer is not responsible for any radio or TV interference caused by unauthorized modifications to this equipment. Such modifications could void the user's authority to operate the equipment.

FCC RF Radiation Exposure Statement:

This equipment complies with FCC radiation exposure limits set forth for an uncontrolled environment. End users must follow the specific operating instructions for satisfying RF exposure compliance. This transmitter must not be co-located or operating in conjunction with any other antenna or transmitter. This equipment has been SAR-evaluated for use in hand. SAR measurements are based on a 5mm spacing from the body and that compliance is achieved at that distance.

CE Mark Warning

CE 1588

This is a class B product. In a domestic environment, this product may cause radio interference, in which case the user may be required to take adequate measures.

Canadian Compliance Statement

This device complies with Industry Canada license-exempt RSS standard(s). Operation is subject to the following two conditions:

- (1) This device may not cause interference, and
- (2) This device must accept any interference, including interference that may cause undesired operation of the device.

Cet appareil est conforme aux norms CNR exemptes de licence d'Industrie Canada. Le fonctionnement est soumis aux deux conditions suivantes:

- (1) cet appareil ne doit pas provoquer d'interférences et
- (2) cet appareil doit accepter toute interférence, y compris celles susceptibles de provoquer un fonctionnement non souhaité de l'appareil.

Industry Canada Statement

Complies with the Canadian ICES-003 Class B specifications.

Cet appareil numérique de la classe B est conforme à la norme NMB-003 du Canada.

This device complies with RSS 210 of Industry Canada. This Class B device meets all the requirements of the Canadian interference-causing equipment regulations.

Cet appareil numérique de la Classe B respecte toutes les exigences du Règlement sur le matériel brouilleur du Canada.

Korea Warning Statements:

당해 무선설비는 운용중 전파혼신 가능성이 있음.

NCC Notice & BSMI Notice

注意！

依據 低功率電波輻射性電機管理辦法

第十二條 經型式認證合格之低功率射頻電機，費經許可，公司、商號或使用者均不得擅自變更頻率、加大功率或變更原設計之特性或功能。

第十四條 低功率射頻電機之使用不得影響飛航安全及干擾合法通行；經發現有干擾現象時，應立即停用，並改善至無干擾時方得繼續使用。前項合法通信，指依電信規定作業之無線電信。低功率射頻電機需忍受合法通信或工業、科學以及醫療用電波輻射性電機設備之干擾。

減少電磁波影響，請妥適使用。

安全諮詢及注意事項

- 請使用原裝電源供應器或只能按照本產品注明的電源類型使用本產品。
- 清潔本產品之前請先拔掉電源線。請勿使用液體、噴霧清潔劑或濕布進行清潔。
- 注意防潮，請勿將水或其他液體潑灑到本產品上。
- 插槽與開口供通風使用，以確保本產品的操作可靠並防止過熱，請勿堵塞或覆蓋開口。
- 請勿將本產品置放於靠近熱源的地方。除非有正常的通風，否則不可放在密閉位置中。
- 請不要私自打開機殼，不要嘗試自行維修本產品，請由授權的專業人士進行此項工作。



Продукт сертифіковано згідно с правилами системи УкрСЕПРО на відповідність вимогам нормативних документів та вимогам, що передбачені чинними законодавчими актами України.



Safety Information

- When product has power button, the power button is one of the way to shut off the product; When there is no power button, the only way to completely shut off power is to disconnect the product or the power adapter from the power source.
- Don't disassemble the product, or make repairs yourself. You run the risk of electric shock and voiding the limited warranty. If you need service, please contact us.
- Avoid water and wet locations.

This product can be used in the following countries:

| | | | | | | | |
|----|----|----|----|----|----|----|----|
| AT | BG | BY | CA | CZ | DE | DK | EE |
| ES | FI | FR | GB | GR | HU | IE | IT |
| LT | LV | MT | NL | NO | PL | PT | RO |
| RU | SE | SK | TR | UA | US | | |

DECLARATION OF CONFORMITY

For the following equipment:

Product Description: **3G Mobile Wi-Fi, 5200mAh Power Bank**

Model No.: **M5360**

Trademark: **TP-LINK**

We declare under our own responsibility that the above products satisfy all the technical regulations applicable to the product within the scope of Council Directives:

Directives 1999/5/EC, Directives 2004/108/EC, Directives 2006/95/EC, Directives 1999/519/EC, Directives 2011/65/EU

The above product is in conformity with the following standards or other normative documents
EN 300 328 V1.8.1

EN 301 489-1 V1.9.2 & EN 301 489-17 V2.2.1

EN 55022: 2010 + AC: 2011

EN 55024: 2010

EN 61000-3-2: 2006 + A1: 2009 + A2: 2009

EN 61000-3-3: 2013

EN 60950-1: 2006 + A11: 2009 + A1: 2010 + A12: 2011

EN 50566: 2013

The product carries the CE Mark:

CE 1588

Person responsible for marking this declaration:



Yang Hongliang

Product Manager of International Business

Date of issue: 2015

TP-LINK TECHNOLOGIES CO., LTD.

Building 24 (floors 1, 3, 4, 5), and 28 (floors 1-4) Central Science and Technology Park,
Shennan Rd, Nanshan, Shenzhen, China

CONTENTS

| | |
|--|-----------|
| Package Contents | 1 |
| Chapter 1. Introduction | 2 |
| 1.1 Product Overview | 2 |
| 1.2 Main Features | 2 |
| 1.3 Physical Description | 2 |
| Chapter 2. Hardware Installation | 5 |
| 2.1 Environment Requirements | 5 |
| 2.2 Hardware Installation | 5 |
| Chapter 3. Quick Installation Guide | 8 |
| 3.1 System Requirements | 8 |
| 3.2 TCP/IP Configuration | 8 |
| 3.3 Connect to the Internet | 8 |
| 3.4 Quick Setup | 9 |
| Chapter 4. Device Configuration | 13 |
| 4.1 Status | 13 |
| 4.2 Wizard | 14 |
| 4.3 SMS | 14 |
| 4.3.1 New Message | 14 |
| 4.3.2 Inbox | 15 |
| 4.3.3 Outbox | 16 |
| 4.3.4 Drafts | 17 |
| 4.3.5 SMS Settings | 18 |
| 4.4 Advanced | 19 |
| 4.4.1 Dial-up | 19 |
| 4.4.2 Wireless | 25 |
| 4.4.3 DHCP Server | 28 |
| 4.4.4 System Tools | 30 |
| Appendix A: FAQ | 36 |
| Appendix B: Configuring the PC | 38 |
| Appendix C: Specifications | 43 |
| Appendix D: Glossary | 44 |

Package Contents

The following items should be found in your package:

- M5360 3G Mobile Wi-Fi, 5200mAh Power Bank
- One micro USB cable
- Quick Installation Guide
- Micro/Nano to Standard SIM Card Adapter

 **Note:**

Make sure that the package contains the above items. If any of the listed items is damaged or missing, please contact your distributor.

Conventions

The Device or M5360 mentioned in this guide stands for M5360 3G Mobile Wi-Fi, 5200mAh Power Bank without any explanation.

Chapter 1. Introduction

1.1 Product Overview

TP-LINK's M5360 is at the forefront of wireless 3G sharing. Equipped with a built-in 3G modem, you can instantly establish your own Wi-Fi hotspot simply by inserting a 3G SIM card at the interior of the device. With up to 21.6Mbps download and 5.76Mbps upload speeds, M5360 is able to provide 3G wireless sharing to up to 10 users simultaneously. Its pocket-sized design and powerful 5200mAh internal battery make it an ideal travel companion, allowing users to work or play for hours on end. Besides, with its innovative OLED display, users can have a much more intuitive view of the device's working status, such as signal strength, network type (2G/3G), Wi-Fi status, message, internet status and battery meter.

1.2 Main Features

- Equipped with a built-in 3G modem - No other bulky devices required
- HSPA+ supported with up to 21.6Mbps download and 5.76Mbps upload speeds
- Supports up to 10 users simultaneously
- Power Bank for charging smart phones and tablets
- 5200mAh internal battery for extended hours of outdoor use
- Micro USB port for versatile recharging
- OLED display provides an intuitive view of the device's working status
- Equipped with a micro SD card slot for up to 32GB of optional storage

1.3 Physical Description

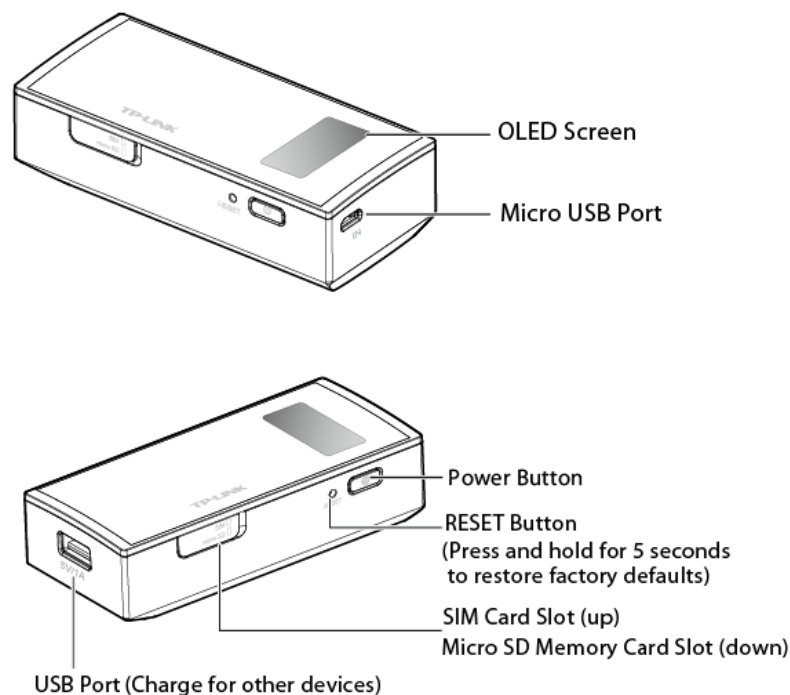

Figure 1-1 the Exterior

The details about the Exterior are explained as below.

➤ **OLED Screen:**

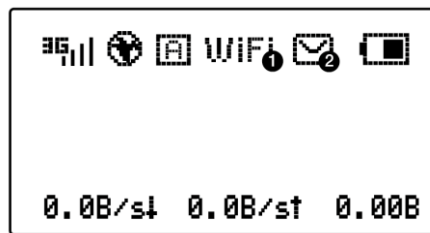

Figure 1-2 OLED Screen

The OLED Indication:

| Item | Description | Indication |
|--------------------------|--------------------------------|---|
| 3G / 2G / R | Network type & Signal strength | Indicates the current network option: 2G /3G /Roam, and signal strength of current network. |
| Internet connection icon | Internet connection | Indicates the successful network connection. |
| M / A | Dial-up type | A Means the automatic mode of Internet connection; M Means the manual mode of Internet connection. |
| WiFi | Wi-Fi connection | Displays the Wi-Fi status and the amount of current wireless clients. |
| SMS icon with 2 | SMS | Indicates that there is un-read short message(s) and the amount of un-read messages. |
| Battery icon | Battery | Displays the remaining battery power. |
| 0.0B/s↓ | Download speed | Indicates the download speed of current data transmission. |
| 0.0B/s↑ | Upload speed | Indicates the upload speed of current data transmission. |
| 0.0B | Data statistics | Indicates the data used in total. The data statistics will be cleared after resetting the Device. |

Table 1-1 The OLED Screen details

Note:

When you leave alone the buttons on the device, the OLED screen will light on for 60 seconds and then turn off. Pressing the power button will light up or turn off the OLED screen.

- **Micro USB Port:** It's for you to connect the Device with the power adapter via the USB cable.
- **Power Button:** When the Device is successfully installed, and it's powered (either by battery or electricity); press this button for about 3 seconds to turn on the Device, and if you want to turn it off, please press this button for another 3 seconds. Double-pressing the power button will switch the work mode to the power bank mode.
- **RESET Button (hole):** It's the button to restore the Device to its factory defaults. With the Device powered on, use a pin to press and hold the RESET button (hole) for about 5 seconds, until the LED screen is off and later displays "TP-LINK"; then release the button

and wait the Device to reboot and restore its factory default settings.

- **SIM Card Slot:** It's where to insert your SIM card.
- **Micro SD Memory Card Slot:** It's where to insert your micro SD memory card.
- **USB Port:** It can charge for other devices via the USB cable.

Chapter 2. Hardware Installation

2.1 Environment Requirements

- Place the Device in a well-ventilated place far from any heater or heating vent
- Avoid direct irradiation of any strong light (such as sunlight)
- Keep at least 2 inches (5 cm) of clear space around the Device
- Operating Temperature: 0°C~40°C (32°F~104°F)
- Operating Humidity: 10%~90%RH, Non-condensing

2.2 Hardware Installation

Install SIM card

Open the card slot cover as shown, then slide the SIM card into the slot until you hear a clicking sound.

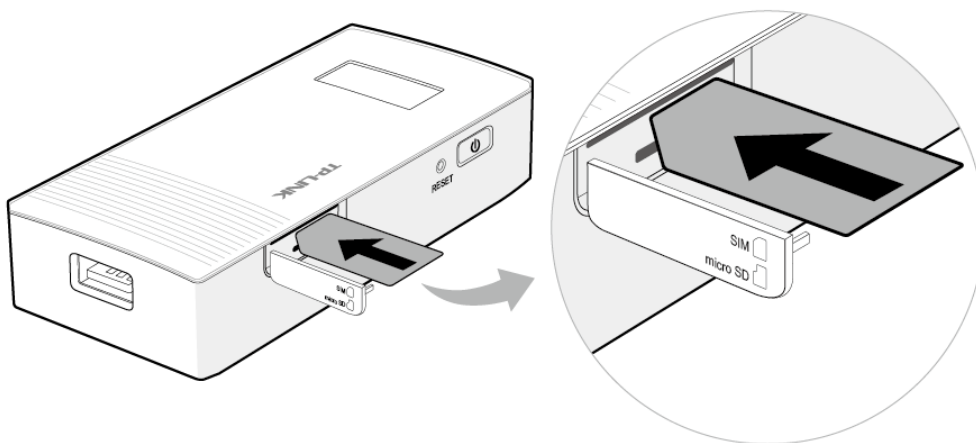

Note:

1. SIM card not provided by TP-LINK.
2. Micro or Nano SIM cards should be converted using provided SIM card trays.
3. Before the SIM card inserted, please make sure that the M5360 is power off and not charged.

Turn on the M5360

Hold the power button until the screen appears as shown below. (You can also hold the power button to turn off the M5360).



Charging your M5360

Via the power adapter

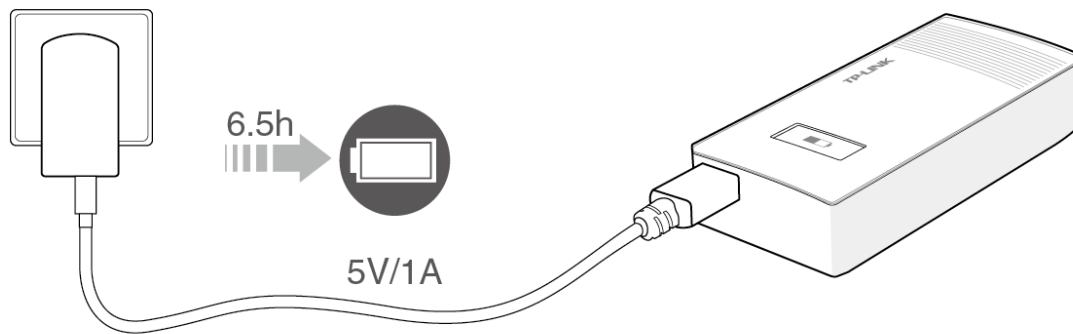

Via the computer USB

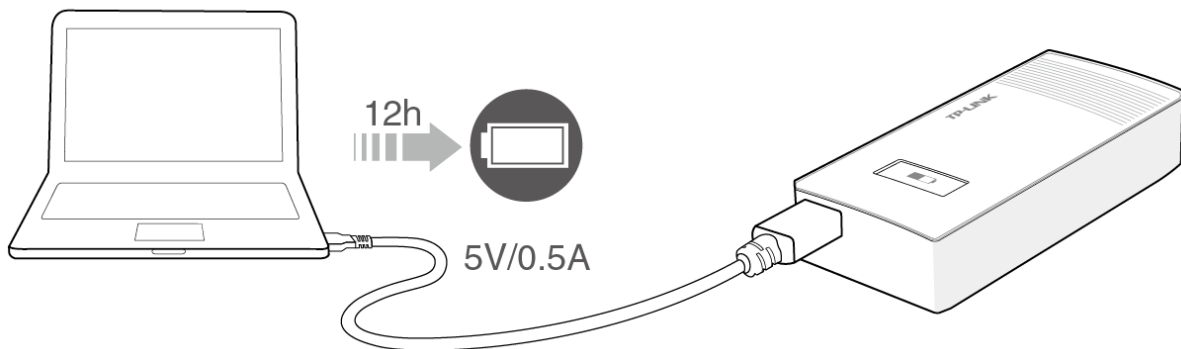

Note:

Your M5360 has been fully charged when the lighting symbol () of battery icon disappeared.

Charging Your Device

M5360 can be used as a 5200mAh power bank to charge smart phones and tablets by using one of the following two modes.

Double-tapping the power button can switch between the two modes.

Simultaneous 3G sharing and charging

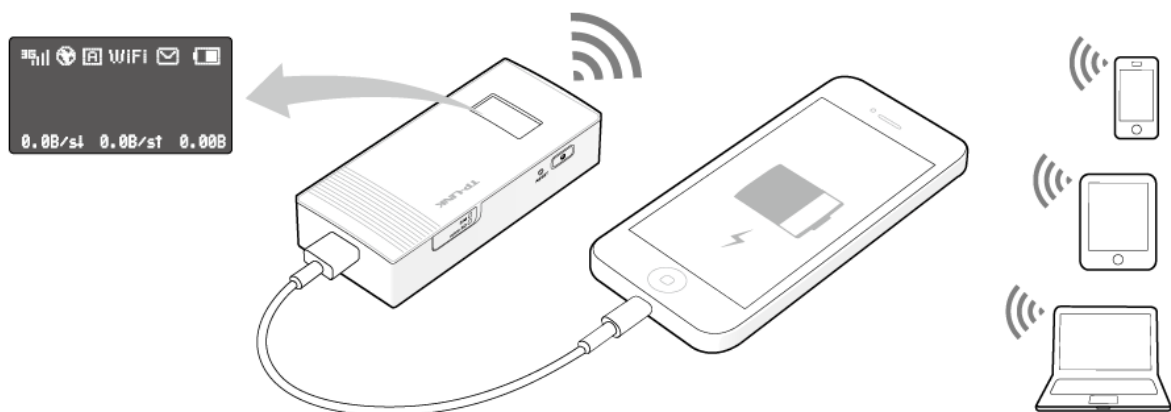

Note:

In this mode, M5360 will become hot as a result of high-load usage. When the M5360 overheats, it will automatically turn off to protect itself from damage. After the heat has dissipated, you can turn it on and use it normally.

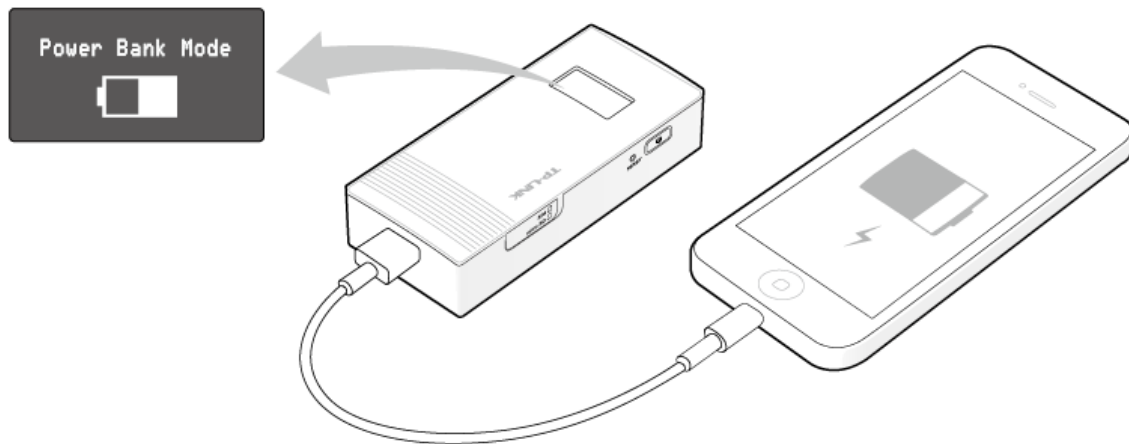
Charging only (Strongly recommended to save power)**Note:**

The M5360 can't be charged and charge other devices at the same time.

Accessing the Micro SD Card

If M5360 is connected to a computer with an USB cable, you can access its micro SD memory card just as access a hard disk.

- 1) Connect one end of the USB cable to the micro USB port of M5360 and the other end to the USB port of your PC.
- 2) If there appears the Found New Hardware Wizard window, please click Cancel to ignore it.
- 3) Double click Computer icon on your desktop. The inserted micro SD card is displayed as removable disk in file explorer (Here we use Removable Disk (F:) as an example). Double click to access the micro SD card just as access a hard disk.

Chapter 3. Quick Installation Guide

This chapter will guide you to quickly set up the basic functions for your M5360.

3.1 System Requirements

- SIM card with Internet access enabled.
- Computer supports only the 2.4GHz wireless band.
- Web browser, such as Mozilla Firefox, Internet Explorer, Google Chrome, Apple Safari, etc.

3.2 TCP/IP Configuration

The default IP address of the M5360 is 192.168.0.1, and the default Subnet Mask is 255.255.255.0, which values can be changed as you desire. In this guide, we use all the default values for description, and take the configuration in Windows 7 for example. While, Pads or Wi-Fi cellphones by default obtain IP address and DNS server address automatically, so you can just skip this step and continue with the [3.3 Connect to the Internet](#).

Note:

Before configuration, please make sure your computer has been equipped with a wireless network adapter.

➤ Obtain an IP address automatically

- 1) Set up the TCP/IP Protocol in "Obtain an IP address automatically" mode on your PC. Please refer to [Appendix B: Configuring the PC](#) for the detailed instructions.
- 2) Then the built-in DHCP server will assign an IP address for the PC.



➤ Configure the IP address manually

- 1) Set up the TCP/IP Protocol for your PC. Please refer to [Appendix B: Configuring the PC](#) for the detailed instructions.
- 2) Configure the network parameters. The IP address is 192.168.0.X (X stands for any number from 2 to 254), Subnet Mask is 255.255.255.0, and Gateway is 192.168.0.1 (the device's default IP address).

3.3 Connect to the Internet

Note:

To log in the Device's web-management page, you need to first connect to the wireless network of the Device.

1. Click the icon  at the bottom of your desktop.
2. Click the refresh button , and then select the SSID of M5360 and then click **Connect**.



Note:

The default SSID (also called Wireless Network Name) of the device is **TP-LINK_M5360_XXXXXX**. (XXXXXX is the last 6 characters of the device's MAC address.)

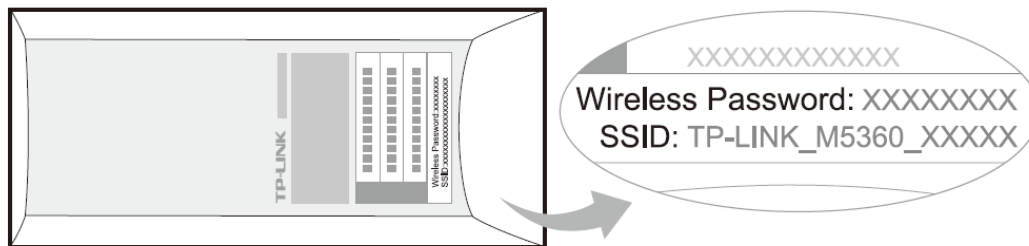

3. Enter the wireless password found on the M5360's back cover, and then click **OK**.

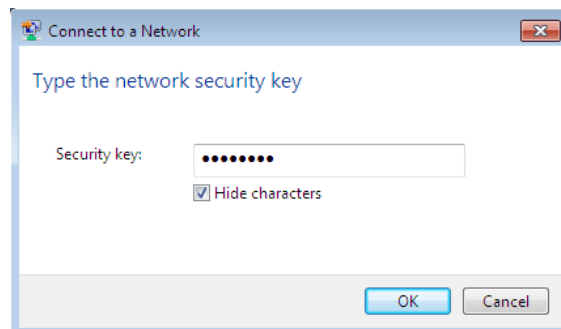

4. When **Connected** appears behind the SSID of M5360, you've successfully connected to its wireless network.

Note:

After successful connection to M5360 (with a SIM card inserted), you can enjoy the 3G mobile connection instantaneously. If not, please refer to [FAQ](#) and retry.

3.4 Quick Setup

1. Open a web-browser, enter the default address **192.168.0.1** in the address field and then

press **Enter**. When the login window appears, enter **admin** (in lower case letters) for Password, and then click the **Log in** button or press the **Enter**.

The image shows a login window for the TP-LINK M5360 device. At the top, there is a black header with the TP-LINK logo on the left and the model number 'M5360' on the right. Below the header, there are two input fields: 'Username:' with the text 'admin' entered, and 'Password:' which is currently empty. Below these fields is a dark button labeled 'Log in'.

Figure 3-1 Login Windows

Note:

If the above screen does not pop-up, it means that your Web-browser has been set to a proxy. Go to **Tools menu > Internet Options > Connections > LAN Settings**, in the screen that appears, cancel the Using Proxy checkbox, and click **OK** to finish it.

2. After successful login, there will appear the Status page. Click Wizard to configure the basic network settings for accessing network. Click **Next** to continue.

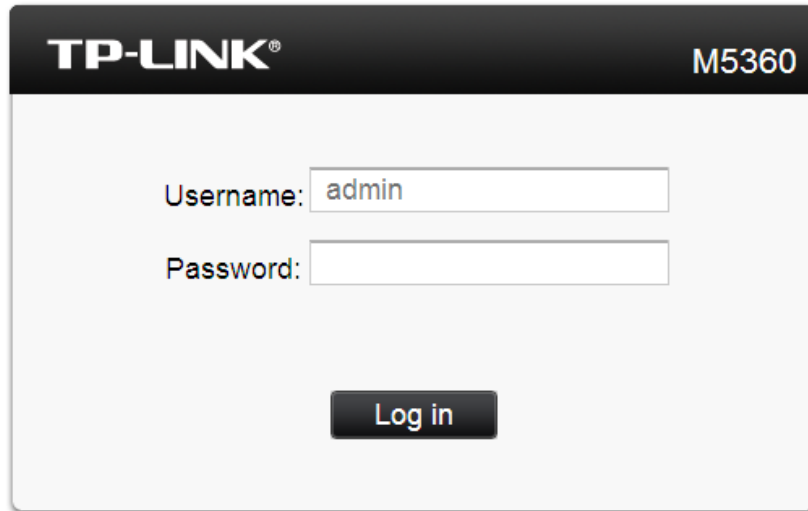
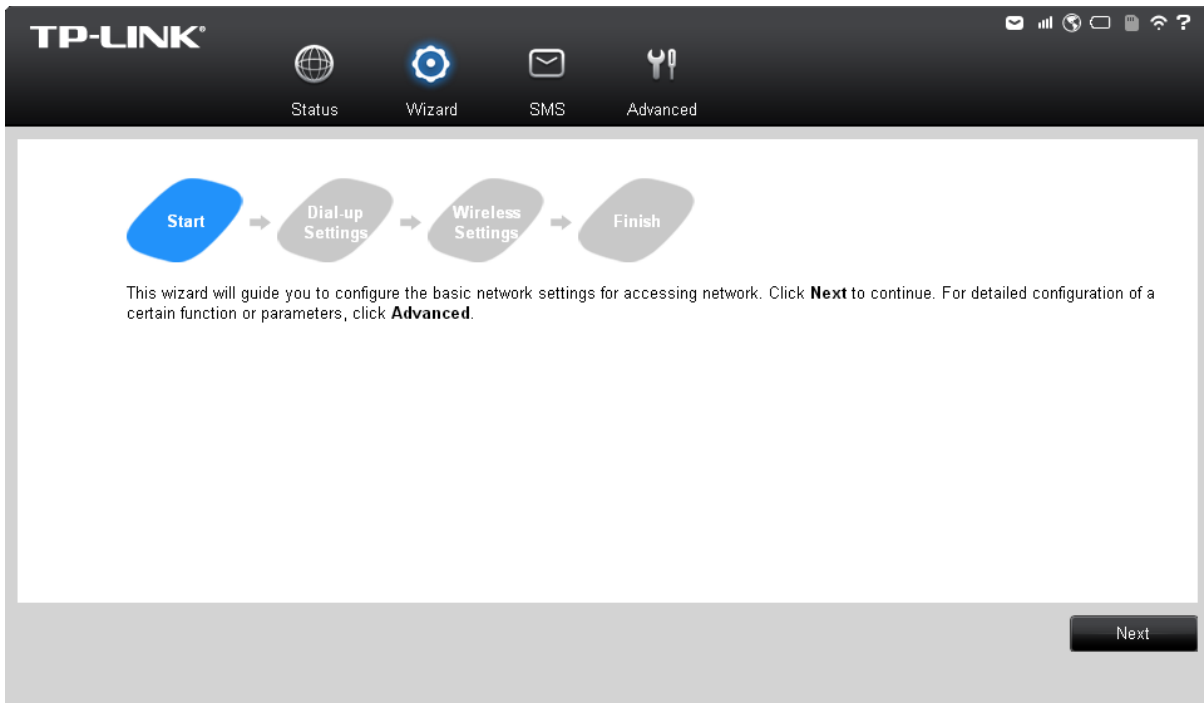

Figure 3-2 Wizard – Start

3. On the Dial-up Settings page shows the ISP information of the SIM card inserted. Click **Next** to continue, if you are sure the information is correct. You can also click **Create** to create a new profile.

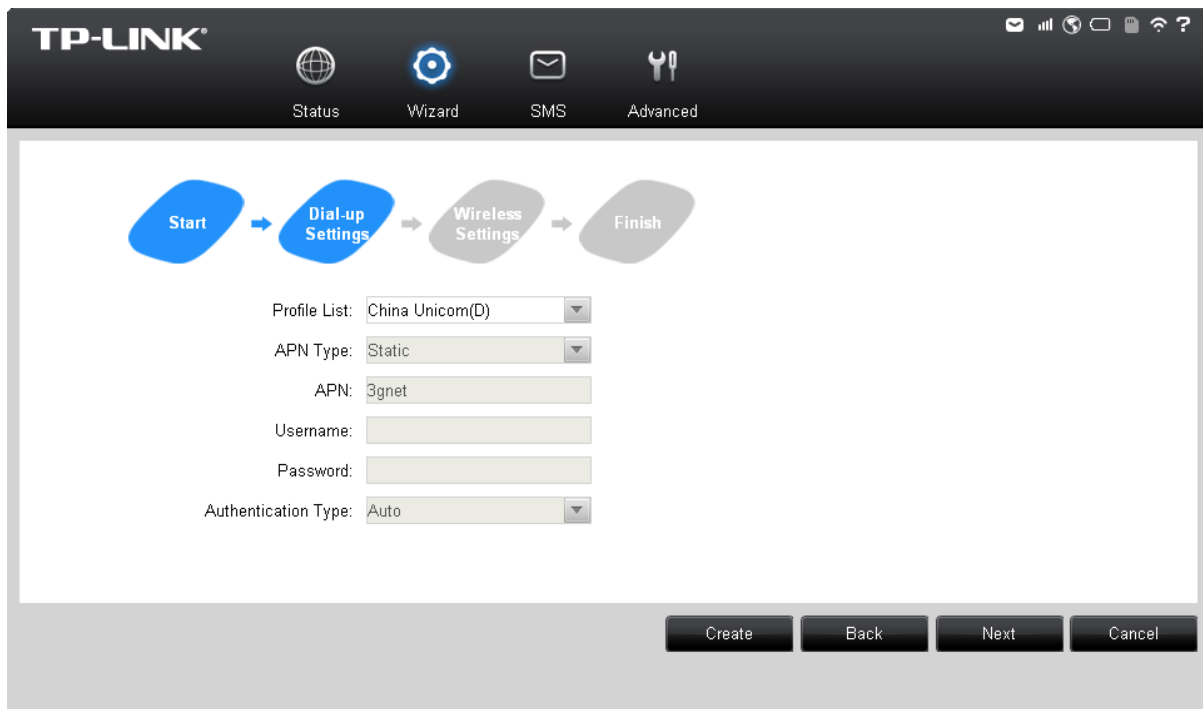

Figure 3-3 Wizard – Dial-up Settings

- On the Wireless Settings page, you can create a unique and easy-to-remember wireless network name (SSID) as well as Wireless Password, or you can keep it default. Then click **Next** to continue.

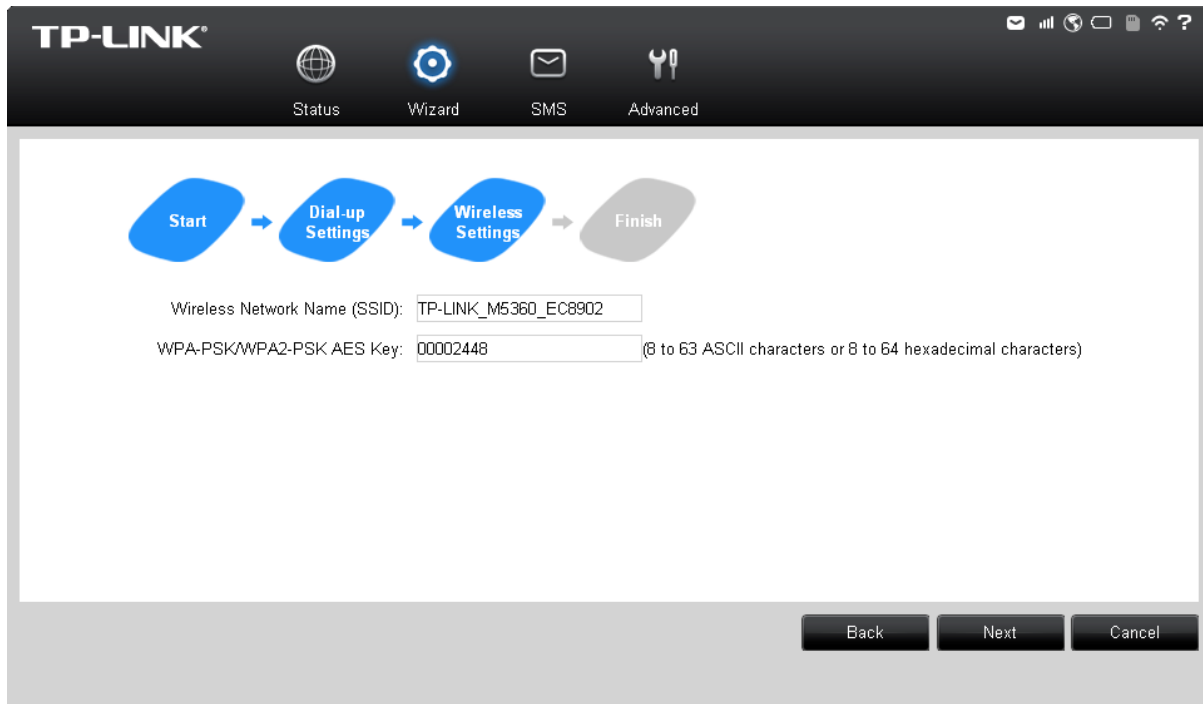

Figure 3-4 Wizard – Wireless Settings

- On the Finish page, please double-check your settings. If all the parameters are verified, click **Finish** to complete the Wizard; if there is anything wrong, you can click **Back** to re-configure it.

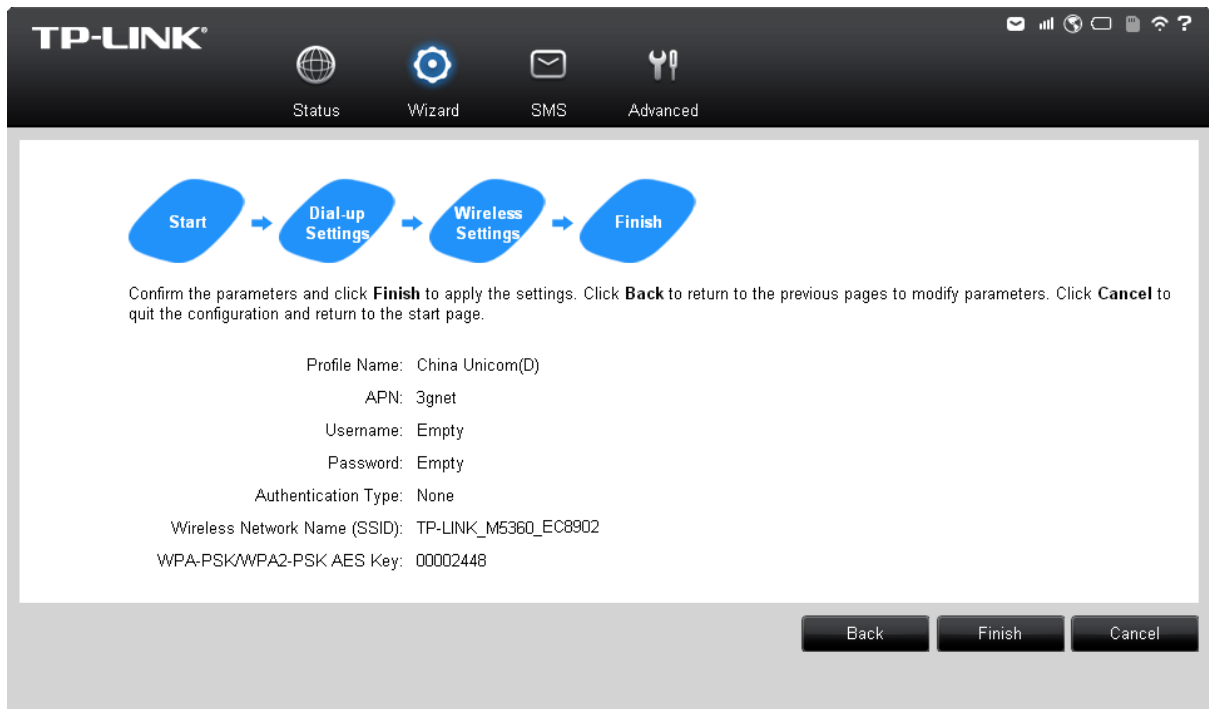

Figure 3-5 Wizard – Finish

Chapter 4. Device Configuration

After the successful login to the web-based management page of M5360, you will see the main menu listing **Status**, **Wizard**, **SMS** and **Advanced** on the top. In the following parts, these items will be explained in details, about their respective functions and configurations.

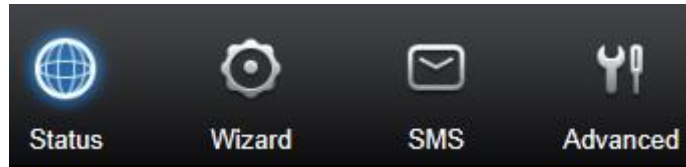

Figure 4-1 Main Menu

4.1 Status

The Status page displays the current status information about the device. All information is read-only.

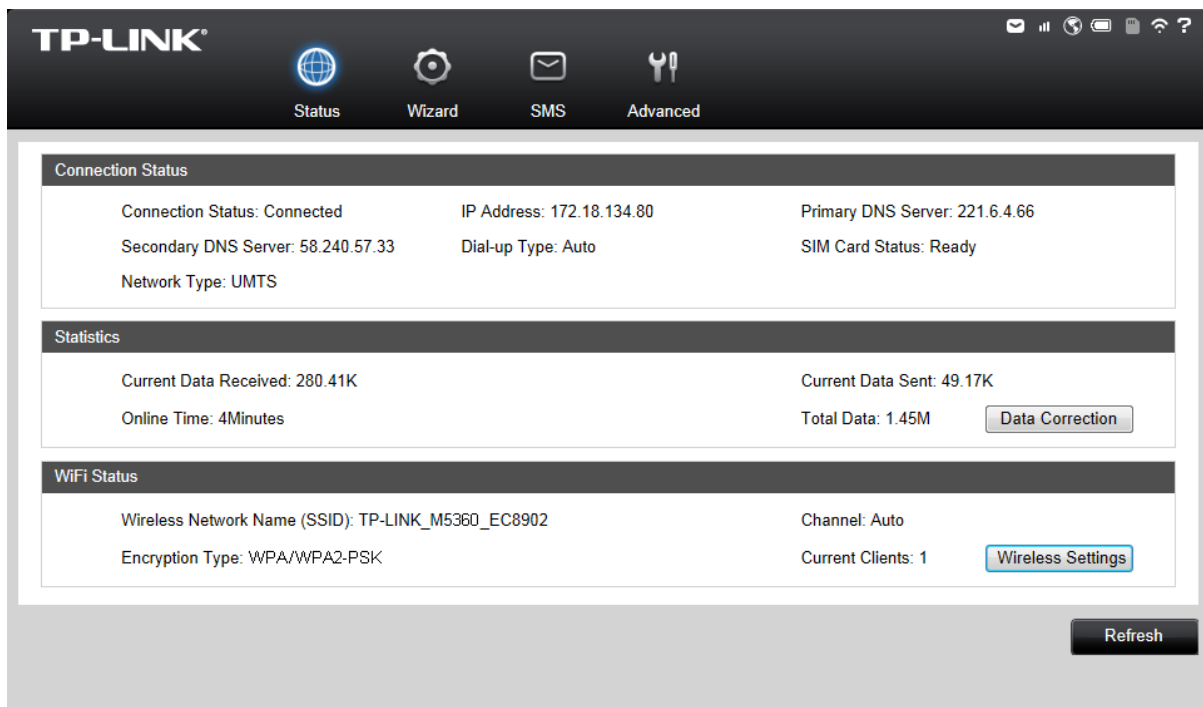

Figure 4-2 Status

- **Connection Status:** Displays the device's current connection status, including the connection and SIM card status, Dial-up and network type, IP address, primary and secondary DNS server.
- **Statistic:** Displays the device's statistics, including current received and sent data, online time and total data used.
- **WiFi Status:** Displays the device's current wireless settings, including SSID, channel, encryption type and current Wireless clients.

Click **Data Correction** to correct the accumulate data used. If the data statistics is different from that your ISP provided, please click **Data Correction** button, and input the data statistics your ISP provided to correct the accumulate data used.

Click **Wireless Settings** to head for the Wireless Basic Settings page and configure it.

Click **Refresh** to get the status information updated.

4.2 Wizard

Please refer to [3.4 Quick Setup](#).

4.3 SMS

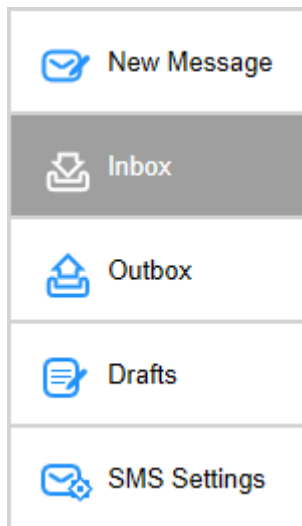

Figure 4-3 SMS Menu

There are five submenus under the **SMS** tab (as shown in Figure 4-3): **New Message**, **Inbox**, **Outbox**, **Drafts** and **SMS Settings**. Click any of them, and you will be able to configure the corresponding functions.

4.3.1 New Message

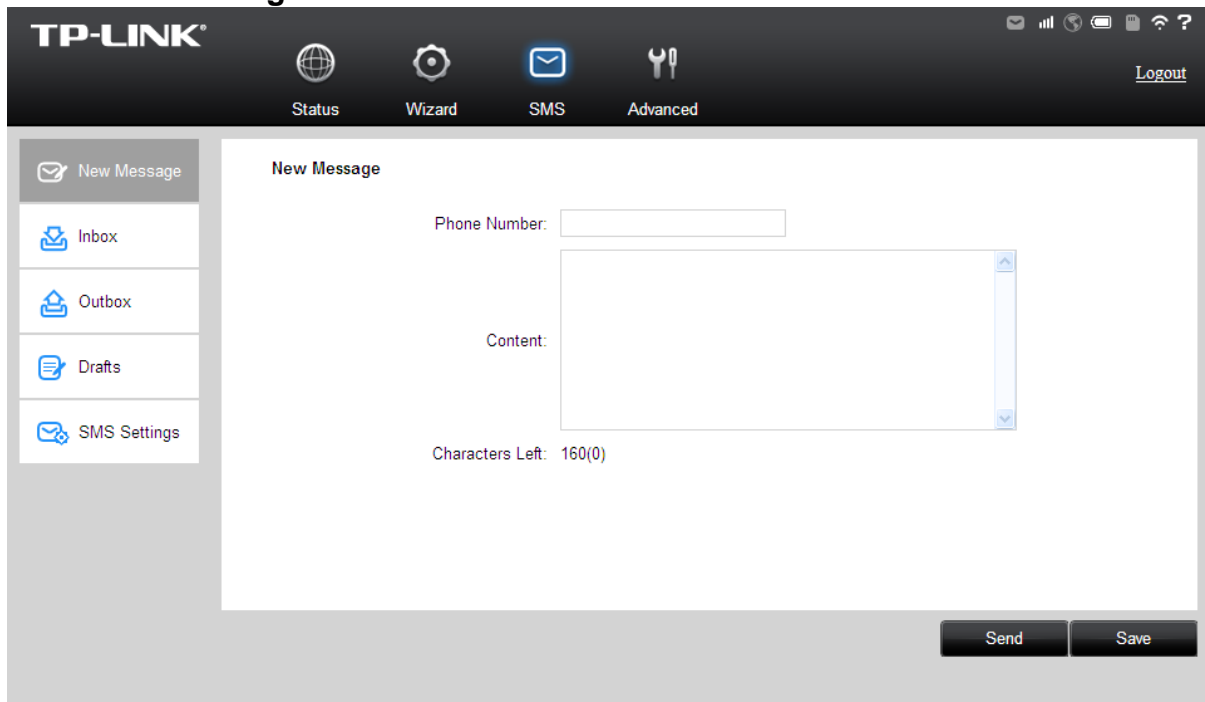

Figure 4-4 New Message

- **Phone Number:** Enter the receiver's cellphone number.
- **Content:** Text your message in this box.

Click **Send** to send the message.

Click **Save** to save the message in the Drafts box.

4.3.2 Inbox

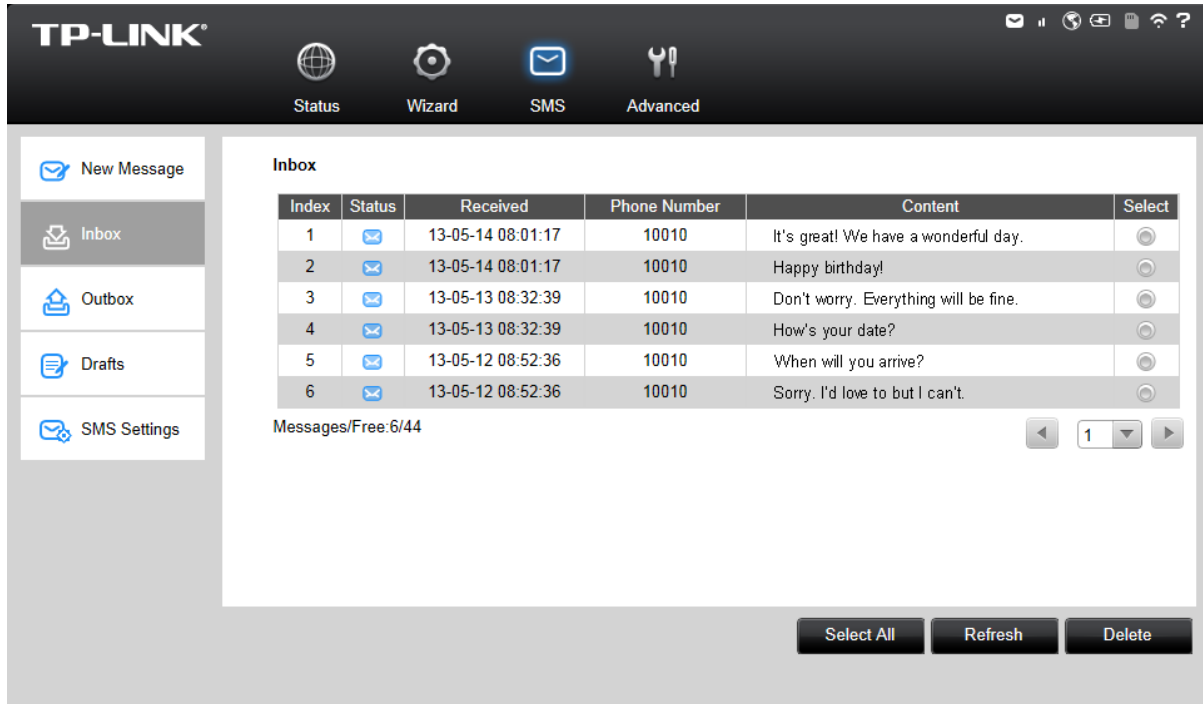

Figure 4-5 Inbox

- **Index:** The index of the message.
- **Status:** means the message has been read. means the message hasn't been read yet.
- **Received:** Shows the date and time when the message was received.
- **Phone Number:** Shows the cellphone number that sent this message.
- **Content:** Click to unfold and read the detailed content of the message.
- **Select:** Select the message(s) for deletion.

Click **Select All** to select all of the messages.

Click **Refresh** to refresh the inbox, and get any new message(s).

Click **Delete** to delete the message(s) selected.

4.3.3 Outbox

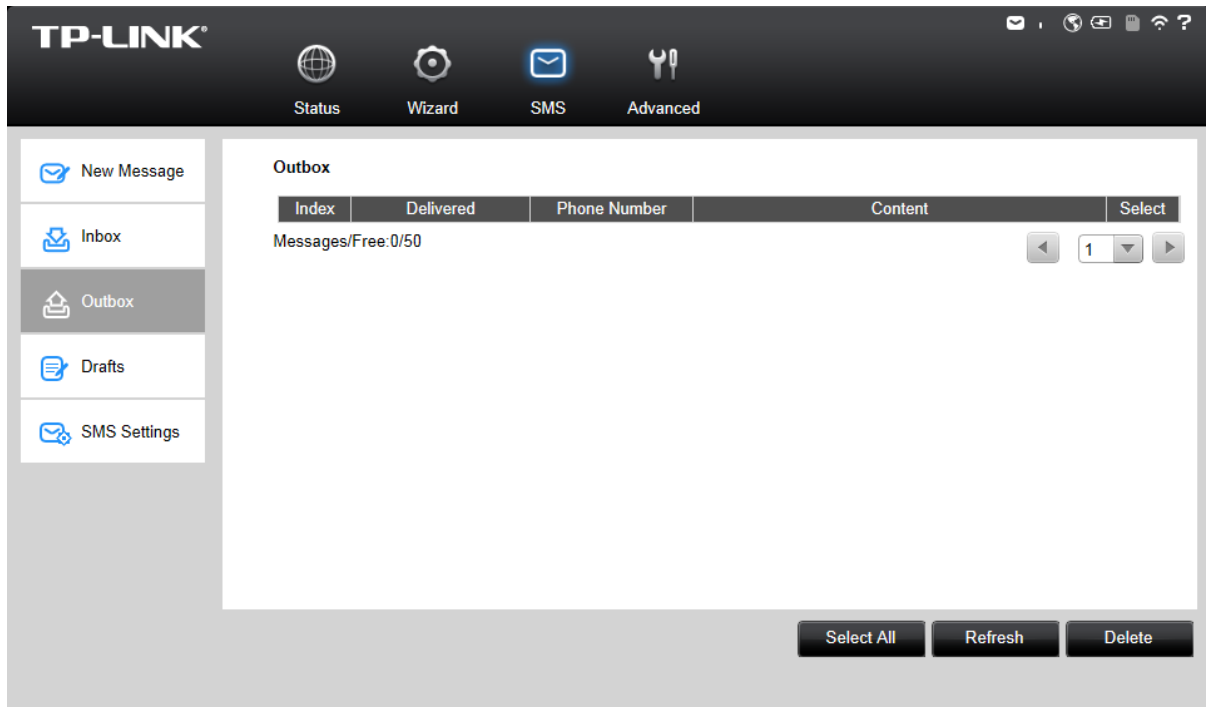

Figure 4-6 Outbox

- **Index:** The index of the message.
- **Delivered:** Shows the date and time when the message was sent.
- **Phone Number:** Shows the cellphone number that the message was planned to be sent to.
- **Content:** Click to unfold and read the detailed content of the message.
- **Select:** Select the message(s) for deletion.

Click **Select All** to select all of the messages.

Click **Refresh** to refresh the inbox.

Click **Delete** to delete the message(s) selected.

4.3.4 Drafts

You can review the unsent saved message(s) on this page.

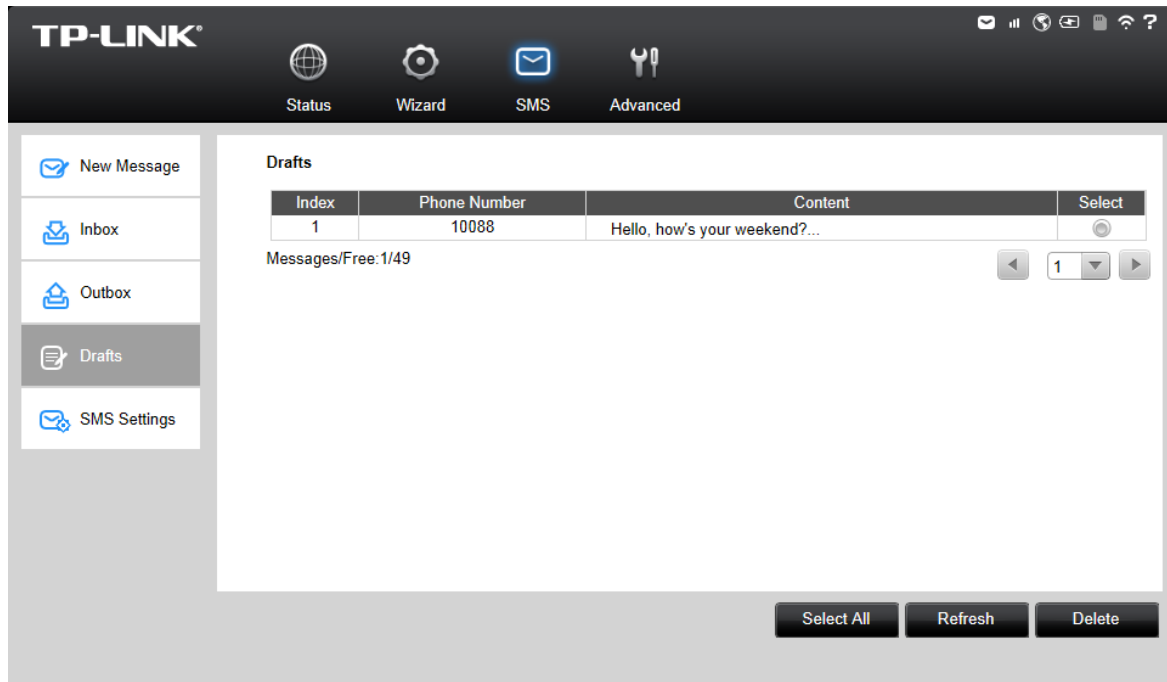

Figure 4-7 Drafts

- **Index:** The index of the message.
- **Phone Number:** Shows the cellphone number that this message was planned to be sent to.
- **Content:** Click to unfold and read the detailed content of the message(s), or for further edition and delivery (as shown in Figure 4-8).
- **Select:** Select the message(s) for deletion.

Click **Select All** to select all of the messages.

Click **Refresh** to refresh the drafts.

Click **Delete** to delete the message(s) selected.

Figure 4-8 Edit Message (Drafts)

4.3.5 SMS Settings

On this page, you can do the following settings:

Figure 4-9 Settings

- **Message Center:** Disabled by default. It's recommended to keep the default setting. If you want to manually set the Message Center Number, please select **Enable**.
- **Message Center Number:** When the Message Center is enabled, you can enter the Message Center Number of the local ISP. If you enter a wrong number, the SMS would be affected and not properly used.
- **Save the Delivered Messages:** Enable it to automatically save the delivered messages in

the Outbox.

- **Auto Replace Old Messages:** If enabled, it will automatically delete the oldest message and save the new one when the Outbox or Drafts box is full. If disabled, you need to manually delete the old messages to save the new ones when the Outbox or Drafts box is full.

Click **Save** to make your settings take effect.

4.4 Advanced

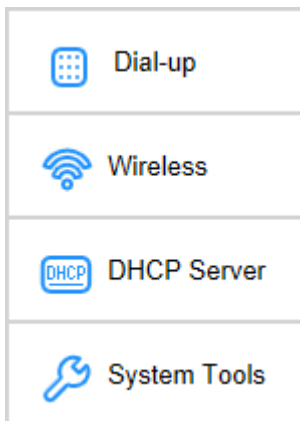

Figure 4-10 Advanced Menu

There are four submenus under the **Advanced** tab (as shown in Figure 4-10): **Dial-up**, **Wireless**, **DHCP Server** and **System Tools**. Click any of them, and you will be able to configure the corresponding functions.

4.4.1 Dial-up

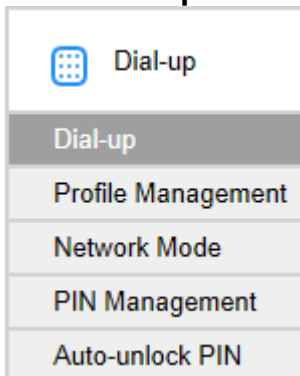

Figure 4-11 Dial-up Menu

4.4.1.1. Dial-up

Dial-up Settings page allows you to do the following configurations.

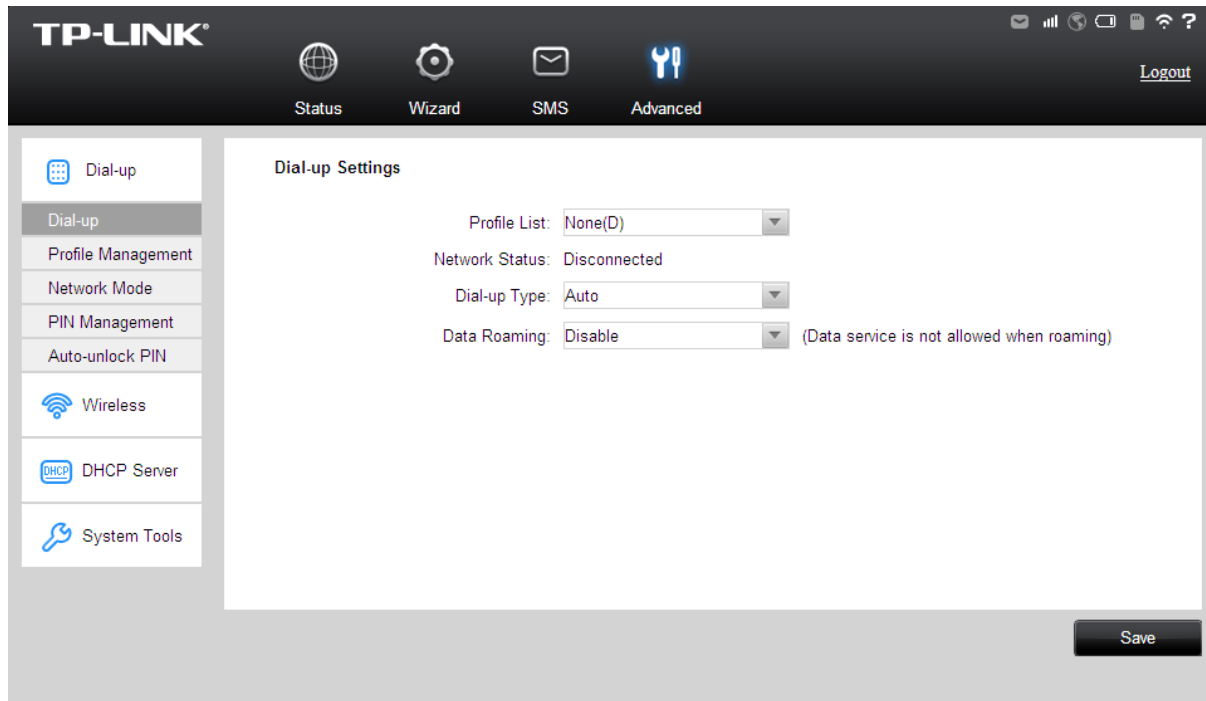

Figure 4-12 Dial-up Settings

- **Profile List:** A list of profile(s). Select the profile of your SIM card currently inserted in the device.
- **Network Status:** Shows whether the Internet is connected or disconnected at present.
- **Dial-up type:** The device provides two types of dial-up – **Auto** and **Manual**. Please select the dial-up type as you need.
 - **Auto:** The device will automatically establish connection once it's started. During the process, if your Internet connection is terminated due to some exterior reasons, the device would automatically attempt connection until it's successful. This option is suggested, if you have the network service paid by month.
 - **Manual:** When you start the device and your computer, or when the connection is terminated during the process, you need to manually dial up for connection in here. If you have the network service paid by hour, this option is suggested.
- **Data Roaming:** It is disabled by default. If disabled, data service is not allowed when roaming. If enabled, data service is allowed when roaming, but may incur significant roaming charges.

Click **Save** to save the above settings and have them take effect.

4.4.1.2. Profile Management

You can manage your profile on this page.

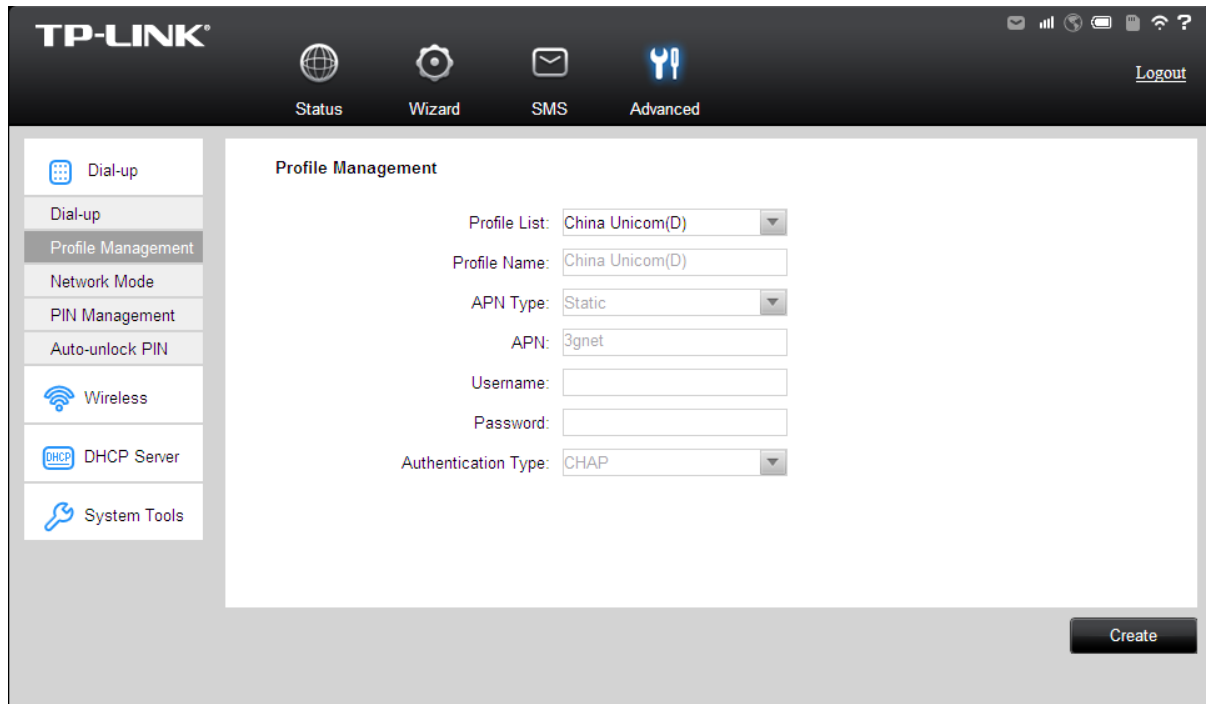

Figure 4-13 Profile Management

- **Profile List:** A list of profile(s). Select the profile of your SIM card currently inserted in the device, and then you can view the related information of it. If you find any parameters wrong, you can click **Create** to create a new profile with the right settings (as shown in Figure 4-14).
- **Profile Name:** Displays the name of the profile you've selected.
- **APN Type:** Displays the type of your APN, either **Dynamic** or **Static**. **Dynamic** means the device have dynamic APN, which needs not to be specified. **Static** means you specify your APN manually.
- **APN:** Displays the Access Point Name provided by your ISP.
- **Username/Password:** Displays the User Name and Password provided by your ISP.
- **Authentication Type:** Displays the specific authentication type your ISP required.
 - **None:** Means no authentication is required.
 - **CHAP:** Means your ISP required Challenge Handshake Authentication Protocol, which allows the device to establish authentication with the peer using three handshakes and checking the peer identity periodically.
 - **PAP:** Means your ISP required Password Authentication Protocol, which allows the device to establish authentication with the peer using two handshakes.

The screenshot shows the 'Create Profile' configuration page in the TP-LINK web interface. The page has a dark header with the TP-LINK logo and navigation icons for Status, Wizard, SMS, and Advanced. A 'Logout' link is in the top right. A left sidebar contains menu items: Dial-up, Profile Management (highlighted), Network Mode, PIN Management, Auto-unlock PIN, Wireless, DHCP Server, and System Tools. The main content area is titled 'Create Profile' and contains the following fields:

- Profile Name:
- APN Type:
- APN:
- Username:
- Password:
- Authentication Type:

At the bottom right of the form area, there are two buttons: 'Cancel' and 'Save'.

Figure 4-14 New Profile

4.4.1.3. Network Mode

The screenshot shows the 'Network Mode Setting' configuration page in the TP-LINK web interface. The page has the same header and sidebar as Figure 4-14. The main content area is titled 'Network Mode Setting' and contains the following fields:

- Network Status:
- Network Mode:

At the bottom right of the form area, there is a 'Save' button.

Figure 4-15 Network Mode Settings

- **Network Status:** Shows whether the Internet is connected or disconnected at present.
- **Network Mode:** The device supports three modes of network connection – **Auto**, **2G only** and **3G only**. You can choose the appropriate mode after disconnecting the network. If your SIM card supports GSM, please select **2G only**; if your SIM card supports WCDMA, please select **3G only**; if you are not very sure about it, please select **Auto** and then the device will detect it automatically.

Click **Save** to save your settings.

4.4.1.4. PIN Management

You can management your PIN code on this page.

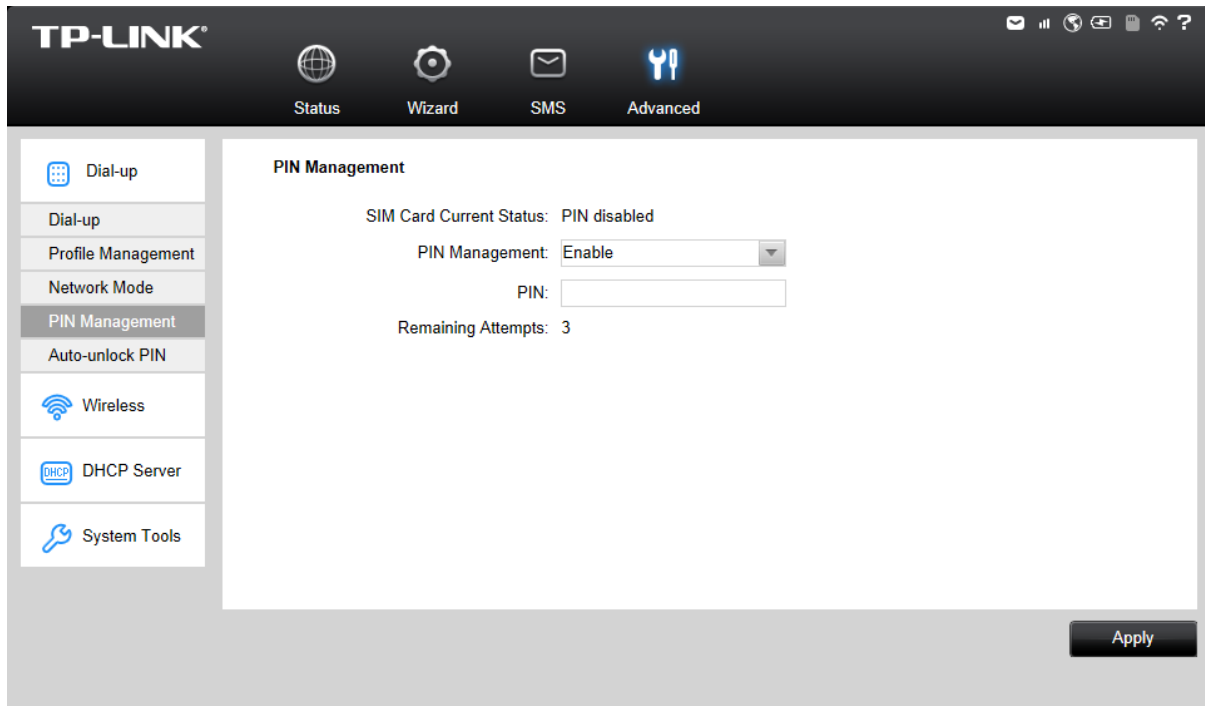

Figure 4-16 PIN Management

- **SIM Card Current Status:** Shows whether your PIN function is enabled or disabled.
- **PIN Management:** You can select whether to enable PIN function or not. Once the PIN function is enabled, every time you start the device with this SIM card inserted, you need to enter the PIN code; while if you go to enable the **Auto-unlock PIN** function, it could save you this trouble.
- **PIN:** You can set a PIN code, which requires 4-8 digits.
- **Remaining Attempts:** Shows how many attempts there are left for you to try entering the PIN code after you failed to enter the right one. You have 3 attempts at most. If you accidentally fail in three attempts, the PIN will be locked and you will be required to enter the PUK code that is written on your SIM card (as shown in Figure 4-17).

If the current status of PIN is disabled, you can select **Enable** and set a PIN code, and then click **Apply** to make your settings take effect. While, if the SIM card's current status is PIN enabled and verified, you can select **Disable** and enter the current PIN code, or select **Modify** and enter the required parameters to set a new PIN code, and then click **Apply** to make your settings take effect.

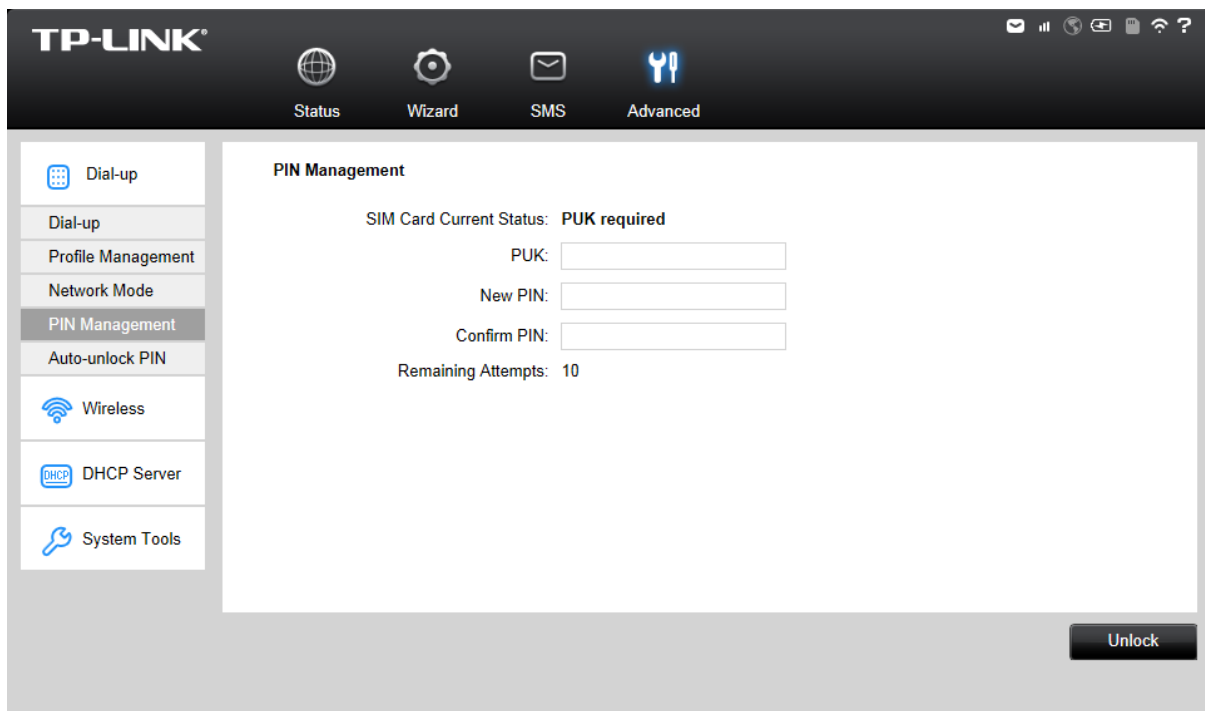

Figure 4-17 PIN Configuration - PUK Decode

A PUK (PIN Unlocked Key), also known as Personal Unlock Code (PUC), is used in 3GPP mobile phones to reset a personal identification number (PIN) that has been lost or forgotten. The PUK is a SIM-specific code assigned by the service provider. If a user does not know his or her PUK and is prompted for it, it should be obtained from the service provider.

On the page as shown in Figure 4-17, first enter the PUK code and then set a new PIN code to unlock your SIM card as well as any device with it inserted.

4.4.1.5. Auto-unlock PIN

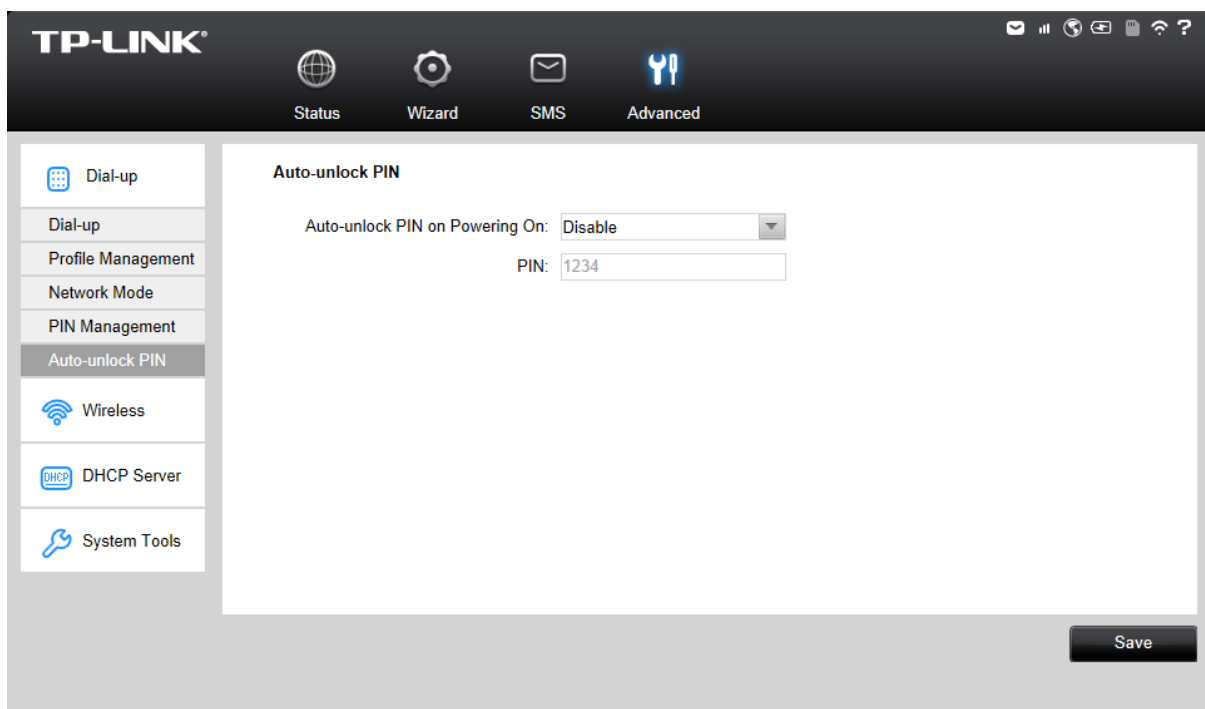

Figure 4-18 PIN Code Auto unlock

- **Auto-unlock PIN on Powering On:** Select to enable or disable this function.
- **PIN:** If you enable the **Auto-unlock PIN on Powering ON** function above, please enter the appropriate PIN code of your SIM card in this field. When the PIN code is required upon device restarting, it will be validated automatically once. If validation failed, please go to **PIN Management** page to input another PIN code.

Click **Save** to save your settings.

4.4.2 Wireless

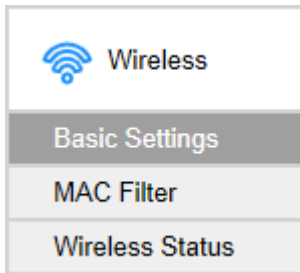

Figure 4-19 Wireless Menu

Wireless Settings can prevent any intruders from connecting your wireless network, occupying your network resources, hacker-overhearing and hacker-attacking, and thus enhance the security of your wireless network.

4.4.2.1. Basic Settings

Wireless basic settings enable you to configure your wireless parameters.

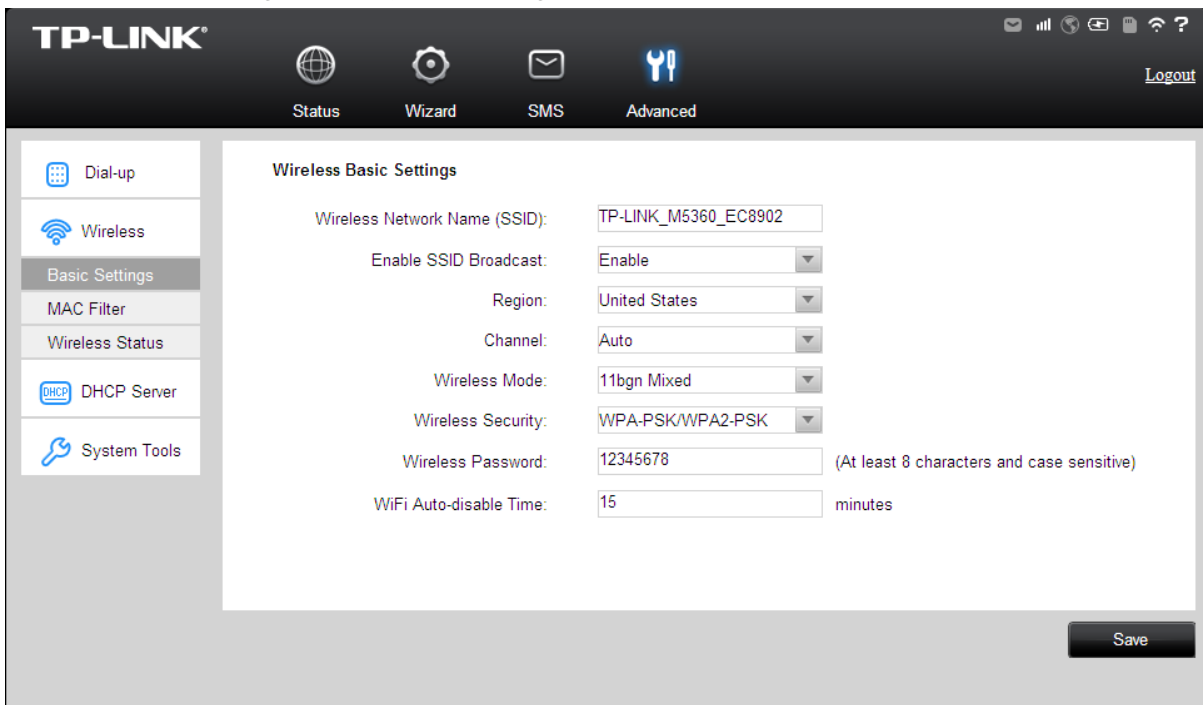

Figure 4-20 Wireless Basic Settings

- **Wireless Network Name (SSID):** SSID is short for Service Set Identification, which is for you to distinguish the different wireless network. The default SSID of this device is TP-LINK_M5360_XXXXXX (XXXXXX stand for the last 6 characters of the MAC address of

the device.) You can rename it as your preference, but the value is limited to 32 characters at most and also it is case-sensitive (For example, TEST is NOT the same as test.). Later on it will display in the wireless network list searched by your devices.

- **Enable SSID Broadcast:** Select to enable or disable this function. When wireless clients search the local area for wireless networks to associate with, they will detect the SSID broadcast by the device. If you Enable SSID Broadcast, the Wireless device will broadcast its name (SSID) on the air; otherwise, you have to manually type in the SSID and then you can join its network.
 - **Region:** Select your region from the drop-down list. This field specifies the region where the wireless function of the device can be used. It may be illegal to use the wireless function of the device in a region other than one of those specified in this field. If your country or region is not listed, please contact your local government agency for assistance.
 - **Channel:** This field determines which operating frequency ranging from 1~11 will be used. If you select **Auto**, then the device will choose the best channel automatically. It is not necessary to change the wireless channel unless you notice interference problems with another nearby access point.
 - **Wireless Mode:** You are provided with two wireless modes here: 11bg Mixed and 11bgn Mixed. The default wireless mode is 11bgn Mixed. If your wireless network card didn't work well in 11bgn Mixed mode, try 11bg Mixed mode.
 - **Wireless Security:** You are provided with two modes of wireless security here: Not Secured, WPA-PSK/WPA2-PSK.
 - **WPA-PSK/WPA2-PSK:** It's the WPA/WPA2 authentication type based on pre-shared pass phrase. It's easy to set and secure to use. So it's perfect for SOHO users.
- Wireless Password:** The default WPA key is the last 8 characters of IMEI. You can keep it default or enter at least 8 ASCII characters or 8 hexadecimal characters as your new Wireless Password.
- **WiFi Auto-disable Time:** If no clients connect to the device's wireless network in a period of time (15 minutes by default), the Wi-Fi will be shut down. You can press the power button to resume the Wi-Fi.

Click **Save** to save your settings.

4.4.2.2. MAC Filter

The Wireless MAC Address Filtering feature allows you to control the wireless stations accessing the device, which depends on the station's MAC addresses. MAC Address is the physical address of the wireless stations, usually in the format of XX-XX-XX-XX-XX-XX format (X is any hexadecimal digit).

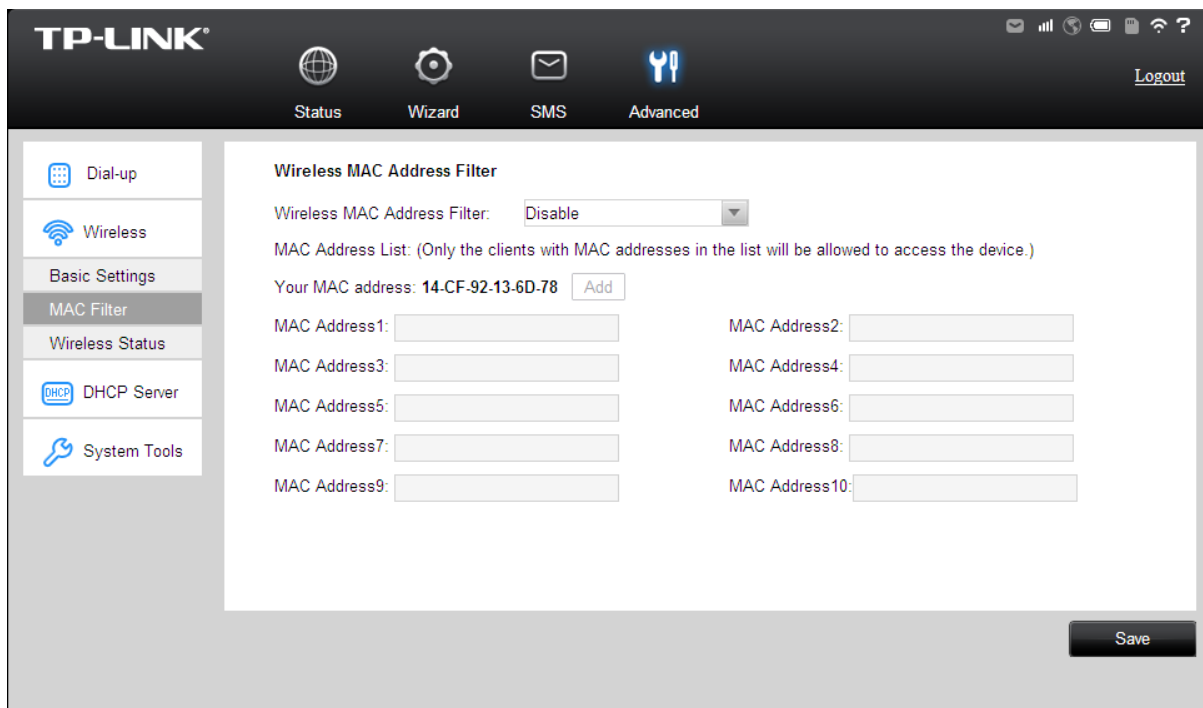

Figure 4-21 Wireless MAC Filter

- **Wireless MAC Address Filter:** Select to Enable or Disable the MAC filter function of the device. The below settings will take effect only when you select **Enable**.
 - **Your MAC Address:** Displays the MAC address of your client(s) currently wirelessly connected to the device.
 - **MAC Address List:** A List of MAC addresses will be allowed to access the device.
- Click **Save** to save your settings.

4.4.2.3. Wireless Status

The Wireless Status page displays the basic information about the Wireless client(s) that are currently connected to the device.

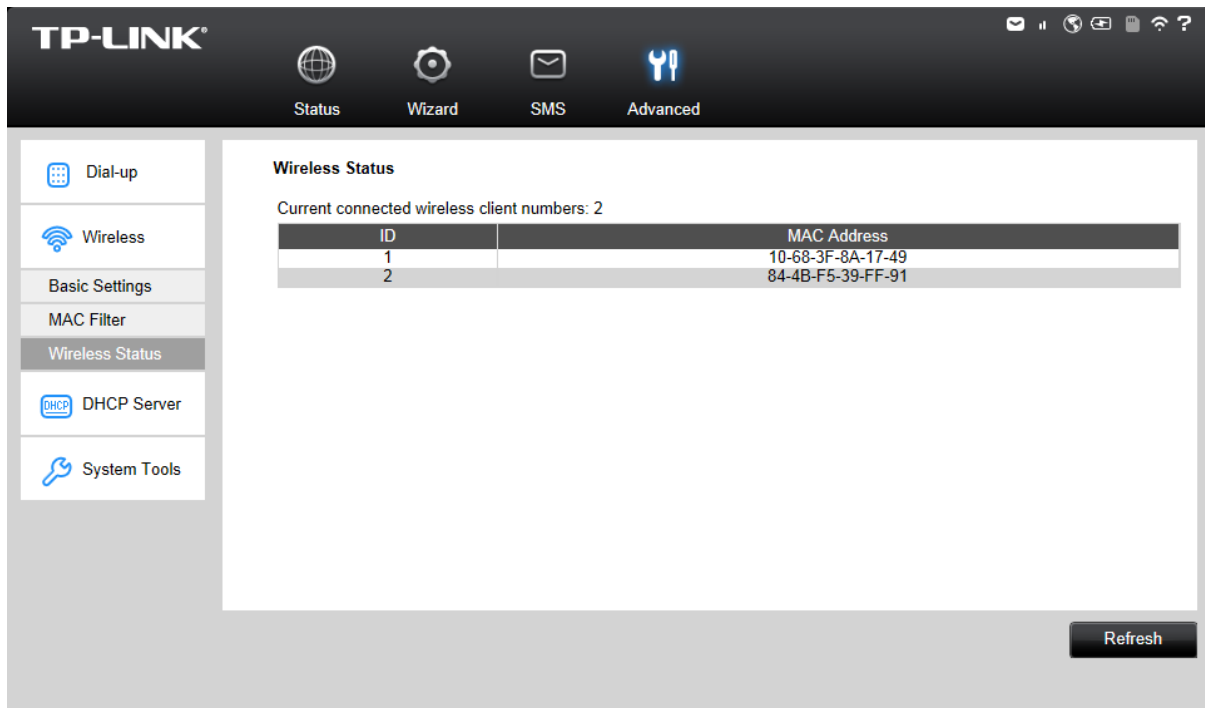

Figure 4-22 Wireless Status

- **ID:** The index of the Wireless Client.
- **MAC Address:** The MAC address of the Wireless client.

Click **Refresh** to update the amount of the Wireless clients and their information.

4.4.3 DHCP Server

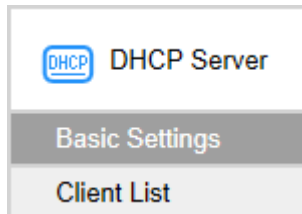

Figure 4-23 DHCP menu

The Device is set up by default as a DHCP (Dynamic Host Configuration Protocol) server, which provides the TCP/IP configuration for all the wireless clients that are connected to the device in the LAN.

4.4.3.1. Basic Settings

The screenshot displays the 'Basic Settings for DHCP Server' configuration page in the TP-LINK web interface. The page features a sidebar on the left with navigation options: Dial-up, Wireless, DHCP Server, Basic Settings (selected), Client List, and System Tools. The main content area contains the following settings:

- IP Address:** 192.168.0.1
- Subnet Mask:** 255.255.255.0
- DHCP Server:** Enable (dropdown menu)
- Start IP Address:** 192.168.0.100
- End IP Address:** 192.168.0.199
- Lease Time:** 120 minutes (Ranging from 1 to 2880, the default value is 120)
- Primary DNS Server:** 192.168.0.1 (optional)
- Secondary DNS Server:** 0.0.0.0 (optional)

A 'Save' button is located at the bottom right of the configuration area.

Figure 4-24 Basic Settings

- **IP Address:** The IP address of the device, which is used to log in its web-based management page. The default value is 192.168.0.1.
- **Subnet Mask:** An address code that determines the size of the network. Normally use 255.255.255.0 as the subnet mask.
- **DHCP Server:** You can select to enable or disable the DHCP server. If you disable the server, you must have another DHCP server within your network, or else you must configure the IP address of the host(s) manually.
- **Start IP Address:** This field specifies the first address in the IP address pool. 192.168.0.100 is the default start IP address.
- **End IP Address:** This field specifies the last address in the IP Address pool. 192.168.0.199 is the default end IP address.
- **Lease Time:** It is the length of time a network user will be allowed to keep connecting to the device with the current IP address (that is assigned by the DHCP server). Enter the amount of time, in minutes, that the IP address will be "leased". The time range is 1~2880 minutes. The default value is 120 minutes.
- **Primary DNS Server:** Input the DNS IP address provided by your ISP. It is optional. The default primary DNS server IP is 192.168.0.100.
- **Secondary DNS Server:** Input the IP address of another DNS server if your ISP provides two DNS servers. It is optional. The default secondary DNS server IP is 192.168.0.199.

Click **Save** to save the changes.

 **Note:**

To use the DHCP server function of the Device, you should configure all the clients in the LAN

as "Obtain an IP Address automatically" mode.

4.4.3.2. Client List

On this page, you can view the information about the clients attached to the device. All the information is read-only. You cannot change any of the values on this page.

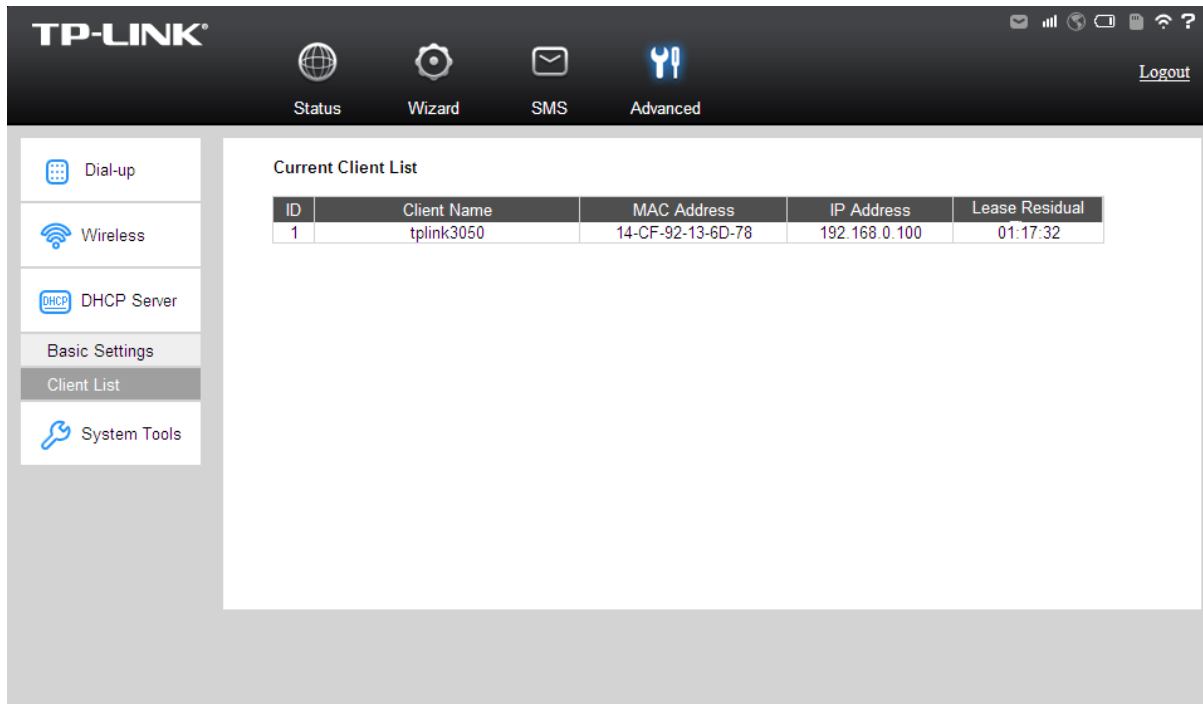

Figure 4-25 Clients List

- **ID:** The index of the DHCP Client.
- **Client Name:** The name of the DHCP client.
- **MAC Address:** The MAC address of the DHCP client.
- **IP Address:** The IP address the device has assigned to the DHCP client.
- **Lease Residual :** The rest lease time for the IP address assigned to the DHCP client. The DHCP client will automatically apply to lengthen the lease time before the dynamic IP address expires.

4.4.4 System Tools

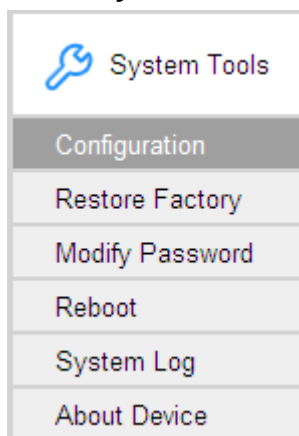

Figure 4-26 System Tools menu

Under **System Tools** menu, you can do such configurations as backing up or uploading a configuration file of the device, restoring all the settings of the device to its factory defaults, modifying the password for your login, rebooting the device, and checking some information about the device. As follows, we will explain them in details.

4.4.4.1. Configuration

On this page, you can back up the configuration of the device to file, or upload a configuration file to the device.

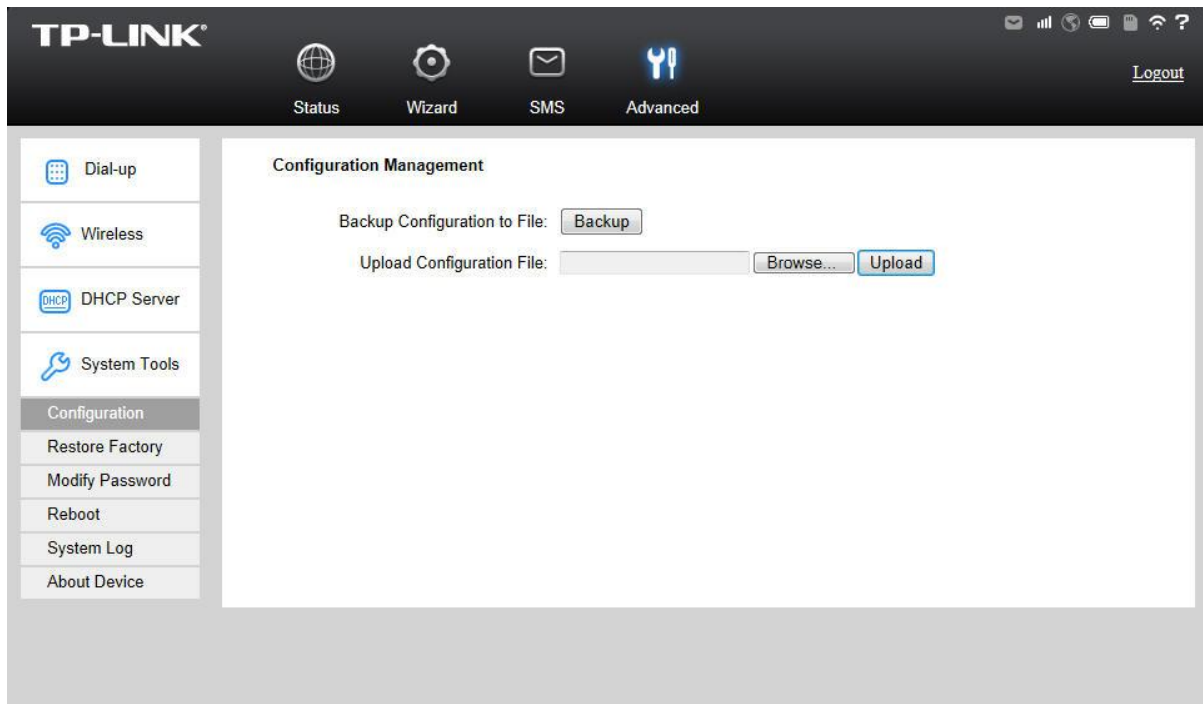

Figure 4-27 Configuration Management

- **Backup Configuration to File:** Click **Backup** to save the configuration file in your computer, for later necessary use. It's strongly recommended to back up the old configuration file before firmware upgrade or new configuration file upload, in case that during those process it might get the original configuration lost.
- **Upload Configuration File:** Click **Browse...** to locate the config.bin file or directly enter its location file, and then click **Upload** to upload the configuration file.

4.4.4.2. Restore Factory

You can restore the device to its factory default settings, when necessary.

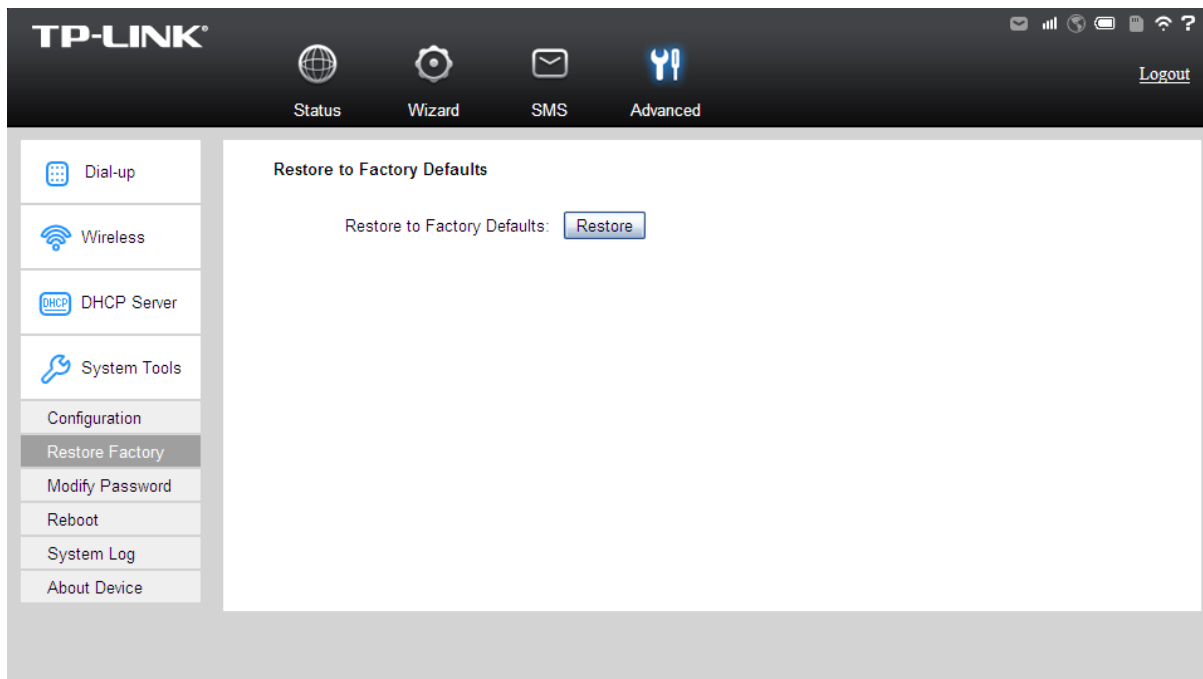

Figure 4-28 Restore to factory defaults

- **Restore to Factory Defaults:** Click **Restore** to reset all configuration settings to their default values. All of the settings you have saved will be lost when the default settings are restored.

You can restore the following factory default values:

- The default login **Password:** admin
- The default **IP Address:** 192.168.0.1
- The default **Subnet Mask:** 255.255.255.0
- The default SSID: TP-LINK_M5360_XXXXXX (XXXXXX is the last 6 characters of the device's MAC address). Please refer to the label on the rear cover of the device for the default SSID.
- The default Wireless Password: Please refer to the label on the rear cover of the device for the default wireless password.

4.4.4.3. Modify Password

It is strongly recommended that you change the factory default login password of the device.

The screenshot shows the TP-LINK web interface for the M5360 device. The main content area is titled "Modify Login Password". A red warning message states: "Username and password can contain between 1 - 15 characters and may not include spaces." Below this warning are four input fields: "Old User Name:", "Old Password:", "New User Name:", and "New Password:". A "Confirm New Password:" field is also present. At the bottom right of the form are "Save" and "Clear" buttons. The left sidebar contains a menu with the following items: Dial-up, Wireless, DHCP Server, System Tools, Configuration, Restore Factory, Modify Password (highlighted), Reboot, System Log, and About Device. The top navigation bar includes the TP-LINK logo, Status, Wizard, SMS, and Advanced icons, and a Logout link.

Figure 4-29 Modify Login Password

- **Old Password/User Name:** The old password/User Name that is used to log in of the device.
- **New Password/User Name:** The new password/User Name you want to set for the login of the device.
- **Confirm New Password:** Enter the new password again for confirmation.

Click **Save** when you finish the setting.

Click **Clear** to clear all the values you have already set, and then you can reset it.

 **Note:**

The new password must not exceed 14 characters in length and not include any spaces.

4.4.4.4. Reboot

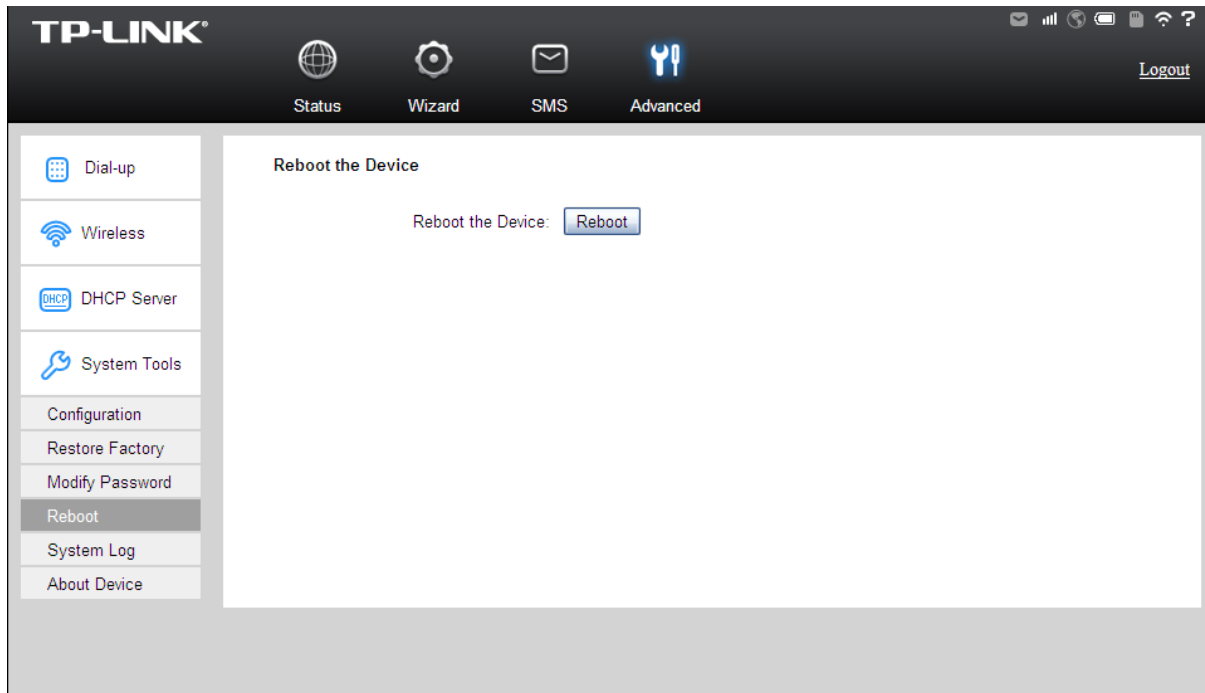

Figure 4-30 Reboot the Device

- **Reboot the Device:** Click **Reboot** to get the device rebooted and the saved settings to take effect.

4.4.4.5. System log

This page displays the log information about this device.

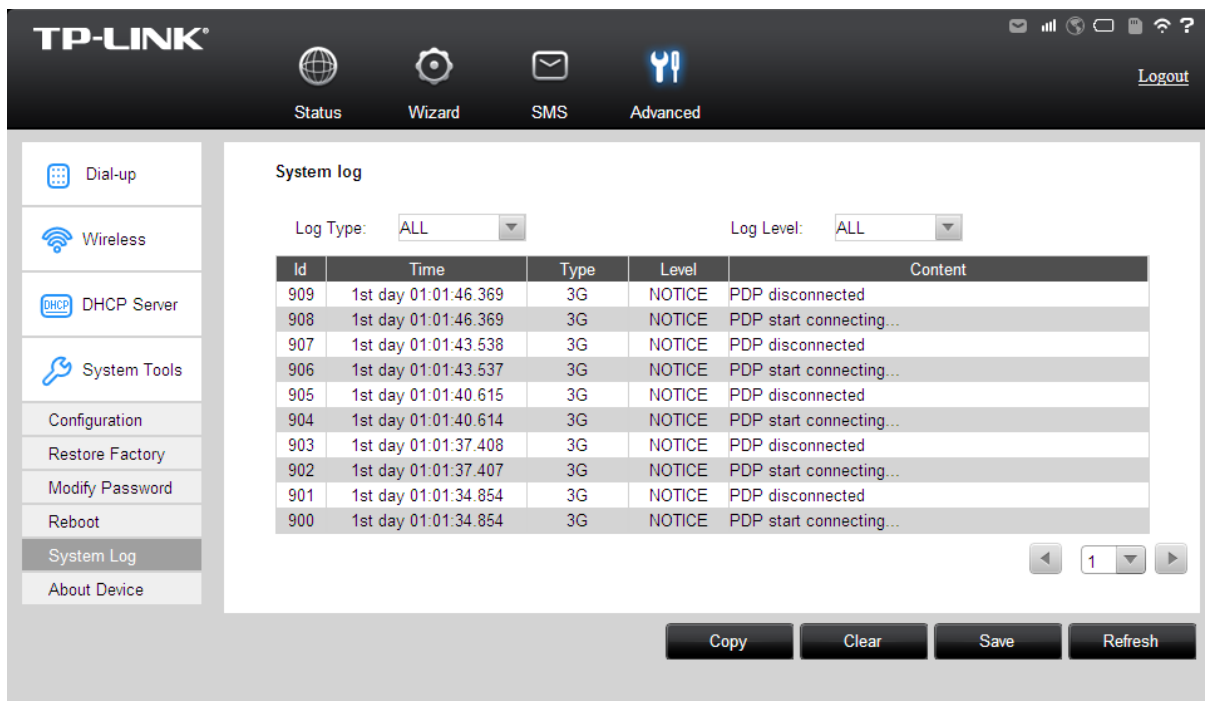

Figure 4-31 System log

- **Log Type:** Please select the log type from the drop-down list.
- **Log Level:** Please select the log level from the drop-down list.

Click **Copy** to copy the system logs.

Click **Save** to save the system logs.

Click **Clear** to clear all the logs.

Click **Refresh** to get the system log information updated.

4.4.4.6. About Device

This page displays the related information about this device, including Model, Firmware Version, Hardware Version, MAC Address, and IMEI.

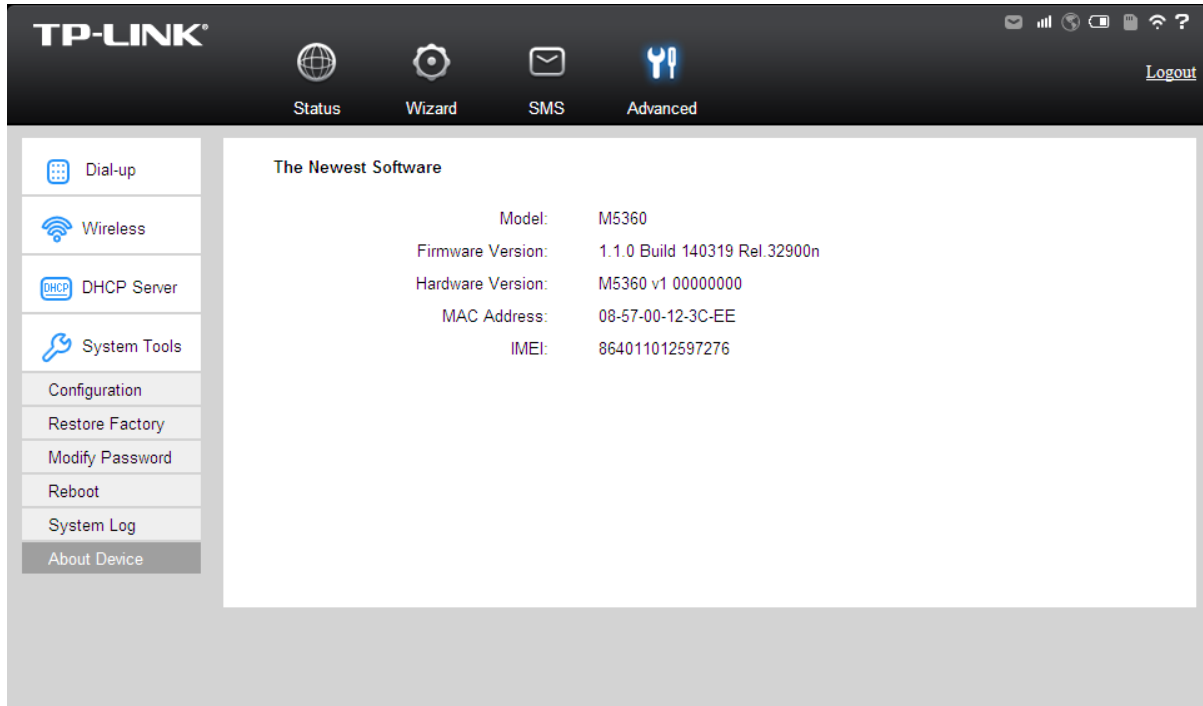

Figure 4-32 Device Information

- **Model:** The Model of the device.
- **Firmware Version:** The current firmware version
- **Hardware Version:** The current hardware version.
- **MAC Address:** The physical address of the device. The value is read-only thus could not be changed.
- **IMEI:** International Mobile Equipment Identity. Composed of 15 digits, it is unique and thus used to identify individual mobile equipment.

Appendix A: FAQ

FAQ1. What should I do if I cannot log into the web-management page?

- 1) Verify that your device is connecting to the M5360.
- 2) Verify that you entered the correct IP address http://192.168.0.1.
- 3) Verify that your device is obtaining an IP address automatically.

FAQ2. What should I do if I cannot access the Internet?

Tip 1: Check the LAN connection

- 1) Open your web browser and type http://192.168.0.1 in the address bar, and then enter the password, which is admin by default.
- 2) Check if you can log into the web-management page successfully. If not, please refer to FAQ 1 and retry.



Tip 2: Enter the PIN Code

- 1) If "PIN REQUIRED" appears on the screen, please open your web browser and type http://192.168.0.1 into the address bar, then enter the password, which is admin by default.
- 2) Choose "Advanced->Dial-up->PIN Management", then enter the correct PIN code according to your ISP and click Unlock for the settings to take effect.

Tip 3: Check your ISP parameters

- 1) Open your web browser and type http://192.168.0.1 in the address bar, and then enter the password, which is admin by default.
- 2) Choose "Advanced->Dial-up->Profile Management" to verify the parameters are correct with your ISP. These parameters include APN, Dial Number, User name and Password.
- 3) If these settings are not correct, please click Create to create a new profile with the correct parameters, and select Dial-up to choose the new profile from the Profile List.

Tip 4: Check the current network connection mode

- 1) Check the network connection mode on the screen. (The  icon means auto connection mode and the  icon means manual connection mode)
- 2) If the current mode is manual, open your web browser and type http://192.168.0.1 into the address bar, then enter the password, which is admin by default.
- 3) Choose "Advanced->Dial-up" to check the network status, if the network is disconnected, click the Connect button to reconnect it.

Note:

In manual connection mode, the M5360 will automatically lose 3G connection if internet activity idles for 5 minutes, in that case, you can repeat Tip 4 to recover.

Tip 5: Check the SIM card status

- 1) Verify that your SIM card has sufficient credit.
- 2) Verify that your SIM is in your ISP's service area.

FAQ3. How do I restore factory default settings?

Tip 1: Hold the RESET button for about 5 seconds until the screen turns off.

Tip 2: Log into the web-management page, and go to “Advanced->System Tools->Restore Factory”.

 Note:

Once M5360 is reset, all the current configurations will be lost and you need to reconfigure it.

Appendix B: Configuring the PC

In this section, we'll introduce how to install and configure the TCP/IP correctly in Windows 7. First make sure your Ethernet Adapter is working, refer to the adapter's manual if needed.

- 1) On the Windows taskbar, click the **Start** button, and then click **Control Panel**.

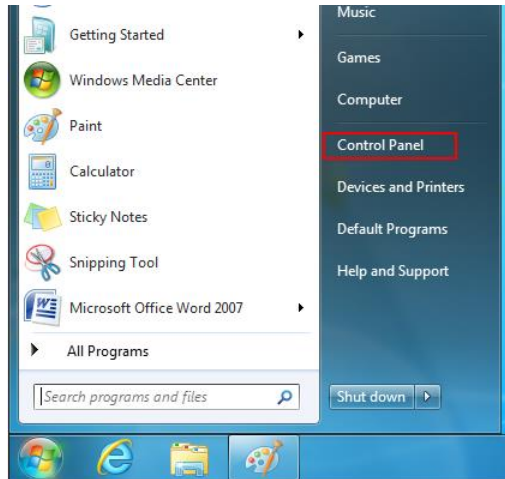

- 2) Click the **View network status and tasks**.

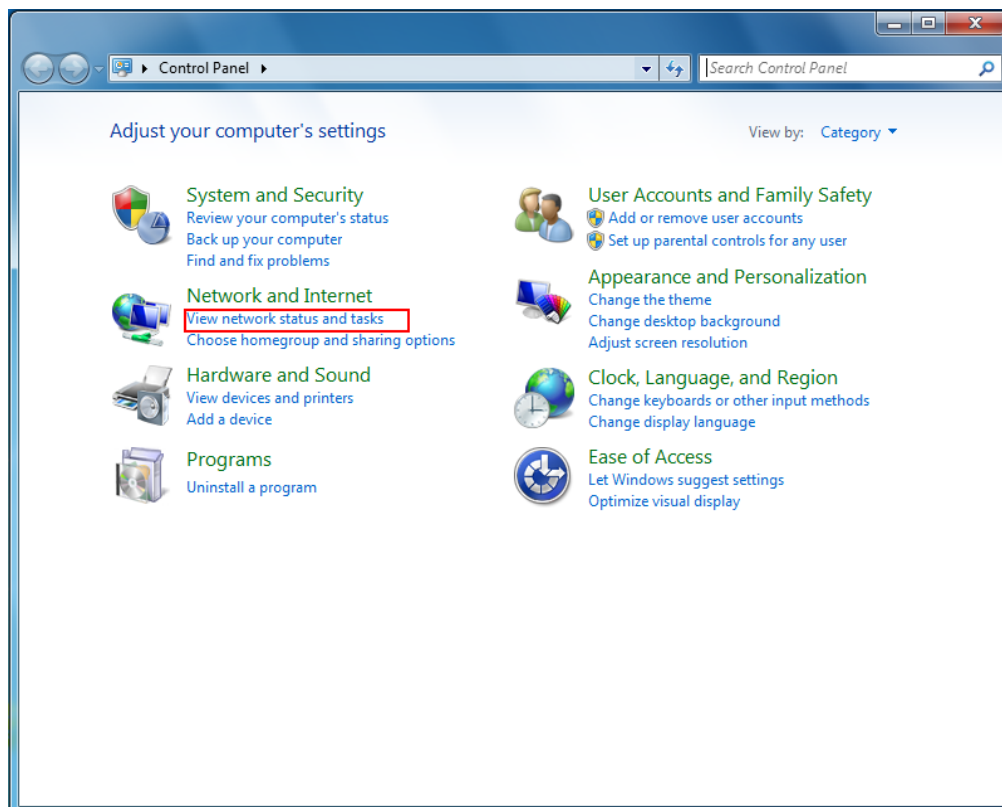

- 3) Click the **Local Area Connection**.

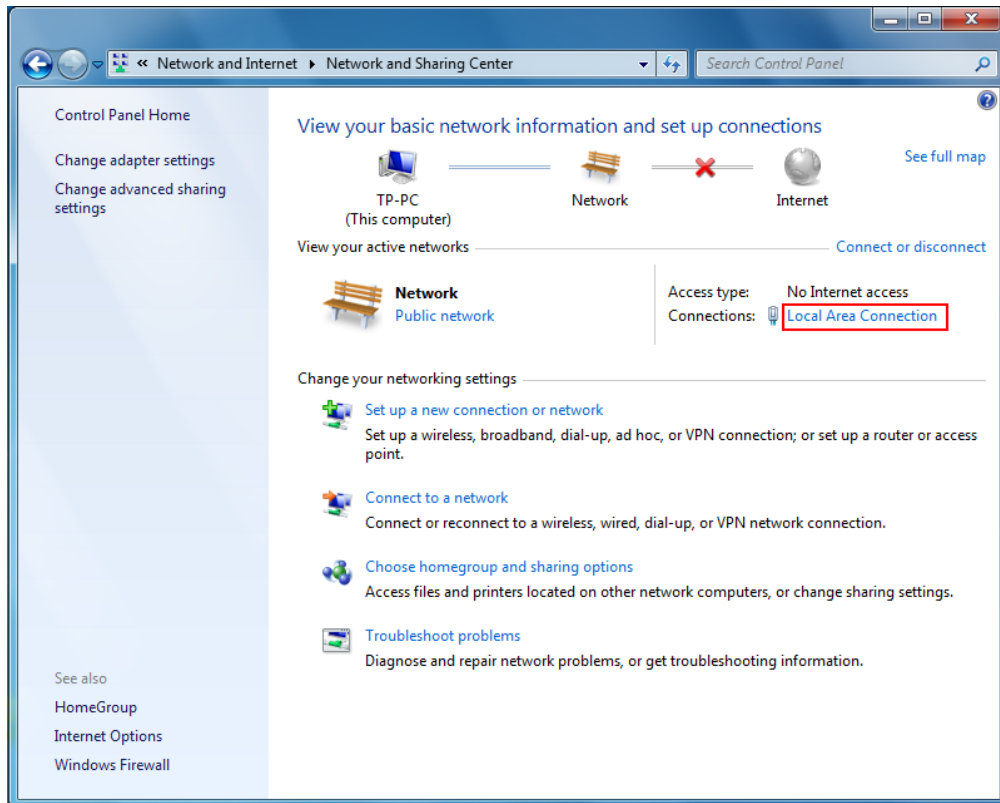

- 4) Select **Properties** on the Local Area Connection status page.

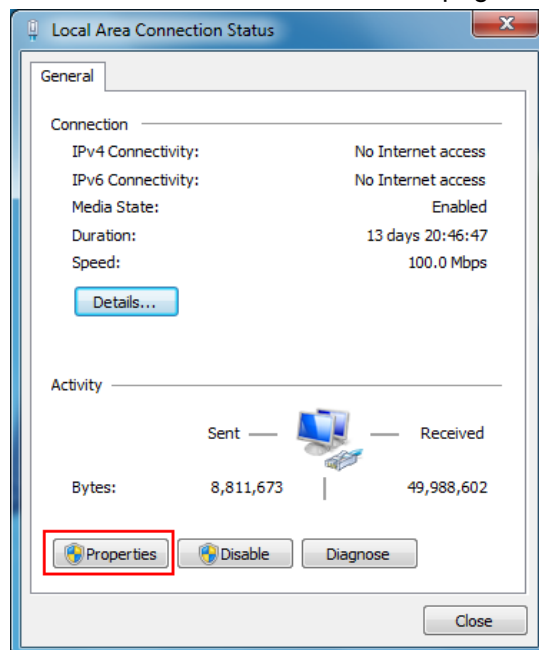

- 5) In the prompt page that showed below, double click on the **Internet Protocol Version 4 (TCP/IPv4)**.

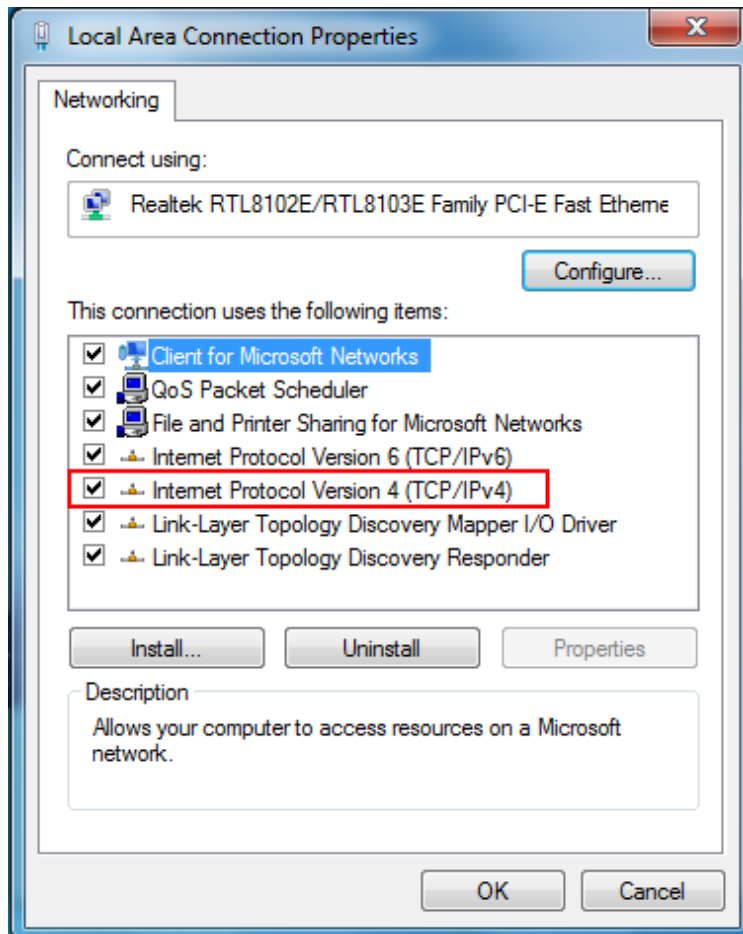

- 6) The following **Internet Protocol Version 4 (TCP/IPv4) Properties** window will display and the **IP Address** tab is open on this window by default.

You have two ways to configure the **TCP/IP** protocol below:

➤ **Setting IP address automatically**

Select **Obtain an IP address automatically**, Choose **Obtain DNS server address automatically**, as shown in the Figure below:

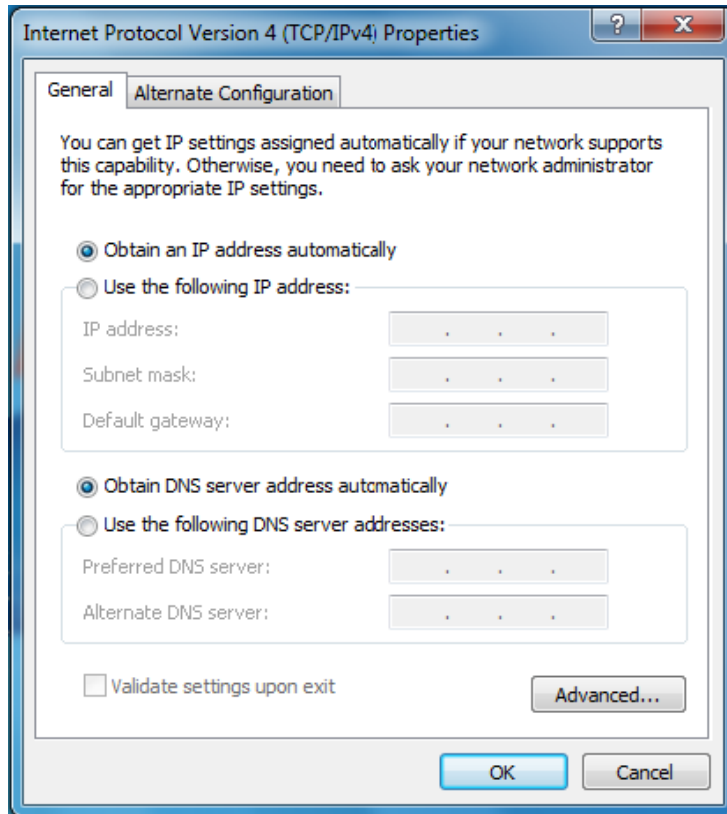





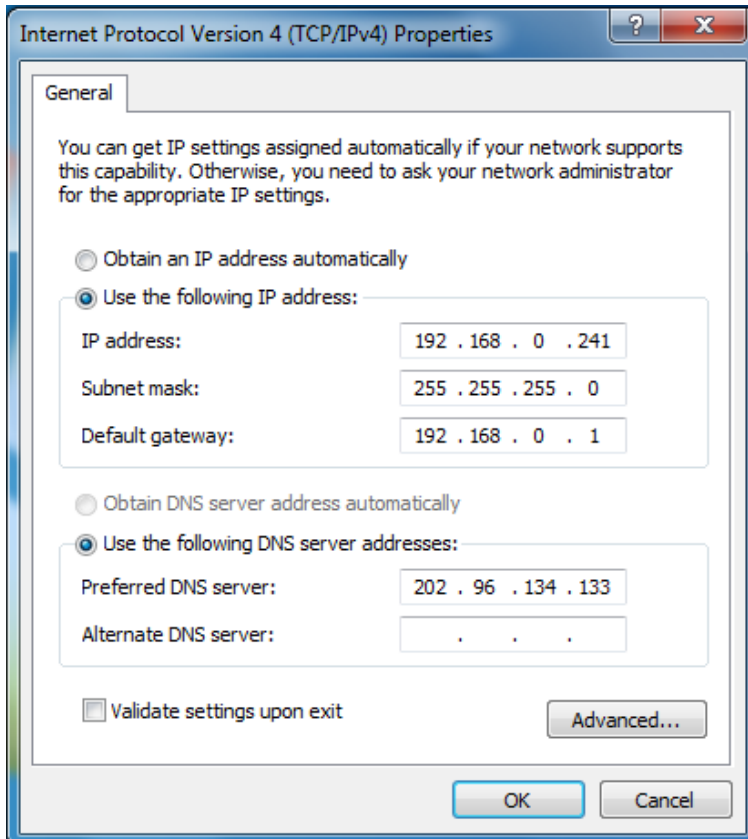

➤ **Setting IP address manually**

- a. Select **Use the following IP address** radio button. And the following items available.
- b. If the Device's LAN IP address is 192.168.0.1, type IP address is 192.168.0.x (x is from 2 to 254), and **Subnet mask** is 255.255.255.0.
- c. Type the Device's LAN IP address (the default IP is 192.168.0.1) into the **Default gateway** field.
- d. Select **Use the following DNS server addresses** radio button. In the **Preferred DNS Server** field you can type the DNS server IP address, which has been provided by your ISP.



- 7) Now click **OK** to keep your settings.

Appendix C: Specifications

| General | |
|---------------|--|
| Standards | IEEE 802.11n, IEEE 802.11b, IEEE 802.11g |
| Network Type | 3G: HSPA+/HSPA/UMTS 2G: EDGE/GRPS/GSM |
| Certification | CE, FCC, RoHS |
| Dimension | 100mm×44.3mm×28.5mm (W x D x H) |
| Interface | One Micro USB port, One USB 2.0 port, One SIM card slot, One Micro SD Memory card slot |
| Button | Power button, RESET button |
| OLED Display | <p> Indicates the current network option: 2G/3G/Roam, and signal strength of current network.</p> <p> Indicates the successful network connection.</p> <p> Means the automatic mode of Internet connection.</p> <p> Means the manual mode of Internet connection.</p> <p>WiFi Displays the Wi-Fi status and the amount of current wireless clients.</p> <p> Indicates that there is un-read short message(s) and the amount of un-read messages.</p> <p> Displays the remaining battery power.</p> <p>0.0B/s ↓ Indicates the download speed of current data transmission.</p> <p>0.0B/s ↑ Indicates the upload speed of current data transmission.</p> <p>0.0B Indicates the data used in total.</p> |
| Power Supply | Internal 5200mAh Rechargeable Battery |
| Wireless | |
| Band | WCDMA: 900/2100Mhz GSM: 850/900/1800/1900Mhz |
| Data Rate | Download: 21.6Mbps Upload: 5.76Mbps |
| Frequency | 2.4-2.4835GHz |
| EIRP | <20dBm |
| Security | 64/128-bit WEP, WPA-PSK/WPA2-PSK |
| Antenna | Internal Antenna |
| Environment | |
| Temperature | Operating : 0℃~40℃ |
| | Storage: -20℃~60℃ |
| Humidity | Operating: 10% ~ 90% RH, Non-condensing |
| | Storage: 5% ~ 90% RH, Non-condensing |

Appendix D: Glossary

- **802.11n** - 802.11n builds upon previous 802.11 standards by adding MIMO (multiple-input multiple-output). MIMO uses multiple transmitter and receiver antennas to allow for increased data throughput via spatial multiplexing and increased range by exploiting the spatial diversity, perhaps through coding schemes like Alamouti coding. The Enhanced Wireless Consortium (EWC) [3] was formed to help accelerate the IEEE 802.11n development process and promote a technology specification for interoperability of next-generation wireless local area networking (WLAN) products.
- **802.11b** - The 802.11b standard specifies a wireless networking at 11 Mbps using direct-sequence spread-spectrum (DSSS) technology and operating in the unlicensed radio spectrum at 2.4GHz, and WEP encryption for security. 802.11b networks are also referred to as Wi-Fi networks.
- **802.11g** - specification for wireless networking at 54 Mbps using direct-sequence spread-spectrum (DSSS) technology, using OFDM modulation and operating in the unlicensed radio spectrum at 2.4GHz, and backward compatibility with IEEE 802.11b devices, and WEP encryption for security.
- **DHCP (Dynamic Host Configuration Protocol)** - A protocol that automatically configure the TCP/IP parameters for the all the PC(s) that are connected to a DHCP server.
- **ISP (Internet Service Provider)** - A company that provides access to the Internet.
- **SSID - A Service Set Identification** is a thirty-two character (maximum) alphanumeric key identifying a wireless local area network. For the wireless devices in a network to communicate with each other, all devices must be configured with the same SSID. This is typically the configuration parameter for a wireless PC card. It corresponds to the ESSID in the wireless Access Point and to the wireless network name.
- **WEP (Wired Equivalent Privacy)** - A data privacy mechanism based on a 64-bit or 128-bit shared key algorithm, as described in the IEEE 802.11 standard.
- **Wi-Fi** - A trade name for the 802.11b wireless networking standard, given by the Wireless Ethernet Compatibility Alliance (WECA, see <http://www.wi-fi.net>), an industry standards group promoting interoperability among 802.11b devices.
- **WLAN (Wireless Local Area Network)** - A group of computers and associated devices communicate with each other wirelessly, which network serving users are limited in a local area.