

TP-LINK®

User Guide

T2600G-28TS (TL-SG3424)

T2600G-52TS (TL-SG3452)

T2600G-28MPS (TL-SG3424P)

JetStream Gigabit L2 Managed Switch



COPYRIGHT & TRADEMARKS

Specifications are subject to change without notice. **TP-LINK®** is a registered trademark of TP-LINK TECHNOLOGIES CO., LTD. Other brands and product names are trademarks or registered trademarks of their respective holders.

No part of the specifications may be reproduced in any form or by any means or used to make any derivative such as translation, transformation, or adaptation without permission from TP-LINK TECHNOLOGIES CO., LTD. Copyright © 2016 TP-LINK TECHNOLOGIES CO., LTD. All rights reserved.

<http://www.tp-link.com>

FCC STATEMENT

This equipment has been tested and found to comply with the limits for a Class A digital device, pursuant to part 15 of the FCC Rules. These limits are designed to provide reasonable protection against harmful interference when the equipment is operated in a commercial environment. This equipment generates, uses, and can radiate radio frequency energy and, if not installed and used in accordance with the instruction manual, may cause harmful interference to radio communications. Operation of this equipment in a residential area is likely to cause harmful interference in which case the user will be required to correct the interference at his own expense.

This device complies with part 15 of the FCC Rules. Operation is subject to the following two conditions:

- 1) This device may not cause harmful interference.
- 2) This device must accept any interference received, including interference that may cause undesired operation.

Any changes or modifications not expressly approved by the party responsible for compliance could void the user's authority to operate the equipment.

CE Mark Warning



This is a class A product. In a domestic environment, this product may cause radio interference, in which case the user may be required to take adequate measures.





Продукт сертифіковано згідно с правилами системи УкрСЕПРО на відповідність вимогам нормативних документів та вимогам, що передбачені чинними законодавчими актами України.

Industry Canada Statement

CAN ICES-3 (A)/NMB-3(A)



Explanation of the symbols on the product label

Symbol	Explanation
	AC voltage
	<p>RECYCLING</p> <p>This product bears the selective sorting symbol for Waste electrical and electronic equipment (WEEE). This means that this product must be handled pursuant to European directive 2012/19/EU in order to be recycled or dismantled to minimize its impact on the environment.</p> <p>User has the choice to give his product to a competent recycling organization or to the retailer when he buys a new electrical or electronic equipment.</p>

Safety Information

- When product has power button, the power button is one of the way to shut off the product; When there is no power button, the only way to completely shut off power is to disconnect the product or the power adapter from the power source.
- Don't disassemble the product, or make repairs yourself. You run the risk of electric shock and voiding the limited warranty. If you need service, please contact us.
- Avoid water and wet locations.

安全諮詢及注意事項

- 請使用原裝電源供應器或只能按照本產品注明的電源類型使用本產品。
- 清潔本產品之前請先拔掉電源線。請勿使用液體、噴霧清潔劑或濕布進行清潔。
- 注意防潮，請勿將水或其他液體潑灑到本產品上。
- 插槽與開口供通風使用，以確保本產品的操作可靠並防止過熱，請勿堵塞或覆蓋開口。
- 請勿將本產品置放於靠近熱源的地方。除非有正常的通風，否則不可放在密閉位置中。
- 請不要私自打開機殼，不要嘗試自行維修本產品，請由授權的專業人士進行此項工作。

此為甲類資訊技術設備，于居住環境中使用時，可能會造成射頻擾動，在此種情況下，使用者會被要求採取某些適當的對策。

CONTENTS

Package Contents	1
Chapter 1 About this Guide	2
1.1 Intended Readers.....	2
1.2 Conventions	2
1.3 Overview of This Guide.....	3
Chapter 2 Introduction.....	8
2.1 Overview of the Switch.....	8
2.2 Appearance Description.....	8
2.2.1 Front Panel	8
2.2.2 Rear Panel	13
Chapter 3 Login to the Switch	14
3.1 Login.....	14
3.2 Configuration.....	15
Chapter 4 System.....	16
4.1 System Info	16
4.1.1 System Summary.....	16
4.1.2 Device Description	17
4.1.3 System Time.....	18
4.1.4 Daylight Saving Time	19
4.1.5 Serial Port Setting	20
4.2 User Management.....	21
4.2.1 User Table	21
4.2.2 User Config	21
4.3 System Tools	23
4.3.1 Boot Config.....	23
4.3.2 Config Restore	24
4.3.3 Config Backup	24
4.3.4 Firmware Upgrade.....	25
4.3.5 System Reboot.....	26
4.3.6 Reboot Schedule.....	26
4.3.7 System Reset	27
4.4 Access Security.....	27
4.4.1 Access Control	27
4.4.2 HTTP Config.....	29
4.4.3 HTTPS Config	29
4.4.4 SSH Config.....	32

4.4.5	Telnet Config	39
4.5	SDM Template.....	39
4.5.1	SDM Template Config	39
Chapter 5	Switching	41
5.1	Port.....	41
5.1.1	Port Config	41
5.1.2	Port Mirror.....	42
5.1.3	Port Security.....	44
5.1.4	Port Isolation	46
5.1.5	Loopback Detection	47
5.2	LAG	49
5.2.1	LAG Table.....	50
5.2.2	Static LAG.....	51
5.2.3	LACP Config.....	52
5.3	Traffic Monitor.....	54
5.3.1	Traffic Summary	54
5.3.2	Traffic Statistics	55
5.4	MAC Address	56
5.4.1	Address Table.....	58
5.4.2	Static Address.....	59
5.4.3	Dynamic Address	60
5.4.4	Filtering Address.....	62
5.4.5	MAC Notification.....	63
5.4.6	MAC VLAN Security.....	64
5.5	L2PT	65
5.5.1	L2PT Config.....	66
Chapter 6	VLAN.....	68
6.1	802.1Q VLAN	69
6.1.1	VLAN Config.....	70
6.1.2	Port Config	71
6.2	Application Example for 802.1Q VLAN.....	73
6.3	MAC VLAN	74
6.3.1	MAC VLAN	75
6.3.2	Port Enable.....	76
6.4	Application Example for MAC VLAN.....	76
6.5	Protocol VLAN.....	78
6.5.1	Protocol Group Table.....	79

6.5.2	Protocol Group	80
6.5.3	Protocol Template.....	80
6.6	Application Example for Protocol VLAN	82
6.7	VLAN VPN.....	84
6.7.1	VPN Config.....	85
6.7.2	Port Enable.....	86
6.7.3	VLAN Mapping	86
6.8	GVRP	89
6.9	Private VLAN.....	92
6.9.1	PVLAN Config	94
6.9.2	Port Config	95
6.10	Application Example for Private VLAN	96
Chapter 7	Spanning Tree.....	99
7.1	STP Config.....	104
7.1.1	STP Config	104
7.1.2	STP Summary	106
7.2	Port Config	107
7.3	MSTP Instance.....	108
7.3.1	Region Config.....	109
7.3.2	Instance Config	109
7.3.3	Instance Port Config.....	110
7.4	STP Security	112
7.4.1	Port Protect	112
7.4.2	TC Protect	115
7.5	Application Example for STP Function	115
Chapter 8	Ethernet OAM.....	120
8.1	Basic Config	123
8.1.1	Basic Config	124
8.1.2	Discovery Info.....	125
8.2	Link Monitoring	127
8.3	RFI.....	128
8.4	Remote Loopback	129
8.5	Statistics	130
8.5.1	Statistics	130
8.5.2	Event Log	131
8.6	DLDP	132
8.7	Application Example for DLDP.....	136

Chapter 9 Multicast.....	139
9.1 IGMP Snooping.....	143
9.1.1 Snooping Config.....	145
9.1.2 Port Config	147
9.1.3 VLAN Config.....	148
9.1.4 Multicast VLAN.....	149
9.1.5 Querier Config	153
9.1.6 Profile Config.....	154
9.1.7 Profile Binding	156
9.1.8 Packet Statistics	157
9.1.9 IGMP Authentication.....	159
9.2 MLD Snooping.....	160
9.2.1 Snooping Config.....	161
9.2.2 Port Config	164
9.2.3 VLAN Config.....	165
9.2.4 Multicast VLAN.....	166
9.2.5 Querier Config	168
9.2.6 Profile Config.....	169
9.2.7 Profile Binding	171
9.2.8 Packet Statistics	172
9.3 Multicast Table.....	174
9.3.1 IPv4 Multicast Table	174
9.3.2 Static IPv4 Multicast Table	174
9.3.3 IPv6 Multicast Table	176
9.3.4 Static IPv6 Multicast Table	176
Chapter 10 Routing	179
10.1 Interface	179
10.2 Routing Table	191
10.2.1 IPv4 Routing Table	191
10.2.2 IPv6 Routing Table	191
10.3 Static Routing	192
10.3.1 IPv4 Static Routing Config	192
10.3.2 IPv6 Static Routing Config	193
10.4 DHCP Server.....	194
10.4.1 DHCP Server.....	200
10.4.2 Pool Setting	201
10.4.3 Manual Binding.....	202

10.4.4	Binding Table	203
10.4.5	Packet Statistics	204
10.4.6	Application Example for DHCP Server and Relay	205
10.5	DHCP Relay	207
10.5.1	Global Config	209
10.5.2	DHCP Server	210
10.6	ARP	211
10.6.1	ARP Table	211
10.6.2	Static ARP	211
Chapter 11	QoS	213
11.1	DiffServ	216
11.1.1	Port Priority	216
11.1.2	Schedule Mode	217
11.1.3	802.1P Priority	218
11.1.4	DSCP Priority	219
11.2	Bandwidth Control	221
11.2.1	Rate Limit	221
11.2.2	Storm Control	222
11.3	Voice VLAN	223
11.3.1	Global Config	225
11.3.2	Port Config	226
11.3.3	OUI Config	227
Chapter 12	PoE	229
12.1	PoE Config	229
12.1.1	PoE Config	230
12.1.2	PoE Profile	231
12.2	Time-Range	232
12.2.1	Time-Range Summary	233
12.2.2	Time-Range Create	233
12.2.3	Holiday Config	235
Chapter 13	ACL	237
13.1	Time-Range	237
13.1.1	Time-Range Summary	237
13.1.2	Time-Range Create	238
13.1.3	Holiday Config	239
13.2	ACL Config	239
13.2.1	ACL Summary	239

13.2.2	ACL Create.....	240
13.2.3	MAC ACL.....	240
13.2.4	Standard-IP ACL.....	242
13.2.5	Extend-IP ACL.....	243
13.2.6	Combined ACL.....	244
13.2.7	IPv6 ACL.....	245
13.3	Policy Config.....	247
13.3.1	Policy Summary.....	247
13.3.2	Policy Create.....	248
13.3.3	Action Create.....	248
13.4	ACL Binding.....	249
13.4.1	Binding Table.....	250
13.4.2	Port Binding.....	251
13.4.3	VLAN Binding.....	252
13.5	Policy Binding.....	252
13.5.1	Binding Table.....	253
13.5.2	Port Binding.....	254
13.5.3	VLAN Binding.....	255
13.6	Application Example for ACL.....	255
Chapter 14 Network Security.....		258
14.1	IP-MAC Binding.....	258
14.1.1	Binding Table.....	258
14.1.2	Manual Binding.....	259
14.1.3	ARP Scanning.....	261
14.2	IPv6-MAC Binding.....	262
14.2.1	Binding Table.....	263
14.2.2	Manual Binding.....	264
14.2.3	ND Snooping.....	266
14.3	DHCP Snooping.....	268
14.3.1	Global Config.....	271
14.3.2	Port Config.....	272
14.3.3	Option 82 Config.....	273
14.4	DHCPv6 Snooping.....	274
14.5	ARP Inspection.....	275
14.5.1	ARP Detect.....	278
14.5.2	ARP Defend.....	279
14.5.3	ARP Statistics.....	280

14.6	ND Detection	281
14.7	IP Source Guard.....	283
14.8	DoS Defend.....	285
14.8.1	DoS Defend.....	286
14.9	802.1X.....	286
14.9.1	Global Config.....	290
14.9.2	Port Config	291
14.10	PPPoE.....	293
14.11	AAA	296
14.11.1	Global Config	297
14.11.2	Privilege Elevation	297
14.11.3	RADIUS Server Config	297
14.11.4	TACACS+ Server Config	298
14.11.5	Authentication Server Group Config.....	299
14.11.6	Authentication Method List Config.....	301
14.11.7	Application Authentication List Config	302
14.11.8	802.1X Authentication Server Config.....	303
14.11.9	Default Settings.....	303
Chapter 15	SNMP.....	305
15.1	SNMP Config.....	307
15.1.1	Global Config.....	307
15.1.2	SNMP View	308
15.1.3	SNMP Group	309
15.1.4	SNMP User.....	310
15.1.5	SNMP Community.....	312
15.2	Notification.....	314
15.3	RMON.....	316
15.3.1	Statistics	317
15.3.2	History	318
15.3.3	Event	319
15.3.4	Alarm Config.....	320
Chapter 16	LLDP.....	322
16.1	Basic Config	326
16.1.1	Global Config.....	326
16.1.2	Port Config	327
16.2	Device Info	328
16.2.1	Local Info.....	328

16.2.2	Neighbor Info	329
16.3	Device Statistics	330
16.4	LLDP-MED	331
16.4.1	Global Config	332
16.4.2	Port Config	332
16.4.3	Local Info	335
16.4.4	Neighbor Info	336
Chapter 17	Maintenance	337
17.1	System Monitor	337
17.1.1	CPU Monitor	337
17.1.2	Memory Monitor	338
17.2	sFlow	339
17.2.1	sFlow Collector	340
17.2.2	sFlow Sampler	341
17.2.3	Default Settings	342
17.3	Log	342
17.3.1	Log Table	342
17.3.2	Local Log	343
17.3.3	Remote Log	344
17.3.4	Backup Log	345
17.4	Device Diagnostics	346
17.4.1	Cable Test	346
17.5	Network Diagnostics	347
17.5.1	Ping	347
17.5.2	Tracert	348
Appendix A.	Password Recovery	349
Appendix B.	Specifications	350
Appendix C.	Glossary	351

Package Contents

The following items should be found in your box:

- One JetStream Gigabit L2 Managed Switch
- One power cord
- Two mounting brackets and other fittings
- Installation Guide
- Resource CD for T2600G-28TS/ T2600G-52TS/ T2600G-28MPS, including:
 - This User Guide
 - CLI Reference Guide
 - SNMP Mibs
 - 802.1X Client Software and its User Guide
 - USB Console Driver
 - Other Helpful Information



Note:

Make sure that the package contains the above items. If any of the listed items are damaged or missing, please contact your distributor.

Chapter 1 About this Guide

This User Guide contains information for setup and management of T2600G-28TS/ T2600G-52TS/ T2600G-28MPS JetStream Gigabit L2 Managed Switch. Please read this guide carefully before operation.

1.1 Intended Readers

This Guide is intended for network managers familiar with IT concepts and network terminologies.

1.2 Conventions



When using this guide, please notice that features of the switch may vary slightly depending on the model and software version you have, and on your location, language, and Internet service provider. All screenshots, images, parameters and descriptions documented in this guide are used for demonstration only.

The information in this document is subject to change without notice. Every effort has been made in the preparation of this document to ensure accuracy of the contents, but all statements, information, and recommendations in this document do not constitute the warranty of any kind, express or implied. Users must take full responsibility for their application of any products.

In this Guide the following conventions are used:

- The switch or the device mentioned in this Guide stands for T2600G-28TS/ T2600G-52TS/ T2600G-28MPS JetStream Gigabit L2 Managed Switch without any explanation.
- **Menu Name**→**Submenu Name**→**Tab page** indicates the menu structure. **System**→**System Info**→**System Summary** means the System Summary page under the System Info menu option that is located under the System menu.
- **Bold font** indicates a button, a toolbar icon, menu or menu item.

Symbols in this Guide:

Symbol	Description
 Note:	Ignoring this type of note might result in a malfunction or damage to the device.
 Tips:	This format indicates important information that helps you make better use of your device.

More Info:

- The latest software, management app and utility can be found at Download Center at <http://www.tp-link.com/support>.
- The Installation Guide (IG) can be found where you find this guide or inside the package of the switch.
- Specifications can be found on the product page at <http://www.tp-link.com>.

- A Technical Support Forum is provided for you to discuss our products at <http://forum.tp-link.com>.
- Our Technical Support contact information can be found at the Contact Technical Support page at <http://www.tp-link.com/support>.

1.3 Overview of This Guide

Chapter	Introduction
Chapter 1 About This Guide	Introduces the guide structure and conventions.
Chapter 2 Introduction	Introduces the features, application and appearance of T2600G-28TS/ T2600G-52TS/ T2600G-28MPS switch.
Chapter 3 Login to the Switch	Introduces how to log on to the Web management page.
Chapter 4 System	<p>This module is used to configure system properties of the switch. Here mainly introduces:</p> <ul style="list-style-type: none"> ● System Info: Configure the description, system time and network parameters of the switch. ● User Management: Configure the user name and password for users to log on to the Web management page with a certain access level. ● System Tools: Manage the configuration file of the switch. ● Access Security: Provide different security measures for the login to enhance the configuration management security. ● SDM Template: Manage the hardware TCAM resources.
Chapter 5 Switching	<p>This module is used to configure basic functions of the switch. Here mainly introduces:</p> <ul style="list-style-type: none"> ● Port: Configure the basic features for the port. ● LAG: Configure Link Aggregation Group. LAG is to combine a number of ports together to make a single high-bandwidth data path. ● Traffic Monitor: Monitor the traffic of each port. ● MAC Address: Configure the address table of the switch. ● L2PT: Configure the Layer 2 Protocol Tunneling feature.

Chapter	Introduction
Chapter 6 VLAN	<p>This module is used to configure VLANs to control broadcast in LANs. Here mainly introduces:</p> <ul style="list-style-type: none"> ● 802.1Q VLAN: Configure port-based VLAN. ● MAC VLAN: Configure MAC-based VLAN without changing the 802.1Q VLAN configuration. ● Protocol VLAN: Create VLANs in application layer to make some special data transmitted in the specified VLAN. ● VLAN VPN: VLAN VPN allows the packets with VLAN tags of private networks to be encapsulated with VLAN tags of public networks at the network access terminal of the Internet Service Provider. ● GVRP: GVRP allows the switch to automatically add or remove the VLANs via the dynamic VLAN registration information and propagate the local VLAN registration information to other switches, without having to individually configure each VLAN. ● Private VLAN: Designed to save VLAN resources of uplink devices and decrease broadcast. Private VLAN mainly used in campus or enterprise networks to achieve user layer-2-separation and to save VLAN resources of uplink devices.
Chapter 7 Spanning Tree	<p>This module is used to configure spanning tree function of the switch. Here mainly introduces:</p> <ul style="list-style-type: none"> ● STP Config: Configure and view the global settings of spanning tree function. ● Port Config: Configure CIST parameters of ports. ● MSTP Instance: Configure MSTP instances. ● STP Security: Configure protection function to prevent devices from any malicious attack against STP features.
Chapter 8 Ethernet OAM	<p>This module is used to configure Ethernet OAM function of the switch. Here mainly introduces:</p> <ul style="list-style-type: none"> ● Basic Config: Enable the Ethernet OAM function, configure its OAM mode, and check out the connection status. ● Link Monitoring: Configure the parameters about OAM link events and choose whether to notify the link event. ● RFI: Choose whether to notify the link faults like dying gasp and critical event. ● Remote Loopback: Start or stop the remote loopback; choose to ignore or to process the received remote loopback request. ● Statistics: View the statistics about the detailed Ethernet OAM traffic information and event log information. ● DLDP: Configure the DLDP function to allow the switch to monitor the physical configuration of the cables and detect whether a unidirectional link exists.

Chapter	Introduction
Chapter 9 Multicast	<p>This module is used to configure multicast function of the switch. Here mainly introduces:</p> <ul style="list-style-type: none"> ● IGMP Snooping: Configure global parameters of IGMP Snooping function, port properties, VLAN and multicast VLAN. ● MLD Snooping: Configure global parameters of MLD Snooping function, port properties, VLAN and multicast VLAN. ● Multicast Table: View the information of IPv4 and IPv6 multicast groups already on the switch.
Chapter 10 Routing	<p>The module is used to configure several IPv4 unicast routing protocols. Here mainly introduces:</p> <ul style="list-style-type: none"> ● Interface: Configure and view different types of interfaces: VLAN, loopback, routed port and port-channel interface. ● Routing table: Displays the routing information summary. ● Static Routing: Configure and view static routes. ● DHCP Server: Configure DHCP server. ● DHCP Relay: Configure DHCP relay. ● ARP: Displays the ARP information.
Chapter 11 QoS	<p>This module is used to configure QoS function to provide different quality of service for various network applications and requirements. Here mainly introduces:</p> <ul style="list-style-type: none"> ● DiffServ: Configure priorities, port priority, 802.1P priority and DSCP priority. ● Bandwidth Control: Configure rate limit feature to control the traffic rate on each port; configure storm control feature to filter broadcast, multicast and UL frame in the network. ● Voice VLAN: Configure voice VLAN to transmit voice data stream within the specified VLAN so as to ensure the transmission priority of voice data stream and voice quality.
Chapter 12 PoE	<p>This module is used to configure the PoE function for the switch to supply power for PD devices. Here mainly introduces:</p> <ul style="list-style-type: none"> ● PoE Config: Configure PoE function globally. ● PoE Time-Range: Configure the effective time for PoE port to supply power.
Chapter 13 ACL	<p>This module is used to configure match rules and process policies of packets to filter packets in order to control the access of the illegal users to the network. Here mainly introduces:</p> <ul style="list-style-type: none"> ● Time-Range: Configure the effective time for ACL rules. ● ACL Config: ACL rules. ● Policy Config: Configure operation policies. ● ACL Binding: Bind the ACL to a port/VLAN to take its effect on a specific port/VLAN. ● Policy Binding: Bind the policy to a port/VLAN to take its effect on a specific port/VLAN.

Chapter	Introduction
Chapter 14 Network Security	<p>This module is used to configure the protection measures for the network security. Here mainly introduces:</p> <ul style="list-style-type: none"> ● IP-MAC Binding: Bind the IP address, MAC address, VLAN ID and the connected Port number of the Host together. ● IPv6-MAC Binding: Bind the IPv6 address, MAC address, VLAN ID and the connected Port number of the Host together. ● DHCP Snooping: DHCP Snooping functions to monitor the process of the Host obtaining the IP address from DHCP server, and record the IP address, MAC address, VLAN and the connected Port number of the Host for automatic binding. ● DHCPv6 Snooping: DHCPv6 Snooping functions to monitor the process of the Host obtaining the IPv6 address from DHCPv6 server, and record the IPv6 address, MAC address, VLAN and the connected Port number of the Host for automatic binding. ● ARP Inspection: Configure ARP inspection feature to prevent the network from ARP attacks. ● ND Detection: Configure ND detection feature to prevent the network from ND attacks. ● IP Source Guard: Configure IP source guard feature to filter IP packets in the LAN. ● DoS Defend: Configure DoS defend feature to prevent DoS attack. ● 802.1X: Configure common access control mechanism for LAN ports to solve mainly authentication and security problems. ● PPPoE: Configure the PPPoE ID insertion feature. ● AAA: Configure the authentication, authorization and accounting features.
Chapter 15 SNMP	<p>This module is used to configure SNMP function to provide a management frame to monitor and maintain the network devices. Here mainly introduces:</p> <ul style="list-style-type: none"> ● SNMP Config: Configure global settings of SNMP function. ● Notification: Configure notification function for the management station to monitor and process the events. ● RMON: Configure RMON function to monitor network more efficiently.
Chapter 16 LLDP	<p>This module is used to configure LLDP function to provide information for SNMP applications to simplify troubleshooting. Here mainly introduces:</p> <ul style="list-style-type: none"> ● Basic Config: Configure the LLDP parameters of the device. ● Device Info: View the LLDP information of the local device and its neighbors. ● Device Statistics: View the LLDP statistics of the local device. ● LLDP-MED: Configure the LLDP-MED features.

Chapter	Introduction
Chapter 17 Maintenance	<p>This module is used to assemble the commonly used system tools to manage the switch. Here mainly introduces:</p> <ul style="list-style-type: none"> ● System Monitor: Monitor the memory and CPU of the switch. ● Log: View configuration parameters on the switch. ● Device Diagnostics: Test the connection status of the cable connected to the switch, test if the port of the switch and the connected device are available. ● Network Diagnostics: Test if the destination is reachable and the account of router hops from the switch to the destination.
Appendix A Password Recovery	Introduces the procedure to reset passwords on TP-LINK switches.
Appendix B Specifications	Lists the hardware specifications of the switch.
Appendix C Glossary	Lists the glossary used in this manual.

[Return to CONTENTS](#)

Chapter 2 Introduction

Thanks for choosing the T2600G-28TS/ T2600G-52TS/ T2600G-28MPS JetStream Gigabit L2 Managed Switch!

2.1 Overview of the Switch

Designed for workgroups and departments, T2600G-28TS/ T2600G-52TS/ T2600G-28MPS from TP-LINK provides wire-speed performance and full set of L2 and L2+ management features. It provides a variety of service features and multiple powerful functions with high security.

The EIA-standardized framework and smart configuration capacity can provide flexible solutions for a variable scale of networks. Static routing allows devices in different VLANs/subnets to communicate with each other in an IPv4/IPv6 network. OAM, L2PT and sFlow can meet the requirement of large ISP customers. ACL, 802.1x and Dynamic ARP Inspection provide robust security strategies. QoS and IGMP snooping/filtering optimize voice and video application. Link aggregation (LACP) increases aggregated bandwidth, optimizing the transport of business critical data. SNMP, RMON, WEB and CLI Log-in bring abundant management policies. TP-LINK JetStream L2 Managed Switch integrates multiple functions with excellent performance, and is friendly to manage, which can fully meet the need of the users demanding higher networking performance.

2.2 Appearance Description

2.2.1 Front Panel

The front panel of T2600G-28TS is shown as Figure 2-1.



Figure 2-1 Front Panel of T2600G-28TS

The following parts are located on the front panel of T2600G-28TS:

➤ LEDs

Name	Status	Indication
PWR	On	The switch is powered on.
	Off	The switch is powered off or power supply is abnormal.
	Flashing	Power supply is abnormal.
SYS	Flashing	The switch works properly.
	On/Off	The switch works improperly.
1000Mbps	On	A 1000Mbps device is connected to the corresponding port but no activity.
	Off	No device is connected to the corresponding port.

Name	Status	Indication
Link/Act	On	A device is linked to the corresponding port and running properly.
	Flashing	Data is being transmitted or received.
	Off	No device is linked to the corresponding port.

➤ **Console (RJ-45) Port**

Designed to connect with the serial port of a computer or terminal for monitoring and configuring the switch.

➤ **Console (USB) Port**

Designed to connect with the USB port of a computer for monitoring and configuring the switch. The switch has an RJ-45 console port and a micro-USB console port available. Console input is active on only one console port at a time. By default, the micro-USB connector takes precedence over the RJ-45 connector.

➤ **10/100/1000Mbps RJ45 Port**

Designed to connect to the device with a bandwidth of 10Mbps, 100Mbps or 1000Mbps. Each 10/100/1000Mbps RJ45 port has a corresponding 1000Mbps LED and Link/Act LED.

➤ **SFP Port**

Designed to install the SFP module. T2600G-28TS features 4 individual SFP ports and supports 1000M SFP module connection only.

The front panel of T2600G-52TS is shown as Figure 2-2.

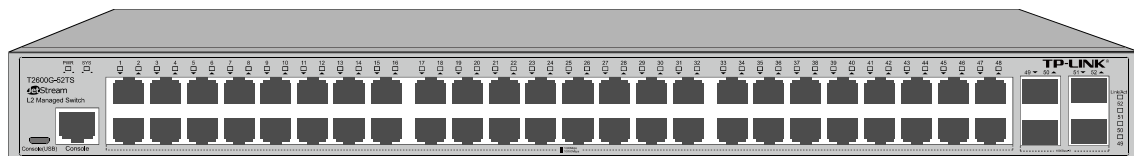

Figure 2-2 Front Panel of T2600G-52TS

The following parts are located on the front panel of T2600G-52TS:

➤ **Console (USB) Port**

Designed to connect with the USB port of a computer for monitoring and configuring the switch. The switch has an RJ-45 console port and a micro-USB console port available. Console input is active on only one console port at a time. By default, the micro-USB connector takes precedence over the RJ-45 connector.

➤ **Console (RJ-45) Port**

Designed to connect with the serial port of a computer or terminal for monitoring and configuring the switch.

➤ **LEDs**

Name	Status	Indication	
PWR	On	The switch is powered on.	
	Off	The switch is powered off or power supply is abnormal.	
	Flashing	Power supply is abnormal.	
SYS	Flashing	The switch works properly.	
	On/Off	The switch works improperly.	
10/100/1000 Mbps (port 1-48)	Green	On	A 1000Mbps device is connected to the corresponding port but no activity.
		Flashing	A 1000Mbps device is connected to the corresponding port and data is being transmitted or received.
	Yellow	On	A 10/100Mbps device is connected to the corresponding port but no activity.
		Flashing	A 10/100Mbps device is connected to the corresponding port and data is being transmitted or received.
	Off	No device is connected to the corresponding port.	
Link/Act (port 49-52)	On	There is a device linked to the corresponding SFP port but no activity.	
	Flashing	The corresponding SFP port is transmitting or receiving data.	
	Off	There is no device linked to the corresponding SFP port.	

➤ **10/100/1000Mbps RJ45 Port**

Designed to connect to the device with a bandwidth of 10Mbps, 100Mbps or 1000Mbps. Each 10/100/1000Mbps RJ45 port has a corresponding 1000Mbps LED.

➤ **SFP Port**

Designed to install the SFP module. T2600G-52TS features 4 individual SFP ports and supports 1000M SFP module connection only.

The front panel of T2600G-28MPS is shown as Figure 2-3.



Figure 2-3 Front Panel of T2600G-28MPS

T2600G-28MPS has an LED mode switch button which is for switching the LED status indication. When the Speed LED is on, the port LED is indicating the data transmission rate. When the PoE LED is on, the port LED is indicating the power supply status. By default the Speed LED is on. Pressing the mode switch button, the Speed LED will turn off and the PoE LED will light up. Then the PoE LED will turn off after being on for 60 seconds and the Speed LED will light up again.

When the Speed LED is on, the port LED is indicating the data transmission status.

➤ **LEDs**

Name	Status	Indication	
PWR	On	The switch is powered on.	
	Off	The switch is powered off or power supply is abnormal.	
	Flashing	Power supply is abnormal.	
SYS	Flashing	The switch works properly.	
	On/Off	The switch works improperly.	
FAN	Green	All the fans work properly.	
	Yellow	Not all the fans work properly.	
	Off	The switch works improperly.	
Speed or PoE (Port 1-24)	Green	On	A 1000Mbps device is connected to the corresponding port but no activity.
		Flashing	A 1000Mbps device is connected to the corresponding port and data is being transmitted or received.
	Yellow	On	A 10/100Mbps device is connected to the corresponding port but no activity.
		Flashing	A 10/100Mbps device is connected to the corresponding port and data is being transmitted or received.
	Off	No device is connected to the corresponding port.	
1000Base-X (Port 25-28)	On	There is a device linked to the corresponding SFP port but no activity.	
	Flashing	The corresponding SFP port is transmitting or receiving data.	
	Off	There is no device linked to the corresponding SFP port.	

When the PoE LED is on, the port LED is indicating the power supply status.

➤ **LEDs**

Name	Status	Indication
PWR	On	The switch is powered on.
	Off	The switch is powered off or power supply is abnormal.
	Flashing	Power supply is abnormal.
SYS	Flashing	The switch works properly.
	On/Off	The switch works improperly.
PoE Max	On	The remaining PoE power $\leq 7W$.
	Flashing	The remaining PoE power keeps $\leq 7W$ after this LED is on for 2 minutes.
	Off	The remaining PoE power $> 7W$.

Name	Status	Indication	
FAN	Green	All the fans work properly.	
	Yellow	Not all the fans work properly.	
	Off	The switch works improperly.	
Speed or PoE (Port 1-24)	Green	On	The port is supplying power normally.
		Flashing	The supply power exceeds the corresponding port's maximum power.
	Yellow	On	Overload or short circuit is detected.
		Flashing	Power-on self-test has failed.
	Off	Not providing PoE power on the port.	
1000Base-X (Port 25-28)	On	There is a device linked to the corresponding SFP port but no activity.	
	Flashing	The corresponding SFP port is transmitting or receiving data.	
	Off	There is no device linked to the corresponding SFP port.	

➤ **Console (RJ-45) Port**

Designed to connect with the serial port of a computer or terminal for monitoring and configuring the switch.

➤ **Console (USB) Port**

Designed to connect with the USB port of a computer for monitoring and configuring the switch. The switch has an RJ-45 console port and a micro-USB console port available. Console input is active on only one console port at a time. By default, the micro-USB connector takes precedence over the RJ-45 connector.

➤ **10/100/1000Mbps RJ45 Port**

Designed to connect to the device with a bandwidth of 10Mbps, 100Mbps or 1000Mbps. Each 10/100/1000Mbps RJ45 port has a corresponding 1000Mbps LED.

➤ **SFP Port**

Designed to install the SFP module. T2600G-28MPS features 4 individual SFP ports and supports 1000M SFP module connection only.

➤ **Port Feature**

Model	10/100/1000Mbps RJ45 Port	SFP Port	Console Port
T2600G-28TS	24	4	2
T2600G-52TS	48	4	2
T2600G-28MPS	24	4	2

2.2.2 Rear Panel

The rear panel of T2600G-28TS/ T2600G-52TS/ T2600G-28MPS features a Kensington security slot, a Grounding Terminal (marked with⊕) and a power socket.

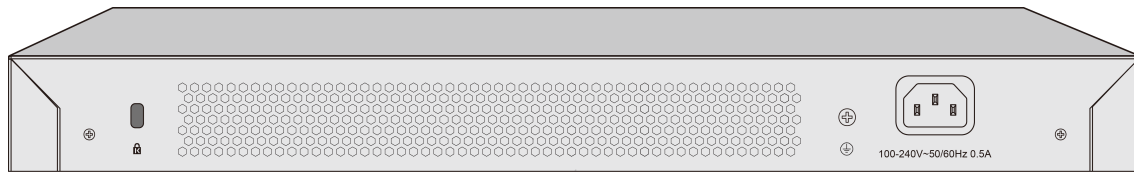

Figure 2-4 Rear Panel

- **Kensington Security Slot:** Secure the lock (not provided) into the security slot to prevent the device from being stolen.
- **Grounding Terminal:** The switch already comes with lightning protection mechanism. You can also ground the switch through the PE (Protecting Earth) cable of AC cord or with Ground Cable.
- **AC Power Socket:** Connect the female connector of the power cord here, and the male connector to the AC power outlet.

[Return to CONTENTS](#)

Chapter 3 Login to the Switch

3.1 Login

- 1) To access the configuration utility, open a web-browser and type in the default address `http://192.168.0.1` in the address field of the browser, then press the **Enter** key.



Figure 3-1 Web-browser



Tips:

To log in to the switch, the IP address of your PC should be set in the same subnet addresses of the switch. The IP address is 192.168.0.x ("x" is any number from 2 to 254), Subnet Mask is 255.255.255.0.

- 2) After a moment, a login window will appear, as shown in Figure 3-2. Enter **admin** for the User Name and Password, both in lower case letters. Then click the **Login** button or press the **Enter** key.

A screenshot of the TP-LINK login page. At the top, there is a dark blue header with the "TP-LINK" logo in white. Below the header, the page has a light blue background. There are two input fields: "User Name:" with the text "admin" entered, and "Password:" with six black dots. Below these fields are two buttons: "Login" and "Clear".

Figure 3-2 Login

3.2 Configuration

After a successful login, the main page will appear as Figure 3-3, and you can configure the function by clicking the setup menu on the left side of the screen.

The screenshot displays the TP-LINK web interface for a T2600G-28TS switch. The top navigation bar includes tabs for System Summary, Device Description, System Time, Daylight Saving Time, and Serial Port Setting. The left sidebar contains a menu with categories like System, Switching, Routing, and Network Security, with 'Save Config' highlighted in a red box. The main content area shows 'Port Status' with a grid of 28 ports (1-28) and 'System Info' with a table of device details. At the bottom of the main content area are 'Refresh' and 'Help' buttons.

System Description:	JetStream 24-Port Gigabit L2 Managed Switch with 4 SFP Slots
Device Name:	T2600G-28TS
Device Location:	SHENZHEN
Contact Information:	www.tp-link.com
Hardware Version:	T2600G-28TS 1.0
Firmware Version:	1.0.1 Build 20151216 Rel.65850(s)
Mac Address:	00-0A-EB-13-23-97
System Time:	2006-01-04 14:08:06
Running Time:	3 day - 6 hour - 8 min - 46 sec

Figure 3-3 Main Setup-Menu

Note:

Clicking **Apply** can only make the new configurations effective before the switch is rebooted. If you want to keep the configurations effective even the switch is rebooted, please click **Save Config**. You are suggested to click **Save Config** before cutting off the power or rebooting the switch to avoid losing the new configurations.

[Return to CONTENTS](#)

Chapter 4 System

The System module is mainly for system configuration of the switch, including four submenus: **System Info**, **User Management**, **System Tools**, **Access Security** and **SDM Template**.

4.1 System Info

The System Info, mainly for basic properties configuration, can be implemented on **System Summary**, **Device Description**, **System Time**, **Daylight Saving Time** and **Serial Port Setting** pages.

4.1.1 System Summary

On this page you can view the port connection status and the system information.

The port status diagram shows the working status of 48 10/100/1000Mbps RJ45 ports and 4 SFP ports of the switch.

Choose the menu **System**→**System Info**→**System Summary** to load the following page.

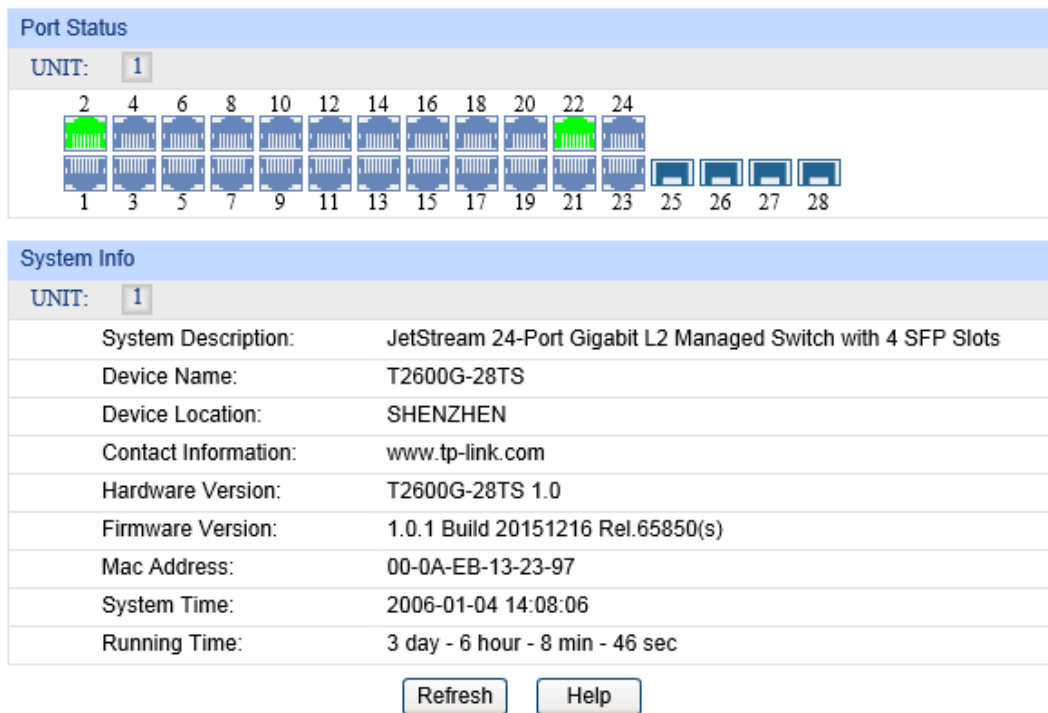

Figure 4-1 System Summary

➤ Port Status



Indicates the 1000Mbps port is not connected to a device.



Indicates the 1000Mbps port is at the speed of 1000Mbps.



Indicates the 1000Mbps port is at the speed of 10Mbps or 100Mbps.



Indicates the SFP port is not connected to a device.



Indicates the SFP port is at the speed of 1000Mbps.

When the cursor moves on the port, the detailed information of the port will be displayed.

Port: 1/0/2
Type: 1000M RJ45 Speed: 1000M, FullDuplex Status: Link Up

Figure 4-2 Port Information

➤ **Port Info**

- Port:** Displays the port number of the switch.
- Type:** Displays the type of the port.
- Rate:** Displays the maximum transmission rate of the port.
- Status:** Displays the connection status of the port.

Click a port to display the bandwidth utilization on this port. The actual rate divided by theoretical maximum rate is the bandwidth utilization. The following figure displays the bandwidth utilization monitored every four seconds. Monitoring the bandwidth utilization on each port facilitates you to monitor the network traffic and analyze the network abnormalities.

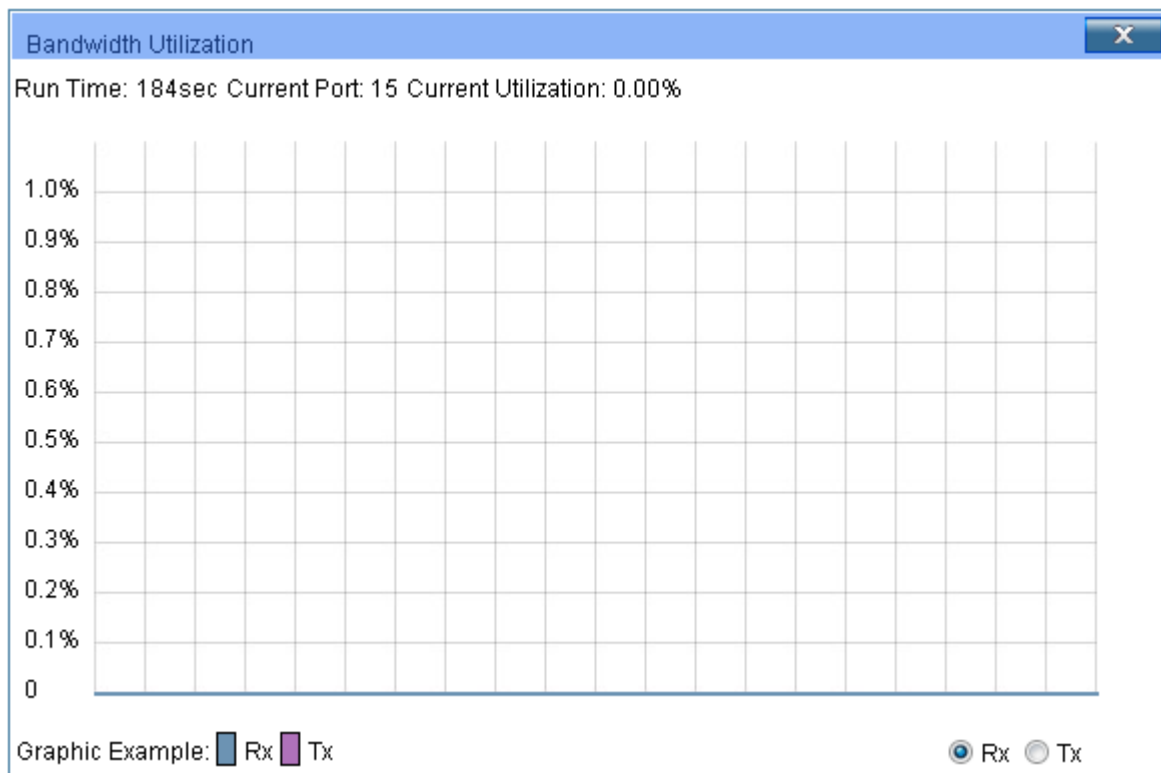

Figure 4-3 Bandwidth Utilization

➤ **Bandwidth Utilization**

- Rx:** Select Rx to display the bandwidth utilization of receiving packets on this port.
- Tx:** Select Tx to display the bandwidth utilization of sending packets on this port.

4.1.2 Device Description

On this page you can configure the description of the switch, including device name, device location and system contact.

Choose the menu **System**→**System Info**→**Device Description** to load the following page.

Device Description

Device Name: T2600G-28TS (1-32 characters)

Device Location: SHENZHEN (1-32 characters)

System Contact: www.tp-link.com (1-32 characters)

Apply

Note:

The Device Name, Location and Contact should not be more than 32 characters.

Figure 4-4 Device Description

The following entries are displayed on this screen:

➤ **Device Description**

- Device Name:** Enter the name of the switch.
- Device Location:** Enter the location of the switch.
- System Contact:** Enter your contact information.

4.1.3 System Time

System Time is the time displayed while the switch is running. On this page you can configure the system time and the settings here will be used for other time-based functions.

You can manually set the system time, get time from an NTP server or synchronize with PC's clock as the system time.

Choose the menu **System**→**System Info**→**System Time** to load the following page.

Time Info

Current System Date: 2006-01-01 09:38:34 Sunday

Current Time Source: Manual

Time Config

Manual

Date: 2006 01 01

Time: 09 38 34

Get Time from NTP Server

Time Zone: (UTC+08:00) Beijing, Chongqing, Hong Kong, Urumqi, Singapore

Primary Sever: 133.100.9.2

Secondary Sever: 139.78.100.163

Update Rate: 12 hour(s)

Synchronize with PC's Clock

Apply

Refresh

Help

Figure 4-5 System Time

The following entries are displayed on this screen:

➤ **Time Info**

- Current System Time:** Displays the current date and time of the switch.
- Current Time Source:** Displays the current time source of the switch.

➤ Time Config

Manual:

When this option is selected, you can set the date and time manually.

Get Time from NTP Server:

When this option is selected, you can configure the time zone and the IP Address for the NTP Server. The switch will get UTC automatically if it has connected to an NTP Server.

- **Time Zone:** Select your local time.
- **Primary/Secondary Server:** Enter the IP Address for the NTP Server.
- **Update Rate:** Specify the rate fetching time from NTP server.

Synchronize with PC'S Clock:

When this option is selected, the administrator PC's clock is utilized.



Note:

1. The system time will be restored to the default when the switch is restarted and you need to reconfigure the system time of the switch.
2. When Get Time from NTP Server is selected and no time server is configured, the switch will get time from the time server of the Internet if it has connected to the Internet.

4.1.4 Daylight Saving Time

Here you can configure the Daylight Saving Time of the switch.

Choose the menu **System**→**System Info**→**Daylight Saving Time** to load the following page.

DST Config

DST Status:

Predefined Mode
 USA Australia Europe New Zealand

Recurring Mode
Offset: (minutes)
Start Time: Week Day Month
End Time: Week Day Month

Date Mode
Offset: (minutes)
Start Time: (YY/MM/DD HH:MM)
End Time: (YY/MM/DD HH:MM)

Figure 4-6 Daylight Saving Time

The following entries are displayed on this screen:

➤ **DST Config**

- DST Status:** Enable or disable the DST.
- Predefined Mode:** Select a predefined DST configuration.
- USA: Second Sunday in March, 02:00 ~ First Sunday in November, 02:00.
 - Australia: First Sunday in October, 02:00 ~ First Sunday in April, 03:00.
 - Europe: Last Sunday in March, 01:00 ~ Last Sunday in October, 01:00.
 - New Zealand: Last Sunday in September, 02:00 ~ First Sunday in April, 03:00.
- Recurring Mode:** Specify the DST configuration in recurring mode. This configuration is recurring in use.
- Offset: Specify the time adding in minutes when Daylight Saving Time comes.
 - Start/End Time: Select starting time and ending time of Daylight Saving Time.
- Date Mode:** Specify the DST configuration in Date mode. This configuration is recurring in use.
- Offset: Specify the time adding in minutes when Daylight Saving Time comes.
 - Start/End Time: Select starting time and ending time of Daylight Saving Time.



Note:

1. When the DST is disabled, the predefined mode, recurring mode and date mode cannot be configured.
2. When the DST is enabled, the default daylight saving time is of European in predefined mode.

4.1.5 Serial Port Setting

On this page you can configure the Baud Rate of the console connection.

Choose the menu **System**→**System Info**→**Serial Port Setting** to load the following page.

The screenshot shows a web interface for 'Serial Port Settings'. It features a blue header bar with the title 'Serial Port Settings'. Below the header, there are four configuration items: 'Baud Rate' with a dropdown menu set to '38400', 'Data Bits' set to '8', 'Parity Bits' set to 'None', and 'Stop Bits' set to '1'. At the bottom right of the form is an 'Apply' button.

Figure 4-7 User Table

The following entries are displayed on this screen:

➤ **Serial Port Settings**

- Baud Rate:** Configure the baud rate of the console connection. It is 38400 bps by default.
- Data Bits:** Displays the default data bits.
- Parity Bits:** Displays the parity bits.
- Stop Bits:** Displays the stop bits.

4.2 User Management

User Management functions to configure the user name and password for users to log on to the Web management page with a certain access level so as to protect the settings of the switch from being randomly changed.

The User Management function can be implemented on **User Table** and **User Config** pages.

4.2.1 User Table

On this page you can view the information about the current users of the switch.

Choose the menu **System**→**User Management**→**User Table** to load the following page.

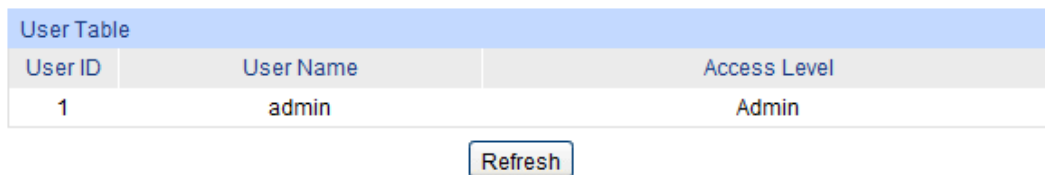

User Table		
User ID	User Name	Access Level
1	admin	Admin

Figure 4-8 User Table

4.2.2 User Config

On this page you can configure the access level of the user to log on to the Web management page. The switch provides four access levels: Admin, Operator, Power User and User. “Admin” means that you can edit, modify and view all the settings of different functions. “Operator” means that you can edit, modify and view most of the settings of different functions. “Power User” means that you can edit, modify and view some of the settings of different functions. “User” means that you can only view some of the settings of different functions without the right to edit or modify. The Web management pages contained in this guide are subject to the admin’s login without any explanation.

Choose the menu **System**→**User Management**→**User Config** to load the following page.

User Info

User Name:

Access Level:

Password:

Confirm Password:

User Table

Select	User ID	User Name	Access Level	Operation
<input type="checkbox"/>	1	admin	Admin	Edit

Note:
The User Name should be no more than 16 characters and Password should be no more than 31 characters.

Figure 4-9 User Config

The following entries are displayed on this screen:

➤ **User Info**

User Name: Create a name for users' login.

Access Level: Select the access level to login.

- Admin: Admin can edit, modify and view all the settings of different functions.
- Operator: Operator can edit, modify and view most of the settings in different functions.
- Power User: Power User can edit, modify and view some of the settings in different functions.
- User: User only can view the settings without the right to edit and modify.

Password: Type a password for users' login.

Confirm Password: Retype the password.

➤ **User Table**

Select: Select the desired entry to delete the corresponding user information. It is multi-optional. The current user information can't be deleted.

User ID, User Name, Access Level: Displays the current user ID, user name, and access level.

Operation: Click the **Edit** button of the desired entry, and you can edit the corresponding user information. After modifying the settings, please click the **Apply** button to make the modification effective. Access level of the current user information cannot be modified.

4.3 System Tools

The System Tools function, allowing you to manage the configuration file of the switch, can be implemented on **Boot Config**, **Config Restore**, **Config Backup**, **Firmware Upgrade**, **System Reboot**, **Reboot Schedule** and **System Reset** pages.

4.3.1 Boot Config

On this page you can configure the boot file of the switch. When the switch is powered on, it will start up with the startup image. If it fails, it will try to start up with the backup image. If this fails too, you will enter into the bootutil menu of the switch.

Choose the menu **System** → **System Tools** → **Boot Config** to load the following page.

Boot Table				
Select	Unit	Current Startup Image	Next Startup Image	Backup Image
<input type="checkbox"/>			image1.bin	image2.bin
<input type="checkbox"/>	1	image2.bin	image2.bin	image1.bin

Image Table	
UNIT:	1
- Current Startup Image	Exist & OK
Image Name	image2.bin
Flash Version	1.3.0
Software Version	1.0.0
- Next Startup Image	Exist & OK
Image Name	image2.bin
Flash Version	1.3.0
Software Version	1.0.0
- Backup Image	Exist & OK
Image Name	image1.bin
Flash Version	1.3.0
Software Version	1.0.0

Note:

1. The image should be image1.bin or image2.bin.
2. The next startup and backup image should not be the same.
3. After switching the next startup and backup image, the device must be reboot in order to take effect.

Figure 4-10 Boot Config

The following entries are displayed on this screen:

➤ **Boot Table**

Select: Select the unit(s).

Unit: Displays the unit ID.

- Current Startup Image:** Displays the current startup image.
- Next Startup Image:** Select the next startup image.
- Backup Image:** Select the backup boot image.

4.3.2 Config Restore

On this page you can upload a backup configuration file to restore your switch to this previous configuration.

Choose the menu **System**→**System Tools**→**Config Restore** to load the following page.

Config Restore

Restore the config from the saved config file.

Select a backup config file and click the **Import** button, and then you can restore to the previous config.

Target Unit:

Config file:

Note:

1. It will take a long time to restore the config file. Please wait without any operation.
2. After the configuration file is restored successfully, the device will reboot to make the configuration change effective.
3. Wrong uploaded configuration file may cause the switch unmanaged.

Figure 4-11 Config Restore

The following entries are displayed on this screen:

➤ **Config Restore**

- Target Unit:** Select a member switch to import the configuration file.
- Config File:** Click the **Browse** button to select a backup file and click the **Import** button to restore the startup configuration file.

 **Note:**

1. It will take a few minutes to restore the configuration. Please wait without any operation.
2. After the configuration file is restored successfully, the device will reboot to make the configuration change effective.
3. Wrong uploaded configuration file may cause the switch unmanaged.

4.3.3 Config Backup

On this page you can download the current configuration and save it as a file to your computer for your future configuration restore.

Choose the menu **System**→**System Tools**→**Config Backup** to load the following page.

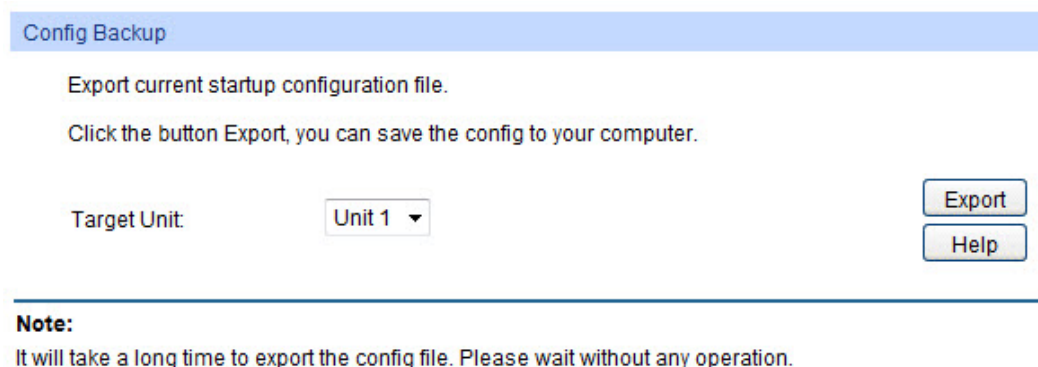

Config Backup

Export current startup configuration file.

Click the button Export, you can save the config to your computer.

Target Unit:

Note:
It will take a long time to export the config file. Please wait without any operation.

Figure 4-12 Config Backup

The following entries are displayed on this screen:

➤ **Config Backup**

Target Unit: Select a member switch to export the configuration file.

Click the **Export** button to save the current startup configuration file to your computer. You are suggested to take this measure before upgrading.



Note:
It will take a few minutes to backup the configuration. Please wait without any operation.

4.3.4 Firmware Upgrade

The switch system can be upgraded via the Web management page. To upgrade the system is to get more functions and better performance. Go to <http://www.tp-link.com> to download the updated firmware.

Choose the menu **System**→**System Tools**→**Firmware Upgrade** to load the following page.

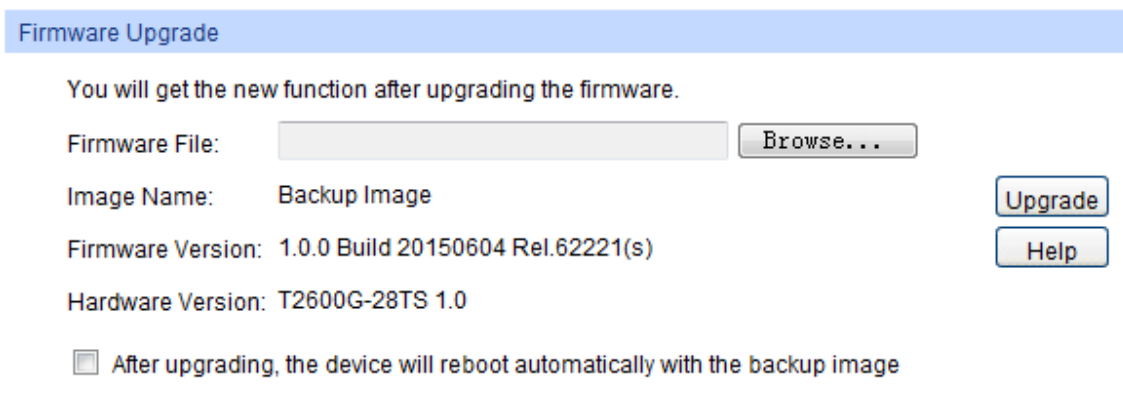

Firmware Upgrade

You will get the new function after upgrading the firmware.

Firmware File:

Image Name: Backup Image

Firmware Version: 1.0.0 Build 20150604 Rel.62221(s)

Hardware Version: T2600G-28TS 1.0

After upgrading, the device will reboot automatically with the backup image

- Note:**
1. Upgrading the firmware will only upgrade the backup image.
 2. You are suggested to backup the configuration before upgrading.
 3. Please select the proper software version matching with your hardware to upgrade.
 4. To avoid damage, please don't turn off the device while upgrading.

Figure 4-13 Firmware Upgrade

Please pay attention to the checkbox **“After upgrading, the device will reboot automatically with the backup image”**. If the checkbox is checked, the switch will reboot with the uploaded firmware file, and the current Next Startup Image will switch to the Backup Image. If the checkbox

is not checked, the uploaded firmware file will take place of the Backup Image. To start with the uploaded firmware, you should exchange the Next Startup Image and Backup Image in [Boot Config](#) and reboot the switch.



Note:

1. Upgrading the firmware will only upgrade the backup image.
2. You are suggested to backup the configuration before upgrading.
3. Please select the proper software version matching with your hardware to upgrade.
4. To avoid damage, please don't turn off the device while upgrading.

4.3.5 System Reboot

On this page you can reboot the switch and return to the login page. Please save the current configuration before rebooting to avoid losing the configuration unsaved.

Choose the menu **System**→**System Tools**→**System Reboot** to load the following page.

System Reboot

Target Unit: All Unit ▾

Save Config:

Reboot:

Note:
To avoid damage, please don't turn off the device while rebooting.

Figure 4-14 System Reboot



Note:

To avoid damage, please don't turn off the device while rebooting.

4.3.6 Reboot Schedule

On this page you can schedule a reboot plan for the switch. Users can configure the reboot schedule in two modes. The first one is to reboot the switch in a specific time interval. The second one is to reboot the switch at a specific time and date.

Users can choose whether to save the configurations before the reboot. If **Save Before Reboot** is not checked, the reboot schedule will be deleted after the next reboot.

Choose the menu **System**→**System Tools**→**Reboot Schedule** to load the following page.

Reboot Schedule Setting

Time Interval(1-43200): min

Time (HH:MM):

Date (DD/MM/YY):

Save Before Reboot:

Note:
To avoid damage, please don't turn off the device while rebooting.

Figure 4-15 Reboot Schedule Setting

The following entries are displayed on this screen:

➤ **Reboot Schedule Setting**

- Time Interval:** Specify a period of time. The switch will reboot after this period. It ranges from 1 to 43200 minutes. This reboot schedule recurs if users check the **Save Before Reboot**.
- Time:** Specify the time for the switch to reboot, in the format of HH:MM.
- Date:** Specify the date for the switch to reboot, in the format of DD/MM/YYYY. The date should be within 30 days. If no date is specified and the time you set here is later than the time that this above Time is set, the switch will reboot later that day; otherwise the switch will reboot at the time point the next day.
- Save Before Reboot:** Select to save the switch's configurations before it reboots.



Note:

To avoid damage, please don't turn off the device while rebooting.

4.3.7 System Reset

On this page you can reset the switch to the default. All the settings will be cleared after the switch is reset.

Choose the menu **System**→**System Tools**→**System Reset** to load the following page.

System Reset

Target Unit: All Unit ▾

Reset: Reset

Note:

The System Reset option will restore the configuration to default and your current settings will be lost.

Figure 4-16 System Reset



Note:

After the system is reset, the switch will be reset to the default and all the settings will be cleared.

4.4 Access Security

Access Security provides different security measures for the remote login so as to enhance the configuration management security. It can be implemented on **Access Control**, **HTTP Config**, **HTTPS Config**, **SSH Config** and **Telnet Config** pages.

4.4.1 Access Control

On this page you can control the users logging on to the Web management page to enhance the configuration management security.

Choose the menu **System**→**Access Security**→**Access Control** to load the following page.

Access Control Config

Control Mode:

Access Interface: SNMP Telnet SSH HTTP HTTPS Ping
 All

IP Address: Mask:

MAC Address: (Format: 00-00-00-00-00-01)

Port:

UNIT:

2	4	6	8	10	12	14	16	18	20	22	24	26	28
1	3	5	7	9	11	13	15	17	19	21	23	25	27

Unselected Port(s) Selected Port(s) Not Available for Selection

Figure 4-17 Access Control

The following entries are displayed on this screen:

➤ **Access Control Config**

- Control Mode:** Select the control mode for users to log on to the Web management page.
- Disable: Select to disable Access Control function.
 - IP-based: Select this option to limit the IP-range of the users for login.
 - MAC-based: Select this option to limit the MAC Address of the users for login.
 - Port-based: Select this option to limit the ports for login.
- Access Interface:** Select the interface for access control to apply.
- IP Address & Mask** These fields is available to configure only when IP-based mode is selected. Only the users within the IP-range you set here are allowed for login.
- MAC Address:** The field is available to configure only when MAC-based mode is selected. Only the user with this MAC Address you set here are allowed for login.
- Port:** The field is available to configure only when Port-based mode is selected. Only the users connecting to the ports selected are allowed to manage the switch.

4.4.2 HTTP Config

With the help of HTTP (Hyper Text Transfer Protocol), you can manage the switch through a standard browser. The standards development of HTTP was coordinated by the Internet Engineering Task Force and the World Wide Web Consortium.

On this page you can configure the HTTP function.

Choose the menu **System**→**Access Security**→**HTTP Config** to load the following page.

The screenshot shows the following configuration options:

- Global Config:** HTTP: Enable Disable. Buttons: Apply, Help.
- Session Config:** Session Timeout: min (5-30). Button: Apply.
- Access User Number:** Number Control: Enable Disable. Admin Number: (1-16). Guest Number: (0-15). Button: Apply.

Figure 4-18 HTTP Config

The following entries are displayed on this screen:

➤ **Global Config**

HTTP: Select Enable/Disable the HTTP function on the switch.

➤ **Session Config**

Session Timeout: If you do nothing with the Web management page within the timeout time, the system will log out automatically. If you want to reconfigure, please login again.

➤ **Access User Number**

Number Control: Select Enable/Disable the Number Control function.

Admin Number: Enter the maximum number of the users logging on to the Web management page as Admin.

Guest Number: Enter the maximum number of the users logging on to the Web management page as Guest.

4.4.3 HTTPS Config

SSL (Secure Sockets Layer), a security protocol, is to provide a secure connection for the application layer protocol (e.g. HTTP) communication based on TCP. SSL is widely used to secure the data transmission between the Web browser and servers. It is mainly applied through ecommerce and online banking.

SSL mainly provides the following services:

1. Authenticate the users and the servers based on the certificates to ensure the data are transmitted to the correct users and servers;
2. Encrypt the data transmission to prevent the data being intercepted;
3. Maintain the integrity of the data to prevent the data being altered in the transmission.

Adopting asymmetrical encryption technology, SSL uses key pair to encrypt/decrypt information. A key pair refers to a public key (contained in the certificate) and its corresponding private key. By default the switch has a certificate (self-signed certificate) and a corresponding private key. The Certificate/Key Download function enables the user to replace the default key pair.

After SSL is effective, you can log on to the Web management page via <https://192.168.0.1>. For the first time you use HTTPS connection to log into the switch with the default certificate, you will be prompted that “The security certificate presented by this website was not issued by a trusted certificate authority” or “Certificate Errors”. Please add this certificate to trusted certificates or continue to this website.

The switch also supports HTTPS connection for IPv6. After configuring an IPv6 address (for example, 3001::1) for the switch, you can log on to the switch’s Web management page via [https://\[3001::1\]](https://[3001::1]).

On this page you can configure the HTTPS function.

Choose the menu **System**→**Access Security**→**HTTPS Config** to load the following page.

The screenshot displays the 'HTTPS Config' page with the following sections and controls:

- Global Config:** Includes radio buttons for 'Enable' and 'Disable' for 'HTTPS:', 'SSL Version 3:', and 'TLS Version 1:'. 'Apply' and 'Help' buttons are on the right.
- CipherSuite Config:** Includes radio buttons for 'Enable' and 'Disable' for 'RSA_WITH_RC4_128_MD5:', 'RSA_WITH_RC4_128_SHA:', 'RSA_WITH_DES_CBC_SHA:', and 'RSA_WITH_3DES_EDE_CBC_SHA:'. An 'Apply' button is on the right.
- Session Config:** Includes a text input for 'Session Timeout' (value: 10) and a label 'min (5-30)'. An 'Apply' button is on the right.
- Access User Number:** Includes radio buttons for 'Enable' and 'Disable' for 'Number Control:'. Text inputs for 'Admin Number:' (range: 1-16) and 'Guest Number:' (range: 0-15) are present. An 'Apply' button is on the right.
- Certificate Download:** Includes a 'Browse...' button for 'Certificate File:' and a 'Download' button.
- Key Download:** Includes a 'Browse...' button for 'Key File:' and a 'Download' button.

Note:

1.The SSL certificate and key downloaded must match each other; otherwise the HTTPS connection will not work.

Figure 4-19 HTTPS Config

The following entries are displayed on this screen:

➤ **Global Config**

HTTPS: Select Enable/Disable the HTTPS function on the switch.

SSL Version 3: Enable or Disable Secure Sockets Layer Version 3.0. By default, it's enabled.

TLS Version 1: Enable or Disable Transport Layer Security Version 1.0. By default, it's enabled.

➤ **CipherSuite Config**

RSA_WITH_RC4_128_MD5: Key exchange with RC4 128-bit encryption and MD5 for message digest. By default, it's enabled.

RSA_WITH_RC4_128_SHA: Key exchange with RC4 128-bit encryption and SHA for message digest. By default, it's enabled.

RSA_WITH_DES_CBC_SHA: Key exchange with DES-CBC for message encryption and SHA for message digest. By default, it's enabled.

RSA_WITH_3DES_EDE_CBC_SHA: Key exchange with 3DES and DES-EDE3-CBC for message encryption and SHA for message digest. By default, it's enabled.

➤ **Session Config**

Session Timeout: If you do nothing with the Web management page within the timeout time, the system will log out automatically. If you want to reconfigure, please login again.

➤ **Access User Number**

Number Control: Select Enable/Disable the Number Control function.

Admin Number: Enter the maximum number of the users logging on to the Web management page as Admin.

Guest Number: Enter the maximum number of the users logging on to the Web management page as Guest.

➤ **Certificate Download**

Certificate File: Select the desired certificate to download to the switch. The certificate must be BASE64 encoded.

➤ **Key Download**

Key File: Select the desired key to download to the switch. The key must be BASE64 encoded.



Note:

1. The SSL certificate and key downloaded must match each other; otherwise the HTTPS connection will not work.
2. To establish a secured connection using https, please enter https:// into the URL field of the browser.
3. It may take more time for https connection than that for http connection, because https connection involves authentication, encryption and decryption etc.

4.4.4 SSH Config

As stipulated by IETF (Internet Engineering Task Force), SSH (Secure Shell) is a security protocol established on application and transport layers. SSH-encrypted-connection is similar to a telnet connection, but essentially the old telnet remote management method is not safe, because the password and data transmitted with plain-text can be easily intercepted. SSH can provide

information security and powerful authentication when you log on to the switch remotely through an insecure network environment. It can encrypt all the transmission data and prevent the information in a remote management being leaked.

Comprising server and client, SSH has two versions, V1 and V2 which are not compatible with each other. In the communication, SSH server and client can auto-negotiate the SSH version and the encryption algorithm. After getting a successful negotiation, the client sends authentication request to the server for login, and then the two can communicate with each other after successful authentication. This switch supports SSH server and you can log on to the switch via SSH connection using SSH client software.

SSH key can be downloaded into the switch. If the key is successfully downloaded, the certificate authentication will be preferred for SSH access to the switch.

Choose the menu **System**→**Access Security**→**SSH Config** to load the following page.

The screenshot displays the SSH configuration page with the following sections:

- Global Config:** SSH (radio buttons for Enable and Disable, with Disable selected), Protocol V1 (radio buttons for Enable and Disable, with Enable selected), Protocol V2 (radio buttons for Enable and Disable, with Enable selected), Idle Timeout (input field with 120, unit sec (1-120)), and Max Connect (input field with 5, unit (1-5)). Buttons for Apply and Help are present.
- Encryption Algorithm:** Checkboxes for AES128-CBC, AES192-CBC, AES256-CBC, Blowfish-CBC, Cast128-CBC, and 3DES-CBC, all of which are checked. An Apply button is present.
- Data Integrity Algorithm:** Checkboxes for HMAC-SHA1 and HMAC-MD5, both of which are checked. An Apply button is present.
- Key Download:** A text prompt: "Choose the SSH public key file to download into switch." Below it, a Key Type dropdown menu is set to "SSH-2 RSA/DSA", and a Key File input field is empty with a "Browse..." button. A "Download" button is also present.

Note:

- 1.It will take a long time to download the key file. Please wait without any operation.
- 2.After the Key File is downloaded, the user's original key of the same type will be replaced. The wrong downloaded file will result in the SSH access to the switch via Password authentication.

Figure 4-20 SSH Config

The following entries are displayed on this screen:

➤ **Global Config**

- SSH:** Select Enable/Disable SSH function.
- Protocol V1:** Select Enable/Disable SSH V1 to be the supported protocol.
- Protocol V2:** Select Enable/Disable SSH V2 to be the supported protocol.

Idle Timeout: Specify the idle timeout time. The system will automatically release the connection when the time is up. The default time is 120 seconds.

Max Connect: Specify the maximum number of the connections to the SSH server. No new connection will be established when the number of the connections reaches the maximum number you set. The default value is 5.

➤ **Encryption Algorithm**

Configure SSH encryption algorithms.

AES128-CBC: Select the checkbox to enable the AES128-CBC algorithm of SSH.

AES128-CBC: Select the checkbox to enable the AES128-CBC algorithm of SSH.

AES192-CBC: Select the checkbox to enable the AES192-CBC algorithm of SSH.

AES256-CBC: Select the checkbox to enable the AES256-CBC algorithm of SSH.

Blowfish-CBC: Select the checkbox to enable the Blowfish-CBC algorithm of SSH.

Cast128-CBC: Select the checkbox to enable the Cast128-CBC algorithm of SSH.

3DES-CBC: Select the checkbox to enable the 3DES-CBC algorithm of SSH.

➤ **Data Integrity Algorithm**

Configure SSH data integrity algorithms.

HMAC-SHA1: Select the checkbox to enable the HMAC-SHA1 algorithm of SSH.

HMAC-MD5: Select the checkbox to enable the HMAC-MD5 algorithm of SSH.

➤ **Key Download**

Key Type: Select the type of SSH Key to download. The switch supports two types: SSH-2 RSA/DSA and SSH-1 RSA.

Key File: Please ensure the key length of the downloaded file is in the range of 512 to 3072 bits.

Download: Click the **Download** button to download the desired key file to the switch.



Note:

1. It will take a long time to download the key file. Please wait without any operation.
2. After the Key File is downloaded, the user's original key of the same type will be replaced. The wrong downloaded file will result in the SSH access to the switch via Password authentication.

Application Example 1 for SSH:

➤ Network Requirements

1. Log on to the switch via password authentication using SSH and the SSH function is enabled on the switch.
2. PuTTY client software is recommended.

➤ Configuration Procedure

1. Open the software to log on to the interface of PuTTY. Enter the IP address of the switch into **Host Name** field; keep the default value 22 in the **Port** field; select **SSH** as the Connection type.

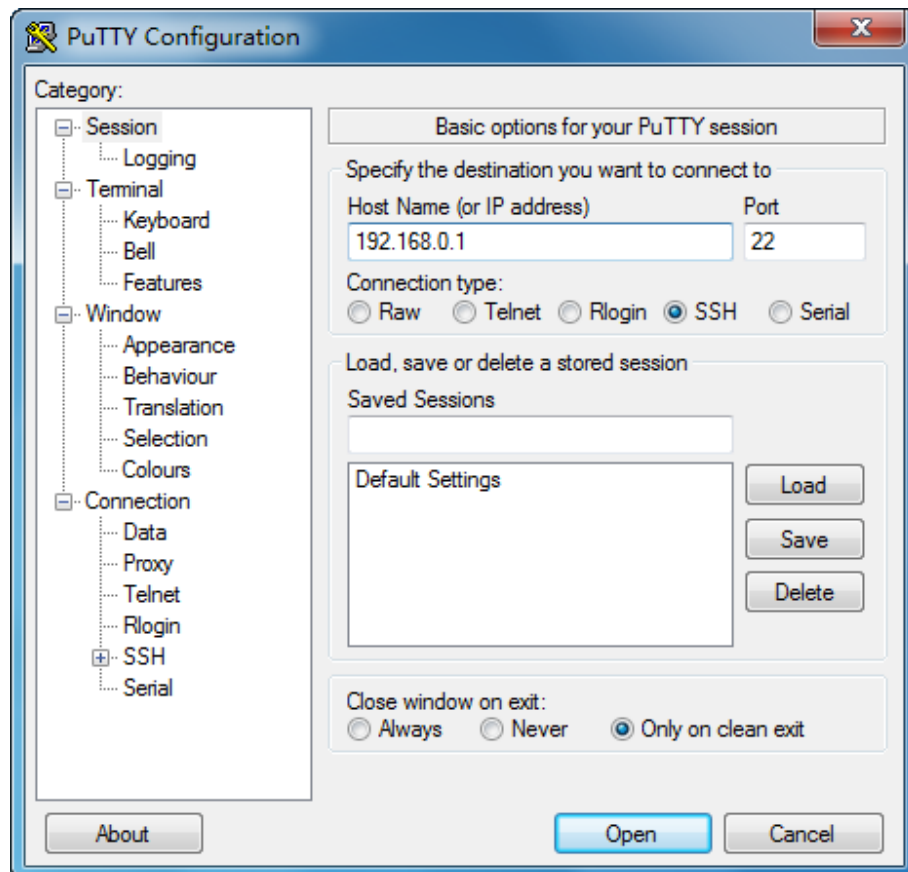

2. Click the **Open** button in the above figure to log on to the switch. Enter the login user name and password, and then you can continue to configure the switch.

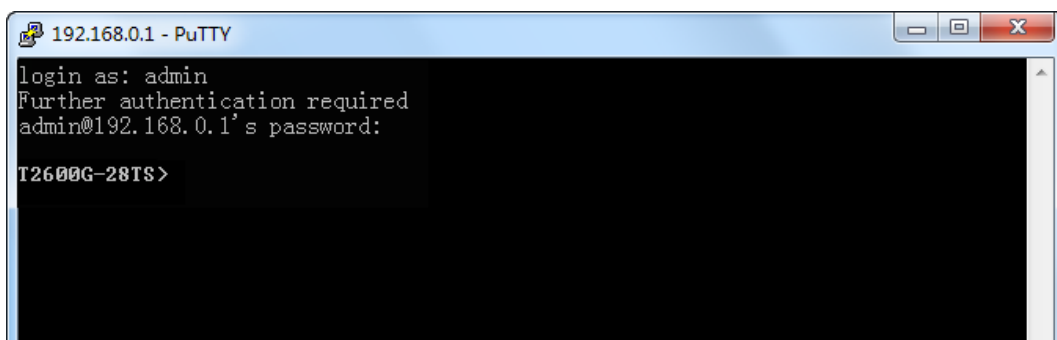

Application Example 2 for SSH:

➤ Network Requirements

1. Log on to the switch via key authentication using SSH and the SSH function is enabled on the switch.
2. PuTTY client software is recommended.

➤ Configuration Procedure

1. Select the key type and key length, and generate SSH key.

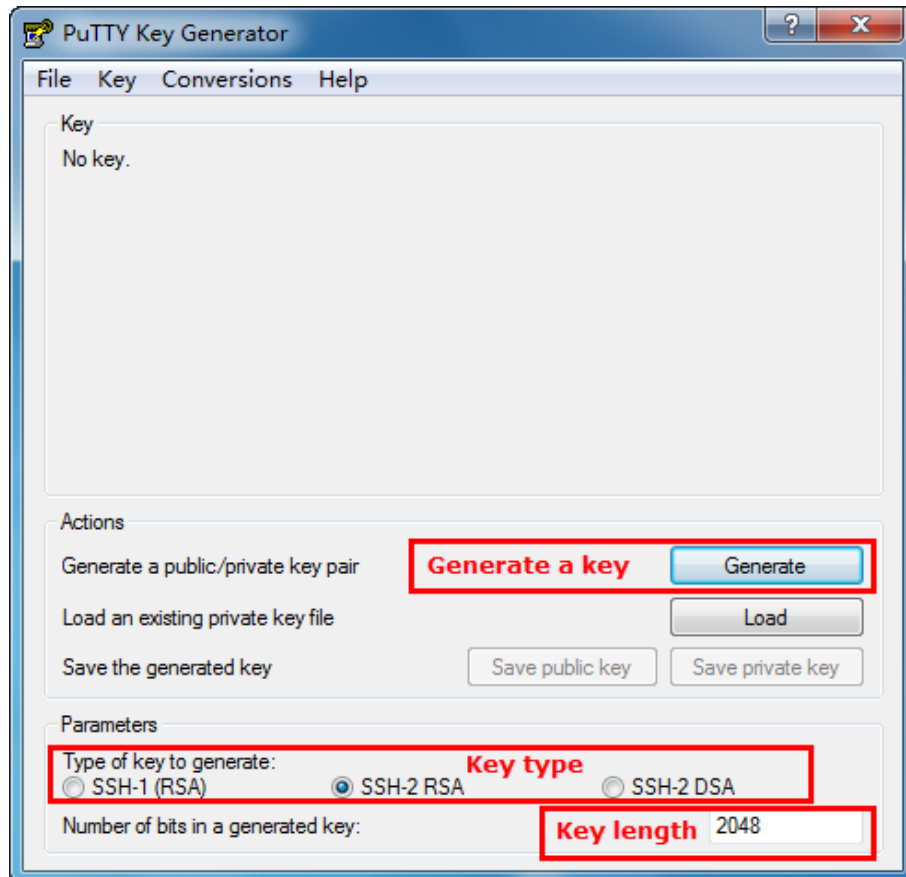

⚠ Note:

1. The key length is in the range of 512 to 3072 bits.
2. During the key generation, randomly moving the mouse quickly can accelerate the key generation.

2. After the key is successfully generated, please save the public key and private key to the computer.

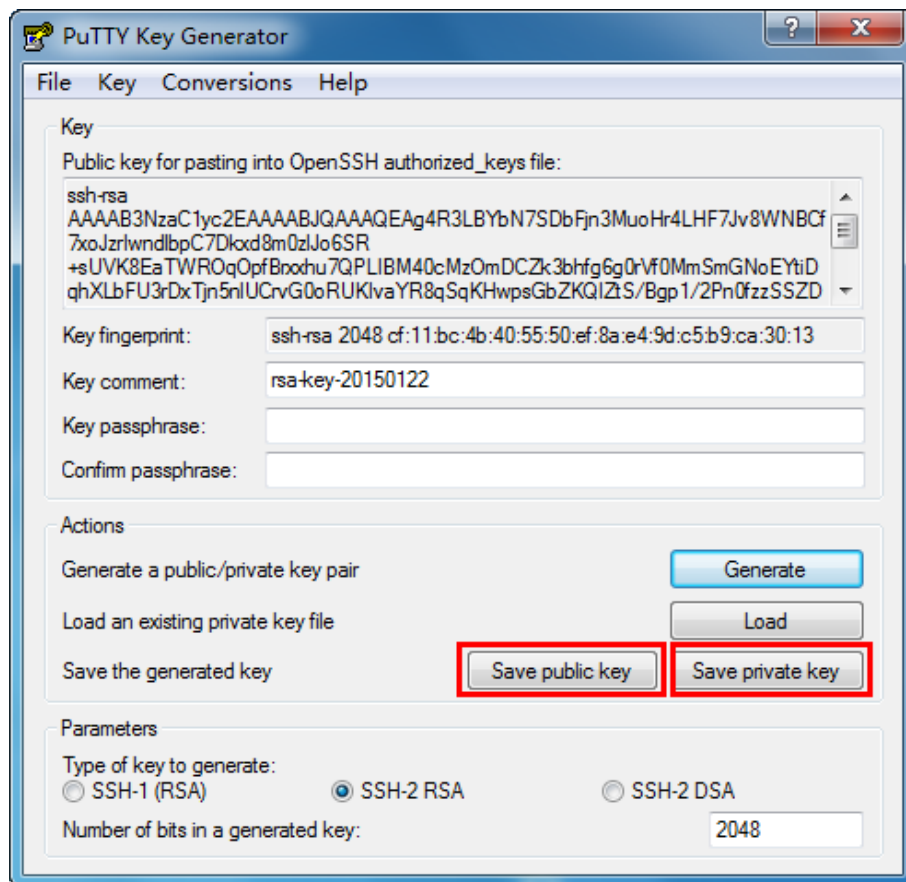

3. On the Web management page of the switch, download the public key file saved in the computer to the switch.

Key Download

Choose the SSH public key file to download into switch.

Key Type:

Key File:

 Note:

1. The key type should accord with the type of the key file.
2. The SSH key downloading cannot be interrupted.

4. After the public key and private key are downloaded, please log on to the interface of PuTTY and enter the IP address for login.

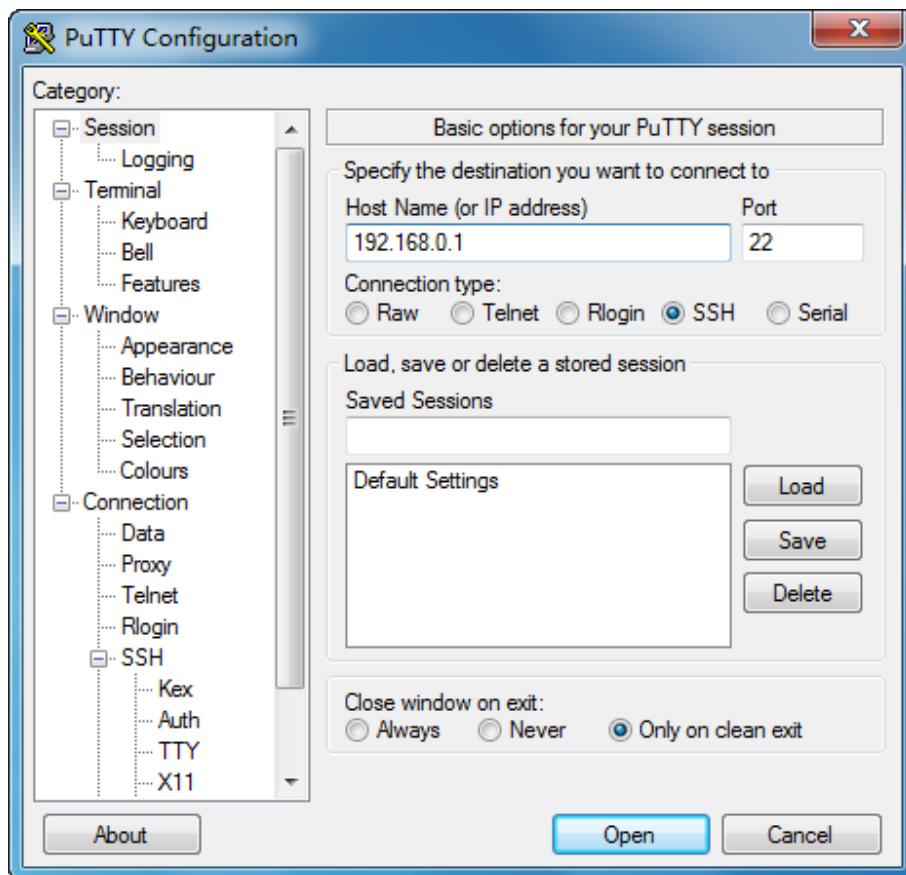

5. Click **Browse** to download the private key file to SSH client software and click **Open**.

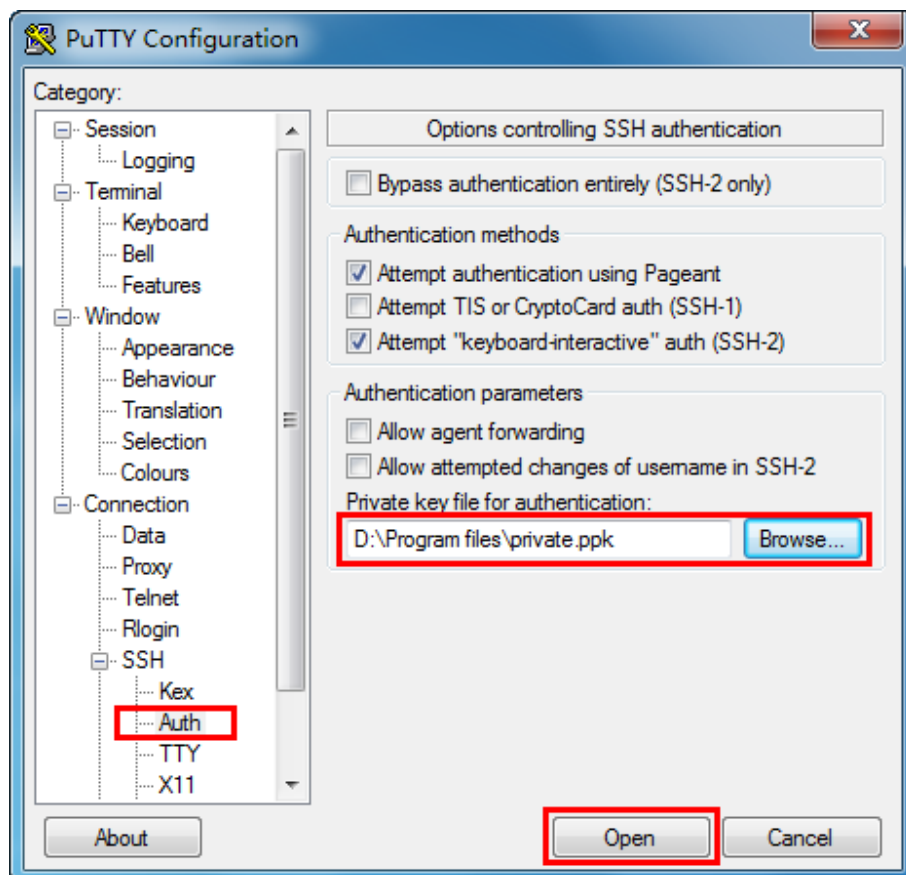

After successful authentication, please enter the login user name. If you log on to the switch without entering password, it indicates that the key has been successfully downloaded.

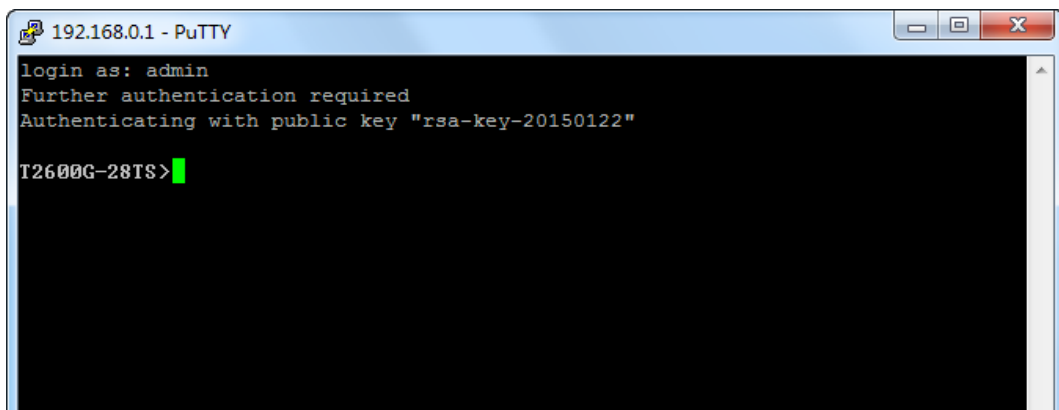

```
192.168.0.1 - PuTTY
login as: admin
Further authentication required
Authenticating with public key "rsa-key-20150122"
T2600G-28TS>
```

4.4.5 Telnet Config

On this page you can Enable/Disable Telnet function globally on the switch.

Choose the menu **System**→**Access Security**→**Telnet Config** to load the following page.

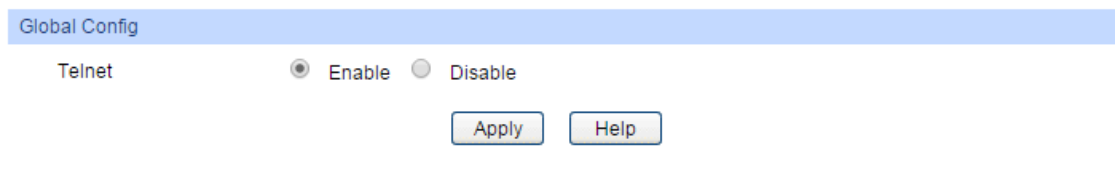

Figure 4-21 Access Control

The following entries are displayed on this screen:

➤ **Global Config**

Telnet: Select Enable/Disable Telnet function globally on the switch.

4.5 SDM Template

SDM (Switch Database Management) provides different templates for users to efficiently manage the hardware TCAM resources. Users can select the appropriate template according to the application environment.

4.5.1 SDM Template Config

On this page you can configure and view the SDM templates on the switch.

Choose the menu **System**→**SDM Template**→**SDM Template Config** to load the following page.

Select Options

Current Template ID: default

Next Template ID: default

Select Next Template: Apply

Template Table

SDM Template	IP ACL Rules	MAC ACL Rules	COMBINED ACL Rules	IPv6 ACL Rules	ARP Detection Entries	IPv6 Source Guard Entries
default	200	100	50	0	200	0
enterpriseV4	320	200	50	0	7	0
enterpriseV6	100	100	0	50	7	118

Help

Figure 4-22 SDM Template Config

➤ **Select Options**

Current Template ID:

Displays the SDM template currently in use.

Next Template ID:

Displays the SDM template that will become active after a reboot.

Select Next Template:

Configure the SDM template that will become active after the next reboot.

➤ **Template Table**

SDM Template:

Displays the template name.

IP ACL Rules:

Displays the number of TCAM entries for IP ACL Rules, which include Lay3 ACL Rules and Lay4 ACL Rules.

MAC ACL Rules:

Displays the number of TCAM entries for Lay2 ACL Rules.

Combined ACL Rules:

Displays the number of combined ACL rules.

IPv6 ACL Rules:

Displays the number of IPv6 ACL rules.

ARP Detection Entries:

Displays the number of TCAM entries for ARP defend.

IPv6 Source Guard Entries:

Displays the number of IPv6 source guard entries.

[Return to CONTENTS](#)

Chapter 5 Switching

Switching module is used to configure the basic functions of the switch, including four submenus: **Port**, **LAG**, **Traffic Monitor**, **MAC Address** and **L2PT**.

5.1 Port

The Port function, allowing you to configure the basic features for the port, is implemented on the **Port Config**, **Port Mirror**, **Port Security**, **Port Isolation** and **Loopback Detection** pages.

5.1.1 Port Config

On this page, you can configure the basic parameters for the ports. When the port is disabled, the packets on the port will be discarded. Disabling the port which is vacant for a long time can reduce the power consumption effectively. And you can enable the port when it is in need.

The parameters will affect the working mode of the port, please set the parameters appropriate to your needs.

Choose the menu **Switching**→**Port**→**Port Config** to load the following page.

Select	Port	Type	Description	Status	Speed	Duplex	Flow Control	Jumbo	LAG
<input type="checkbox"/>			<input type="text"/>						
<input type="checkbox"/>	1/0/1	Copper		Enable	Auto	Auto	Disable	Disable	---
<input type="checkbox"/>	1/0/2	Copper		Enable	Auto	Auto	Disable	Disable	---
<input type="checkbox"/>	1/0/3	Copper		Enable	Auto	Auto	Disable	Disable	---
<input type="checkbox"/>	1/0/4	Copper		Enable	Auto	Auto	Disable	Disable	---
<input type="checkbox"/>	1/0/5	Copper		Enable	Auto	Auto	Disable	Disable	---
<input type="checkbox"/>	1/0/6	Copper		Enable	Auto	Auto	Disable	Disable	---
<input type="checkbox"/>	1/0/7	Copper		Enable	Auto	Auto	Disable	Disable	---
<input type="checkbox"/>	1/0/8	Copper		Enable	Auto	Auto	Disable	Disable	---
<input type="checkbox"/>	1/0/9	Copper		Enable	Auto	Auto	Disable	Disable	---
<input type="checkbox"/>	1/0/10	Copper		Enable	Auto	Auto	Disable	Disable	---
<input type="checkbox"/>	1/0/11	Copper		Enable	Auto	Auto	Disable	Disable	---
<input type="checkbox"/>	1/0/12	Copper		Enable	Auto	Auto	Disable	Disable	---
<input type="checkbox"/>	1/0/13	Copper		Enable	Auto	Auto	Disable	Disable	---
<input type="checkbox"/>	1/0/14	Copper		Enable	Auto	Auto	Disable	Disable	---
<input type="checkbox"/>	1/0/15	Copper		Enable	Auto	Auto	Disable	Disable	---

Note:

1. The description only allows letters, numbers, space and some special symbols: -@_/. , and the length is not more than 16 characters.
2. The description cannot be cleared by web, while it can be cleared by CLI.

Figure 5-1 Port Config

The following entries are displayed on this screen:

➤ **Port Config**

UNIT:1/LAGS: Click **1** to configure the physical ports. Click **LAGS** to configure the link aggregation groups.

Select: Select the desired port for configuration. It is multi-optional.

Port: Displays the port number.

Type: Displays the medium type of the port.

- Description:** Give a description to the port for identification.
- Status:** Allows you to Enable/Disable the port. When Enable is selected, the port/LAG can forward the packets normally.
- Speed:** Select the Speed mode for the port. The device connected to the switch should be in the same Speed and Duplex mode with the switch. When 'Auto' is selected, the Speed mode will be determined by auto negotiation.
- Duplex:** Select the Duplex mode for the port. When 'Auto' is selected, the Duplex mode will be determined by auto negotiation.
- Flow Control:** Allows you to Enable/Disable the Flow Control feature. When Flow Control is enabled, the switch can synchronize the speed with its peer to avoid the packet loss caused by congestion.
- Jumbo:** Allows you to Enable/Disable the Jumbo feature. The default maximum transmission unit (MTU) size is 1518 bytes. When Jumbo is enabled, the MTU size is 9216 bytes.
- LAG:** Displays the LAG number which the port belongs to.



Note:

1. The switch cannot be managed through the disabled port. Please enable the port which is used to manage the switch.
2. The SFP ports support 1000M SFP module connection only.

5.1.2 Port Mirror

Port Mirror, the packets obtaining technology, functions to forward copies of packets from one/multiple ports (mirrored port) to a specific port (mirroring port). Usually, the mirroring port is connected to a data diagnose device, which is used to analyze the mirrored packets for monitoring and troubleshooting the network.

Choose the menu **Switching**→**Port**→**Port Mirror** to load the following page.

Mirror Session List				
Session	Destination	Mode	Source	Operation
1	--	Ingress Only		Edit Clear
		Egress Only		
		Both		

[Help](#)

Figure 5-2 Mirror Group List

The following entries are displayed on this screen.

➤ **Mirror Session List**

Session: Displays the mirror session number.

Destination: Displays the mirroring port.

- Mode:** Displays the mirror mode. The value will be "Ingress Only", "Egress Only" or "Both".
- Source:** Displays the mirrored ports.
- Operation:** You can configure the mirror session by clicking **Edit**, or clear the mirror session configuration by clicking the **Clear**.

Click **Edit** to display the following figure.

Destination Port

Destination Port: (Format: 1/0/1)

UNIT:

2 4 6 8 10 12 14 16 18 20 22 24 26 28
1 3 5 7 9 11 13 15 17 19 21 23 25 27

Unselected Port(s) Selected Port(s) Not Available for Selection

Source Port

UNIT:

Select	Port	Ingress	Egress	LAG
<input type="checkbox"/>		<input type="text"/>	<input type="text"/>	
<input type="checkbox"/>	1/0/1	Disable	Disable	---
<input type="checkbox"/>	1/0/2	Disable	Disable	---
<input type="checkbox"/>	1/0/3	Disable	Disable	---
<input type="checkbox"/>	1/0/4	Disable	Disable	---
<input type="checkbox"/>	1/0/5	Disable	Disable	---
<input type="checkbox"/>	1/0/6	Disable	Disable	---
<input type="checkbox"/>	1/0/7	Disable	Disable	---
<input type="checkbox"/>	1/0/8	Disable	Disable	---
<input type="checkbox"/>	1/0/9	Disable	Disable	---
<input type="checkbox"/>	1/0/10	Disable	Disable	---
<input type="checkbox"/>	1/0/11	Disable	Disable	---
<input type="checkbox"/>	1/0/12	Disable	Disable	---

Figure 5-3 Port Mirror Config

The following entries are displayed on this screen:

➤ **Destination Port**

Destination Port: Input or select a physical port from the port panel as the mirroring port.

➤ **Source Port**

Select: Select the desired port as a mirrored port. It is multi-optional.

Port: Displays the port number.

Ingress: Select Enable/Disable the Ingress feature. When the Ingress is

enabled, the incoming packets received by the mirrored port will be copied to the mirroring port.

Egress:

Select Enable/Disable the Egress feature. When the Egress is enabled, the outgoing packets sent by the mirrored port will be copied to the mirroring port.

LAG:

Displays the LAG number which the port belongs to. The LAG member cannot be selected as the mirrored port or mirroring port.



Note:

1. The LAG member cannot be selected as the mirrored port or mirroring port.
2. A port cannot be set as the mirrored port and the mirroring port simultaneously.
3. The Port Mirror function can span the multiple VLANs.

5.1.3 Port Security

MAC Address Table maintains the mapping relationship between the port and the MAC address of the connected device, which is the base of the packet forwarding. The capacity of MAC Address Table is fixed. MAC Address Attack is the attack method that the attacker takes to obtain the network information illegally. The attacker uses tools to generate the cheating MAC address and quickly occupy the MAC Address Table. When the MAC Address Table is full, the switch will broadcast the packets to all the ports. At this moment, the attacker can obtain the network information via various sniffers and attacks. When the MAC Address Table is full, the packets traffic will flood to all the ports, which results in overload, lower speed, packets drop and even breakdown of the system.

Port Security is to protect the switch from the malicious MAC Address Attack by limiting the maximum number of MAC addresses that can be learned on the port. The port with Port Security feature enabled will learn the MAC address dynamically. When the learned MAC address number reaches the maximum, the port will stop learning. Thereafter, the other devices with the MAC address unlearned cannot access to the network via this port.

Choose the menu **Switching**→**Port**→**Port Security** to load the following page.

Port Security					
UNIT: 1					
Select	Port	Max Learned MAC	Learned Num	Learn Mode	Status
<input type="checkbox"/>		<input type="text"/>		<input type="text"/>	<input type="text"/>
<input type="checkbox"/>	1/0/1	64	0	Dynamic	Disable
<input type="checkbox"/>	1/0/2	64	0	Dynamic	Disable
<input type="checkbox"/>	1/0/3	64	0	Dynamic	Disable
<input type="checkbox"/>	1/0/4	64	0	Dynamic	Disable
<input type="checkbox"/>	1/0/5	64	0	Dynamic	Disable
<input type="checkbox"/>	1/0/6	64	0	Dynamic	Disable
<input type="checkbox"/>	1/0/7	64	0	Dynamic	Disable
<input type="checkbox"/>	1/0/8	64	0	Dynamic	Disable
<input type="checkbox"/>	1/0/9	64	0	Dynamic	Disable
<input type="checkbox"/>	1/0/10	64	0	Dynamic	Disable
<input type="checkbox"/>	1/0/11	64	0	Dynamic	Disable
<input type="checkbox"/>	1/0/12	64	0	Dynamic	Disable
<input type="checkbox"/>	1/0/13	64	0	Dynamic	Disable
<input type="checkbox"/>	1/0/14	64	0	Dynamic	Disable
<input type="checkbox"/>	1/0/15	64	0	Dynamic	Disable

Note:

The maximum number of MAC addresses learned from individual port can be set to 64.

Figure 5-4 Port Security

The following entries are displayed on this screen:

➤ **Port Security**

- Select:** Select the desired port for Port Security configuration. It is multi-optional.
- Port:** Displays the port number.
- Max Learned MAC:** Specify the maximum number of MAC addresses that can be learned on the port.
- Learned Num:** Displays the number of MAC addresses that have been learned on the port.
- Learn Mode:** Select the Learn Mode for the port.
- **Dynamic:** When Dynamic mode is selected, the learned MAC address will be deleted automatically after the aging time.
 - **Static:** When Static mode is selected, the learned MAC address will be out of the influence of the aging time and can only be deleted manually. The learned entries will be cleared after the switch is rebooted.
 - **Permanent:** When Permanent mode is selected, the learned MAC address will be out of the influence of the aging time and can only be deleted manually. The learned entries will be saved even the switch is rebooted.

Status:

Select Enable/Disable the Port Security feature for the port.

**Note:**

The Port Security function is disabled for the LAG port member. Only the port is removed from the LAG, will the Port Security function be available for the port.

5.1.4 Port Isolation

Port Isolation provides a method of restricting traffic flow to improve the network security by forbidding the port to forward packets to the ports that are not on its forward portlist.

Choose the menu **Switching**→**Port**→**Port Isolation** to load the following page.

Port Isolation List		
UNIT: <input type="text" value="1"/> LAGS		
Port	LAG	Forward Portlist
1/0/1	--	1/0/1-28,LAG1-14
1/0/2	--	1/0/1-28,LAG1-14
1/0/3	--	1/0/1-28,LAG1-14
1/0/4	--	1/0/1-28,LAG1-14
1/0/5	--	1/0/1-28,LAG1-14
1/0/6	--	1/0/1-28,LAG1-14
1/0/7	--	1/0/1-28,LAG1-14
1/0/8	--	1/0/1-28,LAG1-14
1/0/9	--	1/0/1-28,LAG1-14
1/0/10	--	1/0/1-28,LAG1-14
1/0/11	--	1/0/1-28,LAG1-14

Figure 5-5 Port Isolation

The following entries are displayed on this screen:

➤ **Port Isolation List**

UNIT :1/LAGS : Click **1** to show the information of the physical ports. Click **LAGS** to show the information of the link aggregation groups.

Port: Displays the port number.

LAG : Displays the LAG number which the port belongs to.

Forward Portlist: Displays the forward portlist.

Click **Edit** to display the following figure.

The screenshot displays the 'Port Isolation Config' interface. It is divided into two main sections: 'Port' and 'Forward Portlist'. Both sections show a grid of port numbers from 1 to 28, arranged in two rows. The 'Port' section has buttons for 'All', 'Clear', and 'Help'. The 'Forward Portlist' section has buttons for 'All', 'Clear', 'Apply', and 'Back'. Below the sections is a legend with three items: 'Unselected Port(s)' represented by a white square with a blue border, 'Selected Port(s)' represented by a solid blue square, and 'Not Available for Selection' represented by a grey square.

Figure 5-6 Port Isolation Config

5.1.5 Loopback Detection

With loopback detection feature enabled, the switch can detect loops using loopback detection packets. When a loop is detected, the switch will display an alert or further block the corresponding port according to the port configuration.

Choose the menu **Switching**→**Port**→**Loopback Detection** to load the following page.

Global config

Loopback Detection Status: Enable Disable

Detection Interval: seconds(1-1000)

Automatic Recovery Time: detection times(1-100) Apply

Web Refresh Status: Enable Disable

Web Refresh Interval: seconds(3-100)

Port Config

UNIT:

Select	Port	Status	Operation mode	Recovery mode	Loop status	Block status	LAG
<input type="checkbox"/>							
<input type="checkbox"/>	1/0/1	Disable	Alert	Auto	---	---	---
<input type="checkbox"/>	1/0/2	Disable	Alert	Auto	---	---	---
<input type="checkbox"/>	1/0/3	Disable	Alert	Auto	---	---	---
<input type="checkbox"/>	1/0/4	Disable	Alert	Auto	---	---	---
<input type="checkbox"/>	1/0/5	Disable	Alert	Auto	---	---	---
<input type="checkbox"/>	1/0/6	Disable	Alert	Auto	---	---	---
<input type="checkbox"/>	1/0/7	Disable	Alert	Auto	---	---	---
<input type="checkbox"/>	1/0/8	Disable	Alert	Auto	---	---	---
<input type="checkbox"/>	1/0/9	Disable	Alert	Auto	---	---	---
<input type="checkbox"/>	1/0/10	Disable	Alert	Auto	---	---	---
<input type="checkbox"/>	1/0/11	Disable	Alert	Auto	---	---	---
<input type="checkbox"/>	1/0/12	Disable	Alert	Auto	---	---	---
<input type="checkbox"/>	1/0/13	Disable	Alert	Auto	---	---	---
<input type="checkbox"/>	1/0/14	Disable	Alert	Auto	---	---	---

Note:

Loopback Detection must coordinate with storm control.

Figure 5-7 Loopback Detection Config

The following entries are displayed on this screen:

➤ **Global Config**

LoopbackDetection Status:

Here you can enable or disable Loopback Detection function globally.

Detection Interval:

Set a loopback detection interval between 1 and 1000 seconds. By default, it's 30 seconds.

Automatic Recovery Time:

Time after which the blocked port would automatically recover to normal status. It can be set as integral times of detection interval.

Web Refresh Status:

Here you can enable or disable web automatic refresh.

Web Refresh Interval:

Set a web refresh interval between 3 and 100 seconds. By default, it's 6 seconds.

➤ **Port Config**

Select:

Select the desired port for Loopback Detection configuration. It is multi-optional.

Port:

Displays the port number.

Status:	Enable or disable Loopback Detection function for the port.
Operation Mode:	Select the mode how the switch processes the detected loops. <ul style="list-style-type: none"> Alert: When a loop is detected, display an alert. Port based: When a loop is detected, display an alert and block the port.
Recovery Mode:	Select the mode how the blocked port recovers to normal status. <ul style="list-style-type: none"> Auto: Block status can be automatically removed after recovery time. Manual: Block status only can be removed manually.
Loop Status:	Displays the port status whether a loopback is detected.
Block Status:	Displays the port status about block or unblock.
LAG:	Displays the LAG number the port belongs to.
Recover:	Click the Recover button to manually remove the loop or block status of selected ports.



Note:

Loopback Detection must coordinate with storm control.

5.2 LAG

LAG (Link Aggregation Group) is to combine a number of ports together to make a single high-bandwidth data path, so as to implement the traffic load sharing among the member ports in the group and to enhance the connection reliability.

For the member ports in an aggregation group, their basic configuration must be the same. The basic configuration includes **STP**, **QoS**, **VLAN**, **port attributes**, **MAC Address Learning mode** and other associated settings. More details are explained below:

- If the ports, which are enabled for the **802.1Q VLAN**, **STP**, **QoS** and **Port Configuration (Speed and Flow Control)**, are in a LAG, their configurations would be the same as the LAG's.
- The ports, which are enabled for the **half-duplex**, **Port Security**, **Port Mirror** and **MAC Address Filtering**, cannot be added to the LAG.

If the LAG is needed, you are suggested to configure the LAG function here before configuring the other functions for the member ports.



Tips:

1. Calculate the bandwidth for a LAG: If a LAG consists of the four ports in the speed of 1000Mbps Full Duplex, the whole bandwidth of the LAG is up to 8000Mbps (2000Mbps * 4) because the bandwidth of each member port is 2000Mbps counting the up-linked speed of 1000Mbps and the down-linked speed of 1000Mbps.
2. The traffic load of the LAG will be balanced among the ports according to the Aggregate Arithmetic. If the connections of one or several ports are broken, the traffic of these ports will be transmitted on the normal ports, so as to guarantee the connection reliability.

The LAG function is implemented on the **LAG Table**, **Static LAG** and **LACP Config** configuration pages.

5.2.1 LAG Table

On this page, you can view the information of the current LAG of the switch.

Choose the menu **Switching**→**LAG**→**LAG Table** to load the following page.

Select	Group Number	Description	Member	Operation
<input type="checkbox"/>	1	Static LAG	1/0/23-24	Edit Detail
<input type="checkbox"/>	2	Static LAG	N/A	Edit Detail
<input type="checkbox"/>	3	Static LAG	N/A	Edit Detail
<input type="checkbox"/>	4	Static LAG	N/A	Edit Detail
<input type="checkbox"/>	5	Static LAG	N/A	Edit Detail

Figure 5-8 LAG Table

The following entries are displayed on this screen:

➤ Global Config

Hash Algorithm:

Select the applied scope of Aggregate Arithmetic, which results in choosing a port to transfer the packets.

- **SRC MAC:** When this option is selected, the Aggregate Arithmetic will apply to the source MAC addresses of the packets.
- **DST MAC:** When this option is selected, the Aggregate Arithmetic will apply to the destination MAC addresses of the packets.
- **SRC MAC + DST MAC:** When this option is selected, the Aggregate Arithmetic will apply to the source and destination MAC addresses of the packets.
- **SRC IP:** When this option is selected, the Aggregate Arithmetic will apply to the source IP addresses of the packets.
- **DST IP:** When this option is selected, the Aggregate Arithmetic will apply to the destination IP addresses of the packets.
- **SRC IP + DST IP:** When this option is selected, the Aggregate Arithmetic will apply to the source and destination IP addresses of the packets.

➤ LAG Table

Select:

Select the desired LAG. It is multi-optional.

Group Number:

Displays the LAG number here.

Description:

Displays the description of LAG.

Member:

Displays the LAG member.

Operation:

Allows you to view or modify the information for each LAG.

- **Edit:** Click to modify the settings of the LAG.
- **Detail:** Click to get the information of the LAG.

Click the **Detail** button for the detailed information of your selected LAG.

Detail Info	
Group Number:	LAG1
LAG Type:	Static
Port Status:	Enable
Rate:	Auto
Port mirror:	Disable
Ingress Bandwidth (bps):	--
Egress Bandwidth (bps):	--
Broadcast Control (bps):	--
Multicast Control (bps):	--
UL Control (bps):	--
QoS Priority:	CoS 0
Join VLAN:	1

Figure 5-9 Detailed Information

5.2.2 Static LAG

On this page, you can manually configure the LAG.

Choose the menu **Switching**→**LAG**→**Static LAG** to load the following page.

LAG Config

Group Number:

Description:

Member Port

UNIT:

2	4	6	8	10	12	14	16	18	20	22	24	26	28
1	3	5	7	9	11	13	15	17	19	21	23	25	27

Unselected Port(s) Selected Port(s) Not Available for Selection

Note:

1. LAG* denotes the Link Aggregation Group which the port belongs to.
2. It's not suggested to set 100M and 1000M ports in the same LAG.
3. The LAG created by LACP can't be modified.

Figure 5-10 Manually Config

The following entries are displayed on this screen:

➤ **LAG Config**

Group Number: Select a Group Number for the LAG.

Description: Displays the description of the LAG.

➤ **Member Port**

Member Port: Select the port as the LAG member. Clearing all the ports of the LAG will delete this LAG.



Tips:

1. The LAG can be deleted by clearing its all member ports.
2. A port can only be added to a LAG. If a port is the member of a LAG, the port number will be displayed in gray and cannot be selected.

5.2.3 LACP Config

LACP (Link Aggregation Control Protocol) is defined in IEEE802.3ad and enables the dynamic link aggregation and disaggregation by exchanging LACP packets with its partner. The switch can dynamically group similarly configured ports into a single logical link, which will highly extend the bandwidth and flexibly balance the load.

With the LACP feature enabled, the port will notify its partner of the system priority, system MAC, port priority, port number and operation key (operation key is determined by the physical properties of the port, upper layer protocol and admin key). The device with higher priority will lead the aggregation and disaggregation. System priority and system MAC decide the priority of the device. The smaller the system priority, the higher the priority of the device is. With the same system priority, the device owning the smaller system MAC has the higher priority. The device with the higher priority will choose the ports to be aggregated based on the port priority, port number and operation key. Only the ports with the same operation key can be selected into the same aggregation group. In an aggregation group, the port with smaller port priority will be considered as the preferred one. If the two port priorities are equal, the port with smaller port number is preferred. After an aggregation group is established, the selected ports can be aggregated together as one port to transmit packets.

On this page, you can configure the LACP feature of the switch.

Choose the menu **Switching**→**LAG**→**LACP Config** to load the following page.

Global Config

System Priority: (0-65535)

LACP Config

UNIT:

Select	Port	Admin Key	Port Priority(0-65535)	Mode	Status	LAG
<input type="checkbox"/>		<input style="width: 50px;" type="text"/>	<input style="width: 50px;" type="text"/>	<input type="button" value="v"/>	<input type="button" value="v"/>	
<input type="checkbox"/>	1/0/1	0	32768	Passive	Disable	---
<input type="checkbox"/>	1/0/2	0	32768	Passive	Disable	---
<input type="checkbox"/>	1/0/3	0	32768	Passive	Disable	---
<input type="checkbox"/>	1/0/4	0	32768	Passive	Disable	---
<input type="checkbox"/>	1/0/5	0	32768	Passive	Disable	---
<input type="checkbox"/>	1/0/6	0	32768	Passive	Disable	---
<input type="checkbox"/>	1/0/7	0	32768	Passive	Disable	---
<input type="checkbox"/>	1/0/8	0	32768	Passive	Disable	---
<input type="checkbox"/>	1/0/9	0	32768	Passive	Disable	---
<input type="checkbox"/>	1/0/10	0	32768	Passive	Disable	---
<input type="checkbox"/>	1/0/11	0	32768	Passive	Disable	---
<input type="checkbox"/>	1/0/12	0	32768	Passive	Disable	---
<input type="checkbox"/>	1/0/13	0	32768	Passive	Disable	---
<input type="checkbox"/>	1/0/14	0	32768	Passive	Disable	---
<input type="checkbox"/>	1/0/15	0	32768	Passive	Disable	---

Note:

1. To avoid any broadcast storm when LACP takes effect, you are suggested to enable Spanning Tree function.
2. LACP function can not be enabled for the port already in a static link aggregation group.

Figure 5-11 LACP Config

The following entries are displayed on this screen:

➤ **Global Config**

System Priority: Specify the system priority for the switch. The system priority and MAC address constitute the system identification (ID). A lower system priority value indicates a higher system priority. When exchanging information between systems, the system with higher priority determines which link aggregation a link belongs to, and the system with lower priority adds the proper links to the link aggregation according to the selection of its partner.

➤ **LACP Config**

Select: Select the desired port for LACP configuration. It is multi-optional.

Port: Displays the port number.

Admin Key: Specify an Admin Key for the port. The member ports in a dynamic aggregation group must have the same Admin Key.

- Port Priority:** Specify a Port Priority for the port. This value determines the priority of the port to be selected as the dynamic aggregation group member. The port with smaller Port Priority will be considered as the preferred one. If the two port priorities are equal; the port with smaller port number is preferred.
- Mode:** Specify LACP mode for your selected port.
- Status:** Enable/Disable the LACP feature for your selected port.
- LAG:** Displays the LAG number which the port belongs to.

5.3 Traffic Monitor

The Traffic Monitor function, monitoring the traffic of each port, is implemented on the **Traffic Summary** and **Traffic Statistics** pages.

5.3.1 Traffic Summary

Traffic Summary screen displays the traffic information of each port, which facilitates you to monitor the traffic and analyze the network abnormality.

Choose the menu **Switching**→**Traffic Monitor**→**Traffic Summary** to load the following page.

Auto Refresh

Auto Refresh: Enable Disable

Refresh Rate: sec (3-300) Apply

Traffic Summary

UNIT: LAGS

Select	Port	Packets Rx	Packets Tx	Octets Rx	Octets Tx	Statistics
<input type="checkbox"/>	1/0/1	0	0	0	0	Statistics
<input type="checkbox"/>	1/0/2	0	0	0	0	Statistics
<input type="checkbox"/>	1/0/3	0	0	0	0	Statistics
<input type="checkbox"/>	1/0/4	0	0	0	0	Statistics
<input type="checkbox"/>	1/0/5	0	0	0	0	Statistics
<input type="checkbox"/>	1/0/6	0	0	0	0	Statistics
<input type="checkbox"/>	1/0/7	0	0	0	0	Statistics
<input type="checkbox"/>	1/0/8	0	0	0	0	Statistics
<input type="checkbox"/>	1/0/9	0	0	0	0	Statistics
<input type="checkbox"/>	1/0/10	0	0	0	0	Statistics
<input type="checkbox"/>	1/0/11	0	0	0	0	Statistics
<input type="checkbox"/>	1/0/12	0	0	0	0	Statistics
<input type="checkbox"/>	1/0/13	0	0	0	0	Statistics
<input type="checkbox"/>	1/0/14	0	0	0	0	Statistics
<input type="checkbox"/>	1/0/15	0	0	0	0	Statistics

Figure 5-12 Traffic Summary

The following entries are displayed on this screen:

➤ **Auto Refresh**

Auto Refresh: Allows you to Enable/Disable refreshing the Traffic Summary automatically.

Refresh Rate: Enter a value in seconds to specify the refresh interval.

➤ **Traffic Summary**

- UNIT:1/LAGS:** Click **1** to show the information of the physical ports. Click **LAGS** to show the information of the link aggregation groups
- Select:** Select the desired port for clearing. It is multi-optional.
- Port:** Displays the port number.
- Packets Rx:** Displays the number of packets received on the port. The error packets are not counted in.
- Packets Tx:** Displays the number of packets transmitted on the port.
- Octets Rx:** Displays the number of octets received on the port. The error octets are counted in.
- Octets Tx:** Displays the number of octets transmitted on the port.
- Statistics:** Click the **Statistics** button to view the detailed traffic statistics of the port.

5.3.2 Traffic Statistics

Traffic Statistics screen displays the detailed traffic information of each port, which facilitates you to monitor the traffic and locate faults promptly.

Choose the menu **Switching**→**Traffic Monitor**→**Traffic Statistics** to load the following page.

Auto Refresh

Auto Refresh: Enable Disable Apply

Refresh Rate: sec (3-300)

Port Select

Port Select

UNIT: 1 LAGS

2	4	6	8	10	12	14	16	18	20	22	24	26	28
1	3	5	7	9	11	13	15	17	19	21	23	25	27

Unselected Port(s)
 Selected Port(s)
 Not Available for Selection

Statistics

Received		Sent	
Broadcast	143,464	Broadcast	1,251
Multicast	227,377	Multicast	4
Unicast	13,425	Unicast	13,862
Jumbo	0	Jumbo	0
Alignment Errors	0	Collisions	0
UndersizePkts	0		
Pkts64Octets	54,619		
Pkts65to127Octets	20,547		
Pkts128to255Octets	101,862		
Pkts256to511Octets	190,529		
Pkts512to1023Octets	16,709		
Pkts1024to1518Octets	0		

Refresh
 Help

Figure 5-13 Traffic Statistics

The following entries are displayed on this screen:

➤ **Auto Refresh**

Auto Refresh: Allows you to Enable/Disable refreshing the Traffic Summary

automatically.

Refresh Rate: Enter a value in seconds to specify the refresh interval.

➤ **Port Select**

UNIT:1/LAGS: Click **1** to show the information of the physical ports. Click **LAGS** to show the information of the link aggregation groups.

Port: Enter a port number and click the **Select** button or select the port to view the traffic statistics of the corresponding port.

➤ **Statistics**

Received: Displays the details of the packets received on the port.

Sent: Displays the details of the packets transmitted on the port.

Broadcast: Displays the number of good broadcast packets received or transmitted on the port. The error frames are not counted in.

Multicast: Displays the number of good multicast packets received or transmitted on the port. The error frames are not counted in.

Unicast: Displays the number of good unicast packets received or transmitted on the port. The error frames are not counted in.

Jumbo: Displays the number of good jumbo packets received or transmitted on the port. The error frames are not counted in.

Alignment Errors: Displays the number of the received packets that have a bad Frame Check Sequence (FCS) with a non-integral octet (Alignment Error). The length of the packet is between 64 bytes and 1518 bytes.

UndersizePkts: Displays the number of the received packets (excluding error packets) that are less than 64 bytes long.

Pkts64Octets: Displays the number of the received packets (including error packets) that are 64 bytes long.

Pkts65to127Octets: Displays the number of the received packets (including error packets) that are between 65 and 127 bytes long.

Pkts128to255Octets: Displays the number of the received packets (including error packets) that are between 128 and 255 bytes long.

Pkts256to511Octets: Displays the number of the received packets (including error packets) that are between 256 and 511 bytes long.

Pkts512to1023Octets: Displays the number of the received packets (including error packets) that are between 512 and 1023 bytes long.

PktsOver1023Octets: Displays the number of the received packets (including error packets) that are over 1023 bytes.

Collisions: Displays the number of collisions experienced by a port during packet transmissions.

5.4 MAC Address

The main function of the switch is forwarding the packets to the correct ports based on the destination MAC address of the packets. Address Table contains the port-based MAC address

information, which is the base for the switch to forward packets quickly. The entries in the Address Table can be updated by auto-learning or configured manually. Most entries are generated and updated by auto-learning. In the stable networks, the static MAC address entries can facilitate the switch to reduce broadcast packets and enhance the efficiency of packets forwarding remarkably. The address filtering feature allows the switch to filter the undesired packets and forbid its forwarding so as to improve the network security.

The types and the features of the MAC Address Table are listed as the following:

Type	Configuration Way	Aging out	Being kept after reboot (if the configuration is saved)	Relationship between the bound MAC address and the port
Static Address Table	Manually configuring	No	Yes	The bound MAC address cannot be learned by the other ports in the same VLAN.
Dynamic Address Table	Automatically learning	Yes	No	The bound MAC address can be learned by the other ports in the same VLAN.
Filtering Address Table	Manually configuring	No	Yes	-

Table 5-1 Types and features of Address Table

This function includes four submenus: **Address Table**, **Static Address**, **Dynamic Address** and **Filtering Address**.

5.4.1 Address Table

On this page, you can view all the information of the Address Table.

Choose the menu **Switching**→**MAC Address**→**Address Table** to load the following page.

Search Option

MAC Address: (Format: 00-00-00-00-00-01)
 VLAN ID: (1-4094)
 Type: All Static Dynamic Filter

Port:

UNIT: LAGS

2	4	6	8	10	12	14	16	18	20	22	24	26	28
1	3	5	7	9	11	13	15	17	19	21	23	25	27

Unselected Port(s)

Selected Port(s)

Not Available for Selection

Address Table

UNIT:

MAC Address	VLAN ID	Port	Type	Aging Status
00-0A-EB-13-7B-00	1	1/0/3	Dynamic	Aging
00-0A-EB-84-19-03	1	1/0/3	Dynamic	Aging
00-0A-EB-AC-88-15	1	1/0/3	Dynamic	Aging
40-16-9F-BF-51-0C	1	1/0/3	Dynamic	Aging
50-E5-49-1E-06-80	1	1/0/3	Dynamic	Aging

Unit: 1 Address Num Displayed: 5
 Total Address Num of All Unit: 5

Note:
 The maximum of the displayed entries is 100 by default, please click the Search button to get the complete address entries.

Figure 5-14 Address Table

The following entries are displayed on this screen:

➤ **Search Option**

MAC Address: Enter the MAC address of your desired entry.

VLAN ID: Enter the VLAN ID of your desired entry.

Type: Select the type of your desired entry.

- **All:** This option allows the address table to display all the address entries.
- **Static:** This option allows the address table to display the static address entries only.
- **Dynamic:** This option allows the address table to display the dynamic address entries only.
- **Filter:** This option allows the address table to display the filtering address entries only.

Port: Select the corresponding port number or LAG of your desired entry.

➤ **Address Table**

MAC Address: Displays the MAC address learned by the switch.

VLAN ID: Displays the corresponding VLAN ID of the MAC address.

- Port:** Displays the corresponding Port number of the MAC address.
- Type:** Displays the type of the MAC address.
- Aging Status:** Displays the aging status of the MAC address.

5.4.2 Static Address

The static address table maintains the static address entries which can be added or removed manually, independent of the aging time. In the stable networks, the static MAC address entries can facilitate the switch to reduce broadcast packets and remarkably enhance the efficiency of packets forwarding without learning the address. The static MAC address learned by the port with **Port Security** enabled in the static learning mode will be displayed in the Static Address Table.

Choose the menu **Switching**→**MAC Address**→**Static Address** to load the following page.

Create Static Address

MAC Address: (Format: 00-00-00-00-00-01)

VLAN ID: (1-4094)

Port:

UNIT:

2	4	6	8	10	12	14	16	18	20	22	24	26	28
1	3	5	7	9	11	13	15	17	19	21	23	25	27

Unselected Port(s)
 Selected Port(s)
 Not Available for Selection

Search Option

Search Option:

Static Address Table

UNIT:

Select	MAC Address	VLAN ID	Port	Type	Aging Status
<input type="checkbox"/>			<input type="text"/>		

No entry in the table.

Unit: 1 Address Num Displayed: 0
 Total Address Num of All Unit: 0

Note:
 The maximum of the displayed entries is 100 by default. please click the Search button to get the complete address entries.

Figure 5-15 Static Address

The following entries are displayed on this screen:

➤ **Create Static Address**

- MAC Address:** Enter the static MAC Address to be bound.
- VLAN ID:** Enter the corresponding VLAN ID of the MAC address.
- Port:** Select the corresponding port of your desired entry.

➤ **Search Option**

- Search Option:** Select a Search Option from the pull-down list and click the **Search** button to find your desired entry in the Static Address Table.
 - **MAC:** Enter the MAC address of your desired entry.

- **VLAN ID:** Enter the VLAN ID number of your desired entry.
- **Port:** Enter the Port number of your desired entry.

➤ **Static Address Table**

Select:	Select the entry to delete or modify the corresponding port number. It is multi-optional.
MAC Address:	Displays the static MAC Address.
VLAN ID:	Displays the corresponding VLAN ID of the MAC address.
Port:	Displays the corresponding port number of the MAC address. Here you can modify the port number to which the MAC address is bound. The new port should be in the same VLAN.
Type:	Displays the type of the MAC address.
Aging Status:	Displays the aging status of the MAC address.



Note:

1. If the corresponding port number of the MAC address is not correct, or the connected port (or the device) has been changed, the switch cannot forward the packets correctly. Please reset the static address entry appropriately.
2. If the MAC address of a device has been added to the Static Address Table, connecting the device to another port will cause its address not to be recognized dynamically by the switch. Therefore, please ensure the entries in the Static Address Table are correct and valid.
3. The MAC address in the Static Address Table cannot be added to the Filtering Address Table or bound to a port dynamically.

5.4.3 Dynamic Address

The dynamic address can be generated by the auto-learning mechanism of the switch. The Dynamic Address Table can update automatically by auto-learning or the MAC address aging out mechanism.

To fully utilize the MAC address table, which has a limited capacity, the switch adopts an aging mechanism for updating the table. That is, the switch removes the MAC address entries related to a network device if no packet is received from the device within the aging time.

On this page, you can configure the dynamic MAC address entry.

Choose the menu **Switching**→**MAC Address**→**Dynamic Address** to load the following page.

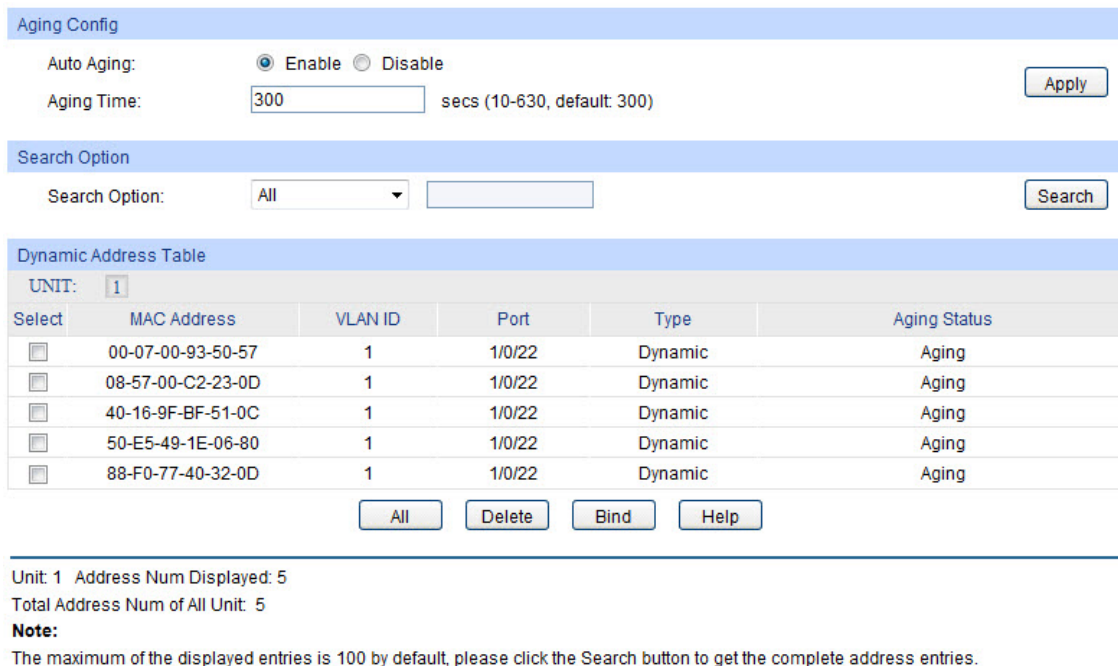

Aging Config

Auto Aging: Enable Disable

Aging Time: secs (10-630, default: 300)

Search Option

Search Option:

Dynamic Address Table

UNIT:

Select	MAC Address	VLAN ID	Port	Type	Aging Status
<input type="checkbox"/>	00-07-00-93-50-57	1	1/0/22	Dynamic	Aging
<input type="checkbox"/>	08-57-00-C2-23-0D	1	1/0/22	Dynamic	Aging
<input type="checkbox"/>	40-16-9F-BF-51-0C	1	1/0/22	Dynamic	Aging
<input type="checkbox"/>	50-E5-49-1E-06-80	1	1/0/22	Dynamic	Aging
<input type="checkbox"/>	88-F0-77-40-32-0D	1	1/0/22	Dynamic	Aging

Unit: 1 Address Num Displayed: 5
Total Address Num of All Unit: 5
Note:
The maximum of the displayed entries is 100 by default, please click the Search button to get the complete address entries.

Figure 5-16 Dynamic Address

The following entries are displayed on this screen:

➤ **Aging Config**

Auto Aging: Allows you to Enable/Disable the Auto Aging feature.

Aging Time: Enter the Aging Time for the dynamic address.

➤ **Search Option**

Search Option: Select a Search Option from the pull-down list and click the **Search** button to find your desired entry in the Dynamic Address Table.

- **MAC:** Enter the MAC address of your desired entry.
- **VLAN ID:** Enter the VLAN ID number of your desired entry.
- **Port:** Enter the Port number of your desired entry.

➤ **Dynamic Address Table**

Select: Select the entry to delete the dynamic address or to bind the MAC address to the corresponding port statically. It is multi-optional.

MAC Address: Displays the dynamic MAC Address.

VLAN ID: Displays the corresponding VLAN ID of the MAC address.

Port: Displays the corresponding port number of the MAC address.

Type: Displays the type of the MAC address.

Aging Status: Displays the aging status of the MAC address.

Bind: Click the **Bind** button to bind the MAC address of your selected entry to the corresponding port statically.



Tips:

Setting aging time properly helps implement effective MAC address aging. The aging time that is too long or too short results in a decrease of the switch performance. If the aging time is too long, excessive invalid MAC address entries maintained by the switch may fill up the MAC address table. This prevents the MAC address table from updating with network changes in time. If the aging time is too short, the switch may remove valid MAC address entries. This decreases the forwarding performance of the switch. It is recommended to keep the default value.

5.4.4 Filtering Address

The filtering address is to forbid the undesired packets to be forwarded. The filtering address can be added or removed manually, independent of the aging time. The filtering MAC address allows the switch to filter the packets which includes this MAC address as the source address or destination address, so as to guarantee the network security. The filtering MAC address entries act on all the ports in the corresponding VLAN.

Choose the menu **Switching**→**MAC Address**→**Filtering Address** to load the following page.

Create Filtering Address

MAC Address: (Format: 00-00-00-00-00-01)

VLAN ID: (1-4094) Create

Search Option

Search Option: All Search

Filtering Address Table

Select	MAC Address	VLAN ID	Port	Type	Aging Status
No entry in the table.					

All Delete Help

Total Address Num:0

Note:
The maximum of the displayed entries is 100 by default, please click the Search button to get the complete address entries.

Figure 5-17 Filtering Address

The following entries are displayed on this screen:

➤ **Create Filtering Address**

MAC Address: Enter the MAC Address to be filtered.

VLAN ID: Enter the corresponding VLAN ID of the MAC address.

➤ **Search Option**

Search Option: Select a Search Option from the pull-down list and click the **Search** button to find your desired entry in the Filtering Address Table.

- **MAC Address:** Enter the MAC address of your desired entry.
- **VLAN ID:** Enter the VLAN ID number of your desired entry.

➤ **Filtering Address Table**

Select: Select the entry to delete the corresponding filtering address. It is multi-optional.

MAC Address: Displays the filtering MAC Address.

- VLAN ID:** Displays the corresponding VLAN ID.
- Port:** Here the symbol "--" indicates no specified port.
- Type:** Displays the type of the MAC address.
- Aging Status:** Displays the aging status of the MAC address.



Note:

The MAC address in the Filtering Address Table cannot be added to the Static Address Table or bound to a port dynamically.

5.4.5 MAC Notification

The MAC notification function is used to monitor the status of the MAC address table, and the MAC address learned on each port.

Choose the menu **Switching**→**MAC Address**→**MAC Notification** to load the following page.

Mac Notification Global Config

Global Status: Enable Disable

Table Full Notification: Enable Disable Apply

Notification Interval: Seconds(1-1000)

Mac Notification Port Config

UNIT:

Select	Port	Learned Mode Change	Exceed Max Learned	New Mac Learned
<input type="checkbox"/>		▼	▼	▼
<input type="checkbox"/>	1/0/1	Disable	Disable	Disable
<input type="checkbox"/>	1/0/2	Disable	Disable	Disable
<input type="checkbox"/>	1/0/3	Disable	Disable	Disable
<input type="checkbox"/>	1/0/4	Disable	Disable	Disable
<input type="checkbox"/>	1/0/5	Disable	Disable	Disable
<input type="checkbox"/>	1/0/6	Disable	Disable	Disable
<input type="checkbox"/>	1/0/7	Disable	Disable	Disable
<input type="checkbox"/>	1/0/8	Disable	Disable	Disable
<input type="checkbox"/>	1/0/9	Disable	Disable	Disable
<input type="checkbox"/>	1/0/10	Disable	Disable	Disable
<input type="checkbox"/>	1/0/11	Disable	Disable	Disable
<input type="checkbox"/>	1/0/12	Disable	Disable	Disable
<input type="checkbox"/>	1/0/13	Disable	Disable	Disable
<input type="checkbox"/>	1/0/14	Disable	Disable	Disable

All
Apply
Help

The following entries are displayed on this screen:

➤ **MAC Notification Global Config**

- Global Status:** Enable/Disable the MAC notification globally.
- Table Full Notification:** Enable/Disable the sending of a MAC Full Notification when the MAC address table is full.
- Notification Interval:** Specify the interval time between notifications. It ranges from 1 to 1000 seconds and the default interval is 1 second.

➤ **MAC Notification Port Config**

- Select:** Select the specified port(s) for configuration. It is multi-optional.
- Port:** Displays the port number.
- Learned Mode Change:** Enable/Disable the Learned Mode Change notification on the port. The port's learned mode includes: Dynamic, Static and Permanent.
- Exceed Max Learned:** Enable/Disable the Exceed Max Learned notification on the port. The number of the max learned MAC addresses on each port is 64 by default.
- New MAC Learned:** Enable/Disable the New MAC Learned notification on the port.

5.4.6 MAC VLAN Security

The MAC VLAN Security function is used to configure the MAC address security in the specified VLAN.

Choose the menu **Switching**→**MAC Address**→**MAC VLAN Security** to load the following page.

Vlan Security Config

VLAN ID: (1-4094) Create

Max Learned MAC: (0-16383) Clear

Mode:

Vlan Security Table

Select	VLAN ID	Max Learned MAC	Learned Number	Mode	Operation
No entry in the table.					

All Delete Help

The following entries are displayed on this screen:

➤ **MAC Notification Global Config**

- VLAN ID:** Enter the VLAN ID to configure its MAC address security.
- Max Learned MAC:** Specify the max MAC addresses that can be learned in this VLAN.
- Mode:** Choose the mode to process the new arrival packets (whose source MAC address is not in the current VLAN's address table) when learned MAC number exceeds the max learned MAC number of VLAN security entry.
- Drop: The packets will be dropped when learned mac number exceeds the max learned number of VLAN security entry.
 - Forward: The packets will be forward but not be learned when learned mac number exceeds the max learned number of VLAN security entry.
 - Disable: The vlan security entry exists, but is not valid.

➤ VLAN Security Table

Select:	Select the desired entry to delete the corresponding VLAN security entry. It's multi-optional.
VLAN ID:	Displays the VLAN ID of the VLAN security entry.
Max Learned MAC:	Displays the max learned MAC number of VLAN security entry.
Learned Number:	Displays the learned MAC number of VLAN security entry.
Mode:	Displays the mode of the vlan security entry.
Operation:	Click to edit the max learned MAC and the mode.

5.5 L2PT

L2PT (Layer 2 Protocol Tunneling) is a feature for service providers to transmit packets from different customers across their ISP networks and maintain Layer 2 protocol configurations of each customer. The supported Layer 2 protocols are STP (Spanning Tree Protocol), GVRP (GARP VLAN Registration Protocol), CDP (Cisco Discovery Protocol), VTP (VLAN Trunking Protocol), PAgP (Port Aggregation Protocol), UDLD (UniDirectional Link Detection) and PVST+(Per VLAN Spanning Tree Plus).

When L2PT is enabled and the switch receives the specified Layer 2 protocol packets from the UNI port, the switch encapsulates these packets with a special MAC address and sends them across the service-provider network through the NNI port. The devices in the ISP network do not process these packets but forward them as normal packets. The switch on the outbound side of the ISP network receives these packets on its NNI port and restore their MAC address to their original Layer 2 protocol destination MAC address.

The L2PT protocol is usually used with VLAN VPN feature. Thus the NNI ports that connecting to the ISP network are configured as VPN Up-link ports.

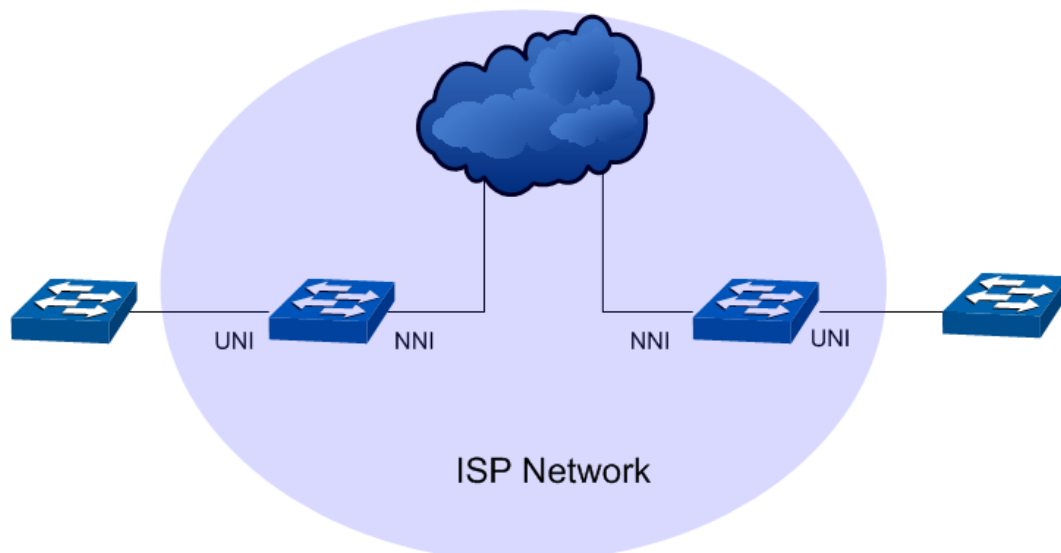

Figure 5-1 A Typical L2PT Topology

5.5.1 L2PT Config

Choose the menu **Switching**→**L2PT**→**L2PT Config** to load the following page.

Global Config

Layer 2 Protocol Tunneling : Enable Disable Apply

Port Config

UNIT: 1 LAGS

Select	Port	Type	Protocol	Threshold	LAG
<input type="checkbox"/>		<input type="text" value="NONE"/>	<input type="text" value="---/---/---/---"/>	<input type="text" value="---/---/---/---"/>	---
<input type="checkbox"/>	1/0/1	NONE	---/---/---/---	---/---/---/---	---
<input type="checkbox"/>	1/0/2	NONE	---/---/---/---	---/---/---/---	---
<input type="checkbox"/>	1/0/3	NONE	---/---/---/---	---/---/---/---	---
<input type="checkbox"/>	1/0/4	NONE	---/---/---/---	---/---/---/---	---
<input type="checkbox"/>	1/0/5	NONE	---/---/---/---	---/---/---/---	---
<input type="checkbox"/>	1/0/6	NONE	---/---/---/---	---/---/---/---	---
<input type="checkbox"/>	1/0/7	NONE	---/---/---/---	---/---/---/---	---
<input type="checkbox"/>	1/0/8	NONE	---/---/---/---	---/---/---/---	---
<input type="checkbox"/>	1/0/9	NONE	---/---/---/---	---/---/---/---	---
<input type="checkbox"/>	1/0/10	NONE	---/---/---/---	---/---/---/---	---
<input type="checkbox"/>	1/0/11	NONE	---/---/---/---	---/---/---/---	---
<input type="checkbox"/>	1/0/12	NONE	---/---/---/---	---/---/---/---	---
<input type="checkbox"/>	1/0/13	NONE	---/---/---/---	---/---/---/---	---
<input type="checkbox"/>	1/0/14	NONE	---/---/---/---	---/---/---/---	---
<input type="checkbox"/>	1/0/15	NONE	---/---/---/---	---/---/---/---	---

All Refresh Apply Help

Figure 5-2 L2PT Config

Configuration Procedure:

- 1) Enable the Layer 2 Protocol Tunneling globally under **Global Config**.
- 2) Configure the tunneling and protocol type on the specified port under **Port Config**.
- 3) Click **Apply** to save your configurations.

Entry Explanation:

UNIT:1/LAGS: Click **1** to configure the physical ports. Click **LAGS** to configure the link aggregation groups.

Select: Specify the port(s) to configure its L2PT feature. It is multi-optional.

Type: Choose the port type according to its connecting device in the network.

- None: Disable the L2PT on this port.
- UNI: Specify the port's type as UNI if it is connecting to the user's local network.
- NNI: Specify the port's type as NNI if it is connecting to the ISP network.

Protocol: Select the supported Layer 2 protocol type. Packets of the specified protocol will be encapsulated with their destination MAC address before they are sent to the ISP network. Packets will be decapsulated to restore their Layer 2 protocol and MAC address information before they are sent to the customer network.

- STP: Enable protocol tunneling for the STP packets.
- GVRP: Enable protocol tunneling for the GVRP packets.
- 01000CCCCC: Enable protocol tunneling for the packets with

their destination MAC address as 01000CCCCCCC, which includes CDP, VTP, PAgP and UDLD.

- 01000CCCCCD: Enable protocol tunneling for the PVST+ packets.
- ALL: All the above Layer 2 protocols are supported for tunneling.

Threshold

Configure the threshold for packets-per-second accepted for encapsulation. Packets beyond the threshold will be dropped. If no protocol is specified, the threshold applies to each Layer 2 protocol types.

LAG:

Displays the port's aggregation group.

[Return to CONTENTS](#)

Chapter 6 VLAN

The traditional Ethernet is a data network communication technology based on CSMA/CD (Carrier Sense Multiple Access/Collision Detect) via shared communication medium. Through the traditional Ethernet, the overfull hosts in LAN will result in serious collision, flooding broadcasts, poor performance or even breakdown of the Internet. Though connecting the LANs through switches can avoid the serious collision, the flooding broadcasts cannot be prevented, which will occupy plenty of bandwidth resources, causing potential serious security problems.

A Virtual Local Area Network (VLAN) is a network topology configured according to a logical scheme rather than the physical layout. The VLAN technology is developed for switches to control broadcast in LANs. By creating VLANs in a physical LAN, you can divide the LAN into multiple logical LANs, each of which has a broadcast domain of its own. Hosts in the same VLAN communicate with one another as if they are in a LAN. However, hosts in different VLANs cannot communicate with one another directly. Therefore, broadcast packets are limited in a VLAN. Hosts in the same VLAN communicate with one another via Ethernet whereas hosts in different VLANs communicate with one another through the Internet devices such as router, the Layer 3 switch, etc. The following figure illustrates a VLAN implementation.

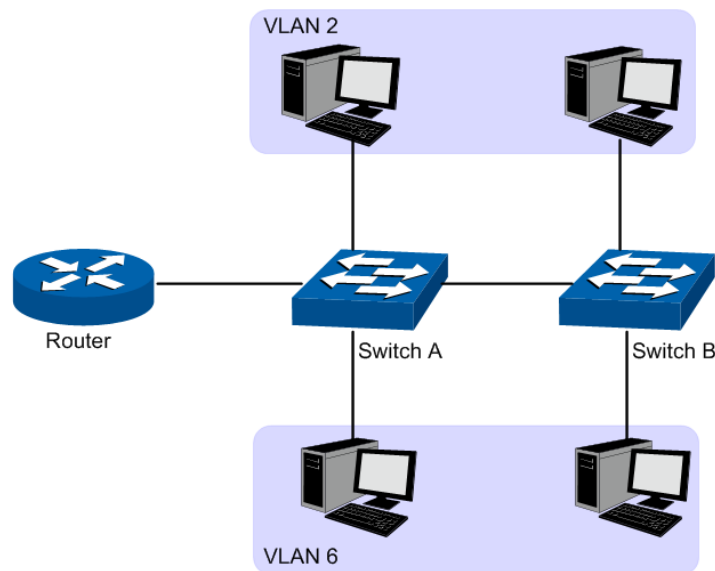

Figure 6-1 VLAN implementation

Compared with the traditional Ethernet, VLAN enjoys the following advantages.

- (1) Broadcasts are confined to VLANs. This decreases bandwidth utilization and improves network performance.
- (2) Network security is improved. VLANs cannot communicate with one another directly. That is, a host in a VLAN cannot access resources in another VLAN directly, unless routers or Layer 3 switches are used.
- (3) Network configuration workload for the host is reduced. VLAN can be used to group specific hosts. When the physical position of a host changes within the range of the VLAN, you do not need to change its network configuration.

A VLAN can span across multiple switches, or even routers. This enables hosts in a VLAN to be dispersed in a looser way. That is, hosts in a VLAN can belong to different physical network segments. This switch supports 802.1Q VLAN to classify VLANs. VLAN tags in the packets are necessary for the switch to identify packets of different VLANs.

6.1 802.1Q VLAN

VLAN tags in the packets are necessary for the switch to identify packets of different VLANs. The switch works at the data link layer in OSI model and it can identify the data link layer encapsulation of the packet only, so you can add the VLAN tag field into the data link layer encapsulation for identification.

In 1999, IEEE issues the IEEE 802.1Q protocol to standardize VLAN implementation, defining the structure of VLAN-tagged packets. IEEE 802.1Q protocol defines that a 4-byte VLAN tag is encapsulated after the destination MAC address and source MAC address to show the information about VLAN.

As shown in the following figure, a VLAN tag contains four fields, including TPID (Tag Protocol Identifier), Priority, CFI (Canonical Format Indicator), and VLAN ID.

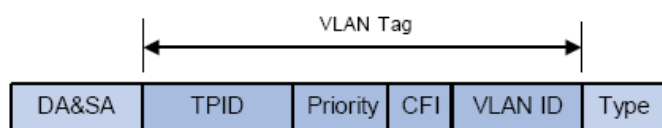

Figure 6-2 Format of VLAN Tag

- (1) **TPID:** TPID is a 16-bit field, indicating that this data frame is VLAN-tagged. By default, it is 0x8100 in this switch.
- (2) **Priority:** Priority is a 3-bit field, referring to 802.1p priority. Refer to section “QoS & QoS profile” for details.
- (3) **CFI:** CFI is a 1-bit field, indicating whether the MAC address is encapsulated in the standard format in different transmission media. This field is not described in detail in this chapter.
- (4) **VLAN ID:** VLAN ID is a 12-bit field, indicating the ID of the VLAN to which this packet belongs. It is in the range of 0 to 4,095. Generally, 0 and 4,095 is not used, so the field is in the range of 1 to 4,094.

VLAN ID identifies the VLAN to which a packet belongs. When the switch receives a un-VLAN-tagged packet, it will encapsulate a VLAN tag with the default VLAN ID of the inbound port for the packet, and the packet will be assigned to the default VLAN of the inbound port for transmission.

In this User Guide, the tagged packet refers to the packet with VLAN tag whereas the untagged packet refers to the packet without VLAN tag, and the priority-tagged packet refers to the packet with VLAN tag whose VLAN ID is 0.

➤ Link Types of ports

When creating the 802.1Q VLAN, you should set the link type for the port according to its connected device. The link types of port including the following two types: **Untagged** and **Tagged**.

- (1) **Untagged:** The untagged port can be added in multiple VLANs. If a VLAN-tagged packet arrives at a port and the VLAN ID in its VLAN tag does not match any of the VLAN the ingress port belongs to, this packet will be dropped. The packets forwarded by the untagged port are untagged.
- (2) **Tagged:** The tagged port can be added in multiple VLANs. If a VLAN-tagged packet arrives at a port and the VLAN ID in its VLAN tag does not match any of the VLAN the ingress port belongs to, this packet will be dropped. When the VLAN-tagged packets are forwarded by the Tagged port, its VLAN tag will not be changed.

➤ **PVID**

PVID (Port VLAN ID) is the default VID of the port. When the switch receives an un-VLAN-tagged packet, it will add a VLAN tag to the packet according to the PVID of its received port and forward the packets.

When creating VLANs, the PVID of each port, indicating the default VLAN to which the port belongs, is an important parameter with the following two purposes:

- (1) When the switch receives an un-VLAN-tagged packet, it will add a VLAN tag to the packet according to the PVID of its received port
- (2) PVID determines the default broadcast domain of the port, i.e. when the port receives UL packets or broadcast packets, the port will broadcast the packets in its default VLAN.

Different packets, tagged or untagged, will be processed in different ways, after being received by ports of different link types, which is illustrated in the following table.

Port Type	Receiving Packets		Forwarding Packets	
	Untagged Packets	Tagged Packets	Untagged Packets	Tagged Packets
Untagged	When untagged packets are received, the port will add the default VLAN tag, i.e. the PVID of the ingress port, to the packets.	If the VID of packet is allowed by the port, the packet will be received.	The packet will be forwarded unchanged.	The packet will be forwarded after removing its VLAN tag
Tagged		If the VID of packet is forbidden by the port, the packet will be dropped.	The packet will be forwarded with the PVID of egress port as its VLAN tag.	The packet will be forwarded with its current VLAN tag.

Table 6-1 Relationship between Port Types and VLAN Packets Processing

IEEE 802.1Q VLAN function is implemented on the **VLAN Config** and **Port Config** pages.

6.1.1 VLAN Config

On this page, you can configure the 802.1Q VLAN and its ports.

Choose the menu **VLAN**→**802.1Q VLAN**→**VLAN Config** to load the following page.

Select	VLAN_ID	Name	Members	Operation
<input type="checkbox"/>	1	System-VLAN	1/0/1-52,LAG1	Edit Detail

Total VLAN: 1

Figure 6-3 VLAN Table

To ensure the normal communication of the factory switch, the default VLAN of all ports is set to VLAN1.

The following entries are displayed on this screen:

➤ **VLAN Table**

- Select:** Select the desired entry to delete the corresponding VLAN. It is multi-optional.
- VLAN ID:** Displays the VLAN ID.
- Name:** Displays the name of the specific VLAN.
- Members:** Displays the port members in the VLAN.
- Operation:** Allows you to view or modify the information for each entry.
- **Edit:** Click to modify the settings of VLAN.
 - **Detail:** Click to get the information of VLAN.

Click **Edit** and the following content will be shown.

The screenshot displays the 'VLAN Info' configuration interface. At the top, there is a header 'VLAN Info'. Below it, the 'VLAN ID' is set to 33 (range 1-4094) and the 'Name' is 'tplink' (16 characters maximum). The interface is divided into two main sections: 'Untagged port' and 'Tagged port'. Each section shows 'UNIT: 1 LAGS' and a grid of port numbers from 1 to 28. In the 'Untagged port' section, ports 1-28 are all unselected. In the 'Tagged port' section, ports 1-28 are all selected. Below the grids are buttons for 'All', 'Clear', 'Apply', and 'Help'. At the bottom, a legend shows three icons: a white box for 'Unselected Port(s)', a blue box for 'Selected Port(s)', and a grey box for 'Not Available for Selection'.

Figure 6-4 VLAN Info

➤ **VLAN Info**

- VLAN ID:** Displays the ID number of VLAN.
- Name:** Displays the name of the specific VLAN.
- Untagged Port:** Displays the untagged ports of the specific VLAN.
- Tagged Port:** Displays the tagged ports of the specific VLAN.

6.1.2 Port Config

Before creating the 802.1Q VLAN, please acquaint yourself with all the devices connected to the switch in order to configure the ports properly.

Choose the menu **VLAN**→**802.1Q VLAN**→**Port Config** to load the following page.

Select	Port	Link Type	PVID	LAG	VLAN
<input type="checkbox"/>		<input type="text" value=""/>	<input type="text" value=""/>		
<input type="checkbox"/>	1/0/1	ACCESS	1	---	Detail
<input type="checkbox"/>	1/0/2	ACCESS	1	---	Detail
<input type="checkbox"/>	1/0/3	ACCESS	1	---	Detail
<input type="checkbox"/>	1/0/4	ACCESS	1	---	Detail
<input type="checkbox"/>	1/0/5	ACCESS	1	---	Detail
<input type="checkbox"/>	1/0/6	ACCESS	1	---	Detail
<input type="checkbox"/>	1/0/7	ACCESS	1	---	Detail
<input type="checkbox"/>	1/0/8	ACCESS	1	---	Detail
<input type="checkbox"/>	1/0/9	ACCESS	1	---	Detail
<input type="checkbox"/>	1/0/10	ACCESS	1	---	Detail
<input type="checkbox"/>	1/0/11	ACCESS	1	---	Detail
<input type="checkbox"/>	1/0/12	ACCESS	1	---	Detail
<input type="checkbox"/>	1/0/13	ACCESS	1	---	Detail
<input type="checkbox"/>	1/0/14	ACCESS	1	---	Detail
<input type="checkbox"/>	1/0/15	ACCESS	1	---	Detail

Figure 6-5 Port Config

The following entries are displayed on this screen:

➤ **VLAN Port Config**

UNIT:1/LAGS: Click **1** to configure the physical ports. Click **LAGS** to configure the link aggregation groups.

Select: Select the desired port for configuration. It is multi-optional.

Port: Displays the port number.

Link Type: Select the Link Type from the pull-down list for the port.

- **ACCESS:** The ACCESS port can be added in a single VLAN, and the egress rule of the port is UNTAG. The PVID is same as the current VLAN ID. If the current VLAN is deleted, the PVID will be set to 1 by default.
- **TRUNK:** The TRUNK port can be added in multiple VLANs. The egress rule of the port is UNTAG if the arriving packet's VLAN tag is the same as the port's PVID, otherwise the egress rule is TAG. The PVID can be set as the VID number of any valid VLAN.
- **GENERAL:** The GENERAL port can be added in multiple VLANs and set various egress rules according to the different VLANs. The default egress rule is UNTAG. The PVID can be set as the VID number of any valid VLAN.

PVID: Enter the PVID number of the port.

LAG: Displays the LAG to which the port belongs.

VLAN: Click the **Detail** button to view the information of the VLAN to which the port belongs.

Click the **Detail** button to view the information of the corresponding VLAN.

VLAN of Port 1/0/8		
VLAN ID	Name	Operation
1	System-VLAN	Remove

Figure 6-6 View the Current VLAN of Port

The following entries are displayed on this screen:

➤ **VLAN of Port**

VLAN ID: Displays the ID number of VLAN.

Name: Displays the user-defined description of VLAN.

Operation: Allows you to remove the port from the current VLAN.

Configuration Procedure:

Step	Operation	Description
1	Set the link type for port.	Required. On the VLAN→802.1Q VLAN→Port Config page, set the link type for the port basing on its connected device.
2	Create VLAN.	Required. On the VLAN→802.1Q VLAN→VLAN Config page, click the Create button to create a VLAN. Enter the VLAN ID and the description for the VLAN. Meanwhile, specify its member ports.
3	Modify/View VLAN.	Optional. On the VLAN→802.1Q VLAN→VLAN Config page, click the Edit/Detail button to modify/view the information of the corresponding VLAN.
4	Delete VLAN	Optional. On the VLAN→802.1Q VLAN→VLAN Config page, select the desired entry to delete the corresponding VLAN by clicking the Delete button.

6.2 Application Example for 802.1Q VLAN

➤ **Network Requirements**

- Switch A is connecting to PC A and Server B;
- Switch B is connecting to PC B and Server A;
- PC A and Server A is in the same VLAN;
- PC B and Server B is in the same VLAN;
- PCs in the two VLANs cannot communicate with each other.

➤ **Network Diagram**

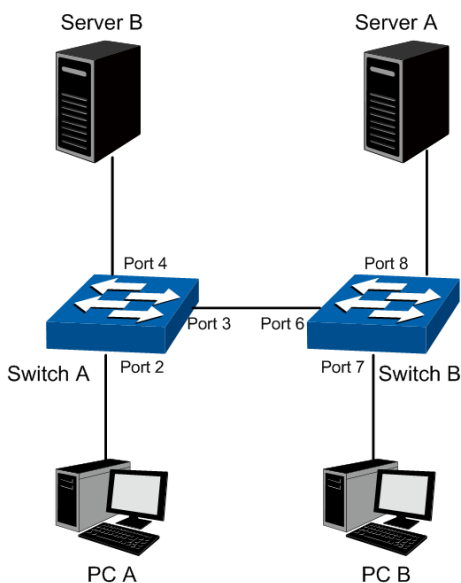

➤ **Configuration Procedure**

- Configure switch A

Step	Operation	Description
1	Configure the Link Type of the ports	Required. On VLAN→802.1Q VLAN→Port Config page, configure the link type of Port 2, Port 3 and Port 4 as ACCESS, TRUNK and ACCESS respectively
2	Create VLAN10	Required. On VLAN→802.1Q VLAN→VLAN Config page, create a VLAN with its VLAN ID as 10, owning Port 2 and Port 3.
3	Create VLAN20	Required. On VLAN→802.1Q VLAN→VLAN Config page, create a VLAN with its VLAN ID as 20, owning Port 3 and Port 4.

- Configure switch B

Step	Operation	Description
1	Configure the Link Type of the ports	Required. On VLAN→802.1Q VLAN→Port Config page, configure the link type of Port 7, Port 6 and Port 8 as ACCESS, TRUNK and ACCESS respectively.
2	Create VLAN10	Required. On VLAN→802.1Q VLAN→VLAN Config page, create a VLAN with its VLAN ID as 10, owning Port 6 and Port 8.
3	Create VLAN20	Required. On VLAN→802.1Q VLAN→VLAN Config page, create a VLAN with its VLAN ID as 20, owning Port 6 and Port 7.

6.3 MAC VLAN

MAC VLAN technology is the way to classify VLANs according to the MAC addresses of Hosts. A MAC address corresponds to a single VLAN ID. For the device in a MAC VLAN, if its MAC address is bound to VLAN, the device can be connected to another member port in this VLAN and still takes its member role effect without changing the configuration of VLAN members.

The packet in MAC VLAN is processed in the following way:

- When receiving an untagged packet, the switch matches the packet with the current MAC VLAN. If the packet is matched, the switch will add a corresponding MAC VLAN tag to it. If no MAC VLAN is matched, the switch will add a tag to the packet according to the PVID of the received port. Thus, the packet is assigned automatically to the corresponding VLAN for transmission.
- When receiving tagged packet, the switch will process it basing on the 802.1Q VLAN. If the received port is the member of the VLAN to which the tagged packet belongs, the packet will be forwarded normally. Otherwise, the packet will be discarded.
- If the MAC address of a Host is classified into 802.1Q VLAN, please set its connected port of switch to be a member of this 802.1Q VLAN so as to ensure the packets forwarded normally.

6.3.1 MAC VLAN

On this page, you can create MAC VLAN and view the current MAC VLANs in the table.

Choose the menu **VLAN**→**MAC VLAN** to load the following page.

Create MAC VLAN

MAC Address: (Format: 00-00-00-00-00-01)

Description: (8 characters maximum)

VLAN ID: (1-4094)

MAC VLAN Table

Select	MAC Address	Description	VLAN ID	Operation
No entry in the table.				

Total MAC VLAN:0

Figure 6-7 Create and View MAC VLAN

The following entries are displayed on this screen:

➤ **Create MAC VLAN**

- MAC Address:** Enter the MAC address.
- Description:** Give a description to the MAC address for identification.
- VLAN ID:** Enter the ID number of the MAC VLAN. This VLAN should be one of the 802.1Q VLANs the ingress port belongs to.

➤ **MAC VLAN Table**

- Select:** Select the desired entry. It is multi-optional.
- MAC Address:** Displays the MAC address.
- Description:** Displays the user-defined description of the MAC address.
- VLAN ID:** Displays the corresponding VLAN ID of the MAC address.

Operation: Click the **Edit** button to modify the settings of the entry. And click the **Modify** button to apply your settings.

6.3.2 Port Enable

On this page, you can enable the port for the MAC VLAN feature. Only the port is enabled, can the configured MAC VLAN take effect.

Choose the menu **VLAN**→**MAC VLAN**→**Port Enable** to load the following page.

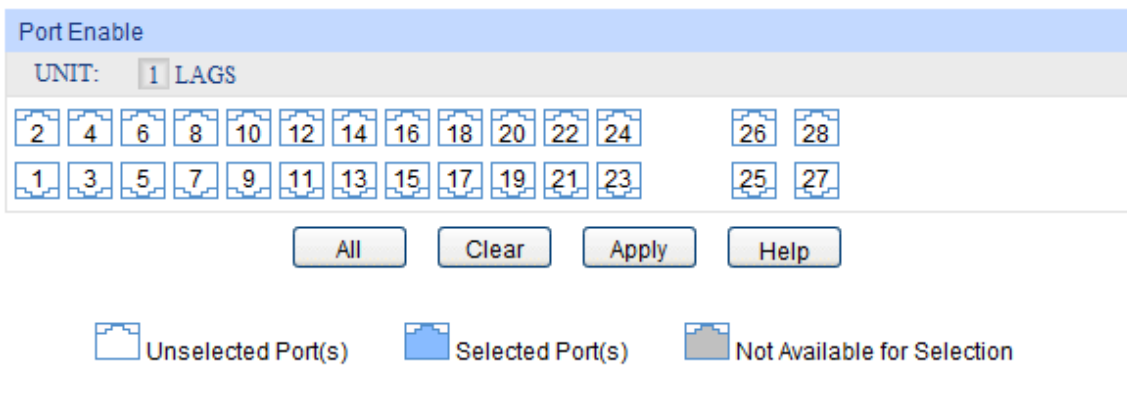

Figure 6-8 Enable Port for MAC VLAN

UNIT: Click **1** to configure the physical ports. Click **LAGS** to configure the link aggregation groups.

Select your desired port for MAC VLAN function. All the ports are disabled for MAC VLAN function by default.

Configuration Procedure:

Step	Operation	Description
1	Set the link type for port.	Required. On the VLAN → 802.1Q VLAN → Port Config page, set the link type for the port basing on its connected device.
2	Create VLAN.	Required. On the VLAN → 802.1Q VLAN → VLAN Config page, click the Create button to create a VLAN. Enter the VLAN ID and the description for the VLAN. Meanwhile, specify its member ports.
3	Create MAC VLAN.	Required. On the VLAN → MAC VLAN page, create the MAC VLAN. For the device in a MAC VLAN, it's required to set its connected port of switch to be a member of this VLAN so as to ensure the normal communication.
4	Select your desired ports for MAC VLAN feature.	Required. On the VLAN → MAC VLAN → Port Enable page, select and enable the desired ports for MAC VLAN feature.

6.4 Application Example for MAC VLAN

➤ Network Requirements

- Switch A and switch B are connected to meeting room A and meeting room B respectively, and the two rooms are for all departments;
- Notebook A and Notebook B, special for meeting room, are of two different departments;

- The two departments are in VLAN10 and VLAN20 respectively. The two notebooks can just access the server of their own departments, that is, Server A and Server B, in the two meeting rooms;
- The MAC address of Notebook A is 00-19-56-8A-4C-71, Notebook B's MAC address is 00-19-56-82-3B-70.

➤ **Network Diagram**

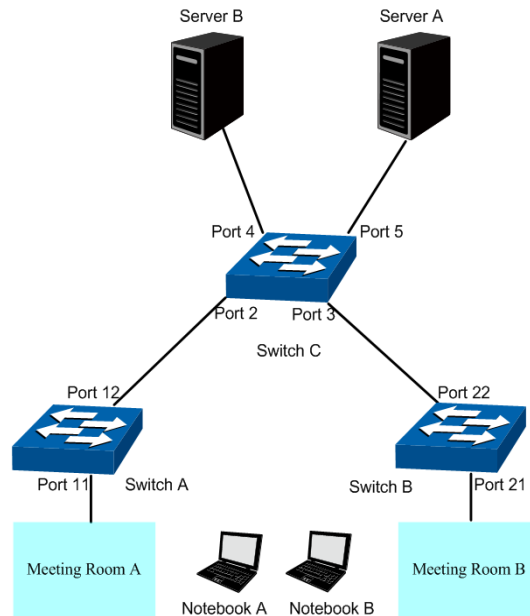

➤ **Configuration Procedure**

- Configure switch A

Step	Operation	Description
1	Configure the Link Type of the ports	Required. On VLAN→802.1Q VLAN→Port Config page, configure the link type of Port 11 and Port 12 as GENERAL and TRUNK respectively.
2	Create VLAN10	Required. On VLAN→802.1Q VLAN→VLAN Config page, create a VLAN with its VLAN ID as 10, owning Port 11 and Port 12, and configure the egress rule of Port 11 as Untag.
3	Create VLAN20	Required. On VLAN→802.1Q VLAN→VLAN Config page, create a VLAN with its VLAN ID as 20, owning Port 11 and Port 12, and configure the egress rule of Port 11 as Untag.
4	Configure MAC VLAN 10	On VLAN→MAC VLAN→MAC VLAN page, create MAC VLAN10 with the MAC address as 00-19-56-8A-4C-71.
5	Configure MAC VLAN 20	On VLAN→MAC VLAN→MAC VLAN page, create MAC VLAN20 with the MAC address as 00-19-56-82-3B-70.
6	Port Enable	Required. On the VLAN→MAC VLAN→Port Enable page, select and enable Port 11 and Port 12 for MAC VLAN feature.

- Configure switch B

Step	Operation	Description
1	Configure the Link Type of the ports	Required. On VLAN→802.1Q VLAN→Port Config page, configure the link type of Port 21 and Port 22 as GENERAL and TRUNK respectively.
2	Create VLAN10	Required. On VLAN→802.1Q VLAN→VLAN Config page, create a VLAN with its VLAN ID as 10, owning Port 21 and Port 22, and configure the egress rule of Port 21 as Untag.
3	Create VLAN20	Required. On VLAN→802.1Q VLAN→VLAN Config page, create a VLAN with its VLAN ID as 20, owning Port 21 and Port 22, and configure the egress rule of Port 21 as Untag.
4	Configure MAC VLAN 10	On VLAN→MAC VLAN→MAC VLAN page, create MAC VLAN10 with the MAC address as 00-19-56-8A-4C-71.
5	Configure MAC VLAN 20	On VLAN→MAC VLAN→MAC VLAN page, create MAC VLAN20 with the MAC address as 00-19-56-82-3B-70.
6	Port Enable	Required. On the VLAN→MAC VLAN→Port Enable page, select and enable Port 21 and Port 22 for MAC VLAN feature.

- Configure switch C

Step	Operation	Description
1	Configure the Link Type of the ports	Required. On VLAN→802.1Q VLAN→Port Config page, configure the link type of Port 2 and Port 3 as GENERAL, and configure the link type of Port 4 and Port 5 as ACCESS.
2	Create VLAN10	Required. On VLAN→802.1Q VLAN→VLAN Config page, create a VLAN with its VLAN ID as 10, owning Port 2, Port 3 and Port 5,
3	Create VLAN20	Required. On VLAN→802.1Q VLAN→VLAN Config page, create a VLAN with its VLAN ID as 20, owning Port 2, Port 3 and Port 4,

6.5 Protocol VLAN

Protocol VLAN is another way to classify VLANs basing on network protocol. Protocol VLANs can be sorted by IP, IPX, DECnet, AppleTalk, Banyan and so on. Through the Protocol VLANs, the broadcast domain can span over multiple switches and the Host can change its physical position in the network with its VLAN member role always effective. By creating Protocol VLANs, the network administrator can manage the network clients basing on their actual applications and services effectively.

This switch can classify VLANs basing on the common protocol types listed in the following table. Please create the Protocol VLAN to your actual need.

Protocol Type	Type value
ARP	0x0806
IP	0x0800
MPLS	0x8847/0x8848

Protocol Type	Type value
IPX	0x8137
IS-IS	0x8000
LACP	0x8809
802.1X	0x888E

Table 6-1 Protocol types in common use

The packet in Protocol VLAN is processed in the following way:

1. When receiving an untagged packet, the switch matches the packet with the current Protocol VLAN. If the packet is matched, the switch will add a corresponding Protocol VLAN tag to it. If no Protocol VLAN is matched, the switch will add a tag to the packet according to the PVID of the received port. Thus, the packet is assigned automatically to the corresponding VLAN for transmission.
2. When receiving tagged packet, the switch will process it basing on the 802.1Q VLAN. If the received port is the member of the VLAN to which the tagged packet belongs, the packet will be forwarded normally. Otherwise, the packet will be discarded.
3. If the Protocol VLAN is created, please set its enabled port to be the member of corresponding 802.1Q VLAN so as to ensure the packets forwarded normally.

6.5.1 Protocol Group Table

On this page, you can create Protocol VLAN and view the information of the current defined Protocol VLANs.

Choose the menu **VLAN**→**Protocol VLAN**→**Protocol Group Table** to load the following page.

Protocol Group Table				
Select	Protocol Name	VLAN ID	Member	Operate
No entry in the table.				
<input type="button" value="All"/> <input type="button" value="Create"/> <input type="button" value="Delete"/> <input type="button" value="Help"/>				

Figure 6-9 Create Protocol VLAN

The following entries are displayed on this screen:

➤ Protocol Group Table

- Select:** Select the desired entry. It is multi-optional.
- Protocol Name:** Displays the protocol of the protocol group.
- VLAN ID:** Displays the corresponding VLAN ID of the protocol.
- Member:** Displays the member of the protocol group.
- Operate:** Click the **Edit** button to modify the settings of the entry. And click the **Apply** button to apply your settings.

6.5.2 Protocol Group

On this page, you can configure the Protocol Group.

Choose the menu **VLAN**→**Protocol VLAN**→**Protocol Group** to load the following page.

Protocol Group Config

Protocol Name:

VLAN ID: (1-4094)

Protocol Group Member

UNIT: LAGS

Unselected Port(s) Selected Port(s) Not Available for Selection

Figure 6-10 Enable Protocol VLAN for Port

➤ Protocol Group Config

Protocol Name: Select the defined protocol template.

VLAN ID: Enter the ID number of the Protocol VLAN. This VLAN should be one of the 802.1Q VLANs the ingress port belongs to.

➤ Protocol Group Member

UNIT: Click **1** to configure the physical ports. Click **LAGS** to configure the link aggregation groups.

6.5.3 Protocol Template

The Protocol Template should be created before configuring the Protocol VLAN. By default, the switch has defined the IP Template, ARP Template, RARP Template, etc. You can add more Protocol Template on this page.

Choose the menu **VLAN**→**Protocol VLAN**→**Protocol Template** to load the following page.

Create Protocol Template

Protocol Name: (8 characters maximum)

Frame Type: Create

Ether Type: (4 Hex integers,0600-FFFF)

Protocol Template Table

Select	ID	Protocol Name	Protocol type
<input type="checkbox"/>	1	IP	Ethernet II ether-type 0800
<input type="checkbox"/>	2	ARP	Ethernet II ether-type 0806
<input type="checkbox"/>	3	RARP	Ethernet II ether-type 8035
<input type="checkbox"/>	4	IPX	SNAP ether-type 8137
<input type="checkbox"/>	5	AT	SNAP ether-type 809B

All
Delete
Help

Figure 6-11 Create and View Protocol Template

The following entries are displayed on this screen:

➤ **Create Protocol Template**

- Protocol Name:** Give a name for the Protocol Template.
- Frame Type:** Select a Frame Type for the Protocol Template.
- Ether Type:** Enter the Ethernet protocol type field in the protocol template.
- DSAP:** Enter the DSAP field when selected LLC.
- SSAP:** Enter the SSAP field when selected LLC.

➤ **Protocol Template Table**

- Select:** Select the desired entry. It is multi-optional.
- ID** Displays the Protocol Template ID.
- Protocol Name:** Displays the Protocol Name.
- Protocol Type:** Displays the Protocol type.

Note:
The Protocol Template bound to VLAN cannot be deleted.

Configuration Procedure:

Step	Operation	Description
1	Set the link type for port.	Required. On the VLAN → 802.1Q VLAN → Port Config page, set the link type for the port basing on its connected device.

Step	Operation	Description
2	Create VLAN.	Required. On the VLAN→802.1Q VLAN→VLAN Config page, click the Create button to create a VLAN. Enter the VLAN ID and the description for the VLAN. Meanwhile, specify its member ports.
3	Create Protocol Template.	Required. On the VLAN→Protocol VLAN→Protocol Template page, create the Protocol Template before configuring Protocol VLAN.
4	Create Protocol VLAN.	Required. On the VLAN→Protocol VLAN→Protocol Group page, select the protocol name and enter the VLAN ID to create a Protocol VLAN. Meanwhile, enable protocol VLAN for ports.
5	Modify/View VLAN.	Optional. On the VLAN→Protocol VLAN→Protocol Group Table page, click the Edit button to modify/view the information of the corresponding VLAN.
6	Delete VLAN.	Optional. On the VLAN→Protocol VLAN→Protocol Group Table page, select the desired entry to delete the corresponding VLAN by clicking the Delete button.

6.6 Application Example for Protocol VLAN

➤ Network Requirements

- Department A is connected to the company LAN via Port12 of switch A;
- Department A has IP host and AppleTalk host;
- IP host, in VLAN10, is served by IP server while AppleTalk host is served by AppleTalk server;
- Switch B is connected to IP server and AppleTalk server.

➤ **Network Diagram**

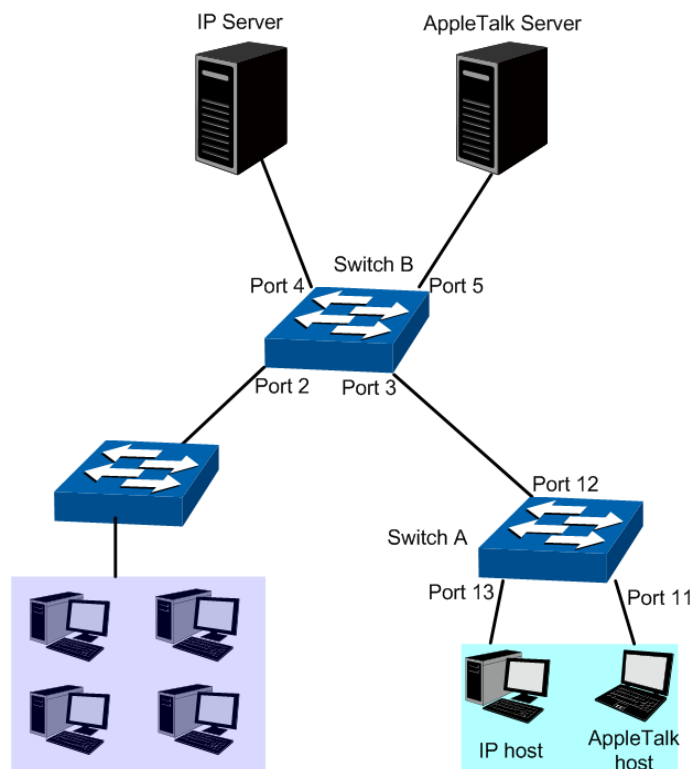

➤ **Configuration Procedure**

- Configure switch A

Step	Operation	Description
1	Configure the Link Type of the ports	Required. On VLAN→802.1Q VLAN→Port Config page, configure the link type of Port 11 and Port 13 as ACCESS, and configure the link type of Port 12 as GENERAL.
2	Create VLAN10	Required. On VLAN→802.1Q VLAN→VLAN Config page, create a VLAN with its VLAN ID as 10, owning Port 12 and Port 13, and configure the egress rule of Port 12 as Untag.
3	Create VLAN20	Required. On VLAN→802.1Q VLAN→VLAN Config page, create a VLAN with its VLAN ID as 20, owning Port 11 and Port 12, and configure the egress rule of Port 12 as Untag.

- Configure switch B

Step	Operation	Description
1	Configure the Link Type of the ports	Required. On VLAN→802.1Q VLAN→Port Config page, configure the link type of Port 4 and Port 5 as ACCESS, and configure the link type of Port 3 as GENERAL.
2	Create VLAN10	Required. On VLAN→802.1Q VLAN→VLAN Config page, create a VLAN with its VLAN ID as 10, owning Port 3 and Port 4, and configure the egress rule of Port 3 as Untag.
3	Create VLAN20	Required. On VLAN→802.1Q VLAN→VLAN Config page, create a VLAN with its VLAN ID as 20, owning Port 3 and Port 5, and configure the egress rule of Port 3 as Untag.

Step	Operation	Description
4	Create Protocol Template	Required. On VLAN→Protocol VLAN→Protocol Template page, configure the protocol template practically. E.g. the Ether Type of IP network packets is 0800 and that of AppleTalk network packets is 809B.
5	Create Protocol VLAN 10	On VLAN→Protocol VLAN→Protocol Group page, create protocol VLAN 10 with Protocol as IP. Select and enable Port 3, Port 4 and Port 5 for Protocol VLAN feature.
6	Create Protocol VLAN 20	On VLAN→Protocol VLAN→Protocol Group page, create protocol VLAN 20 with Protocol as AppleTalk. Select and enable Port 3, Port 4 and Port 5 for Protocol VLAN feature.

6.7 VLAN VPN

With the increasing application of the Internet, the VPN (Virtual Private Network) technology is developed and used to establish the private network through the operators' backbone networks. VLAN-VPN (Virtual Private Network) function, the implement of a simple and flexible Layer 2 VPN technology, allows the packets with VLAN tags of private networks to be encapsulated with VLAN tags of public networks at the network access terminal of the Internet Service Provider. And these packets will be transmitted with double-tag across the public networks.

The VLAN-VPN function provides you with the following benefits:

- (1) Provides simple Layer 2 VPN solutions for small-sized LANs or intranets.
- (2) Saves public network VLAN ID resource.
- (3) You can have VLAN IDs of your own, which is independent of public network VLAN IDs.
- (4) When the network of the Internet Service Provider is upgraded, the user's network with a relative independence can still work normally without changing the current configurations.

In addition, the switch supports the feature to adjust the TPID Values of VLAN VPN Packets. TPID (Tag Protocol Identifier) is a field of the VLAN tag. IEEE 802.1Q specifies the value of TPID to be 0x8100. This switch adopts the default value of TPID (0x8100) defined by the protocol. Other manufacturers use other TPID values (such as 0x9100 or 0x9200) in the outer tags of VLAN-VPN packets. To be compatible with devices coming from other manufacturers, this switch can adjust the TPID values of VLAN-VPN packets globally. You can configure TPID values by yourself. When a port receives a packet, this port will replace the TPID value in the outer VLAN tag of this packet with the user-defined value and then send the packet again. Thus, the VLAN-VPN packets sent to the public network can be recognized by devices of other manufacturers.

The position of the TPID field in an Ethernet packet is the same as the position of the protocol type field in the packet without VLAN Tag. Thus, to avoid confusion happening when the switch forwards or receives a packet, you must not configure the following protocol type values listed in the following table as the TPID value.

Protocol type	Value
ARP	0x0806
IP	0x0800
MPLS	0x8847/0x8848
IPX	0x8137
IS-IS	0x8000

Protocol type	Value
LACP	0x8809
802.1X	0x888E

Table 6-2 Values of Ethernet frame protocol type in common use

This VLAN VPN function is implemented on the **VPN Config**, **VLAN Mapping** and **Port Enable** pages.

6.7.1 VPN Config

This page allows you to enable the VPN function, adjust the global TPID for VLAN-VPN packets and enable the VPN up-link port. When VPN mode is enabled, the switch will add a tag to the received tagged packet basing on the VLAN mapping entries.

Choose the menu **VLAN**→**VLAN VPN**→**VPN Config** to load the following page.

The screenshot displays the 'VPN Global Config' page. It is divided into two main sections: 'Global Config' and 'VPN Up-link Ports'.
Global Config: Contains 'VPN Mode' with radio buttons for 'Enable' and 'Disable' (selected), and 'Global TPID' with a text input field containing '8100' and a note '(4 Hex integers)'. An 'Apply' button is present.
VPN Up-link Ports: Shows 'UNIT: 1 LAGS'. Below this is a grid of 28 port selection buttons, numbered 1 through 28. Below the grid are 'All', 'Clear', 'Apply', and 'Help' buttons. A legend at the bottom identifies three port states: 'Unselected Port(s)' (white box), 'Selected Port(s)' (blue box), and 'Not Available for Selection' (grey box).

Figure 6-12 VPN Global Config

The following entries are displayed on this screen:

➤ **Global Config**

VPN Mode: Allows you to Enable/Disable the VLAN-VPN function.

Global TPID: Enter the global TPID (Tag protocol identifier).

➤ **VPN Up-link Ports**

Unit: Click **1** to configure the physical ports. Click **LAGS** to configure the link aggregation groups.

VPN Up-link ports: Select the desired port as the VPN Up-link port.

Note:
 If VPN mode is enabled, please create VLAN Mapping entries on the VLAN Mapping function page.

6.7.2 Port Enable

On this page, you can enable the port for the VLAN Mapping function. Only the port is enabled, can the configured VLAN Mapping function take effect.

VPN Port Enable

UNIT: 1 LAGS

2 4 6 8 10 12 14 16 18 20 22 24 26 28

1 3 5 7 9 11 13 15 17 19 21 23 25 27

All Clear Apply Help

Unselected Port(s) Selected Port(s) Not Available for Selection

Figure 6-13 Enable Port for VLAN Mapping

> VPN Port Enable

UNIT: Click **1** to configure the physical ports. Click **LAGS** to configure the link aggregation groups.

Select your desired port for VLAN Mapping function. All the ports are disabled for VLAN Mapping function by default.

6.7.3 VLAN Mapping

VLAN Mapping function defines a new VLAN TAG to be inserted before the VLAN TAG of the packets according to the VLAN Mapping entries. And these packets can be forwarded in the new VLAN. If VLAN VPN function is enabled, a received packet already carrying a VLAN tag will be tagged basing on the VLAN Mapping entries and becomes a double-tagged packet to be forwarded in the new VLAN.

Choose the menu **VLAN**→**VLAN VPN**→**VLAN Mapping** to load the following page.

Global Config

VLAN Mapping: Enable Disable Apply

VLAN Mapping Config

Port: Choose (Format:1/0/1)

C VLAN: (1-4094) Create

SP VLAN: (1-4094) Clear

Name: (16 characters maximum)

VLAN Mapping List

Select	Port	C VLAN	SP VLAN	Description	Operation
No entry in the table.					

All
Delete
Help

Figure 6-14 Create VLAN Mapping Entry

The following entries are displayed on this screen:

➤ **Global Config**

VLAN Mapping: Enable/Disable the VLAN mapping function. Enable/Disable the VLAN mapping function. If VLAN mapping is disabled and VLAN VPN is enabled, the packet will be encapsulated with an outer tag according to the PVID of its arriving port.

➤ **VLAN Mapping Config**

Port: Select/Input the port number.

C VLAN: Enter the ID number of the Customer VLAN. C VLAN refers to the VLAN to which the packet received by switch belongs.

SP VLAN: Enter the ID number of the Service Provider VLAN.

Name: Give a name to the VLAN Mapping entry or leave it blank.

➤ **VLAN Mapping List**

Select: Select the desired entry to delete the corresponding VLAN Mapping entry. It is multi-optional.

Operation: Click the **Edit** button to modify the settings of the entry.

Click **Edit** to display the following figure:

Global Config

VLAN Mapping: Enable Disable

VLAN Mapping Config

Port: (Format:1/0/1)

C VLAN: (1-4094)

SP VLAN: (1-4094)

Name: (16 characters maximum)

VLAN Mapping List

Select	Port	C VLAN	SP VLAN	Description	Operation
<input type="checkbox"/>	6/0/6	2	3	test	Edit

Figure 6-15 VLAN Mapping Entry Config

Modify the SP VLAN and name of the selected entry and click **Edit** to apply.

Note:
 When VPN mode is globally enabled, VPN function takes effect on all ports. If VPN mode is disabled, VLAN Mapping function can be enabled by selecting your desired port on this Port Enable page.

Configuration Procedure of VLAN VPN Function:

Step	Operation	Description
1	Enable VPN mode.	Required. On the VLAN→VLAN VPN→VPN Config page, enable the VPN mode.
2	Configure the global TPID.	Optional. On the VLAN→VLAN VPN→VPN Config page, configure the global TPID basing on the devices connected to the up-link port.
3	Set the VPN up-link port.	Required. On the VLAN→VLAN VPN→VPN Config page, specify the desired port to be the VPN up-link port. It's required to set the port connected to the backbone networks to be up-link port.
4	Create VLAN Mapping entries.	Required. On the VLAN→VLAN VPN→VLAN Mapping page, configure the VLAN Mapping entries basing on the actual application.
5	Create SP (Service Provider) VLAN.	Optional. On the VLAN→802.1Q VLAN page, create the SP VLAN. For the steps of creating VLAN, please refer to 802.1Q VLAN .

Configuration Procedure of VLAN Mapping Function:

Step	Operation	Description
------	-----------	-------------

Step	Operation	Description
1	Create VLAN Mapping entries.	Required. On the VLAN→VLAN VPN→VLAN Mapping page, configure the VLAN Mapping entries basing on the actual application.
2	Enable VLAN Mapping function for port.	Required. On the VLAN→VLAN VPN→Port Enable page, enable VLAN Mapping function for the ports.
3	Create SP (Service Provider) VLAN	Optional. On the VLAN→802.1Q VLAN page, create the SP VLAN. For the steps of creating VLAN, please refer to 802.1Q VLAN .

6.8 GVRP

GVRP (GARP VLAN Registration Protocol) is an implementation of GARP (generic attribute registration protocol). GVRP allows the switch to automatically add or remove the VLANs via the dynamic VLAN registration information and propagate the local VLAN registration information to other switches, without having to individually configure each VLAN.

➤ GARP

GARP provides the mechanism to assist the switch members in LAN to deliver, propagate and register the information among the members. GARP itself does not work as the entity among the devices. The application complied with GARP is called GARP implementation, and GVRP is the implementation of GARP. When GARP is implemented on a port of device, the port is called GARP entity.

The information exchange between GARP entities is completed by messages. GARP defines the messages into three types: Join, Leave and LeaveAll.

- **Join Message:** When a GARP entity expects other switches to register certain attribute information of its own, it sends out a Join message. And when receiving the Join message from the other entity or configuring some attributes statically, the device also sends out a Join message in order to be registered by the other GARP entities.
- **Leave Message:** When a GARP entity expects other switches to deregister certain attribute information of its own, it sends out a Leave message. And when receiving the Leave message from the other entity or deregistering some attributes statically, the device also sends out a Leave message.
- **LeaveAll Message:** Once a GARP entity starts up, it starts the LeaveAll timer. After the timer times out, the GARP entity sends out a LeaveAll message. LeaveAll message is to deregister all the attribute information so as to enable the other GARP entities to re-register attribute information of their own.

Through message exchange, all the attribute information to be registered can be propagated to all the switches in the same switched network.

The interval of GARP messages is controlled by timers. GARP defines the following timers:

- **Hold Timer:** When a GARP entity receives a piece of registration information, it does not send out a Join message immediately. Instead, to save the bandwidth resources, it starts the Hold timer, puts all registration information it receives before the timer times out into one Join message and sends out the message after the timer times out.

- **Join Timer:** To transmit the Join messages reliably to other entities, a GARP entity sends each Join message two times. The Join timer is used to define the interval between the two sending operations of each Join message.
- **Leave Timer:** When a GARP entity expects to deregister a piece of attribute information, it sends out a Leave message. Any GARP entity receiving this message starts its Leave timer, and deregisters the attribute information if it does not receive a Join message again before the timer times out.
- **LeaveAll Timer:** Once a GARP entity starts up, it starts the LeaveAll timer, and sends out a LeaveAll message after the timer times out, so that other GARP entities can re-register all the attribute information on this entity. After that, the entity restarts the LeaveAll timer to begin a new cycle.

➤ **GVRP**

GVRP, as an implementation of GARP, maintains dynamic VLAN registration information and propagates the information to other switches by adopting the same mechanism of GARP.

After the GVRP feature is enabled on a switch, the switch receives the VLAN registration information from other switches to dynamically update the local VLAN registration information, including VLAN members, ports through which the VLAN members can be reached, and so on. The switch also propagates the local VLAN registration information to other switches so that all the switching devices in the same switched network can have the same VLAN information. The VLAN registration information includes not only the static registration information configured locally, but also the dynamic registration information, which is received from other switches.

In this switch, only the port with TRUNK link type can be set as the GVRP application entity to maintain the VLAN registration information. GVRP has the following three port registration modes: Normal, Fixed, and Forbidden.

- **Normal:** In this mode, a port can dynamically register/deregister a VLAN and propagate the dynamic/static VLAN information.
- **Fixed:** In this mode, a port cannot register/deregister a VLAN dynamically. It only propagates static VLAN information. That is, the port in Fixed mode only permits the packets of its static VLAN to pass.
- **Forbidden:** In this mode, a port cannot register/deregister VLANs. It only propagates VLAN 1 information. That is, the port in Forbidden mode only permits the packets of the default VLAN (namely VLAN 1) to pass.

Choose the menu **VLAN**→**GVRP**→**GVRP Config** to load the following page.

Global Config

GVRP : Enable Disable Apply

Port Config

UNIT: LAGS

Select	Port	Status	Registration Mode	LeaveAll Timer (centisecond)	Join Timer (centisecond)	Leave Timer (centisecond)	LAG
<input type="checkbox"/>		<input type="text" value=""/>	<input type="text" value=""/>	<input type="text" value=""/>	<input type="text" value=""/>	<input type="text" value=""/>	
<input type="checkbox"/>	1/0/1	Disable	Normal	1000	20	60	---
<input type="checkbox"/>	1/0/2	Disable	Normal	1000	20	60	---
<input type="checkbox"/>	1/0/3	Disable	Normal	1000	20	60	---
<input type="checkbox"/>	1/0/4	Disable	Normal	1000	20	60	---
<input type="checkbox"/>	1/0/5	Disable	Normal	1000	20	60	---
<input type="checkbox"/>	1/0/6	Disable	Normal	1000	20	60	---
<input type="checkbox"/>	1/0/7	Disable	Normal	1000	20	60	---
<input type="checkbox"/>	1/0/8	Disable	Normal	1000	20	60	---
<input type="checkbox"/>	1/0/9	Disable	Normal	1000	20	60	---
<input type="checkbox"/>	1/0/10	Disable	Normal	1000	20	60	---
<input type="checkbox"/>	1/0/11	Disable	Normal	1000	20	60	---
<input type="checkbox"/>	1/0/12	Disable	Normal	1000	20	60	---
<input type="checkbox"/>	1/0/13	Disable	Normal	1000	20	60	---
<input type="checkbox"/>	1/0/14	Disable	Normal	1000	20	60	---

All Apply Help

NOTE:
 leaveAllTimer >= leaveTimer*10, leaveTimer >= JoinTimer*2.

Figure 6-16 GVRP Config

 **Note:**
 If the GVRP feature is enabled for a member port of LAG, please ensure all the member ports of this LAG are set to be in the same status and registration mode.

The following entries are displayed on this screen:

➤ **Global Config**

GVRP: Allows you to Enable/Disable the GVRP function.

➤ **Port Config**

Unit: Click **1** to configure the physical ports. Click **LAGS** to configure the link aggregation groups.

Select: Select the desired port for configuration. It is multi-optional.

Port: Displays the port number.

Status: Enable/Disable the GVRP feature for the port. The port type should be set to TRUNK before enabling the GVRP feature.

Registration Mode: Select the Registration Mode for the port.

- **Normal:** In this mode, a port can dynamically register/deregister a VLAN and propagate the dynamic/static VLAN information.

- **Fixed:** In this mode, a port cannot register/deregister a VLAN dynamically. It only propagates static VLAN information.
- **Forbidden:** In this mode, a port cannot register/deregister VLANs. It only propagates VLAN 1 information.

LeaveAll Timer: Once the LeaveAll Timer is set, the port with GVRP enabled can send a LeaveAll message after the timer times out, so that other GARP ports can re-register all the attribute information. After that, the LeaveAll timer will start to begin a new cycle. The LeaveAll Timer ranges from 1000 to 30000 centiseconds.

Join Timer: To guarantee the transmission of the Join messages, a GARP port sends each Join message two times. The Join Timer is used to define the interval between the two sending operations of each Join message. The Join Timer ranges from 20 to 1000 centiseconds.

Leave Timer: Once the Leave Timer is set, the GARP port receiving a Leave message will start its Leave timer, and deregister the attribute information if it does not receive a Join message again before the timer times out. The Leave Timer ranges from 60 to 3000 centiseconds.

LAG: Displays the LAG to which the port belongs.



Note:

LeaveAll Timer $\geq 10 \times$ Leave Timer, Leave Timer $\geq 2 \times$ Join Timer.

Configuration Procedure:

Step	Operation	Description
1	Set the link type for port.	Required. On the VLAN→802.1Q VLAN→Port Config page, set the link type of the port to be TRUNK.
2	Enable GVRP function.	Required. On the VLAN→GVRP page, enable GVRP function.
3	Configure the registration mode and the timers for the port.	Required. On the VLAN→GVRP page, configure the parameters of ports basing on actual applications.

6.9 Private VLAN

Private VLANs, designed to save VLAN resources of uplink devices and decrease broadcast, are sets of VLAN pairs that share a common primary identifier. To guarantee user information security, the ease with which to manage and account traffic for service providers, in campus network, service providers usually require that each individual user is Layer-2 separated. VLAN feature can solve this problem. However, as stipulated by IEEE 802.1Q protocol, a device can only support up to 4094 VLANs. If a service provider assigns one VLAN per user, the VLANs will be far from enough; as a result, the number of users this service provider can support is limited.

Private VLAN adopts Layer 2 VLAN structure. A Private VLAN consists of a Primary VLAN and a Secondary VLAN, providing a mechanism for achieving layer-2-separation between ports. For uplink devices, all the packets received from the downstream are without VLAN tags. Uplink

devices need to identify Primary VLANs but not Secondary VLANs. Therefore, they can save VLAN resources without considering the VLAN configuration in the lower layer. Meanwhile, the service provider can assign each user an individual Secondary VLAN, so that users are separated at the Layer 2 level.

Private VLAN technology is mainly used in campus or enterprise networks to achieve user Layer-2-separation and to save VLAN resources of uplink devices.

➤ **The Elements of a Private VLAN**

Promiscuous port: A promiscuous port connects to and communicates with the uplink device. The PVID of the promiscuous port is the same with the Primary VLAN ID. One promiscuous port can only join to one Primary VLAN.

Host port: A host port connects to and communicates with terminal device. The PVID of the host port is the same as the Secondary VLAN ID. One host port can only belong to one Private VLAN.

Primary VLAN: A Private VLAN has one Primary VLAN and one Secondary VLAN. Primary VLAN is the user VLAN uplink device can identify but it is not the actual VLAN the end user is in. Every port in a private VLAN is a member of the primary VLAN. The primary VLAN carries unidirectional traffic downstream from the promiscuous ports to the host ports and to other promiscuous ports.

Secondary VLAN: Secondary VLAN is the actual VLAN the end user is in. Secondary VLANs are associated with a primary VLAN, and are used to carry traffic from hosts to uplink devices. There are two types of secondary VLANs:

- Isolated VLAN—The VLAN that an isolated port is associated with is called isolated VLAN. Each isolated VLAN must bind to a primary VLAN.
- Community VLAN—The VLAN that a community port is associated with is called community VLAN. Each community VLAN must bind to a primary VLAN.

➤ **Features of Private VLAN**

1. A Private VLAN contains one Primary VLAN and one Secondary VLAN.
2. A VLAN cannot be set as the Primary VLAN and Secondary VLAN simultaneously.
3. A Secondary VLAN can only join one private VLAN.
4. A Primary VLAN can be associated with multi-Secondary VLANs to create multi-Private VLANs.

➤ **Private VLAN Implementation**

To hide Secondary VLANs from uplink devices and save VLAN resources, Private VLAN containing one Primary VLAN and one Secondary VLAN requires the following characteristics:

- Packets from different Secondary VLANs can be forwarded to the uplink device via promiscuous port and carry no corresponding Secondary VLAN information.
- Packets from Primary VLANs can be sent to end users via host port and carry no Primary VLAN information.

Private VLAN functions are implemented on the **PVLAN Config** and **Port Config** pages.

6.9.1 PVLAN Config

On this page, you can create Private VLAN and view the information of the current defined Private VLANs.

Choose the menu **VLAN**→**Private VLAN**→**PVLAN Config** to load the following page.

Create Private VLAN

Primary VLAN: (2-4094)

Secondary VLAN: (Format:2,4-5,8)

Secondary VLAN Type:

Search Option

Search Option:

Private VLAN Table

Select	Primary VLAN	Secondary VLAN	VLAN Type	Port
No entry in the table.				

Total Private VLAN:0

Note:

It's recommended to create less than 10 Private VLANs at a time.

Figure 6-17 Create Private VLAN

The following entries are displayed on this screen:

➤ **Create Private VLAN**

Primary VLAN: Enter the ID number of the Primary VLAN.

Secondary VLAN: Enter the ID number of the Secondary VLAN.

➤ **Search Option**

Search Option: Select a Search Option from the pull-down list and click the **Search** button to find your desired entry in Private VLAN.

- **All:** Enter either the Primary VLAN ID or Secondary VLAN ID of the desired Private VLAN.
- **Primary VLAN ID:** Enter the Primary VLAN ID number of the desired Private VLAN.
- **Secondary VLAN ID:** Enter the Secondary VLAN ID number of the desired Private VLAN.

➤ **Private VLAN Table**

Select: Select the entry to delete. It is multi-optional.

- Primary VLAN:** Displays the Primary VLAN ID number of the Private VLAN.
- Secondary VLAN:** Displays the Secondary VLAN ID number of the Private VLAN.
- Port:** Displays the port list of the Private VLAN.

6.9.2 Port Config

The Private VLAN provides two Port Types for the ports, Promiscuous and Host. Usually, the Promiscuous port is used to connect to uplink devices while the Host port is used to connect to the terminal hosts, such as PC and Server.

Choose the menu **VLAN**→**Private VLAN**→**Port Config** to load the following page.

Port Config

Port selected: (Format:1/0/1)

Port Type:

Primary VLAN: (2-4094)

Secondary VLAN: (2-4094)

UNIT: LAGS

2	4	6	8	10	12	14	16	18	20	22	24	26	28
1	3	5	7	9	11	13	15	17	19	21	23	25	27

Unselected Port(s)

Selected Port(s)

Not Available for Selection

Private VLAN Port Table

UNIT:

Port ID	Port Type	Operation
No entry in the table.		

NOTE:

If you want to add a Promiscuous port to different Private VLANs with the same Primary VLAN, you just need add the Promiscuous port to any one of these Private VLANs.

Figure 6-18 Create and View Protocol Template

The following entries are displayed on this screen:

➤ **Port Config**

- Port selected:** Select the desired port for configuration. You can input one or select from the port table down the blank.
- Port Type:** Select the Port Type from the pull-down list for the port.
- Primary VLAN:** Specify the Primary VLAN the port belongs to.
- Secondary VLAN:** Specify the Secondary VLAN the port belongs to.

UNIT: Click **1** to configure the physical ports. Click **LAGS** to configure the link aggregation groups.

➤ **Private VLAN Port Table**

Port ID: Displays the port number.

Port Type: Displays the corresponding Port Type.



Note:

1. A Host Port can only join to one Private VLAN.
2. A Promiscuous Port can only join to one Primary VLAN.
3. If you want to add a Promiscuous port to different Private VLANs with the same Primary VLAN, you need to add the Promiscuous port to any one of these Private VLANs.

Configuration Procedure:

Step	Operation	Description
1	Create Private VLAN.	Required. On the VLAN→Private VLAN→PVLAN Config page, Enter the Primary VLAN and Secondary VLAN, select one type of secondary VLAN and then click the Create button.
2	Add ports to Private VLAN	Required. On the VLAN→Private VLAN→Port Config page, select the desired ports and configure the port types and click the Apply button.
3	Delete VLAN.	Optional. On the VLAN→Private VLAN→PVLAN Config page, select the desired entry to delete the corresponding VLAN by clicking the Delete button.

6.10 Application Example for Private VLAN

➤ **Network Requirements**

- Switch C is connecting to switch A, switch A is connecting to switch B;
- Switch A is connecting to VLAN4 and VLAN5;
- Switch B is connecting to VLAN5 and VLAN8;
- For switch C, packets from switch A and switch B have no VLAN tags. Switch C needs not to consider the VLANs of switch A and switch B;

➤ **Network Diagram**

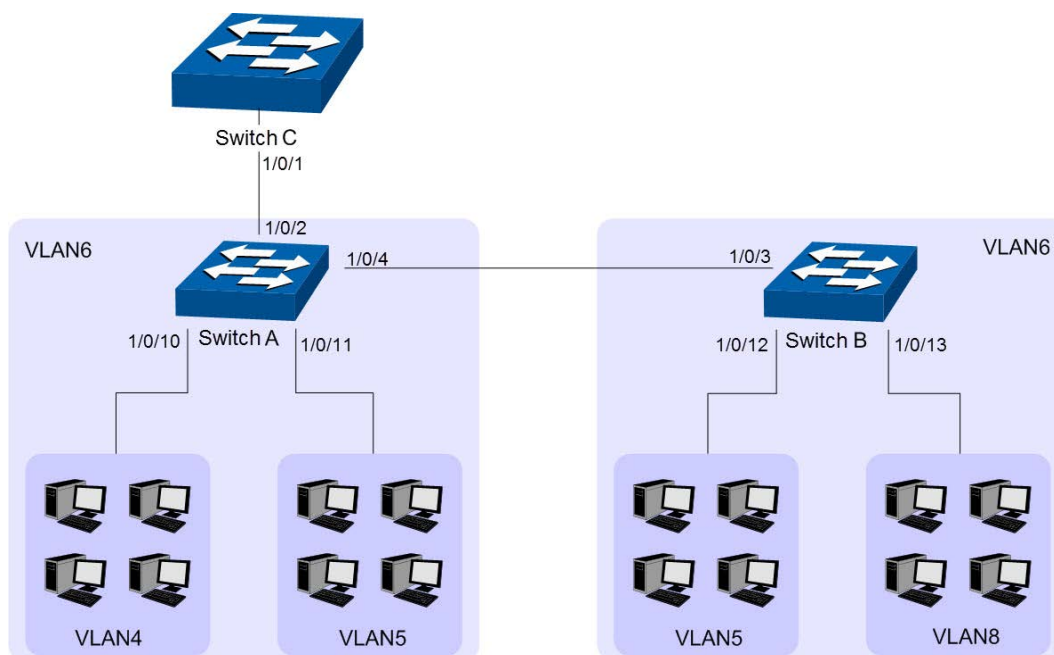

➤ **Configuration Procedure**

- Configure Switch C

Step	Operation	Description
1	Create VLAN6	Required. On VLAN→802.1Q VLAN→VLAN Config page, create a VLAN with its VLAN ID as 6, owning Port 1/0/1.

- Configure switch A

Step	Operation	Description
1	Create Private VLANs.	Required. On the VLAN→Private VLAN→PVLAN Config page, Enter the Primary VLAN 6 and Secondary VLAN 4-5, select one type of secondary VLAN and then click the Create button.
2	Add Promiscuous port to Private VLANs	Required. On the VLAN→Private VLAN→Port Config page, configure the port type of Port 1/0/2 and Port 1/0/4 as Promiscuous , enter Primary VLAN 6 and Secondary VLAN 4, and click the Apply button.
3	Add Host port to Private VLANs	Required. On the VLAN→Private VLAN→Port Config page, configure the port type of Port 1/0/10 as Host , enter Primary VLAN 6 and Secondary VLAN 4, and click the Apply button. Configure the port type of Port 1/0/11 as Host , enter Primary VLAN 6 and Secondary VLAN 5, and click the Apply button

- Configure switch B

Step	Operation	Description
1	Create Private VLANs.	Required. On the VLAN→Private VLAN→PVLAN Config page, enter the Primary VLAN 6 and Secondary VLAN 5 and 8, select one type of secondary VLAN and then click the Create button.

2	Add Promiscuous port to Private VLANs	Required. On the VLAN→Private VLAN→Port Config page, configure the port type of Port 1/0/3 as Promiscuous , enter Primary VLAN 6 and Secondary VLAN 5, and click the Apply button.
3	Add Host port to Private VLANs	Required. On the VLAN→Private VLAN→Port Config page, configure the port type of 1/0/12 as Host , enter Primary VLAN 6 and Secondary VLAN 5, and click the Apply button. Configure the port type of Port 1/0/13 as Host , enter Primary VLAN 6 and Secondary VLAN 8, and click the Apply button

[Return to CONTENTS](#)

Chapter 7 Spanning Tree

STP (Spanning Tree Protocol), subject to IEEE 802.1D standard, is to disbranch a ring network in the Data Link layer in a local network. Devices running STP discover loops in the network and block ports by exchanging information, in that way, a ring network can be disbranched to form a tree-topological ring-free network to prevent packets from being duplicated and forwarded endlessly in the network.

BPDU (Bridge Protocol Data Unit) is the protocol data that STP and RSTP use. Enough information is carried in BPDU to ensure the spanning tree generation. STP is to determine the topology of the network via transferring BPDUs between devices.

To implement spanning tree function, the switches in the network transfer BPDUs between each other to exchange information and all the switches supporting STP receive and process the received BPDUs. BPDUs carry the information that is needed for switches to figure out the spanning tree.

➤ STP Elements

Bridge ID (Bridge Identifier): Indicates the value of the priority and MAC address of the bridge. Bridge ID can be configured and the switch with the lower bridge ID has the higher priority.

Root Bridge: Indicates the switch has the lowest bridge ID. Configure the best PC in the ring network as the root bridge to ensure best network performance and reliability.

Designated Bridge: Indicates the switch has the lowest path cost from the switch to the root bridge in each network segment. BPDUs are forwarded to the network segment through the designated bridge. The switch with the lowest bridge ID will be chosen as the designated bridge.

Root Path Cost: Indicates the sum of the path cost of the root port and the path cost of all the switches that packets pass through. The root path cost of the root bridge is 0.

Bridge Priority: The bridge priority can be set to a value in the range of 0~32768. The lower value priority has the higher priority. The switch with the higher priority has more chance to be chosen as the root bridge.

Root Port: Indicates the port that has the lowest path cost from this bridge to the Root Bridge and forwards packets to the root.

Designated Port: Indicates the port that forwards packets to a downstream network segment or switch.

Port Priority: The port priority can be set to a value in the range of 0~255. The lower value priority has the higher priority. The port with the higher priority has more chance to be chosen as the root port.

Path Cost: Indicates the parameter for choosing the link path by STP. By calculating the path cost, STP chooses the better links and blocks the redundant links so as to disbranch the ring-network to form a tree-topological ring-free network.

The following network diagram shows the sketch map of spanning tree. Switch A, B and C are connected together in order. After STP generation, switch A is chosen as root bridge, the path from port 2 to port 6 is blocked.

- Bridge: Switch A is the root bridge in the whole network; switch B is the designated bridge of switch C.
- Port: Port 3 is the root port of switch B and port 5 is the root port of switch C; port 1 is the designated port of switch A and port 4 is the designated port of switch B; port 6 is the blocked port of switch C.

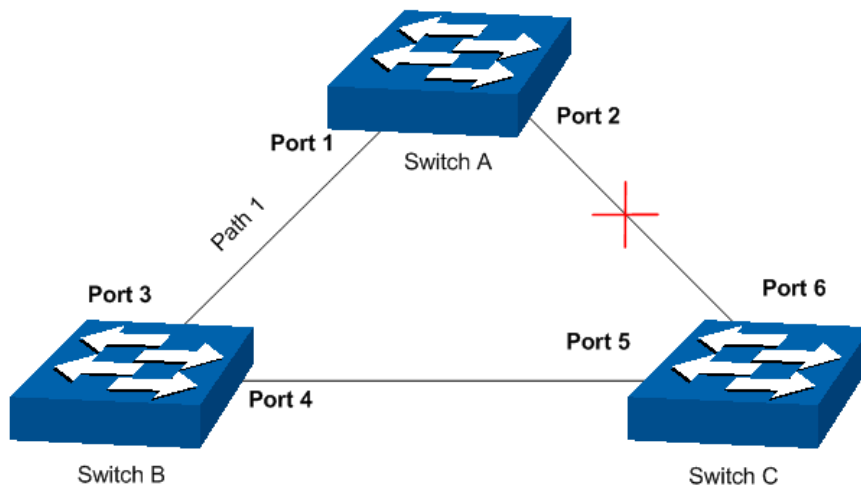

Figure 7-1 Basic STP diagram

➤ STP Timers

Hello Time:

Hello Time ranges from 1 to 10 seconds. It specifies the interval to send BPDU packets. It is used to test the links.

Max. Age:

Max. Age ranges from 6 to 40 seconds. It specifies the maximum time the switch can wait without receiving a BPDU before attempting to reconfigure.

Forward Delay:

Forward Delay ranges from 4 to 30 seconds. It specifies the time for the port to transit its state after the network topology is changed.

When the STP regeneration caused by network malfunction occurs, the STP structure will get some corresponding change. However, as the new configuration BPDUs cannot be spread in the whole network at once, the temporal loop will occur if the port transits its state immediately. Therefore, STP adopts a state transit mechanism, that is, the new root port and the designated port begins to forward data after twice forward delay, which ensures the new configuration BPDUs are spread in the whole network.

➤ BPDU Comparing Principle in STP mode

Assuming two BPDUs: BPDU X and BPDU Y

If the root bridge ID of X is smaller than that of Y, X is superior to Y.

If the root bridge ID of X equals that of Y, but the root path cost of X is smaller than that of Y, X is superior to Y.

If the root bridge ID and the root path cost of X equal those of Y, but the bridge ID of X is smaller than that of Y, X is superior to Y.

If the root bridge ID, the root path cost and bridge ID of X equal those of Y, but the port ID of X is smaller than that of Y, X is superior to Y.

➤ STP Generation

- In the beginning

In the beginning, each switch regards itself as the root, and generates a configuration BPDU for each port on it as a root, with the root path cost being 0, the ID of the designated bridge being that of the switch, and the designated port being itself.

- Comparing BPDUs

Each switch sends out configuration BPDUs and receives a configuration BPDU on one of its ports from another switch. The following table shows the comparing operations.

Step	Operation
1	If the priority of the BPDU received on the port is lower than that of the BPDU if of the port itself, the switch discards the BPDU and does not change the BPDU of the port.
2	If the priority of the BPDU is higher than that of the BPDU of the port itself, the switch replaces the BPDU of the port with the received one and compares it with those of other ports on the switch to obtain the one with the highest priority.

Table 7-1 Comparing BPDUs

- Selecting the root bridge

The root bridge is selected by BPDU comparing. The switch with the smallest root ID is chosen as the root bridge.

- Selecting the root port and designate port

The operation is taken in the following way:

Step	Operation
1	For each switch (except the one chosen as the root bridge) in a network, the port that receives the BPDU with the highest priority is chosen as the root port of the switch.
2	Using the root port BPDU and the root path cost, the switch generates a designated port BPDU for each of its ports. <ul style="list-style-type: none"> • Root ID is replaced with that of the root port; • Root path is replaced with the sum of the root path cost of the root port and the path cost between this port and the root port; • The ID of the designated bridge is replaced with that of the switch; • The ID of the designated port is replaced with that of the port.
3	The switch compares the resulting BPDU with the BPDU of the desired port whose role you want to determine. <ul style="list-style-type: none"> • If the resulting BPDU takes the precedence over the BPDU of the port, the port is chosen as the designated port and the BPDU of this port is replaced with the resulting BPDU. The port regularly sends out the resulting BPDU; • If the BPDU of this port takes the precedence over the resulting BPDU, the BPDU of this port is not replaced and the port is blocked. The port only can receive BPDUs.

Table 7-2 Selecting root port and designated port



Tips:

In a STP with stable topology, only the root port and designated port can forward data, and the other ports are blocked. The blocked ports only can receive BPDUs.

RSTP (Rapid Spanning Tree Protocol), evolved from the 802.1D STP standard, enable Ethernet ports to transit their states rapidly. The premises for the port in the RSTP to transit its state rapidly are as follows.

- The condition for the root port to transit its port state rapidly: The old root port of the switch stops forwarding data and the designated port of the upstream switch begins to forward data.
- The condition for the designated port to transit its port state rapidly: The designated port is an edge port or connecting to a point-to-point link. If the designated port is an edge port, it can directly transit to forwarding state; if the designated port is connecting to a point-to-point link, it can transit to forwarding state after getting response from the downstream switch through handshake.

➤ **RSTP Elements**

Edge Port: Indicates the port connected directly to terminals.

P2P Link: Indicates the link between two switches directly connected.

MSTP (Multiple Spanning Tree Protocol), compatible with both STP and RSTP and subject to IEEE 802.1s standard, not only enables spanning trees to converge rapidly, but also enables packets of different VLANs to be forwarded along their respective paths so as to provide redundant links with a better load-balancing mechanism.

Features of MSTP:

- MSTP combines VLANs and spanning tree together via VLAN-to-instance mapping table. It binds several VLANs to an instance to save communication cost and network resources.
- MSTP divides a spanning tree network into several regions. Each region has several internal spanning trees, which are independent of each other.
- MSTP provides a load-balancing mechanism for the packets transmission in the VLAN.
- MSTP is compatible with both STP and RSTP.

➤ **MSTP Elements**

MST Region (Multiple Spanning Tree Region): An MST Region comprises switches with the same region configuration and VLAN-to-Instances mapping relationship.

IST (Internal Spanning Tree): An IST is a spanning tree in an MST.

CST (Common Spanning Tree): A CST is the spanning tree in a switched network that connects all MST regions in the network.

CIST (Common and Internal Spanning Tree): A CIST, comprising IST and CST, is the spanning tree in a switched network that connects all switches in the network.

The following figure shows the network diagram in MSTP.

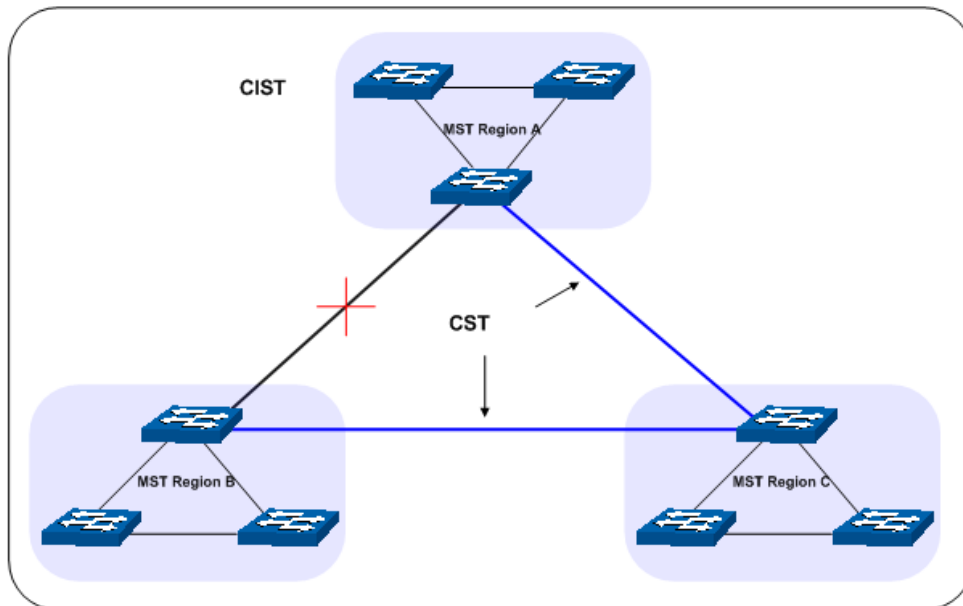

Figure 7-2 Basic MSTP diagram

➤ **MSTP**

MSTP divides a network into several MST regions. The CST is generated between these MST regions, and multiple spanning trees can be generated in each MST region. Each spanning tree is called an instance. As well as STP, MSTP uses BPDUs to generate spanning tree. The only difference is that the BPDUs for MSTP carry the MSTP configuration information on the switches.

➤ **Port States**

In an MSTP, ports can be in the following four states:

- Forwarding: In this status the port can receive/forward data, receive/send BPDUs as well as learn MAC address.
- Learning: In this status the port can receive/send BPDUs and learn MAC address.
- Blocking: In this status the port can only receive BPDUs.
- Disconnected: In this status the port is not participating in the STP.

➤ **Port Roles**

In an MSTP, the following roles exist:

- Root Port: Indicates the port that has the lowest path cost from this bridge to the Root Bridge and forwards packets to the root.
- Designated Port: Indicates the port that forwards packets to a downstream network segment or switch.
- Master Port: Indicates the port that connects a MST region to the common root. The path from the master port to the common root is the shortest path between this MST region and the common root.
- Alternate Port: Indicates the port that can be a backup port of a root or master port.
- Backup Port: Indicates the port that is the backup port of a designated port.
- Disabled: Indicates the port that is not participating in the STP.

The following diagram shows the different port roles.

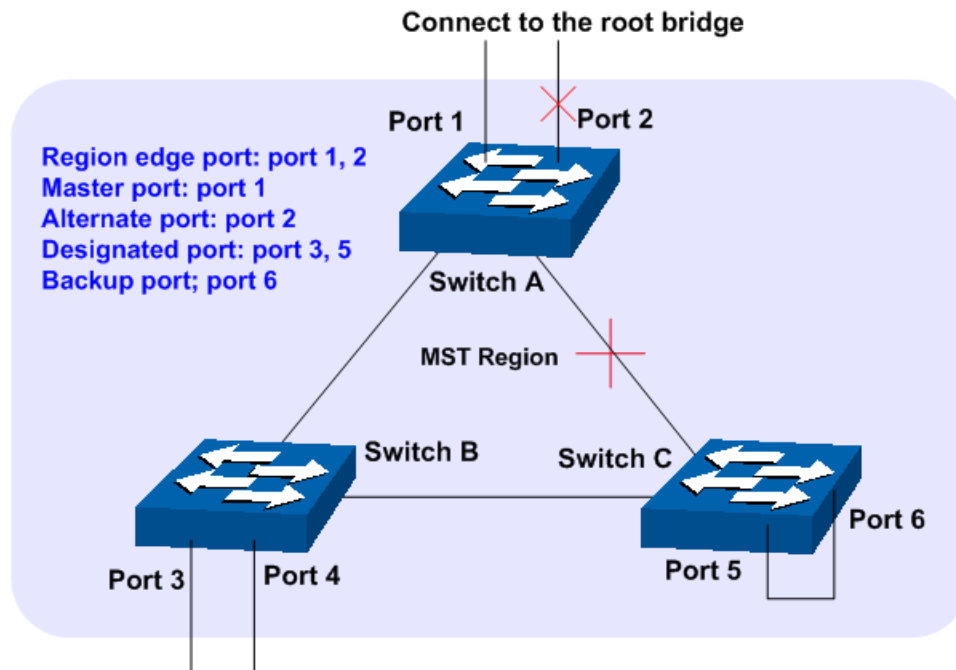

Figure 7-3 Port roles

The Spanning Tree module is mainly for spanning tree configuration of the switch, including four submenus: **STP Config**, **Port Config**, **MSTP Instance** and **STP Security**.

7.1 STP Config

The STP Config function, for global configuration of spanning trees on the switch, can be implemented on **STP Config** and **STP Summary** pages.

7.1.1 STP Config

Before configuring spanning trees, you should make clear the roles each switch plays in each spanning tree instance. Only one switch can be the root bridge in each spanning tree instance. On this page you can globally configure the spanning tree function and related parameters.

Choose the menu **Spanning Tree**→**STP Config**→**STP Config** to load the following page.

Global Config

STP: Enable Disable

Version:

Parameters Config

CIST Priority: (0-61440)

Hello Time: sec (1-10)

Max Age: sec (6-40)

Forward Delay: sec (4-30)

TxHoldCount: pps (1-20)

Max Hops: hop (1-40)

Figure 7-4 STP Config

The following entries are displayed on this screen:

➤ **Global Config**

Spanning-Tree: Select Enable/Disable STP function globally on the switch.

Mode: Select the desired STP mode on the switch.

- **STP:** Spanning Tree Protocol.
- **RSTP:** Rapid Spanning Tree Protocol.
- **MSTP:** Multiple Spanning Tree Protocol.

➤ **Parameters Config**

CIST Priority: Enter a value from 0 to 61440 to specify the priority of the switch for comparison in the CIST. CIST priority is an important criterion on determining the root bridge. In the same condition, the switch with the highest priority will be chosen as the root bridge. The lower value has the higher priority. The default value is 32768 and should be exact divisor of 4096.

Hello Time Enter a value from 1 to 10 in seconds to specify the interval to send BPDU packets. It is used to test the links. $2 * (\text{Hello Time} + 1) \leq \text{Max Age}$. The default value is 2 seconds.

Max Age: Enter a value from 6 to 40 in seconds to specify the maximum time the switch can wait without receiving a BPDU before attempting to reconfigure. The default value is 20 seconds.

Forward Delay: Enter a value from 4 to 30 in seconds to specify the time for the port to transit its state after the network topology is changed. $2 * (\text{Forward Delay} - 1) \geq \text{Max Age}$. The default value is 15 seconds.

TxHold Count: Enter a value from 1 to 20 to set the maximum number of BPDU packets transmitted per Hello Time interval. The default value is 5pps.

Max Hops: Enter a value from 1 to 40 to set the maximum number of hops that occur in a specific region before the BPDU is discarded. The default value is 20 hops.



Note:

1. The forward delay parameter and the network diameter are correlated. A too small forward delay parameter may result in temporary loops. A too large forward delay may cause a network unable to resume the normal state in time. The default value is recommended.
2. An adequate hello time parameter can enable the switch to discover the link failures occurred in the network without occupying too much network resources. A too large hello time parameter may result in normal links being regarded as invalid when packets drop occurred in the links, which in turn result in spanning tree being regenerated. A too small hello time parameter may result in duplicated configuration being sent frequently, which increases the network load of the switches and wastes network resources. The default value is recommended.
3. A too small max age parameter may result in the switches regenerating spanning trees frequently and cause network congestions to be falsely regarded as link problems. A too large max age parameter result in the switches unable to find the link problems in time, which in turn handicaps spanning trees being regenerated in time and makes the network less adaptive. The default value is recommended.
4. If the TxHold Count parameter is too large, the number of MSTP packets being sent in each hello time may be increased with occupying too much network resources. The default value is recommended.

7.1.2 STP Summary

On this page you can view the related parameters for Spanning Tree function.

Choose the menu **Spanning Tree**→**STP Config**→**STP Summary** to load the following page.

STP Summary	
Spanning-Tree :	Disable
Spanning-Tree Mode :	--
Local Bridge :	--
Root Bridge :	--
External Path Cost :	--
Regional Root Bridge :	--
Internal Path Cost :	--
Designated Bridge :	--
Root Port :	--
Latest TC Time :	--
TC Count :	0

MSTP Instance Summary	
Instance ID :	1 ▾
Instance Status :	Disable
Local Bridge :	--
Regional Root Bridge :	--
Internal Path Cost :	--
Designated Bridge :	--
Root Port :	--
Latest TC Time :	--
TC Count :	--

Figure 7-5 STP Summary

7.2 Port Config

On this page you can configure the parameters of the ports for CIST.

Choose the menu **Spanning Tree**→**Port Config** to load the following page.

Select	Port	Status	Priority	Ext-Path Cost	Int-Path Cost	Edge Port	P2P Link	MCheck	Port Mode	Port Role	Port Status	LAG
<input type="checkbox"/>												
<input type="checkbox"/>	1/0/1	Disable	128	Auto	Auto	Disable	Auto	---	---	---	---	---
<input type="checkbox"/>	1/0/2	Disable	128	Auto	Auto	Disable	Auto	---	---	---	---	---
<input type="checkbox"/>	1/0/3	Disable	128	Auto	Auto	Disable	Auto	---	---	---	---	---
<input type="checkbox"/>	1/0/4	Disable	128	Auto	Auto	Disable	Auto	---	---	---	---	---
<input type="checkbox"/>	1/0/5	Disable	128	Auto	Auto	Disable	Auto	---	---	---	---	---
<input type="checkbox"/>	1/0/6	Disable	128	Auto	Auto	Disable	Auto	---	---	---	---	---
<input type="checkbox"/>	1/0/7	Disable	128	Auto	Auto	Disable	Auto	---	---	---	---	---
<input type="checkbox"/>	1/0/8	Disable	128	Auto	Auto	Disable	Auto	---	---	---	---	---
<input type="checkbox"/>	1/0/9	Disable	128	Auto	Auto	Disable	Auto	---	---	---	---	---
<input type="checkbox"/>	1/0/10	Disable	128	Auto	Auto	Disable	Auto	---	---	---	---	---
<input type="checkbox"/>	1/0/11	Disable	128	Auto	Auto	Disable	Auto	---	---	---	---	---
<input type="checkbox"/>	1/0/12	Disable	128	Auto	Auto	Disable	Auto	---	---	---	---	---
<input type="checkbox"/>	1/0/13	Disable	128	Auto	Auto	Disable	Auto	---	---	---	---	---
<input type="checkbox"/>	1/0/14	Disable	128	Auto	Auto	Disable	Auto	---	---	---	---	---
<input type="checkbox"/>	1/0/15	Disable	128	Auto	Auto	Disable	Auto	---	---	---	---	---

Note :
If the Path Cost of a port is set to 0, it will alter automatically according to the port's link speed.

Figure 7-6 Port Config

The following entries are displayed on this screen:

➤ Port Config

UNIT:1/LAGS: Click **1** to configure the physical ports. Click **LAGS** to configure the link aggregation groups.

Select: Select the desired port for STP configuration. It is multi-optional.

Port: Displays the port number of the switch.

Status: Select Enable /Disable STP function for the desired port.

Priority: Enter a value from 0 to 240 divisible by 16. Port priority is an important criterion on determining if the port connected to this port will be chosen as the root port. The lower value has the higher priority.

ExtPath Cost: ExtPath Cost is used to choose the path and calculate the path costs of ports in different MST regions. It is an important criterion on determining the root port. The lower value has the higher priority.

IntPath Cost: IntPath Cost is used to choose the path and calculate the path costs of ports in an MST region. It is an important criterion on determining the root port. The lower value has the higher priority.

Edge Port: Select Enable/Disable Edge Port. The edge port can transit its state from blocking to forwarding rapidly without waiting for forward delay.

P2P Link: Select the P2P link status. If the two ports in the P2P link are root port or designated port, they can transit their states to forwarding rapidly to reduce the unnecessary forward delay.

MCheck: Select Enable to perform MCheck operation on the port. Unchange means no MCheck operation.

- Port Mode:** Display the spanning tree mode of the port.
- Port Role:** Displays the role of the port played in the STP Instance.
- **Root Port:** Indicates the port that has the lowest path cost from this bridge to the Root Bridge and forwards packets to the root.
 - **Designated Port:** Indicates the port that forwards packets to a downstream network segment or switch.
 - **Master Port:** Indicates the port that connects a MST region to the common root. The path from the master port to the common root is the shortest path between this MST region and the common root.
 - **Alternate Port:** Indicates the port that can be a backup port of a root or master port.
 - **Backup Port:** Indicates the port that is the backup port of a designated port.
 - **Disabled:** Indicates the port that is not participating in the STP.
- Port Status:** Displays the working status of the port.
- **Forwarding:** In this status the port can receive/forward data, receive/send BPDU packets as well as learn MAC address.
 - **Learning:** In this status the port can receive/send BPDU packets and learn MAC address.
 - **Blocking:** In this status the port can only receive BPDU packets.
 - **Disconnected:** In this status the port is not participating in the STP.
- LAG:** Displays the LAG number which the port belongs to.



Note:

1. Configure the ports connected directly to terminals as edge ports and enable the BPDU protection function as well. This not only enables these ports to transit to forwarding state rapidly but also secures your network.
2. All the links of ports in a LAG can be configured as point-to-point links.
3. When the link of a port is configured as a point-to-point link, the spanning tree instances owning this port are configured as point-to-point links. If the physical link of a port is not a point-to-point link and you forcibly configure the link as a point-to-point link, temporary loops may be incurred.

7.3 MSTP Instance

MSTP combines VLANs and spanning tree together via VLAN-to-instance mapping table (VLAN-to-spanning-tree mapping). By adding MSTP instances, it binds several VLANs to an instance to realize the load balance based on instances.

Only when the switches have the same MST region name, MST region revision and VLAN-to-Instance mapping table, the switches can be regarded as in the same MST region.

The MSTP Instance function can be implemented on **Region Config**, **Instance Config** and **Instance Port Config** pages.

7.3.1 Region Config

On this page you can configure the name and revision of the MST region.

Choose the menu **Spanning Tree**→**MSTP Instance**→**Region Config** to load the following page.

Region Config

Region Name:

Revision: (0-65535)

Figure 7-7 Region Config

The following entries are displayed on this screen:

➤ Region Config

Region Name: Create a name for MST region identification using up to 32 characters.

Revision: Enter the revision from 0 to 65535 for MST region identification.

7.3.2 Instance Config

Instance Configuration, a property of MST region, is used to describe the VLAN to Instance mapping configuration. You can assign VLAN to different instances appropriate to your needs. Every instance is a VLAN group independent of other instances and CIST.

Choose the menu **Spanning Tree**→**MSTP Instance**→**Instance Config** to load the following page.

VLAN-Instance Mapping

Instance ID : (0-8, 0 stand for CIST)

VLAN ID : (1-4094, format: 1,3,4-7,11-30)

Select	Instance ID	Status	Priority	VLAN ID	
<input type="checkbox"/>			<input type="text"/>	<input type="text"/>	
<input type="checkbox"/>	CIST	Disable	32768	1-4094,	Show All Clear All
<input type="checkbox"/>	1	Disable	32768		Show All Clear All
<input type="checkbox"/>	2	Disable	32768		Show All Clear All
<input type="checkbox"/>	3	Disable	32768		Show All Clear All
<input type="checkbox"/>	4	Disable	32768		Show All Clear All
<input type="checkbox"/>	5	Disable	32768		Show All Clear All
<input type="checkbox"/>	6	Disable	32768		Show All Clear All
<input type="checkbox"/>	7	Disable	32768		Show All Clear All
<input type="checkbox"/>	8	Disable	32768		Show All Clear All

Note :

Instance(except CIST) will be automatically enabled when VLAN ID is mapped to it.

Figure 7-8 Instance Config

The following entries are displayed on this screen:

➤ **VLAN-Instance Mapping**

- Instance ID:** Enter the corresponding instance ID.
- VLAN ID:** Enter the desired VLAN ID. After modification here, the new VLAN ID will be added to the corresponding instance ID and the previous VLAN ID won't be replaced.

➤ **Instance Table**

- Select:** Select the desired Instance ID for configuration. It is multi-optional.
- Instance ID:** Displays Instance ID of the switch.
- Status:** Displays status of the instance.
- Priority:** Enter the priority of the switch in the instance. It is an important criterion on determining if the switch will be chosen as the root bridge in the specific instance.
- VLAN ID:** Enter the VLAN ID which belongs to the corresponding instance ID. After modification here, the previous VLAN ID will be cleared and mapped to the CIST.
- Clear All:** Click **Clear All** to clear up all VLAN IDs from the instance ID. The cleared VLAN ID will be automatically mapped to the CIST.

7.3.3 Instance Port Config

A port can play different roles in different spanning tree instance. On this page you can configure the parameters of the ports in different instance IDs as well as view status of the ports in the specified instance.

Choose the menu **Spanning Tree**→**MSTP Instance**→**Instance Port Config** to load the following page.

Instance ID Select

Instance ID :

Instance Port Config

UNIT: LAGS

Select	Port	Priority	Path Cost	Port Role	Port Status	LAG
<input type="checkbox"/>		<input type="text"/>	<input type="text"/>			
<input type="checkbox"/>	1/0/1	128	Auto	---	---	---
<input type="checkbox"/>	1/0/2	128	Auto	---	---	---
<input type="checkbox"/>	1/0/3	128	Auto	---	---	---
<input type="checkbox"/>	1/0/4	128	Auto	---	---	---
<input type="checkbox"/>	1/0/5	128	Auto	---	---	---
<input type="checkbox"/>	1/0/6	128	Auto	---	---	---
<input type="checkbox"/>	1/0/7	128	Auto	---	---	---
<input type="checkbox"/>	1/0/8	128	Auto	---	---	---
<input type="checkbox"/>	1/0/9	128	Auto	---	---	---
<input type="checkbox"/>	1/0/10	128	Auto	---	---	---
<input type="checkbox"/>	1/0/11	128	Auto	---	---	---
<input type="checkbox"/>	1/0/12	128	Auto	---	---	---
<input type="checkbox"/>	1/0/13	128	Auto	---	---	---
<input type="checkbox"/>	1/0/14	128	Auto	---	---	---
<input type="checkbox"/>	1/0/15	128	Auto	---	---	---

Note :
If the Path Cost of a port is set to 0, it will alter automatically according to the port's link speed.

Figure 7-9 Instance Port Config

The following entries are displayed on this screen:

➤ **Instance ID Select**

Instance ID: Select the desired instance ID for its port configuration.

➤ **Instance Port Config**

UNIT:1/LAGS: Click **1** to configure the physical ports. Click **LAGS** to configure the link aggregation groups.

Select: Select the desired port to specify its priority and path cost. It is multi-optional.

Port: Displays the port number of the switch.

Priority: Enter the priority of the port in the instance. It is an important criterion on determining if the port connected to this port will be chosen as the root port.

Path Cost: Path Cost is used to choose the path and calculate the path costs of ports in an MST region. It is an important criterion on determining the root port. The lower value has the higher priority.

Port Role:	Displays the role of the port played in the MSTP Instance.
Port Status:	Displays the working status of the port.
LAG:	Displays the LAG number which the port belongs to.



Note:

The port status of one port in different spanning tree instances can be different.

Global configuration Procedure for Spanning Tree function:

Step	Operation	Description
1	Make clear roles the switches play in spanning tree instances: root bridge or designated bridge	Preparation.
2	Globally configure MSTP parameters	Required. Enable Spanning Tree function on the switch and configure MSTP parameters on Spanning Tree → STP Config → STP Config page.
3	Configure MSTP parameters for ports	Required. Configure MSTP parameters for ports on Spanning Tree → Port Config → Port Config page.
4	Configure the MST region	Required. Create MST region and configure the role the switch plays in the MST region on Spanning Tree → MSTP Instance → Region Config and Instance Config page.
5	Configure MSTP parameters for instance ports	Optional. Configure different instances in the MST region and configure MSTP parameters for instance ports on Spanning Tree → MSTP Instance → Instance Port Config page.

7.4 STP Security

Configuring protection function for devices can prevent devices from any malicious attack against STP features. The STP Security function can be implemented on **Port Protect** and **TC Protect** pages.

Port Protect function is to prevent the devices from any malicious attack against STP features.

7.4.1 Port Protect

On this page you can configure loop protect feature, root protect feature, TC protect feature, BPDU protect feature and BPDU filter feature for ports. You are suggested to enable corresponding protection feature for the qualified ports.

➤ Loop Protect

In a stable network, a switch maintains the states of ports by receiving and processing BPDU packets from the upstream switch. However, when link congestions or link failures occurred to the network, a down stream switch does not receive BPDU packets for certain period, which results in spanning trees being regenerated and roles of ports being reselected, and causes the blocked ports to transit to forwarding state. Therefore, loops may be incurred in the network.

The loop protect function can suppresses loops. With this function enabled, a port, regardless of the role it plays in instances, is always set to blocking state, when the port does not receive BPDU

packets from the upstream switch and spanning trees are regenerated, and thereby loops can be prevented.

➤ **Root Protect**

A CIST and its secondary root bridges are usually located in the high-bandwidth core region. Wrong configuration or malicious attacks may result in configuration BPDU packets with higher priorities being received by the legal root bridge, which causes the current legal root bridge to lose its position and network topology jitter to occur. In this case, flows that should travel along high-speed links may lead to low-speed links, and network congestion may occur.

To avoid this, MSTP provides root protect function. Ports with this function enabled can only be set as designated ports in all spanning tree instances. When a port of this type receives BPDU packets with higher priority, it transits its state to blocking state and stops forwarding packets (as if it is disconnected from the link). The port resumes the normal state if it does not receive any configuration BPDU packets with higher priorities for a period of two times of forward delay.

➤ **TC Protect**

A switch removes MAC address entries upon receiving TC-BPDU packets. If a user maliciously sends a large amount of TC-BPDU packets to a switch in a short period, the switch will be busy with removing MAC address entries, which may decrease the performance and stability of the network.

To prevent the switch from frequently removing MAC address entries, you can enable the TC protect function on the switch. With TC protect function enabled, if the account number of the received TC-BPDUs exceeds the maximum number you set in the TC threshold field, the switch will not perform the removing operation in the TC protect cycle. Such a mechanism prevents the switch from frequently removing MAC address entries.

➤ **BPDU Protect**

Ports of the switch directly connected to PCs or servers are configured as edge ports to rapidly transit their states. When these ports receive BPDUs, the system automatically configures these ports as non-edge ports and regenerates spanning trees, which may cause network topology jitter. Normally these ports do not receive BPDUs, but if a user maliciously attacks the switch by sending BPDUs, network topology jitter occurs.

To prevent this attack, MSTP provides BPDU protect function. With this function enabled on the switch, the switch shuts down the edge ports that receive BPDUs and reports these cases to the administrator. If a port is shut down, only the administrator can restore it.

➤ **BPDU Filter**

BPDU filter function is to prevent BPDUs flood in the STP network. If a switch receives malicious BPDUs, it forwards these BPDUs to the other switched in the network, which may result in spanning trees being continuously regenerated. In this case, the switch occupying too much CPU or the protocol status of BPDUs is wrong.

With BPDU filter function enabled, a port does not receive or forward BPDUs, but it sends out its own BPDUs. Such a mechanism prevents the switch from being attacked by BPDUs so as to guarantee generation the spanning trees correct.

Choose the menu **Spanning Tree**→**STP Security**→**Port Protect** to load the following page.

Select	Port	Loop Protect	Root Protect	TC Protect	BPDU Protect	BPDU Filter	LAG
<input type="checkbox"/>							
<input type="checkbox"/>	1/0/1	Disable	Disable	Disable	Disable	Disable	---
<input type="checkbox"/>	1/0/2	Disable	Disable	Disable	Disable	Disable	---
<input type="checkbox"/>	1/0/3	Disable	Disable	Disable	Disable	Disable	---
<input type="checkbox"/>	1/0/4	Disable	Disable	Disable	Disable	Disable	---
<input type="checkbox"/>	1/0/5	Disable	Disable	Disable	Disable	Disable	---
<input type="checkbox"/>	1/0/6	Disable	Disable	Disable	Disable	Disable	---
<input type="checkbox"/>	1/0/7	Disable	Disable	Disable	Disable	Disable	---
<input type="checkbox"/>	1/0/8	Disable	Disable	Disable	Disable	Disable	---
<input type="checkbox"/>	1/0/9	Disable	Disable	Disable	Disable	Disable	---
<input type="checkbox"/>	1/0/10	Disable	Disable	Disable	Disable	Disable	---
<input type="checkbox"/>	1/0/11	Disable	Disable	Disable	Disable	Disable	---
<input type="checkbox"/>	1/0/12	Disable	Disable	Disable	Disable	Disable	---
<input type="checkbox"/>	1/0/13	Disable	Disable	Disable	Disable	Disable	---
<input type="checkbox"/>	1/0/14	Disable	Disable	Disable	Disable	Disable	---
<input type="checkbox"/>	1/0/15	Disable	Disable	Disable	Disable	Disable	---

Figure 7-10 Port Protect

The following entries are displayed on this screen:

➤ **Port Protect**

- UNIT:1/LAGS:** Click **1** to configure the physical ports. Click **LAGS** to configure the link aggregation groups.
- Select:** Select the desired port for port protect configuration. It is multi-optional.
- Port:** Displays the port number of the switch.
- Loop Protect:** Loop Protect is to prevent the loops in the network brought by recalculating STP because of link failures and network congestions.
- Root Protect:** Root Protect is to prevent wrong network topology change caused by the role change of the current legal root bridge.
- TC Protect:** TC Protect is to prevent the decrease of the performance and stability of the switch brought by continuously removing MAC address entries upon receiving TC-BPDUs in the STP network.
- BPDU Protect:** BPDU Protect is to prevent the edge port from being attacked by maliciously created BPDUs
- BPDU Filter:** BPDU Filter is to prevent BPDUs flood in the STP network.
- LAG:** Displays the LAG number which the port belongs to.

7.4.2 TC Protect

When TC Protect is enabled for the port on **Port Protect** page, the TC threshold and TC protect cycle need to be configured on this page.

Choose the menu **Spanning Tree**→**STP Security**→**TC Protect** to load the following page.

TC Protect

TC Threshold: packet (1-100)

TC Protect Cycle: sec (1-10)

Apply

Help

Figure 7-11 TC Protect

The following entries are displayed on this screen:

➤ TC Protect

TC Threshold: Enter a number from 1 to 100. It is the maximum number of the TC-BPDUs received by the switch in a TC Protect Cycle. The default value is 20.

TC Protect Cycle: Enter a value from 1 to 10 to specify the TC Protect Cycle. The default value is 5.

7.5 Application Example for STP Function

➤ Network Requirements

- Switch A, B, C, D and E all support MSTP function.
- A is the central switch.
- B and C are switches in the convergence layer. D, E and F are switches in the access layer.
- There are 6 VLANs labeled as VLAN101-VLAN106 in the network.
- All switches run MSTP and belong to the same MST region.
- The data in VLAN101, 103 and 105 are transmitted in the STP with B as the root bridge. The data in VLAN102, 104 and 106 are transmitted in the STP with C as the root bridge.

➤ **Network Diagram**

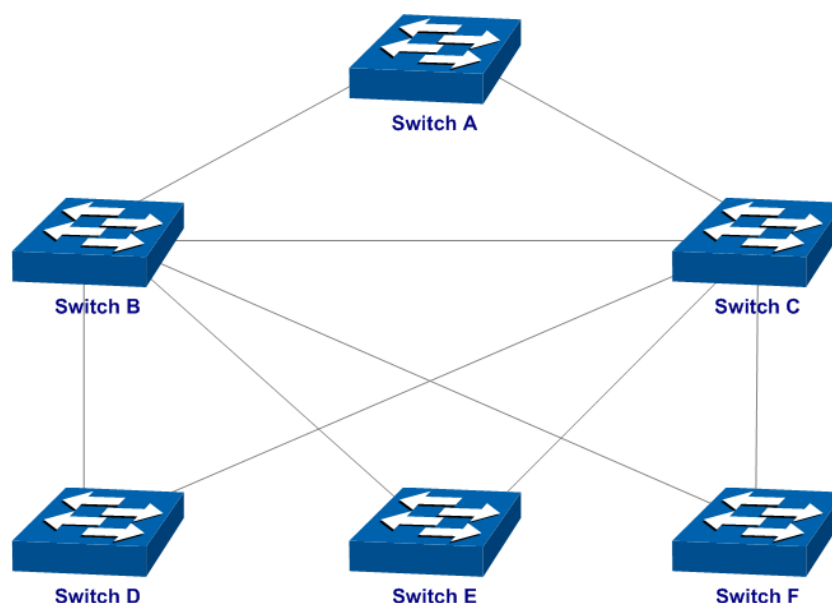

➤ **Configuration Procedure**

- Configure Switch A:

Step	Operation	Description
1	Configure ports	On VLAN→802.1Q VLAN→VLAN Config page, configure the link type of the related ports as Tagged, and add the ports to VLAN101-VLAN106. The detailed instructions can be found in the section 802.1Q VLAN .
2	Enable STP function	On Spanning Tree→STP Config→STP Config page, enable STP function and select MSTP version. On Spanning Tree→STP Config→Port Config page, enable MSTP function for the port.
3	Configure the region name and the revision of MST region	On Spanning Tree→MSTP Instance→Region Config page, configure the region as TP-LINK and keep the default revision setting.
4	Configure VLAN-to-Instance mapping table of the MST region	On Spanning Tree→MSTP Instance→Instance Config page, configure VLAN-to-Instance mapping table. Map VLAN 101, 103 and 105 to Instance 1; map VLAN 102, 104 and 106 to Instance 2.

- Configure Switch B:

Step	Operation	Description
1	Configure ports	On VLAN→802.1Q VLAN→VLAN Config page, configure the link type of the related ports as Tagged, and add the ports to VLAN101-VLAN106. The detailed instructions can be found in the section 802.1Q VLAN .
2	Enable STP function	On Spanning Tree→STP Config→STP Config page, enable STP function and select MSTP version. On Spanning Tree→STP Config→Port Config page, enable MSTP function for the port.

Step	Operation	Description
3	Configure the region name and the revision of MST region	On Spanning Tree→MSTP Instance→Region Config page, configure the region as TP-LINK and keep the default revision setting.
4	Configure VLAN-to-Instance mapping table of the MST region	On Spanning Tree→MSTP Instance→Instance Config page, configure VLAN-to-Instance mapping table. Map VLAN 101, 103 and 105 to Instance 1; map VLAN 102, 104 and 106 to Instance 2.
5	Configure switch B as the root bridge of Instance 1	On Spanning Tree→MSTP Instance→Instance Config page, configure the priority of Instance 1 to be 0.
6	Configure switch B as the designated bridge of Instance 2	On Spanning Tree→MSTP Instance→Instance Config page, configure the priority of Instance 2 to be 4096.

- Configure Switch C:

Step	Operation	Description
1	Configure ports	On VLAN→802.1Q VLAN→VLAN Config page, configure the link type of the related ports as Tagged, and add the ports to VLAN101-VLAN106. The detailed instructions can be found in the section 802.1Q VLAN .
2	Enable STP function	On Spanning Tree→STP Config→STP Config page, enable STP function and select MSTP version. On Spanning Tree→STP Config→Port Config page, enable MSTP function for the port.
3	Configure the region name and the revision of MST region	On Spanning Tree→MSTP Instance→Region Config page, configure the region as TP-LINK and keep the default revision setting.
4	Configure VLAN-to-Instance mapping table of the MST region	On Spanning Tree→MSTP Instance→Instance Config page, configure VLAN-to-Instance mapping table. Map VLAN101, 103 and 105 to Instance 1; map VLAN102, 104 and 106 to Instance 2.
5	Configure switch C as the root bridge of Instance 1	On Spanning Tree→MSTP Instance→Instance Config page, configure the priority of Instance 1 to be 4096.
6	Configure switch C as the root bridge of Instance 2	On Spanning Tree→MSTP Instance→Instance Config page, configure the priority of Instance 2 to be 0.

- Configure Switch D:

Step	Operation	Description
1	Configure ports	On VLAN→802.1Q VLAN→VLAN Config page, configure the link type of the related ports as Tagged, and add the ports to VLAN101-VLAN106. The detailed instructions can be found in the section 802.1Q VLAN .
2	Enable STP function	On Spanning Tree→STP Config→STP Config page, enable STP function and select MSTP version. On Spanning Tree→STP Config→Port Config page, enable MSTP function for the port.
3	Configure the region name and the revision of MST region	On Spanning Tree→MSTP Instance→Region Config page, configure the region as TP-LINK and keep the default revision setting.
4	Configure VLAN-to-Instance mapping table of the MST region	On Spanning Tree→MSTP Instance→Instance Config page, configure VLAN-to-Instance mapping table. Map VLAN101, 103 and 105 to Instance 1; map VLAN102, 104 and 106 to Instance 2.

- The configuration procedure for switch E and F is the same with that for switch D.

➤ **The topology diagram of the two instances after the topology is stable**

- For Instance 1 (VLAN101, 103 and 105), the red paths in the following figure are connected links; the gray paths are the blocked links.

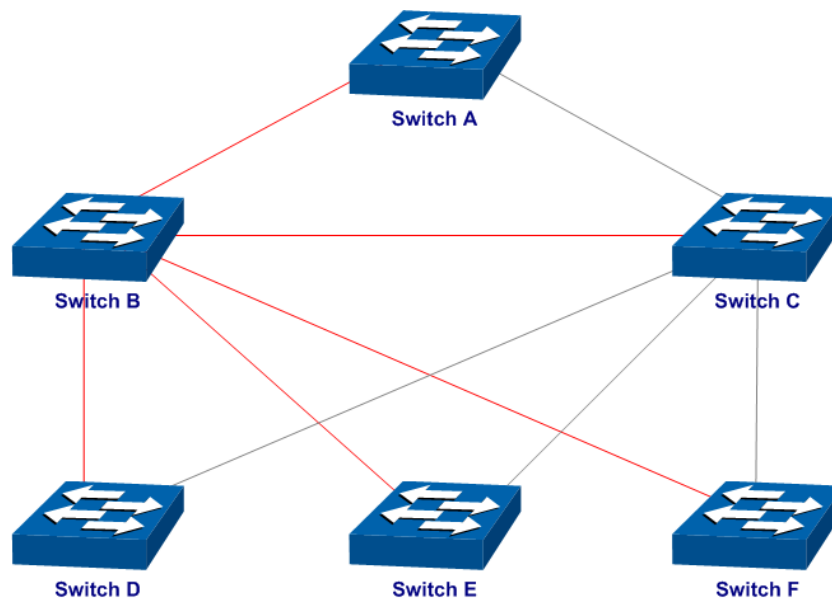

- For Instance 2 (VLAN102, 104 and 106), the blue paths in the following figure are connected links; the gray paths are the blocked links.

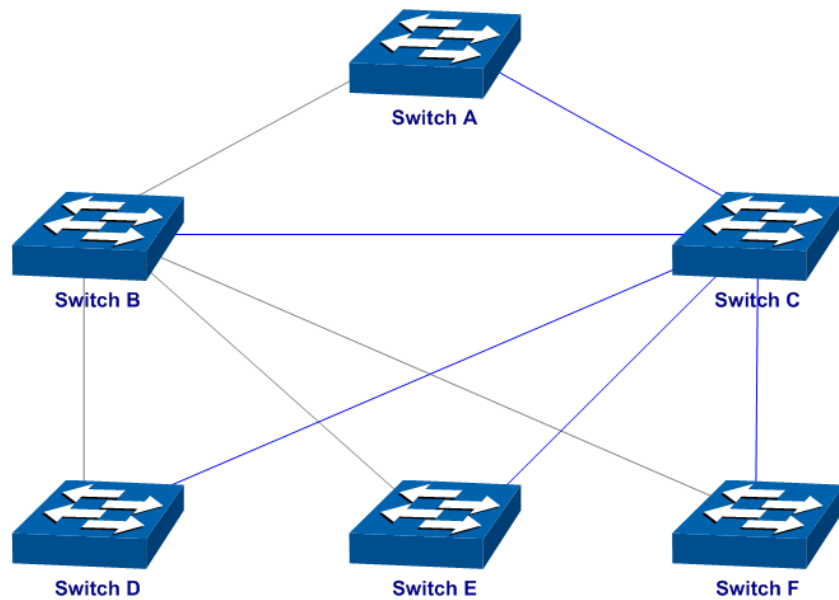

➤ **Suggestion for Configuration**

- Enable TC Protect function for all the ports of switches.
- Enable Root Protect function for all the ports of root bridges.
- Enable Loop Protect function for the non-edge ports.

Enable BPDU Protect function or BPDU Filter function for the edge ports which are connected to the PC and server.

[Return to CONTENTS](#)

Chapter 8 Ethernet OAM

➤ OAM Overview

Ethernet OAM (Operation, Administration, and Maintenance) is a Layer 2 protocol for monitoring and troubleshooting Ethernet networks. It can report the network status to network administrators through the OAMPDUs exchanged between two OAM entities, facilitating network management.

Ethernet OAM is a slow protocol with very limited bandwidth requirement. The frame transmission rate is limited to a maximum of 10 frames per second; therefore, the impact of OAM on data traffic is negligible.

On a point-to-point link between two OAM-enabled devices, OAM helps to monitor the link status from the following three points.

1. Link performance monitoring, for detecting link errors.
2. Fault detection and alarm, for reporting link errors to the administrators.
3. Loopback testing, for detecting link errors through non-OAMPDUs.

Currently, Ethernet OAM is mainly used to monitor the data link in the “last mile”.

➤ OAMPDUs

There are six types of OAMPDUs. The following figure shows the details of the most commonly used OAMPDUs, namely, Information OAMPDU, Event Notification OAMPDU and Loopback Control OAMPDU.

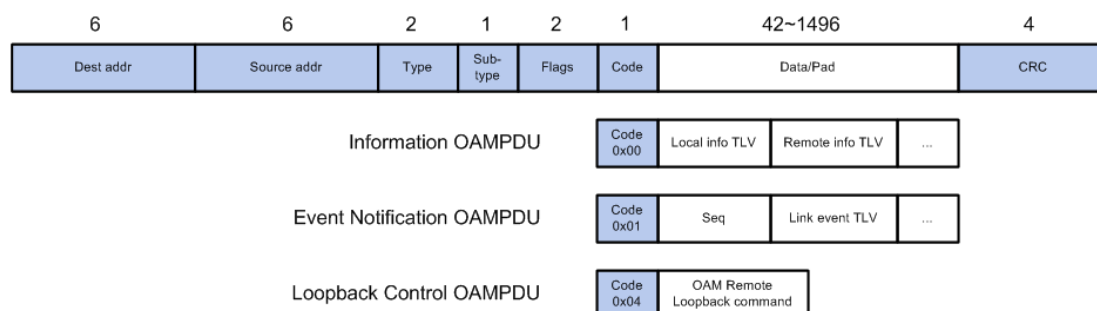

Figure 8-1 OAMPDUs

As Figure 8-1 shows, OAMPDUs are standard length Ethernet frames. They must be untagged and range from 64 to 1518 bytes.

- (1) Dest addr: The Dest addr (Destination MAC address) of an OAMPDU is the Slow_Protocols_Multicast address (01:80:c2:00:00:02).
- (2) Source addr: The Source addr is the MAC address associated with the port through which the OAMPDU is transmitted.
- (3) Type: The type field is fixed to 0x8809.
- (4) Sub-type: The Sub-type field is fixed to 0x03.
- (5) Flags: The flags field contains status bits of an OAM entity.
- (6) Code: The code field identifies the specific type of OAMPDU. As mentioned above, Information OAMPDU, Event Notification OAMPDU and Loopback control OAMPDU are commonly used, and their codes are 0x00, 0x01, and 0x04. The three OAMPDUs are described as follows.

Information OAMPDU: Information OAMPDU is used for discovery. It transmits the state information of an OAM entity (including local, remote, and organization-specific information) to another OAM entity, and maintains OAM connection.

Event Notification OAMPDU: Event Notification OAMPDU is used for link monitoring. It is sent as an alarm when a failure occurs to the link connecting the local OAM entity and a remote OAM entity.

Loopback Control OAMPDU: Loopback Control OAMPDU is used to control the remote client's OAM remote loopback state. Its Data field consists of a remote loopback command to enable or disable the OAM remote loopback, so that the local client can enable/disable loopback on the remote OAM entity.

➤ **OAM Functions**

As defined by IEEE 802.3 Clause 57, *Ethernet in the First Mile.*, OAM functions include Discovery, Link Monitoring, Remote Failure Indication, and Remote Loopback.

Discovery

Discovery is the first phase of Ethernet OAM. During this phase, an OAM entity discovers other OAM entities and establishes connections using Information OAMPDUs.

As for OAM connection, an OAM entity can operate in two modes: active and passive. Only the active OAM entity can initiate an OAM connection process. The passive OAM entity waits and responds to OAM connection establishment requests. Interconnected OAM entities notify the peer of their OAM configuration information and the OAM capabilities of the local nodes to support OAM by exchanging Information OAMPDUs, and then determine if OAM connections can be established. Only when the settings concerning Loopback, link detecting, and link event of the both side match can an OAM connection be established.

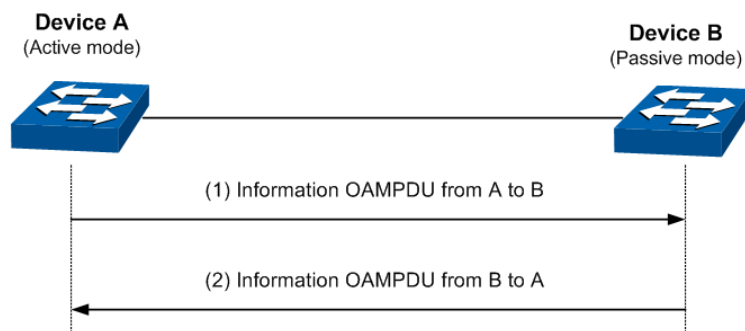

Figure 8-2 OAM Discovery

The difference between active OAM mode and passive OAM mode is shown as follows.

Item	Active OAM mode	Passive OAM mode
Initiating OAM Discovery	Available	Unavailable
Responding to OAM Discovery	Available	Available
Transmitting Information OAMPDUs	Available	Available
Transmitting Event Notification OAMPDUs	Available	Available
Transmitting Information OAMPDUs with the Data/Pad field being empty	Available	Available

Item	Active OAM mode	Passive OAM mode
Transmitting Loopback Control OAMPDU	Available	Unavailable
Responding to Loopback Control OAMPDU	Available (if both sides operate in active OAM mode)	Available
Transmitting organization-specific OAMPDU	Available	Available

Table 8-1 Differences between active OAM mode and passive OAM mode

After an OAM connection is established, the OAM entities on both sides exchange Information OAMPDU periodically to keep the OAM connection valid. The OAM entity considers the OAM connection invalid if it does not receive the Information OAMPDU from the peer entity for 5 seconds.

Link Monitoring

Link Monitoring is for detecting and locating link faults under a variety of circumstances. When there are problems detected on the link, the device will send its remote peer the Event Notification OAMPDU to report link events. The link events are described as follows:

OAM Link Events	Description
Symbol Period Error	A Symbol Period Error event occurs if the number of symbol errors exceeds the threshold during a specific period of time.
Frame Error	A Frame Error event occurs if the number of frame errors exceeds the threshold during a specific period of time.
Frame Period Error	A Frame Period Error event occurs if the number of frame errors in specific number of received frames exceeds the threshold.
Frame Seconds Error	A Frame Seconds Error event occurs if the number of error frame seconds exceeds the threshold during a specific period of time. A second is called an error frame second if error frames occur in the second.

Table 8-2 OAM Link Events

Remote Failure Indication

Faults in Ethernet are difficult to detect, especially when the physical connection in the network is not interrupted but network performance degrades gradually. A flag in the OAMPDU allows an OAM entity to convey failure conditions to its peer. The failure conditions are as follows:

Link Fault: Peer link signal is lost. This is sent once per second in the Information OAMPDU.

Dying Gasp: An unrecoverable fault, such as power failure, occurs. This is sent immediately and continuously.

Critical Event: Unspecified critical event occurs. This is sent immediately and continuously.

As Information OAMPDUs are sent between the OAM entities periodically, an OAM entity can inform one of its OAM peers of link faults through Information OAMPDUs. So the network administrator can get informed of the link faults and take action in time.

Remote Loopback

Remote loopback helps to ensure the quality of links during installation or when troubleshooting. After the OAM connection is established, the active OAM entity can put its OAM peer into loopback mode using a loopback control OAMPDU.

With remote loopback enabled, the active OAM entity sends remote loopback requests and the peer responds. If the peer is in the loopback mode, it returns all frames except OAMPDUs and pause frames to the senders along the original paths. Through these return frames, administrators can test the link performance like delay, jitter, and frame loss rate.

The following figure shows how remote loopback testing works.

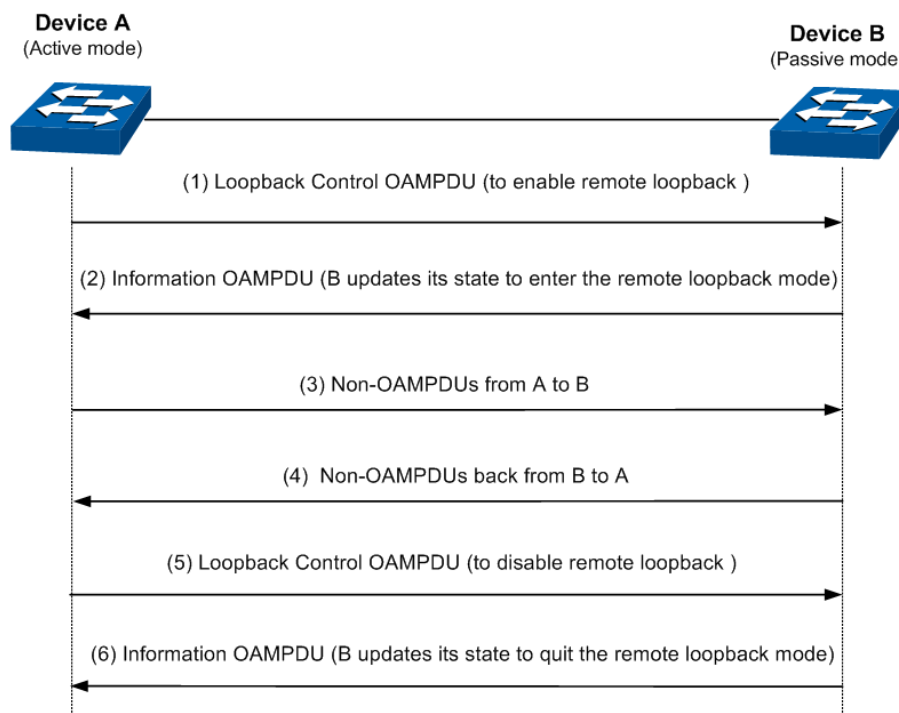

Figure 8-3 Remote Loopback

8.1 Basic Config

On the **Basic Config** page, you can enable the Ethernet OAM function on a specified port, and configure its OAM mode as active or passive. Also, you can check out the connection status on the **Discovery Info** page.

8.1.1 Basic Config

Choose the menu **Ethernet OAM**→ **Basic Config**→ **Basic Config** to load the following page.

Basic Config			
UNIT: <input type="text" value="1"/>			
Select	Port	Mode	State
<input type="checkbox"/>		<input type="text" value=""/>	<input type="text" value=""/>
<input type="checkbox"/>	1/0/1	Active	Disable
<input type="checkbox"/>	1/0/2	Active	Disable
<input type="checkbox"/>	1/0/3	Active	Disable
<input type="checkbox"/>	1/0/4	Active	Disable
<input type="checkbox"/>	1/0/5	Active	Disable
<input type="checkbox"/>	1/0/6	Active	Disable
<input type="checkbox"/>	1/0/7	Active	Disable
<input type="checkbox"/>	1/0/8	Active	Disable
<input type="checkbox"/>	1/0/9	Active	Disable
<input type="checkbox"/>	1/0/10	Active	Disable
<input type="checkbox"/>	1/0/11	Active	Disable
<input type="checkbox"/>	1/0/12	Active	Disable
<input type="checkbox"/>	1/0/13	Active	Disable
<input type="checkbox"/>	1/0/14	Active	Disable
<input type="checkbox"/>	1/0/15	Active	Disable

Note:

1. You cannot establish an OAM connection between two OAM entities in the passive mode.

Figure 8-4 Basic Config

The following entries are displayed on this screen:

➤ **Basic Config**

- Port Select:** Click the **Select** button to quick-select the corresponding port based on the port number you entered.
- Select:** Select the desired port for configuration. It is multi-optional.
- Mode:** Select the OAM mode for the desired port.
- State:** Select Enable/Disable the Ethernet OAM function for the desired port.



Note:

You cannot establish an OAM connection between two OAM entities that work in the passive mode.

8.1.2 Discovery Info

Choose the menu **Ethernet OAM**→ **Basic Config**→ **Discovery Info** to load the following page.

Discovery Info	
Port <input type="text" value="1"/> <input type="button" value="Select"/>	
Local Client	
OAM	Disabled
Mode	Active
Max OAMPDU	1518 Bytes
Remote Loopback	Supported
Unidirection	Not Supported
Link Monitoring	Supported
Variable Request	Not Supported
PDU Revision	0
Operation Status	Disable
Loopback Status	No Loopback
Remote Client	
Mode	---
Mac Address	---
Vendor(OUI)	---
Max OAMPDU	---
Remote Loopback	---
Unidirection	---
Link Monitoring	---
Variable Request	---
PDU Revision	---
Vendor Information	---

Figure 8-5 Discovery Info

The following entries are displayed on this screen:

➤ Local Client

The local client part shows the information of the local OAM entity.

- OAM:** Displays whether the OAM function is enabled or disabled on the selected port.
- Mode:** Displays the OAM mode of the selected port.
- Max OAMPDU:** Displays the maximum size of the OAMPDU.
- Remote Loopback:** Displays whether the local client supports remote loopback function.
- Unidirection:** Displays whether the local client supports unidirectional OAM operation.
Some devices support unidirectional OAM operation. These devices provide an OAMPDU-based mechanism to notify the remote OAM entity when one direction of a link is non-operational and therefore data transmission is disabled.

Link Monitoring:	Displays whether the local client supports link monitoring function.
Variable Request:	Displays whether the local client supports variable request. If supports, the local client can send some variable requests to the remote client to learn about the link status from the response of the remote client.
PDU Revision:	Displays the Information TLV revision of Information OAMPDU.
Operation Status:	<p>Displays the operating status of the OAM connection.</p> <ul style="list-style-type: none"> • Disable: OAM is disabled on this port. • LinkFault: The link has detected a fault and is transmitting OAMPDUs with a link fault indication. • PassiveWait: The port is in passive mode and is waiting to see if the peer device is OAM capable. • ActiveSendLocal: The port is in active mode and is sending local information. • SendLocalAndRemote: The local port has discovered the peer but has not yet accepted or rejected the configuration of the peer. • SendLocalAndRemoteOK: The local device agrees the OAM peer entity. • PeeringLocallyRejected: The local OAM entity rejects the remote peer OAM entity. • PeeringRemotelyRejected: The remote OAM entity rejects the local device. • NonOperHalfDuplex: Since Ethernet OAM functions are not designed to work completely over half-duplex ports. This value indicates Ethernet OAM is enabled but the port is in half-duplex operation.
Loopback Status:	<p>Displays the loopback status.</p> <ul style="list-style-type: none"> • No Loopback: Neither the local client nor the remote client is in the loopback mode. • Local Loopback: The local client is in the loopback mode. • Remote Loopback: The remote client is in the loopback mode.

➤ **Remote Client**

The local client part shows the information of the remote OAM entity.

Mode:	Displays the OAM mode of the remote client.
Mac Address:	Displays the MAC address of the remote client.
Vendor(OUI):	<p>Displays the vender's OUI of the remote client.</p> <p>An OUI address is a unique identifier assigned by IEEE to a device vendor.</p>
Max OAMPDU:	Displays the maximum size of the OAMPDU.
Remote Loopback:	Displays whether the remote client supports remote loopback function.
Unidirection:	Displays whether the remote client supports unidirectional OAM operation.
Link Monitoring:	Displays whether the remote client supports link monitoring function.

- Variable Request:** Displays whether the remote client supports variable request.
- PDU Revision:** Displays the TLV revision of the OAMPDU.
- Vendor Information:** Displays the vender information of the remote client.

8.2 Link Monitoring

On this page, you can configure the parameters about OAM link events, including the threshold and the detection period. Also, you can choose whether to notify the link event.

Choose the menu **Ethernet OAM**→**Link Monitoring**→**Link Monitoring** to load the following page.

Current Link Event

Link Event: Symbol Period Error ▼

Link Monitoring Config

UNIT: 1

Select	Port	Threshold(Error Symbol)	Window(100ms)	Notify
<input type="checkbox"/>		<input style="width: 50px;" type="text"/>	<input style="width: 50px;" type="text"/>	<input type="text" value="▼"/>
<input type="checkbox"/>	1/0/1	1	10	Enable
<input type="checkbox"/>	1/0/2	1	10	Enable
<input type="checkbox"/>	1/0/3	1	10	Enable
<input type="checkbox"/>	1/0/4	1	10	Enable
<input type="checkbox"/>	1/0/5	1	10	Enable
<input type="checkbox"/>	1/0/6	1	10	Enable
<input type="checkbox"/>	1/0/7	1	10	Enable
<input type="checkbox"/>	1/0/8	1	10	Enable
<input type="checkbox"/>	1/0/9	1	10	Enable
<input type="checkbox"/>	1/0/10	1	10	Enable
<input type="checkbox"/>	1/0/11	1	10	Enable
<input type="checkbox"/>	1/0/12	1	10	Enable
<input type="checkbox"/>	1/0/13	1	10	Enable
<input type="checkbox"/>	1/0/14	1	10	Enable
<input type="checkbox"/>	1/0/15	1	10	Enable

All
Apply
Help

Figure 8-6 Link Monitoring

The following entries are displayed on this screen:

➤ **Link Monitoring Config**

Link Event: Select one type of the link events to configure. Link events include Symbol Period Error, Frame Error, Frame Period Error, and Frame Seconds Error. For more details about link events, please refer to [OAM Link Events](#).

Port Select: Click the **Select** button to quick-select the corresponding port based on the port number you entered.

Select: Select the desired port for configuration. It is multi-optional.

- Threshold:** Specify the threshold for the selected link event.
- For Symbol Period Error, it is the number of error symbols in the period that is required to be exceeded.
 - For Frame Error, it is the number of error frames in the period (measured by 100ms) that is required to be exceeded.
 - For Frame Period Error, it is the number of error frames in the period (measured by frames) that is required to be exceeded.
 - For Frame Seconds Error, it is the number of error frame seconds in the period that is required to be exceeded.
- Window:** Specify the detection period.
- For Frame Period Error, the period is specified by a number of received frames.
 - For other link events, the period is specified by a time interval.
- Notify:** Choose whether to notify the selected link event or not.

8.3 RFI

On this page, you can choose whether to notify the link faults like dying gasp and critical event. Choose the menu **Ethernet OAM**→**RFI**→**Remote Failure Indication** to load the following page.

Select	Port	Dying Gasp Notify	Critical Event Notify
<input type="checkbox"/>			
<input type="checkbox"/>	1/0/1	Enable	Enable
<input type="checkbox"/>	1/0/2	Enable	Enable
<input type="checkbox"/>	1/0/3	Enable	Enable
<input type="checkbox"/>	1/0/4	Enable	Enable
<input type="checkbox"/>	1/0/5	Enable	Enable
<input type="checkbox"/>	1/0/6	Enable	Enable
<input type="checkbox"/>	1/0/7	Enable	Enable
<input type="checkbox"/>	1/0/8	Enable	Enable
<input type="checkbox"/>	1/0/9	Enable	Enable
<input type="checkbox"/>	1/0/10	Enable	Enable
<input type="checkbox"/>	1/0/11	Enable	Enable
<input type="checkbox"/>	1/0/12	Enable	Enable
<input type="checkbox"/>	1/0/13	Enable	Enable
<input type="checkbox"/>	1/0/14	Enable	Enable
<input type="checkbox"/>	1/0/15	Enable	Enable

Figure 8-7 Remote Failure Indication

The following entries are displayed on this screen:

➤ **Remote Failure Indication Config**

- Port Select:** Click the **Select** button to quick-select the corresponding port based on the port number you entered.

- Select:** Select the desired port for configuration. It is multi-optional.
- Dying Gasp Notify:** Choose whether to notify the dying gasp or not.
- Critical Event Notify:** Choose whether to notify the critical event or not.

8.4 Remote Loopback

On this page, you can initiate remote loopback if the OAM connection is established and the local client works in active mode. You can also choose to ignore or to process the received remote loopback request.

Choose the menu **Ethernet OAM**→**Remote Loopback**→**Remote Loopback** to load the following page.

Select	Port	Received Remote Loopback	Remote Loopback
<input type="checkbox"/>			
<input type="checkbox"/>	1/0/1	Ignore	---
<input type="checkbox"/>	1/0/2	Ignore	---
<input type="checkbox"/>	1/0/3	Ignore	---
<input type="checkbox"/>	1/0/4	Ignore	---
<input type="checkbox"/>	1/0/5	Ignore	---
<input type="checkbox"/>	1/0/6	Ignore	---
<input type="checkbox"/>	1/0/7	Ignore	---
<input type="checkbox"/>	1/0/8	Ignore	---
<input type="checkbox"/>	1/0/9	Ignore	---
<input type="checkbox"/>	1/0/10	Ignore	---
<input type="checkbox"/>	1/0/11	Ignore	---
<input type="checkbox"/>	1/0/12	Ignore	---
<input type="checkbox"/>	1/0/13	Ignore	---
<input type="checkbox"/>	1/0/14	Ignore	---
<input type="checkbox"/>	1/0/15	Ignore	---

Note:

1. You can perform remote loopback only after establishing the OAM connection.
2. Remote loopback is used to test a single link and it is not supported on aggregated ports.

Figure 8-8 Remote Loopback

The following entries are displayed on this screen:

➤ **Remote Loopback Config**

- Port Select:** Click the **Select** button to quick-select the corresponding port based on the port number you entered.
- Select:** Select the desired port for configuration. It is multi-optional.
- Received Remote Loopback:** Choose to ignore or to process the received remote loopback request.

Remote Loopback: To start or stop the remote loopback.

8.5 Statistics

You can view the statistics about the detailed Ethernet OAM traffic information and event log information of a specific port here.

8.5.1 Statistics

On this page, you can view the detailed Ethernet OAM traffic information of a specific port. The device will recount the numbers every time you click the **clear** button or the device is rebooted.

Choose the menu **Ethernet OAM**→**Statistics**→**Statistics** to load the following page.

Statistics

UNIT: 1

2 4 6 8 10 12 14 16 18 20 22 24 26 28
1 3 5 7 9 11 13 15 17 19 21 23 25 27

Unselected Port(s) Selected Port(s) Not Available for Selection

Port 1/0/1		
	Tx	Rx
Information OAMPDUs:	0	0
Unique Event Notification OAMPDUs:	0	0
Duplicate Event Notification OAMPDUs:	0	0
Variable Request OAMPDUs:	0	0
Variable Response OAMPDUs:	0	0
Loopback Control OAMPDUs:	0	0
Organization Specific OAMPDUs:	0	0
Unsupported OAMPDUs:	0	0
Frames Lost Due To OAM:	0	0

Clear Refresh Help

Figure 8-9 Statistics

The following entries are displayed on this screen:

➤ **Statistics**

Port Select: Click the **Select** button to quick-select the corresponding port based on the port number you entered.

Tx: Displays the number of OAMPDUs that have been transmitted on the port.

Rx: Displays the number of OAMPDUs that have been received on the port.

Information OAMPDUs: Displays the number of information OAMPDUs that have been transmitted or received on the port.

Unique Notification OAMPDU:	Event	Displays the number of unique event notification OAMPDUs that have been transmitted or received on the port.
Duplicate Notification OAMPDU:	Event	Displays the number of duplicate event notification OAMPDUs that have been transmitted or received on the port.
Variable Request OAMPDU:	Request	Displays the number of variable request OAMPDUs that have been transmitted or received on the port.
Variable Response OAMPDU:	Response	Displays the number of variable response OAMPDUs that have been transmitted or received on the port.
Loopback Control OAMPDU:	Control	Displays the number of loopback control OAMPDUs that have been transmitted or received on the port.
Organization Specific OAMPDU:		Displays the number of organization specific OAMPDUs that have been transmitted or received on the port.
Unsupported OAMPDU:		Displays the number of unsupported OAMPDUs that have been transmitted or received on the port.
Frames Lost Due To OAM:		Displays the number of frames that would otherwise be transmitted by the OAM sublayer, but did not due to an internal OAM sublayer transmit error.

8.5.2 Event Log

On this page, you can view the detailed Ethernet OAM event log information of a specific port. The device will recount the numbers every time you click the **clear** button or the device is rebooted.

Choose the menu **Ethernet OAM**→**Statistics**→**Event Log** to load the following page.

Event Log

UNIT: 1

2
4
6
8
10
12
14
16
18
20
22
24

26
28

1
3
5
7
9
11
13
15
17
19
21
23

25
27

Unselected Port(s)

Selected Port(s)

Not Available for Selection

Event Log Statistics

	Local	Remote
Error Symbol Period Event:	0	0
Error Frame Event:	0	0
Error Frame Period Event:	0	0
Error Frame Seconds Event:	0	0
Dying Gasp:	0	0
Critical Event:	0	0

Event Log Table

Type	Location	Timestamp	Value	Window	Threshold	Accumulated Errors
No entry in the table.						

Clear
Refresh
Help

Figure 8-10 Event Log

The following entries are displayed on this screen:

➤ **Event Log Statistics**

Port Select: Click the **Select** button to quick-select the corresponding port based on the port number you entered.

Local: Displays the number of link events that have occurred on the local link.

Remote: Displays the number of link events that have occurred on the remote link.

Error Symbol Event: Displays the number of error symbol period link events that have occurred on the local link or remote link.

Error Frame Event: Displays the number of error frame link events that have occurred on the local link or remote link.

Error Frame Period Event: Displays the number of error frame period link events that have occurred on the local link or remote link.

Error Frame Seconds Event: Displays the number of error frame seconds link events that have occurred on the local link or remote link.

Dying Gasp: Displays the number of Dying Gasp link events that have occurred on the local link or remote link.

Critical Event: Displays the number of Critical Event link events that have occurred on the local link or remote link.

➤ **Event Log Table**

Type: Displays the type of the link event.

Location: Displays the location where the link event occurred.

Timestamp: Displays the time reference when the link event occurred.

Value: Displays the number of errors in the period.

Window: Displays the period of the link event.

Threshold: Displays the number of errors that is required to be exceeded in order for the event to be generated.

Accumulated Errors: Displays the number of errors that have been detected since the OAM sublayer was reset.

8.6 DLDP

➤ **DLDP Overview**

DLDP (Device Link Detection Protocol) is a Layer 2 protocol that enables devices connected through fiber or twisted-pair Ethernet cables to monitor the physical configuration of the cables and detect whether a unidirectional link exists. When a unidirectional link appears, the local device can receive packets from the peer device through the link layer, but the peer device cannot receive packets from the local device. Unidirectional links can cause a variety of problems, such as

spanning-tree topology loops. Once detecting a unidirectional link, DLDP can shut down the related port automatically or inform users.

➤ DLDP Operation Mechanism

1. DLDP Link States

DLDP defines 6 link states for a device: Initial, Inactive, Active, Advertisement, Probe and Disable.

State	Description
Initial	DLDP is disabled.
Inactive	DLDP is enabled but the link is down.
Active	This state is temporary and it indicates that: 1. DLDP is enabled and the link is up. 2. The neighbor entries in this device are empty.
Advertisement	This state indicates that no unidirectional link is detected, which includes two kinds of situations: 1. This device establishes bidirectional links with all its neighbors. 2. DLDP remains in Active state for more than 5 seconds.
Probe	A device enters this state from the Active state if it receives a packet from an unknown neighbor. In this state, the device will send out Probe packets to detect whether the link is unidirectional.
Disable	This state indicates that a unidirectional link is detected.

Table 8-3 DLDP Link State

2. DLDP Work Process

The general DLDP work process chart is shown below:

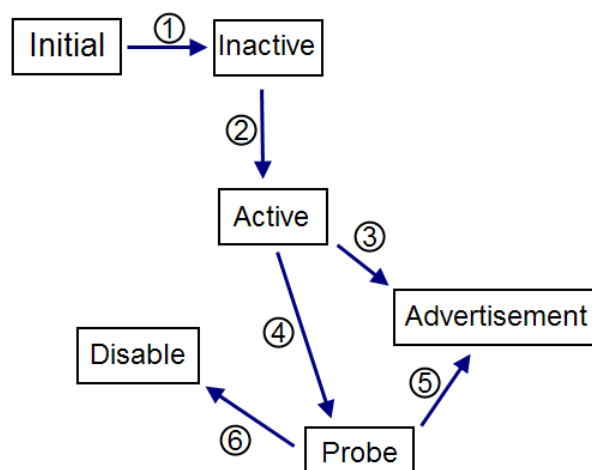

Figure 8-11 DLDP Process

The process is illustrated below:

- ①: When DLDP is enabled on the link in down state, the DLDP link state will transit to Inactive.
- ②: When the DLDP-enabled link is up, the DLDP link state will transit to Active. The device will send out Advertisement packets to the peer device with resynchronization tag in this state.

③: If the device doesn't receive any DLDP packets within 5 seconds, the DLDP link state will transit to Advertisement.

④: After receiving a packet from an unknown neighbor, the device's link state will transit from Active to Probe, and then send out several probe packets to detect the link state.

⑤: If the device receives echo packets from its peer device, the link state between them will be tagged as bidirectionally linked and the DLDP state will transit from Probe to Advertisement. A device in the Advertisement state will send advertisement packets.

⑥: If the device receives no echo packets after a specified period of time, the link will be tagged as unidirectional and the DLDP state will transit from Probe to Disable. This port will be shut down automatically or manually (depending on the Shut Mode configured).

The typical bidirectional link detection process is ② → ④ → ⑤, and the typical unidirectional link detection process is ② → ④ → ⑥.

On the **DLDP** page, you can enable the DLDP state globally and configure the interval of the advertisement packets and the port shutdown mode. You can also configure the refresh frequency of the port states and reset the certain port's DLDP state manually.

Choose the menu **Ethernet OAM** → **DLDP** → **DLDP** to load the following page.

Global Config

DLDP State Enable Disable

Adver Interval seconds(1-30)

Shut Mode Apply

Web Refresh State Enable Disable

Web Refresh Interval seconds(1-100)

Port Config

UNIT:

Select	Port	DLDP State	Protocol State	Link State	Neighbour State
<input type="checkbox"/>		<input type="text" value=""/>			
<input type="checkbox"/>	1	Disable	Initial	Link-Down	N/A
<input type="checkbox"/>	2	Disable	Initial	Link-Down	N/A
<input type="checkbox"/>	3	Disable	Initial	Link-Down	N/A
<input type="checkbox"/>	4	Disable	Initial	Link-Down	N/A
<input type="checkbox"/>	5	Disable	Initial	Link-Down	N/A
<input type="checkbox"/>	6	Disable	Initial	Link-Down	N/A
<input type="checkbox"/>	7	Disable	Initial	Link-Down	N/A
<input type="checkbox"/>	8	Disable	Initial	Link-Down	N/A
<input type="checkbox"/>	9	Disable	Initial	Link-Down	N/A
<input type="checkbox"/>	10	Disable	Initial	Link-Down	N/A
<input type="checkbox"/>	11	Disable	Initial	Link-Down	N/A
<input type="checkbox"/>	12	Disable	Initial	Link-Up	N/A
<input type="checkbox"/>	13	Disable	Initial	Link-Down	N/A
<input type="checkbox"/>	14	Disable	Initial	Link-Down	N/A
<input type="checkbox"/>	15	Disable	Initial	Link-Down	N/A

Note

1. A DLDP-capable port cannot detect a unidirectional link if it is connected to a DLDP-incapable port of another switch.
2. Make sure that both sides of the link have the same configuration.

Figure 8-12 DLDP Config

The following entries are displayed on this screen:

➤ **Global Config**

DLDP State: Enable/Disable the DLDP function globally.

Adver Interval: Config the interval to send advertisement packets, ranging from 1 to 30 seconds. The default value is 5 seconds.

Shut Mode: Once detecting a unidirectional link, the port can be shut down in one of the following two modes:

- **Auto:** In this mode, DLDP generates logs and traps and shuts down the corresponding port on detecting unidirectional links, and the DLDP link state transits to Disable.
- **Manual:** In this mode, DLDP only generates logs and traps if it detects unidirectional links, and the operation to shut down the unidirectional link ports is accomplished by the administrator.

Web Refresh State: Enable/Disable the web automatic refresh function.

Web Refresh Interval: Configure the interval to refresh the web page, ranging from 1 to 100 seconds, and the default value is 5 seconds.

➤ **Port Config**

Port Select: Click the **Select** button to quick-select the corresponding port based on the port number you entered.

Select: Select the desired port for configuration. It is multi-optional.

Port: Port list of the switch.

DLDP State: Enable/Disable DLDP on the selected port.

Protocol State: Displays the DLDP protocol state.

Link State: Displays the state of the links.

Neighbor State: Displays the state of the selected port's neighbor.

Configuration Procedure:

1	Enable DLDP globally.	Required. On the Ethernet OAM→DLDP→DLDP page, configure DLDP State as Enable under the Global Config tab.
2	Enable DLDP on the specified port.	Required. On the Ethernet OAM→DLDP→DLDP page, configure DLDP State as Enable on specified port in the Port Config table.
3	Configure Shut Mode.	Optional. On the Ethernet OAM→DLDP→DLDP page, configure the Shut Mode as Auto or Manual under the Global Config tab.
4	Reset DLDP state.	Optional. On the Ethernet OAM→DLDP→DLDP page, select the specified ports or select all the ports in the Port Config table and click the Reset button to restore their state.

8.7 Application Example for DLDP

➤ **Network requirements**

1. Device A and Device B are connected through two fiber pairs, which are cross-connected, as shown in Figure 8-13.
2. The unidirectional link should be disconnected once being detected, and the ports shut down by DLDP can be restored after the fiber pairs are correctly connected.

➤ **Network Diagram**

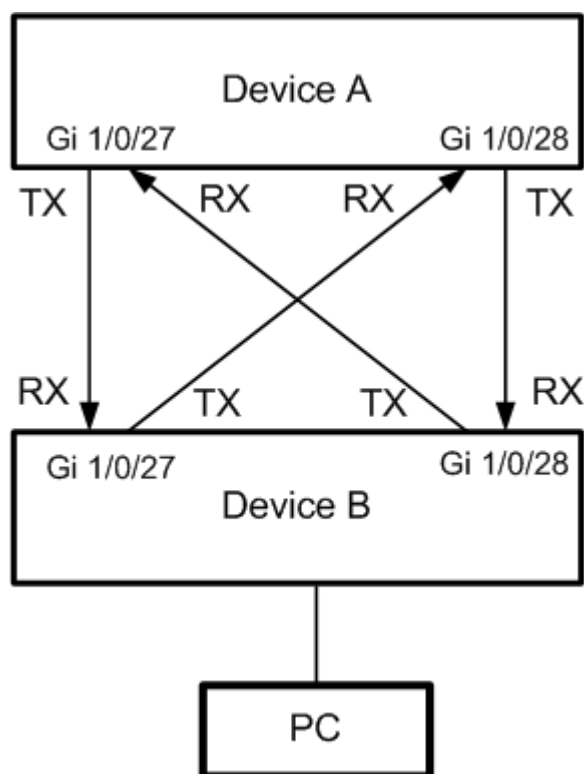

Figure 8-13 DLDP Application Example

➤ **Configuration Procedure**

1	Enable DLDP globally.	Required. On the Ethernet OAM → DLDP → DLDP page, configure DLDP State as enable under the Global Config tab in device A and B.
2	Enable DLDP on the specified ports.	Required. On the Ethernet OAM → DLDP → DLDP page, configure DLDP State as enable on Gigabit Ethernet ports 1/0/27 and 1/0/28 in the Port Config table in device A and device B.
3	Configure Shut Mode.	Required. On the Ethernet OAM → DLDP → DLDP page, configure the Shut Mode as auto under the Global Config tab in device A and B.
4	Check the ports' state.	Required. On the Ethernet OAM → DLDP → DLDP page, select ports 1/0/27 and 1/0/28 in the Port Config table and click the Reset button to bring them up.

The DLDP information of Gigabit Ethernet ports 1/0/27 and 1/0/28 is shown below:

Global Config

DLDP State: Enable Disable

Adver Interval: seconds(1-30)

Shut Mode:

Web Refresh State: Enable Disable

Web Refresh Interval: seconds(1-100)

Port Config

Port

Select	Port	DLDP State	Protocol State	Link State	Neighbor State
<input type="checkbox"/>		<input type="text" value=""/>			
<input type="checkbox"/>	19	Disable	Initial	Link-Down	N/A
<input type="checkbox"/>	20	Disable	Initial	Link-Down	N/A
<input type="checkbox"/>	21	Disable	Initial	Link-Down	N/A
<input type="checkbox"/>	22	Disable	Initial	Link-Down	N/A
<input type="checkbox"/>	23	Disable	Initial	Link-Down	N/A
<input type="checkbox"/>	24	Disable	Initial	Link-Down	N/A
<input type="checkbox"/>	25	Disable	Inactive	Link-Down	N/A
<input type="checkbox"/>	26	Disable	Inactive	Link-Down	N/A
<input checked="" type="checkbox"/>	27	Enable	Disable	Link-Down	Unidirectional
<input checked="" type="checkbox"/>	28	Enable	Disable	Link-Down	Unidirectional

Note:

1. A DLDP-capable port cannot detect a unidirectional link if it is connected to a DLDP-incapable port of another switch.
2. Make sure that both sides of the link have the same configuration.

After these four ports are correctly connected, select ports 1/0/27 and 1/0/28 in the Port Config table and click the **Reset** button to restore their state from Disable.

Chapter 9 Multicast

➤ Multicast Overview

In the network, packets are sent in three modes: unicast, broadcast and multicast. In unicast, the source server sends separate copy information to each receiver. When a large number of users require this information, the server must send many pieces of information with the same content to the users. Therefore, large bandwidth will be occupied. In broadcast, the system transmits information to all users in a network. Any user in the network can receive the information, no matter the information is needed or not.

Point-to-multipoint multimedia business, such as video conferences and VoD (video-on-demand), plays an important part in the information transmission field. Suppose a point to multi-point service is required, unicast is suitable for networks with sparsely users, whereas broadcast is suitable for networks with densely distributed users. When the number of users requiring this information is not certain, unicast and broadcast deliver a low efficiency. Multicast solves this problem. It can deliver a high efficiency to send data in the point to multi-point service, which can save large bandwidth and reduce the network load. In multicast, the packets are transmitted in the following way as shown in Figure 9-1.

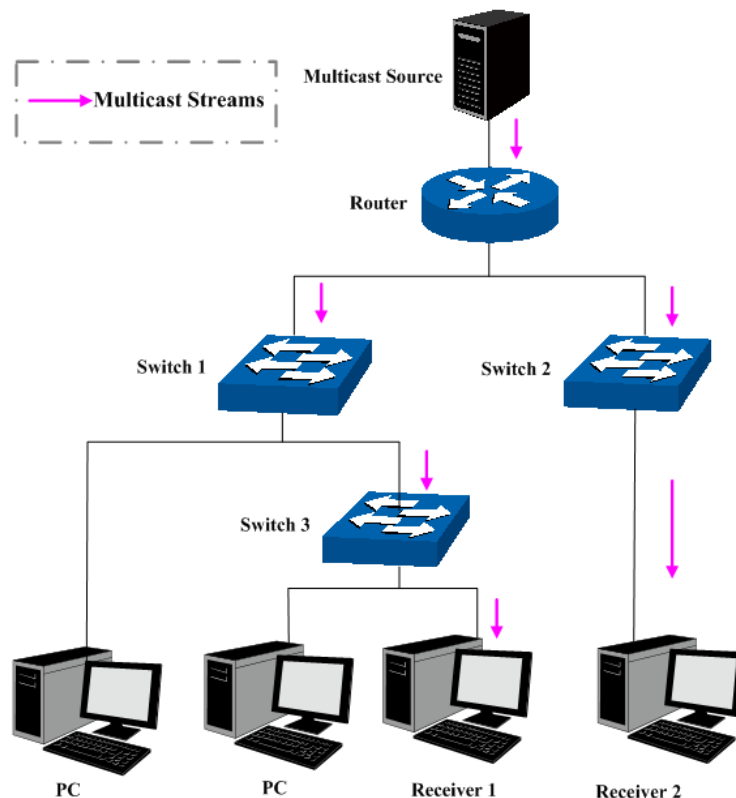

Figure 9-1 Information transmission in the multicast mode

Features of multicast:

1. The number of receivers is not certain. Usually point-to-multipoint transmission is needed;
2. Multiple users receiving the same information form a multicast group. The multicast information sender just need to send the information to the network device once;
3. Each user can join and leave the multicast group at any time;
4. Real time is highly demanded and certain packets drop is allowed.

➤ **IPv4 Multicast Address**

1. IPv4 Multicast IP Address:

As specified by IANA (Internet Assigned Numbers Authority), Class D IP addresses are used as destination addresses of multicast packets. The multicast IP addresses range from 224.0.0.0~239.255.255.255. The following table displays the range and description of several special multicast IP addresses.

224.0.0.0~224.0.0.255	Reserved multicast addresses for routing protocols and other network protocols
224.0.1.0~224.0.1.255	Addresses for video conferencing
239.0.0.0~239.255.255.255	Local management multicast addresses, which are used in the local network only

Table 9-1 Range of the special multicast IP

2. IPv4 Multicast MAC Address:

When a unicast packet is transmitted in an Ethernet network, the destination MAC address is the MAC address of the receiver. When a multicast packet is transmitted in an Ethernet network, the destination is not a receiver but a group with uncertain number of members, so a multicast MAC address, a logical MAC address, is needed to be used as the destination address.

As stipulated by IANA, the high-order 24 bits of a multicast MAC address begins with 01-00-5E while the low-order 23 bits of a multicast MAC address are the low-order 23 bits of the multicast IP address. The mapping relationship is described as Figure 9-2.

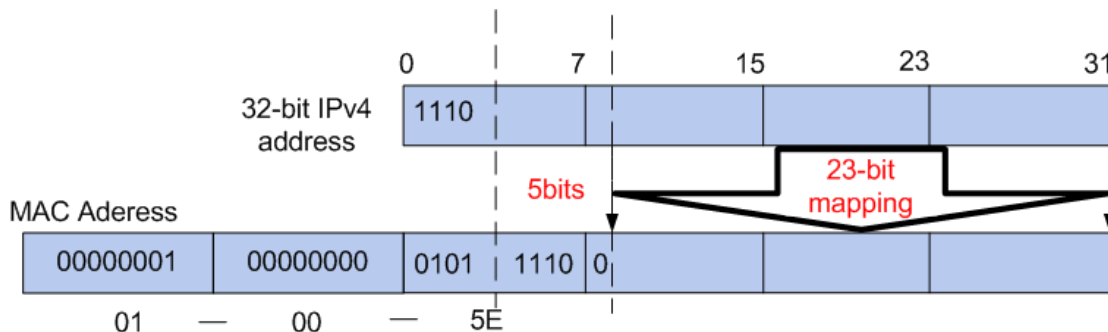

Figure 9-2 Mapping relationship between multicast IPv4 address and multicast MAC address

The high-order 4 bits of the IP multicast address are 1110, identifying the multicast group. Only 23 bits of the remaining low-order 28 bits are mapped to a multicast MAC address. In that way, 5 bits of the IP multicast address is not utilized. As a result, 32 IP multicast addresses are mapped to the same MAC addresses.

➤ **IPv6 Multicast Address**

1. IPv6 Multicast Address

An IPv6 multicast address is an identifier for a group of interfaces, and has the following format:

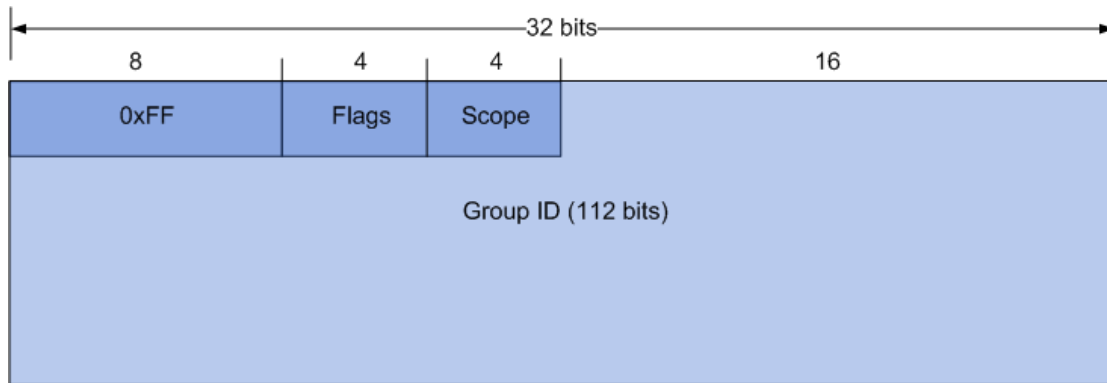

- 0XFF at the start of the address identifies the address as being a multicast address.
- Flags have 4 bits:



- (1) The high-order flag is reserved, and must be initialized to 0.
 - (2) R: Set to 0 to indicate this IPv6 multicast address does not contain an embedded RP address; set to 1 to indicate this IPv6 multicast address contains an embedded RP address. When this bit is set to 1, the P and T bits must also be set to 1.
 - (3) P: Set to 0 to indicate this IPv6 multicast address is not based on a unicast prefix; set to 1 to indicate this IPv6 multicast address is based on a unicast prefix. When this bit is set to 1, the T bit must also be set to 1.
 - (4) T: Set to 0 to indicate that this address is an IPv6 multicast address permanently assigned by the Internet Assigned Numbers Authority (IANA); set to 1 to indicate that this address is a transient, or dynamically assigned IPv6 multicast address.
- Scope is a 4-bit value used to limit the scope of the multicast group. The values are as follows:

0、3、F	reserved
1	Interface-Local scope
2	Link-Local scope
4	Admin-Local scope
5	Site-Local scope
6、7、9~D	unassigned
8	Organization-local scope
E	Global scope

Table 9-2 Indications of the Scope

- Group ID: 112 bits, IPv6 multicast group identifier that uniquely identifies an IPv6 multicast group in the scope defined by the Scope field.

Reserved Multicast Addresses:

FF01::1	All interface-local IPv6 nodes
FF02::1	All link-local IPv6 nodes
FF01::2	All interface-local IPv6 routers
FF02::2	All link-local IPv6 routers
FF05::2	All site-local IPv6 routers
FF0X::	X ranges from 0 to F. These multicast addresses are reserved and shall never be assigned to any multicast group.

Table 9-3 Reserved IPv6 Multicast Addresses

The solicited-node multicast address is a multicast group that corresponds to an IPv6 unicast or anycast address. It is usually used for obtaining the Layer 2 link-layer addresses of neighboring nodes within the local-link or applied in IPv6 Duplicate Address Detection. A node is required to join the associated Solicited-Node multicast addresses for all unicast and anycast addresses that have been configured for the node's interfaces.

IPv6 Solicited-Node Multicast Address Format:

FF02:0:0:0:0:1:FFXX:XXXX

The IPv6 solicited-node multicast address has the prefix FF02:0:0:0:0:1:FF00:0000/104 concatenated with the 24 low-order bits of a corresponding IPv6 unicast or anycast address.

2. IPv6 Multicast MAC Address

The high-order 16 bits of an IPv6 multicast MAC address begins with 0x3333 while the low-order 32 bits of an IPv6 multicast MAC address are the low-order 32 bits of the IPv6 multicast IP address. The mapping relationship is described as the following figure:

128-bit IPv6 address

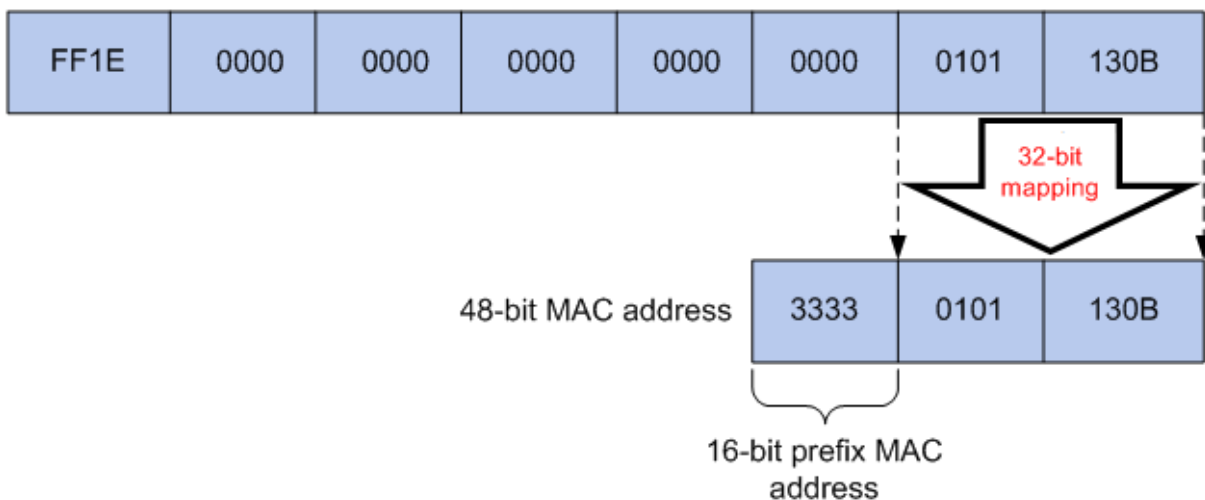

Figure 9-3 Mapping relationship between multicast IPv6 address and multicast IPv6 MAC address

The high-order 16 bits of the IP multicast address are 0x3333, identifying the IPv6 multicast group. The low-order 32 bits of the IPv6 multicast IP address are mapped to the multicast MAC address.

➤ **Multicast Address Table**

The switch is forwarding multicast packets based on the multicast address table. As the transmission of multicast packets cannot span the VLAN, the first part of the multicast address table is VLAN ID, based on which the received multicast packets are forwarded in the VLAN owning the receiving port. The multicast address table is not mapped to an egress port but a group port list. When forwarding a multicast packet, the switch looks up the multicast address table based on the destination multicast address of the multicast packet. If the corresponding entry cannot be found in the table, the switch will broadcast the packet in the VLAN owning the receiving port. If the corresponding entry can be found in the table, it indicates that the destination address should be a group port list, so the switch will deliver this multicast data to each port. The general format of the multicast address table is described as Figure 9-4 below.

VLAN ID	Multicast IP	Port
---------	--------------	------

Figure 9-4 Multicast Address Table

➤ **IGMP Snooping**

In the network, the hosts apply to the near router for joining (leaving) a multicast group by sending IGMP (Internet Group Management Protocol) messages. When the up-stream device forwards down the multicast data, the switch is responsible for sending them to the hosts. IGMP Snooping is a multicast control mechanism, which can be used on the switch for dynamic registration of the multicast group. The switch, running IGMP Snooping, manages and controls the multicast group via listening to and processing the IGMP messages transmitted between the hosts and the multicast router, thereby effectively prevents multicast groups being broadcasted in the network.

➤ **MLD Snooping**

Multicast Listener Discovery(MLD)snooping is applied for efficient distribution of IPv6 multicast data to clients and routers in a Layer 2 network. With MLD snooping, IPv6 multicast data is selectively forwarded to a list of ports that want to receive the data, instead of being flooded to all ports in a VLAN. The list is constructed and maintained by snooping IPv6 multicast control packets. MLD snooping performs a similar function in IPv6 as IGMP snooping in IPv4.

The Multicast module is mainly for multicast management configuration of the switch, including three submenus: **IGMP Snooping**, **MLD Snooping** and **Multicast Table**.

9.1 IGMP Snooping

➤ **IGMP Snooping Process**

The switch, running IGMP Snooping, listens to the IGMP messages transmitted between the host and the router, and tracks the IGMP messages and the registered port. When receiving IGMP report message, the switch adds the port to the multicast address table; when the switch listens to IGMP leave message from the host, the router sends the Group-Specific Query message of the port to check if other hosts need this multicast, if yes, the router will receive IGMP report message; if no, the router will receive no response from the hosts and the switch will remove the port from the multicast address table. The router regularly sends IGMP query messages. After receiving the IGMP query messages, the switch will remove the port from the multicast address table if the switch receives no IGMP report message from the host within a period of time.

➤ IGMP Messages

The switch, running IGMP Snooping, processes the IGMP messages of different types as follows.

1. IGMP Query Message

IGMP query message, sent by the router, falls into two types, IGMP general query message and IGMP group-specific-query message. The router regularly sends IGMP general message to query if the multicast groups contain any member. When receiving IGMP leave message, the receiving port of the router will send IGMP group-specific-query message to the multicast group and the switch will forward IGMP group-specific-query message to check if other members in the multicast group of the port need this multicast.

When receiving IGMP general query message, the switch will forward them to all other ports in the VLAN owning the receiving port. The receiving port will be processed: if the receiving port is not a router port yet, it will be added to the router port list with its router port time specified; if the receiving port is already a router port, its router port time will be directly reset.

When receiving IGMP group-specific-query message, the switch will send the group-specific query message to the members of the multicast group being queried.

2. IGMP Report Message

IGMP report message is sent by the host when it applies for joining a multicast group or responses to the IGMP query message from the router.

When receiving IGMP report message, the switch will send the report message via the router port in the VLAN as well as analyze the message to get the address of the multicast group the host applies for joining. The receiving port will be processed: if the receiving port is a new member port, it will be added to the multicast address table with its member port time specified; if the receiving port is already a member port, its member port time will be directly reset.

3. Member Leave Message

The host will send IGMP leave message when leaving a multicast group to inform the router of its leaving.

When Immediate Leave is not enabled in a VLAN and a leave message is received on a port of this VLAN, the switch will generate Multicast-Address-Specific Queries (MASQs) on this port to check if there are other members in this multicast group. The user can control when a port membership is removed for an existing address in terms of the number and interval of MASQs. If there is no Report message received from this port during the switch maximum response time, the port on which the MASQ was sent is deleted from the multicast group. If the deleted port is the last member of the multicast group, the multicast group is also deleted. The switch will send leave message to the router ports of the VLAN.

In IPv4, Layer 2 switches can use IGMP Snooping to limit the flooding of multicast traffic by dynamically configuring Layer 2 interfaces so that IPv4 multicast data is selectively forwarded to a list of ports that want to receive the data. This list is constructed by snooping IPv4 multicast control packets.

➤ IGMP Snooping Fundamentals

1. Ports

Router Port: Indicates the switch port directly connected to the multicast router.

Member Port: Indicates a switch port connected to a multicast group member.

2. Timers

Router Port Time: Within the time, if the switch does not receive IGMP query message from the router port, it will consider this port is not a router port any more. The default value is 300 seconds.

Member Port Time: Within the time, if the switch does not receive IGMP report message from the member port, it will consider this port is not a member port any more. The default value is 260 seconds.

Last Listener Query Interval: The interval between the switch sends out MASQs.

Last Listener Query Count: The number of MASQs that the switch sends before aging out a multicast address when there is no IGMP report response.

The IGMP Snooping function can be implemented on the following pages: **Snooping Config, Port Config, VLAN Config, Multicast VLAN, Querier Config, Profile Config, Profile Binding, Packet Statistics** and **IGMP Authentication**.

9.1.1 Snooping Config

To configure the IGMP Snooping on the switch, please firstly configure IGMP global configuration and related parameters on this page.

If the multicast address of the received multicast data is not in the multicast address table, the switch will broadcast the data in the VLAN. When Unknown Multicast Discard feature is enabled, the switch drops the received unknown multicast so as to save the bandwidth and enhance the process efficiency of the system. Please configure this feature appropriate to your needs.

Choose the menu **Multicast** → **IGMP Snooping** → **Snooping Config** to load the following page.

Global Config

IGMP Snooping Enable Disable

Unknown Multicast Forward Discard

Report Message Suppression Enable Disable

Router Port Time sec (60-600)

Member Port Time sec (60-600)

Last Listener Query Interval: secs(1-5)

Last Listener Query Count: (1-5)

IGMP Snooping Status

Description	Member
Enable ports	
Enable VLAN	

Note:

IGMP Snooping will take effect only when Global Config, Port Config and VLAN Config are all enabled.

Figure 9-5 Basic Config

The following entries are displayed on this screen:

➤ **Global Config**

IGMP Snooping: Select Enable/Disable IGMP Snooping function globally on the switch.

Unknown Multicast: Select the operation for the switch to process unknown multicast, Forward or Discard.

Report Message Suppression: Enable or disable Report Message Suppression function globally. If this function is enabled, the first Report Message from the listener will be forwarded to the router ports while the subsequent Report Message will be suppressed to reduce the IGMP packets.

Router Port Time: Specify the aging time of the router port. Within this time, if the switch does not receive IGMP query message from the router port, it will consider this port is not a router port any more.

Member Port Time: Specify the aging time of the member port. Within this time, if the switch does not receive IGMP report message from the member port, it will consider this port is not a member port any more.

Last Listener Query Interval: Enter the interval between the switch sends out MASQs.

Last Listener Query Count: Enter the number of MASQs that the switch sends before aging out a multicast address when there is no IGMP report response.

➤ **IGMP Snooping Status**

Description: Displays IGMP Snooping status.

Member: Displays the member of the corresponding status.

9.1.2 Port Config

On this page you can enable or disable the IGMP Snooping and Fast Leave feature for ports of the switch.

Choose the menu **Multicast** → **IGMP Snooping** → **Port Config** to load the following page.

Select	Port	IGMP Snooping	Fast Leave	LAG
<input type="checkbox"/>		▼	▼	
<input type="checkbox"/>	1/0/1	Disable	Disable	---
<input type="checkbox"/>	1/0/2	Disable	Disable	---
<input type="checkbox"/>	1/0/3	Disable	Disable	---
<input type="checkbox"/>	1/0/4	Disable	Disable	---
<input type="checkbox"/>	1/0/5	Disable	Disable	---
<input type="checkbox"/>	1/0/6	Disable	Disable	---
<input type="checkbox"/>	1/0/7	Disable	Disable	---
<input type="checkbox"/>	1/0/8	Disable	Disable	---
<input type="checkbox"/>	1/0/9	Disable	Disable	---
<input type="checkbox"/>	1/0/10	Disable	Disable	---
<input type="checkbox"/>	1/0/11	Disable	Disable	---
<input type="checkbox"/>	1/0/12	Disable	Disable	---
<input type="checkbox"/>	1/0/13	Disable	Disable	---
<input type="checkbox"/>	1/0/14	Disable	Disable	---
<input type="checkbox"/>	1/0/15	Disable	Disable	---

Figure 9-6 Port Config

The following entries are displayed on this screen:

➤ **Port Config**

UNIT:1/LAGS: Click **1** to configure the physical ports. Click **LAGS** to configure the link aggregation groups.

Select: Select the desired port for IGMP Snooping feature configuration. It is multi-optional.

Port: Displays the port of the switch.

IGMP Snooping: Select Enable/Disable IGMP Snooping for the desired port.

Fast Leave: Select Enable/Disable Fast Leave feature for the desired port. If Fast Leave is enabled for a port, the switch will immediately remove this port from the multicast group upon receiving IGMP leave messages.

LAG: Displays the LAG number which the port belongs to.

Note:

1. Fast Leave on the port is effective only when the host supports IGMPv2 or IGMPv3.
2. When both Fast Leave feature and Unknown Multicast Discard feature are enabled, the leaving of a user connected to a port owning multi-user will result in the other users intermitting the multicast business.

9.1.3 VLAN Config

Multicast groups established by IGMP Snooping are based on VLANs. On this page you can configure different IGMP parameters for different VLANs.

Choose the menu **Multicast**→**IGMP Snooping**→**VLAN Config** to load the following page.

VLAN Config

VLAN ID: (1-4094)

Router Port Time: 0 sec (0,60-600, recommend: 300)

Member Port Time: 0 sec (0,60-600, recommend: 260)

Static Router Ports

UNIT: 1 LAGS

2 4 6 8 10 12 14 16 18 20 22 24 26 28

1 3 5 7 9 11 13 15 17 19 21 23 25 27

Forbidden Router Ports

UNIT: 1 LAGS

2 4 6 8 10 12 14 16 18 20 22 24 26 28

1 3 5 7 9 11 13 15 17 19 21 23 25 27

Unselected Port(s) Selected Port(s) Not Available for Selection

Vlan Table

Select	VLAN ID	Router Port Time	Member Port Time	Static Router Ports	Dynamic Router Ports	Forbidden Router Ports	Operation
No entry in the table.							

Note:
The settings here will be invalid when multicast VLAN is enabled.

Figure 9-7 VLAN Config

The following entries are displayed on this screen:

➤ **VLAN Config**

VLAN ID: Enter the VLAN ID to enable IGMP Snooping for the desired VLAN.

Router Port Time: Specify the aging time of the router port. Within this time, if the switch doesn't receive IGMP query message from the router port, it will consider this port is not a router port any more. By default, it is 0 and the global router-time will be used.

Member Port Time: Specify the aging time of the member port. Within this time, if the switch doesn't receive IGMP report message from the member port, it will consider this port is not a member port any more. By default, it is 0 and the global member-time will be used.

Router Ports: Specify the static router port which is mainly used in the network with stable topology.

➤ **VLAN Table**

Select: Select the desired VLAN ID for configuration. It is multi-optional.

VLAN ID: Displays the VLAN ID.

Router Port Time: Displays the router port time of the VLAN.

Member Port Time: Displays the member port time of the VLAN.

Static Router Ports: Displays the static router ports of the VLAN.

Dynamic Router Ports: Displays the dynamic router ports of the VLAN.

Forbidden Router Ports: Displays the forbidden router ports of the VLAN.



Note:

The settings here will be invalid when multicast VLAN is enabled.

Configuration procedure:

1	Enable IGMP Snooping function	Required. Enable IGMP Snooping globally on the switch and for the port on Multicast→IGMP Snooping→Snooping Config and Port Config page.
2	Configure the multicast parameters for VLANs	Optional. Configure the multicast parameters for VLANs on Multicast→IGMP Snooping→VLAN Config page. If a VLAN has no multicast parameters configuration, it indicates the IGMP Snooping is not enabled in the VLAN, thus the multicast data in the VLAN will be broadcasted.

9.1.4 Multicast VLAN

In old multicast transmission mode, when users in different VLANs apply for join the same multicast group, the multicast router will duplicate this multicast information and deliver each VLAN owning a receiver one copy. This mode wastes a lot of bandwidth.

The problem above can be solved by configuring a multicast VLAN. By adding switch ports to the multicast VLAN and enabling IGMP Snooping, you can make users in different VLANs share the same multicast VLAN. This saves the bandwidth since multicast streams are transmitted only within the multicast VLAN and also guarantees security because the multicast VLAN is isolated from user VLANs.

Before configuring a multicast VLAN, you should firstly configure a VLAN as multicast VLAN and add the corresponding ports to the VLAN on the **802.1Q VLAN** page. If the multicast VLAN is enabled, the multicast configuration for other VLANs on the **VLAN Config** page will be invalid, that is, the multicast streams will be transmitted only within the multicast VLAN.

Choose the menu **Multicast**→**IGMP Snooping**→**Multicast VLAN** to load the following page.

Multicast VLAN

Multicast VLAN: Enable Disable

VLAN ID: (2-4094)

Router Port Time: 0 sec (0,60-600, recommend: 300)

Member Port Time: 0 sec (0,60-600, recommend: 260)

Replace Source IP: 0.0.0.0 (format:192.168.0.1)

Dynamic Router Ports

UNIT: 1 LAGS

2	4	6	8	10	12	14	16	18	20	22	24	26	28
1	3	5	7	9	11	13	15	17	19	21	23	25	27

Static Router Ports

UNIT: 1 LAGS

2	4	6	8	10	12	14	16	18	20	22	24	26	28
1	3	5	7	9	11	13	15	17	19	21	23	25	27

Forbidden Router Ports

UNIT: 1 LAGS

2	4	6	8	10	12	14	16	18	20	22	24	26	28
1	3	5	7	9	11	13	15	17	19	21	23	25	27

Unselected Port(s) Selected Port(s) Not Available for Selection

Note:

1. All IGMP packet will be processed in the Multicast VLAN after Multicast VLAN is created.
2. The Multicast VLAN won't take effect unless you first complete the configuration on the VLAN Config page.
3. The Replace Source IP won't take effect if the IP is set to 0.0.0.0.

Figure 9-8 Multicast VLAN

The following entries are displayed on this screen:

➤ **Multicast VLAN**

- Multicast VLAN:** Select Enable/Disable Multicast VLAN feature.
- VLAN ID:** Enter the VLAN ID of the multicast VLAN.
- Router Port Time:** Specify the aging time of the router port. Within this time, if the switch doesn't receive IGMP query message from the router port, it will consider this port is not a router port any more.
- Member Port Time:** Specify the aging time of the member port. Within this time, if the switch doesn't receive IGMP report message from the member port, it will consider this port is not a member port any more.

- Replace Source IP:** Specify the IP address with which the switch will replace the source of IGMP packets.
- Dynamic Router Ports:** Displays the dynamic router ports of the multicast VLAN.
- Static Router Ports:** Specify the static router port which is mainly used in the network with stable topology.
- Forbidden Router Ports:** Specify the forbidden router ports which is mainly used to forbid ports becoming router ports.



Note:

1. The router port should be in the multicast VLAN, otherwise the member ports cannot receive multicast streams.
2. The Multicast VLAN won't take effect unless you first complete the configuration for the corresponding VLAN owning the port on the **802.1Q VLAN** page.
3. Configure the link type of the router port in the multicast VLAN as Tagged otherwise all the member ports in the multicast VLAN cannot receive multicast streams.
4. After a multicast VLAN is created, all the IGMP packets will be processed only within the multicast VLAN.

Configuration procedure:

1	Enable IGMP Snooping function	Required. Enable IGMP Snooping globally on the switch and for the port on Multicast→IGMP Snooping→Snooping Config and Port Config page.
2	Create a multicast VLAN	Required. Create a multicast VLAN and add all the member ports and router ports to the VLAN on the VLAN→802.1Q VLAN→VLAN Config page. <ul style="list-style-type: none"> • Configure the link type of the router ports as Tagged.
3	Configure parameters for multicast VLAN	Optional. Enable and configure a multicast VLAN on the Multicast→IGMP Snooping→Multicast VLAN page. It is recommended to keep the default time parameters.
4	Look over the configuration	If it is successfully configured, the VLAN ID of the multicast VLAN will be displayed in the IGMP Snooping Status table on the Multicast→IGMP Snooping→Snooping Config page.

Application Example for Multicast VLAN:

➤ **Network Requirements**

Multicast source sends multicast streams via the router, and the streams are transmitted to user A and user B through the switch.

Router: Its WAN port is connected to the multicast source; its LAN port is connected to the switch. The multicast packets are transmitted in VLAN3.

Switch: Port 3 is connected to the router and the packets are transmitted in VLAN3; port 4 is connected to user A and the packets are transmitted in VLAN4; port 5 is connected to user B and the packets are transmitted in VLAN5.

User A: Connected to Port 4 of the switch.

User B: Connected to port 5 of the switch.

Configure a multicast VLAN, and user A and B receive multicast streams through the multicast VLAN.

➤ **Network Diagram**

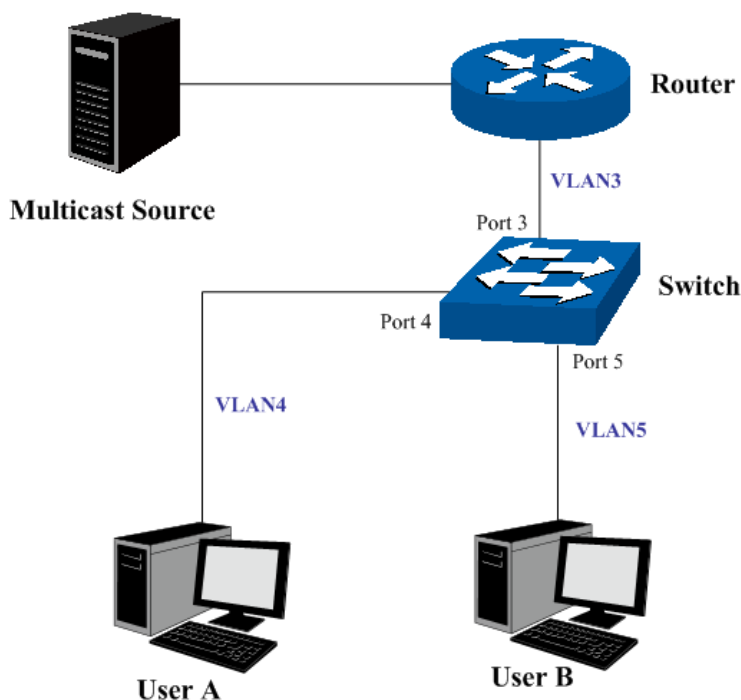

➤ **Configuration Procedure**

1	Create VLANs	Create three VLANs with the VLAN ID 3, 4 and 5 respectively, and specify the description of VLAN3 as Multicast VLAN on VLAN→802.1Q VLAN page.
2	Configure ports	On VLAN→802.1Q VLAN function pages. For port 3, configure its link type as Tagged, and add it to VLAN3, VLAN4 and VLAN5. For port 4, configure its link type as Untagged, and add it to VLAN3 and VLAN4. For port 5, configure its link type as Untagged, and add it to VLAN3 and VLAN5.
3	Enable IGMP Snooping function	Enable IGMP Snooping function globally on Multicast→IGMP Snooping→Snooping Config page. Enable IGMP Snooping function for port 3, port4 and port 5 on Multicast→IGMP Snooping→Port Config page.
4	Enable Multicast VLAN	Enable Multicast VLAN, configure the VLAN ID of a multicast VLAN as 3 and keep the other parameters as default on Multicast→IGMP Snooping→Multicast VLAN page.

5	Check Multicast VLAN	Port 3-5 and Multicast VLAN 3 will be displayed in the IGMP Snooping Status table on the Multicast→IGMP Snooping→Snooping Config page.
---	----------------------	---

9.1.5 Querier Config

In an IP multicast network that runs IGMP, a Layer 3 multicast device works as an IGMP querier to send IGMP queries and manage the multicast table. But IGMP is not supported by the devices in Layer 2 network. IGMP Snooping Querier can act as an IGMP Router in Layer 2 network. It can help to create and maintain multicast forwarding table on the switch with the Query messages it generates.

Choose the menu **Multicast→IGMP Snooping→Querier Config** to load the following page.

Figure 9-9 Querier Config

The following entries are displayed on this screen:

➤ **IGMP Snooping Querier Config**

- VLAN ID:** Enter the ID of the VLAN that enables IGMP Snooping Querier.
- Query Interval:** Enter the time interval of sending a general query frame by IGMP Snooping Querier.
- Max Response Time:** Enter the maximal time for the host to respond to a general query frame sent by IGMP Snooping Querier.
- General Query Source IP:** Enter the source IP of the general query frame sent by IGMP Snooping Querier. It should not be a multicast IP or a broadcast IP.

➤ **IGMP Snooping Querier Table**

- Select:** Select the desired entry. It is multi-optional.
- VLAN ID:** Displays the ID of the VLAN that enables IGMP Snooping Querier.
- Query Interval:** Displays the Query Interval of the IGMP Snooping Querier.
- Max Response Time:** Displays the maximal time for the host to respond to a general query frame sent by IGMP Snooping Querier.

General Query Source IP:

Displays the source IP of the general query frame sent by IGMP Snooping Querier.

9.1.6 Profile Config

On this page you can configure an IGMP profile.

Choose the menu **Multicast**→**IGMP Snooping**→**Profile Config** to load the following page.

The screenshot shows a web interface for configuring an IGMP profile. It is divided into three main sections:

- Profile Creation:** Contains a text input field for 'Profile ID' with a '(1-999)' constraint, a radio button for 'Mode' (with 'Deny' selected), and a 'Create' button.
- Search Option:** Contains a dropdown menu for 'Search Option' (set to 'All') and a 'Search' button.
- IGMP Profile Info:** A table with columns: 'Select', 'Profile ID', 'Mode', 'Bind Ports', and 'Operation'. The table is currently empty, displaying the message 'No entry in the table.' Below the table are three buttons: 'All', 'Delete', and 'Help'.

Note

You can click edit to create IP range of profile.

Figure 9-10 Profile Config

The following entries are displayed on this screen:

➤ **Profile Creation**

Profile ID: Specify the Profile ID you want to create, and it should be a number between 1 and 999.

Mode: The attributes of the profile.

- **Permit:** Only permit the IP address within the IP range and deny others.
- **Deny:** Only deny the IP address within the IP range and permit others.

➤ **Search Option**

Search Option: Select the rules for displaying profile entries.

- **All:** Display all profile entries.
- **Profile ID:** Display profile entry of the ID.

➤ **IGMP Profile Info**

Select: Select the desired entry for configuration.

Profile ID: Displays the profile ID.

- Mode:** Displays the attribute of the profile.
- **Permit:** Only permit the IP address within the IP range and deny others.
 - **Deny:** Only deny the IP address within the IP range and permit others.
- Bind Ports:** Displays the ports that the Profile bound to.
- Operation:** Click the **Edit** button to configure the mode or IP-range of the Profile.

After you have created a profile ID, click **Edit** to display the following figure.

Profile mode

Profile ID:

Mode:

Add IP-range

Start IP: (Format:225.0.0.1)

End IP: (Format:225.0.0.1)

IP-range Table

Select	Index	Start IP	End IP
No entry in the table.			

The following entries are displayed on this screen:

➤ **Profile Mode**

Profile ID: Displays the Profile ID you have created.

Mode: The attributes of the profile.

- **Permit:** Only permit the IP address within the IP range and deny others.
- **Deny:** Only deny the IP address within the IP range and permit others.

➤ **Add IP-range**

Start IP: Enter start IP address of the IP-range.

End IP: Enter end IP address of the IP-range.

➤ **IP-range Table**

Select: Select the desired entry for configuration.

Index: Displays index of the IP-range which is not configurable.

Start IP: Displays the start IP address of the IP-range.

End IP: Displays the end IP address of the IP-range.

9.1.7 Profile Binding

When the switch receives IGMP report message, it examines the profile ID bound to the access port to determine if the port can join the multicast group. If the multicast IP is not filtered, the switch will add the port to the forward port list of the multicast group. Otherwise, the switch will drop the IGMP report message. In that way, you can control the multicast groups that users can access.

Choose the menu **Multicast**→**IGMP Snooping**→**Profile Binding** to load the following page.

Profile and Max Group Binding						
UNIT: <input type="text" value="1"/> LAGS						
Select	Port	Profile ID	Max Group	Overflow Action	LAG	
<input type="checkbox"/>		<input type="text"/>	<input type="text"/>	<input type="text"/>		
<input type="checkbox"/>	1/0/1		1000	Drop	---	ClearBinding
<input type="checkbox"/>	1/0/2		1000	Drop	---	ClearBinding
<input checked="" type="checkbox"/>	1/0/3		1000	Drop	---	ClearBinding
<input type="checkbox"/>	1/0/4		1000	Drop	---	ClearBinding
<input type="checkbox"/>	1/0/5		1000	Drop	LAG 1	ClearBinding
<input type="checkbox"/>	1/0/6		1000	Drop	LAG 1	ClearBinding
<input type="checkbox"/>	1/0/7		1000	Drop	---	ClearBinding
<input type="checkbox"/>	1/0/8		1000	Drop	---	ClearBinding
<input type="checkbox"/>	1/0/9		1000	Drop	---	ClearBinding
<input type="checkbox"/>	1/0/10		1000	Drop	---	ClearBinding
<input type="checkbox"/>	1/0/11		1000	Drop	---	ClearBinding
<input type="checkbox"/>	1/0/12		1000	Drop	---	ClearBinding
<input type="checkbox"/>	1/0/13		1000	Drop	---	ClearBinding
<input type="checkbox"/>	1/0/14		1000	Drop	---	ClearBinding
<input type="checkbox"/>	1/0/15		1000	Drop	---	ClearBinding

Note:

The port profile binding configuration here has no effect on static multicast IP.

Figure 9-11 Profile Binding

The following entries are displayed on this screen:

➤ **Profile and Max Group Binding**

- UNIT:1/LAGS:** Click **1** to configure the physical ports. Click **LAGS** to configure the link aggregation groups.
- Select:** Select the desired entry for configuration.
- Port:** It is multi-optional. Displays the port number.
- Profile ID:** The existing Profile ID bound to the selected port.
- Max Group:** The maximum multicast group a port can join.

Overflow Action: The policy should be taken when the number of multicast group a port has joined reach the maximum.

- **Drop:** Drop the successive report packet, and this port can not join any other multicast group.
- **Replace:** When the number of the dynamic multicast groups that a port joins has exceeded the max-group, the newly joined multicast group will replace an existing multicast group with the lowest multicast group address.

LAG: Displays the LAG number which the port belongs to.

Clear Binding: Click the **ClearBinding** button to clear all profiles bound to the port.

Configuration Procedure:

1	Create Profile	Required. Configure the Profile ID and mode on Multicast→IGMP Snooping→Profile Config page.
2	Configure IP-Range	Required. Click Edit of the specified entry in the IGMP Profile Info table on Multicast→IGMP Snooping→Profile Config page to configure the mode or IP-range of the Profile.
3	Configure Profile Binding for ports	Optional. Configure Profile Binding for ports on Multicast→IGPM Snooping→Porfile Binding page.

9.1.8 Packet Statistics

On this page you can view the multicast data traffic on each port of the switch, which facilitates you to monitor the IGMP messages in the network.

Choose the menu **Multicast→IGMP Snooping→Packet Statistics** to load the following page.

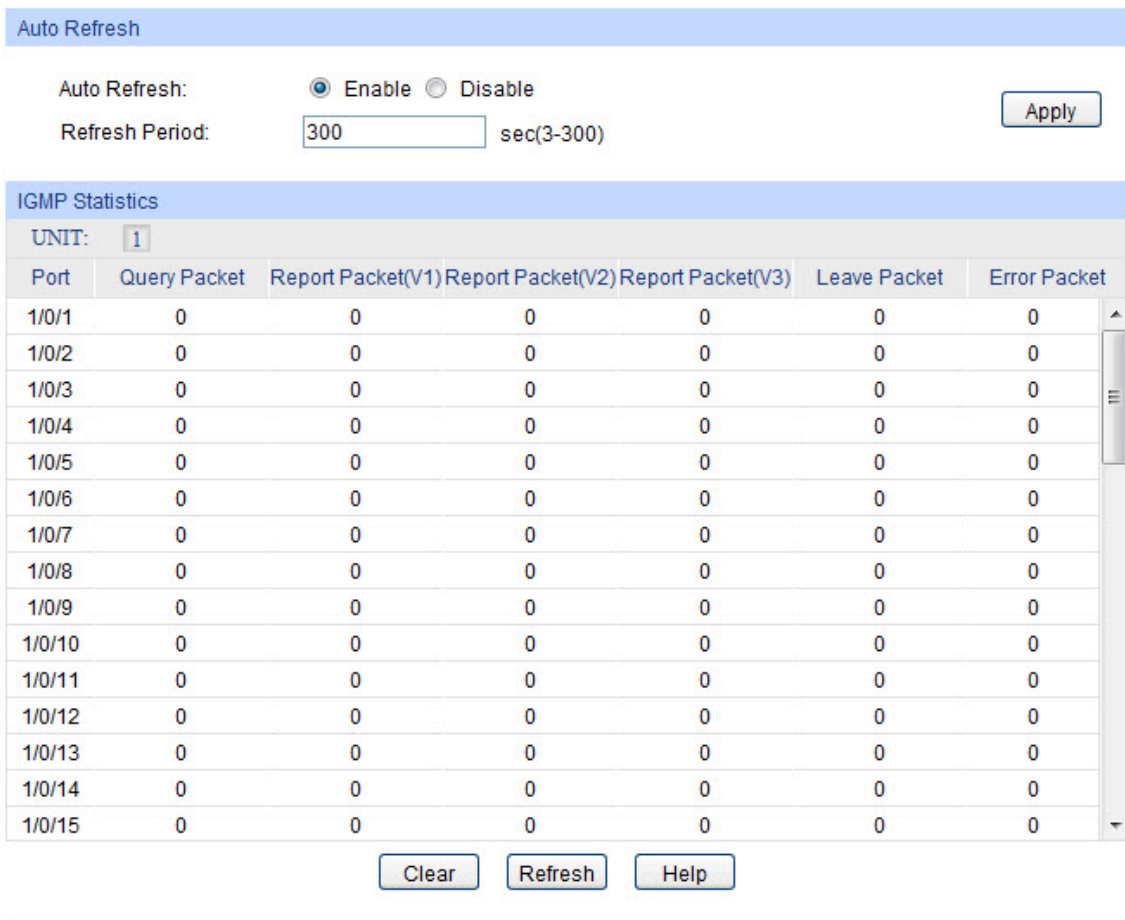

Figure 9-12 Packet Statistics

The following entries are displayed on this screen:

➤ **Auto Refresh**

Auto Refresh: Select Enable/Disable auto refresh feature.

Refresh Period: Enter the time from 3 to 300 in seconds to specify the auto refresh period.

➤ **IGMP Statistics**

Port: Displays the port number of the switch.

Query Packet: Displays the number of query packets the port received.

Report Packet (V1): Displays the number of IGMPv1 report packets the port received.

Report Packet (V2): Displays the number of IGMPv2 report packets the port received.

Report Packet (V3): Displays the number of IGMPv3 report packets the port received.

Leave Packet: Displays the number of leave packets the port received.

Error Packet: Displays the number of error packets the port received.

9.1.9 IGMP Authentication

IGMP Authentication (Internet Group membership Authentication Protocol) is a multicast authentication protocol used to authenticate who wants to join the limited multicast source. On this page you can configure IGMP Authentication feature for port.

Choose the menu **Multicast**→**IGMP Snooping**→**IGMP Authentication** to load the following page.

Global Config

Accounting Enable Disable

Port Config

UNIT: 1 LAGS

Select	Port	IGMP Authentication	LAG
<input type="checkbox"/>			
<input type="checkbox"/>	1/0/1	Disable	---
<input type="checkbox"/>	1/0/2	Disable	---
<input type="checkbox"/>	1/0/3	Disable	---
<input type="checkbox"/>	1/0/4	Disable	---
<input type="checkbox"/>	1/0/5	Disable	---
<input type="checkbox"/>	1/0/6	Disable	---
<input type="checkbox"/>	1/0/7	Disable	---
<input type="checkbox"/>	1/0/8	Disable	---
<input type="checkbox"/>	1/0/9	Disable	---
<input type="checkbox"/>	1/0/10	Disable	---
<input type="checkbox"/>	1/0/11	Disable	---
<input type="checkbox"/>	1/0/12	Disable	---
<input type="checkbox"/>	1/0/13	Disable	---
<input type="checkbox"/>	1/0/14	Disable	---
<input type="checkbox"/>	1/0/15	Disable	---

Note:

The IGMP Authentication feature will take effect only when AAA function is enabled and the RADIUS Server is configured.

Figure 9-13 IGMP Authentication

The following entries are displayed on this screen:

➤ **Global Config**

Accounting: Enable/Disable the IGMP Authentication Account feature.

➤ **Port Config**

Port Select: Click the Select button to quick-select the corresponding port based on the port number you entered.

Select: Select the desired port for IGMP Authentication feature configuration. It is multi-optional.

Port: Displays the port number of the switch.

General Query Source IP:	Enter the source IP of the general query frame sent by IGMP Snooping Querier. It should not be a multicast IP or a broadcast IP.
IGMP Authentication:	Select Enable/Disable IGMP Authentication for the desired port.
LAG:	Displays the LAG number which the port belongs to.



Note:

The IGMP Authentication feature will take effect only when AAA function is enabled and the RADIUS server is configured. For how to enable AAA function and configure RADIUS server, please refer to [13.11 AAA](#).

9.2 MLD Snooping

➤ MLD Snooping

Multicast Listener Discovery (MLD) snooping is applied for efficient distribution of IPv6 multicast data to clients and routers in a Layer 2 network. With MLD snooping, IPv6 multicast data is selectively forwarded to a list of ports that want to receive the data, instead of being flooded to all ports in a VLAN. The list is constructed and maintained by snooping IPv6 multicast control packets. MLD snooping performs a similar function in IPv6 as IGMP snooping in IPv4.

The switch, running MLD Snooping, listens to the MLD messages transmitted between the host and the router, and tracks the MLD messages and the registered port. When receiving MLD report message, the switch adds the port to the multicast address table; when the switch listens to MLD Done message from the host, the router sends the Multicast-Address-Specific Query message of the port to check if other hosts need this multicast, if yes, the switch will receive MLD report message; if no, the switch will receive no response from the hosts and the switch will remove the port from the multicast address table. The router regularly sends MLD query messages. After receiving the MLD query messages, the switch will remove the port from the multicast address table if the switch receives no MLD report message from the host within a period of time.

➤ MLD Snooping Fundamentals

1. MLD Messages

MLD Queries: MLD Queries include General Queries and Multicast-Address-Specific Queries (MASQs) and are sent out from the MLD router.

MLD Reports: When a host wants to join a multicast group or responds to the MLD queries, it will send out an MLD report.

MLD Done Messages: When a host wants to leave a multicast group, it will send out an MLD Done message to inform the IPv6 multicast routers of its leave.

2. Relevant Ports of the Switch

Router Port: Indicates the switch port that links toward the MLD router.

Member Port: Indicates the switch port that links toward the multicast members.

3. Timers

Router Port Aging Time: Within this time, if the switch does not receive MLD queries from the router port, it will delete this port from the router port list. The default value is 300 seconds.

Member Port Aging Time: Within this time, if the switch does not receive MLD reports from the member port, it will delete this port from the MLD multicast group. The default value is 260 seconds.

General Query Interval: The interval between the multicast router sends out general queries.

Last Listener Query Interval: The interval between the switch sends out MASQs.

Last Listener Query Count: The number of MASQs that the switch sends before aging out a multicast address when there is no MLD report response.

➤ **MLD Snooping Process**

1. General Query

The MLD router regularly sends MLD general queries to query if the multicast groups contain any members. When receiving MLD general queries, the switch will forward them to all other ports in the VLAN. The receiving port will be processed: if the receiving port is not a router port yet, it will be added to the router port list with its router port aging time specified; if the receiving port is already a router port, its router port aging time will be directly reset.

2. Membership Report

The host will send MLD report messages when it applies for joining a multicast group or responds to the MLD query message from the router.

When receiving MLD report message, the switch will forward the report message via the router port in the VLAN, and analyze the message to get the address of the multicast group the host applies for joining. If the multicast group does not exist, it will create the group entry. The receiving port will be processed: if the receiving port is a new member port, it will be added to the forward list of the multicast group with its member port aging time specified; if the receiving port is already a member port, its member port aging time will be directly reset.

3. Member Leave

The host will send MLD Done message when leaving a multicast group to inform the router of its leaving.

When Immediate Leave is not enabled in a VLAN and a Done message is received on a port of this VLAN, the switch will generate MASQs on this port to check if there are other members in this multicast group. The user can control when a port membership is removed for an exiting address in terms of the number and interval of MASQs. If there is no Report message received from this port during the switch maximum response time, the port on which the MASQ was sent is deleted from the multicast group. If the deleted port is the last member of the multicast group, the multicast group is also deleted. The switch will send Done message to the router ports of the VLAN.

In IPv6, Layer 2 switches can use Multicast Listener Discovery (MLD) Snooping to limit the flooding of multicast traffic by dynamically configuring Layer 2 interfaces so that IPv6 multicast data is selectively forwarded to a list of ports that want to receive the data. This list is constructed by snooping IPv6 multicast control packets.

The MLD Snooping function can be implemented on **Snooping Config, Port Config, VLAN Config, Multicast VLAN, Querier Config, Profile Config, Profile Binding** and **Packet Statistics** pages.

9.2.1 Snooping Config

To configure the MLD Snooping on the switch, please firstly configure MLD global configuration and related parameters on this page.

Chose the menu **Multicast**→**MLD Snooping**→**Snooping Config** to load the following page.

Global Config

MLD Snooping Enable Disable

Unknown Multicast Forward Discard

Report Message Suppression Enable Disable

Router Port Time sec (60-600)

Member Port Time sec (60-600) Apply

Last Listener Query Interval: secs(1-5)

Last Listener Query Count: (1-5)

MLD Snooping Status

Description	Member
Enable ports	
Enable VLAN	

Refresh
Help

Note:

MLD Snooping will take effect only when Global Config, Port Config and VLAN Config are all enabled.

Figure 9-14 Snooping Config

The following entries are displayed on this screen:

➤ **Global Config**

- MLD Snooping:** Enable or disable MLD Snooping function globally.
- Unknown Multicast:** Choose to forward or drop unknown multicast data.
Unknown IPv6 multicast packets refer to those packets without corresponding forwarding entries in the IPv6 multicast table:
When unknown multicast filter is enabled, the switch will discard all received unknown IPv6 multicast packets;
When unknown multicast filter is disabled, all unknown IPv6 multicast packets are flooded in the ingress VLAN.
- Report Message Suppression:** Enable or disable Report Message Suppression function globally. If this function is enabled, the first Report Message from the listener will forward to the router ports while the subsequent Report Message from the group will be suppressed to reduce the MLD traffic in the network.
- Router Port Time:** Enter the global router port aging time. If the router port does not receive Query Message in the aging time, it will be aged.
- Member Port Time:** Enter the global member port aging time. If the member port does not receive Report Message in the aging time, it will be aged.

Last Listener Query Interval:

Enter the interval between the switch sends out MASQs.

Last Listener Query Count:

Enter the number of MASQs that the switch sends before aging out a multicast address when there is no MLD report response.

➤ **MLD Snooping Status**

Description:

Displays MLD Snooping status.

Member:

Displays the member of the corresponding status.



Note:

1. Configurations of the Router Port Time and Member Port Time in [8.2.3 VLAN Config](#) override their global configurations here.
3. Before creating a Multicast VLAN, you should enable the MLD snooping function in this VLAN in [8.2.3 VLAN Config](#).

Configuration Procedure of Multicast VLAN:

1	Create VLAN.	Required. On the VLAN → 802.1Q VLAN → VLAN Config page, click the Create button to create a VLAN. Enter the VLAN ID and the description for the VLAN. Meanwhile, specify its member ports.
2	Enable MLD Snooping globally.	Required. On the Multicast → MLD Snooping → Global Config page, enable the MLD Snooping function globally.
3	Enable MLD Snooping in the VLAN.	Required. On the Multicast → MLD Snooping → VLAN Config page, specify the VLAN ID as the VLAN created in step 1.
4	Enable the Multicast VLAN.	Required. On the Multicast → MLD Snooping → Multicast page, enable the Multicast VLAN function and specify the Multicast VLAN ID as the VLAN specified in Step 1.

9.2.2 Port Config

On this page you can configure MLD Snooping function with each single port.

Choose the menu **Multicast**→**MLD Snooping**→**Port Config** to load the following page.

Select	Port	MLD Snooping	Fast Leave	LAG
<input type="checkbox"/>		<input type="text" value=""/>	<input type="text" value=""/>	
<input type="checkbox"/>	1/0/1	Disable	Disable	---
<input type="checkbox"/>	1/0/2	Disable	Disable	---
<input type="checkbox"/>	1/0/3	Disable	Disable	---
<input type="checkbox"/>	1/0/4	Disable	Disable	---
<input type="checkbox"/>	1/0/5	Disable	Disable	LAG 1
<input type="checkbox"/>	1/0/6	Disable	Disable	LAG 1
<input type="checkbox"/>	1/0/7	Disable	Disable	---
<input type="checkbox"/>	1/0/8	Disable	Disable	---
<input type="checkbox"/>	1/0/9	Disable	Disable	---
<input type="checkbox"/>	1/0/10	Disable	Disable	---
<input type="checkbox"/>	1/0/11	Disable	Disable	---
<input type="checkbox"/>	1/0/12	Disable	Disable	---
<input type="checkbox"/>	1/0/13	Disable	Disable	---
<input type="checkbox"/>	1/0/14	Disable	Disable	---
<input type="checkbox"/>	1/0/15	Disable	Disable	---

Figure 9-15 Port Config

The following entries are displayed on this screen:

➤ **Port Config**

UNIT:1/LAGS

Click **1** to configure the physical ports. Click **LAGS** to configure the link aggregation groups.

Select:

Select the port you want to configure.

Port:

Displays the port number.

MLD Snooping:

Select Enable/Disable MLD Snooping for the desired port.

Fast Leave:

Select Enable/Disable Fast Leave feature for the desired port. If Fast Leave is enabled for a port, the switch will immediately remove this port from the multicast group upon receiving MLD done messages.

LAG:

Displays the LAG number.

9.2.3 VLAN Config

On this page you can configure MLD Snooping function with each single VLAN. You need to create VLAN if you want to enable MLD Snooping function in this VLAN.

Choose the menu **Multicast**→**MLD Snooping**→**VLAN Config** to load the following page.

Note:
The settings here will be invalid when multicast VLAN is enabled.

Figure 9-16 VLAN Config

The following entries are displayed on this screen:

➤ **VLAN Config**

- VLAN ID:** Enter the VLAN ID you want to configure.
- Router Port Time:** Specify the aging time of the router port. Within this time, if the switch don't receive MLD query message from the router port, it will consider this port is not a router port any more. By default, it is 0 and the global router-time will be used.
- Member Port Time:** Specify the aging time of the member port. Within this time, if the switch don't receive MLD report message from the member port, it will consider this port is not a member port any more. By default, it is 0 and the global member-time will be used.
- Static Router Ports:** Specify the static router port which is mainly used in the network with stable topology.
- Forbidden Router Ports:** Specify the forbidden router ports which is mainly used to forbid ports becoming router ports.

➤ **VLAN Table**

- Select:** Select the VLAN ID you want to change.
- VLAN ID:** Displays the VLAN ID.

Router Port Time:	Displays the router port time of this VLAN.
Member Port Time:	Displays the member port time of this VLAN.
Static Router Ports:	Displays the static router ports of this VLAN.
Dynamic Router Ports:	Displays the dynamic router ports of this VLAN.
Forbidden Router Ports:	Displays the forbidden router ports of the VLAN.



Note:

1. The MLD snooping function in a VLAN will take effect when global MLD Snooping function is enabled in [9.2.1 Snooping Config](#) and the VLAN is created in [Chapter 6 VLAN](#).
2. When the router port time or member port time is set for a VLAN, this value overrides the value configured globally in [9.2.1 Snooping Config](#).

9.2.4 Multicast VLAN

In old multicast transmission mode, when users in different VLANs apply for join the same multicast group, the multicast router will duplicate this multicast information and deliver each VLAN owning a receiver one copy. This mode wastes a lot of bandwidth.

The problem above can be solved by configuring a multicast VLAN. By adding switch ports to the multicast VLAN and enabling MLD Snooping, you can make users in different VLANs share the same multicast VLAN. This saves the bandwidth since multicast streams are transmitted only within the multicast VLAN and also guarantees security because the multicast VLAN is isolated from user VLANs.

Before configuring a multicast VLAN, you should firstly configure a VLAN as multicast VLAN and add the corresponding ports to the VLAN on the **802.1Q VLAN** page. If the multicast VLAN is enabled, the multicast configuration for other VLANs on the **VLAN Config** page will be invalid, that is, the multicast streams will be transmitted only within the multicast VLAN.

Choose the menu **Multicast**→**MLD Snooping**→**Multicast VLAN** to load the following page.

Multicast VLAN

Multicast VLAN: Enable Disable

VLAN ID: (2-4094)

Router Port Time: sec (0,60-600, recommend: 300)

Member Port Time: sec (0,60-600, recommend: 260)

Replace Source IP: (format:FE80::ABEC:12EA)

Dynamic Router Ports

UNIT: LAGS

2	4	6	8	10	12	14	16	18	20	22	24	26	28
1	3	5	7	9	11	13	15	17	19	21	23	25	27

Static Router Ports

UNIT: LAGS

2	4	6	8	10	12	14	16	18	20	22	24	26	28
1	3	5	7	9	11	13	15	17	19	21	23	25	27

Forbidden Router Ports

UNIT: LAGS

2	4	6	8	10	12	14	16	18	20	22	24	26	28
1	3	5	7	9	11	13	15	17	19	21	23	25	27

Unselected Port(s) Selected Port(s) Not Available for Selection

Note:

1. All MLD packet will be processed in the Multicast VLAN after Multicast VLAN is created.
2. The Multicast VLAN won't take effect unless you first complete the configuration on the VLAN Config page.
3. The Replace Source IP won't take effect if the IP is set to ..

Figure 9-17 Multicast VLAN Config

The following entries are displayed on this screen:

➤ **Multicast VLAN**

- Multicast VLAN:** Select Enable/Disable Multicast VLAN feature.
- VLAN ID:** Enter the VLAN ID of the multicast VLAN.
- Router Port Time:** Specify the aging time of the router port. Within this time, if the switch doesn't receive IGMP query message from the router port, it will consider this port is not a router port any more.
- Member Port Time:** Specify the aging time of the member port. Within this time, if the switch doesn't receive IGMP report message from the member port, it will consider this port is not a member port any more.
- Replace Source IP:** Specify the IP address with which the switch will replace the source of MLD packets.
- Dynamic Router Ports:** Displays the dynamic router ports of the multicast VLAN.
- Static Router Ports:** Specify the static router port which is mainly used in the network with stable topology.

Forbidden Router Ports:

Specify the forbidden router ports which is mainly used to forbid ports becoming router ports.



Note:

1. The router port should be in the multicast VLAN, otherwise the member ports cannot receive multicast streams.
2. The Multicast VLAN won't take effect unless you first complete the configuration for the corresponding VLAN owning the port on the **802.1Q VLAN** page.
3. Configure the link type of the router port in the multicast VLAN as Tagged otherwise all the member ports in the multicast VLAN cannot receive multicast streams.
4. After a multicast VLAN is created, all the MLD packets will be processed only within the multicast VLAN.

9.2.5 Querier Config

In an IPv6 multicast network that runs MLD, a Layer 3 multicast device works as an MLD querier to send out MLD queries and manage the multicast table. But MLD is not supported by the devices in Layer 2 network. MLD Snooping Querier can act as an MLD Router in Layer 2 network. It can help to create and maintain multicast forwarding table on the switch with the Query messages it generates.

Choose the menu **Multicast**→**MLD Snooping**→**Querier Config** to load the following page.

MLD Snooping Querier Config

VLAN ID: (1-4094)

Query Interval: secs(10-300)

Max Response Time: secs(1-25)

General Query Source IP: (formatFE80::ABEC:12EA)

MLD Snooping Querier Table

Select	VLAN ID	Query Interval	Max Response Time	General Query Source IP
<input type="checkbox"/>		<input type="text"/>	<input type="text"/>	<input type="text"/>

No entry in the table.

Total Querier Number: 0

Figure 9-18 Querier Config

The following entries are displayed on this screen:

➤ **MLD Snooping Querier Config**

- VLAN ID:** Enter the VLAN ID which you want to start Querier.
- Query Interval:** Enter the Query message interval time. The Querier will send General Query Message within this interval.
- Max Response Time:** Enter the value of Maximum Response Time of the Query message.
- General Query Source IP:** Enter the Query Message source IP address. It is FE80::02FF:FFFF:FE00:0001 by default.

➤ **MLD Snooping Querier List**

- Select:** Select the Querier you want to change.
- VLAN ID:** Displays the VLAN ID.
- Query Interval:** Displays the Query message interval time.
- Max Response Time:** Displays the value of Maximum Response Time of the Query message.
- General Query Source IP:** Displays the Query message source IP address.

Note:
 The MLD Snooping Querier doesn't participate in the MLD Querier Election, but an MLD Snooping Querier will affect the MLD Querier Election in the IPv6 network running MLD because of its relatively smaller IP address.

9.2.6 Profile Config

On this page you can configure an MLD profile.

Choose the menu **Multicast**→**MLD Snooping**→**Profile Config** to load the following page.

Profile Creation

Profile ID: (1-999)

Mode: Permit Deny

Search Option

Search Option:

MLD Profile Info

Select	Profile ID	Mode	Bind Ports	Operation
No entry in the table.				

Note
 You can click edit to create IP range of profile.

Figure 9-19 Profile Config

The following entries are displayed on this screen:

➤ **Profile Creation**

- Profile ID:** Specify the Profile ID you want to create, and it should range from 1 to 999.
- Mode:** The attributes of the profile.
 - **Permit:** Only permit the IP address within the IP range and deny others.
 - **Deny:** Only deny the IP address within the IP range and permit others.

➤ **Search Option**

- Search Option:** Select the rules for displaying profile entries.

- **All:** Display all profile entries.
- **Profile ID:** Display profile entry of the ID.

➤ **MLD Profile Info**

- Select:** Select the profile entries you want to config.
- Profile ID:** Displays the profile ID.
- Mode:** Displays the attribute of the profile.
- **Permit:** Only permit the IP address within the IP range and deny others.
 - **Deny:** Only deny the IP address within the IP range and permit others.
- Bind Ports:** Displays the ports that the profile bound to.
- Operation:** Click the **Edit** button to configure the mode or IP-range of the Profile.

After you have created a profile ID, click **Edit** to display the following figure.

Profile mode

Profile ID:

Mode:

Add IP-range

Start IP: (Format:ff01::1234:01)

End IP: (Format:ff01::1234:01)

IP-range Table

Select	Index	Start IP	End IP
No entry in the table.			

The following entries are displayed on this screen:

➤ **Profile Mode**

- Profile ID:** Displays the Profile ID you have created.
- Mode:** Displays the attribute of the profile.
- **Permit:** Only permit the IP address within the IP range and deny others.
 - **Deny:** Only deny the IP address within the IP range and permit others.

➤ **Add IP-range**

- Start IP:** Enter start IP address of the IP-range.
- End IP:** Enter end IP address of the IP-range.

➤ **IP-range Table**

- Select:** Select the desired entry for configuration.
- Index:** Displays index of the IP-range which is not configurable.
- Start IP:** Displays the start IP address of the IP-range.
- End IP:** Displays the end IP address of the IP-range.

9.2.7 Profile Binding

When the switch receives MLD report message, it examines the profile ID bound to the access port to determine if the port can join the multicast group. If the multicast IP is not filtered, the switch will add the port to the forward port list of the multicast group. Otherwise, the switch will drop the MLD report message. In that way, you can control the multicast groups that users can access.

Choose the menu **Multicast**→**MLD Snooping**→**Profile Binding** to load the following page.

Profile and Max Group Binding						
UNIT: 1 LAGS						
Select	Port	Profile ID	Max Group	Overflow Action	LAG	
<input type="checkbox"/>		<input type="text"/>	<input type="text"/>	<input type="text"/>		
<input type="checkbox"/>	1/0/1		1000	Drop	--	ClearBinding
<input type="checkbox"/>	1/0/2		1000	Drop	--	ClearBinding
<input type="checkbox"/>	1/0/3		1000	Drop	--	ClearBinding
<input type="checkbox"/>	1/0/4		1000	Drop	--	ClearBinding
<input type="checkbox"/>	1/0/5		1000	Drop	LAG 1	ClearBinding
<input type="checkbox"/>	1/0/6		1000	Drop	LAG 1	ClearBinding
<input type="checkbox"/>	1/0/7		1000	Drop	--	ClearBinding
<input type="checkbox"/>	1/0/8		1000	Drop	--	ClearBinding
<input type="checkbox"/>	1/0/9		1000	Drop	--	ClearBinding
<input type="checkbox"/>	1/0/10		1000	Drop	--	ClearBinding
<input type="checkbox"/>	1/0/11		1000	Drop	--	ClearBinding
<input type="checkbox"/>	1/0/12		1000	Drop	--	ClearBinding
<input type="checkbox"/>	1/0/13		1000	Drop	--	ClearBinding
<input type="checkbox"/>	1/0/14		1000	Drop	--	ClearBinding
<input type="checkbox"/>	1/0/15		1000	Drop	--	ClearBinding

Note:

The port profile binding configuration here has no effect on static multicast IP.

Figure 9-20 Profile Config

The following entries are displayed on this screen:

➤ **Profile and Max Group Binding**

- UNIT:1/LAGS:** Click **1** to configure the physical ports. Click **LAGS** to configure the link aggregation groups.
- Select:** Select the desired port for multicast filtering. It is multi-optional.

- Port:** The port to be bound.
- Profile ID:** The existing Profile ID bound to the selected port.
- Max Group:** The maximum multicast group a port can join, range from 0 to 1000.
- Overflow Action:** The policy should be taken when the number of multicast group a port has joined reach the maximum.
- **Drop:** Drop the successive report packet, and this port cannot join any other multicast group.
 - **Replace:** When the number of the dynamic multicast groups that a port joins has exceeded the max-group, the newly joined multicast group will replace an existing multicast group with the lowest multicast group address.
- LAG:** The LAG number which the port belongs to.
- Clear Binding:** Click the **Clear Binding** button to clear all profiles bound to the port.

Configuration Procedure:

1	Create Profile	Required. Configure the Profile ID and mode on Multicast→MLD Snooping→Profile Config page.
2	Configure IP-Range	Required. Click Edit of the specified entry in the IGMP Profile Info table on Multicast→MLD Snooping→Profile Config page to configure the mode or IP-range of the Profile.
3	Configure Profile Binding for ports	Optional. Configure Profile Binding for ports on Multicast→MLD Snooping→Profile Binding page.

9.2.8 Packet Statistics

On this page you can view the MLD packets the switch received. It helps you to monitor the MLD Snooping function.

Choose the menu **Multicast**→**MLD Snooping**→**Packet Statistics** to load the following page.

Auto Refresh

Auto Refresh: Enable Disable Apply

Refresh Period: sec(3-300)

MLD Statistics

UNIT:

Port	Query Packet	Report Packet(V1)	Report Packet(V2)	done Packet	Error Packet
1/0/1	0	0	0	0	0
1/0/2	0	0	0	0	0
1/0/3	0	0	0	0	0
1/0/4	0	0	0	0	0
1/0/5	0	0	0	0	0
1/0/6	0	0	0	0	0
1/0/7	0	0	0	0	0
1/0/8	0	0	0	0	0
1/0/9	0	0	0	0	0
1/0/10	0	0	0	0	0
1/0/11	0	0	0	0	0
1/0/12	0	0	0	0	0
1/0/13	0	0	0	0	0
1/0/14	0	0	0	0	0
1/0/15	0	0	0	0	0

Clear
Refresh
Help

Figure 9-21 Packet Statistics

The following entries are displayed on this screen:

➤ **Auto Fresh**

Auto Fresh: Select Enable/Disable auto fresh feature.

Fresh Period: Enter the time from 3 to 300 seconds to specify the auto fresh period.

➤ **MLD Statistics**

Port: Displays the port number of the switch.

Query Packet: Displays the number of query packets the port received.

Report Packet (V1): Displays the number of query packets the port received.

Report Packet (V2): Displays the number of MLDv2 report packets the port received.

Done Packet: Displays the number of leave packets the port received.

Error Packet: Displays the number of error packets the port received.

9.3 Multicast Table

In a network, receivers can join different multicast groups appropriate to their needs. The switch forwards multicast streams based on IPv4/IPv6 multicast address table.

The **Multicast Table** function is implemented on the **IPv4 Multicast Table**, **Static IPv4 Multicast Table**, **IPv6 Multicast Table** and **Static IPv6 Multicast Table** pages.

9.3.1 IPv4 Multicast Table

On this page you can view the information of the multicast groups already on the switch. Multicast IP addresses range from 224.0.0.0 to 239.255.255.255. The range for receivers to join is from 224.0.1.0 to 239.255.255.255.

Choose the menu **Multicast**→**Multicast Table**→**IPv4 Multicast Table** to load the following page.

Multicast IP	VLAN ID	Forward Port
No entry in the table.		

The number of multicast groups is : 0

Figure 9-22 IPv4 Multicast Table

The following entries are displayed on this screen:

➤ Search Option

- Search Option:** Select the rule for displaying multicast IP table.
- **All:** Displays all multicast IP entries.
 - **Multicast IP:** Enter the multicast IP address the desired entry must carry.
 - **VLAN ID:** Enter the VLAN ID the desired entry must carry.
 - **Forward Port:** Enter the port number the desired entry must carry.

➤ Multicast IP Table

- Multicast IP:** Displays multicast IP address.
- VLAN ID:** Displays the VLAN ID of the multicast group.
- Forward Port:** Displays the forward port of the multicast group.
- Type:** Displays the type of the multicast IP.

9.3.2 Static IPv4 Multicast Table

On this page you can configure the static IPv4 multicast table.

Choose the menu **Multicast**→**Multicast Table**→**Static IPv4 Multicast Table** to load the following page.

Create Static Multicast

Multicast IP: (Format: 225.0.0.1)

VLAN ID: (1-4094)

Forward Port:

UNIT: LAGS

<input type="checkbox"/>	<input type="checkbox"/>	<input type="checkbox"/>	<input type="checkbox"/>	<input type="checkbox"/>	<input type="checkbox"/>	<input type="checkbox"/>	<input type="checkbox"/>	<input type="checkbox"/>	<input type="checkbox"/>	<input type="checkbox"/>	<input type="checkbox"/>	<input type="checkbox"/>	<input type="checkbox"/>	<input type="checkbox"/>	<input type="checkbox"/>	<input type="checkbox"/>
<input type="checkbox"/>	<input type="checkbox"/>	<input type="checkbox"/>	<input type="checkbox"/>	<input type="checkbox"/>	<input type="checkbox"/>	<input type="checkbox"/>	<input type="checkbox"/>	<input type="checkbox"/>	<input type="checkbox"/>	<input type="checkbox"/>	<input type="checkbox"/>	<input type="checkbox"/>	<input type="checkbox"/>	<input type="checkbox"/>	<input type="checkbox"/>	<input type="checkbox"/>

Unselected Port(s)
 Selected Port(s)
 Not Available for Selection

Search Option

Search Option

Static Multicast IP Table

Select	Multicast IP	VLAN ID	Forward Port
No entry in the table.			

The number of static multicast groups is : 0

Figure 9-23 Static IPv4 Multicast Table

The following entries are displayed on this screen:

➤ **Create Static Multicast**

Multicast IP: Enter the multicast IP address the desired entry must carry.

VLAN ID: Enter the VLAN ID the desired entry must carry.

Forward Port: Enter the forward ports.

➤ **Search Option**

- Search Option:** Select the rule for displaying multicast IP table.
- **All:** Displays all static multicast IP entries.
 - **Multicast IP:** Enter the multicast IP address the desired entry must carry.
 - **VLAN ID:** Enter the VLAN ID the desired entry must carry.
 - **Forward Port:** Enter the port number the desired entry must carry.

➤ **Static Multicast Table**

Select: Select the static multicast group entries you want to configure.

Multicast IP: Displays multicast IP address.

- VLAN ID:** Displays the VLAN ID of the multicast group.
- Forward Port:** Displays the forward port of the multicast group.

9.3.3 IPv6 Multicast Table

This page displays the IPv6 multicast groups which are already on the switch.

Choose the menu **Multicast**→**Multicast Table**→**IPv6 Multicast Table** to load the following page.

Search Option

Search Option: All [] Search

Multicast IP Table

Multicast IP	VLAN ID	Forward Port
No entry in the table.		

[Refresh] [Help]

The number of multicast groups is : 0

Figure 9-24 IPv6 Multicast Table

The following entries are displayed on this screen:

➤ **Search Option**

- Search Option:** Select the rules for displaying multicast IP table.
- **All:** Displays all multicast IP entries.
 - **Multicast IP:** Enter the multicast IP address the desired entry must carry.
 - **VLAN ID:** Enter the VLAN ID the desired entry must carry.
 - **Forward Port:** Enter the port number the desired entry must carry.

➤ **Multicast IP Table**

- Multicast IP:** Displays the multicast IP.
- VLAN ID:** Displays the VLAN ID.
- Forward Ports:** Displays the forward ports of the group.

9.3.4 Static IPv6 Multicast Table

On this page you can configure the static IPv6 multicast table.

Choose the menu **Multicast**→**Multicast Table**→**Static IPv6 Multicast Table** to load the following page.

Create Static Multicast

Multicast IP: (Format ff01::1234:01)

VLAN ID: (1-4094) Create

Forward Port:

UNIT: LAGS

<input type="checkbox"/> 2	<input type="checkbox"/> 4	<input type="checkbox"/> 6	<input type="checkbox"/> 8	<input type="checkbox"/> 10	<input type="checkbox"/> 12	<input type="checkbox"/> 14	<input type="checkbox"/> 16	<input type="checkbox"/> 18	<input type="checkbox"/> 20	<input type="checkbox"/> 22	<input type="checkbox"/> 24	<input type="checkbox"/> 26	<input type="checkbox"/> 28
<input type="checkbox"/> 1	<input type="checkbox"/> 3	<input type="checkbox"/> 5	<input type="checkbox"/> 7	<input type="checkbox"/> 9	<input type="checkbox"/> 11	<input type="checkbox"/> 13	<input type="checkbox"/> 15	<input type="checkbox"/> 17	<input type="checkbox"/> 19	<input type="checkbox"/> 21	<input type="checkbox"/> 23	<input type="checkbox"/> 25	<input type="checkbox"/> 27

All
Clear

Unselected Port(s)
 Selected Port(s)
 Not Available for Selection

Search Option

Search Option Search

Static Multicast IP Table

Select	Multicast IP	VLAN ID	Forward Port
No entry in the table.			

All
Delete
Help

The number of static multicast groups is : 0

Figure 9-25 IPv6 Multicast Table

The following entries are displayed on this screen:

➤ **Create Static Multicast**

- Multicast IP:** Enter the multicast IP address the desired entry must carry.
- VLAN ID:** Enter the VLAN ID the desired entry must carry.
- Forward Port:** Enter the forward ports.

➤ **Search Option**

- Search Option:** Select the rule for displaying multicast IP table.
 - **All:** Displays all static multicast IP entries.
 - **Multicast IP:** Enter the multicast IP address the desired entry must carry.
 - **VLAN ID:** Enter the VLAN ID the desired entry must carry.
 - **Forward Port:** Enter the port number the desired entry must carry.

➤ **Static Multicast Table**

- Select:** Select the static multicast group entries you want to configure.
- Multicast IP:** Displays multicast IP address.
- VLAN ID:** Displays the VLAN ID of the multicast group.
- Forward Port:** Displays the forward port of the multicast group.

Note:

The max number of multicast entries is 1000. The IPv4 multicast table and IPv6 multicast table share the total entry number of 1000.

[Return to CONTENTS](#)

Chapter 10 Routing

Routing is the method by which the host or gateway decides where to send the datagram. Routing is the task of finding a path from a sender to a desired destination. It may be able to send the datagram directly to the destination, if that destination is on one of the networks that are directly connected to the host or gateway. However, what if the destination is not directly reachable? The host or gateway will attempt to send the datagram to a gateway that is nearer to the destination. The goal of a routing protocol is very simple: It is to supply the information that is needed to do routing.

The Routing module is mainly for routing management configuration of the switch, including the following submenus: **Interface**, **Routing Table**, **Static Routing**, **DHCP Server**, **DHCP Relay** and **ARP**.

10.1 Interface

Interface is a virtual interface in Layer 3 mode and mainly used for realizing the Layer 3 connectivity between VLANs or routed ports. Each VLAN interface is corresponding to one VLAN. Each routed port is corresponding to one port. Each Layer 3 port-channel is corresponding to one port channel. Loopback Interface is purely software implemented. Interface has its own IP address and subnet mask to identify the subnet it belongs to, and it works as the gateway of the subnet to forward Layer 3 IP packets.

Introduction of IPv6 Address

IPv6 (Internet Protocol version 6), also called IPng (IP next generation), was developed by the IETF (Internet Engineering Task Force) as the successor to IPv4 (Internet Protocol version 4). Compared with IPv4, IPv6 increases the IP address size from 32 bits to 128 bits; this solves the IPv4 address exhaustion problem.

➤ IPv6 features

IPv6 has the following features:

1. **Adequate address space:** The source and destination IPv6 addresses are both 128 bits (16 bytes) long. IPv6 can provide 3.4×10^{38} addresses to completely meet the requirements of hierarchical address division as well as allocation of public and private addresses.
2. **Header format simplification:** IPv6 cuts down some IPv4 header fields or move them to IPv6 extension headers to reduce the load of basic IPv6 headers, thus making IPv6 packet handling simple and improving the forwarding efficiency. Although the IPv6 address size is four times that of IPv4 addresses, the size of basic IPv6 headers is 40 bytes and is only twice that of IPv4 headers (excluding the Options field).
3. **Flexible extension headers:** IPv6 cancels the Options field in IPv4 packets but introduces multiple extension headers. In this way, IPv6 enhances the flexibility greatly to provide scalability for IP while improving the handling efficiency. The Options field in IPv4 packets contains 40 bytes at most, while the size of IPv6 extension headers is restricted by that of IPv6 packets.
4. **Built-in security:** IPv6 uses IPSec as its standard extension header to provide end-to-end security. This feature provides a standard for network security solutions and improves the interoperability between different IPv6 applications.

5. **Automatic address configuration:** To simplify the host configuration, IPv6 supports stateful and stateless address configuration.

- Stateful address configuration means that a host acquires an IPv6 address and related information from a server (for example, DHCP server).
- Stateless address configuration means that a host automatically configures an IPv6 address and related information on basis of its own link-layer address and the prefix information advertised by a router.

In addition, a host can generate a link-local address on basis of its own link-layer address and the default prefix (FE80::/64) to communicate with other hosts on the link.

6. **Enhanced neighbor discovery mechanism:** The IPv6 neighbor discovery protocol is a group of Internet control message protocol version 6 (ICMPv6) messages that manages the information exchange between neighbor nodes on the same link. The group of ICMPv6 messages takes the place of Address Resolution Protocol (ARP) message, Internet Control Message Protocol version 4 (ICMPv4) router discovery message, and ICMPv4 redirection message to provide a series of other functions.

➤ **Introduction to IPv6 address**

1. IPv6 address format

An IPv6 address is represented as a series of 16-bit hexadecimal, separated by colons (:). An IPv6 address is divided into eight groups, and the 16 bits of each group are represented by four hexadecimal numbers which are separated by colons, for example, 2001:0d02:0000:0000:0014: 0000:0000:0095. The hexadecimal letters in IPv6 addresses are not case-sensitive.

To simplify the representation of IPv6 addresses, zeros in IPv6 addresses can be handled as follows:

- Leading zeros in each group can be removed. For example, the above-mentioned address can be represented in shorter format as 2001:d02:0:0:14:0:0:95.
- Two colons (::) may be used to compress successive hexadecimal fields of zeros at the beginning, middle, or end of an IPv6 address. For example, the above-mentioned address can be represented in the shortest format as 2001:d02::14:0:0:95.



Note:

Two colons (::) can be used only once in an IPv6 address, usually to represent the longest successive hexadecimal fields of zeros. If two colons are used more than once, the device is unable to determine how many zeros double-colons represent when converting them to zeros to restore a 128-bit IPv6 address.

An IPv6 address consists of two parts: address prefix and interface ID. The address prefix and the interface ID are respectively equivalent to the network ID and the host ID in an IPv4 address.

An IPv6 address prefix is represented in "IPv6 address/prefix length" format, where "IPv6 address" is an IPv6 address in any of the above-mentioned formats and "prefix length" is a decimal number indicating how many leftmost bits from the preceding IPv6 address are used as the address prefix.

2. IPv6 address classification

IPv6 addresses fall into three types: unicast address, multicast address, and anycast address.

- Unicast address: An identifier for a single interface, on a single node. A packet that is sent to a unicast address is delivered to the interface identified by that address.
- Multicast address: An identifier for a set of interfaces (typically belonging to different nodes), similar to an IPv4 multicast address. A packet sent to a multicast address is delivered to all interfaces identified by that address. There are no broadcast addresses in IPv6. Their function is superseded by multicast addresses.
- Anycast address: An identifier for a set of interfaces (typically belonging to different nodes). A packet sent to an anycast address is delivered to one of the interfaces identified by that address (the nearest one, according to the routing protocols' measure of distance).

The type of an IPv6 address is designated by the first several bits called format prefix. The following table lists the mappings between address types and format prefixes.

Type		Format Prefix (binary)	IPv6 Prefix ID
Unicast address	Unassigned address	00...0 (128 bits)	::/128
	Loopback address	00...1 (128 bits)	::1/128
	Link-local address	1111111010	FE80::/10
	Site-local address	1111111011	FEC0::/10
	Global unicast address (currently assigned)	001	2xxx::/4 or 3xxx::/4
	Reserved type (to be assigned in future)	Other formats	
Multicast address		11111111	FF00::/8
Anycast address		Anycast addresses are taken from unicast address space and are not syntactically distinguishable from unicast addresses.	

Table 10-1 Mappings between address types and format prefixes

3. IPv6 Unicast Address:

IPv6 unicast address is an identifier for a single interface. It consists of a subnet prefix and an interface ID.

- Subnet Prefix: This section is allocated by the IANA (The Internet Assigned Numbers Authority), the ISP (Internet Service Provider) or the organizations.
- Interface ID: An interface ID is used to identify interfaces on a link. The interface ID must be unique to the link.

There are several ways to form interface IDs. The IPv6 addresses with format prefixes 001 through 111, except for multicast addresses (1111 1111), are all required to have 64-bit interface IDs in EUI-64 format.

For all IEEE 802 interface types (for example, Ethernet and FDDI interfaces), Interface IDs in the modified EUI-64 format are constructed in the following way:

The first three octets (24 bits) are taken from the Organizationally Unique Identifier (OUI) of the 48-bit link-layer address (the MAC address) of the interface, the fourth and fifth octets (16 bits) are a fixed hexadecimal value of FFFE, and the last three octets (24 bits) are taken from the last three octets of the MAC address. The construction of the interface ID is completed by setting the universal/local (U/L) bit--the seventh bit of the first octet--to a value of 0 or 1. A value of 0 indicates a locally administered identifier; a value of 1 indicates a globally unique IPv6 interface identifier.

Take MAC address 0012:0B0A:2D51 as an example. Insert **FFFE** to the middle of the address to get 0012:0BFF:FE0A:2D51. Then set the U/L bit to 1 to obtain an interface ID in EUI-64 format as 0212:0BFF:FE0A:2D51.

IPv6 unicast address can be classified into several types, as shown in Table 10-1. The two most common types are introduced below:

Global unicast address

A Global unicast address is an IPv6 unicast address that is globally unique and is routable on the global Internet.

Global unicast addresses are defined by a global routing prefix, a subnet ID, and an interface ID. The IPv6 global unicast address starts with binary value 001 (2000::/3). The global routing prefix is a value assigned to a site (a cluster of subnets/links) by IANA. The subnet ID is an identifier of a subnet within the site.

The figure below shows the structure of a global unicast address.

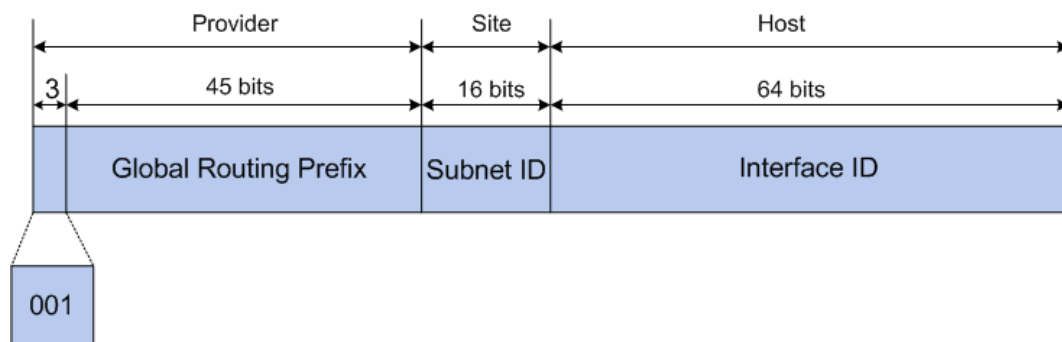

Figure 10-1 Global Unicast Address Format

Link-local address

A link-local address is an IPv6 unicast address that can be automatically configured on any interface using the link-local prefix FE80::/10 (1111 1110 10) and the interface identifier in the modified EUI-64 format. Link-local addresses are used in the neighbor discovery protocol and the stateless autoconfiguration process. Nodes on a local link can use link-local addresses to communicate. The figure below shows the structure of a link-local address.

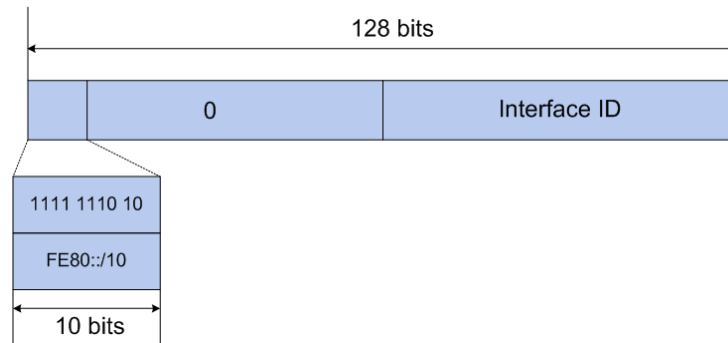

Figure 10-2 Link-local Address Format

IPv6 devices must not forward packets that have link-local source or destination addresses to other links.



Note:

You can configure multiple IPv6 addresses per interface, but only one link-local address.

➤ IPv6 Neighbor Discovery

The IPv6 neighbor discovery process uses ICMP messages and solicited-node multicast addresses to determine the link-layer address of a neighbor on the same network (local link), verify the reachability of a neighbor, and track neighboring devices.

1. IPv6 Neighbor Solicitation Message and Neighbor Advertisement Message

A value of 135 in the Type field of the ICMP packet header identifies a neighbor solicitation (NS) message. Neighbor solicitation messages are sent on the local link when a node wants to determine the link-layer address of another node on the same local link.

After receiving the neighbor solicitation message, the destination node replies by sending a neighbor advertisement (NA) message, which has a value of 136 in the Type field of the ICMP packet header, on the local link. After the source node receives the neighbor advertisement, the source node and destination node can communicate.

Neighbor advertisement messages are also sent when there is a change in the link-layer address of a node on a local link.

Address Resolution

The address resolution procedure is as follows:

- Node A multicasts an NS message. The source address of the NS message is the IPv6 address of an interface of node A and the destination address is the solicited-node multicast address of node B. The NS message contains the link-layer address of node A.

- After receiving the NS message, node B judges whether the destination address of the packet corresponds to the solicited-node multicast address. If yes, node B can learn the link-layer address of node A, and unicasts an NA message containing its link-layer address.
- Node A acquires the link-layer address of node B from the NA message.

Neighbor Reachability Detection

After node A acquires the link-layer address of its neighbor node B, node A can verify whether node B is reachable according to NS and NA messages.

- Node A sends an NS message whose destination address is the IPv6 address of node B.
- If node A receives an NA message from node B, node A considers that node B is reachable. Otherwise, node B is unreachable.

Duplicate Address Detection

Neighbor solicitation messages are used in the stateless autoconfiguration process to verify the uniqueness of unicast IPv6 addresses before the addresses are assigned to an interface. After node A acquires an IPv6 address, it will perform duplicate address detection (DAD) to determine whether the address is being used by other nodes (similar to the gratuitous ARP function of IPv4). DAD is accomplished through NS and NA messages. The DAD procedure is as follows:

- Node A sends an NS message whose source address is the unassigned address `::` and destination address is the corresponding solicited-node multicast address of the IPv6 address to be detected. The NS message contains the IPv6 address.
- If node B uses this IPv6 address, node B returns an NA message. The NA message contains the IPv6 address of node B.
- Node A learns that the IPv6 address is being used by node B after receiving the NA message from node B. Otherwise, node B is not using the IPv6 address and node A can use it.

2. IPv6 Router Advertisement Message

Router advertisement (RA) messages, which have a value of 134 in the Type field of the ICMP packet header, are periodically sent out each configured interface of an IPv6 router.

RA messages typically include the following information:

- One or more onlink IPv6 prefixes that nodes on the local link can use to automatically configure their IPv6 addresses.
- Lifetime information for each prefix included in the advertisement.
- Sets of flags that indicate the type of autoconfiguration (stateless or stateful) that can be completed.

- Default router information (whether the device sending the advertisement should be used as a default router and, if so, the amount of time, in seconds, the device should be used as a default router).
- Additional information for hosts, such as the hop limit and maximum transmission unit (MTU) a host should use in packets that it originates.

RAs are also sent in response to device solicitation messages. Device solicitation messages, which have a value of 133 in the Type field of the ICMP packet header, are sent by hosts at system startup or anytime needed so that the host can immediately autoconfigure without needing to wait for the next scheduled RA message.

Hosts discover and select default devices by listening to Router Advertisements (RAs).

Stateless address autoconfiguration means that the node automatically configures an IPv6 address and other information for its interface according to the address prefix and other configuration parameters in the received RA messages.

3. IPv6 Neighbor Redirect Message

A value of 137 in the type field of the ICMP packet header identifies an IPv6 neighbor redirect message. Devices send neighbor redirect messages to inform hosts of better first-hop nodes on the path to a destination.

A device will send an IPv6 ICMP redirect message when the following conditions are satisfied:

- The receiving interface is the forwarding interface.
- The selected route itself is not created or modified by an IPv6 ICMP redirect message.
- The selected route is not the default route.
- The forwarded IPv6 packet does not contain any routing header.

You can configure the system's Layer 3 interfaces on this page.

Choose the menu **Routing**→**Interface**→**Interface Config** to load the following page.

Creating Interface

Interface ID: VLAN (1-4094)

IP Address Mode: None Static DHCP BOOTP

IP Address: (Format: 192.168.0.1) Create

Subnet Mask: (Format: 255.255.255.0)

Admin Status: Enable

Interface Name: (Optional. 1-32 characters)

Interface List

Select	ID	Mode	IP Address	Subnet mask	Interface Name	Status	Operation
<input type="checkbox"/>	Vlan1	Static	192.168.0.1	255.255.255.0		Up	Edit Detail

All
Delete
Help

Interface Count : 1

Note:
The addresses of two interfaces can't be same.

Figure 10-3 Interface Config

The following entries are displayed on this screen:

➤ **Create Interface**

Interface ID: Enter the ID of the interface corresponding to VLAN interface, loopback interface, routed port or port channel.

IP Address Mode: Specify IP Address allocation mode.

- **None:** without ip.
- **Static:** setup manually.
- **DHCP:** allocated through DHCP.
- **BOOTP:** allocated through BOOTP.

IP Address: Specify the IP address of the interface.

Subnet Mask: Specify the subnet mask of the interface's IP address.

Admin Status: Specify interface administrator status. Choose **Disable** to disable the interface's Layer 3 capabilities.

Interface Name: Specify the name of the network interface.

➤ **Interface List**

Select: Select the interfaces to modify or delete.

ID: Displays the ID of the interface.

Mode: Display IP address allocation mode.

- **None:** without ip.
- **Static:** setup manually.
- **DHCP:** allocated through DHCP.
- **BOOTP:** allocated through BOOTP.

IP Address: Displays the IP address of the interface.

Subnet Mask: Displays the subnet mask of the interface.

Interface Name: Displays the name of the interface.

Status: Displays interface current working status. Working status is up when admin status is enabled, line protocol is up and IP Address is set.

Operation: You can configure the interface by clicking the **Edit**, or check Detail information by clicking **Detail**.

- **For IPv4 interface**

Click **Edit** to display the following figure:

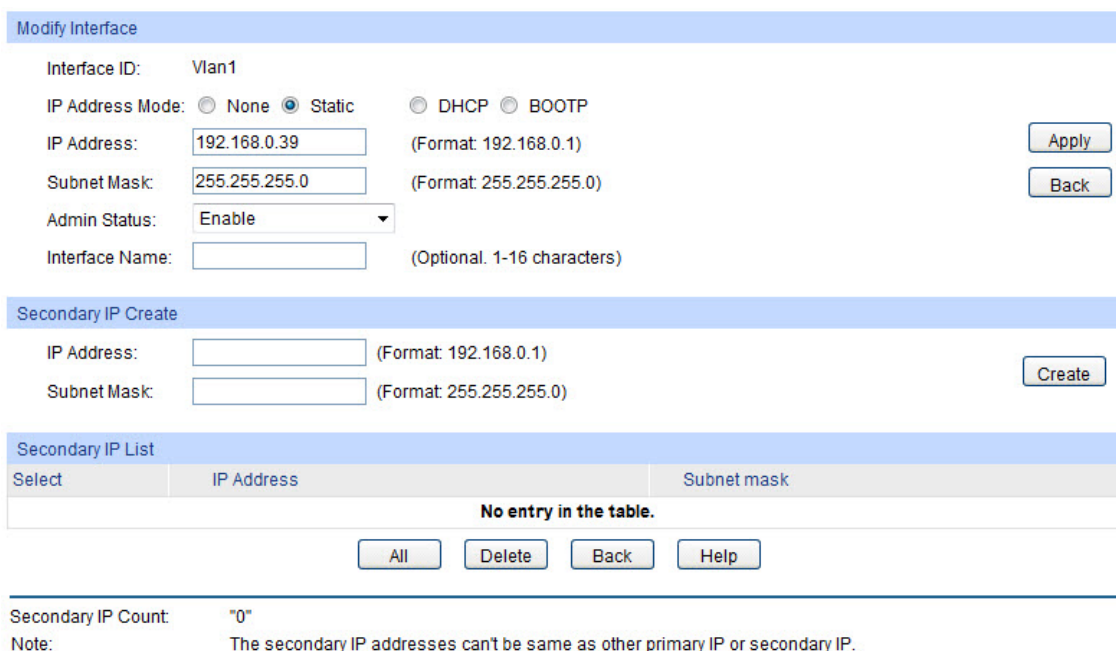

Modify Interface

Interface ID: Vlan1

IP Address Mode: None Static DHCP BOOTP

IP Address: (Format: 192.168.0.1)

Subnet Mask: (Format: 255.255.255.0)

Admin Status:

Interface Name: (Optional. 1-16 characters)

Secondary IP Create

IP Address: (Format: 192.168.0.1)

Subnet Mask: (Format: 255.255.255.0)

Secondary IP List

Select	IP Address	Subnet mask
No entry in the table.		

Secondary IP Count: "0"

Note: The secondary IP addresses can't be same as other primary IP or secondary IP.

Figure 10-4 IPv4 Interface Config

➤ **Modify Interface**

Interface ID: Display the ID of the interface corresponding to the VLAN interface, loopback interface, routed port or port channel.

IP Address Mode: View and modify the IP address allocation mode.

- **None:** without ip.
- **Static:** setup manually.
- **DHCP:** allocated through DHCP.
- **BOOTP:** allocated through BOOTP.

IP Address: View and modify the IP address of the interface.

Subnet Mask: View and modify the subnet mask of the interface.

Admin Status: View and modify the Admin status. Choose **Disable** to disable the interface's Layer 3 capabilities.

Interface Name: View and modify the interface name.

➤ **Secondary IP Create**

IP Address: Specify the secondary IP address of the interface.

Subnet Mask: Specify the subnet mask of the interface's secondary IP address.

➤ **Secondary IP List**

Select: Select the secondary IP.

IP Address: Displays the secondary IP address of the current interface.

Subnet Mask: Displays the subnet mask of the secondary IP address.

- **For IPv6 interface**

Click **Edit** to display the following figure:

The screenshot displays the System IPv6 configuration interface, organized into several sections:

- Global Config:** Features a radio button for IPv6, currently set to **Enable**. Below it, the **Interface ID** is set to **VLAN** with a value of **1** (range 1-4094).
- Link-local Address Config:** Shows **Config Mode** set to **Auto**. The **Link-local Address** is **fe80::20a:ebff:fe13:2383** (Format: fe80::1). The **Status** is **Normal**.
- Global Address Autoconfig via RA Message:** A checkbox is checked for **Enable global address auto configuration via RA message**.
- Global Address Autoconfig via DHCPv6 Server:** A checkbox is unchecked for **Enable global address auto configuration via DHCPv6 Server**.
- Add a Global Address Manually:** Shows **Address Format** set to **EUI-64** and an empty **Global Address** field (Format: 3001::1/64).
- Global Address Table:** A table with columns: **Select**, **Global Address**, **Prefix Length**, **Type**, **Preferred Lifetime**, **Valid Lifetime**, and **Status**. The table is currently empty, displaying **No entry in the table.** Below the table are **Delete**, **Modify**, and **Help** buttons.

Figure 10-5 System IPv6

The following entries are displayed on this screen:

➤ **Global Config**

IPv6: Enable/Disable IPv6 function globally on the switch.

Interface ID: Choose the interface type and input the interface ID. Interface types include VLAN, routed port and port channel.

➤ **Link-local Address Config**

Config Mode: Select the link-local address configuration mode.

- **Manual:** When this option is selected, you should assign a link-local address manually.
- **Auto:** When this option is selected, the switch will generate a link-local address automatically.

Link-local Address: Enter a link-local address.

- Status:** Displays the status of the link-local address.
- **Normal:** Indicates that the link-local address is normal.
 - **Try:** Indicates that the link-local address may be newly configured.
 - **Repeat:** Indicates that the link-local address is duplicate. It is illegal to access the switch using the IPv6 address (including link-local and global address).
- **Global Address Autoconfig via RA Message**
- Enable global address auto configuration via RA message:** When this option is enabled, the switch automatically configures a global address and other information according to the address prefix and other configuration parameters from the received RA (Router Advertisement) message.
- **Global Address Autoconfig via DHCPv6 Server**
- Enable Global Address Autoconfig via DHCPv6 Server:** When this option is enabled, the system will try to obtain the global address from the DHCPv6 Server.
- **Add a global address manually**
- Address Format:** You can select the global address format according to your requirements.
- **EUI-64:** Indicates that you only need to specify an address prefix, and then the system will create a global address automatically.
 - **Not EUI-64:** Indicates that you have to specify an intact global address.
- Global Address:** When selecting the mode of EUI-64, please input the address prefix here, otherwise, please input an intact IPv6 address here.
- **Global address Table**
- Select:** Select the desired entry to delete or modify the corresponding global address.
- Global Address:** Modify the global address.
- Prefix Length:** Modify the prefix length of the global address.
- Type:** Displays the configuration mode of the global address.
- **Manual:** Indicates that the corresponding address is configured manually.
 - **Auto:** Indicates that the corresponding address is created automatically using the RA message or obtained from the DHCPv6 Server.
- Preferred Lifetime/Valid Lifetime:** Displays the preferred time and valid time of the global address.

Status:

Displays the status of the global address.

- **Normal:** Indicates that the global address is normal.
- **Try:** Indicates that the global address may be newly configured.
- **Repeat:** Indicates that the corresponding address is duplicate. It is illegal to access the switch using this address.

**Tips:**

After adding a global IPv6 address to your switch manually here, you can configure your PC's global IPv6 address in the same subnet with the switch and login to the switch via its global IPv6 address.

Click **Detail** to display the following figure:

Detail Information	
Interface ID:	VLAN1
IP Address Mode:	Static
IP Address:	192.168.0.39/255.255.255.0
Secondary IP:	
Interface Status:	Up
Line Protocol Status:	Up
Admin Status:	Enable
Interface Name:	
Interface Setting Detail Information	
MTU is 1500 bytes	
Directed broadcast forwarding is disabled	
ICMP redirects are never sent	
ICMP unreachable are never sent	
ICMP mask replies are never sent	

Figure 10-6 The Interface's Detail Information

➤ **Detail Information**

Interface ID:

Displays the ID of the interface, including VLAN interface, loopback interface, routed port and port channel.

IP Address Mode:

Displays the IP address allocation mode.

- **None:** without ip.
- **Static:** setup manually.
- **DHCP:** allocated through DHCP.
- **BOOTP:** allocated through BOOTP.

IP Address:

Displays the IP address and subnet mask of the interface.

Secondary IP:

Displays Secondary IP Address and subnet mask.

Interface Status:

Displays the interface current working status, which is up when Admin Status is enable, line protocol is up and IP address is set.

Line Protocol Status:

Displays the line protocol status, which is up if any up-link port is connected to the interface.

Admin Status: Displays the Admin status. Choose **Disable** to disable the interface's Layer 3 capabilities.

Interface Name: Displays the name of the interface.

➤ **Interface Setting Detail Information**

Displays the detailed setting information of the interface.

10.2 Routing Table

This page displays the routing information summary generated by different routing protocols.

10.2.1 IPv4 Routing Table

Choose the menu **Routing**→**Routing Table**→**IPv4 Routing Table** to load the following page.

Routing Information Summary					
Protocol	Destination/Mask	Next Hop	Distance	Metric	Interface name
connected	192.168.0.0/24	192.168.0.1	0	0	

Route Count: 1

Figure 10-7 Routing Table

The following entries are displayed on this screen:

➤ **Routing Information Summary**

Protocol Displays the protocol of the route.

Destination/Mask: Displays the destination and subnet of the route.

Next Hop: Displays the IP address to which the packet should be sent next.

Distance: Displays the management distance of the route. The smaller the distance, the higher the priority.

Metric: Displays the metric of the route.

Interface name: Displays the description of the egress interface.

10.2.2 IPv6 Routing Table

Choose the menu **Routing**→**Routing Table**→**IPv6 Routing Table** to load the following page.

IPv6 Routing Information Summary					
Protocol	Destination Network	Next Hop	Distance	Metric	Interface Name
No entry in the table.					

Route Count: 0

Figure 10-8 IPv6 Routing Table

The following entries are displayed on this screen:

➤ **IPv6 Routing Information Summary**

- Protocol** Displays the protocol of the route.
- Destination/Mask:** Displays the destination and subnet of the route.
- Next Hop:** Displays the IPv6 address to which the packet should be sent next.
- Distance:** Displays the management distance of the route. The smaller the distance, the higher the priority.
- Metric:** Displays the metric of the route.
- Interface name:** Displays the description of the egress interface.

10.3 Static Routing

Static routes are special routes manually configured by the administrator and cannot change automatically with the network topology accordingly. Hence, static routes are commonly used in a relative simple and stable network. Proper configuration of static routes can greatly improve network performance.

10.3.1 IPv4 Static Routing Config

Choose the menu **Routing**→**Static Routing**→**Static Routing Config** to load the following page.

Static Routing Config

Destination: (Format: 10.10.10.0)
Subnet Mask: (Format: 255.255.255.0)
Next Hop: (Format: 192.168.0.2)
Distance: (Optional, range: 1-255) Create

Static Route Table

Select	Destination	Subnet Mask	Next Hop	Distance	Metric	Interface name
<input type="checkbox"/>			<input type="text"/>	<input type="text"/>		

No entry in the table.

Apply Delete Help

Static routing count: 0

Figure 10-9 Static Routing Config

The following entries are displayed on this screen:

➤ **Static Routing Config**

- Destination:** Specify the destination IP address of the packets.
- Subnet Mask:** Specify the subnet mask of the destination IP address.
- Next Hop:** Enter the IP address to which the packet should be sent next.
- Distance:** Enter the distance metric of route. The smaller the distance, the higher the priority.

➤ **Static Route Table**

- Select:** Specify the static route entries to modify.
- Destination Address:** Displays the destination IP address of the packets.
- Subnet Mask:** Displays the subnet mask of the destination IP address.
- Next Hop:** Displays the IP address to which the packet should be sent next.
- Distance:** Displays the distance metric of route. The smaller the distance, the higher the priority.
- Metric:** Displays the metric of the route.
- Interface Name:** Displays the name of the VLAN interface.

10.3.2 IPv6 Static Routing Config

Choose the menu **Routing**→**Static Routing**→**Static Routing Config** to load the following page.

IPv6 Static Routing Config

IPv6 Address: (Format: 2001::)
 Prefix Length: (Format: 64)
 Next Hop: (Format: 3001::2)
 Distance: (Optional. range: 1-255)

IPv6 Static Route Table

Select	IPv6 Address/Prefix Length	Next Hop	Distance	Metric	Interface Name
<input type="checkbox"/>		<input type="text"/>	<input type="text"/>		
No entry in the table.					

Static routing count: 0

Figure 10-10 Static Routing Config

The following entries are displayed on this screen:

➤ **Static Routing Config**

- IPv6 Address:** Specify the destination IPv6 address of the packets.
- Prefix Length:** Specify the prefix length of the IPv6 address.
- Next Hop:** Enter the IPv6 address to which the packet should be sent next.
- Distance:** Enter the distance metric of route. The smaller the distance, the higher the priority.

➤ **Static Route Table**

- Select:** Select the IPv6 static route entries to modify.
- IPv6 Address:** Displays the destination IPv6 address of the packets.
- Prefix Length:** Displays the prefix length of the destination IPv6 address.

Next Hop:	Displays the IPv6 address to which the packet should be sent next.
Distance:	Displays the distance metric of route. The smaller the distance, the higher the priority.
Metric:	Displays the metric of the route.
Interface Name:	Displays the name of the VLAN interface.

10.4 DHCP Server

DHCP module is used to configure the DHCP functions of the switch, including two submenus, **DHCP Server** and **DHCP Relay**.

➤ Overview

DHCP (Dynamic Host Configuration Protocol) is a network configuration protocol for hosts on TCP/IP networks, and it provides a framework for distributing configuration information to hosts. DHCP is adding the capability of automatic allocation of reusable network addresses and additional configuration options. DHCP captures the behavior of DHCP participants so the administrator can manage the parameters of the host in the network.

As workstations and personal computers proliferate on the Internet, the administrative complexity of maintaining a network is increased by an order of magnitude. The assignment of local network resources to each client represents one such difficulty. In most environments, delegating such responsibility to the user is not plausible and, indeed, the solution is to define the resources in uniform terms, and to automate their assignment.

The DHCP dealt with the issue of assigning an internet address to a client, as well as some other resources.

➤ DHCP Elements

DHCP is built on a client-server model, where designated DHCP server hosts allocate network addresses and deliver configuration parameters to DHCP clients. Generally a DHCP server can allocate configuration parameters to more than one client. Figure 10-11 DHCP model shows you the model.

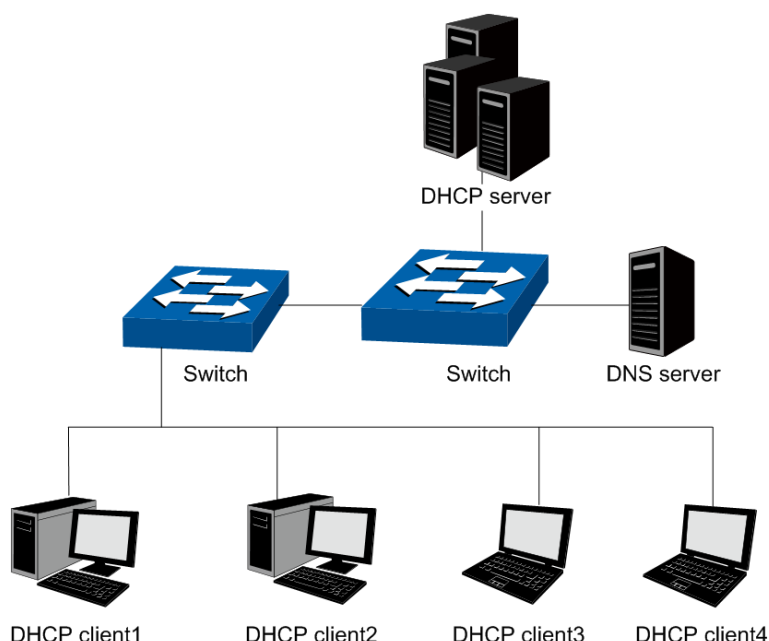

Figure 10-11 DHCP model

To meet the different requirements of DHCP clients, DHCP server is always designed to supply hosts with the configuration parameters in three policies.

- 1) Manual Assignment: For the specific DHCP clients (e.g., web server), the configuration parameters are manually specified by the administrator and are assigned to these clients via a DHCP server.
- 2) Automatic Assignment: The DHCP server must supplies the configuration parameters to DHCP client with the lease time continued for ever.
- 3) Dynamic Assignment: A network administrator assigns a range of IP addresses to DHCP server, and each client computer on the LAN is configured to request an IP address from the DHCP server with a fixed period of time (e.g., 2 hours), allowing the DHCP server to reclaim (and then reallocate) IP addresses that are not renewed.

➤ **The Process of DHCP**

DHCP uses UDP as its transport protocol. DHCP messages from a client to a server are sent to the 'DHCP server' port (67), and DHCP messages from a server to a client are sent to the 'DHCP client' port (68). DHCP clients and servers both construct DHCP messages by filling in fields in the fixed format section of the message and appending tagged data items in the variable length option area. The process is shown as follows.

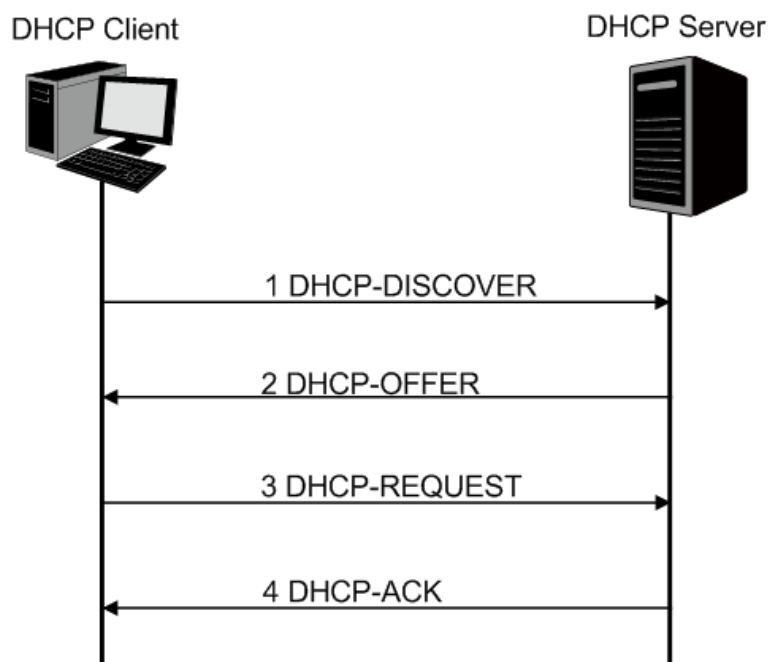

Figure 10-12 The Process of DHCP

- 1) DHCP discover: the client broadcasts messages on the physical subnet to discover available DHCP servers in the LAN. Network administrators can configure a local router (e.g. a relay agent) to forward DHCP-DISCOVER messages to a DHCP server in a different subnet.
- 2) DHCP offer: Each server who received the DHCP-DISCOVER message may respond a DHCP-OFFER message that includes configuration parameters (in the example below, IP address) to the client. The server unicast the DHCP-OFFER message to the client (using the DHCP/BOOTP relay agent if necessary) if possible, or may broadcast the message to a broadcast address on the client's subnet.
- 3) DHCP request: A client can receive DHCP offers from multiple servers, but it will accept only one DHCP-OFFER and broadcast a DHCP-REQUEST message which includes the server's

identifier and the IP address offered by the server. Based on the server's identifier, servers are informed whose offer the client has accepted.

- 4) DHCP acknowledgement: The server selected in the DHCP-REQUEST message commits the binding for the client to persistent storage and responds with a DHCP-ACK message containing the configuration parameters for the requesting client. If the selected server is unable to satisfy the DHCP-REQUEST message (e.g., the requested IP address has been allocated), the server should respond with a DHCP-NAK message.
- 5) In Dynamic assignment policy, the DHCP client is assigned an IP address with a lease time (e.g. 2 hours) from the DHCP server. This IP address will be reclaimed by the DHCP server when its lease time expires. If the client wants to use the IP address continually, it should unicast a DHCP-REQUEST message to the server to extend its lease.

After obtaining parameters via DHCP, a host should be able to exchange packets with any other host in the networks.

➤ The Format of DHCP Message

Figure 10-12 The Process of DHCP gives the process of DHCP and Figure 10-13 describes each field in the DHCP message. The numbers in parentheses indicate the size of each field in octets. The names for the fields given in the figure will be used throughout this document to refer to the fields in DHCP messages.

op (1)	htype (1)	hlen (1)	hops (1)
xid (4)			
secs (2)		flags (2)	
ciaddr (4)			
yiaddr (4)			
siaddr (4)			
giaddr (4)			
chaddr (16)			
sname (64)			
file (128)			
options (312)			

Figure 10-13 The Format of DHCP Message

- 1) op: Message type, '1' = BOOT-REQUEST, '2' = BOOT-REPLY.
- 2) htype: Hardware address type, '1' for ethernet.
- 3) hlen: Hardware address length, '6' for ethernet.
- 4) hops: Clients set this field to zero and broadcast the DHCP-REQUEST message, optionally used by relay-agents when booting via a relay-agent.
- 5) xid: Transaction ID, a random number chosen by the client, used by the client and server to associate messages.
- 6) secs: Filled in by client, seconds elapsed since client started trying to boot.
- 7) flags: A client that cannot receive unicast IP datagrams until its protocol software has been configured with an IP address should set the first bit in the 'flags' field to 1 in any DHCP-DISCOVER or DHCP-REQUEST message that client sends. A client that can receive

unicast IP datagrams before its protocol software has been configured should clear the first bit to 0. A server or relay agent sending or relaying a DHCP message directly to a DHCP client should examine the first bit in the 'flags' field. If this bit is set to 1, the DHCP message should be sent as an IP broadcast and if the bit is cleared to 0, the message should be sent as an IP unicast. The remaining bits of the flags field are reserved for future use and must be set to zero by clients and ignored by servers and relay agents.

- 8) ciaddr: Client IP address, filled in by client in DHCPREQUEST when verifying previously allocated configuration parameters.
- 9) yiaddr: 'your' (client) IP address, configuration parameters allocated to the client by DHCP server.
- 10) siaddr: IP address of next server to use in bootstrap, returned in DHCPOFFER, DHCPACK and DHCPNAK by server.
- 11) giaddr: Relay agent IP address, used in booting via a relay-agent.
- 12) chaddr: Client hardware address.
- 13) sname: Optional server host name, null terminated string.
- 14) file: Boot file name, null terminated string, "generic" name or null in DHCPDISCOVER, fully qualified directory-path name in DHCPOFFER.
- 15) options: Optional parameters field. See the options documents (RFC 2132) for a list of defined options. We will introduce some familiar options in the next section.

➤ **DHCP Option**

This section defines a generalized use of the 'options' field for giving information useful to a wide class of machines, operating systems and configurations. Sites with a single DHCP server that is shared among heterogeneous clients may choose to define other, site-specific formats for the use of the 'options' field. Figure 10-14 gives the format of options field.

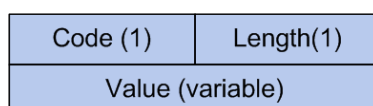

Figure 10-14 DHCP Option

All options begin with a Code octet, which uniquely identifies the option followed by the length octet. The value of the length octet does not include the Code and Length octets. The common options are illustrated as below.

- 1) option 1: Subnet Mask option. The subnet mask option is option1 which identifies the assigned IP address with network, and its length is 4 octets.
- 2) option 3: Router option. The router option is option 3 which specifies an IP address for routers on the client's subnet.
- 3) option 6: DNS option. The DNS option is option 6, and it assigns the IP address of domain name server to the client which allows the client can use the web service in the internet.
- 4) option 12: Host Name option. The option12 is used to specify the name of the client, which may be requested by the DHCP server for authentication.
- 5) option 50: Requested IP Address option. The option 50 is used in a DHCP-REQUEST message to allow the client to request the particular IP address.

- 6) option 51: Lease Time option. In DHCP-OFFER and DHCP-ACK message, the DHCP server uses this option to specify the lease time in which the clients can use the IP address legally.
- 7) option 53: Message Type option. This option is used to convey the type of the DHCP message. Legal values for this option show in Table 10-2:

Value	Message Type
1	DHCP-DISCOVER
2	DHCP-OFFER
3	DHCP-REQUEST
4	DHCP-DECLINE
5	DHCP-ACK
6	DHCP-NAK
7	DHCP-RELEASE
8	DHCP-INFORM

Table 10-2 Option 53

- 8) option 54: Server Identifier option. DHCP servers include option 54 in the DHCP-OFFER message in order to allow the client to distinguish between lease offers. DHCP clients use the option in a DHCP-REQUEST message to indicate which lease offers is being accepted.
- 9) option 55: Parameter Request List option. This option is used by a DHCP client to request values for specified configuration parameters.
- 10) option 61: Client hardware address.
- 11) option 66: TFTP server name option. This option is used to identify a TFTP server.
- 12) option 67: Boot-file name option. This option is used to identify a boot-file.
- 13) option 150: TFTP server address option. This option is used to specify the address of the TFTP server which assigns the boot-file to the client.

For particulars of DHCP option, please refer to RFC 2132. In the next section, DHCP Server and DHCP Relay function on this switch will be introduced in detail.

➤ **Application Environment of DHCP Server**

DHCP Server assigns IP address to the client efficiently in the following environment.

- 1) More and more device proliferates in the network, and it is a hard work to configure the IP parameter for every device manually.
- 2) There are not enough network resources to assign to every device exclusively.
- 3) Only a little device need static IP address to connect the network.

➤ **Details of DHCP Server**

A typical application of the switch working at DHCP Server function is shown below. It can be altered to meet the network requirement.

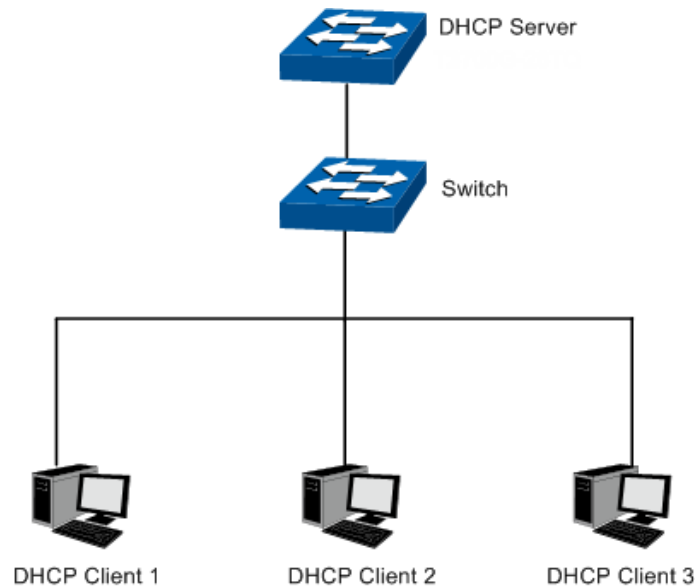

Figure 10-15 DHCP Server Application

To guarantee the process of assigning IP address fluently and in safety, and to keep the network run steadily, the DHCP Server function on the switch performs the following tasks.

- Create different IP pool for every VLAN. The device in different VLAN can get the IP address in different subnet.
- When receiving a DHCP-DISCOVER packet from the client, the switch judges the VLAN which the ingress port belong to, and chooses the IP in the same subnet with the VLAN interface to assign to the client.
- With a DHCP Relay running between the client and the server, when receiving a DHCP-DISCOVER packet transmitting from the Relay, the switch will choose the IP from the IP pool in the same subnet with the Relay's IP to assign to the client. If the IP pool is not configured on the switch or the configured IP pool doesn't match the Relay's network segment, the client may not get network parameters successfully.
- The switch can detect the IP address automatically before assigning it to avoid conflict.

➤ IP Detection

To avoid IP conflict, the switch will detect the IP address to be assigned in LAN through Ping test.

The DHCP server will send the Ping test packet with the destination IP being the IP address to be assigned. If the server receives the Reply packet from the destination host in the ping time, it means that the IP address has been used, and the server will choose another IP as destination IP to test again. The server will assign the IP address if the server not receives the Reply packet in the Ping time.

➤ Policy of IP Assignment

The switch chooses the IP assigned to clients based on the rules shown as follows.

- 1) First, the server will choose the IP which has been bound to the client manually.
- 2) Then, the server will assign the IP which has been assigned to the client once.
- 3) For the next, the server will assign the IP which is specified in the DHCP-DISCOVER packet from the client.
- 4) At last, the server will choose the first IP from the IP pool which has not been assigned.

➤ Tips for Configure DHCP Server Function

- 1) Configure the Excluded IP address which cannot be assigned by the switch, e.g. web server's IP, broadcast IP of subnet and gateway's IP.
- 2) Specify IP address for specific clients, and then the switch will supply these IP address to them only forever.
- 3) Configure the IP pool in which the IP address can be assigned to the clients.

The DHCP Server, allowing the clients in all VLANs to get the IP address from the server automatically, is implemented on the **DHCP Server**, **Pool Setting**, **Manual Binding**, **Binding Table** and **Packet Statistics** pages.

10.4.1 DHCP Server

This page allows you to enable the DHCP Server function, configure the Excluded IP Address which cannot be assigned by the switch in every network.

Choose the menu **Routing**→**DHCP Server**→**DHCP Server** to load the following page.

Global Config

DHCP Server Enable Disable

Option 60: (Optional) Apply

Option 138: (Optional. Format: 192.168.0.1)

Ping Time Config

Ping Packets: (0-10 packets, 0 for disable ping) Apply

Ping Timeout: (100-10000 milliseconds)

Excluded IP Address

Start IP Address: (Format: 192.168.0.1)

End IP Address: (Format: 192.168.0.1) Create

Excluded IP Address Table

Select	ID	Start IP Address	End IP Address
No entry in the table.			

All
Delete
Help

Figure10-16 DHCP Server

The following entries are displayed on this screen:

➤ **Global Config**

DHCP Server: Enable/Disable the switch as a DHCP server.

Option 60: Configure DHCP option 60. If this option is configured, DHCP server will response packets containing this option if the client running CAPWAP protocol requests this option.

Option 138: Configure DHCP option 138. If this option is configured, DHCP server will response packets containing this option if the client running CAPWAP protocol request this option.

➤ **Ping Time Config**

Ping Packets: The number of packets to be sent.

Ping Timeout: The time it takes to determine the specific IP not exist.

➤ **Excluded IP Address**

Configure the Excluded IP Address which cannot be assigned by the switch.

Start IP Address: The first one of the IP addresses that should not be assigned.

End IP Address: The last one of the IP addresses that should not be assigned.

➤ **Excluded IP Address Table**

Select: Select the entry to delete the Excluded IP Address pool.

ID: Displays the corresponding ID of the Excluded IP Address pool.

Start IP Address: Displays the start IP Address of the Excluded IP Address pool.

End IP Address: Displays the last IP Address of the Excluded IP Address pool.

10.4.2 Pool Setting

This page shows you how to configure the IP pool in which the IP address can be assigned to the clients in the network.

Choose the menu **Routing**→**DHCP Server**→**DHCP Server Pool** to load the following page.

DHCP Server Pool

Pool Name:	<input type="text"/>	(8 characters maximum)	
Network Address:	<input type="text"/>	(Format: 192.168.0.0)	
Subnet Mask:	<input type="text"/>	(Format: 255.255.255.0)	
Lease Time:	<input type="text"/>	(1-2880 min, Default: 120)	
Default Gateway:	<input type="text"/>	(Optional, Format: 192.168.0.1)	
DNS Server:	<input type="text"/>	(Optional, Format: 192.168.0.1)	<input type="button" value="Create"/> <input type="button" value="Clear"/>
Netbios Server:	<input type="text"/>	(Optional, Format: 192.168.0.1)	
Netbios Node Type:	<input type="text"/>	(Optional, b/p/m/h/none)	
Next Server Address:	<input type="text"/>	(Optional, Format: 192.168.0.1)	
Domain Name:	<input type="text"/>	(0 to 200 characters)	
Bootfile:	<input type="text"/>	(0 to 128 characters)	

Pool Table

Select	Pool Name	Network Address	Subnet Mask	Lease Time	Operation
No entry in the table.					

Note:
Configurations here will take effect only when the DHCP server is enabled.

Figure 10-17 Pool Setting

The following entries are displayed on this screen:

➤ **DHCP Server Pool**

Pool Name:	Enter the name of the pool.
Network Address:	Specify the network number of the IP addresses in the pool.
Subnet Mask:	Specify the corresponding subnet mask of the IP address in the pool.
Lease Time:	Specify the lease time of IP addresses in the pool.
Default Gateway:	Specify the IP address of the default gateway for a client.
DNS Server:	Specify the IP address of the DNS server for a client.
Netbios Server:	Specify the IP address of the Netbios server.
Netbios Node Type:	Specify the node type of the Netbios server.
Next Server Address:	Specify the next DHCP server's ip address during the DHCP boot process.
Domain Name:	Specify the domain name of the DHCP client.
Bootfile:	Specify the boot file name of the DHCP client.

➤ **Pool Table**

Select:	Select the entry to delete the IP pool.
Pool Name:	Displays the name of the IP Pool.
Network Address:	Displays the network address of the IP Pool.
Subnet Mask:	Displays the subnet mask of the IP Pool.
Lease Time:	Displays the lease time of the IP Pool.
Operation:	Allows you to view or modify the information of the corresponding IP Pool. <ul style="list-style-type: none">● Edit: Click to modify the settings of the Pool.● Detail: Click to get the information of the Pool.

10.4.3 Manual Binding

In this page, you can specify the IP address for specific clients, and then the switch will supply these specified parameters to them only forever.

Choose the menu **Routing**→**DHCP Server**→**Manual Binding** to load the following page.

Figure 10-18 Manual Binding

The following entries are displayed on this screen:

➤ **Manual Binding**

- Pool Name:** Select the IP Pool containing the IP address to be bound.
- IP Address:** Specify the IP address to be bound.
- Binding Mode:** Select the binding mode of the manual binding.
- Client ID:** Specify the identifier of the client.
- Hardware Address:** Specify the hardware address to be bound.
- Hardware Type:** Select the hardware protocol of the client.

➤ **Manual Binding Table**

Displays the list of the configured binding entries of IP addresses and hardware addresses.

10.4.4 Binding Table

In this page, you can view the information about the clients attached to the Server.

Choose the menu **Routing**→**DHCP Server**→**Binding Table** to load the following page.

Figure 10-19 DHCP Server Binding Table

➤ **DHCP Server Binding Table**

- ID:** Displays the ID of the client.
- IP Address:** Displays the IP address that the Switch has allocated to the client.
- Client ID / Hardware Address:** Displays the MAC address of the client.

- Type:** Displays the type of this binding entry.
- Lease Time Left(s):** Displays the lease time of the client left.

Click **Delete** to delete the selected entry.

10.4.5 Packet Statistics

In this page, you can view the DHCP packets the switch received or sent.

Choose the menu **Routing**→**DHCP Server**→**Packet Statistics** to load the following page.

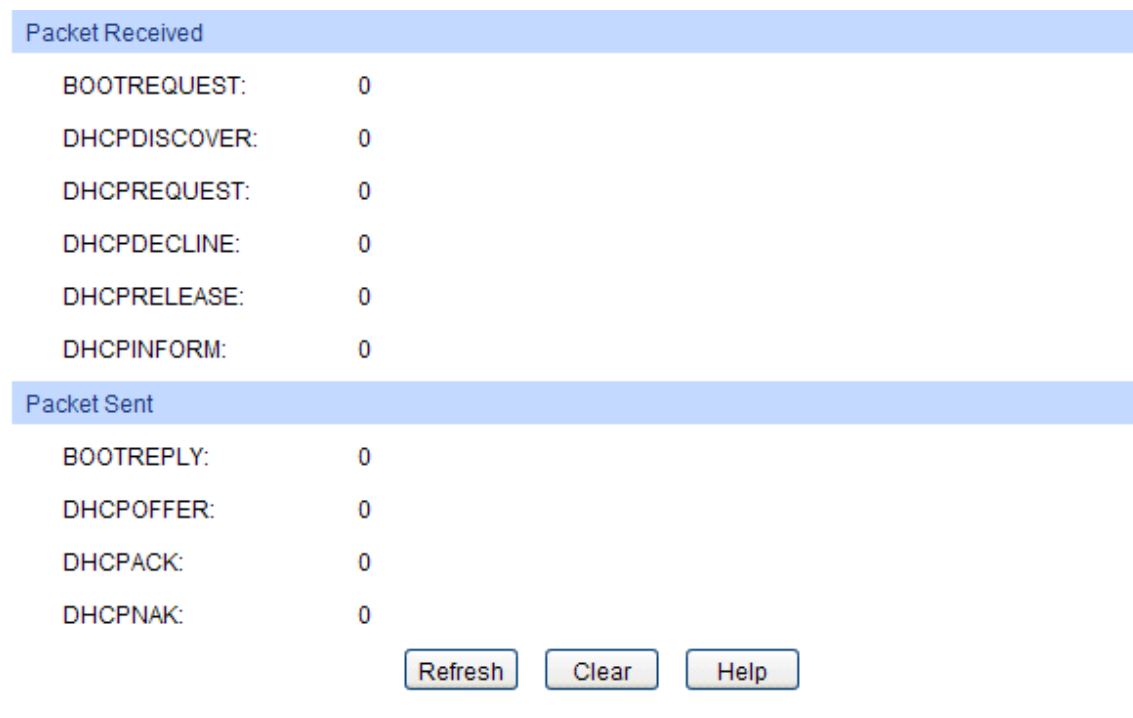

Figure10-20 Statistics

The following entries are displayed on this screen:

➤ **Packets Received**

- BOOTREQUEST:** Displays the Bootp Request packet received.
- DHCPDISCOVER:** Displays the Discover packet received.
- DHCPREQUEST:** Displays the Request packet received.
- DHCPDECLINE:** Displays the Decline packet received.
- DHCPRELEASE:** Displays the Release packet received.
- DHCPINFORM:** Displays the Inform packet received.

➤ **Packets Sent**

- BOOTREPLY:** Displays the Bootp Reply packet sent.
- DHCPOFFER:** Displays the Offer packet sent.
- DHCPACK:** Displays the Ack packet sent.
- DHCPNAK:** Displays the Nak packet sent.

Configuration Procedure:

Step	Operation	Description
1	Set the link type for port.	Required. On the VLAN→802.1Q VLAN→Port Config page, set the link type for the port basing on its connected device.
2	Create VLAN.	Required. On the VLAN→802.1Q VLAN→VLAN Config page, click the Create button to create a VLAN. Enter the VLAN ID and the description for the VLAN. Meanwhile, specify its member ports.
3	Create VLAN interface.	Required. On the Routing→Static Routing→Static Routing Config page, create the interface IP address of the VLAN.
4	Enable DHCP Server.	Required. On the Routing→DHCP Server→DHCP Server page, enable the DHCP Server function.
5	Configure Excluded IP Address.	Optional. On the Routing→DHCP Server→DHCP Server page, configure the Excluded IP Address which cannot be assigned by the switch.
6	Configure IP Pool.	Required. On the Routing→DHCP Server→Pool Setting page, configure the parameters of IP Pool, including Mask, lease time, gateway and DNS address.
7	Bind IP Manually	Optional. On the Routing→DHCP Server→Manual Binding page, you can specify the IP address for specific clients.

10.4.6 Application Example for DHCP Server and Relay

➤ Network Requirements

- Every building in the campus belongs to separate VLANs with different network segments.
- The access points in each building are divided into two parts. One part is the fixed computers with static IP addresses in the teachers' offices; the other is the classroom, in which most clients are laptops with dynamic IP addresses obtained from the DHCP server.
- DNS Server is in VLAN 1 and its IP address is 160.20.30.2.

➤ **Network Diagram**

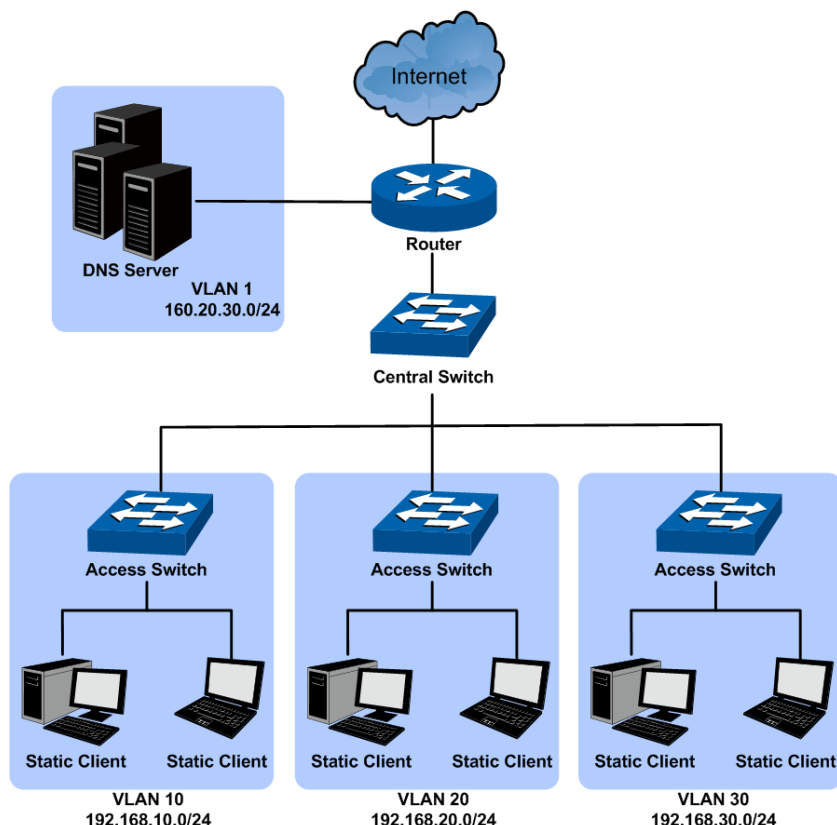

Use the central switch and enable its DHCP server function to allocate IP addresses to clients in the network. Enable the DHCP relay function on each access switch in VLAN 10, 20 and 30. For details about DHCP relay, please refer to [10.5 DHCP Relay](#).

➤ **Configuration Procedure**

- Configure Central Switch

Step	Operation	Note
1	Create VLAN	Required. On page VLAN → 802.1Q VLAN → VLAN Config , create VLAN10, VLAN20 and VLAN30, and configure their ports.
2	Create VLAN interface	Required. On page Routing → Interface → Interface Config , configure VLAN interface 192.168.10.1/24 for VLAN10, 192.168.20.1/24 for VLAN20, and 192.168.30.1 for VLAN30.
3	Enable DHCP Server	Required. On page Routing → DHCP Server → DHCP Server , enable DHCP Server function under the Global Config.
4	Configure the IP address pool	Required. On page Routing → DHCP Server → Pool Setting , configure IP address pool parameters for each VLAN interface. Take VLAN10 as an example, configure its Network Address as 192.168.10.0, Subnet Mask as 255.255.255.0, Default gateway as 192.168.10.1 (the IP address of the VLAN interface), DNS Server as 160.20.30.2, and customize the Pool Name and Lease Time.
5	Configure the reserved addresses	Required. On page Routing → DHCP Server → DHCP Server , under the Excluded IP Address, configure reserved IP addresses for the fixed computers in each VLAN.

Step	Operation	Note
6	Manually binding IP addresses	Optional. On page Routing→ DHCP Server→Manual Binding , bind specified ip addresses to the specific clients.

- Configure Access Switch

Step	Operation	Note
•	Enable DHCP Relay.	Required. On the Routing→DHCP Server→Global Config page, enable the DHCP Server function, and the DHCP Relay function will be enabled at the same time.
•	Configure Option 82 support.	Optional. On the Routing→DHCP Relay→Global Config page, configure the Option 82 parameters.
•	Configure DHCP Server.	Required. On the Routing→DHCP Relay→DHCP Server page, specify the DHCP Server with the IP address of the central switch.

10.5 DHCP Relay

➤ Application Environment of DHCP Relay

In DHCP model, DHCP clients broadcast its DHCP request, so the DHCP sever and clients must be on the same subnet, which require the DHCP server is available in every subnet. It is costly to build so much DHCP Server. DHCP relay agent solves the problem. Via a relay agent, DHCP clients request an IP address from the DHCP server in another subnet, and DHCP clients in different subnets can share the same DHCP server in the internet.

➤ Details of DHCP Relay

A typical application of the switch working at DHCP Relay function is shown below. It can be altered to meet the network requirement.

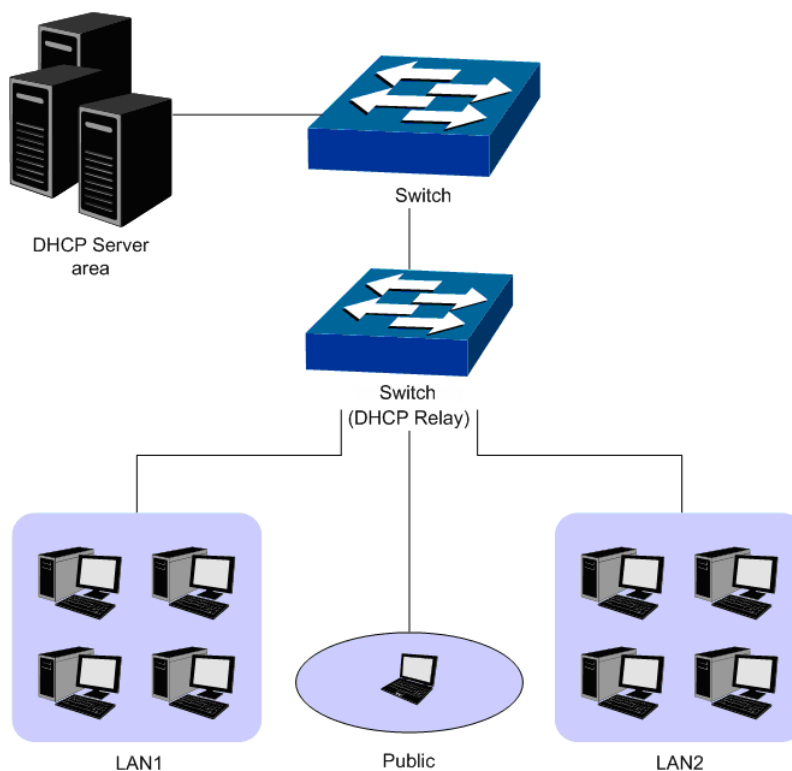

Figure 10-21 DHCP Relay Application

To allow all clients in different VLAN request IP address from one server successfully, the DHCP Relay function can transmit the DHCP packet between clients and server in different VLANs, and all clients in different VLANs can share one DHCP Server.

- When receiving DHCP-DISCOVER and DHCP-REQUEST packets, the switch will fill the giaddr field with the interface IP of the receiving port, optionally insert the option 82 information, and then forward the packet to the server.
- When receiving DHCP-OFFER and DHCP-ACK packets from the server, the switch will delete the option 82 information and forward the packet to the interface which receives the request.

The process will be shown as follows.

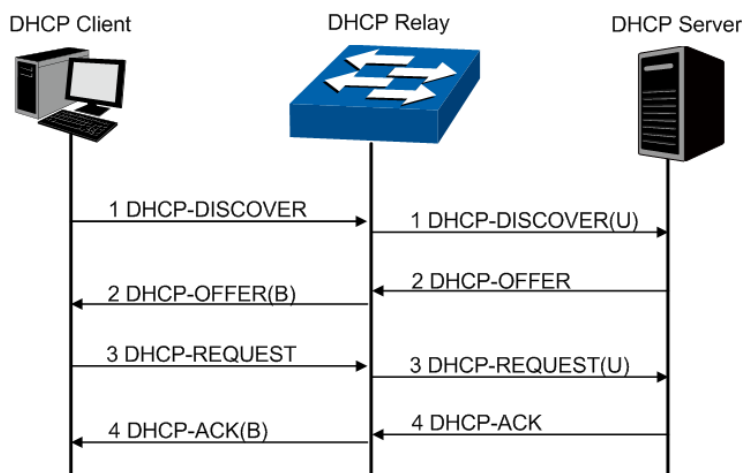

Figure 10-22 DHCP Relay Process

➤ DHCP Relay Configuration

- 1) Configure the Option 82 parameters to record the information of the clients. You are suggested to configure the option82 on the nearest Relay of the client.
- 2) Specify the DHCP Server which assigns IP addresses actually.

➤ Option 82

On this switch, Option 82 is used to record the location of the DHCP Client, the ethernet port and the VLAN, etc. Upon receiving the DHCP-REQUEST packet, the switch adds the Option 82 field to the packet and then transmits the packet to DHCP Server. The Server can be acquainted with the location of the DHCP Client via Option 82, so as to locate the DHCP Client, and assign the distribution policy of IP addresses and the other parameters for fulfilling the security control and account management of the client.

Option 82 can contain 255 sub-options at most. If Option 82 is defined, at least one sub-option should be defined. This Switch supports two sub-options, Circuit ID and Remote ID. Since there is no universal standard about the content of Option 82, different manufacturers define the sub-options of Option 82 to their need. For this Switch, the sub-options are defined as follows:

The Circuit ID is defined to be the number and VLAN of the port which receives the DHCP Request packets. The Remote ID is defined to be the MAC address of DHCP Relay device which receives the DHCP Request packets from DHCP Clients. Furthermore these two parameters also can be manually configured.

The format of Option 82 defined on the switch by default is given in the following figure. The numbers in parentheses indicate the size of each field in octets. By default, sub-option1 is Circuit ID option recording the VLAN and ethernet port information, while sub-option2 is Remote ID option recording the MAC address information of the client. You can define the sub-options manually.

option82	Length(1)		
sub-option1(1)	Length(1)	VLAN(2)	Port(2)
sub-option1(1)	Length(1)	Hardware address(6)	

Figure10-23 Option 82



Note:

The option 82 parameters configured on the switch should base on and meet the requirement of the network.

The DHCP Relay, allowing the clients to get the IP address from the server in another subnet, is implemented on the **DHCP Relay** page.

10.5.1 Global Config

This page allows you to enable the DHCP Relay function.

Choose the menu **Routing**→**DHCP Relay**→**Global Config** to load the following page.

Global Config

DHCP Relay: Enable Disable

Option 82 Configuration

Option 82 Support: Enable Disable

Existed Option 82 field:

Customization: Enable Disable

Circuit ID:

Remote ID:

Note:

Circuit ID or Remote ID can only use number or letters.

Figure 10-24 Global Config

The following entries are displayed on this screen:

➤ **Global Config**

DHCP Relay: Enable the DHCP relay feature.

➤ **Option 82 configuration**

Configure the Option 82 which cannot be assigned by the switch.

Option 82 Support: Enable or disable the Option 82 feature.

Existed Option 82 Field: Select the operation for the existed Option 82 field of the DHCP request packets from the Host.

- Keep: Indicates to keep the Option 82 field of the packets.
- Replace: Indicates to replace the Option 82 field of the packets with the switch defined one.
- Drop: Indicates to discard the packets including the Option 82 field.

- Customization:** Enable or disable the switch to define the Option 82 field.
- Circuit ID:** Enter the sub-option Circuit ID for the customized Option 82 field.
- Remote ID:** Enter the sub-option Remote ID for the customized Option 82 field.

10.5.2 DHCP Server

This page enables you to configure DHCP Servers on the specified interface.

Choose the menu **Routing**→**DHCP Relay**→**DHCP Server** to load the following page.

Add DHCP Server Address

Interface ID: (1-4094)

Server Address: (Format: 192.168.2.1)

DHCP Server List

Select	Interface ID	Server Address
No entry in the table.		

Note:

Each interface can add 10 DHCP Server IP address at most.

Figure 10-25 DHCP Server

The following entries are displayed on this screen:

➤ **Add DHCP Server Address**

- Interface ID:** Select the interface type and enter the interface ID.
- Server Address:** Enter the DHCP server IP address.

➤ **DHCP Server List**

- Select:** Select the desire DHCP server item.
- Interface ID:** Displays the interface ID.
- Server Address:** Displays the DHCP server address.

Configuration Procedure:

Step	Operation	Description
1	Enable DHCP Relay.	Required. On the Routing → DHCP Relay → Global Config page, enable the DHCP Relay function.
2	Configure Option 82 support.	Optional. On the Routing → DHCP Relay → Global Config page, configure the Option 82 parameters.
3	Configure DHCP Server.	Required. On the Routing → DHCP Relay → DHCP Server page, specify the DHCP Server with IP address.

10.6 ARP

Address Resolution Protocol (ARP) records the mapping relationship between IP addresses and MAC addresses in the ARP table. You can also define a static ARP cache entry on the page Static ARP.

10.6.1 ARP Table

Choose the menu **Routing**→**ARP**→**ARP Table** to load the following page.

Interface	IP Address	MAC Address	Type
Vlan1	192.168.0.200	50-e5-49-1e-06-80	DYNAMIC
Vlan1	192.168.0.4	00-0a-eb-13-7b-00	DYNAMIC

Refresh Help

ARP count: 3

Figure 10-26 ARP Table

The following entries are displayed on this screen:

➤ ARP Table

- Interface:** Displays the network interface of ARP entry.
- IP Address:** Enter the IP address of the ARP entry.
- MAC Address:** Displays the MAC address of ARP entry.
- Type:** Displays the type of ARP entry, e.g. Static, Dynamic.

10.6.2 Static ARP

You can configure the static ARP entry on this page.

Choose the menu **Routing**→**ARP**→**Static ARP** to load the following page.

ARP Config

IP address: (Format: 192.168.0.10)

MAC address: (Format: 00-00-00-00-00-01)

Select	IP address	MAC address
<input type="checkbox"/>		

No entry in the table.

Delete Help

Static ARP count: 0

Figure 10-27 Static ARP

➤ ARP Config

- IP Address:** Configure the IP address of the ARP entry.
- MAC address:** Configure the MAC address of the ARP entry.

➤ ARP Table

Here you can view or delete the current static ARP entries.

[Return to CONTENTS](#)

Chapter 11 QoS

QoS (Quality of Service) functions to provide different quality of service for various network applications and requirements and optimize the bandwidth resource distribution so as to provide a network service experience of a better quality.

➤ QoS

This switch classifies the ingress packets, maps the packets to different priority queues and then forwards the packets according to specified scheduling algorithms to implement QoS function.

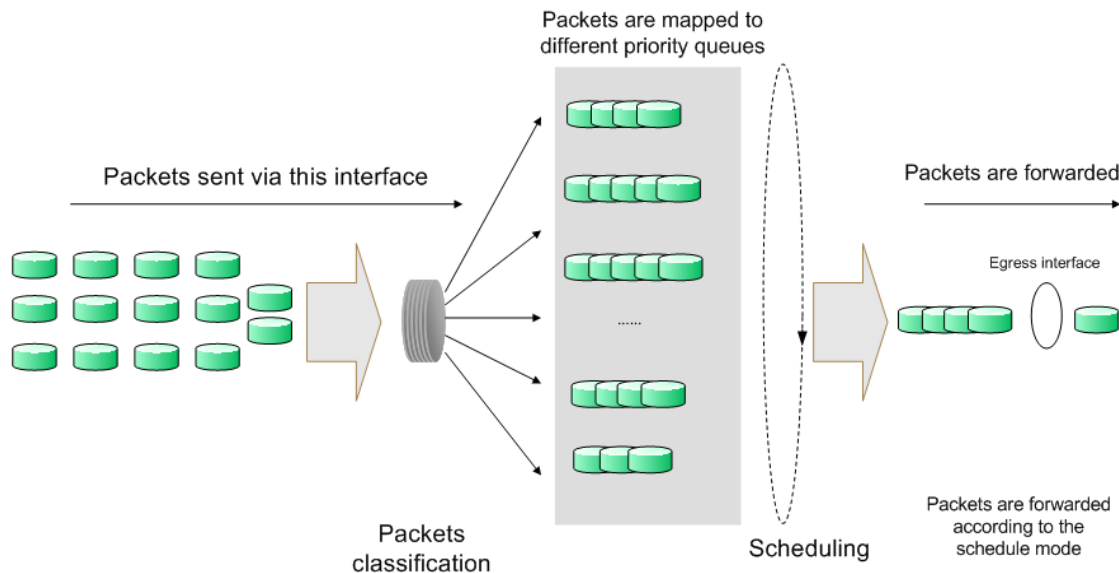

Figure 11-1 QoS function

- Traffic classification: Identifies packets conforming to certain characters according to certain rules.
- Map: The user can map the ingress packets to different priority queues based on the priority modes. This switch implements three priority modes based on port, on 802.1P and on DSCP.
- Queue scheduling algorithm: When the network is congested, the problem that many packets compete for resources must be solved, usually in the way of queue scheduling. The switch supports four schedule modes: SP, WRR, SP+WRR and Equ.

➤ Priority Mode

This switch implements three priority modes based on port, on 802.1P and on DSCP. By default, the priority mode based on port is enabled and the other two modes are optional.

1. Port Priority

Port priority is just a property of the port. After port priority is configured, the data stream will be mapped to the egress queues according to the CoS of the port and the mapping relationship between CoS and queues.

2. 802.1P Priority

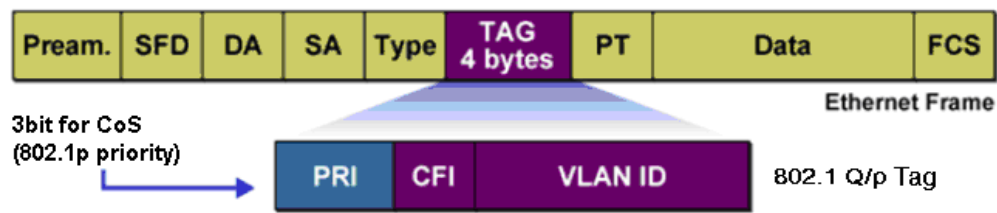

Figure 11-2 802.1Q frame

As shown in the figure above, each 802.1Q Tag has a Pri field, comprising 3 bits. The 3-bit priority field is 802.1p priority in the range of 0 to 7. 802.1P priority determines the priority of the packets based on the Pri value. On the Web management page of the switch, you can configure different priority tags mapping to the corresponding priority levels, and then the switch determine which packet is sent preferentially when forwarding packets. The switch processes untagged packets based on the default priority mode.

3. DSCP Priority

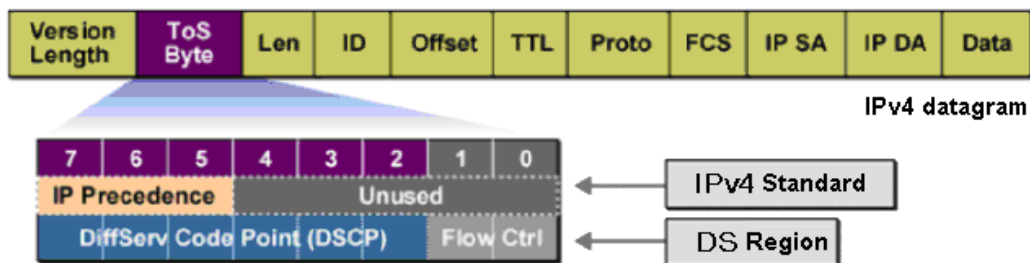

Figure 11-3 IP datagram

As shown in the figure above, the ToS (Type of Service) in an IP header contains 8 bits. The first three bits indicate IP precedence in the range of 0 to 7. RFC2474 re-defines the ToS field in the IP packet header, which is called the DS field. The first six bits (bit 0-bit 5) of the DS field indicate DSCP precedence in the range of 0 to 63. The last 2 bits (bit 6 and bit 7) are reserved. On the Web management page, you can configure different DS field mapping to the corresponding priority levels. Non-IP datagram with 802.1Q tag are mapped to different priority levels based on 802.1P priority mode; the untagged non-IP datagram are mapped based on port priority mode.

➤ Schedule Mode

When the network is congested, the problem that many packets compete for resources must be solved, usually in the way of queue scheduling. The switch implements eight scheduling queues, TC0, TC1, TC2, TC3, TC4, TC5, TC6 and TC7. TC0 has the lowest priority while TC7 has the highest priority. The switch provides four schedule modes: SP, WRR, SP+WRR and Equ.

1. SP-Mode: Strict-Priority Mode. In this mode, the queue with higher priority will occupy the whole bandwidth. Packets in the queue with lower priority are sent only when the queue with higher priority is empty. The switch has eight egress queues labeled as TC0, TC1, TC2, TC3, TC4, TC5, TC6 and TC7. In SP mode, their priorities increase in order. TC7 has the highest priority. The disadvantage of SP queue is that: if there are packets in the queues with higher priority for a long time in congestion, the packets in the queues with lower priority will be “starved to death” because they are not served.

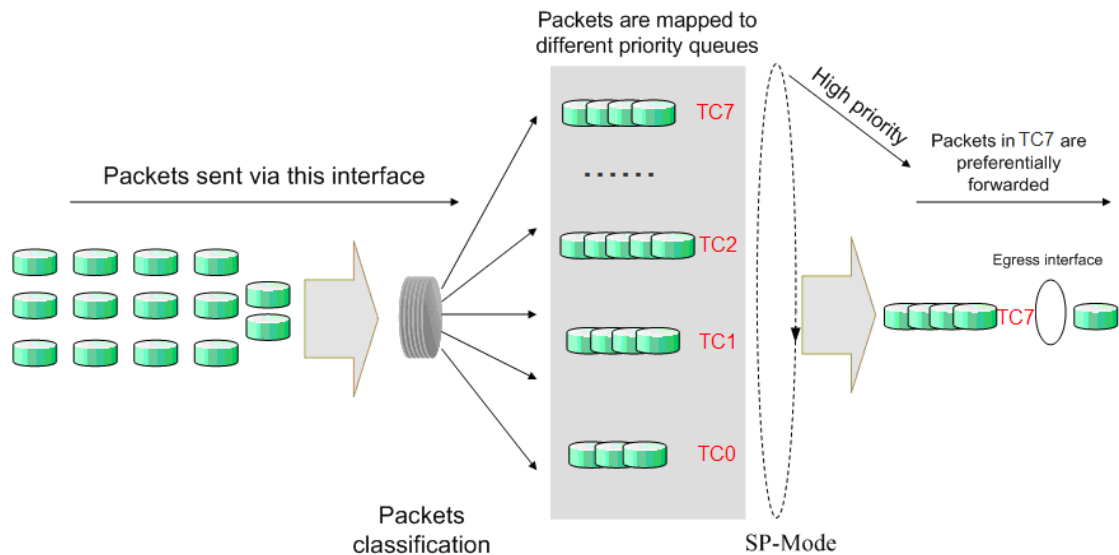

Figure 11-4 SP-Mode

2. **WRR-Mode: Weight Round Robin Mode.** In this mode, packets in all the queues are sent in order based on the weight value for each queue and every queue can be assured of a certain service time. The weight value indicates the occupied proportion of the resource. WRR queue overcomes the disadvantage of SP queue that the packets in the queues with lower priority cannot get service for a long time. In WRR mode, though the queues are scheduled in order, the service time for each queue is not fixed, that is to say, if a queue is empty, the next queue will be scheduled. In this way, the bandwidth resources are made full use of. The default weight value ratio of TC0, TC1, TC2, TC3, TC4, TC5, TC6 and TC7 is 1:2:4:8:16:32:64:127.

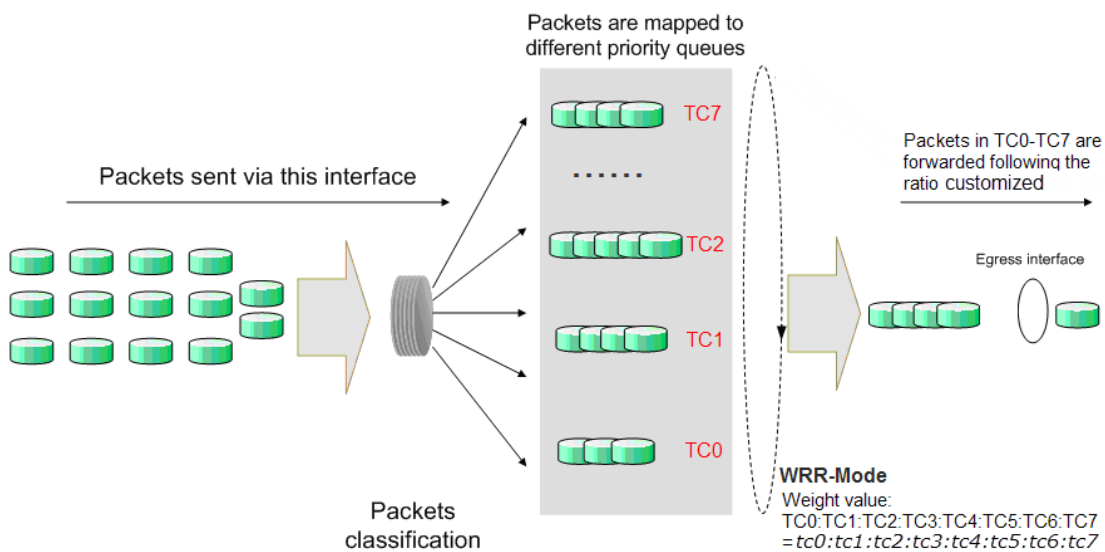

Figure 11-5 WRR-Mode

3. **SP+WRR Mode: Strict-Priority + Weight Round Robin Mode.** In this mode, the switch provides two scheduling groups, SP group and WRR group. Queues in SP group and WRR group are scheduled strictly based on Strict-Priority mode while the queues inside WRR group follow the WRR mode. In SP + WRR mode, TC7 and the queue with its weight value set as 0 are in the SP group; other queues, with none-zero weight value, belong to the WRR group and the weight value can be customized, ranging from 0 to 127. In this way, when scheduling queues, the switch allows TC7 and zero-weight-value queue to occupy the whole bandwidth following the SP mode and the queues in the WRR group will take up the bandwidth according to their ratio.

- Equ-Mode: Equal-Mode. In this mode, all the queues occupy the bandwidth equally. The weight value ratio of all the queues is 1:1:1:1:1:1:1.



Note:

In SP + WRR mode, TC7 and the queue with its weight value set as 0 are in the SP group.

The QoS module is mainly for traffic control and priority configuration, including three submenus: **DiffServ**, **Bandwidth Control** and **Voice VLAN**.

11.1 DiffServ

This switch classifies the ingress packets, maps the packets to different priority queues and then forwards the packets according to specified scheduling algorithms to implement QoS function.

This switch implements three priority modes based on port, on 802.1P and on DSCP, and supports four queue scheduling algorithms. The port priorities are labeled as CoS0, CoS1... CoS7.

The DiffServ function can be implemented on **Port Priority**, **Schedule Mode**, **802.1P Priority** and **DSCP Priority** pages.

11.1.1 Port Priority

On this page you can configure the port priority.

Choose the menu **QoS**→**DiffServ**→**Port Priority** to load the following page.

Port Priority Config			
UNIT: 1 LAGS			
Select	Port	Priority	LAG
<input type="checkbox"/>			
<input type="checkbox"/>	1/0/1	COS 0	---
<input type="checkbox"/>	1/0/2	COS 0	---
<input type="checkbox"/>	1/0/3	COS 0	---
<input type="checkbox"/>	1/0/4	COS 0	---
<input type="checkbox"/>	1/0/5	COS 0	LAG 1
<input type="checkbox"/>	1/0/6	COS 0	LAG 1
<input type="checkbox"/>	1/0/7	COS 0	---
<input type="checkbox"/>	1/0/8	COS 0	---
<input type="checkbox"/>	1/0/9	COS 0	---
<input type="checkbox"/>	1/0/10	COS 0	---
<input type="checkbox"/>	1/0/11	COS 0	---
<input type="checkbox"/>	1/0/12	COS 0	---
<input type="checkbox"/>	1/0/13	COS 0	---
<input type="checkbox"/>	1/0/14	COS 0	---
<input type="checkbox"/>	1/0/15	COS 0	---

Note:

Port priority is one property of the port. When the port priority is specified, the data will be classified into the egress queue based on the CoS value of the ingress port and the mapping relation between the CoS and TC in 802.1P/CoS mapping.

Figure 11-6 Port Priority Config

The following entries are displayed on this screen:

➤ **Port Priority Config**

- UNIT:1/LAGS:** Click **1** to configure the physical ports. Click **LAGS** to configure the link aggregation groups.
- Select:** Select the desired port to configure its priority. It is multi-optional.
- Port:** Displays the physical port number of the switch.
- Priority:** Specify the priority for the port.
- LAG:** Displays the LAG number which the port belongs to.

Configuration Procedure:

Step	Operation	Description
1	Select the port priority	Required. On QoS→DiffServ→Port Priority page, configure the port priority.
2	Configure the mapping relation between the 802.1P priority and TC	Required. On QoS→DiffServ→802.1P Priority page, configure the mapping relation between the 802.1P priority and TC.
3	Select a schedule mode	Required. On QoS→DiffServ→Schedule Mode page, select a schedule mode.

11.1.2 Schedule Mode

On this page you can select a schedule mode for the switch. When the network is congested, the problem that many packets compete for resources must be solved, usually in the way of queue scheduling. The switch will control the forwarding sequence of the packets according to the priority queues and scheduling algorithms you set. On this switch, the priority levels are labeled as TC0, TC1... TC7.

Choose the menu **QoS→DiffServ→Schedule Mode** to load the following page.

Schedule Mode Config

Schedule Mode:

Queue Weight:

TC0:

TC1:

TC2:

TC3:

TC4:

TC5:

TC6:

TC7:

Note:

For WRR mode, TC queue weight ranges from 1 to 127. For SP+WRR mode, the queue weight ranges from 0 to 127, 0 stands for sp mode.

Figure 11-7 Schedule Mode

The following entries are displayed on this screen:

➤ **Schedule Mode Config**

Schedule Mode:

Select a schedule mode.

- **SP-Mode:** Strict-Priority Mode. In this mode, the queue with higher priority will occupy the whole bandwidth. Packets in the queue with lower priority are sent only when the queue with higher priority is empty.
- **WRR-Mode:** Weight Round Robin Mode. In this mode, packets in all the queues are sent in order based on the weight value for each queue. The weight values of TC0-TC7 can be customized and their default values are 1:2:4:8:16:32:64:127 respectively.
- **SP+WRR-Mode:** Strict-Priority + Weight Round Robin Mode. In this mode, the switch provides two scheduling groups, SP group and WRR group. SP group is processed prior to WRR group. Queues in SP group are scheduled strictly based on Strict-Priority mode while the queues inside WRR group follow the WRR mode. In SP+WRR mode, TC7 and the queue with its weight value set as 0 are in the SP group; other queues, with none-zero weight value, belong to the WRR group and the weight value can be customized. The default weight values of TC0-TC6 are 1:2:4:8:16:32:64 respectively, while the value of TC7 is 0 and non-configurable.
- **Equ-Mode:** Equal-Mode. In this mode, all the queues occupy the bandwidth equally. The weight value ratio of all the queues is 1:1:1:1:1:1:1:1.

Queue Weight:

Input the queue weight of the 8 TC queues. Configuration is not available when Equ-Mode or SP-Mode is selected as the schedule mode.

11.1.3 802.1P Priority

On this page you can configure the mapping relation between the 802.1P priority tag-id/CoS-id and the TC-id.

802.1P gives the Pri field in 802.1Q tag a recommended definition. This field, ranging from 0-7, is used to divide packets into 8 priorities. 802.1P Priority is enabled by default, so the packets with 802.1Q tag are mapped to different priority levels based on 802.1P priority mode but the untagged packets are mapped based on port priority mode. With the same value, the 802.1P priority tag and the CoS will be mapped to the same TC.

Choose the menu **QoS**→**DiffServ**→**802.1P Priority** to load the following page.

Priority and CoS-mapping Config		
Select	Tag-id/CoS-id	Queue TC-id
<input type="checkbox"/>		<input type="text" value=""/>
<input type="checkbox"/>	0	TC1
<input type="checkbox"/>	1	TC0
<input type="checkbox"/>	2	TC2
<input type="checkbox"/>	3	TC3
<input type="checkbox"/>	4	TC4
<input type="checkbox"/>	5	TC5
<input type="checkbox"/>	6	TC6
<input type="checkbox"/>	7	TC7

Figure 11-8 802.1P Priority

The following entries are displayed on this screen:

➤ **Priority and CoS-mapping Config**

- Select:** Select the desired 802.1P tag-id/cos-id for 802.1P priority configuration. It is multi-optional.
- Tag-id/CoS-id:** Indicates the precedence level defined by IEEE 802.1P and the CoS ID.
- Queue TC-id:** Indicates the priority level of egress queue the packets with tag and CoS-id are mapped to. The priority levels of egress queue are labeled as TC0, TC1, TC2 ...TC7.



Note:

To complete QoS function configuration, you have to go to the **Schedule Mode** page to select a schedule mode after the configuration is finished on this page.

Configuration Procedure:

Step	Operation	Description
1	Configure the mapping relation between the 802.1P priority Tag/CoS and the TC	Required. On QoS → DiffServ → 802.1P Priority page, configure the mapping relation between the 802.1P priority Tag/CoS and the TC.
2	Select a schedule mode	Required. On QoS → DiffServ → Schedule Mode page, select a schedule mode.

11.1.4 DSCP Priority

On this page you can configure DSCP priority. DSCP (DiffServ Code Point) is a new definition to IP ToS field given by IEEE. This field is used to divide IP datagram into 64 priorities. When DSCP Priority is enabled, IP datagram are mapped to different priority levels based on DSCP priority mode; non-IP datagram with 802.1Q tag are mapped to different priority levels based on 802.1P priority mode if 802.1P Priority mode is enabled; the untagged non-IP datagram are mapped based on port priority mode.

Choose the menu **QoS**→**DiffServ**→**DSCP Priority** to load the following page.

DSCP Priority Config

DSCP Priority: Enable Disable Apply

Select	DSCP	Priority
<input type="checkbox"/>		
<input type="checkbox"/>	0	COS0
<input type="checkbox"/>	1	COS0
<input type="checkbox"/>	2	COS0
<input type="checkbox"/>	3	COS0
<input type="checkbox"/>	4	COS0
<input type="checkbox"/>	5	COS0
<input type="checkbox"/>	6	COS0
<input type="checkbox"/>	7	COS0
<input type="checkbox"/>	8	COS1
<input type="checkbox"/>	9	COS1

All Apply Help

Note:

Among the priority levels COS0, COS1...COS7, the bigger value, the higher priority.

Figure 11-9 DSCP Priority

The following entries are displayed on this screen:

➤ **DSCP Priority Config**

DSCP Priority: Select Enable or Disable DSCP Priority.

➤ **Priority Level**

Select: Select the desired DSCP value for DSCP priority configuration. It is multi-optional.

DSCP: Indicates the priority determined by the DS region of IP datagram. It ranges from 0 to 63.

Priority Level: Indicates the 802.1P priority the packets with tag are mapped to. The priorities are labeled as CoS0 ~ CoS7.

Configuration Procedure:

Step	Operation	Description
1	Configure the mapping relation between the DSCP priority and 802.1P priority	Required. On QoS → DiffServ → DSCP Priority page, enable DSCP Priority and configure the mapping relation between the DSCP priority and CoS.
2	Configure the mapping relation between the CoS and the TC	Required. On QoS → DiffServ → 802.1P Priority page, configure the mapping relation between the CoS and the TC.
3	Select a schedule mode	Required. On QoS → DiffServ → Schedule Mode page, select a schedule mode.

11.2 Bandwidth Control

Bandwidth function, allowing you to control the traffic rate and broadcast flow on each port to ensure network in working order, can be implemented on **Rate Limit** and **Storm Control** pages.

11.2.1 Rate Limit

Rate limit functions to control the ingress/egress traffic rate on each port via configuring the available bandwidth of each port. In this way, the network bandwidth can be reasonably distributed and utilized.

Choose the menu **QoS**→**Bandwidth Control**→**Rate Limit** to load the following page.

Select	Port	Ingress Rate(1-1000000Kbps)	Egress Rate(1-1000000Kbps)	LAG
<input type="checkbox"/>				
<input checked="" type="checkbox"/>	1/0/1	---	---	---
<input type="checkbox"/>	1/0/2	---	---	---
<input type="checkbox"/>	1/0/3	---	---	---
<input type="checkbox"/>	1/0/4	---	---	---
<input type="checkbox"/>	1/0/5	---	---	LAG 1
<input type="checkbox"/>	1/0/6	---	---	LAG 1
<input type="checkbox"/>	1/0/7	---	---	---
<input type="checkbox"/>	1/0/8	---	---	---
<input type="checkbox"/>	1/0/9	---	---	---
<input type="checkbox"/>	1/0/10	---	---	---
<input type="checkbox"/>	1/0/11	---	---	---
<input type="checkbox"/>	1/0/12	---	---	---

Note:

For one port, you cannot enable the Storm Control and the Ingress rate control at the same time.

Figure 11-10 Rate Limit

The following entries are displayed on this screen:

➤ **Rate Limit Config**

UNIT:1/LAGS:

Click **1** to configure the physical ports. Click **LAGS** to configure the link aggregation groups.

Select:

Select the desired port for Rate configuration. It is multi-optional.

Port:

Displays the port number of the switch.

Ingress Rate (1-1000000Kbps):

Configure the bandwidth for receiving packets on the port. You can select a rate from the dropdown list or manually set Ingress rate, the system will automatically select integral multiple of 64Kbps that closest to the rate you entered as the real Ingress rate.

Egress Rate(1-1000000Kbps):

Configure the bandwidth for sending packets on the port. You can select a rate from the dropdown list or manually set Egress rate, the system will automatically select integral multiple of 64Kbps that closest to the rate you entered as the real Egress rate.

LAG:

Displays the LAG number which the port belongs to.



Note:

1. If you enable ingress rate limit feature for the storm control-enabled port, storm control feature will be disabled for this port.
2. When manually set Ingress/Egress rate, the system will automatically select integral multiple of 64Kbps that closest to the rate you entered as the real Ingress/Egress rate. For example, if you enter 1000Kbps for egress rate, the system will automatically select 1024Kbps as the real Egress rate.
3. When egress rate limit feature is enabled for one or more ports, you are suggested to disable the flow control on each port to ensure the switch works normally.

11.2.2 Storm Control

Storm Control function allows the switch to filter broadcast, multicast and UL frame in the network. If the transmission rate of the three kind packets exceeds the set bandwidth, the packets will be automatically discarded to avoid network broadcast storm.

Choose the menu **QoS**→**Bandwidth Control**→**Storm Control** to load the following page.

Storm Control Config									
UNIT: 1 LAGS									
Select	Port	PPS	Broadcast Rate Mode	Broadcast	Multicast Rate Mode	Multicast	UL-Frame Rate Mode	UL-Frame	LAG
<input type="checkbox"/>									
<input type="checkbox"/>	1/0/1	Disable	kbps	---	kbps	---	kbps	---	---
<input type="checkbox"/>	1/0/2	Disable	kbps	---	kbps	---	kbps	---	---
<input type="checkbox"/>	1/0/3	Disable	kbps	---	kbps	---	kbps	---	---
<input type="checkbox"/>	1/0/4	Disable	kbps	---	kbps	---	kbps	---	---
<input type="checkbox"/>	1/0/5	Disable	kbps	---	kbps	---	kbps	---	---
<input type="checkbox"/>	1/0/6	Disable	kbps	---	kbps	---	kbps	---	---
<input type="checkbox"/>	1/0/7	Disable	kbps	---	kbps	---	kbps	---	---
<input type="checkbox"/>	1/0/8	Disable	kbps	---	kbps	---	kbps	---	LAG 1
<input type="checkbox"/>	1/0/9	Disable	kbps	---	kbps	---	kbps	---	---
<input type="checkbox"/>	1/0/10	Disable	kbps	---	kbps	---	kbps	---	LAG 1
<input type="checkbox"/>	1/0/11	Disable	kbps	---	kbps	---	kbps	---	---
<input type="checkbox"/>	1/0/12	Disable	kbps	---	kbps	---	kbps	---	---

Note:

For one port, you cannot enable the Storm Control and the Ingress rate control at the same time.

Figure 11-11 Storm Control

The following entries are displayed on this screen:

➤ **Storm Control Config**

UNIT:1/LAGS:

Click **1** to configure the physical ports. Click **LAGS** to configure the link aggregation groups.

Select:

Select the desired port for Storm Control configuration. It is multi-optional.

Port:	Displays the port number of the switch.
PPS:	Enable or disable the PPS mode.
Broadcast Rate Mode:	Select the broadcast rate mode, pps mode is invalid if the PPS is disabled. <ul style="list-style-type: none"> • kbps: Specify the threshold in kbits per second. • ratio: Specify the threshold as a percentage of the bandwidth. • pps: Specify the threshold in packets per second.
Broadcast:	Enable/Disable broadcast control feature for the port.
Multicast Rate Mode:	Select the multicast rate mode, pps mode is invalid if PPS is disabled.
Multicast:	Enable/Disable multicast control feature for the port.
UL-Frame Rate Mode:	Select the UL-Frame rate mode, pps mode is invalid if PPS is disabled.
UL-Frame:	Enable/Disable UL-Frame control feature for the port.
LAG:	Displays the LAG number which the port belongs to.



Note:

1. If you enable storm control feature for the ingress rate limit-enabled port, ingress rate limit feature will be disabled for this port.
2. If the PPS function is enabled, the storm control type can ONLY be pps. If the PPS function is disabled, the storm control type can be set as kbps or ratio.

11.3 Voice VLAN

Voice VLANs are configured specially for voice data stream. By configuring Voice VLANs and adding the ports with voice devices attached to voice VLANs, you can perform QoS-related configuration for voice data, ensuring the transmission priority of voice data stream and voice quality.

- OUI Address (Organizationally unique identifier address)

The switch can determine whether a received packet is a voice packet by checking its source MAC address. If the source MAC address of a packet complies with the OUI addresses configured by the system, the packet is determined as voice packet and transmitted in voice VLAN.

An OUI address is a unique identifier assigned by IEEE (Institute of Electrical and Electronics Engineers) to a device vendor. It comprises the first 24 bits of a MAC address. You can recognize which vendor a device belongs to according to the OUI address. The following table shows the OUI addresses of several manufacturers. The following OUI addresses are preset of the switch by default.

Number	OUI Address	Vendor
1	00-01-e3-00-00-00	Siemens phone
2	00-03-6b-00-00-00	Cisco phone
3	00-04-0d-00-00-00	Avaya phone
4	00-60-b9-00-00-00	Philips/NEC phone
5	00-d0-1e-00-00-00	Pingtel phone
6	00-e0-75-00-00-00	Polycom phone
7	00-e0-bb-00-00-00	3com phone

Table 11-1 OUI addresses on the switch

➤ Port Voice VLAN Mode

A voice VLAN can operate in two modes: automatic mode and manual mode.

Automatic Mode: In this mode, the switch automatically adds a port which receives voice packets to voice VLAN and determines the priority of the packets through learning the source MAC of the UNTAG packets sent from IP phone when it is powered on. The aging time of voice VLAN can be configured on the switch. If the switch does not receive any voice packet on the ingress port within the aging time, the switch will remove this port from voice VLAN. Voice ports are automatically added into or removed from voice VLAN.

Manual Mode: You need to manually add the port of IP phone to voice VLAN, and then the switch will assign ACL rules and configure the priority of the packets through learning the source MAC address of packets and matching OUI address.

In practice, the port voice VLAN mode is configured according to the type of packets sent out from voice device and the link type of the port. The following table shows the detailed information.

Port Voice VLAN Mode	Voice Stream Type	Link type of the port and processing mode
Automatic Mode	TAG voice stream	Untagged: Not supported.
		Tagged: Supported. The default VLAN of the port cannot be voice VLAN.
	UNTAG voice stream	Untagged: Supported.
		Tagged: Not supported.
Manual Mode	TAG voice stream	Untagged: Not supported.
		Tagged: Supported. The default VLAN of the port should not be voice VLAN.
	UNTAG voice stream	Untagged: Supported.
		Tagged: Not supported.

Table 11-2 Port voice VLAN mode and voice stream processing mode

➤ **Security Mode of Voice VLAN**

When voice VLAN is enabled for a port, you can configure its security mode to filter data stream. If security mode is enabled, the port just forwards voice packets, and discards other packets whose source MAC addresses do not match OUI addresses. If security mode is not enabled, the port forwards all the packets.

Security Mode	Packet Type	Processing Mode
Enable	UNTAG packet	When the source MAC address of the packet is the OUI address that can be identified, the packet can be transmitted in the voice VLAN. Otherwise, the packet will be discarded.
	Packet with voice VLAN TAG	
	Packet with other VLAN TAG	The processing mode for the device to deal with the packet is determined by whether the port permits the VLAN or not, independent of voice VLAN security mode.
Disable	UNTAG packet	Do not check the source MAC address of the packet and all the packets can be transmitted in the voice VLAN.
	Packet with voice VLAN TAG	
	Packet with other VLAN TAG	The processing mode for the device to deal with the packet is determined by whether the port permits the VLAN or not, independent of voice VLAN security mode.

Table 11-3 Security mode and packets processing mode



Note:

Don't transmit voice stream together with other business packets in the voice VLAN except for some special requirements.

The Voice VLAN function can be implemented on **Global Config**, **Port Config** and **OUI Config** pages.

11.3.1 Global Config

On this page, you can configure the global parameters of the voice VLAN, including VLAN ID and aging time.

Choose the menu **QoS**→**Voice VLAN**→**Global Config** to load the following page.

Global Config

Voice VLAN: Enable Disable

VLAN ID : (2-4094)

Aging Time: min (1-43200, default: 1440)

Priority:

Figure 11-12 Global Configuration

The following entries are displayed on this screen:

➤ **Global Config**

Voice VLAN: Select Enable/Disable Voice VLAN function.

- VLAN ID:** Enter the VLAN ID of the voice VLAN.
- Aging Time:** Specifies the living time of the member port in auto mode after the OUI address is aging out.
- Priority:** Select the priority of the port when sending voice data.

11.3.2 Port Config

Before the voice VLAN function is enabled, the parameters of the ports in the voice VLAN should be configured on this page.

Choose the menu **QoS**→**Voice VLAN**→**Port Config** to load the following page.

Port Config					
UNIT: 1 LAGS					
Select	Port	Port Mode	Security Mode	Member State	LAG
<input type="checkbox"/>		<input type="text"/>	<input type="text"/>		
<input type="checkbox"/>	1/0/1	Auto	Disable	Inactive	---
<input type="checkbox"/>	1/0/2	Auto	Disable	Inactive	---
<input type="checkbox"/>	1/0/3	Auto	Disable	Inactive	---
<input type="checkbox"/>	1/0/4	Auto	Disable	Inactive	---
<input type="checkbox"/>	1/0/5	Auto	Disable	Inactive	LAG 1
<input type="checkbox"/>	1/0/6	Auto	Disable	Inactive	LAG 1
<input type="checkbox"/>	1/0/7	Auto	Disable	Inactive	---
<input type="checkbox"/>	1/0/8	Auto	Disable	Inactive	---
<input type="checkbox"/>	1/0/9	Auto	Disable	Inactive	---
<input type="checkbox"/>	1/0/10	Auto	Disable	Inactive	---
<input type="checkbox"/>	1/0/11	Auto	Disable	Inactive	---
<input type="checkbox"/>	1/0/12	Auto	Disable	Inactive	---
<input type="checkbox"/>	1/0/13	Auto	Disable	Inactive	---
<input type="checkbox"/>	1/0/14	Auto	Disable	Inactive	---
<input type="checkbox"/>	1/0/15	Auto	Disable	Inactive	---

Figure 11-13 Port Config



Note:

To enable voice VLAN function for the LAG member port, please ensure its member state accords with its port mode.

If a port is a member port of voice VLAN, changing its port mode to be “Auto” will make the port leave the voice VLAN and will not join the voice VLAN automatically until it receives voice streams.

The following entries are displayed on this screen:

➤ **Port Config**

UNIT:1/LAGS: Click **1** to configure the physical ports. Click **LAGS** to configure the link aggregation groups.

Select: Select the desired port for voice VLAN configuration. It is multi-optional.

- Port:** Displays the port number of the switch.
- Port Mode:** Select the mode for the port to join the voice VLAN.
- **Auto:** In this mode, the switch automatically adds a port to the voice VLAN or removes a port from the voice VLAN by checking whether the port receives voice data or not.
 - **Manual:** In this mode, you can manually add a port to the voice VLAN or remove a port from the voice VLAN.
- Security Mode:** Configure the security mode for forwarding packets.
- **Disable:** All packets are forwarded.
 - **Enable:** Only voice data are forwarded.
- Member State:** Displays the state of the port in the current voice VLAN.
- LAG:** Displays the LAG number which the port belongs to.

11.3.3 OUI Config

The switch supports OUI creation and adds the MAC address of the special voice device to the OUI table of the switch. The switch determines whether a received packet is a voice packet by checking its OUI address. The switch analyzes the received packets. If the packets recognized as voice packets, the access port will be automatically added to the Voice VLAN.

Choose the menu **QoS**→**Voice VLAN**→**OUI Config** to load the following page.

Create OUI

OUI: (Format: 00-00-00-00-00-01)

Mask: (Default: FF-FF-FF-00-00-00) Create

Description: (16 characters maximum)

OUI Table

Select	OUI	Mask	Description
<input type="checkbox"/>	00-01-e3-00-00-00	ff-ff-ff-00-00-00	Siemens Phone
<input type="checkbox"/>	00-03-6b-00-00-00	ff-ff-ff-00-00-00	Cisco Phone
<input type="checkbox"/>	00-04-0d-00-00-00	ff-ff-ff-00-00-00	Avaya Phone
<input type="checkbox"/>	00-60-b9-00-00-00	ff-ff-ff-00-00-00	Philips Phone
<input type="checkbox"/>	00-d0-1e-00-00-00	ff-ff-ff-00-00-00	Pingtel Phone
<input type="checkbox"/>	00-e0-75-00-00-00	ff-ff-ff-00-00-00	PolyCom Phone
<input type="checkbox"/>	00-e0-bb-00-00-00	ff-ff-ff-00-00-00	3Com Phone

All
Delete
Help

Figure 11-14 OUI Configuration

The following entries are displayed on this screen:

➤ **Create OUI**

- OUI:** Enter the OUI address of the voice device.
- Mask:** Enter the OUI address mask of the voice device.
- Description:** Give a description to the OUI for identification.

➤ **OUI Table**

Select: Select the desired entry to view the detailed information.

OUI: Displays the OUI address of the voice device.

Mask: Displays the OUI address mask of the voice device.

Description: Displays the description of the OUI.

Configuration Procedure of Voice VLAN:

Step	Operation	Description
1	Create VLAN	Required. On VLAN→802.1Q VLAN→VLAN Config page, click the Create button to create a VLAN.
2	Add OUI address	Optional. On QoS→Voice VLAN→OUI Config page, you can check whether the switch is supporting the OUI template or not. If not, please add the OUI address.
3	Configure the parameters of the ports in voice VLAN.	Required. On QoS→Voice VLAN→Port Config page, configure the parameters of the ports in voice VLAN.
4	Enable Voice VLAN	Required. On QoS→Voice VLAN→Global Config page, configure the global parameters of voice VLAN.

[Return to CONTENTS](#)

Chapter 12 PoE



Note:

Only T2600G-28MPS support PoE function.

PoE (Power over Ethernet) technology describes a system to transmit electrical power along with data to remote devices over standard twisted-pair cable in an Ethernet network. It is especially useful for supplying power to IP telephones, wireless LAN access points, cameras and so on.

➤ Composition

A PoE system usually consists of PSE and PD.

PSE: Power sourcing equipment (PSE) is a device such as a switch that provides power on the Ethernet cable to the linked device.

PD: A powered device (PD) is a device accepting power from the PSE and thus consumes energy. PDs fall into two types, standard PDs and nonstandard PDs. Standard PDs refer to the powered devices that comply with IEEE 802.3af and IEEE 802.3at. Examples include wireless LAN access points, IP Phones, IP cameras, network hubs, embedded computers etc.

➤ Advantage

- Cheap cabling: The remote device such as cameras can be powered by PSE in no need of prolonging its power cord additionally and Ethernet cable is much cheaper than AC wire or power cord.
- Easy to connect: PoE uses only one Ethernet cable with no need of external power supply.
- Reliable: A powered device can be either powered by PSE using Ethernet cable or powered through the provided power adapter. It is very convenient to provide a backup power supply for the PDs.
- Flexibility: In compliance with IEEE 802.3af and IEEE 802.3at, global organizations can deploy PoE everywhere without concern for any local variance in AC power standards, outlets, plugs, or reliability.
- Wide use: It can be applied to wireless LAN access points, IP Phones, IP cameras, network hubs, embedded computers etc.

T2600G-28MPS is a Power Sourcing Equipment (PSE). All the Auto-Negotiation RJ45 ports on the switch support Power over Ethernet (PoE) function, which can automatically detect and supply power for those powered devices (PDs) complying with IEEE 802.3af and IEEE 802.3at. The maximum power T2600G-28MPS can supply is 384W and the maximum power each PoE port can supply is 30W.

PoE function can be configured in the two sections, **PoE Config** and **PoE Time-Range**.

12.1 PoE Config

All the RJ45 ports on the switch can be configured to supply power for the powered devices that comply with IEEE 802.3af and IEEE 802.3at. As the power every port or the system can provide is limited, some attributes should be set to make full use of the power and guarantee the adequate power to the linked PDs. When the power exceeds the maximum power limit or the power is inadequate to power the device, the switch may disconnect the power supply to the PD linked to the port with lower priority. When detecting a PD is unplugged, the switch will stop supplying the power to the PD.

PoE Config, mainly for PoE attributes configuration, is implemented on **PoE Config** and **PoE Profile** pages.

12.1.1 PoE Config

On this page, you can configure the parameters to implement PoE function.

Choose the menu **PoE**→**PoE Config**→**PoE Config** to load the following page.

The screenshot displays the PoE Config interface, divided into two main sections: Global Config and Port Config.

Global Config: This section includes three input fields: 'System Power Limit' (set to 384.0), 'System Power Consumption' (0.0w), and 'System Power Remain' (384.0w). An 'Apply' button is located to the right of these fields.

Port Config: This section features a table with columns for 'Select', 'Port', 'PoE Status', 'PoE Priority', 'Power Limit (0.1w-30.0w)', 'Time Range', 'PoE Profile', 'Power(w)', 'Current(mA)', 'Voltage(v)', 'PD Class', and 'Power Status'. A 'Port' dropdown menu and a 'Select' button are positioned above the table. The table lists 15 ports, each with a checkbox, 'Enable' status, 'Low' priority, 'Class 4' power limit, 'No Limit' time range, and 'OFF' power status. 'Apply' and 'Help' buttons are located below the table.

Figure 12-1 PoE Config

The following items are displayed on this screen:

➤ Global Config

System Power Limit: Defines the max power the PoE switch can supply. It ranges from 1W to 384W.

System Power Consumption: Displays the PoE switch's real time system power consumption.

System Power Remain: Displays the PoE switch's real time remaining system power.

➤ Port Config

Port Select: Click the **Select** button to quick-select the corresponding entry based on the port number you entered.

Select: Select the desired port to configure its parameters.

Port: Displays the port number.

PoE Status: Select to disable/enable the PoE feature for the corresponding port. If set enable, the corresponding port can supply power to the linked PD (Powered Device).

PoE Priority:	The priority levels include High, Middle and Low in descending order. When the supply power exceeds the system power limit, the port with lower priority will stop supplying power; If these ports have the same priority levels, the port with smaller port number will stop supplying power first.
Power Limit (0.1w-30w):	Defines the max power the corresponding port can supply. Class1 represents 4W, Class2 represents 7W, Class3 represents 15.4W and Class4 represents 30W.
Time Range:	Select the time range for the PoE port to supply power. If No limit is selected, the PoE port will supply power all the time.
PoE Profile:	Select the profile you want to apply to the selected port. If a PoE Profile is selected, the three attributes including PoE Status, PoE Priority and Power Limit are not available.
Power (W):	Displays the port's real time power supply.
Current (mA):	Displays the port's real time current.
Voltage (V):	Displays the port's real time voltage.
PD Class:	Displays the class the linked PD (Powered Device) belongs to.
Power Status:	Displays the port's real time power status.



Note:

When Time Range is selected, the corresponding port's other PoE configurations would not work.

12.1.2 PoE Profile

PoE (Power over Ethernet) Profile is a short cut for the configuration of the PoE port. You can create some profiles to be applied to the ports. In a profile, the PoE status, PoE priority and Power limit are configured.

Choose the menu **PoE**→**PoE Config**→**Profile Profile** to load the following page.

Create PoE Profile

Profile Name:	<input type="text"/>		
PoE Status:	<input checked="" type="radio"/> Enable <input type="radio"/> Disable		<input type="button" value="Create"/>
PoE Priority:	<input type="text" value="High"/> ▾		
Power Limit:	<input type="text" value="Auto"/> ▾		

PoE Profile

Select	Profile Name	PoE Status	PoE Priority	Power Limit (w)
<input type="button" value="All"/> <input type="button" value="Delete"/> <input type="button" value="Help"/>				

Figure 12-2 Profile Config

The following items are displayed on this screen:

➤ Create PoE Profile

Profile Name:	Enter the name of the profile.
PoE Status:	Select to the enable/disable PoE feature for the corresponding port. If set enable, the port may supply power to the linked PD (Power Device).
PoE Priority:	The priority levels include High, Middle and Low in descending order. When the supply power exceeds the system power limit, the PD linked to the port with lower priority will be disconnected.
Power Limit:	Defines the max power the corresponding port can supply. Class1 represents 4W, Class2 represents 7W, Class3 represents 15.4W, and Class4 represents 30W.

➤ PoE Profile

Select:	Select the desired profile to delete.
Profile Name:	Displays the name of the profile.
PoE Status:	Displays the PoE status of the port in the profile.
PoE Priority:	Displays the PoE priority of the port in the profile.
Power Limit:	Displays the max power the port in the profile can supply.

12.2 Time-Range

A time-range based PoE enables you to implement PoE power supply by differentiating the time-ranges. A time-range can be specified for each port. The port will not supply power when the specified time-range is configured and the system time is not within the time-range.

On this switch time-range consists of **Holiday**, **Absolute** and **Periodic**. A specific Time-range is the intersection of Absolute Time and Periodic Time, combined with the Holiday you defined.

Absolute Time-range defines one or several time ranges with specific starting time and ending time in the Gregorian calendar. Seven time ranges can be created at most, and their union is the Absolute Time-range. Absolute Time-range does not recur. If no absolute time range is configured, the Absolute Time-range takes effect from January 1, 2000 00:00 to December 31, 2099 24:00.

For example, under Absolute type, create time range 1 from January 1, 2015 00:00 to January 31, 2015 24:00, and time range 2 from March 1, 2015 00:00 to March 31, 2015 24:00, which makes Absolute Time-range effective in both January and March.

Periodic Time-range defines one or several time ranges with specific starting time and ending time in a week. Periodic Time-range recurs periodically on the day/days you configured in the week. Seven time ranges can be created at most, and their union is the Periodic Time-range. If no periodic time range is configured, the Periodic Time-range takes effect all the time from Monday to Sunday.

If the Holiday mode is configured as Include, the Time-range will be the intersection of the Absolute Time and the Periodic Time.

If the Holiday mode is configure as Exclude, the Time range will be the intersection of the Absolute Time and the Periodic Time, with Holiday excluded.

The Time-Range configuration can be implemented on **Time-Range Summary**, **Time-Range Create** and **Holiday Config** pages.

12.2.1 Time-Range Summary

On this page you can view or delete the current Time-ranges.

Choose the menu **PoE**→**Time-Range**→**Time-Range Summary** to load the following page.

Time-Range Table					
Select	Index	Time-Range Name	Mode	State	Operation
<input type="checkbox"/>	1	1	Include Holiday	Active	Edit Detail
<input type="checkbox"/>	2	2	Include Holiday & Absolute & Periodic	Inactive	Edit Detail

Figure 12-3 Time-Range Table

The following items are displayed on this screen:

➤ Time-Range Table

- Select:** Select the desired entry to delete the corresponding time-range.
- Index:** Displays the index of the time-range.
- Time-Range Name:** Displays the name of the time-range.
- Mode:** Displays the mode of the time-range. The mode can be one or a combination of the following modes: **Include/Exclude Holiday**, **Absolute** and **Periodic**. Refer to [Time-Range Create](#) and [Holiday Config](#) for more details.
- State** Displays active state of the time-range.
- Operation:** Click **Edit** to modify this time-range and click **Detail** to display the complete information of this time-range.

12.2.2 Time-Range Create

On this page you can create time-ranges.

Choose the menu **PoE**→**Time-Range**→**Time-Range Create** to load the following page.

Time Range Config

Name (1-16 characters)

Holiday Include Exclude

Add Absolute or Periodic

Type

From Time / / -- : (YYYY/MM/DD-hh:mm)

To Time / / -- : (YYYY/MM/DD-hh:mm)

Absolute Time Table

Index	From Time	To Time	Operation
No entry in the table.			

Periodic Time Table

Index	Start Time	End Time	Day of the Week	Operation
No entry in the table.				

Note:

1. If no entry in the Absolute Time Table, the absolute time is 2000/01/01-00:00 to 2099/12/31-24:00 by default.
2. If no entry in the Periodic Time Table, the periodic time is 00:00 to 24:00 from Monday to Sunday by default.

Figure 12-4 Time-Range Create



Note:

1. Up to 7 absolute time-ranges and 7 periodic time-ranges can be created in one Time-range.
2. If there is no entry in the Absolute Time table, the Absolute Time-range is from 2000/01/01-00:00 to 2099/12/31-24:00 by default.
3. If there is no entry in the Periodic Time table, the Periodic Time-range takes effect all the time from Monday to Sunday by default.

The following items are displayed on this screen:

➤ **Time Range Config**

Name: Enter the name of the time-range for time identification.

Holiday: Select Holiday mode. By default, the mode is Include.

Include: The Holiday has no effect on the Time-range, which means the final Time-range will be the intersection of the Absolute Time and Periodic Time.

Exclude: The final Time range will be the intersection of the Absolute Time and the Periodic Time, with Holiday excluded.

➤ **Add Absolute or Periodic**

Type: Select the time range type, Absolute or Periodic.

Absolute Time-range defines up to 7 time ranges with specific starting time and ending time in the Gregorian calendar. It does not recur.

Periodic Time-range defines up to 7 time ranges with specific starting time and ending time in a week. Periodic Time-range recurs periodically on the day/days you configured in the week.

From Time: Set the start time of the absolute time range.

- To Time:** Set the end time of the absolute time range.
- **Absolute Time Table**
 - Index:** Displays the index of the absolute time range.
 - From Time:** Displays start time of the absolute time range.
 - To Time:** Displays end time of the absolute time range.
 - Operation:** Click the **Delete** button to delete the corresponding time range.
- **Periodic Time Table**
 - Index:** Displays the index of the periodic time range.
 - Start Time:** Displays the start time of the periodic time range.
 - End Time:** Displays the end time of the periodic time range.
 - Day of the Week:** Displays the recurring days in the periodic time range.
 - Operation:** Click the **Delete** button to delete the corresponding time range.

12.2.3 Holiday Config

You can define holidays in this page. The holiday will be excluded from the Time-range you created if the Holiday mode is Exclude.

Choose the menu **PoE**→**Time-Range**→**Holiday Config** to load the following page.

Figure 12-5 Holiday Configuration

The following entries are displayed on this screen:

- **Create Holiday**
 - Holiday Name:** Enter the name of the holiday.
 - Start Date:** Specify the start date of the holiday.
 - End Date:** Specify the end date of the holiday.
- **Holiday Table**
 - Select:** Select the desired entry to delete the corresponding holiday.
 - Index:** Displays the index of the holiday.
 - Holiday Name:** Displays the name of the holiday.
 - Start Date:** Displays the start date of the holiday.

End Date:

Displays the end date of the holiday.

[Return to CONTENTS](#)

Chapter 13 ACL

ACL (Access Control List) is used to filter packets by configuring match rules and process policies of packets in order to control the access of the illegal users to the network. Besides, ACL functions to control traffic flows and save network resources. It provides a flexible and secured access control policy and facilitates you to control the network security.

On this switch, ACLs classify packets based on a series of match conditions, which can be L2-L4 protocol key fields carried in the packets. A time-range based ACL enables you to implement ACL control over packets by differentiating the time-ranges.

The ACL module is mainly for ACL configuration of the switch, including four submenus: **Time-Range**, **ACL Config**, **Policy Config**, **ACL Binding** and **Policy Binding**.

13.1 Time-Range

If a configured ACL is needed to be effective in a specified time-range, a time-range should be firstly specified in the ACL. As the time-range based ACL takes effect only within the specified time-range, data packets can be filtered by differentiating the time-ranges.

On this switch absolute time, week time and holiday can be configured. Configure an absolute time section in the form of “the start date to the end date” to make ACLs effective; configure a week time section to make ACLs effective on the fixed days of the week; configure a holiday section to make ACLs effective on some special days. In each time-range, four time-slices can be configured.

The Time-Range configuration can be implemented on **Time-Range Summary**, **Time-Range Create** and **Holiday Config** pages.

13.1.1 Time-Range Summary

On this page you can view the current time-ranges.

Choose the menu **ACL**→**Time-Range**→**Time-Range Summary** to load the following page.



Select	Index	Time-Range Name	Slice 1	Slice 2	Slice 3	Slice 4	Mode	Operation
No entry in the table.								

Figure 13-1 Time-Range Table

The following entries are displayed on this screen:

➤ Time-Range Table

- Select:** Select the desired entry to delete the corresponding time-range.
- Index:** Displays the index of the time-range.
- Time-Range Name:** Displays the name of the time-range.
- Slice:** Displays the time-slice of the time-range.
- Mode:** Displays the mode the time-range adopts.
- Operation:** Click the **Edit** button to modify the time-range. Click the **Detail** button to display the complete information of this time-range.

13.1.2 Time-Range Create

On this page you can create time-ranges.

Choose the menu **ACL**→**Time-Range**→**Time-Range Create** to load the following page.

Create Time-Range

Name:

Holiday

Absolute Start Date: 2000 / 01 / 01 End Date: 2000 / 01 / 01

Week Mon Tue Wed Thu Fri Sat Sun

Create Time-Slice

Start Time: 00 : 00

End Time: 24 : 00

Time-Slice Table

Index	Start Time	End Time	Delete
-------	------------	----------	--------

Figure 13-2 Time-Range Create



Note:

To successfully configure time-ranges, please firstly specify time-slices and then time-ranges.

The following entries are displayed on this screen:

➤ Create Time-Range

- Name:** Enter the name of the time-range for time identification.
- Holiday:** Select Holiday you set as a time-range. The ACL rule based on this time-range takes effect only when the system time is within the holiday.
- Absolute:** Select Absolute to configure absolute time-range. The ACL rule based on this time-range takes effect only when the system time is within the absolute time-range.
- Week:** Select Week to configure week time-range. The ACL rule based on this time-range takes effect only when the system time is within the week time-range.

➤ Create Time-Slice

- Start Time:** Set the start time of the time-slice.
- End Time:** Set the end time of the time-slice.

➤ Time-Slice Table

- Index:** Displays the index of the time-slice.
- Start Time:** Displays the start time of the time-slice.

End Time: Displays the end time of the time-slice.

Delete: Click the **Delete** button to delete the corresponding time-slice.

13.1.3 Holiday Config

Holiday mode is applied as a different secured access control policy from the week mode. On this page you can define holidays according to your work arrangement.

Choose the menu **ACL**→**Time-Range**→**Holiday Config** to load the following page.

The screenshot shows the 'Holiday Configuration' interface. At the top is a 'Create Holiday' section with three input fields: 'Start Date' (01 / 01), 'End Date' (01 / 01), and 'Holiday Name' (empty). An 'Apply' button is to the right. Below is a 'Holiday Table' with the following data:

Select	Index	Holiday Name	Start Date	End Date
<input type="checkbox"/>	1	NewYearDay	01/01	01/01

At the bottom of the table are three buttons: 'All', 'Delete', and 'Help'.

Figure 13-3 Holiday Configuration

The following entries are displayed on this screen:

➤ **Create Holiday**

Start Date: Specify the start date of the holiday.

End Date: Specify the end date of the holiday.

Holiday Name: Enter the name of the holiday.

➤ **Holiday Table**

Select: Select the desired entry to delete the corresponding holiday.

Index: Displays the index of the holiday.

Holiday Name: Displays the name of the holiday.

Start Date: Displays the start date of the holiday.

End Date: Displays the end date of the holiday.

13.2 ACL Config

An ACL may contain a number of rules, and each rule specifies a different package range. Packets are matched in match order. Once a rule is matched, the switch processes the matched packets taking the operation specified in the rule without considering the other rules, which can enhance the performance of the switch.

The ACL Config function can be implemented on **ACL Summary**, **ACL Create**, **MAC ACL**, **Standard-IP ACL**, **Extend-IP ACL**, **Combined ACL** and **IPv6 ACL** pages.

13.2.1 ACL Summary

On this page, you can view the current ACLs configured in the switch.

Choose the menu **ACL**→**ACL Config**→**ACL Summary** to load the following page.



Figure 13-4 ACL Summary

The following entries are displayed on this screen:

➤ **Search Option**

- Select ACL:** Select the ACL you have created
- ACL Type:** Displays the type of the ACL you select.
- Rule Order:** Displays the rule order of the ACL you select.

13.2.2 ACL Create

On this page you can create ACLs.

Choose the menu **ACL**→**ACL Config**→**ACL Create** to load the following page.

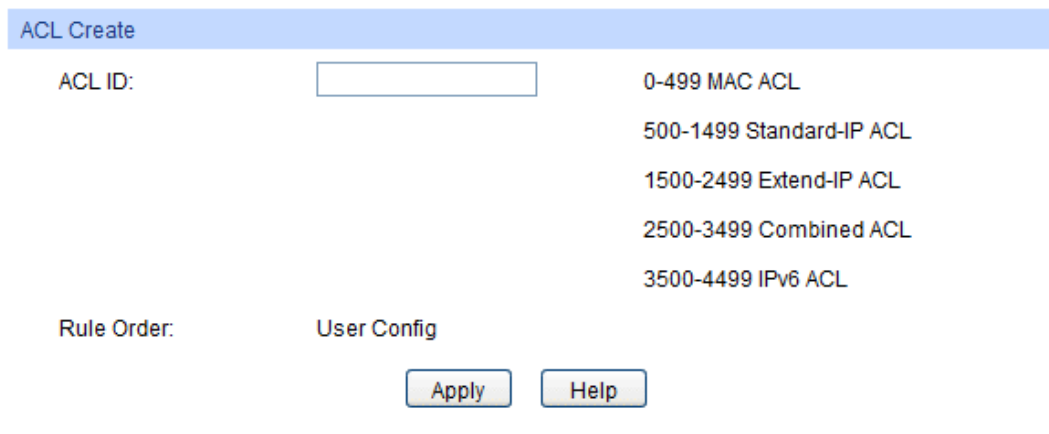

Figure 13-5 ACL Create

The following entries are displayed on this screen:

➤ **ACL Create**

- ACL ID:** Enter ACL ID of the ACL you want to create.
- Rule Order:** User Config order is set to be match order in this ACL.

13.2.3 MAC ACL

MAC ACLs analyze and process packets based on a series of match conditions, which can be the source MAC addresses and destination MAC addresses carried in the packets.

Choose the menu **ACL**→**ACL Config**→**MAC ACL** to load the following page.

Create MAC-Rule

ACL ID:

Rule ID: (0-999)

Operation:

S-MAC: Mask: (Format: 00-00-00-00-00-01)

D-MAC: Mask:

VLAN ID:

EtherType: (4-hex number)

User Priority:

Time-Range:

Figure 13-6 Create MAC Rule

The following entries are displayed on this screen:

➤ **Create MAC-Rule**

- ACL ID:** Select the desired MAC ACL for configuration.
- Rule ID:** Enter the rule ID.
- Operation:** Select the operation for the switch to process packets which match the rules.
- **Permit:** Forward packets.
 - **Deny:** Discard Packets.
- S-MAC:** Enter the source MAC address contained in the rule.
- D-MAC:** Enter the destination MAC address contained in the rule.
- MASK:** Enter MAC address mask. If it is set to 1, it must strictly match the address.
- VLAN ID:** Enter the VLAN ID contained in the rule.
- EtherType:** Enter EtherType contained in the rule.
- User Priority:** Select the user priority contained in the rule for the tagged packets to match.
- Time-Range:** Select the time-range for the rule to take effect.

13.2.4 Standard-IP ACL

Standard-IP ACLs analyze and process data packets based on a series of match conditions, which can be the source IP addresses and destination IP addresses carried in the packets.

Choose the menu **ACL**→**ACL Config**→**Standard-IP ACL** to load the following page.

Create Standard-IP Rule

ACL ID: Standard-IP ACL ▼

Rule ID: (0-1999)

Operation: Permit ▼

S-IP: Mask: (Format: 192.168.0.1)

D-IP: Mask:

Time-Range: No Limit ▼

Figure 13-7 Create Standard-IP Rule

The following entries are displayed on this screen:

➤ Create Standard-IP ACL

- ACL ID:** Select the desired Standard-IP ACL for configuration.
- Rule ID:** Enter the rule ID.
- Operation:** Select the operation for the switch to process packets which match the rules.
- **Permit:** Forward packets.
 - **Deny:** Discard Packets.
- S-IP:** Enter the source IP address contained in the rule.
- D-IP:** Enter the destination IP address contained in the rule.
- Mask:** Enter IP address mask. If it is set to 1, it must strictly match the address.
- Time-Range:** Select the time-range for the rule to take effect.

13.2.5 Extend-IP ACL

Extend-IP ACLs analyze and process data packets based on a series of match conditions, which can be the source IP addresses, destination IP addresses, IP protocol and other information of this sort carried in the packets.

Choose the menu **ACL**→**ACL Config**→**Extend-IP ACL** to load the following page.

Create Extend-IP Rule

ACL ID: Extend-IP ACL

Rule ID: (0-1999)

Operation: Permit

Fragment:

S-IP: Mask: (Format: 192.168.0.1)

D-IP: Mask:

IP Protocol: All

TCP Flag: URG * ACK * PSH * RST * SYN * FIN *

S-Port:

D-Port:

DSCP: No Limit

IP ToS: No Limit IP Pre: No Limit

Time-Range: No Limit

Apply Help

Figure 13-8 Create Extend-IP Rule

The following entries are displayed on this screen:

➤ Create Extend-IP ACL

- ACL ID:** Select the desired Extend-IP ACL for configuration.
- Rule ID:** Enter the rule ID.
- Operation:** Select the operation for the switch to process packets which match the rules.
- **Permit:** Forward packets.
 - **Deny:** Discard Packets.
- Fragment:** Select if the rule will take effect on the fragment packets. When the fragment is selected, this rule will process all the fragments and the last piece of fragment will be always forwarded.
- S-IP:** Enter the source IP address contained in the rule.
- D-IP:** Enter the destination IP address contained in the rule.
- Mask:** Enter IP address mask. If it is set to 1, it must strictly match the address.
- IP Protocol:** Select IP protocol contained in the rule.

- TCP Flag:** Configure TCP flag when TCP is selected from the pull-down list of IP Protocol.
- S-Port:** Configure TCP/IP source port contained in the rule when TCP/UDP is selected from the pull-down list of IP Protocol.
- D-Port:** Configure TCP/IP destination port contained in the rule when TCP/UDP is selected from the pull-down list of IP Protocol.
- DSCP:** Enter the DSCP information contained in the rule.
- IP ToS:** Enter the IP ToS contained in the rule.
- IP Pre:** Enter the IP Precedence contained in the rule.
- Time-Range:** Select the time-range for the rule to take effect.

13.2.6 Combined ACL

Combined ACLs analyze and process data packets based on a series of match conditions, which can be the source MAC addresses, destination MAC addresses source IP addresses, destination IP addresses and other information of this sort carried in the packets.

Choose the menu **ACL**→**ACL Config**→**Combined ACL** to load the following page.

Figure 13-9 Combined ACL

The following entries are displayed on this screen:

➤ **Create combined Rule**

- ACL ID:** Select the desired Combined ACL for configuration.
- Rule ID:** Enter the rule ID.
- Operation:** Select the operation for the switch to process packets which match the rules.
 - **Permit:** Forward packets.
 - **Deny:** Discard Packets.

S-MAC:	Enter the source MAC address contained in the rule.
D-MAC:	Enter the destination MAC address contained in the rule.
Mask:	Enter IP address mask. If it is set to 1, it must strictly match the address.
VLAN ID	Enter the VLAN ID contained in the rule.
EtherType	Enter EtherType contained in the rule.
User Priority	Select the user priority contained in the rule for the tagged packets to match.
Fragment:	Select if the rule will take effect on the fragment packets. When the fragment is selected, this rule will process all the fragments and the last piece of fragment will be always forwarded.
S-IP:	Enter the source IP address contained in the rule.
D-IP:	Enter the destination IP address contained in the rule.
Mask:	Enter IP address mask. If it is set to 1, it must strictly match the address.
Time-Range:	Select the time-range for the rule to take effect.



Note:

Before binding a Combined ACL to an interface or VLAN, you should configure the SDM template as “default” or “enterpriseV4” and save your configurations. See [SDM Template](#) for more information about SDM template configuration.

13.2.7 IPv6 ACL

IPv6 ACLs analyze and process data packets based on a series of match conditions, such as the source IPv6 addresses, destination IPv6 addresses and port number carried in the packets.

Choose the menu **ACL**→**ACL Config**→**IPv6 ACL** to load the following page.

ACL ID: IPv6 ACL

Rule ID: (0-999)

Operation: Permit

DSCP: (0-63)

Flow Label: (5-hex number)

IPv6 Source IP: (Format: FE80::1)

S-IP:

Mask:

IPv6 Destination IP:

D-IP:

Mask:

S-Port: (0-65535)

D-Port:

Time-Range: No Limit

Apply Help

Note:

- 1: IPv6 ACL only supports the upper 64 bits of the source/destination IPv6 address.
- 2: The L4 source/destination port field cannot be identified if there is more than one extension header in the IPv6 packet.

Figure 13-10 IPv6 ACL Config

The following entries are displayed on this screen:

➤ **Create Extend-IP ACL**

- ACL ID:** Select the desired IPv6 ACL for configuration.
- Rule ID:** Enter the rule ID.
- Operation:** Select the operation for the switch to process packets which match the rules.
- **Permit:** Forward packets.
 - **Deny:** Discard Packets.
- DSCP:** Enter the DSCP information contained in the rule.
- Flow Label:** Enter the Flow Label information contained in the rule.
- IPv6 Source IP:** Click to enable the IPv6 source IP verification.
- S-IP:** Enter the source IPv6 address contained in the rule, you can input all the 128 bits, but only upper 64 bits are verified.
- Mask:** Enter IP address mask. If it is set to 1, the upper 64 bits in the source address of the packet must strictly match the S-IP you configured. This field is 64-bit long.
- IPv6 Destination IP:** Click to enable the IPv6 destination IP verification.

D-IP: Enter the destination IPv6 address contained in the rule, you can input all the 128 bits, but only upper 64 bits are verified.

Mask: Enter IP address mask. If it is set to 1, the upper 64 bits in the destination address of the packet must strictly match the D-IP you configured. This field is 64-bit long.

S-Port: Configure L4 source port contained in the rule when TCP/UDP is defined.

D-Port: Configure L4 destination port contained in the rule when TCP/UDP is defined.

Time-Range: Select the time-range for the rule to take effect.



Note:

Before binding an IPv6 ACL to an interface or VLAN, you should configure the SDM template as “enterpriseV6” and save your configurations. See [SDM Template](#) for more information about SDM template configuration.

13.3 Policy Config

A Policy is used to control the data packets those match the corresponding ACL rules by configuring ACLs and actions together for effect.

The Policy Config can be implemented on **Policy Summary**, **Police Create** and **Action Create** pages.

13.3.1 Policy Summary

On this page, you can view the ACL and the corresponding operations in the policy.

Choose the menu **ACL**→**Policy Config**→**Policy Summary** to load the following page.

Select	Index	ACL ID	S-Mirror	S-Condition	Redirect	QoS Remark	Operation
No entry in the table.							

Figure 13-11 Policy Summary

The following entries are displayed on this screen:

➤ **Search Option**

Select Policy: Select name of the desired policy for view. If you want to delete the desired policy, please click the **Delete** button.

➤ **Action Table**

Select: Select the desired entry to delete the corresponding policy.

Index: Displays the index of the policy.

ACL ID: Displays the ID of the ACL contained in the policy.

- S-Mirror:** Displays the source mirror port of the policy.
- S-Condition:** Displays the source condition added to the policy.
- Redirect:** Displays the redirect added to the policy.
- QoS Remark:** Displays the QoS remark added to the policy.
- Operation:** Edit the information of this action.

13.3.2 Policy Create

On this page you can create the policy.

Choose the menu **ACL**→**Policy Config**→**Policy Create** to load the following page.

Figure 13-12 Create Policy

The following entries are displayed on this screen:

➤ **Create Policy**

Policy Name: Enter the name of the policy.

13.3.3 Action Create

On this page you can add ACLs for the policy.

Choose the menu **ACL**→**Policy Config**→**Action Create** to load the following page.

Figure 13-13 Action Create

The following entries are displayed on this screen:

➤ **Create Action**

Select Policy:	Select the name of the policy.
Select ACL:	Select the ACL for configuration in the policy.
S-Mirror:	Select S-Mirror to mirror the data packets in the policy to the specific port.
S-Condition:	Select S-Condition to limit the transmission rate of the data packets in the policy. <ul style="list-style-type: none"> • Rate: Specify the forwarding rate of the data packets those match the corresponding ACL. • Out of Band: Specify the disposal way of the data packets those are transmitted beyond the rate.
Redirect:	Select Redirect to change the forwarding direction of the data packets in the policy. <ul style="list-style-type: none"> • Destination Port: Forward the data packets those match the corresponding ACL to the specific port.
QoS Remark:	Select QoS Remark to forward the data packets based on the QoS settings. <ul style="list-style-type: none"> • DSCP: Specify the DSCP region for the data packets those match the corresponding ACL. • Local Priority: Specify the local priority for the data packets those match the corresponding ACL.

13.4 ACL Binding

ACL Binding function can have the ACL take its effect on a specific port/VLAN. The ACL will take effect only when it is bound to a port/VLAN. In the same way, the port/VLAN will receive the data packets and process them based on the ACL only when the ACL is bound to the port/VLAN.

The ACL Binding can be implemented on **Binding Table**, **Port Binding** and **VLAN Binding** pages.

13.4.1 Binding Table

On this page view the ACL bound to port/VLAN.

Choose the menu **ACL**→**ACL Binding**→**Binding Table** to load the following page.

Search Options

Show Mode:

ACL Vlan-Bind Table

Select	Index	ACL ID	Interface	Direction
No entry in the table.				

ACL Port-Bind Table

UNIT:

Select	Index	ACL ID	Interface	Direction
<input type="checkbox"/>				
No entry in the table.				

Figure 13-14 Binding Table

The following entries are displayed on this screen:

➤ **Search Option**

Show Mode: Select a show mode appropriate to your needs.

➤ **ACL VLAN-Bind Table**

Select: Select the desired entry to delete the corresponding binding ACL.

Index: Displays the index of the binding ACL.

ACL ID: Displays the ID of the binding ACL.

Interface: Displays the port number or VLAN ID bound to the ACL.

Direction: Displays the binding direction.

➤ **ACL Port-Bind Table**

Select: Select the desired entry to delete the corresponding binding ACL.

Index: Displays the index of the binding ACL.

ACL ID: Displays the ID of the binding ACL.

Interface: Displays the port number or VLAN ID bound to the ACL.

Direction: Displays the binding direction.

13.4.2 Port Binding

On this page you can bind an ACL to a port.

Choose the menu **ACL**→**ACL Binding**→**Port Binding** to load the following page.

The screenshot shows the 'Port-Bind Config' section with a dropdown menu for 'ACL ID' set to 'Select ACL', a 'Port' field, and 'Apply' and 'Help' buttons. Below is a grid of port selection buttons (1-28) and a legend for 'Unselected Port(s)', 'Selected Port(s)', and 'Not Available for Selection'. The 'Port-Bind Table' section shows a table with columns 'Index', 'ACL ID', 'Port', and 'Direction', and a message 'No entry in the table.'.

Index	ACL ID	Port	Direction
No entry in the table.			

Figure 13-15 Bind the policy to the port

The following entries are displayed on this screen:

➤ **Port-Bind Config**

ACL ID: Select the ID of the ACL you want to bind.

Port: Select the number of the port you want to bind.

➤ **Port-Bind Table**

Index: Displays the index of the binding ACL.

ACL ID: Displays the ID of the binding ACL.

Port: Displays the number of the port bound to the corresponding ACL.

Direction: Displays the binding direction.

13.4.3 VLAN Binding

On this page you can bind an ACL to a VLAN.

Choose the menu **ACL**→**ACL Binding**→**VLAN Binding** to load the following page.

The screenshot shows two configuration pages. The top page, titled "VLAN-Bind Config", has a light blue header. It contains two input fields: "ACL ID:" with a dropdown menu showing "Select ACL" and "Apply" button, and "VLAN ID:" with a text input field and "(Format:1)" label, and a "Help" button. The bottom page, titled "VLAN-Bind Table", also has a light blue header and a table with four columns: "Index", "ACL ID", "VLAN ID", and "Direction". The table body is empty and contains the text "No entry in the table."

Figure 13-16 Bind the policy to the VLAN

The following entries are displayed on this screen:

➤ **VLAN-Bind Config**

ACL ID: Select the ID of the ACL you want to bind.

VLAN ID: Enter the ID of the VLAN you want to bind.

➤ **VLAN-Bind Table**

Index: Displays the index of the binding ACL.

ACL ID: Displays the ID of the binding ACL.

VLAN ID: Displays the ID of the VLAN bound to the corresponding ACL.

Direction: Displays the binding direction.

Configuration Procedure:

Step	Operation	Description
1	Configure ACL rules	Required. On ACL → ACL Config configuration pages, configure ACL rules to match packets.
2	Bind the ACL to the port/VLAN	Required. On ACL → ACL Binding configuration pages, bind the ACL to the port/VLAN to make the ACL effective on the corresponding port/VLAN.

13.5 Policy Binding

Policy Binding function can have the policy take its effect on a specific port/VLAN. The policy will take effect only when it is bound to a port/VLAN. In the same way, the port/VLAN will receive the data packets and process them based on the policy only when the policy is bound to the port/VLAN.

The Policy Binding can be implemented on **Binding Table**, **Port Binding** and **VLAN Binding** pages.

13.5.1 Binding Table

On this page view the policy bound to port/VLAN.

Choose the menu **ACL**→**Policy Binding**→**Binding Table** to load the following page.

The screenshot shows a web interface for configuring binding tables. At the top, there is a 'Search Options' section with a 'Show Mode:' label and a dropdown menu set to 'Show All'. Below this are two main sections:

Policy Vlan-Bind Table

Select	Index	Policy Name	Interface	Direction
No entry in the table.				

Buttons: All, Delete

Policy Port-Bind Table

UNIT: 1

Select	Index	Policy Name	Interface	Direction
<input type="checkbox"/>				
No entry in the table.				

Buttons: All, Delete, Help

Figure 13-17 Binding Table

The following entries are displayed on this screen:

➤ **Search Option**

Show Mode: Select a show mode appropriate to your needs.

➤ **Policy VLAN-Bind Table**

Select: Select the desired entry to delete the corresponding binding policy.

Index: Displays the index of the binding policy.

Policy Name: Displays the name of the binding policy.

Interface: Displays the port number or VLAN ID bound to the policy.

Direction: Displays the binding direction.

➤ **Policy Port-Bind Table**

Select: Select the desired entry to delete the corresponding binding policy.

Index: Displays the index of the binding policy.

Policy Name: Displays the name of the binding policy.

Interface: Displays the port number or VLAN ID bound to the policy.

Direction: Displays the binding direction.

13.5.2 Port Binding

On this page you can bind a policy to a port.

Choose the menu **ACL**→**ACL Binding**→**Port Binding** to load the following page.

The screenshot shows the 'Port-Bind Config' interface. At the top, there is a 'Policy Name' dropdown menu set to 'Select Policy' and a 'Port' field. Below these are 'Apply' and 'Help' buttons. A 'UNIT' dropdown is set to '1'. A grid of 28 numbered buttons (1-28) is displayed, with buttons 1-24 being unselected and buttons 25-28 being selected. A legend below the grid shows an unselected port icon, a selected port icon, and a 'Not Available for Selection' icon. Below the legend is the 'Port-Bind Table' section, which has a 'UNIT' dropdown set to '1' and a table with columns 'Index', 'Policy Name', 'Port', and 'Direction'. The table contains the text 'No entry in the table.'

Figure 13-18 Bind the policy to the port

The following entries are displayed on this screen:

➤ **Port-Bind Config**

Policy Name: Select the name of the policy you want to bind.

Port: Select the number of the port you want to bind.

➤ **Port-Bind Table**

Index: Displays the index of the binding policy.

Policy Name: Displays the name of the binding policy.

Port: Displays the number of the port bound to the corresponding policy.

Direction: Displays the binding direction.

13.5.3 VLAN Binding

On this page you can bind a policy to a VLAN.

Choose the menu **ACL**→**Policy Binding**→**VLAN Binding** to load the following page.

The screenshot shows two configuration pages. The top page, titled 'VLAN-Bind Config', has a light blue header. It contains two input fields: 'Policy Name:' with a dropdown menu showing 'Select Policy' and an 'Apply' button to its right; and 'VLAN ID:' with a text input field and '(Format:1)' to its right, and a 'Help' button to its right. The bottom page, titled 'VLAN-Bind Table', also has a light blue header. It features a table with four columns: 'Index', 'Policy Name', 'VLAN ID', and 'Direction'. The table body is empty, with the text 'No entry in the table.' centered below the header row.

Figure 13-19 Bind the policy to the VLAN

The following entries are displayed on this screen:

➤ **VLAN-Bind Config**

Policy Name: Select the name of the policy you want to bind.

VLAN ID: Enter the ID of the VLAN you want to bind.

➤ **VLAN-Bind Table**

Index: Displays the index of the binding policy.

Policy Name: Displays the name of the binding policy.

VLAN ID: Displays the ID of the VLAN bound to the corresponding policy.

Direction: Displays the binding direction.

Configuration Procedure:

Step	Operation	Description
1	Configure ACL rules	Required. On ACL → ACL Config configuration pages, configure ACL rules to match packets.
2	Configure Policy	Required. On ACL → Policy Config configuration pages, configure the policy to control the data packets those match the corresponding ACL rules.
3	Bind the policy to the port/VLAN	Required. On ACL → Policy Binding configuration pages, bind the policy to the port/VLAN to make the policy effective on the corresponding port/VLAN.

13.6 Application Example for ACL

➤ **Network Requirements**

1. The manager of the R&D department can access to the forum of the company and the Internet without any forbiddance. The MAC address of the manager is 00-64-A5-5D-12-C3.
2. The staff of the R&D department cannot access to the Internet but can visit the forum.

3. The staff of the marketing department can access to the Internet but cannot visit the forum.
4. The R&D department and marketing department cannot communicate with each other.

➤ **Network Diagram**

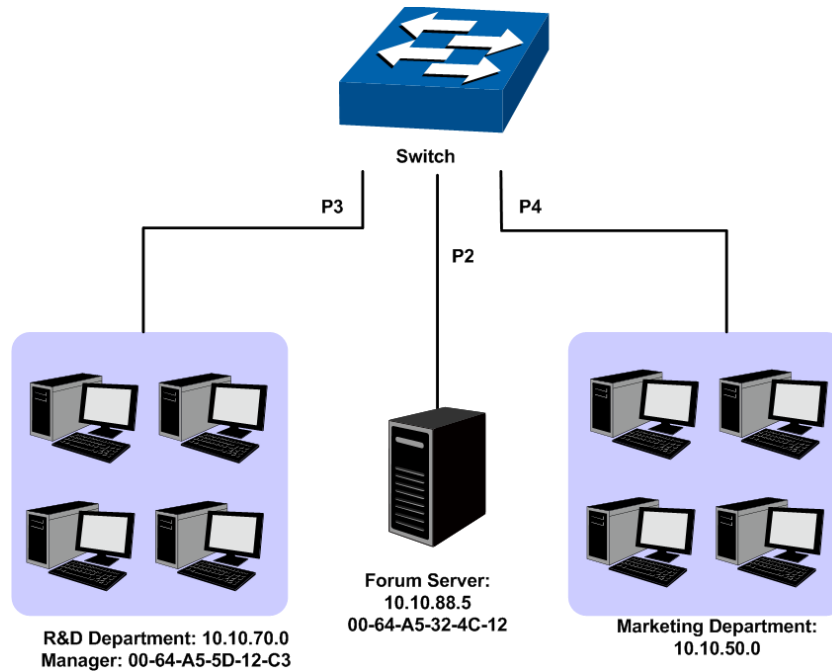

➤ **Configuration Procedure**

Step	Operation	Description
1	Configure for requirement 1	<p>On ACL→ACL Config→ACL Create page, create ACL 11.</p> <p>On ACL→ACL Config→MAC ACL page, select ACL 11, create Rule 1, configure the operation as Permit, configure the S-MAC as 00-64-A5-5D-12-C3 and mask as FF-FF-FF-FF-FF-FF.</p> <p>On ACL→Policy Config→Policy Create page, create a policy named manager.</p> <p>On ACL→Policy Config→Action Create page, add ACL 11 to Policy manager.</p> <p>On ACL→Policy Binding→Port Binding page, select Policy manager to bind to port 3.</p>

Step	Operation	Description
2	Configure requirement and 4 for 2	<p>On ACL→ACL Config→ACL Create page, create ACL 500.</p> <p>On ACL→ACL Config→Standard-IP ACL page, select ACL 500, create Rule 1, configure operation as Deny, configure S-IP as 10.10.70.0 and mask as 255.255.255.0, configure D-IP as 10.10.50.0 and mask as 255.255.255.0.</p> <p>On ACL→ACL Config→Standard-IP ACL page, select ACL 500, create Rule 2, configure operation as Deny, configure S-IP as 10.10.70.0 and mask as 255.255.255.0, configure D-IP as 10.10.88.5 and mask as 255.255.255.255.</p> <p>On ACL→ACL Config→Standard-IP ACL page, select ACL 500, create Rule 3, configure operation as Permit, configure S-IP as 10.10.70.0 and mask as 255.255.255.0, configure D-IP as 10.10.88.5 and mask as 255.255.255.255.</p> <p>On ACL→Policy Config→Policy Create page, create a policy named limit1.</p> <p>On ACL→Policy Config→Action Create page, add ACL 500 to Policy limit1.</p> <p>On ACL→Policy Binding→Port Binding page, select Policy limit1 to bind to port 3.</p>
3	Configure requirement and 4 for 3	<p>On ACL→ACL Config→ACL Create page, create ACL 501.</p> <p>On ACL→ACL Config→Standard-IP ACL page, select ACL 501, create Rule 4, configure operation as Deny, configure S-IP as 10.10.50.0 and mask as 255.255.255.0, configure D-IP as 10.10.70.0 and mask as 255.255.255.0.</p> <p>On ACL→ACL Config→Standard-IP ACL page, select ACL 501, create Rule 5, configure operation as Deny, configure S-IP as 10.10.50.0 and mask as 255.255.255.0, configure D-IP as 10.10.88.5 and mask as 255.255.255.255.</p> <p>On ACL→Policy Config→Policy Create page, create a policy named limit2.</p> <p>On ACL→Policy Config→Action Create page, add ACL 501 to Policy limit2.</p> <p>On ACL→Policy Binding→Port Binding page, select Policy limit2 to bind to port 4.</p>

[Return to CONTENTS](#)

Chapter 14 Network Security

Network Security module is to provide the multiple protection measures for the network security, including five submenus: **IP-MAC Binding**, **IPv6-MAC Binding**, **DHCP Snooping**, **DHCPv6 Snooping**, **ARP Inspection**, **ND Detection**, **IP Source Guard**, **DoS Defend**, **802.1X**, **PPPoE** and **AAA**. Please configure the functions appropriate to your need.

14.1 IP-MAC Binding

The IP-MAC Binding function allows you to bind the IP address, MAC address, VLAN ID and the connected Port number of the Host together. Basing on the IP-MAC binding table, ARP Inspection and IP Source Guard functions can control the network access and only allow the Hosts matching the bound entries to access the network.

The following three IP-MAC Binding methods are supported by the switch.

- (1) **Manually:** You can manually bind the IP address, MAC address, VLAN ID and the Port number together in the condition that you have got the related information of the Hosts in the LAN.
- (2) **Scanning:** You can quickly get the information of the IP address, MAC address, VLAN ID and the connected port number of the Hosts in the LAN via the ARP Scanning function, and bind them conveniently. You are only requested to enter the IP address on the ARP Scanning page for the scanning.
- (3) **DHCP Snooping:** You can use DHCP Snooping functions to monitor the process of the Host obtaining the IP address from DHCP server, and record the IP address, MAC address, VLAN and the connected Port number of the Host for automatic binding.

These three methods are also considered as the sources of the IP-MAC Binding entries. The entries from various sources should be different from one another to avoid collision. Among the entries in collision, only the entry from the source with the highest priority will take effect. These three sources (Manual, Scanning and Snooping) are in descending order of priority.

The **IP-MAC Binding** function is implemented on the **Binding Table**, **Manual Binding** and **ARP Scanning** pages.

14.1.1 Binding Table

On this page, you can view the information of the bound entries.

Choose the menu **Network Security**→**IP-MAC Binding**→**Binding Table** to load the following page.

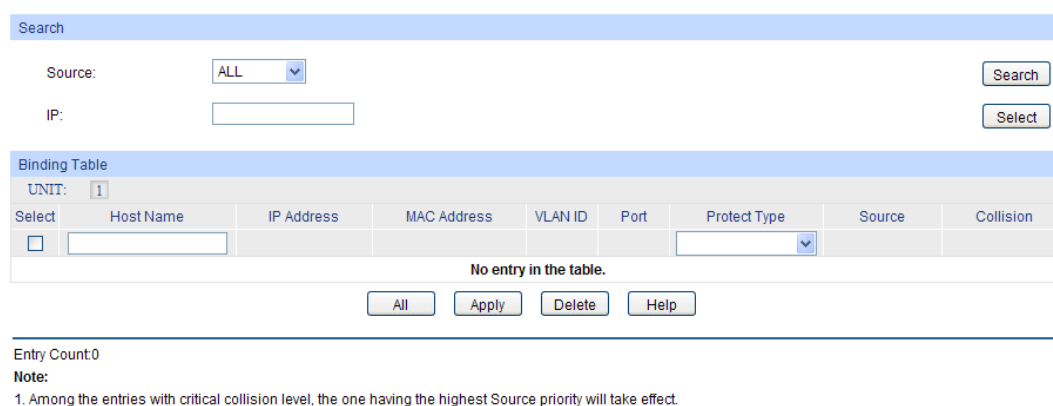

Search

Source: ALL

IP:

Binding Table

UNIT: 1

Select	Host Name	IP Address	MAC Address	VLAN ID	Port	Protect Type	Source	Collision
<input type="checkbox"/>	<input type="text"/>					<input type="text"/>		

No entry in the table.

Entry Count:0

Note:

1. Among the entries with critical collision level, the one having the highest Source priority will take effect.

Figure 14-1 Binding Table

The following entries are displayed on this screen:

➤ **Search**

- Source:** Displays the Source of the entry.
- **All:** All the bound entries will be displayed.
 - **Manual:** Only the manually added entries will be displayed.
 - **Scanning:** Only the entries formed via ARP Scanning will be displayed.
 - **Snooping:** Only the entries formed via DHCP Snooping will be displayed.

IP Select Click the Select button to quick-select the corresponding entry based on the IP address you entered.

➤ **Binding Table**

Select: Select the desired entry to modify the Host Name and Protect Type. It is multi-optional.

Host Name Displays the Host Name here.

IP Address Displays the IP Address of the Host.

MAC Address Displays the MAC Address of the Host.

VLAN ID: Displays the VLAN ID here.

Port: Displays the number of port connected to the Host.

Protect Type: Allows you to view and modify the Protect Type of the entry.

Source: Displays the Source of the entry.

Collision: Displays the Collision status of the entry.

- **Warning:** Indicates that the collision may be caused by the MSTP function.
- **Critical:** Indicates that the entry has a collision with the other entries.



Note:

Among the entries with Critical collision level, the one with the highest Source priority will take effect.

14.1.2 Manual Binding

You can manually bind the IP address, MAC address, VLAN ID and the Port number together in the condition that you have got the related information of the Hosts in the LAN.

Choose the menu **Network Security**→**IP-MAC Binding**→**Manual Binding** to load the following page.

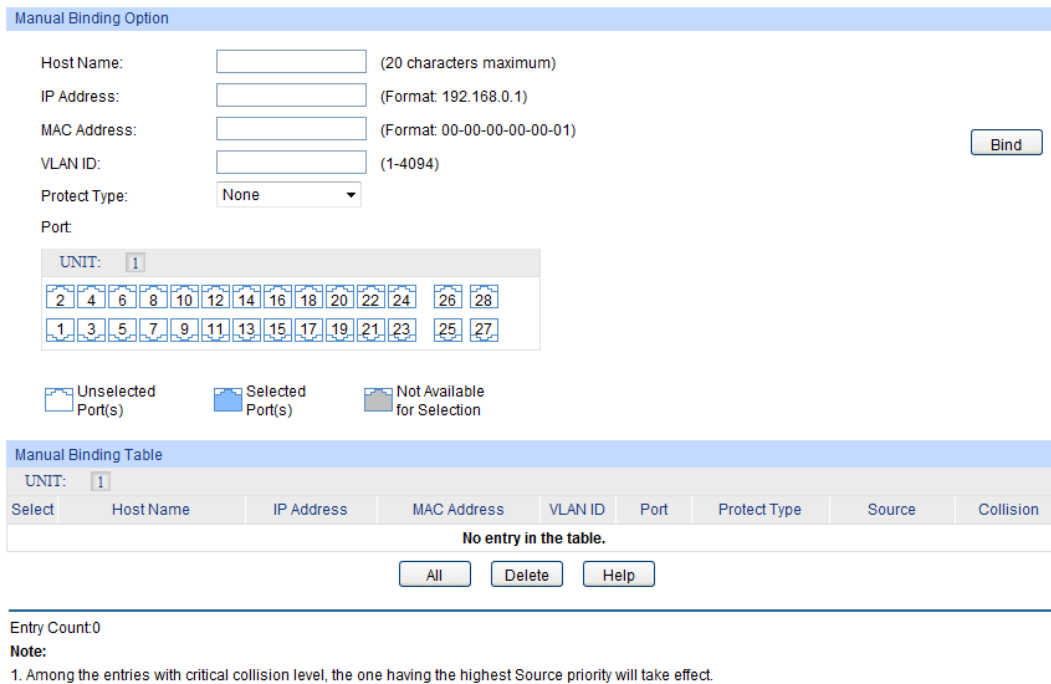

Manual Binding Option

Host Name: (20 characters maximum)

IP Address: (Format: 192.168.0.1)

MAC Address: (Format: 00-00-00-00-00-01)

VLAN ID: (1-4094)

Protect Type:

Port:

UNIT:

2	4	6	8	10	12	14	16	18	20	22	24	26	28
1	3	5	7	9	11	13	15	17	19	21	23	25	27

Unselected Port(s)
 Selected Port(s)
 Not Available for Selection

Manual Binding Table

UNIT:

Select	Host Name	IP Address	MAC Address	VLAN ID	Port	Protect Type	Source	Collision
No entry in the table.								

Entry Count:0

Note:

1. Among the entries with critical collision level, the one having the highest Source priority will take effect.

Figure 14-2 Manual Binding

The following entries are displayed on this screen:

➤ **Manual Binding Option**

- Host Name:** Enter the Host Name.
- IP Address:** Enter the IP Address of the Host.
- MAC Address:** Enter the MAC Address of the Host.
- VLAN ID:** Enter the VLAN ID.
- Protect Type:** Select the Protect Type for the entry.
- Port:** Select the number of port connected to the Host.

➤ **Manual Binding Table**

- Select:** Select the desired entry to be deleted. It is multi-optional.
- Host Name:** Displays the Host Name here.
- IP Address:** Displays the IP Address of the Host.
- MAC Address:** Displays the MAC Address of the Host.
- VLAN ID:** Displays the VLAN ID here.
- Port:** Displays the number of port connected to the Host.
- Protect Type:** Displays the Protect Type of the entry.
- Source:** Displays the source of the entry.

Collision:

Displays the Collision status of the entry.

- **Warning:** Indicates that the collision may be caused by the MSTP function.
- **Critical:** Indicates that the entry has a collision with the other entries.

14.1.3 ARP Scanning

ARP (Address Resolution Protocol) is used to analyze and map IP addresses to the corresponding MAC addresses so that packets can be delivered to their destinations correctly. IP address is the address of the Host on Network layer. MAC address, the address of the Host on Data link layer, is necessary for the packet to reach the very device. So the destination IP address carried in a packet need to be translated into the corresponding MAC address.

ARP functions to translate the IP address into the corresponding MAC address and maintain an ARP Table, where the latest used IP address-to-MAC address mapping entries are stored. When the Host communicates with a strange Host, ARP works as the following figure shown.

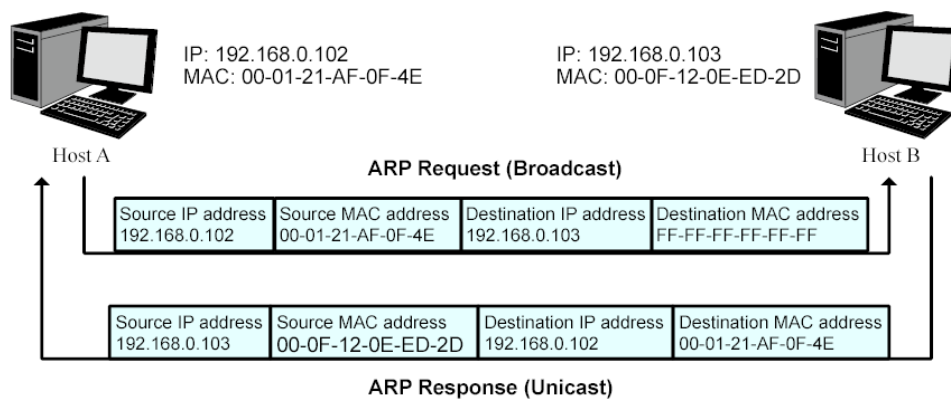
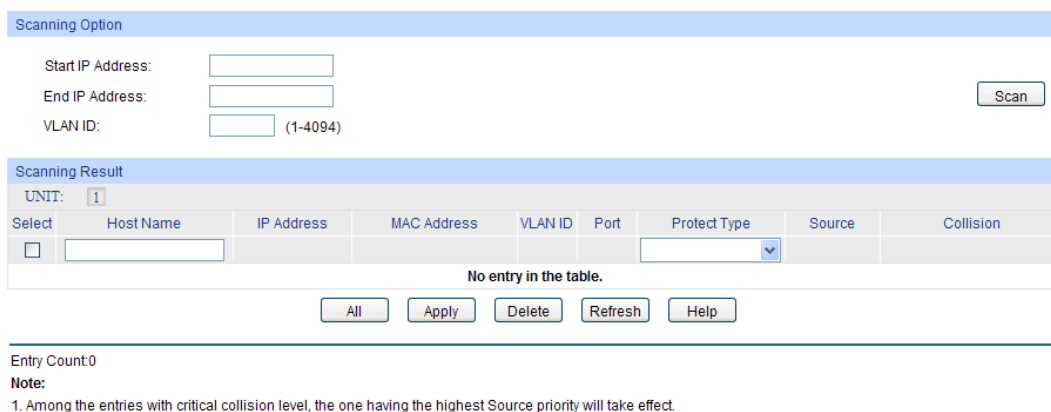

Figure 14-3 ARP Implementation Procedure

- (1) Suppose there are two hosts in the LAN: Host A and Host B. To send a packet to Host B, Host A checks its own ARP Table first to see if the ARP entry related to the IP address of Host B exists. If yes, Host A will directly send the packets to Host B. If the corresponding MAC address is not found in the ARP Table, Host A will broadcast ARP request packet, which contains the IP address of Host B, the IP address of Host A, and the MAC address of Host A, in the LAN.
- (2) Since the ARP request packet is broadcasted, all hosts in the LAN can receive it. However, only the Host B recognizes and responds to the request. Host B sends back an ARP reply packet to Host A, with its MAC address carried in the packet.
- (3) Upon receiving the ARP reply packet, Host A adds the IP address and the corresponding MAC address of Host B to its ARP Table for the further packets forwarding.

ARP Scanning function enables the switch to send the ARP request packets of the specified IP field to the Hosts in the LAN or VLAN. Upon receiving the ARP reply packet, the switch can get the IP address, MAC address, VLAN and the connected port number of the Host by analyzing the packet and bind them conveniently.

Choose the menu **Network Security**→**IP-MAC Binding**→**ARP Scanning** to load the following page.



Scanning Option

Start IP Address:

End IP Address:

VLAN ID: (1-4094) Scan

Scanning Result

UNIT:

Select	Host Name	IP Address	MAC Address	VLAN ID	Port	Protect Type	Source	Collision
<input type="checkbox"/>	<input type="text"/>					<input type="text"/>		

No entry in the table.

Entry Count: 0

Note:

1. Among the entries with critical collision level, the one having the highest Source priority will take effect.

Figure 14-4 ARP Scanning

The following entries are displayed on this screen:

➤ **Scanning Option**

- Start IP Address:** Specify the Start IP Address.
- End IP Address:** Specify the End IP Address.
- VLAN ID:** Enter the VLAN ID.
- Scan:** Click the **Scan** button to scan the Hosts in the LAN.

➤ **Scanning Result**

- Select:** Select the desired entry to be deleted or bound. It is multi-optional.
- Host Name:** Displays the Host Name here.
- IP Address:** Displays the IP Address of the Host.
- MAC Address:** Displays the MAC Address of the Host.
- VLAN ID:** Displays the VLAN ID here.
- Port:** Displays the number of port connected to the Host.
- Protect Type:** Displays the Protect Type of the entry.
- Source:** Displays the source of the entry.
- Collision:** Displays the Collision status of the entry.
 - **Warning:** Indicates that the collision may be caused by the MSTP function.
 - **Critical:** Indicates that the entry has a collision with the other entries.

14.2 IPv6-MAC Binding

The IPv6-MAC Binding function allows you to bind the IPv6 address, MAC address, VLAN ID and the connected Port number of the Host together. Basing on the IPv6-MAC binding table, ND

detection and IPv6 Source Guard functions can control the network access and only allow the Hosts matching the bound entries to access the network.

The following three IPv6-MAC Binding methods are supported by the switch.

- (1) **Manually:** You can manually bind the IPv6 address, MAC address, VLAN ID and the Port number together in the condition that you have got the related information of the Hosts in the LAN.
- (2) **ND Snooping:** You can use ND Snooping functions to monitor the process of the duplication address detection, And record the IP address, MAC address, VLAN and the connected Port number of the Host for automatic binding.
- (3) **DHCP Snooping:** You can use DHCPv6 Snooping functions to monitor the process of the Host obtaining the IPv6 address from DHCPv6 server, and record the IPv6 address, MAC address, VLAN and the connected Port number of the Host for automatic binding.

These three methods are also considered as the sources of the IPv6-MAC Binding entries. The entries from various sources should be different from one another to avoid collision. Among the entries in collision, only the entry from the source with the highest priority will take effect. These three sources (Manual, DHCP Snooping, ND Snooping) are in descending order of priority.

The IPv6-MAC Binding function is implemented on the **Binding Table**, **Manual Binding** and **ND Snooping** pages.

14.2.1 Binding Table

On this page, you can view the information of the IPv6-related bound entries.

Choose the menu **Network Security**→**IPv6-MAC Binding**→**Binding Table** to load the following page.

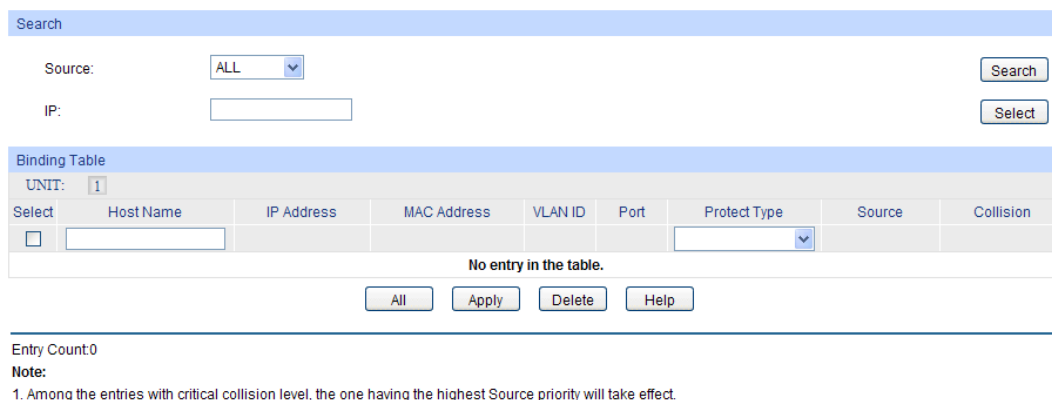

Search

Source: ALL

IP:

Binding Table

UNIT: 1

Select	Host Name	IP Address	MAC Address	VLAN ID	Port	Protect Type	Source	Collision
<input type="checkbox"/>	<input type="text"/>					<input type="button" value="v"/>		

No entry in the table.

Entry Count:0

Note:

1. Among the entries with critical collision level, the one having the highest Source priority will take effect.

Figure 14-5 Binding Table

The following entries are displayed on this screen:

➤ Search

Source:

Displays the Source of the entry.

- **All:** All the bound entries will be displayed.
- **Manual:** Only the manually added entries will be displayed.
- **ND Snooping:** Only the entries generated via ND snooping will be displayed.

- **DHCP Snooping:** Only the entries generated via DHCP Snooping will be displayed.

IP Select

Click the Select button to quick-select the corresponding entry based on the IPv6 address you entered.

➤ Binding Table

Select: Select the desired entry to modify the Host Name and Protect Type. It is multi-optional.

Host Name Displays the Host Name here.

IP Address Displays the IPv6 Address of the Host.

MAC Address Displays the MAC Address of the Host.

VLAN ID: Displays the VLAN ID here.

Port: Displays the number of port connected to the Host.

Protect Type: Allows you to view and modify the Protect Type of the entry.

Active Status: Displays the active status of the entry.

Source: Displays the Source of the entry.

Collision: Displays the Collision status of the entry.

- **Warning:** Indicates that the collision may be caused by the MSTP function.
- **Critical:** Indicates that the entry has a collision with the other entries.



Note:

Among the entries with Critical collision level, the one with the highest Source priority will take effect.

14.2.2 Manual Binding

You can manually bind the IP address, MAC address, VLAN ID and the Port number together in the condition that you have got the related information of the Hosts in the LAN.

Choose the menu **Network Security**→**IPv6-MAC Binding**→**Manual Binding** to load the following page.

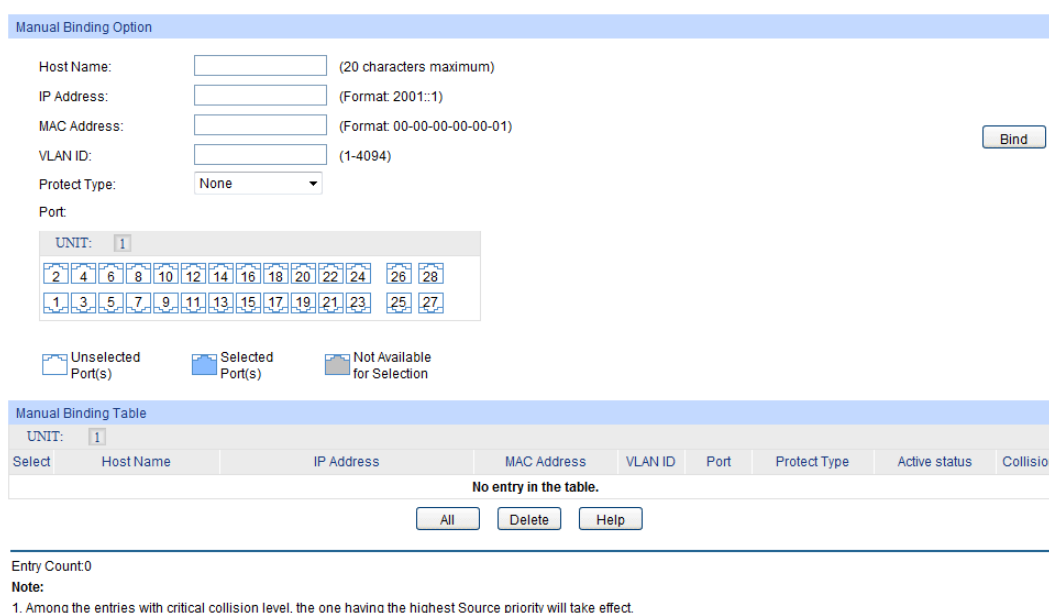

Manual Binding Option

Host Name: (20 characters maximum)

IP Address: (Format 2001::1)

MAC Address: (Format 00-00-00-00-00-01)

VLAN ID: (1-4094)

Protect Type:

Port

UNIT:

2 4 6 8 10 12 14 16 18 20 22 24 26 28

1 3 5 7 9 11 13 15 17 19 21 23 25 27

Unselected Port(s) Selected Port(s) Not Available for Selection

Manual Binding Table

UNIT:

Select	Host Name	IP Address	MAC Address	VLAN ID	Port	Protect Type	Active status	Collision
No entry in the table.								

Entry Count:0

Note:

1. Among the entries with critical collision level, the one having the highest Source priority will take effect.

Figure 14-6 Manual Binding

The following entries are displayed on this screen:

➤ **Manual Binding Option**

- Host Name:** Enter the Host Name.
- IP Address:** Enter the IPv6 Address of the Host.
- MAC Address:** Enter the MAC Address of the Host.
- VLAN ID:** Enter the VLAN ID.
- Protect Type:** Select the Protect Type for the entry.
- Port:** Select the number of port connected to the Host.

➤ **Manual Binding Table**

- Select:** Select the desired entry to be deleted. It is multi-optional.
- Host Name:** Displays the Host Name here.
- IP Address:** Displays the IP Address of the Host.
- MAC Address:** Displays the MAC Address of the Host.
- VLAN ID:** Displays the VLAN ID here.
- Port:** Displays the number of port connected to the Host.
- Protect Type:** Displays the Protect Type of the entry.
- Active Status:** Displays the active status of the entry.

Collision:

Displays the Collision status of the entry.

- **Warning:** Indicates that the collision may be caused by the MSTP function.
- **Critical:** Indicates that the entry has a collision with the other entries.

14.2.3 ND Snooping

ND snooping maintains an ND snooping table using the DAD NS messages in IPv6. ND snooping entries in this table is used to:

- Cooperate with the IPv6-MAC binding.
- Cooperate with the ND detection feature.
- Cooperate with the IPv6 Source Guard feature.

1. Creating an ND snooping entry

The switch only uses received DAD NS messages to create ND snooping entries.

2. Updating an ND snooping entry

Upon receiving an ND packet, the switch searches the ND snooping table for an entry containing the source IPv6 address of the packet. The switch matches the ND packet's MAC address and the receiving port against that in the entry.

- If both of them match those in the entry, the switch updates the aging time in this ND snooping entry.
- If neither of them matches the entry, the switch initiates a verification process.

1) The switch checks the validity of the existing ND snooping entry.

The switch sends out an NS message according to the ND snooping entry. If a corresponding NA message (whose source IPv6 address, source MAC address, receiving port, and source VLAN are consistent with those of the existing entry) is received, the device updates the aging time of the existing entry. If no corresponding NA message is received within one second after the NS message is sent, the device starts to check the validity of the received ND packet.

2) The switch checks the validity of the received ND packet.

The switch sends out an NS message to verify the reachability of the ND packet (marked as packet A). The NS message's destination IPv6 address is specified as the source IPv6 address of packet A. If a corresponding NA message (whose source IPv6 address, source MAC address, receiving port, and source VLAN are consistent with those of packet A) is received, the switch updates the existing entry. If no corresponding NA message is received within one second after the NS message is sent, the switch deletes the entry.

3. Aging out an ND snooping entry

An ND snooping entry is aged out after 120 minutes. If an ND snooping entry is not updated within 60 minutes, the switch initiates a verification. The switch sends out an NS message including the IPv6 address of the ND snooping entry.

- If a corresponding NA message is received (the source IPv6 address, source MAC address, receiving port, and source VLAN are consistent with those of the existing entry), the switch updates the aging time of the existing entry.
- If no corresponding NA message is received within one second after the NS message is sent

out, the switch removes the entry when the timer expires.

Choose the menu **Network Security**→**IPv6-MAC Binding**→**ND Snooping** to load the following page.

ND Snooping

ND Snooping: Enable Disable

VLAN ID: Enable Disable
(1-4094, format: 1,3,4-7,11-30)

VLAN Configuration Display:

Apply

Port Configure

UNIT:

Select	Port	Maximum Entry (0~1024)	LAG
<input type="checkbox"/>		<input type="text"/>	
<input type="checkbox"/>	1/0/1	1024	---
<input type="checkbox"/>	1/0/2	1024	---
<input type="checkbox"/>	1/0/3	1024	---
<input type="checkbox"/>	1/0/4	1024	---
<input type="checkbox"/>	1/0/5	1024	---
<input type="checkbox"/>	1/0/6	1024	---
<input type="checkbox"/>	1/0/7	1024	---
<input type="checkbox"/>	1/0/8	1024	---
<input type="checkbox"/>	1/0/9	1024	---
<input type="checkbox"/>	1/0/10	1024	---
<input type="checkbox"/>	1/0/11	1024	---
<input type="checkbox"/>	1/0/12	1024	---
<input type="checkbox"/>	1/0/13	1024	---
<input type="checkbox"/>	1/0/14	1024	---
<input type="checkbox"/>	1/0/15	1024	---

All Apply Help

Figure 14-7 ARP Scanning

The following entries are displayed on this screen:

➤ **ND Snooping**

ND Snooping: Enable/Disable the ND Snooping function globally.

VLAN ID: Enable/Disable the ND Snooping function in the specified VLAN.

VLAN Configuration Display: Displays the VLANs with ND Snooping function enabled.

➤ **Port Configure**

UNIT:1: Click 1 to configure the physical ports.

Select:	Select your desired port for configuration. It is multi-optional.
Port:	Displays the number of port.
Maximum Entry:	Configure the max ND binding entries a port can learn via ND snooping.
LAG:	Displays the LAG which the port belongs to.

14.3 DHCP Snooping

Nowadays, the network is getting larger and more complicated. The amount of the PCs always exceeds that of the assigned IP addresses. The wireless network and the laptops are widely used and the locations of the PCs are always changed. Therefore, the corresponding IP address of the PC should be updated with a few configurations. DHCP (Dynamic Host Configuration Protocol), the network configuration protocol optimized and developed basing on the BOOTP, functions to solve the above mentioned problems.

➤ DHCP Working Principle

DHCP works via the “Client/Server” communication mode. The Client applies to the Server for configuration. The Server assigns the configuration information, such as the IP address, to the Client, so as to reach a dynamic employ of the network source. A Server can assign the IP address for several Clients, which is illustrated in the following figure.

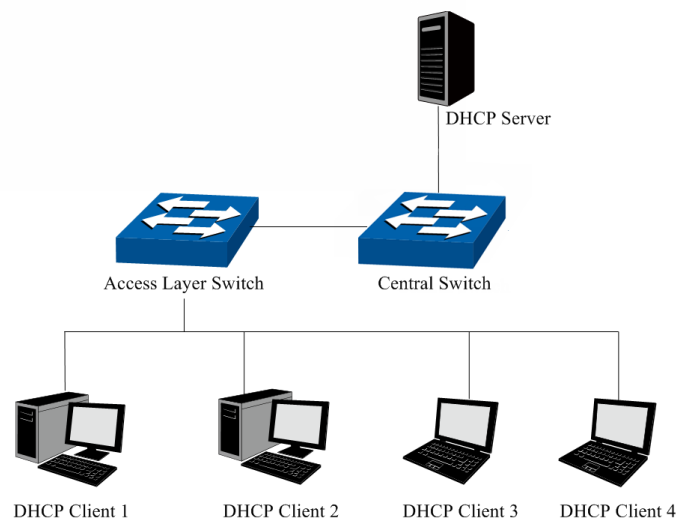

Figure 14-8 Network diagram for DHCP-snooping implementation

For different DHCP Clients, DHCP Server provides three IP address assigning methods:

- (1) Manually assign the IP address: Allows the administrator to bind the static IP address to the specific Client (e.g.: WWW Server) via the DHCP Server.
- (2) Automatically assign the IP address: DHCP Server assigns the IP address without an expiration time limitation to the Clients.
- (3) Dynamically assign the IP address: DHCP Server assigns the IP address with an expiration time. When the time for the IP address expired, the Client should apply for a new one.

The most Clients obtain the IP addresses dynamically, which is illustrated in the following figure.

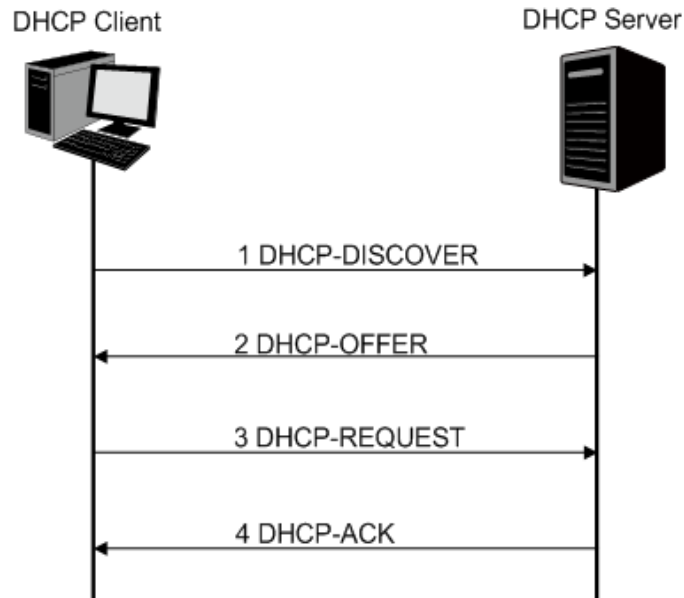

Figure 14-9 Interaction between a DHCP client and a DHCP server

- (1) **DHCP-DISCOVER Stage:** The Client broadcasts the DHCP-DISCOVER packet to find the DHCP Server.
- (2) **DHCP-OFFER Stage:** Upon receiving the DHCP-DISCOVER packet, the DHCP Server selects an IP address from the IP pool according to the assigning priority of the IP addresses and replies to the Client with DHCP-OFFER packet carrying the IP address and other information.
- (3) **DHCP-REQUEST Stage:** In the situation that there are several DHCP Servers sending the DHCP-OFFER packets, the Client will only respond to the first received DHCP-OFFER packet and broadcast the DHCP-REQUEST packet which includes the assigned IP address of the DHCP-OFFER packet.
- (4) **DHCP-ACK Stage:** Since the DHCP-REQUEST packet is broadcasted, all DHCP Servers on the network segment can receive it. However, only the requested Server processes the request. If the DHCP Server acknowledges assigning this IP address to the Client, it will send the DHCP-ACK packet back to the Client. Otherwise, the Server will send the DHCP-NAK packet to refuse assigning this IP address to the Client.

➤ Option 82

The DHCP packets are classified into 8 types with the same format basing on the format of BOOTP packet. The difference between DHCP packet and BOOTP packet is the Option field. The Option field of the DHCP packet is used to expand the function, for example, the DHCP can transmit the control information and network parameters via the Option field, so as to assign the IP address to the Client dynamically. For the details of the DHCP Option, please refer to RFC 2132.

Option 82 records the location of the DHCP Client. Upon receiving the DHCP-REQUEST packet, the switch adds the Option 82 to the packet and then transmits the packet to DHCP Server. Administrator can be acquainted with the location of the DHCP Client via Option 82 so as to locate the DHCP Client for fulfilling the security control and account management of Client. The Server supported Option 82 also can set the distribution policy of IP addresses and the other parameters according to the Option 82, providing more flexible address distribution way.

Option 82 can contain 255 sub-options at most. If Option 82 is defined, at least a sub-option should be defined. This switch supports two sub-options: Circuit ID and Remote ID. Since there is no universal standard about the content of Option 82, different manufacturers define the sub-options of Option 82 to their need. For this switch, the sub-options are defined as the following: The Circuit ID is defined to be the number of the port which receives the DHCP Request packets and its VLAN number. The Remote ID is defined to be the MAC address of DHCP Snooping device which receives the DHCP Request packets from DHCP Clients.

➤ DHCP Cheating Attack

During the working process of DHCP, generally there is no authentication mechanism between Server and Client. If there are several DHCP servers in the network, network confusion and security problem will happen. The common cases incurring the illegal DHCP servers are the following two:

- (1) It's common that the illegal DHCP server is manually configured by the user by mistake.
- (2) Hacker exhausted the IP addresses of the normal DHCP server and then pretended to be a legal DHCP server to assign the IP addresses and the other parameters to Clients. For example, hacker used the pretended DHCP server to assign a modified DNS server address to users so as to induce the users to the evil financial website or electronic trading website and cheat the users of their accounts and passwords. The following figure illustrates the DHCP Cheating Attack implementation procedure.

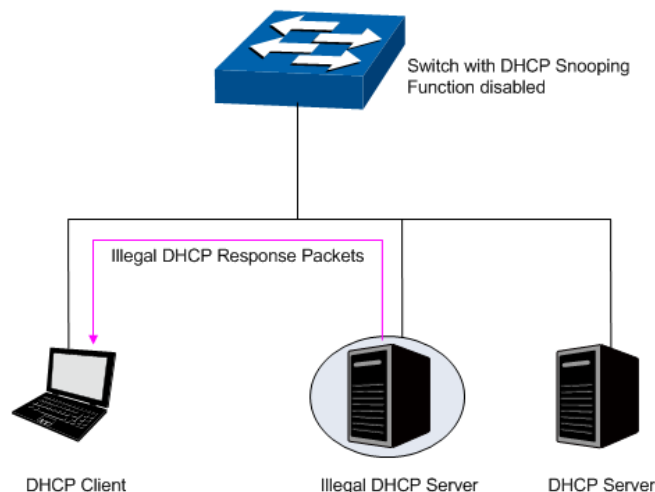

Figure 14-10 DHCP Cheating Attack Implementation Procedure

DHCP Snooping feature only allows the port connected to the DHCP Server as the trusted port to forward all types of DHCP packets and thereby ensures that users get proper IP addresses. DHCP Snooping is to monitor the process of the Host obtaining the IP address from DHCP server, and record the IP address, MAC address, VLAN and the connected Port number of the Host for automatic binding. The bound entry can cooperate with the ARP Inspection, IP Source Guard and the other security protection features. DHCP Snooping feature prevents the network from the DHCP Server Cheating Attack by discarding the DHCP response packets on the distrusted port, so as to enhance the network security.

14.3.1 Global Config

Choose the menu **Network Security**→**DHCP Snooping**→**Global Config** to load the following page.

DHCP Snooping Configuration

DHCP Snooping: Enable Disable

VLAN ID: Enable Disable
(1-4094, format: 1,3,4-7,11-30)

VLAN Configuration Display:

Figure 14-11 DHCP Snooping

The following entries are displayed on this screen:

➤ **DHCP Snooping Configuration**

- | | |
|------------------------------------|--|
| DHCP Snooping: | Enable/Disable the DHCP Snooping function globally. |
| VLAN ID: | Enable/Disable the DHCP Snooping function in the specified VLAN. |
| VLAN Configuration Display: | Display the VLANs which enable DHCP Snooping function. |

14.3.2 Port Config

Choose the menu **Network Security**→**DHCP Snooping**→**Port Config** to load the following page.

Select	Port	Trusted Port	MAC Verify	Rate Limit	Decline Protect	LAG
<input type="checkbox"/>						
<input type="checkbox"/>	1/0/1	Disable	Enable	Disable	Disable	---
<input type="checkbox"/>	1/0/2	Disable	Enable	Disable	Disable	---
<input type="checkbox"/>	1/0/3	Disable	Enable	Disable	Disable	---
<input type="checkbox"/>	1/0/4	Disable	Enable	Disable	Disable	---
<input type="checkbox"/>	1/0/5	Disable	Enable	Disable	Disable	---
<input type="checkbox"/>	1/0/6	Disable	Enable	Disable	Disable	---
<input type="checkbox"/>	1/0/7	Disable	Enable	Disable	Disable	---
<input type="checkbox"/>	1/0/8	Disable	Enable	Disable	Disable	---
<input type="checkbox"/>	1/0/9	Disable	Enable	Disable	Disable	---
<input type="checkbox"/>	1/0/10	Disable	Enable	Disable	Disable	---
<input type="checkbox"/>	1/0/11	Disable	Enable	Disable	Disable	---
<input type="checkbox"/>	1/0/12	Disable	Enable	Disable	Disable	---
<input type="checkbox"/>	1/0/13	Disable	Enable	Disable	Disable	---
<input type="checkbox"/>	1/0/14	Disable	Enable	Disable	Disable	---
<input type="checkbox"/>	1/0/15	Disable	Enable	Disable	Disable	---

Figure 14-12 DHCP Snooping

➤ DHCP Snooping Port Configuration

- UNIT:1/LAGS:** Click **1** to configure the physical ports. Click **LAGS** to configure the link aggregation groups.
- Select:** Select your desired port for configuration. It is multi-optional.
- Port:** Displays the port number.
- Trusted Port:** Select Enable/Disable the port to be a Trusted Port. Only the Trusted Port can receive the DHCP packets from DHCP servers.
- MAC Verify:** Select Enable/Disable the MAC Verify feature. There are two fields of the DHCP packet containing the MAC address of the Host. The MAC Verify feature is to compare the two fields and discard the packet if the two fields are different.
- Rate Limit:** Select the value to specify the maximum amount of DHCP messages that can be forwarded by the switch of this port per second. The excessive DHCP packets will be discarded.
- Decline Protect:** Select the value to specify the maximum amount of DHCP decline packets that can be forwarded by the switch of this port per second. The excessive DHCP decline packets will be discarded.

LAG:

Displays the LAG to which the port belongs.

14.3.3 Option 82 Config

The switch can propagate the control information and the network parameters via the Option 82 field to provide more information for the Host. When the DHCP option 82 feature is enabled on the switch, a host is identified by the switch port through which it connects to the network (in addition to its MAC address). The DHCP option 82 feature is supported only when DHCP snooping is globally enabled.

Choose the menu **Network Security**→**DHCP Snooping**→**Option 82 Config** to load the following page.

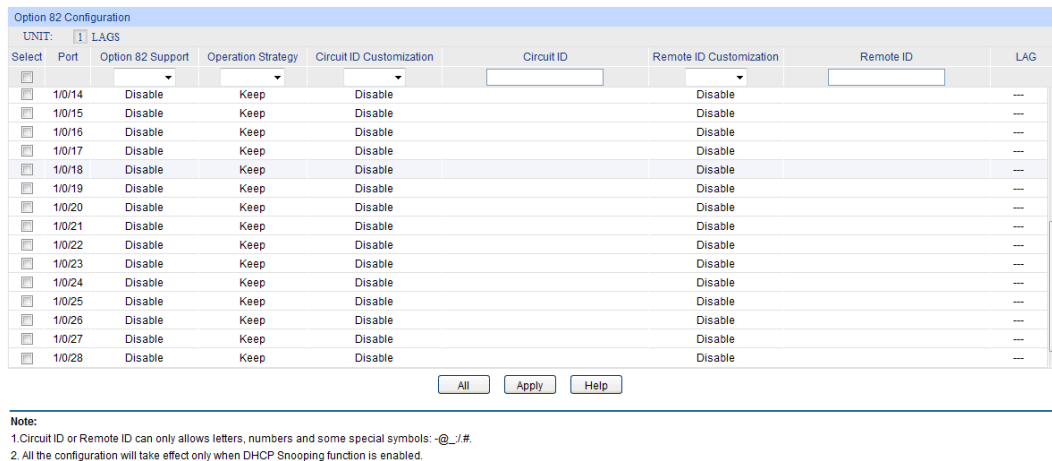

Note:
 1. Circuit ID or Remote ID can only allow letters, numbers and some special symbols: -@_/#.
 2. All the configuration will take effect only when DHCP Snooping function is enabled.

Figure 14-13 Option 82 Config

➤ Option 82 Configuration

UNIT:1/LAGS:

Click **1** to configure the physical ports. Click **LAGS** to configure the link aggregation groups.

Select:

Select your desired port for configuration. It is multi-optional.

Port:

Displays the port number.

Option 82 Support:

Enable/Disable the Option 82 feature.

Operation Strategy:

Select the operation for the existed Option 82 field of the DHCP request packets from the Host. The option 82 field in DHCP reply packets will be removed when the option 82 feature is enabled, no matter which operation is configured for the existed option 82 field.

- **Keep:** Indicates to keep the Option 82 field of the packets.
- **Replace:** Indicates to replace the Option 82 field of the packets with the switch defined one.
- **Drop:** Indicates to discard the packets including the Option 82 field.

Circuit ID Customization:

Enable or disable the switch to define the Option 82 sub-option Circuit ID field. With Disable selected, configure VLAN ID and port number from which the packet is received as the circuit ID default value.

- Circuit ID:** Enter the sub-option Circuit ID for the customized Option 82 field.
- Remote ID Customization:** Enable or disable the switch to define the Option 82 sub-option Remote ID field. With Disable selected, configure the switch system MAC address as the remote ID default value.
- Remote ID:** Enter the sub-option Remote ID for the customized Option 82.
- LAG:** Displays the LAG to which the port belongs.

14.4 DHCPv6 Snooping

DHCPv6 Snooping functions to monitor the process of the host obtaining the IPv6 address from the DHCPv6 server. DHCPv6 Snooping records the IPv6 address, MAC address, VLAN and the connected port number of the host for automatic binding.

Choose the menu **Network Security**→**DHCPv6 Snooping**→**DHCPv6 Snooping** to load the following page.

Figure 14-14 DHCPv6 Snooping

➤ **DHCPV6 Snooping**

- DHCPv6 Snooping:** Enable/Disable the DHCPv6 Snooping function globally.
- VLAN ID:** Enable/Disable the DHCPv6 Snooping function in the specified VLAN.
- VLAN Configuration Display:** Displays the VLANs with DHCPv6 Snooping function enabled.

➤ **Trusted Port**

- UNIT:1/LAGS:** Select the desired unit or LAGS for configuration.

Trusted Port:

Select the port to be a Trusted Port. Only the Trusted Port can forward the DHCPv6 packets from DHCPv6 servers.

14.5 ARP Inspection

According to the ARP Implementation Procedure stated in 14.1.3 ARP Scanning, it can be found that ARP protocol can facilitate the Hosts in the same network segment to communicate with one another or access to external network via Gateway. However, since ARP protocol is implemented with the premise that all the Hosts and Gateways are trusted, there are high security risks during ARP Implementation Procedure in the actual complex network. Thus, the cheating attacks against ARP, such as imitating Gateway, cheating Gateway, cheating terminal Hosts and ARP Flooding Attack, frequently occur to the network, especially to the large network such as campus network. The following part will simply introduce these ARP attacks.

➤ Imitating Gateway

The attacker sends the MAC address of a forged Gateway to Host, and then the Host will automatically update the ARP table after receiving the ARP response packets, which causes that the Host cannot access the network normally. The ARP Attack implemented by imitating Gateway is illustrated in the following figure.

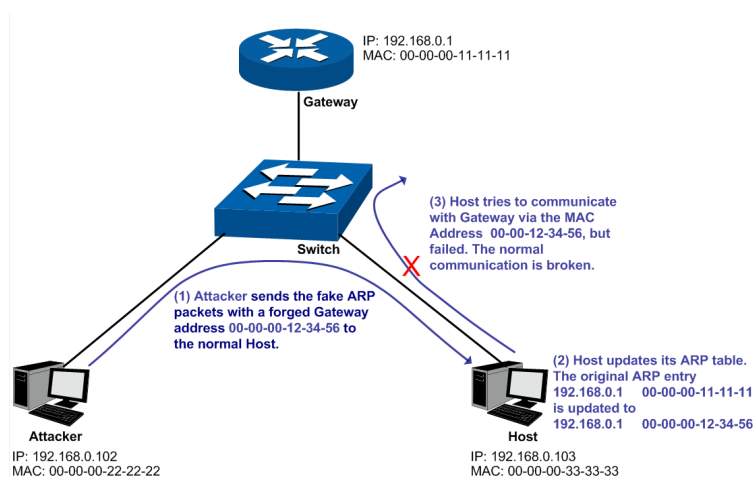

Figure 14-15 ARP Attack - Imitating Gateway

As the above figure shown, the attacker sends the fake ARP packets with a forged Gateway address to the normal Host, and then the Host will automatically update the ARP table after receiving the ARP packets. When the Host tries to communicate with Gateway, the Host will encapsulate this false destination MAC address for packets, which results in a breakdown of the normal communication.

➤ Cheating Gateway

The attacker sends the wrong IP address-to-MAC address mapping entries of Hosts to the Gateway, which causes that the Gateway cannot communicate with the legal terminal Hosts normally. The ARP Attack implemented by cheating Gateway is illustrated in the following figure.

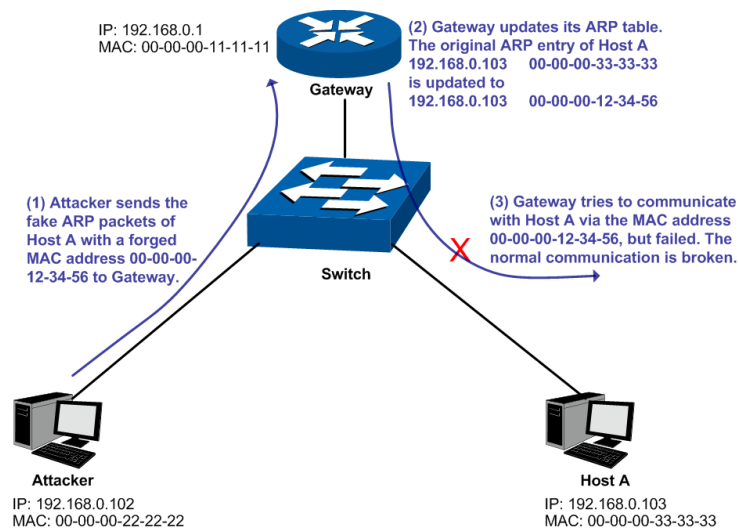

Figure 14-16 ARP Attack – Cheating Gateway

As the above figure shown, the attacker sends the fake ARP packets of Host A to the Gateway, and then the Gateway will automatically update its ARP table after receiving the ARP packets. When the Gateway tries to communicate with Host A in LAN, it will encapsulate this false destination MAC address for packets, which results in a breakdown of the normal communication.

➤ Cheating Terminal Hosts

The attacker sends the false IP address-to-MAC address mapping entries of terminal Host/Server to another terminal Host, which causes that the two terminal Hosts in the same network segment cannot communicate with each other normally. The ARP Attack implemented by cheating terminal Hosts is illustrated in the following figure.

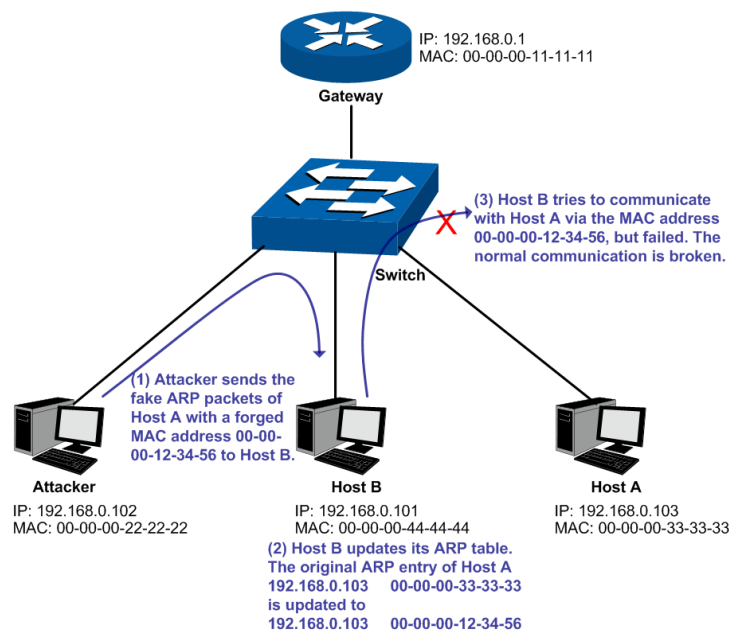

Figure 14-17 ARP Attack – Cheating Terminal Hosts

As the above figure shown, the attacker sends the fake ARP packets of Host A to Host B, and then Host B will automatically update its ARP table after receiving the ARP packets. When Host B tries to communicate with Host A, it will encapsulate this false destination MAC address for packets, which results in a breakdown of the normal communication.

➤ Man-In-The-Middle Attack

The attacker continuously sends the false ARP packets to the Hosts in LAN so as to make the Hosts maintain the wrong ARP table. When the Hosts in LAN communicate with one another, they will send the packets to the attacker according to the wrong ARP table. Thus, the attacker can get and process the packets before forwarding them. During the procedure, the communication packets information between the two Hosts are stolen in the case that the Hosts were unaware of the attack. That is called Man-In-The-Middle Attack. The Man-In-The-Middle Attack is illustrated in the following figure.

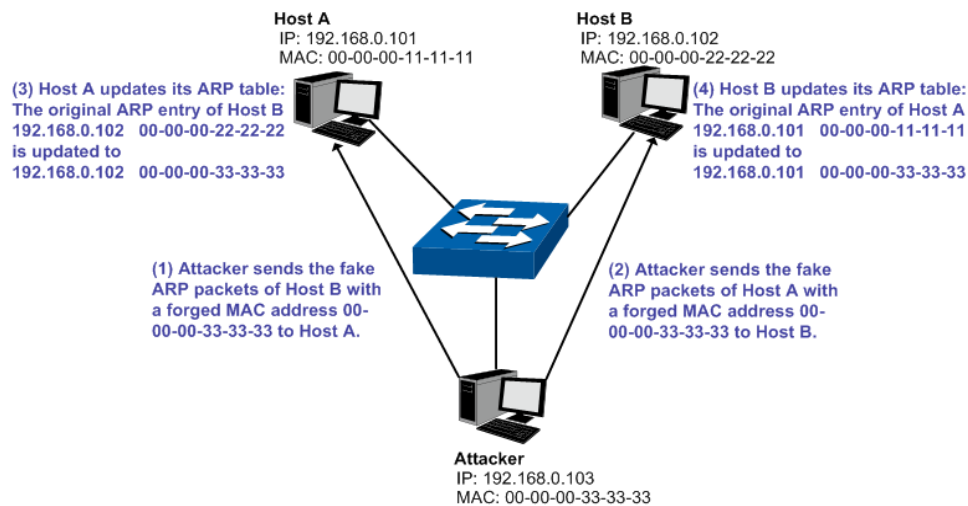

Figure 14-18 Man-In-The-Middle Attack

Suppose there are three Hosts in LAN connected with one another through a switch.

Host A: IP address is 192.168.0.101; MAC address is 00-00-00-11-11-11.

Host B: IP address is 192.168.0.102; MAC address is 00-00-00-22-22-22.

Attacker: IP address is 192.168.0.103; MAC address is 00-00-00-33-33-33.

1. First, the attacker sends the false ARP response packets.
2. Upon receiving the ARP response packets, Host A and Host B updates the ARP table of their own.
3. When Host A communicates with Host B, it will send the packets to the false destination MAC address, i.e. to the attacker, according to the updated ARP table.
4. After receiving the communication packets between Host A and Host B, the attacker processes and forwards the packets to the correct destination MAC address, which makes Host A and Host B keep a normal-appearing communication.
5. The attacker continuously sends the false ARP packets to the Host A and Host B so as to make the Hosts always maintain the wrong ARP table.

In the view of Host A and Host B, their packets are directly sent to each other. But in fact, there is a Man-In-The-Middle stolen the packets information during the communication procedure. This kind of ARP attack is called Man-In-The-Middle attack.

➤ ARP Flooding Attack

The attacker broadcasts a mass of various fake ARP packets in a network segment to occupy the network bandwidth viciously, which results in a dramatic slowdown of network speed. Meantime, the Gateway learns the false IP address-to-MAC address mapping entries from these ARP

packets and updates its ARP table. As a result, the ARP table is fully occupied by the false entries and unable to learn the ARP entries of legal Hosts, which causes that the legal Hosts cannot access the external network.

The IP-MAC Binding function allows the switch to bind the IP address, MAC address, VLAN ID and the connected Port number of the Host together when the Host connects to the switch. Basing on the predefined IP-MAC Binding entries, the ARP Inspection functions to detect the ARP packets and filter the illegal ARP packet so as to prevent the network from ARP attacks.

The **ARP Inspection** function is implemented on the **ARP Detect**, **ARP Defend** and **ARP Statistics** pages.

14.5.1 ARP Detect

ARP Detect feature enables the switch to detect the ARP packets basing on the bound entries in the IP-MAC Binding Table and filter the illegal ARP packets, so as to prevent the network from ARP attacks, such as the Network Gateway Spoofing and Man-In-The-Middle Attack, etc.

Choose the menu **Network Security**→**ARP Inspection**→**ARP Detect** to load the following page.

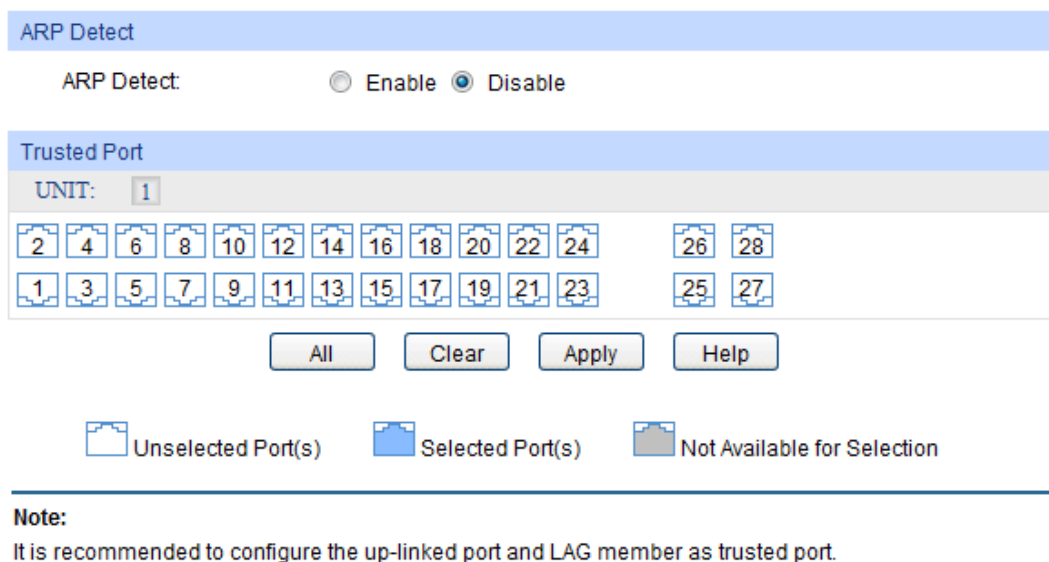

Figure 14-19 ARP Detect

The following entries are displayed on this screen:

➤ **ARP Detect**

ARP Detect: Enable/Disable the ARP Detect function, and click the **Apply** button to apply.

➤ **Trusted Port**

Trusted Port: Select the port for which the ARP Detect function is unnecessary as the Trusted Port. The specific ports, such as up-linked port, routing port and LAG port, should be set as Trusted Port. To ensure the normal communication of the switch, please configure the ARP Trusted Port before enabling the ARP Detect function.

Configuration Procedure:

Step	Operation	Description
1	Bind the IP address, MAC address, VLAN ID and the connected Port number of the Host together.	Required. On the IP-MAC Binding page, bind the IP address, MAC address, VLAN ID and the connected Port number of the Host together via Manual Binding, ARP Scanning or DHCP Snooping.
2	Enable the protection for the bound entry.	Required. On the Network Security→IP-MAC Binding→Binding Table page, specify a protect type for the corresponding bound entry.
3	Specify the trusted port.	Required. On the Network Security→ARP Inspection→ARP Detect page, specify the trusted port. The specific ports, such as up-linked port, routing port and LAG port, should be set as Trusted Port.
4	Enable ARP Detect feature.	Required. On the Network Security→ARP Inspection→ARP Detect page, enable the ARP Detect feature.

14.5.2 ARP Defend

With the ARP Defend enabled, the switch can terminate receiving the ARP packets for 300 seconds when the transmission speed of the legal ARP packet on the port exceeds the defined value so as to avoid ARP Attack flood.

Choose the menu **Network Security→ARP Inspection→ARP Defend** to load the following page.

ARP Defend

UNIT: 1

Select	Port	Defend	Speed (10-100)pps	Current Speed (pps)	Status	LAG	Operation
<input type="checkbox"/>		<input type="text" value="Disable"/>	<input type="text" value="15"/>				
<input type="checkbox"/>	1/0/1	Disable	15	---	---	---	---
<input type="checkbox"/>	1/0/2	Disable	15	---	---	---	---
<input type="checkbox"/>	1/0/3	Disable	15	---	---	---	---
<input type="checkbox"/>	1/0/4	Disable	15	---	---	---	---
<input type="checkbox"/>	1/0/5	Disable	15	---	---	---	---
<input type="checkbox"/>	1/0/6	Disable	15	---	---	---	---
<input type="checkbox"/>	1/0/7	Disable	15	---	---	---	---
<input type="checkbox"/>	1/0/8	Disable	15	---	---	---	---
<input type="checkbox"/>	1/0/9	Disable	15	---	---	---	---
<input type="checkbox"/>	1/0/10	Disable	15	---	---	---	---
<input type="checkbox"/>	1/0/11	Disable	15	---	---	---	---
<input type="checkbox"/>	1/0/12	Disable	15	---	---	---	---
<input type="checkbox"/>	1/0/13	Disable	15	---	---	---	---
<input type="checkbox"/>	1/0/14	Disable	15	---	---	---	---
<input type="checkbox"/>	1/0/15	Disable	15	---	---	---	---

Note:

It is not recommended to enable ARP Defend for LAG member.

Figure 14-20 ARP Defend

The following entries are displayed on this screen:

➤ **ARP Defend**

Select:

Select your desired port for configuration. It is multi-optional.

Port:	Displays the port number.
Defend:	Select Enable/Disable the ARP Defend feature for the port.
Speed(10-100)pps:	Enter a value to specify the maximum amount of the received ARP packets per second.
Current Speed(pps):	Displays the current speed of the received ARP packets.
Status	Displays the status of the ARP attack.
LAG:	Displays the LAG to which the port belongs to.
Operation:	Click the Recover button to restore the port to the normal status. The ARP Defend for this port will be re-enabled.



Note:

It's not recommended to enable the ARP Defend feature for the LAG member port.

14.5.3 ARP Statistics

ARP Statistics feature displays the number of the illegal ARP packets received on each port, which facilitates you to locate the network malfunction and take the related protection measures.

Choose the menu **Network Security**→**ARP Inspection**→**ARP Statistics** to load the following page.

Auto Refresh

Auto Refresh: Enable Disable Apply

Refresh Interval: sec(3-300)

Illegal ARP Packet

UNIT:

Port	Trusted Port	Illegal ARP Packet
1/0/1	No	0
1/0/2	No	0
1/0/3	No	0
1/0/4	No	0
1/0/5	No	0
1/0/6	No	0
1/0/7	No	0
1/0/8	No	0
1/0/9	No	0
1/0/10	No	0
1/0/11	No	0
1/0/12	No	0
1/0/13	No	0
1/0/14	No	0
1/0/15	No	0

Figure 14-21 ARP Statistics

The following entries are displayed on this screen:

- **Auto Refresh**

- Auto Refresh:** Enable/Disable the Auto Refresh feature.
- Refresh Interval:** Specify the refresh interval to display the ARP Statistics.
- **Illegal ARP Packet**
 - Port:** Displays the port number.
 - Trusted Port:** Indicates the port is an ARP Trusted Port or not.
 - Illegal ARP Packet:** Displays the number of the received illegal ARP packets.

14.6 ND Detection

➤ ND Brief Introduction

IPv6 Neighbor Discovery (ND) protocol uses five types of ICMPv6 messages to implement the following functions:

- Address resolution
- Neighbor reachability detection
- Duplicate address detection (DAD)
- Router/prefix discovery and address autoconfiguration
- Redirection

Five types of the ICMPv6 messages are listed below:

ICMPv6 Message	Function
Neighbor Solicitation (NS)	<ul style="list-style-type: none"> • Acquires the neighbor's link-layer address. • Verifies whether a neighbor is reachable. • Detects duplicate address.
Neighbor Advertisement (NA)	<ul style="list-style-type: none"> • Responses to an NS message. • Notifies the neighbor nodes of link layer changes
Router Solicitation (RS)	<ul style="list-style-type: none"> • Requests for an address prefix and other configuration parameters for autoconfiguration.
Router Advertisement (RA)	<ul style="list-style-type: none"> • Responses to an RS message. • Advertises information such as the prefix information options and flag bits.
Redirect (RR)	<ul style="list-style-type: none"> • Informs the source host of another next hop to a particular destination when certain conditions are met.

➤ ND Attack

Because of the absence of security mechanism, ND protocol is easy to be exploited by attackers. Attackers can exploit the ND protocols as follows:

- The attackers send forged NS/NA/RS packets with the IPv6 address of a victim host. The

gateway or the other hosts who have received these NS/NA/RS packets will update their ND entry with the wrong address information. As a result, all packets intended for the victim will be sent to the attacking host rather than the victim host.

- The attackers send forged RA packets with the IPv6 address of a victim gateway. All the hosts attached to the victim gateway may receive incorrect IPv6 configuration parameters and maintain false ND entries.

A forged ND packet has the following two features:

- The source MAC address in the Ethernet frame header is inconsistent with that carried in the source link layer address option of the ND packet.
- The mapping between the source IPv6 address and the source MAC address in the Ethernet frame header is invalid.

➤ ND Detection Process

Generally, the ND detection feature uses the entries in the IPv6-MAC binding table to verify the packets received on the untrusted ports, thus filtering the forged ND packets and keeping out the attacks.

1. ND packets received on the ND-trusted port will not be checked.
2. RS/NS packets with their source IPv6 address unspecified will not be checked.
3. RA/RR packets received on the ND-untrusted port will be discarded directly; the other ND packets received on the ND-untrusted port will be checked.
 - a) Source MAC consistence check. If the RS/NS packet's source MAC address in the Ethernet frame header is different from that carried in the source layer address option, the RS/NS packet will be discarded.
 - b) IPv6-MAC binding check. Look up the IPv6-MAC binding table to compare the IPv6 address, MAC address, VLAN ID and receiving port between the entry and the ND packet. If a match is found, the ND packet is considered legal and forwarded; if no match is found, the ND packet is considered illegal and discarded directly.

Choose the menu **Network Security**→**ND Detection**→**ND Detection** to load the following page.

Note:

It is recommended to configure the up-linked port and LAG member as trusted port.

Figure 14-22 ND Detection

➤ **ND Detection**

- ND Detection:** Enable/Disable the ND Detection function.
- VLAN ID:** Enter the VLAN ID in which you want to enable/disable the ND Detection function.
- VLAN Configuration Display:** Display the VLANs with ND detection function enabled.

➤ **Trusted Port**

- UNIT:1/LAGS** Select the desired unit or LAG for configuration.
- Trusted Port:** Select Enable/Disable the port to be a Trusted Port. Only the Trusted Port can forward the Router Advertisement Message and Router Redirect Message from Routers.

14.7 IP Source Guard

IP Source Guard is to filter the IP packets based on the IP-MAC Binding entries. Only the packets matched to the IP-MAC Binding rules can be processed, which can enhance the bandwidth utility.

Choose the menu **Network Security**→**IP Source Guard** to load the following page.

IP Source Guard Config				
UNIT: 1				
Select	Port	IPv4 Security Type	IPv6 Security Type	LAG
<input type="checkbox"/>		<input type="text" value=""/>	<input type="text" value=""/>	
<input type="checkbox"/>	1/0/1	Disable	Disable	---
<input type="checkbox"/>	1/0/2	Disable	Disable	---
<input type="checkbox"/>	1/0/3	Disable	Disable	---
<input type="checkbox"/>	1/0/4	Disable	Disable	---
<input type="checkbox"/>	1/0/5	Disable	Disable	---
<input type="checkbox"/>	1/0/6	Disable	Disable	---
<input type="checkbox"/>	1/0/7	Disable	Disable	---
<input type="checkbox"/>	1/0/8	Disable	Disable	---
<input type="checkbox"/>	1/0/9	Disable	Disable	---
<input type="checkbox"/>	1/0/10	Disable	Disable	---
<input type="checkbox"/>	1/0/11	Disable	Disable	---
<input type="checkbox"/>	1/0/12	Disable	Disable	---
<input type="checkbox"/>	1/0/13	Disable	Disable	---
<input type="checkbox"/>	1/0/14	Disable	Disable	---
<input type="checkbox"/>	1/0/15	Disable	Disable	---

Note:
IP Source Guard can not be enabled for LAG member.

Figure 14-23 IP Source Guard

The following entries are displayed on this screen:

➤ **IP Source Guard Config**

- Select:** Select your desired port for configuration. It is multi-optional.
- Port:** Displays the port number.
- IPv4 Security Type:** Select Security Type for the port.
- **Disable:** Select this option to disable the IP Source Guard feature for the port.
 - **SIP+MAC:** Only the packets with its source IP address, source MAC address and port number matched to the IP-MAC binding rules can be processed.
- IPv6 Security Type:** Select Security Type for the port.
- **Disable:** Select this option to disable the IPv6 Source Guard feature for the port.
 - **SIPv6+MAC:** Only the packets with its source IPv6 address, source MAC address and port number matched to the IPv6-MAC binding rules can be processed.
- LAG:** Displays the LAG to which the port belongs.

 **Note:**
Before configuring IPv6 Security feature, you should configure the SDM template as “enterpriseV6” and save your configurations. See [SDM Template](#) for more information about SDM template configuration.

14.8 DoS Defend

DoS (Denial of Service) Attack is to occupy the network bandwidth maliciously by the network attackers or the evil programs sending a lot of service requests to the Host, which incurs an abnormal service or even breakdown of the network.

With DoS Defend function enabled, the switch can analyze the specific fields of the IP packets and distinguish the malicious DoS attack packets. Upon detecting the packets, the switch will discard the illegal packets directly and limit the transmission rate of the legal packets if the over legal packets may incur a breakdown of the network. The switch can defend several types of DoS attack listed in the following table.

DoS Attack Type	Description
Land Attack	The attacker sends a specific fake SYN packet to the destination Host. Since both the source IP address and the destination IP address of the SYN packet are set to be the IP address of the Host, the Host will be trapped in an endless circle for building the initial connection. The performance of the network will be reduced extremely.
Scan SYNFIN	The attacker sends the packet with its SYN field and the FIN field set to 1. The SYN field is used to request initial connection whereas the FIN field is used to request disconnection. Therefore, the packet of this type is illegal. The switch can defend this type of illegal packet.
Xmascan	The attacker sends the illegal packet with its TCP index, FIN, URG and PSH field set to 1.
NULL Scan Attack	The attacker sends the illegal packet with its TCP index and all the control fields set to 0. During the TCP connection and data transmission, the packets with all the control fields set to 0 are considered as the illegal packets.
SYN packet with its source port less than 1024	The attacker sends the illegal packet with its TCP SYN field set to 1 and source port less than 1024.
Blat Attack	The attacker sends the illegal packet with its source port and destination port on Layer 4 the same and its URG field set to 1. Similar to the Land Attack, the system performance of the attacked Host is reduced since the Host circularly attempts to build a connection with the attacker.
Ping Flooding	The attacker floods the destination system with Ping broadcast storm packets to forbid the system to respond to the legal communication.
SYN/SYN-ACK Flooding	The attacker uses a fake IP address to send TCP request packets to the Server. Upon receiving the request packets, the Server responds with SYN-ACK packets. Since the IP address is fake, no response will be returned. The Server will keep on sending SYN-ACK packets. If the attacker sends overflowing fake request packets, the network resource will be occupied maliciously and the requests of the legal clients will be denied.

Table 14-1 Defendable DoS Attack Types

14.8.1 DoS Defend

On this page, you can enable the DoS Defend type appropriate to your need.

Choose the menu **Network Security**→**DoS Defend**→**DoS Defend** to load the following page.

Configure	
DoS Protection:	<input type="radio"/> Enable <input checked="" type="radio"/> Disable
Defend Table	
Select	Defend Type
<input type="checkbox"/>	Land Attack
<input type="checkbox"/>	Scan SYNFIN
<input type="checkbox"/>	Xmascan
<input type="checkbox"/>	NULL Scan
<input type="checkbox"/>	SYN sPort less 1024
<input type="checkbox"/>	Blat Attack
<input type="checkbox"/>	Ping Flooding
<input type="checkbox"/>	SYN/SYN-ACK Flooding
<input type="checkbox"/>	WinNuke Attack
<input type="button" value="All"/> <input type="button" value="Apply"/> <input type="button" value="Help"/>	

Figure 14-24 DoS Defend

The following entries are displayed on this screen:

➤ **Defend Config**

DoS Defend: Allows you to Enable/Disable DoS Defend function.

➤ **Defend Table**

Select: Select the entry to enable the corresponding Defend Type.

Defend Type: Displays the Defend Type name.

14.9 802.1X

The 802.1X protocol was developed by IEEE802 LAN/WAN committee to deal with the security issues of wireless LANs. It was then used in Ethernet as a common access control mechanism for LAN ports to solve mainly authentication and security problems.

802.1X is a port-based network access control protocol. It authenticates and controls devices requesting for access in terms of the ports of LAN access control devices. With the 802.1X protocol enabled, a supplicant can access the LAN only when it passes the authentication, whereas those failing to pass the authentication are denied when accessing the LAN.

➤ **Architecture of 802.1X Authentication**

802.1X adopts a client/server architecture with three entities: a supplicant system, an authenticator system, and an authentication server system, as shown in the following figure.

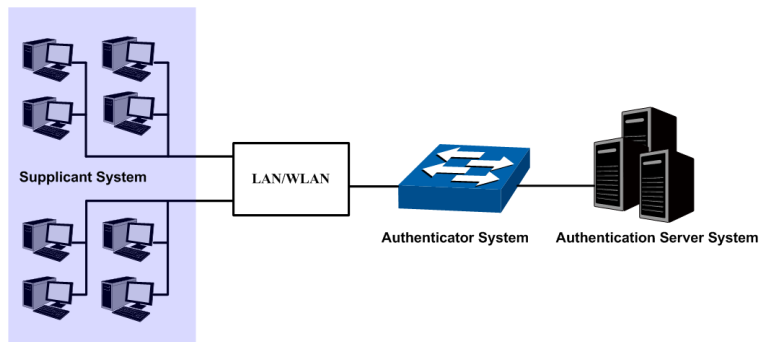

Figure 14-25 Architecture of 802.1X authentication

1. **Supplicant System:** The supplicant system is an entity in LAN and is authenticated by the authenticator system. The supplicant system is usually a common user terminal computer. An 802.1X authentication is initiated when a user launches client program on the supplicant system. Note that the client program must support the 802.1X authentication protocol.
2. **Authenticator System:** The authenticator system is usually an 802.1X-supported network device, such as this TP-LINK switch. It provides the physical or logical port for the supplicant system to access the LAN and authenticates the supplicant system.
3. **Authentication Server System:** The authentication server system is an entity that provides authentication service to the authenticator system. Normally in the form of a RADIUS server. Authentication Server can store user information and serve to perform authentication and authorization. To ensure a stable authentication system, an alternate authentication server can be specified. If the main authentication server is in trouble, the alternate authentication server can substitute it to provide normal authentication service.

➤ **The Mechanism of an 802.1X Authentication System**

IEEE 802.1X authentication system uses EAP (Extensible Authentication Protocol) to exchange information between the supplicant system and the authentication server.

1. EAP protocol packets transmitted between the supplicant system and the authenticator system are encapsulated as EAPOL packets.
2. EAP protocol packets transmitted between the authenticator system and the RADIUS server can either be encapsulated as EAPOR (EAP over RADIUS) packets or be terminated at authenticator system and the authenticator system then communicate with RADIUS servers through PAP (Password Authentication Protocol) or CHAP (Challenge Handshake Authentication Protocol) protocol packets.
3. When a supplicant system passes the authentication, the authentication server passes the information about the supplicant system to the authenticator system. The authenticator system in turn determines the state (authorized or unauthorized) of the controlled port according to the instructions (accept or reject) received from the RADIUS server.

➤ **802.1X Authentication Procedure**

An 802.1X authentication can be initiated by supplicant system or authenticator system. When the authenticator system detects an unauthenticated supplicant in LAN, it will initiate the 802.1X authentication by sending EAP-Request/Identity packets to the supplicant. The supplicant system can also launch an 802.1X client program to initiate an 802.1X authentication through the sending of an EAPOL-Start packet to the switch,

This TP-LINK switch can authenticate supplicant systems in EAP relay mode or EAP terminating mode. The following illustration of these two modes will take the 802.1X authentication procedure initiated by the supplicant system for example.

1. EAP Relay Mode

This mode is defined in 802.1X. In this mode, EAP-packets are encapsulated in higher level protocol (such as EAPOR) packets to allow them successfully reach the authentication server. This mode normally requires the RADIUS server to support the two fields of EAP: the EAP-message field and the Message-authenticator field. This switch supports EAP-MD5, EAP-TLS, EAP-TTLS and EAP-PEAP authentication way for the EAP relay mode. The following figure describes the basic EAP-MD5 authentication procedure.

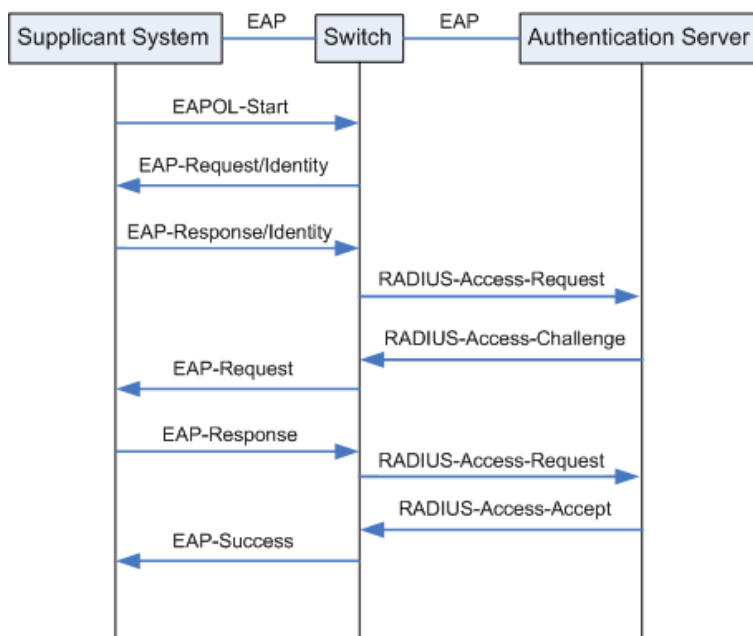

Figure 14-26 EAP-MD5 Authentication Procedure

- (1) A supplicant system launches an 802.1X client program via its registered user name and password to initiate an access request through the sending of an EAPOL-Start packet to the switch. The 802.1X client program then forwards the packet to the switch to start the authentication process.
- (2) Upon receiving the authentication request packet, the switch sends an EAP-Request/Identity packet to ask the 802.1X client program for the user name.
- (3) The 802.1X client program responds by sending an EAP-Response/Identity packet to the switch with the user name included. The switch then encapsulates the packet in a RADIUS Access-Request packet and forwards it to the RADIUS server.
- (4) Upon receiving the user name from the switch, the RADIUS server retrieves the user name, finds the corresponding password by matching the user name in its database, encrypts the password using a randomly-generated key, and sends the key to the switch through an RADIUS Access-Challenge packet. The switch then sends the key to the 802.1X client program.
- (5) Upon receiving the key (encapsulated in an EAP-Request/MD5 Challenge packet) from the switch, the client program encrypts the password of the supplicant system with the key and sends the encrypted password (contained in an EAP-Response/MD5 Challenge packet) to the RADIUS server through the switch. (The encryption is irreversible.)
- (6) The RADIUS server compares the received encrypted password (contained in a RADIUS Access-Request packet) with the locally-encrypted password. If the two match, it will then send feedbacks (through a RADIUS Access-Accept packet and an EAP-Success packet) to the switch to indicate that the supplicant system is authorized.

- (7) The switch changes the state of the corresponding port to accepted state to allow the supplicant system access the network. And then the switch will monitor the status of supplicant by sending hand-shake packets periodically. By default, the switch will force the supplicant to log off if it cannot get the response from the supplicant for two times.
- (8) The supplicant system can also terminate the authenticated state by sending EAPOL-Logoff packets to the switch. The switch then changes the port state from accepted to rejected.

2. EAP Terminating Mode

In this mode, packet transmission is terminated at authenticator systems and the EAP packets are mapped into RADIUS packets. Authentication and accounting are accomplished through RADIUS protocol.

In this mode, PAP or CHAP is employed between the switch and the RADIUS server. This switch supports the PAP terminating mode. The authentication procedure of PAP is illustrated in the following figure.

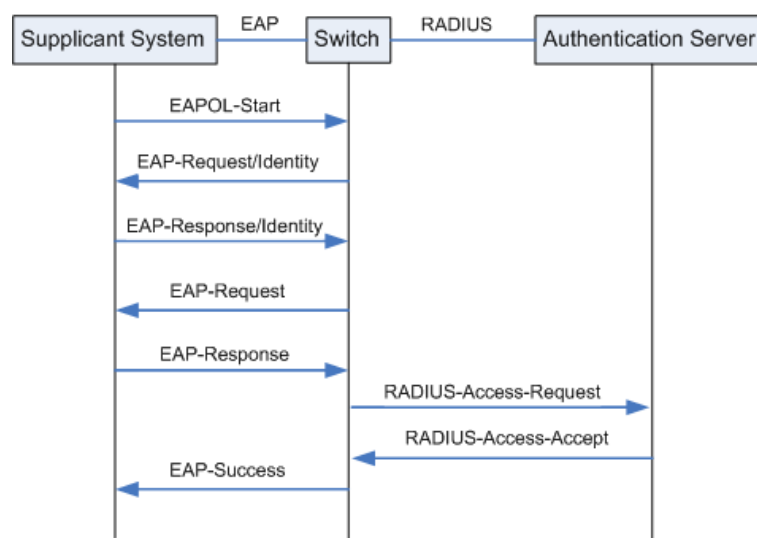

Figure 14-27 PAP Authentication Procedure

In PAP mode, the switch encrypts the password and sends the user name, the randomly-generated key, and the supplicant system-encrypted password to the RADIUS server for further authentication. Whereas the randomly-generated key in EAP-MD5 relay mode is generated by the authentication server, and the switch is responsible to encapsulate the authentication packet and forward it to the RADIUS server.

➤ 802.1X Timer

In 802.1 x authentication, the following timers are used to ensure that the supplicant system, the switch, and the RADIUS server interact in an orderly way:

1. **Supplicant system timer (Supplicant Timeout):** This timer is triggered by the switch after the switch sends a request packet to a supplicant system. The switch will resend the request packet to the supplicant system if the supplicant system fails to respond in the specified timeout period.
2. **RADIUS server timer (Server Timeout):** This timer is triggered by the switch after the switch sends an authentication request packet to RADIUS server. The switch will resend the authentication request packet if the RADIUS server fails to respond in the specified timeout period.

3. **Quiet-period timer (Quiet Period):** This timer sets the quiet-period. When a supplicant system fails to pass the authentication, the switch quiets for the specified period before it processes another authentication request re-initiated by the supplicant system.

➤ **Guest VLAN**

Guest VLAN function enables the supplicants that do not pass the authentication to access the specific network resource.

By default, all the ports connected to the supplicants belong to a VLAN, i.e. Guest VLAN. Users belonging to the Guest VLAN can access the resources of the Guest VLAN without being authenticated. But they need to be authenticated before accessing external resources. After passing the authentication, the ports will be removed from the Guest VLAN and be allowed to access the other resources.

With the Guest VLAN function enabled, users can access the Guest VLAN to install 802.1X client program or upgrade their 802.1x clients without being authenticated. If there is no supplicant past the authentication on the port in a certain time, the switch will add the port to the Guest VLAN.

With 802.1X function enabled and Guest VLAN configured, after the maximum number retries have been made to send the EAP-Request/Identity packets and there are still ports that have not sent any response back, the switch will then add these ports into the Guest VLAN according to their link types. Only when the corresponding user passes the 802.1X authentication, the port will be removed from the Guest VLAN and added to the specified VLAN. In addition, the port will back to the Guest VLAN when its connected user logs off.

The **802.1X** function is implemented on the **Global Config** and **Port Config** pages.

14.9.1 Global Config

On this page, you can enable the 802.1X authentication function globally and control the authentication process by specifying the Authentication Method, Guest VLAN and various Timers. Please disable Handshake feature if you are using other client softwares instead of TP-LINK 802.1X Client.

Choose the menu **Network Security**→**802.1X**→**Global Config** to load the following page.

Global Config

802.1X:	<input type="radio"/> enable <input checked="" type="radio"/> disable	
Auth Method:	<input type="text" value="EAP"/>	
Handshake:	<input checked="" type="radio"/> enable <input type="radio"/> disable	<input type="button" value="Apply"/>
Guest VLAN:	<input type="radio"/> enable <input checked="" type="radio"/> disable	
Guest VLAN ID:	<input type="text" value=""/> (2-4094)	

Authentication Config

Quiet:	<input type="radio"/> enable <input checked="" type="radio"/> disable	
Quiet Period:	<input type="text" value=""/> sec (1-999)	
Retry Times:	<input type="text" value="3"/> (1-9)	<input type="button" value="Apply"/>
Supplicant Timeout:	<input type="text" value="3"/> sec (1-9)	<input type="button" value="Help"/>
Server Timeout:	<input type="text" value="3"/> sec (1-9)	

Figure 14-28 Global Config

The following entries are displayed on this screen:

➤ **Global Config**

- 802.1X:** Enable/Disable the 802.1X function.
- Auth Method:** Select the Authentication Method from the pull-down list.
- **EAP:** EAP relay mode. IEEE 802.1X authentication system uses extensible authentication protocol (EAP) to exchange information between the switch and the client. The EAP protocol packets with authentication data can be encapsulated in the advanced protocol (such as RADIUS) packets to be transmitted to the authentication server.
 - **PAP:** EAP termination mode. IEEE 802.1X authentication system uses extensible authentication protocol (EAP) to exchange information between the switch and the client. The transmission of EAP packets is terminated at the switch and the EAP packets are converted to the other protocol (such as RADIUS) packets for transmission.
- Handshake:** Enable/Disable the Handshake feature. The Handshake feature is used to detect the connection status between the TP-LINK 802.1X Client and the switch. Please disable Handshake feature if you are using other client softwares instead of TP-LINK 802.1X Client.
- Guest VLAN:** Enable/Disable the Guest VLAN feature.
- Guest VLAN ID:** Enter your desired VLAN ID to enable the Guest VLAN feature. The supplicants in the Guest VLAN can access the specified network source.
- **Authentication Config**
- Quiet:** Enable/Disable the Quiet timer.
- Quiet Period:** Specify a value for Quiet Period. Once the supplicant failed to the 802.1X Authentication, then the switch will not respond to the authentication request from the same supplicant during the Quiet Period.
- Retry Times:** Specify the maximum transfer times of the repeated authentication request.
- Supplicant Timeout:** Specify the maximum time for the switch to wait for the response from supplicant before resending a request to the supplicant.
- Server Timeout:** Specify the maximum time for the switch to wait for the response from authentication server before resending a request to the authentication server.

14.9.2 Port Config

On this page, you can configure the 802.1X features for the ports basing on the actual network.

Choose the menu **Network Security**→**802.1X**→**Port Config** to load the following page.

Port Config							
UNIT: 1							
Select	Port	Status	Guest VLAN	Control Mode	Control Type	Authorized	LAG
<input type="checkbox"/>							
<input type="checkbox"/>	1/0/1	Disable	Disable	Auto	MAC Based	Authorized	---
<input type="checkbox"/>	1/0/2	Disable	Disable	Auto	MAC Based	Authorized	---
<input type="checkbox"/>	1/0/3	Disable	Disable	Auto	MAC Based	Authorized	---
<input type="checkbox"/>	1/0/4	Disable	Disable	Auto	MAC Based	Authorized	---
<input type="checkbox"/>	1/0/5	Disable	Disable	Auto	MAC Based	Authorized	---
<input type="checkbox"/>	1/0/6	Disable	Disable	Auto	MAC Based	Authorized	---
<input type="checkbox"/>	1/0/7	Disable	Disable	Auto	MAC Based	Authorized	---
<input type="checkbox"/>	1/0/8	Disable	Disable	Auto	MAC Based	Authorized	---
<input type="checkbox"/>	1/0/9	Disable	Disable	Auto	MAC Based	Authorized	---
<input type="checkbox"/>	1/0/10	Disable	Disable	Auto	MAC Based	Authorized	---
<input type="checkbox"/>	1/0/11	Disable	Disable	Auto	MAC Based	Authorized	---
<input type="checkbox"/>	1/0/12	Disable	Disable	Auto	MAC Based	Authorized	---
<input type="checkbox"/>	1/0/13	Disable	Disable	Auto	MAC Based	Authorized	---
<input type="checkbox"/>	1/0/14	Disable	Disable	Auto	MAC Based	Authorized	---
<input type="checkbox"/>	1/0/15	Disable	Disable	Auto	MAC Based	Authorized	---

Note:
802.1X can not be enabled for LAG member.

Figure 14-29 Port Config

The following entries are displayed on this screen:

➤ **Port Config**

- Select:** Select your desired port for configuration. It is multi-optional.
- Port:** Displays the port number.
- Status:** Select Enable/Disable the 802.1X authentication feature for the port.
- Guest VLAN:** Select Enable/Disable the Guest VLAN feature for the port.
- Control Mode:** Specify the Control Mode for the port.
 - **Auto:** In this mode, the port will normally work only after passing the 802.1X Authentication.
 - **Force-Authorized:** In this mode, the port can work normally without passing the 802.1X Authentication.
 - **Force-Unauthorized:** In this mode, the port is forbidden working for its fixed unauthorized status.
- Control Type:** Specify the Control Type for the port.
 - **MAC Based:** Any client connected to the port should pass the 802.1X Authentication for access.
 - **Port Based:** All the clients connected to the port can access the network on the condition that any one of the clients has passed the 802.1X Authentication.
- Authorized:** Displays the authentication status of the port.
- LAG:** Displays the LAG to which the port belongs to.

Configuration Procedure:

Step	Operation	Description
1	Install the 802.1X client software.	Required. For the client computers, you are required to install the TP-LINK 802.1X Client provided on the CD. Please refer to the software guide in the same directory with the software for more information.
2	Configure the 802.1X globally.	Required. By default, the global 802.1X function is disabled. On the Network Security→802.1X→Global Config page, configure the 802.1X function globally.
3	Configure the 802.1X for the port.	Required. On the Network Security→802.1X→Port Config page, configure the 802.1X feature for the port of the switch basing on the actual network.
4	Connect an authentication server to the switch and do some configuration.	Required. Record the information of the client in the LAN to the authentication server and configure the corresponding authentication username and password for the client.
5	Enable the AAA function globally.	Required. On the Network Security→AAA→Global Config page, enable the AAA function globally.
6	Configure the parameters of the authentication server.	Required. On the Network Security→AAA→RADIUS Server Config page, configure the parameters of the RADIUS server.



Note:

1. The 802.1X function takes effect only when it is enabled globally on the switch and for the port.
2. The 802.1X function cannot be enabled for LAG member ports. That is, the port with 802.1X function enabled cannot be added to the LAG.
3. The 802.1X function should not be enabled for the port connected to the authentication server.

14.10 PPPoE

➤ PPPoE ID-Insertion Overview

- The PPPoE ID-Insertion feature provides a way to extract a Vendor-specific tag as an identifier for the authentication, authorization, and accounting (AAA) access requests on an Ethernet interface. When enabled, the switch attaches a tag to the PPPoE discovery packets, which is called the PPPoE Vendor-Specific tag and it contains a unique line identifier. There are two formats of Vendor-specific tags: Circuit-ID format and Remote-ID format. The BRAS receives the tagged packet, decodes the tag, and uses the Circuit-ID/Remote-ID field of that tag as a NAS-Port-ID attribute in the RADIUS server for PPP authentication and AAA (authentication, authorization, and accounting) access requests. The switch will remove the Circuit-ID/Remote-ID tag from the received PPPoE Active Discovery Offer and Session-confirmation packets from the BRAS.

In this Chapter the switch will work as a DSLAM.

➤ PPPoE ID-Insertion Operation Process

The PPPoE ID insertion includes Circuit-ID tag and Remote-ID tag. The following process takes Circuit-ID insertion as an example:

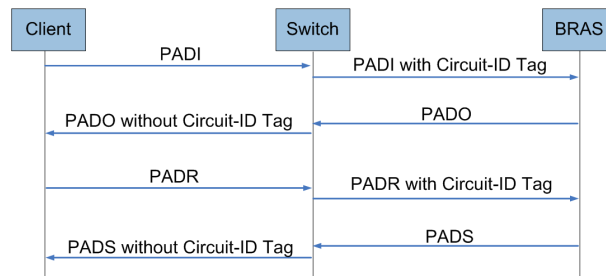

Figure 14-1 PPPoE Discovery Process

The PPPoE discovery process is illustrated below:

1. The client sends PADI (PPPoE Active Discovery Initiation) packets to the switch.
2. The switch intercepts PADI packets and inserts a unique Circuit-ID tag to them.
3. The switch forwards the PADI packets with Circuit-ID tag to the BRAS.
4. The BRAS responds with the PADO (PPPoE Active Discovery Offer) packets after receiving the PADI packets.
5. Upon receiving the PADO packets with the Circuit-ID tag, the switch will remove the tag and send the packets to the client. The switch will forward the PADO packets without the Circuit-ID tag directly.
6. The client sends PADR (PPPoE Active Discovery Request) packets according to the process.
7. The switch intercepts PADR packets and inserts a unique Circuit-ID tag to them.
8. The switch forwards the PADR packets with Circuit-ID tag to the BRAS.
9. The BRAS processes the received Circuit-ID tag in the PADR packets and extracts the Circuit-ID field to the RADIUS for accounting. And the BRAS allocates a PPP process session ID for this PPP session.
10. The BRAS responds with the PADS (PPPoE Active Discovery Session-confirmation) packets after receiving the PADR packets.
11. Upon receiving the PADS packets with the Circuit-ID tag, the switch will remove the tag and send the packets to the client. The switch will forward the PADS packets without the Circuit-ID tag directly.

On the **PPPoE ID Insertion** page, you can enable the PPPoE ID insertion function globally. Each port's PPPoE ID Insertion feature and type can be configured separately.

Choose the menu **Network Security**→**PPPoE**→**PPPoE ID Insertion** to load the following page.

Global Config

PPPoE ID Insertion: Enable Disable

Port Config

UNIT: 1

Select	Port	Circuit-ID	Circuit-ID Type	UDF Value	Remote-ID	Remote-ID Value
<input type="checkbox"/>	1/0/1	Enable	IP	---	Disable	---
<input type="checkbox"/>	1/0/2	Disable	IP	---	Disable	---
<input type="checkbox"/>	1/0/3	Disable	IP	---	Disable	---
<input type="checkbox"/>	1/0/4	Disable	IP	---	Disable	---
<input type="checkbox"/>	1/0/5	Disable	IP	---	Disable	---
<input type="checkbox"/>	1/0/6	Disable	IP	---	Disable	---
<input type="checkbox"/>	1/0/7	Disable	IP	---	Disable	---
<input type="checkbox"/>	1/0/8	Disable	IP	---	Disable	---
<input type="checkbox"/>	1/0/9	Disable	IP	---	Disable	---
<input type="checkbox"/>	1/0/10	Disable	IP	---	Disable	---
<input type="checkbox"/>	1/0/11	Disable	IP	---	Disable	---
<input type="checkbox"/>	1/0/12	Disable	IP	---	Disable	---
<input type="checkbox"/>	1/0/13	Disable	IP	---	Disable	---
<input type="checkbox"/>	1/0/14	Disable	IP	---	Disable	---
<input type="checkbox"/>	1/0/15	Disable	IP	---	Disable	---

Figure 14-30 PPPoE Circuit-ID Config

The following entries are displayed on this screen:

➤ **Global Config**

PPPoE ID Insertion: Enable/Disable the PPPoE Circuit-ID Insertion function globally.

➤ **Port Config**

Port Select: Click the **Select** button to quick-select the corresponding port based on the port number you entered.

Select: Select the desired port for configuration. It is multi-optional.

Port: Displays the port number.

Circuit-ID: Enable/Disable the PPPoE Circuit-ID Insertion feature for the port.

Circuit-ID Type: Specify the Circuit-ID type for the port:

- **IP:** The IP address of the switch will be used to encode the Circuit-ID option. This is the default value.
- **MAC:** The MAC address of the switch will be used to encode the Circuit-ID option.
- **UDF:** The user specified string with the maximum length of 40 characters will be used to encode the Circuit-ID option.
- **UDF ONLY:** Only the user specified string with the maximum length of 40 will be used to encode the Circuit-ID option.

UDF Value: If the UDF is selected, specify a string with the maximum length of 40 characters to encode the Circuit-id option.

Remote-ID:	Enable or Disable the PPPoE Remote-ID Insertion feature for the port.
Remote-ID Value:	A user specified string with the maximum length of 40 characters to encode the Remote-id option

14.11 AAA

➤ Overview

AAA stands for authentication, authorization and accounting. This feature is used to authenticate users trying to log in to the switch or trying to access the administrative level privilege.

Username and password pairs are used for login and privilege authentication. The authentication can be processed locally in the switch or centrally in the RADIUS/TACACS+ server(s). The local authentication username and password pairs can be configured in [4.2 User Management](#).

➤ Applicable Access Application

The authentication can be applied on the following access applications: Console, Telnet, SSH and HTTP.

➤ Authentication Method List

A method list describes the authentication methods and their sequence to authenticate a user. The switch supports Login List for users to gain access to the switch, and Enable List for normal users to gain administrative privileges.

The administrator can set the authentication methods in a preferable order in the list. The switch uses the first listed method to authenticate users, if that method fails to respond, the switch selects the next authentication method in the method list. This process continues until there is a successful communication with a listed authentication method or until all defined methods are exhausted. If authentication fails at any point in this circle, which means the secure server or the local switch denies the user's access, the authentication process stops and no other authentication methods are attempted.

➤ 802.1X Authentication

802.1X protocol uses the RADIUS to provide detailed accounting information and flexible administrative control over authentication process. The Dot1x List feature defines the RADIUS server groups in the 802.1X authentication.

➤ RADIUS/TACACS+ Server

Users can configure the RADIUS/TACACS+ servers for the connection between the switch and the server.

➤ Server Group

Users can define the authentication server group with up to several servers running the same secure protocols, either RADIUS or TACACS+. Users can set these servers in a preferable order, which is called the server group list. When a user tries to access the switch, the switch will ask the first server in the server group list for authentication. If no response is received, the second server will be queried, and so on.

The switch has two built-in authentication server group, one for RADIUS and the other for TACACS+. These two server groups cannot be deleted, and the user-defined RADIUS/TACACS+ server will join these two server groups automatically.

14.11.1 Global Config

This page is used to enable/disable the AAA function globally.

Choose the menu **Network Security**→**AAA**→**Global Config** to load the following page.

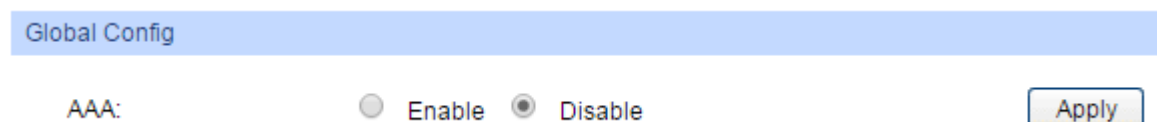

Figure 14-31 AAA Global Config

➤ Configuration Procedure

Click Enable to enable the AAA function globally.

14.11.2 Privilege Elevation

This page is used to elevate the current logged-in user from guest to admin and gain administrator level privileges. The authentication password is possibly authenticated in RADIUS/TACACS+ servers, user-defined server groups or local on the switch.

Choose the menu **Network Security**→**AAA**→**Global Config** to load the following page.

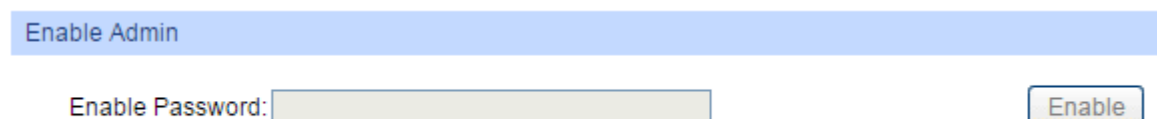

Figure 14-32 Privilege Elevate

➤ Configuration Procedure

Enter the Enable Password and click Enable button to elevate the current logged-in user from guest to admin. Only admin users can configure the following AAA settings.



Tips:

If the Enable password is verified locally, the Enable password should be previously set by the admin users using the command lines. For more details please refer to the command **enable password** in the Command Line Interface Guide on the resource CD.

14.11.3 RADIUS Server Config

This page is used to configure the authentication servers running the RADIUS security protocols.

Choose the menu **Network Security**→**AAA**→**RADIUS Config** to load the following page.

Server Config

Server IP: (Format:192.168.0.1)

Shared Key:

Auth Port: (1-65535)

Acct Port: (1-65535) Add

Retransmit: (1-3)

Timeout: sec(1-9)

Server List

Select	Server IP	Shared Key	Auth Port	Acct Port	Retransmit	Timeout
<input type="checkbox"/>		<input type="text"/>	<input type="text"/>	<input type="text"/>	<input type="text"/>	<input type="text"/>
<input type="checkbox"/>	10.0.0.10	111	1812	1813	2	5
<input type="checkbox"/>	11.0.0.0	111	1812	1813	2	5

Apply
Delete
Help

Note:

- 1.The shared key should be the same as server.
- 2.Timeout and retransmit num should not be too large.

Figure 14-33 RADIUS Server Config

➤ **Configuration Procedure**

Configure the RADIUS server’s IP and other relevant parameters under the Server Config.

View, edit and delete the configured RADIUS servers in the Server list.

➤ **Entry Description**

- Server IP:** Enter the IP of the server running the RADIUS secure protocol.
- Shared Key:** Enter the shared key between the RADIUS server and the switch. The RADIUS server and the switch use the key string to encrypt passwords and exchange responses.
- Auth Port:** Specify the UDP destination port on the RADIUS server for authentication requests.
- Acct Port:** Specify the UDP destination port on the RADIUS server for accounting requests.
- Retransmit:** Specify the number of times a request is resent to a server if the server does not respond.
- Timeout:** Specify the time interval that the switch waits for the server to reply before resending.

14.11.4 TACACS+ Server Config

This page is used to configure the authentication servers running the TACACS+ security protocols.

Choose the menu **Network Security**→**AAA**→**TACACS+ Config** to load the following page.

Server Config

Server IP: (format:192.168.0.2)

Timeout: s(1-9)

Shared Key:

Port: (1-65535)

Server List

Select	Server IP	Timeout	Shared Key	Port
<input type="checkbox"/>		<input type="text"/>	<input type="text"/>	<input type="text"/>

Note:

- 1.The shared key should be the same as server.
- 2.Timeout should not be too large.

Figure 14-34 TACACS+ Server Config

➤ **Configuration Procedure**

Configure the TACACS+ server’s IP and other relevant parameters under the Server Config. View, edit and delete the configured TACACS+ servers in the Server list.

➤ **Entry Description**

- Server IP:** Enter the IP of the server running the TACACS+ secure protocol.
- Shared Key:** Enter the shared key between the TACACS+ server and the switch. The TACACS+ server and the switch use the key string to encrypt passwords and exchange responses.
- Timeout:** Specify the time interval that the switch waits for the server to reply before resending.
- Port:** Specify the TCP port used on the TACACS+ server for AAA.

14.11.5 Authentication Server Group Config

On this page users can group authentication servers running the same secure protocol for authentication. The switch has two built-in authentication server group, one for RADIUS and the other for TACACS+. These two server groups cannot be edited or deleted. The server entries in one group are tried in the order they are added.

The server entries in one group are tried in the order they are added.

Choose the menu **Network Security**→**AAA**→**Server Group** to load the following page.

Add New Server Group

Server Group:

Server Type:

Add

Server Group List

Select	Server Group	Server Type	Operation
<input type="checkbox"/>			
<input type="checkbox"/>	radius	RADIUS	Edit
<input type="checkbox"/>	tacacs	TACACS+	Edit

Delete Help

Figure 14-35 Create New Server Group

Add Server IP

Server Group:

Server Type:

Server IP:

Add

Back

Server List

Select	Server Ip
<input type="checkbox"/>	

No entry in the table.

All Delete Help

Figure 14-36 Add Server to Server Group

➤ **Configuration Procedure**

- 1) Configure the Server Group name and Server Type to create a server group.
- 2) Click edit in the Server Group List to configure the corresponding server group.
- 3) Select Server IP you have previously created and click add to add the server to the server group. (Figure 14-36)

View and delete the configured server groups in the Server Group list.

View and delete the configured servers in the server IP list.

➤ **Entry Description**

- Server Group:** Define a server group with a group name.
- Server Type:** Specify the server type as RADIUS or TACACS+.
- Server IP** Select the IP of the server you have previously configured.

Note:

1. The two built-in server groups radius and tacacs+ cannot be deleted or edited.
2. Up to 16 servers can be added to one server group.

14.11.6 Authentication Method List Config

Before you configure AAA authentication on a certain application, you should define an authentication method list first. An authentication method list describes the sequence and authentication method to be queried to authenticate a user.

The switch uses the first method listed to authenticate users, if that method fails to respond, the switch selects the next authentication method in the method list. This process continues until there is a successful communication with a listed authentication method or until all defined methods are exhausted. If authentication fails at any point in this circle, which means the secure server or the local switch denies the user's access, the authentication process stops and no other authentication methods are attempted.

For example, if a user defines an authentication login method list as tacacs-radius-local, the switch will send an authentication request to the first TACACS+ server in the tacacs server group. If there is no response, the switch will send an authentication request to the second TACACS+ server in the tacacs server group and so on, until the tacacs server group list is exhausted. Then the RADIUS server group will be queried. If no authentication is accomplished in the RADIUS server list, the switch will authenticate the user locally. This forms a backup system for authentication.

Choose the menu **Network Security**→**AAA**→**Authentication List** to load the following page.

Add Method List

Method List Name:

List Type:

Pri1:

Pri2:

Pri3:

Pri4:

Authentication Login Method List

Select	Method List	Pri1	Pri2	Pri3	Pri4
<input type="checkbox"/>		<input type="button" value="--"/>	<input type="button" value="--"/>	<input type="button" value="--"/>	<input type="button" value="--"/>
<input type="checkbox"/>	default	local	--	--	--

Authentication Enable Method List

Select	Method List	Pri1	Pri2	Pri3	Pri4
<input type="checkbox"/>		<input type="button" value="--"/>	<input type="button" value="--"/>	<input type="button" value="--"/>	<input type="button" value="--"/>
<input type="checkbox"/>	default	none	--	--	--

Figure 14-37 Authentication Method List Config

➤ Configuration Procedure

- 1) Enter the method list name.
- 2) Specify the authentication type as Login or Enable.
- 3) Configure the authentication method with priorities. The options are radius, tacacs, local or user-defined server groups.

View and delete the configured method priority list in the Authentication Login Method List and Authentication Enable Method List .

➤ **Entry Description**

- Method List Name:** Define a method list name.
- List Type:** Specify the authentication type as Login or Enable. Login stands for the Authentication Login Method List, and Enable stands for the Authentication Enable Method list.
- Pri1, Pri2, Pri3, Pri4:** Specify the authentication methods in order. The next authentication method is tried only if the previous method does not respond, not if it fails.
- local: Use the local database in the switch for authentication.
- none: No authentication is used.
- radius: Use the remote RADIUS server/server groups for authentication.
- tacacs: Use the remote TACACS+ server/server groups for authentication.
- user-defined server group: Use the user-defined server groups for authentication.



Tips:

If the Enable password is verified on the remote RADIUS server, the switch will send the Enable authentication with the default username as \$enable\$.

14.11.7 Application Authentication List Config

Users can configure authentication method lists on the following access applications: console, telnet, ssh and http.

Choose the menu **Network Security**→**AAA**→**Global Config** to load the following page.

Application Authentication Settings			
Select	Module	Login List	Enable List
<input type="checkbox"/>		default ▼	default ▼
<input type="checkbox"/>	console	default	default
<input type="checkbox"/>	telnet	default	default
<input type="checkbox"/>	ssh	default	default
<input type="checkbox"/>	http	default	default

Figure 14-38 Application Authentication Settings

➤ **Configuration Procedure**

- 1) Select the application module.
- 2) Configure the authentication method list from the Login List drop-down menu. This option defines the authentication method for users accessing the switch.
- 3) Configure the authentication method list from the Enable List drop-down menu. This option defines the authentication method for users requiring the administrator privilege.

➤ **Entry Description:**

- Module:** Lists of the configurable applications on the switch.
- Login List:** Configure an application for the login utilizing a previously configured method list.
- Enable List:** Configure an application to promote the user level to admin-level users utilizing a previously configured method list.

14.11.8 802.1X Authentication Server Config

This page is used to configure the RADIUS server group used in 802.1X Authentication, Accounting and IGMP Authentication.

Choose the menu **Network Security**→**AAA**→**Dot1x List** to load the following page.

The screenshot displays two configuration tables. The top table, titled 'Authentication Dot1x Method List', has three columns: 'Select', 'Method List', and 'Pri1'. The first row has an unchecked checkbox, an empty 'Method List' field, and a 'radius' dropdown menu. The second row has an unchecked checkbox, the text 'default' in the 'Method List' field, and the text 'radius' in the 'Pri1' field. An 'Apply' button is centered below the table. The bottom table, titled 'Accounting Dot1x Method List', has the same three columns. The first row has an unchecked checkbox, an empty 'Method List' field, and a 'radius' dropdown menu. The second row has an unchecked checkbox, the text 'default' in the 'Method List' field, and the text 'radius' in the 'Pri1' field. 'Apply' and 'Help' buttons are centered below this table.

Figure 14-39 802.1X Config

➤ **Configuration Procedure**

- 1) Configure the 802.1X function globally and on the supplicant-connected port. Please refer to 802.1X for more details.
- 2) Configure the 802.1X Authentication RADIUS server group in the Authentication Dot1x Method List Table.
- 3) Configure the 802.1X Accounting RADIUS server group in the Authentication Dot1x Method List Table.

14.11.9 Default Settings

The AAA function is disabled by default.

No enable password is configured by default.

The RADIUS server's Auth Port is 1812, Acct Port is 1813, Retransmit is 2 times and Timeout is 5 seconds.

The TACACS+ server's communication Port is 49 and Timeout is 5 seconds.

All RADIUS servers are added in the server group radius.

All TACACS+ servers are added in the Server group tacacs.

The Authentication Login Method List contains local by default, and the default login username and passwords are both admin.

The Authentication Enable Method List is empty by default, which means users can prompt to administrator privilege without password.

The application console/telnet/ssh/http use the default Login List and default Enable list by default. The 802.1X authentication uses the radius server group by default. The 802.1X accounting uses the radius server group by default.

[Return to CONTENTS](#)

Chapter 15 SNMP

➤ SNMP Overview

SNMP (Simple Network Management Protocol) has gained the most extensive application on the UDP/IP networks. SNMP provides a management frame to monitor and maintain the network devices. It is used for automatically managing the various network devices no matter the physical differences of the devices. Currently, the most network management systems are based on SNMP.

SNMP is simply designed and convenient for use with no need of complex fulfillment procedures and too much network resources. With SNMP function enabled, network administrators can easily monitor the network performance, detect the malfunctions and configure the network devices. In the meantime, they can locate faults promptly and implement the fault diagnosis, capacity planning and report generating.

➤ SNMP Management Frame

SNMP management frame includes three network elements: SNMP Management Station, SNMP Agent and MIB (Management Information Base).

SNMP Management Station: SNMP Management Station is the workstation for running the SNMP client program, providing a friendly management interface for the administrator to manage the most network devices conveniently.

SNMP Agent: Agent is the server software operated on network devices with the responsibility of receiving and processing the request packets from SNMP Management Station. In the meanwhile, Agent will inform the SNMP Management Station of the events whenever the device status changes or the device encounters any abnormalities such as device reboot.

MIB: MIB is the set of the managed objects. MIB defines a few attributes of the managed objects, including the names, the access rights, and the data types. Every SNMP Agent has its own MIB. The SNMP Management station can read/write the MIB objects based on its management right.

SNMP Management Station is the manager of SNMP network while SNMP Agent is the managed object. The information between SNMP Management Station and SNMP Agent are exchanged through SNMP (Simple Network Management Protocol). The relationship among SNMP Management Station, SNMP Agent and MIB is illustrated in the following figure.

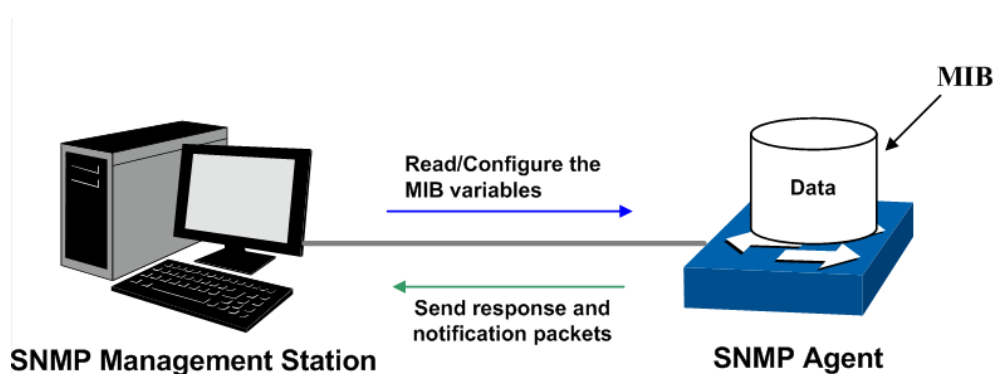

Figure 15-1 Relationship among SNMP Network Elements

➤ SNMP Versions

This switch supports SNMP v3, and is compatible with SNMP v1 and SNMP v2c. The SNMP versions adopted by SNMP Management Station and SNMP Agent should be the same. Otherwise, SNMP Management Station and SNMP Agent cannot communicate with each other normally. You can select the management mode with proper security level according to your actual application requirement.

SNMP v1: SNMP v1 adopts Community Name authentication. The community name is used to define the relation between SNMP Management Station and SNMP Agent. The SNMP packets failing to pass community name authentication are discarded. The community name can limit access to SNMP Agent from SNMP NMS, functioning as a password.

SNMP v2c: SNMP v2c also adopts community name authentication. It is compatible with SNMP v1 while enlarges the function of SNMP v1.

SNMP v3: Based on SNMP v1 and SNMP v2c, SNMP v3 extremely enhances the security and manageability. It adopts VACM (View-based Access Control Model) and USM (User-Based Security Model) authentication. The user can configure the authentication and the encryption functions. The authentication function is to limit the access of the illegal user by authenticating the senders of packets. Meanwhile, the encryption function is used to encrypt the packets transmitted between SNMP Management Station and SNMP Agent so as to prevent any information being stolen. The multiple combinations of authentication function and encryption function can guarantee a more reliable communication between SNMP Management station and SNMP Agent.

➤ **MIB Introduction**

To uniquely identify the management objects of the device in SNMP messages, SNMP adopts the hierarchical architecture to identify the managed objects. It is like a tree, and each tree node represents a managed object, as shown in the following figure. Thus the object can be identified with the unique path starting from the root and indicated by a string of numbers. The number string is the Object Identifier of the managed object. In the following figure, the OID of the managed object B is {1.2.1.1}. While the OID of the managed object A is {1.2.1.1.5}.

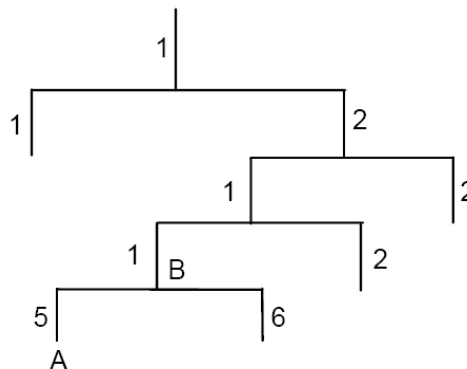

Figure 15-2 Architecture of the MIB tree

➤ **SNMP Configuration Outline**

1. Create View

The SNMP View is created for the SNMP Management Station to manage MIB objects. The managed object, uniquely identified by OID, can be set to under or out of the management of SNMP Management Station by configuring its view type (included/excluded). The OID of managed object can be found on the SNMP client program running on the SNMP Management Station.

2. Create SNMP Group

After creating the SNMP View, it's required to create a SNMP Group. The Group Name, Security Model and Security Level compose the identifier of the SNMP Group. The Groups with these three items the same are considered to be the same. You can configure SNMP Group to control the network access by providing the users in various groups with different management rights via the Read View, Write View and Notify View.

3. Create SNMP User

The User configured in a SNMP Group can manage the switch via the client program on management station. The specified User Name and the Auth/Privacy Password are used for SNMP Management Station to access the SNMP Agent, functioning as the password.

SNMP module is used to configure the SNMP function of the switch, including three submenus: **SNMP Config**, **Notification** and **RMON**.

15.1 SNMP Config

The **SNMP Config** can be implemented on the **Global Config**, **SNMP View**, **SNMP Group**, **SNMP User** and **SNMP Community** pages.

15.1.1 Global Config

To enable SNMP function, please configure the SNMP function globally on this page.

Choose the menu **SNMP**→**SNMP Config**→**Global Config** to load the following page.

The screenshot shows the 'Global Config' page for SNMP. It is divided into three sections:

- Global Config:** Contains a label 'SNMP:' followed by two radio buttons: 'Enable' (unselected) and 'Disable' (selected). An 'Apply' button is to the right.
- Local Engine:** Contains a label 'Local Engine ID:' followed by a text input field containing '80002e57036c626df5acbb' and a '(10-64 Hex)' label. To the right are 'Default ID' and 'Apply' buttons.
- Remote Engine:** Contains a label 'Remote Engine ID:' followed by an empty text input field and a '(0 or 10-64 Hex)' label. To the right are 'Apply' and 'Help' buttons.

Note:

The total hexadecimal characters of Engine ID should be even.

Figure 15-3 Global Config

The following entries are displayed on this screen:

➤ **Global Config**

SNMP: Enable/Disable the SNMP function.

➤ **Local Engine**

Local Engine ID: Specify the switch's Engine ID for the remote clients. The Engine ID is a unique alphanumeric string used to identify the SNMP engine on the switch.

➤ **Remote Engine**

Remote Engine ID: Specify the Remote Engine ID for switch. The Engine ID is a unique alphanumeric string used to identify the SNMP engine on the remote device which receives traps and informs from switch.

**Note:**

The amount of Engine ID characters must be even.

15.1.2 SNMP View

The OID (Object Identifier) of the SNMP packets is used to describe the managed objects of the switch, and the MIB (Management Information Base) is the set of the OIDs. The SNMP View is created for the SNMP management station to manage MIB objects.

Choose the menu **SNMP**→**SNMP Config**→**SNMP View** to load the following page.

View Config

View Name: (16 characters maximum)

MIB Object ID: (61 characters maximum) Create

View Type: Include Exclude

View Table

Select	View Name	View Type	MIB Object ID
<input type="checkbox"/>	viewDefault	Include	1
<input type="checkbox"/>	viewDefault	Exclude	1.3.6.1.6.3.15
<input type="checkbox"/>	viewDefault	Exclude	1.3.6.1.6.3.16
<input type="checkbox"/>	viewDefault	Exclude	1.3.6.1.6.3.18

All
Delete
Help

Figure 15-4 SNMP View

The following entries are displayed on this screen:

➤ **View Config**

View Name: Give a name to the View for identification. Each View can include several entries with the same name.

MIB Object ID: Enter the Object Identifier (OID) for the entry of View.

View Type: Select the type for the view entry.

- **Include:** The view entry can be managed by the SNMP management station.
- **Exclude:** The view entry cannot be managed by the SNMP management station.

➤ **View Table**

Select: Select the desired entry to delete the corresponding view. All the entries of a View will be deleted together.

View Name: Displays the name of the View entry.

View Type: Displays the type of the View entry.

MIB Object ID: Displays the OID of the View entry.

15.1.3 SNMP Group

On this page, you can configure SNMP Group to control the network access by providing the users in various groups with different management rights via the Read View, Write View and Notify View.

Choose the menu **SNMP**→**SNMP Config**→**SNMP Group** to load the following page.

Group Config

Group Name: (16 characters maximum)

Security Model: v1

Security Level: noAuthNoPriv

Read View: viewDefault

Write View: None

Notify View: None

Create Clear

Group Table

Select	Group Name	Security Model	Security Level	Read View	Write View	Notify View	Operation
--------	------------	----------------	----------------	-----------	------------	-------------	-----------

All Delete Help

Note:

A group should contain a read view, and the default read view is viewDefault.

Figure 15-5 SNMP Group

The following entries are displayed on this screen:

➤ **Group Config**

Group Name: Enter the SNMP Group name. The Group Name, Security Model and Security Level compose the identifier of the SNMP Group. The Groups with these three items the same are considered to be the same.

Security Model: Select the Security Model for the SNMP Group.

- **v1:** SNMPv1 is defined for the group. In this model, the Community Name is used for authentication. SNMP v1 can be configured on the SNMP Community page directly.
- **v2c:** SNMPv2c is defined for the group. In this model, the Community Name is used for authentication. SNMP v2c can be configured on the SNMP Community page directly.
- **v3:** SNMPv3 is defined for the group. In this model, the USM mechanism is used for authentication. If SNMPv3 is enabled, the Security Level field is enabled for configuration.

Security Level: Select the Security Level for the SNMP v3 Group.

- **noAuthNoPriv:** No authentication and no privacy security level is used.
- **authNoPriv:** Only the authentication security level is used.
- **authPriv:** Both the authentication and the privacy security levels are used.

Read View: Select the View to be the Read View. The management access is restricted to read-only, and changes cannot be made to the assigned SNMP View.

Write View: Select the View to be the Write View. The management access is writing only and changes can be made to the assigned SNMP View. The View defined both as the Read View and the Write View can be read and modified.

Notify View: Select the View to be the Notify View. The management station can receive trap messages of the assigned SNMP view generated by the switch's SNMP agent.

➤ **Group Table**

Select: Select the desired entry to delete the corresponding group. It is multi-optional.

Group Name: Displays the Group Name here.

Security Model: Displays the Security Model of the group.

Security Level: Displays the Security Level of the group.

Read View: Displays the Read View name in the entry.

Write View: Displays the Write View name in the entry.

Notify View: Displays the Notify View name in the entry.

Operation: Click the **Edit** button to modify the Views in the entry and click the **Modify** button to apply.



Note:

Every Group should contain a Read View. The default Read View is viewDefault.

15.1.4 SNMP User

The User in a SNMP Group can manage the switch via the management station software. The User and its Group have the same security level and access right. You can configure the SNMP User on this page.

Choose the menu **SNMP**→**SNMP Config**→**SNMP User** to load the following page.

User Config

User Name: (16 characters maximum)

User Type: Group Name:

Security Model: Security Level:

Auth Mode: Auth Password: (16 characters maximum)

Privacy Mode: Privacy Password: (16 characters maximum)

User Table

Select	User Name	User Type	Group Name	Security Model	Security Level	Auth Mode	Privacy Mode	Operation

Note:

The security model and security level of the user should be the same with that of its group.

Figure 15-6 SNMP User

The following entries are displayed on this screen:

➤ **User Config**

- User Name:** Enter the User Name here.
- User Type:** Select the type for the User.
 - **Local User:** Indicates that the user is connected to a local SNMP engine.
 - **Remote User:** Indicates that the user is connected to a remote SNMP engine.
- Group Name:** Select the Group Name of the User. The User is classified to the corresponding Group according to its Group Name, Security Model and Security Level.
- Security Model:** Select the Security Model for the User.
- Security Level:** Select the Security Level for the SNMP v3 User.
- Auth Mode:** Select the Authentication Mode for the SNMP v3 User.
 - **None:** No authentication method is used.
 - **MD5:** The port authentication is performed via HMAC-MD5 algorithm.
 - **SHA:** The port authentication is performed via SHA (Secure Hash Algorithm). This authentication mode has a higher security than MD5 mode.
- Auth Password:** Enter the password for authentication.
- Privacy Mode:** Select the Privacy Mode for the SNMP v3 User.
 - **None:** No privacy method is used.
 - **DES:** DES encryption method is used.
- Privacy Password:** Enter the Privacy Password.

➤ **User Table**

- Select:** Select the desired entry to delete the corresponding User. It is multi-optional.
- User Name:** Displays the name of the User.
- User Type:** Displays the User Type.
- Group Name:** Displays the Group Name of the User.
- Security Model:** Displays the Security Model of the User.
- Security Level:** Displays the Security Level of the User.
- Auth Mode:** Displays the Authentication Mode of the User.
- Privacy Mode:** Displays the Privacy Mode of the User.
- Operation:** Click the **Edit** button to modify the Group of the User and click the **Modify** button to apply.



Note:

The SNMP User and its Group should have the same Security Model and Security Level.

15.1.5 SNMP Community

SNMP v1 and SNMP v2c adopt community name authentication. The community name can limit access to the SNMP agent from SNMP network management station, functioning as a password. If SNMP v1 or SNMP v2c is employed, you can directly configure the SNMP Community on this page without configuring SNMP Group and User.

Choose the menu **SNMP**→**SNMP Config**→**SNMP Community** to load the following page.

Community Config

Community Name: (16 characters maximum)

Access:

MIB View:

Community Table

Select	Community Name	Access	MIB View	Operation
<input type="button" value="All"/>		<input type="button" value="Delete"/>		<input type="button" value="Help"/>

Note:

The default MIB view of community is viewDefault.

Figure 15-7 SNMP Community

The following entries are displayed on this screen:

➤ **Community Config**

- Community Name:** Enter the Community Name here.

- Access:** Defines the access rights of the community.
- **read-only:** Management right of the Community is restricted to read-only, and changes cannot be made to the corresponding View.
 - **read-write:** Management right of the Community is read-write and changes can be made to the corresponding View.

MIB View: Select the MIB View for the community to access.

➤ **Community Table**

Select: Select the desired entry to delete the corresponding Community. It is multi-optional.

Community Name: Displays the Community Name here.

Access: Displays the right of the Community to access the View.

MIB View: Displays the Views which the Community can access.

Operation: Click the **Edit** button to modify the MIB View and the Access right of the Community, and then click the **Modify** button to apply.



Note:

The default MIB View of SNMP Community is viewDefault.

Configuration Procedure:

- If SNMPv3 is employed, please take the following steps:

Step	Operation	Description
1	Enable SNMP function globally.	Required. On the SNMP→SNMP Config→Global Config page, enable SNMP function globally.
2	Create SNMP View.	Required. On the SNMP→SNMP Config→SNMP View page, create SNMP View of the management agent. The default View Name is viewDefault and the default OID is 1.
3	Create SNMP Group.	Required. On the SNMP→SNMP Config→SNMP Group page, create SNMP Group for SNMPv3 and specify SNMP Views with various access levels for SNMP Group.
4	Create SNMP User.	Required. On the SNMP→SNMP Config→SNMP User page, create SNMP User in the Group and configure the auth/privacy mode and auth/privacy password for the User.

- If SNMPv1 or SNMPv2c is employed, please take the following steps:

Step	Operation		Description
1	Enable SNMP function globally.		Required. On the SNMP→SNMP Config→Global Config page, enable SNMP function globally.
2	Create SNMP View.		Required. On the SNMP→SNMP Config→SNMP View page, create SNMP View of the management agent. The default View Name is viewDefault and the default OID is 1.
3	Configure access level for the User.	Create SNMP Community directly.	Required alternatively. <ul style="list-style-type: none"> • Create SNMP Community directly. On the SNMP→SNMP Config→SNMP Community page, create SNMP Community based on SNMP v1 and SNMP v2c. • Create SNMP Group and SNMP User. Similar to the configuration way based on SNMPv3, you can create SNMP Group and SNMP User of SNMP v1/v2c. The User name can limit access to the SNMP agent from SNMP network management station, functioning as a community name. The users can manage the device via the Read View, Write View and Notify View defined in the SNMP Group.
		Create SNMP Group and SNMP User.	

15.2 Notification

With the Notification function enabled, the switch can initiatively report to the management station about the important events that occur on the Views (e.g., the managed device is rebooted), which allows the management station to monitor and process the events in time.

The notification information includes the following two types:

Trap: Trap is the information that the managed device initiatively sends to the Network management station without request.

Inform: Inform packet is sent to inform the management station and ask for the reply. The switch will resend the inform request if it doesn't get the response from the management station during the Timeout interval, and it will terminate resending the inform request if the resending times reach the specified Retry times. The Inform type, employed on SNMPv2c and SNMPv3, has a higher security than the Trap type.

On this page, you can configure the notification function of SNMP.

Choose the menu **SNMP**→**Notification**→**Notification Config** to load the following page.

The screenshot shows the 'Notification Config' page. The 'Host Config' section contains the following fields and values: IP Address (empty), User (empty), Security Model (v1), Type (Trap), Retry (empty), Timeout (empty), UDP Port (162), IP Mode (IPv4), and Security Level (noAuthNoPriv). There are 'Create' and 'Clear' buttons. The 'Notification Table' section shows a table with columns: Select, IP Address, IP Mode, UDP Port, User, Security Model, Security Level, Type, Retry, Timeout, and Operation. The table is empty, with the text 'No entry in the table.' and 'All', 'Delete', and 'Help' buttons below it.

Figure 15-8 Notification Config

The following entries are displayed on this screen:

➤ **Host Config**

- IP Address:** Enter the IP Address of the management Host.
- User:** Enter the User name of the management station.
- Security Model:** Select the Security Model of the management station.
- Type:** Select the type for the notifications.
- **Trap:** Indicates traps are sent.
 - **Inform:** Indicates informs are sent. The Inform type has a higher security than the Trap type.
- Retry:** Specify the amount of times the switch resends an inform request. The switch will resend the inform request if it doesn't get the response from the management station during the **Timeout** interval, and it will terminate resending the inform request if the resending times reach the specified **Retry** times.
- Timeout:** Specify the maximum time for the switch to wait for the response from the management station before resending a request.
- UDP Port:** Enter the number of the UDP port used to send notifications. The UDP port functions with the IP address for the notification sending. The default is 162.
- IP Mode:** Select the IP mode of the IP address.
- Security Level:** Select the Security Model of the management station.

➤ **Notification Table**

- Select:** Select the desired entry to delete the corresponding management station.
- IP Address:** Displays the IP Address of the management host.
- IP Mode:** Displays the IP mode of the IP address.
- UDP Port:** Displays the UDP port used to send notifications.

User:	Displays the User name of the management station.
Security Model:	Displays the Security Model of the management station.
Security Level:	Displays the Security Level for the SNMP v3 User.
Type:	Displays the type of the notifications.
Retry:	Displays the amount of times the switch resends an inform request.
Timeout:	Displays the maximum time for the switch to wait for the response from the management station before resending a request.
Operation:	Click the Edit button to modify the corresponding entry and click the Modify button to apply.

15.3 RMON

RMON (Remote Monitoring) based on SNMP (Simple Network Management Protocol) architecture, functions to monitor the network. RMON is currently a commonly used network management standard defined by Internet Engineering Task Force (IETF), which is mainly used to monitor the data traffic across a network segment or even the entire network so as to enable the network administrator to take the protection measures in time to avoid any network malfunction. In addition, RMON MIB records network statistics information of network performance and malfunction periodically, based on which the management station can monitor network at any time effectively. RMON is helpful for network administrator to manage the large-scale network since it reduces the communication traffic between management station and managed agent.

➤ RMON Group

This switch supports the following four RMON Groups defined on the RMON standard (RFC1757): History Group, Event Group, Statistic Group and Alarm Group.

RMON Group	Function
History Group	After a history group is configured, the switch collects and records network statistics information periodically, based on which the management station can monitor network effectively.
Event Group	Event Group is used to define RMON events. Alarms occur when an event is detected.
Statistic Group	Statistic Group is set to monitor the statistic of alarm variables on the specific ports.
Alarm Group	Alarm Group is configured to monitor the specific alarm variables. When the value of a monitored variable exceeds the threshold, an alarm event is generated, which triggers the switch to act in the set way.

The **RMON** Groups can be configured on the **Statistics, History, Event** and **Alarm** pages.

15.3.1 Statistics

On this page you can configure and view the statistics entry.

Choose the menu **SNMP**→**RMON**→**Statistics** to load the following page.

The screenshot shows a web interface for configuring and viewing statistics. It is divided into two main sections: "Statistics Config" and "Statistics Table".

Statistics Config section includes:

- ID:** A text input field with a placeholder "(1-65535)".
- Port:** A text input field with a "Choose" button next to it, and a "(Format: 1/0/1)" note.
- Owner:** A text input field with a "(16 characters maximum)" note.
- Status:** A dropdown menu currently showing "valid".
- Two buttons on the right: "Create" and "Clear".

Statistics Table section includes:

Select	ID	Port	Owner	Status	Operation
No entry in the table.					

Below the table are three buttons: "All", "Delete", and "Help".

Figure 15-9 Statistics

The following entries are displayed on this screen:

➤ **Statistics Config**

- ID:** Enter the ID number of statistics entry, ranging from 1 to 65535.
- Port:** Enter or choose the Ethernet interface from which to collect the statistics.
- Owner:** Enter the owner name.
- Status:** Choose the status of statistics entry.
 - **valid:** The entry exists and is valid.
 - **underCreation:** The entry exists, but is not valid.

➤ **Statistics Table**

- Select:** Select the desired entry to delete the corresponding statistics entry. It's multi-optional.
- ID:** Displays the ID number of the statistics entry.
- Port:** Displays the Ethernet interface from which to collect the statistics.
- Owner:** Displays the owner name.
- Status:** Displays the status of the statistics entry.

15.3.2 History

On this page, you can configure the History Group for RMON.

Choose the menu **SNMP**→**RMON**→**History** to load the following page.

History Control Table						
Select	Index	Port	Interval(sec)	Max Buckets	Owner	Status
<input type="checkbox"/>		<input type="text"/>	<input type="text"/>	<input type="text"/>	<input type="text"/>	<input type="text"/>
<input type="checkbox"/>	1	1/0/1	1800	50	monitor	Disable
<input type="checkbox"/>	2	1/0/1	1800	50	monitor	Disable
<input type="checkbox"/>	3	1/0/1	1800	50	monitor	Disable
<input type="checkbox"/>	4	1/0/1	1800	50	monitor	Disable
<input type="checkbox"/>	5	1/0/1	1800	50	monitor	Disable
<input type="checkbox"/>	6	1/0/1	1800	50	monitor	Disable
<input type="checkbox"/>	7	1/0/1	1800	50	monitor	Disable
<input type="checkbox"/>	8	1/0/1	1800	50	monitor	Disable
<input type="checkbox"/>	9	1/0/1	1800	50	monitor	Disable
<input type="checkbox"/>	10	1/0/1	1800	50	monitor	Disable
<input type="checkbox"/>	11	1/0/1	1800	50	monitor	Disable
<input type="checkbox"/>	12	1/0/1	1800	50	monitor	Disable

Figure 15-10 History Control

The following entries are displayed on this screen:

➤ **History Control Table**

- Select:** Select the desired entry for configuration.
- Index:** Displays the index number of the entry.
- Port:** Specify the port from which the history samples were taken.
- Interval:** Specify the interval to take samplings from the port.
- Max Buckets:** Displays the maximum number of buckets desired for the RMON history group of statistics, ranging from 1 to 130. The default is 50 buckets. 130 buckets supported at most so far.
- Owner:** Enter the name of the device or user that defined the entry.
- Status:** Select Enable/Disable the corresponding sampling entry.

15.3.3 Event

On this page, you can configure the RMON events.

Choose the menu **SNMP**→**RMON**→**Event** to load the following page.

Select	Index	User	Description	Type	Owner	Status
<input type="checkbox"/>		<input type="text"/>	<input type="text"/>	None <input type="button" value="v"/>	<input type="text"/>	Disable <input type="button" value="v"/>
<input type="checkbox"/>	1	public		None	monitor	Disable
<input type="checkbox"/>	2	public		None	monitor	Disable
<input type="checkbox"/>	3	public		None	monitor	Disable
<input type="checkbox"/>	4	public		None	monitor	Disable
<input type="checkbox"/>	5	public		None	monitor	Disable
<input type="checkbox"/>	6	public		None	monitor	Disable
<input type="checkbox"/>	7	public		None	monitor	Disable
<input type="checkbox"/>	8	public		None	monitor	Disable
<input type="checkbox"/>	9	public		None	monitor	Disable
<input type="checkbox"/>	10	public		None	monitor	Disable
<input type="checkbox"/>	11	public		None	monitor	Disable
<input type="checkbox"/>	12	public		None	monitor	Disable

Figure 15-11 Event Config

The following entries are displayed on this screen:

➤ **Event Table**

- Select:** Select the desired entry for configuration.
- Index:** Displays the index number of the entry.
- User:** Enter the name of the User or the community to which the event belongs.
- Description:** Give a description to the event for identification.
- Type:** Select the event type, which determines the act way of the network device in response to an event.
- **None:** No processing.
 - **Log:** Logging the event.
 - **Notify:** Sending trap messages to the management station.
 - **Log&Notify:** Logging the event and sending trap messages to the management station.
- Owner:** Enter the name of the device or user that defined the entry.
- Status:** Select Enable/Disable the corresponding event entry.

15.3.4 Alarm Config

On this page, you can configure Statistic Group and Alarm Group for RMON.

Choose the menu **SNMP**→**RMON**→**Alarm** to load the following page.

Alarm Config												
Select	Index	Variable	Statistics	Sample Type	Rising Threshold	Rising Event	Falling Threshold	Falling Event	Alarm Type	Interval(sec)	Owner	Status
<input type="checkbox"/>												
<input type="checkbox"/>	1	RecBytes		Absolute	100		100		All	1800	monitor	Disable
<input type="checkbox"/>	2	RecBytes		Absolute	100		100		All	1800	monitor	Disable
<input type="checkbox"/>	3	RecBytes		Absolute	100		100		All	1800	monitor	Disable
<input type="checkbox"/>	4	RecBytes		Absolute	100		100		All	1800	monitor	Disable
<input type="checkbox"/>	5	RecBytes		Absolute	100		100		All	1800	monitor	Disable
<input type="checkbox"/>	6	RecBytes		Absolute	100		100		All	1800	monitor	Disable
<input type="checkbox"/>	7	RecBytes		Absolute	100		100		All	1800	monitor	Disable
<input type="checkbox"/>	8	RecBytes		Absolute	100		100		All	1800	monitor	Disable
<input type="checkbox"/>	9	RecBytes		Absolute	100		100		All	1800	monitor	Disable
<input type="checkbox"/>	10	RecBytes		Absolute	100		100		All	1800	monitor	Disable
<input type="checkbox"/>	11	RecBytes		Absolute	100		100		All	1800	monitor	Disable
<input type="checkbox"/>	12	RecBytes		Absolute	100		100		All	1800	monitor	Disable

Figure 15-12 Alarm Config

The following entries are displayed on this screen:

➤ Alarm Config

- Select:** Select the desired entry for configuration.
- Index:** Displays the index number of the entry.
- Variable:** Select the alarm variables from the pull-down list.
- Statistics:** Select the RMON statistics entry from which we get the value of the selected alarm variable.
- Sample Type:** Specify the sampling method for the selected variable and comparing the value against the thresholds.
- **Absolute:** Compares the values directly with the thresholds at the end of the sampling interval.
 - **Delta:** Subtracts the last sampled value from the current value. The difference in the values is compared to the threshold.
- Rising Threshold:** Enter the rising counter value that triggers the Rising Threshold alarm.
- Rising Event:** Select the index of the corresponding event which will be triggered if the sampled value is larger than the Rising Threshold.
- Falling Threshold:** Enter the falling counter value that triggers the Falling Threshold alarm.
- Falling Event:** Select the index of the corresponding event which will be triggered if the sampled value is lower than the Falling Threshold.

Alarm Type:

Specify the type of the alarm.

- **All:** The alarm event will be triggered either the sampled value exceeds the Rising Threshold or is under the Falling Threshold.
- **Rising:** When the sampled value exceeds the Rising Threshold, an alarm event is triggered.
- **Falling:** When the sampled value is under the Falling Threshold, an alarm event is triggered.

Interval:

Enter the alarm interval time in seconds.

Owner:

Enter the name of the device or user that defined the entry.

Status:

Select Enable/Disable the corresponding alarm entry.

**Note:**

When alarm variables exceed the Threshold on the same direction continuously for several times, an alarm event will only be generated on the first time, that is, the Rising Alarm and Falling Alarm are triggered alternately for that the alarm following to Rising Alarm is certainly a Falling Alarm and vice versa.

[Return to CONTENTS](#)

Chapter 16 LLDP

LLDP (Link Layer Discovery Protocol) is a Layer 2 protocol that is used for network devices to advertise their own device information periodically to neighbors on the same IEEE 802 local area network. The advertised information, including details such as device identification, capabilities and configuration settings, is represented in TLV (Type/Length/Value) format according to the IEEE 802.1ab standard, and these TLVs are encapsulated in LLDPDU (Link Layer Discovery Protocol Data Unit). The LLDPDU distributed via LLDP is stored by its recipients in a standard MIB (Management Information Base), making it possible for the information to be accessed by a Network Management System (NMS) using a management protocol such as the Simple Network Management Protocol (SNMP).

An IETF Standard MIB, as well as a number of vendor specific MIBs, have been created to describe a network's physical topology and associated systems within that topology. However, there is no standard protocol for populating these MIBs or communicating this information among stations on the IEEE 802 LAN. LLDP protocol specifies a set. The device running LLDP can automatically discover and learn about the neighbors, allowing for interoperability between the network devices of different vendors. This protocol allows two systems running different network layer protocols to learn about each other.

LLDP-MED (Link Layer Discovery Protocol for Media Endpoint Devices) is an extension of LLDP intended for managing endpoint devices such as Voice over IP phones and network switches. The LLDP-MED TLVs advertise information such as network policy, power via MDI, inventory management, and device location details.

The LLDP and LLDP-MED information can be used by SNMP applications to simplify troubleshooting, enhance network management, and maintain an accurate network topology.

➤ LLDPDU Format

Each LLDPDU includes an ordered sequence of three mandatory TLVs followed by one or more optional TLVs plus an End of LLDPDU TLV, as shown in the figure below. Chassis ID TLV, Port ID TLV, TTL TLV and End TLV are the four mandatory TLVs for a LLDPDU. Optional TLVs provide various details about the LLDP agent advertising them and they are selected by network management.

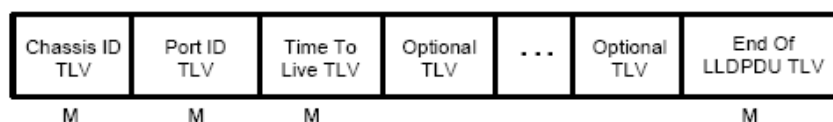

M - mandatory TLV - required for all LLDPDUs

The maximum length of the LLDPDU shall be the maximum information field length allowed by the particular transmission rate and protocol. In IEEE 802.3 MACs, for example, the maximum LLDPDU length is the maximum data field length for the basic, untagged MAC frame (1500 octets).

➤ LLDP Working Mechanism

1) LLDP Admin Status

The transmission and the reception of LLDPDUs can be separately enabled for every port, making it possible to configure an implementation to restrict the port either to transmit only or receive only, or to allow the port to both transmit and receive LLDPDUs. Four LLDP admin statuses are supported by each port.

- Tx&Rx: the port can both transmit and receive LLDPDUs.
- Rx_Only: the port can receive LLDPDUs only.
- Tx_Only: the port can transmit LLDPDUs only.
- Disable: the port cannot transmit or receive LLDPDUs.

2) LLDPDU transmission mechanism

- If the ports are working in TxRx or Tx mode, they will advertise local information by sending LLDPDUs periodically.
- If there is a change in the local device, the change notification will be advertised. To prevent a series of successive LLDPDUs transmissions during a short period due to frequent changes in local device, a transmission delay timer is set by network management to ensure that there is a defined minimum time between successive LLDP frame transmissions.
- If the LLDP admin status of the port is changed from Disable/Rx to TxRx/Tx, the Fast Start Mechanism will be active, the transmit interval turns to be 1 second, several LLDPDUs will be sent out, and then the transmit interval comes back to the regular interval.

3) LLDPDU receipt mechanism

When a port is working in TxRx or Rx mode, the device will check the validity of the received LLDPDUs and the attached TLVs, save this neighbor information to the local device and then set the aging time of this information according to the TTL value of TTL (Time To Live) TLV. Once the TTL is 0, this neighbor information will be aged out immediately.

The aging time of the local information in the neighbor device is determined by TTL. Hold Multiplier is a multiplier on the Transmit Interval that determines the actual TTL value used in an LLDPDU. $TTL = Hold\ Multiplier * Transmit\ Interval$.

➤ TLV

TLV refers to Type/Length/Value and is contained in a LLDPDU. Type identifies what kind of information is being sent, Length indicates the length of information string in octets and Value is the actual information to be sent. The basic TLV Format is shown as follows:

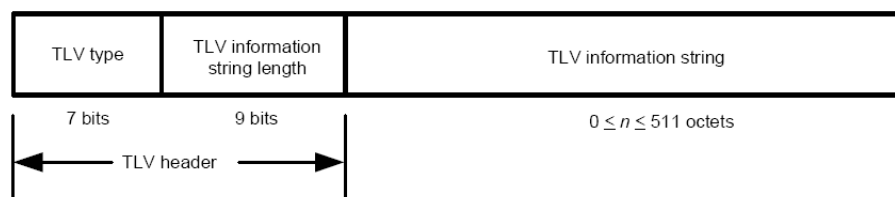

Each TLV is identified by a unique TLV type value that indicates the particular kind of information contained in the TLV.

The following table shows the details about the currently defined TLVs.

TLV type	TLV Name	Description	Usage in LLDPDU
0	End of LLDPDU	Mark the end of the TLV sequence in LLDPDUs. Any information following an End Of LLDPDU TLV shall be ignored.	Mandatory
1	Chassis ID	Identifies the Chassis address of the connected device.	Mandatory
2	Port ID	Identifies the specific port that transmitted the LLDP frame. When the device does not advertise MED TLV, this field displays the port name of the port; when the device advertises MED TLV, this field displays the MAC address of the port.	Mandatory
3	Time To Live	Indicates the number of seconds that the neighbor device is to regard the local information to be valid.	Mandatory
4	Port Description	Identifies the description string of the port.	Optional
5	System Name	Identifies the system name.	Optional
6	System Description	Identifies the system description.	Optional
7	System Capabilities	Identifies the main functions of the system and the functions enabled.	Optional
8	Management Address	Identifies the management IP address, the corresponding interface number and OID (Object Identifier). The management IP address is specified by the user.	Optional
127	Organizationally Specific	Allows different organizations, such as IEEE 802.1, IEEE 802.3, IETF, as well as individual software and equipment vendors, to define TLVs that advertise information to remote device.	Optional

Optional TLVs are grouped into two categories including basic management TLV and Organizationally-specific TLV.

1) Basic Management TLV

A set of TLVs considered to be basic to the management of the network stations are required for all LLDP implementations.

2) Organizationally Specific TLV

Different organizations have defined various TLVs. For instance, Port VLAN ID TLV, Port and Protocol VLAN ID TLV, VLAN Name TLV And Protocol Identity TLV are defined by IEEE 802.1, while MAC/PHY Configuration/Status TLV, Power Via MDI TLV, Link Aggregation TLV and Maximum Frame TLV are defined by IEEE 802.3. Some specific TLVs are for LLDP-MED protocol, such as LLDP-MED Capabilities TLV, Network Policy TLV, Extended Power-via-MDI TLV, Hardware Revision TLV and so on.

**Note:**

For detailed introduction of TLV, please refer to IEEE 802.1AB standard and ANSI/TIA-1057.

In TP-LINK switch, the following LLDP optional TLVs are supported.

TLV Type	Description
Port Description TLV	The Port Description TLV allows network management to advertise the IEEE 802 LAN station's port description.
System Capabilities TLV	The System Capabilities TLV identifies the primary functions of the system and whether or not these primary functions are enabled.
System Description TLV	The System Description TLV allows network management to advertise the system's description, which should include the full name and version identification of the system's hardware type, software operating system, and networking software.
System Name TLV	The System Name TLV allows network management to advertise the system's assigned name, which should be the system's fully qualified domain name.
Management Address TLV	The Management Address TLV identifies an address associated with the local LLDP agent that may be used to reach higher entities to assist discovery by network management.
Port VLAN ID TLV	The Port VLAN ID TLV allows a VLAN bridge port to advertise the port's VLAN identifier (PVID) that will be associated with untagged or priority tagged frames.
Port And Protocol VLAN ID TLV	The Port And Protocol VLAN ID TLV allows a bridge port to advertise a port and protocol VLAN ID.
VLAN Name TLV	The VLAN Name TLV allows an IEEE 802.1Q-compatible IEEE 802 LAN station to advertise the assigned name of any VLAN with which it is configured.
Link Aggregation TLV	The Link Aggregation TLV indicates whether the link is capable of being aggregated, whether the link is currently in an aggregation, and if in an aggregation, the port identification of the aggregation.
MAC/PHY Configuration/Status TLV	The MAC/PHY Configuration/Status TLV identifies: a)The duplex and bit-rate capability of the sending IEEE 802.3 LAN node that is connected to the physical medium; b)The current duplex and bit-rate settings of the sending IEEE 802.3 LAN node; c)Whether these settings are the result of auto-negotiation during link initiation or of manual set override action.
Max Frame Size TLV	The Maximum Frame Size TLV indicates the maximum frame size capability of the implemented MAC and PHY.
Power Via MDI TLV	The Power Via MDI TLV allows network management to advertise and discover the MDI power support capabilities of the sending IEEE 802.3 LAN station.

The LLDP module is mainly for LLDP function configuration of the switch, including three submenus: **Basic Config**, **Device Info**, **Device Statistics** and **LLDP-MED**.

16.1 Basic Config

LLDP is configured on the **Global Config** and **Port Config** pages.

16.1.1 Global Config

On this page you can configure the LLDP parameters of the device globally.

Choose the menu **LLDP**→**Basic Config**→**Global Config** to load the following page.

Global Config

LLDP: Enable Disable

Parameters Config

Transmit Interval: sec(5-32768)

Hold Multiplier: (2-10)

Transmit Delay: sec(1-8192)

Reinit Delay: sec(1-10)

Notification Interval: sec(5-3600)

Fast Start Times: (1-10)

Figure 16-1 LLDP Global Configuration

The following entries are displayed on this screen:

➤ **Global Config**

LLDP: Enable/disable LLDP function globally.

➤ **Parameters Config**

Transmit Interval: Enter the interval for the local device to transmit LLDPDU to its neighbors. The default value is 30 seconds.

Hold Multiplier: Enter a multiplier on the Transmit Interval. It determines the actual TTL (Time To Live) value used in an LLDPDU. $TTL = \text{Hold Multiplier} * \text{Transmit Interval}$. The default value is 4.

Transmit Delay: Enter a value from 1 to 8192 in seconds to specify the time for the local device to transmit LLDPDU to its neighbors after changes occur so as to prevent LLDPDU being sent frequently. The default value is 2 seconds.

Reinit Delay: This parameter indicates the amount of delay from when LLDP status becomes "disable" until re-initialization will be attempted. The default value is 2 seconds.

Notification Interval: Specify the interval of Trap message which will be sent from local device to network management system. The default value is 5 seconds.

Fast Start Times:

When the port's LLDP state transforms from Disable (or Rx_Only) to Tx&Rx (or Tx_Only), the fast start mechanism will be enabled, that is, the transmit interval will be shortened to a second, and several LLDPDUs will be sent out (the number of LLDPDUs equals this parameter). The default value is 3.

16.1.2 Port Config

On this page you can configure all ports' LLDP parameters.

Choose the menu **LLDP**→**Basic Config**→**Port Config** to load the following page.

Select	Port	Admin Status	Notification Mode	Included TLVs												
<input type="checkbox"/>				<input checked="" type="checkbox"/>	<input checked="" type="checkbox"/>	<input checked="" type="checkbox"/>	<input checked="" type="checkbox"/>	<input checked="" type="checkbox"/>	<input checked="" type="checkbox"/>	<input checked="" type="checkbox"/>	<input checked="" type="checkbox"/>	<input checked="" type="checkbox"/>	<input checked="" type="checkbox"/>	<input checked="" type="checkbox"/>	<input checked="" type="checkbox"/>	<input checked="" type="checkbox"/>
<input type="checkbox"/>	1/0/1	Tx&Rx	Disable	PD	SC	SD	SN	SA	PV	VP	VA	LA	PS	FS	PW	
<input type="checkbox"/>	1/0/2	Tx&Rx	Disable	PD	SC	SD	SN	SA	PV	VP	VA	LA	PS	FS	PW	
<input type="checkbox"/>	1/0/3	Tx&Rx	Disable	PD	SC	SD	SN	SA	PV	VP	VA	LA	PS	FS	PW	
<input type="checkbox"/>	1/0/4	Tx&Rx	Disable	PD	SC	SD	SN	SA	PV	VP	VA	LA	PS	FS	PW	
<input type="checkbox"/>	1/0/5	Tx&Rx	Disable	PD	SC	SD	SN	SA	PV	VP	VA	LA	PS	FS	PW	
<input type="checkbox"/>	1/0/6	Tx&Rx	Disable	PD	SC	SD	SN	SA	PV	VP	VA	LA	PS	FS	PW	
<input type="checkbox"/>	1/0/7	Tx&Rx	Disable	PD	SC	SD	SN	SA	PV	VP	VA	LA	PS	FS	PW	
<input type="checkbox"/>	1/0/8	Tx&Rx	Disable	PD	SC	SD	SN	SA	PV	VP	VA	LA	PS	FS	PW	
<input type="checkbox"/>	1/0/9	Tx&Rx	Disable	PD	SC	SD	SN	SA	PV	VP	VA	LA	PS	FS	PW	
<input type="checkbox"/>	1/0/10	Tx&Rx	Disable	PD	SC	SD	SN	SA	PV	VP	VA	LA	PS	FS	PW	
<input type="checkbox"/>	1/0/11	Tx&Rx	Disable	PD	SC	SD	SN	SA	PV	VP	VA	LA	PS	FS	PW	
<input type="checkbox"/>	1/0/12	Tx&Rx	Disable	PD	SC	SD	SN	SA	PV	VP	VA	LA	PS	FS	PW	
<input type="checkbox"/>	1/0/13	Tx&Rx	Disable	PD	SC	SD	SN	SA	PV	VP	VA	LA	PS	FS	PW	
<input type="checkbox"/>	1/0/14	Tx&Rx	Disable	PD	SC	SD	SN	SA	PV	VP	VA	LA	PS	FS	PW	
<input type="checkbox"/>	1/0/15	Tx&Rx	Disable	PD	SC	SD	SN	SA	PV	VP	VA	LA	PS	FS	PW	

TLV Abbreviation:

PD - Port Description	SC - System Capabilities	SD - System Description
SN - System Name	SA - Management Address	PV - Port VLAN ID
VP - Port And Protocol VLAN ID	VA - VLAN Name	LA - Link Aggregation
PS - MAC/PHY Configuration/Status	FS - Max Frame Size	PW - Power Via MDI

Figure 16-2 LLDP Port Config

The following entries are displayed on this screen:

➤ LLDP Port Config

Port Select:

Select the desired port to configure.

Admin Status:

Select the port's LLDP operating mode:

Tx&Rx: send and receive LLDP frames.

Rx_Only: Only receive LLDP frames.

Tx_Only: Only send LLDP frames.

Disable: neither send nor receive LLDP frames.

Notification Mode: Allows you to enable or disable the ports' SNMP notification. If enabled, the local device will notify the trap event to SNMP server.

Included TLVs: Select TLVs to be included in outgoing LLDPDU.

16.2 Device Info

You can view the LLDP information of the local device and its neighbors on the **Local Info** and **Neighbor Info** pages respectively.

16.2.1 Local Info

On this page you can see all ports' configuration and system information.

Choose the menu **LLDP**→**Device Info**→**Local Info** to load the following page.

Port 1/0/2	
Local Interface:	1/0/2
Chassis ID Subtype:	MAC address
Chassis ID:	00-0A-EB-13-23-7B
Port ID Subtype:	Interface name
Port ID:	GigabitEthernet1/0/2
TTL:	120
Port Description:	GigabitEthernet1/0/2 Interface
System Name:	T1600G-52TS
System Description:	JetStream 48-Port Gigabit Smart Switch with 4 SFP Slots
System Capabilities Supported:	Bridge Router
System Capabilities Enabled:	Bridge Router
Management Address:	192.168.0.1

Figure 16-3 LLDP Local Information

The following entries are displayed on this screen:

➤ **Auto Refresh**

Auto Refresh: Enable/Disable the auto refresh function.

Refresh Rate: Specify the auto refresh rate.

➤ **Local Info**

Select the desired port number to display the information of the corresponding port.

Local Interface: Display local port number.

Chassis ID Subtype:	Indicate the basis for the chassis ID, and the default subtype is MAC address.
Chassis ID:	Indicate the specific identifier for the particular chassis in local device.
Port ID Subtype:	Indicate the basis for the port ID, and the default subtype is interface name.
Port ID:	Indicate the specific identifier for the port in local device.
TTL:	Indicate the number of seconds that the recipient LLDP agent is to regard the information associated with this chassis ID and port ID identifier to be valid.
Port Description:	Display local port's description.
System Name:	Indicate local device's administratively assigned name.
System Description:	Display local device's system description.
System Capabilities Supported:	Display the supported function of the local device.
System Capabilities Enabled:	Display the primary function of the local device.
Management Address:	Display the supported function of the local device.

16.2.2 Neighbor Info

On this page you can get the information of the neighbors.

Choose the menu **LLDP**→**Device Info**→**Neighbor Info** to load the following page.

Auto Refresh

Auto Refresh: Enable Disable

Refresh Rate: sec(3-300)

UNIT:

2	4	6	8	10	12	14	16	18	20	22	24	26	28	30	32	34	36	38	40	42	44	46	48	50	52
1	3	5	7	9	11	13	15	17	19	21	23	25	27	29	31	33	35	37	39	41	43	45	47	49	51

Unselected Port(s)
 Selected Port(s)
 Not Available for Selection

Port 1/0/2 Neighbor(s) Info

System Name	Chassis ID	System Description	Neighbor Port	Information
No entry in the table.				

Figure 16-4 LLDP Neighbor Information

The following entries are displayed on this screen:

➤ **Auto Refresh**

Auto Refresh: Enable/Disable the auto refresh function.

- Refresh Rate:** Specify the auto refresh rate.
- **Neighbor Info**
 - System Name:** Displays the system name of the neighbor device.
 - Chassis ID:** Displays the Chassis ID of the neighbor device.
 - System Description:** Displays the system description of the neighbor device.
 - Neighbor Port:** Displays the port number of the neighbor linking to local port.
 - Information:** Click Information to display the detailed information of the neighbor device.

16.3 Device Statistics

You can view the LLDP statistics of the local device through this feature.

Choose the menu **LLDP**→**Device Statistics**→**Statistic Info** to load the following page.

Auto Refresh

Auto Refresh: Enable Disable Apply

Refresh Rate: sec(3-300)

Global Statistics

Last Update	Total Inserts	Total Deletes	Total Drops	Total Ageouts
3 days 02h:37m:03s	0	0	0	0

Neighbors Statistics

UNIT:

Port	Transmit Total	Receive Total	Discards	Errors	Ageouts	TLV Discards	TLV Unknowns
1/0/1	0	0	0	0	0	0	0
1/0/2	8	0	0	0	0	0	0
1/0/3	0	0	0	0	0	0	0
1/0/4	0	0	0	0	0	0	0
1/0/5	0	0	0	0	0	0	0
1/0/6	0	0	0	0	0	0	0
1/0/7	0	0	0	0	0	0	0
1/0/8	0	0	0	0	0	0	0
1/0/9	0	0	0	0	0	0	0

Clear
Refresh
Help

Figure 16-5 LLDP Statistic Information

The following entries are displayed on this screen:

- **Auto Refresh**
 - Auto Refresh:** Enable/Disable the auto refresh function.
 - Refresh Rate:** Specify the auto refresh rate.

➤ **Global Statistics**

- Last Update:** Displays latest update time of the statistics.
- Total Inserts:** Displays the number of neighbors inserted till last update time.
- Total Deletes:** Displays the number of neighbors deleted by local device.
- Total Drops:** Displays the number of neighbors dropped by local device.
- Total Ageouts:** Displays the number of overtime neighbors in local device.

➤ **Neighbor Statistics**

- Port:** Displays local device's port number.
- Transmit Total:** Displays the number of LLDPDUs sent by this port.
- Receive Total:** Displays the number of LLDPDUs received by this port.
- Discards:** Displays the number of LLDPDUs discarded by this port.
- Errors:** Displays the number of error LLDPDUs received by this port.
- Ageouts:** Displays the number of overtime neighbors linking to this port.
- TLV Discards:** Displays the number of TLVs dropped by this port.
- TLV Unknowns:** Displays the number of unknown TLVs received by this port.

16.4 LLDP-MED

LLDP-MED is an extension of LLDP intended for managing endpoint devices such as Voice over IP phones and network switches. The LLDP-MED TLVs advertise information such as network policy, power via MDI, inventory management, and device location details.

➤ **Elements**

LLDP-MED Device: Refers to any device which implements this Standard.

LLDP-MED Device Type: LLDP-MED devices are comprised of two primary device types: Network Connectivity Devices and Endpoint Devices.

Network Connectivity Device: Refers to an LLDP-MED Device that provides access to the IEEE 802 based LAN infrastructure for LLDP-MED Endpoint Devices. Bridge is a Network Connectivity Device.

Endpoint Device: Refers to an LLDP-MED Device at the network edge, providing some aspects of IP communications service, based on IEEE 802 LAN technology. Endpoint Devices may be a member of any of the Endpoint Device Classes. Endpoint Devices are composed of three defined Classes: Class I, Class II and Class III.

Generic Endpoint Device (Class I): The most basic class of Endpoint Device.

Media Endpoint Device (Class II): The class of Endpoint Device that supports media stream capabilities.

Communication Device Endpoint (Class III): The class of Endpoint Device that directly supports end users of the IP communication system.

TLV	Description
Network Policy TLV	The Network Policy TLV allows both Network Connectivity Devices and Endpoints to advertise VLAN configuration and associated Layer 2 and Layer 3 attributes that apply for a set of specific applications on that port.

Location Identification TLV	The Location Identification TLV provides for advertisement of location identifier information to Communication Endpoint Devices, based on configuration of the Network Connectivity Device it's connected to. You can set the Location Identification content in Location Identification Parameters. If Location Identification TLV is included and Location Identification Parameters isn't set, a default value is used in Location Identification TLV.
Extended Power-Via-MDI TLV	The Extended Power-Via-MDI TLV is intended to enable advanced power management between LLDP-MED Endpoint and Network Connectivity Devices, and it allows advertisement of fine grained power requirement details, Endpoint power priority, as well as both Endpoint and Network Connectivity Device power status.
Inventory TLV	The Inventory TLV set contains seven basic Inventory management TLVs, that is, Hardware Revision TLV, Firmware Revision TLV, Software Revision TLV, Serial Number TLV, Manufacturer Name TLV, Model Name TLV and Asset ID TLV. If support for any of the TLVs in the Inventory Management set is implemented, then support for all Inventory Management TLVs shall be implemented.

LLDP-MED is configured on the **Global Config**, **Port Config**, **Local Info** and **Neighbor Info** pages.

16.4.1 Global Config

On this page you can configure the LLDP-MED parameters of the device globally.

Choose the menu **LLDP**→**LLDP-MED**→**Global Config** to load the following page.

LLDP-MED Parameters Config

Fast Start Count: (1-10)

Device Class: Network Connectivity

Figure 16-6 LLDP-MED Global Configuration

The following entries are displayed on this screen:

➤ **LLDP-MED Parameters Config**

- Fast Start Count:** When LLDP-MED fast start mechanism is activated, multiple LLDP-MED frames will be transmitted based on this parameter.
- Device Class:** LLDP-MED devices are comprised of two primary device types: Network Connectivity Devices and Endpoint Devices. In turn, Endpoint Devices are composed of three defined Classes: Class I, Class II and Class III. Bridge is a Network Connectivity Device.

16.4.2 Port Config

On this page you can configure all ports' LLDP-MED parameters.

Choose the menu **LLDP**→**LLDP-MED**→**Port Config** to load the following page.

Select	Port	LLDP-MED Status	Included TLVs
<input type="checkbox"/>			
<input type="checkbox"/>	1/0/1	Disable	Detail
<input type="checkbox"/>	1/0/2	Disable	Detail
<input type="checkbox"/>	1/0/3	Disable	Detail
<input type="checkbox"/>	1/0/4	Disable	Detail
<input type="checkbox"/>	1/0/5	Disable	Detail
<input type="checkbox"/>	1/0/6	Disable	Detail
<input type="checkbox"/>	1/0/7	Disable	Detail
<input type="checkbox"/>	1/0/8	Disable	Detail
<input type="checkbox"/>	1/0/9	Disable	Detail
<input type="checkbox"/>	1/0/10	Disable	Detail
<input type="checkbox"/>	1/0/11	Disable	Detail
<input type="checkbox"/>	1/0/12	Disable	Detail
<input type="checkbox"/>	1/0/13	Disable	Detail
<input type="checkbox"/>	1/0/14	Disable	Detail
<input type="checkbox"/>	1/0/15	Disable	Detail

Figure 16-7 LLDP-MED Port Configuration

The following entries are displayed on this screen:

➤ **LLDP-MED Port Config**

- Port:** Displays local device's port number.
- LLDP-MED Status:** Configure the port's LLDP-MED status:
Enable: Enable the port's LLDP-MED status, and the port's Admin Status will be changed to Tx&Rx.
Disable: Disable the port's LLDP-MED status.
- Included TLVs:** Select TLVs to be included in outgoing LLDPDU.
- Detail:** Click the **Detail** button to display the included TLVs and select the desired TLVs.

Included TLVs		
<input checked="" type="checkbox"/> Network Policy	<input checked="" type="checkbox"/> Location Identification	<input checked="" type="checkbox"/> Extended Power-Via-MDI
<input checked="" type="checkbox"/> Inventory	<input checked="" type="checkbox"/> All	

Location Identification Parameters	
<input type="checkbox"/> Emergency Number:	<input type="text"/> Chars.(10-25)
<input checked="" type="checkbox"/> Civic Address	
What:	<input type="text" value="Switch"/>
Country Code:	<input type="text" value="CN China(Default)"/>
Language:	<input type="text"/>
Province/State:	<input type="text"/>
County/Parish/District:	<input type="text"/>
City/Township:	<input type="text"/>
Street:	<input type="text"/>
House Number:	<input type="text"/>
Name:	<input type="text"/>
Postal/Zip Code:	<input type="text"/>
Room Number:	<input type="text"/>
Post Office Box:	<input type="text"/>
Additional Information:	<input type="text"/>
<input type="button" value="Back"/> <input type="button" value="Apply"/> <input type="button" value="Help"/>	

➤ **Included TLVs**

Select TLVs to be included in outgoing LLDPDU.

➤ **Location Identification Parameters**

Configure the Location Identification TLV's content in outgoing LLDPDU of the port.

Emergency Number:

Emergency number is Emergency Call Service ELIN identifier, which is used during emergency call setup to a traditional CAMA or ISDN trunk-based PSAP.

Civic Address:

The Civic address is defined to reuse the relevant sub-fields of the DHCP option for Civic Address based Location Configuration Information as specified by IETF.

16.4.3 Local Info

On this page you can see all ports' LLDP-MED configuration.

Choose the menu **LLDP**→**LLDP-MED**→**Local Info** to load the following page.

Auto Refresh

Auto Refresh: Enable Disable

Refresh Rate: sec(3-300)

LLDP-MED Local Info

UNIT:

2	4	6	8	10	12	14	16	18	20	22	24	26	28	30	32	34	36	38	40	42	44	46	48	50	52
1	3	5	7	9	11	13	15	17	19	21	23	25	27	29	31	33	35	37	39	41	43	45	47	49	51

Unselected Port(s) Selected Port(s) Not Available for Selection

Port 1/0/2

Local Interface:	1/0/2
Device Type:	Network Connectivity
Application Type:	Reserved
Unknown Policy Flag:	Yes
VLAN tagged:	No
Media Policy VLAN ID:	0
Media Policy Layer 2 Priority:	0
Media Policy DSCP:	0

Figure 16-8 LLDP-MED Local Information

The following entries are displayed on this screen:

➤ **Auto Refresh**

Auto Refresh: Enable/Disable the auto refresh function.

Refresh Rate: Specify the auto refresh rate.

➤ **LLDP-MED Local Info**

Select the local port number to display its LLDP information.

 **Note:**

For the switches with PoE function, the local information displayed on the page also include Power Type, Power Source, Power Priority and Available Power Value.

16.4.4 Neighbor Info

On this page you can get the LLDP-MED information of the neighbors.

Choose the menu **LLDP**→**LLDP-MED**→**Neighbor Info** to load the following page.

Auto Refresh

Auto Refresh: Enable Disable

Refresh Rate: sec(3-300)

LLDP-MED Neighbor Info

UNIT:

2	4	6	8	10	12	14	16	18	20	22	24	26	28	30	32	34	36	38	40	42	44	46	48	50	52
1	3	5	7	9	11	13	15	17	19	21	23	25	27	29	31	33	35	37	39	41	43	45	47	49	51

Unselected Port(s)
 Selected Port(s)
 Not Available for Selection

Port 1/0/2

Device Type	Application Type	Location Data Format	Power Type	Information
No entry in the table.				

Figure 16-9 LLDP-MED Neighbor Information

The following entries are displayed on this screen:

➤ **Auto Refresh**

Auto Refresh: Enable/Disable the auto refresh function.

Refresh Rate: Specify the auto refresh rate.

➤ **Neighbor Info**

Device Type: Displays the device type of the neighbor.

Application Type: Displays the application type of the neighbor. Application Type indicates the primary function of the applications defined for the network policy.

Local Data Format: Displays the location identification of the neighbor.

Power Type: Displays the power type of the neighbor device, Power Sourcing Entity (PSE) or Powered Device (PD).

Information: Click the **Information** button to display the detailed information of the corresponding neighbor.

[Return to CONTENTS](#)

Chapter 17 Maintenance

Maintenance module, assembling the commonly used system tools to manage the switch, provides the convenient method to locate and solve the network problem.

- (1) System Monitor: Monitor the utilization status of the memory and the CPU of switch.
- (2) sFlow: A technology for accurately monitoring network traffic at high speeds.
- (3) Log: View the configuration parameters of the switch and find out the errors via the Logs.
- (4) Device Diagnostics: Cable Test tests the connection status of the cable to locate and diagnoses the trouble spot of the network.
- (5) Network Diagnostics: Test whether the destination device is reachable and detect the route hops from the switch to the destination device.

17.1 System Monitor

System Monitor functions to display the utilization status of the memory and the CPU of switch via the data graph. The CPU utilization rate and the memory utilization rate should fluctuate stably around a specific value. If the CPU utilization rate or the memory utilization rate increases markedly, please detect whether the network is being attacked.

The **System Monitor** function is implemented on the **CPU Monitor** and **Memory Monitor** pages.

17.1.1 CPU Monitor

Choose the menu **Maintenance**→**System Monitor**→**CPU Monitor** to load the following page.

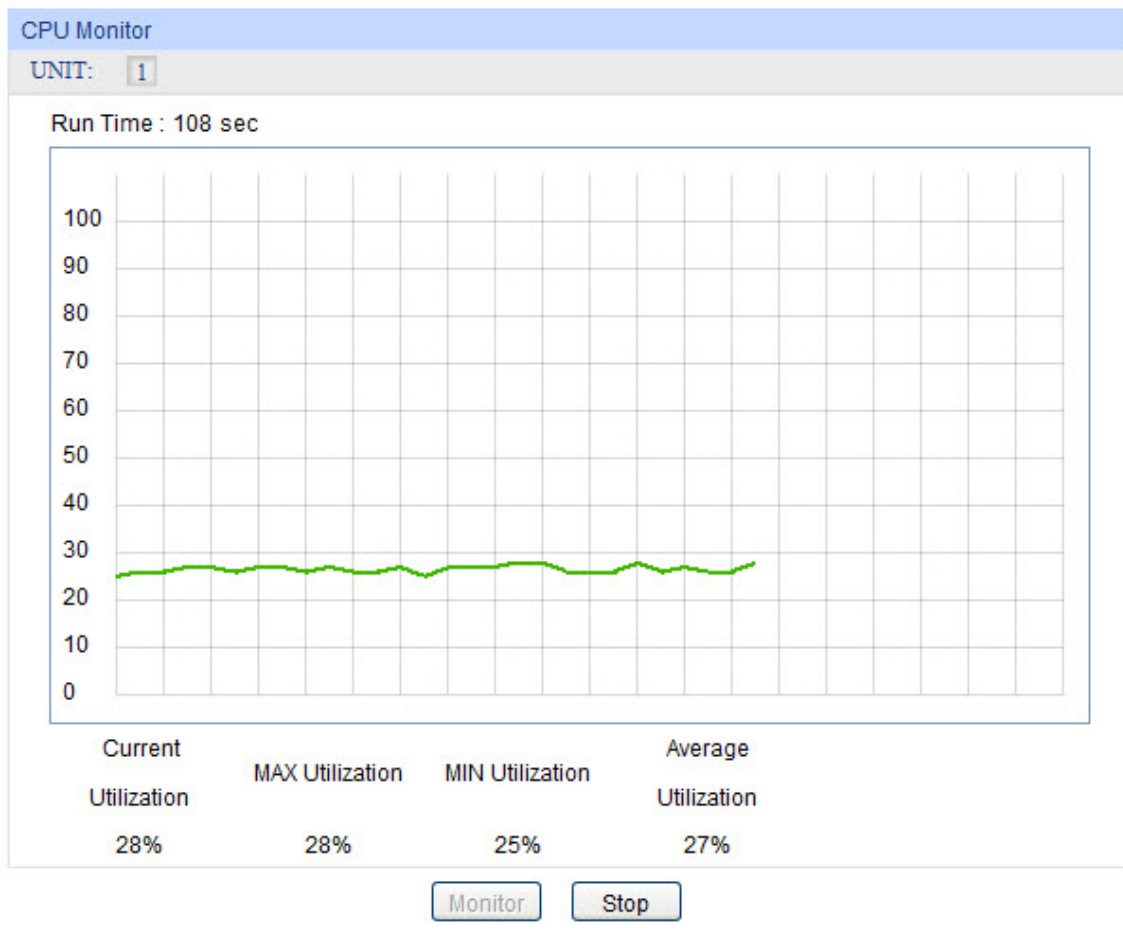

Figure 17-1 CPU Monitor

Click the **Monitor** button to enable the switch to monitor and display its CPU utilization rate every four seconds.

17.1.2 Memory Monitor

Choose the menu **Maintenance**→**System Monitor**→**Memory Monitor** to load the following page.

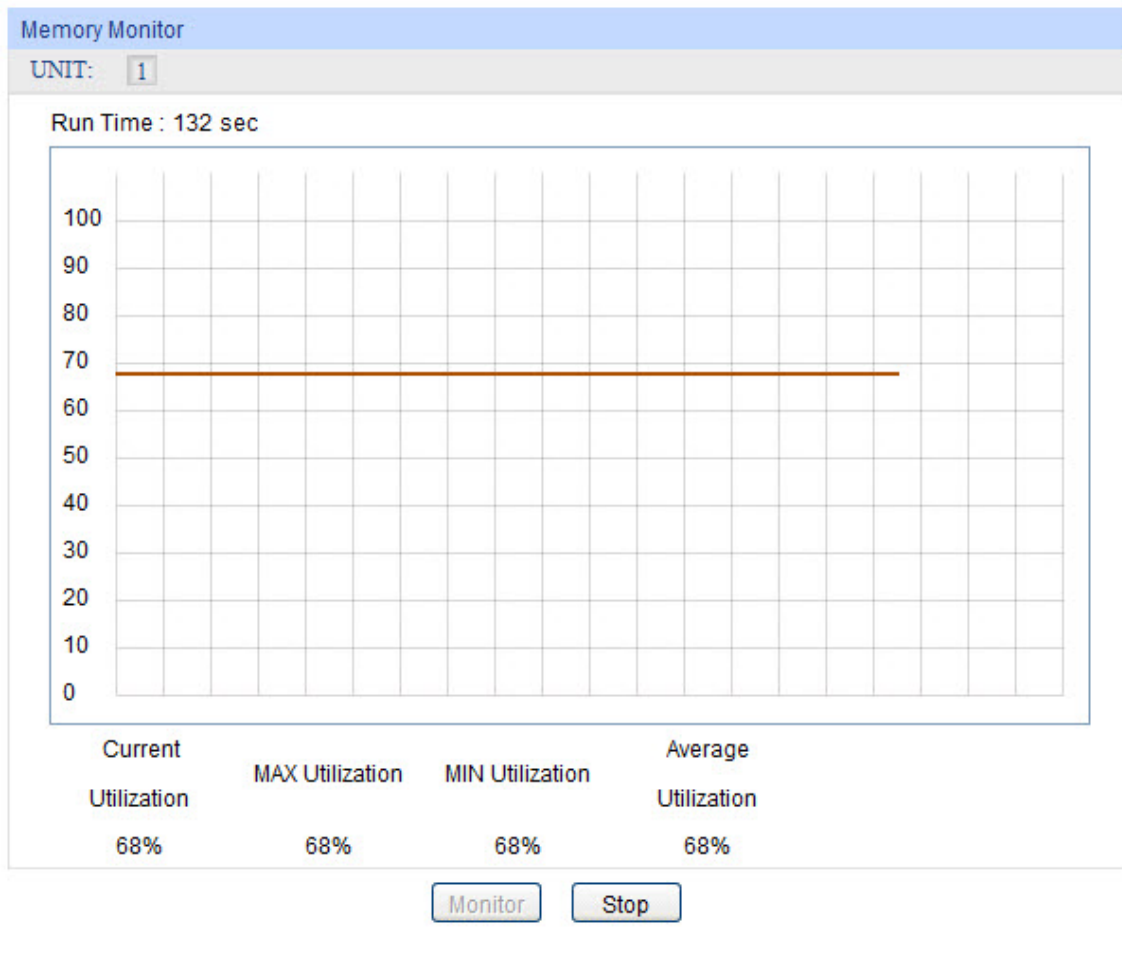

Figure 17-2 Memory Monitor

Click the **Monitor** button to enable the switch to monitor and display its Memory utilization rate every four seconds.

17.2 sFlow

sFlow (Sampled Flow) is a technology for accurately monitoring network traffic at high speeds. The sFlow monitoring system consists of an sFlow agent (embedded in a switch or router or in a standalone probe) and a central sFlow collector. The sFlow agent is a virtual entity using sampling technology to capture traffic statistics from the device it is monitoring. The sFlow collector can be a host receiving sFlow datagrams from the sFlow agent.

The sFlow function is implemented as follows: the sFlow sampler takes samples of traffic statistics and sends sFlow datagrams to the sFlow agent for processing. The sFlow agent will forward sFlow datagrams to the sFlow collector for analysis. The analytic results can be displayed on the sFlow collector.

The **sFlow** function is implemented on the **sFlow Collector** and **sFlow Sampler** pages.

17.2.1 sFlow Collector

Global Config

sFlow Status: Enable Disable

Agent Address: (Format: 192.168.0.1)

sFlow Version: v5

Collector Config

Select	Collector ID	Description	Collector IP	Collector Port	Max Datagram	Timeout (s)	Lifetime (s)
<input type="checkbox"/>		<input type="text"/>	<input type="text"/>	<input type="text"/>	<input type="text"/>	<input type="text"/>	
<input type="checkbox"/>	1		0.0.0.0	6343	300	0	0
<input type="checkbox"/>	2		0.0.0.0	6343	300	0	0
<input type="checkbox"/>	3		0.0.0.0	6343	300	0	0
<input type="checkbox"/>	4		0.0.0.0	6343	300	0	0

Note:

1. Set Timeout zero to make the life cycle of the collector infinite.
2. A valid Agent Address should be assigned before you enable the sFlow function.

Figure 17-3 sFlow Collector

Configuration Procedure:

- 1) Click Enable to enable the sFlow function globally and configure the sFlow agent's IP under the Global Config. For example, you can set the switch's management IP as the sFlow agent's IP.
- 2) Select your desired collector and configure relevant parameters under the Collector Config.

Entry Description:

➤ Global Config

- sFlow Status:** Choose to enable or disable the sFlow function globally on the switch.
- Agent Address:** The IPv4 address of the sFlow agent.
- sFlow Version:** Displays the sFlow version here.

➤ Collector Config

- Select:** Select the desired collector. It is multi-optional.
- Collector ID:** Displays the Collector ID here. The number of collectors you can configure is 4 at most.
- Description:** Give a description to the collector for identification.
- Collector IP:** Assign an IP address to the sFlow collector. The sFlow collector can be a host.
- Collector Port:** Specify the udp port number for the sFlow collector.
- Timeout (s):** Specify the aging time of the sFlow collector. The collector will become invalid after this time. When the timeout is set to 0, it means the life cycle of the collector is infinite.
- Lifetime (s):** Specify the remaining time of the collector. Lifetime will count down from Timeout.

17.2.2 sFlow Sampler

Sampler Config						
UNIT: 1						
Select	Port	Collector ID	Ingress Rate	Egress Rate	Max Header	LAG
<input type="checkbox"/>		<input type="text" value="0"/>	<input type="text" value="0"/>	<input type="text" value="0"/>	<input type="text" value="128"/>	
<input type="checkbox"/>	1/0/1	0	0	0	128	---
<input type="checkbox"/>	1/0/2	0	0	0	128	---
<input type="checkbox"/>	1/0/3	0	0	0	128	---
<input type="checkbox"/>	1/0/4	0	0	0	128	---
<input type="checkbox"/>	1/0/5	0	0	0	128	---
<input type="checkbox"/>	1/0/6	0	0	0	128	---
<input type="checkbox"/>	1/0/7	0	0	0	128	---
<input type="checkbox"/>	1/0/8	0	0	0	128	---
<input type="checkbox"/>	1/0/9	0	0	0	128	---
<input type="checkbox"/>	1/0/10	0	0	0	128	---
<input type="checkbox"/>	1/0/11	0	0	0	128	---
<input type="checkbox"/>	1/0/12	0	0	0	128	---
<input type="checkbox"/>	1/0/13	0	0	0	128	---
<input type="checkbox"/>	1/0/14	0	0	0	128	---
<input type="checkbox"/>	1/0/15	0	0	0	128	---

Note:

1. One port can only be bound to one collector.
2. When the Collector ID is zero, it means no collector is selected.

Figure 17-4 sFlow Sampler

Configuration Procedure:

Configure one or more ports to be a sampler and configure relevant parameters under the Sampler Config. One port can only be bound to one collector.

Entry Description:

- Select** Configure the desired port to be the sFlow sampler.
- Port:** Displays the port of the switch here.
- Collector ID:** Select the sFlow collector for the sFlow sampler. The sampler will send sFlow datagrams to corresponding collector via the sFlow agent. When the Collector ID is 0, it means no collector is selected.
- Ingress Rate:** Specify the ingress sampling frequency of the sFlow sampler. When a sample is taken, the value indicates how many packets to skip before the next sample is taken.
- Egress Rate:** Specify the egress sampling frequency of the sFlow sampler. When a sample is taken, the value indicates how many packets to skip before the next sample is taken.
- Max Header:** Specify the maximum number of bytes that should be copied from a sampled packet.
- LAG:** Displays the LAG number which the port belongs to.

17.2.3 Default Settings

Feature	Default Settings
Global sFlow function	Disabled.
sFlow Agent	The Agent Address is not defined.
sFlow Collector	<ul style="list-style-type: none"> Collector Port is 6343. Max Datagram is 300 bytes. The other parameters are not defined.
sFlow Sampler	<ul style="list-style-type: none"> Collector ID is 0. It means no collector is selected. Ingress Rate is 0. It means no packets will be sampled. Egress Rate is 0. It means no packets will be sampled. Max Header is 128 bytes.

17.3 Log

The Log system of switch can record, classify and manage the system information effectively, providing powerful support for network administrator to monitor network operation and diagnose malfunction.

The Logs of switch are classified into the following eight levels.

Severity	Level	Description
emergencies	0	The system is unusable.
alerts	1	Action must be taken immediately.
critical	2	Critical conditions
errors	3	Error conditions
warnings	4	Warnings conditions
notifications	5	Normal but significant conditions
informational	6	Informational messages
debugging	7	Debug-level messages

Table 17-1 Log Level

The **Log** function is implemented on the **Log Table**, **Local Log**, **Remote Log** and **Backup Log** pages.

17.3.1 Log Table

The switch supports logs output to two directions, namely, log buffer and log file. The information in log buffer will be lost after the switch is rebooted or powered off whereas the information in log file will be kept effective even the switch is rebooted or powered off. Log Table displays the system log information in log buffer.

Choose the menu **Maintenance**→**Log**→**Log Table** to load the following page.

Log Info				
UNIT:	1			
Index	Time	Module	Severity	Content
		All Modules	All Level	
1	2006-01-01 08:48:03	DHCPF	level_6	Enable Gi1/0/4 as trusted port by admin on web (192.168.0.200).
2	2006-01-01 08:48:03	DHCPF	level_6	Enable Gi1/0/2 as trusted port by admin on web (192.168.0.200).
3	2006-01-01 08:48:03	DHCPF	level_6	Enable DHCP Filtering function in vlan 1 by admin on web (192.168.0.200).
4	2006-01-01 08:48:02	DHCPF	level_6	Enable DHCP Filtering successfully by admin on web (192.168.0.200).
5	2006-01-01 08:15:34	User	level_5	Login the web by admin on web (192.168.0.200).
6	2006-01-01 08:00:20	SNMP	level_6	SNMP initialization OK.
7	2006-01-01 08:00:13	LAG	level_6	Changed Link Aggregation Group 1, members: Port 5-6.
8	2006-01-01 08:00:13	FDB	level_6	Deleted all Mac address of Gi1/0/6.
9	2006-01-01 08:00:13	LAG	level_6	Added new Link Aggregation Group 1, members: Port 5.
10	2006-01-01 08:00:13	FDB	level_6	Deleted all Mac address of Gi1/0/5.
11	2006-01-01 08:00:12	NETIF	level_6	Interface Vlan1, set primary ip 192.168.0.39 mask 255.255.255.0.
12	2006-01-01 08:00:12	User	level_6	Set session timeout: 30.
13	2006-01-01 08:00:12	SNMP	level_6	SNMP function enabled.

Note:

1. There are 8 severity levels marked with value 0-7. The smaller value has the higher priority.
2. This page displays logs in the log buffer, and at most 1024 logs are displayed.

Figure 17-1 Log Table

The following entries are displayed on this screen:

➤ **Log Info**

- Index:** Displays the index of the log information.
- Time:** Displays the time when the log event occurs. The log can get the correct time after you configure on the System ->System Info->System Time Web management page.
- Severity:** Displays the severity level of the log information. You can select a severity level to display the log information whose severity level value is the same or smaller.
- Content:** Displays the content of the log information.



Note:

1. The logs are classified into eight levels based on severity. The higher the information severity is, the lower the corresponding level is.
2. This page displays logs in the log buffer, and at most 512 logs are displayed.

17.3.2 Local Log

Local Log is the log information saved in switch. By default, the logs with severities from level_0 to level_6 are saved in log buffer and the logs with severities from level_0 to level_3 are saved in log file meanwhile. On this page, you can set the output channel for logs.

Choose the menu **Maintenance**→**Log**→**Local Log** to load the following page.

Local Log Config				
Select	Channel	Severity	Status	Sync-Periodic
<input type="checkbox"/>				
<input type="checkbox"/>	Log Buffer	level_6	Enable	Immediately
<input type="checkbox"/>	Log File	level_3	Disable	24 hour(s)

Note:

1. Local log includes 2 channels: log buffer and log file.
2. There are 8 severity levels marked with values 0-7. The smaller value has the higher priority.

Figure 17-2 Local Log

The following entries are displayed on this screen:

➤ **Local Log Config**

- Select:** Select the desired entry to configure the corresponding local log.
- Channel:**
- **Log buffer:** Indicates the RAM for saving system log. The information in the log buffer is displayed on the Log Table page. It will be lost when the switch is restarted.
 - **Log File:** Indicates the flash sector for saving system log. The information in the log file will not be lost after the switch is restarted and can be exported on the Backup Log page.
- Severity:** Specify the severity level of the log information output to each channel. Only the log with the same or smaller severity level value will be output.
- Status:** Enable/Disable the channel.
- Sync-Periodic:** Specify how frequent the log information would be synchronized to the log file.

17.3.3 Remote Log

Remote log feature enables the switch to send system logs to the Log Server. Log Server is to centralize the system logs from various devices for the administrator to monitor and manage the whole network.

Choose the menu **Maintenance**→**Log**→**Remote Log** to load the following page.

Log Host					
Select	Index	Host IP	UDP Port	Severity	Status
<input type="checkbox"/>		<input type="text"/>		<input type="text" value="level_6"/>	<input type="text" value="Disable"/>
<input type="checkbox"/>	1	0.0.0.0	514	level_6	Disable
<input type="checkbox"/>	2	0.0.0.0	514	level_6	Disable
<input type="checkbox"/>	3	0.0.0.0	514	level_6	Disable
<input type="checkbox"/>	4	0.0.0.0	514	level_6	Disable

Note:

- 1.Up to 4 log hosts are supported.
- 2.There are 8 severity levels marked with values 0-7. The smaller value has the higher priority.

Figure 17-3 Log Host

The following entries are displayed on this screen:

➤ **Log Host**

- Index:** Displays the index of the log host. The switch supports 4 log hosts.
- Host IP:** Configure the IP for the log host.
- UDP Port:** Displays the UDP port used for receiving/sending log information. Here we use the standard port 514.
- Severity:** Specify the severity level of the log information sent to each log host. Only the log with the same or smaller severity level value will be sent to the corresponding log host.
- Status:** Enable/Disable the log host.



Note:

The Log Server software is not provided. If necessary, please download it on the Internet.

17.3.4 Backup Log

Backup Log feature enables the system logs saved in the switch to be output as a file for device diagnosis and statistics analysis. When a critical error results in the breakdown of the system, you can export the logs to get some related important information about the error for device diagnosis after the switch is restarted.

Choose the menu **Maintenance**→**Log**→**Backup Log** to load the following page.

Backup Log

Click the button here to backup the log file:

Note:

1. When a critical error results in the breakdown of the system, you can export the log file to get some related important information about the error for device diagnosis after the switch is restarted.
2. It will take a few minutes to backup the log file. Please wait without any operation.

Figure 17-4 Backup Log

The following entry is displayed on this screen:

➤ **Backup Log**

Backup Log: Click the **Backup Log** button to save the log as a file to your computer.



Note:

1. When a critical error results in the breakdown of the system, you can export the log file to get some related important information about the error for device diagnosis after the switch is restarted.
2. It will take a few minutes to backup the log file. Please wait without any operation.

17.4 Device Diagnostics

This switch provides Cable Test for device diagnose.

17.4.1 Cable Test

Cable Test functions to test the connection status of the cable connected to the switch, which facilitates you to locate and diagnose the trouble spot of the network.

Choose the menu **Maintenance**→**Device Diagnostics**→**Cable Test** to load the following page.

Pair	Status	Length(meter)	Error(meter)
Pair-A	--	--	--
Pair-B	--	--	--
Pair-C	--	--	--
Pair-D	--	--	--

Note:

1. The interval between two cable test for one port must be more than 3 seconds.
2. The result is more reasonable when the cable pair is in the open status.
3. The result is just for your information.

Figure 17-5 Cable Test

The following entries are displayed on this screen:

➤ **Cable Test**

Port: Select the port for cable testing.

- Pair:** Displays the Pair number.
- Status:** Displays the connection status of the cable connected to the port. The test results of the cable include normal, close, open or impedance.
- Length:** If the connection status is normal, here displays the length range of the cable.
- Error:** If the connection status is close, open or impedance, here displays the error length of the cable.



Note:

1. The interval between two cable tests for one port must be more than 3 seconds.
2. The result is more reasonable when the cable pair is in the open status.
3. The result is just for your information.

17.5 Network Diagnostics

This switch provides Ping test and Tracert test functions for network Diagnostics.

17.5.1 Ping

Ping test function, testing the connectivity between the switch and one node of the network, facilitates you to test the network connectivity and reachability of the host so as to locate the network malfunctions.

Choose the menu **Maintenance**→**Network Diagnostics**→**Ping** to load the following page.

Ping Config	
Destination IP:	<input type="text" value="192.168.0.1"/>
Ping Times:	<input type="text" value="4"/> (1-10)
Data Size:	<input type="text" value="64"/> byte (1-1024)
Interval:	<input type="text" value="1000"/> millsec (100-1000)
	<input type="button" value="Ping"/> <input type="button" value="Help"/>

Ping Result
Pinging 192.168.0.1 with 64 bytes of data :
Reply from 192.168.0.1 : bytes=64 time<16ms TTL=64
Reply from 192.168.0.1 : bytes=64 time<16ms TTL=64
Reply from 192.168.0.1 : bytes=64 time<16ms TTL=64
Reply from 192.168.0.1 : bytes=64 time<16ms TTL=64
Ping statistics for 192.168.0.1:
Packets: Sent = 4 , Received = 4 , Lost = 0 (0% loss)
Approximate round trip times in milli-seconds:
Minimum = 0ms , Maximum = 0ms , Average = 0ms

Figure 17-6 Ping

The following entries are displayed on this screen:

➤ **Ping Config**

- Destination IP:** Enter the IP address of the destination node for Ping test. Both IPv4 and IPv6 are supported.
- Ping Times:** Enter the amount of times to send test data during Ping testing. The default value is recommended.
- Data Size:** Enter the size of the sending data during Ping testing. The default value is recommended.
- Interval:** Specify the interval to send ICMP request packets. The default value is recommended.

17.5.2 Tracert

Tracert test function is used to test the connectivity of the gateways during its journey from the source to destination of the test data. When malfunctions occur to the network, you can locate trouble spot of the network with this tracert test.

Choose the menu **Maintenance**→**Network Diagnostics**→**Tracert** to load the following page.

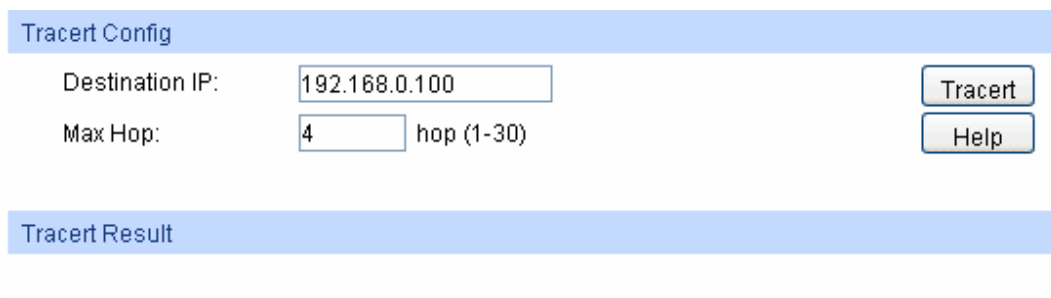

The screenshot shows a web interface for the Tracert function. It is divided into two main sections: "Tracert Config" and "Tracert Result". The "Tracert Config" section has a light blue header. Below the header, there are two input fields: "Destination IP:" with the value "192.168.0.100" and "Max Hop:" with the value "4" and the text "hop (1-30)" next to it. To the right of these fields are two buttons: "Tracert" and "Help". The "Tracert Result" section has a light blue header and is currently empty. A horizontal line is visible below the "Tracert Result" header.

Figure 17-7 Tracert

The following entries are displayed on this screen:

➤ **Tracert Config**

- Destination IP:** Enter the IP address of the destination device. Both IPv4 and IPv6 are supported.
- Max Hop:** Specify the maximum number of the route hops the test data can pass through.

[Return to CONTENTS](#)

Appendix A. Password Recovery

This chapter introduces the procedure to reset passwords on TP-LINK switches.

Steps to reset the password:

1. For Security reasons, the Password Recovery feature requires the user to physically access the switch. Please attach a terminal or PC with terminal emulation program to the RJ-45/Micro-USB console port of the switch.
2. Configure the terminal or the terminal emulation program to use the following settings:
 - Baud rate: 38400 bps
 - Data bits: 8
 - Parity: none
 - Stop bits: 1
 - Flow control: none
3. Power on the switch. After the message 'Hit any key to stop autoboot' is shown on the interface of the terminal emulation program, the switch will allow 3 seconds for the user to press any key to enter the BOOTUTIL Interface.
4. Enter 6 to select the 'Password recovery' option and enter Y to delete all the users and passwords. The default login username and password are both admin. The other configurations in the switch will not be changed.

```
tplink - HyperTerminal
File Edit View Call Transfer Help
Hit any key to stop autoboot: 0
*****
* TP-LINK BOOTUTIL(v1.0.0) *
*****
Copyright (c) 2015 TP-LINK Tech. Co., Ltd
Create Date: Dec 12 2015 - 14:43:55

Boot Menu
0 - Print this boot menu
1 - Reboot
2 - Reset
3 - Start
4 - Activate Backup Image
5 - Display image(s) info
6 - Password recovery

Enter your choice(0-6)

tplink> 6
This will delete all the previously created accounts. Continue?[Y/N]:Y
Operation OK!
tplink> _

Connected 0:00:28 Auto detect 38400 8-N-1 SCROLL CAPS NUM Capture Print echo
```

Appendix B. Specifications

Standards	IEEE802.3i 10Base-T Ethernet
	IEEE802.3u 100Base-TX/100Base-FX Fast Ethernet
	IEEE802.3ab 1000Base-T Gigabit Ethernet
	IEEE802.3z 1000Base-X Gigabit Ethernet
	IEEE802.3x Flow Control
	IEEE802.1p QoS
	IEEE802.1q VLAN
Transmission Rate	Ethernet: 10Mbps HD, 20Mbps FD
	Fast Ethernet: 100Mbps HD, 200Mbps FD
	Gigabit Ethernet: 2000Mbps FD
Transmission Medium	10Base-T: UTP/STP of Cat. 3 or above
	100Base-TX: UTP/STP of Cat. 5 or above
	1000Base-T: 4-pair UTP ($\leq 100\text{m}$) of Cat. 5e, Cat.6 or above
	1000Base-X: MMF or SMF SFP Module (Optional)
LED	T2600G-28TS: PWR, SYS, 1000Mbps, Link/Act
	T2600G-52TS: PWR, SYS, 10/100/1000Mbps (port 1-48), Link/Act (port 49-52)
	T2600G-28MPS: PWR, SYS, 10/100/1000Mbps (port 1-24), Link/Act (port 25-28)
Transmission Method	Store and Forward
Packets Forwarding Rate	10BASE-T: 14881pps/port 100BASE-TX: 148810pps/port 1000Base-T: 1488095pps/port 1000Base-X: 1488095pps/port
Operating Environment	Operating Temperature: 0°C ~ 40°C
	Storage Temperature: -40°C ~ 70°C
	Operating Humidity: 10% ~ 90% RH Non-condensing
	Storage Humidity: 5% ~ 90% RH Non-condensing

[Return to CONTENTS](#)

Appendix C. Glossary

Boot Protocol (BOOTP)

BOOTP is used to provide bootup information for network devices, including IP address information, the address of the TFTP server that contains the devices system files, and the name of the boot file.

Class of Service (CoS)

CoS is supported by prioritizing packets based on the required level of service, and then placing them in the appropriate output queue. Data is transmitted from the queues using weighted round-robin service to enforce priority service and prevent blockage of lower-level queues. Priority may be set according to the port default, the packet's priority bit (in the VLAN tag), TCP/UDP port number, or DSCP priority bit.

Differentiated Services Code Point (DSCP)

DSCP uses a six-bit tag to provide for up to 64 different forwarding behaviors. Based on network policies, different kinds of traffic can be marked for different kinds of forwarding. The DSCP bits are mapped to the Class of Service categories, and then into the output queues.

Domain Name Service (DNS)

A system used for translating host names for network nodes into IP addresses.

Dynamic Host Control Protocol (DHCP)

Provides a framework for passing configuration information to hosts on a TCP/IP network. DHCP is based on the Bootstrap Protocol (BOOTP), adding the capability of automatic allocation of reusable network addresses and additional configuration options..

IEEE 802.1D

Specifies a general method for the operation of MAC bridges, including the Spanning Tree Protocol.

IEEE 802.1Q

VLAN Tagging—Defines Ethernet frame tags which carry VLAN information. It allows switches to assign endstations to different virtual LANs, and defines a standard way for VLANs to communicate across switched networks.

IEEE 802.1p

An IEEE standard for providing quality of service (QoS) in Ethernet networks. The standard uses packet tags that define up to eight traffic classes and allows switches to transmit packets based on the tagged priority value.

IEEE 802.3ac

Defines frame extensions for VLAN tagging.

IEEE 802.3x

Defines Ethernet frame start/stop requests and timers used for flow control on full-duplex links. (Now incorporated in IEEE 802.3-2002)

Internet Group Management Protocol (IGMP)

A protocol through which hosts can register with their local router for multicast services. If there is more than one multicast switch/router on a given subnetwork, one of the devices is made the “querier” and assumes responsibility for keeping track of group membership.

IGMP Snooping

Listening to IGMP Query and IGMP Report packets transferred between IP Multicast routers and IP Multicast host groups to identify IP Multicast group members.

IGMP Query

On each subnetwork, one IGMP-capable device will act as the querier — that is, the device that asks all hosts to report on the IP multicast groups they wish to join or to which they already belong. The elected querier will be the device with the lowest IP address in the subnetwork.

IP Multicast Filtering

It is a feature to allow or deny the Client to add the specified multicast group.

Multicast Switching

A process whereby the switch filters incoming multicast frames for services for which no attached host has registered, or forwards them to all ports contained within the designated multicast group.

Layer 2

Data Link layer in the ISO 7-Layer Data Communications Protocol. This is related directly to the hardware interface for network devices and passes on traffic based on MAC addresses.

Link Aggregation

See Port Trunk.

Management Information Base (MIB)

An acronym for Management Information Base. It is a set of database objects that contains information about a specific device.

MD5 Message-Digest Algorithm

An algorithm that is used to create digital signatures. It is intended for use with 32 bit machines and is safer than the MD4 algorithm, which has been broken. MD5 is a one-way hash function, meaning that it takes a message and converts it into a fixed string of digits, also called a message digest.

Network Time Protocol (NTP)

NTP provides the mechanisms to synchronize time across the network. The time servers operate in a hierarchical-master-slave configuration in order to synchronize local clocks within the subnet and to national time standards via wire or radio.

Port Mirroring

A method whereby data on a target port is mirrored to a monitor port for troubleshooting with a logic analyzer or RMON probe. This allows data on the target port to be studied unobstructively.

Port Trunk

Defines a network link aggregation and trunking method which specifies how to create a single high-speed logical link that combines several lower-speed physical links.

Remote Authentication Dial-in User Service (RADIUS)

RADIUS is a logon authentication protocol that uses software running on a central server to control access to RADIUS-compliant devices on the network.

Remote Monitoring (RMON)

RMON provides comprehensive network monitoring capabilities. It eliminates the polling required in standard SNMP, and can set alarms on a variety of traffic conditions, including specific error types.

Rapid Spanning Tree Protocol (RSTP)

RSTP reduces the convergence time for network topology changes to about 10% of that required by the older IEEE 802.1D STP standard.

Simple Network Management Protocol (SNMP)

The application protocol in the Internet suite of protocols which offers network management services.

Simple Network Time Protocol (SNTP)

SNTP allows a device to set its internal clock based on periodic updates from a Network Time Protocol (NTP) server. Updates can be requested from a specific NTP server, or can be received via broadcasts sent by NTP servers.

Spanning Tree Algorithm (STA)

A technology that checks your network for any loops. A loop can often occur in complicated or backup linked network systems. Spanning Tree detects and directs data along the shortest available path, maximizing the performance and efficiency of the network.

Telnet

Defines a remote communication facility for interfacing to a terminal device over TCP/IP.

Transmission Control Protocol/Internet Protocol (TCP/IP)

Protocol suite that includes TCP as the primary transport protocol, and IP as the network layer protocol.

Trivial File Transfer Protocol (TFTP)

A TCP/IP protocol commonly used for software downloads.

User Datagram Protocol (UDP)

UDP provides a datagram mode for packet-switched communications. It uses IP as the underlying transport mechanism to provide access to IP-like services. UDP packets are delivered just like IP packets – connection-less datagrams that may be discarded before reaching their targets. UDP is useful when TCP would be too complex, too slow, or just unnecessary.

Virtual LAN (VLAN)

A Virtual LAN is a collection of network nodes that share the same collision domain regardless of their physical location or connection point in the network. A VLAN serves as a logical workgroup with no physical barriers, and allows users to share information and resources as though located on the same LAN.

[Return to CONTENTS](#)